





Technische Leuchten
für Handel, Gewerbe, Industrie und Kommunen

























2018 / 2019

LEGENDE

OBERFLÄCHENFARBEN

W	Weiß
WO	Weiß matt
WM	Weiß opal
K	Klar
GI	Gips
S	Silber
SM	Silber matt
G	Grau
S	Schwarz
C	Chrom
	Perlchrom
AN	Aluminium natur
AP	Aluminium poliert
AE	Aluminium eloxiert
AS	Aluminium sandgestrahlt
	Aluminium gebürstet
	Aluminium lackiert
NM	Nickel matt
E	Edelstahl
TI	Titan
SP	Spiegeleffekt
GR	Graphit
AN	Anthrazit
E	Elfenbein
G	Gold
MP	Messing poliert
KU	Kupfer
B	Braun
T	Terracotta
R	Rot
PF	Pfirsich
HB	Hellblau
HG	Hellgrün

ZEICHENERKLÄRUNG

	LED Leuchte (Konverter separat ordern)
	LED Leuchte (anschlußfertig)
	Niedervoltleuchte (Trafo separat ordern)
	Hochvoltleuchte (anschlußfertig)
	Deckeneinbauleuchte
	Wand-/ Deckeneinbauleuchte
	Wandeinbauleuchte
	Bodeneinbauleuchte
	Deckenaufbauleuchte
	Wand-/ Deckenaufbauleuchte
	Wandaufbauleuchte
	Boden-/ Wand-/ Deckenaufbauleuchte
	Pendelleuchte
	Stehleuchte
	Tischleuchte
	Stromschienenleuchte
	inkl./exkl. Betriebsgerät
	inkl. LED Platine
	inkl. Leuchtmittel
	Ausstrahlwinkel
	drehbar
	schwenkbar
IP20	diverse IP Schutzarten
EEL: A+	Energieeffizienz
	Lagerware
	Top Seller
LED	LED Leistung
SYS	Systemleistung

KATALOGINFORMATION

Daten aus diesem Katalog dürfen weder vervielfältigt noch veröffentlicht werden (mittels Druck, Fotokopie, digitaler Scans oder auf jegliche andere Weise), ohne die vorhergehende schriftliche Genehmigung durch die Molto Luce GmbH. Alle Daten in diesem Katalog haben rein informativen Wert. Molto Luce GmbH behält sich das Recht vor, diese Daten, ohne vorhergehende Bekanntgabe oder Begründung zu ändern.

Molto Luce GmbH übernimmt keinerlei Haftung für eventuelle Irrtümer oder Druckfehler.

Alle Maße sind in Natur zu prüfen. Für Farbabweichungen übernehmen wir keinerlei Haftung. Manche der im Prospekt abgebildeten Produkte sind Bildretuschen und dienen zur Veranschaulichung der Einsatzmöglichkeiten.

WIE SCHNELL KÖNNEN WIR LIEFERN?

Globalisierung steigert den Wettbewerb. Kürzere Produktlebenszyklen, höhere Variantenvielfalt beeinflussen die strategische Ausrichtung sowie das operative Tagesgeschäft. Wir von Molto Luce begegnen dieser Herausforderung mit einem „LÄCHELN“ und einer hohen Flexibilität im Beschaffungsmanagement. Im Sinne unserer Kunden.

Alle Produkte, die wir für unsere Kunden auf Lager führen, sind mit einem 😊 gekennzeichnet.

Alle Produkte ohne Kennzeichnung liefern wir längstens innerhalb von 3 Wochen ab Bestelldatum.

IVY ROUND LED



Einbaustrahler, Aluminiumdruckguss, weiß oder schwarz matt feinstruktur pulverbeschichtet, rund, starr, mit zurückversetzter Lichtquelle, exkl. Konverter

LM	Ø	ET	DA Ø	FARBE	LUMEN	REF.	ART. NR.	EURO	LAGER
LED 7W 200mA CRI>90	72	107	60	W	700	20°	472-0260790203005	39,00	😊
	72	107	60	W	670	40°	472-0260790403005	39,00	😊
LED 3000K									
	72	107	60	S	535	20°	472-0260790203006	39,00	😊
	72	107	60	S	620	40°	472-0260790403006	39,00	😊

LED 200mA EEI: A++ - A

TOP PRODUKTE – TOP QUALITÄT – TOP LIEFERFÄHIG = TOP SELLER

Unsere Auswahl an TOP SELLER in diesem Katalog wird auch sie zum LÄCHELN 😊 bringen. Spezielle, trendige Leuchtenprodukte finden Sie mit folgender Kennzeichnung im Katalog. Überzeugen Sie sich von Qualität, Technik, Service, Preis-/Leistung und Lieferfähigkeit dieser TOP Produkte.

UP AC LED

TOP SELLER

















Aufbauleuchte, AC-LED, Aluminium, weiß, schwarz oder grau Feinstruktur pulverbeschichtet, mit geschlossenem opalem Acryldiffusor, homogene Lichtverteilung

LM	LxB	H	LED	LUMEN	FARBE	ART. NR.	EURO	LAGER
SYS 10W 230V CRI>90	100x100	63	2700K	576	W	472-0501090002705	149,00	😊
	100x100	63	2700K	461	S	472-0501090002706	149,00	😊
	100x100	63	2700K	486	G	472-0501090002704	149,00	😊
	100x100	63	3000K	640	W	472-0501090003005	149,00	😊
	100x100	63	3000K	515	S	472-0501090003006	149,00	😊
	100x100	63	3000K	540	G	472-0501090003004	149,00	😊

LED 230V EEI: A++ - A

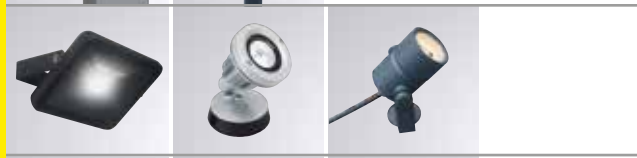
PREISINFORMATION

Sämtliche Preise in diesem Katalog verstehen sich Brutto exkl. MwSt. Mit diesem Katalog verlieren alle bisherigen Preislisten Ihre Gültigkeit. Wir liefern ausschließlich nach unseren, Ihnen bekannten Liefer- und Verkaufsbedingungen. Die Ware bleibt bis zur vollständigen Bezahlung unser Eigentum. Es gelten unsere allgemeinen Geschäftsbedingungen, abrufbar auf www.moltoluce.com.

				DECKENEINBAU
				AUFBAU
				WANDEINBAU
				STRAHLER + STROMSCHIENEN
				OFFICE
				INDUSTRIE
				LED SYSTEME
				EINBAULEUCHTEN AUSSEN
				AUFBAULEUCHTEN AUSSEN
				STEHLEUCHTEN AUSSEN
				FLUTER + STRAHLER AUSSEN
				BETRIEBSGERÄTE
				ZUBEHÖR
				LED-RETROFITS + LEUCHTMITTEL
				INFO

STRAHLER S. 006-037 | DOWNLIGHTS S. 038-063
LEUCHTEN S. 064-071 | PROFILE S. 072-077

STRAHLER S. 078-097 | LEUCHTEN S. 098-129
PENDEL S. 130-141 | PROFILE S. 142-153

LEUCHTEN S. 154-161

STRAHLER + LEUCHTEN S. 162-173 | 3-PHASEN STROMSCHIENE S. 174-177
VOLARE DIRETTA SYSTEM S. 178-187

STEHLEUCHTEN S. 188-193 | PENDEL-/WANDLEUCHTEN S. 194-195
DECKENLEUCHTEN S. 196-197

TRAGSCHIENENSYSTEME S. 198-207 | FEUCHTRAUMLEUCHTEN S. 208-209
HALLENREFLEKTORLEUCHTEN S. 210-211 | NOTLEUCHTEN S. 210-211

LED STRIPES S. 212-221 | PROFILE S. 222-229
LED KONVERTER S. 230-231 | LED STEUERUNGEN S. 230-231

BODENEINBAU S. 232-237 | WANDEINBAU S. 238-245
DECKENEINBAU S. 246-251 | PROFILE S. 252-253

WANDAUFBAU S. 254-267 | DECKENAUFBAU S. 268-275
PROFILE S. 276-277

POLLER S. 278-291
MAST S. 292-293

FLUTER S. 294-303
STRAHLER S. 304-311

TRANSFORMATOREN S. 312-313 | LED KONVERTER S. 314-319
STEUERUNGEN S. 320-323

IP-VERBINDUNGEN S. 324-325
KONFEKTIONIERUNGSSERVICE S. 324-325

LED-RETROFITS + LEUCHTMITTEL S. 326-329

ALLGEMEINE INFORMATIONEN + INDEX S. 330-358

DECKENEINBAU





AGON SQUARE LED

TOP SELLER



Einbaustrahler, Kühlkörper Aluminiumdruckguss und gebürstet oder pulverbeschichtet, quadratisch, schwenkbar 30°, Kühlkörper Aluminiumdruckguss, exkl. Konverter, kompatibel mit HALOX Betoneinbaudose und Frontteil DM 68mm

LM	LxB	ET	DA Ø	FARBE	REF.	ART. NR.	EURO	LAGER
LED 5W 250mA - 550lm CRI>80	80x80	80	68	W	120°	305-0050680202705	37,00	☺
	80x80	80	68	S	120°	305-0050680202706	37,00	☺
LED 2700K	80x80	80	68	AG	120°	305-0050680202715	37,00	☺
	80x80	80	68	W	140°	305-0050680402705	37,00	☺
	80x80	80	68	S	140°	305-0050680402706	37,00	☺
	80x80	80	68	AG	140°	305-0050680402715	37,00	☺
	80x80	80	68	W	120°	305-0050680203005	37,00	☺
LED 5W 250mA - 600lm CRI>80	80x80	80	68	S	120°	305-0050680203006	37,00	☺
	80x80	80	68	AG	120°	305-0050680203015	37,00	☺
LED 3000K	80x80	80	68	W	140°	305-0050680403005	37,00	☺
	80x80	80	68	S	140°	305-0050680403006	37,00	☺
	80x80	80	68	AG	140°	305-0050680403015	37,00	☺

LED 250mA | 30° | exkl. inkl. | IP20 | EEI: A++ - A

LED KONVERTER



INFO	W	mA	V DC	FÜR	LxBxH	FARBE	ART. NR.	EURO	LAGER
nicht dimmbar, 230V AC	13	250	54	2 AGON	111x52x22	W	24-122201	23,00	☺
dimmbar, 1 - 10V/ Push	13	250	53	2 AGON	111x52x22	W	24-123399	42,00	☺
dimmbar, DALI dimm.	10	250	43	2 AGON	111x52x22	W	24-123403	49,00	☺

IP20

VINOS SQUARE LED

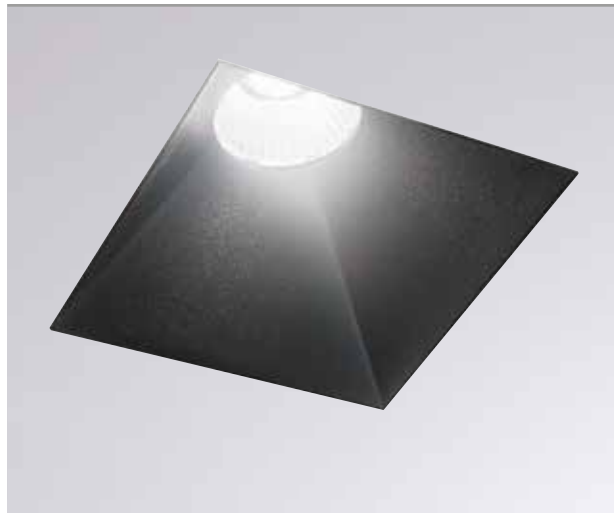

Einbaustrahler, Aluminiumdruckguss, matt pulverbeschichtet, rahmenlos, mit zurückversetzter Lichtquelle, 38° Ausstrahlwinkel, exkl. Konverter

LM	LxB	ET	DA LxB	LUMEN	FARBE	REF.	ART. NR.	EURO	LAGER
LED 13W 350mA CRI>95	109x109	150	110x110	950	W	38°	365-0141390382705	115,00	☺
	109x109	150	110x110	845	S	38°	365-0141390382706	115,00	☺
LED 2700K									
LED 13W 350mA CRI>95	109x109	150	110x110	1050	W	38°	365-0141390383005	115,00	☺
	109x109	150	110x110	1005	S	38°	365-0141390383006	115,00	☺
LED 3000K									

LED 350mA | exkl. inkl. | IP20 | EEI: A++ - A

LED KONVERTER



INFO	W	mA	V DC	FÜR	LxBxH	FARBE	ART. NR.	EURO	LAGER
nicht dimmbar, 230V AC	19	350	54	1 - VINOS	111x52x22	W	24-122201	23,00	☺
dimmbar, 1 - 10V/ Push	15	350	43	1 - VINOS	111x52x22	W	24-123400	44,00	☺
dimmbar, DALI dimm.	15	350	43	1 - VINOS	111x52x22	W	24-123403	49,00	☺

IP20



CLAERO LED



Einbaustrahler, Aluminiumdruckguss, weiß matt pulverbeschichtet oder schwarz lackiert, quadratisch, schwenkbar 30°, exkl. Konverter.

LM	LxB	ET	DA LxB	FARBE	REF.	ART. NR.	EURO	LAGER
LED 15W 700mA	130x130	157	120x120	W	24°	365-0061590243005	139,00	☺
905lm CRI>90	130x130	157	120x120	S	24°	365-0061590243006	139,00	☺
LED 3000K								

LED 700mA | 30° | exkl. inkl. | IP20 | EEI: A++ - A

LED KONVERTER



Symbolfoto

INFO	W	mA	V DC	FÜR	LxBxH	FARBE	ART. NR.	EURO	LAGER
nicht dimmbar, 230V AC	20	700	24	1 CLAERO	111x52x22	W	24-122201	23,00	☺
dimmbar, 1 - 10V/ Push	20	700	29	1 CLAERO	111x52x22	W	24-123400	44,00	☺
dimmbar, DALI dimm.	20	700	28	1 CLAERO	111x52x22	W	24-123403	49,00	☺

IP20

ODIN BIG LED



Einbaustrahler, Aluminiumdruckguss, weiß matt pulverbeschichtet, 90° schwenkbar, Aluminiumreflektor 82° Ausstrahlwinkel, inkl. Schutzglas klar, exkl. Konverter

LM	LxBxH	ET	DA LxB	REF.	FARBE	ART. NR.	EURO	LAGER
LED 38W 1050mA · 2280lm CRI>95	200x103x75	105	180x90	82°	W	365-1001	149,00	☺
LED 3000K								

LED 1050mA | 90° | exkl. inkl. | IP44 | EEI: A++ - A

LED KONVERTER



Symbolfoto

INFO	W	mA	V DC	FÜR	LxBxH	FARBE	ART. NR.	EURO	LAGER
nicht dimmbar, 230V AC	50	1050	48	1 ODIN BIG	124x79x22	W	24-122204	45,00	☺
dimmbar, 1-10V / Push / DALI dimm.	50	1050	48	1 ODIN BIG	124x79x22	W	24-122413	76,00	☺

IP20



COVER LED



Einbaustrahler, Aluminiumdruckguss, weiß oder silber pulverbeschichtet, quadratisch, sandgestrahtes Schutzglas, exkl. Konverter, EB-Gehäuse und EB-Rahmen separat ordern, kompatibel mit HALOX Betoneinbaudose und Frontteil DM 75mm

LM	LxB	ET	DA LxB	FARBE	ART. NR.	EURO	LAGER
LED 6W 140mA · 435lm CRI>80	89x89	108	76x76	W	305-6845w	39,00	☺
	89x89	108	76x76	S	305-6845s	39,00	☺
LED 3000K							



ABDECKUNG

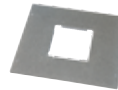

inkl. Zentrierteil DA: 78 x 78mm, zu Betoneinbaugehäuse 332-1001, aus verzinktem Blech, nicht für Sichtbeton geeignet, passend für COVER

LxB	H	ART. NR.	EURO	LAGER
168x168	11	332-1302	19,00	☺

BETONEINBAUEHÄUSE



ohne Abdeckung aus verzinktem Blech, nicht für Sichtbeton geeignet, je eine Schlaucheführung DM 20mm links, rechts und rückseitig, Abdeckung separat ordern

LxB	T	ART. NR.	EURO	LAGER
170x170	116	332-1001	25,00	☺

LED KONVERTER



INFO	W	mA	V DC	FÜR	LxBxH	FARBE	ART. NR.	EURO	LAGER
nicht dimmbar, 230V AC	7,5	140	54	1 COVER	111x52x22	W	24-122203	23,00	☺
dimmbar, 1 - 10V/ Push	7,5	140	53	1 COVER	111x52x22	W	24-123401	44,00	☺
dimmbar, DALI dimm.	7,5	140	53	1 COVER	111x52x22	W	24-123395	49,00	☺



PONTOS SQUARE



Einbaustrahler, Aluminiumdruckguss, weiß, schwarz oder silber pulverbeschichtet, quadratisch, schwenkbar 25°, mit zurückversetzter Lichtquelle, exkl. Konverter.

LM	LxBxH	ET	DA LxB	FARBE	REF.	ART. NR.	EURO	LAGER
LED 10W 250mA · 770lm CRI>80	90x90x80	110	80x80	W	24°	305-621524w	44,00	☺
	90x90x80	110	80x80	S	24°	305-621524b	44,00	☺
LED 3000K	90x90x80	110	80x80	S	24°	305-621524s	44,00	☺
LED 10W 250mA · 732lm CRI>80	90x90x80	110	80x80	W	24°	305-621524w27k	44,00	☺
	90x90x80	110	80x80	S	24°	305-621524b27k	44,00	☺
LED 2700K	90x90x80	110	80x80	S	24°	305-621524s27k	44,00	☺



LED KONVERTER



INFO	W	mA	V DC	FÜR	LxBxH	FARBE	ART. NR.	EURO	LAGER
nicht dimmbar, 230V AC	13	250	54	1 PONTOS	111x52x22	W	24-122201	23,00	☺
dimmbar, DALI dimm.	10	250	43	1 PONTOS	111x52x22	W	24-123403	49,00	☺





IVY SQUARE LED



Einbaustrahler, Aluminiumdruckguss, weiß oder schwarz pulverbeschichtet, quadratisch, runder Deckenausschnitt, starr, mit zurückversetzter Lichtquelle, exkl. Konverter

LM	LxB	ET	DA Ø	FARBE	LUMEN	REF.	ART. NR.	EURO	LAGER
LED 7W 200mA CRI>90	72x72	107	60	W	660	120°	472-0270790203005	42,00	☺
	72x72	107	60	W	650	140°	472-0270790403005	42,00	☺
LED 3000K	72x72	107	60	S	650	120°	472-0270790203006	42,00	☺
	72x72	107	60	S	530	140°	472-0270790403006	42,00	☺

LED 200mA EEL: A++ - A

LED KONVERTER



Symbolfoto

INFO	W	mA	V DC	FÜR	LxBxH	FARBE	ART. NR.	EURO	LAGER
nicht dimmbar, 230V AC	8,3	200	41,5	1 IVY	115x34x19	W	24-122360	23,00	☺
dimmbar, 1 - 10V/Push	9,5	180	54	1 IVY	111x52x22	W	24-123401	44,00	☺
dimmbar, DALI dimm.	9,5	180	53	1 IVY	111x52x22	W	24-123395	49,00	☺

IP20

PLAY DECO



INFO

PLAY DECO ist ein Einbauleuchtersystem aus mehreren separat zu bestellenden Bauteilen. in runder oder quadratischer Ausführung, wahlweise in symmetrischer oder asymmetrischer Ausführung, mit Einbaurahmen oder als rahmenlose Variante

- 1 = LED LICHTAUFSATZ (standardmäßig inkl. 30° Linse)
- 2 = ADAPTER zur Rückversetzung des Lichtaufsatzes (wahlweise separat ordern)
- 2 = ADAPTER für GU10 Leuchtmittel / statt LED Lichtaufsatz (wahlweise separat ordern)
- 3 = LINSEN 15° oder 50° (wahlweise separat ordern)
- 4 = WABENRASTEREINSATZ (wahlweise separat ordern)
- 5 = DEKOREFLEKTOR (rund oder quadratisch, spot oder asymmetrisch, separat ordern)
- 6 = EINBAURAHMEN (mit Rahmen oder Rahmenlos, separat ordern)

1 LICHTAUFSATZ



INFO	LM	ØxH	ET	LED	LUMEN	REF.	FARBE	ART. NR.	EURO	LAGER
LED Lichtaufsatz, Aluminiumdruckguss, weiß pulverbeschichtet, Linse 30° Ausstrahlwinkel - tauschbar, inkl. Konverter, Zubehör separat ordern, ACHTUNG: Einbautiefe variabel	SYS 7W 230V 700mA CRI>80	48x62,4	88 - 145	2700K	570		W	105-7140301437v1	46,50	☺
		48x62,4	88 - 145	3000K	620		W	105-7129091437v2	46,50	☺
		48x62,4	88 - 145	4000K	660		W	105-7151581437v1	46,50	
	SYS 13W 230V 350mA CRI>80	48x74,5	88 - 145	2700K	1240		W	105-7140311437v1	75,00	☺
		48x74,5	88 - 145	3000K	1330		W	105-7132261437v2	75,00	☺
		48x74,5	88 - 145	4000K	1330		W	105-7151591437v1	75,00	

LED 230V IP20 EE: A++ - A

2 ADAPTER GU 10



INFO	ØxH	FARBE	ART. NR.	EURO	LAGER
Adapter für GU10 Leuchtmittel, polycarbonat, schwarz oder weiß, separat ordern (LED Lichtaufsatz wird nicht benötigt) Fassung GU10 separat ordern. GU10 Fassung mit Klemme und Zugentlastung	53x26	S	105-7154546000v1	8,50	☺
	53x26	W	105-7154541460v1	8,50	☺
			259-502991	4,00	☺

2 ADAPTER FÜR LED LICHTAUFSATZ



INFO	ØxH	FARBE	ART. NR.	EURO	LAGER
Adapter, zur Zurücksetzung des LED Lichtaufsatzes, Material-ABS, schwarz, separat ordern	52x26	S	105-7147546000v1	8,50	☺
	52x26	W	105-7147541400v1	8,50	☺

3 LINSE / 4 WABENRASTER

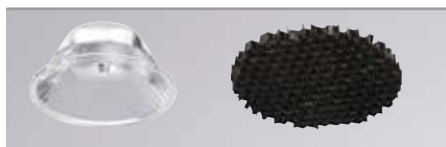

INFO	PRODUKT	REF.	FARBE	ART. NR.	EURO	LAGER
Linse in 2 Ausstrahlwinkeln, Polycarbonat, erhältlich in 15 oder 50° Wabenraster, Aluminium, schwarz	LINSE			105-7156390000	7,00	☺
	LINSE			105-7156400000	7,00	☺
	WABENRASTER		S	105-7151666000v1	4,50	

6 EINBAURAHMEN

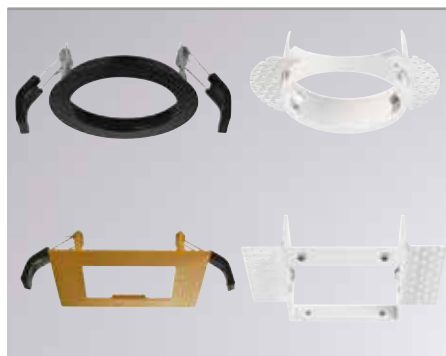

INFO	BAUFORM	Ø bzw. LxB	DA	FARBE	ART. NR.	EURO	LAGER
Einbaurahmen rund oder quadratisch, Aluminiumdruckguss, weiß, schwarz oder gold pulverbeschichtet, geeignet für Deckenstärke 1-25mm rahmenlos, rund oder quadratisch, Aluminiumdruckguss, weiß pulverbeschichtet, geeignet für Deckenstärke 1-25mm	RUND	90	Ø 80	W	105-7147511400	14,50	☺
	RUND	90	Ø 80	G	105-7147512300	14,50	
	RUND	90	Ø 80	S	105-7147516000	14,50	☺
	RUND RAHMENLOS	74	Ø 75	W	105-7151261400	18,00	☺
	QUADRATISCH	110x110	Ø 100	W	105-7151251400	20,50	☺
	QUADRATISCH	110x110	Ø 100	G	105-7151252300	20,50	
	QUADRATISCH	110x110	Ø 100	S	105-7151256000	20,50	☺
	QUADRATISCH RAHMENLOS	73,8x73,5	LxB 75x75	W	105-7151281400	24,00	☺

5 DEKOREFLEKTOREN



INFO	BAUFORM	AUSFÜHRUNG	ØxH bzw. LxBxH	FARBE	ART. NR.	EURO	LAGER
Dekoreflektor rund, rund asymmetrisch, quadratisch oder quadratisch asymmetrisch, Polycarbonat, in den Farben weiß, schwarz, gold, grau, braun oder terracotta	RUND	SYMMETRISCH	70x31,5	W	105-7147521400v2	14,50	☺
	RUND	SYMMETRISCH	70x31,5	G	105-7147522300v2	14,50	☺
	RUND	SYMMETRISCH	70x31,5	S	105-7147526000v2	14,50	
	RUND	SYMMETRISCH	70x31,5	G	105-714752z500v2	17,50	
	RUND	SYMMETRISCH	70x31,5	B	105-714752j600v2	17,50	
	RUND	SYMMETRISCH	70x31,5	T	105-714752dj00v2	17,50	
	RUND	ASYMMETRISCH	70x50,7	W	105-7147531400v2	14,50	
	RUND	ASYMMETRISCH	70x50,7	G	105-7147532300v2	14,50	
	RUND	ASYMMETRISCH	70x50,7	S	105-7147536000v2	14,50	
	RUND	ASYMMETRISCH	70x50,7	G	105-714753z500v2	17,50	
	RUND	ASYMMETRISCH	70x50,7	B	105-714753j600v2	17,50	
	RUND	ASYMMETRISCH	70x50,7	T	105-714753dj00v2	17,50	
	QUADRATISCH	SYMMETRISCH	70x70x31,5	W	105-7151231400v1	18,00	☺
	QUADRATISCH	SYMMETRISCH	70x70x31,5	G	105-7151232300v1	18,00	
	QUADRATISCH	SYMMETRISCH	70x70x31,5	S	105-7151236000v1	18,00	
	QUADRATISCH	SYMMETRISCH	70x70x31,5	G	105-715123z500v1	22,00	
	QUADRATISCH	SYMMETRISCH	70x70x31,5	B	105-715123j600v1	22,00	
	QUADRATISCH	SYMMETRISCH	70x70x31,5	T	105-715123dj00v1	22,00	
	QUADRATISCH	ASYMMETRISCH	70x70x50	W	105-7151241400v1	18,00	
	QUADRATISCH	ASYMMETRISCH	70x70x50	G	105-7151242300v1	18,00	
	QUADRATISCH	ASYMMETRISCH	70x70x50	S	105-7151246000v1	18,00	
	QUADRATISCH	ASYMMETRISCH	70x70x50	G	105-715124z500v1	22,00	
	QUADRATISCH	ASYMMETRISCH	70x70x50	B	105-715124j600v1	22,00	
	QUADRATISCH	ASYMMETRISCH	70x70x50	T	105-715124dj00v1	22,00	





AGON ROUND LED

TOP SELLER



Einbaustrahler, Aluminiumdruckguss und gebürstet oder pulverbeschichtet, rund, schwenkbar 30°. Kühlkörper Aluminiumdruckguss, exkl. Konverter, kompatibel mit HALOX Betoneinbaudose und Frontteil DM 68mm

LM	Ø	ET	DA Ø	FARBE	REF.	ART. NR.	EURO	LAGER
LED SW 250mA - 550lm CRI>80	80	70	68	W	120°	305-0040680202705	35,00	😊
	80	70	68	S	120°	305-0040680202706	35,00	😊
LED 2700K	80	70	68	AG	120°	305-0040680202715	35,00	😊
	80	70	68	W	140°	305-0040680402705	35,00	😊
	80	70	68	S	140°	305-0040680402706	35,00	😊
	80	70	68	AG	140°	305-0040680402715	35,00	😊
LED SW 250mA - 600lm CRI>80	80	70	68	W	120°	305-0040680203005	35,00	😊
	80	70	68	S	120°	305-0040680203006	35,00	😊
LED 3000K	80	70	68	AG	120°	305-0040680203015	35,00	😊
	80	70	68	W	140°	305-0040680403005	35,00	😊
	80	70	68	S	140°	305-0040680403006	35,00	😊
	80	70	68	AG	140°	305-0040680403015	35,00	😊

LED 250mA | 30° | exkl. inkl. | IP20 | EEL: A++ - A

LED KONVERTER



Symbolfoto

INFO	W	mA	V DC	FÜR	LxBxH	FARBE	ART. NR.	EURO	LAGER
nicht dimmbar, 230V AC	13	250	54	1-2 AGON	111x52x22	W	24-122201	23,00	😊
dimmbar, 1 - 10V/Push	13	250	53	1-2 AGON	111x52x22	W	24-123399	44,00	😊
dimmbar, DALI dimm.	10	250	43	1-2 AGON	111x52x22	W	24-123403	49,00	😊

IP20



LOOK SMALL & BIG ROUND LED



LOOK ROUND SMALL LED

Einbaustrahler, Aluminiumdruckguss, weiß pulverbeschichtet, rund, starr, mit zurückversetzter Lichtquelle, exkl. Konverter. Kompatibel mit HALOX Betoneinbaudose und Frontteil DM 68mm

LM	Ø	ET	DA Ø	FARBE	REF.	ART. NR.	EURO	LAGER
LED 7W 350mA - 535lm CRI>90	79	137	67	W	120°	472-291010wr	59,00	☺
LED 3000K								

LED 350mA IP20 | EEL: A+++ - A

LOOK ROUND BIG LED

Einbaustrahler, Aluminiumdruckguss, weiß pulverbeschichtet, rund, starr, mit zurückversetzter Lichtquelle, exkl. Konverter.

LM	Ø	ET	DA Ø	FARBE	REF.	ART. NR.	EURO	LAGER
LED 10,8W 350mA - 795lm CRI>90	114	173	100	W	130°	472-0321090303005	99,00	☺
LED 3000K								

LED 350mA IP20 | EEL: A+++ - A

LED KONVERTER



INFO	W	mA	V DC	FÜR	LxBxH	FARBE	ART. NR.	EURO	LAGER
nicht dimmbar, 230V AC	19	350	54	1 -2 LOOK SMALL	111x52x22	W	24-122201	23,00	☺
dimmbar, 1 - 10V/Push	15	350	43	1 -2 LOOK SMALL	111x52x22	W	24-123400	44,00	☺
dimmbar, DALI dimm.	15	350	43	1 -2 LOOK SMALL	111x52x22	W	24-123403	49,00	☺
nicht dimmbar, 230V AC	19	350	54	1 LOOK BIG	111x52x22	W	24-122201	23,00	☺
dimmbar, Dali, 1 - 10V/Push	15	350	42	1 LOOK BIG	111x52x22	W	24-123403	49,00	☺

IP20



VINOS ROUND LED



Einbastrahler, Aluminiumdruckguss, weiß oder schwarz matt pulverbeschichtet, oder gold lackiert, rahmenlos, rund, mit zurückversetzter Lichtquelle, 38° Ausstrahlwinkel, exkl. Konverter

LM	Ø	ET	DA Ø	FARBE	REF.	ART. NR.	EURO	LAGER
LED 13W 350mA - 850lm CRI>95	100	135	110	W	38°	365-1005132738	105,00	☺
	100	135	110	S	38°	365-1006132738	105,00	☺
LED 2700K	100	135	110	G	38°	365-1003132738	105,00	☺
LED 13W 350mA - 980lm CRI>95	100	135	110	W	38°	365-100513338	105,00	☺
	100	135	110	S	38°	365-100613338	105,00	☺
LED 3000K	100	135	110	G	38°	365-100313338	105,00	☺

LED 350mA EE: A++ - A

LED KONVERTER



INFO	W	mA	V DC	FÜR	LxBxH	FARBE	ART. NR.	EURO	LAGER
nicht dimmbar, 230V AC	19	350	54	1 VINOS	111x52x22	W	24-122201	23,00	☺
dimmbar, 1 - 10V/Push	15	350	43	1 VINOS	111x52x22	W	24-123400	44,00	☺
dimmbar, DALI dimm.	15	350	43	1 VINOS	111x52x22	W	24-123403	49,00	☺

IP20



DITTO LED



Einbaustrahler, Aluminiumdruckguss, weiß oder silber pulverbeschichtet, rund, sandgestrahltes Schutzglas, exkl. Konverter, EB-Gehäuse und EB-Rahmen separat ordern, kompatibel mit HALOX Betoneinbaudose und Frontteil DM 75mm

LM	Ø	ET	DA Ø	FARBE	ART. NR.	EURO	LAGER
LED 6W 140mA · 415lm CRI>80	92	108	76	W	305-6846w	39,00	☺
	92	108	76	S	305-6846s	39,00	☺
LED 3000K							

LED 140mA IP44 | EE: A++ - A

ABDECKUNG

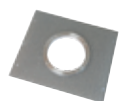

inkl. Zentrierteil DA Ø: 78mm, zu Betoneinbaugehäuse 332-1001, aus verzinktem Blech, nicht für Sichtbeton geeignet, passend für DITTO

LxB	H	ART. NR.	EURO	LAGER
168x168	11	332-1402	19,00	☺

BETONEINBAUGEHÄUSE



ohne Abdeckung aus verzinktem Blech, nicht für Sichtbeton geeignet, je eine Schlauchführung DM 20mm links, rechts und rückseitig, Abdeckung separat ordern

LxB	T	ART. NR.	EURO	LAGER
170x170	116	332-1001	25,00	☺

LED KONVERTER



INFO	W	mA	V DC	FÜR	LxBxH	FARBE	ART. NR.	EURO	LAGER
nicht dimmbar, 230V AC	7,5	140	54	1 DITTO	111x52x22	W	24-122203	23,00	☺
dimmbar, 1 - 10V/ Push	7,5	140	53	1 DITTO	111x52x22	W	24-123401	44,00	☺
dimmbar, DALI dimm.	7,5	140	53	1 DITTO	111x52x22	W	24-123395	49,00	☺

IP20

MOBILIS 250 & MOBILIS 400 LED

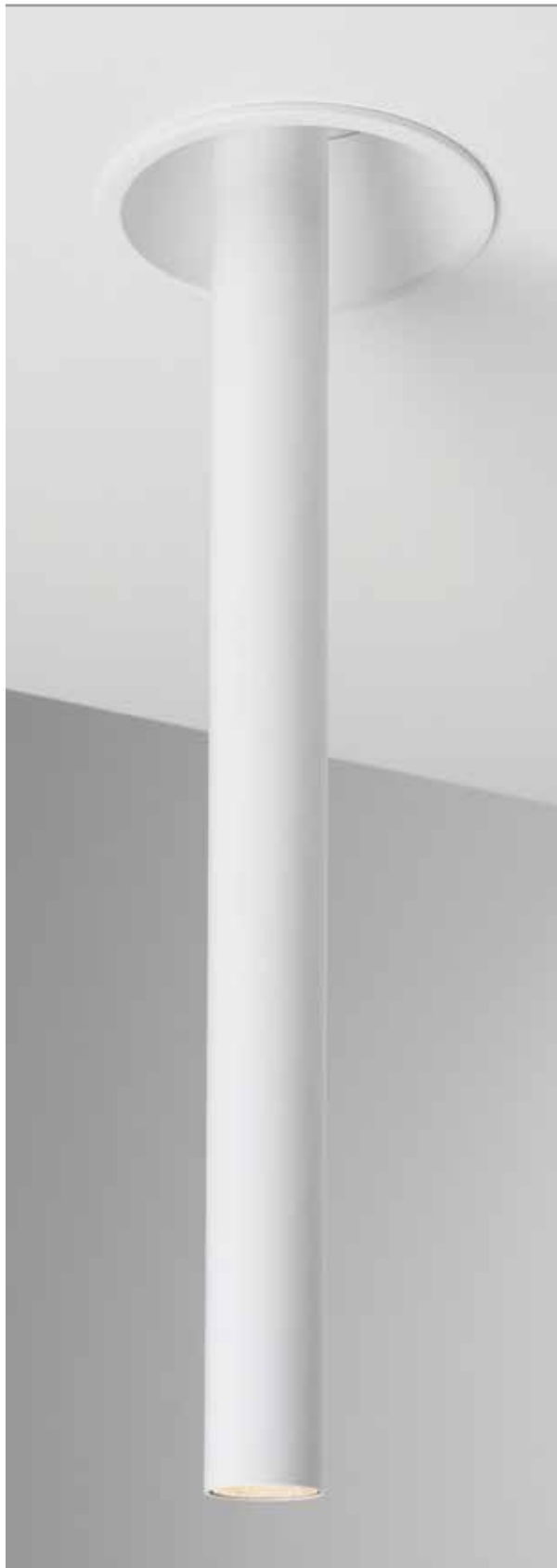

MOBILIS 250 LED

Einbaustrahler, Aluminiumdruckguss, weiß oder schwarz Feinstruktur pulverbeschichtet, Dekorring aus Kunststoff schwarz, zylindrisch, Leuchtenkopf 30° schwenk- und 355° drehbar, ausziehbar von min. 75mm bis 248mm (Einbautiefe beachten), 33° Ausstrahlwinkel, exkl. Konverter

LM	Ø	H max.	ET	DA Ø	FARBE	REF.	ART. NR.	EURO	LAGER
LED 7,8W 700mA - 307lm CRI>80	91	250	75-280	83	W	133°	276-10083080wb	110,00	☺
	91	250	75-280	83	S	133°	276-10083080bb	110,00	☺

LED 3000K

MOBILIS 400 LED

Einbaustrahler, Aluminiumdruckguss, weiß oder schwarz Feinstruktur pulverbeschichtet, Dekorring aus Kunststoff schwarz, zylindrisch, Leuchtenkopf 30° schwenk- und 355° drehbar, ausziehbar von min. 75mm bis 398mm (Einbautiefe beachten), 33° Ausstrahlwinkel, exkl. Konverter

LM	Ø	H max.	ET	DA Ø	FARBE	REF.	ART. NR.	EURO	LAGER
LED 7,8W 700mA - 303lm CRI>80	91	400	75-430	83	W	133°	276-10073080wb	119,00	☺
	91	400	75-430	83	S	133°	276-10073080bb	119,00	☺

LED 3000K

LED 700mA | 30° | 355° | exkl. | inkl. | IP20 | EEL: A++ - A



LED KONVERTER



Symbolfoto

INFO	W	mA	V DC	FÜR	LxBxH	FARBE	ART. NR.	EURO	LAGER
nicht dimmbar, 230 V AC	20	700	28	1-2 MOBILIS	111x52x22	W	24-122201	23,00	☺
dimmbar, 1 - 10V/Push	20	700	36	1-2 MOBILIS	111x52x22	W	24-123400	44,00	☺
dimmbar, DALI dimm.	20	700	28	1-2 MOBILIS	111x52x22	W	24-123403	49,00	☺

W | W | 10V | DALI | IP20



ELIX LED



Einbaustrahler, Aluminiumdruckguss, matt Feinstruktur pulverbeschichtet, Dekorrung aus Kunststoff schwarz, Stahlkopf 45° schwenk- und 355° drehbar, 33° Ausstrahlwinkel, exkl. Konverter

LM	Ø	ET	DA Ø	LUMEN	LED	FARBE	REF.	ART. NR.	EURO	LAGER
LED 9,2W 500mA CRI>90	110	91	102	650	2700K	W	33°	276-0010990332756	83,00	☺
	110	91	102	650	2700K	S	33°	276-0010990332706	83,00	☺
	110	91	102	770	3000K	W	33°	276-0010990333056	83,00	☺
	110	91	102	770	3000K	S	33°	276-0010990333006	83,00	☺

LED 500mA | 45° | 355° | exkl. | inkl. | IP20 | EE: A++ - A

DEKORRING FÜR ELIX LED

INFO	Ø	FARBE	ART. NR.	EURO	LAGER
Ring aus Kunststoff, gold oder weiß, für Elix, werkzeuglos wechselbar. (separat ordern)	60	G	276-7000	5,00	☺
	60	W	276-7001	5,00	☺

WABENRASTER FÜR ELIX LED

INFO	Ø	FARBE	ART. NR.	EURO	LAGER
Wabenraster aus Metall, für Elix, werkzeuglos montierbar. (separat ordern)	60	S	276-1002	4,00	☺

LED KONVERTER



INFO	W	mA	V DC	FÜR	LxBxH	FARBE	ART. NR.	EURO	LAGER
nicht dimmbar, 230V AC	20	500	40	1-2 ELIX	111x52x22	W	24-122201	23,00	☺
dimmbar, 1 - 10V/ Push	20	500	43	1-2 ELIX	111x52x22	W	24-123400	44,00	☺
dimmbar, DALI dimm.	20	500	40	1-2 ELIX	111x52x22	W	24-123403	49,00	☺

IP20

ELIX MINI LED



Einbaustrahler, Aluminiumdruckguss, matt Feinstruktur pulverbeschichtet, Dekorrung aus Kunststoff schwarz, Stahlkopf 90° schwenk- und 350° drehbar, 34° Ausstrahlwinkel, exkl. Konverter

LM	Ø	ET	DA Ø	LUMEN	LED	FARBE	REF.	ART. NR.	EURO	LAGER
LED 6,2W 350mA CRI>90	70	125	64	330	2700K	W	34°	276-0130690342756	79,00	☺
	70	125	64	330	2700K	S	34°	276-0130690342706	79,00	☺
	70	125	64	340	3000K	W	34°	276-0130690343056	79,00	☺
	70	125	64	340	3000K	S	34°	276-0130690343006	79,00	☺

LED 350mA | 90° | 350° | exkl. | inkl. | IP20 | EE: A++ - A

DEKORRING FÜR ELIX MINI LED

INFO	Ø	FARBE	ART. NR.	EURO	LAGER
Ring aus Kunststoff, gold oder weiß, für Elix mini, werkzeuglos wechselbar. (separat ordern)	37	G	276-7002	4,50	☺
	37	W	276-7003	4,50	☺

LED KONVERTER



INFO	W	mA	V DC	FÜR	LxBxH	FARBE	ART. NR.	EURO	LAGER
nicht dimmbar, 230V AC	19	350	54	2 ELIX	111x52x22	W	24-122201	23,00	☺
dimmbar, 1 - 10V/ Push	15	350	43	2 ELIX	111x52x22	W	24-123400	44,00	☺
dimmbar, DALI dimm.	15	350	43	2 ELIX	111x52x22	W	24-123403	49,00	☺

IP20



PONTOS ROUND LED



Einbaustrahler, Aluminiumdruckguss, pulverbeschichtet, rund, schwenkbar 25°, mit zurückversetzter Lichtquelle, exkl. Konverter

LM	ØxH	ET	DA Ø	FARBE	REF.	ART. NR.	EURO	LAGER
LED 10W 250mA 695lm CRI>80	92x77	100	82	W	24°	305-602024w	44,00	☺
	92x77	100	82	S	24°	305-602024b	44,00	☺
	92x77	100	82	S	24°	305-602024s	44,00	☺
LED 3000K								
LED 10W 250mA 644lm CRI>80	92x77	100	82	W	24°	305-602024w27k	44,00	☺
	92x77	100	82	S	24°	305-602024b27k	44,00	☺
	92x77	100	82	S	24°	305-602024s27k	44,00	☺
LED 2700K								

LED 250mA | 25° | exkl. inkl. | IP44 | EE: A++ - A

LED KONVERTER



INFO	W	mA	V DC	FÜR	LxBxH	FARBE	ART. NR.	EURO	LAGER
nicht dimmbar, 230V AC	13	250	57	1 LED	111x52x22	W	24-122201	23,00	☺
dimmbar, DALI dimm.	10	250	43	1 LED	111x52x22	W	24-123403	49,00	☺

IP20

IVY ROUND LED



Einbaustrahler, Aluminiumdruckguss, weiß oder schwarz matt feinstruktur pulverbeschichtet, rund, starr, mit zurückversetzter Lichtquelle, exkl. Konverter

LM	Ø	ET	DA Ø	FARBE	LUMEN	REF.	ART. NR.	EURO	LAGER
LED 7W 200mA CRI>90	72	107	60	W	700	20°	472-0260790203005	39,00	☺
	72	107	60	W	670	40°	472-0260790403005	39,00	☺
LED 3000K									
	72	107	60	S	535	20°	472-0260790203006	39,00	☺
72	107	60	S	620	40°	472-0260790403006	39,00	☺	

LED 200mA | exkl. inkl. | IP54 | EE: A++ - A

LED KONVERTER



INFO	W	mA	V DC	FÜR	LxBxH	FARBE	ART. NR.	EURO	LAGER
nicht dimmbar, 230V AC	8,3	200	41,5	1 IVY	115x34x19	W	24-122360	23,00	☺
dimmbar, 1 - 10V/ Push	9,5	180	54	1 IVY	111x52x22	W	24-123401	44,00	☺
dimmbar, DALI dimm.	9,5	180	53	1 IVY	111x52x22	W	24-123395	49,00	☺

IP20

TIA



Einbaustrahler aus Aluminiumdruckguss, feinstruktur matt pulverbeschichtet, Cover opal, starr, AC LED, zurückversetzte Lichtquelle, hochwertiger vacuumbedampfter Aluminiumreflektor

LM	Ø	ET	DA Ø	LUMEN	LED	FARBE	REF.	ART. NR.	EURO	LAGER
SYS 8W 230V CRI>90	78	107	65	460	2700K	WO	38°	472-0520890382707	63,00	☺
	78	107	65	500	3000K	WO	38°	472-0520890383007	63,00	☺

LED 230V | inkl. | IP20 | EE: A++ - A





Privates Wohnhaus, Österreich

VISIBLE II HV



230V HV | | | |

INFO	LM	LxB	ET	DA LxB	FARBE	ART. NR.	EURO	LAGER
Einbaustrahler, Aluminiumdruckguss, weiß oder silber pulverbeschichtet, quadratisch, schwenkbar 32°, mit zurückversetzter Lichtquelle, EB-Gehäuse und EB-Rahmen separat ordern.	QPAR16 GU10 · 230V max. 50W	85x85	112	74x72	W	305-1440w	20,00	☺
	oder LED RETROFIT GU10	85x85	112	74x72	S	305-1440s	20,00	☺

ABDECKUNG

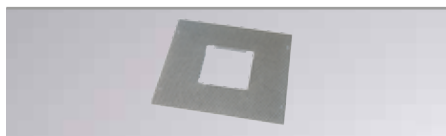

INFO	LxB	H	FÜR	ART. NR.	EURO	LAGER
inkl. Zentrierteil DA: 70 x 75mm, zu Betoneinbaugehäuse 332-1001, aus verzinktem Blech, nicht für Sichtbeton geeignet, passend für VISIBLE II	168x168	11	VISIBLE II	332-1202	19,00	☺

BETONEINBAUGEHÄUSE





INFO	LxB	H	FÜR	ART. NR.	EURO	LAGER
ohne Abdeckung aus verzinktem Blech, nicht für Sichtbeton geeignet, je eine Schlaucheführung DM 20mm links, rechts und rückseitig, Abdeckung separat ordern	170x170	116	VISIBLE II	332-1001	25,00	☺



EDY HV



230V HV    exkl. IP20 | EEL: A++ - D

INFO	LM	LxB	ET	DA LxB	FARBE	ART. NR.	EURO	LAGER
Einbaustrahler, Metall, pulverbeschichtet oder galvanisiert, quadratisch, starr, satiniertes Glas - EB-Gehäuse und EB-Rahmen separat ordern.	QPAR16 GU10 · 230V max. 50W	90x90	90	72x82	W	68-630201	47,00	☺
		90x90	90	72x82	C	68-630231	51,00	☺
	oder LED RETROFIT GU10	90x90	90	72x82	NM	68-630232	51,00	☺

ABDECKUNG

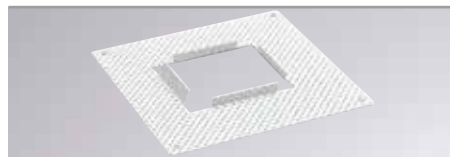

INFO	LxB xH	DA LxB	ART. NR.	EURO	LAGER
für EDY HV Strahler, verzinktes Blech, Achtung: Nicht geeignet für Sichtbeton	150x150x8	110x110	68-0201	17,30	☺

BETONEINBAUGEHÄUSE



INFO	LxBxH	DA LxB x ET	ART. NR.	EURO	LAGER
ohne Abdeckung für EDY HV Strahler, verzinktes Blech, ACHTUNG: Nicht geeignet für Sichtbeton, Abdeckung separat ordern	155x120x90	165x130 x 100	68-0200	18,60	☺

SATINIERTES GLAS



INFO	FARBE	ART. NR.	EURO	LAGER
Satiniertes Glas für Einbaustrahler EDY HV	WO	68-0199	7,50	☺

SERIE 4236 HV



INFO	LM	LxB	ET	DA Ø	FARBE	ART. NR.	EURO	LAGER
Einbaustrahler, Aluminiumdruckguss, pulverbeschichtet oder galvanisiert, quadratisch, runder Deckenausschnitt, schwenkbar 25°, inkl. 30cm Kabel. Kompatibel mit HALOX Betoneinbaudose und Frontteil DM 68mm mit Bajonettverschluss	QPAR16 GU10 · 230V max. 50W	88x88	78	68	MP	8-42361hv	13,50	☺
		88x88	78	68	C	8-42364hv	13,50	☺
	oder	88x88	78	68	S	8-42366hv	11,50	☺
	LED RETROFIT GU10	88x88	78	68	W	8-42367hv	11,50	☺
		88x88	78	68	NM	8-423646hv	13,50	☺

230V HV | | | | | EEL: A++ - D

SERIE 2374 HV



INFO	LM	LxB	ET	DA LxB	FARBE	ART. NR.	EURO	LAGER
Einbaustrahler, Aluminiumdruckguss, pulverbeschichtet oder galvanisiert, quadratisch, schwenkbar 45°, inkl. 30cm Kabel. Kompatibel mit HALOX Betoneinbaudose und Frontteil LxB 75x75mm.	QPAR16 GU10 · 230V max. 50W	96x96	100	80x80	C	8-23744hv	16,00	☺
		96x96	100	80x80	W	8-23747hv	15,50	☺
	oder	96x96	100	80x80	NM	8-237446hv	16,00	☺
LED RETROFIT GU10								

230V HV | | | | | EEL: A++ - D

SERIE 348 HV



INFO	LM	LxB	ET	DA LxB	FARBE	ART. NR.	EURO	LAGER
Einbaustrahler, Aluminiumdruckguss, pulverbeschichtet oder galvanisiert, quadratisch, schwenkbar 30°, mit zurückversetzter Lichtquelle, inkl. 30cm Kabel	QPAR16 GU10 · 230V max. 50W	90x90	110	80x80	W	8-3487hv	16,00	☺
		90x90	110	80x80	NM	8-34846hv	16,50	☺
	oder							
LED RETROFIT GU10								

230V HV | | | | | EEL: A++ - D

QANA 1



INFO	LM	LxB	ET	DA LxB	FARBE	ART. NR.	EURO	LAGER
Einbauleuchte Kardanisch, Aluminium gefräst, lackiert, weiß oder schwarz pulverbeschichtetgefräst, quadratisch, 350° dreh- / 30° schwenkbar, Kompatibel mit HALOX Betoneinbaudose und Frontteil LxB 75x75mm	QPAR16 GU10 · 230V max. 50W	87x87	95	76x76		472-259034hv	42,00	☺
		87x87	95	76x76	W	472-25903405hv	42,00	☺
	oder	87x87	95	76x76	S	472-25903406hv	42,00	☺
LED RETROFIT GU10								

230V HV | | | | | | EEL: A++ - D

QANA 2



Einbauleuchte Kardanisch, Aluminium gefräst, lackiert, weiß oder schwarz pulverbeschichtetgefräst, quadratisch, 350° dreh- / 30° schwenkbar

LM	LxB	ET	DA LxB	FARBE	ART. NR.	EURO	LAGER
2 x QPAR16 GU10 · 230V max. 50W	174x87	95	165x76		472-259035hv	89,00	☺
	174x87	95	165x76	W	472-25903505hv	89,00	☺
	174x87	95	165x76	S	472-25903506hv	89,00	☺
2 x LED RETROFIT GU10							

230V HV | | | | | | EEL: A++ - D



SERIE 332 HV



INFO	LM	Ø	ET	DA Ø	FARBE	ART. NR.	EURO	LAGER
Einbaustrahler, Aluminiumdruckguss, pulverbeschichtet oder galvanisiert, rund, schwenkbar 25°, inkl. 30cm Kabel. Kompatibel mit HALOX Betoneinbaudose und Frontteil DM 68mm mit Bajonettverschluss	QPAR16 GU10 · 230V max. 50W	88	78	68	MP	8-3321hv	13,50	☺
		88	78	68	C	8-3324hv	13,50	☺
	oder	88	78	68	S	8-3326hv	11,50	☺
	LED RETROFIT GU10	88	78	68	W	8-3327hv	11,50	☺
		88	78	68	NM	8-33246hv	13,50	☺

230V HV | | IP20 | EEI: A++ - D

SERIE 1101 HV



INFO	LM	Ø	ET	DA Ø	FARBE	ART. NR.	EURO	LAGER
Einbaustrahler, Aluminiumdruckguss, pulverbeschichtet oder galvanisiert, rund, starr, Schutzglas. Kompatibel mit HALOX Betoneinbaudose und Frontteil DM 75mm	QPAR16 GU10 · 230V max. 50W	85	87	74	C	8-1101b4hv	15,50	☺
		85	87	74	S	8-1101b6hv	14,50	☺
	oder	85	87	74	W	8-1101b7hv	14,50	☺
	LED RETROFIT GU10	85	87	74	NM	8-1101b46hv	15,50	☺

230V HV | | IP65 | EEI: A++ - D

SERIE 3391 HV



INFO	LM	Ø	ET	DA Ø	FARBE	ART. NR.	EURO	LAGER
Einbaustrahler, Aluminiumdruckguss, gebürstet, rund, schwenkbar 45°, inkl. 30cm Kabel, Kompatibel mit HALOX Betoneinbaudose und Frontteil DM 80mm	QPAR16 GU10 · 230V max. 50W	92	65	80	AG	8-3391shv	19,00	☺
oder	LED RETROFIT GU10							

230V HV | | IP20 | EEI: A++ - D

SERIE 223 HV



INFO	LM	Ø	ET	DA Ø	FARBE	ART. NR.	EURO	LAGER
Einbaustrahler, Aluminiumdruckguss, pulverbeschichtet oder galvanisiert, rund, starr, inkl. 30cm Kabel, Kompatibel mit HALOX Betoneinbaudose und Frontteil DM 75mm	QPAR16 GU10 · 230V max. 50W	81	65	70	W	8-2237hv	8,50	☺
		81	65	70	NM	8-22346hv	9,50	☺
oder	LED RETROFIT GU10							

230V HV | | IP20 | EEI: A++ - D

SERIE 3380 HV



INFO	LM	Ø	ET	DA Ø	FARBE	ART. NR.	EURO	LAGER
Einbaustrahler, Aluminiumdruckguss, weiß oder schwarz lackiert, rund, mit zurückversetzter Lichtquelle	QPAR16 GU10 · 230V max. 50W	82	84	75	S	8-33806hv	11,00	☺
		82	84	75	W	8-33807hv	11,00	☺
oder	LED RETROFIT GU10							

230V HV | | IP20 | EEI: A++ - D



SERIE 68 HV



INFO	LM	Ø	ET	DA Ø	FARBE	ART. NR.	EURO	LAGER
Einbaustrahler, Aluminiumdruckguss, pulverbeschichtet oder galvanisiert, rund, schwenkbar 45°, inkl.30cm Kabel, Kompatibel mit HALOX Betoneinbaudose und Frontteil DM 68mm	QPAR16 GU10 · 230V max. 50W	80	96	68	MP	8-681hv	9,00	☺
		80	96	68	C	8-684hv	9,00	☺
	oder	80	96	68	S	8-686hv	8,50	☺
	LED RETROFIT GU10	80	96	68	W	8-687hv	8,50	☺
		80	96	68	NM	8-6846hv	9,00	☺

230V HV | | | | | EEI: A++ - D

SERIE 146 HV



INFO	LM	Ø	ET	DA Ø	FARBE	ART. NR.	EURO	LAGER
Einbaustrahler, Aluminiumdruckguss, pulverbeschichtet oder galvanisiert, rund, starr, inkl.30cm Kabel, Kompatibel mit HALOX Betoneinbaudose und Frontteil DM 68mm	QPAR16 GU10 · 230V max. 50W	77	90	68	C	8-1464hv	7,50	☺
		77	90	68	S	8-1466hv	6,50	☺
	oder	77	90	68	W	8-1467hv	6,50	☺
	LED RETROFIT GU10	77	90	68	NM	8-14646hv	7,50	☺

230V HV | | | | EEI: A++ - D

SERIE 204 HV



INFO	LM	Ø	ET	DA Ø	FARBE	ART. NR.	EURO	LAGER
Einbaustrahler, Stahlblech, pulverbeschichtet oder galvanisiert, rund, schwenkbar 45°, inkl.30cm Kabel, Kompatibel mit HALOX Betoneinbaudose und Frontteil DM 68mm	QPAR16 GU10 · 230V max. 50W	80	60	68	C	8-2044hv	8,50	☺
		80	60	68	S	8-2046hv	7,50	☺
	oder	80	60	68	W	8-2047hv	7,50	☺
	LED RETROFIT GU10	80	60	68	NM	8-20446hv	8,50	☺

230V HV | | | | | EEI: A++ - D

SERIE 015



INFO	LM	Ø	ET	DA Ø	FARBE	ART. NR.	EURO	LAGER
Einbaustrahler, Stahlblech, pulverbeschichtet oder galvanisiert, rund, starr, Schutzglas matt, 1m Silikonkabel und AMP Stecker, exkl. Konverter	QT9 ECO G4 · 12V max. 7W	72	20	55	MP	8-0151	7,50	☺
		72	20	55	C	8-0154	7,50	☺
		72	20	55	W	8-0157	7,00	☺
		72	20	55	NM	8-01546	7,50	☺

12V NV | | | | | EEI: A+ - C

TRIBECA QR111



INFO	LM	Ø	ET	DA Ø	FARBE	ART. NR.	EURO	LAGER
Einbaustrahler, Aluminiumdruckguss, Feinstruktur pulverbeschichtet, rund, schwenkbar 30°, zurückversetzte Lichtquelle, exkl. Konverter	QR111 G53 · 12V max. 50W	170	137	164	W	308-6312	24,00	☺
		170	137	164	S	308-6312b	24,00	☺
oder								
LED RETROFIT G53								

12V NV | | | | | | EEI: A - C



METRIS LED



INFO	LM	Ø	ET	DA Ø	FARBE	ART. NR.	EURO	LAGER
Einbaustrahler, thermoplastisches Polymer, lackiert oder beschichtet, rund, starr, exkl. Konverter, 2m Zuleitung mit Stecker, Micro 12, geeignet für Einbau in Holz	LED1,6W 12V 135lm CRI>80	68	9,2	57	C	86-1093709b	27,00	☺
		68	9,2	57	AL	86-1093710b	27,00	☺
	LED 3200K							

LED 12V | exkl. | inkl. | IP20 | EEL: A++ - A

SMALLY XS



INFO	LM	Ø	ET	DA Ø	FARBE	ART. NR.	EURO	LAGER
Einbaustrahler, thermoplastisches Polymer, lackiert oder beschichtet, rund, starr, exkl. Konverter, 2m Zuleitung mit Stecker, Micro 12, geeignet für Einbau in Holz	LED 3W 12V 360lm CRI>80	64	12	57	W	86-1231001bp	33,00	☺
		64	12	57	C	86-1231009bp	33,00	☺
		64	12	57	AL	86-1231010bp	33,00	☺
	LED 3000K							
	LED 3 W 12V 360lm CRI>80	64	12	57	W	86-1231001b1p	33,00	☺
		64	12	57	C	86-1231009b1p	33,00	☺
	64	12	57	AL	86-1231010b1p	33,00	☺	
LED 2700K								

LED 12V | exkl. | inkl. | IP44 | EEL: A++ - A

CUBIT



INFO	LM	LxB	ET	DA Ø	FARBE	ART. NR.	EURO	LAGER
Einbaustrahler, thermoplastisches Polymer, lackiert oder beschichtet, quadratisch, starr, exkl. Konverter, 2m Zuleitung mit Stecker, Micro 12, geeignet für Einbau in Holz	LED 3W 12V 360lm CRI>80	72x72	12	57	C	86-1243909bp	33,00	☺
		72x72	12	57	AL	86-1243910bp	33,00	☺
	LED 3000K							
	LED 3 W 12V 360lm CRI>80	72x72	12	57	C	86-1243909b1p	33,00	☺
		72x72	12	57	AL	86-1243910b1p	33,00	☺
	LED 2700K							

LED 12V | exkl. | inkl. | IP44 | EEL: A++ - A

LED KONVERTER

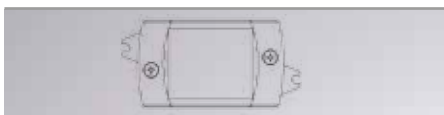

INFO	W / mA	LxB	H	FÜR	FARBE	ART. NR.	EURO	LAGER
LED Konverter für Metris M12, primär mit 2m Zuleitung mit EURO-Flachstecker, sekundär mit 0,5m Leitung mit 10-fach Verteiler, Micro 12	1-15W(12V)	120x45	16	METRIS SMALLY XS CUBIT	W	86-0856501p	35,00	☺

IP44

VERBINDUNGSLEITUNG

INFO	L	FÜR	FARBE	ART. NR.	EURO	LAGER
Verbindungsleitung 2m für Metris, beidseitig mit Stecker (Micro 12)	2000	METRIS SMALLY XS CUBIT	W	86-1145500200s	3,50	☺





ZHOOM



INFO	LM	ØxH	ET	Ø DA	FARBE	LED	LUMEN	ART. NR.	EURO	LAGER
Einbaustrahler, Aluminium, pulverbeschichtet oder galvanisiert, rund, schwenkbar, optisch geschliffene Glaslinse, stufenlos fokussierbar 10°-60°, UV- und IR-freies Licht, exkl. Konverter, Energieeffiziente LEDs mit hoher Farbwiedergabe	LED 2W 500mA	49,5x12	21	42	C	3000K	153	56-85034	155,00	
		49,5x12	21	42	S	3000K	153	56-85037	155,00	
		49,5x12	21	42	S	3000K	153	56-85039	155,00	
		49,5x12	21	42	C	4000K	163	56-85035	155,00	
		49,5x12	21	42	S	4000K	163	56-85036	155,00	
		49,5x12	21	42	S	4000K	163	56-85038	155,00	

LED 500mA | exkl. | inkl. | IP20 | EEI: A++ - A

LED KONVERTER



INFO	W / mA	LxBxH	FÜR	FARBE	ART. NR.	EURO	LAGER
LED-Konverter, nicht dimmbar, 230V AC *Konverter extern setzen, passt nicht in den Deckenausschnitt	6W / 500	60x35x21,5	1 - 2 ZHOOM	W	24-122602	17,00	☺
	20W / 500	111x52x22*	1 - 8 ZHOOM	W	24-122201	23,00	☺

IP20



KADO



LED 500mA

 EEL: A++ - A

INFO	LM	Ø	ET	DA Ø	FARBE	LED	LM	REF.	ART. NR.	EURO	LAGER
Einbaustrahler, Aluminium, chrom oder perchrom galvanisiert, rund, schwenkbar 50°, facettierte Linse 12° oder 30°, exkl. Konverter, Zubehör separat ordern: Glanzgold, Mattgold und Schwarz auf Anfrage	LED 2W 500mA	50	30	42		3000K	126		56-6126ng1	72,00	
		50	30	42		3000K	126		56-6026ng1	72,00	
		50	30	42		3000K	126		56-6127ng1	72,00	
		50	30	42		3000K	126		56-6027ng1	72,00	

LED KONVERTER



IP20

INFO	W / mA	LxBxH	FÜR	FARBE	ART. NR.	EURO	LAGER
LED-Konverter, nicht dimmbar, 230V AC	4W / 500	51x32x18	1 - 2 KADO	S	75-mpl5	11,50	
	20W / 500	111x52x22*	1 - 8 KADO	W	24-122201	23,00	

*Konverter extern setzen, passt nicht in den Deckenausschnitt

UP-DOSE AK75

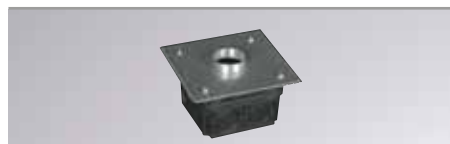

INFO	LxBxH	FARBE	ART. NR.	EURO	LAGER
Unterputzklemmdose für Kado, DM 42mm, Achtung: nur LED Konverter der Serie 75-MPL passen in die Unterputzklemmdose	100x100x60	AP	56-ak7542	25,00	

SAVO 20 ROUND SINGLE



LED 230V | 20° | inkl. | inkl. | IP20 | EEL: A++ - A

INFO

Einbaustrahler aus Aluminiumdruckguss
 Oberfläche pulverbeschichtet in weiß oder schwarz matt
 Nach hinten versetzter Reflektor für bessere Entblendung
 Facettierter Aluminiumreflektor in 3 Ausstrahlwinkeln
 Strahlerelement 20° schwenkbar

LM	ØxH	ET	DA Ø	FARBE	LED	LUMEN	REF.	ART. NR.	EURO	LAGER
SYS 19W 230V PASSIVE COOLING Binning SDCM 2 3000K: PREMIUM CRI>90 4000K: CRI>90 LED 2700K & 3500K Versionen auf Anfrage VERSIONEN AUF ANFRAGE: 13W & 28W	156x137	167	146	W	3000K	1820	spot	633-22004195ng6	168,00	
	156x137	167	146	S	3000K	1820	spot	633-22004196ng6	168,00	
	156x137	167	146	W	3000K	1820	medium	633-22004295ng6	168,00	
	156x137	167	146	S	3000K	1820	medium	633-22004296ng6	168,00	
	156x137	167	146	W	3000K	1820	flood	633-22004395ng6	168,00	
	156x137	167	146	S	3000K	1820	flood	633-22004396ng6	168,00	
	156x137	167	146	W	4000K	1950	spot	633-22002145ng6	168,00	
	156x137	167	146	S	4000K	1950	spot	633-22002146ng6	168,00	
	156x137	167	146	W	4000K	1950	medium	633-22002245ng6	168,00	
	156x137	167	146	S	4000K	1950	medium	633-22002246ng6	168,00	
	156x137	167	146	W	4000K	1950	flood	633-22002345ng6	168,00	
	156x137	167	146	S	4000K	1950	flood	633-22002346ng6	168,00	

SAVO 20 SQUARE SINGLE



LED 230V | 30° | 350° | inkl. | inkl. | IP20 | EEL: A++ - A

INFO

Einbaustrahler aus Aluminiumdruckguss
 Oberfläche pulverbeschichtet in weiß oder schwarz matt
 Nach hinten versetzter Reflektor für bessere Entblendung
 Facettierter Aluminiumreflektor in 3 Ausstrahlwinkeln
 Strahlerelement 30° schwenkbar und 350° drehbar

LM	LxB	ET	DA LxB	FARBE	LED	LUMEN	REF.	ART. NR.	EURO	LAGER
SYS 19W 230V PASSIVE COOLING Binning SDCM 2 3000K: PREMIUM CRI>90 4000K: CRI>90 LED 2700K & 3500K Versionen auf Anfrage VERSIONEN AUF ANFRAGE: 13W & 28W	175x175	179	155x155	W	3000K	1820	spot	633-42004195ng6	195,00	
	175x175	179	155x155	S	3000K	1820	spot	633-42004196ng6	195,00	
	175x175	179	155x155	W	3000K	1820	medium	633-42004295ng6	195,00	
	175x175	179	155x155	S	3000K	1820	medium	633-42004296ng6	195,00	
	175x175	179	155x155	W	3000K	1820	flood	633-42004395ng6	195,00	
	175x175	179	155x155	S	3000K	1820	flood	633-42004396ng6	195,00	
	175x175	179	155x155	W	4000K	1950	spot	633-42002145ng6	195,00	
	175x175	179	155x155	S	4000K	1950	spot	633-42002146ng6	195,00	
	175x175	179	155x155	W	4000K	1950	medium	633-42002245ng6	195,00	
	175x175	179	155x155	S	4000K	1950	medium	633-42002246ng6	195,00	
	175x175	179	155x155	W	4000K	1950	flood	633-42002345ng6	195,00	
	175x175	179	155x155	S	4000K	1950	flood	633-42002346ng6	195,00	

SAVO 20 SQUARE DOUBLE



LED 230V | 30° | 350° | inkl. | inkl. | IP20 | EEL: A++ - A

INFO

Einbaustrahler aus Aluminiumdruckguss
 Oberfläche pulverbeschichtet in weiß oder schwarz matt
 Nach hinten versetzter Reflektor für bessere Entblendung
 Facettierter Aluminiumreflektor in 3 Ausstrahlwinkeln
 Strahlerelement 30° schwenkbar und 350° drehbar

LM	LxB	ET	DA LxB	FARBE	LED	LUMEN	REF.	ART. NR.	EURO	LAGER
SYS 2 x 19W 230V PASSIVE COOLING Binning SDCM 2 3000K: PREMIUM CRI>90 4000K: CRI>90 LED 2700K & 3500K Versionen auf Anfrage VERSIONEN AUF ANFRAGE: 2 x 13W & 2 x 28W	325x175	179	305x155	W	3000K	3640	spot	633-54004195ng6	381,00	
	325x175	179	305x155	S	3000K	3640	spot	633-54004196ng6	381,00	
	325x175	179	305x155	W	3000K	3640	medium	633-54004295ng6	381,00	
	325x175	179	305x155	S	3000K	3640	medium	633-54004296ng6	381,00	
	325x175	179	305x155	W	3000K	3640	flood	633-54004395ng6	381,00	
	325x175	179	305x155	S	3000K	3640	flood	633-54004396ng6	381,00	
	325x175	179	305x155	W	4000K	3900	spot	633-54002145ng6	381,00	
	325x175	179	305x155	S	4000K	3900	spot	633-54002146ng6	381,00	
	325x175	179	305x155	W	4000K	3900	medium	633-54002245ng6	381,00	
	325x175	179	305x155	S	4000K	3900	medium	633-54002246ng6	381,00	
	325x175	179	305x155	W	4000K	3900	flood	633-54002345ng6	381,00	
	325x175	179	305x155	S	4000K	3900	flood	633-54002346ng6	381,00	





Hotel Alpen Parks, Zell am See, Österreich

NOW 2 SQUARE SINGLE



INFO

Einbaustrahler aus Aluminiumdruckguss
 Oberfläche pulverbeschichtet in weiß oder schwarz matt
 Nach hinten versetzter Reflektor für bessere Entblendung
 Facettierter Aluminiumreflektor in 3 Ausstrahlwinkeln
 Strahlerelement 30° schwenkbar und 350° drehbar

LM	LxB	ET	DA Ø	FARBE	LED	LUMEN	REF.	ART. NR.	EURO	LAGER	
SYS 13W 230V PASSIVE COOLING Binning SDCM 2 3000K: PREMIUM CRI>90 4000K: CRI>90 LED 2700K & 3500K Versionen auf Anfrage	130x130	120	115	SM	3000K	1350	spot	635-21204294ng6	129,00		
	130x130	120	115	W	3000K	1350	spot	635-21204295ng6	129,00		
	130x130	120	115	S	3000K	1350	spot	635-21204296ng6	129,00		
	130x130	120	115	SM	3000K	1350	medium	635-21204594ng6	129,00		
	130x130	120	115	W	3000K	1350	medium	635-21204595ng6	129,00		
	130x130	120	115	S	3000K	1350	medium	635-21204596ng6	129,00		
	130x130	120	115	SM	3000K	1350	flood	635-21204894ng6	129,00		
	130x130	120	115	W	3000K	1350	flood	635-21204895ng6	129,00		
	130x130	120	115	S	3000K	1350	flood	635-21204896ng6	129,00		
	130x130	120	115	SM	4000K	1440	spot	635-21202244ng6	129,00		
	130x130	120	115	W	4000K	1440	spot	635-21202245ng6	129,00		
	130x130	120	115	S	4000K	1440	spot	635-21202246ng6	129,00		
	130x130	120	115	SM	4000K	1440	medium	635-21202544ng6	129,00		
	130x130	120	115	W	4000K	1440	medium	635-21202545ng6	129,00		
	130x130	120	115	S	4000K	1440	medium	635-21202546ng6	129,00		
	130x130	120	115	SM	4000K	1440	flood	635-21202844ng6	129,00		
	130x130	120	115	W	4000K	1440	flood	635-21202845ng6	129,00		
	130x130	120	115	S	4000K	1440	flood	635-21202846ng6	129,00		
	SY 19W 230V PASSIVE COOLING Binning SDCM 2 3000K: PREMIUM CRI>90 4000K: CRI>90 LED 2700K & 3500K Versionen auf Anfrage	130x130	120	115	SM	3000K	1840	spot	635-21704294ng6	129,00	
		130x130	120	115	W	3000K	1840	spot	635-21704295ng6	129,00	
130x130		120	115	S	3000K	1840	spot	635-21704296ng6	129,00		
130x130		120	115	SM	3000K	1840	medium	635-21704594ng6	129,00		
130x130		120	115	W	3000K	1840	medium	635-21704595ng6	129,00		
130x130		120	115	S	3000K	1840	medium	635-21704596ng6	129,00		
130x130		120	115	SM	3000K	1840	flood	635-21704894ng6	129,00		
130x130		120	115	W	3000K	1840	flood	635-21704895ng6	129,00		
130x130		120	115	S	3000K	1840	flood	635-21704896ng6	129,00		
130x130		120	115	SM	4000K	1970	spot	635-21702244ng6	129,00		
130x130		120	115	W	4000K	1970	spot	635-21702245ng6	129,00		
130x130		120	115	S	4000K	1970	spot	635-21702246ng6	129,00		
130x130		120	115	SM	4000K	1970	medium	635-21702544ng6	129,00		
130x130		120	115	W	4000K	1970	medium	635-21702545ng6	129,00		
130x130		120	115	S	4000K	1970	medium	635-21702546ng6	129,00		
130x130		120	115	SM	4000K	1970	flood	635-21702844ng6	129,00		
130x130		120	115	W	4000K	1970	flood	635-21702845ng6	129,00		
130x130		120	115	S	4000K	1970	flood	635-21702846ng6	129,00		



Vorwerk Store, Pasching, Österreich

NOW 2 ROUND



INFO

Einbaustrahler aus Aluminiumdruckguss
 Oberfläche pulverbeschichtet in weiß oder schwarz
 Nach hinten versetzter Reflektor für bessere Entblendung
 Facettierter Aluminiumreflektor in 3 Ausstrahlwinkeln
 Strahlerelement 30° schwenkbar

LM	Ø	ET	DA Ø	FARBE	LED	LUMEN	REF.	ART. NR.	EURO	LAGER	
SYS 13W 230V PASSIVE COOLING Binning SDCM 2 3000K: PREMIUM CRI>90 4000K: CRI>90 LED 2700K & 3500K Versionen auf Anfrage	125	120	115	SM	3000K	1350	spot	635-11204294ng6	129,00		
	125	120	115	W	3000K	1350	spot	635-11204295ng6	129,00		
	125	120	115	S	3000K	1350	spot	635-11204296ng6	129,00		
	125	120	115	SM	3000K	1350	medium	635-11204594ng6	129,00		
	125	120	115	W	3000K	1350	medium	635-11204595ng6	129,00		
	125	120	115	S	3000K	1350	medium	635-11204596ng6	129,00		
	125	120	115	SM	3000K	1350	flood	635-11204894ng6	129,00		
	125	120	115	W	3000K	1350	flood	635-11204895ng6	129,00		
	125	120	115	S	3000K	1350	flood	635-11204896ng6	129,00		
	125	120	115	SM	4000K	1440	spot	635-11202244ng6	129,00		
	125	120	115	W	4000K	1440	spot	635-11202245ng6	129,00		
	125	120	115	S	4000K	1440	spot	635-11202246ng6	129,00		
	125	120	115	SM	4000K	1440	medium	635-11202544ng6	129,00		
	125	120	115	W	4000K	1440	medium	635-11202545ng6	129,00		
	125	120	115	S	4000K	1440	medium	635-11202546ng6	129,00		
	125	120	115	SM	4000K	1440	flood	635-11202844ng6	129,00		
	125	120	115	W	4000K	1440	flood	635-11202845ng6	129,00		
	125	120	115	S	4000K	1440	flood	635-11202846ng6	129,00		
	SYS 19W 230V PASSIVE COOLING Binning SDCM 2 3000K: PREMIUM CRI>90 4000K: CRI>90 LED 2700K & 3500K Versionen auf Anfrage	125	120	115	SM	3000K	1840	spot	635-11704294ng6	129,00	
		125	120	115	W	3000K	1840	spot	635-11704295ng6	129,00	
125		120	115	S	3000K	1840	spot	635-11704296ng6	129,00		
125		120	115	SM	3000K	1840	medium	635-11704594ng6	129,00		
125		120	115	W	3000K	1840	medium	635-11704595ng6	129,00		
125		120	115	S	3000K	1840	medium	635-11704596ng6	129,00		
125		120	115	SM	3000K	1840	flood	635-11704894ng6	129,00		
125		120	115	W	3000K	1840	flood	635-11704895ng6	129,00		
125		120	115	S	3000K	1840	flood	635-11704896ng6	129,00		
125		120	115	SM	4000K	1970	spot	635-11702244ng6	129,00		
125		120	115	W	4000K	1970	spot	635-11702245ng6	129,00		
125		120	115	S	4000K	1970	spot	635-11702246ng6	129,00		
125		120	115	SM	4000K	1970	medium	635-11702544ng6	129,00		
125		120	115	W	4000K	1970	medium	635-11702545ng6	129,00		
125		120	115	S	4000K	1970	medium	635-11702546ng6	129,00		
125		120	115	SM	4000K	1970	flood	635-11702844ng6	129,00		
125		120	115	W	4000K	1970	flood	635-11702845ng6	129,00		
125		120	115	S	4000K	1970	flood	635-11702846ng6	129,00		

NOW 2 SQUARE DOUBLE



LED 230V | 30° | 350° | inkl. | inkl. | IP20 | EEL: A++ - A

INFO

Einbaustrahler aus Aluminiumdruckguss
 Oberfläche pulverbeschichtet in weiß oder schwarz
 Nach hinten versetzter Reflektor für bessere Entblendung
 Facettierter Aluminiumreflektor in 3 Ausstrahlwinkeln
 Strahlerelement 30° schwenkbar und 350° drehbar

LM	LxB	ET	DA LxB	FARBE	LED	LUMEN	REF.	ART. NR.	EURO	LAGER	
SYS 2 x 13W 230V PASSIVE COOLING Binning SDCM 2 3000K: PREMIUM CRI>90 4000K: CRI>90 LED 2700K & 3500K Versionen auf Anfrage	245x130	120	230x115	SM	3000K	2700	spot	635-32904294ng6	233,00		
	245x130	120	230x115	W	3000K	2700	spot	635-32904295ng6	233,00		
	245x130	120	230x115	S	3000K	2700	spot	635-32904296ng6	233,00		
	245x130	120	230x115	SM	3000K	2700	medium	635-32904594ng6	233,00		
	245x130	120	230x115	W	3000K	2700	medium	635-32904595ng6	233,00		
	245x130	120	230x115	S	3000K	2700	medium	635-32904596ng6	233,00		
	245x130	120	230x115	SM	3000K	2700	flood	635-32904894ng6	233,00		
	245x130	120	230x115	W	3000K	2700	flood	635-32904895ng6	233,00		
	245x130	120	230x115	S	3000K	2700	flood	635-32904896ng6	233,00		
	245x130	120	230x115	SM	4000K	2880	spot	635-32902244ng6	233,00		
	245x130	120	230x115	W	4000K	2880	spot	635-32902245ng6	233,00		
	245x130	120	230x115	S	4000K	2880	spot	635-32902246ng6	233,00		
	245x130	120	230x115	SM	4000K	2880	medium	635-32902544ng6	233,00		
	245x130	120	230x115	W	4000K	2880	medium	635-32902545ng6	233,00		
	245x130	120	230x115	S	4000K	2880	medium	635-32902546ng6	233,00		
	245x130	120	230x115	SM	4000K	2880	flood	635-32902844ng6	233,00		
	245x130	120	230x115	W	4000K	2880	flood	635-32902845ng6	233,00		
	245x130	120	230x115	S	4000K	2880	flood	635-32902846ng6	233,00		
	SYS 2 x 19W 230V PASSIVE COOLING Binning SDCM 2 3000K: PREMIUM CRI>90 4000K: CRI>90 LED 2700K & 3500K Versionen auf Anfrage	245x130	120	230x115	SM	3000K	3680	spot	635-34004294ng6	233,00	
		245x130	120	230x115	W	3000K	3680	spot	635-34004295ng6	233,00	
245x130		120	230x115	S	3000K	3680	spot	635-34004296ng6	233,00		
245x130		120	230x115	SM	3000K	3680	medium	635-34004594ng6	233,00		
245x130		120	230x115	W	3000K	3680	medium	635-34004595ng6	233,00		
245x130		120	230x115	S	3000K	3680	medium	635-34004596ng6	233,00		
245x130		120	230x115	SM	3000K	3680	flood	635-34004894ng6	233,00		
245x130		120	230x115	W	3000K	3680	flood	635-34004895ng6	233,00		
245x130		120	230x115	S	3000K	3680	flood	635-34004896ng6	233,00		
245x130		120	230x115	SM	4000K	3940	spot	635-34002244ng6	233,00		
245x130		120	230x115	W	4000K	3940	spot	635-34002245ng6	233,00		
245x130		120	230x115	S	4000K	3940	spot	635-34002246ng6	233,00		
245x130		120	230x115	SM	4000K	3940	medium	635-34002544ng6	233,00		
245x130		120	230x115	W	4000K	3940	medium	635-34002545ng6	233,00		
245x130		120	230x115	S	4000K	3940	medium	635-34002546ng6	233,00		
245x130		120	230x115	SM	4000K	3940	flood	635-34002844ng6	233,00		
245x130		120	230x115	W	4000K	3940	flood	635-34002845ng6	233,00		
245x130		120	230x115	S	4000K	3940	flood	635-34002846ng6	233,00		



ONLY XS 19W



INFO

Einbaustrahler, Aluminiumdruckguss, weiß, schwarz oder silber matt pulverbeschichtet, rund, 355° dreh- / 30° schwenkbar, vakuumbedampfter Alurefektor in 3 Ausstrahlwinkeln, Schutzglas, für Deckenstärke, steckerfertig, inkl. Konverter, Versionen auf Anfrage: LED 2700K & 3500K, dimmbare Versionen auf Anfrage

LM	ØxH	ET	DA Ø	FARBE	LED	LUMEN	REF.	ART. NR.	EURO	LAGER
SYS 19W 230V PASSIVE COOLING Binning SDCM 2 3000K: PREMIUM CRI>90 4000K: CRI>90 LED 2700K & 3500K Versionen auf Anfrage	125x93	123	112	SM	3000K	1840	spot	619-11704294ng6	185,00	
	125x93	123	112	W	3000K	1840	spot	619-11704295ng6	185,00	
	125x93	123	112	S	3000K	1840	spot	619-11704296ng6	185,00	
	125x93	123	112	SM	4000K	1970	spot	619-11702244ng6	185,00	
	125x93	123	112	W	4000K	1970	spot	619-11702245ng6	185,00	
	125x93	123	112	S	4000K	1970	spot	619-11702246ng6	185,00	
	125x93	123	112	SM	3000K	1840	medium	619-11704594ng6	185,00	
	125x93	123	112	W	3000K	1840	medium	619-11704595ng6	185,00	
	125x93	123	112	S	3000K	1840	medium	619-11704596ng6	185,00	
	125x93	123	112	SM	4000K	1970	medium	619-11702544ng6	185,00	
	125x93	123	112	W	4000K	1970	medium	619-11702545ng6	185,00	
	125x93	123	112	S	4000K	1970	medium	619-11702546ng6	185,00	
	125x93	123	112	SM	3000K	1840	flood	619-11704894ng6	185,00	
	125x93	123	112	W	3000K	1840	flood	619-11704895ng6	185,00	
	125x93	123	112	S	3000K	1840	flood	619-11704896ng6	185,00	
	125x93	123	112	SM	4000K	1970	flood	619-11702844ng6	185,00	
125x93	123	112	W	4000K	1970	flood	619-11702845ng6	185,00		
125x93	123	112	S	4000K	1970	flood	619-11702846ng6	185,00		

ONLY XS 27W



INFO

Einbaustrahler, Aluminiumdruckguss, weiß, schwarz oder silber matt pulverbeschichtet, rund, 355° dreh- / 30° schwenkbar, vakuumbedampfter Alurefektor in 3 Ausstrahlwinkeln, Schutzglas, für Deckenstärke, steckerfertig, inkl. Konverter, Versionen auf Anfrage: LED 2700K & 3500K, dimmbare Versionen auf Anfrage

LM	ØxH	ET	DA Ø	FARBE	LED	LUMEN	REF.	ART. NR.	EURO	LAGER
SYS 27W 230V PASSIVE COOLING Binning SDCM 2 3000K: PREMIUM CRI>90 4000K: CRI>90 LED 2700K & 3500K Versionen auf Anfrage	125x93	123	112	SM	3000K	2440	spot	619-12504294ng6	214,00	
	125x93	123	112	W	3000K	2440	spot	619-12504295ng6	214,00	
	125x93	123	112	S	3000K	2440	spot	619-12504296ng6	214,00	
	125x93	123	112	SM	4000K	2610	spot	619-12502244ng6	214,00	
	125x93	123	112	W	4000K	2610	spot	619-12502245ng6	214,00	
	125x93	123	112	S	4000K	2610	spot	619-12502246ng6	214,00	
	125x93	123	112	SM	3000K	2440	medium	619-12504594ng6	214,00	
	125x93	123	112	W	3000K	2440	medium	619-12504595ng6	214,00	
	125x93	123	112	S	3000K	2440	medium	619-12504596ng6	214,00	
	125x93	123	112	SM	4000K	2610	medium	619-12502544ng6	214,00	
	125x93	123	112	W	4000K	2610	medium	619-12502545ng6	214,00	
	125x93	123	112	S	4000K	2610	medium	619-12502546ng6	214,00	
	125x93	123	112	SM	3000K	2440	flood	619-12504894ng6	214,00	
	125x93	123	112	W	3000K	2440	flood	619-12504895ng6	214,00	
	125x93	123	112	S	3000K	2440	flood	619-12504896ng6	214,00	
	125x93	123	112	SM	4000K	2610	flood	619-12502844ng6	214,00	
125x93	123	112	W	4000K	2610	flood	619-12502845ng6	214,00		
125x93	123	112	S	4000K	2610	flood	619-12502846ng6	214,00		



ONLY M 34W



LED 230V | 30° / 355° | inkl. | inkl. | IP20 | EEL: A++ - A

INFO

Einbaustrahler, Aluminiumdruckguss, weiß, schwarz oder silber matt pulverbeschichtet, rund, 355° dreh- / 30° schwenkbar, vakuumbadampfter Alurefektor in 3 Ausstrahlwinkeln, Schutzglas, für Deckenstärke von 1-20mm, steckerfertig, inkl. Konverter, Versionen auf Anfrage: LED 2700K & 3500K, dimmbare Versionen auf Anfrage

LM	ØxH	ET	DA Ø	FARBE	LED	LUMEN	REF.	ART. NR.	EURO	LAGER
SYS 34W 230V PASSIVE COOLING Binning SDCM 2 3000K: PREMIUM CRI>90 4000K: CRI>90 LED 2700K & 3500K Versionen auf Anfrage	160x112	142	147	SM	3000K	3430	spot	619-23004294ng6	268,00	
	160x112	142	147	W	3000K	3430	spot	619-23004295ng6	268,00	
	160x112	142	147	S	3000K	3430	spot	619-23004296ng6	268,00	
	160x112	142	147	SM	4000K	3670	spot	619-23002244ng6	268,00	
	160x112	142	147	W	4000K	3670	spot	619-23002245ng6	268,00	
	160x112	142	147	S	4000K	3670	spot	619-23002246ng6	268,00	
	160x112	142	147	SM	3000K	3430	medium	619-23004594ng6	268,00	
	160x112	142	147	W	3000K	3430	medium	619-23004595ng6	268,00	
	160x112	142	147	S	3000K	3430	medium	619-23004596ng6	268,00	
	160x112	142	147	SM	4000K	3670	medium	619-23002544ng6	268,00	
	160x112	142	147	W	4000K	3670	medium	619-23002545ng6	268,00	
	160x112	142	147	S	4000K	3670	medium	619-23002546ng6	268,00	
	160x112	142	147	SM	3000K	3430	flood	619-23004894ng6	268,00	
	160x112	142	147	W	3000K	3430	flood	619-23004895ng6	268,00	
	160x112	142	147	S	3000K	3430	flood	619-23004896ng6	268,00	
	160x112	142	147	SM	4000K	3670	flood	619-23002844ng6	268,00	
	160x112	142	147	W	4000K	3670	flood	619-23002845ng6	268,00	
	160x112	142	147	S	4000K	3670	flood	619-23002846ng6	268,00	

ONLY M QR111



12V NV | 30° / 355° | exkl. | inkl. | IP20 | EEL: A - C

INFO	LM	ØxH	ET	DA Ø	FARBE	ART. NR.	EURO	LAGER
Einbaustrahler, Aluminiumdruckguss, weiß, schwarz oder silber matt pulverbeschichtet, rund, 355° dreh- / 30° schwenkbar, inkl. Adels-Steckverbinder, für Deckenstärke von 1-20mm, exkl. Trafo / Filtergläser separat ordern, Wechsel von Leuchtmittel und Filtergläsern werkzeuglos	QR111	160x116	90	147	SM	544-220004	86,00	☺
	653 · 12V max. 100W	160x116	90	147	W	544-220005	86,00	☺
	oder LED Retrofit 653	160x116	90	147	S	544-220006	86,00	☺

TRAFO FÜR ONLY M QR111

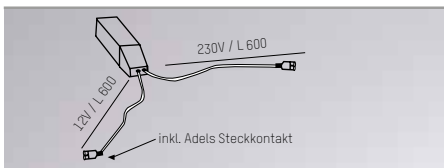

INFO	FÜR	ART. NR.	EURO	LAGER
Konverter, Leistung 105 VA / 12V, inkl. Adels-Steckkontakt	1 x QR111 · max. 100W	522-810	41,00	☺
	1 x LED Retrofit	522-820	52,00	☺



FIRST SINGLE



INFO	LM	LxBxH	ET	DA	FARBE	REF.	ART. NR.	EURO	LAGER
Einbauleuchte Kardanisch, Aluminiumdruckguss, weiß, schwarz oder silber pulverbeschichtet, quadratisch, 35° dreh- / 35° schwenkbar, mit hocheffizientem Reflektor in 3 Ausstrahlwinkeln, Schutzglas, für Deckenstärken 1-25mm, inkl. Konverter	SYS 35W 230V 3983lm CRI>80	196x196x124	154	180x180	S	110°	200-10ao01481115	135,00	
		196x196x124	154	180x180	W	110°	200-10ao01481116	135,00	
	LED 3000K	196x196x124	154	180x180	S	110°	200-10ao01481119	135,00	
		196x196x124	154	180x180	S	124°	200-10ao01481145	135,00	
		196x196x124	154	180x180	W	124°	200-10ao01481146	135,00	
		196x196x124	154	180x180	S	124°	200-10ao01481149	135,00	
		196x196x124	154	180x180	S	130°	200-10ao01481125	135,00	
		196x196x124	154	180x180	W	130°	200-10ao01481126	135,00	
		196x196x124	154	180x180	S	130°	200-10ao01481129	135,00	

LED 230V | 35° | 35° | inkl. | inkl. | IP20 | EEL: A++ - A

FIRST DUO



INFO	LM	LxBxH	ET	DA	FARBE	REF.	ART. NR.	EURO	LAGER
Einbauleuchte Kardanisch, Aluminiumdruckguss, weiß, schwarz oder silber pulverbeschichtet, quadratisch, 35° dreh- / 35° schwenkbar, mit hocheffizientem Reflektor in 3 Ausstrahlwinkeln, Schutzglas, für Deckenstärken 1-25mm, inkl. Konverter	SYS 2 x 35W 230V 2 x 3983lm CRI>80	376x196x124	154	355x180	S	110°	200-10bo21481115	269,00	
		376x196x124	154	355x180	W	110°	200-10bo21481116	269,00	
	LED 3000K	376x196x124	154	355x180	S	110°	200-10bo21481119	269,00	
		376x196x124	154	355x180	S	124°	200-10bo21481145	269,00	
		376x196x124	154	355x180	W	124°	200-10bo21481146	269,00	
		376x196x124	154	355x180	S	124°	200-10bo21481149	269,00	
		376x196x124	154	355x180	S	130°	200-10bo21481125	269,00	
		376x196x124	154	355x180	W	130°	200-10bo21481126	269,00	
		376x196x124	154	355x180	S	130°	200-10bo21481129	269,00	

LED 230V | 35° | 35° | inkl. | inkl. | IP20 | EEL: A++ - A

FIRST TRIO



INFO	LM	LxBxH	ET	DA	FARBE	REF.	ART. NR.	EURO	LAGER
Einbauleuchte Kardanisch, Aluminiumdruckguss, weiß, schwarz oder silber pulverbeschichtet, quadratisch, 35° dreh- / 35° schwenkbar, mit hocheffizientem Reflektor in 3 Ausstrahlwinkeln, Schutzglas, für Deckenstärken 1-25mm, inkl. Konverter	SYS 3 x 35W 230V 3 x 3983lm CRI>80	553x196x126	154	532x180	S	110°	200-10co31481115	403,00	
		553x196x126	154	532x180	W	110°	200-10co31481116	403,00	
	LED 3000K	553x196x126	154	532x180	S	110°	200-10co31481119	403,00	
		553x196x126	154	532x180	S	124°	200-10co31481145	403,00	
		553x196x126	154	532x180	W	124°	200-10co31481146	403,00	
		553x196x126	154	532x180	S	124°	200-10co31481149	403,00	
		553x196x126	154	532x180	S	130°	200-10co31481125	403,00	
		553x196x126	154	532x180	W	130°	200-10co31481126	403,00	
		553x196x126	154	532x180	S	130°	200-10co31481129	403,00	

LED 230V | 35° | 35° | inkl. | inkl. | IP20 | EEL: A++ - A

FIRST CIRCLE



INFO	LM	ØxH	ET	DA Ø	FARBE	REF.	ART. NR.	EURO	LAGER
Einbauleuchte Kardanisch, Aluminiumdruckguss, weiß, schwarz oder silber pulverbeschichtet, rund, 35° dreh- / 35° schwenkbar, mit hocheffizientem Reflektor in 3 Ausstrahlwinkeln, Schutzglas, für Deckenstärken 1-25mm, inkl. Konverter	SYS 35W 230V 3983lm CRI>80	207x125	154	195	S	110°	200-10po01481115	135,00	
		207x125	154	195	W	110°	200-10po01481116	135,00	
	LED 3000K	207x125	154	195	S	110°	200-10po01481119	135,00	
		207x125	154	195	S	124°	200-10po01481145	135,00	
		207x125	154	195	W	124°	200-10po01481146	135,00	
		207x125	154	195	S	124°	200-10po01481149	135,00	
		207x125	154	195	S	130°	200-10po01481125	135,00	
		207x125	154	195	W	130°	200-10po01481126	135,00	
		207x125	154	195	S	130°	200-10po01481129	135,00	

LED 230V | 35° | 35° | inkl. | inkl. | IP20 | EEL: A++ - A

CASA SINGLE

	INFO	LM	LxBxH	ET	DA	FARBE	REF.	ART. NR.	EURO	LAGER		
	Einbauleuchte Kardanisch, Aluminiumdruckguss, weiß, schwarz oder silber pulverbeschichtet, quadratisch, 30° dreh- / 11° schwenkbar, mit hocheffizientem Reflektor in 3 Ausstrahlwinkeln, Schutzglas, für Deckenstärken 1-25mm, inkl. Konverter	SYS 25W 230V 2948lm CRI>80	133x133x71	101	116x116	S	115°	200-110j01481855	112,00			
			133x133x71	101	116x116	W	115°	200-110j01481856	112,00			
			133x133x71	101	116x116	S	115°	200-110j01481859	112,00			
		LED 3000K			133x133x71	101	116x116	S	121°	200-110j01481865	112,00	
					133x133x71	101	116x116	W	121°	200-110j01481866	112,00	
					133x133x71	101	116x116	S	121°	200-110j01481869	112,00	
					133x133x71	101	116x116	S	132°	200-110j01481875	112,00	
					133x133x71	101	116x116	W	132°	200-110j01481876	112,00	
					133x133x71	101	116x116	S	132°	200-110j01481879	112,00	

LED 230V    inkl.  inkl.  EEL: A+++ - A

CASA DUO

	INFO	LM	LxBxH	ET	DA	FARBE	REF.	ART. NR.	EURO	LAGER		
	Einbauleuchte Kardanisch, Aluminiumdruckguss, weiß, schwarz oder silber pulverbeschichtet, quadratisch, 30° dreh- / 11° schwenkbar, mit hocheffizientem Reflektor in 3 Ausstrahlwinkeln, Schutzglas, für Deckenstärken 1-25mm, inkl. Konverter	SYS 2 x 25W 230V 2 x 2948lm CRI>80	252x133x71	101	240x116	S	115°	200-111j21481855	224,00			
			252x133x71	101	240x116	W	115°	200-111j21481856	224,00			
			252x133x71	101	240x116	S	115°	200-111j21481859	224,00			
		LED 3000K			252x133x71	101	240x116	S	121°	200-111j21481865	224,00	
					252x133x71	101	240x116	W	121°	200-111j21481866	224,00	
					252x133x71	101	240x116	S	121°	200-111j21481869	224,00	
					252x133x71	101	240x116	S	132°	200-111j21481875	224,00	
					252x133x71	101	240x116	W	132°	200-111j21481876	224,00	
					252x133x71	101	240x116	S	132°	200-111j21481879	224,00	

LED 230V    inkl.  inkl.  EEL: A+++ - A

CASA TRIO

	INFO	LM	LxBxH	ET	DA	FARBE	REF.	ART. NR.	EURO	LAGER		
	Einbauleuchte Kardanisch, Aluminiumdruckguss, weiß, schwarz oder silber pulverbeschichtet, quadratisch, 30° dreh- / 11° schwenkbar, mit hocheffizientem Reflektor in 3 Ausstrahlwinkeln, Schutzglas, für Deckenstärken 1-25mm, inkl. Konverter	SYS 3 x 25W 230V 3 x 2948lm CRI>80	371x133x71	101	360x116	S	115°	200-112j31481855	336,00			
			371x133x71	101	360x116	W	115°	200-112j31481856	336,00			
			371x133x71	101	360x116	S	115°	200-112j31481859	336,00			
		LED 3000K			371x133x71	101	360x116	S	121°	200-112j31481865	336,00	
					371x133x71	101	360x116	W	121°	200-112j31481866	336,00	
					371x133x71	101	360x116	S	121°	200-112j31481869	336,00	
					371x133x71	101	360x116	S	132°	200-112j31481875	336,00	
					371x133x71	101	360x116	W	132°	200-112j31481876	336,00	
					371x133x71	101	360x116	S	132°	200-112j31481879	336,00	

LED 230V    inkl.  inkl.  EEL: A+++ - A

CASA CIRCLE

	INFO	LM	ØxH	ET	DA Ø	FARBE	REF.	ART. NR.	EURO	LAGER		
	Einbauleuchte Kardanisch, Aluminiumdruckguss, weiß, schwarz oder silber pulverbeschichtet, rund, 30° dreh- / 11° schwenkbar, mit hocheffizientem Reflektor in 3 Ausstrahlwinkeln, Schutzglas, für Deckenstärken 1-25mm, inkl. Konverter	SYS 25W 230V 2948lm CRI>80	138x72	102	116	S	115°	200-108j01481855	112,00			
			138x72	102	116	W	115°	200-108j01481856	112,00			
			138x72	102	116	S	115°	200-108j01481859	112,00			
		LED 3000K			138x72	102	116	S	121°	200-108j01481865	112,00	
					138x72	102	116	W	121°	200-108j01481866	112,00	
					138x72	102	116	S	121°	200-108j01481869	112,00	
					138x72	102	116	S	132°	200-108j01481875	112,00	
					138x72	102	116	W	132°	200-108j01481876	112,00	
					138x72	102	116	S	132°	200-108j01481879	112,00	

LED 230V    inkl.  inkl.  EEL: A+++ - A

LEAN



INFO	LM	ØxH	ET	DA Ø	FARBE	REF.	ART. NR.	EURO	LAGER
Einbaustrahler, Aluminiumdruckguss, weiß, silber oder schwarz pulverbeschichtet, rund, 355° dreh- / 90° schwenkbar, mit hocheffizientem Reflektor in 4 Ausstrahlwinkeln, klarem Schutzglas, für Deckenstärken max. 25mm, inkl. Konverter	SYS 35W 230V 3983lm CRI>80	194x151	181	180	S	110°	200-19ko01481115	135,00	
		194x151	181	180	W	110°	200-19ko01481116	135,00	
	LED 3000K	194x151	181	180	S	110°	200-19ko01481119	135,00	
		194x151	181	180	S	124°	200-19ko01481145	135,00	
		194x151	181	180	W	124°	200-19ko01481146	135,00	
		194x151	181	180	S	124°	200-19ko01481149	135,00	
		194x151	181	180	S	130°	200-19ko01481125	135,00	
		194x151	181	180	W	130°	200-19ko01481126	135,00	
		194x151	181	180	S	130°	200-19ko01481129	135,00	
		194x151	181	180	S	150°	200-19ko01481135	135,00	
		194x151	181	180	W	150°	200-19ko01481136	135,00	
		194x151	181	180	S	150°	200-19ko01481139	135,00	

LED 230V | 90° | 355° | inkl. | inkl. | IP20 | EEI: A++ - A

MINI LEAN



INFO	LM	ØxH	ET	DA Ø	FARBE	REF.	ART. NR.	EURO	LAGER
Einbaustrahler, Aluminiumdruckguss, weiß, silber oder schwarz pulverbeschichtet, rund, 355° dreh- / 90° schwenkbar, mit hocheffizientem Reflektor in 3 Ausstrahlwinkeln, klarem Schutzglas, für Deckenstärken max. 25mm, inkl. Konverter	SYS 27W 230V 3218lm CRI>80	164x91	121	153	S	115°	200-19mk01481115	125,00	
		164x91	121	153	W	115°	200-19mk01481116	125,00	
	LED 3000K	164x91	121	153	S	115°	200-19mk01481119	125,00	
		164x91	121	153	S	120°	200-19mk01481145	125,00	
		164x91	121	153	W	120°	200-19mk01481146	125,00	
		164x91	121	153	S	120°	200-19mk01481149	125,00	
		164x91	121	153	S	130°	200-19mk01481125	125,00	
		164x91	121	153	W	130°	200-19mk01481126	125,00	
		164x91	121	153	S	130°	200-19mk01481129	125,00	

LED 230V | 90° | 355° | inkl. | inkl. | IP20 | EEI: A++ - A

SAVO 10



INFO	LM	ØxH	ET	DA Ø	FARBE	LED	LUMEN	REF.	ART. NR.	EURO	LAGER
Einbaustrahler aus Aluminiumdruckguss Oberfläche pulverbeschichtet in weiß matt Facettierter Aluminiumreflektor in 3 Ausstrahlwinkeln Strahlerelement 355° drehbar und 60° schwenkbar Energieeffiziente COB LED mit Farbwiedergabe CRI >90	SYS 19W 230V PASSIVE COOLING Binning SDCM 2	140x114	144	132	W	3000K	1840	spot	633-12004195ng6	171,00	
		140x114	144	132	W	3000K	1840	medium	633-12004295ng6	171,00	
		140x114	144	132	W	3000K	1840	flood	633-12004395ng6	171,00	
	3000K: PREMIUM CRI>90 4000K: CRI>90	140x114	144	132	W	4000K	1970	spot	633-12002145ng6	171,00	
		140x114	144	132	W	4000K	1970	medium	633-12002245ng6	171,00	
	LED 2700K & 3500K Versionen auf Anfrage	140x114	144	132	W	4000K	1970	flood	633-12002345ng6	171,00	
	SYS 28W 230V PASSIVE COOLING Binning SDCM 2	140x114	144	132	W	3000K	2470	spot	633-12804195ng6	202,00	
		140x114	144	132	W	3000K	2470	medium	633-12804295ng6	202,00	
		140x114	144	132	W	3000K	2470	flood	633-12804395ng6	202,00	
	3000K: PREMIUM CRI>90 4000K: CRI>90	140x114	144	132	W	4000K	2640	spot	633-12802145ng6	202,00	
		140x114	144	132	W	4000K	2640	medium	633-12802245ng6	202,00	
	LED 2700K & 3500K Versionen auf Anfrage	140x114	144	132	W	4000K	2640	flood	633-12802345ng6	202,00	

LED 230V | 60° | 355° | inkl. | inkl. | IP20 | EEI: A++ - A

Einbaustrahler aus Aluminiumdruckguss Oberfläche pulverbeschichtet in weiß matt Facettierter Aluminiumreflektor in 3 Ausstrahlwinkeln Strahlerelement 355° drehbar und 60° schwenkbar Energieeffiziente COB LED mit Farbwiedergabe CRI >90



SUNRAY I LED



LM	ØxH	ET	DA Ø	FARBE	REF.	ART. NR.	EURO	LAGER
LED 9W 250 mA 930lm CRI>80 LED 3000K	95x71	90	84	W	130°	797-0001180303005	68,00	☺

INFO

Einbaustrahler, Aluminiumdruckguss, weiß pulverbeschichtet Feinstruktur, passiv gekühlt, rund, starr, Ausstrahlwinkel 30°, Schutzglas, exkl. Konverter.

LED 250mA | | | | | | EEI: A++ - A

SUNRAY II LED

TOP SELLER



LM	ØxH	ET	DA Ø	FARBE	REF.	ART. NR.	EURO	LAGER
LED 18W 500mA 1805lm CRI>80 LED 3000K	125x100	120	115	W	137°	797-0011880373005	109,00	☺

INFO

Einbaustrahler, Aluminiumdruckguss, weiß pulverbeschichtet Feinstruktur, passiv gekühlt, rund, starr, Ausstrahlwinkel 37°, Schutzglas, exkl. Konverter.

LED 500mA | | | | | | EEI: A++ - A

SUNRAY III LED



LM	ØxH	ET	DA Ø	FARBE	REF.	ART. NR.	EURO	LAGER
LED 27W 700mA 2510lm CRI>80 LED 3000K	150x115	135	138	W	145°	797-0022780453005	129,00	☺

INFO

Einbaustrahler, Aluminiumdruckguss, weiß pulverbeschichtet Feinstruktur, passiv gekühlt, rund, starr, Ausstrahlwinkel 45°, Schutzglas, exkl. Konverter.

LED 700mA | | | | | | EEI: A++ - A

LED KONVERTER



INFO	W	mA	V DC	FÜR	LxBxH	FARBE	ART. NR.	EURO	LAGER
nicht dimmbar, 230V AC	19 20	250 500	57 40	1 SUNRAY I 1 SUNRAY II	111x52x22	W	24-122201	23,00	☺
dimmbar, 1 - 10V/Push	10	250	43	1 SUNRAY I	111x52x22	W	24-123399	42,00	☺
dimmbar, 1 - 10V/Push	20	500	43	1 SUNRAY II	111x52x22	W	24-123400	44,00	☺
dimmbar, DALI dimm.	15 20	350 500	43 40	1 SUNRAY I 1 SUNRAY II	111x52x22	W	24-123403	49,00	☺
nicht dimmbar, 230V AC	50	700	71	1 SUNRAY III	124x79x22	W	24-122204	45,00	☺
dimmbar, Dali, 1 - 10V/Push	50	700	71	1 SUNRAY III	124x79x22	W	24-122413	76,00	☺

| | |

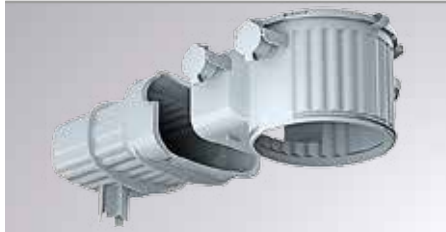

HALOX-100 GEHÄUSE MIT TRAFOTUNNEL

INFO	Ø	FARBE	ART. NR.	EURO	LAGER
 <p>Einbauhöhe inkl. Frontteil 120 mm, 4 Schlagkupplungen M20/25, Kombinationseinführung mit Rohreinführungsbegrenzung zur Vermeidung innerer Rohrkürzung, max. Einbauhöhe NV 105 mm, HV 110 mm, Lampenleistung max. 50 W, für Decken ab 16 cm Stärke, Tunnel für 1 elektronischen Sicherheitstransformator bis 150 VA SELV schlanke Bauform oder abgerundete Bauform (z. B. PC-Mausform), mit Trennwand zwischen Primär- und Sekundärbereich</p>	130	6	113-128130	32,00	☺

HALOX-100 GEHÄUSE

INFO	Ø	FARBE	ART. NR.	EURO	LAGER
 <p>Einbauhöhe inkl. Frontteil 120 mm, 2 Schlagkupplungen M20/25, Kombinationseinführung mit Rohreinführungsbegrenzung zur Vermeidung innerer Rohrkürzung, max. Einbauhöhe NV 105 mm, HV 110 mm, Lampenleistung max. 50W, für Decken ab 16 cm Stärke</p>	130	6	113-128100	13,00	☺

HALOX-100 UNIVERSALFRONTTEIL

INFO	Ø	FARBE	ART. NR.	EURO	LAGER
 <p>variabler Deckenauslass mit Mineralfaserplatte, Deckenauslass bis Ø max. 100 mm stufenlos möglich, zeitsparend ohne weitere Nacharbeiten evtl. Oberfläche glätten, Einsatz von elektronischen Sicherheitstransformatoren erst ab Ø 68 mm möglich</p>	max. 100	6	113-128111	28,20	☺

HALOX-100 UNIVERSALFRONTTEIL

INFO	Ø	FARBE	ART. NR.	EURO	LAGER
 <p>variabler Deckenauslass für Ø von 40, 45, 50, 55, 60, 68, 75, 80, 85, 90, 95, 100 mm, Einsatz von elektronischen Sicherheitstransformatoren erst ab Ø 68 mm möglich</p>	max. 100	6	113-128110	17,10	☺

HALOX-100 FRONTTEILE

INFO	LxB	FARBE	ART. NR.	EURO	LAGER
 <p>HALOX Frontteil für Quadratischen Deckenauslass 68 x 68 mm, - Leuchtenblende min. 75 x 75 mm</p>	68x68 (Leuchtenblende min. 75x75)	6	113-128108	9,10	☺
	75x75 (Leuchtenblende min. 82x82)	6	113-128109	9,10	☺

HALOX-100 FRONTTEILE

INFO	Ø	FARBE	ART. NR.	EURO	LAGER
 <p>HALOX Frontteil für runden Deckenauslass 68 mm, - Leuchtenblende min. 75 mm</p>	68 (Leuchtenblende min. 75)	6	113-128101	9,10	☺
	75 (Leuchtenblende min. 82)	6	113-128102	9,10	☺
	80 (Leuchtenblende min. 87)	6	113-128103	9,10	☺
	85 (Leuchtenblende min. 92)	6	113-128104	9,10	
	95 (Leuchtenblende min. 102)	6	113-128106	9,10	
	100 (Leuchtenblende min. 107)	6	113-128107	9,10	

BETON-EINBAUGEHÄUSE HALOX-100 FÜR ORTBETON

INFO

Für Halogenleuchten (Hochvolt und Niedervolt) und Lautsprecher in Ortbeton ab einer Deckenstärke von 160 mm steht Ihnen mit HaloX-D ein umfangreiches Gehäusesystem zur Verfügung. Runde und quadratische Frontteile, Frontteile mit Mineralfaserplatten, Trafo-Tunnel und Zubehör ermöglichen vielfältige Einbaumöglichkeiten.



Gehäuse um 360° drehbar

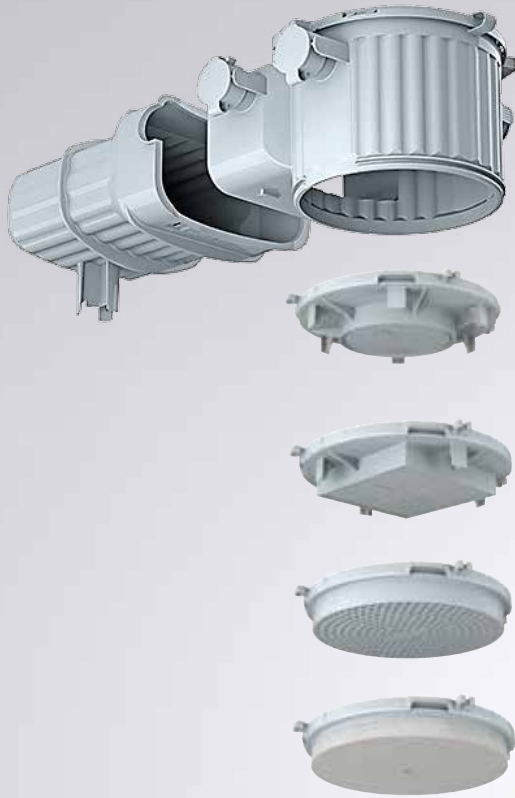

FRONTTEIL DECKENAUSLASS

- Ø 68 mm
- Ø 75 mm
- Ø 80 mm
- Ø 85 mm
- Ø 95 mm
- Ø 100 mm
- ⊠ 68 x 68 mm
- ⊠ 75 x 75 mm

MIN. Ø LEUCHTENBLENDE

- 75 mm
- 82 mm
- 87 mm
- 92 mm
- 102 mm
- 107 mm
- 75 x 75 mm
- 82 x 82 mm

UNIVERSAL-FRONTTEIL

mit variablem Öffnungsmaß (DA) Ø 40 - 100 mm

UNIVERSAL-FRONTTEIL MIT MINERalfaserplatte

mit variablem Öffnungsmaß (DA) bis Ø 100 mm

ABMESSUNGEN & INFO

INFO

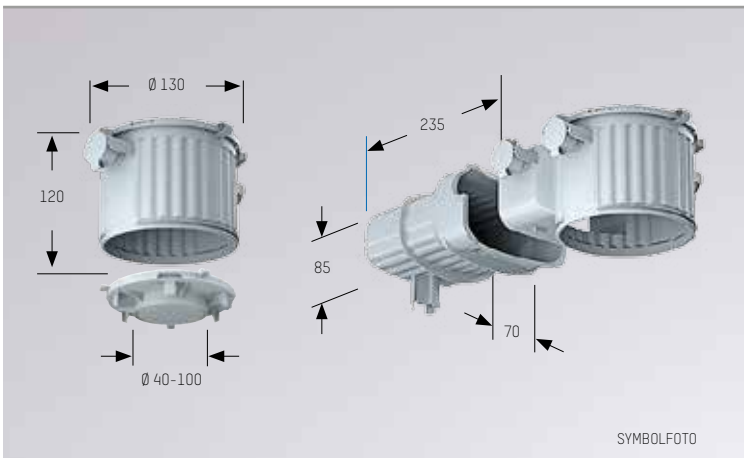

SYMBOLFOTO

- Starre und kardanbefestigte Leuchten
- Lampenleistung max. 50 W
- Nur geprüfte (DIN VDE 0711 / EN 60598) sowie mit oder gekennzeichnete Leuchten verwenden.
- Einsatz von elektronischen Trafos (abgerundete Form) erst ab Öffnungsmaß Ø 68 mm möglich!

INSTALLATIONSTECHNIK FÜR LEUCHTEN

Leuchtauswahl
Halogen Niedervolt (12V)

Temperatur-Profil

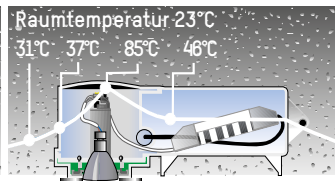
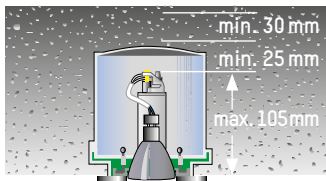

Einbautiefe max. 105 mm

50W QR-CBC 51
(Cool-Beam mit Schutzscheibe).
Wichtig: Keine Kaltlichtreflektorlampen sondern Cool Beam Lampen verwenden!

Leuchtauswahl
Halogen Hochvolt (230 V)

Temperatur-Profil

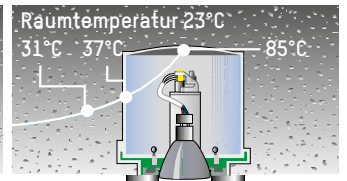
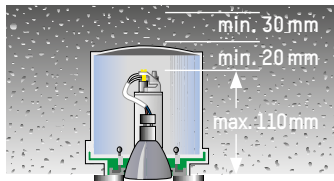

Einbautiefe max. 110 mm

50W-Lampe mit Sockel GU10



MOON SQUARE LED

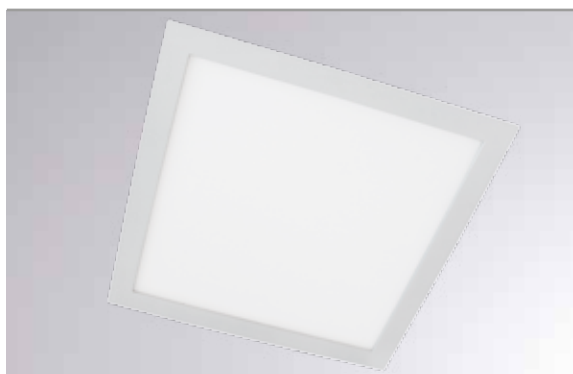

LED 230-700mA

INFO

Einbauleuchte, Aluminium, weiß matt lackiert, passiv gekühlt, quadratisch, sehr homogene Ausleuchtung, opater Diffusor, 120° Ausstrahlwinkel, extrem flach, exkl. Konverter, Achtung: ca. 30mm Platz für Konverter einplanen

LM	LxBxH	ET	DA LxB	FARBE	LED	LUMEN	REF.	ART. NR.	EURO	LAGER
LED 6W 250mA CRI>80	110x110x16	46	95x95	WM	3000K	620	1120°	392-0030680003005	23,00	☺
	110x110x16	46	95x95	WM	4000K	670	1120°	392-0030680004005	23,00	☺
LED 12W 450mA CRI>80	180x180x16	46	170x170	WM	3000K	1215	1120°	392-0041280003005	35,00	☺
	180x180x16	46	170x170	WM	4000K	1335	1120°	392-0041280004005	35,00	☺
LED 18W 700mA CRI>80	300x300x16	46	290x290	WM	3000K	2300	1120°	392-0051880003005	59,00	☺
	300x300x16	46	290x290	WM	4000K	2375	1120°	392-0051880004005	59,00	☺

MOON AUFBAUGEHÄUSE QUADRATISCH



Symbolfoto

INFO	FÜR	LxBxH	ÖFFNUNG LxB	FARBE	ART. NR.	EURO	LAGER
Aufbaugehäuse, Stahlblech, weiß matt lackiert, quadratisch, passend zu Moon Leuchte quadratisch, exkl. Leuchte und Konverter	MOON QUADRAT. 110	113,5x113,5x46	59x59	WM	643-q110agw	26,50	☺
	MOON QUADRAT. 180	184x184x46	130x130	WM	643-q180agw	36,50	☺
	MOON QUADRAT. 300	305x305x46	251x251	WM	643-q300agw	48,50	☺

LED KONVERTER



Symbolfoto

INFO	W	mA	V DC	FÜR	LxBxH	FARBE	ART. NR.	EURO	LAGER
nicht dimmbar, 230V AC	13 20 20	250 450 700	57 44 28	1 - 2 MOON 110 1 MOON 180 1 MOON 300	111x52x22	W	24-122201	23,00	☺
nicht dimmbar, 230V AC	6	250	24	1 MOON 110 (ft. Aufbaugehäuse)	42x40x22	S	24-122812	16,00	☺
dimmbar, 1 - 10V/ Push	20	700	36	1 MOON 300	111x52x22	W	24-123400	44,00	☺
dimmbar, DALI dimm.	10 19 20	250 450 700	43 43 28	1 MOON 110 1 MOON 180 1 MOON 300	111x52x22	W	24-123403	49,00	☺





















MOON ROUND LED



LED 230V-700mA
 exkl. inkl. 

INFO







Einbauleuchte, Aluminium, weiß matt lackiert, passiv gekühlt, rund, sehr homogene Ausleuchtung, opaler Diffusor, 120° Ausstrahlwinkel, extrem flach, exkl. Konverter, Achtung: ca. 30mm Platz für Konverter einplanen

LM	ØxH	ET	DA Ø	FARBE	LED	LUMEN	REF.	ART. NR.	EURO	LAGER
LED 6W 250mA CRI>80	110x16	46	95		3000K	650		392-0000680003005	23,00	
	110x16	46	95		4000K	740		392-0000680004005	23,00	
LED 12W 450mA CRI>80	180x16	46	165		3000K	1420		392-0011280003005	35,00	
	180x16	46	165		4000K	1550		392-0011280004005	35,00	
LED 18W 700mA CRI>80	300x16	46	285		3000K	2055		392-0021880003005	59,00	
	300x16	46	285		4000K	2085		392-0021880004005	59,00	

MOON AUFBAUGEHÄUSE RUND



Symbolfoto









INFO	FÜR	ØxH	ÖFFNUNG Ø	FARBE	ART. NR.	EURO	LAGER
Aufbaugehäuse, Stahlblech, weiß matt lackiert, rund, passend zu Moon Leuchte rund, exkl. Leuchte und Konverter	MOON ROUND 110	112x46	61		643-j110agw	26,50	
	MOON ROUND 180	182x46	126		643-j180agw	36,50	
	MOON ROUND 300	303,5x46	240		643-j300agw	48,50	



LED KONVERTER



Symbolfoto

INFO	W	mA	V DC	FÜR	LxBxH	FARBE	ART. NR.	EURO	LAGER
nicht dimmbar, 230V AC	13 20 20	250 450 700	57 44 28	1 - 2 MOON 110 1 MOON 180 1 MOON 300	111x52x22		24-122201	23,00	
nicht dimmbar, 230V AC	6	250	24	1 MOON 110 (ft. Aufbaugehäuse)	42x40x22		24-122812	16,00	
dimmbar, 1 - 10V/Push	20	700	36	1 MOON 300	111x52x22		24-123400	44,00	
dimmbar, DALI dimm.	10 19 20	250 450 700	43 43 28	1 MOON 110 1 MOON 180 1 MOON 300	111x52x22		24-123403	49,00	

 IP20

GET FLAT XS SQUARE 20W



LED 350mA 500mA 700mA
 inkl. Stecker
 inkl. Buchse
 IP44 | EEL: A++ - A

INFO

Aluminiumdruckguss, weiß matt Feinstruktur pulverbeschichtet, satiniertes PMMA Diffusor oder Microprisma, passiv Kühlung, inkl. Stecker und Buchse mit Rastfunktion, IK06, geeignet für Deckenstärke 1-20mm
Zu betreiben mit 350, 500, oder 700mA. (Konverter separat ordern)

LxBxH	ET	DA LxB	FARBE	LED	DIFFUSER	BEI 350mA	BEI 500mA	BEI 700mA	REF.	ART. NR.	EURO	LAGER
169x169x66	100	150x150	W	3000K	PMMA	10,3W	14,7W	19,7W	90°	468-210011955	124,00	☺
						LUMEN	LUMEN	LUMEN				
169x169x66	100	150x150	W	4000K	PMMA	1104	1501	1965	90°	468-210011455	124,00	☺
169x169x66	100	150x150	W	3000K	MICROPRISM.	945	1284	1681	90°	468-210021955	147,00	
169x169x66	100	150x150	W	4000K	MICROPRISM.	981	1334	1809	90°	468-210021455	147,00	
						KONVERTER SEPARAT ORDERN						
						NICHT DIMMBAR	24-127530	24-127532	24-127534			
						DIMMBAR 1-10V, PUSH, DALI	24-122413	24-122413	24-122413			



GET FLAT M SQUARE 31W



LED 700mA 900mA 1050mA
 inkl. Stecker
 inkl. Buchse
 IP44 | EEL: A++ - A

INFO

Aluminiumdruckguss, weiß matt Feinstruktur pulverbeschichtet, satiniertes PMMA Diffusor oder Microprisma, passiv Kühlung, inkl. Stecker und Buchse mit Rastfunktion, IK06, geeignet für Deckenstärke 1-20mm
Zu betreiben mit 700, 900, oder 1050mA. (Konverter separat ordern)

LxBxH	ET	DA LxB	FARBE	LED	DIFFUSER	BEI 700mA	BEI 900mA	BEI 1050mA	REF.	ART. NR.	EURO	LAGER
230x230x76	100	205x205	W	3000K	PMMA	21,4W	27W	30,5W	90°	468-220011955	150,00	☺
						LUMEN	LUMEN	LUMEN				
230x230x76	100	205x205	W	4000K	PMMA	2388	2944	3426	90°	468-220011455	150,00	☺
230x230x76	100	205x205	W	3000K	MICROPRISM.	2079	2563	2982	90°	468-220021955	177,00	
230x230x76	100	205x205	W	4000K	MICROPRISM.	2273	2806	3214	90°	468-220021455	177,00	
						KONVERTER SEPARAT ORDERN						
						NICHT DIMMBAR	24-127534	24-127536	24-127538			
						DIMMBAR 1-10V, PUSH, DALI	24-122413	24-122413	24-122413			



GET REFL XS SQUARE 20W



LED 350mA 500mA 700mA
 inkl. Stecker
 inkl. Buchse
 IP40 | EEL: A++ - A

INFO

Aluminiumdruckguss, weiß matt Feinstruktur pulverbeschichtet, satiniertes PMMA Diffusor oder Microprisma, passiv Kühlung, inkl. Stecker und Buchse mit Rastfunktion, IK00, geeignet für Deckenstärke 1-20mm
Zu betreiben mit 350, 500, oder 700mA. (Konverter separat ordern)

LxBxH	ET	DA LxB	FARBE	LED	DIFFUSER	BEI 350mA	BEI 500mA	BEI 700mA	REF.	ART. NR.	EURO	LAGER
169x169x66	100	150x150	W	3000K	PMMA	10,3W	14,7W	19,7W	100°	468-210111955	124,00	☺
						LUMEN	LUMEN	LUMEN				
169x169x66	100	150x150	W	4000K	PMMA	1299	1766	2312	100°	468-210111455	124,00	☺
169x169x66	100	150x150	W	3000K	MICROPRISM.	1229	1671	2188	100°	468-210121955	147,00	
169x169x66	100	150x150	W	4000K	MICROPRISM.	1277	1737	2323	100°	468-210121455	147,00	
						KONVERTER SEPARAT ORDERN						
						NICHT DIMMBAR	24-127530	24-127532	24-127534			
						DIMMBAR 1-10V, PUSH, DALI	24-122413	24-122413	24-122413			



GET REFL M SQUARE 31W



LED 700mA 900mA 1050mA
 inkl. Stecker
 inkl. Buchse
 IP40 | EEL: A++ - A

INFO

Aluminiumdruckguss, weiß matt Feinstruktur pulverbeschichtet, satiniertes PMMA Diffusor oder Microprisma, passiv Kühlung, inkl. Stecker und Buchse mit Rastfunktion, IK00, geeignet für Deckenstärke 1-20mm
Zu betreiben mit 700, 900, oder 1050mA. (Konverter separat ordern)

LxBxH	ET	DA LxB	FARBE	LED	DIFFUSER	BEI 700mA	BEI 900mA	BEI 1050mA	REF.	ART. NR.	EURO	LAGER
230x230x76	100	205x205	W	3000K	PMMA	21,4W	27W	30,5W	100°	468-220111955	150,00	☺
						LUMEN	LUMEN	LUMEN				
230x230x76	100	205x205	W	4000K	PMMA	2858	3523	4100	100°	468-220111455	150,00	☺
230x230x76	100	205x205	W	3000K	MICROPRISM.	3125	3859	4372	100°	468-220121955	177,00	
230x230x76	100	205x205	W	4000K	MICROPRISM.	2654	3272	3807	100°	468-220121455	177,00	
						KONVERTER SEPARAT ORDERN						
						NICHT DIMMBAR	24-127534	24-127536	24-127538			
						DIMMBAR 1-10V, PUSH, DALI	24-122413	24-122413	24-122413			





MOLTO LUCE®

LED KONVERTER FÜR GET



Symbolfoto

INFO	SCHALTBAR / DIMMBAR	für mA	LxBxH	FARBE	ART. NR.	EURO	LAGER
LED-Konverter 230 V AC, für Downlightserie GET	schaltbar	350	130x42x30	W	24-127530	13,00	☺
	schaltbar	500	130x42x30	W	24-127532	13,00	☺
	schaltbar	700	130x42x30	W	24-127534	13,00	☺
	schaltbar	900	130x42x30	W	24-127536	16,00	☺
	schaltbar	1050	130x42x30	W	24-127538	17,00	☺
	Dimmbar 1 - 10V, PUSH, DALI	350 - 1050	124x79x22	W	24-122413	76,00	☺

GET AUFBAUGEHÄUSE QUADRATISCH



INFO	FÜR	LxBxH	ÖFFNUNG LxB	FARBE	ART. NR.	EURO	LAGER
Stahlblech, weiß matt Feinstruktur pulverbeschichtet, quadratisch, passend zu GET XS oder GET M Leuchte quadratisch, exkl. Leuchte und Konverter, ACHTUNG: nicht für GET XS 700mA bzw. GET M 1050mA geeignet	GET XS bis max. 500mA	175x175x120	115x115	W	468-2125	63,00	☺
	GET M bis max. 900mA	235x235x130	165x165	W	468-2225	69,00	☺

GET AUSGLEICHSRAHMEN



INFO	FÜR	LxBxH	ÖFFNUNG LxB	EMPF. MAX. DA	FARBE	ART. NR.	EURO	LAGER
Stahlblech, weiß matt Feinstruktur pulverbeschichtet für zu große Deckenausschnitte, ideal bei Sanierungsprojekten, passend zu GET XS oder GET M Leuchte quadratisch	GET XS	240x240x2	150x150	180x180	W	468-2115	20,00	☺
	GET M	300x300x2	205x205	230x230	W	468-2215	23,00	☺

GET FLAT XS ROUND 20W



LED 350mA 500mA 700mA
 inkl. inkl. IP44 | EEL: A++ - A

INFO

Aluminiumdruckguss, weiß matt Feinstruktur pulverbeschichtet, satiniertes PMMA Diffusor oder Microprisma, passiv Kühlung, inkl. Stecker und Buchse mit Rastfunktion, IK06, geeignet für Deckenstärke 1-20mm
Zu betreiben mit 350, 500, oder 700mA. (Konverter separat ordern)

ØxH	ET	DA Ø	FARBE	LED	DIFFUSER	BEI 350mA	BEI 500mA	BEI 700mA	REF.	ART. NR.	EURO	LAGER
169x66	100	150	W	3000K	PMMA	10,3W	14,7W	19,7W	90°	468-110011955	124,00	☺
						LUMEN	LUMEN	LUMEN				
169x66	100	150	W	4000K	PMMA	1321	1796	2351	90°	468-110011455	124,00	☺
						LUMEN	LUMEN	LUMEN				
169x66	100	150	W	3000K	MICROPRISM.	1182	1616	2084	90°	468-110021955	147,00	
						LUMEN	LUMEN	LUMEN				
169x66	100	150	W	4000K	MICROPRISM.	1217	1654	2180	90°	468-110021455	147,00	
						LUMEN	LUMEN	LUMEN				
KONVERTER SEPARAT ORDERN												
NICHT DIMMBAR						24-127530	24-127532	24-127534				
DIMMBAR 1-10V, PUSH, DALI						24-122413	24-122413	24-122413				



GET FLAT M ROUND 31W



LED 700mA 900mA 1050mA
 inkl. inkl. IP44 | EEL: A++ - A

INFO

Aluminiumdruckguss, weiß matt Feinstruktur pulverbeschichtet, satiniertes PMMA Diffusor oder Microprisma, passiv Kühlung, inkl. Stecker und Buchse mit Rastfunktion, IK06, geeignet für Deckenstärke 1-20mm
Zu betreiben mit 700, 900, oder 1050mA. (Konverter separat ordern)

ØxH	ET	DA Ø	FARBE	LED	DIFFUSER	BEI 700mA	BEI 900mA	BEI 1050mA	REF.	ART. NR.	EURO	LAGER
230x76	100	205	W	3000K	PMMA	21,4W	27W	30,5W	90°	468-120011955	150,00	☺
						LUMEN	LUMEN	LUMEN				
230x76	100	205	W	4000K	PMMA	2756	3398	3954	90°	468-120011455	150,00	☺
						LUMEN	LUMEN	LUMEN				
230x76	100	205	W	3000K	MICROPRISM.	2482	3065	3510	90°	468-120021955	177,00	
						LUMEN	LUMEN	LUMEN				
230x76	100	205	W	4000K	MICROPRISM.	2675	3303	3860	90°	468-120021455	177,00	
						LUMEN	LUMEN	LUMEN				
KONVERTER SEPARAT ORDERN												
NICHT DIMMBAR						24-127534	24-127536	24-127538				
DIMMBAR 1-10V, PUSH, DALI						24-122413	24-122413	24-122413				



GET REFL XS ROUND 20W



LED 350mA 500mA 700mA
 inkl. inkl. IP40 | EEL: A++ - A

INFO

Aluminiumdruckguss, weiß matt Feinstruktur pulverbeschichtet, satiniertes PMMA Diffusor oder Microprisma, passiv Kühlung, inkl. Stecker und Buchse mit Rastfunktion, IK00, geeignet für Deckenstärke 1-20mm
Zu betreiben mit 350, 500, oder 700mA. (Konverter separat ordern)

ØxH	ET	DA Ø	FARBE	LED	DIFFUSER	BEI 350mA	BEI 500mA	BEI 700mA	REF.	ART. NR.	EURO	LAGER
169x66	100	150	W	3000K	PMMA	10,3W	14,7W	19,7W	100°	468-110111955	124,00	☺
						LUMEN	LUMEN	LUMEN				
169x66	100	150	W	4000K	PMMA	1293	1758	2301	100°	468-110111455	124,00	☺
						LUMEN	LUMEN	LUMEN				
169x66	100	150	W	3000K	MICROPRISM.	1150	1563	2046	100°	468-110121955	147,00	
						LUMEN	LUMEN	LUMEN				
169x66	100	150	W	4000K	MICROPRISM.	1194	1624	2123	100°	468-110121455	147,00	
						LUMEN	LUMEN	LUMEN				
KONVERTER SEPARAT ORDERN												
NICHT DIMMBAR						24-127530	24-127532	24-127534				
DIMMBAR 1-10V, PUSH, DALI						24-122413	24-122413	24-122413				



GET REFL M ROUND 31W



LED 700mA 900mA 1050mA
 inkl. inkl. IP40 | EEL: A++ - A

INFO

Aluminiumdruckguss, weiß matt Feinstruktur pulverbeschichtet, satiniertes PMMA Diffusor oder Microprisma, passiv Kühlung, inkl. Stecker und Buchse mit Rastfunktion, IK00, geeignet für Deckenstärke 1-20mm
Zu betreiben mit 700, 900, oder 1050mA. (Konverter separat ordern)

ØxH	ET	DA Ø	FARBE	LED	DIFFUSER	BEI 700mA	BEI 900mA	BEI 1050mA	REF.	ART. NR.	EURO	LAGER
230x76	100	205	W	3000K	PMMA	21,4W	27W	30,5W	100°	468-120111955	150,00	☺
						LUMEN	LUMEN	LUMEN				
230x76	100	205	W	4000K	PMMA	2741	3380	3393	100°	468-120111455	150,00	☺
						LUMEN	LUMEN	LUMEN				
230x76	100	205	W	3000K	MICROPRISM.	2502	3084	3589	100°	468-120121955	177,00	
						LUMEN	LUMEN	LUMEN				
230x76	100	205	W	4000K	MICROPRISM.	2735	3378	3868	100°	468-120121455	177,00	
						LUMEN	LUMEN	LUMEN				
KONVERTER SEPARAT ORDERN												
NICHT DIMMBAR						24-127534	24-127536	24-127538				
DIMMBAR 1-10V, PUSH, DALI						24-122413	24-122413	24-122413				



MOLTO LUCE®

Studentenwohnheim, Linz, Österreich

LED KONVERTER FÜR GET



Symbolfoto



INFO	SCHALTBAR / DIMMBAR	für mA	LxBxH	FARBE	ART. NR.	EURO	LAGER
LED-Konverter 230 V AC, für Downtightserie GET	schaltbar	350	130x42x30	W	24-127530	13,00	☺
	schaltbar	500	130x42x30	W	24-127532	13,00	☺
	schaltbar	700	130x42x30	W	24-127534	13,00	☺
	schaltbar	900	130x42x30	W	24-127536	16,00	☺
	schaltbar	1050	130x42x30	W	24-127538	17,00	☺
	Dimmbar 1 - 10V, PUSH, DALI	350 - 1050	124x79x22	W	24-122413	76,00	☺

GET AUFBAUGEHÄUSE RUND



INFO	FÜR	ØxH	ÖFFNUNG Ø	FARBE	ART. NR.	EURO	LAGER
Stahlblech, weiß matt Feinstruktur pulverbeschichtet, quadratisch, passend zu GET XS oder GET M Leuchte rund, exkl. Leuchte und Konverter	GET XS bis max. 500mA	175x120	115	W	468-1125	63,00	☺
	GET M bis max. 900mA	235x130	165	W	468-1225	69,00	☺
ACHTUNG: nicht für GET XS 700mA bzw. GET M 1050mA geeignet							

GET AUSGLEICHSRAHMEN



INFO	FÜR	ØxH	ÖFFNUNG Ø	EMPF. MAX. DA	FARBE	ART. NR.	EURO	LAGER
Stahlblech, weiß matt Feinstruktur pulverbeschichtet für zu große Deckenausschnitte, ideal bei Sanierungsprojekten, passend zu GET XS oder GET M Leuchte rund	GET XS	240x2	150	180	W	468-1115	20,00	☺
	GET M	300x2	205	230	W	468-1215	23,00	☺

SPEAKER 1 + SPEAKER 2



LED 230V | inkl. | inkl. | IP20 | EEL: A+++ - A

INFO

Einbaustrahler, Aluminiumblech tiefgezogen, weiß lackiert, rund, einstellbare Stahlbügel, Diffusor Polycarbonat, inkl. Konverter

LM	ØxH	ET	DA Ø	FARBE	LED	LUMEN	REF.	ART. NR.	EURO	LAGER
SYS 14W 230V CRI>80	188x98	128	186x154	W	3000K	1200	medium	121-2208441000	55,00	☺
	188x98	128	186x154	W	4000K	1300	medium	121-2208441100	55,00	☺
SYS 24W 230V CRI>80	240x98	128	238x202	W	3000K	2013	medium	121-2208441500	73,00	☺
	240x98	128	238x202	W	4000K	2119	medium	121-2208441600	73,00	☺

HONY LED



LED 230V | inkl. | inkl. | IP20 | EEL: A+++ - A

INFO	LM	ØxH	ET	DA Ø	FARBE	REF.	LED	LUMEN	ART. NR.	EURO	LAGER
Einbaudownlight, Aluminium Druckguss, weiß pulverbeschichtet, rund, hocheffizientem Reflektor 100° Ausstrahlwinkel, Opaldiffusor, für Deckenstärken max. 25mm, inkl. Konverter	SYS 17W 230V CRI>80	216x68	98	192	W	1100°	4000K	2475	200-10su01681016	132,00	
		216x68	98	192	W	1100°	3000K	2400	200-10su01481016	132,00	
	SYS 29W 230V CRI>80	216x68	98	192	W	1100°	4000K	3850	200-10st01681016	132,00	
		216x68	98	192	W	1100°	3000K	3725	200-10st01481016	132,00	☺
DALI dimm.	SYS 28W 230V CRI>80	216x68	98	192	W	1100°	4000K	3575	200-10skd16c1016	180,00	
		216x68	98	192	W	1100°	3000K	3525	200-10skd14c1016	180,00	

HONY LED



LED 230V | inkl. | inkl. | IP20 | EEL: A+++ - A

INFO	LM	ØxH	ET	DA Ø	FARBE	REF.	LUMEN	ART. NR.	EURO	LAGER	
Einbaudownlight, Aluminium Druckguss, weiß pulverbeschichtet, rund, hocheffizientem Reflektor 100° Ausstrahlwinkel, Opaldiffusor, für Deckenstärken max. 25mm, inkl. Konverter	SYS 14W 230V CRI>80	216x68	98	200	W	1100°	3000K	1778	200-10sd01481016	131,00	
		216x68	98	200	W	1100°	4000K	1823	200-10sd01681016	131,00	
	SYS 35W 230V CRI>80	216x68	98	200	W	1100°	3000K	4005	200-10so01481016	131,00	
		216x68	98	200	W	1100°	4000K	4118	200-10so01681016	131,00	
	SYS 43W 230V CRI>80	216x68	98	200	W	1100°	3000K	4500	200-10srd14c1016	179,00	
		216x68	98	200	W	1100°	4000K	4635	200-10srd16c1016	179,00	



UNIVERSAL BETONEINBAU-GEHÄUSE

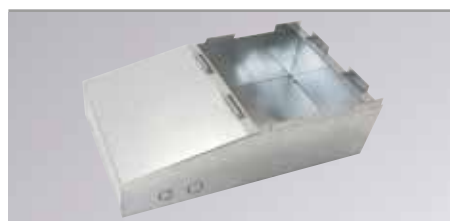

INFO	LxB	H	ART. NR.	EURO	LAGER
Ohne Abdeckung aus verzinktem Blech, nicht für Sichtbeton geeignet, je eine Schlauch-einführung DM20mm und 25mm links und rechts, Abdeckung separat ordern	450x303	136	332-2001	43,00	☺



ABDECKUNG QUADRATISCH



INFO	PASSEND FÜR	LxB	H	DA	ART. NR.	EURO	LAGER
Abdeckung inkl. Zentrierteil zu Betoneinbaugeschäuse 332-2001, aus verzinktem Blech, nicht für Sichtbeton geeignet, passend für GET R M und GET F M, GET R XS und GET F XS & NOW 2 Square Single	GET R M, GET F M	300x250	16	205x205	332-3q205	22,00	☺
	GET R XS, GET F XS	295x295	20	155x155	332-3q155	22,00	☺
	NOW 2 SQUARE SINGLE	300x250	16	115x115	332-3q115	22,00	☺

ABDECKUNG RUND

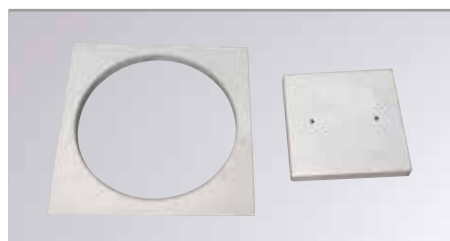

INFO	PASSEND FÜR	LxBxH	DA Ø	ART. NR.	EURO	LAGER
Abdeckung inkl. Zentrierteil zu Betoneinbaugeschäuse 332-2001, aus verzinktem Blech, nicht für Sichtbeton geeignet, passend für Hony, GET F M, Only M, Only XS, GET R M, GET R XS, GET F XS, Sunray II, Sunray III, RELY, SAVO 20 Single, NOW 2 Round Single & SAVO 30	HONY, GET R M, GET F M	300x250x16	208	332-3r205	22,00	☺
	ONLY M, GET R XS, GET F XS, RELY	300x250x16	150	332-3r150	22,00	☺
	SUNRAY III	300x250x16	140	332-3r140	22,00	☺
	ONLY XS, SUNRAY II, NOW 2 ROUND, SAVO 20	300x250x16	115	332-3r115	22,00	☺
	SAVO 30	300x250x16	170	332-3r170	22,00	☺

BADO R LED OPALDIFFUSER

	LM	Ø	ET	DA Ø	AUSFÜHRUNG	FARBE	LUMEN 3000K	LUMEN 4000K	ART. NR.	EURO	LAGER
	SYS 16W · 230V · CRI>80	320	100	305	OPALDIFFUSER	W	1638	1761	445-06321X15	336,00	
	SYS 16W · 230V · CRI>80	320	100	305	OPALDIFFUSER	S	1638	1761	445-06321X16	336,00	
	SYS 16W · 230V · CRI>80	320	100	305	OPALDIFFUSER	SM	1638	1761	445-06321X18	336,00	
	SYS 29W · 230V · CRI>80	420	100	405	OPALDIFFUSER	W	3263	3509	445-06421X15	392,00	☺
	SYS 29W · 230V · CRI>80	420	100	405	OPALDIFFUSER	S	3263	3509	445-06421X16	392,00	
	SYS 29W · 230V · CRI>80	420	100	405	OPALDIFFUSER	SM	3263	3509	445-06421X18	392,00	☺
	SYS 37W · 230V · CRI>80	520	100	505	OPALDIFFUSER	W	4388	4718	445-06521X15	506,00	☺
	SYS 37W · 230V · CRI>80	520	100	505	OPALDIFFUSER	S	4388	4718	445-06521X16	506,00	
	SYS 37W · 230V · CRI>80	520	100	505	OPALDIFFUSER	SM	4388	4718	445-06521X18	506,00	
	SYS 44W · 230V · CRI>80	670	100	655	OPALDIFFUSER	W	5366	5770	445-06671X15	682,00	
	SYS 44W · 230V · CRI>80	670	100	655	OPALDIFFUSER	S	5366	5770	445-06671X16	682,00	
	SYS 44W · 230V · CRI>80	670	100	655	OPALDIFFUSER	SM	5366	5770	445-06671X18	682,00	
	SYS 79W · 230V · CRI>80	980	100	965	OPALDIFFUSER	W	7458	8020	445-06981X15	1.387,00	
	SYS 79W · 230V · CRI>80	980	100	965	OPALDIFFUSER	S	7458	8020	445-06981X16	1.387,00	
	SYS 79W · 230V · CRI>80	980	100	965	OPALDIFFUSER	SM	7458	8020	445-06981X18	1.387,00	

LED 230V      IP20 | EEI: A++ - A

INFO

Einbauleuchte, Aluminium, pulverbeschichtet, rund, Opaldiffuser, für Deckenstärke 1-40mm, inkl. Konverter, Dimmbare S CRI>90 Versionen auf Anfrage, LED 3000K oder 4000K

BESTELINFO:

Ersetzen sie das rote X mit Ihrer gewünschten Lichtfarbe
9 = 3000K / 4 = 4000K

☺ = Lagerware nur in 3000K

BADO R LED MICROPRISMA

	LM	Ø	ET	DA Ø	AUSFÜHRUNG	FARBE	LUMEN 3000K	LUMEN 4000K	ART. NR.	EURO	LAGER
	SYS 16W · 230V · CRI>80	320	100	305	MIKROPRISMA	W	1563	1681	445-06321X25	378,00	
	SYS 16W · 230V · CRI>80	320	100	305	MIKROPRISMA	S	1563	1681	445-06321X26	378,00	
	SYS 16W · 230V · CRI>80	320	100	305	MIKROPRISMA	SM	1563	1681	445-06321X28	378,00	
	SYS 29W · 230V · CRI>80	420	100	405	MIKROPRISMA	W	3113	3347	445-06421X25	450,00	☺
	SYS 29W · 230V · CRI>80	420	100	405	MIKROPRISMA	S	3113	3347	445-06421X26	450,00	
	SYS 29W · 230V · CRI>80	420	100	405	MIKROPRISMA	SM	3113	3347	445-06421X28	450,00	
	SYS 37W · 230V · CRI>80	520	100	505	MIKROPRISMA	W	4185	4500	445-06521X25	589,00	
	SYS 37W · 230V · CRI>80	520	100	505	MIKROPRISMA	S	4185	4500	445-06521X26	589,00	
	SYS 37W · 230V · CRI>80	520	100	505	MIKROPRISMA	SM	4185	4500	445-06521X28	589,00	
	SYS 44W · 230V · CRI>80	670	100	655	MIKROPRISMA	W	5106	5490	445-06671X25	775,00	
	SYS 44W · 230V · CRI>80	670	100	655	MIKROPRISMA	S	5106	5490	445-06671X26	775,00	
	SYS 44W · 230V · CRI>80	670	100	655	MIKROPRISMA	SM	5106	5490	445-06671X28	775,00	
	SYS 79W · 230V · CRI>80	980	100	965	MIKROPRISMA	W	6750	7258	445-06981X25	1.490,00	
	SYS 79W · 230V · CRI>80	980	100	965	MIKROPRISMA	S	6750	7258	445-06981X26	1.490,00	
	SYS 79W · 230V · CRI>80	980	100	965	MIKROPRISMA	SM	6750	7258	445-06981X28	1.490,00	

LED 230V      IP20 | EEI: A++ - A

INFO

Einbauleuchte, Aluminium, pulverbeschichtet, rund, Mikroprismatischer Diffuser, für Deckenstärke 1-40mm, inkl. Konverter, Dimmbare S CRI>90 Versionen auf Anfrage, LED 3000K oder 4000K

BESTELINFO:

Ersetzen sie das rote X mit Ihrer gewünschten Lichtfarbe
9 = 3000K / 4 = 4000K



CADAN R LED OPALDIFFUSER

LM	LxB	ET	DA LxB	AUSFÜHRUNG	FARBE	LUMEN	LUMEN	ART. NR.	EURO	LAGER
						3000K	4000K			
	SYS 13W · 230V · CRI>80	379x379	100	360x360	OPALDIFFUSER	W	1377	1481	445-11371X15	319,00
	SYS 13W · 230V · CRI>80	379x379	100	360x360	OPALDIFFUSER	S	1267	1330	445-11371X16	319,00
	SYS 13W · 230V · CRI>80	379x379	100	360x360	OPALDIFFUSER	SM	1300	1400	445-11371X18	319,00
	SYS 21W · 230V · CRI>80	479x479	100	460x460	OPALDIFFUSER	W	2485	2672	445-11471X15	376,00
	SYS 21W · 230V · CRI>80	479x479	100	460x460	OPALDIFFUSER	S	2232	2400	445-11471X16	376,00
	SYS 21W · 230V · CRI>80	479x479	100	460x460	OPALDIFFUSER	SM	2362	2540	445-11471X18	376,00
	SYS 45W · 230V · CRI>80	621x621	100	604x604	OPALDIFFUSER	W	5512	5927	445-11621X15	543,00
	SYS 45W · 230V · CRI>80	621x621	100	604x604	OPALDIFFUSER	S	4957	5330	445-11621X16	543,00
	SYS 45W · 230V · CRI>80	621x621	100	604x604	OPALDIFFUSER	SM	5236	5630	445-11621X18	543,00
	SYS 116W · 230V · CRI>80	910x910	100	892x892	OPALDIFFUSER	W	10304	11080	445-11911X15	1.137,00
	SYS 116W · 230V · CRI>80	910x910	100	892x892	OPALDIFFUSER	S	9272	9970	445-11911X16	1.137,00
	SYS 116W · 230V · CRI>80	910x910	100	892x892	OPALDIFFUSER	SM	9784	10520	445-11911X18	1.137,00

LED 230V      IP20 | EE: A++ - A

INFO

Einbauleuchte, Aluminium, pulverbeschichtet, quadratisch, Opal-diffuser, für Deckenstärke 1-40mm, inkl. Konverter, Dimmbare S CRI>90 Versionen auf Anfrage, LED 3000K oder 4000K

BESTELLINFO:

Ersetzen sie das rote X mit Ihrer gewünschten Lichtfarbe
9 = 3000K / 4 = 4000K

CADAN R LED MICROPRISMA

LM	LxB	ET	DA LxB	AUSFÜHRUNG	FARBE	LUMEN	LUMEN	ART. NR.	EURO	LAGER
						3000K	4000K			
	SYS 13W · 230V · CRI>80	379x379	100	360x360	MIKROPRISMA	W	1158	1245	445-11371X25	339,00
	SYS 13W · 230V · CRI>80	379x379	100	360x360	MIKROPRISMA	S	1039	1117	445-11371X26	339,00
	SYS 13W · 230V · CRI>80	379x379	100	360x360	MIKROPRISMA	SM	1094	1176	445-11371X28	339,00
	SYS 21W · 230V · CRI>80	479x479	100	460x460	MIKROPRISMA	W	2088	2245	445-11471X25	386,00
	SYS 21W · 230V · CRI>80	479x479	100	460x460	MIKROPRISMA	S	1875	2016	445-11471X26	386,00
	SYS 21W · 230V · CRI>80	479x479	100	460x460	MIKROPRISMA	SM	1986	2136	445-11471X28	386,00
	SYS 45W · 230V · CRI>80	621x621	100	604x604	MIKROPRISMA	W	4631	4980	445-11621X25	564,00
	SYS 45W · 230V · CRI>80	621x621	100	604x604	MIKROPRISMA	S	4164	4477	445-11621X26	564,00
	SYS 45W · 230V · CRI>80	621x621	100	604x604	MIKROPRISMA	SM	4398	4729	445-11621X28	564,00
	SYS 116W · 230V · CRI>80	910x910	100	892x892	MIKROPRISMA	W	9330	10030	445-11911X25	1.241,00
	SYS 116W · 230V · CRI>80	910x910	100	892x892	MIKROPRISMA	S	8400	9030	445-11911X26	1.241,00
	SYS 116W · 230V · CRI>80	910x910	100	892x892	MIKROPRISMA	SM	8870	9530	445-11911X28	1.241,00

LED 230V      IP20 | EE: A++ - A

INFO

Einbauleuchte, Aluminium, pulverbeschichtet, quadratisch, Mikro-prismatischer Diffuser, für Deckenstärke 1-40mm, inkl. Konverter, Dimmbare S CRI>90 Versionen auf Anfrage, LED 3000K oder 4000K

BESTELLINFO:

Ersetzen sie das rote X mit Ihrer gewünschten Lichtfarbe
9 = 3000K / 4 = 4000K



MOLTO LUCE®

Porsche, München, Deutschland

PIANA-LED



LED 700mA 1050mA | exkl. | inkl. | IP40 | EEI: A++ - A

INFO

LED-Paneleinlegeleuchte, Alurahmen weiß lackiert, Modul 625, IP40, mit transluzenter PMMA Opal- oder nanoprismatischer Abdeckung, Zubehör und LED Konverter separat ordern
Zu betreiben mit 700mA oder 1050mA. (Konverter separat ordern)

UGR<19 = Nanoprismatische Ausführung

LxBxH	ET	FARBE	LED	DIFFUSER	BEI 700mA	BEI 1050mA	ART. NR.	EURO	LAGER
622x622x15	55	W	2900K	OPALDIFFUSER	34W CRI>80 LUMEN 4100	52W CRI>80 LUMEN 5800	757-625pm30wok	200,00	☺
622x622x15	55	W	3800K	OPALDIFFUSER	4100	5800	757-625pm40wok	200,00	☺
622x622x15	55	W	2900K	NANOPRISMATISCH	4000	5800	757-625np30wok	152,00	☺
622x622x15	55	W	4000K	NANOPRISMATISCH	3800	5800	757-625np40wok	152,00	☺
KONVERTER SEPARAT ORDERN									
NICHT DIMMBAR					757-k700s	757-k1050s			
EURO					42,00	42,00	☺		
DIMMBAR 1-10V, PUSH, DALI					757-k700d	757-k700d			
EURO					110,00	110,00	☺		
KONVERTERINFO: Seite 318									

AUFBAURAHMEN



INFO

Aufbaurahmen für LED Panelleuchte 757-625xx, weiß lackiert, Panel wird in den Aufbaurahmen eingelegt.



LxBxH	FARBE	ART. NR.	EURO	LAGER
628x628x45	W	757-625abr	60,00	☺

EINBAURAHMEN



INFO

Einbaurahmen für gesägte Deckenöffnungen. z.B. Trockenbaudecke etc. Für LED Panelleuchte 757-625xx sowie EB-Leuchte Serie IBP, LED Panel wird in den Einbaurahmen eingelegt.



LxB	DA: LxB	ET	FARBE	ART. NR.	EURO	LAGER
660x660	645x645	88	W	757-625ebr	48,00	☺

SEILABHÄNGESET



INFO

Seilabhänge-set 2m für LED Panelleuchte 757-625xx, weiß lackiert, bestehend aus: 4 Montagebügel, 4 Seile 2m, 8 Seilstopper (4x Decke + 4x Leuchte).

L	ART. NR.	EURO	LAGER
2000	757-as2000	20,00	☺

EINSPEISESET



INFO

Einspeiseset für LED Panelleuchte 757-625xx bestehend aus: Baldachin weiß inkl. Zugentlastung transp., Baldachin: 80x80x30 mm

Einspeiseset für LED Panelleuchte 757-625xx bestehend aus: Baldachin weiß inkl. Zugentlastung transp., Baldachin: 80x80x30 mm

L	FARBE	ART. NR.	EURO	LAGER
2200 / 3 x 0,75 mm²	W	757-bk3w	16,00	☺
2200 / 5 x 0,75 mm²	W	757-bk5w	20,00	☺



MOLTO LUCE®

Bosch, Linz, Österreich

IBP



INFO	LM	LxBxH	ET	DIFFUSER	LED	LUMEN	FARBE	ART. NR.	EURO	LAGER	
LED-Paneleinlegeleuchte, Stahlblech, PMMA- oder nanoprismatische Abdeckung , inkl. LED Konverter, Zubehör separat ordern	SYS 32W 230V CRI>80	622x622x90	200	PMMA	3000K	4100	W	757-I6006	104,00		
		622x622x90	200	PMMA	4000K	4100	W	757-I6007	104,00		
		622x622x90	200	NANOPRISMA	3000K	4200	W	757-I6008	104,00		
		622x622x90	200	NANOPRISMA	4000K	4200	W	757-I6009	104,00		
	SYS 32W 230V CRI>80 DALI dimm.		622x622x90	200	PMMA	3000K	4100	W	757-I6006dali	164,00	
			622x622x90	200	PMMA	4000K	4100	W	757-I6007dali	164,00	
			622x622x90	200	NANOPRISMA	3000K	4200	W	757-I6008dali	164,00	
			622x622x90	200	NANOPRISMA	4000K	4200	W	757-I6009dali	164,00	

LED 230V inkl. inkl. IP54 | EE: A++ - A

I T5 ALDP



LM	LxBxH	ET	DA LxB	FARBE	ART. NR.	EURO	LAGER
4 x T16 · 65 · 230 V · 14 W · EVG	622x622x60	110	602x602	W	757-6000	96,00	☺
4 x T16 · 65 · 230 V · 24 W · EVG	622x622x60	110	602x602	W	757-6001	104,00	☺
4 x T16 · 65 · 230 V · 14 W · EVG · DALI Dimm	622x622x60	110	602x602	W	757-6000dali	156,00	☺
4 x T16 · 65 · 230 V · 24 W · EVG · DALI Dimm	622x622x60	110	602x602	W	757-6001dali	164,00	☺

Einbauleuchte, Stahlblech, mit **hochglänzendem** BAP-Raster, inkl. EVG, Montagebügel separat ordern [UGR<19](#)

230V HV

I T5 ALDP



LM	LxBxH	ET	DA LxB	FARBE	ART. NR.	EURO	LAGER
2 x T16 · 65 · 230 V · 28 W · EVG	1246x310x60	110	1226x290	W	757-6003	96,00	☺
2 x T16 · 65 · 230 V · 54 W · EVG	1246x310x60	110	1226x290	W	757-6005	92,00	
2 x T16 · 65 · 230 V · 28 W · EVG · DALI Dimm	1246x310x60	110	1226x290	W	757-6003dali	156,00	
2 x T16 · 65 · 230 V · 54 W · EVG · DALI Dimm	1246x310x60	110	1226x290	W	757-6005dali	152,00	

Einbauleuchte, Stahlblech, mit **hochglänzendem** BAP-Raster, inkl. EVG, Montagebügel separat ordern [UGR<19](#)

230V HV

I T5 MATDP

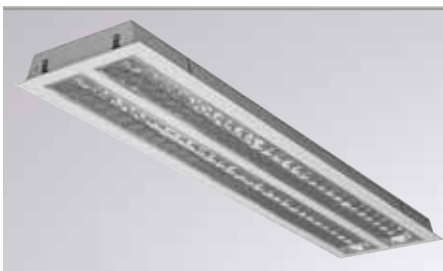

LM	LxBxH	ET	DA LxB	FARBE	ART. NR.	EURO	LAGER
2 x T16 · 65 · 230 V · 28 W · EVG	1246x310x60	110	1226x290	W	757-6015	96,00	
2 x T16 · 65 · 230 V · 54 W · EVG	1246x310x60	110	1226x290	W	757-6017	92,00	
2 x T16 · 65 · 230 V · 28 W · EVG · DALI Dimm	1246x310x60	110	1226x290	W	757-6015dali	156,00	
2 x T16 · 65 · 230 V · 54 W · EVG · DALI Dimm	1246x310x60	110	1226x290	W	757-6017dali	152,00	

Einbauleuchte, Stahlblech, mit **mattem** BAP-Raster, inkl. EVG, Montagebügel separat ordern [UGR<19](#)

230V HV

MONTAGEBÜGEL FÜR I T5



INFO	ART. NR.	EURO	LAGER
Set für Serie I T5, für Deckenstärke max. 16mm	757-ef8000	4,00	☺

I SS AC



LM	LxBxH	ET	DA LxB	LED	LUMEN	FARBE	ART. NR.	EURO	LAGER
SYS 39W 230V CRI>80	622x622x52	110	602x602	3000K	3800	W	757-l6000	152,00	☺
	622x622x52	110	602x602	4000K	3800	W	757-l6001	152,00	☺
SYS 39W 230V CRI>80 DALI dimm.	622x622x52	110	602x602	3000K	3800	W	757-l6000dali	212,00	☺
	622x622x52	110	602x602	4000K	3800	W	757-l6001dali	212,00	☺
SYS 39W 230V CRI>80	1246x310x52	110	1226x290	3000K	3800	W	757-l6002	164,00	
	1246x310x52	110	1226x290	4000K	3800	W	757-l6003	164,00	☺
	1246x310x52	110	1226x290	3000K	3800	W	757-l6002dali	224,00	
	1246x310x52	110	1226x290	3000K	3800	W	757-l6003dali	224,00	☺

LED-Einbauleuchte, Stahlblech, **Hochglanzreflektor**, inkl. LED Konverter und Montagebügel [UGR<19](#)

LED 230V



RIDE LED

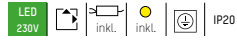

INFO

Einbauleuchte aus stranggepresstem Aluminiumprofil, Oberfläche eloxiert, weiß oder schwarz pulverbeschichtet, opale PMMA Abdeckung kubisch oder flach, erhältlich in 6 Längen, energieeffiziente LEDs mit hoher Farbwiedergabe, **microprismatische Abdeckung flach auf Anfrage**

Opaldiffuser kubisch: H 35mm
Opaldiffuser flach: H 1mm

EEL: A++ - A

BESTELINFO:

Ersetzen Sie das rote X der Artikelnummer mit Ihrer gewünschten Abdeckung

PMMA Opaldiffuser flach = 1
PMMA Opaldiffuser kubisch = 2

Bestellbeispiel:

577-011011023050- Opaldiffuser kubisch

Auf Anfrage 3500K

LM	LxB	DA LxB	ET	FARBE	LED	kubisch	flach	ART. NR.	EURO kubisch	EURO flach	LAGER
SYS 11W · 230V · CRI>90	581x44	578x37	75	W	2700K	840lm	750lm	577-01101X023050	311,00	279,00	
SYS 11W · 230V · CRI>90	581x44	578x37	75	S	2700K	840lm	750lm	577-01101X023060	311,00	279,00	
SYS 11W · 230V · CRI>90	581x44	578x37	75	AE	2700K	840lm	750lm	577-01101X023080	311,00	279,00	
SYS 11W · 230V · CRI>90	581x44	578x37	75	W	3000K	920lm	820lm	577-01101X029050	311,00	279,00	
SYS 11W · 230V · CRI>90	581x44	578x37	75	S	3000K	920lm	820lm	577-01101X029060	311,00	279,00	
SYS 11W · 230V · CRI>90	581x44	578x37	75	AE	3000K	920lm	820lm	577-01101X029080	311,00	279,00	
SYS 11W · 230V · CRI>90	581x44	578x37	75	W	4000K	1000lm	890lm	577-01101X024050	311,00	279,00	
SYS 11W · 230V · CRI>90	581x44	578x37	75	S	4000K	1000lm	890lm	577-01101X024060	311,00	279,00	
SYS 11W · 230V · CRI>90	581x44	578x37	75	AE	4000K	1000lm	890lm	577-01101X024080	311,00	279,00	
SYS 16W · 230V · CRI>90	861x44	858x37	75	W	2700K	1260lm	1120lm	577-01102X023050	367,00	331,00	
SYS 16W · 230V · CRI>90	861x44	858x37	75	S	2700K	1260lm	1120lm	577-01102X023060	367,00	331,00	
SYS 16W · 230V · CRI>90	861x44	858x37	75	AE	2700K	1260lm	1120lm	577-01102X023080	367,00	331,00	
SYS 16W · 230V · CRI>90	861x44	858x37	75	W	3000K	1410lm	1230lm	577-01102X029050	367,00	331,00	
SYS 16W · 230V · CRI>90	861x44	858x37	75	S	3000K	1410lm	1230lm	577-01102X029060	367,00	331,00	
SYS 16W · 230V · CRI>90	861x44	858x37	75	AE	3000K	1410lm	1230lm	577-01102X029080	367,00	331,00	
SYS 16W · 230V · CRI>90	861x44	858x37	75	W	4000K	1500lm	1340lm	577-01102X024050	367,00	331,00	
SYS 16W · 230V · CRI>90	861x44	858x37	75	S	4000K	1500lm	1340lm	577-01102X024060	367,00	331,00	
SYS 16W · 230V · CRI>90	861x44	858x37	75	AE	4000K	1500lm	1340lm	577-01102X024080	367,00	331,00	
SYS 21W · 230V · CRI>90	1141x44	1138x37	75	W	2700K	1680lm	1500lm	577-01103X023050	430,00	383,00	
SYS 21W · 230V · CRI>90	1141x44	1138x37	75	S	2700K	1680lm	1500lm	577-01103X023060	430,00	383,00	
SYS 21W · 230V · CRI>90	1141x44	1138x37	75	AE	2700K	1680lm	1500lm	577-01103X023080	430,00	383,00	
SYS 21W · 230V · CRI>90	1141x44	1138x37	75	W	3000K	1840lm	1640lm	577-01103X029050	430,00	383,00	
SYS 21W · 230V · CRI>90	1141x44	1138x37	75	S	3000K	1840lm	1640lm	577-01103X029060	430,00	383,00	
SYS 21W · 230V · CRI>90	1141x44	1138x37	75	AE	3000K	1840lm	1640lm	577-01103X029080	430,00	383,00	
SYS 21W · 230V · CRI>90	1141x44	1138x37	75	W	4000K	2010lm	1780lm	577-01103X024050	430,00	383,00	
SYS 21W · 230V · CRI>90	1141x44	1138x37	75	S	4000K	2010lm	1780lm	577-01103X024060	430,00	383,00	
SYS 21W · 230V · CRI>90	1141x44	1138x37	75	AE	4000K	2010lm	1780lm	577-01103X024080	430,00	383,00	
SYS 26W · 230V · CRI>90	1421x44	1418x37	75	W	2700K	2110lm	1870lm	577-01104X023050	485,00	435,00	
SYS 26W · 230V · CRI>90	1421x44	1418x37	75	S	2700K	2110lm	1870lm	577-01104X023060	485,00	435,00	
SYS 26W · 230V · CRI>90	1421x44	1418x37	75	AE	2700K	2110lm	1870lm	577-01104X023080	485,00	435,00	
SYS 26W · 230V · CRI>90	1421x44	1418x37	75	W	3000K	2310lm	2050lm	577-01104X029050	485,00	435,00	
SYS 26W · 230V · CRI>90	1421x44	1418x37	75	S	3000K	2310lm	2050lm	577-01104X029060	485,00	435,00	
SYS 26W · 230V · CRI>90	1421x44	1418x37	75	AE	3000K	2310lm	2050lm	577-01104X029080	485,00	435,00	
SYS 26W · 230V · CRI>90	1421x44	1418x37	75	W	4000K	2510lm	2230lm	577-01104X024050	485,00	435,00	
SYS 26W · 230V · CRI>90	1421x44	1418x37	75	S	4000K	2510lm	2230lm	577-01104X024060	485,00	435,00	
SYS 26W · 230V · CRI>90	1421x44	1418x37	75	AE	4000K	2510lm	2230lm	577-01104X024080	485,00	435,00	



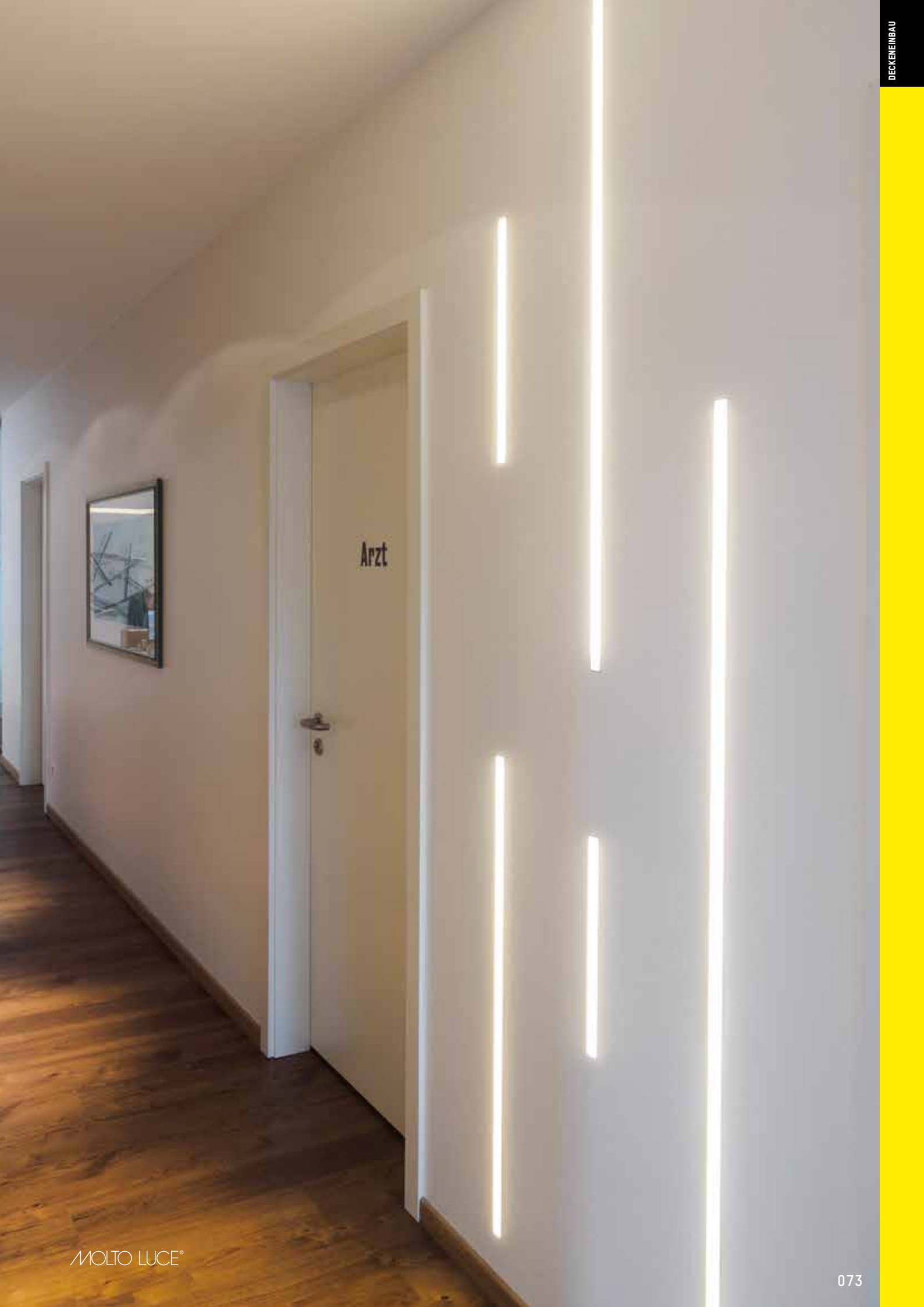

LOG IN II LED



INFO

Einbauleuchte, Aluminium-Strangpress-Profil (mit umlaufendem Rand), eloxiert, weiß oder schwarz pulverbeschichtet, Abdeckung mit Mikroprismenoptik oder PMMA Opaldiffusor, Energieeffiziente LEDs mit hoher Farbwiedergabe, inkl. Konverter, geeignet für den Einbau in Zwischendecken von 7-20mm, Dimmbare Versionen auf Anfrage

EEL A++ - A
CRI>80

BESTELLINFO:

Esetzen Sie das rote X der Artikelnummer mit Ihrem gewünschten Lichteinsatz

0 = HIGH EFFECENCY VERSION
1 = HIGH OUTPUT VERSION

Ergänzen Sie die Artikelnummer mit Ihrer gewünschten Abdeckung

Mikroprismenabdeckung = mp

PMMA Opaldiffusor = pm

Bestellbeispiel:
628-340095mp = Mikroprismenabdeckung

LM	LUMEN MP	LUMEN PM	Lx8xH	ET	DA	FARBE	LED	ART. NR.	EURO MP	EURO PM	LAGER
HE / HO	HE / HO	HE / HO									
SYS 16W / 30W · 230V	1390 / 2580	1490 / 2760	869x92x86	130	859x80	W	3000K	628-316X95..	353,00	314,00	
SYS 16W / 30W · 230V	1390 / 2580	1490 / 2760	869x92x86	130	859x80	S	3000K	628-316X96..	353,00	314,00	
SYS 16W / 30W · 230V	1390 / 2580	1490 / 2760	869x92x86	130	859x80	AE	3000K	628-316X98..	353,00	314,00	
SYS 16W / 30W · 230V	1460 / 2700	1560 / 2900	869x92x86	130	859x80	W	4000K	628-316X45..	353,00	314,00	
SYS 16W / 30W · 230V	1460 / 2700	1560 / 2900	869x92x86	130	859x80	S	4000K	628-316X46..	353,00	314,00	
SYS 16W / 30W · 230V	1460 / 2700	1560 / 2900	869x92x86	130	859x80	AE	4000K	628-316X48..	353,00	314,00	
SYS 20W / 41W · 230V	1860 / 3440	1990 / 3690	1150x92x86	130	1140x80	W	3000K	628-320X95..	402,00	360,00	
SYS 20W / 41W · 230V	1860 / 3440	1990 / 3690	1150x92x86	130	1140x80	S	3000K	628-320X96..	402,00	360,00	
SYS 20W / 41W · 230V	1860 / 3440	1990 / 3690	1150x92x86	130	1140x80	AE	3000K	628-320X98..	402,00	360,00	
SYS 20W / 41W · 230V	1950 / 3610	2090 / 3860	1150x92x86	130	1140x80	W	4000K	628-320X45..	402,00	360,00	
SYS 20W / 41W · 230V	1950 / 3610	2090 / 3860	1150x92x86	130	1140x80	S	4000K	628-320X46..	402,00	360,00	
SYS 20W / 41W · 230V	1950 / 3610	2090 / 3860	1150x92x86	130	1140x80	AE	4000K	628-320X48..	402,00	360,00	
SYS 25W / 51W · 230V	2320 / 4300	2490 / 4610	1431x92x86	130	1421x80	W	3000K	628-325X95..	444,00	402,00	
SYS 25W / 51W · 230V	2320 / 4300	2490 / 4610	1431x92x86	130	1421x80	S	3000K	628-325X96..	444,00	402,00	
SYS 25W / 51W · 230V	2320 / 4300	2490 / 4610	1431x92x86	130	1421x80	AE	3000K	628-325X98..	444,00	402,00	
SYS 25W / 51W · 230V	2440 / 4510	2610 / 4830	1431x92x86	130	1421x80	W	4000K	628-325X45..	444,00	402,00	
SYS 25W / 51W · 230V	2440 / 4510	2610 / 4830	1431x92x86	130	1421x80	S	4000K	628-325X46..	444,00	402,00	
SYS 25W / 51W · 230V	2440 / 4510	2610 / 4830	1431x92x86	130	1421x80	AE	4000K	628-325X48..	444,00	402,00	
SYS 40W / 82W · 230V	3720 / 6770	3980 / 6880	2275x92x86	130	2265x80	W	3000K	628-340X95..	741,00	660,00	
SYS 40W / 82W · 230V	3720 / 6770	3980 / 6880	2275x92x86	130	2265x80	S	3000K	628-340X96..	741,00	660,00	
SYS 40W / 82W · 230V	3720 / 6770	3980 / 6880	2275x92x86	130	2265x80	AE	3000K	628-340X98..	741,00	660,00	
SYS 40W / 82W · 230V	3900 / 7110	4180 / 7720	2275x92x86	130	2265x80	W	4000K	628-340X45..	741,00	660,00	
SYS 40W / 82W · 230V	3900 / 7110	4180 / 7720	2275x92x86	130	2265x80	S	4000K	628-340X46..	741,00	660,00	
SYS 40W / 82W · 230V	3900 / 7110	4180 / 7720	2275x92x86	130	2265x80	AE	4000K	628-340X48..	741,00	660,00	
SYS 50W / 102W · 230V	4640 / 8600	4980 / 9220	2837x92x86	130	2827x80	W	3000K	628-350X95..	832,00	748,00	
SYS 50W / 102W · 230V	4640 / 8600	4980 / 9220	2837x92x86	130	2827x80	S	3000K	628-350X96..	832,00	748,00	
SYS 50W / 102W · 230V	4640 / 8600	4980 / 9220	2837x92x86	130	2827x80	AE	3000K	628-350X98..	832,00	748,00	
SYS 50W / 102W · 230V	4880 / 9020	5220 / 9660	2837x92x86	130	2827x80	W	4000K	628-350X45..	832,00	748,00	
SYS 50W / 102W · 230V	4880 / 9020	5220 / 9660	2837x92x86	130	2827x80	S	4000K	628-350X46..	832,00	748,00	
SYS 50W / 102W · 230V	4880 / 9020	5220 / 9660	2837x92x86	130	2827x80	AE	4000K	628-350X48..	832,00	748,00	
SYS 60W / 123W · 230V	5580 / 10320	5970 / 10320	3399x92x86	130	3389x80	W	3000K	628-360X95..	1058,00	960,00	
SYS 60W / 123W · 230V	5580 / 10320	5970 / 10320	3399x92x86	130	3389x80	S	3000K	628-360X96..	1058,00	960,00	
SYS 60W / 123W · 230V	5580 / 10320	5970 / 10320	3399x92x86	130	3389x80	AE	3000K	628-360X98..	1058,00	960,00	
SYS 60W / 123W · 230V	5850 / 10830	6270 / 11580	3399x92x86	130	3389x80	W	4000K	628-360X45..	1058,00	960,00	
SYS 60W / 123W · 230V	5850 / 10830	6270 / 11580	3399x92x86	130	3389x80	S	4000K	628-360X46..	1058,00	960,00	
SYS 60W / 123W · 230V	5850 / 10830	6270 / 11580	3399x92x86	130	3389x80	AE	4000K	628-360X48..	1058,00	960,00	
SYS 75W / 153W · 230V	6960 / 12900	7470 / 13830	4242x92x86	130	4232x80	W	3000K	628-375X95..	1234,00	1114,00	
SYS 75W / 153W · 230V	6960 / 12900	7470 / 13830	4242x92x86	130	4232x80	S	3000K	628-375X96..	1234,00	1114,00	
SYS 75W / 153W · 230V	6960 / 12900	7470 / 13830	4242x92x86	130	4232x80	AE	3000K	628-375X98..	1234,00	1114,00	
SYS 75W / 153W · 230V	7320 / 13530	7830 / 14490	4242x92x86	130	4232x80	W	4000K	628-375X45..	1234,00	1114,00	
SYS 75W / 153W · 230V	7320 / 13530	7830 / 14490	4242x92x86	130	4232x80	S	4000K	628-375X46..	1234,00	1114,00	
SYS 75W / 153W · 230V	7320 / 13530	7830 / 14490	4242x92x86	130	4232x80	AE	4000K	628-375X48..	1234,00	1114,00	



LOG IN



230V HV

INFO

Einbauleuchte, Aluminium-Strangpress-Profil (mit umlaufendem Rand), eloxiert, weiß oder schwarz pulverbeschichtet, Abdeckung mit Mikroprismenoptik, PMMA Opaldiffusor oder BAP-Raster 60°, optional mit innenliegendem Hochglanzreflektor, inkl. EVG, geeignet für den Einbau in Zwischendecken von 7-20mm, Dimmbare Versionen auf Anfrage



REFLEKTORVERSIONEN

Optional mit innenliegendem Hochglanzreflektor für mp & pm Versionen auf Anfrage erhältlich

HINWEIS:
AUF ANFRAGE AUCH ALS
LEUCHTENSYSTEM ERHÄLTlich

LM	ABDECKUNG	LxBxH	ET	DA	FARBE	ART. NR.	EURO	LAGER
T16 · 65 · 28/54W · 230V · EVG	MICROPRISMA	1195x76x90	130	1185x64	W	528-981545	243,00	
T16 · 65 · 28/54W · 230V · EVG	MICROPRISMA	1195x76x90	130	1185x64	S	528-981546	243,00	
T16 · 65 · 28/54W · 230V · EVG	MICROPRISMA	1195x76x90	130	1185x64	AE	528-98154	243,00	
T16 · 65 · 28/54W · 230V · EVG	OPALDIFFUSER	1195x76x90	130	1185x64	W	528-901545	223,00	
T16 · 65 · 28/54W · 230V · EVG	OPALDIFFUSER	1195x76x90	130	1185x64	S	528-901546	223,00	
T16 · 65 · 28/54W · 230V · EVG	OPALDIFFUSER	1195x76x90	130	1185x64	AE	528-90154	223,00	
T16 · 65 · 28/54W · 230V · EVG	BAP RASTER	1195x76x90	130	1185x64	W	528-911545	285,00	
T16 · 65 · 28/54W · 230V · EVG	BAP RASTER	1195x76x90	130	1185x64	S	528-911546	285,00	
T16 · 65 · 28/54W · 230V · EVG	BAP RASTER	1195x76x90	130	1185x64	AE	528-91154	285,00	
2 x 1 x T16 · 65 · 28/54W · 230V · EVG	MICROPRISMA	2251x76x90	130	2241x64	W	528-982545	367,00	
2 x 1 x T16 · 65 · 28/54W · 230V · EVG	MICROPRISMA	2251x76x90	130	2241x64	S	528-982546	367,00	
2 x 1 x T16 · 65 · 28/54W · 230V · EVG	MICROPRISMA	2251x76x90	130	2241x64	AE	528-98254	367,00	
2 x 1 x T16 · 65 · 28/54W · 230V · EVG	OPALDIFFUSER	2251x76x90	130	2241x64	W	528-902545	326,00	
2 x 1 x T16 · 65 · 28/54W · 230V · EVG	OPALDIFFUSER	2251x76x90	130	2241x64	S	528-902546	326,00	
2 x 1 x T16 · 65 · 28/54W · 230V · EVG	OPALDIFFUSER	2251x76x90	130	2241x64	AE	528-90254	326,00	
2 x 1 x T16 · 65 · 28/54W · 230V · EVG	BAP RASTER	2371x76x90	130	2361x64	W	528-912545	433,00	
2 x 1 x T16 · 65 · 28/54W · 230V · EVG	BAP RASTER	2371x76x90	130	2361x64	S	528-912546	433,00	
2 x 1 x T16 · 65 · 28/54W · 230V · EVG	BAP RASTER	2371x76x90	130	2361x64	AE	528-91254	433,00	
3 x 1 x T16 · 65 · 28/54W · 230V · EVG	MICROPRISMA	3307x76x90	130	3297x64	W	528-983545	554,00	
3 x 1 x T16 · 65 · 28/54W · 230V · EVG	MICROPRISMA	3307x76x90	130	3297x64	S	528-983546	554,00	
3 x 1 x T16 · 65 · 28/54W · 230V · EVG	MICROPRISMA	3307x76x90	130	3297x64	AE	528-98354	554,00	
3 x 1 x T16 · 65 · 28/54W · 230V · EVG	OPALDIFFUSER	3307x76x90	130	3297x64	W	528-903545	492,00	
3 x 1 x T16 · 65 · 28/54W · 230V · EVG	OPALDIFFUSER	3307x76x90	130	3297x64	S	528-903546	492,00	
3 x 1 x T16 · 65 · 28/54W · 230V · EVG	OPALDIFFUSER	3307x76x90	130	3297x64	AE	528-90354	492,00	
3 x 1 x T16 · 65 · 28/54W · 230V · EVG	BAP RASTER	3547x76x90	130	3537x64	W	528-913545	688,00	
3 x 1 x T16 · 65 · 28/54W · 230V · EVG	BAP RASTER	3547x76x90	130	3537x64	S	528-913546	688,00	
3 x 1 x T16 · 65 · 28/54W · 230V · EVG	BAP RASTER	3547x76x90	130	3537x64	AE	528-91354	688,00	
T16 · 65 · 35/49/80W · 230V · EVG	MICROPRISMA	1495x76x90	130	1485x64	W	528-981805	269,00	
T16 · 65 · 35/49/80W · 230V · EVG	MICROPRISMA	1495x76x90	130	1485x64	S	528-981806	269,00	
T16 · 65 · 35/49/80W · 230V · EVG	MICROPRISMA	1495x76x90	130	1485x64	AE	528-98180	269,00	
T16 · 65 · 35/49/80W · 230V · EVG	OPALDIFFUSER	1495x76x90	130	1485x64	W	528-901805	243,00	
T16 · 65 · 35/49/80W · 230V · EVG	OPALDIFFUSER	1495x76x90	130	1485x64	S	528-901806	243,00	
T16 · 65 · 35/49/80W · 230V · EVG	OPALDIFFUSER	1495x76x90	130	1485x64	AE	528-90180	243,00	
T16 · 65 · 35/49/80W · 230V · EVG	BAP RASTER	1495x76x90	130	1485x64	W	528-911805	316,00	
T16 · 65 · 35/49/80W · 230V · EVG	BAP RASTER	1495x76x90	130	1485x64	S	528-911806	316,00	
T16 · 65 · 35/49/80W · 230V · EVG	BAP RASTER	1495x76x90	130	1485x64	AE	528-91180	316,00	
2 x 1 x T16 · 65 · 35/49/80W · 230V · EVG	MICROPRISMA	2851x76x90	130	2841x64	W	528-982805	436,00	
2 x 1 x T16 · 65 · 35/49/80W · 230V · EVG	MICROPRISMA	2851x76x90	130	2841x64	S	528-982806	436,00	
2 x 1 x T16 · 65 · 35/49/80W · 230V · EVG	MICROPRISMA	2851x76x90	130	2841x64	AE	528-98280	436,00	
2 x 1 x T16 · 65 · 35/49/80W · 230V · EVG	OPALDIFFUSER	2851x76x90	130	2841x64	W	528-902805	388,00	
2 x 1 x T16 · 65 · 35/49/80W · 230V · EVG	OPALDIFFUSER	2851x76x90	130	2841x64	S	528-902806	388,00	
2 x 1 x T16 · 65 · 35/49/80W · 230V · EVG	OPALDIFFUSER	2851x76x90	130	2841x64	AE	528-90280	388,00	
2 x 1 x T16 · 65 · 35/49/80W · 230V · EVG	BAP RASTER	2971x76x90	130	2961x64	W	528-912805	514,00	
2 x 1 x T16 · 65 · 35/49/80W · 230V · EVG	BAP RASTER	2971x76x90	130	2961x64	S	528-912806	514,00	
2 x 1 x T16 · 65 · 35/49/80W · 230V · EVG	BAP RASTER	2971x76x90	130	2961x64	AE	528-91280	514,00	



MOLTO LUCE®

Musikverein, Anif, Österreich

LOG IN

	LM	ABDECKUNG	LxBxH	ET	DA	FARBE	ART. NR.	EURO	LAGER
	3 x 1 x T16 · 65 · 35/49/80W · 230V · EVG	MICROPRISMA	4207x76x90	130	4197x64	W	528-983805	645,00	
	3 x 1 x T16 · 65 · 35/49/80W · 230V · EVG	MICROPRISMA	4207x76x90	130	4197x64	S	528-983806	645,00	
	3 x 1 x T16 · 65 · 35/49/80W · 230V · EVG	MICROPRISMA	4207x76x90	130	4197x64	AE	528-98380	645,00	
	3 x 1 x T16 · 65 · 35/49/80W · 230V · EVG	OPALDIFFUSER	4207x76x90	130	4197x64	W	528-903805	568,00	
	3 x 1 x T16 · 65 · 35/49/80W · 230V · EVG	OPALDIFFUSER	4207x76x90	130	4197x64	S	528-903806	568,00	
	3 x 1 x T16 · 65 · 35/49/80W · 230V · EVG	OPALDIFFUSER	4207x76x90	130	4197x64	AE	528-90380	568,00	
	3 x 1 x T16 · 65 · 35/49/80W · 230V · EVG	BAP RASTER	4447x76x90	130	4437x64	W	528-913805	781,00	
	3 x 1 x T16 · 65 · 35/49/80W · 230V · EVG	BAP RASTER	4447x76x90	130	4437x64	S	528-913806	781,00	
	3 x 1 x T16 · 65 · 35/49/80W · 230V · EVG	BAP RASTER	4447x76x90	130	4437x64	AE	528-91380	781,00	

230V
HV inkl. IP20 | EEI: A+ - B

AUFBAU

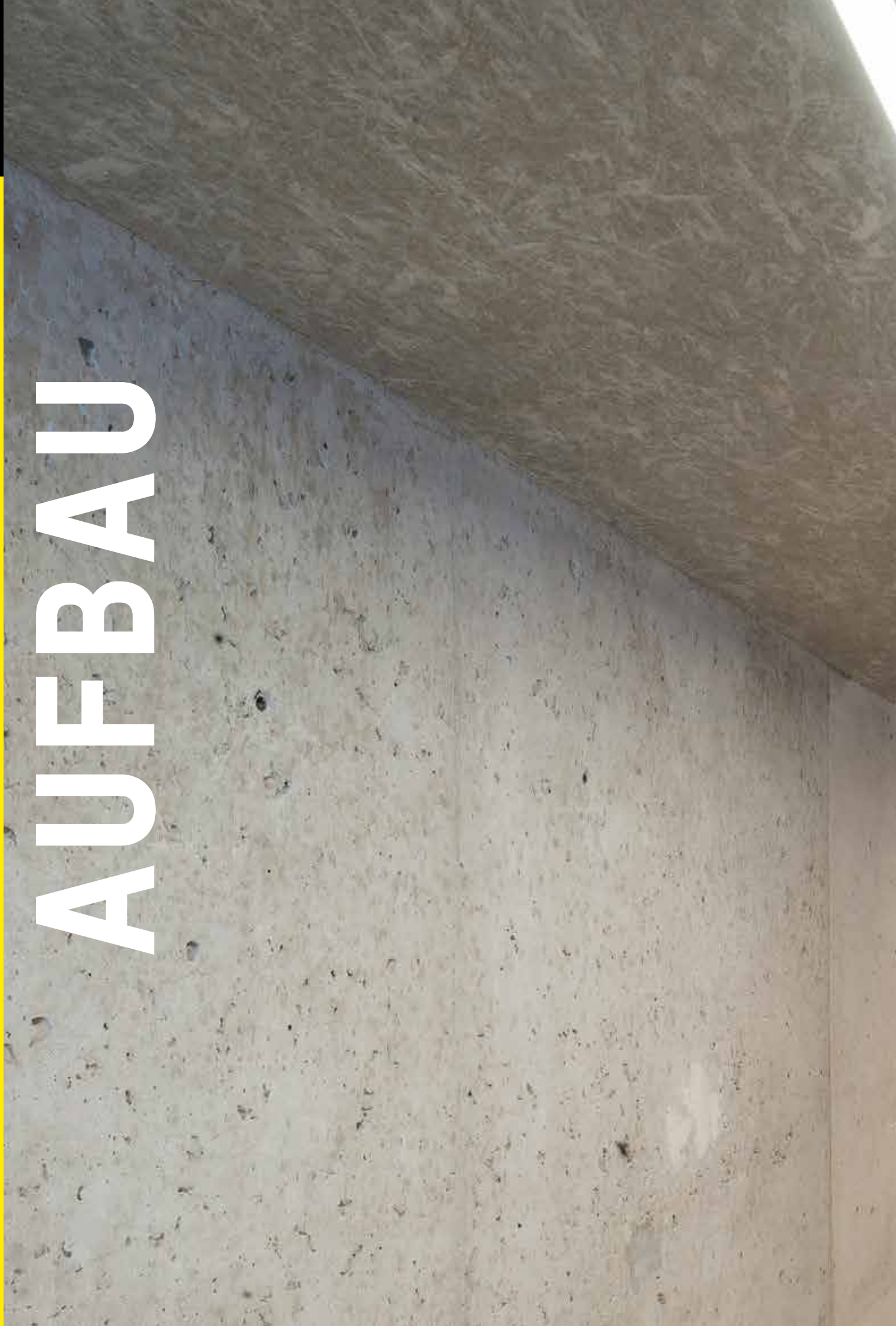





UP AC LED

TOP SELLER



Aufbauleuchte, AC-LED, Aluminium, weiß, schwarz oder grau Feinstruktur pulverbeschichtet, mit geschlossenem opalem Acryldiffusor, homogene Lichtverteilung

LM	LxB	H	LED	LUMEN	FARBE	ART. NR.	EURO	LAGER
SYS 10W 230V CRI>90	100x100	63	2700K	576	W	472-0501090002705	149,00	😊
	100x100	63	2700K	461	S	472-0501090002706	149,00	😊
	100x100	63	2700K	486	G	472-0501090002704	149,00	😊
100x100	63	3000K	640	W	472-0501090003005	149,00	😊	
	63	3000K	515	S	472-0501090003006	149,00	😊	
	63	3000K	540	G	472-0501090003004	149,00	😊	

LED 230V inkl. IP20 | EEL: A++ - A

POLUS LED

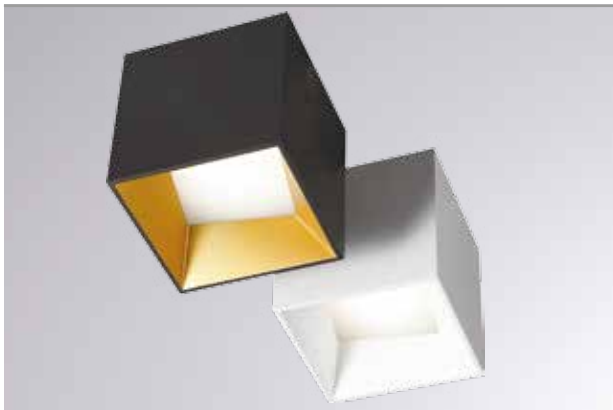

Aufbauleuchte, Aluminiumdruckguss, weiß oder außen schwarz - innen weiß oder gold Feinstruktur pulverbeschichtet, inkl. Konverter 500mA

LM	LxB	H	LUMEN	FARBE	ART. NR.	EURO	LAGER
SYS 11,3W · 230V CRI>90	105x105	105	606	W	276-0091190003005	129,00	😊
	105x105	105	580	S G	276-0091190003063	157,00	😊
LED 3000K							

LED 230V inkl. IP44 | EEL: A++ - A

JOLINE LED



Aufbauleuchte, Aluminium schwarz Feinstruktur pulverbeschichtet, 30° Ausstrahlwinkel, Leuchtenkopf 60° dreh- / 30° schwenkbar, inkl. Konverter

LM	LxB	H	REF.	FARBE	ART. NR.	EURO	LAGER
SYS 20W · 230V 1340lm · CRI>90	130x130	130	38°	S	472-0291690383006	175,00	☺

LED 3000K



QANA BOX I

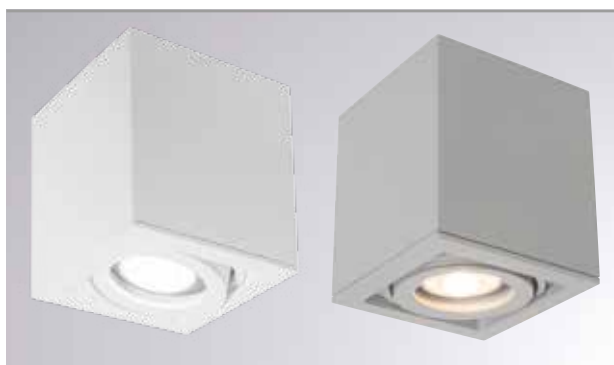

Aufbauleuchte 1-flammig aus Aluminium, weiß, schwarz oder grau Feinstruktur pulverbeschichtet, Leuchtenkopf: Vollaluminium gefräst 30° dreh- / 30° schwenkbar

LM	LxB	H	FARBE	ART. NR.	EURO	LAGER
QPAR16 GU10 · 230V max. 35W	83x83	90	W	472-258951w	79,00	☺
	83x83	90	S	472-258951b	79,00	☺
oder	83x83	90	G	472-258951s	79,00	☺

LED RETROFIT
GU10



QANA BOX II



Aufbauleuchte 2-flammig aus Aluminium, weiß, schwarz oder grau Feinstruktur pulverbeschichtet, Leuchtenköpfe: Vollaluminium gefräst 30° dreh- / 30° schwenkbar

LM	LxB	H	FARBE	ART. NR.	EURO	LAGER
2 x QPAR16 GU10 · 230V max. 35W	165x83	90	W	472-258952w	130,00	☺
	165x83	90	S	472-258952b	130,00	☺
	165x83	90	G	472-258952s	130,00	☺

2 x
LED RETROFIT
GU10



ALEA DL



Aufbauleuchte, Glas satiniert oder verchromt, Sockel aus lackiertem Metall, Version mit gespiegeltem Glas: Spiegeleffekt bei ausgeschalteter Leuchte, Transparenzeffekt bei eingeschalteter Leuchte

LM	LxB	H	FARBE	ART. NR.	EURO	LAGER
QT14 ECO G9 · 230V max. 33W	100x100	130	WO	68-518557	88,00	☺
	100x100	130	SP	68-518555	112,00	☺

LED RETROFIT
G9

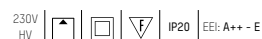



AEON LED

TOP SELLER



AEON SMALL ROUND LED

Runde LED Aufbauleuchte aus Aluminium, matt Feinstruktur pulverbeschichtet, inkl. Konverter

LM	Ø	H	REF.	LED	LUMEN	FARBE	ART. NR.	EURO	LAGER
SYS 6,2W 230V CRI>80	80	95	445°	2700K	496	W	305-602527w	69,00	🟢
	80	95	445°	3000K	522	W	305-602530w	69,00	🟢
	80	95	445°	2700K	496	S	305-602527b	69,00	🟢
	80	95	445°	3000K	522	S	305-602530b	69,00	🟢



AEON SMALL SQUARE LED

Quadratische LED Aufbauleuchte aus Aluminium, matt Feinstruktur pulverbeschichtet, inkl. Konverter

LM	LxB	H	REF.	LED	LUMEN	FARBE	ART. NR.	EURO	LAGER
SYS 6,2W 230V CRI>80	80x80	95	445°	2700K	496	W	305-602427w	69,00	🟢
	80x80	95	445°	3000K	522	W	305-602430w	69,00	🟢
	80x80	95	445°	2700K	496	S	305-602427b	69,00	🟢
	80x80	95	445°	3000K	522	S	305-602430b	69,00	🟢



AEON BIG ROUND LED

Runde LED Aufbauleuchte aus Aluminium, matt Feinstruktur pulverbeschichtet, inkl. Konverter, DALI dimmbar

LM	Ø	H	REF.	LED	LUMEN	FARBE	ART. NR.	EURO	LAGER
SYS 15,3W 230V CRI>80	125	158	450°	2700K	1280	W	305-604527wddd	199,00	🟢
	125	158	450°	3000K	1350	W	305-604530wddd	199,00	🟢
	125	158	450°	2700K	1280	S	305-604527bddd	199,00	🟢
	125	158	450°	3000K	1350	S	305-604530bddd	199,00	🟢



AEON BIG SQUARE LED

Quadratische LED Aufbauleuchte aus Aluminium, matt Feinstruktur pulverbeschichtet, inkl. Konverter, DALI dimmbar

LM	LxB	H	REF.	LED	LUMEN	FARBE	ART. NR.	EURO	LAGER
SYS 15,3W 230V CRI>80	120x120	158	450°	2700K	1280	W	305-604427wddd	199,00	🟢
	120x120	158	450°	3000K	1350	W	305-604430wddd	199,00	🟢
	120x120	158	450°	2700K	1280	S	305-604427bddd	199,00	🟢
	120x120	158	450°	3000K	1350	S	305-604430bddd	199,00	🟢





BROOK AC LED



BROOK ROUND AC LED

Aufbauleuchte, Aluminium matt Feinstruktur pulverbeschichtet, zylindrisch, AC-LED

LM	ØxH	LED	REF.	LUMEN	FARBE	ART. NR.	EURO	LAGER
SYS 10W 230V CRI>90	130x115	2700K	38°	464	W W	472-0101090382756	179,00	☺
	130x115	2700K	38°	450	S S	472-0101090382706	179,00	☺
	130x115	2700K	38°	490	S G	472-0101090382763	179,00	☺
	130x115	3000K	38°	515	W W	472-0101090383056	179,00	☺
	130x115	3000K	38°	500	S S	472-0101090383006	179,00	☺
	130x115	3000K	38°	545	S G	472-0101090383063	179,00	☺

LED 230V | inkl. | IP20 | EEI: A++ - A

BROOK SQUARE AC LED

Aufbauleuchte, Aluminium matt Feinstruktur pulverbeschichtet, quadratisch, AC-LED

LM	LxBxH	LED	REF.	LUMEN	FARBE	ART. NR.	EURO	LAGER
SYS 10W 230V CRI>90	130x130x115	2700K	38°	465	W W	472-0111090382756	199,00	☺
	130x130x115	2700K	38°	453	S S	472-0111090382706	199,00	☺
	130x130x115	2700K	38°	495	S G	472-0111090382763	199,00	☺
	130x130x115	3000K	38°	515	W W	472-0111090383056	199,00	☺
	130x130x115	3000K	38°	505	S S	472-0111090383006	199,00	☺
	130x130x115	3000K	38°	550	S G	472-0111090383063	199,00	☺

LED 230V | inkl. | IP20 | EEI: A++ - A



ARIK LED



ARIK SHORT LED

Aufbauleuchte, Aluminiumdruckguss, matt Feinstruktur pulverbeschichtet, zylindrisch, Acryldiffusor matt satiniert, inkl. Konverter

LM	Ø	H	FARBE	ART. NR.	EURO	LAGER
SYS 9W · 230V · 360lm · CRI>90	99	70	W	472-260029	145,00	☺
LED 3000K	99	70	S	472-260030	145,00	☺

LED 230V inkl. IP20 | EEI: A++ - A

ARIK LONG LED

Aufbauleuchte, Aluminiumdruckguss matt Feinstruktur pulverbeschichtet, zylindrisch, Acryldiffusor matt satiniert, inkl. Konverter

LM	Ø	H	FARBE	ART. NR.	EURO	LAGER
SYS 9W · 230V · 360lm · CRI>90	99	230	W	472-260031	185,00	☺
LED 3000K	99	230	S	472-260032	185,00	☺

LED 230V inkl. IP20 | EEI: A++ - A

TIA



Aufbaustrahler Aluminiumdruckguss, matt Feinstruktur pulverbeschichtet, Cover opal, starr, AC LED, zurückversetzte Lichtquelle, hochwertiger vacuumbedampfter Aluminiumreflektor

LM	Ø	H	LUMEN	LED	FARBE	REF.	ART. NR.	EURO	LAGER
SYS 8W 230V CRI>90	78	70	460	2700K	WO W		472-0530890382705	93,00	☺
	78	70	485	3000K	WO W		472-0530890383005	93,00	☺
	78	70	460	2700K	WO S		472-0530890382706	93,00	☺
	78	70	485	3000K	WO S		472-0530890383006	93,00	☺

LED 230V IP20 | EEI: A++ - A



CARMi AC LED



Aufbauleuchte, Aluminiumdruckguss, Oberflächen matt Feinstruktur pulverbeschichtet, zylindrisch, AC-LED

LM	Ø	H	LED	LUMEN	FARBE	ART. NR.	EURO	LAGER
SYS 10W 230V CRI>90	140	50	2700K	552	W W	472-0121090002705	169,00	☺
	140	50	2700K	457	S S	472-0121090002706	169,00	☺
	140	50	2700K	487	S G	472-0121090002763	169,00	☺
	140	50	3000K	615	W W	472-0121090003005	169,00	☺
	140	50	3000K	510	S S	472-0121090003006	169,00	☺
	140	50	3000K	540	S G	472-0121090003063	169,00	☺

LED 230V inkl. EE: A++ - A

TURN ON 110 AC



INFO	LM	∅	H	FARBE	INNENRING	LUMEN	ART. NR.	EURO	LAGER	
Aufbauleuchte, AC-LED, Aluminiumdruckguss, weiß oder schwarz Feinstruktur pulverbeschichtet, rund, satinierter zurückgesetzter Diffusor aus PMMA, Dekor-Innenring in weiß, schwarz oder gold, TRIAC dimmbar	SYS 10W · 230V CRI>80	110	91	W	W	400	597-1101955	206,00	☺	
	LED 3000K	110	91	W	S	400	597-1101956	206,00	☺	
		110	91	W	G	400	597-1101953	227,00	☺	
		110	91	S	W	400	597-1101965	206,00	☺	
		110	91	S	S	400	597-1101966	206,00	☺	
					S	G	400	597-1101963	227,00	☺

LED 230V EEI: A++ - A

TURN ON 150 AC



INFO	LM	∅	H	FARBE	INNENRING	LUMEN	ART. NR.	EURO	LAGER
Aufbauleuchte, AC-LED, Aluminiumdruckguss, weiß oder schwarz Feinstruktur pulverbeschichtet, rund, satinierter zurückgesetzter Diffusor aus PMMA, Dekor-Innenring in weiß, schwarz oder gold, TRIAC dimmbar	SYS 15W · 230V CRI>80	150	109	W	W	710	597-2201955	254,00	☺
	LED 3000K	150	109	W	S	710	597-2201956	254,00	☺
		150	109	W	G	710	597-2201953	274,00	☺
		150	109	S	W	710	597-2201965	254,00	☺
		150	109	S	S	710	597-2201966	254,00	☺
		150	109	S	G	710	597-2201963	274,00	☺

LED 230V EEI: A++ - A

FOKUS DL



INFO	LM	∅	H	FARBE	ART. NR.	EURO	LAGER
Aufbauleuchte, Glas satiniert, Sockel aus lackiertem Metall	QT14 ECO G9 · 230V max. 33W	110	140	WO	68-518657	92,00	☺
oder	LED RETROFIT G9						

230V HV EEI: A++ - E

FOKUS DL



INFO	LM	∅	H	FARBE	ART. NR.	EURO	LAGER
Aufbauleuchte, Aluminium eloxiert oder weiß pulverbeschichtet, verschiedene Filtereinsätze oder Ring mit Glas - separat ordern	QPAR 16/20 GU10 · 230V max. 50W/75W	110	105	W	68-517401	127,00	☺
	oder	LED RETROFIT GU10	110	105	AE	68-517445	117,00

230V HV EEI: A++ - D



1 PLAY DECO AUFBAU



INFO	LM	ØxH	LED	LUMEN	REF.	FARBE	ART. NR.	EURO	LAGER
Aufbaustrahler, Aluminiumdruckguss, weiß oder schwarz pulverbeschichtet, Standardlinse 30° Ausstrahlwinkel - tauschbar, Diffusor aus Polycarbonat, inkl. Konverter, Linsen 15° oder 50°, Dekorreflektoren und Zubehör separat ordern	SYS 7W 230V CRI>80	72,5x200	2700K	570		W	105-1552641400v1	154,00	
		72,5x200	3000K	620		W	105-1552651400v1	154,00	
		72,5x200	2700K	570		S	105-1552646000v1	154,00	
		72,5x200	3000K	620		S	105-1552656000v1	154,00	
	SYS 13W 230V CRI>80	72,5x200	2700K	1240		W	105-1552681400v1	188,00	
		72,5x200	3000K	1330		W	105-1552691400v1	188,00	
		72,5x200	2700K	1240		S	105-1552686000v1	188,00	
		72,5x200	3000K	1330		S	105-1552696000v1	188,00	

LED 230V inkl. inkl. IP20 | EEL: A++ - A

LINSEN ZU PLAY DECO AUFBAU



INFO	PRODUKT	REF.	ART. NR.	EURO	LAGER
Linse in 2 Ausstrahlwinkeln, Polycarbonat, erhältlich in 15° oder 50°	REFLEKTOR		105-7156390000	7,00	
	REFLEKTOR		105-7156400000	7,00	

2 DEKOREFLEKTOREN ZU PLAY DECO AB



INFO	BAUFORM	AUSFÜHRUNG	ØxH bzw. LxBxH	FARBE	ART. NR.	EURO	LAGER
Dekoreflektor rund, rund asymmetrisch, Polycarbonat, in den Farben weiß, schwarz, gold, grau, braun oder terracotta	RUND	SYMMETRISCH	70x31,5	W	105-7147521400v2	14,50	
	RUND	SYMMETRISCH	70x31,5	G	105-7147522300v2	14,50	
	RUND	SYMMETRISCH	70x31,5	S	105-7147526000v2	14,50	
	RUND	SYMMETRISCH	70x31,5	G	105-714752z500v2	17,50	
	RUND	SYMMETRISCH	70x31,5	B	105-714752j600v2	17,50	
	RUND	SYMMETRISCH	70x31,5	T	105-714752dj00v2	17,50	

3 PLAY DECO ABHÄNGUNG



INFO	ØxH	KABEL	FARBE	ART. NR.	EURO	LAGER
Baldachin mit Kabelabhangung, Aluminiumdruckguss, wei oder schwarz pulverbeschichtet, Kabel L=1500mm, Baldachin DMxH=65x40mm Optional ordern fur Hangeleuchte Play Deco	65x40	1500	W	105-7151741414	38,00	
	65x40	1500	S	105-7151746060	38,00	

4 PLAY DECO ABHÄNGUNG



INFO	ØxH	FARBE	ART. NR.	EURO	LAGER
Baldachin mit Gelenk, Aluminiumdruckguss, wei oder schwarz pulverbeschichtet, 355° dreh- und 90° schwenkbar, Baldachin DMxH=65x40mm Optional ordern fur Strahler Play Deco	65x107	W	105-7151751414	38,00	
	65x107	S	105-7151756060	38,00	



Anwendungsbeispiele mit Reflektor gold



MAGIS

Aufbaustrahler, Aluminiumdruckguss, matt Feinstruktur pulverbeschichtet, Dekorring aus Metall (standardmäßig in Gehäusefarbe), Strahlerkopf 90° schwenk- und 350° drehbar, 40° Reflektor (im Lieferumfang enthalten), 20° oder 28° Reflektor separat bestellbar, Wand- oder Deckenmontage, inkl. Konverter 500mA - **TRIAC dimmbar**

LM	Ø	H	REF.	FARBE	ART. NR.	EURO	LAGER
SYS 15,8W · 230V 1030lm · CRI>90	100	103	40°	W	276-0021590402705tr	199,00	🟢
LED 2700K	100	103	40°	S	276-0021590402706tr	199,00	🟢

LM	Ø	H	REF.	FARBE	ART. NR.	EURO	LAGER
SYS 15,8W · 230V 1070lm · CRI>90	100	103	40°	W	276-0021590403005tr	199,00	🟢
LED 3000K	100	103	40°	S	276-0021590403006tr	199,00	🟢

MAGIS DOUBLE

Aufbaustrahler 2-flammig, Aluminiumdruckguss, matt Feinstruktur pulverbeschichtet, Dekorring aus Metall (standardmäßig in Gehäusefarbe), Strahlerkopf 90° schwenk- und 350° drehbar, 40° Reflektor (im Lieferumfang enthalten), 20° oder 28° Reflektor separat bestellbar, Wand- oder Deckenmontage, inkl. Konverter 500mA - **TRIAC dimmbar**

LM	LxB	H	REF.	FARBE	ART. NR.	EURO	LAGER
SYS 30W · 230V 2x1030lm · CRI>90	212x100	103	40°	W	276-0103090402705tr	345,00	🟢
LED 2700K	212x100	103	40°	S	276-0103090402706tr	345,00	🟢

LM	LxB	H	REF.	FARBE	ART. NR.	EURO	LAGER
SYS 30W · 230V 2x1070lm · CRI>90	212x100	103	40°	W	276-0103090403005tr	345,00	🟢
LED 3000K	212x100	103	40°	S	276-0103090403006tr	345,00	🟢



DEKORRING FÜR MAGIS & MAGIS DOUBLE (OPTIONAL)

INFO	FARBE	ART. NR.	EURO	LAGER
Ring aus Metall pulverbeschichtet, weiß, schwarz oder gold, werkzeuglos wechselbar mit Magnethalterung. (separat ordern)	G	276-7004	9,00	🟢
	W	276-7005	9,00	🟢
	S	276-7006	9,00	🟢

REFLEKTOR FÜR MAGIS & MAGIS DOUBLE (OPTIONAL)

INFO	REF.	ART. NR.	EURO	LAGER
Reflektor für werkzeuglos wechselbar (separat ordern)	20°	276-7010	12,00	🟢
	28°	276-7011	12,00	🟢

MAGIS MINI



MAGIS MINI

Aufbaustrahler, Aluminiumdruckguss, matt F einstruktur pulverbeschichtet, Dekorring aus Metall (standardmäßig in Gehäusefarbe), Strahlerkopf 90° schwenk- und 350° drehbar, 40° Reflektor (im Lieferumfang enthalten), 23° oder 34° Reflektor separat bestellbar, Wand- oder Deckenmontage, inkl. Konverter 500mA - **TRIAC dimmbar**

LM	Ø	H	REF.	FARBE	ART. NR.	EURO	LAGER
SYS 11,1W · 230V 615lm · CRI>90	75	91		W	276-0111190502705tr	129,00	☺
LED 2700K	75	91		S	276-0111190502706tr	129,00	☺

LM	Ø	H	REF.	FARBE	ART. NR.	EURO	LAGER
SYS 11,1W · 230V 630lm · CRI>90	75	91		W	276-0111190503005tr	129,00	☺
LED 3000K	75	91		S	276-0111190503006tr	129,00	☺

MAGIS MINI DOUBLE

Aufbaustrahler 2-flammig, Aluminiumdruckguss, matt Feinstruktur pulverbeschichtet, Dekorring aus Metall (standardmäßig in Gehäusefarbe), Strahlerkopf 90° schwenk- und 350° drehbar, 40° Reflektor (im Lieferumfang enthalten), 23° oder 34° Reflektor separat bestellbar, Wand- oder Deckenmontage, inkl. Konverter 500mA - **TRIAC dimmbar**

LM	LxB	H	REF.	FARBE	ART. NR.	EURO	LAGER
SYS 22,2W · 230V 2x615lm · CRI>90	160x75	91		W	276-0122190502705tr	225,00	☺
LED 2700K	160x75	91		S	276-0122190502706tr	225,00	☺

LM	LxB	H	REF.	FARBE	ART. NR.	EURO	LAGER
SYS 22,2W · 230V 2x630lm · CRI>90	160x75	91		W	276-0122190503005tr	225,00	☺
LED 3000K	160x75	91		S	276-0122190503006tr	225,00	☺



DEKORRING FÜR MAGIS MINI & MAGIS MINI DOUBLE (OPTIONAL)

INFO	FARBE	ART. NR.	EURO	LAGER
Ring aus Metall pulverbeschichtet, weiß, schwarz oder gold, werkzeuglos wechselbar mit Magnethalterung. (separat ordern)	G	276-7007	7,50	☺
	W	276-7008	7,50	☺
	S	276-7009	7,50	☺

REFLEKTOR FÜR MAGIS MINI & MAGIS MINI DOUBLE (OPTIONAL)

INFO	REF.	ART. NR.	EURO	LAGER
Reflektor für werkzeuglos wechselbar (separat ordern)		276-7012	6,00	☺
		276-7013	6,00	☺



MISSOR I / II LED



MISSOR I LED

Aufbaustrahler, Aluminiumdruckguss, Feinstruktur matt pulverbeschichtet, Dekorring aus Kunststoff schwarz, Strahlerkopf 90° schwenk- und 355° drehbar, 33° Ausstrahlwinkel, Wand- oder Deckenmontage, inkl. Konverter 500mA - **TRIAC dimmbar**

LM	LxB	H	REF.	FARBE	ART. NR.	EURO	LAGER
SYS 11,9W · 230V 660lm · CRI>90	175x60	148		W	276-0061290333056	159,00	
	175x60	148		S	276-0061290333006	159,00	
LED 3000K							

MISSOR II LED

Aufbaustrahler, 2 flammig, Aluminiumdruckguss, Feinstruktur matt pulverbeschichtet, Dekorring aus Kunststoff schwarz, Strahlerkopf 90° schwenk- und 355° drehbar, 33° Ausstrahlwinkel, Wand- oder Deckenmontage, inkl. Konverter 500mA - **TRIAC dimmbar**

LM	LxB	H	REF.	FARBE	ART. NR.	EURO	LAGER
SYS 21,1W · 230V 1340lm · CRI>90	336x60	148		W	276-0072190333056	235,00	
	336x60	148		S	276-0072190333006	235,00	
LED 3000K							



DEKORRING FÜR MISSOR I & MISSOR II LED

INFO	Ø	FARBE	ART. NR.	EURO	LAGER
Ring aus Kunststoff, gold oder weiß, für Missor I, Missor II und Elix, werkzeuglos wechselbar. (separat ordern)	60	G	276-7000	5,00	
	60	W	276-7001	5,00	

WAABENRASTER FÜR MISSOR I & MISSOR II LED

INFO	Ø	FARBE	ART. NR.	EURO	LAGER
Waabenraster aus Metall, für Missor I und Missor II, werkzeuglos montierbar. (separat ordern)	60	S	276-1002	4,00	

NOEL



Aufbaustrahler aus Aluminiumdruckguss, Feinstruktur matt pulverbeschichtet, AC LED, zurückversetzte Strahlerköpfe 350° dreh- und 90° schwenkbar, hochwertige vacuumbedampfte Aluminiumreflektoren

LM	LxB	H	LUMEN	LED	FARBE	REF.	ART. NR.	EURO	LAGER
SYS 16W 230V CRI>90	180x80	57	750	2700K	W		472-0541690112705	210,00	
	180x80	57	770	3000K	W		472-0541690113005	210,00	
	180x80	57	750	2700K	S		472-0541690112706	210,00	
	180x80	57	770	3000K	S		472-0541690113006	210,00	



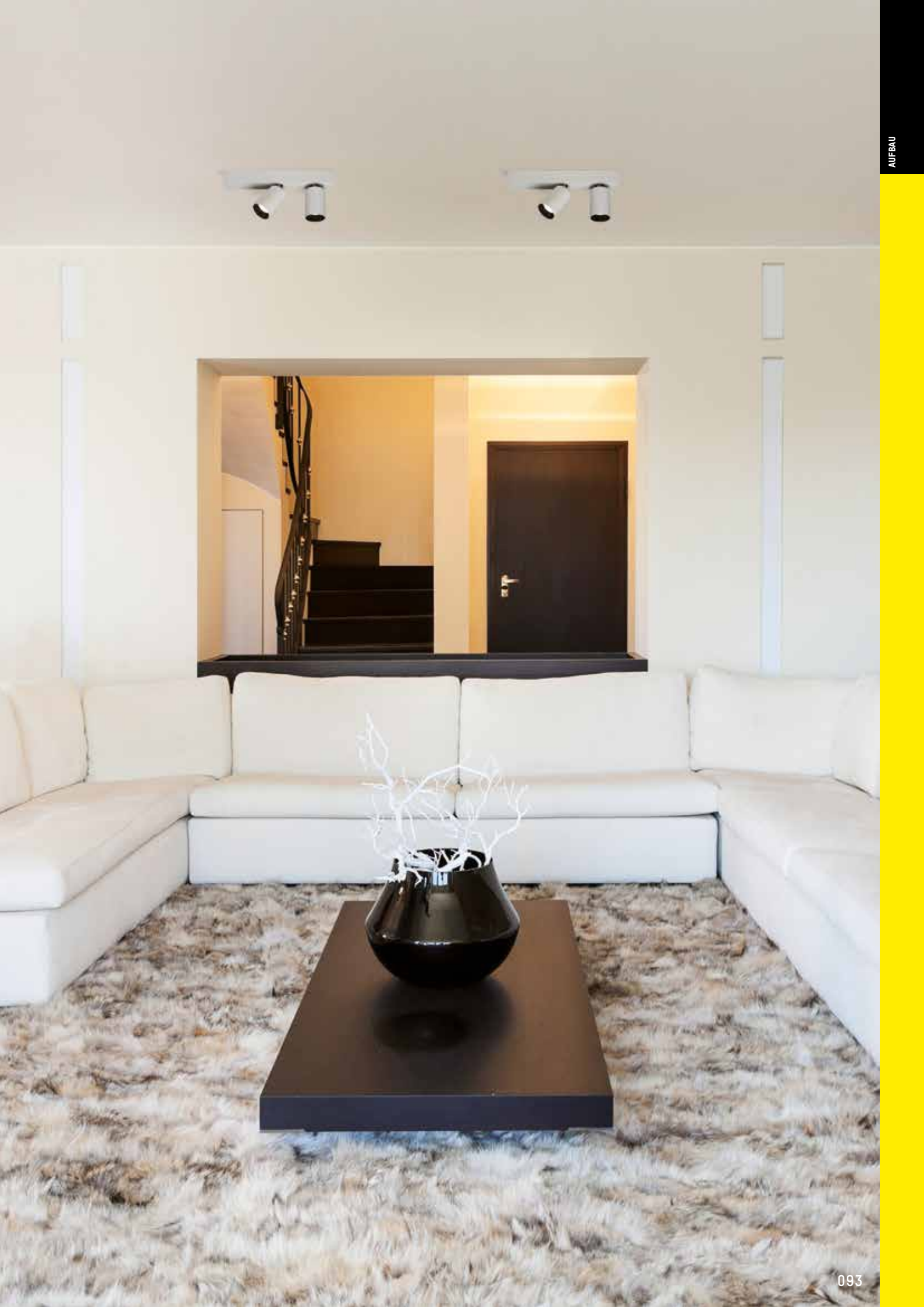

DASH AC 11W



INFO	LM	ØxH	FARBE	REF.	ART. NR.	EURO	LAGER
<p>Aufbaustrahler, Aluminiumdruckguss, pulverbeschichtet oder galvanisiert, Leuchtenkopf 350° dreh- / 90° schwenkbar, vakuumbedampfter Alurefektor in 2 Ausstrahlwinkeln, AC-LED mit integrierter Vorschalt elektronik</p>	<p>SYS 11W 230V CRI >90 650lm PASSIVE COOLING Binning SDCM 3</p> <p>LED 2700K</p>	65x143	C	medium	599-31402531ng2	191,00	☺
		65x143	SM	medium	599-31402534ng2	171,00	☺
		65x143	W	medium	599-31402535ng2	171,00	☺
		65x143	S	medium	599-31402536ng2	171,00	☺
		65x143	C	flood	599-31402831ng2	191,00	☺
		65x143	SM	flood	599-31402834ng2	171,00	☺
		65x143	W	flood	599-31402835ng2	171,00	☺
		65x143	S	flood	599-31402836ng2	171,00	☺
		<p>SYS 11W 230V CRI >90 690lm PASSIVE COOLING Binning SDCM 3</p> <p>LED 3000K</p>	65x143	C	medium	599-31402591ng2	191,00
	65x143		SM	medium	599-31402594ng2	171,00	☺
	65x143		W	medium	599-31402595ng2	171,00	☺
	65x143		S	medium	599-31402596ng2	171,00	☺
	65x143		C	flood	599-31402891ng2	191,00	☺
	65x143		SM	flood	599-31402894ng2	171,00	☺
	65x143		W	flood	599-31402895ng2	171,00	☺
	65x143		S	flood	599-31402896ng2	171,00	☺

LED 230V | 90° | 350° | inkl. | IP20 | EEL: A++ - A

DASH L AC 11W



INFO	LM	ØxH	FARBE	REF.	ART. NR.	EURO	LAGER	
<p>Aufbaustrahler, Aluminiumdruckguss, pulverbeschichtet oder galvanisiert, Leuchtenkopf 350° dreh- / 90° schwenkbar, vakuumbedampfter Alurefektor in 2 Ausstrahlwinkeln, AC-LED mit integrierter Vorschalt elektronik</p> <p>Dekorring innenliegend standard schwarz, optional in anderen Farben verfügbar (separat ordern)</p>	<p>SYS 11W 230V CRI >90 650lm PASSIVE COOLING Binning SDCM 3</p> <p>LED 2700K</p>	65x156	SM	medium	599-61402534ng2	181,00	☺	
		65x156	W	medium	599-61402535ng2	181,00	☺	
		65x156	S	medium	599-61402536ng2	181,00	☺	
		65x156	SM	flood	599-61402834ng2	181,00	☺	
		65x156	W	flood	599-61402835ng2	181,00	☺	
		65x156	S	flood	599-61402836ng2	181,00	☺	
		<p>SYS 11W 230V CRI >90 690lm PASSIVE COOLING Binning SDCM 3</p> <p>LED 3000K</p>	65x156	SM	medium	599-61402594ng2	181,00	☺
			65x156	W	medium	599-61402595ng2	181,00	☺
			65x156	S	medium	599-61402596ng2	181,00	☺
	65x156		SM	flood	599-61402894ng2	181,00	☺	
	65x156		W	flood	599-61402895ng2	181,00	☺	
	65x156		S	flood	599-61402896ng2	181,00	☺	

LED 230V | 90° | 350° | inkl. | IP20 | EEL: A++ - A

DEKORRING FÜR DASH L

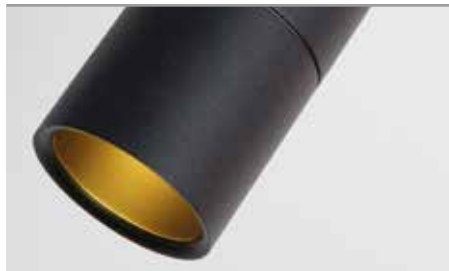

INFO	SKIZZE	FARBE	ART. NR.	EURO	LAGER
innenliegend, separat ordern		SM	599-12	9,20	☺
		G	599-13	9,20	☺
		W	599-15	9,20	☺



MOLTO LUCE®

Privates Wohnhaus, Österreich

SHOPSTAR AC



INFO	LM	ØxBxH	FARBE	LED	LUMEN	REF.	ART. NR.	EURO	LAGER
AC Aufbaustrahler, Aluminiumdruckguss, silber matt, weiß oder schwarz Feinstruktur pulverbeschichtet, Vakuumbedampfter Aluminiumreflektor 31° und 40° Ausstrahlwinkel, Leuchtenkopf 350° drehbar und 90° schwenkbar, speziell beschichtetes Schutzglas, AC-LED mit integrierter Vorschalt elektronik	SYS 11W 230V CRI >90 PASSIVE COOLING Binning SDCM 3	95x135x162	SM	3000K	690	flood 31°	608-71202894ng2	180,00	
		95x135x162	W	3000K	690	flood 31°	608-71202895ng2	180,00	
		95x135x162	S	3000K	690	flood 31°	608-71202896ng2	180,00	
		95x135x162	SM	4000K	720	flood 31°	608-71202844ng2	180,00	
		95x135x162	W	4000K	720	flood 31°	608-71202845ng2	180,00	
		95x135x162	S	4000K	720	flood 31°	608-71202846ng2	180,00	
	SYS 23W 230V CRI >90 PASSIVE COOLING Binning SDCM 3	95x135x162	SM	3000K	1640	flood 40°	608-72502894ng2	195,00	
		95x135x162	W	3000K	1640	flood 40°	608-72502895ng2	195,00	
		95x135x162	S	3000K	1640	flood 40°	608-72502896ng2	195,00	
		95x135x162	SM	4000K	1750	flood 40°	608-72502844ng2	195,00	
		95x135x162	W	4000K	1750	flood 40°	608-72502845ng2	195,00	
		95x135x162	S	4000K	1750	flood 40°	608-72502846ng2	195,00	

SHOOTER 1



INFO	LM	BxH	FARBE	ART. NR.	EURO	LAGER
Aufbaustrahler, Aluminiumdruckguss, pulverbeschichtet oder galvanisiert, Leuchtenkopf 285° dreh- / 90° schwenkbar, werkzeugloser Lampenwechsel	QPAR16 GU10 · 230V max. 50W	80x130	C	653-00301000011	123,00	☺
		80x130	W	653-00301000055	95,00	☺
	oder	80x130	S	653-00301000066	95,00	☺
	LED RETROFIT GU10					

230V HV | | 90° | 285° | | | IP20 | EE: A++ - D

SHOOTER 2



INFO	LM	BxH	FARBE	ART. NR.	EURO	LAGER
Aufbaustrahler, 2 flammig, Aluminiumdruckguss, pulverbeschichtet oder galvanisiert, Leuchtenkopf 285° dreh- / 90° schwenkbar, werkzeugloser Lampenwechsel	2 x QPAR16 GU10 · 230V max. 50W	140x130	C	653-00302000011	189,00	
		140x130	W	653-00302000055	149,00	☺
	oder	140x130	S	653-00302000066	149,00	
	LED RETROFIT GU10					

230V HV | | 90° | 285° | | | IP20 | EE: A++ - D

VISPO HV



INFO	LM	Ø Rosette	H	FARBE	ART. NR.	EURO	LAGER
Aufbaustrahler, messing, galvanisiert oder lackiert, 360° dreh- / 90° schwenkbar, Abmessungen ohne Leuchtmittel	QPAR16/20 GU10 · 230V max. 50/75W	60	95	MP	26-840001	29,00	☺
		60	95	C	26-840004	29,00	☺
	oder	60	95	W	26-840007	27,00	☺
	LED RETROFIT GU10	60	95	P	26-840046	29,00	☺

230V HV | | 90° | 360° | | | IP20 | EE: A++ - D



CEN LED



Wandbauleuchte, Aluminiumdruckguss, Feinstruktur matt pulverbeschichtet, 350° drehbar, verstellbarer Lichtkegel, inkl. Konverter

LM	Ø	H	FARBE	ART. NR.	EURO	LAGER
SYS 16W · 230V · 565lm · CRI>90	200	94	W	472-260042	215,00	☺
LED 3000K						



BO SINGLE



Wandleuchte, Aluminiumdruckguss, Feinstruktur matt pulverbeschichtet, direkt/indirekt strahlend, Leuchtenkopf 345° drehbar, inkl. Konverter

LM	BxHxT	LUMEN	FARBE	ART. NR.	EURO	LAGER
SYS 5,2W 230V CRI>90	135x30x142	300	W	472-0080490003005	145,00	☺
LED 3000K	135x30x142	185	S	472-0080490003006	145,00	☺



BO DOUBLE



Wandleuchte, 2 flammig, Aluminiumdruckguss, Feinstruktur matt pulverbeschichtet, direkt/indirekt strahlend, Leuchtenköpfe 345° drehbar, inkl. Konverter

LM	BxHxT	LUMEN	FARBE	ART. NR.	EURO	LAGER
SYS 2x5,4W 230V CRI>90	240x30x142	595	W	472-0090890003005	218,00	☺
LED 3000K	240x30x142	350	S	472-0090890003006	218,00	☺



BENTY LED



Wandleuchte, Aluminiumdruckguss, Feinstruktur matt pulverbeschichtet, geschlossener opaler Acryldiffusor, homogene Lichtverteilung, inkl. Konverter

LM	BxHxT	FARBE	ART. NR.	EURO	LAGER
SYS 5,7W 230V 409lm CRI>90	150x145x75	W	472-291007w	125,00	☺
LED 3000K					

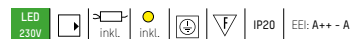



CLARUS



Wandleuchte, Aluminiumdruckguss, matt Feinstruktur pulverbeschichtet, direkt/indirekt, asymmetrisch, 90°schwenkbar, 350° drehbar, inkl. Leselicht, inkl. Konverter

Funktionsweise der Leuchte:

Erste Betätigung des Schalters: einschalten Grundlicht
 Zweite Betätigung des Schalters: einschalten Leselicht, ausschalten Grundlicht
 Dritte Betätigung des Schalters: aus
 Grundlicht & Leselicht können nicht gemeinsam leuchten.

LM	ØxT	FARBE	LUMEN	ART. NR.	EURO	LAGER
SYS 10,8W 230V CRI>90	120x82	W	400	276-0151090402705tr	199,00	☺
	120x82	S	365	276-0151090402706tr	199,00	☺
LED 2700K	120x82	S G	365	276-0151090402763tr	199,00	☺



OBLIQUUS

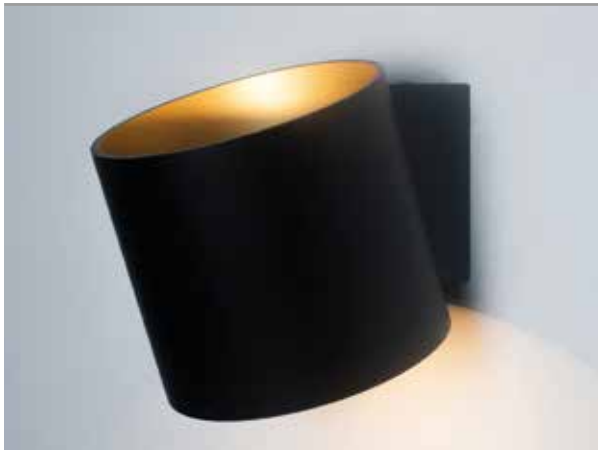

Wandleuchte, Aluminiumdruckguss, matt Feinstruktur pulverbeschichtet, direkt/indirekt, inkl. Konverter, TRIAC Dimmbar, INFO: asymmetrische Bauform

LM	ØxHxT	FARBE	LUMEN	ART. NR.	EURO	LAGER
SYS 10,5W 230V CRI>90	102x92x130	W	595	276-0141090002705tr	179,00	☺
	102x92x130	S	550	276-0141090002706tr	179,00	☺
LED 2700K	102x92x130	S G	550	276-0141090002763tr	199,00	☺
SYS 10,5W 230V CRI>90	102x92x130	W	685	276-0141090003005tr	179,00	☺
	102x92x130	S	605	276-0141090003006tr	179,00	☺
LED 3000K	102x92x130	S G	605	276-0141090003063tr	199,00	☺

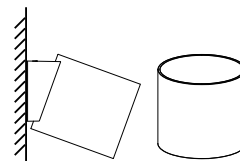

FOKUS WL



Wandleuchte, Glas satiniert, 360° drehbar, Sockel aus lackiertem Metall, direkt/indirekt strahlend

LM	ØxH	T	FARBE	ART. NR.	EURO	LAGER
QT14 ECO G9 · 230V max. 48W	110x110	115	W0	68-428757	114,00	☺
oder LED RETROFIT G9						





TALOS



Wandleuchte, Aluminiumdruckguss, matt Feinstruktur pulverbeschichtet, direkt/indirekt strahlend, inkl. Konverter, TRIAC Dimmbar, INFO: asymmetrische Bauform

LM	LxBxH	FARBE	LUMEN	ART. NR.	EURO	LAGER
SYS 14,2W 230V CRI>90	178x178x106	W	915	276-0161490002705tr	199,00	🟢
	178x178x106	S G	820	276-0161490002763tr	219,00	🟢
LED 2700K						
SYS 14,2W 230V CRI>90	178x178x106	W	970	276-0161490003005tr	199,00	🟢
	178x178x106	S G	870	276-0161490003063tr	219,00	🟢
LED 3000K						

LED 230V inkl. IP40 | EEL: A++ - A

TOP SELLER

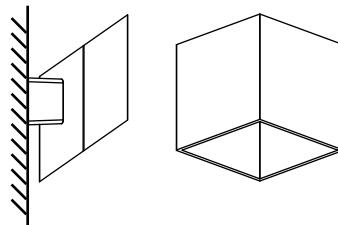



NOVEL LED



TOP SELLER

Wandleuchte, Aluminium lackiert oder pulverbeschichtet, direkt/indirekt strahlend, inkl. Konverter
TRIAC Dimmbar

LM	BxH	T	FARBE	LUMEN	ART. NR.	EURO	LAGER
SYS 7,7W 230V CRI>90	100x100	100	W	359	472-29100427wtr	159,00	😊
	100x100	100	S	132	472-29100427btr	159,00	😊
LED 2700K	100x100	100	S G	189	472-29100427bgtr	187,00	😊
	100x100	100	G	168	472-29100427str	159,00	😊
	100x100	100	AL	263	472-29100427atr	159,00	😊
	100x100	100	W	399	472-29100430wtr	159,00	😊
SYS 7,7W 230V CRI>90	100x100	100	S	147	472-29100430btr	159,00	😊
	100x100	100	S G	210	472-29100430bgtr	187,00	😊
LED 3000K	100x100	100	G	187	472-29100430str	159,00	😊
	100x100	100	AL	292	472-29100430atr	159,00	😊

LED 230V | inkl. | inkl. | IP20 | EE: A+++ - A

TAKE



Wandleuchte, Aluminium lackiert oder pulverbeschichtet, direkt/indirekt strahlend

LM	BxH	T	FARBE	ART. NR.	EURO	LAGER
QT14 ECO 69 · 230V max. 33W	100x100	100	W	472-291009w	59,00	😊
	100x100	100	S	472-291009b	59,00	😊
	100x100	100	G	472-291009s	59,00	😊
	100x100	100	AL	472-291009a	59,00	😊

230V HV | | | IP20 | EE: A+++ - E



ALICA





Wandleuchte, Aluminium, pulverbeschichtet oder lackiert, direkt/indirekt strahlend, inkl. Konverter

LM	BxHxT	FARBE	LUMEN	ART. NR.	EURO	LAGER
SYS 7W 230V CRI>90	200x70x100	W	400	472-0000790002705	155,00	☺
	200x70x100	S	215	472-0000790002706	155,00	☺
LED 2700K	200x70x100	G	255	472-0000790002704	155,00	☺
	200x70x100	AL	320	472-0000790002714	155,00	☺
	200x70x100	S G	307	472-0000790002763	185,00	☺
SYS 7W 230V CRI>90	200x70x100	W	420	472-0000790003005	155,00	☺
	200x70x100	S	220	472-0000790003006	155,00	☺
LED 3000K	200x70x100	G	265	472-0000790003004	155,00	☺
	200x70x100	AL	330	472-0000790003014	155,00	☺
	200x70x100	S G	320	472-0000790003063	185,00	☺

LED 230V inkl. IP20 EEL: A++ - A

ALEA WL

INFO	LM	LxH	T	FARBE	ART. NR.	EURO	LAGER
 <p>Wandleuchte, Aluminium eloxiert oder weiß pulverbeschichtet, 360° drehbar, verschiedene Filtereinsätze oder Rahmen mit Glas - separat ordern</p> <p>oder</p> <p>LED RETROFIT G9</p>	QT14 ECO G9 · 230 V max. 48W	100x100	105	W	68-428101	123,00	☺
		100x100	105	AE	68-428145	110,00	☺

230V HV |  |  | EEL: A++ - E

FILTREINSÄTZE

INFO	FORM	FÜR MAX. W	LxB	FARBE	ART. NR.	EURO	LAGER
 <p>Filtereinsatz, Aluminium eloxiert oder weiß pulverbeschichtet, FORMEN: Dreieck, Schlitz oder Rahmen mit Glas. ACHTUNG: Filtereinsatz ist nur für die jeweils angegebene Wattage verwendbar.</p>	Rahmen m. Glas	20 (G9) / 50 (GU10)	100x100	W	68-020501	26,00	☺
	Rahmen m. Glas	20 (G9) / 50 (GU10)	100x100	AE	68-020545	18,50	☺



ALEA WL

INFO	LM	LxH	T	FARBE	ART. NR.	EURO	LAGER
 <p>Wandleuchte, Glas satiniert oder verchromt, 360° drehbar, Sockel aus lackiertem Metall, Version mit gespiegeltem Glas: Spiegeleffekt bei ausgeschalteter Leuchte, Transparenzeffekt bei eingeschalteter Leuchte</p> <p>oder</p> <p>LED RETROFIT G9</p>	QT14 ECO G9 · 230 V max. 48W	100x100	105	WO	68-428257	95,00	☺
		100x100	105	SP	68-428255	112,00	☺

230V HV |  |  | EEL: A++ - E



FUSO LED

INFO	LM	BxH	T	FARBE	ART. NR.	EURO	LAGER
 <p>Wandleuchte, mundgeblasenem Mattglas weiß, Metallteile verchromt, inkl. Konverter, Schutzgitter separat ordern</p>	SYS 13W · 230 V 1010lm · CR180 LED 3000K	170x300	90	W	68-454257ww	189,00	☺
	SYS 13W · 230 V 1010lm · CR180 LED 3000K	200x400	100	W	68-454357ww	224,00	☺

LED 230V |  |  |  | EEL: A++ - A

FUSO

INFO	LM	BxH	T	FARBE	ART. NR.	EURO	LAGER
 <p>Wandleuchte, mundgeblasenem Mattglas weiß, Metallteile verchromt, inkl. EVG, Schutzgitter separat ordern</p>	A60 ECO E27 · 230 V max. 77W	170x300	90	W	68-402157	114,00	☺
	A60 ECO E27 · 230 V max. 77W	200x400	100	W	68-402357	148,00	☺

230V HV |  |  | EEL: A++ - E

FUSO SCHUTZGITTER

INFO	ART. NR.	EURO	LAGER
Passend für Wandleuchte FUSO KLEIN	68-0009p	16,10	☺
Passend für Wandleuchte FUSO GROSS	68-0009g	18,60	



ARCA LED



Wandleuchte, Aluminium, lackiert, flexiblen Arm, inkl. Konverter

LM	HxLxB	FARBE	REF.	ART. NR.	EURO	LAGER
SYS 4,5 W 230V 190lm CRI>80 LED 3000K	530x60x40	6	25°	365-300803325ng2	119,00	☺

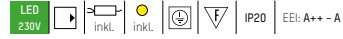

NEONA LED



LED Wandleuchte mit flexiblen Arm aus Aluminium, matt Feinstruktur pulverbeschichtet, stufenlos TOUCH dimm., Touchdimmer ist mit gelbem LED-Punkt visualisiert. inkl. LED Konverter

LM	ØxL	T	REF.	FARBE	ART. NR.	EURO	LAGER
SYS 3,7W · 230V 90lm · CRI>80 LED 3000K	90x440	28	70°	W	365-1006w	119,00	☺
	90x440	28	70°	S	365-1006b	119,00	☺

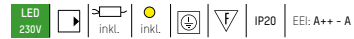

NIA LED



LED Wandleuchte mit flexiblen Arm aus Aluminium, matt Feinstruktur pulverbeschichtet, inkl. LED Konverter

LM	ØxL	T	REF.	FARBE	ART. NR.	EURO	LAGER
SYS 4,5W · 230V 129lm · CRI>80 LED 3000K	80x440	40	20°	W	365-1007w	139,00	☺
	80x440	40	20°	S	365-1007b	139,00	☺

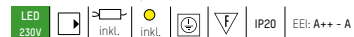



ZHOOM LONG SURFACE



LED 230V | | | | | | EEL: A++ - A

INFO	LM	L max.	FARBE	ART. NR.	EURO	LAGER
Flexible LED Leseleuchte Aluminium, Kopf & Wandmontage Alu natur oder weiß, Flexarm schwarz, Lichtkegel stufenlos am Kopf fokussierbar 10° - 60°, inkl. Ein/Aus Schalter	SYS 2W 230V · CRI>80 153lm	300		56-185033	241,00	
	LED 3000K	300		56-185030	241,00	

MOTUS LONG SURFACE



LED 230V | | | | | | EEL: A++ - A

INFO	LM	L max.	FARBE	ART. NR.	EURO	LAGER
Wandleuchte, Aluminium, chrom oder perchrom galvanisiert, runder Leuchtenkopf, hochwertige Glaslinse 60° klar, flexiblem Arm, Ein/Aus-Schalter an der Leuchte, inkl. Konverter, Kopf: DM=34mm, L=40mm, Baldachin: DM=63mm, H=44mm, Auf Anfrage auch mit 12° oder 30° Glaslinse erhältlich.	SYS 2W 230V · CRI>80 126lm	380		56-53311ng1	187,00	
	LED 3000K	380		56-53312ng1	187,00	

MOTUS SHORT SURFACE



LED 230V | | | | | | EEL: A++ - A

INFO	LM	L max.	FARBE	ART. NR.	EURO	LAGER
Wandleuchte, Aluminium, chrom oder perchrom galvanisiert, runder Leuchtenkopf, hochwertige Glaslinse 60° klar, mit Kugelgelenk, 120° dreh-/ 90° schwenkbar, Ein/Aus-Schalter an der Leuchte, inkl. Konverter, Kopf: DM=34mm, L=40mm, Baldachin: DM=63mm, H=44mm, Auf Anfrage auch mit 12° oder 30° Glaslinse erhältlich.	SYS 2W 230V · CRI>80 126lm	100		56-7300ng1	165,00	
	LED 3000K	100		56-7301ng1	165,00	

PARI LED

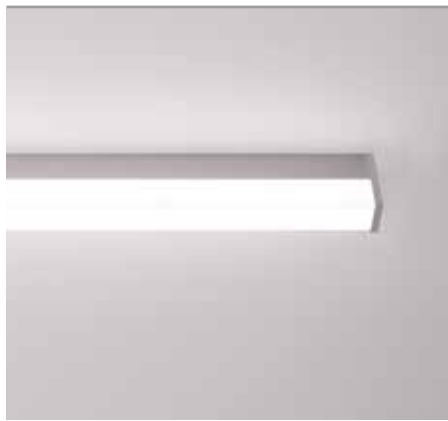

INFO	LM	LxBxT	FARBE	LUMEN	ART. NR.	EURO	LAGER
<p>Aufbauleuchte, stranggepresstes Aluminiumprofil eloxiert, pulverbeschichtet oder galvanisiert, Wand- / Deckenmontage, dreiseitig abstrahlende opale PMMA Abdeckung, Enddeckel in Profillarfarbe, geeignet für Feuchträume - IP43, energieeffiziente LEDs mit hoher Farbwiedergabe, inkl. Konverter, Dimmbare Versionen auf Anfrage</p>	SYS 15W 230V CRI>80 LED 3000K	600x43x81	C	1460	576-0191	295,00	☺
		600x43x81	W	1460	576-0195	233,00	☺
		600x43x81	AE	1460	576-0198	233,00	☺
	SYS 21W 230V CRI>80 LED 3000K	900x43x81	C	2190	576-0291	413,00	☺
		900x43x81	W	2190	576-0295	336,00	☺
		900x43x81	AE	2190	576-0298	336,00	☺
	SYS 28W 230V CRI>80 LED 3000K	1200x43x81	C	2920	576-0391	481,00	☺
		1200x43x81	W	2920	576-0395	378,00	☺
		1200x43x81	AE	2920	576-0398	378,00	☺

LED 230V EEI: A++ - A

MICA IP44



INFO	LM	LxBxT	FARBE	ART. NR.	EURO	LAGER
<p>Wandleuchte, Aluminium, pulverbeschichtet oder galvanisiert, zylindrische Abdeckung, satiniertes Polycarbonat Diffusor, geeignet für Nassräume - IP44, erhältlich in 2 Längen, inkl. Multiwatt EVG, Dimmbare Versionen auf Anfrage</p>	T16 · G5 · 230V · 14/24W · EVG	606x62x52,5	C	520-7141	177,00	☺
	T16 · G5 · 230V · 14/24W · EVG	606x62x52,5	SM	520-7144	151,00	☺
	T16 · G5 · 230V · 21/39W · EVG	904x62x52,5	C	520-7211	190,00	☺
	T16 · G5 · 230V · 21/39W · EVG	904x62x52,5	SM	520-7214	171,00	☺

230V HV EEI: A+ - B

MICA IP44 LED



INFO	LM	LxBxH	FARBE	LUMEN	ART. NR.	EURO	LAGER
<p>Wandleuchte, Aluminium, pulverbeschichtet oder galvanisiert, zylindrische Abdeckung, satiniertes Polycarbonat Diffusor, geeignet für Nassräume - IP44, erhältlich in 2 Längen, inkl. Konverter, Dimmbare Versionen auf Anfrage</p>	SYS 15W 230V CRI >80 · LED 3000K	606x62x52,5	C	1090	520-0191	264,00	☺
		606x62x52,5	SM	1090	520-0194	233,00	☺
	SYS 21W 230V CRI >80 · LED 3000K	904x62x52,5	C	1640	520-0291	389,00	
		904x62x52,5	SM	1640	520-0294	355,00	

LED 230V EEI: A++ - A

HALF



INFO	LM	BxH	T	FARBE	ART. NR.	EURO	LAGER
<p>Wandleuchte, Stahlblech, chrom galvanisiert, direkt/indirekt strahlend, 2x satiniertes Glasdiffusor, inkl. EVG, inkl. Leuchtmittel, R7s Version: inkl. OSRAM Leuchtmittel 120W</p>	QT-DE R7s (114mm) · 230V max. 150 W	240x40	80	C	105-492cr	117,00	☺

230V HV EEI: A++ - D

LORIENT



INFO	LM	BxH	T	FARBE	ART. NR.	EURO	LAGER
<p>Wandleuchte, Sockel aus Stahlblech, chrom galvanisiert, Pressglas weiß satiniert, inkl. Leuchtmittel</p>	2 x QT14 G9 · 230V max. 40W	360x80	140	C	105-05437321f9	112,00	☺

230V HV EEI: A++ - E



ETEA LED



INFO	LM	Ø	H	LED	LUMEN	FARBE	ART. NR.	EURO	LAGER
Aufbauleuchte, rund, Gehäuse und Ring aus Polycarbonat in weiß, Diffusor aus opalem Polycarbonat, Wand-/ Deckenmontage, IP43, inkl. Konverter	SYS 15W · 230V · CRI>80	285	103	3000K	938	W0	260-18211451011	59,00	☺
	SYS 15W · 230V · CRI>80	285	103	4000K	988	W0	260-18211452011	59,00	☺

LED 230V | inkl. | inkl. | IP43 | EEI: A++ - A

CALOT AC LED



INFO	LM	Ø	H	IP SCHUTZ	FARBE	LUMEN	LED	ART. NR.	EURO	LAGER
Aufbauleuchte, AC-LED, Gehäuse aus Thermoplastik, Abdeckung aus opalem Polycarbonat, Passivkühlung, Wand-/ Deckenmontage, mit Durchgangsverdrahtung möglich, nicht dimmbar, wahlweise in IP20 oder IP44 erhältlich	SYS 7,5W 230V 600lm CRI>80	253	80	20	W	600	4000K	200-134003000996	38,50	
		253	80	44	W	570	3000K	200-134003100996	38,50	

LED 230V | inkl. | IP44 | EEI: A++ - A

SPMP

TOP SELLER



INFO	LM	Ø	H	LED	LUMEN	FARBE	ART. NR.	EURO	LAGER
LED Aufbau-leuchte rund, Stahlblech weiß lackiert, mit mikroprismatischem Diffuser aus PMMA, inkl. LED Konverter	SYS 14W 230V CRI>80	190	41	3000K	1400	W	757-I2020	96,00	☺
		190	41	4000K	1400	W	757-I2021	96,00	☺
	SYS 28W 230V CRI>80	370	40	3000K	2900	W	757-I2018	176,00	☺
		370	40	4000K	2900	W	757-I2019	176,00	☺

LED 230V | inkl. | inkl. | IP20 | EEI: A++ - A

BRSB



INFO	LM	Ø	H	LED	LUMEN	FARBE	ART. NR.	EURO	LAGER
LED Aufbau-leuchte rund, Stahlblech weiß lackiert, mit opalem Diffuser aus PMMA, inkl. LED Konverter	SYS 15W 230V CRI>80	285	90	3000K	1200	W	757-I2004	60,00	☺
		285	90	4000K	1200	W	757-I2005	60,00	☺
	SYS 28W 230V CRI>80	375	110	3000K	2500	W	757-I2006	92,00	☺
		375	110	4000K	2500	W	757-I2007	92,00	☺
	SYS 37W 230V CRI>80	480	150	3000K	3500	W	757-I2008	120,00	☺
		480	150	4000K	3500	W	757-I2009	120,00	

LED 230V | inkl. | inkl. | IP44 | EEI: A++ - A



WHITE BELT LED



INFO	LM	ØxH	FARBE	LED	LUMEN	ART. NR.	EURO	LAGER
Wand-/Deckenleuchte, aus rotationsgeschleudertem rundgeformten PE-LLD (Polyethylen linear low density) Diffusor für homogenes schattenfreies Lichtbild, Trägerplatte weiß pulverbeschichtet, inkl. Konverter, dimmbare Versionen auf Anfrage	SYS 28W · 230V CRI>90	400x80	W	3000K	1720	565-001011029050	481,00	☺
		400x80	W	4000K	2020	565-001011024050	481,00	
	SYS 42W · 230V CRI>90	530x95	W	3000K	2580	565-001021029050	620,00	☺
		530x95	W	4000K	3030	565-001021024050	620,00	
	SYS 70W · 230V CRI>90	660x113	W	3000K	4300	565-001031029050	954,00	
		660x113	W	4000K	5060	565-001031024050	954,00	

LED 230V EEL: A++ - A

ROTULA LED



INFO	LM	ØxH	FARBE	LED	LUMEN	ART. NR.	EURO	LAGER
Wand-/Deckenleuchte, aus rotationsgeschleudertem rundgeformten PE-LLD (Polyethylen linear low density) Diffusor für homogenes schattenfreies Lichtbild, Trägerplatte weiß pulverbeschichtet, inkl. Konverter, dimmbare Versionen auf Anfrage	SYS 28W · 230V CRI>90	480x100	W	3000K	1730	575-001011029050	492,00	☺
		480x100	W	4000K	2030	575-001011024050	492,00	
	SYS 42W · 230V CRI>90	640x105	W	3000K	2590	575-001021029050	637,00	☺
		640x105	W	4000K	3050	575-001021024050	637,00	
	SYS 70W · 230V CRI>90	830x115	W	3000K	4330	575-001031029050	957,00	
		830x115	W	4000K	5080	575-001031024050	957,00	

LED 230V EEL: A++ - A

DENY R LED



INFO	LM	LxB	H	FARBE	ART. NR.	EURO	LAGER
Aufbauleuchte, Aluminiumdruckguss, matt Feinstruktur pulverbeschichtet, quadratisch, Diffusor aus opalem Acryl, Wand- oder Deckenmontage, inkl. Konverter 500mA - TRIAC dimmbar	SYS 15,2W · 230V 900lm · CRI>90 LED 3000K	250x250	60	W	472-260048wtr	219,00	☺



LED 230V EEL: A++ - A

DENY E LED



INFO	LM	LxB	H	FARBE	ART. NR.	EURO	LAGER
Aufbauleuchte direkt- / indirekt strahlend, Aluminium, matt Feinstruktur pulverbeschichtet, quadratisch, Diffusor aus opalem Acryl, Wand- oder Deckenmontage, inkl. Konverter 500mA - TRIAC dimmbar	SYS 15,2W · 230V 900lm · CRI>90 LED 3000K	250x250	65	W	472-260049wtr	229,00	☺



LED 230V EEL: A++ - A



LINA LED

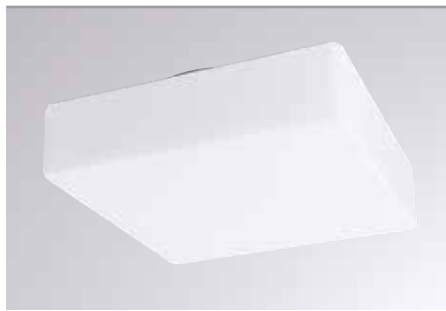

LED 230V

Wand- / Deckenleuchte, Trägerplatte Stahlblech, weiß lackiert, Abdeckung mundgeblasenes Dreischichtglas Triplex-Opal mit mattierter Oberfläche, Halterungen klappbar, inkl. Konverter

LM	LxB	H	Ø SOCKEL	LED	FARBE	LUMEN	ART. NR.	EURO	LAGER
SYS 8W · 230V · CRI>80	200x200	105	172	3000K	WO	970	789-51381	86,00	
SYS 8W · 230V · CRI>80	200x200	105	172	4000K	WO	1010	789-51881	86,00	
SYS 8W · 230V · CRI>80	260x260	110	225	3000K	WO	970	789-51382	101,00	
SYS 8W · 230V · CRI>80	260x260	110	225	4000K	WO	1010	789-51882	101,00	
SYS 11W · 230V · CRI>80	320x320	115	275	3000K	WO	1290	789-51386	133,00	
SYS 11W · 230V · CRI>80	320x320	115	275	4000K	WO	1350	789-51886	133,00	
SYS 30W · 230V · CRI>80	320x320	115	275	3000K	WO	2630	789-49080	203,00	
SYS 30W · 230V · CRI>80	320x320	115	275	4000K	WO	2810	789-49580	203,00	
SYS 15W · 230V · CRI>80	380x380	120	320	3000K	WO	1940	789-51395	195,00	
SYS 15W · 230V · CRI>80	380x380	120	320	4000K	WO	2030	789-51895	195,00	
SYS 37W · 230V · CRI>80	380x380	120	320	3000K	WO	3280	789-49090	252,00	
SYS 37W · 230V · CRI>80	380x380	120	320	4000K	WO	3510	789-49590	252,00	
SYS 29W · 230V · CRI>80	440x440	120	372	3000K	WO	3880	789-51403	320,00	
SYS 29W · 230V · CRI>80	440x440	120	372	4000K	WO	4050	789-51903	320,00	
SYS 36W · 230V · CRI>80	440x440	120	372	3000K	WO	4850	789-51404	339,00	
SYS 29W · 230V · CRI>80	440x440	120	372	4000K	WO	5070	789-51904	339,00	

LINA



230V HV

INFO	LM	LxB	H	Ø SOCKEL	FARBE	ART. NR.	EURO	LAGER
Wand- / Deckenleuchte, Trägerplatte Polycarbonat weiß, mundgeblasenes Dreischichtglas TRIPLEX opal matt, Klapphalterung	A60 ECO · E27 · 230V · max. 42W	200x200	105	172	WO	789-41257	36,00	☺
	A60 ECO · E27 · 230V · max. 70W	260x260	110	225	WO	789-41282	51,00	☺
	2 x A60 ECO · E27 · 230V · max. 42W	260x260	110	225	WO	789-41270	63,00	
	2 x A60 ECO · E27 · 230V · max. 77W	320x320	115	275	WO	789-41307	84,00	
	2 x A60 ECO · E27 · 230V · max. 52W	380x380	120	320	WO	789-42310	109,00	☺
	3 x A60 ECO · E27 · 230V · max. 57W	440x440	120	372	WO	789-43070	196,00	

TILIA LED



LED 230V

Wand- / Deckenleuchte, Trägerplatte Stahlblech, weiß lackiert, opale Polycarbonatabdeckung, Halterungen klappbar, inkl. Konverter

LM	LxB	H	Ø SOCKEL	LED	FARBE	LUMEN	ART. NR.	EURO	LAGER
SYS 20W · 230V · CRI>80	300x300	70	270x270	3000K	WO	2590	789-53405	153,00	
SYS 20W · 230V · CRI>80 · BWM	300x300	70	270x270	3000K	WO	2590	789-53410	186,00	
SYS 20W · 230V · CRI>80	300x300	70	270x270	4000K	WO	2700	789-53905	153,00	
SYS 25W · 230V · CRI>80	300x300	70	270x270	3000K	WO	3230	789-53406	184,00	
SYS 25W · 230V · CRI>80	300x300	70	270x270	4000K	WO	3380	789-53906	184,00	
SYS 25W · 230V · CRI>80	400x400	70	375x375	3000K	WO	3230	789-53422	204,00	
SYS 25W · 230V · CRI>80 · BWM	400x400	70	375x375	3000K	WO	3230	789-53428	226,00	
SYS 25W · 230V · CRI>80	400x400	70	375x375	4000K	WO	3380	789-53922	204,00	
SYS 36W · 230V · CRI>80	400x400	70	375x375	3000K	WO	4850	789-53423	240,00	
SYS 36W · 230V · CRI>80	400x400	70	375x375	4000K	WO	5070	789-53923	240,00	

BWM: mit Bewegungsmelder 1-5m

TILIA



230V HV

INFO	LM	LxB	H	LxB SOCKEL	FARBE	ART. NR.	EURO	LAGER
Wand- / Deckenleuchte, Trägerplatte Stahlblech, weiß lackiert, opale Polycarbonatabdeckung, Halterungen klappbar, BWM: mit Bewegungsmelder 1 - 5m	2 x A60 ECO · E27 · 230V · max. 42W	300x300	70	270x270	WO	789-56155	61,00	☺
	2 x A60 ECO · E27 · 230V · max. 42W · BWM	300x300	70	270x270	WO	789-56159	97,00	
	3 x A60 ECO · E27 · 230V · max. 42W	400x400	70	375x375	WO	789-56171	99,00	☺



AURA LED



LED 230V

Wand- / Deckenleuchte, Trägerplatte Stahlblech, weiß lackiert, mundgeblasenes Dreischichtglas TRIPLEX opal matt, Halterung mittels Bajonettverschluss, inkl. Konverter

LM	Ø	H	Ø SOCKEL	LED	FARBE	LUMEN	ART. NR.	EURO	LAGER
SYS 8W · 230V · CRI>80	200	105	150	3000K	WO	970	789-51262	70,00	
SYS 8W · 230V · CRI>80	200	105	150	4000K	WO	1010	789-51762	70,00	
SYS 8W · 230V · CRI>80	250	110	205	3000K	WO	970	789-51263	75,00	
SYS 8W · 230V · CRI>80	250	110	205	4000K	WO	1010	789-51763	75,00	
SYS 11W · 230V · CRI>80	250	110	205	3000K	WO	1290	789-51264	84,00	
SYS 11W · 230V · CRI>80	250	110	205	4000K	WO	1350	789-51764	84,00	
SYS 11W · 230V · CRI>80	300	115	250	3000K	WO	1290	789-51265	91,00	
SYS 11W · 230V · CRI>80	300	115	250	4000K	WO	1350	789-51765	91,00	
SYS 15W · 230V · CRI>80	300	115	250	3000K	WO	1940	789-51266	116,00	
SYS 15W · 230V · CRI>80	300	115	250	4000K	WO	2030	789-51766	116,00	
SYS 15W · 230V · CRI>80	360	125	290	3000K	WO	1940	789-51274	136,00	
SYS 15W · 230V · CRI>80	360	125	290	4000K	WO	2030	789-51774	136,00	
SYS 20W · 230V · CRI>80	360	125	290	3000K	WO	2590	789-51275	141,00	
SYS 20W · 230V · CRI>80	360	125	290	4000K	WO	2700	789-51775	141,00	
SYS 20W · 230V · CRI>80	420	125	345	3000K	WO	2590	789-51286	181,00	
SYS 20W · 230V · CRI>80	420	125	345	4000K	WO	2700	789-51786	181,00	
SYS 29W · 230V · CRI>80	420	125	345	3000K	WO	3880	789-51287	199,00	
SYS 29W · 230V · CRI>80	420	125	345	4000K	WO	4050	789-51787	199,00	

AURA



230V HV

INFO	LM	Ø	H	Ø SOCKEL	FARBE	ART. NR.	EURO	LAGER
Wand- / Deckenleuchte, Trägerplatte Stahlblech, weiß lackiert, mundgeblasenes Dreischichtglas TRIPLEX opal matt, Halterung mittels Bajonettverschluss	A60 ECO · E27 · 230V · max. 42W	200	105	170	WO	789-42702	26,00	☺
	A60 ECO · E27 · 230V · max. 52W	250	110	205	WO	789-42703	30,00	☺
	2 x A60 ECO · E27 · 230V · max. 42W	300	115	250	WO	789-42709	39,00	☺
	2 x A60 ECO · E27 · 230V · max. 52W	360	125	290	WO	789-42742	54,00	☺
	2 x A60 ECO · E27 · 230V · max. 52W	420	125	345	WO	789-42775	84,00	☺

ELSA LED



LED 230V

Wand- / Deckenleuchte, Trägerplatte Stahlblech, weiß lackiert, Abdeckung mundgeblasenes Dreischichtglas Triplex-Opal mit mattierter Oberfläche, mit Bajonett-Verschluss, inkl. Konverter

LM	Ø	H	Ø SOCKEL	LED	FARBE	LUMEN	ART. NR.	EURO	LAGER
SYS 8W · 230V · CRI>80	250	84	205	3000K	WO	970	789-51295	84,00	
SYS 8W · 230V · CRI>80	250	84	205	4000K	WO	1010	789-51795	84,00	
SYS 11W · 230V · CRI>80	250	84	205	3000K	WO	1290	789-51296	91,00	
SYS 11W · 230V · CRI>80	250	84	205	4000K	WO	1350	789-51796	91,00	
SYS 11W · 230V · CRI>80	300	86	250	3000K	WO	1290	789-51300	99,00	
SYS 11W · 230V · CRI>80	300	86	250	4000K	WO	1350	789-51800	99,00	
SYS 15W · 230V · CRI>80	300	86	250	3000K	WO	1940	789-51301	130,00	
SYS 15W · 230V · CRI>80	300	86	250	4000K	WO	2030	789-51801	130,00	
SYS 20W · 230V · CRI>80	420	90	345	3000K	WO	2590	789-51320	211,00	
SYS 20W · 230V · CRI>80	420	90	345	4000K	WO	2700	789-51820	211,00	
SYS 29W · 230V · CRI>80	420	90	345	3000K	WO	3880	789-51321	238,00	
SYS 29W · 230V · CRI>80	420	90	345	4000K	WO	4050	789-51821	238,00	
SYS 36W · 230V · CRI>80	590	94	465	3000K	WO	4850	789-51339	502,00	
SYS 36W · 230V · CRI>80	590	94	465	4000K	WO	5070	789-51839	502,00	
SYS 58W · 230V · CRI>80	590	94	465	3000K	WO	7760	789-51340	613,00	
SYS 58W · 230V · CRI>80	590	94	465	4000K	WO	8100	789-51840	613,00	

ELSA



230V HV

INFO	LM	Ø	H	Ø SOCKEL	FARBE	ART. NR.	EURO	LAGER
Wand- / Deckenleuchte, Trägerplatte Stahlblech, weiß lackiert, Abdeckung mundgeblasenes Dreischichtglas Triplex-Opal mit mattierter Oberfläche, Bajonett-verschluss	A60 ECO · E27 · 230V · max. 42W	250	84	205	WO	789-44705	39,00	
	2 x A60 ECO · E27 · 230V · max. 42W	300	86	250	WO	789-44741	50,00	
	2 x A60 ECO · E27 · 230V · max. 57W	420	90	345	WO	789-44900	119,00	
	3 x A60 ECO · E27 · 230V · max. 57W	590	94	465	WO	789-54987	372,00	



DELIA LED



LED 230V | inkl. | inkl. | IP54 | EEI: A++ - A

Wand- / Deckenleuchte, Trägerplatte Stahlblech, weiß lackiert, opale Polycarbonat-Abdeckung oder PMMA-Abdeckung, Halterung klappbar, inkl. Konverter

BWM: mit Bewegungsmelder 1-5m

LM	Ø	H	Ø SOCKEL	LED	FARBE	LUMEN	ART. NR.	EURO	LAGER
SYS 15W · 230V · CRI>80	300	75	275	3000K	WO	1940	789-53315	122,00	
SYS 15W · 230V · CRI>80 · BWM	300	75	275	3000K	WO	1940	789-53319	164,00	
SYS 15W · 230V · CRI>80	300	75	275	4000K	WO	2030	789-53815	122,00	
SYS 20W · 230V · CRI>80	300	75	275	3000K	WO	2590	789-53316	140,00	
SYS 20W · 230V · CRI>80	300	75	275	4000K	WO	2700	789-53816	140,00	
SYS 20W · 230V · CRI>80	400	80	375	3000K	WO	2590	789-53335	169,00	
SYS 20W · 230V · CRI>80	400	80	375	4000K	WO	2700	789-53835	169,00	
SYS 29W · 230V · CRI>80	400	80	375	3000K	WO	3880	789-53336	194,00	
SYS 29W · 230V · CRI>80 · BWM	400	80	375	3000K	WO	3880	789-53342	229,00	
SYS 36W · 230V · CRI>80	400	80	375	3000K	WO	4850	789-53337	212,00	
SYS 36W · 230V · CRI>80	400	80	375	4000K	WO	5070	789-53837	212,00	
SYS 29W · 230V · CRI>80	500	85	465	3000K	WO	3880	789-53359	223,00	
SYS 29W · 230V · CRI>80	500	85	465	4000K	WO	4050	789-53859	223,00	
SYS 36W · 230V · CRI>80	500	85	465	3000K	WO	4850	789-53360	223,00	
SYS 36W · 230V · CRI>80 · BWM	500	85	465	3000K	WO	4850	789-53368	256,00	
SYS 58W · 230V · CRI>80	500	85	465	3000K	WO	7760	789-53361	348,00	
SYS 58W · 230V · CRI>80	500	85	465	4000K	WO	8100	789-53861	348,00	
SYS 58W · 230V · CRI>80	650	76	625	3000K	WO	7710	789-53385	445,00	
SYS 58W · 230V · CRI>80	650	76	625	4000K	WO	8100	789-53885	445,00	
SYS 109W · 230V · CRI>80	650	76	625	3000K	WO	14790	789-48228	664,00	
SYS 109W · 230V · CRI>80	650	76	625	4000K	WO	15450	789-48728	664,00	
SYS 76W · 230V · CRI>80	900	81	875	3000K	WO	10280	789-53390	711,00	
SYS 76W · 230V · CRI>80	900	81	875	4000K	WO	10740	789-53890	711,00	
SYS 165W · 230V · CRI>80	900	81	875	3000K	WO	22180	789-48232	1173,00	
SYS 165W · 230V · CRI>80	900	81	875	4000K	WO	23170	789-48732	1173,00	

TITAN LED



LED 230V | inkl. | inkl. | IP54 | EEI: A++ - A

Wand- / Deckenleuchte, Trägerplatte Stahlblech, weiß lackiert, opale Polycarbonatabdeckung oder PMMA-Abdeckung, Halterung mittels Bajonettverschluss, Halterung klappbar, inkl. Konverter

LM	Ø	H	Ø SOCKEL	LED	FARBE	LUMEN	ART. NR.	EURO	LAGER
SYS 15W · 230V · CRI>80	300	110	274	3000K	WO	1940	789-53234	128,00	
SYS 15W · 230V · CRI>80	300	110	274	4000K	WO	2030	789-53734	128,00	
SYS 20W · 230V · CRI>80	300	110	274	3000K	WO	2590	789-53235	139,00	
SYS 20W · 230V · CRI>80	300	110	274	4000K	WO	2700	789-53735	139,00	
SYS 20W · 230V · CRI>80	400	110	375	3000K	WO	2590	789-53254	165,00	
SYS 20W · 230V · CRI>80	400	110	375	4000K	WO	2700	789-53754	165,00	
SYS 36W · 230V · CRI>80	400	110	375	3000K	WO	4850	789-53256	211,00	
SYS 36W · 230V · CRI>80	400	110	375	4000K	WO	5070	789-53756	211,00	
SYS 29W · 230V · CRI>80	500	135	466	3000K	WO	3880	789-53277	217,00	
SYS 29W · 230V · CRI>80	500	135	466	4000K	WO	4050	789-53777	217,00	
SYS 58W · 230V · CRI>80	500	135	466	3000K	WO	7760	789-53279	347,00	
SYS 58W · 230V · CRI>80	500	135	466	4000K	WO	8100	789-53779	347,00	
SYS 58W · 230V · CRI>80	650	150	625	3000K	WO	7710	789-53305	466,00	
SYS 58W · 230V · CRI>80	650	150	625	4000K	WO	8100	789-53805	466,00	
SYS 109W · 230V · CRI>80	650	150	625	3000K	WO	14790	789-48220	692,00	
SYS 109W · 230V · CRI>80	650	150	625	4000K	WO	15450	789-48720	692,00	
SYS 76W · 230V · CRI>80	900	200	875	3000K	WO	10280	789-53310	735,00	
SYS 76W · 230V · CRI>80	900	200	875	4000K	WO	10740	789-53810	735,00	
SYS 165W · 230V · CRI>80	900	200	875	3000K	WO	22180	789-48224	1215,00	
SYS 165W · 230V · CRI>80	900	200	875	4000K	WO	23170	789-48724	1215,00	



DELIA



INFO	LM	Ø	H	Ø SOCKEL	FARBE	ART. NR.	EURO	LAGER
Wand- / Deckenleuchte, Trägerplatte Stahlblech, weiß lackiert, opale Polycarbonatabdeckung, Halterungen klappbar, inkl. EVG, BWM: mit Bewegungs- melder 1-5m	A60 ECO · E27 · 230V · max. 28W	300	75	275	WO	789-56075	42,00	☺
	A60 ECO · E27 · 230V · max. 28W · BWM	300	75	275	WO	789-56079	74,00	
	2 x A60 ECO · E27 · 230V · max. 28W	400	80	375	WO	789-56110	66,00	☺
	2 x A60 ECO · E27 · 230V · max. 28W · BWM	400	80	375	WO	789-56116	98,00	
	3 x A60 ECO · E27 · 230V · max. 28W	500	85	465	WO	789-56130	90,00	☺
	3 x A60 ECO · E27 · 230V · max. 28W · BWM	500	85	465	WO	789-56137	122,00	

230V HV    IP44 | EEL: A++ - E

BADO SD LED OPALDIFFUSER

	LM	Ø	H	AUSFÜHRUNG	FARBE	LUMEN 3000K	LUMEN 4000K	ART. NR.	EURO	LAGER
	SYS 16W · 230V · CRI>80	300	75	OPALDIFFUSER	W	1638	1761	445-01301X15	301,00	☺
	SYS 16W · 230V · CRI>80	300	75	OPALDIFFUSER	S	1638	1761	445-01301X16	301,00	
	SYS 16W · 230V · CRI>80	300	75	OPALDIFFUSER	SM	1638	1761	445-01301X18	301,00	☺
	SYS 29W · 230V · CRI>80	400	75	OPALDIFFUSER	W	3263	3509	445-01401X15	424,00	☺
	SYS 29W · 230V · CRI>80	400	75	OPALDIFFUSER	S	3263	3509	445-01401X16	424,00	
	SYS 29W · 230V · CRI>80	400	75	OPALDIFFUSER	SM	3263	3509	445-01401X18	424,00	☺
	SYS 37W · 230V · CRI>80	500	75	OPALDIFFUSER	W	4388	4718	445-01501X15	506,00	☺
	SYS 37W · 230V · CRI>80	500	75	OPALDIFFUSER	S	4388	4718	445-01501X16	506,00	
	SYS 37W · 230V · CRI>80	500	75	OPALDIFFUSER	SM	4388	4718	445-01501X18	506,00	☺
	SYS 44W · 230V · CRI>80	600	75	OPALDIFFUSER	W	5366	5770	445-01601X15	682,00	
	SYS 44W · 230V · CRI>80	600	75	OPALDIFFUSER	S	5366	5770	445-01601X16	682,00	
	SYS 44W · 230V · CRI>80	600	75	OPALDIFFUSER	SM	5366	5770	445-01601X18	682,00	
	SYS 79W · 230V · CRI>80	900	75	OPALDIFFUSER	W	7485	8020	445-01901X15	1.311,00	
	SYS 79W · 230V · CRI>80	900	75	OPALDIFFUSER	S	7485	8020	445-01901X16	1.311,00	
	SYS 79W · 230V · CRI>80	900	75	OPALDIFFUSER	SM	7485	8020	445-01901X18	1.311,00	
	SYS 158W · 230V · CRI>80	1200	75	OPALDIFFUSER	W	14954	16080	445-011201X15	2.210,00	
	SYS 158W · 230V · CRI>80	1200	75	OPALDIFFUSER	S	14954	16080	445-011201X16	2.210,00	
	SYS 158W · 230V · CRI>80	1200	75	OPALDIFFUSER	SM	14954	16080	445-011201X18	2.210,00	

LED 230V  inkl.  inkl.   IP20 | EE: A++ - A

INFO
Wand- / Deckenleuchte, Aluminium, pulverbeschichtet, rund, direkt strahlend, Opaldiffuser, Energieeffiziente LEDs mit hoher Farbwiedergabe, inkl. Konverter, Dimmbare & CRI>90 Versionen auf Anfrage, LED 3000K oder 4000K

BESTELLINFO:

Ersetzen sie das rote X mit Ihrer gewünschten Lichtfarbe
9 = 3000K / 4 = 4000K

☺ = Lagerware nur in 3000K

BADO SD LED MICROPRISMA

	LM	Ø	H	AUSFÜHRUNG	FARBE	LUMEN 3000K	LUMEN 4000K	ART. NR.	EURO	LAGER
	SYS 16W · 230V · CRI>80	300	75	MIKROPRISMA	W	1563	1681	445-01301X25	342,00	
	SYS 16W · 230V · CRI>80	300	75	MIKROPRISMA	S	1563	1681	445-01301X26	342,00	
	SYS 16W · 230V · CRI>80	300	75	MIKROPRISMA	SM	1563	1681	445-01301X28	342,00	
	SYS 29W · 230V · CRI>80	400	75	MIKROPRISMA	W	3113	3347	445-01401X25	485,00	
	SYS 29W · 230V · CRI>80	400	75	MIKROPRISMA	S	3113	3347	445-01401X26	485,00	
	SYS 29W · 230V · CRI>80	400	75	MIKROPRISMA	SM	3113	3347	445-01401X28	485,00	
	SYS 37W · 230V · CRI>80	500	75	MIKROPRISMA	W	4185	4500	445-01501X25	589,00	
	SYS 37W · 230V · CRI>80	500	75	MIKROPRISMA	S	4185	4500	445-01501X26	589,00	
	SYS 37W · 230V · CRI>80	500	75	MIKROPRISMA	SM	4185	4500	445-01501X28	589,00	
	SYS 44W · 230V · CRI>80	600	75	MIKROPRISMA	W	5106	5490	445-01601X25	775,00	
	SYS 44W · 230V · CRI>80	600	75	MIKROPRISMA	S	5106	5490	445-01601X26	775,00	
	SYS 44W · 230V · CRI>80	600	75	MIKROPRISMA	SM	5106	5490	445-01601X28	775,00	
	SYS 79W · 230V · CRI>80	900	75	MIKROPRISMA	W	6750	7258	445-01901X25	1.417,00	
	SYS 79W · 230V · CRI>80	900	75	MIKROPRISMA	S	6750	7258	445-01901X26	1.417,00	
	SYS 79W · 230V · CRI>80	900	75	MIKROPRISMA	SM	6750	7258	445-01901X28	1.417,00	
	SYS 158W · 230V · CRI>80	1200	75	MIKROPRISMA	W	13533	14552	445-011201X25	2.320,00	
	SYS 158W · 230V · CRI>80	1200	75	MIKROPRISMA	S	13533	14552	445-011201X26	2.320,00	
	SYS 158W · 230V · CRI>80	1200	75	MIKROPRISMA	SM	13533	14552	445-011201X28	2.320,00	

LED 230V  inkl.  inkl.   IP20 | EE: A++ - A

INFO
Wand- / Deckenleuchte, Aluminium, pulverbeschichtet, rund, direkt strahlend, Mikroprismatischer Diffuser, Energieeffiziente LEDs mit hoher Farbwiedergabe, inkl. Konverter, Dimmbare & CRI>90 Versionen auf Anfrage, LED 3000K oder 4000K

BESTELLINFO:

Ersetzen sie das rote X mit Ihrer gewünschten Lichtfarbe
9 = 3000K / 4 = 4000K



BADO SDI LED OPALDIFFUSER

	LM	Ø	H	AUSFÜHRUNG	FARBE	LUMEN 3000K	LUMEN 4000K	ART. NR.	EURO	LAGER
	SYS 22W · 230V · CRI>80	300	80	OPALDIFFUSER	W	2516	2705	445-03301X15	419,00	☺
	SYS 22W · 230V · CRI>80	300	80	OPALDIFFUSER	S	2516	2705	445-03301X16	419,00	
	SYS 22W · 230V · CRI>80	300	80	OPALDIFFUSER	SM	2516	2705	445-03301X18	419,00	☺
	SYS 42W · 230V · CRI>80	400	80	OPALDIFFUSER	W	5019	5397	445-03401X15	516,00	☺
	SYS 42W · 230V · CRI>80	400	80	OPALDIFFUSER	S	5019	5397	445-03401X16	516,00	
	SYS 42W · 230V · CRI>80	400	80	OPALDIFFUSER	SM	5019	5397	445-03401X18	516,00	☺
	SYS 57W · 230V · CRI>80	500	80	OPALDIFFUSER	W	6744	7252	445-03501X15	678,00	☺
	SYS 57W · 230V · CRI>80	500	80	OPALDIFFUSER	S	6744	7252	445-03501X16	678,00	
	SYS 57W · 230V · CRI>80	500	80	OPALDIFFUSER	SM	6744	7252	445-03501X18	678,00	
	SYS 65W · 230V · CRI>80	600	80	OPALDIFFUSER	W	7752	8335	445-03601X15	806,00	☺
	SYS 65W · 230V · CRI>80	600	80	OPALDIFFUSER	S	7752	8335	445-03601X16	806,00	
	SYS 65W · 230V · CRI>80	600	80	OPALDIFFUSER	SM	7752	8335	445-03601X18	806,00	
	SYS 139W · 230V · CRI>80	900	100	OPALDIFFUSER	W	13066	14050	445-03901X15	1.496,00	
	SYS 139W · 230V · CRI>80	900	100	OPALDIFFUSER	S	13066	14050	445-03901X16	1.496,00	
	SYS 139W · 230V · CRI>80	900	100	OPALDIFFUSER	SM	13066	14050	445-03901X18	1.496,00	
	SYS 220W · 230V · CRI>80	1200	100	OPALDIFFUSER	W	20832	22400	445-031201X15	2.453,00	
	SYS 220W · 230V · CRI>80	1200	100	OPALDIFFUSER	S	20832	22400	445-031201X16	2.453,00	
	SYS 220W · 230V · CRI>80	1200	100	OPALDIFFUSER	SM	20832	22400	445-031201X18	2.453,00	

LED 230V IP20 | EEL: A++ - A

INFO

Wand- / Deckenleuchte, Aluminium, pulverbeschichtet, rund, direkt- / indirekt strahlend, Opaldiffuser, Energieeffiziente LEDs mit hoher Farbwiedergabe, inkl. Konverter, Dimmbare & CRI>90 Versionen auf Anfrage, LED 3000K oder 4000K

BESTELINFO:

Ersetzen sie das rote X mit Ihrer gewünschten Lichtfarbe
9 = 3000K / 4 = 4000K

☺ = Lagerware nur in 3000K

BADO SDI LED MICROPRISMA

	LM	Ø	H	AUSFÜHRUNG	FARBE	LUMEN 3000K	LUMEN 4000K	ART. NR.	EURO	LAGER
	SYS 22W · 230V · CRI>80	300	80	MIKROPRISMA	W	2438	2622	445-03301X25	461,00	
	SYS 22W · 230V · CRI>80	300	80	MIKROPRISMA	S	2438	2622	445-03301X26	461,00	
	SYS 22W · 230V · CRI>80	300	80	MIKROPRISMA	SM	2438	2622	445-03301X28	461,00	
	SYS 42W · 230V · CRI>80	400	80	MIKROPRISMA	W	4868	5234	445-03401X25	579,00	
	SYS 42W · 230V · CRI>80	400	80	MIKROPRISMA	S	4868	5234	445-03401X26	579,00	
	SYS 42W · 230V · CRI>80	400	80	MIKROPRISMA	SM	4868	5234	445-03401X28	579,00	
	SYS 57W · 230V · CRI>80	500	80	MIKROPRISMA	W	6542	7034	445-03501X25	761,00	
	SYS 57W · 230V · CRI>80	500	80	MIKROPRISMA	S	6542	7034	445-03501X26	761,00	
	SYS 57W · 230V · CRI>80	500	80	MIKROPRISMA	SM	6542	7034	445-03501X28	761,00	
	SYS 65W · 230V · CRI>80	600	80	MIKROPRISMA	W	7242	7787	445-03601X25	899,00	
	SYS 65W · 230V · CRI>80	600	80	MIKROPRISMA	S	7242	7787	445-03601X26	899,00	
	SYS 65W · 230V · CRI>80	600	80	MIKROPRISMA	SM	7242	7787	445-03601X28	899,00	
	SYS 139W · 230V · CRI>80	900	100	MIKROPRISMA	W	12358	13288	445-03901X25	1.599,00	
	SYS 139W · 230V · CRI>80	900	100	MIKROPRISMA	S	12358	13288	445-03901X26	1.599,00	
	SYS 139W · 230V · CRI>80	900	100	MIKROPRISMA	SM	12358	13288	445-03901X28	1.599,00	
	SYS 220W · 230V · CRI>80	1200	100	MIKROPRISMA	W	19410	20872	445-031201X25	2.577,00	
	SYS 220W · 230V · CRI>80	1200	100	MIKROPRISMA	S	19410	20872	445-031201X26	2.577,00	
	SYS 220W · 230V · CRI>80	1200	100	MIKROPRISMA	SM	19410	20872	445-031201X28	2.577,00	

LED 230V IP20 | EEL: A++ - A

INFO

Wand- / Deckenleuchte, Aluminium, pulverbeschichtet, rund, direkt- / indirekt strahlend, Mikroprismatischer Diffuser, Energieeffiziente LEDs mit hoher Farbwiedergabe, inkl. Konverter, Dimmbare & CRI>90 Versionen auf Anfrage, LED 3000K oder 4000K

BESTELINFO:

Ersetzen sie das rote X mit Ihrer gewünschten Lichtfarbe
9 = 3000K / 4 = 4000K



CADAN SD LED OPALDIFFUSER

	LM	LxB	H	AUSFÜHRUNG	FARBE	LUMEN 3000K	LUMEN 4000K	ART. NR.	EURO	LAGER
	SYS 13W · 230V · CRI>80	330x330	75	OPALDIFFUSER	W	1377	1482	445-07331X15	301,00	
	SYS 13W · 230V · CRI>80	330x330	75	OPALDIFFUSER	S	1267	1330	445-07331X16	301,00	☺
	SYS 13W · 230V · CRI>80	330x330	75	OPALDIFFUSER	SM	1300	1400	445-07331X18	301,00	
	SYS 21W · 230V · CRI>80	430x430	75	OPALDIFFUSER	W	2485	2673	445-07431X15	352,00	
	SYS 21W · 230V · CRI>80	430x430	75	OPALDIFFUSER	S	2232	2400	445-07431X16	352,00	
	SYS 21W · 230V · CRI>80	430x430	75	OPALDIFFUSER	SM	2362	2540	445-07431X18	352,00	☺
	SYS 36W · 230V · CRI>80	530x530	75	OPALDIFFUSER	W	4419	4752	445-07531X15	466,00	
	SYS 36W · 230V · CRI>80	530x530	75	OPALDIFFUSER	S	3980	4280	445-07531X16	466,00	
	SYS 36W · 230V · CRI>80	530x530	75	OPALDIFFUSER	SM	4194	4510	445-07531X18	466,00	
	SYS 45W · 230V · CRI>80	630x630	75	OPALDIFFUSER	W	5513	5928	445-07631X15	537,00	
	SYS 45W · 230V · CRI>80	630x630	75	OPALDIFFUSER	S	4957	5330	445-07631X16	537,00	
	SYS 45W · 230V · CRI>80	630x630	75	OPALDIFFUSER	SM	5236	5630	445-07631X18	537,00	
	SYS 116W · 230V · CRI>80	900x900	75	OPALDIFFUSER	W	10304	11080	445-07901X15	1.200,00	
	SYS 116W · 230V · CRI>80	900x900	75	OPALDIFFUSER	S	9272	9970	445-07901X16	1.200,00	
	SYS 116W · 230V · CRI>80	900x900	75	OPALDIFFUSER	SM	9784	10520	445-07901X18	1.200,00	
	SYS 202W · 230V · CRI>80	1200x1200	75	OPALDIFFUSER	W	17893	19240	445-071201X15	1.844,00	
	SYS 202W · 230V · CRI>80	1200x1200	75	OPALDIFFUSER	S	16108	17320	445-071201X16	1.844,00	
	SYS 202W · 230V · CRI>80	1200x1200	75	OPALDIFFUSER	SM	17000	18280	445-071201X18	1.844,00	

INFO

Wand- / Deckenleuchte, Aluminium, pulverbeschichtet, quadratisch, direkt strahlend, Opaldiffuser, Energieeffiziente LEDs mit hoher Farbwiedergabe, inkl. Konverter, Dimmbare & CRI>90 Versionen auf Anfrage, LED 3000K oder 4000K

BESTELLINFO:

Ersetzen sie das rote X mit Ihrer gewünschten Lichtfarbe
 9 = 3000K / 4 = 4000K

☺ = Lagerware nur in 3000K

CADAN SD LED MICROPRISMA

	LM	LxB	H	AUSFÜHRUNG	FARBE	LUMEN 3000K	LUMEN 4000K	ART. NR.	EURO	LAGER
	SYS 13W · 230V · CRI>80	330x330	75	MIKROPRISMA	W	1158	1245	445-07331X25	353,00	
	SYS 13W · 230V · CRI>80	330x330	75	MIKROPRISMA	S	1038	1117	445-07331X26	353,00	
	SYS 13W · 230V · CRI>80	330x330	75	MIKROPRISMA	SM	1094	1176	445-07331X28	353,00	
	SYS 21W · 230V · CRI>80	430x430	75	MIKROPRISMA	W	2088	2245	445-07431X25	409,00	
	SYS 21W · 230V · CRI>80	430x430	75	MIKROPRISMA	S	1875	2016	445-07431X26	409,00	
	SYS 21W · 230V · CRI>80	430x430	75	MIKROPRISMA	SM	1986	2136	445-07431X28	409,00	
	SYS 36W · 230V · CRI>80	530x530	75	MIKROPRISMA	W	3710	3990	445-07531X25	500,00	
	SYS 36W · 230V · CRI>80	530x530	75	MIKROPRISMA	S	3343	3595	445-07531X26	500,00	
	SYS 36W · 230V · CRI>80	530x530	75	MIKROPRISMA	SM	3522	3788	445-07531X28	500,00	
	SYS 45W · 230V · CRI>80	630x630	75	MIKROPRISMA	W	4631	4980	445-07631X25	568,00	
	SYS 45W · 230V · CRI>80	630x630	75	MIKROPRISMA	S	4164	4477	445-07631X26	568,00	
	SYS 45W · 230V · CRI>80	630x630	75	MIKROPRISMA	SM	4398	4729	445-07631X28	568,00	
	SYS 116W · 230V · CRI>80	900x900	75	MIKROPRISMA	W	9330	10030	445-07901X25	1.251,00	
	SYS 116W · 230V · CRI>80	900x900	75	MIKROPRISMA	S	8400	9030	445-07901X26	1.251,00	
	SYS 116W · 230V · CRI>80	900x900	75	MIKROPRISMA	SM	8870	9530	445-07901X28	1.251,00	

INFO

Wand- / Deckenleuchte, Aluminium, pulverbeschichtet, quadratisch, direkt strahlend, Mikroprismatischer Diffuser, Energieeffiziente LEDs mit hoher Farbwiedergabe, inkl. Konverter, Dimmbare & CRI>90 Versionen auf Anfrage, LED 3000K oder 4000K

BESTELLINFO:

Ersetzen sie das rote X mit Ihrer gewünschten Lichtfarbe
 9 = 3000K / 4 = 4000K



CADAN SDI LED OPALDIFFUSER



LED 230V inkl. inkl. EEL: A++ - A

INFO

Wand- / Deckenleuchte, Aluminium, pulverbeschichtet, quadratisch, direkt- / indirekt strahlend, Opaldiffuser, Energieeffiziente LEDs mit hoher Farbwiedergabe, inkl. Konverter, Dimmbare & CRI>90 Versionen auf Anfrage, LED 3000K oder 4000K

BESTELINFO:

Ersetzen sie das rote X mit Ihrer gewünschten Lichtfarbe
9 = 3000K / 4 = 4000K

☺ = Lagerware nur in 3000K

LM	LxB	H	AUSFÜHRUNG	FARBE	LUMEN 3000K	LUMEN 4000K	ART. NR.	EURO	LAGER
SYS 20W · 230V · CRI>80	330x330	80	OPALDIFFUSER	W	2261	2431	445-08331X15	372,00	
SYS 20W · 230V · CRI>80	330x330	80	OPALDIFFUSER	S	2120	2280	445-08331X16	372,00	
SYS 20W · 230V · CRI>80	330x330	80	OPALDIFFUSER	SM	2186	2350	445-08331X18	372,00	☺
SYS 35W · 230V · CRI>80	430x430	80	OPALDIFFUSER	W	4209	4526	445-08431X15	444,00	
SYS 35W · 230V · CRI>80	430x430	80	OPALDIFFUSER	S	3952	4250	445-08431X16	444,00	
SYS 35W · 230V · CRI>80	430x430	80	OPALDIFFUSER	SM	4029	4400	445-08431X18	444,00	
SYS 56W · 230V · CRI>80	530x530	80	OPALDIFFUSER	W	6782	7293	445-08531X15	548,00	
SYS 56W · 230V · CRI>80	530x530	80	OPALDIFFUSER	S	6343	6821	445-08531X16	548,00	
SYS 56W · 230V · CRI>80	530x530	80	OPALDIFFUSER	SM	6556	7050	445-08531X18	548,00	
SYS 73W · 230V · CRI>80	630x630	80	OPALDIFFUSER	W	9000	9677	445-08631X15	602,00	
SYS 73W · 230V · CRI>80	630x630	80	OPALDIFFUSER	S	8444	9080	445-08631X16	602,00	
SYS 73W · 230V · CRI>80	630x630	80	OPALDIFFUSER	SM	8723	9380	445-08631X18	602,00	
SYS 158W · 230V · CRI>80	900x900	100	OPALDIFFUSER	W	14015	15070	445-08901X15	1.300,00	
SYS 158W · 230V · CRI>80	900x900	100	OPALDIFFUSER	S	12982	13960	445-08901X16	1.300,00	
SYS 158W · 230V · CRI>80	900x900	100	OPALDIFFUSER	SM	13494	14510	445-08901X18	1.300,00	
SYS 262W · 230V · CRI>80	1200x1200	100	OPALDIFFUSER	W	23194	24940	445-081201X15	2.129,00	
SYS 262W · 230V · CRI>80	1200x1200	100	OPALDIFFUSER	S	21408	23020	445-081201X16	2.129,00	
SYS 262W · 230V · CRI>80	1200x1200	100	OPALDIFFUSER	SM	22300	23980	445-081201X18	2.129,00	

CADAN SDI LED MICROPRISMA



LED 230V inkl. inkl. EEL: A++ - A

INFO

Wand- / Deckenleuchte, Aluminium, pulverbeschichtet, quadratisch, direkt- / indirekt strahlend, Mikroprismatischer Diffuser, Energieeffiziente LEDs mit hoher Farbwiedergabe, inkl. Konverter, Dimmbare & CRI>90 Versionen auf Anfrage, LED 3000K oder 4000K

BESTELINFO:

Ersetzen sie das rote X mit Ihrer gewünschten Lichtfarbe
9 = 3000K / 4 = 4000K

LM	LxB	H	AUSFÜHRUNG	FARBE	LUMEN 3000K	LUMEN 4000K	ART. NR.	EURO	LAGER
SYS 20W · 230V · CRI>80	330x330	80	MIKROPRISMA	W	2108	2194	445-08331X25	421,00	
SYS 20W · 230V · CRI>80	330x330	80	MIKROPRISMA	S	1988	2067	445-08331X26	421,00	
SYS 20W · 230V · CRI>80	330x330	80	MIKROPRISMA	SM	2044	2126	445-08331X28	421,00	
SYS 35W · 230V · CRI>80	430x430	80	MIKROPRISMA	W	3943	4100	445-08431X25	489,00	
SYS 35W · 230V · CRI>80	430x430	80	MIKROPRISMA	S	3730	3870	445-08431X26	489,00	
SYS 35W · 230V · CRI>80	430x430	80	MIKROPRISMA	SM	3841	3990	445-08431X28	489,00	
SYS 56W · 230V · CRI>80	530x530	80	MIKROPRISMA	W	6250	6530	445-08531X25	591,00	
SYS 56W · 230V · CRI>80	530x530	80	MIKROPRISMA	S	5883	6135	445-08531X26	591,00	
SYS 56W · 230V · CRI>80	530x530	80	MIKROPRISMA	SM	6062	6328	445-08531X28	591,00	
SYS 73W · 230V · CRI>80	630x630	80	MIKROPRISMA	W	8381	8730	445-08631X25	651,00	
SYS 73W · 230V · CRI>80	630x630	80	MIKROPRISMA	S	7914	8227	445-08631X26	651,00	
SYS 73W · 230V · CRI>80	630x630	80	MIKROPRISMA	SM	8148	8480	445-08631X28	651,00	
SYS 158W · 230V · CRI>80	900x900	100	MIKROPRISMA	W	13038	14020	445-08901X25	1.479,00	
SYS 158W · 230V · CRI>80	900x900	100	MIKROPRISMA	S	12108	13020	445-08901X26	1.479,00	
SYS 158W · 230V · CRI>80	900x900	100	MIKROPRISMA	SM	12573	13520	445-08901X28	1.479,00	



LLX T5 ALDP



INFO	LM	LxB	H	FARBE	ART. NR.	EURO	LAGER
Aufbauleuchte, Stahlblech weiß lackiert, mit hochglänzendem BAP-Raster, inkl. EVG UGR <19	2 x T16 · 65 · 230 V · 28W · EVG	1213x238	65	W	757-2020	75,00	
	2 x T16 · 65 · 230 V · 54W · EVG	1213x238	65	W	757-2022	75,00	😊

230V HV

LLX T5 MATDP



INFO	LM	LxB	H	FARBE	ART. NR.	EURO	LAGER
Aufbauleuchte, Stahlblech weiß lackiert, mit mat-tem BAP-Raster, inkl. EVG UGR <19	2 x T16 · 65 · 230 V · 28W · EVG	1213x238	65	W	757-2030	75,00	
	2 x T16 · 65 · 230 V · 54W · EVG	1213x238	65	W	757-2032	75,00	😊

230V HV

AREL ASYMMETRISCH DIREKT



INFO	LM	LxBxH	DIMMBARKEIT	LED	LUMEN	FARBE	ART. NR.	EURO	LAGER
LED Aufbauleuchte, Stahlblech weiß lackiert, mit weiß lackiertem Reflektor , inkl. LED Konverter, Abhängung zur Verwendung als Pendelleuchte separat ordern.	SYS 35W 230V CRI>80	1245x245x57	nicht dimmbar	3000K	4200	W	757-l2030	156,00	
		1245x245x57	nicht dimmbar	4000K	4200	W	757-l2031	156,00	
		1245x245x57	DALI dimmbar	3000K	4200	W	757-l2030dali	216,00	
		1245x245x57	DALI dimmbar	4000K	4200	W	757-l2031dali	216,00	
SYS 50W 230V CRI>80	1545x245x57	1545x245x57	nicht dimmbar	3000K	6200	W	757-l2032	184,00	
		1545x245x57	nicht dimmbar	4000K	6200	W	757-l2033	184,00	
		1545x245x57	DALI dimmbar	3000K	6200	W	757-l2032dali	244,00	
		1545x245x57	DALI dimmbar	4000K	6200	W	757-l2033dali	244,00	

LED 230V

SEILABHÄNGE + EINSPEISESET



INFO	L	FARBE	ART. NR.	EURO	LAGER
Seilabhängeset 2m für AREL , bestehend aus: 4 Montagebügel, 4 Seile 2m, 8 Seilstopper (4x Decke + 4x Leuchte).	2000		757-zhx11	13,50	😊
Einspeiseset für AREL bestehend aus: Baldachin weiß inkl. Zugentlastung transp., Baldachin: 80x80x30 mm	2200 / 3 x 0,75 mm ²	W	757-bk3w	16,00	😊
Einspeiseset für AREL bestehend aus: Baldachin weiß inkl. Zugentlastung transp., Baldachin: 80x80x30 mm	2200 / 5 x 0,75 mm ²	W	757-bk5w	20,00	😊

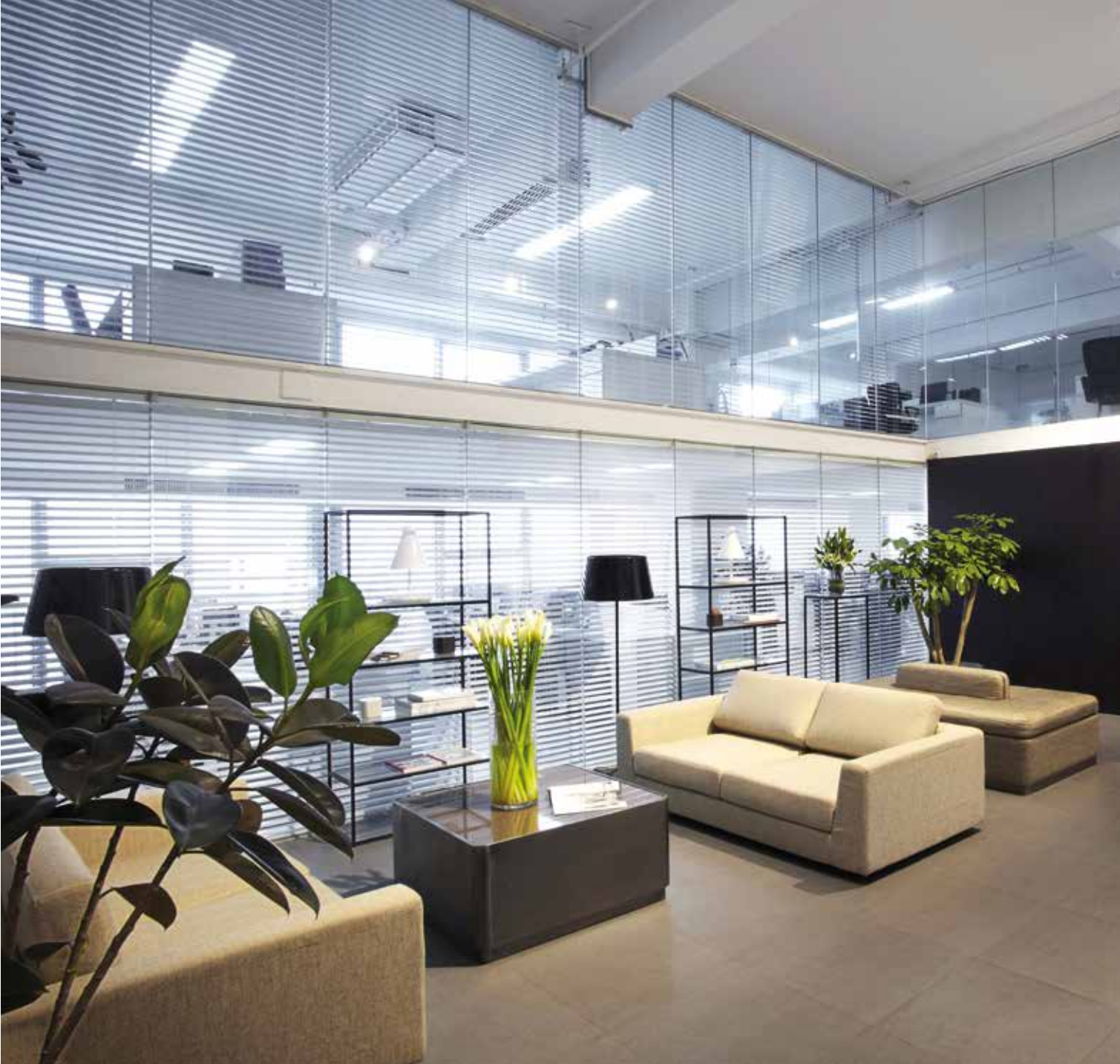

KSK



INFO	LM	LxB	H	LED	LUMEN	FARBE	ART. NR.	EURO	LAGER
Aufbauleuchte, Stahlblech weiß lackiert, mit opaler Abdeckung , Endkappen aus Kunststoff weiß, inkl. LED Konverter	SYS 21W 230V CRI>80	683x208	77	3000K	2500	W	757-I2034	100,00	☺
		683x208	77	4000K	2500	W	757-I2035	100,00	☺
	SYS 41W 230V CRI>80	1293x208	77	3000K	5000	W	757-I2010	176,00	☺
		1293x208	77	4000K	5000	W	757-I2011	176,00	☺
	SYS 65W 230V CRI>80	1293x208	77	3000K	7500	W	757-I2036	192,00	☺
		1293x208	77	4000K	7500	W	757-I2037	192,00	☺
	SYS 30W 230V CRI>80	1593x208	77	3000K	4000	W	757-I2038	148,00	☺
		1593x208	77	4000K	4000	W	757-I2039	148,00	☺
	SYS 63W 230V CRI>80	1593x208	77	3000K	7300	W	757-I2012	200,00	☺
		1593x208	77	4000K	7300	W	757-I2013	200,00	☺

LED 230V inkl. inkl. IP44 | EEL: A++ - A

BADO PDI LED OPALDIFFUSER

	LM	Ø	H	AUSFÜHRUNG	FARBE	LUMEN	LUMEN	ART. NR.	EURO	LAGER
						3000K	4000K			
	SYS 42W · 230V · CRI>80	400	75	OPALDIFFUSER	W	5020	5397	445-04401X15	516,00	☺
	SYS 42W · 230V · CRI>80	400	75	OPALDIFFUSER	S	5020	5397	445-04401X16	516,00	
	SYS 42W · 230V · CRI>80	400	75	OPALDIFFUSER	SM	5020	5397	445-04401X18	516,00	
	SYS 57W · 230V · CRI>80	500	75	OPALDIFFUSER	W	6744	7252	445-04501X15	678,00	
	SYS 57W · 230V · CRI>80	500	75	OPALDIFFUSER	S	6744	7252	445-04501X16	678,00	
	SYS 57W · 230V · CRI>80	500	75	OPALDIFFUSER	SM	6744	7252	445-04501X18	678,00	
	SYS 65W · 230V · CRI>80	600	75	OPALDIFFUSER	W	7752	8335	445-04601X15	806,00	
	SYS 65W · 230V · CRI>80	600	75	OPALDIFFUSER	S	7752	8335	445-04601X16	806,00	
	SYS 65W · 230V · CRI>80	600	75	OPALDIFFUSER	SM	7752	8335	445-04601X18	806,00	
	SYS 139W · 230V · CRI>80	900	75	OPALDIFFUSER	W	13066	14050	445-04901X15	1.496,00	
	SYS 139W · 230V · CRI>80	900	75	OPALDIFFUSER	S	13066	14050	445-04901X16	1.496,00	
	SYS 139W · 230V · CRI>80	900	75	OPALDIFFUSER	SM	13066	14050	445-04901X18	1.496,00	
	SYS 220W · 230V · CRI>80	1200	75	OPALDIFFUSER	W	20832	22400	445-041201X15	2.453,00	
	SYS 220W · 230V · CRI>80	1200	75	OPALDIFFUSER	S	20832	22400	445-041201X16	2.453,00	
	SYS 220W · 230V · CRI>80	1200	75	OPALDIFFUSER	SM	20832	22400	445-041201X18	2.453,00	

LED 230V      IP20 | EEL: A++ - A

INFO

Hängelleuchte, Aluminium, pulverbeschichtet, rund, direkt-/indirekt strahlend, Opaldiffuser, Energieeffiziente LEDs mit hoher Farbwiedergabe, inkl. 1500mm Abhängung und Deckenbaldachin, inkl. Konverter, Dimmbare & CRI>90 Versionen auf Anfrage, LED 3000K oder 4000K

BESTELINFO:

Ersetzen sie das rote X mit Ihrer gewünschten Lichtfarbe
9 = 3000K / 4 = 4000K

☺ = Lagerware nur in 3000K

BADO PDI LED MICROPRISMA

	LM	Ø	H	AUSFÜHRUNG	FARBE	LUMEN	LUMEN	ART. NR.	EURO	LAGER
						3000K	4000K			
	SYS 42W · 230V · CRI>80	400	75	MIKROPRISMA	W	4870	5234	445-04401X25	579,00	
	SYS 42W · 230V · CRI>80	400	75	MIKROPRISMA	S	4870	5234	445-04401X26	579,00	
	SYS 42W · 230V · CRI>80	400	75	MIKROPRISMA	SM	4870	5234	445-04401X28	579,00	
	SYS 57W · 230V · CRI>80	500	75	MIKROPRISMA	W	6542	7034	445-04501X25	761,00	
	SYS 57W · 230V · CRI>80	500	75	MIKROPRISMA	S	6542	7034	445-04501X26	761,00	
	SYS 57W · 230V · CRI>80	500	75	MIKROPRISMA	SM	6542	7034	445-04501X28	761,00	
	SYS 65W · 230V · CRI>80	600	75	MIKROPRISMA	W	7242	7787	445-04601X25	899,00	
	SYS 65W · 230V · CRI>80	600	75	MIKROPRISMA	S	7242	7787	445-04601X26	899,00	
	SYS 65W · 230V · CRI>80	600	75	MIKROPRISMA	SM	7242	7787	445-04601X28	899,00	
	SYS 139W · 230V · CRI>80	900	75	MIKROPRISMA	W	12358	13288	445-04901X25	1.599,00	
	SYS 139W · 230V · CRI>80	900	75	MIKROPRISMA	S	12358	13288	445-04901X26	1.599,00	
	SYS 139W · 230V · CRI>80	900	75	MIKROPRISMA	SM	12358	13288	445-04901X28	1.599,00	
	SYS 220W · 230V · CRI>80	1200	75	MIKROPRISMA	W	19410	20872	445-041201X25	2.577,00	
	SYS 220W · 230V · CRI>80	1200	75	MIKROPRISMA	S	19410	20872	445-041201X26	2.577,00	
	SYS 220W · 230V · CRI>80	1200	75	MIKROPRISMA	SM	19410	20872	445-041201X28	2.577,00	

LED 230V      IP20 | EEL: A++ - A

INFO

Hängelleuchte, Aluminium, pulverbeschichtet, rund, direkt-/indirekt strahlend, Mikroprismatischer Diffuser, Energieeffiziente LEDs mit hoher Farbwiedergabe, inkl. 1500mm Abhängung und Deckenbaldachin, inkl. Konverter, Dimmbare & CRI>90 Versionen auf Anfrage, LED 3000K oder 4000K

BESTELINFO:

Ersetzen sie das rote X mit Ihrer gewünschten Lichtfarbe
9 = 3000K / 4 = 4000K



CADAN PDI LED OPALDIFFUSER

	LM	LxB	H	AUSFÜHRUNG	FARBE	LUMEN 3000K	LUMEN 4000K	ART. NR.	EURO	LAGER
	SYS 35W · 230V · CRI>80	430x430	75	OPALDIFFUSER	W	4209	4526	445-09431X15	485,00	
	SYS 35W · 230V · CRI>80	430x430	75	OPALDIFFUSER	S	3952	4250	445-09431X16	485,00	
	SYS 35W · 230V · CRI>80	430x430	75	OPALDIFFUSER	SM	4029	4400	445-09431X18	485,00	
	SYS 56W · 230V · CRI>80	530x530	75	OPALDIFFUSER	W	6782	7292	445-09531X15	559,00	
	SYS 56W · 230V · CRI>80	530x530	75	OPALDIFFUSER	S	6343	6821	445-09531X16	559,00	
	SYS 56W · 230V · CRI>80	530x530	75	OPALDIFFUSER	SM	6556	7050	445-09531X18	559,00	
	SYS 73W · 230V · CRI>80	630x630	75	OPALDIFFUSER	W	9000	9676	445-09631X15	620,00	
	SYS 73W · 230V · CRI>80	630x630	75	OPALDIFFUSER	S	8444	9080	445-09631X16	620,00	
	SYS 73W · 230V · CRI>80	630x630	75	OPALDIFFUSER	SM	8723	9380	445-09631X18	620,00	
	SYS 158W · 230V · CRI>80	900x900	75	OPALDIFFUSER	W	14015	15070	445-09901X15	1.334,00	
	SYS 158W · 230V · CRI>80	900x900	75	OPALDIFFUSER	S	12982	13960	445-09901X16	1.334,00	
	SYS 158W · 230V · CRI>80	900x900	75	OPALDIFFUSER	SM	13494	14510	445-09901X18	1.334,00	
	SYS 262W · 230V · CRI>80	1200x1200	75	OPALDIFFUSER	W	23194	24940	445-091201X15	2.163,00	
	SYS 262W · 230V · CRI>80	1200x1200	75	OPALDIFFUSER	S	21408	23020	445-091201X16	2.163,00	
	SYS 262W · 230V · CRI>80	1200x1200	75	OPALDIFFUSER	SM	22300	23980	445-091201X18	2.163,00	

LED 230V | inkl. | inkl. | IP20 | EE: A++ - A

INFO

Hängelleuchte, Aluminium, pulverbeschichtet, quadratisch, direkt- / indirekt strahlend, Opaldiffuser, Energieeffiziente LEDs mit hoher Farbwiedergabe, inkl. 1500mm Abhängung und Deckenbaldachin, inkl. Konverter, Dimmbare S CRI>90 Versionen auf Anfrage, LED 3000K oder 4000K

BESTELLINFO:

Ersetzen sie das rote X mit Ihrer gewünschten Lichtfarbe
9 = 3000K / 4 = 4000K

CADAN PDI LED MICROPRISMA

	LM	LxB	H	AUSFÜHRUNG	FARBE	LUMEN 3000K	LUMEN 4000K	ART. NR.	EURO	LAGER
	SYS 35W · 230V · CRI>80	430x430	75	MIKROPRISMA	W	3943	4100	445-09431X25	548,00	
	SYS 35W · 230V · CRI>80	430x430	75	MIKROPRISMA	S	3730	3870	445-09431X26	548,00	
	SYS 35W · 230V · CRI>80	430x430	75	MIKROPRISMA	SM	3841	3990	445-09431X28	548,00	
	SYS 56W · 230V · CRI>80	530x530	75	MIKROPRISMA	W	6250	6530	445-09531X25	602,00	
	SYS 56W · 230V · CRI>80	530x530	75	MIKROPRISMA	S	5883	6135	445-09531X26	602,00	
	SYS 56W · 230V · CRI>80	530x530	75	MIKROPRISMA	SM	6062	6328	445-09531X28	602,00	
	SYS 73W · 230V · CRI>80	630x630	75	MIKROPRISMA	W	8381	8730	445-09631X25	668,00	
	SYS 73W · 230V · CRI>80	630x630	75	MIKROPRISMA	S	7914	8227	445-09631X26	668,00	
	SYS 73W · 230V · CRI>80	630x630	75	MIKROPRISMA	SM	8148	8480	445-09631X28	668,00	
	SYS 158W · 230V · CRI>80	900x900	75	MIKROPRISMA	W	13038	14020	445-09901X25	1.479,00	
	SYS 158W · 230V · CRI>80	900x900	75	MIKROPRISMA	S	12108	13020	445-09901X26	1.479,00	
	SYS 158W · 230V · CRI>80	900x900	75	MIKROPRISMA	SM	12573	13520	445-09901X28	1.479,00	

LED 230V | inkl. | inkl. | IP20 | EE: A++ - A

INFO

Hängelleuchte, Aluminium, pulverbeschichtet, quadratisch, direkt- / indirekt strahlend, Mikroprismatischer Diffuser, Energieeffiziente LEDs mit hoher Farbwiedergabe, inkl. 1500mm Abhängung und Deckenbaldachin, inkl. Konverter, Dimmbare S CRI>90 Versionen auf Anfrage, LED 3000K oder 4000K

BESTELLINFO:

Ersetzen sie das rote X mit Ihrer gewünschten Lichtfarbe
9 = 3000K / 4 = 4000K



AMEA 200 / 400 / 600 LED



AMEA 200 LED

Hängeleuchte, Aluminiumdruckguss, matt pulverbeschichtet, 40° Ausstrahlwinkel, Kabellänge 1000mm, Baldachin DMxH=70x56mm, inkl. Konverter 320mA

LM	ØxH	ABH.	FARBE	REF.	ART. NR.	EURO	LAGER
SYS 7,3W · 230V 346lm · CRI90	35x200	1000	W	40°	365-1003w	167,00	☺
	35x200	1000	S	40°	365-1003b	167,00	☺
LED 3000K							

AMEA 400 LED

Hängeleuchte, Aluminiumdruckguss, matt pulverbeschichtet, 40° Ausstrahlwinkel, Kabellänge 1000mm, Baldachin DMxH=70x56mm, inkl. Konverter 320mA

LM	ØxH	ABH.	FARBE	REF.	ART. NR.	EURO	LAGER
SYS 7,3W · 230V 346lm · CRI90	35x400	1000	W	40°	365-1004w	177,00	☺
	35x400	1000	S	40°	365-1004b	177,00	☺
LED 3000K							

AMEA 600 LED

Hängeleuchte, Aluminiumdruckguss, matt pulverbeschichtet, 40° Ausstrahlwinkel, Kabellänge 1000mm, Baldachin DMxH=70x56mm, inkl. Konverter 320mA

LM	ØxH	ABH.	FARBE	REF.	ART. NR.	EURO	LAGER
SYS 7,3W · 230V 346lm · CRI90	35x600	1000	W	40°	365-1005w	197,00	☺
	35x600	1000	S	40°	365-1005b	197,00	☺
LED 3000K							

ATYS LED



Hängeleuchte, Aluminiumdruckguss, matt pulverbeschichtet, 32° Ausstrahlwinkel, Kabellänge 1000mm, Baldachin H=35mm, inkl. Konverter 350mA

LM	ØxH	ABH.	FARBE	REF.	ART. NR.	EURO	LAGER
SYS 6,7W · 230V 324lm · CRI>90	60x90	1000	W	32°	365-1002w	125,00	☺
	60x90	1000	S	32°	365-1002b	125,00	☺
LED 3000K							



GILO LED



Hängeleuchte, Aluminiumdruckguss, matt Feinstruktur pulverbeschichtet, Diffusor aus opalem Acryl, inkl. Konverter 500mA - **TRIAC dimmbar**

LM	ØxH	ABH.	FARBE	ART. NR.	EURO	LAGER
SYS 6,8W · 230V 339lm · CRI>90	80x90	2180	W	472-260053wtr	149,00	☺
	80x90	2180	S	472-260053btr	149,00	☺

LED 3000K

EEI: A++ - A

MILO



Hängeleuchte, Aluminiumdruckguss, matt Feinstruktur pulverbeschichtet, Diffusor aus opalem Acryl, inkl. Konverter 500mA - **TRIAC dimmbar**

LM	ØxH	ABH	LUMEN	LED	FARBE	ART. NR.	EURO	LAGER
SYS 6,6W 230V CRI>90	100x70	2180	310	2700K	W	472-0550790002705	149,00	☺
	100x70	2180	320	3000K	W	472-0550790003005	149,00	☺
	100x70	2180	150	2700K	S	472-0550790002706	149,00	☺
	100x70	2180	155	3000K	S	472-0550790003006	149,00	☺

EEI: A++ - A

TOP SELLER



SLOPE 22



Pendelleuchte aus Metall, in den Farben weiß-weiß, schwarz-schwarz oder schwarz-rot lackiert, Stoffkabel Länge 3000mm

LM	ØxH	ABHÄNGUNG	FARBE	ART. NR.	EURO	LAGER
A60 E27 · 230V max. 28W	220x300	max. 3000	W W	302-71713010	84,00	
	220x300	max. 3000	S W	302-71713001	94,00	
	220x300	max. 3000	S R	302-71713002	84,00	

230V HV | | | IP20 | EEL: A+++ - D

SLOPE 35



Pendelleuchte aus Metall, in den Farben weiß-weiß oder schwarz-schwarz lackiert, Stoffkabel Länge 3000mm

LM	ØxH	ABHÄNGUNG	FARBE	ART. NR.	EURO	LAGER
A60 E27 · 230V max. 42W	350x300	max. 3000	W W	302-71723010	138,00	
	350x300	max. 3000	S W	302-71723001	154,00	

230V HV | | | IP20 | EEL: A+++ - D

SLOPE 50



Pendelleuchte aus Metall, außen schwarz innen weiß lackiert, Stoffkabel Länge 3000mm

LM	ØxH	ABHÄNGUNG	FARBE	ART. NR.	EURO	LAGER
A60 E27 · 230V max. 57W	500x300	max. 3000	S W	302-71733001	208,00	

230V HV | | | IP20 | EEL: A+++ - D



POP PENDANT



Pendelleuchte aus Metall, in den Farben weiß, schwarz, hellblau, hellgrün oder pfirsich lackiert, Stoffkabel Länge 3000mm

LM	ØxH	ABHÄNGUNG	FARBE	ART. NR.	EURO	LAGER
A60 E27 · 230V max. 42W	215x230	max. 2000	W	302-45833001	42,00	
	215x230	max. 2000	S	302-45833003	42,00	
	215x230	max. 2000	HB	302-45833006	42,00	
	215x230	max. 2000	HG	302-45833023	42,00	
	215x230	max. 2000	PF	302-45833052	42,00	

230V HV IP20 | EE: A+++ - D

POP WALL



Wandleuchte aus Metall, in den Farben weiß, schwarz, hellblau, hellgrün oder pfirsich lackiert, dreh- und schwenkbar, inkl. Anschlußkabel 1800mm

LM	ØxHxT	FARBE	ART. NR.	EURO	LAGER
A60 E27 · 230V max. 42W	155x200x190	W	302-45841001	42,00	
	155x200x190	S	302-45841003	42,00	
	155x200x190	HB	302-45841006	42,00	
	155x200x190	HG	302-45841023	42,00	
	155x200x190	PF	302-45841052	42,00	

230V HV IP20 | EE: A+++ - D

LYNE



Pendelleuchte aus Metall, in den Farben schwarz lackiert oder kupfer, Stoffkabel Länge 2500mm

LM	ØxH	ABHÄNGUNG	FARBE	ART. NR.	EURO	LAGER
A60 E27 · 230V max. 42W	288x200	max. 2500	S	302-84813003	65,00	☺
	288x200	max. 2500	KU	302-84813030	87,00	☺

230V HV IP20 | EE: A+++ - D

ANNIVERSARY



Pendelleuchte aus Metall, in den Farben schwarz oder weiß lackiert, Stoffkabel Länge 2100mm

LM	ØxH	ABHÄNGUNG	FARBE	ART. NR.	EURO	LAGER
A60 E27 · 230V max. 42W	350x160	max. 2100	W W	302-76633001	111,00	☺
	350x160	max. 2100	S W	302-76633003	111,00	☺

230V HV IP20 | EE: A+++ - D



VOLTO COPERTO LED

AUFBAU



INFO

Aufbauleuchte aus stranggepresstem Aluminiumprofil, Oberfläche eloxiert, weiß oder schwarz pulverbeschichtet, opale PMMA Abdeckung kubisch, flach oder rund, erhältlich in 4 Längen, energieeffiziente LEDs mit hoher Farbwiedergabe

Opaldiffuser kubisch: H 52mm
 Opaldiffuser flach: H 39mm
 Opaldiffuser rund: H 37mm

EEL: A++ - A

BESTELLINFO:

Ersetzen Sie das rote X der Artikelnummer mit Ihrer gewünschten Abdeckung

PMMA Opaldiffuser flach = 1

PMMA Opaldiffuser kubisch = 2

PMMA Opaldiffuser rund = 3

LM	LxB	FARBE	LED	LUMEN	ART. NR.	EURO	LAGER
SYS 11W - 230V - CRI>90	570x26	W	2700K	680lm	539-01001X023050	296,00	
SYS 11W - 230V - CRI>90	570x26	S	2700K	680lm	539-01001X023060	296,00	
SYS 11W - 230V - CRI>90	570x26	AE	2700K	680lm	539-01001X023080	296,00	
SYS 11W - 230V - CRI>90	570x26	W	3000K	740lm	539-01001X029050	296,00	
SYS 11W - 230V - CRI>90	570x26	S	3000K	740lm	539-01001X029060	296,00	
SYS 11W - 230V - CRI>90	570x26	AE	3000K	740lm	539-01001X029080	296,00	
SYS 11W - 230V - CRI>90	570x26	W	4000K	810lm	539-01001X024050	296,00	
SYS 11W - 230V - CRI>90	570x26	S	4000K	810lm	539-01001X024060	296,00	
SYS 11W - 230V - CRI>90	570x26	AE	4000K	810lm	539-01001X024080	296,00	
SYS 16W - 230V - CRI>90	850x26	W	2700K	1020lm	539-01002X023050	346,00	
SYS 16W - 230V - CRI>90	850x26	S	2700K	1020lm	539-01002X023060	346,00	
SYS 16W - 230V - CRI>90	850x26	AE	2700K	1020lm	539-01002X023080	346,00	
SYS 16W - 230V - CRI>90	850x26	W	3000K	1110lm	539-01002X029050	346,00	
SYS 16W - 230V - CRI>90	850x26	S	3000K	1110lm	539-01002X029060	346,00	
SYS 16W - 230V - CRI>90	850x26	AE	3000K	1110lm	539-01002X029080	346,00	
SYS 16W - 230V - CRI>90	850x26	W	4000K	1210lm	539-01002X024050	346,00	
SYS 16W - 230V - CRI>90	850x26	S	4000K	1210lm	539-01002X024060	346,00	
SYS 16W - 230V - CRI>90	850x26	AE	4000K	1210lm	539-01002X024080	346,00	
SYS 21W - 230V - CRI>90	1130x26	W	2700K	1360lm	539-01003X023050	403,00	
SYS 21W - 230V - CRI>90	1130x26	S	2700K	1360lm	539-01003X023060	403,00	
SYS 21W - 230V - CRI>90	1130x26	AE	2700K	1360lm	539-01003X023080	403,00	
SYS 21W - 230V - CRI>90	1130x26	W	3000K	1490lm	539-01003X029050	403,00	
SYS 21W - 230V - CRI>90	1130x26	S	3000K	1490lm	539-01003X029060	403,00	
SYS 21W - 230V - CRI>90	1130x26	AE	3000K	1490lm	539-01003X029080	403,00	
SYS 21W - 230V - CRI>90	1130x26	W	4000K	1620lm	539-01003X024050	403,00	
SYS 21W - 230V - CRI>90	1130x26	S	4000K	1620lm	539-01003X024060	403,00	
SYS 21W - 230V - CRI>90	1130x26	AE	4000K	1620lm	539-01003X024080	403,00	
SYS 26W - 230V - CRI>90	1410x26	W	2700K	1700lm	539-01004X023050	453,00	
SYS 26W - 230V - CRI>90	1410x26	S	2700K	1700lm	539-01004X023060	453,00	
SYS 26W - 230V - CRI>90	1410x26	AE	2700K	1700lm	539-01004X023080	453,00	
SYS 26W - 230V - CRI>90	1410x26	W	3000K	1860lm	539-01004X029050	453,00	
SYS 26W - 230V - CRI>90	1410x26	S	3000K	1860lm	539-01004X029060	453,00	
SYS 26W - 230V - CRI>90	1410x26	AE	3000K	1860lm	539-01004X029080	453,00	
SYS 26W - 230V - CRI>90	1410x26	W	4000K	2020lm	539-01004X024050	453,00	
SYS 26W - 230V - CRI>90	1410x26	S	4000K	2020lm	539-01004X024060	453,00	
SYS 26W - 230V - CRI>90	1410x26	AE	4000K	2020lm	539-01004X024080	453,00	

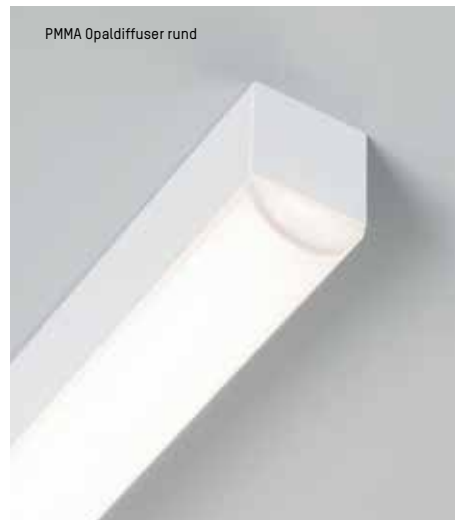
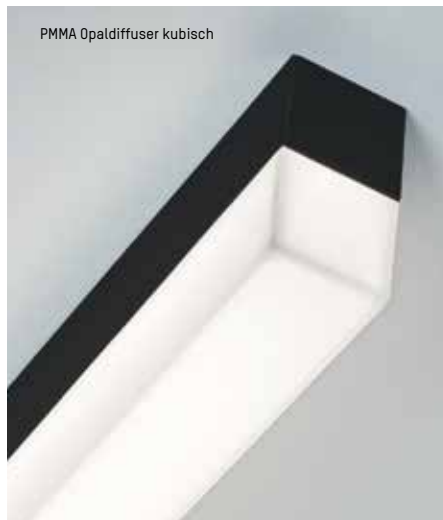
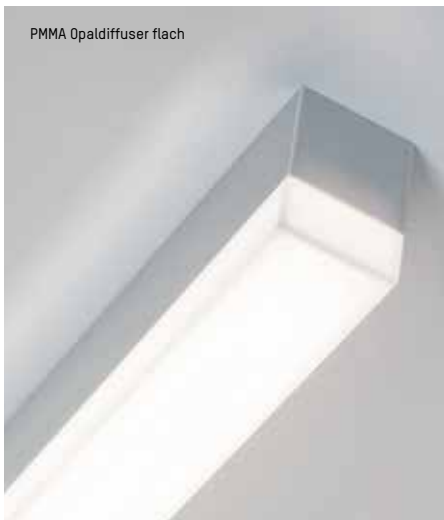



RIDE LED



INFO

Aufbauleuchte aus stranggepresstem Aluminiumprofil, Oberfläche eloxiert, weiß oder schwarz pulverbeschichtet, opale PMMA Abdeckung kubisch oder flach, erhältlich in 6 Längen, energieeffiziente LEDs mit hoher Farbwiedergabe, **microprismatische Abdeckung flach auf Anfrage**

Opaldiffuser kubisch: H 70mm
Opaldiffuser flach: H 35mm

EEL: A++ - A

BESTELINFO:

Ersetzen Sie das rote X der Artikelnummer mit Ihrer gewünschten Abdeckung

PMMA Opaldiffuser flach = 1
PMMA Opaldiffuser kubisch = 2

Bestellbeispiel:

577-010012023050 = Opaldiffuser kubisch

Auf Anfrage 3500K erhältlich

LM	LxB	FARBE	LED	kubisch	flach	ART. NR.	EURO kubisch	EURO flach	LAGER
SYS 11W · 230V · CRI>90	577x35	W	2700K	840lm	750lm	577-01001X023050	331,00	300,00	
SYS 11W · 230V · CRI>90	577x35	S	2700K	840lm	750lm	577-01001X023060	331,00	300,00	
SYS 11W · 230V · CRI>90	577x35	AE	2700K	840lm	750lm	577-01001X023080	331,00	300,00	
SYS 11W · 230V · CRI>90	577x35	W	3000K	920lm	820lm	577-01001X029050	331,00	300,00	
SYS 11W · 230V · CRI>90	577x35	S	3000K	920lm	820lm	577-01001X029060	331,00	300,00	
SYS 11W · 230V · CRI>90	577x35	AE	3000K	920lm	820lm	577-01001X029080	331,00	300,00	
SYS 11W · 230V · CRI>90	577x35	W	4000K	940lm	890lm	577-01001X024050	331,00	300,00	
SYS 11W · 230V · CRI>90	577x35	S	4000K	940lm	890lm	577-01001X024060	331,00	300,00	
SYS 11W · 230V · CRI>90	577x35	AE	4000K	940lm	890lm	577-01001X024080	331,00	300,00	
SYS 16W · 230V · CRI>90	857x35	W	2700K	1260lm	1120lm	577-01002X023050	388,00	352,00	
SYS 16W · 230V · CRI>90	857x35	S	2700K	1260lm	1120lm	577-01002X023060	388,00	352,00	
SYS 16W · 230V · CRI>90	857x35	AE	2700K	1260lm	1120lm	577-01002X023080	388,00	352,00	
SYS 16W · 230V · CRI>90	857x35	W	3000K	1380lm	1230lm	577-01002X029050	388,00	352,00	
SYS 16W · 230V · CRI>90	857x35	S	3000K	1380lm	1230lm	577-01002X029060	388,00	352,00	
SYS 16W · 230V · CRI>90	857x35	AE	3000K	1380lm	1230lm	577-01002X029080	388,00	352,00	
SYS 16W · 230V · CRI>90	857x35	W	4000K	1500lm	1340lm	577-01002X024050	388,00	352,00	
SYS 16W · 230V · CRI>90	857x35	S	4000K	1500lm	1340lm	577-01002X024060	388,00	352,00	
SYS 16W · 230V · CRI>90	857x35	AE	4000K	1500lm	1340lm	577-01002X024080	388,00	352,00	
SYS 21W · 230V · CRI>90	1137x35	W	2700K	1680lm	1500lm	577-01003X023050	450,00	404,00	
SYS 21W · 230V · CRI>90	1137x35	S	2700K	1680lm	1500lm	577-01003X023060	450,00	404,00	
SYS 21W · 230V · CRI>90	1137x35	AE	2700K	1680lm	1500lm	577-01003X023080	450,00	404,00	
SYS 21W · 230V · CRI>90	1137x35	W	3000K	1840lm	1640lm	577-01003X029050	450,00	404,00	
SYS 21W · 230V · CRI>90	1137x35	S	3000K	1840lm	1640lm	577-01003X029060	450,00	404,00	
SYS 21W · 230V · CRI>90	1137x35	AE	3000K	1840lm	1640lm	577-01003X029080	450,00	404,00	
SYS 21W · 230V · CRI>90	1137x35	W	4000K	2010lm	1780lm	577-01003X024050	450,00	404,00	
SYS 21W · 230V · CRI>90	1137x35	S	4000K	2010lm	1780lm	577-01003X024060	450,00	404,00	
SYS 21W · 230V · CRI>90	1137x35	AE	4000K	2010lm	1780lm	577-01003X024080	450,00	404,00	
SYS 26W · 230V · CRI>90	1417x35	W	2700K	2110lm	1870lm	577-01004X023050	506,00	455,00	
SYS 26W · 230V · CRI>90	1417x35	S	2700K	2110lm	1870lm	577-01004X023060	506,00	455,00	
SYS 26W · 230V · CRI>90	1417x35	AE	2700K	2110lm	1870lm	577-01004X023080	506,00	455,00	
SYS 26W · 230V · CRI>90	1417x35	W	3000K	2310lm	2050lm	577-01004X029050	506,00	455,00	
SYS 26W · 230V · CRI>90	1417x35	S	3000K	2310lm	2050lm	577-01004X029060	506,00	455,00	
SYS 26W · 230V · CRI>90	1417x35	AE	3000K	2310lm	2050lm	577-01004X029080	506,00	455,00	
SYS 26W · 230V · CRI>90	1417x35	W	4000K	2510lm	2230lm	577-01004X024050	506,00	455,00	
SYS 26W · 230V · CRI>90	1417x35	S	4000K	2510lm	2230lm	577-01004X024060	506,00	455,00	
SYS 26W · 230V · CRI>90	1417x35	AE	4000K	2510lm	2230lm	577-01004X024080	506,00	455,00	



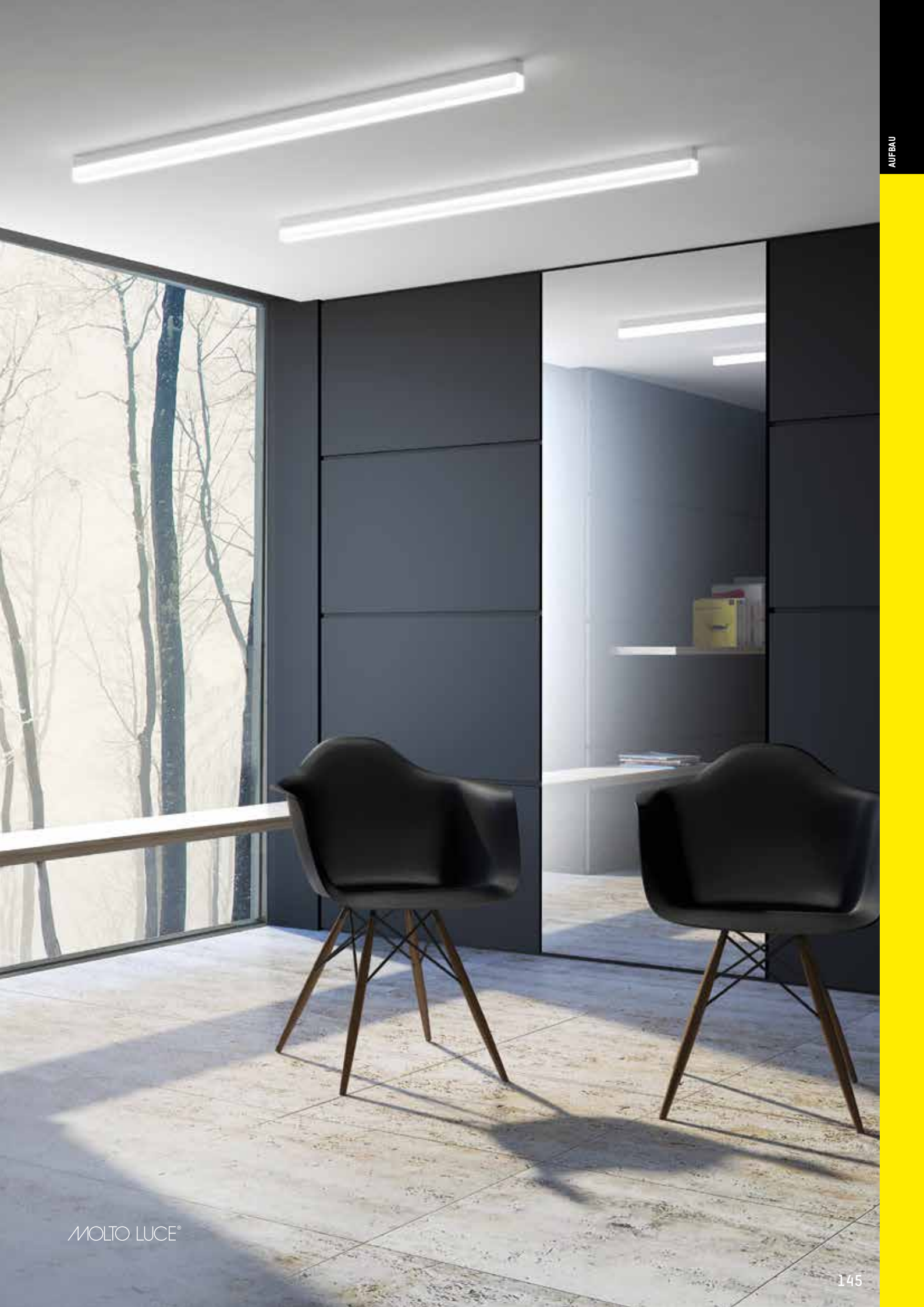

LOG OUT II LED

AUFBAU



INFO

Hängeleuchte, Aluminium-Strangpress-Profil eloxiert oder pulverbeschichtet, Abdeckung mit Mikroprismenoptik oder PMMA Opaldiffusor, Energieeffiziente LEDs mit hoher Farbwiedergabe, inkl. werkzeuglos höhenverstellbarer Abhängung max.3000mm, Endkappen und Einspeisung, inkl. Konverter, Dimmbare Versionen auf Anfrage

EEL: A++ - A
CRI>80

BESTELLINFO:

Esetzen Sie das rote X der Artikelnummer mit Ihrem gewünschten Lichteinsatz

0 = HIGH EFFECENCY VERSION
1 = HIGH OUTPUT VERSION

Ergänzen Sie die Artikelnummer mit Ihrer gewünschten Abdeckung



Mikroprismenabdeckung = mp



PMMA Opaldiffuser = pm

Bestellbeispiel:

628-425095mp = Mikroprismenabdeckung

LM	LUMEN MP	LUMEN PM	LxBxH	FARBE	LED	ART. NR.	EURO mp	EURO pm	LAGER
HE / HO SYS 16W / 30W · 230V	HE / HO 1390 / 2580	HE / HO 1490 / 2760	853x76x90	W	3000K	628-416X95..	491,00	451,00	
SYS 16W / 30W · 230V	1390 / 2580	1490 / 2760	853x76x90	S	3000K	628-416X96..	491,00	451,00	
SYS 16W / 30W · 230V	1390 / 2580	1490 / 2760	853x76x90	AE	3000K	628-416X98..	491,00	451,00	
SYS 16W / 30W · 230V	1460 / 2700	1560 / 2900	853x76x90	W	4000K	628-416X45..	491,00	451,00	
SYS 16W / 30W · 230V	1460 / 2700	1560 / 2900	853x76x90	S	4000K	628-416X46..	491,00	451,00	
SYS 16W / 30W · 230V	1460 / 2700	1560 / 2900	853x76x90	AE	4000K	628-416X48..	491,00	451,00	
SYS 20W / 41W · 230V	1860 / 3440	1990 / 3690	1134x76x90	W	3000K	628-420X95..	542,00	501,00	
SYS 20W / 41W · 230V	1860 / 3440	1990 / 3690	1134x76x90	S	3000K	628-420X96..	542,00	501,00	
SYS 20W / 41W · 230V	1860 / 3440	1990 / 3690	1134x76x90	AE	3000K	628-420X98..	542,00	501,00	
SYS 20W / 41W · 230V	1950 / 3610	2090 / 3860	1134x76x90	W	4000K	628-420X45..	542,00	501,00	
SYS 20W / 41W · 230V	1950 / 3610	2090 / 3860	1134x76x90	S	4000K	628-420X46..	542,00	501,00	
SYS 20W / 41W · 230V	1950 / 3610	2090 / 3860	1134x76x90	AE	4000K	628-420X48..	542,00	501,00	
SYS 25W / 51W · 230V	2320 / 4300	2490 / 4610	1415x76x90	W	3000K	628-425X95..	587,00	544,00	
SYS 25W / 51W · 230V	2320 / 4300	2490 / 4610	1415x76x90	S	3000K	628-425X96..	587,00	544,00	
SYS 25W / 51W · 230V	2320 / 4300	2490 / 4610	1415x76x90	AE	3000K	628-425X98..	587,00	544,00	
SYS 25W / 51W · 230V	2440 / 4510	2610 / 4830	1415x76x90	W	4000K	628-425X45..	587,00	544,00	
SYS 25W / 51W · 230V	2440 / 4510	2610 / 4830	1415x76x90	S	4000K	628-425X46..	587,00	544,00	
SYS 25W / 51W · 230V	2440 / 4510	2610 / 4830	1415x76x90	AE	4000K	628-425X48..	587,00	544,00	
SYS 40W / 82W · 230V	3720 / 6880	3980 / 7380	2259x76x90	W	3000K	628-440X95..	888,00	807,00	
SYS 40W / 82W · 230V	3720 / 6880	3980 / 7380	2259x76x90	S	3000K	628-440X96..	888,00	807,00	
SYS 40W / 82W · 230V	3720 / 6880	3980 / 7380	2259x76x90	AE	3000K	628-440X98..	888,00	807,00	
SYS 40W / 82W · 230V	3900 / 7220	4180 / 7720	2259x76x90	W	4000K	628-440X45..	888,00	807,00	
SYS 40W / 82W · 230V	3900 / 7220	4180 / 7720	2259x76x90	S	4000K	628-440X46..	888,00	807,00	
SYS 40W / 82W · 230V	3900 / 7220	4180 / 7720	2259x76x90	AE	4000K	628-440X48..	888,00	807,00	
SYS 50W / 102W · 230V	4640 / 8600	4980 / 9220	2821x76x90	W	3000K	628-450X95..	1.002,00	918,00	
SYS 50W / 102W · 230V	4640 / 8600	4980 / 9220	2821x76x90	S	3000K	628-450X96..	1.002,00	918,00	
SYS 50W / 102W · 230V	4640 / 8600	4980 / 9220	2821x76x90	AE	3000K	628-450X98..	1.002,00	918,00	
SYS 50W / 102W · 230V	4880 / 9020	5220 / 9660	2821x76x90	W	4000K	628-450X45..	1.002,00	918,00	
SYS 50W / 102W · 230V	4880 / 9020	5220 / 9660	2821x76x90	S	4000K	628-450X46..	1.002,00	918,00	
SYS 50W / 102W · 230V	4880 / 9020	5220 / 9660	2821x76x90	AE	K4000	628-450X48..	1.002,00	918,00	
SYS 60W / 123W · 230V	5580 / 10320	5970 / 11070	3383x76x90	W	3000K	628-460X95..	1.231,00	1.133,00	
SYS 60W / 123W · 230V	5580 / 10320	5970 / 11070	3383x76x90	S	3000K	628-460X96..	1.231,00	1.133,00	
SYS 60W / 123W · 230V	5580 / 10320	5970 / 11070	3383x76x90	AE	3000K	628-460X98..	1.231,00	1.133,00	
SYS 60W / 123W · 230V	5850 / 10830	6270 / 11580	3383x76x90	W	4000K	628-460X45..	1.231,00	1.133,00	
SYS 60W / 123W · 230V	5850 / 10830	6270 / 11580	3383x76x90	S	4000K	628-460X46..	1.231,00	1.133,00	
SYS 60W / 123W · 230V	5850 / 10830	6270 / 11580	3383x76x90	AE	4000K	628-460X48..	1.231,00	1.133,00	
SYS 75W / 153W · 230V	6960 / 12900	7470 / 13830	4226x76x90	W	3000K	628-475X95..	1.412,00	1.292,00	
SYS 75W / 153W · 230V	6960 / 12900	7470 / 13830	4226x76x90	S	3000K	628-475X96..	1.412,00	1.292,00	
SYS 75W / 153W · 230V	6960 / 12900	7470 / 13830	4226x76x90	AE	3000K	628-475X98..	1.412,00	1.292,00	
SYS 75W / 153W · 230V	7320 / 13530	7830 / 14490	4226x76x90	W	4000K	628-475X45..	1.412,00	1.292,00	
SYS 75W / 153W · 230V	7320 / 13530	7830 / 14490	4226x76x90	S	4000K	628-475X46..	1.412,00	1.292,00	
SYS 75W / 153W · 230V	7320 / 13530	7830 / 14490	4226x76x90	AE	4000K	628-475X48..	1.412,00	1.292,00	



LOG OUT



230V HV

INFO

Hängeleuchte, Aluminium-Strangpress-Profil eloxiert oder pulverbeschichtet, Abdeckung mit Mikroprismenoptik, PMMA Opaldiffusor oder BAP-Raster 60°, optional mit innenliegendem Hochglanzreflektor, inkl. werkzeuglos höhenverstellbarer Abhängung max.3000mm, Endkappen und Einspeisung, inkl. EVG, Dimmbare Versionen auf Anfrage



REFLEKTORVERSIONEN

Optional mit innenliegendem Hochglanzreflektor für mp & pm Versionen auf Anfrage erhältlich

HINWEIS:

AUF ANFRAGE AUCH ALS LEUCHTENSYSTEM ERHÄLTICH

LM	ABDECKUNG	LxBxH	FARBE	ART. NR.	EURO	LAGER
T16 · 65 · 28/54W · 230V · EVG	MICROPRISMA	1179x60x90	W	528-991545	342,00	
T16 · 65 · 28/54W · 230V · EVG	MICROPRISMA	1179x60x90	S	528-991546	342,00	
T16 · 65 · 28/54W · 230V · EVG	MICROPRISMA	1179x60x90	AE	528-99154	342,00	
T16 · 65 · 28/54W · 230V · EVG	OPALDIFFUSER	1179x60x90	W	528-941545	321,00	
T16 · 65 · 28/54W · 230V · EVG	OPALDIFFUSER	1179x60x90	S	528-941546	321,00	
T16 · 65 · 28/54W · 230V · EVG	OPALDIFFUSER	1179x60x90	AE	528-94154	321,00	
T16 · 65 · 28/54W · 230V · EVG	BAP RASTER	1179x60x90	W	528-951545	383,00	
T16 · 65 · 28/54W · 230V · EVG	BAP RASTER	1179x60x90	S	528-951546	383,00	
T16 · 65 · 28/54W · 230V · EVG	BAP RASTER	1179x60x90	AE	528-95154	383,00	
2 x 1 x T16 · 65 · 28/54W · 230V · EVG	MICROPRISMA	2235x60x90	W	528-992545	476,00	
2 x 1 x T16 · 65 · 28/54W · 230V · EVG	MICROPRISMA	2235x60x90	S	528-992546	476,00	
2 x 1 x T16 · 65 · 28/54W · 230V · EVG	MICROPRISMA	2235x60x90	AE	528-99254	476,00	
2 x 1 x T16 · 65 · 28/54W · 230V · EVG	OPALDIFFUSER	2235x60x90	W	528-942545	435,00	
2 x 1 x T16 · 65 · 28/54W · 230V · EVG	OPALDIFFUSER	2235x60x90	S	528-942546	435,00	
2 x 1 x T16 · 65 · 28/54W · 230V · EVG	OPALDIFFUSER	2235x60x90	AE	528-94254	435,00	
2 x 1 x T16 · 65 · 28/54W · 230V · EVG	BAP RASTER	2355x60x90	W	528-952545	541,00	
2 x 1 x T16 · 65 · 28/54W · 230V · EVG	BAP RASTER	2355x60x90	S	528-952546	541,00	
2 x 1 x T16 · 65 · 28/54W · 230V · EVG	BAP RASTER	2355x60x90	AE	528-95254	541,00	
3 x 1 x T16 · 65 · 28/54W · 230V · EVG	MICROPRISMA	3291x60x90	W	528-993545	683,00	
3 x 1 x T16 · 65 · 28/54W · 230V · EVG	MICROPRISMA	3291x60x90	S	528-993546	683,00	
3 x 1 x T16 · 65 · 28/54W · 230V · EVG	MICROPRISMA	3291x60x90	AE	528-99354	683,00	
3 x 1 x T16 · 65 · 28/54W · 230V · EVG	OPALDIFFUSER	3291x60x90	W	528-943545	600,00	
3 x 1 x T16 · 65 · 28/54W · 230V · EVG	OPALDIFFUSER	3291x60x90	S	528-943546	600,00	
3 x 1 x T16 · 65 · 28/54W · 230V · EVG	OPALDIFFUSER	3291x60x90	AE	528-94354	600,00	
3 x 1 x T16 · 65 · 28/54W · 230V · EVG	BAP RASTER	3531x60x90	W	528-953545	797,00	
3 x 1 x T16 · 65 · 28/54W · 230V · EVG	BAP RASTER	3531x60x90	S	528-953546	797,00	
3 x 1 x T16 · 65 · 28/54W · 230V · EVG	BAP RASTER	3531x60x90	AE	528-95354	797,00	
T16 · 65 · 35/49/80W · 230V · EVG	MICROPRISMA	1479x60x90	W	528-991805	398,00	
T16 · 65 · 35/49/80W · 230V · EVG	MICROPRISMA	1479x60x90	S	528-991806	398,00	
T16 · 65 · 35/49/80W · 230V · EVG	MICROPRISMA	1479x60x90	AE	528-99180	398,00	
T16 · 65 · 35/49/80W · 230V · EVG	OPALDIFFUSER	1479x60x90	W	528-941805	363,00	
T16 · 65 · 35/49/80W · 230V · EVG	OPALDIFFUSER	1479x60x90	S	528-941806	363,00	
T16 · 65 · 35/49/80W · 230V · EVG	OPALDIFFUSER	1479x60x90	AE	528-94180	363,00	
T16 · 65 · 35/49/80W · 230V · EVG	BAP RASTER	1479x60x90	W	528-951805	450,00	
T16 · 65 · 35/49/80W · 230V · EVG	BAP RASTER	1479x60x90	S	528-951806	450,00	
T16 · 65 · 35/49/80W · 230V · EVG	BAP RASTER	1479x60x90	AE	528-95180	450,00	
2 x 1 x T16 · 65 · 35/49/80W · 230V · EVG	MICROPRISMA	2835x60x90	W	528-992805	616,00	
2 x 1 x T16 · 65 · 35/49/80W · 230V · EVG	MICROPRISMA	2835x60x90	S	528-992806	616,00	
2 x 1 x T16 · 65 · 35/49/80W · 230V · EVG	MICROPRISMA	2835x60x90	AE	528-99280	616,00	
2 x 1 x T16 · 65 · 35/49/80W · 230V · EVG	OPALDIFFUSER	2835x60x90	W	528-942805	562,00	
2 x 1 x T16 · 65 · 35/49/80W · 230V · EVG	OPALDIFFUSER	2835x60x90	S	528-942806	562,00	
2 x 1 x T16 · 65 · 35/49/80W · 230V · EVG	OPALDIFFUSER	2835x60x90	AE	528-94280	562,00	
2 x 1 x T16 · 65 · 35/49/80W · 230V · EVG	BAP RASTER	2955x60x90	W	528-952805	722,00	
2 x 1 x T16 · 65 · 35/49/80W · 230V · EVG	BAP RASTER	2955x60x90	S	528-952806	722,00	
2 x 1 x T16 · 65 · 35/49/80W · 230V · EVG	BAP RASTER	2955x60x90	AE	528-95280	722,00	



MOLTO LUCE®

Emirates Stadion Fanshop, London, England

LOG OUT



LM	ABDECKUNG	LxBxH	FARBE	ART. NR.	EURO	LAGER
3 x 1 x T16 - 65 - 35/49/80W - 230 V - EVG	MICROPRISMA	4191x60x90	W	528-993805	893,00	
3 x 1 x T16 - 65 - 35/49/80W - 230 V - EVG	MICROPRISMA	4191x60x90	S	528-993806	893,00	
3 x 1 x T16 - 65 - 35/49/80W - 230 V - EVG	MICROPRISMA	4191x60x90	AE	528-99380	893,00	
3 x 1 x T16 - 65 - 35/49/80W - 230 V - EVG	OPALDIFFUSER	4191x60x90	W	528-943805	788,00	
3 x 1 x T16 - 65 - 35/49/80W - 230 V - EVG	OPALDIFFUSER	4191x60x90	S	528-943806	788,00	
3 x 1 x T16 - 65 - 35/49/80W - 230 V - EVG	OPALDIFFUSER	4191x60x90	AE	528-94380	788,00	
3 x 1 x T16 - 65 - 35/49/80W - 230 V - EVG	BAP RASTER	4431x60x90	W	528-953805	1.021,00	
3 x 1 x T16 - 65 - 35/49/80W - 230 V - EVG	BAP RASTER	4431x60x90	S	528-953806	1.021,00	
3 x 1 x T16 - 65 - 35/49/80W - 230 V - EVG	BAP RASTER	4431x60x90	AE	528-95380	1.021,00	

230V HV IP20 | EEL: A+ - B

LOG OUT II LED

AUFBAU



INFO

Deckenleuchte, Aluminium-Strangpress-Profil eloxiert oder pulverbeschichtet, Abdeckung mit Mikroprismenoptik oder PMMA Opaldiffusor, Energieeffiziente LEDs mit hoher Farbwiedergabe, Einspeisung mittig, inkl. Endkappen, inkl. Konverter, Dimmbare Versionen auf Anfrage

EEI: A++ - A
CRI>80

BESTELLINFO:

Essetzen Sie das rote X der Artikelnummer mit Ihrem gewünschten Lichteinsatz

0 = HIGH EFFECENCY VERSION
1 = HIGH OUTPUT VERSION

Ergänzen Sie die Artikelnummer mit Ihrer gewünschten Abdeckung



Mikroprismenabdeckung = mp



PMMA Opaldiffuser = pm

Bestellbeispiel:
528-4095mp = Mikroprismenabdeckung

LM	LUMEN MP	LUMEN PM	LxBxH	FARBE	LED	ART. NR.	EURO mp	EURO pm	LAGER
HE / HO	HE / HO	HE / HO							
SYS 16W / 30W · 230V	1390 / 2580	1490 / 2760	853x76x90	W	3000K	628-216X95..	357,00	318,00	
SYS 16W / 30W · 230V	1390 / 2580	1490 / 2760	853x76x90	S	3000K	628-216X96..	357,00	318,00	
SYS 16W / 30W · 230V	1390 / 2580	1490 / 2760	853x76x90	AE	3000K	628-216X98..	357,00	318,00	
SYS 16W / 30W · 230V	1460 / 2700	1560 / 2900	853x76x90	W	4000K	628-216X45..	357,00	318,00	
SYS 16W / 30W · 230V	1460 / 2700	1560 / 2900	853x76x90	S	4000K	628-216X46..	357,00	318,00	
SYS 16W / 30W · 230V	1460 / 2700	1560 / 2900	853x76x90	AE	4000K	628-216X48..	357,00	318,00	
SYS 20W / 41W · 230V	1860 / 3440	1990 / 3690	1134x76x90	W	3000K	628-220X95..	409,00	367,00	
SYS 20W / 41W · 230V	1860 / 3440	1990 / 3690	1134x76x90	S	3000K	628-220X96..	409,00	367,00	
SYS 20W / 41W · 230V	1860 / 3440	1990 / 3690	1134x76x90	AE	3000K	628-220X98..	409,00	367,00	
SYS 20W / 41W · 230V	1950 / 3610	2090 / 3860	1134x76x90	W	4000K	628-220X45..	409,00	367,00	
SYS 20W / 41W · 230V	1950 / 3610	2090 / 3860	1134x76x90	S	4000K	628-220X46..	409,00	367,00	
SYS 20W / 41W · 230V	1950 / 3610	2090 / 3860	1134x76x90	AE	4000K	628-220X48..	409,00	367,00	
SYS 25W / 51W · 230V	2320 / 4300	2490 / 4610	1415x76x90	W	3000K	628-225X95..	452,00	410,00	
SYS 25W / 51W · 230V	2320 / 4300	2490 / 4610	1415x76x90	S	3000K	628-225X96..	452,00	410,00	
SYS 25W / 51W · 230V	2320 / 4300	2490 / 4610	1415x76x90	AE	3000K	628-225X98..	452,00	410,00	
SYS 25W / 51W · 230V	2440 / 4510	2610 / 4830	1415x76x90	W	4000K	628-225X45..	452,00	410,00	
SYS 25W / 51W · 230V	2440 / 4510	2610 / 4830	1415x76x90	S	4000K	628-225X46..	452,00	410,00	
SYS 25W / 51W · 230V	2440 / 4510	2610 / 4830	1415x76x90	AE	4000K	628-225X48..	452,00	410,00	
SYS 40W / 82W · 230V	3720 / 6880	3980 / 7380	2259x76x90	W	3000K	628-240X95..	748,00	668,00	
SYS 40W / 82W · 230V	3720 / 6880	3980 / 7380	2259x76x90	S	3000K	628-240X96..	748,00	668,00	
SYS 40W / 82W · 230V	3720 / 6880	3980 / 7380	2259x76x90	AE	3000K	628-240X98..	748,00	668,00	
SYS 40W / 82W · 230V	3900 / 7220	4180 / 7720	2259x76x90	W	4000K	628-240X45..	748,00	668,00	
SYS 40W / 82W · 230V	3900 / 7220	4180 / 7720	2259x76x90	S	4000K	628-240X46..	748,00	668,00	
SYS 40W / 82W · 230V	3900 / 7220	4180 / 7720	2259x76x90	AE	4000K	628-240X48..	748,00	668,00	
SYS 50W / 102W · 230V	4640 / 8600	4980 / 9220	2821x76x90	W	3000K	628-250X95..	842,00	759,00	
SYS 50W / 102W · 230V	4640 / 8600	4980 / 9220	2821x76x90	S	3000K	628-250X96..	842,00	759,00	
SYS 50W / 102W · 230V	4640 / 8600	4980 / 9220	2821x76x90	AE	3000K	628-250X98..	842,00	759,00	
SYS 50W / 102W · 230V	4880 / 9020	5220 / 9660	2821x76x90	W	4000K	628-250X45..	842,00	759,00	
SYS 50W / 102W · 230V	4880 / 9020	5220 / 9660	2821x76x90	S	4000K	628-250X46..	842,00	759,00	
SYS 50W / 102W · 230V	4880 / 9020	5220 / 9660	2821x76x90	AE	4000K	628-250X48..	842,00	759,00	
SYS 60W / 123W · 230V	5580 / 10320	5970 / 11070	3383x76x90	W	3000K	628-260X95..	1.069,00	972,00	
SYS 60W / 123W · 230V	5580 / 10320	5970 / 11070	3383x76x90	S	3000K	628-260X96..	1.069,00	972,00	
SYS 60W / 123W · 230V	5580 / 10320	5970 / 11070	3383x76x90	AE	3000K	628-260X98..	1.069,00	972,00	
SYS 60W / 123W · 230V	5850 / 10830	6270 / 11580	3383x76x90	W	4000K	628-260X45..	1.069,00	972,00	
SYS 60W / 123W · 230V	5850 / 10830	6270 / 11580	3383x76x90	S	4000K	628-260X46..	1.069,00	972,00	
SYS 60W / 123W · 230V	5850 / 10830	6270 / 11580	3383x76x90	AE	4000K	628-260X48..	1.069,00	972,00	
SYS 75W / 153W · 230V	6960 / 12900	7470 / 13830	4226x76x90	W	3000K	628-275X95..	1.251,00	1.131,00	
SYS 75W / 153W · 230V	6960 / 12900	7470 / 13830	4226x76x90	S	3000K	628-275X96..	1.251,00	1.131,00	
SYS 75W / 153W · 230V	6960 / 12900	7470 / 13830	4226x76x90	AE	3000K	628-275X98..	1.251,00	1.131,00	
SYS 75W / 153W · 230V	7320 / 13530	7830 / 14490	4226x76x90	W	4000K	628-275X45..	1.251,00	1.131,00	
SYS 75W / 153W · 230V	7320 / 13530	7830 / 14490	4226x76x90	S	4000K	628-275X46..	1.251,00	1.131,00	
SYS 75W / 153W · 230V	7320 / 13530	7830 / 14490	4226x76x90	AE	4000K	628-275X48..	1.251,00	1.131,00	



LOG OUT



230V HV inkl. IP20 | EEI: A+ - B

INFO

Deckenleuchte, Aluminium-Strangpress-Profil eloxiert oder pulverbeschichtet, Abdeckung mit Mikroprismenoptik, PMMA Opaldiffusor oder BAP-Raster 60°, optional mit innenliegendem Hochglanzreflektor, Einspeisung mittig, inkl. Endkappen, inkl. EVG, Dimmbare Versionen auf Anfrage



REFLEKTORVERSIONEN

Optional mit innenliegendem Hochglanzreflektor für mp & pm Versionen auf Anfrage erhältlich

HINWEIS:

AUF ANFRAGE AUCH ALS LEUCHTENSYSTEM ERHÄLTICH

LM	ABDECKUNG	LxBxH	FARBE	ART. NR.	EURO	LAGER
T16 · 65 · 28/54W · 230V · EVG	MICROPRISMA	1179x60x90	W	528-9101545	236,00	
T16 · 65 · 28/54W · 230V · EVG	MICROPRISMA	1179x60x90	S	528-9101546	236,00	
T16 · 65 · 28/54W · 230V · EVG	MICROPRISMA	1179x60x90	AE	528-910154	236,00	
T16 · 65 · 28/54W · 230V · EVG	OPALDIFFUSER	1179x60x90	W	528-921545	215,00	
T16 · 65 · 28/54W · 230V · EVG	OPALDIFFUSER	1179x60x90	S	528-921546	215,00	
T16 · 65 · 28/54W · 230V · EVG	OPALDIFFUSER	1179x60x90	AE	528-92154	215,00	
T16 · 65 · 28/54W · 230V · EVG	BAP RASTER	1179x60x90	W	528-931545	277,00	
T16 · 65 · 28/54W · 230V · EVG	BAP RASTER	1179x60x90	S	528-931546	277,00	
T16 · 65 · 28/54W · 230V · EVG	BAP RASTER	1179x60x90	AE	528-93154	277,00	
2 x 1 x T16 · 65 · 28/54W · 230V · EVG	MICROPRISMA	2235x60x90	W	528-9102545	352,00	
2 x 1 x T16 · 65 · 28/54W · 230V · EVG	MICROPRISMA	2235x60x90	S	528-9102546	352,00	
2 x 1 x T16 · 65 · 28/54W · 230V · EVG	MICROPRISMA	2235x60x90	AE	528-910254	352,00	
2 x 1 x T16 · 65 · 28/54W · 230V · EVG	OPALDIFFUSER	2235x60x90	W	528-922545	311,00	
2 x 1 x T16 · 65 · 28/54W · 230V · EVG	OPALDIFFUSER	2235x60x90	S	528-922546	311,00	
2 x 1 x T16 · 65 · 28/54W · 230V · EVG	OPALDIFFUSER	2235x60x90	AE	528-92254	311,00	
2 x 1 x T16 · 65 · 28/54W · 230V · EVG	BAP RASTER	2355x60x90	W	528-932545	417,00	
2 x 1 x T16 · 65 · 28/54W · 230V · EVG	BAP RASTER	2355x60x90	S	528-932546	417,00	
2 x 1 x T16 · 65 · 28/54W · 230V · EVG	BAP RASTER	2355x60x90	AE	528-93254	417,00	
3 x 1 x T16 · 65 · 28/54W · 230V · EVG	MICROPRISMA	3291x60x90	W	528-9103545	553,00	
3 x 1 x T16 · 65 · 28/54W · 230V · EVG	MICROPRISMA	3291x60x90	S	528-9103546	553,00	
3 x 1 x T16 · 65 · 28/54W · 230V · EVG	MICROPRISMA	3291x60x90	AE	528-910354	553,00	
3 x 1 x T16 · 65 · 28/54W · 230V · EVG	OPALDIFFUSER	3291x60x90	W	528-923545	491,00	
3 x 1 x T16 · 65 · 28/54W · 230V · EVG	OPALDIFFUSER	3291x60x90	S	528-923546	491,00	
3 x 1 x T16 · 65 · 28/54W · 230V · EVG	OPALDIFFUSER	3291x60x90	AE	528-92354	491,00	
3 x 1 x T16 · 65 · 28/54W · 230V · EVG	BAP RASTER	3531x60x90	W	528-933545	687,00	
3 x 1 x T16 · 65 · 28/54W · 230V · EVG	BAP RASTER	3531x60x90	S	528-933546	687,00	
3 x 1 x T16 · 65 · 28/54W · 230V · EVG	BAP RASTER	3531x60x90	AE	528-93354	687,00	
T16 · 65 · 35/49/80W · 230V · EVG	MICROPRISMA	1479x60x90	W	528-9101805	268,00	
T16 · 65 · 35/49/80W · 230V · EVG	MICROPRISMA	1479x60x90	S	528-9101806	268,00	
T16 · 65 · 35/49/80W · 230V · EVG	MICROPRISMA	1479x60x90	AE	528-910180	268,00	
T16 · 65 · 35/49/80W · 230V · EVG	OPALDIFFUSER	1479x60x90	W	528-921805	242,00	
T16 · 65 · 35/49/80W · 230V · EVG	OPALDIFFUSER	1479x60x90	S	528-921806	242,00	
T16 · 65 · 35/49/80W · 230V · EVG	OPALDIFFUSER	1479x60x90	AE	528-92180	242,00	
T16 · 65 · 35/49/80W · 230V · EVG	BAP RASTER	1479x60x90	W	528-931805	315,00	
T16 · 65 · 35/49/80W · 230V · EVG	BAP RASTER	1479x60x90	S	528-931806	315,00	
T16 · 65 · 35/49/80W · 230V · EVG	BAP RASTER	1479x60x90	AE	528-93180	315,00	
2 x 1 x T16 · 65 · 35/49/80W · 230V · EVG	MICROPRISMA	2835x60x90	W	528-9102805	425,00	
2 x 1 x T16 · 65 · 35/49/80W · 230V · EVG	MICROPRISMA	2835x60x90	S	528-9102806	425,00	
2 x 1 x T16 · 65 · 35/49/80W · 230V · EVG	MICROPRISMA	2835x60x90	AE	528-910280	425,00	
2 x 1 x T16 · 65 · 35/49/80W · 230V · EVG	OPALDIFFUSER	2835x60x90	W	528-922805	378,00	
2 x 1 x T16 · 65 · 35/49/80W · 230V · EVG	OPALDIFFUSER	2835x60x90	S	528-922806	378,00	
2 x 1 x T16 · 65 · 35/49/80W · 230V · EVG	OPALDIFFUSER	2835x60x90	AE	528-92280	378,00	
2 x 1 x T16 · 65 · 35/49/80W · 230V · EVG	BAP RASTER	2955x60x90	W	528-932805	504,00	
2 x 1 x T16 · 65 · 35/49/80W · 230V · EVG	BAP RASTER	2955x60x90	S	528-932806	504,00	
2 x 1 x T16 · 65 · 35/49/80W · 230V · EVG	BAP RASTER	2955x60x90	AE	528-93280	504,00	



MOLTO LUCE®

JAF Frischeis, Linz, Österreich

LOG OUT



LM	ABDECKUNG	LxBxH	FARBE	ART. NR.	EURO	LAGER
3 x 1 x T16 - 65 - 35/49/80W - 230V - EVG	MICROPRISMA	4191x60x90	W	528-9103805	641,00	
3 x 1 x T16 - 65 - 35/49/80W - 230V - EVG	MICROPRISMA	4191x60x90	S	528-9103806	641,00	
3 x 1 x T16 - 65 - 35/49/80W - 230V - EVG	MICROPRISMA	4191x60x90	AE	528-910380	641,00	
3 x 1 x T16 - 65 - 35/49/80W - 230V - EVG	OPALDIFFUSER	4191x60x90	W	528-923805	564,00	
3 x 1 x T16 - 65 - 35/49/80W - 230V - EVG	OPALDIFFUSER	4191x60x90	S	528-923806	564,00	
3 x 1 x T16 - 65 - 35/49/80W - 230V - EVG	OPALDIFFUSER	4191x60x90	AE	528-92380	564,00	
3 x 1 x T16 - 65 - 35/49/80W - 230V - EVG	BAP RASTER	4431x60x90	W	528-933805	777,00	
3 x 1 x T16 - 65 - 35/49/80W - 230V - EVG	BAP RASTER	4431x60x90	S	528-933806	777,00	
3 x 1 x T16 - 65 - 35/49/80W - 230V - EVG	BAP RASTER	4431x60x90	AE	528-93380	777,00	

230V HV EEI: A+ - B

WAND E I N B A U



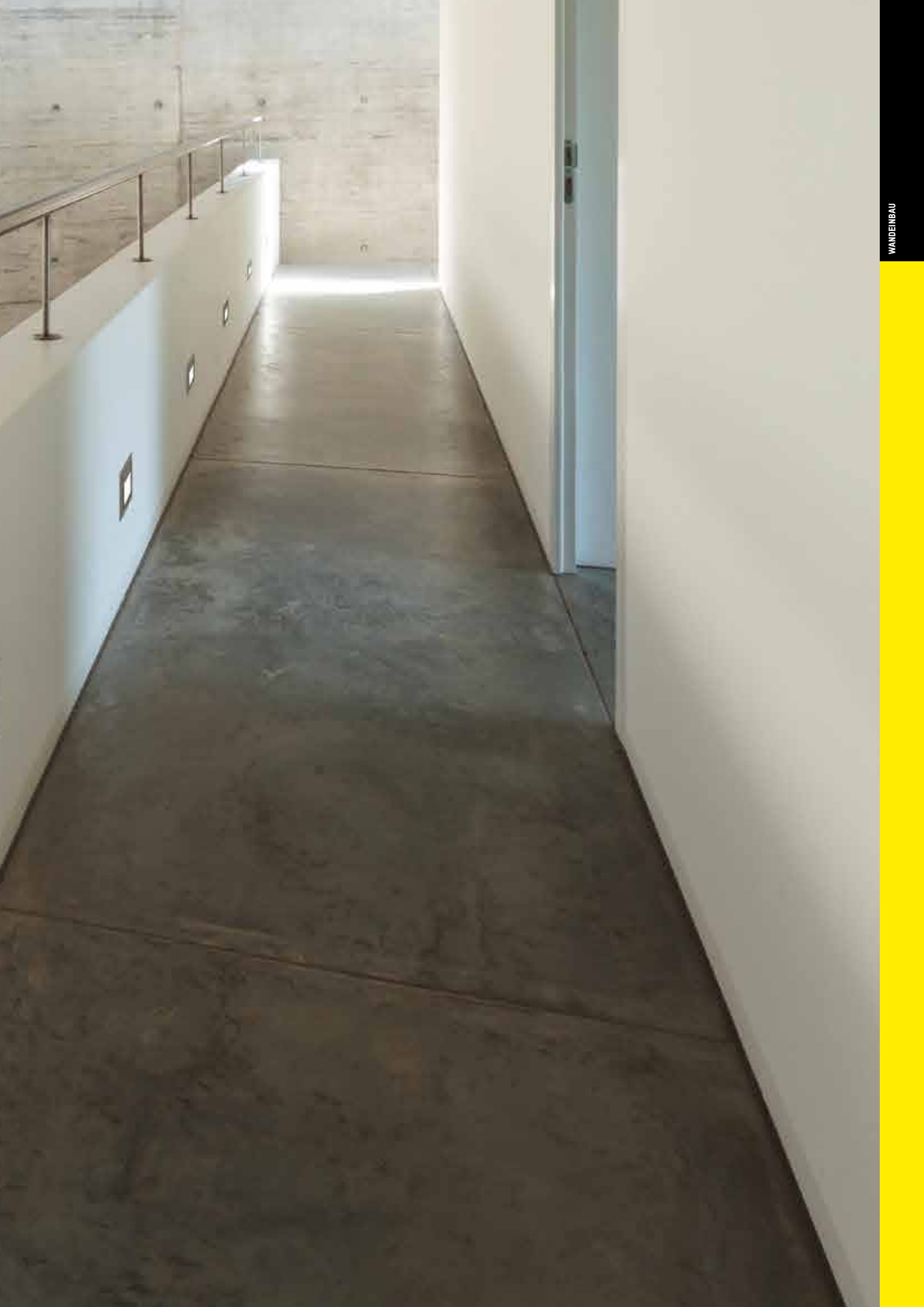



WINDOW LED



WINDOW I LED

Wandeinbauleuchte, Aluminium eloxiert, quadratisch, symmetrisch, inkl. Haltefedern für Hohlwandmontage, exkl. Konverter, Einbaubox separat ordern

LM	BxH	ET	DA BxH	FARBE	ART. NR.	EURO	LAGER
LED 3W 250mA · 234lm CRI>80	80x80	38	69x69	AE	305-6801p	39,00	☺
LED 3000K							

LED 250mA | exkl. | inkl. | IP20 | EE: A+++ - A

WINDOW II LED

Wandeinbauleuchte, Aluminium eloxiert, quadratisch, asymmetrisch, inkl. Haltefedern für Hohlwandmontage, exkl. Konverter, Einbaugehäuse separat ordern

LM	BxH	ET	DA BxH	FARBE	ART. NR.	EURO	LAGER
LED 3W 250mA · 167lm CRI>80	80x80	38	69x69	AE	305-6800p	39,00	☺
LED 3000K							

LED 250mA | exkl. | inkl. | IP20 | EE: A+++ - A

BETONEINBAUGEHÄUSE



Aus verzinktem Blech, inkl. Einputzrahmen, passend für WINDOW, nicht für Sichtbeton geeignet

LxB	T	ART. NR.	EURO	LAGER
138x142	38	305-5058	19,00	☺

LED KONVERTER STM/U



INFO	W	mA	V DC	LxBxH	FARBE	ART. NR.	EURO	LAGER
LED-Konverter, nicht dimmbar, 230 V AC	6	250	12	42x40x22	S	24-122812	16,00	☺

IP20

PAN

TOP SELLER



Wandeinbauleuchte Aluminiumdruckguss, matt Feinstruktur pulverbeschichtet, asymmetrischer Lichtaustritt, Diffusor opal, exkl. Konverter, Einbaubox separat ordern

LM	BxHxT	ET	WA Ø	LUMEN	FARBE	ART. NR.	EURO	LAGER
LED 3W 250mA CRI>80	80x80x32	50	69x69	155	W	305-0130380003005	35,00	😊
	80x80x32	50	69x69	155	S	305-0130380003004	35,00	😊

LED 250mA | | | | | EEL: A+++ - A

BETONEINBAUGEHÄUSE



Aus verzinktem Blech, inkl. Einputzrahmen, passend für PAN, nicht für Sichtbeton geeignet

LxB	T	ART. NR.	EURO	LAGER
138x142	38	305-5058	19,00	😊

LED KONVERTER STM/U



INFO

LED-Konverter, nicht dimmbar, 230V AC

W	mA	V DC	LxBxH	FARBE	ART. NR.	EURO	LAGER
6	250	24	42x40x22	S	24-122812	16,00	😊

Symbolfoto

| | IP20

EDY MINI 45° LED



Wandeinbauleuchte, Metall, pulverbeschichtet oder galvanisiert, quadratisch, starr, Leuchtmittel im 45° Winkel eingebaut, exkl. Konverter (LED 1W-350mA oder LED 2W-500mA)

LM	LxB	ET	WA LxB	FARBE	ART. NR.	EURO	LAGER
LED1W 350mA	63x63	66	52x52	W	68-629901ww	116,00	😊
oder LED 2W 500mA max. 65lm CRI>80	63x63	66	52x52	C	68-629931ww	116,00	😊
	63x63	66	52x52	NM	68-629932ww	120,00	😊
LED 3000K							

LED 350mA 500mA | | | | | EEL: A+++ - A

LED KONVERTER



INFO

LED-Konverter, nicht dimmbar, 230V AC

LED-Konverter, schaltbar nicht dimmbar, 230V AC

W / mA	LxBxH	FÜR	FARBE	ART. NR.	EURO	LAGER
4W / 350	60x35x21,5	1 - 3 EDY MINI	W	24-122596	17,00	😊
6W / 500	60x35x21,5	1 - 2 EDY MINI	W	24-122602	17,00	😊
19W / 350 20W / 500	111x52x22	1 - 14 EDY MINI 1 - 8 EDY MINI	W	24-122201	23,00	😊

| | IP20

ABDECKUNG



INFO

für EDY MINI 45° LED Strahler

LxB	H	ART. NR.	EURO	LAGER
110x110	8	68-0219	14,90	😊

BETONEINBAUGEHÄUSE

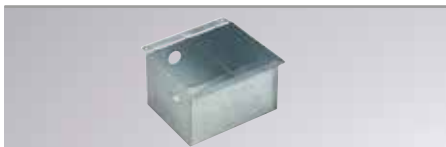

INFO

für EDY MINI 45° LED Strahler

nicht für Sichtbeton geeignet

LxB	H	ART. NR.	EURO	LAGER
110x110	90	68-0218	17,30	😊

SPOON QUADRO LED



INFO	LM	LxB	ET	WA Ø	FARBE	ART. NR.	EURO	LAGER
Wandeinbauleuchte, Aluminium eloxiert oder weiß lackiert, quadratisch, starr, asymmetrisch, inkl. Kühlkörper, exkl. Konverter (LED 1W-350mA oder LED 2W-500mA), Einbaubox oder Betoneinbauhülse separat ordern LED 3000K	LED 1W 350mA oder LED 2W 500mA max. 65lm CRI>80	45x45	47	38	W	68-635101ww	78,00	
		45x45	47	38	AE	68-635145ww	84,00	

LED 350mA 500mA | exkl. | inkl. | IP40 | EE: A++ - A

CERCHIETTO LED



INFO	LM	Ø	ET	WA Ø	FARBE	ART. NR.	EURO	LAGER
Wandeinbauleuchte, Aluminium, weiß lackiert, rund, starr, inkl. Kühlkörper, exkl. Konverter (LED 1W-350mA oder LED 2W-500mA), Montage mit oder ohne Einbaubox möglich, Einbaubox oder Betoneinbauhülse separat ordern LED 3000K	LED 1W 350mA oder LED 2W 500mA max. 40lm CRI>80	36	48	30	W	68-639101ww	95,00	☺

LED 350mA 500mA | exkl. | inkl. | IP44 | EE: A++ - A

LED KONVERTER



INFO	W / mA	LxBxH	FÜR	FARBE	ART. NR.	EURO	LAGER
LED-Konverter, nicht dimmbar, 230V AC	4W / 350	60x35x21,5	1 - 3 LED	W	24-122596	17,00	☺
	6W / 500	60x35x21,5	1 - 2 LED	W	24-122602	17,00	☺
LED-Konverter, schaltbar nicht dimmbar, 230V AC	19W / 350 20W / 500	111x52x22	1 - 14 LED 1 - 8 LED	W	24-122201	23,00	☺

Achtung: Konverter extern setzen, passt nicht in Wandausschnitt

IP20

EINBAUBOX INKL. PUTZRAHMEN



INFO		LxB	H	ART. NR.	EURO	LAGER
Einbaubox inkl. Putzrahmen für Spoon (H= 52 + 8mm Aufkantung, Ausschnitt DM=38mm) für Cerchietto (H= 52 + 8mm Aufkantung, Ausschnitt DM=30mm)	für SPOON	123x90	52 + 8 Aufkantung	68-0214	20,40	☺
	für CERCHIETTO	123x90	52 + 8 Aufkantung	68-0213	19,80	☺

BETONEINBAUHÜLSEN



INFO		Ø	ET	ART. NR.	EURO	LAGER
Wandeinbauhülse, Kunststoff, für Spoon und Cerchietto	für SPOON	48	80	68-0217	4,30	☺
	für CERCHIETTO	40	70	68-0216	3,70	☺

MONTAGEANLEITUNGEN

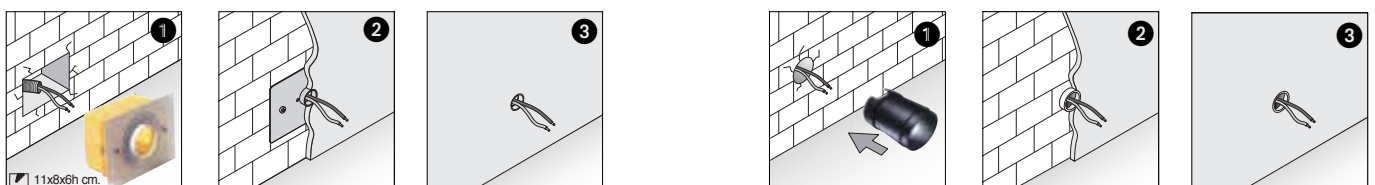

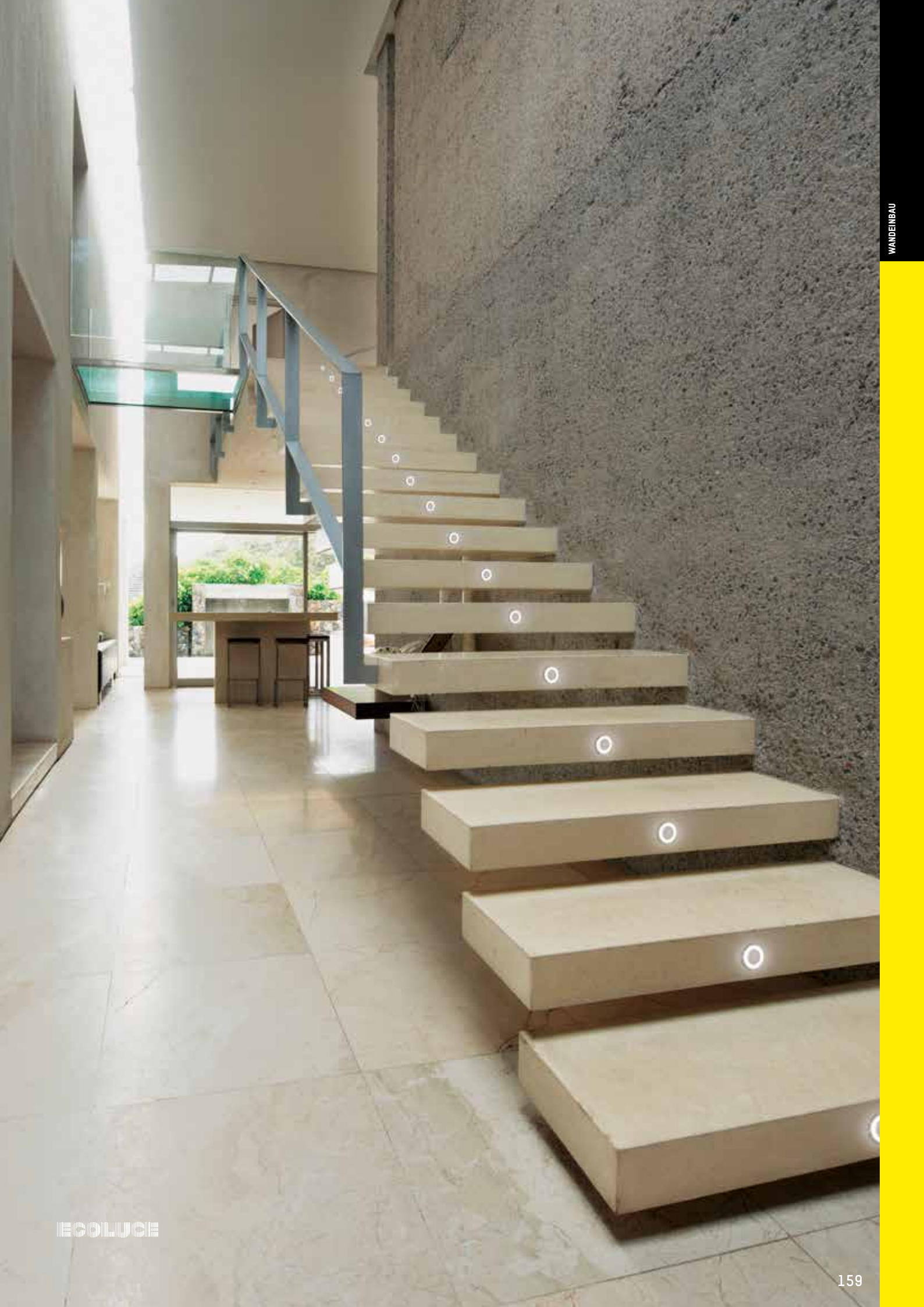

MOTUS LONG RECESSED



INFO	LM	L max.	FARBE	ART. NR.	EURO	LAGER
<p>Halbeinbauleuchte (Leseleuchte), Aluminium, chrom oder perlchrom galvanisiert, runder Leuchtenkopf, hochwertige Glaslinse 60° klar, flexiblem Arm, Ein/Aus-Schalter an der Leuchte, exkl. Konverter, Auf Anfrage auch mit 12° oder 30° Glaslinse erhältlich.</p> <p>Kopf: Ø 34, L 40 Baldachin: Ø 59, H 5 WA: 38 ET: 15</p>	SYS 2W 500mA 126lm	350		56-53011ng1	109,00	
	LED 3000K	350		56-53012ng1	109,00	

LED 500mA EEI: A++ - A

LED KONVERTER



INFO	W / mA	LxBxH	FÜR	FARBE	ART. NR.	EURO	LAGER
LED-Konverter, nicht dimmbar, 230V AC	4W (500mA)	51x32x18	1 LED 2W		75-mpt5	11,50	

IP20

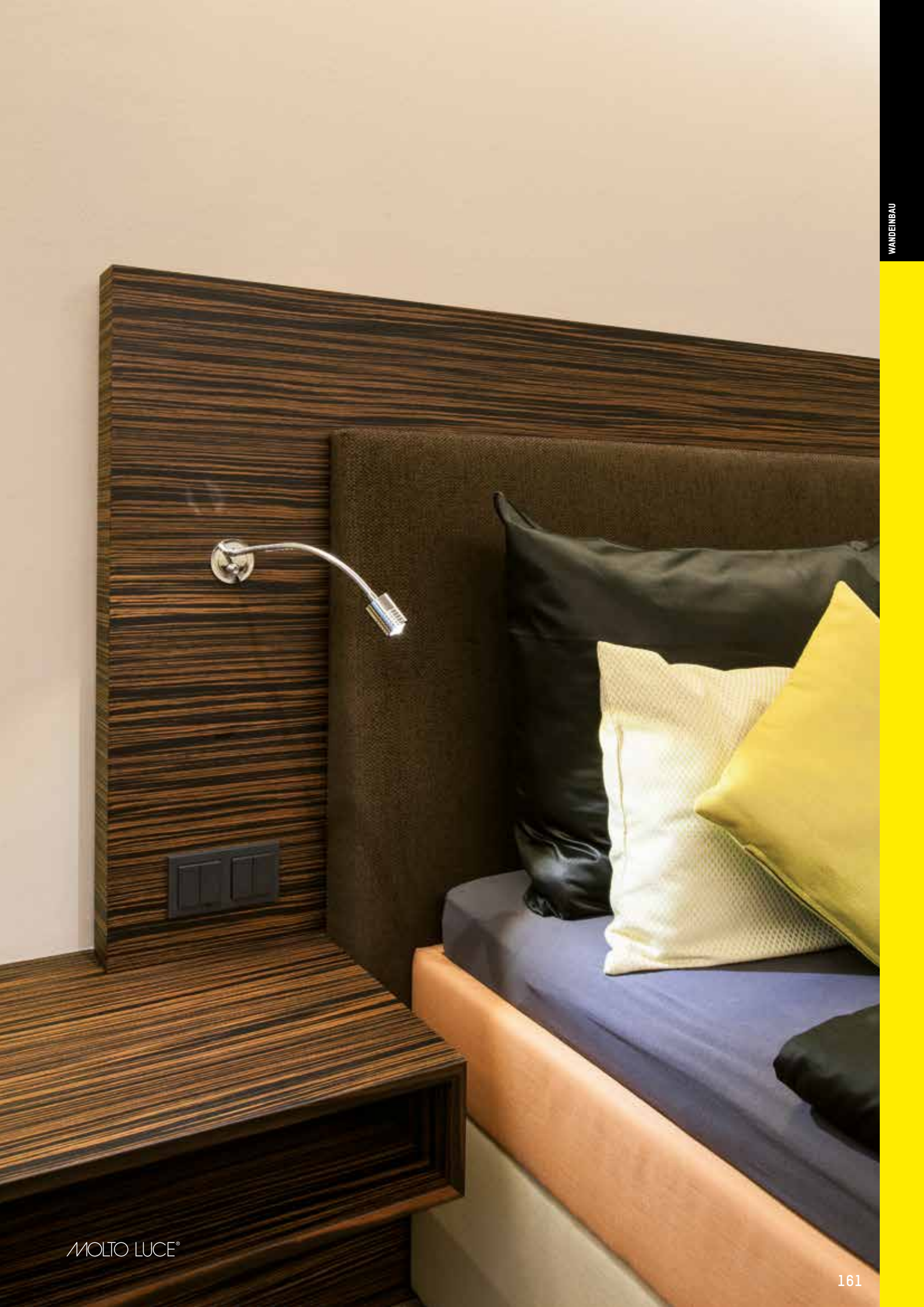

STRAHLER + STROMSCHENEN



D.N.A. FALL WINTER 15 RELEASE



SHOPSTAR HORIZONTAL

STRÄHLER + STROMSCHENEN



INFO	LM	ØxBxH	FARBE	LED	LUMEN	REF.	ART. NR.	EURO	LAGER
<p>LED Stromschienenstrahler Aluminiumdruckguss, Feinstruktur pulverbeschichtet in weiß, schwarz oder silber matt, Vakuumbedampfter Reflektor in 3 Ausstrahlwinkeln, Leuchtenkopf 350° drehbar und 90° schwenkbar, Energieeffiziente COB LED mit hoher Farbwiedergabe</p> <p>Achtung: Strahlerpasst ausschließlich in Nordic XTS Stromschiene</p> <p>3000K: PREMIUM CRI>90 4000K: CRI>90</p> <p>LED 2700K & 3500K Versionen auf Anfrage</p>	SYS 27W 230V PASSIVE COOLING Binning SDCM 2	95x176x168	SM	3000K	2500	spot	608-42504294ng6	233,00	
		95x176x168	W	3000K	2500	spot	608-42504295ng6	233,00	
		95x176x168	S	3000K	2500	spot	608-42504296ng6	233,00	
		95x176x168	SM	4000K	2670	spot	608-42502244ng6	233,00	
		95x176x168	W	4000K	2670	spot	608-42502245ng6	233,00	
		95x176x168	S	4000K	2670	spot	608-42502246ng6	233,00	
		95x176x168	SM	3000K	2500	medium	608-42504594ng6	233,00	
		95x176x168	W	3000K	2500	medium	608-42504595ng6	233,00	😊
		95x176x168	S	3000K	2500	medium	608-42504596ng6	233,00	😊
		95x176x168	SM	4000K	2670	medium	608-42502544ng6	233,00	
		95x176x168	W	4000K	2670	medium	608-42502545ng6	233,00	
		95x176x168	S	4000K	2670	medium	608-42502546ng6	233,00	
	95x176x168	SM	3000K	2500	flood	608-42504894ng6	233,00		
	95x176x168	W	3000K	2500	flood	608-42504895ng6	233,00	😊	
	95x176x168	S	3000K	2500	flood	608-42504896ng6	233,00	😊	
	95x176x168	SM	4000K	2670	flood	608-42502844ng6	233,00		
	95x176x168	W	4000K	2670	flood	608-42502845ng6	233,00		
	95x176x168	S	4000K	2670	flood	608-42502846ng6	233,00		
	SYS 36W 230V PASSIVE COOLING Binning SDCM 2	95x176x168	SM	3000K	3050	spot	608-43024294ng6	233,00	
		95x176x168	W	3000K	3050	spot	608-43024295ng6	233,00	
		95x176x168	S	3000K	3050	spot	608-43024296ng6	233,00	
		95x176x168	SM	4000K	3260	spot	608-43022244ng6	233,00	
		95x176x168	W	4000K	3260	spot	608-43022245ng6	233,00	
		95x176x168	S	4000K	3260	spot	608-43022246ng6	233,00	
95x176x168		SM	3000K	3050	medium	608-43024594ng6	233,00		
95x176x168		W	3000K	3050	medium	608-43024595ng6	233,00	😊	
95x176x168		S	3000K	3050	medium	608-43024596ng6	233,00	😊	
95x176x168		SM	4000K	3260	medium	608-43022544ng6	233,00		
95x176x168		W	4000K	3260	medium	608-43022545ng6	233,00		
95x176x168		S	4000K	3260	medium	608-43022546ng6	233,00		
95x176x168	SM	3000K	3050	flood	608-43024894ng6	233,00			
95x176x168	W	3000K	3050	flood	608-43024895ng6	233,00	😊		
95x176x168	S	3000K	3050	flood	608-43024896ng6	233,00	😊		
95x176x168	SM	4000K	3260	flood	608-43022844ng6	233,00			
95x176x168	W	4000K	3260	flood	608-43022845ng6	233,00			
95x176x168	S	4000K	3260	flood	608-43022846ng6	233,00			

LED 230V | 90° | 350° | inkl. | inkl. | IP20 | EE: A+++ - A



UNITED COLORS
OF BENETTON.

SHOPSTAR VERTIKAL

STRÄHLER + STROMSCHIENEN



INFO	LM	ØxBxH	FARBE	LED	LUMEN	REF.	ART. NR.	EURO	LAGER	
<p>LED Stromschienenstrahler Aluminiumdruckguss, Feinstruktur pulverbeschichtet in weiß, schwarz oder silber matt, Vakuumbedampfter Reflektor in 3 Ausstrahlwinkeln, Leuchtenkopf 350° drehbar und 320° schwenkbar, Energieeffiziente COB LED mit hoher Farbwiedergabe</p> <p>3000K: PREMIUM CRI>90 4000K: CRI>90</p> <p>LED 2700K & 3500K Versionen auf Anfrage</p>	<p>SYS 27W 230V PASSIVE COOLING Binning SDCM 2</p>	95x153x176	SM	3000K	2500	spot	608-52504294ng6	233,00		
		95x153x176	W	3000K	2500	spot	608-52504295ng6	233,00		
		95x153x176	S	3000K	2500	spot	608-52504296ng6	233,00		
		95x153x176	SM	4000K	2670	spot	608-52502244ng6	233,00		
		95x153x176	W	4000K	2670	spot	608-52502245ng6	233,00		
		95x153x176	S	4000K	2670	spot	608-52502246ng6	233,00		
		95x153x176	SM	3000K	2500	medium	608-52504594ng6	233,00		
		95x153x176	W	3000K	2500	medium	608-52504595ng6	233,00		
		95x153x176	S	3000K	2500	medium	608-52504596ng6	233,00		
		95x153x176	SM	4000K	2670	medium	608-52502544ng6	233,00		
		95x153x176	W	4000K	2670	medium	608-52502545ng6	233,00		
		95x153x176	S	4000K	2670	medium	608-52502546ng6	233,00		
		95x153x176	SM	3000K	2500	flood	608-52504894ng6	233,00		
		95x153x176	W	3000K	2500	flood	608-52504895ng6	233,00		
		95x153x176	S	3000K	2500	flood	608-52504896ng6	233,00		
		95x153x176	SM	4000K	2670	flood	608-52502844ng6	233,00		
		95x153x176	W	4000K	2670	flood	608-52502845ng6	233,00		
		95x153x176	S	4000K	2670	flood	608-52502846ng6	233,00		
		<p>SYS 36W 230V PASSIVE COOLING Binning SDCM 2</p>	95x153x176	SM	3000K	3050	spot	608-53024294ng6	233,00	
			95x153x176	W	3000K	3050	spot	608-53024295ng6	233,00	
			95x153x176	S	3000K	3050	spot	608-53024296ng6	233,00	
			95x153x176	SM	4000K	3260	spot	608-53022244ng6	233,00	
			95x153x176	W	4000K	3260	spot	608-53022245ng6	233,00	
			95x153x176	S	4000K	3260	spot	608-53022246ng6	233,00	
95x153x176	SM		3000K	3050	medium	608-53024594ng6	233,00			
95x153x176	W		3000K	3050	medium	608-53024595ng6	233,00			
95x153x176	S		3000K	3050	medium	608-53024596ng6	233,00			
95x153x176	SM		4000K	3260	medium	608-53022544ng6	233,00			
95x153x176	W		4000K	3260	medium	608-53022545ng6	233,00			
95x153x176	S		4000K	3260	medium	608-53022546ng6	233,00			
95x153x176	SM		3000K	3050	flood	608-53024894ng6	233,00			
95x153x176	W		3000K	3050	flood	608-53024895ng6	233,00			
95x153x176	S		3000K	3050	flood	608-53024896ng6	233,00			
95x153x176	SM		4000K	3260	flood	608-53022844ng6	233,00			
95x153x176	W		4000K	3260	flood	608-53022845ng6	233,00			
95x153x176	S		4000K	3260	flood	608-53022846ng6	233,00			

LED 230V | 320° | 350° | inkl. | inkl. | IP20 | EEI: A++ - A



LION 19W



INFO	LM	LxBxH	FARBE	LED	LUMEN	REF.	ART. NR.	EURO	LAGER
<p>Stromschienenstrahler, Aluminium, Feinstruktur matt weiß oder schwarz pulverbeschichtet, Kühlkörper eloxiert, Leuchtenkopf 360° dreh- / 90° schwenkbar, Vakuumbedampfter Alurefektor in 3 Ausstrahlwinkeln, spezial beschichtetes Schutzglas, inkl. Konverter</p> <p>3000K: PREMIUM CRI>90 4000K: CRI>90</p> <p>LED 2700K & 3500K Versionen auf Anfrage</p>	<p>SYS 19W 230V PASSIVE COOLING Binning SDCM 2</p>	223x85x214	W	3000K	1900	spot	650-11704295ng6	209,00	
		223x85x214	S	3000K	1900	spot	650-11704296ng6	209,00	
		223x85x214	W	4000K	2030	spot	650-11702245ng6	209,00	
		223x85x214	S	4000K	2030	spot	650-11702246ng6	209,00	
		223x85x214	W	3000K	1900	medium	650-11704595ng6	209,00	
		223x85x214	S	3000K	1900	medium	650-11704596ng6	209,00	
		223x85x214	W	4000K	2030	medium	650-11702545ng6	209,00	
		223x85x214	S	4000K	2030	medium	650-11702546ng6	209,00	
		223x85x214	W	3000K	1900	flood	650-11704895ng6	209,00	
		223x85x214	S	3000K	1900	flood	650-11704896ng6	209,00	
		223x85x214	W	4000K	2030	flood	650-11702845ng6	209,00	
		223x85x214	S	4000K	2030	flood	650-11702846ng6	209,00	

LED 230V | 90° | 360° | inkl. | inkl. | IP20 | EEI: A++ - A

LION 28W



INFO	LM	LxBxH	FARBE	LED	LUMEN	REF.	ART. NR.	EURO	LAGER
<p>Stromschienenstrahler, Aluminium, Feinstruktur matt weiß oder schwarz pulverbeschichtet, Kühlkörper eloxiert, Leuchtenkopf 360° dreh- / 90° schwenkbar, Vakuumbedampfter Alurefektor in 3 Ausstrahlwinkeln, spezial beschichtetes Schutzglas, inkl. Konverter</p> <p>3000K: PREMIUM CRI>90 4000K: CRI>90</p> <p>LED 2700K & 3500K Versionen auf Anfrage</p>	<p>SYS 28W 230V PASSIVE COOLING Binning SDCM 2</p>	223x85x231	W	3000K	2550	spot	650-22504295ng6	228,00	
		223x85x231	S	3000K	2550	spot	650-22504296ng6	228,00	
		223x85x231	W	4000K	2730	spot	650-22502245ng6	228,00	
		223x85x231	S	4000K	2730	spot	650-22502246ng6	228,00	
		223x85x231	W	3000K	2550	medium	650-22504595ng6	228,00	
		223x85x231	S	3000K	2550	medium	650-22504596ng6	228,00	
		223x85x231	W	4000K	2730	medium	650-22502545ng6	228,00	
		223x85x231	S	4000K	2730	medium	650-22502546ng6	228,00	
		223x85x231	W	3000K	2550	flood	650-22504895ng6	228,00	
		223x85x231	S	3000K	2550	flood	650-22504896ng6	228,00	
		223x85x231	W	4000K	2730	flood	650-22502845ng6	228,00	
		223x85x231	S	4000K	2730	flood	650-22502846ng6	228,00	

LED 230V | 90° | 360° | inkl. | inkl. | IP20 | EEI: A++ - A

LION 36W



INFO	LM	LxBxH	FARBE	LED	LUMEN	REF.	ART. NR.	EURO	LAGER
<p>Stromschienenstrahler, Aluminium, Feinstruktur matt weiß oder schwarz pulverbeschichtet, Kühlkörper eloxiert, Leuchtenkopf 360° dreh- / 90° schwenkbar, Vakuumbedampfter Alurefektor in 3 Ausstrahlwinkeln, spezial beschichtetes Schutzglas, inkl. Konverter</p> <p>3000K: PREMIUM CRI>90 4000K: CRI>90</p> <p>LED 2700K & 3500K Versionen auf Anfrage</p>	<p>SYS 36W 230V PASSIVE COOLING Binning SDCM 2</p>	223x85x231	W	3000K	3120	spot	650-23024295ng6	230,00	
		223x85x231	S	3000K	3120	spot	650-23024296ng6	230,00	
		223x85x231	W	4000K	3340	spot	650-23022245ng6	230,00	
		223x85x231	S	4000K	3340	spot	650-23022246ng6	230,00	
		223x85x231	W	3000K	3120	medium	650-23024595ng6	230,00	
		223x85x231	S	3000K	3120	medium	650-23024596ng6	230,00	
		223x85x231	W	4000K	3340	medium	650-23022545ng6	230,00	
		223x85x231	S	4000K	3340	medium	650-23022546ng6	230,00	
		223x85x231	W	3000K	3120	flood	650-23024895ng6	230,00	
		223x85x231	S	3000K	3120	flood	650-23024896ng6	230,00	
		223x85x231	W	4000K	3340	flood	650-23022845ng6	230,00	
		223x85x231	S	4000K	3340	flood	650-23022846ng6	230,00	

LED 230V | 90° | 360° | inkl. | inkl. | IP20 | EEI: A++ - A

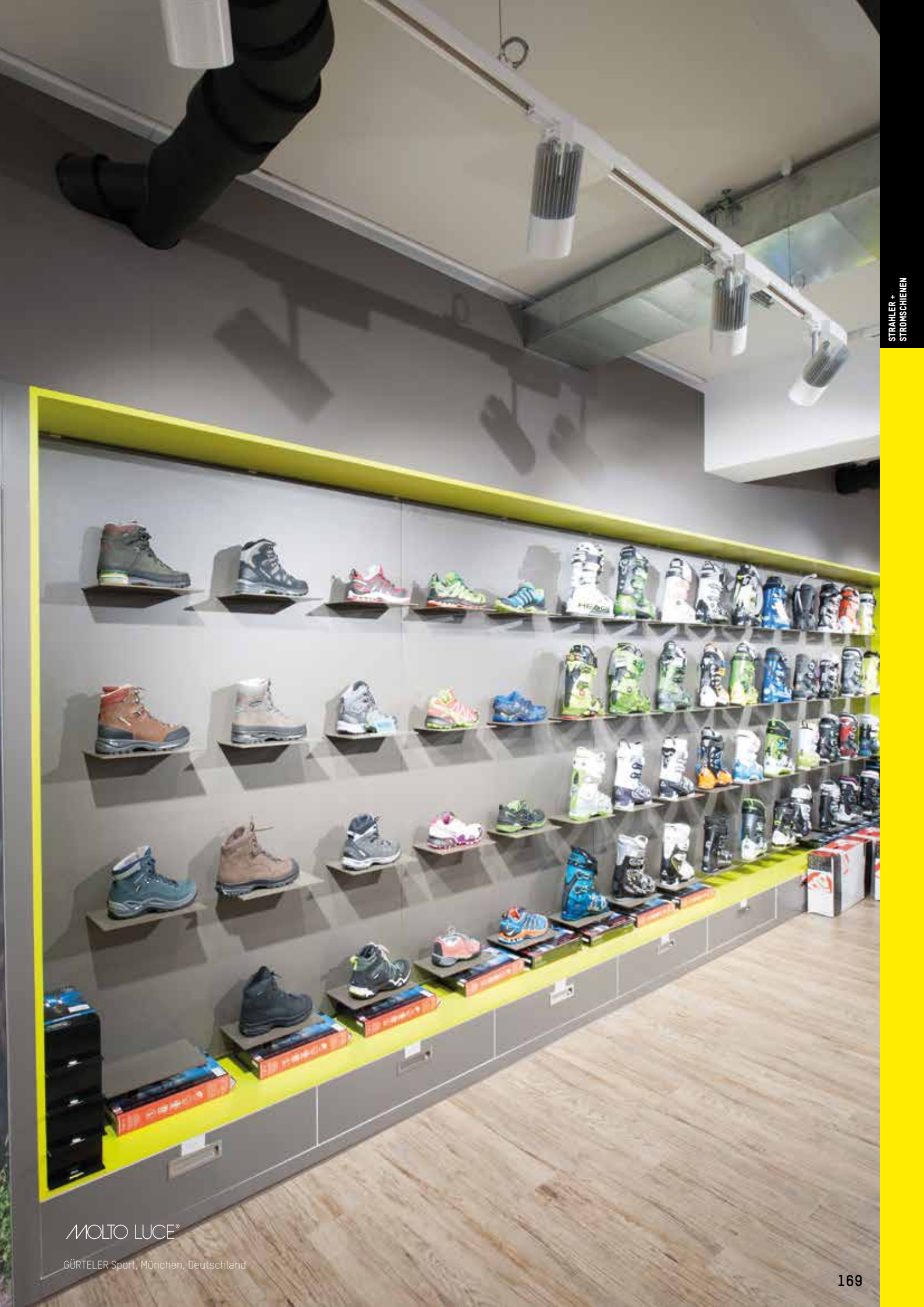

MOLTO LUCE®

GÜRTELER Sport, München, Deutschland

GA-017 CASA

	INFO	LM	ØxLxH	FARBE	REF.	ART. NR.	EURO	LAGER
	Stromschienenstrahler, Aluminiumdruckguss, weiß, schwarz oder silber pulverbeschichtet, Passivkühlung, Leuchtenkopf 350° dreh- / 90° schwenkbar, Reflektor aus hochwertigem facettiertem Aluminium in 3 Ausstrahlwinkeln, Bajonettverschluss, klares Schutzglas, inkl. Konverter	SYS 25W 230V 2948lm CRI>80 LED 3000K	74x162x83	S	15°	200-135j01437855	112,00	
			74x162x83	W	15°	200-135j01437856	112,00	
			74x162x83	S	15°	200-135j01437859	112,00	
			74x162x83	S	21°	200-135j01437885	112,00	
			74x162x83	W	21°	200-135j01437886	112,00	
			74x162x83	S	21°	200-135j01437889	112,00	
			74x162x83	S	32°	200-135j01437875	112,00	
			74x162x83	W	32°	200-135j01437876	112,00	
			74x162x83	S	32°	200-135j01437879	112,00	

LED 230V | 90° | 350° inkl. | IP20 | EEI: A++ - A

GA-017 STANDARD

	INFO	LM	ØxLxH	FARBE	REF.	ART. NR.	EURO	LAGER
	Stromschienenstrahler, Aluminiumdruckguss, weiß, schwarz oder silber pulverbeschichtet, Passivkühlung, Leuchtenkopf 350° dreh- / 90° schwenkbar, Reflektor aus hochwertigem facettiertem Aluminium in 3 Ausstrahlwinkeln, Bajonettverschluss, klares Schutzglas, inkl. Konverter	SYS 25W 230V 2993lm CRI>80 LED 3000K	84x162x92	S	15°	200-136j01437115	120,00	
			84x162x92	W	15°	200-136j01437116	120,00	
			84x162x92	S	15°	200-136j01437119	120,00	
			84x162x92	S	20°	200-136j01437145	120,00	
			84x162x92	W	20°	200-136j01437146	120,00	
			84x162x92	S	20°	200-136j01437149	120,00	
			84x162x92	S	30°	200-136j01437125	120,00	
			84x162x92	W	30°	200-136j01437126	120,00	
			84x162x92	S	30°	200-136j01437129	120,00	

LED 230V | 90° | 350° inkl. | IP20 | EEI: A++ - A

CASA AC

	INFO	LM	ØxH	LED	LUMEN	FARBE	REF.	ART. NR.	EURO	LAGER
	AC- Stromschienenstrahler, Aluminiumdruckguss, weiß, schwarz oder silber pulverbeschichtet, Passivkühlung, Leuchtenkopf 350° dreh- / 90° schwenkbar, Reflektor aus hochwertigem facettiertem Aluminium in 2 Ausstrahlwinkeln, Bajonettverschluss, klares Schutzglas	SYS 13W 230V CRI>80	74x83	2700	950	S	15°	200-176000144115	69,00	
			74x83	2700	950	W	15°	200-176000144116	69,00	
			74x83	2700	950	S	15°	200-176000144119	69,00	
			74x83	2700	950	S	24°	200-176000144125	69,00	
			74x83	2700	950	W	24°	200-176000144126	69,00	
			74x83	2700	950	S	24°	200-176000144129	69,00	
			74x83	3000	950	S	15°	200-176000244115	69,00	
			74x83	3000	950	W	15°	200-176000244116	69,00	
			74x83	3000	950	S	15°	200-176000244119	69,00	
			74x83	3000	950	S	24°	200-176000244125	69,00	😊
			74x83	3000	950	W	24°	200-176000244126	69,00	😊
			74x83	3000	950	S	24°	200-176000244129	69,00	😊

LED 230V | 90° | 350° inkl. | IP20 | EEI: A++ - A

SHOPSTAR AC

	INFO	LM	ØxBxH	FARBE	LED	LUMEN	REF.	ART. NR.	EURO	LAGER
	AC Schienenstrahler für 3-Phasen Schiene, Aluminiumdruckguss, weiß, schwarz oder silber matt Feinstruktur pulverbeschichtet, Vakuumdampfer Aluminiumreflektor FLOOD, Leuchtenkopf 350° drehbar und 90° schwenkbar, spezial beschichtetes Schutzglas, HV LED mit integrierter Vorschalt elektronik	SYS 11W 230V CRI >90 PASSIVE COOLING Binning SDCM 3	95x135x167	SM	3000K	690	flood	608-61202894ng2	170,00	
			95x135x167	W	3000K	690	flood	608-61202895ng2	170,00	
			95x135x167	S	3000K	690	flood	608-61202896ng2	170,00	
			95x135x167	SM	4000K	720	flood	608-61202844ng2	170,00	
			95x135x167	W	4000K	720	flood	608-61202845ng2	170,00	
			95x135x167	S	4000K	720	flood	608-61202846ng2	170,00	
		SYS 23W 230V CRI >90 PASSIVE COOLING Binning SDCM 3	95x135x167	SM	3000K	1640	flood	608-62502894ng2	185,00	
			95x135x167	W	3000K	1640	flood	608-62502895ng2	185,00	
			95x135x167	S	3000K	1640	flood	608-62502896ng2	185,00	
			95x135x167	SM	4000K	1750	flood	608-62502844ng2	185,00	
			95x135x167	W	4000K	1750	flood	608-62502845ng2	185,00	
			95x135x167	S	4000K	1750	flood	608-62502846ng2	185,00	

LED 230V | 90° | 350° inkl. | IP20 | EEI: A++ - A



MOLTO LUCE®

DIESEL Store, Salzburg, Österreich

RESPECT DOUBLE



LED 230V | inkl. | IP20 | EEL: A++ - A

INFO	LM	LxBxH	FARBE	REF.	ART. NR.	EURO	LAGER
Stromschienenleuchte, Aluminiumdruckguss, weiß pulverbeschichtet, Passivkühlung, Abdeckung opal, direkter oder doppelasymmetrischer Lichtaustritt	SYS 27W 230V 3150lm CRI>80 LED 3000K	469x56x43	W	direkt	200-124g04144956	125,00	
		469x56x43	W	doppelasymmetrisch	200-124g04144966	125,00	

RESPECT SINGLE



LED 230V | inkl. | IP20 | EEL: A++ - A

INFO	LM	LxBxH	FARBE	REF.	ART. NR.	EURO	LAGER
Stromschienenleuchte, Aluminiumdruckguss, weiß pulverbeschichtet, Passivkühlung, Abdeckung opal, direkter Lichtaustritt	SYS 15W 230V 1620lm CRI>80 LED 3000K	463x32x43	W	direkt	200-123g03944956	99,00	

SCOPE



LED 230V | 90° | inkl. | IP20 | EEL: A++ - A

INFO	LM	LxBxH	FARBE	REF.	ART. NR.	EURO	LAGER
Stromschienenleuchte, Aluminiumdruckguss, weiß oder schwarz pulverbeschichtet, Passivkühlung, Abdeckung opal, direkter oder doppelasymmetrischer Lichtaustritt, 90° schwenkbar	SYS 27W 230V 3150lm CRI>80 LED 3000K	454x63x66	W	direkt	200-125g04144956	144,00	
		454x63x66	W	doppelasymmetrisch	200-125g04144966	144,00	
		454x63x66	S	direkt	200-125g04144959	144,00	
		454x63x66	S	doppelasymmetrisch	200-125g04144969	144,00	

DASH AC 11W



INFO	LM	ØxH	FARBE	REF.	ART. NR.	EURO	LAGER
AC Stromschienenstrahler, Aluminiumdruckguss, pulverbeschichtet oder galvanisiert, Leuchtenkopf 350° dreh- / 90° schwenkbar, vakuumbedampfter Alurefektor in 2 Ausstrahlwinkeln, AC-LED mit integrierter Vorschalt elektronik	SYS 11W 230V CRI >90 650lm PASSIVE COOLING Binning SDCM 3 LED 2700K	65x125	SM	medium	599-11402534ng2	160,00	☺
		65x125	W	medium	599-11402535ng2	160,00	☺
		65x125	S	medium	599-11402536ng2	160,00	☺
		65x125	SM	flood	599-11402834ng2	160,00	☺
		65x125	W	flood	599-11402835ng2	160,00	☺
		65x125	S	flood	599-11402836ng2	160,00	☺
	SYS 11W 230V CRI >90 690lm PASSIVE COOLING Binning SDCM 3 LED 3000K	65x125	SM	medium	599-11402594ng2	160,00	☺
		65x125	W	medium	599-11402595ng2	160,00	☺
		65x125	S	medium	599-11402596ng2	160,00	☺
		65x125	SM	flood	599-11402894ng2	160,00	☺
		65x125	W	flood	599-11402895ng2	160,00	☺
		65x125	S	flood	599-11402896ng2	160,00	☺

LED 230V | | | | inkl. | | IP20 | EEL: A++ - A

DASH L AC 11W



INFO	LM	ØxH	FARBE	REF.	ART. NR.	EURO	LAGER
AC Aufbaustrahler, Aluminiumdruckguss, pulverbeschichtet oder galvanisiert, Leuchtenkopf 350° dreh- / 90° schwenkbar, vakuumbedampfter Alurefektor in 2 Ausstrahlwinkeln, AC-LED mit integrierter Vorschalt elektronik Dekorring innenliegend standard schwarz, optional in anderen Farben verfügbar (separat ordern)	SYS 11W 230V CRI >90 650lm PASSIVE COOLING Binning SDCM 3 LED 2700K	65x155	SM	medium	599-41402534ng2	171,00	
		65x155	W	medium	599-41402535ng2	171,00	
		65x155	S	medium	599-41402536ng2	171,00	
		65x155	SM	flood	599-41402834ng2	171,00	
		65x155	W	flood	599-41402835ng2	171,00	
		65x155	S	flood	599-41402836ng2	171,00	
	SYS 11W 230V CRI >90 690lm PASSIVE COOLING Binning SDCM 3 LED 3000K	65x155	SM	medium	599-41402594ng2	171,00	
		65x155	W	medium	599-41402595ng2	171,00	
		65x155	S	medium	599-41402596ng2	171,00	
		65x155	SM	flood	599-41402894ng2	171,00	
		65x155	W	flood	599-41402895ng2	171,00	
		65x155	S	flood	599-41402896ng2	171,00	

LED 230V | | | | inkl. | | IP20 | EEL: A++ - A

DEKORRING FÜR DASH L



INFO	SKIZZE	FARBE	ART. NR.	EURO	LAGER
innenliegend, separat ordern		SM	599-12	9,20	☺
		G	599-13	9,20	☺
		W	599-15	9,20	☺



LITIN AC 10W



INFO	LM	ØxH	FARBE	REF.	ART. NR.	EURO	LAGER
Stromschienenstrahler, Aluminiumdruckguss, weiß, schwarz oder silber Feinstruktur matt pulverbeschichtet, Leuchtenkopf 350° dreh- / 90° schwenkbar, Satinierter bündiger Dif- fusor aus PMMA, HV LED mit integrier- ter Vorschalt elektronik, kompatibel mit 3-Phasen Hochvoltstromschiene, Entblendungsring in zwei Ausführun- gen als Zubehör separat ordern	SYS 10W 230V CRI >80 600lm	90x82	SM	flood	651-00102141344	153,00	
		90x82	W	flood	651-00102141355	153,00	
	PASSIVE COOLING Binning SDCM 3	90x82	S	flood	651-00102141366	153,00	
	LED 2700K						
	SYS 10W 230V CRI >80 600lm	90x82	SM	flood	651-00102141944	153,00	
		90x82	W	flood	651-00102141955	153,00	
PASSIVE COOLING Binning SDCM 3	90x82	S	flood	651-00102141966	153,00		
LED 3000K							

LED 230V | 90° | 350° | inkl. | IP20 | EE: A++ - A

ENTBLENDUNGSRING FÜR LITIN



INFO	SKIZZE	FARBE	ART. NR.	EURO	LAGER
Entblendungsring schräg oder gerade mit Bajonettverschluss, Aluminium, pulverbeschichtet		SM	651-000024	17,50	
		W	651-000025	17,50	
		S	651-000026	17,50	
		SM	651-000014	17,50	
		W	651-000015	17,50	
		S	651-000016	17,50	

VISPO HV



INFO	LM	H	FARBE	ADAPTER	ART. NR.	EURO	LAGER
Stromschienenstrahler, galvanisiert oder lackiert, 360° dreh- / 90° schwenkbar, inkl. 3-Phasen UNI Adapter, Abmessungen ohne Leucht- mittel	QPAR16/20 GU10 · 230V max. 50W	95	C	G	26-840604	36,00	☺
	oder	95	P	G	26-840646	35,00	☺
	LED RETROFIT GU10	95	W	W	26-840207	35,00	☺

230V HV | 90° | 360° | IP20 | EE: A++ - D

3-PHASEN STROMSCHIENE AUFBAU



3-Phasen Stromschiene, Aufbau oder Pendelmontage, extrudiertes Aluminiumprofil, weiß, schwarz oder grau lackiert, Kupferleiter DM 4mm², asymmetrischer Aufbau, XTS, Zubehör separat ordern

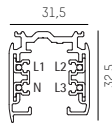

L	FARBE	ART. NR.	EURO	LAGER
1000	W	208-19104103	25,00	☺
1000	S	208-19104102	25,00	☺
1000	G	208-19104105	25,00	☺
2000	W	208-19104203	49,50	☺
2000	S	208-19104202	49,50	☺
2000	G	208-19104205	49,50	☺
3000	W	208-19104303	74,00	☺
3000	S	208-19104302	74,00	☺
3000	G	208-19104305	74,00	☺
4000	W	208-19104403	108,00	☺
4000	S	208-19104402	108,00	☺
4000	G	208-19104405	108,00	☺

230V HV IP20

3-PHASEN STROMSCHIENE EINBAU

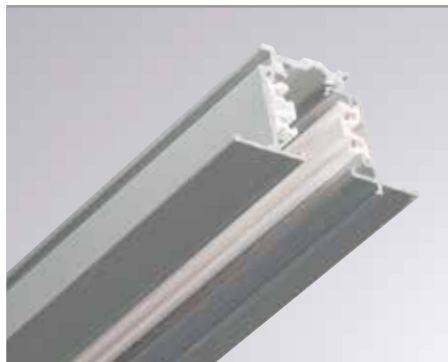

3-Phasen Stromschiene, Einbaumontage, extrudiertes Aluminiumprofil, weiß, schwarz oder grau lackiert, Kupferleiter DM 4mm², asymmetrischer Aufbau, XTSF, Zubehör separat ordern

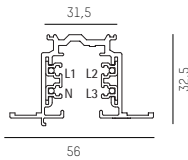

L	FARBE	ART. NR.	EURO	LAGER
1000	W	208-19105103	32,50	☺
1000	S	208-19105102	32,50	☺
1000	G	208-19105105	32,50	☺
2000	W	208-19105203	63,50	☺
2000	S	208-19105202	63,50	☺
2000	G	208-19105205	63,50	☺
3000	W	208-19105303	94,00	☺
3000	S	208-19105302	94,00	☺
3000	G	208-19105305	94,00	☺

230V HV IP20

MONTAGEBÜGEL

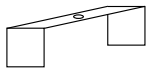

Montagebügel für 3-Phasen Stromschiene Einbau, Stahlblech, inkl. Schrauben M4x60

FARBE	ART. NR.	EURO	LAGER
NM	775-hv60000808	6,00	☺

ENDKAPPE

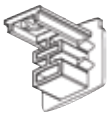

Endkappe XTS41, Alle Stromschiene müssen mit einer Endkappe versehen werden!

FARBE	ART. NR.	EURO	LAGER
W	208-19170413	0,80	☺
S	208-19170412	0,80	☺
G	208-19170411	0,80	☺

ENDEINSPEISUNG

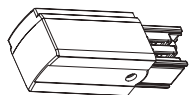

XTS11
Schutzleiter rechts / Earth right

LxB	FARBE	ART. NR.	EURO	LAGER
66x30	W	208-19170113	9,50	☺
66x30	S	208-19170112	9,50	☺
66x30	G	208-19170111	9,50	☺



Schutzleiter links / Earth left
XTS12

LxB	FARBE	ART. NR.	EURO	LAGER
66x30	W	208-19170123	9,50	☺
66x30	S	208-19170122	9,50	☺
66x30	G	208-19170121	9,50	☺

MITTELEINSPEISUNG



Schutzleiter links Earth left
XTS14
Schutzleiter rechts Earth right

LxB	FARBE	ART. NR.	EURO	LAGER
100x30	W	208-19170143	19,00	☺
100x30	S	208-19170142	19,00	☺
100x30	G	208-19170141	19,00	☺

LINEARVERBINDER ELEKTRISCH



INFO	FARBE	ART. NR.	EURO	LAGER
Linearverbinder XTS21 elektrisch, zum Verbinden von zwei Stromschienen	W	208-19170213	6,30	☺
	S	208-19170212	6,30	☺
	G	208-19170211	6,30	☺

FLEXIBLER VERBINDER

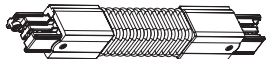

INFO	LxB	FARBE	ART. NR.	EURO	LAGER
Flexibler Verbinder XTS23, biegsam 0 - 360°, Flexschlauch	175x30	W	208-19170233	25,00	☺
	175x30	S	208-19170232	25,00	☺
	175x30	G	208-19170231	25,00	☺



WINKELVERBINDER

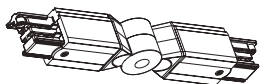

INFO	LxB	FARBE	ART. NR.	EURO	LAGER
Winkelverbinder XTS24, einstellbar 60 - 300°	160x30	W	208-19170243	25,00	☺
	160x30	S	208-19170242	25,00	☺
	160x30	G	208-19170241	25,00	☺



ECKVERBINDER

mit Einspeisungsmöglichkeit

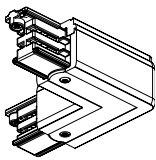

INFO	LxB	FARBE	ART. NR.	EURO	LAGER
mit Einspeisungsmöglichkeit	66x66	W	208-19170343	20,50	☺
	66x66	S	208-19170342	20,50	☺
	66x66	G	208-19170341	20,50	☺
mit Einspeisungsmöglichkeit	66x66	W	208-19170353	20,50	☺
	66x66	S	208-19170352	20,50	☺
	66x66	G	208-19170351	20,50	☺

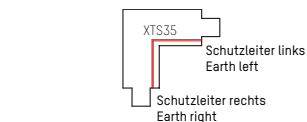
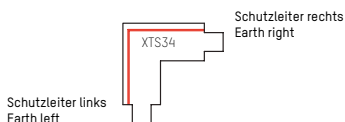

T-VERBINDER

mit Einspeisungsmöglichkeit

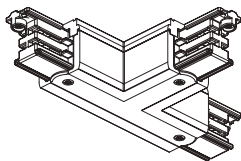

INFO	LxB	FARBE	ART. NR.	EURO	LAGER
mit Einspeisungsmöglichkeit	100x66	W	208-19170363	31,50	☺
	100x66	S	208-19170362	31,50	☺
	100x66	G	208-19170361	31,50	☺
mit Einspeisungsmöglichkeit	100x66	W	208-19170373	31,50	☺
	100x66	S	208-19170372	31,50	☺
	100x66	G	208-19170371	31,50	☺
mit Einspeisungsmöglichkeit	100x66	W	208-19170393	31,50	☺
	100x66	S	208-19170392	31,50	☺
	100x66	G	208-19170391	31,50	☺
mit Einspeisungsmöglichkeit	100x66	W	208-19170403	31,50	☺
	100x66	S	208-19170402	31,50	☺
	100x66	G	208-19170401	31,50	☺

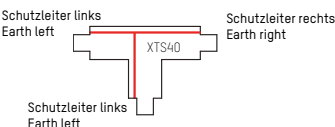
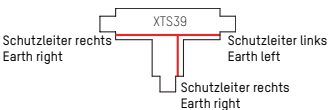
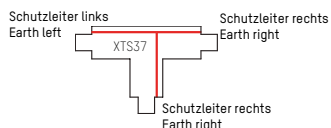
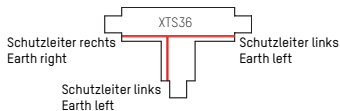

X-VERBINDER

mit Einspeisungsmöglichkeit

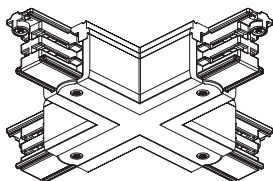

INFO	LxB	FARBE	ART. NR.	EURO	LAGER
mit Einspeisungsmöglichkeit	100x100	W	208-19170383	41,00	☺
	100x100	S	208-19170382	41,00	☺
	100x100	G	208-19170381	41,00	☺

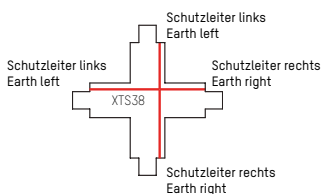

DECKENHALTERUNG

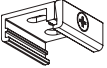
INFO	FARBE	ART. NR.	EURO	LAGER
 <p>Deckenhalterung SKB12, Aluminium eloxiert oder weiß, schwarz lackiert</p>	W	208-19180123	3,40	☺
	S	208-19180122	3,40	☺
	A	208-19180121	3,40	☺

ABHÄNGESET

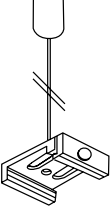
INFO	L	FARBE	ART. NR.	EURO	LAGER
 <p>Abhängegerät bestehend aus je 1x SKB12, SKB30 und SKB34, inkl. Höhenversteller an der Schiene</p>	1500	W	208-19003	3,70	☺
	1500	S	208-19002	3,70	☺
	1500	G	208-19001	3,70	☺
	3000	W	208-19005	9,50	☺
	3000	S	208-19006	9,50	☺
	3000	G	208-19004	9,50	☺

DECKENBEFESTIGUNG

INFO	FARBE	ART. NR.	EURO	LAGER
 <p>Deckenbefestigung SKB11T, für Aufbauschiene XTS, zum Befestigen an einer Rasterdecke mit T-Profil</p>	W	208-19180116	4,80	☺
	S	208-19180115	4,80	☺
	G	208-19180114	4,80	☺

SCHNELLEBFESTIGUNGSSET

INFO	FARBE	ART. NR.	EURO	LAGER
 <p>Höhenverstellbar, Nickel glänzend, Seil separat ordern</p>	N	639-as	6,50	☺

SEILABHÄNGUNG

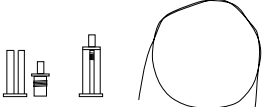
INFO	ART. NR.	EURO	LAGER
 <p>Werkzeuglos montierbar, beliebig kürzbar, Dübel und Schrauben im Lieferumfang nicht enthalten, L 3000mm, DM 1,2mm², 639-as Schnellbefestigungsset separat ordern</p>	639-s3000	6,50	☺

STAHLSEIL METERWARE

INFO	ART. NR.	EURO	LAGER
 <p>Stahlseil SPW 50-1, je Laufmeter, DM 1,5mm²</p>	208-19190501	0,70	☺

DECKENBEFESTIGUNGSSET

INFO	FARBE	ART. NR.	EURO	LAGER
 <p>2 Deckenhalter + 2 Seilstopper, werkzeuglos höhenverstellbar, Nickel glänzend</p>	N	5-plsb	13,00	☺

MULTIADAPTER

INFO	LxBxH	FARBE	ART. NR.	EURO	LAGER
 <p>Multiadapter XTSA68, Tragkraft max.10kg</p>	85x30x55	W	208-19130681	10,50	☺
	85x30x55	S	208-19130685	10,50	☺
	85x30x55	G	208-19130684	10,50	☺

MULTIADAPTER

INFO	LxBxH	FARBE	ART. NR.	EURO	LAGER
 <p>Multiadapter GA69, Tragkraft max.5kg</p>	85x30x40	W	208-19130698	9,00	☺
	85x30x40	S	208-19130697	9,00	☺
	85x30x40	G	208-19130696	9,00	☺

BLINDADAPTER

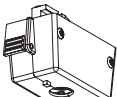
INFO	FARBE	ART. NR.	EURO	LAGER
 <p>Blindadapter zur Aufhängung von Leuchten XTSK17, Tragkraft max.10kg</p>	W	208-19162173	5,00	☺

ALUNIPPEL

INFO	Maße	FARBE	ART. NR.	EURO	LAGER
 <p>Alunippel XTSA55/12 (M13x1) und XTSA57/12 (M10x1) zur Befestigung des Strahlers am Adapter</p>	M 13 x 1, L: 12	AP	208-19130551	1,80	☺
	M 10 x 1, L: 12	AP	208-19130571	1,80	☺
	M 10 x 1, L: 8	AP	208-19130591	1,80	☺

ZUGENTLASTUNG

INFO	FARBE	ART. NR.	EURO	LAGER
 <p>Zum Aufschrauben auf Alu-Nippel M10</p>	W	208-19825016	0,70	☺
	S	208-19825019	0,70	☺

SCHUKO-ADAPTER

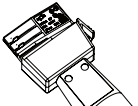
INFO	FARBE	ART. NR.	EURO	LAGER
 <p>Schukokupplung zum Einstecken in die Schiene, max. 16A XTSA67S</p>	W	208-19130678	41,50	☺

SCHIENENADAPTER FÜR DEKOHAKEN

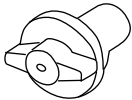
INFO	FARBE	ART. NR.	EURO	LAGER
 <p>Schiennenadapter für Dekohaken XTAK14, Kunststoff, zum Einclippen in XTS-Schiene, Dekohaken separat ordern</p>	W	208-19160143	0,80	☺
	S	208-19160142	0,80	☺
	G	208-19160141	0,80	☺

DEKOHAKEN

INFO	FARBE	ART. NR.	EURO	LAGER
 <p>Dekohaken XTAK11-1, DM 2mm, zum Eindrehen in Schienenadapter</p>	E	208-19160111	0,20	☺

EINBAURAHMEN

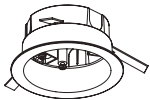
INFO	ØxET	DA Ø	FARBE	ART. NR.	EURO	LAGER
 <p>Einbaurahmen XTSA71, in Verbindung FIX POINT GA70 zu ordern</p>	130x60	105-114	W	208-19130713	18,00	☺
	130x60	105-114	S	208-19130712	18,00	☺
	130x60	105-114	G	208-19130711	18,00	☺

FIX POINT

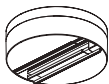
INFO	ØxH	FARBE	ART. NR.	EURO	LAGER
 <p>Fix Point GA70, für Deckenaufbau, max.10A, Tragkraft max.5kg, nicht geeignet für Adapter mit integriertem Konverter</p>	100x32	W	208-19121703	26,00	☺
	100x32	S	208-19121702	26,00	☺
	100x32	G	208-19121701	26,00	☺

ABDECKPLATTE

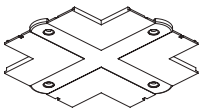
INFO	FARBE	ART. NR.	EURO	LAGER
 <p>für T- / 90° und Kreuzverbinder, nur für Einbauschiensystem XTSF, inkl. Bruchkante XTSF 30</p>	W	208-19172303	2,80	☺
	S	208-19172302	2,80	☺
	G	208-19172301	2,80	☺

ABDECKPLATTE

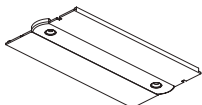
INFO	FARBE	ART. NR.	EURO	LAGER
 <p>Abdeckplatte XTSA10, für Mittel- und Endeinspeisung, nur für Einbauschiensystem XTSF, inkl. Bruchkante</p>	W	208-19172103	2,50	☺
	S	208-19172102	2,50	☺
	G	208-19172101	2,50	☺

BIEGEWERKZEUG

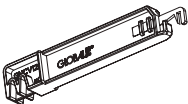
INFO	ART. NR.	EURO	LAGER
 <p>Biegewerkzeug XTSA12, zur einfachen Stromleiterbiegung bei gekrümmten Schienen notwendig</p>	208-19135121	11,50	☺

DASH AC 11W



INFO	LM	ØxH	FARBE	REF.	ART. NR.	EURO	LAGER
Stromschienenstrahler, Aluminiumdruckguss, matt Feinstruktur pulverbeschichtet oder galvanisiert, Leuchtenkopf 350° dreh- / 90° schwenkbar, vakuumbedampfter Alurefektor in 2 Ausstrahlwinkeln, HV LED mit integrierter Vorschalt elektronik, kompatibel mit Volare Diretta Hochvoltstromschiene	SYS 11W 230V CRI >90 650lm PASSIVE COOLING Binning SDCM 3 LED 2700K	65x124	C	medium	599-21402531ng3	176,00	
		65x124	SM	medium	599-21402534ng3	165,00	
		65x124	W	medium	599-21402535ng3	165,00	☺
		65x124	S	medium	599-214025366ng3	165,00	☺
		65x124	C	flood	599-21402831ng3	176,00	
		65x124	SM	flood	599-21402834ng3	165,00	
		65x124	W	flood	599-21402835ng3	165,00	☺
		65x124	S	flood	599-214028366ng3	165,00	☺
	SYS 11W 230V CRI >90 690lm PASSIVE COOLING Binning SDCM 3 LED 3000K	65x124	C	medium	599-21402591ng3	176,00	
		65x124	SM	medium	599-21402594ng3	165,00	
		65x124	W	medium	599-21402595ng3	165,00	☺
		65x124	S	medium	599-214025966ng3	165,00	☺
		65x124	C	flood	599-21402891ng3	176,00	
		65x124	SM	flood	599-21402894ng3	165,00	
		65x124	W	flood	599-21402895ng3	165,00	☺
		65x124	S	flood	599-214028966ng3	165,00	☺

LED 230V | 90° | 350° | inkl. | IP20 | EEL: A++ - A

DASH L AC 11W



INFO	LM	ØxH	FARBE	REF.	ART. NR.	EURO	LAGER	
Stromschienenstrahler, Aluminiumdruckguss, matt Feinstruktur pulverbeschichtet oder galvanisiert, Leuchtenkopf 350° dreh- / 90° schwenkbar, vakuumbedampfter Alurefektor in 2 Ausstrahlwinkeln, HV LED mit integrierter Vorschalt elektronik, kompatibel mit Volare Diretta Hochvoltstromschiene Dekorring innenliegend standard schwarz, optional in anderen Farben verfügbar (separat ordern)	SYS 11W 230V CRI >90 650lm PASSIVE COOLING Binning SDCM 3 LED 2700K	65x150	SM	medium	599-51402534ng3	175,00		
		65x150	W	medium	599-51402535ng3	175,00		
		65x150	S	medium	599-514025366ng3	175,00		
		65x150	SM	flood	599-51402834ng3	175,00		
		65x150	W	flood	599-51402835ng3	175,00		
		65x150	S	flood	599-514028366ng3	175,00		
		SYS 11W 230V CRI >90 690lm PASSIVE COOLING Binning SDCM 3 LED 3000K	65x152	SM	medium	599-51402594ng3	175,00	
			65x152	W	medium	599-51402595ng3	175,00	
	65x152		S	medium	599-514025966ng3	175,00		
	65x152		SM	flood	599-51402894ng3	175,00		
	65x152		W	flood	599-51402895ng3	175,00		
	65x152		S	flood	599-514028966ng3	175,00		

LED 230V | 90° | 350° | inkl. | IP20 | EEL: A++ - A

DEKORRING FÜR DASH L

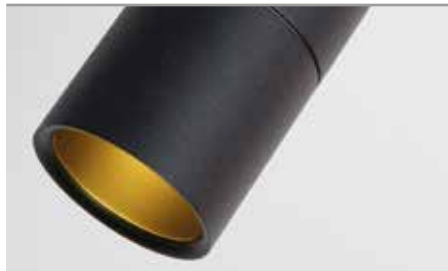

INFO	SKIZZE	FARBE	ART. NR.	EURO	LAGER
innenliegend, separat ordern		SM	599-12	9,20	☺
		G	599-13	9,20	☺
		W	599-15	9,20	☺



LITIN AC 10W



INFO	LM	ØxH	FARBE	REF.	ART. NR.	EURO	LAGER
Stromschienstrahler, Aluminiumdruckguss, matt Feinstruktur pulverbeschichtet oder galvanisiert, Leuchtenkopf 350° dreh- / 90° schwenkbar, Satinierter bündiger Diffusor aus PMMA, HV LED mit integrierter Vorschalt elektronik, kompatibel mit Volare Diretta Hochvoltstromschiene, Entblendungsring in zwei Ausführungen als Zubehör separat ordern	SYS 10W 230V CRI >80 600lm PASSIVE COOLING Binning SDCM 3 LED 2700K	90x85	C	flood	651-00202141311	173,00	☺
		90x85	SM	flood	651-00202141344	163,00	☺
		90x85	W	flood	651-00202141355	163,00	☺
		90x85	S	flood	651-00202141366	163,00	☺
	SYS 10W 230V CRI >80 600lm PASSIVE COOLING Binning SDCM 3 LED 3000K	90x85	C	flood	651-00202141911	173,00	☺
		90x85	SM	flood	651-00202141944	163,00	☺
		90x85	W	flood	651-00202141955	163,00	☺
		90x85	S	flood	651-00202141966	163,00	☺

LED 230V | 90° | 350° | inkl. | IP20 | EEI: A++ - A

ENTBLENDUNGSRING FÜR LITIN



INFO	SKIZZE	FARBE	ART. NR.	EURO	LAGER
Entblendungsring schräg oder gerade mit Bajonettverschluss, Aluminium, matt Feinstruktur pulverbeschichtet		SM	651-000024	17,50	☺
		W	651-000025	17,50	☺
		S	651-000026	17,50	☺
		SM	651-000014	17,50	☺
		W	651-000015	17,50	☺
		S	651-000016	17,50	☺

ELOS



INFO	LM	ØxBxH	FARBE	ART. NR.	EURO	LAGER
Stromschienstrahler, Aluminium, lackiert oder galvanisiert, Leuchtenkopf 340° dreh- / 90° schwenkbar, kompatibel mit Volare Diretta Hochvoltstromschiene	OPAR16 GU10 · 230V max. 50W	65x82x114	C	654-00250000011	125,00	☺
		65x82x114	SM	654-00250000042	125,00	☺
	oder LED RETROFIT GU10	65x82x114	W	654-00250000055	125,00	☺
		65x82x114	S	654-00250000066	125,00	☺

230V HV | 90° | 340° | IP20 | EEI: A++ - D



SENSO



INFO	LM	LxBxH	FARBE	AUSFÜHRUNG	ART. NR.	EURO	LAGER
Stromschiene Strahler, Aluminium, lackiert oder galvanisiert, Leuchtenkopf 285° dreh- / 90° schwenkbar, kompatibel mit Volare Diretta und 3-Phasen Hochvoltstromschiene oder mit Deckenbaldachin (Ø = 80mm)	QPAR16/20 GU10 · 230V max. 50W	40x40x142	SM	VOLARE DIRETTA	658-00275000044	73,00	☺
		40x40x142	C	VOLARE DIRETTA	658-00275000011	79,00	☺
	oder	40x40x142	W	VOLARE DIRETTA	658-00275000055	73,00	☺
	LED RETROFIT GU10	40x40x142	S	VOLARE DIRETTA	658-00275000066	73,00	☺
		40x40x137	SM	3-PH ADAPTER	658-00175000044	59,00	☺

230V HV EEL: A+++ - D

CONTE



INFO	LM	ØxBxH	FARBE	ART. NR.	EURO	LAGER
Stromschiene Strahler, Aluminium, lackiert oder galvanisiert, Leuchtenkopf 340° dreh- / 90° schwenkbar, kompatibel mit Volare Diretta Hochvoltstromschiene, Dekkoring separat ordern	QPAR16/20 GU10 · 230V max. 50W	59x82x114	C	659-00275000011	85,00	☺
		59x82x114		659-00275000042	85,00	☺
	oder	59x82x114	W	659-00275000055	85,00	☺
	LED RETROFIT GU10	59x82x114	S	659-00275000066	85,00	☺

230V HV EEL: A+++ - D

DEKORRING FÜR CONTE



SKIZZE	FÜR LM	FARBE	ART. NR.	EURO	LAGER	
Dekkorring für Conte, Aluminium, lackiert oder galvanisiert 	QPAR 16	C	659-000011	18,00	☺	
	QPAR 16		659-000012	18,00	☺	
	QPAR 16	W	659-000015	18,00	☺	
	QPAR 16	S	659-000016	18,00	☺	
	QPAR 20	C	659-000021	20,00	☺	
	QPAR 20		659-000022	20,00	☺	
	QPAR 20	W	659-000025	20,00	☺	
	QPAR 20	S	659-000026	20,00	☺	



SHOOTER 1



INFO	LM	BxH	FARBE	AUSFÜHRUNG	ART. NR.	EURO	LAGER
Stromschiene Strahler, Aluminiumdruckguss, pulverbeschichtet oder galvanisiert, Leuchtenkopf 285° dreh- / 90° schwenkbar, werkzeugloser Lampenwechsel, kompatibel mit Volare Direccion und 3-Phasen Hochvoltstromschiene	QPAR16 GU10 · 230V max. 50W	80x130	C	VOLARE DIRETTA	653-00201000011	110,00	
		80x130	W	VOLARE DIRETTA	653-00201000055	99,00	
		80x130	S	VOLARE DIRETTA	653-00201000066	99,00	
	LED RETROFIT GU10	80x130	C	3-PH ADAPTER	653-00101000061	110,00	
		80x130	W	3-PH ADAPTER	653-00101000055	99,00	
		80x130	S	3-PH ADAPTER	653-00101000066	99,00	

230V HV | | | | | EEL: A+++ - D

SHOOTER 2



INFO	LM	BxH	FARBE	AUSFÜHRUNG	ART. NR.	EURO	LAGER
Stromschiene Strahler, 2 flammig, Aluminiumdruckguss, pulverbeschichtet oder galvanisiert, Leuchtenkopf 285° dreh- / 90° schwenkbar, werkzeugloser Lampenwechsel, kompatibel mit Volare Direccion und 3-Phasen Hochvoltstromschiene	2 x QPAR16 GU10 · 230V max. 50W	140x130	C	VOLARE DIRETTA	653-00202000011	175,00	
		140x130	W	VOLARE DIRETTA	653-00202000055	154,00	
		140x130	S	VOLARE DIRETTA	653-00202000066	154,00	
	LED RETROFIT GU10	140x130	C	3-PH ADAPTER	653-00102000061	165,00	
		140x130	W	3-PH ADAPTER	653-00102000055	145,00	
		140x130	S	3-PH ADAPTER	653-00102000066	145,00	

230V HV | | | | | EEL: A+++ - D

MIX



INFO	LM	ØxH	FARBE	AUSFÜHRUNG	ART. NR.	EURO	LAGER
Stromschiene Strahler, Aluminiumdruckguss, eloxiert, Leuchtenkopf 285° dreh- / 90° schwenkbar, Glas opal satiniert, werkzeugloser Lampenwechsel, kompatibel mit Volare Direccion und 3-Phasen Hochvoltstromschiene oder mit Deckenbaldauchin (Ø= 80mm)	QPAR16 GU10 · 230V max. 50W	70x197	AE	VOLARE DIRETTA	656-00250000048	79,00	☺
		70x191	AE	3-PH ADAPTER	656-00150000048	79,00	☺

230V HV | | | | | EEL: A+++ - D

ROCCO



INFO	LM	ØxH	FARBE	AUSFÜHRUNG	ART. NR.	EURO	LAGER
Stromschiene Strahler, Aluminium, lackiert oder galvanisiert, Leuchtenkopf starr, Glas opal satiniert, kompatibel mit Volare Direccion und 3-Phasen Hochvoltstromschiene	QT14 ECO G9 · 230V max. 60W	70x194		VOLARE DIRETTA	657-00260000042	109,00	☺
		70x194	C	VOLARE DIRETTA	657-00260000011	109,00	☺
		70x194	W	VOLARE DIRETTA	657-00260000055	109,00	☺
	LED RETROFIT G9	70x194	S	VOLARE DIRETTA	657-00260000066	109,00	☺
		70x190		3-PH ADAPTER	657-00160000044	109,00	☺

230V HV | | | EEL: A+++ - E



VOLARE DIRETTA STROMSCHIENE



INFO
2-Phasen Stromschiene, Aluminium-Strangpressprofil eloxiert, pulverbeschichtet oder galvanisiert, beliebig kürzbar, inkl. Bohrungen und Befestigungsmaterial, Installation als Aufbau- und Pendelmontage, Systemzubehör separat ordern, kompatibel mit einer Vielzahl an Leuchten, max. Belastung: 10A pro Phase

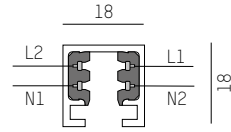

230V
HV



L	FARBE	ART. NR.	EURO	LAGER
1000	C	652-0010100001	69,00	☺
2000	C	652-0010200001	125,00	☺
1000	AE	652-0010100008	54,00	☺
2000	AE	652-0010200008	97,00	☺
2950	AE	652-0010300008	139,00	☺
1000	W	652-0010100005	54,00	☺
2000	W	652-0010200005	97,00	☺
2950	W	652-0010300005	139,00	☺
1000	S	652-0010100006	54,00	☺
2000	S	652-0010200006	97,00	☺
2950	S	652-0010300006	139,00	☺

ENDKAPPE

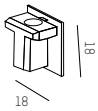

INFO
Endkappe, Kunststoff, lackiert, alle Stromschiene
müssen mit einer Endkappe versehen werden!

FARBE	ART. NR.	EURO	LAGER
SM	652-0050200004	7,00	☺
G	652-0050200008	3,20	☺
S	652-0050200006	4,50	☺
W	652-0050200005	4,50	☺

EINSPEISUNG

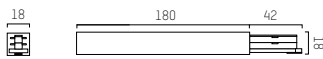

INFO
Endeinspeisung, Aluminium Strangpressprofil eloxiert, pulverbeschichtet oder chrom galvanisiert

FARBE	ART. NR.	EURO	LAGER
C	652-0040100001	118,00	☺
AE	652-0040100008	99,00	☺
W	652-0040100005	99,00	☺
S	652-0040100006	99,00	☺

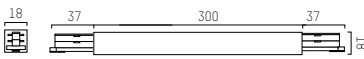

INFO
Miteinspeisung, Aluminium Strangpressprofil eloxiert, pulverbeschichtet oder chrom galvanisiert

FARBE	ART. NR.	EURO	LAGER
C	652-0040200001	155,00	☺
AE	652-0040200008	140,00	☺
W	652-0040200005	140,00	☺
S	652-0040200006	140,00	☺

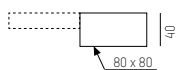

INFO
Endeinspeisung mit Baldachin, Aluminium Druckguss eloxiert, pulverbeschichtet oder chrom galvanisiert, für Direktmontage an Volare Diretta Schiene

FARBE	ART. NR.	EURO	LAGER
C	652-0040300001	105,00	☺
AE	652-0040300008	95,00	☺
W	652-0040300005	95,00	☺
S	652-0040300006	95,00	☺

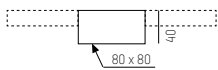

INFO
Miteinspeisung mit Baldachin, Aluminium Druckguss eloxiert, pulverbeschichtet oder chrom galvanisiert, für Direktmontage an Volare Diretta Schiene

FARBE	ART. NR.	EURO	LAGER
C	652-0040400001	137,00	☺
AE	652-0040400008	113,00	☺
W	652-0040400005	113,00	☺
S	652-0040400006	113,00	☺

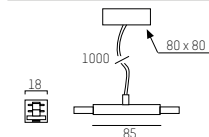

INFO
Miteinspeisung mit Baldachin, Aluminium eloxiert, pulverbeschichtet oder chrom galvanisiert, Baldachin 80x80x40mm, Kabel L= max.1000mm, 5x1,5mm², beliebig kürzbar

L	FARBE	ART. NR.	EURO	LAGER
1000	C	652-0040500001	185,00	☺
1000	AE	652-0040500008	164,00	☺
1000	W	652-0040500005	164,00	☺
1000	S	652-0040500006	164,00	☺

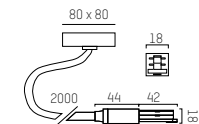

INFO
Kabelendeinspeisung mit Baldachin, Aluminium eloxiert, pulverbeschichtet oder chrom galvanisiert, Baldachin 80x80x40mm, Kabel L= max.2000mm, 5x1,5mm², beliebig kürzbar

L	FARBE	ART. NR.	EURO	LAGER
2000	C	652-0040700001	179,00	☺
2000	AE	652-0040700008	164,00	☺
2000	W	652-0040700005	164,00	☺
2000	S	652-0040700006	164,00	☺



INFO
Kabelendeinspeisung ohne Baldachin, Aluminium eloxiert, pulverbeschichtet oder chrom galvanisiert, Kabel L= max.2000mm, 5x1,5mm², beliebig kürzbar

L	FARBE	ART. NR.	EURO	LAGER
2000	C	652-0040800001	152,00	☺
2000	AE	652-0040800008	142,00	☺
2000	W	652-0040800005	142,00	☺
2000	S	652-0040800006	142,00	☺

VERBINDER

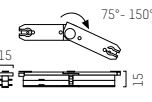
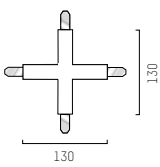
	INFO	FARBE	ART. NR.	EURO	LAGER
	Linearverbinder, Aluminium eloxiert, 4x1,5mm ² , zur abstandslosen elektrischen Verbindung von zwei Stromschienen	C	652-0030100001	32,00	☺
	2-Phasen-Stromschienen Isolierverbinder, eloxiert oder pulverbeschichtet, zur abstandslosen Isolierung von 2 Stromschienen	C	652-0030200001	30,00	☺
	Flexibler Winkelverbinder, Aluminium eloxiert, 4x1,5mm ² , zur elektrischen Verbindung von zwei Stromschienen, 90 - 270°	C	652-0030300001	73,00	☺
	90° Winkelverbinder, Aluminium eloxiert, pulverbeschichtet oder galvanisiert, 4x1,5mm ² , zur abstandslosen elektrischen Verbindung von zwei Stromschienen	C	652-0030400001	78,00	☺
		AE	652-0030400008	75,00	☺
		W	652-0030400005	75,00	☺
		S	652-0030400006	75,00	☺
	T-Verbinder, Aluminium eloxiert, pulverbeschichtet oder galvanisiert, 4x1,5mm ² , zur abstandslosen elektrischen Verbindung von drei Stromschienen	C	652-0030500001	189,00	☺
		AE	652-0030500008	179,00	☺
		W	652-0030500005	179,00	☺
		S	652-0030500006	179,00	☺
	Kreuzverbinder, Aluminium eloxiert, pulverbeschichtet oder galvanisiert, 4x1,5mm ² , zur abstandslosen elektrischen Verbindung von vier Stromschienen	C	652-0030600001	257,00	☺
		AE	652-0030600008	245,00	☺
		W	652-0030600005	245,00	☺
		S	652-0030600006	245,00	☺

BEFESTIGUNGEN

	INFO	FARBE	ART. NR.	EURO	LAGER
	Deckenbefestigung, Aluminium eloxiert, pulverbeschichtet oder galvanisiert, Distanzstück zur Vergrößerung des Decken oder Wandabstandes	C	652-0020200001	29,50	☺
		AE	652-0020200008	28,00	☺
		W	652-0020200005	28,00	☺
		S	652-0020200006	28,00	☺
	Deckenbefestigung, Aluminium eloxiert, pulverbeschichtet oder galvanisiert, Distanzstück zur Vergrößerung des Decken oder Wandabstandes	C	652-0020100001	13,00	☺
		AE	652-0020100008	12,00	☺
		W	652-0020100005	12,00	☺
		S	652-0020100006	12,00	☺
	Seilabhangung, Aluminium eloxiert, pulverbeschichtet oder galvanisiert, Seil L= max.1000mm, beliebig kürzbar	C	652-0020300001	40,00	☺
		AE	652-0020300008	39,00	☺
		W	652-0020300005	39,00	☺
		S	652-0020300006	39,00	☺

ABDECKUNG

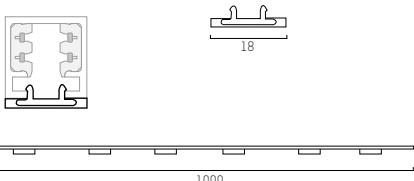
	INFO	FARBE	ART. NR.	EURO	LAGER
	Blindabdeckung für 2-Phasen Stromschiene, inkl. 6 Halteclips, L: 1000mm	C	652-0050100001	49,00	☺
		AE	652-0050100008	43,60	☺
		W	652-0050100005	43,60	☺
		S	652-0050100006	43,60	☺

OFFICE





SYSTEM 01



INFO	LM	AUSFÜHRUNG	LxBxH	FARBE	ART. NR.	EURO	LAGER
Stehleuchte, Aluminiumprofil eloxiert oder weiß pulverbeschichtet, direkt-/ indirekt strahlend, Direktabdeckung mit hochtransparenter Mikroprismenoptik, 2-Stufen-Schalter, dimmbar Taster oder Bewegungsmelder und Lichtsensor, inkl. EVG UGR<19	4 x TC-L 2611 - 230V 55W · EVG	2-stufig schaltbar	600x330x1946	AE	570-stl455e	592,00	☺
		2-stufig schaltbar	600x330x1946	W	570-stl455ew	653,00	☺
		Taster dimmbar	600x330x1946	AE	570-stl455d	729,00	☺
		Taster dimmbar	600x330x1946	W	570-stl455dw	790,00	☺
		Bewegungsmelder und Tageslichtsteuerung	600x330x1946	AE	570-stl455bwmng1	946,00	☺
		Bewegungsmelder und Tageslichtsteuerung	600x330x1946	W	570-stl455bwmng1	1007,00	

230V HV | | | | EEL: A++ - B

SYSTEM 01 LED

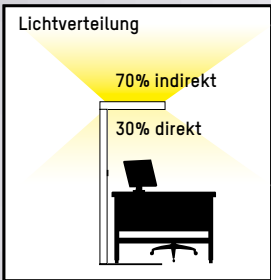
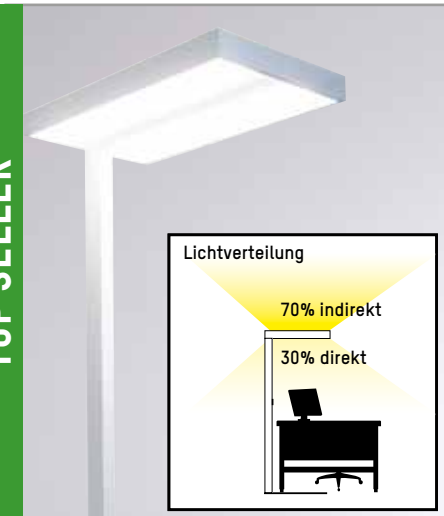

LM	AUSFÜHRUNG	LxBxH	FARBE	LED	LUMEN	ART. NR.	EURO	LAGER
SYS 145W 230V CRI >80	direkt / indirekt schaltbar	600x330x1946	AE	3000K	16769	570-1011198	1137,00	☺
		600x330x1946	W	3000K	16769	570-10111955	1199,00	☺
		600x330x1946	AE	4000K	17657	570-1011148	1137,00	☺
		600x330x1946	W	4000K	17657	570-10111455	1199,00	☺
SYS 133W 230V CRI >80	Taster dimmbar	600x330x1946	AE	3000K	16769	570-1012198	1173,00	
		600x330x1946	W	3000K	16769	570-10121955	1234,00	
		600x330x1946	AE	4000K	17659	570-1012148	1173,00	
		600x330x1946	W	4000K	17659	570-10121455	1234,00	
SYS 135W 230V CRI >80	Bewegungsmelder und Tageslichtsteuerung mit Schwarm Netzwerkfunktion (Fernbedienung erforderlich)	600x330x1946	AE	3000K	16769	570-1013198	1423,00	
		600x330x1946	W	3000K	16769	570-10131955	1484,00	
		600x330x1946	AE	4000K	17659	570-1013148	1423,00	
		600x330x1946	W	4000K	17659	570-10131455	1484,00	
	FERNBEDIENUNG		S			30-747635	103,00	☺

LED Stehleuchte, Aluminiumprofil eloxiert oder weiß pulverbeschichtet, direkt-/ indirekt strahlend, Direktabdeckung mit hochtransparenter Mikroprismenoptik, 2-Stufen-Schalter, dimmbar Taster oder Bewegungsmelder und Lichtsensor mit Schwarm-Netzwerkfunktion, inkl. LED Konverter

UGR<19
LED 230V | | | | EEL: A++ - A

SYSTEM 01 LED

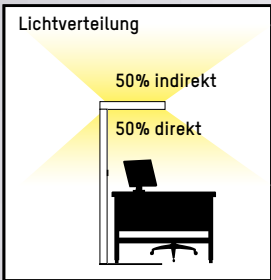
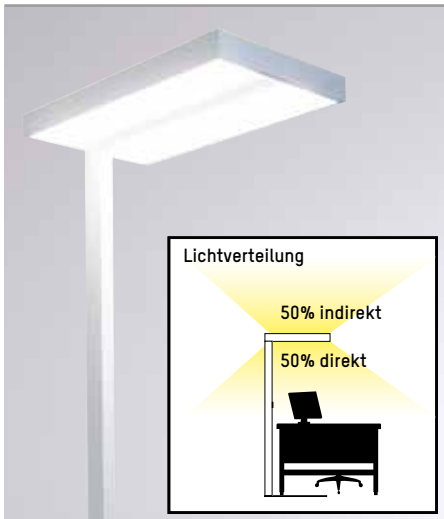

LM	AUSFÜHRUNG	LxBxH	FARBE	LED	LUMEN	ART. NR.	EURO	LAGER
SYS 115W 230V CRI >80	direkt / indirekt schaltbar	600x330x1946	AE	3000K	13350	570-1001198	988,00	☺
		600x330x1946	W	3000K	13350	570-10011955	1049,00	☺
		600x330x1946	AE	4000K	14057	570-1001148	988,00	☺
		600x330x1946	W	4000K	14057	570-10011455	1049,00	
SYS 103W 230V CRI >80	Taster dimmbar	600x330x1946	AE	3000K	13350	570-1002198	1123,00	☺
		600x330x1946	W	3000K	13350	570-10021955	1184,00	☺
		600x330x1946	AE	4000K	14057	570-1002148	1123,00	☺
		600x330x1946	W	4000K	14057	570-10021455	1184,00	
SYS 105W 230V CRI >80	Bewegungsmelder und Tageslichtsteuerung mit Schwarm Netzwerkfunktion (Fernbedienung erforderlich)	600x330x1946	AE	3000K	13350	570-1003198	1320,00	☺
		600x330x1946	W	3000K	13350	570-10031955	1381,00	☺
		600x330x1946	AE	4000K	14057	570-1003148	1320,00	☺
		600x330x1946	W	4000K	14057	570-10031455	1381,00	☺
	FERNBEDIENUNG		S			30-747635	103,00	☺

LED Stehleuchte, Aluminiumprofil eloxiert oder weiß pulverbeschichtet, direkt-/ indirekt strahlend, Direktabdeckung mit hochtransparenter Mikroprismenoptik, 2-Stufen-Schalter, dimmbar Taster oder Bewegungsmelder und Lichtsensor mit Schwarm-Netzwerkfunktion, inkl. LED Konverter

UGR<19
LED 230V | | | | EEL: A++ - A



SYSTEM 02 LED

LM	AUSFÜHRUNG	LxBxH	FARBE	LED	LUMEN	ART. NR.	EURO	LAGER
 <p>LED Stehleuchte, Aluminiumprofil eloxiert oder weiß pulverbeschichtet, direkt-/ indirekt strahlend, Direktabdeckung mit hochtransparenter Mikroprismenoptik, 2-Stufen-Schalter, dimmbar Taster oder Bewegungsmelder und Lichtsensor mit Schwarm-Netzwerkfunktion, inkl. LED Konverter</p>	SYS 145W 230V CRI >80	direkt / indirekt schaltbar	600x350x1946	AE	3000K	16769	625-1011198	1157,00
			600x350x1946	W	3000K	16769	625-10111955	1218,00
			600x350x1946	AE	4000K	17657	625-1011148	1157,00
			600x350x1946	W	4000K	17657	625-10111455	1218,00
	SYS 133W 230V CRI >80	Taster dimmbar	600x350x1946	AE	3000K	16769	625-1012198	1241,00
			600x350x1946	W	3000K	16769	625-10121955	1302,00
			600x350x1946	AE	4000K	17659	625-1012148	1241,00
			600x350x1946	W	4000K	17659	625-10121455	1302,00
SYS 135W 230V CRI >80	Bewegungsmelder und Tageslicht- steuerung mit Schwarm Netzwerkfunktion (Fernbedienung erforderlich)	600x350x1946	AE	3000K	16769	625-1013198	1547,00	
		600x350x1946	W	3000K	16769	625-10131955	1608,00	
		600x350x1946	AE	4000K	17659	625-1013148	1547,00	
		600x350x1946	W	4000K	17659	625-10131455	1608,00	
	FERNBEDIENUNG		S			30-747635	103,00	☺

UGR <19

LED 230V | inkl. | inkl. | IP20 | EEI: A++ - A

SYSTEM 02 LED

LM	AUSFÜHRUNG	LxBxH	FARBE	LED	LUMEN	ART. NR.	EURO	LAGER
 <p>LED Stehleuchte, Aluminiumprofil eloxiert oder weiß pulverbeschichtet, direkt-/ indirekt strahlend, Direktabdeckung mit hochtransparenter Mikroprismenoptik, 2-Stufen-Schalter, dimmbar Taster oder Bewegungsmelder und Lichtsensor mit Schwarm-Netzwerkfunktion, inkl. LED Konverter</p>	SYS 115W 230V CRI >80	direkt / indirekt schaltbar	600x350x1946	AE	3000K	13350	625-1001198	988,00
			600x350x1946	W	3000K	13350	625-10011955	1049,00
			600x350x1946	AE	4000K	14057	625-1001148	988,00
			600x350x1946	W	4000K	14057	625-10011455	1049,00
	SYS 103W 230V CRI >80	Taster dimmbar	600x350x1946	AE	3000K	13350	625-1002198	1123,00
			600x350x1946	W	3000K	13350	625-10021955	1184,00
			600x350x1946	AE	4000K	14057	625-1002148	1123,00
			600x350x1946	W	4000K	14057	625-10021455	1184,00
SYS 105W 230V CRI >80	Bewegungsmelder und Tageslicht- steuerung mit Schwarm Netzwerkfunktion (Fernbedienung erforderlich)	600x350x1946	AE	3000K	13350	625-1003198	1433,00	
		600x350x1946	W	3000K	13350	625-10031955	1495,00	
		600x350x1946	AE	4000K	14057	625-1003148	1433,00	
		600x350x1946	W	4000K	14057	625-10031455	1495,00	
	FERNBEDIENUNG		S			30-747635	103,00	☺



UGR <19

LED 230V | inkl. | inkl. | IP20 | EEI: A++ - A









SYSTEM 01

INFO	LM	LxBxH	FARBE	ART. NR.	EURO	LAGER
 <p>Hängeleuchte, Aluminiumprofil eloxiert oder weiß pulverbeschichtet, Direkt/Indirekt strahlend, Direktabdeckung mit hochtransparenter Mikroprismenoptik, inkl. EVG, Dimmbare Versionen auf Anfrage</p> <p>UGR<19</p>	2 x T16 · G5 · 230V · 28/54W · EVG	1223x197x46	AE	570-hl254e	393,00	
	2 x T16 · G5 · 230V · 28/54W · EVG	1223x197x46	W	570-hl254ew	441,00	
	2 x T16 · G5 · 230V · 35/49/80W · EVG	1523x197x46	AE	570-hl249e	447,00	
	2 x T16 · G5 · 230V · 35/49/80W · EVG	1523x197x46	W	570-hl249ew	495,00	

230V HV      | IP20 | EEL: A++ - B





SYSTEM 01 LED

INFO	LM	LxBxH	FARBE	LED	LUMEN	ART. NR.	EURO	LAGER
 <p>Hängeleuchte, Aluminiumprofil eloxiert oder weiß pulverbeschichtet, Direkt/Indirekt strahlend, Direktabdeckung mit hochtransparenter Mikroprismenoptik, inkl. Konverter, Dimmbare Versionen auf Anfrage</p> <p>UGR<19</p>	SYS 54W 230V · CRI >80	1213x149x46	AE	3000K	6090	570-hl226we	659,00	☺
		1213x149x46	W	3000K	6090	570-hl226ew	706,00	
		1213x149x46	AE	4000K	6420	570-hl226ne	659,00	
		1213x149x46	W	4000K	6420	570-hl226new	709,00	
	SYS 68W 230V · CRI >80	1498x149x46	AE	3000K	7620	570-hl233we	771,00	☺
		1498x149x46	W	3000K	7620	570-hl233ew	818,00	
		1498x149x46	AE	4000K	8030	570-hl233ne	771,00	
		1498x149x46	W	4000K	8030	570-hl233new	818,00	

LED 230V      | IP20 | EEL: A+++ - A





SYSTEM 02 LED

INFO	LM	LxBxH	FARBE	LED	LUMEN	ART. NR.	EURO	LAGER
 <p>Hängeleuchte, Aluminiumprofil eloxiert oder weiß pulverbeschichtet, Direkt/Indirekt strahlend, Direktabdeckung mit hochtransparenter Mikroprismenoptik, inkl. Konverter, Dimmbare Versionen auf Anfrage</p> <p>UGR<19</p>	SYS 68W 230V · CRI >80	1530x154x43	AE	3000K	7620	625-hl233we	771,00	
		1530x154x43	W	3000K	7620	625-hl233ew	818,00	
		1530x154x43	AE	4000K	8030	625-hl233ne	771,00	
		1530x154x43	W	4000K	8030	625-hl233new	818,00	

LED 230V      | IP20 | EEL: A+++ - A





SYSTEM 01

INFO	LM	LxBxH	FARBE	ART. NR.	EURO	LAGER
 <p>Wandleuchte, Aluminiumprofil eloxiert oder weiß pulverbeschichtet, Direkt/Indirekt strahlend, Direktabdeckung mit hochtransparenter Mikroprismenoptik, Einspeisung mittig, inkl. Wandbefestigung, inkl. EVG, Dimmbare Versionen auf Anfrage</p> <p>UGR<19</p>	2 x TC-L · 2G11 · 230V · 55W · EVG	600x205x46	AE	570-wl255e	228,00	
	2 x TC-L · 2G11 · 230V · 55W · EVG	600x205x46	W	570-wl255ew	288,00	

230V HV      | IP20 | EEL: A+++ - B

SYSTEM 01 LED

INFO	LM	LxBxH	FARBE	LED	LUMEN	ART. NR.	EURO	LAGER
 <p>Wandleuchte, Aluminiumprofil eloxiert oder weiß pulverbeschichtet, Direkt/Indirekt strahlend, Direktabdeckung mit hochtransparenter Mikroprismenoptik, Einspeisung mittig, inkl. Wandbefestigung, inkl. Konverter, Dimmbare Versionen auf Anfrage</p> <p>UGR<19</p>	SYS 27W 230V · CRI >80	600x188x46	AE	3000K	3040	570-wl213we	406,00	
		600x188x46	W	3000K	3040	570-wl213ew	466,00	
		600x188x46	AE	4000K	3210	570-wl213ne	406,00	
		600x188x46	W	4000K	3210	570-wl213new	466,00	

LED 230V      | IP20 | EEL: A+++ - A





LED 700mA 1050mA | exkl. | inkl. | IP40 | EEI: A++ - A

INFO

LED-Paneleinlegeleuchte, Alurahmen weiß lackiert, Modul 625, IP40, mit nanoprismatischer Abdeckung (UGR>19), Zubehör und LED Konverter separat ordern
Zu betreiben mit 700mA oder 1050mA.

UGR<19

LxBxH	ET	FARBE	LED	DIFFUSER	BEI 700mA	BEI 1050mA	ART. NR.	EURO	LAGER
622x622x15	55	W	3000K	NANOPRISMATISCH	28W CRI>80 LUMEN	38W CRI>80 LUMEN	757-625np30uswok	108,00	😊
622x622x15	55	W	4000K	NANOPRISMATISCH	3000	3850	757-625np40uswok	108,00	😊
KONVERTER SEPARAT ORDERN									
NICHT DIMMBAR					757-k700s	757-k1050s			
EURO					42,00	42,00			😊
DIMMBAR 1-10V, PUSH, DALI					757-k700d	757-k700d			
EURO					110,00	110,00			😊
KONVERTERINFO: Seite 318									

IS

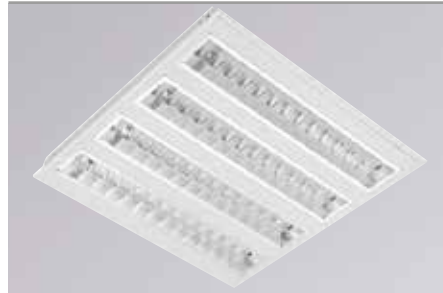

LED 230V | inkl. | inkl. | IP20 | EEI: A++ - A

INFO	LM	LxBxH	ET	DA LxB	LED	LUMEN	FARBE	ART. NR.	EURO	LAGER
LED-Einbauleuchte, Stahlblech, Hochglanzreflektor , inkl. LED Konverter und Montagebügel UGR<19	SYS 28W 230V CRI>80	622x622x52	150	602x602	3000K	3100	W	757-l6004	152,00	😊
		622x622x52	150	602x602	4000K	3100	W	757-l6005	152,00	😊
	SYS 28W 230V CRI>80	622x622x52	150	602x602	3000K	3100	W	757-l6004dali	212,00	
	DALI dimm.	622x622x52	150	602x602	4000K	3100	W	757-l6005dali	212,00	

AREL SYMMETRISCH DIREKT

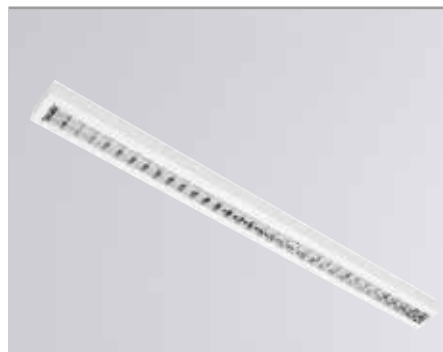

LED 230V | inkl. | inkl. | IP20 | EEI: A++ - A

INFO	LM	LxBxH	DIMMBARKEIT	LED	LUMEN	FARBE	ART. NR.	EURO	LAGER
LED Aufbauleuchte, Stahlblech weiß lackiert, mit hochglänzendem symmetrischen BAP-Raster , inkl. LED Konverter, Abhängung zur Verwendung als Pendelleuchte separat ordern. UGR<19	SYS 15W 230V CRI>80	1245x160x55	nicht dimmbar	3000K	1500	W	757-l2022	130,00	
		1245x160x55	nicht dimmbar	4000K	1500	W	757-l2023	130,00	
		1245x160x55	DALI dimmbar	3000K	1500	W	757-l2022dali	190,00	
		1245x160x55	DALI dimmbar	4000K	1500	W	757-l2023dali	190,00	
	SYS 23W 230V CRI>80	1545x160x55	nicht dimmbar	3000K	2300	W	757-l2024	130,00	😊
		1545x160x55	nicht dimmbar	4000K	2300	W	757-l2025	130,00	
		1545x160x55	DALI dimmbar	3000K	2300	W	757-l2024dali	190,00	😊
		1545x160x55	DALI dimmbar	4000K	2300	W	757-l2025dali	190,00	
	SYS 39W 230V CRI>80	1245x245x55	nicht dimmbar	3000K	3900	W	757-l2026	178,00	
		1245x245x55	nicht dimmbar	4000K	3900	W	757-l2027	178,00	
		1245x245x55	DALI dimmbar	3000K	3900	W	757-l2026dali	238,00	
		1245x245x55	DALI dimmbar	4000K	3900	W	757-l2027dali	238,00	
SYS 43W 230V CRI>80	1245x245x55	nicht dimmbar	3000K	4500	W	757-l2028	206,00	😊	
	1245x245x55	nicht dimmbar	4000K	4500	W	757-l2029	206,00	😊	
	1245x245x55	DALI dimmbar	3000K	4500	W	757-l2028dali	266,00		
	1245x245x55	DALI dimmbar	4000K	4500	W	757-l2029dali	266,00		



AREL SYMMETRISCH DIREKT/INDIREKT



INFO	LM	LxBxH	DIMMBARKEIT	LED	LUMEN	FARBE	ART. NR.	EURO	LAGER
LED Hängeleuchte, direkt- / indirekt strahlend, Stahlblech weiß lackiert, mit hochglänzendem asymmetrischem BAP-Raster , inkl. LED Konverter und Seilabhänger, Einspeise-set separat ordern . UGR<19	SYS 56W 230V CRI>80	1245x245x55	nicht dimmbar	3000K	5000	W	757-l1000	246,00	☺
		1245x245x55	nicht dimmbar	4000K	5000	W	757-l1001	246,00	☺
		1245x245x55	DALI dimmbar	3000K	5000	W	757-l1000dali	346,00	
		1245x245x55	DALI dimmbar	4000K	5000	W	757-l1001dali	346,00	
	SYS 82W 230V CRI>80	1545x245x55	nicht dimmbar	3000K	7500	W	757-l1002	286,00	
		1545x245x55	nicht dimmbar	4000K	7500	W	757-l1003	286,00	
		1545x245x55	DALI dimmbar	3000K	7500	W	757-l1002dali	386,00	
		1545x245x55	DALI dimmbar	4000K	7500	W	757-l1003dali	386,00	

LED 230V | inkl. | inkl. | IP20 | EEL: A++ - A

SEILABHÄNGE + EINSPEISESET

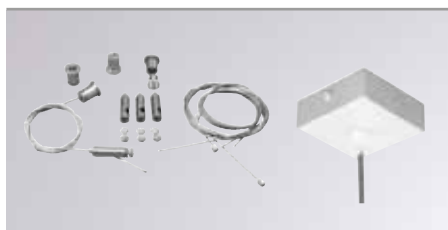

INFO	L	FARBE	ART. NR.	EURO	LAGER
Seilabhängeset 2m für AREL , bestehend aus: 4 Montagebügel, 4 Seile 2m, 8 Seilstopper (4x Decke + 4x Leuchte).	2000		757-zhx11	13,50	☺
Einspeise-set für AREL bestehend aus: Baldachin weiß inkl. Zugentlastung transp., Baldachin: 80x80x30 mm	2200 / 3 x 0,75 mm²	W	757-bk3w	16,00	☺
Einspeise-set für AREL bestehend aus: Baldachin weiß inkl. Zugentlastung transp., Baldachin: 80x80x30 mm	2200 / 5 x 0,75 mm²	W	757-bk5w	20,00	☺

LLL KV

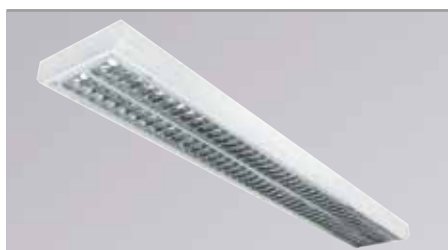

INFO	LM	LxB	H	LED	LUMEN	FARBE	ART. NR.	EURO	LAGER
LED Aufbauleuchte, Stahlblech weiß lackiert, mit hochglänzendem BAP-Raster , inkl. LED Konverter UGR<19	SYS 26W 230V CRI>80	1210x238	52	3000K	2900	W	757-l2000	152,00	☺
		1210x238	52	4000K	2900	W	757-l2001	152,00	☺
	SYS 60W 230V CRI>80	1510x238	52	3000K	5800	W	757-l2002	160,00	☺
		1510x238	52	4000K	5800	W	757-l2003	160,00	☺

LED 230V | inkl. | inkl. | IP20 | EEL: A++ - A

INDUSTRIE





ONE ROW TRAGSCHIENE



Sehr verwindungssteifes Aluminium Profil
Oberfläche alu eloxiert, weiß oder schwarz pulverbeschichtet
Durchgangsverdrahtung erfolgt mit den Systemeinheiten
Montagezubehör werkzeuglos montierbar



AUSFÜHRUNG	FÜR	LxBxH	FARBE	ART. NR.	EURO	LAGER
OHNE Durchgangsverdrahtung	21/42W	1149x70x48	W	639-15	35,00	
OHNE Durchgangsverdrahtung	21/42W	1149x70x48	S	639-16	35,00	
OHNE Durchgangsverdrahtung	21/42W	1149x70x48	AE	639-18	35,00	
OHNE Durchgangsverdrahtung	31/62W	1712x70x48	W	639-25	45,00	
OHNE Durchgangsverdrahtung	31/62W	1712x70x48	S	639-26	45,00	
OHNE Durchgangsverdrahtung	31/62W	1712x70x48	AE	639-28	45,00	
OHNE Durchgangsverdrahtung	41/82W	2275x70x48	W	639-35	55,00	
OHNE Durchgangsverdrahtung	41/82W	2275x70x48	S	639-36	55,00	
OHNE Durchgangsverdrahtung	41/82W	2275x70x48	AE	639-38	55,00	
OHNE Durchgangsverdrahtung	2 x 31/62W	3424x70x48	W	639-45	75,00	
OHNE Durchgangsverdrahtung	2 x 31/62W	3424x70x48	S	639-46	75,00	
OHNE Durchgangsverdrahtung	2 x 31/62W	3424x70x48	AE	639-48	75,00	
OHNE Durchgangsverdrahtung	2 x 41/82W	4550x70x48	W	639-55	94,00	
OHNE Durchgangsverdrahtung	2 x 41/82W	4550x70x48	S	639-56	94,00	
OHNE Durchgangsverdrahtung	2 x 41/82W	4550x70x48	AE	639-58	94,00	

ENDECKEL

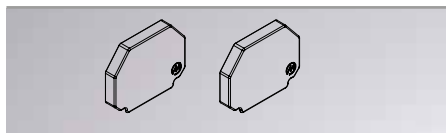

INFO	LxB	FARBE	ART. NR.	EURO	LAGER
Enddeckel (2 Stk.) für Tragschiene ONE ROW	70x50	W	639-te5	4,50	
	70x50	S	639-te6	4,50	
	70x50	SM	639-te4	4,50	

ENDECKEL IP54

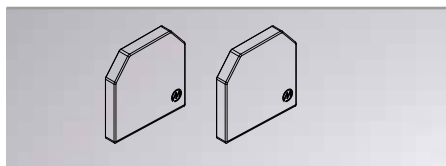

INFO	LxB	FARBE	ART. NR.	EURO	LAGER
Enddeckel (2 Stk.) für Tragschiene ONE ROW in Verbindung mit Abdeckungen IP54 zu ordern (siehe Seite 206)	70x80	W	639-teip5	35,00	
	70x80	S	639-teip6	35,00	
	70x80	SM	639-teip4	35,00	

EINSPEISUNGS-SET

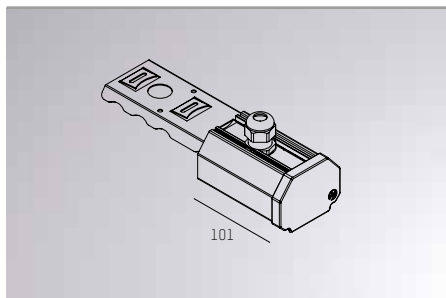

INFO	ANSCHLUSS	FARBE	ART. NR.	EURO 5 polig	EURO 7 polig	LAGER
inkl. Buchse & Erdungsset inkl. Einspeiseklemme ACHTUNG!!!! Ergänzen Sie das YY der Art. Nr. mit Ihrer gewünschten Verdrahtung 5 polig = 05 7 polig = 07 (für DALI dimm.)	PG 13,5	W	639-epg1YY5	45,00	47,00	
	PG 13,5	S	639-epg1YY6	45,00	47,00	
	PG 13,5	AE	639-epg1YY8	45,00	47,00	
	PG 16	W	639-epg2YY5	44,00	47,00	
	PG 16	S	639-epg2YY6	44,00	47,00	
	PG 16	AE	639-epg2YY8	44,00	47,00	

EINSPEISEKLEMME 5 POL.

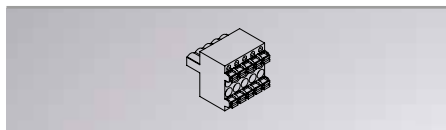

INFO	ART. NR.	EURO	LAGER
inkl. Erdungsset	639-dve05	11,00	

EINSPEISEKLEMME 7 POL.

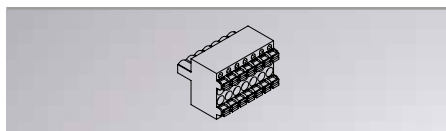

INFO	ART. NR.	EURO	LAGER
inkl. Erdungsset für DALI dimm.	639-dve07	13,5 0	



MOLTO LUCE®

Weingut Gesellmann, Deutschkreuz, Österreich

ONE ROW LED LICHTEINSÄTZE



LM	REFL.	L	LED	LUMEN	ART. NR.	EURO 5 polig	EURO 7 polig	EURO 9 polig	EURO 11 polig	LAGER
21W LICHTEINSATZ MIT HOHER EFFIZIENZ										
SYS 21W · 230V	breitstrahlend	1148	3000K	2880	639-11YY98bs	228,00	287,00	240,00	302,00	
SYS 21W · 230V	doppelasymm.	1148	3000K	2980	639-11YY98da	230,00	289,00	242,00	304,00	
SYS 21W · 230V	tiefstrahlend	1148	3000K	2940	639-11YY98ts	228,00	287,00	240,00	302,00	
SYS 21W · 230V	breitstrahlend	1148	4000K	2880	639-11YY48bs	228,00	287,00	240,00	302,00	
SYS 21W · 230V	doppelasymm.	1148	4000K	2980	639-11YY48da	230,00	289,00	242,00	304,00	
SYS 21W · 230V	tiefstrahlend	1148	4000K	2940	639-11YY48ts	228,00	287,00	240,00	302,00	
42W LICHTEINSATZ MIT HOHEM OUTPUT										
SYS 42W · 230V	breitstrahlend	1148	3000K	5360	639-12YY98bs	238,00	297,00	250,00	312,00	
SYS 42W · 230V	doppelasymm.	1148	3000K	5830	639-12YY98da	240,00	299,00	252,00	314,00	
SYS 42W · 230V	tiefstrahlend	1148	3000K	5760	639-12YY98ts	238,00	297,00	250,00	312,00	
SYS 42W · 230V	breitstrahlend	1148	4000K	5360	639-12YY48bs	238,00	297,00	250,00	312,00	
SYS 42W · 230V	doppelasymm.	1148	4000K	5830	639-12YY48da	240,00	299,00	252,00	314,00	
SYS 42W · 230V	tiefstrahlend	1148	4000K	5760	639-12YY48ts	238,00	297,00	250,00	312,00	
31W LICHTEINSATZ MIT HOHER EFFIZIENZ										
SYS 31W · 230V	breitstrahlend	1711	3000K	4310	639-21YY98bs	288,00	347,00	303,00	364,00	
SYS 31W · 230V	doppelasymm.	1711	3000K	4460	639-21YY98da	290,00	349,00	305,00	366,00	
SYS 31W · 230V	tiefstrahlend	1711	3000K	4410	639-21YY98ts	288,00	347,00	303,00	364,00	
SYS 31W · 230V	breitstrahlend	1711	4000K	4310	639-21YY48bs	288,00	347,00	303,00	364,00	
SYS 31W · 230V	doppelasymm.	1711	4000K	4460	639-21YY48da	290,00	349,00	305,00	366,00	
SYS 31W · 230V	tiefstrahlend	1711	4000K	4410	639-21YY48ts	288,00	347,00	303,00	364,00	
62W LICHTEINSATZ MIT HOHEM OUTPUT										
SYS 62W · 230V	breitstrahlend	1711	3000K	8450	639-22YY98bs	301,00	360,00	316,00	377,00	
SYS 62W · 230V	doppelasymm.	1711	3000K	8740	639-22YY98da	303,00	362,00	318,00	379,00	
SYS 62W · 230V	tiefstrahlend	1711	3000K	8640	639-22YY98ts	301,00	360,00	316,00	377,00	
SYS 62W · 230V	breitstrahlend	1711	4000K	8450	639-22YY48bs	301,00	360,00	316,00	377,00	
SYS 62W · 230V	doppelasymm.	1711	4000K	8740	639-22YY48da	303,00	362,00	318,00	379,00	
SYS 62W · 230V	tiefstrahlend	1711	4000K	8640	639-22YY48ts	301,00	360,00	316,00	377,00	
41W LICHTEINSATZ MIT HOHER EFFIZIENZ										
SYS 41W · 230V	breitstrahlend	2274	3000K	5750	639-31YY98bs	348,00	407,00	368,00	429,00	
SYS 41W · 230V	doppelasymm.	2274	3000K	5950	639-31YY98da	350,00	409,00	370,00	431,00	
SYS 41W · 230V	tiefstrahlend	2274	3000K	5880	639-31YY98ts	348,00	407,00	368,00	429,00	
SYS 41W · 230V	breitstrahlend	2274	4000K	5750	639-31YY48bs	348,00	407,00	368,00	429,00	
SYS 41W · 230V	doppelasymm.	2274	4000K	5950	639-31YY48da	350,00	409,00	370,00	431,00	
SYS 41W · 230V	tiefstrahlend	2274	4000K	5880	639-31YY48ts	348,00	407,00	368,00	429,00	
82W LICHTEINSATZ MIT HOHEM OUTPUT										
SYS 82W · 230V	breitstrahlend	2274	3000K	11260	639-32YY98bs	363,00	422,00	383,00	444,00	
SYS 82W · 230V	doppelasymm.	2274	3000K	11650	639-32YY98da	365,00	424,00	385,00	446,00	
SYS 82W · 230V	tiefstrahlend	2274	3000K	11520	639-32YY98ts	363,00	422,00	383,00	444,00	
SYS 82W · 230V	breitstrahlend	2274	4000K	11260	639-32YY48bs	363,00	422,00	383,00	444,00	
SYS 82W · 230V	doppelasymm.	2274	4000K	11650	639-32YY48da	365,00	424,00	385,00	446,00	
SYS 82W · 230V	tiefstrahlend	2274	4000K	11520	639-32YY48ts	363,00	422,00	383,00	444,00	

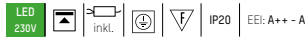

Systemlichteinsatz mit 3 unterschiedlichen Optiken. Breitstrahlend, Tiefstrahlend oder Doppelasymmetrisch, Durchgangsverdrahtung 5-, 7-, 9-, 11-polig

7- und 11-polige Version DALI dimmbar

ACHTUNG!!!!
Ergänzen Sie das **YY** der Art. Nr. mit Ihrer gewünschten Verdrahtung

- 5 polig = **05**
- 7 polig = **07** (für DALI dimm.)
- 5+4 polig = **09**
- 7+4 polig = **11** (für DALI dimm.)

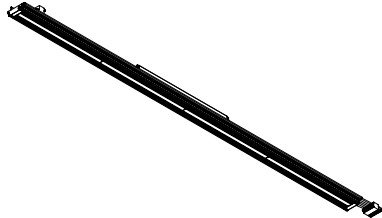

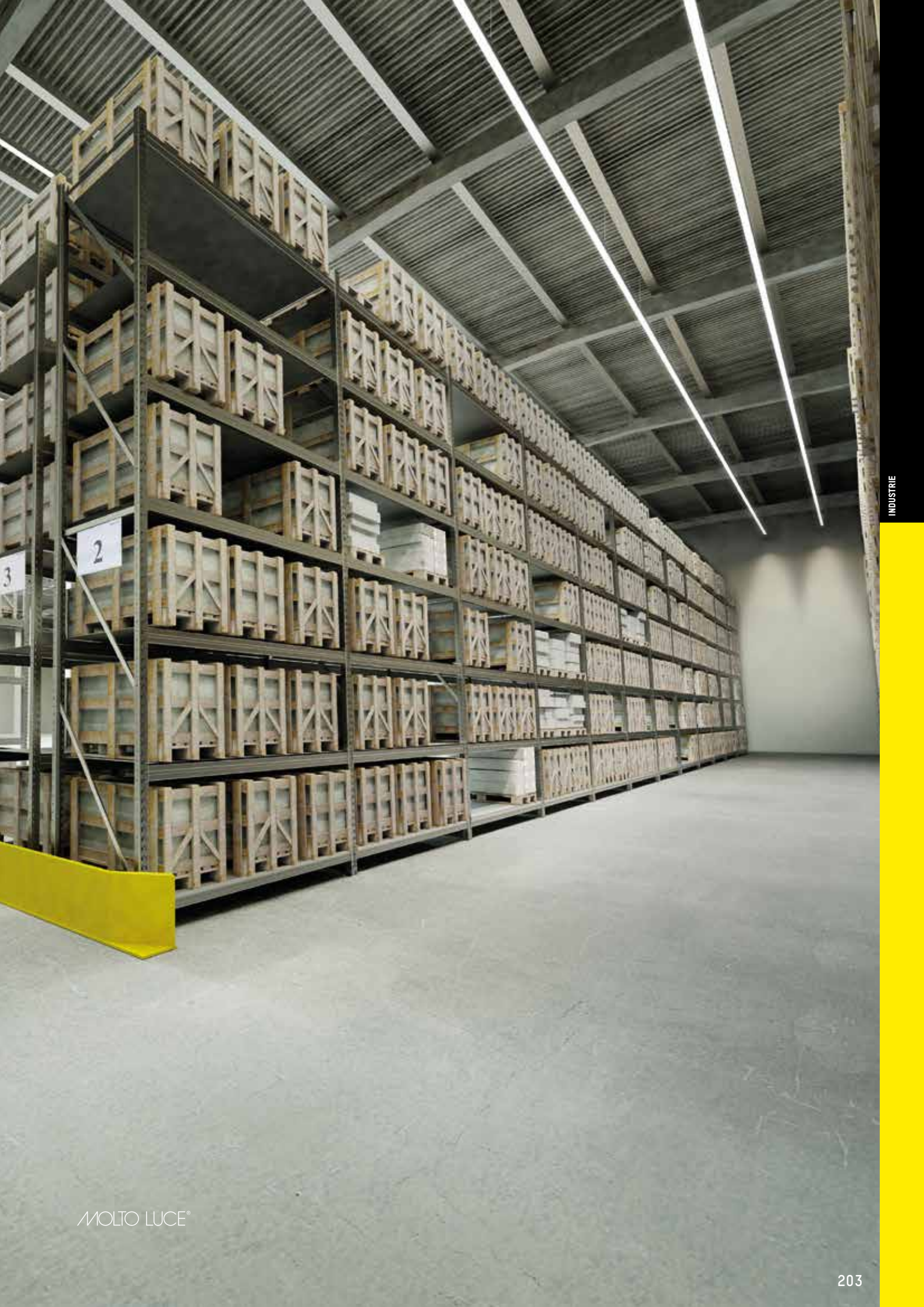

ONE ROW 2 GO



LED 230V | 350° drehbar | 180° schwenkbar | inkl. | inkl. | IP20 | EEL: A++ - A

System LED Strahler aus Aluminium. Vakuumbadempfter Reflektor in 4 Ausstrahlwinkel, Durchgangsverdrahtung 5-, 7-, 9-, 11-polig, schaltbar, 350° drehbar, 180° schwenkbar. Sehr energieeffiziente LEDs mit hoher Farbwiedergabe

3000K: PREMIUM CRI>90 / 4000K: CRI>90

LED 2700K, 3500K und Sonderlichtfarben Versionen auf Anfrage
Keine DALI Versionen verfügbar

ACHTUNG!!!!

Ergänzen Sie das YY der Art. Nr. mit Ihrer gewünschten Verdrahtung

- 5 polig = 05
- 7 polig = 07
- 5+4 polig = 09
- 7+4 polig = 11

LM	FARBE	LED	LUMEN	REF.	ART. NR.	EURO 5 polig	EURO 7 polig	EURO 9 polig	EURO 11 polig	LAGER
SYS 27W 230V	W	3000K	2500	17°	639-1YY04295	228,00	238,00	238,00	248,00	
PASSIVE COOLING	S	3000K	2500	17°	639-1YY04296	228,00	238,00	238,00	248,00	
Binning SDCM 2	SM	3000K	2500	17°	639-1YY04294	228,00	238,00	238,00	248,00	
	W	4000K	2630	17°	639-1YY02245	228,00	238,00	238,00	248,00	
	S	4000K	2630	17°	639-1YY02246	228,00	238,00	238,00	248,00	
	SM	4000K	2630	17°	639-1YY02244	228,00	238,00	238,00	248,00	
	W	3000K	2500	24°	639-1YY04595	228,00	238,00	238,00	248,00	
	S	3000K	2500	24°	639-1YY04596	228,00	238,00	238,00	248,00	
	SM	3000K	2500	24°	639-1YY04594	228,00	238,00	238,00	248,00	
	W	4000K	2630	24°	639-1YY02545	228,00	238,00	238,00	248,00	
	S	4000K	2630	24°	639-1YY02546	228,00	238,00	238,00	248,00	
	SM	4000K	2630	24°	639-1YY02544	228,00	238,00	238,00	248,00	
	W	3000K	2500	40°	639-1YY04895	228,00	238,00	238,00	248,00	
	S	3000K	2500	40°	639-1YY04896	228,00	238,00	238,00	248,00	
	SM	3000K	2500	40°	639-1YY04894	228,00	238,00	238,00	248,00	
	W	4000K	2630	40°	639-1YY02845	228,00	238,00	238,00	248,00	
	S	4000K	2630	40°	639-1YY02846	228,00	238,00	238,00	248,00	
	SM	4000K	2630	40°	639-1YY02844	228,00	238,00	238,00	248,00	
	W	3000K	2500	asym.	639-1YY04695	228,00	238,00	238,00	248,00	
	S	3000K	2500	asym.	639-1YY04696	228,00	238,00	238,00	248,00	
	SM	3000K	2500	asym.	639-1YY04694	228,00	238,00	238,00	248,00	
	W	4000K	2630	asym.	639-1YY02645	228,00	238,00	238,00	248,00	
	S	4000K	2630	asym.	639-1YY02646	228,00	238,00	238,00	248,00	
	SM	4000K	2630	asym.	639-1YY02644	228,00	238,00	238,00	248,00	

LICHTEINSATZ RETTUNGSZEICHEN



LED 230V | 350° drehbar | inkl. | inkl. | IP20 | EEL: A++ - A

INFO	LM	ANSCHLUSS	LxBxH	FARBE	ART. NR.	EURO	LAGER
Rettungszeichenleuchte, Gehäuse aus selbstverlöschendem Kunststoff weiß, Aufladezeit: 12h, Erkennungsreichweite 32m, inkl. Piktogramm (1x links, 1x rechts, 2x nach unten)	SYS 1,7W 230V	5+4 polig	289x34x274	AE	639-rz098	299,00	
	Brenndauer 3h	7+4 polig	289x34x274	AE	639-rz118	307,00	

LICHTEINSATZ NOTLEUCHE



LED 230V | inkl. | inkl. | IP20 | EEL: A++ - A

INFO	LM	MONTAGEHÖHE	ANSCHLUSS	LxBxH	FARBE	ART. NR.	EURO	LAGER
Sicherheitsleuchten-Systemeinsatz für One Row, Akkulaufzeit 3h, in 5+4poliger oder 7+4 poliger Ausführung inkl. Linse für Fluchtwegausleuchtung und Antipanikbeleuchtung, Abstand Leuchte-Leuchte 21m für eine normgerechte Ausleuchtung von 1lx	SYS 1,7W 230V	max. 3 Meter	5+4-polig	355x182x73	W	639-nle095	429,00	
	Brenndauer 3h	max. 3 Meter	7+4-polig	355x182x73	W	639-nle115	436,00	
	SYS 1,7W 230V	max. 10 Meter	5+4-polig	355x182x73	W	639-nlh095	486,00	
	Brenndauer 3h	max. 10 Meter	7+4-polig	355x182x73	W	639-nlh115	493,00	

WALLWASHER



INFO	L	FARBE	ART. NR.	EURO	LAGER
Wallwasher für ONE ROW, Werkzeuglose montage	1148	W	639-ww15	22,00	
	1148	AE	639-ww18	22,00	
	1711	W	639-ww25	28,00	
	1711	AE	639-ww28	28,00	
	2274	W	639-ww35	34,00	
	2274	AE	639-ww38	34,00	

BEFESTIGUNGSZUBEHÖR

SEILABHÄNGUNG

INFO	L	FARBE	ART. NR.	EURO	LAGER
 <p>Werkzeuglos montierbar, beliebig kürzbar, Dübel und Schrauben im Lieferumfang nicht enthalten. Schnellbefestigung separat ordern. Seilabstand max. 3000mm</p>	3000	E	639-s3000	6,50	

SEIL SCHNELLBESTIFTUNG

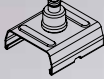
INFO	FARBE	ART. NR.	EURO	LAGER
 <p>für Seildurchmesser 1,2mm, Seilabhängung separat ordern</p>	E	639-as	6,50	

SEIL SCHNELLBESTIFTUNG HOCH

INFO	FARBE	ART. NR.	EURO	LAGER
 <p>für Seildurchmesser 1,2mm und zusätzliche Mitführung eines 25mm Installationsrohrs, Seilabhängung separat ordern</p>	E	639-ash	12,50	☺

SCHRÄGSEIL SCHNELLBESTIFTUNG

INFO	FARBE	ART. NR.	EURO	LAGER
 <p>Y-Seilabhängung für Seildurchmesser 1,2mm, Seilabhängung separat ordern</p>	E	639-ay	27,00	☺

DECKENBESTIFTUNG

INFO	FARBE	ART. NR.	EURO	LAGER
 <p>Dübel und Schrauben im Lieferumfang nicht enthalten</p>	E	639-ad	6,00	☺

KETTENABHÄNGUNG

INFO	FARBE	ART. NR.	EURO	LAGER
 <p>Werkzeuglos montierbar, Kette im Lieferumfang nicht enthalten</p>	E	639-ak	7,50	☺

VERBINDER

LINEARVERBINDER TRAGSCHIENE

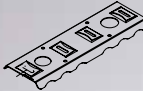
INFO	ART. NR.	EURO	LAGER
 <p>Linearverbinder für Tragschiene, mechanisch</p>	639-tv	12,00	

X-VERBINDER TRAGSCHIENE

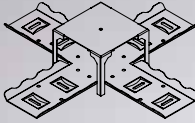
INFO	FARBE	ART. NR.	EURO	LAGER
 <p>X-Verbinder für Tragschiene, mechanisch, Kabel-Verbindungssatz separat ordern</p>	W	639-xtv5	47,00	
	S	639-xtv6	47,00	
	SM	639-xtv4	47,00	

L-VERBINDER TRAGSCHIENE

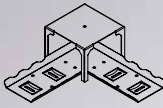
INFO	FARBE	ART. NR.	EURO	LAGER
 <p>L-Verbinder für Tragschiene, mechanisch, Kabel-Verbindungssatz separat ordern</p>	W	639-ltv5	36,00	
	S	639-ltv6	36,00	
	SM	639-ltv4	36,00	

T-VERBINDER TRAGSCHIENE

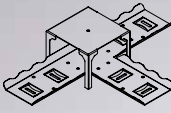
INFO	FARBE	ART. NR.	EURO	LAGER
 <p>T-Verbinder für Tragschiene, mechanisch, Kabel-Verbindungssatz separat ordern</p>	W	639-ttv5	39,00	
	S	639-ttv6	39,00	
	SM	639-ttv4	39,00	

KABEL-VERBINDUNGSSATZ

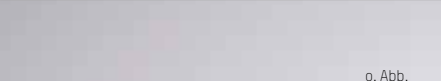
INFO	VERDRÄHTUNG	ART. NR.	EURO	LAGER
 <p>Kabelset zur elektrischen Verbindung für L, X, T -Verbinder</p>	5-Polig	639-kvs05	49,00	
	7-Polig	639-kvs07	62,00	

o. Abb.

ABDECKUNGEN

BLINDABDECKUNG METALL



5 - 11 polig durchgangsverdrahtet

ACHTUNG!!!!

Ergänzen Sie das **YY** der Art. Nr. mit Ihrer gewünschten Verdrahtung

- 5 polig = **05**
- 7 polig = **07** (für DALI dimm.)
- 5+4 polig = **09**
- 7+4 polig = **11** (für DALI dimm.)

LÄNGE	FARBE	ART. NR.	EURO 5 polig	EURO 7 polig	EURO 9 polig	EURO 11 polig	LAGER
1148	W	639-tam1YY5	64,00	74,00	74,00	84,00	
1148	S	639-tam1YY6	64,00	74,00	74,00	84,00	
1148	AE	639-tam1YY8	64,00	74,00	74,00	84,00	
1711	W	639-tam2YY5	73,00	84,00	83,00	94,00	
1711	S	639-tam2YY6	73,00	84,00	83,00	94,00	
1711	AE	639-tam2YY8	73,00	84,00	83,00	94,00	
2274	W	639-tam3YY5	86,00	97,00	96,00	107,00	
2274	S	639-tam3YY6	86,00	97,00	96,00	107,00	
2274	AE	639-tam3YY8	86,00	97,00	96,00	107,00	
281	W	639-tam4YY5	48,00	58,00	58,00	68,00	
281	S	639-tam4YY6	48,00	58,00	58,00	68,00	
281	AE	639-tam4YY8	48,00	58,00	58,00	68,00	

Blindabdeckung OHNE Durchgangsverdrahtung

LÄNGE	FARBE	ART. NR.	EURO	LAGER
4500	W	639-tam5005	56,00	
4500	S	639-tam5006	56,00	
4500	AE	639-tam5008	56,00	

ABDECKUNG KLAR IP54

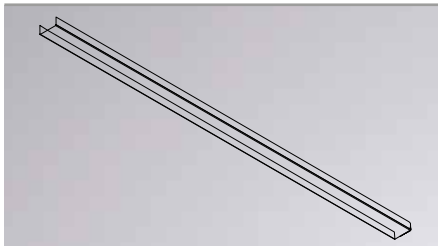

INFO	LÄNGE	FÜR LICHT-EINSATZ	FARBE	ART. NR.	EURO	LAGER
Für IP 54 Lösungen, werkzeuglose montage, Abdichtungs-Set separat ordern Endkappen separat ordern	1148	21/42W	K	639-taip1	29,00	
	1711	31/62W	K	639-taip2	37,00	
	2273	41/82W	K	639-taip3	46,00	
	3420	2 x 31/62W	K	639-taip4	62,00	
	4545	2 x 41/82W	K	639-taip5	88,00	

ABDICHTUNG-SET PROFILSCHNITT IP54



INFO	ART. NR.	EURO	LAGER
Bestehend aus Gummidichtung für die Profilloberseite und UV-beständigem Abdichtungsband klar, selbstklebend. Wird bei Profil- und Abdeckung klar bei Stößen für IP 54 Lösungen verklebt	639-tdip	13,00	

ZUBEHÖR

MONTAGECLIPS FÜR ANBAULEUCHTEN

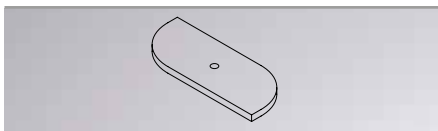

INFO	ART. NR.	EURO	LAGER
mit M4 Gewinde	639-bcm	2,50	☺

ADAPTER FÜR HIGH BAY LEUCHTEN

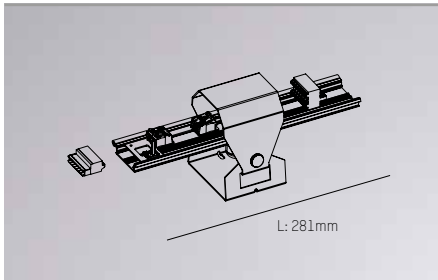

INFO	FARBE	ART. NR.	EURO 5 polig	EURO 7 polig	EURO 9 polig	EURO 11 polig	LAGER
ACHTUNG!!!! Ergänzen Sie das YY der Art. Nr. mit Ihrer gewünschten Verdrahtung	W	639-hbYY5	81,00	88,00	86,00	93,00	
	S	639-hbYY6	81,00	88,00	86,00	93,00	
	AE	639-hbYY8	81,00	88,00	86,00	93,00	
5 polig = 05							
7 polig = 07							
5+4 polig = 09							
7+4 polig = 11							

Adapter zur elektrischen und mechanischen Abbildung der High Bay Leuchte Astro oder Saturno an One Row



ONE ROW IP20

Zu Bestellende Komponenten:

- Profil
- Lichteinsatz
- Enddeckel
- Zubehör



ONE ROW IP54

Zu Bestellende Komponenten:

- Profil
- Lichteinsatz
- IP 54 Enddeckel
- IP54 Abdeckung klar
- Abdichtungs-Set Profilschnitt (optional)
- Zubehör

HYDRO LED



LED 230V IP65 | EEL: A++ - A

INFO

Feuchtraumwanneleuchte aus Polycarbonat mit Quick-Connect-Buchse, Kunststoffverschlüsse, bruchfest und selbstlöschend V2, inkl. Montaggebügel in Edelstahl und Kettenbefestigung, Wand-/Deckenmontage möglich, inkl. Konverter

LM	LUMEN	LxBxH	FARBE	ART. NR.	EURO	LAGER
ohne Durchgangsverdrahtung						
SYS 28W · 230V · LED 4000K · CRI>80	3144	1260x120x102		125-16472000	115,00	
SYS 42W · 230V · LED 4000K · CRI>80	4492	1260x120x102		125-16472100	118,00	
SYS 38W · 230V · LED 4000K · CRI>80	5187	1260x120x102		125-16474000	122,00	
SYS 51W · 230V · LED 4000K · CRI>80	7048	1260x120x102		125-16474100	128,00	
mit Durchgangsverdrahtung (Stecker und Buchse separat ordern)						
SYS 28W · 230V · LED 4000K · CRI>80	3144	1260x120x102		125-16472072	138,00	
SYS 42W · 230V · LED 4000K · CRI>80	4492	1260x120x102		125-16472172	141,00	
SYS 38W · 230V · LED 4000K · CRI>80	5187	1260x120x102		125-16474072	150,00	
SYS 51W · 230V · LED 4000K · CRI>80	7048	1260x120x102		125-16474172	155,00	
QUICK CONNECTOR BUCHSE				125-99804100	4,50	
QUICK CONNECTOR STECKER				125-99804200	4,50	

HYDRO T16



230V HV IP66 | EEL: A+ - B

INFO

Feuchtraumwanneleuchte 1 oder 2-flammig aus Polycarbonat, Kunststoffverschlüsse, bruchfest und selbstlöschend V2, inkl. Montaggebügel in Edelstahl und Kettenbefestigung, Wand-/Deckenmontage möglich, inkl. EVG

LM	LxBxH	FARBE	ART. NR.	EURO	LAGER
T16 · 65 · 230V · 54W · EVG	1300x92x99		125-16453600	64,00	
T16 · 65 · 230V · 49W · EVG	1600x92x99		125-16453700	64,00	
2 x T16 · 65 · 230V · 54W · EVG	1300x152x104		125-16453800	76,00	
2 x T16 · 65 · 230V · 49W · EVG	1600x152x104		125-16453900	76,00	

TEL

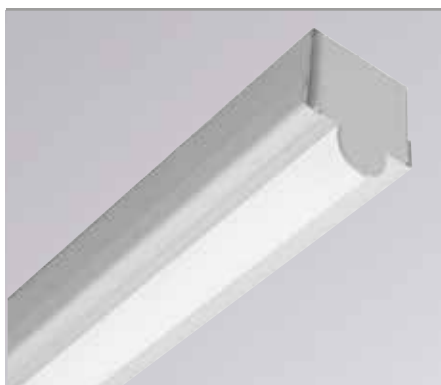

LED 230V IP20 | EEL: A++ - A

INFO	LM	LxB	H	LED	LUMEN	FARBE	ART. NR.	EURO	LAGER
LED Lichtleiste, Stahlblech, mit opalem Diffuser aus PMMA, inkl. LED Konverter	SYS 16W 230V CRI>80	605x38	47	3000K	1800		757-I2040	76,00	
		605x38	47	4000K	1800		757-I2041	76,00	
SYS 28W 230V CRI>80		1186x38	47	3000K	3100		757-I2014	92,00	
		1186x38	47	4000K	3100		757-I2015	92,00	
SYS 43W 230V CRI>80		1486x38	47	3000K	5500		757-I2016	116,00	
		1486x38	47	4000K	5500		757-I2017	116,00	



ASTRO



LED 230V EEI: A++ - A

Hallenleuchte, Körper/Rahmengestell aus Aluminiumdruckguss mit im Abdeckungsbereich intigriertem Kühlkörper, graphit pulverbeschichtet, PMMA-Optik, Diffusor aus durchsichtigem gehärtetem Glas - 4mm Dicke, inkl. Konverter Dimmbar 1-10V, Abhängung durch Kette oder Seil möglich - separat ordern

LM	ØxH	FARBE	LUMEN	ART. NR.	EURO	LAGER
SYS 103W · 230V · CRI>80	462x163	GR	11240	125-33009700	874,00	
SYS 135W · 230V · CRI>80	462x163	GR	14758	125-33009300	869,00	
SYS 202W · 230V · CRI>80	462x163	GR	22137	125-33009400	1.220,00	
SYS 269W · 230V · CRI>80	512x163	GR	29528	125-33009500	1.421,00	
breit strahlend						
LED 4000K						
SYS 101W · 230V · CRI>80	462x163	GR	10558	125-33014700	1060,00	
SYS 135W · 230V · CRI>80	462x163	GR	14078	125-33014400	1094,00	
SYS 203W · 230V · CRI>80	462x163	GR	21117	125-33014500	1500,00	
SYS 270W · 230V · CRI>80	512x163	GR	28150	125-33014600	1851,00	
eliptisch strahlend						
LED 4000K						

SATURNO



LED 230V EEI: A++ - A

Hallenleuchte, Körper/Rahmengestell aus Aluminiumdruckguss mit im Abdeckungsbereich intigriertem Kühlkörper, graphit pulverbeschichtet, PMMA-Optik, Diffusor aus durchsichtigem gehärtetem Glas - 4mm Dicke, Abhängung durch Kette oder Seil möglich - separat ordern

LM	ØxH	FARBE	LUMEN	ART. NR.	EURO	LAGER
SYS 66W · 230V · CRI>80	400x136	GR	7531	125-33074000	641,00	
SYS 108W · 230V · CRI>80	400x136	GR	12552	125-33074100	695,00	
SYS 151W · 230V · CRI>80	400x136	GR	17574	125-33074200	748,00	
breit strahlend						
LED 4000K						

VIALED EVO



LED 230V EEI: A++ - A

INFO
Notlichtleuchte, Gehäuse aus selbstverlöschendem Kunststoff weiß, Aufladezeit: 12h, Brenndauer 3h, inkl. Konverter
Für Raumdeckenhöhe bis zu 3m geeignet

LM	ØxH	ET	DA	FARBE	ART. NR.	EURO	LAGER
SYS 5,3W 230V · 300lm Brenndauer 3h	85x18	48	55	W	282-ve03f30abr	195,00	☺

VIALED HIGH



LED 230V EEI: A++ - A

INFO
Notlichtleuchte, Gehäuse aus selbstverlöschendem Kunststoff weiß, Aufladezeit: 12h, Brenndauer 3h, inkl. Konverter
Für Raumdeckenhöhe bis zu 10m geeignet

LM	ØxH	ET	DA	FARBE	ART. NR.	EURO	LAGER
SYS 5,3W 230V · 300lm Brenndauer 3h	85x18	48	55	W	282-vh03f30abr	229,00	☺

LYRA EVO



LED 230V EEI: A++ - A

INFO
Rettungszeichenleuchte, Gehäuse aus selbstverlöschendem Kunststoff weiß, Aufladezeit: 12h, Erkennungsreichweite 32m, inkl. Piktogramm (1x links, 1x rechts, 2x nach unten), inkl. Decken- / Wandbefestigung (parallel zur Wand), Brenndauer 1h oder 3h, inkl. Konverter

LM	LxBxH	FARBE	ART. NR.	EURO	LAGER
SYS 1,7W 230V Brenndauer 3h	289x34x261	W	282-lv32n30abr	155,00	☺



LED SYSTEME
INNEN + AUSSEN

LED SYSTEME

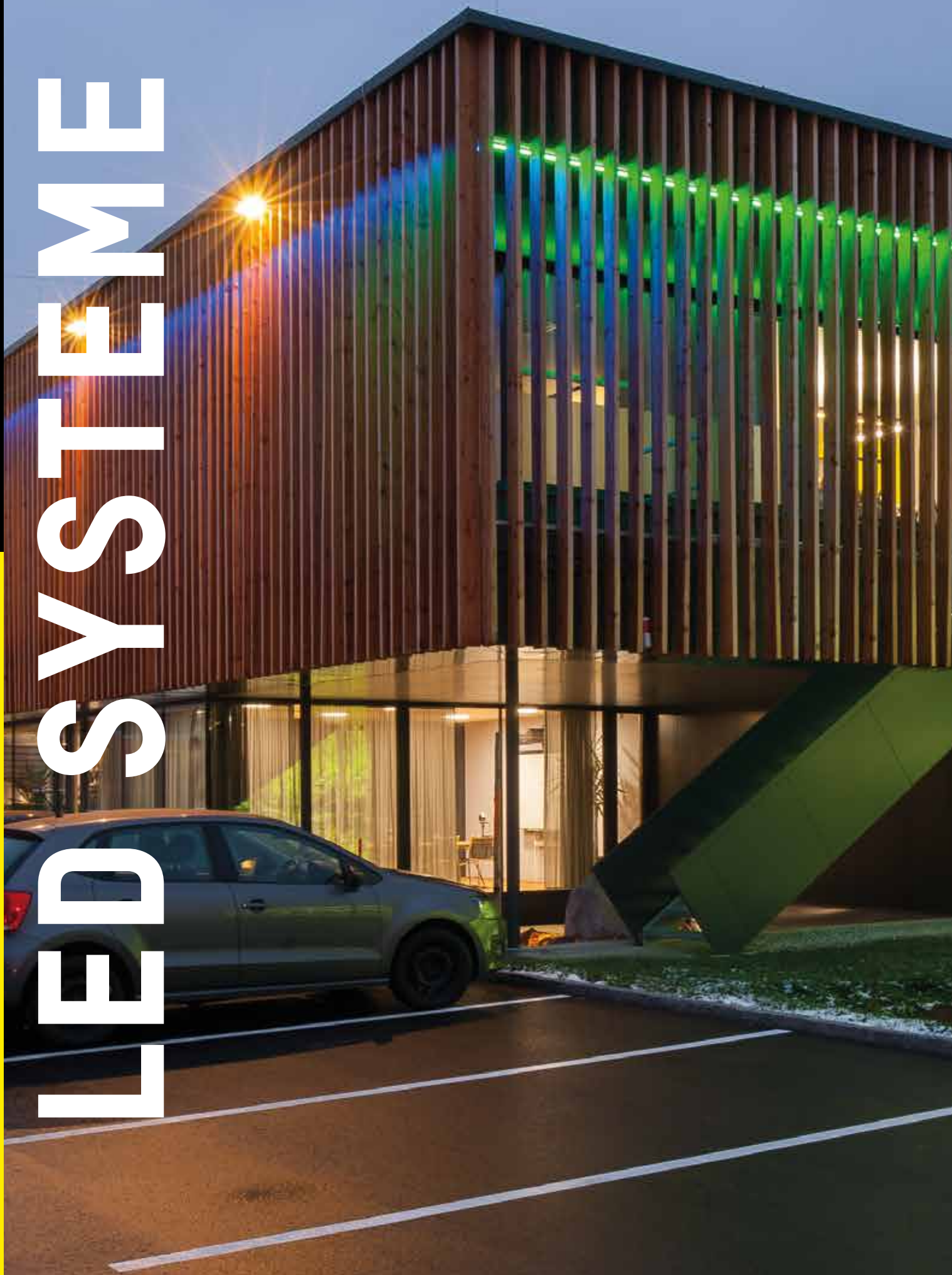



LED SYSTEME
INNEN + AUSSEN

PREMIUM LED STRIPE 24V 9,0W/M IP65 METERWARE

TOP SELLER



LED 24V EE: A++ - A

INFO	LM / LFM.	LxBxH	LED	ART. NR.	EURO PER LFM.	LAGER
Flexibles PREMIUM LED Stripe, IP65 mittels Nanobeschichtung, Meterware, 120 LEDs / Meter, 9,0W / Meter, trennbar alle 5cm, Befestigung durch doppelseitiges 3M Klebeband, exkl. Konverter, ACHTUNG: maximale Länge pro Einspeisepunkt 10m. Um eine lange Lebensdauer und einwandfreie Funktion der LED-Strips zu garantieren, ist eine Montage auf wärmeleitendem Material Voraussetzung! Preisangabe ohne Zuschchnitt! Bitte kalkulieren sie pro Zuschchnitt 1x283-konf zusätzlich	120 x LED 9W / 24V DC 950lm · CRI>90	lt. orderx8x1,4	2500K	283-240965uuwwkonf	45,00	😊
	120 x LED 9W / 24V DC 1054lm · CRI>90	lt. orderx8x1,4	2700K	283-240965uwkwkonf	45,00	😊
	120 x LED 9W / 24V DC 1058lm · CRI>90	lt. orderx8x1,4	3000K	283-240965wwkwkonf	45,00	😊
	120 x LED 9W / 24V DC 1134lm · CRI>90	lt. orderx8x1,4	4000K	283-240965nwkwkonf	45,00	😊

PREMIUM LED STRIPE 24V 18,0W/M IP65 METERWARE

TOP SELLER



LED 24V EE: A++ - A

INFO	LM / LFM.	LxBxH	LED	ART. NR.	EURO PER LFM.	LAGER
Flexibles PREMIUM LED Stripe, IP65 mittels Nanobeschichtung, Meterware, 120 LEDs / Meter, 18,0W / Meter, trennbar alle 5cm, Befestigung durch doppelseitiges 3M Klebeband, exkl. Konverter, ACHTUNG: maximale Länge pro Einspeisepunkt 6m. Um eine lange Lebensdauer und einwandfreie Funktion der LED-Strips zu garantieren, ist eine Montage auf wärmeleitendem Material Voraussetzung! Preisangabe ohne Zuschchnitt! Bitte kalkulieren sie pro Zuschchnitt 1x283-konf zusätzlich	120 x LED 18W / 24V DC 1755lm · CRI>90	lt. orderx8x1,4	2500K	283-241865uuwwkonf	49,00	😊
	120 x LED 18W / 24V DC 1934lm · CRI>90	lt. orderx8x1,4	2700K	283-241865uwkwkonf	49,00	😊
	120 x LED 18W / 24V DC 1980lm · CRI>90	lt. orderx8x1,4	3000K	283-241865wwkwkonf	49,00	😊
	120 x LED 18W / 24V DC 2148lm · CRI>90	lt. orderx8x1,4	4000K	283-241865nwkwkonf	49,00	😊

PREMIUM LED STRIPE 24V 28,0W/M IP65 METERWARE

TOP SELLER



LED 24V EE: A++ - A

INFO	LM / LFM.	LxBxH	LED	ART. NR.	EURO PER LFM.	LAGER
Flexibles PREMIUM LED Stripe, IP65 mittels Nanobeschichtung, Meterware, 120 LEDs / Meter, 28,0W / Meter, trennbar alle 5cm, Befestigung durch doppelseitiges 3M Klebeband, exkl. Konverter, ACHTUNG: maximale Länge pro Einspeisepunkt 4m. Um eine lange Lebensdauer und einwandfreie Funktion der LED-Strips zu garantieren, ist eine Montage auf wärmeleitendem Material Voraussetzung! Preisangabe ohne Zuschchnitt! Bitte kalkulieren sie pro Zuschchnitt 1x283-konf zusätzlich	120 x LED 28W / 24V DC 2500lm · CRI>90	lt. orderx8x1,4	2500K	283-242865uuwwkonf	57,00	😊
	120 x LED 28W / 24V DC 2890lm · CRI>90	lt. orderx8x1,4	2700K	283-242865uwkwkonf	57,00	😊
	120 x LED 28W / 24V DC 2922lm · CRI>90	lt. orderx8x1,4	3000K	283-242865wwkwkonf	57,00	😊
	120 x LED 28W / 24V DC 3191lm · CRI>90	lt. orderx8x1,4	4000K	283-242865nwkwkonf	57,00	😊

KONFEKTIONIERUNG BEI METERWARE

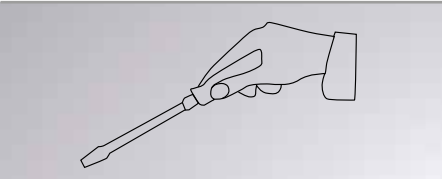

INFO	ART. NR.	EURO	LAGER
LED Band IP65 pro Zuschchnitt beinhaltet: Zuschchnitt, 50cm Anschlusskabel gelötet, An schnittversiegelung , Systemtest, ESD-Verpackung	283-konf	19,50	😊



LED SYSTEME
INNEN + AUSSEN

BASIC LED STRIPE 24V 4,8W/M IP67



LED 24V EEL: A++ - A

INFO	LM	LxBxH	LED	ART. NR.	EURO	LAGER
Flexibles BASIC LED Stripe, Rolle 5000mm, 300 SMD5060 LEDs, 60 LEDs / Meter, 4,8W / Meter, trennbar alle 6 LEDs (ca. 10cm), ACHTUNG: muss nach Trennung versiegelt werden!, Befestigung durch doppelseitiges 3M Klebeband, inkl. DC Stecker und 2 Buchsen, exkl. Konverter, ACHTUNG: maximale Länge pro Einspeisepunkt 5m , ACHTUNG: Keine Beständigkeit gegen chemische Substanzen oder Dämpfe (zb. Chlor u. dgl), Um eine lange Lebensdauer und einwandfreie Funktion der LED-Strips zu garantieren, ist eine Montage auf wärmeleitendem Material Voraussetzung!	300 x LED 24W / 24V DC 950lm · CRI>80	5000x10x4	2600-2800K	746-242467ww	69,00	☺
	300 x LED 24W / 24V DC 1100lm · CRI>80	5000x10x4	3800-4250K	746-242467nw	69,00	☺

BASIC LED STRIPE 24V 14,4W/M IP67



LED 24V EEL: A++ - A

INFO	LM	LxBxH	LED	ART. NR.	EURO	LAGER
Flexibles BASIC LED Stripe, Rolle 5000mm, 300 SMD5060 LEDs, 60 LEDs / Meter, 14,4W / Meter, trennbar alle 6 LEDs (ca. 10cm), ACHTUNG: muss nach Trennung versiegelt werden!, Befestigung durch doppelseitiges 3M Klebeband, inkl. DC Stecker und 2 Buchsen, exkl. Konverter, ACHTUNG: maximale Länge pro Einspeisepunkt 5m , ACHTUNG: Keine Beständigkeit gegen chemische Substanzen oder Dämpfe (zb. Chlor u. dgl), Um eine lange Lebensdauer und einwandfreie Funktion der LED-Strips zu garantieren, ist eine Montage auf wärmeleitendem Material Voraussetzung!	300 x LED 72W / 24V DC 3300lm · CRI>80	5000x14,2x4	2600-2800K	746-247267wwng1	139,00	☺
	300 x LED 72W / 24V DC 3450lm · CRI>80	5000x14,2x4	3800-4250K	746-247267nw	139,00	☺

BASIC LED STRIPE 24V IP67 ZUBEHÖR



INFO	ARTIKEL	ART. NR.	EURO	LAGER
separat ordern	SILIKONENDKAPPE für 24V DC LED Strip Weiß	746-1001	0,50	☺
	SCHRUMPFSCHLAUCH für 24V DC LED Strip	746-1004	0,40	☺
	EINSPEISUNGSABDECKUNG für 24V DC LED Strip	746-1101	1,50	☺
	DC STECKER für 24V DC LED Strip inkl. 130mm Kabel	746-1100	2,10	☺
	DC BUCHSE für 24V DC LED Strip inkl. 130mm Kabel	746-1200	2,10	☺

BASIC LED STRIPE RGB 24V 14,4W/M IP67



LED 24V EEL: A++ - A

INFO	LM	LxBxH	LED	ART. NR.	EURO	LAGER
Flexibles BASIC LED Stripe, Rolle 5000mm, 300 SMD5060 LEDs, 60 LEDs / Meter, 14,4W / Meter, trennbar alle 6 LEDs (ca. 10cm), ACHTUNG: muss nach Trennung versiegelt werden!, Befestigung durch doppelseitiges 3M Klebeband, exkl. Konverter, ACHTUNG: maximale Länge pro Einspeisepunkt 5m , ACHTUNG: Keine Beständigkeit gegen chemische Substanzen oder Dämpfe (zb. Chlor u. dgl), Um eine lange Lebensdauer und einwandfreie Funktion der LED-Strips zu garantieren, ist eine Montage auf wärmeleitendem Material Voraussetzung!	300 x LED 72W / 24V DC 1080lm	5000x12,2x4	RGB	746-247267rgb	149,00	☺

BASIC LED STRIPE RGB 24V 14,4W/M ZUBEHÖR

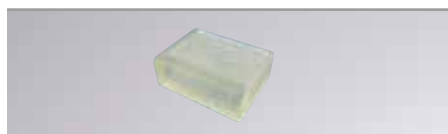

INFO	ARTIKEL	ART. NR.	EURO	LAGER
separat ordern	SILIKONENDKAPPE für 24V DC RGB LED Strip	746-1002	0,50	☺



LED SYSTEME
INNEN + AUSSEN

MOLTO LUCE®

Privates Wohnhaus, Österreich

BASIC LED STRIPE 24V 4,8W/M IP20

TOP SELLER



INFO	LM	LxBxH	LED	ART. NR.	EURO	LAGER
Flexibles BASIC LED Stripe, Rolle 5000mm, 300 SMD3528 LEDs, 60 LEDs / Meter, trennbar alle 6 LEDs (ca. 10cm), Befestigung durch doppelseitiges 3M Klebeband, exkl. Konverter, ACHTUNG: maximale Länge pro Einspeisepunkt 10m. ACHTUNG: Keine Beständigkeit gegen chemische Substanzen oder Dämpfe (zb. Chlor u. dgl), Um eine lange Lebensdauer und einwandfreie Funktion der LED-Strips zu garantieren, ist eine Montage auf wärmeleitendem Material Voraussetzung!	300 x LED 24W / 24V DC 1050lm · CRI>80	5000x8x3	2600 - 2800K	746-242420ww	49,00	😊
	300 x LED 24W / 24V DC 1200lm · CRI>80	5000x8x3	3800 - 4250K	746-242420nw	49,00	😊

LED 24V EEI: A+++ - A

BASIC LED STRIPE 24V 4,8W/M IP20 METERWARE



INFO	LM / LFM.	LxBxH	LED	ART. NR.	EURO PER LFM.	LAGER
Flexibles BASIC LED Stripe, Meterware, 60 SMD3528 LEDs / Meter, 4,8W / Meter, trennbar alle 6 LEDs (ca. 10cm), Befestigung durch doppelseitiges 3M Klebeband, exkl. Konverter, ACHTUNG: maximale Länge pro Einspeisepunkt 10m. ACHTUNG: Keine Beständigkeit gegen chemische Substanzen oder Dämpfe (zb. Chlor u. dgl), Um eine lange Lebensdauer und einwandfreie Funktion der LED-Strips zu garantieren, ist eine Montage auf wärmeleitendem Material Voraussetzung!	60 x LED 4,8W / 24V DC 210lm · CRI>80	lt. orderx8x3	2600 - 2800K	746-242420wwkonf	9,80	😊
	60 x LED 4,8W / 24V DC 240lm · CRI>80	lt. orderx8x3	3800 - 4250K	746-242420nwkonf	9,80	😊

LED 24V EEI: A+++ - A

BASIC LED STRIPE 24V 9,6W/M IP20

TOP SELLER



INFO	LM	LxBxH	LED	ART. NR.	EURO	LAGER
Flexibles BASIC LED Stripe, Rolle 5000mm, 300 SMD2835 LEDs, 60 LEDs / Meter, trennbar alle 6 LEDs (ca. 10cm), Befestigung durch doppelseitiges 3M Klebeband, exkl. Konverter, ACHTUNG: maximale Länge pro Einspeisepunkt 8m. ACHTUNG: Keine Beständigkeit gegen chemische Substanzen oder Dämpfe (zb. Chlor u. dgl), Um eine lange Lebensdauer und einwandfreie Funktion der LED-Strips zu garantieren, ist eine Montage auf wärmeleitendem Material Voraussetzung!	300 x LED 48W / 24V DC 3000lm · CRI>80	5000x8x3	2600 - 2800K	746-244820ww	59,00	😊
	300 x LED 48W / 24V DC 3300lm · CRI>80	5000x8x3	3800 - 4250K	746-244820nw	59,00	😊

LED 24V EEI: A+++ - A

BASIC LED STRIPE 24V 9,6W/M IP20 METERWARE



INFO	LM / LFM.	LxBxH	LED	ART. NR.	EURO PER LFM.	LAGER
Flexibles BASIC LED Stripe, Meterware, 60 SMD2835 LEDs / Meter, 9,6W / Meter, trennbar alle 6 LEDs (ca. 10cm), Befestigung durch doppelseitiges 3M Klebeband, exkl. Konverter, ACHTUNG: maximale Länge pro Einspeisepunkt 8m. ACHTUNG: Keine Beständigkeit gegen chemische Substanzen oder Dämpfe (zb. Chlor u. dgl), Um eine lange Lebensdauer und einwandfreie Funktion der LED-Strips zu garantieren, ist eine Montage auf wärmeleitendem Material Voraussetzung!	60 x LED 9,6W / 24V DC 600 lm · CRI>80	lt. orderx8x3	2600 - 2800K	746-244820wwkonf	11,80	😊
	60 x LED 9,6W / 24V DC 660 lm · CRI>80	lt. orderx8x3	3800 - 4250K	746-244820nwkonf	11,80	😊

LED 24V EEI: A+++ - A

BASIC LED STRIPE 24V IP20 ZUBEHÖR



INFO	ARTIKEL	ART. NR.	EURO	LAGER
separat ordern für 24V DC - IP20 LED Bänder weiß mit Breite 8mm	SCHNELLEINSPEISER, inkl. 200mm Kabel	746-fc1220w	2,50	😊
	SCHNELLVERBINDER	746-lc1220w	1,20	😊
	LINEARVERBINDER FLEXIBEL, inkl. 100mm Kabel	746-lcf1220w	2,40	😊

KONFEKTIONIERUNG BEI METERWARE

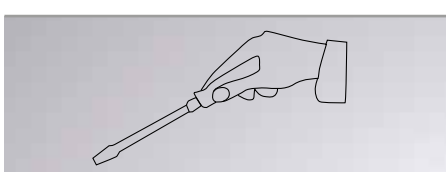

INFO	ART. NR.	EURO	LAGER
LED Band IP20 pro Zuschnitt beinhaltet: Zuschnitt, 50cm Anschlußkabel gelötet, Systemtest, ESD-Verpackung	746-konfip20	19,50	😊

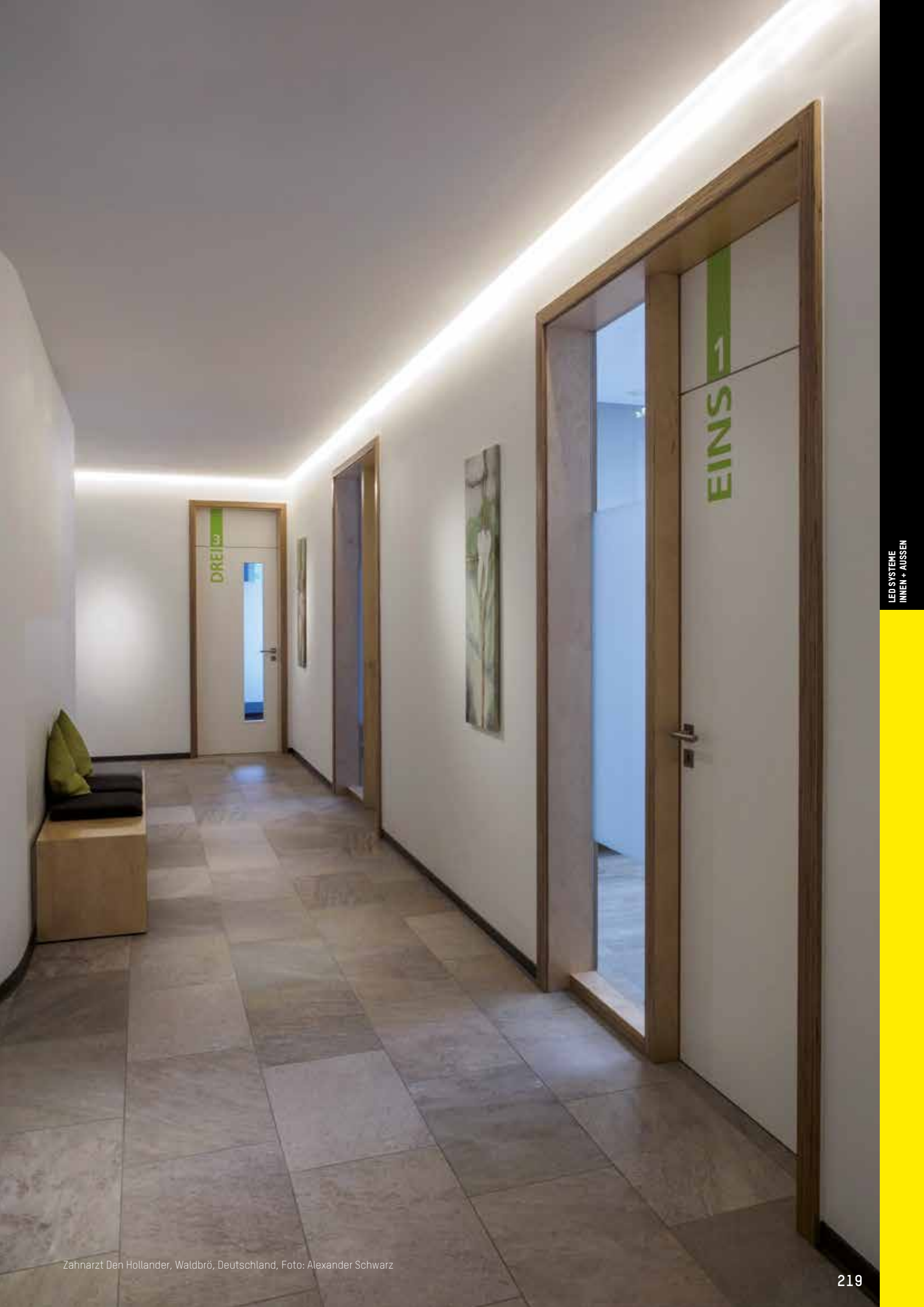

BASIC LED STRIPE 24V 14,4W/M IP20



LED 24V EEI: A++ - A

INFO	LM	LxBxH	LED	ART. NR.	EURO	LAGER
Flexibles BASIC LED Stripe, Rolle 5000mm, 300 SMD5060 LEDs, 60 LEDs / Meter, 14,4W / Meter, trennbar alle 6 LEDs (ca. 10cm), Befestigung durch doppelseitiges 3M Klebeband, exkl. Konverter, ACHTUNG: maximale Länge pro Einspeisepunkt 6m. ACHTUNG: Keine Beständigkeit gegen chemische Substanzen oder Dämpfe (zb. Chlor u. dgl), Um eine lange Lebensdauer und einwandfreie Funktion der LED-Strips zu garantieren, ist eine Montage auf wärmeleitendem Material Voraussetzung!	300 x LED 72W / 24V DC 3500lm · CRI>80	5000x12x4	2600 - 2800K	746-247220ww	99,00	☺
	300 x LED 72W / 24V DC 3650lm · CRI>80	5000x12x4	3800 - 4250K	746-247220nwng1	99,00	☺

BASIC LED STRIPE 24V 14,4W/M IP20 METERWARE



LED 24V EEI: A++ - A

INFO	LM / LFM.	LxBxH	LED	ART. NR.	EURO PER LFM.	LAGER
Flexibles BASIC LED Stripe, Meterware, 60 SMD5060 LEDs / Meter, 14,4W / Meter, trennbar alle 6 LEDs (ca. 10cm), Befestigung durch doppelseitiges 3M Klebeband, exkl. Konverter, ACHTUNG: maximale Länge pro Einspeisepunkt 6m. ACHTUNG: Keine Beständigkeit gegen chemische Substanzen oder Dämpfe (zb. Chlor u. dgl), Um eine lange Lebensdauer und einwandfreie Funktion der LED-Strips zu garantieren, ist eine Montage auf wärmeleitendem Material Voraussetzung!	60 x LED 14,4W / 24V DC 700lm · CR>80	lt. orderx12x4	2600 - 2800K	746-247220wwkonf	19,80	☺
	60 x LED 14,4W / 24V DC 730lm · CR>80	lt. orderx12x4	3800 - 4250K	746-247220nwkonf	19,80	☺

BASIC LED STRIPE 24V 14,4W/M IP20 ZUBEHÖR



INFO	ARTIKEL	ART. NR.	EURO	LAGER
separat ordern für 24V DC - IP20 LED Bänder weiß mit Breite 12mm	SCHNELLEINSPEISER, inkl. 200mm Kabel	746-fc2420w	2,50	☺
	SCHNELLVERBINDER	746-lc2420w	1,20	☺
	LINEARVERBINDER FLEXIBEL, inkl. 100mm Kabel	746-lcf2420w	2,60	☺

KONFEKTIONIERUNG BEI METERWARE

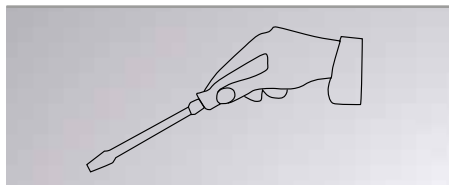

INFO	ART. NR.	EURO	LAGER
LED Band IP20 pro Zuschnitt beinhaltet: Zuschnitt, 50cm Anschlußkabel gelötet, Systemtest, ESD-Verpackung	746-konfip20	19,50	☺

BASIC LED STRIPE 24V 28,8W/M IP20



LED 24V EEI: A++ - A

INFO	LM	LxBxH	LED	ART. NR.	EURO	LAGER
Flexibles BASIC LED Stripe, Rolle 2500mm, 300 SMD5060 LEDs, doppelreihig bestückt , (120 LEDs pro Meter), 28,8W/Meter, trennbar alle 12 LEDs (ca. alle 10cm) Befestigung durch doppelseitiges Klebeband, ACHTUNG: maximale Länge pro Einspeisepunkt: 2,5 meter! ACHTUNG: Keine Beständigkeit gegen chemische Substanzen oder Dämpfe (zb. Chlor u. dgl)	300 x LED 72W / 24V DC 3300lm · CRI>80	2500x15x3	2600 - 2800K	746-247420ww	99,00	☺
	300 x LED 72W / 24V DC 3600lm · CRI>80	2500x15x3	3800 - 4250K	746-247420nw	99,00	☺



OX Restaurant & Steakhouse, Starmovie Wels, Österreich

LED SYSTEME
INNEN + AUSSEN

BASIC LED STRIPE RGB 24V 14,4W/M IP20

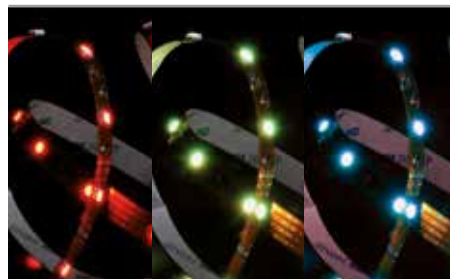

LED 24V IP20 | EEL: A+++ - A

INFO	LM	LxBxH	LED	ART. NR.	EURO	LAGER
Flexibles BASIC LED Stripe RGB, Rolle 5000mm, 300 SMD5060 LEDs (60 LEDs pro Meter), 14,4W/Meter, trennbar alle 6 LEDs (ca. alle 10cm) Befestigung durch doppelseitiges Klebeband. ACHTUNG: maximale Länge pro Einspeisepunkt 6m! ACHTUNG: Keine Beständigkeit gegen chemische Substanzen oder Dämpfe (zb. Chlor u. dgl). Um eine lange Lebensdauer und einwandfreie Funktion der LED-Strips zu garantieren, ist eine Montage auf wärmeleitendem Material Voraussetzung!	300 x LED 72W / 24V DC 1200lm	5000x10x4	RGB	746-247220rgb	119,00	☺

BASIC LED STRIPE RGB 24V 14,4W/M ZUBEHÖR

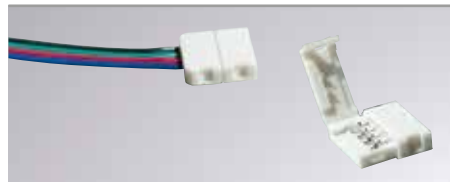

INFO	ARTIKEL	ART. NR.	EURO	LAGER
separat ordern	SCHNELLEINSPEISER, inkl. 200mm Kabel	746-fc1220rgb	2,50	☺
für 24V DC - IP20 LED Bänder RGB mit Breite 10mm	SCHNELLVERBINDER	746-lc1220rgb	1,20	☺
	LINEARVERBINDER, inkl. 100mm Kabel	746-lcf1220rgb	2,70	☺

BASIC LED STRIPE RGB/W 24V 17,3W/M IP20

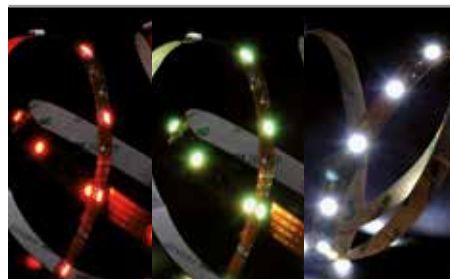

LED 24V IP20 | EEL: A+++ - A

INFO	LM	LxBxH	LED	ART. NR.	EURO	LAGER
Flexibles BASIC LED Stripe RGB-W, Rolle 5000mm, 300 SMD5060 LEDs (60 LEDs pro Meter, 150 LEDs warm-weiß+150LEDs RGB), 17,3W/Meter, trennbar alle 10 LEDs (ca. alle 17cm) Befestigung durch doppelseitiges Klebeband ACHTUNG: maximale Länge pro Einspeisepunkt 5m! ACHTUNG: Keine Beständigkeit gegen chemische Substanzen oder Dämpfe (zb. Chlor u. dgl) Um eine lange Lebensdauer und einwandfreie Funktion der LED-Strips zu garantieren, ist eine Montage auf wärmeleitendem Material Voraussetzung!	300 x LED 86,4W / 24V DC 700lm (RGB) 1650lm (W)	5000x15x2,5	RGB + 2600-2800K	746-248720rgbw	118,00	☺

ALUMINIUM AUFBAUPROFIL MINI

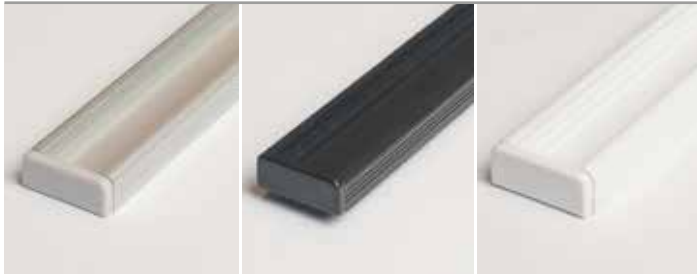

INFO

LED Aufbauprofil MINI, sehr flaches Profil aus stranggepresstem Aluminium, **geeignet für LED Flexbänder bis Breite 10mm**, in den Farben Aluminium eloxiert, schwarz eloxiert oder weiß lackiert erhältlich, Abdeckungen, Befestigungen oder Endkappen separat ordern. **Hinweis: geeignet für LED Bänder bis max. 18W**

PRODUKT	LxBxH	FARBE	ART. NR.	EURO	LAGER
PROFIL ①	2000x20x8	AE	252-a2001s	13,00	☺
PROFIL ①	2000x20x8	S	252-a2001b	15,00	☺
PROFIL ①	2000x20x8	W	252-a2001w	17,00	☺
ENDKAPPEN (Set 2 Stk.)	KUNSTSTOFF	G	252-ek8000as	1,50	☺
ENDKAPPEN (Set 2 Stk.)	KUNSTSTOFF	S	252-ek8000ab	1,50	☺
ENDKAPPEN (Set 2 Stk.)	KUNSTSTOFF	W	252-ek8000aw	1,50	☺

ALUMINIUM AUFBAUPROFIL MIDI

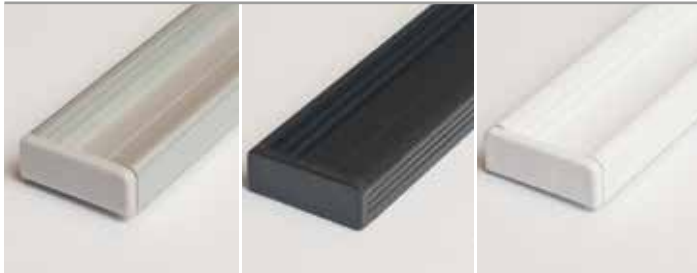

INFO

LED Aufbauprofil MIDI, flaches Profil aus stranggepresstem Aluminium, **geeignet für LED Flexbänder bis Breite 14mm**, in den Farben Aluminium eloxiert, schwarz eloxiert oder weiß lackiert erhältlich, Abdeckungen, Befestigungen oder Endkappen separat ordern. **Hinweis: geeignet für LED Bänder bis max. 28W**

PRODUKT	LxBxH	FARBE	ART. NR.	EURO	LAGER
PROFIL ②	2000x24x9	AE	252-a2002s	15,00	☺
PROFIL ②	2000x24x9	S	252-a2002b	16,00	☺
PROFIL ②	2000x24x9	W	252-a2002w	21,00	☺
ENDKAPPEN (Set 2 Stk.)	KUNSTSTOFF	G	252-ek8001as	2,00	☺
ENDKAPPEN (Set 2 Stk.)	KUNSTSTOFF	S	252-ek8001ab	2,00	☺
ENDKAPPEN (Set 2 Stk.)	KUNSTSTOFF	W	252-ek8001aw	2,00	☺

ALUMINIUM AUFBAUPROFIL MAXI

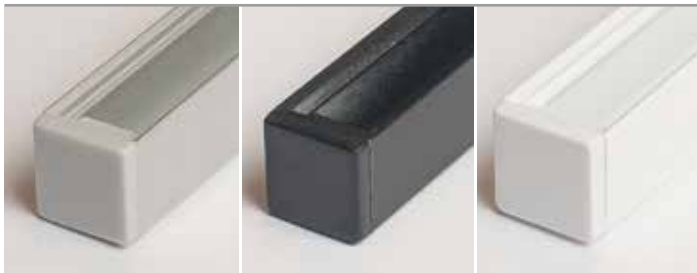

INFO

LED Aufbauprofil MAXI, Profil aus stranggepresstem Aluminium, **geeignet für LED Flexbänder bis Breite 20mm**, in den Farben Aluminium eloxiert, schwarz eloxiert oder weiß lackiert erhältlich, Abdeckungen, Befestigungen oder Endkappen separat ordern. **Hinweis: geeignet für LED Bänder bis max. 28W**

PRODUKT	LxBxH	FARBE	ART. NR.	EURO	LAGER
PROFIL ②	2000x23x25	AE	252-a2003s	24,00	☺
PROFIL ②	2000x23x25	S	252-a2003b	28,00	☺
PROFIL ②	2000x23x25	W	252-a2003w	27,00	☺
ENDKAPPEN (Set 2 Stk.)	KUNSTSTOFF	G	252-ek8002s	2,50	☺
ENDKAPPEN (Set 2 Stk.)	KUNSTSTOFF	S	252-ek8002b	2,50	☺
ENDKAPPEN (Set 2 Stk.)	KUNSTSTOFF	W	252-ek8002w	2,50	☺

ALUMINIUM AUFBAU-ECKPROFIL MIDI

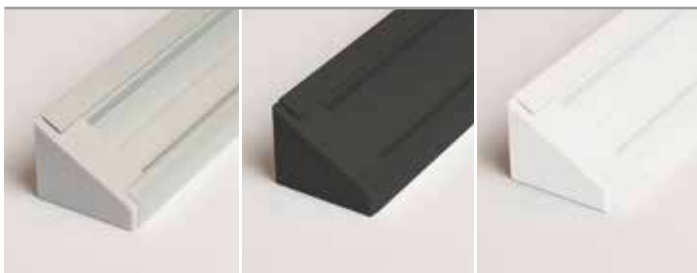

INFO

LED Aufbau-Eckprofil MIDI, Profil aus stranggepresstem Aluminium, **geeignet für LED Flexbänder bis Breite 14mm**, in den Farben Aluminium eloxiert, schwarz eloxiert oder weiß lackiert erhältlich, Abdeckungen, Befestigungen oder Endkappen separat ordern. **Hinweis: geeignet für LED Bänder bis max. 28W**

PRODUKT	LxBxH	FARBE	ART. NR.	EURO	LAGER
PROFIL ②	2000x24x19	AE	252-a2004s	17,00	☺
PROFIL ②	2000x24x19	S	252-a2004b	18,00	☺
PROFIL ②	2000x24x19	W	252-a2004w	25,00	☺
ENDKAPPEN (Set 2 Stk.)	KUNSTSTOFF	G	252-ek8003s	2,00	☺
ENDKAPPEN (Set 2 Stk.)	KUNSTSTOFF	S	252-ek8003b	2,00	☺
ENDKAPPEN (Set 2 Stk.)	KUNSTSTOFF	W	252-ek8003w	2,00	☺

ALUMINIUM EINBAUPROFIL MIDI



INFO

LED Einbauprofil MIDI, sehr flaches Profil aus stranggepresstem Aluminium, **geeignet für LED Flexbänder bis Breite 14mm**, in den Farben Aluminium eloxiert, schwarz eloxiert oder weiß lackiert erhältlich, Abdeckungen, Befestigungen oder Endkappen separat ordern. **ET: 7mm, Ausschnitt B: 22mm**
Hinweis: geeignet für LED Bänder bis max. 18W, Bitte beachten: Bei Verwendung Endkappen Ausschnitt pro Seite + 2mm

PRODUKT	LxBxH	FARBE	ART. NR.	EURO	LAGER
PROFIL ②	2000x28x8	AE	252-e2001s	14,00	☺
PROFIL ②	2000x28x8	S	252-e2001b	15,00	☺
PROFIL ②	2000x28x8	W	252-e2001w	22,00	☺
ENDKAPPEN (Set 2 Stk.)	KUNSTSTOFF	G	252-ek8104s	1,50	☺
ENDKAPPEN (Set 2 Stk.)	KUNSTSTOFF	S	252-ek8104b	1,50	☺
ENDKAPPEN (Set 2 Stk.)	KUNSTSTOFF	W	252-ek8104w	1,50	☺

ALUMINIUM EINBAUPROFIL MAXI PLUS



INFO

LED Einbauprofil MAXI; schmales Profil aus stranggepresstem Aluminium, **geeignet für LED Flexbänder bis Breite 20mm**, in den Farben Aluminium eloxiert, schwarz eloxiert oder weiß lackiert erhältlich, Abdeckungen, Befestigungen oder Endkappen separat ordern. **ET: 19,5mm, Ausschnitt B: 23mm**
Hinweis: geeignet für LED Bänder bis max. 28W, Bitte beachten: Bei Verwendung Endkappen Ausschnitt pro Seite + 2mm

PRODUKT	LxBxH	FARBE	ART. NR.	EURO	LAGER
PROFIL ②	2000x23x20,5	AE	252-e2003s	21,00	☺
PROFIL ②	2000x23x20,5	S	252-e2003b	23,00	☺
PROFIL ②	2000x23x20,5	W	252-e2003w	23,00	☺
ENDKAPPEN (Set 2 Stk.)	KUNSTSTOFF	G	252-ek8006s	2,50	☺
ENDKAPPEN (Set 2 Stk.)	KUNSTSTOFF	S	252-ek8006b	2,50	☺
ENDKAPPEN (Set 2 Stk.)	KUNSTSTOFF	W	252-ek8006w	2,50	☺

PMMA ABDECKUNGEN



FÜR PRODUKT	LxBxH	FARBE	ART. NR.	EURO	LAGER
für PROFIL ②	2000x17,6x5	TRANSPARENT	252-ak200	9,50	☺
für PROFIL ②	2000x17,6x5	SATINIERT	252-a200	9,50	☺
für PROFIL ①	2000x13,1x3,8	TRANSPARENT	252-ak201	9,00	☺
für PROFIL ①	2000x13,1x3,8	SATINIERT	252-a201	9,00	☺
für PROFIL ②	2000x23x15	SATINIERT	252-au200	18,00	☺
Endkappe für kubische Abdeckung	Set 2 Stk.		252-ek8007	3,00	☺

MONTAGEBÜGEL



FÜR PRODUKT	LxBxH	FARBE	ART. NR.	EURO	LAGER
für PROFIL ①	22x16x4	EDELSTAHL	252-mc8000	1,50	☺
für PROFIL ②	22x19x4	EDELSTAHL	252-mc8001	1,50	☺

EINBAUFEDER

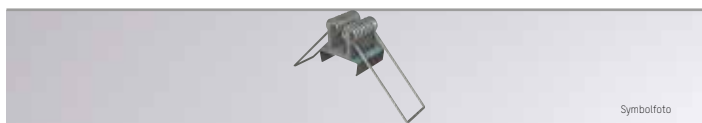

FÜR PRODUKT	FARBE	ART. NR.	EURO	LAGER
für EB-PROFIL MAXI PLUS	ALUMINIUM	252-ef8001	6,00	☺

ALUSTREIFEN



AUSFÜHRUNG	LxBxH	FARBE	ART. NR.	EURO	LAGER
ohne Bohrungen	1000x10x3	ALUMINIUM	746-1000	7,50	☺
mit Bohrungen	1000x10x3	ALUMINIUM	746-1000b	15,00	
ohne Bohrungen	3000x10x3	ALUMINIUM	746-3000	27,00	☺
mit Bohrungen	3000x10x3	ALUMINIUM	746-3000b	35,00	

ALUMINIUM AUFBAUPROFIL RIDE

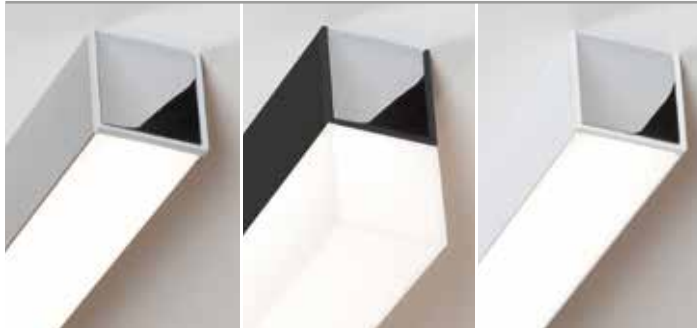

INFO

LED Aufbauprofil RIDE aus stranggepresstem Aluminium, **geeignet für LED Flexbänder**, in den Farben Aluminium eloxiert, schwarz oder weiß pulverbeschichtet erhältlich, Enddeckel und Abdeckungen separat ordern.

PRODUKT	LxBxH	FARBE	ART. NR.	EURO	LAGER
PROFIL	2000x35x35	AE	577-128leer	49,50	☺
PROFIL	2000x35x35	S	577-126leer	49,50	☺
PROFIL	2000x35x35	W	577-125leer	49,50	☺
ENDKAPPEN (Set 2 Stk.)	für Abdeckung flach	S	577-4604	54,00	☺
ENDKAPPEN (Set 2 Stk.)	für Abdeckung flach	S	577-4606	54,00	☺
ENDKAPPEN (Set 2 Stk.)	für Abdeckung flach	W	577-4605	54,00	☺
ENDKAPPEN (Set 2 Stk.)	für Abdeckung kubisch	S	577-4624	57,00	☺
ENDKAPPEN (Set 2 Stk.)	für Abdeckung kubisch	S	577-4626	57,00	☺
ENDKAPPEN (Set 2 Stk.)	für Abdeckung kubisch	W	577-4625	57,00	☺

ALUMINIUM EINBAUPROFIL RIDE



LED Einbauprofil RIDE aus stranggepresstem Aluminium, **geeignet für LED Flexbänder**, in den Farben Aluminium eloxiert, schwarz oder weiß pulverbeschichtet erhältlich, Enddeckel und Abdeckung separat ordern. **ET: 75mm, Ausschnitt B: 37mm, Länge Profil - 3mm, Nur flache Abdeckung möglich**

PRODUKT	LxBxH	FARBE	ART. NR.	EURO	LAGER
PROFIL	2000x44x35	AE	577-228leer	50,50	☺
PROFIL	2000x44x35	W	577-225leer	50,50	☺
PROFIL	2000x44x35	S	577-226leer	50,50	
ENDKAPPEN (Set 2 Stk.)	für Abdeckung flach	S	577-4704	22,00	☺
ENDKAPPEN (Set 2 Stk.)	für Abdeckung flach	W	577-4705	22,00	☺
ENDKAPPEN (Set 2 Stk.)	für Abdeckung flach	S	577-4706	22,00	☺
MONTAGESET			577-5000	6,00	☺

PMMA ABDECKUNGEN FÜR PROFIL RIDE



PRODUKT	LxBxH	FARBE	ART. NR.	EURO	LAGER
ABDECKUNG FLACH	2000x35x2	WO	577-20pm	41,50	☺
ABDECKUNG KUBISCH	2000x35x35	WO	577-20pmk	56,00	☺

VERBINDER FÜR PROFIL RIDE

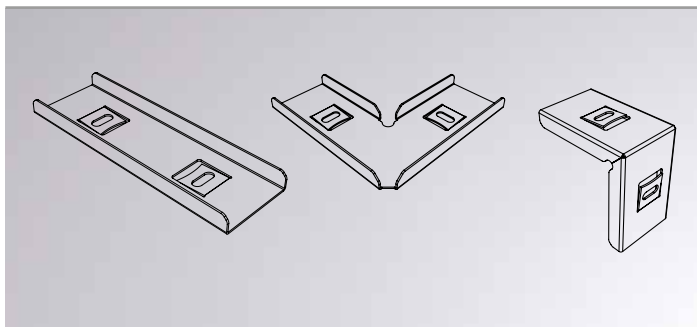

PRODUKT	ART. NR.	EURO	LAGER
LINEARVERBINDER	577-4300	7,00	☺
ECKVERBINDER FÜR HORIZONTALE LICHTLÖSUNGEN	577-4400	10,00	☺
ECKVERBINDER FÜR VERTIKALE LICHTLÖSUNGEN	577-4410	12,50	☺



eLEDments U-PROFIL



INFO

LED U-Profil für freie (schwebende) Flächen mit Gipskarton und Unterkonstruktion, Zinkblech grundiert, Montage auf Gipskartonplatte 12,5 mm

LED Profile nur geeignet für LED Bänder IP20

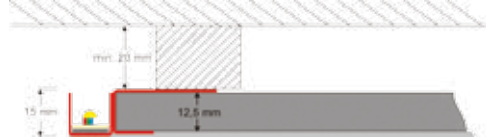
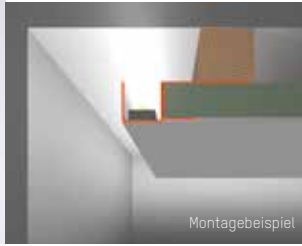

LxH	ART. NR.	EURO	LAGER
2000x15	338-p1000	122,00	☺

eLEDments L-PROFIL



INFO

LED L-Profil für Gipskarton, Zinkblech grundiert, Montage auf Gipskartonplatte 12,5 mm

LED Profile nur geeignet für LED Bänder IP20



Einbauvariante mit Unterkonstruktion

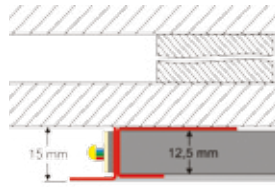

Einbauvariante ohne Unterkonstruktion

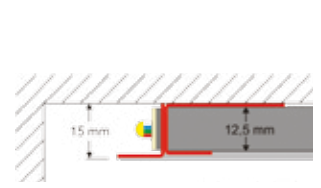

LxH	ART. NR.	EURO	LAGER
2000x15	338-p1001	122,00	☺

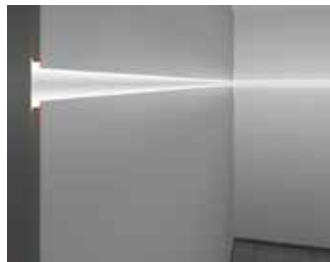

eLEDments L-PROFIL ASYMMETRISCH

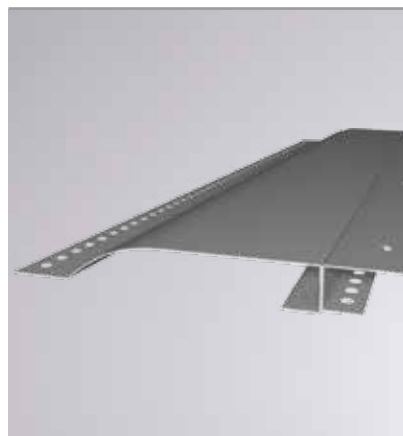

INFO

LED L-Profil mit asymmetrischem Reflektor, für Gipskarton, Zinkblech grundiert, Reflektor mit Vliesbeschichtung, Montage auf Gipskartonplatte 12,5 mm

LED Profile nur geeignet für LED Bänder IP20

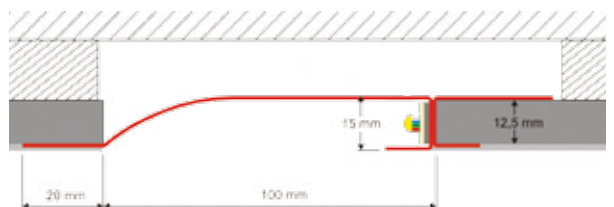

LxH	ART. NR.	EURO	LAGER
2000x15	338-p1002	142,00	☺



eLEDments FLEXIBLES L-PROFIL

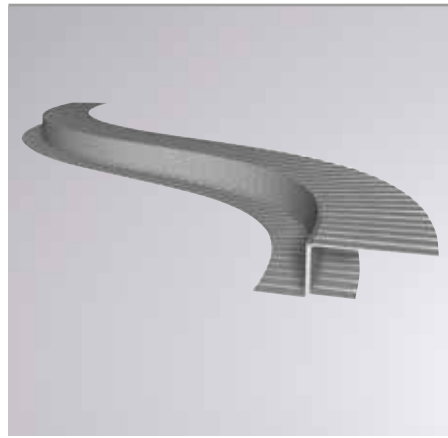

INFO	LxH	ART. NR.	EURO	LAGER
<p>LED L-Profil flexibel für Gipskarton, Zinkblech grundiert, Montage auf Gipskartonplatte H=12,5mm</p> <p>LED Profile nur geeignet für LED Bänder IP20</p>	2000x15	338-p1003	156,00	☺

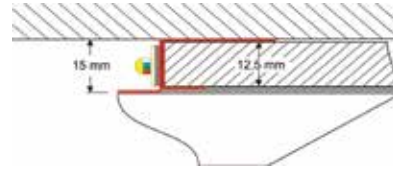
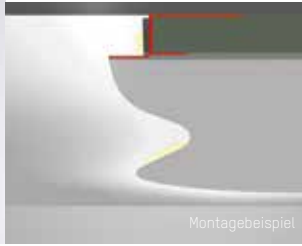

eLEDments FLEXIBLES U-PROFIL

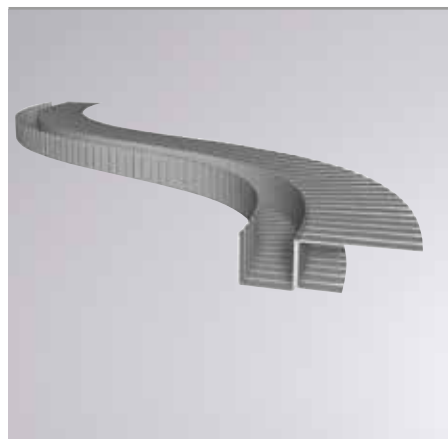

INFO	LxH	ART. NR.	EURO	LAGER
<p>LED U-Profil flexibel für freie [schwebende] Flächen mit Gipskarton & Unterkonstruktion, Zinkblech grundiert, Montage auf Gipskartonplatte H=12,5mm</p> <p>LED Profile nur geeignet für LED Bänder IP20</p>	2000x15	338-p1004	156,00	☺

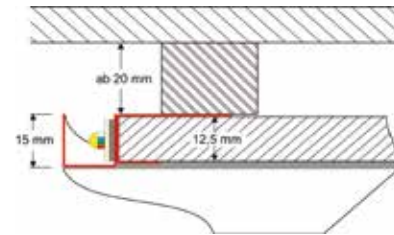
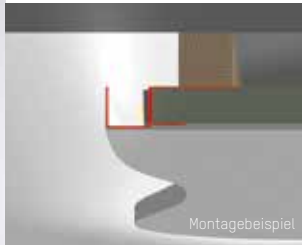

eLEDments MAGNETBAND

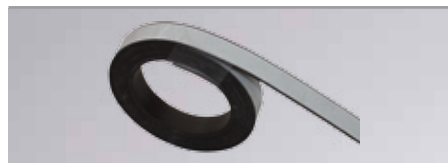

INFO	LxBxH	ART. NR.	EURO	LAGER
<p>Isotropes Magnetband, selbstklebend, notwendig für thermische Verbindung von LED Produkt und Profil sowie zur einfachen Montage des LED Produktes</p> <p>ACHTUNG: Magnetband ist für die Montage unbedingt erforderlich um eine Wärmeableitung einwandfrei gewährleisten zu können.</p>	5000x10x1	338-z1001	25,50	☺

eLEDments ABDECKUNG



INFO	AUSFÜHRUNG	LxB	ART. NR.	EURO	LAGER
<p>Abdeckung, PMMA klar oder opal, Passend für eLEDments Profil 338-p1002</p>	KLAR	2000x12,5	338-a1000	27,50	☺
	OPAL	2000x12,5	338-a1001	27,50	☺

eLEDments ANSTRICHVLIES

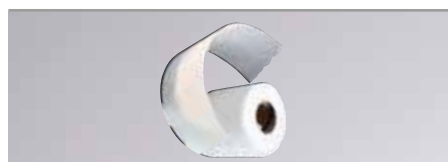

INFO	LxB	ART. NR.	EURO	LAGER
<p>Anstrichvlies für eLEDments Profil, zur Verspachtelung der Übergangsfläche Profil/Gipskartonplatte notwendig!</p>	20500x90	338-z1000	7,50	☺



LED KONVERTER VST

INFO	W	V DC	LxBxH	FARBE	ART. NR.	EURO	LAGER
 <p>LED Konverter für LED Strips, nicht dimmbar, 230 V AC</p>	50	24	225x60x36	W	24-122752	75,00	☺
	70	24	225x60x36	W	24-122750	93,00	☺
	150	24	240x60x49	S	24-122754n	98,00	☺



LED KONVERTER EFU

INFO	W	V DC	LxBxH	FARBE	ART. NR.	EURO	LAGER
 <p>LED Konverter für LED Strips, nicht dimmbar, 230 V AC</p>	25	24	146x55x19	W	24-122322	20,00	☺



LED KONVERTER VSTR 1-10V / PUSH / IR

INFO	W	V DC	LxBxH	FARBE	ART. NR.	EURO	LAGER
 <p>LED-Konverter für LED Strips, dimmbar 1-10 V & Push Dimm., IR-Zubehör separat ordern</p>	3x40W (RGB) 1x100 W (weiß)	24	231x60x49	W	24-122730	152,00	☺

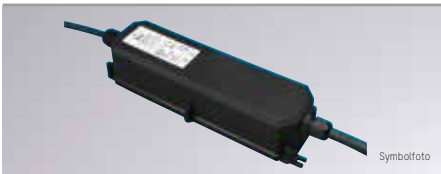

LED KONVERTER ST2 IP67

INFO	W	V DC	LxBxH	FARBE	ART. NR.	EURO	LAGER
 <p>LED Konverter für LED Strips, nicht dimmbar, 230 V AC</p>	70	24	270x66,5x51	S	24-122479	99,00	☺
	150	24	270x66,5x51	S	24-122511	214,00	☺



WEITERE KONSTANTSPANNUNGSKONVERTER AB SEITE 320 FOLGEND

DIMMER FÜR RGB-LED, DMX 512 ODER DALI

INFO	V DC	LxBxH	FARBE	ART. NR.	EURO	LAGER
 <p>Dimmer für LED-RGB Strips 12-24V DC, Achtung: 12 V DC oder 24V DC Konverter separat ordern</p> <p>Steuereingang 1 für DALI geeignet Steuereingang 2 für DMX 512 geeignet</p> <p>Input 12-24V DC / Output 3 x 12-24V dimm. je Kanal 2A max. belastbar</p>	12-24	110x70x23	W	75-dmx200	42,00	☺



DMX RGBW LED DIMMER

INFO	V DC	LxBxH	FARBE	ART. NR.	EURO	LAGER
 <p>RGBW LED Dimmer 12-36V DMX, 12V - 36V DC, geeignet zur Steuerung von RGBW LED Flexbänder, max. 5A/Kanal</p>	12-36	160x45x18	W	354-dimrgbw	115,00	☺



UNIVERSALDIMMER

INFO	V DC	LxBxH	FARBE	ART. NR.	EURO	LAGER
 <p>Universaldimmer 1 Kanal, separater Steuereingang für DALI, 1-10V, Push, Sync Anschluß für bis zu 9 Slaves bei 1-10V oder Push Ansteuerung, max. Anschluß: 5A Zulentlastung separat ordern</p> <p>Zugentlastung für 1-Kanal Universaldimmer, 2 Stück</p>	12-50	153x30x21	W	322-ud3000	99,00	☺
				322-ud7001	8,00	☺



RGBW FUNK DIMMER



INFO	W	V DC	LxBxH	FARBE	ART. NR.	EURO	LAGER
4-Kanal RGBW Funk Dimmer zur Ansteuerung von RGBW, RGB oder weißen LED Stripes max. 8A/Kanal, Spannungsversorgung separat ordern	768W	12-24	170x59x29	W	322-ec2002	160,00	☺

IP20

LED LICHTSZENENKONTROLLER



INFO	V DC	BxHxT	FÜR	FARBE	ART. NR.	EURO	LAGER
RGBW DMX / Funk Controller für bis zu 4 Zonen, bis zu 4 Stimmungen, 8 fixe Farbläufe Geschwindigkeit und Helligkeit kann angepasst werden; Steuerung kann auf Standard EB-Dose 68mm montiert werden	12-24	86x86x10	DMX	S	322-con1000	160,00	☺
	12-24	86x86x10	WIFI/FUNK	S	322-con2001	160,00	☺

IP20

WLAN GATEWAY



INFO	V DC	BxHxT	FARBE	ART. NR.	EURO	LAGER
W-Lan Gateway, zur Ansteuerung von allen EASY Color Komponenten, dazugehöriges App. EASYColor Pro im Appstore bzw. Playstore kostenlos erhältlich, Integration in hauseigenes WLAN möglich	12-24	120x52x115	S	322-ec2001	160,00	☺

IP20

FUNK FERNBEDIENUNG



INFO	LxBxH	FARBE	ART. NR.	EURO	LAGER
Funk Fernbedienung für bis zu 4 Zonen, bis zu 4 Stimmungen, 8 fixe Farbläufe Geschwindigkeit und Helligkeit kann angepasst werden, inkl. Wandhalterung	140x46x19	S	322-ec2003	160,00	☺

RGB LED CONTROLLER



INFO	V DC	LxBxH	FARBE	ART. NR.	EURO	LAGER
2,4GHz RGBW Funk-Controller 12-24V mit Touch Fernbedienung, Reichweite max. 30m, geeignet zur Steuerung von RGBW LED Streifen, Funktionen über Fernbedienung steuerbar: Monofarben mittels Farbrad, weiß, 15 Farbverlaufsprogramme, Dimmfunktion (9 Stufen), Memory-Funktion Ausgangsstrom max. 24A (4 x 6A)	12-24	85x45x27	W	354-con1001	95,00	☺

IP20

RGB LED CONTROLLER



INFO	V DC	LxBxH	FARBE	ART. NR.	EURO	LAGER
RGB-LED Controller, komplett mit Funkfernbedienung, Eingangsspannung, 12-24V DC, Ausgänge rot/grün/blau, je 4A belastbar (1x Plus und 3x-Minus), Reichweite Funksteuerung: max.15m, Fernbedienung weiß, Controller silber, 8 wählbare Farben (rot, grün, blau, orange, gelb, cyan, pink), automatischer Farbdurchlauf, 12V oder 24V Konverter separat ordern	12-24	130x64x24	G	354-con1000	62,00	☺

IP20

EINBAULEUCHTEN AUSSEN

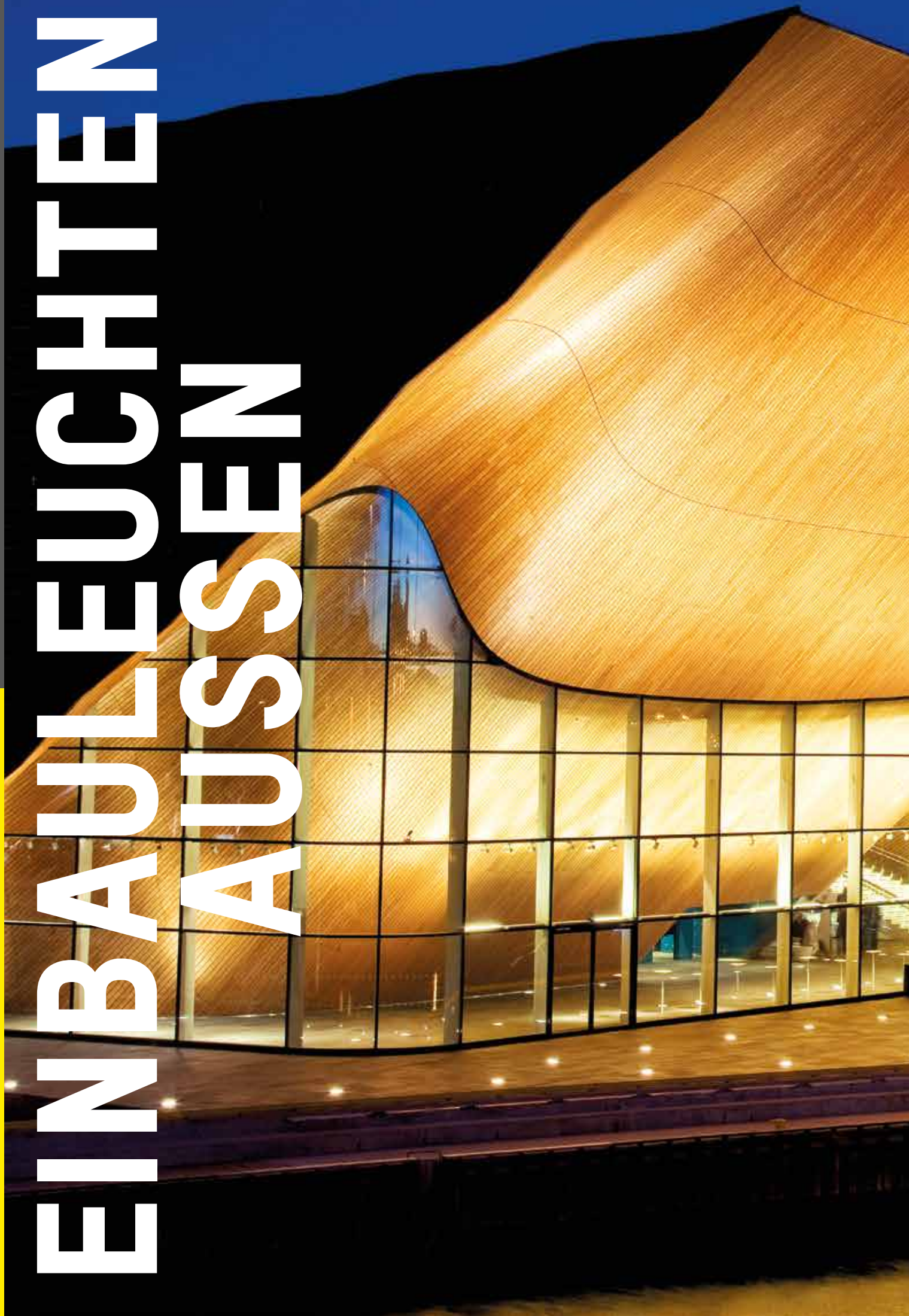



MICROZIP SQUARE LED



INFO	LM	LxB	ET	FARBE	REF	ART. NR.	EURO	LAGER
Bodeneinbaustrahler, Aluminiumdruckguss, Doppelte Pulverbeschichtung mit hoher Resistenz, quadratisch, Abdeckring aus Edelstahl - Stärke 2mm, Diffusor aus gehärtetem satiniertem Glas - Stärke 8mm, 91° Ausstrahlwinkel, belastbar bis 1000kg, Schrauben aus Edelstahl, Leuchte anschlussfertig mit Gummikabel H07RN-F inkl. Leitungsverbinder und Einbautopf aus Polypropylen (Einbautopf: LxBxH= 120x120x110mm), Dichtung Silikon, inkl. Konverter	SYS 2,2W 230V · CRI>90 20lm LED 3000K	85x85	110	E	91°	851-s5822w19	294,00	☺

LED 230V EEL: A++ - A

MINIZIP SQUARE



INFO	LM	LxB	ET	AUSFÜHRUNG	FARBE	ART. NR.	EURO	LAGER
Bodeneinbaustrahler, Aluminiumdruckguss, Doppelte Pulverbeschichtung mit hoher Resistenz, quadratisch, Abdeckring aus Edelstahl - Stärke 2mm, Diffusor aus gehärtetem teil oder ganz satiniertem Glas - Stärke 8mm, schwenkbar 15°, belastbar bis 1000kg, Schrauben aus Edelstahl, Leuchte anschlussfertig mit Gummikabel H07RN-F inkl. Leitungsverbinder und Einbautopf aus Polypropylen (Einbautopf: LxBxH= 165x165x135mm), Dichtung Silikon, ohne Leuchtmittel	QPAR16 GU10 · 230V 35W	130x130	135	Glas satiniert	E	851-s8866s19	258,00	☺
	oder	130x130	135	Glas klar	E	851-s8867s19	278,00	☺
LED RETROFIT GU10								

230V HV EEL: A++ - D

ZIP SQUARE LED



INFO	LM	LxB	ET	FARBE	REF	ART. NR.	EURO	LAGER
Bodeneinbaustrahler, Aluminiumdruckguss, Doppelte Pulverbeschichtung mit hoher Resistenz, quadratisch, Abdeckring aus Edelstahl - Stärke 2mm, Diffusor aus gehärtetem teil satiniertem Glas - Stärke 10mm, 38° Ausstrahlwinkel, schwenkbar 15°, belastbar bis 1000kg, Schrauben aus Edelstahl, Leuchte anschlussfertig mit Gummikabel H07RN-F inkl. Leitungsverbinder und Einbautopf aus Polypropylen (Einbautopf: LxBxH= 190x190x240mm), Dichtung Silikon, inkl. Konverter	SYS 14W 230V · CRI>90 950lm LED 3000K	200x200	240	E	38°	851-s8882w19	626,00	

LED 230V EEL: A++ - A

ZIP SQUARE LED



INFO	LM	LxB	ET	FARBE	REF	ART. NR.	EURO	LAGER
Bodeneinbaustrahler, Aluminiumdruckguss, Doppelte Pulverbeschichtung mit hoher Resistenz, quadratisch, Abdeckring aus Edelstahl - Stärke 2mm, Diffusor aus gehärtetem teil satiniertem Glas - Stärke 10mm, Asymmetrischer Ausstrahlwinkel, nicht schwenkbar, belastbar bis 1000kg, Schrauben aus Edelstahl, Leuchte anschlussfertig mit Gummikabel H07RN-F inkl. Leitungsverbinder und Einbautopf aus Polypropylen (Einbautopf: LxBxH= 190x190x240mm), Dichtung Silikon, inkl. Konverter	SYS 14W 230V · CRI>90 748lm LED 3000K	200x200	240	E	41°x72°	851-s8883w19	643,00	

LED 230V EEL: A++ - A



SIMES
luce per l'architettura

MEGAZIP SQUARE LED



LED 230V | 15° | inkl. | inkl. | IP67 | EEL: A++ - A

INFO	LM	LxB	ET	FARBE	REF	LUMEN	ART. NR.	EURO	LAGER
Bodeneinbaustrahler, Aluminiumdruckguss, Doppelte Pulverbeschichtung mit hoher Resistenz, quadratisch, Abdeckring aus Edelstahl - Stärke 2mm, Diffusor aus gehärtetem teil satiniertem Glas - Stärke 12mm, 31° Ausstrahlwinkel, schwenkbar 15°, belastbar bis 1000kg, Schrauben aus Edelstahl, Leuchte anschlussfertig mit Gummikabel H07RN-F inkl. Leitungsverbinder und Einbautopf aus Polypropylen (Einbautopf: LxBxH=263x263x240mm), Dichtung Silikon, inkl. Konverter	SYS 28W 230V · CRI>90 LED 3000K	275x275	240	E	31° 2573	2573	851-s8586w19	834,00	







MEGAZIP SQUARE LED









LED 230V | inkl. | inkl. | IP67 | EEL: A++ - A

INFO	LM	LxB	ET	FARBE	REF	LUMEN	ART. NR.	EURO	LAGER
Bodeneinbaustrahler, Aluminiumdruckguss, Doppelte Pulverbeschichtung mit hoher Resistenz, quadratisch, Abdeckring aus Edelstahl - Stärke 2mm, Diffusor aus gehärtetem teil satiniertem Glas - Stärke 12mm, Asymmetrischer Ausstrahlwinkel, nicht schwenkbar, belastbar bis 1000kg, Schrauben aus Edelstahl, Leuchte anschlussfertig mit Gummikabel H07RN-F inkl. Leitungsverbinder und Einbautopf aus Polypropylen (Einbautopf: LxBxH=263x263x240mm), Dichtung Silikon, inkl. Konverter	SYS 28W 230V · CRI>90 LED 3000K	275x275	240	E	41°x72° 1810	1810	851-s8587w19	851,00	







MICROZIP ROUND LED

	INFO	LM	Ø	ET	FARBE	REF	ART. NR.	EURO	LAGER
	<p>Bodeneinbaustrahler, Aluminiumdruckguss, Doppelte Pulverbeschichtung mit hoher Resistenz, rund, Abdeckung aus Edelstahl - Stärke 2mm, Diffusor aus gehärtetem satiniertem Glas - Stärke 8mm, 91° Ausstrahlwinkel, belastbar bis 1000kg, Schrauben aus Edelstahl, Leuchte anschlussfertig mit Gummikabel H07RN-F inkl. Leitungsverbinder und Einbautopf aus Polypropylen (Einbautopf: DMxH= 120x110mm), Dichtung Silikon, inkl. Konverter</p>	SYS 2,2W 230V · CRI>90 20lm	85	110	E	91°	851-s5812w19	280,00	☺
		LED 3000K							
<p>LED 230V      EE: A++ - A</p>									





MINIZIP ROUND

	INFO	LM	Ø	ET	AUSFÜHRUNG	FARBE	ART. NR.	EURO	LAGER	
	<p>Bodeneinbaustrahler, Aluminiumdruckguss, Doppelte Pulverbeschichtung mit hoher Resistenz, rund, Abdeckung aus Edelstahl - Stärke 2mm, Diffusor aus gehärtetem teil satiniertem Glas - Stärke 8mm, schwenkbar 15°, belastbar bis 1000kg, Schrauben aus Edelstahl, Leuchte anschlussfertig mit Gummikabel H07RN-F inkl. Leitungsverbinder und Einbautopf aus Polypropylen (Einbautopf: DMxH= 165x135mm), Dichtung Silikon, ohne Leuchtmittel</p>	QPAR16 GU10 · 230V 35W	130	135	Glas satiniert	E	851-s8846sl19	234,00	☺	
		oder				Glas klar	E	851-s8847sl19	244,00	☺
		LED RETROFIT GU10								
<p>230V HV      EE: A++ - D</p>										

ZIP ROUND LED

	INFO	LM	Ø	ET	FARBE	REF	ART. NR.	EURO	LAGER
	<p>Bodeneinbaustrahler, Aluminiumdruckguss, Doppelte Pulverbeschichtung mit hoher Resistenz, rund, Abdeckung aus Edelstahl - Stärke 2mm, Diffusor aus gehärtetem teil satiniertem Glas - Stärke 10mm, 38° Ausstrahlwinkel, schwenkbar 15°, belastbar bis 1000kg, Schrauben aus Edelstahl, Leuchte anschlussfertig mit Gummikabel H07RN-F inkl. Leitungsverbinder und Einbautopf aus Polypropylen (Einbautopf: DMxH= 190x240mm), Dichtung Silikon, inkl. Konverter</p>	SYS 14W 230V · CRI>90 950lm	200	240	E	38°	851-s8862w19	584,00	
		LED 3000K							
<p>LED 230V      EE: A++ - A</p>									

ZIP ROUND LED

	INFO	LM	Ø	ET	FARBE	REF	ART. NR.	EURO	LAGER
	<p>Bodeneinbaustrahler, Aluminiumdruckguss, Doppelte Pulverbeschichtung mit hoher Resistenz, rund, Abdeckung aus Edelstahl - Stärke 2mm, Diffusor aus gehärtetem teil satiniertem Glas - Stärke 10mm, Asymmetrischer Ausstrahlwinkel, nicht schwenkbar, belastbar bis 1000kg, Schrauben aus Edelstahl, Leuchte anschlussfertig mit Gummikabel H07RN-F inkl. Leitungsverbinder und Einbautopf aus Polypropylen (Einbautopf: DxH= 190x240mm), Dichtung Silikon, inkl. Konverter</p>	SYS 14W 230V · CRI>90 748lm	200	240	E	41°x72°	851-s8863w19	597,00	
		LED 3000K							
<p>LED 230V     EE: A++ - A</p>									



SIMES
Luce per l'architettura

MEGAZIP ROUND LED



LED 230V | | 15° | | | | | EEL: A++ - A

INFO	LM	Ø	ET	FARBE	REF	ART. NR.	EURO	LAGER
Bodeneinbaustrahler, Aluminiumdruckguss, Doppelte Pulverbeschichtung mit hoher Resistenz, rund, Abdeckung aus Edelstahl - Stärke 2mm, Diffusor aus gehärtetem teil satinierem Glas - Stärke 12mm, 31° Ausstrahlwinkel, schwenkbar 15°, belastbar bis 1000kg, Schrauben aus Edelstahl, Leuchte anschlussfertig mit Gummikabel H07RN-F inkl. Leitungsverbinder und Einbautopf aus Polypropylen (Einbautopf: DMxH=260x245mm), Dichtung Silikon, inkl. Konverter	SYS 28W 230V · CRI>90 2573lm LED 3000K	275	245			851-s8566w19	730,00	

MEGAZIP ROUND LED



LED 230V | | | | | | EEL: A++ - A

INFO	LM	Ø	ET	FARBE	REF	LUMEN	ART. NR.	EURO	LAGER
Bodeneinbaustrahler, Aluminiumdruckguss, Doppelte Pulverbeschichtung mit hoher Resistenz, quadratisch, Abdeckung aus Edelstahl - Stärke 2mm, Diffusor aus gehärtetem teil satinierem Glas - Stärke 12mm, Asymmetrischer Ausstrahlwinkel, nicht schwenkbar, belastbar bis 1000kg, Schrauben aus Edelstahl, Leuchte anschlussfertig mit Gummikabel H07RN-F inkl. Leitungsverbinder und Einbautopf aus Polypropylen (Einbautopf: DxH=263x240mm), Dichtung Silikon, inkl. Konverter	SYS 28W 230V · CRI>90 LED 3000K	275	240		41°x72°	1810	851-s8567w19	775,00	

NAUTO LED



INFO	LM	Ø	ET	DA Ø	FARBE	REF	LED	ART. NR.	EURO	LAGER
Bodeneinbaustrahler aus hitzeresistentem Technopolymer, rund, Ring aus Edelstahl, Scheibe aus unzerbrechlichem Polycarbonat, belastbar bis 1000kg, Doppelte PG7 Verschraubung, inkl. Einbautopf, Oberflächentemperatur max. 40°C, exkl. Konverter	LED 1,5W 24V CRI>80	88	96	80	E	93°	3500K	290-1543180	52,00	☺
	3500K: 70lm BLAU: 55lm	88	96	80	E	93°	BLAU	290-1546480	52,00	☺

LED 24V | exkl. | inkl. | IP68 | 3m | EEL: A++ - A

LED KONVERTER



INFO	W / V	LxB	H	FÜR	FARBE	ART. NR.	EURO	LAGER
LED-Konverter, nicht dimmbar, 230V AC	20W / 24V DC	146x55	19	1 - 10 NAUTO	W	24-122322	20,00	☺

W | V | G | IP20

WALKER LED

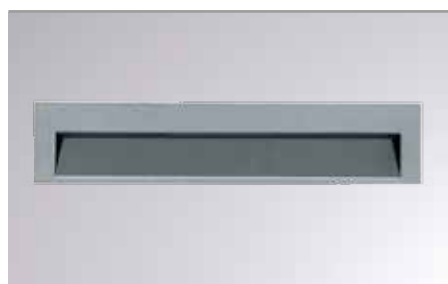

INFO	LM	BxH	T	FARBE	ART. NR.	EURO	LAGER
Wandeinbauleuchte, Aluminiumdruckguss, Doppelte Pulverbeschichtung mit hoher Resistenz, weiß oder grau, Diffusor aus gehärtetem opal Klarglas - Stärke 4mm, Schrauben aus Edelstahl V4A, Leuchtgehäuse ist mittels eines Klemmfedermechanismus entnehmbar, Vorbereitet für Durchgangsverdrahtung, Silikondichtung, inkl. Konverter, Eingießgehäuse separat ordern	SYS 13,5W 230V · CRI>90 346lm LED 3000K	310x65	50	W	851-s6320w01	313,00	
		310x65	50	G	851-s6320w14	313,00	☺

LED 230V | inkl. | inkl. | IP65 | EEL: A++ - A

INGIESSGEHÄUSE

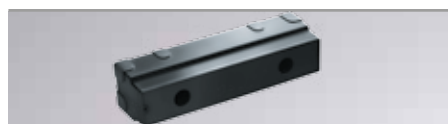

INFO	BxH	ET	FARBE	ART. NR.	EURO	LAGER
Eingießgehäuse für Walker LED, separat ordern	310x79	86	S	851-s6329	40,00	☺

MINIEOS QUADRATISCH LED



INFO	LM	BxH	T	FARBE	ART. NR.	EURO	LAGER
Wandeinbauleuchte, Aluminiumdruckguss mit hohem Korrosionsschutz, Doppelte Pulverbeschichtung mit hoher Resistenz, grau, quadratisch, Reflektor aus 99,98% reinem Aluminium, Diffusor aus gehärtetem Opalglas, Schrauben Edelstahl, Einzelverdrahtung, Doppelter Kabeleingang, Dichtung Dutral, inkl. Konverter, Eingießgehäuse separat Ordern (zur Montage erforderlich)	SYS 4W 230V · CRI>90 39lm LED 3000K	105x105	95	G	851-s4610w14	188,00	☺

LED 230V | inkl. | inkl. | IP55 | EEL: A++ - A



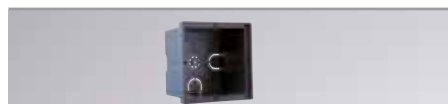





INGIESSGEHÄUSE



INFO	BxH	ET	FARBE	ART. NR.	EURO	LAGER
Eingießgehäuse schwarz für Minieos LED quadratisch, separat ordern	98x98	95	S	851-s4613	10,00	☺











EOS QUADRATISCH LED

	INFO	LM	BxH	T	FARBE	ART. NR.	EURO	LAGER
	Wandeinbauleuchte, Aluminiumdruckguss mit hohem Korrosionsschutz, Doppelte Pulverbeschichtung mit hoher Resistenz, grau, quadratisch, Reflektor aus 99,98% reinem Aluminium, Diffusor aus gehärtetem Opalglas, Schrauben Edelstahl, Einzelverdrahtung, Doppelter Kabeleingang, Silikondichtung, inkl. Konverter, Eingießgehäuse separat Ordern (zur Montage erforderlich)	SYS 14W 230V · CRI>90 179lm LED 3000K	230x200	100	G	851-s4605w14	380,00	
      								

EINGIESSGEHÄUSE

	INFO	BxH	ET	FARBE	ART. NR.	EURO	LAGER
	Eingießgehäuse schwarz für EOS quadratisch, separat ordern	217x187	100	S	851-s4343	34,00	☺









EOS RECHTECKIG LED

	INFO	LM	BxH	T	FARBE	ART. NR.	EURO	LAGER
	Wandeinbauleuchte, Aluminiumdruckguss mit hohem Korrosionsschutz, Doppelte Pulverbeschichtung mit hoher Resistenz, grau, rechteckig, Reflektor aus 99,98% reinem Aluminium, Diffusor aus gehärtetem Opalglas, Schrauben Edelstahl, Einzelverdrahtung, Doppelter Kabeleingang, Silikondichtung, inkl. Konverter, Eingießgehäuse separat Ordern (zur Montage erforderlich)	SYS 17W 230V · CRI>90 172lm LED 3000K	275x145	95	G	851-s4615w14	381,00	☺
      								

EINGIESSGEHÄUSE

	INFO	BxH	ET	FARBE	ART. NR.	EURO	LAGER
	Eingießgehäuse schwarz für EOS rechteckig, separat ordern	263x135	95	S	851-s4523	26,00	☺

MICROBLINKER LED

	INFO	LM	BxH	T	FARBE	ART. NR.	EURO	LAGER
	Wandeinbauleuchte, Aluminiumdruckguss mit hohem Korrosionsschutz, Doppelte Pulverbeschichtung mit hoher Resistenz, grau, Diffusor aus gehärtetem Opalglas - Stärke 4mm, Schrauben aus Edelstahl V4A, Vorbereitet für Durchgangsverdrahtung, Silikondichtung, inkl. Konverter, Eingießgehäuse separat Ordern (zur Montage erforderlich)	SYS 4,8W 230V · CRI>90 30lm LED 3000K	45x230	100	G	851-s6060w14	284,00	
      								

EINGIESSGEHÄUSE

	INFO	BxH	ET	ART. NR.	EURO	LAGER
	Eingießgehäuse, verzinktes Blech, für Microblinker LED, separat ordern	70x300	105	851-s6063	41,00	☺



SIMES

luce per l'architettura

MINIBLINKER LED



INFO	LM	BxH	T	FARBE	ART. NR.	EURO	LAGER
<p>Wandeinbauleuchte, Aluminiumdruckguss mit hohem Korrosionsschutz, Doppelte Pulverbeschichtung mit hoher Resistenz, grau, Diffusor aus gehärtetem Opalglas - Stärke 4mm, Schrauben aus Edelstahl V4A, Vorbereitet für Durchgangsverdrahtung, Silikonichtung, inkl. Konverter, Eingießgehäuse separat Ordern (zur Montage erforderlich)</p>	<p>SYS 17W 230V - CRI>90 281lm</p> <p>LED 3000K</p>	100x230	120	G	851-s6070w14	373,00	☺







LED 230V inkl. inkl. IP65 | EEL: A++ - A

EINGIESSGEHÄUSE









INFO	BxH	ET	ART. NR.	EURO	LAGER
<p>Eingießgehäuse, verzinktes Blech, für Miniblinker LED, separat ordern</p>	110x300	130	851-s6073	45,00	☺







ZEPELIN TONDO LED

INFO	LM	Ø	ET	WA Ø	REF.	FARBE	ART. NR.	EURO	LAGER
 <p>starrer Einbaustrahler aus Stahl mit satiniertem Schutzglas, begehbar bis 500 kg, Zubehör separat ordern</p> <p>LED 1W 350mA oder LED 2W 500mA max 60lm CRI>80 LED 3000K</p> <p>für Gipskarton WA Ø 32 mm im Lieferumfang enthalten</p>		40	75	30	178°	E	68-634833ww	117,50	☺
    									







ZEPELIN QUADRO LED

INFO	LM	LxB	ET	WA Ø	REF.	FARBE	ART. NR.	EURO	LAGER
 <p>starrer Einbaustrahler aus Stahl mit satiniertem Schutzglas, begehbar bis 500 kg, Zubehör separat ordern</p> <p>LED 1W 350mA oder LED 2W 500mA max 60lm CRI>80 LED 3000K</p> <p>für Gipskarton WA Ø 32 mm im Lieferumfang enthalten</p>		40x40	75	30	178°	E	68-634933ww	117,50	☺
    									







CERCHIO LED

INFO	LM	Ø	ET	WA Ø	FARBE	ART. NR.	EURO	LAGER
 <p>Einbaustrahler, Edelstahl matt, Rahmen aus rostfreiem Stahl AISI316L, rund, Kühlkörper aus Aluminium, inkl. 30cm Neopren Stromkabel, begehbar bis 500kg, Halterung für Gipskarton WA DM=40mm im Lieferumfang enthalten, exkl. Konverter 350mA(1W) - 500mA (2W), Zubehör separat ordern</p> <p>LED 1W 350mA oder LED2W 500mA 40lm CRI>80 LED 3000K</p>		47	75	38	E	68-638933ww	160,00	
    								

LED KONVERTER

INFO	W / mA	LxBxH	FÜR	FARBE	ART. NR.	EURO	LAGER
 <p>LED-Konverter, nicht dimmbar, 230V AC</p> <p>LED-Konverter, schaltbar nicht dimmbar, 230V AC</p> <p>Achtung: Konverter extern setzen, passt nicht in Ausschnitt!</p>	4W / 350	60x35x21,5	1 - 3 LED	W	24-122596	17,00	☺
	6W / 500	60x35x21,5	1 - 2 LED	W	24-122602	17,00	☺
	19W / 350 20W / 500	111x52x22	1 - 14 LED 1 - 8 LED	W	24-122201	23,00	☺
     							

LED KONVERTER IP65

INFO	W / mA	LxB	H	FÜR	FARBE	ART. NR.	EURO	LAGER
 <p>LED-Konverter, nicht Dimmbar, 230V AC, 14W 500mA</p>	14W / 500	161x22	22	1 - 6 LED	W	24-122448ip	34,00	☺
     								



BODENEINBAUHÜLSEN



INFO		Ø	ET	ART. NR.	EURO	LAGER
Bodeneinhülse, Kunststoff, für Zeppelin und Cerchio, inkl. Verbinder IP67, Drainage erforderlich, exkl. Konverter	für ZEPPELIN	110	100	68-0220	23,50	☺
	für CERCHIO	110	100	68-0250	23,50	☺

WANDEINBAUHÜLSEN



INFO		Ø	ET	ART. NR.	EURO	LAGER
Wandeneinhülse, Kunststoff, für Zeppelin und Cerchio	für ZEPPELIN	40	70	68-0216	3,70	☺
	für CERCHIO	48	80	68-0217	4,30	☺

MONTAGEANLEITUNGEN

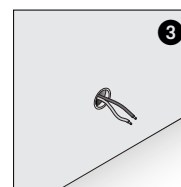
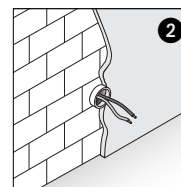
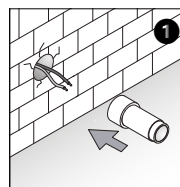
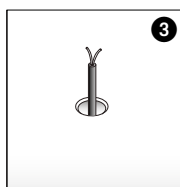
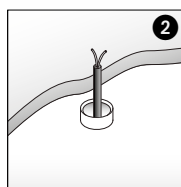
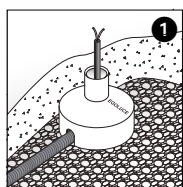

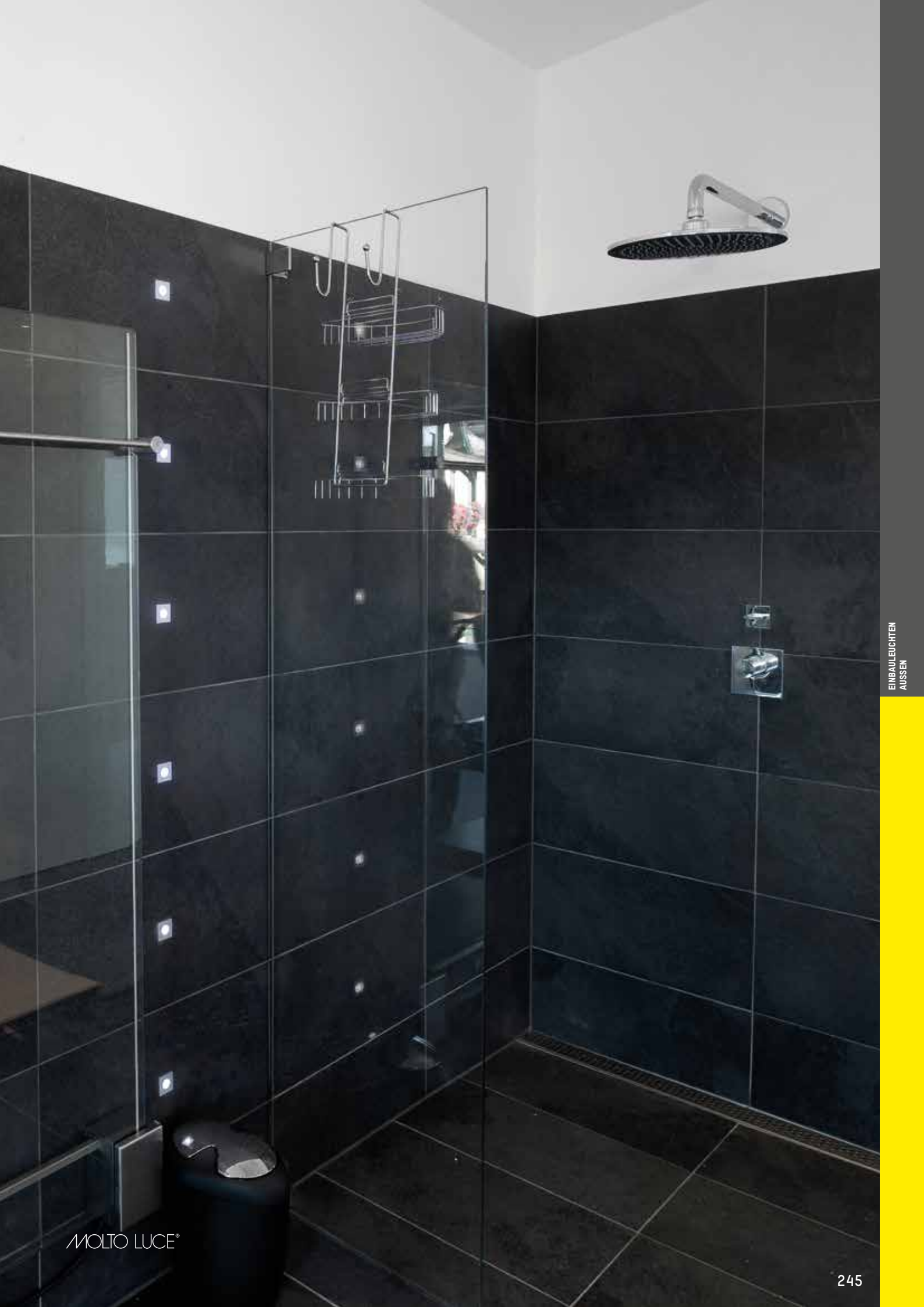

MINILOBBY LED



INFO	LM	ØxH	ET	DA Ø	LUMEN	FARBE	REF	ART. NR.	EURO	LAGER
Einbaudownlight, Aluminiumdruckguss, grau, Doppelte Pulverbeschichtung mit hoher Resistenz, rund, Aluminiumfrontring mit sichtbaren Schraubenköpfen, teilmattiertes - gehärtetes Glas Stärke 10mm, Leuchte anschlussfertig mit Gummikabel 1m H07RN-F, Silikondichtung, A4 Edelstahlschrauben, Deckenstärke min. 5mm bis max. 40mm, inkl. Konverter, Betoneinbaugehäuse auf Anfrage.	SYS 8,6W 230V · CRI>83	140x110	120	130	563	6	157°	851-s7300w14	350,00	
	LED 3000K	140x110	120	130	658	6	123°	851-s7305w14	342,00	

LED 230V IP65 | EE: A++ - A

LOBBY LED



INFO	LM	ØxH	ET	DA Ø	LUMEN	FARBE	REF	ART. NR.	EURO	LAGER
Einbaudownlight, Aluminiumdruckguss, grau, Doppelte Pulverbeschichtung mit hoher Resistenz, rund, Aluminiumfrontring mit sichtbaren Schraubenköpfen, teilmattiertes - gehärtetes Glas Stärke 10mm, Leuchte anschlussfertig mit Gummikabel 1m H07RN-F, Silikondichtung, A4 Edelstahlschrauben, Deckenstärke min. 5mm bis max. 40mm, inkl. Konverter, Betoneinbaugehäuse auf Anfrage.	SYS19,6W 230V · CRI>83	200x130	150	190	1623	6	179°	851-s7320w14	463,00	
	LED 3000K	200x130	150	190	1769	6	136°	851-s7325w14	453,00	

LED 230V IP65 | EE: A++ - A



CHICCO ROUND LED

TOP SELLER



Einbaustrahler, Aluminiumdruckguss Feinstruktur matt pulverbeschichtet, starr, zurückversetzte Lichtquelle, 30° Ausstrahlwinkel, exkl. Konverter

LM	Ø	ET	DA Ø	LUMEN	FARBE	REF.	ART. NR.	EURO	LAGER
LED 7W 350mA CRI>90	90	80	78	510	W	30°	308-0010790302705	39,00	☺
	90	80	78	455	S	30°	308-0010790302706	39,00	☺
LED 2700K	90	80	78	465	S	30°	308-0010790302704	39,00	☺
LED 7W 350mA CRI>90	90	80	78	555	W	30°	308-0010790303005	39,00	☺
	90	80	78	515	S	30°	308-0010790303006	39,00	☺
LED 3000K	90	80	78	525	S	30°	308-0010790303004	39,00	☺

LED 350mA IP65 | EEI: A+++ - A

CHICCO SQUARE LED

TOP SELLER

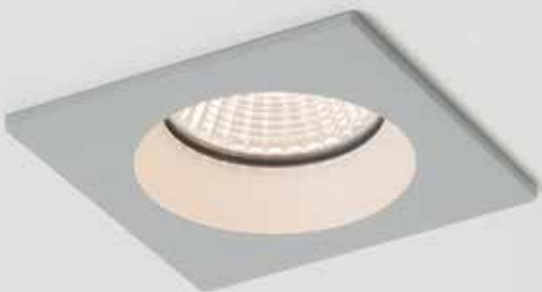

Einbaustrahler, Aluminiumdruckguss Feinstruktur matt pulverbeschichtet, starr, zurückversetzte Lichtquelle, 30° Ausstrahlwinkel, exkl. Konverter

LM	LxB	ET	DA Ø	LUMEN	FARBE	REF.	ART. NR.	EURO	LAGER
LED 7W 350mA CRI>90	90x90	80	78	510	W	30°	308-0020790302705	39,00	☺
	90x90	80	78	455	S	30°	308-0020790302706	39,00	☺
LED 2700K	90x90	80	78	465	S	30°	308-0020790302704	39,00	☺
LED 7W 350mA CRI>90	90x90	80	78	555	W	30°	308-0020790303005	39,00	☺
	90x90	80	78	515	S	30°	308-0020790303006	39,00	☺
LED 3000K	90x90	80	78	525	S	30°	308-0020790303004	39,00	☺

LED 350mA IP65 | EEI: A+++ - A

LED KONVERTER



INFO	W	mA	V DC	FÜR	LxBxH	FARBE	ART. NR.	EURO	LAGER
nicht dimmbar, 230 V AC	8	350	24	1 CHICCO	60x35x21,5	W	24-122598	17,00	☺
dimmbar, 1 - 10V/Push	15	350	43	1 - 2 CHICCO	111x52x22	W	24-123400	44,00	☺
dimmbar, DALI dimm.	15	350	43	1 - 2 CHICCO	111x52x22	W	24-123403	49,00	☺

IP20

CITY Z LED



Einbaustrahler, Aluminium, Feinstruktur matt pulverbeschichtet, quadratisch, starr, inkl. klarem Schutzglas, 37° Ausstrahlwinkel, exkl. Konverter

LM	LxB	ET	DA LxB	FARBE	REF.	ART. NR.	EURO	LAGER
LED 12W 350mA 1220lm CRI>80	87x87	120	82x82	W	37°	308-101512337ng1	109,00	☺
	87x87	120	82x82	S	37°	308-101612337ng1	109,00	☺
LED 3000K								

LED 350mA IP54 | EEI: A+++ - A

LED KONVERTER



INFO	W	mA	V DC	FÜR	LxBxH	FARBE	ART. NR.	EURO	LAGER
nicht dimmbar, 230 V AC	19	350	57	1 CITY Z	111x52x22	W	24-122201	23,00	☺
dimmbar, 1 - 10V/Push	15	350	43	1 CITY Z	111x52x22	W	24-123400	44,00	☺
dimmbar, DALI dimm.	15	350	43	1 CITY Z	111x52x22	W	24-123403	49,00	☺

IP20



IVY SQUARE LED



Einbaustrahler, Aluminiumdruckguss, Feinstruktur matt pulverbeschichtet, quadratisch, runder Deckenausschnitt, starr, mit zurückversetzter Lichtquelle, erhältlich in 2 Ausstrahlwinkeln, exkl. Konverter

LM	LxB	ET	DA Ø	FARBE	LUMEN	REF.	ART. NR.	EURO	LAGER
LED 7W 200mA CRI>90	72x72	107	60	W	660	20°	472-0270790203005	42,00	☺
	72x72	107	60	W	650	40°	472-0270790403005	42,00	☺
LED 3000K	72x72	107	60	S	650	20°	472-0270790203006	42,00	☺
	72x72	107	60	S	530	40°	472-0270790403006	42,00	☺

LED 200mA EEI: A++ - A

IVY ROUND LED



Einbaustrahler, Aluminiumdruckguss, Feinstruktur matt pulverbeschichtet, rund, starr, mit zurückversetzter Lichtquelle, erhältlich in 2 Ausstrahlwinkeln, exkl. Konverter

LM	Ø	ET	DA Ø	FARBE	LUMEN	REF.	ART. NR.	EURO	LAGER
LED 7W 200mA CRI>90	72	107	60	W	700	20°	472-0260790203005	39,00	☺
	72	107	60	W	670	40°	472-0260790403005	39,00	☺
LED 3000K	72	107	60	S	535	20°	472-0260790203006	39,00	☺
	72	107	60	S	620	40°	472-0260790403006	39,00	☺

LED 200mA EEI: A++ - A

LED KONVERTER



INFO	W / mA	LxB	H	FÜR	FARBE	ART. NR.	EURO	LAGER
LED-Konverter, nicht dimmbar, 230V AC	8,3 / 200	115x34	19	1 IVY	W	24-122360	23,00	☺

CIRCINO LED



Einbaustrahler, Aluminium gefräst, Aluminium gebürstet und transparent lackiert oder Feinstruktur matt pulverbeschichtet, 35° schwenkbar, 24° Ausstrahlwinkel, exkl. Konverter

LM	Ø	ET	DA Ø	FARBE	REF.	ART. NR.	EURO	LAGER
LED 15W 700mA 1555lm CRI>90	100	130	90	W	24°	365-0051590243005	99,00	☺
	100	130	90	S	24°	365-0051590243006	99,00	☺
LED 3000K	100	130	90	AG	24°	365-0051590243014	99,00	☺

LED 700mA EEI: A++ - A

LED KONVERTER



INFO	W	mA	V DC	FÜR	LxBxH	FARBE	ART. NR.	EURO	LAGER
nicht dimmbar, 230V AC	20	700	28	1 CIRCINO	111x52x22	W	24-122201	23,00	☺
dimmbar, 1 - 10V/Push	20	700	36	1 CIRCINO	111x52x22	W	24-123400	44,00	☺
dimmbar, DALI dimm.	20	700	28	1 CIRCINO	111x52x22	W	24-123403	49,00	☺



RIDE IP54 LED

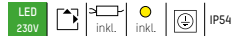

INFO

Einbauleuchte aus stranggepresstem Aluminiumprofil, Oberfläche eloxiert, weiß oder schwarz pulverbeschichtet, opale PMMA Abdeckung flach, erhältlich in 4 Längen, energieeffiziente LEDs mit hoher Farbwiedergabe

EEL: A++ - A

Auf Anfrage 3500K

LM	LxB	DA LxB	ET	FARBE	LED	LUMEN	ART. NR.	EURO	LAGER
SYS 11W · 230V · CRI>90	606x44	600x37	75	W	2700K	750lm	577-014011023050	309,00	
SYS 11W · 230V · CRI>90	606x44	600x37	75	S	2700K	750lm	577-014011023060	309,00	
SYS 11W · 230V · CRI>90	606x44	600x37	75	AE	2700K	750lm	577-014011023080	309,00	
SYS 11W · 230V · CRI>90	606x44	600x37	75	W	3000K	820lm	577-014011029050	309,00	
SYS 11W · 230V · CRI>90	606x44	600x37	75	S	3000K	820lm	577-014011029060	309,00	
SYS 11W · 230V · CRI>90	606x44	600x37	75	AE	3000K	820lm	577-014011029080	309,00	
SYS 11W · 230V · CRI>90	606x44	600x37	75	W	4000K	890lm	577-014011024050	309,00	
SYS 11W · 230V · CRI>90	606x44	600x37	75	S	4000K	890lm	577-014011024060	309,00	
SYS 11W · 230V · CRI>90	606x44	600x37	75	AE	4000K	890lm	577-014011024080	309,00	
SYS 16W · 230V · CRI>90	886x44	880x37	75	W	2700K	1120lm	577-014021023050	361,00	
SYS 16W · 230V · CRI>90	886x44	880x37	75	S	2700K	1120lm	577-014021023060	361,00	
SYS 16W · 230V · CRI>90	886x44	880x37	75	AE	2700K	1120lm	577-014021023080	361,00	
SYS 16W · 230V · CRI>90	886x44	880x37	75	W	3000K	1230lm	577-014021029050	361,00	
SYS 16W · 230V · CRI>90	886x44	880x37	75	S	3000K	1230lm	577-014021029060	361,00	
SYS 16W · 230V · CRI>90	886x44	880x37	75	AE	3000K	1230lm	577-014021029080	361,00	
SYS 16W · 230V · CRI>90	886x44	880x37	75	W	4000K	1340lm	577-014021024050	361,00	
SYS 16W · 230V · CRI>90	886x44	880x37	75	S	4000K	1340lm	577-014021024060	361,00	
SYS 16W · 230V · CRI>90	886x44	880x37	75	AE	4000K	1340lm	577-014021024080	361,00	
SYS 21W · 230V · CRI>90	1166x44	1160x37	75	W	2700K	1500lm	577-014031023050	413,00	
SYS 21W · 230V · CRI>90	1166x44	1160x37	75	S	2700K	1500lm	577-014031023060	413,00	
SYS 21W · 230V · CRI>90	1166x44	1160x37	75	AE	2700K	1500lm	577-014031023080	413,00	
SYS 21W · 230V · CRI>90	1166x44	1160x37	75	W	3000K	1640lm	577-014031029050	413,00	
SYS 21W · 230V · CRI>90	1166x44	1160x37	75	S	3000K	1640lm	577-014031029060	413,00	
SYS 21W · 230V · CRI>90	1166x44	1160x37	75	AE	3000K	1640lm	577-014031029080	413,00	
SYS 21W · 230V · CRI>90	1166x44	1160x37	75	W	4000K	1780lm	577-014031024050	413,00	
SYS 21W · 230V · CRI>90	1166x44	1160x37	75	S	4000K	1780lm	577-014031024060	413,00	
SYS 21W · 230V · CRI>90	1166x44	1160x37	75	AE	4000K	1780lm	577-014031024080	413,00	
SYS 26W · 230V · CRI>90	1446x44	1440x37	75	W	2700K	1870lm	577-014041023050	465,00	
SYS 26W · 230V · CRI>90	1446x44	1440x37	75	S	2700K	1870lm	577-014041023060	465,00	
SYS 26W · 230V · CRI>90	1446x44	1440x37	75	AE	2700K	1870lm	577-014041023080	465,00	
SYS 26W · 230V · CRI>90	1446x44	1440x37	75	W	3000K	2050lm	577-014041029050	465,00	
SYS 26W · 230V · CRI>90	1446x44	1440x37	75	S	3000K	2050lm	577-014041029060	465,00	
SYS 26W · 230V · CRI>90	1446x44	1440x37	75	AE	3000K	2050lm	577-014041029080	465,00	
SYS 26W · 230V · CRI>90	1446x44	1440x37	75	W	4000K	2230lm	577-014041024050	465,00	
SYS 26W · 230V · CRI>90	1446x44	1440x37	75	S	4000K	2230lm	577-014041024060	465,00	
SYS 26W · 230V · CRI>90	1446x44	1440x37	75	AE	4000K	2230lm	577-014041024080	465,00	



PMMA Opaldiffuser Flach

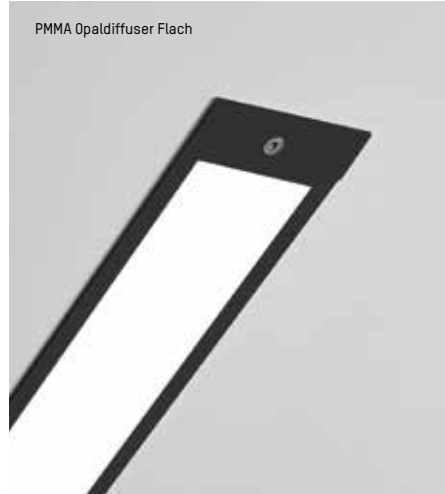

PMMA Opaldiffuser Flach



AUFBAULEUCHTEN AUSSEN

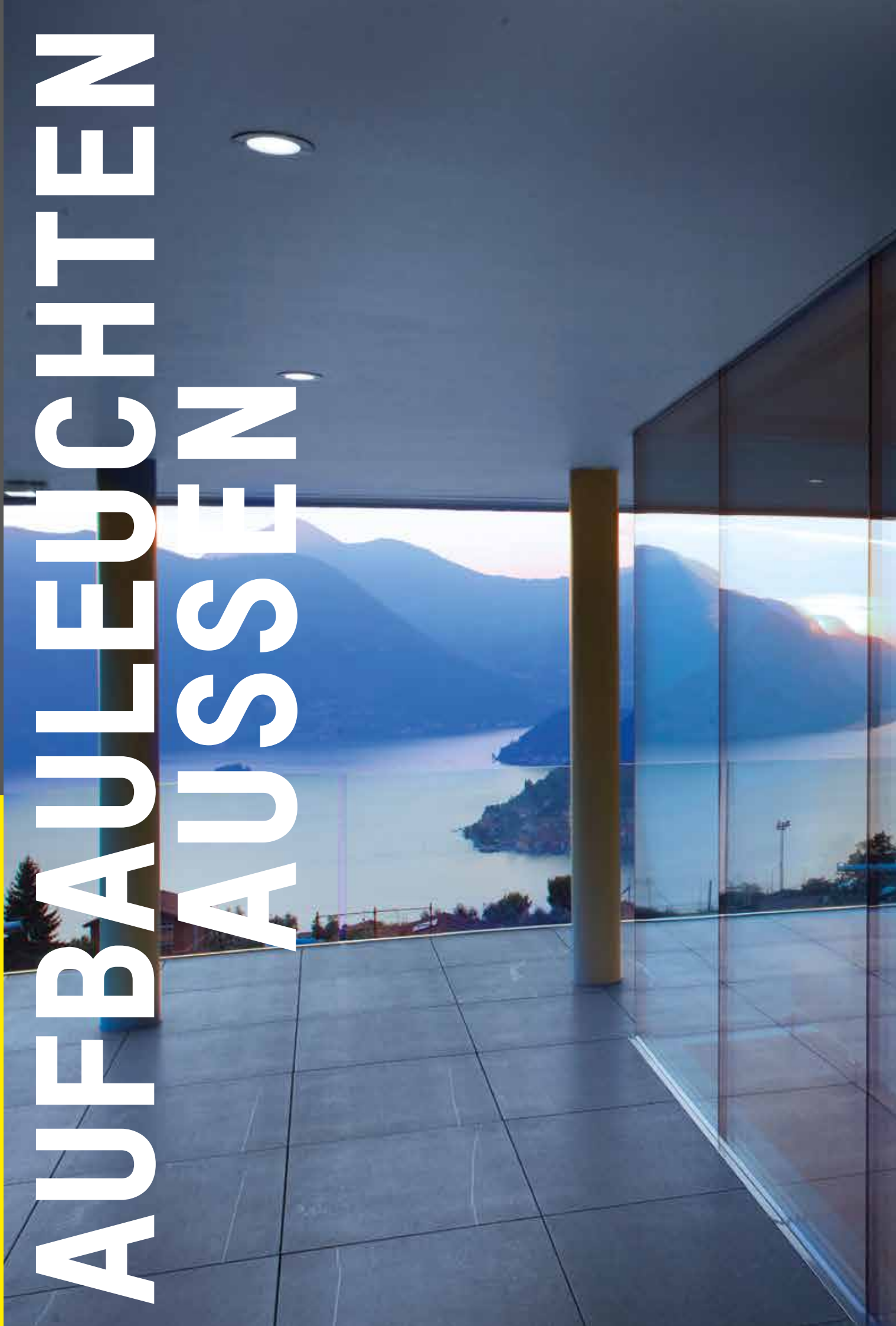



NEXT LED

TOP SELLER



Wandleuchte, Aluminium, Feinstruktur matt pulverbeschichtet, schwenkbare Doppelreflektoren für individuelle Lichtbildgestaltung, direkt/indirekt strahlend, inkl. Konverter

LM	BxH	T	FARBE	ART. NR.	EURO	LAGER
SYS 7W 230V 2 x 105lm CRI>90	100x100	100	W	472-291008w	199,00	😊
	100x100	100	G	472-291008s	199,00	😊
LED 3000K	100x100	100	S G	472-291008bgng1	229,00	😊
	100x100	100	AN	472-291008ag	199,00	😊

LED 230V inkl. inkl. IP54 | EEL: A++ - A



KATHA I LED



Wandleuchte, Aluminium, Feinstruktur matt pulverbeschichtet, schwenkbare Doppelreflektoren für individuelle Lichtbildgestaltung, direkt/indirekt strahlend, inkl. Konverter

LM	BxH	T	FARBE	ART. NR.	EURO	LAGER
SYS 7W 230V 2 x 105lm CRI>90	80x68	123	W	472-645a11w	215,00	😊
	80x68	123	G	472-645a11s	215,00	😊

LED 3000K

LED 230V inkl. inkl. IP54 | EEL: A++ - A



QUADRO UP/DOWN



Wandleuchte, Aluminium, perchrom lackiert, rechteckig, hochwertige Optikklinen mit 2 Ausstrahlwinkel, direkt/indirekt strahlend, inkl. Konverter

LM	TxBxH	FARBE	REF.	ART. NR.	EURO	LAGER
SYS 4W 230V 2 x 112lm	63x60x150		2 x spot	56-5212ng2	242,00	
	63x60x150		2 x medium	56-5213ng2	242,00	
LED 3000K	63x60x150		1 x spot + 1 x medium	56-5214ng2	242,00	

LED 230V inkl. inkl. IP54 | EEL: A++ - A



BEN SQUARE LED



Wandleuchte, Aluminium, weiß matt, Feinstruktur pulverbeschichtet, rechteckig, direkt/indirekt strahlend, inkl. Konverter

LM	BxH	T	LUMEN	FARBE	ART. NR.	EURO	LAGER
SYS 9W · 230V CRI>90	80x200	80	525lm	W	472-0060890003005	179,00	☺
	80x200	80	360lm	G	472-0060890003004	179,00	☺
LED 3000K	80x200	80	320lm	AN	472-0060890003011	179,00	☺

LED 230V IP65 | EEI: A+++ - A

SKYE LED



Wandleuchte, Aluminium, Feinstruktur matt pulverbeschichtet, direkt/indirekt strahlend, schwenkbare Doppelreflektoren für individuelle Lichtbildgestaltung, inkl. Konverter

LM	BxHxT	LUMEN	FARBE	ART. NR.	EURO	LAGER
SYS 16W 230V CRI>90	150x150x150	550lm	W	472-260025	295,00	☺
	150x150x150	480lm	G	472-260026	295,00	☺
LED 3000K						

LED 230V IP54 | EEI: A+++ - A

ANGLE



Wandleuchte, lackiert, Armatur aus Stahl, flacher und quadratischer Diffusor, schräge Abstrahlung, direkt oder indirekt strahlend montierbar

LM	BxHxT	LED	LUMEN	FARBE	ART. NR.	EURO	LAGER
SYS 10,6W 230V · CRI>80	120x200x101	3000K	1288	W	105-05983714cl	106,00	
	120x200x101	3000K	1288	AN	105-05983725cl	106,00	

LED 230V IP54 | EEI: A+++ - A



MINILIFT LED







LED 230V EEt: A++ - A





Wandleuchte, Aluminiumdruckguss mit hohem Korrosionsschutz, Doppelte Pulverbeschichtung mit hoher Resistenz, Diffusor - mattiertes gehärtetes Glas, direkt oder direkt/indirekt strahlend, Schrauben Edelstahl, Doppelter Kabeleingang, Silikonichtung, inkl. Konverter

AUSFÜHRUNG	LM	BxHxT	FARBE	ART. NR.	EURO	LAGER
 1 x 43°	SYS 3,5W 230V · CRI>80 38lm LED 3000K	120x120x140	6	851-s5077w14	318,00	
 2 x 43°	SYS 6,5W 230V · CRI>80 2 x 38lm LED 3000K	120x120x140	6	851-s5027w14	348,00	☺
 1 x 3° + 1 x 43°	SYS 6,5W 230V · CRI>80 1 x 20lm 1 x 38lm LED 3000K	120x120x140	6	851-s5037w14	383,00	☺





MINI COOL LED

	INFO	LM	BxHxT	FARBE	ART. NR.	EURO	LAGER
	<p>Wandleuchte, Aluminiumdruckguss mit hohem Korrosionsschutz, Doppelte Pulverbeschichtung mit hoher Resistenz, weiß oder grau, indirekt strahlend, gehärtetes Abdeckglas, Schrauben Edelstahl, Einzelverdrahtung, Silikondichtung, inkl. Konverter</p>	<p>SYS 12,5 W 230V · CRI>90 LED 3000K</p> <p>562lm</p>	33x220x90	W	851-s7231w01	349,00	
			33x220x90	G	851-s7231w14	349,00	
<p>LED 230V     EEI: A++ - A</p>							





COOL LED

	INFO	LM	BxHxT	FARBE	ART. NR.	EURO	LAGER
	<p>Wandleuchte, Aluminiumdruckguss mit hohem Korrosionsschutz, Doppelte Pulverbeschichtung mit hoher Resistenz, weiß oder grau, indirekt strahlend, gehärtetes Abdeckglas, Schrauben Edelstahl, Einzelverdrahtung, Silikondichtung, inkl. Konverter</p>	<p>SYS 19,1 W 230V · CRI>90 LED 3000K</p> <p>963lm</p>	43x290x105	W	851-s7270w01	467,00	
			43x290x105	G	851-s7270w14	467,00	😊
<p>LED 230V     EEI: A++ - A</p>							

MINISMOOTH LED

	INFO	LM	BxHxT	FARBE	ART. NR.	EURO	LAGER
	<p>Wandleuchte, Aluminiumdruckguss mit hohem Korrosionsschutz, Doppelte Pulverbeschichtung mit hoher Resistenz, weiß oder grau, direkt/indirekt strahlend, gehärtetes Abdeckglas, Schrauben Edelstahl, Einzelverdrahtung, Silikondichtung, inkl. Konverter</p>	<p>SYS 11 W 230V · CRI>90 LED 3000K</p> <p>884lm</p>	60x248x115	W	851-s2905w01	440,00	
			60x248x115	G	851-s2905w14	440,00	
<p>LED 230V     EEI: A++ - A</p>							

SMOOTH LED

	INFO	LM	BxHxT	FARBE	ART. NR.	EURO	LAGER
	<p>Wandleuchte, Aluminiumdruckguss mit hohem Korrosionsschutz, Doppelte Pulverbeschichtung mit hoher Resistenz, weiß oder grau, direkt/indirekt strahlend, gehärtetes Abdeckglas, Schrauben Edelstahl, Einzelverdrahtung, Silikondichtung, inkl. Konverter</p>	<p>SYS 23,6 W 230V · CRI>90 LED 3000K</p> <p>2076lm</p>	85x338x155	W	851-s2915w01	624,00	
			85x338 x155	G	851-s2915w14	624,00	
<p>LED 230V     EEI: A++ - A</p>							

SIMES

luce per l'architettura

MINIPLAN LED



LED 230V IP65 | EEL: A++ - A

INFO

Wandleuchte, Aluminiumdruckguss mit hohem Korrosionsschutz, Doppelte Pulverbeschichtung mit hoher Resistenz, weiß oder grau, direkt strahlend, gehärtetes Abdeckglas, Schrauben Edelstahl, Einzelverdrahtung, Silikondichtung, inkl. Konverter

LM	BxHxT	FARBE	ART. NR.	EURO	LAGER
SYS 13,5 W 230V · CRI>90 LED 3000K 475lm	220x80x38	W	851-s3883w01	331,00	
	220x80x38	G	851-s3883w14	331,00	

MINIPLAN LED



LED 230V IP65 | EEL: A++ - A

INFO

Wandleuchte, Aluminiumdruckguss mit hohem Korrosionsschutz, Doppelte Pulverbeschichtung mit hoher Resistenz, weiß oder grau, indirekt/direkt strahlend, gehärtetes Abdeckglas, Schrauben Edelstahl, Einzelverdrahtung, Silikondichtung, inkl. Konverter

LM	BxHxT	FARBE	ART. NR.	EURO	LAGER
SYS 13,5 W 230V · CRI>90 LED 3000K 389lm	220x80x43	W	851-s3884w01	364,00	
	220x80x43	G	851-s3884w14	364,00	

JAKE LED



Wandleuchte, Aluminiumdruckguss, Feinstruktur matt pulverbeschichtet, direkt/indirekt strahlend, inkl. Konverter

LM	BxHxT	FARBE	ART. NR.	EURO	LAGER
SYS 5,3W 230V 230lm CRI>90	130x30x145	W	472-0280490003005	135,00	☺
	130x30x145	G	472-0280490003004	135,00	☺

LED 3000K



ZAHRA LED



Wandleuchte, Aluminiumdruckguss, Feinstruktur matt pulverbeschichtet, direkt/indirekt strahlend, inkl. Konverter

LM	BxHxT	FARBE	ART. NR.	EURO	LAGER
SYS 7,6W 230V 2 x 160lm CRI>90	100x100x45	W	472-260023	179,00	☺
	100x100x45	G	472-260024	179,00	☺

LED 3000K

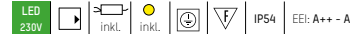

PIATTA LED



Wandleuchte, Aluminiumdruckguss, Feinstruktur matt pulverbeschichtet, direkt strahlend, Diffuser PMMA opal, inkl. Konverter

LM	BxHxT	LUMEN	FARBE	ART. NR.	EURO	LAGER
SYS 7W 230V CRI>90	170x75x45	464	W	472-643m21w	222,00	☺
	170x75x45	308	G	472-643m21s	222,00	☺

LED 3000K

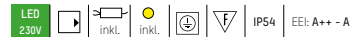

AVA LED



Wandleuchte, Aluminiumdruckguss, Feinstruktur matt pulverbeschichtet, direkt/indirekt strahlend, inkl. Konverter

LM	BxHxT	LUMEN	FARBE	ART. NR.	EURO	LAGER
SYS 11W 230V CRI>90	187x100x60	780	W	472-0030990003005	165,00	☺
	187x100x60	480	G	472-0030990003004	165,00	☺

LED 3000K





ZEON W



Wandleuchte, Aluminiumdruckguss, Feinstruktur matt pulverbeschichtet, opaler Diffusor und Klarglasabdeckung, indirekt strahlend, inkl. Konverter

LM	Ø	H	LUMEN	LED	FARBE	ART. NR.	EURO	LAGER
SYS 10W 230V CRI>90	120	90	320	3000K	S	472-0561090003006	199,00	😊
	120	90	320	3000K	AN	472-0561090003011	199,00	😊

LED 230V | inkl. | IP54 | EE: A++ - A

FYNN C AC-LED



Wandleuchte, Aluminiumdruckguss, Feinstruktur matt pulverbeschichtet, Diffusor aus opalem Acryl, AC-LED

LM	BxH	T	FARBE	ART. NR.	EURO	LAGER
SYS 10W · 230V 642 lm · CRI>90	100x100	120	G	472-260055s	139,00	😊
LED 3000K	100x100	120	AN	472-260055ag	139,00	😊

LED 230V | inkl. | IP54 | EE: A++ - A

NELL WALL LED

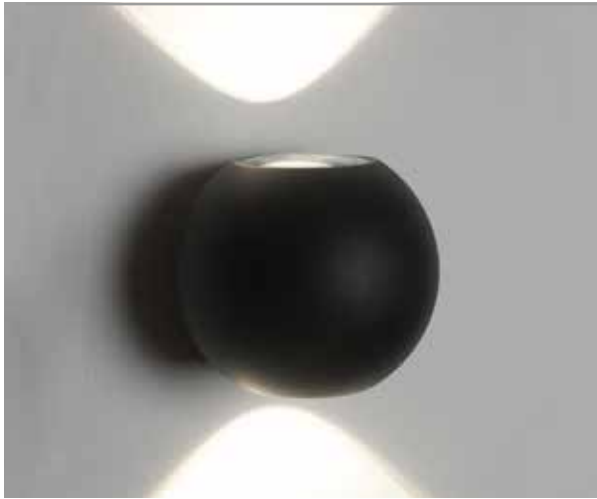

Wandleuchte, Aluminiumdruckguss, Feinstruktur matt pulverbeschichtet, kugelförmig, Linse aus Glas, 80° Ausstrahlwinkel, direkt/indirekt strahlend, inkl. Konverter 700mA - **TRIAC dimmbar**

LM	Ø	T	REF.	LUMEN	FARBE	ART. NR.	EURO	LAGER
SYS 6,4W · 230V CRI>90	100	88		325lm	W	472-0370690003005	190,00	
	100	88		275lm	S	472-0370690003006	190,00	
LED 3000K								

LED 230V EEI: A++ - A



BEN ROUND LED



Wandleuchte, Aluminium, weiß matt, Feinstruktur matt pulverbeschichtet, zylindrisch, direkt/indirekt strahlend, inkl. Konverter 400mA

LM	ØxH	T	FARBE	ART. NR.	EURO	LAGER
SYS 9,2W · 230V 2 x 116lm · CRI>90	90x250	95	W	472-0050890003005	219,00	
	90x250	95	G	472-0050890003004	219,00	
	90x250	95	AN	472-0050890003011	219,00	
LED 3000K						

LED 230V EEI: A+++ - A

TUBE LED



Wandleuchte, Aluminium gefräst, gebürstet, direkt strahlend, inkl. Konverter

LM	BxH	T	FARBE	REF.	ART. NR.	EURO	LAGER
SYS 9W 230V 535lm CRI>90	79x79	92	AG		472-256002	225,00	
LED 3000K							

LED 230V EEI: A+++ - A

TURN UP/DOWN LED



Wandleuchte, Aluminium gefräst, Feinstruktur matt pulverbeschichtet, direkt-/indirekt strahlend, inkl. Konverter

LM	BxH	T	REF.	FARBE	ART. NR.	EURO	LAGER
SYS 14W · 230V 2 x 420lm · CRI>90	82x162	120		G	472-260043	299,00	
	82x162	120		AN	472-260044	299,00	
LED 3000K							

LED 230V EEI: A+++ - A



SKILL SQUARE LED



INFO	LM	BxHxT	FARBE	ART. NR.	EURO	LAGER
Wandaufbauleuchte, Aluminiumdruckguss mit hohem Korrosionsschutz, Doppelte Pulverbeschichtung mit hoher Resistenz, weiß oder grau, gehärtetes Abdeckglas, Schrauben Edelstahl, Einzelverdrahtung, Silikondichtung, inkl. Konverter, Für Wandeinbauversion Eingießgehäuse und Einbaupaket separat ordern	SYS 12,5 W 230V · CRI>90 LED 3000K	200x200x30	W	851-s6260w01	310,00	
		200x200x30	G	851-s6260w14	310,00	☺
	378lm					

LED 230V IP65 | EEL: A++ - A

EINGIESSGEHÄUSE SKILL SQUARE

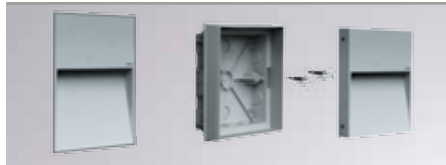

INFO	ZUBEHÖR	BxH	ET	ART. NR.	EURO	LAGER
Eingießgehäuse, für quadratische Skill Ausführung, auch für Montage in Sichtbeton geeignet, inkl. Befestigungsset		217x217	70	851-s6268	87,00	☺

SKILL RECTANGULAR LED



INFO	LM	BxHxT	FARBE	ART. NR.	EURO	LAGER
Wandaufbauleuchte, Aluminiumdruckguss mit hohem Korrosionsschutz, Doppelte Pulverbeschichtung mit hoher Resistenz, weiß oder grau, rechteckig, gehärtetes Abdeckglas, Schrauben Edelstahl, Einzelverdrahtung, Silikondichtung, inkl. Konverter, Für Wandeinbauversion Eingießgehäuse und Einbaupaket separat ordern	SYS 13,5 W 230V · CRI>90 LED 3000K	270x115x32	W	851-s6240w01	317,00	
		270x115x32	G	851-s6240w14	317,00	☺
	424lm					

LED 230V IP65 | EEL: A++ - A

EINGIESSGEHÄUSE SKILL RECTANGULAR

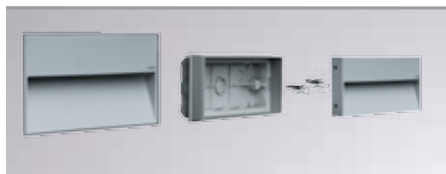

INFO	ZUBEHÖR	BxH	ET	ART. NR.	EURO	LAGER
Eingießgehäuse, für rechteckige Skill Ausführung, auch für Montage in Sichtbeton geeignet, inkl. Befestigungsset		288x133	75	851-s6247	88,00	☺

SKILL SQUARE 270 LED



INFO	LM	BxHxT	FARBE	ART. NR.	EURO	LAGER
Wandaufbauleuchte, Aluminiumdruckguss mit hohem Korrosionsschutz, Doppelte Pulverbeschichtung mit hoher Resistenz, weiß oder grau, quadratisch, gehärtetes Abdeckglas, Schrauben Edelstahl, Einzelverdrahtung, Silikondichtung, inkl. Konverter, Für Wandeinbauversion Eingießgehäuse und Einbaupaket separat ordern	SYS 23W 230V · CRI>90 LED 3000K	270x270x38	W	851-s6255w01	508,00	
		270x270x38	G	851-s6255w14	508,00	
	680lm					

LED 230V IP65 | EEL: A++ - A

EINGIESSGEHÄUSE SKILL SQUARE



INFO	ZUBEHÖR	BxH	ET	ART. NR.	EURO	LAGER
Eingießgehäuse, für flächenbündige, quadratische Skill 270 Ausführung, auch für Montage in Sichtbeton geeignet, inkl. Befestigungsset		290x290	80	851-s6257	125,00	☺





SIMES
Luce per l'architettura

AUFBAULEUCHTEN
AUSSEN

SKILL ROUND LED



INFO	LM	ØxT	FARBE	ART. NR.	EURO	LAGER
<p>Wandaufbauleuchte, Aluminiumdruckguss mit hohem Korrosionsschutz, Doppelte Pulverbeschichtung mit hoher Resistenz, weiß oder grau, rund, gehärtetes Abdeckglas, Schrauben Edelstahl, Einzelverdrahtung, Silikonichtung, inkl. Konverter, Für Wandeinbauversion Eingießgehäuse und Einbaukit separat ordern</p>	<p>SYS 12,5W 230V · CRI>90 LED 3000K</p> <p>399lm</p>	220x30	W	851-s6280w01	303,00	
		220x30	G	851-s6280w14	303,00	☺

LED 230V IP65 | EEL: A++ - A



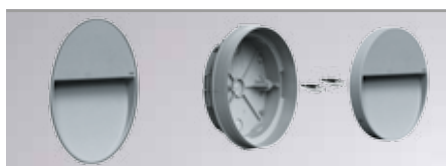

INGIESSGEHÄUSE SKILL ROUND



INFO	ZUBEHÖR	Ø	ET	ART. NR.	EURO	LAGER
<p>Eingießgehäuse, für runde Skill Ausführung, auch für Montage in Sichtbeton geeignet, inkl. Befestigungsset</p>		237	70	851-s6288	84,00	☺





ZEN SQUARE LED

INFO	LM	BxH	T	FARBE	ART. NR.	EURO	LAGER
 <p>Wand-/ Deckenleuchte, Aluminiumdruckguss mit hohem Korrosionsschutz, Doppelte Pulverbeschichtung mit hoher Resistenz, weiß oder grau, quadratisch, Mattierte Glasabdeckung sandgestrahlt, Schrauben Edelstahl, Dichtung Dutral, Durchgangsverdrahtung, inkl. Konverter</p>	SYS 10W 230V · CRI>90 526lm	220x220	70	W	851-s6960w01	336,00	
	LED 3000K	220x220	70	G	851-s6960w14	336,00	☺

LED 230V |  |  |  |  |  | EEI: A++ - A



KÖSSEL-LED

INFO	LM	LxBxH	LED	LUMEN	FARBE	ART. NR.	EURO	LAGER
 <p>Deckenleuchte, grau pulverbeschichtet, Kunststoff Gehäuse aus ABS, opale Polycarbonatabdeckung, Ausführung quadratisch, inkl. LED Konverter</p>	SYS 6,5W · 230V CRI>80	220x220x55	3000K	644	G	105-15977834clv1	170,00	
	SYS 19W · 230V CRI>80	400x400x90	3000K	2268	G	105-15980634cl	206,00	

LED 230V |  |  |  |  |  | EEI: A++ - A



SERIE 270T

INFO	LM	Ø	H	FARBE	ART. NR.	EURO	LAGER
 <p>Wand-/ Deckenleuchte, Thermoplastik, weiß oder schwarz, Opaldiffusor verstärkt mit Fiberglas</p>	A60 ECO E27 · 230V max. 57W oder Retrofit E27	270	91	W	290-127400	26,00	☺
		270	91	S	290-127401	26,00	☺

230V HV |  |  |  | EEI: A++ - E

SERIE 330

INFO	LM	LxB	H	FARBE	ART. NR.	EURO	LAGER
 <p>Wand-/ Deckenleuchte, Thermoplastik, weiß oder schwarz, Opaldiffusor verstärkt mit Fiberglas</p>	A60 ECO E27 · 230V max. 57W oder LED RETROFIT E27	330x180	120	W	290-133400	25,00	☺
		330x180	120	S	290-133401	25,00	☺

230V HV |  |  |  | EEI: A++ - E



ROC



Wand- und Deckenleuchte, Gehäuse aus eloxiertem und weiß lackiertem Aluminium, Diffusor aus opalisiertem Acrylglas. Schirm aus Pressglas, extraktal und poliert.

LM	LUMEN	Ø	H	FARBE	ART. NR.	EURO	LAGER
SYS 8,7W 230V CRI>80	670	165	65	W	68-553901ww	210,00	
LED 3000K							



JAZZ



Wand-/Deckenleuchte, Gehäuse aus eloxiertem Aluminium und Diffusor aus satiniertem Methacrylat. Reflektor aus eloxiertem Aluminium.

LM	LUMEN	Ø	H	FARBE	ART. NR.	EURO	LAGER
SYS 8,7W 230V CRI>80	670	190	80	W	68-553801ww	210,00	
	670	190	80	S	68-553802ww	210,00	
LED 3000K	670	190	80	KU	68-553838ww	252,00	



OPAL-LED



Deckenleuchte, weiß pulverbeschichtet, transluzente Grundplatte aus ABS, opale Polycarbonatabdeckung, Ausführung rund, direkt-/ indirekte Lichtverteilung, inkl. LED Konverter

LM	ØxH	LED	LUMEN	FARBE	ART. NR.	EURO	LAGER
SYS 14,5W · 230V CRI>80	300x90	3000K	1340	W	105-15967714cl	101,00	
	300x90	4000K	1488	W	105-15967714cm	101,00	



OPAL



Deckenleuchte, weiß pulverbeschichtet, transluzente Grundplatte aus ABS, opale Polycarbonatabdeckung, direkt-/ indirekte Lichtverteilung

LM	ØxH	FARBE	ART. NR.	EURO	LAGER
2 x TC-TSE · E27 · 230V · 23W max.	300x90	W	105-15967714m1	48,50	





BADO SD LED / IP54



LED 230V | inkl. | inkl. | IP54 | EEL: A++ -A

INFO

Runde LED Aufbauleuchte aus Aluminium
 Oberfläche pulverbeschichtet in weiß, schwarz oder silber matt
 Abdeckung als Opal-Diffusor
 Energieeffiziente LEDs mit hoher Farbwiedergabe (CRI>80)
 Dimmbare und CRI>90 Versionen auf Anfrage, LED 3000 oder 4000K

BESTELLINFO:

Ersetzen sie das rote X mit Ihrer gewünschten Lichtfarbe
 9 = 3000K / 4 = 4000K

LM	Ø	H	AUSFÜHRUNG	FARBE	LUMEN 3000K	LUMEN 4000K	ART. NR.	EURO	LAGER
SYS 16W · 230V · CRI>80	300	75	OPALDIFFUSER	W	1638	1761	445-02301X15	398,00	
SYS 16W · 230V · CRI>80	300	75	OPALDIFFUSER	S	1638	1761	445-02301X16	398,00	
SYS 16W · 230V · CRI>80	300	75	OPALDIFFUSER	SM	1638	1761	445-02301X18	398,00	
SYS 29W · 230V · CRI>80	400	75	OPALDIFFUSER	W	3263	3509	445-02401X15	495,00	
SYS 29W · 230V · CRI>80	400	75	OPALDIFFUSER	S	3263	3509	445-02401X16	495,00	
SYS 29W · 230V · CRI>80	400	75	OPALDIFFUSER	SM	3263	3509	445-02401X18	495,00	
SYS 37W · 230V · CRI>80	500	75	OPALDIFFUSER	W	4388	4718	445-02501X15	597,00	
SYS 37W · 230V · CRI>80	500	75	OPALDIFFUSER	S	4388	4718	445-02501X16	597,00	
SYS 37W · 230V · CRI>80	500	75	OPALDIFFUSER	SM	4388	4718	445-02501X18	597,00	
SYS 44W · 230V · CRI>80	600	75	OPALDIFFUSER	W	5366	5770	445-02601X15	797,00	
SYS 44W · 230V · CRI>80	600	75	OPALDIFFUSER	S	5366	5770	445-02601X16	797,00	
SYS 44W · 230V · CRI>80	600	75	OPALDIFFUSER	SM	5366	5770	445-02601X18	797,00	



COSMOS-LED



Deckenleuchte, weiß oder anthrazit lackiert, aus hochreinem Aluminium, zylindrische Ausführung, mit einem satin Kristall-Glasdiffusor, inkl. Dekorringe in weiß, grau oder gold

LM	ØxH	LED	LUMEN	FARBE	ART. NR.	EURO	LAGER
SYS 12W · 230V CRI>80	126x132	3000K	1290	W	105-15979014cl	188,00	
	126x132	3000K	1290	AN	105-159790z5cl	188,00	
SYS 23,2W · 230V CRI>80	168x150	3000K	2526	W	105-15990414cl	266,00	
	168x150	3000K	2526	AN	105-159904z5cl	266,00	



TURN 2



Aufbaustrahler, Aluminium gefräst, 90° schwenkbar

LM	BxH	T	FARBE	ART. NR.	EURO	LAGER
QPAR16 GU10 · 230V max. 35W	88x90	115	AG	472-256012	105,00	☺

oder

LED RETROFIT
GU10

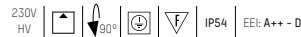

FYNN 0 AC-LED



Aufbauleuchte, AC-LED, Aluminiumdruckguss, weiß matt, grau oder anthrazit grau pulverbeschichtet, Diffusor aus opalem Acryl

LM	BxH	T	FARBE	ART. NR.	EURO	LAGER
SYS 10,5W · 230V 790lm · CRI>90	100x100	113	W	472-260056w	129,00	☺
			G	472-260056s	129,00	☺
			AN	472-260056ag	129,00	☺

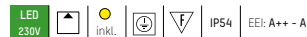

AFRODITA

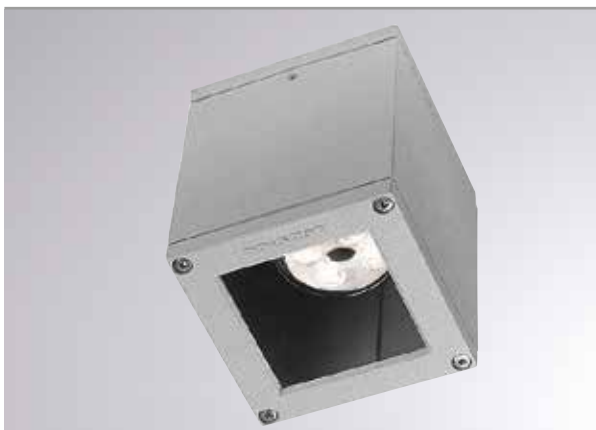

Aufbauleuchte, Aluminiumdruckguss, grau oder anthrazit pulverbeschichtet, quadratisch, Schutzglas transparent

LM	LxBxH	FARBE	ART. NR.	EURO	LAGER
QPAR 16 GU10 · 230V max. 35W	90x90x110	G	105-1594803437	68,00	☺
	90x90x110	AN	105-159480z537	68,00	☺

oder

LED RETROFIT
GU10





RIDE IP54 LED

	LM	LxB	FARBE	LED	kubisch	flach	ART. NR.	EURO kubisch	EURO flach	LAGER
	SYS 11W · 230V · CRI>90	578x37	W	2700K	840lm	750lm	577-01301X023050	341,00	309,00	
	SYS 11W · 230V · CRI>90	578x37	S	2700K	840lm	750lm	577-01301X023060	341,00	309,00	
	SYS 11W · 230V · CRI>90	578x37	AE	2700K	840lm	750lm	577-01301X023080	341,00	309,00	
	SYS 11W · 230V · CRI>90	578x37	W	3000K	920lm	820lm	577-01301X029050	341,00	309,00	
	SYS 11W · 230V · CRI>90	578x37	S	3000K	920lm	820lm	577-01301X029060	341,00	309,00	
	SYS 11W · 230V · CRI>90	578x37	AE	3000K	920lm	820lm	577-01301X029080	341,00	309,00	
	SYS 11W · 230V · CRI>90	578x37	W	4000K	1000lm	890lm	577-01301X024050	341,00	309,00	
	SYS 11W · 230V · CRI>90	578x37	S	4000K	1000lm	890lm	577-01301X024060	341,00	309,00	
	SYS 11W · 230V · CRI>90	578x37	AE	4000K	1000lm	890lm	577-01301X024080	341,00	309,00	
	SYS 16W · 230V · CRI>90	858x37	W	2700K	1260lm	1120lm	577-01302X023050	397,00	361,00	
SYS 16W · 230V · CRI>90	858x37	S	2700K	1260lm	1120lm	577-01302X023060	397,00	361,00		
SYS 16W · 230V · CRI>90	858x37	AE	2700K	1260lm	1120lm	577-01302X023080	397,00	361,00		
SYS 16W · 230V · CRI>90	858x37	W	3000K	1410lm	1230lm	577-01302X029050	397,00	361,00		
SYS 16W · 230V · CRI>90	858x37	S	3000K	1410lm	1230lm	577-01302X029060	397,00	361,00		
SYS 16W · 230V · CRI>90	858x37	AE	3000K	1410lm	1230lm	577-01302X029080	397,00	361,00		
SYS 16W · 230V · CRI>90	858x37	W	4000K	1500lm	1340lm	577-01302X024050	397,00	361,00		
SYS 16W · 230V · CRI>90	858x37	S	4000K	1500lm	1340lm	577-01302X024060	397,00	361,00		
SYS 16W · 230V · CRI>90	858x37	AE	4000K	1500lm	1340lm	577-01302X024080	397,00	361,00		
SYS 21W · 230V · CRI>90	1138x37	W	2700K	1680lm	1500lm	577-01303X023050	460,00	413,00		
SYS 21W · 230V · CRI>90	1138x37	S	2700K	1680lm	1500lm	577-01303X023060	460,00	413,00		
SYS 21W · 230V · CRI>90	1138x37	AE	2700K	1680lm	1500lm	577-01303X023080	460,00	413,00		
SYS 21W · 230V · CRI>90	1138x37	W	3000K	1840lm	1640lm	577-01303X029050	460,00	413,00		
SYS 21W · 230V · CRI>90	1138x37	S	3000K	1840lm	1640lm	577-01303X029060	460,00	413,00		
SYS 21W · 230V · CRI>90	1138x37	AE	3000K	1840lm	1640lm	577-01303X029080	460,00	413,00		
SYS 21W · 230V · CRI>90	1138x37	W	4000K	2010lm	1780lm	577-01303X024050	460,00	413,00		
SYS 21W · 230V · CRI>90	1138x37	S	4000K	2010lm	1780lm	577-01303X024060	460,00	413,00		
SYS 21W · 230V · CRI>90	1138x37	AE	4000K	2010lm	1780lm	577-01303X024080	460,00	413,00		
SYS 26W · 230V · CRI>90	1418x37	W	2700K	2110lm	1870lm	577-01304X023050	515,00	465,00		
SYS 26W · 230V · CRI>90	1418x37	S	2700K	2110lm	1870lm	577-01304X023060	515,00	465,00		
SYS 26W · 230V · CRI>90	1418x37	AE	2700K	2110lm	1870lm	577-01304X023080	515,00	465,00		
SYS 26W · 230V · CRI>90	1418x37	W	3000K	2310lm	2050lm	577-01304X029050	515,00	465,00		
SYS 26W · 230V · CRI>90	1418x37	S	3000K	2310lm	2050lm	577-01304X029060	515,00	465,00		
SYS 26W · 230V · CRI>90	1418x37	AE	3000K	2310lm	2050lm	577-01304X029080	515,00	465,00		
SYS 26W · 230V · CRI>90	1418x37	W	4000K	2510lm	2230lm	577-01304X024050	515,00	465,00		
SYS 26W · 230V · CRI>90	1418x37	S	4000K	2510lm	2230lm	577-01304X024060	515,00	465,00		
SYS 26W · 230V · CRI>90	1418x37	AE	4000K	2510lm	2230lm	577-01304X024080	515,00	465,00		



INFO

Aufbauleuchte aus stranggepresstem Aluminiumprofil, Oberfläche eloxiert, weiß oder schwarz pulverbeschichtet, opale PMMA Abdeckung kubisch oder flach, erhältlich in 6 Längen, energieeffiziente LEDs mit hoher Farbwiedergabe

Opaldiffuser kubisch: H 72mm
Opaldiffuser flach: H 37mm

EEL: A++ - A

BESTELLINFO:

Ersetzen Sie das rote X der Artikelnummer mit Ihrer gewünschten Abdeckung

PMMA Opaldiffuser flach = 1
PMMA Opaldiffuser kubisch = 2

Bestellbeispiel:
577-013012023050 = Opaldiffuser kubisch
Auf Anfrage 3500K erhältlich





STEHLLEUCHTEN AUSSEN







SIMES
luce per l'architettura

COOL SQUARE LONG POLLER LED

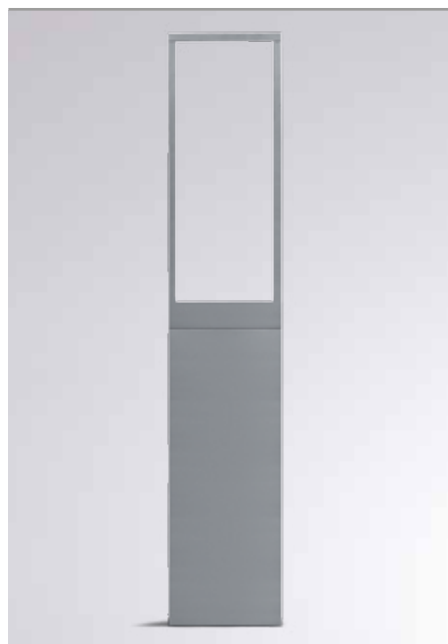

INFO	LM	BxLxH	FARBE	ART. NR.	EURO	LAGER
Pollerleuchte, Aluminiumdruckguss mit hohem Korrosionsschutz, Doppelte Pulverbeschichtung mit hoher Resistenz, weiß oder grau, gehärtetes Abdeckglas, Schrauben Edelstahl, Einzelverdrahtung, Silikondichtung, inkl. Konverter BETONEINGIESSANKER für COOL SQUARE LED Pollerleuchte, mit Edelstahlschrauben	SYS 23,4W 230V · CRI>90 LED 3000K 1273lm	85x220x1160	W	851-s7295w01	982,00	
		85x220x1160	G	851-s7295w14	982,00	
		95x333x250	G	851-s7289	85,00	

LED 230V | inkl. | inkl. | IP54 | EE: A++ - A

COOL SQUARE LONG POLLER LED



INFO	LM	BxLxH	FARBE	ART. NR.	EURO	LAGER
Pollerleuchte, Aluminiumdruckguss mit hohem Korrosionsschutz, Doppelte Pulverbeschichtung mit hoher Resistenz, weiß oder grau, gehärtetes Abdeckglas, Schrauben Edelstahl, Einzelverdrahtung, Silikondichtung, inkl. Konverter BETONEINGIESSANKER für COOL SQUARE LED Pollerleuchte, mit Edelstahlschrauben	SYS 23,4W 230V · CRI>90 LED 3000K 1273lm	85x220x580	W	851-s7290w01	732,00	
		85x220x580	G	851-s7290w14	732,00	
		95x333x250	G	851-s7289	85,00	

LED 230V | inkl. | inkl. | IP54 | EE: A++ - A



SIMES
Luce per l'architettura

STELLEUCHTEN
AUSSEN

MINI IKONIC POLLER LED



INFO	LM	ØxH	FARBE	ART. NR.	EURO	LAGER
<p>Pollerleuchte, Aluminiumdruckguss mit hohem Korrosionsschutz, Doppelte Pulverbeschichtung mit hoher Resistenz, grau, gehärtetes Abdeckglas, Schrauben Edelstahl, Einzeldrahtung, Silikondichtung, inkl. Konverter</p>	<p>SYS 18 W 230V · CRI>90 LED 3000K 533lm</p>	<p>140x755</p>	<p>6</p>	<p>851-s4104w14</p>	<p>748,00</p>	
<p>BETONEINGIESSANKER für MINI IKONIC Pollerleuchte, mit Edelstahlschrauben</p>		<p>140x115</p>	<p>6</p>	<p>851-s4172</p>	<p>48,40</p>	

LED 230V |  inkl. |  inkl. |  |  | IP65 | EE: A++ - A

GLOBO OUT



INFO	LM	∅	FARBE	ART. NR.	EURO	LAGER
Kugelleuchte aus Polyethylen, weiß, UV-beständig, hohe Zugfestigkeit, inkl. 2m Anschlusskabel schwarz, Erdspieß und Schraubsockel, Montage auf Beton- sowie Erdböden möglich	1 x TC-DSE · E27 · 14W · 230V	300	wo	292-a30w	140,00	☺
	1 x TC-DSE · E27 · 23W · 230V	400	wo	292-a40w	176,00	☺
	1 x TC-DSE · E27 · 23W · 230V	500	wo	292-a50w	205,00	☺
	1 x TC-DSE · E27 · 23W · 230V	600	wo	292-a60w	277,00	☺
	oder LED RETROFIT · E27					

230V HV IP55 | EE: A++ - D

CUBO OUT



INFO	LM	LxBxH	FARBE	ART. NR.	EURO	LAGER
Würfelleuchte aus Polyethylen, weiß, UV-beständig, hohe Zugfestigkeit, inkl. 2m Anschlusskabel schwarz, Erdspieß und Schraubsockel, Montage auf Beton- sowie Erdböden möglich	1 x TC-DSE · E27 · 14W · 230V	300x300x300	wo	292-lpcue030	140,00	☺
	1 x TC-DSE · E27 · 23W · 230V	430x430x430	wo	292-lpcue040	154,00	☺
	oder LED RETROFIT · E27					

230V HV IP55 | EE: A++ - D







COOL SQUARE POLLER LED



Pollerleuchte, Aluminiumdruckguss mit hohem Korrosionsschutz, Doppelte Pulverbeschichtung mit hoher Resistenz, grau, gehärtetes Abdeckglas, Schrauben Edelstahl, Einzelverdrahtung, Silikonichtung, inkl. Konverter

LM	BxLxH	FARBE	ART. NR.	EURO	LAGER
SYS 23,4 W 230V · CRI>90 LED 3000K 1133lm	85x220x580	6	851-s7285w14	793,00	
BETONEINGIESSANKER für COOL SQUARE, mit Edelstahlschrauben	95x333x250	6	851-s7289	85,00	



LED 230V | inkl. | inkl. | IP54 | EEI: A+++ - A

CUBASE



Pollerleuchte, grau pulverbeschichtet, Gehäuse aus Aluminiumdruckguß, Diffusor aus transparentem Polycarbonat, Energieeffiziente und moderne Pollerleuchte für den Außenbereich

LM	LxBxH	LUMEN	LED	FARBE	ART. NR.	EURO	LAGER
SYS 9W 230V CRI>80	110x110x650	648	3000K	6	105-55969034m2	303,00	

LED 230V | inkl. | inkl. | IP54 | EEI: A++ - A

NEWTON



Stehleuchte, grau lackiert, aus hochreinem Aluminium, Diffusor aus mattem Glas und transparentem Polycarbonat, gibt das Licht zielgerichtet zu allen Seiten ab. Eingießanker separat ordern

LM	ØxH	LUMEN	LED	FARBE	ART. NR.	EURO	LAGER
SYS 13W 230V CRI>80	160x800	1205	3000K	AN	105-559791z5clv1	363,00	
EINGIESSANKER für NEWTON LED Pollerleuchte, Stahl verzinkt	Ø120 				105-7199524848	19,00	

LED 230V | inkl. | inkl. | IP65 | EEI: A+++ - A



STEHLEUCHTEN
AUSSEN

SIMES
luce per l'architettura

CITI LED



INFO	LM	BxTxH	FARBE	ART. NR.	EURO	LAGER
Pollerleuchte, Aluminium, Feinstruktur matt pulverbeschichtet, inkl. Konverter	SYS 7W 230V 263 lm CRI>90 LED 3000K	150x50x600	6	472-686013c60s	365,00	☺
		150x50x300	6	472-685813c30s	290,00	☺

LED 230V IP54 | EE: A++ - A

GAYA



INFO	LM	BxH	FARBE	ART. NR.	EURO	LAGER
Pollerleuchte Aluminium gefräst, klar lackiert, Diffusor aus opalem Glas, Grundplatte oder Erdspeiß separat ordern	QT14-ECO G9 - 230V max. 28W oder LED RETROFIT G9 QT14	60x500	AG	472-256075	185,00	☺

230V HV IP54 | EE: A++ - E

ERDSPIESS ZU GAYA

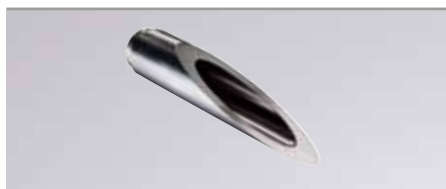

INFO	ØxH	FARBE	ART. NR.	EURO	LAGER
Erdspeiß aus hochwertigem Vollaluminium gefräst	60x285	AG	472-256079	55,00	☺

GRUNDPLATTE ZU GAYA



INFO	ØxH	FARBE	ART. NR.	EURO	LAGER
Grundplatte aus hochwertigem Vollaluminium gefräst	99x5	AG	472-256078	22,00	☺



YARA FLAT LED



INFO	LM	ØxH	FARBE	ART. NR.	EURO	LAGER
<p>Pollerleuchte, Aluminium-druckguss, Feinstruktur matt pulverbeschichtet, PC-Diffusor klar, 180° Ausstrahlwinkel, inkl. Konverter 120mA</p>	<p>SYS 10,4W 230V 800lm CRI>80 LED 3000K</p>	165x800	6	273-1000s	228,00	☺

LED 230V | | | | | | EE: A++ - A

FARO MIT LAMELLENRASTER SILBER



INFO	LM	ØxH	FARBE	ART. NR.	EURO	LAGER
<p>Pollerleuchte, extrudiertem Aluminium, Dreiphasen Pulverbeschichtung, graphit oder silber, zylindrische Form, Abdeckung transparent aus Polycarbonat, bruchfest und V2-selbstlöschend, UV-stabilisiert, Lamellenraster aus 99,85-Aluminium, oxydiert, inkl. VVG und Leuchtmittel 4000K bei HIE Version, Sockel: DM=250mm</p>	A60 ECO · E27 · 230V · max. 57W	180x1100	GR	125-51000300	299,00	☺
	A60 ECO · E27 · 230V · max. 57W	180x1100	S	125-51000321	315,00	☺

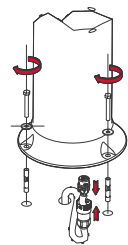

230V HV | | | | | | EE: A++ - E

UNIVERSAL EINGRABSTÜCK



INFO	ØxH	ART. NR.	EURO	LAGER
<p>Universal Eingrabstück, Aluminiumrohr mit Verdrehschutz und 3 Befestigungsschrauben, passend für Faro Pollerleuchten.</p> <p>Montagehinweis: Die Bodenplatte muß waagrecht liegen und mit der Unterkante mit der Erdoberfläche abschließen (Abb. rechts)</p>	250x400	88-981072	105,00	☺

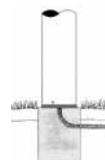





GLOBO LED KUGEL MIT SOCKEL FÜR MAST

INFO	LM	ØxH	FARBE	ART. NR.	EURO	LAGER
 <p>Mastleuchte, Kugel aus bruchfestem V2-Polycarbonat, obere Teile verspiegelt, Basis aus Aluminiumdruckguss, silber pulverbeschichtet, Zopf 60/76mm, inkl. Konverter, Mast separat ordern</p>	SYS 27W 230V 1309lm CRI 80 LED 4000K	400x520	S	125-42560000	415,00	☺
	<p>LED 230V</p> <p>inkl. inkl.</p> <p>IP65 EEI: A++ - A</p>					

GLOBI KUGEL MIT SOCKEL FÜR MAST

INFO	LM	ØxH	FARBE	ART. NR.	EURO	LAGER
 <p>Mastaufsatzleuchte, Kugel aus bruchfestem und V2-selbstlöschendem opalem Polycarbonat, Grundplatte aus schwarzem Polyamid, Lampenfassung mit den Silikonkabeln verdrahtet und an die Klemme in der Grundplatte angeschlossen, Mast separat ordern</p>	A60 ECO · E27 · 230V · max. 42W	260x290	WO S	125-42670100	42,00	☺
	A60 ECO · E27 · 230V · max. 42W	320x355	WO S	125-42670500	47,00	☺
<p>230V HV</p> <p>inkl. </p> <p>IP65 EEI: A++ - D</p>						

GLOBI KUGEL OHNE SOCKEL FÜR MAST

INFO	LM	ØxH	FARBE	ART. NR.	EURO	LAGER
 <p>Mastaufsatzleuchte, Kugel aus bruchfestem und V2-selbstlöschendem opalem Polycarbonat, Fassungssockel und Mast separat ordern</p>		400x388	WO	125-42562100	68,00	☺
		450x436	WO	125-42561300	84,00	

FASSUNGS SOCKEL FÜR MAST

INFO	LM	FÜR KUGEL	FARBE	ART. NR.	EURO	LAGER
 <p>Fassungssockel für Mast, Aluminium, pulverbeschichtet, schwarze Grundplatte und weißer Sockelhalter, IP65 mit montierter Kugel, Mast separat ordern, Zopf: DM=60mm, für Kugel mit DM 400/450mm</p>	A60 ECO · E27 · 230V · max. 77W	400/450	S	125-42625900	68,00	☺
	<p>230V HV</p> <p>inkl. </p> <p>IP65 EEI: A++ - E</p>					

MAST FÜR GLOBO/GLOBI

INFO	LM	ØxH	FARBE	ART. NR.	EURO	LAGER
 <p>Mast für GLOBO/GLOBI, ohne Inspektionsfenster aus glasfaserverstärktem Nylon, schwarz, korrosionstfest, UV stabilisiert und Flansch mit Mastsockel, gerade, Vorteile vom Polyester-masten: leichter, geringe Wartung, keine Korrosionsschäden, elektrisch isolierend, hohe Stoßfestigkeit, Kugel und Mastsockel separat ordern, Zopf Ø 60mm</p> <p>GLOBO/GLOBI</p> <p>MAST</p> <p>MASTSOCKEL</p>		60x1000	S	125-99190300	13,50	
		60x1500	S	125-99190400	20,50	
		60x2000	S	125-99190500	27,00	☺

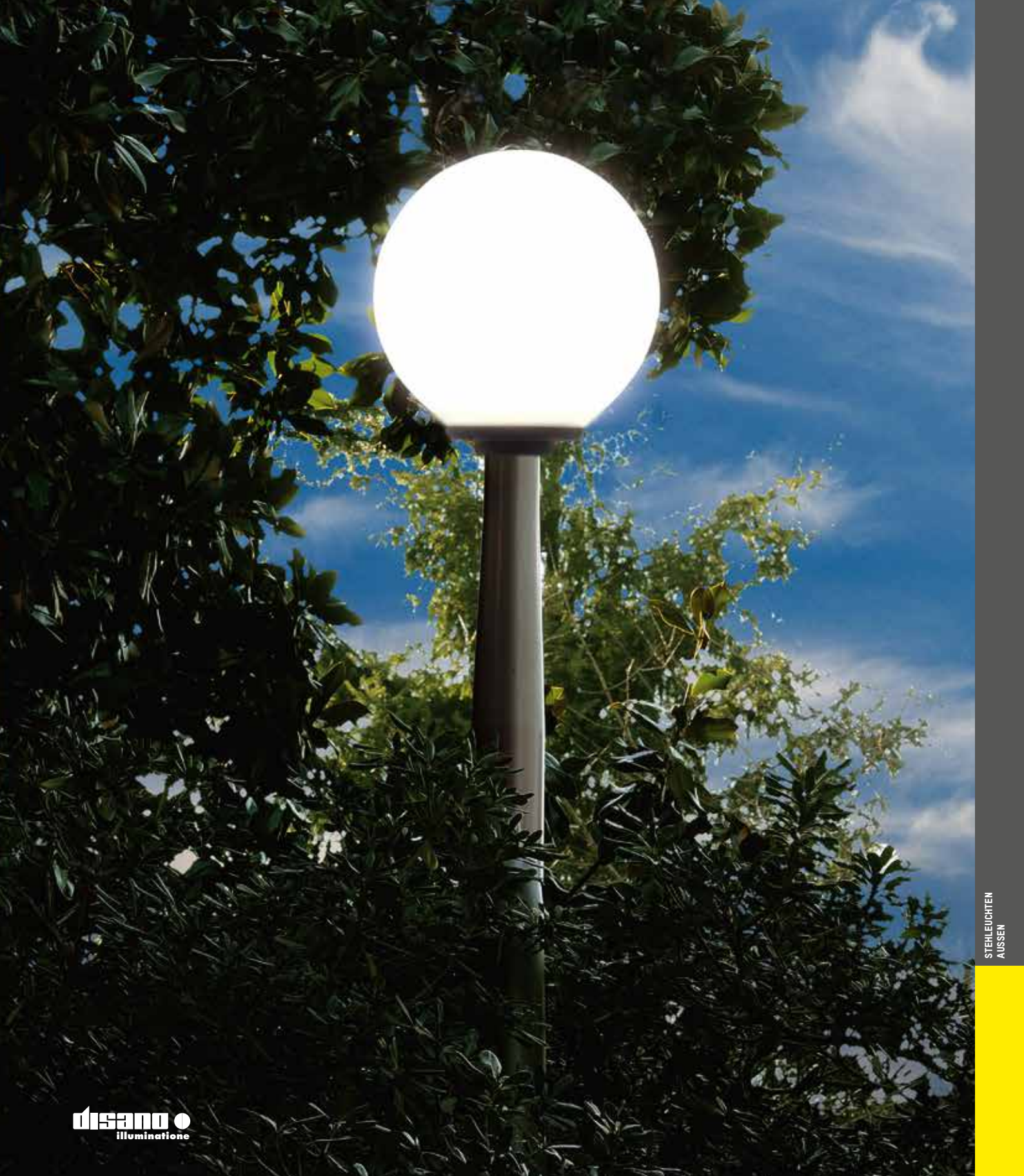

disano illumination

MASTSOCKEL



INFO

für Mast Ø 60, inkl. Eingrabanke, max. Masthöhe 2000mm

ØxH	FARBE	ART. NR.	EURO	LAGER
190x115	S	125-99121600	34,00	☺

FLUTER+ STRAHLER





STAGE SYMMETRISCH LED

INFO	LM	BxHxT	FARBE	ART. NR.	EURO	LAGER
 <p>Fluter mit Gehäuse aus Aluminiumdruckguss, Schrauben Edelstahl. Symmetrischer Reflektor aus Aluminium. Diffusor aus gehärtetem Klarglas. Elektronische Multi-Power Stromversorgung 220V/240V 50/60Hz mit Deep-Switch zur Stromauswahl am Ausgang. Die Leuchte ist für eine Durchverkablung mit Kabelklemme vorgesehen. Silikondichtung. Dreiphasen doppelte Pulverbeschichtung.</p>	SYS 106W 230V · CRI>90 12800lm	300x390x57	6	851-s1200w14	1143,00	
	LED 3000K					

LED 230V       EEL: A++ - A

STAGE ASYMMETRISCH LED

INFO	LM	BxHxT	FARBE	ART. NR.	EURO	LAGER
 <p>Fluter mit Gehäuse aus Aluminiumdruckguss, Schrauben Edelstahl. Asymmetrischer Reflektor aus Aluminium. Diffusor aus gehärtetem Klarglas. Elektronische Multi-Power Stromversorgung 220V/240V 50/60Hz mit Deep-Switch zur Stromauswahl am Ausgang. Die Leuchte ist für eine Durchverkablung mit Kabelklemme vorgesehen. Silikondichtung. Dreiphasen doppelte Pulverbeschichtung.</p>	SYS 85W 230V · CRI>90 8950lm	300x390x57	6	851-s1205w14	1469,00	
	LED 3000K					

LED 230V       EEL: A++ - A

MOVIT RECTANGULAR SYMMETRISCH LED

INFO	LM	BxHxT	FARBE	ART. NR.	EURO	LAGER
 <p>Fluter mit symmetrischem Reflektor, Aluminiumdruckguss mit hoher Korrosionsresistenz, Doppelte Pulverbeschichtung mit hoher Resistenz, weiß oder grau, rechteckig, Diffusor aus gehärtetem Klarglas, Reflektoren aus 99,98% reinem Aluminium HI-GRADE, schwenkbar 180°, Schrauben Edelstahl V4A, Leuchte festverdrahtet mit H05SRN-F Kabel 1m, Silikondichtung, inkl. Konverter</p>	SYS 9W 230V · CRI>90 699lm	130x34x843	W	851-s3010w01	629,00	
	LED 3000K	130x34x843	6	851-s3010w14	629,00	

LED 230V       EEL: A++ - A

UL

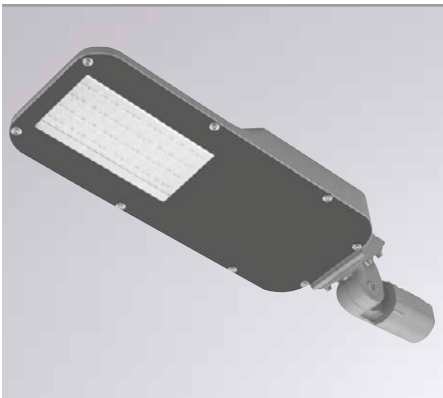
INFO	LM	BxHxT	FARBE	LUMEN	ART. NR.	EURO	LAGER
 <p>Mastleuchte aus Aluminiumdruckguss, grau pulverbeschichtet, Glasabdeckung - Dicke 4mm, geeignet für Mastzopf Ø 42 - 60mm, Schwenkbarkeit: - 30 - +90°, inkl. Konverter, nicht dimmbar</p>	SYS 56W · 230V · CRI>70	240x71x650	6	7650	757-I3001	680,00	
	SYS 87W · 230V · CRI>70	240x71x650	6	11100	757-I3002	680,00	
	SYS 103W · 230V · CRI>70	240x71x650	6	13200	757-I3003	840,00	
	SYS 144W · 230V · CRI>70	240x71x650	6	16700	757-I3004	840,00	
LED 5000K							

LED 230V       EEL: A++ - A

SIMES

Luce per l'architettura



FLUTER +
STRAHLER

RODIO SYMMETRISCH LED

INFO	LM	BxHxT	FARBE	LUMEN	ART. NR.	EURO	LAGER
 <p>Fluter aus Aluminiumdruckguss, graphith pulverbeschichtet mit symmetrische Linsenoptik, 90° schwenkbar, gehärtetes Schutzglas - Dicke 4mm, inkl. Konverter</p> <p>LED 4000K</p>	SYS 52W · 230V · CRI>80	333x568x85	GR	5912lm	125-41478400	527,00	
	SYS 81W · 230V · CRI>80	333x568x85	GR	8363lm	125-41478500	534,00	☺
	SYS 121W · 230V · CRI>80	333x568x85	GR	12211lm	125-41478600	591,00	
	SYS 169W · 230V · CRI>80	333x568x85	GR	15293lm	125-41478700	652,00	
							

RODIO ASYMMETRISCH LED

INFO	LM	BxHxT	FARBE	LUMEN	ART. NR.	EURO	LAGER
 <p>Fluter aus Aluminiumdruckguss, graphith pulverbeschichtet mit asymmetrische Linsenoptik, 90° schwenkbar, gehärtetes Schutzglas - Dicke 4mm, inkl. Konverter</p> <p>LED 4000K</p>	SYS 52W · 230V · CRI>80	333x568x85	GR	6030	125-41475400	527,00	
	SYS 81W · 230V · CRI>80	333x568x85	GR	8528	125-41475500	534,00	☺
	SYS 121W · 230V · CRI>80	333x568x85	GR	12452	125-41475600	591,00	
	SYS 169W · 230V · CRI>80	333x568x85	GR	15515	125-41475700	652,00	
							

WANDAUSLEGER

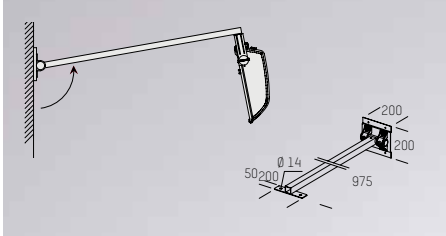
INFO	L	FARBE	ART. NR.	EURO	LAGER
 <p>Wandausleger, Stahl, schwenkbar, für Rodio</p>	975	S	125-99550400	150,00	

MASTAUFSAZKONSOLE

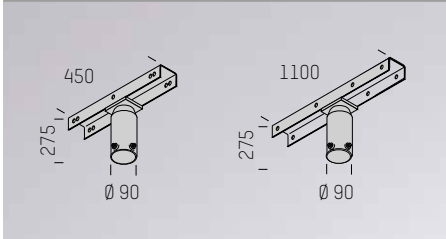
INFO	FÜR	ØxLxH	ART. NR.	EURO	LAGER
 <p>Mastaufsatzkonsole, verzinkt, für Mastzopf 60/76mm, Befestigung von 1-2 oder 2-4 Strahlern möglich, für Rodio, Fluter separat ordern</p>	1 oder 2 Fluter	90x450x275	125-99790000	126,00	
	2 oder 4 Fluter	90x1100x275	125-99790100	162,00	

MASTAUFSAZKONSOLE

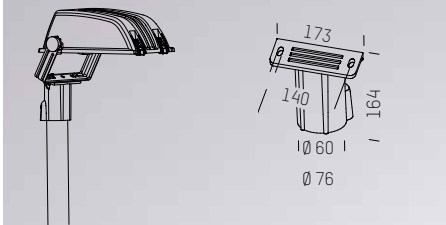
INFO	FÜR	ØxLxH	FARBE	ART. NR.	EURO	LAGER
 <p>Mastaufsatzkonsole, Aluminium, für Mastzopf DM= 60mm oder 76mm, für Lito, Indio und Rodio, Fluter separat ordern</p>	1 Fluter für Mastzopf Ø 60	60x173x164	GR	125-99791500	51,00	
	1 Fluter für Mastzopf Ø 76	76x173x164	GR	125-99791600	51,00	

MASTAUFSAZKONSOLE

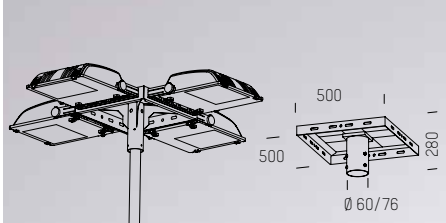
INFO	FÜR	LxBxH	ART. NR.	EURO	LAGER
 <p>Mastaufsatzkonsole, verzinkt, für Mastzopf 60/76mm, Befestigung von 1-4 Strahlern möglich, für Rodio, Fluter separat ordern</p>	1 - 4 Fluter für Mastzopf Ø 60/76	500x500x280	125-99809700	278,00	



LED FLUTER 10W

TOP SELLER



INFO	LM	LxTxH	FARBE	LED	LUMEN	REF.	ART. NR.	EURO	LAGER
Fluter, Gehäuse aus Aluminiumdruckguss mit Kühlrippen, Feinstruktur matt pulverbeschichtet, 4mm starkes gehärtetes Glas, Silikondichtung, hochglanz Aluminiumreflektor, 270° schwenkbar, Metallbügel mit Winkelmesskala, inkl. Konverter	SYS 10,2W 230V CRI>70	158x192x51	G	3000K	746	100°	263-1030s	48,00	☺
		158x192x51	G	4000K	831	100°	263-1040s	48,00	☺
		158x192x51	S	3000K	746	100°	263-1030b	48,00	☺
		158x192x51	S	4000K	831	100°	263-1040b	48,00	☺
Fluter mit Ausleger, technische Beschreibung siehe oben	SYS 10,2W 230V CRI>70	158x750x51	G	3000K	746	100°	263-1030sal	159,00	☺
		158x750x51	G	4000K	831	100°	263-1040sal	159,00	☺
		158x750x51	S	3000K	746	100°	263-1030bal	159,00	☺
		158x750x51	S	4000K	831	100°	263-1040bal	159,00	☺

LED 230V | 270° | inkl. | inkl. | IP65 | EEL: A+++ - A

LED FLUTER 30W



INFO	LM	LxTxH	FARBE	LED	LUMEN	REF.	ART. NR.	EURO	LAGER
Fluter, Gehäuse aus Aluminiumdruckguss mit Kühlrippen, Feinstruktur matt pulverbeschichtet, 4mm starkes gehärtetes Glas, Silikondichtung, hochglanz Aluminiumreflektor, 270° schwenkbar, Metallbügel mit Winkelmesskala, inkl. Konverter	SYS 33,1W 230V CRI>70	253x308x81	G	3000K	2434	100°	263-3030s	145,00	☺
		253x308x81	G	4000K	2490	100°	263-3040s	145,00	☺
		253x308x81	S	3000K	2434	100°	263-3030b	145,00	☺
		253x308x81	S	4000K	2490	100°	263-3040b	145,00	☺
Fluter mit Ausleger, technische Beschreibung siehe oben	SYS 33,1W 230V CRI>70	253x818x81	G	3000K	2434	100°	263-3030sal	269,00	☺
		253x818x81	G	4000K	2490	100°	263-3040sal	269,00	☺
		253x818x81	S	3000K	2434	100°	263-3030bal	269,00	☺
		253x818x81	S	4000K	2490	100°	263-3040bal	269,00	☺

LED 230V | 270° | inkl. | inkl. | IP65 | EEL: A+++ - A

LED FLUTER 30W SENSOR



INFO	LM	LxBxH	FARBE	LED	LUMEN	REF.	ART. NR.	EURO	LAGER
Fluter, Gehäuse aus Aluminiumdruckguss mit Kühlrippen, Feinstruktur matt pulverbeschichtet, 4mm starkes gehärtetes Glas, Silikondichtung, hochglanz Aluminiumreflektor, 270° schwenkbar, Metallbügel mit Winkelmesskala, inkl. Konverter	SYS 33,1W 230V CRI>70	253x308x81	G	3000K	2434	100°	263-3030sp	165,00	☺
		253x308x81	G	4000K	2490	100°	263-3040sp	165,00	☺
		253x308x81	S	3000K	2434	100°	263-3030bp	165,00	☺
		253x308x81	S	4000K	2490	100°	263-3040bp	165,00	☺
Bewegungsmelder: Tag/Nacht oder nur Nachtfunktion, Erfassungsbereich 120°, max. 7m									

LED 230V | 270° | inkl. | inkl. | IP65 | EEL: A+++ - A

LED FLUTER 50W



INFO	LM	LxBxH	FARBE	LED	LUMEN	REF.	ART. NR.	EURO	LAGER
Fluter, Gehäuse aus Aluminiumdruckguss mit Kühlrippen, Feinstruktur matt pulverbeschichtet, 4mm starkes gehärtetes Glas, Silikondichtung, hochglanz Aluminiumreflektor, 270° schwenkbar, Metallbügel mit Winkelmesskala, inkl. Konverter	SYS 51,4W 230V CRI>70	253x308x81	G	3000K	4082	100°	263-5030s	197,00	☺
		253x308x81	G	4000K	4158	100°	263-5040s	197,00	☺
		253x308x81	S	3000K	4082	100°	263-5030b	197,00	☺
		253x308x81	S	4000K	4158	100°	263-5040b	197,00	☺
Fluter mit Ausleger, technische Beschreibung siehe oben	SYS 51,4W 230V CRI>70	253x818x81	G	3000K	4082	100°	263-5030sal	299,00	☺
		253x818x81	G	4000K	4158	100°	263-5040sal	299,00	☺
		253x818x81	S	3000K	4082	100°	263-5030bal	299,00	☺
		253x818x81	S	4000K	4158	100°	263-5040bal	299,00	☺

LED 230V | 270° | inkl. | inkl. | IP65 | EEL: A+++ - A

FLUTER + STRAHLER



MOLTO LUCE®





FORIS



Strahler, Aluminiumdruckguss, matt pulverbeschichtet, AC LED, Leuchtkopf 330° drehbar und 90° schwenkbar, inkl. Erdspieß, **Entblendungsring in zwei Ausführungen als Zubehör separat ordern**

LM	ØxH	FARBE	REF.	LED	ART. NR.	EURO	LAGER
SYS 10W 230V CRI >80 740lm	110x140	AN	150°	3000K	341-0011080503011	165,00	☺

LED 230V | 90° | 330° | inkl. | IP56 | EEI: A++ - A

ENTBLENDUNGSRING FÜR FORIS



Entblendungsring schräg mit Schraubverschluss, Aluminiumdruckguss matt pulverbeschichtet, geeignet für Strahler FORIS

ØxH	LUMENWERT VON FORIS BEI MONTAGE	FARBE	ART. NR.	EURO	LAGER
102x100	525lm	AN	341-7000	39,00	☺

ENTBLENDUNGSKREUZRASTER FÜR FORIS

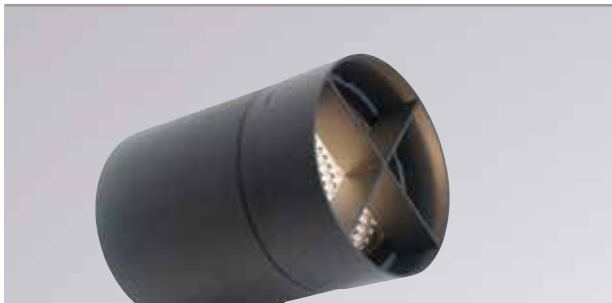

Entblendungskreuzraster gerade mit Schraubverschluss, Aluminiumdruckguss matt pulverbeschichtet, geeignet für Strahler FORIS

ØxH	LUMENWERT VON FORIS BEI MONTAGE	FARBE	ART. NR.	EURO	LAGER
102x 40	550lm	AN	341-7001	29,00	☺

MICRO



Strahler, braun, aus eloxiertem Aluminium, Lampenkopf kann 90° nach oben und unten abgewinkelt werden, inkl. Reflektor wahlweise 15° oder 24°, inkl. Erdspieß zur Befestigung, **Befestigungsstange zur erhöhten Montage separat ordern**

LM	ØxH	LUMEN	LED	FARBE	ART. NR.	EURO	LAGER
SYS 3W 230V CRI >80	52x156	396	3000K	B	105-059881j6clv1	109,00	
BEFESTIGUNGS-STANGE für MICRO Strahler, Stahl verzinkt	80x800			B	105-719940j6j6	58,00	

LED 230V | 90° | inkl. | IP65 | EEI: A++ - A



HARK AC-LED

TOP SELLER



Aufbaustrahler, AC-LED, Aluminiumdruckguss, Feinstruktur matt pulverbeschichtet, Diffusor aus Glas, 40° Ausstrahlwinkel, 350° dreh- und 90° schwenkbar, inkl. 168mm Erdspieß

LM	ØxB	H	REF.	FARBE	ART. NR.	EURO	LAGER
SYS 4W 230V 255lm CRI>80	54x80	96	40°	AN	472-0250480403011	139,00	☺
LED 3000K							



KOALA LED



Aufbaustrahler, Aluminiumdruckguss, Dreiphasen Pulverbeschichtung, silber oder graphit, 90° schwenkbar, mit breiten Kühlrippen für eine hohe Wärmeableitung, 46° Ausstrahlwinkel, Sockel aus bruchfestem Polyamid, gehärtetes Siebdruckglas, inkl. Konverter

LM	ØxH KOPF	ØxH SOCKEL	FARBE	REF.	ART. NR.	EURO	LAGER
SYS 14W 230V 1250lm CRI>90	114x132	127x62	S	46°	125-43182800	119,00	☺
LED 3000K			GR	46°	125-43182900	119,00	



KOALA



Aufbaustrahler, Aluminiumdruckguss, Dreiphasen Pulverbeschichtung, silber, 90° schwenkbar, mit breiten Kühlrippen für eine hohe Wärmeableitung, Sockel aus bruchfestem Polyamid, gehärtetes Siebdruckglas, inkl. Leuchtmittel

LM	ØxH KOPF	ØxH SOCKEL	FARBE	ART. NR.	EURO	LAGER
QPAR16 GU10 - 230V max. 50W	114x132	127x62	S	125-43181500	55,00	☺
oder LED RETROFIT GU10						



ZUBEHÖR

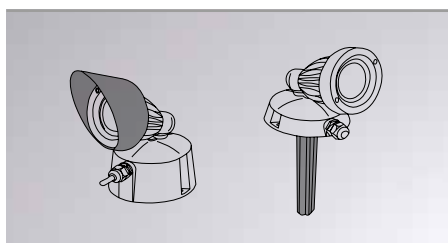

INFO	FÜR	MASSE	FARBE	ART. NR.	EURO	LAGER
BLENDSCHUTZ	KOALA	ØxT: 119x98	G	125-99133000	27,00	☺
ERDSPIESS	KOALA	LxBxH: 74x30x175	S	125-99133500	5,50	☺



LEVI AC 10W



Wandauslegerstrahler, Aluminiumdruckguss, Feinstruktur matt pulverbeschichtet, AC LED, Leuchtenkopf 350° drehbar und 90° schwenkbar, satinierter bündiger Diffusor aus PMMA, erhältlich in zwei Längen, Entblendungsring in zwei Ausführungen als Zubehör separat ordern

LM	KOPF ØxH	SOCKEL ØxH	L	FARBE	LED	ART. NR.	EURO	LAGER
SYS 10W 230V CRI >80 600lm PASSIVE COOLING Binning SDCM 3	90x30	90x37	688	SM	3000K	611-110194	233,00	☺
	90x30	90x37	688	W	3000K	611-110195	233,00	☺
	90x30	90x37	688	S	3000K	611-110196	233,00	☺
	90x30	90x37	688	SM	4000K	611-110144	233,00	
	90x30	90x37	688	W	4000K	611-110145	233,00	
	90x30	90x37	688	S	4000K	611-110146	233,00	
	90x30	90x37	388	SM	3000K	611-210194	228,00	☺
	90x30	90x37	388	W	3000K	611-210195	228,00	☺
	90x30	90x37	388	S	3000K	611-210196	228,00	☺
	90x30	90x37	388	SM	4000K	611-210144	228,00	
	90x30	90x37	388	W	4000K	611-210145	228,00	
	90x30	90x37	388	S	4000K	611-210146	228,00	

LED 230V inkl. IP54 | EEI: A+++ - A

ENTBLENDUNGSRING FÜR LEVI

INFO



Entblendungsring schräg oder gerade mit Bajonettverschluss, Aluminium, Feinstruktur matt pulverbeschichtet, geeignet für Strahler Levi AC

SKIZZE	Ø	FARBE	ART. NR.	EURO	LAGER
	85	SM	651-000024	17,50	☺
	85	W	651-000025	17,50	☺
	85	S	651-000026	17,50	☺
	85	SM	651-000014	17,50	☺
	85	W	651-000015	17,50	☺
	85	S	651-000016	17,50	☺



FRANZISKUS APOTHEKE

FRANZISKUS
APOTHEKE



Auslegerleuchte, Aluminiumdruckguss, matt pulverbeschichtet, AC LED, Leuchtenkopf 90° schwenkbar, 320° drehbar, **Montagehinweis: nur direkt strahlend!**

LM	LxBxH	FARBE	REF.	LED	ART. NR.	EURO	LAGER
SYS 8W 230V CRI >80 475lm	650x95x236	SM	150°	3000K	341-0000880503004	165,00	😊
		AN	150°	3000K	341-0000880503011	165,00	😊

LED 230V | 90° | 320° | inkl. | IP55 | EEI: A++ - A



VIDERI LONG



Auslegerleuchte, Aluminiumdruckguss, matt pulverbeschichtet, AC LED, Leuchtenkopf 120° schwenkbar, 140° drehbar, **Montagehinweis: nur direkt strahlend!**

LM	LxBxH	FARBE	REF.	LED	ART. NR.	EURO	LAGER
SYS 15W 230V CRI >80 910lm	680x130x95	SM	120°	3000K	341-0021580003004	187,00	😊
		AN	120°	3000K	341-0021580003011	187,00	😊

LED 230V | 90° | 340° | inkl. | IP55 | EEI: A++ - A



VIDERI SHORT



Wandleuchte, Aluminiumdruckguss, matt pulverbeschichtet, AC LED, Leuchtenkopf 120° schwenkbar, 140° drehbar, **Montagehinweis: nur direkt strahlend!**

LM	LxBxH	FARBE	REF.	LED	ART. NR.	EURO	LAGER
SYS 15W 230V CRI >80 910lm	200x130x95	SM	120°	3000K	341-0031580003004	167,00	😊
		AN	120°	3000K	341-0031580003011	167,00	😊

LED 230V | 120° | 340° | inkl. | IP55 | EEI: A++ - A





INDIVIDUALITÄT UND FREIHEIT

Moderne Architekturkonzepte gestalten Räume zu einem perfekt aufeinander abgestimmten, harmonischen Ganzen. Funktionale, zielgruppenorientierte Beleuchtungsabläufe leisten dabei einen wesentlichen Beitrag zu Stimmung, Atmosphäre und Individualität. Schöpfen Sie aus dem breiten Spektrum hochwertiger Qualitätsleuchten, lassen Sie sich von unseren kreativsten Planungen überraschen und genießen Sie den modernen Lifestyle.

Internationale
Beleuchtungsrends
für Wohn- und
Büro- sowie
einzelne Schaufenster
in Wien und Wien.

MOLTO LUCE®

1000 Wien, Turpostrasse 95
1230 Wien, Vauxhofgasse 28



www.molto luce.com



INDIVIDUALITÄT UND FREIHEIT

Moderne Architekturkonzepte gestalten Räume zu einem perfekt aufeinander abgestimmten, harmonischen Ganzen. Funktionale, zielgruppenorientierte Beleuchtungsabläufe leisten dabei einen wesentlichen Beitrag zu Stimmung, Atmosphäre und Individualität. Schöpfen Sie aus dem breiten Spektrum hochwertiger Qualitätsleuchten, lassen Sie sich von unseren kreativen Planungen überraschen und genießen Sie den modernen Lifestyle.

Internationale
Beleuchtungsrends
für Wohn- und
Büro- sowie
einzelne Schaufenster
in Wien und Wien.

MOLTO LUCE®

Wien | Wien | Graz

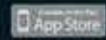

www.molto luce.com

ELEKTRONISCHER TRANSFORMATOR



Symbolfoto



INFO	W	LxBxH	FARBE	ART. NR.	EURO	LAGER
Elektronischer Transformator, weiß, dimmbar mit Phasen-/ abschnittdimmer, thermisch progressive Sicherung (NTC), gesichert gegen Kurzschluß und Überlast auf Sekundärseite, automatische Wiederherstellung, elektromagnetische Verträglichkeit, Funkenstörfilter gem. EN55014/5, Transformatorbefestigung durch Ösen und Schrauben, Klemmabdeckung mit integrierter Zugentlastung, primär 2,5mm ² , sekundär bis 2,5mm ² (60-105VA), bzw. bis 6mm ² (150VA), * nur Phasenabschnitt dimmbar (210 und 250VA)	10-60	94x31x20	W	24-119654	11,00	☺
	20-60	128x38x28	W	24-119910	10,50	☺
	20-105	128x38x28	W	24-119730	12,00	☺
	30-150	166x47x35	W	24-119851u	22,00	☺
	50-210*	180x45x40	W	24-119475c	32,00	
	50-250*	180x45x40	W	24-119475	38,00	☺

ELEKTRONISCHER TRANSFORMATOR



Symbolfoto

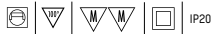

INFO	W	LxBxH	FARBE	ART. NR.	EURO	LAGER
Elektronischer Transformator, weiß, Sekundär mit 6-fachem AMP-Verteiler, primär mit Kabel 0,75mm ² doppelt isoliert, Länge 2000mm und Eurostecker, dimmbar mit Phasen-/ abschnittdimmer, durch thermisch progressive Sicherung (NTC) gesichert gegen Kurzschluß und Überlast auf Sekundärseite, automatische Wiederherstellung	10-60	94x31x20	W	24-119654c	17,50	☺
	20-105	128x38x28	W	24-119721d	21,00	☺

SICHERHEITSTRANSFORMATOR



INFO	W	LxBxH	FARBE	ART. NR.	EURO	LAGER
Sicherheitstransformator 41.020.10, weiß, Installationsvorschriften VDE 100 Teil 523/6.81 und Teil 430/6.81 beachten, dimmbar mit Dimmer für induktive Lasten (Phasenanschnittdimmer), Eingangsspannung: 230- ± 10%, Ausgangsleistung 12V+, Frequenz 50-60Hz, Umgebungstemperatur max. 40°	20	64x54x48	W	205-20	22,00	☺
	60	83x69x60	W	205-60	33,00	☺
	105	88x74x79	W	205-105	39,00	☺
	150	101x85x85	W	205-150	49,00	☺
	200	101x85x99	W	205-200	58,00	☺
	250	101x85x99	W	205-250	62,00	☺
	300	101x85x99	W	205-300	83,00	☺
	400	140x117x116	W	205-400	109,00	☺

RINGKERN TRANSFORMATOR



Symbolfoto



INFO	VA	ØxH	ART. NR.	EURO	LAGER
Ringkern Transformator, hergestellt nach EN 61558-1 / EN 61558-2-6, Wärmedämmung Klasse B = 120 °C	20	68x31	205-4602010	27,00	☺
	50	82x32	205-4605010	34,00	☺
	60	88x32	205-4606010	35,00	☺
	80	90x39	205-4608010	40,00	☺
	105	98x40	205-4610510	48,00	☺
	150	98x45	205-4615010	59,00	☺
	200	115x45	205-4620010	72,00	☺
	250	118x48	205-4625010	77,00	☺
	300	130x45	205-4630010	95,00	☺

ELEKTRONISCHER TRANSFORMATOR



Symbolfoto



INFO	W	LxBxH	FARBE	ART. NR.	EURO	LAGER
Elektronischer Transformator, schwarz, vergossen, dimmbar mit Phasenabschrittdimmer, thermisch progressive Sicherung gesichert gegen Kurzschluß und Überlast auf Sekundärseite, elektromagnetische Verträglichkeit, Funkenstörfilter gem. EN55014/5, Anschluß mit Litzeleitung Länge 200mm, Primärleitung 2x 0,75mm² doppelt isoliert, Sekundärleitung 2x 0,75mm², Umgebungstemperatur -10° bis +40°	20-60	104x30x21	S	75-pr60	15,00	☺
	20-105	134x30x21	S	75-pr105	21,00	☺

ELEKTRONISCHER TRANSFORMATOR



Symbolfoto



INFO	W	ØxH	FARBE	ART. NR.	EURO	LAGER
Elektronischer Transformator, weiß, rund, dimmbar mit Phasen- / abschnittdimmer, thermisch progressive Sicherung (NTC) gesichert gegen Kurzschluß und Überlast auf Sekundärseite, Wiederherstellung automatisch, elektromagnetische Verträglichkeit, Funkenstörfilter gem. EN55014/5, Ausgangsspannung 12V	20-60	53x19	W	24-119640	13,00	☺
	20-105	70x22	W	24-119618	18,00	☺

ELEKTRONISCHER TRANSFORMATOR

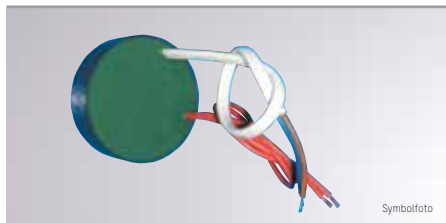

Symbolfoto



INFO	W	ØxH	ART. NR.	EURO	LAGER
Elektronischer Transformator, rund, vergossen, dimmbar mit Phasenabschrittdimmer, thermisch progressive Sicherung gesichert gegen Kurzschluß und Überlast auf Sekundärseite, automatische Wiederherstellung, elektromagnetische Verträglichkeit, Funkenstörfilter gem. EN55014/5, Primärleitung und Sekundärkabel 170/200mm, Eingangsspannung 240V- +/- 10%, Ausgangsspannung 12V-Frequenz [Hz] 50-60, Umgebungstemperatur max. 40°C	20-70	53x19	75-tr70	14,00	☺
	35-105	70x22	75-tr105	20,00	☺

ELEKTRONISCHER TRAFU - SONDERAUSFÜHRUNG FÜR LED RETROFIT



Symbolfoto



INFO	W	LxBxH	FÜR	FARBE	ART. NR.	EURO	LAGER
elektronischer Trafo für LED RETROFIT Leuchtmittel, Ausgangsspannung 12V dimmbar mit Phasen- / abschnittdimmer	70	123x34x21	1-70W Halogen LM 1-50W LED Retrofit	W	24-119772	23,00	☺

KONSTANTSTROM KONVERTER

LED KONVERTER STF/U



INFO	W	mA	V DC	LxBxH	FARBE	ART. NR.	EURO	LAGER
LED-Konverter, nicht dimmbar, 230 V AC	4	350	12	46x26x23	W	24-122140	15,00	☺



LED KONVERTER STM/U



INFO	W	mA	V DC	LxBxH	FARBE	ART. NR.	EURO	LAGER
LED-Konverter, nicht dimmbar, 230 V AC	6	250	24	42x40 x22	S	24-122812	16,00	☺
	8	350	24	42x40 x22	S	24-122811	16,00	☺
	6	500	12	42x40 x22	S	24-122813	16,00	☺
	6	700	12	42x40 x22	S	24-122815	16,00	☺



LED KONVERTER BULL/U



INFO	W	mA	V DC	LxBxH	FARBE	ART. NR.	EURO	LAGER
LED-Konverter, nicht dimmbar, 230 V AC	9	250	36	60x35x21,5	W	24-122599	18,00	☺
	4	350	12	60x35x21,5	W	24-122596	17,00	☺
	8	350	24	60x35x21,5	W	24-122598	17,00	☺
	6	500	12	60x35x21,5	W	24-122602	17,00	☺



LED KONVERTER STC/U



INFO	W	mA	V DC	LxBxH	FARBE	ART. NR.	EURO	LAGER
LED-Konverter, nicht dimmbar, 230 V AC	8	350	24	51x31x21	S	24-122633	14,00	☺
	6	500	12	51x31x21	S	24-122635	14,00	☺
	6	1200	5	51x31x21	S	24-127010	25,00	☺



LED KONVERTER SLIM/U



INFO	W	mA	V DC	LxBxH	FARBE	ART. NR.	EURO	LAGER
LED-Konverter, nicht dimmbar, 230 V AC	15	350	43	142x22x19	W	24-122440	23,00	☺



LED KONVERTER PMR



INFO	W	mA	V DC	ØxH	FARBE	ART. NR.	EURO	LAGER
LED-Konverter, nicht dimmbar, 230 V AC	8,4	700	12	53x19	W	75-pmr12	17,00	☺



LED KONVERTER MPL



INFO	W	mA	V DC	LxBxH	FARBE	ART. NR.	EURO	LAGER
LED-Konverter, nicht dimmbar, 230 V AC	1,5	350	6	51x32x18	S	75-mpl1	11,00	☺
	4	350	12	51x32x18	S	75-mpl3	11,00	☺
	2	700	6	51x32x18	S	75-mpl4	12,50	☺
	4	500	9	51x32x18	S	75-mpl5	11,50	☺



KONSTANTSTROM KONVERTER

LED KONVERTER STPM/U IP54



INFO	W	mA	V DC	LxBxH	FARBE	ART. NR.	EURO	LAGER
LED-Konverter, nicht dimmbar, 230 V AC	8	350	24	44x46x26,5	S	24-122800	26,00	☺
	6	500	12	44x46x26,5	S	24-122802	26,00	☺
	6	700	12	44x46x26,5	S	24-122804	26,00	

Symbolfoto IP54

LED KONVERTER DCC/U S IP54



INFO	W	mA	V DC	LxBxH	FARBE	ART. NR.	EURO	LAGER
LED-Konverter, nicht dimmbar, 230 V AC	15	350	43	133x40,5x20	W	24-122370	31,00	
	12	500	24	133x40,5x20	W	24-122376	31,00	
	12	700	17	133x40,5x20	W	24-122372	31,00	

Symbolfoto IP54

LED KONVERTER MP15



INFO	W	mA	V DC	LxBxH	FARBE	ART. NR.	EURO	LAGER
LED-Konverter, nicht dimmbar, 230 V AC	2,5 - 15	60 - 360	41,5	115x34x19	W	24-122360	23,00	☺

Einstellbar mittels DIP-SWITCH:

mA	W	V DC	mA	W	V DC
60	2,5	41,5	220	9,1	41,5
80	3,3	41,5	240	10	41,5
100	4,1	41,5	260	10,8	41,5
120	5	41,5	280	11,6	41,5
140	5,8	41,5	300	12,4	41,5
160	6,6	41,5	320	13,2	41,5
180	7,4	41,5	340	14,1	41,5
200	8,3	41,5	360	15	41,5

Symbolfoto IP20

LED KONVERTER UNIVERSALE 20 LC



INFO	W	mA	V DC	LxBxH	FARBE	ART. NR.	EURO	LAGER
LED-Konverter, nicht dimmbar, 230 V AC	5,4 - 20	100 - 380	54	111x52x22	W	24-122203	23,00	☺

Einstellbar mittels DIP-SWITCH:

Konstantstrom

mA	W	V DC	mA	W	V DC
100	5,4	54	260	14	54
140	7,5	54	300	16	54
180	10	54	340	18	54
220	12	54	380	20	54

Konstantspannung

W	V DC
9	24

Symbolfoto IP20

LED KONVERTER UNIVERSALE 20



INFO	W	mA	V DC	LxBxH	FARBE	ART. NR.	EURO	LAGER
LED-Konverter, nicht dimmbar, 230 V AC	13 - 20	250 - 700	57 - 28	111x52x22	W	24-122201	23,00	☺

Einstellbar mittels DIP-SWITCH:

Konstantstrom

mA	W	V DC	mA	W	V DC
250	13	54	500	20	40
350	19	54	550	20	37
400	20	50	600	20	34
450	20	44	700	20	29

Konstantspannung

W	V DC
16	24

Symbolfoto IP20

KONSTANTSTROM KONVERTER

LED KONVERTER PROFESSIONALE 34

INFO	W	mA	V DC	LxBxH	FARBE	ART. NR.	EURO	LAGER																																				
 <p>LED-Konverter, nicht dimmbar, 230 V AC</p> <p>Einstellbar mittels DIP-SWITCH:</p> <table border="1"> <thead> <tr> <th>mA</th> <th>W</th> <th>V DC</th> <th>mA</th> <th>W</th> <th>V DC</th> </tr> </thead> <tbody> <tr><td>250</td><td>12</td><td>50</td><td>500</td><td>25</td><td>50</td></tr> <tr><td>300</td><td>15</td><td>50</td><td>550</td><td>27</td><td>50</td></tr> <tr><td>350</td><td>17</td><td>50</td><td>600</td><td>30</td><td>50</td></tr> <tr><td>400</td><td>20</td><td>50</td><td>650</td><td>32</td><td>49</td></tr> <tr><td>450</td><td>22</td><td>50</td><td>700</td><td>34</td><td>48</td></tr> </tbody> </table>	mA	W	V DC	mA	W	V DC	250	12	50	500	25	50	300	15	50	550	27	50	350	17	50	600	30	50	400	20	50	650	32	49	450	22	50	700	34	48	12 - 34	250 - 700	50 - 48	130x42x30	W	24-127480	19,00	☺
mA	W	V DC	mA	W	V DC																																							
250	12	50	500	25	50																																							
300	15	50	550	27	50																																							
350	17	50	600	30	50																																							
400	20	50	650	32	49																																							
450	22	50	700	34	48																																							

IP20

LED KONVERTER PROFESSIONALE 42

INFO	W	mA	V DC	LxBxH	FARBE	ART. NR.	EURO	LAGER																																																						
 <p>LED-Konverter, nicht dimmbar, 230 V AC</p> <p>Einstellbar mittels DIP-SWITCH:</p> <table border="1"> <thead> <tr> <th>mA</th> <th>W</th> <th>V DC</th> <th>mA</th> <th>W</th> <th>V DC</th> </tr> </thead> <tbody> <tr><td>300</td><td>13</td><td>44</td><td>700</td><td>31</td><td>44</td></tr> <tr><td>350</td><td>15</td><td>44</td><td>750</td><td>32</td><td>44</td></tr> <tr><td>400</td><td>18</td><td>44</td><td>800</td><td>33</td><td>42</td></tr> <tr><td>450</td><td>20</td><td>44</td><td>850</td><td>35</td><td>42</td></tr> <tr><td>500</td><td>22</td><td>44</td><td>900</td><td>38</td><td>42</td></tr> <tr><td>550</td><td>24</td><td>44</td><td>950</td><td>40</td><td>42</td></tr> <tr><td>600</td><td>27</td><td>44</td><td>1000</td><td>42</td><td>42</td></tr> <tr><td>650</td><td>29</td><td>44</td><td>1050</td><td>42</td><td>40</td></tr> </tbody> </table>	mA	W	V DC	mA	W	V DC	300	13	44	700	31	44	350	15	44	750	32	44	400	18	44	800	33	42	450	20	44	850	35	42	500	22	44	900	38	42	550	24	44	950	40	42	600	27	44	1000	42	42	650	29	44	1050	42	40	13 - 42	300 - 1050	44 - 40	130x42x30	W	24-127484	20,00	☺
mA	W	V DC	mA	W	V DC																																																									
300	13	44	700	31	44																																																									
350	15	44	750	32	44																																																									
400	18	44	800	33	42																																																									
450	20	44	850	35	42																																																									
500	22	44	900	38	42																																																									
550	24	44	950	40	42																																																									
600	27	44	1000	42	42																																																									
650	29	44	1050	42	40																																																									

IP20

LED KONVERTER MP 50 K3

INFO	W	mA	V DC	LxBxH	FARBE	ART. NR.	EURO	LAGER																																				
 <p>LED-Konverter, nicht dimmbar, 230 V AC</p> <p>Einstellbar mittels DIP-SWITCH:</p> <table border="1"> <thead> <tr> <th>mA</th> <th>W</th> <th>V DC</th> <th>mA</th> <th>W</th> <th>V DC</th> </tr> </thead> <tbody> <tr><td>350</td><td>25</td><td>74</td><td>750</td><td>50</td><td>66</td></tr> <tr><td>500</td><td>35</td><td>72</td><td>850</td><td>50</td><td>58</td></tr> <tr><td>550</td><td>39</td><td>72</td><td>900</td><td>50</td><td>55</td></tr> <tr><td>650</td><td>46</td><td>72</td><td>1050</td><td>50</td><td>48</td></tr> <tr><td>700</td><td>50</td><td>71</td><td></td><td></td><td></td></tr> </tbody> </table>	mA	W	V DC	mA	W	V DC	350	25	74	750	50	66	500	35	72	850	50	58	550	39	72	900	50	55	650	46	72	1050	50	48	700	50	71				25 - 50	350 - 1050	74 - 48	124x79x22	W	24-122204	45,00	☺
mA	W	V DC	mA	W	V DC																																							
350	25	74	750	50	66																																							
500	35	72	850	50	58																																							
550	39	72	900	50	55																																							
650	46	72	1050	50	48																																							
700	50	71																																										

IP20

LED KONVERTER MP 50 TCM

INFO	W	mA	V DC	LxBxH	FARBE	ART. NR.	EURO	LAGER																																				
 <p>LED-Konverter, nicht dimmbar, 230 V AC, für Durchgangsverdrahtung</p> <p>Einstellbar mittels DIP-SWITCH:</p> <table border="1"> <thead> <tr> <th>mA</th> <th>W</th> <th>V DC</th> <th>mA</th> <th>W</th> <th>V DC</th> </tr> </thead> <tbody> <tr><td>350</td><td>25</td><td>74</td><td>750</td><td>50</td><td>66</td></tr> <tr><td>500</td><td>35</td><td>72</td><td>850</td><td>50</td><td>58</td></tr> <tr><td>550</td><td>39</td><td>72</td><td>900</td><td>50</td><td>55</td></tr> <tr><td>650</td><td>46</td><td>72</td><td>1050</td><td>50</td><td>48</td></tr> <tr><td>700</td><td>50</td><td>71</td><td></td><td></td><td></td></tr> </tbody> </table>	mA	W	V DC	mA	W	V DC	350	25	74	750	50	66	500	35	72	850	50	58	550	39	72	900	50	55	650	46	72	1050	50	48	700	50	71				25 - 50	350 - 1050	74 - 48	174x83x35	W	24-1222044	55,00	☺
mA	W	V DC	mA	W	V DC																																							
350	25	74	750	50	66																																							
500	35	72	850	50	58																																							
550	39	72	900	50	55																																							
650	46	72	1050	50	48																																							
700	50	71																																										

IP20

LED KONVERTER MP 55 HC TCM

INFO	W	mA	V DC	LxBxH	FARBE	ART. NR.	EURO	LAGER																								
 <p>LED-Konverter, nicht dimmbar, 230 V AC, für Durchgangsverdrahtung</p> <p>Einstellbar mittels DIP-SWITCH:</p> <table border="1"> <thead> <tr> <th>mA</th> <th>W</th> <th>V DC</th> <th>mA</th> <th>W</th> <th>V DC</th> </tr> </thead> <tbody> <tr><td>1050</td><td>45</td><td>44</td><td>1600</td><td>55</td><td>35</td></tr> <tr><td>1200</td><td>52</td><td>44</td><td>1750</td><td>55</td><td>30</td></tr> <tr><td>1400</td><td>55</td><td>39</td><td>2100</td><td>55</td><td>26</td></tr> </tbody> </table>	mA	W	V DC	mA	W	V DC	1050	45	44	1600	55	35	1200	52	44	1750	55	30	1400	55	39	2100	55	26	45 - 55	1050 - 2100	44 - 26	174x83x35	W	24-1222084	57,00	☺
mA	W	V DC	mA	W	V DC																											
1050	45	44	1600	55	35																											
1200	52	44	1750	55	30																											
1400	55	39	2100	55	26																											

IP20

LED KONVERTER MINI JOLLY 20

INFO	W	mA	V DC	LxBxH	FARBE	ART. NR.	EURO	LAGER																														
 <p>LED-Konverter, 1-10V & PUSH dimmbar, 230 V AC</p> <p>Einstellbar mittels DIP-SWITCH:</p> <p>Konstantstrom</p> <table border="1"> <thead> <tr> <th>mA</th> <th>W</th> <th>V DC</th> <th>mA</th> <th>W</th> <th>V DC</th> </tr> </thead> <tbody> <tr><td>350</td><td>15</td><td>43</td><td>700</td><td>20</td><td>36</td></tr> <tr><td>500</td><td>20</td><td>43</td><td>850</td><td>20</td><td>24</td></tr> <tr><td>550</td><td>20</td><td>43</td><td>900</td><td>20</td><td>22</td></tr> </tbody> </table> <p>Konstantspannung</p> <table border="1"> <thead> <tr> <th>W</th> <th>V DC</th> </tr> </thead> <tbody> <tr><td>10</td><td>12</td></tr> <tr><td>20</td><td>24</td></tr> </tbody> </table>	mA	W	V DC	mA	W	V DC	350	15	43	700	20	36	500	20	43	850	20	24	550	20	43	900	20	22	W	V DC	10	12	20	24	15 - 20	350 - 900	43 - 22	111x52x22	W	24-123400	44,00	☺
mA	W	V DC	mA	W	V DC																																	
350	15	43	700	20	36																																	
500	20	43	850	20	24																																	
550	20	43	900	20	22																																	
W	V DC																																					
10	12																																					
20	24																																					

IP20

KONSTANTSTROM KONVERTER

LED KONVERTER MINI JOLLY HV

INFO	W	mA	V DC	LxBxH	FARBE	ART. NR.	EURO	LAGER																																				
 <p>LED-Konverter, 1-10V & PUSH dimmbar, 230 V AC</p> <p>Einstellbar mittels DIP-SWITCH: Konstantstrom</p> <table border="1"> <thead> <tr> <th>mA</th> <th>W</th> <th>V DC</th> <th>mA</th> <th>W</th> <th>V DC</th> </tr> </thead> <tbody> <tr> <td>250</td> <td>13</td> <td>53</td> <td>500</td> <td>20</td> <td>40</td> </tr> <tr> <td>350</td> <td>17</td> <td>52</td> <td>550</td> <td>20</td> <td>37</td> </tr> <tr> <td>400</td> <td>20</td> <td>50</td> <td>600</td> <td>20</td> <td>34</td> </tr> <tr> <td>450</td> <td>20</td> <td>44</td> <td>700</td> <td>20</td> <td>29</td> </tr> </tbody> </table> <p>Konstantspannung</p> <table border="1"> <thead> <tr> <th>W</th> <th>V DC</th> </tr> </thead> <tbody> <tr> <td>16</td> <td>24</td> </tr> <tr> <td>20</td> <td>48</td> </tr> </tbody> </table> <p>Symbolfoto</p>	mA	W	V DC	mA	W	V DC	250	13	53	500	20	40	350	17	52	550	20	37	400	20	50	600	20	34	450	20	44	700	20	29	W	V DC	16	24	20	48	13 - 20	250 - 700	53 - 29	111x52x22	W	24-123399	42,00	☺
mA	W	V DC	mA	W	V DC																																							
250	13	53	500	20	40																																							
350	17	52	550	20	37																																							
400	20	50	600	20	34																																							
450	20	44	700	20	29																																							
W	V DC																																											
16	24																																											
20	48																																											

 IP20

LED KONVERTER MINI JOLLY LC 20

INFO	W	mA	V DC	LxBxH	FARBE	ART. NR.	EURO	LAGER																																		
 <p>LED-Konverter, 1-10V & PUSH dimmbar, 230 V AC</p> <p>Einstellbar mittels DIP-SWITCH: Konstantstrom</p> <table border="1"> <thead> <tr> <th>mA</th> <th>W</th> <th>V DC</th> <th>mA</th> <th>W</th> <th>V DC</th> </tr> </thead> <tbody> <tr> <td>100</td> <td>5,8</td> <td>54</td> <td>260</td> <td>14</td> <td>54</td> </tr> <tr> <td>140</td> <td>7,5</td> <td>54</td> <td>300</td> <td>16</td> <td>54</td> </tr> <tr> <td>180</td> <td>9,5</td> <td>54</td> <td>340</td> <td>18</td> <td>54</td> </tr> <tr> <td>220</td> <td>12</td> <td>54</td> <td>380</td> <td>20</td> <td>54</td> </tr> </tbody> </table> <p>Konstantspannung</p> <table border="1"> <thead> <tr> <th>W</th> <th>V DC</th> </tr> </thead> <tbody> <tr> <td>9</td> <td>24</td> </tr> </tbody> </table> <p>Symbolfoto</p>	mA	W	V DC	mA	W	V DC	100	5,8	54	260	14	54	140	7,5	54	300	16	54	180	9,5	54	340	18	54	220	12	54	380	20	54	W	V DC	9	24	5,4 - 20	100 - 380	54	111x52x22	W	24-123401	44,00	☺
mA	W	V DC	mA	W	V DC																																					
100	5,8	54	260	14	54																																					
140	7,5	54	300	16	54																																					
180	9,5	54	340	18	54																																					
220	12	54	380	20	54																																					
W	V DC																																									
9	24																																									

 IP20

LED KONVERTER MINI JOLLY DALI 20

INFO	W	mA	V DC	LxBxH	FARBE	ART. NR.	EURO	LAGER																																		
 <p>LED-Konverter, DALI dimmbar, 230 V AC</p> <p>Einstellbar mittels DIP-SWITCH: Konstantstrom</p> <table border="1"> <thead> <tr> <th>mA</th> <th>W</th> <th>V DC</th> <th>mA</th> <th>W</th> <th>V DC</th> </tr> </thead> <tbody> <tr> <td>250</td> <td>10</td> <td>43</td> <td>500</td> <td>20</td> <td>40</td> </tr> <tr> <td>350</td> <td>15</td> <td>43</td> <td>550</td> <td>20</td> <td>36</td> </tr> <tr> <td>400</td> <td>17</td> <td>43</td> <td>600</td> <td>20</td> <td>33</td> </tr> <tr> <td>450</td> <td>19</td> <td>43</td> <td>700</td> <td>20</td> <td>28</td> </tr> </tbody> </table> <p>Konstantspannung</p> <table border="1"> <thead> <tr> <th>W</th> <th>V DC</th> </tr> </thead> <tbody> <tr> <td>16</td> <td>24</td> </tr> </tbody> </table> <p>Symbolfoto</p>	mA	W	V DC	mA	W	V DC	250	10	43	500	20	40	350	15	43	550	20	36	400	17	43	600	20	33	450	19	43	700	20	28	W	V DC	16	24	10 - 20	250 - 700	43 - 28	111x52x22	W	24-123403	49,00	☺
mA	W	V DC	mA	W	V DC																																					
250	10	43	500	20	40																																					
350	15	43	550	20	36																																					
400	17	43	600	20	33																																					
450	19	43	700	20	28																																					
W	V DC																																									
16	24																																									

 IP20

LED KONVERTER MINI JOLLY LC DALI

INFO	W	mA	V DC	LxBxH	FARBE	ART. NR.	EURO	LAGER																																		
 <p>LED-Konverter, DALI dimmbar, 230 V AC</p> <p>Einstellbar mittels DIP-SWITCH: Konstantstrom</p> <table border="1"> <thead> <tr> <th>mA</th> <th>W</th> <th>V DC</th> <th>mA</th> <th>W</th> <th>V DC</th> </tr> </thead> <tbody> <tr> <td>100</td> <td>5,3</td> <td>54</td> <td>260</td> <td>14</td> <td>52</td> </tr> <tr> <td>140</td> <td>7,5</td> <td>54</td> <td>300</td> <td>16</td> <td>52</td> </tr> <tr> <td>180</td> <td>9,5</td> <td>53</td> <td>340</td> <td>18</td> <td>51</td> </tr> <tr> <td>220</td> <td>12</td> <td>53</td> <td>380</td> <td>20</td> <td>51</td> </tr> </tbody> </table> <p>Konstantspannung</p> <table border="1"> <thead> <tr> <th>W</th> <th>V DC</th> </tr> </thead> <tbody> <tr> <td>9</td> <td>24</td> </tr> </tbody> </table> <p>Symbolfoto</p>	mA	W	V DC	mA	W	V DC	100	5,3	54	260	14	52	140	7,5	54	300	16	52	180	9,5	53	340	18	51	220	12	53	380	20	51	W	V DC	9	24	5,4 - 20	100 - 380	54 - 51	111x52x22	W	24-123395	49,00	☺
mA	W	V DC	mA	W	V DC																																					
100	5,3	54	260	14	52																																					
140	7,5	54	300	16	52																																					
180	9,5	53	340	18	51																																					
220	12	53	380	20	51																																					
W	V DC																																									
9	24																																									

 IP20

LED KONVERTER PROFESSIONALE 36

INFO	W	mA	V DC	LxBxH	FARBE	ART. NR.	EURO	LAGER																																																										
 <p>LED-Konverter, DALI dimmbar, 230 V AC</p> <p>Einstellbar mittels DIP-SWITCH: Konstantstrom</p> <table border="1"> <thead> <tr> <th>mA</th> <th>W</th> <th>V DC</th> <th>mA</th> <th>W</th> <th>V DC</th> </tr> </thead> <tbody> <tr> <td>300</td> <td>16</td> <td>54</td> <td>700</td> <td>36</td> <td>51</td> </tr> <tr> <td>350</td> <td>18,5</td> <td>54</td> <td>750</td> <td>36</td> <td>48</td> </tr> <tr> <td>400</td> <td>21,5</td> <td>54</td> <td>800</td> <td>36</td> <td>45</td> </tr> <tr> <td>450</td> <td>24</td> <td>54</td> <td>850</td> <td>36</td> <td>42</td> </tr> <tr> <td>500</td> <td>27</td> <td>54</td> <td>900</td> <td>36</td> <td>40</td> </tr> <tr> <td>550</td> <td>29,5</td> <td>54</td> <td>950</td> <td>36</td> <td>37,5</td> </tr> <tr> <td>600</td> <td>32</td> <td>54</td> <td>1000</td> <td>36</td> <td>36</td> </tr> <tr> <td>650</td> <td>35</td> <td>54</td> <td>1050</td> <td>36</td> <td>34</td> </tr> </tbody> </table> <p>Konstantspannung</p> <table border="1"> <thead> <tr> <th>W</th> <th>V DC</th> </tr> </thead> <tbody> <tr> <td>16</td> <td>24</td> </tr> </tbody> </table> <p>Symbolfoto</p>	mA	W	V DC	mA	W	V DC	300	16	54	700	36	51	350	18,5	54	750	36	48	400	21,5	54	800	36	45	450	24	54	850	36	42	500	27	54	900	36	40	550	29,5	54	950	36	37,5	600	32	54	1000	36	36	650	35	54	1050	36	34	W	V DC	16	24	16 - 36	300 - 1050	54 - 34	130x42x30	W	24-127490	42,00	☺
mA	W	V DC	mA	W	V DC																																																													
300	16	54	700	36	51																																																													
350	18,5	54	750	36	48																																																													
400	21,5	54	800	36	45																																																													
450	24	54	850	36	42																																																													
500	27	54	900	36	40																																																													
550	29,5	54	950	36	37,5																																																													
600	32	54	1000	36	36																																																													
650	35	54	1050	36	34																																																													
W	V DC																																																																	
16	24																																																																	

 IP20

KONSTANTSTROM KONVERTER

LED KONVERTER MAXI JOLLY US 50

INFO	W	mA	V DC	LxBxH	FARBE	ART. NR.	EURO	LAGER																																				
 <p>LED-Konverter, 1-10V, PUSH & DALI dimmbar, 230 V AC</p> <p>Einstellbar mittels DIP-SWITCH:</p> <table border="1"> <thead> <tr> <th>mA</th> <th>W</th> <th>V DC</th> <th>mA</th> <th>W</th> <th>V DC</th> </tr> </thead> <tbody> <tr> <td>350</td> <td>25</td> <td>74</td> <td>750</td> <td>50</td> <td>66</td> </tr> <tr> <td>500</td> <td>35</td> <td>72</td> <td>850</td> <td>50</td> <td>58</td> </tr> <tr> <td>550</td> <td>39</td> <td>72</td> <td>900</td> <td>50</td> <td>55</td> </tr> <tr> <td>650</td> <td>46</td> <td>72</td> <td>1050</td> <td>50</td> <td>48</td> </tr> <tr> <td>700</td> <td>50</td> <td>71</td> <td></td> <td></td> <td></td> </tr> </tbody> </table>	mA	W	V DC	mA	W	V DC	350	25	74	750	50	66	500	35	72	850	50	58	550	39	72	900	50	55	650	46	72	1050	50	48	700	50	71				25 - 50	350 - 1050	74 - 48	124x79x22	W	24-122413	76,00	☺
mA	W	V DC	mA	W	V DC																																							
350	25	74	750	50	66																																							
500	35	72	850	50	58																																							
550	39	72	900	50	55																																							
650	46	72	1050	50	48																																							
700	50	71																																										

IP20

LED KONVERTER MAXY JOLLY TC DALI 55

INFO	W	mA	V DC	LxBxH	FARBE	ART. NR.	EURO	LAGER																																																																		
 <p>LED-Konverter, 1-10V, PUSH & DALI dimmbar, 230 V AC, für Durchgangsverdrahtung</p> <p>Einstellbar mittels DIP-SWITCH:</p> <table border="1"> <thead> <tr> <th>mA</th> <th>W</th> <th>V DC</th> <th>mA</th> <th>W</th> <th>V DC</th> </tr> </thead> <tbody> <tr> <td>300</td> <td>15</td> <td>52</td> <td>800</td> <td>40</td> <td>50</td> </tr> <tr> <td>350</td> <td>17</td> <td>52</td> <td>850</td> <td>42</td> <td>50</td> </tr> <tr> <td>400</td> <td>20</td> <td>50</td> <td>900</td> <td>45</td> <td>50</td> </tr> <tr> <td>450</td> <td>22</td> <td>50</td> <td>950</td> <td>47</td> <td>50</td> </tr> <tr> <td>500</td> <td>25</td> <td>50</td> <td>1000</td> <td>49</td> <td>49</td> </tr> <tr> <td>550</td> <td>27</td> <td>50</td> <td>1050</td> <td>51</td> <td>49</td> </tr> <tr> <td>600</td> <td>30</td> <td>50</td> <td>1100</td> <td>53</td> <td>49</td> </tr> <tr> <td>650</td> <td>32</td> <td>50</td> <td>1150</td> <td>55</td> <td>48</td> </tr> <tr> <td>700</td> <td>35</td> <td>50</td> <td>1200</td> <td>55</td> <td>46</td> </tr> <tr> <td>750</td> <td>37</td> <td>50</td> <td></td> <td></td> <td></td> </tr> </tbody> </table>	mA	W	V DC	mA	W	V DC	300	15	52	800	40	50	350	17	52	850	42	50	400	20	50	900	45	50	450	22	50	950	47	50	500	25	50	1000	49	49	550	27	50	1050	51	49	600	30	50	1100	53	49	650	32	50	1150	55	48	700	35	50	1200	55	46	750	37	50				15 - 55	300 - 1200	52 - 46	169x83x35	W	24-123164	86,00	☺
mA	W	V DC	mA	W	V DC																																																																					
300	15	52	800	40	50																																																																					
350	17	52	850	42	50																																																																					
400	20	50	900	45	50																																																																					
450	22	50	950	47	50																																																																					
500	25	50	1000	49	49																																																																					
550	27	50	1050	51	49																																																																					
600	30	50	1100	53	49																																																																					
650	32	50	1150	55	48																																																																					
700	35	50	1200	55	46																																																																					
750	37	50																																																																								

IP20

LED KONVERTER MAXI JOLLY HC TC 55

INFO	W	mA	V DC	LxBxH	FARBE	ART. NR.	EURO	LAGER																								
 <p>LED-Konverter, 1-10V, PUSH & DALI dimmbar, 230 V AC, für Durchgangsverdrahtung</p> <p>Einstellbar mittels DIP-SWITCH:</p> <table border="1"> <thead> <tr> <th>mA</th> <th>W</th> <th>V DC</th> <th>mA</th> <th>W</th> <th>V DC</th> </tr> </thead> <tbody> <tr> <td>1050</td> <td>45</td> <td>44</td> <td>1600</td> <td>55</td> <td>35</td> </tr> <tr> <td>1200</td> <td>52</td> <td>44</td> <td>1750</td> <td>55</td> <td>30</td> </tr> <tr> <td>1400</td> <td>55</td> <td>39</td> <td>2100</td> <td>55</td> <td>26</td> </tr> </tbody> </table>	mA	W	V DC	mA	W	V DC	1050	45	44	1600	55	35	1200	52	44	1750	55	30	1400	55	39	2100	55	26	45 - 55	1050 - 2100	44 - 26	169x83x35	W	24-123170	88,00	☺
mA	W	V DC	mA	W	V DC																											
1050	45	44	1600	55	35																											
1200	52	44	1750	55	30																											
1400	55	39	2100	55	26																											

IP20

SYNCHRONISATIONSKABEL FÜR MAXI JOLLY

INFO	L	FARBE	ART. NR.	EURO	LAGER
 <p>Für MAXI JOLLY LED-Konverter</p>	1500	W	24-485720512	6,00	☺
	4000	W	24-485720513	9,00	☺

LED KONVERTER FÜR LED PANELLEUCHTEN

INFO	SCHALTBAR / DIMMBAR	mA	LxBxH	FARBE	ART. NR.	EURO	LAGER
 <p>LED-Konverter 230 V AC, für Panelleuchte 757-625xx; inkl. STUCCHI Steckverbindung</p>	schaltbar	700	133x67x30	W	757-k700s	42,00	☺
	schaltbar	1050	133x67x30	W	757-k1050s	42,00	☺
	Dimmbar 1 - 10V, PUSH & DALI	700/1050	124x79x22	W	757-k700d	110,00	☺

IP20

KONSTANTSPANNUNGSKONVERTER

LED KONVERTER DRP FÜR HUTSCHIENE

INFO	W	V DC	LxBxH	FARBE	ART. NR.	EURO	LAGER
 <p>LED Konverter zur Montage auf Hutschiene, DIN-Rail Schutzschaltungen gegen Überlast und Überspannung, Kurzschlusserkennung mit automatischem Wiederanlauf, eingebauter PFC-Schaltkreis</p>	240	24	126x126x100	W	647-drp24024	171,00	

IP20

PARASITIC CURRENT PROTECTOR HV



INFO	LxBxH	ART. NR.	EURO	LAGER
Entstörfiltereinheit gegen Nachglimmen bei LED Modulen verwendbar bis max. 500mA & max. 80W belastbar notwendiger Anschlussblock 30-245254 (2x) separat ordern	145x22x22	30-223061	11,00	☺

IP20

ANSCHLUSSBLOCK



INFO	ART. NR.	EURO	LAGER
Anschlussblock für Entstörfiltereinheit 30-223061 pro Einheit werden 2 Anschlussblöcke (Eingang & Ausgang) benötigt, Kabellänge Klemmblock / JST Adapter = ca 80mm	30-245254	5,50	☺

DALI REPEATER SO DALI STEUERGERÄT



INFO	LxBxH	ART. NR.	EURO	LAGER
DALI Signalverstärker (Repeater) Erweiterung von DALI Anlagen um jeweils 64 EVG Die an den Repeater angeschlossenen EVG arbeiten als Gruppe Touch DIM Steuerung von jeweils 64 DALI EVG (ohne integrierten Lastkontakt) für Leuchteneinbau	198x30x21	28-292599	183,00	☺

IP20

DALI REPEATER SO DALI STEUERGERÄT



INFO	LxBxH	ART. NR.	EURO	LAGER
DALI-Signalverstärker / Steuergerät mit TOUCH-DIMM, Eingang für max. 64 DALI EVG, Ansteuerung mit jedem handelsüblichen Taster, der DALI-Ausgang erlaubt die Ansteuerung von OSRAM fremden DALI-EVG's (Philips, Tridonic usw.), mit TOUCH-DIMM Funktion, 230V, 50-60Hz	72x96x62	28-301093	220,00	☺

IP20

DALI MCU DALI STEUERGERÄT



INFO	BxH	ET	BLENDE BxH	ART. NR.	EURO	LAGER
DALI MCU Drehregler für max. 25 DALI EVG's, biszu 4 DALI MCU sind parallel verwendbar, Kompatibel mit Abdeckungen von Becker, Siemens und Gira, für genauere Informationen benutzen Sie bitte den aktuellen OSRAM Katalog, 230V / 50-60Hz, inkl. Blende (80x80mm) cremeweiß	71x71	50	80x80	28-189721	123,00	☺

IP20

DALI PCU STEUERGERÄT



INFO	LxBxH	ART. NR.	EURO	LAGER
DALI PCU Steuergerät (Eingang Taster / Ausgang DALI für 25 DALI Geräte) für Einbau in UP-Dose	48x48x22	28-955622	145,00	

IP20

DALIECO CONTROL STEUERGERÄT



IP20

INFO	LxBxH	ART. NR.	EURO	LAGER
2-Kanal-Lichtsteuergerät mit DALI-Schnittstelle; Anschluss für bis zu 32 elektronische Vorschaltgeräte möglich Ausgänge mit elektronisch reversiblen Übertemperatur-, Kurzschluss-, Überlastschutz	118x30x21	28-988645	56,00	

DALIECO CI KIT

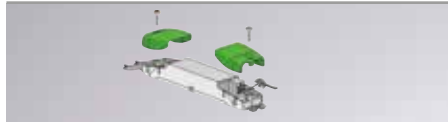

INFO	ART. NR.	EURO	LAGER
Zugentlastungskit für DALIECO CONTROL Steuergerät notwendig bei externer Montage von Steuergerät DALIECO CONTROL [Deckeneinbau]	28-392091	14,60	☺

DALIECO LS/PD LI

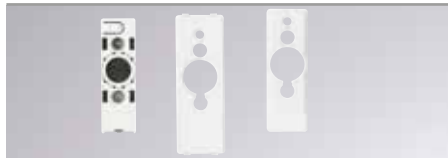

IP20

INFO	LxBxH	ART. NR.	EURO	LAGER
Licht- & Präsenzsensoren für Arbeitsplätze Präsenzerfassung über passives IR-Element, Präsenzerfassungsbereich über integrierte Shutter zwischen 40...90° einstellbar, Funktionsanzeige mit zweifarbigem LED, Integrierter Infrarot-Fernbedienungs-Empfänger; maximale Installationshöhe 5m, für externe Montage Zubehör separat bestellen	48x15x17	28-988652	54,00	

DALIECO DECKENEINBAUADAPTER



INFO	ØxHxD	ART. NR.	EURO	LAGER
Deckeneinbauadapter für DALIECO Sensoren [LS/PD]	80x36x68	28-920293	37,00	

DALIECO DECKENAUFBAUGEHÄUSE



INFO	LxBxH	ART. NR.	EURO	LAGER
Aufbaugehäuse für DALIECO Sensoren [LS/PD]	65x65x34	28-173385	43,00	

DALIECO REMOTE KIT MASTER



INFO	LxBxH	ART. NR.	EURO	LAGER
Fernbedienung [Master] für die Konfiguration und Inbetriebnahme des DALIECO Lichtsteuerungssystems; Digitale IR-Übertragung mit Reichweite bis 10m, LEDs zur Anzeige von Betriebs- und Programmiermodus und Signalübertragung, mit PC-Schnittstelle; im Lieferprogramm sind enthalten: Fernbedienung, 2 Stück Knopfzellen Typ CR2032, USB Verbindungskabel, DALIECO PC Software	230x45x13	28-195967	168,00	

DALIECO REMOTE USER



INFO	LxBxH	ART. NR.	EURO	LAGER
Fernbedienung [User] für das DALIECO-Lichtsteuerungssystem zur manuellen Steuerung von bis zu 15 Systemen, Digitale IR-Übertragung bis zu 10m Reichweite; Folgende Steuerungsmöglichkeiten sind mit dieser Fernbedienung möglich: Unabhängiges Dimmen und Schalten von zwei Lichtgruppen / Zentrales Schalten von zwei Lichtgruppen / Speicherung und Abruf von vier Lichtszenen Temporäre Deaktivierung der Präsenzerfassung (Holiday-Funktion); im Lieferumfang ist enthalten: Fernbedienung, 2 Knopfzellen Typ CR2032	230x33x10	28-826435	82,00	

DIMMER FÜR RGB-LED, DMX 512 ODER DALI



INFO	V DC	LxBxH	FARBE	ART. NR.	EURO	LAGER
<p>Dimmer für LED-RGB Strips 12-24V DC, Achtung: 12 V DC oder 24 V DC Konverter separat ordern</p> <p>Steuereingang 1 für DALI geeignet Steuereingang 2 für DMX 512 geeignet</p> <p>Input 12-24 V DC / Output 3 x 12-24 V dimm. je Kanal 2 A max. belastbar</p>	12-24	110x70x23	W	75-dmx200	42,00	☺

IP20

RGBW FUNK DIMMER



INFO	W	V DC	LxBxH	FARBE	ART. NR.	EURO	LAGER
<p>4-Kanal RGBW Funk Dimmer zur Ansteuerung von RGBW, RGB oder weißen LED Stripes max. 8A/Kanal, Spannungsversorgung separat ordern</p>	250W	12-36	170x59x29	W	322-ec2002	160,00	☺

IP20

UNIVERSALDIMMER



INFO	V DC	LxBxH	FARBE	ART. NR.	EURO	LAGER
<p>Universaldimmer 1 Kanal, separater Steuereingang für DALI, 1-10V, Push, Sync Anschluß für bis zu 9 Slaves bei 1-10V oder Push Ansteuerung, max. Anschluß: 5A Zugentlastung separat ordern</p>	12-50	153x30x21	W	322-ud3000	99,00	☺
Zugentlastung für 1-Kanal Universaldimmer, 2 Stück				322-ud7001	8,00	☺

IP20

DMX RGBW LED DIMMER



INFO	V DC	LxBxH	FARBE	ART. NR.	EURO	LAGER
<p>RGBW LED Dimmer 12-36V DMX, 12V - 36V DC, geeignet zur Steuerung von RGBW LED Flexbänder, max. 2,6A/Kanal</p>	12-36	160x45x18	W	354-dimrgbw	115,00	☺

IP20

LED LICHTSZENENKONTROLLER

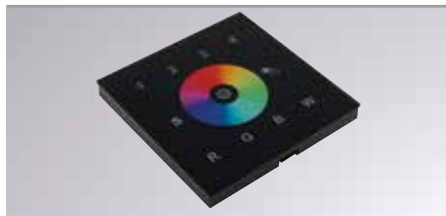

INFO	V DC	BxHxT	FÜR	FARBE	ART. NR.	EURO	LAGER
<p>RGBW DMX / Funk Controller für bis zu 4 Zonen, bis zu 4 Stimmungen, 8 fixe Farbbläufe Geschwindigkeit und Helligkeit kann angepasst werden; Steuerung kann auf Standard EB-Dose 68mm montiert werden</p>	12-24	86x86x10	DMX	S	322-con1000	160,00	☺
	12-24	86x86x10	WIFI/FUNK	S	322-con2001	160,00	☺

IP20

WLAN GATEWAY



INFO	V DC	BxHxT	FARBE	ART. NR.	EURO	LAGER
<p>W-Lan Gateway, zur Ansteuerung von allen EASY Color Komponenten, dazugehöriges App. EASYColor Pro im Appstore bzw. Playstore kostenlos erhältlich, Integration in hauseigenes WLAN möglich</p>	12-24	120x52x115	S	322-ec2001	160,00	☺

IP20

FUNK FERNBEDIENUNG



INFO	LxBxH	FARBE	ART. NR.	EURO	LAGER
Funk Fernbedienung für bis zu 4 Zonen, bis zu 4 Stimmungen, 8 fixe Farbabläufe Geschwindigkeit und Helligkeit kann angepasst werden, inkl. Wandhalterung	140x46x19	S	322-ec2003	160,00	☺

RGB LED CONTROLLER



Symbolfoto

INFO	V DC	LxBxH	FARBE	ART. NR.	EURO	LAGER
2,4GHz RGBW Funk-Controller 12-24V mit Touch Fernbedienung, Reichweite max. 30m, geeignet zur Steuerung von RGBW LED Streifen, Funktionen über Fernbedienung steuerbar: Monofarben mittels Farbrad, weiß, 15 Farbverlaufsprogramme, Dimmfunktion (9 Stufen), Memory-Funktion Ausgangsstrom max. 24A (4 x 6A)	12-24	85x45x27	W	354-con1001	95,00	☺

IP20

RGB LED CONTROLLER



Symbolfoto

INFO	V DC	LxBxH	FARBE	ART. NR.	EURO	LAGER
RGB-LED Controller, komplett mit Funkfernbedienung, Eingangsspannung, 12-24V DC, Ausgänge rot/grün/blau, je 4A belastbar (1x Plus und 3x-Minus), Reichweite Funksteuerung: max. 15m, Fernbedienung weiß, Controller silber, 8 wählbare Farben (rot, grün, blau, orange, gelb, cyan, pink), automatischer Farbdurchlauf, 12V oder 24V Konverter separat ordern	12-24	130x64x24	G	354-con1000	62,00	☺

IP20



PG KLEMMROHR

INFO	LxØ	FARBE	ART. NR.	EURO	LAGER
 <p>Klemmrohr mit PG Verschraubung für Wasserdichte Kabelverbindungen, 3-poliger Block, Verwendung nur mit Kabel H05SS-F, für Kabel Ø 5-13 mm</p> <p>IP68</p>	115x26,5	S	102-thb400a2a	10,20	☺

PG KLEMMROHR T-FORM

INFO	LxB	FARBE	ART. NR.	EURO	LAGER
 <p>Klemmrohr mit PG Verschraubung für Wasserdichte Kabelverbindungen, 3-poliger Block, Verwendung nur mit Kabel H05SS-F, für Kabel Ø 5-13,5 mm</p> <p>IP68</p>	116x92 Ø: 1x32, 2x26	S	102-thb402c2a	12,40	☺

LED TERMINAL 3050

INFO	FARBE	ART. NR.	EURO	LAGER
 <p>LED Verteiler in Serienschaltung (1 Eingang 2 Ausgänge), max. 60VDC bzw. 48VAC, max. 6A, Schneidbuchsen für 0,34 - 0,5mm², Ø 35mm, H 12mm</p> <p>zur leichten Serienschaltung</p>	W	802-601103	2,50	☺

FASSUNG GU5,3

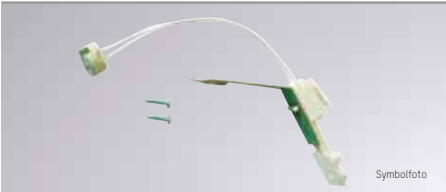
INFO	L	ART. NR.	EURO	LAGER
 <p>mit Klemme und Zugentlastung</p> <p>Symbolfoto</p>	115	259-502990	2,00	☺

12V
NV

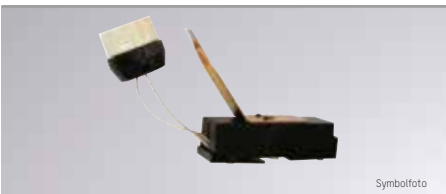

FASSUNG GU10

INFO	ART. NR.	EURO	LAGER
 <p>mit Klemme und Zugentlastung</p> <p>Symbolfoto</p>	259-502991	4,00	☺



230V
HV



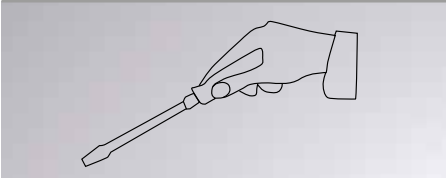

KONFEKTIONIERUNG LED STRIPE IP20/IP66

INFO	ART. NR.	EURO	LAGER
 <p>LED Band IP20 pro Zuschnitt beinhaltet: Zuschnitt, 50cm Anschlusskabel gelötet, Systemtest, ESD-Verpackung</p>	746-konfig20	19,50	☺
<p>LED Band IP65 pro Zuschnitt beinhaltet: Zuschnitt, 50cm Anschlusskabel gelötet, Anschnittversiegelung mit Silikon Schutzlack, Systemtest, ESD-Verpackung</p>	283-konf	19,50	☺

LED RETROFITS

SKIZZE	TYPE	WATTAGE	AUSSTRAHLWINKEL	EEL	LICHTFARBE	FASSUNG	ART. NR
	ST64 / Classic LED Bulb	4	>300	A++	827	E27	30-574034
	ST64 / Classic LED Bulb	7	>300	A++	827	E27	30-742754
	ST64 / Classic LED Bulb	7	>300	A++	806	E27	30-575697
	A60 / Classic LED Bulb	4	>300	A++	827	E27	30-573990
	A60 / Classic LED Bulb	6	>300	A++	827	E27	30-574010
	A60 / Classic LED Bulb	7,5	>300	A++	827	E27	30-709429
	G93 / Classic LED Bulb	7	>300	A++	806	E27	30-575758

SKIZZE	TYPE	WATTAGE	AUSSTRAHLWINKEL	EEL	LICHTFARBE	FASSUNG	ART. NR
	ST64 / Classic LED Bulb gold	7,5	>300	A+	820	E27	30-575734
	A60 / Classic LED Bulb gold	7	>300	A+	820	E27	30-575673
	G93 / Classic LED Bulb gold	7	>300	A+	820	E27	30-575772

SKIZZE	TYPE	WATTAGE	AUSSTRAHLWINKEL	EEL	LICHTFARBE	FASSUNG	ART. NR
	MasterLED Bulb klar	6	>300	A+	827-822	E27	30-481288
	MasterLED Bulb klar	9	>300	A+	827-822	E27	30-481325
	Master LED Bulb	11	>300	A+	827	E27	30-555514
	Master LED Bulb	15	>300	A+	827	E27	30-555552

SKIZZE	TYPE	WATTAGE	AUSSTRAHLWINKEL	EEL	LICHTFARBE	FASSUNG	ART. NR
	MasterLED Spot	5,5	25	A+	827	E27	30-460634
	MasterLED Spot	5,5	25	A+	830	E27	30-460658



SKIZZE	TYPE	WATTAGE	AUSSTRAHLWINKEL	EEL	LICHTFARBE	FASSUNG	ART. NR
	MasterLED Spot	9,5	25	A+	827	E27	30-550809



SKIZZE	TYPE	WATTAGE	AUSSTRAHLWINKEL	EEL	LICHTFARBE	FASSUNG	ART. NR
	MasterLED Spot	13	25	A+	827	E27	30-713761

SKIZZE	TYPE	WATTAGE	AUSSTRAHLWINKEL	EEL	LICHTFARBE	FASSUNG	ART. NR
	B35 / Classic LED Candle	2	>300	A++	827	E14	30-574072
	P45 / Classic LED Luster	2	>300	A++	827	E14	30-574133

SKIZZE	TYPE	WATTAGE	AUSSTRAHLWINKEL	EEL	LICHTFARBE	FASSUNG	ART. NR
	MasterLED Candle	4	>300	A+	827-822	E14	30-453681
	MasterLED Candle	6	>300	A+	827-822	E14	30-453506
	Master LED Luster	4	>300	A+	827-822	E14	30-453780
	Master LED Luster	6	>300	A+	827-822	E14	30-453582

LED RETROFITS

SKIZZE	TYPE	WATTAGE	AUSSTRAHLWINKEL	EEI	LICHTFARBE	FASSUNG	ART. NR
	CorePro LED Spot	2	36	A++	827	GU10	30-563229
	CorePro LED Spot	3,5	36	A+	827	GU10	30-485941
	MasterLED Spot VLE	4	36	A+	927	GU10	30-708095
	MasterLED Spot Expert Colour	4	25	A+	930	GU10	30-707517
	MasterLED Spot Expert Colour	4	36	A+	930	GU10	30-707579
	MasterLED Spot Expert Colour	5	36	A+	927	GU10	30-708118
	MasterLED Spot Expert Colour	5,5	25	A+	930	GU10	30-707630
	MasterLED Spot Expert Colour	2	36	A+	930	GU10	30-707692
	Classic LED Spot	4,6	36	A+	827	GU10	30-599945

SKIZZE	TYPE	WATTAGE	AUSSTRAHLWINKEL	EEI	LICHTFARBE	FASSUNG	ART. NR
	CorePro LED Spot	5	36	A+	827	GU5,3	30-579435
	MasterLED Spot VLE	3,4	24	A	827	GU5,3	30-475706
	MasterLED Spot VLE	3,4	24	A	830	GU5,3	30-475768
	MasterLED Spot VLE	3,4	36	A	827	GU5,3	30-475720
	MasterLED Spot VLE	3,4	36	A	830	GU5,3	30-475744
	MasterLED Spot	6,5	24	A	827-822	GU5,3	30-442135
	MasterLED Spot	6,3	24	A	830	GU5,3	30-490235
	MasterLED Spot	6,5	36	A	827-822	GU5,3	30-442159
	MasterLED Spot	6,3	36	A	830	GU5,3	30-490297

SKIZZE	TYPE	WATTAGE	AUSSTRAHLWINKEL	EEI	LICHTFARBE	FASSUNG	ART. NR
	MasterLED Spot	10	24	A	827	G53	30-514887
	MasterLED Spot	10	24	A	830	G53	30-514900
	MasterLED Spot	10	40	A	827	G53	30-514924
	MasterLED Spot	10	40	A	830	G53	30-514948
	MasterLED Spot	15	24	A	827	G53	30-514962
	MasterLED Spot	15	24	A	830	G53	30-514986
	MasterLED Spot	15	40	A	827	G53	30-515006
	MasterLED Spot	15	40	A	830	G53	30-515020
	MasterLED Spot	20	24	A	827	G53	30-515044

SKIZZE	TYPE	VOLT	WATTAGE	AUSSTRAHLWINKEL	EEI	LICHTFARBE	FASSUNG	ART. NR
	CorePro LED		2,5	>200	A+	827	G9	30-419205

SKIZZE	TYPE	VOLT	WATTAGE	AUSSTRAHLWINKEL	EEI	LICHTFARBE	FASSUNG	ART. NR
	CorePro LED		1,2		A+	830	G4	30-422281

SKIZZE	TYPE	VOLT	WATTAGE	AUSSTRAHLWINKEL	EEI	LICHTFARBE	FASSUNG	ART. NR
	CorePro LED		6,5	>300	A++	830	R7s	30-522530
	CorePro LED		14	>300	A+	830	R7s	30-578797

LEUCHTMITTEL

SKIZZE	TYPE	VOLT	WATTAGE	AUSSTRAHLWINKEL	EEI	LICHTFARBE	FASSUNG	ART. NR
	A60 ECO	230V	20		D	2700K	E27	28-927163
	A60 ECO	240V	30		D	2700K	E27	28-229267
	A60 ECO	240V	46		D	2700K	E27	28-229281
	A60 ECO	240V	57		D	2800K	E27	28-403315
	A60 ECO	240V	77		D	2800K	E27	28-927200
	A60 ECO	240V	116		D	2800K	E27	28-928153

SKIZZE	TYPE	VOLT	WATTAGE	AUSSTRAHLWINKEL	EEI	LICHTFARBE	FASSUNG	ART. NR
	D45 ECO	230V	20		D	2700K	E14	28-927446
	D45 ECO	230V	30		D	2700K	E14	28-927460
	D45 ECO	230V	46		D	2700K	E14	28-927484

SKIZZE	TYPE	VOLT	WATTAGE	AUSSTRAHLWINKEL	EEI	LICHTFARBE	FASSUNG	ART. NR
	QT14 ECO	240V	20		D	2700K	G9	28-945556
	QT14 ECO	230V	33		D	2700K	G9	28-208668
	QT14 ECO	240V	48		D	2800K	G9	28-945334
	QT14 ECO	240V	60		D	2800K	G9	28-945655

SKIZZE	TYPE	VOLT	WATTAGE	AUSSTRAHLWINKEL	EEI	LICHTFARBE	FASSUNG	ART. NR
	QT32 ECO	230V	70		D	2800K	E27	28-393821
	QT32 ECO	240V	100		D	2900K	E27	28-393845
	QT32 ECO	240V	150		D	2900K	E27	28-393869
	QT32 ECO	240V	205		D	3000K	E27	28-393883

SKIZZE	TYPE	WATTAGE	WATTAGE	AUSSTRAHLWINKEL	EEI	LICHTFARBE	FASSUNG	ART. NR
	QR-CBCS1 ECO	12	14	10	B	3000K	GU5,3	--
	QR-CBCS1 ECO	12	14	36	B	3000K	GU5,3	28-945044
	QR-CBCS1 ECO	12	20	10	B	3000K	GU5,3	28-620169
	QR-CBCS1 ECO	12	20	24	B	3000K	GU5,3	28-620183
	QR-CBCS1 ECO	12	20	36	B	3000K	GU5,3	28-620206
	QR-CBCS1 ECO	12	35	10	B	3000K	GU5,3	28-516592
	QR-CBCS1 ECO	12	35	24	B	3000K	GU5,3	28-516615
	QR-CBCS1 ECO	12	35	36	B	3000K	GU5,3	28-516639
	QR-CBCS1 ECO	12	50	10	B	3000K	GU5,3	28-516677
	QR-CBCS1 ECO	12	50	24	B	3000K	GU5,3	28-516691
	QR-CBCS1 ECO	12	50	36	B	3000K	GU5,3	28-516714

SKIZZE	TYPE	VOLT	WATTAGE	AUSSTRAHLWINKEL	EEI	LICHTFARBE	FASSUNG	ART. NR
	QR-111 ECO	12	35	6	B	2900K	G53	28-656823
	QR-111 ECO	12	35	24	B	2900K	G53	28-656847
	QR-111 ECO	12	50	6	B	3000K	G53	28-656861
	QR-111 ECO	12	50	24	B	3000K	G53	28-656885
	QR-111 ECO	12	50	40	B	3000K	G53	28-909237
	QR-111 ECO	12	60	6	B	3000K	G53	-
	QR-111 ECO	12	60	24	B	3000K	G53	28-786094
	QR-111 ECO	12	60	40	B	3000K	G53	28-909251

LEUCHTMITTEL

SKIZZE	TYPE	WATTAGE	AUSSTRAHLWINKEL	EEI	LICHTFARBE	FASSUNG	ART. NR
	T16	14	VPE 40	A+	827	G5	28-645933
	T16	14	VPE 40	A+	830	G5	28-464824
	T16	14	VPE 20	A+	830	G5	28-591520
	T16	14	VPE 40	A+	840	G5	28-464688
	T16	14	VPE 20	A+	840	G5	28-591384
	T16	21	VPE 40	A+	827	G5	28-645971
	T16	21	VPE 20	A+	827	G5	28-645957
	T16	21	VPE 40	A+	830	G5	28-464800
	T16	21	VPE 20	A+	830	G5	28-591506
	T16	21	VPE 40	A+	840	G5	28-464701
	T16	21	VPE 20	A+	840	G5	28-591407
	T16	24	VPE 20	A	827	G5	28-646077
	T16	24	VPE 40	A	830	G5	28-453491
	T16	24	VPE 20	A	830	G5	28-591667
	T16	24	VPE 40	A	840	G5	28-453477
	T16	24	VPE 20	A	840	G5	28-591643
	T16	28	VPE 40	A+	827	G5	28-646015
	T16	28	VPE 20	A+	827	G5	28-645995
	T16	28	VPE 40	A+	830	G5	28-464787
	T16	28	VPE 20	A+	830	G5	28-591483
	T16	28	VPE 40	A+	840	G5	28-464725
	T16	28	VPE 20	A+	840	G5	28-591421
	T16	35	VPE 40	A+	827	G5	28-646053
	T16	35	VPE 20	A+	827	G5	28-646039
	T16	35	VPE 40	A+	830	G5	28-464763
	T16	35	VPE 20	A+	830	G5	28-591469
	T16	35	VPE 40	A+	840	G5	28-464749
	T16	35	VPE 20	A+	840	G5	28-591445
	T16	39	VPE 40	A+	827	G5	28-646138
	T16	39	VPE 40	A+	830	G5	28-453552
	T16	39	VPE 20	A+	830	G5	28-591728
	T16	39	VPE 40	A+	840	G5	28-453538
	T16	39	VPE 20	A+	840	G5	28-591704
	T16	49	VPE 20	A+	827	G5	28-796772
	T16	49	VPE 40	A+	830	G5	28-657158
	T16	49	VPE 20	A+	830	G5	28-796758
	T16	49	VPE 40	A+	840	G5	28-657134
	T16	49	VPE 20	A+	840	G5	28-796710
	T16	54	VPE 20	A+	827	G5	28-646152
	T16	54	VPE 40	A+	830	G5	28-453415
T16	54	VPE 20	A+	830	G5	28-591605	
T16	54	VPE 40	A+	840	G5	28-453392	
T16	54	VPE 20	A+	840	G5	28-591582	
T16	80	VPE 40	A+	827	G5	28-646213	
T16	80	VPE 40	A+	830	G5	28-515137	
T16	80	VPE 20	A+	830	G5	28-591827	
T16	80	VPE 40	A+	840	G5	28-515 151	
T16	80	VPE 20	A+	840	G5	28-591841	

HINWEISE FÜR BODENEINBAUSTRALER

Allgemeine Hinweise

Die Auswahl von Bodeneinbaustrahler wird von wichtigen Kriterien bestimmt, wie etwa Oberflächentemperatur (Verletzungsgefahr) oder Einbauort (Innen / Außen) und Belastungsanforderung (begehbar / überrollbar). Diese sind grundsätzlich von einem Fachmann zu beurteilen, dennoch hier eine kurze Erklärung: Begehbar heißt, daß der Strahler der statischen Belastung standhält, die ein Mensch beim Darübergehen verursacht. Überrollbar bedeutet, daß ein Fahrzeug darüberrollen darf. Bremsvorgänge und Lenkbewegungen sind aber auf dem Bodeneinbaustrahler nicht erlaubt, da sie eine enorme Belastung darstellen. Die Belastbarkeit wird im Datenblatt angegeben. z.B.: 2000kg bei max. 20 km/h. Es dürfen keine Lasten dauerhaft auf einem Strahler verbleiben. Halten und Parken auf einem Strahler ist daher nicht erlaubt.

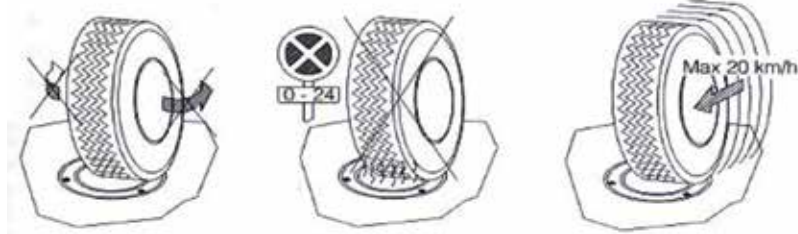

Vor dem Einbau eines Strahlers ist zusätzlich die originale Einbauanleitung zu lesen, um etwaige Besonderheiten oder Eigenschaften eines Strahlers kennenzulernen. Grundsätzlich ist die professionelle Montage von Bodeneinbaustrahler eine Präzisionsarbeit. Das erfordert Zeit und einen ordentlichen Arbeitsablauf, tadelloses Werkzeug ist Voraussetzung. Trockene Witterungsverhältnisse sind bei der Montage von Vorteil.

Bodeneinbaustrahler im Außenbereich - Schutzart IP67 / IP68 - Bedeutung

Die Schutzart eines Bodeneinbaustrahlers betrifft nur den Strahler selbst, nicht aber das Einbaugehäuse, in welches der Strahler montiert wird. Das Betoneinbaugehäuse dient lediglich als äußeres Gehäuse, das einbetoniert wird. Dieses Gehäuse kann aus Metall oder Kunststoff sein, und dient zur mechan. Befestigung des Strahlers. In der Fuge zwischen Strahler und Gehäuse kann demnach Wasser eindringen. Es ist wichtig, daß dieses Wasser im Boden rasch ablaufen kann, und der Bodeneinbaustrahler nicht im Wasser steht. Durch die Hitzeentwicklung bei eingeschaltetem Strahler herrscht im Inneren ein Überdruck, die heiße Luft dehnt sich also aus und entweicht. Wird der Strahler abgeschaltet, so kühlt er ab, und es entsteht im Inneren ein Unterdruck, es wird Luft angesaugt. Steht der Strahler aber im Wasser, so wird Wasser angesaugt!

Das Einbaugehäuse

Manche Hersteller fertigen ihre Bodeneinbaugehäuse nach unten offen, was den Wasserablauf deutlich begünstigt.



Andere Hersteller fertigen geschlossene Einbaugehäuse, die keinen ordentlichen Wasserablauf erwarten lassen, aber Vorteile beim Einbau im Innenbereich haben (Eindringen von Beton). Bei Verwendung im Außenbereich ist es hier notwendig, bauseits eine entsprechend große Öffnung in den Boden des Einbaugehäuses zu schneiden, um einen raschen Wasserablauf zu ermöglichen.

Drainage

Jede Drainage muß vor Installation der Leuchte auf Funktionsfähigkeit überprüft werden! Füllen sie zu diesem Zweck das Einbaugehäuse mit Wasser, nach spätestens 30 Minuten muß das Gehäuse leer sein, ansonst ist die Drainage unzureichend!



Kiesdrainage

Unter dem Einbaugehäuse wird eine 20-30cm dicke Kiesschicht aufgefüllt, die ein Abfließen des in das Einbaugehäuse eingedrungenes Wasser gewährleistet! Achtung: Sand, Bauschotter oder dergleichen sind für eine Drainage aufgrund der zu geringen Abflussgeschwindigkeit ungeeignet.



Keine Kiesdrainage – Wasserablauf durch Schlauch

Falls es nicht möglich ist eine Kiesdrainage herzustellen (z.B. Balkon) muß der Wasserablauf durch einen Schlauch gewährleistet werden. Dieser muß ausreichend dimensioniert sein und darf nicht durch Verschmutzung verstopfen.

Bodenmaterial - Bodenbelag

Das Einbaugeschäule darf durch den Einbau keinesfalls in seiner Form verbogen, gestaucht etc. werden. Besondere Vorsicht ist hier bei Steinplatten geboten. Wird das Geschäule verbogen, kann der Befestigungsring des Schutzglases klemmen, und der Strahler kann somit undicht werden.

Die Anschlussleitung

hier ist ausschließlich ein Kabel der Type H07RN-F oder H07RN8-F zu verwenden. Jedes andere Kabel wird gemeinsam mit der Kabelverschraubung nicht dicht werden, da es bei Kälte nicht flexibel ist.

H07 RN-F



H07 RN8-F



Kabelverbindungen

sind einfach und dauerhaft mit IP68 Klemmrohren auszuführen. Kabeldurchmesser beachten. Es darf im Strahler keine zusätzliche Bohrung für eine weitere Kabel- Verschraubung vorgenommen werden.



Betriebsgeräte

Einige Bodeneinbaustrahler sind besonders klein, und haben aus Platzgründen oder thermischen Gründen das Betriebsgerät nicht eingebaut, benötigen also ein externes Betriebsgerät. Im Innenbereich kann das Betriebsgerät in das Einbaugeschäule gelegt werden (Achtung Wärme). Im Außenbereich gehört das Betriebsgerät aber nicht in das Einbaugeschäule des Strahlers, dort hat es nichts verloren, denn das Betriebsgerät könnte dort im Wasser liegen. Es gehört daher in einen Subverteiler oder einen Verteilerkasten, der an geeigneter Stelle montiert ist.

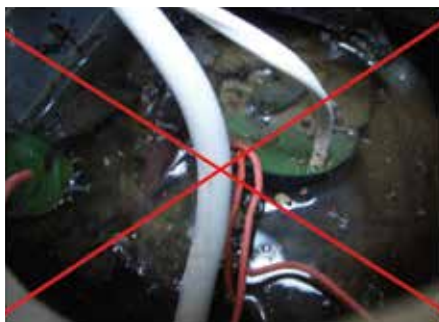

Reinigung der Dichtflächen

Die Dichtung und die Dichtflächen müssen vor dem Einbau gereinigt werden, am besten mit Alkohol oder einem geeigneten Lösungsmittel. Anschließend sind die Dichtung und die Dichtflächen mit einem dünnen Film Vaseline einzufetten. Wichtig: Anschließend nicht mehr beschmutzen: Sand, Staub, Fasern etc.

Die Befestigungsschrauben

Befestigungsschrauben, welche das Glas oder den Befestigungsring mit der Dichtung an die Dichtfläche pressen, müssen leichtgängig sein und ein unbeschädigtes Gewinde aufweisen. Die Befestigungsschrauben sind jeweils gegenüberliegend anzuziehen, am Besten in 2-3 Durchgängen mit jeweils gesteigertem Drehmoment. Bei Nichtbeachtung sinkt die mechanische Belastbarkeit drastisch und das Glas kann zerspringen. Eventuelle Angaben zum Drehmoment berücksichtigen. Falls der Hersteller keine Angaben macht die Schrauben gefühlvoll, aber handfest anziehen.

Leuchtmittel wechseln

Nach dem Leuchtmittelwechsel müssen Glas und Dichtung gereinigt werden. Beim Einsetzen der Dichtung Vaseline benutzen.

Dichtungen

Falls es vom Hersteller Ersatzdichtungen für den Strahler gibt, ist es sinnvoll, bei defekten, alten Dichtungen diese gegen neue auszutauschen. Abdichtungen mit Fugen-Silikon sind bei einem Bodeneinbaustrahler völlig sinnlos und daher zu unterlassen!

EVG - INSTALLATIONSHINWEISE

Ein elektronisches Vorschaltgerät ist ein elektrisches Betriebsmittel. Beachten Sie daher die fünf Sicherheitsregeln für die Durchführung von Arbeiten an elektrischen Anlagen (diese finden Sie in den einschlägigen Vorschriften der Elektrotechnik). Dies bedeutet im Besonderen, dass der Anschluss eines EVGs sowie Wartungsarbeiten oder das Ersetzen eines Leuchtmittels nur in spannungsfreiem Zustand erfolgen darf! Weiters gibt es einige Punkte die zu beachten sind:

1a. LED-Konverter: maximale Anzahl von LED-Konvertern pro Leitungsschutzschalter (LS), z. B. MP50K3 (24-122204), 15 Stück (Leitungsschutzschalter 16A, Auslösecharakteristik B).

Da es viele Hersteller gibt und die Palette an LED-Konvertern je Hersteller sehr groß ist, können hierzu keine genauen Angaben gemacht werden. Für verlässliche Daten überprüfen Sie bitte genau welcher LED-Konverter in der betroffenen Leuchte verbaut ist und fragen beim Hersteller des LED-Konverters nach.

1b. Leuchtstofflampen: maximale Anzahl der EVGs pro Leitungsschutzschalter (LS), für einen Leitungsschutzschalter Standardtype 16A mit Auslösecharakteristik B.

Da es viele EVG-Hersteller gibt und die Palette an EVGs je Hersteller sehr groß ist, können hierzu keine genauen Angaben gemacht werden. Für verlässliche Daten überprüfen Sie bitte genau welches EVG in der betreffenden Leuchte verbaut ist und fragen beim Hersteller des EVGs nach. Verbindliche Angaben sind auch durch die Vielzahl der Hersteller von EVGs und Leitungsschutzschalter nicht möglich.

1c. Hochdruckentladungslampen: maximale Anzahl der EVGs pro Leitungsschutzschalter (LS), für einen Leitungsschutzschalter Standardtype 16A mit Auslösecharakteristik B.

2. Die Umgebungstemperatur eines EVGs bei Deckeneinbau (für EVGs allgemein)

Die Lebensdauer eines EVGs hängt wesentlich von der Umgebungstemperatur ab. Auf jedem EVG gibt es einen Tc-Messpunkt dessen aufgedruckte maximal zulässige Temperatur nicht überschritten werden darf.

Beispiel: auf dem EVG ist aufgedruckt Tc=75°C.

Die zu erwartende Temperatur in der Leuchte liegt in der Praxis meist ca. 15°C niedriger, also bei etwa 60°C.

Die **maximal zulässige Umgebungstemperatur in der Decke** ist nochmals ca. 15°C niedriger und **liegt somit bei etwa 45°C**. Es ist daher wichtig für ausreichende Belüftung in der Decke zu sorgen. Werden diese Temperaturen z.B. um 10°C überschritten, so sinkt die Lebensdauer des EVGs auf etwa die Hälfte. Eine **Wärmedämmung ist bei Einbauleuchten daher grundsätzlich zu vermeiden**, nicht nur wegen Brandgefahr.

3. Spannungsversorgung im 3-Phasen Netz: Sternpunkt beachten!

Bei einer Dreiphasen-Installation hat der Neutralleiter einen besonderen Stellenwert, dieser sorgt dafür, dass die Sternpunkt-Nullspannungen genau 230V betragen. Wird der Neutralleiter unterbrochen oder erst nach dem Phasenleiter angeschlossen, gibt es keinen definierten Sternpunkt, was zur sofortigen Zerstörung der EVGs führt. An diesen liegt nämlich ohne definiertem Sternpunkt direkt die Außenleiterspannung von 400V an. Bei einer Neutralleiterunterbrechung passiert das Gleiche.

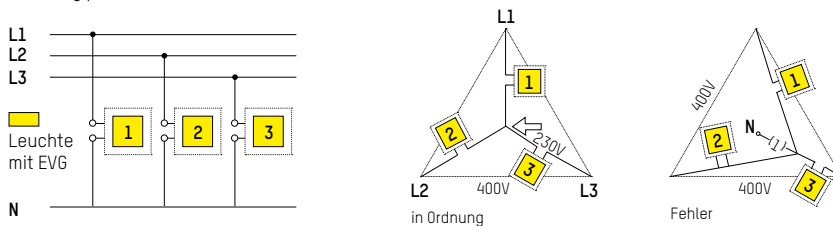

4. Treppenhausautomat: Schaltfestigkeit von EVGs und Leuchtstofflampen / Kompaktleuchtstofflampen / Energiesparlampen

EVGs und Leuchtstofflampen / Kompaktleuchtstofflampen sind nicht oder nur bedingt für die große Schalt häufigkeit eines Treppenhausautomaten geeignet!

Es ist mit einer teilweise drastischen Verkürzung der Lebensdauer bei Lampe und/oder EVG zu rechnen.

Bei Energiesparlampen mit integriertem EVG (E27 Fassung) gibt es Sondertypen (Osram) die speziell für den Einsatz an Treppenhausautomaten geeignet sind.

5. Dimmen von EVGs und Leuchtstofflampen / Kompaktleuchtstofflampen

Standard-EVGs sind NICHT dimmbar! Dimmbare EVGs gibt es in analoger Technologie (1-10V), oder digitaler Technologie (DALI). Beide Technologien benötigen eine 5-polige Anspeisung (Phase / Neutralleiter / Schutzleiter, und zwei Steuerleitungen)

SwitchDIMM: EVGs die mit dieser Funktion ausgestattet sind, können mit einem handelsüblichen Taster ein/ausgeschaltet und gedimmt werden.

Für Osram-SwitchDIMM gilt: maximal 4-6 EVGs pro Taster, bei mehreren EVGs pro Stromkreis DALI-Repeater oder DALI-MCU-Steuergerät benutzen.

Diese finden Sie in diesem Katalog in der Rubrik Betriebsgeräte.

Hinweis: SwitchDIMM ist lediglich eine Zusatzfunktion mancher Hersteller bei EVGs und kein Bestandteil des DALI-Standards.



6. Lebensdauer von Hochdruckentladungslampen (professionelle Wartung)



Alle HIT und HST-Leuchtmittel müssen am Ende ihrer Lebensdauer zuverlässig ausgetauscht werden. Dies gilt sowohl für den Betrieb am KVG als auch am EVG.

Bei sichtbarer Verfärbung des eingeschalteten Leuchtmittels (Farbabweichung z.B. grünlich), bei deutlich verminderter Lichtleistung, bei flackerndem Leuchtmittel und bei allen anderen Symptomen welche am Lebensdauerende einer Hochdruckentladungslampe auftreten können, muss das Leuchtmittel umgehend ersetzt werden. Falls kein Austausch erfolgt besteht ernsthafte Gefahr einer Beschädigung des Strahlers durch Überhitzung bis hin zu Folgeschäden wie Verfärbung von Oberflächen oder sogar Brandschäden etc.



IP - SCHUTZARTEN		
1. Ziffer	Berührungsschutz	Schutz gegen das Eindringen von Fremdkörpern und Staub
IP 0X	ungeschützt	kein besonderer Schutz
IP 1X	Schutz gegen Fremdkörper > 50 mm	Größere Körperteile wie eine Hand (jedoch keine Schutzmaßnahme gegen bewusste Berührung)
IP 2X	Schutz gegen Fremdkörper > 12 mm	Finger und dergleichen bis 80 mm Länge; Fremdkörper >12 mm Durchmesser
IP 3X	Schutz gegen Fremdkörper > 2,5 mm	Werkzeuge, Drähte usw. mit Durchmesser oder Dicke > 2,5 mm; Fremdkörper > 2,5mm
IP 4X	Schutz gegen Fremdkörper >1 mm	Drähte oder Streifen > 1mm; Fremdkörper > 1 mm Durchmesser
IP 5X	Staubschutz	Eindringen von Staub wird nicht völlig verhindert, aber Staub dringt nicht in solchen Mengen ein, daß ordnungsgemäßer Betrieb behindert wird.
IP 6X	Staubdicht	kein Eindringen von Staub
2. Ziffer	Wasserschutz	Schutz gegen das Eindringen von Wasser
IP X0	ungeschützt	kein besonderer Schutz
IP X1	Schutz gegen Tropfwasser	Tropfwasser (senkrecht fallende Tropfen) verursacht keine Schädigung.
IP X2	Schutz gegen Tropfwasser unter 15°	Senkrecht fallende Tropfen dürfen keine Schädigung bewirken, wenn das Gehäuse bis zu 15° aus seiner bestimmungsgemäßen Gebrauchslage gekippt wird.
IP X3	Schutz gegen Sprühwasser	Sprühwasser darf aus einer Neigung bis 60° gegen die Senkrechte keine Schädigung verursachen.
IP X4	Schutz gegen Spritzwasser	Spritzwasser aus beliebiger Richtung darf keine Schädigung verursachen
IP X5	Schutz gegen Strahlwasser	Strahlwasser aus einer Düse aus einer Richtung darf keine Schädigung verursachen.
IP X6	Schutz gegen schwere See	Schwere See oder Strahlwasser unter hohem Druck dürfen nicht in gefahrbringender Menge in das Gehäuse eindringen.
IP X7	Schutz gegen das Eintauchen (t)	Eindringen von Wasser in gefahrbringender Menge dürfen beim Eintauchen in Wasser unter vorgegebenen Bedingungen hinsichtlich Druck und Zeit nicht stattfinden.
IP X8	Schutz gegen Untertauchen (t ...m)	Das Gerät ist unter Bedingungen, die vom Hersteller genannt werden, für Dauerbetrieb unter Wasser geeignet. Anmerkung: Üblicherweise bedeutet dies, daß das Gerät vollständig abgedichtet ist. Jedoch kann dies bei bestimmten Geräten auch bedeuten, das Wasser zwar eindringt, jedoch keine Schädigung verursacht.

SCHUTZKLASSEN	
	<p>Schutzklasse I: Geräte und Leuchten mit Anschlussstelle für Schutzleiter, mit der alle berührbaren Metallteile verbunden sein müssen, die im Fehlerfall unmittelbar Spannung annehmen können. Anschluss an Netzschutzleiter zwingend erforderlich. Das Symbol ist an der Anschlussstelle angebracht.</p>
	<p>Schutzklasse II: Bei solchen Geräten dürfen keine Metallteile berührbar sein, die im Fehlerfall unmittelbar Spannung annehmen können (Schutzisolierung oder doppelte Isolierung). Leuchte darf keinen Schutzleiteranschluss haben und nicht mit Netz- Schutzleiter verbunden werden.</p>
	<p>Schutzklasse III: Leuchten zum Betreiben mit Schutzkleinspannung (SELV), d.h. mit Spannungen unter 50V, die ein Sicherheitstransformator nach DIN VDE 0551 (EN60742) erzeugt oder die aus Batterien bzw. Akkumulatoren entnommen werden. Das Gerät darf keinen Schutzleiteranschluss haben und nicht mit Netz- Schutzleitern verbunden werden.</p>

LEUCHTEN- UND BRANDSCHUTZ	
	<p>F-Zeichen Leuchten mit dieser Kennzeichnung sind zur unmittelbaren Montage auf Gebäudeteilen aus nicht brennbarem, schwer- und normal entflammablen Baustoffen nach DIN 4102 geeignet. Leuchten mit F-Zeichen müssen so gebaut sein, dass an der Befestigungsfläche die Temperatur im anormalen Betrieb 130°C und im Fehlerfall des Vorschaltgeräts 180°C nicht überschritten werden.</p>
	<p>M-Zeichen Leuchten mit M-Kennzeichnung sind für den Einbau in Möbel bestimmt. Sie sind so gebaut, dass im Fehlerfall des Vorschaltgeräts schwer- und normalentflammbare Werkstoffe im Sinn von DIN 4102, z.B. Ecken in Möbeln nicht entzündet werden können.</p>
	<p>MM-Zeichen Leuchten mit MM-Kennzeichen sind zum Ein- oder Anbau an Möbel bestimmt, die aus Werkstoffen bestehen, deren Entflammeigenschaften nicht bekannt sind. Sie sind so gebaut, dass im normale Betrieb keine Befestigungsfläche und andere benachbarte Flächen der Möbel eine Temperatur von 95°C überschreiten. Bei 1,1-facher Nennspannung und im Fehlerfall des Vorschaltgeräts darf die maximale Temperatur an der Befestigungsfläche 115°C betragen.</p>

DIMMEN VON LED & LEUCHTSTOFFLAMPEN

DIMMEN DALI - TASTER

nur DALI EVGs mit integrierter Touch DIM Funktion
für max. 2 EVGs möglich, 1-Phasen Betrieb möglich

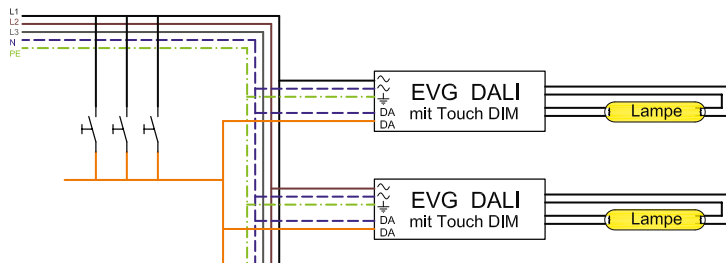

... max. 2 DALI EVG



Schalten und Dimmen mit allen handelsüblichen Tastern

DIMMEN DALI - DALI MCU

alle DALI EVGs

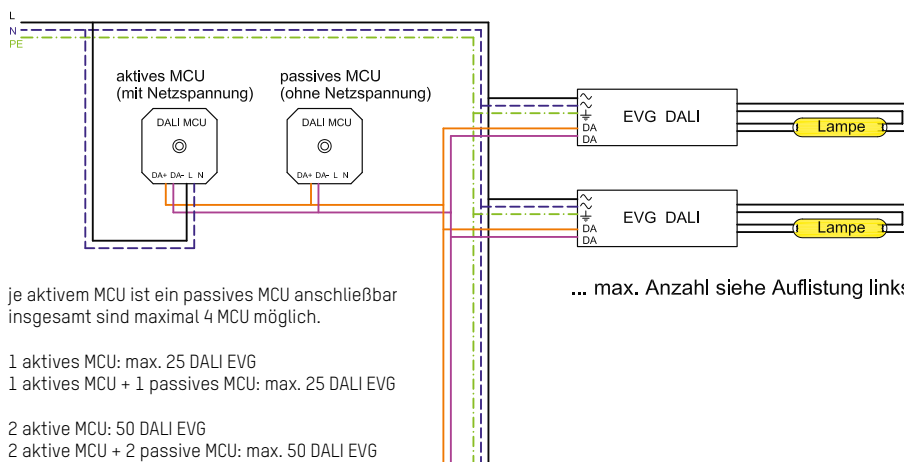

je aktivem MCU ist ein passives MCU anschließbar
insgesamt sind maximal 4 MCU möglich.

- 1 aktives MCU: max. 25 DALI EVG
- 1 aktives MCU + 1 passives MCU: max. 25 DALI EVG
- 2 aktive MCU: 50 DALI EVG
- 2 aktive MCU + 2 passive MCU: max. 50 DALI EVG
- 3 aktive MCU: 75 DALI EVG
- 3 aktive MCU + 1 passives MCU: max. 75 DALI EVG
- 4 aktive MCU: max. 100 DALI EVG

... max. Anzahl siehe Auflistung links



Schalten und Dimmen mit handelsüblichem Potentiometer

DIMMEN DALI - DALI REPEATER S0

alle DALI EVGs, für max. 64 EVGs

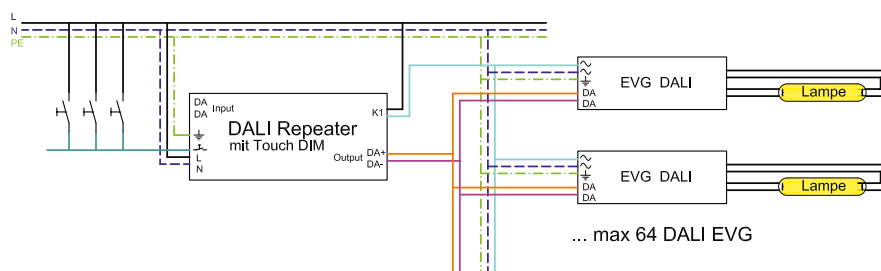

... max 64 DALI EVG

LED - HINWEISE ZUR VERKABELUNG

Der Anschluß von elektrischen Verbrauchern an das elektrische Stromnetz unterliegt bestimmten Kriterien, diese sind Spannung, Strom, Polarität und Frequenz, und wir unterscheiden wie folgt:

1. Spannung

alle Verbraucher die die **gleiche Spannung** benötigen, werden **parallel an** die Spannungsquelle angeschlossen. Die Höhe des Stroms der durch die einzelnen Verbraucher fließt wird durch den Verbraucher bestimmt.

Transformatoren konventioneller Bauart sind Geräte welche Wechselspannung in der Höhe verändern können, z.B. von 230V/50Hz auf 12V/50Hz.

Transformatoren elektronischer Bauart sind Geräte welche Wechselspannung in der Höhe verändern können, dabei aber auch die Frequenz verändern, z.B. von 230V/50Hz auf 12V/20kHz. 12V Glühlampen kommen damit zurecht, andere Verbraucher aber nicht, auch keine 12V LEDs. (Ausnahme LED Retrofit)

1.1 Parallel - Schaltung

1.1.1 Niedervolt Reflektor- Lampen 12V (20W, 35W, 50W,)

Diese sind seit vielen Jahren weit verbreitet. Hier werden alle Lampen an die 12V Ausgangsspannung des Trafos angeschlossen. Es können konventionelle Trafos mit 12V/50Hz Ausgangsspannung verwendet werden, oder elektronische Trafos mit 12V/20 kHz Ausgang (Hochfrequenz).

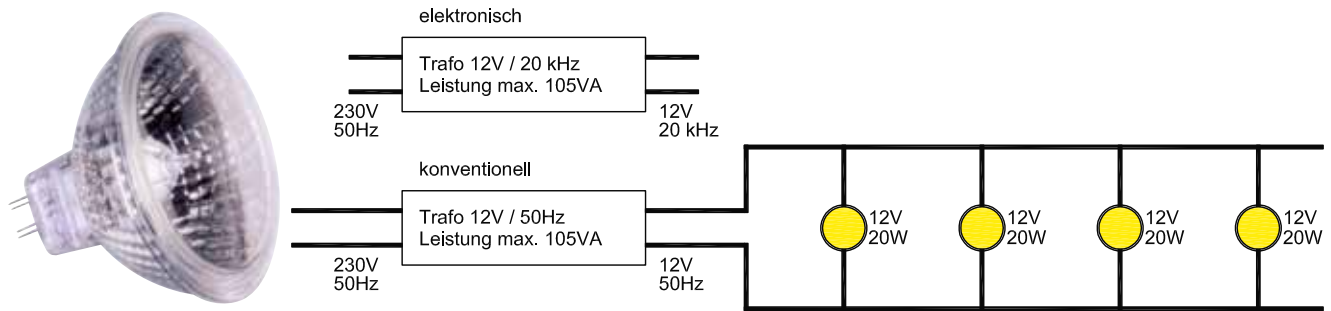

Dimmen: Phasenanschnitt-Dimmer für konventionelle Trafos
 Phasenabschnitt-Dimmer für elektronische Trafos

2. Strom

alle Verbraucher die den **gleichen Strom** benötigen, werden **in Serie (in Reihe)** an die Stromquelle angeschlossen. Somit fließt der gleiche Strom durch alle Verbraucher hindurch (Vergleichbar mit einer Perlenkette). Die Höhe der Spannung die am einzelnen Verbraucher abfällt, wird durch den Verbraucher selbst bestimmt.

Gleichstrom, mit definierter Richtung, dieser ist zeitlich in seiner Höhe unveränderlich, also ein konstanter Strom, daher spricht man auch von Konstantstromquellen. Diesen Strom finden wir z.B. bei LED Betriebsgeräten (z.B. 350mA) für LEDs.

Wechselstrom, mit wechselnder Polarität hat für LEDs keine Bedeutung und wird daher hier nicht weiter behandelt.

Konverter sind elektronische Geräte welche meist 230V/50Hz Wechselspannung aufnehmen und als Konstantstromquelle dann z.B 350mA Gleichstrom zur Verfügung stellen. Die Polarität ist zu beachten. Wird die Polarität nicht beachtet, können Konverter und LED zerstört werden.

2.1 Serien- / Reihen- Schaltung

2.1.1 einzelne LEDs

Alle LEDs müssen vom gleichen Strom durchflossen werden (z.B. 350mA), und sind daher in Serie anzuschließen. Die Polarität (Plus- Kabel **ROT** und Minus- Kabel **SCHWARZ**) ist unbedingt zu beachten ! Bei falschem Anschluß werden die LEDs zerstört !!! Der Konverter regelt selbsttätig den Strom auf z.B. 350mA, solange die angegeben Anzahl an Strahler korrekt ist.

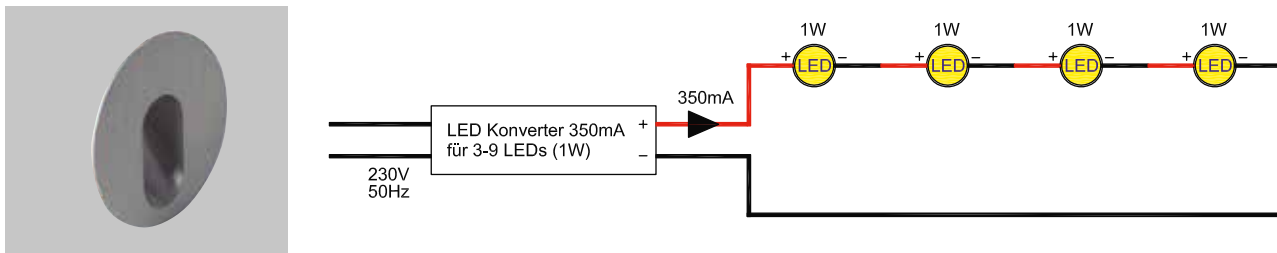

Dimmen: nur mit speziellen, dimmbaren Convertern möglich. Ein herkömmlicher Dimmer darf nicht verwendet werden – Zerstörung der LEDs + Konverter.

2.1.3 Multi Chip LED

Moderne Power-LED-Strahler verwenden Multi-Chip-LEDs. Auf dem Multi Chip befinden sich mehrere einzelne LEDs. Da auch hier alle LEDs vom gleichen Strom durchflossen werden müssen, ist ebenfalls ein geeigneter Konverter notwendig. Polarität beachten! Ein Beispiel für einen Multi-Chip-LED-Strahler ist unser AGON Strahler, dieser benötigt einen 140mA-Konverter.

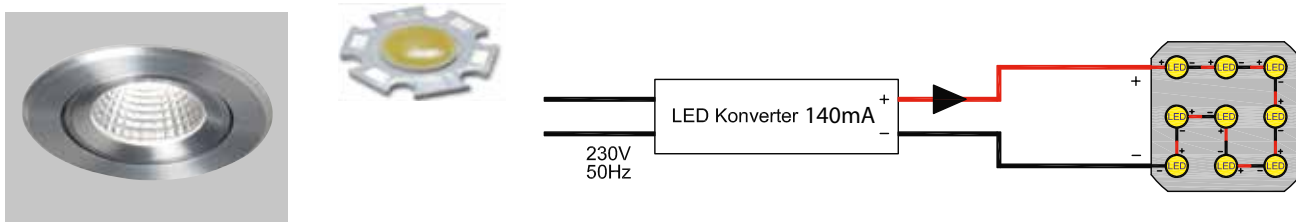

Dimmen: nur mit speziellen, dimmbaren Convertern möglich. Ein herkömmlicher Dimmer darf nicht verwendet werden – Zerstörung der LEDs + Konverter.

LED-KONVERTER RGB 1-10V & PUSH & IR

DIMMEN WEISSER LED STRIPES 24V DIMMEN PER TASTER

kurzer Tastendruck zum Ein-/Ausschalten, langer Tastendruck zum Auf-/Abdimmen, mit Auto-Stop bei minimalen und maximalen Werten mit dimmbarem Betriebsgerät VSTR 120 (230V-50Hz auf 0-24V DC) 24V Konverter (100W) für maximal 1 x 6,9m weißes LED Strip 24V (je 14.4W/lfm)

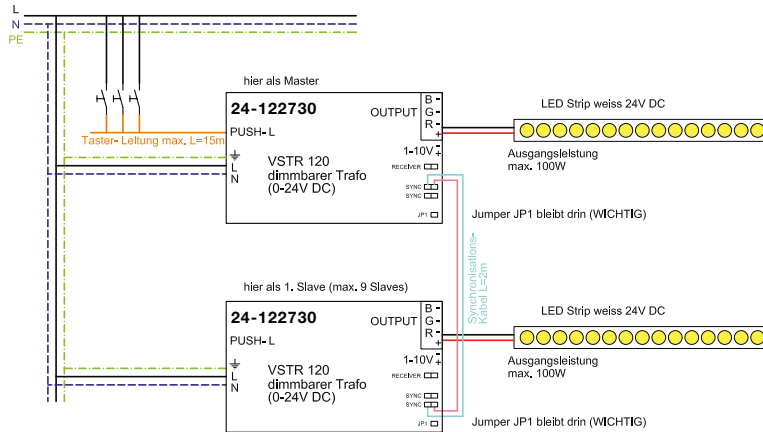

DIMMEN WEISSER LED STRIPES 24V DIMMEN 1-10V

Dimmen mit Potentiometer am 1-10V Eingang mit dimmbarem Betriebsgerät VSTR 120 (230V-50Hz auf 0-24V DC) 24V Konverter (100W) für maximal 1 x 6,9m weißes LED Strip 24V (je 14.4W/lfm)

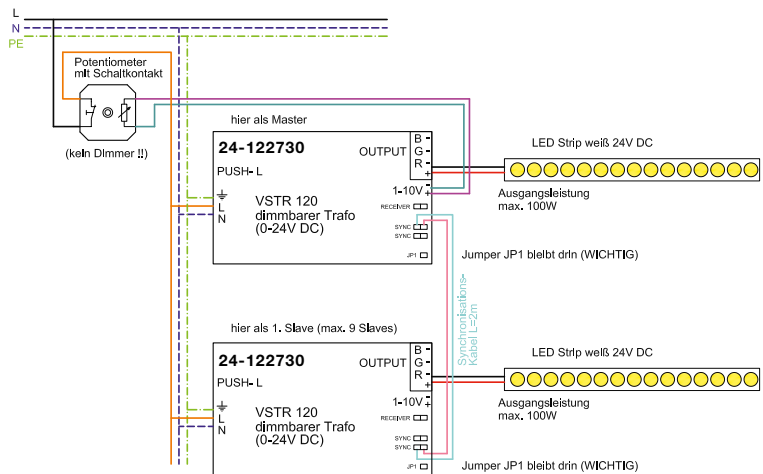

DIMMEN RGB LED STRIPES 24V DIMMEN PER FERNBEDIENUNG

Infrarotfernbedienung: es können alle drei Farbkanäle einzeln oder gemeinsam gedimmt werden + einfacher Farbdurchlauf mit dimmbarem Betriebsgerät VSTR 120 (230V-50Hz auf 0-24V DC) 24V Konverter (120W) für maximal 1 x 8,5m weißes LED Strip 24V (je 14.4W/lfm)

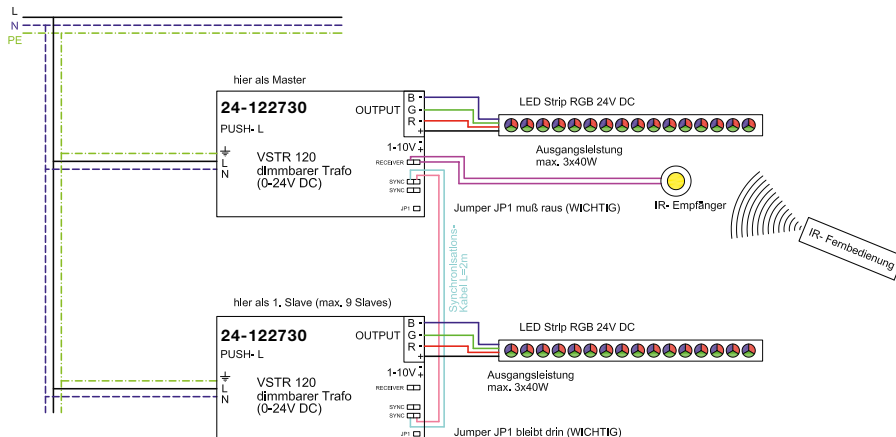

UNIVERSALDIMMER

Dimmer zur Ansteuerung über DALI, 1 - 10V oder PUSH Dimm. für weisse 24V LED Stripes

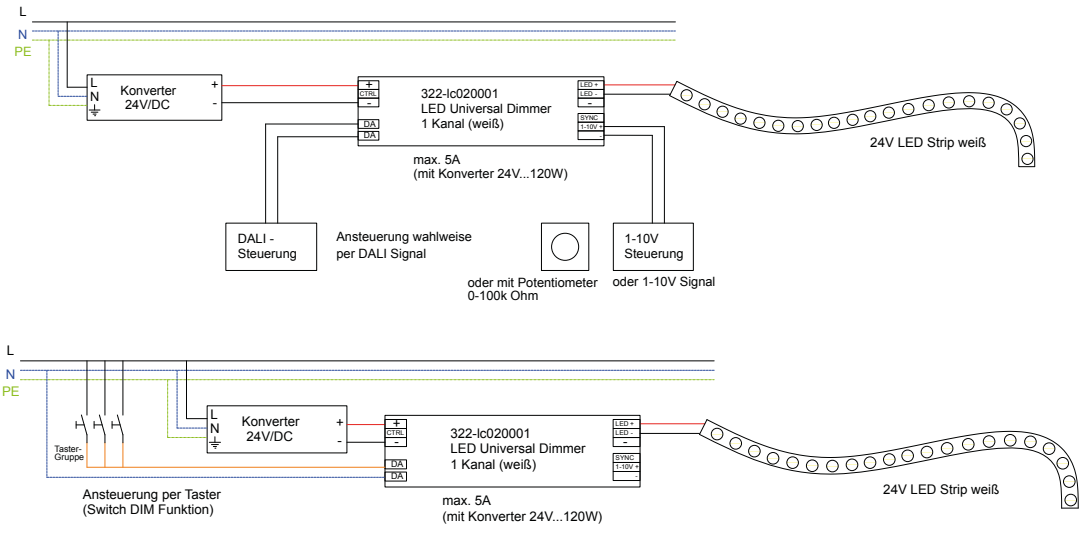

DMX 200

DIMMEN DMX/DALI-RGB FÜR RGB LED 24V STRIPES

für die DMX oder DALI Ansteuerung von max. 2 x 5m RGB LED Stripes 24V bei 14,4W/lm (Entspricht 144W Gesamtleistung)

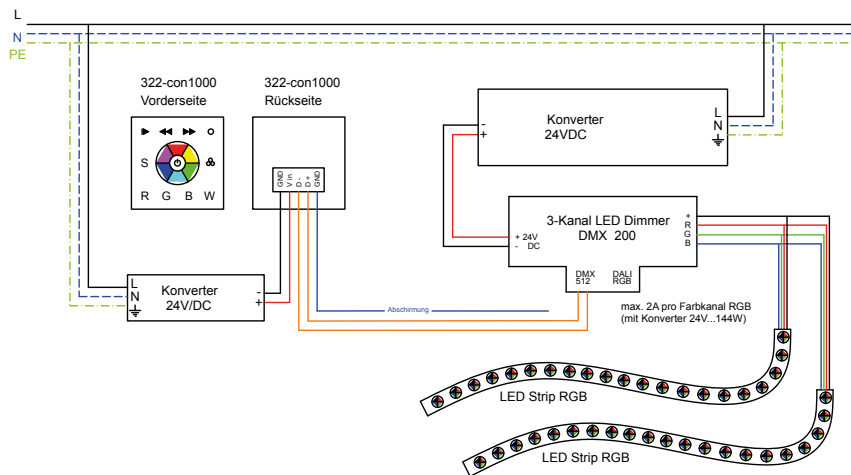

DMX RGBW DIMMER

für die DMX Ansteuerung von max. 14m RGBW LED Stripes 24V bei 17,3W/lm (Entspricht 250W Gesamtleistung)

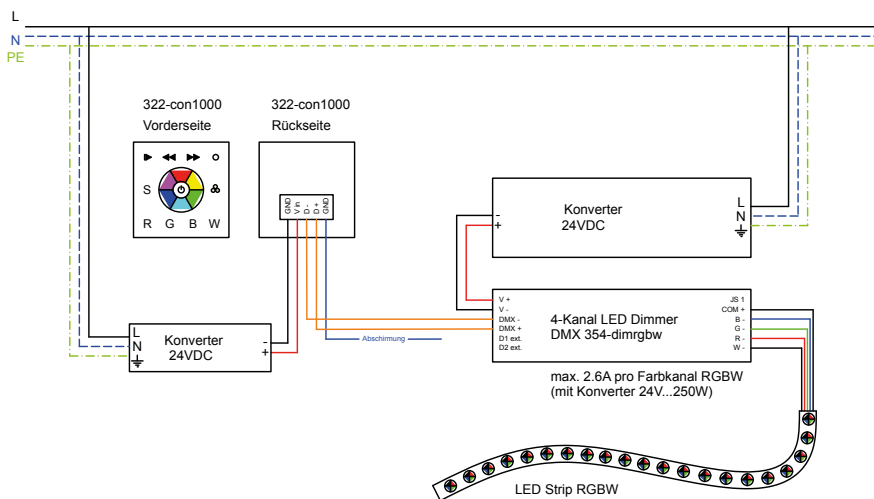

RGBW FUNKDIMMER

Zum Ansteuern von 24V RGBW LED Stripes mit Funkfernbedienung

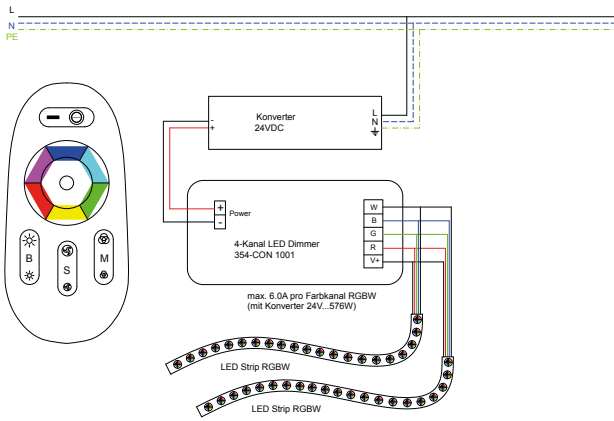

RGB FUNKDIMMER

Zum Ansteuern von 24V RGB LED Stripes mit Funkfernbedienung

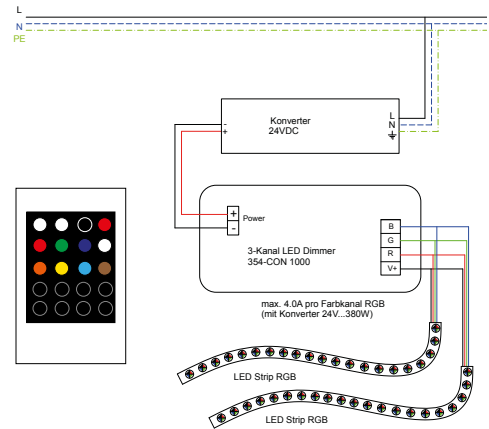

RGBW FUNKDIMMER

Zur Ansteuerung von 24V LED Stripes RGB, RGBW oder weissen 24V LED Stripes. Kommunikation zwischen Controller und Bedienstellen erfolgt über Funk. Optionale APP Steuerung möglich (siehe unten)

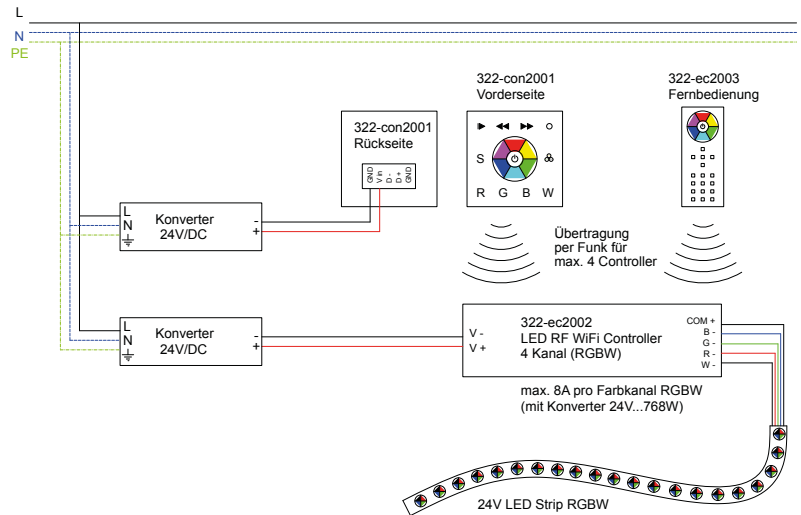

RGBW FUNKDIMMER

APP Steuerung des RGBW Funkdimmers zur Integration in ein häuseigenes WLAN, APP steht zum kostenlosen Download in diversen APP Stores zur Verfügung

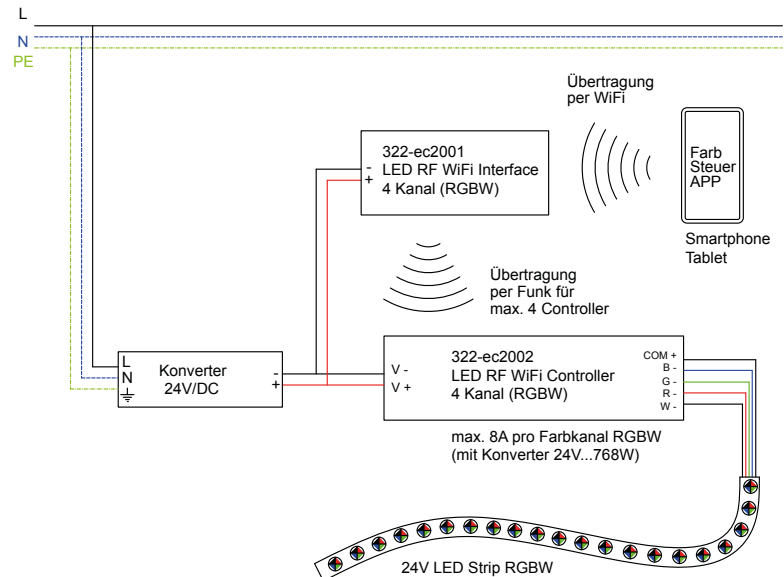

MAXI JOLLY

DIMMEN POWER LEDS DIMMEN PER TASTER

Kurzer Tastendruck zum EIN/AUS- Schalten, langer Tastendruck zum AUF/AB- Dimmen, mit Auto-Stop bei min. und max. Werten, die Stellung der DIP-Schalter (DIP switch) legt den Konstantstrom des Konverters am Ausgang fest.

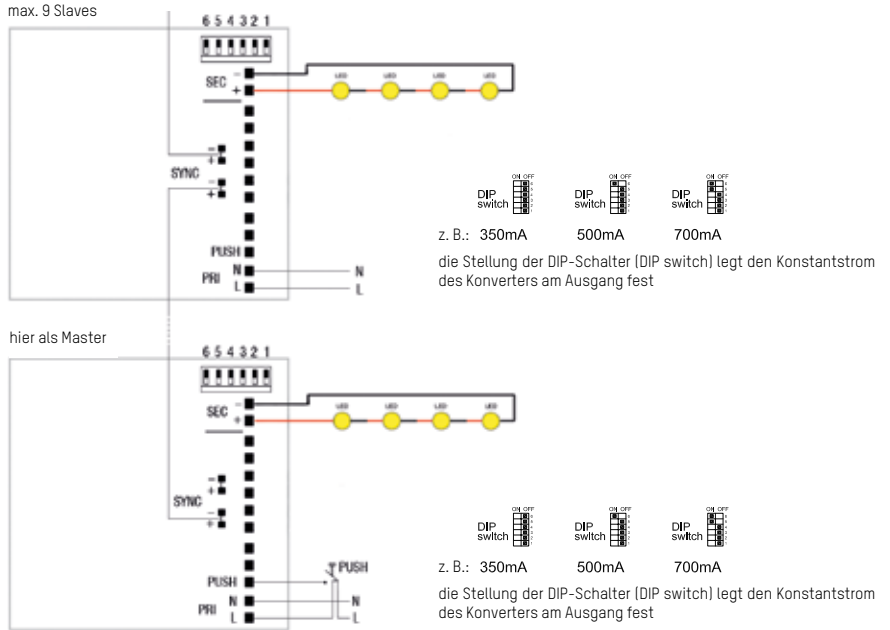

DIMMEN POWER LEDS DIMMEN 1-10 V

Dimmen mit Potentiometer am 1-10V Eingang mit dimmbarem Betriebsgerät MAXI JOLLY, die Stellung der DIP-Schalter (DIP switch) legt den Konstantstrom des Konverters am Ausgang fest.

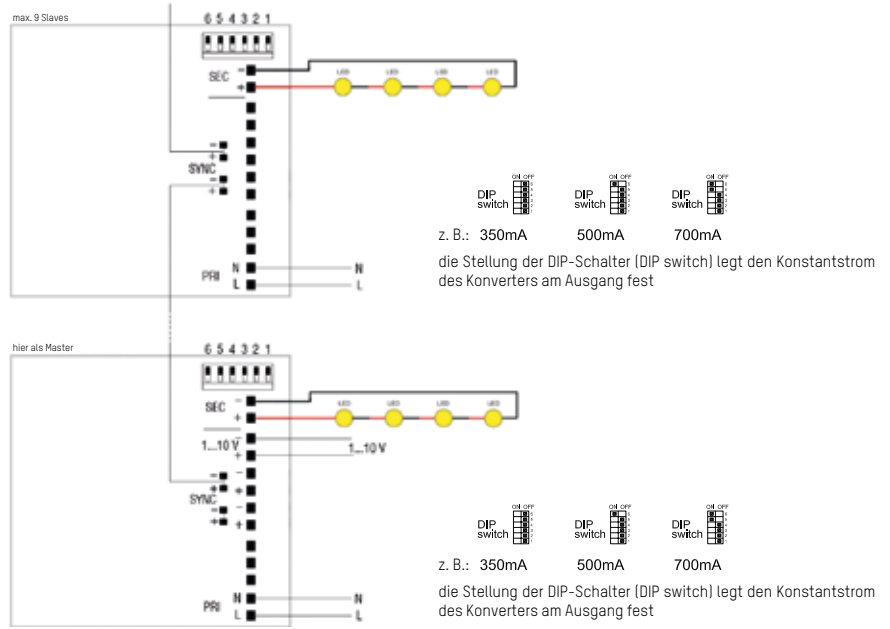

DIMMEN POWER LEDS DIMMEN DALI

Dimmen über DALI Steuerung, die Stellung der DIP-Schalter (DIP switch) legt den Konstantstrom des Konverters am Ausgang fest.

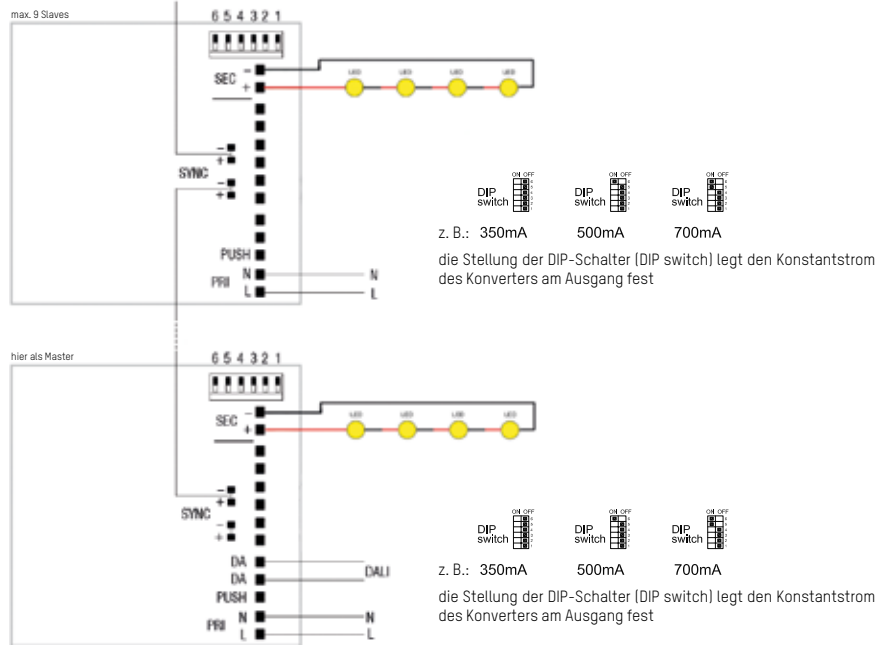

DALIeco ALS MANUELLE TASTENSTEUERUNG

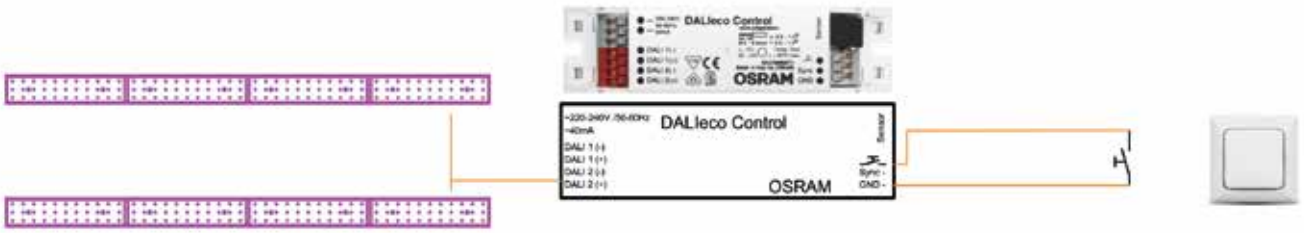

Manuelle Dimmen und Schalten von bis zu 32 EVG's
 Länge des Anschlusskabels zu den Tasten von bis zu 50m, beliebig viele Teilnehmer

DALIeco ALS MANUELLE 2-KANAL-TASTENSTEUERUNG (kein Sensor angeschlossen)

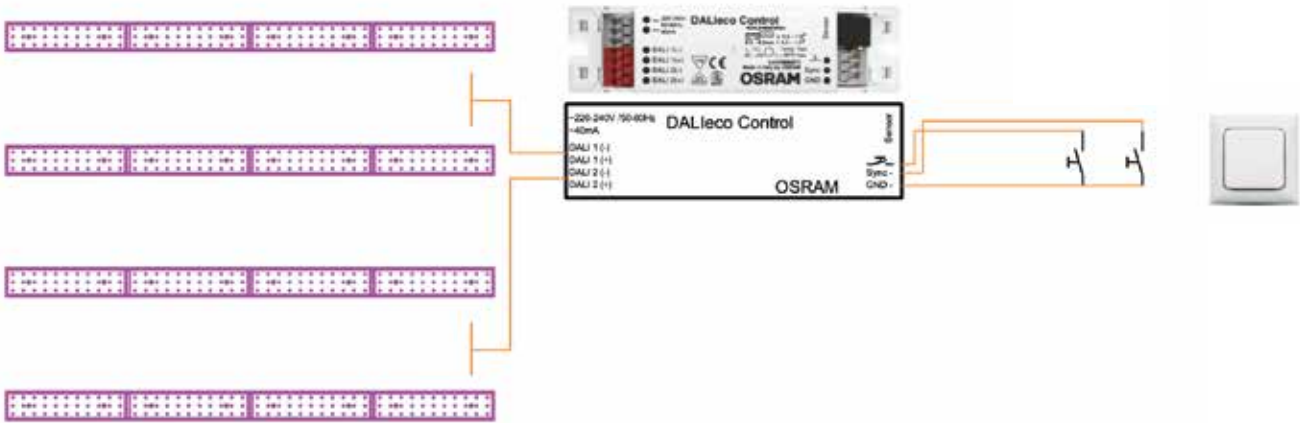

Manuelle Dimmen und Schalten von bis zu 2 x 16 EVG's
 Aktivierung des Tastersteuerungseingangs für Kanal 2 durch gleichzeitiges Drücken beider Taster für 10 Sek.
 Länge des Anschlusskabels zu den Tastern von bis zu 50m, beliebig viele Taster anschließbar

DALIeco FÜR DIE AUTOMATISCHE LICHTSTEUERUNG VON EINZELLEUCHTEN/EINZELBÜROS

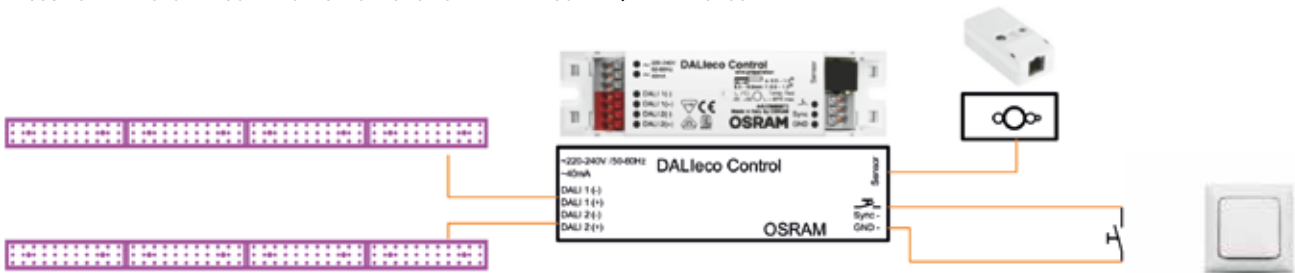

Länge des Anschlusskabels zu den Tastern von bis zu 50m, beliebig viele Taster anschließbar

ANSCHLUSSSCHEMA FÜR ENTSTÖRFILTER (PARASITIC CURRENT PROTECTOR HV)

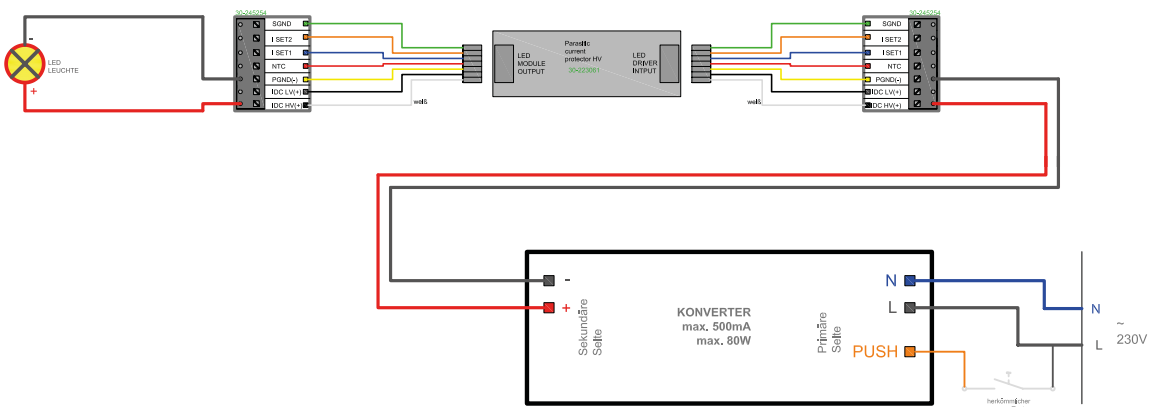

FARBWIEDERGABE

Um die Qualität eines Leuchtmittels im Bereich der Farbwiedergabe darstellen und zwischen unterschiedlichen Lichtquellen gleicher, korrelierter Farbtemperatur vergleichbar machen zu können, verwendet man den Farbwiedergabeindex CRI (Colour Rendering Index). Der Farbwiedergabeindex, auch mit Ra abgekürzt, wird anhand von acht Grundfarben definiert. Er hängt nicht von der Lichtfarbe des Leuchtmittel ab.

Premium CRI 90



PREMIUM CRI 90



Symbolfoto STANDARD CRI 90

Symbolfoto

Da im normalen Farbwiedergabeindex nur die acht genormten Pastellfarben bewertet werden, ist die Aussagekraft des CRI-Wertes nicht vollumfassend. Insbesondere im Fashion- und Retail-Bereich, wo auch gesättigte Farben perfekt wiedergegeben werden müssen, reicht ein Standard-CRI oft nicht aus. Aus diesem Grund haben wir den Premium-CRI 90 in unserem Sortiment, welcher anhand von 14 Grundfarben bewertet wird. Zu den acht Pastellfarben kommen noch sechs gesättigte Farben hinzu, z.B. R9 für gesättigtes Rot. Auf diese Weise ist gewährleistet, alle Farben in sehr guter Qualität wiederzugeben.

BINNING

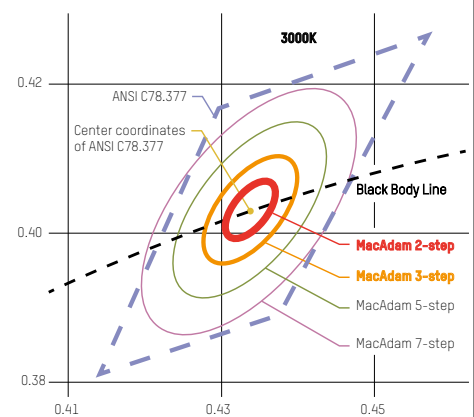

Produktionsbedingt gibt es bei der Herstellung von LEDs immer kleine Unterschiede in Lichtfarbe, Farbwiedergabe und Helligkeit der einzelnen LEDs. Diese Unterschiede würden im Vergleich mehrerer gleicher Produkte auffallen. Um dies zu vermeiden gibt es das sogenannte Binning. Bei dieser Sortierung werden alle LEDs einzeln getestet und in Gruppen, sogenannte Bins sortiert. Ein Bin enthält nur LEDs mit gleichen Werten. Dieser Binning-Prozess wird anhand der MacAdam Ellipse durchgeführt. Diese Ellipse definiert jenen Bereich, in dem keine Unterschiede für den Menschen wahrnehmbar sind. Entsprechend dem Stand der Technik werden bei Molto Luce Produkten ausschließlich LEDs führender Hersteller mit MacAdam [SDCM] 2Step oder 3Step Binning verbaut.

AC-LEUCHTEN

Durch den Einsatz neuer Technologien ist es möglich, spezielle LED-Chips so zu verschalten, dass diese als LED-Modul direkt mit Netzspannung betrieben werden können. Vorteil dabei ist die kleine Schutzbeschaltung, wodurch viele neue Anwendungen möglich wurden. Insbesondere dort von Vorteil, wo Betriebsgehäuse stören oder nicht realisierbar sind.

COB - CHIP ON BOARD

Bei COB Modulen werden die LED-Chips direkt auf wärmeleitendes Material (Board) geklebt und mittels dünnen Golddrähten elektrisch miteinander verbunden. Um den mechanischen Schutz der Bauteile zu gewährleisten und weißes Licht erzeugen zu können, wird diese Anordnung danach mit einem Silikon-Phosphor-Gemisch stabilisiert. Ein wesentlicher Vorteil dieser Technologie liegt im geringeren Wärmeübergang der LED-Chips auf den Kühlkörper (thermischer Widerstand). Ein optimiertes Wärmemanagement verbessert in der Folge unmittelbar Lebensdauer und Farbdrift der Chips. Mehrere LED-Chips können so auf einer kleinen Fläche untergebracht und kollektiv enorme Lichtströme erzeugt werden.



ENERGIELABEL

Um die Energieeffizienz von Leuchten einfacher miteinander vergleichen zu können – ohnezusätzlich in Datenblättern oder Produktinformationen zu suchen – wird das Klassensymbol mittels Abbildung bei jedem Produkt verwendet. Hintergrund für diese neue Kennzeichnung ist eine Energieverordnung, die „erhebliches Potenzial“ bei der Einsparung von Energie bei gleichwertigen Produkten bewertet. Diese Richtlinien 2010/20 EU und Verordnung 874/2012 geben die genormten Kennzeichnungen vor.

Die zum Zeitpunkt der Drucklegung des Katalogs verfügbaren Daten sind teilweise berechnete Werte. Die Leuchten werden nach dem Stand der Technik laufend optimiert. Elektrische Leistungsangaben sowie Lumenwerte unterliegen einer Toleranz von +/- 10%. Durch ein zertifiziertes Institut gemessene Werte sind nach aktuellem Stand in den Produktinformationen auf www.moltoluce.com und in der Lichtplanungssoftware DIALux zu finden.



INDEX

ARTIKELNUMMER	SEITE	ARTIKELNUMMER	SEITE	ARTIKELNUMMER	SEITE	ARTIKELNUMMER	SEITE
5-plsb	176	24-122633	314	56-6126ng1	037	86-1145500200s	034
8-0151	032	24-122635	314	56-6127ng1	037	86-1231001b1p	034
8-0154	032	24-122730	319	56-7300ng1	107	86-1231001bp	034
8-01546	032	24-122750	319	56-7301ng1	107	86-1231009b1p	034
8-0157	032	24-122752	319	56-85034	036	86-1231009bp	034
8-681hv	032	24-122754n	319	56-85035	036	86-1231010b1p	034
8-6846hv	032	24-122800	315	56-85036	036	86-1231010bp	034
8-684hv	032	24-122802	315	56-85037	036	86-1243909b1p	034
8-686hv	032	24-122804	315	56-85038	036	86-1243909bp	034
8-687hv	032	24-122811	314	56-85039	036	86-1243910b1p	034
8-1101b46hv	030	24-122812	314	56-ak7530	244	86-1243910bp	034
8-1101b4hv	030	24-122813	314	56-ak7536	244	88-981072	290
8-1101b6hv	030	24-122815	314	56-ak7542	037	102-thb400a2a	324
8-1101b7hv	030	24-123164	318	56-be9804	244	102-thb402c2a	324
8-14646hv	032	24-123170	318	56-be9805	244	105-05437321f9	108
8-1464hv	032	24-123395	317	56-b16836	244	105-05983714cl	258
8-1466hv	032	24-123399	317	68-0009g	104	105-059837z5cl	258
8-1467hv	032	24-123400	316	68-0009p	104	105-059881j6clv1	306
8-20446hv	032	24-123401	317	68-0199	027	105-1552641400v1	088
8-2044hv	032	24-123403	317	68-0200	027	105-1552646000v1	088
8-2046hv	032	24-127010	314	68-0201	027	105-1552651400v1	088
8-2047hv	032	24-127480	316	68-020501	104	105-1552656000v1	088
8-22346hv	030	24-127484	316	68-020545	104	105-1552681400v1	088
8-2237hv	030	24-127490	317	68-0213	158	105-1552686000v1	088
8-237446hv	028	24-127530	059	68-0214	158	105-1552691400v1	088
8-23744hv	028	24-127532	059	68-0216	158	105-1552696000v1	088
8-23747hv	028	24-127534	059	68-0217	158	105-1594803437	274
8-3321hv	030	24-127536	059	68-0218	157	105-159480z537	274
8-33246hv	030	24-127538	059	68-0219	157	105-15967714cl	270
8-3324hv	030	24-127901	319	68-0220	243	105-15967714cm	270
8-3326hv	030	24-127903	319	68-0250	243	105-15967714m1	270
8-3327hv	030	24-127905	319	68-402157	104	105-15977834clv1	268
8-33806hv	030	24-485720512	318	68-402357	104	105-15979014cl	274
8-33807hv	030	24-485720513	318	68-428101	104	105-159790z5cl	274
8-3391shv	030	26-840001	096	68-428145	104	105-15980634cl	268
8-34846hv	028	26-840004	096	68-428255	104	105-15990414cl	274
8-3487hv	028	26-840007	096	68-428257	104	105-159904z5cl	274
8-42361hv	028	26-840046	096	68-428757	100	105-492cr	108
8-423646hv	028	26-840207	173	68-454257ww	104	105-55969034m2	286
8-42364hv	028	26-840604	173	68-454357ww	104	105-559791z5clv1	286
8-42366hv	028	26-840646	173	68-517401	086	105-7129091437v2	014
8-42367hv	028	28-173385	321	68-517445	086	105-7132261437v2	014
24-119475	312	28-189721	320	68-518555	081	105-7140301437v1	014
24-119475c	312	28-195967	321	68-518557	081	105-7140311437v1	014
24-119618	313	28-292599	320	68-518657	086	105-7147511400	014
24-119640	313	28-392091	321	68-553801ww	270	105-7147512300	014
24-119654	312	28-301093	320	68-553802ww	270	105-7147516000	014
24-119654c	312	28-452893	319	68-553838ww	270	105-7147521400v2	015
24-119721d	312	28-452916	319	68-553901ww	270	105-7147522300v2	015
24-119730	312	28-826435	321	68-629901ww	157	105-7147526000v2	015
24-119772	313	28-920293	321	68-629931ww	157	105-714752dj00v2	015
24-119851u	312	28-955622	320	68-629932ww	157	105-714752j600v2	015
24-119910	312	28-988645	321	68-630201	027	105-714752z500v2	015
24-122140	314	28-988652	321	68-630231	027	105-7147531400v2	015
24-122201	315	30-223061	320	68-630232	027	105-7147532300v2	015
24-122203	315	30-245254	320	68-634833ww	242	105-7147536000v2	015
24-122204	316	30-747635	190	68-634933ww	242	105-714753dj00v2	015
24-1222044	316	56-185030	107	68-635101ww	158	105-714753j600v2	015
24-1222084	316	56-185033	107	68-635145ww	158	105-714753z500v2	015
24-122322	319	56-5212ng2	256	68-638933ww	242	105-7147541400v1	014
24-122360	315	56-5213ng2	256	68-639101ww	158	105-7147546000v1	014
24-122370	315	56-5214ng2	256	75-dmx200	322	105-7151231400v1	015
24-122372	315	56-53011ng1	160	75-mpl1	314	105-7151232300v1	015
24-122376	315	56-53012ng1	160	75-mpl3	314	105-7151236000v1	015
24-122413	318	56-53311ng1	107	75-mpl4	314	105-715123dj00v1	015
24-122440	314	56-53312ng1	107	75-mpl5	314	105-715123j600v1	015
24-122442	319	56-60061ang1	244	75-pmr12	314	105-715123z500v1	015
24-122448ip	242	56-60062ang1	244	75-pr105	313	105-7151241400v1	015
24-122479	319	56-6011ng1	244	75-pr60	313	105-7151242300v1	015
24-122511	319	56-6019ng1	244	75-tr105	313	105-7151246000v1	015
24-122596	314	56-6026ng1	037	75-tr70	313	105-715124dj00v1	015
24-122598	314	56-6027ng1	037	86-0856501p	034	105-715124j600v1	015
24-122599	314	56-6111ng1	244	86-1093709b	034	105-715124z500v1	015
24-122602	314	56-6119ng1	244	86-1093710b	034	105-7151251400	014

ARTIKELNUMMER	SEITE	ARTIKELNUMMER	SEITE	ARTIKELNUMMER	SEITE	ARTIKELNUMMER	SEITE
105-7151252300	014	125-51000321	290	200-110j01481859	049	200-19ko01481146	050
105-7151256000	014	125-99121600	293	200-110j01481865	049	200-19ko01481149	050
105-7151261400	014	125-99133000	306	200-110j01481866	049	200-19mk01481115	050
105-7151281400	014	125-99133500	306	200-110j01481869	049	200-19mk01481116	050
105-7151581437v1	014	125-99190300	292	200-110j01481875	049	200-19mk01481119	050
105-7151591437v1	014	125-99190400	292	200-110j01481876	049	200-19mk01481125	050
105-7151666000v1	014	125-99190500	292	200-110j01481879	049	200-19mk01481126	050
105-7151741414	088	125-99550400	298	200-111j21481855	049	200-19mk01481129	050
105-7151746060	088	125-99790000	298	200-111j21481856	049	200-19mk01481145	050
105-7151751414	088	125-99790100	298	200-111j21481859	049	200-19mk01481146	050
105-7151756060	088	125-99791500	298	200-111j21481865	049	200-19mk01481149	050
105-7154541460v1	014	125-99791600	298	200-111j21481866	049	205-105	312
105-7154546000v1	014	125-99804100	208	200-111j21481869	049	205-150	312
105-7156390000	014	125-99804200	208	200-111j21481875	049	205-20	312
105-7156400000	014	125-99809700	298	200-111j21481876	049	205-200	312
105-7199406j6	306	200-108j01481855	049	200-111j21481879	049	205-250	312
105-7199524848	286	200-108j01481856	049	200-112j31481855	049	205-300	312
113-128100	054	200-108j01481859	049	200-112j31481856	049	205-400	312
113-128101	054	200-108j01481865	049	200-112j31481859	049	205-4602010	312
113-128102	054	200-108j01481866	049	200-112j31481865	049	205-4605010	312
113-128103	054	200-108j01481869	049	200-112j31481866	049	205-4606010	312
113-128104	054	200-108j01481875	049	200-112j31481869	049	205-4608010	312
113-128106	054	200-108j01481876	049	200-112j31481875	049	205-4610510	312
113-128107	054	200-108j01481879	049	200-112j31481876	049	205-4615010	312
113-128108	054	200-10ao01481115	048	200-112j31481879	049	205-4620010	312
113-128109	054	200-10ao01481116	048	200-123g03944956	171	205-4625010	312
113-128110	054	200-10ao01481119	048	200-124g04144956	171	205-4630010	312
113-128111	054	200-10ao01481125	048	200-124g04144966	171	205-60	312
113-128130	054	200-10ao01481126	048	200-125g04144956	171	208-19001	176
121-2208441000	062	200-10ao01481129	048	200-125g04144959	171	208-19002	176
121-2208441100	062	200-10ao01481145	048	200-125g04144966	171	208-19003	176
121-2208441500	062	200-10ao01481146	048	200-125g04144969	171	208-19004	176
121-2208441600	062	200-10ao01481149	048	200-134003000996	110	208-19005	176
125-16453600	208	200-10bo21481115	048	200-134003100996	110	208-19006	176
125-16453700	208	200-10bo21481116	048	200-135j01437855	170	208-19104102	174
125-16453800	208	200-10bo21481119	048	200-135j01437856	170	208-19104103	174
125-16453900	208	200-10bo21481125	048	200-135j01437859	170	208-19104105	174
125-16472000	208	200-10bo21481126	048	200-135j01437875	170	208-19104202	174
125-16472072	208	200-10bo21481129	048	200-135j01437876	170	208-19104203	174
125-16472100	208	200-10bo21481145	048	200-135j01437879	170	208-19104205	174
125-16472172	208	200-10bo21481146	048	200-135j01437885	170	208-19104302	174
125-16474000	208	200-10bo21481149	048	200-135j01437886	170	208-19104303	174
125-16474072	208	200-10co31481115	048	200-135j01437889	170	208-19104305	174
125-16474100	208	200-10co31481116	048	200-136j01437115	170	208-19104402	174
125-16474172	208	200-10co31481119	048	200-136j01437116	170	208-19104403	174
125-33009300	210	200-10co31481125	048	200-136j01437119	170	208-19104405	174
125-33009400	210	200-10co31481126	048	200-136j01437125	170	208-19105102	174
125-33009500	210	200-10co31481129	048	200-136j01437126	170	208-19105103	174
125-33009700	210	200-10co31481145	048	200-136j01437129	170	208-19105105	174
125-33014400	210	200-10co31481146	048	200-136j01437145	170	208-19105202	174
125-33014500	210	200-10co31481149	048	200-136j01437146	170	208-19105203	174
125-33014600	210	200-10po01481115	048	200-136j01437149	170	208-19105205	174
125-33014700	210	200-10po01481116	048	200-176000144115	170	208-19105302	174
125-33074000	210	200-10po01481119	048	200-176000144116	170	208-19105303	174
125-33074100	210	200-10po01481125	048	200-176000144119	170	208-19105305	174
125-33074200	210	200-10po01481126	048	200-176000144125	170	208-19121701	177
125-41475400	298	200-10po01481129	048	200-176000144126	170	208-19121702	177
125-41475500	298	200-10po01481145	048	200-176000144129	170	208-19121703	177
125-41475600	298	200-10po01481146	048	200-176000244115	170	208-19130551	177
125-41475700	298	200-10po01481149	048	200-176000244116	170	208-19130571	177
125-41478400	298	200-10sd01481016	062	200-176000244119	170	208-19130591	177
125-41478500	298	200-10sd01681016	062	200-176000244125	170	208-19130678	177
125-41478600	298	200-10skd14c1016	062	200-176000244126	170	208-19130681	176
125-41478700	298	200-10skd16c1016	062	200-176000244129	170	208-19130684	176
125-42560000	292	200-10sl01481016	062	200-19ko01481115	050	208-19130685	176
125-42561300	292	200-10sl01681016	062	200-19ko01481116	050	208-19130696	176
125-42562100	292	200-10so01481016	062	200-19ko01481119	050	208-19130697	176
125-42625900	292	200-10so01681016	062	200-19ko01481125	050	208-19130698	176
125-42670100	292	200-10srd14c1016	062	200-19ko01481126	050	208-19130711	177
125-42670500	292	200-10srd16c1016	062	200-19ko01481129	050	208-19130712	177
125-43181500	306	200-10su01481016	062	200-19ko01481135	050	208-19130713	177
125-43182800	306	200-10su01681016	062	200-19ko01481136	050	208-19135121	177
125-43182900	306	200-110j01481855	049	200-19ko01481139	050	208-19160111	177
125-51000300	290	200-110j01481856	049	200-19ko01481145	050	208-19160141	177

INDEX

ARTIKELNUMMER	SEITE	ARTIKELNUMMER	SEITE	ARTIKELNUMMER	SEITE	ARTIKELNUMMER	SEITE
208-19160142	177	252-ak200	223	276-0072190333006	092	292-a30w	282
208-19160143	177	252-ak201	223	276-0072190333056	092	292-a40w	282
208-19162173	176	252-au200	223	276-0091190003005	080	292-a50w	282
208-19170111	174	252-e2001b	223	276-0091190003063	080	292-a60w	282
208-19170112	174	252-e2001s	223	276-0103090402705tr	090	292-lpcue030	282
208-19170113	174	252-e2001w	223	276-0103090402706tr	090	292-lpcue040	282
208-19170121	174	252-e2003b	223	276-0103090403005tr	090	302-45833001	140
208-19170122	174	252-e2003s	223	276-0103090403006tr	090	302-45833003	140
208-19170123	174	252-e2003w	223	276-0111190502705tr	091	302-45833006	140
208-19170141	174	252-ef8001	223	276-0111190502706tr	091	302-45833023	140
208-19170142	174	252-ek8000ab	222	276-0111190503005tr	091	302-45833052	140
208-19170143	174	252-ek8000as	222	276-0111190503006tr	091	302-45841001	140
208-19170211	175	252-ek8000aw	222	276-0122190502705tr	091	302-45841003	140
208-19170212	175	252-ek8001ab	222	276-0122190502706tr	091	302-45841006	140
208-19170213	175	252-ek8001as	222	276-0122190503005tr	091	302-45841023	140
208-19170231	175	252-ek8001aw	222	276-0122190503006tr	091	302-45841052	140
208-19170232	175	252-ek8002b	222	276-0130690342706	022	302-71713001	138
208-19170233	175	252-ek8002s	222	276-0130690342756	022	302-71713002	138
208-19170241	175	252-ek8002w	222	276-0130690343006	022	302-71713010	138
208-19170242	175	252-ek8003b	222	276-0130690343056	022	302-71723001	138
208-19170243	175	252-ek8003s	222	276-0141090002705tr	100	302-71723010	138
208-19170341	175	252-ek8003w	222	276-0141090002706tr	100	302-71733001	138
208-19170342	175	252-ek8006b	223	276-0141090002763tr	100	302-76633001	140
208-19170343	175	252-ek8006s	223	276-0141090003005tr	100	302-76633003	140
208-19170351	175	252-ek8006w	223	276-0141090003006tr	100	302-84813003	140
208-19170352	175	252-ek8007	223	276-0141090003063tr	100	302-84813030	140
208-19170353	175	252-ek8104b	223	276-0151090402705tr	100	305-0040680202705	016
208-19170361	175	252-ek8104s	223	276-0151090402706tr	100	305-0040680202706	016
208-19170362	175	252-ek8104w	223	276-0151090402763tr	100	305-0040680202715	016
208-19170363	175	252-mc8000	223	276-0161490002705tr	101	305-0040680203005	016
208-19170371	175	252-mc8001	223	276-0161490002763tr	101	305-0040680203006	016
208-19170372	175	259-502990	324	276-0161490003005tr	101	305-0040680203015	016
208-19170373	175	259-502991	324	276-0161490003063tr	101	305-0040680402705	016
208-19170381	175	260-18211451011	110	276-1002	022	305-0040680402706	016
208-19170382	175	260-18211452011	110	276-10073080bb	020	305-0040680402715	016
208-19170383	175	263-1030b	300	276-10073080wb	020	305-0040680403005	016
208-19170391	175	263-1030bal	300	276-10083080bb	020	305-0040680403006	016
208-19170392	175	263-1030s	300	276-10083080wb	020	305-0040680403015	016
208-19170393	175	263-1030sal	300	276-7000	022	305-0050680202705	008
208-19170401	175	263-1040b	300	276-7001	022	305-0050680202706	008
208-19170402	175	263-1040bal	300	276-7002	022	305-0050680202715	008
208-19170403	175	263-1040s	300	276-7003	022	305-0050680203005	008
208-19170411	174	263-1040sal	300	276-7004	090	305-0050680203006	008
208-19170412	174	263-3030b	300	276-7005	090	305-0050680203015	008
208-19170413	174	263-3030bal	300	276-7006	090	305-0050680402705	008
208-19172101	177	263-3030bp	300	276-7007	091	305-0050680402706	008
208-19172102	177	263-3030s	300	276-7008	091	305-0050680402715	008
208-19172103	177	263-3030sal	300	276-7009	091	305-0050680403005	008
208-19172301	177	263-3030sp	300	276-7010	090	305-0050680403006	008
208-19172302	177	263-3040b	300	276-7011	090	305-0050680403015	008
208-19172303	177	263-3040bal	300	276-7012	091	305-0130380003004	157
208-19180114	176	263-3040bp	300	276-7013	091	305-0130380003005	157
208-19180115	176	263-3040s	300	282-lv32n30abr	210	305-1440s	026
208-19180116	176	263-3040sal	300	282-ve03f30abr	210	305-1440w	026
208-19180121	176	263-3040sp	300	282-vh03f30abr	210	305-5058	156
208-19180122	176	263-5030b	300	283-240965nwkconf	214	305-602024b	024
208-19180123	176	263-5030bal	300	283-240965uuwwkconf	214	305-602024b27k	024
208-19190501	176	263-5030s	300	283-240965uwwkconf	214	305-602024s	024
208-19825016	177	263-5030sal	300	283-240965wwkconf	214	305-602024s27k	024
208-19825019	177	263-5040b	300	283-241865nwkconf	214	305-602024w	024
252-a200	223	263-5040bal	300	283-241865uuwwkconf	214	305-602024w27k	024
252-a2001b	222	263-5040s	300	283-241865uwwkconf	214	305-602427b	082
252-a2001s	222	263-5040sal	300	283-241865wwkconf	214	305-602427w	082
252-a2001w	222	273-1000s	290	283-242865nwkconf	214	305-602430b	082
252-a2002b	222	276-0010990332706	022	283-242865uuwwkconf	214	305-602430w	082
252-a2002s	222	276-0010990332756	022	283-242865uwwkconf	214	305-602527b	082
252-a2002w	222	276-0010990333006	022	283-242865wwkconf	214	305-602527w	082
252-a2003b	222	276-0010990333056	022	283-konf	214	305-602530b	082
252-a2003s	222	276-0021590402705tr	090	290-127400	268	305-602530w	082
252-a2003w	222	276-0021590402706tr	090	290-127401	268	305-604427bddd	082
252-a2004b	222	276-0021590403005tr	090	290-133400	268	305-604427wddd	082
252-a2004s	222	276-0021590403006tr	090	290-133401	268	305-604430bddd	082
252-a2004w	222	276-0061290333006	092	290-1543180	238	305-604430wddd	082
252-a201	223	276-0061290333056	092	290-1546480	238	305-604527bddd	082

ARTIKELNUMMER	SEITE	ARTIKELNUMMER	SEITE	ARTIKELNUMMER	SEITE	ARTIKELNUMMER	SEITE
305-604527wddd	082	365-0051590243014	250	445-01401928	120	445-03301416	122
305-604530bddd	082	365-0061590243005	010	445-01501415	120	445-03301418	122
305-604530wddd	082	365-0061590243006	010	445-01501416	120	445-03301425	122
305-621524b	012	365-0141390382705	008	445-01501418	120	445-03301426	122
305-621524b27k	012	365-0141390382706	008	445-01501425	120	445-03301428	122
305-621524s	012	365-0141390383005	008	445-01501426	120	445-03301915	122
305-621524s27k	012	365-0141390383006	008	445-01501428	120	445-03301916	122
305-621524w	012	365-1001	010	445-01501915	120	445-03301918	122
305-621524w27k	012	365-1002b	134	445-01501916	120	445-03301925	122
305-6800p	156	365-1002w	134	445-01501918	120	445-03301926	122
305-6801p	156	365-1003132738	018	445-01501925	120	445-03301928	122
305-6845s	012	365-100313338	018	445-01501926	120	445-03401415	122
305-6845w	012	365-1003b	134	445-01501928	120	445-03401416	122
305-6846s	019	365-1003w	134	445-01601415	120	445-03401418	122
305-6846w	019	365-1004b	134	445-01601416	120	445-03401425	122
308-0010790302704	248	365-1004w	134	445-01601418	120	445-03401426	122
308-0010790302705	248	365-1005132738	018	445-01601425	120	445-03401428	122
308-0010790302706	248	365-100513338	018	445-01601426	120	445-03401915	122
308-0010790303004	248	365-1005b	134	445-01601428	120	445-03401916	122
308-0010790303005	248	365-1005w	134	445-01601915	120	445-03401918	122
308-0010790303006	248	365-1006132738	018	445-01601916	120	445-03401925	122
308-0020790302704	248	365-100613338	018	445-01601918	120	445-03401926	122
308-0020790302705	248	365-1006b	106	445-01601925	120	445-03401928	122
308-0020790302706	248	365-1006w	106	445-01601926	120	445-03501415	122
308-0020790303004	248	365-1007b	106	445-01601928	120	445-03501416	122
308-0020790303005	248	365-1007w	106	445-01901415	120	445-03501418	122
308-0020790303006	248	365-300803325ng2	106	445-01901416	120	445-03501425	122
308-101512337ng1	248	392-0000680003005	057	445-01901418	120	445-03501426	122
308-101612337ng1	248	392-0000680004005	057	445-01901425	120	445-03501428	122
308-6312	032	392-0011280003005	057	445-01901426	120	445-03501915	122
308-6312b	032	392-0011280004005	057	445-01901428	120	445-03501916	122
322-con1000	322	392-0021880003005	057	445-01901915	120	445-03501918	122
322-con2001	322	392-0021880004005	057	445-01901916	120	445-03501925	122
322-ec2001	322	392-0030680003005	056	445-01901918	120	445-03501926	122
322-ec2002	322	392-0030680004005	056	445-01901925	120	445-03501928	122
322-ec2003	322	392-0041280003005	056	445-01901926	120	445-03601415	122
322-ud3000	322	392-0041280004005	056	445-01901928	120	445-03601416	122
322-ud7001	322	392-0051880003005	056	445-02301415	272	445-03601418	122
332-1001	012	392-0051880004005	056	445-02301416	272	445-03601425	122
332-1202	026	445-011201415	120	445-02301418	272	445-03601426	122
332-1302	012	445-011201416	120	445-02301915	272	445-03601428	122
332-1402	019	445-011201418	120	445-02301916	272	445-03601915	122
332-2001	063	445-011201425	120	445-02301918	272	445-03601916	122
332-3q115	063	445-011201426	120	445-02401415	272	445-03601918	122
332-3q155	063	445-011201428	120	445-02401416	272	445-03601925	122
332-3q205	063	445-011201915	120	445-02401418	272	445-03601926	122
332-3r115	063	445-011201916	120	445-02401915	272	445-03601928	122
332-3r140	063	445-011201918	120	445-02401916	272	445-03901415	122
332-3r150	063	445-011201925	120	445-02401918	272	445-03901416	122
332-3r170	063	445-011201926	120	445-02501415	272	445-03901418	122
332-3r205	063	445-011201928	120	445-02501416	272	445-03901425	122
338-a1000	228	445-01301415	120	445-02501418	272	445-03901426	122
338-a1001	228	445-01301416	120	445-02501915	272	445-03901428	122
338-p1000	226	445-01301418	120	445-02501916	272	445-03901915	122
338-p1001	226	445-01301425	120	445-02501918	272	445-03901916	122
338-p1002	226	445-01301426	120	445-02601415	272	445-03901918	122
338-p1003	228	445-01301428	120	445-02601416	272	445-03901925	122
338-p1004	228	445-01301915	120	445-02601418	272	445-03901926	122
338-z1000	228	445-01301916	120	445-02601915	272	445-03901928	122
338-z1001	228	445-01301918	120	445-02601916	272	445-041201415	130
341-0000880503004	310	445-01301925	120	445-02601918	272	445-041201416	130
341-0000880503011	310	445-01301926	120	445-031201415	122	445-041201418	130
341-0011080503011	306	445-01301928	120	445-031201416	122	445-041201425	130
341-0021580003004	310	445-01401415	120	445-031201418	122	445-041201426	130
341-0021580003011	310	445-01401416	120	445-031201425	122	445-041201428	130
341-0031580003004	310	445-01401418	120	445-031201426	122	445-041201915	130
341-0031580003011	310	445-01401425	120	445-031201428	122	445-041201916	130
341-7000	306	445-01401426	120	445-031201915	122	445-041201918	130
341-7001	306	445-01401428	120	445-031201916	122	445-041201925	130
354-con1000	322	445-01401915	120	445-031201918	122	445-041201926	130
354-con1001	322	445-01401916	120	445-031201925	122	445-041201928	130
354-dimrgbw	322	445-01401918	120	445-031201926	122	445-04401415	130
365-0051590243005	250	445-01401925	120	445-031201928	122	445-04401416	130
365-0051590243006	250	445-01401926	120	445-03301415	122	445-04401418	130

INDEX

ARTIKELNUMMER	SEITE	ARTIKELNUMMER	SEITE	ARTIKELNUMMER	SEITE	ARTIKELNUMMER	SEITE
445-04401425	130	445-06521428	064	445-07631416	124	445-08631925	126
445-04401426	130	445-06521915	064	445-07631418	124	445-08631926	126
445-04401428	130	445-06521916	064	445-07631425	124	445-08631928	126
445-04401915	130	445-06521918	064	445-07631426	124	445-08901415	126
445-04401916	130	445-06521925	064	445-07631428	124	445-08901416	126
445-04401918	130	445-06521926	064	445-07631915	124	445-08901418	126
445-04401925	130	445-06521928	064	445-07631916	124	445-08901425	126
445-04401926	130	445-06671415	064	445-07631918	124	445-08901426	126
445-04401928	130	445-06671416	064	445-07631925	124	445-08901428	126
445-04501415	130	445-06671418	064	445-07631926	124	445-08901915	126
445-04501416	130	445-06671425	064	445-07631928	124	445-08901916	126
445-04501418	130	445-06671426	064	445-07901415	124	445-08901918	126
445-04501425	130	445-06671428	064	445-07901416	124	445-08901925	126
445-04501426	130	445-06671915	064	445-07901418	124	445-08901926	126
445-04501428	130	445-06671916	064	445-07901425	124	445-08901928	126
445-04501915	130	445-06671918	064	445-07901426	124	445-091201415	132
445-04501916	130	445-06671925	064	445-07901428	124	445-091201416	132
445-04501918	130	445-06671926	064	445-07901915	124	445-091201418	132
445-04501925	130	445-06671928	064	445-07901916	124	445-091201915	132
445-04501926	130	445-06981415	064	445-07901918	124	445-091201916	132
445-04501928	130	445-06981416	064	445-07901925	124	445-091201918	132
445-04601415	130	445-06981418	064	445-07901926	124	445-09431415	132
445-04601416	130	445-06981425	064	445-07901928	124	445-09431416	132
445-04601418	130	445-06981426	064	445-081201415	126	445-09431418	132
445-04601425	130	445-06981428	064	445-081201416	126	445-09431425	132
445-04601426	130	445-06981915	064	445-081201418	126	445-09431426	132
445-04601428	130	445-06981916	064	445-081201915	126	445-09431428	132
445-04601915	130	445-06981918	064	445-081201916	126	445-09431915	132
445-04601916	130	445-06981925	064	445-081201918	126	445-09431916	132
445-04601918	130	445-06981926	064	445-08331415	126	445-09431918	132
445-04601925	130	445-06981928	064	445-08331416	126	445-09431925	132
445-04601926	130	445-071201415	124	445-08331418	126	445-09431926	132
445-04601928	130	445-071201416	124	445-08331425	126	445-09431928	132
445-04901415	130	445-071201418	124	445-08331426	126	445-09531415	132
445-04901416	130	445-071201915	124	445-08331428	126	445-09531416	132
445-04901418	130	445-071201916	124	445-08331915	126	445-09531418	132
445-04901425	130	445-071201918	124	445-08331916	126	445-09531425	132
445-04901426	130	445-07331415	124	445-08331918	126	445-09531426	132
445-04901428	130	445-07331416	124	445-08331925	126	445-09531428	132
445-04901915	130	445-07331418	124	445-08331926	126	445-09531915	132
445-04901916	130	445-07331425	124	445-08331928	126	445-09531916	132
445-04901918	130	445-07331426	124	445-08431415	126	445-09531918	132
445-04901925	130	445-07331428	124	445-08431416	126	445-09531925	132
445-04901926	130	445-07331915	124	445-08431418	126	445-09531926	132
445-04901928	130	445-07331916	124	445-08431425	126	445-09531928	132
445-06321415	064	445-07331918	124	445-08431426	126	445-09631415	132
445-06321416	064	445-07331925	124	445-08431428	126	445-09631416	132
445-06321418	064	445-07331926	124	445-08431915	126	445-09631418	132
445-06321425	064	445-07331928	124	445-08431916	126	445-09631425	132
445-06321426	064	445-07431415	124	445-08431918	126	445-09631426	132
445-06321428	064	445-07431416	124	445-08431925	126	445-09631428	132
445-06321915	064	445-07431418	124	445-08431926	126	445-09631915	132
445-06321916	064	445-07431425	124	445-08431928	126	445-09631916	132
445-06321918	064	445-07431426	124	445-08531415	126	445-09631918	132
445-06321925	064	445-07431428	124	445-08531416	126	445-09631925	132
445-06321926	064	445-07431915	124	445-08531418	126	445-09631926	132
445-06321928	064	445-07431916	124	445-08531425	126	445-09631928	132
445-06421415	064	445-07431918	124	445-08531426	126	445-09901415	132
445-06421416	064	445-07431925	124	445-08531428	126	445-09901416	132
445-06421418	064	445-07431926	124	445-08531915	126	445-09901418	132
445-06421425	064	445-07431928	124	445-08531916	126	445-09901425	132
445-06421426	064	445-07531415	124	445-08531918	126	445-09901426	132
445-06421428	064	445-07531416	124	445-08531925	126	445-09901428	132
445-06421915	064	445-07531418	124	445-08531926	126	445-09901915	132
445-06421916	064	445-07531425	124	445-08531928	126	445-09901916	132
445-06421918	064	445-07531426	124	445-08631415	126	445-09901918	132
445-06421925	064	445-07531428	124	445-08631416	126	445-09901925	132
445-06421926	064	445-07531915	124	445-08631418	126	445-09901926	132
445-06421928	064	445-07531916	124	445-08631425	126	445-09901928	132
445-06521415	064	445-07531918	124	445-08631426	126	445-11371415	066
445-06521416	064	445-07531925	124	445-08631428	126	445-11371416	066
445-06521418	064	445-07531926	124	445-08631915	126	445-11371418	066
445-06521425	064	445-07531928	124	445-08631916	126	445-11371425	066
445-06521426	064	445-07631415	124	445-08631918	126	445-11371426	066

ARTIKELNUMMER	SEITE	ARTIKELNUMMER	SEITE	ARTIKELNUMMER	SEITE	ARTIKELNUMMER	SEITE
445-11371428	066	468-220011955	058	472-0530890383005	084	472-291010wr	017
445-11371915	066	468-220021455	058	472-0530890383006	084	472-643m21s	262
445-11371916	066	468-220021955	058	472-0541690112705	092	472-643m21w	262
445-11371918	066	468-220111455	058	472-0541690112706	092	472-645a11s	256
445-11371925	066	468-220111955	058	472-0541690113005	092	472-645a11w	256
445-11371926	066	468-220121455	058	472-0541690113006	092	472-685813c30s	288
445-11371928	066	468-220121955	058	472-0550790002705	136	472-686013c60s	288
445-11471415	066	468-2215	059	472-0550790002706	136	520-0191	108
445-11471416	066	468-2225	059	472-0550790003005	136	520-0194	108
445-11471418	066	472-0000790002704	103	472-0550790003006	136	520-0291	108
445-11471425	066	472-0000790002705	103	472-0561090003006	263	520-0294	108
445-11471426	066	472-0000790002706	103	472-0561090003011	263	520-7141	108
445-11471428	066	472-0000790002714	103	472-0571390003006	284	520-7144	108
445-11471915	066	472-0000790002763	103	472-0571390003011	284	520-7211	108
445-11471916	066	472-0000790003004	103	472-256002	264	520-7214	108
445-11471918	066	472-0000790003005	103	472-256012	274	522-810	046
445-11471925	066	472-0000790003006	103	472-256075	288	522-820	046
445-11471926	066	472-0000790003014	103	472-256078	288	528-90154	076
445-11471928	066	472-0000790003063	103	472-256079	288	528-901545	076
445-11621415	066	472-0030990003004	262	472-258951b	081	528-901546	076
445-11621416	066	472-0030990003005	262	472-258951s	081	528-90180	076
445-11621418	066	472-0050890003004	264	472-258951w	081	528-901805	076
445-11621425	066	472-0050890003005	264	472-258952b	081	528-901806	076
445-11621426	066	472-0050890003011	264	472-258952s	081	528-90254	076
445-11621428	066	472-0060890003004	258	472-258952w	081	528-902545	076
445-11621915	066	472-0060890003005	258	472-25903405hv	028	528-902546	076
445-11621916	066	472-0060890003011	258	472-25903406hv	028	528-90280	076
445-11621918	066	472-0080490003005	098	472-259034hv	028	528-902805	076
445-11621925	066	472-0080490003006	098	472-25903505hv	028	528-902806	076
445-11621926	066	472-0090890003005	098	472-25903506hv	028	528-90354	076
445-11621928	066	472-0090890003006	098	472-259035hv	028	528-903545	076
445-11911415	066	472-0101090382706	083	472-260023	262	528-903546	076
445-11911416	066	472-0101090382756	083	472-260024	262	528-90380	077
445-11911418	066	472-0101090382763	083	472-260025	258	528-903805	077
445-11911425	066	472-0101090383006	083	472-260026	258	528-903806	077
445-11911426	066	472-0101090383056	083	472-260029	084	528-910154	152
445-11911428	066	472-0101090383063	083	472-260030	084	528-9101545	152
445-11911915	066	472-0111090382706	083	472-260031	084	528-9101546	152
445-11911916	066	472-0111090382756	083	472-260032	084	528-910180	152
445-11911918	066	472-0111090382763	083	472-260042	098	528-9101805	152
445-11911925	066	472-0111090383006	083	472-260043	264	528-9101806	152
445-11911926	066	472-0111090383056	083	472-260044	264	528-910254	152
445-11911928	066	472-0111090383063	083	472-260046	284	528-9102545	152
468-110011455	060	472-0121090002705	085	472-260047	284	528-9102546	152
468-110011955	060	472-0121090002706	085	472-260048wtr	112	528-910280	152
468-110021455	060	472-0121090002763	085	472-260049wtr	112	528-9102805	152
468-110021955	060	472-0121090003005	085	472-260053btr	136	528-9102806	152
468-110111455	060	472-0121090003006	085	472-260053wtr	136	528-910354	152
468-110111955	060	472-0121090003063	085	472-260055ag	263	528-9103545	152
468-110121455	060	472-0250480403011	306	472-260055s	263	528-9103546	152
468-110121955	060	472-0260790203005	024	472-260056ag	274	528-910380	153
468-1115	061	472-0260790203006	024	472-260056s	274	528-9103805	153
468-1125	061	472-0260790403005	024	472-260056w	274	528-9103806	153
468-120011455	060	472-0260790403006	024	472-260057ag	284	528-91154	076
468-120011955	060	472-0270790203005	013	472-260057s	284	528-911545	076
468-120021455	060	472-0270790203006	013	472-29100427atr	102	528-911546	076
468-120021955	060	472-0270790403005	013	472-29100427bgtr	102	528-91180	076
468-120111455	060	472-0270790403006	013	472-29100427btr	102	528-911805	076
468-120111955	060	472-0280490003004	262	472-29100427str	102	528-911806	076
468-120121455	060	472-0280490003005	262	472-29100427wtr	102	528-91254	076
468-120121955	060	472-0291690383006	081	472-29100430atr	102	528-912545	076
468-1215	061	472-0321090303005	017	472-29100430bgtr	102	528-912546	076
468-1225	061	472-0370690003005	264	472-29100430btr	102	528-91280	076
468-210011455	058	472-0370690003006	264	472-29100430str	102	528-912805	076
468-210011955	058	472-0501090002704	080	472-29100430wtr	102	528-912806	076
468-210021455	058	472-0501090002705	080	472-291007w	098	528-91354	076
468-210021955	058	472-0501090002706	080	472-291008ag	256	528-913545	076
468-210111455	058	472-0501090003004	080	472-291008bgngl	256	528-913546	076
468-210111955	058	472-0501090003005	080	472-291008s	256	528-91380	077
468-210121455	058	472-0501090003006	080	472-291008w	256	528-913805	077
468-210121955	058	472-0520890382707	024	472-291009a	102	528-913806	077
468-2115	059	472-0520890383007	024	472-291009b	102	528-92154	152
468-2125	059	472-0530890382705	084	472-291009s	102	528-921545	152
468-220011455	058	472-0530890382706	084	472-291009w	102	528-921546	152

INDEX

ARTIKELNUMMER	SEITE	ARTIKELNUMMER	SEITE	ARTIKELNUMMER	SEITE	ARTIKELNUMMER	SEITE
528-92180	152	528-981806	076	539-010022029060	142	570-10011455	190
528-921805	152	528-98254	076	539-010022029080	142	570-1001148	190
528-921806	152	528-982545	076	539-010023023050	142	570-10011955	190
528-92254	152	528-982546	076	539-010023023060	142	570-1001198	190
528-922545	152	528-98280	076	539-010023023080	142	570-10021455	190
528-922546	152	528-982805	076	539-010023024050	142	570-1002148	190
528-92280	152	528-982806	076	539-010023024060	142	570-10021955	190
528-922805	152	528-98354	076	539-010023024080	142	570-1002198	190
528-922806	152	528-983545	076	539-010023029050	142	570-10031455	190
528-92354	152	528-983546	076	539-010023029060	142	570-1003148	190
528-923545	152	528-98380	077	539-010023029080	142	570-10031955	190
528-923546	152	528-983805	077	539-010031023050	142	570-1003198	190
528-92380	153	528-983806	077	539-010031023060	142	570-10111455	190
528-923805	153	528-983806	077	539-010031023080	142	570-1011148	190
528-923806	153	528-99154	148	539-010031024050	142	570-10111955	190
528-93154	152	528-991545	148	539-010031024060	142	570-1011198	190
528-931545	152	528-991546	148	539-010031024080	142	570-10121455	190
528-931546	152	528-99180	148	539-010031029050	142	570-1012148	190
528-93180	152	528-991805	148	539-010031029060	142	570-10121955	190
528-931805	152	528-991806	148	539-010031029080	142	570-1012198	190
528-931806	152	528-99254	148	539-010031029080	142	570-1012198	190
528-93254	152	528-992545	148	539-010032023050	142	570-10131455	190
528-932545	152	528-992546	148	539-010032023060	142	570-1013148	190
528-932546	152	528-99280	148	539-010032023080	142	570-10131955	190
528-93280	152	528-992805	148	539-010032024050	142	570-1013198	190
528-932805	152	528-992806	148	539-010032024060	142	570-hl226ne	194
528-932806	152	528-99354	148	539-010032024080	142	570-hl226new	194
528-93354	152	528-993545	148	539-010032029050	142	570-hl226we	194
528-933545	152	528-993546	148	539-010032029060	142	570-hl226wew	194
528-933546	152	528-99380	149	539-010032029080	142	570-hl233ne	194
528-93380	153	528-993805	149	539-010032029080	142	570-hl233new	194
528-933805	153	528-993806	149	539-010033023050	142	570-hl233we	194
528-933806	153	539-010011023050	142	539-010033023060	142	570-hl233wew	194
528-933806	153	539-010011023060	142	539-010033023080	142	570-hl249e	194
528-94154	148	539-010011023080	142	539-010033024050	142	570-hl249ew	194
528-941545	148	539-010011024050	142	539-010033024060	142	570-hl254e	194
528-941546	148	539-010011024060	142	539-010033024080	142	570-hl254ew	194
528-94180	148	539-010011024080	142	539-010033029050	142	570-stl455bwmngl	190
528-941805	148	539-010011029050	142	539-010033029060	142	570-stl455bwmngl	190
528-941806	148	539-010011029060	142	539-010041023050	142	570-stl455d	190
528-94254	148	539-010011029080	142	539-010041023060	142	570-stl455dw	190
528-942545	148	539-010012023050	142	539-010041023080	142	570-stl455e	190
528-942546	148	539-010012023060	142	539-010041024050	142	570-stl455ew	190
528-94280	148	539-010012023080	142	539-010041024060	142	570-wl213ne	194
528-942805	148	539-010012024050	142	539-010041024080	142	570-wl213new	194
528-942806	148	539-010012024060	142	539-010041029050	142	570-wl213we	194
528-94354	148	539-010012024080	142	539-010041029060	142	570-wl213wew	194
528-943545	148	539-010012029050	142	539-010041029080	142	570-wl255e	194
528-943546	148	539-010012029060	142	539-010042023050	142	570-wl255ew	194
528-94380	149	539-010012029080	142	539-010042023060	142	575-001011029050	112
528-943805	149	539-010013023050	142	539-010042023080	142	575-001011024050	112
528-943806	149	539-010013023060	142	539-010042024050	142	575-001021029050	112
528-95154	148	539-010013023080	142	539-010042024060	142	575-001021024050	112
528-951545	148	539-010013024050	142	539-010042024080	142	575-001031029050	112
528-951546	148	539-010013024060	142	539-010042029050	142	575-001031024050	112
528-95180	148	539-010013024080	142	539-010042029060	142	576-0191	108
528-951805	148	539-010013029050	142	539-010042029080	142	576-0195	108
528-951806	148	539-010013029060	142	539-010043023050	142	576-0198	108
528-95254	148	539-010013029080	142	539-010043023060	142	576-0291	108
528-952545	148	539-010021023050	142	539-010043023080	142	576-0295	108
528-952546	148	539-010021023060	142	539-010043024050	142	576-0298	108
528-95280	148	539-010021023080	142	539-010043024060	142	576-0298	108
528-952805	148	539-010021024050	142	539-010043024080	142	576-0391	108
528-952806	148	539-010021024060	142	539-010043029050	142	576-0395	108
528-95354	148	539-010021024080	142	539-010043029060	142	576-0398	108
528-953545	148	539-010021029050	142	539-010043029080	142	577-010011023050	144
528-953546	148	539-010021029060	142	539-010043029080	142	577-010011023060	144
528-95380	149	539-010021029080	142	544-220004	046	577-010011023080	144
528-953805	149	539-010022023050	142	544-220005	046	577-010011024050	144
528-953806	149	539-010022023060	142	544-220006	046	577-010011024060	144
528-953806	149	539-010022023080	142	565-001011029050	112	577-010011024060	144
528-98154	076	539-010022023080	142	565-001011024050	112	577-010011029050	144
528-981545	076	539-010022024050	142	565-001021029050	112	577-010011029060	144
528-981546	076	539-010022024060	142	565-001021024050	112	577-010011029080	144
528-98180	076	539-010022024080	142	565-001031029050	112	577-010012023050	144
528-981805	076	539-010022029050	142	565-001031024050	112	577-010012023060	144

ARTIKELNUMMER	SEITE	ARTIKELNUMMER	SEITE	ARTIKELNUMMER	SEITE	ARTIKELNUMMER	SEITE
577-010012023080	144	577-011012024060	072	577-013012029050	276	577-014021029080	252
577-010012024050	144	577-011012024080	072	577-013012029060	276	577-014031023050	252
577-010012024060	144	577-011012029050	072	577-013012029080	276	577-014031023060	252
577-010012024080	144	577-011012029060	072	577-013021023050	276	577-014031023080	252
577-010012029050	144	577-011012029080	072	577-013021023060	276	577-014031024050	252
577-010012029060	144	577-011021023050	072	577-013021023080	276	577-014031024060	252
577-010012029080	144	577-011021023060	072	577-013021024050	276	577-014031024080	252
577-010021023050	144	577-011021023080	072	577-013021024060	276	577-014031029050	252
577-010021023060	144	577-011021024050	072	577-013021024080	276	577-014031029060	252
577-010021023080	144	577-011021024060	072	577-013021029050	276	577-014031029080	252
577-010021024050	144	577-011021024080	072	577-013021029060	276	577-014041023050	252
577-010021024060	144	577-011021029050	072	577-013021029080	276	577-014041023060	252
577-010021024080	144	577-011021029060	072	577-013021029080	276	577-014041023080	252
577-010021029050	144	577-011021029080	072	577-013022023050	276	577-014041024050	252
577-010021029060	144	577-011022023050	072	577-013022023060	276	577-014041024060	252
577-010021029080	144	577-011022023060	072	577-013022023080	276	577-014041024080	252
577-010022023050	144	577-011022023080	072	577-013022024050	276	577-014041029050	252
577-010022023060	144	577-011022024050	072	577-013022024060	276	577-014041029060	252
577-010022023080	144	577-011022024060	072	577-013022024080	276	577-014041029080	252
577-010022024050	144	577-011022024080	072	577-013022029050	276	577-125leer	224
577-010022024060	144	577-011022029050	072	577-013022029060	276	577-126leer	224
577-010022024080	144	577-011022029060	072	577-013022029080	276	577-128leer	224
577-010022029050	144	577-011022029080	072	577-013031023050	276	577-20pm	224
577-010022029060	144	577-011031023050	072	577-013031023060	276	577-20pmk	224
577-010022029080	144	577-011031023060	072	577-013031023080	276	577-225leer	224
577-010031023050	144	577-011031023080	072	577-013031024050	276	577-226leer	224
577-010031023060	144	577-011031024050	072	577-013031024060	276	577-228leer	224
577-010031023080	144	577-011031024060	072	577-013031024080	276	577-4300	224
577-010031024050	144	577-011031024080	072	577-013031029050	276	577-4400	224
577-010031024060	144	577-011031029050	072	577-013031029060	276	577-4410	224
577-010031024080	144	577-011031029060	072	577-013031029080	276	577-4604	224
577-010031029050	144	577-011031029080	072	577-013032023050	276	577-4605	224
577-010031029060	144	577-011032023050	072	577-013032023060	276	577-4606	224
577-010031029080	144	577-011032023060	072	577-013032023080	276	577-4624	224
577-010032023050	144	577-011032023080	072	577-013032024050	276	577-4625	224
577-010032023060	144	577-011032024050	072	577-013032024060	276	577-4626	224
577-010032023080	144	577-011032024060	072	577-013032024080	276	577-4626	224
577-010032029050	144	577-011032029050	072	577-013032029050	276	577-4704	224
577-010032029060	144	577-011032029060	072	577-013032029060	276	577-4705	224
577-010032029080	144	577-011032029080	072	577-013032029080	276	577-4706	224
577-010032029080	144	577-011032029080	072	577-013041023050	276	577-5000	224
577-010041023050	144	577-011041023050	072	577-013041023060	276	597-1101953	086
577-010041023060	144	577-011041023060	072	577-013041023080	276	597-1101955	086
577-010041023080	144	577-011041023080	072	577-013041024050	276	597-1101956	086
577-010041024050	144	577-011041024050	072	577-013041024060	276	597-1101963	086
577-010041024060	144	577-011041024060	072	577-013041024080	276	597-1101965	086
577-010041024080	144	577-011041024080	072	577-013041029050	276	597-1101966	086
577-010041029050	144	577-011041029050	072	577-013041029060	276	597-2201953	086
577-010041029060	144	577-011041029060	072	577-013041029080	276	597-2201955	086
577-010041029080	144	577-011042023050	072	577-013042023050	276	597-2201956	086
577-010042023050	144	577-011042023060	072	577-013042023060	276	597-2201963	086
577-010042023060	144	577-011042023080	072	577-013042023080	276	597-2201965	086
577-010042023080	144	577-011042024050	072	577-013042023080	276	597-2201966	086
577-010042024050	144	577-011042024060	072	577-013042024050	276	599-11402534ng2	172
577-010042024060	144	577-011042024060	072	577-013042024060	276	599-11402535ng2	172
577-010042024080	144	577-011042024080	072	577-013042029050	276	599-11402536ng2	172
577-010042029050	144	577-011042029050	072	577-013042029060	276	599-11402594ng2	172
577-010042029060	144	577-011042029060	072	577-013042029080	276	599-11402595ng2	172
577-010042029080	144	577-013011023050	276	577-014011023050	252	599-11402596ng2	172
577-010042029080	144	577-013011023060	276	577-014011023060	252	599-11402834ng2	172
577-011011023050	072	577-013011023080	276	577-014011023080	252	599-11402835ng2	172
577-011011023060	072	577-013011024050	276	577-014011024050	252	599-11402836ng2	172
577-011011023080	072	577-013011024060	276	577-014011024060	252	599-11402894ng2	172
577-011011024050	072	577-013011024080	276	577-014011024080	252	599-11402895ng2	172
577-011011024060	072	577-013011029050	276	577-014011029050	252	599-11402896ng2	172
577-011011024080	072	577-013011029060	276	577-014011029060	252	599-12	094
577-011011029050	072	577-013011029080	276	577-014011029080	252	599-13	094
577-011011029060	072	577-013012023050	276	577-014021023050	252	599-15	094
577-011011029080	072	577-013012023060	276	577-014021023060	252	599-21402531ng3	178
577-011012023050	072	577-013012023080	276	577-014021023080	252	599-21402533ng3	178
577-011012023060	072	577-013012024050	276	577-014021024050	252	599-21402535ng3	178
577-011012023080	072	577-013012024060	276	577-014021024060	252	599-21402536ng3	178
577-011012024050	072	577-013012024080	276	577-014021024080	252	599-21402591ng3	178
577-011012024060	072	577-013012029050	276	577-014021029050	252	599-21402594ng3	178
577-011012024080	072	577-013012029060	276	577-014021029060	252	599-21402595ng3	178
577-011012029050	072	577-013012029080	276	577-014021029080	252		

INDEX

ARTIKELNUMMER	SEITE	ARTIKELNUMMER	SEITE	ARTIKELNUMMER	SEITE	ARTIKELNUMMER	SEITE
599-214025966ng3	178	608-42504595ng6	164	608-71202894ng2	095	619-23004896ng6	046
599-21402831ng3	178	608-42504596ng6	164	608-71202895ng2	095	625-10011455	192
599-21402834ng3	178	608-42504894ng6	164	608-71202896ng2	095	625-1001148	192
599-21402835ng3	178	608-42504895ng6	164	608-72502844ng2	095	625-10011955	192
599-214028366ng3	178	608-42504896ng6	164	608-72502845ng2	095	625-1001198	192
599-21402891ng3	178	608-43022244ng6	164	608-72502846ng2	095	625-10021455	192
599-21402894ng3	178	608-43022245ng6	164	608-72502894ng2	095	625-1002148	192
599-21402895ng3	178	608-43022246ng6	164	608-72502895ng2	095	625-10021955	192
599-214028966ng3	178	608-43022544ng6	164	608-72502896ng2	095	625-1002198	192
599-31402531ng2	094	608-43022545ng6	164	611-110144	308	625-10031455	192
599-31402534ng2	094	608-43022546ng6	164	611-110145	308	625-1003148	192
599-31402535ng2	094	608-43022844ng6	164	611-110146	308	625-10031955	192
599-31402536ng2	094	608-43022845ng6	164	611-110194	308	625-1003198	192
599-31402591ng2	094	608-43022846ng6	164	611-110195	308	625-10111455	192
599-31402594ng2	094	608-43024294ng6	164	611-110196	308	625-1011148	192
599-31402595ng2	094	608-43024295ng6	164	611-210144	308	625-10111955	192
599-31402596ng2	094	608-43024296ng6	164	611-210145	308	625-1011198	192
599-31402831ng2	094	608-43024594ng6	164	611-210146	308	625-10121455	192
599-31402834ng2	094	608-43024595ng6	164	611-210194	308	625-1012148	192
599-31402835ng2	094	608-43024596ng6	164	611-210195	308	625-10121955	192
599-31402836ng2	094	608-43024894ng6	164	611-210196	308	625-1012198	192
599-31402891ng2	094	608-43024895ng6	164	619-11702244ng6	044	625-10131455	192
599-31402894ng2	094	608-43024896ng6	164	619-11702245ng6	044	625-1013148	192
599-31402895ng2	094	608-52502244ng6	166	619-11702246ng6	044	625-10131955	192
599-31402896ng2	094	608-52502245ng6	166	619-11702544ng6	044	625-1013198	192
599-41402534ng2	172	608-52502246ng6	166	619-11702545ng6	044	625-h1233ne	194
599-41402535ng2	172	608-52502544ng6	166	619-11702546ng6	044	625-h1233new	194
599-41402536ng2	172	608-52502545ng6	166	619-11702844ng6	044	625-h1233we	194
599-41402594ng2	172	608-52502546ng6	166	619-11702845ng6	044	625-h1233wew	194
599-41402595ng2	172	608-52502844ng6	166	619-11702846ng6	044	628-216045mp	150
599-41402596ng2	172	608-52502845ng6	166	619-11704294ng6	044	628-216045pm	150
599-41402834ng2	172	608-52502846ng6	166	619-11704295ng6	044	628-216046mp	150
599-41402835ng2	172	608-52504294ng6	166	619-11704296ng6	044	628-216046pm	150
599-41402836ng2	172	608-52504295ng6	166	619-11704594ng6	044	628-216048mp	150
599-41402894ng2	172	608-52504296ng6	166	619-11704595ng6	044	628-216048pm	150
599-41402895ng2	172	608-52504594ng6	166	619-11704596ng6	044	628-216095mp	150
599-41402896ng2	172	608-52504595ng6	166	619-11704894ng6	044	628-216095pm	150
599-51402534ng3	178	608-52504596ng6	166	619-11704895ng6	044	628-216096mp	150
599-51402535ng3	178	608-52504894ng6	166	619-11704896ng6	044	628-216096pm	150
599-514025366ng3	178	608-52504895ng6	166	619-12502244ng6	044	628-216098mp	150
599-51402594ng3	178	608-52504896ng6	166	619-12502245ng6	044	628-216098pm	150
599-51402595ng3	178	608-53022244ng6	166	619-12502246ng6	044	628-216145mp	150
599-514025966ng3	178	608-53022245ng6	166	619-12502544ng6	044	628-216145pm	150
599-51402834ng3	178	608-53022246ng6	166	619-12502545ng6	044	628-216146mp	150
599-51402835ng3	178	608-53022544ng6	166	619-12502546ng6	044	628-216146pm	150
599-514028366ng3	178	608-53022545ng6	166	619-12502844ng6	044	628-216148mp	150
599-51402894ng3	178	608-53022546ng6	166	619-12502845ng6	044	628-216148pm	150
599-51402895ng3	178	608-53022844ng6	166	619-12502846ng6	044	628-216195mp	150
599-514028966ng3	178	608-53022845ng6	166	619-12504294ng6	044	628-216195pm	150
599-61402534ng2	094	608-53022846ng6	166	619-12504295ng6	044	628-216196mp	150
599-61402535ng2	094	608-53024294ng6	166	619-12504296ng6	044	628-216196pm	150
599-61402536ng2	094	608-53024295ng6	166	619-12504594ng6	044	628-216198mp	150
599-61402594ng2	094	608-53024296ng6	166	619-12504595ng6	044	628-216198pm	150
599-61402595ng2	094	608-53024594ng6	166	619-12504596ng6	044	628-220045mp	150
599-61402596ng2	094	608-53024595ng6	166	619-12504894ng6	044	628-220045pm	150
599-61402834ng2	094	608-53024596ng6	166	619-12504895ng6	044	628-220046mp	150
599-61402835ng2	094	608-53024894ng6	166	619-12504896ng6	044	628-220046pm	150
599-61402836ng2	094	608-53024895ng6	166	619-23002244ng6	046	628-220048mp	150
599-61402894ng2	094	608-53024896ng6	166	619-23002245ng6	046	628-220048pm	150
599-61402895ng2	094	608-61202844ng2	170	619-23002246ng6	046	628-220095mp	150
599-61402896ng2	094	608-61202845ng2	170	619-23002544ng6	046	628-220095pm	150
608-42502244ng6	164	608-61202846ng2	170	619-23002545ng6	046	628-220096mp	150
608-42502245ng6	164	608-61202894ng2	170	619-23002546ng6	046	628-220096pm	150
608-42502246ng6	164	608-61202895ng2	170	619-23002844ng6	046	628-220098mp	150
608-42502544ng6	164	608-61202896ng2	170	619-23002845ng6	046	628-220098pm	150
608-42502545ng6	164	608-62502844ng2	170	619-23002846ng6	046	628-220145mp	150
608-42502546ng6	164	608-62502845ng2	170	619-23004294ng6	046	628-220145pm	150
608-42502844ng6	164	608-62502846ng2	170	619-23004295ng6	046	628-220146mp	150
608-42502845ng6	164	608-62502894ng2	170	619-23004296ng6	046	628-220146pm	150
608-42502846ng6	164	608-62502895ng2	170	619-23004594ng6	046	628-220148mp	150
608-42504294ng6	164	608-62502896ng2	170	619-23004595ng6	046	628-220148pm	150
608-42504295ng6	164	608-71202844ng2	095	619-23004596ng6	046	628-220195mp	150
608-42504296ng6	164	608-71202845ng2	095	619-23004894ng6	046	628-220195pm	150
608-42504594ng6	164	608-71202846ng2	095	619-23004895ng6	046	628-220196mp	150

INDEX

ARTIKELNUMMER	SEITE	ARTIKELNUMMER	SEITE	ARTIKELNUMMER	SEITE	ARTIKELNUMMER	SEITE
628-416048pm	146	628-440095pm	146	628-475096pm	146	635-11204296ng6	041
628-416095mp	146	628-440096mp	146	628-475098mp	146	635-11204594ng6	041
628-416095pm	146	628-440096pm	146	628-475098pm	146	635-11204595ng6	041
628-416096mp	146	628-440098mp	146	628-475145mp	146	635-11204596ng6	041
628-416096pm	146	628-440098pm	146	628-475145pm	146	635-11204894ng6	041
628-416098mp	146	628-440145mp	146	628-475146mp	146	635-11204895ng6	041
628-416098pm	146	628-440145pm	146	628-475146pm	146	635-11204896ng6	041
628-416145mp	146	628-440146mp	146	628-475148mp	146	635-11702244ng6	041
628-416145pm	146	628-440146pm	146	628-475148pm	146	635-11702245ng6	041
628-416146mp	146	628-440148mp	146	628-475195mp	146	635-11702246ng6	041
628-416146pm	146	628-440148pm	146	628-475195pm	146	635-11702544ng6	041
628-416148mp	146	628-440195mp	146	628-475196mp	146	635-11702545ng6	041
628-416148pm	146	628-440195pm	146	628-475196pm	146	635-11702546ng6	041
628-416195mp	146	628-440196mp	146	628-475198mp	146	635-11702844ng6	041
628-416195pm	146	628-440196pm	146	628-475198pm	146	635-11702845ng6	041
628-416196mp	146	628-440198mp	146	633-12002145ng6	050	635-11702846ng6	041
628-416196pm	146	628-440198pm	146	633-12002245ng6	050	635-11704294ng6	041
628-416198mp	146	628-450045mp	146	633-12002245ng6	050	635-11704295ng6	041
628-416198pm	146	628-450045pm	146	633-12004195ng6	050	635-11704296ng6	041
628-420045mp	146	628-450046mp	146	633-12004295ng6	050	635-11704594ng6	041
628-420045pm	146	628-450046pm	146	633-12004395ng6	050	635-11704595ng6	041
628-420046mp	146	628-450048mp	146	633-12802145ng6	050	635-11704596ng6	041
628-420046pm	146	628-450048pm	146	633-12802245ng6	050	635-11704894ng6	041
628-420048mp	146	628-450095mp	146	633-12802345ng6	050	635-11704895ng6	041
628-420048pm	146	628-450095pm	146	633-12802345ng6	050	635-11704896ng6	041
628-420095mp	146	628-450096mp	146	633-12804195ng6	050	635-11704896ng6	041
628-420095pm	146	628-450096pm	146	633-12804295ng6	050	635-21202244ng6	040
628-420096mp	146	628-450098mp	146	633-12804395ng6	050	635-21202245ng6	040
628-420096pm	146	628-450098pm	146	633-22002145ng6	038	635-21202246ng6	040
628-420098mp	146	628-450145mp	146	633-22002146ng6	038	635-21202544ng6	040
628-420098pm	146	628-450145pm	146	633-22002245ng6	038	635-21202545ng6	040
628-420145mp	146	628-450146mp	146	633-22002246ng6	038	635-21202546ng6	040
628-420145pm	146	628-450146pm	146	633-22002345ng6	038	635-21202844ng6	040
628-420146mp	146	628-450148mp	146	633-22002346ng6	038	635-21202845ng6	040
628-420146pm	146	628-450148pm	146	633-22004195ng6	038	635-21202846ng6	040
628-420148mp	146	628-450195mp	146	633-22004196ng6	038	635-21204294ng6	040
628-420148pm	146	628-450195pm	146	633-22004295ng6	038	635-21204295ng6	040
628-420195mp	146	628-450196mp	146	633-22004296ng6	038	635-21204296ng6	040
628-420195pm	146	628-450196pm	146	633-22004395ng6	038	635-21204594ng6	040
628-420196mp	146	628-450198mp	146	633-22004396ng6	038	635-21204595ng6	040
628-420196pm	146	628-450198pm	146	633-42002145ng6	038	635-21204596ng6	040
628-420198mp	146	628-460045mp	146	633-42002146ng6	038	635-21204894ng6	040
628-420198pm	146	628-460045pm	146	633-42002245ng6	038	635-21204895ng6	040
628-425045mp	146	628-460046mp	146	633-42002246ng6	038	635-21204896ng6	040
628-425045pm	146	628-460046pm	146	633-42002345ng6	038	635-21702244ng6	040
628-425046mp	146	628-460048mp	146	633-42002346ng6	038	635-21702245ng6	040
628-425046pm	146	628-460048pm	146	633-42004195ng6	038	635-21702246ng6	040
628-425048mp	146	628-460095mp	146	633-42004196ng6	038	635-21702544ng6	040
628-425048pm	146	628-460095pm	146	633-42004295ng6	038	635-21702545ng6	040
628-425095mp	146	628-460096mp	146	633-42004296ng6	038	635-21702546ng6	040
628-425095pm	146	628-460096pm	146	633-42004395ng6	038	635-21702844ng6	040
628-425096mp	146	628-460098mp	146	633-42004396ng6	038	635-21702845ng6	040
628-425096pm	146	628-460098pm	146	633-54002145ng6	038	635-21702846ng6	040
628-425098mp	146	628-460145mp	146	633-54002146ng6	038	635-21704294ng6	040
628-425098pm	146	628-460145pm	146	633-54002245ng6	038	635-21704295ng6	040
628-425145mp	146	628-460146mp	146	633-54002246ng6	038	635-21704296ng6	040
628-425145pm	146	628-460146pm	146	633-54002345ng6	038	635-21704594ng6	040
628-425146mp	146	628-460148mp	146	633-54002346ng6	038	635-21704595ng6	040
628-425146pm	146	628-460148pm	146	633-54004195ng6	038	635-21704596ng6	040
628-425148mp	146	628-460195mp	146	633-54004196ng6	038	635-21704894ng6	040
628-425148pm	146	628-460195pm	146	633-54004295ng6	038	635-21704895ng6	040
628-425195mp	146	628-460196mp	146	633-54004296ng6	038	635-21704896ng6	040
628-425195pm	146	628-460196pm	146	633-54004395ng6	038	635-32902244ng6	042
628-425196mp	146	628-460198mp	146	633-54004396ng6	038	635-32902245ng6	042
628-425196pm	146	628-460198pm	146	635-11202244ng6	041	635-32902246ng6	042
628-425198mp	146	628-460198pm	146	635-11202245ng6	041	635-32902544ng6	042
628-425198pm	146	628-475045mp	146	635-11202246ng6	041	635-32902545ng6	042
628-440045mp	146	628-475045pm	146	635-11202544ng6	041	635-32902546ng6	042
628-440045pm	146	628-475046mp	146	635-11202545ng6	041	635-32902844ng6	042
628-440046mp	146	628-475046pm	146	635-11202546ng6	041	635-32902845ng6	042
628-440046pm	146	628-475048mp	146	635-11202844ng6	041	635-32902846ng6	042
628-440048mp	146	628-475048pm	146	635-11202845ng6	041	635-32904294ng6	042
628-440048pm	146	628-475095mp	146	635-11202846ng6	041	635-32904295ng6	042
628-440048pm	146	628-475095pm	146	635-11204294ng6	041	635-32904296ng6	042
628-440095mp	146	628-475096mp	146	635-11204295ng6	041	635-32904594ng6	042

ARTIKELNUMMER	SEITE	ARTIKELNUMMER	SEITE	ARTIKELNUMMER	SEITE	ARTIKELNUMMER	SEITE
635-32904595ng6	042	639-10902544	204	639-120598ts	202	639-310548da	202
635-32904596ng6	042	639-10902545	204	639-120748bs	202	639-310548ts	202
635-32904894ng6	042	639-10902546	204	639-120748da	202	639-310598bs	202
635-32904895ng6	042	639-10902644	204	639-120748ts	202	639-310598da	202
635-32904896ng6	042	639-10902645	204	639-120798bs	202	639-310598ts	202
635-34002244ng6	042	639-10902646	204	639-120798da	202	639-310748bs	202
635-34002245ng6	042	639-10902844	204	639-120798ts	202	639-310748da	202
635-34002246ng6	042	639-10902845	204	639-120948bs	202	639-310748ts	202
635-34002544ng6	042	639-10902846	204	639-120948da	202	639-310798bs	202
635-34002545ng6	042	639-10902846	204	639-120948ts	202	639-310798da	202
635-34002546ng6	042	639-10904294	204	639-120998bs	202	639-310798ts	202
635-34002844ng6	042	639-10904295	204	639-120998da	202	639-310948bs	202
635-34002845ng6	042	639-10904296	204	639-120998ts	202	639-310948da	202
635-34002846ng6	042	639-10904594	204	639-121148bs	202	639-310948ts	202
635-34004294ng6	042	639-10904595	204	639-121148da	202	639-310998bs	202
635-34004295ng6	042	639-10904596	204	639-121148ts	202	639-310998da	202
635-34004296ng6	042	639-10904694	204	639-121198bs	202	639-310998ts	202
635-34004296ng6	042	639-10904695	204	639-121198da	202	639-311148bs	202
635-34004595ng6	042	639-10904696	204	639-121198ts	202	639-311148da	202
635-34004596ng6	042	639-10904894	204	639-15	200	639-311148ts	202
635-34004596ng6	042	639-10904895	204	639-16	200	639-311198bs	202
635-34004894ng6	042	639-10904896	204	639-18	200	639-311198da	202
635-34004895ng6	042	639-110548bs	202	639-210548bs	202	639-311198ts	202
635-34004896ng6	042	639-110548da	202	639-210548da	202	639-320548bs	202
639-10502244	204	639-110548ts	202	639-210548ts	202	639-320548da	202
639-10502245	204	639-110598bs	202	639-210598bs	202	639-320598bs	202
639-10502246	204	639-110598da	202	639-210598da	202	639-320598da	202
639-10502544	204	639-110598ts	202	639-210598ts	202	639-320598ts	202
639-10502545	204	639-110748bs	202	639-210748bs	202	639-320748bs	202
639-10502546	204	639-110748da	202	639-210748da	202	639-320748da	202
639-10502644	204	639-110748ts	202	639-210798bs	202	639-320748ts	202
639-10502645	204	639-110798bs	202	639-210798da	202	639-320798bs	202
639-10502646	204	639-110798da	202	639-210798ts	202	639-320798da	202
639-10502844	204	639-110798ts	202	639-210948bs	202	639-320798ts	202
639-10502845	204	639-110948bs	202	639-210948da	202	639-320948bs	202
639-10502846	204	639-110948da	202	639-210948ts	202	639-320948da	202
639-10504294	204	639-110948ts	202	639-210998bs	202	639-320948ts	202
639-10504295	204	639-110998bs	202	639-210998da	202	639-320998bs	202
639-10504296	204	639-110998da	202	639-210998ts	202	639-320998da	202
639-10504594	204	639-11102244	204	639-211148bs	202	639-320998ts	202
639-10504595	204	639-11102245	204	639-211148da	202	639-321148bs	202
639-10504596	204	639-11102246	204	639-211148ts	202	639-321148da	202
639-10504694	204	639-11102544	204	639-211198bs	202	639-321148ts	202
639-10504695	204	639-11102545	204	639-211198da	202	639-321198bs	202
639-10504696	204	639-11102546	204	639-211198ts	202	639-321198da	202
639-10504894	204	639-11102644	204	639-220548bs	202	639-321198ts	202
639-10504895	204	639-11102645	204	639-220548da	202	639-35	200
639-10504896	204	639-11102646	204	639-220548ts	202	639-36	200
639-10702244	204	639-11102844	204	639-220598bs	202	639-38	200
639-10702245	204	639-11102845	204	639-220598da	202	639-45	200
639-10702246	204	639-11102846	204	639-220598ts	202	639-46	200
639-10702544	204	639-11104294	204	639-220748bs	202	639-48	200
639-10702545	204	639-11104295	204	639-220748da	202	639-55	200
639-10702546	204	639-11104296	204	639-220748ts	202	639-56	200
639-10702644	204	639-11104594	204	639-220798bs	202	639-58	200
639-10702645	204	639-11104595	204	639-220798da	202	639-ad	205
639-10702646	204	639-11104596	204	639-220798ts	202	639-ak	205
639-10702844	204	639-11104694	204	639-220948bs	202	639-as	205
639-10702845	204	639-11104695	204	639-220948da	202	639-ash	205
639-10702846	204	639-11104696	204	639-220948ts	202	639-ay	205
639-10704294	204	639-11104894	204	639-220998bs	202	639-bcm	206
639-10704295	204	639-11104895	204	639-220998da	202	639-dve05	200
639-10704296	204	639-11104896	204	639-220998ts	202	639-dve07	200
639-10704594	204	639-111148bs	202	639-221148bs	202	639-epg1055	200
639-10704595	204	639-111148da	202	639-221148da	202	639-epg1056	200
639-10704596	204	639-111148ts	202	639-221148ts	202	639-epg1058	200
639-10704694	204	639-111198bs	202	639-221198bs	202	639-epg1075	200
639-10704695	204	639-111198da	202	639-221198da	202	639-epg1076	200
639-10704696	204	639-111198ts	202	639-221198ts	202	639-epg1078	200
639-10704894	204	639-120548bs	202	639-25	200	639-epg2055	200
639-10704895	204	639-120548da	202	639-26	200	639-epg2056	200
639-10704896	204	639-120548ts	202	639-28	200	639-epg2058	200
639-10902244	204	639-120598bs	202	639-310548bs	202	639-epg2075	200
639-10902245	204	639-120598da	202				

INDEX

ARTIKELNUMMER	SEITE	ARTIKELNUMMER	SEITE	ARTIKELNUMMER	SEITE	ARTIKELNUMMER	SEITE
639-epg2076	200	639-tam4096	206	651-000016	173	652-0040500006	186
639-epg2078	200	639-tam4098	206	651-000024	173	652-0040500008	186
639-hb055	206	639-tam4115	206	651-000025	173	652-0040700001	186
639-hb056	206	639-tam4116	206	651-000026	173	652-0040700005	186
639-hb058	206	639-tam4118	206	651-00102141344	173	652-0040700006	186
639-hb075	206	639-tam5005	206	651-00102141355	173	652-0040700008	186
639-hb076	206	639-tam5006	206	651-00102141366	173	652-0040800001	186
639-hb078	206	639-tam5008	206	651-00102141944	173	652-0040800005	186
639-hb095	206	639-tdip	206	651-00102141955	173	652-0040800006	186
639-hb096	206	639-te4	200	651-00102141966	173	652-0040800008	186
639-hb098	206	639-te5	200	651-00202141311	180	652-0050100001	187
639-hb115	206	639-te6	200	651-00202141344	180	652-0050100005	187
639-hb116	206	639-teip4	200	651-00202141355	180	652-0050100006	187
639-hb118	206	639-teip5	200	651-00202141366	180	652-0050100008	187
639-kvs05	205	639-teip6	200	651-00202141911	180	652-0050200004	186
639-kvs07	205	639-ttv4	205	651-00202141944	180	652-0050200005	186
639-ltv4	205	639-ttv5	205	651-00202141955	180	652-0050200006	186
639-ltv5	205	639-ttv6	205	651-00202141966	180	652-0050200008	186
639-ltv6	205	639-tv	205	652-0010100001	186	653-00101000055	184
639-nle095	204	639-ww15	204	652-0010100005	186	653-00101000061	184
639-nle115	204	639-ww18	204	652-0010100006	186	653-00101000066	184
639-nlh095	204	639-ww25	204	652-0010100008	186	653-00102000055	184
639-nlh115	204	639-ww28	204	652-0010200001	186	653-00102000061	184
639-rz098	204	639-ww35	204	652-0010200005	186	653-00102000066	184
639-rz118	204	639-ww38	204	652-0010200006	186	653-00201000011	184
639-s3000	176	639-xtv4	205	652-0010200008	186	653-00201000055	184
639-taip1	206	639-xtv5	205	652-0010300005	186	653-00201000066	184
639-taip2	206	639-xtv6	205	652-0010300006	186	653-00202000011	184
639-taip3	206	643-j110agw	057	652-0010300008	186	653-00202000055	184
639-taip4	206	643-j180agw	057	652-0020100001	187	653-00202000066	184
639-taip5	206	643-j300agw	057	652-0020100005	187	653-00301000011	096
639-tam1055	206	643-q110agw	056	652-0020100006	187	653-00301000055	096
639-tam1056	206	643-q180agw	056	652-0020100008	187	653-00301000066	096
639-tam1058	206	643-q300agw	056	652-0020200001	187	653-00302000011	096
639-tam1075	206	647-drp24024	318	652-0020200005	187	653-00302000055	096
639-tam1076	206	647-hlg24024	319	652-0020200006	187	653-00302000066	096
639-tam1078	206	650-11702245ng6	168	652-0020200008	187	654-00250000011	180
639-tam1095	206	650-11702246ng6	168	652-0020300001	187	654-00250000042	180
639-tam1096	206	650-11702545ng6	168	652-0020300005	187	654-00250000055	180
639-tam1098	206	650-11702546ng6	168	652-0020300006	187	654-00250000066	180
639-tam1115	206	650-11702845ng6	168	652-0020300008	187	656-00150000048	184
639-tam1116	206	650-11702846ng6	168	652-0030100001	187	656-00250000048	184
639-tam1118	206	650-11704295ng6	168	652-0030200001	187	657-00160000044	184
639-tam2055	206	650-11704296ng6	168	652-0030300001	187	657-00260000011	184
639-tam2056	206	650-11704595ng6	168	652-0030400001	187	657-00260000042	184
639-tam2058	206	650-11704596ng6	168	652-0030400005	187	657-00260000055	184
639-tam2075	206	650-11704895ng6	168	652-0030400006	187	657-00260000066	184
639-tam2076	206	650-11704896ng6	168	652-0030400008	187	658-00175000044	182
639-tam2078	206	650-22502245ng6	168	652-0030500001	187	658-00275000011	182
639-tam2095	206	650-22502246ng6	168	652-0030500005	187	658-00275000044	182
639-tam2096	206	650-22502545ng6	168	652-0030500006	187	658-00275000055	182
639-tam2098	206	650-22502546ng6	168	652-0030500008	187	658-00275000066	182
639-tam2115	206	650-22502845ng6	168	652-0030600001	187	659-000011	182
639-tam2116	206	650-22502846ng6	168	652-0030600005	187	659-000021	182
639-tam2118	206	650-22504295ng6	168	652-0030600006	187	659-000015	182
639-tam3055	206	650-22504296ng6	168	652-0030600008	187	659-000016	182
639-tam3056	206	650-22504595ng6	168	652-0040100001	186	659-000021	182
639-tam3058	206	650-22504596ng6	168	652-0040100005	186	659-000022	182
639-tam3075	206	650-22504895ng6	168	652-0040100006	186	659-000025	182
639-tam3076	206	650-22504896ng6	168	652-0040100008	186	659-000026	182
639-tam3078	206	650-23022245ng6	168	652-0040200001	186	659-00275000011	182
639-tam3095	206	650-23022246ng6	168	652-0040200005	186	659-00275000042	182
639-tam3096	206	650-23022545ng6	168	652-0040200006	186	659-00275000055	182
639-tam3098	206	650-23022546ng6	168	652-0040200008	186	659-00275000066	182
639-tam3115	206	650-23022845ng6	168	652-0040300001	186	746-1000	223
639-tam3116	206	650-23022846ng6	168	652-0040300005	186	746-1000b	223
639-tam3118	206	650-23024295ng6	168	652-0040300006	186	746-1001	216
639-tam4055	206	650-23024296ng6	168	652-0040300008	186	746-1002	216
639-tam4056	206	650-23024595ng6	168	652-0040400001	186	746-1004	216
639-tam4058	206	650-23024596ng6	168	652-0040400005	186	746-1100	216
639-tam4075	206	650-23024895ng6	168	652-0040400006	186	746-1101	216
639-tam4076	206	650-23024896ng6	168	652-0040400008	186	746-1200	216
639-tam4078	206	651-000014	173	652-0040500001	186	746-242420nw	218
639-tam4095	206	651-000015	173	652-0040500005	186	746-242420nwkonf	218

ARTIKELNUMMER	SEITE	ARTIKELNUMMER	SEITE	ARTIKELNUMMER	SEITE	ARTIKELNUMMER	SEITE
746-242420ww	218	757-l2004	110	757-zhx11	128	789-53234	118
746-242420wwkonf	218	757-l2005	110	775-hv60000808	174	789-53235	118
746-242467nw	216	757-l2006	110	789-41257	114	789-53254	118
746-242467ww	216	757-l2007	110	789-41270	114	789-53256	118
746-244820nw	218	757-l2008	110	789-41282	114	789-53277	118
746-244820nwkonf	218	757-l2009	110	789-41307	114	789-53279	118
746-244820ww	218	757-l2010	129	789-42310	114	789-53305	118
746-244820wwkonf	218	757-l2011	129	789-42702	116	789-53310	118
746-247220nwkonf	221	757-l2012	129	789-42703	116	789-53315	118
746-247220nwnngl	221	757-l2013	129	789-42709	116	789-53316	118
746-247220rgb	221	757-l2014	208	789-42742	116	789-53319	118
746-247220ww	221	757-l2015	208	789-42775	116	789-53335	118
746-247220wwkonf	221	757-l2016	208	789-43070	114	789-53336	118
746-247267nw	216	757-l2017	208	789-44705	116	789-53337	118
746-247267rgb	216	757-l2018	110	789-44741	116	789-53342	118
746-247267wwngl	216	757-l2019	110	789-44900	116	789-53359	118
746-247420nw	221	757-l2020	110	789-48220	118	789-53360	118
746-247420ww	221	757-l2021	110	789-48224	118	789-53361	118
746-248720rgbw	221	757-l2022	196	789-48228	118	789-53368	118
746-3000	223	757-l2022dali	196	789-48232	118	789-53385	118
746-3000b	223	757-l2023	196	789-48720	118	789-53390	118
746-fc1220rgb	221	757-l2023dali	196	789-48724	118	789-53405	114
746-fc1220w	218	757-l2024	196	789-48728	118	789-53406	114
746-fc2420w	221	757-l2024dali	196	789-48732	118	789-53410	114
746-konfip20	218	757-l2025	196	789-49080	114	789-53422	114
746-lc1220rgb	221	757-l2025dali	196	789-49090	114	789-53423	114
746-lc1220w	218	757-l2026	196	789-49580	114	789-53428	114
746-lc2420w	221	757-l2026dali	196	789-49590	114	789-53734	118
746-lcf1220rgb	221	757-l2027	196	789-51262	116	789-53735	118
746-lcf1220w	218	757-l2027dali	196	789-51263	116	789-53754	118
746-lcf2420w	221	757-l2028	196	789-51264	116	789-53756	118
757-2020	128	757-l2028dali	196	789-51265	116	789-53777	118
757-2022	128	757-l2029	196	789-51266	116	789-53779	118
757-2030	128	757-l2029dali	196	789-51274	116	789-53805	118
757-2032	128	757-l2030	128	789-51275	116	789-53810	118
757-6000	070	757-l2030dali	128	789-51286	116	789-53815	118
757-6000dali	070	757-l2031	128	789-51287	116	789-53816	118
757-6001	070	757-l2031dali	128	789-51295	116	789-53835	118
757-6001dali	070	757-l2032	128	789-51296	116	789-53837	118
757-6003	070	757-l2032dali	128	789-51300	116	789-53859	118
757-6003dali	070	757-l2033	128	789-51301	116	789-53861	118
757-6005	070	757-l2033dali	128	789-51320	116	789-53885	118
757-6005dali	070	757-l2034	129	789-51321	116	789-53890	118
757-6015	070	757-l2035	129	789-51339	116	789-53905	114
757-6015dali	070	757-l2036	129	789-51340	116	789-53906	114
757-6017	070	757-l2037	129	789-51381	114	789-53922	114
757-6017dali	070	757-l2038	129	789-51382	114	789-53923	114
757-625abr	068	757-l2039	129	789-51386	114	789-54987	116
757-625ebrw	068	757-l2040	208	789-51395	114	789-56075	119
757-625np30uswok	196	757-l2041	208	789-51403	114	789-56079	119
757-625np30wok	068	757-l3001	296	789-51404	114	789-56110	119
757-625np40uswok	196	757-l3002	296	789-51762	116	789-56116	119
757-625np40wok	068	757-l3003	296	789-51763	116	789-56130	119
757-625pm30wok	068	757-l3004	296	789-51764	116	789-56137	119
757-625pm40wok	068	757-l6000	070	789-51765	116	789-56155	114
757-as2000	068	757-l6000dali	070	789-51766	116	789-56159	114
757-bk3w	068	757-l6001	070	789-51774	116	789-56171	114
757-bk5w	068	757-l6001dali	070	789-51775	116	797-0001180303005	052
757-ef8000	070	757-l6002	070	789-51786	116	797-0011880373005	052
757-k1050s	068	757-l6002dali	070	789-51787	116	797-0022780453005	052
757-k700d	068	757-l6003	070	789-51795	116	851-s1200w14	296
757-k700s	068	757-l6003dali	070	789-51796	116	851-s1205w14	296
757-l1000	197	757-l6004	196	789-51800	116	851-s2905w01	260
757-l1000dali	197	757-l6004dali	196	789-51801	116	851-s2905w14	260
757-l1001	197	757-l6005	196	789-51820	116	851-s2915w01	260
757-l1001dali	197	757-l6005dali	196	789-51821	116	851-s2915w14	260
757-l1002	197	757-l6006	069	789-51839	116	851-s3010w01	296
757-l1002dali	197	757-l6006dali	069	789-51840	116	851-s3010w14	296
757-l1003	197	757-l6007	069	789-51881	114	851-s3883w01	261
757-l1003dali	197	757-l6007dali	069	789-51882	114	851-s3883w14	261
757-l2000	197	757-l6008	069	789-51886	114	851-s3884w01	261
757-l2001	197	757-l6008dali	069	789-51895	114	851-s3884w14	261
757-l2002	197	757-l6009	069	789-51903	114	851-s4104w14	281
757-l2003	197	757-l6009dali	069	789-51904	114	851-s4172	281



Gerne erstellen wir Ihnen für Ihr Objekt eine Lichtplanung und ein individuelles Angebot. Sprechen Sie uns an. Wir beraten Sie gerne.

Ich bitte um Rückruf!

_____ Ansprechpartner/Telefonnummer

Bitte senden Sie uns Ihren Außendienst

**Meine Kontaktdaten/
oder Firmenstempel:**

_____ Firma

_____ Ansprechpartner

_____ Straße

_____ PLZ, Ort

_____ E-Mail

_____ Telefon

_____ Datum, Unterschrift

KTL 2018.01

RMBH GmbH
Steinweg 3 – 5
91567 Herrieden

Fon +49 (0) 9825 203829-0
Fax +49 (0) 9825 203829-19
E-Mail info@rmbh.de



WEEE-Reg.-Nr. DE48228320

www.rmbh.de ■ ■ ■