



20  
22

 **Beta** *Action*

**Promotie**

**valabila pana la 31.12.2022**

Preturile sunt exprimate in RON  
si nu includ TVA



# Beta

## RSC 55



**Configura-ti  
atelierul on-line**

**www.rsc55.com**

## INDEX

MOBILIER MODULAR C45PRO - RSC55	2÷4	
DULAPURI SCULE	5÷10	
COMPONENTE SCULE ȘI TĂVI TERMOFORMATE	11÷16	
SISTEM MODULAR COMBO	18-19	
BANCURI DE LUCRU	20-21	
CĂRUCIOARE ȘI TROLLERE SCULE	17-21-22	
GENȚI SCULE	23÷26	
SCULE DE MÂNĂ	27÷30	
ȘURUBELNIȚE	31	
SCULE CODATE PE CULORI	32-33	
TUBULARE ȘI ACCESORII	34÷36	
CHEI DINAMOMETRICE	37-38	
CLEȘTI	39-40	
SCULE PENTRU GĂURIT ȘI FILETAT	41-42	
CIOCANE ȘI DĂLȚI	43	
SCULE ÎNTREȚINERE GENERALĂ	44÷49	
LĂMPI DE LUCRU	50÷52	
SCULE IZOLATE 1000V	53-54	
SCULE PENTRU TĂIERE	55	
ABRAZIVE	56	
POLIZOARE UNGHIULARE	57	
AUTOMOTIVE	58÷81	
DISPOZITIVE PENTRU RIDICARE  Robur	82-83	
SCULE PNEUMATICE	84÷88	
ÎNCĂLȚĂMINTE DE PROTECȚIE	89÷96	
ÎMBRĂCĂMINTE DE LUCRU	97÷103	
BETA COLLECTION	104	

# C45PRO

# MOBILIER MODULAR GAMA C45PRO

## // C45PRO

Combinatia cuprinde:

- Modul fix cu 7 sertare (C45PRO M7)
- Modul de service fix (C45PRO MS)
- Dulap mobil cu 7 sertare (C45PRO C7)
- Dulap cu doua usi (C45PRO AS2)
- 3 panouri de scule perforate (C45PRO PF)
- 3 dulapuri montate pe perete (C45PRO PM)
- 3 suporturi de perete, late (C45PRO SL)
- 1 suport de perete, tip ingust (C45PRO SS)



2000 mm  
495 mm  
2955 mm

### // 045000001 C45PRO X

~~19.800 RON~~ **13.200 RON**

- Blat din MDF si otel inoxidabil (C45PX / 3-2.0MT)



// **305 kg**

### // 045000002 C45PRO W

~~19.300 RON~~ **12.867 RON**

- Blat din lemn stratificat (C45PW / 3-2.0MT)



// **303 kg**



## // C45PRO A

Combinatia cuprinde:

- Modul fix cu 7 sertare (C45PRO M7)
- Modul de service fix (C45PRO MS)
- Modul fix cu doua usi (C45PRO MA)
- 3 dulapuri montate pe perete (C45PRO PM)
- 3 panouri de scule perforate (C45PRO PF)
- 2 console de perete, late (C45PRO SL)
- 2 suporturi de perete, tip ingust (C45PRO SS)



2000 mm  
495 mm  
2040 mm

### // 045000003 C45PRO AX

~~13.800 RON~~ **9.200 RON**

- Blat din MDF si otel inoxidabil (C45PX / 3-2.0MT)



// **206 kg**

### // 045000004 C45PRO AW

~~13.250 RON~~ **8.833 RON**

- Blat de lucru din lemn stratificat (C45PW / 3-2.0MT)



// **204 kg**





## // C45PRO B

Combinatia cuprinde:

- Modul fix cu 5 sertare (C45PRO M5)
- Modul fix cu doua usi (C45PRO MA)
- dulap cu scule cu o singura usa (C45PRO AS1)
- 2 dulapuri montate pe perete (C45PRO PM)
- 2 panouri perforate pentru scule (C45PRO PF)
- 2 console de perete, tip lat (C45PRO SL)
- 1 suport de perete, tip ingust (C45PRO SS)



### // 045000021 C45PRO BX

**12.250 RON 8.167 RON**

- Blat din MDF si oțel inoxidabil (C45PX / 2-1.3MT)



**191 kg**

### // 045000022 C45PRO BW

**11.750 RON 7.833 RON**

- Blat de lucru din lemn stratificat (C45PW / 2-1.3MT)



**190 kg**

## // C45PRO D

Combinatia cuprinde:

- 1 modul fix cu 7 sertare (C45PRO M7)
- 1 dulap mobil cu 7 sertare (C45PRO C7)
- 1 modul de service fix (C45PRO MS)
- 1 modul fix cu 5 sertare (C45PRO M5)

- 1 modul fix cu doua usi (C45PRO MA)
- 5 panouri perforate pentru scule (C45PRO PF)
- 5 dulapuri montate pe perete (C45PRO PM)
- 7 console de perete, tip lat (C45PRO SL)
- 2 suporturi de perete, tip ingust (C45PRO SS)
- 2 dulapuri cu o singura usa (C45PRO AS1)



2000 mm  
495 mm  
3500/2820 mm

### // 045000031 C45PRO DX

**39.050 RON 26.033 RON**

- 1 blat din MDF si oțel inoxidabil (C45PX / 3-2,0MT)
- 1 blat din MDF si oțel inoxidabil (C45PX / 2-1,3MT)
- 1 colț complet autoportant cu blat din MDF acoperit din oțel inoxidabil (C45PRO C/X)



**572 kg**



### // 045000032 C45PRO DW

**37.750 RON 25.167 RON**

- 1 blat de lucru din lemn stratificat (C45PW / 3-2.0MT)
- 1 blat de lucru din mai multe straturi din lemn (C45PW / 2-1.3MT)
- 1 colț complet autoportant cu blat din lemn (C45PRO C / W)



**568 kg**

C55

## MOBILIER MODULAR GAMA RSC55

055000065

C55PB-PRO/7

37.050 RON

24.700 RON

MOBILIER DE LUCRU MODULAR,  
GAMA RSC55

Compus din:

**C55B**

Banc cu blat de lucru (2050x700 mm) acoperit cu o folie de protectie rezistenta la socuri, anti-zgarieturi, uleiuri si produse chimice.

Prevazut cu:

- Gauri pentru menghina (1599F/150, se achizitioneaza separat)
- Picioare ajustabile vertical

**C55M7**

Modul fix cu 7 sertare (588x367 mm) cu rulmenti

- Deschidere din aluminiu pe toata suprafata sertarului
- Sertare protejate cu garnituri din spuma de cauciuc
- Inchidere centralizata frontala
- Se pot dota cu suporturi termoformate de scule

**C55MS**

Modul fix service

- Cos de gunoi incorporat
- Compartiment pentru rola de hartie
- Sertar, 305x270 mm

**C55/2PM + C55/PF**

Panouri perforate cu dulapuri suspendate

- 2 dulapuri suspendate, 1024x400x300 mm, cu amortizare cu gaz
- 2 panouri sustinere pentru rafturi suspendate, 1024x620x25 mm
- 2 panouri perforate, 1024x620x25 mm



055000066

C55PB-PRO/8

31.850 RON

21.233 RON

MOBILIER DE LUCRU MODULAR,  
GAMA RSC55

Compus din:

**C55B**

Banc cu blat de lucru (2050x700 mm) acoperit cu o folie de protectie rezistenta la socuri, anti-zgarieturi, uleiuri si produse chimice.

Prevazut cu:

- Gauri pentru menghina (1599F/150, se achizitioneaza separat)
- Picioare ajustabile vertical

**C55C7**

Dulap mobil format din 7 sertare (588x367 mm) cu rulmenti

- 4 roti Ø 100 mm, 2 fixe (una cu sistem blocare) si 2 pivotante
- Deschidere din aluminiu pe toata suprafata sertarului
- Sertare protejate cu garnituri din spuma de cauciuc
- Inchidere centralizata frontala
- Se pot dota cu suporturi termoformate de scule

**C55MA**

Modul fix cu doua usi

- Sistem de deschidere push-pull
- Cu încuietoare
- Raft interior, reglabil pe verticală

**C55PS**

Panou de scule cu jaluzea si inchidere,

- Panou din aluminiu ajustabil vertical, cu inchidere
- Panou perforat pentru scule detasabil



NEW





## //C37A7

**DULAP MOBIL 7 SERTARE  
CU SISTEM  
ANTI-RASTURNARE**

## //C37

### DULAP MOBIL

- Blat de lucru multifuncțional robust
- Tavi și orificii pentru depozitarea șurubelnitelor
- Maner de aluminiu cu funcție de blocare a sertarului
- Margini din material moale pe toată înălțimea dulapului, pentru a evita deteriorarea vehiculelor din garaj
- Baza sertarelor protejate cu covorase din spuma de cauciuc.
- Patru roți Ø 125 mm:
- 2 fixe și 2 orientabile (dintre care una cu frână)
- Închidere centralizată frontală
- Capacitate de încărcare statică: 1000 kg
- Suporturi laterale pentru sticle și hartie încorporate, reglabile în mai multe poziții

1000 kg



1000 kg



1004 mm  
482 mm  
803 mm

71 kg

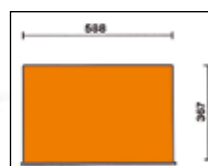

n°	mm	Max
5	75 mm	30 kg
1	150 mm	35 kg
1	225 mm	35 kg



	Ral 2011	Ral 7016	Ral 3000	n°	mm	max	kg	RON
C37/6	037000061	037000062	037000063	4	75 mm	30 kg	69	<del>5.050 RON</del> <b>3.367 RON</b>
				1	150 mm	35 kg		
				1	305 mm	40 kg		
C37/7	037000071	037000072	037000073	5	75 mm	30 kg	71	<del>5.220 RON</del> <b>3.480 RON</b>
				1	150 mm	35 kg		
				1	225 mm	35 kg		
C37/8	037000081	037000082	037000083	6	75 mm	30 kg	73	<del>5.420 RON</del> <b>3.613 RON</b>
				2	150 mm	35 kg		



**// 5.365 RON 3.577 RON**

Ral 2011	Ral 7016	Ral 3000
037000271	037000272	037000273

## //C39

### DULAP MOBIL

- Patru roți Ø 125 mm: 2 fixe și 2 orientabile (una cu frână)
- Încuietoare de siguranță centralizată față
  - Capacitate de încărcare statică: 1200 kg
  - Suport pentru sticle încorporat (poate fi aplicat pe ambele părți)
  - Blat multifuncțional cu margini anti-cădere și opt găuri pentru depozitarea șurubelnitelor
  - Maner cu sistem de blocare pe toată lungimea sertarului

1200 kg



**STĂLPI ȘI MÂNERE SERTAR FABRICATE DIN ALUMINIU**



971 mm  
500 mm  
800 mm



	Ral 2011	Ral 7016	Ral 3000	n°	mm	max	kg	RON
C39/6	039000031	039000032	039000033	4	70 mm	30 kg	59	<del>7.325 RON</del> <b>4.883 RON</b>
				1	140 mm	35 kg		
				1	280 mm	40 kg		
C39/7	039000001	039000002	039000003	5	70 mm	30 kg	61	<del>7.750 RON</del> <b>5.167 RON</b>
				1	140 mm	35 kg		
				1	210 mm	35 kg		
C39/8	039000041	039000042	039000043	6	70 mm	30 kg	64	<del>8.275 RON</del> <b>5.517 RON</b>
				2	140 mm	35 kg		

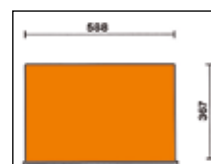

**NEW**



## DESCOPERA NOUA GAMA RSC!

Beta are placerea de a prezenta noua gama de produse RSC care a fost proiectata și dezvoltata pentru a satisface cerintele tuturor profesionistilor.

Noul design, inspirat din lumea Racing, ofera acestei game de dulapuri un stil unic: gratie noilor culori și finisaje, noua gama de produse RSC se remarca prin unicitate.

Structura robusta precum si materialele utilizate garanteaza o durata lunga de viata, completand astfel activitatea zilnica a celor ce opereaza in departamentele de productie industriala, service-uri auto si de uz general.

Mai mult decat atat, majoritatea dulapurilor RSC a primit o prestigioasa certificare TÜV, care garanteaza siguranta si calitatea produselor, certificare obtinuta la finalizarea cu succes a testelor riguroase din cadrul protocolului EK5 / TA5.



## ACCESORII

024004901 **2400 RSC24/PL**  
385 RON **256 RON**

Blad de lucru din lemn  
pentru dulapul RSC24



024004902 **2400 RSC24/PF**  
310 RON **206 RON**

Panou de scule perforat,  
pentru dulapul RSC24



024004909 **2400 RSC24/SPC**  
585 RON **389 RON**

Suport calculator  
pentru dulapul RSC24  
• Cu sertar detasabil  
• Nu poate fi utilizat  
la modelul RSC24AXL



**NEW**

050000901 **5000MS**  
283 RON **188 RON**

Raft pliabil pentru caruciorul  
mobil C50S

- Utilizare ca si blad de lucru suplimentar
- Dimensiuni blat: 390x440 mm, protejat de un covor anti-ulei si anti-cauciuc
- Capacitate de incarcare statica: 20 kg.

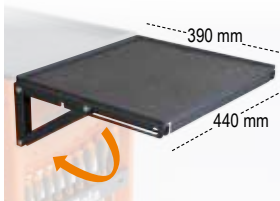

**2400 RSC24/PD**

Suport documente  
potrivit gamei de dulapuri RSC24



**2400 RSC24/PC**

Suport rola hartie



		RON	
GRI ANTRACIT	024004907	180 RON	<b>120 RON</b>
NEGRU	024004908	180 RON	<b>120 RON</b>

		RON	
GRI ANTRACIT	024004903	102 RON	<b>68 RON</b>
NEGRU	024004904	102 RON	<b>68 RON</b>



# //RSC24

## DULAP MOBIL

- Blat multifunctional cu margini anti-cadere si opt gauri pentru incorporarea surubelnitelor
- Patru roti Ø 125 mm: 2 fixe și 2 directii (una cu frana)
- Incuietoare de siguranta centralizata fata
- Capacitate de incarcare statica: 800 kg
- Suport pentru sticle încorporat (poate fi aplicat pe ambele parti)

Accesorii disponibile -optionale:

- Blat de lucru din lemn 2400 RSC24 / PL
- Panou de scule perforat 2400 RSC24 / PF
- Raft pliant 5000MS
- Suport document 2400 RSC24 / PD (disponibil în gri antracit sau negru)
- Suport pentru role pentru hartie 2400 RSC24 / PC (disponibil in gri antracit sau negru)



**NEW**



800 kg

969 mm  
445 mm  
740 mm

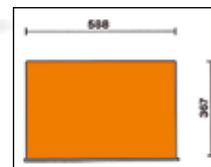

	Ral 2011	Ral 7016	Ral 5015 Ral 7016	Ral 9006 Ral 7016	Ral 9005	Ral 2011 Ral 7016	Ral 3000 Ral 7016	kg	RON
<b>RSC24/5</b>	024004050	024004057	024004056	024004052	024004059	024004051	024004053	60	<del>3.845 RON</del> <b>2.300 RON</b>
<b>RSC24/6</b>	024004060	024004067	024004066	024004062	024004069	024004061	024004063	62	<del>4.175 RON</del> <b>2.440 RON</b>
<b>RSC24/7</b>	024004070	024004077	024004076	024004072	024004079	024004071	024004073	63	<del>4.535 RON</del> <b>2.490 RON</b>
<b>RSC24/8</b>	024004080	024004087	024004086	024004082	024004089	024004081	024004083	66	<del>4.890 RON</del> <b>2.990 RON</b>

RSC24/5		
n°	mm	Max
2	70 mm	25 kg
2	140 mm	30 kg
1	280 mm	35 kg

RSC24/6		
n°	mm	Max
4	70 mm	25 kg
1	140 mm	30 kg
1	280 mm	35 kg

RSC24/7		
n°	mm	Max
5	70 mm	25 kg
1	140 mm	30 kg
1	210 mm	30 kg

RSC24/8		
n°	mm	Max
6	70 mm	25 kg
2	140 mm	30 kg

# RSC24AXL

## DULAP MOBIL, SISTEM ANTI-RASTURNARE, VARIANTA LUNGA

- Blat nou de lucru armat cu ABS, cu margini anti-cadere, opt gauri pentru adaugarea surubelnitelor si posibilitatea gazduirii a 6 tavi termoformate /sertar
- Bazele sertarelor protejate de covoare din cauciuc spumat.
- 4 roti, Ø 125 mm:
- 2 fixe și 2 de direcție dintre care una prevazuta cu frana).
- Inchidere frontala centralizata
- Capacitate de Incarcare statica: 1.000 kg.
- Suport lateral pentru sticle incorporat (poate fi montat pe ambele parti).

Se pot adăuga urmatoarele accesorii:

- Blat de lucru din lemn 2400 RSC24 / PL
- Suport document 2400 RSC24 // PD-A
- Suport rola pentru hartie 2400 RSC24 / PC-A

1000 kg

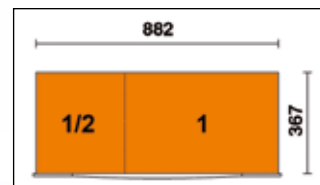
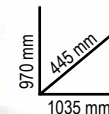

	Ral 2011 Ral 7016	Ral 7016	Ral 3000 Ral 7016	n°	↓ max	kg	RON
RSC24AXL/7	024004271	024004277	024004273	5	70 mm	30 kg	<del>6.100 RON</del> <b>3.900 RON</b>
				1	140 mm	35 kg	
				1	210 mm	35 kg	
RSC24AXL/8	024004281	024004287	024004283	6	70 mm	30 kg	<del>6.525 RON</del> <b>4.200 RON</b>
				2	140 mm	35 kg	
RSC24AXL/9	024004291	024004297	024004293	8	70 mm	30 kg	<del>6.925 RON</del> <b>4.400 RON</b>
				1	140 mm	35 kg	

# RSC24L/7

## DULAP MOBIL 7 SERTARE SI POLITE LATERALE

Caracteristici principale:

- 7 sertare (588x367 mm) cu glisiere pe rulmenti cu bile:
- 5 sertare, 70 mm inaltime
- 1 sertar, 140 mm inaltime
- 1 sertar, 210 mm inaltime.
- Bazele sertarelor protejate de covoare din cauciuc spumat.
- 4 roti, Ø 125 mm:
- 2 fixe și 2 de direcție (dintre care una prevazuta cu frana).
- Incuietoare centralizata frontala.
- Capacitate de încărcare statica: 1.100 kg.
- Blat de lucru din lemn stratificat, cu gauri pentru menghina 1599F/125 (se va comanda separat).
- Compartiment lateral cu raft reglabil pe verticala.
- Suport pentru role de hartie incorporat.
- Suport dublu pentru sticla in spate.

1100 kg

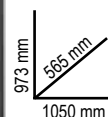

80 kg



~~6.750 RON~~ **4.300 RON**

	Ral 2011 Ral 7016	Ral 7016	Ral 3000 Ral 7016	n°	↓ Max
024004371	024004377	024004373	5	70 mm	25 kg
			1	140 mm	30 kg
			1	210 mm	30 kg



## //RSC24L-CAB

### DULAP MOBIL 7 SERTARE, BLAT DE LEMN SI ETAJERA LATERALA CU INCHIDERE

- Bazele sertarelor protejate de covoare din cauciuc spumat.
- 4 roți, Ø 125 mm:
- 2 fixe și 2 de direcție (dintre care una prevăzută cu frână).
- Incuietoare centralizată frontală
- Etajera laterală pentru scule cu ușa blocabilă și raft interior reglabil pe verticală.
- Static load capacity: 1,100 kg.
- Capacitate de încărcare statică: 1.100 kg.
- Blat de lucru din lemn stratificat, cu găuri pentru mânghina 1599F/100 (se va comanda separat)
- Suport pentru role de hartie încorporat.
- Suport dublu pentru sticla în spate.



kg  
1100



973 mm  
585 mm  
1050 mm



6.950 RON 4.500 RON

Ral 2011	Ral 7016	Ral 3000
Ral 7016	Ral 7016	Ral 7016
024004471	024004477	024004473

n°	Max
5	70 mm 25 kg
1	140 mm 30 kg
1	210 mm 30 kg

82 kg

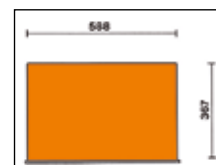

## //RSC28

### SUPERTANK, DULAP MOBIL CU 10 SERTARE SI BLAT DE LEMN

Specificatii:

- 10 sertare (588x367 mm) culisare pe rulmenti
- Sistem rapid și sigur pentru închidere și deschidere sertare cu protecție plastic și fibra de sticlă

#### 5 sertare laterale:

- 4 sertare, 70 mm înălțime
- 1 sertar, 210 mm înălțime

#### 5 sertare frontale:

- 4 sertare, 70 mm înălțime
- 1 sertar, 210 mm înălțime.

- Bazele sertarelor protejate de covoare din cauciuc spumat.
- 4 roți de mare capacitate, Ø 150 mm:
- 2 fixe și 2 direcție cu frâne.
- 2 încuietori de siguranță centralizate.
- 3 sertare pentru scule frontale.
- Blat de lucru din lemn stratificat, cu găuri pentru mânghina 1599F/150 (se va comanda separat).
- Compartiment pentru scule încorporat.
- Compartiment lateral cu uși rabatabile și închidere.
- Suporturi pentru sticle încorporate.
- Locas cu înălțimea de 135 mm acoperit cu blat termoformat

kg  
1200



943 mm  
800 mm  
1235 mm

130 kg



11.950 RON 7.967 RON

Ral 2011	Ral 7016	Ral 3000
Ral 7016	Ral 7016	Ral 7016
028003001	028003007	028003003

n°	Max
8	70 mm 25 kg
2	210 mm 30 kg

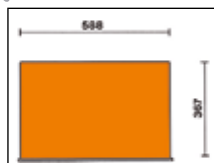

# //C50S

## CARUCIOR MOBIL CU 3 SERTARE

Caracteristici principale:

- Blat de lucru termoplastic
- 3 sertare (588x367 mm) cu glisiere cu rulmenti cu bile, inaltime de 70 mm
- Bazele sertarelor protejate de covoare din cauciuc spumat
- Incuietoare de siguranta centralizata fata
- Raft mare inferior protejat de un covor anti-ulei si anti-cauciuc
- Patru roti, Ø 125 mm:
- 2 fixe și 2 de direcție (una cu frana)
- Capacitate de incarcare statica: 400 kg
- Capacitatea fiecărui sertar: 15 kg, distribuita uniform
- Suportul pentru role de hartie articolul 2400S-R / PC poate fi aplicat (se comanda separat)

kg  
400



- Suport lateral pentru surubelnita inclus
- Doua suporturi laterale incorporate pentru recipiente

890 mm  
460 mm  
770 mm



2.445 RON 1.630 RON

Ral 2011	Ral 7016	Ral 3000
050000301	050000302	050000303

38 kg

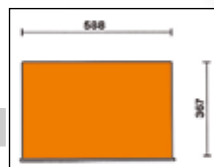

n°	mm	Max
3	70 mm	15 kg



1150 mm

050000901 5000MS  
283 RON 188 RON

Raft pliabil pentru caruciorul mobil C50S RSC24-RSC24A

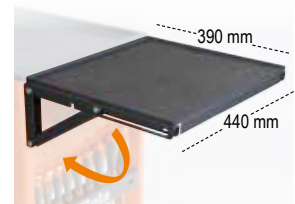

024003077 C04TSS/7  
12.250 RON 8.167 RON

## DULAP MOBIL 7 SERTARE DIN INOX , ROTI CARE NU LASA URME

- 4 roti Ø 125 mm
- 2 fixe și 2 pivotante (una cu sistem blocare)
- Inchidere frontala centralizata
- Cadru in totalitate din INOX AISI 304
- Rotile, suportii, rulmentii, interiorul sertarelor și ghidajele in totalitate din INOX
- Deschidere din aluminiu pe toata suprafata sertarului

kg  
700



935 mm  
470 mm  
680 mm

63 kg

**nu lasa urme**

n°	mm	max
6	83 mm	25 kg
1	170 mm	30 kg

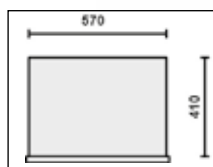
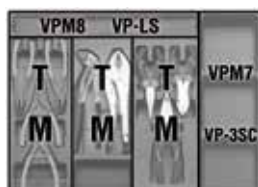





059880356 **5988VU/M**  
14.450 RON **9.633 RON**



**COMPONENTĂ 214 SCULE ÎN SUPT BURETE**

Recomandata pentru RSC24 -RSC24L/7 - C37 - C39 - RSC28 - RSC24L-CAB C59 - RSC55

Cantitate/Descriere	Beta N.	TR
22 chei combinate 6-7-8-9-10-11-12-13-14-15-16-17-18-19-20-21-22-24-27-30-32-36 mm	42	M01
11 chei fixe 6x7-8x9-10x11-12x13-14x15-16x17-18x19-20x22-21x23-24x27-30x32 mm	55	M30
11 chei inelare cotite 6x7-8x9-10x11-12x13-14x15-16x17-18x19-20x22-21x23-24x27-30x32 mm	90	M30
9 chei hexagonale cu cap sferic Ø 1,5+10 mm	96BPC/SC9	M30
1 adaptor	895/1	M100
1 adaptor	895/3	M100
1 adaptor	895/6	M100
13 tubulare hexagonale actionare 1/4" Ø 4-4,5-5-5,5-6-7-8-9-10-11-12-13-14 mm	900	M100
9 tubulare hexagonale, lungi, actionare 1/4" Ø 5-6-7-8-9-10-11-12-13 mm	900L	M100
5 imbusuri hexagonale cu actionare 1/4" Ø 3-4-5-6-7 mm	900ME	M100
4 imbusuri pentru șuruburi cu cap drept ● 0,8x4-1x5-5-1,2x6-5-1,2x8 mm	900LP	M100
4 imbusuri Phillips® cu actionare 1/4" ● PH1-PH2-PH3-PH4	900PH	M100
7 imbusuri Torx® cu actionare 1/4" ● T10-T15-T20-T25-T27-T30-T40	900TX	M100
1 prelungitor actionare 1/4" 50 mm	900/20	M100
1 prelungitor actionare 1/4" 100 mm	900/20L	M100
1 prelungitor actionare 1/4" 150 mm	900/21	M100
1 Articulație universala 1/4"	900/25	M100
1 mâner cu antrenare 1/4"	900BG/30	M100
1 Mâner în T articulată de 1/4"	900/42	M100
1 Clichet reversibil 1/4" ⊕	900/55	M100
21 tubulare hexagonale actionare 1/2" Ø 8-10-11-12-13-14-15-16-17-18-19-20-21-22-23-24-26-27-28-30-32 mm	920A	M100
1 adaptor de la 1/2" mamă și 3/8" tată 125 mm	920/15	M100
1 Articulație universala 1/2" 250 mm	920/25	M100
1 prelungitor actionare oscilant actionare 1/2" 125 mm	920AN/125	M100
1 prelungitor actionare oscilant actionare 1/2" 250 mm	920AN/250	M100
1 Mâner în T glisant cu antrenare 1/2" 305 mm	920/42	M100
1 Clichet reversibil cu antrenare 1 1/2" ⊕	920/55	M100
8 tubulare Torx® actionare 1/2" ● 10-12-14-16-18-20-22-24 mm	920FTX	M100
11 tubulare hexagonale, lungi, actionare 1/2" Ø 10-12-13-14-15-16-17-18-19-21-22 mm	920AL	M100
1 clește drept pentru sigurante, de interior Ø 180 mm	1032	M129
1 clește indoit pentru sigurante, de interior Ø 170 mm	1034	M129
1 clește drept pentru sigurante, de exterior ● 175 mm	1036	M129
1 clește indoit pentru sigurante, de exterior ● 175 mm	1038	M129
1 clește reglabil ● 175 mm 1048 M129	1048	M129
1 clește autoblocant 240 mm	1052	M129
1 Clește sfic ⚡ 160 mm	1082BM	M129
1 clește constructor 220 mm	1098	M129
1 foarfecă de tablă 250 mm	1112	M129
1 foarfecă electrician, lame drepte	1128BM	M129
1 clește patent = 180 mm	1150BM	M129
1 clește spit ● 160 mm	1166BM	M129
1 Clește spit cu vârf indoit ● 160 mm	1168BM	M129
6 șurubelnițe pentru șuruburi cu cap drept ● 2,5x50-3x75-4x100-5,5x125-6,5x150-8x200 mm	1201E	M213

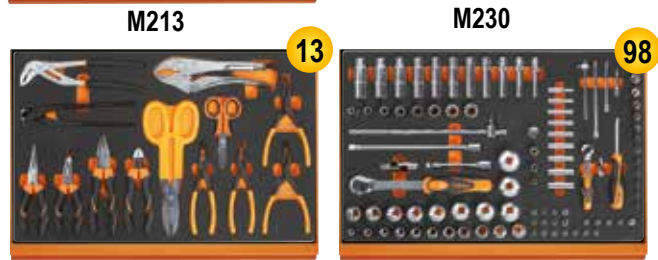
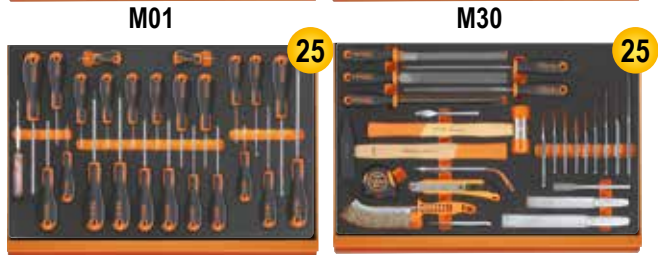
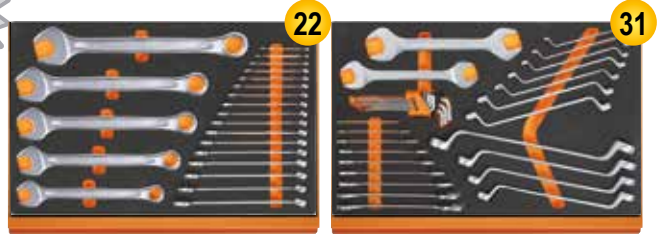

- |   |             |      |
|---|-------------|------|
| 1 șurubelniță pentru șuruburi cu drept, scurtă ● 4x30 mm  | 1201EN      | M213 |
| 4 șurubelnițe pentru șuruburi Phillips® ● PH0,60-PH1x80- PH2x100- PH3x150 mm                        | 1202E       | M213 |
| 1 șurubelniță pentru șuruburi Phillips®, scurtă ● PH1x30 mm   | 1202EN      | M213 |
| 12 șurubelnițe pentru șuruburi cu cap Torx®, cu mâner ● T6-T7-T8-T9-T10-T15-T20-T25-T27-T30-T40-T45 | 1207E/TX    | M213 |
| 1 șurubelniță de testare a rețelei ●  | 1253        | M213 |
| 3 dormiri 2-3-4 mm  | 30          | M230 |
| 6 pini 2-3-4-5-6-8  | 31          | M230 |
| 1 punctat Ø 4 mm  | 32          | M230 |
| 1 dalți plate 150 mm  | 34          | M230 |
| 2 dalți plate, tip nervurat 200-250 mm  | 35          | M230 |
| 1 dalta tip standard 125 mm   | 36          | M230 |
| 1 ciocan fier 500 g   | 1370        | M230 |
| 1 ciocan plastic Ø 35 mm  | 1390        | M230 |
| 1 ruleta 3 m  | 1692        | M230 |
| 1 magnet telescopic cu cap flexibil   | 1712TF      | M230 |
| 1 pila patrata 200 mm   | 1719BMA...Q | M230 |
| 1 pila triunghiulara 200 mm   | 1719BMA...T | M230 |
| 1 pila dreapta 200 mm   | 1719BMA...P | M230 |
| 1 pila semicirculara 200 mm   | 1719BMA...M | M230 |
| 1 pila cilindrica 200 mm  | 1719BMA...R | M230 |
| 1 perie de sarma de oțel  | 1737NX      | M230 |
| 1 cutter  | 1771        | M230 |



059040416 **5904VA/T**  
7.975 RON **5.317 RON**



**COMPONENTA 102 SCULE IN SUPT DE BURETE**

Cantitate/Descriere	Beta N.	TR
21 chei combinate 6-7-8-9-10-11-12-13-14-15-16-17-18-19-20-21-22-24-27-30-32 mm	42	T05
8 chei fixe 6x7-8x9-10x11-12x13-14x15-16x17-18x19-20x22 mm	55	+T06 T33
9 imbusuri hexagonale Ø 1,5+10 mm	96/SC9	T33
6 imbusuri hexagonale, cu mâner Ø 2-2,5-3-4-5-6 mm	96T	T52
8 chei cu mâner în T articulate Ø 7-8-10-12-13-14-17-19 mm	952	T63
19 tubulare actionare 1/2" Ø 10-11-12-13-14-15-16-17-18-19-20-21-22-23-24-26-27-30-32 mm	920A	T83
1 prelungitor actionare 1/2" 125 mm	920/21	T83
1 prelungitor actionare 1/2" 255 mm	920/22	T83
1 Articulație cardanica 1/2"	920/25	T83
1 Mâner în T glisant cu actionare 1/2" 305 mm	920/42	T83
1 Clichet reversibil cu antrenare 1/2" ⊕	920/55	T83
1 clește sfic ⚡ 160 mm	1084BM	T137
1 clește patent = 180 mm	1150BM	T137
1 clește spit ● 160 mm	1166BM	T137
1 clește drept pentru sigurante, de interior Ø 180 mm	1032	T145
1 clește indoit pentru sigurante, de interior Ø 170 mm	1034	T145
1 clește drept pentru sigurante, de exterior ● 175 mm	1036	T145
1 clește indoit pentru sigurante, de exterior ● 175 mm	1038	T145
1 clește autoblocant 240 mm	1052	T153
1 clește reglabil 250 mm	1048	T153
7 șurubelnițe pentru șuruburi cu cap drept ● 2,5x50 -3x75 - 3,5x100 - 4x125 -5,5x100 - 5,5x150 - 6,5x150 mm	1260	T199
6 șurubelnițe pentru șuruburi Phillips® ● PH0x60 - PH0x100 - PH1x80 - PH1x120 - PH2x100 - PH2x150 mm	1262	T202
2 dalți plate, tip nervurat 100-200 mm	35	T234
1 ciocan de fier 300 g	1370	T234
1 ciocan de plastic Ø 35 mm	1390	T234
1 tavă termoformată goală		VP5

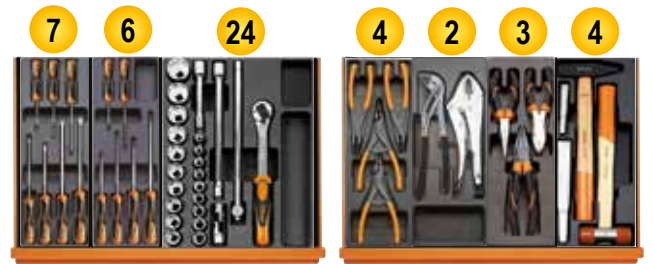



059040426 **5904VU/M**  
6.175 RON **4.117 RON**



**COMPONENTĂ 91 SCULE ÎN SUPORT BURETE**

Recomandata pentru RSC24 - RSC24L/7 - C37 - C39 - RSC28 - RSC24L-CAB - C59 - RSC55

16 17 7 6



M05 M33 M199 M202



8 24



M50 M83

3 2 4 4



M137 M153 M234 M145

**Cantitate/Descriere**

Cantitate/Descriere	Beta N.	TR
16 chei combinate 6÷21 mm	42	M05
8 chei fixe 6x7 - 8x9 - 10x11 - 12x13 - 14x15 - 16x17 - 18x19 - 20x22 mm	55	M33
9 imbusuri hexagonale $\odot$ 1,5 - 2 - 2,5 - 3 - 4 - 5 - 6 - 8 - 10 mm	96/SC9	M33
7 șurubelnițe pentru șuruburi cu cap drept $\bullet$ 2,5x50 - 3x75 - 3,5x100 - 4x125 - 5,5x100 - 5,5x150 - 6,5x150 mm	1260	M199
6 șurubelnițe pentru șuruburi Phillips $\oplus$ PH0x60 - PH0x100 - PH1x80 - PH1x120 - PH2x100 - PH2x150 mm	1262	M202
8 chei imbusuri hexagonale cu mâner $\odot$ 2-2,5-3-4-5-6-7-8 mm	96T	M50
1 prelungitor cu cap oscilant acționare 1/2" 125 mm	920AN/125	M83
1 prelungitor cu cap oscilant acționare 1/2" 250 mm	920AN/250	M83
1 articulație cardanică acționare 1/2"	920/25	M83
1 Mâner T culisant cu antrenare 1/2"	920/42	M83
1 Clichet reversibil cu antrenare 1/2" $\oplus$	920/55	M83
19 tubulare hexagonale de 1/2". $\odot$ 10÷24 - 26 - 27 - 30 - 32 mm	920A	M83
1 Clește sific $\nlessgtr$ 160 mm	1084	M132
1 clește patent $\equiv$ 180 mm	1150	M132
1 clește spiț $\bullet$ 160 mm 2	1166	M132
1 clește reglabil 250 mm 3	1048	M153
1 clește autoblocant 240 mm	1052	M153
2 dălți plate, tip nervurat 100-200 mm	35	M234
1 ciocan de fier 300 g 4	1370	M234
1 ciocan plastic $\varnothing$ 35 mm	1390	M234
1 clește drept pentru sigurante, de interior $\odot$ 180 mm	1032	M145
1 clește indoit pentru sigurante, de interior $\odot$ 170 mm	1034	M145
1 clește drept pentru sigurante, de exterior $\bullet$ 175 mm	1036	M145
1 clește indoit pentru sigurante, de exterior $\bullet$ 175 mm	1038	M145



059041220 **5904VG/3M**  
8.075 RON **5.383 RON**



**COMPONENTA 130 SCULE IN SUPT DE BURETE**

Recomandata pentru RSC24 - RSC24L/7 - C37 - C39 - RSC28 - RSC24L-CAB - C59 - RSC55



16 5 2 8 5 4



M05 M06 M153



M50 M55 M292

10 45 4 24 3 4



M208 M85 M234



M83 M134 M145

**Cantitate/Descriere**

Cantitate/Descriere	Beta N.	TR
16 chei combinate 6÷21 mm	42	M05
5 chei combinate 22 - 24 - 27 - 30 - 32 mm	42	M06
1 clește reglabil 250 mm	1048	M153
1 clește autoblocant 240 mm	1052	M153
8 imbusuri hexagonale cu mâner $\odot$ 2-2,5-3-4-5-6-7-8 mm	96T	M50
5 imbusuri cap Torx <sup>®</sup> , cu mâner $\odot$ T10-T15-T20-T25-T30	97TTX	M55
1 cheie reglabilă 250 mm	111	M292
1 foarfece de electrician, lame drepte	1128BMX	M292
1 ruletă 5 m	1692/5	M292
1 cuțit utilitar cu lamă snap-off 170 mm	1771	M292
5 șurubelnițe pentru șuruburi cu cap drept $\bullet$ 3x75 - 3,5x100 - 4x125 - 5,5x150 - 6,5x150 mm	1260	M208
3 șurubelnițe pentru șuruburi Phillips $\oplus$ PH0x60 - PH1x80 - PH2x100 mm	1262	M208
1 șurubelnițe pentru șuruburi cu cap drept, scurtă $\bullet$ 4x30 mm	1260N	M208
1 șurubelnițe pentru șuruburi Phillips $\oplus$ , scurtă $\oplus$ PH1x30 mm	1262N	M208
5 biți pentru șuruburi cu cap drept, colorate $\bullet$ 0,5x3 - 0,6x4,5 - 0,8x5,5 - 1x5,5 - 1,2x6,5 mm	860LP	M85
8 biți hexagonali, colorate $\odot$ 2 - 2,5 - 3 - 4 - 5 - 6 - 8 - 10 mm	860PE	M85
5 biți pentru șuruburi Phillips $\oplus$ , colorate $\oplus$ PH0 - PH1 - PH2 -PH3 - PH4	860PH	M85
4 biți pentru șuruburi cu cap în cruce Pozidriv <sup>®</sup> - Supadriv <sup>®</sup> , colorate	860PZ	M85
11 biți pentru șuruburi cu cap Torx <sup>®</sup> , colorate $\odot$ T6-T7-T8-T9-T10 - T15-T20-T25-T27-T30-T40	860TX	M85
8 biți pentru șuruburi cu cap Torx <sup>®</sup> cu gaura, colorate $\oplus$ T9-T10-T15-T20-T25-T27-T30-T40	860RTX	M85
1 suport magnetic pentru biți cu mâner 230 mm	860/55	M85
1 clichet reversibil pentru biți 100 mm	882P	M85
1 bara de extensie suport magnetic 80 mm	892	M85
2 adaptoare pentru drivere $\blacksquare$ 1/4 - $\square$ 1/4	35	M234
1 daltă plate, tip nervurat 100 - 200 mm	1370	M234
1 ciocan de fier 300 g	1390	M234
1 ciocan cu plastic $\varnothing$ 35 mm	920AN	M83
1 Prelungitor 1/2" 125 mm	920AN	M83
1 Prelungitor 1/2" 250 mm	920/25	M83
1 Articulație cardanică cu antrenare de 1/2".	920/42	M83
1 Mâner în T glisant cu antrenare de 1/2".	920/55	M83
19 Clichet reversibil cu antrenare de 1/2" $\oplus$	920A	M83
1 Tubulare hexagonale cu antrenare 1/2" $\odot$ 10÷24-26-27-30-32 mm	1082GBM	M134
1 Clește sific $\nlessgtr$ 160 mm	1150GBM	M134
1 clește pantent $\equiv$ 180 mm	1166GBM	M134
1 clește drept pentru sigurante, de interior $\odot$ 180 mm	1032	M145
1 clește indoit pentru sigurante, de interior $\odot$ 170 mm	1034	M145
1 clește drept pentru sigurante, de exterior $\bullet$ 175 mm	1036	M145
1 clește indoit pentru sigurante, de exterior $\bullet$ 175 mm	1038	M145



02450001 **M01**  
2.015 RON 1.343 RON



22

4,5 kg

42 6-7-8-9-10-11-12-13-14-15-16-17-18  
19-20-21-22-24-27-30-32-36 mm

02450030 **M30**  
1.895 RON 1.257 RON



31

4,2 kg

55 6x7-8x9-10x11-12x13-14x15-16x17-18x19-20x22-21x23-24x27-30x32 mm  
90 6x7-8x9-10x11-12x13-14x15-16x17-18x19-20x22-21x23-24x27-30x32 mm  
96BPC/SC9 1,5-2-2,5-3-4-5-6-8-10 mm

02450044 **M44**  
1.305 RON 870 RON



12

141 8-9-10-11-12  
13-14-15-16  
17-18-19 mm

1,3 kg

02450060 **M60**  
1.745 RON 1.163 RON



23

1,9 kg

○ 96T 2-2,5-3-4-5-6-7-8-10 mm  
○ 97BTX/SC8 T9-T10-T15-T20-T25-T27-T30-T40 mm  
○ 944BX 5-6-7-8-10-13 mm



02450063 **M63**  
1.610 RON 1.073 RON



8

3,4 kg

○ 952 7-8-10-12-13-14-17-19 mm

024500100 **M100** 14" 12"  
5.640 RON 3.760 RON



98

6,7 kg

895/1 - 895/3 - 895/6

○ 900 4-4,5-5-5,5-6-7-8-9-10-11-12-13-14 mm

○ 900L 5-6-7-8-9-10-11-12-13 mm

○ 900ME 3-4-5-6-7 mm

● 900LP 0,8x4-1x5,5-1,2x6,5-1,2x8 mm

⊕ 900PH PH1-PH2-PH3-PH4

○ 900TX T10-T15-T20-T25-T27-T30-T40

900/20 50 mm - 900/20L 100 mm

900/21 150 mm

900/25 - 900BG/30 - 900/42

⊗ 900/55

○ 920A 8-10-11-12-13-14-15-16-17-18-19-20-21-22-23-24-26-27-28-30-32 mm

920/15 - 920/25

920AN/125 125 mm

920AN/250 250 mm

920/42

⊗ 920/55

○ 920FTX 10-12-14-16-18-20-22-24 mm

○ 920AL 10-12-13-14-15-16-17-18-19-21-22 mm

024500871 **M105** 14" 38" 12"  
6.075 RON 4.050 RON



116

7,7 kg

- 900 4-4,5-5-5,5-6-7-8-9-10  
11-12-13-14 mm
- 900L 5-6-7-8-9-10-11-12-13 mm
- 96BPC/SC9 1,5-2-2,5-3-4-5-6-8-10 mm  
895/1 - 895/3 - 895/6
- 900ME 3-4-5-6-7 mm
- 900LP 0,8x4-1x5,5-1,2x6,5-2x8 mm
- ⊕ 900PH PH1-PH2-PH3-PH4
- 900TX T10-T15-T20-T25-T27-T30-T40
- 900/16 □ 1/4 - ■ 3/8
- 900/... 50-100-150 mm
- 900/25 - 900BG/30 - 900/42
- ⊕ 900/55
- 910A 6-7-8-9-10-11-12-13-14-15-16-17-18-19-20-21-22 mm
- 910/15 □ 3/8 - ■ 1/4
- 910/16 □ 3/8 - ■ 1/2
- 910/21 125 mm
- 910/22 250 mm
- 910/25 - 910/42
- ⊕ 910/55
- 920A 8-10-11-12-13-14-15-16-17-18-19-20-21-22-23-24-26-27-28-30-32 mm
- 920/15 □ 1/2 - ■ 3/8
- 920/25 125 - 250 mm
- 920AN 125 - 250 mm
- 920/42
- ⊕ 920/55
- 956E 16-17,8-20,8 mm

024500115 **M115** 12"  
5.365 RON 3.577 RON



54

7,8 kg

- ⊕ 666N 40÷200 Nm
- 920A 13-14-15-16-17-18-19-20-21-22-24-26-27-30-32 mm
- 920FTX 12-14-16-18-20-22-24 mm
- 920PE 6-7-8-8L-10-10L-12-12L-14-14L
- 920TX T20-T25-T27-T30-T40-T45-T50-T55-T60-T20L-T25L-T27L-T30L-T40L-T45L-T50L
- 920/21 125 mm
- 920/22 255 mm
- 920/25
- 920/42 305 mm
- ⊕ 920/55

024500120 **M120** 12"  
6.025 RON 4.017 RON



75

6,9 kg

- 920A 10-11-12-13-14-15-16-17-18-19-20-21-22-24-26-27-30-32 mm
- 920AN/125 125 mm
- 920AN/250 250 mm
- 920/25 - 920/42
- 920AL 10-12-13-14-15-16-17-18-19-22-24-27-30-32 mm
- 920FTX 10-12-14-16-18-20-22-24 mm
- ⊕ 920/55
- 920PE 5-5L-6-6L-7-7L-8-8L-10-10L-12-12L-14-14L
- 920TX T20-T25-T27-T30-T40-T45-T50-T55-T60-T20L-T25L-T27L-T30L-T40L-T45L-T50L

024500128 **M128** 12"  
4.405 RON 2.937 RON



50

8,9 kg

- 720 10-11-12-13-14-15-16-17-18-19-21-22-24-27-30-32 mm
- 720L 11-12-13-14-15-16-17-18-19-21-22-24-27-30-32 mm
- ⊕ 720TX T30-T40-T45-T50-T55
- 720ME 5-6-8-10-12-14-17-19 mm
- 720LC 17-19-21 mm
- 720/21 125 mm
- 720/25

024500129 **M129**  
2.095 RON 1.337 RON



13

3,4 kg

- 1032 180 mm
- 1034 170 mm
- 1036 175 mm
- 1038 175 mm
- 1048 250 mm
- 1052 240 mm
- ⊏ 1082BM 160 mm
- 1098 220 mm
- 1112 250 mm
- 1128BM
- ≡ 1150BM 180 mm
- 1166BM 160 mm
- 1168BM 160 mm

024500133 **M133**  
383 RON 254 RON



3

650 g

- ⊏ 1082G 160 mm
- ≡ 1150G 180 mm
- 1166G 160 mm

024500134 **M134**  
485 RON 323 RON



3

750 g

- ⊏ 1082GBM 160 mm
- ≡ 1150GBM 180 mm
- 1166GBM 160 mm



024500162 **M162**  
670 RON 447 RON



8

- 1241 5,5x100-6,5x125-8x150-10x200 mm
- 1242 PH1x100-PH2x100-PH3x150-PH4x200 mm

1,4 kg

024500195 **M195**  
1.430 RON 953 RON



25

- 1260 2,5x50-3x75-4x100-5,5x125-6,5x150-8x200 mm 4x30 mm
- 1260N PH0x60-PH1x80-PH2x100-PH3x150 mm
- 1262 PH1X30 mm
- 1262 T6-T7-T8-T9-T10-T15-T20-T25-T27-T30-T40-T45
- 1267TX 3,5x100 mm
- 1253

2,3 kg

024500213 **M213**  
1.013 RON 674 RON

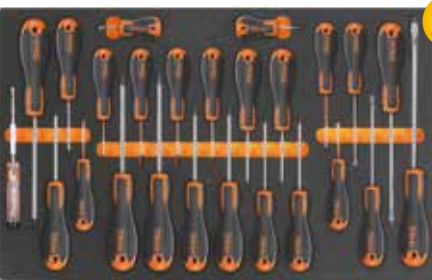

25

- 1201E 2,5x50-3x75-4x100-5,5x125-6,5x150-8x200 mm
- 1201EN 4x30 mm
- 1202E PH0x60-PH1x80-PH2x100-PH3x150 mm
- 1202EN PH1X30 mm
- 1207E/TX T6-T7-T8-T9-T10-T15-T20-T25-T27-T30-T40-T45
- 1253

1,8 kg

024500230 **M230**  
1.890 RON 1.260 RON



25

- 30 Ø 2-3-4 mm
- 31 Ø 2-3-4-5-6-8 mm
- 32 Ø 4 mm
- 34 150 mm
- 35 200-250 mm
- 36 125 mm
- 1370 500 g
- 1390 Ø 35 mm
- 1692 3 m
- 1712
- ▲ 1719BMA/Q 200 mm
- ▲ 1719BMA/T 200 mm
- 1719BMA/P 200 mm
- ▶ 1719BMA/M 200 mm
- 1719BMA/R 200 mm
- 1737
- 1771 18 mm

3,2 kg

024240001 **T01**  
1.223 RON 814 RON



17

- 42 6-7-8-10-11-12-13-14-16-17-18-19-21-22-24-27-30 mm

2,7 kg

024240005 **T05**  
940 RON 627 RON



16

- 42 6-7-8-9-10-11-12-13-14-15-16-17-18-19-20-21 mm

1,5 kg

024240006 **T06**  
668 RON 444 RON



5

- 42 22-24-27-30-32 mm

2,1 kg

024240031 **T31**  
1.015 RON 677 RON



27

- 31 Ø 2-3-4-5-6 mm 32 Ø 4 mm  
55 6x7-8x9-10x11-12x13-14x15-16x17-18x19-20x22-21x23-24x26-27x29-30x32 mm  
O96N/SC9 1,5÷10 mm

3 kg

024240040 **T40**  
483 RON 270 RON



7

- 90 6x7-8x9-10x11-12x13-14x15-16x17-18x19 mm

810 g

024240045 **T45**  
1.445 RON 963 RON



12

- 142 8-9-10-11-12-13-14-15-16-17-18-19 mm

1,3 kg

024240050 **T50**  
810 RON 540 RON



11

- 96T 2-2,5-3-3,5-4-4,5-5-6-7-8-10 mm

1,3 kg

024240055 **T55**  
455 RON 303 RON



6

- 97TTX T10-T15-T20 T25-T27-T30

330 g

**024240063 T63**  
1.548 RON **999 RON**

**8**



**3,8 kg**

952 7-8-10-12-13-14-17-19 mm

**024240083 T83**  
1.500 RON **1.000 RON**

**24**



**12"**

**3,6 kg**

920A 10-11-12-13-14-15-16-17-18  
19-20-21-22-23-24-26-27-30-32 mm  
920/21 125 mm 920/42 305 mm  
920/22 255 mm 920/55 275 mm  
920/25

**024240091 T91**  
1.048 RON **580 RON**

**25**



**14"**

**560 g**

900 4-4,5-5-5,5-6-7-8-9-10-11-12-13-14 mm  
900ME 2,5-3-4-5-6-8 mm  
900/20 50 mm  
900/21 150 mm  
900/25

**024240092 T92**  
1.183 RON **660 RON**

**22**



**38"**

**1,5 kg**

910A 6-7-8-9-10-11-12-13-14-15-16-17-18-19-20-21-22 mm  
910/21 125 mm 910/42 210 mm  
910/22 250 mm 910/55 200 mm  
910/25

**024240124 T124**  
458 RON **304 RON**

**3**



**640 g**

**NEW**

1082GBM 160 mm  
1150GBM 180 mm  
1166GBM 160 mm

**024240137 T137**  
523 RON **348 RON**

**3**



**750 g**

1084BM 160 mm  
1150BM 180 mm  
1166BM 160 mm

**024240145 T145**  
580 RON **387 RON**

**4**



**640 g**

1032 180 mm  
1034 170 mm  
1036 175 mm  
1038 175 mm

**024240153 T153**  
358 RON **238 RON**

**2**



**1,1 kg**

1048 250 mm  
1052 240 mm

**024240199 T199**  
273 RON **181 RON**

**7**



**490 g**

**Beta GRIP**

1260 2,5x50 - 3x75 - 3,5x100  
4x125 - 5,5x100 - 5,5x150 - 6,5x150 mm

**024240202 T202**  
250 RON **167 RON**

**6**



**490 g**

**Beta GRIP**

1262 PH0x60 - PH0x100 - PH1x80  
PH1x120 - PH2x100 - PH2x150 mm

**024240205 T205**  
358 RON **238 RON**

**7**



**460 g**

**Beta GRIP**

1267TX T6-T7-T8-T9-T10-T15-T20

**024240211 T211**  
198 RON **131 RON**

**7**



**490 g**

**Beta evox**

1201E 2,5x50-3x75-3,5x100  
4x125-5,5x100-5,5x150-6,5x150 mm

**024240213 T213**  
215 RON **143 RON**

**6**



**490 g**

**Beta evox**

1202E PH0x60-PH1x80  
PH1x120-PH2x100  
PH2x150-PH3x150 mm

**024240234 T234**  
448 RON **298 RON**

**4**



**1,3 kg**

35 100-200 mm  
1370 300 g  
1390 ø 35 mm

**024240236 T236**  
445 RON **289 RON**

**5**



**870 g**

1719BMA/Q 200 mm  
1719BMA/T 200 mm  
1719BMA/P 200 mm  
1719BMA/M 200 mm  
1719BMA/R 200 mm

**024240239 T239**  
598 RON **398 RON**

**7**



**850 g**

31BM ø 2-3-4-5-6-8 mm  
32 ø 4 mm



# NEW Beta BRUTUS

Beta

048000230 C48M

12.800 RON 8.533 RON



## Carucior transport electric

- Platforma motorizata, cu motor de 24V - 400W, baterie de 2x12V 33Ah si card de control.
- Podea din otel robust, acoperita cu cauciuc antiderapant, cu panouri laterale care impiedica caderea obiectelor in timpul transportului.
- Panourile pot fi indepartate, pentru a satisface cerintele individuale de transport.
- Echipat cu 2 roti pneumatice de tractiune (Ø 260 mm) si 2 roti rotative din cauciuc (Ø 150 mm), frana electromagnetica si cutie diferentiala.
- Livrat cu încărcător de baterie externa, 220V / 50Hz - V / A 24/12



Panoul de control este echipat cu urmatoarele:

- 1 cheie de contact
- 2 buton de reglare a vitezei
- 3 manere laterale pentru controlul tractiunii
- 4 sunet intermitent, care este activat atunci cand se deplaseaza in sens invers
- 5 indicator de incarcare a bateriei
- 6 buton electric pentru decuplarea franei
- 7 buton pentru franare de urgenta.

## DURATA MARE DE UTILIZARE PANA LA 4H

### SPECIFICATII

- Capacitate de transport: **400 kg**
- Viteza de conducere: **4-6 km / h** (reglabilă)
- Durata de viata a bateriei: **4 ore**
- Panta maxima admisa cu o sarcina 400kg: **6%**
- Panta maximă admisa cu o sarcină de 100 kg: **18%**

### Dispozitivele de siguranta:

- Frana electronica
- Claxon
- Protectie anti-strivire
- Indicator de incarcare a bateriei
- Carucior de control Curtis

### SPECIFICATII TEHNICE

- Dimensiuni totale: 1280x630x1100h mm
- Dimensiuni utile ale platformei de incarcare cu panouri: 1150x570 mm
- Dimensiuni utile ale platformei de încărcare fara panouri: 1260x620 mm
- Inaltimea platformei de incarcare de la podea: 320 mm
- Inaltimea compartimentului bateriei de la podea: 65 mm
- Greutate totala cu baterii: 140 kg



kg  
400

kg  
140

mm  
1100  
mm  
630  
mm  
1280

## VITEZA REGLABILA DE LA 4-6KM/H

048000030 C48P

1.203 RON 801 RON

## Carucior scule pliant

- Platforma de incarcare din polipropilena armata (PP), cu protectie antiderapanta si insertii TPV pentru protectia colturilor
- Maner retractabil pentru depozitare rapida si compacta
- Patru role, Ø 125 mm: 2 fixe și 2 directii cu frane
- Capacitate maxima: 300 kg.
- Latimea de lucru a platformei de incarcare: 705 mm
- Adancimea platformei de incarcare: 480 mm
- Intiltimea platformei de incarcare: 200 mm



kg  
300

kg  
11





059900001 **5990V1**  
2.788 RON **1.853 RON**



**COMPONENTA 44 SCULE PENTRU MODULUL C99V1 DIN GAMA COMBO, IN SUPT BURETE**

Cantitate/Descriere	Beta N.
9 imbusuri hexagonale cu cap sferic $\odot$ 1,5-2-2,5-3-4-5-6-8-10 mm	96BPC/SC9
1 cutter 18 mm	1771
1 Clește reglabil 250 mm	1048
6 2 dornuri, 1 punctatos, 3 dălți plate cu suport metalic	38/B6
3 șurubelnițe pentru șuruburi cu cap drept $\bullet$ 3,5x100-5,5x125-6,5x150 mm	1260
3 șurubelnițe pentru șuruburi Phillips® $\oplus$ PH0x60-PH1x80-PH2x100 mm	1262
1 foarfecă electrician, lame drepte	1128BMX
16 chei combinate 6-7-8-9-10-11-12-13-14-15- 16-17-18-19-21-22 mm	42
1 ruletă 5 m	1692/5
1 ciocan de fier 300 g 1370	1370
1 Clește șfic, mâner bimatereale, finisaj industrial $\blacktriangleleft$ 160 mm	1082GBM
1 clește patent, mâner bimatereale, finisaj industrial $\equiv$ 180 mm	1150GBM



059900003 **5990V3** 14" 12"  
3.965 RON **2.643 RON**

**COMPONENTA 116 SCULE PENTRU MODULUL C99V3/2C, DIN GAMA COMBO, IN SUPT BURETE**

Cantitate/Descriere	Beta N.
5 imbusuri hexagonale $\odot$ 2,5-3-4-5-6 mm	96T/S5P
1 cheie reglabila 250 mm	111
1 Mâner rotor cu antrenare 1 1/4"	900BG/30
1 șurubelniță de testare a rețelei $\bullet$	1253
1 mini nivelă cu bula magnetica	1695XS
1 lanternă de inspecție LED, realizată din aluminiu anodizat	1833XS/2
31 de biți cu suport magnetic cu eliberare rapidă în carcasă de plastic $\bullet$ $\circ$ $\oplus$ $\otimes$	860MIX/A31
1 adaptor biți	895
12 tubulare hexagonale 1/4" $\odot$ 4-4,5-5-5,5-6-7-8-9-10-11-12-13 mm	900
1 prelungitor 1/4" 50 mm	900/20
1 prelungitor 1/4" 100 mm	900/20L
1 Mâner T pivotant de 1/4"	900/42
1 Clichet reversibil cu antrenare de 1/4", mecanism cu 72 dinți $\otimes$	900/55Z
38 microșurubelnițe, 36 interschimbabile de 4 mm biți și extensie magnetica	1256/C36-2
1 ciocan plastic $\varnothing$ 35mm	1390
1 Articulație cardanica 1/4"	900/25
13 tubulare hexagonale 1/2" 10-11-12-13- 14-15-16-17-18-19-20-21-22 mm	920A
1 prelungitor 1/2" 125 mm	920/21
1 prelungitor 1/2" 255 mm	920/22
1 Articulație cardanica 1/2"	920/25
1 Mâner T glisant cu antrenare 1/2"	920/42
1 Clichet reversibil cu antrenare de 1/2" $\otimes$	920/55

**Componenta recomandata pentru C99V3/2C**

**COMBO**  
Componentă recomandată în combinație cu Beta Combo C99



**Componenta recomandata pentru C99V1**

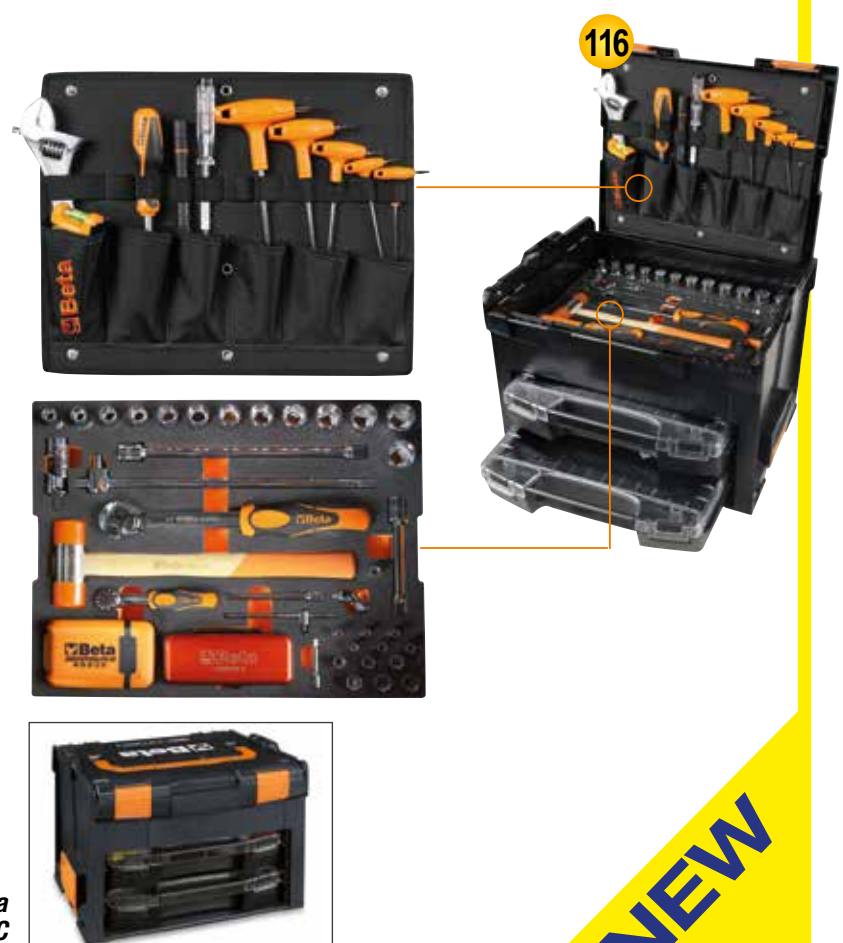

116

**NEW**



# COMBO

## SITEMUL MODULA BETA COMBO

Cutiile pentru scule pot fi ușor unite între ele printr-un simplu clic, prin mecanismul lateral inovativ. Cutiile pot fi aranjate după bunul plac, în funcție de nevoile dv.

**Cutie pentru scule din ABS, capac transparent, sistem modular COMBO**

Main features:

- Capac transparent din policarbonat pentru identificarea rapida a continutului
- Dimensiuni exterioare: 445x358x118 mm

099000200 **C99V0-P12**

745 RON **497 RON**

- Potrivit în special pentru transportul articolelor mici, inclusiv șuruburi, piulițe, șaibe, nituri și dibluri
- Livrat complet cu un kit de 18 tavi
- 2 tavi roșii, 52x52 mm
- 3 tavi galbene, 104x52 mm
- 2 tavi albastre, 104x104 mm
- 1 tava verde, 104x156 mm
- 2 tavi portocalii, 208x52 mm
- 2 tavi gri, 312x71 mm și 6 pereti despartitori reglabili

kg  
25



kg 3,2 kg

445x358x118 mm

099000202 **C99V0**

525 RON **350 RON**

445x358x118 mm



kg 2,5 kg

**NEW**

099000010 **C99**

3.160 RON **2.107 RON**

### BETA COMBO sistem modular

- Carucior pliant din aluminiu ultracompact C99P (485x520x1195 mm)
- Cutie de scule ABS C99V1 (445x358x152 mm)
- Cutie de scule ABS C99V2 (445x358x254 mm)
- Cutie de scule ABS cu 2 tavi portabile C99V3 / 2C (445x358x322 mm)

099000250 **C99V1**

533 RON **354 RON**

### Cutie pentru scule din ABS

Caracteristici principale:

- Dimensiuni exterioare: 445x358x152 mm
- Max. capacitate de încărcare interioară: 25 kg

kg  
25



445x358x152 mm

kg 2,2 kg

099000350 **C99V2**

590 RON **393 RON**

### Cutie pentru scule din ABS

- Dimensiuni exterioare: 445x358x254 mm
- Capacitate max. de încărcare interioară: 25 kg

kg  
25



445x358x254 mm

kg 2,8 kg

099000450 **C99V3/2C**

1.135 RON **757 RON**

### Cutie pentru scule din ABS, cu 2 tavi portabile

- Dimensiuni exterioare: 445x358x322 mm
- Se livrează cu 2 tavi de tip C99C-V3, goale

kg  
25



kg 5,6 kg

445x358x322 mm

099000101 **C99P**

903 RON **601 RON**

### Carucior pliant din aluminiu

Caracteristici principale:

- Carucior pliant ultracompact, fabricat din aluminiu anodizat
- Maner telescopic
- Dimensiuni la deschidere: 485x520x1195 mm
- Dimensiuni la închidere: 485x60x905 mm
- Dimensiunile bazei rabatabile: 485x350 mm
- Doua roti rezistente la perforare, Ø 175

1095 mm  
520 mm  
485 mm

kg  
100



kg 5,8 kg

# //C56B

## BANC DE LUCRU CU BLAT DE LEMN

Caracteristici principale:

- Blat de lucru din lemn stratificat, cu gauri pentru menghina 1599F/125 (se va comanda separat).
- Cadru din oțel cu 4 picioare sustinere
- Capacitate incarcare statica: 800kg
- Raft inferior pentru depozitare
- Se poate fixa in pardoseala



Ral 2011	Ral 7016	Ral 3000
056000401	056000402	056000403

// ~~2.925 RON~~ **1.950 RON**

kg  
600



930 mm  
720 mm  
2000 mm

// **54,5 kg**

# //C59A

## BANC DE LUCRU CU 6 SERTARE

Caracteristici principale:

- Blat de lucru din lemn stratificat, prevzut cu gauri pentru menghina 1599F / 125 (se comanda separat).
- 6 sertare (588x367 mm) cu glisiera cu rulmenti cu bile:  
4 sertare, 70 mm inaltime  
1 sertar, inalt de 140 mm  
1 sertar, 280 mm inaltime.
- Sertare protejate cu garnituri din spuma de cauciuc.
- Sertare cu rulmenti - se pot dota cu suporturi termoformate de scul
- Inchidere centralizata frontala
- Raftul inferior pentru depozitare obiecte.
- Se pot completa cu un suport pentru suluri de hartie 2400S-R/PC si unul pentru recipiente 2400 S/PF ), care se comanda separat.



Ral 2011	Ral 7016	Ral 3000
059000001	059000021	059000041

// ~~7.725 RON~~ **5.150 RON**

kg  
1500



931 mm  
700 mm  
2000 mm

// **115 kg**



n°		max
4	70 mm	25 kg
1	140 mm	30 kg
1	280 mm	35 kg

# //C56

## BANC DE LUCRU

- Blat de lucru din tablă vopsită în câmp electrostatic.
- Cadru de oțel cu 6 picioare de sprijin.
- Două sertare cu încuietori.
- Se poate fixa pe pardoseală.



Ral 2011	Ral 7016	Ral 3000
056000201	056000202	056000203

// ~~4.400 RON~~ **2.800 RON**

kg  
1200



930 mm  
640 mm  
2000 mm

// **82 kg**



056000021 **C56PL 0**  
1.695 RON **1.130 RON**

## BANC DE LUCRU METALIC, PLIABIL, VERSIUNE USOARA

- Compact și ușor de transportat
- Banc din metal galvanizat, cu protecție din cauciuc anti ulei și petrol
- Maner cu protecție de cauciuc pentru transport ușor
- capacitate susținere 200kg
- Picioare cu strat anti-alunecare
- Capacitate de încărcare statică: 18,5 kg.



18,5 kg



**EXTREM DE UȘOR, NUMAI 18.5 KG.**

860 mm  
500 mm  
910 mm



## C51 CĂRUCIOR CU 3 POLIȚE

- 3 polițe acoperite cu cauciuc anti-alunecare.
- Două variante de fixare pentru suprafața de lucru centrală.
- Patru roți Ø 100 mm: 2 fixe și 2 orientabile (cu 1 frână).
- Capacitate de susținere: 200 kg (distribuite pe cele 3 rafturi).

200 kg



21 kg



Ral 2011	Ral 7016	Ral 3000
051000001	051000002	051000003

1.233 RON **821 RON**

## C27S CĂRUCIOR MOBIL CU POLIȚE TIP SERTARE, PLIABIL

- Cărucior de scule pliabil, cu coloane retractabile pentru transportul fără efort.
- 2 sertare, 588x277 mm, cu glisieră pe rulmenți, pentru deschideri pe ambele părți.
- Compartiment inferior mare, 588x277x220 mm.
- Structură din tablă de oțel.
- 2 roți fixe, Ø 160 mm și 2 roți orientabile, Ø 100 mm cu frână.
- Suprafață de lucru termoplastică cu 6 locașuri de scule încorporate.
- Încădire centralizată.



20 kg



570 mm



Ral 2011	Ral 7016	Ral 3000
027000201	027000202	027000203

3.165 RON **2.110 RON**

n°	h	max
2	70 mm	20 kg

# //C41H

## DULAP SCULE 2 MODULE

Caracteristici principale:

- Cadru din tablă și capace din plastic, de o rezistență remarcabilă și cu o greutate redusă
- 2 module detasabile
- 1 modul superior
- 1 modul cu 2 sertare 95 mm înaltime
- 1 carcasa detasabila din plastic, 66mm înaltime și 1 sertar 290 mm înaltime
- Roti (160 mm)
- Inchidere centralizata pentru inchiderea sertarelor din modulul inferior
- Sertare cu rulmenti.
- Maner telescopic din aluminiu.
- Suport pentru scule mici încorporat în modulul superior.



C41H W  
RAL 9016

C41H Y  
RAL 1023

C41H R  
RAL 3000

C41H V  
RAL 6016

C41H B  
RAL 5002

C41H G  
RAL 7016

C41H N  
RAL 9005



920 mm  
336 mm  
536 mm

21 kg

- 041000002 041000021
- 041000024 041000006
- 041000012 041000008
- 041000010 041000005

~~2.660 RON~~ **1.773 RON**

## // 021200002 C20L

~~383 RON~~ **254 RON**

Cutie de scule cu 5 secțiuni rabatabile, confecționată din tablă



550x200x210 mm

5,4 kg

## // 021170500 CP17

~~398 RON~~ **264 RON**

Cutie de scule, din inox și plastic cu tavă de scule detașabilă



500x200x220 mm

2,5 kg



## // 021203001 C20TSS

~~1.365 RON~~ **910 RON**

Cutie pentru scule prevazuta cu 5 compartimente, fabricata din otel inoxidabil AISI 304

Poate fi utilizat in medii critice - adica in zone in care nu este permis nivelul minim de contaminare - rezistent la rugina si la acizii principali si poate fi sterilizat in autoclava la 121 °.



4 kg

450x200x210 mm

## // 021150201 CP15

~~215 RON~~ **143 RON**

Cutie de scule, din plastic

- o tavă de scule detașabilă de dimensiunea cutiei
- 2 cutii pentru piese mici, detașabile cu despărțituri reglabile
- capacitate portantă 30kg



445x240x250 mm

2,5 kg





# GENȚI SCULE

020330250 **2033L/VV**  
1.698 RON **1.067 RON**

**Cutie pentru scule de prete, din aluminiu, goala**

- Extrem de rezistent la socuri
- Finisaj anti-zgarieturi
- Maner ergonomic cu protecție din cauciuc
- Inchidere dubla cu cifru
- 2 panouri de scule cu benzi elastice
- Parte interioară cu pereți despărțitori detașabili



**NEW**

470x375x205 mm

4,8 kg

020800100 **2080/VG**  
748 RON **493 RON**

**Cutie de scule cu organizator, din ABS cu tavi pivotante**

- Cu organizator superior pentru piese mici (145 mm în diametru) și 4 tavi pivotante:
  - 1 tava cu diametrul de 305 mm
  - 3 tavi cu diametrul de 445 mm
- Livrat complet cu 12 partiții pentru utilizarea în 3 tavi pivotante mai mari, pentru a obține până la 8 compartimente pe nivel



3,4 kg

**NEW**

020290000 **2029/VV**  
1.595 RON **1.057 RON**

**Geantă pentru scule, din polipropilenă groasă, cu structură aluminiu**

- 2 panouri interioare, pentru scule



490x380x230 mm

6,1 kg

020800000 **2080/V12**  
268 RON **178 RON**

**Cutie de scule organizatoare cu 12 tăvi detașabile**

Detașabil, pliabil transparent tote-tavi, pentru recunoașterea imediată a conținutului



300x330x145 mm

1,8 kg

020380000 **2038/TV**  
3.918 RON **2.607 RON**

**Troller scule cu maner, fabricat din polipropilena**

- Extrem de rezistent la socuri
- Profil de închidere din aluminiu
- Maner telescopic și roți masive cu rulmenți
- Spațiu generos de depozitare
- Buzunar pentru documente
- 3 cutii pentru piese mici



2 încuietori TSA prevăzute cu chei



2 manere laterale



9 kg

430x500x340 mm

2 panouri scule detașabile

021030000 **C3**

295 RON **197 RON**

**Geanta mini scule, din tesatura tehnica**

Caracteristici principale:

- 1 buzunar frontal exterior, inchidere cu fermoar
- 2 buzunare laterale cu tavi plastic
- 1 buzunar spate cu inchidere Velcro
- 1 panou de instrumente interior detașabil, cu benzi elastice pe ambele părți
- Livrat cu curea de umăr



330x320x150 mm

890 g



**O MINI GEANTĂ DE SCULE PE CARE SA O AVEȚI MEREU LA ÎNDEMÂNĂ**

**NEW**



port USB pt încărcarea dispozitivelor mobile



021050000 **C5**

710 RON **473 RON**

**Rucsac de scule din țesătură tehnică**

- Panou interior detașabil
- 6 buzunare exterioare
- 2 buzunare interioare
- Baza impermeabilă din plastic
- Spate căptușit ergonomic

021050100 **C5S**

253 RON **168 RON**

**Rucsac de scule din poliester rezistent**

- Mâner dublu în partea superioară a rucsacului
- Două buzunare frontale mari
- Două buzunare interioare mari
- 2 curele Velcro pentru scule
- Geantă de rulare la îndemână, compusă din 4 panouri de scule
- Curele de umăr reglabile



2,5 kg

500x400x180 mm



**2 BUZUNARE MARI FRONTALE**



900 g

370x300x100 mm



021060010 **C6T**

1.010 RON **673 RON**

**Rucsac cu roțile**

- Mâner telescopic pentru transport ușor
- Roti încorporate, practice, husă pentru bretelele de rucsac
- Două panouri detașabile pentru scule
- Buzunar interior pentru computer și cinci buzunare exterioare
- Baza din plastic rezistentă la apa



4,5 kg

480x370x220 mm



021110000 **C11**  
420 RON **280 RON**

**Geanta de scule din tesatura tehnica**

- Bază impermeabilă din plastic
- Benzi elastice și buzunare interioare și exterioare
- Suport pentru documente



2 kg

400x240x220 mm

021100001 **C10S**  
563 RON **374 RON**

420x220x250 mm

2,3 kg

**Geantă pentru scule**

- Cadru robust
- Baza dublată.
- Mâner basculant pentru un acces mai ușor la unelte
- Benzi elastice pentru scule și buzunare interioare și exterioare
- Tavă pentru scule inclusă în dublu fund
- Poate fi folosit cu căruciorul C8

021100000 **C10**  
715 RON **477 RON**

520x220x250 mm

3,3 kg



020010151 **2001/BZV**  
215 RON **143 RON**

**Geanta scule realizata din tesatura tehnica**

- Maner superior dublu pentru o fixare optima
- Buzunar mare in partea din fata pentru documente, inchidere cu fermoar
- Curea cu velcro pe spate pentru o mai buna fixare a manerului
- 20 de compartimente pentru scule (6 buzunare și 14 benzi elastice)
- 2 locase speciale pentru ciocane
- Cureaua de umar C9 / RT poate fi de asemenea inclusa (se comandă separat)



380x290x60 mm

675 g

**NEW**

020010157 **2001/BZ27 VU**  
1.305 RON **870 RON**

**Geanta pliabila cu set de 27 scule, pentru uz general**



**Cantitate/Descriere**

1 foarfecă electrician, lame drepte	Beta N. 1128BMX
1 clește patent 180 mm	1150
6 chei combinate 7-8-10-13-17-19 mm	42
3 șurubelnițe pentru șuruburi cu cap drept 3x75 - 4x100 - 5,5x150 mm	1201E
3 șurubelnițe pentru șuruburi Phillips® PH0x60 - PH1x80 - PH2x100 mm	1202E
9 imbusuri hexagonale 1,5-2-2,5-3-4-5-6-8-10 mm	96/SC9
1 ciocan defier 300 g	1370
1 Clește reglabil 250 mm	1048
1 ruletă 5 m	1692/5
1 cuțit utilitar cu lamă snap-off 18 mm	1771

**NEW**



**020050030 2005PA/E**  
**195 RON 130 RON**

**Centura prevazuta cu buzunare pentru scule**

- Doua buzunare mari cu benzi elastice pentru scule
- Doua buzunare pentru foarfece
- Doua compartimente laterale:
  - buzunar stang cu carlig metalic robust pentru ruleta
  - buzunar dublu drept, închidere cu fermoar
- Catarama cu agatoare pentru banda adeziva
- Curea reglabila (70 ÷ 120 cm)



≡ 260x250x190 mm

**020050035 2005PA/ET**  
**1000 V 835 RON 557 RON**

**Centura cu set 8 scule pentru intretinere electrotehnica**



**Cantitate/Descriere**

- 1 clește sfic 1000V ⚡ 160 mm
- 1 foarfecă electrician, lame drepte
- 1 șurubelniță testare siguranțe
- 2 PH1x80 - PH2x100
- 2 3,5x100 - 4,5x100
- 1 bandă izolatoare PVC

**Beta N.**

- 1082MQ  
 1128BMX  
 1253  
 1272MQF  
 1274MQF  
 1639ESB

**020050040 2005PA/U**  
**840 RON 560 RON**

**Centura cu set 17 scule pentru uz general**



**Cantitate/Descriere**

- 9 imbusuri hexagonale
- 1 cheie reglabila 200 mm
- 1 Clește reglabil
- 1 foarfecă electrician, lame drepte
- 2 șurubelnițe pentru șuruburi cu cap drept 4x100 - 5,5x125 mm
- 2 șurubelnițe pentru șuruburi Phillips® PH1x80 - PH2x100 mm
- 1 ruletă 3 m

**Beta N.**

- 96/SC9  
 111  
 1048  
 1128BMX  
 1201E  
 1202E  
 1692

**020050060 2005MPU**  
**125 RON 83 RON**

**Centura, fabricata din nylon, pentru scule**

- Cinci buzunare mari pentru scule
- Un buzunar frontal pentru foarfece
- Catarama cu agatoare pentru banda adeziva
- Curea reglabila (70 ÷ 120 cm)



≡ 155x285x80 mm

**020050065 2005MPU/E**  
**420 RON 280 RON**

**Centura cu set 5 scule**



**Cantitate/Descriere**

- 1 foarfece electrician, lame drepte
- 1 clește patent ≡ 180 mm
- 2 șurubelnițe pentru șuruburi cu cap drept
- 3,5x100 - 4x100 mm
- 1 șurubelniță pentru șuruburi Phillips® PH1x80 mm

**Beta N.**

- 1128BMX  
 1150BM  
 1201E  
 1202E





## SCULE DE MÂNĂ

42

**Cheia noastră celebră 42 are o formă nouă.**

O formă elegantă, subțire, îmbunătățită de un profil revoluționar, mai plăcută la atingere. Rezistența și designul ergonomic al cheii Beta ajung la standarde și mai mari, pentru a oferi utilizatorilor cele mai bune unelte posibile. Procesul de fabricație se desfășoară în fabricile noastre din Sovico și Sulmona, pe baza tehnologiei de automatizare de ultimă generație și a celor mai bine pregătiți muncitori.

**PUTERNIC**

Valoarea cuplului este mai mult decât dublă față de cerințele care trebuie îndeplinite conform ISO 1711.

**ERGONOMICĂ**

Partea inelară are un unghi de 15 grade pentru a proteja mâna. Forma se obține dintr-o matrită; nu este îndoită mai târziu.

Forță remarcabilă: în caz de utilizare necorespunzătoare, cheia se îndoaie, fără a se rupe brusc și periculos.

**IMPORTANT!**

**Noua formă a cheii 42 este perfect compatibilă cu toate recipientele și tăvile cheii noastre 42**



000421078 **42/SP15**  
845 RON **563 RON**

**Set 15 chei combinate**

- with holder

6-7-8-9-10-11-12-13-  
14-15-16-17-19-22-24 mm



000421087 **42/SC9I**  
495 RON **330 RON**

**Set 9 chei combinate, in suport compact**

- Suport compact, practic, ușor de transportat
- Sistem de identificare rapidă a dimensiunii
- Cheie blocată în siguranță în suport

8-10-11-12-13-14-15-17-19 mm



000421070 **42/S26**  
2.025 RON **1.350 RON**

**Set 26 chei combinate**

6-7-8-9-10-11-12-13-14-15-16-17-  
18-19-20-21-22-23-24-25-26-27-  
28-29-30-32 mm



26x

000420478 **42SLIM/B8NI**  
488 RON **324 RON**

**Set de 8 chei combinate, subtiri in husa din poliester**

10-11-12-13-14-15-17-19 mm

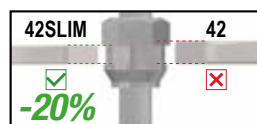

001410069 **141/B9**  
~~903 RON~~ **601 RON**

Set chei combinate cu clichet,  
 9 piese, în suport compact

8-10-11-12-13-14-15-17-19 mm



001420259 **142SN/SC9**  
~~1.228 RON~~ **799 RON**

Set 9 chei combinate cu clichet,  
 colorate, in suport compact

8-10-11-12-13-14-15-17-19 mm



001420087 **142/SC9I**  
~~1.023 RON~~ **681 RON**

Set 9 chei combinate cu clichet,  
 colorate, in suport compact

8-10-11-12-13-14-15-17-19 mm



000550164 **55/B12N**  
~~673 RON~~ **448 RON**

Set 12 chei fixe in husa din poliester

6x7-8x9-10x11-12x13  
 14x15-16x17-18x19  
 20x22-21x23-24x26  
 25x28-30x32 mm



**111**

Cheie reglabilă, cromată, cu scală

- Deschidere mobilă a fălcilor cu rotație la dreapta a știftului
- Cap înclinat la 22,5 grade, cu scară în mm și inch



	L mm	A max	g		RON
<b>111/100</b>	100	15 mm	60	001110010	<del>111 RON</del> <b>73 RON</b>
<b>111/150</b>	150	24 mm	165	001110015	<del>115 RON</del> <b>77 RON</b>
<b>111/200</b>	200	28 mm	325	001110020	<del>140 RON</del> <b>93 RON</b>
<b>111/250</b>	250	34 mm	505	001110025	<del>173 RON</del> <b>114 RON</b>
<b>111/300</b>	300	35 mm	790	001110030	<del>228 RON</del> <b>151 RON</b>
<b>111/450</b>	450	54 mm	2043	001110045	<del>740 RON</del> <b>493 RON</b>
<b>111/600</b>	600	62 mm	3300	001110060	<del>1.025 RON</del> <b>683 RON</b>

001860008 **186 8-32**  
~~233 RON~~ **154 RON**

Cheie reglabilă cu prindere automată  
 pentru piulițe hexagonale, de la 8 la 32mm

Ideală pentru piulițe hexagonale, Spline și capete Torx®,  
 inclusiv pentru capete de șuruburi deteriorate



SPLINE®  
 12 colțuri

patrat

Torx®

hexagonale

șuruburi  
 deteriorate  
 70%



001950066 **195/B5**  
640 RON **427 RON**

Set 5 chei inelare cu clichet, duble, in husa textila

8x10-12x13-14x15-16x18-17x19 mm



000960374 **96/SC9** ○  
98 RON **64 RON**

Set 9 chei imbus in L 96/SC9

Ø mm	L mm
1,5	45
2	50
2,5	57
3	64
4	72
5	83
6	94
8	105
10	119



000960354 **96BPC/SC9** ○  
205 RON **137 RON**

Set de 9 chei imbus în L, cu cap sferic

Ø mm	L mm
1,5	79
2	85
2,5	89
3	100
4	110
5	129
6	152
8	173
10	194



000970164 **97BTX/SC8** ⊛  
365 RON **243 RON**

Set de 8 chei imbus în L, cu cap sferic, pentru șuruburi cu cap Torx®, varianta lunga

Ø mm	L mm
T9	65
T10	74
T15	84
T20	96
T25	98
T27	109
T30	123
T40	136



000961354 **96LBP/SC9** ○  
239 RON **158 RON**

Set of 9 ball head offset hexagon key wrenches

Ø mm	L mm
1,5	91
2	100
2,5	113
3	130
4	142
5	163
6	185
8	205
10	231

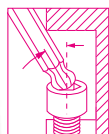

**VARIANTA LUNGA**  
**+30%**



000970364 **97BTXL/SC8** ⊛  
423 RON **281 RON**

Set de 8 chei imbus în L, cu cap sferic, pentru șuruburi cu cap Torx®, varianta lunga

Ø mm	L mm
T9	83
T10	89
T15	103
T20	114
T25	130
T27	145
T30	166
T40	183



**VARIANTA LUNGA**  
**+25%**

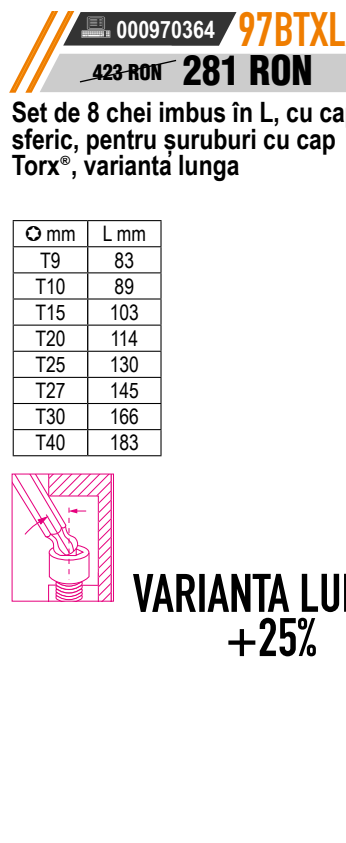

## PRIMUL

Rapid și ușor de manevrat. Mânerul de dimensiuni mici este perfect echilibrat pentru a se roti rapid în palmă. Forma ergonomică permite cheii să fie folosită pentru cupluri mari. Capetele hexagonale sunt proiectate pentru a transmite maxim de cuplu posibil la șurub.



### O SINGURA TIJA INCORPORATA IN MANER

000960946 **96T/S5P**  
295 RON **197 RON**

Set imbusuri, tip T, cu maner,

○ 2,5-3-4-5-6 mm



000970791 **97TTX/S6**  
420 RON **280 RON**

Set imbusuri Torx, tip T, cu maner

○ T10-T15-T20-T25-T30-T40



009510687 **951/S6**  
595 RON **397 RON**

Set imbusuri cu mâner culisant

○ 2,5-3-4-5-6-8 mm



## CEL ORIGINAL

Când a fost lansată această cheie, în 1980, a fost o unealtă revoluționară. Concepută pentru a lucra cu șuruburi de o rezistență ridicată, este perfectă pentru o manipulare rapidă, potrivire precisă și utilizare flexibilă.

Mânerul hexagonal în T poate fi reglat după cum este necesar.

Capetele hexagonale sunt proiectate pentru a transmite cuplul maxim posibil la șurub.

Lungimea tijei permite cupluri ridicate, aplicate fără efort pe șuruburi.

Îmbunătățirile continue de producție s-au tradus, de exemplu, în finisaje sablate și ascuțite capete hexagonale care permit o potrivire mai bună pe orice șuruburi, inclusiv pe cele deteriorate.

Laser marcajul are ca rezultat o tijă mai robustă.

## FIABIL

Pre-poziționarea fiabilă, precisă reprezintă secretul succesului lucrului cu această cheie.

Articulația își menține funcționarea de-a lungul anilor, nefiind nevoie de alte ajustări.

Unghiul de rotație al tubularei: 50°.

Poate fi folosită la 90° în poziție fixă.

Mâner T glisant ce poate fi fixat în poziția dorită.

Marcaj dimensiune în capăt.

009520079 **952/D7**  
1.153 RON **768 RON**

Set 7 T-uri culisante cu tubulara articulata

○ 7-8-10-12-13-14-17 mm

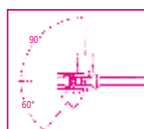



# Beta **evox**

## EVOLUŢIA ŞURUBELNIŢEI!

012031018 / **1203E/D8P**   
~~203 RON~~ **134 RON**

**Set 8 surubelnite**

1201E 2,5x50-3x75-4x100-5,5x100  
 6,5x150 mm  
 1202E PH0x60-PH1x80-PH2x100 mm

012071207 / **1207E/TX-D7**   
~~263 RON~~ **174 RON**

**Set 7 surubelnite Torx®**

1207E/TX T6-T8-T10-T15  
 T20-T25-T30

012031019 / **1203E/D10N**   
~~258 RON~~ **171 RON**

**Set 10 surubelnite**

1201E 2,5x50-3x75-4x100-5,5x150  
 6,5x150 mm  
 1202E PH0x60-PH1x80-PH2x100 mm  
 1201E/N 0,8x4x30 mm  
 1202E/N PH1x4,5x30 mm



012630008 / **1263/D8**   
~~278 RON~~ **184 RON**

**Set 8 surubelnite**

1260 2,5x50-3x75-4x100- 5,5x125  
 6,5x150 mm  
 1262 PH0x60-PH1x80-PH2x100 mm

012630010 / **1263/D10**   
~~353 RON~~ **234 RON**

**Set 10 surubelnite**

1260 3x75-3,5x100-4x125-5,5x150-6,5x150 mm  
 1262 PH0x60- PH1x8-PH2x100 mm  
 1260N 4x30 mm  
 1262N PH1x30 mm

012670307 / **1267TX/D7**   
~~348 RON~~ **231 RON**

**Set 7 surubelnite Torx®**

1267TX T6-T8-T10-T15  
 T20-T25-T30



012930401 / **1293/D6**   
~~273 RON~~ **181 RON**

**Set 6 surubelnite**

1290 0,6x3,5x75-1x5,5x150  
 1,2x6,5x150 mm  
 1292 PH0x3x60 -PH1x4,5x80  
 PH2x6x100 mm



012930408 / **1293INOX/D8**   
~~393 RON~~ **261 RON**

**Set surubelnite combinate inox, 8 piese**

1290INOX 2,5x50-3x75-4x100  
 5,5x150-6,5x150 mm  
 1292INOX PH0x60-PH1x80-PH2x100 mm





000961619 **96BP-CL/SC9** ○  
 250 RON **167 RON**  
 Set de 9 chei imbus în L, cu cap sferic, colorate

Ø mm	L mm
1,5	91
2	100
2,5	113
3	130
4	142
5	163
6	185
8	205
10	231

**EXTRA LONG VERSION +30%**



000971658 **97BTX-C/SC8** ⚙️  
 405 RON **270 RON**

Set de 8 chei imbus în L, cu cap sferic, pentru șuruburi cu cap Torx®, colorate

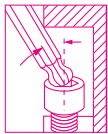

Ø mm	L mm
T9	80
T10	86
T15	90
T20	95
T25	100
T27	105
T30	114
T40	124



001422087 **142MC/SC9I** ○  
 1.070 RON **713 RON**

Set 9 chei combinate cu clichet, colorate, in suport compact

Ø mm	L mm
8x8	136
10x10	159
11x11	168
12x12	174
13x13	180
14x14	190
15x15	200
17x17	233
19x19	248



# COLOR

## O CULOARE, O MARIME

009202964 **920MC/C14** ○ 1 1/2"  
 1.405 RON **937 RON**

Set 15 tubulare hexagonale colorate si 5 accesorii, in cutie metalica

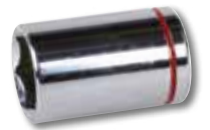

420x185x60 mm

4,2 kg

	920MC	8-10-11-12-13-14-15-16-17-18-19-21-22-24 mm
	920/21	125 mm
	920/22	255 mm
	920/25	
	920/42	
	920/55	

009002960 **900MC/C24** 1 1/4"  
 1.775 RON **1.183 RON**

Set scule format din 11 tubulare hexagonale, 13 tubulare cu biti cu antrenare 1/4" si 6 accesorii, in cutie metalica

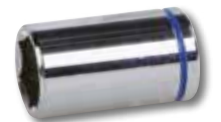

270x120x45 mm

1 kg

	900MC	4-5-6-7-8-9-10-11-12-13-14 mm
	900MC/PH	PH1 - PH2 - PH3
	900MC/TX	T10-T15-T20-T25-T27-T30- T40
	900MC/LP	0,8x4 - 1,2x6,5 - 1,2x8 mm
	900/20	50 mm
	900/21	150 mm
	900/25	
	900BG/30	
	900/42	
	900/55	



# CODE

## O CULOARE, UN STIL

007202913 **720MC/C13** 12"  
933 RON **621 RON**

Set de 13 tubulare de impact, antrenare 1/2"  
colorat, fosfatat, în carcasă metalică



mm
10
11
12
13
14
15
16
17
18
19
21
22
24

335x145x60 mm

2,4 kg

012570210 **1257LPH/S8** 1/4"  
313 RON **208 RON**

Set 8 micro-surubelnite combinate  
in cutie de plastic

- 1257PH + PH0-PH0-PH1
- 1257LP ● 0,4x2-0,4x2,5-0,5x3
- 0,6x3,5-0,8x4 mm



180x120x50 mm

012632008 **1263MC/D8** 1/4"  
295 RON **197 RON**

Set 8 surubelnite colorate

- 1260 ● 2,5x50-3x75-4x100- 5,5x125
- 6,5x150 mm
- 1262 + PH0x60-PH1x80
- PH2x100 mm



012672307 **1267MC/TX-D7** 1/4"  
365 RON **243 RON**

Set 7 surubelnite Torx®, colorate

- 1267TX + T6-T8-T10-T15-T20-T25-T30



008600880 **860/C27** 1/4"  
415 RON **230 RON**

25 de biți, 1 conector și 1 clichet reversibil  
in cutie de plastic

- 860LP 0,5x3-1,0x5,5-1,2x6,5 mm
- 860PE 2-2,5-3-4-5-6-mm
- + 860PH PH1-PH2(x2)-PH3
- + 860TX T6-T8-T10-T15-T20-T25-T30-T40
- + 860PZ PZ1 - PZ2(2x) - PZ3
- 860/55 100 mm
- 892/0



008600902 **860MIX/A31** 1/4"  
408 RON **271 RON**

Set de 30 de biți cu suport magnetic  
pentru biți in cutie de plastic

- 860LP 0,5x3 - 0,6x4,5 - 0,8x5,5
- 1,0x5,5 - 1,2x6,5 mm
- 860PE 2-2,5-3-4-5-6-8-10 mm
- + 860PH PH0 - PH1 - PH2 - PH3 - PH4
- + 860RTX T9-T10-T15-T20-T25-T27-T30-T40
- + 860PZ PZ1 - PZ2 - PZ3 - PZ4
- 882MSR/50 ○ 1/4 ● 1/4



# // 861PB

Set 6 biti in manseta cu inchizatoare magnetica

## // 008610956 MIX1 168 RON 111 RON

- ⊕ 861PH PH1 - PH2
- ⊕ 861PZ PZ1 - PZ2
- 861PE 4 - 5 mm



## // 008610966 MIX2 170 RON 113 RON

- ⊕ 861PH PH2
- ⊕ 861PZ PZ2
- ⊕ 861TX TX20 - TX25 - TX30 - TX40



## // 008620950 862F/A7 1/4 235 RON 157 RON

Set de 7 biti magnetici, prize hexagonale, in carcasă de plastic



862F ○ 5,5-6-7-8-10-12-13 mm

## // 008670901 867/C52 10mm 633 RON 350 RON

Set 52 de biti hexagonali, 10 mm și 2 accesorii

	867PE	○ 4-5-6-7-8-10-12 mm
	867PE/L	○ 4-5-6-7-8-10-12 mm
	867XZN	○ M5-M6-M8-M10-M12
	867XZN/L	○ M5-M6-M8-M10-M12
	867TX	⊕ T20-T25-T30-T40-T45-T50-T55
	867TX/L	⊕ T20-T25-T30-T40-T45-T50-T55
	867RTX	⊕ T20-T25-T30-T40-T45-T50-T55
	867RTX/L	⊕ T20-T25-T30-T40-T45-T50-T55
	867/1	○ 10 mm - □ 3/8"
	867/2	○ 10 mm - □ 1/2"



250x170x70 mm // 2,1 kg

## // 016000008 1600Q 8 1/4 138 RON 91 RON

Cheie pentru panouri, articulata, 4 capete

Cheie pentru utilizare pentru lucrări de întreținere în nenumărate industrii, de ex. electrice, hidraulică, ventilație și gaz.



## // 016000010 1600Q 10 1/4 175 RON 117 RON

Cheie pentru panouri, articulata, 8 capete

- Cheie cu opt profile, poate fi rotită cu ușurință selectați capul de utilizat.
- Articulație magnetică pentru creșterea cuplului.
- Unitate tată de 1/4" pentru utilizarea prizelor.
- Cheie pentru panouri folosite în nenumărate industrii, de ex. electricitate, hidraulică, ventilație și gaz.



## // 012560100 1256/C36-2 323 RON 214 RON

Microșurubelniță bimaterială cu 36 biți interschimbabili de 4 mm și magnetice extensie

	1256TX	⊕ T3-T4-T5-T6-T7-T8-T9-T10-T15
	1256RTX	⊕ T6-T7-T8-T9-T10
	1256LP	● 0,8-1,2-1,5-1,8-2-2,5-3-3,5-4 mm
	1256PE	○ 0,7-0,9-1,3-1,5-2 mm
	1256PH	⊕ PH000-PH00-PH0-PH1
	1256PZ	⊕ PZ000-PZ00-PZ0-PZ1
	1256/20	
	1256/30	



130x60x35 mm // 200 g



009000882 **900/55Z**  
220 RON **147 RON**

Cheie cu clichet, actionare 1/4",  
72 dinti

**UNGHII DE PRELUARE  
DE 5° : RAPIDITATE  
CRESCUTA**

**MECANISM  
COMPACT  
CU 72 DINȚI**



15 dinti in  
contact cu  
carcasa in  
orice moment:  
rezistența  
crescută

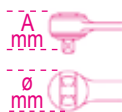

L mm	Ø mm	A mm	■
126	25	23	1/4



Clichet reversibil



	L mm	Ø mm	A mm	■	g		RON
<b>910/55</b>	200	30	33	3/8"	239	009100882	<del>238 RON</del> <b>158 RON</b>
<b>920/55</b>	275	40	43	1/2"	475	009200882	<del>290 RON</del> <b>193 RON</b>

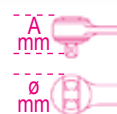

009000971 **900/C11** 14" 1/4"  
1.058 RON **704 RON**

11 tubulare hexagonale, 20 de biți și 8 accesorii,  
in carcasă metalică

	861LP	●	0,5x3-0,8x5,5-1x5,5-1,2x6,5 mm
	861PE	○	3-4-5-6-8 mm
	861PH	⊕	PH0-PH1-PH2-PH3
	861TX	⊗	T8-T10-T15-T20-T25-T30-T40
	895/1	□	□1/4" - □1/4"
	900	○	5-5,5-6-7-8-9-10-11-12-13-14 mm
	900/16	□	□1/4 - ■1/4"
	900/20		50 mm
	900/21		150 mm
	900/25		
	900/42		
	900BG/30		
	900/55	⊕	

270x120x45 mm



1,2 kg

009020807 **902A/C22** 12" 14"  
1.795 RON **1.137 RON**

Set 22 tubulare hexagonale  
și 6 accesorii, în carcasă metalică

<b>1/4"</b>		900	○	5-5,5-6-7-8-9-10-11-12-13 mm
		900/20		50 mm
		900/25		
<b>1/2"</b>		900/55	⊕	
		920A	○	10-13-14-15-17-18-19-22-24 27-30-32 mm
		920/21		125 mm
		920/25		
		920/55	⊕	

420x185x60 mm



3,5 kg

**Set 16 tubulare hexagonale si 5 accesorii, in cutie metalica**

38"



≡ 335x145x60 mm

	910A	○	6-7-8-9-10-11-12-13-14-15-16-17-18-19-21-22 mm
	910/21		125 mm
	910/22		250 mm
	910/25		
	910/42		210 mm

009100936 **910A/C16** 38"  
1.233 RON **821 RON**

Clichet reversibil (910/55)



009100935 **910A/C16HR** 38"  
1.360 RON **907 RON**

Clichet reversibil cu mâner rotativ (910/58)



**Set 17 tubulare hexagonale si 5 accesorii, in cutie metalica**

12"



≡ 420x185x60 mm

	920A	○	10-11-12-13-14-15-16-17-18-19-20-21-22-24-27-30-32 mm
	920/21		125 mm
	920/22		255 mm
	920/25		
	920/42		305 mm

009200924 **920A/C17M** 12"  
1.515 RON **1.010 RON**

Clichet reversibil (920/55)



009200937 **920A/C17MR** 12"  
1.660 RON **1.107 RON**

Clichet reversibil cu mâner rotativ (920/58)



009280955 **928A/C12** 34"  
3.935 RON **2.623 RON**

Set 12 tubulare hexagonale si accesorii, in cutie tabla



≡ 530x220x80 mm

	928A	○	22-24-27-30-32-34-36-38-41-46-50-55 mm
	928/21		200 mm
	928/22		380 mm
	928/25		
	928/42		450 mm
	928/55	⊗	



//605E<sup>14"</sup>

Cheie dinamometrica cu clichet reversibil  
pentru strangere stanga-dreapta  
Acuratete: ± 6%

UNI EN 26789 ISO 6789



	Nm mm	kgfm	lbf.in	■	L (mm)	g	006050105	RON
<b>605E/5</b>	1÷5	0,1÷0,5	10÷45	1/4"	190	180	006050105	<del>1.015 RON</del> <b>677 RON</b>
<b>605E/10</b>	2÷10	0,2÷1,0	18÷90	1/4"	190	180	006050110	<del>1.068 RON</del> <b>707 RON</b>

## //666N

Cheie dinamometrică pentru  
strângere pe dreapta, cu  
clichet reversibil  
clasă de precizie: ± 3%

- Scala crescută cu 60% pentru o vizibilitate îmbunătățită și precizia setării
- Viteza de reglare a cuplului a crescut cu 40%
- Culoarea roșie a inelului indică faptul că cheia este deblocată iar cuplul poate fi reglat

- Materiale pentru mâner și lentile rezistente la toate substanțele chimice substanțe utilizate în sectorul auto, industrie și aviație

UNI EN 26789 ISO 6789



	Nm mm	kgfm	lbf.in	■	L (mm)	g	006660002	RON
<b>666N/2</b>	5÷25	0,5÷2,5	4÷18	1/4"	220	300	006660002	<del>1.520 RON</del> <b>1.013 RON</b>
<b>666N/2X</b>	5÷25	0,5÷2,5	4÷18	3/8"	220	300	006660003	<del>1.550 RON</del> <b>1.033 RON</b>
<b>666N/5</b>	10÷50	1÷5	7÷37	3/8"	325	660	006660005	<del>1.125 RON</del> <b>630 RON</b>
<b>666N/10</b>	20÷100	2÷10	15÷75	3/8"	367	730	006660010	<del>1.133 RON</del> <b>640 RON</b>
<b>666N/10X</b>	20÷100	2÷10	15÷75	1/2"	367	800	006660011	<del>1.158 RON</del> <b>650 RON</b>
<b>666N/20</b>	40÷200	4÷20	30÷150	1/2"	465	1010	006660020	<del>1.233 RON</del> <b>690 RON</b>
<b>666N/30</b>	60÷300	6÷30	50÷220	1/2"	581	1380	006660030	<del>1.400 RON</del> <b>778 RON</b>



## //674/C

Bara dinamometrica, cu antrenor  
cilindric Ø 22 mm,  
pentru strangere dreapta-stanga  
precizie cuplu: ± 4%, in cutie

- Scala dubla pentru reglarea precisa a cuplului
- Buton de siguranta pentru mentinerea valorii cuplului setat
- Cand nu este utilizat, setati cuplul la cea mai mica valoare a intervalului den cuplu

CAPĂT ROTUND  
Ø 22 mm

NEW



UNI EN ISO 6789

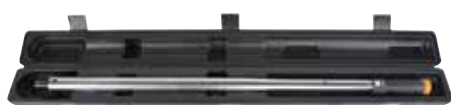

006740005 **674/C50**  
~~3.745 RON~~ **2.497 RON**

006740008 **674/C80**  
~~3.965 RON~~ **2.643 RON**

006740010 **674/C100**  
~~4.020 RON~~ **2.680 RON**

Nm	kgfm	Lbf.ft	L mm	kg
100÷500	10÷50	80÷400	786	3,4

Nm	kgfm	Lbf.ft	L mm	kg
160÷800	16÷80	120÷600	997	4,5

Nm	kgfm	Lbf.ft	L mm	kg
200÷1000	20÷100	150÷750	997	4,5

# //677/C 3/4"

Cheie dinamometrică cu clichet reversibil pentru strângere dreapta-stanga, precizie ±4%, in cutie de plastic

UNI EN 26789 ISO 6789

677/C100



	Nm mm	kgfm	lbf.in	■	L (mm)	kg	006770606	RON
<b>677/C50</b>	10÷500	10÷50	70÷350	3/4"	915	5,2	006770606	<del>4.485 RON</del> <b>2.990 RON</b>
<b>677/C70</b>	150÷700	15÷70	100÷500	3/4"	1140	6,2	006770611	<del>4.665 RON</del> <b>3.110 RON</b>
<b>677/C100</b>	300÷1000	30÷100	200÷750	3/4"	1470	7,5	006770615	<del>5.465 RON</del> <b>3.643 RON</b>

UNI EN 26789 ISO 6789



## // 006100025 610/5 12"

845 RON **563 RON**

Cheie dinamometrică cu clichet reversibil, dedicată pentru service roți, cu 5 valori presetate, clasa de precizie: ± 4%

- Valori presetate: 90 - 100 - 110 - 120 - 130 Nm
- Trageți capatul manerului pentru a debloca cheia și selectați cuplul de strângere necesar
- Când nu este utilizat, setați cuplul la cea mai mică valoare



## DEDICATA PENTRU SERVICE ROTI

## // 006100125 610L/5 12"

750 RON **500 RON**

Bara dinamometrica de strângere, dedicată pentru service roți, cu 5 valori presetate, clasa de precizie: ± 4%

- Valori presetate: 90 - 100 - 110 - 120 - 130 Nm
- Trageți capatul manerului pentru a debloca cheia și selectați cuplul de strângere necesar
- Când nu este utilizat, setați cuplul la cea mai mică valoare

# CE //665 12" 3/8"

Cheie dinamometrică cu reglaj digital și clichet reversibil, pentru strângere pe dreapta, precizia cuplului ± 3%

- Oprire automată după 30" când cuplul este setat sub pragul minim
- Afișajul va rămâne pornit cu valoarea setată a cuplului
- Setarea cuplului la cifra zecimală
- Alimentare: 1 baterie 3V (inclusă)



UNI EN 26789 ISO 6789

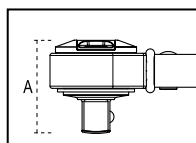
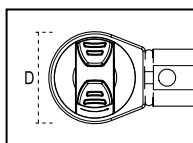

## REGLARE RAPIDĂ ȘI PRECISĂ A CUPLULUI

## // 006650100 665/SW 114 RON **76 RON**



Dispozitiv de calibrare pentru chei digitale

Dispozitivul permite calibrarea cheilor 665 (după verificarea cu dispozitivele 680 și 682), fără a fi nevoie să demontați cheia. Echipat cu micro port USB, pentru actualizări.



	Nm mm	■	D (mm)	A (mm)	L (mm)	g	006650006	RON
<b>665/6</b>	10÷60	3/8	30	33	335	655	006650006	<del>1.125 RON</del> <b>750 RON</b>
<b>665/10</b>	20÷100	3/8	30	33	375	725	006650010	<del>1.133 RON</del> <b>754 RON</b>
<b>665/10X</b>	20÷100	1/2	30	37	375	725	006650011	<del>1.158 RON</del> <b>771 RON</b>
<b>665/20</b>	40÷200	1/2	40	43	470	995	006650020	<del>1.233 RON</del> <b>821 RON</b>
<b>665/30</b>	60÷330	1/2	40	43	590	1260	006650030	<del>1.400 RON</del> <b>933 RON</b>



**PINUL DESCENTRAT DE ÎMBINARE PERMITE CLEȘTILOR O MANIPULARE MAI EXACTĂ ȘI MAI UȘOARĂ**

011690133 **1169BM/D3**  
456 RON **303 RON**

Set clești, 3 piese, compus din patent, sfiic, șiți



011690273 **1169GBM/D3**  
405 RON **270 RON**

Set cleste spit, sfiic, patent



011690014 **1169/D4**  
538 RON **353 RON**

Set 4 clești, finisare cromata



010310000 **1031/S4**  
520 RON **347 RON**

Set 4 clești pentru siguranțe elastice

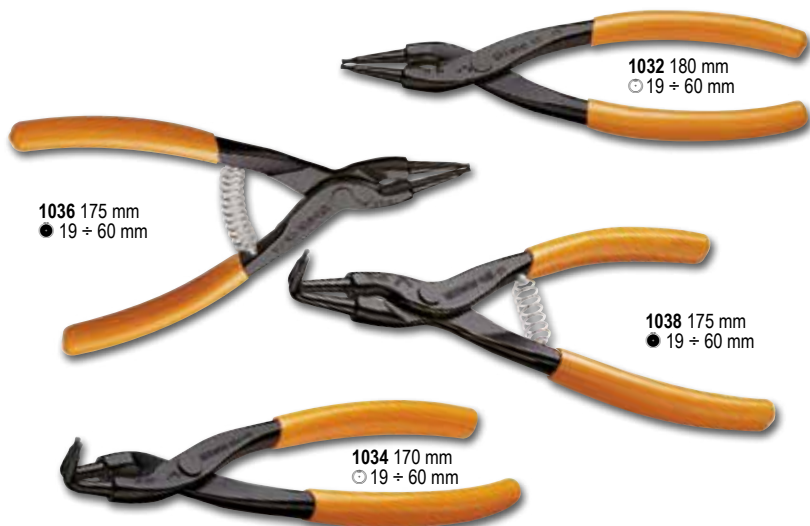

011500618 **1150HPC**  
283 RON **188 RON**

Clește combinat heavy-duty cu muchii tăietoare integrate, din oțel sinterizat și mâner bi-material

- Alinierea perfectă a falcul și profilul subțire permite utilizarea cleștilor în zone foarte mici.
- Corpul cleștelui este realizat dintr-un material fibil oțel molibden care a fost tratat termic pentru a fi flexibili și rezistent astfel încât să garanteze o prindere sigură în orice moment.

**PATENTAT**



**ABSOLUT INOVATOR  
CAPACITATE DE TĂIERE  
REMARCABILĂ**

duritatea muchiilor tăietoare =	<b>-73%</b>
articulație poziționată asimetric, pentru îmbunătățirea efectului pârghiei	<b>+127%</b>
durata medie de viață a muchiilor tăietoare mai mare	<b>65HRC</b>

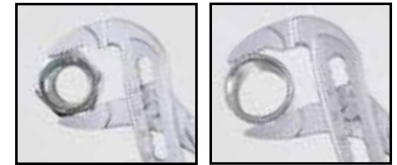

# // 1048

Clește papagal

9 POZITII DE BLOCARE

010480010 **1048 175**  
~~155 RON~~ **103 RON**

L 175 mm	ø Max 32 mm	Max 30 mm
----------	-------------	-----------

010480015 **1048 250**  
~~168 RON~~ **111 RON**

L 250 mm	ø Max 50 mm	Max 48 mm
----------	-------------	-----------

010480020 **1048 300**  
~~248 RON~~ **164 RON**

L 300mm	ø Max 58 mm	Max 56 mm
---------	-------------	-----------

010470240 **1047/240**  
~~225 RON~~ **150 RON**

Clește reglabil, tip papagal

- Reglare rapidă, precisă prin apăsare de buton
- Fără ajustări greșite accidentale
- Fălci tratate termic

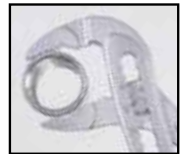

L 240 mm	ø Max 36 mm	Max 32 mm
----------	-------------	-----------

# // 1052

Clește autoblocant, falci concave



	L mm	ø Max mm	g		RON
<b>1052/140</b>	140	22	175	010520014	<del>124 RON</del> <b>82 RON</b>
<b>1052/190</b>	190	36	360	010520019	<del>148 RON</del> <b>93 RON</b>
<b>1052/240</b>	240	42	590	010520024	<del>158 RON</del> <b>100 RON</b>
<b>1052/300</b>	300	55	900	010520030	<del>250 RON</del> <b>167 RON</b>

004370550 **437U/09**  
~~1.600 RON~~ **1.067 RON**

Set reparatie filete, in cutie de lemn

- M5X0,8
- M6X1,0
- M8X1,25
- M10X1,5
- M12X1,75



370x230x55 mm

004370003 **437P**  
~~223 RON~~ **148 RON**

Dispozitiv rectificat filete

P 0,80÷3,00 mm



010090060 **1009L/DP-S2**  
~~355 RON~~ **237 RON**

Set clești extralungi, 2 piese

L 340 mm





## 004120469 **412M/SP19** 378 RON **251 RON**

Set burghie cu tija cilindrica HSS, 1-10mm, 19 piese, HSS, AISI M2

- Auto-centrare
- Eficienta marita de gaurire
- Pentru aliaje otel, fonta si alte metale

Ø 1÷10 x 0,5 mm

R ≤ 850 N/mm<sup>2</sup>  
HV ≈ 820  
DIN 338



≡ 115x170x40 mm

## 004150440 **415CO/SP19A** 660 RON **440 RON**

Set burghie cu tija cilindrica, HSS-CO 5%

- Pentru inox, otel aliat, fonta si aliaje usoare

Ø 1÷10 x 0,5 mm

R ≤ 1400 N/mm<sup>2</sup>  
HV ≈ 850÷920  
DIN 338



≡ 115x170x40 mm

## 004120415 **412/SP25P** 593 RON **394 RON**

Set burghie cu tija cilindrica, 25 piese, HSS

Ø 1÷13 x 0,5 mm

R ≤ 700 N/mm<sup>2</sup>  
HV ≈ 750÷820  
DIN 338



≡ 115x170x40 mm

## 004460060 **446/C110** 4.115 RON **2.743 RON**

Set filiere si tarozi cu accesorii, pentru filete metrice, 110 piese, M2-M16, in cutie de lemn

435/0 444/1 436/1  
435/3 444/2



430 M mm	433 M mm	440/440A M mm	441/441A M mm
2x0,4	6x0,75 - 7x0,75	2x0,4	6x0,75 - 7x0,75
3x0,5	8x0,75 - 8x1	3x0,5	8x0,75 - 8x1
4x0,7	9x0,75 - 9x1	4x0,7	9x0,75 - 9x1
5x0,8	10x0,75 - 10x1	5x0,8	10x0,75 - 10x1
6x1	10x1,25 - 11x0,75	6x1	10x1,25 - 11x0,75
7x1	11x1 - 11x1,25	7x1	11x1 - 11x1,25
8x1,25	12x0,75 - 12x1	8x1,25	12x0,75 - 12x1
9x1,25	12x1,25 - 12x1,5	9x1,25	12x1,25 - 12x1,5
10x1,5	14x1 - 14x1,25	10x1,5	14x1 - 14x1,25
11x1,5	14x1,5 - 16x1	11x1,5	14x1,5 - 16x1
12x1,75	16x1,5 - 18x1,5	12x1,75	16x1,5 - 18x1,5
14x2		14x2	
16x2		16x2	

≡ 500x337x60 mm

## 004530107 **453C/C7** 1.465 RON **977 RON**

Set 7 freze cilindrice, scurte, HSS-G

Ø 12-14-16-18-20-22  
+ cheie eliberare rapida  
R ≤ 850 N/mm<sup>2</sup>



≡ 160x145x57 mm

## 004110197 **411/K7** 313 RON **208 RON**

Set 7 burghie multifunctionale pentru taierea tuturor tipuri de materiale

Ø 3÷10 mm  
HVA~1650  
HRC~40÷50



≡ 160x98x18 mm

## 004250600 **425E/SP3** 1.415 RON **943 RON**

Set 3 burghie în trepte HSS-G

Ø 4÷12 ; 4÷20 ;  
4÷30 mm  
R ≤ 800 N/mm<sup>2</sup>  
HV 820



≡ 110x150x40 mm

# NEW

## NOUL EXTRACTOR BETA 1517C

se bazează pe un mecanism de autoblocare a bratelor declanșat de arc pe traversă. Această caracteristică îl face ușoara poziționarea și blocarea extractorului pe piesa de extras.

După ce extractorul a fost fixat pe piesa, bratele pot fi blocate cu ajutorul inelului.

Piesa centrală are 4 locuri care permit extractorului 1517C să fie folosit cu 2 brate – pentru lucrări mai rapide – și 3 picioare – pentru o fermitate sporită. Știftul de forfecare de pe capul șurubului se rupe atunci când cuplul maxim admis este depășit, protejând extractorul de suprasarcini.

# 1517C

Extractor combinat cu 2 sau 3 brate autoblocabile

- Suport pentru folosirea a 2 sau 3 brate.
- Deschidere simultană a bratelor.
- Efect de autoblocare.
- Brate articulate.
- Lungimea totală a țijeii filetate: 360 mm)



	A min+Max mm min+Max mm	L mm	L1 mm	● mm		RON
<b>1517C/0</b>	12÷140	145	250	18	015170500	<del>1.045 RON</del> <b>697 RON</b>
<b>1517C/1</b>	20÷180	200	300	18	015170501	<del>1.285 RON</del> <b>857 RON</b>
<b>1517C/2</b>	30÷280	270	300	18	015170502	<del>1.595 RON</del> <b>1.063 RON</b>

# 1502

## SISTEM DE ELIBERARE RAPIDA

Extractor universal cu două brate cu reglare și poziționare rapidă a bratelor

Specificații:

- Pentru interior și exterior
- Bratele pot fi mutate de-a lungul traversei
- Bratele sunt blocate cu ajutorul unui mecanism rapid de eliberare a pârghiei



	A min+Max mm	A1 min+Max mm	L mm	L1 mm	● mm		RON
<b>1502/0</b>	40÷90	80÷130	100	166	17	015020000	<del>585 RON</del> <b>390 RON</b>
<b>1502/1</b>	50÷130	90÷170	100	166	17	015020001	<del>638 RON</del> <b>424 RON</b>
<b>1502/2</b>	65÷150	115÷210	150	247	22	015020002	<del>1.013 RON</del> <b>674 RON</b>
<b>1502/3</b>	65÷190	125÷260	150	247	22	015020003	<del>1.120 RON</del> <b>747 RON</b>
<b>1502/4</b>	70÷235	170÷335	200	321	27	015020004	<del>1.925 RON</del> <b>1.283 RON</b>

# 015450011 1545/C5M

~~2.590 RON~~ **1.727 RON**

Presa extractoare pentru interior 1542/1 cu 5 extractoare 1544

	A mm	C mm
1544/1	9÷12	0,80
1544/2	13÷17	1,15
1544/3	16÷21	1,70
1544/4	20÷25	1,65
1544/5	25÷30	2,00

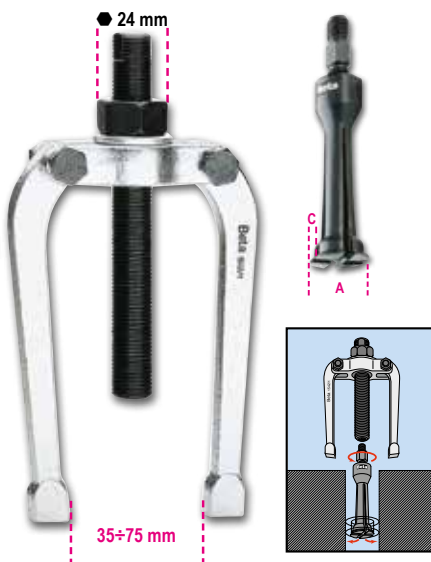

# 014300105 1430/S5

~~120 RON~~ **80 RON**

Extractoare conice

1430/1-1430/2-1430/3  
1430/4-1430/5



265x180x45 mm

110x150x40 mm



# CIOCANE ȘI DĂLȚI

000310420 **31BM/D6**  
~~498 RON~~ **331 RON**

Set 6 dornuri cu maner

Ø 2-3-4-5-6-8 mm

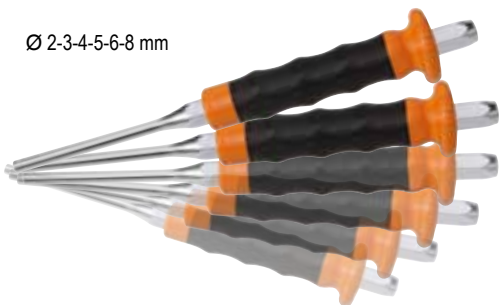

000320160 **32AU**  
~~258 RON~~ **171 RON**

Punctator



L 150 mm



## //1370

Ciocan, mâner lemn

UNI 7778 DIN 1041

	g	g		RON
<b>1370/300</b>	300	439	013700053	<del>73 RON</del> <b>48 RON</b>
<b>1370/500</b>	500	669	013700055	<del>88 RON</del> <b>58 RON</b>
<b>1370/800</b>	800	949	013700058	<del>116 RON</del> <b>77 RON</b>
<b>1370/1000</b>	1000	1180	013700060	<del>138 RON</del> <b>91 RON</b>
<b>1370/1500</b>	1500	1722	013700065	<del>158 RON</del> <b>104 RON</b>
<b>1370/2000</b>	2000	2181	013700070	<del>185 RON</del> <b>123 RON</b>



## //1370T

Ciocan de fier, cu mâner de fibră

	g	g		RON
<b>1370T/300</b>	300	452	013700630	<del>107 RON</del> <b>71 RON</b>
<b>1370T/500</b>	500	663	013700650	<del>116 RON</del> <b>77 RON</b>
<b>1370T/800</b>	800	1017	013700680	<del>124 RON</del> <b>82 RON</b>
<b>1370T/1000</b>	1000	1279	013700700	<del>158 RON</del> <b>104 RON</b>
<b>1370T/1500</b>	1500	1740	013700750	<del>183 RON</del> <b>121 RON</b>



## //1390

Ciocan cu capete de plastic, interschimbabile

UNI 7784

	Ø mm	g		RON
<b>1390/22</b>	22	134	013900022	<del>88 RON</del> <b>58 RON</b>
<b>1390/28</b>	28	230	013900028	<del>109 RON</del> <b>72 RON</b>
<b>1390/35</b>	35	365	013900035	<del>148 RON</del> <b>98 RON</b>
<b>1390/45</b>	45	698	013900045	<del>235 RON</del> <b>157 RON</b>
<b>1390/60</b>	60	1462	013900060	<del>400 RON</del> <b>267 RON</b>



NEW

016970030 **1697 30**  
1.220 RON **813 RON**



Nivela cu laser, distanta 30m, raza verde, cu baza magnetica si agatatoare de perete, in cutie

SPECIFICATII TEHNICE:

- nivel autoreglabil
- functia de autonivelare poate fi dezactivata
- dioda laser 515 Nm, class 2
- raza actiune: 30 m
- precizie : ± 1 mm at 5 m
- interval de autonivelare: 3° ± 0.5°
- corp fabricat din ABS si cauciuc aderent
- cuplaj interior de 1/4"
- baterii 2xAA
- durata baterie: 4 ore



320x230x90 mm



BAZA:

- 1 baza magnetica pentru folosire individuala sau un combinatie cu cleva, cuplaj exterior de 1/4"
- 1 cleva reglabila pentru potrivirea pe diverse profile (impreuna cu baza magnetica)
- nivel rapid la 90°, orizontal si vertical



016930020 **1693 20**  
578 RON **384 RON**

Telemetru laser, distanta 20m

TIPURI DE MASURARI:

- masurarea distantei unice
- masurare continua sau masurare minima
- Functia de oprire automata
- Durata de viata a bateriei: pana la 4.000 de masuratori

Date tehnice:

- Interval masurare: 0.05 ÷ 20 m ((0.2ft÷ 66f)
- Selectie scala: m, in, ft
- Precizie: ±1.5 mm (± 0.06 in)
- Clasa laser: 2
- Baterii: AAA 2 x 1.5V



100 mm  
23 mm  
36 mm

115 mm  
28 mm  
48 mm



80 m

016930080 **1693M 80**  
978 RON **651 RON**

Telemetru laser, distanta 80m

TIPURI DE MASURARI:

- masurarea distantei unice
- masurare continua sau masurare minima
- FUNCTII:
- adunare / scadere
- masurarea suprafeteci
- masurarea volumului
- masurare indirecta (masurare pitagoreica)
- masurarea inclinarii

Functia de oprire automata

Laveta (inclusa)  
Durata de viata a bateriei: pana la 4.000 de masuratori

Date tehnice:

- Interval masurare: 0.05 ÷ 80 m (0.2 in ÷ 229f)
- Selectie scala: m, in, ft
- Precizie: ±1.5 mm (± 0.06 in)
- Clasa laser: 2
- Capacitate stocare: 99 masuratori
- Baterii: AAA 2 x 1.5V





# //1650

Șubler din  
oțel inoxidabil

- Diviziune 0,05 mm
- Blocare cu arc

DIN 862

UNI EN ISO 13385-1

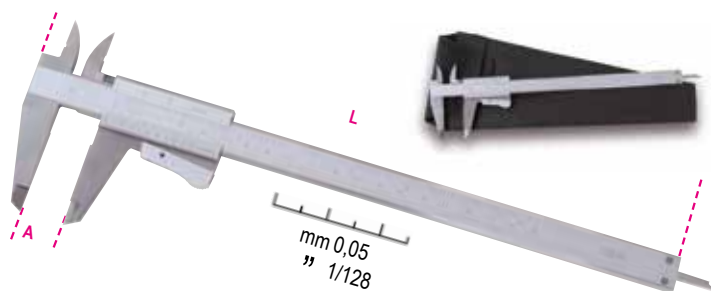

A MAX 150 mm L 225 mm

016500001 **1650/150**  
~~295 RON~~ **197 RON**

A MAX 200 mm L 290 mm

016500002 **1650/200**  
~~388 RON~~ **258 RON**

# //363

Clește din aluminiu  
pentru conducte



	L m	Ø (")	Ø (mm)		RON
<b>363 350</b>	350	2" gas	60	003630035	<del>325 RON</del> <b>217 RON</b>
<b>363 450</b>	450	2 1/2" gas	76	003630045	<del>435 RON</del> <b>290 RON</b>
<b>363 600</b>	600	3" gas	90	003630060	<del>735 RON</del> <b>490 RON</b>
<b>363 900</b>	900	5" gas	140	003630090	<del>1.375 RON</del> <b>917 RON</b>

# // 017500100 **1750KG10**

~~903 RON~~ **601 RON**

Pompa manuală de gresare, 10kg cu furtun  
de înaltă presiune, lungime 2m

Contine recipient, maner de transport, levier  
de acționare și furtun de livrare rotativ

3 nivele de livrare/ciclu:

- 4 g la 275 bar
- 7 g la 206 bar
- 9 g la 137 bar



# // 003420030 **342**

~~243 RON~~ **161 RON**

Clește taiat tevi plastic, cu clichet

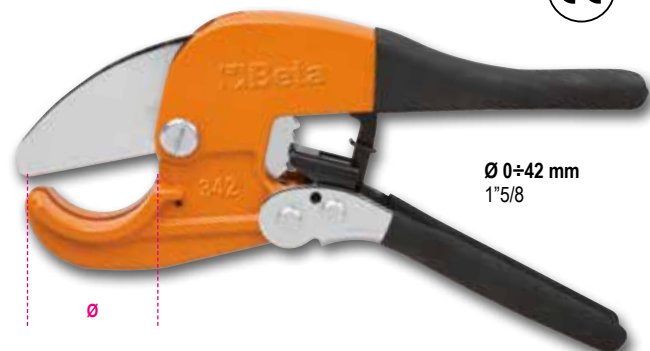

# // 017500500 **1750**

~~208 RON~~ **133 RON**

Gresor manual, 500 cc



**550 BAR**

018600255 **1860RG**

260 RON **173 RON**

**Vinclu magnetic ajustabil, 30°÷270°**

- Ideal pentru pozitionarea pieselor cu profil rotund sau plat,
- 15 kg forta magnetica,
- Livrat cu cheie hexagonala pentru blocare
- Livrat cu pini speciali de blocare la unghi de 30°-45°-90°/270°-180°
- Cu deschizatura hexagonala pentru desprindere usoara a magnetului

**30°÷270°**



**15 kg**



018600290 **1860EI**

163 RON **108 RON**

**Vinclu magnetic, 90°, pentru unghiuri interioare si exterioare**

- Ideal pentru pozitionarea pieselor cu profil rotund sau plat,
- 18 kg forta magnetica
- Cu bula de planeitate pentru unghiuri 30° si 60°
- Cu deschizatura hexagonala pentru desprindere usoara a magnetului

**90°**



**18 kg**



018600210 **1860SQ**

393 RON **261 RON**

**Vinclu magnetic, 45°/90°**

- Ideal pentru pozitionarea pieselor cu profil rotund sau plat
- 25 kg forta magnetica
- nu necesita baterie, efect ON / OFF obtinut prin inclinarea magnetilor interiori
- indepartarea mai usoara a elementelor magnetice in pozitia OFF

**45°**



**90°**



**45°/90°**



**25 kg**



**INTERVALUL DE TEMPERATURA: -20 ° C ÷ +600 ° C**



IP54 (CE)

017600710 **1760/TMC**

3.950 RON **2.633 RON**

**Camera termica cu infrarosiu**

Camera termica compacta pentru masurarea temperaturii fara contact, potrivita pentru aplicatii in constructii, instalatii mecanice, electrice si industrie

- Afisaj LCD TFT, 2", 240x320
- senzor, 32x32 pixeli
- frecventa de achizitie 7Hz
- sensibilitate termica <347mK
- achizitionarea automata a punctelor calde si reci
- camera pentru capturarea de imagini in format BMP (max. 100 de imagini)
- emisivitate reglabila
- sursa de alimentare: 3 baterii alcaline AAA
- Interfata USB
- IP54
- intervalul de temperatura: -20 ° C ÷ +600 ° C
- banda infrarosie: 6,5 ÷ 14µm
- fuziunea imaginii vizibile / infrarosii: 0,5; 1; 2m
- functie de alarma, selectand temperaturi maxime si minime acceptabile

018270100 **1827/K**

988 RON **658 RON**

**Pistol de lipit cu gaz cu 7 accesorii livrat în cutie cu suport moale din spumă de polietilenă**

- Putere: 30 wați până la 125 wați
- Temperatura vârfului poate fi reglată între 250 °C și 500 °C
- Regulator de debit de gaz
- Timp de încălzire: 15 secunde
- Rezervorul conține gaz pentru 120 de minute de funcționare non-stop
- Rezervor transparent pentru monitorizarea nivelului de gaz
- Poate fi reumplut cu gaz butan





070420001 **7042LCD**  
~~900 RON~~ **600 RON**



Masca de sudura LCD, automata ; MMA/MIG/MAG/TIG si plasma.

Alimentare prin celule fotovoltaice si baterii cu litiu

- Zona de vizibilitate: 98x43 mm
- Nuante de intunecare: DIN 9-13, reglare din exterior
- Protectie UV/IR
- Iluminare/intunecare: 1/25000s
- Intunecare/iluminare: 0.25-1s
- Sensibilitate la intunecare si temporizare reglabila
- Pornire/oprire automata
- Functie polizare
- Forma optimizata care usureaza respiratia atunci cand ecranul este coborat



070410001 **7041LCD/4S**  
~~1.280 RON~~ **853 RON**



Masca de sudura LCD, automata ; MMA/MIG/MAG/TIG si plasma.

Alimentare prin celule fotovoltaice si baterii cu litiu

- Zona de vizibilitate: 98x80 mm
- Nuante de intunecare: 5+8.5/ 9-13, reglare din interior
- Protectie UV/IR DIN16
- Iluminare/intunecare: 1/25000s
- Intunecare/iluminare: 0.1-2.0s
- Sensibilitate la intunecare si temporizare reglabila
- Pornire/oprire automata
- Indicator baterie descarcata
- Functie polizare
- Forma optimizata care usureaza respiratia atunci cand ecranul este coborat
- Piulita pentru reglarea pozitionarea corecta



070430001 **7043**  
~~523 RON~~ **348 RON**



Masca de sudura LCD, automata ; MMA/MIG/MAG/TIG si plasma.

Alimentare prin celule fotovoltaice

- Zona de vizibilitate: 92x43 mm
- Nuante de intunecare: DIN 9-13, reglare din exterior
- Protectie UV/IR
- Iluminare/intunecare: 1/1000s
- Intunecare/iluminare: 0.1-1.0 s
- Sensibilitate la intunecare si temporizare reglabila
- Pornire/oprire automata
- Functie polizare
- Forma optimizata care usureaza respiratia atunci cand ecranul este coborat



018520175 **1852R1750**  
6.975 RON **4.650 RON**

**Sistem de incalzire prin inductie**

- Incalzeste si desface bolturi intepenite.
- Permite incalzirea oricarui tip de metal feromagnetic

**SIGURANȚĂ MAXIMĂ  
FĂRĂ UTILIZAREA  
FLACĂRII**

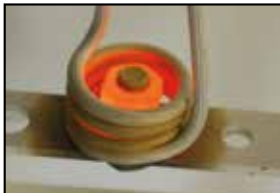

480x370x130 mm



**Date tehnice:**

- tensiune alimentare 230V AC, 50/60 HZ
- curent intrare: max 7,5A
- putere: max 1,75Kw

**Echipament optional:**

- Bobinele sunt disponibile si in alte dimensiuni

**Beneficii:**

1. Economisire timp pretios: incalzire rapida si acuratete foarte mare
2. Siguranta privind incendiile: nu produce flacari, siguranta maxima pentru operator
3. Funcional: poate fi folosit cu o singura mana, schimbare rapida a adaptoarelor

**Aplicatii:**

- Industria auto
- Intretinere si mentenanta
- Industria aeronautica
- Industria navala
- Industria petro-chimica
- Aviation industry
- Naval industry
- Petrochemical industry

**Echipe standard:**

- (1) 2 adaptoare tip arc, Ø 19 si 26 mm, pentru piulite
- (3) un adaptor suprafete plane
- (2) un adaptor flexibil, 600mm
- livrat in cutie de plastic

017600020 **1760/RMS**  
1.395 RON **930 RON**

**Multimetru digital industrial precis și robust, într-o carcasă cu parte exterioară din cauciuc antiderapante, rezistență la șocuri**

- Protecție la apă IP67
- Protecție pana la 1000V
- Testat pentru căderi accidentale de până la 2 m
- Prize protejate
- Autocalibrare
- Afișaj mare de citire directă, iluminat din spate, albastru
- Sondă de temperatură de tip K (inclusă)
- Auto-oprire
- Bază din cauciuc pentru un confort sporit de operare
- Borne izolate dublu, 1000V, lungime 1 m
- Furnizat într-o husă moale
- CAT IV 600V/ CAT III 1000V
- Valoarea efectivă reală TRUE RMS

	<b>Banda de măsurare</b>	<b>Precizia bazei</b>
AC/DC voltaj	110mV – 600V ±0.8%	- ±2% rdg
AC/DC curent	110µA – 10A ±1.5%	- ±2% rdg
Rezistență	110Ω – 40MΩ ±1.2%	- ±2.5% rdg
Capacitate	11nF – 40mF ±5%	- ±10% rdg (up to 11mF)
Frecvență	1100Hz – 110 MHz ±1.2%	- ±1.5% rdg
Temperatură	-32°C – +1000°C ±3%	- ±5% rdg
Test diodă	3V DC ±10% rdg	
Test continuitate	<30 Ω	



011490010 **1149F**  
83 RON **54 RON**

**Clește pentru dezizolat, cu lama de taiere, auto-reglare**



0,2÷6 mm<sup>2</sup>

**1740B**

**Clește compact pentru pop nituri**

- Raport optimizat al pârghiei pentru o mai bună manevrabilitate.
- Sistem de blocare cu 3 fălci pentru o prindere perfectă.
- Cap reglabil pentru tragerea nitului prin 2 până la 5 mișcări ale brațelor.

2,4÷4,8 mm oțel

017400280 **1740B 280**  
349 RON **231 RON**

2,4÷6,4 mm oțel

017400330 **1740B 330**  
403 RON **268 RON**



**3 FĂLCI, SISTEM DE PRINDERE ÎMBUNĂȚĂȚIT**



L 330 mm

CU REZERVOR PENTRU COZILE DE NIT

016090101 **1609B**  
1.480 RON **987 RON**

**Clește pentru sertizare**

- Pentru borne de cupru neizolate, 10÷120 mm<sup>2</sup>
- Mâner din cauciuc antiderapant
- Știftul interior cu secțiune „H”.
- Fabricat din oțel brunat



10÷120 mm<sup>2</sup>



L 600 mm



017410000 **1741B**  
183 RON **121 RON**

Clește nituri pop cu 4 duze interschimbabile



L 250 mm

017410450 **1741U**  
220 RON **147 RON**

Clește nituri pop ultra compact și forță ajustabilă, cu 4 duze interschimbabile



3 FĂLCI, SISTEM DE PRINDERE ÎMBUNĂTĂȚIT



L 200 mm

017490005 **1749AC**  
180 RON **120 RON**

Pistol silicon de marte forță



230 mm  
STANDARD Ø 50 mm

017490010 **1749A**  
203 RON **134 RON**

Pistol pentru lipire, model profesional, tub de aluminiu



018700220 **1870I**  
1.173 RON **781 RON**

Aspirator umed/uscător, 20 l, recipient din inox

CARACTERISTICI TEHNICE

- motor by-pass cu o singură treaptă
- tensiune: 230/240 V
- frecvență: 50/60 Hz
- putere max: 1200 W
- debit de aer: 58 l/sec.
- presiune de aspirare max: 190 mbar
- capacitate recipient max: 20 l, din oțel inoxidabil
- emisii acustice: <70 dB(A)
- lungime cablu: 5 m

ACCESORII STANDARD Ø 36 mm

- 1 furtun ondulat cu maner ergonomic și aerisire
- 2 tuburi prelungitoare dure
- 1 perie multifuncțională pentru pardoseli și fluide
- 1 duză plată
- 1 pungă de hârtie



**NEW**

SISTEME DE FILTRARE

- 1 filtru de aer de suprafață cartus 1900 cm<sup>2</sup> - 12 μm nom.
- 1 filtru antispumă PPI 45/PPI 30

# //1833...

Lanternă inspectie LED, din aluminiu anodizat

- focus reglabil
- 2 setari de luminozitate



durata baterie 10.0 h - L 150 mm

018330002 **1833 S**  
178 RON **118 RON**

durata baterie 7.5 h - L 162 mm

018330003 **1833 M**  
223 RON **148 RON**

durata baterie 8.5 h - L 196 mm

018330004 **1833 L**  
368 RON **244 RON**

durata baterie 22 h - L 300 mm

018330005 **1833 XL**  
460 RON **307 RON**

018380221 **1838SLIM**  
338 RON **224 RON**

Lanternă de inspectie reincarcabila, articulata, subtire cu 3 LED-uri

- Baza magnetica
- Timp de incarcare: 2,5h
- Durata de viata a bateriei: 2-4h

Emisie tripla de lumina

- fata: 100/200 lumeni
- spate: 180 lumeni
- capat: 80 lumeni



307x29x17 mm

018380400 **1838AM**  
500 RON **333 RON**

Lampa de inspectie LED, reincarcabila, cu doua trepte de iluminare, articulata, care se poate roti la 180°, cu baza magnetica pivotanta si carlig de agatare

- doua trepte de iluminare: frontal: LED COB, 60-700 lumeni, intensitate reglabila spot: LED SMD, 120 lumeni, ON-OFF
- acumulator 3.6V 2600mAh Li-ion
- port USB-C
- furnizata cu incarcator 100-240V / 50-60Hz
- timp de incarcare: 4h
- durata de functionare: frontal: 2,5-16h spot: 10h
- indicator al nivelului de curent din acumulator
- articulata, se poate roti la 180° (± 90° fata de axa)
- Baza cu magnet, pivotanta (magnet din neodimium), care se poate roti la 90°
- carlig de agatare pivotant



**NEW**

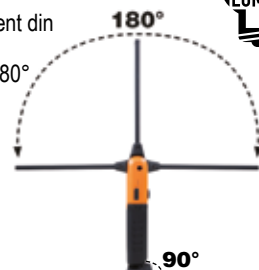

L 405 mm



018380300 **1838FLASH**  
1.550 RON **1.033 RON**

Proiector reincarcabil, ultracompact, conceput pentru a oferi cea mai buna solutie pentru fiecare aplicatie

- IP65 - fara alimentare externa
- Luminozitate dubla: 650 / 300 lumeni
- Baterie din polimer de litiu 7,4 V 4000 mAh, inclusa

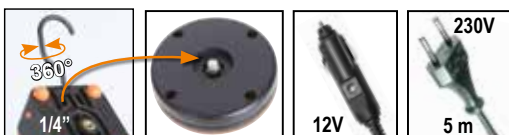

85x100x155 mm







018380122 **1838S**

~~400 RON~~ **267 RON**

### Lampă inspecție LED, articulată, reincarcabila

- poate fi rotita 180 grade
- lumina dubla, in fata si in varf
- 700 lumeni / spot 200 lumeni
- corp anti-alunecare din cauciuc
- carlige prindere
- magneti la baza si in spate pentru ajustabilitate crescuta
- cu incarcator 100-240V / 50-60Hz
- timp incarcare: 4 ore
- timp de functionare: 2-7.5 ore



260x52x38 mm



018380010 **1838COB**

~~433 RON~~ **288 RON**

### Lampă de inspecție compactă, reincărcabilă, cu LED-uri de foarte mare putere, baterie litiu-polimer

- Corp compact din cauciuc anti-alunecare
- Cârlig orientabil
- Baza magnetică se poate roti cu 180 de grade
- Cu alimentator de 100-240V c.a. / 50-60Hz
- 100 / 200 lumeni
- Intervalul de funcționare: 5 / 2,5 ore
- IP65

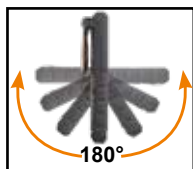

120x59x25 mm

018360050 **1836A**

~~245 RON~~ **163 RON**

### Lampă de cap cu senzor ON/OFF fără contact

- 120/65 lumens
- IP54
- Baterii: 3xAAA incluse



67x48x46 mm



**1837C**



### Proiector LED reincarcabil

- 3 setari de luminozitate
- Incarcator baterie: intrare: 100-240V c.a. - 50 / 60Hz; iesire: 15V 1.5A
- Timp de incarcare: 4 ore
- Indicator de incarcare cu 3 LED-uri
- Se poate roti până la 180 °
- Clasa protectie IP65
- Rezistenta impact IK07



500/1000/2100 lumen

018370210 **1837C/2100**

~~873 RON~~ **581 RON**



220x225x70 mm

1100/2200/4300 lumen

018370430 **1837C/4300**

~~1.280 RON~~ **853 RON**



266x236,6x59 mm

018380111 **1838/11LED**

~~765 RON~~ **510 RON**

### Lampă inspecție LED

- Corp compact cu mâner anti-alunecare
- Cârlig orientabil
- Magnet la bază
- Cu alimentator de 110-230V c.a. / 50-60Hz
- LED-uri laterale 320 lumeni
- IP65
- Indicator încărcare



**MAI COMPACT SI MAI PUTERNIC**



**LED FRONTAL**



**CÂRLIG AGĂTARE ROTATIV**





NEW

018380270 **1838E**  
855 RON **570 RON**

**Lampa de lucru cu LED pentru lucrul sub capota**

- Reglaj intensitate lumina in 3 trepte: 500/1000/2000 lumeni
- Poate fi rotit 360 °
- Suport prindere rglabil: 116 ÷ 188 cm
- Corp din aluminiu
- Carlige de cauciuc antiderapante
- Incarcare USB-C
- Livrat cu incarcator de baterii
- Intrare: 100-240V ~ 50 / 60Hz
- iesire: DC 5V - 2000 mA
- durata baterie: 3-9 ore



- 2 moduri de incarcare:**
- *incarcati prin portul USB al lampii*
  - *incarcati prin portul USB al bateriei interne*

018380271 **1838E-BT**  
240 RON **160 RON**

**Baterie reincarcabila port USB-C pentru reperul 1838E**

- Li-Ion 3,6V
- DC 5V - 2000 mA



018370450 **1837M**  
1.360 RON **907 RON**



**Proiector reincarcabil cu LED COLOUR MATCH, pentru controlul culorii vizuale, index ridicat de redare a culorilor (CRI 96+), până la 2.000 de lumeni**

- 3 setari de luminozitate: 500 / 1.000 / 2.000 lumeni
- CRI (index de redare a culorilor): 96+
- CCT (temperatura de culoare corelată): 2700K / 3500K / 4500K / 5500K / 6500K
- încărcător baterie: intrare: 100-240V c.a. - 50 / 60Hz; ieșire: 15V 1.5A
- conector de incarcare cu eliberare rapida
- timpul de incarcare: 3,5 ore
- durata de viata a bateriei: 8/4/2 h
- indicator de incarcare
- buton și indicator LED de temperatura a culorii
- buton și indicator de luminozitate LED
- se poate roti până la 180 °
- IP65
- IK07



**96 CRI+**



220x225x70 mm

**NEW NOUA GAMĂ DE ROLE RETRACTABILE**

Gama noua, variata și cuprinzatoare de role de la Beta a fost proiectata și dezvoltata pentru a satisface cerintele tuturor profesionistilor.

Arc de inalta rezistenta care asigura o durabilitate remarcabila și o rulare usoara.

Carcasa fabricata din polipropilena groasa, pentru rezistenta sporita la soc.

Dispozitiv de clichetare care determina oprirea derularii automate a cablului, usor de dezactivat, pentru a permite tragerea continua.

Fiecare tambur este prevazut cu un suport de montare pe perete pivotant de 180° si un suport suplimentar pentru conectarea rapida si deconectarea de la suportul de montare pe perete.

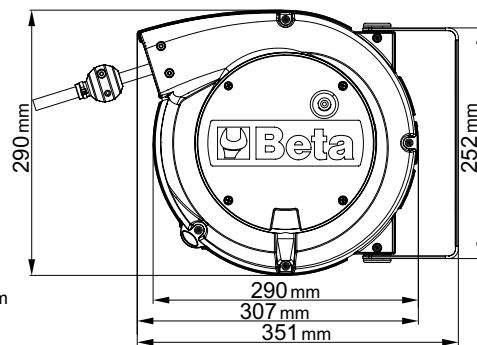
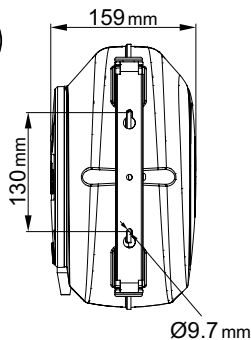

018420821 **1842 15-H05/LED**  
1.585 RON **1.057 RON**

**Rola retractabila de curent, cu lampa LED, 100-240Vac**

- cu transformator 230/12V
- cablu H05VV-F 2x1.0 mm<sup>2</sup>



018440315 **1844 15-H05**  
943 RON **628 RON**

**Rola retractabila de curent cu cablu 3Gx1.5 mm<sup>2</sup>**

- cablu 3Gx1.5 mm<sup>2</sup>
- cu protectie termica
- putere maxima (infasurat): 1500W (230V-20°C)
- putere maxima (desfasurat): 2500W (230V-20°C)



018440316 **1844 15-H05/SCK**  
1.108 RON **738 RON**

**Rola retractabila de curent cu cablu 3Gx1.5 mm<sup>2</sup>, cu priza SCHUKO**

- cablu 3Gx1.5 mm<sup>2</sup>
- cu protectie termica
- putere maxima (infasurat): 1500W (230V-20°C)
- putere maxima (desfasurat): 2500W (230V-20°C)



# SCULE IZOLATE 1000V

**1000 V**

012730851 **1273MQ/D6**   
~~325 RON~~ **217 RON**

**Set 6 șurubelnițe izolate 1000V**  
 1274MQ 3x100-4x100-5,5x125 mm  
 1272MQ PH0x60-PH1x80-PH2x100 mm



012730606 **1273MQF/D6**   
~~415 RON~~ **277 RON**

**Set 6 șurubelnițe izolate 1000V cu capăt subtire**  
 1274MQ/F 0.5x3,5x100 - 0.8x4,5x100 - 1x5,5x125 - 1.2x6,5x150 mm  
 1272MQ/F PH1x4.5x80- PH2x6x100 mm



011690143 **1169MQ/D2**   
~~468 RON~~ **311 RON**

**Set patent și sfic izolați 1000V**



009140054 **914MQ-A/S4**   
~~285 RON~~ **190 RON**

**Set tubulare hexagonale 3/8",** fabricate din tehnopolimeri speciali pe baza de poliamida



Ø mm	Max (Nm)
8	6
10	9
13	20
17	30

Pentru utilizare cu cheie dinamometrica

011280101 **1128MQ**   
~~233 RON~~ **154 RON**

IEC 60900



**Foarfece de electrician, lame din oțel inoxidabil, cu microdinți izolata 1000V**

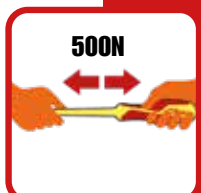

017600025 **1760/OHM**   
 3.860 RON **2.573 RON**

Multimetru/megohmmetru pentru testarea izolației de înaltă tensiune indicator TRUE RMS



 CAT. IV 600V  
 CAT. III 1000V

	Interval de măsurare	Precizie
Tensiune AC/DC:	50mV - 1000V	±0,06% - ±0,1% rdg
Curent AC/DC:	0,01µA - 10A	±0,5% - ±1% rdg
Rezistență:	0,01Ω - 50MΩ	±0,2% - ±2% rdg
Meg OHM:	0,01 - 5000MΩ	±4% rdg. curent maxim 1mA
Capacitate:	5nF - 10mF ±1,5%	- ±3% rdg
Frecvență:	50 Hz - 100 MHz	±0,02% - ±0,1% rdg
Temperatura:	- 50 °C - +1350 °C	±0,5% rdg
Test diode:	3V dc	
Test de continuitate:	<30 Ω	

059880400 **5988VHB-MQ/A**  
 13.300 RON **8.867 RON**

Componenta 66 scule in suport burete, izolate 1000V



Cantitate/Descriere	Beta N.	TR
12 chei fixe izolate 1000V 7-8-10-11-12-13-14-15-16-17-19-22 mm	52MQ	M49
12 chei inelare cotite izolate 1000V 7-8-10-11-12-13-14-15-16-17-19-22 mm	89MQ	M49
4 imbusuri hexagonale izolate 1000V $\odot$ 4-5-6-8 mm	910MQ/PE	M108
11 tubulare bihexagonale izolate 1000V $\odot$ 7-8-10-11-12-13-14-15-16-17-19 mm	910MQ/B	M108
6 imbusuri cu cap Torx® izolate 1000V $\odot$ T15-T20-T25-T27-T30-T40	910MQ/TX	M108
2 imbusuri cu cap XZN® izolate 1000V, $\odot$ 8-10 mm	910MQ/XZN	M108
1 prelungitor 3/8" izolat 1000V, 125 mm	910MQ/21	M108
1 prelungitor 3/8" izolat 1000V, 250 mm	910MQ/22	M108
1 Măner în T 3/8" izolat 1000V,	910MQ/T	M108
1 Clichet reversibil cu antrenare izolat 1000V, 3/8" ,	910MQ/55	M108
1 foarfecă electrician izolat 1000V	1128MQ	M161
1 clește reglabil 250 mm izolat 1000V	1048MQ	M161
1 clește sfic $\nless$ 160 mm izolat 1000V	1082MQ	M161
1 clește patent $\equiv$ 180 mm izolat 1000V	1150MQ	M161
1 clește spîț cu vîrf plat izolat 1000V, $\equiv$ 160 mm	1162MQ	M161
1 clește spîț cu vîrf plat indoit izolat 1000V $\equiv$ 160 mm	1164MQ	M161
4 șurubelnițe pentru șuruburi Phillips® izolate 1000V 1000V PH0x60 - PH1x80 - PH2x100 - PH3x150 mm	1272MQ	M161
4 șurubelnițe pentru șuruburi cu cap drept izolate 1000V 2,5x75 - 3x100 - 4x100 - 5,5x125 mm	1274MQ	M161
1 cutter izolat 1000V	1777MQ/U	M161

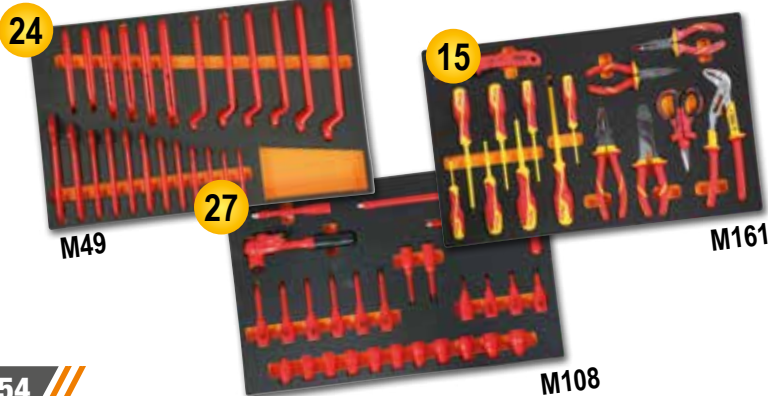

021150332 **2115PL-MQ32**  
 5.580 RON **3.720 RON**

Set 32 scule izolate 1000V pentru automobile, în cutie mobilă de plastic



$\Delta$  1000 V

Cantitate/Descriere	Beta N.
1 Clichet reversibil 1/2", izolat 1000V	920MQ/55A
1 Cheie inelară cotită 10-12 mm, izolată 1000V	89MQ
1 Adaptor biți $\odot$ 1/4", izolat 1000V	850MQ
10 Set 10 biți Torx $\odot$ T7-T8-T9-T10-T15-T20- T25-T27-T30-T40, izolat 1000V	860TX/A10
7 Tubulare hexagonale 1/2 $\odot$ 8-10-12-13-14- 17-19 mm, izolate 1000V	920MQ/A
1 Preungitor 1/2" 125mm, izolat 1000V	920MQ/21
1 Prolungitor 1/2", izolat 1000V	920MQ/22
1 Clește reglabil 250mm, izolat 1000V	1048MQ 250
1 Clește patent $\equiv$ 180mm, izolat 1000V	1150MQ
1 Clește spîț cu vîrf indoit $\equiv$ 160mm, izolat 1000V	1164MQ160
2 Șurubelniță cruce 4.5X80-6X100mm, izolata 1000V	1272MQ
3 Șurubelniță dreaptă 3X100-4X100-5.5X125, 1000V	1274MQ
1 Mănuși izolate 1000V	1995MQ/G2
1 Cutie plastic pentru depozitare dimensiune 558 x 277 x 270mm	CP15L

020010154 **2001/BZ24 MQ**  
 1.565 RON **1.043 RON**

Geanta pliabila cu set de 24 scule, pentru electricieni

**NEW**



380x290x60 mm



Cantitate/Descriere	Beta N.
1 foarfecă de electrician, lame drepte	1128BMX
1 clește patent izolat 1000V $\equiv$ 180 mm	1150MQ
5 chei combinate 8-10-13-17-19 mm	42NEW
3 șurubelnițe pentru șuruburi cu cap drept, 1000V 3x100 - 4x100 - 5,5x125 mm	1274MQ
3 șurubelnițe pentru șuruburi Phillips®, 1000V PH0x60 - PH1x80 - PH2x100 mm	1272MQ
9 imbusuri hexagonale cu cap sferic 1,5-2-2,5-3-4-5-6-8-10 mm	96BP/SC9
1 șurubelniță testare siguranțe $\bullet$	1253
1 clește sfic izolat 1000V $\nless$ 160 mm	1082MQ



## O NOUĂ PERSPECTIVĂ

Pentru a reprojeta foarfecele noastre de electrician, am observat munca zilnică a utilizatorilor. Am transformat-o într-un instrument universal, încorporând cele 4 caracteristici principale într-un singur obiect.

### Tăiere

Rapid și ascuțit, pentru cabluri de până la 50 mm<sup>2</sup>. Cu o canelură de tăiere a cablului și o lamă cu microdinți, pentru o prindere îmbunătățită.

### Sertizarea

Sigur și durabil, pentru terminale de tub.

### Dezizolarea

Pinul sensibil anti-slăbire permite chiar și cele mai subțiri cabluri să fie dezlipite cu precizie.

### Zencuirea

Profilul unic de frezare permite găurilor din cutiile de tragere să fie curățate cu precizie.

011280095 **1128FXS**

~~183 RON~~ **121 RON**

Foarfece de electrician cu profile de frezat gradat, lame drepte din inox, cu microdinți, canelură de tăiere a cablurilor și clești de sertizare pentru bornele tubului

- Suport cu cârlig articulat pentru centură
- Mânere bimateriale
- Pin anti-slăbire
- Profil și freză: concepute pentru a mări găurile pe plastic, de la 13 la 21 mm



011280088 **1128BAX**

~~160 RON~~ **107 RON**

Foarfece electricieni cu dublă acțiune, cu profile de frezat din oțel inoxidabil acoperit cu DLC

- Duritate mare a suprafeței lamei (rezistența la abraziune și uzură)
- Coeficient scăzut de frecare (netezime și anti-aderență)
- Cu carcasă din plastic articulată

**+DURITATE  
-COEFICIENT DE  
FRECARE**



conceput pentru a se mări găuri pe plastic, de la 13 la 25 mm.



017260050 **1726BM**

~~220 RON~~ **147 RON**

Fierăstrău, cu sistem de eliberare rapidă a lamei

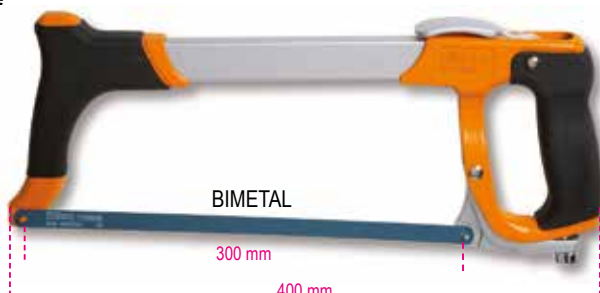

017780088 **1778P**

~~180 RON~~ **120 RON**

Briceag pliabil cu lama, maner din otel inoxidabil și insertie din aluminiu, cu buton de deschidere în suport



017780080 **1778SOS**

~~158 RON~~ **104 RON**

Briceag SOS cu dispozitiv spargere geam și tăietor centură de siguranță, în husă

- Cu clemă de prindere
- Mâner din aluminiu anodizat
- Blocare de siguranță a lamei



017710050 **1771BM**

~~98 RON~~ **64 RON**

Cutter, 18mm, cu 6 lame de rezervă

- Mâner bimaterial antiderapant
- Încărcarea automată a lamei
- Piuliță de blocare a lamei pentru o mai bună stabilitate a lamei
- Glisor de siguranță antiretur



017720040 **1772M**

~~89 RON~~ **59 RON**

Cutter cu lamă retractabilă, livrat cu 3 lame

- Lama se retrage printr-un automat mecanic cu arc
- Corp din aliaj turnat sub presiune
- Sistem de îndepărtare a capselor încorporat în mâner



**TĂIEREA REGLABILĂ  
ADÂNCIMEA Ø÷25 MM**

Noua familie de produse Beta Abrasives este numele pentru o gamă cuprinzătoare de abrazivi duri și flexibili și au ca rezultat un ajutor remarcabil pentru profesioniști aduse de liderii de piață reprezentate de companiile AbraBeta și Elpa.

### // 11001

Disc taiere otel, tip oala

A30S

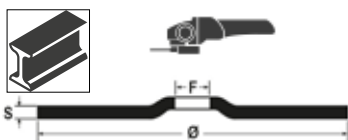

Ø mm	S mm	F mm		RON	
230	3,2	22,23	110010233	<del>14 RON</del>	<b>9 RON</b>

### // 11035-11038 **TOP** — LINE —

Disc taiere otel și inox, subtire

A46U

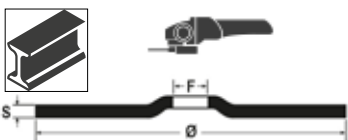

	Ø mm	S mm	F mm		RON	
11035	125	1,0	22,23	110350022	<del>9 RON</del>	<b>6 RON</b>
11035	125	1,6	22,23	110350062	<del>9 RON</del>	<b>6 RON</b>
11038	230	2,0	22,23	110380022	<del>16 RON</del>	<b>10 RON</b>

### // 11049 **PREMIUM** — LINE —

Disc taiere otel și inox, subtire

A36Q

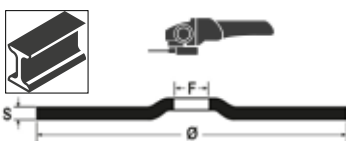

Ø mm	S mm	F mm		RON	
230	2,0	22,23	110490019	<del>14 RON</del>	<b>9 RON</b>

### // 11011

Disc slefuire otel, tip oala

A24N

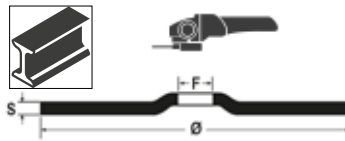

Ø mm	S mm	F mm		RON	
230	6,5	22,23	110110230	<del>24 RON</del>	<b>16 RON</b>

### // 11046 **PREMIUM** — LINE —

Disc taiere otel și inox, subtire

A46Q

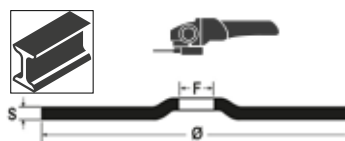

Ø mm	S mm	F mm		RON	
125	1,0	22,23	110460010	<del>7 RON</del>	<b>4 RON</b>
125	1,6	22,23	110460016	<del>7 RON</del>	<b>4 RON</b>

### // 11210B **PREMIUM** — LINE —

Disc conic lamelar abraziv pentru slefuit, zirconiu, spate fibra de sticla

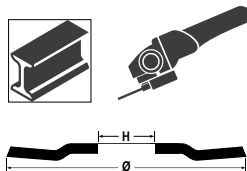

Ø mm	P	F mm		RON	
125	40	22,23	112100104	<del>14 RON</del>	<b>9 RON</b>
125	60	22,23	112100106	<del>14 RON</del>	<b>8 RON</b>
125	80	22,23	112100108	<del>14 RON</del>	<b>9 RON</b>

### // 11220B **TOP** — LINE —

Disc conic lamelar abraziv pentru slefuit, zirconiu, spate fibra de sticla

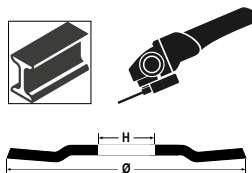

Ø mm	P	F mm		RON	
125	40	22,23	112200104	<del>17 RON</del>	<b>11 RON</b>
125	60	22,23	112200106	<del>17 RON</del>	<b>11 RON</b>
125	80	22,23	112200108	<del>17 RON</del>	<b>11 RON</b>



## NOUA GAMA DE POLIZOARE UNGHIULARE MARCA BETA

Puterea, fiabilitatea și durabilitatea sunt cele trei caracteristici ale noii game, cu accentul pus și pe siguranța maximă și ușurința utilizării de către profesioniști.

### • Performanța remarcabilă:

Motor puternic, rezistent la uzură, durabil  
Guri de aerisire care asigură o răcire optimă, protejate împotriva infiltrării prafului

### • Siguranța suplimentară pentru operatori:

Dispozitiv de blocare a axului pentru schimbări rapide de disc  
Protecție împotriva activării accidentale  
Pornire lina, pentru limitarea intrării inițiale mari a curentului la pornire

### • Confort unic și ușurința în manipulare:

Maner ergonomic antiderapant pentru o aderență îmbunătățită  
Parte frontală îngustă care permite lucrul în spații restrânse  
Cablul cauciuc de 4 metri lungime pentru o ușurință sporită a mișcării

Maner suplimentar care poate fi montat pe ambele părți

Disponibil pentru discuri cu diametrul de 115/125/230 mm, putere absorbită nominală variind de la 750 W la 2.400 W.

**NEW**

- Protecție împotriva pornirii accidentale
- Maner suplimentar care poate fi montat pe ambele părți
- Rotire fără cheie a aparatului
- Dispozitiv de blocare a axului pentru schimbarea rapidă a discului
- Comutator cu glisare de blocare / oprire
- Aerisiri protejate împotriva infiltrării prafului, asigurând o ventilație optimă a motorului
- Cheie blocare inclusă

019560011 1956 115-750W **750W**  
295 RON **197 RON**

### Polizor unghiular pentru discuri Ø 115 mm

Ideal pentru tăiat și polizat

**Motor puternic (750 W)**

Maner ergonomic antiderapant pentru confort și siguranță sporită

Parte frontală îngustă pentru lucrul în spații restrânse

Extrem de ușor (**nu cântărește mai mult de 1,8 kg**)

- Protecție împotriva pornirii accidentale
- Maner suplimentar care poate fi montat pe ambele părți



#### Date tehnice

- Putere absorbită: 750 W
- Tensiune: 220-240 V / 50 Hz
- Diametrul discului (discul nu este inclus): 115 mm
- Viteza liberă: 11.000 rpm
- Filetul axului: M14
- Lungime cablu: 4 m
- Greutate: 1,8 kg

019560125 1956 125-1400W **1400W**  
575 RON **383 RON**

### Polizor unghiular pentru discuri Ø 125 mm

Ideal pentru tăiat și polizat

**Motor puternic (1400 W)**

Maner ergonomic antiderapant pentru confort și siguranță sporită

Parte frontală îngustă pentru lucrul în spații restrânse

- Protecție împotriva pornirii accidentale
- Maner suplimentar care poate fi montat pe ambele părți



#### Date tehnice

- Putere absorbită: 1400 W
- Tensiune: 220-240 V / 50 Hz
- Diametrul discului (discul nu este inclus): 125/115 mm
- Viteza liberă: 3.000 - 10.000
- Filetul axului: M14
- Lungime cablu: 4 m
- Greutate: 2,5 kg

019560230 1956 230-2400W **2400W**  
775 RON **517 RON**

### Polizor unghiular pentru discuri Ø 230 mm

Ideal pentru tăiat și polizat

**Motor puternic (2400 W)**

Maner ergonomic antiderapant pentru confort și siguranță sporită

- Protecție împotriva pornirii accidentale
- Maner suplimentar care poate fi montat pe ambele părți



#### Date tehnice

- Putere absorbită: 2400 W
- Tensiune: 220-240 V / 50 Hz
- Diametrul discului (discul nu este inclus): 230 mm
- Viteza liberă: 6.500rpm
- Filetul axului: M14
- Lungime cablu: 4 m
- Greutate: 5,8kg

018980004 **1898/K40**

~~21.500 RON~~ **14.333 RON**

**Dispozitiv de curatare piese, cu incalzire, ecologic**

- Folosind lichidul bioactiv inclus, uleiul și reziduurile pot fi îndepărtate eficient din piesele mecanice fara a fi nevoie de substanțe chimice agresive
- Lichidul bioactiv transforma uleiul si alte reziduuri în dioxid de carbon si apa care pot fi refolosite din nou
- nu este nevoie de colectarea și eliminarea deseurilor de catre specialisti
- adecvat atat pentru piese metalice, cat si pentru cele din plastice

**Echipament:**

- Perie lungă cu fire si teava de legatura
- Funcția de operare la dreapta și la stânga
- Grilă perforată din oțel inoxidabil
- Roți cu frâne
- Display pentru afisare temperatura si alerta la nivel scazut

**Accesorii incluse:**

- 2 cutii de 20 l de detergent lichid ecologic și 2 pachete de bacterii
- 2 pachete de lichid bioactiv

**EFICIENT SI ECOLOGIC.**
**DATE TEHNICE:**

Debit maxim pompei	10 l/min
Capacitate rezervor	40 l
Temperatura de functionare	+5°C ÷ +40°C
Greutate	50 kg (cand este gol)

**ATENȚIE**

Țări în care produsul 1898/K40 poate fi distribuit: Austria, Belgia, Franța (din 2021), Ungaria, Italia, Olanda, Polonia, Portugalia, Spania, Regatul Unit.

**1895**

**Cu functie speciala de degazare**

- Curatarea cu ultrasunete se bazeaza pe incalzirea fluidelor pentru a curata eficient piesele de schimb și piesele metalice în general (injectoare, carburatoare, supape etc.)
- Afisaj digital pentru selectarea temperaturii si a timpului de curatare
- Doua moduri de curatare: „usoara” si „normala”
- Pentru curatarea normala, folositi doar apa la o temperatura de 50/60 °C
- Pentru o curatare mai precisa, adaugati detergent non-spumant specific rezervoarelor cu ultrasunete
- Utilizarea modului “degaz” accelerează degajarea aerului în tot rezervorul, îmbunătățind astfel eficiența de curățare cu ultrasunete



**1895 6    1895 13    1895 27**

Capacitate	6 l	13 l	27 l
Robinet de scurgere	✓	✓	✓
Putere	150 Watt	300 Watt	500 Watt
Putere incalzire	300 Watt	400 Watt	500 Watt
Temperatura lucru	0÷80°C	0÷80°C	0÷80°C
Interval timp de curatare	0-99 minutes	0-99 minutes	0-99 minutes
Frecventa	40 kHz	40 kHz	40 kHz
Alimentare	220/230V	220/230V	220/230V
Dimensiuni totale	330x180x310 mm	350x325x320 mm	530x330x380 mm

018950060 **1895 6 I**  
~~3.365 RON~~ **2.243 RON**

018950130 **1895 13 I**  
~~5.220 RON~~ **3.480 RON**

018950270 **1895 27 I**  
~~7.275 RON~~ **4.850 RON**



014980108 **1498/8A**  
1.050 RON **700 RON**

**8A**



**Incarcator baterii, 12 V-16A**

- Protecție la inversarea polarității și scurtcircuit
- Selectare manuală a tipului de baterie
- Display digital
- Carlig de fixare



Tensiune de alimentare	220V-240V
Frecvența	50-60 Hz
Curent (min-max)	2-8 Amp
Vltaj baterie	12V
Capacitate baterie	5Ah-160Ah
Clasa de protecție	IP65
Tipul bateriei	Wet-Gel-Dry-AGM

014980126 **1498/16A**  
2.210 RON **1.473 RON**

**16A**



**Incarcator electronic multifunctional, 12-24V**

- Afișaj digital
- Curent max de incarcare: 16A, continuu
- Incarcarea și intretinerea bateriei
- Protejat împotriva inversării polarității și a scurtcircuitelor
- 9 trepte de incarcare
- Funcție showroom (13,8V - 12A)
- Funcția de alimentare (14V - 12A)
- Funcție de pastrare a memoriei (13,8V - 12A)
- Funcție de regenerare a bateriei
- Suport clema pentru agatare
- Carlig cu fixare plan inclinat
- Accesoriu furnizate: cablu cu clești, clema cu ocheti



**Date tehnice:**

- Alimentare: 220-240V
- Putere: 240W
- Curent de incarcare: 4-16A
- Tipuri de baterii: Agm - Umed - Litiu (LiFePo4)
- Capacitate de incarcare: 5-360Ah
- Capacitate de intretinere: 5-550Ah
- Tensiune iesire: 12-24V
- Tensiunea minima a bateriei: 0,8V
- Grad de protecție: IP20

017600008 **1760DGT/2**

**Multimetru digital auto, portabil, cu osciloscop cu 2 canale și generator de forme de unda**



**Kitul contine**

- cabluri multimetrice
- 2 cabluri BNC
- sondă osciloscop (1X și 10X)
- incarcator de baterii
- teaca de nailon



199 mm  
40 mm  
98 mm



**SPECIFICAȚII OSCILOSCOP Orizontală**

- Lățime de bandă: 40MHz
- Gama de frecvență de eșantionare: 250MSa / s (canal unic) - 125MSa / s (canal dublu)
- Gama SEC / DIV: 5ns / div ÷ 500s / div 1,2,5 secvență

**Vertical**

- Gama VOLTS / DIV: intrare BNC 10mV / div ÷ 10V / divat
- Analog selectabil, limită de lățime de bandă, tipic: 20MHz
- Răspuns de joasă frecvență (-3db): ≤10Hz a BNC
- Precizie de câștig DC: ± 3% pentru modul de achiziție normal sau mediu, 10V / div ÷ 10 mV / div

**Declanșator**

- Tipul: Edge
- Mod: Auto, Normal, Single
- Panta: în creștere, cădere, în creștere și cădere
- Sursa: CH1, CH2 intrare
- Cuplaj: DC, AC sau GND
- Factori de atenuare a sondei acceptate: 1X, 10X, 100X, 1000X
- Generator de forme de undă arbitrar
- Frecvența formei de undă: sinusoidal (1Hz ÷ 25MHz), pătrat (1Hz ÷ 10MHz),
- Rampă (1Hz ÷ MHz), EXP (1Hz ÷ 5MHz)
- Lățime: 2,5Vpp (50Ω) - 5Vpp (impedanță ridicată)
- Impedanță de ieșire: 50Ω

**TECHNICAL DATA**

Display	2.8" colour TFT
Rezoluție	320 x 240 pixels
Incarcator de baterii	100V-240V AC, 50Hz-60Hz; DC INPUT 5V DC-2A
Baterie	2 x 2600 mAh

**SPECIFICAȚII MULTIMETRULUI**

Test: tensiune, curent, rezistență, Capacitate, diode și On-Off  
Max. tensiune: 600V DC  
Max. curent: 10A DC  
Max. rezistență: 40 MOHM  
Max. capacitate: 100uF

NEW

014970180 **1497TE**  
114 RON **76 RON**

**Clește pentru demontarea  
conectorilor electrici**

Falcile extrem de subțiri permit detasarea  
clemelor fără a deteriora conectorii

L mm	A Max mm	Ø mm
215	63	4



014970200 **1497/C23**  
1.065 RON **710 RON**

**Set de 23 scule de desfacere a  
conexiunilor electrice**



440x250x70 mm

014970300 **1497/C94**  
1.875 RON **1.250 RON**

**Set de 94 de conexiuni pentru testarea  
automobilelor**

**Assortment contents:**

- 2 adaptoare T
- 2 potențiometre
- 2 lumini de avertizare
- 2 conexiuni SRS
- 2 clame crocodil
- 2 sonde aciculare
- 2 ace
- 2 fișe banana duble
- 4 fișe banana simple
- 24 borne tata plate de 0,6÷6 mm
- 12 borne tata rotunde de 1,6÷3.9 mm
- 24 borne mama plate de 0,6÷6 mm
- 12 borne mama rotunde de 1,6÷3.9 mm



430x390x100 mm

**PREVAZUT CU 2 TESTERE  
CABLAJ TIP PENSETA**

017600000 **1760PA/AC-DC**  
1.560 RON **1.040 RON**

**Clemă ampermetrică  
și multimetru digital**

**ȘPECIFICAȚII**

Tensiune DC: 0,1mV ÷ 600V  
Tensiune AC: 0,1mV ÷ 600V  
Curent AC: 0,01A ÷ 1000A  
Curent DC: 0,01A ÷ 1000A  
Rezistență: 0.1Ω ÷ 40MΩ  
Capacitate: 0,001nF ÷ 40 μF  
Frecvență: 0.001kHz ÷ 4kHz  
Temperatura: -40°C ÷ 1000 °C  
-40°F ÷ 1832°F"



500°C

017600350 **1760/IR500**  
750 RON **500 RON**

**Termometru digital cu infraroșu  
și sistem dual de țintire cu laser**

**Date tehnice:**

- Interval de temperatură: -50 ÷ 500 °C (-22 ÷ +932 °F)
- Rezoluția afișajului: 0,1 °C (0,1 °F)
- Emisie: 0,1 ÷ 1 reglabil
- Precizie: -50 °C ÷ +20 °C (+/- 3 °C); 20 ÷ 500 °C (+/- 2% sau 2 °C)
- Rezoluție optică (D: S): 12: 1
- Oprire automată: cca. 10 secunde
- Temperatura de funcționare: 0 °C ÷ 50 °C
- Temperatura de depozitare: -20 °C ÷ 60 °C
- Alimentare: 1 baterie de 9V



014980014 **1498LT/12-24**  
 7.925 RON **5.283 RON**

## POTRIVIT PENTRU VEHICULE, VEHICULE COMERCIALE SI CAMIOANE 12-24 VOLT



Robot pornire compact, 12-24 V,

Microprocesorul ofera o protectie completa impotriva:

- Inversarea polaritatii
- Scurtcircuite
- Tensiune incorecta
- Supraincercarii
- Subdescarcarii
- Supraincalzire



Lungimea  
 cablului:  
 160 cm

**UP TO 10,000A  
 IN 5 KG WEIGHT!**



**DATE TEHNICE**

- Tensiune de functionare: 12 V/24V
- Amperaj continuu: 2000/1000 A
- Amperajul maxim de pornire: 5000/2500 A
- Amperajul de varf: 10000/5000 A
- Sectiune cablu: 25mm<sup>2</sup>
- Alimentare automata: 4 Amp
- Functie de economisire a memoriei
- Dimensiuni: 350x240x140 mm
- Greutate: 5 kg



**NEW**

014980012 **1498LT/12**   
 4.000 RON **2.667 RON**

Robot de pornire compact



Tensiune de functionare	12V
Amperaj continuu	800A
Amperajul maxim de preluare	2000A
Amperajul de varf	4000A
Lungimea cablului	500 mm
Tipul bateriei	LifePo4 cu 4 celule
Functie de economisire a memoriei	DA
Dimensiuni	260x135x72 mm
Echipat cu sursa de alimentare de incarcare	12 V 1,3A



**4000A**

**NU CANTARESTE  
 MAI MULT  
 DE 2,5 KG.**

014980000 **1498MN/12**   
 1.745 RON **1.143 RON**

Starter portabil multifunctional

- Porneste masini cu motoare de pana la 2000cc
- Poate fi utilizat ca si incarcator portabil pentru telefoane, tablete si alte dispozitive electronice
- Indicator LED status baterie



240x185x60 mm



Curent porniret	600A
Tip baterie	5V 1A-2A
Voltaj pornire	12 Volt

014980490 **1498/24**  
6.700 RON **4.467 RON**



**Robot de pornire portabil pentru autoturisme și vehicule comerciale, 12-24V**

- Curent de anclansare: 4200A (12V) - 2100A (24V)
- Include cureaua de umar
- Acumulator etans cu placi de plumb si acid sulfuric, electrolit (AGM) de tip solid



017600170 **1760/RSE**  
2.185 RON **1.457 RON**



**Detector de semnal**

Permite testarea sursei de alimentare a pieselor, inclusiv electroinjectoare common rail, electroinjectoare benzina / GPL, injectoare piezoelectrice, electrovalve de reglare a debitului, electrovalve EGR și bobine

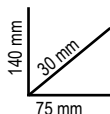

Efectuarea diagnosticului pieselor individuale ale sistemului electric necesită aducerea sondei aproape de partea testată. În sistemele cu piese electromecanice / electronice controlate de o unitate de control, acest instrument face posibilă verificarea dacă:

- Unitatea de control este alimentată cu energie și își îndeplinește funcția de control
- Cablurile care conectează unitatea de comandă la piesă sunt eficiente
- Piesa testată nu a fost deconectată
- Piesa nu a fost scurtcircuitată
- Piesa funcționează electronic

014980401 **1498TB/12-24**  
3.160 RON **2.107 RON**



**Tester digital pentru acumulatori , 12V si sistem de pornire 12-24V**

- Permite testarea de: acumulatori, alternatoare și electromotoare
- Prevazut cu software pentru imprimarea testelor de la PC
- Afișaj cu fond luminos
- Carcasa compacta, rezistenta la socuri
- Software în 10 limbi
- Include un dispozitiv de intrare pentru conexiunea la o mini-imprimanta (accesoriu optional)



**DISPLAY ILUMINAT DIN SPATE**



435x320x100 mm



Aplicații	testarea bateriilor cu 12V, testarea încărcării alternatoarelor de 12 V, testarea demoarelor
Intervalul de funcționare	100-2000 CCA
Standarde de referință	CCA, SAE, DIN, EN, IEC, JIS
Acumulatorii la care se poate utiliza	PB, WET, GEL, AGM, AGM FLAT, EFB
Voltmetru	9V-36V
Cable length	1600 mm
Limbi	Italiană, engleză, franceză, germană, spaniolă, polonă, română, olandeză, suedeză și finlandeză
Accesorii incluse	Cablu USB și software



018990010 **1899A**  
5.865 RON **3.910 RON**



### Mașină de curățare a sistemului DPF/FAP®

Detergenții speciali pot fi utilizați periodic, curăța și restaurează sistemele DPF și FAP® deteriorate de depunerile de funingine și cenușă. Rezultatele pot fi verificate prin autodiagnosticare, care permite diferențierea cantității de funingine și presi în filtrul de particule diesel înainte și după tratamentul stabilit.

**COMPATIBIL CU ORICE  
MARCA DE DETERGENT  
PENTRU ACEST TIP  
DE MAȘINA.**



**NEW**



- Livrat cu:
- 1 conductă de alimentare de 2 m lungime
  - 1 cuplare rapidă + duză de furtun pentru furtunuri de senzori diferențial
  - 1 niple M18x1,5 cu duză de furtun pentru conectare directă la sonda lambda
    - 1 furtun prelungitor
  - 1 duză de pulverizare DPF/FAP®
    - 1 suport teava magnetica
  - 1 conductă DPF/FAP® cu presetupă de reglare plus niple M14/16/18 mm pentru conectare sonde lambda
- Specificatii tehnice:
- tensiune de lucru: 12 V
  - lungimea cablului de alimentare: 3,9 m
  - capacitate rezervor: 1 l



017670100 **1767B**  
693 RON **461 RON**

**NEW**

### Kit de blocare a volanului și a pedalei de accelerație

Mecanismul de reglare a declansatorului asigură setări precise când vehiculul este accelerat



490x285x95 mm

014650010 **1465**  
5.530 RON **3.687 RON**



### Tester de eficiența a motorului

Permite testarea compresiei endotermice a motorului în doar câteva secunde, fără a necesita conectarea la motor, preluând puterea de la bateria vehiculului, printr-un software dedicat

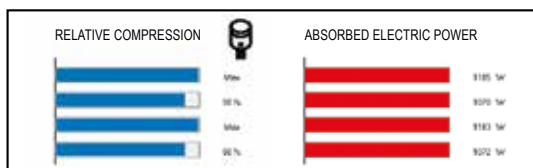
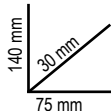

**DUREAZA DOAR  
CATEVA SECADE  
PENTRU A TESTA  
COMPRESIA**

Pasul 1	calcularea rpm a motorului
Pasul 2	testarea tendinței tensiunii bateriei în timpul fiecărei rotații
Pasul 3	afișarea puterii absorbite și a compresiei calculate prin funcționarea demarorului pentru fiecare piston
Pasul 4	testarea încărcării și eficienței bateriei



009600510 **960AD/TP2**  
~~2.455 RON~~ **1.637 RON**

**Set adaptoare pentru testerul 1464T, in cutie plastic**

- Contine:
- Injectoare false
  - Bujii incandescente false
  - Adaptoare bujii
  - Adaptoare sonda ulei
  - Cuple sistem injectie benzina
  - Set garnituri

≡ 430x310x50 mm



1464T ✓

014640377 **1464IC-RK**  
~~898 RON~~ **598 RON**

**Kit injectoare false pentru automobile, camioane si masini agricole**

Furnizat impreuna cu art. 1464IC

≡ 200x110x30mm



1464T ✓

014640300 **1464CBD**  
~~3.388 RON~~ **2.253 RON**

**Set complet de adaptoare pentru testarea compresiei la motoarele pe benzina și diesel, pentru testerul 1464T**

Face posibila conectarea la motor pentru a testa compresia benzina si motorina cu testerul 1464T

- Contine:
- 44 bujii incandescente false
  - 8 injectoare false
  - 1 kit injector fals pentru camioane, motoare vapoare și mașini agricole
  - 1 adaptor 90°, supapa de presiune si conducta de legatura
  - loc special prevăzut pentru testerul 1464T

≡ 510x410x140 mm



1464T ✓

014640470 **1464FG**  
~~1.445 RON~~ **963 RON**

**Trusa reglatoare false common rail (pentru testerele Beta 1464T-1464AP)**

Utilizat impreuna cu testerul si adaptorii potriviti face posibila indentificarea daca problema este la pompa de inalta presiune sau la regulator cand nu este presiune in circuitul common rail. Recomandat pentru reglatoarele de presiune Bosch, Delphi, Denso si Siemens.

≡ 350x250x80 mm



1464T ✓

014640050 **1464T**  
~~4.145 RON~~ **2.763 RON**

**Tester digital presiune si compresie**

SPECIFICATII

- display 5" touch screen
- baterie reincarcabila litiu-polimer
- complet cu senzor 80 bar si cablu USB



014640450 **1464AP**  
~~3.745 RON~~ **2.497 RON**

**Set pentru testarea sistemului common rail de înaltă presiune, pentru testerul 1464T**

- set furtune inalta presiune
- adaptorii
- senzor 2,000 bar



≡ 430x310x50 mm

1464T ✓

014640500 **1464APB**  
~~1.848 RON~~ **1.227 RON**

**Set adaptorii presiune motoare FSI, 200 bar, pentru testerul 1464T**

Prevazut cu un senzor 200 bar si conectori



≡ 240x210x50 mm

1464T ✓





**014640550 1464PT**  
**805 RON 537 RON**

**Set adaptori testare presiune turbo, pentru testerul 1464T**

Prevazut cu senzor si cablu conector



240x210x50 mm

**014640570 1464VD**  
**913 RON 608 RON**

**Set testare vacuum pentru 1464T**

Afiseaza valoarea presiunii de vacuum si valoarea maxima a acesteia

Livrat impreuna cu:

- senzor 800 mbar
- adaptori de 6 and 8 mm
- cablu 3-m lungime RJ45



240x210x50 mm

- Date tehnice:
- Vacuum test: 0+800 mbar
  - Diviziune: 1 mbar
  - Memorare valoare maxima

**014640600 1464TDI**  
**578 RON 384 RON**

**Set pentru testarea presiunii pompei la motoarele TDI, pentru testerul 1464T**

Prevazut cu conectori

240x210x50 mm



**014640610 1464FAP**  
**913 RON 608 RON**

**Set testare presiune filtru particule diesel (DPF) pentru 1464T**

Date tehnice:

- Test presiune: 0+500 mbar
- Diviziune: 1 mbar

240x210x50 mm



**014640620 1464ADB**  
**425 RON 283 RON**

**Set testare sistem presiune Adblue® pentru 1464T**

Livrat impreuna cu adaptori pentru utilizarea senzorului de 80bar care vine impreuna cu 1464T

240x210x50 mm



**014640650 1464PF**  
**3.295 RON 2.197 RON**

**Set pentru testarea presiunii în sistemul de frânare, pentru testerul 1464T**

Prevazut cu adaptori si conectori

400x280x60 mm



**014640700 1464PB**  
**2.555 RON 1.703 RON**

**Set 9 conectori pentru testarea presiunii combustibilului (pentru testerul 1464T)**

Permite verificarea rapida a presiunii la motoarele diesel si benzina

520x440x120 mm



049000112 **CA49-G**  
3.635 RON **2.423 RON**

Dulap multifunctional cu usa

049000102 **CX49-G**  
3.235 RON **1.900 RON**

Dulap multifunctional

## DULAP MULTIFUNCTIONAL

poate fi folosit ca post de lucru mobil cu dispozitive pentru diagnoza, laptop, testere, incarcatoare de bateri

- Structura metalica, cu un sertar pentru tastatura si doua polite fixe, ajustabile pe inaltime
  - Maner ergonomic
  - 2 roti fixe Ø 160 mm
  - 2 roti orientabile Ø 125 mm (dintre care una prevazuta cu frana)



Baza superioara pe 2 nivele

2 polite cu pozitie ajustabila si unul fix



Sertar glisant pentru mini tastatura



4 suporturi pentru agatat cabluri



**CX49-G**



2 suporti plastic pentru piese mici



1 paper holder

1089 mm  
460 mm  
435 mm

052000201 **CB52-0**  
3.065 RON **2.043 RON**

Carucior mobil cu sistem de recuperare a lichidului

Prevazut cu plan inclinat si gauri de scurgere către tancul de colectare

**CAPACITATE 7 L**

**kg 400**



870 mm  
640 mm  
1200 mm  
Ø 100 mm

**kg 60**

Echiptat cu:

- 4 roti orientabile, incluzand 2 cu frana
- sertar pentru scule
- tanc de colectare tip sertar, capacitate 7 l
- polita inferioara



## RECUPERATOR MOBIL

- indicator nivel
- palnie cu diametru marit, capacitate 12 l
- golire pneumatica prin intermediul unui furtun de 1,8m

018770008 **1877**  
3.320 RON **2.213 RON**

Recuperator mobil pentru ulei uzat cu recipient de 90l



018770080 **1877A**  
5.860 RON **3.907 RON**

Recuperator mobil pentru ulei uzat cu recipient de 90l si vas de vizitare, prin cadere si absorbtie

- vas de vizitare transparent: capacitate 9,5 l
- furtun 1,8 m

Accesorii standard:

- 1 sonda dura, Ø 5x700 mm
- 1 sonda flexibila, Ø 5x700 mm
- 1 sonda dura, Ø 6x600 mm
- 1 sonda flexibila, Ø 6x700 mm
- 1 sonda flexibila, Ø 7x700 mm
- 1 sonda flexibila, Ø 8x700 mm
- adaptoare pentru VW, BMW, CITROËN



014820110 **1482SN**  
280 RON **187 RON**

Quick coupler swivel pliers for fuel pipes, with articulated jaws

**NEW**

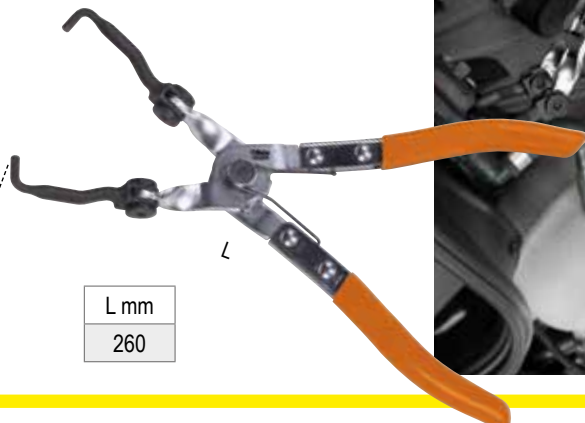

L mm  
260



017580035 **1758B-RNT**  
122 RON **81 RON**

Cupla rapida pentru reperul 1758B

Pentru motorul Renault  
1.5 dCi



017580030 **1758B**  
173 RON **114 RON**

Palnie anti-retur, cuple rapide

Special pentru masinile VAG

**ANTI-RETUR**



014940325 **1494MRC** 38"  
74 RON **49 RON**

Cheie speciala pentru busonul  
din plastic de scurgere a  
uleiului la motoarele  
Mercedes

17 mm



017580040 **1758B/K5**  
485 RON **323 RON**

Set adaptori antiretur, pentru palnia  
1758B

Kit-ul contine:

- 1 adaptor pentru motoare 1.5 dCi Renault, Dacia, Nissan
- 1 adaptor pentru motoare 1.5/1.6 dCi Renault, Dacia, Nissan
- 1 adaptor pentru motoare 3.0 BMW diesel
- 1 adaptor pentru motoare 1.5/2.0 petrol, VAG
- 1 adaptor de conectare pentru palnie, cu valva



014940330 **1494MAN** 38"  
74 RON **49 RON**

Cheie speciala pentru busonul  
din plastic de scurgere a  
uleiului la motoarele DAF  
si MAN

17 mm



014940350 **1494T/C5** 38"  
345 RON **230 RON**

Set chei speciale pentru busoanele  
din plastic de scurgere a uleiului

Setul contine:

- 1 cheie speciala pentru buson de scurgere a uleiului pentru grupul VAG
- 1 cheie speciala pentru buson de scurgere a uleiului pentru BMW
- 1 cheie speciala pentru buson de scurgere a uleiului pentru grupul PSA si Ford
- 1 cheie speciala pentru buson de scurgere a uleiului pentru Mercedes
- 1 cheie cu maner "T"

17 mm



173x125x50 mm



014870100 **1487/K2** 38"  
130 RON **87 RON**

Set 2 cuple pentru actionarea  
busoanelor de golire  
a radiatoarelor

17 mm



014930087 **1493HK**  
130 RON **87 RON**

Cheie filtru ulei in 15 laturi pentru  
motoare disele Hyundai Kia

15x



**NEW**

NEW

014930900 **1493C/ADB**  
~~79 RON~~ **52 RON**

Tubulara pentru deschiderea  
 capacului AdBlue®, pentru vehiculele  
 din grupul PSA



17 mm

014930910 **1493U/ADB**  
~~57 RON~~ **38 RON**

Tubulara pentru deschiderea busonului  
 de scurgere AdBlue®



17 mm

009600780 **960KPC**  
~~1.510 RON~~ **1.007 RON**

Pistol pneumatic impact extras bujii  
 incandescente cu accesorii



420x185x60 mm

- extractorul pneumatic este prevazut cu cuplu reglabil și tubulare lungi de impact ce permit deșurubarea bujiilor incandescente, minimizând astfel riscul de deteriorare
- tubulare de impact de 1/4", lungi, special concepute pentru bujii incandescente: 8-9-10-11-12 mm, 2 prelungitoare și 1 articulație cardanica
- comutator cu 4 pozitii pentru reglarea cuplului: 10-20-30-40 Nm
- Comutator de schimbarea sensului

017590063 **1759HD/3**  
~~2.695 RON~~ **1.797 RON**

Dispozitiv de testare a etanseitatii  
 și de umplere a circuitelor de răcire

Dau posibilitatea testarii sub presiune  
 a etanseitatii circuitelor (conduce,  
 racorduri, pompe, radiatoare)  
 și umplerii rapide a circuitelor, previne  
 formarea dopurilor de aer

600x500x140 mm



SECTIUNE 6MM

NEW

019490050 **1949R**  
~~323 RON~~ **214 RON**

Pistol de suflat pentru curatarea  
 radiatoarelor



The 5 holes that are perpendicular  
 to the handle allow dirt to be removed  
 from radiators

$\frac{\pm S}{T}$ mm	L mm
6	600

017580050 **1758ADB-D**  
~~165 RON~~ **110 RON**

Palnie cu supapa, un singur sens  
 pentru AdBlue®, cuplare liniara

I max
1

CAPACITATE  
 MAX. 1L

017580060 **1758ADB-45°**  
~~178 RON~~ **118 RON**

Palnie cu supapa pentru AdBlue®,  
 cuplare 45°

I max
1

CAPACITATE  
 MAX. 1L



NEW



014620235 **1462/KI**  
~~11.775 RON~~ **7.850 RON**

**Kit extragere injectoare diesel common rail**

Permite extragerea injectoarelor DELPHI-BOSCH-SIEMENS-DENSO

- Cu extragere mecanică sau hidraulică
- Cilindru 12t inclus
- Poate fi utilizat direct pe mașină
- Cu ajutorul adaptorilor incluși, poate fi folosit pe majoritatea motoarelor



≡ 530x470x140 mm



009600801 **960KC-M8/M9/M10**  
~~2.055 RON~~ **1.370 RON**

**Trusa extragere bujii incandescente rupte**

**PENTRU BUJII FILETATE M8-M9-M10**



≡ 380x290x50 mm

009600280 **960BC/C5** 12"   
~~715 RON~~ **477 RON**

**Set 5 tubulare extragere injectoare cu conexiuni electrice**

**22 mm**

Setul contine:

- 1 tubulara decupata, 25 mm
- 1 tubulara decupata, 27 mm
- 1 tubulara decupata, 29 mm
- 1 tubulara decupata, 30 mm
- 1 tubulara bi-hexagonala, 28 mm

≡ 280x160x55 mm



**NEW**  
 ≡ 1,9 kg

014620110 **1462/MB**  
~~1.415 RON~~ **943 RON**

**Kit extragere injectoare**

Kit-ul contine:

- 1 ciocan inertial de 4kg cu tija de 400 mm
- 1 adaptor articulata, filet exterior M10x1.5, filet interior M22x1.5 mm
- 1 adaptor, filet exterior M22x1.5, filet interior M13x1.4 mm
- 1 adaptor, filet exterior M14x1.5, filet interior M27x1 mm
- 1 adaptor, filet exterior M14x1.5, filet exterior M25x1 mm
- 1 adaptor, filet exterior M14x1.5, filet exterior M27x1 mm
- 1 adaptor, filet exterior M14x1.5, filet interior M14x1.5 mm
- 1 adaptor, filet exterior M14x1.5, filet exterior M20x1 mm
- 1 adaptor, filer exterior M14x1.5, filet exterior M17x1 mm

≡ 500x250x80 mm



≡ 7,2 kg

NEW

009600726 **960ER**  
285 RON **190 RON**

Ciocan inertial pentru saibe de injector

**BURGHIE IN TREPTE**



NEW

014720250 **1472B/RNLT**  

86 RON **57 RON**  
Tubulara dubla special conceputa pentru demontarea clemelor furtunului de aspiratie de la motoarele Renault

 **9 mm**



NEW

014540010 **1454P**  
200 RON **133 RON**

Razuiitor pentru eliminarea depunerilor si resturilor  
Recomandat in special pentru curatarea si netezirea suprafetelor plane



 mm	L mm	L1 mm
3,3	210	32

NEW

014810212 **1481T/C12**  
590 RON **393 RON**

Set cuple pentru conductele de combustibil  
3 perechi cuple rapide mama/tata pentru inchiderea liniilor de combustibil



275x220x45 mm

018840010 **1884**  
2.270 RON **1.513 RON**

Pompa de umplere cu ulei a cutiilor de viteze manuale, automate si a diferentialelor

- Dispune de 12 adaptoare pentru conexiunea directa
- Prevazut cu o supapa de retinere pentru umplerea cu ulei fara scurgeri
- Capacitate: 70 cc la o cursa a pompei
- Capacitatea rezervorului: 7,5 l
- Vascozitatea maxima permisa a uleiului: SAE 140



**12 ADAPTOARE**

FORD	AT-101
UNIVERSAL (Bmw, Honda, Nissan...)	AT-102
VW-AUDI	AT-103
VW-AUDI-PORSCHE	AT-104
VW-AUDI-MINI COOPER	AT-105
MERCEDES	AT-106
DSG	AT-107
VW-AUDI CVT	AT-108
VOLVO	AT-109
TOYOTA-LEXUS	AT-110
SKODA	AT-111
VW Passat/Tiguan <2007	AT-112

NEW

018840200 **1884N/C8**  
550 RON **367 RON**

Set 8 adaptoare pentru reperul 1884

Setul contine:

- 1 adaptor pentru Infiniti, 7 trepte, M8x1.0
- 1 adaptor pentru Honda, Hyundai, Kia 5x8x200 mm
- 1 adaptor pentru Skoda M18x1.5
- 1 adaptor pentru Mini M14x1.5
- 1 adaptor pentru Nissan M10x1.5
- 1 adaptor pentru Nissan Juke M12x1.25
- 1 adaptor pentru GM M12x1.75
- 1 adaptor pentru vehicule din grupul VAG, 7 trepte



200x145x40 mm



014380260 **1438K/DSG-2**

~~2.780 RON~~ **1.853 RON**

**NEW**

**Kit pozitionare ambreiaj DSG cu 6 si 7 trepte**

Pentru DSG cu 6 trepte si schimbare manuala, Cutii de viteze DSG cu 7 trepte (seria 1 și 2) si S-tronic.



350x370x117 mm

10 kg

014910001 **1491**

38" 12"

~~228 RON~~ **151 RON**

**Cheie de filtru cu banda reglabila**



Ø min: 65 mm  
Ø Max: 110 mm

014380270 **1438K/PWR**

~~1.900 RON~~ **1.267 RON**

**Kit pozitionare ambreiaj cu dubla transmisie Powershift**



440x400x85 mm

10 kg

014380305 **1438DCT/S**

~~1.445 RON~~ **963 RON**

**Kit pozitionare ambreiaj uscat Ford**

Pentru pozitionarea ambreiajului dupa efectuarea unor lucrari precum efectuarea schimbului de ulei



440x400x85 mm

8 kg



014710101 **1471M/C22**  
1.445 RON **802 RON**

**Dispozitiv pneumatic pentru împingerea înapoi și rotirea pistoanelor discurilor de frână dreapta și stânga, cu accesorii, în cutie din plastic**

- Împingere automată
- Un nou sortiment complet cu toate adaptoarele noi
- Forța de împingere: 150 kg
- Presiunea de lucru 5+8 bari



350x310x85 mm

014660100 **1466/C5**  
608 RON **404 RON**

**Set 5 chei pentru aerisit conducte de frână**

kitul conține:

- 5 chei de dimensiunile 7-8-9-10-11 mm
- 1 furtun scurgere cu valvă

260x170x50 mm

**LICHIDUL SE SCURGE PRIN FURTUN**



014670080 **1467T/C6**  
1.285 RON **857 RON**

**Kit adaptori pentru busonul vasului de lichid de frână, pentru reperele 1467LF și 1467LF/2**

Setul conține:

- 1 buson pentru vehiculele Toyota
- 1 buson pentru vehiculele Ford, Hyundai, Mazda, Mitsubishi, Nissan, Subaru
- 1 buson pentru vehiculele Honda
- 1 buson pentru vehiculele Mazda și Suzuki
- 1 buson pentru vehiculele Nissan
- 1 adaptor pentru curgerea lichidului de frână pentru vehiculele europene

350x240x85 mm



**NEW**

014710400 **1471T/C5**  
1.198 RON **798 RON**

**Set 5 chei desfacere suruburi etrieri de camioane**

poate fi utilizat cu chei dinamometrice pentru strângere la cuplu

- chei Torx femele E18, E20, E24
- chei inelare M24, M26



275x220x60 mm

**NEW**

019490018 **1949GPA**  
505 RON **337 RON**

**Pistol de umflat**

- corp acoperit cu cauciuc rezistent la șocuri
- pârghie de acționare metalică
- presiunea de lucru: 0,5 ÷ 12 bar, 7 ÷ 174 psi
- funcție de eliberare a presiunii
- funcție de măsurare a presiunii
- lungimea țevii: 58 cm
- Rotirea furtunului la 360°
- admisie aer 1/4"



**NEW**

019490021 **1949DGT/2**  
608 RON **404 RON**

**Pistol de umflat digital**

- corp acoperit cu cauciuc rezistent la șocuri
- pârghie de acționare metalică
- presiunea de lucru: 0,5 ÷ 12 bar, 7 ÷ 174 psi
- 4 unități de măsură, bar / psi / kpa / kgf
- ecran LCD cu iluminare
- diviziune: 0,05 bari
- auto-oprire după 1,5 minute
- lungimea furtunului: 58 cm
- Rotirea furtunului la 360°
- sursa de alimentare: 2 baterii AAA
- admisie aer 1/4"





**NEW**

009720010 **972/C10**  
1.375 RON **917 RON**

**Kit extragere prezoane deteriorate**

For use on anti-theft and conventional nuts



290x250x60 mm



009720004 **972/C4BMW**  
1.090 RON **727 RON**

**Kit extragere piulite anti-furt pentru BMW si Mini**



516x145x66 mm

009830010 **983PM**  
358 RON **238 RON**

**Perie abraziva pentru curatarea butucilor**

12" 14"



Ø1 mm	Ø2 mm
90	150

009700011 **970IVECO**  
300 RON **200 RON**

**Tubulara piulita butuc Iveco Daily hub nuts**

Pentru versiuni incepand cu anul 2014

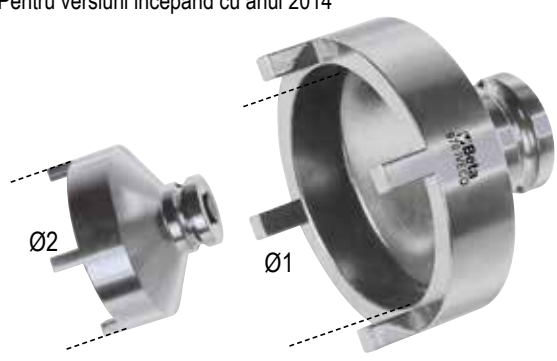

Ø1 mm	Ø2 mm
61,5	74,8

015310107 **1531/C7**  
~~3.490 RON~~ **2.327 RON**

Kit extragere butuci, rulmenti si sigurante



- dimensiuni incluse:
- 1 cleste Ø 40÷45 mm
  - 1 cleste Ø 45÷51 mm
  - 1 cleste Ø 50÷55 mm
  - 1 cleste Ø 55÷61 mm

390x315x96 mm

015630010 **1563/C4**   
~~228 RON~~ **151 RON**

Set 4 tubulare pentru inlocuirea pivotilor

**22/24 mm**



Utilizabil cu scule pneumatice

- Setul contine:
- 1 tubulara M12x1.25 mm
  - 1 tubulara M12x1.5 mm
  - 1 tubulara M14x1.5 mm
  - 1 tubulara M16x1.5 mm

015680001 **1568**  
~~1.125 RON~~ **750 RON**

Dispozitiv pneumatica pentru montat burdufuri de planetara din silicon

- 8 brațe de întindere
- Întindere maximă a brațului: 145 mm

L mm	L1 mm
420	195

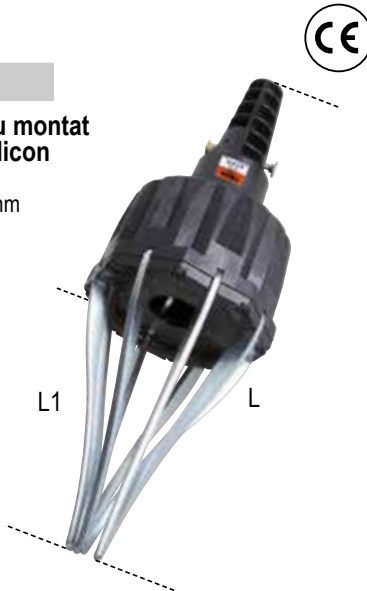

009890015 **989B**  
~~295 RON~~ **197 RON**

Clește plumbi

- Utilizari:
- indepartare plumbi adezivi
  - indepartare plumbi de pe jante de table
  - ciocan de batut plumbii cu invelis de protectie PE-HD
  - falci pentru extragere plumbi de pe jante tabla



015670001 **1567**  
~~1.575 RON~~ **1.050 RON**

Parghie pentru demontare bascula si amortizor

Poate fi utilizata de o singura persoana

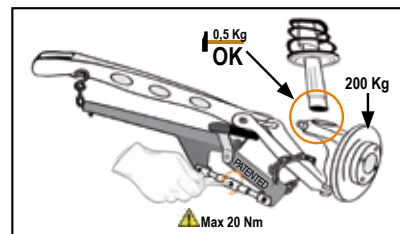
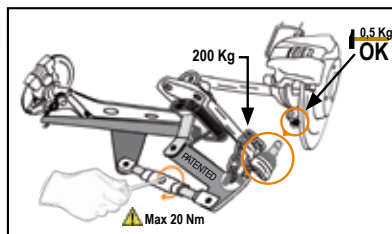



015510020 **1551/C20** 12"   
~~740 RON~~ **493 RON**

**Kit pentru demontarea flanselor de amortizor**

Kitul contine:

- 7 tubulare hexagonale, dimensiuni: 16 - 17 - 18 - 19 - 21 - 22 - 24
- 1 prelungitor, lungime: 120 mm
- 3 biti interiori cu fante, dimensiuni: 8x5 - 8x6 - 11x8
- 1 bit hexagonal interior, dimensiune: 10 mm
- 1 bit XZ<sup>(R)</sup> exterior, dimensiune: M10
- 1 bit Torx<sup>(R)</sup> exterior, dimensiune: T50
- 4 biti hexagonali exteriori, dimensiuni: 5-6 - 7 - 8
- Extensie suport 1 bit, lungime: 95 mm
- Extensie suport 1 bit, lungime: 190 mm



≡ 320x245x71 mm

015520020 **1552/C9**  
~~585 RON~~ **390 RON**

**Kit demontare amortizor de pe fuzeta**

Lucrul cu cap retractor unic sau dublu face posibilă lucrul la articulatii duble, de ex. din grupul VAG



≡ 195x140x40 mm



○ mm  
13

**TRACTIUNE MAXIMA: 2 TONE (10 BARE)**



1670 mm  
610 mm  
825 mm



015500010 **1550U**  
~~14.100 RON~~ **9.400 RON**

**Dispozitiv pneumatic pentru inlocuire amortizoare auto, destinat autoturismelor, SUV-urilor și vehiculelor comerciale**

Caracteristici

- Tractie maxima: 2 tone (10 bare) - 1,6 tone (8 bare) - 1,2 tone (6 bare)
- Cursa de compresie a arcului: 335 mm

Livrat cu 2 furci inferioare pentru diametre 78-205 mm

TECHNICAL DATA

Maximum thrust:

2 tons (10 bars) - 1.6 tons (8 bars) - 1.2 tons (6 bars)

Spring compression stroke: 335 mm



015500018 **1550U/SS187**  
~~1.765 RON~~ **1.177 RON**

**Furca pentru dispozitivul 1550U**

Potrivit in special pentru arcurile masinilor Nissan Qashqai și Renault Koleos



015500021 **1550U/M**  
~~1.675 RON~~ **1.117 RON**

**Menghina pentru dispozitivul 1550U**

Permite blocarea tije amortizorului



014790150 **1479LB/C5**  
508 RON **338 RON**

Kit 5 dispozitive de indepartare a stifturilor metalice



215x165x50 mm

013650013 **1365/K13**  
3.210 RON **2.140 RON**

Kit impins caroserii, 10 t, in cutie mobila de plastic



900x420x180 mm

Conținutul trusei:

- pompa de presiune hidraulica și piston 10tf
- pană hidraulica 0,5tf
- 3 prelungitoare
- 8 terminali diversi, pentru fixare pe caroserie

014790604 **1479L/K4**  
163 RON **108 RON**

Set 4 leviere pentru demontarea componentelor din bord si habitacul



017660510 **1766ER/VW**  
74 RON **49 RON**

Levier ingust pentru demontarea ancadramentelor cu spatiu mic de prindere

Potrivit pentru demontarea ancadramentelor cu spatii mici de prindere, din grupul VAG



L mm	H mm
215	4

013660250 **1366B**  
233 RON **154 RON**

Ciocan inertial pentru tragere pastile de plastic  
Greutate ciocan inertial: 500 g

L mm
440



013660205 **1366KF**



013440100 **1344A/VW**  
79 RON **52 RON**

Dispozitiv extragere maner usa VW



L mm
260



**NEW**



017680010 **1768**

~~893 RON~~ **594 RON**

Platforma cu trepte din aluminiu

• capacitate maxima de sustinere: 200 kg

kg 200

**SUPRAFATA  
ACOPERITA  
CU MATERIAL  
ANTIDERAPANT**



L mm	L1 mm	H mm
960	300	475



**NEW**

030090001 **3009**

~~2.015 RON~~ **1.343 RON**

Dispozitiv ridicare roti

Dispozitiv ridicare roti

- Capacitatea maxima de ridicare: 550 kg
- 4 roti pivotante
- Latimea rotilor: 200 mm
- Pentru roti cu latimea de pana la 240 mm



IDEAL PENTRU:

- INCARCAREA AUTOVEHICULELOR AVARIATE PE REMORCI
- SERVICE-URI AUTO
- MUTAREA MASINILOR IN SHOWROOM-URI

022540101 **2254K**

~~138 RON~~ **91 RON**

Husa protectie reutilizabila scaun, volan si maneta schimbator viteze

Se potriveste pentru majoritatea scaunelor, volanelor si manetelor schimbatorului de viteze



**2254A**

Huse auto, pentru uz exterior, impermeabile si rezistente la UV

Specificatii tehnice:

- finisaj exterior cu tratament protectie UV
- finisaj interior moale, anti-zgarieturi
- 6 snururi pentru do mai buna potrivire
- 2 deschizaturi cu fermoare pentru acces in interiorul masinii
- locasuri pentru oglinzi
- reflectorizanta

ACESTE HUSE SUNT IDEALE PENTRU PROTEJAREA VEHICULELOR AVARIATE IN TIMP CE ASTEAPTA SA FIE REPARATE



022540002 **M**  
~~718 RON~~ **478 RON**

recomandata pentru masinile berline

4000X1450X1300 mm

022540000 **L**  
~~803 RON~~ **534 RON**

recomandata pentru monovolum si break

5300X1450X1150mm

022540001 **XL**  
~~735 RON~~ **490 RON**

recomandata pentru SUV-uri

4700X1450X1580mm

**NEW**

# //3099E

Husa moto pentru exterior, rezistenta la apa si la praf protejeaza vopseaua de zgarieturi, praf si lumina soarelului

- Marimea „M” recomandata pentru motocicletele sportive si scutere de dimensiuni medii
- Marimea " L " recomandata pentru motocicletele maxi enduro si crossover

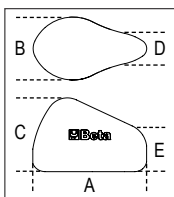

**NEW**

	Tg	A mm	B mm	C mm	D mm	E mm		RON
<b>3099E/M</b>	M	2290	990	1250	350	900	030990102	<del>385 RON</del> <b>257 RON</b>
<b>3099E/L</b>	L	2500	1110	1650	1100	1500	030990103	<del>475 RON</del> <b>317 RON</b>

# //3099T

Husa moto pentru interior, din tesatura elastica protejeaza vopseaua de zgarieturi, praf si lumina soarelului

- Marimea „M” ,recomandata pentru motocicletele sportive si scutere de dimensiuni medii
- Marimea " L " recomandata pentru motocicletele maxi enduro si crossover
- Marimea " XL " recomandata pentru motocicletele super tur

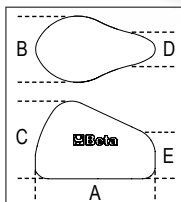

	Tg	A mm	B mm	C mm	D mm	E mm		RON
<b>3099T/M</b>	M	2050	900	1000	350	800	030990202	<del>335 RON</del> <b>223 RON</b>
<b>3099T/L</b>	L	2700	1100	1300	550	1100	030990203	<del>410 RON</del> <b>273 RON</b>
<b>3099T/XL</b>	XL	3100	1300	1400	700	1200	030990204	<del>498 RON</del> <b>331 RON</b>

## TESATURA ELASTICA



# // 030020001 3002

538 RON **358 RON**

Pat si scaun de lucru

- Cadru robust din otel
- Căptuseala din PVC cu tapiterie
- Permite transformarea patului de lucru in scaun de lucru



100 mm



030030150 **3003PRO**  
1.590 RON **1.060 RON**

## Pat de lucru fabricat din plastic rezistent la socuri

Livrat împreună cu:

- perna ergonomică pentru cap
- zona lombară protectoare
- 2 roți duble de 178 mm pentru utilizarea cu ușurință pe suprafețe neuniforme și tevi / cabluri
- 1 rotor
- reglare dubla a înălțimii de la sol: 38 sau 76 mm
- 2 lămpi LED portabile (250 lumini) cu magneti de fixare
- capacitate de încărcare: 200 kg
- greutate: 7,7 kg



**LAMPĂ LED DUBLĂ CU MAGNET**

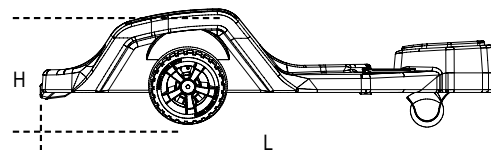
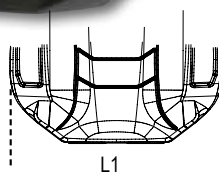

H min mm	H Max mm	L mm	L1 mm
170	230	1040	570

030030151 **3003PRO/SP**  
425 RON **283 RON**

## Suport de perete pentru patul de lucru 3003PRO

Poate fi montat pe pereți, cricuri sau alte echipamente, permitând astfel fixarea patului de lucru printr-un sistem rapid cu închidere de siguranță.



030290120 **3029L/2T**  
2.270 RON **1.513 RON**

## Cric hidraulică cu platforma joasă, lungă, 2 t, 4 roți

Permite lucrul la vehicule cu înălțime redusă și fără puncte de ridicare

- Control al vitezei de coborâre
- Pedala apropiere rapidă
- Cadru din oțel și roți din nailon

**ÎNĂLȚIME MIN./MAX. 75/530 MM**

**CAPACITATE: 2 TONS**



030290020 **3029/2T**  
1.960 RON **1.307 RON**

## Cric hidraulică cu platforma joasă, 2 t, 4 roți

- Pedala apropiere rapidă
- Cadru din oțel și roți din nailon
- Înălțimea minimă: 75 mm

**ÎNĂLȚIMEA MINIMA: 75/500 MM**

**CAPACITATE: 2 TONS**



030030152 **3003PRO/PM**  
46 RON **30 RON**

## Suport magnetic de scule, rotund, pentru reperul 3003PRO

Poate fi atașat de patul de lucru 3003PRO ca suport pentru piese mici



**NEW**

030330130 **3033E/3T**  
1.865 RON **1.243 RON**



**Cric hidraulic, 3 t**

- viteza coborare controlata
- roti din nailon



H min-Max mm	L mm	L1 mm
95÷515	700	370

**CAPACITATE:  
3 TONS**



030300220 **3030H/2T**  
3.185 RON **2.123 RON**



**Cric hidraulic tip crocodil 2 t, cu inaltime mare de ridicare, 6 roti**

- Face posibil lucrul la vehiculele cu garda inalta la sol
- viteza coborare controlata
  - pedala de apropiere rapida
  - roti din nailon



H min-Max mm	L mm	L1 mm
85÷780	1010	300

**CAPACITATE:  
2 TONS**



030300020 **3030/2T**  
3.895 RON **2.537 RON**



**Cric hidraulic tip crocodil, 2t, prevazut cu 6 roti**

- Roti basculante duble din material plastic (PTFE)
- Cricul poate fi manevrat cu usurinta pe pardoseli neorizontale, neregulate
- Capacitate maxima: 2 tone



**CAPACITATE:  
2 TONS**

H min-Max mm	L mm	L1 mm
85÷520	860	400



030330030 **3033/3T**  
4.935 RON **3.290 RON**



**Cric hidraulic, 3t, varianta lunga**

- Caracteristici:
- Utilizare recomandata pentru vehiculele comerciale
  - Capacitate maxima: 3 t
  - Roti din poliamida
  - Lungime: 1180 mm
  - Inaltimea minima a platformei: 140 mm
  - Inaltimea maxima a platformei: 520 mm

H min-Max mm	L mm	L1 mm
140÷520	1180	370

**CAPACITATE:  
3 TONS**





**NEW**

030230050 **3023**

1.008 RON **671 RON**

Cric pentru canal cu reglare prin insurubare

**SARCINA MAXIMA:  
400 KG**



H min-Max mm	Ø mm
1350÷2030	300



**//3010T**

Set capre susținere



	L mm	A max	g		RON
<b>3010/T2</b>	100	15 mm	60	030100002	<del>475</del> RON <b>317 RON</b>
<b>3010/T3</b>	150	24 mm	165	030100003	<del>563</del> RON <b>374 RON</b>
<b>3010/T6</b>	200	28 mm	325	030100006	<del>818</del> RON <b>544 RON</b>
<b>3010/T10</b>	250	34 mm	505	030100010	<del>1.410</del> RON <b>940 RON</b>

**//3011T**

Cric hidraulic tip butelie



	Max kg	H min mm	H Max mm		RON
<b>3011/T3,5</b>	2000	280	60	030110035	<del>475</del> RON <b>317 RON</b>
<b>3011/T5</b>	3000	285	165	030110050	<del>533</del> RON <b>354 RON</b>
<b>3011/T10</b>	6000	400	325	030110100	<del>795</del> RON <b>530 RON</b>
<b>3011/T15</b>	10000	471	245	030110150	<del>978</del> RON <b>651 RON</b>
<b>3011/T20</b>	20000	34 mm	505	030110200	<del>1.400</del> RON <b>933 RON</b>

030250001 **3025**  
9.075 RON **6.050 RON**

Macara tip girafa

- Cadru rabatabil
- Supapă de limitare a sarcinii și stand din oțel cromat
- Viteză de coborâre controlabilă
- Roți din teflon
- Înălțimea maximă: 2400 mm
- Dimensiuni: 1560 x 1000 mm



**//3050/600**

Cric electro-hidraulic pentru motociclete, 600 kg

Specificatii tehnice:

- Sigurante electrice, mecanice si hidraulice
- Capacitate: 600 kg
- Unitate electrohidraulica integrata: 230V - 50 Hz
- Pompa hidraulica
- Viteza de coborare controlata
- Siguranta de protectie pentru soc electric
- Panou de actionare cu buton
- Certificat CE, aprobat TÜV



24.950 RON **16.633 RON**

**198 kg**

Ral 2011	Ral 7016	Ral 3000
030500201	030500202	030500203

L mm	H Min mm	H Max mm
2100	185	1110

# // 8097

Lant dublu de ridicare cu carlige, clasa 8

DATE TEHNICE:  
 • factor securitate: 4  
 • tabla de identificare  
 CERTIFICARE ATASATE  
 • Specificatii tehnice ale produsului

# // 8097SL

Lanturi de ridicare, 2 picioare, cu autoblocare și carlige de prindere, clasa 8

**080970022 8097 D7-2**  
**1.120 RON 747 RON**  

WLL t	Ø	L m
2,12	7	2

**7,1 kg**

**080970222 8097SL D7-2**  
**1.355 RON 903 RON**  

WLL t	Ø	L m
2,12	7	2

**7,2 kg**

**080970042 8097 D8-2**  
**1.255 RON 837 RON**  

WLL t	Ø	L m
2,8	8	2

**9,1 kg**

**080970242 8097SL D8-2**  
**1.480 RON 987 RON**  

WLL t	Ø	L m
2,8	8	2

**9,1 kg**

**080970052 8097 D10-2**  
**1.915 RON 1.277 RON**  

WLL t	Ø	L m
4,25	10	2

**14,7 kg**

**080970252 8097SL D10-2**  
**2.245 RON 1.497 RON**  

WLL t	Ø	L m
4,25	10	2

**15 kg**

EN818-4

EN818-4

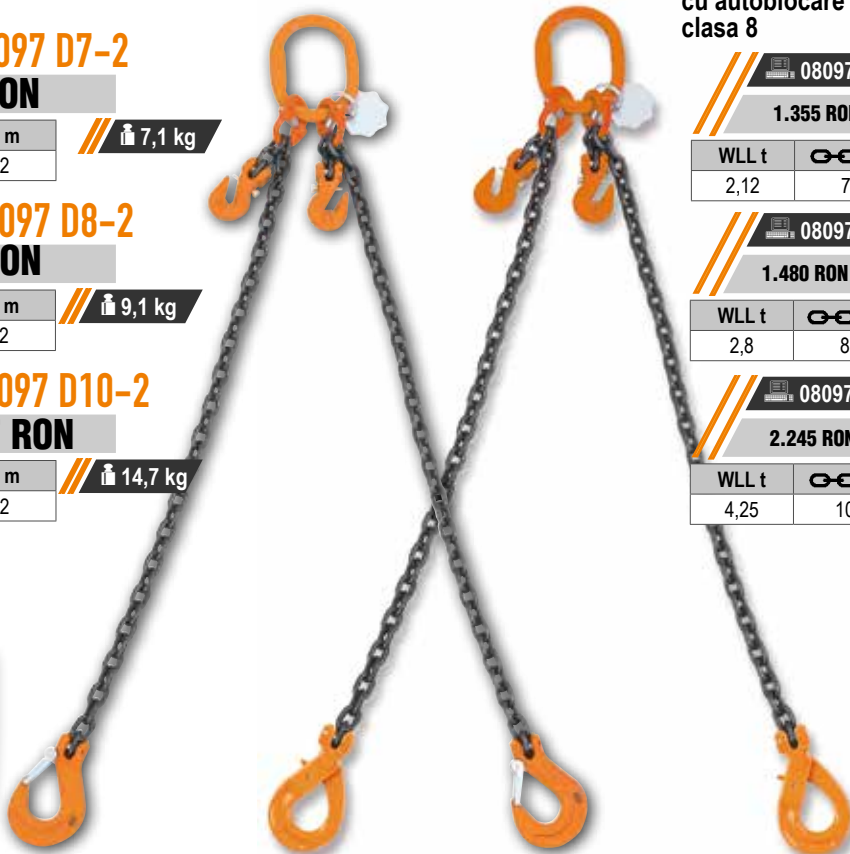

# // 8143

Palan manual

- Model profesional, respectă standardul EN13157, realizat din materiale de prima clasa
- Proiectat pentru ridicarea rapidă și sigura a incarcaturilor grele
- Poate fi conectat la un punct fix sau dispozitive mobile

**081430005 8143 0,5T**  
**993 RON 661 RON**  

WLL t	L m
0,5	3

**9,2 kg**

**081430010 8143 1T**  
**1.173 RON 781 RON**  

WLL t	L m
1	3

**11,7 kg**

**081430020 8143 2T**  
**1.700 RON 1.133 RON**  

WLL t	L m
2	3

**19,5 kg**

EN13157



# // 8146 EN13157

Palan cu parghie

- Model profesional, respectă standardul EN13157, usor de instalat și de utilizat.
- Proiectat pentru a ridica, trage și securiza sarcinile grele rapid și sigur.
- Poate fi conectat la un punct fix sau dispozitive mobile pentru operațiuni de ridicare.

**081460002 8146C 0,25**  
**1.115 RON 743 RON**  

WLL t	L m
0,25	1,5

**2,5 kg**

**081460008 8146 0,75 T**  
**1.298 RON 804 RON**  

WLL t	L m
0,75	1,5

**6,7 kg**

**081460015 8146 1,5 T**  
**1.725 RON 1.150 RON**  

WLL t	L m
1,50	1,5

**11,2 kg**

USER-FRIENDLY, SAFE





# // 8135

## Clema din otel cu autoagatare, pentru placi, articulata

- Model profesional, conform EN13155, realizat din materiale de inalta calitate
- Potrivit pentru ridicarea plăcilor de otel, rotirea cu 180° și transportul plăcilor in pozitie verticală
- Pentru plăci cu duritate de pana la 30HRC (300HB)
- Blocare de siguranta cu came pentru o inserare mai usoara a tablelor de otel și o prindere sigură
- Plăcuța de identificare cu numărul de serie și numărul lotului
- Factor de siguranță: 3: 1
- WLL minim este de 10% din WLL maxim

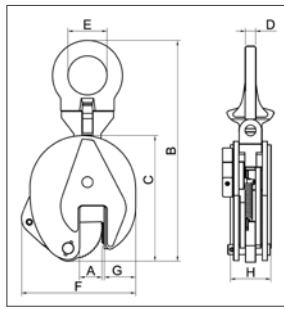

### DATE TEHNICE

- Factor de siguranță: 3
  - Plăcuța de identificare a numărului de serie
- CERTIFICATE DISPONIBILE**
- Certificatul producătorului
  - Declarația de conformitate CE
  - Raport de testare UNI EN10204 tip 2.2
  - Specificații tehnice ale produsului



	max WLL t	A mm	kg		RON	
<b>8135 0,75 T</b>	0,75	0-15	2	081350005	<del>615 RON</del>	<b>410 RON</b>
<b>8135 1,0 T</b>	1,0	0-20	5	081350010	<del>830 RON</del>	<b>553 RON</b>
<b>8135 2,0 T</b>	2,0	0-25	8	081350020	<del>1.233 RON</del>	<b>821 RON</b>
<b>8135 3,0 T</b>	3,0	0-30	15	081350032	<del>2.090 RON</del>	<b>1.393 RON</b>
<b>8135 5,0 T</b>	5,0	0-50	23	081350050	<del>2.945 RON</del>	<b>1.963 RON</b>

max WLL (t)	Dimensiuni mm							
	B	C	D	E	F	G	H	
0,75	205	125	10	27	105	35	40	
1,0	290	170	12	48	145	45	56	
2,0	375	205	17	67	175	56	56	
3,0	425	237	20	75	215	60	78	
5,0	480	262	20	80	232	65	90	

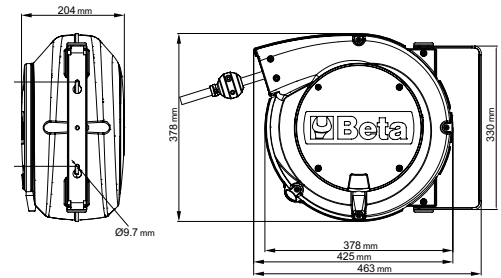
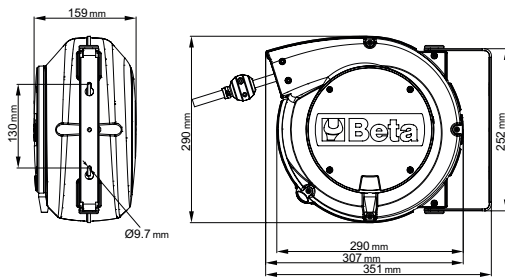

## // 019000080 **1900S 8X10** ~~805 RON~~ **537 RON**

## // 019000115 **1900M 10X15** ~~1.128 RON~~ **751 RON**

carcasa fabricata din plastic rezistent la socuri, pentru aer comprimat sau apa

- cadru din polipropilena
- dispozitiv pentru fixarea automata a furtunului la lungimea necesars
- mecanismul de retragere poate fi dezactivat pentru a mentine furtunul tras
- intervalul de temperatura de funcționare a apei: -5 ° C / +50 ° C
- livrat cu un suport pivotant de 180° si un suport suplimentar de conectare rapidă



### 1900S 8X10 1900M 10X15

	GAS	1/4"	3/8"
Admisie de aer			
Lungime furtun	m	10	15
Presiunea de lucru	bar	15	15
Ø Furtun	mm	8x12	10x14
Material furtun		poliuretan	poliuretan

**NEW**

019270030 **1927XM** **12"**  
1.355 RON **890 RON**

**Pistol pneumatic de impact, compact**

- Incredibil de compact și de puternic
- Pârghie schimbare sens de acționare
- Trei poziții de reglare a puterii de acționare
- Evacuare aer prin maner
- Carlig echilibrare poziție

Turatie libera	rpm	10.000
Sistem acționare		Single hammer
Cuplu maxim	Nm	770
Domeniu utilizare	Cl 8.8	M22●34 mm
Domeniu utilizare	Cl 12.9	M18●27 mm
Admisie de aer	GAS	1/4"
Presiunea de lucru	bar	6,2
Dimensiunea interioara a furtunului (Ø)	mm	10
Consumul mediu de aer	l/min	122

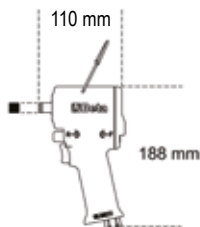

**1,3 kg**

019270129 **1927XM/K5**  
1.660 RON **950 RON**

**Set pistol pneumatic si 5 tubulare de impact, in cutie de plastic**

○ 720 17-19-21-22-24 mm

307x206x86 mm



**2,8 kg**

019270008 **1927P** **12"**  
2.030 RON **1.090 RON**

**Pistol pneumatic de impact, din material compozit**

- Mecanism de acționare "double hammer"
- Carcasa din material compozit
- Schimbator de sens
- Trei trepte de strangere
- Evacuare aer prin maner
- Maner cu protectie vibratie

Turatie libera	rpm	7.500
Sistem acționare		Double hammer
Cuplu maxim	Nm	1750
Domeniu utilizare	Cl 8.8	M24●36 mm
Domeniu utilizare	Cl 12.9	M20●30 mm
Admisie de aer	GAS	1/4"
Presiunea de lucru	bar	6,2
Dimensiunea interioara a furtunului (Ø)	mm	10
Consumul mediu de aer	l/min	290

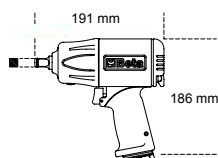

**2 kg**



019270118 **1927P/K3** **12"**  
2.360 RON **1.311 RON**

**Pistol pneumatic de impact, din material compozit, si set 3 tubulare de impact, in cutie plastic**



○ 720LC 17-19-21 mm

350x305x86 mm



**4 kg**

019270007 **1927CD** **12"**  
1.845 RON **990 RON**

**Pistol pneumatic de impact**

- Mecanism de acționare "double hammer"
- Ușor și echilibrat pentru mai mare ușurință la utilizare
- Pârghie schimbare sens de acționare
- Trei poziții de reglare a puterii de acționare
- Evacuare aer prin mâner
- Maner cu protectie vibratie
- Silentios

Turatie libera	rpm	7.000
Sistem acționare		Double hammer
Cuplu maxim	Nm	1020
Domeniu utilizare	Cl 8.8	M22●34 mm
Domeniu utilizare	Cl 12.9	M18●27 mm
Admisie de aer	GAS	1/4"
Presiunea de lucru	bar	6,2
Dimensiunea interioara a furtunului (Ø)	mm	10
Consumul mediu de aer	l/min	130

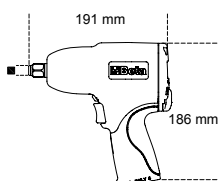

**2,3 kg**

019270107 **1927CD/K3** **12"**  
2.070 RON **1.150 RON**

**Set pistol pneumatic de impact si 3 tubulare de impact**

○ 720LC 17-19-21 mm

350x305x86 mm



**4 kg**





019270022 **1927B**  
890 RON **593 RON**

1 1/2"

### Pistol pneumatic de impact

- Dispozitiv de impuls „Pin Clutch”
- Maner cauciuc
- Maneta reversibila
- Trei pozitii de reglare a puterii de actionare
- Evacuare aer prin maner

Turatie libera	rpm	7.000
Sistem actionare		Pin Clutch
Cuplu maxim	Nm	705
Domeniu utilizare	Cl 8.8	M22 ● 34 mm
Domeniu utilizare	Cl 12.9	M18 ● 27 mm
Admisie de aer	GAS	1/4"
Presiunea de lucru	bar	6,2
Dimensiunea interioara a furtunului (Ø)	mm	10
Consumul mediu de aer	l/min	133



019270122 **1927B/K5**  
1.183 RON **788 RON**

NEW

### Pistol pneumatic de impact, fabricat din aluminiu, in cutie, si 5 tubulare de impact

1 1/2"



007200525 **720ME/C8**  
715 RON **477 RON**

1 1/2" ○

### Set 8 imbusuri hexagonale tubulare de impact, in cutie metalica

○ 5-6-8-10-12-14-17-19 mm



007200653 **720LC/C3**  
188 RON **126 RON**

1 1/2" ○

### Set 3 tubulare de impact cu protectie

○ 17 - 19 - 21 mm



007200904 **720/C24**  
1.960 RON **1.307 RON**

1 1/2" ○

### Set 24 tubulare de impact, actionare 1/2", in cutie metalica



Cantitate/Descriere	Beta N.
15 10-12-13-14-15-16-17-18 19-21-22-24-27-30-32 mm	720
6 13-17-19-21-22-24 mm	720L
3 17-19-21 mm	720LC

019280022 **1928DA**  
3.890 RON **2.593 RON**

3/4"

### Pistol pneumatic de impact

- Dispozitiv de actionare „Double hammer”
- Rezistent și compact; cuplu mare
- Maner auxiliar
- Pârghie schimbare sens de acționare
- Trei pozitii de reglare a puterii de actionare
- Evacuare superioara
- Maner ergonomic antiderapant

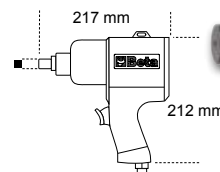

Turatie libera	rpm	5.000
Sistem actionare		Double hammer
Cuplu maxim	Nm	1.695
Domeniu utilizare	Cl 8.8	M30 ● 46 mm
Domeniu utilizare	Cl 12.9	M27 ● 41 mm
Admisie de aer	GAS	3/8"
Presiunea de lucru	bar	6,2
Dimensiunea interioara a furtunului (Ø)	mm	10
Consumul mediu de aer	l/min	210





3/4"

**SUPER COMPACT  
SI PUTERNIC**

**1.600 Nm!**

019280030 **1928XM**  
2.690 RON **1.793 RON**

**Pistol pneumatic de impact compact**

- Dispozitiv de acționare „Double hammer”
- Puternit si compact
- Parghie schimbare sens de acționare
- Trei poziții de reglare a puterii de acționare
- Evacuare aer prin maner

2,9 kg

Turatie libera	rpm	4.800
Sistem acționare		Double hammer
Cuplu maxim	Nm	1600
Domeniu utilizare	Cl 8.8	M27●41 mm
Domeniu utilizare	Cl 12.9	M24●36 mm
Admisie de aer	GAS	3/8"
Presiunea de lucru	bar	6,2
Dimensiunea interioara a furtunului (Ø)	mm	10
Consumul mediu de aer	l/min	175

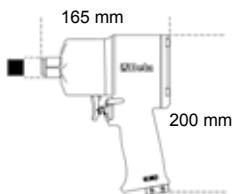

019280007 **1928CD**  
4.430 RON **2.461 RON**

3/4"

**Pistol pneumatic de impact, material compozit**

- Dispozitiv de acționare „Double hammer”
- Raport foarte bun greutate/putere
- Parghie schimbare sens de acționare
- Trei poziții de reglare a puterii de acționare
- Evacuare aer prin mâner
- Atenuator de zgomot

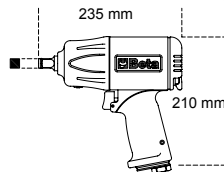

Turatie libera	rpm	4.500
Sistem acționare		Double hammer
Cuplu maxim	Nm	1.800
Domeniu utilizare	Cl 8.8	M27●41 mm
Domeniu utilizare	Cl 12.9	M24●36 mm
Admisie de aer	GAS	3/8"
Presiunea de lucru	bar	6,2
Dimensiunea interioara a furtunului (Ø)	mm	10
Consumul mediu de aer	l/min	215

3,5 kg

019300032 **1930PA**  
5.820 RON **3.880 RON**

1"

**Pistol pneumatic de impact**

- Dispozitiv de acționare „Double hammer”
- Maner auxiliar
- Parghie schimbare sens de acționare
- Trei poziții de reglare a puterii de acționare
- Evacuare superioara

Turatie libera	rpm	3.500
Sistem acționare		Double hammer
Cuplu maxim	Nm	2445
Domeniu utilizare	Cl 8.8	M36●55mm
Domeniu utilizare	Cl 12.9	M30●46mm
Admisie de aer	GAS	1/2"
Presiunea de lucru	bar	6,2
Dimensiunea interioara a furtunului (Ø)	mm	13
Consumul mediu de aer	l/min	350

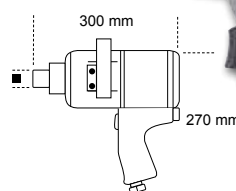

9,6 kg

019300030 **1930LH**  
6.000 RON **3.800 RON**

1"

**Pistol pneumatic de impact**

- Dispozitiv de acționare "Double hammer"
- lungime ax acționare 210 mm (8.3")
- maner pozitionat la 70 grade pentru a reduce presiunea de pe incheietura utilizatorului
- maner auxiliar
- parghie schimbare sens de acționare
- trei poziții de reglare a puterii de acționare
- evacuare superioara
- raport excelent greutate/putere

**GREUTATE  
REDUSA/RAPORT PUTERE  
FOARTE BUN**

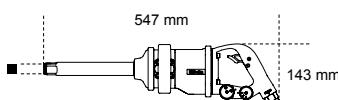

Turatie libera	rpm	6.000
Sistem acționare		Double hammer
Cuplu maxim	Nm	2.441
Domeniu utilizare	Cl 8.8	M36 ● 55 mm
Domeniu utilizare	Cl 12.9	M30 ● 46 mm
Admisie de aer	GAS	1/2"
Presiunea de lucru	bar	6,2
Dimensiunea interioara a furtunului (Ø)	mm	13
Consumul mediu de aer	l/min	280

7,1 kg



## CLICHET PNEUMATIC CU IMPACT

- Sistem impact "Double rocking dog"
- Usor de utilizat: mecanismul de impact previne rotirea la capatul strangerii si scurteaza durata de utilizare
- Compact si puternic: cuplu maxim de strangere este semnificativ mai mare decat cel obtinut la sistemele fara impact
- Maner ergonomic din cauciuc

Turatie libera	rpm	700
Cuplu maxim	Nm	68
Domeniu utilizare	Cl 8.8	M10●16 mm
Domeniu utilizare	Cl 12.9	M8●13 mm
Admisie de aer	GAS	1/2"
Presiune de lucru	bar	6,2
Dimensiunea interioara a furtunului (Ø)	mm	10
Consumul mediu de aer	l/min	88

019220006 **1922P1**  
1.243 RON **828 RON**

1/4"

019220010 **1922P2**  
1.243 RON **828 RON**

3/8"

019220013 **1922P3**  
1.955 RON **1.303 RON**

1/2"

Turatie libera	rpm	600
Cuplu maxim	Nm	136
Domeniu utilizare	Cl 8.8	M12●18 mm
Domeniu utilizare	Cl 12.9	M10●16 mm
Admisie de aer	GAS	1/2"
Presiune de lucru	bar	6,2
Dimensiunea interioara a furtunului (Ø)	mm	10
Consumul mediu de aer	l/min	113



164 mm

0,6 kg



292 mm

1,5 kg

### CUPLU MARE FARA A PUNE PRESIUNE PE INCHEIETURA MAINII

019330006 **1933IH**  
990 RON **660 RON**

#### Biax de mare putere

- Mandrina de Ø 3 mm și 6 mm

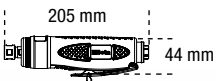

800 g

Turatie libera	rpm	20.000
Capacitatea mandrinei	mm	3-6
Putere	kW	0,75
Admisie de aer	GAS	1/4"
Presiune de lucru	bar	6,2
Dimensiunea interioara a furtunului (Ø)	mm	10
Consumul mediu de aer	l/min	370

019360025 **1936/5A**  
2.015 RON **1.330 RON**

#### Polizor unghiular pneumatic

- Extrem de compact și usor de utilizat
- Regulator de aer pentru controlul automat al vitezei maxime
- Mâner auxiliar pentru schimbare sens
- Buton de blocare ax
- Accesorii pentru schimbarea rapidă a discurilor
- Capacul de siguranță poate fi reglat rapid în nouă poziții diferite prin eliberare rapidă
- Evacuare aer prin maner



Ø 125 mm

1,9 kg

Turatie libera	rpm	10.000
Capacitatea mandrinei	mm	125
Putere	kW	0,66
Admisie de aer	GAS	1/4"
Presiune de lucru	bar	6,2
Dimensiunea interioara a furtunului (Ø)	mm	10
Consumul mediu de aer	l/min	390

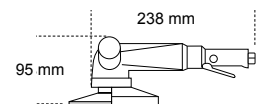

**1937**

#### Masina de slefuit pneumatica ce nu necesita lubrefiere, din material compozit

- Nu necesita lubrifiere
- Extrem de compacta si usor de manevrat
- Diametrul orbitei: 5 mm
- Disc Velcro cu 6 gauri
- Reglaj continuu al turatiei motorului
- Mâner din material moale anti-alunecare
- Conceputa pentru sisteme de absorbtie cu fittinguri oscilante
- Evacuare rotativa

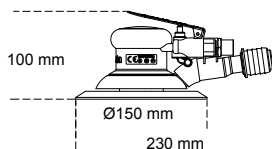

860 g

Turatie libera	rpm	12.000
Putere	kW	0,18
Diametrul discului	mm	150
Filetul axului		5/16"-24
Admisie de aer	GAS	1/4"
Presiunea de lucru	bar	6,2
Dimensiunea interioara a furtunului (Ø)	mm	10
Consumul mediu de aer	l/min	170

	Ø mm		RON
<b>1937 2.5</b>	2,5	019370000	<del>2.130 RON</del> <b>1.420 RON</b>
<b>1937 5.0</b>	5,0	019370001	<del>2.130 RON</del> <b>1.420 RON</b>

017500111 **1750TA**  
213 RON **141 RON**

**Duza gresare autoblocanta cu 6 pini**

Odata pozitionata, ramane pozitionata pe nitul de gresare. Nu trebuie pozitionata precum duzele obisnuite. Usor de deconectat, chiar si atunci cand se afla sub presiune. Filet M10x1: potrivita pentru toate tipurile de gresoare: manua, pneumatic, electric. Punct de deformare: peste 550 bar



019460006 **1946C4,8**  
2.850 RON **1.880 RON**

**Pistol pneumatic de nituit, 2,4-4,8mm**

- Pistol de nituit pneumatic profesional cu tije lungi de 2,4 - 3,2 - 4,0 - 4,8 mm, din otel inox, pentru nituri din aluminiu si cupru
- Ajustaj conic
- Puternic si usor de manevrat, cu maner din material compozit
- Include un container cu cuie de siguranta si ulei pentru pistol
- Supapa integrata de inchidere/deschidere

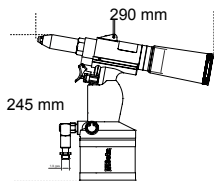

Material/Nituri	2,4	3,2	4	4,8
Cupru	✓	✓	✓	✓
aluminiu	✓	✓	✓	✓
otel	✓	✓	✓	✓
otel inoxidabil	✓	✓	✓	✓

Puterea de tractiune	N	8.900
Lungimea cursei	mm	15
Diametru maxim nituri	Otel Ø	4,8 mm
Admisie de aer	GAS	1/4"
Presiune de lucru	bar	6,2
Dimensiunea interioara a furtunului (Ø)	mm	10
Consum aer comprimat	l/ciclu	2,6

1,5 kg

019420000 **1942A**  
1.495 RON **990 RON**

**Fierestrau pneumatic**

- Puternic si usor de folosit
- Conceput pentru taierea caroseriilor, a tevilor si tobelor de esapament, a aluminiului si plasticului
- Cu maner de cauciuc, teava de evacuare și furtun pneumatic
- Evacuare prin maner

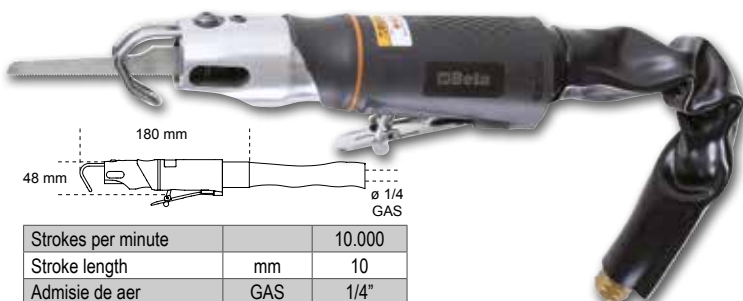

Strokes per minute		10.000
Stroke length	mm	10
Admisie de aer	GAS	1/4"
Presiunea de lucru	bar	6,2
Dimensiunea interioara a furtunului (Ø)	mm	8
Consumul mediu de aer	l/min	75

550 g

019490030 **1949U5**  
175 RON **117 RON**

**Pistol de suflat aer cu 5 duze**

- Corp realizat dintr-un material compozit durabil, rezistent la socuri
- 3 duze de otel, 100/160/320 mm, inlocuibile si rezistente la zgaraieturi
- 1 duza "Turbo" din fibra de sticla si varf de siguranta
- 1 duza rotativa, 100 mm, fabricată din nailon armat cu fibra de sticlă
- Cu sistem de fixare rapida



934 g

019490310 **1949P/U3**  
185 RON **123 RON**

**Mini-pistol suflat aer cu 3 duze**

- Corp realizat dintr-un material compozit durabil, rezistent la socuri
- Sistem de fixare rapida a duzelor
- Debitul de aer poate fi reglat prin rotirea piulitei
- 1 duza de otel, 100 mm, cu varf de cauciuc de protectie impotriva zgaraieturilor (1949U5 / A)
- 1 duza plata, in forma de ventilator, fabricata din nailon armat cu fibra de sticlă (1949U5 / F)
- 1 duză OSHA, fabricată din nailon armat cu fibră de sticlă (1949U5 / G)



019470060 **1947G2**  
808 RON **538 RON**

**Pistol de gresat 2-in-1**

- Pentru alimentarea continua sau non-continua cu vaselina
- Cap turnat din aluminiu
- Maner ergonomic
- Foloseste cartuse de 400 cc sau vaselina vrac pana la 500 cc

Dimensiune furtun	mm	54 (interior) x 276 mm
Admisie de aer:	GAS	1/4"
Presiunea de lucru:	bar	3÷10



2,2 Kg





- BOMBEU DIN MATERIAL COMPOZIT
- TALPA ANTIPENETRARE DIN FIBRE COMPOZITE

EN ISO  
20345  
2011

**7353Y** 420 g  
~~748 RON~~ **498 RON**

Pantof din microfibră, cu inserții TPU pentru o mai bună aerisire, parte reflectorizantă pentru o mai bună vizibilitate

EU	UK	
38	5	073530038
39	6	073530039
40	6,5	073530040
41	7	073530041
42	8	073530042
43	9	073530043
44	10	073530044
45	10,5	073530045
46	11	073530046
47	12	073530047
48	13	073530048



**S1P HRO SRC**

**7354N** 460 g  
~~600 RON~~ **400 RON**

Pantof din microfibră, waterproof, cu inserții TPU

EU	UK	
38	5	073540038
39	6	073540039
40	6,5	073540040
41	7	073540041
42	8	073540042
43	9	073540043
44	10	073540044
45	10,5	073540045
46	11	073540046
47	12	073540047
48	13	073540048



**S3 HRO SRC**

**7352A** 450 g  
~~580 RON~~ **387 RON**

Pantof din microfibră, cu aerisire, cu inserții TPU pentru o mai bună aerisire

EU	UK	
38	5	073520038
39	6	073520039
40	6,5	073520040
41	7	073520041
42	8	073520042
43	9	073520043
44	10	073520044
45	10,5	073520045
46	11	073520046
47	12	073520047
48	13	073520048



**S1P HRO SRC**

**7352B** 450 g  
~~580 RON~~ **387 RON**

Pantof din microfibră, respirabil, cu inserții TPU pentru o mai bună aerisire

EU	UK	
38	5	073520138
39	6	073520139
40	6,5	073520140
41	7	073520141
42	8	073520142
43	9	073520143
44	10	073520144
45	10,5	073520145
46	11	073520146
47	12	073520147
48	13	073520148



**S1P HRO SRC**

**7352G** 450 g  
~~603 RON~~ **401 RON**

Pantof din microfibră, respirabil, cu inserții TPU  
Suport pentru stabilitatea  
calcaului, sireturi  
traditionale



NEW

EU	UK	
38	5	073520338
39	6	073520339
40	6,5	073520340
41	7	073520341
42	8	073520342
43	9	073520343
44	10	073520344
45	10,5	073520345
46	11	073520346
47	12	073520347
48	13	073520348



**S1P HRO SRC ESD**



EN ISO  
20345  
2011

- BOMBEU DIN MATERIAL COMPOZIT
- TALPA ANTIPENETRARE DIN FIBRE COMPOZITE

**7356G** 460 g  
~~620 RON~~ **413 RON**

Pantofi din microfibra , impermeabili, TPU insert, suport pentru stabilitatea calcaiului, deschizatura elastica

EU	UK	
38	5	073560038
39	6	073560039
40	6,5	073560040
41	7	073560041
42	8	073560042
43	9	073560043
44	10	073560044
45	10,5	073560045
46	11	073560046
47	12	073560047
48	13	073560048

**S3 HRO SRC**



**7356V** 460 g  
~~620 RON~~ **413 RON**

Pantofi din microfibra , impermeabili, TPU insert, suport pentru stabilitatea calcaiului, deschizatura elastica

EU	UK	
38	5	073560138
39	6	073560139
40	6,5	073560140
41	7	073560141
42	8	073560142
43	9	073560143
44	10	073560144
45	10,5	073560145
46	11	073560146
47	12	073560147
48	13	073560148

**S3 HRO SRC**



**7357G** 480 g  
~~685 RON~~ **457 RON**

Pantofi din microfibra , impermeabili, TPU insert, suport pentru stabilitatea calcaiului, deschizatura elastica

EU	UK	
38	5	073570038
39	6	073570039
40	6,5	073570040
41	7	073570041
42	8	073570042
43	9	073570043
44	10	073570044
45	10,5	073570045
46	11	073570046
47	12	073570047
48	13	073570048

**S3 HRO SRC**



**7357V** 480 g  
~~685 RON~~ **457 RON**

Pantofi din microfibra , impermeabili, TPU insert, suport pentru stabilitatea calcaiului, deschizatura elastica

EU	UK	
38	5	073570138
39	6	073570139
40	6,5	073570140
41	7	073570141
42	8	073570142
43	9	073570143
44	10	073570144
45	10,5	073570145
46	11	073570146
47	12	073570147
48	13	073570148

**S3 HRO SRC**







EN ISO  
20345  
2011

- BOMBEU DIN MATERIAL POLIMERIC
- TALPA ANTIPENETRARE DIN MATERIAL COMPOZIT

**7317NA**  
~~340 RON~~ **227 RON**

Pantofi piele intoarsa, perforati, cu intarire din microfibra in partea calcaiului

**S1P SRC**



EU	UK	
35	2,5	073170135
36	3,5	073170136
37	4,5	073170137
38	5	073170138
39	6	073170139
40	6,5	073170140
41	7	073170141
42	8	073170142
43	9	073170143
44	10	073170144
45	10,5	073170145
46	11	073170146
47	12	073170147
48	13	073170148

**7320NA**  
~~358 RON~~ **238 RON**

Pantofi din piele, impermeabili, parte frontala din material rezistent la zgarieturi

**S3 SRC**



EU	UK	
35	2,5	073200435
36	3,5	073200436
37	4,5	073200437
38	5	073200438
39	6	073200439
40	6,5	073200440
41	7	073200441
42	8	073200442
43	9	073200443
44	10	073200444
45	10,5	073200445
46	11	073200446
47	12	073200447
48	13	073200448

**7321NA**  
~~370 RON~~ **247 RON**

Ghete din piele, impermeabili, cu sistem de deschidere rapida si parte frontala din material rezistent la zgarieturi.

**S3 RS SRC**



**SISTEM DESCHIDERE RAPIDA**

EU	UK	
35	2,5	073210435
36	3,5	073210436
37	4,5	073210437
38	5	073210438
39	6	073210439
40	6,5	073210440
41	7	073210441
42	8	073210442
43	9	073210443
44	10	073210444
45	10,5	073210445
46	11	073210446
47	12	073210447
48	13	073210448

- BOMBEU CU PROTECTIE DIN ALUMINIU
- TALPA ANTIPENETRARE DIN FIBRE COMPOZITE

**//7340B**  
~~738 RON~~ **491 RON**

Pantof din panza, cu aerisire, insertii PU si protectie a varfurilor din piele de caprioara.

**EN ISO 20345 2011**

**S1P SRC**

EU	UK	Articol
36	3,5	073400236
37	4,5	073400237
38	5	073400238
39	6	073400239
40	6,5	073400240
41	7	073400241
42	8	073400242
43	9	073400243
44	10	073400244
45	10,5	073400245
46	11	073400246
47	12	073400247



FIT PRO NET

**//7341N**  
~~775 RON~~ **517 RON**

Pantofi de lucru din piele intoarsa, impermeabili insertii PU si protectie a varfurilor din piele de caprioara.

**EN ISO 20345 2011**

**S3 SRC**

EU	UK	Articol
36	3,5	073410236
37	4,5	073410237
38	5	073410238
39	6	073410239
40	6,5	073410240
41	7	073410241
42	8	073410242
43	9	073410243
44	10	073410244
45	10,5	073410245
46	11	073410246
47	12	073410247



FIT PRO NET

**//7322SA**  
~~385 RON~~ **257 RON**

Pantofi din panza, extrem de rezistenti cu suport pentru stabilitatea calcaiului

**S3 SRC**

EU	UK	Articol
35	2,5	073220435
36	3,5	073220436
37	4,5	073220437
38	5	073220438
39	6	073220439
40	6,5	073220440
41	7	073220441
42	8	073220442
43	9	073220443
44	10	073220444
45	10,5	073220445
46	11	073220446
47	12	073220447
48	13	073220448



**//7323SA**  
~~398 RON~~ **264 RON**

Ghete din panza, extrem de rezistente, cu sistem deschidere rapida si suport pentru stabilitatea calcaiului

**S3 RS SRC**

EU	UK	Articol
35	2,5	073230435
36	3,5	073230436
37	4,5	073230437
38	5	073230438
39	6	073230439
40	6,5	073230440
41	7	073230441
42	8	073230442
43	9	073230443
44	10	073230444
45	10,5	073230445
46	11	073230446
47	12	073230447
48	13	073230448



SISTEM DESCHIDERE RAPIDA

NEW



• BOMBEU CU PROTECTIE DIN MATERIAL COMPOZIT  
 • TALPA ANTIPENETRARE CU INSERȚIE ELASTICĂ, DIN MATERIAL COMPOZIT



**//7212FG**  
 330 RON **220 RON**

Pantofi de piele întoarsă, cu aerisire, talpa antipenetrare cu inserție elastică, din material compozit

EU	UK	Articol
35	2,5	072120035
36	3,5	072120036
37	4,5	072120037
38	5	072120038
39	6	072120039
40	6,5	072120040
41	7	072120041
42	8	072120042
43	9	072120043
44	10	072120044
45	10,5	072120045
46	11	072120046
47	12	072120047
48	13	072120048

**S1P SRC**



**//7213FG**  
 330 RON **220 RON**

Pantofi de piele întoarsă, perforați, cu inserții din panza, aerisiți

EU	UK	Articol
35	2,5	072130035
36	3,5	072130036
37	4,5	072130037
38	5	072130038
39	6	072130039
40	6,5	072130040
41	7	072130041
42	8	072130042
43	9	072130043
44	10	072130044
45	10,5	072130045
46	11	072130046
47	12	072130047
48	13	072130048

**S1P SRC**



**//7214FN**  
 358 RON **238 RON**

Pantofi lucru piele întoarsă, impermeabili, din material rezistent la zgărieturi

EU	UK	Articol
35	2,5	072140035
36	3,5	072140036
37	4,5	072140037
38	5	072140038
39	6	072140039
40	6,5	072140040
41	7	072140041
42	8	072140042
43	9	072140043
44	10	072140044
45	10,5	072140045
46	11	072140046
47	12	072140047
48	13	072140048

**S3 SRC**



**//7218FN**  
 375 RON **250 RON**

Pantof de piele întoarsă, impermeabili, parte frontală din material rezistent la zgărieturi și sistem de deschidere rapidă

EU	UK	Articol
35	2,5	072180035
36	3,5	072180036
37	4,5	072180037
38	5	072180038
39	6	072180039
40	6,5	072180040
41	7	072180041
42	8	072180042
43	9	072180043
44	10	072180044
45	10,5	072180045
46	11	072180046
47	12	072180047
48	13	072180048

**S3 RS SRC**

**SISTEM DESCHIDERE RAPIDA**



• BOMBEU CU PROTECTIE DIN MATERIAL COMPOZIT

• TALPA ANTIPENETRARE CU INSERTIE ELASTICA, DIN ATERIAL COMPOZIT

**//7238WR**  
460 RON **307 RON**

Pantofi de lucru piele intoarsa, perforati, cu insertii din panza, impermeabili, cu talpa rezistenta din cauciuc si sistem de deschidere rapida

**SISTEM DESCHIDERE RAPIDA**



**S3 HRO RS WR SRC**

**EN ISO 20345 2011**

EU	UK	
35	2,5	072380235
36	3,5	072380236
37	4,5	072380237
38	5	072380238
39	6	072380239
40	6,5	072380240
41	7	072380241
42	8	072380242
43	9	072380243
44	10	072380244
45	10,5	072380245
46	11	072380246
47	12	072380247
48	13	072380248

**//7293HM**  
818 RON **544 RON**

Pantofi piele cu talpa cauciuc VIBRAM®, protectie varf din cauciuc, impermeabili, parte frontala din material rezistent la zgarieturi

**Vibram** **tt** **EN ISO 20345 2011**  
**S3 HRO HI SRC**

EU	UK	
39	6	072930639
40	6,5	072930640
41	7	072930641
42	8	072930642
43	9	072930643
44	10	072930644
45	10,5	072930645
46	11	072930646
47	12	072930647
48	13	072930648



**//7294HM**  
865 RON **577 RON**

Ghete din piele cu talpa cauciuc VIBRAM®, protectie varf din cauciuc, impermeabile, parte frontala din material rezistent la zgarieturi

**Vibram** **tt** **EN ISO 20345 2011**  
**S3 HRO HI SRC**

EU	UK	
39	6	072940639
40	6,5	072940640
41	7	072940641
42	8	072940642
43	9	072940643
44	10	072940644
45	10,5	072940645
46	11	072940646
47	12	072940647
48	13	072940648



**//7249GK**  
288 RON **191 RON**

Ghete din piele intoarsa cu insertii din nilon, impermeabile, cu sistem de deschidere rapida si varf protectie suplimentara din poliuretan

**SISTEM DESCHIDERE RAPIDA**

EU	UK	
35	2,5	072490235
36	3,5	072490236
37	4,5	072490237
38	5	072490238
39	6	072490239
40	6,5	072490240
41	7	072490241
42	8	072490242
43	9	072490243
44	10	072490244
45	10,5	072490245
46	11	072490246
47	12	072490247
48	13	072490248



**S1P RS SRC**

**//7236BK**  
343 RON **228 RON**

Ghete din piele, impermeabili cu sistem de deschidere rapida si varf protectie suplimentara din poliuretan

**SISTEM DESCHIDERE RAPIDA**

EU	UK	
35	2,5	072360335
36	3,5	072360336
37	4,5	072360337
38	5	072360338
39	6	072360339
40	6,5	072360340
41	7	072360341
42	8	072360342
43	9	072360343
44	10	072360344
45	10,5	072360345
46	11	072360346
47	12	072360347
48	13	072360348



**S3 RS SRC**

TREKKING



- BOMBEU DIN FIBRA DE STICLA
- TALPA ANTIPENETRARE DIN MATERIAL COMPOZIT



EN ISO  
20345  
2011

## //7221PEK

313 RON **208 RON**

Ghete din piele , impermeabile, insertii din panza, parte frontala din material rezistent la zgarieturi

**SISTEM DESCHIDERE RAPIDA**

EU	UK	Articol
35	2,5	072210235
36	3,5	072210236
37	4,5	072210237
38	5	072210238
39	6	072210239
40	6,5	072210240
41	7	072210241
42	8	072210242
43	9	072210243
44	10	072210244
45	10,5	072210245
46	11	072210246
47	12	072210247
48	13	072210248

**S3 RS SRC**



## //7220PEK

300 RON **200 RON**

Pantofi piele , impermeabili, insertii din panza ,parte frontala din material rezistent la zgarieturi

EU	UK	Articol
35	2,5	072200235
36	3,5	072200236
37	4,5	072200237
38	5	072200238
39	6	072200239
40	6,5	072200240
41	7	072200241
42	8	072200242
43	9	072200243
44	10	072200244
45	10,5	072200245
46	11	072200246
47	12	072200247
48	13	072200248

**S3 SRC**



## //7222PEK

288 RON **191 RON**

Pantof din piele de intoarasa, perforati, cu insertii din plasa, aerisiti

EU	UK	Articol
35	2,5	072220135
36	3,5	072220136
37	4,5	072220137
38	5	072220138
39	6	072220139
40	6,5	072220140
41	7	072220141
42	8	072220142
43	9	072220143
44	10	072220144
45	10,5	072220145
46	11	072220146
47	12	072220147
48	13	072220148

**S1P SRC**



## //7225PEK

298 RON **198 RON**

Pantofi piele inoarsa, perforati

EU	UK	Articol
35	2,5	072250135
36	3,5	072250136
37	4,5	072250137
38	5	072250138
39	6	072250139
40	6,5	072250140
41	7	072250141
42	8	072250142
43	9	072250143
44	10	072250144
45	10,5	072250145
46	11	072250146
47	12	072250147
48	13	072250148

**S1P SRC**



**NEW**

• BOMBEU CU PROTECȚIE DIN OTEL  
• TALPA ANTIPENETRARE CU INSERTIE ELASTICĂ, DIN MATERIAL COMPOZIT

**//7243CK**  
228 RON **151 RON**

Pantofi piele, impermeabili,  
cu sistem de deschidere rapida

EN ISO  
20345  
2011

S3 RS SRC



SISTEM DESCHIDERE  
RAPIDA

EU	UK	Articol
35	2,5	072431335
36	3,5	072431336
37	4,5	072431337
38	5	072431338
39	6	072431339
40	6,5	072431340
41	7	072431341
42	8	072431342
43	9	072431343
44	10	072431344
45	10,5	072431345
46	11	072431346
47	12	072431347
48	13	072431348

**//7245BK**  
263 RON **174 RON**

Ghete piele pentru sudor, impermeabile,  
cu sistem de deschidere rapida si  
clapeta de protectie din piele

SISTEM DESCHIDERE  
RAPIDA

EN ISO  
20345  
2011

S3 RS SRC



EU	UK	Articol
35	2,5	072451235
36	3,5	072451236
37	4,5	072451237
38	5	072451238
39	6	072451239
40	6,5	072451240
41	7	072451241
42	8	072451242
43	9	072451243
44	10	072451244
45	10,5	072451245
46	11	072451246
47	12	072451247
48	13	072451248

**//7246BK**  
228 RON **151 RON**

Pantofi din piele intoarsa, cu aerisire

EN ISO  
20345  
2011

S1P SRC



EU	UK	Articol
35	2,5	072461235
36	3,5	072461236
37	4,5	072461237
38	5	072461238
39	6	072461239
40	6,5	072461240
41	7	072461241
42	8	072461242
43	9	072461243
44	10	072461244
45	10,5	072461245
46	11	072461246
47	12	072461247
48	13	072461248

**//7200BKK**  
343 RON **228 RON**

Pantofi din piele naturala ,  
impermeabili

SISTEM DESCHIDERE  
RAPIDA

EN ISO  
20345  
2011

S3 SRC



EU	UK	Articol
35	2,5	072000235
36	3,5	072000236
37	4,5	072000237
38	5	072000238
39	6	072000239
40	6,5	072000240
41	7	072000241
42	8	072000242
43	9	072000243
44	10	072000244
45	10,5	072000245
46	11	072000246
47	12	072000247
48	13	072000248

**//7201BKK**  
363 RON **241 RON**

Pantofi din piele naturala ,  
impermeabili

EN ISO  
20345  
2011

S3 SRC



EU	UK	Articol
35	2,5	072010435
36	3,5	072010436
37	4,5	072010437
38	5	072010438
39	6	072010439
40	6,5	072010440
41	7	072010441
42	8	072010442
43	9	072010443
44	10	072010444
45	10,5	072010445
46	11	072010446
47	12	072010447
48	13	072010448



- 90% nailon - 10% spandex, 260 g / m<sup>2</sup>, gri antracit
- Buzunare pentru protectie spuma genunchi, buzunare spate din tesatura poliester 600D
- Slim
- Spate cu talie mai inalta pentru protectie sporita a spatelui
- Doua buzunare frontale mari, unul cu buzunar mic cu inchidere orizontala cu fermoar
- Doua buzunare spate cu inchidere cu curea
- Buzunar mare pe piciorul stang cu inchidere cu curea și buzunar vertical cu inchidere cu fermoar
- Buzunar frontal pe piciorul drept cu inchidere orizontala cu fermoar
- Buzunare mari pentru genunchere

TOP  
line

**7650**  
423 RON **281 RON**

Pantaloni de lucru stretch, buzunare multiple

XS	076500000
S	076500001
M	076500002
L	076500003
XL	076500004
XXL	076500005
XXXL	076500006

**SLIM FIT**



GRI ANTRACIT

**7650B**  
423 RON **281 RON**

Pantaloni de lucru stretch, buzunare multiple

**SLIM FIT**



XS	076500100
S	076500101
M	076500102
L	076500103
XL	076500104
XXL	076500105
XXXL	076500106

ALBASTRU



NEW

- Tesatura elastica 86% nailon, 14% spandex, 140 g / m<sup>2</sup>
- Buzunare pentru genunchere de spuma, buzunare spate cu tesatura din poliester 300D
- Doua buzunare mari frontale cu inchidere prin fermoar
- Doua buzunare spate intarite, unul cu inchidere cu fermoar

**SLIM FIT** **NEW**

GRI ANTRACIT

**7660G**  
363 RON **241 RON**

Pantaloni de lucru stretch, subtiri, buzunare multiple

XS	076600000
S	076600001
M	076600002
L	076600003
XL	076600004
XXL	076600005
XXXL	076600006



ALBASTRU

**7660B**  
363 RON **241 RON**

Pantaloni de lucru stretch, subtiri, buzunare multiple

XS	076600100
S	076600101
M	076600102
L	076600103
XL	076600104
XXL	076600105
XXXL	076600106

- Tesatura elastica 86% nailon, 14% spandex, 140 g / m<sup>2</sup>
- Buzunare pentru genunchere de spuma, buzunare spate cu tesatura din poliester 300D
- Doua buzunare mari frontale cu inchidere prin fermoar
- Doua buzunare spate intarite, unul cu inchidere cu fermoar

**SLIM FIT**



**7661G**  
315 RON **210 RON**

Pantaloni de lucru scurți, stretch, subtiri, buzunare multiple

XS	076610000
S	076610001
M	076610002
L	076610003
XL	076610004
XXL	076610005
XXXL	076610006



GRI ANTRACIT

**7661B**  
315 RON **210 RON**

Pantaloni de lucru scurți, stretch, subtiri, buzunare multiple

XS	076610100
S	076610101
M	076610102
L	076610103
XL	076610104
XXL	076610105
XXXL	076610106



ALBASTRU

NEW

7664G

233 RON 154 RON

GRI



Hanorac, fermoar lung

- 60% bumac 40% poliester, 280 g/m2
- Mansete elastice
- Doua buzunare mari in talie cu inchidere prin fermoar
- Buzunar la piept cu inchidere verticala prin fermoar



TOP line

XS	076640100
S	076640101
M	076640102
L	076640103
XL	076640104
XXL	076640105
XXXL	076640106

7664N

233 RON 154 RON

NEGRU



XS	076640000
S	076640001
M	076640002
L	076640003
XL	076640004
XXL	076640005
XXXL	076640006

7665N

253 RON 168 RON

NEGRU

XS	076650000
S	076650001
M	076650002
L	076650003
XL	076650004
XXL	076650005
XXXL	076650006

Hanorac cu gluga, fermoar lung

- 60% bumac 40% poliester, 280 g/m2
- Mansete elastice
- Doua buzunare mari in talie cu inchidere prin fermoar
- Buzunar la piept cu inchidere verticala prin fermoar
- Gluga fixa cu snururi reglabile

TOP line



7665G

253 RON 168 RON

GRI



XS	076650100
S	076650101
M	076650102
L	076650103
XL	076650104
XXL	076650105
XXXL	076650106



**//7654N**

**203 RON 134 RON**

Hanorac fleece cu fermoar scurt  
180 g/m<sup>2</sup>, negru  
95% poliester, 5% spandex

XS	076540000
S	076540001
M	076540002
L	076540003
XL	076540004
XXL	076540005
XXXL	076540006



TOP  
line



**//7657N**

**258 RON 171 RON**

Hanorac fleece cu fermoar,  
280 g/m<sup>2</sup>, negru  
95% poliester, 5% spandex

XS	076570000
S	076570001
M	076570002
L	076570003
XL	076570004
XXL	076570005
XXXL	076570006



**//7654B**

**203 RON 134 RON**

Pulover elastic din microfleece,  
cu fermoar scurt

- 95% poliester, 5% spandex, 280 g / m<sup>2</sup>
- Mansete elastice
- Buzunar la piept cu inchidere verticala prin fermoar
- Doua buzunare interioare
- Insertii din poliester pe maneci si buzunarul de la piept



XS	076540100
S	076540101
M	076540102
L	076540103
XL	076540104
XXL	076540105
XXXL	076540106

TOP  
line



**//7657B**

**258 RON 171 RON**

Pulover elastic din microfleece,  
cu fermoar

- 95% poliester, 5% spandex, 280 g / m<sup>2</sup>
- Mansete elastice
- Buzunar la piept cu inchidere verticala prin fermoar
- Doua buzunare interioare
- Insertii din poliester pe maneci si buzunarul de la piept



XS	076570100
S	076570101
M	076570102
L	076570103
XL	076570104
XXL	076570105
XXXL	076570106

NEW

//7669N

463 RON 308 RON

TOP line

NEW

Jacheta stretch, subtire, buzunare multiple

- 86% nailon, 14% spandex, 140 g/m<sup>2</sup>, negru
- Cu maneci dsi gluga etasabile.
- Rezistenta la apa si la vant.



XS	076690000
S	076690001
M	076690002
L	076690003
XL	076690004
XXL	076690005
XXXL	076690006

//7659N

660 RON 440 RON

TOP line

Jacheta softshell cu gluga si maneci detasabile

Jacheta softshell, 94% poliester, 6% spandex, 290 g/m<sup>2</sup>



S	076590001
M	076590002
L	076590003
XL	076590004
XXL	076590005
XXXL	076590006

//7904N

493 RON 328 RON

Beta EASY

Jacheta de lucru, matlasata

tesatura T/C, 270 g/m<sup>2</sup>, "Oxford", neagra captuseala din poliester, 140 g/m<sup>2</sup>



XS	079040800
S	079040801
M	079040802
L	079040803
XL	079040804
XXL	079040805
XXXL	079040806
XXXXL	079040807

//7670G

463 RON 308 RON

CE

TOP line

NEW

Jacheta Anorak din poliester Oxford 300D, impermeabil, acoperit cu PU, culoare: gri antracit

- Tesatura exterioara: 100% poliester
- Tesatura interioara: 100% poliester
- Acoperit cu PU (rezistenta la coloane de apa de pana la 2.000 mm - respirabilitate 2.000 mvp)



S	076700001
M	076700002
L	076700003
XL	076700004
XXL	076700005
XXXL	076700006

//7673NG

425 RON 283 RON

CE

NEW

Vesta de lucru fara maneci cu captuseala GRAPHENE, 80 g / m<sup>2</sup>

- Tesatura exterioara: fata si umeri: tesatura softshell - 96% poliester, 4% spandex
- spate: 100% nailon 20D
- Tesatura interioara: 100% poliester

TOP line



S	076730001
M	076730002
L	076730003
XL	076730004
XXL	076730005
XXXL	076730006



## LIGHTWEIGHT 180G

### // 7860G 238 RON 158 RON

#### Pantaloni de lucru subtiri Design nou, imbunatatit

- panza T/C, 65% poliester, 35% bumbac, 180 g/m<sup>2</sup>
- Insertii si genunchiere din poliester de tip „Oxford” / PU, 220 g / m<sup>2</sup>
- Inchidere cu fermoar metalic
- Doua buzunare frontale adanci cu insertii mici pentru scule cu inchidere cu curea
- Buzunar mare pe piciorul stang cu inchidere cu curea, buzunar pentru telefonul mobil si insert pentru insigna
- Buzunare mari in spate cu tesatura tip "Oxford" si inchidere cu curea
- Buzunar de rigla si bucla de ciocan
- Buzunare pentru genunchere de spuma

XS	078600800
S	078600801
M	078600802
L	078600803
XL	078600804
XXL	078600805
XXXL	078600806
XXXXL	078600807



### // 7861G 200 RON 133 RON

#### Pantaloni scurti, subtiri Design nou, imbunatatit

- panza T/C, 65% poliester, 35% bumbac, 180 g/m<sup>2</sup>
- Inchidere cu fermoar metalic
- Doua buzunare frontale adanci cu insertii mici pentru scule, inchidere prin curea
- Buzunar mare pentru piciorul stang cu inchidere cu curea, buzunar pentru telefonul mobil si insert pentru insigna
- Buzunare mari in spate cu intaritura tip "Oxford", inchidere cu curea



XS	078610800
S	078610801
M	078610802
L	078610803
XL	078610804
XXL	078610805
XXXL	078610806
XXXXL	078610807

### // 7869G 260 RON 173 RON

#### Jacheta de lucru, subtire Design nou, imbunatatit

- panza T/C, 65% poliester, 35% bumbac, 180 g/m<sup>2</sup>
- Inserturi din poliester tip „Oxford” / PU, 220 g / m<sup>2</sup>
- Mansete cu reglaj
- Inchidere prin fermoar dublu
- Talie reglabila
- Buzunare la piept cu inchidere cu curea, buzunar stilou si insertie pentru insigna
- Doua buzunare adanci in talie cu inchidere cu curea

XS	078690800
S	078690801
M	078690802
L	078690803
XL	078690804
XXL	078690805
XXXL	078690806
XXXXL	078690807



### // 7865G 380 RON 253 RON

#### Combinezon de lucru subtire Design nou, imbunatatit

- panza T/C, 65% poliester, 35% bumbac, 180 g/m<sup>2</sup>
- Insertii si genunchiere din poliester „Oxford” / PU, 220 g / m<sup>2</sup>
- Mansete cu reglaje pentru curele
- Inchidere cu curea din fata cu fermoar dublu, acoperit cu clapeta
- Banda elastica
- Buzunare la piept cu inchidere cu curea si buzunar stilou
- Doua buzunare frontale adanci cu insertii mici pentru scule cu inchidere cu curea
- Buzunar mare in partea stanga cu inchidere cu curea, buzunar pentru telefonul mobil si insert pentru insigna
- Buzunare mari din spate cu armatura „Oxford” si inchidere cu curea
- Buzunar de rigla si bucla de ciocan
- Insertii pentru genunchi



XS	078650800
S	078650801
M	078650802
L	078650803
XL	078650804
XXL	078650805
XXXL	078650806
XXXXL	078650807

### // 7867G 223 RON 148 RON

#### Vesta de lucru subtire Design nou, imbunatatit

- panza T/C, 65% poliester, 35% bumbac, 180 g/m<sup>2</sup>
- Buzunare la piept cu inchidere prin curea, buzunar stilou si insertie pentru insigna
- Buzunare mari in talie cu inchidere prin curea

XS	078670800
S	078670801
M	078670802
L	078670803
XL	078670804
XXL	078670805
XXXL	078670806
XXXXL	078670807



### // 7863G 293 RON 194 RON

#### Salopeta de lucru subtire Design nou, imbunatatit

- panza T/C, 65% poliester, 35% bumbac, 180 g/m<sup>2</sup>
- Inchidere cu fermoar metalic
- Curele de umar reglabile, cu cleme cu eliberare rapida din plastic
- Banda elastica
- Buzunar mare la piept cu inchidere prin curea
- Doua buzunare frontale adanci cu insertii mici pentru scule cu inchidere cu curea
- Buzunar mare in partea stanga cu inchidere prin curea, buzunar pentru telefonul mobil si insert pentru insigna
- Buzunare mari din spate cu tesatura tip "Oxford" si inchidere cu curea
- Buzunare pentru genunchere de spuma

XS	078630800
S	078630801
M	078630802
L	078630803
XL	078630804
XXL	078630805
XXXL	078630806
XXXXL	078630807



## EASY CANVAS 260G

**7900...**  
~~263 RON~~ **174 RON**

### Pantaloni lucru Design nou, imbuntatit

- panza T/C, 65% poliester, 35% bumbac, 260 g/m<sup>2</sup>
- Insertii si genunchiere din poliester „Oxford” / PU, 260 g / m<sup>2</sup>
- Inchidere cu fermoar metalic
- Doua buzunare frontale adanci cu insertii mici pentru scule cu inchidere cu curea
- Buzunar mare pentru piciorul stang cu inchidere cu curea, buzunar pentru telefonul mobil si insert pentru insigna
- Buzunare mari din spate cu intaritura tip " Oxford " si inchidere cu curea
- Buzunare pentru genunchere de spuma

**7900P**

**ALBASTRU PETROL**

**7900V VERDE**

**7900B ALBASTRU**

**7900G GRI**



**GRI ALBASTRU ALBASTRU VERDE ALBASTRU PETROL**

XS	S	M	L	XL	XXL	XXXL	XXXXL
079000800	079000700	079000500	079000600	079000801	079000701	079000501	079000601
079000802	079000702	079000502	079000602	079000803	079000703	079000503	079000603
079000804	079000704	079000504	079000604	079000805	079000705	079000505	079000605
079000806	079000706	079000506	079000606	079000807	079000707	079000507	079000607

- panza T/C, 65% poliester, 35% bumbac, 260 g/m<sup>2</sup>
- Inserturi și genunchiere din poliester „Oxford” / PU, 260 g / m<sup>2</sup>
- Inchidere cu fermoar metalic
- Curele de umar reglabile, cu carlige eliberare rapida din plastic
- Banda elastica
- Buzunar mare la piept cu Inchidere prin curea
- Doua buzunare frontale adanci cu insertii mici pentru scule cu inchidere cu curea
- Buzunar mare in partea stanga cu inchidere prin curea, buzunar pentru telefonul mobil si insert pentru insignă
- Buzunare mari in spate cu tesatura tip „Oxford” si inchidere prin curea
- Protectie pentru genunchi

**7903G GRI**  
~~330 RON~~ **220 RON**

### Salopeta de lucru Design nou, imbuntatit

XS	S	M	L	XL	XXL	XXXL	XXXXL
079030800	079030801	079030802	079030803	079030804	079030805	079030806	079030807

**7903P ALBASTRU PETROL**  
~~330 RON~~ **220 RON**

### Salopeta de lucru Design nou, imbuntatit

XS	S	M	L	XL	XXL	XXXL	XXXXL
079030600	079030601	079030602	079030603	079030604	079030605	079030606	079030607



**7901G**  
~~215 RON~~ **143 RON**

### Pantaloni scurți de lucru Design nou, imbuntatit

- panza T/C, 65% poliester, 35% bumbac, 260 g/m<sup>2</sup>
- Insertii si genunchiere din poliester „Oxford” / PU, 260 g / m<sup>2</sup>
- Inchidere cu fermoar metalic
- Doua buzunare frontale adanci cu insertii mici pentru scule cu inchidere cu curea
- Buzunar mare pentru piciorul stang cu inchidere cu curea, buzunar pentru telefonul mobil si insert pentru insigna
- Buzunare mari din spate cu intaritura tip „Oxford” si inchidere cu curea
- Protectie pentru genunchi

XS	S	M	L	XL	XXL	XXXL	XXXXL
079010800	079010801	079010802	079010803	079010804	079010805	079010806	079010807





## EASY CANVAS 260G

**//7905G**  
413 RON

**274 RON**

### Combinezon de lucru Design nou, imbuntatit

- panza T/C, 65% poliester, 35% bumbac, 260 g/m<sup>2</sup>
- Inserturi si genunchiere din poliester „Oxford” / PU, 260 g / m<sup>2</sup>
- Mansete cu reglaj
- Inchidere cu fermoar dublu
- Banda elastica
- Buzunare la piept cu inchidere prin curea si buzunar stilou
- Doua buzunare frontale adanci cu insertii mici pentru scule cu inchidere prin curea
- Buzunar mare In partea stanga cu inchidere prin curea, buzunar pentru telefonul mobil si insert pentru insigna
- Buzunare mari in spate cu tesatur tip „Oxford” si inchidere cu curea
- Protectie pentru genunchi



XS	079050800
S	079050801
M	079050802
L	079050803
XL	079050804
XXL	079050805
XXXL	079050806
XXXXL	079050807

**//7907**

### Jacheta de lucru

- T/C canvas, 65% polyester, 35% cotton, 260 g/m<sup>2</sup>
- Inserturi din poliester tip „Oxford” / PU, 260 g / m<sup>2</sup>
- Mansete cu reglaj
- Inchidere prin fermoar dublu
- Talie reglabila
- Buzunare la piept cu inchidere cu curea, buzunar stilou si insertie pentru insigna
- Doua buzunare adanci in talie cu inchidere cu curea



**//7907G GRI**  
243 RON

**161 RON**

**ALBASTRU  
PETROL**

**GRI**

XS	079070800	079070600
S	079070801	079070601
M	079070802	079070602
L	079070803	079070603
XL	079070804	079070604
XXL	079070805	079070605
XXXL	079070806	079070606
XXXXL	079070807	079070607



**//7907P ALBASTRU PETROL**  
243 RON

**161 RON**

**//7909**

### Jacheta de lucru

- T/C canvas, 65% polyester, 35% cotton, 260 g/m<sup>2</sup>
- Inserturi din poliester tip „Oxford” / PU, 260 g / m<sup>2</sup>
- Mansete cu reglaj
- Inchidere prin fermoar dublu
- Talie reglabila
- Buzunare la piept cu inchidere cu curea, buzunar stilou si insertie pentru insigna
- Doua buzunare adanci in talie cu inchidere cu curea



**//7909B ALBASTRU**  
293 RON

**194 RON**



**GRI**  
**//7909G**  
293 RON

**194 RON**



**VERDE**  
**//7909V**  
293 RON

**194 RON**

**GRI ALBASTRU VERDE PETROL**

XS	079090800	079090700	079090500	079090600
S	079090801	079090701	079090501	079090601
M	079090802	079090702	079090502	079090602
L	079090803	079090703	079090503	079090603
XL	079090804	079090704	079090504	079090604
XXL	079090805	079090705	079090505	079090605
XXXL	079090806	079090706	079090506	079090606
XXXXL	079090807	079090707	079090507	079090607



**ALBASTRU PETROL**  
**//7909P**  
293 RON

**194 RON**

095630020 **9563U**

~~1.620 RON~~ **1.080 RON**

Scaun birou, ergonomic



095740 **95740**

~~175 RON~~ **117 RON**

Manusi de lucru, cu mansete elastice, degetul mare si aratator, confectionate din piele sintetica capabila sa atinga ecranul tactil

M	095740202
L	095740203
XL	095740204
XXL	095740205



095930200 **9593S**

~~675 RON~~ **450 RON**

Ceas inteligent, atingere ecran tactila, modul fitness, curea silicon



095930205 **9593SB**

~~498 RON~~ **331 RON**

Bratara fitness smart, rezistenta la apa



**NEW**

095800100 **9580S**

~~158 RON~~ **104 RON**

Ochelari de soare



095490091 **9549ABW**

~~148 RON~~ **98 RON**

Casti wireless



**NEW**

095230050 **9523T**

~~108 RON~~ **67 RON**

Termos din otel inoxidabil, 500 ml



**NEW**



# Beta R50

**NEW**

www.790



ZOOM LENS EF-S 18-135

# Beta

## Castigam, impreuna

### Fabio Quartararo

MotoGP World Champion 2021

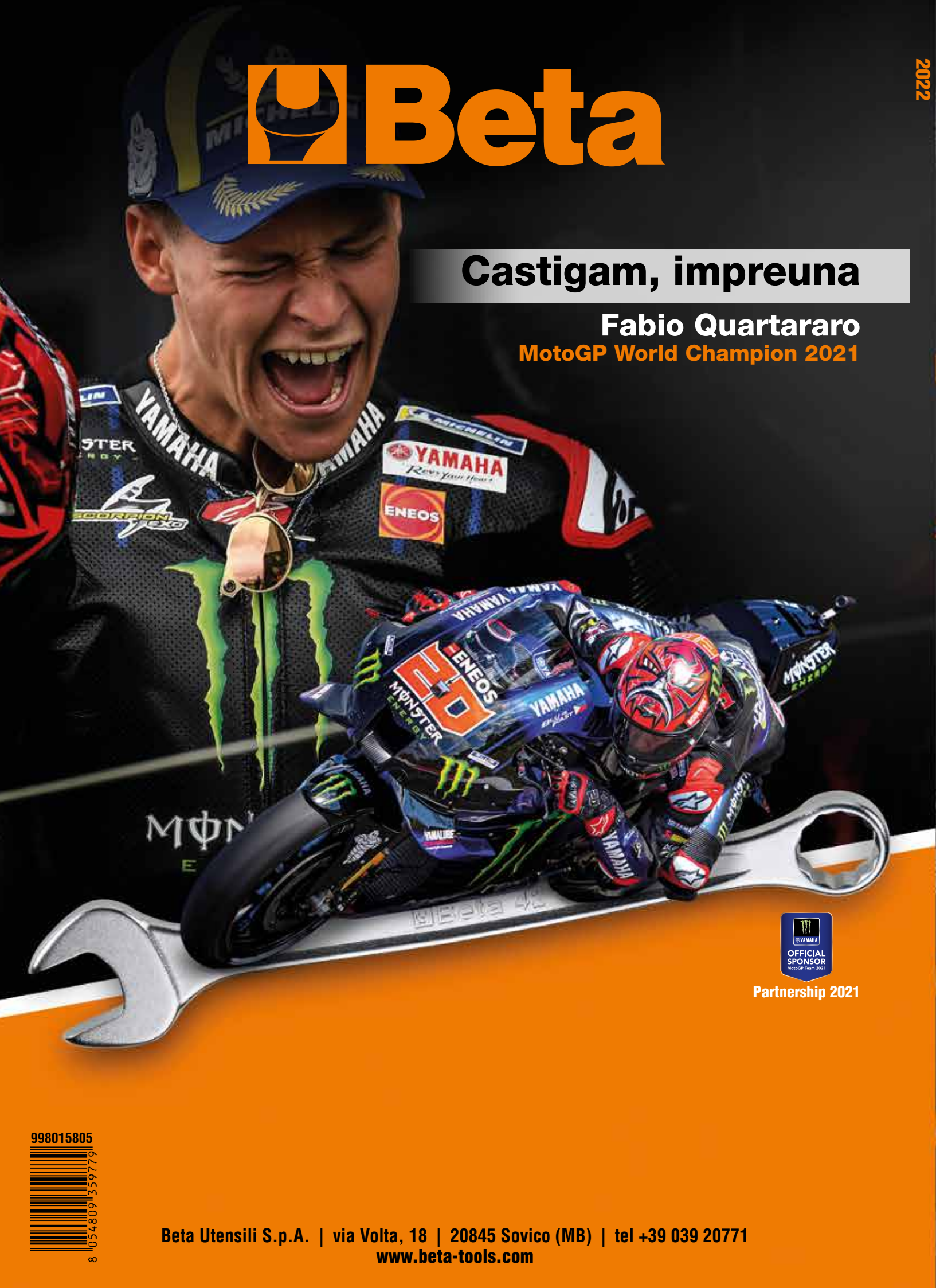

Partnership 2021

998015805



8 054809 359779