

WELDING *Journal*

October 2008



- **Welding in the Auto Industry**
- **An Automotive Structures Road Map**
- **Solutions to Sensor Problems**
- **Brazing & Soldering Today**
- **Metal-to-Ceramic Brazing**
- **Soldering Specification Introduced**

One Word Defines Select-Arc's New Electrode Line and Reputation for Quality...

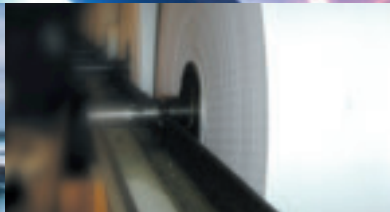

Stainless.

Select-Arc, Inc. has earned an outstanding reputation in the industry as a manufacturer of premium quality tubular welding electrodes for carbon and low alloy steel welding.

Now Select-Arc has expanded its range of exceptional products with the introduction of a complete line of austenitic, martensitic and ferritic stainless steel electrodes. Both the new SelectAlloy and Select stainless steel wires deliver the superior feedability, superb welding charac-

teristics, consistent deposit chemistry and excellent overall performance you have come to expect from Select-Arc.

The chart below shows that SelectAlloy flux cored

electrodes' higher deposition rates improve productivity and reduce welding costs.

SelectAlloy's smooth bead contour, easy peeling slag, minimal spatter, closely controlled weld deposit compositions and metal soundness deliver additional savings.

The Select 400-Series metal cored electrodes offer the same advantages as SelectAlloy and are ideally suited for difficult-to-weld applications, such as auto exhaust systems.

Discover for yourself the many benefits of specifying Select-Arc's new premium stainless steel electrodes. Call us today at **1-800-341-5215** or you can visit our website at www.select-arc.com for more information.

Typical Deposition Rates for Various Stainless Steel Consumables

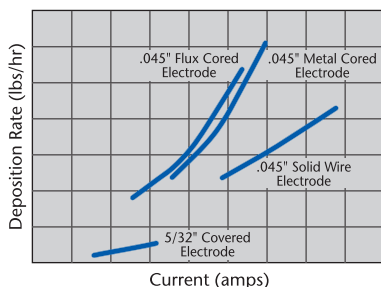

600 Enterprise Drive
P.O. Box 259
Fort Loramie, OH 45845-0259
Phone: (937) 295-5215
Fax: (888) 511-5217
www.select-arc.com



**WE'RE TAKING A
MOMENT TO CELEBRATE**
THEN, BACK TO WORK.

For 100 years, National Standard has set the standard for consistent product quality. And our weld wire is no exception. We deliberately make premium products and packaging innovations that will improve productivity even within the toughest specifications. Do it enough, and you earn a reputation for being the most demanding industry leader.

WE'RE SOLID WIRE EXPERTS, WITH A JOB TO DO.



©2007 National Standard, A Heico Wire Group Company.

WELD MOLD COMPANY

YOUR RESOURCE



ISO 9001:2000 Certified

We're large enough to serve the big guys
...and small enough to be flexible and responsive—
and provide **spectacular service!**

- Stock tool steel alloys from .035" to 156" in spool and cut lengths. Electrodes from 1/16" to 3/4" diameter.
- Stock maintenance and repair alloys .035-.156 solid, metal cored, flux cored in spool and cut length.
- All grades of hard facing products, electrodes, flux cored and open arc wires.
- 100 lb minimums for custom electrode manufacturing.
- 250 lb minimums for custom metal cored, flux cored or open arc wire.

*Stock orders shipped same
or next day!*

Let us be YOUR resource. We'll send you our alloy Wall Chart and our Technical Handbook FREE! These tools will help ensure that you spec the right product every time. Call us and we'll ship them to you!

www.weldmold.com

800.521.9755

CONTENTS

October 2008 • Volume 87 • Number 10

AWS Web site www.aws.org



Features

- 26** A New Road for Automotive Architectures
The objective of this “road map” was to gain a high-level, global view of the drivers and directions of the automotive structures market
J. Jennings and J. Gould
- 32** Protecting Sensors in the Weld Cell: The Fastest Way to Increase Productivity
Solutions are offered to prevent wastage of sensors in robotic weld cells
D. Bird
- 36** Study Yields Zero Weld Defects in Auto Seat Frames
In an effort to achieve even higher quality levels an auto supplier requested a study to determine root causes of torque failures

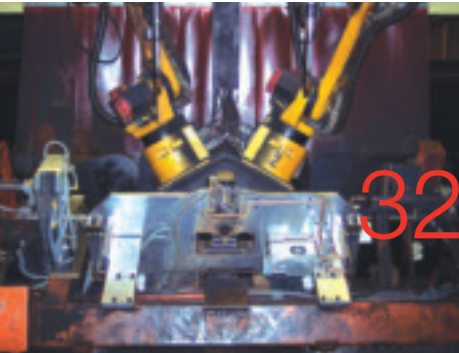

Brazing & Soldering Today

- *39** Effects of Joint Clearance on the Capillary Rise of a Molten Filler Metal
Some simple calculations help to explain the effects of joint clearance during brazing
M. J. Kuta
- 43** Comparing Metal-Ceramic Brazing Methods
This article will familiarize you with the brazing methods commonly used to join metals to ceramics and outline the advantages and disadvantages of each
C. A. Walker and V. C. Hodges
- *53** AWS Breaks New Ground with Soldering Specification
A short synopsis is provided of AWS's first specification to specifically address soldering technology
P. T. Vianco
- 55** Head to Orlando for the Latest in Brazing and Soldering
Preview the highlights of next year's International Brazing & Soldering Conference



Welding Research Supplement

- 249-s** A Gleeble®-based Method for Ranking the Strain-Age Cracking Susceptibility of Ni-Based Superalloys
Strain-age cracking susceptibility of six, gamma-prime strengthened Ni-based superalloys were evaluated using a Gleeble-based test method
D. A. Metzler
- 257-s** Ductility-Dip Cracking Susceptibility of Nickel-Based Weld Metals Part 1: Strain-to-Fracture Testing
Ductility-dip cracking susceptibility of high-chromium, Ni-based filler metals frequently used in nuclear power plant applications were evaluated using strain-to-fracture testing
N. E. Nissley and J. C. Lippold
- 265-s** Robotic Stud Welding Process Optimization with Designed Experiment
A short-cycle stud welding process using a cool, slow arc energy delivery method produced strong welds and process stability
C. Hsu et al.

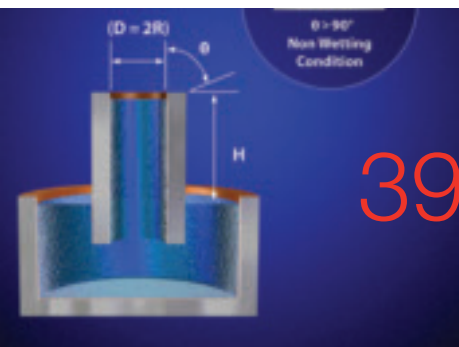

Departments

- Washington Watchword*4
- Press Time News*6
- Editorial*8
- News of the Industry*10
- Aluminum Q&A*16
- New Products*20
- Brazing & Soldering Today*
- Technology*57
- Coming Events*.....60
- Society News*65
- Tech Topics*66
- Tech Inquiry D15.1*67
- Sperko: ASME Section IX*68
- Guide to AWS Services*.....79
- Welding Workbook*84
- New Literature*.....86
- Personnel*90
- Classifieds*99
- Advertiser Index*102



Welding Journal (ISSN 0043-2296) is published monthly by the American Welding Society for \$120.00 per year in the United States and possessions, \$160 per year in foreign countries; \$7.50 per single issue for domestic AWS members and \$10.00 per single issue for nonmembers and \$14.00 single issue for international. American Welding Society is located at 550 NW LeJeune Rd., Miami, FL 33126-5671; telephone (305) 443-9353. Periodicals postage paid in Miami, Fla., and additional mailing offices. **POSTMASTER:** Send address changes to *Welding Journal*, 550 NW LeJeune Rd., Miami, FL 33126-5671. **Canada Post:** Publications Mail Agreement #40612608 Canada Returns to be sent to Bleuchip International, P.O. Box 25542, London, ON N6C 6B2

Readers of *Welding Journal* may make copies of articles for personal, archival, educational or research purposes, and which are not for sale or resale. Permission is granted to quote from articles, provided customary acknowledgment of authors and sources is made. Starred (*) items excluded from copyright.

Bill Introduced to Fund Targeted Workforce Training

Legislation to support partnerships between employers and potential employees for training programs in targeted areas has been introduced in Congress — the Strengthening Employment Clusters to Organize Regional Success (SECTORS) Act of 2008, sponsored by Senators Sherrod Brown (D-Ohio) and Olympia Snowe (R-Maine). This legislation would support “sector” or “industry partnerships,” which have been utilized for years around the country but have never received Congressionally authorized funding. These partnerships attempt to target specific industries in an effort to create or improve opportunities for workers, address the workforce needs of employers, and promote economic development at the regional level.

Fatal Occupational Injuries Decline

The Bureau of Labor Statistics recently reported that fatal work injuries in 2007 totaled 5488, representing a 6% decline from just one year earlier. While the results are preliminary (final results to be issued in April 2009), this figure represents the smallest annual preliminary total since the Census of Fatal Occupational Injuries (CFOI) program was first conducted in 1992. Other key findings of the 2007 CFOI include as follows:

- Construction continued to incur the most fatalities of any industry;
- Structural iron and steel workers had the fourth highest fatality rate of any occupation at 45.5; and
- There were increases in some types of work fatalities — fatal falls on the job rose to a high of 835 in 2007, and workplace homicides increased by 13%.

Higher Education Act Reauthorized

The first full reauthorization of the Higher Education Act in more than a decade has been signed into law. The statute, which is more than 1000 pages in length and includes a large variety of provisions, has received mixed reviews from the media and interested organizations. Even Congress and the White House have been reluctant to cite this law as a major accomplishment. Nevertheless, the statute appears to have several positive provisions, including increasing the maximum Pell grant amount to \$8000 and authorizing year-round Pell grants, instead of just during the academic year, which may be particularly beneficial to vocational education students. The law also creates inducements for states to hold tuition steady, simplifies the FAFSA student aid application, and establishes several new grant programs, including Business-Workforce Partnership Grants, College Partnership Grants, and Bridges from Jobs to Careers Grants.

California Adopts New Green Building Code

The state of California has adopted the nation’s first statewide green building standards code. Approved by the state’s Building Standards Commission in mid-July, the new standards are designed to encourage construction of new buildings to use at least 15% less energy, conserve water, and reduce the use of products containing toxic substances. Building more energy-efficient buildings and homes is a key element of the state’s strategy to comply

with its mandate to cut greenhouse gases to 20% below 2005 levels by 2020, or by about 30%. Initially voluntary, the new standards become mandatory with the state’s 2010 California Building Code.

New Foreign Trade Regulations Established for Export Process

Effective October 1, 2008, the Census Bureau is requiring mandatory filing of export information through the Automated Export System (AES) or through the AESDirect for all shipments where a paper Shipper’s Export Declaration is required. New regulations also have tougher penalty provisions that affect everyone in the export process. Penalties may be imposed per violation of the Foreign Trade Regulations from \$1100 to \$10,000 both civil and criminal, for the delayed filing, failure to file, false filing of export information, and/or using the AES to further any illegal activity.

Congress Likely to Set New Record for Bills Introduced

A little more than 10,000 bills have been introduced in the current U.S. Congress, placing it on a pace to exceed the current record of 10,537 set by the 109th Congress in 2005–2006. The last several years have shown a consistent increase in the number of bills introduced in each Congress. The 104th Congress (1995–1996), for example, saw more than 6500 bills introduced, and this increased to more than 7500 in the 105th Congress. Later Congresses prior to the 109th held steady in the high 8000s. Of course, only a small fraction of bills introduced are actually considered, much less passed into law.

Manufacturing Workers Represent Large Share of Displaced Workers

The Bureau of Labor Statistics released its most recent survey of worker displacement. Displaced workers are defined as persons 20 years of age and older who lost or left jobs because their plant or company closed or moved, there was insufficient work for them to do, or their position or shift was abolished. A few highlights from the survey are as follows:

- As was the case in prior surveys, manufacturing accounted for a disproportionately large share of displaced workers;
- Nearly 1 in 4 long-tenured displaced workers lost a job in manufacturing;
- About 45% of long-tenured displaced workers cited plant or company closings or moves as the reason for their displacement;
- Manufacturing displacements were concentrated within the durable goods component, particularly in transportation equipment and in computers and electronic products; and
- Of the 8.3 million displaced workers, 67% had found new jobs. ♦

Contact the AWS Washington Government Affairs Office at 1747 Pennsylvania Ave. NW, Washington, DC 20006; e-mail hwebster@wc-b.com; FAX (202) 835-0243.

INTRODUCING THE ALL NEW **AUTO-REAMER™**

Extend the Life and Performance
of your Robotic Torch Consumables.

The New 2100E & 2100EC Features:

- Electronic Control for Cycle
- Electronic Control of Anti-Spatter Spray
- 1 or 2 Blade Reamer Design
- Adjustable Spray Control
- Optional Center Spray for one stop Reaming/Spraying



Model 2100EC

Model WC-95

Model WC-95E

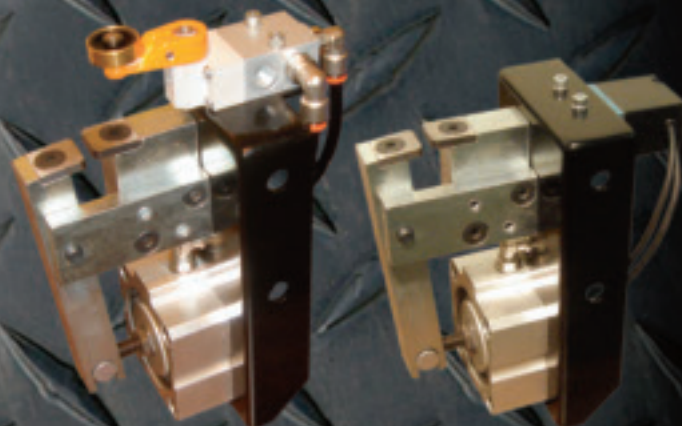

For more information on CM Industries new line of
2100 series Nozzle Cleaning Stations,
go to CMINDUSTRIES.COM.

The Wire Cutter can be easily
mounted to a remote location
or directly to our Nozzle
Cleaning Station, and can be
used with all makes and models
of robotic equipment.

Model 2100E

Model SC-4

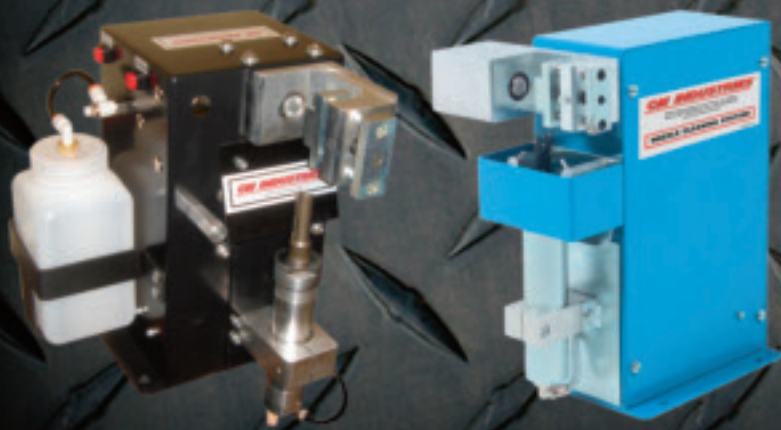

CM INDUSTRIES®
INC.

www.cmindustries.com

For Info go to www.aws.org/ad-index

MANUFACTURED BY CM INDUSTRIES, INC. IN LAKE ZURICH, ILLINOIS U.S.A.

CM Industries, Inc. 505 Oakwood Rd. Lake Zurich, IL 60047 ph: 847-550-0033 www.cmindustries.com

New Flux Cored Wire Company to Begin Production Early Next Year



CEO of ESAB Welding & Cutting Products and is now reentering the industry with the backing of a team of investors and welding experts.

The new facility, located at 2015 W. Stanfield Rd., Troy, Ohio, will be filled with patented manufacturing equipment. Flux cored wire production is expected to begin early next year. The facility will produce all types of FCAW wires — gas shielded, self-shielded, stainless steel, and low alloy — in a variety of packaging options. The company is investing more than \$14 million in capital.

“We’re excited about what we’re doing,” Blanchard said. “One of our objectives is to help manufacturing stay in the United States.”

When questioned whether there was a need for a new wire manufacturer, Blanchard responded, “I’m not concerned with saturation. There is a need for a true, high-quality flux cored wire.” One area in which the company will concentrate will be core fill percentage accuracy. Marketing and distribution will be multichannel, both domestic and international.

The Troy site was selected for several reasons, Blanchard said, including its central location, large base of fabrication customers within a 200–250 mile radius, well-established supply chain, and Ohio’s history of having welding equipment and supplies as among its core industries.

Although Blanchard declined to state the number of workers the company expects to eventually hire, he did state the building “will be big enough for us to become a major force in the industry.” This 80,000-sq-ft research and manufacturing facility will also incorporate environmentally sound “green” construction materials. The company’s business plan calls for a five-year phase-in period.

ATI Enterprises to Award Veterans Scholarships

In support of U.S. veterans in the state of Texas, ATI Enterprises, Inc., is presenting the new Larry Gilbert/VFW Memorial Scholarship. In memory of Gilbert, ATI will award up to 16 scholarships — two at each of the eight current Texas ATI Enterprises campuses — to OIF and OEF veterans in collaboration with the Veterans of Foreign Wars and the Texas Veterans Leadership Program of the Texas Workforce Commission. Each scholarship will provide a veteran with 12 months to 3 years of career training at ATI in many fields, including welding. Selected veterans may opt for the program of their choice where they meet entrance requirements for that specific program.

“Larry Gilbert was loved by everyone at ATI, in the community, and by state and federal government officials, as he lived a committed and exemplary life, combining his great love for the Marines with his passion for education. We want to honor him by thanking our veterans for their service and sacrifices,” said Arthur E. Benjamin, vice chairman and CEO of ATI Enterprises.

Applications are available at www.ATI4Veterans.com and must be submitted no later than October 31. The selection process will be conducted between November 1 and 15. Successful candidates will be notified by November 25.

Unified Testing Services Awarded Contract Renewal

Unified Testing Services (UTS), a member of TUV Rheinland of North America, recently announced its nondestructive examination services contract with Atlanta-based Southern Co. has been renewed for an additional three years. UTS will provide nondestructive examination services at approximately 20 of Southern’s electrical power-generation plants in Alabama, Florida, Mississippi, and Georgia. Additionally, the contract involves weld inspection during outages or rebuilds and component inspection of power-generating turbines and boilers, as well as high-pressure piping.

Publisher *Andrew Cullison*

Editorial

Editorial Director *Andrew Cullison*

Editor *Mary Ruth Johnsen*

Associate Editor *Howard M. Woodward*

Associate Editor *Kristin Campbell*

Peer Review Coordinator *Erin Adams*

Publisher Emeritus *Jeff Weber*

Graphics and Production

Production Manager *Zaida Chavez*

Senior Production Coordinator *Brenda Flores*

Advertising

National Sales Director *Rob Saltzstein*

Advertising Sales Representative *Lea Garrigan Badwy*

Advertising Production Manager *Frank Wilson*

Subscriptions

Subscriptions Representative *Edalia Suarez*

esuarez@aws.org

American Welding Society

550 NW LeJeune Rd., Miami, FL 33126

(305) 443-9353 or (800) 443-9353

Publications, Expositions, Marketing Committee

D. L. Doench, Chair

Hobart Brothers Co.

T. A. Barry, Vice Chair

Miller Electric Mfg. Co.

J. D. Weber, Secretary

American Welding Society

R. L. Arn, *WELDECH International*

S. Bartholomew, *ESAB Welding & Cutting Prod.*

D. Brown, *Weiler Brush*

J. Deckrow, *Hypertherm*

D. DeCorte, *RoMan Mfg.*

J. Dillhoff, *OKI Bering*

J. R. Franklin, *Sellstrom Mfg. Co.*

J. Horvath, *Thermadyne Industries*

D. Levin, *Airgas*

J. Mueller, *Thermadyne Industries*

R. G. Pali, *J. P. Nissen Co.*

J. F. Saenger Jr., *Consultant*

S. Smith, *Weld-Aid Products*

D. Wilson, *Wilson Industries*

J. C. Bruskotter, Ex Off., *Bruskotter Consulting Services*

H. Castner, Ex Off., *Edison Welding Institute*

L. G. Kvidahl, Ex Off., *Northrup Grumman Ship Systems*

G. E. Lawson, Ex Off., *ESAB Welding & Cutting Prod.*

E. C. Lipphardt, Ex Off., *Consultant*

S. Liu, Ex Off., *Colorado School of Mines*

E. Norman, Ex Off., *Southwest Area Career Center*

R. W. Shook, Ex Off., *American Welding Society*

Copyright © 2008 by American Welding Society in both printed and electronic formats. The Society is not responsible for any statement made or opinion expressed herein. Data and information developed by the authors of specific articles are for informational purposes only and are not intended for use without independent, substantiating investigation on the part of potential users.



LIFETIME WARRANTY

Every cut is covered.

PUROX® torches, regulators and flowmeters now come with a lifetime warranty.

For years, ESAB Welding & Cutting has made welders' lives easier with its reliable, innovative PUROX line of torches, regulators and flowmeters. And now, PUROX joins OXWELD® and Prest-O-Lite® by offering a lifetime warranty,* giving you peace of mind along with incredible performance.

*The new warranty applies to standard torches, regulators and flowmeters manufactured on or after January 1, 2008. All items manufactured before that date will still have a five-year warranty.



Be Safe When Welding or Cutting. Please read and understand the safety labels, instruction manuals and/or safety data sheets for your welding or cutting products before you weld or cut. Always follow safe practices and use adequate ventilation when welding or cutting. More information on welding health and safety can be found at www.esabna.com.

GREAT THINGS HAPPEN WHEN YOU PUT US TO WORK

esabna.com + 1.800.ESAB.123

For Info go to www.aws.org/ad-index



Our Strategic Focus: Welder Workforce Development

The AWS and the AWS Foundation have made welder workforce development initiatives their major strategic issue. This involves addressing the critical shortage of welders in the United States from "recruitment to retirement." The major focus of the AWS Foundation's **Welding for the Strength of America** capital campaign inaugurated in 2006 has two goals: establish additional scholarships to support entry-level students and those already involved in the welding profession, and build funding to support the **AWS Welder Workforce Development Program**. To address the anticipated welder shortage of 200,000 by 2010, we feel it is critical for us at AWS to assume this role and enlist our industry partners for both financial and creative solutions.

An experienced welding industry authority with more than 30 years in the welding profession, Al Crichton, after consultations with many others in the welding industry, helped us design a plan to begin addressing, in a meaningful way, these critical welding personnel shortages. These shortages are not only affecting those whose businesses depend totally on the welding profession but also manufacturing, construction, and other industries. For example, to build ships, bridges, nuclear plants, and oil rigs, welding is a critical component. The AWS board of directors and the AWS Foundation trustees late last year quickly adopted the components of the plan and implementation is fully underway. The successful implementation of the plan's many aspects will depend upon the financial support we receive.

We have implemented the building of our **Solutions Opportunity Squad (SOS)**, who are staff members working with all issues involving welding workforce development (see p. 72). Initial focuses are on regional and area issues that can have widespread application and serve as a template to take beyond a local area. The SOS staff are being recruited and placed throughout the United States so they are accessible and close to the geographical regions being served. This also allows them to focus on important industries close to them and the welder shortages they have. The SOS members will build linkages between the private and public sector, inclusive of the educational institutions and training facilities supporting welder training. The major focus is building welder workforce development from recruitment to retirement.

Some of our industry partners are supporting a number of special initiatives that you will hear about shortly. We feel these are innovative and will focus on image and recruitment. We must enforce at all levels the excellent career paths that are available to a welding professional. With additional training and educational programs, an entry-level welder can pursue an interesting career both in job content and financial rewards. As with many other professions, the advancements available are unlimited and dependent only on the work efforts, education and training gained, and aspiration of the welder professional.

Yes, the numbers discussed are staggering: 200,000 welders needed by 2010. We are moving forward one step at a time. We hope many of these steps are giant steps and will have an impact on influencing significant growth in the welding workforce. Everyone reading this can have an influence on this effort. Help us recruit! You have had, I hope, a successful work experience either directly in a welding profession or in a closely related career field. Talk with young people; influence the local educational leadership to put energy and funds into welder training programs. If you are in a position in which you can, mentor young people and discuss career opportunities with them. Be an active recruiter for the welding industry. Help us help others know that there are many related career opportunities.

We Need You!



Ronald C. Pierce
Chair, AWS Foundation Board of Trustees



Officers

- President *Gene E. Lawson*
ESAB Welding & Cutting Products
- Vice President *Victor Y. Matthews*
The Lincoln Electric Co.
- Vice President *John C. Bruskotter*
Bruskotter Consulting Services, LLC
- Vice President *John L. Mendoza*
CPS Energy
- Treasurer *Earl C. Lipphardt*
Consultant
- Executive Director *Ray W. Shook*
American Welding Society

Directors

- B. P. Albrecht (At Large), *Miller Electric Mfg. Co.*
- O. Al-Erhayem (At Large), *JOM*
- A. J. Badeaux Sr. (Dist. 3), *North Point High School for Science, Technology & Industry*
- J. R. Bray (Dist. 18), *Affiliated Machinery, Inc.*
- H. R. Castner (At Large), *Edison Welding Institute*
- N. A. Chapman (Dist. 6), *Entergy Nuclear Northeast*
- J. D. Compton (Dist. 21), *College of the Canyons*
- G. Fairbanks (Dist. 9), *Fairbanks Inspection & Testing Services*
- D. A. Flood (Dist. 22), *Tri Tool, Inc.*
- M. V. Harris (Dist. 15), *Valley National Gases*
- R. A. Harris (Dist. 10), *Consultant*
- D. C. Howard (Dist. 7), *Concurrent Technologies Corp.*
- J. Jones (Dist. 17), *Thermadyne*
- W. A. Komlos (Dist. 20), *ArcTech LLC*
- D. J. Kotecki (Past President), *The Lincoln Electric Co.*
- D. Landon (Dist. 16), *Vermeer Mfg. Co.*
- R. C. Lanier (Dist. 4), *Pitt C.C.*
- J. Livesay (Dist. 8), *Tennessee Technology Center*
- D. L. McQuaid (At Large), *DL McQuaid & Associates*
- S. Mattson (Dist. 5), *Mattson Repair Service*
- S. P. Moran (Dist. 12), *Miller Electric Mfg. Co.*
- R. L. Norris (Dist. 1), *Consultant*
- T. C. Parker (Dist. 14), *Miller Electric Mfg. Co.*
- W. R. Polanin (Dist. 13), *Illinois Central College*
- W. A. Rice (At Large), *OKI Bering, Inc.*
- N. S. Shannon (Dist. 19), *Carlson Testing of Portland*
- E. Siradakis (Dist. 11), *Airgas Great Lakes*
- K. R. Stockton (Dist. 2), *PSE&G, Maplewood Testing Serv.*
- G. D. Uttrachi (Past President), *WA Technology, LLC*
- D. R. Wilson (At Large), *Wilson Industries*

Arcos 625 Takes High Nickel Alloy Quality to Extremes

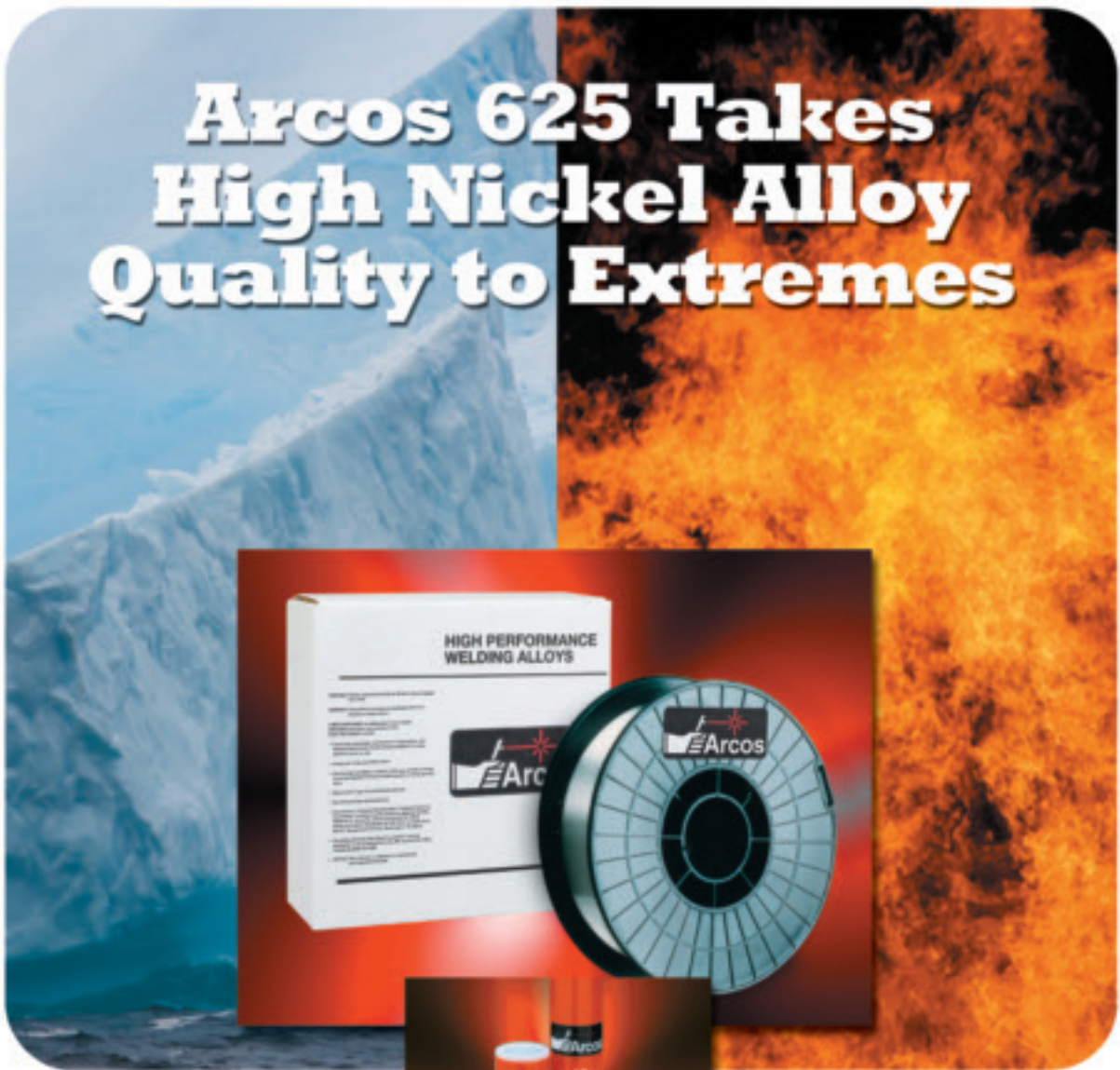

Arcos, *The Standard of Excellence in Covered Electrodes and Bare Wire*, offers two outstanding welding products designed to withstand critical temperature extremes.

Arcos 625 and Arcos 1N12 (625) are nickel-chromium-molybdenum products which are designed to be virtually immune to chloride-ion stress-cracking. They feature moderate strength, good fabricability and excellent oxidation resistance. Each is military-approved and provides superior corrosion resistance, over a range of temperatures from cryogenic to extremely elevated (up to 1,800°F).

Arcos 625 is ideal for welding alloys 625, 601, 802 and 9% nickel. This wire is well suited for welding piping systems and reactor components in the power generation industry and for high temperature service in a wide variety of other engineering applications.

Arcos 1N12 (625) is utilized for welding alloys such



as 625, 800, 801, 825 and 600. This covered electrode is the smart choice for applications including petrochemical plants, reactor components, furnace equipment, heat exchangers and offshore marine environments.

To learn about the many advantages of specifying Arcos 625 and Arcos 1N12, call us today at **800-233-8460** or visit our website at www.arcos.us.

Arcos Industries, LLC

One Arcos Drive • Mt. Carmel, PA 17851
Phone: (570) 339-5200 • Fax: (570) 339-5206



NASA's Marshall Center Demonstrates First Weld with Tools to Be Used on Ares 1



John Meyer (tooling engineer, Jacobs ESTS Group/JTI) adjusts a friction stir weld pin tool mounted on the MSFC robotic weld tool. Meyer supports the MSFC friction stir weld production facility, where weld parameters are being optimized for manufacturing Ares launch vehicles. (Photo by David Higginbotham/courtesy of NASA.)

At NASA's Marshall Space Flight Center (MSFC) in Huntsville, Ala., engineers recently made the first "official" weld with tools that will enable development of the upper stage of the *Ares 1* rocket. These engineers used tools that soon will aid in the manufacture of major test hardware for the *Ares 1* rocket, slated to carry human missions back to the moon, on to Mars, and out into the solar system in coming decades.

Friction stir welding, first used in the aerospace industry in 2005 to weld elements of the space shuttle external tank, will be used. This process produces high-strength, almost defect-free bonding at joints, and can weld materials with uniform precision.

Currently, NASA is developing hardware and systems for the *Ares 1*. Beginning in 2015, the rocket will launch the Orion crew capsule to the International Space Station, carrying six astronauts and small pressurized cargo payloads.

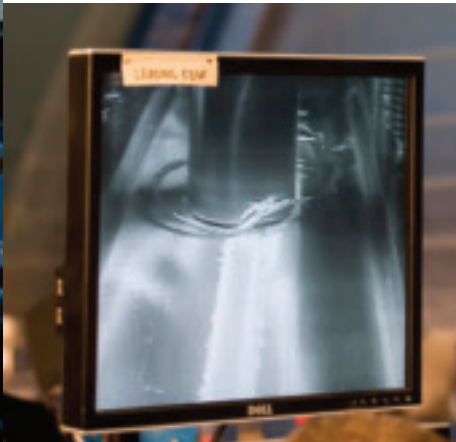

A television monitor records the first official welds of the new friction stir welding machine at the MSFC. The machine will be used to develop the processes for welding manufacturing the Ares 1 upper stage component of the Ares launch vehicle. (Photo courtesy of NASA.)

Ultrasonically Welded Suit Swims to the Top at Beijing Olympics

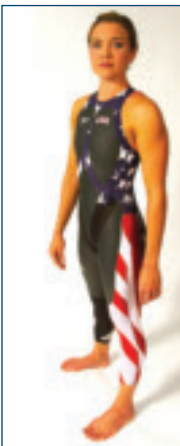

Swimming recently took center stage as one of the most highly anticipated events to watch at the Beijing 2008 Olympic Games held in China August 8–24. During those games, a sophisticated swimsuit from Speedo®, the LZR RACER™, received a lot of attention and many athletes who wore it achieved major milestones.

Impressively, in eight days of swimming, 23 out of 25 world records were achieved by athletes wearing the suit at the Beijing Games (92%); 94% of gold medals and 89% of all medals were won in the suit; and every event in men's swimming was won by an athlete wearing it.

Speedo utilized the expertise of NASA

During the Beijing 2008 Olympic Games, Speedo's LZR RACER swimsuit played an important role, and included in its high-tech construction was the use of ultrasonic welding. Shown above is gold medal swimmer Natalie Coughlin in the Team USA LZR RACER designed by Comme des Garçons.

along with international research institutes for the suit's creation. Aqualab, the company's global research and development facility, developed its concept. Other development details included water flume tests, CFD analysis, 3D body scanning, and working with the world's best athletes.

Instead of using a conventionally stitched or woven seam, the suit is ultrasonically welded, giving the effect of no seams at all. Due to this, the 100% bonded seams provide 6% less skin friction drag (the force that tends to slow a swimmer down by means of the water passing along the surface of the suit and/or skin).

"It feels like a spacesuit," USA champion Michael Phelps is quoted as saying on the Web site www.speedo80.com/lzr-racer/. Phelps himself made history by winning eight gold medals at these games.

Rick Sharp, a professor of exercise physiology who is also director of Iowa State University's kinesiology laboratories, was part of a team of outside experts who helped design the suit. He insisted though it is the swimmer, and not necessarily the suit, that will ultimately produce a gold medal.

"The suit has a lot of outstanding technical qualities, but it doesn't know how to swim," said Sharp. "It's that interaction between talent and technology that makes it really special, I think." The design team spent more than three years and worked with collaborative bodies to get the suit where it is.

Features of the suit include 5-10% less passive drag than the

company's other streamlined suits. Passive drag affects a swimmer in the streamlined position, which is achieved after the initial dive and after a turn.

According to Speedo, the LZR RACER made from an ultra lightweight, low drag, water-repellent, and fast-drying fabric called LZR PULSE™ is the world's first fully bonded competition swimsuit.

Thermadyne Honors Cee Kay Supply



Thermadyne Industries, Inc., St. Louis, Mo., honored distributor Cee Kay Supply on its 60th anniversary. The company presented representatives of Cee Kay with a sculpture welded by artist Brother Mel Meyer, S.M. From left are Cee Kay President Tom Dunn; Thermadyne Executive Vice President of Global Sales & Marketing Martin Quinn; Meyer; and Ned Lane and Heath Wells of Cee Kay.

PSEG Collaborates with HIWT to Create Program for Welding Training



Here's the boiler repair welder mechanic's class of 2008. From left are Donald Locke, Chris Magielnicki, Michael Wolff (welding instructor with HIWT), Kurt Miller, John C. Atkinson, and Karl Brown.

To help alleviate the shortage of skilled welders, Public Service Enterprise Group (PSEG), Newark, N.J., joined forces with



ORBITAL WELDING SOLUTIONS

P4 Performance!



- **XXL TOUCH SCREEN** for intuitive graphically assisted programming.
- **Automatic Procedure Generation (APG).**
- Load/store and transmit all data via **USB or Ethernet connection.**
- Complete and comprehensive **traceability.**

P4, the intelligent and communicating orbital welding power source.

ASTRO ARC POLYSOUDE INC
24856 Avenue Rockefeller
VALENCIA, CA 91355
sales@astroarc.com
T. 661-702-0141 - F. 661-702-0632
www.astroarc.com

For info go to www.aws.org/ad-index

MATHEY DEARMAN

TULSA, OK USA

Experts in
Cutting & Aligning
Pipe



4344 S. Maybelle Avenue

Tulsa, OK 74107

(918) 447-1288 • 1-800-725-7311

FAX (918) 447-0188

www.mathey.com sales@mathey.com



Student Joe Wright works on his overhead plate test using shielded metal arc welding.

Hobart Institute of Welding Technology (HIWT) this spring to develop a customized welder training program presented April 27 to July 25.

Consisting of 480 hours of instruction, it focused on shielded metal arc welding (SMAW) and gas tungsten arc welding of pipe. Upon completion, the six participating PSEG system mechanics received HIWT certificates and promotion to boiler repair welder mechanic.

Also, on July 1 PSEG kicked off its second welding program for the company's newly hired system mechanics. The objective of the eight-week program is to introduce mechanics to the basics of welding. Oxyacetylene safety and cutting, plasma cutting, plate SMAW, and theory were covered. After completing the program, students will continue their mechanical training through PSEG's Fossil Training Group in South Plainfield, N.J.

With many new employees, PSEG and the Middlesex County (New Jersey) Board of Education formed an alliance to hold the system mechanics welding training programs at the district's two vocational high schools in East Brunswick and Piscataway during the summer recess.

This partnership has proven to be beneficial to both the company and school district. PSEG is able to recruit students to meet its needs by offering good career opportunities to the district's student population. In 2009, the PSEG Fossil Training Group is planning to hold three additional welding programs.

AMT to Partner with FABTECH International & AWS Welding Show and METALFORM

The Association for Manufacturing Technology (AMT), FABTECH International & AWS Welding Show and METAL-

For info go to www.aws.org/ad-index

FORM have announced a partnership to combine the expertise of several trade associations resulting in an event with appeal to a wider range of metal forming, metal fabricating, and welding industry professionals. The industry partnership begins immediately with the combined efforts directed toward the event in Chicago set for November 2009.

In addition, following the 2008 International Manufacturing Technology Show, IMTS will no longer feature a Metal Forming & Fabricating/Lasers Pavilion. A new Nontraditional Machining & Processes Pavilion will debut at IMTS 2010. According to AMT President John B. Byrd III, AMT will recommend that companies with forming, fabricating, laser, and welding/joining technology exhibit at the FABTECH International & AWS Welding Show and METALFORM event.

Laser Institute of America Commemorates 40 Years of Advancing Laser Technology

The Laser Institute of America (LIA), Orlando, Fla., is celebrating 40 years of promoting the growth of laser applications and their safe use worldwide. The organization was formed in 1968 by a group of academics, scientists, developers, and engineers who were passionate about turning the emerging new laser technology into a viable industry.

Among the institute's accomplishments are training laser safety officers, serving as the secretariat and publisher of the ANSI Z136 series of laser safety standards, forming the Board of Laser Safety in 2002 as a nonprofit organization affiliated with LIA, and developing an alliance with the Occupational Safety and Health Administration in 2005.

Wet Welding

Take Your Welding Skills Underwater. Train In 5 Months For A High-Paying And Exciting Career As An Underwater Welder. Dive In, Get Wet... And See Sparks Fly In Your New Career!

DIVERS ACADEMY INTERNATIONAL

Classes Now Forming

Call Today!
800-238-DIVE

www.diversacademy.com

Commercial Deep Sea Dive Training Since 1977

For info go to www.aws.org/ad-index

Grip-It™ Modular Weldhead

Take Hold of Your Next Pipe Welding Job™

Single Action - Quick Clamping and...
A field proven Orbital Welding Solution!



FAST & EASY SET-UP - PERFECT FOR ALL BOILER TUBES
NO COSTLY CHAINS, TRACKS OR GUIDE RINGS...

Grip-It™ Attach Directly to the Pipe



WELDHEAD FEATURES:

- 2 Optional Modular Clamping Systems
 - Full Range Adjustable
 - Specific Size Chuck Clamping Pads with WaterCooling for Pre-Heated Tubes



- Tilttable Torch for Socket Welds (45°)

- Clutch for Rapid Cable Unwinding (Models 195 thru 275)



- Optional Modular Attachments
 - Arc Voltage & Oscillation Control
 - Wire Feed, On-Board or Remote
 - Remote Control Vision System
 - Modules for I.D. Welds & Cladding

- Models Available for 1/4" thru 10" NPS

Grip-It™ Modular Weldhead

...And It's Only From



Orbital Welding Solutions

Grip-It™ is a Trademark of Astro Arc

* IN PIPING

ASTRO ARC POLYSOUDE INC
24856 Avenue Rockefeller - Valencia, CA 91355
T. 661-702-0141 - F. 661-702-0632
www.astroarc.com - sales@astroarc.com

For info go to www.aws.org/ad-index

IPG Awarded Contract to Supply Fiber Lasers to German Automaker

IPG Photonics Corp., Oxford, Mass., recently announced its German subsidiary, IPG Laser GmbH, has received an order for continuous wave ytterbium fiber laser systems totaling 63 kW in power from the BMW Group in Munich, Germany. These high-power fiber lasers will be used in the new production line at BMW Group for the welding of automotive doors. The contract also represents the first large-scale production use of fiber laser systems for the German automotive manufacturer.

Set for manufacturing at IPG's facility in Burbach, Germany, the lasers are scheduled for delivery in the fourth quarter of 2008.

Additionally, BMW Group purchased the company's fiber lasers with its newly released integrated cooling system. The systems are further equipped with an integrated beam switch and flexible processing fibers.

ESAB Opens New Flux Plant

ESAB Welding & Cutting Products has added a flux plant to its filler metal manufacturing facility in Hanover, Pa., providing the company with an upgrade in manufacturing capacity. The addition of this larger flux plant will allow the company to produce many of its bonded subarc fluxes in North America.

According to Chris Depew, product business manager for the flux product line, it features current technology including lean manufacturing and will produce a broad range of products for a variety of market segments including shipbuilding, wind towers, structural steel construction, and general fabrication.



Many of the fluxes used in subarc welding applications, such as the one shown here, will be produced at ESAB's latest flux plant.

— continued on page 93

We make companies, small or large, **Stand Out.**

About AWS Corporate Memberships:

The American Welding Society (AWS), understands that one size does not fit all. For that reason, we've created FOUR different levels of corporate membership, starting for as little as \$150 per year, allowing you to select a program that best fits with the way your company operates. With an 88-year history in the welding industry, and 50,000+ members worldwide, AWS Corporate Membership offers your company the ability to **INCREASE ITS EXPOSURE and IMPROVE ITS COMPETITIVE POSITION.**



American Welding Society

Contact Us:

CALL US FOR MORE INFORMATION, OR TO JOIN AT:
(800) 443-9353, EXT. 480, OR (305) 443-9353, EXT. 480.
OR VISIT US ON-LINE AT WWW.AWS.ORG/MEMBERSHIP.



Just About the Only Type of Positioner We Don't Make.



HT Series
Head - Tailstock

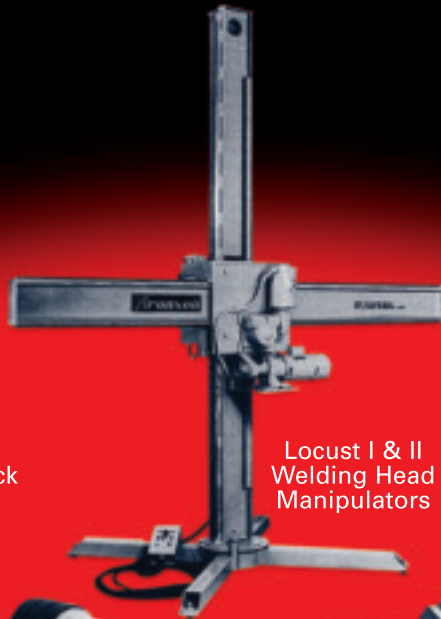

Locust I & II
Welding Head
Manipulators



HD Series
Gear Driven
Positioner



TR Series
Turning Rolls



Koike Aronson positioning equipment can't tee up your 392-dimple favorite, but we have you covered nearly everywhere else — from 100 lbs. to 4 million lbs., at any angle. Koike Aronson/Ransome can help you weld just about any type of piece more profitably. Call us to find out how we can make your welding operation more efficient.



For Info go to www.aws.org/ad-index

Koike Aronson, Inc./Ransome Arcade, NY USA 800-252-5232 Houston, TX 800-868-0640

www.koike.com

Q: Many filler metals used for welding steel are required to have a guaranteed minimum Charpy V-notch impact toughness value, especially for applications where low-temperature service is to be experienced. How is this issue addressed in aluminum? I know that aluminum is used in cryogenic applications. Are the aluminum filler metals that are used in these very low temperature applications required to be tested in order to meet minimum impact toughness requirements?

A: You are correct, aluminum is used in cryogenic applications. In physics or engineering, cryogenics is the study of the production of very low temperatures (below -150°C , -238°F , or 123K) and the behavior of materials at those temperatures. The word cryogenic originates from the Greek word Kryos, which means very cold. Aluminum is used in many applications that are very cold. One of the most well known is LNG tankers. LNG tankers are large ships that carry vast amounts of liquid natural gas (LNG) in very large welded aluminum spheres — Fig. 1.

Many materials, when subjected to these



Fig. 1 — Liquid natural gas (LNG) tanker with four large welded aluminum spheres (tanks).

very low temperatures, undergo changes in their physical structure that severely limit their usefulness in cryogenic applications. Some metals, like many steels for example, become extremely brittle.

Aluminum alloys, however, have been demonstrated to have an unusual ability to maintain their ductility and resistance to shock loading at extremely low temperatures approaching absolute zero -459°F (-273°C). As temperature decreases below room temperature, aluminum's tensile and yield strengths actually increase as the temperature decreases, and the ductility and toughness of most alloys increase as well. Even at the lowest test temperatures available, in liquid helium, strength remains high and ductility and toughness remain well above values at room temperature for most alloys — Fig. 2.

Consequently, aluminum alloys offer distinct advantages over most steels when used for construction of cryogenic equipment or for structures that will experience cryogenic cold.

One type of test used to establish the ability of a material to deform plastically in the presence of a severe stress raiser is the notch tensile test, conducted in accordance with the American Society for Testing and Materials International (ASTM) E338 - 03 Standard Test Method of Sharp-Notch Tension Testing of High-Strength Sheet Materials, and E602 - 03 Standard Test Method for Sharp-Notch Tension Testing with Cylindrical Specimens. The notch-yield ratio from such tests, the ratio of the fracture strength of a severely notched specimen to the tensile yield strength of the material, illustrates whether or not the material yields before fracturing in the presence of a severe crack or flaw, and comparison of values over a range of temperatures illustrates susceptibility to embrittlement effects if deterioration is evidenced.

Tests have shown that Alloy 5083-0,

Lower the Cost ...Not the Quality



NEW! Low Cost AMDRY® Braze Filler Metals for Automotive Applications

Our new braze filler metals cost less than nickel-based filler metals, braze with similar cycles and produce joints with equal strength and corrosion resistance. For more information, contact our Braze Product Manager at +1 248 280 3113 or Deni.Fortuna@Sulzer.com.

SULZER

Sulzer Metco (US) Inc.
1101 Prospect Ave
Westbury NY 11590
U.S.A.
Tel.: +1 516 334 1300
Fax: +1 516 338 2414
www.sulzermetco.com

Average results of tensile tests of some aluminum alloys for low-temperature service

Alloy and Temper	Temperature Deg F	Tensile Strength psi	Yield Strength psi	Elongation in 2 in %	Reduction of Area %	Notch Tensile Strength psi
2219-T851	Room Temp	67,600	53,800	11.0	27	79,400
2219-T851	-320	82,500	63,800	13.8	30	94,500
2219-T851	-452	96,100	69,000	14.0	26	102,100
3003-H114	Room Temp	22,900	21,100	16.8	68	Not available
3003-H114	-320	36,600	25,900	32.5	56	Not available
3003-H114	-452	58,100	30,100	32.0	49	65,100
5083-0	Room Temp	46,800	20,400	19.5	26	54,000
5083-0	-320	63,000	23,000	34.0	34	61,000
5083-0	-452	80,800	25,800	32.0	33	62,300
5083-H321	Room Temp	48,600	34,100	15.0	23	61,100
5083-H321	-320	66,100	39,700	31.5	33	70,400
5083-H321	-452	85,800	40,500	29.0	33	73,700
6061-T6	Room Temp	44,900	42,200	16.5	50	69,200
6061-T6	-320	58,300	48,900	23.0	48	83,400
6061-T6	-452	70,100	55,000	25.5	42	89,900

Fig. 2 — Mechanical properties of aluminum alloys increase as the temperature decreases.

which is often chosen for cryogenic applications, sustains more than twice its tensile yield strength before fracturing, even at temperatures approaching absolute zero. Data for many other aluminum alloys illustrate that they too are free of any type of brittle-to-ductile transition in fracture behavior.

Much technical data are available that demonstrate outstanding cryogenic performance of aluminum alloys. Tensile, compressive yield, and shear ultimate strengths increase with the decrease in temperature; at -320°F (-196°C) ultimate strengths are 35-50% above room temperature values, and yield strengths are 15-25% higher. The moduli of elasticity increase with decrease in temperature; precise measurements at -320°F (-196°C) have shown that moduli are 15-17% above the room temperature values. Fatigue strengths, like static tensile and shear strengths, increase with decrease in temperature; at -320°F (-196°C), for 5xxx alloys, both base metal and weldments have fatigue strengths about 25% above room temperature values. Toughness as measured by notch-yield ratio (notch tensile strength/tensile yield strength), unit propagation energy (tear resistance), and plane stress or plane strain fracture toughness remains high over the entire range of cryogenic temperatures; for those alloys recommended most often for cryogenic service, toughness by any indicator is well above the room temperature value, even near absolute zero. As mentioned earlier, there is no indication of a ductile-to-brittle fracture transition with aluminum, as often exhibited by some ferritic materials, even for the highest strength aluminum alloys.

Conclusion

In response to the original question: Are the aluminum filler metals that are used in these very low temperature applications required to be tested in order to meet minimum impact toughness requirements?

As seen above, at very low temperatures aluminum alloys show an improvement in their mechanical properties, yield and tensile strengths can increase significantly, and elongation and impact strength remains relatively constant. Because aluminum alloys exhibit these characteristics and the fact that aluminum has no ductile-to-brittle transition, neither the American Welding Society (AWS) nor American Society of Mechanical Engineers (ASME) welding standards require low-temperature Charpy or Izod impact testing for aluminum filler metals. ♦

Acknowledgment

I would like to thank the Aluminum Association for permission to reproduce material from its publication *Aluminum Alloys for Cryogenic Applications*.

TONY ANDERSON is corporate technical training manager for ESAB North America and coordinates specialized training in aluminum welding technology for AlcoTec Wire Corporation. He is a Registered Chartered Engineer and holds numerous positions on AWS technical committees. He is chairman of the Aluminum Association Technical Advisory Committee for Welding and author of the book *Welding Aluminum Questions and Answers* currently available from the AWS. Questions may be sent to Mr. Anderson c/o *Welding Journal*, 550 NW LeJeune Rd., Miami, FL 33126, or via e-mail at tanderson@esab.com.

Weld smarter, not harder.

Swagelok® M200 Power Supply for Orbital Welding



- Auto-create feature for weld schedules includes 12 different material options
- Up to 200-amp peak output capability
- High-resolution, 12.1-inch (307 mm) color SVGA industrial touch screen
- Integrated mass-flow controller automatically controls OD shield gas flow
- Real-time monitoring and recording of weld output performance to support industry requirements
- Swagelok global presence, support and training, with more than 20 years in orbital welding

www.swagelok.com/M200

Swagelok®

MEET THE CHALLENGESM

Swagelok - TM Swagelok Company, Meet the Challenge - SM Swagelok Company ©2008 Swagelok Company

For info go to www.aws.org/ad-index

4th International Brazing & Soldering Conference (IBSC)



American Welding Society

April 26-29, 2009

Hilton in the Walt Disney World Resort, Orlando, Florida

Recognized by industry professionals as the world's premier event for the brazing and soldering community.



- Interaction with hundreds of professionals, scientists and engineers from around the globe
- Exchange and discussion of research, development and application of brazing and soldering
- Comprehensive technical programs for brazing and soldering
- Valuable networking opportunities
- Pre-conference educational programs
- Over 60 exhibitors
- Key information on trends, products, processes and techniques

Areas covered at IBSC

The following is a listing of some of the topical areas that have been covered at the IBSC. Stay tuned for full program information to be provided in the future. This premier event is truly one that anyone involved in the brazing and soldering community should plan to attend.

- Aircraft and Aerospace
- Automotive and Transportation
- Brazing and Soldering Standards
- Ceramic/Glass to Metal Joining
- Chemical and Petroleum Production
- Composite Materials
- Electronic Packaging/Sensors
- Filler Metal Properties
- Fluxes and Atmospheres
- Fixture Design and Use
- Musical Instruments
- Power and Electrical Equipment
- Sensors/Microelectronics
- Solder Joining Methods
- Special/Advanced Brazing Processes
- Structural Solder Applications
- Test Methods and Evaluation
- Furnace/Vacuum Brazing
- Joint Design and Reliability
- Lead-free Solders
- Light Metals
- Materials and Process Design/Control
- Medical/Dental
- Mining & Heavy Equipment
- Modeling and Process Control
- Consumer Products
- Factory Automation
- Job-Shop & Process Customization
- Thermal Management
- Vacuum Brazing
- Gases and Plumbing
- LEAN Brazing Processes
- Low-volume Critical Components

Register Today At:

www.aws.org/education/ibsc or call 800-443-9353, ext. 213
(outside North America 305-443-9353) or for more information,
call (800)443-9353, ext. 455, email: nlopez@aws.org or sharon@aws.org
Registration includes: Evening Reception on Monday, April 27, 2009 &
Networking Dinner on Tuesday, April 28, 2009



Reach the innovators, influencers and decision-makers in the brazing and soldering industry from around the world.

Exhibit and Sponsorship Opportunities

IBSC provides a forum to showcase the latest trends, products, processes and techniques in the industry. The exposition features exhibitors from all sectors of the brazing and soldering community and draws decision-makers with purchasing power from around the world. There is no better opportunity to conduct business with the brazing and soldering community than to have a presence at this conference.

ASM International and AWS are dedicated to delivering the audience you want and the value you need. Your exhibitor fee includes one technical session pass for you or someone in your organization to attend the full conference. Plan now and reserve your space and/or sponsorship for 2009!



Photo: Marty Alan McGill

Exhibit Dates and Times

Monday, April 27
 Noon – 6:00 PM
 Lunch: Noon – 1:00 PM
 Networking Reception: 6:00 PM – 7:00 PM

Tuesday, April 28
 9:30 AM – 3:00 PM
 Lunch: Noon – 1:00 PM

Wednesday, April 29
 9:30 AM – 3:00 PM
 Lunch: Noon – 1:00 p.m.



Pricing:

Tabletop Exhibit*.....	\$1200
Tabletop Exhibit* and Reception Sponsorship.....	\$1800
Reception Sponsorship Only.....	\$750

***Complimentary full conference registration included with your tabletop!
 Customized packages that best meet your needs also available!**

To download a complete Exhibit/Sponsor Information Packet, visit the web at www.aws.org/education/ibsc/tabletop.html

Reserve Your Exhibit Space and Sponsorship Today

For more information or to reserve exhibit space and sponsorship at the IBSC call (440) 338-1733, or (440) 338-5422, email: kelly.thomas@asminternational.org or vickie.shalhoup@asminternational.org



Photo: Marty Alan McGill

Brazing Alloys, Solders Offered for Plumbing and HVAC Applications



The Viper line of brazing alloys, solders, and fluxes fulfills a variety of functions. It includes five brazing rod alloys, five solders, four high-silver alloys, three fluxes, and an aluminum repair kit. The brazing alloys line is useful for joining copper to copper and are self fluxing in this application. They include silver, copper, and phosphorus brazing alloys. Additionally, these alloys can be used on bronze and brass. Viper alloys feature compositions for a full range of flow and fill characteristics. The premium alloys are available in 28 stick packages. Also, the high-silver brazing alloys are cadmium free and come in a range of compositions. These alloys are offered in wire coil form and in many sizes ranging from 1 to 5 troy ounces. The SX solder is a lead-free, anti-mony-free product offering a low melting point and a wide melting range for good flow and control. This nontoxic solder is safe for potable water and creates corrosion-resistant, leak-tight joints. The silver-bearing solder is presented as well in two compositions — SI recommended for fast-melting, free-flowing jobs, and SS rec-

ommended when a wider melting point is desired. These solders are cadmium free and lead free. Plus, the soldering flux paste is a water-soluble, nontoxic flux for use on copper, brass, tin, silver, galvanized iron, lead, mild steel, zinc, and malleable iron. This paste cleans as it solders and is an all-weather flux for use in various climates. The silver brazing flux paste is high-heat resistant and has powerful cleaning action to minimize waste of silver solders. Aluminum flux paste solders aluminum at lower temperatures and works well with all Viper solders. The aluminum repair kit, designed for repairing aluminum evaporators and ducts, includes aluminum flux paste and solder; it can be used to solder aluminum to copper.

TurboTorch®
www.turbotorch.com
(636) 728-3000

GTAW Machine Features Big LCD Screen



The Invertec® V310-T AC/DC was designed to serve as a welding solution for advanced motorsports, aerospace, ship building, and construction. The machine features a large, bright LCD screen — the patent-pending Dynamic Display™. The user has control over weld processes from simple SMA mode and basic GTA to AC/DC GTA pulse welding. Also, the screen allows for easy viewing of adjustable parameters with a single control knob. More complicated controls are readily viewable and, for example, show how the arc is affected when parameters are changed or adjusted. Other highlights include the following: increased portability with its lighter weight, less space re-

quirements, an auto reconnect, and simplified installation; lower operating costs with decreased power consumption, higher power factor, and lower current draw; optional inclusion of a “smart” water cooler system; and detailed setup menu with the ability to customize the machine through enabling optional controls.

The Lincoln Electric Co.
www.lincolnelectric.com
(216) 481-8100

Variable-Speed Conveyor Included in Brazing System



With the company’s automatic coil brazing system, users can automatically braise copper return bends to A/C condenser coils while reducing skilled labor

and alloy costs. It further allows users to produce parts with consistent quality, improve cosmetics and joint strength, reduce field failures, and increase throughput. This cross-fire system features Auto-Ignition, a small footprint, a variable-speed conveyor, a variable output combustion system, and a heavy-duty air cool module. It is PLC controlled and fully programmable. Two manually adjustable manifolds allow brazing of 1–4 row coils.

Precision Engineered Systems
www.brazingsystems.com
(888) 272-0464

Flux Cored Wire Comes in Three Grades



The recently introduced Stoody® 300 series stainless steel flux cored wires are

stocked in Grades 308L, 309L, and 316L; and in both the flat/horizontal and all-position welding formulations.

Stoody® Co.
www.stoody.com
(636) 728-3000

Soldering Station Designed for Pb-Free Processes



The BT 8808 is a high-performance soldering station for lead-free processes. Using the microprocessor-driven JBC Advanced Technology that provides a fast thermal recovery, the station has up to 140 W of power allowing for higher throughputs while working at lower temperatures,

COMMERCIAL DIVING

**UNDERWATER WELDING
DIVE MEDIC TECHNICIAN
UNDERWATER BURNING
NDT LEVEL I & II
RIGGING AND CRANE SPECIALIST**





- Accredited and Licensed.
- Financial Aid Available for those that Qualify.
- Approved for Montgomery GI Bill.
- 16-Week Program.
- On-Campus Dorm and Meal Plan Available.

COMMERCIAL DIVING ACADEMY

www.888-424-2222 www.COMMERCIALDIVINGACADEMY.com



For info go to www.aws.org/ad-index



**SPECIALTY CORED WIRE
COATED WELDING ELECTRODES
TOOL STEEL MIG & TIG**



ASK US ABOUT FLOOD WELDING

- COBALT
- NICKEL
- HARDFACE
- STAINLESS
- ALLOY STEEL
- TOOL STEEL
- MAINTENANCE
- FORGE ALLOYS
- CUSTOM ALLOYS

12500 Grand River Road
Brighton, MI 48116
(810) 227-3251 or
(800) 848-2719
www.cor-met.com

For info go to www.aws.org/ad-index

which in turn provides better solder joint reliability and removes cold joint issues.

JBC Tools USA, Inc.
www.jbctools.com
(866) 429-5753

Device Delivers and Installs Brazing, Solder Rings



The automated VIN-R ring application system, using the combined principle of the company's VIN insertion system and locking bit, is designed to automatically feed individual rings like for brazing and coils onto tubing, or other user-specified part. Its nosepiece is customized for each user's unique ring and part, and is available in hand-held or fixtured system

configurations, or as a machine builder component. Also, this system allows the operator sensory feedback, enabling them to feel the part and ring connection prior to actuation for assembly accuracy.

Visumatic Industrial Products
www.visumatic.com
(859) 255-7907

Metal Cored Wires Reduce Rework, Cleanup



The Tri-Mark® Metalloy Vantage™ and Metalloy Vantage Ni1 gas shielded metal cored wires include patented technology that reduces silicon island formation and produces weld bead toe lines that are almost completely free of silicon deposits. The Vantage wire is useful for sin-

gle- or multipass welding on carbon steel applications, including those in the automotive, railcar, heavy equipment manufacturing, and general fabrication industries. The Vantage Ni1 wire is designed for welding nickel-molybdenum steel. Available in a variety of packages and diameters, both wires have additional features that minimize rework and cleanup, including improved wetting action along with good root opening bridging and sidewall fusion.

Hobart Brothers Co.
Hobartbrothers.com
(800) 424-1543

Automotive Weld Joint Inspection Technology Presented

The VIRO^{ws}i inspection system identifies a broad range of defects that occur in weld joints and that could be missed during manual weld inspection. It is useful for the automotive welding industry and improves vehicle craftsmanship. Automatic weld inspection is based on the laser triangulation method. A semiconductor laser, housed in a compact sensor, projects a line on the welded joint while a high-speed camera, also housed in the



You buy more than Brazing Filler Metals
- you buy knowledge

Try out our new developed FeCr - based
BrazeLet™ F300.

jim.morris@nah.com
www.nah.com

North American Höganäs 

For info go to www.aws.org/ad-index

C370SA Cold Saw has infinitely variable blade speed for precise cutting



▶ Infinitely variable blade speed control to match the job requirement

▶ Semi-Automatic push button solenoid operation

▶ Air-over-hydraulic system for optimum sawing rates

▶ Vertical column construction for vibration-free sawing

▶ Air vise with infinitely variable clamping pressure to prevent distortion

▶ Full electronic control/information system



6700 Quality Way
Portage, MI 49002
269-321-8860
Fax: 269-321-8890
www.kmtsaw.com

For info go to www.aws.org/ad-index



sensor, captures the line as an elevation profile. A three-dimensional image of the welded joint surface is created gradually through the relative motion of the sensor and object. All relevant deviation of the welded joint can be identified with 100% accuracy.

Vitronic Machine Vision, Ltd.
www.vitronic.com
 (502) 266-2699

Hand Torch Works in Any Position



The Twister@2 self-igniting hand torch has combined easy start electric ignition with the Twister@ swirl combustion technology to produce a faster lighting and more efficient product for the plumber and HVAC technician. It can be operated with M A P // P r o™, propane, or propylene. The swirl combustion flame is stable even in windy conditions and will operate in any position, even upside down. This torch with trigger lock and instant release can be used for soldering and brazing of copper, brass, and aluminum tubing.

dering and brazing of copper, brass, and aluminum tubing.

Uniweld Products, Inc.
www.uniweld.com
 (800) 323-2111

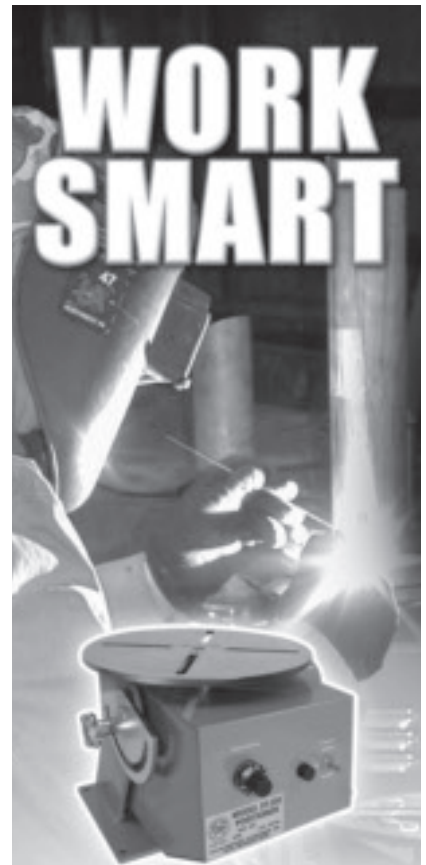

Model 200 Positioner
 3 models available:
 100 pound, 200 pound and
 500 pound capacity.



Model 1200 Pipemate
 Rotates pipe and tube
 from 1 1/2" to 17" diameter,
 up to 1200 pounds.

**Smart Work Handling
 Means
 Increased Productivity**



800-962-9353
www.atlaswelding.com

For info go to www.aws.org/ad-index

www.BSXGEAR.COM

**PROTECTION
 DONE RIGHT™**

VISIT US AT 2008 FABTECH/AWS Booth #12163

For info go to www.aws.org/ad-index

Welding System Utilizes Choice of CO₂ Slab Lasers



The Remote Welding System (RWS) concept has the laser system mounted above the working area, on a gantry, with the laser beam being delivered to the working area below by a series of mirrors. This is suited to applications within the automotive industry where large "body in white" components can be easily processed within the system. Depending upon the application, the system can in-

corporate one of a range of the company's CO₂ slab lasers. In addition, the Gaussian beam of the slab laser gives a depth of focus measured in tens of millimeters, and the effective working envelope of the RWS has been increased to 1500 × 2000 mm. With the capability to operate continuously on a three-shift pattern, approximately 20 million welding cycles equating to more than 300 km of weld joint can be generated without replacing any of the typical system wear parts.

Rofin-Baasel Inc.
www.rofin-baasel.com
(978) 635-9100

Solder Pots Contain Gray Cast Iron Crucibles

A line of industrial solder pots is designed for use with most lead-free solder alloys used for dip soldering and pretinning applications. They are also for use with RoHS compliant lead-free solders and feature gray cast iron crucibles that are resistant to the solvent powers of tin. The operating temperature of these pots should be 100°–150°F above the liquid temperature of the solder alloy and if kept below 800°F will be unaffected by the higher levels of tin found in lead-free solders. They are offered in two sizes, 1- and



2.5-lb capacities (320 and 600 W, respectively). Both include a removable stainless steel dross skimmer assembly, operate over a 350°–850°F range, and require 110/120 VAC 50/60 Hz.

American Beauty Soldering Tools
www.americanbeautytools.com
(800) 550-2510

Sensor Measures Four Items Simultaneously



The Model ZG 2-dimensional profiling laser sensor completes a full height and width inspection to capture entire shapes by measuring the X and Z axis in a single pass in milliseconds. It measures up to four items simultaneously and features a real-time profile display on the controller's built-in LCD monitor, too. A range of sensing heads capture profiles from 3 to 70 mm wide using a visible laser. With guided setup menus and 18 built-in measuring tools, the sensor is ready to inspect in three steps. It can further be configured to gauge height, 2-point step, 3-point step, edge position, edge width, angle and area, and perform comparative calculations between measurements. Also, the sensor is useful for automotive applications such as inspecting the quality and contour of body welds, positioning of body components, inspecting engine and drive train parts, and checking engine seal integrity.

Omron Electronics LLC
www.omron247.com
(866) 886-6766

Midalloy

Stainless, Nickel, and Low Alloy Welding Consumables

- **Consistent High Quality Products**
- **Technical Support**

In stock: St. Louis and Houston

1.800.776.3300
www.midalloy.com

For info go to www.aws.org/ad-index

NO-MARTM
Magnetic Fitting Tools

Attention: Metal Fabricators and Fitters

Is fit up a time consuming hassle?

Tired of grinding off temporary weldments and marring your metal?

Interested in tools that will cut your task time by up to 95% and increase your profits?

Don't keep wasting time and money! Visit our web site to view our catalog and get the best fitting tools in the industry!



Easily remove high-low mismatch
Power from a magnet you just won't believe!

Powered By
 MAGSWITCH

MAG-PRYTM
Pry Bar with 1,100 lb. Breakaway Magnet - No Electricity!

 **Fit Up Gear**TM
Innovators of fitting tools

NO-MAR Magnetic Fitting Tools - Changing the mindset of the welding industry!

Fit Up Gear is a Romar/MEC, LLC Company
218 W. Richey Road Houston, TX 77090 Phone: 281-440-1725 Fax: 281-440-1724 www.fitupgear.com Patent Pending

Changing the way things are done.

Introducing Revolutionary Magswitch Technology and Our New Line of MagSquares.

Magswitch will forever change your perception of magnets. Once you use Magswitch MagSquares, they'll have a permanent place in your toolbox. Our MagSquares provide a new level of fast and easy multiplane workholding when positioning steel. Magswitch MagSquares exert a powerful magnetic field with a simple 180-degree rotation of the knob.

Magswitch – changing the way things are done.



Compact and Strong

Holds metal on multiplanes for welding ease!



Precise Positioning

Shaped for 90-degree angles. Attach to flat/round surfaces.

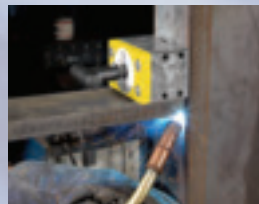

Stays Clean

Turn off Magswitch and wipe away debris.



magswitch[®]

Visit our website to learn more about revolutionary new Magswitch products:
www.magswitch.com.au

For info go to www.aws.org/ad-index

A New Road for Automotive Architectures



The Cadillac CTS features an aluminum hood. (Photo courtesy of Novelins.)

Traditional automobile welding processes won't be eliminated anytime soon, but automakers will need to expand their use of nontraditional joining technologies

BY JONATHAN JENNINGS AND JERRY GOULD

From soldered electrical connections to welded plastic gas tanks and gas metal arc (GMA) welded engine cradles materials joining is pervasive throughout automotive vehicles. To better understand the impact of joining on modern vehicle manufacturing, the Edison Welding Institute (EWI) has recently developed an automotive structures roadmap. The objective of the roadmap was to gain a high-level, global view of the drivers and directions of the automotive structures market. Due to the wide range of applications, it was determined that to maintain focus EWI's roadmap would be limited to the vehicle's structural components. By structural components we are referring to the body-in-white (BIW), chassis, subframes, interior structures, intrusion beams, and suspension systems.

The roadmap was developed through dozens of in-person interviews with senior technical staff, designers, materials researchers, and managers within the original equipment manufacturers (OEMs) and their supply base. In addition to the interviews, EWI conducted a Web-based survey of the automotive structures market. The interviews and Web-based survey, which were augmented by a literature review, focused on the critical business drivers and technical needs of this segment.

Business Drivers

Early conversations with automotive leaders identified three primary business drivers that are impacting product requirements. Those business drivers in-

JONATHAN JENNINGS (jjjenning@ewi.org) is automotive business development manager, and JERRY GOULD is technology leader, Resistance & Solid-State Welding, Edison Welding Institute, Columbus, Ohio.

Based on a paper presented at the AWS Detroit Section's Sheet Metal Welding Conference XIII, held May 13-16 in Livonia, Mich.



Fig. 1 — A cutaway illustration of a Chrysler Sebring depicting various grades of high-strength steels used in the structure. Blue indicates hot-stamped steel, purple indicates DP 590, and green indicates high-strength steel. (Photo courtesy of Auto-Steel Partnership.)

cluded vehicle safety, fuel economy and environmental issues, and massive changes in the business climate.

Vehicle Safety

Over the next decade as radar and vision technologies mature, we will see widespread implementation across most vehicle platforms of “active” safety devices. These active safety devices will provide consumers with life-saving technologies like adaptive cruise control, lane detection, and collision avoidance. In the meantime, the National Highway Transportation and Safety Administration (NHTSA) has proposed changes to Federal Motor Vehicle Safety Standard (FMVSS) No. 216, Roof Crush Resistance. When the new roof crush requirement is enacted, all vehicles up to 4500 kg (10,000 lb) will have to pass the test, currently the tests are limited to vehicles less than 2700 kg (6000 lb).

Under the pending changes to FMVSS 216 is one regarding the force that the roof must resist. Where the current test requires that the vehicle’s roof withstand a force of 1.5 times the gross vehicle weight rating (GVWR), the updated standard will increase the force to 2.5 times GVWR. To meet the pending changes, the industry has initially addressed the standard with a mass and cost neutral approach. This has largely been done through the introduction of new grades of steels known as advanced high-strength steels (AHSS). In addition to being mass and cost neutral, this approach has been implemented without significant changes to their welding processes — Fig. 1.

Table 1 — Where Automakers Expect to Gain 35% Fuel Efficiency

	Efficiency Expectation (%)
Powertrain efficiencies	10–20
Weight reductions	3–10
Aerodynamics/other improvements	5

Fuel Economy and Environmental Issues

When the roadmapping exercise began in summer 2007, gas prices were under \$2.90 per gallon. The major concern within the industry was that the revised CAFÉ standards under consideration in Congress would mandate a minimum 35% increase in fuel efficiency by 2020. To address this mandate, there is consensus that the majority of fuel improvements will come from changes to powertrain technologies ranging from cylinder deactivation and six-speed transmissions to widespread use of hybrids and, eventually, fuel cells (Table 1). Weight reduction will also make up to one third of the needed efficiency gains.

The challenge for weight reduction is twofold. On one hand, additional components are constantly being added to the vehicle for improved vehicle emissions, safety devices, and information/entertainment. Each of these devices increases the weight of the vehicle. Even fuel-efficient devices like hybrid battery systems can add up to 180 kg (400 lb) to the vehicle’s weight. On the other hand, OEMs are driving for weight reductions on the order of 320 kg (700 lb).

Industry leaders also expressed con-

cern over potential efforts in Washington with respect to greenhouse gas emissions. With the approach of the U.S. 2008 elections, it is also expected that additional climate-change legislation will be passed. There is consensus within the automotive industry that if serious greenhouse gas legislation comes into play at the federal or state level, it could require 60 to 80 mpg fuel economy, which is something none of them is prepared to handle. To meet the changing product requirements, automakers must take new approaches that allow them to meet the rising safety standards, reduce weight, and reduce cost.

Material Directions

The majority of the materials currently used in a vehicle structure are under 800 MPa. The survey results suggest a striking change in material direction. The majority of responses from the survey indicated that five types of materials: DP 980, martensitic, hot-stamped boron, aluminum, and magnesium materials are being considered for future use — Fig. 2.

Material Selection Factors

Further, in response to what were the leading factors that drove material selec-

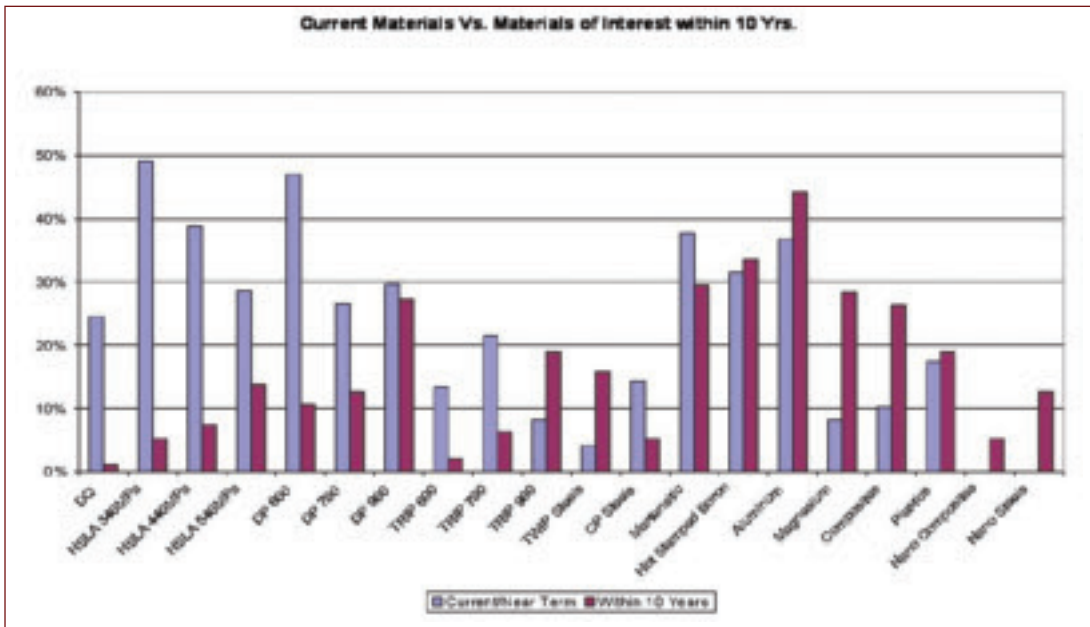

Fig. 2 — Survey results comparing the primary materials in use now vs. materials being considered for structural applications within the next ten years.

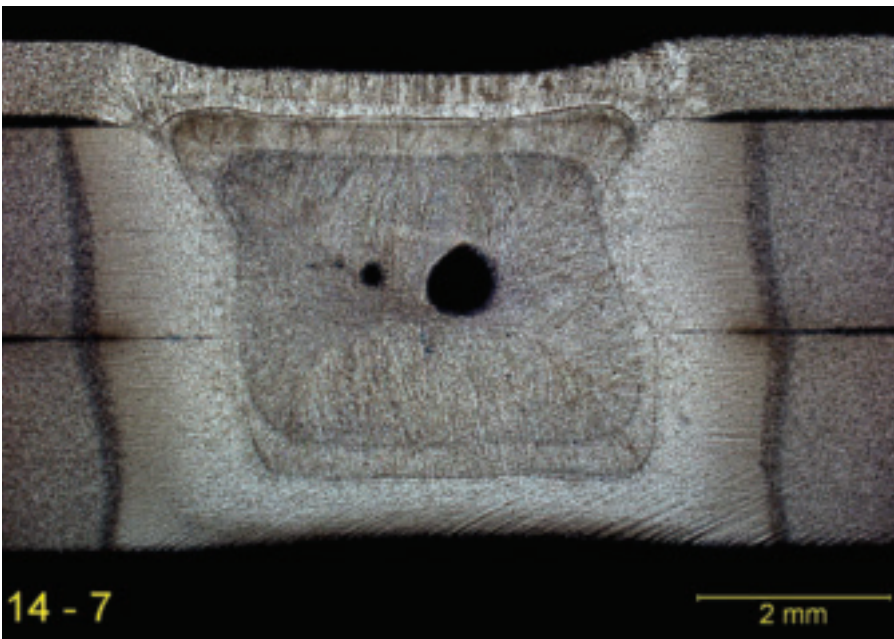

Fig. 3 — Cross section of a complex stack-up resistance spot weld allowing attachment of a thin outer sheet to two thicker sheets.

tion decisions, it was not surprising to see that structural performance was the leading factor. The second leading deciding factor used to select a material was its manufacturability. A great example of the “manufacturability factor” is the OEMs’ view with respect to hot-stamped steels. Due the combination of ultrahigh strength (a UHSS grade of steel), high formability, and relative weldability, hot-stamped steels are one of the fastest growing materials for critical safety applications. However, given the high costs associated with the hot-forming process, a preference was expressed for other materials if the formability issue could be addressed.

This formability issue has been acute for the higher strength dual-phased (DP) steels like DP 980. These issues include springback and cracking during stamping. The newly introduced TRIP steels offer better formability, but their high levels of aluminum and magnesium as well as variability in chemistry make these materials problematic to weld. Although OEMs would like to find a lower cost alternative to hot-stamped steels, the reality is until better formability processes are developed for 1000 MPa steels or OEMs become more comfortable with welding TRIP steels, the use of hot-stamped steels will likely increase.

There were also concerns expressed regarding global sourcing of steels. Specifically, automakers are concerned about global availability of specific grades of steel. Challenges rise when an auto manufacturer launches a vehicle that will be built and sold in multiple regions around the world (Asia, North America, and Europe). There is concern that specific grades of higher strength steels may either not be available around the globe, or that the specifics of the product (chemistry/processing) might vary from one continent to the next. All this makes the standardization of welding procedures difficult to maintain from plant to plant. As a result of these issues, automakers often end up using lower grades of steels that are available on a global basis.

Architectural Changes

Automotive structures have evolved from body-on-frame designs to unibody designs and back to body-on-frame. Over the years, other concepts such as space-frame designs have been attempted but have never taken hold for higher volume applications. In light of the high focus on weight reduction, the majority of engineers believe that the industry will make a dramatic shift toward unibody designs. An example of this shift is the growth of the smaller car-based crossover utility vehicles.

One of the key advantages the new UHSS offer is the ability to downgrade material thickness while still meeting the strength requirements. The original applications of AHSS and UHSS have been on limited structural components like B-pillars, door intrusion beams, and the BIW substructure. As automakers urgently attempt to reduce vehicle weight,

designers will expand their use of downgauging through UHSS to components like the frames and outer skins. Chrysler body engineer Don Baskin points out that “there is a point where downgauging only gets you so far before off-axis structural integrity is insufficient, then you have to look to other weight-reduction ideas.” From a welding standpoint, downgauging materials can lead to new challenges. Several OEMs are finding it difficult to resistance spot weld complex material stack-ups involving combinations of two thicker materials and a third thinner sheet — Fig. 3. As engine cradles and subframes are downgauged, engineers voiced concerns over welding thin-walled structures.

Several OEMs expressed renewed interest in looking to some variation of a “space frame” vehicle. Tubular structures or space frames can be constructed from hydroforming, roll-formed tubes, or box-shaped tubes. Space frames concepts have been traditionally considered only applicable for lower volume applications. However, they provide substantial opportunities for reducing vehicle weight. Space-framed vehicles can also work well within an agile manufacturing system. By attaching different outer panels to the space frames, OEMs can build multiple vehicles off the same frame. If tubular or space frame designs are employed, robust single-sided welding technologies will need to be developed.

Shawn Tarr, principal engineer in Honda’s Body Design group, echoed the interest of other OEMs in reducing flange width or ultimately converting to flangeless design. Weld flanges mainly serve to create resistance spot weld joints. If designers could employ flangeless designs, many advantages — from weight reduction and materials savings to better driver visibility — could be realized.

Tailor-welded blanks are another method that designers use to reduce weight since it is possible to optimize the strength and stiffness of the panels by changing materials and thickness within the blank. For this technology to be fully implemented, OEMs have said that lower cost approaches, such as batch welded blanks, need to be developed.

Multi-Material Vehicles (MMVs)

There has also been a substantial shift in the view of the range of materials to be considered in body structures. The industry perspective up to about 18 months ago was “cars are made out of steel, and will always be made from steel.” In addition, “the main safety cage will continue to be an ultrahigh-strength grade of steel for the foreseeable future.” However, one of the biggest changes that was identified in

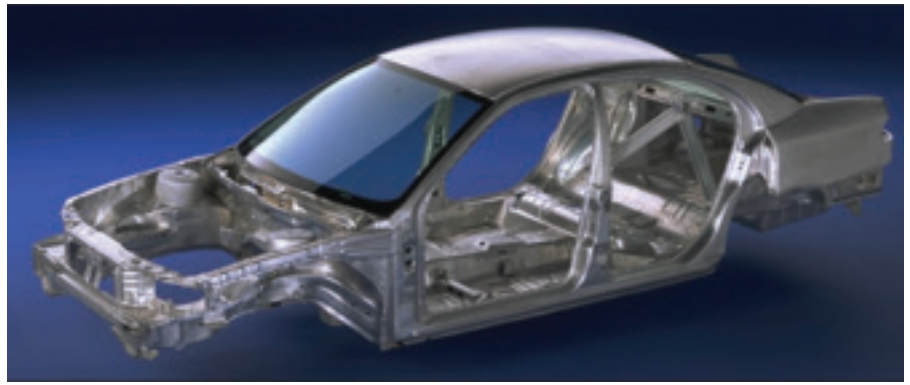

Fig. 4 — Jaguar’s aluminum BIW uses a combination of self-piercing rivets and adhesive. (Photo courtesy of Novelius.)



Fig. 5 — EWI concept tubular space frame incorporating magnetic pulse welding, deformation resistance welding, and controlled short circuit gas metal arc welding technologies (Al-steel).

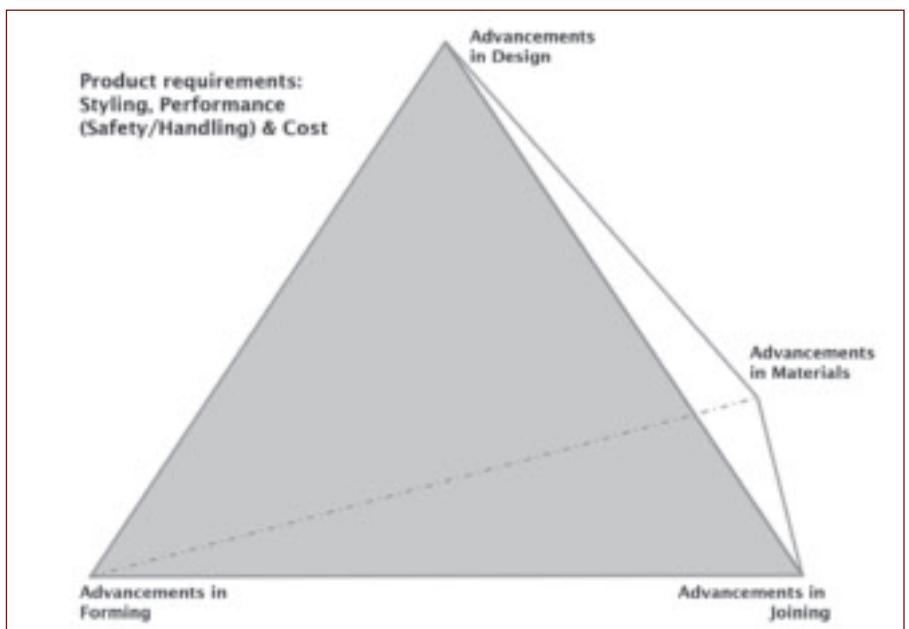

Fig. 6 — Multifaceted technical advancements will be required to meet changing vehicle product requirements.

the roadmap was the interest in using light materials for structural applications.

The interest in these alternative materials was so strong that some follow-up work was done to find out which light materials and material combinations were most likely to be brought into play, and which were the likely target applications for light metals. Engineers and designers expressed interest in joining any combination of UHSS, aluminum, magnesium, or cast steel. The initial applications for these will likely be closures (hoods, trunks, and doors), subframes, and suspension systems. Several OEMs are also actively interested in joining an aluminum roof to a steel side rail. An example of how far things could go in terms of MMVs was a magnesium door inner with an aluminum outer, bolted to a steel A-pillar.

Joining Process Trends

Resistance welding has long been a staple joining process in auto assembly plants. For thicker gauge applications like frames and suspension systems, gas metal arc welding is also widely used. The roadmap suggests that these processes won't be

eliminated anytime soon. One trend identified is the interest in expanding the use of brazing for BIW and structural applications. GMA brazing has seen limited application over the years but more recently laser brazing has enjoyed some success. In addition, direct laser welding offers potential for high productivities, high assembled structure stiffness, and a reduction in required flange widths. As a result, car makers are also looking to expand their use of this technology in the body shop.

Based on the high level of interest in applying MMV designs, OEMs and structural suppliers will have to employ a range of nonstandard joining technologies. These range from clinching and self-piercing rivets to weld-bonding and solid-state welding processes. Most of these technologies have been utilized on limited, low-volume applications. One of the challenges automakers must tackle is how to rapidly mature these processes for high-volume structural applications — Figs. 4, 5.

Critical Situation

Through the use of AHSS, the vehicles being built today have become much

stronger without adding mass to the structure. Governmental regulations and increasing fuel prices, however, are driving dramatic changes in vehicle product requirements. To meet the new product requirements, it is anticipated that there will be a transformation in a vehicle's powertrain and structure. Addressing the new challenges will require major changes to the materials, designs, and joining processes used to fabricate tomorrow's vehicles — Fig. 6. While these are major engineering challenges that will require serious R&D and tooling investments, the downside for the OEMs is reluctance from consumers to pay for these added features. While consumers see value added to the vehicle for additional features such as info-tainment systems, there is an expectation that improved safety and fuel economy are implicit in new generations of automobiles. Perhaps the most difficult issue automakers are facing is the pace at which they must make all of these changes at the same time that the North American car market is seeing its worst sales in years. ♦

WASHINGTON ALLOY CO.
We solve your silver brazing alloy needs with...
SUPERFLOW
High Quality Silver Alloys & Fluxes

- * 1, 3 & 5 T.O. coils, re-sealable packs
- * Flux coated Rods, 35, 45 & 56% Ag
- * 20" or 36" high-silver rods
- * Superflow quality brazing fluxes
- * 0-15% Phos.coppers

Technical reps available for product and application questions

ISO 9001:2000
Registered Quality Management Systems

U.S. ALLOY CO.
dba WASHINGTON ALLOY CO

East Coast:
7010-G Reames Rd.
Charlotte, NC 28216
(888)522-8296 T (704)598-6673 F

West Coast:
8535 Utica Ave
Rancho Cucamonga, CA 91730
(800)830-9033 T (909)291-4586 F

SE HABLA ESPAÑOL

For info go to www.aws.org/ad-index

GEDİK WELDING TECHNOLOGY

"IT IS ALL ABOUT WELDING"

**FABTECH
INTERNATIONAL &
AWS WELDING
SHOW 2008 LAS
VEGAS / USA
OCTOBER 06-08 ,
2008 BOOTH NO :
14129**

GeKa GeKaTeK GEDİK Welding

STICK ELECTRODES

Mild Steel Electrodes, Low Alloyed Electrodes, Creep Resisting Electrodes
High Strength Steel Electrodes, Stainless Steel Electrodes, Cast Iron Electrodes
Hard Facing Electrodes, Pipe Welding Electrodes, High Strength Cryogenic
Electrodes, High Temperature & Creep Resistant Electrodes, Corrosion Resistant
Electrodes, Heat Resistant Electrodes, Nickel Base Electrodes

WELDING WIRES

MIG Welding Wires, TIG Welding Rods, Submerged Arc Welding Wires, Mild
Steel Welding Wires, High Temperature & Creep Resistant Welding Wires, Flux
Cored Wire, Aluminium Wire, Bronze Wire, Copper Zinc Tin Alloyed Wires,
Oxyfuel Gas Welding Rods

WELDING MACHINES

MIG/MAG & Rectifiers; conventional and inverter type of welding machines
such as CO₂, MAG, MIG, AC/MIG, TIG, AC/DC TIG AC/DC TIG DC TIG
Pulsed MIG/MAG Synergic MIG/MAG AC/MIG-MAG and air plasma cutting

**"VERY
COMPETITIVE
PRICING"**



For Info go to www.aws.org/ad-index

GEDİK WELDING INC.

Ankara Caddesi No: 306 Seyhli 34913 Pendik - ISTANBUL / TURKEY
Tel: +90 216 378 50 00 (Pbx) Fax: +90 216 378 79 36 - 378 20 44
Web: www.gedikwelding.com E-mail: gedik@gedik.com.tr



Protecting Sensors in the Weld Cell: The Fastest Way to Increase Productivity

Some common sense solutions are offered for problems that plague sensors

BY DAVE BIRD

One weld cell manager said, “Sensors in welding cells are simply failure prone. They’re associated with high material consumption, and they are the cause of both planned and unplanned downtime. It’s the way it is. We work around the issues, have sensor change out down to a few minutes, and have even installed a couple of industrial vending machines so availability is instantaneous. We’ve simply accepted it and live in this paradigm.”

When it comes to sensors, cables, and connectors in weld cells, weld cell management people are so used to the high cost of constant replacement, downtime, and lost productivity that they begin to think it’s natural that weld cells are hostage to large amounts of production-robbing downtime. Sensors are frequently physically damaged by loading impact. Slag, weld debris, and heat ruin not only the sensors, but their associated connectivity. It gets to the point that most people involved with weld cells start thinking there’s not much you can do about the wastage but put in a vending machine or some kind of sensor-dispensing system close at hand — as if having replacement parts nearby is a viable process improvement.

Take a New Look at the Problem

It’s time to break the high sensor wastage weld cell paradigm.

It’s time to dispel the myth that maintaining weld cells equals high costs, constant replacement, and frequent maintenance

episodes. The reason that many weld cells have such high costs is that the sensors used may not match the application, and/or they are incorrectly placed in the cell, and insufficiently protected from heat, slag, and impact. It doesn’t end there. Often connectivity is supplied with the wrong cable jacketing material. Sensor mounts are often the wrong design for weld cell service or they are manufactured from the wrong materials such as lightweight plastics that are vulnerable to weld hostilities.

What Kills Sensors in Weld Cells?

Problem: Heat and Slag

High burst temperatures and weld debris, also known as weld slag, weld berries, or weld BBs, attack sensor enclosures, faces, connections, and flimsy plastic mounting brackets — Fig. 1.

Solution: Choose the Right Sensors

Sensors are rated devices and are application-specific. Choose the right sensor for the right application in every cell location, taking into account the type of welding being accomplished. Gas metal arc, gas tungsten arc, laser, and resistance welding all have their own unique set of characteristics. It cannot be assumed that every cell location can accept the same sensor type. Coated sensors provide a thermal



Fig. 1 — A sensor being destroyed by heat and slag.

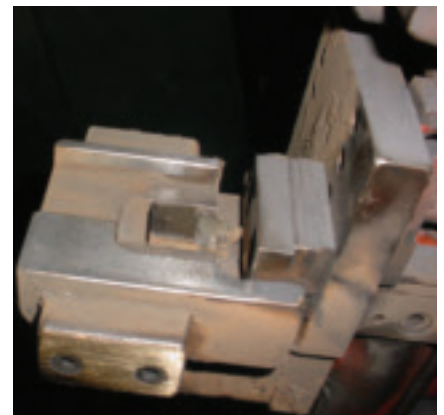

Fig. 2 — This flatpack sensor has a slag-resistant coating that greatly increases service life.

DAVE BIRD is welding industry manager, Balluff, Inc., Florence, Ky.

barrier, resist weld debris, resist slag accumulation, and resist, to a degree, impact on the sensor face. Steel-faced sensors are also noncontact devices, and tend to be more robust and resist impact. Try to use only “flush” (shielded) type sensors in weld cells — Fig. 2. They can be surrounded or encapsulated in metal, and there’s less potential risk to shearing off the exposed coil as with tubular nonflush types.

Problem: Loading Impact

Parts to be joined, or completed components that are loaded and unloaded, either manually or by robot, are dropped on exposed and vulnerable sensors, physically destroying the sensor (Fig. 3) or the entire sensing system. If an inductive proximity sensor located on a clamp comes in contact with metal to be joined, usually through loading impact, this can cause extensive sensor damage and premature failure.



Fig. 3 — A sensor destroyed by impact.

Solution: Bunker and Protect

Mechanical protection is central to the integration of any sensor in hostile manufacturing environments. These protective accessories provide a means of rapid change out and unparalleled deep thermal protection, act as a heat sink, guard against the heaviest of direct impact and weld debris, and ensure continuous sensor function. The time and effort spent to protect sensors from impact damage is more than well worth it — Fig. 4.



Fig. 4 — This prox sensor installed in a bunker block is well protected from heat, slag, and impact.

Problem: Cable and Sensor Don’t Line Up Correctly

This condition puts pressure and tension on the sensor/connector connection and leaves it open to heat and slag — Fig. 5. With heat, slag accumulation, and flex, connectors break at the most vulnerable location, causing premature failure.



Fig. 5 — These unprotected connections were destroyed by slag, heat, and impact.

Solution: Use the Highest Grade of Cost-Effective Connectors

Thermoplastic elastomer (TPE) exhibits excellent chemical, lubricant, flex, heat, nick, coolant, and pinch resistance. There are models that can function with every sensor found in the typical weld facility, making standardization easy and transparent to the organization. Use the right-angle connector to avoid strain on the cabling.

Seal your entire sensor/connector/mounting system with a new-generation self-fusing, self-bonding silicone wrap (Fig. 6) that’s rated to 500°F, is clear so LEDs can be observed, guards connections against fine weld spray, and eliminates the need for hose clamps (which attract weld berries) and zip ties for attachment.

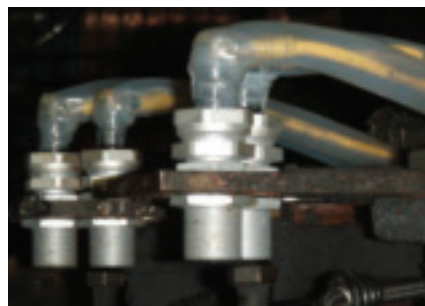

Fig. 6 — These sensors and connectivity will likely last 20 times longer than unprotected models.

Problem: Flimsy Mounting Brackets

Substandard mounting brackets deteriorate rapidly in welding environments — Fig. 7. This contributes to false sensing, no sensing, or increased vulnerability of the sensor itself. Moreover, with these brackets, sensor bodies are usually not encapsulated, therefore exposing them to high heat, weld debris spray, and impact.



Fig. 7 — These plastic brackets have been eaten away by slag and heat.

Solution: Greater Protection

Using a bunker block in conjunction with a quick-change prox mount protects the sensor body and face from debilitating physical damage. Prox mounts and bunker blocks are made of machined aluminum or steel and can be Teflon® coated. Teflon coating significantly prolongs sensor life by providing a thermal

barrier to protect against heat, retarding build up of weld slag spatter and spray, and easing removal of surrounding deposits of weld debris during scheduled maintenance periods.

These products together with Teflon-coated one-piece steel-bodied sensors, create a fortress against slag, heat, and impact that can usually last for months. Sensors with one-piece gun drilled stainless steel housings stand up to major incidental impacts. Their long life characteristics combined with Teflon coatings give them long term survivability in tough weld cell applications, and their price-performance ratio is the best in the market.

Teflon coating on the face of the proximity sensor also repels weld slag accumulation and protects the sensor face from damage even in the most severe welding environments. To connect the sensor, start with a high durability TPE cable, and then cover the cable and the sensor and its protective products with silicone tubing and weld wrap. This system (Fig. 8) protects the cable and secures the jacket in its proper location while sealing the remaining connectivity components against harsh, hot weld spray.



Fig. 8 — System to protect the cable and secure jacket in proper location.

Problem: Incorrectly Applied Photoelectric Sensors

Photoelectric sensors require attention to perform well in welding environments. Plastic-body photoelectric sensors must be protected from parts loading impact. In addition, just as with a pair of glasses, if the optical lens becomes excessively occluded, photoelectric sensors cannot perform their function — Fig. 9.



Fig. 9 — Unprotected plastic-bodied photoelectric sensors don't stand a chance in weld cells.

Solution: Choose Photoelectric Sensors with Heat and Mar-Resistant Lenses

Choose devices with high excess gain properties that can sense through dense weld smoke and debris. Use lens blow-off shields or air knives to create a positive air pressure in front of the sensor, lengthening the time it takes to fog over and reduce frequent maintenance wipe downs. Bunker all photoelectric sensors (Fig. 10) as you would any inductive proximity type. Avoid fiberoptics. One speck of debris and the fiber lens is usually rendered useless and both glass and plastic fiberoptic bundles are frequently broken in welding cells.



Fig. 10 — This photoelectric bunker block has a long productive life.

Problem: Cylinder Sensor Failure

Cylinder sensors are used to indicate clamp position that come in contact with the aluminum wall of a pneumatic cylinder in order to sense Gauss emitted by the piston magnet. They often can gather weld spray under the sensor element. This creates insulation that prevents proper position sensing. Often, the sensor is interpreted as nonfunctioning.

Solution: Clean and Seal

Cleaning the cylinder, reinstalling, and sealing against spray accumulation is the correct maintenance action.

Seal the pneumatic clamping cylinder sensors against fine weld spray from gathering between the sensor element and the cylinder wall. Many sensors interpreted to be nonfunctioning are tossed out every

day. Use the same protective tubing as with inductive sensors on cylinder sensor connectors and terminations — Fig. 11.

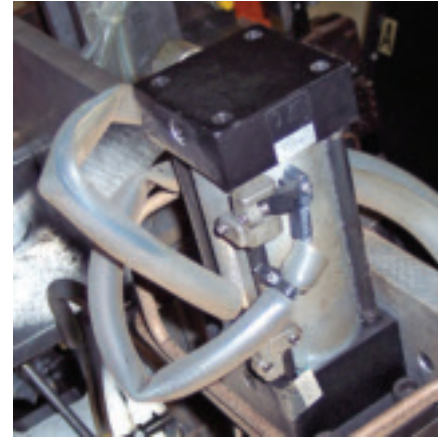

Fig. 11 — This cylinder switch is weld field immune and slag resistant.

Cable and Connector Protection

Protect cabling and connectors as well as sensors — Fig. 12. It's important to note that all of these sensor types are generally hard-wired to M12 DC Micro or M8 Nano-style connectors. One of the largest problems with sensors in weld cells revolves around the issue of cable/connector burn through.



Fig. 12 — This well protected weld cell is ready for months of maintenance-free operation.

PVC jacket material on connectors should never be used in a weld environment. PVC burns through quickly or can become extremely brittle in a short period of time. Polyurethane (PUR) styles offer a better degree of nick resistance, flex characteristics, and resistance to welding

debris, but a new generation of TPE (thermoplastic elastomer) takes the positive aspects of PUR to a higher degree of positive performance. Most weld cell users have learned to further encapsulate their connectors with opaque, medical-grade silicone that resists weld slag and “weld berries” and significantly prevents cable burn through. Newer materials such as woven ceramic fibers are currently being investigated.

Thermoplastic elastomer (TPE) jacketed connectors with medical-grade silicone protective sleeves resist the hostilities found in weld cells and lengthens connector life. Connector cables with TPE jackets offer superior weld slag resistance and flexibility. With their proven performance in weld cells, TPE cables are becoming a standard.

While TPE cables have outperformed other cable materials such as PVC and PUR, there are additional steps that can be taken to protect connector cables. Tubular silicone jacketing, cut to length and applied to the cables back from the connector will protect the cabling from ambient temperatures of up to 500°F as well as prevent slag buildup on the cabling.

Weld Repel™ wrap is a special silicone tape that once applied, like tape on a hockey stick, will protect the sensor and connector from slag and heat just as well as silicone jacketing. Once applied, the Weld Repel wrap bonds to itself, becoming a solid barrier to heat and slag, protecting anything it is applied to.

Vending Machines: Detours to Productivity

Vending and dispensing solutions may offer increased convenience, but they do nothing to lower operational costs — in fact, they tend to do the opposite. Vending machines make it easier to sacrifice sensors to a replacement process that actually may be out of control with little tracking of sensors as to where, why, and how often they are being installed. Before more dispensing machines are installed, get to the root cause of failure and fix the problems first. Worry about supply-chain management after the root causes of problems have been fixed.

Streamline your storeroom/crib MRO inventory. After you’ve gotten your arms around sensor-related problems, consolidated the number and types of sensors in stores/electrical cribs, weed out what you don’t need or will never use again. How many electrical cribs carry totally obsolete sensors and connectors? How many times has the wrong device been installed causing another downtime issue? Eliminate redundant sensors. Your sensor manufacturer should be able to help you through this process.

Get Started toward a More Efficient Weld Cell

Get a weld cell audit. If you’re experiencing what you believe to be heavy consumption of sensors used in your day-to-day welding process, or you believe maintenance time is out of ordinary, an audit of each individual sensor in every weld cell location may be warranted. In almost every instance, it’s possible, even highly probable, that you’ll dramatically increase production, reduce machine downtime, reduce material and maintenance costs, and increase profitability by integration of even a few of these recommended weld cell improvement methods.

Understand through a bona fide, documented weld cell audit, how every sensor in every location on the plant floor is performing, where recurrent problems occur and why, and where maintenance people are constantly replacing sensors. Get a handle on the problems, and regain control of your processes. Remember, the definition of insanity is doing the same thing over and over again and expecting a different result. Get buy-in and support for a sensor improvement/upgrade program from plant management down through the entire organization. It’s got to become embraced by the organization. A little pain (change) and a little cost-effective upgrade expense on the front end will pay massive dividends down the road. And it will allow maintenance personnel to do other, more important things.

Examine Your Process

A comprehensive weld audit will provide weld cell management with a complete review of weld cell sensor use. That means how well sensors are working, how well they are protected, and a means to lower sensor consumption and associated costs while significantly raising overall weld cell productivity. Here’s just one example of what happened when we did this for a large Tier One automotive supplier.

- From January 1 to April 27, 2007, the most problematic cell experienced 117 minutes of sensor-related downtime.

- Five different types of M18 proximity sensors were mounted in simple L brackets at various points in the weld cell. These sensors were exposed to large helping of slag, weld debris, and heat in the GMAW process.

- Unlighted connectors supplied through vending machines were experiencing extensive burn through.

The bottom line was that the downtime on this machine was assigned a value of \$422/min times 117 min of sensor-related downtime, which annualizes out to \$148,000.

Following an audit, all existing sensors and connectors were removed and replaced with two appropriate application-specific sensors. The sensors were installed in heavy bunker blocks with rapid-change out ready prox mounts or PTFE-coated prox mounts. Original unlighted sensor connectors were replaced with visible lighted TPE versions (which have high resistance to weld debris, slag, nicks, flex, etc.), all covered with medical-grade silicone weld-resistant jacketing and sealed with Weld Repel wrap. Once this was accomplished, the cell had a significantly upgraded sensor system protected from the weld environment by the latest in heat and slag protective technology.

After more than six months of evaluation, here’s what was reported:

- Zero sensor failures due to slag or heat.

- One sensor was damaged when a heavy component was dropped on it, but replacement downtime was not charged as a “Sensor Failure.”

- No maintenance interruptions due to weld cell hostilities or standard operational conditions were experienced.

The Bottom Line

Excluding cost of material for retrofit, this once problematic cell is now at a run rate to produce an overall per annum net savings of \$137,000, allowing maintenance personnel to be more productive. This reduces stress on the organization and reduces dependency on a vending machine to supply high-consumption components that shouldn’t be highly consumed devices in the first place.

Now that you’ve got your sensor problems straightened out, and your cribs are clean, resolve never get into this situation again. On your next weld cell order, be certain that you meet with your most able sensor manufacturer representative. Review sensor designs with that individual. Let him make suggestions and recommendations. Gather input as to what he thinks needs to go in each sensor location. Involve your own most able maintenance personnel and gather their input as well. After all, these are the people who live with the issues each day. Spend a little extra money on the front end for the best bunkering and protection, rapid change-out mounts, application-specific sensors, and connectivity systems you can find. Write the specification not only for the brand, but for the type of system that goes into the cell design, sensor location by individual location. Your weld cell OEM should be more than willing to accommodate your request for what you decide is best to ensure sensor longevity in your new cell. ♦

Study Yields Zero Weld Defects in Auto Seat Frames

A project at Middle Tennessee State University to improve torque failures found quality gets better as the weld tip pressure is reduced

A major Tier 1 automotive supplier was achieving a very good level of quality in its manufacturing process welding nuts to a metal seat frame. The operation produced 6 defects out of 10,000 units fabricated each week, resulting in a sigma level of 5.1. The company, however, wanted to achieve even higher quality levels.

It contacted Middle Tennessee State University (MTSU) and requested a design of experiments (DOE) study to determine root causes of torque failures and areas of improvement. The MTSU project team used Design-Ease® software from Stat-Ease, Inc., to perform a full-factorial model requiring a total of 36 runs.

The experiment provided optimal values for each factor and showed, surprisingly, that quality improves as the tip pressure is reduced. This is the opposite of what most company and MTSU participants originally thought. When the company implemented the optimal values determined by the experiment, the torque failures quickly disappeared.

Putting Metal Seat Frames Together

The welding operation in question involves attaching four nuts to the lower seat support in the front bucket seat of an automobile. Bolts are then used to fasten the nuts to guide rails that allow the occupant to adjust the seat. In the welding station operation, the lower seat-support-pan fixture rotates counterclockwise to align the seat frame with four projection nut welding machines. Each welding machine feeds a 6-mm nut to the pan using the same basic welding equipment configuration. A weld nut is automatically fed to



Fig. 1 — Seat pan with four weld joints marked with yellow numbers.

each lower alignment pin with a pneumatic feed system.

An upper cylinder has an attached electrode that mates with the seat pan, weld nut, and lower electrode. When this cylinder is extended, an electrical circuit is made that allows high current to flow from a transformer through a copper shunt to the electrode. This current passes through the nut and seat pan, generating

heat to weld the nut to the seat pan. The four profusions on each nut are melted and fused with the sheet metal — Fig. 1. The projection geometry permits the use of flat electrodes, thus producing welds at the projections.

Welding Process Characteristics

The factors in the welding operation

For more information, contact Middle Tennessee State University, Engineering Technology Dept., 1500 Greenland Ave., Murfreesboro, TN 37132, (615) 898-2776, FAX (615) 898-5697, dgore@mtsu.edu, <http://etis.web.mtsu.edu>; or Stat-Ease, Inc., 2021 E. Hennepin Ave., Ste. 480, Minneapolis, MN 55413-2726, (612) 378-9449, FAX (612) 746-2069, info@stateease.com, www.stateease.com.

include the following:

A) Tip force — the pressure level with which the electrodes contact the metal is controlled by an air pressure regulator.

B) Weld current — current amperage levels are controlled by a transformer and weld timer controller.

C) Squeeze time — the amount of time the electrodes make contact before the current is passed through.

D) Hold time — the amount of time the upper electrode makes contact with the nut while the current is passing through.

E) Cool time — the amount of time the electrode makes contact while the weld is in the cool-down period.

The response for the experiment is the torque at which each nut weld fails as measured with a peak-reading torque wrench. The low specification limit that ensures a proper weld is 354 in.-lb. Since there are four weld nuts per seat and 10,000 units fabricated per week, the original defect rate per million opportunities is 150.

Importance of Design of Experiments Studies

“The challenge in optimizing this process is that every operations person had their own recipe that had proven successful for them in the past,” said David W. Gore, associate professor at MTSU and project leader for this study. “All of these recipes worked but they did not provide optimal results. DOE offers the opportunity to move manufacturing operations to a higher level by scientifically mapping the application space. While human intuition is usually only capable of grasping first-order effects, DOE also considers second-order and multiple factor interaction effects. Design-Ease greatly simplifies the use of DOE by automating the process of designing experiments and analyzing the results.”

Carrying Out Tests

Gore used Design-Ease to design a two-level, full-factorial experiment with four midpoints for linearity checks (Table 1). The tests were run on a Saturday with MTSU students handling the identification, welding, and torque measurement of the parts, and company personnel operating the welding machine. Each part was tested until failure and the breakaway torque recorded.

The ANOVA for the five-factor model indicated the model was significant with an F-value of 13.11. The weld current, weld time, tip force, and interaction between squeeze time and weld time were identified as significant factors. Hold time was not a significant factor. The model

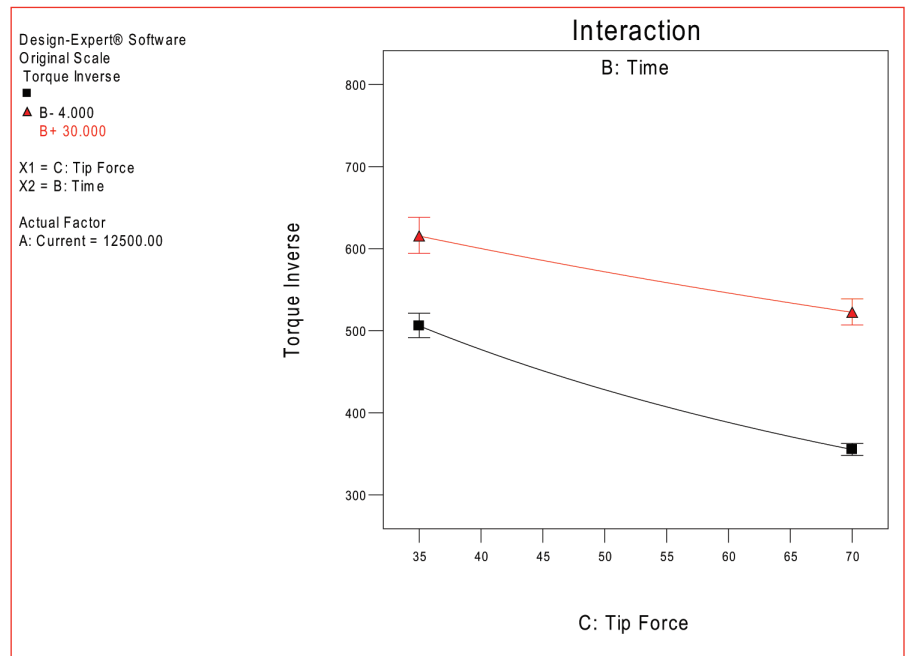

Fig. 2 — Interaction between time and tip force.

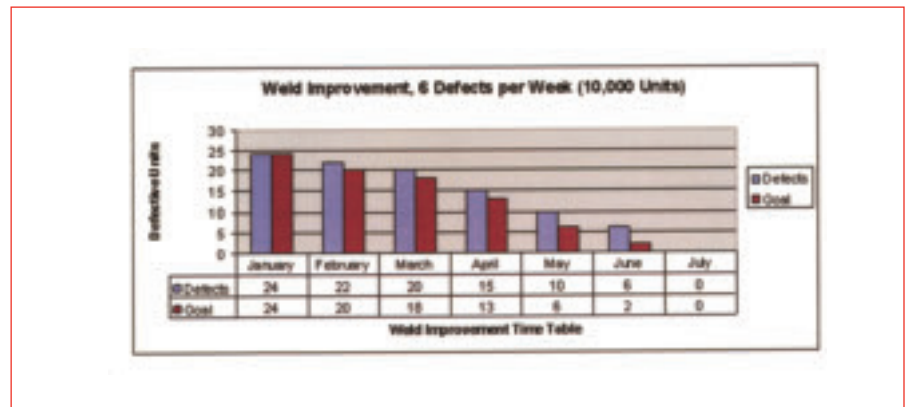

Fig. 3 — Quality results showing good progress.

“predicted vs. actual” showed some correlation but not strong enough for reliable predictions. The company welding engineer suggested combining squeeze time and weld time into a new factor called time and dropping hold time. The same results were reanalyzed as a three-factor interaction model.

The ANOVA for the new model provided a much improved F-value of 136.8. Weld current, time, tip force, and interactions between weld current and time and between time and tip force were all now significant. To improve the “normal plot of residuals,” the data were transformed with a power transform that further improved the results. This model was robust enough to reliably predict output

Table 1 — Two-Level, Three-Factor Model with Power Transformation

Test	Current (A)	Time (Cycles)	Tip Force (lb/in. ²)	Output Torque (in.-lb)
1	10,000	4	35	425
3	10,000	30	35	500
5	10,000	4	70	315
7	10,000	30	70	426
9	12,500	17	52.5	480
10	12,500	17	52.5	500
11	12,500	17	52.5	511
12	12,500	17	52.5	500
2	15,000	4	35	625
4	15,000	30	35	800
6	15,000	4	70	407
8	15,000	30	70	675

ALL NEW WEBSITE!

NBM NATIONAL BRONZE & METALS, INC.

National Bronze & Metals, Inc. carries large inventories of RWMA alloys in diameter bars, squares, coil, hex, and plates.

RWMA ALLOYS

WWW.NBMMETALS.COM

C15000 C17200 C17510 C18000 C18150 C18200

713-869-9600
TOLL FREE: 1-800-231-0771
sales@nbmmetals.com
www.nbmmetals.com

PO BOX 800818
HOUSTON, TX 77280
fax: 713-869-9124



THE LEADING MANUFACTURER AND MASTER DISTRIBUTOR OF BRASS, BRONZE, AND COPPER ALLOYS IN THE USA

For info go to www.aws.org/ad-index

WELDHUGGER COVER GAS DISTRIBUTION SYSTEMS

Snake Kit

Includes 6 nozzles, manifold, gooseneck assembly & magnet

\$349.⁹⁵

- Flows gas evenly over and behind the weld pool.
- Reduces oxidation and discolorization
- Designed for trailing shield and a variety of other applications.
- 316L Stainless steel nozzles and manifolds.

They're Bendable!

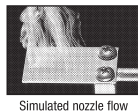
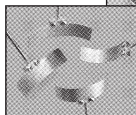
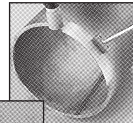

Simulated nozzle flow

Basic Kit

Includes 6 nozzles & manifold

\$249.⁹⁵

Trailing Shield Kit

Includes 6 nozzles & straight gas flow manifold

\$249.⁹⁵

WELDHUGGER LLC

Toll Free: (877) WELDHGR (877) 935-3447 Fax: (480) 940-9366

Visit our website at: www.weldhugger.com

For info go to www.aws.org/ad-index

torques for a wide range of factor settings — Fig. 2.

Based on this model, Gore concluded that the current setting of 70 lb/in.² for tip force is a primary contributor to low torque failures. Most participants in the study felt that a higher tip pressure would improve breakaway torque by holding the parts more tightly together. But a company engineer pointed out that reducing the tip pressure increases the resistance of the joint, which in turn increases the electrical resistance and results in more heat being generated by the welding operation.

Gore recommended that tip force be reduced to a value based upon the desired throughput time and welding amperage. For lowest 4-cycle weld time, he recommended that the tip force be set to 35 lb/in.² and the weld current to 12,100 A. The breakaway torque will then have a mean of 500 in.-lb and be above 400 in.-lb within a 99% confidence level.

For lower weld current and a more typical weld time setting, Gore recommended setting the weld current to 11,350 A and the weld time to 10 cycles total at the 35 lb/in.² tip force. The predicted torque measurements will then be the same as the preceding settings. If it is necessary to increase the tip force to 52.5 lb/in.², the weld current will need to be increased to 12,500 A for a weld time of approximately 11 cycles to duplicate the torque levels of the previous two examples.

Last Touch Finishes

Based on the study predictions, the company made a running change to reduce the welding tip force to the recommended levels. As shown in Fig. 3, this change quickly eliminated the small number of defects that were experienced in the past, and the company is currently running with essentially zero defects.

"This application demonstrates how DOE can provide an objective measurement of the root cause of quality problems and enable quick implementation of a solution," Gore said. "It also provides an excellent example of university and industry project team collaboration. The industry project champion provided the resources needed by the university team. The university provided the technical expertise to set up the DOE and coordinate testing with all members of the project team. The undergraduate students worked diligently with the maintenance technicians in actually performing the tests and measurements. The company was delighted with the results." ♦

BRAZING & SOLDERING TODAY

Effects of Joint Clearance on the Capillary Rise of a Molten Filler Metal

A few simple calculations demystify the brazing process, joint clearances, and quantity of preform to use

BY MARCIN J. KUTA

Understanding Capillary Force

Brazing can be defined as a process in which metals are joined or fused together through the application of heat and a filler metal that melts above 450°C (840°F) but below the melting point of the base metals being fused together. One of the key elements in brazing is the capillary force also known as capillary action. The goal of this article is to analyze the effects of joint clearance on a capillary rise of a molten filler metal. In this article, capillary action is defined in terms of a force that is generated by the combination of adhesive and cohesive forces leading to a displacement of liquid including molten metals within a closely spaced cavity (Ref. 1). In order to give a better understanding of the mechanics behind capillary force, an example of glass tubing submerged in a liquid bath is analyzed. As shown in Fig. 1, a glass tube is submerged into a liquid bath. The change in height of the liquid H in the tube is an unknown variable that must be determined. Some of the variables that affect the change in height H of a liquid pulled upward within the glass tubing are contact angle θ , density of the liquid ρ , coefficient of surface tension Y , and the radius of the glass tubing R . The change in H can be calculated as follows

$$2\pi R Y \cos\theta = \rho g \pi R^2 H \quad (1)$$

Using Equation 1 to solve for H

$$H = 2\pi R Y \cos\theta / \rho g \pi R^2 \quad (2)$$

where g is the force of gravity (Ref. 3). In order for the capillary action to occur, the following factors have to be met: the surface of a solid must be residue free, oxide free, and wettable by a liquid, the contact angle θ must be less than 90 deg, and

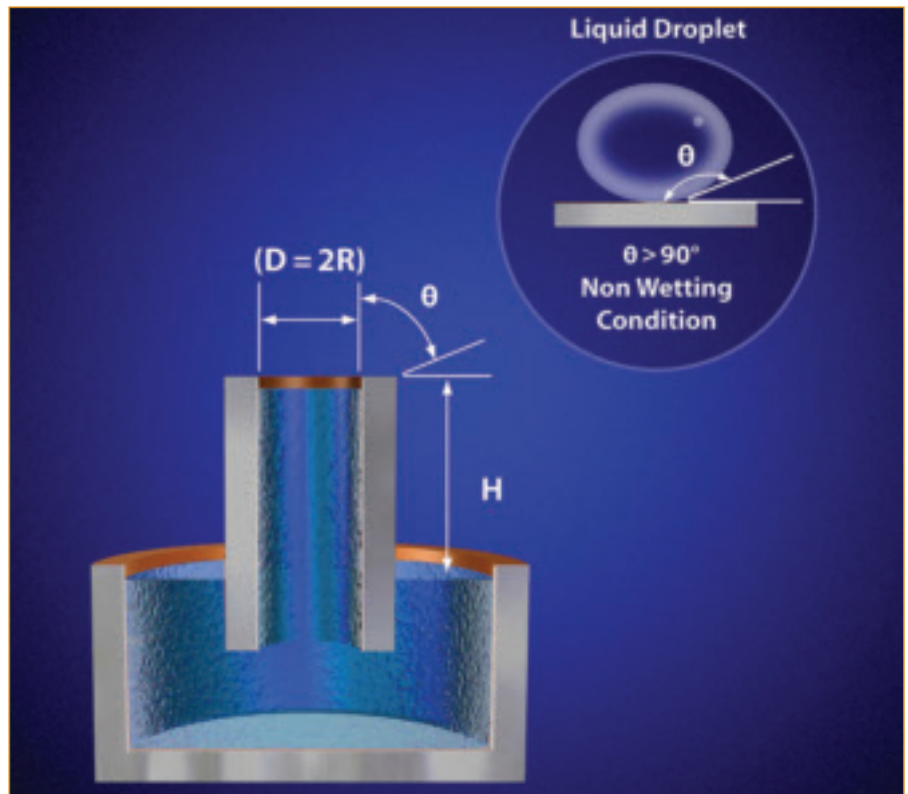

Fig. 1 — A cross-sectional view of a tube inserted in a liquid shows the liquid rises inside the tube to height H due to capillary action. As the diameter of the tube D increases, the height H water rises inside decreases.

most importantly the adhesive forces generated at the solid-liquid interface must be greater than the cohesive forces of a liquid on a molecular level. The adhesive force can be defined as a molecular attraction between bodies in contact. The cohesive force can be defined as an attraction between molecules of a body on the intermolecular level.

As an example, for an ammonia-air-glass interface in 8-mm-diameter glass tub-

ing, the capillary rise was equal to 1.7 mm. It was observed that with larger-diameter glass tubing ($D = 12$ mm) the capillary rise H decreased, as calculated below (Y and ρ values from Ref. 3, Table A.3).

Given $\theta = 0$ deg, $Y = 0.0213$ N/m, $D = 8$ mm, $\rho = 608$ kg/m³, and $R = D/2 = 4$ mm. Using Equation 2:

$$H = \frac{2(\pi)(0.004 \text{ m})(0.0213 \text{ N/m})(\cos 0)}{(608 \text{ kg/m}^3)(9.81 \text{ m/s}^2)(\pi)(0.004 \text{ m})^2}$$

BRAZING & SOLDERING TODAY

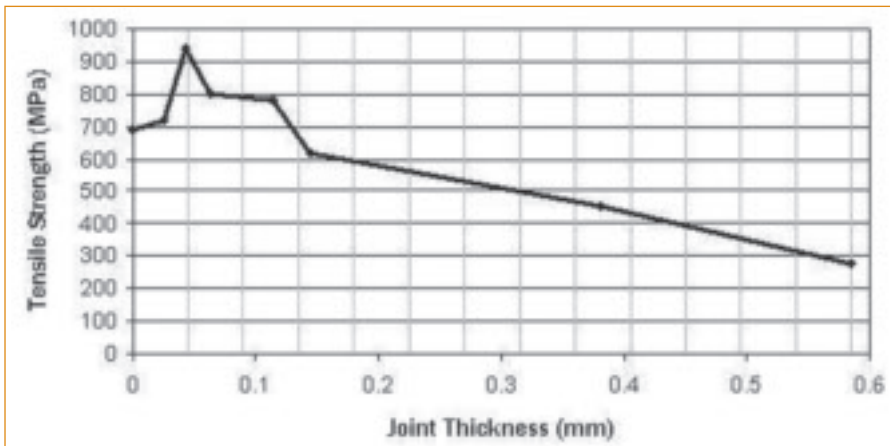

Fig. 2 — Effect of joint thickness on tensile strength.

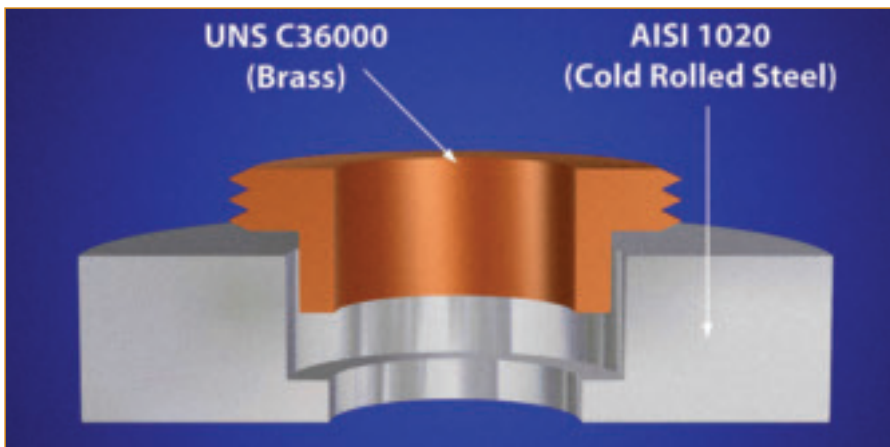

Fig. 3 — The brass insert is to be brazed to a cold-rolled steel base. The different coefficients of expansion for brass and steel must be considered when the parts are heated to brazing temperature to ensure there is sufficient capillary action to draw the filler metal into the joint.

Table 1 — Measurements

Wire Diameter (in.)	Inside Ring Diameter (in.)	Volume (in. ³)
0.047	0.495	0.00295
0.062	0.495	0.00528
0.070	0.495	0.00683

$$H = 0.0017 \text{ m} = 1.7 \text{ mm} (0.067 \text{ in.})$$

Given $\theta = 0$ deg, $Y = 0.0213 \text{ N/m}$, $D = 12 \text{ mm}$, $\rho = 608 \text{ kg/m}^3$, $R = D/2 = 6 \text{ mm}$. Using Equation 2:

$$H = \frac{2(\pi)(0.006 \text{ m})(0.0213 \text{ N/m})(\cos 0^\circ)}{(608 \text{ kg/m}^3)(9.81 \text{ m/s}^2)(\pi)(0.006 \text{ m})^2}$$

$$H = 0.0012 \text{ m} = 1.2 \text{ mm} (0.047 \text{ in.})$$

Assuming the variables such as contact angle and surface tension remained constant with the exception of a glass tubing diameter, why did the capillary rise decrease? With an increase in the diameter of glass tubing, the amount of liquid in the tube increased leading to a decrease in the capillary force. This is a very important factor in brazing. Numerous handbooks, including the American Welding Society's *Brazing Handbook*, correlate joint clearance to joint strength of a brazed assembly. It is a common standard to see joint clearances fall within a radial range of 0.050 to 0.127 mm (0.002 to 0.005 in.). With reduced clearance, there is less molten alloy within the joint resulting in higher capillary rise. Therefore, it is safe to say that in brazing, less is more. For further evaluation of joint strength and an explanation of the variables affecting joint

strength, refer to Lucas-Milhaupt/Handy & Harman Bulletins T-2 through T-5, which are available on the company's Web site (www.lucasmilhaupt.com).

Estimating Joint Clearances

The tensile strength of joints decreases with increasing joint thickness or joint clearance — Fig. 2. Therefore, it is very important to calculate joint clearances at braze temperatures to obtain the maximum strength out of the brazed assembly. This is especially important when brazing dissimilar metals because each metal expands and contracts at different rates.

Effects of Joint Thickness on Tensile Strength

One approach to determine the joint clearances at braze temperatures is to use a linear expansion theory as presented in Equation 3 (Ref. 2). The change in diametric clearance is ΔDC

$$\Delta DC = (T_2 - T_1)(D_2\alpha_2 - D_1\alpha_1) \quad (3)$$

Where T_1 = room temperature, T_2 = solidus temperature of the brazing filler metal, D_1 = OD of the male part at room temperature, α_1 = coefficient of thermal expansion of the male part, D_2 = ID of the female part at room temperature, and α_2 = coefficient of thermal expansion of the female part.

Consider the joint design shown in Fig. 3 where a brass male component with $D_1 = 12.57 \text{ mm}$ and $\alpha_1 = 20.5 \times 10^{-6} \text{ m/m}^\circ\text{C}$ is to be brazed to a steel female component with $D_2 = 12.70 \text{ mm}$ and $\alpha_2 = 12.8 \times 10^{-6} \text{ m/m}^\circ\text{C}$. The joint clearance was originally designed for 0.127 mm total joint clearances at room temperature. How much will the joint clearance change if this assembly is brazed with Braze™ 505 (AWS BAg-24) alloy with a solidus temperature of 660°C?

$$\text{Given } T_1 = 20^\circ\text{C}, T_2 = 660^\circ\text{C}, D_1 = 0.01257 \text{ m}, \alpha_1 = 20.5 \times 10^{-6} \text{ m/m}^\circ\text{C}, D_2 = 0.0127 \text{ m}, \alpha_2 = 12.8 \times 10^{-6} \text{ m/m}^\circ\text{C}.$$

Inserting these data into Equation 3:

$$\Delta DC = (660^\circ - 20^\circ\text{C})[(0.0127 \text{ m})(12.8 \times 10^{-6} \text{ m/m}^\circ\text{C}) - (0.01257 \text{ m})(20.5 \times 10^{-6} \text{ m/m}^\circ\text{C})] = -0.061 \text{ mm}$$

The joint clearance at brazing temperature will decrease by -0.061 mm (0.002 in.). The negative sign (-) indicates a decrease in joint clearance; whereas a

BRAZING & SOLDERING TODAY

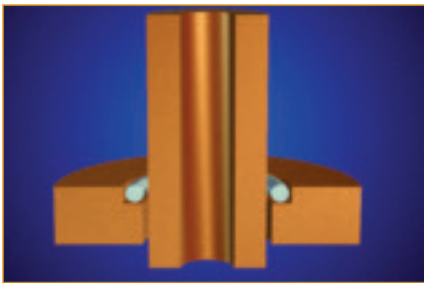

Fig. 4 — A cross-sectional view of two parts to be brazed showing preform filler metal.

positive sign (+) would indicate an increase in joint clearance.

Although there are several factors that affect the success of a brazed assembly, one of the key elements in proper joint design is to obtain a proper fitup.

The reduction in joint clearance at braze temperature from room temperature can lead to insufficient alloy penetration within the joint due to decreased volume of the joint. Similarly, the joint clearance increase at braze temperature from

room temperature may lead to voids within the joint due to lack of sufficient alloy content within the joint due to increased volume of the joint. Therefore, it is recommended to calculate joint clearances at braze temperatures — not room temperature — especially when brazing dissimilar metals. When brazing similar grades of alloys, the issue of thermal expansion is not as critical.

How to Estimate the Amount of Alloy in the Joint

Generally, once the joint clearance is established at the braze temperature, a theoretical amount of filler metal can be calculated. Consider the example where two base metals of the same grade are being brazed as shown in Fig. 4. Using the basic formula for volume, $V = \pi R^2 L$, the volume of the joint can be determined. The volume should be calculated at the largest possible joint clearance.

Given ID plate = 12.70 ± 0.127 mm, OD

tube = 12.57 ± 0.051 mm, shear depth (overlap distance) = 12.70 mm

$$V = [(\pi \times (12.83 \text{ mm}/2)^2) - ((\pi \times (12.52 \text{ mm}/2)^2)] \times 12.70 \text{ mm} = 76.2 \text{ mm}^3.$$

After interpolation of the data, the minimum wire diameter necessary to fill the joint is equal to 1.57 mm (0.062 in.) as shown in Table 1. Generally, an additional 20% of alloy is added to the total weight of the preform to compensate for potential alloy losses during fillet formation or alloy shrinkage during solidification process. ♦

References

1. Davis, J. R. 1992. A definition of capillary force. *ASM Materials Engineering Dictionary*. ASM International, Materials Park, Ohio.
2. Herrschaft, D. C. 1959. Predicting gap change reduces trial runs in brazing dissimilar metal joints. *Welding Journal* 38(3): 232–235.
3. White, Frank M. 1999. *Fluid Mechanics*, 4th ed. pp. 30, 31. McGraw-Hill.

Join us.



DVS
GERMAN
WELDING SOCIETY

MESSE
ESSEN
Place of Events

ESSEN SHOW THE SUPERBRAND IN THE WELDING WORLD

14.–19. SEPT. 2009 GERMANY

PLEASE VISIT US AT FABTECH,
BOOTH # 10269, OCT. 06–08, 2008.

ESSEN TRADE SHOWS c/o GACC
Tel. +1-914-962-1310,
karen@essentradeshows.com

www.schweissen-schneiden.com

SILICON BRAZING ALLOY FOR COPPER AND BRASS
BLOCKADE[®]

Harris Exclusive!



Silicon brazing alloys offer significant advantages over phos/copper and silver/phos/copper (BCuP) brazing alloys and present important differences in the brazing of copper and its alloys.

- ▶ **Outstanding ability to form a large shoulder, or cap, at the braze connection**
- ▶ **Distinct, favorable color changes in the finished braze alloy**
- ▶ **Improved ductility over non-silver-bearing BCuP-2 braze alloys**
- ▶ **Easily brazes brass and brass alloys without the addition of silver**
- ▶ **Significantly reduces brazing temperatures compared to BCuP braze alloys**



The Harris Products Group • A Lincoln Electric Company
4501 Quality Place Mason, OH
Customer Service 1.800.733.4043
www.harrisproductsgroup.com

For Info go to www.aws.org/ad-index

Comparing Metal-Ceramic Brazing Methods

The advantages and disadvantages of the various methods for joining metals to ceramics are outlined

BY C. A. WALKER AND V. C. HODGES

Designers and engineers have many options to choose from when considering how to join metals to non-metals for structural, electrical, and packaging applications. These options could include mechanical means of fastening such as screws, bolts, rivets and other fasteners, or an elevated-temperature means such as soldering or brazing. Metal-ceramic brazing, the topic of this article, is particularly useful for fabricating high-reliability devices such as those used in high-voltage applications or requiring hermetically sealed joints. This article is intended to familiarize the designer with brazing methods commonly used to join metals to ceramics, discuss the advantages and disadvantages of each method, and show the relative tensile strengths obtained from samples fabricated using these methods. Alumina is one of the most commonly used engineering ceramic materials, offering high hardness and wear resistance with excellent electrical insulation properties. Alumina ceramic is commonly available in purities ranging from 88 to 99.9%, with high-temperature glasses making up the balance of the composition. For most cases discussed, 94% alumina ceramic (6% glassy phase) ASTM-F19 tensile button samples were joined to Fe-29Ni-17Co alloy using a gold- or silver-based braze filler metal. The versatile design of the ASTM-F19 tensile specimen allows a helium mass-spectrometer leak detection test to be performed prior to tensile testing (Ref. 1).

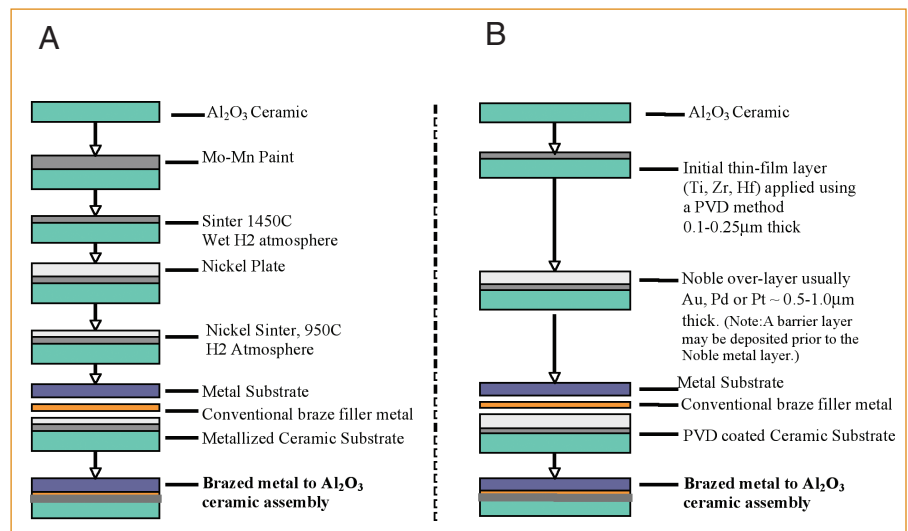

Fig. 1 — Commonly used ceramic metallization methods. A — Moly-manganese metalization process; B — thin-film metallization process.

Metal-to-ceramic brazing can be accomplished by first applying a metallic layer onto the ceramic surface or by brazing directly to the unmodified ceramic (oxide) surface. Several metallization methods have been proven to work effectively; however, this article is limited to the two metallization methods most commonly used (Refs. 2-4) for joining metals to ceramics: the molybdenum-manganese/nickel plating method and physical-vapor deposition or thin-film method.

Molybdenum-Manganese/Nickel Plating Method

The molybdenum-manganese/nickel plating method, also known as moly-manganese metallization, is performed as follows: A coating of molybdenum and manganese particles mixed with glass additives and volatile carriers is applied to the ceramic surface to be brazed — Fig. 1A.

C. A. WALKER (cawalke@sandia.gov) and V. C. HODGES are with Sandia National Laboratories, Albuquerque, N.Mex.

Sandia is a multiprogram laboratory operated by Sandia Corp., a Lockheed Martin Company, for the U.S. Dept. of Energy under contract DE-AC04-94AL85000.

Based on a paper presented at the International Brazing & Soldering Symposium held during the 2007 FABTECH International & AWS Welding Show, Nov. 11-14, in Chicago, Ill.

BRAZING & SOLDERING TODAY

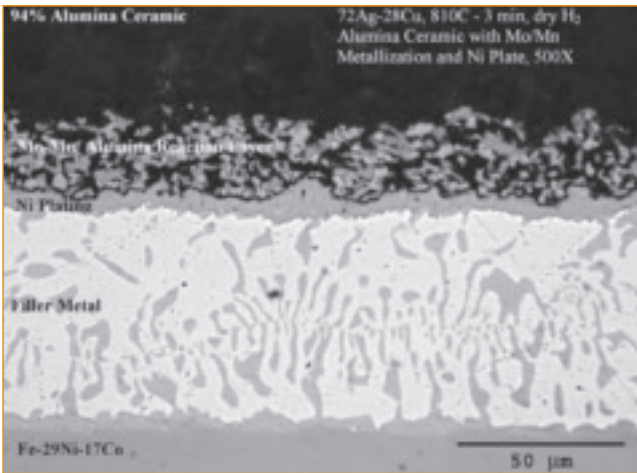

Fig. 2 — Ceramic-to-metal braze using molybdenum-manganese/nickel plate metallization.

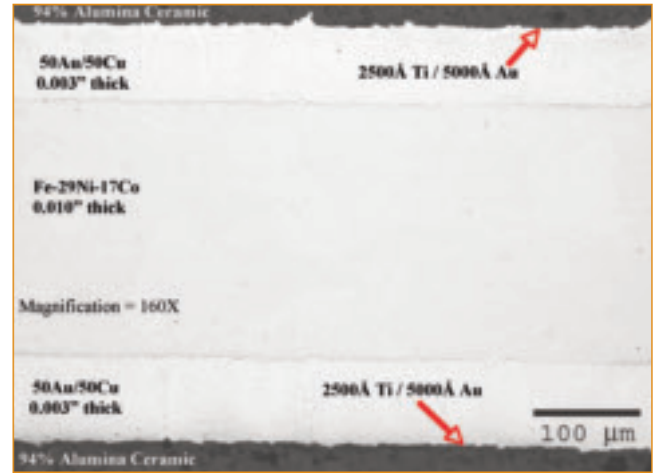

Fig. 3 — Au/Cu brazed metal-to-ceramic sample made using thin-film metallization.

Table 1 — Moly-Manganese/Nickel Plate ASTM-F19 Tensile Button Test Results

Filler Metal	Nonmetal Substrate	Metal Substrate	Brazing Temperature/Time	Furnace Atmosphere	Average Tensile Strength ^(a)
65 Cu/35 Au	94% Alumina	Fe-29Ni-17Co	1040°C/3 min	Dry Hydrogen	14.5 ksi/100 MPa
50 Au/50 Cu	94% Alumina	Fe-29Ni-17Co	1000°C/3 min	Dry Hydrogen	17 ksi/118 MPa
72 Ag-28 Cu	94% Alumina	Fe-29Ni-17Co	810°C/3 min	Dry Hydrogen	14.3 ksi/99 MPa
77 Au-13Ag-10 Ge	94% Alumina	Fe-29Ni-17Co	495°C/3 min	Dry Hydrogen	15.6 ksi/108 MPa
77 Au-13 Ag-10 Ge (2x thk)	94% Alumina	Fe-29Ni-17Co	455°C/5 min	Dry Hydrogen	16.1 ksi/111 MPa

(a) Tensile strength averages are ± 2 ksi/14 MPa.

The application of the coating may be hand-painted, sprayed, or robotically applied. After air drying, the coating is fired in a wet hydrogen environment (15°–30°C dew point) at 1450°–1600°C leaving a “glassy” metallic coating 300–500 micro-inches (7.6–12.7 microns) thick. The fired coating is subsequently plated with a 0.001–0.003 in. (25.4–76.2 microns) layer of nickel. The nickel plating is sinter-fired at 850°–950°C in a dry hydrogen (–50°C dew point or less) atmosphere leaving a finished metallic surface that can be readily brazed using standard braze filler metals.

Some of the advantages of the molybdenum-manganese/nickel plating method are as follows:

- 1) Having been developed in the 1930s (Ref. 2), moly-manganese metallization is a mature technology with a proven history of success;
- 2) Postmetallization, ceramic materials can be easily brazed using standard braze filler metals; and
- 3) Commercial suppliers are available

to provide the necessary metallization component materials or metallization services.

The molybdenum-manganese/nickel plating method also has several disadvantages. Included in these are the following:

- 1) **Expense.** Specialized high-temperature furnaces and plating equipment are necessary — Fig. 1.
 - 2) **Lengthy time requirements.** Multiple high-temperature furnace operations are required as well as the care and maintenance of plating baths.
 - 3) **Rework limitations.** Excessive nickel depletion into the braze filler metal can lead to poor braze joint performance.
 - 4) **Geometric constraints.** Large sizes and thick cross sections are difficult to process.
 - 5) **Batch size.** Process development for small quantities is often cost prohibitive.
- Table 1 shows the average strengths typically obtained [14–17 ksi (99–117 MPa)] when using various gold- and silver-based brazing filler metals to braze 94% alumina ceramic to Fe-29Ni-17Co alloy, a

controlled expansion alloy often used when brazing to ceramics. All of the brazed samples shown in Table 1, as well as those shown in the subsequent tables (Tables 2–4) passed a helium mass-spectrometer leak detection test (leak rate $< 2.0^{-9}$ atm-cc/s) prior to being tensile tested. The crosshead speed used for the tensile tests was 3.3^{-4} in./s (8.38^{-6} m/s). The tensile strengths shown in the tables are averages of samples tested. Variations of ± 2 ksi (14 MPa) from the average tensile strengths were observed. Formulations of brazing filler metals are displayed in wt-%.

A scanning electron microscope (SEM) image of a cross-sectioned brazed metal-ceramic assembly, utilizing moly-manganese metallization and nickel plating is shown in Fig. 2. The ceramic is 94% alumina, and the metal member is Fe-29Ni-17Co. Notice the 25–35- μ m-thick reaction zone where the moly-manganese metallization diffuses and reacts with the glassy phases of the alumina ceramic. The clearly defined nickel plating layer shown has been sufficiently wetted by the braz-

BRAZING & SOLDERING TODAY

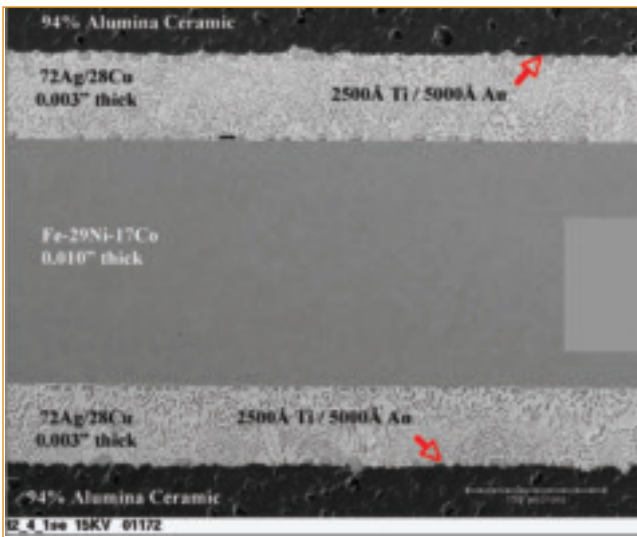

Fig. 4 — Ag/Cu brazed metal-to-ceramic sample made using thin-film metallization.

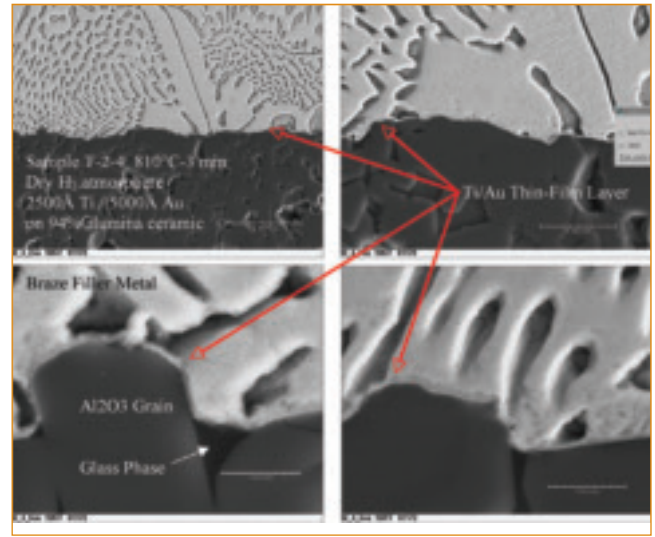

Fig. 5 — Ti/Au thin-film deposition layer on Ag/Cu brazed metal-ceramic sample.

Table 2 — Thin-Film Metallization ASTM-F19 Tensile Button Test Results

Filler Metal	Substrates	Thin Films	Brazing Temperature/Time	Furnace Atmosphere	Average Tensile Strength ^(a)
50 Au/50 Cu	94% Alumina Fe-29Ni-17Co	0.25 μm Ti/ 0.5 μm Au	1000°C/3 min	Dry Hydrogen	15.1 ksi/102 MPa
50 Au/50 Cu	94% Alumina Fe-29Ni-17Co	0.25 μm Ti/ 0.5 μm Au	1020°C/10 min	Dry Hydrogen	12.9 ksi/89 MPa
50 Au/50 Cu	94% Alumina Fe-29Ni-17Co	0.25 μm Ti/ 0.02 μm Pd/ 0.5 μm Au	1000°C/3 min	Dry Hydrogen	16.1 ksi/111 MPa
50 Au/50 Cu	94% Alumina Fe-29Ni-17Co	0.25 μm Ti/ 0.02 μm Pd/ 0.5 μm Au	1020°C/10 min	Dry Hydrogen	11.8 ksi/81 MPa
72 Ag-28 Cu	94% Alumina Fe-29Ni-17Co	0.25 μm Ti/ 0.5 μm Au	810°C/3 min	Dry Hydrogen	13.0 ksi/90 MPa
63 Ag-27 Cu-10 In	94 % Alumina Fe-29Ni-17Co	0.25 μm Ti/ 0.5 μm Pt	755°C/2 min	UHP Argon	13.2 ksi/91 MPa
63 Ag-27 Cu-10 In	951 LTCC Fe-29Ni-17Co	0.25 μm Ti/ 0.5 μm Pt	755°C/2 min	UHP Argon	8.2 ksi/57 MPa
63 Ag-27 Cu-10 In	951 LTCC Fe-29Ni-17Co	0.5 μm Ti/ 0.5 μm Au	755°C/5 min	UHP Argon	6.5 ksi/45 MPa
63 Ag-27 Cu-10 In	951 LTCC Fe-29Ni-17Co	0.5 μm Ti/ 0.5 μm Pd	755°C/5 min	UHP Argon	3.8 ksi/26 MPa

(a) Tensile strength averages are ± 2 ksi/14 MPa.

ing filler metal to provide high joint strength and hermeticity. The light and dark areas within the brazed joint are the silver-rich and copper-rich regions.

Thin-Film Deposition

Depicted in Fig. 1B, thin-film deposition is another commonly used (Refs. 2, 3) method to apply a metallization layer

to a ceramic substrate so that it may be joined using conventional braze filler metals. A combination of materials, usually two or three, are deposited onto the nonmetallic surface using a physical vapor deposition (PVD) method such as evaporation or sputtering. The first layer deposited, often titanium, is typically 0.05–0.25 μm thick. Other strong oxide-forming elements such as hafnium, zirconium, chromium, niobium, etc. may be chosen depending on the application and service temperature. Occasionally, an intermediate layer or layers are deposited to prevent unwanted metallurgical reactions between the initial metal layer and the braze filler metal. The top, or outer, layer is normally a noble metal such as gold, platinum, or palladium that is 0.25–1.0 μm thick. A noble metal is cho-

sen depending on the application and service temperature. Occasionally, an intermediate layer or layers are deposited to prevent unwanted metallurgical reactions between the initial metal layer and the braze filler metal. The top, or outer, layer is normally a noble metal such as gold, platinum, or palladium that is 0.25–1.0 μm thick. A noble metal is cho-

BRAZING & SOLDERING TODAY

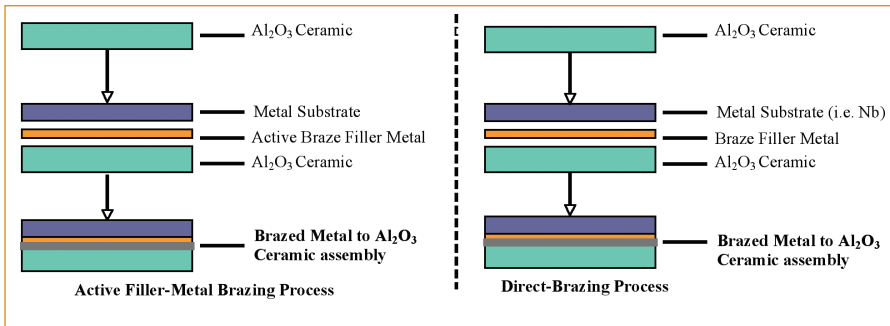

Fig. 6 — Direct metal-to-ceramic brazing processes.

sen in order to prevent the underlying layer from oxidizing and subsequently preventing proper braze filler metal wetting and flow. Detailed brazing-related concerns when using thin-film metallization coatings for ceramic assemblies have been published (Ref. 3).

The following are a few of the advantages for using thin-film metallization coatings:

- They have a proven brazing practice history and are forgiving when used with standard filler metals.
- Versatility. A wide range of metal choices exist for the engineer or designer that can be deposited to address special applications or environments.
- Another important advantage is the speed, which can often be less than a

few hours total, that simple geometries can be prepared for brazing.

The primary disadvantages of thin-film metallization coatings are as follows:

- Specialized equipment is required to apply the coatings.
- Intricate masking may become necessary to prevent the deposition of metal in unwanted locations.
- Ceramic geometric constraints, which may prohibit the proper positioning of the ceramic member or hinder the application of uniform coating thicknesses, of most thin-film deposition chambers.

Tensile button strengths obtained using various thin-film metallization schemes are shown in Table 2. Captured in Table 2 (compare lines 1 and 2, then lines 3 and 4) is the increased size of the

brazing process window (peak temperature and time ranges) that can be obtained without the drastic decline in tensile strength usually witnessed when using the moly-manganese metallization method. This is because the thin-film metallization method, in contrast to moly-manganese metallization, does not use nickel plating, which readily dissolves into the braze filler metal at higher temperatures and longer peak soak times. Also shown in Table 2 are the tensile strengths of brazed Fe-29Ni-17Co tensile buttons to Low-Temperature Co-Fired Ceramic (LTCC) interlayers. When using a 63Ag-27Cu-10In braze filler metal, the tensile strengths varied by a factor of two, depending on which thin-film metallization scheme was chosen (Ref. 5). This strength loss is due to the formation of brittle intermetallic compounds within the braze joints or at the braze joint interfaces.

Shown in Fig. 3 is an SEM image of a cross-sectioned ceramic-metal-ceramic brazed sample utilizing a thin-film scheme of 2500 Å (0.25 μm) titanium and 5000 Å (0.50 μm) gold. A 50Au-50Cu brazing filler metal was utilized for the joining operation. The same substrate materials and geometry were joined with a silver-based braze filler metal, 72 Ag-28Cu, and shown in Fig. 4. In both SEM images, the samples exhibit excellent wetting and flow onto the irregular alumina ceramic surface with little or no base

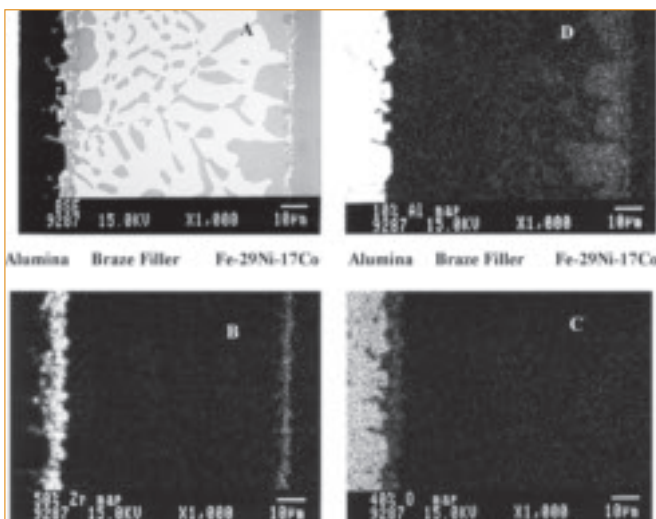

Fig. 7 — SEM backscattered image (BSE) with energy-dispersive spectroscopy (EDS) maps showing postbrazed zirconium, oxygen, and aluminum (counterclockwise from upper left) concentrations in an active brazed specimen.

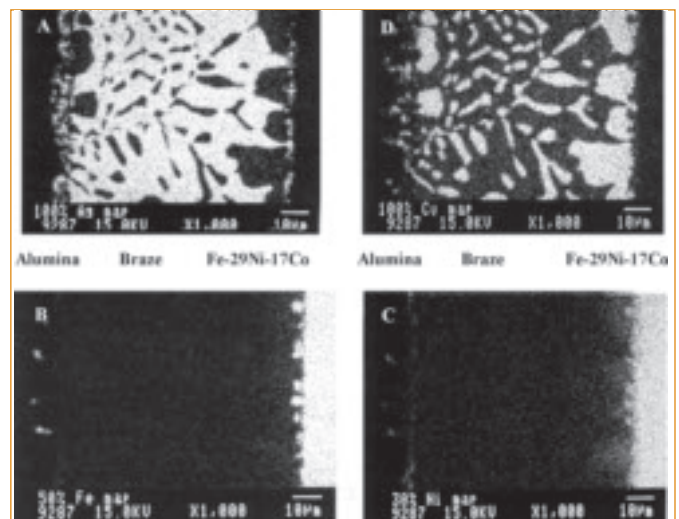

Fig. 8 — Energy-dispersive spectroscopy maps showing postbrazed silver, iron, nickel, and copper concentrations (counterclockwise from upper left) in an active brazed specimen.

BRAZING & SOLDERING TODAY

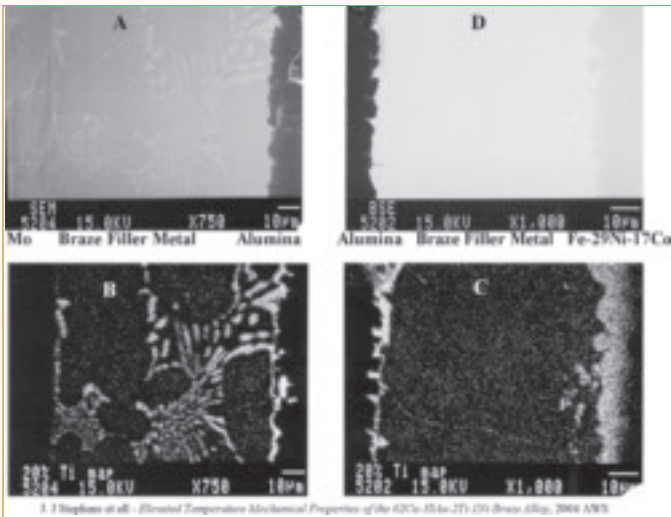

Fig. 9 — Active brazed molybdenum to 94% alumina ceramic sample (A and B) and active brazed Fe-29Ni-17Co to 94% alumina ceramic (C and D).

metal erosion. Figure 5 shows higher magnification images of the thin-film/ceramic interface from Fig. 4. Easily seen in these images is the continuous thin-film metallization layer along the alumina grain boundaries. The dark regions seen along the interface and between the alumina grains are the glassy phase of the 94% alumina ceramic.

Active Filler Metal Brazing

Active filler metal brazing is an area of high growth within the metal-ceramic brazing community. A primary reason for this growth is that unlike the moly-manganese metallization that is very material dependent, active filler metals display good wetting with most ceramic materials (Refs. 6, 7). Active filler metal brazing is a metal-ceramic joining method that permits the use of standard brazing techniques when making metal-to-ceramic brazements without the need to apply any metallization to the ceramic substrate. As shown in the left-hand portion of Fig. 6, the metal and nonmetal substrates are cleaned, and the active filler metal preform or paste (Ref. 8) is positioned or applied between the faying surfaces of the brazement. The brazing operation is usually performed in an inert or ultrahigh vacuum environment. For certain applications and component geometries, the transfer from a conventional brazing process to an active brazing process is accomplished quite readily. Many times,

however, the braze joint might require a redesign to accommodate the preplacement of brazing filler metal between the faying surfaces of the brazement. Capillary flow is inhibited by the bare oxide ceramic surface that exhibits limited spreading and flow of the brazing filler metal. High-vacuum or inert atmospheres are required because excessive oxygen in the atmosphere can react with the active element in the active braze filler metal and compromise joint strength and integrity (Refs. 9, 10).

Apart from these limitations, there are many advantages to using an active filler metal brazing process for certain brazing applications. These include the following:

- 1) The number of required steps to make metal-ceramic brazes are reduced and greatly simplified;
- 2) There are a variety of commercially available filler metal compositions for use in a wide range of processing temperatures and service conditions;
- 3) Specialized metallization equipment and the associated time-consuming metallization processes are eliminated.

There are, however, several disadvantages of using an active brazing process over a conventional metallization and

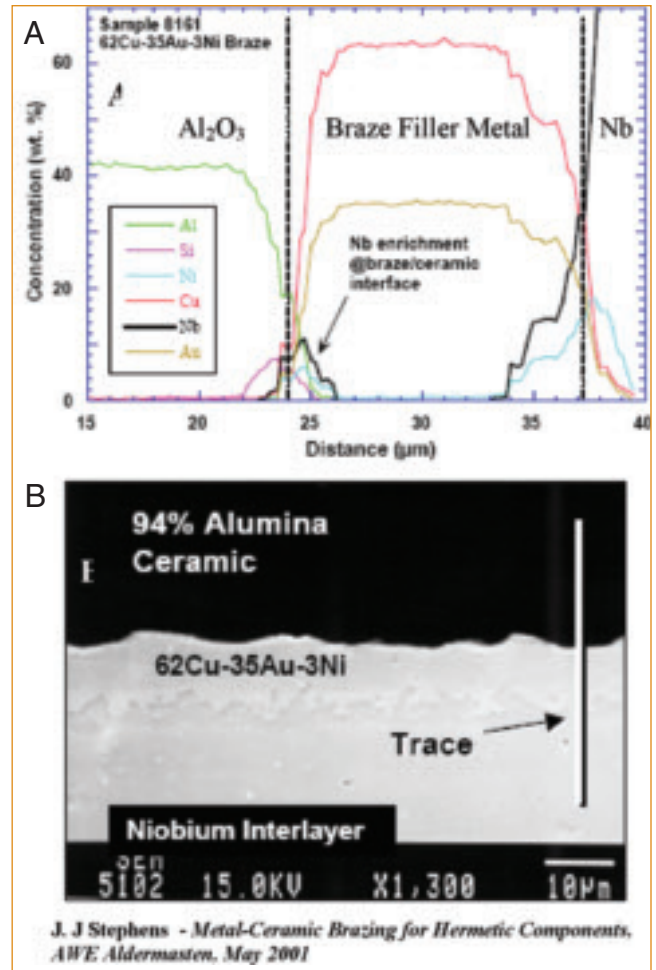

Fig. 10 — A — Electron microprobe analysis, and B — SEM image of a direct brazed niobium-94% alumina ceramic sample.

subsequent standard brazing process. The primary disadvantages are as follows:

- 1) Active brazing processes require more stringent atmospheric control;
- 2) Not all braze joint geometries are compatible with active brazing processes;
- 3) Processing equipment capable of adequate atmospheric control can be a limiting factor, placing size constraints on brazed assemblies.

Figures 7 and 8 illustrate the distribution of elements in an active braze filler metal following a brazing process. Figure 7A is a backscattered SEM image showing a portion of a 94% alumina ceramic that has been brazed using a 97Ag-1Cu-2Zr active braze filler metal. The sample was brazed at a temperature of 950°C, with a peak soak time of 5 min in a 12-torr ultrahigh-purity (UHP) argon partial pressure atmosphere. Figure 7B

BRAZING & SOLDERING TODAY

Table 3 — Active Filler Metal Brazed ASTM-F19 Tensile Button Test Results

Filler Metal	Nonmetal Substrate	Metal Substrate	Brazing Temperature/Time	Furnace Atmosphere	Average Tensile Strength ^(a)
62 Cu-35 Au-2Ti-1Ni	94% Alumina	Fe-29Ni-17Co	1006°–1026°C 6–8 min	Vacuum/Partial pressure Ar	11–14 ksi/76–97 MPa
97 Ag-1Cu-2Zr	94% Alumina	Fe-29Ni-17Co	990°C/5 min	UHV/Dry Hydrogen	15.4 ksi/106 MPa
97 Ag-1Cu-2Zr	94% Alumina	Fe-29Ni-17Co	963°C, 3 min above liquidus	Partial pressure Ar	21.3 ksi/147 MPa
63.00 Ag-35.24Cu-1.75Ti	94% Alumina	Fe-29Ni-17Co	1040°C/2 min	Dry Hydrogen	14.5 ksi/100 MPa
63.00 Ag-35.25Cu-1.75Ti	94% Alumina	Fe-29Ni-17Co	825°–1040°C/2–10 min	Partial Pressure Ar	11–14 ksi/76–97 MPa
63.00 Ag-35.25Cu-1.75Ti	94% Alumina	Fe-29Ni-17Co	825°–1040°C/2–10 min	Vacuum	11–16 ksi/76–110 MPa
59.00 Ag-27.25Cu-12.5In-1.25 Ti	94% Alumina	Fe-29Ni-17Co	755°C/5 min	Vacuum	14.5 ksi/99 MPa
59.00 Ag-27.25Cu-12.5In-1.25 Ti	DuPont 951 LTCC	Fe-29Ni-17Co	755°C/5 min	Vacuum	8 ksi/55 MPa

(a) Tensile strength averages are ± 2 ksi/14 MPa.

shows the migration of the elemental zirconium to the ceramic surface where it reacts with available oxygen and forms the layer that the primary filler metal element, silver, will wet and adhere to. A trace amount of zirconium can also be seen in the same image bound to the surface of the Fe-29Ni-17Co. Figure 7C shows a small concentration of oxygen that has dissolved into the zirconium-rich region of the solidified braze filler metal. Notice in Fig. 7D that a slight amount of aluminum from the ceramic material, having been replaced by zirconium, has diffused through the molten braze filler metal toward the Fe-29Ni-17Co surface. Figure 8 A–D are companion energy dispersive spectroscopy (EDS) maps that show the silver- and copper-rich phases of the resolidified brazing filler metal along with limited dissolved Fe-29Ni-17Co base metal.

The choice of the base metal substrate and active filler metal element can have a substantial impact on the end product as reported by Stephens et al. (Ref. 11), and shown in Fig. 9. A and B show a molybdenum substrate brazed to a 94% alumina ceramic using a gold-based active braze filler metal, 62Cu-35Au-2Ti-1Ni. C and D show the results when the molybdenum is replaced with Fe-29Ni-17Co. 9B and 9C are EDS maps showing the resulting titanium concentrations in the brazed samples. Figure 9B demonstrates that a

minimal amount of the active element, titanium, has reacted with the molybdenum allowing for the majority of the titanium metal to react with the ceramic substrate. Figure 9C reveals that a substantial portion of the titanium has reacted with the Fe-29Ni-17Co substrate to the point of causing some base metal erosion to occur and hindering the ability to make a hermetic seal. This scavenging of the titanium element can be prevented by coating the Fe-29Ni-17Co member with a barrier layer (Refs. 12–14). While some scavenging of titanium does occur, there is sufficient titanium in commercially available active brazing filler metals to make hermetic braze joints to Fe-29Ni-17Co substrates when careful attention is given to surface preparation, fixturing, atmosphere, and the brazing thermal cycle (Refs. 15, 16).

Tensile test results of tensile button samples made with gold- and silver-based active braze filler metals are displayed in Table 3. A comparison of the sample strengths in Tables 1 and 2 to those in Table 3 reveals that the results are very similar for tensile samples brazed with similar composition filler metal families and temperatures. Of particular interest in Table 3 are the high tensile strengths obtained when using the 97Ag-1Cu-2Zr active braze filler metal. Samples averaging more than 21 ksi (147 MPa) were obtained using this recently developed

active braze filler metal. This relatively new (Refs. 17, 18) silver-based filler metal uses zirconium as the active element, but currently has very limited commercial availability.

Direct-Brazing Method

The direct-brazing method is the last method for joining metals to ceramics to be considered. As the name implies, the direct-brazing method allows metals to be directly brazed to ceramics without the need for metallization coatings. Unlike active filler metal brazing, however, the direct-brazing method utilizes standard brazing filler metals to accomplish the metal-to-ceramic braze. The direct-brazing process is illustrated on the right-hand side of Fig. 6. Comparisons of the two brazing methods portrayed in Fig. 6 illustrate how similar these processes are. Similar to the active brazing process, a direct-braze is made by cleaning the ceramic and metal materials, fixturing the assembly with the braze filler metal preplaced between the metal and ceramic substrates and then brazing the entire assembly, usually in an inert or UHV brazing atmosphere. During the direct-braze process, specific metal substrates and braze filler metal combinations interact to form an adherent metallic oxide layer on the oxide ceramic faying surface.

The dissolution, migration, and inter-

BRAZING & SOLDERING TODAY

Table 4 — Direct Brazed ASTM-F19 Tensile Button Test Results

Filler Metal	Nonmetal Substrate	Metal Substrate	Brazing Temperature/Time	Furnace Atmosphere	Average Tensile Strength
92 Au-8Pd	94% Alumina	Niobium	1270°C/4 min	Vacuum	12.8 ksi ± 1.8 ksi/ 88 MPa ± 12 MPa
62 Cu-35Au-3Ni	94% Alumina	Niobium	1058°C/3 min	Vacuum	8.8 ksi ± 1.0 ksi/ 61 MPa ± 7 MPa
50 Au-50Cu	94% Alumina	Niobium	1000°C/3 min	Vacuum	8.8 ksi ± 1.0 ksi/ 61 MPa ± 7 MPa

action of the base metal with the filler metal and ceramic surface are shown in Fig. 10 (Ref. 19). Electron microprobe analysis (EMPA) of a niobium-94% alumina ceramic sample brazed with 62Cu-35Au-3Ni (BAu-3) braze filler metal shows how the niobium base metal is enriched at the alumina ceramic surface, where it forms a relatively stable oxide. To perform a successful direct-braze, candidate metal substrates must contain an element or elements able to form thermally stable oxides and have sufficient solubility within the chosen liquid braze filler metal. As shown in Table 4, the direct-braze method was used to produce tensile button assemblies having average tensile strengths ranging from 9 to 13 ksi (61–88 MPa). For these assemblies, niobium base metal provided the active element required to react with the alumina ceramic.

There is a host of benefits for the designer or engineer to use the direct-brazing method. Some of these advantages are

- 1) Ease of use and lower expense, compared to other metal-ceramic brazing methods;
- 2) No metallization equipment or associated processes and process development is required;
- 3) A variety of conventional braze filler metals can be utilized covering a wide range of temperatures;
- 4) The direct-brazing method has been successfully used to hermetically join metal-ceramic components used in high-reliability long-term applications.

There are several disadvantages to using the direct-braze method. Among these are

- 1) Not all joint designs are viable. Similar to active brazing in this regard, the braze filler metal must be preplaced between the faying surfaces because the filler metal is unable to be drawn by capillary forces along the bare ceramic surface.

- 2) Good atmospheric control, while not as stringent as that required when active brazing, is also necessary when using the direct-brazing method.

- 3) The strengths obtained using the direct-braze method are slightly inferior to those obtained using the other discussed metal-ceramic brazing methods, as seen when comparing the strength data in

Active braze filler metals can be used as a replacement system for most metal-to-ceramic brazed assemblies with no loss of mechanical properties.

Table 4 to that shown in Tables 1–3. Transmission electron microscopy (TEM) analysis results on niobium-94% alumina ceramic direct brazed samples (Ref. 20) showed the niobium bonded with the glass-phase only. Though not yet evaluated, it is anticipated that a metal with the ability to form more thermally stable oxides than those of niobium will be required to adequately join high-purity alumina ceramics using the direct braze method.

In conclusion, high-strength, hermetically sealed metal-ceramic assemblies can be successfully brazed using a variety of methods, some requiring metallization of the ceramic member and others allowing the direct brazing of metals to ceramics.

The designer, engineer, or user can choose from a traditional metallization method such as moly-manganese/nickel plating or from a variety of thin-film coatings applied using PVD methods, which are specifically tailored to meet the needs of the application. Active braze filler metals can be used as a replacement system for most metal-to-ceramic brazed assemblies with no loss of mechanical properties. Whether choosing to use metallized ceramics or the direct-braze process, conventional braze filler metals can be used for the brazing operation. The direct-braze process has been demonstrated with a limited set of conventional filler metals to have adequate bond strength when used in conjunction with niobium metal substrates. Premetallized substrates may be used without joint geometry restrictions; however, active and direct-brazing techniques work best with butt or lap-style braze joint geometries where the brazing filler metal may be preplaced between the faying surfaces. ♦

Acknowledgments

The authors wish to express their thanks and appreciation to Mike Hosking and Paul Vianco for guidance and project support; Don Susan for his review of the manuscript; and Tom Crenshaw, Alice Kilgo, and Bonnie McKenzie for their mechanical testing capabilities, metallographic sample preparation, and image analysis skills.

References

1. AWS C3.2M/3.2:2008, *Standard Method for Evaluating the Strength of Brazed Joints*. 2008. Miami, Fla.: American Welding Society. pp. 17–23.
2. *Brazing Handbook*, 5th Edition. 2007. Miami, Fla.: American Welding

BRAZING & SOLDERING TODAY

Society. pp. 462–464, 579–580.

3. Humpston, G., and Jacobson, D. M. 1993. *Principles of Soldering and Brazing*. Metals Park, Ohio: ASM International. pp. 140–143.

4. Schwartz, M. M. *Ceramic Joining*. 1990. Metals Park, Ohio: ASM International. pp. 89–93.

5. Walker, C. A., Uribe, F., Monroe, S. L., Stephens, J. J., Goeke, R. S., and Hodges, V. C. 2006. High-temperature joining of low-temperature co-fired ceramics. *Proceedings of the 3rd International Brazing and Soldering Conference*, eds. J. J. Stephens and K. S. Weil. Metals Park, Ohio: ASM International. pp. 54–59.

6. Mizuhara, H. 2000. *Ceramic-to-Metal Joining: Past, Current and Future*. Advanced Brazing and Soldering Technologies. Eds. P. T. Vianco and M. Singh. Metals Park, Ohio: ASM International. pp. 278–283.

7. Hosking, F. M., Cadden, C. H., Yang, N. Y. C., Glass, S. J., Stephens, J.

J., Vianco, P. V., and Walker, C. A. 2000. Microstructural and mechanical characterization of actively brazed alumina tensile specimens. *Welding Journal* 79(8): 222-s to 230-s.

8. Walker, C. A., Neugebauer, G. L., Susan, D. F., and Hodges, V. C. 2007. Brazing optimization of mechanically applied active braze filler metal paste. 2007. *Proceedings of the LOT 2007, 8th International Conference, Brazing, High Temperature Brazing and Diffusion Bonding*. Aachen, Germany.

9. Mizuhara, H., Huebel, E., and Oyama, T. 1989. High-reliability joining of ceramic to metal. *Ceramic Bulletin*, Vol. 68, No. 9, pp. 1591–1599.

10. Jacobson, D. M., and Humpston, G. H. 2005. *Principles of Brazing*. Metals Park, Ohio: ASM International. p. 243.

11. Stephens, J. J., Schmale, D. T., Caris, J. B., Hosking, F. M., and Hlava, P. F. 2004. Elevated temperature mechanical properties of the 62Cu-35Au-2Ti-1Ni (“Nicoro+2%Ti”) braze alloy. *AWS*

International Brazing and Soldering Symposium, Chicago, Ill.

12. Stephens, J. J., Vianco, P. V., Hlava, P. F., and Walker, C. A. 2000. Microstructure and performance of Kovar® alumina joints made with silver-copper base active metal braze alloys. *Advanced Brazing and Soldering Technologies*, eds. P. T. Vianco and M. Singh. Metals Park, Ohio: ASM International. pp. 240–251.

13. Vianco, P. V., Stephens, J. J., Hlava, P. F., and Walker, C. A. 2003. Titanium scavenging in Ag-Cu-Ti active braze joints. *Welding Journal* 82(10): 268-s to 277-s.

14. Vianco, P. V., Stephens, J. J., Hlava, P. F., and Walker, C. A. 2003. A barrier layer approach to limit Ti scavenging in FeNiCo/Ag-Cu-Ti/Al₂O₃ active braze joints. *Welding Journal* 82(9): 252-s to 262-s.

15. Oyama, T., Demmons, A., and Mizuhara, H. 2004. Hermetic joint between alumina and Kovar® by active brazing process. *AWS International Brazing and Soldering Symposium*, Chicago, Ill.

16. Oyama, T., Demmons, A., and Mizuhara, H. 2006. Hermetic seal between alumina and Kovar® by active-metal brazing process. *3rd International Brazing and Soldering Conference*, San Antonio, Tex.

17. Stephens, J. J., Hosking, F. M., Yost, F. G., Walker, C. A., and Dudley, E. 2006. The evolution of a ternary Ag-Cu-Zr active braze filler metal for Kovar®/alumina braze joints. *Proceedings of the 3rd International Brazing and Soldering Conference*. Eds. J. J. Stephens and K. S. Weil. Metals Park, Ohio: ASM International. pp. 207–213.

18. Stephens, J. J., and Neilsen, M. K. 2006. Mechanical behavior of the Ag-2Zr and Ag-1Cu-2Zr active braze alloys. *Proceedings of the 3rd International Brazing and Soldering Conference*. Eds. J. J. Stephens and K. S. Weil. Metals Park, Ohio: ASM International. pp. 226–233.

19. Stephens, J. J. 2001. Metal/ceramic brazing for hermetic components. AWE presentation. Aldermasten, UK.

20. Headley, T. 2004. TEM characterization of two Nicoro/Nb/AL500 brazes. Unpublished internal work, Sandia National Laboratories, Albuquerque, N.Mex.



Turnkey Brazing and Soldering Automation

All you need from ONE SOURCE!



Strong, void-free
brazed joints

- **Filler Metals** —
Paste form, no separate fluxing
- **Dispensers** —
Eliminate filler metal waste
- **Automatic Machines** —
Fixed station and Rotary Index,
60 to 2,000 per hour



Rotary Index Machine
400 parts per hour

FUSION INCORPORATED

1-800-626-9501
or (440) 946-3300
www.fusion-inc.com
info@fusion-inc.com

For info go to www.aws.org/ad-index

SOLVAY



NOCOLOK® is a registered trademark of Solvay Fluor GmbH

NOCOLOK® Flux for Brazing Aluminum Heat Exchangers

Always on Top.

NOCOLOK® Flux is the top choice for brazing aluminum heat exchangers in the refrigeration and air-conditioning industry.

Top Heat Transfer: A brazed connection metallurgically bonds fins and tubes eliminating all potential sources of contact resistance.

Top Refrigerant Charge Reduction: Smaller exchange surfaces at the condenser and at the evaporator are required creating a higher eco-efficiency.

Top Reliability: A higher resistance to corrosion and higher mechanical resistance ensures higher durability.

Top Design Opportunities: Substituting round tubes with microchannels offers improved heat transfer on both refrigerant and air sides.

Top Noise Reduction: The microchannels have a smaller air stream shadow limiting turbulence, consequently reducing the noise level.

Without a doubt –

NOCOLOK® Flux users are always on top!

Solvay Fluorides, LLC
3333 Richmond Avenue,
Houston, TX 77098
Tel. 713-525 67 00
www.solvay-fluor.com

Solvay Fluorides



a Passion for Progress®

Disclaimer: To our present knowledge, the information contained herein is accurate as of the date of this document. However, neither Solvay nor any of its affiliates makes any warranty, express or implied, or accepts any liability in connection with this information or its use. This information is for use by technically skilled persons at their own discretion and risk and does not relate to the use of this product in combination with any other substance or any other process. This is not a license under any patent or other proprietary right. The user alone must finally determine suitability of any information or material for any contemplated use, the manner of use in compliance with relevant legislations and whether any patents are infringed. Solvay reserves its right to make additions, deletions, or modifications to the information at any time without prior notification.

Chemical and Pharmaceutical Group
For Info go to www.aws.org/ad-index

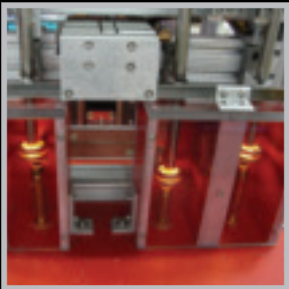
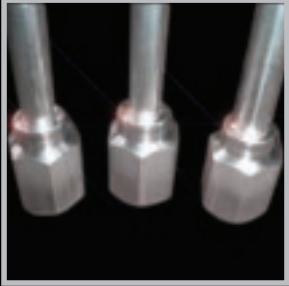
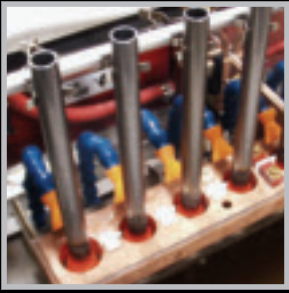

RADYNE

The Innovators In Induction Brazing & Heating Systems

has what it takes to turn
up the

HEAT

for

BRAZING



Notice: Coil guards must be used with induction heating systems to prevent contact with exposed parts in excess of 50V to ground.



Experience Radyne innovation with our state-of-the-art multi-station, multi-point, induction brazing systems for high, medium, and low volume production runs. Radyne Brazing Systems deliver unmatched quality, repeatability, throughput, and safety that can't be achieved with flame or hand induction systems.

- **Repeatable processes that produce quality parts every time**
- **Standard Vacuum or Controlled Atmosphere Systems, no cleaning required**
- **Reduced energy costs with lean, green induction**
- **Manual, semi & fully automatic systems scaled to your needs**
- **Available modular, manual and automatic tooling changes**

Radyne continues to innovate with new **non-toxic** brazing techniques that deliver **super-strong**, low cost braze joints. From induction brazing to heat treating systems, and power sources from 3 kW to 5000 kW, Radyne delivers the best induction equipment with the fastest delivery for any application large or small.

Call us for 24 X 7 rapid field service response, quality coil and tooling design, and re-certification.

Radyne Corporation.,
211 West Boden Street,
Milwaukee, WI 53207

For more information, call 800/236-8360 or visit www.radyne.com or email sales@radyne.com

SEE US AT THE FABTECH/AWS SHOW BOOTH #15094



Leading Manufacturers of Melting, Thermal Processing & Production Systems for the Metals & Materials Industry Worldwide.
For Info go to www.aws.org/ad-index

AWS Breaks New Ground with Soldering Specification

Qualification of solderers and soldering procedures are addressed in this new specification

BY PAUL T. VIANCO

Joining technologies continue to advance with new materials, process innovations, and inspection techniques. An increasing number of high-valued, high-reliability applications — from boilers and ship hulls to rocket motors and medical devices — have required the development of industry standards and specifications in order to ensure that the best design and manufacturing practices are being used to produce safe, durable products and assemblies. Standards writing has always had an important role at the American Welding Society (AWS). The AWS standards and specifications cover such topics as filler materials, joining processes, inspection techniques, and qualification methods that are used in welding and brazing technologies. These AWS standards and specifications, all of which are approved by the American National Standards Institute (ANSI), have also provided the basis for many similar documents used in Europe and in Pacific Rim countries.

AWS B2.3/B2.3M:2008

This year, AWS broke ground in its standards and specifications efforts with its first approved document that addresses, specifically, soldering technology. That document is titled AWS B2.3/B2.3M:2008, *Specification for Soldering Procedure and Performance Qualification*. The AWS B2.3 specification is the result of efforts by the AWS B2 Committee on Procedure and Performance Qualification chaired by G. M. Wisbrock Jr. It began with document preparation by members of the AWS B2E Subcommittee on Soldering Qualification, chaired by E.



Complex lap joint made with Sn-Sb solder for a high-reliability assembly.

W. Beckman. Consultation was provided by the AWS C3B Subcommittee on Soldering (F. M. Hosking, chair), under the auspices of the AWS C3 Committee on Brazing and Soldering (P. T. Vianco, chair).

The abstract to the AWS B2.3 document reads as follows:

“This specification provides the requirements for qualification of soldering procedure specifications, solderers, and soldering operators for manual, mechanized, and automatic soldering. The sol-

dering processes included are torch soldering, furnace soldering, resistance soldering, dip soldering, infrared soldering, and induction soldering. Base metals, soldering filler metals, soldering fluxes, soldering atmospheres, and soldering joint clearances are also included.”

Compilation of the AWS B2.3 document began by using AWS B2.2-91, *Standard for Brazing Procedure and Performance Qualification*, as the template. The AWS B2.2 document was selected for this role because, in terms of technical details,

BRAZING & SOLDERING TODAY

soldering has a greater similarity to brazing than it has to welding. Thus, committee members were able to minimize the extent of development required to create the new document. Nevertheless, there remained a sufficient number of technical distinctions between soldering and brazing that warranted a substantial revision to the AWS B2.2 document. For example, although the types of base materials used to make solder joints are similar to those used in brazing applications, it was necessary to replace brazing filler metals with solder alloys. Permission was granted by the American Society for Testing and Materials (ASTM, 100 Bar Harbor Dr., West Conshohocken, PA 19428) to directly reference ASTM B 32-04, *Standard Specification for Solder Metal*, for the solder materials used in the qualification activities. (ISO/DIS 9453, *Soft Solder Alloys — Chemical Composition and Forms*, is similar to the ASTM specification.) A second ASTM document, ASTM B 907-05, *Standard Specification for Zinc, Tin and Cadmium Base Alloys Used as Solders*, was

used to round out the alloy listing for the AWS B2.3 specification.

AWS B2.3 also lists inorganic acid fluxes according to the applicable base material(s). The fact that this flux type is highlighted in the document by no means insinuates that only these fluxes can be used in qualification activities. Other flux types, including rosin-based materials, organic acid fluxes, and synthetic fluxes can be utilized; it is simply easier to specify them from other documents such as ASTM B813, *Standard Specification for Liquid and Paste Fluxes for Soldering of Copper and Copper Alloy Tube*, and ANSI/J-STD 004, *Requirements for Soldering Fluxes*. A listing of additional flux standards are found in Tables 4.3 and 4.4 of the *Soldering Handbook*, third edition (2000, AWS). Although the ANSI/J-STD-004 and other flux specifications have their roots in electronic soldering, they can also be used to specify fluxes for structural soldering.

At the heart of the document are the two sections titled: “Soldering Procedure

Qualification” and “Soldering Performance Qualification.” The first section establishes the specimen geometry, fabrication procedures, and solder joint test and evaluation data that are used to accept the level of workmanship. Besides visual inspection, which is performed on all test specimens, the type of joint — butt, lap, and nonstandard configurations — dictates the mechanical test format, be it the tension test, bend test, or peel test as outlined in the appropriate subsections. Metallographic cross sections, together with macroetching techniques, are used to identify defects in the soldered joint. Acceptance criteria for all of the evaluation techniques are provided in those respective subsections.

The second section, “Soldering Performance Qualification,” addresses the ability of a solderer, a person who performs the manual soldering process; or the soldering operator, a person who operates semiautomated or fully automated soldering equipment; to make a solder joint that passes the acceptance criteria. The test soldered joints are made by the solderer or soldering operator by an established soldering procedure specification (SPS).

Both the Soldering Procedure Qualification and Soldering Performance Qualification steps must be reperformed in the event that there is a change to any of the SPS critical variables (e.g., different base material types, base material thickness, solder alloy, or a host of other factors).

Future Soldering Specifications

An unforeseen consequence of the effort to produce AWS B2.3 was a review of the standards and specifications currently active in the soldering industry as a whole. By and large, soldering specifications have been dominated by those generated within the electronics industry. Although the fundamentals of soldering are the same, the details of electronic soldering are sufficiently different from those of structural soldering as to require separate specifications and standards. At this time, the discipline of structural soldering does not have standards and specifications that address the variety of joint geometries and process options. The C3B Subcommittee has been requested by the C3 Committee to assess the need for such documents and the resources that would be required to develop them. ♦

Metglas®

www.Brazing.Metglas.com

Metglas® Amorphous Brazing Filler Metals are 100% metallic ductile foils without organic binders or contaminating residues, which creates virtually reject-free joints with high strength and superior corrosion resistance.

Metglas® Brazing Foils are available in various alloy compositions and widths and can be stamped into preforms with precise shapes for applications such as:

- ★ Aerospace
- ★ Honeycomb Lightweight Structures
- ★ Precise Machining
- ★ Plate Heat Exchangers

Also ideal for use in automotive applications such as:

- ★ Heat Exchangers
- ★ EGR Coolers
- ★ Fuel Coolers
- ★ Oil Coolers
- ★ Metallic Catalyst Substrates
- ★ Diesel Exhaust Components

email: metglas@metglas.com

Europe	USA / Americas	Asia
(49) 211 160 0923	1-800-581-7654 (843)349-7319	(85) 227 227 680

For info go to www.aws.org/ad-index

BRAZING & SOLDERING TODAY

Head to Orlando for the Latest in Brazing and Soldering

The brazing and soldering community will gather in Orlando, Fla., April 26–29, to share information at this preeminent event

The American Welding Society (AWS) and ASM International have once again joined forces to bring the 4th International Brazing & Soldering Conference (IBSC) to Orlando, Fla., on April 26–29, 2009. Held every three years, the event offers preconference education sessions along with three days of technical sessions on the latest developments in the brazing and soldering industries. In addition, top companies in the industry will exhibit the latest brazing and soldering products, giving participants the opportunity to evaluate new products, problem solve, and network with their peers.

Upcoming Conference Details

Major players of the world brazing community have already committed to participate in the IBSC 2009. Scientists and engineers from at least 12 countries will present new achievements in more than 80 papers during the nine planned sessions. These sessions encompass practically all fields of joining technology, including solders and soldering technology; ceramic, composite, and glass joining; filler metals; light metals joining; brazing processing; new brazing applications; joining modeling and measurements; joint reliability; and joining fundamentals.

Other highlights include an educational program on Sunday, April 26, as well as the table top exhibition during the technical sessions. Early signs from the preliminary program indicate that the IBSC 2009 will again have a large international presence. A special memorial symposium on ceramic joining is also being organized to honor Dr. John Stephens, one of the brazing community's significant contributors in the area of active filler metal brazing, related



A few highlights of the last International Brazing & Soldering Conference held April 23–26, 2006, in San Antonio, Tex., included technical paper presentations, poster exhibits, and vendor displays. It also registered 263 attendees. In 2009, this opportunity to meet and share information with colleagues from around the world on the most recent brazing and soldering technologies will once more be presented.

mechanical properties, and constitutive relationships. Keynote addresses in brazing and soldering are also planned to open the technical sessions.

While visiting the exhibition area, a special Photo Exhibition, compliments of Dr. Alex Shapiro, will also be featured. The exhibition will include a display of more than 140 photos demonstrating a huge variety of brazing and soldering applications in our civilization. The photos exemplify the outstanding achievements of brazing and soldering colleagues, industrial companies, and universities throughout the United States and around the world.

A large group of dedicated AWS C3 Brazing Committee members have volunteered their time to participate in organizing the event together with AWS and ASM

International staff. Through these collaborative efforts, the conference will no doubt achieve the same highly recognized success as previous IBSCs held in both 2003 and 2006.

Benefits of Participating

By attending the IBSC 2009 in Orlando, individuals can share their knowledge with colleagues, potential customers, and the joining community. This international networking event, with many of the most respected brazing and soldering technologists and suppliers in the field, offers an unparalleled opportunity that occurs only once every three years. Take this as an invitation to play a part in the IBSC 2009.

Information regarding the 2009 International Brazing & Soldering Conference can be found at www.aws.org/education/ibsc or by calling (800) 443-9353 (outside North America (305) 443-9353), ext. 213.

BRAZING & SOLDERING TODAY

Conference History Basics

The first IBSC was held in Albuquerque, N.Mex., during April 2000. The original goal of the organizers was to bring together world-class experts and leaders in materials joining to exchange ideas and advances in brazing and soldering science and technology. The event was organized through the cooperative efforts of AWS and ASM International, in coordination with the LÖT International Conference on Brazing, High Temperature Brazing and Diffusion Bonding and under the sponsorship of the German Welding Society (DVS), the European Association for Brazing and Soldering (EABS), and the Japanese Welding Society (JWS). Occurring once every three years, the IBSC has become the authoritative source for the latest in technical advances, industrial applications, and leading edge research and development for brazing and soldering technology.

In April 2006, more than 350 researchers, practitioners, and suppliers in

brazing, soldering, and affiliated joining technologies from around the world converged on San Antonio, Tex., for IBSC 2006. They met and discussed the latest advances in their respective technical areas of expertise and presented examples of how to apply this knowledge to real-world applications. The conference provided a varied program, including educational seminars that were offered on Sunday prior to the start of the technical sessions. Eighty attendees arrived early to learn the basics of brazing and advances in joining technology from professional experts. The seminars were followed by a special interview with Robert Peaslee, known to many in the brazing community as the "Father of Nickel Brazing."

The technical sessions opened on Monday morning. This third AWS/ASM International Brazing and Soldering Conference provided many opportunities for the assembled novices, engineers, suppliers, scientists, and academics to share and discuss the topics (more than 90 presentations) that were presented during three days of excellent technical programming.

The papers covered topics including light metal joining, ceramic brazing and glass joining, brazing filler metals, soldering and solder process behavior, fundamental studies in brazing and soldering, process modeling and measurements, emerging braze processes, and joint reliability. The technical sessions were kicked off with two plenary talks, one by Dr. Tadashi Ariga, Tokai University, on brazing advances and research in Japan, and the other by Dr. Paul Vianco, Sandia National Laboratories, on environmental mandates to soldering technology. A parallel tabletop exhibition hosted 40 suppliers and provided the attendees an opportunity in a focused forum to obtain the latest product and technology information from these suppliers.

Overall, the IBSC 2006 nurtured a collegial atmosphere with many great networking opportunities for its attendees. Almost 35% of the conference attendees were international and represented more than 20 countries that contributed greatly to the breadth of the information on emerging technologies and markets. ♦



pi PRINCE / IZANT CO.
BRAZING ALLOYS AND PREFORMS

- PREFORMS
- PRECIOUS METALS
- SPECIALTY ALLOYS
- R & D THROUGH PRODUCTION

CERTIFIED AND REGISTERED TO
AS9100:2004 REV. B

CALL TOLL FREE: (800) 634-0437

Local or outside U.S. call: (216) 362 - 7000
Fax: (216) 362 - 7456

www.princeizant.com

For info go to www.aws.org/ad-index

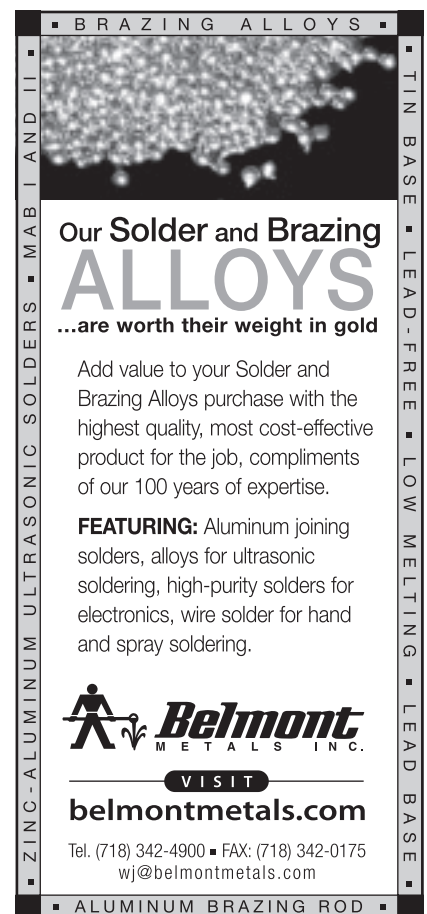

▪ BRAZING ALLOYS ▪

TIN BASE ▪ LEAD-FREE ▪ LOW MELTING ▪ LEAD BASE

Our Solder and Brazing
ALLOYS
...are worth their weight in gold

Add value to your Solder and Brazing Alloys purchase with the highest quality, most cost-effective product for the job, compliments of our 100 years of expertise.

FEATURING: Aluminum joining solders, alloys for ultrasonic soldering, high-purity solders for electronics, wire solder for hand and spray soldering.

belmontmetals.com

VISIT
Tel. (718) 342-4900 ▪ FAX: (718) 342-0175
wj@belmontmetals.com

▪ ZINC-ALUMINUM ULTRASONIC SOLDERS ▪ MAB I AND II ▪

ALUMINUM BRAZING ROD

For info go to www.aws.org/ad-index

BRAZING & SOLDERING TODAY

TECHNOLOGY NEWS

New Ag-Al Brazing Filler Metals for High-Temperature Electrochemical Devices

Silver-aluminum-based air brazing of ceramics was attempted in the Pacific Northwest National Laboratory, Richland, Wash., using an in situ alloying and brazing process (Ref. 1). Layers of foils of aluminum and silver were laid between alumina plates in an alternating fashion to achieve three target compositions representing Ag, Ag₃Al, and Ag₂Al phases. The assemblies were heated in air at 2°C/min to a final temperature of 600°, 800°, 1000°, or 1100°C and held for 6 min before furnace cooling. Microstructure, mechanical properties, and fracture of joints were studied. Room-temperature four-point bend testing of joints was conducted.

Joints brazed with foils containing 9.8 at.-% Al formed a long continuous layer parallel to the direction of the original aluminum foil. The fracture occurred at low bend strength 6–12 MPa (0.9–1.7 ksi) through the interface between this newly

formed along the alumina layer and the braze metal. Joints containing 26.5 at.-% Al in the braze metal experienced the series of phase transformations, resulting in cracks in as-brazed specimens. The fracture initiated through these preexisting cracks, and the strength of these joints was extremely low. The joints prepared using foils with 35.1 at.-% Al exhibited good interface even though interfacial alumina particles formed during air brazing. Crack propagation occurred along the interface between the alumina substrate and in situ formed interfacial alumina particles or directly through these particles. Due to the good interface, the best bend strength 46–52 MPa (6.7–7.5 ksi) was achieved for the brazing filler metal containing 35 at.-% Al.

In all the braze compositions, the sample heated up to 800°C revealed alloying of aluminum and silver, and the alloying was mostly complete at 1000°C.

New Alloys for Brazing Fe-Based Materials

Traditional brazing of stainless steels is performed by nickel-based or copper-based

brazing materials. Except a corrosion problem, the use of Ni- or Cu-based filler metals is limited in a number of food applications. There is a need of Fe-based materials such as highly alloyed steel heat exchangers, which must be brazed with alloys that exhibit similar corrosion resistance, etc. Iron-balanced alloys exhibit good wetting of crevices. New Fe-based brazing filler metals disclosed by Alpha Laval Corporate AB, Sweden, contain (wt-% Cr + wt-% Ni + wt-% Mo) ≥ 33 or 38 wt-%, and where wt-% Fe > wt-% Cr and wt-% Ni ≥ wt-% Mo are suggested. These alloys also contain melting point depressants wt-% P + 1.1 × wt-% Si + 3 × wt-% B altogether in the range of 5–20 wt-% (Refs. 2, 3).

An example within those ranges demonstrated is an alloy comprised of 15–30 wt-% Cr, 0–5 wt-% Mn, 15–30 wt-% Ni, 0–12 wt-% Mo, 0–4 wt-% Cu, 0–1 wt-% N, 0–20 wt-% Si, 0–2 wt-% B, 0–16 wt-% P, 0–25 wt-% of additional metals such as W, Ti, or Al, and ~40 wt-% Fe. Other alternative alloys are possible, with decreased wt-% Mo or greater wt-% Mo, the other elements varying accordingly. The alloy is intended for use at tempera-

TECHNICAL TRAINING

The *Hobart Institute of Welding Technology* offers our comprehensive *Technical Training* courses throughout the year! Upcoming dates:

Prep for AWS Certified Welding Supervisor Exam

Nov 17-21 • Feb 16-20 • Jun 22-26 • Aug 10-14

Prep for AWS Welding Inspector/Educator Exam

Oct 20-31 • Dec 1-12 • Jan 19-30 • Feb 23-Mar 6 • May 11-22

Visual Inspection

Dec 16-18 • Feb 17-18 • Apr 7-8 • Jun 30-Jul 1

Welding for the Non Welder

Nov 3-6 • Jan 6-9 • Apr 27-30 • Jun 22-25 • Aug 17-20

Arc Welding Inspection & Quality Control

Oct 13-17 • Mar 16-20 • May 4-8 • Jul 27-31

Weldability of Metals, Ferrous & Nonferrous

Oct 20-24 • Nov 17-21 • Dec 15-19 • Jan 26-30 • Feb 23-27

Liquid Penetrant & Magnetic Particle Inspection

Nov 10-14 • Jan 12-16 • Apr 13-17 • Aug 3-7



1-800-332-9448

or visit us at www.welding.org
for more information.

© 2008 Hobart Institute of Welding
Technology, Troy, OH
St. of Ohio Reg. No. 70-12-0064HT

For info go to www.aws.org/ad-index

PIRANHA II

Tungsten Electrode Grinder



ECONOMICALLY PRICED TUNGSTEN GRINDER

SAFETY: Enclosed diamond wheel grinding area

WELD QUALITY: 20 Ra finish improves tungsten life, starting & arc stability

PRODUCTIVITY: Longitudinal diamond grind your tungsten under 30 seconds

VALUE: Diamond flat, grind & cut your tungsten economically

DIAMOND GROUND PRODUCTS, INC.

2550 Azurite Circle Newbury Park CA 91320

Phone (805) 498-3837 • FAX (805) 498-9347

Email: sales@diamondground.com

Visit our website: www.diamondground.com

For info go to www.aws.org/ad-index

BRAZING & SOLDERING TODAY

TECHNOLOGY NEWS

tures at least at 1100°C, near its solidus temperature.

A related alloy that finds use for its narrow melting interval, while also providing good wetting when containing 20.1 wt-% Cr, 1.03 wt-% Mn, 18.2 wt-% Ni, 6.2 wt-% Mo, 0.19 wt-% N, 10.58 wt-% Si, 0.49 wt-% B, 0.8 wt-% Cu, and Fe in the balance of previously mentioned additional metals (Ref. 2). The filler metal has solidus temperature 1097°C (2005°F) and liquidus temperature 1221°C (2230°F). Another alloy (Ref. 3) contains phosphorus 5 wt-%, while other elements are 17.42 wt-% Cr, 1.67 wt-% Mn, 13.33 wt-% Ni, 1.99 wt-% Mo, 3.69 wt-% Si, 0.013 wt-% C, and Fe in the balance. This alloy has solidus temperature 1055°C (1930°F) and liquidus 1100°C (2012°F). Capillary force breakers are recommended for use with the alloy to braze a wide range of complex parts. The alloy may be manufactured by gas atomizing, water atomizing, or melt spinning, and may be alternatively manufactured as a paste containing either hydrophobic and/or hydrophilic binders.

Reactive Brazing of Al to Mg Using Zn-Based Filler Metal

Different physical and mechanical properties of magnesium and aluminum alloys make it difficult to weld them together. Direct contact reaction brazing of Mg and Al results in the formation of brittle intermetallic phases that make the shear strength of joints less than 10 MPa (1.45 ksi). An alternative method of contact reaction brazing of magnesium Alloy AZ31B to aluminum Alloy A6061 using an economical zinc solder was investigated in the Dalian University of Technology, China (Ref. 4).

First, the aluminum substrate was coated with the zinc solder Zn-1.5Al-2REM by dipping it in a solder pot at 450°C. The contact reaction with magnesium alloy was performed at a pressure of 5 MPa (0.7 ksi) in air in a furnace at 390–400°C for 10 s.

There was no significant intermetallic

phase formation observed — only a few MgZn₂ intermetallic phases existed homogeneously in the reaction zone with magnesium alloy. The aluminum alloy substrate and solder were bonded with the thin layer of Al-Zn solid solution. This means that the application of zinc solder completely impedes the formation of brittle Mg-Al intermetallics. The average shear strength of soldered joints was about 45 MPa (6.5 ksi), while the failure of joints was located at the interface between the reaction zone and solder metal starting from few pores that appeared in this zone.

It was suggested that the joining course includes the following: (a) a small amount of eutectic reaction liquid phase occurred by interdiffusion Mg/Zn in the contacting area, (b) more liquid phase was formed on the magnesium surface, and (c) the solder was dissolved into the liquid phase. The joint is formed when the liquid phase filled up the joint clearance under pressure.

More Efficient Microwave Brazing Methods

A new method of microwave brazing has been proposed by General Electric Co., Schenectady, N.Y., to melt alloys on a substrate without melting or damaging the substrate for application in instances where a braze alloy has similar composition to the base metal of a substrate. This microwave brazing technique improves upon previous work in that unintended heat loss to areas outside the braze is minimized.

The brazing alloy is comprised of a powder of smaller particles that individually require less energy to melt, and therefore a lower frequency wave can be used, which is preferable for larger components. Microwave power levels from 1 to 10 kW are expected. In experiment, 5 g of nano-sized nickel powder in 25 g of a larger nickel powder were heated to 1140°C (2084°F) by a 1-kW microwave radiation at regulation preferred frequency of 2.45 GHz (Ref. 5). The larger powder remained more than 200°C cooler.

An addition to this technique is to introduce particulates with diameter ratios of 1:1000 to 1:400 the size of alloy particles, or less than 100 nm, to the surface of said particles to further improve melting; these particulates being melting-point depressants and/or microwave coupling enhancers (Ref. 6). Recommended quantity of particulates is ~8 to 19 vol-% per par-

**Do your part for the future of
resistance welding.
Give this ad to a college student.**

A \$2,500 annual scholarship was established in 2005 by the Resistance Welder Manufacturers' Association for a college junior who wishes to become involved in the resistance welding industry. The hope is that the scholarship recipients will learn to appreciate the simple elegance and robustness of the process, so that they can carry the message forward to the next generation. The scholarship is awarded based on an essay, academics and recommendations. The deadline for the 2009 fall award is January 15. For details, visit <http://www.aws.org/foundation/scholarships/rwma.html>

RWMA

Resistance Welding Manufacturing Alliance
<http://www.aws.org/rwma>

BRAZING & SOLDERING TODAY

TECHNOLOGY NEWS

ticle. These particulates are attached to the surface of particles by mechanical alloying instead of by chemical vapor deposition or diffusion methods. Among melting point depressants recommended are Si, Ag, Ga, Zr, Pd, B, and Hf; common microwave coupling enhancers demonstrated are Si, SiC, Ga, Ni₂O₃, Ti, Al, Fe, C, Co, Ge, Zn, etc.

More Efficient Method of Preparing a Surface for Coating

A method of treating a brazed surface is proposed so that powder on the surface of the braze from the flux does not delaminate with later coating of that area. The method involves applying a flux-removing agent to the brazed surface for 30 to 180 s. The flux-removing agent described is potassium fluoride KF with concentrations of 2.5–3.5% in an aqueous solution when considering aluminum alloys as base metals (Ref. 7).

The process was tested with the NO-COLOK® flux used to braze the A3003 aluminum alloy in a controlled atmosphere furnace. The scanning electron microscopy image of a surface of the aluminum manifold after fluxing and brazing shows flux powder crystals covering the aluminum surface. Then, the brazed aluminum surface was immersed into the 3.0% KF aqueous bath to remove the flux crystals. The cleaned aluminum surface was suitable to receive a subsequent coating without substantial delamination after the braze, because crystals from the solution suspending the flux were removed by the method, as confirmed by energy dispersive spectroscopy.

A Potassium Fluoroaluminate Flux Containing Cs-La or Cs-Bi Cations for Brazing Aluminum Alloys

During the brazing of aluminum alloy parts, a flux is applied onto the surface of joining to remove aluminum oxide and contaminants that would otherwise inhibit brazing. The flux melts when heated, cleaning the surface — this occurs before the filler metal melts — it is applied in the form of a composition with other additives as a paste or fluid form. A composition of a flux for this purpose that may be applied as a powder via an electrostatic applica-

Annealing at 220°C and reflowing at 260°C can significantly reduce the tin whisker growth.

tion is disclosed by Solvay Fluor GmbH, Hannover, Germany, and Alcan Rhenalu, Paris, France, to be comprised of fluoroaluminate anions, potassium cations, cesium cations, and one metal cation from the group of bismuth, cerium, and lanthanum (Ref. 8).

The flux may be produced by mixing potassium fluoroaluminate and cesium fluoroaluminate. Other components are taken from respective amounts of bismuth oxide, cerium oxide, or lanthanum oxide. A flux comprising of 1 wt-% Cs and 1 wt-% Bi, Ce, or La content was found to produce preferable synthesis, and Al-0.5Mg alloy parts were successfully brazed with this flux at 605°C in a nitrogen atmosphere.

For example, the flux preparation procedure includes (a) mixing water with 50% HF solution, (b) adding the appropriate amount of Al(OH)₃, (c) adding lanthanum oxide, cesium lye, and potassium lye into the reactor and heating the mixture to 80°C, (d) stirring the precipitated product for 2.5 h during the post-reaction phase, and (e) drying at 200°C and milling the flux.

Relieving Sn Whisker Growth by Oxidation of Cu Leadframe

Tin whisker growth is a serious reliability issue for application of lead-free solders in electronics. The mechanism of whisker growth from Sn finish on copper leadframe was investigated in National Chiao Tung University and Integrated Service Technology Co., Taiwan (Ref. 9). The temperature/humidity storage test was used for this purpose at 60°/90% humidity. Humidity has a significant effect on whisker growth, especially in a long run test for 3000 h.

It was found that oxidation of the Sn finish was the driving force behind the whisker growth. Two thermal treatments including annealing at 220°C and reflowing at 260°C can significantly reduce the

tin whisker growth. Authors suggested that both heat treatments can relieve residual stresses in the Sn finishes and modify their grain structure that results in a lower oxidation rate. Since oxidation provides the compressive stress needed for the Sn whiskers growth, the heat treatment could mitigate this growth.

The reflowing treatment can also change the columnar grain structure of the tin film to obtain an equiaxed grain structure in some regions, resulting in a lower grain boundary diffusion rate of tin crystals. Therefore, the reflowing is an excellent way for relieving Sn whisker growth. ♦

References

1. Kim, J. Y., Hardy, J. S., and Weil, K. S. 2007. Ag-Al based air braze for high temperature electrochemical devices. *Int. Journal of Hydrogen Energy* v. 32: 3754–3762.
2. Sjodin, P. 2008. *Brazing material, a method of brazing, a brazed article and a paste comprising this brazing material*. International Patent Application No. 2008/060225.
3. Sjodin, P. 2008. *Brazing material*. International Patent Application No. 2008/060226.
4. Liu, L., Tan, J., and Liu, X. 2007. Reactive brazing of Al alloy to Mg alloy using zinc-based brazing alloy. *Materials Letters* v. 61: 2373–2377.
5. Budinger, D. E. 2007. *Microwave brazing process*. EU Patent Application No. 07121654.3.
6. Creteigny, L. 2008. *Brazing material and processes for making and using*. U.S. Patent Application No. 2008/0142575.
7. Lazarz, K., and Evans, T. V. 2008. *Method for preparing a brazed surface for receiving a coating*. U.S. Patent Application No. 2008/0145542.
8. Seseke-Koyro, U., Becker, A., Wilshusen, M., Dulac, S., and Gabriel, A. 2007. *Flux for brazing of aluminum*. World International Patent Application No. 2007/131993.
9. Wei, C. C., Liu, P. C., and Chen, C. 2007. Relieving Sn whisker growth driven by oxidation on Cu leadframe by annealing and reflowing treatments. *Journal of Applied Physics* v. 102, 043521 (1–7).

Information provided by LEO A. SHAPIRO and ALEXANDER E. SHAPIRO (ashapiro@titanium-brazing.com), Titanium Brazing, Inc., Columbus, Ohio.

NOTE: A DIAMOND (◆) DENOTES AN AWS-SPONSORED EVENT.

◆ **FABTECH International & AWS Welding Show.** Oct. 6–8, Las Vegas Convention Center, Las Vegas, Nev. This show is the largest event in North America dedicated to showcasing the full spectrum of metal forming, fabricating, tube and pipe, and welding equipment and technology. Contact American Welding Society, (800/305) 443-9353, ext. 455; www.aws.org.

◆ **New Technologies in Thermal Cutting.** Oct. 6, Las Vegas Convention Center, Las Vegas, Nev. In conjunction with the FABTECH International & AWS Welding Show. Contact American Welding Society, (800/305) 443-9353, ext. 455; www.aws.org.

◆ **New Nondestructive Testing Technologies Conf.** Oct. 7, Las Vegas Convention Center, Las Vegas, Nev. In conjunction with the FABTECH International & AWS Welding Show. Contact American Welding Society, (800/305) 443-9353, ext. 455; www.aws.org.

◆ **Friction Stir Welding Conf.** Oct. 8, Las Vegas Convention Center, Las Vegas, Nev. In conjunction with the FABTECH International & AWS Welding Show. Contact American Welding Society, (800/305) 443-9353, ext. 455; www.aws.org.

ISR '08, 39th Int'l Symposium on Robotics. Oct. 15–17, COEX Convention Center, Seoul, Korea. Visit www.isr08.org.

2nd Int'l Railroad Symposium and Trade Expo. Oct. 15–17, Hay-

darpa Train Station, Istanbul, Turkey. Visit www.irsturkey.org.

ICALEO® 2008, 27th Int'l Congress on Applications of Lasers & Electro-Optics. Oct. 20–23. Pechanga Resort & Casino, Temecula, Calif. Contact Laser Institute of America, (800) 345-2737, (407) 380-1553, www.icaleo.org.

Lean to Green Manufacturing. Oct. 27–29. Doubletree Hotel & Executive Meeting Center, Portland, Ore. Contact Society of Mfg. Engineers, (800) 733-4763, www.sme.org/leantogreen.

CNC Machining Clinic. Nov. 4–6. Doubletree Hotel, Oak Brook, Ill. Contact Society of Mfg. Engineers, (800) 733-4763, www.sme.org.

ASNT Fall Conf. & Quality Testing Show. Nov. 10–14. Charleston Convention Center, Charleston, S.C. For complete information or to register, visit www.asnt.org/events/conferences/fc08/fc08.htm.

17th Rolling Conf. and 4th Conf. on Uses of Steel. Nov. 10–13. Metropolitan Convention Center, Rosario, Argentina. Contacts www.iom3.org/events/17th-rolling-conference-and-4th-conference-uses-steel; conferencia@siderurgia.org.ar; (54) 3461 461805.

5th METALFORM Mexico Expo. Nov. 11–13. Centro Banamex, Mexico City, Mexico. Sponsored by Precision Metalforming Assn. Visit www.metalform.com/mexico.

BUY AMERICAN
Joe Fuller, LLC

Turning Rolls • Positioners • Manipulators • Welding Chucks
COMPARE PRICE! QUALITY! DELIVERY!
We Buy, Sell & Repair New and Used Welding Equipment
5029 Milwee, Building 4 • Houston, Texas 77092
979-277-8343 • Fax 281-290-6184
www.joefuller.com

Turning The World
EXTENDING THE LIFE OF YOUR EQUIPMENT

JFRD-UFR1-10
10 Ton Tank Turning Rolls

JFRD-UFR1-20
20 Ton Tank Turning Rolls

JFRD-UFR1-30
30 Ton Tank Turning Rolls

JFRD-UFR1-60
60 Ton Tank Turning Rolls

JFRD-UFR1-90
90 Ton Tank Turning Rolls

JFRD-UFR1-120
120 Ton Tank Turning Rolls

JFRD-3000/JFR-3000
3 Ton Pipe Roll

For info go to www.aws.org/ad-index

Mark With Solid Paint

The smooth writing Nissen® Solid Paint Markers are solid sticks of paint protected by an unbreakable plastic case. The markers can conveniently and cleanly be carried in your pocket. They make permanent marks on metal, wood, plastic, glass, cardboard, etc. They write on any surface: rough or smooth, wet or oily; even marks underwater.

The plastic case prevents the paint from drying out so it always writes easily and smoothly. The case also allows you to use the entire stick without needing a separate holder.

The markers are available in two sizes: Standard and Jumbo and four fast-drying, lead-free colors: white, yellow, red and black.

*Call, Fax, or Write
for Additional Information.*

Nissen
J.P. Nissen Co.
P.O. Box 339 • Glenside, PA 19038
(215) 886-2025 • Fax: (215) 886-0707
www.nissenmarkers.com

For info go to www.aws.org/ad-index

◆ **Welding of Engineering Plastics and Composites Conf.** Nov. 11, 12. Contact American Welding Society, (800/305) 443-9353, ext. 455; www.aws.org/conferences.

8th Int'l Symposium of the Japan Welding Society. Nov. 16-18, Kyoto, Japan. Visit www.nta-aps.jp/8WS/.

Aerospace Measurement, Inspection & Analysis Conf. Nov. 18, 19. Ft. Worth Convention Center, Ft. Worth, Tex. Contact Society of Mfg. Engineers, (800) 733-4763, www.sme.org/aerotest.

PACE 2009, The Power of Paint & Coatings. Feb. 15-18, 2009. New Orleans Convention Center, New Orleans, La. Visit www.pace2009.com.

HOUSTEX, 2009. Feb. 24-26, 2009. George R. Brown Convention Center, Houston, Tex. Contact Society of Mfg. Engineers, (800) 733-4763, www.sme.org/houstex.

◆ **Joining Dissimilar Metals Conf.** March 3, 4, 2009. Orlando, Fla. Contact American Welding Society, (800/305) 443-9353, ext. 455; visit www.aws.org.

Lean for the Supply Chain. March 3-5, 2009. Crown Plaza Hotel, San Jose, Calif. Contact Society of Mfg. Engineers, (800) 733-4763, www.sme.org.

ILSC® Int'l Laser Safety Conf. March 23-26, 2009. John Ascuaga's Nugget Hotel, Reno, Nev. Sponsored by Laser Institute of America, www.laserinstitute.org/conferences/ilsc; or call (407) 380-1553.

SPATTER

- Non-Toxic
- Biodegradable
- Aerosol & Liquid

WELD-KLEEN®

WELD-AID Ph: 800.935.3243
Fax: 313.883.4930
weldaid.com

World's Leading Brand of Anti-Spatter

For info go to www.aws.org/ad-index



THERE'S SOMETHING NEW IN THE AIR.

Sperian OS100 PAPR Powered Air Purifying Respirator, NIOSH Edition

Get complete protection from dust, metal fumes, UV/IR radiation and flying particles with our new OS100 PAPR.

The new system utilizes a High Efficiency Particulate Air (HEPA) filter system and a motorized blower that draws ambient air in through the filter, delivering cool, fresh filtered air through ports in the helmet.

Keep cool and breathe easier with the Sperian OS100 PAPR.



For more information, call 1-800-336-3255 or visit www.sperianprotection.com

SPERIAN
Protection you can trust

For info go to www.aws.org/ad-index

WESTEC. March 30–April 2, 2009. Los Angeles Convention Center, Los Angeles, Calif. Contact Society of Mfg. Engineers, (800) 733-4763, www.sme.org/westec.

MicroManufacturing and NanoManufacturing Conf. & Exhibits. March 31–April 1, 2009. Sheraton Bloomington Hotel, Minneapolis, Minn. Contact Society of Mfg. Engineers, (800) 733-4763, www.sme.org/micro, www.sme.org/nano.

◆ **IBSC, 4th Int'l Brazing and Soldering Conf.** April 26–29, 2009, Hilton Hotel in the Walt Disney World Resort, Orlando, Fla. Cosponsored by AWS and ASM International. Contact American Welding Society, (800/305) 443-9353, ext. 229; visit www.aws.org.

JOM-15, 15th Int'l Conf. on the Joining of Materials, and 6th Int'l Conf. on Education in Welding. May 3–6, 2009, Helsingør, Denmark. Contact JOM Institute, jom_aws@post10.tele.dk.

RAPID 2009. May 12–14, 2009. Renaissance Schaumburg Convention Center, Schaumburg, Ill. Contact Society of Mfg. Engineers, (800) 733-4763, www.sme.org/rapid.

Advanced Manuf. Expo. and Plant Maintenance & Design Engineering Show. May 19–21, 2009. Place Bonaventure, Montreal, Que., Canada. Contact Society of Mfg. Engineers, (800) 733-4763, www.sme.org.

EASTEC. May 19–21, 2009. Eastern States Exposition Grounds, W. Springfield, Mass. Contact Society of Mfg. Engineers, (800) 733-4763, www.sme.org/eastec.

◆ **Weld Cracking Heat-Affected Zone Conf.** June 9, 10, 2009, Columbus, Ohio. Contact American Welding Society, (800/305)

443-9353, ext. 229; www.aws.org.

First Int'l Conf. on Welding Technologies. June 11–13, 2009. Gazi University, Ankara, Turkey. Visit www.icwet09.org.

Western Mfg. Technology Show. June 16–18, 2009. Northlands Park-AgriCom, Edmonton, Alb., Canada. Contact Society of Mfg. Engineers, (800) 733-4763, www.sme.org/eastec.

◆ **Welding Corrosion-Resistant Alloys Conf.** Sept. 22, 23, 2009, New Orleans, La. Contact American Welding Society, (800/305) 443-9353, ext. 229; www.aws.org.

SOUTH-TEC. Oct. 6–8, 2009. Charlotte Convention Center, Charlotte, N.C. Contact Society of Mfg. Engineers, (800) 733-4763, www.sme.org/southtec.

◆ **FABTECH International & AWS Welding Show.** Nov. 15–18, 2009, McCormick Place, Chicago, Ill. This show is the largest event in North America dedicated to showcasing the full spectrum of metal forming, fabricating, tube and pipe, welding equipment, and technology. Contact American Welding Society, (800/305) 443-9353, ext. 455; www.aws.org.

◆ **Adhesive Bonding Conf.** Nov. 16, 2009, Chicago, Ill. Held during the FABTECH International & AWS Welding Show. Contact American Welding Society, (800/305) 443-9353, ext. 455; www.aws.org.

◆ **Welding Chrome-Moly Steels Conf.** Nov. 17, 2009, Chicago, Ill. Held during the FABTECH International & AWS Welding Show. Contact American Welding Society, (800/305) 443-9353, ext. 455; www.aws.org.

Genstar Technologies Co., Inc.
909-606-2726
www.genstartech.com

Weld Smarter With Total Welding Management

Implementing the principles and concepts in this book could save you \$15,000 to \$25,000 annually per welder.

Drawing on more than 50 years of welding experience, author Jack R. Barckhoff, P.E., gives you a solid step-by-step plan to manage your welding operations for maximum productivity and cost efficiency. Specific recommendations and real-life production examples illustrate how your welding team can realize productivity gains of 20 percent to 50 percent. *Total Welding Management* explains the management principles, structure, and details you need to transform your welding operations from a cost center into a profit center. A must-read for supervisors, managers, and executives who seek to make their welding operations more efficient and more productive. 185 pages, 35 figure, 20 tables, hardbound.

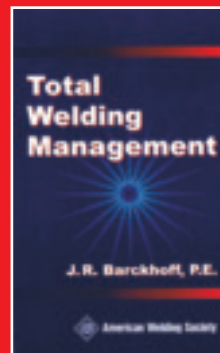

Order yours today: 888-WELDING (935-3464).

Outside North America: 305-824-1177.

Online: www.aws.org/standards

Order code: AWS TWM, \$49.50

© American Welding Society 2006

WJS1235

For info go to www.aws.org/ad-index

AWS Certification Schedule

Certification Seminars, Code Clinics and Examinations

Application deadlines are six weeks before the scheduled seminar or exam. Late applications will be assessed a \$250 Fast Track fee.

Certified Welding Inspector (CWI)

LOCATION	SEMINAR DATES	EXAM DATE
Corpus Christi, TX	EXAM ONLY	Nov. 22
Sacramento, CA	Nov. 30-Dec. 5	Dec. 6
Spokane, WA	Nov. 30-Dec. 5	Dec. 6
Syracuse, NY	Nov. 30-Dec. 5	Dec. 6
St. Louis, MO	EXAM ONLY	Dec. 6
Miami, FL	Dec. 7-12	Dec. 13
Reno, NV	Dec. 7-12	Dec. 13
Fresno, CA	Jan. 11-16, 2009	Jan. 17, 2009
Beaumont, TX	Jan. 11-16	Jan. 17
Knoxville, TN	EXAM ONLY	Jan. 17
Miami, FL	Jan. 25-30	Jan. 31
Albuquerque, NM	Jan. 25-30	Jan. 31
Corpus Christi, TX	EXAM ONLY	Jan. 31
Pittsburgh, PA	Feb. 1-6	Feb. 7
Denver, CO	Feb. 1-6	Feb. 7
Seattle, WA	Feb. 1-6	Feb. 7
Miami, FL	EXAM ONLY	Feb. 19
Milwaukee, WI	Mar. 1-6	Mar. 7
Indianapolis, IN	Mar. 1-6	Mar. 7
Atlanta, GA	Mar. 1-6	Mar. 7
Houston, TX	Mar. 8-13	Mar. 14
San Diego, CA	Mar. 8-13	Mar. 14
Norfolk, VA	Mar. 8-13	Mar. 14
Miami, FL	EXAM ONLY	Mar. 19
Rochester, NY	EXAM ONLY	Mar. 21
Anchorage, AK	Mar. 22-27	Mar. 28
Portland, OR	Mar. 22-27	Mar. 28
Boston, MA	Mar. 22-27	Mar. 28
Phoenix, AZ	Mar. 22-27	Mar. 28
York, PA	EXAM ONLY	Mar. 28
Miami, FL	Mar. 29-Apr. 3	Apr. 4
Chicago, IL	Mar. 29-Apr. 3	Apr. 4
Corpus Christi, TX	EXAM ONLY	Apr. 11
Dallas, TX	Apr. 19-24	Apr. 25
Springfield, MO	Apr. 19-24	Apr. 25
Baton Rouge, LA	Apr. 19-24	Apr. 25
Mobile, AL	EXAM ONLY	Apr. 25
San Francisco, CA	Apr. 26-May 1	May 2
Portland, ME	Apr. 26-May 1	May 2
Las Vegas, NV	Apr. 26-May 1	May 2
Waco, TX	EXAM ONLY	May 2
Miami, FL	EXAM ONLY	May 14
Nashville, TN	May 10-15	May 16
Jacksonville, FL	May 10-15	May 16
Baltimore, MD	May 10-15	May 16
Long Beach, CA	EXAM ONLY	May 30
Detroit, MI	May 31-Jun. 5	Jun. 6
Miami, FL	May 31-Jun. 5	Jun. 6
Albuquerque, NM	May 31-Jun. 5	Jun. 6
Spokane, WA	Jun. 7-12	Jun. 13
Oklahoma City, OK	Jun. 7-12	Jun. 13
Birmingham, AL	Jun. 7-12	Jun. 13
Hartford, CT	Jun. 14-19	Jun. 20
Pittsburgh, PA	Jun. 14-19	Jun. 20
Beaumont, TX	Jun. 14-19	Jun. 20
Corpus Christi, TX	EXAM ONLY	Jun. 20
Miami, FL	EXAM ONLY	Jul. 16
Fargo, ND	Jul. 12-17	Jul. 18

9-Year Recertification Seminar for CWI/SCWI

LOCATION	SEMINAR DATES	EXAM DATE
Miami, FL	Dec. 1-6	NO EXAM
New Orleans, LA	Jan. 12-17, 2009	NO EXAM
Denver, CO	Feb. 23-28	NO EXAM
Dallas, TX	Mar. 30-Apr. 4	NO EXAM
Sacramento, CA	May 4-9	NO EXAM
Pittsburgh, PA	Jun. 1-6	NO EXAM
San Diego, CA	Jul. 13-18	NO EXAM
Orlando, FL	Aug. 24-29	NO EXAM

For current CWIs and SCWIs needing to meet education requirements without taking the exam. If needed, recertification exam can be taken at any site listed under Certified Welding Inspector.

Certified Welding Supervisor (CWS)

LOCATION	SEMINAR DATES	EXAM DATE
Atlanta, GA	Nov. 17-21	Nov. 22
Long Beach, CA	Dec. 8-12	Dec. 13
Atlanta, GA	Jan. 26-30, 2009	Jan. 31, 2009
Houston, TX	Mar. 2-6	Mar. 7
Baton Rouge, LA	Apr. 20-24	Apr. 25
Columbus, OH	Jun. 1-5	Jun. 6
Minneapolis, MN	Jul. 20-24	Jul. 25
Philadelphia, PA	Aug. 31- Sep. 4	Sep. 5

CWS exams are also given at all CWI exam sites.

Certified Radiographic Interpreter (CRI)

LOCATION	SEMINAR DATES	EXAM DATE
Seattle, WA	Nov. 17-21	Nov. 22
Jacksonville, FL	Dec. 8-12	Dec. 13
Long Beach, CA	Feb. 2-6, 2009	Feb. 7, 2009
Miami, FL	Mar. 9-13	Mar. 14
Indianapolis, IN	Apr. 20-24	Apr. 25
Miami, FL	Jun. 22-26	Jun. 27
Houston, TX	Jul. 27-31	Aug. 1

Radiographic Interpreter certification can be a stand-alone credential or can exempt you from your next 9-Year Recertification.

Certified Welding Educator (CWE)

Seminar and exam are given at all sites listed under Certified Welding Inspector. Seminar attendees will not attend the Code Clinic portion of the seminar (usually first two days).

Senior Certified Welding Inspector (SCWI)

Exam can be taken at any site listed under Certified Welding Inspector. No preparatory seminar is offered.

Code Clinics & Individual Prep Courses

The following workshops are offered at all sites where the CWI seminar is offered (code books not included with individual prep courses): Welding Inspection Technology (general knowledge and prep course for CWI Exam-Part A); Visual Inspection Workshop (prep course for CWI Exam-Part B); and D1.1 and API-1104 Code Clinics (prep courses for CWI Exam-Part C).

On-site Training and Examination

On-site training is available for larger groups or for programs customized to meet specific needs of a company. Call ext. 455 for more information.

International CWI Courses and Exams

AWS training and certification for CWI and other programs are offered in many countries. For international certification program schedules and contact information, please visit http://www.aws.org/certification/inter_contact.html

For information on any of our seminars and certification programs, visit our website at www.aws.org/certification or contact AWS at (800/305) 443-9353, Ext. 273 for Certification and Ext. 455 for Seminars. Please apply early to save Fast Track fees. **This schedule is subject to change without notice.** Please verify the dates with the Certification Dept. and confirm your course status before making final travel plans.



American Welding Society®

Conference on Welding Engineering Plastics and Composites

Orlando, Florida • November 11-12, 2008

Conference sessions will cover topics such as:

- Fundamentals of welding thermoplastics
- Part and joint design considerations
- Welding polyimides (nylon)
- Welding polycarbonates and other thermal plastics
- Joining thermoplastic composites
- Welding fiberglass pipe
- Heat fusion welding of HDPE pipe
- Engineering adhesives
- Resistance welding of advanced composites
- Ultrasonic welding
- Vibration welding with reinforcements
- Laser, infrared laser, and micro-laser welding
- 3-D laser welding

Welded products consisting of engineering plastics have found many applications in such industries as automotive, medical devices, electronics, appliances, and aerospace. The processes used to weld these materials are numerous, to say the least, ranging from ultrasonic welding to vibration welding to laser welding to resistance welding. With all of these processes, consideration has to be given to surface preparation, heating, and pressing. And the materials being welded include thermoplastics, nylons, polycarbonates, fiberglass, advanced composites, and others.

Fundamentals of Welding of Thermoplastics

Avraham Benatar, Director – Plastics and Composites Joining Laboratory, Department of Industrial, Welding and Systems Engineering, The Ohio State University, Columbus, OH

Ultrasonic Welding of Plastics

Sophie Morneau, Manager, Plastics Joining Laboratory, Branson Ultrasonics Corp., Danbury, CT

Polyamide (Nylon) Welding Overview

Rob Cunningham, Engineering Team Leader, Application Engineering, LanXess Corporation, Pittsburgh, PA

Unique Approaches to Thermoplastic Composite Joining

Sean T. Flowers, Project Engineer, and Marc St. John, Edison Welding Institute, Columbus, OH

Vibration Welding Polypropylene Composites: The Effect of Reinforcements from Nanoclay to Continuous Fibres

Phil Bates, Professor, Department of Chemistry and Chemical Engineering, Royal Military College of Canada, Kingston, Ontario, Canada

Laser Transmission Properties for Engineering Plastics

Chul S. Lee, Applications Technology Leader, BASF Corp., Wyandotte, MI

Welding of Fiberglass Pipe

Kevin Schmit, Engineering Director, ITT Corporation, Baton Rouge, LA

Popular Methods Used for the Welding of Engineering Plastics

Jeffrey A. Weddell, Sales Manager, Bielomatik Inc., New Hudson, MI

Resistance Welding of Advanced Thermoplastic Composites

Ali Yousefpour, Research Officer, Aerospace Manufacturing Technology Center, Institute for Aerospace Research, National Research Council Canada, Montreal, Quebec, Canada

Part and Weld Joint Design Considerations for Welding of Plastics

Marc St. John, Senior Engineer, Edison Welding Institute, Columbus, OH

Infrared Laser Welding of Engineering Plastics

William H. Cawley, Process Chemist, Gentex Corp., Carbondale, PA

Engineering Adhesive Solutions

Scott Tremblay, Director, North American Engineering Center, Henkel Corp., Rocky Hill, CT

3-D Laser Welding of Plastics

Bill Miller, National Sales Manager, Leister Technologies, LLC, Itasca, IL

Heat Fusion Welding of HDPE Pipe

James Craig, Industry Relations Manager, McElroy Manufacturing, Inc., Tulsa, OK

Welding of Polycarbonate and Other Thermoplastics

Richard Peters, Secondary Operations Leader, SABIC Innovative Plastics, Pittsfield, MA

Through Transmission Micro-Laser Welding for Microfluidic and MEMS Applications

Avraham Benatar, Director, Plastics and Composites Joining Laboratory, Department of Industrial, Welding and Systems Engineering, The Ohio State University, Columbus, OH

To register or to receive a descriptive brochure, call (800) 443-9353 ext. 455, (outside North America, call 305-443-9353), or visit www.aws.org/conferences



American Welding Society

SOCIETY NEWS

BY HOWARD M. WOODWARD

AWS Leaders and Welding Instructors Train at AWS HQ



The 2008 Leadership Symposium was held July 20–23 at AWS headquarters in Miami, Fla. The attendees were (top photo, District numbers in parentheses) **Kevin Throgmorton (2)**, **Justin Heistand (3)**, **Bobby Perkins (4)**, **Ron Vann (5)**, **Wesley P. Czajkowski (6)**, **Peter G. Kinney (7)**, **Josh Burgess (8)**, **William Harris (9)**, **Lawrence A. Boros (10)**, **Keith Steelman and Michael Karagoulis (11)**, **Ray Connolly (12)**, **Craig Tichelar (13)**, **Joyce Kent (14)**, **Larry Postnikoff (15)**, **Bob Kephart (16)**, **Adam Ensminger and Howard Record (17)**, **Ellery**

A. Francisco and Michael Huelskamp (18), **David Koch (19)**, **Adam K. Johnson (20)**, **Jeff Davis (21)**, and **Liisa Pine Schoonmaker (22)**. **Ron Gilbert** of GEMS of Florida was the facilitator with **Lee Kvindahl**, a past AWS president.

Attending the 2008 Instructors Institute July 29–Aug. 2 at AWS headquarters were (bottom photo) **Richard Fuller (1)**, **Harland Thompson (2)**, **Leslie Lorenz (2)**, **James D. Stump (4)**, **Bobby Hathaway (5)**, **Greg Hutchison (6)**, **Jim Colter (7)**, **Mike Russell (8)**, **Donald Berger (9)**, **Mike Lorey (11)**, **Mike Pelegrino (13)**, **Michael**

Anderson (14), **Todd Bridigum (15)**, **Andy Zinn (16)**, **Dennis Pickering (17)**, **Chris Hobson (19)**, **Leland J. Vetter (20)**, **Danielle Medina-Hartsell (21)**, and **Tom Smeltzer (22)**. **Ron Gilbert** served as facilitator. The presenters included **Rick Polanin**, District 13 director; **Jim Greer**, a past AWS president; and **Ed Norman**, Southwest Area Career Center, Monett, Mo. The manufacturing representatives were **Jay Ginder** and **Tony Anderson**, ESAB; **Branden Muehlbrandt** and **Lou Kleinsmith**, Lincoln Electric; and **Neal Brochert** from Miller Electric.

ISO/TC 44 Meets in Berlin



Delegations from Canada, Denmark, Finland, France, Germany, India, Japan, Korea, Malaysia, Russian Federation, Sweden, United Kingdom, United States, and IIW members convened for the meeting of ISO/TC 44, Welding and Allied Processes, held at the German National Standards Institute (DIN) offices in Berlin, July 17 and 18. Members of the U.S. delegation included AWS President Gene Lawson, Damian Kotecki, Walter Sperko, David Fink, and Andrew Davis, AWS managing director, technical services.

New Standards Projects

Development work has begun on the following revised standards. Directly and materially affected individuals are invited to contribute to their development. Participation on all AWS Technical Committees and Subcommittees is open to all persons. Those wanting to participate should contact Staff Engineer R. Gupta, ext. 301.

A5.14/A5.14M:200X, *Specification for Nickel and Nickel-Alloy Bare Welding Electrodes and Rods*. The chemical compositions of nearly 50 nickel and nickel-alloy welding electrodes and rods are specified, including three compositions not previously classified. This specification makes use of both U.S. Customary Units and the International System of Units (SI). Stakeholders: Welding industry.

A5.22/A5.22M:200X, *Specification for Stainless Steel Flux Cored and Metal Cored Welding Electrodes and Rods*. Classification and other requirements are specified for numerous grades of flux cored and metal cored stainless steel electrodes and rods. New classifications include a duplex alloy and three high-carbon classifications plus all of the metal cored electrodes currently in A5.9/A5.9M. The next revision of A5.9/A5.9M will not list these electrodes. Stakeholders: Welding industry.

Standard for Public Review

A5.14/A5.14M:200X, *Specification for Nickel and Nickel-Alloy Bare Welding Electrodes and Rods*. \$25. 10/20/2008.

AWS was approved as an accredited standards-preparing organization by the American National Standards Institute (ANSI) in 1979. AWS rules, as approved by ANSI, require that all standards be open to public review for comment during the approval process. The following revised standard is open for public review

until the date shown. A draft copy may be obtained from Rosalinda O'Neill, ext. 451, roneill@aws.org.

Standards Approved by ANSI

C3.9M/C3.9:2009, *Specification for Resistance Brazing*. New. Approved 7/30/08.

B2.1/B2.1M:2009, *Specification for Welding Procedure and Performance Qualification*. Revised. Approved 8/22/08.

C1.4M/C1.4:2009, *Specification for Resistance Welding of Carbon and Low-Alloy Steels*. Revised. Approved 8/22/08.

ISO Standard for Public Review

ISO/DIS 3580, *Welding consumables — Covered electrodes for manual metal arc welding of creep-resisting steels — Classification*.

Copies of this standard are available from your national standards body, which in the United States is ANSI, 25 W. 43rd St., 4th Fl., New York, NY 10036; (212) 642-4900. Any comments regarding ISO documents should be sent to your national standards body. In the United States, if you wish to participate in the development of international standards for welding, contact Andrew Davis, ext. 466, adavis@aws.org.

Technical Committee Meetings

Oct. 5, C7 Committee on High Energy Beam Welding and Cutting. Las Vegas, Nev. Call R. Starks, ext. 304.

Oct. 5, C7B Subcommittee on Electron Beam Welding and Cutting. Las Vegas, Nev. Call R. Starks, ext. 304.

Oct. 6, A5K Subcommittee on Titanium and Zirconium Filler Metals. Las Vegas, Nev. Call S. Borrero, ext. 334.

Oct. 6, C5 Committee on Arc Welding and Cutting. Las Vegas, Nev. Call M. Rubin, ext. 215.

Oct. 6, D10 Committee on Piping and Tubing. Las Vegas, Nev. Call B. McGrath, ext. 311.

Oct. 6, D14I Subcommittee on Welding Hydraulic Cylinders. Las Vegas, Nev. Call M. Rubin, ext. 215.

Oct. 6, D15C Subcommittee on Track Welding. Las Vegas, Nev. Call R. Starks, ext. 304.

Oct. 6, D18 Committee on Welding in Sanitary Applications. Las Vegas, Nev. Call R. Starks, ext. 304.

Oct. 6, G2D Subcommittee on Reactive Alloys. Las Vegas, Nev. Call S. Borrero, ext. 334.

Oct. 7, B1 Committee on Methods of Inspection. Las Vegas, Nev. Call B. McGrath, ext. 311.

Oct. 7, C2 Committee on Thermal Spraying. Las Vegas, Nev. Call R. Starks, ext. 304.

Oct. 7, C6 Committee on Friction Welding. Las Vegas, Nev. Call R. Starks, ext. 304.

Oct. 7, D9 Committee on the Welding, Brazing, and Soldering of Sheet Metal. Las Vegas, Nev. Call A. Alonso, ext. 299.

Oct. 7, D14B Subcommittee on General Design and Practices. Las Vegas, Nev. Call M. Rubin, ext. 215.

Oct. 7, D14C Subcommittee on Earth-moving and Construction Equipment. Las Vegas, Nev. Call M. Rubin, ext. 215.

Oct. 7, D14G Subcommittee on Welding of Rotating Equipment. Las Vegas, Nev. Call M. Rubin, ext. 215.

Oct. 7, D16 Committee on Robotic and Automatic Welding. Las Vegas, Nev. Call M. Rubin, ext. 215.

Oct. 7, 8, C3 Committee on Brazing and Soldering and Subcommittees. Las Vegas, Nev. Call S. Borrero, ext. 334.

Oct. 8, A5H Subcommittee on Filler Metals and Fluxes for Brazing. Las Vegas,

Nev. Call S. Borrero, ext. 334.

Oct. 8, D14 Committee on Machinery and Equipment. Las Vegas, Nev. Call M. Rubin, ext. 215.

Oct. 8, Committee on Personnel and Facilities Qualification. Las Vegas, Nev. Call J. Gayler, ext. 472.

Oct. 8-9, D15 Committee on Railroad Welding. Las Vegas, Nev. Call R. Starks, ext. 304.

Oct. 8, 9, D15A Subcommittee on Freight Cars and Locomotives. Las Vegas, Nev. Call R. Starks, ext. 304.

Oct. 8, 9, D17K Subcommittee on Fusion Welding. Las Vegas, Nev. Call R. Starks, ext. 304.

Oct. 9, D17 Committee on Welding in the Aircraft and Aerospace. Las Vegas, Nev. Call R. Starks, ext. 304.

Oct. 9, D17D Subcommittee on Resistance Welding. Las Vegas, Nev. Call R. Starks, ext. 304.

Oct. 15, SH1 Subcommittee on Fumes and Gases. Columbus, Ohio. Call S. Hedrick, ext. 305.

Oct. 20-22, A2 Committee on Definitions and Symbols. Wheeling, W.Va. Call A. Alonso, ext. 299.

AWS C7.4 Laser Welding Standard Implemented at University of Wisconsin



The University of Wisconsin — Madison, Department of Engineering Professional Development, celebrated the 'overwhelming success' of the first year of its Laser Welding Certification Program in June. AWS C7.4/C7.4M:2008, Process Specification and Operator Qualification for Laser Beam Welding, is a required text for the class. Shown is the June 2008 laser welding class with (front row) Simon Engle of HDE Technologies, Inc., technical director of the laser welding certification program, with Elaine Bower, program director at the university.

Technical Inquiry D15.1

Subject: Clarification of Section 8.7.1

Code Edition: D15.1/D15.1M:2007

Code Provision: Section 8.7, p. 63

AWS Log: D15.1-05-I01

Inquiry: The welding procedure in paragraph 8.7.1 specifies welding Column Guide Wear Plates onto side frames. My question is does this also include the welding of roof liner stops when applying TransDyne® "clip-on" type roof liners? Reference the latest edition of AAR RP-323 or manufacturer's instructions.

Response: Let us answer your question by showing the Committee's logic for adding Clause 8.7 to D15.1. Most of us in the railroad industry have experienced the frustration of having to try to qualify a welding procedure (WPS) on wear plates or wear liners. These wear liners are historically made of extremely hard materials that get welded into place in the car. When qualifying a WPS, trying to get these materials to pass mechanical tests can be extremely difficult and often yield meaningful results. Additionally, in most cases, there are specific instructions for welding these materials given in either the Association of American Railroads (AAR) Specification or in manufacturer (supplier) instructions. The thought was since we are given specific instructions on welding (from either the AAR or supplier) and because of the difficulty in achieving meaningful results, coupled with the fact that in most cases these welds are not structural in nature and subject mostly to compressive-type loads, there was no need to force our end-users to go

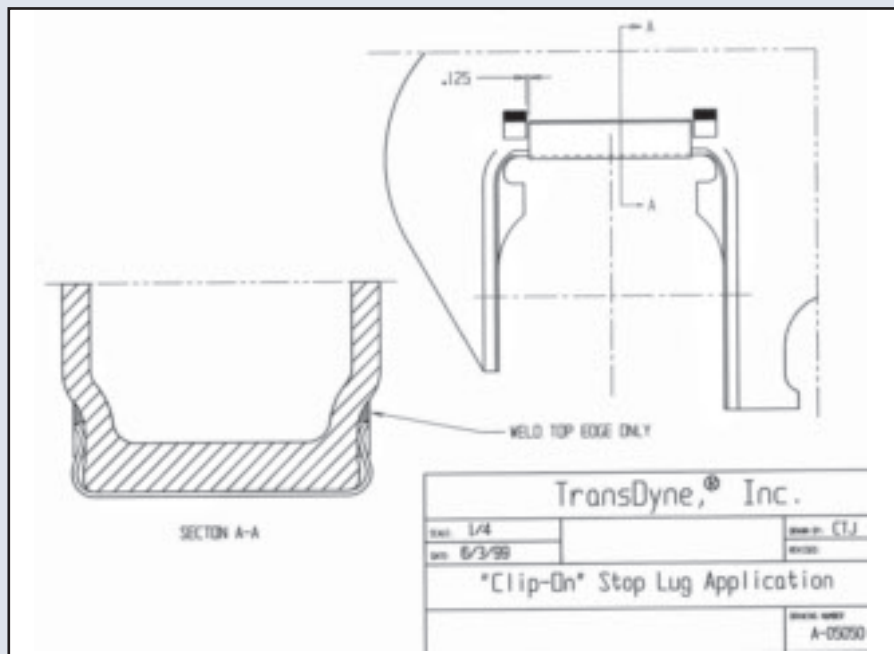

through the motions of requiring procedure qualification. We assigned a task force to look into the various types of wear plates and wear liners that the industry generally uses and make suggestions to the committee. The results are included in Clause 8.7.

Specifically, the reason that the type of wear plate that your question refers to is not included in Clause 8.7 is that there is no welding directly to the clip-on roof liner itself. The application of the bar stock material shown in the AAR and supplier documents is attached directly to the side frame itself. And while the side frame

is a cast material that can be difficult to weld to, if the proper techniques (preheating, filler metals, etc.) are utilized, acceptable results can be achieved. This can be proven out through the standard procedure qualification process described in Clause 10 of AWS D15.1. Additionally, there is no specific welding information given to lead us to an acceptable welding procedure — as a result one would need to be developed by the end-user.

It is hoped this response has adequately answered your inquiry. If not, contact AWS Staff Engineer Reino Starks for additional information.

A Summary of Changes in ASME Section IX 2007 Edition, 2008 Addenda

BY WALTER J. SPERKO, P.E.

The following is a summary of the changes that appear in the 2007 Edition, 2008 Addenda, of ASME Section IX. The opinions expressed in this article are those of the author and not the official opinions of Subcommittee IX. The changes become mandatory Jan. 1, 2009.

Welding Procedure Qualifications Are Good for Forever Most of the Time

Since the earliest days of Section IX, it has been understood that Welding Procedure Specifications (WPSs) meeting the requirements of previous editions or addenda of Section IX were permitted to be followed when constructing boilers, pressure vessels, and piping even when the component being built was constructed to a later edition or addenda than that under which the WPS was qualified. The rationale for allowing the use of “old” WPSs is twofold: first, if the WPS was good enough for Code construction when it was qualified, it’s good enough for Code construction today; and second, the quality and properties of both base metals and welding consumables are better today than they used to be. QW-100.3, which addresses this, will continue to permit use of WPSs meeting the requirements of the 1962 or later edition without being updated to meet later code changes, but these addenda add one exception — when Subcommittee IX reassigns a material to a different P-number than the one to which it was previously assigned. When this happens, the WPS and supporting Procedure Qualification Records (PQRs) must be reviewed for the following:

1. If the test coupon material recorded on the PQR is a material that was among the materials that were reassigned, the PQR must be revised to show the new P-number assignment.

2. If a PQR supporting the WPS is revised, the WPS must be revised to show the new P-number assignment; this may require writing additional WPSs when more than one PQR supports a WPS and the test coupon materials shown on the PQRs are not the same in all PQRs.

3. PQRs and WPSs need to be revised only for new construction. The old WPS and PQR are still valid for repair work to previous editions of the Code where the old P-Number assignment was in effect.

To illustrate, in 1990, Subcommittee IX reassigned all materials previously assigned to P-5 into three new P-number groupings, P-5A, P-5B, or P-5C; further, the related rules were adjusted to require

separate qualification for materials assigned to P-5A, P-5B, or P-5C. As a result, if an existing PQR recorded the test coupon material as SA-387 Grade 22 (2¼% Cr, 1% Mo), annealed condition, previously assigned to P-5, that PQR would be revised to show the new assignment as P-5A and the WPS would be revised to limit the range of materials permitted to be welded to those assigned P-5A. Under the old material assignments, one could weld all P-5 materials, which included a broad range of materials including 2¼% Cr-1%Mo, 3%Cr-1%Mo, 5%Cr-1½%Mo, 7%Cr½%Mo, 9%Cr-1%Mo, 9%Cr-1%Mo-V-Nb-N, and all combinations thereof. Under the new assignments, qualification with 2¼% Cr, 1% Mo only qualified 2¼% Cr, 1% Mo, and 3% Cr, 1% Mo materials.

While most Code users recognized that the above was appropriate, it was not required that the changes to PQRs and WPSs described above be made; this addenda simply adds a reference in QW-100.3 to QW-420 where the requirement to make the appropriate changes are contained.

The basis for this change is purely technical; when Subcommittee IX reassigns a material to a different or new P-number, that material (or collection of materials as was the case for P-5) has been recognized as having sufficiently different weldability characteristics that they simply do not belong in the P-number that they were previously assigned to. This change does not invalidate any PQRs, but it usually results in more restrictive WPSs.

The reason that this is important is that in the 2009 addenda, creep-strength enhanced ferritic steels such as Grades 91, 92, 911, 23, and 24, some of which are currently assigned to P-5B, Group 2, will be assigned to P-15A through P-15E, the specific assignment depending on the alloy’s nominal chromium content. As readers have seen from my previous articles, these high-performance, creep-strength enhanced chromium-molybdenum steels are exceedingly sensitive to conditions such as inadequate preheating or hydrogen control, stress corrosion cracking in the as-welded condition, filler metals that crater-crack due to tramp elements, uncontrolled PWHT and local torch heating during fabrication that can lead to failures; to make it easier to identify and control these materials in both Section IX and in the Construction Codes, they will be assigned to their own special P-number family.

Welding Procedure (QW-200) Changes

When performing bend tests, QW-466.1 provides a figure and a table that specifies the dimensions of the test fixture and, most importantly, the diameter “A” around which the bend test specimen of thickness “t” must be bent. For most materials, the applicable line is near the bottom of the table, “All others with $\geq 20\%$ ductility.” It specifies a B/t ratio of 4:1, which results in a strain in the metal on the convex surface of the specimen of 20%. The other lines on the table specify B/t ratios as large as 16½ for materials that have been assigned P-numbers that exhibit less than 20% ductility. The last line of the table covers materials that are not assigned P-numbers that also exhibit less than 20% ductility by referring one to footnote (b), which provides the following formula:

$$\text{thickness of specimen (t)} = A \times (\% \text{ elongation}) [100 - (\% \text{ elongation})]$$

If one has a fixture where “A” is known and a material of known tensile elongation, this formula allows one to calculate the minimum thickness “t” to which the bend test specimen must be machined. For example, if one has a standard fixture where $A = 1\frac{1}{2}$ in. (38 mm) and the material being qualified has a minimum ductility of 8% according to the base metal specification, the formula requires the specimen to be machined to 0.113 in. (2.8 mm) minimum thickness.

Note that one can always bend a specimen over a smaller radius or use a thicker specimen for a given radius than that specified in QW-466.1 since that results in more strain in the outer fibers of the specimen than that which occurs when the specified A/t ratio is used.

The last line of the table in QW-466.1 confuses most people who, on casual examination, attempt to apply it the same as they would apply the upper portion of the table; careful examination, however, shows that the dimensions are maximum dimensions, so if one conducts a bend test, the minimum elongation that the material must exhibit is 3%. The changes in these addenda add footnote (e) which allows use of a macro-etch specimen in accordance with QW-183(a) in lieu of each required bend test, so for procedure qualification, four macro-etch specimens would be required.

A new welding process has been added to those covered by ASME — *Friction Stir*

Welding. It is not in Section IX yet, but is incorporated as Code Case 2593, Use of Friction Stir Welding (FSW) for Appendix 26 Bellows Constructed of 5052 Aluminum Alloy Plate, Section VIII, Division 1. The Case contains a full set of essential and nonessential variables for friction stir welding. As with most code cases, this one was adopted with limited applicability so that a manufacturer could utilize this new technology without waiting a full code publication cycle, which can be as long as two years depending on timing; it will undoubtedly be incorporated into Section IX in the near future.

Several SFA filler metal specifications contain electrode or filler metal classifications that are identified as “G” in the suffix (e.g., E8018-G). While such a classified electrode or filler metal will have an F-number, the chemical composition of the weld metal for a “G” classification is “as agreed between the supplier and the purchaser.” As a result, different suppliers can supply electrodes or filler metals under the same AWS classification, but the chemical composition of the weld deposit could be significantly different! That would allow one to establish an A-number using one manufacturer’s E8018-G then use another manufacturer’s E8018-G — possibly of a different chemical analysis — in production. Changes were made in this addenda to QW-404.5 (basic A-number variable) and QW-404.12 (supplementary essential variable restricting the AWS Classification to that used to weld the test coupon) to further limit “G” designation electrodes to the manufacturer’s trade name used during qualification.

Several supplementary essential variables such as QW-404.12 contain a sentence that says: “This limitation does not apply when a WPS is qualified with a PWHT above the upper transformation temperature or when an austenitic material is solution annealed after welding.” To clarify the intent, the word “limitation” was changed to “variable,” making it clear that the whole variable, not just portions of it did not apply when one of these heat treatments was performed. The main reason for mentioning it here is simply to make it easier for those who work with these variables to identify them quickly.

All the welding procedure and performance qualification forms in non-mandatory Appendix B were revised. While the forms are helpful in preparing WPSs, PQRs, and welder qualification records, they are not a substitute for properly recording and addressing essential and nonessential variables as required by code.

Welder Qualification (QW-300) Changes

No changes were made to the require-

ments for welder or welding operator qualification.

Base Metals and Filler Metals

Various grades of materials were added and deleted from QW/QB-422. Those changes are most easily identified in the Summary of Changes that begins on page (c) of Section IX. An aluminum casting alloy that is manufactured to EN 1706, Alloy CA43000 was added as P-No. 26, so at all paragraphs and tables where “P-No. 21 through P-No. 25” is mentioned, P-No. 25 will be bumped up to P-No. 26. In addition, two EN grades and one JIS grade have been added.

Several filler metal specifications have been revised and issued. One new one is SFA 5.34, *Specification for Nickel Alloy Electrodes for Flux Core Arc Welding*, and the other is SFA 5.02, *Filler Metal Standard Sizes and Packaging*. The first is self-explanatory by its title, while the second reflects a move by AWS to consolidate information that is repeated in every specification into a single specification that others will refer to. As the other SFA specifications are revised, information on packaging and standard sizes will no longer be in each specification; instead, they will refer to SFA 5.02 for that information.

SFA 5.23, *Low-Alloy Submerged Arc Electrodes and Fluxes*, was revised to tighten up composition ranges for B9 electrodes in response to concerns raised by ASME. SFA 5.7, *Copper and Copper Alloy Bare Electrodes and Wire*, added some new classifications. Several other SFA specifications were simply reaffirmed.

Brazing (QB) Changes

There were no significant changes to the rules on Brazing.

Inquiries

There were several inquiries of interest that are informative to users of Section IX. Inquiry BC07-1041 asked if QW-409.2, the GMAW transfer mode variable, applies to the flux cored arc welding process? The reply is “yes” since ASME considers flux cored arc welding to be a subset of GMAW. The transfer modes commonly found when using flux cored wire are spray or globular, and when writing a WPS using flux cored wire, one can specify either or both transfer modes. To the best of the writer’s knowledge, no flux cored wire operates in the short-circuiting transfer mode, but the manufacturer’s literature should be checked if there is doubt.

Item BC07-1343 addresses QW-404.23 that covers solid, metal cored, and flux cored wires for GMAW. The back-

ground is that some AWS classifications for filler metal include a portion of the designation showing that the filler metal is solid or metal cored wire (e.g., in classification ER80S-B3, the “S” indicates that the wire is solid, whereas in the classification ER80C-B3, the “C” indicates a metal core [composite] wire). The question was — if one specified a filler metal classification that included a designation showing that the filler metal was solid wire (e.g., ER80S-B2) — does one need to also specify that the wire is solid wire to satisfy the requirement to address QW-404.23. The reply was “no” since the AWS classification clearly specified solid or metal cored wire. If an unclassified wire is used, then the WPS has to specify that the wire be solid or metal cored in addition to the trade name.

The question of when a heat treatment not required by a construction code has to be qualified was addressed in item 06-285. A manufacturer fabricated a multi-convolution bellows of SB-409 UNS N08800, and, although the Code does not require it, the manufacturer performed heat treatment at 1750°F subsequent to completing all welding and forming.

The question was: Does Section IX consider that heat treatment to be a post-weld heat treatment for the purpose of procedure qualification in accordance with Section IX, paragraph QW-407.1(b). The reply was “yes.” A similar question was asked many years ago when a manufacturer of glass-lined water heaters asked if heating a Section VIII pressure vessel to 1800°F for the purpose of sintering the glass lining was considered to be a post-weld heat treatment “above the upper transformation temperature” as described in QW-407.1(a)(3) even though such a heat treatment was not required by Section VIII. The reply was also “yes” for this case.

Coming Attractions

As mentioned above, due to significant concerns over abuse of Grade 91 and similar creep-strength enhanced ferritic steels, such as Grades 92, 911, 23, etc., these materials will be assigned to P-15A through P-15G to distinguish them from the older P-5A through P-5C materials. All materials currently assigned S-numbers will be magically converted to P-number and all references to S-numbers will disappear from Section IX. Finally, a new column will be added to QW-QB-422 providing the group number assigned to ASME materials in accordance with ISO 15608, the ISO material grouping system; however, there will be no provisions to allow use of the ISO groupings in lieu of the P-number groupings at this time.

All ASME Code Committee meetings are open to the public. The meeting schedule is available at www.asme.org. ♦

Member-Get-A-Member Campaign

Shown are the August 15 standings for the 2008–2009 AWS Member-Get-A-Member Campaign. See page 81 of this *Welding Journal* or visit www.aws.org/mgm for campaign rules and prize list. If you have any questions regarding your member proposer points, call the Membership Dept., (800) 443-9353, ext. 480.

Winner's Circle

Members who have sponsored 20 or more new Individual Members, per year, since June 1, 1999. The superscript indicates the number of times the member has achieved Winner's Circle status.

J. Compton, San Fernando Valley⁷
E. Ezell, Mobile⁶
J. Merzthal, Peru²
G. Taylor, Pascagoula²
B. Mikeska, Houston¹
R. Peaslee, Detroit¹
W. Shreve, Fox Valley¹
M. Karagoulis, Detroit¹
S. McGill, NE Tennessee¹
L. Taylor, Pascagoula¹
T. Weaver, Johnstown/Altoona¹

G. Woomer, Johnstown/Altoona¹
R. Wray, Nebraska¹
M. Haggard, Inland Empire¹

President's Roundtable

Sponsors of 9–19 new Members.
P. Betts, Mobile — 12

President's Club

Sponsors of 3–8 new Members.
W. Rice, Tri-State — 5
C. Becker, Northwest — 3
M. Rahn, Iowa — 3
M. Wheat, Western Carolina — 3

President's Honor Roll

M. Boyer, Detroit — 2
B. Donaldson, British Columbia — 2
F. Hendrix, New Jersey — 2
J. Padilla, Cuautitlan Izcalli — 2
J. Polson, L.A./Inland Empire — 2
K. Smith, North Texas — 2
A. Stute, Madison-Beloit — 2
D. Wright, Kansas City — 2
M. Yung, Portland — 2

Student Member Sponsors

Sponsors of 3 or more students.
A. Rowe, Philadelphia — 36
T. Moore, New Orleans — 32
D. Berger, New Orleans — 30
B. Benyon, Pittsburgh — 28
E. Norman, Ozark — 26
D. Schnalzer, Lehigh Valley — 22
R. Munns, Utah — 19
D. Pickering, Central Arkansas — 16
R. Rummel, Central Texas — 13
A. Stute, Madison-Beloit — 13
D. Taylor, Kern — 13
R. Hutchinson, Long Bch./Or. Cty. — 12
R. Evans, Siouxsland — 11
R. Norris, Maine — 9
N. Carlson, Idaho/Montana — 7
S. MacKenzie, Northern Michigan — 7
J. Boyer, Lancaster — 6
D. Howard, Johnstown-Altoona — 6
D. Kowalski, Pittsburgh — 4
J. Reed, Ozark — 4
C. Schiner, Wyoming — 4
D. Zabel, Southeast Nebraska — 4
B. Hallila, New Orleans — 3
M. Rahn, Iowa — 3
D. Vranich, North Florida — 3

Nominees Sought for Welding Achievement Awards

Prof. Masubuchi Award

November 3, 2008, is the deadline for submitting nominations for the 2009 Prof. Koichi Masubuchi Award, sponsored by the Dept. of Ocean Engineering at Massachusetts Institute of Technology. This award includes an honorarium of \$5000. It is presented each year to one person who has made significant contributions to the advancement of materials joining through

research and development.

The candidate must be 40 years old or younger, may live anywhere in the world, and need not be an AWS member. The nomination package should be prepared by someone familiar with the research background of the candidate. It should include the candidate's résumé listing background, experience, publications, honors, and awards, plus at

least three letters of recommendation from fellow researchers.

This award was established to recognize Prof. Koichi Masubuchi for his numerous contributions to the advancement of the science and technology of welding, especially in the fields of fabricating marine and outer space structures.

E-mail your nominations to Prof. John DuPont at jnd1@lehigh.edu.

Robotic Arc Welding Award

December 31 is the deadline for submitting nominations for the 2009 Robotic and Automatic Arc Welding Award. The award includes a plaque and a \$1500 honorarium.

The nomination packet should include a summary statement of the candidate's accomplishments, interests, educational background, professional experience, publications, honors, and awards. Send your nomination package to Wendy Sue Reeve, awards coordinator, 550 NW

LeJeune Rd., Miami, FL 33126. For more information, contact Reeve at wreeve@aws.org, or call (800/305) 443-9353, ext. 293.

In 2004, the AWS D16 Robotic and Automatic Arc Welding Committee, with the approval of the AWS Board of Directors, established the Robotic and Automatic Arc Welding Award.

The award was created to recognize individuals for their significant achievements in the area of robotic arc welding.

This work can include the introduction of new technologies, establishment of the proper infrastructure (training, service, etc.) to enable success, and any other activity that has significantly improved the state of a company and/or industry.

The Robotic Arc Welding Award is funded by private contributions. This award is presented at a special ceremony during the FABTECH International & AWS Welding Show held each fall.

2008 District and Section Awardees Announced

Section Meritorious Award

- District No. — Awardee — Section
2 — Robert Bartley — New Jersey
2 — Anthony Zampelli — Long Island
3 — Becky Lorenz — Washington, D.C.
3 — David May — Washington, D.C.
3 — John Wilkins — Cumberland Valley
3 — Claudia Bottenfield — York-Central Pa.
3 — Trina Siegrist — Lancaster
4 — Jon Cookson — Tidewater
4 — Bill Rhodes — SW Virginia
8 — Rayburn Johnson — Greater Huntsville
9 — Todd Gauthreaux — New Orleans
9 — Sterling Dolese — New Orleans
9 — Charles Everett — Pascagoula
9 — Duncan Perkins — Pascagoula
9 — Brenda Bradley — Mobile
10 — Carl Ford — Mahoning Valley
10 — Craig Newell — NW Pennsylvania
11 — John McKenzie — Detroit
13 — Craig Tichelar — Chicago
14 — Ric Eckstein — Indiana
14 — Mike Collins — Indiana
14 — Bennie Flynn — Indiana
14 — Bill Davis — Indiana
14 — Karl Watson — Lexington
14 — Ned Lance — St. Louis
15 — Logan Kucerak — Northwest
15 — Bob Schuster — Northwest
15 — Thomas LaVenture — Northwest
16 — Ruben Martinez — Nebraska
17 — Firdosh Menta — N. Texas
17 — Veronica Covey — Central Texas
17 — Dan Bricker — E. Texas
17 — Brian Walker — Ozark
17 — Jimmy Brewer — Central Arkansas
18 — Misty Ralls — Corpus Christi
18 — Juan Diaz — Corpus Christi
18 — John Castillo — Corpus Christi
18 — Julie Theiss — Houston
18 — Justin Gordy — Houston
18 — Derek Stelly — Houston
18 — Hamp Drew — San Antonio
18 — Tom Holt — Sabine
20 — Dave Murphy — Colorado
20 — Fred Schaefer — Colorado
20 — Greg Bugni — Utah
20 — Brian Stephenson — Utah
20 — Russell Pontarolo — Wyoming
20 — Wade Florence — New Mexico
20 — Richard Moku — New Mexico
20 — Charles Tolle — Idaho/Montana
22 — Alex Gutierrez — Santa Clara Valley
22 — Andre Lopez — San Francisco
22 — Kerry Shatell — Sacramento Valley

District Meritorious Award

- 2 — Kevin Thromorton — Philadelphia
2 — Jeff Feiner — Long Island
3 — Becky Lorenz — Washington, D.C.
3 — Claudia Bottenfield — York-Central Pa.
4 — David Cash — SW Virginia
4 — Carl Yaeger — NE Carolina
8 — Jeff Hankins — NE Tennessee
9 — George Fairbanks — Baton Rouge
9 — Rodney DuFour — New Orleans
10 — Ward Kiser — Drake Well
11 — Efithios Siradakis — Saginaw Valley
11 — Donald DeCorte — Detroit
12 — Dan Jones — Madison-Beloit
13 — Bernard Piotrowski — Illinois Valley
14 — Pat Cody — St. Louis
14 — David Jackson — Indiana
15 — Michael Hanson — Northwest
15 — Augustin Marisca — Saskatoon
16 — Ruben Martinez — Nebraska
17 — Bryan Baker — E. Texas
17 — Phil Walker — Ozark
18 — John Husfeld — Houston

- 18 — Rusty Smith — Corpus Christi
18 — Ellery Francisco — Corpus Christi
18 — Ruel Riggs — Sabine
19 — Ken Johnson — Puget Sound
19 — Rick Henson — Spokane
20 — Paul Tremblay — Idaho/Montana
21 — Mark Bell — San Diego
22 — Durella Combs — Santa Clara Valley
22 — Randy Naylor — Sierra Nevada

Section CWI of the Year

- 3 — David Nicholas — Cumberland Valley
4 — Robert Smilie — Charlotte
5 — Rick Vencis — Florida W. Coast
8 — Jeremy Burrell — NE Mississippi
9 — Delton Fairbanks — Baton Rouge
9 — James Ivy — Pascagoula
10 — Mark Hollenbank — Mahoning Valley
14 — Craig Gonet — St. Louis
14 — Ray Brown — St. Louis
14 — Gary Dugger — Indiana
16 — Pat Naylor — Iowa
16 — Eric Nordhues — Nebraska
17 — Mike Porter — Central Arkansas
18 — Glynn Savage — Sabine
20 — Marjorie Oliver — Colorado
20 — Jeffrey Connors — Colorado
20 — Robert Shook — Idaho/Montana
20 — Michael Thomas — Albuquerque
22 — Derek Brawley — Fresno

District CWI of the Year

- 1 — Geoffrey Durant — Boston
2 — Nagesh Goel — New Jersey
3 — David Nicholas — Cumberland Valley
4 — Bobby Perkins — NE Carolina
4 — Eric Braddy — NE Carolina
4 — Robert Simpson — Charlotte
4 — Stewart Harris — Triangle
5 — Rick Vencis — Florida W. Coast
8 — Kevin Reed — NE Mississippi
9 — Michael Moore — Mobile
9 — Cresente Gotango — New Orleans
10 — Mark Demchak — Cleveland
12 — Ken Karwowski — Racine-Kenosha
14 — Larry Wesemann — St. Louis
14 — Tony Brosio — Indiana
16 — Eric Nordhues — Nebraska
16 — Pat Naylor — Iowa
17 — John Schrader — Central Texas
17 — William Drake Jr. — Ozark
18 — Howard Thomas — San Antonio
19 — Philip Zammit — Spokane
19 — Mike Virgilio — Puget Sound
20 — Patrick Bauman — Albuquerque
22 — Dale Phillips — San Francisco
22 — William R. Kates — Fresno

Section Educator Award

- 4 — Eric Braddy — NE Carolina
4 — Brandon Hoffner — Charlotte
4 — Lori Safrit — Charlotte
5 — Albert Sedory — Florida W. Coast
8 — Gary Gammill — NE Mississippi
8 — Bill Warwick — NE Tennessee
8 — Steve Linn — NE Tennessee
8 — David Hamilton — Chattanooga
8 — Joe Smith — Greater Huntsville
9 — Wilfred Bivius — Pascagoula
9 — Kenneth Caliva — New Orleans
9 — Jeremy Whittemore — Baton Rouge
14 — Kevin Schaff — St. Louis
14 — Robert Murphy — Lexington
14 — Rick Ferguson — Indiana
14 — Eric Copper — Indiana
14 — John Crager — Indiana
15 — Todd Bridgum — Northwest
16 — Keith Simpson — Iowa
16 — John Kirke — Nebraska

- 16 — Austin Parker — E. Iowa
17 — Curtis Jenkins — N. Texas
17 — Jimmie Carter — Oklahoma City
17 — Mark Bradley — Central Arkansas
17 — Ryan Rummel — Central Texas
17 — Sergio Sanchez — E. Texas
17 — John Knapp — Tulsa
17 — Marvin Seela — Ozark
18 — Pete Lopez — Corpus Christi
18 — Morris Weeks — Sabine
19 — Darryl Main — Puget Sound
20 — Glen Edwards — Colorado
20 — Dusty Heritage — Albuquerque
20 — John Grovau — Utah
20 — Donnie Noel — Idaho/Montana
20 — Stanley Niccolos — Wyoming
22 — Scott Miner — San Francisco
22 — Mark Reese — Sacramento

District Educator

- 1 — John Morash — Boston
2 — David Griep — New Jersey
3 — Robert Wordan — Lehigh Valley
3 — Richard Gallagher Jr. — Lehigh Valley
4 — Teresa Williams — NE Carolina
4 — Bobby Perkins — NE Carolina
4 — James Stump — SW Virginia
4 — Robert Simpson — Charlotte
5 — Albert Sedory — Florida W. Coast
6 — Bruce LaVallee — N. New York
8 — Jimmy Kee — W. Tennessee
9 — Jefferson Reid — Pascagoula
10 — Mark Brereton — NW Pennsylvania
11 — Robert Solmose — Detroit
12 — Scott Tennant — Fox Valley
12 — Dan Jones — Madison-Beloit
14 — Gary Miller — St. Louis
14 — Mike Anderson — Indiana
16 — Keith Simpson — Iowa
16 — John Kirke — Nebraska
16 — Austin Parker — E. Iowa
17 — Charles Credicott — N. Texas
17 — Jim Bridwell — Ozark
18 — Wayne Knuppel — Houston
19 — Darryl Main — Puget Sound
20 — Jeff Taniguchi — Utah
20 — Stephen Liu — Colorado
22 — Don Robinson — Sacramento
22 — Jason Roberts — Sacramento

Section Private Sector Instructor Award

- 9 — Darren Haas — Pascagoula
9 — William Harris — Pascagoula
9 — Aldo Duron — New Orleans
13 — Phil England — Peoria
13 — Phil Baldwin — Peoria
14 — Robert Richwine — Indiana
14 — Bobby Coffey — Lexington
16 — Chris Mann — Iowa
16 — Wayne Seitz — Nebraska
17 — Vernon Yeager — N. Texas
17 — Brent Russell — Ozark
18 — Fred Schweighardt — Houston
18 — J. W. Ralls — Corpus Christi
20 — Lynn Sturgill — Colorado
20 — Jay Voth — Colorado

District Private Sector Instructor Award

- 2 — Richard Libert — New Jersey
9 — Gerald McCranie — Mobile
9 — Darel Marcotte — New Orleans
12 — Edward Bohnart — Fox Valley
13 — Eldon LaFevre — J.A.K.
14 — Gary Tucker — Indiana
14 — Jack Lesko — St. Louis
16 — Chris Mann — Iowa
16 — Wayne Seitz — Nebraska
17 — Bill Hall — N. Texas
17 — Chris Trumbull — Ozark

Jay Leno Supports Welding Careers in Online Videos



Jay Leno (right) proudly displays his AWS Life Member certificate presented to him by **Ray Shook**, AWS executive director, in recognition of Leno's enthusiastic promotion of welding as a satisfying and financially rewarding career. Leno has posted videos on the Internet strongly endorsing welding as a career and recommending that his fans contact AWS to learn more. Leno's interview with Shook is posted on his Web site. Watch Leno's videos at www.aws.org and www.jaylenosgarage.com/video/video_player.shtml?vid=276886. The Life Member award presentation was held during Shook's recent visit to Leno's garage in Los Angeles, Calif.

The AWS Foundation's Solutions Opportunity Squad (SOS) Is on the Move



Monica Pfarr

Connie Bowling

Monica Pfarr and **Connie Bowling** are the first members of the AWS Foundation's Solutions Opportunity Squad (SOS), recently formed to build strategies for local businesses, other organizations, and national companies that have specific welder workforce development needs. Their efforts will involve the process of welder workforce issues from recruitment to retirement. The AWS Welder Workforce Development Program is a major strate-

gic focus of AWS, and the Welding for the Strength of America capital campaign is now underway at the AWS Foundation.

The functions of the SOS unit will evolve as the critical needs for manpower within the United States are addressed. Pfarr, corporate director, SOS, based in Dayton, Ohio, holds an engineering degree from The Ohio State University and a masters from Central Michigan University. She has 12 years of experience with General Motors, and most recently worked in workforce development at Sinclair Community College.

Bowling, director, SOS, holds a welding engineering degree from The Ohio State University. She has ten years of industrial engineering experience in welding and manufacturing, most recently with Bell Steel Co. in Pensacola, Fla. She will head SOS activities in the Gulf Coast Division within its Welder Workforce Development Program.

District Director Awards Announced

The District Director Award provides a means for District directors to recognize individuals who have contributed their time and effort to the affairs of their local Section and/or District.

Richard Harris, District 10 director, has named the following members to receive the award:
 Ward Kiser — Drake Well
 Travis Crate — Drake Well
 Scott Burdge — Stark Central
 Ryan Eubank — Cleveland
 Harry Sadler — Cleveland
 Mark Demchak — Cleveland
 Bob Gardner — Cleveland
 David N. Hughes — Mahoning Valley
 Huck Hughes — Mahoning Valley

Sean Moran, District 12 director, has named the following members to receive the award:
 Ben Newcomb — Madison-Beloit
 David Ramseur — Lakeshore

John Bray, District 18 director, has named the following members to receive the award:
 Ellery Francisco — Corpus Christi
 John Husfeld — Houston
 Tac Edwards — Lake Charles
 Ken Dillard — Sabine
 Robert Medina — San Antonio

Neil Shannon, District 19 director, has named the following members to receive the award:
 Lyndell Cane — Willamette Valley
 Michael J. Yung — Portland
 Bruce Weisman — Alaska
 Peter Macksey — Alaska

Do Some Holiday Shopping at the AWS Foundation's Silent Auction

The AWS Foundation's Eighth Silent Auction fund-raising event will be held during the FABTECH International & AWS Welding Show, Oct. 6-8, at the Las Vegas Convention Center in Las Vegas, Nev.

Up for auction will be a wide variety of national company gift cards in amounts of \$200 to \$250. With the holidays coming soon after the Show, these cards can make excellent gifts for everyone on your list. Plus, all funds received will support the Foundation's scholarship program.

For complete information, contact Nazhdia Prado-Pulido at npradopulido@aws.org; (800) 443-9353, ext. 250.

The gift cards already available for bid at the Silent Auction include Macy's, Legal Sea Foods, Target, Barnes & Noble, Shell Gas, The Honey Baked Ham Co., Olive Garden Italian Restaurant, Lowes Hardware, Bass Pro Shop, Bed, Bath & Beyond, Best Buy, The Lincoln Electric Co. store, Longhorn Steak House, JC Penney, Home Depot, California Pizza Kitchen, Ruth's Chris Steak House, Tony Roma's, Omaha Steaks, plus a 1584-lb pallet of E71T-1 flux cored welding wire donated by **Select-Arc, Inc.**

Other donors include:

ABICOR Binzel Corp.
Nancy and Barry Carlson

Cincinnati Section
Dayton Section
Dengensha America Corp.
Hobart Brothers Co.
Hypertherm, Inc.
IWDC, Inc.

Mobile Section
Nebraska Section
Rochester Section
Ray and Sandy Shook
The Lincoln Electric Co.

Tri-River Section
Tulsa Section

Twin Tier Section
WESCO Gas & Welding Supply, Inc.
Howard Woodward

SECTION NEWS



Shown at the District 1 conference are (seated, from left) Dave Paquin, Warren Ballard, Sue and Walt Chojnacki, Geoff Putnam, Tom and Cheri Ferri, Joan Tokarski, and Ellie Crain. Standing (from left) are Doug Desrochers, Scott Lee, Stephen and Georgie Hedrick, District 1 Director Russ Norris, Jim Reid, Jim and Lisa Shore, Joe Tokarski, and Phil Wittman.

District 1

Russ Norris, director
(207) 283-1861
rnorris@maine.rr.com

District 1 Conference

MAY 31

Activity: **Thomas Ferri**, Boston Section vice chairman, was named to serve as District 1 director beginning 2010. **Warren Ballard** assembled a team to present the annual scholarship awards. **Steve Hedrick**, AWS staff manager, safety and health, presented **Doug Desrochers** the District secretary pen, and a District Attendance Award to **Dave Paquin**. District 1 Director **Russ Norris** and Hedrick made presentations. Others attending the conference were **Dave Paquin**, **Warren Ballard**, **Sue and Walt Chojnacki**, **Geoff Putnam**, **Cheri Ferri**, **Joan Tokarski**, **Ellie Crain**, **Scott Lee**, **Jim Reid**, **Jim and Lisa Shore**, **Joe Tokarski**, and **Phil Wittman**. The program was held at Providence Hilton in Providence, R.I., followed by a social dinner at Fire & Ice Restaurant.



Steve Hedrick (left) is shown with District 1 Secretary Doug Desrochers at the District 1 conference held in May.



Dave Paquin (right) receives a District attendance award from Steve Hedrick at the District 1 conference.

GREEN & WHITE MTS.

AUGUST 3

Activity: The Section held an executive board and planning meeting hosted by Chairman **Ray Hendersen II**. Others participating were Vice Chair **Gary Buckley**, **Geoff Putnam**, **Jerry Ouellette**, **John Steel**, Treasurer **Phil Wittman**, **Ernie Plumb**, and **Russ Norris**, District 1 direc-



Shown at the Green & White Mountains Section board meeting are (from left) Geoff Putnam, Jerry Ouellette, John Steel, Phil Wittman, Ernie Plumb, Chairman Ray Hendersen II, and Gary Buckley.



Shown at the Maine Section's event are (from left) Mark Legal, Warren Swan, and Russ Norris, District 1 director.

tor. The meeting was held at Members Advantage Credit Union in White River Junction, Vt.

MAINE

AUGUST 2

Activity: The Section hosted a Certified Welding Supervisor exam for 18 members at Maine Oxy in Auburn, Maine. Conducting the test were **Mark Legal**, chief welding instructor at Southern Maine Community College, **Russ Norris**, District 1 director, and **Warren Swan**.

District 2

Kenneth R. Stockton, director
(908) 412-7099
kenneth.stockton@pseg.com

District 3

Alan J. Badeaux Sr., director
(301) 753-1759
abadeaux@ccboe.com

District 4

Roy C. Lanier, director
(252) 321-4285
rlanier@email.pittcc.edu

District 5

Steve Mattson, director
(904) 260-6040
stevemattson@bellsouth.net

District 6

Neal A. Chapman, director
(315) 349-6960
weldingengineer@inbox.com

District 7

Don Howard, director
(814) 269-2895
howard@ctc.com

District 8

Joe Livesay, director
(931) 484-7502, ext. 143
joe.livesay@ttcc.edu

CHATTANOOGA

MAY 16

Activity: The Section hosted its 55th annual fish fry at Camp Columbus in Hixson, Tenn. The fish-fry chefs included **Bill Brooks**, **Meredith Carpenter**, and **Richard Dafron**. **Wayne Turner** cooked the hush puppies. In addition to the presentation of many door prizes, the Section awarded a \$500 scholarship to welding student **Drayton Hales**.

District 9

George D. Fairbanks Jr., director
(225) 473-6362
fits@bellsouth.net

District 10

Richard A. Harris, director
(440) 338-5921
richaharris@alltel.net

MAHONING VALLEY

MAY 15

Speaker: **Todd Ray**, regional sales manager
Affiliation: Bug-O Systems
Topic: Modular automated welding and cutting systems
Activity: The Section members met at

Columbiana County Career Center welding lab in Columbiana, Ohio, for a talk and demonstrations of automated welding and cutting systems. The event included a hands-on participation program. Among the 35 attendees were members of the Columbiana Student Chapter and Advisor **Huck Hughes**.

District 11

Eftihios Siradakis, director
(989) 894-4101
ft.siradakis@airgas.com

DETROIT

JULY 18

Activity: Section Chair **Don Czerniewski** served as host for the annual scholarship golf outing held at Sycamore Hills Golf Club in Macomb, Mich. More than 100 participants helped the event raise more than \$1500 for the Section's scholarship program. Top performers were **Pat Gilmour**, longest drive; **Jon Grugel**, closest to the pin; **Joe Cyrek** and **Perry Tsipis**, putting contest; and **Pat Gilmour** and the RoboVent team members for best overall score. Bagpiper **Bob Donovan** performed at the event.

NORTHWEST OHIO

JULY 18

Activity: The Section hosted its golf outing at South Toledo Golf Club in Toledo, Ohio. **Mike Rogers** and **Tony Duris** chaired the event. The proceeds went to the Section's scholarship fund to offer local welding students assistance with their tuition at Owens Community College. The scholarship was named for Donald J. Leonardt, a Section member, AWS CWI, and a test supervisor. Nearly 60 golfers participated in the program. The dinner was served after the game.

District 12

Sean P. Moran, director
(920) 954-3828
sean.moran@hobartbrothers.com

District 13

W. Richard Polanin, director
(309) 694-5404
rpolanin@icc.edu

CHICAGO

JULY 23

Activity: **Craig Tichelar** received the Silver Membership Certificate commemorating his 25 years of service to the Society. **Victor Y. Matthews**, AWS vice president, made the presentation at AWS headquarters in Miami during the AWS Leadership Symposium where Tichelar represented District 13.



Making it happen at the Chattanooga Section's 55th annual fish fry are chefs Meredith Carpenter (left) and Richard Dafron.



Chattanooga Section members and guests continued their fish fry tradition for the 55th year.



Craig Tichelar (right) accepts his Silver Member Certificate from Victor Matthews, AWS vice president.



Bagpiper Bob Donovan (far left) is shown with members of the Dengensha-sponsored teams at the Detroit Section golf outing in July.

Illinois Central College Student Chapter

Activity: Advisor **Eric Ockerhausen** reports his Chapter members have been involved in a number of community activities in the recent past, including working with the International Brotherhood of Electrical Workers to make the stakes for the annual East Peoria, Ill., Festival of Lights event. Currently, the students are working on a construction project for the Peoria Fire Department firemen training program. They also reconfigured two six-foot end loader buckets donated by Caterpillar into a large snow plow for use by the college staff. They also built the charcoal grills used during a Steak Fry event held last May, and made the signs for a musical event held on campus. When not working, the Chapter members toured the Komatsu Plant to study truck manufacture, and learn about welding job opportunities in the area, how to prepare for a job interview, and fill out job applications. The students also do projects for Habitat for Humanity and the college, and prac-



Shown at the Mahoning Valley Section program are (from left) Harper Farish, Columbiana Student Chapter treasurer; speaker Todd Ray; and Huck Hughes, Student Chapter advisor.



Mahoning Valley Section and Columbiana Student Chapter members participated in hands-on demonstrations of welding and cutting systems at their May program.



Indiana Section members enjoy dinner following their day on the greens.



Shown at the District 16 conference are (from left) Eric Peterson; David Landon, District 16 director; Ray Shook, AWS executive director; and Charles Burg.



Shown at the Indiana Section golf outing are Mike Anderson (left) and Dick Alley, a past AWS president.

tice for the SkillsUSA contests. Currently, Ockerhausen is busy learning to speak Chinese so he can communicate better with two of his Asian students and getting ready for more events, including an upcoming metal sculpture contest.

District 14

Tully C. Parker, director
(618) 667-7795
tparke@millerwelds.com

INDIANA

JULY

Activity: The Section hosted its annual golf outing at Sarah Shank Golf Course in Indianapolis, Ind. The members of the winning team were **F. Semenick, D. Plunkett, T. Davies, and M. Burton**. The second-place team included **Damian Kline, Dustin Kline, Steve Stacey, and Dave Kontz**. **Bill Porter** and **Chris Barefoot** won closest-to-the-pin awards. **Jeff Flint** and **Steve Stacey** took the longest-drive awards. About 50 members and guests participated in the event.

District 15

Mace V. Harris, director
(612) 861-3870
macevh@aol.com

District 16

David Landon, director
(641) 621-7476
dlandon@vermeermfg.com

District 16 Conference

JUNE 14

Activity: **David Landon**, District 16 director, conducted the District conference at Des Moines Area Community College in Ankeny, Iowa. The Iowa Section representatives were **Mike Rahn, Robert Kephart, Chris Mann, Keith Simpson, Charles Burg, and Eric Peterson**. The Nebraska Section members included **Monty Rodgers, Karl Fogleman, and Jason Hill**. The Eastern Iowa Section attendees were **Andy Zinn** and **Mike Myers**. **Brian K. McKee** and **Dennis Wright** represented the Kansas City Section. **Greg Reeder** represented the Southeast Nebraska Section. **Ray Shook**, AWS executive director, served as the headquarters staff representative at the event.

District 17

J. J. Jones, director
(940) 368-3130
jjones@thermadyne.com



Lynn Sturgill conducted the Colorado Section-sponsored CWI course and exam.



The Corpus Christi Section board members met to plan for the District 18 conference. District 18 Director John Bray is shown standing, fourth from the left.

District 18

John Bray, director
(281) 997-7273
sales@affiliatedmachinery.com

CORPUS CHRISTI

FEBRUARY 28

Activity: The Section's executive committee met to make plans for hosting the District 18 conference. The meeting was chaired by **John Bray**, District 18 director. In attendance were **Steven Vidaurn**, **Jennifer Rowe**, **Misty Ralls**, **Jerry Rowe**, Chairman **Johnny Grimes**, Vice Chair **Ellery Francisco**, and **Mike Huelskamp**.



Shown at the District 20 conference are (from left) **Bruce Madigan**, **Danny MacCallum**, **Pierrette Gorman**, **Russell Rux**, **Rhenda Mayo**, District 20 Director **Bill Komlos**, **Bob Teuscher**, **Dean Mitchell**, **Adam Johnson**, and **James Corbin**.

District 19

Neil Shannon, director
(503) 419-4546
neilshnn@msn.com

District 20

William A. Komlos, director
(801) 560-2353
bkoz@arctechllc.com

COLORADO

JULY 27–AUGUST 3

Activity: The Section sponsored a CWI seminar and testing program at the Embassy Suites in Denver, Colo. **Lynn Sturgill**, an AWS CWI instructor, Sturgill Welding and Code Consulting, conducted the week-long class for 45 attendees. The exams were presented Aug. 2,

3, supervised by CWI **Galen Altman** and Section Chairman **James Corbin**, a CWI, CWE, and CTE.

District 20 Conference

JUNE 6

Speaker: **Bill Komlos**, District 20 director
Affiliation: ArcTech LLC

Topic: Annual director's report

Activity: In attendance were **Bruce Madigan** (Montana), **Danny MacCallum**, **Pierrette Gorman** (New Mexico), **Russell Rux** (Wyoming), **Bob Teuscher**, **Dean Mitchell** (Colorado), **Adam Johnson** (Utah), and **James Corbin** (Colorado). **Rhenda Mayo**, AWS director, member services, presented a staff report. Komlos presented the various Section and District awards. The conference was held in Salt Lake City, Utah.

District 21

Jack D. Compton, director
(661) 362-3218
jack.compton@canyons.edu

CALIFORNIA CENTRAL COAST

MARCH 21

Activity: The Section hosted a career day at Mesa Middle School headed by Chairman **Stan Luis**, territory manager for Praxair in Santa Maria, Calif.

District 22

Dale Flood, director
(916) 288-6100, ext. 172
flashflood@email.com

New AWS Supporters

Sustaining Member Companies

Aerospace Precision Welding Div. APT, Inc.

758 Four Rod Rd.
Berlin, CT 06037-3268
www.apwweld.com

Representative: **Joseph Malaro**

Aerospace Precision Welding is a new division of AMCO Precision Tool, Inc., a 46-year veteran in aerospace machining. The principals have more than a century of experience in the aerospace metal-joining and metal work fields providing a single source for producing everything from complex prototype components to volume production supporting the most rigorous aerospace requirements. Its certifications include ISO 9001:2000, AS 9100B, and Nadcap accreditation.

Astilleros Navales Ecuatorianos

Vacas Galindo y Viveros
PBX 09-01-7172, Guayas
Guayaquil 594, Ecuador
www.astinave.com.ec

Representative: **Carlos A. Jaime Jacome**

Astilleros Navales Ecuatorianos (ASTINAVE), founded in 1972, has more than 30 years' experience building a better business future for Ecuador. The company designs and builds all types of craft from small boats to deep-draft tankers, and repairs and services all kinds of vessels. The company is 100% devoted to delivering professional quality and services and meeting delivery deadlines.

Pan Gulf Welding Solutions

Ghumata St., Raka Area (behind Goodyear)
PO Box 2374, Al Khobar 31952
Saudi Arabia

www.pangulfws.com

Representative: **Andrew Barrie Leigh**

Pan Gulf Welding Solutions (PGWF), established in 2005, provides sales, rentals, and service of the latest welding and cutting machines, consumables, spare parts, and safety equipment to the steel-fabrication and related industries throughout the Middle East, with warehouses located in Al-Khobar, Jeddah, and Riyadh. Its own brand-name products, METWELD, offer the best ratio of price to quality. The company is ISO certified for better service and higher customer satisfaction.

New Welding Distributor

Andy J. Egan Co.
2001 Waldorf NW
Grand Rapids, MI 49544

Supporting Companies

BEC Mfg. Corp.
3 Rosol Ln.
Saddle Brook, NJ 07663

E. K. Machine Co., Inc.
671 S. Main
Fall River, WI 53932

Kaydon Custom Filtration Corp.
1571 Lukken Industrial Dr. W.
LaGrange, GA 30240

MetFab, Inc.
314 Allen Genoa
Houston, TX 77017

Affiliate Companies

AA Master Metal & Welding Shop
PO Box 9136
San Juan, PR 00908

Blue Ridge Marine, LLC
1309 Appling St.
Chattanooga, TN 37406

Calfee Welding II, Inc.
10710 House Rd.
Conroe, TX 77304

Complete Steel Fabricators
2137 Glen Lily Rd.
Bowling Green, KY 42101

Diamond's Electric Signs & Lighting
230 Power Ct., Ste. 150
Sanford, FL 32771

F & F Aluminum and Iron
2290 NW 17th Ave.
Miami, FL 33142

Hammersmith Mfg.
401 Central Ave.
Horton, KS 66439

J. Louis Crum Corp.
PO Box 1285
Columbia, MO 65205

Kuhn Construction Co.
PO Box 1419
Hockessin, DE 19707

LoDolce Machine
196 Malden Tpk.
Saugerties, NY 12477

McElroy Welding
428 CR 2097
Liberty, TX 77575

Millerbernd Design & Fabrication
330 6th St. S.
Winsted, MN 55395

P. T. Viking Engineering
JL Brigjend Katamso KM 6
TG Unlang Batam 29432, Indonesia

Quality Fabrications LLC
PO Box 72, B Powell Cir.
Ariton, AL 36311

T T Asia Co., Ltd.
100/475 Thich Quang Duc St., Ward 5
Phu Nhuan Dist., Ho Chi Minh, Vietnam

United Steel Grating
PO Box 8230, Dammam 31482
Eastern Province, Saudi Arabia

Educational Institutions

**Associated Builders & Contractors
Central California Chapter**
1608 Norris Rd., Bakersfield, CA 93308

Flathead Valley Community College
777 Grandview Dr.
Kalispell, MT 59932

Plumbers and Pipefitters Local 716
21 Gabriel Dr.
Augusta, ME 04330

Schuylkill Technology Center
15 Maple Ave.
Marlin, PA 17951

Membership Counts

Member Grades	As of 9/01/08
Sustaining.....	505
Supporting.....	327
Educational.....	462
Affiliate.....	449
Welding distributor.....	51
Total corporate members.....	1,794
Individual members.....	49,119
Student + transitional members.....	4,787
Total members.....	53,906

Guide to AWS Services

550 NW LeJeune Rd., Miami, FL 33126
www.aws.org; (800/305) 443-9353; FAX (305) 443-7559
(Staff telephone extensions are shown in parentheses.)

AWS PRESIDENT

Gene E. Lawson
glawson@esab.com

ESAB Welding & Cutting Products
25108 Margurite Pkwy. P.M.B #165
Mission Viejo, CA 92692

ADMINISTRATION

Executive Director

Ray W. Shook.. rshook@aws.org(210)

CFO/Deputy Executive Director

Frank R. Tarafa.. tarafa@aws.org(252)

Deputy Executive Director

Cassie R. Burrell.. cburrell@aws.org(235)

Senior Associate Executive Director

Jeff Weber.. jweber@aws.org(246)

Executive Assistant for Board Services

Gricelda Manalich.. gricelda@aws.org(294)

Administrative Services

Managing Director

Jim Lankford.. jiml@aws.org(214)

IT Network Director

Armando Campana..acampana@aws.org ... (296)

Director

Hidail Nuñez.. hidail@aws.org(287)

Database Administrator

Natalia Swain..nswain@aws.org(245)

Human Resources

Director, Compensation and Benefits

Luisa Hernandez.. luisa@aws.org(266)

Manager, Human Resources

Dora A. Shade.. dshade@aws.org(235)

INT'L INSTITUTE of WELDING

Senior Coordinator

Sissibeth Lopez.. sissi@aws.org(319)
Provides liaison services with other national and international professional societies and standards organizations.

GOVERNMENT LIAISON SERVICES

Hugh K. Webster.. hwebster@wc-b.com

Webster, Chamberlain & Bean, Washington, D.C., (202) 785-9500; FAX (202) 835-0243. Identifies funding sources for welding education, research, and development. Monitors legislative and regulatory issues of importance to the welding industry.

CONVENTION and EXPOSITIONS

Senior Associate Executive Director

Jeff Weber.. jweber@aws.org(246)

Corporate Director, Exhibition Sales

Joe Krall.. jkrall@aws.org(297)
Organizes the annual AWS Welding Show and Convention, regulates space assignments, registration items, and other Expo activities.

Brazing and Soldering Manufacturers' Committee

Jeff Weber.. jweber@aws.org(246)

RWMA — Resistance Welding Manufacturing Alliance

Manager

Susan Hopkins.. susan@aws.org(295)

WEMCO — Welding Equipment Manufacturers Committee

Manager

Natalie Tapley.. tapley@aws.org(444)

PUBLICATION SERVICES

Department Information(275)

Managing Director

Andrew Cullison.. cullison@aws.org(249)

Welding Journal

Publisher

Andrew Cullison.. cullison@aws.org(249)

Editor

Mary Ruth Johnsen.. mjohansen@aws.org (238)

National Sales Director

Rob Saltzstein.. salty@aws.org(243)

Society and Section News Editor

Howard Woodward..woodward@aws.org .(244)

Welding Handbook

Welding Handbook Editor

Annette O'Brien.. aobrien@aws.org(303)
Publishes the Society's monthly magazine, *Welding Journal*, which provides information on the state of the welding industry, its technology, and Society activities. Publishes *Inspection Trends*, the *Welding Handbook*, and books on general welding subjects.

MARKETING COMMUNICATIONS

Director

Ross Hancock.. rhancock@aws.org(226)

Webmaster

Angela Miller.. amiller@aws.org(456)

MEMBER SERVICES

Department Information(480)

Deputy Executive Director

Cassie R. Burrell.. cburrell@aws.org(253)

Director

Rhenda A. Mayo.. rhenda@aws.org(260)
Serves as a liaison between Section members and AWS headquarters. Informs members about AWS benefits and activities.

CERTIFICATION SERVICES

Department Information(273)

Managing Director, Certification Operations

John Filippi.. jfilippi@aws.org(222)

Managing Director, Technical Operations

Peter Howe.. phowe@aws.org(309)
Manages and oversees the development, integrity, and technical content of all certification programs.

Director, Int'l Business & Certification Programs

Priti Jain.. pjain@aws.org(258)
Directs all int'l business and certification programs. Is responsible for oversight of all agencies handling AWS certification programs.

EDUCATION SERVICES

Managing Director

Dennis Marks.. dmarks@aws.org(449)

Director, Education Services Administration
and Convention Operations

John Ospina.. jospina@aws.org(462)

AWS AWARDS, FELLOWS, COUNSELORS

Senior Manager

Wendy S. Reeve.. wreeve@aws.org(293)
Coordinates AWS awards and AWS Fellow and Counselor nominees.

TECHNICAL SERVICES

Department Information(340)

Managing Director

Andrew R. Davis.. adavis@aws.org(466)
Int'l Standards Activities, American Council of the Int'l Institute of Welding (IIW)

Director, National Standards Activities

John L. Gayler.. gayler@aws.org(472)
Personnel and Facilities Qualification, Computerization of Welding Information

Manager, Safety and Health

Stephen P. Hedrick.. stveh@aws.org (305)
Metric Practice, Safety and Health, Joining of Plastics and Composites, Welding Iron Castings

Technical Publications

AWS publishes about 200 documents widely used throughout the welding industry.

Senior Manager

Rosalinda O'Neill.. roneill@aws.org(451)

Staff Engineers/Standards Program Managers

Annette Alonso.. aalonso@aws.org(299)
Automotive Welding, Resistance Welding, Oxygen Gas Welding and Cutting, Definitions and Symbols, Sheet Metal Welding

Stephen Borrero.. sborrero@aws.org(334)

Joining of Metals and Alloys, Brazing and Soldering, Brazing Filler Metals and Fluxes, Brazing Handbook, Soldering Handbook

Rakesh Gupta.. gupta@aws.org(301)

Filler Metals and Allied Materials, Int'l Filler Metals, Instrumentation for Welding, UNS Numbers Assignment

Brian McGrath.. bmcgrath@aws.org(311)

Methods of Inspection, Mechanical Testing of Welds, Welding in Marine Construction, Piping and Tubing, Robotic and Automatic Welding

Selvis Morales.. smorales@aws.org(313)

Welding Qualification, Structural Welding

Matthew Rubin.. mrrubin@aws.org(215)

Machinery and Equipment, Robotics Welding, Arc Welding and Cutting Processes

Reino Starks.. rstarks@aws.org(304)

Welding in Sanitary Applications, High-Energy Beam Welding, Aircraft and Aerospace, Friction Welding, Railroad Welding, Thermal Spray

Note: Official interpretations of AWS standards may be obtained only by sending a request in writing to the Managing Director, Technical Services. Oral opinions on AWS standards may be rendered. However, such opinions represent only the personal opinions of the particular individuals giving them. These individuals do not speak on behalf of AWS, nor do these oral opinions constitute official or unofficial opinions or interpretations of AWS. In addition, oral opinions are informal and should not be used as a substitute for an official interpretation.

Nominees for National Office

Only Sustaining Members, Members, Honorary Members, Life Members, or Retired Members who have been members for a period of at least three years shall be eligible for election as a director or national officer.

It is the duty of the National Nominating Committee to nominate candidates for national office. The committee shall hold an open meeting, preferably at the Annual Meeting, at which members may appear to present and discuss the eligibility of all candidates.

To be considered a candidate for the positions of president, vice president, treasurer, or director-at-large, the following qualifications and conditions apply:

President: To be eligible to hold the office of president, an individual must have served as a vice president for at least one year.

Vice President: To be eligible to hold the office of vice president, an individual must have served at least one year as a director, other than executive director and secretary.

Treasurer: To be eligible to hold the of-

fice of treasurer, an individual must be a member of the Society, other than a Student Member, must be frequently available to the national office, and should be of executive status in business or industry with experience in financial affairs.

Director-at-large: To be eligible for election as a director-at-large, an individual shall previously have held office as chairman of a Section; as chairman or vice chairman of a standing, technical, or special committee of the Society; or as District director.

Interested persons should submit a letter stating which office they seek, including a statement of qualifications, their willingness and ability to serve if nominated and elected, and a biographical sketch.

E-mail the letter to Gricelda Manalich, gricelda@aws.org, c/o Gerald D. Uttrachi, chair, National Nominating Committee.

The next meeting of the National Nominating Committee is scheduled for October 2008. The terms of office for candidates nominated at this meeting will commence January 1, 2010.

Honorary Meritorious Awards

The Honorary-Meritorious Awards Committee makes recommendations for the nominees presented for Honorary Membership, National Meritorious Certificate, William Irrgang Memorial, and the George E. Willis Awards. These awards are presented during the FABTECH International & AWS Welding Show held each fall. The deadline for submissions is December 31 prior to the year of awards presentations. Send candidate materials to Wendy Sue Reeve, secretary, Honorary Meritorious Awards Committee, wreeve@aws.org; 550 NW LeJeune Rd., Miami, FL 33126. Descriptions of the awards follow.

William Irrgang Memorial Award is awarded each year to the individual who has done the most over the past five years to enhance the American Welding Society's goal of advancing the science and technology of welding.

This award consists of a \$2500 honorarium and a certificate. It is presented during the FABTECH International & AWS Welding Show held each fall. The award is administered by the American Welding Society and sponsored by The Lincoln Electric Co. to honor the late William Irrgang.

George E. Willis Award is awarded each year to an individual who promotes the advancement of welding internationally by fostering cooperative participation in areas such as technology transfer, standards rationalization, and promotion of industrial goodwill.

The award consists of a \$2500 honorarium and a certificate. It is presented during the FABTECH International & AWS Welding Show held each fall. The award is administered by the American Welding Society and sponsored by The Lincoln Electric Co. to honor George E. Willis.

Honorary Membership Award is presented to a person of acknowledged eminence in the welding profession, or who is accredited with exceptional accomplishments in the development of the welding art, upon whom the American Welding Society sees fit to confer an honorary distinction. Honorary Members have full rights of membership.

National Meritorious Certificate Award is given in recognition of the candidate's counsel, loyalty, and devotion to the affairs of the Society, assistance in promoting cordial relations with industry and other organizations, and for the contribution of time and effort on behalf of the Society.

International Meritorious Certificate Award is given in recognition of significant contributions to the welding industry for service to the international welding community in the broadest terms. The awardee is not required to be an AWS member. Multiple awards may be given. The award consists of a certificate and a one-year AWS membership.

AWS Publications Sales

Purchase AWS standards, books, and other publications from **World Engineering Xchange (WEX), Ltd.**
orders@awspubs.com; www.awspubs.com
Toll-free (888) 935-3464 (U.S., Canada)
(305) 824-1177; FAX (305) 826-6195

Welding Journal Reprints

Copies of *Welding Journal* articles may be purchased from Ruben Lara.
(800/305) 443-9353, ext. 288; rlara@aws.org

Custom reprints of *Welding Journal* articles, in quantities of 100 or more, may be purchased from

FosteReprints

Claudia Stachowiak
Reprint Marketing Manager
866-879-9144, ext. 121
claudia@fostereprints.com

AWS Foundation

AWS Foundation, Inc., is a not-for-profit corporation established to provide support for educational and scientific endeavors of the American Welding Society. Information on gift-giving programs is available upon request.

Chairman, Board of Trustees
Ronald C. Pierce

Executive Director, AWS
Ray Shook, ext. 210, rshook@aws.org

Executive Director, Foundation
Sam Gentry, ext. 331, sgentry@aws.org

Corporate Director, Solutions Opportunity Squad
Monica Pfarr, ext. 461, mpfarr@aws.org

Director, Solutions Opportunity Squad
Connie Bowling, ext. 308, cbowling@aws.org

550 NW LeJeune Rd., Miami, FL 33126
(305) 445-6628; (800) 443-9353, ext. 293
General Information:
(800) 443-9353, ext. 689; vpinsky@aws.org

AWS Mission Statement

The mission of the American Welding Society is to advance the science, technology, and application of welding and allied processes, including joining, brazing, soldering, cutting, and thermal spraying.

It is the intent of the American Welding Society to build AWS to the highest quality standards possible. The Society welcomes your suggestions. Please contact any staff member or AWS President **Gene E. Lawson**, as listed on the previous page.

“My NEW Powermax45

cuts what I need to cut. Goes where I go. Does what I want to do.

All it wants to do is work.”

Sébastien Henault
Production Manager
Le Matériel Industriel
Canada



Portable. Versatile. Productive.
The NEW Powermax45 Plasma System

Introducing Hypertherm's new Powermax45® Plasma System. At just 37 pounds, the portable Powermax45 now puts go-anywhere, cut-everything power and versatility in your hands. For hand cutting, gouging or mechanized applications. To cut up to 3/4"-thick mild steel, stainless steel and aluminum with outstanding speed and cut quality. To move quickly from one job to the next – in the shop or in the field. Which is why Sébastien Henault says, “Now I can pack my whole workday into this portable box.” Check out the new Powermax45 system at www.powerfulplasma.com.

Hypertherm®

MANUAL PLASMA | MECHANIZED PLASMA | AUTOMATION | LASER | CONSUMABLES

CELEBRATING
40 YEARS

For Info go to www.aws.org/ad-index

Know the Allied Processes

The following figure shows the processes related to welding and joining and their official AWS letter designations. These allied processes include thermal spraying and a variety of thermal cutting processes.

Thermal spraying (THSP) is a group of processes in which finely divided metallic or nonmetallic surfacing materials are deposited in a molten or semimolten condition on a substrate to form a thermal spray deposit. The surfacing material may be in the form of powder, rod, cord, or wire.

Oxygen cutting (OC) refers to the group of cutting processes used to sever, gouge, pierce, or remove metals by means of the high-temperature exothermic reaction of oxygen with a base metal. With some oxidation-resistant metals, the reaction may be aided

by the use of a chemical flux or a metal powder. Oxyfuel gas cutting and its variations are important processes commonly used in structural fabrication, shipbuilding, heavy machinery manufacturing, and in the fabrication, repair, and maintenance of pressure vessels and storage tanks, among other industries.

Arc cutting (AC) refers to the group of thermal cutting processes that severs or removes metal by melting with the heat of an arc between an electrode and the workpiece.

High energy beam cutting (HEBC) refers to the group of thermal cutting processes that severs or removes material by localized melting, burning, or vaporizing of the workpieces using beams having high energy densities. These processes include electron beam and laser beam cutting.

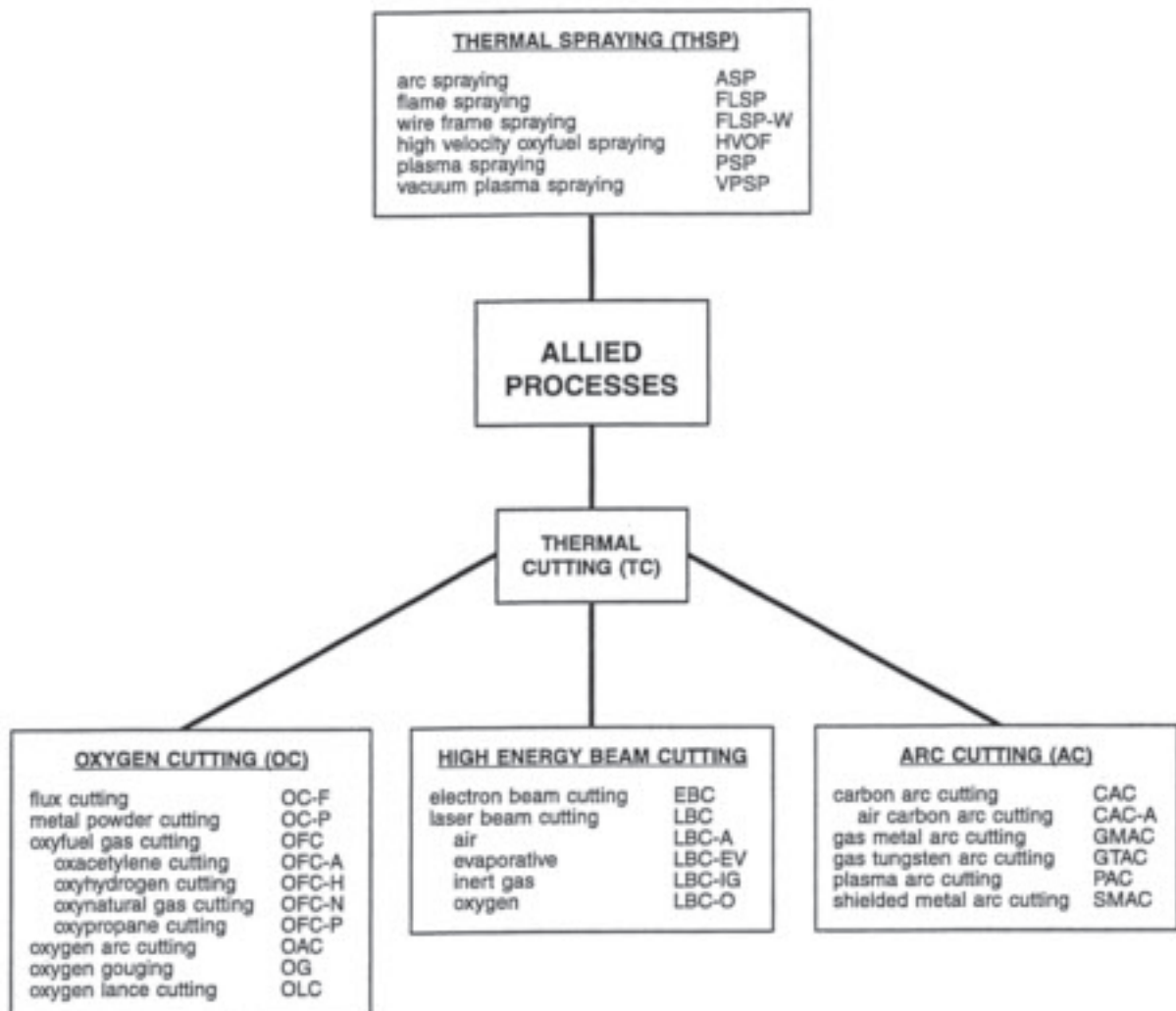

Fig. 1 — Master chart of allied processes.

Excerpted from AWS A3.0:2001, *Standard Welding Terms and Definitions*, and the *Welding Handbook*, Vol. 2, ninth edition.

The Micro ADM™ with
Multiple Part Select and
WPM-08 PC Based Weld
Process Monitor and
Operator Interface Panel.

NEW



WPM-08 Front View

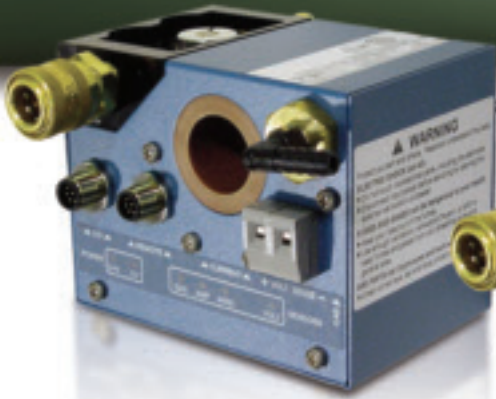

MicroADM™ (senses
Volts, Amps, WFS, and Gas).



LEARNS up to Eight different Parts. **TESTS** utilizing Weld Count, Weld Volume Applied, and Accumulated Arc Density. **DISPLAYS** weld process and "PASS/FAIL" signals. **NETWORKS** with Plant Ethernet and offers Web-Based Internet access for remote monitoring, SPC Data Archiving and Quality "Alerts".

Computer Weld Technology is the leading supplier of Weld Monitors, Thru-Arc Seam Tracking Weld Controls and Heavy Duty Cross Slide Assemblies, Weld Oscillators, and Gas Turbine Flow Monitors.™



Computer Weld Technology, Inc.

"Automating, controlling and monitoring the welding process."

For Info go to www.aws.org/ad-index

Visit www.cweldtech.com for more information or email us at cwt@cweldtech.com.

©1994-2005 Computer Weld Technology, Inc. All rights reserved.

10702 Old Bammel N Houston Rd. • Houston, TX 77086 • Phone (713) 462-2118 • Fax (713) 462-2503

Guide Discusses GMA Welding Technology

The *MIG Welding Guide* provides a comprehensive, easy-to-understand coverage of the gas metal arc welding process. Detailed information is provided for selecting shielding gases, filler metals, and welding equipment along with a lot of practical advice. Provided is an overview of new developments in various processes, such as flux cored arc welding, new high-production methods, pulsed GMA welding and GMA brazing, robotic welding applications, and occupational health and safety information. The book is intended for welding engineers, production engineers, designers, and everyone involved in industrial manufacturing. The price is about \$360 plus shipping. For information, visit www.researchandmarkets.com/product/ff0c17/mig_welding_guide.

Flange Lock Fasteners Pictured in Brochure

A new four-page, full-color brochure illustrates and describes the company's



proprietary Spinner-Grip™ flange lock nuts and flange locking bolts offering superior holding power for heavy-vibration applications. The integral flange design provides self-locking without the need for lock washers or other parts. The brochure lists pertinent applications in both U.S. Customary and metric systems with recommended torques, ordering informa-

tion, and instructions for ordering products made to user's specifications.

Jergens, Inc.
www.jergensinc.com
 (800) 537-4367

Cumulative Damage of Welded Joints Published

The 464-page, *Cumulative Damage of Welded Joints*, written by Dr. Gurney of The Welding Institute, UK, is described as a comprehensive source of invaluable information for welding engineers, supervisors, inspection personnel, designers, and academics working in the fields of structural and mechanical engineering. It covers the research in the field of fatigue strength and its role in the design and manufacture of welded components. For book information and to order, visit www.researchandmarkets.com/product/f798fc/cumulative_damage_of_welded_joints.

Catalog Showcases Reels

A 40-page, full-color catalog showcases the company's complete lines of

— continued on page 88



➔ HELP FOUND

BETTER CANDIDATES, BETTER RESULTS

AWS JobFind works better than other job sites because it specializes in the materials joining industry. Hire those hard-to-find Certified Welding Inspectors (CWIs), Welders, Engineers, Welding Managers, Consultants and more at www.awsjobfind.com. You'll find more than 2,000 résumés of top job seekers in the industry!

THE TOOLS TO DO MORE

AWS JobFind provides companies with the tools to post, edit and manage their job listings easily and effectively, any day or time, have immediate access to an entire résumé database of qualified candidates, look for candidates who match their employment needs: full-time, part-time or contract employees, receive and respond to résumés, cover letters, etc. via e-mail.

POST JOBS, FIND JOBS AT THE INDUSTRY'S CAREER MEETING PLACE
VISIT WWW.AWSJOBFIND.COM



weldOffice[®]
...the industry standard...

**The Smartest Way To Manage Your
Welding Documentation**

WPS PQR WPQ NDE

ASME IX AWS D1.1 ISO
automated code compliance

Industry standard QA/QC Software for automatic creation and management of Welding Procedures, Welder Qualifications and NDE reports. Designed and supported by welding engineers and codes & standards committee members.

Thousands of companies worldwide depend on WeldOffice software. Impress your boss and your clients with superior knowledge and productivity by delivering accurate professional welding documentation in seconds.

Call 877-977-7999

Superior Software...

Superior Support...

**"... It's like having a full-time welding engineer
plus a code expert on your staff ..."**



For Info go to www.aws.org/ad-index

Download free demo from:

www.weldoffice.com



reels for industrial and commercial applications. Illustrated is a wide selection of hose, cord, and cable reels, including six new series and 80 new models. The product photographs and descriptions are organized to help the reader quickly find the products desired.

Coxreels
www.coxreels.com
(800) 269-7335

Online Videos Show Pipe Welding Techniques

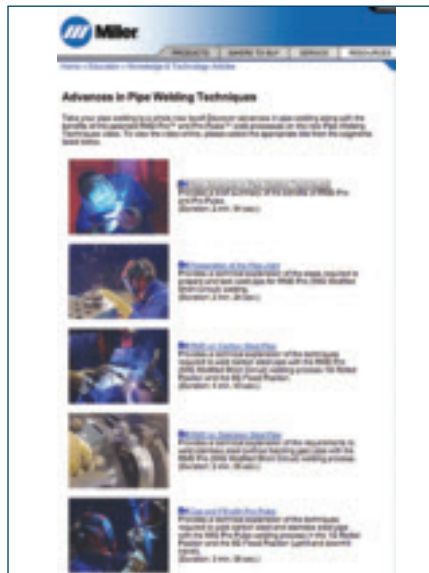

Pipe Welding Technique videos can be downloaded without charge from the company's Web site. The five topics include new advances in pipe welding techniques, preparation of the pipe joint, carbon steel pipe, stainless steel pipe, and making fill and cap passes using the ProPulse™ technology. A CD of these videos is available. Visit the Web site, then type "pipe welding videos" in the search box

to reach the downloadable videos and order page for the CD.

Miller Electric Mfg. Co.
www.millerwelds.com
(920) 734-9821

Data Sheet Details Direct Contact Thermometer



A two-page, full-color data sheet details the features of the Estik™ direct contact industrial thermometer for use in critical welding, heat treating, pipeline construction, metal fabrication, laboratory, and motor maintenance applications. The hand-held unit, featuring a measuring range of 32°–999°F (0°–537°C) with ±2% accuracy and 5-s response time, is shown in use on a metal surface with the temperature shown on a backlit digital display.

Tempil®
www.tempil.com
(800) 757-8301

Corrosion in the Alternative Power Industry Detailed in Literature

The seven-page, well-illustrated, full-color, *Sustainable Solutions for Corrosion Protection*, compares the costs and environmental factors of using hot-dip galvanized vs. zinc-epoxy/polyurethane paint to control corrosion on windmill farms, biofuel plants, hydroelectric dams, and solar energy installations. Case studies are presented for the Lake Erie Biofuels Plant, Erie, Pa.; Cambridge Ethanol Project, Cambridge, Neb.; Gaspé Wind Energy Project, Gaspé, QC, Canada; Norris Dam Steel Substation, Knoxville, Tenn.; Xcel Energy Big Falls Hydro Plant, Ladysmith, Wis.; Indiana Wind Farm; Nevada Solar One — Solargenix Energy, Boulder City, Nev.; Johnson & Johnson Solar Roof Panel, New Brunswick, N.J.; South San Joaquin Irrigation Distribution Solar Farm, Oakdale, Calif.; and oth-

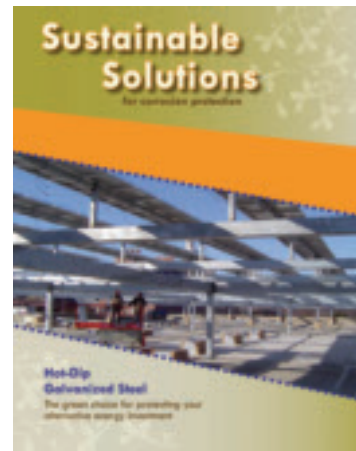

ers. The PDF may be downloaded from the Web site, or call for a hard copy or more information.

American Galvanizers Assn.
www.galvanizeit.org
(720) 554-0900, ext. 15

Weld Purging Guide Offered

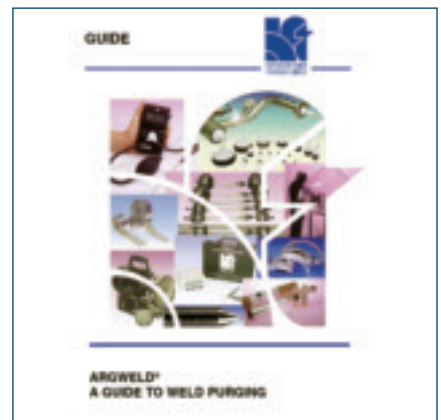

The 20-page, full-color, *A Guide to Weld Purging*, presents easy-to-understand text with graphics to define the essential terminology and techniques. Arranged alphabetically, a few of the topics include argon, backing bars and tape, bladders, ceramic tiles, chambers, cleanliness, dams, pipe and elbow purging, flexible enclosures, foam, flow meters, purging gases, high-temperature systems, paste and plugs for purging, plastic films, purge monitors, reasons for purging, stainless steel and titanium, trailing shields, water-soluble purge materials, etc. Information is provided for Argweld® purge monitors, backing tape, quick purge systems, and water-soluble purge films. The Guide may be downloaded from the Web site.

Huntingdon Fusion Techniques Ltd.
www.huntingdonfusion.com/downloadfiles/AGtPdf
44 (0) 1554 836 836



SUMIG

ROBOTICS

ONE TORCH BODY. HUNDREDS OF COMBINATIONS.

One of the product's highlights is the easiness to replace parts or accessories, turning the equipment maintenance quicker and more economic. Manufactured with most advanced materials, the product shows impressive resistance and durability, higher than any other similar available.

With innumerable combinations of cooling systems and torch head possibilities, the SUMIG ROBOT SYSTEM becomes the most complete solution for robot torches in the world market.



- ISO 9001:2000 certified.
- Brazilian welding torches market leader.
- Present in overseas market.
- New worldwide partners wanted.

SUMIG GROUP

SUMIG
TORCHES

SUMIG
EQUIPAMENTOS

COMING SOON
ROBOTICS

COMING SOON
TRADING

Av. Ângelo Corsetti, 1281 Caxias do Sul RS 95042-000 BRAZIL
phone: +55 54 3220 3900 fax: +55 54 3220 3920
home-page: www.sumig.com.br - e-mail: export@sumig.com.br

For Info go to www.aws.org/ad-index



Member Milestones

Kotecki Named Treasurer and Board Member of IIW



Damian Kotecki (left) is installed as IIW treasurer on July 11 by Detlef von Hofe who presented him with a whimsical piggy bank 'treasury' to commemorate the event.

Damian J. Kotecki was named treasurer of the International Institute of Welding (IIW) July 11 at a ceremony held during the IIW Annual Assembly in Kiev, Ukraine. As treasurer, Dr. Kotecki becomes a member of the IIW board of directors. He was officially installed by outgoing treasurer Prof. Dr. **Detlef von Hofe** of Germany.

Kotecki, president of Damian Kotecki Welding Consultants, Inc., Cleveland, Ohio, and author of the Stainless Q+A column published bimonthly in the *Welding Journal*, is a past AWS president and past chairman of the A5 Committee on Filler Metals and Allied Materials.

Levert Honored by Lockheed Martin



Ernest D. Levert Sr.

Ernest D. Levert Sr., a senior staff manufacturing engineer at Lockheed Martin Corp. and a past AWS president, was inducted as an inaugural member of the Production Technical Excellence Staff (PTES) for his "outstanding service to Lockheed Martin in the Operations fields of welding and materials joining technologies." The PTES recognizes the Production Operations engineers, scientists, and technical professionals who have demonstrated exemplary technical leadership, business acumen, and education. A PTES Wall of Honor listing the names of the honorees is located outside the company's Production Operations in Dallas, Tex., and Orlando, Fla.

Airgas Makes Top Management Changes

Airgas, Inc., Radnor, Pa., has named **Andy Cichocki** a division president of Airgas, and promoted **Steve Marinelli** to succeed Cichocki as president of Airgas National Welders. Marinelli, with the company for 28 years, has served since 2000 as vice president of marketing.

Wall Colmonoy Appoints VP and HR Manager

Wall Colmonoy Corp., Madison Heights, Mich., has appointed **Robert M. Heminger** vice president of finance and administration, and **Marianne Huesing**



Robert M. Heminger



Marianne Huesing

corporate human resource manager for the company's U.S. locations. Heminger, with the company for 20 years, previously served as corporate controller. Huesing, who joined the company 30 years ago as administrative assistant to the vice president of manufacturing, most recently

served as general administrative/technical services coordinator.

Coshocton Career Center Names Welding Instructor

AWS member **Nick Baughman** has joined the Coshocton County Career Center, Coshocton, Ohio, staff as welding trades instructor, replacing **Craig Neff** who has retired after 15 years in the post. Baughman is a third-generation metallurgist, and a certified welder with commercial experience in weld and machine shop work. He's currently pursuing his AWS CWI and CWE, and teaching evening classes in welding, mechanical drawing, and computer-aided design at Stark State College.

LIA Awards Laser Pioneer

Laser Institute of America, Orlando, Fla., has presented **Eckhard Beyer** the Arthur L. Schawlow Award for his outstanding contributions to laser science and engineering. Prof. Beyer, with the University of Technology, Dresden, Germany, and executive director of the Fraunhofer Institute for Material and Beam Technology, has more than 20 years' experience in the industry. He developed a rotating hollow needle for beam diagnostics and holds several patents for laser cutting and welding. He is a recognized authority in hybrid laser deep-penetration welding, laser coating, and novel laser beam techniques.

Worldwide Superabrasives Names Sales Manager



Dan Herzog

Worldwide Superabrasives LLC, Ft. Lauderdale, Fla., has named **Dan Herzog** Midwest regional sales manager. Herzog brings 40 years' experience to the position.

Harris Products Names Three to Key Posts

The Harris Products Group, a Lincoln Electric Company, Mason, Ohio, has appointed **Bill Kingsley** regional manager — west region, based in Phoenix, Ariz.; **Jason High** as supply chain manager; and **Luis De Arruda** as international business develop-

— continued on page 94

STRUCTURAL WELDING IS built on D1

**New
edition!**



Working under ANSI procedures, the contributors and reviewers of AWS D1 codes have built upon the work of hundreds of prior experts who, since the first D1 code in 1928, have continuously labored to represent proven practices. The result is a resource that provides a consensus of the finest minds in the industry on the most reliable approaches to achieving a successful final outcome. That's why D1 code books have been mandated by local, state, and overseas codes, approved by ANSI, adopted by the Defense Department, preferred by NASA, and required by contracts for countless industrial and construction applications.

Order your 2008 edition of AWS D1.1 by visiting www.aws.org/d1, or call 888-WELDING for information on all of AWS's structural welding codes.



American Welding Society®

www.aws.org

The AWS Foundation

is pleased to announce additional scholarships

Section Named Scholarship Program

Scholarships sponsored by AWS Sections to support students in their communities.

AWS International Scholarship Program for 2008-2009

International Scholarships are awarded to full-time international students pursuing undergraduate or graduate studies in joining sciences.



Congratulations to **Karem E. Tello**, AWS International Scholarship recipient.

"I want to thank the AWS Foundation and its supporting companies for the International Scholarship Award. This will be very helpful towards the development of my career in welding science. I look forward to repaying the generosity of AWS through the continuation of my welding work."

Colorado School of Mines, Ph.D. in Materials Science



Congratulations to **Duncan McRae**, the 2008-2009 recipient of the Ronald S. Theiss - Houston Section Named Scholarship.

"It was a great honor to be the recipient of the Ronald S. Theiss - Houston Section Named Scholarship. I would like to personally thank all the members of the American Welding Society for the continued support in my education."

Texas A & M University, Manufacturing and Mechanical Engineering Technology



Congratulations to **Kelly M. Wilson**, the 2008-2009 recipient of the Ronald C. and Joyce Pierce - Mobile Section Named Scholarship.

"I am honored to receive the Ronald C. and Joyce Pierce - Mobile Section Named Scholarship, and would like to thank the members of the AWS Foundation and Mr. and Mrs. Pierce for their outstanding generosity. Support of youth and education is critical for building a strong legacy for the AWS Foundation, and I feel privileged to be a part of it."

University of Alabama, Materials and Metallurgical Engineering



Congratulations to **Nathan D. Goldsmith**, the 2008-2009 recipient of the Amos and Marilyn Winsand - Detroit Section Named Scholarship.

"It is great that the Detroit Section of the AWS is so dedicated to helping financially support welding education. I would also like to thank the Winsand family for their generous contribution by endowing this scholarship. With the financial help of this scholarship and the AWS I hope to ultimately make as big of a contribution to the welding industry as the Winsand Scholarship recipients that have preceded me!"

Ferris State University, Welding Engineering Technology

An Investment for You and the Future of the AWS Foundation

A charitable gift annuity with the AWS Foundation will guarantee you a valuable tax benefit, a contracted fixed payment for you, or for you and another individual, while insuring a gift to the AWS Foundation. The AWS Foundation, as the beneficiary of an irrevocable charitable donation, can enter into an agreement to pay you an income for life.

Based upon the age of the donor, and the size of the donation, the rate of return is determined using tables provided by the National Committee on Gift Annuities. The rate of return is fixed and will not vary for the life of the annuitant.

The donor may also delay the payments coming to the annuitant to a more convenient time, while enjoying the tax

benefits at the time of the gift. This option is called a Deferred Gift Annuity. Payments with this type of annuity are started on the date the donor provides. Like the Charitable Gift Annuity, payments are made to the annuitant for life.

Let us send you a "Donor's Guide" that you may review and discuss with your tax advisor and legal counsel. Contact Sam Gentry at 800-443-9353, ext. 331 or Vicki Pinsky, ext. 212 in the AWS Foundation for a copy. Invest with us to support welding education in the future.



Foundation, Inc.

Building Welding's Future through Education

Welding for the Strength of America

The Campaign for the American Welding Society Foundation

— continued from page 14

Also, the new plant went through engineering, quality, and applications testing to validate the quality of the flux produced was identical to what was received previously from Europe.

Wallace Community College Receives Workforce Development Grant

The Governor's Office of Workforce Development recently awarded a \$24,300 grant to Wallace Community College (WCC). It will fund dual enrollment scholarships for qualified high school students interested in entering the welding or industrial maintenance workforce.

The funding will assist juniors and seniors from Abbeville, Barbour County, Dale County, Eufaula, and Headland high schools, and will cover the cost of tuition, fees, books, and supplies at the college. "The schools we targeted are those that didn't already have a technical program in place," said Dr. Mike Babb, WCC dean of career technical instruction.

The scholarships will pay for 12 students from each high school to attend either the Wallace Campus in Dothan, Ala., or the Sparks Campus in Eufaula, Ala. Students will receive college and high school credits upon successful completion of the program.

Industry Notes

- The **American National Standards Institute** will publish, on an ongoing basis, a series of snapshots with diverse standards initiatives undertaken in the global and national arena. Recently featured was bridge welding, including the AASHTO/AWS D1.5M/D1.5: 2008, *Bridge Welding Code*.
- The reimbursement of fees associated with becoming a Certified Laser Safety Officer has been approved for veterans' benefits by the State of Florida, Department of Veterans' Affairs. This certification is available through the **Board of Laser Safety**, Orlando, Fla. To learn more, visit www.gibill.va.gov.
- Celebrating its 20th anniversary in America this year is **MISUMI USA, Inc.**, Schaumburg, Ill., a subsidiary of the Japan-based Misumi Corp. The company is a supplier of configurable and fixed components for factory automation.
- Pure Helium, an international supplier of liquid and gaseous helium, helium-based mixtures, and argon, has been acquired by **Air Liquide**, Paris.
- Chemetall Oakite, New Providence, N.J., a provider of specialty chemical products, has changed its name to **Chemetall**.
- **Barnes Aerospace**, Windsor, Conn., has doubled the size of its maintenance, repair, and overhaul business in Singapore.
- **Thermo Fisher Scientific Inc.**, Billerica, Mass., a manufacturer of hand-held X-ray fluorescence analyzers, has been awarded the R&D 100 Award for technological innovation.
- Thirty participants from fifteen different countries were recently hosted by **RathGibson** in its annual Global Training Program held in its Janesville, Wis., facility.

- The assets of Eugene Welding Co. and its parent, Tarpon Industries, Inc., have been obtained by **Heartland Steel Products, Inc.**, Marysville, Mich.
- **The Wagner Companies**, Milwaukee, Wis., has added a Mazak Fabrigear 300, 4000-W tube laser to its manufacturing operation. This can cut at any desired angle for weld preparation.
- Certain assets of Exel Orbital Systems, Santa Monica, Calif., and certain intellectual property related to its automated orbital welding products have been bought by **Arc Machines, Inc.**
- The Speedglas™ SL welding shield from **3M**, St. Paul, Minn., has won a 2008 Gold Award in a design competition, the International Design Excellence Awards.
- **Alfa Laval Group**, Sweden, has acquired Pressko AG, a German company providing fully welded heat exchangers.
- *Modern Marvels: Iron* recently aired on The History Channel. Featured were the **American Iron and Steel Institute** and a tour of the ArcelorMittal mine in Minnesota.
- The maintenance and modification unit of **Day & Zimmermann**, Philadelphia, Pa., has completed the acquisition of a fabrication and machining facility in Moss Point, Miss., from Industrial Maintenance and Machine, Inc.
- **Industrial Metal Supply Co.** is creating a new business unit to provide six-axis, 3-D laser cutting and fabrication services to its customer base in southern California and Arizona.

WELDING REPRINTS

Take Advantage of your Editorial Exposure

Reprints of Welding Journal are a simple way to put information directly into the hands of your target audience. Having been featured in a well-respected publication adds the credibility of a third-party endorsement to your message.

Reprints are ideal for:

- PR Materials and Media Kits
- Direct Mail Enclosures
- Trade Shows/Promotional Events
- Conferences/ Speaking Engagements
- Recruitment and Training Packages
- Customer and Prospect Communications/ Presentations

Give yourself a competitive advantage with reprints!



For additional information, please contact FosteReprints, the official reprint provider for *Welding Journal*.
Email: sales@fostereprints.com or call 866-879-9144



Bill Kingsley



Jason High



Luis De Arruda

ment manager. Kingsley, with the company for more than 19 years, previously served as regional manager — north central region. Before joining the company, High worked for Messier Bugatti USA as supply chain manager for North America.

De Arruda previously served Metal Technologies, Inc., where he was sales manager for the Mexican territory.

Stillwater Technologies Names Engineering Head



Tony Newport

Stillwater Technologies, Inc., Troy, Ohio, a contract tooling and machining company and manufacturer of resistance welding products, has named **Tony Newport** engineering/design manager. Most recently, Newport was design engineer and

sales consultant for Trifecta Tool and Engineering in Dayton, Ohio.

Weiler Corp. Names President and VP



Chris Weiler



Jim McDaniel

Weiler Corp., Cresco, Pa., a manufacturer of power brushes, abrasives, and maintenance products, has named **Chris Weiler** president and COO. Former president and CEO **Dick Gommel** will continue as CEO. With the company since 1998,

Weiler most recently served as executive vice president of sales and marketing. **Jim McDaniel** has joined the company as vice president, sales and marketing. McDaniel most recently served as vice president of marketing and business development at Cooper Industries.

Wagner Fills Key Post



Jackie Heinrichs

The Wagner Companies, Milwaukee, Wis., has named **Jackie Heinrichs** manager of production control. Previously, Heinrichs worked two years as a project manager for Everbrite Inc., and earlier worked for The Wagner Companies' inside sales, custom polishing sales, and production control groups.

Welding Sales Manager Announced at CMW



Jeff Schemel

CMW Inc., Indianapolis, Ind., has promoted **Jeff Schemel** to welding sales manager for its resistance welding business. Most recently, Schemel served as a major account manager.

Jergens Names Sales Director



Eric Van Steenlandt

Jergens, Inc., Cleveland, Ohio, has appointed **Eric Van Steenlandt** director of sales and marketing for its operations in North America. Before joining the company, Van Steenlandt served as a corporate national sales manager and as a systems design and development engineer.

and as a welding instructor at Montgomery County Career Center. He was a talented welder, machinist, blacksmith, woodworker, and inventor who loved all things mechanical. His passion was building and restoring farm equipment. He served as a member of the Centerville Historical Society, Case Collectors Assoc., Old Timers Club, and several area antique tractor clubs. A member of Belmont United Methodist Church, Deets is survived by his wife, Sarah; daughters Jean Moran and Kay Cheek; and a son, Douglas; a sister, Lois Allison; five grandchildren and seven great-grandchildren.

Vincent M. Cimino

Vincent M. "Jim" Cimino, 84, died May 11 in Rochester, N.Y. A member of the AWS Rochester Section, he served as its chairman 1961–1963, and as District 6 director from 1984 to 1990.

Cimino served in the U.S. Army during WW II where he participated in the invasion of Normandy on Omaha Beach, D-Day 1944. He worked as a manufacturing engineer in fabrication at Xerox Corp. for many years, retiring in 1986. He shared his knowledge of metallurgy by conducting welding classes and seminars throughout his career. Cimino was an active member of many veterans organizations, including The American Legion, Forty & Eight, Veterans of Foreign Wars, Purple Heart, Disabled American Veterans, and AMVETS. He also was active with the Gates Republican Committee and St. Helen's Church. He is survived by his daughter, Rose Ann; son, James; sisters, Rose and Nancy; brothers, Joseph, Anthony, and Matthew; three grandchildren; and two great-grandchildren.

Glenn E. Smith



Glenn E. Smith

Glenn E. Smith, 82, died July 18 in Wichita, Kan. An AWS member since 1951, he served as national sales and marketing manager for Tweco Products, Inc., until his retirement in 1986. During his career at Tweco, he established distribu-

tionships in all 50 states and more than 30 foreign countries. In 1975, he was a featured speaker at the National Welding Supply Association (currently Gases and Welding Distributors Association) convention in San Francisco, Calif. He is survived by his wife, Eleanor; daughters, Nancy Custer and Karen S. Smith; a sister, Euella Randall; and granddaughters Jenna and Jill Custer.

Obituaries

Milton L. Deets

Milton L. Deets, 90, a past chairman of the Dayton Section, died May 8 in Dayton, Ohio. Deets served in the U.S. Army Air Corps during WW II. He later worked as a machinist for several area companies

PROFESSIONAL PROGRAM ABSTRACT SUBMITTAL
Annual FABTECH International & AWS Welding Show
Chicago, IL – November 15-18, 2009

Submission Deadline: March 13, 2009

(Complete a separate submittal for each paper to be presented.)

Primary Author (Full Name):			
Affiliation:			
Mailing Address:			
City:	State/Province	Zip/Mail Code	Country:
Email:			
Co-Author(s):			
Name (Full Name):		Name (Full Name):	
Affiliation:		Affiliation:	
Address:		Address:	
City:		City:	
State/Province:		State/Province:	
Zip/Mail Code:		Zip/Mail Code:	
Country:		Country:	
E-Mail:		E-Mail:	
Name (Full Name):		Name (Full Name):	
Affiliation:		Affiliation:	
Address:		Address:	
City:		City:	
State/Province:		State/Province:	
Zip/Mail Code:		Zip/Mail Code:	
Country:		Country:	
E-Mail:		E-Mail:	
Answer the following about this paper			
Original submittal? Yes <input type="checkbox"/> No <input type="checkbox"/> Progress report? Yes <input type="checkbox"/> No <input type="checkbox"/> Review paper? Yes <input type="checkbox"/> No <input type="checkbox"/> Tutorial? Yes <input type="checkbox"/> No <input type="checkbox"/>			
What are the welding/Joining processes used?			
What are the materials used?			
What is the main emphasis of this paper? Process Oriented <input type="checkbox"/> Materials Oriented <input type="checkbox"/> Modeling <input type="checkbox"/>			
To what industry segments is this paper most applicable?			
Has material in this paper ever been published or presented previously? Yes <input type="checkbox"/> No <input type="checkbox"/>			
If "Yes", when and where?			
Is this a graduate study related research? Yes <input type="checkbox"/> No <input type="checkbox"/>			
If accepted, will the author(s) present this paper in person? Yes <input type="checkbox"/> Maybe <input type="checkbox"/> No <input type="checkbox"/>			
Keywords: Please indicate the top four keywords associated with your research below			

Guidelines for abstract submittal and selection criteria:			
<ul style="list-style-type: none"> ▪ Only those abstracts submitted on this form will be considered. Follow the guidelines and word limits indicated. ▪ Complete this form using MSWord. Submit electronically via email to techpapers@aws.org 			
<u>Technical/Research Oriented</u>	<u>Applied Technology</u>	<u>Education</u>	
<ul style="list-style-type: none"> ▪ New science or research. ▪ Selection based on technical merit. ▪ Emphasis is on previously unpublished work in science or engineering relevant to welding, joining and allied processes. ▪ Preference will be given to submittals with clearly communicated benefit to the welding industry. 	<ul style="list-style-type: none"> ▪ New or unique applications. ▪ Selection based on technical merit. ▪ Emphasis is on previously unpublished work that applies known principles of joining science or engineering in unique ways. ▪ Preference will be given to submittals with clearly communicated benefit to the welding industry. 	<ul style="list-style-type: none"> ▪ Innovation in welding education at all levels. ▪ Emphasis is on education/training methods and their successes. Papers should address overall relevance to the welding industry.	
<input checked="" type="checkbox"/> Check the category that best applies:			
<input type="checkbox"/> Technical/Research Oriented	<input type="checkbox"/> Applied Technology	<input type="checkbox"/> Education	

Proposed Title (max. 50 characters):

Proposed Subtitle (max. 50 characters):

Abstract:

Introduction (100 words max.) – Describe the subject of the presentation, problem/issue being addressed and its practical implications for the welding industry. Describe the basic value to the welding community with reference to specific communities or industry sectors.

Technical Approach, for technical papers only (100 words max.) – Explain the technical approach, experimental methods and the reasons why this approach was taken.

Results/Discussion (300 words max.) – For technical papers, summarize the results with emphasis on why the results are new or original, why the results are of value to further advance the welding science, engineering and applications. For applied technology and education papers, elaborate on why this paper is of value to the welding community, describe key aspects of the work developed and how this work benefits the welding industry and education.

Conclusions (100 words max.) – Summarize the conclusions and how they could be put to use – how and by whom.

NOTE: Abstract must not exceed one page and must not exceed the recommended word limit given above

Note: The Technical Program is not the venue for commercial promotions of a company or a product. All presentations should avoid the use of product trade names. The Welding Show provides ample opportunities for companies to showcase and advertise their processes and products.

Return this form, completed on both sides, to

AWS Education Services
Professional Program 2009
550 NW LeJeune Road
Miami FL 33126
FAX 305-648-1655

MUST BE RECEIVED NO LATER THAN MARCH 13, 2009

POSTER ABSTRACT SUBMITTAL
Annual FABTECH International & AWS Welding Show

Chicago, IL – November 15-18, 2009

(Complete a separate submittal for each poster.)

Primary Author (Full Name):			
School/Company:			
Mailing Address:			
City:	State/Province:	Zip/Mail Code:	Country:
Email:			
Poster Title (max. 50 characters):			
Poster Subtitle (max. 50 characters):			

Co-Author(s):			
Name (Full Name):		Name (Full Name):	
Affiliation:		Affiliation:	
Address:		Address:	
City:		City:	
State/Province:		State/Province:	
Zip/Mail Code:		Zip/Mail Code:	
Country:	Email:	Country:	Email:

Poster Requirements and Selection Criteria:

- Only those abstracts submitted on this form will be considered. Follow the guidelines and word limits indicated. Complete this form using MSWord. Submit electronically via email to techpapers@aws.org or print and mail.
- Maximum size – 44 inches tall x 30 inches wide. (Vertical format, please).
- Must be legible from a distance of 6 feet. A minimum font size of 14 pt. is suggested.
- Posters must be submitted to AWS as a single flat printed medium (e.g. laminated print or foam core board mount).
- Any technical topic relevant to the welding industry is acceptable (e.g. welding processes & controls, welding procedures, welding design, structural integrity related to welding, weld inspection, welding metallurgy, etc.).
- Submittals that are incomplete and that do not satisfy these basic guidelines will not be considered for competition.

Posters accepted for competition will be judged based on technical content, clarity of communication, novelty/relevance of the subject & ideas conveyed and overall aesthetic impression.

Criteria by category as follows:

<p><u>(A) Student</u></p> <ul style="list-style-type: none"> ▪ Students enrolled in 2 yr. college and/or certificate programs at time of submittal. ▪ Presentation need not represent actual experimental work. Rather, emphasis is placed on demonstrating a clear understanding of technical concepts and subject matter. ▪ Practical application is important and should be demonstrated. 	<p><u>(B) Student</u></p> <ul style="list-style-type: none"> ▪ For students enrolled in baccalaureate engineering or engineering technology programs at the time of submittal. ▪ Poster should represent the student's own experimental work. Emphasis is place on demonstrating a clear understanding of technical concepts and subject matter. ▪ Practical application and/or potential relevance to the welding industry is important and should be demonstrated. 	<p><u>(C) Student</u></p> <ul style="list-style-type: none"> ▪ For students enrolled in graduate degree programs in engineering or engineering technology at time of submittal. ▪ Poster should represent the student's own experimental work. Poster must demonstrate technical or scientific concepts. Emphasis is placed on originality and novelty of ideas presented. ▪ Potential relevance to the welding industry is important and should be demonstrated. 	<p><u>(D) Professional</u></p> <ul style="list-style-type: none"> ▪ For anyone working in the welding industry or related field. ▪ Poster must demonstrate technical or scientific concepts. Emphasis is placed on original contributions and the novelty of the presentation. ▪ Potential relevance to the welding industry is important and should be demonstrated. <p><u>(E) High School</u></p> <ul style="list-style-type: none"> ▪ Junior or Senior high school students enrolled in a welding concentration at the time of submittal. ▪ Presentation should represent technical concepts and application to the welding industry. ▪ Practical application and creativity are important and should be demonstrated.
--	--	---	---

Check the category that applies:

- (A) Student 2-yr. or Certificate Program (B) Student 4-yr. Undergraduate (C) Graduate Student (D) Professional (E) High School

Poster Title (max. 50 characters):

Poster Subtitle (max. 50 characters):

Abstract:

Introduction (100 words) – Describe the subject of the poster, problem/issue being addressed and its practical implications for the welding industry.

Technical Approach & Results (200 words) – Explain the technical approach. Summarize the work that was done as it relates to the subject of the poster.

Conclusions (100 words) – Summarize the conclusions and how they could be used in a welding application.

CAREER OPPORTUNITIES

Inspectors

Experienced:

- AWS-Certified Welding Inspectors
- ASNT Nondestructive Testing Technicians
 - ASNT Level II or Level III RT, UT, MT, PT
- Quality Control Technicians
 - Positive Materials Identification Verification (PMIV)
 - Hardness Testing
 - Dimensional Verification
- Verbal and written communication skills with ability to multi-task
- Proficient with MS Office programs and report writing capabilities

Email resume and wage requirements to:
 employment@scottprocess.com
 or mail to:
 Scott Process Systems, Inc.
 1160 Sunnyside Street
 Hartville, Ohio 44632
 Attn: QA/QC

Welder

Halliburton Energy Services is looking for experienced welders to work in our climate-controlled manufacturing center in Duncan, Oklahoma. Since 1919, Halliburton has been opening Worlds of Opportunity around the globe. We're one of the world's largest and most safety-conscious providers of oil field services. Come in and explore your future! Welders will perform assembly and welding processes such as GTAW, SMAW, SAW, PTAW hardfacing, Oxyfuel brazing and heat treating. Halliburton offers competitive pay and benefits and supports a drug-free work environment through pre-employment chemical testing. Pay range is \$13-\$20 per hour with overtime opportunities.

Please send resumes to:
 danny.mccall@halliburton.com.

Inspector - CWI

The Westech Companies, located in the heart of Wyoming, are currently looking for 2 Certified Welding Inspectors.

The Westech Companies build very LARGE off road mining equipment at our facility in Casper. This job offers a great benefits package with competitive pay. Night shift is required.

If you like the great outdoors, with plenty of hunting and world class fly fishing contact Linda at:
 (307) 235-1591, x237
 or e-mail
 lakers@wstch.com

Manufacturer's Representative

MASTER WELD PRODUCTS is a U.S. manufacturer of MIG & TIG welding torches and consumables. We are seeking Manufacturer's Reps to support defined territories nationwide from 4 strategically located warehouse or manufacturing facilities. Contact Jason Reigner via e-mail:
 Jason@masterweld.net or call
 (610) 972-7500.

Sales Representatives

Oxford Alloys, Inc., Inc a worldwide supplier of high-quality welding filler metals, has opportunities for experienced outside sales representatives residing in the Midwest and Southeast regions.

Candidates joining the expanding Oxford Alloys team will develop new business and cultivate existing customer relationships in the designated territory, via promotion of entire product line and value-added services.

Oxford Alloys is continuing to grow and constantly in search of motivated employees. We offer competitive wages, excellent benefits and a superior work environment.

If you are professional, focused and disciplined with the ability to develop strong working relationships, we'd like to hear from you.

Forward your letter of interest and resume to:
bethh@oxfordalloys.com
 or FAX (225) 214-5366.

Structural Flux Core Welder

Must pass drug, background, and welding test.

Premium Pay in Alabama and Florida

Phone: (251) 665-3830
 Or e-mail to:
 ggallardo@blkhawkgroup.com

AWS JobFind

**Post Jobs.
 @ Find Jobs.
www.aws.org/jobfind**

Job categories for welders, engineers, inspectors, and more than 17 other materials joining industry classifications!

MITROWSKI RENTS

Made in U.S.A.

Tank Turning Rolls 10-Ton thru 1000-Ton



Used Equipment for Sale

www.mitrowskiwelding.com
 sales@mitrowskiwelding.com
 800-218-9620
 713-943-8032

**We Buy & Sell Surplus
 Welding Rod & Wire**

All types, sizes & Quantities



Call us first!

800-523-2791
 PA: 610-825-1250
 FAX: 610-825-1553

**Put Your Products and
 Services to Work in
 January 2009**



Generate sales leads by showcasing your full-color product photo, a product description, website, or other sales literature. These showcases reach 70,000 qualified buyers. Great exposure for just pennies a contact.

Closing November 14, 2008.

Call our sales team at:
 1-800-443-9353

Rob Saltzstein at ext. 243
 salty@aws.org

Lea Garrigan at ext. 220
 garrigan@aws.org

AWS CWI Tool Kit

Inspection Tool Kit, NEW.

Call 425-785-9603

**Boiler Tube
 Alignment Tools**



Walhonde Wallbanger™

- DB model fits 2 tubes on specific OD's ranging from 7/8" to 1-3/4".
- HD model fits 1 tube on specific OD's ranging from 1-3/4" to 3-1/4" (Patented)



**Walhonde Wallstick™
 NEW**

- Quickly & accurately aligns waterwall tubes with 1/4" or 3/8" membrane. Fits OD tube sizes: 7/8" through 3" (Patented)

More alignment tools available at our website: www.walhonde.com

Walhonde Tools, Inc.

1-800-TUBE FIT (882-3348)
 Tel: 304-756-3796 / Fax: 304-756-3834

**Welding Positioners & Turning Rolls
 New and Used**

Large selection in stock for immediate delivery.

www.allfabcorp.com

Call, Fax or Email for a free catalog.



Email: sales@allfabcorp.com
 Web: www.allfabcorp.com
 Phone: 269-673-6572
 Fax: 269-673-1644

**Place Your
 Classified Ad
 Here!**

Contact Frank Wilson,
 Advertising Production
 Manager

**(800) 443-9353,
 ext. 465**

fwilson@aws.org

**3 Major Problems with
 Thermal Stress Relief**

And How Meta-Lax® Technology
 Overcomes Them All

FREE Report

"Overcoming Thermal
 Stress Relief Problems"

BONAL TECHNOLOGIES  **800-Metal-29**
www.bonal.com • info@bonal.com

We buy and sell
WELDING RODS & WIRE
 **ALL TYPES ** ALL SIZES **
 ALL QUANTITIES



Excess Welding Alloys, Inc.
 A division of Weld Wire Company Inc.

800-523-1266 FAX 610-265-7806
www.weldwire.net

EQUIPMENT FOR SALE OR RENT

Turning Rolls
Positioners
& Manipulators
New and Used

Joe Fuller LLC
@ www.joefuller.com
or email joe@joefuller.com

Phone: 979-277-8343
Fax: 281-290-6184

ATTENTION!!

RETOOLING? CHANGING PRODUCTS?
CLOSING SHOP? GOIN' FISHING?

We pay good prices for used welding machinery!

We are looking for any used welding machinery like: Turning
Rolls, Positioners, Manipulators, Seamers, etc.

Send Photos to:

melissa@weldplus.com **WELD PLUS**
or call 800.288.9414



RED-D-ARC
Quality-Checked™
Used Equipment
www.red-d-arc.com

An Excellent Selection of Used Welding
and Positioning Equipment for Sale

1-800-245-3660
Service Centers Across North America

VERSA-TIG™

MULTIPLE TIG TORCH
SELECTORS

www.versa-tig.com

CINCINNATI, OHIO **800-288-9414**

WELD PLUS www.weldplus.com
WELD PLUS, INC. Fax: 513-467-3585 email: melissa@weldplus.com

KOIKE-ARONSON/RANSOME
MANIPULATORS
IN STOCK
10' X 10' 12' X 10'
12' X 12' 14' X 12'
14' X 14'
Welding Equipment can be fitted to a
Manipulator to meet your specifications.

OVER 50 "BRAND NEW" POSITIONERS IN STOCK!!!

"BRAND NEW" IN OUR STOCK!!!
POSITIONERS - PANDJIRIS, ARONSON, IRCO, PROFAX & MBC
RANSOME MANIPULATORS - JETLINE SEAMERS
WEBB & PANDJIRIS TURNING ROLLS

Well Over 150 Positioners, Up to 60 Tons!!
Head/Tailstocks, Turntables up to 100 Tons. Manipulators up
to 14' x 14'. Travel cars, Longitudinal Seamers from 6 in. to
26 ft. Turning Rolls up to 200 Tons. Circular Weld Systems,
Welding Lathes, Motoman and Panasonic Welding Robots.

"WE KNOW WELDING"
TALK TO US!! ... COME VISIT US!!
800-288-9414
Todd, Dennis, Tom or Melissa

SERVICES

Got Clean Welds?



www.weldhugger.com

Mechanical Drawings Created

We make drawings to your
specifications to meet ASME
Y14.5 and AWS 2.4.

Contact CAD Star at:
cad_star@hotmail.com

South Bay Inspection

Visual and Non Destructive Testing Services

Radiography	AWS Certified Weld Inspection
Ultrasonics	API 510 Pressure Inspection
Liquid Penetrant	API 653 Tank Inspection
Magnetic Particle	API 570 Piping Inspection
NDT Training	Level III Services
	Turnaround Inspection Staffing
	Field and Laboratory Testing

SOUTH BAY INSPECTION
1325 W Gaylord St.
Long Beach, CA 90813

Phone: (562) 983-5505 Fax: (562) 983-5237

VISIT US ON THE WEB
www.southbayinspection.com

CERTIFICATION & TRAINING

CWI Refresher...a fresh approach!

- Review and learn the most controversial, often-misinterpreted issues facing welding inspectors.
- Master quality tools to implement true quality solutions for your clients or your company.

Learn more: Call for the 40 hour syllabus,
comparable to the AWS body of knowledge.

*Suitable as continuing education for CWIs
or for any welding inspection personnel*

Convenient classes in Chicago:
312-642-8362 | info@atema.com
www.atema.com/cwi.htm



BUSINESS FOR SALE

For Sale

Very Profitable Small
Fabrication/Welding
Service Business

Phoenix, Arizona, est. 1989,
S-Corp, Commercial and Government
Projects, City of Phoenix certified as
SBE, DBE, WBE, Certified Welders,
5,000 Sq. Ft. Facility, Great Potential
For Growth.

Call Emma @ 480-545-5936 or
480-252-0449

E-mail: emmaweld@cox.net



CWI PREPARATORY

Guarantee - Pass or Repeat FREE!

2 WEEK COURSE (10 DAYS)
MORE HANDS-ON/PRACTICAL APPLICATIONS
Pascagoula, MS Oct. 15-24 Dec. 10-19
Baton Rouge, LA Oct. 29-Nov. 7

SAT-FRI COURSE (7 DAYS)
EXTRA INSTRUCTION TO GET A HEAD START
Pascagoula, MS Oct. 18-24 Dec. 13-19
Beaumont, TX Nov. 29-Dec. 19
Baton Rouge, LA Nov. 1-7

MON-FRI COURSE (5 DAYS)
GET READY-FAST PACED COURSE!
Pascagoula, MS Oct. 20-24 Dec. 15-19
Beaumont, TX Dec. 1-5
Baton Rouge, LA Nov. 3-7

Test follows on Saturday at same facility

FOR DETAILS CALL OR E-MAIL:

(800) 489-2890

info@realeducational.com

Also offering API 510 and
API 570 courses!

Abicor Binzel IBC www.abicorusa.com800-542-4867	KMT Saw22 www.kmtsaw.com269-321-8860
Arcos Industries, LLC9 www.arcos.us800-233-8460	Koike Aronson, Inc./Ransome15 www.koike.com800-252-5232
Astro Arc Polysoude11, 13 www.astroarc.com661-702-0141	Lincoln Electric Co.OBC www.lincolnelectric.com216-481-8100
Atlas Welding Accessories, Inc.23 www.atlaswelding.com800-962-9353	Magswitch25 www.magswitch.com.au303-468-0662
AWS Certification Services63 www.aws.org800-443-9353	Mathey Dearman12 www.mathey.com800-725-7311
AWS Education Services18, 64 www.aws.org800-443-9353	Metglas54 www.brazing.metglas.com800-581-7654
AWS Foundation92 www.aws.org800-443-9353	Midalloy24 www.midalloy.com800-776-3300
AWS Membership Services14, 86 www.aws.org800-443-9353	National Bronze & Metals, Inc.38 www.nbmmetals.com713-869-9600
AWS Publications62 www.aws.org800-443-9353	National Standard1 www.nationalstandard.com800-777-1618
AWS RWMA58 www.aws.org800-443-9353	North American Höganäs22 www.nah.com+46 (0)42 33 80 00
AWS Technical Department91 www.aws.org800-443-9353	Prince & Izant, Co.56 www.princeizant.com216-362-7000
Belmont Metals, Inc.56 www.belmontmetals.com718-342-4900	Radyne Corp.52 www.radyne.com800-236-8360
CM Industries, Inc.5 www.cmindustries.com847-550-0033	Revco Industries, Inc.23 www.bsxgear.com800-527-3826
Commercial Diving Acaemy21 www.commercialdivingacademy.com888-974-2232	Romar/MEC, LLC Co.25 www.fitupgear.com281-440-1725
Computer Weld Technology, Inc.85 www.cweldtech.com713-462-2118	Schweissen & Schneiden/ESSEN Trade Shows41 www.schweissen-schneiden.com+1-914-962-1310
Cor-Met21 www.cor-met.com810-227-3251	Select Arc, Inc.IFC www.select-arc.com937-295-5215
C-Spec87 www.weldoffice.com877-977-7999	Solvay Fluorides, LLC51 www.solvay-fluor.com713-525-6700
Diamond Ground Products, Inc.57 www.diamondground.com805-498-3837	Sperian61 www.sperianprotection.com800-336-3255
Divers Academy International13 www.diversacademy.com800-238-3483	Sulzer Metco (US), Inc.16 www.sulzermetco.com516-334-1300
ESAB Welding & Cutting Products7 www.esabna.com800-372-2123	Sumig Torches89 www.sumig.com.br+55 54 3220 3900
Fusion, Inc.50 www.fusion-inc.com800-626-9501	Swagelok17 www.swagelok.com/M200web contacts only
Gedik Welding, Inc.31 www.gedikwelding.com+90 216 378 50 00	Washington Alloy/U.S. Alloy Co.30 www.weldingwire.com800-830-9033
Genstar Technologies62 www.genstartech.com909-606-2726	Weld Aid61 www.weldaid.com800-935-3243
Harris Products Group42 www.harrisproductsgroup.com800-733-4043	Weld Hugger, LLC38 www.weldhugger.com877-935-3447
Hobart Inst. of Welding Tech.57 www.welding.org800-332-9448	Weld Mold Co., USA2 www.weldmold.com800-521-9755
Hypertherm83 www.hypertherm.com800-643-0030	
Joe Fuller, LLC60 www.joefuller.com979-277-8343	
J. P. Nissen. Co.60 www.nissenmarkers.com215-886-2025	

IFC = Inside Front Cover
IBC = Inside Back Cover
OBC = Outside Back Cover

Visit Our Interactive Ad Index: www.aws.org/ad-index



A Gleeble®-based Method for Ranking the Strain-Age Cracking Susceptibility of Ni-Based Superalloys

Results of thermomechanical testing for cracking susceptibility were compared to those obtained from other investigations

BY D. A. METZLER

ABSTRACT. Gamma-prime strengthened Ni-based superalloys comprise a family of critical construction materials for modern gas turbines used in land-based power-generation and aviation applications. Strain-age cracking during postweld heat treatment remains a critical issue in the widespread use of higher-strength members of this alloy family. Previous work (Ref. 1) demonstrated that the load frame-based controlled heating rate test (CHRT) was capable of ranking the strain-age cracking susceptibility of these alloys. Various attempts have been made over the years to adapt this test methodology to the Gleeble® thermomechanical simulator using a variety of specimen geometries and thermomechanical cycles. In this study, the strain-age cracking susceptibility of six, gamma-prime strengthened Ni-based superalloys was evaluated using a simple (both from a specimen geometry and thermomechanical cycle perspective), Gleeble-based test method and compared to results obtained by previous investigators.

Introduction

Gamma-prime strengthened Ni-based superalloys embrace a unique combination of high-temperature mechanical strength, resistance to creep deformation, and oxidation resistance necessary for efficient operation of modern gas turbine equipment. Typically, aluminum, titanium, and possibly niobium are added to an oxidation-resistant Ni-Cr-Co-Mo matrix to develop higher strengths in the 538°–871°C (1000°–1600°F) operating

range and, in the case of aluminum additions, further augment the alloy's resistance to oxidation. Because these elements precipitate from solid solution over that same temperature range, this alloy family can become susceptible to a post-fabrication heat treatment cracking phenomenon known as strain-age cracking. This type of cracking can occur when alloys containing gamma-prime-forming elements in solid solution (such as mill-annealed products) are heated through the 593°–982°C (1100°–1800°F) temperature range during postfabrication solution-annealing heat treatment. During gamma-prime precipitation, alloy ductility may drop significantly. Cracking will occur if the alloy is subjected to strains that exceed its available ductility. In mechanically restrained parts, tensile stresses will develop because precipitation of gamma-prime from solid solution also produces a bulk volume contraction of the matrix (Refs. 2, 3). Cracking may also be aggravated by a coarse grain size, an oxidizing environment (Ref. 2) (producing oxygen embrittlement at grain boundaries) and by grain boundary carbide films produced by constitutional liquation. These factors are often associated with welding processes

because of grain growth in the associated HAZ, constitutional liquation in the HAZ, and geometric stress concentration at the weld toe. Strain-age cracking, however, is not exclusively limited to weld HAZs and can occur in unaffected base material (Ref. 2).

As alloy designs become more sophisticated, secondary processing effects such as strain-age cracking are more likely to be examined in the development of new compositions. This highlights the need for a robust method for assessing a given alloy's susceptibility to strain-age cracking. Such a test method should 1) deliver a quantitative index of alloy susceptibility to strain-age cracking, 2) deliver a reproducible index of alloy susceptibility to strain-age cracking, and 3) deliver results that accurately reflect real-world experience.

The test method should be 1) mechanically simple, 2) usable with sheet and plate materials as well as bar stock, 3) require minimal setup/stabilization time, and 4) adaptable to existing mechanical test equipment.

A wide variety of strain-age cracking tests have been described in the literature and reviewed by Rowe (Ref. 1). He found that circular patch-type tests required considerable investment in automated weld equipment and, at best, produced semiquantitative results. Others (Refs. 4, 5) reported that this test did not consistently crack R-41 alloy (considered very strain-age-cracking susceptible) unless conducted as a repair weld simulation. This finding severely limits the usefulness of the circular patch test in ascertaining the strain-age susceptibility of less crack-prone alloys.

The Gleeble thermomechanical simulator offers considerable flexibility in ther-

KEYWORDS

Gleeble
 Gamma-Prime
 Heat Treatment
 Ni-Based Superalloy
 Strain-Age Cracking

D. A. METZLER (dmetzler@haynesintl.com) is senior mechanical metallurgist, Haynes International, Kokomo, Ind.

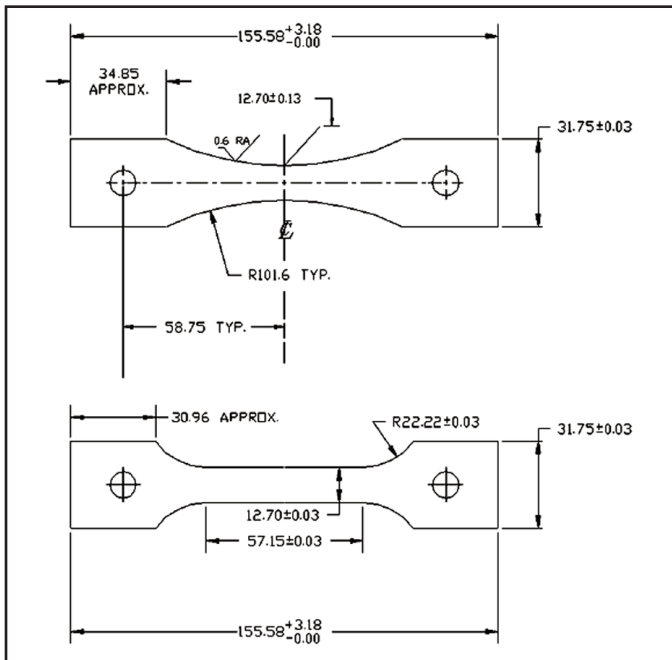

Fig. 1 — Modified and standard CHRT sample geometries (dimensions in mm).

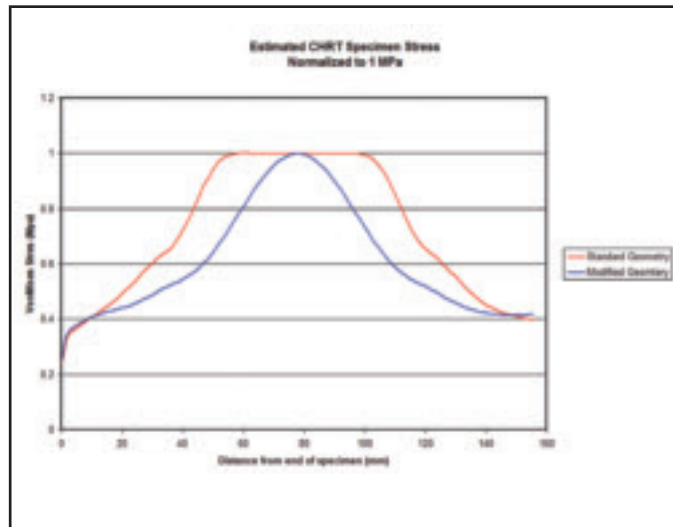

Fig. 2 — FEA stress analysis of modified and standard CHRT samples.

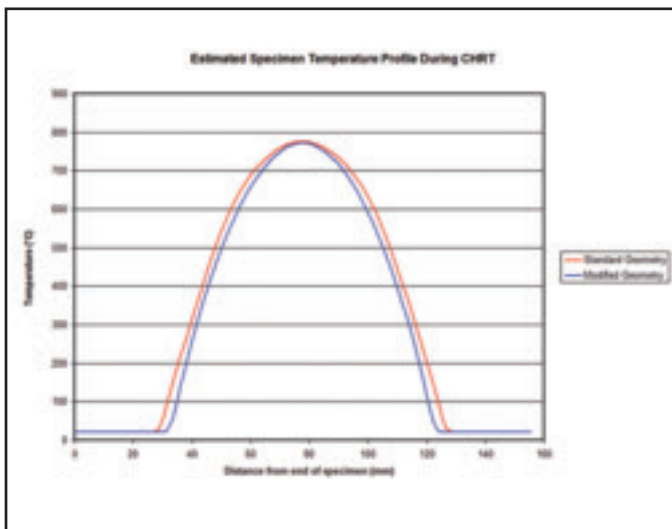

Fig. 3 — FEA thermal analysis of modified and standard CHRT samples.

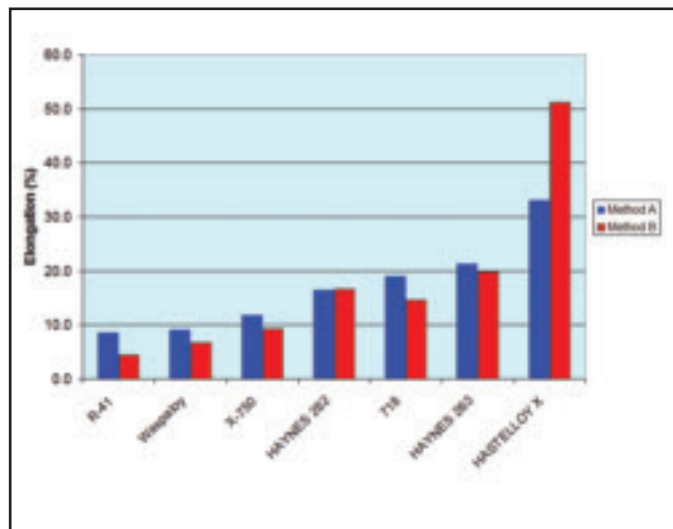

Fig. 4 — Methods A and B results (25.4-mm gauge length).

mal cycles and loads that can be applied to a number of different sample geometries. Various Gleeble-based test methods have also been reviewed (Refs. 1, 6, 8), but most methods were either confined to round bar samples or notched sheet samples. Additionally, various Gleeble-based methods reported in the literature appear as the subject of a single study/paper and thus have not been widely accepted in the welding arena. Little or no correlation of their results with real-world strain-age cracking incidents has been reported.

Among the many test methods de-

scribed in the literature, the controlled heating rate test (CHRT) appears to have the greatest potential as an economical method for ranking the strain age cracking susceptibility of Ni-based superalloys. In this test, developed in the late 1960s by Prager et al. (Ref. 7), a solution-annealed (mill-annealed) tension test sample is heated at a controlled (usually constant) rate to a temperature in the gamma-prime precipitation range and pulled to failure at a controlled extension rate. Generally, this procedure is repeated over a range of temperatures in the gamma-prime precip-

itation range and the minimum elongation to failure taken as a given alloy's index of strain-age cracking susceptibility. This test method appears to meet a number of the desired test attributes listed below.

1) This test method is mechanically simple, essentially loading a simple sample geometry in tension, only.

2) The CHRT method appears adaptable to sheet and plate materials, as well as bar stock.

3) Existing mechanical test equipment (both conventional loading frames and Gleeble thermomechanical simulators)

Table 1 — Composition of Alloys Used in CHRT Trials

Alloy Element	Rene 41 wt-%	Waspaloy wt-%	HAYNES 282 wt-%	718 wt-%	X-750 wt-%	HAYNES 263 wt-%	HASTELLOY X wt-%
Al	1.49	1.35	1.46	0.63	0.58	0.57	0.00
B	0.01	0.00	0.00	0.00	0.00	0.00	0.00
C	0.09	0.08	0.06	0.05	0.04	0.06	0.07
Co	10.69	13.37	10.11	0.11	0.00	19.91	1.26
Cr	19.42	18.87	19.67	18.22	15.39	19.91	22.10
Cu	0.01	0.01	0.00	0.07	0.01	0.00	0.00
Fe	3.72	0.00	0.20	18.14	8.23	0.36	18.27
Mn	0.01	0.00	0.04	0.17	0.15	0.41	0.65
Mo	9.91	4.26	8.36	2.99	0.00	5.77	8.99
Si	0.05	0.05	0.04	0.13	0.14	0.23	0.48
Ti	3.11	2.99	2.08	1.01	2.55	2.19	0.00
V	0.02	0.00	0.01	0.00	0.00	0.00	0.00
W	0.05	0.00	0.00	0.00	0.00	0.00	0.75
Nb	0.00	0.00	0.00	5.31	0.96	0.00	0.00
Ni	51.43	59.02	57.97	53.17	71.95	50.59	47.43
Est. Gamma-Prime Vol. Fraction at 500°C	0.30	0.28	0.24	0.24	0.21	0.15	0.00
Atomic-% Al+Ti+Nb+Ta	6.93	6.49	5.63	5.88	4.91	3.86	0.00
Initial Grain Size (microns)	76	76	107	32	53	107	90

can be used to perform CHRT.

4) Nonmaterial-related test input variables such as sample heat-up rate, steady-state temperature distribution, and strain rate to failure can be accurately controlled, reducing variation in test results.

Rowe (Ref. 1) was able to adapt this technique to a standard elevated-temperature tension testing load frame and resistance-heated clamshell furnace arrangement with relatively good success, reporting excellent correlation of minimum CHRT elongation with estimated volume fraction of gamma-prime over a range of alloy compositions. Rowe's technique, however, required testing each alloy composition at a minimum of three temperatures in the gamma-prime precipitation temperature range. Each test required considerable setup time, involving the installation and wiring of three control thermocouples to the samples and furnace control system. The vertically oriented tension test/heating furnace equipment also required careful insulation to avoid inadvertent thermal gradients produced by "chimney effects." Even with proper equipment setup, sample heating rates barely reached the desired 17°C (30°F) per minute into the gamma-prime range. These equipment constraints, coupled with the three-temperature per alloy testing requirement, limited the practical sample size per alloy composition to a relatively small number. This, in turn, made rigorous assessment of this test method's discrimination and inherent variability difficult.

The temperature/heating rate/loading

rate versatility of the Gleeble, coupled with the simplicity of the CHRT test method, potentially offers a way to meet the broad strain-age cracking test requirements outlined above. Since samples are directly heated, electrically, under closed-loop, real-time temperature control using a sensing thermocouple, percussion welded directly to the test specimen, very high, yet controlled heating rates are available with this testing machine. Closed loop control obviates the need for careful insulation around the test specimen, reducing test setup time considerably, compared to conventional load frame arrangements. Similarly, loading rates are not necessarily confined to the relatively slow rates (≤ 500 mm/min) achievable with screw-driven, conventional load frames. Additionally, since test specimens are enclosed in a relatively small chamber in the Gleeble, this apparatus offers the possibility of performing CHRT tests in environments other than air (and perhaps quantifying the effects of oxygen-induced grain boundary embrittlement).

In spite of its apparent advantages, adapting the Gleeble for CHRT tests poses one serious challenge. Any sample geometry must be clamped in the machine's jaws at each end, to serve both as a contact for the electrical current used for heating and for introduction of the programmed mechanical load cycle. Contact at the jaws introduces a heat sink at each end of the sample and thermal conduction through the sample produces thermal gradients along the sample's axis. If a stan-

dard, constant gauge section sheet tensile sample were used as a CHRT specimen, this specimen would reach its peak temperature at its midspan. Gamma-prime precipitation would first occur at this location, relative to the rest of the sample. The sample becomes "strongest" at its midspan. If the CHRT load were applied over a short time period, the sample would likely fail off-center in the areas that have not yet undergone (or have undergone significantly less) gamma-prime precipitation. This could produce abnormally high or erratic elongation to break values in the CHRT test.

In this study, two approaches were explored in an effort to circumvent the effects of these undesired thermal gradients in CHRT test samples. They are as follows:

1. Modify the sample geometry so its cross section increases with distance from its axial centerline, forcing it to break at midspan. This approach, however, could introduce shear components to the applied stress that could possibly reduce sample elongation during CHRT loading.

2. "Pre-age-harden" CHRT samples before testing and add a solution-annealing treatment (before the classic CHRT heating cycle) to the beginning of the CHRT testing thermal cycle. Presumably this would "strengthen" those portions of the gauge section that did not reach peak temperature due to the axial thermal gradient along the sample's axis. Unfortunately, this approach more closely simulates a repair weld than an initial fabrication.

Table 2 — Modified CHRT Test Results and Tests for Significant Differences

Elongation in 25.4 mm - Method A				Elongation in 38.1 mm - Method A				Elongation in 50.8 mm - Method A			
Alloy	Count	Mean	Homogeneous Groups	Alloy	Count	Mean	Homogeneous Groups	Alloy	Count	Mean	Homogeneous Groups
R-41	5	8.59 X		Waspaloy	5	6.83 X		Waspaloy	5	5.94 X	
Waspaloy	5	9.07 X		R-41	5	6.91 X		R-41	5	6.13 X	
X-750	5	11.85 X		X-750	5	8.04 X		X-750	5	6.37 X	
HAYNES 282	5	16.42 X		718	5	12.84 X		718	5	9.99 X	
718	5	19.00 X		HAYNES 282	5	12.97 X		HAYNES 282	5	10.47 X	
HAYNES 263	5	21.35 X		HAYNES 263	5	18.85 X		HAYNES 263	5	16.21 X	
HASTELLOY X	5	33.11 X		HASTELLOY X	5	23.98 X		HASTELLOY X	5	18.33 X	
95% CL = +/- 0.885 (Fisher's least significant difference method)				95% CL = +/- 0.763 (Fisher's least significant difference method)				95% CL = +/- 0.722 (Fisher's least significant difference method)			

Elongation in 25.4 mm - Method B				Elongation in 38.1 mm - Method B				Elongation in 50.8 mm - Method B			
Alloy	Count	Mean	Homogeneous Groups	Alloy	Count	Mean	Homogeneous Groups	Alloy	Count	Mean	Homogeneous Groups
Waspaloy	5	4.42 X		Waspaloy	5	3.04 X		Waspaloy	5	2.42 X	
R-41	5	6.64 X		R-41	5	5.08 X		R-41	5	4.30 X	
X-750	5	9.28 X		X-750	5	8.83 X		X-750	5	8.03 X	
718	5	14.62 X		718	5	11.70 X		718	5	11.02 X	
HAYNES 282	5	16.57 X		HAYNES 282	5	18.17 X		HAYNES 263	5	21.08 X	
HAYNES 263	5	19.80 X		HAYNES 263	5	22.04 X		HAYNES 262	5	22.33 X	
HASTELLOY X	5	51.10 X		HASTELLOY X	5	38.77 X		HASTELLOY X	5	31.40 X	
95% CL = +/- 2.103 (Fisher's least significant difference method)				95% CL = +/- 2.250 (Fisher's least significant difference method)				95% CL = +/- 2.520 (Fisher's least significant difference method)			

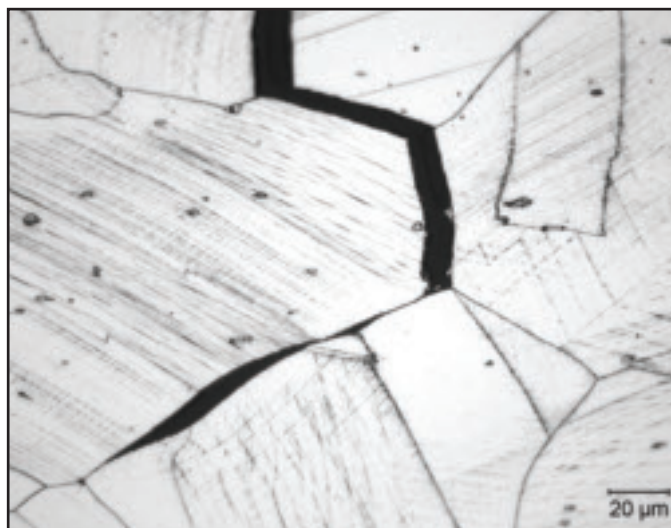
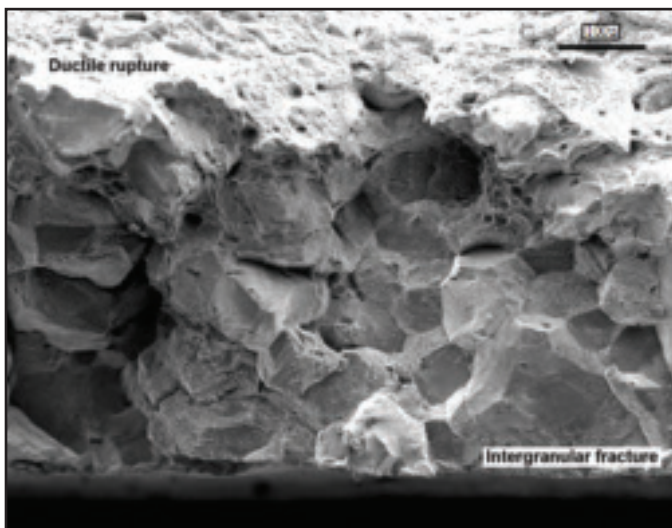

Fig. 5 — Post-CHRT (Method A) fracture surface (282 alloy).

Fig. 6 — Intergranular fracture propagation in post-CHRT (Rene 41).

Preliminary Analysis of Sample Geometry

A simple modification to a standard sheet tension test sample was constructed and subjected to simple mechanical and thermal analyses by finite element analysis (FEA). The modified geometry was constructed by replacing the standard sample's constant gauge width with 101.6-mm (4.0-in.) radii tangent to the original gauge section. A 101.6-mm radius was chosen because, when tangent to the original 12.7-mm (0.5-in.) gauge width at the midspan of the specimen, its intersection with the tensile blank profile produced tabs very similar in size to a standard sheet tension test sample. This modified geometry (and standard geometry for comparison's sake) is depicted in Fig. 1.

The mechanical analysis was solved for the von Mises stress in both sample geometries under constant-stress, linear elastic conditions using FEA. Similarly, the thermal analysis was constructed by applying a constant heat flux to all sample surfaces except at the sample contact surfaces at the Gleeble jaws. Here, a constant temperature boundary condition was applied, approximating the heat sink effect of the water-cooled jaws. The steady-state temperature profile was calculated by FEA. Results for both analyses are shown in Figs. 2 and 3.

These results demonstrated that the modified sample geometry produced a narrower band of peak stress and temperature at the sample midspan relative to the standard geometry, thereby reducing its

likelihood of off-center fracture. Based on these results, this study focused on comparing Gleeble-based CHRT test results for seven different Ni-based superalloys using both this modified sample geometry and a modified CHRT thermal cycle as described above.

Experimental Method

Seven different Ni-based superalloys were chosen for evaluation by two differently modified CHRT testing methods. Six of these alloys represented gamma-prime strengthened materials. One solid-solution strengthened alloy was included in this study as a baseline. These alloys and their compositions are listed in Table 1.

Gamma-prime-forming elemental con-

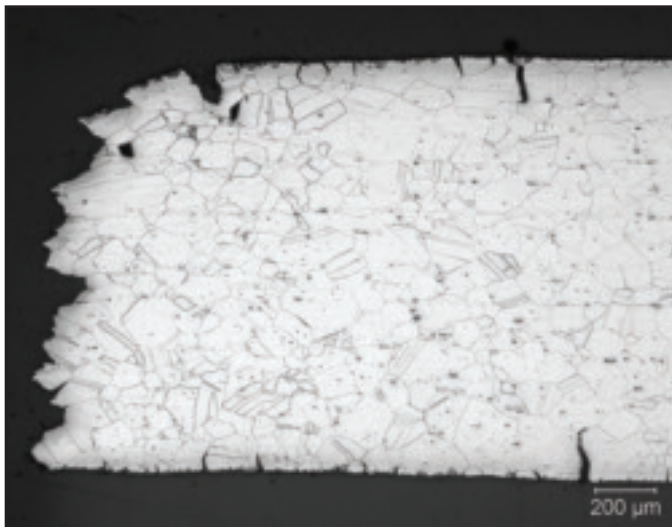

Fig. 7 — Surface-based fracture initiation (282 alloy).

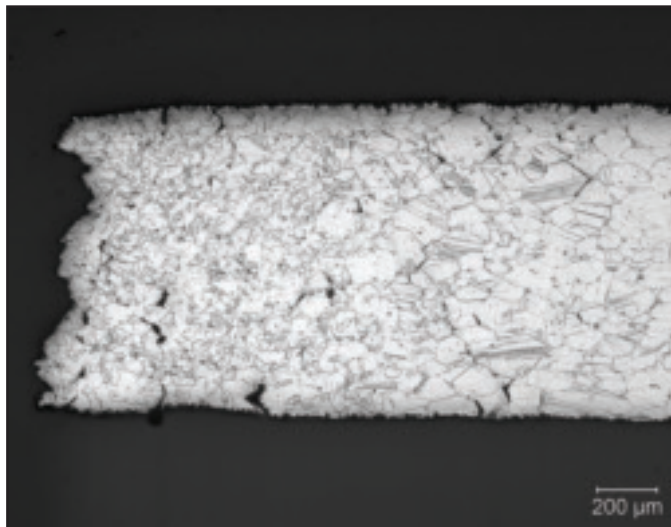

Fig. 8 — Surface/interior-based fracture initiation (263 alloy).

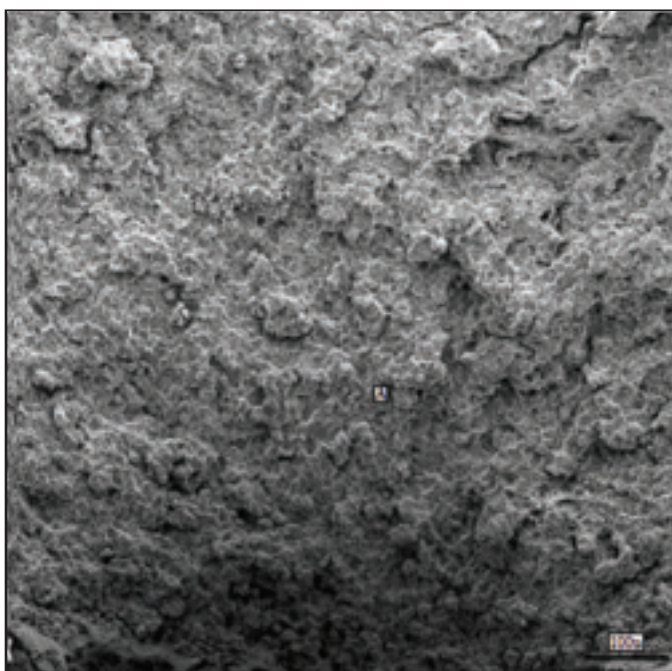
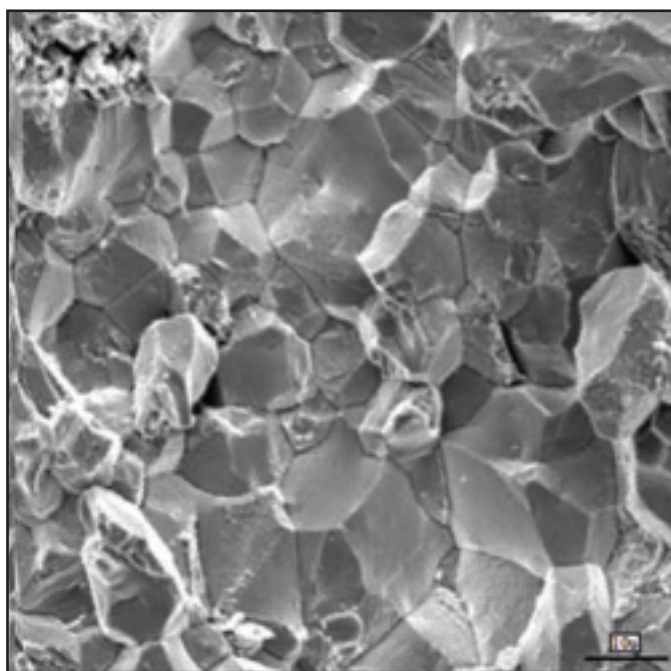

Fig. 9 — Post-CHRT intergranular fracture surface (fine-grain 718 alloy).



tent as a total atomic percent was calculated for each material. Gamma-prime volume fraction was estimated from thermodynamic phase stability calculations performed with Pandat™ software and v7.0 of the Ni-Data database of thermodynamic properties published by Thermotech, Ltd. Calculations were performed at 500°C (931°F) to represent the maximum fraction of gamma-prime that each material could potentially precipitate. Other phases, expected to form at time scales well beyond CHRT test duration were suspended from the calculations.

Modified CHRT Sample Geometry (Method A)

Five samples from each of the alloys under test were cut from mill-annealed sheet material ranging from 1.0 to 2.5 mm (0.040 to 0.100 in.) thick using a mechanical shear. All samples were oriented transverse to the final sheet rolling direction and contained either bright-annealed or annealed and pickled surfaces. Modified CHRT samples were machined from each group according to the dimensions detailed in Fig. 1. Prior to CHRT tests (in the Gleeble), each

sample was inscribed with three sets of gauge marks at 25.4, 38.1, and 50.8 mm (1.0, 1.5, and 2.0 in.) separation. A single Type K thermocouple was percussion welded to the center of each sample on one of the broad faces. Samples were mounted between austenitic stainless steel (low thermal conductivity) flat jaws in a PC-controlled Gleeble 1500D. Each sample was heated to 593°C at 56°C/s (1100°F at 100°F/s), then heated to 788°C (1450°F) at 17°C/min (30°F/min), and finally pulled to failure (holding 788°C) at 1.60 mm/min (0.063 in./min). The 788°C (1450°F) test

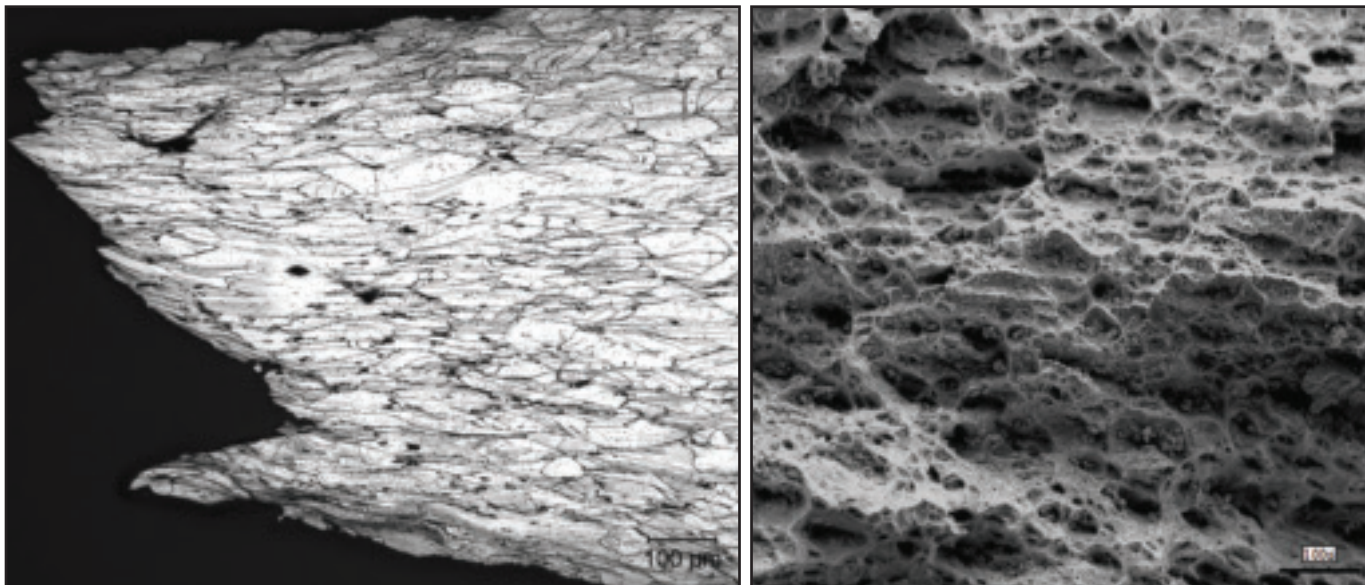

Fig. 10 — Post-CHRT fracture surface in solid solution strengthened (Alloy X).

Table 3 — Pre and Post CHRT Specimen Grain Size

Alloy	Method A				Method B			
	Pre-Test Grain Size		Post-Test Grain Size		Pre-Test Grain Size		Post-Test Grain Size	
	ASTM	microns	ASTM	microns	ASTM	microns	ASTM	microns
Rene 41	4.5	76	4.5	76	4.5	76	1.5	214
Waspaloy	4.5	76	4.5	76	4.5	76	4.5	76
X-750	5.5	53	5.5	53	5.5	53	3.5	107
HAYNES 282	3.5	107	3.5	107	3.5	107	3.5	107
718	7.0	32	7.0	32	7.0	32	3.5	107
HAYNES 263	3.5	107	3.5	107	3.5	107	3.5	107
HASTELLOYS X	4.0	90	4.0	90	4.0	90	3.5	107

temperature was chosen as a compromise between CHRT minimum ductility temperatures exhibited by classic gamma-prime-forming (Al/Ti-containing) alloys and Nb-modified alloys (such as 718 and X-750) in Rowe's (Ref. 1) earlier load frame-based work. Postfailure, elongation to break was measured using each of the three sets of gauge marks. These groups of data were compared using standard statistical methods for normally distributed data. Typical fracture surfaces from each material were examined via optical and electron metallography (SEM).

Standard CHRT Sample Geometry (Method B)

Five samples from each of the alloys under test were cut from mill-annealed sheet material ranging from 1.0 to 2.5 mm (0.04 to 0.10 in.) thick using a mechanical shear. All samples were oriented transverse to the final sheet rolling direction. Each group of blanks was aged to peak hardness following the manufacturer's recommended cycle and then machined

into standard tension test blanks (lower part of Fig. 1). Sample broad faces were not further machined or pickled. Each sample was prepared and mounted in the Gleeble as described above (Method A). Each sample was heated to 1094°C (2000°F) at 56°C/s (100°F/s), held at 1094°C for 60 s, then allowed to cool (below 300°C) in the Gleeble. Following this in-situ solution anneal, each sample was subjected to the same CHRT thermo-mechanical cycle described above (Method A). Postfailure, elongation to break was measured using each of the three sets of gauge marks. These groups of data were compared using standard statistical methods for normally distributed data. Typical fracture surfaces from each material were examined via optical and electron metallography (SEM).

Results

Modified CHRT test results (average of five replicate specimens) for test methods A and B and the results of tests for statistically significant differences (Fisher's

least significant difference method at a 95% CL) are illustrated in Table 2.

All "Method A" specimens failed at midspan (as expected). Some "Method B" samples failed off-center, but all broke within the 25.4-mm gauge sections. The non-gamma-prime strengthened material (HASTELLOYS® X) produced significantly higher elongation to break using both test methods A and B and all three sets of gauge marks. The gamma-prime and gamma-double-prime strengthened alloys yielded elongation results that appeared consistent with estimated volume fraction of the strengthening phase — elongations generally decreased as the volume fraction of strengthening phase increased. The 25.4-mm and 38.1-mm gauge marks yielded apparently good elongation discrimination among alloys, but those differences became less significant when the 50.8-mm gauge marks were used to calculate elongations to break. Method A produced a narrower range of elongations over the range of alloys tested compared to method B, but the amount of sample-to-sample variation was considerably

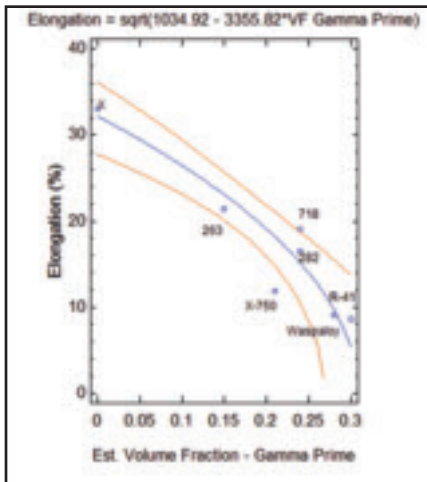

Fig. 11 — CHRT elongation vs. estimated volume fraction gamma-prime/gamma double prime.

lower. Method A vs. Method B comparative results for 25.4-mm gauge length specimens are depicted in Fig. 4. Pretest and posttest grain sizes (both Method A and Method B) are listed in Table 3.

Specimen grain size did not change during CHRT using Method A. X-750 and 718 alloys exhibited significant grain size increases during CHRT, using Method B. The only apparent difference in ranking between the two methods was that 718 and HAYNES® 282® swapped positions, with 718 yielding higher elongation using Method A. Since mill-annealed material was used in these tests, the 718 specimens contained a finer grain size (ASTM 6-7) than the other groups (typically ASTM 3-4). Alloy 718 is intentionally produced this way. This grain size was retained in Method A, but coarsened in Method B by the pre-CHRT cycle, 2000°F simulated solution anneal. Thus, 718 should have performed better (and, in fact, did exhibit higher elongation) in Method A. This increase in Alloy 718 hot ductility with decreasing grain size was also observed by Norton and Lippold (Ref. 6) during development of a different Gleeble-based PWHT cracking sensitivity test. In both methods evaluated, here, the overall ranking of materials was virtually identical to that produced by Rowe's (Ref. 1) earlier load-frame-based CHRT tests. The only exception was Alloy X-750, which produced lower elongations than Rowe measured. This result was evident in both "Method A" and "Method B" results and is probably characteristic of the particular heat of X-750 tested, rather than a product of the test methods, themselves.

Fractography and Metallography: Typical Examples

The post-CHRT fracture surfaces of

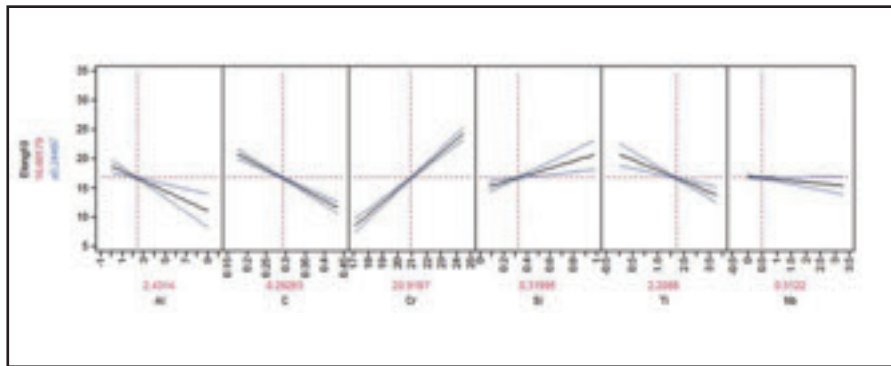

Fig. 12 — Individual element effects on CHRT elongation.

all gamma-prime/gamma-double-prime-strengthened materials, whether tested by Method A or Method B, exhibited areas of both ductile rupture and intergranular fracture. A typical example (HAYNES® 282®) is depicted in Fig. 5.

A typical example of crack propagation by intergranular fracture in Rene® 41 is illustrated in Fig. 6.

In the higher-strength materials, fracture appeared to nucleate at the specimen surface and propagate inward (Fig. 7), while the lower-strength materials exhibited signs of crack nucleation at both their surfaces and interiors — Fig. 8.

Intergranular fracture was readily evident even at very fine grain sizes (718 alloy) as shown in Fig. 9. This suggests the intergranular fracture mode observed in these tests was enhanced by gamma-prime/gamma-double-prime precipitation rather than being produced by environmentally driven grain boundary embrittlement. In contrast, HASTELLOY® X, a solid-solution strengthened alloy, exhibited only ductile rupture in post-CHRT fracture surfaces — Fig. 10.

Correlation of CHRT Results with Alloy Composition

Previous studies examined the relationship of alloy composition and estimated gamma-prime/gamma-double-prime minimum elongation over the 760°–871°C (1400°–1600°F) test temperature range. In the interest of standardizing and simplifying the CHRT, this study confined testing to one temperature 788°C (1450°F), only. Because of this change and modification of the specimen geometry, the CHRT elongation vs. estimated gamma-prime/gamma-double-prime phase fraction was reexamined for Method A, 25.4-mm gauge length results. Best fit results are shown in Fig. 11.

This analysis yielded a correlation coefficient (adjusted for degrees of freedom) of 90%, indicating a statistically

strong correlation between CHRT elongation and an alloy's capability of precipitating gamma-prime/gamma-double-prime.

Based on these results, an attempt was made to fit CHRT response (Method A, 25.4-mm gauge length) to alloy composition expressed in at.-%. A simple (first order) linear model was constructed using at.-% Al, Ti, Nb, C, Cr, and Si as the inputs, and CHRT elongation as the response. 788°C CHRT elongations for 282 alloy (16.4%) and HAYNES® 214® (tested outside this study – 12.1% elongation) were reserved as validation data sets for the model. A least squares model fit produced the following predictor equation:

$$\text{CHRT elongation} = -15.374 - 0.305 (\%Al) - 35.486 (\%C) + 2.037 (\%Cr) + 10.626 (\%Si) - 1.277 (\%Ti)$$

with an $R^2 > 99\%$.

Calculated CHRT elongations for the 282 and 214 alloys were 15.6 and 13.8%, respectively. Refitting the linear model, with all data included, yielded a slightly modified elongation predictor

$$\text{CHRT elongation} = -12.626 - 0.839 (\%Al) - 35.784 (\%C) + 2.111 (\%Cr) + 6.091 (\%Si) - 1.843 (\%Ti) - 0.473 (\%Nb)$$

Individual element effects are illustrated graphically in Fig. 12. Each panel depicts the linearly decoupled CHRT elongation response to changes in the levels of individual alloying elements — the blue lines represent the 95% confidence limits and the black lines represent the mean response for each alloying element, respectively.

This approach was not intended to address how each constituent affects alloy CHRT behavior from a detailed physical metallurgy perspective, but rather to suggest general trends and possibilities for future work. As expected, gamma-prime/gamma-double-prime forming elements reduced CHRT elongation, with the effects of Al and Ti approximately

twice as strong as Nb's effect. Cr and Si appeared to mitigate the effects of these gamma-prime formers, while C appeared to exacerbate their effects. This model appears valid within the envelope of data generated by this testing program, but should only be extrapolated with extreme caution.

Discussion

Strain-age (SA) cracking requires the simultaneous presence of (tensile) stresses and a ductility decrease (produced by precipitation of gamma-prime/gamma-double-prime) in the material under test. Significant precipitation hardening must occur before significant stress relaxation takes place by shear, creep, or any other thermally activated process. An ideal choice of heat-up rate and test temperature ensures that these conditions are met. The six age-hardenable alloys evaluated here typically are held for 4 to 6 hours between 720° and 900°C to produce peak strength (although some employ more complex, multistep heat treatments). Across the spectrum of Ni-based alloys examined, the mean (primary) age hardening temperature was ~790°C, hence its choice as a "universal" test temperature. The choice of test heating rate (17°C/min) was largely based on two considerations:

1) The ability to directly compare Gleeble-based CHRT results with prior load-frame based CHRT results reported by Rowe (Ref. 1) and Prager et. al. (Ref. 2) (who also reported that this heating rate was approximately representative of those likely to be experienced by fabricated parts undergoing postweld solution annealing).

2) The necessity that all alloys under test undergo partial age hardening during CHRT. This condition essentially combines precipitation reaction kinetics with estimated gamma-prime/gamma-double-prime volume fraction as a single, integrated material property that determines that material's propensity toward fracture during PWHT.

The choice of specimen extension rate (1.60 mm/min) was also based upon these two considerations.

Based on these requirements, a single heating rate (17°C/min) into the gamma-prime and/or gamma-double-prime precipitation temperature range (593°–788°C), coupled with a specimen extension rate of 1.6 mm/min was chosen for this series of experiments. The Gleeble's ability to reproduce a wide range of heat-up and strain (extension) rates, however, provides an opportunity to optimize CHRT test conditions with respect to heating rate, test temperature and strain rate. Such studies are currently in progress.

In this study, Gleeble-based CHRT results (using the test condition described

above) provided clear discrimination among the SA cracking behaviors of six different age-hardenable Ni-based superalloys, using both modified (Method A) and standard (Method B) specimen geometries. While both methods are capable, in a statistical sense, Method A appeared to offer several advantages over Method B as noted below.

1) The modified stress distribution ensured that failure occurred at (or very near) midspan, within the prescribed (25.4-mm) gauge length.

2) Consequently, failure always occurred at or near the site of peak specimen temperature, ensuring that failure occurred in a region where gamma-prime/gamma-double-prime precipitation was ongoing, thus adequately simulating SA cracking field failures.

3) Since no prior aging and in-situ solution annealing thermal cycles were needed, grain size modification did not occur prior to or during CHRT and add additional variation to CHRT results. Changes in alloy grain size can (and usually will) produce corresponding changes in material creep response, with larger grain sizes (less grain boundary area available to accommodate sliding and related short-circuit diffusion processes) favoring decreased creep rates. Since creep-related processes are expected to provide some reduction of stresses available to promote SA cracking, it follows that uncontrolled grain size changes during CHRT could skew results in unexpected ways.

4) Similarly, no significant pre-CHRT surface oxidation was present in Method A. No decrease in CHRT elongation to break would have resulted from oxygen penetration into grain boundaries (Ref. 2). Since no specimen surface preparation or cleaning was needed, no surface residual stresses would have been present that could have added additional variation to test results.

5) Experimental results strongly suggested that Method A yielded lower variation in test results (elongation to break), compared to Method B (Table 2).

6) In those cases where SA cracking behavior during PWHT after repair welding is to be assessed, Method A's specimen geometry could be combined with Method B's thermomechanical cycle to offer potentially lower variation in material response.

Conclusions

1. Gleeble-based CHRT methods reproduce the results of earlier load-frame based CHRT method.

2. Simple specimen geometry modifications can be used to reduce test variation and ensure that samples fail at the center of their gauge section.

3. A single test temperature (788°C), heating rate (17°C/min), and specimen extension rate (1.6 mm/min) provide adequate discrimination of strain-age cracking susceptibility and considerably simplify implementation of Gleeble-based CHRT methods.

4. Gleeble-based CHRT can be performed with mill-annealed sheet stock.

5. Relatively small differences in SA cracking susceptibility can be distinguished by this test, using a radiused specimen gauge section and 25.4-mm gauge length. Less than 1.0% elongation difference is significant at the 95% CL.

6. Post-CHRT (Gleeble-based) fracture surfaces exhibited areas of intergranular fracture in all gamma-prime/gamma-double-prime containing alloys. HASTELLOY® X, which precipitates no gamma-prime or gamma-double-prime, exhibited only ductile rupture.

7. Alloy CHRT (Gleeble-based) behavior appears describable by a first-order linear function of composition.

Acknowledgments

Daniel Hunt and Lori Meacham of Haynes International are gratefully acknowledged. Meacham assisted with Gleeble-based CHRT operation, along with Hunt who also provided valuable technical input on Gleeble operation, limitations, and programming.

References

- Rowe, M. D. 2006. Ranking the resistance of wrought superalloys to strain-age cracking. *Welding Journal* 85(2): 27-s to 34-s.
- Prager, M., and Shira, C. S. 1968. Welding of precipitation hardenable nickel-base alloys, *WRC Bulletin No. 128*.
- Sims, C. T., and Hagel, W. C., eds. 1972. *The Superalloys*, pp. 529–531, New York, N.Y., Wiley.
- Lepkowski, W. J., Monroe, R. E., and Riepel, P. J. 1960. Studies on repair welding age-hardenable nickel-base alloys. *Welding Journal* 39(9): 392-s to 400-s.
- Weiss, S., Hughes, W. P., and Macke, H. J. 1962. Welding evaluation of high temperature sheet materials by restrained patch testing. *Welding Journal* 41(1): 17-s to 22-s.
- Norton, S. J., and Lippold, J. C. 2003. Development of a Gleeble-based test for postweld heat treatment cracking susceptibility. *Trends in Welding Research, Proc. of the 6th International Conference*, ASM International, pp. 609–614.
- Fawley, R. W., Prager, M., Carlton, J. B., and Sines, G. 1970. Recent studies of cracking during postwelding heat treatment of nickel-base alloys, *WRC Bulletin No. 150*.
- Norton, S. J. 2002. Development of a Gleeble based test for post weld heat treatment cracking in nickel alloys, M.S. thesis, Columbus, Ohio, The Ohio State University.

Ductility-Dip Cracking Susceptibility of Nickel-Based Weld Metals

Part 1: Strain-to-Fracture Testing

This investigation examines various factors including the threshold strain for cracking, transition to gross cracking, and effects of small compositional changes

BY N. E. NISSLEY AND J. C. LIPPOLD

ABSTRACT. In Part 1 of this investigation, the ductility-dip cracking (DDC) susceptibility of Ni-Cr-Fe filler metals was evaluated using the strain-to-fracture (STF) Gleeble-based testing technique. These high-chromium Ni-based filler metals are frequently used in nuclear power plant applications for welding Ni-based Alloy 690 and include filler metals 82, 52, and 52M (FM-82, FM-52, and FM-52M), a number of FM-52M-type experimental alloys including two with additions of molybdenum and niobium. The interpretation of the STF results includes both the threshold strain for cracking and the transition to gross cracking. In Part 2, an in-depth microstructural analysis of select alloys was conducted to add insight to the DDC mechanism.

The compositional changes in the FM-52M experimental alloys resulted in a range of DDC susceptibility, indicating the strong effect of minor changes in composition. A significant decrease in DDC susceptibility was observed in the experimental alloys with both Mo and Nb additions. The threshold strain for cracking in the 2.5% Nb and 4% Mo Ni-Cr-Fe alloy was approximately 8%, as compared to threshold values of approximately 1–3% for the other filler metals. The DDC resistance of the Mo and Nb modified filler metals was more than twice that observed in typical FM-82 alloys.

Introduction

Safety and life extension requirements in nuclear applications have driven the development of alloys with improved corrosion and elevated temperature properties. These new materials have, in turn, required the development of welding con-

sumables and joining techniques that meet or exceed the properties of the base materials.

In the 1950s, Ni-based Alloy 600 replaced 304 stainless steel in applications where resistance to stress corrosion cracking (SCC) was required (Ref. 1). Subsequent work to develop matching welding consumables led to the development of filler metal 82 (FM-82) (AWS A5.14 ERNiCr-3). Since then, Alloy 690 was developed with even better resistance to SCC and has replaced Alloy 600 for use in many nuclear steam generator components (Ref. 1). The first generation matching consumable for joining Alloy 690 was filler metal 52 (FM-52) (AWS A5.14 ERNiCrFe-7), which demonstrated better SCC and hot cracking resistance compared to FM-82 (Ref. 1). However, in highly restrained weldments, this filler metal was found to be susceptible to DDC (Refs. 2, 3). To overcome some of the problems encountered with FM-52, a second-generation consumable filler metal 52M (FM-52M) (AWS 5.14 ERNiCrFe-7A) (Ref. 1) was developed. It contained additions of B, Nb, and Zr to improve resistance to DDC and had reduced Al and Ti to reduce the tendency for floating oxide impurities.

Most of the DDC susceptible materials have a face-centered cubic and/or austenitic microstructure. They tend to be single phase from room temperature to melting and solidify as FCC. Ductility-dip cracking can occur along solidification or migrated grain boundaries (MGB) in weld metals of single-phase materials (Refs.

4–6). Migrated grain boundaries are the crystallographic portion of a solidification boundary that has moved or migrated from the compositional portion due to grain growth and grain boundary straightening (see Fig. 2.3) (Ref. 7). Materials with low impurity levels, no second phases, or precipitates have less resistance to MGB mobility and grain growth and as a result of this extra grain boundary mobility, these materials tend to have larger grains. Larger grain materials tend to be more susceptible to DDC than fine grain materials (Refs. 2, 3, 8–10); consequently, matching weld metals are typically more susceptible than wrought base materials (Refs. 3, 11). Lippold et al. (Ref. 12) proposed that this is a result of strain localization at grain boundaries, which increases with larger grained materials (less grain boundary area). Larger grains result in less boundary area for deformation mechanisms such as grain boundary sliding, which is considered to be a major element in DDC (Refs. 4, 5, 13). Under some conditions, second-phase precipitates have been reported to be effective in pinning migrated grain boundaries (Refs. 4, 14, 15) preventing grain growth and resulting in wavy boundaries. The grain boundary orientation relative to the applied stress was also found to be an important factor in the formation of DDC (Ref. 3) and has proven successful in reducing DDC in some applications.

Ductility-dip cracks are generally small, typically less than 3 mm long by 1 mm deep (Refs. 3, 16, 17). In high restraint weldments, however, they may be much larger. Liquation cracks and ductility-dip cracks often occur in the same weldment (Refs. 8, 18) and may be distinguished by fractographic examination employing scanning electron microscopy. Liquation cracks can be recognized by the evidence of liquid films along the fracture path while ductility-dip cracks show no evidence of liquation. However, not all liquation cracks exhibit clear evidence of liquid films; in such circumstances, they

KEYWORDS

Ductility-Dip Cracking (DDC)
Ni-Cr-Fe
Strain-to-Fracture (STF)
Alloy 690
Filler Metals 82, 52, and 52M
GTA Spot Weld

N. E. NISSLEY (nathannissley@gmail.com), formerly a graduate research associate at The Ohio State University, is currently with ExxonMobil Upstream Research Co., Houston, Tex. J. C. LIPPOLD is a professor in the Welding Engineering program at The Ohio State University.

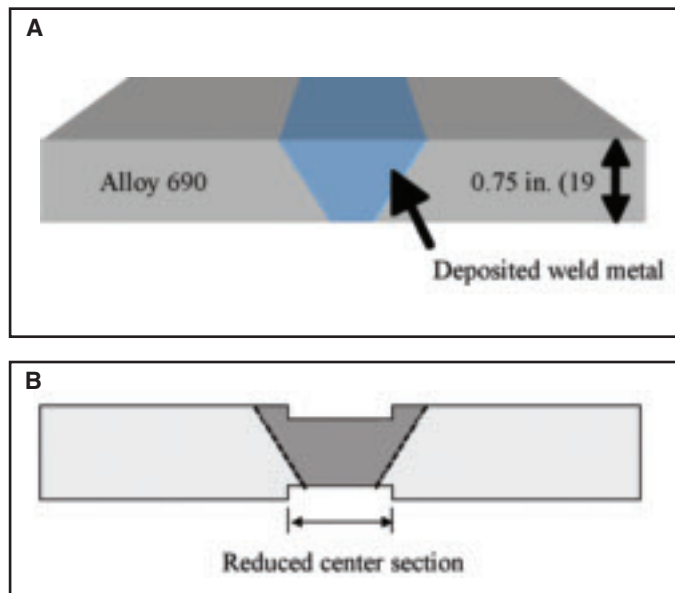
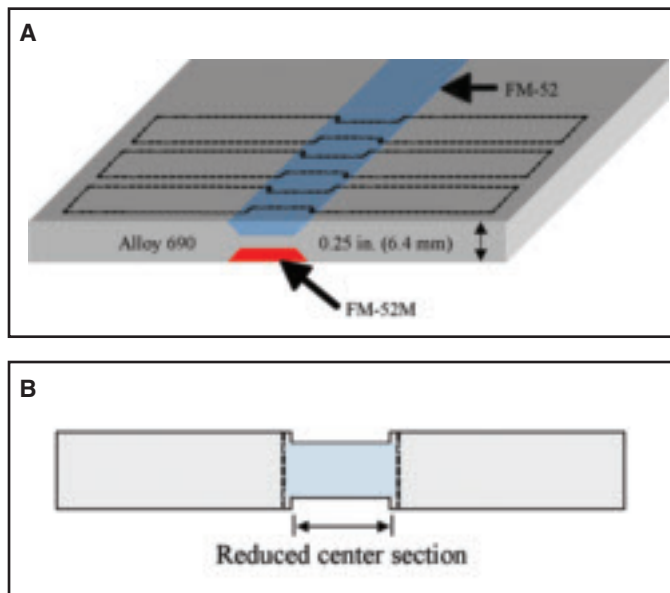

Fig. 1 — Sample preparation Method 1. *A* — Cross-sectional view of multipass welded plate with FM-52 and FM-52M filler metals. Strain-to-fracture sample blanks cut from the plate (dashed lines); *B* — face of the STF sample blank with reduced center section. The cross-hatched area indicates the location of the deposited weld metal with FM-52 on one side and the FM-52M on the other.

Fig. 2 — Sample preparation Method 2. *A* — Cross-sectional view of multipass welded plate with the different compositions tested. Sample had a single V-groove with a 60-deg included angle; *B* — face of the STF sample blank with reduced center section. The cross-hatched area indicates the location of the deposited weld metal.

can be confused with DDC unless detailed fractographic analysis is performed. Unequivocal evaluation and identification of DDC requires a test technique with sufficient control to avoid liquation cracking altogether.

Some of the most common test techniques used to evaluate DDC are the strain-to-fracture (STF) test (Ref. 19), the Transverse-Varestraint and Gleeble hot ductility tests (Ref. 2) and the spot-on-spot (double-spot) Varestraint test (Ref. 4). Several other tests are discussed elsewhere (Ref. 4). Many of these cracking tests have a significant number of uncontrolled vari-

ables that can affect cracking or crack interpretation (Ref. 9). The Varestraint tests can have solidification, liquation, and ductility-dip cracking occur in the same sample, which can make interpretation difficult and may affect the actual strain applied for DDC. Additionally, calculating the cracking temperature requires precise temperature gradient knowledge and even with skilled interpretation, it can lead to errors. Since cracking susceptibility is dependant upon the grain boundary orientation relative to the applied strain (Refs. 3, 20), all of the above tests except the STF and double spot Varestraint are sensitive to the base

material microstructure as well as the location and orientation that the samples are removed. While all of these tests have advantages and disadvantages, the authors feel that the STF test offers the greatest flexibility for evaluating the effect of applied strain and temperature on cracking susceptibility.

The Gleeble-based STF test was developed at The Ohio State University in 2002 to differentiate the DDC susceptibility of a variety of alloys and microstructures at different temperatures and strains (Ref. 19). Samples are heated to the testing temperature and strained a fixed amount. The use of the term “fracture” in the name refers to the formation of cracks (i.e., samples are strained a fixed amount and then examined for cracks). The Gleeble approach allows for precise control of temperature and strain during both STF testing and thermal processing so that each test specimen evaluates if cracking occurs at a given temperature and strain. Since the temperature is essentially uniform across the gauge section, there are no temperature gradient effects and the strain is applied at a fixed temperature. The STF test can evaluate the on-heating and on-cooling temperature range over which the ductility-dip phenomenon is observed in a material. However, in weldments it is unclear at what temperature the strain reaches sufficient levels for cracking to occur and, as such, it is not entirely clear which STF data are most relevant (Ref. 6).

Table 1 — All Weld Metal Compositions of Commercial Heats Tested FM-52, FM-52M, and Alloy 690 Base Plate (wt-%)

	FM-52 Heat NX9277	FM-52M Heat EXOA51P	Alloy 690 Plate
Ni	60.12	60.37	61.06
Cr	29.09	30.04	26.67
Fe	8.88	8.42	9.20
Nb + Ta	0.02	0.85	0.01
C	0.026	0.020	0.017
Mn	0.25	0.81	0.17
S	0.0037	0.001	0.001
P	0.0044	0.004	0.004
Si	0.17	0.03	0.06
Cu	0.011	0.02	0.02
Al	0.71	0.10	0.29
Ti	0.50	0.21	0.16
Mo	0.05	0.02	0.02
Co	—	0.007	0.009
B	—	0.004	0.001
Zr	—	0.015	—

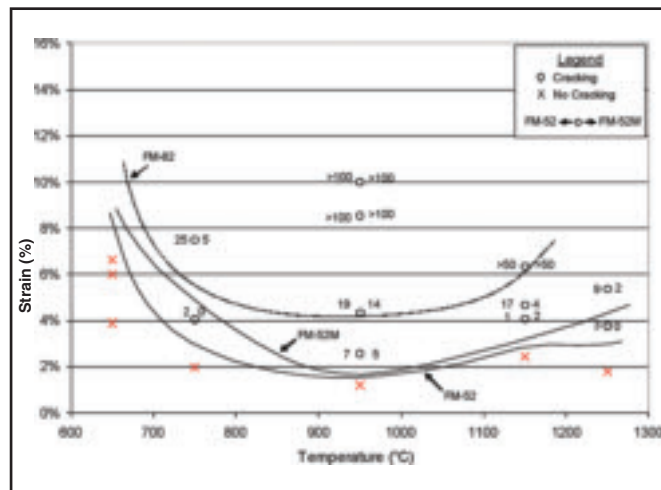
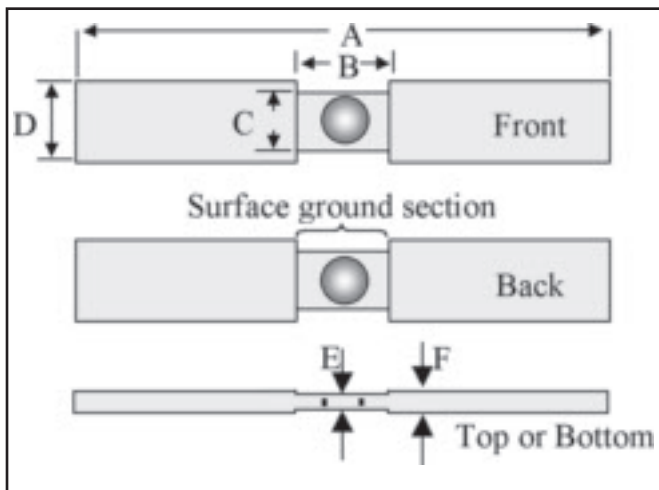

Fig. 3 — Final STF sample geometry showing dimensions and spot weld location. A = 12.7 cm (5 in.), B = 19 mm (0.75 in.), C = 15.3 mm (0.6 in.), D = 19 mm (0.75 in.), E = nominally 5.6 mm (0.22 in.), F = 6.4 mm (0.25 in.). Gauge marks were made on the top and bottom of the sample with a nominal spacing of 4 mm.

Fig. 4 — Temperature-strain curve (strain to form cracks) for FM-52 (NX9277) and FM-52M (heat EX0A51P) with results from FM-82 (heat YN7355) (Ref. 20) for comparison. An “x” represents a tested sample with no cracking and “o” a sample with cracking. The number to the left or right of the circle represents the number of cracks in FM-52 and FM-52M, respectively.

Strain-to-fracture tests have been performed on a variety of Ni-based wrought materials and filler metals and provide a good data set for comparison with the current work (Refs. 4, 11, 19, 20).

For the STF test, the DDC susceptibility of a material is evaluated by the magnitude of the ductility-dip temperature range (DTR), the threshold strain for cracking, and the transition to gross cracking. The threshold strain is defined as the maximum strain achievable before cracking occurs. The transition to gross cracking was introduced to differentiate among materials with similar threshold strains, but clear differences in cracking above the threshold (i.e., the strain level at which the cracks begin to join together, beyond which accurately counting cracks becomes difficult).

Experimental Procedures

Materials

A series of experiments was performed to investigate the effect of composition on the DDC susceptibility of Ni-based filler metals and commercially pure nickel plate. First, a heat of commercially available FM-52 (NX9277) and FM-52M (EX0A51P) was evaluated to compare the relative cracking resistance of the two alloys.

Subsequently, eight experimental FM-52M and FM-52M-like alloys were evaluated and designated A through H. Material A was a FM-152M filler metal; a SMAW electrode that is comparable to FM-52M. The remaining alloys were 0.045-in.-diameter GMAW welding wires; B, C, and G were FM-52M, E and F were

FM-72 with low and ultralow sulfur, D and H were FM-52M-like composition and additions of Nb and Mo. Filler metal 72 (FM-72) (AWS A5.14 ERNiCr-4) is often used for weld overlays of superheater tubing in power boilers to provide resistance to high-temperature corrosion.

Additionally, commercially pure Nickel 200 (99.6%) was selected for testing to evaluate a more simple alloy system to develop a fundamental understanding of DDC with fewer complex compositional interactions. The compositions of the commercial heats and the experimental alloys tested are listed in Tables 1, 2, and 3, respectively.

Sample Preparation

Two different preparation methods were used to make the STF samples. To compare the commercial consumables listed in Table 1, a preparation method (Method 1) was developed such that two different filler metal compositions could be tested in a single STF sample — Fig. 1. This preparation method allowed both

Table 2 — All Weld Metal Compositions of the Eight Experimental Alloys (A–H) (wt-%)

	Mat. A FM-152M	Mat. B FM-52M	Mat. C FM-52M	Mat. D (N/A)	Mat. E FM-72	Mat. F FM-72	Mat. G FM-52M	Mat. H (N/A)
Ni	57.2	59.54	60.38	55.5	55.90	55.87	60.14	53.87
Cr	28.68	30.06	29.5	29.6	43.33	43.09	29.53	30.18
Fe	8.75	8.22	8.04	9.0	0.08	0.27	8.33	8.2
Nb	1.53	0.83	0.82	1.0	—	—	0.78	2.48
C	0.03	0.02	0.03	0.02	0.01	0.020	0.014	0.021
Mn	3.16	0.80	0.77	0.68	<0.01	0.01	0.68	0.8
S	0.008	0.001	0.001	0.001	0.0005	0.001	0.0007	0.001
P	0.008	0.003	0.004	0.015	0.001	0.002	0.004	0.004
Si	0.3	0.09	0.12	0.03	0.03	0.03	0.12	0.2
Cu	0.04	0.02	0.01	<0.05	<0.01	<0.01	0.03	—
Al	0.04	0.11	0.12	0.05	—	—	0.13	0.04
Ti	0.07	0.22	0.19	0.20	0.55	0.53	0.19	0.2
Mo	—	—	—	4.0	—	—	0.02	4
B	0.002	0.003	0.001	0.004	—	—	0.001	0.001
Zr	0.003	0.01	0.008	0.006	—	—	0.0006	0.007

Table 3 — Nominal and Actual Compositions of the Ni 200 Plate

	Nickel 200 Specifications	Nickel 200 Heat N13T8A12
Ni (+Co)	99.0 min	99.54
Cu	0.25 max	0.07
Fe	0.40 max	0.10
Mn	0.35 max	0.20
C	0.15 max	0.06
Si	0.35 max	0.03
S	0.01 max	<0.001

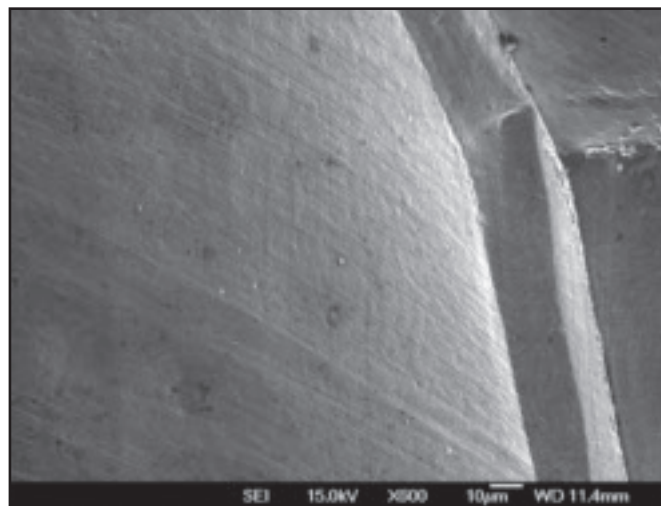
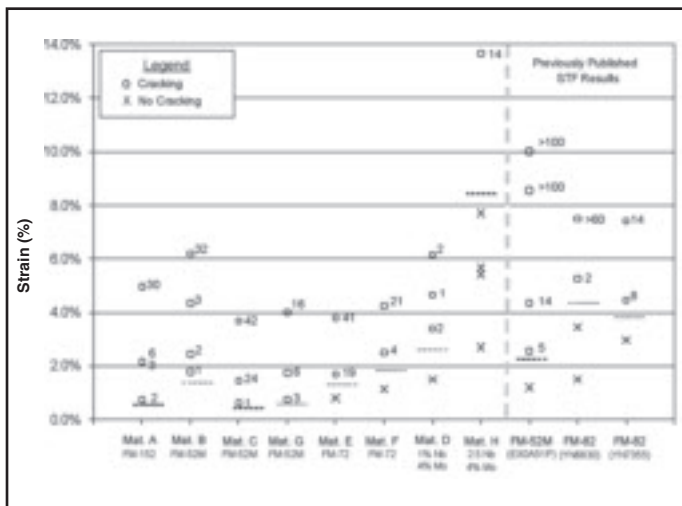

Fig. 5 — STF test results (strain to form cracks) for baseline testing at 950°C for experimental FM-52M and FM-72 compositions (A through H) along with the results of previously tested FM-52M and FM-82 (Ref. 20). An “x” represents a tested sample with no cracking and “o” a sample with cracking. The number next to the circle is the number of cracks found. For each material, the dashed line approximates the threshold strain (strain at which cracks initiate).

Fig. 6 — Fracture surface of Ni 200 STF sample tested at 950°C showing the intersection of several grains with macroscopically flat intergranular fractures and evidence of crystallographic slip. The grain boundaries are relatively clean and free of carbides.

filler metals to be tested at the same temperature and strain (in a single sample). A 0.25-in.- (6.4-mm-) thick plate of Alloy 690 was machined with 0.75 in. (19 mm) wide by 0.083 in. (2.1 mm) deep grooves with 45-deg beveled edges on opposite sides of the plate. Alternating passes of FM-52 and FM-52M (Table 1) were made on opposite sides of the plate (distortion control) to fill in the machined grooves with weld metal. The GTAW process with cold wire feed (CWF) was used to deposit

the filler metal. Three layers of weld metal beads (3 or 4 per layer) were required to completely fill the grooves and dilution of the top layer of weld metal by Alloy 690 base metal was estimated to be 10% (using metallographic evaluation of cross section). Any weld reinforcement was ground flush, radiographed, and standard STF sample blanks were laser cut from the welded plates so that the location of the FM-52 and FM-52M welds corresponded with the reduced center section of the STF sample. The final sample dimensions are provided in Fig. 3.

The experimental consumables listed in Table 2 were evaluated with a more standard preparation method (Method 2) where samples were prepared so that a single composition could be tested with each sample — Fig. 2. Two 0.75-in.- (19-mm-) thick plates of Alloy 690 had 30-deg beveled faces machined so they formed a 60-deg included angle V-groove. The weld metal was deposited to completely fill the groove (Fig. 2), any weld reinforcement was ground flush and the samples were radiographed. Grooves 0.75 in. (19 mm) wide were machined on the top and bottom of the sample to make the reduced

center section. The plate was cut into 0.25-in. (6.4-mm) pieces with a band saw and squared with a mill into standard STF sample blanks with dimensions shown in Fig. 3. These samples were prepared by the Special Metals Welding Products Co. (Ref. 21).

For the commercially pure Ni 200 samples, STF sample blanks were laser cut from a 0.25-in. (6.4-mm) plate using the standard procedure for wrought materials (Ref. 19). The final sample dimensions are provided in Fig. 3. The starting microstructure (e.g., grain size, boundary morphology, carbide type, and distribution) in a STF sample is known to have a significant effect on the DDC susceptibility (Refs. 3, 6, 14, 20, 22). Since each of the above sample preparation methods impart different thermal histories and chemistry variations in the samples due to the multipass welding techniques applied, autogenous gas tungsten arc spot welds were made on both the front and back faces of each reduced section of sample before STF testing (Fig. 3) to create a reproducible microstructure (Refs. 11, 19).

The welding procedures used for the GTA spot welds are listed in Table 4. These welds were made in a copper fixture to provide consistent and controlled heat flow from the sample. One of the spot weld variables is the downslope time and is defined as the time for the current to ramp down from the peak current of 140 A to 20 A. All of the previous STF tests (Ref. 19) and the majority of the samples tested during this investigation were performed with a 12.7-s

Table 4 — Welding Procedures for STF Spot Welds Using GTAW

	Value	Time
Voltage	12.5 V	
Preflow	20 ft ³ /h	10 s
Start Level	20 A	0.1 s
Initial Slope		5 s
Weld	140 A	20 s
Downslope		12.7 s (standard) 5 s (where noted)
Final Level	20 A	0.1 s
Postflow	20 ft ³ /h	15 s
Shielding Gas	20 ft ³ /h Argon (99.998%)	

Table 5 — Microstructural Variation in Material B Comparing a 5- and 12.7-s Downslope Spot Weld

Downslope Time	Avg. Subgrain Spacing	MC-Type Carbides	
		Optical Area Fraction	SEM Area Fraction
5 s	16.4 µm	1.30%	0.26%
12.7 s	20.4 µm	0.80%	0.19%
Difference	24%	62%	37%

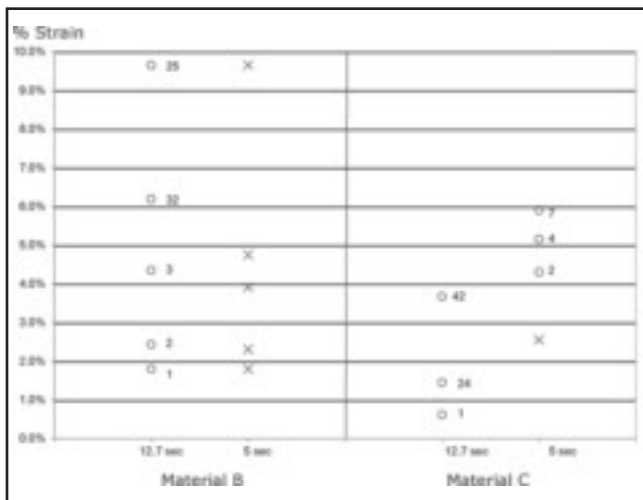

Fig. 7 — Results of 5- and 12.7-s downslope in spot welds of B and C tested at 950°C. An “x” represents a tested sample with no cracking and “o” a sample with cracking. The number next to the circle is the number of cracks found.

downslope time. However, initial welds in the Ni 200 plate with the 12.7-s downslope prewelds resulted in extensive cracking that was only avoided by reducing the downslope to 5 s. As a result of this finding, all the Ni 200 samples and select Ni-Cr-Fe filler metal STF tests were run with a downslope time of 5 s.

Following the placement of the spot welds on the sample, the front and back faces of the reduced center section were surface ground (equivalent to at least 320 grit SiC grinding paper) to remove any surface roughness or oxidation caused by welding and to allow for easier crack detection after testing (Fig. 3). In contrast to previous STF testing reported by the authors, the samples were not pre-etched prior to STF testing as this was found to be an unnecessary sample preparation step, and it had no detectable effect on cracking (Ref. 4).

Gauge marks with a spacing of 4 mm (0.157 in.) were placed on the bottom and top of each sample (Fig. 3) with two square indentions made with a modified punch. The initial (and final) gauge spacing was measured between the punch marks at 100 \times magnification on a stage controlled by a digital micrometer. This technique allows for precise and consistent strain measurement in the gauge section of the sample after testing.

STF Testing Procedure and Analysis

The STF testing was performed using a Gleeble 3800 utilizing a hot zone L-strain gauge to measure deformation across the gauge section of the STF sample. The L-strain gauge was seated into the square indentions used to mark the gauge and allowed for real-time information on sample deformation to be used

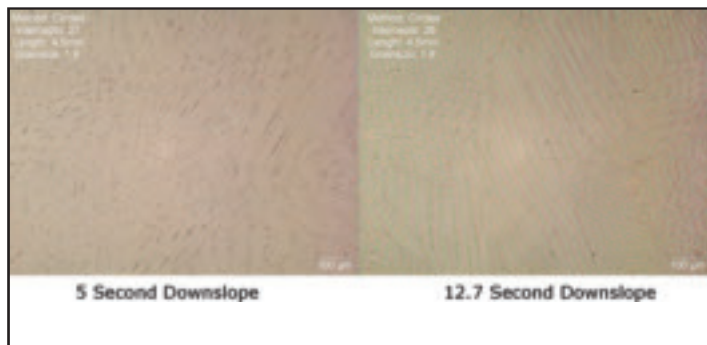

Fig. 8 — Typical optical photomicrographs of B made with 5- and 12.7-s downslope spot welds. The grain size did not vary significantly, but the 5-s downslope weld had a greater area fraction of MC-type carbides and a finer subgrain size.

for feedback control. A K-type control thermocouple was used to measure temperature.

Prepared samples were mounted in stainless steel hot jaws with knurled tool steel grips in the Gleeble with a jaw (or free-span) spacing of 2 in. (50.8 mm). A rough vacuum (10^{-2} torr) was applied to the chamber of the Gleeble and then back purged with argon (99.998% Ar). This was repeated to ensure minimal oxidation during testing.

For this work, samples were only tested on-heating to minimize the number of testing variables (peak temperature, time at temperature, cooling rate, etc.). The Gleeble was programmed to heat the sample to the test temperature at 100°C/s and hold at the test temperature for 10 s to allow the temperature to stabilize within the gauge section. The sample was then strained by moving the jaws of the Gleeble at a constant rate of 0.06 cm/s (0.024 in./s) until the L-strain gauge reached a predetermined value indicating that the sample had been strained to the desired level. Details of the Gleeble program are available elsewhere (Ref. 4). Once the desired strain was obtained, the heating was turned off and the sample was allowed to free cool to room temperature under a zero load condition (using load control to compensate for thermal contraction). By cooling under a zero load condition, any cracking that occurred could be attributed to straining at the test temperature rather than strain that accumulated during cooling.

The tested samples were evaluated for cracking using a stereo microscope at magnifications from 10 to 30 \times . The final gauge spacing was measured on the top and bottom of the sample, and the actual plastic strain was calculated as $\Delta L/L_0$. The average strain (top and bottom) and the test temperature were plotted on a temperature-strain curve. The threshold

strain and the transition to gross cracking were used to evaluate the DDC susceptibility of the tested materials. The threshold strain is defined as the minimum strain (over the DDC temperature range) at which DDC occurs. The transition to gross (massive) cracking was considered to have occurred when the ability to accurately count the number of cracks in one spot weld became difficult. The transition to gross cracking is typically observed when the number of cracks in a spot weld exceeds approximately 20 cracks. However, in highly susceptible materials where cracks begin joining together at low strains, the transition to gross cracking is not as easy to define using simply a fixed number of cracks. Rather, it can be quantified by calculating the rate of increase in the number of cracks from one sample to the next and occurs when approximately 10 cracks per percent strain is reached.

Solidification Microstructure Analysis

The as-welded spot weld microstructure of both downslope conditions (12.7 and 5 s) were evaluated with SEM and optical microscopy. SEM images at 500 \times magnification and optical images at 100 \times magnifications were analyzed to determine the grain size, dendrite arm spacing, and area fraction of MC-type carbides. For each downslope condition, grain size and precipitate area fraction measurement were conducted on multiple images that traversed the spot weld. *PAX-it* (Ref. 23) was used to measure the ASTM grain size, and *ImageTool* (Ref. 24) was used to quantify the area fraction of MC-type carbides. Since the solidification subgrain (cell and dendrite) microstructure varied across the spot weld, the dendrite arm spacing was measured at a distance of 1.5 mm from the edge of the spot for consistency. The distance across multiple dendrites was measured, and the average was calculated with a minimum of 35

measurements.

The cooling rate in spot welds for different (weld current) downslope times was investigated with thermocouple measurements. A 1.75-mm- (0.069-in.-) diameter hole was machined in the back side of the sample to within 1.5 mm (0.06 in.) of the front surface (located just inside the spot weld fusion zone). The hole was located so that it would be approximately 1.5 mm (0.06 in.) from the spot weld edge for comparison with the metallographic analysis. A thermocouple with a 1.5-mm (0.06-in.) ceramic insulator was inserted in the hole and a spot weld was made on the front face of the sample. The results of the 5- and 12.7-s downslope spot welds were compared to understand the thermal histories and resulting microstructures.

Results and Discussion

FM-52 and FM-52M (Method 1)

Samples of FM-52 and FM-52M (Table 1) were made using sample preparation Method 1 (Fig. 1) and STF tested from 650° to 1250°C with the results shown in Fig. 4. The compositions of the two alloys are similar with the exception of B, Nb, and Zr additions to FM-52M. Samples that did not crack were marked with an "x" and samples of either FM-52 or FM-52M that cracked were marked with a circle. The actual number of cracks observed in each sample is included next to each point (FM-52 and FM-52M are to the left and right, respectively) to further aid in the interpretation of the results. A curved line was drawn separating cracked and crack-free samples, which represent the threshold strain required for DDC across the entire temperature range. While a more precise determination of the threshold strain can be determined if additional samples are run, cracking trends are observed in STF data and a good approximation of the threshold strain estimated when samples are 1–2% apart.

Over the temperature range evaluated, the minimum in the threshold strain curve for both materials occurred at approximately 950°C and 2% strain with FM-52M demonstrating a slightly higher resistance (fewer cracks observed in all but one sample). The temperature where the minimum threshold strain was observed (950°C) is consistent with STF testing of other materials (usually occurring somewhere between 900° and 1000°C) (Ref. 19). Previous results from STF testing of FM-82 (Ref. 20) are superimposed on Fig. 4 for reference.

With the exception of one sample (1150°C, 4.1%), FM-52M consistently had fewer total cracks than FM-52 including two samples where cracks were only found

in FM-52 (750°C, 4.1%, and 1250°C, 3.8%). In these two samples where cracking did not occur in FM-52M, evidence of grain boundary sliding and localized strain around the boundaries was observed indicating the sample was on the verge of cracking (Ref. 4). As the strain increased, the cracking susceptibility difference between the filler metals became less obvious.

These results are consistent with the heat-to-heat variation in DDC resistance reported in the literature (Ref. 20). Since DDC susceptibility is sensitive to small changes in composition (and susceptibility), these results should be assumed to be a heat-to-heat comparison and not a general representation of these two alloys. Since the current understanding of the DDC mechanism does not include a robust understanding of the overall effect of composition, testing of individual heats for DDC susceptibility should be considered for critical applications.

Experimental Ni-Cr-Fe Alloys (Method 2)

Previous testing (Refs. 19, 20) has shown that the STF ductility minimum for most nickel alloys occurs between 850° and 1050°C and gross cracking is typically observed first in this temperature range (i.e., at lower strains than other temperatures). Based on this observation, STF testing was performed at a single temperature of 950°C to assess susceptibility of a large number of filler metal compositions using only a limited number of samples. Based on previous experience with the STF test, it was felt that this approach was appropriate for screening multiple compositions. The results of STF testing at 950°C are shown in Fig. 5 with previously reported STF results for FM-52M and FM-82 compositions plotted for reference.

The threshold strains for A–G varied between 1 and 3% while that for H was significantly higher at approximately 8%. Accordingly, the transition to gross cracking for A–G varied between 4 and 7% while for H it was >14%. The composition of B and C were of particular interest because while their compositions were quite similar (except for a small variation in boron), they exhibited significantly different resistance to DDC. Both B and C had a relatively low threshold strain at 950°C (<1.5%), but the additional strain required to transition to gross cracking was much higher in B (>5%) vs. in C (1.5%). Thus, although the threshold strains are similar, testing at higher strains suggests that C is much more susceptible to DDC than B.

Based upon this screening, the DDC resistance of the FM-52M (B, C, G) and FM-72 (E, F) alloys is lower than that of FM-82 while the FM-52M-type composi-

tion with the addition of 4% Mo and 2.5% Nb (H) was the highest. Of the 30% Cr Ni-based filler metals tested to date, the combined additions of Nb and Mo exhibited the best DDC resistance at 950°C.

E and F are heats of FM-72 that were evaluated because of their low sulfur content. Since sulfur has been identified by other investigations (Refs. 5, 15, 20, 25) to be contributory to DDC, these heats were of interest. The sulfur levels found in F would, under most conditions, be considered low while the ultralow sulfur level found in E required additional processing. The number of DDC cracks that were observed in F and the ultralow sulfur E could not have been solely predicted based on the level of sulfur. Several factors do complicate the interpretation of this result including the higher Cr (Ref. 26) in FM-72 and lower Mn (Ref. 15). This result does not dismiss the effect of sulfur; instead, it highlights the complexity of the DDC mechanism and the combined effect of several factors. While sulfur has been shown to increase DDC (and solidification cracking) (Refs. 5, 20, 25, 27), it may also affect boundary mobility and materials with extremely low impurity content have been found susceptible to DDC (Ref. 4). An optimum sulfur value likely exists where positive boundary drag effects balance a negative embrittling effect.

D and H (FM-52M-type) with 4% molybdenum and 1 and 2.5% niobium, respectively, exhibited improved cracking resistance when compared to the other six materials tested in this investigation. D had a threshold strain and gross cracking strain of 2.5 and >6%, respectively, which is high compared to the other alloys with 1% niobium. H had a threshold strain and a gross cracking strain of 8 and 14%, respectively, which approaches that of materials that are quite resistant to DDC such as austenitic stainless steel weld metal containing ferrite (Refs. 19, 28).

Niobium has been proposed to be an element that improves DDC resistance by forming MC-type carbides at the end of solidification and which subsequently pin grain boundaries (Refs. 14, 15). While Ni-based alloys with 2 to 3% niobium are consistently more resistant to DDC than those with less than 1%, niobium content by itself has not been directly correlated to cracking resistance (Refs. 14, 15). The morphology, size, temperature of formation, and distribution of the MC carbides are affected by other alloying elements, and it is likely the combined effect of other elements with Nb (such as Mo) that is contributing to the overall improvement of these alloys.

Based upon the results of the initial screening, three alloys were selected for further metallurgical evaluation. H was

selected for its superior DDC resistance at 950°C. B and C were selected because of their similar compositions but differing DDC resistance. The results of this subsequent metallurgical evaluation are the subject of Part 2 of this paper.

Commercially Pure Ni 200

During the preparation of the Ni 200 samples, extensive cracking was observed at the completion spot welds made with 12.7-s downslope spot welds. It was discovered that crack-free welds were produced with a faster downslope time of 5 s, and these were subsequently STF tested in the Gleeble. Cracking occurred in all Ni 200 samples tested (all at 950°C), regardless of the strain and the extent of gross cracking prohibited a comparative crack count. Analysis of the fracture surface confirmed that the cracks were macroscopically flat intergranular fractures, consistent with other DDC cracks — Fig. 6. The lack of second phases in the alloy and the resulting large grains in the spot weld may have contributed to the extreme sensitivity to DDC observed in this alloy. Further evaluation of this alloy was not conducted due to the extent of DDC by both Type 2B (DDC in primary weld metal) and 2C (DDC in reheated weld metal) cracking (Ref. 29). The observed cracking difference from the spot weld solidification microstructure (produced through spot weld downslope time variations) was investigated further with the experimental Ni-Cr-Fe alloys.

Solidification Microstructure Effects (Downslope Time)

In standard STF testing, an autogenous spot weld was made before STF testing with a 12.7-s downslope time from 140 to 20 A is used to ensure a controlled solidification microstructure that is consistent from sample to sample. Through previous studies, this spot weld has been shown to generate a radial pattern of grain boundaries that is relatively consistent among the various materials tested (Ref. 11). To evaluate the effect of a shorter downslope time on the solidification microstructure and resultant cracking observed in Ni 200, samples of B and C were made with a 12.7- and 5-s downslope spot weld on opposite sides of the same sample. This allowed a direct comparison as the chemistry, temperature, and strain were the same for a given sample. To confirm the second spot weld did not affect the first, the spot weld sequence was made randomly. Post-test evaluation found no significant effect of the spot weld sequence on the DDC susceptibility when welding was conducted in the copper fixture, which provided a larger thermal mass.

Results of this experiment (Fig. 7)

demonstrated that reducing the current downslope time significantly decreased the cracking susceptibility (both the threshold strain and gross cracking transitions) of both B and C, although a greater improvement was observed in B. Embedded thermocouples revealed that the time required for the sample to cool from 1400° to 1150°C was 4 s for the fast downslope time and 6.8 s for the normal downslope time (Ref. 4). The cooling rate below 1150°C (approximately the nonequilibrium solidification solidus based upon JMatPro calculations) was the same for both welds because the thermal mass of the copper fixture was sufficient to overcome the difference in heat input.

Microstructural evaluations of B (Fig. 8) revealed that decreasing the downslope time from 12.7 to 5 s had little effect on the final grain size (average of ASTM 1.85 and 2.0, respectively) but reduced the subgrain size (cell and dendrite spacing) by 24%, and increased the area fraction of MC-type carbides by approximately 50% area fraction — Table 5.

The decrease in the number of MC-type carbides under the slower cooling rate condition (12.7-s downslope) was attributed to the metastable nature of these carbides. The MC-type carbides form at the end of solidification due to the segregation of Nb that promotes a terminal eutectic reaction consisting of austenite and Nb-rich MC carbide (Ref. 30). Since the MC carbides are not a stable equilibrium phase at elevated temperatures (in FM-52 or FM-52M), they begin to dissolve into the matrix with additional time at temperature (slower cooling rate). While MC-type carbides have been proposed to improve cracking resistance by limiting grain boundary migration (Ref. 20), no significant grain size differences were observed optically. The effect of small changes in the amount and morphology of MC carbide on grain boundary tortuosity and grain boundary properties is still not fully understood, but these carbides have been attributed to greater resistance to DDC in some cases (Ref. 14). It is unclear if the improved resistance is the result of the MC-type carbides, the finer substructure, or a combination of both. A series of additional heat treatments to control carbide dissolution would be required to better understand this observation.

In arc welding, heat input affects the cooling rate in a similar manner as downslope does in the STF spot welds. Therefore, any variation in cracking resistance as a result of the spot weld has potential implications on the heat input in production welds. To date, no STF testing variable has been found with greater influence on DDC susceptibility than the downslope time of the spot welds.

Conclusions

1. The FM-52M-like filler metal with 2.5% Nb and 4% Mo had significantly improved DDC resistance at 950°C relative to other 30% Cr alloys and FM-82.

2. The FM-52M experimental alloys exhibited a large variation in DDC susceptibility that could not be simply explained by the minor differences in composition.

3. For preparation of the strain-to-fracture samples, the GTA spot weld downslope time and subsequent solidification microstructure had a significant effect on the DDC susceptibility. This is the most influential STF test variable evaluated to date.

4. Commercially pure Ni 200 was found to be extremely sensitive to DDC and is the most DDC susceptible alloy tested to date with the STF test.

5. Reducing the downslope time of the GTA spot weld was found to reduce DDC susceptibility in FM-52M. The faster cooling rate through the solidification temperature range promoted a finer solidification substructure and a higher fraction of MC carbide that improved the DDC resistance of the materials.

Acknowledgments

The authors would like to thank Sam Kiser of Special Metals, and Dr. Suresh Babu, Morgan Gallagher, Ray Unocic, and Kenny Izor from The Ohio State University for their assistance and insight during the course of this investigation. Thanks also to Special Metals Welding Products Co. for supplying filler metals and sample blanks used in some of the testing. Partial financial support for project was provided by BWXT, Inc.

References

1. Kiser, S. D., et al. 2005. Nickel alloy welding requirements for nuclear service. *Focus on Nuclear Power Generation* 2005.
2. Lin, W., and Cola, M. J. 1997. Weldability of Inconel filler metal 52. 78th American Welding Society Annual Meeting, Abstracts of Papers, April 13–17, Los Angeles, Calif.
3. Kikel, J. M., and Parker, D. M. 1998. Ductility-dip cracking susceptibility of filler metal 52 and Alloy 690. *Trends in Welding Research*, June 1–5, Pine Mountain, Ga.
4. Nissley, N. E. 2006. Intermediate temperature grain boundary embrittlement in nickel-base weld metals. Columbus, Ohio: The Ohio State University, p. 204, www.ohiolink.edu/etd/view.cgi?acc_num=osu1156949345.
5. Nishimoto, K., Saida, K., and Okauchi, H. 2006. Microcracking in multipass weld metal of Alloy 690, Part 1 — Microcracking susceptibility in reheated weld metal. *Science and Technology of Welding and Joining* 11(4): 455–461.
6. Ramirez, A. J., and Lippold, J. C. 2004.

High temperature behavior of Ni-base weld metal. I. Ductility and microstructural characterization. *Materials Science & Engineering A* 380(1-2).

7. Lippold, J. C., Clark, W. A. T., and Tumuluru, M. 1992. An investigation of weld metal interfaces. *The Metal Science of Joining*, published by The Metals, Minerals and Materials Society: 141-146.

8. Gooch, T. G., and Honeycombe, J. 1975. Microcracking in fully austenitic stainless steel weld metal. *Metals Construct.* 7(3): 146-148.

9. Yeniscavich, W. 1966. A correlation of Ni-Cr-Fe alloy weld metal fissuring with hot ductility behavior. *Welding Journal* 45(8): 344-s to 356-s and 384-s.

10. Newell. 1933. The performance of 18-8 at high temperature. *Book of Stainless Steel*. Ed. E. E. Thum. The American Society for Steel Treating, p. 364.

11. Nissley, N. E. 2002. Development of the strain-to-fracture test to study ductility-dip cracking in austenitic alloys. *Welding Engineering*. Columbus, Ohio: The Ohio State University, p. xv, 104 leaves.

12. Lippold, J. C., and Ramirez, A. J. July 2004. Insight into the mechanism of ductility dip cracking. *IIW-IX-2123-04*. Osaka, Japan.

13. Zhang, Y. C., Nakagaw, H., and Matsuda, R. 1985. Weldability of Fe-36%Ni alloy (Report V). *Transactions of JWRI* 14(2): 119-124.

14. Collins, M. G., Ramirez, A. J., and Lippold, J. C. 2004. An investigation of ductility-dip cracking in nickel-based weld metals — Part III. *Welding Journal* 83(2): 39-s to 49-s.

15. Ramirez, A. J., and Lippold, J. C. 2004. High temperature behavior of Ni-base weld metal. II. Insight into the mechanism for ductility dip cracking. *Materials Science & Engineering A* 380(1-2).

16. Hadrill, D. M., and Baker, R. G. 1965. Microcracking in austenitic weld metal. *British Welding Journal* 12(9).

17. Blum, B. S., and Witt, R. H. 1963. Heat-affected zone cracking in A-286 weldments. *Welding Journal* 42(8): 365-s to 370-s.

18. Honeycombe, J., and Gooch, T. G. 1970. Microcracking in fully austenitic stainless steel weld metal. *Metal Construction & British Welding Journal* 2(9): 375-380.

19. Nissley, N. E., et al. 2002. Development of the strain-to-fracture test for evaluating ductility-dip cracking in austenitic stainless steels and Ni-base alloys. *Welding in the World* 46(7/8): 32-40.

20. Collins, M. G., and Lippold, J. C. 2003. An investigation of ductility dip cracking in nickel-based filler metals — Part I. *Welding Journal* 82(10): 288-s to 295-s.

21. Special Metals Welding Products Co. 2006 cited. Visit www.specialmetals.com.

22. Ramirez, A. J., and Lippold, J. C. March 2004. New insight into the mechanism of ductility dip cracking in Ni-base weld metals. *1st International Workshop, Hot Cracking Phenomena in Welds*, 19-41. Berlin: Springer-Verlag.

23. Midwest Information Systems, I.M. *PAX-it* image management and image analysis software. 2006 cited. Visit www.paxit.com.

24. Wilcox, C. D., et al. *ImageTool*. 2002 cited. Visit ddsdx.uthscsa.edu/dig/itdesc.html.

25. Nishimoto, K., Mori, H., and Hongoh, S. 1999. Effect of sulfur and thermal cycles on re-heat cracking susceptibility in multi-pass weld metal of Fe-36% Ni alloy. *IIW Doc. IX-1934-99*.

26. Yzoung, G. A., et al. 2008. The mechanism of ductility dip cracking in nickel-chromium alloys. *Welding Journal* 87(2): 31-s.

27. Collins, M. G. 2002. An investigation of ductility dip cracking in nickel-base filler materials. The Ohio State University, p. xix, 240 leaves.

28. Lippold, J. C., and Nissley, N. E. 2008. Ductility dip cracking in high-Cr Ni-base filler metals. *International Workshop on Hot Cracking*. Berlin: Springer-Verlag.

29. Hemsworth, B., Boniszewski, T., and Eaton, N. F. 1969. Classification and definition of high temperature welding cracks in alloys. *Metal Construction & British Welding Journal*: 5-16.

30. DuPont, J. N., Robino, C. V., and Marder, A. R. 1998. Modeling solute redistribution and microstructural development in fusion welds of Nb-bearing superalloys. *Acta Materialia* 46(13): 4781-4790.

Call for Papers

1st International Conference on Welding Technologies '09
June 11-13, 2009
Gazi University, Ankara, Turkey

Abstract submission deadline: October 25, 2008

The following areas and topics are proposed as a guide for papers, but authors are not limited to these topics.

- Welding Metallurgy
- Welding Processes
- Industrial Applications
- Microjoining
- Automation
- Welding Design
- Mechanical Properties
- Welding Defects and Testing
- Modeling/Simulation
- Education and Training on Welding
- Advanced Welding Technologies
- Health and Environment

Authors are invited to submit abstracts of papers for presentation in the conference technical program. Abstracts must be 100-150 words and should not contain figures or tables. Abstracts should include title, name and full address of the author, and name and address of coauthors, if any. Authors should indicate whether they would prefer to present their papers orally or as a poster. Submit abstracts online at icwet09@gazi.edu.tr. For additional information, visit the conference Web site at www.icwet09.org.

Robotic Stud Welding Process Optimization with Designed Experiment

Weld process optimization of large-diameter, auto-feed, threaded stud short-cycle drawn-arc welding in plate vertical position

BY C. HSU, J. MUMAW, J. THOMAS, AND P. MARIA

ABSTRACT. This paper presents the findings of process optimization of using the short-cycle stud welding process to weld $\frac{3}{8}$ -in. (9.5-mm) auto-feed studs on vertically positioned $\frac{3}{8}$ -in. clean plates, with design of experiment (DOE) methodology in a 180-weld, two-level factorial design. Results were measured primarily by tensile strength, and showed that the welds were stronger than the studs during destructive tensile testing. Other quality considerations such as undercut, expulsion, flash ring formation, and the stable process signals were also recorded and used as acceptance criteria.

It was found that cool, slow arc energy delivery is the best method with optimum results and process stability. It can be concluded with a 99% confidence level that good tensile value and a strong weld (relative to shank) can be achieved using optimum welding parameters (stud-negative polarity, low lift height, cool and slow energy delivery).

It was also found that undercut is minimized with lower arc energy; uniform flash ring can be attained with stud-negative polarity and lower lift; spatter and smut can be avoided with lower arc energy and lower lift. In addition, pilot arc energy was not a significant factor relative to other factors in the ranges studied. Lastly, both tri-mix and argon+CO₂ gases can be used for the application with similar process tolerance.

The findings are based on lab conditions to study carefully controlled process factors while suppressing other "noise" factors. In a production environment, there are many factors that can affect the weld quality not studied in this DOE, such as arc blow, gas leak or blockage, stud feeding, handling and positioning, chuck deterioration, weld cable deterioration, part surface contamination, etc. The introduction of these factors can result in new optimization of process variables and conditions.

C. HSU, J. MUMAW, J. THOMAS, and P. MARIA are with Nelson Stud Welding, Inc., Elyria, Ohio, www.nelsonstud.com.

Background and Objective

To improve weld quality and productivity in a global economy, many fabricators have resorted to robotic automation to manufacture switch gears, agricultural equipment, construction equipment, and transformer enclosures. For stud welding this means to automate stud feed using studs designed for a feeder, short-cycle stud welding process, and a servo-electric head held by a robot arm.

Short-cycle welding is a special drawn-arc stud welding process with a very short weld time and without ferrule. The benefit of ferrule-less welding is that it lends itself to automation, with automatic stud feed, in high-volume automotive and industrial applications. A typical welding setting for 9-mm studs is 800 A and 120 ms, but it is necessary to test the welds for a specific application to reduce susceptibility to porosity and brittleness (Ref. 1). Short-cycle welding can be practiced with or without gas shielding depending on the suitability of the application.

Design of experiment (DOE) is used to evaluate process variables in automotive stud welding applications (Ref. 2). It was found that stud geometry and stud polarity play a large role in weld quality. In addition, the study found shear strength is a better quality indicator than torsion strength in automotive sheet metal stud welding.

The short-cycle process replaces ferrules with shielding gas; however, this process is usually limited by the stud diameter, and in some cases, welding positions. In order to meet the return-on-in-

vestment requirement, the robot must weld in both plate horizontal (flat) position and plate vertical position (stud horizontal) to justify the investment. Previous studies in Nelson (Ref. 3) have shown that up to 20% of the welds failed in the plate vertical position with $\frac{3}{8}$ -in. (9.5-mm) Auto-feed Threaded Carbon (ATC) steel studs.

The objective of this study was to employ design of experiment (DOE) methodology to optimize the welding process variables and to determine process viability in the plate vertical position.

Experiment and Experimental Procedures

Experimental Design

The experiment was a two-level factorial design in six variables: stud polarity, gas type, weld current, weld time, lift distance, and pilot arc energy (Table 1).

The Pilot Amp Second (amp*s) (factor F) represents pilot arc energy. The low level of F is 1.6, from 0.04 s multiplied by 40 A. The high level of F, 10, is a product of 0.1 s and 100 A. The shielding gas (Ar+CO₂) was a mixture of 90% argon and 10% CO₂ gas. The other gas chosen was a tri-mix, at 90% helium, 7.5% argon, and 2.5% CO₂. Five replicates were chosen with a total of 180 runs, among them 20 center points without blocking. The input factors and their ranges were chosen based on the previous two experiments (Ref. 2) and general knowledge in short-cycle welding of this particular type of stud.

The output factors were undercut, expulsion, tensile strength, location of failure, and process monitor output from the welding machine. The undercut had a rating from 1 to 3 (with 1 \geq 10%, 2 < 10%, and 3 equaling 0%). The expulsion (including spatter and smut) had a rating from 1 to 3 (with 1 meaning excessive, 2 equaling some, and 3 being little or no). The tensile was the ultimate strength in lbf. Flash ring percent was a measure of the completeness of flash metal at the base

KEYWORDS

Drawn Arc Stud Welding
Robotic Stud Welding
Designed Experiment
Process Optimization for
Volume Production

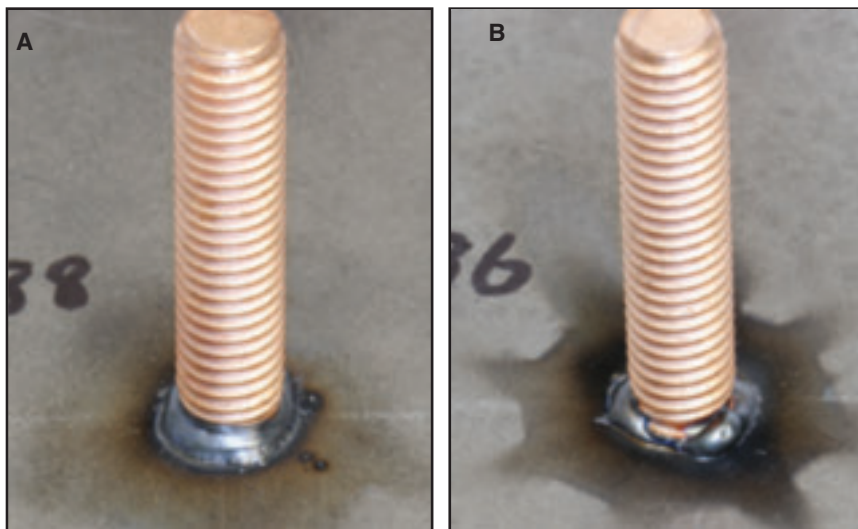

Fig. 1 — Examples of 3/8-in. ATC stud welded to 3/8-in. plate. A — Complete flash ring; B — incomplete.

of the welded stud from 0–100% — Fig. 1. Location of failure in the tensile test is coded 0 for the weld and 1 for the shank. The N3 welding machine monitored key process variables, including actual weld current, actual weld time, plunge distance, lift distance, and weld voltage, with a pass/fail window set at ± 100 A in weld current and ± 5 ms in weld time. The weld monitor signal (Process QA) response was coded 0 for fail and 1 for pass.

Materials

The base metal was 3/8-in.- (9.5-mm-) thick, AISI 1018 low-carbon steel (HR bar stock), cut into 3 \times 3-in. squares for one weld

per square. The squares were free from oil contamination and surface coating.

The studs used were the 3/8-in. (9.5-mm-) diameter ATC studs in AISI 1008 with copper flash plating, having a conical-shaped weld base of 11 mm diameter and a 7-deg taper.

Equipment

The welding machine used was Nelson's N3 with 1800-A output capacity. Feeder FSE100 was used to feed the stud pneumatically and servoelectric weld head KSE100 is positioned horizontally toward the base metal — Fig. 1. KSE100 can be programmed to position the stud in

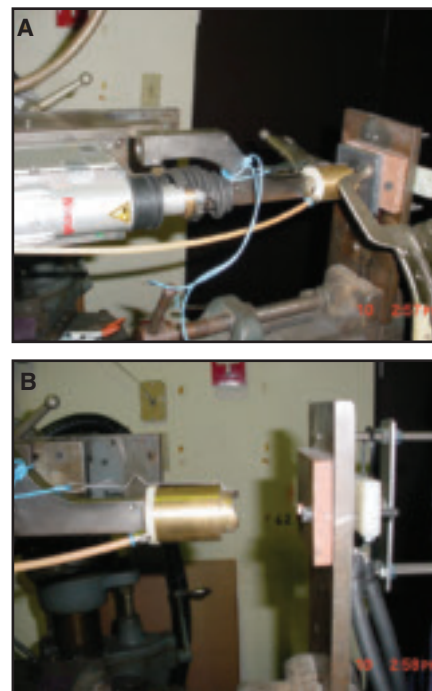

Fig. 2 — Stud welding DOE test fixture showing the following: A — KSE100 gun; B — grounding.

increments of 0.1 mm precisely during approach, lift, and plunge.

Figure 2B shows a copper plate and a spring-loaded plunger that is aligned coaxially with the stud to pass the current directly to the ground cables behind the fixture. This ensures the most reliable grounding and that asymmetric ground current flow is not a contributing noise factor in the DOE. Part loading and unloading were done manually, and it was clamped down with a C-clamp to the copper backup support block and the plunger. An ad hoc gas shielding cup with adequate side vents was used to provide gas shielding.

Results and Discussion

Weld Quality Response Models

Table 2 summarizes the weld quality

Table 1 — DOE Input Factors and Their Ranges

Factor	Name	Units	Type	Low Actual	High Actual
A	Polarity		Categoric	stud+	stud-
B	Gas Type		Categoric	tri-mix	Ar+Co ₂
C	Weld Current	amp	Numeric	1000	1800
D	Weld Time	ms	Numeric	60	100
E	Lift	mm	Numeric	1.5	3.5
F	Pilot Amp Sec	amp*s	Numeric	1.6	10

Table 2 — DOE Response Surface Models Expressed in Coded Input Factors

Weld Quality	Statistical Model	Probability > F
Undercut	Undercut = 2.03–0.41 * C–0.29 * D	<0.0001
Flash Ring %	Sqrt(FlashRing) = 6.26+1.62 * A+0.98 * C+0.53 * D–0.84 * E –0.85 * A * C+0.90 * A * E–1.09 * C * D	<0.0001
Expulsion	Expulsion = 1.90–0.51 * C–0.20 * D–0.19 * E–0.16 * C * D	<0.0001
Tensile	Tensile Strength = 6670.57–417.24 * A+25.74 * B–96.89 * C –145.48 * D+59.08 * A * B–194.16 * A * C–213.52 * A * D +394.43 * B * C+294.44 * B * D–449.79 * C * D +372.52 * A * B * C+292.56 * A * B * D–369.33 * A * C * D	<0.0001
Tensile Break Location	Sqrt(FailureLocation) = 0.64 + 0.044 * C + 0.019 * D–0.21 * C * D	<0.0001
Weld Monitor Signal	(Process QA + 0.01) ^ 1.86 = 0.89 + 0.032 * C + 0.032 * E – 0.13 * C * E	<0.0001

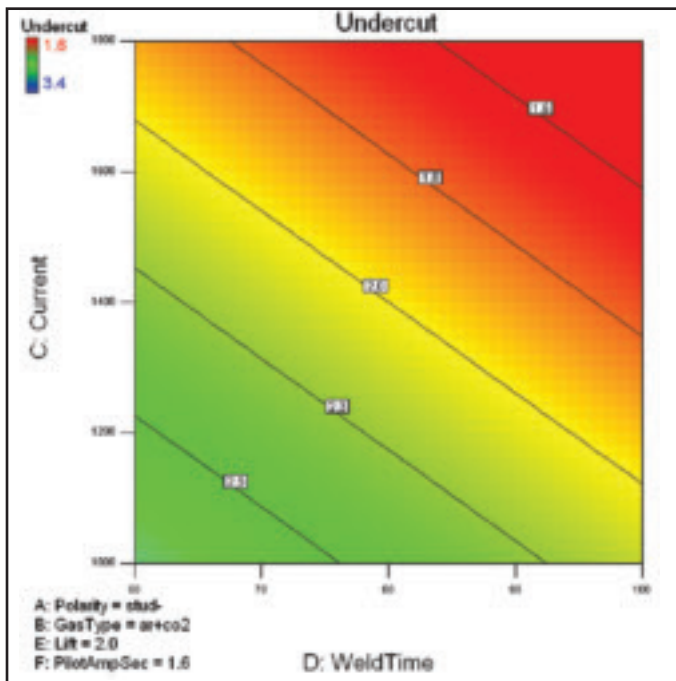

Fig. 3 — Undercut as a function of weld current and time (green = no undercut, red = a lot of undercut).

DOE output response models in terms of coded input factors listed in Table 1. All input factors are coded as -1 to +1.

The last column in Table 2, Probability > F, is a statistical measurement of the likelihood that the observed behavior could have occurred purely as a result of random error. The smaller the value of Probability > F, the greater the significance of the model. All models are chosen to be as simple as possible without transformation while being very significant and passing all statistical diagnostic tests including residuals and Box-Cox plot.

Subjective Weld Qualities

Undercut was influenced by weld current and time as shown as a color contour diagram in Fig. 3. A score of 3 in undercut is the best performance associated with “green” color or “go,” while a score of 1 is the worst performance with “red” color or “no go.” Lower arc energy inhibits undercut in the green lower-left corner.

The flash ring completeness involves four factors, with polarity as the dominant factor as shown in Fig. 4. Stud-negative polarity and lower lift produce a fuller flash ring. With stud negative, green bipolar-distributed “go” regions of fuller flash ring could be achieved either with the hot-and-fast weld or the cool-and-slow weld settings shown in two opposing green corners.

As shown in Fig. 5, lower arc energy reduces expulsion. Moreover, lower lift (Fig. 5A) has a larger green zone than the higher lift (Fig. 5B).

Weld quality monitor (Process QA pass/fail) model in Fig. 6 indicates that at low welding current, high lift is desirable, and at high welding current, lower lift is desirable.

Objective Weld Qualities

The tensile strength model was the most complex, with many 2 or 3 factor interactions (see Fig. 7 and Table 2). The maximum tensile strength was 7435 lbf (33.0 kN) and minimum was 1268 lbf (5.6 kN). A total of 123 weldments (68%) broke at the shank with tensile strength ranging from 6923 to 7435 lbf (30.8–33.0 kN). The remaining 57 weldments broke at the weld with half of them exceeding 6095 lbf (27.1 kN) tensile. In other words, half of the weld broke at a high tensile value, indistinguishable from the shank break. Figure 7A is a tensile model with argon+CO₂ gas, while Fig. 7B is the model with the tri-mix gas. It can be observed that the low arc energy corner (cool and fast) is red for the cooler argon+CO₂ gas while the high arc energy corner (hot

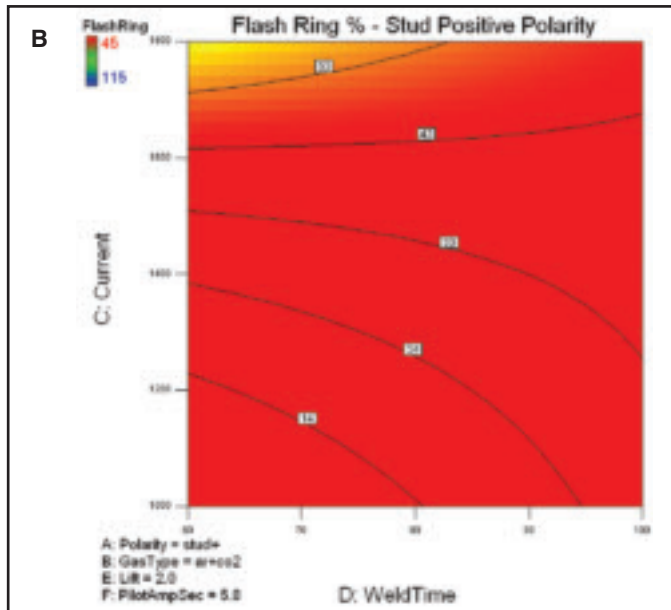
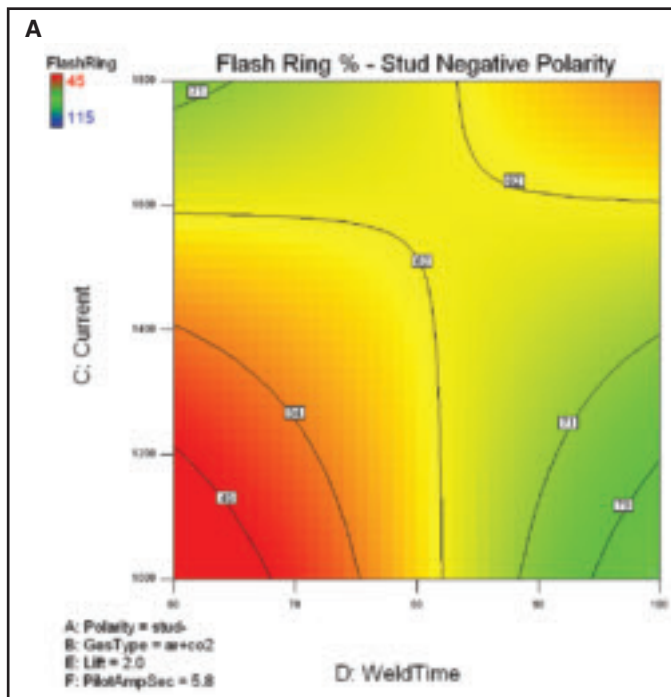

Fig. 4 — Flash ring completeness as a function of weld current and time (green = more than 70%, red = under 40%). A — Stud negative; B — stud positive.

and slow) is red for the hotter tri-mix gas. Interestingly both lift (E) and pilot arc amp*s (F) are not significant factors in determining tensile strength.

Failure location, or the break location when the weldment is subject to a tensile test, is a strong function of arc energy. Figure 8 clearly shows the bipolar behavior of failure location as a function of arc time and current (stud negative, argon+CO₂ gas, 2.0-mm lift, pilot amp*s 5.8). Stronger welds (stronger than the shank) can be achieved with low current and long weld time (cool and slow), or high current but short weld

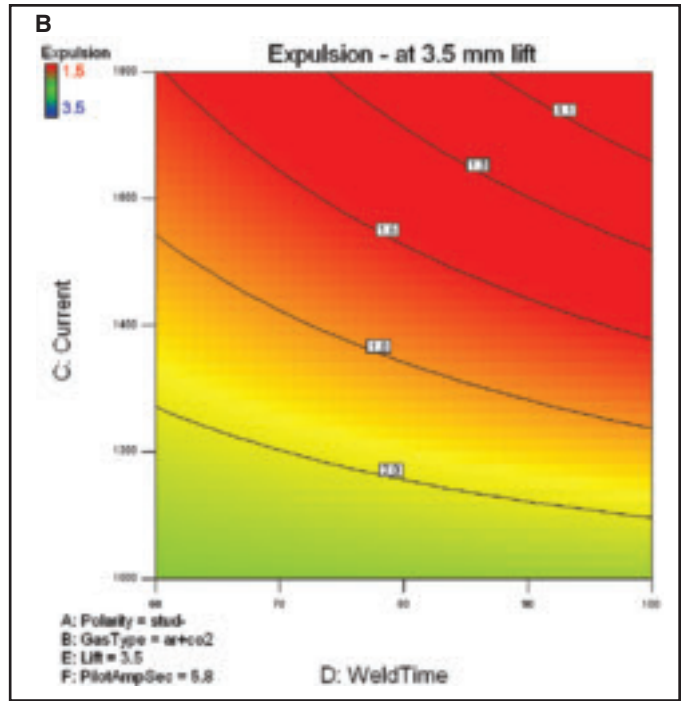
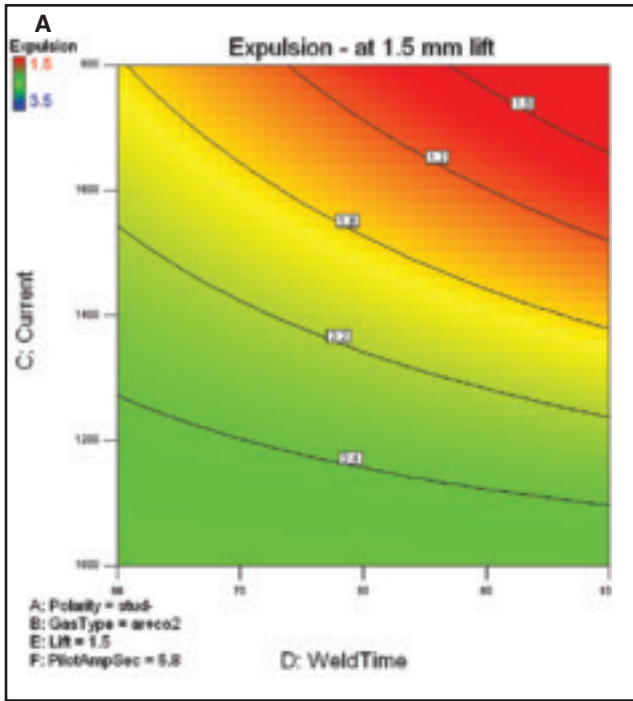

Fig. 5 — Expulsion as a function of weld current and time (green = little expulsion, red = lots of expulsion). A — Low lift; B — high lift.

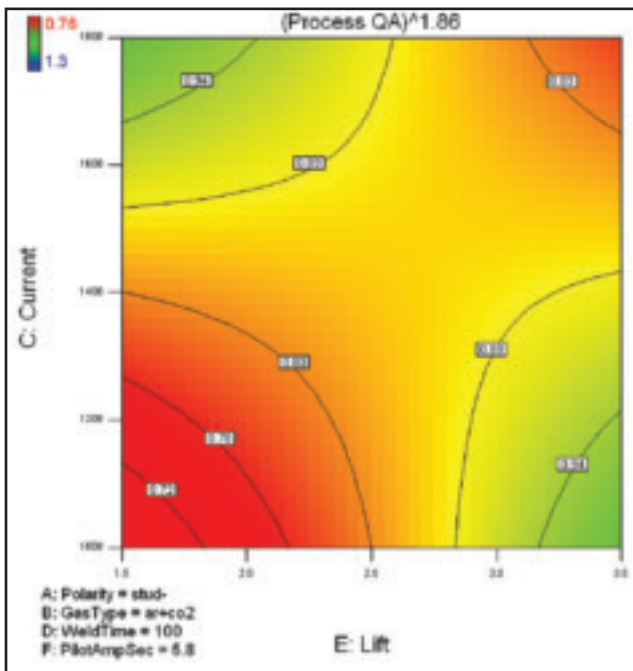

Fig. 6 — Weld quality monitor pass/fail signal as a function of weld current and lift distance.

time (hot and fast). This can be explained that a certain amount of energy input (100–108 amp*s) yields good welds, while too much energy (hot and slow) or too little (cool and fast) do not.

When tensile value (Fig. 7) and tensile break location (Fig. 8) are compared, it can be observed that the break location is a more demanding objective quality criteria with a less liberal process parameter range. If Figs. 7 and 8 are overlapped, it can be observed that the two green corners in Fig. 8 happen to be green in Fig. 7 also. These two corners represent the hot-and-fast and cool-and-slow settings, respectively, re-

gardless of shielding gas. Furthermore, tensile failure location (Fig. 8) is more restrictive than tensile strength (Fig. 7) in the selection of green operating conditions.

Operating Window Analysis

To assess the overall weld performance taking all the responses into consideration, an “operating window analysis” method was used. This method establishes acceptance criteria for each response and maps out the green “go” region where all the responses passed its respective criteria, and “no go” red region where any response fails its acceptance criteria. Two objective weld quality criteria were chosen somewhat arbitrarily below:

- Tensile Strength ≥ 6000 lbf (26.7 kN)
- Tensile Failure Location ≥ 0.5 (its square root is > 0.707).

Figure 9 maps the green/red regions, demarcated by tensile strength and tensile break location. Each factor pass/fail line carves out a pass/fail region in the map. For example, the tensile strength pass/fail curve goes across from the upper-left corner to the lower-right corner, with the area under the curve higher than 6000 lbf (26.7 kN) (pass) and the area above fail. The tensile failure location of 0.5 has two curves, marking break location in the upper-left corner and lower-right corner higher than 0.5. Only when all factors pass its respective acceptance criteria, the region shows green on the map. There are two green “go” zones on the maps, the hot-and-fast upper corner, and the cool-and-slow lower corner. The change of gas

Table 3 — Relative Importance and Optimization Goal of Weld Quality Measures

Quality	Optimization Goal	Importance
Undercut	Maximize	+++
Flash Ring %	Maximize	+++
Expulsion	Maximize	+++
Tensile Strength	Above 5000, maximize	+++++
Tensile Break Location	Maximize	+++++
Weld Monitor Signal	Maximize	+++

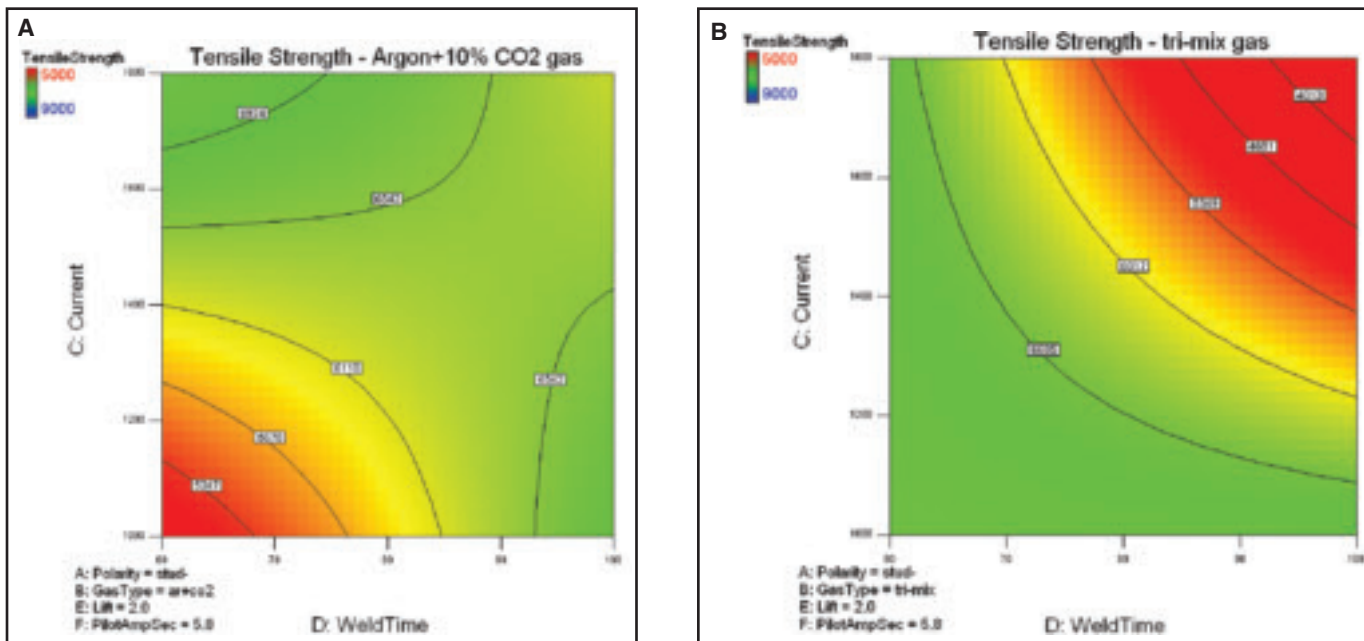

Fig. 7 — Tensile strength as a function of weld current and weld time. A — With Ar+CO₂ gas; B — with tri-mix.

from tri-mix (Fig. 9A) to argon+CO₂ (Fig. 9B) moves up the tensile strength acceptance curve in the map.

When additional subject factors are considered as follows with somewhat arbitrary pass/fail criteria, the maps are busier (Fig. 10):

- Undercut ≥ 2.0
- Flash ring completeness $> 75\%$
- Expulsion ≥ 2.0
- Weld Monitor Signal ≥ 0.85

It can be observed in Fig. 10 that the green “go” zone is obtained only with the “cool and slow” arc energy delivery method. The upper-left corner (hot and fast) of the green zone in Fig. 9 is disqualified. The combinational demands of undercut and flash ring completeness preclude the hot-and-fast weld procedure as a viable option.

Desirability Analysis

The desirability method of searching for stable, good welding parameters is introduced here.

While the operating window uses pass/fail for weld quality criteria selection to find common pass regions, another method of searching for good welding parameters is the desirability analysis. The relative importance given to each quality and the optimization goal of each quality measure is given in Table 3. The least important quality is given one plus, and the most important quality is given five pluses. The importance gives the relative contribution of each quality measure to the “desirability” function, and the optimization goal relates each quality to desirability lin-

early. For example, 0 tensile desirability is assigned to tensile values of 5000 lbf (22.2 kN) and below, 1 tensile desirability is assigned to 7435 lbf (33.0 kN), and the tensile desirability in between the two tensile values is linearly interpolated. The contribution of tensile strength to overall desirability is four pluses. Since the tensile break location is the most objective criteria, it is given five pluses in importance, followed by tensile strength with four pluses. The normalized result of desirability (from 0 to 1 scale, and 1 as the most desirable) as a function of input factors is shown in Fig. 11.

It can be observed in Fig. 11 that the greatest desirability (> 0.76) with both gases can be found in the cool-and-slow procedure. Also, good desirability (> 0.715) can be found in the hourglass-shaped zone from the left-upper corner to the right bottom, sandwiched by the two 0.715 curves. The hourglass zone corre-

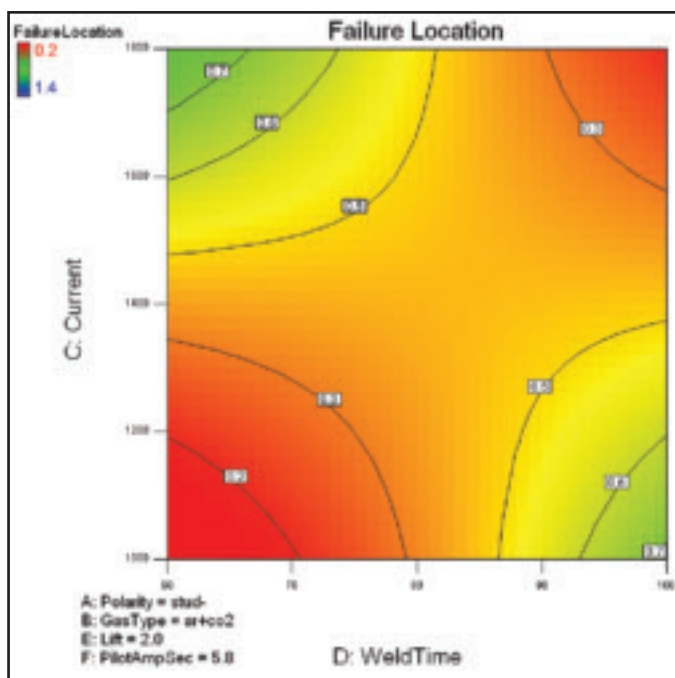

Fig. 8 — Tensile break location as a function of weld current and weld time (1 at shank, 0 at weld).

sponds to a certain level of arc energy that yields good overall quality desirability. Furthermore, the larger red zone in the tri-mix chart (Fig. 11A) suggests the hot tri-mix gas has less tolerance with hot-and-slow excessive arc energy. The presence of the red zone in the argon+CO₂ chart (Fig. 11B) suggests that the cooler gas has less tolerance with cool-and-fast insufficient arc energy.

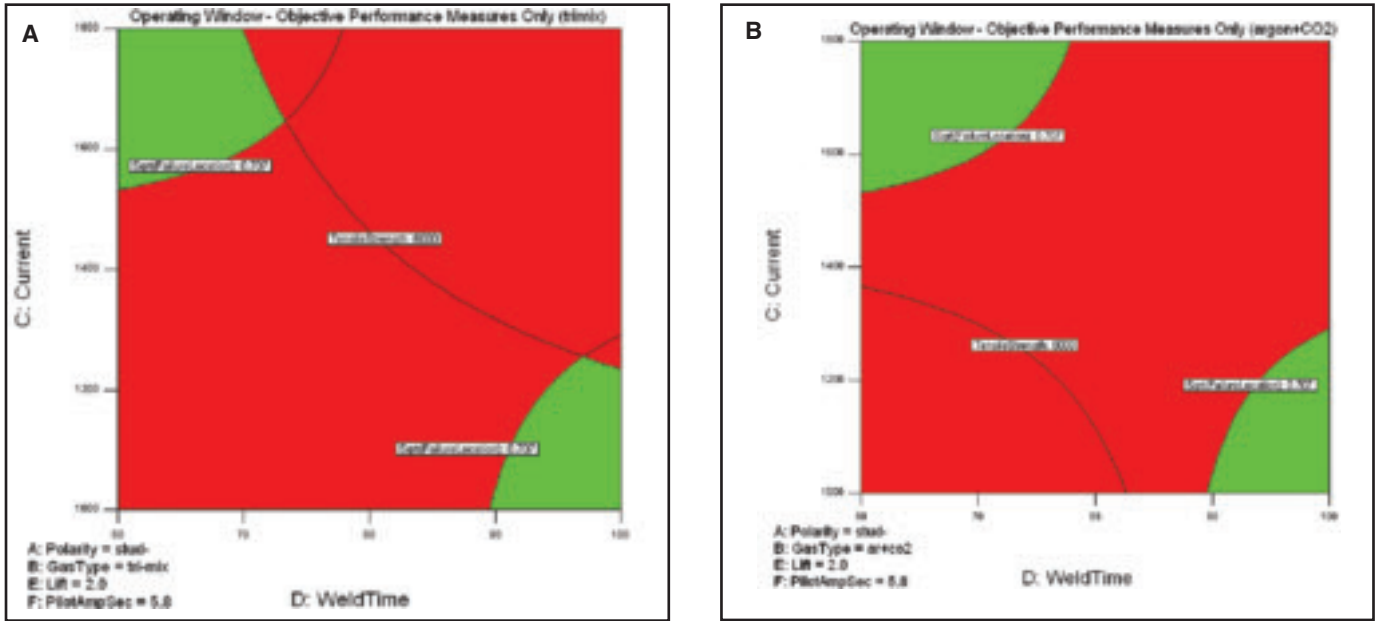

Fig. 9 — Operating window using objective quality measures only (tensile strength and break location). A — Tri-mix gas; B — argon + CO₂ gas.

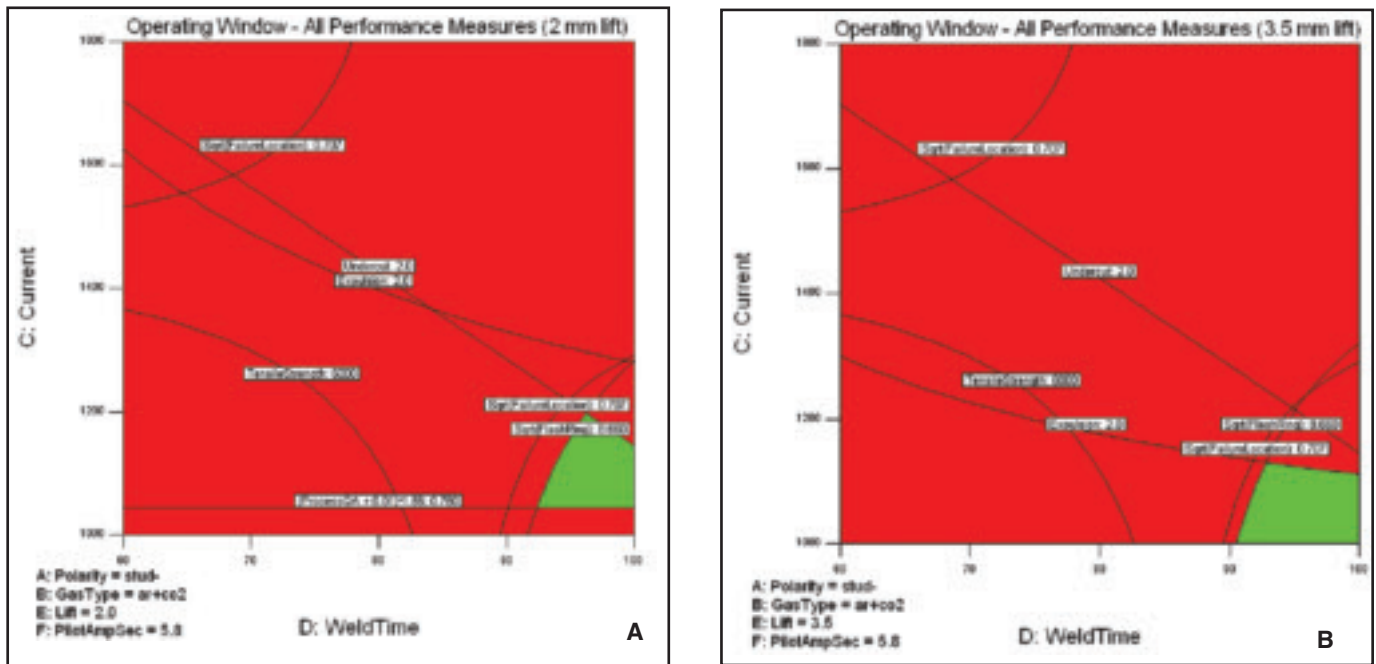

Fig. 10 — Operating window with all quality measures considered. A — 2-mm lift; B — 3.5-mm lift.

Table 4 — Weld Performance Statistics of Optimum Settings

Weld Quality	Prediction	SE Mean	99% CI		SE Pred	99% PI	
			low	high		low	high
Undercut	2.200	0.092	1.910	2.390	0.690	0.350	3.950
Flash Ring %	88.9	0.2	66.3	114.9	5.3	11.8	237.8
Expulsion	2.200	0.080	1.980	2.400	0.460	0.980	3.400
Tensile Strength	6909	209	6364	7455	749	4957	8862
Tensile Break Loc	0.681	0.004	0.436	0.980	0.176	0.068	3.648
Weld Monitor Signal	0.990	0.194	0.912	1.063	0.523	0.411	1.362

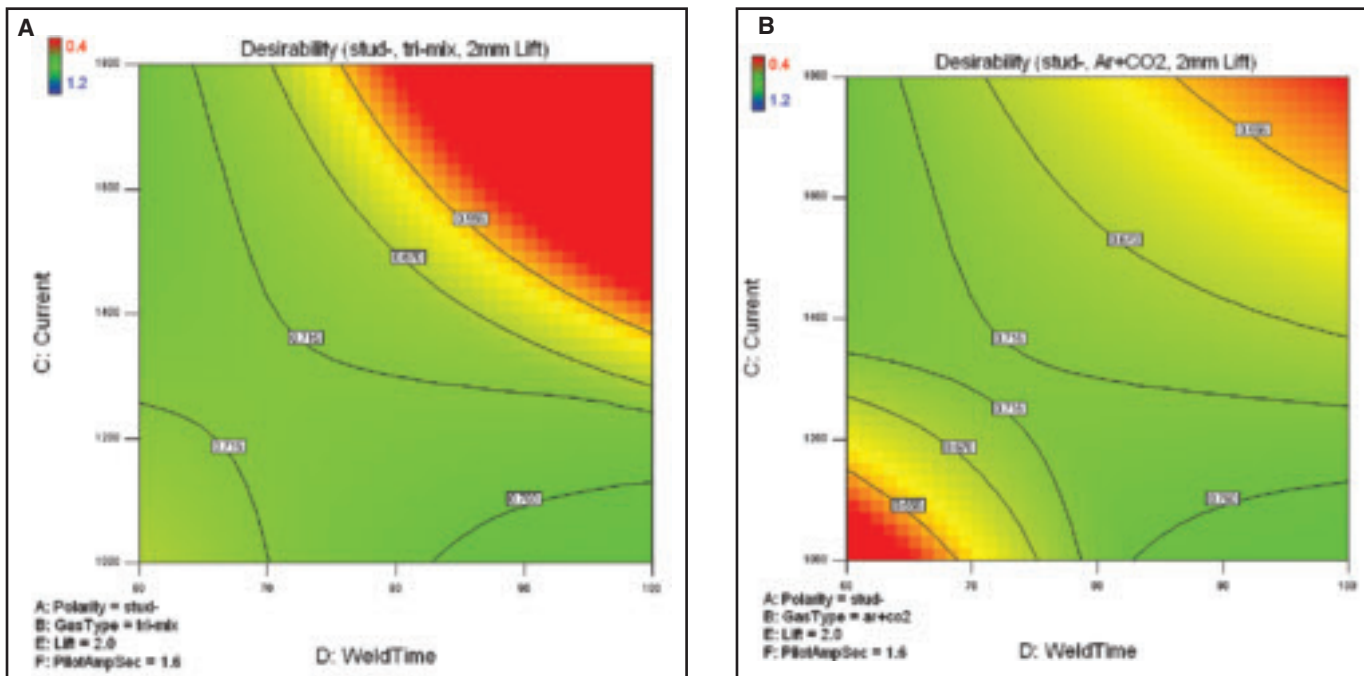

Fig. 11 — Desirability as a function of weld time and current. A — Tri-mix gas; B — argon+CO₂ gas.

Weld Quality Prediction Using Optimum Process Parameters in Production

The statistical behavior of weld quality metrics for a hypothetical production run with a selected weld setting can be predicted from the response surface models. Table 4 exhibits the predicted weld quality metrics with a cool-and-slow point picked in the green operating windows in Figs. 10 and 11: stud negative, argon+CO₂ gas, 1000-A current, 100-ms arc time, 3.5-mm lift, and 1.6 pilot amp*s. SE is standard error, CI is confidence interval of average, and PI is prediction interval, which is larger than CI from more scatter in individual values than in averages of the replicates. In other words, CI is based on average, and PI is based on worst case.

It can be observed in Table 4 that we have 99% confidence level of a tensile value between 6364 and 7455 lbf (28.3 and 33.2 kN), with little or no expulsion or undercut, and 70–96% flash ring completeness, using the average confidence interval (CI). Using the worst case scenario using individual replicate data (PI), one can predict with 99% confidence that a weld strength > 4957 lbf (22.0 kN) can be achieved along with unpredictable results

in undercut, flash ring formation, expulsion, tensile break location during tensile and actual welding signals. It should be pointed out that a tensile break location under 99% PI low is 0.068 or breaks at the shank.

Weld Verification Tests

Weld verification tests were performed with both argon+CO₂ gas and a tri-mix gas. For argon+CO₂ gas, the setting includes stud negative, 1800 A, 60 ms, 2.2-mm lift, and 40-A/40-ms pilot arc. For the tri-mix gas, the setting includes stud negative, 1000 A, 90 ms, 2.2-mm lift, and 40-A/40-ms pilot arc. Thirty-five welds were made using each gas. All welds passed the weld monitor and all weldments broke at the shank when subjected to tensile testing



Fig. 12 — Weld samples prior to tensile testing.

— Fig. 12. The statistics of other qualities are shown in Table 5.

Conclusions

A designed experiment was conducted to short-cycle weld a 3/8-in.-diameter ATC stud to a vertically positioned, clean, low-carbon steel plate of 3/8-in. thickness. The DOE is a two-level factorial design with two categorical factors (output polarity, shielding gas) and four numeric factors (arc current, arc time, lift distance, and pilot arc energy) with a total of 180 welds. The following was found:

Table 5 — Performance Statistics of Weld Verification Tests

Gas	Undercut		Flash Ring		Expulsion		Tensile Strength	
	Average	Std. Dev.	Average	Std. Dev.	Average	Std. Dev.	Average	Std. Dev.
Ar/CO ₂	2.24	0.70	88.5	12.8	2.06	0.24	7238	147
Tri-Mix	2.86	0.42	98.3	6.8	2.00	0.00	7297	124

1. Cool and slow arc energy delivery resulted in the best outcome of observed weld performance metrics, including high tensile, weld stronger than stud shank, low undercut and expulsion, complete flash ring, and stable process signals.

2. Using argon+CO₂ gas, stud-negative polarity, 1000-A arc current, 100-ms arc time, 3.5-mm lift, and 1.6 pilot amp*s, it can be predicted with 99% confidence that the tensile value exceeds 4957 lbf (22.0 kN).

3. With optimum parameters, in a worst-case scenario, one cannot predict if

the weld is stronger than the shank in a tensile test, nor if appearance and expulsion are satisfactory.

4. Lower arc energy from low weld current and/or weld time reduces undercut.

5. Stud-negative polarity and lower lift form a more uniform flash ring.

6. Lower arc energy and lower lift reduce expulsion.

7. Pilot arc energy is not a significant factor relative to other factors studied in the ranges studied.

8. Both tri-mix and argon+CO₂ can be used for the application with similar

process tolerance. Avoid high arc energy with tri-mix and avoid low arc energy with argon+CO₂.

References

1. *Welding Handbook*, Vol. 2, Welding Processes, Part 1, Ninth Edition. 2004. Miami, Fla.: American Welding Society, pp. 416–419.

2. Ramasamy, S., Gould, J., and Workman, D. 2002. Design-of-experiments study to examine the effect of polarity on stud welding. *Welding Journal* 81(2): 19-s to 26-s.

3. Mumaw, J., ADR #505 Test Report, Nelson Stud Welding Internal Report.

WELDING JOURNAL

Instructions and Suggestions for Preparation of Feature Articles

Text

- approximately 1500–3500 words in length
- submit hard copy
- submissions via disk or electronic transmission — preferred format is Mac but common PC files are also acceptable
- acceptable disks include zip, CD, and DVD.

Format

- include a title
- include a subtitle or “blurb” highlighting major point or idea
- include all author names, titles, affiliations, geographic locations
- separate paper into sections with headings

Photos/Illustrations/Figures

- glossy prints, slides, or transparencies are acceptable
- black and white and color photos must be scanned at a minimum of 300 dpi
- line art should be scanned at 1000 dpi
- photos must include a description of action/object/person and relevance for use as a caption
- prints must be a minimum size of 4 in. x 6 in., making certain the photo is sharp
- do not embed the figures or photos in the text
- acceptable electronic format for photos and figures are EPS, JPEG, and TIFF. TIFF format is preferred.

Other

- illustrations should accompany article

- drawings, tables, and graphs should be legible for reproduction and labeled with captions
- references/bibliography should be included at the end of the article

Editorial Deadline

- January issue deadline is November 21
- February issue deadline is December 19
- March issue deadline is January 23
- April issue deadline is February 20
- May issue deadline is March 23
- June issue deadline is April 20
- July issue deadline is May 22
- August issue deadline is June 22
- September issue deadline is July 24
- October issue deadline is August 21
- November issue deadline is September 21
- December issue deadline is October 22

Suggested topics for articles

- case studies, specific projects
- new procedures, “how to”
- applied technology

Mail to:

Mary Ruth Johnsen
Editor, Welding Journal
550 NW LeJeune Road
Miami, FL 33126
(305) 443-9353, x 238; FAX (305) 443-7404
mjohansen@aws.org



IGNITE

INNOVATION GIVES NEW IMPORTANCE TO EFFICIENCY

OMEGA™ MIG-GUNS

- 250 - 450 amperes



ALPHA® MIG-GUNS

- 180 - 450 amperes



MB MIG-GUNS

- 180 - 350 amperes



Technology for the
Welder's World.



Alexander Binzel Corporation
650 Medimmune Ct., Suite 110
Frederick, Maryland 21703
Phone: 800.542.4867
Fax: 301.846.4497

For Info go to www.aws.org/ad-index

www.abicorusa.com



I CHOOSE LINCOLN.™



▶ MIG Welders ▶ TIG Welders ▶ Engine Driven Welders

www.lincolnelectric.com

LINCOLN®
ELECTRIC
THE WELDING EXPERTS®

For Info go to www.aws.org/ad-index