



ELECTRICAL FITTINGS & SUPPLIES



TOPAZ™

Friendly Service... Powerful Solutions

TABLE OF CONTENTS

EMT CONDUIT	1
LIQUID TIGHT	2
BX-FLEX-MC	3
NM CABLE	4
SERVICE ENTRANCE	5
CONDUIT BODIES	6
CONDUIT SUPPORT	7
RIGID-IMC CONDUIT	8
TUBULAR PRODUCTS	9
FLEXIBLE CORD	10
NYLON PRODUCTS	11
GROUNDING	12
WIRE ACCESSORIES	13
BOX ACCESSORIES	14
FIXTURE ACCESSORIES	15
HANGING & SUPPORT DEVICES	16
PVC - SCHEDULE 40	17
HVAC	18
WEATHERPROOF	19
INDEX	20

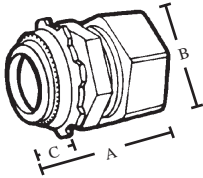

CAT#	A	B	C
651/651i	1.26	1.10	.420
652/652i	1.34	1.31	.420
653/653i	1.49	1.67	.525
654/654i	1.67	2.10	.630
655/655i	1.87	2.30	.620
656/656i	2.01	2.85	.680
657/657i	2.63	3.70	.860
658/658i	2.77	4.49	1.01
659/659i	2.77	5.06	.94
660/660i	2.77	5.63	1.00

EMT CONNECTORS COMPRESSION TYPE

• CONCRETE TIGHT 1/2" - 4"

ZINC DIE CAST

TOPAZ CAT #	UPC#	SIZE	UNIT CTN	SHIP CASE	WT/ CASE
651	16590	1/2"	50	500	50
652	16600	3/4"	25	250	35
653	16610	1"	50	200	40
654	16620	1 1/4"	—	25	10
655	16630	1 1/2"	—	20	11
656	16640	2"	—	15	12
657	16650	2 1/2"	—	12	13
658	16660	3"	—	12	16
659	16670	3 1/2"	—	10	18
660	16680	4"	—	6	12



1/2"-2"
2 1/2"-4"

E148720
E148716

INSULATED THROAT

651i	16690	1/2"	50	200	50
652i	16700	3/4"	25	250	35
653i	16710	1"	50	200	40
654i	16720	1 1/4"	—	25	10
655i	16730	1 1/2"	—	20	11
656i	16740	2"	—	15	12
657i	16750	2 1/2"	—	12	13
658i	16760	3"	—	12	16
659i	16770	3 1/2"	—	10	18
660i	16780	4"	—	6	12



1/2"-2"
2 1/2"-4"

E148720
E148716

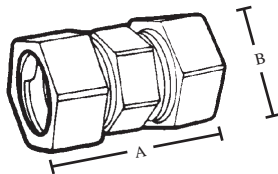

CAT#	A	B
661	1.50	1.10
662	1.62	1.31
663	1.84	1.67
664	2.05	2.10
665	2.47	2.30
666	2.56	2.85
667	3.29	3.70
668	3.42	4.49
669	3.51	5.06
670	3.54	5.63

EMT COUPLINGS COMPRESSION TYPE

• CONCRETE TIGHT 1/2" - 4"

ZINC DIE CAST

TOPAZ CAT #	UPC#	SIZE	UNIT CTN	SHIP CASE	WT/ CASE
661	16910	1/2"	50	500	60
662	16920	3/4"	25	250	48
663	16930	1"	50	200	56
664	16940	1 1/4"	—	25	11
665	16950	1 1/2"	—	20	14
666	16960	2"	—	15	14
667	16970	2 1/2"	—	12	16
668	16980	3"	—	12	21
669	16990	3 1/2"	—	10	22
670	17000	4"	—	6	15



1/2"-2"
2 1/2"-4"

E148720
E148716

EMT CONNECTORS SET SCREW TYPE

• CONCRETE TIGHT WHEN TAPED

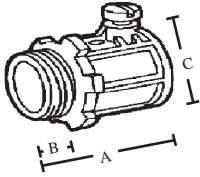

CAT#	A	B	C
631/631i	1.16	.400	1.06
632/632i	1.39	.400	1.30
633/633i	1.55	.520	1.52
634/634i	1.93	.560	1.95
635/635i	2.28	.720	1.18
636/636i	2.50	.730	2.64
637/637i	3.08	.920	3.27
638/638i	3.37	1.050	3.91
639/639i	3.46	1.050	4.46
640/640i	3.75	1.050	4.99

1/2"-1" 1 SCREW
1 1/4"-4" 2 SCREW

ZINC DIE CAST

TOPAZ CAT #	UPC#	SIZE	UNIT CTN	SHIP CASE	WT/ CASE
631	16290	1/2"	50	500	35
632	16300	3/4"	25	250	25
633	16310	1"	50	200	30
634	16320	1 1/4"	—	25	8
635	16330	1 1/2"	—	25	10
636	16340	2"	—	20	11
637*	16350	2 1/2"	—	12	10
638*	16360	3"	—	12	12
639*	16370	3 1/2"	—	10	13
640*	16380	4"	—	6	9

INSULATED THROAT

631i	16390	1/2"	50	500	35
632i	16400	3/4"	25	250	25
633i	16410	1"	50	200	30
634i	16420	1 1/4"	—	25	8
635i	16430	1 1/2"	—	25	10
636i	16440	2"	—	20	11
637i*	16450	2 1/2"	—	12	10
638i*	16460	3"	—	12	12
639i*	16470	3 1/2"	—	10	13
640i*	16480	4"	—	6	8

*EMT & RIGID



1/2"-1 1/2"
2"-4"



E18472
E148716



1/2"-1 1/2"
2"-4"



E18472
E148716

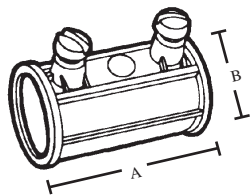

CAT#	A	B
641	1.53	0.93
642	1.92	1.16
643	1.00	1.44
644	2.52	1.84
645	2.85	2.05
646	3.41	2.51
647	4.21	3.30
648	4.67	4.01
649	4.85	4.52
650	5.47	5.01

1/2"-1" 2 SCREW
1 1/4"-4" 4 SCREW

EMT COUPLINGS SET SCREW TYPE

• CONCRETE TIGHT WHEN TAPED

ZINC DIE CAST

TOPAZ CAT #	UPC#	SIZE	UNIT CTN	SHIP CASE	WT/ CASE
641	16490	1/2"	50	500	35
642	16500	3/4"	25	250	25
643	16510	1"	50	200	28
644	16520	1 1/4"	—	25	8
645	16530	1 1/2"	—	25	15
646	16540	2"	—	20	11
647*	16550	2 1/2"	—	12	9
648*	16560	3"	—	12	12
649*	16570	3 1/2"	—	10	12
650*	16580	4"	—	6	10

*EMT & RIGID

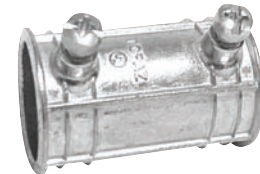

1/2"-1 1/2"
2"-4"



E18472
E148716

EMT CONNECTORS COMPRESSION TYPE

• CONCRETE TIGHT

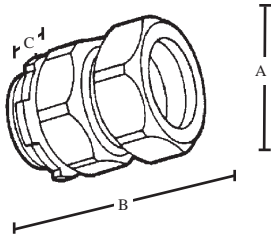

CAT#	A	B	C
651S/Si	1.750	1.250	.406
652S/Si	1.813	1.563	.406
653S/Si	2.000	1.813	.406
654S/Si	2.750	2.188	.500
655S/Si	3.000	2.438	.500
656S/Si	3.188	2.938	.688
657S/Si	3.875	3.688	.750
658S/Si	4.375	4.313	.938
659S/Si	4.500	4.875	.938
660S/Si	4.750	5.375	.938

STEEL

TOPAZ CAT #	UPC#	SIZE	UNIT CTN	SHIP CASE	WT/ CASE
651S	16790	1/2"	25	250	30
652S	16800	3/4"	25	250	43
653S	16810	1"	10	100	25
654S	16820	1 1/4"	—	25	12
655S	16830	1 1/2"	—	20	12
656S	16840	2"	—	15	15
657S*	16844	2 1/2"	—	12	19
658S*	16842	3"	—	6	15
659S*	16843	3 1/2"	—	6	16
660S*	16844	4"	—	6	21



*EMT & RIGID

INSULATED THROAT

STEEL

TOPAZ CAT #	UPC#	SIZE	UNIT CTN	SHIP CASE	WT/ CASE
651Si	16850	1/2"	25	250	30
652Si	16860	3/4"	25	250	43
653Si	16870	1"	10	100	25
654Si	16880	1 1/4"	—	25	12
655Si	16890	1 1/2"	—	20	12
656Si	16900	2"	—	15	15
657Si*	16901	2 1/2"	—	12	19
658Si*	16902	3"	—	6	15
659Si*	16903	3 1/2"	—	6	16
660Si*	16904	4"	—	6	21



*EMT & RIGID

EMT COUPLINGS COMPRESSION TYPE

• CONCRETE TIGHT

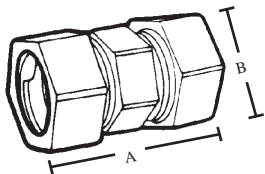

CAT#	A	B
661S	1.688	1.250
662S	2.000	1.563
663S	2.125	1.813
664S	3.063	2.188
665S	3.125	2.438
666S	3.375	2.938
667S	4.875	3.688
668S	5.250	4.313
669S	5.500	4.875
670S	5.750	5.375

STEEL

TOPAZ CAT #	UPC#	SIZE	UNIT CTN	SHIP CASE	WT/ CASE
661S	17010	1/2"	25	250	32
662S	17020	3/4"	25	250	40
663S	17030	1"	10	100	31
664S	17040	1 1/4"	—	25	15
665S	17050	1 1/2"	—	20	15
666S	17060	2"	—	15	18
667S*	17061	2 1/2"	—	6	14
668S*	17062	3"	—	6	19
669S*	17063	3 1/2"	—	6	21
670S*	17064	4"	—	3	15



*EMT & RIGID

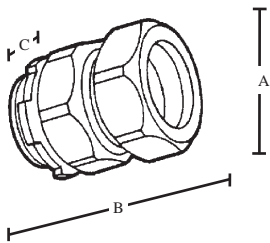

CAT#	A	B	C
651SRT	.689	.500	1.125
652SRT	.750	.500	1.375
653SRT	.846	.562	1.687
654SRT	1.687	1.012	2.062
655SRT	1.717	1.062	2.250
656SRT	1.875	1.125	2.750
657SRT	1.968	1.562	3.625
658SRT	2.689	1.562	4.250
659SRT	2.812	1.812	4.687
660SRT	2.812	1.812	5.187

651SiRT	.689	.500	1.125
652SiRT	.750	.500	1.375
653SiRT	.846	.562	1.687
654SiRT	1.687	1.012	2.062
655SiRT	1.717	1.062	2.250
656SiRT	1.875	1.125	2.750
657SiRT	1.968	1.562	3.625
658SiRT	2.689	1.562	4.250
659SiRT	2.812	1.812	4.687
660SiRT	2.812	1.812	5.187

EMT CONNECTORS

COMPRESSION TYPE

RAIN TIGHT

• CONCRETE TIGHT

STEEL

TOPAZ CAT #	UPC#	SIZE	UNIT CTN	SHIP CASE	WT/ CASE
651SRT	83059	1/2"	25	250	30
652SRT	83060	3/4"	25	250	43
653SRT	83061	1"	10	100	25
654SRT	83062	1 1/4"	—	25	12
655SRT	83063	1 1/2"	—	20	12
656SRT	83064	2"	—	15	15
657SRT	83598	2 1/2"	—	12	19
658SRT	83599	3"	—	12	15
659SRT	83600	3 1/2"	—	5	16
660SRT	83601	4"	—	3	21



E170258

INSULATED THROAT

STEEL

651SiRT	83006	1/2"	25	250	30
652SiRT	83007	3/4"	25	250	43
653SiRT	83008	1"	10	100	25
654SiRT	83009	1 1/4"	—	25	12
655SiRT	83010	1 1/2"	—	20	12
656SiRT	83011	2"	—	15	15
657SiRT	83512	2 1/2"	—	12	19
658SiRT	83513	3"	—	6	15
659SiRT	83614	3 1/2"	—	5	16
660SiRT	83615	4"	—	3	21



E170258

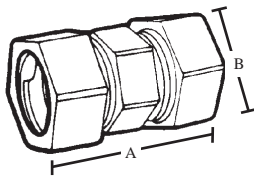

CAT#	A	B
661SRT	1.625	1.125
662SRT	1.750	1.375
663SRT	1.875	1.687
664SRT	2.250	2.062
665SRT	2.250	2.250
666SRT	2.375	2.750
667SRT	3.875	3.625
668SRT	4.000	4.250
669SRT	4.687	4.687
670SRT	4.937	5.187

EMT COUPLINGS

RAIN TIGHT
COMPRESSION TYPE

• CONCRETE TIGHT

STEEL

TOPAZ CAT #	UPC#	SIZE	UNIT CTN	SHIP CASE	WT/ CASE
661SRT	83071	1/2"	25	500	35
662SRT	83072	3/4"	25	250	25
663SRT	83073	1"	50	200	28
664SRT	83074	1 1/4"	—	25	15
665SRT	83075	1 1/2"	—	20	15
666SRT	83076	2"	—	15	18
667SRT	83602	2 1/2"	—	12	14
668SRT	83603	3"	—	6	19
669SRT	83604	3 1/2"	—	5	21
670SRT	83605	4"	—	6	15



E170258

EMT CONNECTORS SET SCREW TYPE

• CONCRETE TIGHT WHEN TAPED

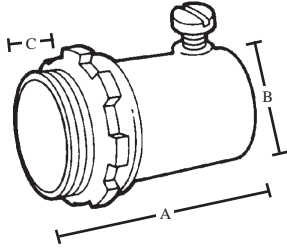

CAT#	A	B	C
631S/Si	1.469	1.063	.406
632S/Si	1.531	1.313	.438
633S/Si	1.625	1.563	.469
634S/Si	2.250	1.938	.563
635S/Si	2.500	2.250	.563
636S/Si	2.750	2.750	.563
637S/Si	3.313	3.563	.750
638S/Si	3.813	4.188	.938
639S/Si	3.938	4.688	.938
640S/Si	4.188	5.188	1.000

1/2"-1" 1 SCREW
1 1/4"-4" 2 SCREW

TOPAZ CAT #	UPC#	SIZE	UNIT CTN	SHIP CASE	WT/CASE
631S	23000	1/2"	50	500	50
632S	23010	3/4"	25	250	35
633S	23020	1"	50	200	46
634S	23030	1 1/4"	—	25	10
635S	23040	1 1/2"	—	25	14
636S	23050	2"	—	20	16
637S*	23060	2 1/2"	—	12	17
638S*	23070	3"	—	12	22
639S*	23080	3 1/2"	—	6	15
640S*	23090	4"	—	6	17



*EMT & RIGID

INSULATED THROAT



631Si	23100	1/2"	50	500	50
632Si	23110	3/4"	25	250	35
633Si	23120	1"	50	200	46
634Si	23130	1 1/4"	—	25	10
635Si	23140	1 1/2"	—	25	14
636Si	23150	2"	—	20	16
637Si*	23160	2 1/2"	—	12	17
638Si*	23170	3"	—	12	22
639Si*	23180	3 1/2"	—	6	15
640Si*	23190	4"	—	6	17

*EMT & RIGID



 
1/2-2" E148720
2 1/2-4" E148716



 
1/2-2" E148720
2 1/2-4" E148716

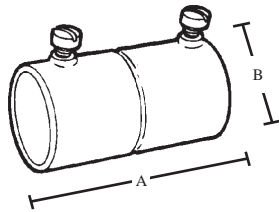

CAT#	A	B
641S	1.750	.88
642S	2.125	1.06
643S	2.500	1.31
644S	3.25	1.69
645S	3.75	1.94
646S	4.00	2.38
647S	4.25	3.19
648S	4.50	3.19
649S	4.75	4.31
650S	5.00	4.81

1/2"-1" 2 SCREW
1 1/4"-4" 4 SCREW

EMT COUPLINGS SET SCREW TYPE

• CONCRETE TIGHT WHEN TAPED

TOPAZ CAT #	UPC#	SIZE	UNIT CTN	SHIP CASE	WT/CASE
641S	23200	1/2"	50	500	50
642S	23210	3/4"	25	250	38
643S	23220	1"	10	100	24
644S	23230	1 1/4"	—	25	11
645S	23240	1 1/2"	—	25	17
646S	23250	2"	—	20	18
647S*	23260	2 1/2"	—	12	19
648S*	23270	3"	—	12	26
649S*	23280	3 1/2"	—	6	15
650S*	23290	4"	—	6	17

*EMT & RIGID



 
1/2-2" E148720
2 1/2-4" E148716

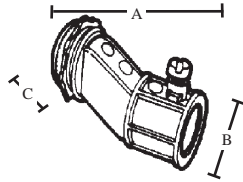

CAT#	A	B	C
771	2.10	.94	.52
772	3.00	1.16	.52
773	3.16	1.42	.67

EMT OFFSET CONNECTORS, EMT TO BOX

ZINC DIE CAST

TOPAZ CAT #	UPC#	SIZE	UNIT CTN	SHIP CASE	WT/ CASE
----------------	------	------	-------------	--------------	-------------

SET SCREW TYPE

• CONCRETE TIGHT WHEN TAPED

771	17960	1/2"	10	100	12
772	17970	3/4"	10	100	19
773	17980	1"	10	100	25

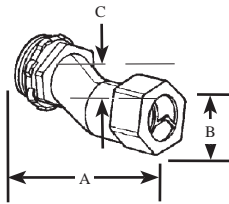
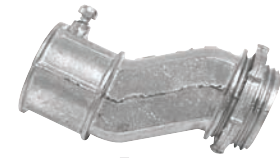

CAT#	A	B	C
781	2.13	1.00	.52
782	2.90	1.19	.75

COMPRESSION TYPE

• CONCRETE TIGHT

781	17990	1/2"	20	200	26
782	18000	3/4"	10	100	21

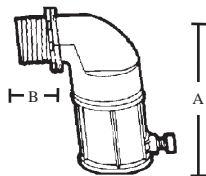

CAT#	A	B
161	1.66	.52
162	1.98	.52

EMT 90° ANGLE CONNECTORS

ZINC DIE CAST

TOPAZ CAT #	UPC#	SIZE	UNIT CTN	SHIP CASE	WT/ CASE
----------------	------	------	-------------	--------------	-------------

SET SCREW TYPE

• CONCRETE TIGHT WHEN TAPED

161	11350	1/2"	25	250	40
162	11360	3/4"	20	200	50

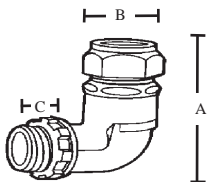

CAT#	A	B	C
431	1.75	.83	.52
432	1.86	.95	.52
433	2.21	1.12	.67

COMPRESSION TYPE

431	13960	1/2"	25	250	50
432	13970	3/4"	20	200	52
433	13980	1"	10	100	46



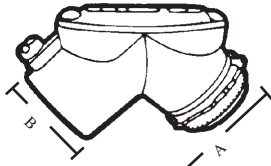

CAT#	A	B
371	1.31	.93
372	1.47	1.22

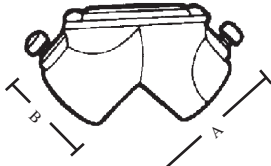

CAT#	A	B
381	1.31	.94
382	1.59	1.24
383	1.94	1.61
384	2.26	2.00

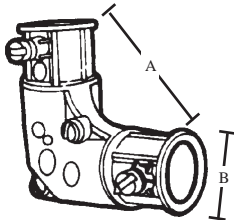

CAT#	A	B
341	1.81	1.00
342	2.00	1.25

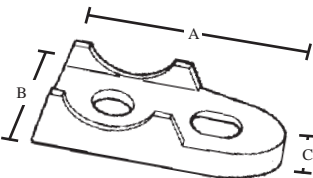

CAT#	A	B	C
481	2.06	1.00	.50
482	2.38	1.06	.50
483	2.94	1.25	.56
484	3.50	1.88	.75
485	3.81	1.44	.81
486	4.75	1.94	1.00
487	5.75	2.44	.75
488	6.69	2.63	.88
489	7.13	2.88	1.06
489A	8.88	3.06	1.06
489B	10.13	3.75	.60
489C	12.19	4.00	.75

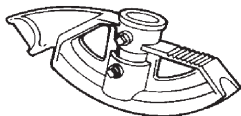

90° EMT PULL ELBOWS SET SCREW TYPE

ZINC DIE CAST

TOPAZ CAT #	UPC#	SIZE	UNIT CTN	SHIP CASE	WT/ CASE
EMT TO BOX					
371	13610	1/2"	10	100	22
372	13620	3/4"	5	50	17

EMT TO EMT

381	13630	1/2"	10	100	24
382	13640	3/4"	5	50	19
383	13650	1"	—	25	16
384	13660	1 1/4"	—	20	20

EMT TO EMT, INSIDE CORNER

341	13470	1/2"	10	100	20
342	13480	3/4"	5	50	15

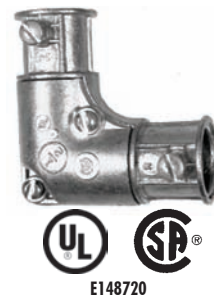

EMT/RIGID CLAMP BACKS

MALLEABLE IRON

TOPAZ CAT #	UPC#	SIZE	UNIT CTN	SHIP CASE	WT/ CASE
481	14510	1/2"	25	250	16
482	14520	3/4"	25	250	22
483	14530	1"	25	250	35
484	14540	1 1/4"	10	100	21
485	14550	1 1/2"	10	100	27
486	14560	2"	5	50	22
487	14570	2 1/2"	—	25	14
488	14580	3"	—	10	9
489	14590	3 1/2"	—	10	14
489A	14600	4"	—	10	18
489B	14601	5"	—	10	25
489C	14602	6"	—	10	30



EMT BENDERS

MALLEABLE IRON

TOPAZ CAT #	UPC#	SIZE	UNIT CTN	SHIP CASE	WT/ CASE
EB1	23420	1/2"	—	10	20
EB2	23430	3/4"	—	10	17
EB3	23440	1"	—	2	16



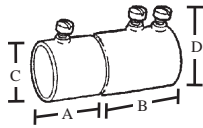

CAT#	A	B	C	D	SCREWS
391S	0.850	1.200	0.720	0.855	2
392S	1.000	1.310	0.940	1.065	2
393S	1.270	1.530	1.170	1.320	3

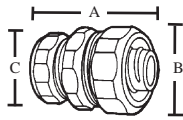

CAT#	A	B	C
271	1.64	1.39	1.09
272	1.75	1.72	1.30
273	2.00	1.75	1.50

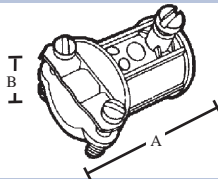

CAT#	A	B (Min)	B (Max)
180	1.35	0.17	0.63

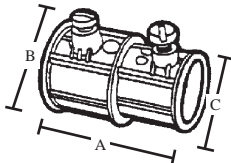

CAT#	A	B	C
590	1.25	0.93	0.78

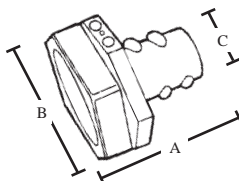

CAT#	A	B	C
131	1.660	1.000	.723
132	1.680	1.180	.931
133	1.895	1.625	1.070

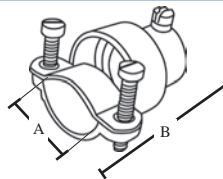

CAT#	A (Min)	A (Max)	B
181	.75	.95	1.65
182	.75	1.20	1.93
182A	.75	1.40	2.00

COMBINATION COUPLINGS

TOPAZ CAT #	UPC#	SIZE	UNIT CTN	SHIP CASE	STEEL WT/CASE
-------------	------	------	----------	-----------	---------------

EMT TO RIGID

- SET SCREW TYPE

391S	70210	1/2" - 1/2"	25	250	33
392S	70220	3/4" - 3/4"	10	100	25
393S	70230	1" - 1"	10	100	33



E170258

EMT TO LIQUID TIGHT

- COMPRESSION TYPE
- FOR USE WITH METALLIC & NON METALLIC CONDUIT

271	12260	1/2" - 1/2"	25	250	20
272	12270	3/4" - 3/4"	20	200	14
273	12280	1" - 1"	10	100	16



1/2" E148716
3/4"-1" E170258

EMT TO BX OR NM CABLE

ZINC DIE CAST

- SET SCREW TO CLAMP TYPE

180	11410	1/2" - 3/8"	50	500	40
-----	-------	-------------	----	-----	----



E170258

EMT TO BX

- SET SCREW TYPE

590	15780	1/2" - 3/8"	25	250	15
-----	-------	-------------	----	-----	----



E170258

EMT COMPRESSION TO FLEX

- SCREW-IN TYPE

131	10840	1/2" - 1/2"	50	500	40
132	10850	3/4" - 3/4"	25	250	28
133	10860	1" - 1"	25	250	58



E148716

EMT TO FLEX

- SET SCREW TO CLAMP TYPE

181	11420	1/2" - 1/2"	25	250	25
182	11430	3/4" - 3/4"	—	100	15
182A	11431	1" - 1"	—	50	13



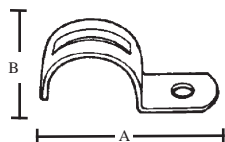

CAT#	A	B
511	1.79	.57
512	1.96	.62
513	2.25	.75
514	2.85	.88
515	3.16	.99
516	3.93	1.10
517	5.00	1.28
518	5.55	1.28
519	6.37	1.28
520	6.87	1.28

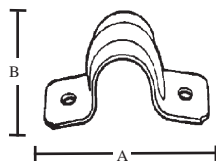

CAT#	A	B
521	2.20	.56
522	2.67	.62
523	2.97	.68
524	3.67	.75
525	4.22	.88
526	4.91	1.00
527	5.91	1.00
528	6.71	1.00
529	7.51	1.00
530	8.31	1.00

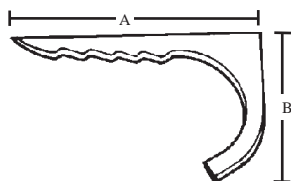

CAT#	A	B
DS1	2.13	1.10
DS2	2.13	1.20
DS3	2.25	1.50

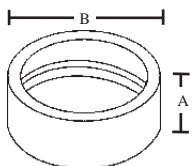

CAT#	A	B
1661	.522	.570
1662	.538	.764
1663	.614	.954
1664	.620	1.26
1665	.620	1.44
1666	.619	1.86
1667	1.12	2.34
1668	1.19	2.78
1669	1.22	3.27
1670	1.22	3.71

EMT STRAPS SNAP-ON TYPE

TOPAZ CAT #	UPC#	SIZE	UNIT CTN	SHIP CASE	STEEL WT/ CASE
ONE HOLE					
511	15610	1/2"	100	1000	25
512	15620	3/4"	100	1000	30
513	15630	1"	50	500	25
514	15640	1 1/4"	25	250	20
515	15650	1 1/2"	10	100	12
516	15660	2"	10	100	16
517*	15670	2 1/2"	—	50	21
518*	15680	3"	—	25	13
519*	15690	3 1/2"	—	25	18
520*	15700	4"	—	25	20

*EMT & RIGID

TWO HOLE

TOPAZ CAT #	UPC#	SIZE	UNIT CTN	SHIP CASE	STEEL WT/ CASE
521	14950	1/2"	50	500	10
522	14960	3/4"	50	500	10
523	14970	1"	50	500	15
524	14980	1 1/4"	20	200	12
525	14990	1 1/2"	20	200	16
526	15000	2"	—	50	7
527*	15010	2 1/2"	—	25	6
528*	15020	3"	—	25	7
529*	15030	3 1/2"	—	25	8
530*	15040	4"	—	25	7

*EMT & RIGID

EMT DRIVE STRAPS FLAT TYPE

TOPAZ CAT #	UPC#	SIZE	UNIT CTN	SHIP CASE	STEEL WT/ CASE
DS1	20380	1/2"	100	1000	10
DS2	20390	3/4"	100	1000	18
DS3	20400	1"	100	1000	23

EMT INSULATING BUSHING

TOPAZ CAT #	UPC#	SIZE	UNIT CTN	SHIP CASE	6/6 NYLON WT/ CASE
1661	18451	1/2"	100	1000	5
1662	18452	3/4"	100	1000	6
1663	18453	1"	50	500	5
1664	18454	1 1/4"	25	250	4
1665	18455	1 1/2"	25	250	5
1666	18456	2"	20	200	5
1667*	18457	2 1/2"	—	25	1
1668*	18458	3"	—	25	2
1669*	18459	3 1/2"	—	25	2
1670*	18460	4"	—	25	2

*EMT & RIGID



LIQUID TIGHT CONNECTORS

COMPONENT TYPE

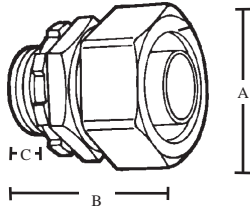

CAT#	A	B	C
470/470i	1.446	1.260	.400
471/471i	1.500	1.385	.420
472/472i	1.603	1.720	.420
473/473i	1.792	1.900	.550
474/474i	1.900	2.290	.546
475/475i	1.737	2.633	.520
476/476i	2.080	3.156	.585
477	3.025	4.205	.775
478	3.530	4.910	.920
479	3.660	5.470	.920
480	3.875	5.925	.987

ZINC DIE CAST

TOPAZ CAT #	UPC#	CONDUIT SIZE	UNIT CTN	SHIP CASE	WT/ CASE
STRAIGHT					
470	14250	3/8" 1/2" KO	20	200	36
471	14260	1/2"	20	200	40
472	14270	3/4"	10	100	23
473	14280	1"	5	50	20
474	14290	1 1/4"	5	50	30
475	14300	1 1/2"	2	20	15
476	14310	2"	2	20	24
477*	14320	2 1/2"	—	1	1
478*	14330	3"	—	1	2
479*	14340	3 1/2"	—	1	3
480*	14350	4"	—	1	4



E170258

STRAIGHT WITH INSULATED THROAT

470i	14360	3/8" 1/2" KO	20	200	40
471i	14370	1/2"	20	200	34
472i	14380	3/4"	10	100	25
473i	14390	1"	5	50	22
474i	14400	1 1/4"	5	50	34
475i	14410	1 1/2"	2	20	18
476i	14420	2"	2	20	28



E170258

90° ANGLE

490	14610	3/8" 1/2" KO	10	100	27
491	14620	1/2"	10	100	28
492	14630	3/4"	10	100	38
493	14640	1"	5	50	32
494	14650	1 1/4"	2	20	20
495	14660	1 1/2"	2	20	26
496	14670	2"	1	10	19
497*	14680	2 1/2"	—	1	4
498*	14690	3"	—	1	5
499*	14700	3 1/2"	—	1	6
500*	14710	4"	—	1	7



E170258

90° ANGLE WITH INSULATED THROAT

490i	14720	3/8" 1/2" KO	10	100	30
491i	14730	1/2"	10	100	27
492i	14740	3/4"	10	100	39
493i	14750	1"	5	50	33
494i	14760	1 1/4"	2	20	21
495i	14770	1 1/2"	2	20	26
496i	14780	2"	1	10	20



E170258

*2 1/2" - 4" Straight and 90° all insulated throat

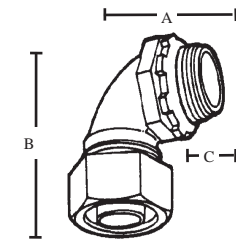

CAT#	A	B	C
490/490i	2.062	2.340	.52
491/491i	2.220	2.340	.52
492/492i	2.550	3.550	.68
493/493i	2.820	3.785	.67
494/494i	3.362	3.960	.70
495/495i	3.450	4.130	.70
496/496i	4.036	4.700	.57
497	5.215	5.375	.77
498	6.100	6.500	1.10
499	6.715	7.450	1.10
500	6.780	8.00	1.10

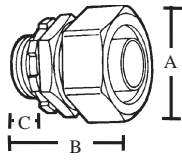

CAT#	A	B	C
470S	1.38	.56	1.69
471S	1.38	.59	1.69
472S	1.64	.63	1.81
473S	1.91	.75	2.13
474S	2.44	.78	2.19
475S	2.72	.91	2.44
476S	3.25	1.00	2.88
477S	4.00	1.50	3.25
478S	4.63	1.50	3.88
479S	5.50	1.50	4.00
480S	5.82	1.63	4.00

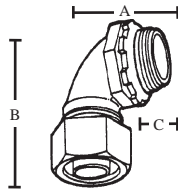

CAT#	A	B	C
490S	1.31	1.81	.50
491S	1.41	1.88	.50
492S	1.63	2.06	.53
493S	2.06	2.25	.69
494S	2.13	2.75	.72
495S	2.69	3.13	.84
496S	2.94	3.88	.94
497S	6.00	6.50	1.50
498S	6.50	7.00	1.50
500S	9.00	9.50	1.50

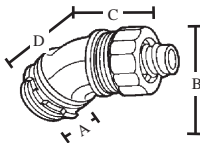

CAT#	A	B	C	D
230S	.50	1.38	1.38	1.00
231S	.50	1.38	1.38	1.06
232S	.53	1.64	1.50	1.19
233S	.69	1.91	1.69	1.38
234S	.72	2.44	1.94	1.63
235S	.84	2.72	2.25	1.81
236S	.94	3.25	2.75	1.94
237S	1.50	4.00	4.00	3.50
238S	1.50	4.63	4.50	4.00
239S	1.63	5.81	5.00	4.50
240S	1.63	5.81	5.00	4.50

LIQUID TIGHT CONNECTORS INSULATED THROAT-COMPONENT TYPE

MALLEABLE IRON

TOPAZ CAT #	UPC#	CONDUIT SIZE	UNIT CTN	SHIP CASE	WT/ CASE
STRAIGHT					
470S	14430	3/8" 1/2" KO	25	250	25
471S	14440	1/2"	20	200	26
472S	14450	3/4"	10	100	18
473S	14460	1"	5	50	16
474S	33620	1 1/4"	5	50	37
475S	33630	1 1/2"	2	20	21
476S	33640	2"	2	20	33
477S	33650	2 1/2"	—	1	3
478S	33660	3"	—	1	4
479S	33670	3 1/2"	—	1	4
480S	33680	4"	—	1	5



90° ANGLE

MALLEABLE IRON

TOPAZ CAT #	UPC#	CONDUIT SIZE	UNIT CTN	SHIP CASE	WT/ CASE
490S	14790	3/8" 1/2" KO	10	100	26
491S	14800	1/2"	10	100	26
492S	14810	3/4"	10	100	24
493S	14820	1"	5	50	34
494S	33690	1 1/4"	2	20	24
495S	33700	1 1/2"	2	20	40
496S	33710	2"	1	20	28
497S	33720	2 1/2"	—	1	7
498S	33730	3"	—	1	11
500S	33750	4"	—	1	10



45° ANGLE

MALLEABLE IRON

TOPAZ CAT #	UPC#	CONDUIT SIZE	UNIT CTN	SHIP CASE	WT/ CASE
230S	11960	3/8" 1/2" KO	10	100	24
231S	11970	1/2"	10	100	28
232S	11980	3/4"	10	100	42
233S	11990	1"	5	50	32
234S	33550	1 1/4"	2	20	22
235S	33560	1 1/2"	2	20	32
236S	33570	2"	2	20	49
237S	33580	2 1/2"	—	1	5
238S	33590	3"	—	1	7
239S	33591	3 1/2"	—	1	10
240S	33610	4"	—	1	12



UL rated suitable for hazardous locations.

Class I, Div. 2; Class II, Div. 1 and 2; Class III, Div. 1 and 2;
NEC 501-4(b), 502-4(a) (2), 503-3(a)

LIQUID TIGHT CONNECTORS

COMPONENT TYPE FOR FLEXIBLE NONMETALLIC LIQUID TIGHT TUBING

125°

6/6 NYLON

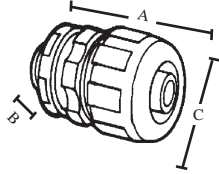

CAT#	A	B	C
P470/B	2.00	.44	1.09
P471/B	2.00	.44	1.09
P472/B	2.03	.46	1.30
P473/B	2.25	.57	1.50
P474/B	2.00	.57	2.40
P475/B	2.25	.57	2.68
P476/B	2.50	.57	3.31

TOPAZ CAT #	UPC#	CONDUIT SIZE	UNIT CTN	SHIP CASE	WT/ CASE
STRAIGHT - GRAY					
P470	21570	3/8" 1/2" KO	25	100	7
P471	21580	1/2"	25	100	6
P472	21590	3/4"	10	100	8
P473	21600	1"	5	50	12
P474	21602	1 1/4"	5	50	12
P475	21604	1 1/2"	5	20	14
P476	21606	2"	2	20	9



E148716

STRAIGHT - BLACK

P470B	21610	3/8" 1/2" KO	25	100	7
P471B	21620	1/2"	25	100	6
P472B	21630	3/4"	10	100	8
P473B	21640	1"	5	50	12
P474B	21721	1 1/4"	5	50	12
P475B	21722	1 1/2"	5	50	14
P476B	21723	2"	2	20	9



E148716

90° ANGLE - GRAY

P490	21650	3/8" 1/2" KO	10	100	9
P491	21660	1/2"	10	100	8
P492	21670	3/4"	10	100	11
P493	21680	1"	5	50	8
P494	21681	1 1/4"	2	20	8
P495	21682	1 1/2"	2	20	10
P496	21683	2"	1	10	9

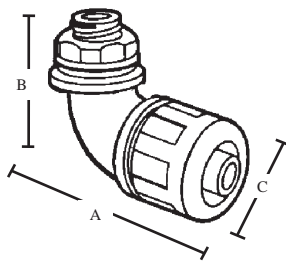

CAT#	A	B	C
P490/B	2.56	2.14	1.09
P491/B	2.56	2.14	1.09
P492/B	2.84	2.38	1.30
P493/B	2.25	2.81	1.50
P494/B	3.96	3.36	2.40
P495/B	4.13	3.45	2.68
P496/B	4.68	4.04	3.31

90° ANGLE - BLACK

P490B	21690	3/8" 1/2" KO	10	100	9
P491B	21700	1/2"	10	100	8
P492B	21710	3/4"	10	100	11
P493B	21720	1"	5	50	8
P494B	21724	1 1/4"	2	20	8
P495B	21725	1 1/2"	2	20	10
P496B	21726	2"	1	10	9



E148716



E148716

TOP-FLEX I CONDUIT

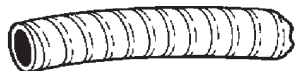

TRADE SIZE	PART DIMENSIONS (inches)				WALL THICKNESS
	OUTSIDE DIAMETER		INSIDE DIAMETER		
	MIN.	MAX.	MIN.	MAX.	
3/8	.690	.710	.484	.504	.21
1/2	.820	.840	.622	.642	.21
3/4	1.030	1.050	.820	.840	.21
1	1.290	1.315	1.041	1.066	.25
1 1/4	1.630	1.660	1.380	1.410	.25
1 1/2	1.865	1.900	1.575	1.600	.30
2	2.340	2.375	2.020	2.045	.33

TOPAZ CAT #	UPC#	SIZE	UNIT CTN	SHIP CASE	WT/ CASE
STRAIGHT					
HF138	30000	3/8"	—	100'	10
HF112	30010	1/2"	—	100'	13
HF112R	30015	1/2"	REEL	1000'	130
HF134	30020	3/4"	—	100'	18
HF134R	30025	3/4"	REEL	800'	144
HF11	30030	1"	—	100'	25
HF1114	30040	1 1/4"	—	100'	33
HF1112	30050	1 1/2"	—	50'	23
HF12	30060	2"	—	50'	30



UL TYPE B FLEXIBLE NONMETALLIC LIQUID TIGHT CONDUIT

- 3/8" THRU 2" TRADE SIZES
- USE WITH TOP-FLEX NYLON CONNECTORS STRAIGHT OR RIGHT ANGLE
- MAY ALSO BE USED WITH TOPAZ DIE-CAST CONNECTORS FOR LIQUID TIGHT CONDUIT
- RESISTS CORROSION, ABRASION, OIL, WATER, ACID, METAL SHAVINGS, AND ROUGH ENVIRONMENTS
- RESISTS ABUSE, PULL, AND CRUSHING
- SMOOTH INSIDE FOR EASIER WIRE PULLING, NO HAZARDOUS SHARP EDGES OR BURRS; WILL NOT DAMAGE CONDUCTORS
- FOR DIRECT BURIAL
- LIGHTWEIGHT AND LOWER INSTALLED COST
- QUICK INSTALLATION, CUTS WITH UTILITY KNIFE OR PVC CUTTER (CATALOG #VF28)
- INTEGRAL RIGID AND FLEXIBLE PVC CONSTRUCTION
- SUITABLE FOR INDOOR/OUTDOOR USE: HVAC EQUIPMENT MACHINE TOOLS MOTORS AND CONTROLS MARINE EQUIPMENT PRINTING EQUIPMENT PUMPS REFRIGERATION EQUIPMENT
- UV RATED
- 80° C

TOP-FLEX II TUBING



TRADE SIZE	PART DIMENSIONS (inches)				WALL THICKNESS
	OUTSIDE DIAMETER		INSIDE DIAMETER		
	MIN.	MAX.	MIN.	MAX.	
1/4	.560	.575	.385	.405	.17
3/8	.690	.710	.484	.504	.21
1/2	.820	.840	.622	.642	.21
3/4	1.030	1.050	.820	.840	.21
1	1.290	1.315	1.041	1.066	.25
1 1/4	1.630	1.660	1.380	1.410	.25
1 1/2	1.865	1.900	1.575	1.600	.30
2	2.340	2.375	2.020	2.045	.33

TOPAZ CAT #	UPC#	SIZE	UNIT CTN	SHIP CASE	WT/ CASE
STRAIGHT					
HF214	30065	1/4"	—	100'	4
HF238	30070	3/8"	—	100'	6
HF212	30080	1/2"	—	100'	8
HF234	30090	3/4"	—	100'	10
HF21	30100	1"	—	100'	15
HF2114	23412	1 1/4"	—	100'	19
HF2112	23415	1 1/2"	—	50'	22
HF22	23416	2"	—	50'	60



FLEXIBLE NONMETALLIC LIQUID ELECTRICAL TUBING

- 1/4" THRU 1" TRADE SIZES, CONSULT TOPAZ FOR 1 1/4", 1 1/2", AND 2" SIZES
- USE WITH TOP-FLEX NYLON CONNECTORS - STRAIGHT OR RIGHT ANGLE
- RESISTS CORROSION, OIL AND WATER
- MAXIMUM FLEXIBILITY, CAN BE USED IN EXTREMELY TIGHT QUARTERS
- SMOOTH INSIDE FOR EASIER WIRE PULLING
- LIGHTWEIGHT AND LOWER INSTALLED COST
- QUICK INSTALLATION, CUTS WITH UTILITY KNIFE OR PVC CUTTER (CATALOG #VF28)
- INTEGRAL RIGID AND FLEXIBLE PVC CONSTRUCTION
- IDEAL FOR FIBER OPTIC CABLE PROTECTION
- SUITABLE FOR USE IN HIGH VIBRATION OR FLEXIBLE APPLICATIONS: AUTOMOTIVE EQUIPMENT COMPUTERS AND PERIPHERALS FIBER OPTICS LAB EQUIPMENT LASERS OFFICE EQUIPMENT PROCESSING CONTROLS AND MONITORING EQUIPMENT ROBOTICS WHITE GOODS
- 70° C

CUTTING TOOL

- FOR TOP-FLEX I CONDUIT AND TOP-FLEX II TUBING
- CUTS CLEANLY AND EVENLY
- CUTS UP TO 1 1/4" PVC

TOPAZ CAT #	UPC#	UNIT CTN	SHIP CASE	WT/ CASE
VF28	30105	1	1	0.4

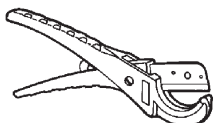

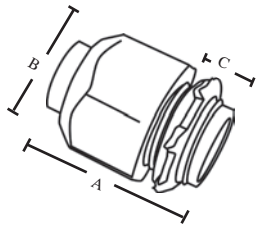

CAT#	A	B	C
1501	1.750	.500	1.250
1502	1.800	.625	1.500

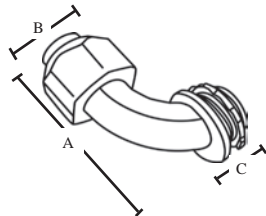

CAT#	A	B	C
1521	1.875	.500	3.125
1522	2.375	.625	3.500

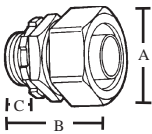

CAT#	A	B	C
470ST	1.09	1.19	.63
471ST	1.19	1.34	.63
472ST	1.43	1.43	.63
473ST	1.75	1.63	.66
474ST	2.16	1.84	.67
475ST	2.38	2.00	.72
476ST	2.88	2.13	.72

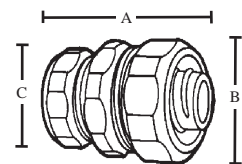

CAT#	A	B	C
271	1.64	1.39	1.09
272	1.75	1.72	1.30
273	2.00	1.75	1.50

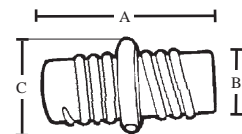

CAT#	A	B	C
P461	1.736	.620	.856
P462	1.736	.812	.965

LIQUID TIGHT CONNECTORS

ONE PIECE TYPE

TOPAZ CAT #	UPC#	SIZE	UNIT CTN	SHIP CASE	PVC WT/ CASE
STRAIGHT - GRAY					
1501	83022	1/2"	25	100	20
1502	83023	3/4"	25	100	28

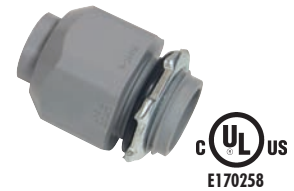

TOPAZ CAT #	UPC#	SIZE	UNIT CTN	SHIP CASE	PVC WT/ CASE
90° ANGLE - GRAY					
1521	83024	1/2"	10	100	28
1522	83025	3/4"	10	100	30



TOPAZ CAT #	UPC#	SIZE	UNIT CTN	SHIP CASE	STEEL WT/ CASE
STEEL					
470ST	14439	3/8" 1/2" KO	20	200	26
471ST	14441	1/2"	20	200	26
472ST	14451	3/4"	10	100	18
473ST	14461	1"	5	50	16
474ST	14471	1 1/4"	5	50	37
475ST	14481	1 1/2"	2	20	21
476ST	14491	2"	2	20	3

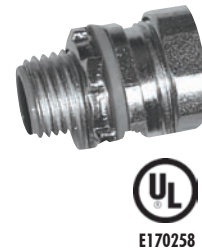

COMBINATION COUPLINGS

EMT TO LIQUID TIGHT

- COMPRESSION TYPE
- FOR USE WITH METALLIC AND NONMETALLIC CONDUIT

TOPAZ CAT #	UPC#	SIZE	UNIT CTN	SHIP CASE	STEEL WT/ CASE
271	12260	1/2" - 1/2"	25	250	20
272	12270	3/4" - 3/4"	20	200	14
273	12280	1" - 1"	10	100	16



LIQUID TIGHT COUPLINGS

NON-METALLIC

TOPAZ CAT #	UPC#	SIZE	UNIT CTN	SHIP CASE	PVC WT/ CASE
P461	83026	1/2"	50	500	2
P462	83027	3/4"	25	250	3



LIQUID TIGHT

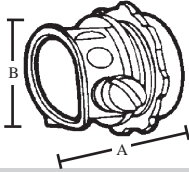

CAT#	A	B	RANGE
130	.84	.64	.38 - .63

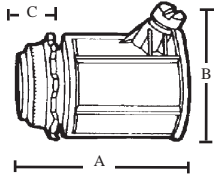

CAT#	A	B	C
121	1.38	1.26	.380
121A	1.54	1.50	.406
121B	1.75	1.75	.540

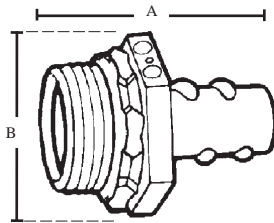

CAT#	A	B
450/450i	1.31	.92
451/451i	1.38	.92
452/452i	1.63	1.10
453/453i	1.94	1.38
454/454i	2.12	1.75
455/455i	2.31	2.13
456/456i	2.58	2.67

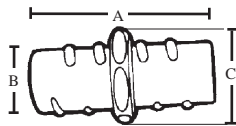

CAT#	A	B	C
461	1.80	.92	1.062
462	2.09	1.12	1.372
463	2.41	1.37	1.687
464	2.74	1.81	2.125
465	3.05	2.12	2.375
466	3.27	2.67	2.937

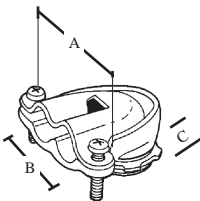

CAT#	A	B	C
561A	1.5	.858	.380

BX-FLEX CONNECTORS

SET SCREW TYPE ZINC DIE CAST

TOPAZ CAT #	UPC#	BX SIZE	KO	UNIT CTN	SHIP CASE	WT/ CASE
-------------	------	---------	----	----------	-----------	----------

STRAIGHT

130	10830	3/8"	1/2"	100	1000	50
121	10700	1/2"	1/2"	25	250	25
121A	10701	3/4"	3/4"	25	250	25
121B	10702	1"	1"	-	50	10

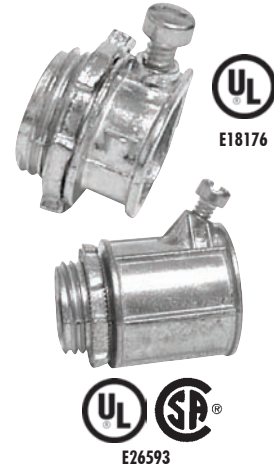

BX-FLEX CONNECTORS

SCREW IN TYPE ZINC DIE CAST

TOPAZ CAT #	UPC#	BX SIZE	KO SIZE	UNIT CTN	SHIP CASE	WT/ CASE
-------------	------	---------	---------	----------	-----------	----------

450	14030	3/8"	1/2"	50	500	30
451	14040	1/2"		50	500	30
452	14050	3/4"		25	250	25
453	14060	1"		25	250	40
454	14070	1 1/4"		10	100	28
455	14080	1 1/2"		10	40	15
456	14090	2"		10	40	25



INSULATED THROAT

450i	14100	3/8"	1/2"	50	500	30
451i	14110	1/2"		50	500	30
452i	14120	3/4"		25	250	25
453i	14130	1"		25	250	40
454i	14140	1 1/4"		10	100	28
455i	14150	1 1/2"		10	40	15
456i	14160	2"		10	40	25

FLEX COUPLINGS

SCREW IN TYPE ZINC DIE CAST

TOPAZ CAT #	UPC#	CONDUIT SIZE	UNIT CTN	SHIP CASE	WT/ CASE
-------------	------	--------------	----------	-----------	----------

461	14190	1/2"	50	500	30
462	14200	3/4"	25	250	23
463	14210	1"	25	250	38
464	14220	1 1/4"	10	100	25
465	14230	1 1/2"	10	40	16
466	14240	2"	10	40	24



DUPLEX CONNECTOR

90 DEGREES MALLEABLE IRON

TOPAZ CAT #	UPC#	BX-FLEX SIZE	KO SIZE	UNIT CTN	SHIP CASE	WT/ CASE
-------------	------	--------------	---------	----------	-----------	----------

561A	15341	3/8"	1/2"	25	250	37
------	-------	------	------	----	-----	----



BX-FLEX CONNECTORS

SQUEEZE TYPE

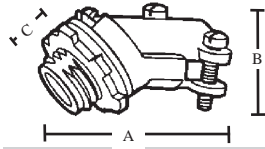

CAT#	A	B	C
390	1.588	1.132	.382

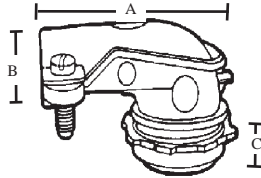

CAT#	A	B (Min-Max)	C	SCREWS
100/i	1.740	0.43-0.72	.370	2
101/i	2.110	0.64-1.03	.400	2
102/i	2.400	0.76-1.15	.400	2
103/i	2.870	1.09-1.73	.540	2
104/i	4.000	1.34-1.97	.640	2
105/i	6.000	1.65-2.61	.750	2
106/i	6.000	1.54-2.54	.740	2
107	7.187	2.45-2.98	.875	4
108	7.875	2.93-3.45	1.031	4
109	9.400	3.28-3.95	1.031	4
110	10.200	3.68-4.43	1.031	4

101M	1.750	0.78-0.95	.440	2
102M	1.810	0.91-1.02	.440	2
103M	2.060	1.25-1.38	.560	2
104M	2.810	1.41-1.63	.560	2
105M	3.810	1.75-2.00	.560	2
106M	4.750	2.19-2.44	.690	2
107M	6.250	2.75-3.00	.880	4
108M	7.250	3.25-3.50	1.000	4
109M	10.250	3.70-4.16	1.250	4
110M	13.000	4.11-4.56	1.250	4

101Mi	1.750	0.78-0.95	.440	2
102Mi	1.810	0.91-1.02	.440	2
103Mi	2.060	1.25-1.38	.560	2
104Mi	2.810	1.41-1.63	.560	2
105Mi	3.810	1.75-2.00	.560	2
106Mi	4.750	2.19-2.44	.690	4
107Mi	6.250	2.75-3.00	.880	4
108Mi	7.250	3.25-3.50	1.000	4
109Mi	10.250	3.70-4.16	1.250	4
110Mi	13.000	4.11-4.56	1.250	4

ZINC DIE CAST

TOPAZ CAT #	UPC#	CONDUIT SIZE	UNIT CTN	SHIP CASE	WT/CASE
-------------	------	--------------	----------	-----------	---------

45° ANGLE

390	13670	3/8" 1/2" KO	50	500	45
-----	-------	--------------	----	-----	----

90° ANGLE

100	10340	3/8" 1/2" KO	50	500	45
101	10350	1/2"	25	250	35
102	10360	3/4"	10	100	20
103	10370	1"	5	50	19
104	10380	1 1/4"	10	40	20
105	10390	1 1/2"	—	5	5
106	10400	2"	—	5	6
107	10410	2 1/2"	—	5	18
108	10420	3"	—	2	9
109	10430	3 1/2"	—	1	9
110	10440	4"	—	1	10

INSULATED THROAT

100i	10341	3/8" 1/2" KO	50	500	45
101i	10351	1/2"	25	250	35
102i	10361	3/4"	10	100	20
103i	10371	1"	5	50	19
104i	10381	1 1/4"	10	40	20
105i	10391	1 1/2"	—	5	5
106i	10401	2"	—	5	6

90° ANGLE

MALLEABLE IRON

101M	10510	1/2"	25	250	40
102M	10520	3/4"	10	100	30
103M	10530	1"	5	50	30
104M	10540	1 1/4"	—	50	38
105M	10550	1 1/2"	—	5	5
106M	10560	2"	—	5	10
107M	10570	2 1/2"	—	5	16
108M	10580	3"	—	2	9
109M	10590	3 1/2"	—	1	14
110M	10600	4"	—	1	24

INSULATED THROAT

101Mi	10511	1/2"	25	250	16
102Mi	10521	3/4"	10	100	30
103Mi	10531	1"	5	50	60
104Mi	10541	1 1/4"	5	50	76
105Mi	10551	1 1/2"	—	5	100
106Mi	10561	2"	—	5	200
107Mi	10571	2 1/2"	—	5	320
108Mi	10581	3"	—	2	450
109Mi	10591	3 1/2"	—	1	1400
110Mi	10601	4"	—	1	2400

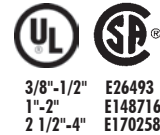

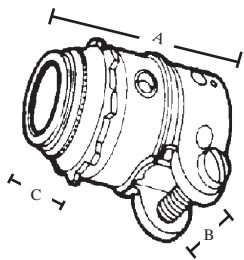

CAT#	A	B (Min-Max)	C	SCREWS
150	1.00	0.58-0.61	.370	1
151/i	1.47	0.74-0.95	.400	1
152/i	1.58	0.88-1.11	.400	1
153/i	1.75	1.14-1.38	.540	1
154/i	1.91	1.42-1.65	.640	1
155/i	2.09	1.68-1.94	.750	1
156/i	2.34	2.08-2.56	.740	1
157	2.81	2.85-3.25	.875	2
158	3.84	3.33-3.63	1.03	2
159	4.19	3.75-4.10	1.03	2
160	4.56	4.18-4.58	1.03	2

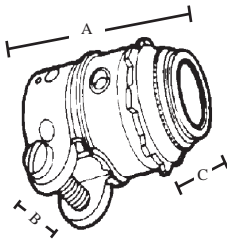

CAT#	A	B (Min-Max)	C	SCREWS
151M	0.94	0.78-0.94	0.50	1
152M	1.13	0.91-1.08	0.50	1
153M	1.19	1.28-1.44	0.56	1
154M	1.25	1.44-1.63	0.63	1
155M	1.88	1.63-1.88	0.69	1
156M	2.00	2.19-2.38	0.75	1
157M	2.06	2.70-2.95	0.94	2
158M	2.25	3.13-3.50	0.94	2
159M	3.56	3.72-4.00	1.25	2
160M	3.69	4.06-4.44	1.25	2

151Mi	0.94	0.78-0.94	0.50	1
152Mi	1.13	0.91-1.08	0.50	1
153Mi	1.19	1.28-1.44	0.56	1
154Mi	1.25	1.44-1.63	0.63	1
155Mi	1.88	1.63-1.88	0.69	1
156Mi	2.00	2.19-2.38	0.75	1
157Mi	2.06	2.70-2.95	0.94	2
158Mi	2.25	3.13-3.50	0.94	2
159Mi	3.56	3.72-4.00	1.25	2
160Mi	3.69	4.06-4.44	1.25	2

BX-FLEX CONNECTORS

SQUEEZE TYPE

ZINC DIE CAST

TOPAZ CAT #	UPC#	CONDUIT SIZE	UNIT CTN	SHIP CASE	WT/ CASE
STRAIGHT					
150	10990	3/8" 1/2" KO	50	500	35
151	11000	1/2"	25	250	25
152	11010	3/4"	25	250	32
153	11020	1"	10	100	20
154	11030	1 1/4"	10	100	29
155	11040	1 1/2"	5	50	20
156	11050	2"	10	40	21
157	11060	2 1/2"	—	10	9
158	11070	3"	—	10	17
159	11080	3 1/2"	—	1	3
160	11090	4"	—	1	3

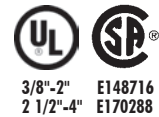

INSULATED THROAT

151i	11001	1/2"	25	250	25
152i	11011	3/4"	25	250	32
153i	11021	1"	10	100	20
154i	11031	1 1/4"	10	100	29
155i	11041	1 1/2"	5	50	20
156i	11051	2"	10	40	21



MALLEABLE IRON

151M	11100	1/2"	25	250	30
152M	11110	3/4"	25	250	48
153M	11120	1"	10	100	26
154M	11130	1 1/4"	10	100	39
155M	11140	1 1/2"	5	50	33
156M	11150	2"	—	20	21
157M	11160	2 1/2"	—	10	14
158M	11170	3"	—	2	4
159M	11180	3 1/2"	—	1	5
160M	11190	4"	—	1	7



INSULATED THROAT

151Mi	11101	1/2"	25	250	12
152Mi	11111	3/4"	25	250	19
153Mi	11121	1"	10	100	26
154Mi	11131	1 1/4"	10	100	39
155Mi	11141	1 1/2"	5	50	66
156Mi	11151	2"	—	20	105
157Mi	11161	2 1/2"	—	10	150
158Mi	11171	3"	—	2	200
159Mi	11181	3 1/2"	—	1	500
160Mi	11191	4"	—	1	700



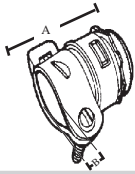

CAT#	A	B (Min-Max)
191	1.413	.620-.780



CAT#	A	B (RANGE)
140	1.192	.18-.63

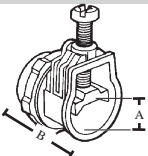

CAT#	A(Min)	A(Max)	B
170	.400	.500	.935
171	.660	.990	1.356
172	.700	1.150	1.520
173	1.100	1.400	1.680

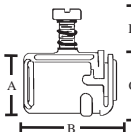

CAT#	A	B	C	D
AMC1	14/2-10/2	1.390	.844	.846
AMC2	10/4-6/3	1.630	1.88	.522
AMC12	14/2-12/2	1.520	.916	.868

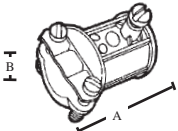

CAT#	A	B(Min)	B(Max)
180	1.35	0.17	0.63

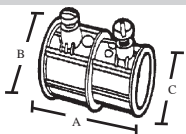

CAT#	A	B	C
590	1.25	.93	.78

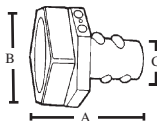

CAT#	A	B	C
131	1.660	1.000	.723
132	1.680	1.180	.931
133	1.895	1.625	1.070

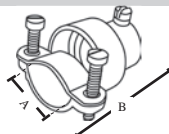

CAT#	A(Min)	A(Max)	B
181	0.75	0.95	1.65
182	0.75	1.20	1.93
182A	0.75	1.40	2.00

BX-FLEX, NM AND MC CABLE CONNECTORS

ZINC DIE CAST

TOPAZ CAT #	UPC#	BX-FLEX SIZE	KO SIZE	UNIT CTN	SHIP CASE	WT/ CASE
• SQUEEZE STRAP TYPE						
191	11530	FITS MC RANGE .620 - .780	1/2"	25	250	25

• 2 SCREW CLAMP TYPE						
140	10920	3/8" FITS MC RANGE .400 - .500	1/2"	100	1000	60

• SADDLE TYPE						
170	11380	3/8" FITS ALUMINUM, STEEL SMOOTH EXTRUDED MC	1/2"	50	500	40

171	11381	1/2"	1/2"	25	250	11
172	11382	3/4"	3/4"	20	200	16
173	11383	1"	1"	10	100	25

STEEL

• SNAP-IN SET SCREW TYPE W/INSULATED THROAT						
AMC1	33370	1/2"	50	500	38	
AMC2	33771	3/4"	25	250	48	
AMC12*	33772	1/2"	20	200	14	

*DUPLX AMC12

COMBINATION COUPLINGS

ZINC DIE CAST

TOPAZ CAT #	UPC#	SIZE	UNIT CTN	SHIP CASE	WT/ CASE
-------------	------	------	----------	-----------	----------

EMT TO BX OR NM CABLE

• SET SCREW TO CLAMP TYPE					
180	11410	1/2"-3/8"	50	500	40

EMT TO BX

• SET SCREW TYPE					
590	15780	1/2"-3/8"	25	250	15

EMT COMPRESSION TO FLEX

• SCREW-IN TYPE					
131	10840	1/2"-1/2"	50	500	40
132	10850	3/4"-3/4"	25	250	28
133	10860	1"-1"	25	250	58

EMT TO FLEX

• SET SCREW TO CLAMP TYPE					
181	11420	1/2"-1/2"	25	250	25
182	11430	3/4"-3/4"	-	100	15
182A	11431	1"-1"	-	50	13



E148743



E18176



E148713



E18176



E148716



E170258



E148716



1/2" E148716
3/4-1" E170258

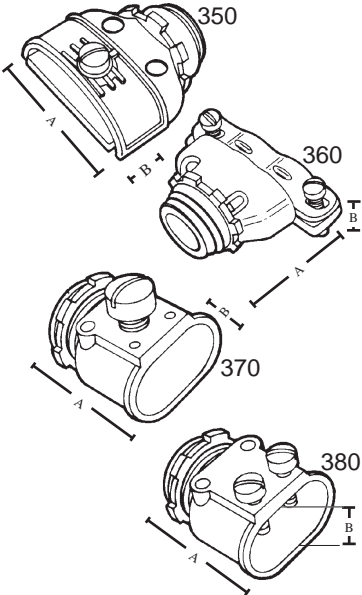

CAT#	A	B (Min)	B (Max)
350	1.57	.13	.65
360	1.59	.24	.63

CAT#	A	B (Min)	C
370	1.42	.63	---
380	1.42	.63	---

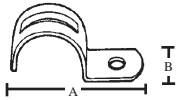

CAT#	A	B
510BX	1.25	.48
1101TC	.625	.5
1105TC	.75	.562
1106TC	1.00	.625

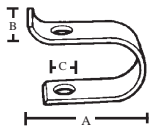

CAT#	A	B	C
90	1.200	.670	.175

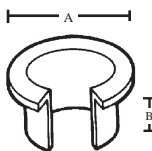

CAT#	A	B
0/0B	.550	.595
1/1B	.66	.67
2/2B	.845	.610
3/3B	.94	.680
4/4B	1.16	.775

CAT#	Fits Cable
0/0B	14/2, 14/3, 12/2, 12/3
1/1B	14/4, 6/1, 4/1
2/2B	12/4, 10/2, 10/3, 2/1
3/3B	10/4, 8/2, 8/3, 1/1
4/4B	8/4, 6/2, 6/3, 6/4, 4/2, 4/3

DUPLEX CONNECTORS

ZINC DIE CAST

TOPAZ CAT #	UPC#	SIZE	KO	UNIT CTN	SHIP CASE	WT/ CASE
-------------	------	------	----	----------	-----------	----------

FOR BX-FLEX, NM & MC CABLE

• 1 SCREW CLAMP TYPE

350	13490	3/8"	1/2"	25	250	32
-----	-------	------	------	----	-----	----

FITS ALUMINUM SMOOTH EXTRUDED MC RANGE .210-.500

• 2 SCREW CLAMP TYPE

360	13500	3/8"	1/2"	25	250	32
-----	-------	------	------	----	-----	----

FITS ALUMINUM SMOOTH EXTRUDED MC RANGE .210-.500

FOR BX-FLEX

• 1 SCREW SET SCREW TYPE

370	13590	3/8"	1/2"	25	250	28
-----	-------	------	------	----	-----	----

• 2 SCREW SET SCREW TYPE

380	13600	3/8"	1/2"	25	250	25
-----	-------	------	------	----	-----	----

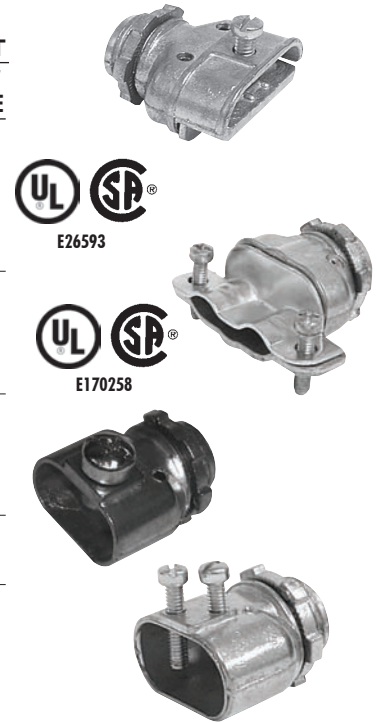

BX STRAP

ONE HOLE

STEEL

TOPAZ CAT #	UPC#	SIZE	UNIT CTN	SHIP CASE	WT/ CASE
510BX	15590	14/2 TO 10/3	100	1000	14
1101TC	14868	1/4" MINI	100	1000	13
1105TC	14872	1/2"	50	100	14
1106TC	14871	9/16"	50	100	16



BX-FLEX U-CLIP

STEEL

TOPAZ CAT #	UPC#	SIZE	UNIT CTN	SHIP CASE	WT/ CASE
90	10320	3/8" FLEXIBLE	-	500	5



ANTI-SHORT BUSHINGS

PLASTIC

TOPAZ CAT #	UPC#	SIZE	FLEX SIZE	PER BAG	SHIP CASE	WT/ CASE
-------------	------	------	-----------	---------	-----------	----------

PACKED IN POLY BAGS

0	10000	0	5/16"	35	500 BAGS	15
1	10010	1	3/8"	35	400 BAGS	12
2	10020	2	7/16"	35	300 BAGS	18
3	10030	3	1/2"	20	200 BAGS	16
4	10040	4	3/4"	16	100 BAGS	9

BULK

0B	10041	0	5/16"	-	5000	3
1B	10042	1	3/8"	-	5000	3
2B	10043	2	7/16"	-	2000	4
3B	10044	3	1/2"	-	2000	4
4B	10045	4	3/4"	-	1000	3



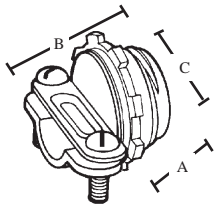

CAT#	A	B	C
120	.44	.814	.92

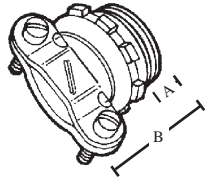

CAT#	A	B
952	.42	1.03
953	.57	1.20
954	.64	1.32
955	.60	1.32
956	.71	1.55

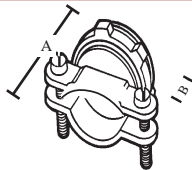

CAT#	A	B
143R	1.190	.645
144R	1.330	.660
145R	1.470	.740
146R	1.620	.750

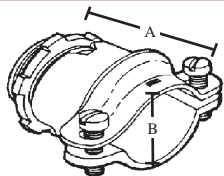

CAT#	A	B(Min)	B(Max)
971	1.87	.40	0.95
972	1.84	.50	1.10
973	2.00	.62	1.40
974	2.28	.50	1.38
975	2.49	.75	1.61
976	3.35	.90	2.04

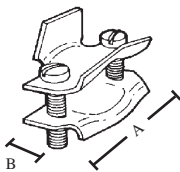

CAT#	A	B
441	1.310	.640
442	1.750	.765
444	2.120	.765
445	2.500	.780

NM CLAMP TYPE CONNECTORS

- NON-WATERTIGHT
- TWO SCREWS

TOPAZ		ZINC DIE CAST				
CAT #	UPC#	SIZE	FITS CABLE	UNIT CTN	SHIP CASE	WT/ CASE
3/8" NM CABLE						
120	10690	1/2"	NM CABLE FROM 2#14 TO .64 MAX OPENING	100	1000	50

FOR OVAL NM CABLE

952	19500	3/4"	OVAL NM 8-2 TO 6-3	25	250	25
953	19510	1"	OVAL NM 8-3 TO 4-3	25	250	37
954	19520	1 1/4"	OVAL NM 4-3 TO 1-3	10	100	24
955	19530	1 1/2"	OVAL NM 1-3 TO 1/0-3	10	100	34
956	19540	2"	OVAL NM 1/0-3 TO 4/0-3	5	50	45

FOR NM & SE CABLE

		• ROUND CABLE				
143R	10950	1"	SE CABLE 6-3, 4-3, 4-2, 2-2 NM CABLE 12-3, 12-4, 10-3, 10-4 8-3, 8-2, 6-2, 4-2	25	250	37
144R	10960	1 1/4"	SE CABLE 10-2, 8-2, 6-2, 4-2 NM CABLE 8-3, 6-3, 4-3, 2-3	10	100	24
145R	10970	1 1/2"	SE CABLES 3-3, 3-2, 3-1	10	100	34
146R	10980	2"	SE CABLES 3-4/0	5	50	23

FOR NM & ROUND SE CABLE

		• TAKE-ALL TYPE				
971	19580	1/2"	ROUND NM .630-.810	25	250	25
972	19590	3/4"	ROUND NM 8-2 TO 6-3	20	200	20
973	19600	1"	ROUND NM 8-3 TO 4-3	10	100	15
974	19610	1 1/4"	ROUND NM 4-3 TO 1-3	10	100	25
975	19620	1 1/2"	ROUND NM 1-3 TO 1/0-3	5	50	34
976	19630	2"	ROUND NM 1/0-3 TO 4/0-3	—	50	45

NM BOX CONNECTORS

- TWO PIECE CLAMP BUTTERFLY TYPE

TOPAZ		STEEL				
CAT #	UPC#	SIZE	FITS CABLE	UNIT CTN	SHIP CASE	WT/ CASE
441	13990	3/8" TO 1/2"	2 OR 3#14, 12, 10, 8	100	1000	50
442	14000	3/4" TO 1"	2 OR 3#8, 6, 4	50	500	35
444	14010	1 1/4"	#2/0	25	250	25
445	14020	1 1/2"	#3/0, #4/0	25	250	40



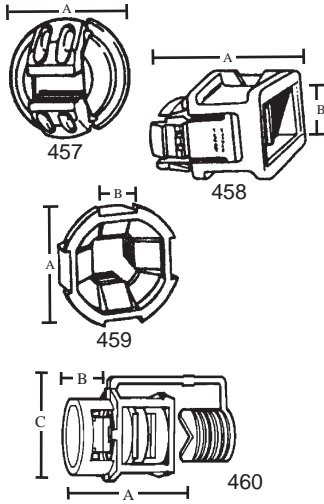

CAT#	A	B	C
457	1.00	—	—
458	1.25	.25	—
459	1.0938	.375	—
460	1.031	.475	.976

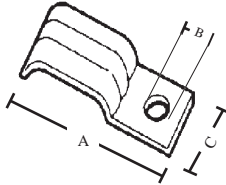

CAT#	A	B	C
510RX	1.08	.28	.50

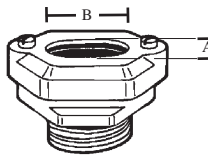

CAT#	FITS CABLE	GROMMET OPENING	
		A	B
873C	2#2	.625 X	1.00
875C	3#2	.625 X	1.00
876E	3#4/0	.830 X	1.415

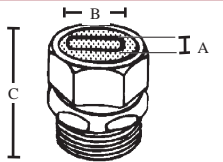

CAT#	FITS CABLE	GROMMET OPENING		
		A	B	C
873	3#8	.410 X	.650	1.875
873A	3#6	.460 X	.715	1.875
873B	3#4	.530 X	.850	1.875
874	3#3	.550 X	.910	1.937
874A	3#2	.580 X	.960	1.937
874B	3#1	.660 X	1.120	1.937
875	3#1/0	.705 X	1.195	2.375
875A	3#2/0	.740 X	1.235	2.375
876	3#1/0	.890 X	1.540	2.250
876A	3#2/0	.750 X	1.195	2.250
876B	3#3/0	.740 X	1.235	2.250
876C	3#4/0	.830 X	1.415	2.250
876D	3#4/0	.995 X	1.580	2.250
871/S	2#14	.220 X	.440	1.437
872/S	3#14	.220 X	.660	1.750

HIT-LOCK CONNECTORS

TOPAZ CAT #	UPC#	KO SIZE	UNIT CTN	SHIP CASE	WT/ CASE
457	14091	1/2" 14/2 & 12/2	100	1000	1.38
458	14092	1/2" 2-WIRE TWO: 14/2 OR 12/2 ONE: 14/2 OR 12/2	50	500	.14
459	14093	3/4" ONE: 14/3 OR 12/3 ONE: 10/2, 8/3 OR 6/3	50	500	.44

NM BOX CONNECTORS

TOPAZ CAT #	UPC#	SIZE	UNIT CTN	SHIP CASE	WT/ CASE
460	14180	3/8" 1/2" KO ONE: 14/2 OR 12/2 TWO: 14/2 OR 12/2	25	250	1

NM STRAP

TOPAZ CAT #	UPC#	SIZE	UNIT CTN	SHIP CASE	WT/ CASE
510RX	15600	14/2, 12/2	100	1000	14

WATER TIGHT CONNECTORS

TOPAZ CAT #	UPC#	WIRE SIZE	SIZE	UNIT CTN	SHIP CASE	WT/ CASE
873C	18749	2#2	1"	10	100	20
875C	18823	3#2	1 1/2"	5	50	44
876E	18871	3#4/0	2"	5	50	44

TOPAZ CAT #	UPC#	WIRE SIZE	SIZE	UNIT CTN	SHIP CASE	WT/ CASE
873	18750	3#8	1"	10	100	34
873A	18760	3#6	1"	10	100	34
873B	18770	3#4	1"	10	100	34
874	18780	3#3	1 1/4"	10	100	52
874A	18790	3#2	1 1/4"	10	100	52
874B	18800	3#1	1 1/4"	10	100	52
875	18810	3#1/0	1 1/2"	5	50	33
875A	18820	3#2/0	1 1/2"	5	50	32
876	18830	3#1/0	2"	5	50	44
876A	18840	3#2/0	2"	5	50	44
876B	18850	3#3/0	2"	5	50	44
876C	18860	3#4/0	2"	5	50	44
876D	18870	3#4/0	2"	5	50	44

TOPAZ CAT #	UPC#	WIRE SIZE	SIZE	UNIT CTN	SHIP CASE	WT/ CASE
871	18730	14-2 12-2 10-2	1/2"	25	250	43
872	18740	14-3 12-3 10-3	3/4"	25	250	65
871S	18731	14-2 12-2	1/2" STEEL	25	250	30
872S	18741	14-3 12-3 10-3	3/4" STEEL	25	250	45

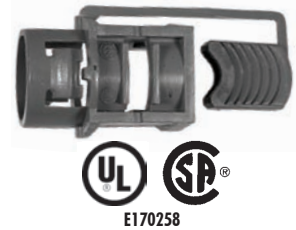

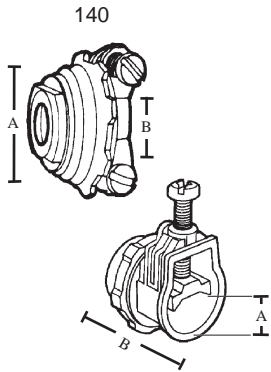

CAT#	A	B (RANGE)
140	1.192	.18-.63

CAT#	A (MIN)	A (MAX)	B
170	.400	.500	.935
171	.660	.990	1.356
172	.700	1.150	1.520
173	1.100	1.400	1.680

COMBINATION CONNECTORS

ZINC DIE CAST

TOPAZ CAT #	UPC#	BX-FLEX SIZE	KO SIZE	UNIT CTN	SHIP CASE	WT/ CASE
-------------	------	--------------	---------	----------	-----------	----------

FOR BX-FLEX, NM, AND MC CABLE

• 2 SCREW CLAMP TYPE

140	10920	3/8" FITS MC RANGE .400-.500	1/2"	100	1000	60
-----	-------	------------------------------------	------	-----	------	----

• SADDLE TYPE

170	11380	3/8" FITS ALUMINUM, STEEL SMOOTH EXTRUDED MC	1/2"	50	500	40
-----	-------	--	------	----	-----	----

171	11381	1/2"	1/2"	25	250	11
-----	-------	------	------	----	-----	----

172	11382	3/4"	3/4"	20	200	16
-----	-------	------	------	----	-----	----

173	11383	1"	1"	10	100	25
-----	-------	----	----	----	-----	----



E170258

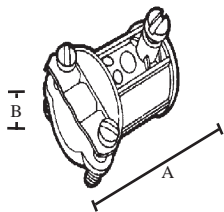

CAT#	A(MIN)	B(MAX)	C
180	.17	.63	1.35

COMBINATION COUPLINGS

ZINC DIE CAST

TOPAZ CAT #	UPC#	SIZE	UNIT CTN	SHIP CASE	WT/ CASE
-------------	------	------	----------	-----------	----------

EMT TO BX OR NM

• SET SCREW CLAMP TYPE

180	11410	1/2" - 3/8"	50	500	40
-----	-------	-------------	----	-----	----



E148716

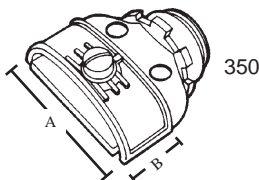

DUPLEX CONNECTORS

ZINC DIE CAST

TOPAZ CAT #	UPC#	SIZE	KO SIZE	UNIT CTN	SHIP CASE	WT/ CASE
-------------	------	------	---------	----------	-----------	----------

FOR BX-FLEX, NM, AND MC CABLE*

• 1 SCREW CLAMP TYPE

350	13490	3/8"	1/2"	25	250	32
-----	-------	------	------	----	-----	----

FITS MC RANGE .210-.500

• 2 SCREW CLAMP TYPE

360	13500	3/8"	1/2"	25	250	32
-----	-------	------	------	----	-----	----

FITS MC RANGE .210-.500

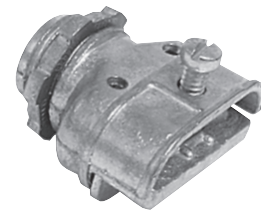

E26493

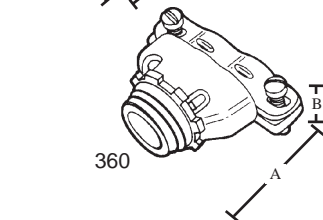

CAT#	A	B (MIN)	B (MAX)
350	1.57	.13	.650
360	1.59	.24	.630

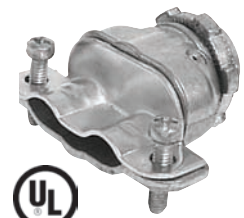

E170258

SE STRAPS

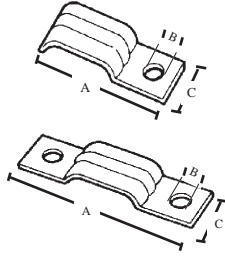

CAT#	A	B	C
501	1.695	.25	.570
502	1.950	.25	.580
503	2.480	.35	1.000
504	2.795	.35	1.010
506	2.395	.25	.750
507	2.740	.25	.750
508	3.150	.25	.750
509	3.485	.25	.750

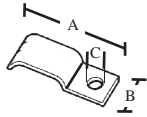

CAT#	A	B	C
232A	2.0625	.625	.25
282A	2.625	.75	.26
284A	2.9375	1.0	.32

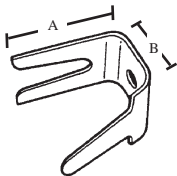

CAT#	A	B
135	1.420	.750
136	1.52	.750
137	1.620	.780
138	1.82	.890
139	2.20	1.000

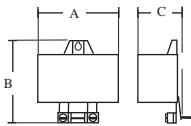

CAT#	A	B	C
709	4.25	5.00	2.00
710	6.00	5.19	2.50

STEEL

TOPAZ CAT #	UPC#	SIZE	UNIT CTN	SHIP CASE	WT/ CASE
ONE HOLE					
501	14870	3#8,6,4	100	1000	20
502	14880	3#3,2	100	1000	20
503	14890	3#1,1/0,2/0	25	250	18
504	14900	3#3/0,4/0	25	250	20

TWO HOLE

506	14910	3#8,6,4	100	1000	26
507	14920	3#3,2	100	1000	28
508	14930	3#1/0,2/0	25	250	11
509	14940	3#3/0,4/0	25	250	10

ONE HOLE

TOPAZ CAT #	UPC#	SIZE	UNIT CTN	SHIP CASE	WT/ CASE
232A	12015	3# 8-4	100	1000	2
282A	12055	3# 1/0-2/0 SE	50	500	5
284A	12056	3# 3/0-4/0 SE	50	500	5

ALUMINUM



SE LOCK OVER CLIPS

TOPAZ CAT #	UPC#	SIZE	UNIT CTN	SHIP CASE	WT/ CASE
135	10870	6/3	100	1000	8
136	10880	4/3	100	1000	10
137	10890	2/3	100	1000	15
138	10900	2/0	50	500	20
139	10910	4/0	50	500	25

SERVICE ENTRANCE HOODS

TOPAZ CAT #	UPC#	SIZE	UNIT CTN	SHIP CASE	WT/ CASE
709	17432	3#3-1	—	10	28
710	17434	3#2/0-4/0	—	10	54



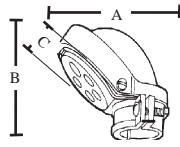

CAT#	A	B	C
731	2.93	2.62	2.00
732	3.25	2.75	2.37
733	3.50	3.25	2.62
734	4.50	3.25	3.00
735	5.00	4.75	3.31
736	6.75	6.00	4.62
737	10.50	7.50	6.00
738	11.50	9.00	8.00
739	12.00	9.00	8.00
740	12.00	9.00	8.00

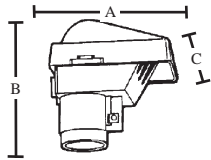

CAT#	A	B	C
721	2.75	2.87	2.00
722	3.25	3.18	2.43
723	3.31	3.31	2.50
724	4.00	3.81	3.00
725	4.10	3.75	3.00
726	6.50	5.00	4.25

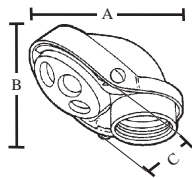

CAT#	A	B	C
741	2.68	2.60	2.00
742	3.80	2.72	2.37
743	3.32	3.11	2.62
744	4.46	3.20	3.00
745	4.85	4.34	3.31
746	6.62	5.44	4.62
747	9.74	7.80	6.00
748	10.50	8.00	8.00
749	13.02	9.39	8.00
750	13.14	8.54	8.00
750A	11.28	8.77	8.25
750B	12.25	9.76	8.25

SERVICE ENTRANCE CAPS

ALUMINUM

TOPAZ CAT #	UPC#	SIZE	INS. HOLE SIZE	# HOLES	UNIT CTN	SHIP CASE	WT/ CASE
CLAMP ON TYPE							
731	17640	1/2"	19/64	4	10	50	12
732	17650	3/4"	3/8 13/32	2 3	10	50	15
733	17660	1"	7/16 1/2	2 3	5	25	8
734	17670	1 1/4"	27/64 5/8	2 3	5	25	10
735	17680	1 1/2"	19/32 7/16 3/4	2 1 3	3	15	11
736	17690	2"	17/32 3/4 1	1 2 3	-	5	9
737	17700	2 1/2"	7/8 1 1 5/16	3 1 3	-	1	4
738	17710	3"	7/8 1 1 5/16	3 1 3	-	1	6
739	17720	3 1/2"	1 1/8 1 3/4	4 3	-	1	6
740	17730	4"	1 1/8 1 3/4	4 3	-	1	7

THERMOPLASTIC

721	17550	1/2"	-	-	25	4
722	17560	3/4"	-	-	25	4
723	17570	1"	-	-	20	5
724	17580	1 1/4"	-	-	10	5
725	17590	1 1/2"	-	-	10	6
726	17600	2"	-	-	5	4

THREADED TYPE

ALUMINUM

741	17740	1/2"	19/64	4	5	50	12
742	17750	3/4"	3/8 13/32	2 3	5	50	15
743	17760	1"	7/16 1/2	2 3	-	50	15
744	17770	1 1/4"	27/64 5/8	2 3	-	20	10
745	17780	1 1/2"	19/32 7/16 3/4	2 1 3	-	10	7
746	17790	2"	17/32 3/4 1	1 2 3	-	5	4
747	17800	2 1/2"	7/8 1 1 5/16	3 1 3	-	2	8
748	17810	3"	7/8 1 1 5/16	3 1 3	-	1	6
749	17820	3 1/2"	1 1/8 1 3/4	4 3	-	1	6
750	17830	4"	1 1/8 1 3/4	4 3	-	1	7
750A	17840	5"	1 1/8 1 3/4	2 4	-	1	12
750B	17850	6"	1 1/8 1 3/4	2 4	-	1	14



E170258



E170258



E170258

SERVICE ENTRANCE CAPS

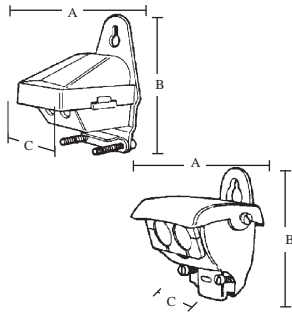

CAT#	A	B	C
727	2.75	2.75	1.87
728	4.25	4.25	3.00
729	4.25	4.25	3.00
707	2.37	2.25	2.25
708	4.93	3.12	3.75

THERMOPLASTIC					
TOPAZ CAT #	UPC#	FITS CABLE	UNIT CTN	SHIP CASE	WT/ CASE
727	17610	2/3	—	30	8
728	17620	1/0,2/0	—	10	7
729	17630	3#2/0,#4/0	—	10	11

WITH SPLIT INSULATOR					
			ZINC DIE CAST		
TOPAZ CAT #	UPC#	FITS CABLE	UNIT CTN	SHIP CASE	WT/ CASE
707	17400	3#8 TO 3#1	—	20	8
708	17430	1/0 TO 4/0	—	10	11



E170258



SET SCREW TYPE

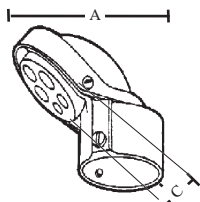

CAT#	A	B	C
704	4.75	4.00	3.12
705	5.25	4.00	3.00
706	7.00	5.50	4.50

ALUMINUM						
TOPAZ CAT #	UPC#	PIPE SIZE	HEAD SIZE	UNIT CTN	SHIP CASE	WT/ CASE
704	17390	2"	1 1/4"	—	10	10
705	17400	2 1/2"	1 1/4"	—	10	20
706	17410	2 1/2"	2"	—	10	20



E170258

ROOF FLASHINGS

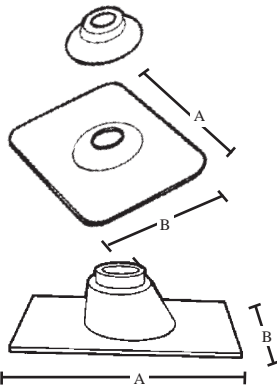

CAT#	A	B
984	12.50	8.75
985	12.50	8.75
986	14.50	10.75
987	14.50	10.75
994	11.50	9.00
995	11.50	9.00
996	11.50	9.00
997	13.50	10.00

GALVANIZED WITH NEOPRENE SEAL					
TOPAZ CAT #	UPC#	SIZE	UNIT CTN	SHIP CASE	WT/ CASE
984	19660	1 1/4"	—	10	9
985	19670	1 1/2"	—	10	9
986	19680	2"	—	10	12
987	19690	2 1/2"	—	10	14



NEOPRENE					
TOPAZ CAT #	UPC#	SIZE	UNIT CTN	SHIP CASE	WT/ CASE
994	19730	1 1/4" - 1 1/2"	—	12	9
995	19740	2"	—	12	8
996	19750	2 1/2"	—	12	9
997	19760	3"	—	12	12



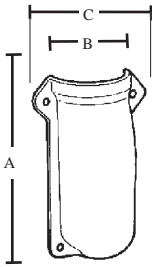

CAT#	A	B	C
591	2.37	1.00	2.61
593	2.50	1.25	3.00
594	2.61	1.56	3.76
595	3.580	1.738	3.568
596	5.81	1.88	3.48
596A	4.20	2.29	4.76

SILL PLATES WITH SEALING COMPOUND AND SCREWS

TOPAZ CAT #	UPC#	SIZE	UNIT CTN	SHIP CASE	WT/ CASE
591	15790	1/2" EMT & 3/4" EMT	10	100	10
593	15800	1" EMT & 3/3 SEU	10	100	40
594	15810	1 1/4" EMT & 2/3 SEU	—	25	15
595	15811	1 1/2" EMT	—	25	.41
596	15820	4/0 SEU	—	20	17
596A	15821	2" EMT	—	25	.63



DUCT-SEAL WEATHERPROOF COMPOUND

GRAY, ASBESTOS FREE

- PERMANENTLY SOFT
- NON-CORROSIVE TO METALS OR PLASTIC

TOPAZ CAT #	UPC#	SIZE	UNIT CTN	SHIP CASE	WT/ CASE
961	19550	1 LB.	—	50	50
965	19560	5 LB.	—	10	50



R11374

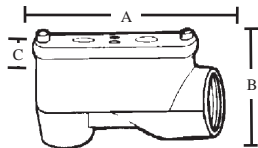
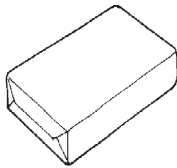

CAT#	A	B	WITH C
211	3.155	1.187	1.375
212	3.470	1.360	1.625
213	4.180	1.720	1.9375
214	5.515	2.178	2.4375
215	6.095	2.410	2.6875
216	6.595	2.846	3.0625
214XL	7.91	2.75	2.75
215XL	7.74	3.88	3.375

SERVICE ENTRANCE ELLS-SLB

COPPER FREE ALUMINUM

TOPAZ CAT #	UPC#	SIZE	UNIT CTN	SHIP CASE	WT/ CASE
211	11650	1/2"	10	50	13
212	11660	3/4"	10	50	16
213	11670	1"	5	25	12
214	11680	1 1/4"	2	10	8
214XL	11682	1 1/4" LONG	—	2	3
215	11690	1 1/2"	1	5	6
216	11700	2"	1	5	10
216XL	11702	2" LONG	—	1	3



E170258

WIREHOLDERS

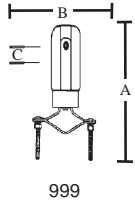

999



1001
1002

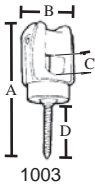

1003



1004



1008

CAT#	Opening			
	A	B	C	D
999	7.62	5.60	1.0 x .875	---
1001	3.0625	1.375	.5 x .375	1.687
1002	5.25	1.968	.5 x .375	2.25
1003	6.1563	1.875	1.0 x .875	2.25
1004	8.1563	1.875	1.0 x .875	5.00
1008	6.416	1.875	1.0 x .875	3.375

PORCELAIN, STEEL

TOPAZ CAT #	UPC#	SIZE	UNIT CTN	SHIP CASE	WT/ CASE
-------------	------	------	----------	-----------	----------

ADJUSTABLE

999	70240	1 1/4" - 3"	-	20	34
-----	-------	-------------	---	----	----

LIGHT DUTY

• LAG SCREW

		LAG			
1001	70260	1-11/16"	10	100	25

MEDIUM DUTY

1002	70270	2 1/4"	-	50	32
------	-------	--------	---	----	----

HEAVY DUTY PORCELAIN, STEEL REINFORCED

• LAG SCREW

		LAG			
1003	70280	2 1/4"	-	50	34

• BOLT & NUT

		BOLT SIZE			
1004	70290	3/8" X 5"	-	25	22

1008	70322	2" HANGER	-	25	31
------	-------	-----------	---	----	----



WEDGE GRIP CLAMPS

• WITH SOLID 6 1/2" STAINLESS STEEL BAIL

ALUMINUM

TOPAZ CAT #	UPC#	SIZE	UNIT CTN	SHIP CASE	WT/ CASE
-------------	------	------	----------	-----------	----------

1005	70300	6 ACSR - 2 ACSR	-	50	8
------	-------	-----------------	---	----	---

1006	70310	4 ACSR - 1/0 ACSR	-	25	7
------	-------	-------------------	---	----	---

1007	70320	2/0 ACSR - 4/0 ACSR	-	25	8
------	-------	---------------------	---	----	---

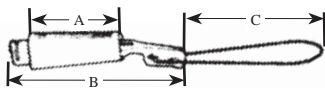

CAT#	A	B	C
1005	3.00	6.07	5.45
1006	3.75	7.26	5.45
1007	3.75	7.28	5.45



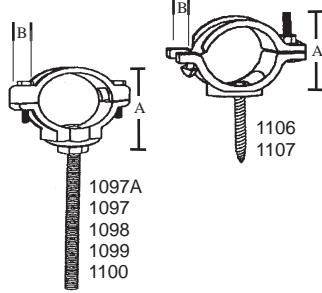
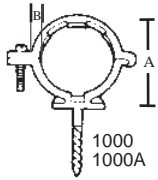

CONDUIT SUPPORTS

2 1/2" LAG SCREW TYPE				ALUMINUM		
TOPAZ CAT #	UPC#	CONDUIT SIZE	LAG	UNIT CTN	SHIP CASE	WT/CASE
1000	70250	2"	2.375	-	20	8
1000A	70251	2 1/2"	2.375	-	25	42
				MALLEABLE IRON		
1106	19715	2"	2.375	-	25	37
1107	19716	2 1/2"	2.375	-	35	87



CAT#	A	B
1000	2.875	.875
1000A	3.30	.875
1106	2.70	.985
1107	3.295	1.080
1097A	2.70	.985
1097	3.33	1.071
1098	4.50	1.040
1099	5.125	1.075
1100	5.593	1.075

SPLIT RING

		BOLT SIZE				
TOPAZ CAT #	UPC#	CONDUIT SIZE	BOLT SIZE	UNIT CTN	SHIP CASE	WT/CASE
1097A	83597	2"	1/2"-10"	-	25	12
1097	19711	2 1/2"	1/2"-10"	-	25	13
1098	19712	3"	5/8"-13"	-	10	25
1099	19713	3 1/2"	5/8"-13"	-	10	27
1100	19714	4"	5/8"-13"	-	10	28

UNIVERSAL PIPE SUPPORT

• WITH 10" BOLT				STEEL		
TOPAZ CAT #	UPC#	PIPE SIZE	BOLT SIZE	UNIT CTN	SHIP CASE	WT/CASE
998	19761	1 1/4" - 3"	1/2"	-	20	18

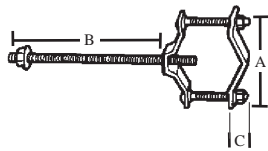

CAT#	A	B	C
998	4.125	9.75	1.25



SE MAST KIT

TOPAZ CAT #	UPC#	PIPE SIZE	HEAD SIZE	UNIT CTN	SHIP CASE	WT/CASE
1514	19717	2"	1 1/4"	-	1	5
Consists of 704, 986, (2) 1000, 1203, 1008						
1515	19718	2 1/2"	2"	-	1	6
Consists of 706, 999, 987, (2)998						

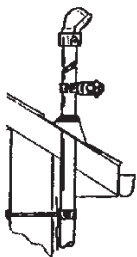

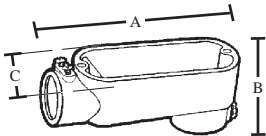

CAT#	A	B	C
ELB1	4.295	2.150	1.330
ELB2	5.090	2.430	1.540
ELB3	5.915	2.765	1.740
ELB4	7.894	3.665	2.490
ELB5	7.894	3.665	2.490
ELB6	10.134	4.275	3.100
ELB7	12.500	5.437	4.450
ELB8	12.500	5.657	4.450
ELB9	15.500	6.922	5.500
ELB10	15.500	6.922	5.500

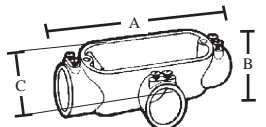

CAT#	A	B	C
ET1	4.720	1.370	2.030
ET2	5.570	1.625	2.335
ET3	6.460	1.900	2.705
ET4	8.528	2.770	3.630
ET5	8.528	2.770	3.630
ET6	10.831	3.335	3.980
ET7	13.500	4.060	5.825
ET8	13.50	4.685	5.825
ET9	15.937	5.450	7.060
ET10	15.937	5.450	7.060

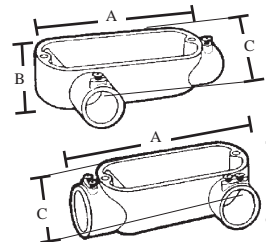

CAT#	A	B	C
ELR1/ELL1	4.295	1.370	2.030
ELR2/ELL2	5.090	1.625	2.330
ELR3/ELL3	5.915	1.900	2.650
ELR4/ELL4	7.894	2.770	3.385
ELR5/ELL5	7.894	2.770	3.385
ELR6/ELL6	10.134	3.335	3.810
ELR7/ELL7	12.500	5.437	4.450
ELR8/ELL8	12.500	5.657	4.450
ELR9/ELL9	15.500	6.922	5.500
ELR10/ELL10	15.500	6.922	5.500

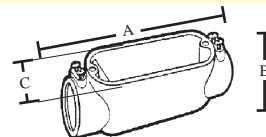

CAT#	A	B	C
EC1	4.720	1.370	1.330
EC2	5.570	1.625	1.540
EC3	6.460	1.900	1.740
EC4	8.528	2.770	2.490
EC5	8.528	2.770	2.490
EC6	10.831	3.335	3.100
EC7	13.00	4.063	5.709
EC8	12.50	4.682	5.506
EC9	15.50	5.452	6.171
EC10	15.50	5.452	6.171

CONDUIT BODIES

EMT SET SCREW TYPE

COPPER FREE ALUMINUM

TOPAZ CAT #	UPC#	SIZE	UNIT CTN	SHIP CASE	WT/ CASE
EMT LB TYPE					
ELB1	20470	1/2"	10	100	28
ELB2	20480	3/4"	10	50	19
ELB3	20490	1"	5	25	20
ELB4	20500	1 1/4"	2	10	13
ELB5	20510	1 1/2"	2	10	14
ELB6	20520	2"	1	5	13
ELB7	20530	2 1/2"	—	1	6
ELB8	20540	3"	—	1	6
ELB9	20550	3 1/2"	—	1	8
ELB10	20560	4"	—	1	8

EMT T TYPE

ET1	20690	1/2"	10	100	32
ET2	20700	3/4"	10	50	30
ET3	20710	1"	5	25	15
ET4	20720	1 1/4"	2	10	17
ET5	20730	1 1/2"	2	10	19
ET6	20740	2"	—	2	5
ET7	20781	2 1/2"	—	1	7
ET8	20782	3"	—	1	7
ET9	20783	3 1/2"	—	1	9
ET10	20784	4"	—	1	9

EMT LR TYPE

ELR1	20630	1/2"	10	100	30
ELR2	20640	3/4"	10	50	24
ELR3	20650	1"	5	25	16
ELR4	20660	1 1/4"	2	10	14
ELR5	20670	1 1/2"	2	10	17
ELR6	20680	2"	1	5	14
ELR7	20681	2 1/2"	—	1	6
ELR8	20682	3"	—	1	6
ELR9	20683	3 1/2"	—	1	8
ELR10	20684	4"	—	1	8

EMT LL TYPE

ELL1	20570	1/2"	10	100	30
ELL2	20580	3/4"	10	50	23
ELL3	20590	1"	5	25	18
ELL4	20600	1 1/4"	2	10	14
ELL5	20610	1 1/2"	2	10	16
ELL6	20620	2"	1	5	14
ELL7	20621	2 1/2"	—	1	6
ELL8	20622	3"	—	1	6
ELL9	20623	3 1/2"	—	1	8
ELL10	20624	4"	—	1	8

EMT C TYPE

EC1	20410	1/2"	10	100	24
EC2	20420	3/4"	10	50	21
EC3	20430	1"	5	25	25
EC4	20440	1 1/4"	2	10	15
EC5	20450	1 1/2"	2	10	17
EC6	20460	2"	1	5	13
EC7	20461	2 1/2"	—	1	6
EC8	20462	3"	—	1	7
EC9	20463	3 1/2"	—	1	8
EC10	20464	4"	—	1	8



E170258



E170258



E170258



E170258



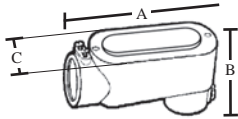

CAT#	A	B	C
ELB1CG	4.295	2.150	1.330
ELB2CG	5.090	2.430	1.540
ELB3CG	5.915	2.765	1.740
ELB4CG	7.894	3.665	2.490
ELB5CG	7.894	3.665	2.490
ELB6CG	10.134	4.275	3.100
ELB7CG	12.500	5.437	4.450
ELB8CG	12.500	5.657	4.450
ELB9CG	15.500	6.922	5.500
ELB10CG	15.500	6.922	5.500

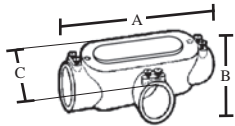

CAT#	A	B	C
ET1CG	4.720	1.370	2.030
ET2CG	5.570	1.625	2.335
ET3CG	6.460	1.900	2.705
ET4CG	8.528	2.770	3.630
ET5CG	8.528	2.770	3.630
ET6CG	10.831	3.335	3.980
ET7CG	13.500	4.060	5.825
ET8CG	13.50	4.685	5.825
ET9CG	15.937	5.450	7.060
ET10CG	15.937	5.450	7.060

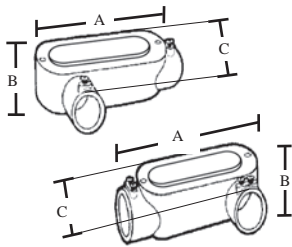

CAT#	A	B	C
ELR1CG/ELL1CG	4.295	1.370	2.030
ELR2CG/ELL2CG	5.090	1.625	2.330
ELR3CG/ELL3CG	5.915	1.900	2.650
ELR4CG/ELL4CG	7.894	2.770	3.385
ELR5CG/ELL5CG	7.894	2.770	3.385
ELR6CG/ELL6CG	10.134	3.335	3.810
ELR7CG/ELL7CG	12.500	5.437	4.450
ELR8CG/ELL8CG	12.500	5.657	4.450
ELR9CG/ELL9CG	15.500	6.922	5.500
ELR10CG/ELL10CG	15.500	6.922	5.500

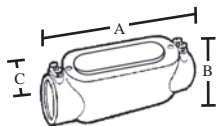

CAT#	A	B	C
EC1CG	4.720	1.370	1.330
EC2CG	5.570	1.625	1.540
EC3CG	6.460	1.900	1.740
EC4CG	8.528	2.770	2.490
EC5CG	8.528	2.770	2.490
EC6CG	10.831	3.335	3.100
EC7CG	13.00	4.063	5.709
EC8CG	12.50	4.682	5.506
EC9CG	15.50	5.452	6.171
EC10CG	15.50	5.452	6.171

CONDUIT BODIES WITH COVERS & GASKETS

EMT SET SCREW TYPE

COPPER FREE ALUMINUM

TOPAZ CAT #	UPC#	SIZE	UNIT CTN	SHIP CASE	WT/ CASE
EMT LB TYPE					
ELB1CG	20471	1/2"	10	100	32
ELB2CG	20481	3/4"	10	50	23
ELB3CG	20491	1"	5	25	19
ELB4CG	20501	1 1/4"	2	10	14
ELB5CG	20511	1 1/2"	2	10	15
ELB6CG	20521	2"	1	5	14
ELB7CG	20531	2 1/2"	-	1	7
ELB8CG	20541	3"	-	1	7
ELB9CG	20551	3 1/2"	-	1	10
ELB10CG	20561	4"	-	1	10



TOPAZ CAT #	UPC#	SIZE	UNIT CTN	SHIP CASE	WT/ CASE
EMT T TYPE					
ET1CG	20691	1/2"	5	50	38
ET2CG	20701	3/4"	10	50	30
ET3CG	20711	1"	5	25	20
ET4CG	20721	1 1/4"	2	10	19
ET5CG	20731	1 1/2"	2	10	21
ET6CG	20745	2"	-	2	5
ET7CG	20744	2 1/2"	-	1	8
ET8CG	20747	3"	-	1	8
ET9CG	20748	3 1/2"	-	1	11
ET10CG	20749	4"	-	1	11

TOPAZ CAT #	UPC#	SIZE	UNIT CTN	SHIP CASE	WT/ CASE
EMT LR TYPE					
ELR1CG	20631	1/2"	10	100	36
ELR2CG	20641	3/4"	5	10	28
ELR3CG	20651	1"	5	25	17
ELR4CG	20661	1 1/4"	2	10	15
ELR5CG	20671	1 1/2"	2	10	18
ELR6CG	20685	2"	1	5	14
ELR7CG	20686	2 1/2"	-	1	7
ELR8CG	20687	3"	-	1	7
ELR9CG	20688	3 1/2"	-	1	10
ELR10CG	20689	4"	-	1	10

TOPAZ CAT #	UPC#	SIZE	UNIT CTN	SHIP CASE	WT/ CASE
EMT LL TYPE					
ELL1CG	20571	1/2"	10	100	30
ELL2CG	20581	3/4"	5	50	23
ELL3CG	20591	1"	5	25	18
ELL4CG	20601	1 1/4"	2	10	14
ELL5CG	20611	1 1/2"	2	10	16
ELL6CG	20625	2"	1	5	14
ELL7CG	20626	2 1/2"	-	1	6
ELL8CG	20627	3"	-	1	6
ELL9CG	20628	3 1/2"	-	1	8
ELL10CG	20629	4"	-	1	8

TOPAZ CAT #	UPC#	SIZE	UNIT CTN	SHIP CASE	WT/ CASE
EMT C TYPE					
EC1CG	20411	1/2"	10	100	24
EC2CG	20421	3/4"	5	50	21
EC3CG	20431	1"	5	25	25
EC4CG	20441	1 1/4"	5	25	15
EC5CG	20451	1 1/2"	5	10	17
EC6CG	20465	2"	1	5	13
EC7CG	20466	2 1/2"	-	1	6
EC8CG	20467	3"	-	1	6
EC9CG	20468	3 1/2"	-	1	8
EC10CG	20469	4"	-	1	8

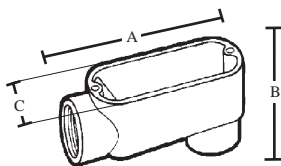

CONDUIT BODIES RIGID THREADED TYPE

COPPER FREE ALUMINUM

CAT#	A	B	C
LB1	4.295	2.150	1.330
LB2	5.090	2.430	1.540
LB3	5.915	2.765	1.740
LB4	7.894	3.665	2.490
LB5	7.894	3.665	2.490
LB6	10.134	4.275	3.100
LB7	12.500	5.437	4.450
LB8	12.500	5.675	4.450
LB9	15.500	6.922	5.500
LB10	15.500	6.922	5.500

TOPAZ CAT #	UPC#	SIZE	UNIT CTN	SHIP CASE	WT/ CASE
RIGID LB TYPE					
LB1	20840	1/2"	10	100	28
LB2	20850	3/4"	10	50	19
LB3	20860	1"	5	25	18
LB4	20870	1 1/4"	2	10	13
LB5	20880	1 1/2"	2	10	14
LB6	20890	2"	1	5	13
LB7	20900	2 1/2"	—	1	6
LB8	20910	3"	—	1	6
LB9	20920	3 1/2"	—	1	8
LB10	20930	4"	—	1	8

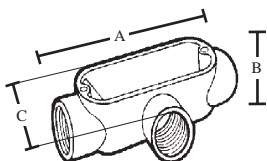

CAT#	A	B	C
T1	4.720	1.370	2.030
T2	5.570	1.625	2.335
T3	6.460	1.900	2.705
T4	8.528	2.770	3.630
T5	8.528	2.770	3.630
T6	10.831	3.335	3.980
T7	13.500	4.060	5.825
T8	13.000	4.685	5.825
T9	15.937	5.450	7.060
T10	15.937	5.450	7.060

RIGID T TYPE

T1	21730	1/2"	10	100	32
T2	21740	3/4"	10	50	26
T3	21750	1"	5	25	18
T4	21760	1 1/4"	2	10	17
T5	21770	1 1/2"	2	10	19
T6	21780	2"	—	2	5
T7	21790	2 1/2"	—	1	7
T8	21800	3"	—	1	7
T9	21810	3 1/2"	—	1	9
T10	21820	4"	—	1	9

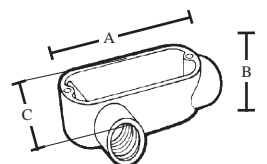
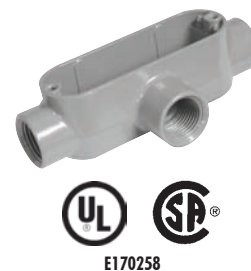

CAT#	A	B	C
LR1	4.295	1.370	2.030
LR2	5.090	1.625	2.330
LR3	5.915	1.900	2.650
LR4	7.894	2.770	3.385
LR5	7.894	2.770	3.385
LR6	10.134	3.335	3.810
LR7	13.000	4.063	5.709
LR8	12.750	4.682	5.506
LR9	15.500	5.452	6.171
LR10	15.500	5.452	6.171

RIGID LR TYPE

LR1	21240	1/2"	10	100	29
LR2	21250	3/4"	10	50	24
LR3	21260	1"	5	25	19
LR4	21270	1 1/4"	2	10	14
LR5	21280	1 1/2"	2	10	17
LR6	21290	2"	1	5	14
LR7	21300	2 1/2"	—	1	6
LR8	21310	3"	—	1	6
LR9	21320	3 1/2"	—	1	8
LR10	21330	4"	—	1	8

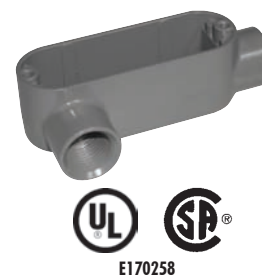

CONDUIT BODIES RIGID THREADED TYPE

COPPER FREE ALUMINUM

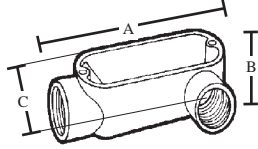

CAT#	A	B	C
LL1	4.295	1.370	2.030
LL2	5.090	1.625	2.330
LL3	5.915	1.900	2.650
LL4	7.894	2.770	3.385
LL5	7.894	2.770	3.385
LL6	10.134	3.335	3.810
LL7	13.000	4.063	5.709
LL8	12.750	4.682	5.506
LL9	15.500	5.452	6.171
LL10	15.500	5.452	6.171

TOPAZ CAT #	UPC#	SIZE	UNIT CTN	SHIP CASE	WT/ CASE
RIGID LL TYPE					
LL1	21040	1/2"	10	100	28
LL2	21050	3/4"	10	50	23
LL3	21060	1"	5	25	18
LL4	21070	1 1/4"	2	10	14
LL5	21080	1 1/2"	2	10	16
LL6	21090	2"	1	5	14
LL7	21100	2 1/2"	—	1	6
LL8	21110	3"	—	1	6
LL9	21120	3 1/2"	—	1	8
LL10	21130	4"	—	1	8

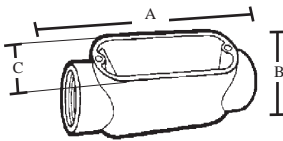

CAT#	A	B	C
C1	4.720	1.370	1.330
C2	5.570	1.625	1.540
C3	6.460	1.900	1.740
C4	8.528	2.770	2.490
C5	8.528	2.770	2.490
C6	10.831	3.335	3.100
C7	13.500	4.060	4.450
C8	13.000	4.685	4.450
C9	15.937	5.450	5.500
C10	15.937	5.450	5.500

RIGID C TYPE

CAT #	UPC#	SIZE	UNIT CTN	SHIP CASE	WT/ CASE
C1	19900	1/2"	10	100	24
C2	19910	3/4"	10	50	21
C3	19920	1"	5	25	15
C4	19930	1 1/4"	2	10	15
C5	19940	1 1/2"	2	10	17
C6	19950	2"	1	5	13
C7	19960	2 1/2"	—	1	6
C8	19970	3"	—	1	6
C9	19980	3 1/2"	—	1	8
C10	19990	4"	—	1	8

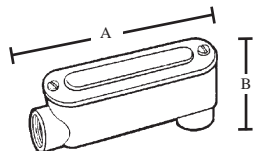

CAT#	A	B
MLBCG4	10.19	4.06
MLBCG4	15.54	4.88
MLBCG4	15.54	4.88

MOGUL CONDUIT BODIES WITH COVERS & GASKETS

RIGID LB TYPE

COPPER FREE ALUMINUM

TOPAZ CAT #	UPC#	SIZE	UNIT CTN	SHIP CASE	WT/ CASE
MLBCG4	32110	1 1/4"	—	5	8
MLBCG5	32120	1 1/2"	—	2	10
MLBCG6	32130	2"	—	2	9



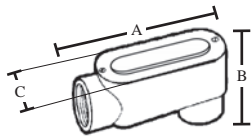

CAT#	A	B	C
LB1CG	4.295	2.150	1.330
LB2CG	5.090	2.430	1.540
LB3CG	5.915	2.765	1.740
LB4CG	7.894	3.665	2.490
LB5CG	7.894	3.665	2.490
LB6CG	10.134	4.275	3.100
LB7CG	12.500	5.437	4.450
LB8CG	12.500	5.675	4.450
LB9CG	15.500	6.922	5.500
LB10CG	15.500	6.922	5.500

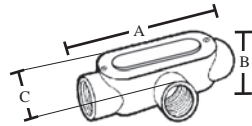

CAT#	A	B	C
T1CG	4.720	1.370	1.330
T2CG	5.570	1.625	1.540
T3CG	6.460	1.900	1.740
T4CG	8.528	2.770	2.490
T5CG	8.528	2.770	2.490
T6CG	10.831	3.335	3.100
T7CG	13.500	4.060	5.825
T8CG	13.000	4.685	5.825
T9CG	15.937	5.450	7.060
T10CG	15.937	5.450	7.060

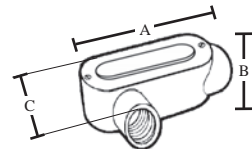

CAT#	A	B	C
LR1CG	4.295	1.370	2.030
LR2CG	5.090	1.625	2.330
LR3CG	5.915	1.900	2.650
LR4CG	7.894	2.770	3.385
LR5CG	7.894	2.770	3.385
LR6CG	10.134	3.335	3.810
LR7CG	13.000	4.063	5.709
LR8CG	12.750	4.682	5.506
LR9CG	15.500	5.452	6.171
LR10CG	15.500	5.452	6.171

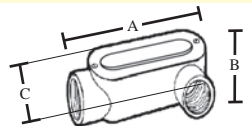

CAT#	A	B	C
LL1CG	4.295	1.370	2.030
LL2CG	5.090	1.625	2.330
LL3CG	5.915	1.900	2.650
LL4CG	7.894	2.770	3.385
LL5CG	7.894	2.770	3.385
LL6CG	10.134	3.335	3.810
LL7CG	13.000	4.063	5.709
LL8CG	12.750	4.682	5.506
LL9CG	15.500	5.452	6.171
LL10CG	15.500	5.452	6.171

CONDUIT BODIES WITH COVERS & GASKETS

RIGID THREADED TYPE

COPPER FREE ALUMINUM

TOPAZ CAT #	UPC#	SIZE	UNIT CTN	SHIP CASE	WT/ CASE
LB1CG	20841	1/2"	10	100	34
LB2CG	20851	3/4"	10	50	23
LB3CG	20861	1"	5	25	19
LB4CG	20871	1 1/4"	2	10	14
LB5CG	20881	1 1/2"	2	10	15
LB6CG	20891	2"	1	5	14
LB7CG	20901	2 1/2"	—	1	7
LB8CG	20911	3"	—	1	7
LB9CG	20921	3 1/2"	—	1	10
LB10CG	20931	4"	—	1	10

RIGID T TYPE

T1CG	21731	1/2"	10	100	38
T2CG	21741	3/4"	10	50	30
T3CG	21751	1"	5	25	20
T4CG	21761	1 1/4"	2	10	19
T5CG	21771	1 1/2"	2	10	21
T6CG	21781	2"	—	2	5
T7CG	21791	2 1/2"	—	1	8
T8CG	21801	3"	—	1	8
T9CG	21811	3 1/2"	—	1	11
T10CG	21821	4"	—	1	11

RIGID LR TYPE

LR1CG	21241	1/2"	10	100	36
LR2CG	21251	3/4"	10	50	28
LR3CG	21261	1"	5	25	17
LR4CG	21271	1 1/4"	2	10	15
LR5CG	21281	1 1/2"	2	10	18
LR6CG	21291	2"	1	5	14
LR7CG	21301	2 1/2"	—	1	7
LR8CG	21311	3"	—	1	7
LR9CG	21321	3 1/2"	—	1	10
LR10CG	21331	4"	—	1	10

RIGID LL TYPE

LL1CG	21041	1/2"	10	100	36
LL2CG	21051	3/4"	10	50	23
LL3CG	21061	1"	5	25	19
LL4CG	21071	1 1/4"	2	10	15
LL5CG	21081	1 1/2"	2	10	16
LL6CG	21091	2"	1	5	14
LL7CG	21101	2 1/2"	—	1	7
LL8CG	21111	3"	—	1	7
LL9CG	21121	3 1/2"	—	1	10
LL10CG	21131	4"	—	1	10



E170258



E170258



E170258



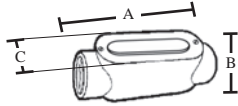

CAT#	A	B	C
C1CG	4.720	1.370	1.330
C2CG	5.570	1.625	1.540
C3CG	6.460	1.900	1.740
C4CG	8.528	2.770	2.490
C5CG	8.528	2.770	2.490
C6CG	10.831	3.335	3.100
C7CG	13.500	4.060	4.450
C8CG	13.000	4.685	4.450
C9CG	15.937	5.450	5.500
C10CG	15.937	5.450	5.500

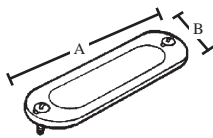

CAT#	A	B	SCREW SIZE
571	3.875	1.310	8/32 X 3/8
572	4.625	1.520	8/32 X 3/8
573	5.315	1.710	8/32 X 3/8
574	7.240	2.510	12/24 X 3/8
576	9.484	3.110	12/24 X 3/8
577	12.187	4.440	5/16 X 3/8
579	14.937	5.500	5/16 X 3/8

571S	3.875	1.310	8/32 X 3/8
572S	4.625	1.520	8/32 X 3/8
573S	5.315	1.710	8/32 X 3/8
574S	7.240	2.510	12/24 X 3/8
576S	9.484	3.110	12/24 X 3/8
577S	12.187	4.440	5/16 X 3/8
579S	14.937	5.500	5/16 X 3/8

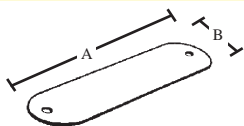

CAT#	A	B
581	3.935	1.360
582	4.600	1.550
583	5.370	1.760
584	7.250	2.500
586	9.500	3.070
587	12.125	4.355
589	14.812	5.400

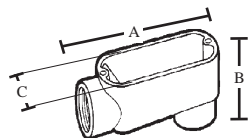

CAT#	A	B	C
LB1M	4.56	2.06	1.31
LB2M	5.31	2.37	1.48
LB3M	6.25	2.63	1.75
LB4M	8.22	3.50	2.40
LB5M	8.22	3.75	2.40
LB6M	10.48	4.31	3.05
LB7M	13.75	4.45	4.38
LB8M	13.75	4.45	4.38
LB9M	16.75	5.80	5.63
LB10M	16.75	5.80	5.63

CONDUIT BODIES WITH COVERS & GASKETS

RIGID THREADED TYPE

COPPER FREE ALUMINUM

TOPAZ CAT #	UPC#	SIZE	UNIT CTN	SHIP CASE	WT/ CASE
RIGID C TYPE					
C1CG	19901	1/2"	10	100	30
C2CG	19911	3/4"	10	50	25
C3CG	19921	1"	5	25	18
C4CG	19931	1 1/4"	2	10	17
C5CG	19941	1 1/2"	2	10	19
C6CG	19951	2"	1	5	14
C7CG	19961	2 1/2"	—	1	7
C8CG	19971	3"	—	1	7
C9CG	19981	3 1/2"	—	1	10
C10CG	19991	4"	—	1	10

CONDUIT BODY COVERS WITH SCREWS

ALUMINUM

TOPAZ CAT #	UPC#	SIZE	UNIT CTN	SHIP CASE	WT/ CASE
571	15450	1/2"	25	250	15
572	15460	3/4"	25	250	20
573	15470	1"	10	100	9
574	15480	1 1/4"-1 1/2"	—	25	4
576	15490	2"	—	25	7
577	15500	2 1/2"-3"	—	10	8
579	15510	3 1/2"-4"	—	5	7

STEEL

571S	15520	1/2"	25	250	15
572S	15530	3/4"	25	250	20
573S	15540	1"	10	100	8
574S	15550	1 1/4"-1 1/2"	—	25	4
576S	15560	2"	—	25	7
577S	15570	2 1/2"-3"	—	10	7
579S	15580	3 1/2"-4"	—	5	9

CONDUIT BODY GASKETS

NEOPRENE

TOPAZ CAT #	UPC#	SIZE	UNIT CTN	SHIP CASE	WT/ CASE
581	15710	1/2"	50	500	1
582	15720	3/4"	50	500	1
583	15730	1"	25	500	2
584	15740	1 1/4"-1 1/2"	25	500	2
586	15750	2"	25	250	2
587	15760	2 1/2"-3"	10	100	2
589	15770	3 1/2"-4"	5	50	2

All Covers and Gaskets fit LB, LL, LR, C and T's, Aluminum and Malleable, Set Screw and Rigid Bodies

CONDUIT BODIES

RIGID THREADED TYPE MALLEABLE IRON

TOPAZ CAT #	UPC#	SIZE	UNIT CTN	SHIP CASE	WT/ CASE
RIGID LB TYPE					
LB1M	20940	1/2"	—	10	7
LB2M	20950	3/4"	—	10	9
LB3M	20960	1"	—	5	6
LB4M	20970	1 1/4"	—	10	23
LB5M	20980	1 1/2"	—	10	26
LB6M	20990	2"	—	5	26
LB7M	21000	2 1/2"	—	1	10
LB8M	21010	3"	—	1	13
LB9M	21020	3 1/2"	—	1	22
LB10M	21030	4"	—	1	24



E170258



E170258

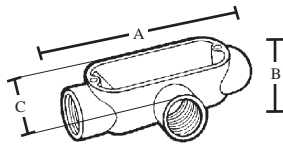

CAT#	A	B	C
T1M	5.35	1.31	2.02
T2M	6.00	1.62	2.22
T3M	7.06	1.88	2.56
T4M	7.25	2.50	3.50
T5M	9.25	2.67	3.50
T6M	11.50	3.29	4.25
T7M	15.00	3.9375	5.718
T8M	15.125	4.75	5.875
T9M	18.125	5.2031	6.812
T10M	18.125	5.5625	7.203

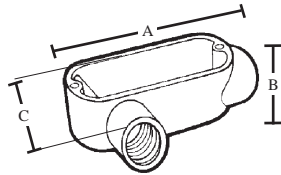

CAT#	A	B	C
LR1M	4.56	1.31	2.06
LR2M	5.31	1.62	2.23
LR3M	6.25	1.88	2.50
LR4M	8.22	2.50	3.40
LR5M	8.22	2.67	3.48
LR6M	10.48	3.29	4.07
LR7M	13.75	4.45	4.38
LR8M	13.75	4.45	4.38
LR9M	16.75	5.80	5.63
LR10M	16.75	5.80	5.63

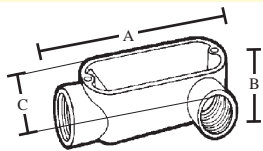

CAT#	A	B	C
LL1M	4.56	1.31	2.06
LL2M	5.31	1.62	2.23
LL3M	6.25	1.88	2.50
LL4M	8.22	2.50	3.40
LL5M	8.22	2.67	3.48
LL6M	10.48	3.29	4.07
LL7M	13.6094	3.9063	5.718
LL8M	13.875	4.75	5.875
LL9M	16.50	6.8125	7.125
LL10M	16.50	7.1875	7.125

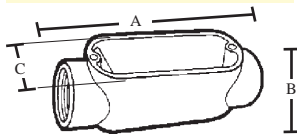

CAT#	A	B	C
C1M	5.35	1.31	1.31
C2M	6.00	1.62	1.48
C3M	7.06	1.88	1.75
C4M	9.25	2.50	2.40
C5M	9.25	2.67	2.40
C6M	11.50	3.29	3.05
C7M	15.00	3.9063	4.312
C8M	15.125	4.75	4.312
C9M	18.125	5.1875	4.875
C10M	18.125	5.5625	4.875

CONDUIT BODIES RIGID THREADED TYPE

TOPAZ CAT #	UPC#	SIZE	UNIT CTN	SHIP CASE	WT/ CASE
RIGID T TYPE					
T1M	21830	1/2"	—	10	7
T2M	21840	3/4"	—	5	10
T3M	21850	1"	—	10	16
T4M	21860	1 1/4"	—	10	28
T5M	21870	1 1/2"	—	10	29
T6M	21880	2"	—	2	12
T7M	21890	2 1/2"	—	1	12
T8M	21900	3"	—	1	15
T9M	21910	3 1/2"	—	1	27
T10M	21920	4"	—	1	28



E170258

RIGID LR TYPE

LR1M	21340	1/2"	—	10	7
LR2M	21350	3/4"	—	10	9
LR3M	21360	1"	—	5	6
LR4M	21370	1 1/4"	—	10	23
LR5M	21380	1 1/2"	—	10	26
LR6M	21390	2"	—	5	26
LR7M	21400	2 1/2"	—	1	10
LR8M	21410	3"	—	1	13
LR9M	21420	3 1/2"	—	1	22
LR10M	21430	4"	—	1	24



E170258

RIGID LL TYPE

LL1M	21140	1/2"	—	10	7
LL2M	21150	3/4"	—	10	9
LL3M	21160	1"	—	5	6
LL4M	21170	1 1/4"	—	10	23
LL5M	21180	1 1/2"	—	10	26
LL6M	21190	2"	—	5	26
LL7M	21200	2 1/2"	—	1	10
LL8M	21210	3"	—	1	13
LL9M	21220	3 1/2"	—	1	22
LL10M	21230	4"	—	1	24



E170258

RIGID C TYPE

C1M	20000	1/2"	—	10	7
C2M	20010	3/4"	5	25	23
C3M	20020	1"	—	5	6
C4M	20030	1 1/4"	—	10	23
C5M	20040	1 1/2"	—	10	26
C6M	20050	2"	—	5	26
C7M	20051	2 1/2"	—	5	10
C8M	20052	3"	—	1	12
C9M	20053	3 1/2"	—	1	21
C10M	20054	4"	—	1	23



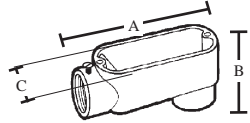

CAT#	A	B	C
LB1SS	4.56	2.06	1.31
LB2SS	5.31	2.37	1.48
LB3SS	6.25	2.63	1.75
LB4SS	8.22	3.50	2.40
LB5SS	8.22	3.75	2.40

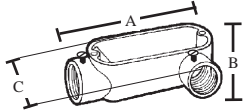

CAT#	A	B	C
LL1SS	4.56	1.31	2.06
LL2SS	5.31	1.62	2.23
LL3SS	6.25	1.88	2.50
LL4SS	8.22	2.50	3.40
LL5SS	8.22	2.67	3.48
LL6SS	10.48	3.29	4.07

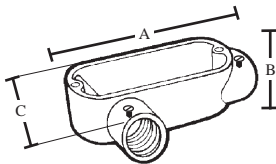

CAT#	A	B	C
LR1SS	4.56	1.31	2.06
LR2SS	5.31	1.62	2.23
LR3SS	6.25	1.88	2.50
LR4SS	8.22	2.50	3.40
LR5SS	8.22	2.67	3.48
LR6SS	10.48	3.29	4.07

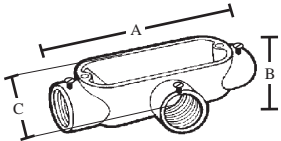

CAT#	A	B	C
T1SS	5.35	1.31	2.02
T2SS	6.00	1.62	2.22
T3SS	7.06	1.88	2.56
T4SS	7.25	2.50	3.50
T5SS	9.25	2.67	3.50
T6SS	11.50	3.29	4.25

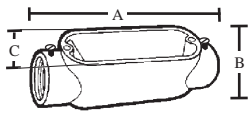

CAT#	A	B	C
C1SS	5.35	1.31	1.31
C2SS	6.00	1.62	1.48
C3CS	7.06	1.88	1.75
C4SS	9.25	2.50	2.40
C5SS	9.25	2.67	2.40
C6SS	11.50	3.29	3.05

CONDUIT BODIES

EMT AND RIGID COMBINATION

ALUMINUM

TOPAZ CAT #	UPC#	SIZE	UNIT CTN	SHIP CASE	WT/ CASE
EMT & RIGID LB TYPE					
LB1SS	20842	1/2"	10	100	28
LB2SS	20852	3/4"	10	50	19
LB3SS	20862	1"	5	25	18
LB4SS	20872	1 1/4"	2	10	13
LB5SS	20882	1 1/2"	2	10	14
LB6SS	20892	2"	-	5	13



EMT & RIGID LL TYPE

LL1SS	21042	1/2"	10	100	28
LL2SS	21052	3/4"	10	50	23
LL3SS	21062	1"	5	25	18
LL4SS	21072	1 1/4"	2	10	14
LL5SS	21082	1 1/2"	2	10	16
LL6SS	21092	2"	-	5	14

EMT & RIGID LR TYPE

LR1SS	21242	1/2"	10	100	29
LR2SS	21252	3/4"	10	50	24
LR3SS	21262	1"	5	25	19
LR4SS	21272	1 1/4"	2	10	14
LR5SS	21282	1 1/2"	2	10	17
LR6SS	21292	2"	-	5	4

EMT & RIGID T TYPE

T1SS	21732	1/2"	10	100	32
T2SS	21742	3/4"	10	50	26
T3SS	21752	1"	5	25	18
T4SS	21762	1 1/4"	2	10	17
T5SS	21772	1 1/2"	2	10	19
T6SS	21782	2"	-	5	5

EMT & RIGID C TYPE

C1SS	19902	1/2"	10	100	24
C2SS	19912	3/4"	10	50	21
C3SS	19922	1"	5	25	15
C4SS	19932	1 1/4"	2	10	15
C5SS	19942	1 1/2"	2	10	17
C6SS	19952	2"	-	5	13

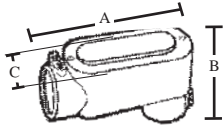

CAT#	A	B	C
LB1SSCG	4.56	2.06	1.31
LB2SSCG	5.31	2.37	1.48
LB3SSCG	6.25	2.63	1.75
LB4SSCG	8.22	3.50	2.40
LB5SSCG	8.22	3.75	2.40

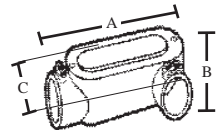

CAT#	A	B	C
LL1SSCG	4.56	1.31	2.06
LL2SSCG	5.31	1.62	2.23
LL3SSCG	6.25	1.88	2.50
LL4SSCG	8.22	2.50	3.40
LL5SSCG	8.22	2.67	3.48
LL6SSCG	10.48	3.29	4.07

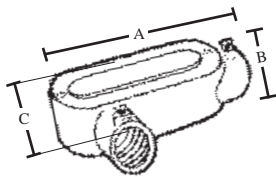

CAT#	A	B	C
LR1SSCG	4.56	1.31	2.06
LR2SSCG	5.31	1.62	2.23
LR3SSCG	6.25	1.88	2.50
LR4SSCG	8.22	2.50	3.40
LR5SSCG	8.22	2.67	3.48
LR6SSCG	10.48	3.29	4.07

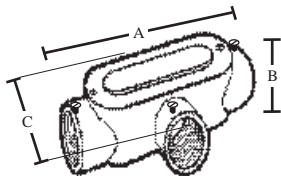

CAT#	A	B	C
T1SSCG	5.35	1.31	2.02
T2SSCG	6.00	1.62	2.22
T3SSCG	7.06	1.88	2.56
T4SSCG	7.25	2.50	3.50
T5SSCG	9.25	2.67	3.50
T6SSCG	11.50	3.29	4.25

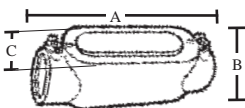

CAT#	A	B	C
C1SSCG	5.35	1.31	1.31
C2SSCG	6.00	1.62	1.48
C3SSCG	7.06	1.88	1.75
C4SSCG	9.25	2.50	2.40
C5SSCG	9.25	2.67	2.40
C6SSCG	11.50	3.29	3.05

CONDUIT BODIES WITH COVERS & GASKETS

EMT AND RIGID COMBINATION

		ALUMINUM			
TOPAZ CAT #	UPC#	SIZE	UNIT CTN	SHIP CASE	WT/ CASE
EMT & RIGID LB TYPE					
LB1SSCG	83768	1/2"	10	100	34
LB2SSCG	83769	3/4"	10	50	23
LB3SSCG	83770	1"	5	25	19
LB4SSCG	83771	1 1/4"	2	10	14
LB5SSCG	83772	1 1/2"	2	10	15
LB6SSCG	83773	2"	-	5	14

		ALUMINUM			
TOPAZ CAT #	UPC#	SIZE	UNIT CTN	SHIP CASE	WT/ CASE
EMT & RIGID LL TYPE					
LL1SSCG	83774	1/2"	10	100	36
LL2SSCG	83775	3/4"	10	50	23
LL3SSCG	83776	1"	5	25	19
LL4SSCG	83777	1 1/4"	2	10	15
LL5SSCG	83778	1 1/2"	2	10	16
LL6SSCG	83779	2"	-	5	14

		ALUMINUM			
TOPAZ CAT #	UPC#	SIZE	UNIT CTN	SHIP CASE	WT/ CASE
EMT & RIGID LR TYPE					
LR1SSCG	83780	1/2"	10	100	36
LR2SSCG	83781	3/4"	10	50	28
LR3SSCG	83782	1"	5	25	17
LR4SSCG	83783	1 1/4"	2	10	15
LR5SSCG	83784	1 1/2"	2	10	18
LR6SSCG	83785	2"	-	5	14

		ALUMINUM			
TOPAZ CAT #	UPC#	SIZE	UNIT CTN	SHIP CASE	WT/ CASE
EMT & RIGID T TYPE					
T1SSCG	83792	1/2"	10	100	38
T2SSCG	83793	3/4"	10	50	30
T3SSCG	83794	1"	5	25	20
T4SSCG	83795	1 1/4"	2	10	19
T5SSCG	83796	1 1/2"	2	10	21
T6SSCG	83797	2"	-	5	5

		ALUMINUM			
TOPAZ CAT #	UPC#	SIZE	UNIT CTN	SHIP CASE	WT/ CASE
EMT & RIGID C TYPE					
C1SSCG	83786	1/2"	10	100	30
C2SSCG	83787	3/4"	10	50	25
C3SSCG	83788	1"	5	25	18
C4SSCG	83789	1 1/4"	2	10	17
C5SSCG	83790	1 1/2"	2	10	19
C6SSCG	83791	2"	-	5	14



E170258



E170258



E170258



E170258



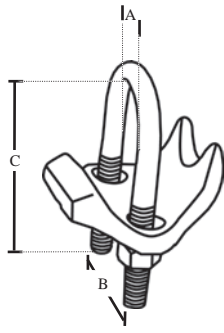

RIGHT ANGLE CONDUIT SUPPORT

CAT#	A	B	C
1550	.820	1.00	1.12
1551	1.00	1.25	2.50
1552	1.125	1.125	2.8125
1553	1.375	1.375	3.0625
1554	1.75	1.75	3.1875
1555	2.00	2.375	3.50
1556	2.50	2.50	4.50
1557	3.00	3.00	4.875
1558	3.625	3.875	5.375
1559	4.0625	4.5625	5.875
1559A	4.6875	5.0625	6.6875

TOPAZ CAT #	UPC#	SIZE	MALLEABLE IRON		
			UNIT CTN	SHIP CASE	WT/ CASE
1550	52001	3/8"	—	50	25
1551	52002	1/2"	—	50	40
1552	52003	3/4"	—	50	43
1553	52004	1"	—	50	48
1554	52005	1 1/4"	—	50	53
1555	52006	1 1/2"	—	50	58
1556	52007	2"	—	50	85
1557	52008	2 1/2"	—	25	106
1558	52009	3"	—	25	110
1559	52011	3 1/2"	—	25	128
1559A	52010	4"	—	25	140

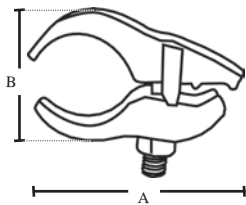

PARALLEL CONDUIT SUPPORT

CAT#	A	B
1560	2.00	1.370
1561	2.875	1.4375
1562	3.0625	1.6875
1563	3.25	2.00
1564	3.625	2.125
1565	3.875	2.1875
1566	4.625	2.875
1567	5.25	3.25
1568	5.875	3.875
1569	6.3125	4.3125
1570	6.8125	4.8125

TOPAZ CAT #	UPC#	SIZE	MALLEABLE IRON		
			UNIT CTN	SHIP CASE	WT/ CASE
1560	52012	3/8"	—	50	32
1561	52013	1/2"	—	50	58
1562	52014	3/4"	—	50	64
1563	52015	1"	—	50	70
1564	52016	1 1/4"	—	25	72
1565	52017	1 1/2"	—	25	93
1566	52018	2"	—	25	100
1567	52019	2 1/2"	—	25	135
1568	52020	3"	—	10	155
1569	52021	3 1/2"	—	10	190
1570	52022	4"	—	10	205

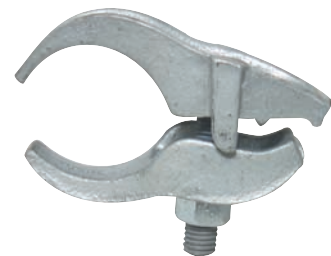

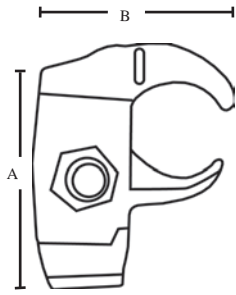

CAT#	A	B
1571	2.8125	2.125
1572	2.9375	2.375
1573	3.0625	2.625
1574	3.0625	3.0625
1575	3.9375	3.25
1576	4.50	4.0625
1577	5.125	4.625
1578	5.75	5.25

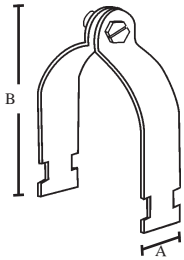

CAT#	A	B
X2101	1.24	2.30
X2102	1.24	2.46
X2103	1.24	2.68
X2104	1.24	3.21
X2105	1.24	3.42
X2106	1.24	4.00
X2107	1.24	5.00
X2108	1.24	5.55
X2109	1.24	6.00
X2110	1.24	6.50

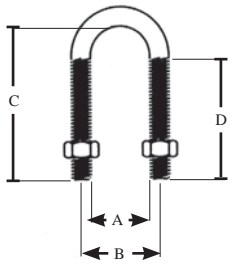

CAT#	A	B	C	D
761	1	1-1/4	2-1/2	1-13/16
762	1-1/8	1-3/8	2-13/16	1-13/16
763	1-3/8	1-5/8	3-1/16	1-13/16
764	1-3/4	2	3-3/16	1-13/16
765	2	2-3/8	3-1/2	1-13/16
766	2-1/2	2-1/2	4-1/2	2-5/8
767	3	3-1/4	4-7/8	2-5/8
768	3-5/8	3-7/8	5-3/8	2-5/8
769	4-1/16	4-9/16	5-7/8	2-5/8
770	4-11/16	5-1/16	6-11/16	2-5/8

EDGE TYPE CONDUIT SUPPORT

MALLEABLE IRON

TOPAZ CAT #	UPC#	SIZE	UNIT CTN	SHIP CASE	WT/ CASE
1571	52023	1/2"	—	50	67
1572	52024	3/4"	—	50	71
1573	52025	1"	—	25	85
1574	52066	1 1/4"	—	25	91
1575	52027	1 1/2"	—	25	115
1576	52028	2"	—	25	135
1577	52029	2 1/2"	—	10	183
1578	52030	3"	—	10	230



STRUT CLAMP

EMT & RIGID

STEEL

TOPAZ CAT #	UPC#	SIZE	UNIT CTN	SHIP CASE	WT/ CASE
X2101	41031	1/2"	—	100	19
X2102	41032	3/4"	—	100	21
X2103	41033	1"	—	100	23
X2104	41034	1 1/4"	—	100	26
X2105	41035	1 1/2"	—	50	26
X2106	41036	2"	—	50	31
X2107	41037	2 1/2"	—	50	32
X2108	41038	3"	—	25	18
X2109	41039	3 1/2"	—	25	21
X2110	41040	4"	—	25	25

ALL SCREWS - 5/16" X 1-1/4" SLOTTED HEX HEAD

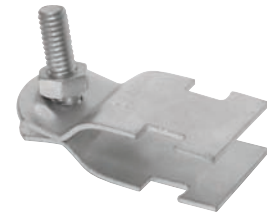

U-BOLTS

RIGID, IMC & EMT

STEEL

TOPAZ CAT #	UPC#	SIZE	BOLT SIZE	UNIT CTN	SHIP CASE	WT/ CASE
761	82541	1/2"	5/16"-18	25	250	12.5
762	82542	3/4"	5/16"-18	25	250	15.6
763	82543	1"	5/16"-18	25	250	15.7
764	82544	1 1/4"	5/16"-18	20	200	15.8
765	82545	1 1/2"	5/16"-18	20	200	18.8
766	82546	2"	3/8"-16	20	200	31.3
767	82547	2 1/2"	3/8"-16	—	10	31.4
768	82548	3"	3/8"-16	—	10	37.5
769	82549	3 1/2"	1/2"-16	—	10	40.6
770	82550	4"	1/2"-16	—	10	43.4



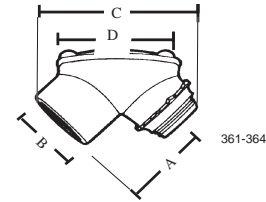
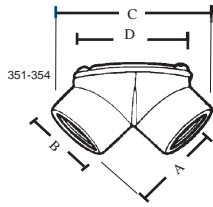

CAT#	A	B	C	D
351	1.31	1.09	2.50	1.78
352	1.43	1.29	2.76	2.13
353	1.95	1.59	3.86	3.17
354	2.26	1.97	4.56	3.25
361	1.31	1.09	2.40	1.80
362	1.47	1.29	2.66	2.14
363	2.80	1.60	3.66	3.16
364	3.13	1.96	5.16	3.24

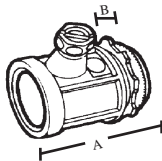

CAT#	A	B
671	1.34	.39
672	1.44	.45
637	3.08	.92
638	3.37	1.05
639	3.46	1.05
640	3.75	1.05

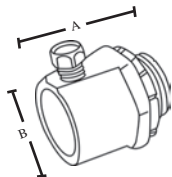

CAT#	A	B
671S	1.125	1.125
672S	1.25	1.375
673S	1.5	1.625
674S	1.75	2
675S	1.875	2.25
676S	2	2.75

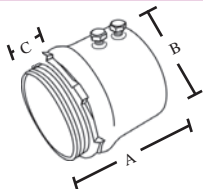

CAT#	A	B	C
637S	3.313	3.563	.750
638S	3.813	4.188	.938
639S	3.938	4.688	.938
640S	4.188	5.188	1.000

2 SCREW

RIGID PULL ELBOWS WITH GASKET

ZINC DIE CAST

TOPAZ CAT #	UPC#	SIZE	UNIT CTN	SHIP CASE	WT/ CASE
351	13510	1/2"	10	100	28
352	13520	3/4"	5	50	17
353	13530	1"	—	25	16
354	13540	1 1/4"	—	20	18

RIGID TO RIGID

351	13510	1/2"	10	100	28
352	13520	3/4"	5	50	17
353	13530	1"	—	25	16
354	13540	1 1/4"	—	20	18

RIGID TO BOX

361	13550	1/2"	10	100	31
362	13560	3/4"	5	50	18
363	13570	1"	—	25	21
364	13580	1 1/4"	—	20	25



E148716



E148716

RIGID CONNECTORS SET SCREW TYPE

• NO THREAD

ZINC DIE CAST

TOPAZ CAT #	UPC#	SIZE	UNIT CTN	SHIP CASE	WT/ CASE
671	17110	1/2"	50	500	50
672	17120	3/4"	25	250	38
637	16350	2 1/2"	—	12	10
638	16360	3"	—	12	12
639	16370	3 1/2"	—	10	13
640	16380	4"	—	6	9



1/2"-4" E148716



E148716
1/2"-2"

MALLEABLE IRON

671S	17135	1/2"	25	250	42
672S	17136	3/4"	25	250	22
673S	17137	1"	25	100	27
674S	17138	1 1/4"	5	50	12
675S	17139	1 1/2"	5	50	7
676S	17140	2"	—	20	10

STEEL

637S*	23060	2 1/2"	—	12	17
638S*	23070	3"	—	12	22
639S*	23080	3 1/2"	—	6	15
640S*	23090	4"	—	6	17

*EMT & RIGID



2 1/2"-4" E148716

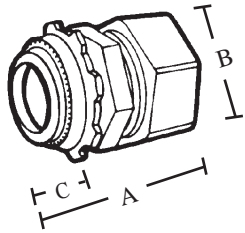

CAT#	A	B	C
657S	2.63	3.70	.860
658S	2.77	4.49	1.01
659S	2.77	5.06	.94
660S	2.77	5.63	1.00

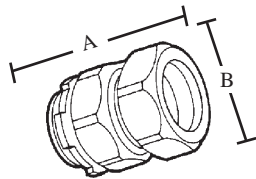

CAT#	A	B
261	1.35	1.17
262	1.48	1.43
263	1.58	1.75
264	1.86	2.15
265	1.94	2.38
266	2.49	3.38
267/i	3.00	3.75
268/i	3.125	4.25
269/i	3.187	4.75
270/i	3.437	5.312

RIGID CONNECTORS COMPRESSION TYPE

- NO THREAD
- CONCRETE TIGHT

TOPAZ CAT #	UPC#	SIZE	UNIT CTN	SHIP CASE	STEEL WT/CASE
657S	16650	2 1/2"	—	12	13
658S	16660	3"	—	12	16
659S	16670	3 1/2"	—	10	18
660S	16680	4"	—	6	12



TOPAZ CAT #	UPC#	SIZE	UNIT CTN	SHIP CASE	STEEL WT/CASE
261	12200	1/2"	20	200	26
262	12210	3/4"	10	100	20
263	12220	1"	5	50	18
264	12230	1 1/4"	5	50	32
265	12240	1 1/2"	—	12	11
266	12250	2"	—	12	14



TOPAZ CAT #	UPC#	SIZE	UNIT CTN	SHIP CASE	MALLEABLE IRON WT/CASE
267	12251	2 1/2"	—	5	14
268	12252	3"	—	3	13
269	12253	3 1/2"	—	2	13
270	12254	4"	—	2	13

INSULATED THROAT

TOPAZ CAT #	UPC#	SIZE	UNIT CTN	SHIP CASE	MALLEABLE IRON WT/CASE
267i	12255	2 1/2"	—	5	14
268i	12256	3"	—	3	13
269i	12257	3 1/2"	—	2	13
270i	12258	4"	—	2	13



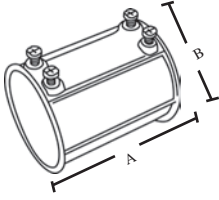

CAT#	A	B
647	4.21	3.30
648	4.67	4.01
649	4.85	4.52
650	5.47	5.01

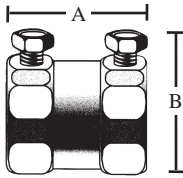

CAT#	A	B
681S	1.5	1.125
682S	1.5	1.375
683S	1.875	1.625
684S	2.1875	2
685S	2.625	2.25
686S	2.75	2.75
647S	4.25	3.19
648S	4.50	3.19
649S	4.75	4.31
650S	5.00	4.81

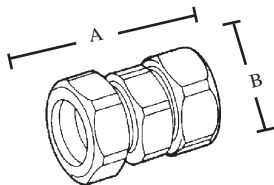

CAT#	A	B
251	1.74	1.17
252	1.82	1.43
253	1.95	1.75
254	2.65	2.15
255	2.70	2.37
256	2.93	3.38
257	5.75	3.93
258	5.72	4.66
259	6.00	5.20
260	6.81	5.75
667S	3.29	3.70
668S	3.42	4.49
669S	3.51	5.06
670S	3.54	5.63

RIGID COUPLINGS SET SCREW TYPE

• NO THREAD

ZINC DIE CAST

TOPAZ CAT #	UPC#	SIZE	UNIT CTN	SHIP CASE	WT/ CASE
647	16550	2 1/2"	—	12	9
648	16560	3"	—	12	12
649	16570	3 1/2"	—	10	12
650	16580	4"	—	6	10



E170258

STEEL

681S	17150	1/2"	25	250	43
682S	17151	3/4"	25	250	25
683S	17152	1"	25	100	28
684S	17153	1 1/4"	5	50	15
685S	17154	1 1/2"	5	50	9
686S	17155	2"	—	20	12

MALLEABLE IRON

647S	23260	2 1/2"	—	12	19
648S	23270	3"	—	12	26
649S	23280	3 1/2"	—	6	15
650S	23290	4"	—	6	17



E170258

COMPRESSION TYPE

• NO THREAD
• CONCRETE TIGHT

STEEL

251	12140	1/2"	10	100	16
252	12150	3/4"	10	100	24
253	12160	1"	5	50	24
254	12170	1 1/4"	5	50	43
255	12180	1 1/2"	—	12	15
256	12190	2"	—	5	8



E170258

MALLEABLE IRON

257	12131	2 1/2"	—	5	260
258	12141	3"	—	3	300
259	12151	3 1/2"	—	2	350
260	12161	4"	—	2	400

STEEL

667S	16970	2 1/2"	—	12	16
668S	16980	3"	—	12	21
669S	16990	3 1/2"	—	10	22
670S	17000	4"	—	6	15



E170258

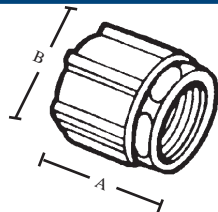

CAT#	A	B
851	1.43	1.36
852	1.63	1.58
853	1.81	1.89
854	2.19	2.38
855	2.31	2.83
856	2.44	3.29

857	2.52	4.03
858	2.58	4.62
859	2.65	5.35
860	3.42	5.87
860A	4.38	7.00
860B	4.38	8.25

851S	1.43	1.31
852S	1.52	1.61
853S	1.70	2.13
854S	2.13	2.40
855S	2.18	2.89
856S	2.36	3.40

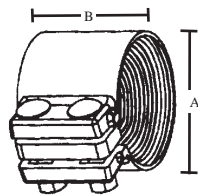

CAT#	A	B
76	1.95	3.35
77	3.25	4.75
78	3.25	5.50
79	3.35	5.75
80	3.40	6.25

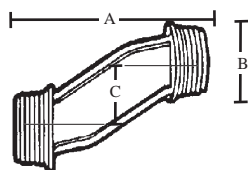

CAT#	A	B	C
111/i	2.460	1.000	.750
112/i	2.560	1.220	.750
113/i	2.560	1.525	.750
114/i	2.910	1.910	.750
115/i	3.080	2.125	.750
116/i	3.145	2.665	.750
117	3.970	3.280	.750
118	4.420	3.795	.750

RIGID COUPLINGS

THREE PIECE TYPE

MALLEABLE IRON

TOPAZ CAT #	UPC#	SIZE	UNIT CTN	SHIP CASE	WT/ CASE
851	18630	1/2"	20	200	40
852	18640	3/4"	10	100	30
853	18650	1"	5	50	23
854	18660	1 1/4"	5	50	55
855	18670	1 1/2"	3	30	44
856	18680	2"	—	20	44

857	18690	2 1/2"	—	10	37
858	18700	3"	—	5	20
859	18710	3 1/2"	—	5	29
860	18720	4"	—	2	18
860A	18722	5"	—	1	12
860B	18724	6"	—	1	21

STEEL					
TOPAZ CAT #	UPC#	SIZE	UNIT CTN	SHIP CASE	WT/ CASE
851S	18631	1/2"	20	200	20
852S	18641	3/4"	10	100	30
853S	18651	1"	5	50	46
854S	18661	1 1/4"	5	50	110
855S	18671	1 1/2"	3	30	147
856S	18681	2"	—	20	220

SLIP-ON TYPE

MALLEABLE IRON

76	70400	2"	5	25	26
77	70410	2 1/2"	2	10	23
78	70420	3"	2	10	30
79	70430	3 1/2"	1	5	19
80	70440	4"	1	5	20

A neoprene gasket makes a concrete tight seal.
Used when conduit cannot be turned.

RIGID OFFSET NIPPLES

3/4" OFFSET

ZINC DIE CAST

TOPAZ CAT #	UPC#	SIZE	UNIT CTN	SHIP CASE	WT/ CASE
111	10610	1/2"	10	100	12
112	10620	3/4"	10	100	16
113	10630	1"	10	100	22
114	10640	1 1/4"	5	50	17
115	10650	1 1/2"	5	50	23
116	10660	2"	2	20	13
117	10670	2 1/2"	—	2	13
118	10680	3"	—	2	6

INSULATED THROAT

111i	10611	1/2"	10	100	12
112i	10621	3/4"	10	100	16
113i	10631	1"	10	100	22
114i	10641	1 1/4"	5	50	17
115i	10651	1 1/2"	5	50	23
116i	10661	2"	2	20	13

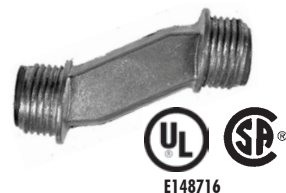
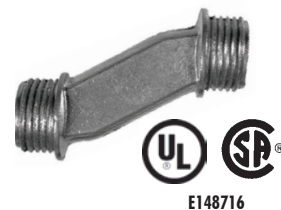
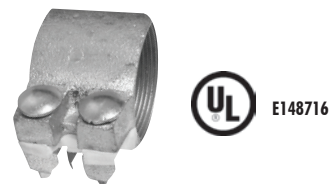
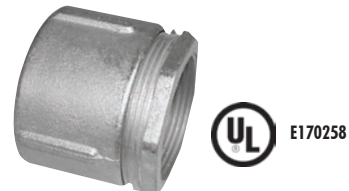
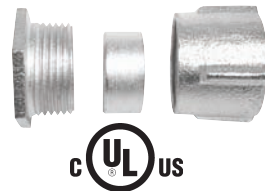

RIGID CONDUIT NIPPLES

ZINC DIE CAST

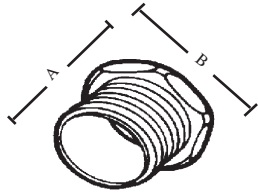

CAT#	A	B
751/751i	.68	1.02
751A	1.00	1.02
752A	1.00	1.29
752/752i	.75	1.29
753/753i	.87	1.53
754/754i	.94	1.89
755/755i	.91	2.30
756/756i	1.07	2.88
757/757i	1.38	3.39
758/758i	1.44	4.06
759/759i	1.47	4.61
760/760i	1.47	5.15

TOPAZ CAT #	UPC#	SIZE	UNIT CTN	SHIP CASE	WT/ CASE
751	17860	1/2"	100	1000	40
751A	17859	1/2" x 1" L	—	100	5
752	17870	3/4"	50	500	30
752A	17851	3/4" x 1" L	—	50	25
753	17880	1"	25	250	25
754	17890	1 1/4"	25	250	35
755	17900	1 1/2"	25	100	20
756	17910	2"	10	40	13
757	17920	2 1/2"	10	40	17
758	17930	3"	10	40	22
759	17940	3 1/2"	10	40	27
760	17950	4"	5	20	14

INSULATED THROAT

751i	17861	1/2"	100	1000	40
752i	17871	3/4"	50	500	30
753i	17881	1"	25	250	25
754i	17891	1 1/4"	25	250	35
755i	17901	1 1/2"	25	100	20
756i	17911	2"	10	40	13
757i	17921	2 1/2"	10	40	17
758i	17931	3"	10	40	22
759i	17941	3 1/2"	10	40	27
760i	17951	4"	5	20	14

MALLEABLE IRON

751M	17862	1/2"	100	1000	5
752M	17872	3/4"	50	500	7
753M	17882	1"	25	250	12
754M	17892	1 1/4"	25	250	15
755M	17902	1 1/2"	25	250	22
756M	17912	2"	10	40	35
757M	17922	2 1/2"	10	40	76
758M	17932	3"	10	40	101
759M	17942	3 1/2"	10	40	124
760M	17943	4"	5	20	200
760A	17952	5"	—	1	75
760B	17953	6"	—	1	65

INSULATED THROAT

751Mi	17863	1/2"	100	1000	7
752Mi	17873	3/4"	50	500	7
753Mi	17883	1"	25	250	12
754Mi	17893	1 1/4"	25	250	15
755Mi	17903	1 1/2"	25	250	22
756Mi	17913	2"	10	40	35
757Mi	17923	2 1/2"	10	40	76
758Mi	17933	3"	10	40	101
759Mi	17943	3 1/2"	10	40	124
760Mi	17944	4"	5	20	200



E148716



E148716



E148716

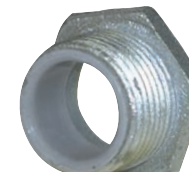

E148716

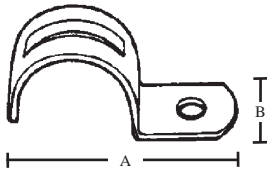

CAT#	A	B
531A	1.51	.562
531B	1.81	.562
531	1.91	.625
532	2.21	.750
533	2.57	.875
534	2.79	.880
535	3.69	.899
536	4.17	1.140
517	5.00	1.280
518	5.55	1.280
519	6.37	1.280
520	6.87	1.280
520A	9.00	1.500
520B	10.35	1.50

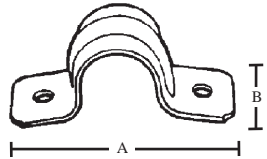

CAT#	A	B
541A	2.15	.562
541B	2.20	.562
541	2.43	.625
542	2.81	.685
543	3.28	.750
544	4.02	.875
545	4.58	1.00
546	5.22	1.00
527	5.91	1.00
528	6.71	1.00
529	7.51	1.00
530	8.31	1.00
530A	10.60	1.25
530B	11.85	1.25

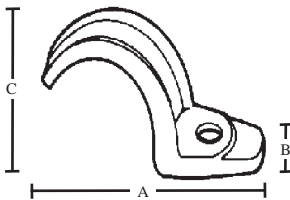

CAT#	A	B	C
561	2.250	.660	.94
562	2.560	.750	1.22
563	3.060	.810	1.50
564	3.690	.880	1.88
565	4.000	1.00	2.06
566	5.060	1.130	2.56
567	5.940	1.380	3.06
568	7.440	1.630	3.81
569	8.190	1.810	4.38
570	8.690	2.000	5.00
570A	9.3750	2.68750	6.00
570B	10.375	3.1250	7.00

RIGID STRAPS

STEEL

TOPAZ CAT #	UPC#	SIZE	UNIT CTN	SHIP CASE	WT/ CASE
ONE HOLE					
• SNAP-ON TYPE 1/2" - 2"					
531A	15041	1/4"	100	1000	20
531B	15045	3/8"	100	1000	20
531	15050	1/2"	50	500	21
532	15060	3/4"	50	500	15
533	15070	1"	25	250	25
534	15080	1 1/4"	20	200	20
535	15090	1 1/2"	20	200	32
536	15100	2"	10	100	22
517*	15670	2 1/2"	—	50	21
518*	15680	3"	—	25	13
519*	15690	3 1/2"	—	25	18
520*	15700	4"	—	25	20
520A*	15702	5"	—	10	5
520B*	15704	6"	—	10	6

* EMT & RIGID

TWO HOLE

541A	15043	1/4"	100	1000	18
541B	15046	3/8"	100	1000	18
541	15150	1/2"	50	500	13
542	15160	3/4"	50	500	16
543	15170	1"	25	250	12
544	15180	1 1/4"	20	200	13
545	15190	1 1/2"	10	100	12
546	15200	2"	—	50	7
527*	15010	2 1/2"	—	25	6
528*	15020	3"	—	25	7
529*	15030	3 1/2"	—	25	8
530*	15040	4"	—	25	7
530A*	15042	5"	—	10	5
530B*	15044	6"	—	10	6

* EMT & RIGID

ONE HOLE

MALLEABLE IRON

561	15350	1/2"	100	1000	40
562	15360	3/4"	50	500	25
563	15370	1"	25	250	20
564	15380	1 1/4"	20	200	20
565	15390	1 1/2"	10	100	16
566	15400	2"	—	25	9
567	15410	2 1/2"	—	25	17
568	15420	3"	—	25	25
569	15430	3 1/2"	—	10	15
570	15440	4"	—	10	22
570A	15441	5"	—	10	35
570B	15442	6"	—	10	45



E170258



E170258



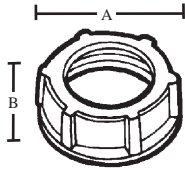

CAT#	A	B
301	1.053	.37
302	1.327	.37
303	1.584	.47
304	1.952	.50
305	2.201	.52
306	2.693	.52
307	3.235	.85
308	3.855	.85
309	4.359	.85
310	5.011	.85

301M	1.223	.48
302M	1.498	.49
303M	1.818	.56
304M	2.423	.61
305M	2.512	.68
306M	3.053	.68
307M	3.624	.85
308M	4.172	.91
309M	4.767	1.00
310M	5.321	1.06
310AM	6.15	1.30
310BM	7.19	1.30

301CB	1.053	.37
302CB	1.327	.37
303CB	1.584	.37
304CB	1.952	.50
305CB	2.201	.52
306CB	2.093	.52
307CB	3.235	.85
308CB	3.855	.85
309CB	4.359	.85
310CB	5.011	.85
310ACB	6.15	1.30

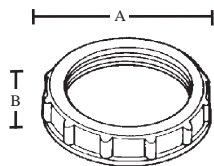

CAT#	A	B
831A	.53	.29
831	1.06	.43
832	1.31	.43
833	1.59	.48
834	1.96	.56
835	2.18	.56
836	2.68	.59
837	3.25	.72
838	3.87	.75
839	4.37	.77
840	5.00	.77
840A	6.25	1.00
840B	7.50	1.00

RIGID CONDUIT BUSHINGS

ZINC DIE CAST

TOPAZ CAT #	UPC#	SIZE	UNIT CTN	SHIP CASE	WT/ CASE
301	12530	1/2"	100	1000	30
302	12540	3/4"	100	1000	50
303	12550	1"	50	500	30
304	12560	1 1/4"	25	250	25
305	12570	1 1/2"	25	250	38
306	12580	2"	25	100	17
307	12590	2 1/2"	10	100	36
308	12600	3"	—	10	5
309	12610	3 1/2"	—	10	6
310	12620	4"	—	10	7

MALLEABLE IRON

301M	12630	1/2"	100	1000	50
302M	12640	3/4"	50	500	30
303M	12650	1"	50	500	24
304M	12660	1 1/4"	25	250	30
305M	12670	1 1/2"	—	25	22
306M	12680	2"	—	25	35
307M	12690	2 1/2"	—	15	20
308M	12700	3"	—	10	10
309M	12710	3 1/2"	—	10	13
310M	12720	4"	—	10	20
310AM	12622	5"	—	10	25
310BM	12623	6"	—	10	35



E148716



E170258

RIGID CAPPED BUSHINGS

STEEL CAP

ZINC DIE CAST

TOPAZ CAT #	UPC#	SIZE	UNIT CTN	SHIP CASE	WT/ CASE
301CB	12531	1/2"	100	1000	5
302CB	12541	3/4"	100	1000	7
303CB	12551	1"	50	500	11
304CB	12561	1 1/4"	25	250	17
305CB	12571	1 1/2"	25	250	21
306CB	12581	2"	25	1000	34
307CB	12591	2 1/2"	10	100	48
308CB	12601	3"	10	100	61
309CB	12611	3 1/2"	—	10	70
310CB	12631	4"	—	10	125
310ACB	12621	5"	—	10	78



INSULATING PLASTIC BUSHINGS

105°C FLAME RETARDANT

THERMOPLASTIC

TOPAZ CAT #	UPC#	SIZE	UNIT CTN	SHIP CASE	WT/ CASE
831A	18448	1/8"	—	1000	4
831	18450	1/2"	100	1000	6
832	18460	3/4"	100	1000	9
833	18470	1"	50	500	11
834	18480	1 1/4"	25	250	5
835	18490	1 1/2"	25	250	7
836	18500	2"	20	200	12
837	18510	2 1/2"	—	50	5
838	18520	3"	—	25	3
839	18530	3 1/2"	—	25	5
840	18540	4"	—	10	7
840A	18550	5"	—	10	3
840B	18560	6"	—	10	4



E148716

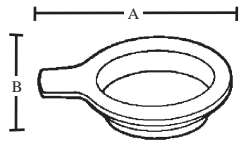

PULL CAPS

• FOR CAPPING PLASTIC OR METAL CONDUIT BUSHINGS

POLYETHYLENE

CAT#	A	B
841	.611	9.60
842	.8125	1.125
843	1.0625	1.3125
844	1.392	1.692
845	1.612	1.978
846	2.70	2.350

TOPAZ CAT #	UPC#	SIZE	UNIT CTN	SHIP CASE	WT/ CASE
841	18570	1/2"	100	1000	10
842	18580	3/4"	100	1000	10
843	18590	1"	100	1000	10
844	18600	1 1/4"	50	500	10
845	18610	1 1/2"	25	250	8
846	18620	2"	25	250	8

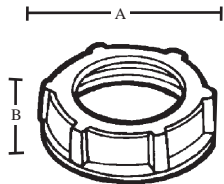

RIGID BUSHINGS INSULATED

• 105° C. THERMOPLASTIC LINERS

ZINC DIE CAST

CAT#	A	B
311	1.053	.394
312	1.327	.394
313	1.584	.477
314	1.952	.503
315	2.201	.522
316	2.693	.564
317	3.235	.866
318	3.855	.866
319	4.359	.866
320	5.011	.866

TOPAZ CAT #	UPC#	SIZE	UNIT CTN	SHIP CASE	WT/ CASE
311	12730	1/2"	100	1000	30
312	12740	3/4"	50	500	20
313	12750	1"	50	500	40
314	12760	1 1/4"	25	250	25
315	12770	1 1/2"	25	250	30
316	12780	2"	—	100	14
317	12790	2 1/2"	—	50	20
318	12800	3"	—	25	12
319	12810	3 1/2"	—	25	14
320	12820	4"	—	10	6



E170258

CAT#	A	B
311M	1.223	.506
312M	1.498	.547
313M	1.818	.662
314M	2.423	.735
315M	2.512	.808
316M	3.053	.808
317M	3.624	.958
318M	4.172	1.052
319M	4.767	1.169
320M	5.321	1.178
320AM	6.15	1.30
320BM	7.19	1.30

MALLEABLE IRON

TOPAZ CAT #	UPC#	SIZE	UNIT CTN	SHIP CASE	WT/ CASE
311M	12830	1/2"	100	1000	20
312M	12840	3/4"	50	500	20
313M	12850	1"	50	500	40
314M	12860	1 1/4"	25	250	43
315M	12870	1 1/2"	25	100	25
316M	12880	2"	10	100	30
317M	12890	2 1/2"	—	50	20
318M	12900	3"	—	25	13
319M	12910	3 1/2"	—	25	18
320M	12920	4"	—	10	10
320AM	12922	5"	—	10	25
320BM	12924	6"	—	10	35



E170258

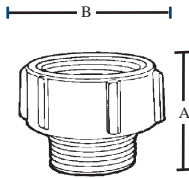

CAT#	A	B
981	1.40	1.35
982	1.40	1.62
983	1.62	2.25

RIGID MALE ENLARGERS

ZINC DIE CAST

TOPAZ CAT #	UPC#	SIZE	UNIT CTN	SHIP CASE	WT/ CASE
981	19640	1/2" M x 3/4" F	25	250	50
982	19650	3/4" M x 1" F	10	100	12
983	19651	1" M x 1 1/4" F	10	100	15



INSULATED METALLIC GROUNDING BUSHINGS WITH ALUMINUM LUG

- FOR COPPER OR ALUMINUM BARE GROUND WIRE
- 105° C. THERMOPLASTIC LINERS

ZINC DIE CAST

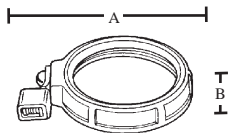

CAT#	A	B
321	1.25	.50
322	1.50	.50
323	1.75	.56
324	2.12	.62
325	2.37	.75
326	2.81	.75
327	3.62	.93
328	4.18	.93
329	4.68	.93
330	5.25	.93

GROUNDING LUG

TOPAZ CAT #	UPC#	SIZE	WIRE SIZE MIN	WIRE SIZE MAX	UNIT CTN	SHIP CASE	WT/ CASE
321	12930	1/2"	14	4	50	500	25
322	12940	3/4"	14	4	50	500	35
323	12950	1"	14	4	25	250	30
324	12960	1 1/4"	14	4	20	200	34
325	12970	1 1/2"	14	2	10	100	20
326	12980	2"	14	2	10	100	35
327	12990	2 1/2"	14	1/0	—	50	25
328	13000	3"	14	1/0	—	10	6
329	13010	3 1/2"	14	2/0	—	10	7
330	13020	4"	6	250 MCM	—	10	8



E148716

321M	1.25	.50
322M	1.48	.54
323M	1.80	.65
324M	2.40	.73
325M	2.50	.80
326M	3.03	.80
327M	3.60	.95
328M	4.16	1.03
329M	4.75	1.15
330M	5.30	1.17
330AM	6.15	1.130
330BM	7.19	1.130

MALLEABLE IRON

321M	13030	1/2"	14	4	50	500	25
322M	13040	3/4"	14	4	50	500	30
323M	13050	1"	14	4	25	250	23
324M	13060	1 1/4"	14	4	20	200	34
325M	13070	1 1/2"	14	2	25	250	53
326M	13080	2"	14	2	25	250	78
327M	13090	2 1/2"	14	1/0	—	10	4
328M	13100	3"	14	1/0	—	10	5
329M	13110	3 1/2"	14	2/0	—	10	15
330M	13120	4"	14	2/0	—	10	20
330AM	13122	5"	6	250 MCM	—	10	25
330BM	13124	6"	6	250 MCM	—	10	35



E170258

INSULATED METALLIC GROUNDING BUSHINGS WITH ALUMINUM LAY-IN LUG

- 105° C. THERMOPLASTIC LINERS
 - FOR COPPER OR ALUMINUM BARE GROUND CONNECTOR
- ZINC DIE CAST**

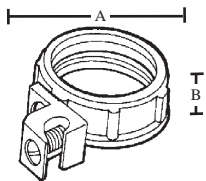

CAT#	A	B
331	1.25	.50
332	1.50	.50
333	1.75	.56
334	2.12	.62
334A	2.12	.62
335	2.37	.75
335A	2.37	.75
336	2.81	.75
336A	2.81	.75
337	3.62	.93
337A	3.62	.93
338	4.18	.93
338A	4.18	.93
339	4.68	.93
339A	4.68	.93
340	5.25	.93
340A	5.25	.93

331M	1.25	.50
332M	1.48	.54
333M	1.80	.65
334M	2.40	.73
334AM	2.40	.73
335M	2.50	.80
335AM	2.50	.80
336M	3.03	.80
336AM	3.03	.80
337M	3.60	.95
337AM	3.60	.95
338M	4.16	1.03
338AM	4.16	1.03
339M	4.75	1.15
339AM	4.75	1.15
340M	5.30	1.17
340AM	6.15	1.30
340ALM	6.15	1.30
340BLM	7.19	1.30

331MSS	1.25	.50
332MSS	1.48	.54
333MSS	1.80	.65
334MSS	2.40	.73
335MSS	2.50	.80
336MSS	3.03	.80
337MSS	3.60	.95
338MSS	4.16	1.03
339MSS	4.75	1.15
340MSS	5.30	1.17
340AMSS	6.15	1.30
340BMSS	7.19	1.30

TOPAZ CAT #	UPC#	SIZE	WIRE SIZE		UNIT CTN	SHIP CASE	WT/ CASE
			MIN	MAX			
331	13130	1/2"	14	4	50	500	30
332	13140	3/4"	14	4	50	500	35
333	13150	1"	14	4	25	250	23
334	13160	1 1/4"	14	4	20	200	26
334A	13170	1 1/4"	14	1/0	20	200	26
335	13180	1 1/2"	14	4	10	100	16
335A	13190	1 1/2"	14	1/0	10	100	16
336	13200	2"	14	4	10	100	21
336A	13210	2"	14	1/0	10	100	21
337	13220	2 1/2"	14	1/0	—	50	20
337A	13230	2 1/2"	6	250 MCM	—	50	20
338	13240	3"	14	1/0	—	50	29
338A	13250	3"	6	250 MCM	—	50	29
339	13260	3 1/2"	14	1/0	—	10	15
339A	13270	3 1/2"	6	250 MCM	—	10	15
340	13280	4"	14	1/0	—	10	20
340A	13290	4"	6	250 MCM	—	10	20

MALLEABLE IRON

331M	13300	1/2"	14	4	50	500	45
332M	13310	3/4"	14	4	50	500	50
333M	13320	1"	14	4	25	250	40
334M	13330	1 1/4"	14	4	20	200	35
334AM	13340	1 1/4"	14	1/0	20	200	35
335M	13350	1 1/2"	14	4	10	100	25
335AM	13360	1 1/2"	14	1/0	10	100	25
336M	13370	2"	14	4	10	100	30
336AM	13380	2"	14	1/0	10	100	30
337M	13390	2 1/2"	14	1/0	—	50	25
337AM	13400	2 1/2"	6	250 MCM	—	50	25
338M	13410	3"	14	1/0	—	25	18
338AM	13420	3"	6	250 MCM	—	25	18
339M	13430	3 1/2"	14	1/0	—	10	20
339AM	13440	3 1/2"	6	250 MCM	—	10	20
340M	13450	4"	14	1/0	—	10	25
340AM	13460	4"	6	250 MCM	—	10	25
340ALM	13462	5"	6	250 MCM	—	10	25
340BLM	13463	6"	6	250 MCM	—	10	35

SET SCREW

			MALLEABLE IRON	
331MSS	13321	1/2"	14-4	50 500 25
332MSS	13331	3/4"	14-4	50 500 30
333MSS	13341	1"	14-4	25 250 23
334MSS	13351	1 1/4"	14-4	20 200 30
335MSS	13361	1 1/2"	14-4	10 100 25
336MSS	13371	2"	14-4	10 100 30
337MSS	13391	2 1/2"	14-1/0	5 50 38
338MSS	13411	3"	14-1/0	— 25 35
339MSS	13431	3 1/2"	14-1/0	— 10 15
340MSS	13451	4"	14-1/0	— 10 20
340AMSS	13461	5"	6-250MCM	— 10 25
340BMSS	13471	6"	6-250MCM	— 10 35



E170258



E170258



E170258

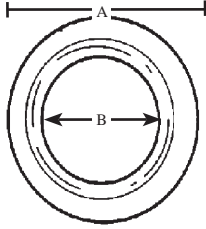

CAT#	A	B
900	1.420	.870
901	1.710	.870
902	1.710	1.060
903	2.080	.870
904	2.080	1.125
905	2.080	1.380
906	2.635	.870
907	2.635	1.060
908	2.635	1.335
909	2.635	1.690
910	3.265	.870
911	3.265	1.060
912	3.265	1.335
913	3.265	1.690
914	3.265	1.935
915	3.265	.870
916	3.265	1.060
917	3.265	1.370
918	3.265	1.750
919	3.265	1.995
920	3.265	2.425
921	4.490	.870
922	4.490	1.060
923	4.490	1.360
924	4.490	1.750
925	4.490	1.995
926	4.490	2.400
927	4.490	2.940
928	5.000	.870
929	5.000	1.060
930	5.000	1.380
931	5.000	1.710
932	5.000	1.980
933	5.000	2.435
934	5.000	2.920
935	5.000	3.560
936	5.500	.870
937	5.500	1.060
938	5.500	1.380
939	5.500	1.715
940	5.500	1.970
941	5.500	2.435
942	5.500	2.920
943	5.500	3.560
944	5.500	4.050

REDUCING WASHERS

TOPAZ CAT #	UPC#	SIZE	UNIT CTN	SHIP CASE	STEEL WT/ CASE
900	19050	3/4" x 1/2"	100	100	2
901	19060	1" x 1/2"	100	100	2
902	19070	1" x 3/4"	100	100	2
903	19080	1 1/4" x 1/2"	50	50	2
904	19090	1 1/4" x 3/4"	50	50	2
905	19100	1 1/4" x 1"	50	50	1
906	19110	1 1/2" x 1/2"	50	50	2
907	19120	1 1/2" x 3/4"	50	50	4
908	19130	1 1/2" x 1"	50	50	4
909	19140	1 1/2" x 1 1/4"	50	50	2
910	19150	2" x 1/2"	25	25	2
911	19160	2" x 3/4"	25	25	2
912	19170	2" x 1"	25	25	2
913	19180	2" x 1 1/4"	25	25	2
914	19190	2" x 1 1/2"	25	25	2
915	19200	2 1/2" x 1/2"	25	25	2
916	19210	2 1/2" x 3/4"	25	25	2
917	19220	2 1/2" x 1"	25	25	2
918	19230	2 1/2" x 1 1/4"	25	25	2
919	19240	2 1/2" x 1 1/2"	25	25	1
920	19250	2 1/2" x 2"	25	25	1
921	19260	3" x 1/2"	25	25	6
922	19270	3" x 3/4"	25	25	5
923	19280	3" x 1"	25	25	5
924	19290	3" x 1 1/4"	25	25	4
925	19300	3" x 1 1/2"	25	25	3
926	19310	3" x 2"	25	25	2
927	19320	3" x 2 1/2"	25	25	2
928	19330	3 1/2" x 1/2"	10	10	3
929	19340	3 1/2" x 3/4"	10	10	3
930	19350	3 1/2" x 1"	10	10	3
931	19360	3 1/2" x 1 1/4"	10	10	3
932	19370	3 1/2" x 1 1/2"	10	10	3
933	19380	3 1/2" x 2"	10	10	3
934	19390	3 1/2" x 2 1/2"	10	10	2
935	19400	3 1/2" x 3"	10	10	2
936	19410	4" x 1/2"	10	10	3
937	19420	4" x 3/4"	10	10	3
938	19430	4" x 1"	10	10	3
939	19440	4" x 1 1/4"	10	10	2
940	19450	4" x 1 1/2"	10	10	2
941	19460	4" x 2"	10	10	2
942	19470	4" x 2 1/2"	10	10	2
943	19480	4" x 3"	10	10	2
944	19490	4" x 3 1/2"	10	10	1



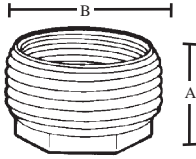

CAT#	A	B
RB1	.563	.750
RB2	.650	.920
RB3	.715	1.125
RB4	.715	1.125
RB5	.820	1.470
RB6	.820	1.470
RB7	.820	1.470
RB8	.850	1.700
RB9	.850	1.700
RB10	.850	1.700
RB11	.850	1.700
RB12	.970	2.230
RB13	.970	2.230
RB14	.970	2.230
RB15	.970	2.230
RB16	.970	2.230

RB17	1.563	2.750
RB18	2.090	2.845
RB19	1.125	2.820
RB20	1.200	3.485
RB21	2.100	3.445
RB22	2.020	3.460
RB23	2.000	3.380
RB24	1.390	4.395
RB25	1.905	4.575
RB26	1.905	4.575
RB27	2.020	3.945
RB28	1.385	4.920
RB29	2.070	5.220
RB30	2.070	5.220
RB31	1.775	5.250
RB32	1.400	5.250

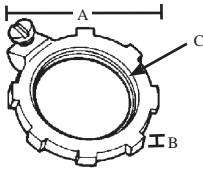

CAT#	A	B	C
551	1.15	.110	.787-.797
552	1.45	.115	.999-1.009
553	1.75	.140	1.250-1.260
554	2.10	.140	1.595-1.605
555	2.40	.140	1.837-1.847
556	2.95	.140	2.307-2.317
557	3.55	.185	2.777-2.788
558	3.55	.190	3.403-3.414
559	4.20	.190	3.892-3.904
560	4.75	.190	4.399-4.411

C=THREAD PITCH DIAMETER

REDUCING BUSHINGS

TOPAZ CAT #	UPC#	SIZE	UNIT CTN	SHIP CASE	WT/ CASE
RB1	20060	1/2" x 3/8"	100	100	4
RB2	20070	3/4" x 1/2"	100	100	4
RB3	20080	1" x 1/2"	50	50	6
RB4	20090	1" x 3/4"	50	50	3
RB5	20100	1 1/4" x 1/2"	25	25	7
RB6	20110	1 1/4" x 3/4"	25	25	6
RB7	20120	1 1/4" x 1"	25	25	4
RB8	20130	1 1/2" x 1/2"	25	25	10
RB9	20140	1 1/2" x 3/4"	25	25	9
RB10	20150	1 1/2" x 1"	25	25	7
RB11	20160	1 1/2" x 1 1/4"	25	25	3
RB12	20170	2" x 1/2"	10	10	5
RB13	20180	2" x 3/4"	10	10	8
RB14	20190	2" x 1"	10	10	7
RB15	20200	2" x 1 1/4"	10	10	5
RB16	20210	2" x 1 1/2"	10	10	4



TOPAZ CAT #	UPC#	SIZE	UNIT CTN	SHIP CASE	WT/ CASE
RB17	20220	2 1/2" x 1"	—	10	9
RB18	20230	2 1/2" x 1 1/4"	—	10	9
RB19	20240	2 1/2" x 1 1/2"	—	10	8
RB20	20250	2 1/2" x 2"	—	10	5
RB21	20260	3" x 1 1/4"	—	10	11
RB22	20270	3" x 1 1/2"	—	10	11
RB23	20280	3" x 2"	—	10	11
RB24	20290	3" x 2 1/2"	—	10	10
RB25	20300	3 1/2" x 1 1/2"	—	10	20
RB26	20310	3 1/2" x 2"	—	10	10
RB27	20320	3 1/2" x 2 1/2"	—	10	9
RB28	20330	3 1/2" x 3"	—	10	15
RB29	20340	4" x 2"	—	10	11
RB30	20350	4" x 2 1/2"	—	10	15
RB31	20360	4" x 3"	—	10	13
RB32	20370	4" x 3 1/2"	—	10	13



GROUNDING LOCKNUTS

TOPAZ CAT #	UPC#	SIZE	THREADS PER INCH	UNIT CTN	SHIP CASE	WT/ CASE
551	15250	1/2"	14	100	1000	30
552	15260	3/4"	14	100	1000	30
553	15270	1"	11 1/2	50	500	25
554	15280	1 1/4"	11 1/2	50	500	30
555	15290	1 1/2"	11 1/2	25	250	22
556	15300	2"	11 1/2	20	200	28
557	15310	2 1/2"	8	—	50	8
558	15320	3"	8	—	50	14
559	15330	3 1/2"	8	—	25	9
560	15340	4"	8	—	25	10



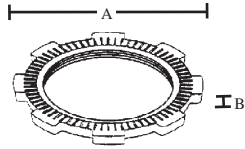

CAT#	A	B
241	1.12	.15
242	1.33	.15
243	1.68	.19
244	2.15	.19
245	2.35	.19
246	2.89	.19
247	3.43	.25
248	4.12	.25
249	4.67	.27
250	5.25	.27

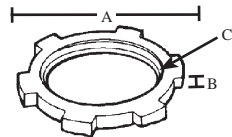

CAT#	A	B	C
281	1.15	.110	.787-.797
282	1.45	.115	.999-1.009
283	1.75	.140	1.250-1.260
284	2.10	.140	1.595-1.605
285	2.40	.140	1.837-1.847
286	2.95	.140	2.307-2.317
287	3.55	.185	2.777-2.788
288	3.55	.190	3.403-3.414
289	4.20	.190	3.892-3.904
290	4.75	.190	4.399-4.411
290A	6.67	.900	5.488-5.500
290B	7.93	.400	6.545-6.557

C=THREAD PITCH DIAMETER

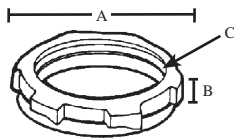

CAT#	A	B	C
711	1.12	.26	.787-.797
712	1.37	.27	.999-1.009
713	1.75	.28	1.250-1.260
714	2.06	.32	1.595-1.605
715	2.37	.32	1.837-1.847
716	2.87	.32	2.307-2.317
717	3.43	.32	2.777-2.788
718	4.12	.32	3.403-3.414
719	4.62	.32	3.892-3.904
720	5.18	.32	4.399-4.411

C=THREAD PITCH DIAMETER

RIGID LOCKNUTS

ZINC DIE CAST

TOPAZ CAT #	UPC#	SIZE	THREADS PER INCH	UNIT CTN	SHIP CASE	WT/ CASE
241	12040	1/2"	14	200	2000	20
242	12050	3/4"	14	100	1000	20
243	12060	1"	11 1/2	100	1000	20
244	12070	1 1/4"	11 1/2	50	500	20
245	12080	1 1/2"	11 1/2	50	500	20
246	12090	2"	11 1/2	50	200	12
247	12100	2 1/2"	8	25	100	13
248	12110	3"	8	25	100	18
249	12120	3 1/2"	8	10	40	13
250	12130	4"	8	10	40	15



E148716

STEEL

281	12300	1/2"	14	100	2000	20
282	12310	3/4"	14	100	1000	20
283	12320	1"	11 1/2	100	1000	30
284	12330	1 1/4"	11 1/2	50	500	20
285	12340	1 1/2"	11 1/2	50	500	30
286	12350	2"	11 1/2	25	250	20
287	12360	2 1/2"	8	—	50	6
288	12370	3"	8	—	50	9
289	12380	3 1/2"	8	—	25	6
290	12390	4"	8	—	25	7
290A	12400	5"	8	—	10	5
290B	12410	6"	8	—	10	8



SEALING LOCKNUTS

• ZINC PLATED WITH PVC MOLDED GASKET

STEEL

TOPAZ CAT #	UPC#	SIZE	THREADS PER INCH	UNIT CTN	SHIP CASE	WT/ CASE
711	17450	1/2"	14	50	500	10
712	17460	3/4"	14	50	500	16
713	17470	1"	11 1/2	25	250	4
714	17480	1 1/4"	11 1/2	10	100	8
715	17490	1 1/2"	11 1/2	10	100	8
716	17500	2"	11 1/2	10	100	12
717	17510	2 1/2"	8	—	25	5
718	17520	3"	8	—	25	5
719	17530	3 1/2"	8	—	25	6
720	17540	4"	8	—	25	6



E170258

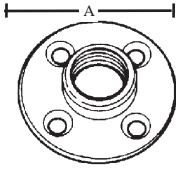

RIGID FLOOR FLANGE PLATES

CAT#	A
291	3.000
292	3.375
293	3.625
294	4.000
295	4.375
296	4.875

MALLEABLE IRON

TOPAZ CAT #	UPC#	SIZE	UNIT CTN	SHIP CASE	WT/ CASE
291	12420	1/2"	—	50	23
292	12430	3/4"	—	50	25
293	12440	1"	—	50	43
294	12450	1 1/4"	—	25	20
295	12460	1 1/2"	—	25	32
296	12470	2"	—	25	27

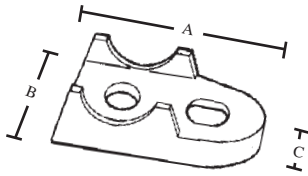

EMT/RIGID CLAMP BACKS

MALLEABLE IRON

CAT#	A	B	C
481	2.057	1.000	.500
482	2.375	1.063	.500
483	2.937	1.250	.563
484	3.500	1.875	.750
485	3.813	1.437	.813
486	4.750	1.936	1.000
487	5.750	2.437	.750
488	6.688	2.625	.875
489	7.125	2.875	1.063
489A	8.875	3.063	1.063
489B	10.13	3.75	.60
489C	12.19	4.00	.75

TOPAZ CAT #	UPC#	SIZE	UNIT CTN	SHIP CASE	WT/ CASE
481	14510	1/2"	25	250	16
482	14520	3/4"	25	250	22
483	14530	1"	25	250	35
484	14540	1 1/4"	10	100	21
485	14550	1 1/2"	10	100	27
486	14560	2"	5	50	22
487	14570	2 1/2"	—	25	14
488	14580	3"	—	10	9
489	14590	3 1/2"	—	10	14
489A	14600	4"	—	10	18
489B	14601	5"	—	10	25
489C	14602	6"	—	10	30



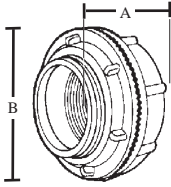

CAT#	A	B
201	1.31	1.54
202	1.37	1.73
203	1.59	2.04
204	1.59	2.42
205	1.59	2.79
206	1.59	3.30
207	2.44	3.70
208	2.44	4.39
209	2.44	4.88
210	2.44	5.50

201B	1.31	1.54
202B	1.37	1.73
203B	1.59	2.04
204B	1.59	2.42
205B	1.59	2.79
206B	1.59	3.30
207B	2.44	3.70
208B	2.44	4.39
209B	2.44	4.88
210B	2.44	5.50

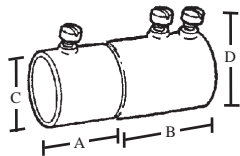

CAT#	A	B	C	D	SCREWS
391S	.850	1.200	.720	.855	2
392S	1.000	1.310	.940	1.065	2
393S	1.270	1.530	1.170	1.320	3

RIGID WATERTIGHT HUBS INSULATED THROAT

ZINC DIE CAST

TOPAZ CAT #	UPC#	SIZE	UNIT CTN	SHIP CASE	WT/CASE
201	11550	1/2"	25	250	47
202	11560	3/4"	10	100	27
203	11570	1"	10	100	40
204	11580	1 1/4"	2	20	10
205	11590	1 1/2"	2	20	13
206	11600	2"	2	20	17
207	11610	2 1/2"	—	2	3
208	11620	3"	—	2	4
209	11630	3 1/2"	—	1	4
210	11640	4"	—	1	5

W/BONDING SCREW

201B	11551	1/2"	25	250	19
202B	11561	3/4"	10	100	27
203B	11571	1"	10	100	40
204B	11581	1 1/4"	2	20	50
205B	11591	1 1/2"	2	20	65
206B	11601	2"	2	20	85
207B	11611	2 1/2"	—	2	150
208B	11621	3"	—	2	200
209B	11631	3 1/2"	—	1	400
210B	11641	4"	—	1	500

COMBINATION COUPLINGS EMT TO RIGID

• SET SCREW TYPE

STEEL

TOPAZ CAT #	UPC#	SIZE	UNIT CTN	SHIP CASE	WT/CASE
391S	70210	1/2"-1/2"	25	250	40
392S	70220	3/4"-3/4"	10	100	23
393S	70230	1"-1"	10	100	40



E148716



E148716



E170258

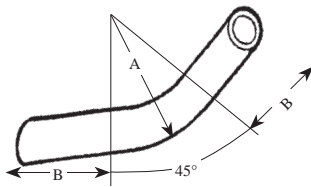

CAT#	A	B
21	4.000	2.875
22	4.500	2.875
23	5.750	3.00
24	7.250	3.25
25	8.250	3.625
26	9.500	4.1875
27	10.500	5.25
28	13.000	5.8125
29	15.000	6.75
30	16.000	6.9375

A=MIN. UL RADIUS
B=STRAIGHT LEG EACH END

EMT 45° RADIUS ELBOW

GALVANIZED STEEL

TOPAZ CAT #	UPC#	SIZE	UNIT CTN	SHIP CASE	WT/ CASE
21	33400	1/2"	—	50	11
22	33410	3/4"	—	50	19
23	33420	1"	—	35	25
24	33430	1 1/4"	—	30	30
25	33440	1 1/2"	—	30	44
26	33450	2"	—	15	31
27	33460	2 1/2"	—	1	5
28	33470	3"	—	1	7
29	33480	3 1/2"	—	1	9
30	33490	4"	—	1	12



E223147

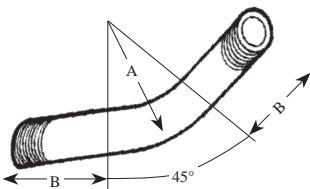

CAT#	A	B
11	4.000	2.875
12	4.500	2.875
13	5.750	3.00
14	7.250	3.25
15	8.250	3.625
16	9.500	4.1875
17	10.500	5.25
18	13.000	5.8125
19	15.000	6.75
20	16.000	6.9375

A=MIN. UL RADIUS
B=STRAIGHT LEG EACH END

RIGID 45° RADIUS ELBOW

GALVANIZED STEEL

TOPAZ CAT #	UPC#	SIZE	UNIT CTN	SHIP CASE	WT/ CASE
11	33300	1/2"	—	50	26
12	33310	3/4"	—	50	38
13	33320	1"	—	35	45
14	33330	1 1/4"	—	30	60
15	33340	1 1/2"	—	15	45
16	33350	2"	—	15	68
17	33360	2 1/2"	—	1	8
18	33370	3"	—	1	13
19	33380	3 1/2"	—	1	16
20	33390	4"	—	1	22



E223147

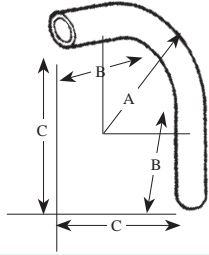

CAT#	A	B	C
81	4.000	2.875	6.343
82	4.500	2.875	6.781
83	5.750	3.000	8.901
84	7.250	3.250	10.250
85	8.250	3.625	11.937
86	9.500	4.1875	14.031
87	10.500	5.250	16.000
88	13.000	5.8125	18.947
89	15.000	6.750	22.218
89A	16.000	6.9375	23.437

A=MIN. UL RADIUS
B=STRAIGHT
C=OFFSET

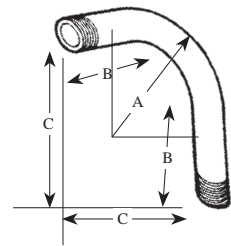

CAT#	A	B	C
61	4.000	1.750	6.343
62	4.500	2.250	6.781
63	5.750	2.250	8.901
64	7.250	3.000	10.250
65	8.250	3.500	11.937
66	9.500	4.000	14.031
67	10.500	4.750	16.000
68	13.000	6.000	18.947
69	15.000	5.500	22.218
70	16.000	5.750	23.437

A=MIN. UL RADIUS
B=STRAIGHT
C=OFFSET

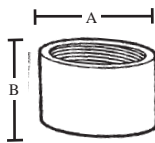

CAT#	A	B
51	1.010	1.563
52	1.250	1.625
53	1.525	2.000
54	1.869	2.063
55	2.155	2.063
56	2.650	2.125
57	3.250	3.125
58	3.870	3.250
59	4.500	3.375
60	4.875	3.500
60A	6.000	3.750
60B	7.200	4.000

EMT 90° RADIUS ELBOW

GALVANIZED STEEL

TOPAZ CAT #	UPC#	SIZE	UNIT CTN	SHIP CASE	WT/ CASE
81	30420	1/2"	—	50	14
82	30430	3/4"	—	50	23
83	30440	1"	—	20	16
84	30450	1 1/4"	—	20	30
85	30460	1 1/2"	—	10	20
86	30470	2"	—	10	30
87	30480	2 1/2"	—	1	6
88	30490	3"	—	1	9
89	30500	3 1/2"	—	1	11
89A	30510	4"	—	1	15



RIGID 90° RADIUS ELBOW

GALVANIZED STEEL

TOPAZ CAT #	UPC#	SIZE	UNIT CTN	SHIP CASE	WT/ CASE
61	31030	1/2"	—	50	40
62	31040	3/4"	—	50	54
63	31050	1"	—	20	40
64	31060	1 1/4"	—	20	60
65	31070	1 1/2"	—	10	42
66	31080	2"	—	10	68
67	31090	2 1/2"	—	1	13
68	31100	3"	—	1	18
69	31110	3 1/2"	—	1	26
70	31120	4"	—	1	33



RIGID COUPLINGS TUBULAR THREADED TYPE

GALVANIZED STEEL

TOPAZ CAT #	UPC#	SIZE	THREADS PER INCH	UNIT CTN	SHIP CASE	WT/ CASE
51	10130	1/2"	14	—	100	13
52	10140	3/4"	14	—	50	10
53	10150	1"	11 1/2	—	30	11
54	10160	1 1/4"	11 1/2	—	25	11
55	10170	1 1/2"	11 1/2	—	25	14
56	10180	2"	11 1/2	—	20	15
57	10190	2 1/2"	8	—	12	22
58	10200	3"	8	—	8	18
59	10210	3 1/2"	8	—	4	15
60	10220	4"	8	—	4	12
60A	10230	5"	8	—	2	10
60B	10240	6"	8	—	1	8





CONDUIT NIPPLES



GALVANIZED STEEL

TOPAZ CAT #	UPC#	CONDUIT SIZE	LENGTH INCHES	SHIP CASE	WT/ CASE
6451	31130	1/2"	CLOSE	25	2
6451112	31140	1/2"	1 1/2	25	2
64512	31150	1/2"	2	25	3
6451212	31160	1/2"	2 1/2	25	4
64513	31170	1/2"	3	25	5
6451312	31180	1/2"	3 1/2	25	6
64514	31190	1/2"	4	25	7
64515	31200	1/2"	5	25	8
6451512	31201	1/2"	5 1/2	25	8
64516	31210	1/2"	6	25	10
64518	31220	1/2"	8	1	1
645110	31230	1/2"	10	1	1
645112	31240	1/2"	12	1	1
6452	31250	3/4"	CLOSE	25	2
64522	31260	3/4"	2	25	4
6452212	31270	3/4"	2 1/2	25	5
64523	31280	3/4"	3	25	6
6452312	31290	3/4"	3 1/2	25	7
64524	31300	3/4"	4	25	9
64525	31310	3/4"	5	25	11
64526	31320	3/4"	6	25	13
64528	31330	3/4"	8	1	1
645210	31340	3/4"	10	1	1
645212	31350	3/4"	12	1	1
6453	31360	1"	CLOSE	25	4
64532	31370	1"	2	25	6
6453212	31380	1"	2 1/2	25	7
64533	31390	1"	3	25	9
6453312	31400	1"	3 1/2	25	11
64534	31410	1"	4	25	12
64535	31420	1"	5	25	16
64536	31430	1"	6	25	20
64538	31440	1"	8	1	1
645310	31450	1"	10	1	11
645312	31460	1"	12	1	2

TOPAZ CAT #	UPC#	CONDUIT SIZE	LENGTH INCHES	SHIP CASE	WT/ CASE
6454	31470	1 1/4"	CLOSE	25	6
64542	31480	1 1/4"	2	25	7
6454212	31490	1 1/4"	2 1/2	25	9
64543	31500	1 1/4"	3	25	12
6454312	31510	1 1/4"	3 1/2	25	14
64544	31520	1 1/4"	4	25	17
64545	31530	1 1/4"	5	25	21
64546	31540	1 1/4"	6	25	25
64548	31550	1 1/4"	8	1	1
645410	31560	1 1/4"	10	1	2
645412	31570	1 1/2"	12	1	2
6455	31580	1 1/2"	CLOSE	25	7
64552	31590	1 1/2"	2	25	9
6455212	31600	1 1/2"	2 1/2	25	11
64553	31610	1 1/2"	3	25	14
6455312	31620	1 1/2"	3 1/2	25	17
64554	31630	1 1/2"	4	25	20
64555	31640	1 1/2"	5	25	26
64556	31650	1 1/2"	6	25	31
64558	31660	1 1/2"	8	1	2
645510	31670	1 1/2"	10	1	2
645512	31680	1 1/2"	12	1	3
6456	31690	2"	CLOSE	25	11
6456212	31700	2"	2 1/2	25	15
64563	31710	2"	3	25	18
6456312	31720	2"	3 1/2	25	22
64564	31730	2"	4	25	26
64565	31740	2"	5	25	33
64566	31750	2"	6	25	40
64568	31760	2"	8	1	2
645610	31770	2"	10	1	3
645612	31780	2"	12	1	3

Continued on next page



CONDUIT NIPPLES



GALVANIZED STEEL

TOPAZ CAT #	UPC#	CONDUIT SIZE	LENGTH INCHES	SHIP CASE	WT/ CASE
6457	31790	2 1/2"	CLOSE	1	1
64573	31800	2 1/2"	3	1	1
6457312	31810	2 1/2"	3 1/2	1	2
64574	31820	2 1/2"	4	1	2
64575	31830	2 1/2"	5	1	3
64576	31840	2 1/2"	6	1	3
64578	31850	2 1/2"	8	1	4
645710	31860	2 1/2"	10	1	5
645712	31870	2 1/2"	12	1	6
6458	31880	3"	CLOSE	1	1
64583	31890	3"	3	1	1
6458312	31900	3"	3 1/2	1	2
64584	31910	3"	4	1	2
64585	31920	3"	5	1	3
64586	31930	3"	6	1	3
64588	31940	3"	8	1	4
645810	31950	3"	10	1	5
645812	31960	3"	12	1	6

TOPAZ CAT #	UPC#	CONDUIT SIZE	LENGTH INCHES	SHIP CASE	WT/ CASE
6459	31970	3 1/2"	CLOSE	1	2
64594	31980	3 1/2"	4	1	2
64595	31990	3 1/2"	5	1	3
64596	32000	3 1/2"	6	1	4
64598	32010	3 1/2"	8	1	5
645910	32020	3 1/2"	10	1	7
645912	32030	3 1/2"	12	1	8
6410	32040	4"	CLOSE	1	2
64104	32050	4"	4	1	3
64105	32060	4"	5	1	4
64106	32070	4"	6	1	4
64108	32080	4"	8	1	6
641010	32090	4"	10	1	8
641012	32100	4"	12	1	9

LIQUID TIGHT CORD GRIPS

- LIQUID TIGHT AT UP TO 70 PS.I. WATER PRESSURE
- LOCKNUTS MUST BE ORDERED SEPARATELY

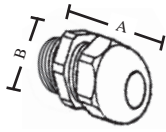

CAT#	A	B
LTF38	1.48	.87
RLTF38	1.48	.87
LTF12	1.53	.93
LTF34	1.78	1.31
RLTF34	1.78	1.31
LTF1	2.15	1.65

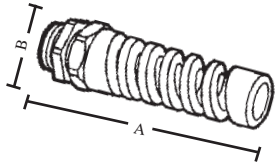

CAT#	A	B
FLEXLTF38	3.09	.87
FLEXRLTF38	3.09	.87
FLEXLTF12	4.03	.93
FLEXRLTF12	4.03	.93
FLEXLTF34	5.09	1.31
FLEXRLTF34	5.09	1.31

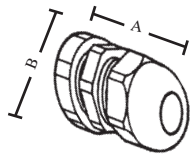

CAT#	A	B
LTF7	1.12	.59
LTF9	1.20	.75
LTF11	1.29	.87
LTF13	1.41	.95
LTF16	1.50	1.07
LTF21	1.66	1.30
LTF29	1.94	1.66

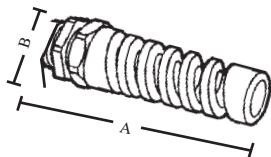

CAT#	A	B
FLEXLTF7	2.46	.59
FLEXLTF9	2.80	.75
FLEXLTF11	3.40	.87
FLEXLTF13	3.89	.95
FLEXLTF16	4.36	1.07
FLEXLTF21	4.95	1.30

6/6 NYLON

TOPAZ CAT #	UPC#	SIZE	CABLE DIAMETER MIN	CABLE DIAMETER MAX	UNIT CTN	SHIP CASE	WT/ CASE
NPT HUBS							
LTF38	30110	3/8"	.19"	.31"	25	100	2
RLTF38	30120	3/8"	.08"	.23"	25	100	2
LTF12	30130	1/2"	.17"	.47"	25	100	3
LTF34	30150	3/4"	.55"	.70"	10	100	5
RLTF34	30160	3/4"	.36"	.63"	10	100	5
LTF1	30170	1"	.71"	1.0"	10	100	6

FLEX NPT HUBS

FLEXLTF38	30300	3/8"	.19"	.31"	25	100	2
FLEXRLTF38	30310	3/8"	.08"	.23"	25	100	2
FLEXLTF12	30320	1/2"	.27"	.48"	25	100	3
FLEXRLTF12	30330	1/2"	.20"	.35"	25	100	3
FLEXLTF34	30340	3/4"	.55"	.70"	10	100	11
FLEXRLTF34	30350	3/4"	.36"	.63"	10	100	11

PG HUBS

- PG THREADS ARE STEEL CONDUIT THREADS PER DIN 40430
- LOCKNUTS INCLUDED

LTF7	30230	PG7	.09"	.26"	25	100	1
LTF9	30240	PG9	.20"	.30"	25	100	2
LTF11	30250	PG11	.23"	.39"	25	100	3
LTF13	30260	PG13	.27"	.48"	25	100	3
LTF16	30270	PG16	.43"	.655"	10	100	4
LTF21	30280	PG21	.55"	.70"	10	100	6
LTF29	30290	PG29	.70"	1.0"	10	100	6

FLEX PG HUBS

FLEXLTF7	30360	PG7	.09"	.26"	25	100	2
FLEXLTF9	30370	PG9	.20"	.30"	25	100	2
FLEXLTF11	30380	PG11	.23"	.39"	25	100	4
FLEXLTF13	30390	PG13	.27"	.48"	25	100	5
FLEXLTF16	30400	PG16	.43"	.55"	10	100	10
FLEXLTF21	30410	PG21	.55"	.70"	10	100	11



E170258



E170258



E170258



E170258

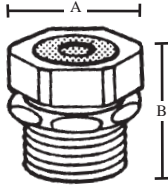

FLEXIBLE CORD CONNECTORS

• STRAIN RELIEF

ZINC DIE CAST

CAT#	A	B	RANGE	
			MIN.	MAX.
881	.96	1.30	.190	.260
881A	.96	1.30	.260	.375
881B	.96	1.30	.375	.500
882	1.20	1.32	.440	.500
882A	1.20	1.32	.500	.625
882B	1.20	1.32	.625	.725
883A	1.51	1.58	.500	.625
883B	1.51	1.58	.625	.750
883C	1.51	1.58	.750	.880
883D	1.51	1.58	.875	.985

TOPAZ CAT #	UPC#	SIZE	CABLE RANGE	UNIT CTN	SHIP CASE	WT/ CASE
881	18880	1/2"	.190 TO .260	25	250	43
881A	18890	1/2"	.260 TO .375	25	250	43
881B	18900	1/2"	.375 TO .500	25	250	43
882	18910	3/4"	.440 TO .500	25	250	65
882A	18920	3/4"	.500 TO .625	25	250	65
882B	18930	3/4"	.625 TO .725	25	250	65
883A	18940	1"	.500 TO .625	10	100	34
883B	18950	1"	.625 TO .750	10	100	34
883C	18960	1"	.750 TO .880	10	100	34
883D	18970	1"	.875 TO .985	10	100	34

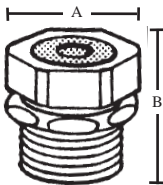

CAT #	A	B	GROMMET
			COLOR
50A250	.975	1.937	RED
50A350	.975	1.937	WHITE
50A450	.975	1.937	BLUE
50A560	.975	1.937	GREEN
50A650	.975	1.937	BROWN
75A250	1.220	1.937	RED
75A350	1.220	1.937	WHITE
75A450	1.220	1.937	BLUE
75A550	1.220	1.937	GREEN
75A650	1.220	1.937	BROWN
75B750	1.220	1.562	YELLOW
75B850	1.220	1.562	PURPLE
100B560	1.50	1.75	GREEN
100B650	1.50	1.75	BROWN
100B750	1.50	1.75	YELLOW
100B850	1.50	1.75	PURPLE
100C950	1.50	1.875	GRAY
100C1050	1.50	1.875	BLACK

STEEL						
TOPAZ CAT #	UPC#	SIZE	CABLE RANGE	UNIT CTN	SHIP CASE	WT/ CASE
50A250	10080	1/2"	.15" TO .25"	—	25	3
50A350	10090	1/2"	.25" TO .35"	—	25	3
50A450	10100	1/2"	.35" TO .45"	—	25	3
50A560	10110	1/2"	.45" TO .56"	—	25	3
50A650	10120	1/2"	.55" TO .65"	—	25	3
75A250	10250	3/4"	.15" TO .25"	—	25	3
75A350	10260	3/4"	.25" TO .35"	—	25	3
75A450	10270	3/4"	.35" TO .45"	—	25	3
75A560	10280	3/4"	.45" TO .55"	—	25	3
75A650	10290	3/4"	.55" TO .65"	—	25	3
75B750	10300	3/4"	.65" TO .75"	—	25	3
75B850	10310	3/4"	.75" TO .85"	—	25	3
100B560	10450	1"	.45" TO .56"	10	100	28
100B650	10460	1"	.55" TO .65"	10	100	28
100B750	10470	1"	.65" TO .75"	10	100	28
100B850	10480	1"	.75" TO .85"	10	100	28
100C950	10490	1"	.85" TO .95"	10	100	28
100C1050	10500	1"	.95" TO 1.05"	10	100	28



SEE SPECIFICATIONS ON NEXT PAGE

FLEXIBLE CORD CONNECTORS - CONT'D

TOPAZ CAT #	SIZE	CABLE RANGE		FOR TYPES S, SO, ST, & STO	FOR TYPES SJ, STO, SJT SJTO, SVO, AND BUS DROP	FOR VNTC TYPE TRAY CABLE
		MIN	MAX			
50A250	1/2"	.150	.250		18-2,3 SVO	
50A350	1/2"	.250	.350		18-2,3 SJT 18-2,3,4 SJO 16-2,3 SJO	18-3,4 & 5 16-3 & 4 14-3
50A450	1/2"	.350	.450	18-2,3,4 16-2,3,4	16-4 SJO 14-2,3,4 SJO 12-2 SJO 14-3 Bus Drop	18-6 to 18-11 16-5 to 16-8 14-4 to 14-7 12-3 & 4 also Composite Cables 3 # 16 & 4 # 14
50A560	1/2"	.450	.560	18-5,6,7 16-5,6 14-2,3	12-3 SJO 12-3 & 10-3 Bus Drop	18-10 to 18-16 16-9 to 16-12 14-8 to 14-9 12-5 & 12-7 10-3 to 10-4 also Composite Cables 3 # 12 & 4 # 14 3 # 10 & 4 # 14
50A650	1/2"	.550	.650	18-8,10 16-7,8 14-4 12-2,3 10-2		18-17 to 18-23 16-13 to 16-19 14-10 to 14-14 12-8 & 9 10-5 to 10-7 8-2 to 8-4 also Composite Cables 3 # 8 & 4 # 14 3 # 10 & 4 # 12
75A250	3/4"	.150	.250		18-2,3 SVO	
75A350	3/4"	.250	.350		18-2,3 SJT 18-2,3,4 SJO 16-2,3 SJO	18-3,4 & 5 16-3,4 14-3
75A450	3/4"	.350	.450	18-2,3,4 16-2,3,4	16-4 SJO 14-2,3,4 SJO 12-2 SJO 14-3 Bus Drop	18-6 to 18-11 16-5 to 16-8 14-4 to 14-7 12-3 & 4 also Composite Cables 3 # 16 & 4 # 14
75A560	3/4"	.450	.560	18-5,6,7 16-5,6 14-2,3	12-3 SJO 12-3 & 10-3 Bus Drop	18-10 to 18-16 16-9 to 16-12 14-8 to 14-9 12-5 to 12-7 10-3 to 10-4 also Composite Cables 3 # 12 & 4 # 14 3 # 10 & 4 # 14
75A650	3/4"	.550	.650	18-8,10 16-7,8 14-4 12-2,3 10-2		18-17 to 18-23 16-13 to 16-19 14-10 to 14-14 12-8 & 9 10-5 to 10-7 8-2 to 8-4 also Composite Cables 3 # 8 & 4 # 14 3 # 10 & 4 # 12
75B750	3/4"	.650	.750	18-12,14 16-10,12 14-5,6,7 12-4,5 10-3,4 8-2	8-3 Bus Drop	18-24 to 18-37 16-20 to 16-27 14-15 to 14-21 12-5 to 12-7 10-3 to 10-4 also Composite Cables 3 # 6 & 4 # 14 3 # 8 & 4 # 12
75B850	3/4"	.750	.850	18-16,18,20 16-14,16,18 14-8 12-6,7,8 10-5 8-3,4 6-2	6-3 Bus Drop	16-28 to 16-33 14-22 to 14-26 12-15 to 12-19 10-10 to 10-11 6-4 4-2 also Composite Cables 3 # 6 & 4 # 12 3 # 6 & 6 # 14 3 # 6 & 6 # 12
100B560	1"	.450	.560	18-5,6,7 16-5,6 14-2,3	12-3 SJO 12-3 & 10-3 Bus Drop	18-10 to 18-16 16-9 to 16-12 14-8 to 14-9 12-5 to 12-7 10-3 to 10-4 also Composite Cables 3 # 12 & 4 # 14 3 # 10 & 4 # 14
100B650	1"	.550	.650	18-8,10 16-7,8 14-4 12-2,3 10-2		18-17 to 18-23 16-13 to 16-19 14-10 to 14-14 12-8,9 10-5 to 10-7 8-2 to 8-4 also Composite Cables 3 # 8 & 4 # 14 3 # 10 & 4 # 12
100B750	1"	.650	.750	18-2,14 16-10,12 14-5,6,7 12-4,5 10-3,4 8-2	8-3 Bus Drop	18-24 to 18-37 16-20 to 16-27 14-15 to 14-21 12-10 to 12-14 10-8 to 10-9 6-3 also Composite Cables 3 # 6 & 4 # 14 3 # 8 & 4 # 12
100B850	1"	.750	.850	18-16,18,20 16-14,16,18 14-8 12-6,7,8 10-5 8-3,4 6-2	6-3 Bus Drop	16-28 to 16-33 14-22 to 14-26 12-15 to 12-19 10-10 to 10-11 6-4 to 4-2 also Composite Cables 3 # 6 & 4 # 12 3 # 6 & 6 # 14 3 # 6 & 6 # 12
100C950	1"	.850	.950	18-22,24,26 16-20,22,24 14-10,12 10-6,7,8 6-3,4	4-3 Bus Drop	16-34 to 16-37 14-27 to 14-33 12-20 to 12-23 10-12 4-3 also Composite Cables 3 # 4 & 4 # 14 3 # 4 & 4 # 12
100C1050	1"	.950	1.050	18-30 16-26 14-14,16 12-10 4-3		14-34 to 14-37 12-24 to 12-30 4-4 2-2 2-3 also Composite Cables 3 # 2 & 4 # 14 3 # 2 & 4 # 12 3 # 2 & 6 # 14

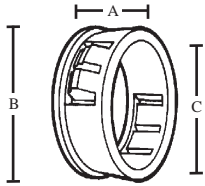

KNOCK-OUT BUSHINGS

SUITABLE FOR USE WITH ELECTRICAL KNOCKOUT

CAT#	A	B	C
SB8756	.375	.953	.453
SB8757	.438	.953	.453
SB8758	.500	.953	.453
SB8759	.563	.953	.453
SB87510	.625	.953	.453
SB87511	.688	.953	.453
SB109313	.813	1.219	.453
SB109314	.875	1.219	.453
SB109315	.938	1.219	.453
SB137514	.875	1.469	.453
SB137516	1.000	1.469	.453
SB175022	1.375	1.875	.453
SB200026	1.625	2.125	.453
SB2.531	1.969	2.656	.719
SB3.039	2.469	3.156	.719
SB3.547	2.938	3.656	.719
SB4.055	3.438	4.156	.719

TOPAZ CAT #	UPC#	INSIDE DIAMETER	K.O. SIZE	UNIT CTN	SHIP CASE	WT/ CASE
SB8756	32620	3/8"	1/2"	100	1000	4
SB8757	32630	7/16"	1/2"	100	1000	4
SB8758	32640	1/2"	1/2"	100	1000	4
SB8759	32650	9/16"	1/2"	100	1000	4
SB87510	32660	5/8"	1/2"	100	1000	4
SB87511	32670	11/16"	1/2"	100	1000	4
SB109313	32690	13/16"	3/4"	100	1000	6
SB109314	32700	7/8"	3/4"	100	1000	6
SB109315	32710	15/16"	3/4"	100	1000	6
SB137514	32760	7/8"	1"	100	1000	8
SB137516	32770	1"	1"	100	1000	8
SB175022	32810	1-3/8"	1 1/4"	50	500	6
SB200026	32820	1-5/8"	1 1/2"	50	500	7
SB2.531	32840	1-31/32"	2"	10	100	4
SB3.039	32850	1-15/32"	2 1/2"	10	100	4
SB3.547	32860	2-15/16"	3"	10	100	4
SB4.055	32870	3-7/16"	3 1/2"	10	100	4



STUD GROMMETS

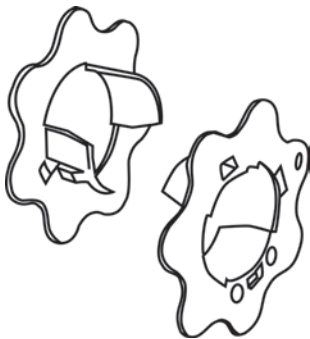

TOPAZ CAT #	UPC#	SIZE	UNIT CTN	SHIP CASE	WT/ CASE
45	14172	UNIVERSAL*	—	200	5

*Fits all stud hole sizes.

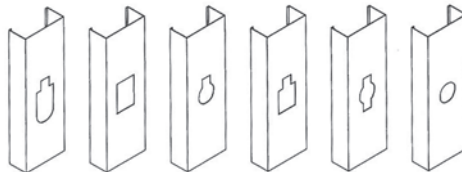

Common hole configurations in metal studs.



HEAVY DUTY CABLE CLAMPS

• 1/2" WIDE, .08" THICK, #8 SCREW 6/6 NYLON



TOPAZ CAT #	UPC#	SIZE	UNIT CTN	SHIP CASE	WT/ CASE
WHITE					
CCH18W	32900	1/8"	100	1000	2
CCH316W	32910	3/16"	100	1000	2
CCH14W	32920	1/4"	100	1000	2
CCH516W	32930	5/16"	100	1000	2
CCH38W	32940	3/8"	100	1000	3
CCH716W	32950	7/16"	100	1000	3
CCH12W	32960	1/2"	100	1000	3
CCH916W	32970	9/16"	100	1000	3
CCH58W	32980	5/8"	100	1000	3
CCH1116W	32990	11/16"	100	1000	3
CCH34W	33000	3/4"	100	1000	4
CCH1316W	33010	13/16"	50	500	3
CCH78W	33020	7/8"	50	500	3
CCH1W	33030	1"	50	500	3
CCH118W	33040	1 1/8"	50	500	3
CCH1916W	33050	1 3/16"	50	500	3
CCH114W	33060	1 1/4"	50	500	4
CCH138W	33070	1 3/8"	50	500	4
CCH112W	33080	1 1/2"	50	500	4

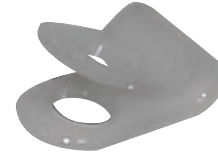

BLACK					
CCH18B	30690	1/8"	100	1000	2
CCH316B	30700	3/16"	100	1000	2
CCH14B	30710	1/4"	100	1000	2
CCH516B	30720	5/16"	100	1000	2
CCH38B	30730	3/8"	100	1000	3
CCH716B	30740	7/16"	100	1000	3
CCH12B	30750	1/2"	100	1000	3
CCH916B	30760	9/16"	100	1000	3
CCH58B	30770	5/8"	100	1000	3
CCH1116B	30780	11/16"	100	1000	3
CCH34B	30790	3/4"	100	1000	4
CCH1316B	30800	13/16"	50	500	3
CCH78B	30810	7/8"	50	500	3
CCH1B	30820	1"	50	500	3
CCH118B	30830	1 1/8"	50	500	3
CCH1916B	30840	1 3/16"	50	500	3
CCH114B	30850	1 1/4"	50	500	4
CCH138B	30860	1 3/8"	50	500	4
CCH112B	30870	1 1/2"	50	500	4



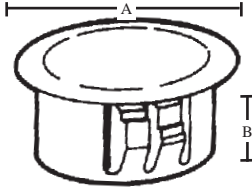

CAT#	A	B
PK050	1.016	.453
PK051	1.219	.453
PK052	1.500	.453
PK053	1.906	.453
PK054	2.141	.453
PK055	2.750	.750

KNOCK-OUT SEALS

GRAY		6/6 NYLON			
TOPAZ CAT #	UPC#	SIZE	UNIT CTN	SHIP CASE	WT/ CASE
PK050	30890	1/2"	100	1000	5
PK051	30900	3/4"	100	1000	6
PK052	30910	1"	100	1000	9
PK053	30920	1 1/4"	50	500	7
PK054	30930	1 1/2"	50	500	8
PK055	30940	2"	10	100	11

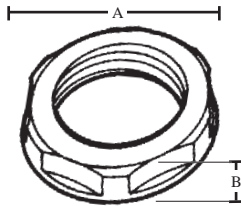

CAT#	A	B
NLN38B	1.078	.266
NLN12B	1.078	.266
NLN34B	1.313	.266
NLN1B	1.625	.266

NPT LOCKNUTS

BLACK		6/6 NYLON			
TOPAZ CAT #	UPC#	SIZE	UNIT CTN	SHIP CASE	WT/ CASE
NLN38B	30950	3/8"	100	1000	5
NLN12B	30970	1/2"	100	1000	5
NLN34B	30990	3/4"	50	500	3
NLN1B	31010	1"	50	200	3

NLN38G	1.078	.266
NLN12G	1.078	.266
NLN34G	1.313	.266
NLN1G	1.625	.266

GRAY		6/6 NYLON			
TOPAZ CAT #	UPC#	SIZE	UNIT CTN	SHIP CASE	WT/ CASE
NLN38G	30960	3/8"	100	1000	5
NLN12G	30980	1/2"	100	1000	5
NLN34G	31000	3/4"	50	500	3
NLN1G	31020	1"	50	200	3

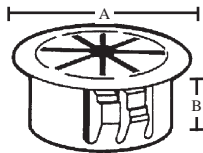

CAT#	A	B	Max Inside DIAM
UB625	.719	.406	.437
UB750	.859	.391	.500
UB812	.859	.391	.500
UB875	.938	.453	.562
UB1000	1.063	.453	.750
UB1093	1.156	.453	.812
UB1375	1.438	.453	1.000

UNIVERSAL BUSHINGS

• .125 MAXIMUM THICKNESS

BLACK		6/6 NYLON				
TOPAZ CAT #	UPC#	MOUNTING HOLE DIAMETER	KO	UNIT CTN	SHIP CASE	WT/ CASE
UB625	30620	0.625		100	1000	4
UB750	30630	0.750		100	1000	4
UB812	30640	0.812		100	1000	4
UB875	30650	0.875	1/2"	100	1000	4
UB1000	30660	1.000		100	1000	5
UB1093	30670	1.093	3/4"	100	1000	5
UB1375	30680	1.375	1"	100	1000	5



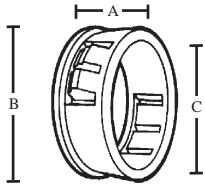

KNOCK-OUT BUSHINGS

SUITABLE FOR USE WITH ELECTRICAL KNOCKOUT

CAT#	A	B	C
SB8756	.375	.953	.453
SB8757	.438	.953	.453
SB8758	.500	.953	.453
SB8759	.563	.953	.453
SB87510	.625	.953	.453
SB87511	.688	.953	.453
SB109313	.813	1.219	.453
SB109314	.875	1.219	.453
SB109315	.938	1.219	.453
SB137514	.875	1.469	.453
SB137516	1.000	1.469	.453
SB175022	1.375	1.875	.453
SB200026	1.625	2.125	.453
SB2.531	1.969	2.656	.719
SB3.039	2.469	3.156	.719
SB3.547	2.938	3.656	.719
SB4.055	3.438	4.156	.719

TOPAZ CAT #	UPC#	INSIDE DIAMETER	K.O. SIZE	UNIT CTN	SHIP CASE	WT/ CASE
SB8756	32620	3/8"	1/2"	100	1000	4
SB8757	32630	7/16"	1/2"	100	1000	4
SB8758	32640	1/2"	1/2"	100	1000	4
SB8759	32650	9/16"	1/2"	100	1000	4
SB87510	32660	5/8"	1/2"	100	1000	4
SB87511	32670	11/16"	1/2"	100	1000	4
SB109313	32690	13/16"	3/4"	100	1000	6
SB109314	32700	7/8"	3/4"	100	1000	6
SB109315	32710	15/16"	3/4"	100	1000	6
SB137514	32760	7/8"	1"	100	1000	8
SB137516	32770	1"	1"	100	1000	8
SB175022	32810	1-3/8"	1 1/4"	50	500	6
SB200026	32820	1-5/8"	1 1/2"	50	500	7
SB2.531	32840	1-31/32"	2"	10	100	4
SB3.039	32850	1-15/32"	2 1/2"	10	100	4
SB3.547	32860	2-15/16"	3"	10	100	4
SB4.055	32870	3-7/16"	3 1/2"	10	100	4



STUD GROMMETS

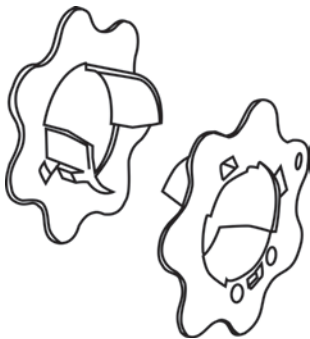

TOPAZ CAT #	UPC#	SIZE	UNIT CTN	SHIP CASE	WT/ CASE
45	14172	UNIVERSAL*	—	200	5

*Fits all stud hole sizes.

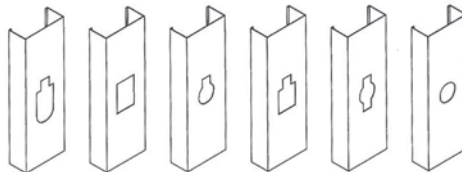

Common hole configurations in metal studs.



HEAVY DUTY CABLE CLAMPS

• 1/2" WIDE, .08" THICK, #8 SCREW 6/6 NYLON



TOPAZ CAT #	UPC#	SIZE	UNIT CTN	SHIP CASE	WT/ CASE
WHITE					
CCH18W	32900	1/8"	100	1000	2
CCH316W	32910	3/16"	100	1000	2
CCH14W	32920	1/4"	100	1000	2
CCH516W	32930	5/16"	100	1000	2
CCH38W	32940	3/8"	100	1000	3
CCH716W	32950	7/16"	100	1000	3
CCH12W	32960	1/2"	100	1000	3
CCH916W	32970	9/16"	100	1000	3
CCH58W	32980	5/8"	100	1000	3
CCH1116W	32990	11/16"	100	1000	3
CCH34W	33000	3/4"	100	1000	4
CCH1316W	33010	13/16"	50	500	3
CCH78W	33020	7/8"	50	500	3
CCH1W	33030	1"	50	500	3
CCH118W	33040	1 1/8"	50	500	3
CCH1916W	33050	1 3/16"	50	500	3
CCH114W	33060	1 1/4"	50	500	4
CCH138W	33070	1 3/8"	50	500	4
CCH112W	33080	1 1/2"	50	500	4

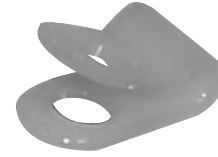

BLACK					
CCH18B	30690	1/8"	100	1000	2
CCH316B	30700	3/16"	100	1000	2
CCH14B	30710	1/4"	100	1000	2
CCH516B	30720	5/16"	100	1000	2
CCH38B	30730	3/8"	100	1000	3
CCH716B	30740	7/16"	100	1000	3
CCH12B	30750	1/2"	100	1000	3
CCH916B	30760	9/16"	100	1000	3
CCH58B	30770	5/8"	100	1000	3
CCH1116B	30780	11/16"	100	1000	3
CCH34B	30790	3/4"	100	1000	4
CCH1316B	30800	13/16"	50	500	3
CCH78B	30810	7/8"	50	500	3
CCH1B	30820	1"	50	500	3
CCH118B	30830	1 1/8"	50	500	3
CCH1916B	30840	1 3/16"	50	500	3
CCH114B	30850	1 1/4"	50	500	4
CCH138B	30860	1 3/8"	50	500	4
CCH112B	30870	1 1/2"	50	500	4



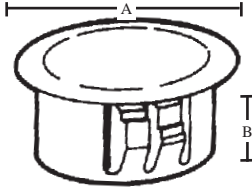

CAT#	A	B
PK050	1.016	.453
PK051	1.219	.453
PK052	1.500	.453
PK053	1.906	.453
PK054	2.141	.453
PK055	2.750	.750

KNOCK-OUT SEALS

GRAY		6/6 NYLON			
TOPAZ CAT #	UPC#	SIZE	UNIT CTN	SHIP CASE	WT/ CASE
PK050	30890	1/2"	100	1000	5
PK051	30900	3/4"	100	1000	6
PK052	30910	1"	100	1000	9
PK053	30920	1 1/4"	50	500	7
PK054	30930	1 1/2"	50	500	8
PK055	30940	2"	10	100	11

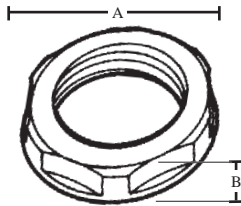

CAT#	A	B
NLN38B	1.078	.266
NLN12B	1.078	.266
NLN34B	1.313	.266
NLN1B	1.625	.266

NPT LOCKNUTS

BLACK		6/6 NYLON			
TOPAZ CAT #	UPC#	SIZE	UNIT CTN	SHIP CASE	WT/ CASE
NLN38B	30950	3/8"	100	1000	5
NLN12B	30970	1/2"	100	1000	5
NLN34B	30990	3/4"	50	500	3
NLN1B	31010	1"	50	200	3

NLN38G	1.078	.266
NLN12G	1.078	.266
NLN34G	1.313	.266
NLN1G	1.625	.266

GRAY		6/6 NYLON			
TOPAZ CAT #	UPC#	SIZE	UNIT CTN	SHIP CASE	WT/ CASE
NLN38G	30960	3/8"	100	1000	5
NLN12G	30980	1/2"	100	1000	5
NLN34G	31000	3/4"	50	500	3
NLN1G	31020	1"	50	200	3

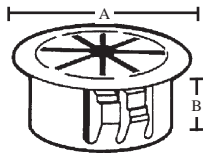

CAT#	A	B	Max Inside DIAM
UB625	.719	.406	.437
UB750	.859	.391	.500
UB812	.859	.391	.500
UB875	.938	.453	.562
UB1000	1.063	.453	.750
UB1093	1.156	.453	.812
UB1375	1.438	.453	1.000

UNIVERSAL BUSHINGS

• .125 MAXIMUM THICKNESS

BLACK		6/6 NYLON				
TOPAZ CAT #	UPC#	MOUNTING HOLE DIAMETER	KO	UNIT CTN	SHIP CASE	WT/ CASE
UB625	30620	0.625		100	1000	4
UB750	30630	0.750		100	1000	4
UB812	30640	0.812		100	1000	4
UB875	30650	0.875	1/2"	100	1000	4
UB1000	30660	1.000		100	1000	5
UB1093	30670	1.093	3/4"	100	1000	5
UB1375	30680	1.375	1"	100	1000	5



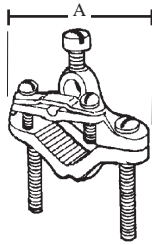

CAT#	A
630B	2.30
630	3.60
630DB	2.30

GROUND CLAMPS

• FITS 8, 6, OR 4 BARE ARMORED GROUND WIRE

BRASS

TOPAZ CAT #	UPC#	SIZE	UNIT CTN	SHIP CASE	WT/ CASE
630B	16240	1/2" TO 1"	10	100	20
630	16250	1 1/4" TO 2"	5	50	30

FOR DIRECT BURIAL

BRONZE

630DB	16260	1/2" TO 1"	10	100	20
-------	-------	------------	----	-----	----



E148716

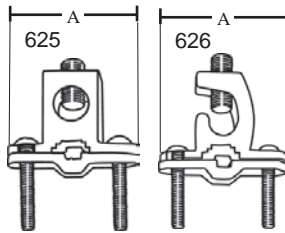

CAT#	A
625	2.36
626	2.52

BRASS GROUND CLAMPS

FOR DIRECT BURIAL STAINLESS STEEL SCREWS

• FITS 8 STR TO 4/0 STR AWG

TOPAZ CAT #	UPC#	SIZE	UNIT CTN	SHIP CASE	WT/ CASE
625	81968	1/2" TO 1"	10	100	30
626	81969	1/2" TO 1"	10	100	30

3/8 To 1" Rebar 1/2" To 1" Water Pipe, Copperwater Pipe and Ground Rod



E170258

GROUND CLAMPS

• FITS NO. 10, 8, 6, 4, & 2 AWG

ZINC DIE CAST

TOPAZ CAT #	UPC#	SIZE	UNIT CTN	SHIP CASE	WT/ CASE
620Z*	16100	1/2" TO 1"	25	250	43
620BP**	16110	1/2" TO 1"	25	250	43

BRASS PLATED

*For Copper and Aluminum Wire

**Non UL

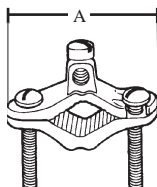

CAT#	A
620Z	2.22
620BP	2.22
626A	2.43
626BS	2.43
626B	3.60
626C	6.35
626D	8.50
620DB	2.28

BRASS

626A	16050	1/2" TO 1"	10	100	19
626BS	16060	1/2" TO 1"	10	100	20

W/BRASS SCREWS

626B	16070	1 1/4" TO 2"	5	50	19
626C	16080	2 1/2" TO 4"	—	10	10
626D	16082	5" TO 6"	—	10	15

FOR DIRECT BURIAL

BRONZE

620DB	16090	1/2" TO 1"	10	100	20
-------	-------	------------	----	-----	----



E14871
(620Z)



E170258

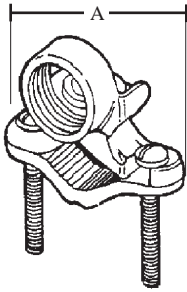

GROUND CLAMPS WITH THREADED HUBS FOR CONDUIT PIPE

TOPAZ CAT #	UPC#	SIZE	UNIT CTN	SHIP CASE	BRASS
					WT/ CASE
WITH 1/2" HUBS					
621	16120	1/2" TO 1"	10	100	26
622	16130	1 1/4" TO 2"	5	50	35
623	16140	2 1/2" TO 4"	—	10	15
624	16150	5" TO 6"	—	10	20

CAT#	A
621	2.250
622	3.600
623	6.340
624	8.500

621A	2.250
622A	3.600
623A	6.340
624A	8.500

WITH 3/4" HUBS

621A	16160	1/2" TO 1"	5	50	20
622A	16170	1 1/4" TO 2"	5	50	37
623A	16180	2 1/2" TO 4"	—	10	12
624A	16190	5" TO 6"	—	10	21

WITH 1" HUBS

621B	16200	1/2" TO 1"	—	10	9
622B	16210	1 1/4" TO 2"	—	10	10
623B	16220	2 1/2" TO 4"	—	10	21
624B	16230	5" TO 6"	—	10	28

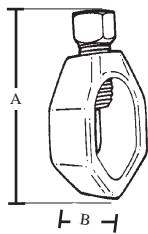

GROUND ROD CLAMPS FOR DIRECT BURIAL W/BRONZE OR STAINLESS SCREWS

TOPAZ CAT #	UPC#	SIZE	UNIT CTN	SHIP CASE	BRONZE
					WT/ CASE
411	13820	1/2"	—	100	9
412	13830	5/8"	—	100	18
413	13840	3/4"	—	50	12

CAT#	A	B	WIRE SIZE
			MIN MAX
411	1.22	.75	10 SOL 2STR
412	1.41	.90	10 SOL 2STR
413	1.47	1.00	10 SOL 2STR



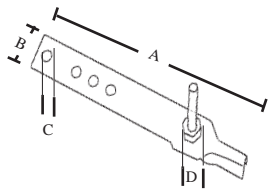

GROUND STRAP

• 16 GAUGE

SOLID COPPER

CAT#	A	B	C	D
G51	5.810	.75	.25	1/4-20 X 1 1/4

TOPAZ CAT #	UPC#	SIZE	UNIT CTN	SHIP CASE	WT/CASE
G51	20760	1/2" TO 1"	—	100	5

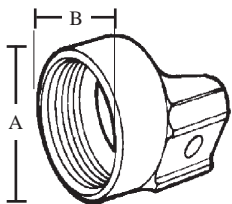

CONDUIT HUBS

BRASS

CAT#	A	B
31	1.15	1.07
32	1.30	1.28
33	1.56	1.50

TOPAZ CAT #	UPC#	SIZE	UNIT CTN	SHIP CASE	WT/CASE
31	10050	1/2"	—	25	3
32	10060	3/4"	—	25	5
33	10070	1"	—	25	6



E170258

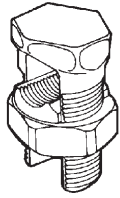

SPLIT BOLT CONNECTORS

SOLDERLESS

SOLID BRONZE

CAT#	WIRE RANGE MAIN AND TAP	
	MIN.	MAX.
690	16 STR	10 STR
691	12 STR	8 STR
692	10 SOL	6 SOL
693	8 SOL	4 SOL
694	6 SOL	2 SOL
695	6 SOL	2 STR
696	4 SOL	1/0 STR
697	2 SOL	2/0 STR
698	2 SOL	3/0 STR
699	1/0 SOL	250 MCM
700	4/0 STR	350 MCM
701	250 MCM	500 MCM
702	350 MCM	750 MCM
703	500 MCM	1000 MCM

TOPAZ CAT #	UPC#	SIZE	UNIT CTN	SHIP CASE	WT/ CASE
FOR COPPER AND COPPERWELD WIRE					
690	17250	10	—	100	2
691	17260	8	—	100	3
692	17270	6	—	100	5
693	17280	4	—	100	6
694	17290	3	—	100	8
695	17300	2	—	100	11
696	17310	1/0	—	50	8
697	17320	2/0	—	25	7
698	17330	3/0	—	25	8
699	17340	4/0-250 MCM	—	25	10
700	17350	350 MCM	—	6	5
701	17360	500 MCM	—	6	5
702	17370	750 MCM	—	3	5
703	17380	1000 MCM	—	4	10



E155861

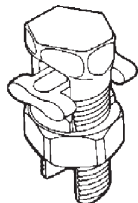

WITH SPACER BAR

- ELECTRO-TINNED BODY, NUT, SPACER, & PRESSURE BAR
FOR COPPER TO COPPER (1,2)

790	18020	10	—	100	4
791	18030	8	—	100	4

CAT#	WIRE RANGE MAIN AND TAP	
	MIN.	MAX.
790	16 STR	10 STR
791	16 STR	8 STR
792	14 STR	6 SOL
793	10 STR	4 SOL
794	8 SOL	3 STR
795	8 SOL	2 STR
796	6 SOL	1/0 STR
797	6 STR	2/0 STR
798	4 STR	3/0 STR
799	4 STR	250 MCM
800	3/0 STR	350 MCM
801	3/0 STR	500 MCM
802	250 MCM	750 MCM
803	350 MCM	1000 MCM

FOR COPPER TO COPPER, COPPER TO ALUMINUM, ALUMINUM TO ALUMINUM (2)

792	18040	6	—	100	7
793	18050	4	—	100	8
794	18060	3	—	100	11
795	18070	2	—	100	15



E170258

FOR COPPER TO COPPER (1,2)

796	18080	1/0	—	50	10
797	18090	2/0	—	25	5
798	18100	3/0	—	25	15
799	18110	4/0-250 MCM	—	25	15
800	18120	350 MCM	—	6	5
801	18130	500 MCM	—	6	7
802	18140	750 MCM	—	4	7
803	18150	1000 MCM	—	2	6

(1) USABLE WITH ALUMINUM CONDUCTOR, HOWEVER NOT UL LISTED FOR THAT APPLICATION.

(2) WHEN MAKING CONNECTIONS WITH ALUMINUM OR ACSR (ALUMINUM CONDUCTOR STEEL REINFORCED) MAKE CERTAIN TO USE AN OXIDE INHIBITING COMPOUND.

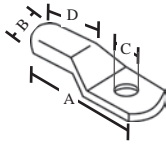

WIRE					
CAT#	SIZE	A	B	C	D
XSL35	8	1.0313	.186	.2031	.3438
XSL50	6	1.2188	.238	.2031	.375
XSL70	4	1.375	.289	.2813	.4375
XSL90	2	1.500	.347	.2813	.500
XSL125	1/0	1.750	.398	.3438	.5625
XSL150	2/0	2.000	.460	.4063	.6875
XSL175	3/0	2.125	.519	.4063	.7813
XSL225	4/0	2.375	.559	.4063	.8438

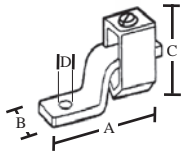

CAT#	A	B	C	D
820	1.00	.3125	.6875	.125
821	1.1875	.375	.75	.1875
822	1.3125	.50	.8125	.25
823	1.5313	.50	1.00	.25
824	1.9688	.625	1.375	.25
825	2.1875	.75	1.5625	.375
826	2.625	1.00	2.00	.3125
827	3.1875	1.00	2.625	.375
828	4.25	1.50	2.75	.375
829	4.625	2.00	3.6875	.50

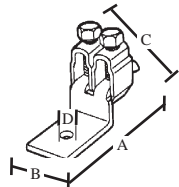

CAT#	A	B	C	D
814	3.375	1.50	2.00	.375
815	3.625	2.75	2.75	.375
816	4.4375	2.00	2.5625	.500

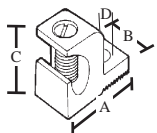

CAT#	A	B	C	D
810	1.0981	.3906	.75	.193
811	1.50	1.6099	1.4375	.25
812	2.2031	2.2031	1.7031	.3125

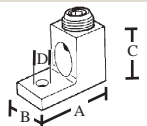

CAT#	A	B	C	D
805	1.0625	.375	.50	.25
806	1.1563	.50	.5625	.25
807	1.4088	.625	.8125	.25
808	1.4688	.625	.8125	.25
809	2.00	.9375	1.0625	.3125
X1810	2.00	.8275	1.0625	.3125
X817	2.25	1.125	1.25	.3125
818	2.75	1.125	1.50	.375
X1818	2.75	1.375	1.50	.375
819	3.50	1.50	1.75	.50
X1820	3.50	1.50	1.25	.50

SOLDERING LUGS

SINGLE HOLE						COPPER
TOPAZ CAT #	UPC#	AMP READING	WIRE SIZE	UNIT CTN	SHIP CASE	WT/ CASE
XSL35	81837	35	8	-	250	3
XSL50	81838	50	6	-	250	6
XSL70	81839	70	4	-	200	6
XSL90	81840	90	2	-	200	9
XSL125	81841	125	1/0	-	100	11
XSL150	81842	150	2/0	-	50	6
XSL175	81843	175	3/0	-	25	4
XSL225	81844	225	4/0	-	25	6



SOLDERLESS LUGS

SINGLE HOLE						COPPER	
TOPAZ CAT #	UPC#	AMP RATING	WIRE RANGE MIN	WIRE RANGE MAX	UNIT CTN	SHIP CASE	WT/ CASE
• OFFSET TANG							
820	18270	25	14	10	-	250	3
821	18280	35-50	14	6	-	250	6
822	18290	70	14	4	-	200	6
823	18300	70-90	12	2	-	200	9
824	18310	125	8	1/0	-	100	11
825	18320	175	4	3/0	-	25	3
826	18330	225	6	4/0	-	25	6
827	18340	300	1/0	350 MCM	-	20	10
828	18350	400	4/0	500 MCM	-	10	7
829	18360	650	600MCM	1000 MCM	-	4	7

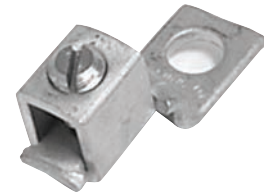

DUPLIX TERMINAL LUGS

814	18240	400	2#1/0	2#4/0	-	10	5
815	18250	600	2#1/0	2#350 MCM	-	5	5
816	18260	800	2#4/0	2#500 MCM	-	4	6



LAY-IN TYPE

• For Use in or outdoor
Used with copper or alum. conductor

ALUMINUM							
TOPAZ CAT #	UPC#	RECOMMENDED TORQUE IN LBS	WIRE RANGE MIN	WIRE RANGE MAX	UNIT CTN	SHIP CASE	WT/ CASE
810	18210	45	14	4	-	250	2
811	18220	50	8	1/0	-	100	6
812	18230	275	6	250 MCM	-	50	7



SINGLE HOLE

805	18160	45	14	6	-	100	2
806	18170	50	14	2	-	100	2
807	18180	50	14	1/0	-	50	6
808	18190	120	14	2/0	-	50	5
809	18200	275	6	4/0	-	25	3
X1810	18269	275	6	300 MCM	10	100	25
817	18201	375	6	350 MCM	-	25	3
818	18202	500	4	500 MCM	-	10	2
X1818	18271	500	9	600 MCM	5	50	35
819	18203	500	350 MCM	800 MCM	-	5	2
X1820	18272	600	500 MCM	1000 MCM	6	60	46



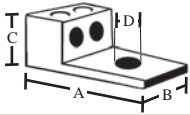

CAT#	A	B	C	D
X2807	1.50	1.1875	.8125	.25
X2808	1.50	1.1875	.8125	.25
X2809	2.5625	1.625	1.1875	.375
X2817	2.875	2.9375	1.25	.50
X2818	3.125	2.375	1.5625	.50
X2819	3.50	2.8125	1.6875	.625
X2820	3.50	2.8125	1.6875	.625

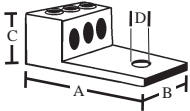

CAT#	A	B	C	D
X3806	2.19	1.59	.62	.3125
X3807	2.19	1.94	.88	.375
X3808	4.1875	2.8125	.8125	.50
X3809	4.1875	3.00	1.25	.50
X3817	4.1875	3.00	1.25	.50
X3818	4.6875	3.75	1.5625	.50

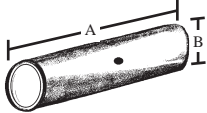

CAT#	A	B
X3101	1.75	.20
X3102	1.75	.20
X3103	1.75	.25
X3105	1.90	.31
X3106	2.20	.39
X3107	2.25	.44
X3108	2.25	.49
X3109	2.75	.55
X3109A	3.25	.59
X3109B	3.50	.66
X3110	3.75	.70
X3110A	3.75	.76
X3111	4.25	.83
X3111A	4.50	.93
X3112	4.75	1.03

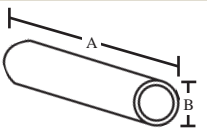

CAT#	A	B
X3301	.90	.17
X3302	1.00	.20
X3303	1.00	.25
X3305	1.25	.31
X3305A	1.60	.39
X3306	1.75	.44
X3307	1.75	.49
X3308	1.90	.55
X3309	2.00	.59
X3309A	2.10	.66
X3310	2.10	.70
X3310A	2.30	.76
X3311	2.50	.83
X3311A	2.50	.93
X3312	3.21	1.03

SOLDERLESS LUGS

COPPER

TOPAZ CAT #	UPC#	AMP RATING	WIRE RANGE MIN	WIRE RANGE MAX	UNIT CTN	SHIP CASE	WT/ CASE
-------------	------	------------	----------------	----------------	----------	-----------	----------

DOUBLE

X2807	81830	50	14	1/0	10	100	23
X2808	81831	50	14	2/0	10	100	24
X2809	81832	275	6	250 MCM	10	100	26
X2817	81833	275	6	350 MCM	4	40	20
X2818	81834	375	2	600 MCM	4	40	19
X2819	81835	375	300 MCM	800 MCM	2	20	14
X2820	81836	375	500 MCM	1000 MCM	2	20	15

TRIPLE

X3806	41175	50	14	#2	10	100	23
X3807	41176	50	14	1/0	10	100	25
X3808	41177	275	6	3/0	10	100	26
X3809	41178	275	6	250 MCM	5	50	17
X3817	41188	275	2	350 MCM	5	50	16
X3818	41189	375	2	600 MCM	5	50	16



COMPRESSION SPLICES

UL LISTED PER 486A UP TO 35KV

COPPER

TOPAZ CAT #	UPC#	WIRE SIZE	COLOR CODE	UNIT CTN	SHIP CASE	WT/ CASE
-------------	------	-----------	------------	----------	-----------	----------

LONG BARREL

X3101	41080	8	RED	100	1000	32
X3102	41081	6	BLUE	100	1000	32
X3103	41082	4	GRAY	100	1000	32
X3105	41084	2	BROWN	100	1000	32
X3106	41085	1/0	PINK	50	1000	18
X3107	41086	2/0	BLACK	50	1000	18
X3108	41087	3/0	ORANGE	50	1000	18
X3109	41088	4/0	PURPLE	25	250	10
X3109A	41089	250 MCM	YELLOW	25	250	10
X3109B	41090	300 MCM	WHITE	25	250	10
X3110	41091	350 MCM	RED	25	250	12
X3110A	41092	400 MCM	BLUE	25	250	12
X3111	41093	500 MCM	BROWN	25	250	12
X3111A	81810	600 MCM	GREEN	25	250	14
X3112	81811	750 MCM	BLACK	25	250	14

SHORT BARREL

X3301	81599	8	RED	100	1000	11
X3302	81600	6	BLUE	100	1000	12
X3303	81601	4	GRAY	100	1000	14
X3305	81602	2	BROWN	100	1000	19
X3305A	81603	1	PINK	100	1000	33
X3306	81604	1/0	BLACK	100	1000	39
X3307	81605	2/0	ORANGE	50	500	39
X3308	81606	3/0	PURPLE	50	500	37
X3309	81607	4/0	YELLOW	50	500	26
X3309A	81608	250 MCM	WHITE	50	500	27
X3310	81609	350 MCM	RED	50	500	27
X3310A	81610	400 MCM	BLUE	50	500	20
X3311	81611	500 MCM	BROWN	50	500	21
X3311A	81612	600 MCM	GREEN	50	500	17
X3312	81613	750 MCM	BLACK	20	200	22



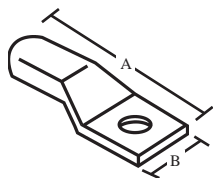

CAT#	A	B
X2901	1.20	.42
X2901A	1.20	.42
X2902	1.50	.42
X2902A	1.50	.42
X2903	1.50	.71
X2903A	1.50	.71
X2903B	1.50	.71
X2905	1.80	.83
X2905A	1.83	.67
X2906	1.83	.74
X2907	2.24	.81
X2907A	2.24	.81
X2908	2.36	.90
X2909	2.36	1.00
X2909A	2.48	1.09
X2909B	2.49	1.19
X2910	2.61	1.28
X2910A	3.95	1.39
X2911	3.28	1.54
X2911A	3.50	1.72
X2912	4.37	1.90

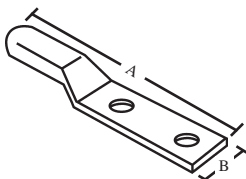

CAT#	A	B
X2921	2.50	.45
X2922	2.56	.45
X2923	2.34	.50
X2925	2.58	.61
X2925A	3.05	.61
X2926	3.14	.75
X2927	3.24	.83
X2927A	4.17	.83
X2928	4.25	.91
X2929	4.28	1.02
X2929A	4.41	1.11
X2929B	4.53	1.24
X2930	4.53	1.24
X2931	4.81	1.34
X2932	4.88	1.52
X2933	4.49	1.73
X2934	4.79	1.89

COMPRESSION LUGS

UL LISTED PER 486A UP TO 35KV COPPER

TOPAZ CAT #	UPC#	WIRE SIZE	COLOR CODE	BOLT SIZE	UNIT CTN	SHIP CASE	WT/ CASE
-------------	------	-----------	------------	-----------	----------	-----------	----------

ONE HOLE SHORT BARREL

X2901	81614	8	RED	10	100	1000	14
X2901A	81615	8	RED	1/4"	100	1000	13
X2902	81616	6	BLUE	1/4"	100	1000	17
X2902A	81617	6	BLUE	5/16"	100	1000	18
X2903	81618	4	GRAY	1/4"	100	1000	20
X2903A	81619	4	GRAY	5/16"	100	1000	18
X2903B	81620	4	GRAY	3/8"	100	1000	19
X2905	81621	2	BROWN	3/8"	100	1000	24
X2905A	81622	1	GREEN	3/8"	100	1000	31
X2906	81623	1/0	PINK	3/8"	100	1000	24
X2907	81624	2/0	BLACK	3/8"	100	1000	34
X2907A	81625	2/0	BLACK	1/2"	100	1000	27
X2908	81626	3/0	ORANGE	3/8"	100	1000	33
X2909	81627	4/0	PURPLE	1/2"	50	500	27
X2909A	81804	250 MCM	YELLOW	1/2"	50	500	27
X2909B	81805	300 MCM	WHITE	1/2"	50	500	27
X2910	81628	350 MCM	RED	1/2"	50	500	36
X2910A	81629	400 MCM	BLUE	1/2"	50	500	26
X2911	81606	500 MCM	BROWN	5/8"	20	200	26
X2911A	81807	600 MCM	GREEN	5/8"	20	200	26
X2912	81630	750 MCM	BLACK	5/8"	20	200	26



TWO HOLE SHORT BARREL

X2921	81813	8	RED	10	100	1000	18
X2922	81814	6	BLUE	1/4"	100	1000	26
X2923	81815	4	GRAY	1/4"	100	1000	20
X2925	81816	2	BROWN	5/16"	100	1000	18
X2925A	81817	2	BROWN	3/8"	100	1000	21
X2926	81818	1/0	PINK	5/16"	100	1000	21
X2927	81819	2/0	BLACK	3/8"	100	1000	21
X2927A	81820	2/0	BLACK	1/2"	100	1000	21
X2928	81821	3/0	ORANGE	1/2"	50	500	28
X2929	81822	4/0	PURPLE	1/2"	50	500	19
X2929A	81803	250 MCM	YELLOW	1/2"	50	500	23
X2929B	81804	300 MCM	WHITE	1/2"	50	500	26
X2930	81825	350 MCM	RED	1/2"	50	500	26
X2931	81826	400 MCM	BLUE	1/2"	20	200	26
X2932	81807	500 MCM	BROWN	1/2"	20	200	26
X2933	81808	600 MCM	GREEN	3/8"	20	200	26
X2934	81839	750 MCM	BLACK	1/2"	20	200	26



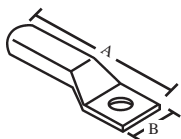

COMPRESSION LUGS (Cont'd)

UL LISTED PER 486A UP TO 35KV COPPER

TOPAZ CAT # UPC# WIRE SIZE COLOR CODE BOLT SIZE UNIT CTN SHIP CASE WT/ CASE

CAT#	A	B
X3001	1.70	.38
X3002	1.77	.38
X3003	1.77	.50
X3005	2.00	.67
X3005A	2.09	.67
X3006	2.20	.75
X3007	2.80	.75
X3008	2.80	.87
X3008A	2.80	.87
X3009	2.80	1.00
X3009A	3.03	1.13
X3009B	3.39	1.13
X3010	3.50	1.13
X3010A	3.74	1.34
X3011	4.02	1.50
X3011A	4.25	1.75
X3012	5.16	1.87

ONE HOLE LONG BARREL

X3001	41050	8	RED	1/4"	100	1000	32
X3002	41051	6	BLUE	1/4"	100	1000	32
X3003	41052	4	GRAY	1/4"	100	1000	32
X3005	41054	2	BROWN	3/8"	100	1000	32
X3005A	81808	1	GREEN	3/8"	100	1000	32
X3006	41055	1/0	PINK	3/8"	50	500	18
X3007	41056	2/0	BLACK	3/8"	50	500	18
X3008	41057	3/0	ORANGE	3/8"	50	500	10
X3008A	81809	3/0	ORANGE	1/2"	50	500	10
X3009	41058	4/0	PURPLE	1/2"	25	250	10
X3009A	41059	250 MCM	YELLOW	1/2"	25	250	10
X3009B	41061	300 MCM	WHITE	1/2"	25	250	10
X3010	41062	350 MCM	RED	1/2"	20	200	8
X3010A	41063	400 MCM	BLUE	1/2"	20	200	8
X3011	41064	500 MCM	BROWN	1/2"	20	200	8
X3011A	41065	600 MCM	GREEN	5/8"	20	200	8
X3012	41066	750 MCM	BLACK	5/8"	20	200	8



E155861

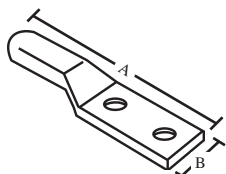

CAT#	A	B
X3201	2.24	.42
X3202	2.24	.42
X3203	2.36	.49
X3205	2.87	.50
X3206	4.40	.74
X3207	4.61	.81
X3208	4.69	.90
X3209	4.72	1.00
X3209A	4.95	1.09
X3209B	5.31	1.19
X3210	5.39	1.28
X3210A	5.47	1.39
X3211	5.79	1.72
X3211A	5.79	1.72
X3212	6.30	1.90

TWO HOLE LONG BARREL

X3201	81812	8	RED	1/4"	100	1000	—
X3202	81633	6	BLUE	1/4"	100	1000	21
X3203	81635	4	GRAY	1/4"	100	1000	21
X3205	81636	2	BROWN	1/2"	100	1000	29
X3206	81638	1/0	PINK	1/2"	100	1000	30
X3207	81640	2/0	BLACK	1/2"	100	1000	25
X3208	81701	3/0	ORANGE	3/8"	50	500	19
X3209	81641	4/0	PURPLE	1/2"	50	500	19
X3209A	81642	250 MCM	YELLOW	1/2"	50	500	27
X3209B	81643	300 MCM	WHITE	1/2"	50	500	29
X3210	81644	350 MCM	RED	1/2"	50	500	37
X3210A	81645	400 MCM	BLUE	1/2"	20	200	39
X3211	81646	500 MCM	BROWN	1/2"	20	200	32
X3211A	81647	600 MCM	GREEN	1/2"	20	200	41
X3212	81648	750 MCM	BLACK	1/2"	20	200	43



E155861



CAT#	WIRE RANGE		VOLTS
	MIN.	MAX.	
WY1	2#18	3#12	600V
WY2	2#18	3#12	600V
WR1	2#14	5#12	600V
WR2	2#14	5#12	600V
WB1	3#12	1#6 & 2#8	600V
WB2	3#12	1#6 & 2#8	600V
WG1	2#14	5#12	
WG2	2#14	5#12	
WT1	3#22	3#10	600V
WT2	3#22	3#10	600V



CAT#	WIRE RANGE		VOLTS
	MIN.	MAX.	
W81G1	2#22	2#16	300V
W82G2	2#22	2#16	300V
W82B1	2#18	3#16	300V
W82B2	2#18	3#16	300V
W8301	2#18	2#14	600V
W8302	2#18	2#14	600V
W84Y1	3#18	4#14&1#18	600V
W84Y2	3#18	4#14&1#18	600V
W86R1	2#14	4#12	600V
W86R2	2#14	4#12	600V



WIRE CONNECTORS

- EASY ASSEMBLY
- COLOR CODED FOR EASY SIZE AND CAPACITY IDENTIFICATION
- TEMPERATURE RATING OF 105°C.
- SQUARE WIRE SPRING INSERT FOR SECURE CONNECTIONS

TOPAZ CAT #	UPC#	COLOR	UNIT CTN	SHIP CASE	WT/ CASE
-------------	------	-------	----------	-----------	----------

WINGED

- JOINS #18 THRU #10 AWG

WY1	21930	YELLOW	100/BOX	5000	16
WY2	21940	YELLOW	500/BAG	5000	16

- JOINS #18 THRU #10 AWG

WR1	21950	RED	100/BOX	5000	27
WR2	21960	RED	500/BAG	5000	27

- JOINS #14 THRU #6 AWG

WB1	21970	BLUE	50/BOX	1000	13
WB2	21980	BLUE	250/BAG	1000	13

- JOINS #14 THRU #10 AWG

WG1	21993	GREEN	100/BOX	5000	16
WG2	21990	GREEN	500/BAG	5000	16

- JOINS #22 THRU #8 AWG

WT1	21992	TAN	100/BOX	1000	13
WT2	21991	TAN	500/BAG	1000	35

FLUTED BODY

- JOINS #22 THRU #14 AWG

W81G1	30520	GRAY1	100/BOX	5000	4
W81G2	30530	GRAY1	500/BAG	5000	4

- JOINS #22 THRU #14 AWG

W82B1	30540	BLUE1	100/BOX	5000	5
W82B2	30550	BLUE1	500/BAG	5000	5

- JOINS #22 THRU #14 AWG

W8301	30560	ORANGE2	100/BOX	5000	13
W8302	30570	ORANGE2	500/BAG	5000	13

- JOINS #18 THRU #10 AWG

W84Y1	30580	YELLOW2	100/BOX	5000	24
W84Y2	30590	YELLOW2	500/BAG	5000	24

- JOINS #18 THRU #8 AWG

W86R1	30600	RED2	100/BOX	5000	52
W86R2	30610	RED2	500/BAG	5000	52

(1) UL RATED AT 300 VOLTS.

(2) UL RATED AT 600 VOLTS, EXCEPT FIXTURES AND SIGNS-1,000 VOLTS.

WIRE CONNECTORS IN JAR

TOPAZ CAT #	UPC#	COLOR	UNIT CTN	SHIP CASE	WT/ CASE
WYRJ	21931	75 YELLOW-WY1/75 RED-WR1	150	12	30



PLASTIC ELECTRICAL TAPE

• 7 MIL

PVC



1 IMPORTED

2 PREMIUM QUALITY IN PLASTIC CONTAINER

TOPAZ CAT #	UPC#	SIZE	COLOR	UNIT CTN	SHIP CASE	WT/ CASE
830T ¹	18370	3/4" X 30'	BLACK	10	500	41
860T ¹	18380	3/4" X 60'	BLACK	10	200	21
866T ¹	18410	3/4" X 66'	BLACK	—	100	20
866-33 ²	18408	3/4" X 66'	BLACK	—	100	21
866BLU ¹	18411	3/4" X 66'	BLUE	—	100	20
866BRN ¹	18412	3/4" X 66'	BROWN	—	100	20
866GRN ¹	18413	3/4" X 66'	GREEN	—	100	20
866GRY ¹	18414	3/4" X 66'	GRAY	—	100	20
866ORN ¹	18415	3/4" X 66'	ORANGE	—	100	20
866PUR ¹	18416	3/4" X 66'	PURPLE	—	100	20
866RED ¹	18417	3/4" X 66'	RED	—	100	20
866WHT ¹	18418	3/4" X 66'	WHITE	—	100	20
866YEL ¹	18419	3/4" X 66'	YELLOW	—	100	20
867T ¹	18440	1 1/2" X 66'	BLACK	—	100	40



TAPE

TOPAZ CAT #	UPC#	SIZE	COLOR		SHIP CASE	WT/ CASE
830BLU	18371	1/2" X 20'	BLUE	Phasing Tape	7	8
830BRN	18372	1/2" X 20'	BROWN	Phasing Tape	7	8
830GRN	18373	1/2" X 20'	GREEN	Phasing Tape	7	8
830GRY	18374	1/2" X 20'	GRAY	Phasing Tape	7	8
830ORN	18375	1/2" X 20'	ORANGE	Phasing Tape	7	8
830PUR	18376	1/2" X 20'	PURPLE	Phasing Tape	7	8
830RED	18377	1/2" X 20'	RED	Phasing Tape	7	8
830WHT	18378	1/2" X 20'	WHITE	Phasing Tape	7	8
830YEL	18379	1/2" X 20'	YELLOW	Phasing Tape	7	8
861	18381	2" X 36 YD	WHITE	Vinyl Tape	24	20
869	18421	3/4" X 60 YD	—	Friction Tape	100	35
870	18420	3/4" X 22 YD	—	Rubber Tape	100	20
870C	18396	2" X 22 YD	—	Rubber Tape	50	25
870T	18423	2" X 55 YD	CLEAR	Film Tape	36	7
871C	18402	2" X 110 YD	CLEAR	Sealing Tape	36	14



CAUTION TAPE

TOPAZ CAT #	UPC#	COLOR	UNIT CTN	SHIP CASE	WT/ CASE
1591	83029	3" x 300' YELLOW "CAUTION"	—	16	16
1592	83030	3" x 1000' YELLOW "CAUTION"	—	8	40
1593	83031	3" x 200' RED "CAUTION BURIED ELECTRIC LINE BELOW"	—	16	16
1594	83032	3" x 1000' RED "CAUTION BURIED ELECTRIC LINE BELOW"	—	8	40
1595	83033	6" x 1000' RED "CAUTION BURIED ELECTRIC LINE BELOW"	—	4	60
1596	83034	2" x 1000' RED "CAUTION BURIED ELECTRIC LINE BELOW"	—	12	60
1597	83035	3" x 1000' RED "CAUTION BURIED ELECTRIC LINE BELOW"	—	8	64
1598	83036	6" x 1000' RED "CAUTION BURIED ELECTRIC LINE BELOW"	—	4	64



CAT#	MIL	
1591	4	Non-Detectable
1592	4	Non-Detectable
1593	4	Non-Detectable
1594	4	Non-Detectable
1595	4	Non-Detectable

1596	5	Detectable
1597	5	Detectable
1598	5	Detectable





HEAVY DUTY CABLE LUBRICANT

TOPAZ CAT #	UPC#	SIZE	UNIT CTN	SHIP CASE	WT/ CASE
1200	19762	1 QUART	—	10	13
1201	19763	1 GALLON	—	4	25
1202	19764	5 GALLON PAIL	—	1	30

Water-based gel, Non-toxicity - Non-flammable. Compatible with all cables. Complete cleanup with water.



DUCT TAPE

TOPAZ CAT #	UPC#	SIZE	UNIT CTN	SHIP CASE	WT/ CASE
868	33760	2" X 60 YARDS	—	24	42
868F	18422	2" X 50 YD FOIL TAPE	—	24	51
868B	18387	2" X 60 YD BLUE DUCT TAPE	—	24	42
868BK	18388	2" X 60 YD BLACK DUCT TAPE	—	24	42
868G	18391	2" X 60 YD GREEN DUCT TAPE	—	24	42
868R	18392	2" X 60 YD RED DUCT TAPE	—	24	42
868Y	18393	2" X 60 YD YELLOW DUCT TAPE	—	24	42



ANTI-OX CONTACT COMPOUND

TOPAZ CAT #	UPC#	SIZE	UNIT CTN	SHIP CASE	WT/ CASE
1209	19765	4 OUNCE BOTTLE	—	12	3
1210	19766	8 OUNCE BOTTLE	—	12	6

Prevents oxidation of aluminum to aluminum. Aluminum to Copper Electrical Conductors. Used for all types of connections, split-bolt and wire connectors.

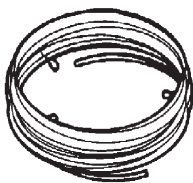

FISH WIRE

- INDIVIDUALLY BAGGED
- REPLACEMENT FOR REWINDERS

SPRING STEEL

TOPAZ CAT #	UPC#	SIZE	UNIT CTN	SHIP CASE	WT/ CASE
890	18980	1/8" X .060" X 25'	—	20	7
891	18990	1/8" X .060" X 50'	—	20	25
892	19000	1/8" X .060" X 100'	—	10	25
893	19010	1/8" X .060" X 200'	—	5	25
895	19020	1/4" X .060" X 50'	—	10	25
896	19030	1/4" X .060" X 100'	—	10	50
897	19040	1/4" X .060" X 200'	—	5	50

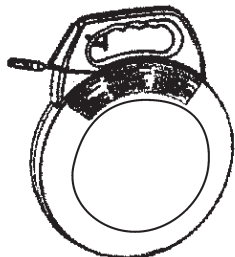

FISH WIRE REEL AND PLASTIC REWINDER

STEEL

TOPAZ CAT #	UPC#	SIZE	UNIT CTN	SHIP CASE	WT/ CASE
891R	18991	1/8" X 50'	—	3	15
892R	19901	1/8" X 100'	—	3	30
893R	19011	1/8" X 200'	—	3	60

Impact-resistant plastic case. Large handle increases stability for better control.



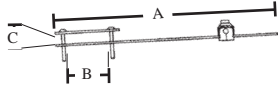

CAT#	OPENINGS			
	A	B (MIN)	B (MAX)	C (MAX)
CBS	11.00	1.00	2.25	1.25

CEILING BOX SUPPORT

STEEL

TOPAZ CAT #	UPC#	SIZE	UNIT CTN	SHIP CASE	WT/ CASE
CBS	19891	1" - 2"	-	24	1

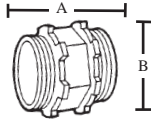

CAT#	A	B
141	1.12	.40
141A	1.12	.95

BOX SPACING CONNECTOR WITH TWIN LOCKNUTS

ZINC DIE CAST

TOPAZ CAT #	UPC#	SIZE	UNIT CTN	SHIP CASE	WT/ CASE
141	10930	1/2"	50	500	40
141A	10932	3/4"	25	250	24



E155861

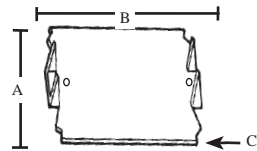

CAT#	A	B	C
187	1.50	6.00	.0598
188	1.50	5.00	.0598
189	1.50	2.50	.0598
189B	1.50	2.50	.0598
189-100	1.50	2.50	.0598

NAIL PLATE WITH PRONGS

- 16 GAUGE
- NAIL HOLES

STEEL

TOPAZ CAT #	UPC#	SIZE	UNIT CTN	SHIP CASE	WT/ CASE
187	11497	1 1/2" X 6"	-	100	49
188	11498	1 1/2" X 5"	-	100	30
189	11500	1 1/2" X 2 1/2"	-	200	20
189B	11501	1 1/2" X 2 1/2" X 1/16"	50	200	20
189-100	11499	1 1/2" X 2 1/2" X 1/16"	-	100	20

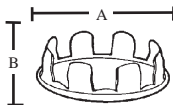

CAT#	A	B
K050	1.07	.37
K051	1.24	.31
K052	1.48	.34
K053	1.80	.31
K054	2.22	.37
K055	2.68	.36

KNOCK-OUT SEALS

STEEL

TOPAZ CAT #	UPC#	SIZE	UNIT CTN	SHIP CASE	WT/ CASE
K050	20780	1/2"	100	1000	10
K051	20790	3/4"	100	1000	20
K052	20800	1"	50	500	9
K053	20810	1 1/4"	50	500	10
K054	20820	1 1/2"	50	500	20
K055	20830	2"	10	100	5

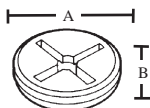

CAT#	A	B
991	.79	.33
992	1.00	.30
993	1.23	.28

CLOSURE PLUGS

ZINC DIE CAST

TOPAZ CAT #	UPC#	SIZE	UNIT CTN	SHIP CASE	WT/ CASE
991	19700	1/2"	-	100	2
992	19710	3/4"	-	50	2
993	19720	1"	-	25	2



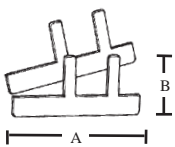

CAT#	A	B
199	5.125	2.250

BOX SUPPORTS

TOPAZ CAT #	UPC#		UNIT CTN	SHIP CASE	STEE WT/ CASE
199	11540	SOLD IN PAIRS	50 PR	500 PR	25

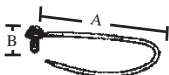

CAT#	A	B
49	7 1/2	10-32 x 3/8
50	7 1/2	10-32 x 3/8

GREEN PIGTAIL W/SLOTTED HEX GROUND SCREW

TOPAZ CAT #	UPC#	SIZE	UNIT CTN	SHIP CASE	COPPER WT/ CASE
49	33505	7 1/2" 12GA. SOLID	-	100	24
50	33506	7 1/2" 14GA. SOLID	-	100	23

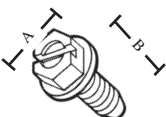

CAT#	A	B
48	.375	.625

GREEN GROUND SCREW

TOPAZ CAT #	UPC#	SIZE	UNIT CTN	SHIP CASE	STEE WT/ CASE
48	33500	10/32" X 3/8"	-	100	1

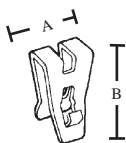

CAT#	A	B
GC99	.24	.65

GREEN GROUND CLIP

TOPAZ CAT #	UPC#	SIZE	UNIT CTN	SHIP CASE	STEE WT/ CASE
GC99	20770	#14 & #12	100	1000	3

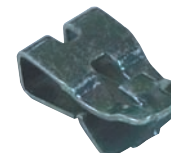

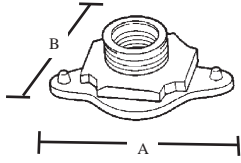

CAT#	A	B
277	1.752	.654

NO BOLT FIXTURE STUD

		ZINC DIE CAST			
TOPAZ CAT #	UPC#	SIZE	UNIT CTN	SHIP CASE	WT/ CASE
277	17730	1/8" F X 3/8" M	—	100	3



CAT#	A	B
278	.625	.20
279	.715	.20
280	1.00	.22

FIXTURE LOCKNUTS

		STEEL			
TOPAZ CAT #	UPC#	SIZE	UNIT CTN	SHIP CASE	WT/ CASE
278	11710	1/8"	100	1000	1
279	11720	1/4"	100	1000	1
280	12290	3/8" SQUARE - HEAVY	—	200	5

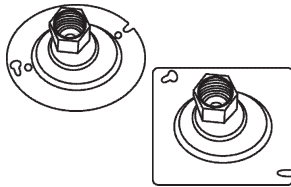

CAT#	
33R	FITS 4" OCTAGON
34S	FITS 4" SQUARE

FLEXIBLE FIXTURE HANGERS

20° SWING FROM VERTICAL

- SUPPORTS WEIGHT 50 LBS.
- BALL TYPE SWIVEL

		STEEL			
TOPAZ CAT #	UPC#	SIZE	UNIT CTN	SHIP CASE	WT/ CASE
33R	10071	1/2" OR 3/4" ROUND	—	25	15
34S	10072	1/2" OR 3/4" SQUARE	—	25	18

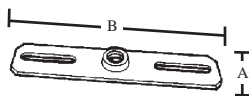

CAT#	A	B
46	1.00	4.12

FIXTURE HANGER

- WITH GREEN GROUND SCREW
- CROSS BAR FITS ALL STANDARD SWITCH BOXES & 3-1/4" & 4" OUTLET BOXES

		STEEL			
TOPAZ CAT #	UPC#	SIZE	UNIT CTN	SHIP CASE	WT/ CASE
46	14170	1/8" FEMALE	—	100	4

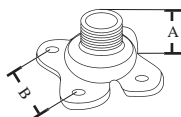

CAT#	A	B
47	1.00	1.10

		MALLEABLE IRON			
TOPAZ CAT #	UPC#	SIZE	UNIT CTN	SHIP CASE	WT/ CASE
47	14171	CROWS FOOT	25	250	8



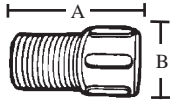

CAT#	A	B
190	1.000	.776
200	1.375	.780

FIXTURE EXTENSIONS

		ZINC DIE CAST				
TOPAZ CAT #	UPC#	SIZE	UNIT CTN	SHIP CASE	WT/ CASE	
190	11510	3/8" M X 3/8" F	100	1000	50	
200	11520	3/8" M X 3/8" F	100	1000	60	



CAT#	A	B
71	1.27	1.12

FIXTURE LOOP

		ZINC DIE CAST				
TOPAZ CAT #	UPC#	SIZE	UNIT CTN	SHIP CASE	WT/ CASE	
71	17440	1/2" MALE	25	250	15	

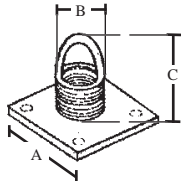

CAT#	A	B	C
71A	1.39	.57 (Opening)	1.12

STUD LOOP & HANGER

		ZINC DIE CAST				
TOPAZ CAT #	UPC#	SIZE	UNIT CTN	SHIP CASE	WT/ CASE	
71A	17442	1/2"	—	100	7	



FLUORESCENT STARTERS

TOPAZ CAT #	UPC#	SIZE	UNIT CTN	SHIP CASE	WT/ CASE
FS2	32180	14, 15 & 20 WATT LAMPS	25	250	6
FS4	32190	13, 30 & 40 WATT LAMPS	25	250	6
FS5	32200	4, 6 & 8 WATT LAMPS	25	250	6
FS12	32210	32 WATT CIRCULINE	25	250	6
FS22	32220	4-22 WATT CIRCULINE	25	250	6
FS25	32230	22-25 WATT LAMPS	25	250	6



E170258

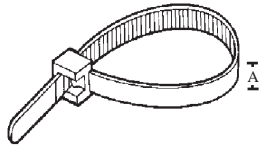

CABLE TIES

6/6 NYLON

TOPAZ CAT #	UPC#	SIZE	MIN TENSILE STRENGTH	PER BAG	SHIP CASE	WT/ 100
-------------	------	------	----------------------	---------	-----------	---------

NATURAL WHITE

NT0418	21440	4"	18	100	1000	.10
NT0530	21450	5"	30	100	1000	.10
NT0540	21453	5 1/2"	40	100	1000	.21
NT0618	21451	6 1/4"	18	100	1000	.41
NT0640	21452	6"	40	100	1000	.41
NT0750	21460	7"	50	100	1000	.42
NT0818	21470	8"	18	100	1000	.34
NT0840	21480	8"	40	100	1000	.38
NT08120	21490	8"	120	100	1000	.43
NT1040	21491	10"	40	100	1000	.45
NT1150	21500	11"	50	100	1000	.54
NT1250	21501	12"	50	100	1000	.55
NT1450	21510	14"	50	100	1000	.69
NT14120	21520	14"	120	100	1000	.71
NT1750	21521	17"	50	100	1000	1.20
NT1950	21522	19"	50	100	1000	2.10
NT21175	21523	21"	175	50	500	2.50
NT24175	21530	24"	175	50	500	2.82
NT27175	21531	27"	175	50	500	3.10
NT30175	21532	30"	175	50	500	3.22
NT32120	21540	32"	120	50	500	3.69
NT34175	21550	34"	175	50	500	4.20
NT48175	21560	48"	175	50	500	5.62

BLACK

BT0418	19770	4"	18	100	1000	.10
BT0530	19780	5"	30	100	1000	.10
BT0540	19783	5 1/2"	40	100	1000	.21
BT0618	19781	6"	18	100	1000	.41
BT0640	19782	6"	40	100	1000	.41
BT0750	19790	7"	50	100	1000	.42
BT0818	19800	8"	18	100	1000	.34
BT0840	19810	8"	40	100	1000	.38
BT08120	19820	8"	120	100	1000	.43
BT1040	19821	10"	40	100	1000	.45
BT1150	19830	11"	50	100	1000	.54
BT1250	19831	12"	50	100	1000	.55
BT1450	19840	14"	50	100	1000	.69
BT14120	19850	14"	120	100	1000	.71
BT1750	19851	17"	50	100	1000	1.20
BT1950	19852	19"	50	100	1000	2.10
BT21175	19853	21"	175	50	500	2.50
BT24175	19860	24"	175	50	500	2.82
BT27175	19861	27"	175	50	500	3.10
BT30175	19862	30"	175	50	500	3.22
BT32120	19870	32"	120	50	500	3.69
BT34175	19890	34"	175	50	500	4.20
BT48175	19890	48"	175	50	500	5.62



AIR HANDLING CABLE TIES

6/6 NYLON



TOPAZ CAT #	UPC#	SIZE	COLOR	MIN TENSILE STRENGTH	PER BAG	SHIP CASE	WT/100
PTB0750	83642	7 1/2"	BURGUNDY	50	100	1000	.42
PTB1150	83644	11"	BURGUNDY	50	100	1000	.54
PTB1450	83646	14 1/2"	BURGUNDY	50	100	1000	.69
PTB0750MH*	83648	7 1/2"	BURGUNDY	50	100	1000	.45
PTB0750LP**	83650	8"	BURGUNDY	50	100	1000	.22



CAT#	BUNDLE DIAMETER		
	MIN	MAX	A
PTB0750	.0625	1.875	.180
PTB1150	.0625	3.062	.180
PTB1450	.0625	4.125	.180
PTB0750MH	.0625	4.125	.177
PTB0750LP	.0625	4.125	.177

*MH = Mounting Head (Round)

**LP = Low Profile (Square)



- Applications: Air Handling Spaces, above drop ceilings and below raised flooring.
- Meets UL 1565 low smoke generation, low heat release, and mechanical strength test.
- UL Listed suitable for use in Air Handling Spaces in accordance with the Section 300.00 (C) and (D) of the National Electrical Code and Rules 12-010 (3), (4), and (5) and 12-020 of the Canadian Electrical Code, Part 1.
- Strong and Pure manufactured from filtered nylon 6/6 reducing particle contamination.
- Mounting Hole Style secures and positions wire bundles, cables, etc. to surfaces with one mechanical fastener.
- Low Profile Style reduced head height increases safety, eliminates snags, cuts, and abrasions to cables, surrounding products, and users.

CONDUIT HANGERS

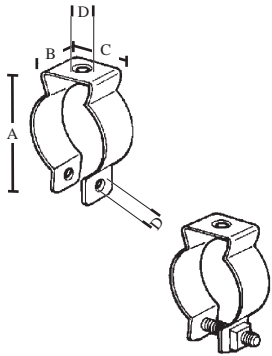

CAT#	A	B	C	D
611/601	1.875	.750	.725	.25
612/602	2.125	.750	.850	.25
613/603	2.437	.875	.975	.25
614/604	2.75	.875	.975	.25
614A/604A	2.875	.875	1.050	.25
615/605	3.125	1.000	1.125	.25
616/606	3.875	1.000	1.145	.25
617/607	4.625	1.250	1.225	.3125
618/608	5.500	1.250	1.275	.3125
619/609	5.750	1.250	1.275	.3125
620/610	6.250	1.250	1.275	.3125

TOPAZ CAT #	UPC#	TRADE SIZE	FOR RIGID	FOR EMT	BOLT SIZE	SHIP CASE	STEEL WT/ CASE
WITH BOLTS & NUTS ATTACHED							
601	15830	0	3/8"-1/2"	1/2"	1/4-20	100	6
602	15840	1	3/4"	3/4"	1/4-20	100	8
603	15850	2	1"	1"	1/4-20	100	8
604	15860	3	1 1/4"	1 1/2"	1/4-20	100	10
604A	15870	2 1/2	---	1 1/4"	1/2-20	100	10
605	15880	4	1 1/2"	---	1/2-20	100	18
606	15890	5	2"	2"	1/2-20	50	10
607	15900	6	2 1/2"	2 1/2"	5/16-18	50	11
608	15910	7	3"	3"	5/16-18	25	6
609	15920	8	3 1/2"	3 1/2"	5/16-18	25	8
610	15930	9	4"	4"	5/16-18	25	12



E170258

WITHOUT BOLTS & NUTS

611	15940	0	3/8"-1/2"	1/2"	---	100	4
612	15950	1	3/4"	3/4"	---	100	6
613	15960	2	1"	1"	---	100	8
614	15970	3	1 1/4"	1 1/2"	---	100	10
614A	15980	2 1/2	---	1 1/4"	---	100	9
615	15990	4	1 1/2"	---	---	100	16
616	16000	5	2"	2"	---	50	10
617	16010	6	2 1/2"	2 1/2"	---	50	11
618	16020	7	3"	3"	---	25	6
619	16030	8	3 1/2"	3 1/2"	---	25	9
620	16040	9	4"	4"	---	25	10



E170258



CAT#	WORKLOAD LIMITS
FC1	50 LBS.

FLUORESCENT CHAIN

TOPAZ CAT #	UPC#	SIZE	UNIT CTN	SHIP CASE	STEEL WT/ CASE
FC1	20750	1 YARD LENGTHS	1 YD.	100	35

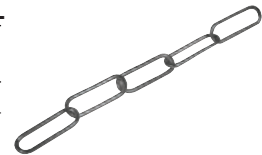

CAT#	WORKLOAD LIMITS
297	16 LBS.
298	29 LBS.
298S	29 LBS.
299	29 LBS.
299B	43 LBS.

JACK CHAIN

TOPAZ CAT #	UPC#	SIZE	UNIT CTN	SHIP CASE	STEEL WT/ CASE
297	12480	14 GAUGE - LIGHT	100 FT.HANKS	10	50
298	12490	12 GAUGE - STANDARD	50 FT.HANKS	10	30
298S	12500	12 GAUGE - STANDARD	100 FT.SPOOLS	8	48
299	12501	12 GAUGE - STANDARD	250 FT.SPOOLS	4	60
299B	12505	10 GAUGE - HEAVY	100 FT.HANKS	1	18



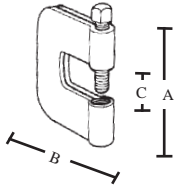

CAT#	A	B	C
126	2.40	2.49	.73

I-BEAM CLAMP C CLAMP

• CLAMP IS TAPPED FOR ROD

STEEL

TOPAZ CAT #	UPC#	SIZE	TAPPING	UNIT CTN	SHIP CASE	WT/ CASE
126	10820	3/4"	3/8" - 16	10	100	30

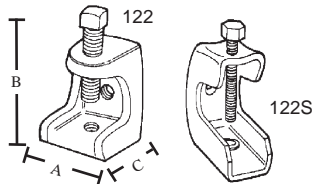

CAT#	A	B	C	TIGHTEN TORQUE
122	1.130	1.400	1.390	60
123	1.990	1.755	1.890	125
123A	1.130	1.400	1.390	60
124	2.530	2.140	2.500	250

122S	.920	1.400	1.630	60
123S	1.210	2.062	2.250	125

BEAM CLAMPS

MALLEABLE IRON

TOPAZ CAT #	UPC#	SIZE	TAPPING	LOAD CAPACITY	UNIT CTN	SHIP CASE	WT/ CASE
122	10710	1"	1/4" - 20	125 LBS.	-	50	11
123	10720	2"	3/8" - 16	300 LBS.	-	50	23
123A	10721	1"	3/8" - 16	300 LBS.	-	50	18
124	10730	2 1/2"	1/2" - 13	800 LBS.	-	25	40

STEEL

122S	10740	1"	1/4" - 20	50 LBS.	-	100	22
123S	10750	2"	3/8" - 16	100 LBS.	-	50	20

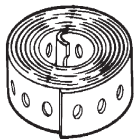

CAT#	
962	1/4" HOLES ON 1/2" CENTER

PERFORATED BAND IRON

• 20 GA

STEEL

TOPAZ CAT #	UPC#	SIZE	UNIT CTN	SHIP CASE	WT/ CASE
962	19570	3/4" x 10'	-	50	30

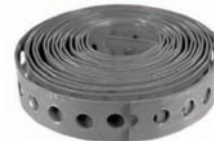

CABLE STAPLES

STEEL

TOPAZ CAT #	UPC#	SIZE	UNIT CTN	SHIP CASE	WT/ CASE
-------------	------	------	----------	-----------	----------

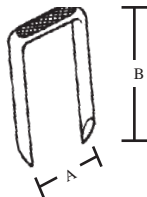

CAT#	A	B
183	.500	1.0
183i	.500	1.0
184	.500	1.0
184i	.500	1.0
185	.500	1.0
185i	.500	1.0
193	.500	1.25
194	.500	1.25
195	.5005	1.25

FOR NMC 2 WIRE #14-12

183	11440	1/2"	100	5000	25
183i*	11441	1/2"	100	5000	26
184	11450	1/2"	500	5000	25
184i*	11442	1/2"	500	5000	26
185	11460	1/2"	BUCKET	5000	26
185i*	11445	1/2"	BUCKET	2500	13

*Insulated

FOR NMC AND ARMORED 3 WIRE #14-12-10

193	11470	9/16"	100	5000	33
194	11480	9/16"	500	5000	31
195	11490	9/16"	BUCKET	5000	35

FOR SEU TO 3 #6

196	11492	13/16"	100	5000	61
197	11494	13/16"	500	5000	61
186	11443	1-11/16"	100	1000	15
198	11444	1-11/32"	100	1000	32





COVER PLATE

- BAKED WHITE ENAMEL
- 2-8/32" SCREWS

CAT#	
175	3 1/2" Screw Separation
176	2 3/4" Screw Separation

TOPAZ CAT #	UPC#	SIZE	UNIT CTN	SHIP CASE	WT/ CASE
175	33510	5"	1 PER BAG	100	18
176	33511	5"	1 PER BAG	100	18

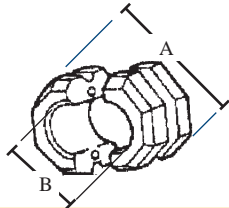

VICTOR SPLIT KNOB

- FOR RUNNING TEMPORARY LIGHTING

CAT#	A	B
V22	2.125	1.00
V38	3.00	1.500

TOPAZ CAT #	UPC#	SIZE	UNIT CTN	SHIP CASE	WT/ CASE
V22	33515	1"	—	100	38
V38	33516	1 1/2"	—	50	104

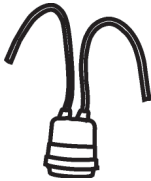

PIGTAIL SOCKET

- RIGHT HANDED THREAD
- #14 Stranded

CAT#	
T124	14GA 6" LONG PIGTAIL

TOPAZ CAT #	UPC#	SIZE	UNIT CTN	SHIP CASE	WT/ CASE
T124	33517	6" LONG	25	250	32

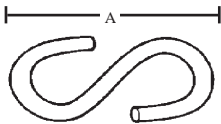

S HOOKS

- ZINC PLATED

CAT#	G	A	WORKLOAD LIMITS
300	14 GA	.96	16 LBS.
300A	12 GA	1.23	29 LBS.
300B	10 GA	1.48	43 LBS.

TOPAZ CAT #	UPC#	SIZE	DUTY	UNIT CTN	SHIP CASE	WT/ CASE
300	12510	14 GAUGE	LIGHT	100	1000	11
300A	12520	12 GAUGE	MEDIUM	100	1000	15
300B	12525	10 GAUGE	HEAVY	100	1000	19

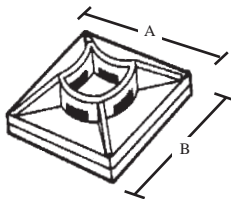

CABLE TIE MOUNTING PLATFORMS

CAT#	A	B	HEIGHT	FLAT MOUNTING HEAD HOLE	FLAT MOUNTING HEAD SCREW
MP4A	1.00	1.00	.157	.197	#6
MP4S	1.00	1.00	.157	.197	#6
MP4AB1.00	1.00	1.00	.157	.197	#6
MP4SB1.00	1.00	1.00	.157	.197	#6

TOPAZ CAT #	UPC#	SIZE	UNIT CTN	SHIP CASE	WT/ CASE
MP4A	32270	4 WAY ADHESIVE BASE	100	1000	5
MP4S	32280	4 WAY SCREW MOUNT	100	1000	5
MP4AB	32320	4 WAY ADHESIVE BASE	100	1000	5
MP4SB	32330	4 WAY SCREW MOUNT	100	1000	5



END CAPS

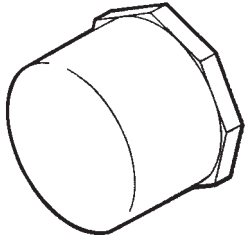

TOPAZ CAT #	UPC#	SIZE	UNIT CTN	SHIP CASE	PVC WT/ CASE
1081	23407	1/2"	—	100	2
1082	23091	3/4"	—	100	5
1083	23092	1"	—	50	8
1084	23093	1 1/4"	—	25	2.68
1085	23094	1 1/2"	—	25	12
1086	23095	2"	—	50	18
1087	23096	2 1/2"	—	25	32
1088	23097	3"	—	25	52
1089	23098	3 1/2"	—	25	68
1090	23099	4"	—	25	88
1090A	23100	5"	—	25	104
1090B	23101	6"	—	10	108



E170258

SERVICE ENTRANCE CAPS

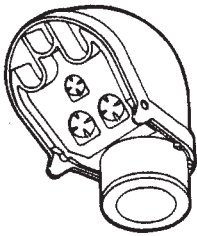

TOPAZ CAT #	UPC#	SIZE	UNIT CTN	SHIP CASE	PVC WT/ CASE
1111	23104	1/2"	—	10	10
1112	23105	3/4"	—	10	10
1113	23106	1"	—	20	20
1114	23107	1 1/4"	—	20	40
1115	23108	1 1/2"	—	20	50
1116	23109	2"	—	5	100
1117	23408	2 1/2"	—	5	500
1118	23111	3"	—	5	500
1119	23112	3 1/2"	—	5	420
1120	23113	4"	—	1	1500



E170258

END BELLS

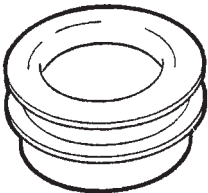

TOPAZ CAT #	UPC#	SIZE	UNIT CTN	SHIP CASE	PVC WT/ CASE
1121	23409	1/2"	—	100	2
1122	23131	3/4"	—	100	2.5
1123	23132	1"	—	50	4
1124	23133	1 1/4"	—	50	4
1125	23134	1 1/2"	—	50	8
1126	23135	2"	—	40	7.5
1127	23436	2 1/2"	—	30	14
1128	23137	3"	—	50	16
1129	23138	3 1/2"	—	50	26
1130	23139	4"	—	50	32
1130A	23372	5"	—	25	36



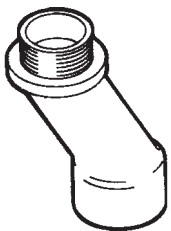

METER OFFSET

TOPAZ CAT #	UPC#	SIZE	UNIT CTN	SHIP CASE	PVC WT/ CASE
1094	23116	1 1/4"	—	25	8
1096	23117	2"	—	8	24



E170258

COUPLINGS

TOPAZ CAT #	UPC#	SIZE	UNIT CTN	SHIP CASE	PVC WT/ CASE
1011	23001	1/2"	—	200	4
1012	23002	3/4"	—	125	4.5
1013	23003	1"	—	70	6
1014	23004	1 1/4"	—	40	7
1015	23005	1 1/2"	—	30	10
1016	23006	2"	—	40	14
1017	23007	2 1/2"	—	20	35
1018	23008	3"	—	40	50
1019	23009	3 1/2"	—	30	70
1020	23401	4"	—	20	90
1020A	23011	5"	—	10	140
1020B	23012	6"	—	8	185

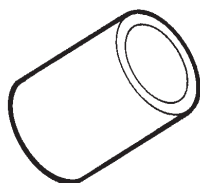

E170258

FEMALE ADAPTERS

TOPAZ CAT #	UPC#	SIZE	UNIT CTN	SHIP CASE	PVC WT/ CASE
1021	23013	1/2"	—	200	2.5
1022	23014	3/4"	—	125	4
1023	23015	1"	—	70	5
1024	23016	1 1/4"	—	40	10
1025	23017	1 1/2"	—	30	11
1026	23018	2"	—	40	15
1027	23019	2 1/2"	—	20	40
1028	23402	3"	—	40	47
1029	23021	3 1/2"	—	30	65
1030	23022	4"	—	20	85
1030A	23023	5"	—	10	140
1030B	23024	6"	—	8	185

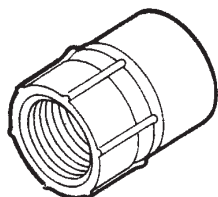

E170258

TERMINAL ADAPTERS

TOPAZ CAT #	UPC#	SIZE	UNIT CTN	SHIP CASE	PVC WT/ CASE
1031	23025	1/2"	—	200	3
1032	23026	3/4"	—	125	6
1033	23027	1"	—	70	5
1034	23028	1 1/4"	—	40	7.5
1035	23029	1 1/2"	—	30	7
1036	23403	2"	—	40	12
1037	23031	2 1/2"	—	20	25
1038	23032	3"	—	40	40
1039	23033	3 1/2"	—	30	59
1040	23034	4"	—	20	60
1040A	23035	5"	—	10	150
1040B	23036	6"	—	8	125

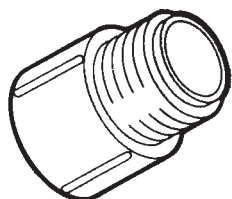

E170258

POLY PLUGS

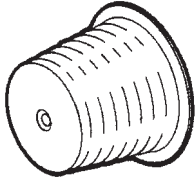

TOPAZ CAT #	UPC#	SIZE	UNIT CTN	SHIP CASE	WT/ CASE	PVC
1206	23142	2"	—	70	6	
1207	23143	3"	—	70	10	
1208	23144	4"	—	90	19	
1208A	23145	5"	—	45	14	
1208B	23146	6"	—	30	10	



REDUCERS

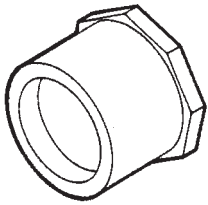

TOPAZ CAT #	UPC#	SIZE	UNIT CTN	SHIP CASE	WT/ CASE
1132	23081	3/4" x 1/2"	—	100	2
1133	23082	1" x 3/4"	—	100	3
1134	23083	1 1/4" x 1"	—	50	1.5
1135	23084	1 1/2" x 1 1/4"	—	50	6
1136	23085	2" x 1 1/2"	—	25	12
1137	23086	2 1/2" x 2"	—	25	20
1138	23087	3" x 2 1/2"	—	25	36
1139	23088	4" x 3"	—	20	55
1140	23089	4" x 3 1/2"	—	20	36



E170258

TWO-HOLE PIPE STRAPS

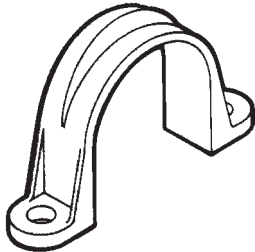

TOPAZ CAT #	UPC#	SIZE	UNIT CTN	SHIP CASE	WT/ CASE
1061	23063	1/2"	—	300	.68
1062	23064	3/4"	—	200	1.20
1063	23065	1"	—	200	1.80
1064	23066	1 1/4"	—	200	2.30
1065	23067	1 1/2"	—	200	2.50
1066	23068	2"	—	200	3.50
1067	23069	2 1/2"	—	100	8.35
1068	23406	3"	—	100	10.50
1070	23071	4"	—	100	12.80



E170258

BOX ADAPTERS

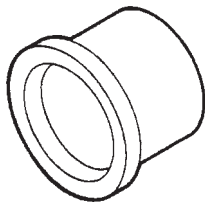

TOPAZ CAT #	UPC#	SIZE	UNIT CTN	SHIP CASE	WT/ CASE
1211	23025	1/2"	—	100	1.65
1212	23026	3/4"	—	100	3.05
1213	23027	1"	—	100	3.60
1214	23028	1 1/4"	—	50	5.00
1215	23029	1 1/2"	—	50	6.00
1216	23030	2"	—	25	10.40
1217	23403	2 1/2"	—	10	23.00
1218	23032	3"	—	10	35.80
1219	23033	3 1/2"	—	10	46.50
1220	23034	4"	—	10	45.80



E170258

90° ELBOWS BELL END

TOPAZ CAT #	UPC#	SIZE	UNIT CTN	SHIP CASE	WT/ CASE	PVC
1241	23164	1/2"	—	50	12	
1242	23165	3/4"	—	35	18	
1243	23166	1"	—	20	40	
1244	23167	1 1/4"	—	30	53	
1245	23168	1 1/2"	—	30	70	
1246	23169	2"	—	15	123	
1247	23174	2 1/2"	—	18	200	
1248	23171	3"	—	14	322	
1249	23172	3 1/2"	—	12	435	
1250	23173	4"	—	10	640	
1250A	23174	5"	—	1	1033	
1250B	23175	6"	—	1	1700	

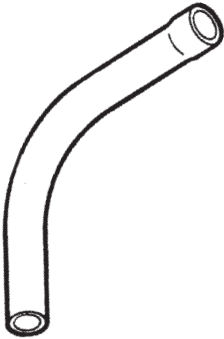

45° ELBOWS BELL END

TOPAZ CAT #	UPC#	SIZE	UNIT CTN	SHIP CASE	WT/ CASE	PVC
1251	23176	1/2"	—	50	10	
1252	23177	3/4"	—	25	12	
1253	23178	1"	—	25	20	
1254	23179	1 1/4"	—	25	36	
1255	23375	1 1/2"	—	20	45	
1256	23181	2"	—	10	80	
1257	23182	2 1/2"	—	20	140	
1258	23183	3"	—	8	192	
1259	23184	3 1/2"	—	5	280	
1260	23185	4"	—	20	395	
1260A	23186	5"	—	1	600	
1260B	23187	6"	—	1	900	

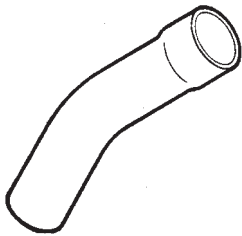

90° ELBOWS PLAIN END

TOPAZ CAT #	UPC#	SIZE	UNIT CTN	SHIP CASE	WT/ CASE	PVC
1041	23038	1/2"	—	50	10	
1042	23039	3/4"	—	35	17	
1043	23404	1"	—	20	30	
1044	23041	1 1/4"	—	30	45	
1045	23042	1 1/2"	—	30	69	
1046	23043	2"	—	15	125	
1047	23044	2 1/2"	—	18	230	
1048	23045	3"	—	14	370	
1049	23046	3 1/2"	—	12	505	
1050	23047	4"	—	10	720	
1050A	23048	5"	—	1	1297	
1050B	23049	6"	—	1	2080	

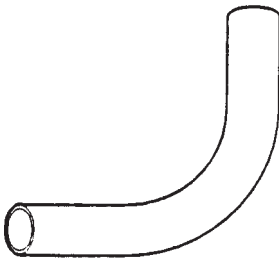

PVC OFFSETS

TOPAZ CAT #	UPC#	SIZE	UNIT CTN	SHIP CASE	WT/ CASE	PVC
1101	23118	1/2"	—	25	8	
1102	23119	3/4"	—	25	12	

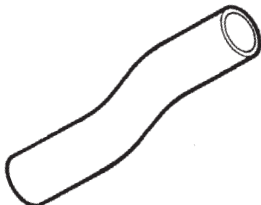

45° ELBOWS PLAIN END



						PVC
TOPAZ CAT #	UPC#	SIZE	UNIT CTN	SHIP CASE	WT/ CASE	
1051	23051	1/2"	—	50	5	
1052	23052	3/4"	—	25	8	
1053	23053	1"	—	20	15	
1054	23054	1 1/4"	—	25	28	
1055	23055	1 1/2"	—	20	35	
1056	23056	2"	—	10	40	
1057	23057	2 1/2"	—	20	105	
1058	23058	3"	—	8	180	
1059	23059	3 1/2"	—	5	260	
1060	23405	4"	—	20	345	
1060A	23061	5"	—	1	650	
1060B	23062	6"	—	1	950	



30° ELBOWS PLAIN END



TOPAZ CAT #	UPC#	SIZE	UNIT CTN	SHIP CASE	WT/ CASE	
1261	23188	1/2"	—	50	5	
1262	23189	3/4"	—	25	9	
1263	23376	1"	—	20	15.2	
1264	23191	1 1/4"	—	25	27	
1265	23192	1 1/2"	—	20	1	
1266	23193	2"	—	10	1	
1267	23194	2 1/2"	—	20	107.6	
1268	23195	3"	—	8	16.4	
1269	23196	3 1/2"	—	5	265	
1270	23197	4"	—	20	275	
1270A	23198	5"	—	30	800	
1270B	23199	6"	—	25	1300	



EXPANSION COUPLINGS TWO PIECE

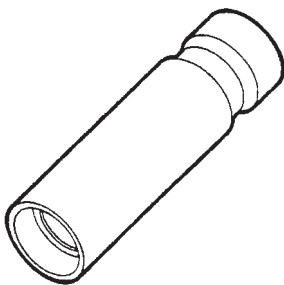

TOPAZ CAT #	UPC#	SIZE	UNIT CTN	SHIP CASE	WT/ CASE	
1071	23152	1/2"	—	25	48	
1072	23153	3/4"	—	10	40	
1073	23154	1"	—	10	80	
1074	23155	1 1/4"	—	5	100	
1075	23156	1 1/2"	—	5	140	
1076	23157	2"	—	25	204	
1077	23158	2 1/2"	—	12	365	
1078	23159	3"	—	12	305	
1079	23373	3 1/2"	—	9	561	
1080	23161	4"	—	6	460	



TYPE T

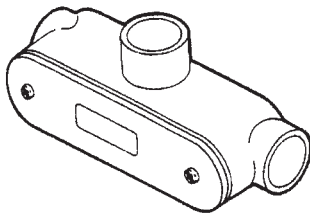

TOPAZ CAT #	UPC#	SIZE	UNIT CTN	SHIP CASE	PVC WT/ CASE
1171	23383	1/2"	—	25	20
1172	23231	3/4"	—	15	25
1173	23232	1"	—	10	40
1174	23233	1 1/4"	—	10	70
1175	23234	1 1/2"	—	10	90
1176	23235	2"	—	5	180
1177	23236	2 1/2"	—	2	550
1178	23237	3"	—	2	500
1179	23238	3 1/2"	—	1	1000
1180	23239	4"	—	1	800



TYPE C

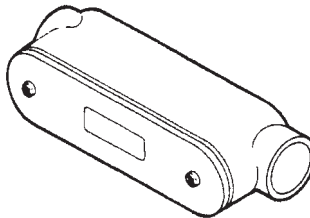

TOPAZ CAT #	UPC#	SIZE	UNIT CTN	SHIP CASE	PVC WT/ CASE
1181	23384	1/2"	—	25	20
1182	23241	3/4"	—	15	25
1183	23242	1"	—	10	40
1184	23243	1 1/4"	—	10	70
1185	23244	1 1/2"	—	10	90
1186	23245	2"	—	5	160
1187	23246	2 1/2"	—	5	550
1188	23247	3"	—	5	460
1189	23248	3 1/2"	—	4	725
1190	23249	4"	—	4	650



TYPE E

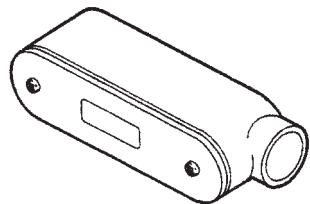

TOPAZ CAT #	UPC#	SIZE	UNIT CTN	SHIP CASE	PVC WT/ CASE
1191	23385	1/2"	—	25	20
1192	23251	3/4"	—	15	28
1193	23252	1"	—	10	30
1194	23253	1 1/4"	—	10	70
1195	23254	1 1/2"	—	10	90
1196	23255	2"	—	5	160
1197	23256	2 1/2"	—	5	168
1198	23257	3"	—	5	380
1199	23258	3 1/2"	—	4	575
1199A	23259	4"	—	4	675



TYPE LB

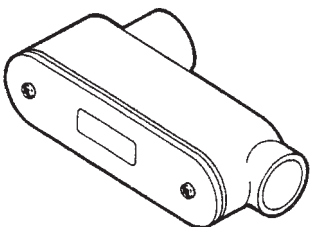

TOPAZ CAT #	UPC#	SIZE	UNIT CTN	SHIP CASE	PVC WT/ CASE
1141	23377	1/2"	—	25	26
1142	23201	3/4"	—	15	27
1143	23202	1"	—	10	30
1144	23203	1 1/4"	—	10	70
1145	23204	1 1/2"	—	10	90
1146	23205	2"	—	5	160
1147	23206	2 1/2"	—	5	460
1148	23207	3"	—	5	465
1149	23208	3 1/2"	—	4	700
1150	23209	4"	—	4	625



TYPE LL

TOPAZ CAT #	UPC#	SIZE	UNIT CTN	SHIP CASE	PVC WT/CASE
1151	23381	1/2"	—	25	20
1152	23211	3/4"	—	15	25
1153	23212	1"	—	10	40
1154	23213	1 1/4"	—	10	40
1155	23214	1 1/2"	—	10	90
1156	23215	2"	—	5	160
1157	23216	2 1/2"	—	5	500
1158	23217	3"	—	5	380
1159	23218	3 1/2"	—	4	725
1160	23219	4"	—	4	500

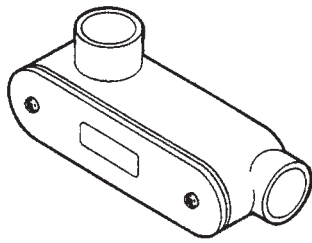

TYPE LR

TOPAZ CAT #	UPC#	SIZE	UNIT CTN	SHIP CASE	WT/CASE
1161	23382	1/2"	—	25	20
1162	23221	3/4"	—	15	25
1163	23222	1"	—	10	40
1164	23223	1 1/4"	—	10	70
1165	23224	1 1/2"	—	10	90
1166	23225	2"	—	5	160
1167	23226	2 1/2"	—	5	500
1168	23227	3"	—	5	500
1169	23228	3 1/2"	—	4	725
1170	23229	4"	—	4	650

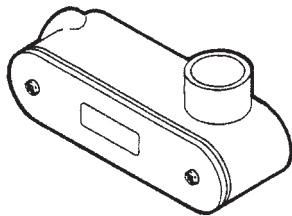

SINGLE TOGGLE SWITCH COVER

TOPAZ CAT #	UPC#	SIZE	UNIT CTN	SHIP CASE	WT/CASE
1316	23115	—	—	10	29

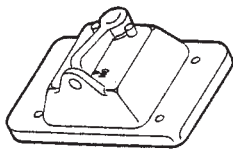

SINGLE RECEPTACLE COVER

TOPAZ CAT #	UPC#	SIZE	Hole Diameter	UNIT CTN	SHIP CASE	WT/CASE
1317	231316	15 amp	1.375	—	10	31.5
1318	23317	20 amp	1.625	—	10	29
1319	23318	30 amp	1.722	—	10	29
1320	23319	50 amp	2.187	—	10	29

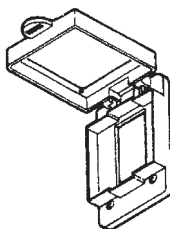
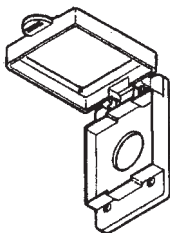

GFI RECEPTACLE COVER

TOPAZ CAT #	UPC#	SIZE	UNIT CTN	SHIP CASE	WT/CASE
1321	23320	—	—	10	30.5

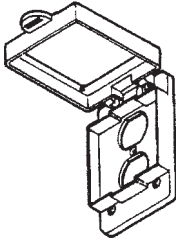

DUPLEX RECEPTACLE COVER

TOPAZ CAT #	UPC#	SIZE	UNIT CTN	SHIP CASE	WT/CASE	PVC
1323	23383	—	—	10	32	



E170258

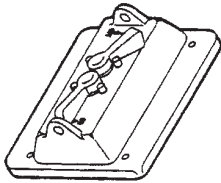

DOUBLE TOGGLE SWITCH COVER

TOPAZ CAT #	UPC#	SIZE	UNIT CTN	SHIP CASE	WT/CASE
1324	23384	—	—	10	41.5



E170258

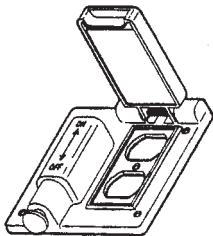

DUPLEX & PLUNGER SWITCH COVER

TOPAZ CAT #	UPC#	SIZE	UNIT CTN	SHIP CASE	WT/CASE
1325	23384	—	—	10	45.7



E170258

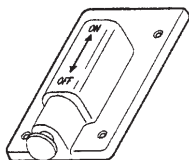

SINGLE PLUNGER SWITCH COVER

TOPAZ CAT #	UPC#	SIZE	UNIT CTN	SHIP CASE	WT/CASE
1326	23384	—	—	10	29



E170258

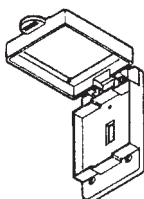

SWITCH COVER

TOPAZ CAT #	UPC#	SIZE	UNIT CTN	SHIP CASE	WT/CASE
1315	23384	—	—	10	32.5



E170258



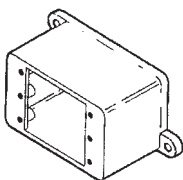

TYPE FD-BLANK

PVC

TOPAZ CAT #	UPC#	SIZE	UNIT CTN	SHIP CASE	WT/CASE
1280	23279	DOUBLE GANG	—	10	24
1281	23391	SINGLE GANG	—	10	12.5

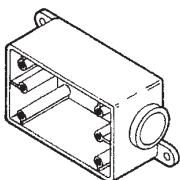

TYPE FSE

TOPAZ CAT #	UPC#	SIZE	UNIT CTN	SHIP CASE	WT/CASE
1282	23281	1/2"	—	10	43
1283	23282	3/4"	—	10	42.5
1284	23283	1"	—	10	40

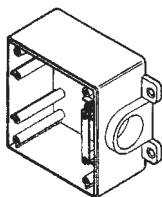
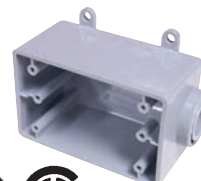

TYPE FSE-TWO-GANG

TOPAZ CAT #	UPC#	SIZE	UNIT CTN	SHIP CASE	WT/CASE
1285	23284	1/2"	—	5	91
1286	23285	3/4"	—	5	91
1287	23286	1"	—	5	91

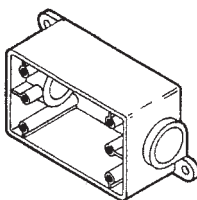

TYPE FSC

TOPAZ CAT #	UPC#	SIZE	UNIT CTN	SHIP CASE	WT/CASE
1288	23287	1/2"	—	10	47.5
1289	23288	3/4"	—	10	45
1290	23289	1"	—	10	42

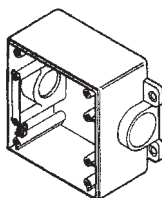
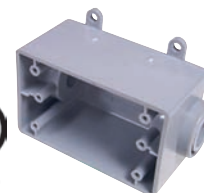

TYPE FSC-TWO-GANG

TOPAZ CAT #	UPC#	SIZE	UNIT CTN	SHIP CASE	WT/CASE
1291	23392	1/2"	—	5	88
1292	23291	3/4"	—	5	88
1293	23292	1"	—	5	88



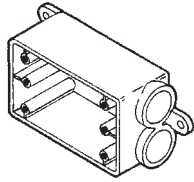

TYPE FSS

TOPAZ CAT #	UPC#	SIZE	UNIT CTN	SHIP CASE	PVC WT/CASE
1294	23293	1/2"	—	10	88
1295	23294	3/4"	—	10	88
1296	23295	1"	—	10	88

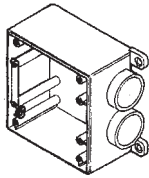

TYPE FSS-TWO-GANG

TOPAZ CAT #	UPC#	SIZE	UNIT CTN	SHIP CASE	PVC WT/CASE
1297	23296	1/2"	—	5	88
1298	23297	3/4"	—	5	88
1299	23298	1"	—	5	88

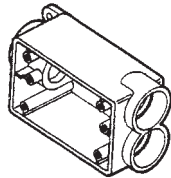
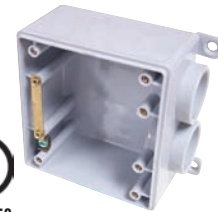

TYPE FSCC

TOPAZ CAT #	UPC#	SIZE	UNIT CTN	SHIP CASE	PVC WT/CASE
1301	23299	1/2"	—	10	49.7
1302	23300	3/4"	—	10	45.8
1303	23301	1"	—	10	42

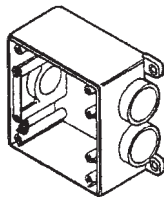

TYPE FSCC-TWO-GANG

TOPAZ CAT #	UPC#	SIZE	UNIT CTN	SHIP CASE	PVC WT/CASE
1304	23302	1/2"	—	5	52.2
1305	23303	3/4"	—	5	48.4
1306	23304	1"	—	5	44.6

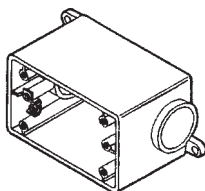

TYPE FDC

TOPAZ CAT #	UPC#	SIZE	UNIT CTN	SHIP CASE	PVC WT/CASE
1307	23306	1/2"	—	10	58.8
1308	23307	3/4"	—	10	58.8
1309	23308	1"	—	10	58.8

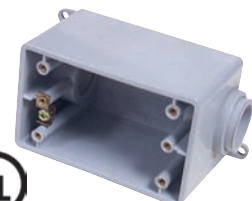

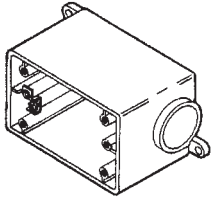

TYPE FDS

TOPAZ CAT #	UPC#	SIZE	UNIT CTN	SHIP CASE	PVC WT/ CASE
1310	23309	1/2"	—	10	58.8
1311	23310	3/4"	—	10	58.8
1312	23311	1"	—	10	58.8

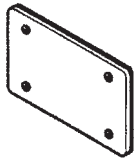
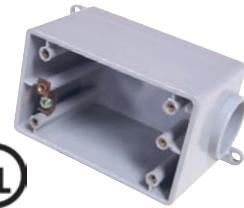

BLANK COVER-SINGLE

TOPAZ CAT #	UPC#	SIZE	UNIT CTN	SHIP CASE	PVC WT/ CASE
1313	23393	—	—	50	8.8

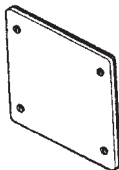

BLANK COVER TWO-GANG

TOPAZ CAT #	UPC#	SIZE	UNIT CTN	SHIP CASE	PVC WT/ CASE
1314	23313	—	—	25	17.6

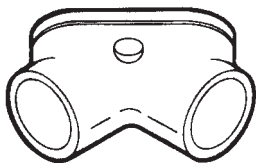

PULL ELBOWS

TOPAZ CAT #	UPC#	SIZE	UNIT CTN	SHIP CASE	PVC WT/ CASE
1091	23114	1/2"	—	75	8
1092	23115	3/4"	—	50	12

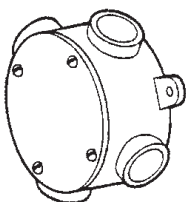

ROUND JUNCTION BOX

TOPAZ CAT #	UPC#	SIZE	UNIT CTN	SHIP CASE	PVC WT/ CASE
1239	23275	1/2" & 3/4"	—	15	90



JUNCTION BOX

TOPAZ CAT #	UPC#	SIZE	CTN	UNIT CASE	SHIP CASE	WT/ CASE
1221	23387	4" X 4" X 2"		—	10	8
1222	23261	4" X 4" X 4"		—	10	10
1223	23262	4" X 4" X 6"		—	10	15
1224	23263	5" X 5" X 2"		—	10	10
1225	23388	6" X 6" X 4"		—	10	20
1226	23265	6" X 6" X 6"		—	5	11
1227	23266	8" X 8" X 4"		—	5	16
1228	23267	8" X 8" X 6"		—	4	15
1229	23268	8" X 8" X 7"		—	4	20
1230	23269	12" X 12" X 4"		—	2	14
1231	23389	12" X 12" X 6"		—	2	15
1232	23271	16" X 14" X 6"		—	1	11
1233	23272	24" X 18" X 8"		—	1	20
1234	23273	24" X 24" X 8"		—	1	24
1235	23274	36" X 24" X 8"		—	1	45

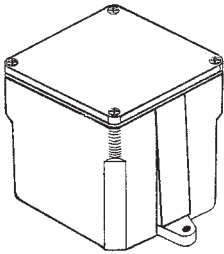

DUPLEX BOXES & COVER

TOPAZ CAT #	UPC#	SIZE	UNIT CTN	SHIP CASE	WT/ CASE
1236	23276	FLOOR BASE BOX (4) 3/4" HUBS (4) 3/4" TO 1/2" REDUCERS LEVEL RING & POUR COVER UL LISTED	—	9	175
1237	23277	FLOOR BASE BOX (2) 3/4" HUBS (2) 1" HUBS (2) 3/4" TO 1/2" REDUCERS LEVEL RING & POUR COVER UL LISTED	—	9	175
1238	23278	PVC-DUPLEX COVER-BRONZE	—	10	40

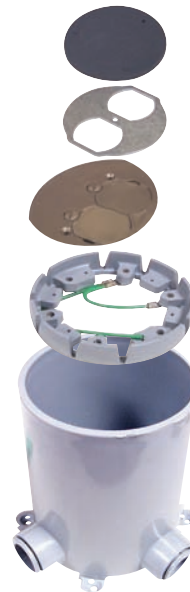
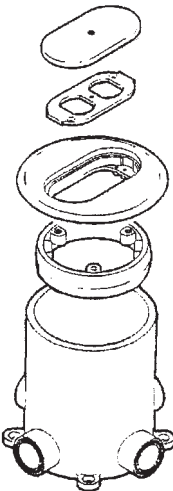

PVC

NM OUTLET BOX

TOPAZ CAT #	UPC#	KO SIZE	UNIT CTN	SHIP CASE	WT/ CASE
1721	83931	1/2"	—	12	70
1722	83935	3/4"	—	12	70

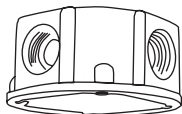

FIXTURE

1718	83932	4" SOCKET	—	12	60
------	-------	-----------	---	----	----

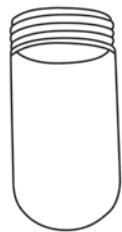

GLOBE

1719	83932	6 1/4" POLY	—	12	60
------	-------	-------------	---	----	----

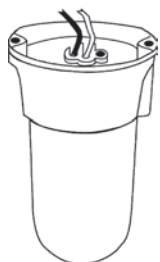

COMPLETE FIXTURE

1720	83934	7 1/2" CLEAR POLY	—	12	90
------	-------	-------------------	---	----	----

Suitable for wet location
60 Watt maximum



SWEDGED REDUCER BELL TO PLAIN END

TOPAZ CAT #	UPC#	SIZE	UNIT CTN	SHIP CASE	WT/ CASE
1480	82522	2-1/2" x 2"	—	20	20
1481	82523	3" x 2"	—	25	31
1482	82524	3" x 2-1/2"	—	25	9
1483	82525	4" x 3"	—	15	17
1484	82526	5" x 4"	—	8	17
1485	82527	6" x 5"	—	4	8

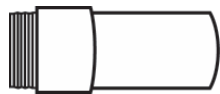

EXPANSION JOINT (METER RISER) SCHEDULE 40

TOPAZ CAT #	UPC#	SIZE	UNIT CTN	SHIP CASE	WT/ CASE
1486	50106	2"	28"	140	696
1487	50108	2 1/2"	28"	135	1075
1488	50109	3"	28"	81	933
1490	50110	4"	28"	51	839

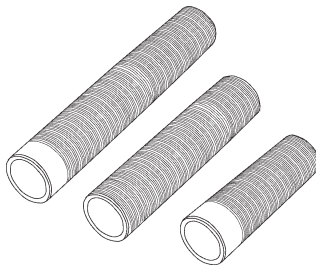

UNIVERSAL NIPPLES

Schedule 80

•PVC Running Thread

TOPAZ CAT #	UPC#	SIZE	UNIT CTN	SHIP CASE	WT/ CASE
1684	83749	1 1/4" x 22"	12	—	8
1685	83750	1 1/2" x 22"	9	—	9
1686	83751	2" x 22"	25	—	38
1687	83752	2 1/2" x 22"	16	—	33
1688	83753	3" x 22"	16	—	49
1690	83754	4" x 22"	9	—	44
1694	83755	1 1/4" x 8"	25	—	9
1695	83756	1 1/2" x 8"	16	—	6
1696	83757	2" x 8"	12	—	7
1697	83758	2 1/2" x 8"	32	—	24
1704	83759	1 1/4" x 16"	25	—	16
1705	83760	1 1/2" x 16"	16	—	13
1706	83761	2" x 16"	25	—	30
1707	83762	2 1/2" x 16"	16	—	26
1708	83763	3" x 16"	25	—	58
1710	83764	4" x 16"	12	—	43



Commercial Length 16" Length 22" Brick Length 8"

INTERMEDIATE SPACERS

TOPAZ CAT #	UPC#	PIPE SIZE	SEPARATION	UNIT CTN	SHIP CASE	WT/ CASE
1331	23326	4	1"	—	200	18
1332	23327	2	1 1/2"	—	350	9
1333	23328	3	1 1/2"	—	225	14
1334	23329	4	1 1/2"	—	150	20
1335	23330	5	1 1/2"	—	100	28
1336	23331	6	1 1/2"	—	100	30
1337	23332	2	2"	—	300	10
1338	23333	3	2"	—	200	15
1339	23334	4	2"	—	125	22
1340	23335	5	2"	—	100	27
1341	23336	6	2"	—	90	34
1342	23337	2	3"	—	200	13
1343	23338	3	3"	—	125	18
1344	23339	4	3"	—	90	27
1345	23340	5	3"	—	80	29
1346	23341	6	3"	—	70	31

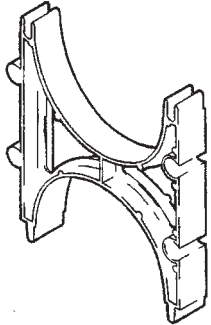

BASE SPACERS

TOPAZ CAT #	UPC#	PIPE SIZE	SEPARATION	UNIT CTN	SHIP CASE	WT/ CASE
1347	23342	4	1"	—	175	20
1348	23343	2	1 1/2"	—	250	12
1349	23344	3	1 1/2"	—	175	18
1350	23345	4	1 1/2"	—	140	28
1351	23346	5	1 1/2"	—	120	35
1352	23347	6	1 1/2"	—	100	32
1353	23348	2	2"	—	225	15
1354	23349	3	2"	—	155	18
1355	23350	4	2"	—	140	30
1356	23351	5	2"	—	120	38
1357	23352	6	2"	—	100	41
1358	23353	2	3"	—	225	16
1359	23354	3	3"	—	150	21
1360	23355	4	3"	—	120	36
1361	23356	5	3"	—	100	38
1362	23357	6	3"	—	95	40

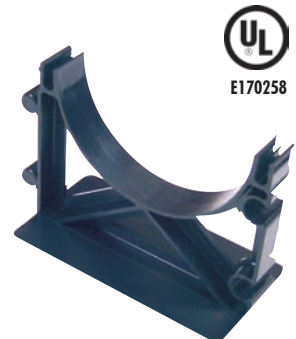
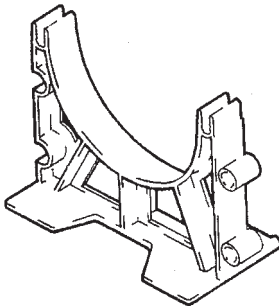

CONDUIT CEMENT

TOPAZ CAT #	UPC#	SIZE	UNIT CTN	SHIP CASE	WT/ CASE
1327	23358	1/2 PINT	—	24	56
1328	23359	PINT	—	12	104
1329	23360	QUART	—	12	200
1330	23361	GALLON	—	6	784
1329H	23371	QUART - HEAVY SET	—	12	200

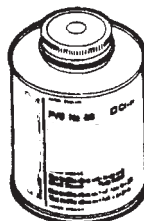

PVC PRIMER/CLEANER

TOPAZ CAT #	UPC#	SIZE	UNIT CTN	SHIP CASE	WT/ CASE
1328P	81877	PINT	—	12	104
1329P	81875	QUART	—	12	200

ENT COUPLINGS

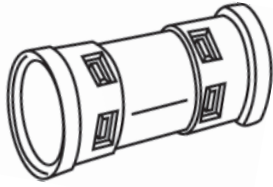

TOPAZ CAT #	UPC#	SIZE	UNIT CTN	SHIP CASE	PVC WT/ CASE
1491	82528	1/2"	—	200	9
1492	82529	3/4"	—	200	16
1493	82530	1"	—	100	14



E170258

ENT TERMINAL ADAPTERS THREADED

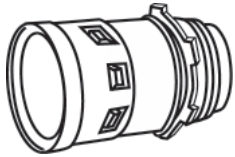

TOPAZ CAT #	UPC#	SIZE	UNIT CTN	SHIP CASE	WT/ CASE
1511	82531	1/2"	—	200	.40
1512	82532	3/4"	—	200	.40
1513	82533	1"	—	100	.40



E170258

ENT TERMINAL ADAPTERS SNAP-IN

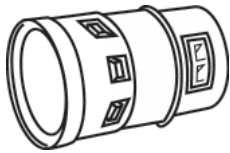

TOPAZ CAT #	UPC#	SIZE	UNIT CTN	SHIP CASE	WT/ CASE
1611	82534	1/2"	—	200	.40
1612	82535	3/4"	—	200	.40
1613	82536	1"	—	100	.40



E170258

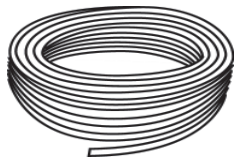

ENT CONDUIT COILS

TOPAZ CAT #	UPC#	SIZE	FEET PER COIL	UNIT CTN	FEET PER PACK	WT/ FOOT
1621	82537	1/2"	200	—	400	.12
1622	82538	3/4"	100	—	200	.14
1623	82539	1"	100	—	100	.17

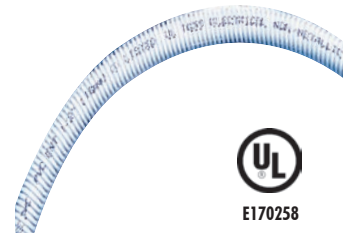

E170258

PVC SPECIAL RADIUS ELBOWS

TOPAZ CAT #	UPC#	SIZE	UNIT CTN	SHIP CASE	PVC WT/ CASE
1377	50001	1" x 90° x 18"	—	1	84
1378	50002	1" x 90° x 24"	—	1	111
1379	50003	1" x 90° x 36"	—	1	140
1380	50004	1" x 90° x 48"	—	1	211
1381	50005	1" x 45° x 18"	—	1	46
1382	50006	1" x 45° x 24"	—	1	57
1383	50007	1" x 45° x 36"	—	1	65
1384	50008	1" x 45° x 48"	—	1	108
1385	50009	1" x 30° x 18"	—	1	33
1386	50010	1" x 30° x 24"	—	1	40
1387	50011	1" x 30° x 36"	—	1	49
1388	50012	1" x 30° x 48"	—	1	54
1389	50013	1-1/4" x 90° x 18"	—	1	125
1390	50014	1-1/4" x 90° x 24"	—	1	160
1391	50015	1-1/4" x 90° x 36"	—	1	201
1392	50016	1-1/4" x 90° x 48"	—	1	307
1393	50017	1-1/4" x 45° x 18"	—	1	68
1394	50018	1-1/4" x 45° x 24"	—	1	86
1395	50019	1-1/4" x 45° x 36"	—	1	94
1396	50020	1-1/4" x 45° x 48"	—	1	160
1397	50021	1-1/4" x 30° x 18"	—	1	51
1398	50022	1-1/4" x 30° x 24"	—	1	62
1399	50023	1-1/4" x 30° x 36"	—	1	89
1400	50024	1-1/4" x 30° x 48"	—	1	113
1401	50025	1-1/2" x 90° x 18"	—	1	149
1402	50026	1-1/2" x 90° x 24"	—	1	191
1403	50027	1-1/2" x 90° x 36"	—	1	280
1404	50028	1-1/2" x 90° x 48"	—	1	368
1405	50029	1-1/2" x 45° x 18"	—	1	84
1406	50030	1-1/2" x 45° x 24"	—	1	103
1407	50031	1-1/2" x 45° x 36"	—	1	175
1408	50032	1-1/2" x 45° x 48"	—	1	191
1409	50033	1-1/2" x 30° x 18"	—	1	61
1410	50034	1-1/2" x 30° x 24"	—	1	75
1411	50035	1-1/2" x 30° x 36"	—	1	95
1412	50036	1-1/2" x 30° x 48"	—	1	136
1413	50037	2" x 90° x 18"	—	1	206
1414	50038	2" x 90° x 24"	—	1	623
1415	50039	2" x 90° x 36"	—	1	262
1416	50040	2" x 90° x 48"	—	1	500
1417	50041	2" x 45° x 18"	—	1	119
1418	50042	2" x 45° x 24"	—	1	144
1419	50043	2" x 45° x 36"	—	1	206
1420	50044	2" x 45° x 48"	—	1	263
1421	50045	2" x 30° x 18"	—	1	88
1422	50046	2" x 30° x 24"	—	1	106
1423	50045	2" x 30° x 36"	—	1	206
1424	50046	2" x 30° x 48"	—	1	188
1425	50049	2-1/2" x 90° x 18"	—	1	337
1426	50050	2-1/2" x 90° x 24"	—	1	426
1427	50051	2-1/2" x 90° x 36"	—	1	614

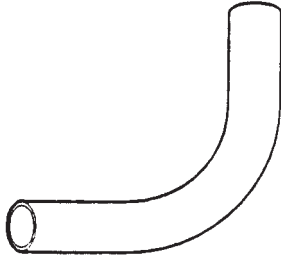

PVC SPECIAL RADIUS ELBOWS - CONT'D

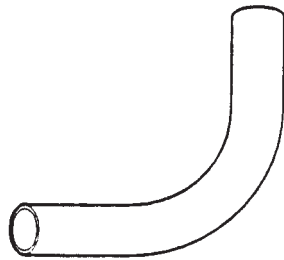

E170258

TOPAZ CAT #	UPC#	SIZE	UNIT CTN	SHIP CASE	PVC WT/ CASE
1428	50052	2-1/2" x 90° x 48"	—	1	803
1429	50053	2-1/2" x 45° x 18"	—	1	199
1430	50054	2-1/2" x 45° x 24"	—	1	238
1431	50055	2-1/2" x 45° x 36"	—	1	337
1432	50056	2-1/2" x 45° x 48"	—	1	426
1433	50057	2-1/2" x 30° x 18"	—	1	149
1434	50058	2-1/2" x 30° x 24"	—	1	178
1435	50059	2-1/2" x 30° x 36"	—	1	280
1436	50060	2-1/2" x 30° x 48"	—	1	390
1437	50061	3" x 90° x 18"	—	1	477
1438	50062	3" x 90° x 24"	—	1	599
1439	50063	3" x 90° x 36"	—	1	881
1440	50064	3" x 90° x 48"	—	1	1115
1441	50065	3" x 45° x 18"	—	1	286
1442	50066	3" x 45° x 24"	—	1	340
1443	50067	3" x 45° x 36"	—	1	476
1444	50068	3" x 45° x 48"	—	1	599
1445	50069	3" x 30° x 18"	—	1	218
1446	50070	3" x 30° x 24"	—	1	258
1447	50071	3" x 30° x 36"	—	1	325
1448	50072	3" x 30° x 48"	—	1	435
1449	50073	3-1/2" x 90° x 24"	—	1	737
1450	50074	3-1/2" x 90° x 36"	—	1	1047
1451	50075	3-1/2" x 90° x 48"	—	1	1358
1452	50076	3-1/2" x 45° x 24"	—	1	631
1453	50077	3-1/2" x 45° x 36"	—	1	589
1454	50078	3-1/2" x 45° x 48"	—	1	736
1455	50079	3-1/2" x 30° x 24"	—	1	325
1456	50080	3-1/2" x 30° x 36"	—	1	426
1457	50081	3-1/2" x 30° x 48"	—	1	640
1458	50082	4" x 90° x 24"	—	1	892
1459	50083	4" x 90° x 36"	—	1	1260
1460	50084	4" x 90° x 48"	—	1	1628
1461	50085	4" x 45° x 24"	—	1	523
1462	50086	4" x 45° x 36"	—	1	717
1463	50087	4" x 45° x 48"	—	1	892
1464	50088	4" x 30° x 24"	—	1	407
1465	50089	4" x 30° x 36"	—	1	510
1466	50090	4" x 30° x 48"	—	1	659
1467	50091	5" x 90° x 36"	—	1	1760
1468	50092	5" x 90° x 48"	—	1	2260
1469	50093	5" x 45° x 36"	—	1	1025
1470	50094	5" x 45° x 48"	—	1	1261
1471	50095	5" x 30° x 36"	—	1	1110
1472	50096	5" x 30° x 48"	—	1	1104
1473	50097	6" x 90° x 36"	—	1	2354
1474	50098	6" x 90° x 48"	—	1	2865
1475	50099	6" x 45° x 36"	—	1	1399
1476	50100	6" x 45° x 48"	—	1	1706
1477	50101	6" x 30° x 36"	—	1	1040
1478	50102	6" x 30° x 48"	—	1	1296

AC DISCONNECT

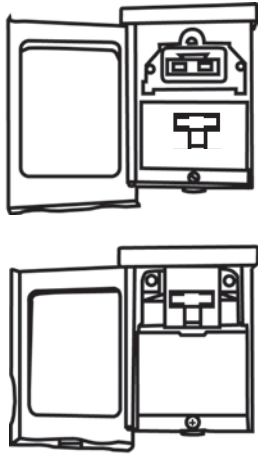

CAT#	CABINET SIZE		
	H	W	D
ACD48	6 1/24	4 7/8	2 3/4
ACD49	6 1/2	4 7/8	2 3/4
ACD50	9	4 7/8	2 3/4
ACD51	9	4 7/8	2 3/4
ACD52	10 1/2	6 1/2	3 3/8
ACD53	10 1/2	6 1/2	3 3/8

TOPAZ CAT #	UPC#	SIZE	VOLTAGE	STEEL	
				SHIP CASE	WT/CASE
ACD48	33772	60 AMP SWITCHABLE	120/240	6	20
ACD49	33773	60 AMP NON-FUSED PULLOUT	120/240	6	20
ACD50	33774	30 AMP FUSED	120/240	6	20
ACD51	33775	60 AMP FUSED	120/240	6	20
ACD52	32286	60 AMP NON-FUSED PULLOUT W/15 AMP GFCI RECP.	120/240	6	30
ACD53	33777	60 AMP SWITCHABLE W/15 AMP GFCI RECP.	120/240	6	30



WIRE RANGE DATA: CONNECTORS	COPPER		LUG TIGHTENING TORQUE (lb-in)	SCREW TYPE	WIRE SIZE	TORQUE
	SOL	STR.				
LINE	14-10	14-3	SLOTTED		8	36-40
LOAD	14-10	14-3			6-4	41-35
EQUIP.GRD.	12-10	12-4			3-2	45-50



AC WHIPS

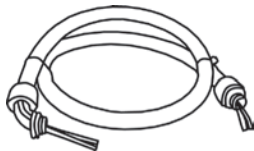

CAT#	LENGTH	WIRE REDUCING WASHER	
		SIZE	WASHER
ACW10	4	#10	1/2 X 3/4
ACW11	6	#10	1/2 X 3/4
ACW12	4	#8	3/4 X 1
ACW13	6	#8	3/4 X 1

TOPAZ CAT #	UPC#	CONNECTORS	CONDUIT SIZE	UNIT CTN	NON-METALLIC	
					SHIP CASE	WT/CASE
ACW10	33776	1/2" ST. 1/2" 90°	1/2"	—	12PK	400
ACW11	33777	1/2" ST. 1/2" 90°	1/2"	—	12PK	400
ACW12	33778	3/4" ST. 3/4" 90°	3/4"	—	12PK	400
ACW13	33779	3/4" ST. 3/4" 90°	3/4"	—	12PK	400



WITH ST. & 90° NM CONNECTORS

MAGNETIC CIRCUIT BREAKER LABELS CBL

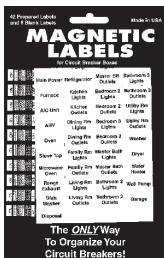

TOPAZ CAT #	UPC#	PREPRINTED	BLANK	UNIT CTN	SHIP CASE	WT/CASE
CBL	19949	42	6	—	24	1



HANGS ON A POINT OF PURCHASE DISPLAY. 12 PER DISPLAY.

WEATHERPROOF COVERS

• GREY

COPPER FREE ALUMINUM

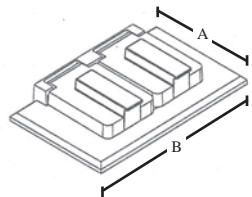

CAT#	A	B
XWC1	2.81	4.56

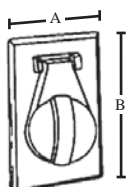

CAT#	A	B
XWC2	2.77	4.52

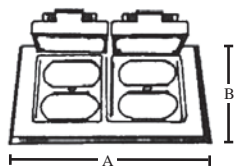

CAT#	A	B
XWC3	4.54	4.54

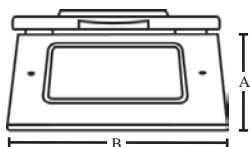

CAT#	A	B
XWC4	2.81	4.56

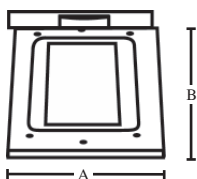

CAT#	A	B
XWC5	2.81	4.56

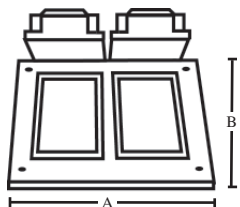

CAT#	A	B
XWC6	4.54	4.54

DUPLEX RECEPTACLE SINGLE GANG

TOPAZ CAT #	UPC#	SHIP CASE	WT/CASE
XWC1	81892	50	35



E170258

SINGLE RECEPTACLE/SWITCH SINGLE GANG

TOPAZ CAT #	UPC#	SHIP CASE	WT/CASE
XWC2	81893	50	16



E170258

DUPLEX DOUBLE GANG

TOPAZ CAT #	UPC#	SHIP CASE	WT/CASE
XWC3	81894	25	15



E170258

GFCI - SINGLE GANG HORIZONTAL

TOPAZ CAT #	UPC#	SHIP CASE	WT/CASE
XWC4	81895	50	20



E170258

GFCI - SINGLE GANG VERTICAL

TOPAZ CAT #	UPC#	SHIP CASE	WT/CASE
XWC5	81896	50	20



E170258

GFCI - DOUBLE GANG

TOPAZ CAT #	UPC#	SHIP CASE	WT/CASE
XWC6	81897	50	35



E170258

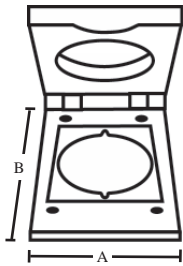

CAT#	A	B
XWC7	2.81	4.56

WEATHERPROOF COVERS

• GREY

COPPER FREE ALUMINUM

TOPAZ CAT #	UPC#	SHIP CASE	WT/ CASE
-------------	------	-----------	----------

30/50 AMP RECEPTACLE - SINGLE GANG

XWC7	81898	50	16
------	-------	----	----



E170258

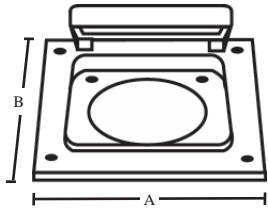

CAT#	A & B	Hole Diameter
XWC8	4.54	2.125
XWC9	4.54	2.64

20/50 AMP POWER OUTLET - DOUBLE GANG

XWC8	81899	8	7
XWC9	81900	8	7



E170258

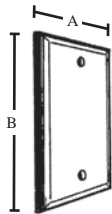

CAT#	A	B
XWC10	2.77	4.54

BLANK - SINGLE GANG

ALUMINUM

XWC10	81901	100	5
-------	-------	-----	---



E170258

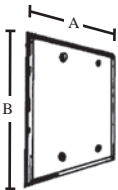

CAT#	A	B
XWC11	4.62	4.57

BLANK - DOUBLE GANG

ALUMINUM

XWC11	81902	100	11
-------	-------	-----	----



E170258

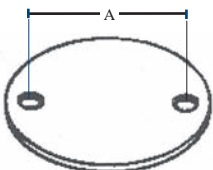

CAT#	A
XWC12	4.08

BLANK - ROUND

ALUMINUM

XWC12	81903	100	8
-------	-------	-----	---

ALL COVERS COME WITH GASKETS AND SCREWS



E170258

SINGLE GANG BOXES

- 18 CUBIC INCH CAPACITY
- GREY

COPPER FREE ALUMINUM

TOPAZ CAT #	UPC#	K.O.	SHIP CASE	WT/ CASE
-------------	------	------	-----------	----------

3 HOLES

XWB1	81878	1/2"	25	15
XWB2	81879	3/4"	25	15

4 HOLES

XWB3	81880	1/2"	25	14
XWB4	81881	3/4"	25	14

5 HOLES

XWB5	81882	1/2"	25	13
XWB6	81883	3/4"	25	13

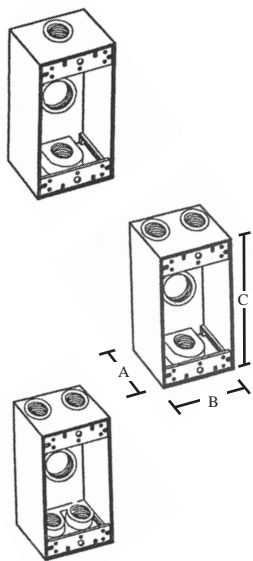

CAT#	A	B	C
XWB1	1.97	2.85	4.61
XWB2	1.97	2.85	4.61
XWB3	1.97	2.85	4.61
XWB4	1.97	2.85	4.61
XWB5	1.97	2.85	4.61
XWB6	1.97	2.85	4.61



E170258



E170258



E170258

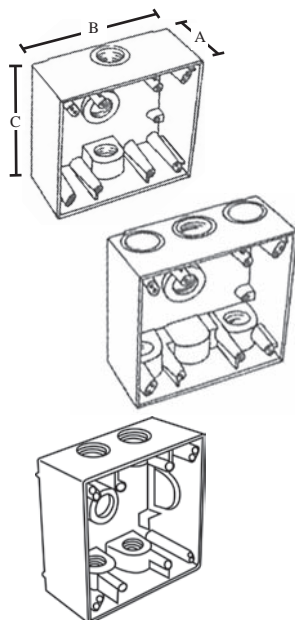

CAT#	A	B	C
XWB7	2.15	4.52	4.52
XWB8	2.15	4.52	4.52
XWB9	2.15	4.52	4.52
XWB10	2.15	4.52	4.52
XWB11	2.15	4.52	4.52
XWB12	2.15	4.52	4.52

DOUBLE GANG BOXES

- 31 CUBIC INCH CAPACITY
- GREY

COPPER FREE ALUMINUM

TOPAZ CAT #	UPC#	K.O.	SHIP CASE	WT/ CASE
-------------	------	------	-----------	----------

3 HOLES

XWB7	81884	1/2"	10	22
XWB8	81885	3/4"	10	22

4 HOLES

XWB9	81886	1/2"	10	21
XWB10	81887	3/4"	10	21

5 HOLES

XWB11	81888	1/2"	10	20
XWB12	81889	3/4"	10	20

ALL BOXES COME WITH MOUNTING LUGS, CLOSURE PLUGS AND GROUNDING SCREWS



E170258



E170258



E170258

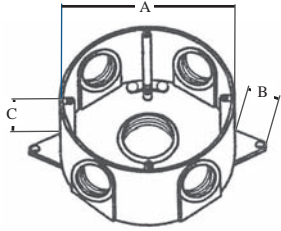

CAT#	A	B	C
XWB13	4.31	0.65	1.58
XWB14	4.31	0.65	1.58
XWB13W	4.31	0.65	1.58
XWB14W	4.31	0.65	1.58

4" ROUND BOX

- 17.2 CUBIC INCH CAPACITY
- GREY

COPPER FREE ALUMINUM

TOPAZ CAT #	UPC#	K.O.	SHIP CASE	WT/ CASE
XWB13	81890	1/2"	25	14
XWB14	81891	3/4"	25	14
XWB13W	83631	1/2"	25	14
XWB14W	83632	3/4"	25	14

*WHITE

USED WITH ALL STANDARD OUTLET BOX AND LAMPHOLDER COVERS.
INCLUDES FOUR CLOSURE PLUGS AND GROUNDING SCREWS.

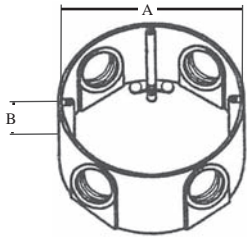

CAT#	A	B
XWB15	4.31	1.58
XWB16	4.31	1.58

4" ROUND EXTENSION

- GREY

COPPER FREE ALUMINUM

TOPAZ CAT #	UPC#	K.O.	SHIP CASE	WT/ CASE
XWB15	83576	1/2"	10	6
XWB16	83577	3/4"	10	6

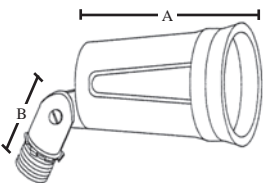

CAT#	A	B
XPART1	2.57	2.00
XPART1W	2.57	2.00

PAR LAMP HOLDER

- MEDIUM BASE
- GREY

COPPER FREE ALUMINUM

TOPAZ CAT #	UPC#	K.O.	SHIP CASE	WT/ CASE
XPART1	80868	1/2"	50	22
XPART1W*	83633	1/2"	50	22

*WHITE

COMES WITH 1/2" LOCKNUT AND GASKET. 150 WATTS MAX.
PAR 38 SWIVELS 180°.

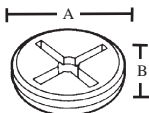

CAT#	A	B
991	.79	.33
992	1.00	.30
993	1.23	.28

CLOSURE PLUGS

ZINC DIE CAST

TOPAZ CAT #	UPC#	SIZE	UNIT CTN	SHIP CASE	WT/ CASE
991	19700	1/2"	—	100	2
992	19710	3/4"	—	50	2
993	19720	1"	—	25	2



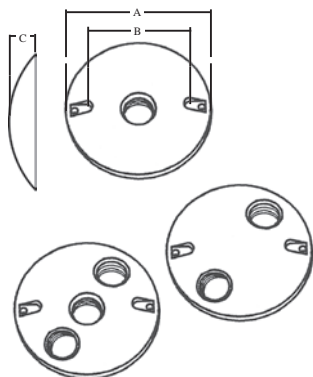

CAT.#	A	B	C
XTY1	4.50	3.5	.875
XTY2	4.50	3.5	.875
XTY3	4.50	3.5	.875
XTY1W*	4.50	3.5	.875
XTY2W*	4.50	3.5	.875
XTY3W*	4.50	3.5	.875

ROUND COVERS

• GREY		COPPER FREE ALUMINUM			
TOPAZ CAT #	UPC#	# HOLES	K.O.	SHIP CASE	WT/ CASE
XTY1	81132	1	1 1/2"	100	30
XTY2	81133	2	2 1/2"	100	30
XTY3	81134	3	3 1/2"	100	30
XTY1W*	83616	1	1 1/2"	100	30
XTY2W*	83617	2	2 1/2"	100	30
XTY3W*	83618	3	3 1/2"	100	30

* WHITE

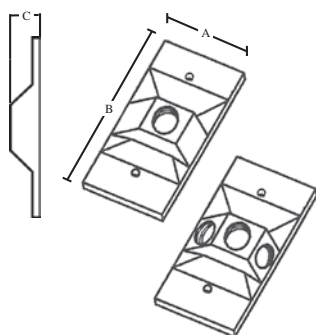

CAT.#	A	B	C
XRC1	2.79	4.55	.99
XRC3	2.79	4.55	.99
XRC1W*	2.79	4.55	.99
XRC3W*	2.79	4.55	.99

RECTANGULAR COVERS

• GREY		COPPER FREE ALUMINUM			
TOPAZ CAT #	UPC#	# HOLES	K.O.	SHIP CASE	WT/ CASE
XRC1	81943	1	1 1/2"	50	14
XRC3	80916	3	3 1/2"	50	14
XRC1W*	83629	1	1 1/2"	50	14
XRC3W*	83630	3	3 1/2"	50	14

* WHITE

ALL COVERS COME WITH GASKET AND SCREWS.

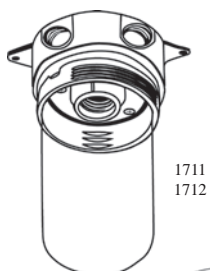
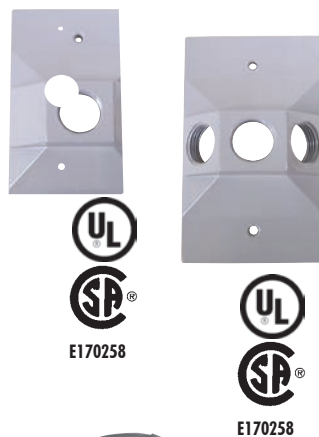

1711
1712



1713
1714

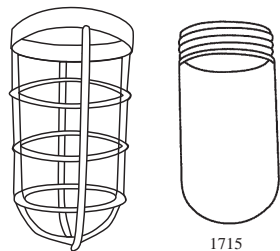

1716

1715

VAPOR PROOF FIXTURE

• GREY		COPPER FREE ALUMINUM			
TOPAZ CAT #	UPC#	# HOLES	K.O.	SHIP CASE	WT/ CASE
1711	83868	5	1/2"	6	8
1712	83869	5	3/4"	6	8
1713	83872	5	1/2"	12	20
1714	83871	5	3/4"	12	20

VAPOR PROOF 7" GLOBE

• CLEAR		POLY	
TOPAZ CAT #	UPC#	SHIP CASE	WT/ CASE
1715	83870	6	5

CAST CAGE

1716	83936	16	18
------	-------	----	----



ALPHA-NUMERIC LISTING BY CATALOG NUMBER

0	3-5	71A	15-2	111i	8-4	157Mi	3-3	215	5-4
0B	3-5	75A250	10-2	112	8-4	158	3-3	216	5-4
1	3-5	75A350	10-2	112i	8-4	158M	3-3	216XL	5-4
1B	3-5	75A450	10-2	113	8-4	158Mi	3-3	230S	2-2
2	3-5	75A560	10-2	113i	8-4	159	3-3	231S	2-2
2B	3-5	75A650	10-2	114	8-4	159M	3-3	232A	5-1
3	3-5	75B750	10-2	114i	8-4	159Mi	3-3	232S	2-2
3B	3-5	75B850	10-2	115	8-4	160	3-3	233S	2-2
4	3-5	76	8-4	115i	8-4	160M	3-3	234S	2-2
4B	3-5	77	8-4	116	8-4	160Mi	3-3	235S	2-2
11	9-1	78	8-4	116i	8-4	161	1-6	236S	2-2
12	9-1	79	8-4	117	8-4	162	1-6	237S	2-2
13	9-1	80	8-4	118	8-4	170	3-4,4-3	238S	2-2
14	9-1	81	9-2	119	8-4	171	3-4,4-3	239S	2-2
15	9-1	82	9-2	119A	8-4	172	3-4,4-3	240S	2-2
16	9-1	83	9-2	120	4-1	173	3-4,4-3	241	8-13
17	9-1	84	9-2	121	3-1	175	16-5	242	8-13
18	9-1	85	9-2	121A	3-1	176	16-5	243	8-13
19	9-1	86	9-2	121B	3-1	180	1-8,3-4,4-3	244	8-13
20	9-1	87	9-2	122	16-4	181	1-8,3-4	245	8-13
21	9-1	88	9-2	122S	16-4	182	1-8,3-4	246	8-13
22	9-1	89	9-2	123	16-4	182A	1-8,3-4	247	8-13
23	9-1	89A	9-2	123A	16-4	183	16-4	248	8-13
24	9-1	90	3-5	123S	16-4	183i	16-4	249	8-13
25	9-1	100	3-2	124	16-4	184	16-4	250	8-13
26	9-1	100B560	10-2	126	16-4	184i	16-4	251	8-3
27	9-1	100B650	10-2	130	3-1	185	16-4	252	8-3
28	9-1	100B750	10-2	131	1-8,3-4	185i	16-4	253	8-3
29	9-1	100B850	10-2	132	1-8,3-4	186	16-4	254	8-3
30	9-1	100C950	10-2	133	1-8,3-4	187	14-1	255	8-3
31	12-3	100C1050	10-2	135	5-1	188	14-1	256	8-3
32	12-3	100i	3-2	136	5-1	189	14-1	257	8-3
33	12-3	101	3-2	137	5-1	189B	14-1	258	8-3
33R	15-1	101i	3-2	138	5-1	189-100	14-1	259	8-3
34S	15-1	101M	3-2	139	5-1	190	15-2	260	8-3
45	11-1	101Mi	3-2	140	3-4,4-3	191	3-4	261	8-2
46	15-1	102	3-2	141	14-1	193	16-4	262	8-2
47	15-1	102i	3-2	141A	14-1	194	16-4	263	8-2
48	14-2	102M	3-2	143R	4-1	195	16-4	264	8-2
49	14-2	102Mi	3-2	144R	4-1	196	16-4	265	8-2
50	14-2	103	3-2	145R	4-1	197	16-4	266	8-2
50A250	10-2	103i	3-2	146R	4-1	198	16-4	267	8-2
50A350	10-2	103M	3-2	150	3-3	199	14-2	267i	8-2
50A450	10-2	103Mi	3-2	151	3-3	200	15-1	268	8-2
50A560	10-2	104	3-2	151i	3-3	201	8-15	268i	8-2
50A650	10-2	104i	3-2	151M	3-3	201B	8-15	269	8-2
51	9-2	104M	3-2	151Mi	3-3	202	8-15	269i	8-2
52	9-2	104Mi	3-2	152	3-3	202B	8-15	270	8-2
53	9-2	105	3-2	152i	3-3	203	8-15	270i	8-2
54	9-2	105i	3-2	152M	3-3	203B	8-15	271	1-8,2-5
55	9-2	105M	3-2	152Mi	3-3	204	8-15	272	1-8,2-5
56	9-2	105Mi	3-2	153	3-3	204B	8-15	273	1-8,2-5
57	9-2	106	3-2	153i	3-3	205	8-15	277	15-1
58	9-2	106i	3-2	153M	3-3	205B	8-15	278	15-1
59	9-2	106M	3-2	153Mi	3-3	206	8-15	279	15-1
60	9-2	106Mi	3-2	154	3-3	206B	8-15	280	15-1
60A	9-2	107	3-2	154i	3-3	207	8-15	281	8-13
60B	9-2	107M	3-2	154M	3-3	207B	8-15	282	8-13
61	9-2	107Mi	3-2	154Mi	3-3	208	8-15	282A	5-1
62	9-2	108	3-2	155	3-3	208B	8-15	283	8-13
63	9-2	108M	3-2	155i	3-3	209	8-15	284	8-13
64	9-2	108Mi	3-2	155M	3-3	209B	8-15	284A	5-1
65	9-2	109	3-2	155Mi	3-3	210	8-15	285	8-13
66	9-2	109M	3-2	156	3-3	210B	8-15	286	8-13
67	9-2	109Mi	3-2	156i	3-3	211	5-4	287	8-13
68	9-2	110	3-2	156M	3-3	212	5-4	288	8-13
69	9-2	110M	3-2	156Mi	3-3	213	5-4	289	8-13
70	9-2	110Mi	3-2	157	3-3	214	5-4	290	8-13
71	15-2	111	8-4	157M	3-3	214XL	5-4	290A	8-13

ALPHA-NUMERIC LISTING BY CATALOG NUMBER

290B	8-13	320M	8-8	340M	8-10	472i	2-1	502	5-1
291	8-14	321	8-9	340MSS	8-10	472S	2-2	503	5-1
292	8-14	321M	8-9	341	1-7	472ST	2-5	504	5-1
293	8-14	322	8-9	342	1-7	473	2-1	506	5-1
294	8-14	322M	8-9	350	3-5,4-3	473i	2-1	507	5-1
295	8-14	323	8-9	351	8-1	473S	2-2	508	5-1
296	8-14	323M	8-9	352	8-1	473ST	2-5	509	5-1
297	16-3	324	8-9	353	8-1	474	2-1	510BX	3-5
298	16-3	324M	8-9	354	8-1	474i	2-1	510RX	4-2
298S	16-3	325	8-9	360	3-5,4-3	474S	2-2	511	1-9
299	16-3	325M	8-9	361	8-1	474ST	2-5	512	1-9
299B	16-3	326	8-9	362	8-1	475	2-1	513	1-9
300	16-5	326M	8-9	363	8-1	475i	2-1	514	1-9
300A	16-5	327	8-9	364	8-1	475S	2-2	515	1-9
300B	16-5	327M	8-9	370	3-5	475ST	2-5	516	1-9
301	8-7	328	8-9	371	1-7	476	2-1	517	1-9,8-6
301CB	8-7	328M	8-9	372	1-7	476i	2-1	518	1-9,8-6
301M	8-7	329	8-9	380	3-5	476S	2-2	519	1-9,8-6
302	8-7	329M	8-9	381	1-7	476ST	2-5	520	1-9,8-6
302CB	8-7	330	8-9	382	1-7	477	2-1	520A	8-6
302M	8-7	330AM	8-9	383	1-7	477S	2-2	520B	8-6
303	8-7	330BM	8-9	384	1-7	478	2-1	521	1-9
303CB	8-7	330M	8-9	390	3-2	478S	2-2	522	1-9
303M	8-7	331	8-10	391S	1-8,8-15	479	2-1	523	1-9
304	8-7	331M	8-10	392S	1-8,8-15	479S	2-2	524	1-9
304CB	8-7	331MSS	8-10	393S	1-8,8-15	480	2-1	525	1-9
304M	8-7	332	8-10	411	12-2	480S	2-2	526	1-9
305	8-7	332M	8-10	412	12-2	481	1-7,8-14	527	1-9,8-6
305CB	8-7	332MSS	8-10	413	12-2	482	1-7,8-14	528	1-9,8-6
305M	8-7	333	8-10	431	1-6	483	1-7,8-14	529	1-9,8-6
306	8-7	333M	8-10	432	1-6	484	1-7,8-14	530	1-9,8-6
306CB	8-7	333MSS	8-10	433	1-6	485	1-7,8-14	530A	8-6
306M	8-7	334	8-10	441	4-1	486	1-7,8-14	530B	8-6
307	8-7	334A	8-10	442	4-1	487	1-7,8-14	531	8-6
307CB	8-7	334AM	8-10	444	4-1	488	1-7,8-14	531A	8-6
307M	8-7	334M	8-10	445	4-1	489	1-7,8-14	531B	8-6
308	8-7	334MSS	8-10	450	3-1	489A	1-7,8-14	532	8-6
308CB	8-7	335	8-10	450i	3-1	489B	1-7,8-14	533	8-6
308M	8-7	335A	8-10	451	3-1	489C	1-7,8-14	534	8-6
309	8-7	335AM	8-10	451i	3-1	490	2-1	535	8-6
309CB	8-7	335M	8-10	452	3-1	490i	2-1	536	8-6
309M	8-7	335MSS	8-10	452i	3-1	490S	2-2	541	8-6
310	8-7	336	8-10	453	3-1	491	2-1	541A	8-6
310ACB	8-7	336A	8-10	453i	3-1	491i	2-1	541B	8-6
310AM	8-7	336AM	8-10	454	3-1	491S	2-2	542	8-6
310BM	8-7	336M	8-10	454i	3-1	492	2-1	543	8-6
310CB	8-7	336MSS	8-10	455	3-1	492i	2-1	544	8-6
310M	8-7	337	8-10	455i	3-1	492S	2-2	545	8-6
311	8-8	337A	8-10	456	3-1	493	2-1	546	8-6
311M	8-8	337AM	8-10	456i	3-1	493i	2-1	551	8-12
312	8-8	337M	8-10	457	4-2	493S	2-2	552	8-12
312M	8-8	337MSS	8-10	458	4-2	494	2-1	553	8-12
313	8-8	338	8-10	459	4-2	494i	2-1	554	8-12
313M	8-8	338A	8-10	460	4-2	494S	2-2	555	8-12
314	8-8	338AM	8-10	461	3-1	495	2-1	556	8-12
314M	8-8	338M	8-10	462	3-1	495i	2-1	557	8-12
315	8-8	338MSS	8-10	463	3-1	495S	2-2	558	8-12
315M	8-8	339	8-10	464	3-1	496	2-1	559	8-12
316	8-8	339A	8-10	465	3-1	496i	2-1	560	8-12
316M	8-8	339AM	8-10	466	3-1	496S	2-2	561	8-6
317	8-8	339M	8-10	470	2-1	497	2-1	561A	3-1
317M	8-8	339MSS	8-10	470i	2-1	497S	2-2	562	8-6
318	8-8	340	8-10	470S	2-2	498	2-1	563	8-6
318M	8-8	340A	8-10	470ST	2-5	498S	2-2	564	8-6
319	8-8	340ALM	8-10	471	2-1	499	2-1	565	8-6
319M	8-8	340AM	8-10	471i	2-1	499S	2-2	566	8-6
320	8-8	340AMSS	8-10	471S	2-2	500	2-1	567	8-6
320AM	8-8	340BLM	8-10	471ST	2-5	500S	2-2	568	8-6
320BM	8-8	340BMSS	8-10	472	2-1	501	5-1	569	8-6

ALPHA-NUMERIC LISTING BY CATALOG NUMBER

570	8-6	626	12-1	651	1-1	664	1-1	725	5-2
570A	8-6	626A	12-1	651i	1-1	664S	1-3	726	5-2
570B	8-6	626B	12-1	651S	1-3	664SRT	1-4	727	5-3
571	6-6	626BS	12-1	651Si	1-3	665	1-1	728	5-3
571S	6-6	626C	12-1	651SRT	1-4	665S	1-3	729	5-3
572	6-6	626D	12-1	651SiRT	1-4	665SRT	1-4	731	5-2
572S	6-6	630	12-1	652	1-1	666	1-1	732	5-2
573	6-6	630B	12-1	652i	1-1	666SRT	1-4	733	5-2
573S	6-6	630DB	12-1	652S	1-3	667	1-1,8-3	734	5-2
574	6-6	631	1-2	652Si	1-3	667S	1-3	735	5-2
574S	6-6	631i	1-2	652SRT	1-4	667SRT	1-4	736	5-2
576	6-6	631S	1-5	652SiRT	1-4	668	1-1,8-3	737	5-2
576S	6-6	631Si	1-5	653	1-1	668S	1-3	738	5-2
577	6-6	632	1-2	653i	1-1	668SRT	1-4	739	5-2
577S	6-6	632i	1-2	653S	1-3	669	1-1,8-3	740	5-2
579	6-6	632S	1-5	653Si	1-3	669S	1-3	741	5-2
579S	6-6	632Si	1-5	653SRT	1-4	669SRT	1-4	742	5-2
581	6-6	633	1-2	653SiRT	1-4	670	1-1,8-3	743	5-2
582	6-6	633i	1-2	654	1-1	670S	1-3	744	5-2
583	6-6	633S	1-5	654i	1-1	670SRT	1-4	745	5-2
584	6-6	633Si	1-5	654S	1-3	671	8-1	746	5-2
586	6-6	634	1-2	654Si	1-3	671S	8-1	747	5-2
587	6-6	634i	1-2	654SRT	1-4	672	8-1	748	5-2
589	6-6	634S	1-5	654SiRT	1-4	672S	8-1	749	5-2
590	1-8,3-4	634Si	1-5	655	1-1	673S	8-1	750	5-2
591	5-4	635	1-2	655i	1-1	674S	8-1	750A	5-2
593	5-4	635i	1-2	655S	1-3	675S	8-1	750B	5-2
594	5-4	635S	1-5	655Si	1-3	676S	8-1	751	8-5
595	5-4	635Si	1-5	655SRT	1-4	681S	8-3	751A	8-5
596	5-4	636	1-2	655SiRT	1-4	682S	8-3	751i	8-5
596A	5-4	636i	1-2	656	1-1	683S	8-3	751M	8-5
601	16-3	636S	1-5	656i	1-1	684S	8-3	751Mi	8-5
602	16-3	636Si	1-5	656S	1-3	685S	8-3	752	8-5
603	16-3	637	1-2,8-1	656Si	1-3	686S	8-3	752A	8-5
604	16-3	637i	1-2	656SRT	1-4	690	13-1	752i	8-5
604A	16-3	637S	1-5,8-1	656SiRT	1-4	691	13-1	752M	8-5
605	16-3	637Si	1-5	657	1-1,8-2	692	13-1	752Mi	8-5
606	16-3	638	1-2,8-1	657i	1-1	693	13-1	753	8-5
607	16-3	638i	1-2	657S	1-3	694	13-1	753i	8-5
608	16-3	638S	1-5,8-1	657Si	1-3	695	13-1	753M	8-5
609	16-3	638Si	1-5	657SRT	1-4	696	13-1	753Mi	8-5
610	16-3	639	1-2,8-1	657SiRT	1-4	697	13-1	754	8-5
611	16-3	639i	1-2	658	1-1,8-2	698	13-1	754i	8-5
612	16-3	639S	1-5,8-1	658i	1-1	699	13-1	754M	8-5
613	16-3	639Si	1-5	658S	1-3	700	13-1	754Mi	8-5
614	16-3	640	1-2,8-1	658Si	1-3	701	13-1	755	8-5
614A	16-3	640i	1-2	658SRT	1-4	702	13-1	755i	8-5
615	16-3	640S	1-5,8-1	658SiRT	1-4	703	13-1	755M	8-5
616	16-3	640Si	1-5	659	1-1,8-2	704	5-3	755Mi	8-5
617	16-3	641	1-2	659i	1-1	705	5-3	756	8-5
618	16-3	641S	1-5	659S	1-3	706	5-3	756i	8-5
619	16-3	642	1-2	659Si	1-3	707	5-3	756M	8-5
620	16-3	642S	1-5	659SRT	1-4	708	5-3	756Mi	8-5
620BP	12-1	643	1-2	659SiRT	1-4	709	5-1	757	8-5
620DB	12-1	643S	1-5	660	1-1,8-2	710	5-1	757i	8-5
620Z	12-1	644	1-2	660i	1-1	711	8-13	757M	8-5
621	12-2	644S	1-5	660S	1-3	712	8-13	757Mi	8-5
621A	12-2	645	1-2	660Si	1-3	713	8-13	758	8-5
621B	12-2	645S	1-5	660SRT	1-4	714	8-13	758i	8-5
622	12-2	646	1-2	660SiRT	1-4	715	8-13	758M	8-5
622A	12-2	646S	1-5	661	1-1	716	8-13	758Mi	8-5
622B	12-2	647	1-2,8-3	661S	1-3	717	8-13	759	8-5
623	12-2	647S	1-5,8-3	661SRT	1-4	718	8-13	759i	8-5
623A	12-2	648	1-2,8-3	662	1-1	719	8-13	759M	8-5
623B	12-2	648S	1-5,8-3	662S	1-3	720	8-13	759Mi	8-5
624	12-2	649	1-2,8-3	662SRT	1-4	721	5-2	760	8-5
624A	12-2	649S	1-5,8-2	663	1-1	722	5-2	760A	8-5
624B	12-2	650	1-2,8-3	663S	1-3	723	5-2	760B	8-5
625	12-1	650S	1-5,8-3	663SRT	1-4	724	5-2	760i	8-5

ALPHA-NUMERIC LISTING BY CATALOG NUMBER

760M	8-5	834	8-7	874A	4-2	938	8-11	1030A	17-2
760Mi	8-5	835	8-7	874B	4-2	939	8-11	1030B	17-2
761	7-2	836	8-7	875	4-2	940	8-11	1031	17-2
762	7-2	837	8-7	875A	4-2	941	8-11	1032	17-2
763	7-2	838	8-7	875C	4-2	942	8-11	1033	17-2
764	7-2	839	8-7	876	4-2	943	8-11	1034	17-2
765	7-2	840	8-7	876A	4-2	944	8-11	1035	17-2
766	7-2	840A	8-7	876B	4-2	952	4-1	1036	17-2
767	7-2	840B	8-7	876C	4-2	953	4-1	1037	17-2
768	7-2	841	8-8	876D	4-2	954	4-1	1038	17-2
769	7-2	842	8-8	876E	4-2	955	4-1	1039	17-2
770	7-2	843	8-8	881	10-2	956	4-1	1040	17-2
771	1-6	844	8-8	881A	10-2	961	5-4	1040A	17-2
772	1-6	845	8-8	881B	10-2	962	16-4	1040B	17-2
773	1-6	846	8-8	882	10-2	965	5-4	1041	17-4
781	1-6	851	8-4	882A	10-2	971	4-1	1042	17-4
782	1-6	851S	8-4	882B	10-2	972	4-1	1043	17-4
790	13-1	852	8-4	883A	10-2	973	4-1	1044	17-4
791	13-1	852S	8-4	883B	10-2	974	4-1	1045	17-4
792	13-1	853	8-4	883C	10-2	975	4-1	1046	17-4
793	13-1	853S	8-4	883D	10-2	976	4-1	1047	17-4
794	13-1	854	8-4	890	13-8	981	8-9	1048	17-4
795	13-1	854S	8-4	891	13-8	982	8-9	1049	17-4
796	13-1	855	8-4	891R	13-8	983	8-9	1050	17-4
797	13-1	855S	8-4	892	13-8	984	5-3	1050A	17-4
798	13-1	856	8-4	892R	13-8	985	5-3	1050B	17-4
799	13-1	856S	8-4	893	13-8	986	5-3	1051	17-5
800	13-1	857	8-4	893R	13-8	987	5-3	1052	17-5
801	13-1	858	8-4	895	13-8	991	14-1,19-4	1053	17-5
802	13-1	859	8-4	896	13-8	992	14-1,19-4	1054	17-5
803	13-1	860	8-4	897	13-8	993	14-1,19-4	1055	17-5
805	13-2	860A	8-4	900	8-11	994	5-3	1056	17-5
806	13-2	860B	8-4	901	8-11	995	5-3	1057	17-5
807	13-2	860T	13-7	902	8-11	996	5-3	1058	17-5
808	13-2	861	13-7	903	8-11	997	5-3	1059	17-5
809	13-2	866-33	13-7	904	8-11	998	5-6	1060	17-5
810	13-2	866BLU	13-7	905	8-11	999	5-5	1060A	17-5
811	13-2	866BRN	13-7	906	8-11	1000	5-6	1060B	17-5
812	13-2	866GRN	13-7	907	8-11	1000A	5-6	1061	17-3
814	13-2	866GRY	13-7	908	8-11	1001	5-5	1062	17-3
815	13-2	866ORN	13-7	909	8-11	1002	5-5	1063	17-3
816	13-2	866PUR	13-7	910	8-11	1003	5-5	1064	17-3
817	13-2	866RED	13-7	911	8-11	1004	5-5	1065	17-3
818	13-2	866T	13-7	912	8-11	1005	5-5	1066	17-3
819	13-2	866WHT	13-7	913	8-11	1006	5-5	1067	17-3
820	13-2	866YEL	13-7	914	8-11	1007	5-5	1068	17-3
821	13-2	867C	4-2	915	8-11	1008	5-5	1070	17-3
822	13-2	867T	13-7	916	8-11	1011	17-2	1071	17-5
823	13-2	868	13-8	917	8-11	1012	17-2	1072	17-5
824	13-2	868B	13-8	918	8-11	1013	17-2	1073	17-5
825	13-2	868BK	13-8	919	8-11	1014	17-2	1074	17-5
826	13-2	868F	13-8	920	8-11	1015	17-2	1075	17-5
827	13-2	868G	13-8	921	8-11	1016	17-2	1076	17-5
828	13-2	868R	13-8	922	8-11	1017	17-2	1077	17-5
829	13-2	868Y	13-8	923	8-11	1018	17-2	1078	17-5
830BLU	13-7	869	13-7	924	8-11	1019	17-2	1079	17-5
830BRN	13-7	870	13-7	925	8-11	1020	17-2	1080	17-5
830GRN	13-7	870C	13-7	926	8-11	1020A	17-2	1081	17-1
830GRY	13-7	870T	13-7	927	8-11	1020B	17-2	1082	17-1
830ORN	13-7	871	4-2	928	8-11	1021	17-2	1083	17-1
830PUR	13-7	871C	13-7	929	8-11	1022	17-2	1084	17-1
830RED	13-7	871S	4-2	930	8-11	1023	17-2	1085	17-1
830WHT	13-7	872	4-2	931	8-11	1024	17-2	1086	17-1
830YEL	13-7	872S	4-2	932	8-11	1025	17-2	1087	17-1
830T	13-7	873	4-2	933	8-11	1026	17-2	1088	17-1
831	8-7	873A	4-2	934	8-11	1027	17-2	1089	17-1
831A	8-7	873B	4-2	935	8-11	1028	17-2	1090	17-1
832	8-7	873C	4-2	936	8-11	1029	17-2	1090A	17-1
833	8-7	874	4-2	937	8-11	1030	17-2	1090B	17-1

ALPHA-NUMERIC LISTING BY CATALOG NUMBER

1091	17-11	1164	17-7	1233	17-12	1307	17-10	1388	17-16
1092	17-11	1165	17-7	1234	17-12	1308	17-10	1389	17-16
1094	17-2	1166	17-7	1235	17-12	1309	17-10	1390	17-16
1096	17-2	1167	17-7	1236	17-12	1310	17-11	1391	17-16
1097	5-6	1168	17-7	1237	17-12	1311	17-11	1392	17-16
1097A	5-6	1169	17-7	1238	17-12	1312	17-11	1393	17-16
1098	5-6	1170	17-7	1239	17-11	1313	17-11	1394	17-16
1099	5-6	1171	17-6	1241	17-4	1314	17-11	1395	17-16
1100	5-6	1172	17-6	1242	17-4	1315	17-8	1396	17-16
1101	17-4	1173	17-6	1243	17-4	1316	17-7	1397	17-16
1101TC	3-5	1174	17-6	1244	17-4	1317	17-7	1398	17-16
1102	17-4	1175	17-6	1245	17-4	1318	17-7	1399	17-16
1105TC	3-5	1176	17-6	1246	17-4	1319	17-7	1400	17-16
1106	5-6	1177	17-6	1247	17-4	1320	17-7	1401	17-16
1106TC	3-5	1178	17-6	1248	17-4	1321	17-7	1402	17-16
1107	5-6	1179	17-6	1249	17-4	1323	17-8	1403	17-16
1111	17-1	1180	17-6	1250	17-4	1324	17-8	1404	17-16
1112	17-1	1181	17-6	1250A	17-4	1325	17-8	1405	17-16
1113	17-1	1182	17-6	1250B	17-4	1326	17-8	1406	17-16
1114	17-1	1183	17-6	1251	17-4	1327	17-14	1407	17-16
1115	17-1	1184	17-6	1252	17-4	1328	17-14	1408	17-16
1116	17-1	1185	17-6	1253	17-4	1328P	17-14	1409	17-16
1117	17-1	1186	17-6	1254	17-4	1329	17-14	1410	17-16
1118	17-1	1187	17-6	1255	17-4	1329H	17-14	1411	17-16
1119	17-1	1188	17-6	1256	17-4	1329P	17-14	1412	17-16
1120	17-1	1189	17-6	1257	17-4	1330	17-14	1413	17-16
1121	17-1	1190	17-6	1258	17-4	1331	17-14	1414	17-16
1122	17-1	1191	17-6	1259	17-4	1332	17-14	1415	17-16
1123	17-1	1192	17-6	1260	17-4	1333	17-14	1416	17-16
1124	17-1	1193	17-6	1260A	17-4	1334	17-14	1417	17-16
1125	17-1	1194	17-6	1260B	17-4	1335	17-14	1418	17-16
1126	17-1	1195	17-6	1261	17-5	1336	17-14	1419	17-16
1127	17-1	1196	17-6	1262	17-5	1337	17-14	1420	17-16
1128	17-1	1197	17-6	1263	17-5	1338	17-14	1421	17-16
1129	17-1	1198	17-6	1264	17-5	1339	17-14	1422	17-16
1130	17-1	1199	17-6	1265	17-5	1340	17-14	1423	17-16
1130A	17-1	1199A	17-6	1266	17-5	1341	17-14	1424	17-16
1132	17-3	1200	13-8	1267	17-5	1342	17-14	1425	17-16
1133	17-3	1201	13-8	1268	17-5	1343	17-14	1426	17-16
1134	17-3	1202	13-8	1269	17-5	1344	17-14	1427	17-16
1135	17-3	1206	17-3	1270	17-5	1345	17-14	1428	17-17
1136	17-3	1207	17-3	1270A	17-5	1346	17-14	1429	17-17
1137	17-3	1208	17-3	1270B	17-5	1347	17-14	1430	17-17
1138	17-3	1208A	17-3	1280	17-9	1348	17-14	1431	17-17
1139	17-3	1208B	17-3	1281	17-9	1349	17-14	1432	17-17
1140	17-3	1209	13-8	1282	17-9	1350	17-14	1433	17-17
1141	17-6	1210	13-8	1283	17-9	1351	17-14	1434	17-17
1142	17-6	1211	17-3	1284	17-9	1352	17-14	1435	17-17
1143	17-6	1212	17-3	1285	17-9	1353	17-14	1436	17-17
1144	17-6	1213	17-3	1286	17-9	1354	17-14	1437	17-17
1145	17-6	1214	17-3	1287	17-9	1355	17-14	1438	17-17
1146	17-6	1215	17-3	1288	17-9	1356	17-14	1439	17-17
1147	17-6	1216	17-3	1289	17-9	1357	17-14	1440	17-17
1148	17-6	1217	17-3	1290	17-9	1358	17-14	1441	17-17
1149	17-6	1218	17-3	1291	17-9	1359	17-14	1442	17-17
1150	17-6	1219	17-3	1292	17-9	1360	17-14	1443	17-17
1151	17-7	1220	17-3	1293	17-9	1361	17-14	1444	17-17
1152	17-7	1221	17-12	1294	17-10	1362	17-14	1445	17-17
1153	17-7	1222	17-12	1295	17-10	1377	17-16	1446	17-17
1154	17-7	1223	17-12	1296	17-10	1378	17-16	1447	17-17
1155	17-7	1224	17-12	1297	17-10	1379	17-16	1448	17-17
1156	17-7	1225	17-12	1298	17-10	1380	17-16	1449	17-17
1157	17-7	1226	17-12	1299	17-10	1381	17-16	1450	17-17
1158	17-7	1227	17-12	1301	17-10	1382	17-16	1451	17-17
1159	17-7	1228	17-12	1302	17-10	1383	17-16	1452	17-17
1160	17-7	1229	17-12	1303	17-10	1384	17-16	1453	17-17
1161	17-7	1230	17-12	1304	17-10	1385	17-16	1454	17-17
1162	17-7	1231	17-12	1305	17-10	1386	17-16	1455	17-17
1163	17-7	1232	17-12	1306	17-10	1387	17-16	1456	17-17

ALPHA-NUMERIC LISTING BY CATALOG NUMBER

1457	17-17	1574	7-2	64514	9-3	64573	9-4	C2SSCG	6-9
1458	17-17	1575	7-2	6451412	9-3	6457312	9-4	C3	6-4
1459	17-17	1576	7-2	64515	9-3	64574	9-4	C3CG	6-6
1460	17-17	1577	7-2	6451512	9-3	64575	9-4	C3M	6-7
1461	17-17	1578	7-2	64516	9-3	64576	9-4	C3SS	6-8
1462	17-17	1591	13-7	6451712	9-3	64578	9-4	C3SSCG	6-9
1463	17-17	1592	13-7	64518	9-3	645710	9-4	C4	6-4
1464	17-17	1593	13-7	645110	9-3	645712	9-4	C4CG	6-6
1465	17-17	1594	13-7	645112	9-3	6458	9-4	C4M	6-7
1466	17-17	1595	13-7	645118	9-3	64583	9-4	C4SS	6-8
1467	17-17	1596	13-7	645124	9-3	6458312	9-4	C4SSCG	6-9
1468	17-17	1597	13-7	6452	9-3	64584	9-4	C5	6-4
1469	17-17	1598	13-7	6452112	9-3	64585	9-4	C5CG	6-6
1470	17-17	1611	17-15	64522	9-3	64586	9-4	C5M	6-7
1471	17-17	1612	17-15	6452212	9-3	64588	9-4	C5SS	6-8
1472	17-17	1613	17-15	64523	9-3	645810	9-4	C5SSCG	6-9
1473	17-17	1621	17-15	6452312	9-3	645812	9-4	C6	6-4
1474	17-17	1622	17-15	64524	9-3	6459	9-4	C6CG	6-6
1475	17-17	1623	17-15	64525	9-3	64594	9-4	C6M	6-7
1476	17-17	1661	1-9	64526	9-3	64595	9-4	C6SSCG	6-9
1477	17-17	1662	1-9	64528	9-3	64596	9-4	C7	6-4
1478	17-17	1663	1-9	645210	9-3	64598	9-4	C7CG	6-6
1480	17-13	1664	1-9	645212	9-3	645910	9-4	C7M	6-7
1481	17-13	1665	1-9	6453	9-3	645912	9-4	C8	6-4
1482	17-13	1666	1-9	64532	9-3	ACD48	18-1	C8CG	6-6
1483	17-13	1667	1-9	6453212	9-3	ACD49	18-1	C8M	6-7
1484	17-13	1668	1-9	64533	9-3	ACD50	18-1	C9	6-4
1485	17-13	1669	1-9	6453312	9-3	ACD51	18-1	C9CG	6-6
1486	17-13	1670	1-9	64534	9-3	ACD52	18-1	C9M	6-7
1487	17-13	1684	17-13	64535	9-3	ACD53	18-1	C10	6-4
1488	17-13	1685	17-13	64536	9-3	ACW10	18-1	C10CG	6-6
1490	17-13	1686	17-13	64537	9-3	ACW11	18-1	C10M	6-7
1491	17-15	1687	17-13	64538	9-3	ACW12	18-1	CBL	18-1
1492	17-15	1688	17-13	645310	9-3	ACW13	18-1	CBS	14-1
1493	17-15	1690	17-13	645312	9-3	AMC1	3-4	CCH1B	11-2
1501	2-5	1694	17-13	6454	9-3	AMC2	3-4	CCH1W	11-2
1502	2-5	1695	17-13	64542	9-3	AMC12	3-4	CCH12B	11-2
1511	17-15	1696	17-13	6454212	9-3	BT0418	16-1	CCH12W	11-2
1512	17-15	1697	17-13	64543	9-3	BT0530	16-1	CCH14B	11-2
1513	17-15	1704	17-13	6454312	9-3	BT0540	16-1	CCH14W	11-2
1514	5-6	1705	17-13	64544	9-3	BT0618	16-1	CCH18B	11-2
1515	5-6	1706	17-13	64545	9-3	BT0640	16-1	CCH18W	11-2
1521	2-5	1707	17-13	6454512	9-3	BT0750	16-1	CCH34B	11-2
1522	2-5	1708	17-13	64546	9-3	BT0818	16-1	CCH34W	11-2
1550	7-1	1710	17-13	64548	9-3	BT0840	16-1	CCH38B	11-2
1551	7-1	1711	19-5	645410	9-3	BT08120	16-1	CCH38W	11-2
1552	7-1	1712	19-5	645412	9-3	BT1040	16-1	CCH58B	11-2
1553	7-1	1713	19-5	6455	9-3	BT1150	16-1	CCH58W	11-2
1554	7-1	1714	19-5	64552	9-3	BT1250	16-1	CCH78B	11-2
1555	7-1	1715	19-5	6455212	9-3	BT1450	16-1	CCH78W	11-2
1556	7-1	1716	19-5	64553	9-3	BT1750	16-1	CCH112B	11-2
1557	7-1	1718	17-12	6455312	9-3	BT1950	16-1	CCH112W	11-2
1558	7-1	1719	17-12	64554	9-3	BT14120	16-1	CCH114B	11-2
1559	7-1	1720	17-12	64555	9-3	BT21175	16-1	CCH114W	11-2
1559A	7-1	1721	17-12	64556	9-3	BT24175	16-1	CCH118B	11-2
1560	7-1	1722	17-12	64558	9-3	BT27175	16-1	CCH118W	11-2
1561	7-1	6410	9-4	645510	9-3	BT30175	16-1	CCH138B	11-2
1562	7-1	64104	9-4	645512	9-3	BT32120	16-1	CCH138W	11-2
1563	7-1	64105	9-4	6456	9-4	BT34175	16-1	CCH316B	11-2
1564	7-1	64106	9-4	6456212	9-4	BT48175	16-1	CCH316W	11-2
1565	7-1	64108	9-4	64563	9-4	C1	6-4	CCH516B	11-2
1566	7-1	641010	9-4	6456312	9-4	C1CG	6-6	CCH516W	11-2
1567	7-1	641012	9-4	64564	9-4	C1M	6-7	CCH716B	11-2
1568	7-1	6451	9-3	64565	9-4	C1SS	6-8	CCH716W	11-2
1569	7-1	6451112	9-3	64566	9-4	C1SSCG	6-9	CCH916B	11-2
1570	7-1	64512	9-3	64568	9-4	C2	6-4	CCH916W	11-2
1571	7-2	6451212	9-3	645610	9-4	C2CG	6-6	CCH1116B	11-2
1572	7-2	64513	9-3	645612	9-4	C2M	6-7	CCH1116W	11-2
1573	7-2	6451312	9-3	6457	9-4	C2SS	6-8	CCH1316B	11-2

ALPHA-NUMERIC LISTING BY CATALOG NUMBER

CCH1316W	11-2	ELR1	6-1	HF138	2-4	LL3M	6-7	LR10CG	6-5
CCH1916B	11-2	ELR1CG	6-2	HF212	2-4	LL3SS	6-8	LR10M	6-7
CCH1916W	11-2	ELR2	6-1	HF214	2-4	LL3SSCG	6-9	LTF1	10-1
DS1	1-9	ELR2CG	6-2	HF234	2-4	LL4	6-4	LTF7	10-1
DS2	1-9	ELR3	6-1	HF238	2-4	LL4CG	6-5	LTF9	10-1
DS3	1-9	ELR3CG	6-2	HF1112	2-4	LL4M	6-7	LTF11	10-1
EB1	1-7	ELR4	6-1	HF1114	2-4	LL4SS	6-8	LTF12	10-1
EB2	1-7	ELR4CG	6-2	HF2112	2-4	LL4SSCG	6-9	LTF13	10-1
EB3	1-7	ELR5	6-1	HF2114	2-4	LL5	6-4	LTF16	10-1
EC1	6-1	ELR5CG	6-2	KO50	14-1	LL5CG	6-5	LTF21	10-1
EC1CG	6-2	ELR6	6-1	KO51	14-1	LL5M	6-7	LTF29	10-1
EC2	6-1	ELR6CG	6-2	KO52	14-1	LL5SS	6-8	LTF34	10-1
EC2CG	6-2	ELR7	6-1	KO53	14-1	LL5SSCG	6-9	LTF38	10-1
EC3	6-1	ELR7CG	6-2	KO54	14-1	LL6	6-4	MLBCG4	6-4
EC3CG	6-2	ELR8	6-1	KO55	14-1	LL6CG	6-5	MLBCG5	6-4
EC4	6-1	ELR8CG	6-2	LB1	6-3	LL6M	6-7	MLBCG6	6-4
EC4CG	6-2	ELR9	6-1	LB1CG	6-5	LL6SSCG	6-9	MP4A	16-5
EC5	6-1	ELR9CG	6-2	LB1M	6-6	LL7	6-4	MP4S	16-5
EC5CG	6-2	ELR10	6-1	LB1SS	6-8	LL7CG	6-5	MP4AB	16-5
EC6	6-1	ELR10CG	6-2	LB1SSCG	6-9	LL7M	6-7	MP4SB	16-5
EC6CG	6-2	ET1	6-1	LB2	6-3	LL8	6-4	NLN1B	11-3
EC7	6-1	ET1CG	6-2	LB2CG	6-5	LL8CG	6-5	NLN1G	11-3
EC7CG	6-2	ET2	6-1	LB2M	6-6	LL8M	6-7	NLN12B	11-3
EC8	6-1	ET2CG	6-2	LB2SS	6-8	LL9	6-4	NLN12G	11-3
EC8CG	6-2	ET3	6-1	LB2SSCG	6-9	LL9CG	6-5	NLN34B	11-3
EC9	6-1	ET3CG	6-2	LB3	6-3	LL9M	6-7	NLN34G	11-3
EC9CG	6-2	ET4	6-1	LB3CG	6-5	LL10	6-4	NLN38B	11-3
EC10	6-1	ET4CG	6-2	LB3M	6-6	LL10CG	6-5	NLN38G	11-3
EC10CG	6-2	ET5	6-1	LB3SS	6-8	LL10M	6-7	NT0418	16-1
ELB1	6-1	ET5CG	6-2	LB3SSCG	6-9	LR1	6-3	NT0530	16-1
ELB1CG	6-2	ET6	6-1	LB4	6-3	LR1CG	6-5	NT0540	16-1
ELB2	6-1	ET6CG	6-2	LB4CG	6-5	LR1M	6-7	NT0618	16-1
ELB2CG	6-2	ET7	6-1	LB4M	6-6	LR1SS	6-8	NT0640	16-1
ELB3	6-1	ET7CG	6-2	LB4SS	6-8	LR1SSCG	6-9	NT0750	16-1
ELB3CG	6-2	ET8	6-1	LB4SSCG	6-9	LR2	6-3	NT0818	16-1
ELB4	6-1	ET8CG	6-2	LB5	6-3	LR2CG	6-5	NT0840	16-1
ELB4CG	6-2	ET9	6-1	LB5CG	6-5	LR2M	6-7	NT08120	16-1
ELB5	6-1	ET9CG	6-2	LB5M	6-6	LR2SS	6-8	NT1040	16-1
ELB5CG	6-2	ET10	6-1	LB5SS	6-8	LR2SSCG	6-9	NT1150	16-1
ELB6	6-1	ET10CG	6-2	LB5SSCG	6-9	LR3	6-3	NT1250	16-1
ELB6CG	6-2	FC1	16-3	LB6	6-3	LR3CG	6-5	NT1450	16-1
ELB7	6-1	FLEXLTF7	10-1	LB6CG	6-5	LR3M	6-7	NT14120	16-1
ELB7CG	6-2	FLEXLTF9	10-1	LB6M	6-6	LR3SS	6-8	NT1750	16-1
ELB8	6-1	FLEXLTF11	10-1	LB6SS	6-8	LR3SSCG	6-9	NT1950	16-1
ELB8CG	6-2	FLEXLTF12	10-1	LB6SSCG	6-9	LR4	6-3	NT21175	16-1
ELB9	6-1	FLEXLTF13	10-1	LB7	6-3	LR4CG	6-5	NT24175	16-1
ELB9CG	6-2	FLEXLTF16	10-1	LB7CG	6-5	LR4M	6-7	NT27175	16-1
ELB10	6-1	FLEXLTF21	10-1	LB7M	6-6	LR4SS	6-8	NT30175	16-1
ELB10CG	6-2	FLEXLTF34	10-1	LB8	6-3	LR4SSCG	6-9	NT32120	16-1
ELL1	6-1	FLEXLTF38	10-1	LB8CG	6-5	LR5	6-3	NT34175	16-1
ELL1CG	6-2	FLEXRLTF12	10-1	LB8M	6-6	LR5CG	6-5	NT48175	16-1
ELL2	6-1	FLEXRLTF34	10-1	LB9	6-3	LR5M	6-7	P461	2-5
ELL2CG	6-2	FLEXRLTF38	10-1	LB9CG	6-5	LR5SS	6-8	P462	2-5
ELL3	6-1	FS2	15-2	LB9M	6-6	LR5SSCG	6-9	P470	2-3
ELL3CG	6-2	FS4	15-2	LB10	6-3	LR6	6-3	P470B	2-3
ELL4	6-1	FS5	15-2	LB10CG	6-5	LR6CG	6-5	P471	2-3
ELL4CG	6-2	FS12	15-2	LB10M	6-6	LR6M	6-7	P471B	2-3
ELL5	6-1	FS22	15-2	LL1	6-4	LR6SS	6-8	P472	2-3
ELL5CG	6-2	FS25	15-2	LL1CG	6-5	LR6SSCG	6-9	P472B	2-3
ELL6	6-1	GC99	14-2	LL1M	6-7	LR7	6-3	P473	2-3
ELL6CG	6-2	GS1	12-3	LL1SS	6-8	LR7CG	6-5	P473B	2-3
ELL7	6-1	HF11	2-4	LL1SSCG	6-9	LR7M	6-7	P474	2-3
ELL7CG	6-2	HF12	2-4	LL2	6-4	LR8	6-3	P474B	2-3
ELL8	6-1	HF21	2-4	LL2CG	6-5	LR8CG	6-5	P475	2-3
ELL8CG	6-2	HF22	2-4	LL2M	6-7	LR8M	6-7	P475B	2-3
ELL9	6-1	HF112	2-4	LL2SS	6-8	LR9	6-3	P476	2-3
ELL9CG	6-2	HF112R	2-4	LL2SSCG	6-9	LR9CG	6-5	P476B	2-3
ELL10	6-1	HF134	2-4	LL3	6-4	LR9M	6-7	P490	2-3
ELL10CG	6-2	HF134R	2-4	LL3CG	6-5	LR10	6-3	P490B	2-3

ALPHA-NUMERIC LISTING BY CATALOG NUMBER

P491	2-3	SB200026	11-1	WB2	13-6	X3002	13-5	XRC1	19-5
P491B	2-3	SB2.531	11-1	WG1	13-6	X3003	13-5	XRC1W	19-5
P492	2-3	SB3.039	11-1	WG2	13-6	X3005	13-5	XRC3	19-5
P492B	2-3	SB3.547	11-1	WR1	13-6	X3005A	13-5	XRC3W	19-5
P493	2-3	SB4.055	11-1	WR2	13-6	X3006	13-5	XSL35	13-2
P493B	2-3	T1	6-3	WT1	13-6	X3007	13-5	XSL50	13-2
P494	2-3	T124	16-5	WT2	13-6	X3008	13-5	XSL70	13-2
P494B	2-3	T1CG	6-5	WY1	13-6	X3008A	13-5	XSL90	13-2
P495	2-3	T1M	6-7	WY2	13-6	X3009	13-5	XSL125	13-2
P495B	2-3	T1SS	6-8	WYRJ	13-6	X3009A	13-5	XSL150	13-2
P496	2-3	T1SSCG	6-9	X1810	13-2	X3009B	13-5	XSL175	13-2
P496B	2-3	T2	6-3	X1818	13-2	X3010	13-5	XSL225	13-2
PK050	11-3	T2CG	6-5	X1820	13-2	X3010A	13-5	XTY1	19-5
PK051	11-3	T2M	6-7	X2101	7-2	X3011	13-5	XTY2	19-5
PK052	11-3	T2SS	6-8	X2102	7-2	X3011A	13-5	XTY3	19-5
PK053	11-3	T2SSCG	6-9	X2103	7-2	X3012	13-5	XTY1W	19-5
PK054	11-3	T3	6-3	X2104	7-2	X3101	13-3	XTY2W	19-5
PK055	11-3	T3CG	6-5	X2105	7-2	X3102	13-3	XTY3W	19-5
PTB0750	16-2	T3M	6-7	X2106	7-2	X3103	13-3	XWB1	19-3
PTB0750LP	16-2	T3SS	6-8	X2107	7-2	X3105	13-3	XWB2	19-3
PTB0750MH	16-2	T3SSCG	6-9	X2108	7-2	X3106	13-3	XWB3	19-3
PTB1150	16-2	T4	6-3	X2109	7-2	X3107	13-3	XWB4	19-3
PTB1450	16-2	T4CG	6-5	X2110	7-2	X3108	13-3	XWB5	19-3
RB1	8-12	T4M	6-7	X2807	13-3	X3109	13-3	XWB6	19-3
RB2	8-12	T4SS	6-8	X2808	13-3	X3109A	13-3	XWB7	19-3
RB3	8-12	T4SSCG	6-9	X2809	13-3	X3109B	13-3	XWB8	19-3
RB4	8-12	T5	6-3	X2817	13-3	X3110	13-3	XWB9	19-3
RB5	8-12	T5CG	6-5	X2818	13-3	X3110A	13-3	XWB10	19-3
RB6	8-12	T5M	6-7	X2819	13-3	X3111	13-3	XWB11	19-3
RB7	8-12	T5SS	6-8	X2820	13-3	X3111A	13-3	XWB12	19-3
RB8	8-12	T5SSCG	6-9	X2901	13-4	X3112	13-3	XWB13	19-4
RB9	8-12	T6	6-3	X2901A	13-4	X3201	13-5	XWB13W	19-4
RB10	8-12	T6CG	6-5	X2902	13-4	X3202	13-5	XWB14	19-4
RB11	8-12	T6M	6-7	X2902A	13-4	X3203	13-5	XWB14W	19-4
RB12	8-12	T6SS	6-8	X2903	13-4	X3205	13-5	XWB15	19-4
RB13	8-12	T6SSCG	6-9	X2903A	13-4	X3206	13-5	XWB16	19-4
RB14	8-12	T7	6-3	X2903B	13-4	X3207	13-5	XWC1	19-1
RB15	8-12	T7CG	6-5	X2905	13-4	X3208	13-5	XWC2	19-1
RB16	8-12	T7M	6-7	X2905A	13-4	X3209	13-5	XWC3	19-1
RB17	8-12	T8	6-3	X2906	13-4	X3209A	13-5	XWC4	19-1
RB18	8-12	T8CG	6-5	X2907	13-4	X3209B	13-5	XWC5	19-1
RB19	8-12	T8M	6-7	X2907A	13-4	X3210	13-5	XWC6	19-1
RB20	8-12	T9	6-3	X2908	13-4	X3210A	13-5	XWC7	19-2
RB21	8-12	T9CG	6-5	X2909	13-4	X3211	13-5	XWC8	19-2
RB22	8-12	T9M	6-7	X2909A	13-4	X3211A	13-5	XWC9	19-2
RB23	8-12	T10	6-3	X2909B	13-4	X3212	13-5	XWC10	19-2
RB24	8-12	T10CG	6-5	X2910	13-4	X3301	13-3	XWC11	19-2
RB25	8-12	T10M	6-7	X2910A	13-4	X3302	13-3	XWC12	19-2
RB26	8-12	UB625	11-3	X2911	13-4	X3303	13-3		
RB27	8-12	UB750	11-3	X2911A	13-4	X3305	13-3		
RB28	8-12	UB812	11-3	X2912	13-4	X3305A	13-3		
RB29	8-12	UB875	11-3	X2921	13-4	X3306	13-3		
RB30	8-12	UB1000	11-3	X2922	13-4	X3307	13-3		
RB31	8-12	UB1093	11-3	X2923	13-4	X3308	13-3		
RB32	8-12	UB1375	11-3	X2925	13-4	X3309	13-3		
RLTF34	10-1	V22	16-5	X2925A	13-4	X3309A	13-3		
RLTF38	10-1	V38	16-5	X2926	13-4	X3310	13-3		
SB8756	11-1	VF28	2-4	X2927	13-4	X3310A	13-3		
SB8757	11-1	W81G1	13-6	X2927A	13-4	X3311	13-3		
SB8758	11-1	W81G2	13-6	X2928	13-4	X3311A	13-3		
SB8759	11-1	W82B1	13-6	X2929	13-4	X3312	13-3		
SB87510	11-1	W82B2	13-6	X2929A	13-4	X3806	13-3		
SB87511	11-1	W8301	13-6	X2929B	13-4	X3807	13-3		
SB109313	11-1	W8302	13-6	X2930	13-4	X3808	13-3		
SB109314	11-1	W84Y1	13-6	X2931	13-4	X3809	13-3		
SB109315	11-1	W84Y2	13-6	X2932	13-4	X3817	13-3		
SB137514	11-1	W86R1	13-6	X2933	13-4	X3818	13-3		
SB137516	11-1	W86R2	13-6	X2934	13-4	XPART1	19-4		
SB175022	11-1	WB1	13-6	X3001	13-5	XPART1W	19-4		

TERMS AND CONDITIONS OF SALE

TERMS: 2% cash discount 10th proximo, net end of month. Cash discount will be allowed if invoices are paid on or before the 10th of the following month. Invoices not discounted are due in full on the last day of the month following the month in which the invoice was dated. Invoices dated after the 25th of the month will be considered as being dated the first of the following month and due accordingly.

All orders are accepted subject to credit approval.

MINIMUM CHARGE: Due to the cost of processing small orders a minimum charge of \$100.00 will be applied for each invoice regardless of the dollar value.

FREIGHT: All product is sold F.O.B. factory. Full freight allowed on shipments weighing 750 lbs. or invoiced at \$1,200.00 within the continental United States. To Alaska and Hawaii freight is allowed to the West Coast. If meeting export minimums, freight will be prepaid to port of exit. All prepaid shipments will be routed by TOPAZ.

TOPAZ will not be responsible for any loss or damage which might occur during shipment. Buyer is responsible once freight is delivered to the first carrier.

TAXES: Liability for all taxes, excise tax, duties, revenues, imports, licenses, or other fees imposed upon products, sale shipment, or use of the company's products shall be assumed and paid for by the buyer, and buyer shall indemnify TOPAZ against any such liability.

PRICES: All prices are subject to change without notice. Orders shall be invoiced at prices in effect at time of shipment. Written quotations will be protected for 15 days from day of quote.

CLAIMS: All claims for shortages or defects must be made to TOPAZ within 15 days from receipt of merchandise.

CANCELLATIONS AND RETURNS: Orders may not be cancelled without prior written consent of TOPAZ. Returning product for credit is permitted only if an R.G.A. (return goods authorization) is issued by TOPAZ. All freight charges will be borne by buyer and a restocking fee of 20% will be charged.

WARRANTY

TOPAZ ELECTRIC UTILIZES A DOUBLE CHECK INSPECTION SYSTEM IN ORDER TO MINIMIZE THE POSSIBILITY OF DEFECTIVE GOODS LEAVING OUR FACILITY. TOPAZ PRODUCTS ARE WARRANTED AGAINST DEFECTS IN WORKMANSHIP AND MATERIALS AT THE TIME OF SHIPMENT. TOPAZ WILL REPLACE FREE OF CHARGE ANY PART IT DETERMINES TO BE DEFECTIVE IN MATERIAL OR WORKMANSHIP PROVIDED THAT:

1. A CLAIM IS MADE WITHIN ONE YEAR AFTER RECEIVING SHIPMENT.
2. THE PART HAS NOT BEEN PHYSICALLY DAMAGED OR OTHERWISE ABUSED.

THERE ARE NO EXPRESS OR IMPLIED WARRANTIES OF MERCHANTABILITY OR FITNESS FOR A PARTICULAR PURPOSE, AND ANY SUCH WARRANTIES ARE SPECIFICALLY DISCLAIMED. NO OTHER LIABILITIES ARE INCLUDED, SUCH AS THE COST OF REMOVAL AND REPLACEMENT OF DEFECTIVE PARTS, LABOR COSTS, LOSS OF ANTICIPATED PROFITS, CLAIMS OF BUYER'S CUSTOMERS, OR CONSEQUENTIAL DAMAGES OF ANY KIND. THE LIMITED WARRANTY CONTAINED IN THE PRECEDING PARAGRAPH IS THE SOLE AND ONLY WARRANTY OFFERED BY TOPAZ.

SOME STATES DO NOT ALLOW LIMITATIONS AS TO HOW LONG AN IMPLIED WARRANTY LASTS, OR THE EXCLUSION OR LIMITATION OF INCIDENTAL OR CONSEQUENTIAL DAMAGES, SO THE LIMITATIONS OR EXCLUSIONS MAY NOT APPLY TO YOU.

ALTHOUGH THIS WARRANTY GIVES YOU SPECIFIC LEGAL RIGHTS, YOU MAY ALSO HAVE OTHER RIGHTS THAT VARY FROM STATE TO STATE.

TOPAZ ELECTRIC PRODUCTS ARE MANUFACTURED FOR NEC INSTALLATION ON LISTED RACEWAYS.

Product listed by Underwriters Laboratories and certified by the Canadian Standards Association are indicated accordingly. All listings are as of the publication date of this catalog. Updated listings are available upon request.



Underwriters Laboratories, Inc.



Canadian Standards Association



General Services Administration

TOPAZ ELECTRIC products are manufactured in compliance with Federal Specifications W-F-406D and W-F-408D, ANSI/NEMA-FB1-1993, UL 514-B, UL 467 and CSA C222 No. 18-1987, C222 No. 41-1987.



CITY OF NEW YORK
DEPARTMENT OF
GENERAL SERVICES

Member:



NAED
ASSOCIATE



Uniform Code Council (UCC) manufacturer number= **751338**. This prefix in conjunction with the 5 digit number listed for each item throughout the catalog provides the complete Universal Product Code (UPC) number.

\$5.00



Friendly Service... Powerful Solutions

CORPORATE HEADQUARTERS

**925 Waverly Ave.
Holtsville, NY 11742**

800-666-2852

Fax: 800-333-3488

www.topaz-usa.com