

# **STANDARD**<sup>®</sup>

**STWCB-13**  
Supersedes STWCB-09

## **WIRE & CABLE** **ILLUSTRATED PARTS GUIDE**

**FOR DOMESTIC & IMPORT CARS & TRUCKS**

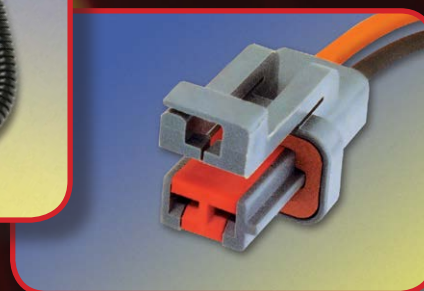

table of

# contents

SECTION	PAGE #	SECTION	PAGE #
<b>A Ignition Wires</b> .....	A1-A24	<b>F Sockets, Pigtails &amp; Switches</b> .....	F1-F30
<b>B Battery Cables</b> .....	B1-B38	<b>G Safety Accessories</b> .....	G1-G8
<b>C Primary Wire</b> .....	C1-C14	<b>H O.E. Interchanges</b> .....	H1-H10
<b>D Terminals &amp; Connectors</b> .....	D1-D36	<b>I Index</b> .....	I1-I18
<b>E Trailer Connectors</b> .....	E1-E31		

ITEM	PAGE #	ITEM	PAGE #	ITEM	PAGE #
3-way Terminals.....	D9, D16	Electrical Wire.....	C2-C5, C7-C8, E31	Primary Wire.....	C2-C5, C7-C8
4-way Terminals.....	D9	Electronic Brake Control.....	E13	Quick Splice Terminals.....	D13
Alligator Clips.....	B34	Emergency Battery Cable Ends.....	B18	Quick-Connect Battery Terminals.....	B28
Amperage Guide.....	C6	Emergency Battery Terminals.....	B27	Replacement Ends.....	B18
Asphalt Coated Loom.....	C9	Extension Cords.....	G8	Retainers.....	A22
Assortments.....	A14, A23, B23, B38, D29-D33	Fluorescent Droplights.....	G6	Ring Terminals.....	D3-D6, D12, D16, D19-D22
Auxiliary Starting System.....	B33	Fuse Block Taps.....	D14	Safe-Mate® Battery Couplers.....	B32
Battery Bolts and Nuts.....	B20, B27-B28	Fuse Holders.....	D15	Safety Accessories.....	G2-G8
Battery Cable.....	B4-B20, B22	Fuse Taps.....	D14	Shims.....	B30
Battery Cable Assortment.....	B17	Fusible Link Wire.....	C4	Shrink Tubing.....	B36-B38
Battery Cable Lugs.....	B24-B25, B29-30	Fusible Links.....	C4	Silicone Compound.....	A22
Battery Cable Replacement Ends.....	B18	Grommets.....	C11	Single Plug Wires.....	A8, A15
Battery Hold Downs.....	B34-B35	Ground Cables.....	B17	Slide Terminals.....	D7-D9, D12, D15-D16, D20, D22
Battery Isolators.....	B21	Ground Straps.....	B17	Sockets.....	F2-F11
Battery Protector.....	B31	Heat Guns.....	B38	Solder Slugs.....	B23
Battery Terminal Adapters.....	B28	Heat Shields.....	A16	Spade Terminals.....	D6-D7, D12, D16, D19, D21-D22
Battery Terminal Covers.....	B31	Heat Shrink Guns.....	B38	Spark Plug Boots.....	A10-A14
Battery Terminal Guards.....	B31	Heat Shrink Terminals.....	D3-D11, D14, D19-D22	Spark Plug Heat Shields.....	A16
Battery Terminals.....	B24-B28	Heat Shrink Tubing.....	B36-B38	Spark Plug Terminals.....	A16-A17, A22
Battery Tools.....	B34-B35, D35	High Temperature Loom.....	C9	Spark Plug Wire.....	A22
Bonded Parallel Primary Wire.....	C5	Hold Down Bolts.....	B34	Spark Plug Wire Separators.....	A22
Booster Cables.....	G4	Hold Downs.....	B35	Speaker Wire.....	C4
Booster Cable Clamps.....	G5	Hook Terminals.....	D6, D12	Specialty Terminals.....	D19-D22
Booster Cable Systems.....	B32-B33	Ignition Wire Assortments.....	A14-A15	Spiral Wrap.....	C9, C13
Boots.....	A16-A17	Ignition Wire Terminals.....	A22-A23	Splice Connectors.....	B17, B30, D9-D14, D16
Boot Pullers.....	A24	Ignition Wire Tools.....	A24	Split Loom.....	C9, C13
Bulk Battery Cable.....	B22, C8	Individual Plug Wires.....	A8-A15	Starter Cable Lugs.....	B24-B25, B29-B30
Bulk Booster Cable.....	B23	Jumper Cable.....	G4	Step-down Connectors.....	B17, B30, D16
Bulk Ignition Wire.....	A22	Jumper Cable Systems.....	B32-B33	Switches.....	F28-F30
Bulk Marine Battery Cable.....	C8	Lead-free Battery Terminals.....	B26	Terminal Assortments.....	A23, D29-D33
Bulk Spark Plug Wire.....	A22	Light Sockets.....	F2-F11	Terminal Covers.....	B31
Bulk Trailer Cable.....	E31	Loom.....	C9, C13	Test Clips.....	B34
Bulk Wire Dispenser.....	C3, D34	Loom Tee Connectors.....	C10	Testers.....	D35, E29
Bullet Connectors.....	D11-D12, D16, D20	Loom Installation Tool.....	C9	Tie Straps.....	C11-C13
Bundling Accessories.....	C9-C13	Lugs.....	B24-B25, B29-B30	Tools.....	A24, B34-B35, D35
Butt Splice Connectors.....	D10-D12, D16, D20-D22	Marine Battery Cable.....	C8	Torches.....	B38
Cabinets.....	D34	Marine Battery Terminals.....	B27	Trailer Cable.....	E31
Cable Crimping Tools.....	B35	Marine Primary Wire.....	C7-C8	Trailer Connector Applications.....	E18-E28
Cable Lugs.....	B24-B25, B29-B30	Motorcycle Wire Sets.....	A5	Trailer Connector Brackets.....	E17
Catalog Rack.....	D34	Mounting Clips.....	C10	Trailer Connectors.....	E3-E16
Circuit Testers.....	D35	Multi Wire Connectors.....	D9, D16	Trouble Lights.....	G6-G8
Clear Tubing.....	C9	Multi-Colored Loom.....	C13	Truck Wire Sets.....	A5
Coil Boots.....	A16	Multi-Colored Tie Straps.....	C13	Uninsulated Terminals.....	D15-D16
Coil Nipples.....	A16	Multi-Conductor Cable.....	B23	Universal Switches.....	F28-F30
Coil-On-Plug Boots.....	A18-A21	Multi-Conductor Wire.....	C4-C5, C8, E31	Universal Wire Sets.....	A6
Coil-On-Plug Boot Per Car Kits.....	A21	Multiple Battery Harnesses.....	B19-B20	Vacuum Caps.....	C10
Compression Terminals.....	B25	Multiple Battery Isolators.....	B21	Voltage Testers.....	D35
Connector Assortments.....	A23, D29-D33	Nipples.....	A16-A17	Welding Cable.....	B23
Convuluted Tubing.....	C9, C13	O.E.M. Electronic Terminals.....	D23-D29	Wire Clamps.....	C10
Corrosion Protection.....	B31	O.E.M. Tools.....	D35	Wire Display Rack.....	C3
Crimp Tools.....	A24, B35, D35	Parallel Connectors.....	D10	Wire Nuts.....	D13-D14
Crosslink Wire.....	C5	Per Car Engine Kits.....	A21	Wire Separators.....	A22
Custom Ignition Leads.....	A2-A5	Pigtails.....	F12-F27	Wire Ties.....	C11-C13
Custom Lead Assortments.....	A14-A15	Pin Terminals.....	D11	Wiring Tools.....	C9, C11, D35
Di-Electric Compound.....	A22	Plug Wire Assortments.....	A14-A15	Zip Ties.....	C11-C13
Distributor Boots.....	A17	Plug Wire Boots.....	A16-A17		
Drawer.....	D34	Plug Wire Retainers.....	A22		
Droplights.....	G6-G8	Plug Wire Terminals.....	A22-A23		
Electrical Cable.....	C4, G7	Posi-Lock® Terminals.....	D17		



# ***Ignition Wires***

***Battery Cables***

***Primary Wire***

***Terminals & Connectors***

***Trailer Connectors***

***Sockets, Pigtails & Switches***

***Safety Accessories***

***O.E. Interchanges***

***Index***

# PREMIUM IGNITION WIRE SETS



## **STANDARD**

### **OE Plus** performance

## IGNITION WIRE QUALITY ENGINEERED FROM END TO END...

## ...KNOW YOUR IGNITION WIRE



### PREMIUM QUALITY MATERIALS

- Conductive Silicone Core
- Magnetic Suppression Core
- Metallic Core
- Blended Silicone Insulation
- Fiberglass Braid
- Corrosion Resistant Terminals
- Heavy Duty Silicone Boots
- Silicone Outer Jacket

**ISO/TS  
16949**

### Warranty Statement

Our wire sets are warranted to be free from defects in material and workmanship. Should the wire set fail at any time during the life of the vehicle on which it was originally installed, it will be replaced at no charge, upon presentation of the defective wire set and proof of purchase to any authorized distributor of our wire & cable products.

This warranty is limited to replacement of the wire set only, and does not include incidental or consequential damages. Our company is not liable for injury or property damage resulting directly or indirectly from an actual or alleged defect in material and/or workmanship. Failure due to incorrect installation or the wrong application is not covered by this warranty.

# PREMIUM IGNITION WIRE SETS

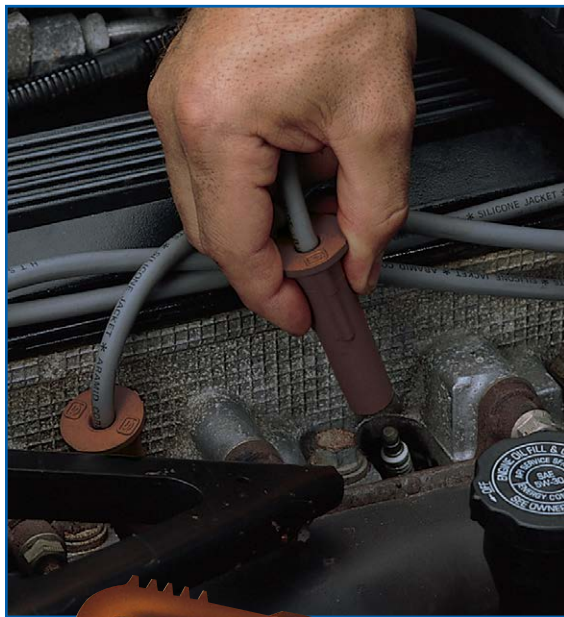

## WHY PREMIUM WIRE IS CRITICAL...

Hotter running engines, crowded engine compartments and higher voltage output make premium wire sets a key component of any ignition system.

The primary cause of ignition wire failure is prolonged exposure to HEAT. The termination at the spark plug end is most susceptible to these high temperatures. When the extreme heat from the spark plug transfers to the wire, the core is exposed to temperatures that can char, melt away and cause core burnout; the number one cause of ignition wire failure.

Domestic O.E. manufacturers use an extruded silicone core to solve this problem and so does Standard. The latex fiberglass core used by most other aftermarket companies simply won't last.

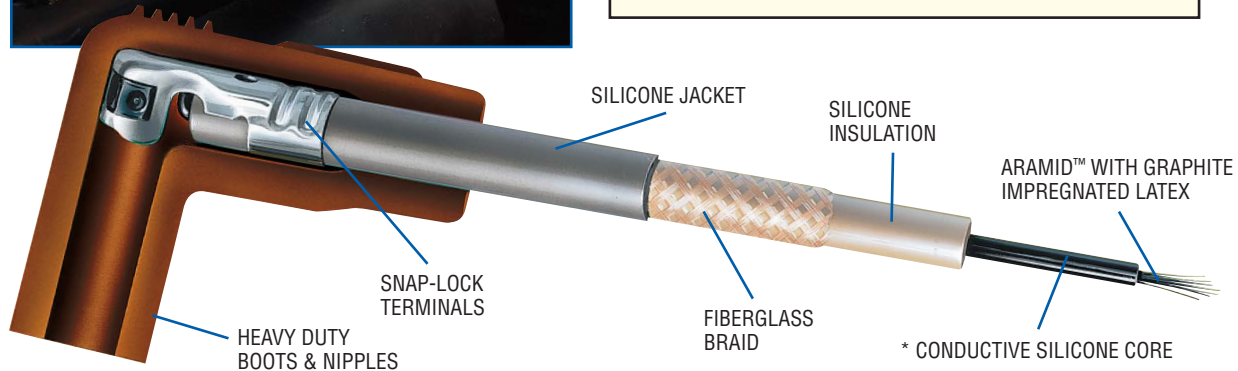

## PREMIUM QUALITY MATERIALS

**CONDUCTIVE SILICONE CORE** — A core of super-strong aramid fiber is impregnated with a graphite/latex mixture calibrated to vary resistance, suppress radio static (RFI) and deliver voltage to the spark plug. Conductive silicone rubber is extruded over this inner core combining unsurpassed toughness and superior heat resistance. This conductive silicone core virtually eliminates core burnout. Every premium wire set in the line has this conductive silicone core rated at 100,000 miles.

**MAGNETIC SUPPRESSION CORE** — Stainless steel conductive winding with heat resistant latex. OE on certain domestic vehicles from 1995

**METALLIC CORE** — Metallic conductor OE on many European vehicles.

**SILICONE INSULATION** — The insulation layer shields the core and protects against voltage leaks and shorts to ground. We use silicone which has superior insulating properties.

**FIBERGLASS BRAID** — A fiberglass braid around the insulation layer provides added strength, toughness and increased flexibility. It also improves terminal pull off forces.

**SILICONE OUTER JACKET** — Like the silicone core, the silicone outer jacket protects against harsh under hood conditions - heat, moisture, grease, oil and other contaminants. It combines

superior thermal protection and durability. Each set in our line has a silicone jacket - Foreign and domestic, vintage and late model applications all meet or exceed O.E. quality.

**CORROSION RESISTANT TERMINALS** — Tight positive connections between the terminal and the spark plug, distributor cap, or coil ensure uninterrupted current flow and consistent driveability. Gold chromate snap-lock terminal clips provide additional anti-corrosion protection. The snap-lock feature provides a positive connection between the spark plug and the wire. Engine vibration won't cause the terminals to back out and lose contact. Terminal pull-off values are consistently over 50lbs. at room temperature and far exceed SAE J2032 specification of 20 lbs. heated at 90°C.

**HEAVY DUTY SILICONE BOOTS** — Silicone has unmatched resistance to heat. That's why O.E. uses silicone. That's why we use conductive silicone core on all premium wire sets, silicone boots on all applications specified by O.E. and high temperature silicone boots on many high heat car and truck applications.

**PREMIUM WIRES** — are made up of these various protective layers that enhance overall performance and ensure long life. Lesser grades of wire omit many of these layers. From the conductive silicone core to the heavy duty silicone spark plug boots, Standard Plus wire provides a host of benefits that make them the best ignition wire sets you can buy.

\* Magnetic Suppression Core or Metallic Core where specified by OE

# PREMIUM IGNITION WIRE SETS

## 5000 SERIES NORMAL TEMPERATURE\*



## 6000 SERIES HIGH TEMPERATURE\*



## 7000 SERIES\* 9000 SERIES\* HIGH TEMPERATURE



## CERAMIC BOOT SERIES SEVERE TEMPERATURE\*



**STANDARD** WIRE SETS PROVIDE THE PERFECT FIT WITH THE HIGHEST PERFORMANCE DEMANDED BY SERVICE PROFESSIONALS!



### CUSTOM FIT – FOR TOP PERFORMANCE

Proper fit is a high priority for premium quality ignition wires. “Proper fit” means the fit of the replacement wire set closely follows the fit of the original wires, in length, as well as terminal and boot configuration (straight, 135° or 90°). The closer the fit matches, the easier it is to follow the routing pattern specified by OE.

This is important because:

- The OE routing pattern minimizes “crossfire” (the tendency of an improperly routed plug wire to induce voltage into an adjacent wire.) Crossfire can cause a second spark plug to fire at the incorrect time, resulting in engine backfire.

In computerized vehicles, an improperly routed plug wire can induce voltage in sensor leads, which are designed to carry less than 1 volt. The induced voltage can generate incorrect sensor signals, or even short out a sensor or damage the computer itself.

- Proper fit ensures that you won’t have to stretch wires or leave too much slack. Excessively long wires can contact hot or moving engine parts such as exhaust manifolds or fan blades. Correct wire length eliminates extra stress on the boot and terminal, and ensures a reliable connection. It also eliminates sharp bends in the wire, which can cause higher resistance and result in premature wire failure.

**To be sure your wires always fit, always specify Standard Premium Ignition Wires!**

\* For a complete listing of all wire set applications, refer to our most current Engine Management Application Guide, or visit our website [www.StandardBrand.com](http://www.StandardBrand.com).

### METALLIC CORE

Part No.	Application*	Ceramic Boot Set Wire Lengths								Coil
		1	2	3	4	5	6	7	8	
9947	GM Med. & H.D. Trk.	28	32	32	32	36	36	36	44	12
9952	GM Lt. Trk.	24	26	28	28	32	36	36	40	12
9961	GM Trk.	18.5	20.5	22.5	28.5	28.5	30.5	30.5	34.5	12.5
9965	GM Med. & H.D. Trk.	26	28	28	28	28	32	38	41	
9984	GM Med. & H.D. Trk.	24	28	32	32	36	40	40	52	

# TRUCK & MOTORCYCLE WIRE SETS



## TRUCK WIRE SETS

- Premium Inner Silicone Boot for Maximum Thermal Protection
- Ceramic Spark Plug Sleeve Resists 1750°F for Durability in Extreme Conditions
- High Temperature Silicone Insulation and Jacket
- Woven Fiberglass Braid for Increased Cable Strength
- Extra Thick Silicone Core for Long Lasting Performance
- 8.5mm Magnetic Suppression Winding for Reduced RFI

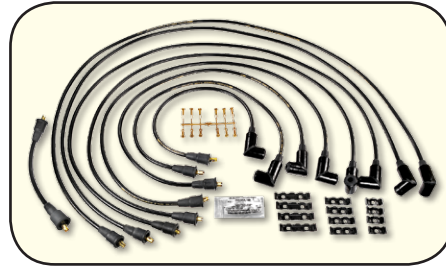

Part No.	Description	Part No.	Description
69401	Ford Light Truck 4.9 Eng 96-76	69419	Ford Light Truck 2.8, 2.9, 3.0 Eng 95-83
69402	Chevrolet and GMC Truck Light Truck 5.0, 5.7 Eng 95-87	69420	Chevrolet and GMC Truck Light Truck, Ford Light Truck, Chrysler, Dodge Light Truck, most engines
69403	Ford Light Truck 5.0, 5.8, 7.5 Eng 97-84	69421	Chevrolet and GMC Truck Light Truck 4.1, 4.6, 4.8, 5.4, 5.7, 6.7 Eng 89-61
69404	Ford Light Truck 5.0, 5.8, 6.6, 7.5 Eng 93-77	69422	Chevrolet Light Truck, Dodge Light Truck 6.0, 6.5, 6.6, 7.4 Eng, 5.9L Eng., 5.0, 5.8, 6.6 Eng. 74-66, 60-55
69405	Chevrolet and GMC Truck Light Truck 6.6, 7.4 Eng 97-77	69423	Ford Light Truck 5.0, 5.8 Eng 97 - 80
69406	Chevrolet and GMC Truck Light Truck 4.3, 7.4 Eng 97-86	69424	Chevrolet and GMC Truck Light Truck, Ford Light Truck 7.4 Eng, 5.0, 5.8 Eng. 76-75
69407	Dodge Light truck, Ford Light Truck 5.2, 5.9 Eng, 5.8, 5.9, 6.4, 7.5 Eng 78-70	69425	Chevrolet and GMC Truck Light Truck, Cadillac, Isuzu 4.3, 5.0, 5.7, 7.4 Eng 07-96
69408	Chevrolet and GMC Truck Light Truck 5.0, 5.7, 6.6 Eng 88-75	69426	Chevrolet and GMC Truck Light Truck, Cadillac, Isuzu 5.0, 5.7 Eng 02-96
69409	Ford Light Truck 2.3, 4.0 Eng 88-75	69427	Dodge Light Truck 6.6, 7.2 Eng 79-71
69410	Chevrolet and GMC Truck Light Truck 5.0, 5.7 Eng 86-81	69428	Dodge Light Truck 5.2, 5.9 Eng 03 - 98
69411	Chevrolet and GMC Truck Light Truck, Ford Light Truck 2.8, 3.1 Eng, 3.0 Eng. 95-82	69429	Dodge Light truck, Plymouth, Chrysler 3.3, 3.8 Eng 00-96
69412	Chevrolet and GMC Truck Light Truck, Ford Light Truck 4.6, 5.0, 5.4, 5.7, 6.7 Eng 74-61	69430	Chevrolet and GMC Truck Light Truck, Cadillac 4.8, 5.3, 6.0, 7.4 Eng 07-98
69414	Chevrolet and GMC Truck Light Truck, Ford Light Truck 5.0, 5.7, 6.6 Eng 96-75	69501	Single Lead Straight Boot Universal
69415	Toyota Trucks 2.4 Eng 92-80	69502	Single Lead 90° Boot Universal
69416	Dodge Light truck 5.2, 5.9 Eng 91-79		
69417	Dodge Light truck 3.9, 5.2, 5.9 Eng 98-92		
69418	Chevrolet and GMC Truck Light Truck, Ford Light Truck 7.4 Eng 89-85		

## MOTORCYCLE WIRE SETS



Part No.	Application	OEM No.
MC1105	84-80 FLH, 99-85 Softail, and 98-91 FXD	32093-98
MC1106	96-85 Evolution 1340 FLT, FLHT, FLHR, and 93-82 FLHS	32091-98
MC1107	99-82 FXR	32090-98
MC1108	02-86 XL, except XL1200S	32092-98
MC1109	98-97 FLHT, FLHCT, FLHTCU, FLHR	32094-98
MC1110	02-99 Touring, FLHT, FLT	31932-99
MC1111	99-up Dyna	31930-99
MC1112	98-up 4 plug XL1200S	32054-98
MC1113	00-up Softail	32358-00A
MC1115	06-04 XL	31958-04A
MC1116	07-up XL	31901-08
MC1117	09-up Touring	32325-08

### Universal Fit

STANDARD® Universal Kits come complete with easy to install brass locking terminals and easy to follow instructions.

Part No.	Application	OEM No.
MC1104	Universal application except 98-up XL1200S and 99-up Twin Cam.	32095-98
MC1114	Universal 4 plug kit for dual coil or 4 cyl.	



### Copper Core

For older points-style applications we offer a 'Copper Core' wire for special improved electrical conductivity and mechanical strength.

These 'Copper Core', non-resistive sets should be used with only point-style ignitions. All of our ready to install top of the line wire sets are made in the USA.

Part No.	Application
MC1101	69-58 XL, XLCH with Magneto
MC1102	78-71 XLH, XLCH
MC1103	78-65 FL, FLH, 78-71 FX, FXE



# UNIVERSAL WIRE SETS

## 3000 SERIES UNIVERSAL WIRE SETS

### 3000 SERIES Conductive Silicone or Metallic Core

Wires in each 3000-series set have one end fitted with a bendable terminal and a flexible silicone boot that can serve for straight, 90° and 135° applications.

Wires are extra long and are un-terminated at the distributor end. Each wire set includes two full sets of distributor boots: one straight and one for 90° distributor ends. Both ends of the coil wire are un-terminated, with all parts supplied for either straight or 90° termination at either end.

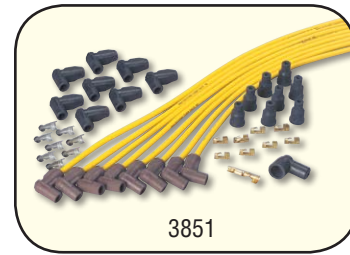

3851

### UNIVERSAL WIRES

Metallic Core wires are not static suppressing. These 3000 Series universal wire sets are 7mm and 8mm silicone and designed specifically for off-road and racing use.

Cyl.	Conductive Silicone Core			Metallic Core			Wire Length (Inches)								
	7mm CPE Jacket	7mm Silicone	8mm Silicone	7mm CPE Jacket	High Performance 7mm Silicone	8mm Silicone	1	2	3	4	5	6	7	8	Coil
4	3400	3401		3402	3403		37	37	37	37					35
6	3600	3601		3602	3603		33	33	40	40	46	46			30
8	3800	3801		3802	3803		35	35	40	45	50	55	60	60	18
8			3840†			3850†	35	35	37	39	39	51	55	55	20
8						3851†	35	35	37	39	39	51	55	55	20

† 3840 and 3850 have straight spark plug boots; 3851 has 90° spark plug boots. Straight and 90° distributor boots are furnished.

## OTHER UNIVERSAL WIRE SETS

### 8000 SERIES Silicone Core

Each wire is factory terminated at the plug end only. Distributor terminals and boots are furnished. Special "TWIN TERMER" sets (Part Nos. 8613 and 8840) come with straight plug boots at one end and 90° boots at the other end. Remove unwanted end and trim to size; then assemble distributor terminal and boot to cut end.

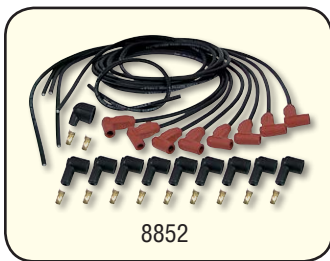

8852

### CONDUCTIVE SILICONE CORE

Cyl.	7mm CPE Jacket	Boot Config.	1	2	3	4	5	6	7	8	Coil
6	8613		31	31	36	41	46	46			30
8	8840	Str./90°	33	35	37	41	48	48	56	56	18
	8852		28	30	33	37	45	50	50	56	16

### "W" SERIES 7mm Metallic Core

Each wire is factory terminated at the spark plug end; user cuts and terminates the distributor end with parts supplied. Fabricated from metallic core wire having a special rubber compound insulation with a black outer jacket. Features tightly fitted, molded spark plug boots for a waterproof, oil-proof and flash-proof connection.

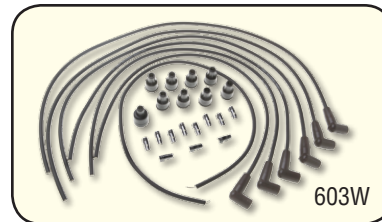

603W

### METALLIC CORE

Cyl.	7mm CPE Jacket	Boot Config.	1	2	3	4	5	6	7	8	Coil
4	403W	Str.	25	30	30	33					13
6	603W	90°	23	25	25	28	30	30			28
	605W	Str.	13	16	19	37	40	40			13
	608W	Str.	13	13	16	19	25	28			20
8	801W	90°	30	33	37	37	45	48	48	48	16
	804W	Str.	30	30	33	37	37	37	42	45	18
	806W	Str.	28	28	28	30	30	30	33	33	16
	809W	90°	30	33	40	40	45	54	54	54	16

To assure reliable and quality terminations, use the right tools and materials. (Refer to pages A22 through A24)



# Any product in the catalog

# — OVERNIGHT!\*

# STANDARD'S "OVERNIGHT" PROGRAM

Never be out of stock. If it's in the catalog, it's in your hands the next day. Just phone, fax, or Direct Connect\*\* your order to one of our Distribution Centers by 2 PM their time, and have guaranteed next-day delivery\*.

No need to tie up dollars in slow-moving inventory. With our Overnight Delivery program, anything you need is just a phone call away. Call or fax your Distribution Center for immediate service. If you are a jobber, have your warehouse distributor place your order.

## Disputanta, Virginia

2 PM Eastern Time  
Phone: (804) 862-1500  
Fax: (804) 862-9200

## Edwardsville, Kansas

2 PM Central Time  
Phone: (913) 441-6500  
Fax: (913) 441-0531

## Four Seasons

Lewisville, Texas  
2 PM Central Time  
Phone: (972) 316-8100  
Fax: (972) 316-8211



\* This program is not available in Canada.

\*\* For information about Direct Connect, call (718) 392-0200, ext. 4237

**STANDARD**<sup>®</sup>  
Engine Performance Specialists

[www.standardbrand.com](http://www.standardbrand.com)













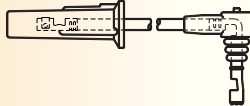

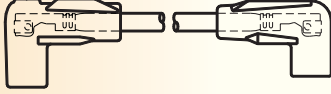

# INDIVIDUAL IGNITION WIRES

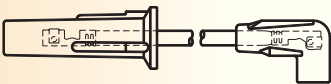

- **PREMIUM QUALITY**
- **COST EFFECTIVE**
- **READY-TO-USE CONVENIENCE**

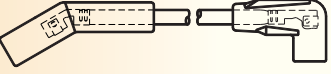
- **Factory-Terminated at Both Ends**
- **Broad Coverage; Minimum Stock Investment**
- **All Wires Have Conductive Silicone With Aramid Center**
- **All Spark Plug Boots Are Silicone**
- **All Leads Are Made With Silicone Jackets**

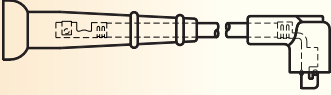
## PLUG WIRES – 7MM

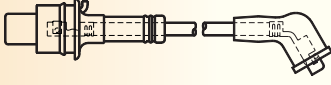
Part No.	Length	Part No.	Length	Plug End	Dist. End	Illustration
712AF	12"	716AF	16"			
712AK	12"	728AK	28"	* 		
716AK	16"	732AK	32"			
724AK	24"	736AK	36"			
712AL	12"	736AL	36"	* 		
716AL	16"	744AL	44"			
720AL	20"	748AL	48"			
724AL	24"	752AL	52"			
728AL	28"	756AL	56"			
732AL	32"					
718BK	18"	728BK	28"	* 		
724BK	24"	732BK	32"			
		736BK	36"			
725BL	25"	740BL	40"			
736BL	36"					
719CH	19"	728CH	28"			
727CK	27"	741CK	41"			

\* High Temperature Silicone Spark Plug Boots

# INDIVIDUAL IGNITION WIRES



**ALL WIRES HAVE CONDUCTIVE SILICONE CORE WITH ARAMID CENTER**









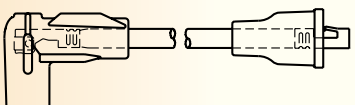

## PLUG WIRES – 7MM

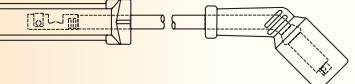

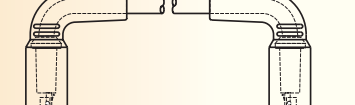

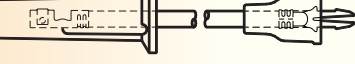
Part No.	Length	Part No.	Length	Plug End	Dist. End	Illustration
717CL	17"	724CL	24"			
710CS 716CS	10" 16"	734CS	34"			
712CT 719CT 726CT	12" 19" 26"	734CT	34"			
727CW	27"	Universal not terminated on either end Straight Resistor Distributor Boot				
737CW	37"	Universal not terminated on spark plug boot end 90° Non Resistor Distributor Boot				
745CW	45"	90° Non Resistor Distributor Boot				
741J	41"					
718JB 722JB 728JB	18" 22" 28"					
712K 716K 722K	12" 16" 22"	726K 731K 735K	26" 31" 35"			
718L 723L	18" 23"	727L 734L	27" 34"			

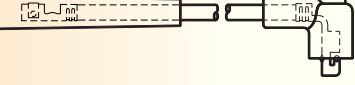
IGNITION WIRES

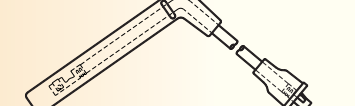
# INDIVIDUAL IGNITION WIRES

## ALL SPARK PLUG BOOTS ARE SILICONE

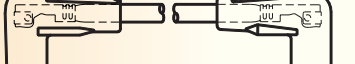
PLUG WIRES – 7MM						
Part No.	Length	Part No.	Length	Plug End	Dist. End	Illustration
722M 726M 732M	22" 26" 32"	741M 749M	41" 49"			
708NS 711NS	8" 11"					
715NT	15"					
713T 717T	13" 17"	725T	25"			
712XA 716XA 722XA	12" 16" 22"	726XA 731XA 735XA	26" 31" 35"			
707XD 716XD	7" 16"	722XD 727XD	22" 27"			

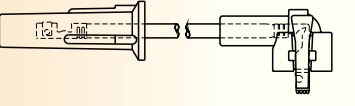









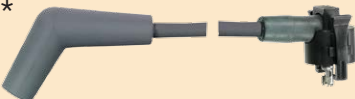

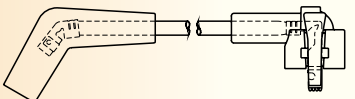

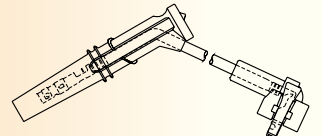

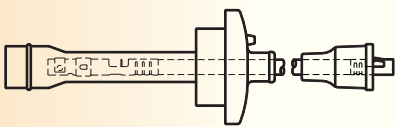
PLUG WIRES – 8MM						
Part No.	Length	Part No.	Length	Plug End	Dist. End	Illustration
818AH 828AH 832AH	18" 28" 32"	836AH 840AH 848AH	36" 40" 48"			
812AK † 818AK 824AK 828AK 832AK	12" 18" 24" 28" 32"	838AK 844AK 848AK 855AK	38" 44" 48" 55"			
† Coil Wire EDPM Boot						
813FT 817FT 825FT 831FT	13" 17" 25" 31"					

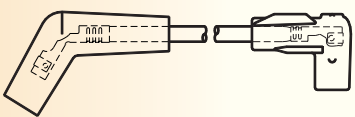
\* High Temperature silicone spark plug boots

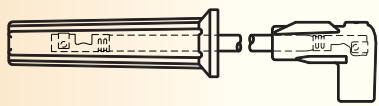
# INDIVIDUAL IGNITION WIRES

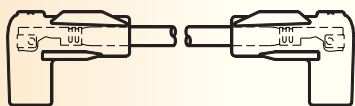

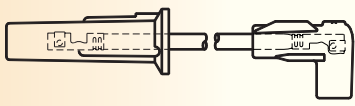
**ALL LEADS ARE MADE WITH SILICONE JACKETS**

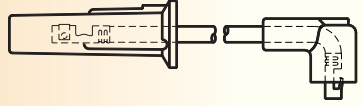









PLUG WIRES – 8MM				Plug End	Dist. End	Illustration
Part No.	Length	Part No.	Length			
814FW 818FW 824FW	14" 18" 24"	830FW 835FW 845FW	30" 35" 45"	* 		
820GT 824GT 828GT 834GT	20" 24" 28" 34"	840GT 848GT 856GT	40" 48" 56"			
818N	18"	829N	29"			
814P 818P 822P 826P	14" 18" 22" 26"	832P 836P 840P 845P	32" 36" 40" 45"	* 		
818Q 822Q 828Q	18" 22" 28"	832Q 840Q	32" 40"	* 		
818R 822R 828R 832R	18" 22" 28" 32"	838R 844R 848R 855R	38" 44" 48" 55"	* 		
812X 816X 820X 822X 824X 826X	12" 16" 20" 22" 24" 26"	828X 832X 836X 840X 845X	28" 32" 36" 40" 45"	* 		
813XC 818XC 821XC	13" 18" 21"	827XC 834XC	27" 34"	* 		

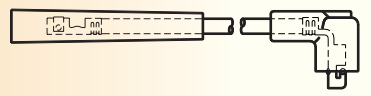

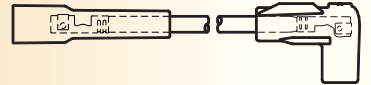

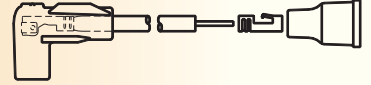

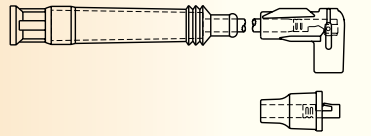

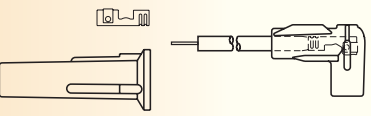

\* High Temperature silicone spark plug boots

IGNITION WIRES

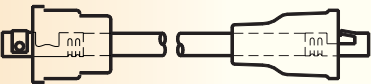
# INDIVIDUAL IGNITION WIRES

## FACTORY TERMINATED AT BOTH ENDS

PLUG WIRES – UNIVERSAL						
Part No.	Length	Part No.	Length	Plug End	Dist. End	Illustration
716U 720U 724U 730U	16" 20" 24" 30"	734U 738U 744U 750U	34" 38" 44" 50"	7mm 		
724US 736US*	24" 36"	760US*	60"	7mm * 		
* Includes straight terminal and distributor boot						
716UW 725UW 736UW	16" 25" 36"	743UW* 754UW	43" 54"	7mm * 		
* Bendable terminal with a straight spark plug boot						
760UX	60"			7mm 		
Ceramic Spark Plug Boot Metallic Core						
860UP	60"			8mm 		

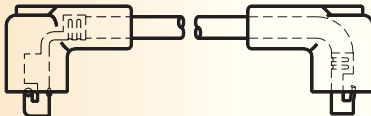
COIL WIRES – 7MM						
Part No.	Length	Part No.	Length	Coil End	Dist. End	Illustration
724CD 729CD	24" 29"	739CD	39"			
716CC	16"	725CC	25"			
711CE 717CE 720CE	11" 17" 20"	726CE 736CE	26" 36"			
713EE 718EE	13" 18"	724EE 727EE	24" 27"			

# COIL WIRES

## BROAD COVERAGE, MINIMUM STOCK INVESTMENT



### COIL WIRES – 7MM

Part No.	Length	Part No.	Length	Coil End	Dist. End	Illustration
712GG 718GG	12" 18"	722GG	22"			
719HA 725HA	19" 25"	742HA	42"			
718UC	18"	Universal				

### COIL WIRES – 8MM

Part No.	Length	Part No.	Length	Coil End	Dist. End	Illustration
812CA 814CA	12" 14"	817CA 827CA	17" 27"			
814CB 818CB	14" 18"	825CB	25"			
819DD	19"					
813HH	13"					

# WIRE ASSORTMENTS

## PREMIUM QUALITY INDIVIDUAL IGNITION WIRES!

### Unbeatable Custom Wire Coverage!

For Domestic & Import Cars, Light Trucks and Vans

### Great For Self Service Selling!

Included in each assortment:

1. 52 different part numbers.
2. "Do-It-Yourself" Application Guide.
3. Colorful, eye-catching header.
4. Adhesive-tags attached to each wire — for easy part number identification. Wire hangs from the rack by the boot.
5. Free display rack.

Part No.	Description	Std. Pkg.
700SLA-1	Large Domestic Asst.	1
701PLA-1	Small Domestic Asst.	1
705PLA	Import Asst.	1
700PLR-1*	Single Wire Rack	1

\* Includes free leads to offset cost of rack



### 700SLA-1 (LARGE) AND 701PLA-1 (SMALL) DOMESTIC ASSORTMENTS

Part No.	Quantity* Per Assortment		Part No.	Quantity* Per Assortment	
	700 SLA-1	701 PLA-1		700 SLA-1	701 PLA-1
711CE	1	1	818R	5	1
712K	5	2	820X	5	2
713T	5	2	822P	5	2
716K	5	2	822Q	2	1
717CE	2	1	822R	5	2
720CE	2	1	822X	5	2
722K	5	2	824X	5	2
722M	2	1	825CB	1	1
724CD	1	1	826P	5	2
725CC	1	1	826X	3	3
726CE	1	1	827CA	1	1
726K	5	2	828Q	5	2
726M	2	1	828R	5	1
729CD	1	1	828X	5	3
731K	5	3	832P	5	2
732M	5	2	832Q	3	2
735K	5	2	832R	4	2
741J	5	1	832X	5	2
741M	5	1	836P	2	1
749M	5	1	836X	3	2
812CA	2	1	838R	2	2
812X	5	1	840Q	4	2
814CA	2	1	840X	3	2
814CB	2	1	844R	3	2
816X	5	2	845X	3	1
817CA	1	1	848R	1	1

\* Total leads: 700SLA-1 = 180; 701PLA-1 = 82

### 705PLA (IMPORT) ASSORTMENT

Part No.	Quantity**	Part No.	Quantity**
707XD	1	725HA	1
711CE	2	726CE	2
712AF	2	726K	3
712GG	2	726XA	5
712K	4	727CK	2
712XA	5	727EE	1
713EE	2	727L	2
716AF	2	727XD	1
716K	5	728CH	2
716XA	4	731K	3
716XD	2	731XA	4
717CE	2	734L	1
717CL	1	735K	1
718EE	3	735XA	4
718GG	2	736CE	1
718L	2	741CK	2
719CH	2	742HA	1
719HA	1	813HH	1
720CE	2	813XC	2
722GG	2	818N	2
722K	5	818XC	2
722XA	5	819DD	2
722XD	1	821XC	1
723L	1	827XC	2
724CL	1	829N	2
724EE	2	834XC	2

\*\* Total leads = 115



# WIRE ASSORTMENTS



## PREMIUM QUALITY INDIVIDUAL IGNITION WIRES!

### Late Model Coverage

Fits newer Domestic Cars, Light Trucks, and Vans. Complements the large 700SLA-1 and small 701PLA-1 assortments.

### Included In Each Assortment!

1. 32 different part numbers.
2. Adhesive-tags attached to each wire — for easy part number identification. Wire hangs from the rack by the boot.
3. Free display rack.

### 702PLA-SINGLE LEAD ASSORTMENT

Part No.	Qty.	Part No.	Qty.
712CT	1	712AK	1
719CT	1	724BK	1
724AL	1	728AK	1
726CT	1	728BK	1
728AL	1	732AK	1
734CT	1	732BK	1
736AL	1	736AK	1
744AL	1	736BK	1
818FW	1	824AK	1
820GT	1	828AK	1
824FW	1	832AK	1
824GT	1	838AK	1
828GT	1	840GT	1
830FW	1	844AK	1
834GT	1	848GT	1
835FW	1	856GT	1

Total Leads = 32

### 702PLR Single Lead Rack\*

- 2 tiered 32 slot rack (rack only, no product)
- Complements full assortments by providing space for later model coverage.
- Economically provides coverage with minimal investment.
- Excellent for displaying coil wires or specific make/model coverage for fleets, etc.

\* Includes 5 free leads to offset cost of rack



702PLA

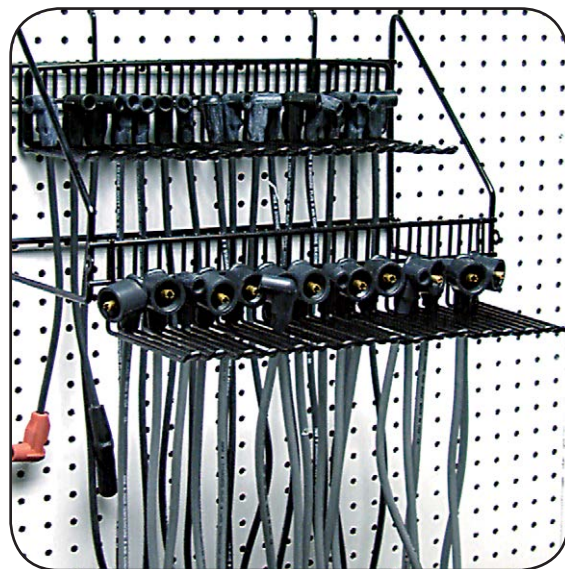

702PLR  
Bare rack only

IGNITION WIRES

# BOOTS & NIPPLES & RETAINERS

## COIL NIPPLES

Part No.	Description	Wire Diam.	Std. Pkg.
TN8E	Straight EPDM rubber	7mm	25
TN10	90° EPDM or Neoprene	7mm	10
TN17	Straight EPDM rubber (Universal application) Straight vinyl	7mm	10
TN19	Straight vinyl	7mm	25
TN20	Straight boots for ABITS coils, requires TN23 insulator, use w/ ST27 terminal	7mm	25
TN21	90° boots for ABITS coils, requires TN23 insulator, use w/ ST27 terminal	7mm	25
TN22	135° boots for ABITS coils, requires TN23 insulator, use w/ ST27 terminal	7mm	25
TN23	Insulator for ABITS coils, use with TN20, TN21, and TN22 boots and ST27 terminal	7mm	50
TN24	Aftermarket style coil boot for 1st generation Ford DIS systems, use with ST28 terminal	8mm	25
TN25	OE style coil boot for 1st generation Ford DIS systems, requires TN26 retainer clip, use with ST28 terminal	8mm	25
TN26	OE style retainer clip for 1st generation DIS systems, use with TN25 boot	8mm	25
TN27	Coil boot for 2nd generation Ford DIS systems, use with ST30 terminal	8mm	25
<b>NEW!</b> TN28	Ford DIS coil clip		25

### Instructions for Assembling ABITS Terminals and Boots

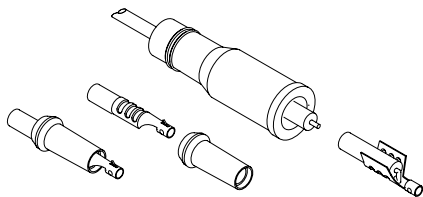

- Slide TN20, TN21, or TN22 boot over wire.
- Strip wire to reveal 1/2" of conductor.
- Fold conductor over and crimp ST27 terminal on wire.
- Slide TN23 insulator over ST27 terminal. Snap into place.
- Slide boot over terminal and insulator.

## HEAT SHIELDS

Part No.	Description	Std. Pkg.
SPP33	GM heat shield. Fits SPP22 or SPP32 boots	2
SPP34	GM heat shield. Fits SPP11 or SPP31 boots	2
SPP35	Spark plug boot insulating sleeve Universal size-fits most boots-even 90° Reflects and dissipates heat up to 1200°F Protects plug wire from extremely hot exhaust manifolds & headers Excellent for race cars, motor homes & RVs	2
SPP36	Fits GM 90° spark plug boots	2
SPP37	Fits Ford 135° spark plug boots	2

## SPECIAL SPARK PLUG BOOTS

Part No.	Description	Std. Pkg.
SPP7	For Buick 8 Cyl. to 1965, replaces 2965024	25
SPP8	For VW and Corvair	10
SPP20	Spark plug well seal, for VW and Corvair	25



# BOOTS & NIPPLES



SPP1

SPP2

SPP3

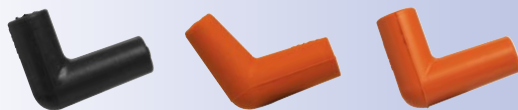

SPP4

SPP5

SPP6

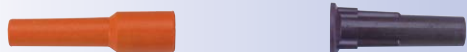

SPP10

SPP11 SPP31



SPP17

SPP15

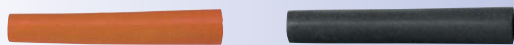

SPP19

SPP23

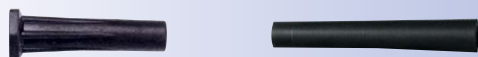

SPP22 SPP32

SPP24



SPP25

SPP29



SPP28

SPP38



SPP26  
SPP30

TN7

TN7E



TN9

TN9E

TN11



TN15

TN16

TN18

## STRAIGHT SPARK PLUG BOOTS

Part No.	Description	Std. Pkg.
SPP3	8mm silicone	10
SPP10	7mm silicone	50
SPP11	7mm and 8mm silicone	25
SPP15	7mm silicone	25
SPP19	7mm silicone. Chrysler type; can be used with ST119 terminals	25
SPP22	7 & 8 mm silicone for GM applications	10
SPP23	8mm silicone for Ford applications	10
SPP24	7mm Hypalon	25
SPP31	7 & 8 mm severe duty brown silicone	25
SPP32	7 & 8 mm severe duty brown silicone	10

## IMPORT SPARK PLUG BOOTS

Part No.	Description	Std. Pkg.
SPP25	7mm bakelite with internal resistor 1000 OHMS Resistor	4
SPP38	VW boot with metal heat shield 5000 OHMS Resistor	2

## ANGLED SPARK PLUG BOOTS

Part No.	Description	Std. Pkg.
SPP1	7mm silicone 90° Orange	10
SPP2	7mm silicone 90° Black	10
SPP4	8mm silicone 90° Black	10
SPP5	7mm silicone 110° Orange	10
SPP6	8mm silicone 90° Orange	10
SPP17	7mm silicone 90° ABITS Ignition	8
SPP26	8mm silicone - 135°	8
SPP28	8mm silicone 135° Ford DIS	8
SPP29	7 & 8 mm severe duty brown silicone - 90°	25
SPP30	8mm severe duty gray silicone - 135°	8

## DISTRIBUTOR BOOTS

Part No.	Description	Wire Dia.	Std. Pkg.
TN7	Straight vinyl	7mm	50
TN7E	Straight EPDM rubber	7mm	50
TN9	90° vinyl	7mm	10
TN9E	90° EPDM rubber	7mm	10
TN11	90° EPDM rubber	8mm	10
TN15	90° EPDM rubber (distributor coil)	8mm	10
TN16	90° EPDM rubber (AMC, Ford, GM applications)	7mm & 8mm	10
TN18	90° EPDM rubber (GM applications with short towers)	7mm	10

# COIL-ON-PLUG BOOTS

## COIL-ON-PLUG TECHNOLOGY

Coil-On-Plug (direct fire) technology is an important part of the new ignition systems.

Coil-On-Plug Boot multi-pack quantities are available for limited time. Sell out and re-order "E" suffix per each part numbers. "Per Car" engine kits are available for popular applications. See page A21 for complete listing of part numbers and applications.

**SPP27 – sell out**

**SPP27E – re-order**

### COIL-ON-PLUG BOOTS

Part No.	Std. Pkg.	Part No.	Std. Pkg.	Description
SPP27	4	SPP27E	1	GM quad 4 spark plug boot 2.4L, 2.3L, 02-88
SPP27HT	4	SPP27HTE	1	Heavy duty all rubber version of SPP27
SPP39	4	SPP39E	1	Ford Crown Victoria, Mustang & Ford Truck, 4.6L, 5.4L, 12-97
		SPP39L	50	Box of 50 SPP39
SPP39HT	4	SPP39HTE	1	High Temperature version of SPP39
SPP40	6	SPP40E	1	Olds Aurora, Intrigue 3.5H 02-99
SPP41	8	SPP41E	1	Olds Aurora, Cadillac 4.0C 03-00
SPP42	2	SPP42E	1	Mazda 1.6L Protégé 03-99
SPP43	4			Heavy duty all rubber version of SPP27
SPP44	2	SPP44E	1	Chrysler, Concorde, Dodge Intrepid 2.7 06-98
SPP45	6	SPP45E	1	JEEP Cherokee, Grand Cherokee 4.0S 06-00
SPP46	4	SPP46E	4	Ford Mustang, Lincoln Continental 4.6V 11-97
SPP47	4	SPP47E	1	Saturn 2.2L 07-00
SPP48	2	SPP48E	1	Mazda 2.0 Protégé 03-95
SPP49	3	SPP49E	1	Lexus GS, SC 300 05-98, IS300 05-01
SPP50	2	SPP50E	1	Nissan 350Z, Infiniti G35, 3.5 06-03
SPP51	2	SPP51E	1	Nissan Pathfinder, Altima, Maxima 07-01, Infiniti 03-00
SPP52	2	SPP52E	1	Mazda Miata 1.8L 05-01
SPP53	2	SPP53E	1	Infiniti J30 3.0L 94-93
SPP54	2	SPP54E	1	Infiniti J30 3.0L 97-94
SPP55	2	SPP55E	1	Mitsubishi Galant, Mirage, Eclipse, Outlander 05-97
SPP56	2	SPP56E	1	Audi A4, S4, A6 Quattro 02-98
SPP57	2	SPP57E	1	Audi 8 cyl. A8 Quattro 98-95
SPP58	2	SPP58E	1	Audi 5 cyl. A6, S6 Quattro 98-95
SPP59	4	SPP59E	1	Dodge Ram Pickup (Hemi) 8 cyl. 5.7L 05-03
SPP60	1	SPP60E	1	Isuzu Axiom, Amigo, Rodeo, Trooper 6 cyl. 3.5X Short Type 04-00, Honda Passport 3.2L 02-00
SPP61	1	SPP61E	1	Isuzu Amigo, Rodeo, Trooper 6 cyl. 3.5X Long Type 03-00, Honda Passport 02-00
SPP62	2	SPP62E	1	Nissan 4 cyl. 2.5 Altima 09-02
SPP63	2	SPP63E	1	Hyundai Sonata 2.4L & Santa Fe 2.4L, 06-99
SPP64	2	SPP64E	1	Ford V6 Sable ME, Taurus E, 3.0L 24V 08-00
SPP65	2	SPP65E	1	GMC 6 cyl. 4.2X S10, S15 Series, Olds 6 cyl. 4.2X Bravada, GM 4 cyl. 2.8-8 ST1, 5 cyl. 3.5-6 ST1 05-02
SPP66	4	SPP66E	1	Ford V8 3.9L DOHC Thunderbird, Lincoln 05-02
SPP67	2	SPP67E	1	BMW V6 2.5L M50; BMW V8 3.0L; BMW V8 4.0L M60 96-90
SPP68	2	SPP68E	1	Lincoln LS 3.0L V6 DOHC 24V 05-00
SPP69	2	SPP69E	1	BMW L6, V8 300 Series, 500 Series, 740i, 840 ci, X5, M3, Z3 04-96
SPP70	2	SPP70E	1	Porsche 911 Turbo, Carrera, GT2, GT#, 3.6L 08-01
SPP71	2	SPP71E	1	Porsche Boxter 2.5L, 2.7L, 3.2L, 911 Carrera 3.4L 04-97
SPP72	3	SPP72E	1	Land Rover Freelander 2.5L DOHC 05-02

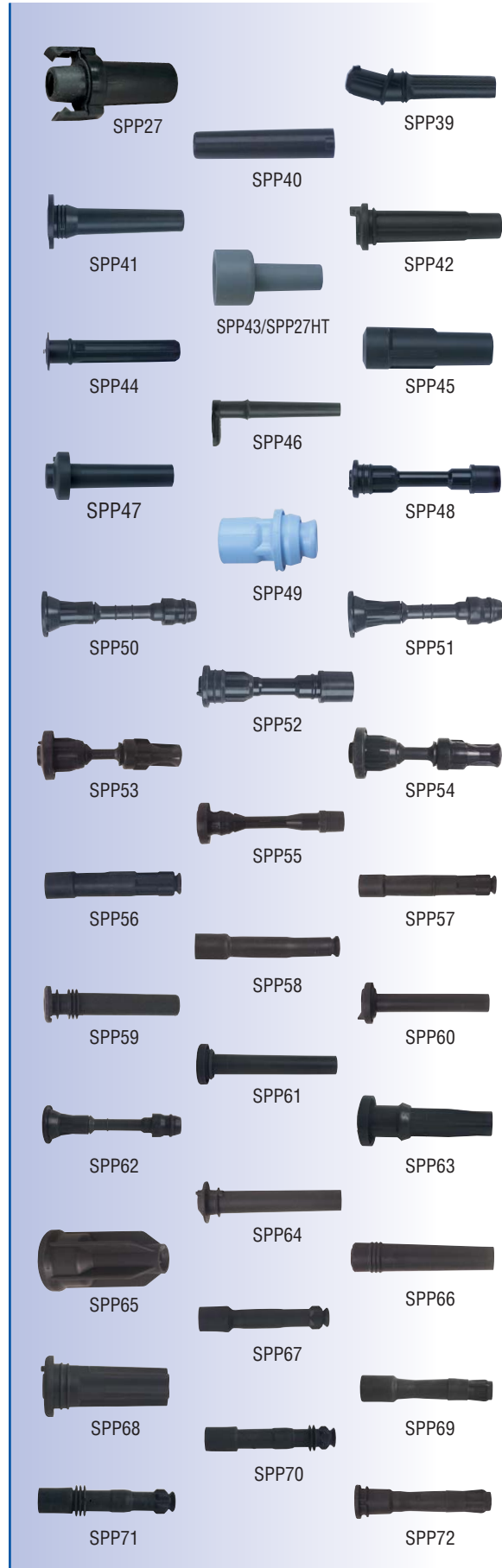

# COIL-ON-PLUG BOOTS



COIL-ON-PLUG BOOTS				
Part No.	Std. Pkg.	Part No.	Std. Pkg.	Description
SPP73	2	SPP73E	1	Mitsubishi Lancer Evolution 2.0L, Turbo 06-03
SPP74	1	SPP74E	1	Mercedes Benz C230 L4 2.3L 97, L6 C36 3.6L 97-95, L6C280 2.8L 97-04, L6 E300 2.8L 93, L6E 320 3.2L 97-94, L6 S320 3.2L 99-94, L6 SL320 3.2L 97-94
SPP75	3	SPP75E	1	Toyota Avalon, Camry, Sienna, Solara 3.0L; Lexus ES300 1MZFE 01-96
SPP76	1	SPP76E	1	Infiniti I35, Nissan Maxima 6 cyl. - right bank cyl. 02-95
SPP77	1	SPP77E	1	Infiniti I30, Nissan Maxima 6 cyl. - left bank cyl. 99-94
SPP78	1	SPP78E	1	Infiniti I30, Nissan Maxima 6 cyl. - left bank cyl. 01-99
SPP79	3	SPP79E	1	Toyota 5VZFE 3.4L eng. 4-Runner, T100, Tacoma, Tundra 02-95
SPP80	2	SPP80E	1	Toyota 5EFE eng. 1.5L Paseo, Tercel 99-95
SPP81	2	SPP81E	1	Mercedes Benz SLK230 04-01
SPP82	2	SPP82E	1	Mercedes Benz S420 4.2L 8 cyl. 99-97
SPP83	2	SPP83E	1	Toyota Avalon 97-95, Camry 97-94 3.0L 1MZFE
SPP84	1	SPP84E	1	Nissan VQ35DE Eng. Pathfinder 01 cyl. 2-6
SPP85	1	SPP85E	1	Nissan VQ35DE Eng. Pathfinder 01 cyl. 1
SPP86	3	SPP86E	1	Hyundai XG350 3.5L 05-02, Kia Sedona 3.5L 05-02
SPP87	4	SPP87E	1	Ford Mustang, F series Pick Up V10 6.8L & V8 5.4L 08-05
SPP88	2	SPP88E	1	Ford Escape 2.3L 08-05, Escape Hybrid 2.3L 08-05, Mazda Tribute 2.3L 08-05, Mazda 3 2.3L, 2.0L 05-04
SPP89	2	SPP89E	1	Kia Sephia, Spectra 1.8L 04-00
SPP90	4	SPP90E	1	Ford Distributorless Coil Boot 4.6L, 5.4L eng. 02-97 - High Temperature
SPP91	2	SPP91E	1	Chevrolet Tracker, Suzuki Vitara 2.0L, 2.3L, 2.5L 06-00
SPP92	2	SPP92E	1	Suzuki L4 Esteem 1.6L, 00, cyl. 1 & 4 only
SPP93	2	SPP93E	1	Suzuki L6 Verona 2.5L 06-04
SPP94	2	SPP94E	1	Mercedes - Benz 4 cyl. C230 1.8L 05-03
SPP95	2	SPP95E	1	Kia sportage 2.0L 3FE 02-95
SPP96	2	SPP96E	1	Nissan Sentra QG18DE 1.8L 06-02
SPP97	2	SPP97E	1	Mercedes Benz C, CLK, SLK, E Series 3.0L, 3.5L, Dodge Sprinter 3.5L 07-06
SPP98	3	SPP98E	1	Nissan Maxima 3.0L VE30DE left bank 94-92
SPP99	2	SPP99E	1	Nissan Pulsa NX 1.8L, 1.6L CA18D & CA16D 89-87
SPP100	3	SPP100E	1	Nissan Maxima 3.0L VE30DE right bank 94-92
SPP101	1	SPP101E	1	Volvo V70 2.3L, 2.4L Turbo, S60, S70 2.3L, 2.4L, 2.5L 5 cyl., S80 6 cyl. 09-99
SPP102	1	SPP102E	1	Volvo 2.3L. 2.4L. 2.5L 09-04
SPP103	8	SPP103E	1	Chrysler Aspen 5.7L V8 Vin 2 Hemi 08-06
SPP104	1	SPP104E	1	Mitsubishi Lancer, Evolution Turbo 2.0L, 8/05-11/06
SPP105	1	SPP105E	1	Mitsubishi Endeavor, Galant 3.8L 07-04
SPP106	1	SPP106E	1	Ford Fusion 2.3L, Mazda 3, 6, Miata, CX-7, 08-07
SPP107	1	SPP107E	1	Ford Fusion 3.0L, Ford Escape 3.0L, Lincoln Zephyr 3.0L 07-06
SPP108	1	SPP108E	1	Jaguar XJ6 4.0L 97-95, XJS 4.0L 96-94
SPP109	1	SPP109E	1	Jaguar XJ8, Vanden Plas 4.0L 03-00, XJR 100 4.0L 02, XK8, XKR 02-00
SPP110	1	SPP110E	1	Mitsubishi Montero 3.8L 06-03

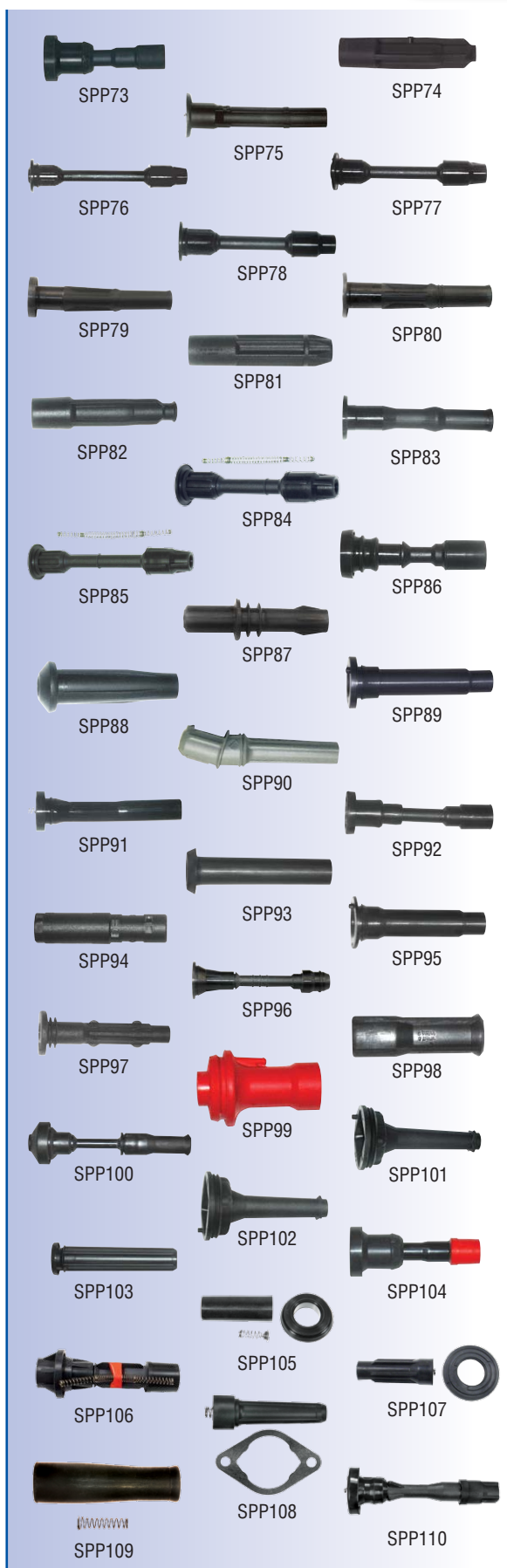

IGNITION WIRES

# COIL-ON-PLUG BOOTS

## COIL-ON-PLUG BOOTS

Part No.	Std. Pkg.	Description
<b>NEW!</b> SPP111E	1	Honda FIT L4 1.5 08-07
<b>NEW!</b> SPP112E	1	Porsche Cayenne 4.5L 06-03
<b>NEW!</b> SPP113E	1	Ford Explorer, Mustang 4.6L, F150 Truck 4.6L, 6.8L, Mercury Mountaineer 4.6L, Lincoln Navigator 5.4L 10-08
<b>NEW!</b> SPP114E	1	Ford Escape 3.0L V6 24V 06-05, Mazda MPV & Mazda 6 08-02
<b>NEW!</b> SPP115E	1	Lexus 1MZFE ES300 01-95, Toyota V6 3.0L, Avalon 99-96, Camry 01-96, Sienna 00-98
<b>NEW!</b> SPP116E	1	Chevrolet Cobalt, Saturn Ion L4 2.0L 07-04
<b>NEW!</b> SPP117E	1	Chevrolet Colorado 2.9L, 3.7L 10-07, Chevrolet Trailblazer, GMC Envoy 4.2L 09-06
<b>NEW!</b> SPP118E	1	Subaru Tribeca 3.6L 09-08, Outback 3.0L 09-01, Legacy 3.0L 09-08
<b>NEW!</b> SPP119E	1	Cadillac CTS 3.2L 04-03, Catera 01-99, Saturn L, LS, Vue 3.0L 05-00
<b>NEW!</b> SPP120E	1	Chevrolet Cobalt, HHR, Pontiac G5, G6, Solstice, Saturn Aura, Vue, Sky 2.0L, 2.2L, 2.4L 09-06
<b>NEW!</b> SPP121E	1	Subaru Legacy 2.5L H4 10-05
<b>NEW!</b> SPP122E	1	Mazda 5 2.3L 07-06
<b>NEW!</b> SPP123E	1	Lexus GS400, LS400, SC400 4.0L 00-98
<b>NEW!</b> SPP124E	1	Dodge Magnum, Charger, Avenger, Chrysler Sebring, 300 2.7L, 3.5L, 10-06; Chrysler Town & Country, Pacifica, Dodge Grand Caravan 4.0L 10-08; Volkswagen Routan 4.0L 10-09
<b>NEW!</b> SPP125E	1	Suzuki Grand Vitara V6 2.7L 08-06, SX-4 L4 2.0L 09-07
<b>NEW!</b> SPP127E	1	Suzuki Grand Vitara 2.4L 11-09, SX4 2.0L 11-10
<b>NEW!</b> SPP128E	1	Mazda 5 2.3L 10-08
<b>NEW!</b> SPP129E	1	Mercedes Benz SL600, CL600, S600 V12 02-96
<b>NEW!</b> SPP130E	1	Nissan Sentra 2.0L DOHC MR20DE 10-07
<b>NEW!</b> SPP131E	1	Subaru Impreza 2.0L 05-03
<b>NEW!</b> SPP132E	1	Nissan Versa 1.6L (HR16DE) 11-09; Nissan Cube, Versa 1.8L (MR18DE) 11-07; Nissan Sentra 2.0L (MR20DE) 11-09, Nissan Altima, Rogue, Sentra 2.5L (QR25DE) 11-07; Infiniti FX50 5.0L, M56 5.6L 12-09
<b>NEW!</b> SPP133E	1	Nissan Platina L4 1.6L, Renault Clio L4 1.6L, 2.0L 11-98
<b>NEW!</b> SPP134E	1	Infiniti Q45 4.5L 93-90 (to 2/93)
<b>NEW!</b> SPP135E	1	Hyundai Santa Fe, Kia Optima 2.7L 09-07
<b>NEW!</b> SPP136E	1	Chrysler Aspen, Dodge Dakota, Dodge Ramcharger Pickup, Jeep Commander, Cherokee 4.7L 10-07
<b>NEW!</b> SPP137E	1	Lexus ES350, IS350, RX350 08-07, Toyota Avalon, Camry, Highlander, RAV4, Sienna 3.5L 08-05
<b>NEW!</b> SPP138E	1	Dodge Dakota, Durango, Nitro, Ram 1500, Raider, Jeep Grand Cherokee, Commander Liberty 3.7L V6 11-09
<b>NEW!</b> SPP139E	1	Ford F250, 350 Super Duty Pickups 6.2-6 V8 12-11, F150 11-10
<b>NEW!</b> SPP140E	1	Lexus GS350, GS450H, IS350 3.5L, IS250 2.5L, LS460 4.6L, LS600H 5.0L, LX570 5.7L, 09; Toyota Land Cruiser, Sequoia, Tundra 5.7L 09-07
<b>NEW!</b> SPP141E	1	Ford Edge, Flex, Taurus; Lincoln MKS, MKX, MKZ; Mercury Sable V6 3.5L, 3.7L 10-07
<b>NEW!</b> SPP142E	1	Buick LaCrosse, Cadillac CTS, Chevrolet Camaro, Malibu, Equinox, Traverse, GMC Acadia, Pontiac G6, G8, Torrent; V6 3.6L, 3.0L, 2.8L 11-07
<b>NEW!</b> SPP143E	1	Toyota Echo 1.5L 05-00, Prius 1.5L 09-01, Yaris 1.5L 09-07, Scion XA, XB 1.5L 06-03



# COIL-ON-PLUG BOOTS & PER CAR ENGINE KITS



## COIL-ON-PLUG BOOTS

Part No.	Std. Pkg.	Description
<b>NEW!</b> SPP144E	1	Toyota Camry, Highlander, RAV4, Corolla, Matrix, Solara 2.4L 09-01; Toyota RAV4 2.0L 08-01; Scion TC 2.4L 09-05 (2AZFE) w/ 3-7/8" coil stem
<b>NEW!</b> SPP145E	1	Toyota Corolla, Matrix, Celica, MR2 Spyder, L4 1.8L 08-00; Pontiac Vibe 09-03, Chevrolet Prizm 02-00
<b>NEW!</b> SPP146E	1	Toyota Avalon, Camry, Highlander, Sienna, V6 3.0L 06-01, Lexus RX, ES300 3.0L 03-99
<b>NEW!</b> SPP148E	1	Toyota 4 Runner, Land Cruiser, Sequoia, Tundra V8 4.3L, 4.7L 09-04; Lexus SC, GS, LS430 4.3L, 4.7L 09-04
<b>NEW!</b> SPP149E	1	Toyota 4 Runner, Land Cruiser, Sequoia, Tundra V8 4.3L, 4.7L 05-98; Lexus LX470, LS, SC, GS430 4.3L, 4.7L 05-98
<b>NEW!</b> SPP150E	1	Toyota Tacoma L4, 2.4L, 2.7L 04-00
<b>NEW!</b> SPP151E	1	Toyota 4 Runner, FJ Cruiser, Tacoma, Tundra 4.0L V6 (1GRFE) 11-03; Toyota Camry, Corolla, Matrix, Solara 2.4L 10-06; Toyota Tacoma 2.7L 11-05; Lexus IS F 5.0L V8 (2URGSE) 09-08; Scion XB 2.4L (2AZFE) 09-04 w/ 4-1/4" coil stem

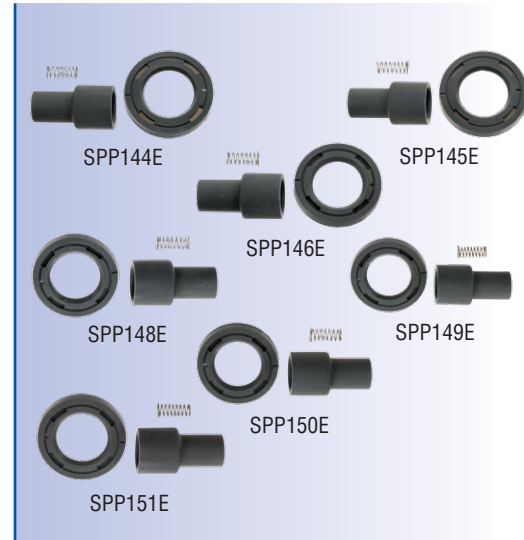

IGNITION WIRES

## PER CAR ENGINE KITS

- Application specific by engine
- Full set of boots for complete tune-up
- Sold as standard package of 1

Std. Part No.	Pkg.	Description	No. of Boots Included
<b>NEW!</b> CPBK100	1	GM Quad 4 Spark Plug Boot 2.4L, 2.3L 02-88	4
<b>NEW!</b> CPBK105	1	Quad 4 Boot heavy duty version of SPP27	4
<b>NEW!</b> CPBK110	1	Chevrolet Tracker, Suzuki Vitara 1.6L, 2.0L, 2.3L, 2.5L 06-99	4
<b>NEW!</b> CPBK120	1	Chevy Colorado 4 cyl. 2.8l, 5 cyl. 3.5L 06-04, Chevy Trailblazer, GMC Canyon, Envoy, Olds Bravada 6 cyl. 4.2X 06-02	6
<b>NEW!</b> CPBK130	1	Saturn 2.2L 07-00, Chevrolet Cavalier, Malibu, Cobalt, HHR 2.2L 06-00, Olds. Alero, Pontiac Sunfire, Grand Am, Pursuit 2.2L 06-02	4
<b>NEW!</b> CPBK140	1	Olds Aurora 4.0C, Cadillac 4.6 03-00	8
<b>NEW!</b> CPBK200	1	Ford Distributorless Coil Boot 4.6L, 5.4L, 6.8L 08-97	8
<b>NEW!</b> CPBK205	1	Ford Distributorless Coil Boot 4.6L, 5.4L Engines 07-97 - High Temperature	8
<b>NEW!</b> CPBK210	1	Ford Escape 2.3L 05, Escape Hybrid 2.3L 06-05, Mazda Tribute 2.3L 06-05, Mazda 3 2.3L, 2.0L 05-04	4
<b>NEW!</b> CPBK220	1	Ford Escape, Mazda Tribute 3.0-1 08-01, Ford 500, Freestyle 3.0L 07-05, Ford Taurus E, Sable ME, V6 3.0S 24V DOHC 04, 00	6
<b>NEW!</b> CPBK230	1	Ford GT, Mustang, Lincoln Continental, Mark VIII 4.6V DOHC 07-97	8
<b>NEW!</b> CPBK240	1	Ford Mustang, F series Pick Up V10 6.8L and V8 5.4L 06-05 SOHC	8
<b>NEW!</b> CPBK250	1	Ford V8 3.9L DOHC Thunderbird, Lincoln LS 07-02	8
<b>NEW!</b> CPBK260	1	JEEP Cherokee, Grand Cherokee 4.0S 06-00	6
<b>NEW!</b> CPBK300	1	Chrysler Concorde, Dodge Intrepid 2.7R 08-98	6
<b>NEW!</b> CPBK400 **	1	Infiniti I30 VQ30DE 01-00, Nissan Maxima 01-99 6 cyl. Right bank and Left bank cylinders (3 ea.)	6
<b>NEW!</b> CPBK405 **	1	Infiniti I30 VQ30DE 01-96, Nissan Maxima 99-95 6 cyl. Right bank and Left bank cylinders (3 ea.)	6
<b>NEW!</b> CPBK410 **	1	Infiniti QX4, Nissan VQ35DE Eng. Pathfinder 02-01 cyl 1 and 2-6 (1 and 5)	6
<b>NEW!</b> CPBK420	1	Nissan 4 cyl. 2.5 Altima, Sentra 06-02	4
<b>NEW!</b> CPBK430	1	Nissan 350Z 06-03, Infiniti G35, 3.5 06-03	6
<b>NEW!</b> CPBK440 **	1	Nissan Maxima 3.0L 94-92 VE30DE - Left bank and Right bank (3 ea.)	6
<b>NEW!</b> CPBK450	1	Nissan Pathfinder, Altima, Maxima 06-01, Infiniti I30, QX4, I35, M45, Q45 06-00, Nissan Armada 5.6L, Infiniti Q45, M45 4.5L 07-05	6
<b>NEW!</b> CPBK460	1	Nissan Sentra QG18DE 1.8L 06-02	4
<b>NEW!</b> CPBK500 **	1	Honda Passport 3.2L 02-00, Isuzu Axiom, Amigo, Rodeo, Trooper cyl. 6, 3.5X Short Type (1) and Long Type (5) 04-98	6
<b>NEW!</b> CPBK600	1	Toyota Avalon 95, Camry 97-94 3.0L 1MZFE	6
<b>NEW!</b> CPBK700	1	Audi A4, S4, A6 Quattro 02-98 - Volkswagen Passat	4
<b>NEW!</b> CPBK710	1	BMW L6, V8 300 series, 500 series, 740i, 840ci, X5, M3, Z3 02-96	6
<b>NEW!</b> CPBK720	1	Volvo 5 cyl. C70 05-99, S60 05-01, S70 05-99, V70 05-99; 6 cyl. S80 05-99	5

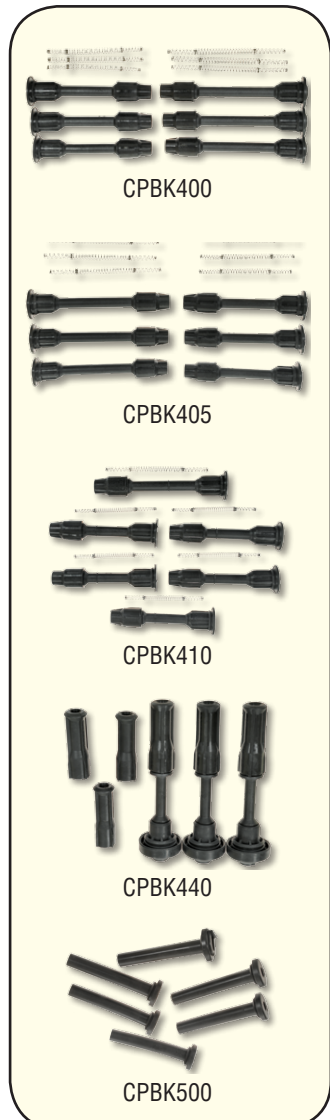

\*\* Varying boot combinations for certain applications

# RETAINERS, IGNITION WIRE & TERMINALS

## IGNITION WIRE RETAINER RINGS

Part No.	Description	Std. Pkg.
6600R*	Retainer ring for 4 cylinder, in-line 6 cylinder GM engines	1
6800R	Retainer ring for V6 and 8 cylinder GM engines with HEI ignition systems	1

\* Available until supply lasts

## WIRE SEPARATORS

Part No.	Description	Std. Pkg.
ET61	Spark plug wire separator for 8mm	4
ET66	Ignition wire clips - snap to hold up to 4 wires neatly in specific routing pattern, 7&8 mm	2
ST522	Spark plug wire separator for 8 & 9mm wire	1 Set
ST523	Spark plug wire separator for 7mm wire	1 Set

## BULK IGNITION WIRE

100 Ft. Spool	25 Ft. Spool	Jacket	Core Type	Color
CC7L	CD7L	7 mm Silicone/Silicone Hi Perf.	Tinned Copper	Yellow
CC7M		7 mm Silicone/Silicone	Mag Suppression	Grey
CC7S	CD7S	7 mm Silicone/Silicone	Suppression	Black
CC7D		7 mm EPS / EPDM	Suppression	Black
CC7N		7 mm EPDM / EPDM	Tinned Copper	Black
CC8M		8 mm Silicone/Silicone	Mag Suppression	Grey
CC8S		8 mm Silicone/Silicone	Suppression	Grey
CC8LC	CC8LL†	8 mm Silicone/Silicone Hi Perf.	Tinned Copper	Yellow
NEW! CC75C		7.5mm EPDM Hi Perf.	Mag Suppression	Red
NEW! CC85C		8.5mm EPDM Hi Perf.	Mag Suppression	Red

† 50 ft. spool

## SECONDARY TERMINALS

Part No.	Description	Wire Diam	Qty. per Pkg.
ST106	Straight	7mm	100
ST107	90°	7mm	100
ST113	Straight	7+8mm	50
ET113			8
ST114	90°	7+8mm	50
ET114	(Also used as distributor terminal on 8mm wire)		8
ST119	Bendable (to 90°)	7+8mm	50
ST122	Straight, Long for 3 piece boots	8mm	25
ST131	135° Snap-lock	7+8mm	50

\* ET Display Pkg.

**Silicone Dielectric Compound** for module heat dissipation, lubrication of spark plug boots, and corrosion protection for electrical connection. Vital in preventing spark plug boots from sticking to spark plugs. A thin coating of compound to the inner lip of spark plug boot protects against spark plug adhesion and prolongs the wire set life.

**SL3** — 1 gram per packet. Std. pkg 10 packets

**SL4** — 1.25 oz per tube. Std. pkg 10 tubes

Contains: Dimethylpolysiloxane





# IGNITION WIRE & TERMINALS



## DISTRIBUTOR TERMINALS

Part No.	Description	Wire Diam.	Qty per Pkg.
ST22	For "strip and fold" wire	7mm	100
ST25	Terminal with 3/8" spike, for non-strippable wire		100
ST26 ET26	Straight	7mm	100 10
ST27	Stainless steel bendable terminal for ABITS coils, use w/ TN20, TN21, and TN22 boots, requires TN23 insulator	7mm	50
ST28	Stainless steel bendable terminal for 1st generation Ford DIS coils, use w/ TN24 and TN25 boots	8mm	50
ST30	Brass bendable terminal for 2nd generation Ford DIS coils, use w/ TN27 boot	8mm	25
ST115	Staple for non-strippable resistance-type wire. Provides continuity between terminal and core		100
ST116 ET116	90°, install with WTT4 tool	7mm	100 8
ST120	Stainless Steel forked terminal - Chrysler (4 cyl.) applications	7mm	10
ST121	Brass 90° Coil Terminal	8mm	25

\* ET Display Pkg

## STA10 WIRE TERMINAL ASSORTMENT

Assortment of popular ignition wire terminals plus WTT4 Crimpmaster tool. CONTENTS — 126 pieces

Part No.	Qty.	Part No.	Qty.
ST22	25	ST114	15
ST25	10	ST116	5
ST26	10	ST119	10
ST106	25	TN7E	5
ST107	10	WTT4	1
ST113	10		

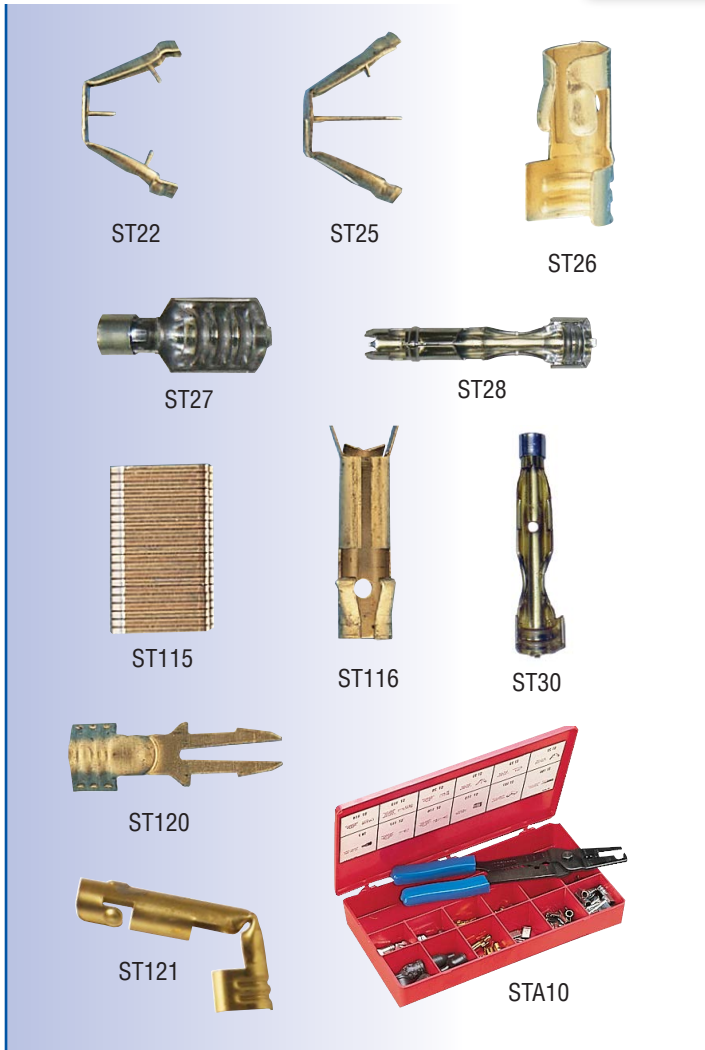

IGNITION WIRES

## IGNITION WIRE MAKE-UP TECHNIQUES

1. Measure and cut a length of wire that is 1-1/4" longer than the original wire. Slide the desired boot onto the wire, using oil or soapy water as a lubricant if necessary. Check for proper orientation.
2. Using the 14 gauge "notch" on stripping tool, strip each end of the wire. Be careful not to damage the core during stripping.
3. The bare core should be 1/8" longer than the crimping area on the terminal used.
4. Starting with the spark plug end, fold the core back over the outer jacket tightly and hold the tuck while the plug terminal is positioned so the barrel of the terminal traps the folded core against the jacket.
5. Using the notch marked "7 & 8 mm", squeeze the tabs on the terminal so they encircle the wire completely. Make final crimps at several locations along the barrel of the terminal. Make sure the terminal is securely crimped and that no excess core ("tail") is exposed.
6. Slide boot over terminal.

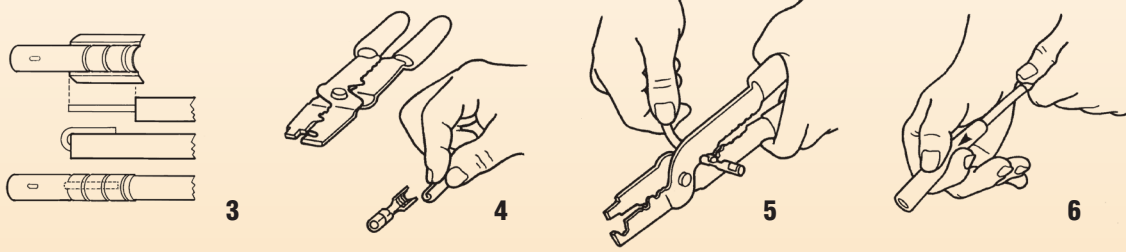

## WIRING TOOLS

### WTT4 Crimpmaster

- 10" long; display packed
- For professional crimps on ignition wire terminals and 90° terminals, insulated and uninsulated solderless terminals (including "W" crimps)
- Stripping notches for 22 to 10 ga. primary wire
- Std. Pkg. 1

### WTT5 Crimp 'N Cut

- 8" long; boxed
- Strips wire, crimps terminals, cuts screws
- Color-coded crimping notches for insulated solderless terminals
- Wire cutter plus stripping notches for 22 to 10 gauge primary wire
- Special crimping nest for 7mm ignition wire terminals
- Std. Pkg. 1
- **ET10** display version of WTT5

### WTT6 Wire Stripper

- The original "Miller Stripper"
- Cuts and strips wire from 24 to 10 gauge, with adjusting cam
- Individually bagged
- Std. Pkg. 5

### ET100 Economy Crimping Tool

- 8" long, display packed
- Cuts and strips primary wire 26 to 10 gauge
- Crimps insulated and non-insulated terminals
- Std. Pkg. 1

### WTT17 Premium Crimping Tool

- 8" long, display packed
- Cuts and strips primary wire 26 to 10 gauge
- Crimps insulated and non-insulated terminals
- Cushion grip handles
- Precision ground
- Made in the U.S.A.
- Std. Pkg. 1

### WTT18 Premium Crimping Tool

- 8-5/8" long
- Professional crimps on primary wire
- Crimps connectors 22-10 gauge
- Adjustable tension
- Molded hand grips
- Added leverage eases hand fatigue
- Std. Pkg. 1

### WTT27 Easy Stripper

- 8-1/2" long; boxed
- Self adjusting stripper
- Cuts and strips 26-10 gauge wire
- Crimps insulated and non-insulated terminals
- Cushion grip handles.
- Std. Pkg. 1

### WTT38 Premium Spark Plug Boot Puller

- 5 Position Adjustable Jaws
- Made in the U.S.A.
- Std. Pkg. 1

### WTT39 Spark Plug Boot Puller

- Made in the U.S.A.
- Std. Pkg. 1

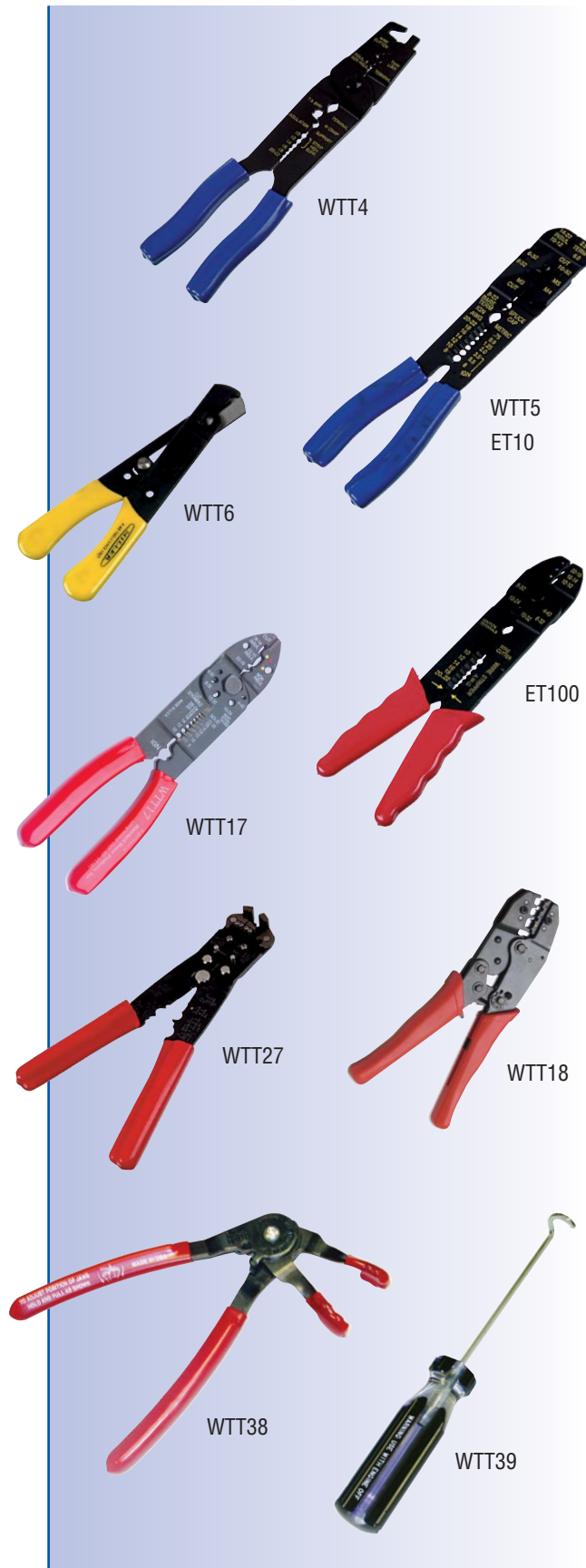



*Ignition Wires*

***Battery Cables***

*Primary Wire*

*Terminals & Connectors*

*Trailer Connectors*

*Sockets, Pigtails & Switches*

*Safety Accessories*

*O.E. Interchanges*

*Index*

# BATTERY CABLES

## BATTERY CABLES QUALITY ENGINEERED FROM END TO END...

### 1. Terminals

Precision diecast electrolytic grade lead alloy.

### 2. Casting

Overlaps cable insulation to protect cable from corrosion (the prime cause of cable failure).

### 3. Steel skeleton

Embedded in casting for extra strength and more reliable electrical connection.

### 4. Lug

Formed by high-pressure crimping a plated copper thimble onto a section of stripped cable. The resulting lug is an integral solid mass that makes an extremely reliable connection.

### 5. Cable

Composed of multiple strands of 99% pure copper for maximum flexibility and conductivity. High conductivity cable helps assure easier cold weather starts.

### 6. Hi-Temperature Outer Jacket

Tough, durable crosslinked synthetic rubber (not PVC or vinyl). Won't burn, soften or melt on contact with hot engine parts. Also resists corrosive action of gasoline and battery acid. Meets SAE J1127, Rated at 105°C/221°F.

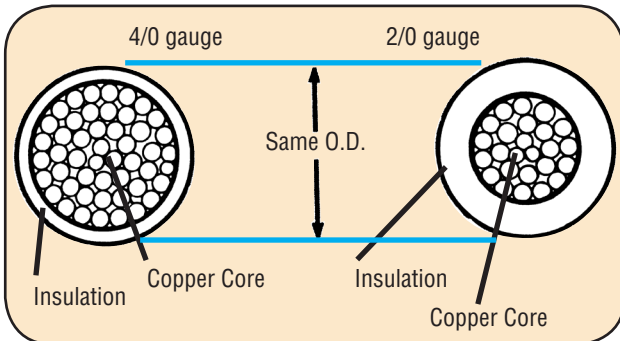
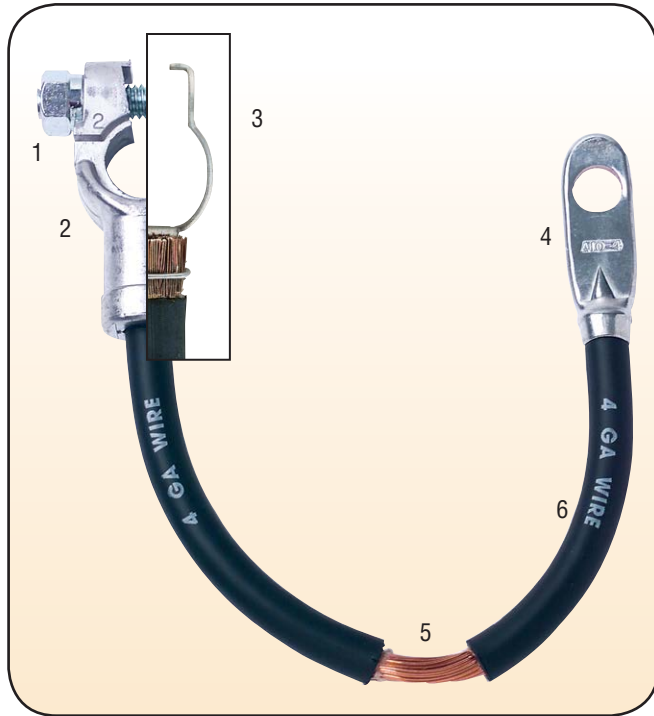

## WARNING:

Battery posts, terminals and related accessories contain lead, lead compounds and cadmium chemicals known to the State of California to cause cancer and reproductive harm.

**WASH HANDS AFTER HANDLING!**

## ...KNOW YOUR BATTERY CABLES

- The outside diameter of a cable may have nothing to do with its "gauge". The gauge is determined by the cross-sectional area of the copper core. (See illustration above.)
- Doubling the length of a cable will double its electrical resistance (ohms).
- A longer cable must have a larger copper core (smaller gauge number) than a shorter cable, in order to carry the same current without excessive voltage drop.



# BATTERY CABLES & GROUND STRAPS



## CABLE IDENTIFICATION SYSTEM

The following chart explains what you can learn about a cable from the part number.

- PREFIX** - All cables have a prefix letter: **A** or **B**.  
 Prefix A - indicates an insulated cable.  
 Prefix B - indicates an uninsulated cable (metal braid).
- NUMERALS** - The numerals before the dash indicate the length of the cable in inches (center-to-center). See figure 1.  
 - The numeral(s) after the dash indicate the wire gauge.
- SUFFIX** - The suffix letter(s) indicate the cable type. Cable types are explained below.

Suffix	Type	Suffix	Type
No Suffix	Lead top-post terminal with lug	LF	Switch-to-starter, one 1/4" lug, one 3/8" lug
ACN	Lug to lug	LH	Switch-to-starter, two 1/2" lugs
ACP	Lug to lug	LM	Switch-to-starter, two 1/4" lugs
AEN	GM type top terminal, NEG w/o aux post	LT	Switch-to-starter w/ auxiliary lead
AEP	GM type top terminal, POS w/o aux post	LTF	Switch-to-starter w/ auxiliary lead, w/ fusible link
APN	GM type top terminal, NEG w/ aux post	PN	Lug to lug
APP	GM type top terminal, POS w/ aux post	PP	Lug to lug
C	Chrysler type, lead top-post two auxiliary leads	RDF	Ford type top terminal, w/ fusible link
CLT	Lead-free top-post terminal with center lug(s)	RDN	Ford type top terminal, NEG w/o aux post
D	GM type side terminal, one auxiliary lead	RDP	Ford type top terminal, POS w/o aux post
DA	GM type side terminal, one 8 Ga. auxiliary lead w/ butt splice connector or ring terminal	RPP	Ford type top terminal, POS w/ aux post
DB	GM type side terminal, multiple battery diesel w/ auxiliary leads on both ends	T	Lead-free top-post terminal, no auxiliary leads
DBB	GM type side terminal, multiple battery diesel w/ auxiliary lead on one end	TA	Lead-free top-post terminal, one auxiliary lead 6 Ga. or larger May also include detached starter lead
DBN	GM type side terminal, multiple battery diesel w/ no auxiliary leads	TAF	Lead-free top-post terminal, fusible link in main cable, one or two auxiliary leads
DC	GM side terminal, w/ one auxiliary lead 6 Ga. or larger	TB	Lead-free top-post terminal, one auxiliary wire 6 Ga. or larger
DD	GM type side terminal, w/ two auxiliary leads	TC	Lead-free top-post terminal, w/ primary wire auxiliary leads
DE	GM type side terminal, two auxiliary leads 6 Ga. or larger	TCC	Lead-free top-post terminal, w/ primary wire auxiliary leads one from lug end or center
DF	GM type side terminal, w/ custom auxiliary lead w/ fusible link	TD	Lead-free top-post terminal, w/ one auxiliary lead from lug end 6 Ga. or larger
DFB	GM type side terminal, multiple battery diesel w/ fusible link auxiliary lead	TL	Lead-free top-post terminal, terminal bolts to lug to lug cable w/ 90° lug
DG	GM side terminal, w/ one auxiliary lead 6 Ga. or larger, and one smaller auxiliary lead	TLA	Lead-free top-post terminal, w/ auxiliary lead 6 Ga. or larger
DN	GM type side terminal, no auxiliary leads	TLCL	Lead-free top-post terminal, terminal bolts to lug to lug cable w/ 90° lug, w/ center lug
DS	GM type side terminal, w/ auxiliary lead from lug end	U	Lead top-post terminal, w/ one auxiliary lead
E	Ground strap, non insulated, lead top-post terminal w/ multiple lugs	UA	Lead top-post terminal, w/ one 8 Ga. auxiliary lead. May also include detached starter lead
F	Lead cable w/ fusible link auxiliary wire	UAB	Lead top-post terminal, w/ auxiliary lead w/ OE type auxiliary lead from lug end
FLN	Lug to lug	UAC	Lead-free top-post terminal w/ auxiliary lead w/ OE type auxiliary lead from lug end
FLP	Lug to lug	UC	Lead-free top-post terminal three auxiliary leads, one from terminal and two from center splice
G	Ground strap, non insulated, lug to lug	UD	Lead-free top-post terminal w/ auxiliary lead from both ends
GEN	Lug to lug	UDC	Lead-free top-post terminal w/ auxiliary lead from both ends with ring terminals
GEP	Lug to lug	UH	Lead top-post terminal, w/ one auxiliary lead, w/ 1/2" lug
H	Dual battery jumper, two lead top-post terminals	UHC	Lead-free top-post terminal, w/ one auxiliary lead w/ ring terminal, 1/2" lug
HBD	GM type side terminal, dual battery diesel, w/ one auxiliary lead 6 Ga. or larger	UHCL	Lead top-post terminal, w/ one auxiliary lead from lug end, 1/2" lug
HD	GM type side terminal, w/ one auxiliary lead 6 Ga. or larger	UT	Lead-free top-post terminal, w/ one auxiliary lead w/ butt splice connector
HDA	GM type side terminal, w/ auxiliary leads on both ends	UTC	Lead-free top-post terminal, w/ one auxiliary lead w/ ring terminal
HDCL	GM type side terminal, w/ one auxiliary lead, w/ center lug		
HDD	GM type side terminal, w/ one auxiliary lead 6 Ga. or larger		
HP	Multiple battery lead top-post, w/ auxiliary lead		
K	Stackable for stud top (group 31) batteries		
KN	Lug to lug		
KP	Lug to lug		
L	Switch-to-starter, lug to lug		

Example

<b>A</b>	<b>40</b>	—	<b>2</b>	<b>D</b>
Prefix "A" (insulated)	40" long		Wire Gauge	Suffix "D" (Side Term.)

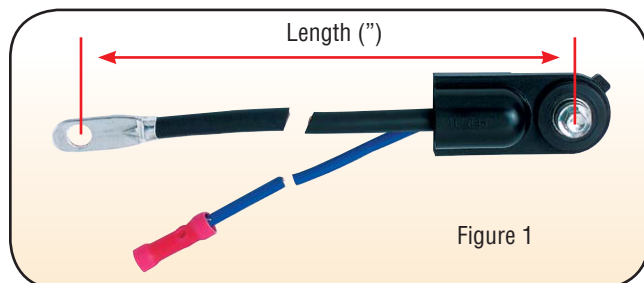

Figure 1

# BATTERY CABLES

## INSULATED BATTERY CABLES (PREFIX "A")

### No Suffix Conventional Cables

6 Gauge	4 Gauge	2 Gauge	1 Gauge	2/0 Gauge*
A12-6	A10-4	A12-2	A12-1	A12-00
A17-6	<b>NEW!</b> A14-4	A36-2	A16-1	A18-00
A24-6	<b>NEW!</b> A16-4	A42-2	A19-1	A24-00
A29-6	<b>NEW!</b> A19-4		A23-1	A30-00
A36-6	<b>NEW!</b> A22-4		<b>NEW!</b> A27-1	A36-00
	<b>NEW!</b> A26-4		A30-1	A42-00
	A30-4		<b>NEW!</b> A35-1	A48-00
	A36-4		A42-1	A54-00
	<b>NEW!</b> A42-4		A53-1	A60-00
	<b>NEW!</b> A45-4		A58-1	A66-00
	A48-4		A65-1	A72-00
	A56-4		<b>NEW!</b> A73-1	
	A62-4		A78-1	
	A84-4			

\* For heavy duty and fleet applications – lug for 1/2" bolt

### Suffix "ACN" Lug To Lug

	Gauge	Length
<b>NEW!</b> A27-8ACN	8	27"
<b>NEW!</b> A40-6ACN	6	40"

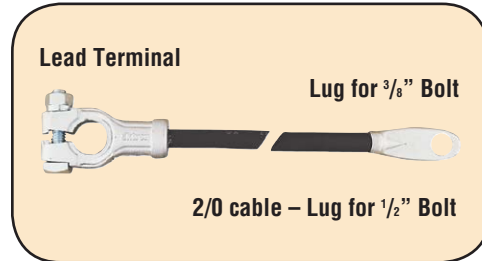

### Suffix "ACP" Lug To Lug

	Gauge	Length
<b>NEW!</b> A18-6ACP	6	18"



### Suffix "AEN" GM Type Top Terminal, NEG Without Aux Post

	Gauge	Aux. Lead
<b>NEW!</b> A35-4AEN	4	8 Ga. x 14"
<b>NEW!</b> A49-4AEN	4	6 Ga. x 10"
<b>NEW!</b> A14-2AEN	2	
<b>NEW!</b> A57-2AEN	2	4 Ga. x 10"
<b>NEW!</b> A58-2AEN	2	6 Ga. x 13"
<b>NEW!</b> A61-2AEN	2	4 Ga. x 20"

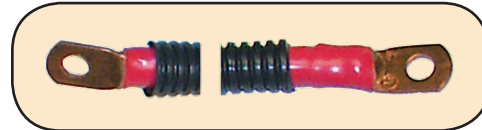

### Suffix "AEP" GM Type Top Terminal, POS Without Aux Post

	Gauge	Aux. Lead
<b>NEW!</b> A39-4AEP	4	6 Ga. x 17"
<b>NEW!</b> A49-2AEP	2	4 Ga. x 27"
<b>NEW!</b> A52-2AEP	2	4 Ga. x 18"
<b>NEW!</b> A78-2AEP	2	4 Ga. x 23"
<b>NEW!</b> A224-2AEP	2	8 Ga. x 10"

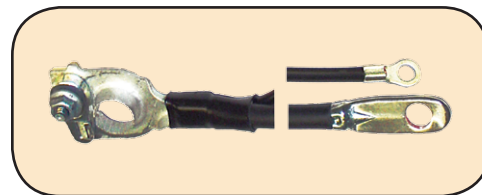

### Suffix "APN" GM Type Top Terminal, NEG With Aux Post

	Gauge	Aux. Lead 1	Aux. Lead 2
<b>NEW!</b> A49-2APN	2	4 Ga. x 22"	12 Ga. x 18"

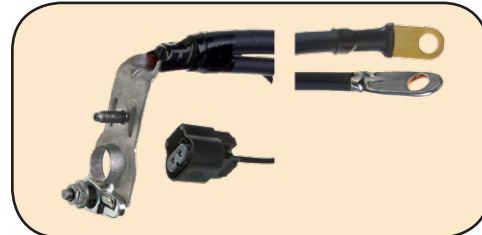
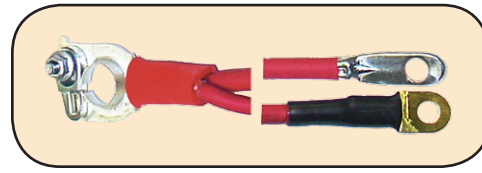

### Suffix "APP" GM Type Top Terminal, POS With Aux Post

	Gauge	Aux. Lead
<b>NEW!</b> A54-4APP	4	n/a
<b>NEW!</b> A55-4APP	4	4 Ga. x 24"
<b>NEW!</b> A199-2APP	2	8 Ga. x 9"

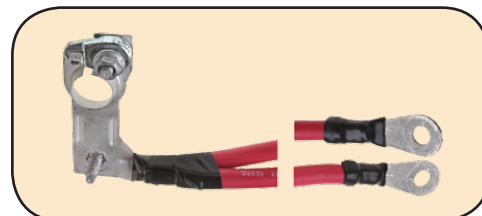

# BATTERY CABLES



## INSULATED BATTERY CABLES (PREFIX "A")

### Suffix "C" Chrysler Type, Lead Top-Post Two Auxiliary leads

	Gauge	Aux. lead #1	Aux. lead #2
A26-6C	6	6 Ga. x 10"	12 Ga. x 9"
A41-6C	6		
A50-6C	6		
A60-6C	6		
A66-6C	6		
A72-6C	6		
A73-6C*	6		
<b>NEW!</b> A33-0C	1/0	8 Ga. x 36"	10 Ga. x 19"

\* Includes solenoid pigtail

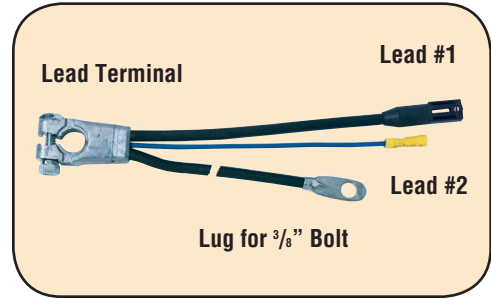

### Suffix "CLT", "CLTA", "CLTB", "CLTC", "CLTD" Lead-Free Top-Post Terminal With Center Lug(s)

	Gauge	Length	Bat. To Center Lug	Bat. To Center Lug 2
<b>NEW!</b> A17-6CLT	6	17"	9"	
<b>NEW!</b> A24-6CLT	6	24"	15"	
<b>NEW!</b> A25-6CLT	6	25"	14"	
A28-6CLT	6	28"	12"	
A29-6CLT	6	29"	20"	
A30-6CLT	6	30"	15"	
A32-6CLT	6	33"	18"	
A34-6CLT	6	34"	17"	
A35-6CLT	6	35"	12"	25"
<b>NEW!</b> A37-6CLT	6	37"	9"	
A38-6CLT	6	39"	13"	
<b>NEW!</b> A39-6CLT	6	39"	10"	
A46-6CLT	6	46"	17"	
A47-6CLT	6	48"	12"	
A59-6CLT	6	59"	9"	
A25-4CLT	4	26"	14"	
A30-4CLT	4	30"	6"	
A30-4CLTA	4	31"	17"	
A31-4CLT	4	31"	15"	
A32-4CLT	4	32"	10"	
A32-4CLTA	4	32"	15"	
A34-4CLT	4	34"	13"	
A35-4CLT	4	36"	13"	
A35-4CLTA	4	35"	17"	
A36-4CLT	4	36"	21"	
A37-4CLT	4	37"	16"	
A38-4CLT	4	39"	28"	
A39-4CLT	4	40"	21"	
A40-4CLT	4	40"	27"	
A40-4CLTA	4	40"	14"	
A40-4CLTB	4	40"	8"	
<b>NEW!</b> A40-4CLTD	4	40"	28"	
A42-4CLT	4	43"	12"	30"
A42-4CLTA	4	42"	15"	
<b>NEW!</b> A44-4CLT	4	44"	32"	
A46-4CLT	4	47"	20"	
A48-4CLT	4	48"	7"	36"
A49-4CLT	4	50"	30"	
A52-4CLTC	4	52"	15"	
A57-4CLT	4	58"	20"	
<b>NEW!</b> A58-4CLT	4	58"	28"	
<b>NEW!</b> A65-4CLT	4	65"	32"	
<b>NEW!</b> A23-2CLT	2	23"	16"	
<b>NEW!</b> A23-2CLTB	2	23"	15"	
A27-2CLT	2	27"	16"	
A30-2CLT	2	30"	15"	
<b>NEW!</b> A31-2CLT	2	31"	14"	
<b>NEW!</b> A31-2CLTB	2	31"	11"	
<b>NEW!</b> A33-2CLT	2	33"	16"	
A35-2CLT	2	35"	15"	
<b>NEW!</b> A35-2CLTB	2	35"	13"	
A36-2CLT	2	36"	11"	
<b>NEW!</b> A41-2CLT	2	41"	20"	



BATTERY CABLES

# BATTERY CABLES

## INSULATED BATTERY CABLES (PREFIX "A")

### Suffix "D" GM Type Side Terminal With One Auxiliary Lead

4 Gauge			2 Gauge			1/0
A10-4D	A35-4D	A55-4D	<b>NEW</b> A14-2D	A40-2D	A65-2D	<b>NEW</b> A13-0D <sup>1</sup>
A20-4D	A40-4D	A60-4D	A20-2D	A45-2D	A70-2D	A56-0D <sup>1</sup>
A25-4D	A45-4D	A65-4D	A25-2D	A50-2D	A76-2D	A95-0D <sup>2</sup>
A30-4D	A50-4D		A30-2D	A55-2D	A90-2D	
			A35-2D	<b>NEW</b> A60-2D		
Fusible Link Lead 14 Ga. x 9"			Aux. Lead 10 Ga. x 9"			Aux. Lead
<sup>1</sup> 10 Ga. x 9"		<sup>2</sup> 8 Ga. x 12"				

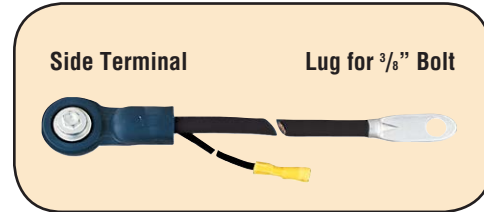

### Suffix "DA" GM Type Side Terminal, One 8 Ga. Aux Lead With Butt Splice Connector Or Ring terminal

4 Gauge	Aux. Lead	2 Gauge	Aux. Lead
A20-4DA	8 Ga. x 8"	A35-2DA	8 Ga. x 15"
A25-4DA	8 Ga. x 8"	A40-2DA	8 Ga. x 15"
A27-4DA	14 Ga. x 10"	A60-2DA	8 Ga. x 58"
A30-4DA	8 Ga. x 8"	A85-2DA	8 Ga. x 15"
A35-4DA	8 Ga. x 8"	A90-2DA	8 Ga. x 15"
A40-4DA	8 Ga. x 8"	A95-2DA	8 Ga. x 15"
A45-4DA	8 Ga. x 8"		
<b>NEW</b> A50-4DA	8 Ga. x 8"		
<b>NEW</b> A55-4DA	8 Ga. x 8"		
<b>NEW</b> A60-4DA	8 Ga. x 8"		

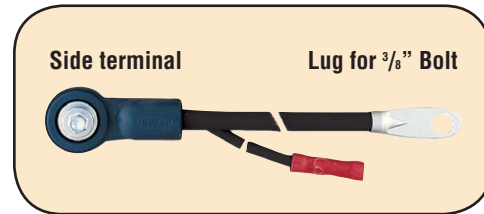

### Suffix "DAC" Side Terminal Cable With Auxiliary Lead

	Gauge	Aux. Lead
<b>NEW</b> A23-4DAC	4	8 Ga. x 12"
<b>NEW</b> A23-2DAC	2	8 Ga. x 14"
<b>NEW</b> A28-2DAC	2	8 Ga. x 10"
<b>NEW</b> A32-2DAC	2	8 Ga. x 10"
A33-2DAC	2	8 Ga. x 36"
<b>NEW</b> A53-2DAC	2	8 Ga. x 33"
<b>NEW</b> A30-0DAC	1/0	8 Ga. x 12"
A32-0DAC	1/0	8 Ga. x 12"
A46-0DAC	1/0	8 Ga. x 27"
<b>NEW</b> A63-0DAC	1/0	8 Ga. x 9"

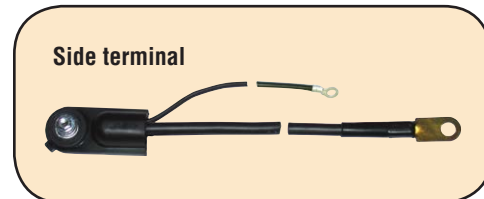

### Suffix "DB", "DBB", "DFB", "DBN", "HBD" Dual Side Terminal / Dual Battery

	Aux. Lead 1	Aux. Lead 2
<b>NEW</b> A8-2DBN	-	-
<b>NEW</b> A30-2DBN	-	-
<b>NEW</b> A63-2HBD	4 Ga. x 37"	4 Ga. x 20"
A65-2DB	8 Ga. x 8"	8 Ga. x 8"
A65-2HBD	6 Ga. x 35"	
A70-2DB	8 Ga. x 8"	8 Ga. x 8"
A72-2DBB	8 Ga. x 15"	
A87-2DB	8 Ga. x 8"	8 Ga. x 8"
A87-2DBB	6 Ga. x 48"	
A87-2DFB	8 Ga. x 18"*	
A88-2DFB	6 Ga. x 34"	8 Ga. x 18"*

\* With fusible link

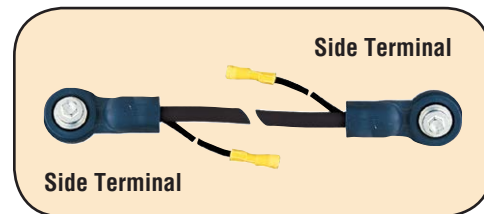

### Suffix "DC" GM Type Side Terminal With One Auxiliary Lead 6 Ga. Or Larger

2 Gauge	Aux. Lead
<b>NEW</b> A47-2DC	6 Ga. x 34"
<b>NEW</b> A48-2DC	6 Ga. x 33"

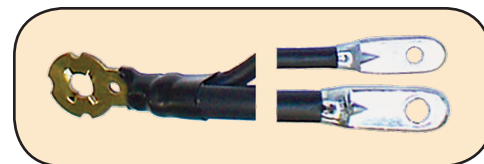

### Suffix "DD" GM Type Side Terminal, With Two Auxiliary Leads

4 Gauge	Aux. Lead 1	Aux. Lead 2	2 Gauge	Aux. Lead 1	Aux. Lead 2
A28-4DD	10 Ga. x 11"	10 Ga. x 11"	A31-2DD	10 Ga. x 11"	10 Ga. x 11"
A35-4DD	8 Ga. x 15"	12 Ga. x 12"	A56-2DD	8 Ga. x 15"	12 Ga. x 12"
A40-4DD	12 Ga. x 8"	12 Ga. x 7"*			

\* With fusible link

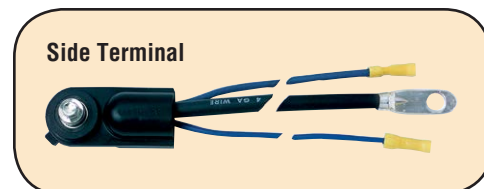



# BATTERY CABLES



BATTERY CABLES

## INSULATED BATTERY CABLES (PREFIX "A")

### Suffix "DDC" Side Terminal With 2 Auxiliary Leads

	Aux. Lead 1	Aux. Lead 2
A33-2DDC	8 Ga. x 36"	10 Ga. x 13"
<b>NEW!</b> A36-2DDC	8 Ga. x 36"	10 Ga. x 13"
A44-2DDC	8 Ga. x 23"	10 Ga. x 27"
A53-2DDC	8 Ga. x 12"	10 Ga. x 13"

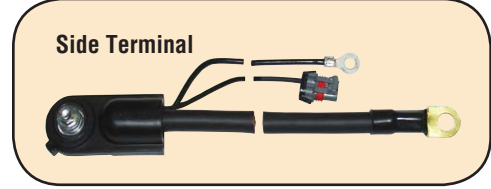

### Suffix "DDF" Side Terminal With 2 Auxiliary Leads

	Gauge	Aux. Lead 1	Aux. Lead 2
A40-4DDF	4	10 Ga. x 8"	8 Ga. x 32" w/ fusible link
A41-4DDF	4	10 Ga. x 13"	8 Ga. x 33" w/ fusible link
A45-4DDF	4	10 Ga. x 13"	8 Ga. x 18" w/ fusible link
A16-2DDF	2	10 Ga. x 20"	6 Ga. x 99" w/ fusible link
<b>NEW!</b> A18-2DDF	2	10 Ga. x 50" w/ fusible link	6 Ga. x 18" w/ fusible link
<b>NEW!</b> A42-2DDF	2	8 Ga. x 81" w/ fusible link	8 Ga. x 46" w/ fusible link
<b>NEW!</b> A46-2DDF	2	4 Ga. x 66" w/ fusible link	6 Ga. x 27" w/ fusible link
<b>NEW!</b> A47-2DDF	2	6 Ga. x 17"	6 Ga. x 27" w/ fusible link
<b>NEW!</b> A70-2DDF	2	10 Ga. x 8"	8 Ga. x 18" w/ fusible link
<b>NEW!</b> A45-0DDF	1/0	10 Ga. x 8"	6 Ga. x 27" w/ fusible link
<b>NEW!</b> A47-0DDF	1/0	4 Ga. x 66" w/ fusible link	6 Ga. x 27" w/ fusible link

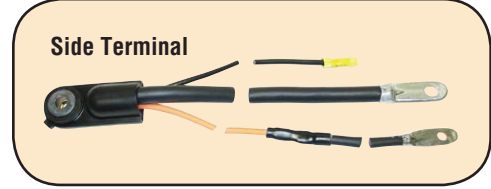

### Suffix "DE" and "DEE" GM Type Side Terminal, 2 Aux Leads 6 Ga. Or Larger

	Gauge	Aux. Lead 1	Aux. Lead 2
<b>NEW!</b> A38-4DE	4	6 Ga. x 83"	6 Ga. x 66"
A40-4DE	4	4 Ga. x 28"	6 Ga. x 37"
A41-4DE	4	6 Ga. x 82"	6 Ga. x 34"
A42-4DE	4	6 Ga. x 25"	6 Ga. x 46"
<b>NEW!</b> A42-4DEE	4	6 Ga. x 78"	6 Ga. x 29"
A43-4DE	4	6 Ga. x 29"	6 Ga. x 14"
A44-4DE	4	6 Ga. x 26"	6 Ga. x 37"
A48-4DE	4	6 Ga. x 25"	6 Ga. x 46"
<b>NEW!</b> A54-4DE	4	4 Ga. x 37"	6 Ga. x 49"
A68-4DE	4	6 Ga. x 41"	6 Ga. x 46"
<b>NEW!</b> A64-2DE	2	4 Ga. x 51"	6 Ga. x 36"
A68-2DE	2	6 Ga. x 13"	6 Ga. x 27"



### Suffix "DEF" Side Terminal With 2 Auxiliary Leads

	Aux. Lead 1	Aux. Lead 2
A41-4DEF	4 Ga. x 9"	4 Ga. x 24" w/ fusible link
<b>NEW!</b> A42-4DEF	6 Ga. x 77"	4 Ga. x 32" w/ fusible link
<b>NEW!</b> A41-2DEF	4 Ga. x 24"	4 Ga. x 44" w/ fusible link
<b>NEW!</b> A49-2DEF	4 Ga. x 21" w/ fusible link	4 Ga. x 35" w/ fusible link
<b>NEW!</b> A58-2DEF	6 Ga. x 34"	6 Ga. x 61" w/ fusible link

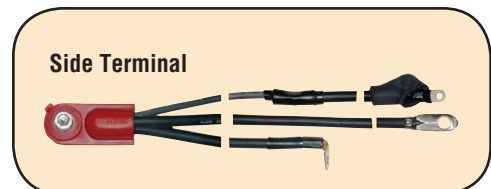

### Suffix "DF" GM Type Side Terminal With Custom Auxiliary Lead With Fusible Link

	Gauge	Aux. Lead
A40-4DF	4	10 Ga. x 19" w/ fusible link
A46-4DF	4	12 Ga. x 25" w/ fusible link
<b>NEW!</b> A38-2DF	2	8 Ga. x 79" w/ fusible link
A41-2DF	2	8 Ga. x 18" w/ fusible link
A43-2DF	2	6 Ga. x 31" w/ fusible link
A70-2DF	2	8 Ga. x 18" w/ fusible link
A50-0DF	1/0	6 Ga. x 31" w/ fusible link

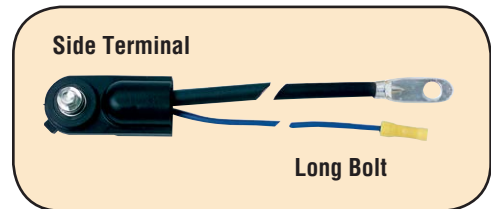

### Suffix "DG" GM Side Terminal, With 1 Aux Lead 6 Ga. Or Larger, And 1 Smaller Aux Lead

	Gauge	Aux. Lead 1	Aux. Lead 2
A35-4DG	4	6 Ga. x 25"	10 Ga. x 15"
A43-4DG	4	6 Ga. x 27"	12 Ga. x 12"
<b>NEW!</b> A45-4DG	4	6 Ga. x 17"	8 Ga. x 23"
A46-4DG	4	6 Ga. x 19"	8 Ga. x 8"
A26-2DG	2	4 Ga. x 25"	18 Ga. x 15"
A28-2DG	2	4 Ga. x 30"	18 Ga. x 15"
A40-2DG	2	6 Ga. x 23"	14 Ga. x 8"
A67-2DG	2	6 Ga. x 19"	8 Ga. x 8"

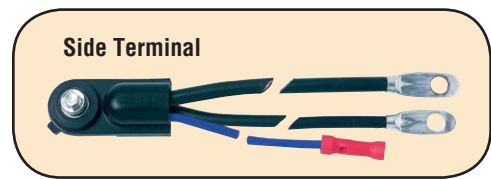

### Suffix "DG2" Side Terminal Cable With 2 Auxiliary Leads

	Gauge	Aux. Lead 1	Aux. Lead 2
<b>NEW!</b> A27-4DG2	4	4 Ga. x 25"	16 Ga. x 10"
A28-2DG2	2	4 Ga. x 17"	18 Ga. x 15"

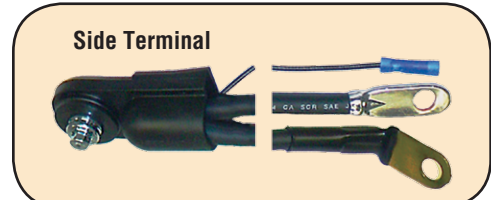

# BATTERY CABLES

## INSULATED BATTERY CABLES (PREFIX "A")

### Suffix "DN" GM Type Side Terminal Without Auxiliary Lead

6 Gauge	4 Gauge	2 Gauge	1/0 Gauge
A8-6DN A18-6DN A46-6DN	<b>NEW!</b> A21-4DN A25-4DN A35-4DN A65-4DN <b>NEW!</b> A66-4DN	<b>NEW!</b> A10-2DN A14-2DN A80-2DN	<b>NEW!</b> A28-0DN <b>NEW!</b> A35-0DN <b>NEW!</b> A70-0DN

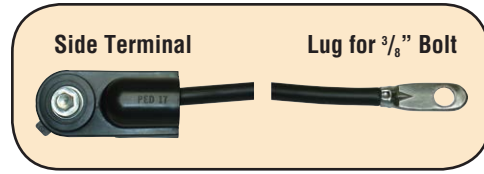

### Suffix "DNCL" Side Terminal With Center Lug

	Length	Length to Center Lug
A19-4DNCL	19"	7"
A22-4DNCL	22"	7"
A25-4DNCL	25"	7"

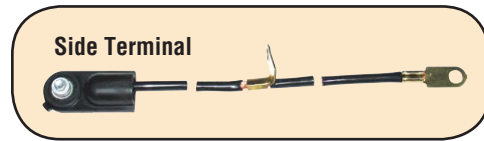

### Suffix "DS" GM Type Side Terminal, With Auxiliary Lead From Lug End

6 Gauge	Fusible Link
A95-6DS	12 Ga. x 8"

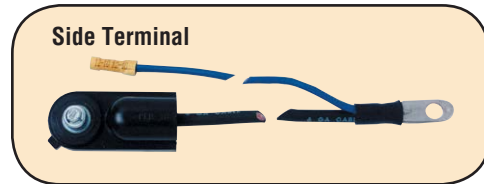

### Suffix "FLP" Lug To Lug

	Gauge	Aux. Lead
<b>NEW!</b> A100-2FLP	2	10 Ga. x 31"
<b>NEW!</b> A59-0FLP	1/0	n/a

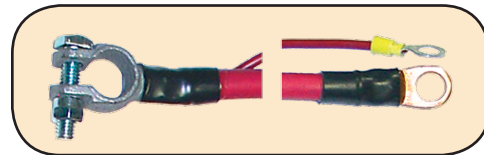

### Suffix "GEN" Lug To Lug

	Gauge	Length
<b>NEW!</b> A43-6GEN	6	43"
<b>NEW!</b> A24-4GEN	4	24"
<b>NEW!</b> A17-1GEN	1	17"
<b>NEW!</b> A24-1GEN	1	24"
<b>NEW!</b> A31-1GEN	1	31"
<b>NEW!</b> A42-1GEN	1	42"



### Suffix "GEP" Lug To Lug

4 Gauge	Length
<b>NEW!</b> A21-4GEP	21"

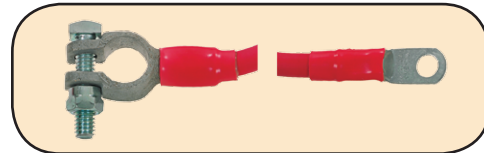

### Suffix "H" Dual Battery Jumper, Two Lead Top-Post Terminals

2 Gauge	1 Gauge	2/0 Gauge	
A8-2H A12-2H A15-2H	A8-1H A12-1H A15-1H A18-1H	A8-00H A12-00H A19-00H	A24-00H A36-00H A48-00H



### Suffix "HD" GM Type Side Terminal, With One Auxiliary Lead 6 Ga. Or Larger

6 Gauge	Aux. Lead
A45-6HD	6 Ga. x 12"
A60-6HD	6 Ga. x 52"
A84-6HD	6 Ga. x 33"

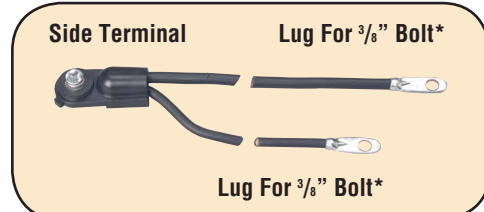

# BATTERY CABLES



## INSULATED BATTERY CABLES (PREFIX "A")

### Suffix "HD" GM Type Side Terminal, With One Auxiliary Lead 6 Ga. Or Larger

4 Gauge	Aux. Lead	4 Gauge	Aux. Lead
A11-4HD	6 Ga. x 18"	A35-4HD	4 Ga. x 14"
A16-4HD	6 Ga. x 13"	A35-4HD2	4 Ga. x 12"
A20-4HD	6 Ga. x 95"	A36-4HD	4 Ga. x 20"
A21-4HD	6 Ga. x 14"	A37-4HD	6 Ga. x 27"
<b>NEW!</b> A22-4HD	4 Ga. x 16"	A39-4HD	4 Ga. x 40"
<b>NEW!</b> A23-4HD	4 Ga. x 16"	A40-4HD	6 Ga. x 14"
<b>NEW!</b> A25-4HD	6 Ga. x 26"	<b>NEW!</b> A41-4HD	6 Ga. x 23"
A26-4HD	6 Ga. x 14"	<b>NEW!</b> A42-4HD	6 Ga. x 10"
A29-4HD	6 Ga. x 26"	<b>NEW!</b> A43-4HD	4 Ga. x 25"
A30-4HD	6 Ga. x 29"	A48-4HD	6 Ga. x 16"
<b>NEW!</b> A31-4HD	6 Ga. x 32"	A49-4HD	6 Ga. x 12"
A32-4HD	6 Ga. x 32"	A52-4HD	6 Ga. x 13"
<b>NEW!</b> A32-4HD2	6 Ga. x 11"	A55-4HD	6 Ga. x 8"
A33-4HD	6 Ga. x 48"		
A34-4HD	6 Ga. x 25"		

### Suffix "HD" GM Type Side Terminal, With One Auxiliary Lead 6 Ga. Or Larger

2 Gauge	Aux. Lead	2 Gauge	Aux. Lead
<b>NEW!</b> A10-2HD	6 Ga. x 14"	A46-2HD	6 Ga. x 36"
<b>NEW!</b> A21-2HD	6 Ga. x 14"	A55-2HD	6 Ga. x 14"
A30-2HD	4 Ga. x 13"	A66-2HD	6 Ga. x 9"
A34-2HD	6 Ga. x 13"	A68-2HD	6 Ga. x 38"
A35-2HD	4 Ga. x 12"	A70-2HD	6 Ga. x 82"
A36-2HD	6 Ga. x 27"	<b>NEW!</b> A73-2HD	6 Ga. x 82"
<b>NEW!</b> A37-2HD	4 Ga. x 13"	<b>NEW!</b> A136-2HD	6 Ga. x 18"
<b>NEW!</b> A38-2HD	4 Ga. x 14"	<b>NEW!</b> A152-2HD	6 Ga. x 17"
A40-2HD	6 Ga. x 23"		
A42-2HD	4 Ga. x 41"		
A43-2HD	6 Ga. x 30"		
<b>NEW!</b> A44-2HD	6 Ga. x 24"		
A45-2HD	6 Ga. x 41"		

### Suffix "HD" GM Type Side Terminal, With One Auxiliary Lead 6 Ga. Or Larger

1 Gauge	Aux. Lead	1/0 Gauge	Aux. Lead	Aux. Lead
A55-1HD	6 Ga. x 18"	<b>NEW!</b> A37-0HD	6 Ga. x 14"	10 Ga. x 20"
		<b>NEW!</b> A46-0HD	4 Ga. x 16"	
		A70-0HD	6 Ga. x 20"	
		A73-0HD	6 Ga. x 19"	
		<b>NEW!</b> A87-0HD	4 Ga. x 16"	
		<b>NEW!</b> A92-0HD	6 Ga. x 21"	
		<b>NEW!</b> A94-0HD	4 Ga. x 16"	
		<b>NEW!</b> A245-0HD	6 Ga. x 17"	
		<b>NEW!</b> A272-0HD	6 Ga. x 17"	

### Suffix "HDA" GM Type Side Terminal, With Auxiliary Leads On Both Ends

	Gauge	Aux. Lead From Terminal	Aux. Lead From Lug End
A83-6HDA	6	6 Ga. x 33"	8 Ga. x 15"
A32-4HDA	4	16 Ga. x 14" w/ fusible link	12 Ga. x 18" w/ fusible link
<b>NEW!</b> A33-4HDA	4	8 Ga. x 14"	8 Ga. x 18" w/ fusible link*
<b>NEW!</b> A37-4HDA	4	6 Ga. x 11"	6 Ga. x 24" w/ fusible link*
A41-4HDA	4	4 Ga. x 19"	6 Ga. x 31" w/ fusible link*
A42-4HDA	4	8 Ga. x 23"	14 Ga. x 15" w/ fusible link
A16-2HDA	2	14 Ga. x 8"	8 Ga. x 31"
A70-2HDA	2	4 Ga. x 20"	10 Ga. x 42" w/ fusible link*
A16-0HDA	1/0	12 Ga. x 12"	6 Ga. x 35"
<b>NEW!</b> A36-0HDA	1/0	4 Ga. x 16"	10 Ga. x 20" *
A137-0HDA	1/0	6 Ga. x 23"	8 Ga. x 15"

\*From auxiliary lead

Side Terminal

Lug For 3/8" Bolt\*



Lug For 3/8" Bolt\*

Side Terminal

Lug for 3/8" Bolt



# BATTERY CABLES

## INSULATED BATTERY CABLES (PREFIX "A")

### Suffix "HDCL" GM Type Side Terminal, With One Aux Lead, With Center Lug

	Battery To Center Lug	Aux. Lead
A35-4HDCL	17"	6 Ga. x 15"
A35-4HDCL2	22"	6 Ga. x 15"
A76-2HDCL	26"	6 Ga. x 18"
<b>NEW</b> A75-2HDCL	23"	4 Ga. x 16"
<b>NEW</b> A78-2HDCL	31"	4 Ga. x 16", 6 Ga. x 33"
<b>NEW</b> A79-2HDCL	31"	4 Ga. x 16"

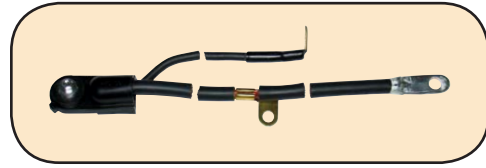

### Suffix "HDD" GM Type Side Terminal With One Auxiliary Lead 6 Ga. Or Larger

2 Gauge	Aux. Lead
<b>NEW</b> A35-2HDD	6 Ga. x 30"
<b>NEW</b> A44-2HDD	6 Ga. x 44"

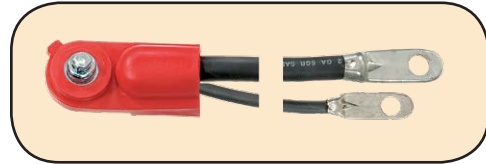

### Suffix "HP" Multiple Battery Lead Top-Post With Auxiliary Lead

2/0 Gauge	Aux. Lead	Battery To Battery
A116-00HP Ford Diesel Cable Center with Die Cast Terminal Aux. Lead	10 Ga. x 22"	62"
A123-00HP	6 Ga. x 37"	66"

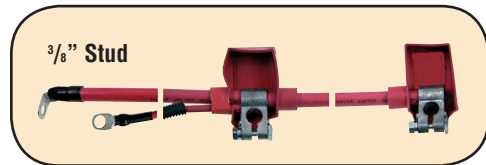

### Suffix "KN" Lug To Lug

6 Gauge	Aux. Lead 1	Aux. Lead 2
<b>NEW</b> A26-6KN	16 Ga. x 10"	16 Ga. x 10"

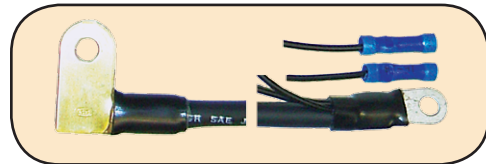

### Suffix "KP" Lug To Lug

	Gauge	Aux. Lead
<b>NEW</b> A45-6KP	6	14 Ga. x 10"
<b>NEW</b> A47-6KP	6	14 Ga. x 10" (2)
<b>NEW</b> A44-2KP (Top-Post)	2	14 Ga. x 10"

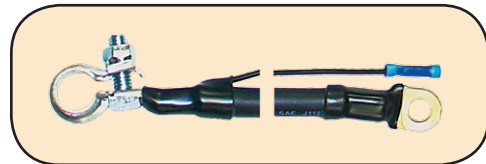

### Suffix "L" Switch-To-Starter, Lug To Lug

10 Gauge	8 Gauge	6 Gauge	4 Gauge	2 Gauge	1 Gauge
<b>NEW</b> A5-10L	<b>NEW</b> A8-8L <b>NEW</b> A11-8L	<b>NEW</b> A6-6L A13-6L A14-6L A18-6L A19-6L A24-6L <b>NEW</b> A27-6L A34-6L A40-6L <b>NEW</b> A44-6L A53-6L	<b>NEW</b> A10-4L A14-4L <b>NEW</b> A15-4L <b>NEW</b> A16-4L <b>NEW</b> A18-4L A19-4L <b>NEW</b> A20-4L A24-4L A30-4L A38-4L A40-4L A43-4L A51-4L A60-4L <b>NEW</b> A69-4L	<b>NEW</b> A13-2L A22-2L <b>NEW</b> A23-2L <b>NEW</b> A25-2L A26-2L <b>NEW</b> A27-2L A30-2L A33-2L A40-2L A41-2L <b>NEW</b> A43-2L <b>NEW</b> A46-2L A83-2L	<b>NEW</b> A12-1L A15-1L A19-1L A32-1L A49-1L A60-1L A68-1L

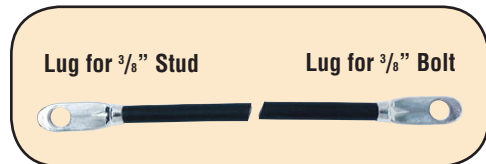

### Suffix "LF" and "LFF" Switch-To-Starter, One 1/4" Lug, One 3/8" Lug

4 Gauge	2 Gauge
A12-4LF A16-4LF A20-4LF A30-4LF A36-4LF A40-4LF <b>NEW</b> A40-4LFF	<b>NEW</b> A43-4LF A52-4LF <b>NEW</b> A54-4LF <b>NEW</b> A58-4LF A60-4LF A65-4LF <b>NEW</b> A67-4LF
	A12-2LF

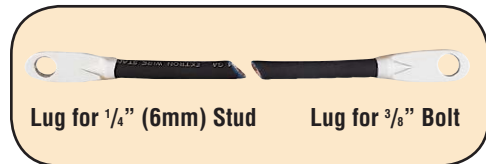

# BATTERY CABLES



BATTERY CABLES

## INSULATED BATTERY CABLES (PREFIX "A")

### Suffix "LH" Switch-To-Starter, Two 1/2" Lugs

4 Gauge				
A20-4LH	A24-4LH	A28-4LH	A33-4LH	A40-4LH

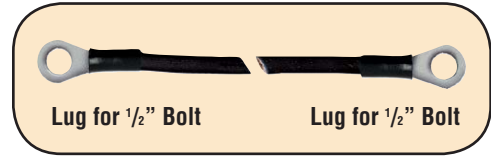

### Suffix "LM" Switch-To-Starter, Two 1/4" Lugs

6 Gauge		
A8-6LM	A16-6LM	A24-6LM



### Suffix "LT" Switch-To-Starter With Auxiliary Lead

4 Gauge	Aux. Lead	2 Gauge	Aux. Lead
A16-4LT	6 Ga. x 24"	<b>NEW!</b> A52-2LT	4 Ga. x 16"
<b>NEW!</b> A33-4LT	6 Ga. x 39"	A53-2LT	6 Ga. x 54"
<b>NEW!</b> A48-4LT	6 Ga. x 55"	<b>NEW!</b> A55-2LT	6 Ga. x 55"
		<b>NEW!</b> A57-2LT	6 Ga. x 54"



### Suffix "LTF" Switch-To-Starter With Auxiliary Lead, With Fusible Link

4 Gauge	Aux. Lead	2 Gauge	Aux. Lead
<b>NEW!</b> A36-4LTF	4 Ga. x 16" w/ fusible link	<b>NEW!</b> A52-2LTF	4 Ga. x 46" w/ fusible link
<b>NEW!</b> A49-4LTF	4 Ga. x 46" w/ fusible link		
<b>NEW!</b> A53-4LTF	4 Ga. x 43" w/ fusible link		
<b>NEW!</b> A58-4LTF	4 Ga. x 55" w/ fusible link		
<b>NEW!</b> A65-4LTF	4 Ga. x 38" w/ fusible link		

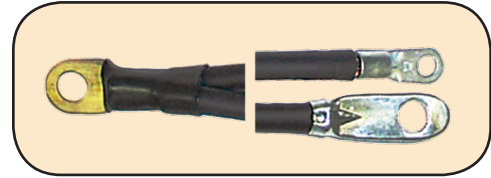

### Suffix "PN" Lug-To-Lug

6 Gauge	Length
<b>NEW!</b> A12-6PN	12"
<b>NEW!</b> A15-6PN	15"
<b>NEW!</b> A23-6PN	23"
<b>NEW!</b> A78-6PN	78"
<b>NEW!</b> A84-6PN	84"
<b>NEW!</b> A100-6PN	100"

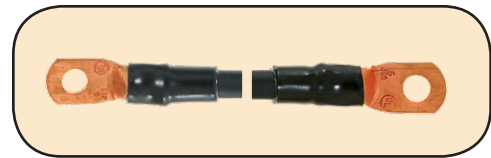

### Suffix "PP" Lug-To-Lug

6 Gauge	Length
<b>NEW!</b> A9-6PP	9"
<b>NEW!</b> A22-6PP	22"

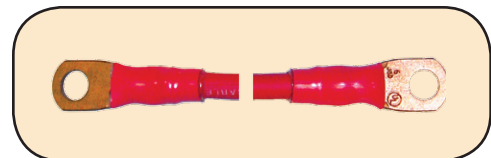

### Suffix "RD" Ford Type Top Terminal

	Gauge	Aux. Lead 1
<b>NEW!</b> A30-4RD	4	6 Ga. x 15"
<b>NEW!</b> A28-0RD	1/0	n/a

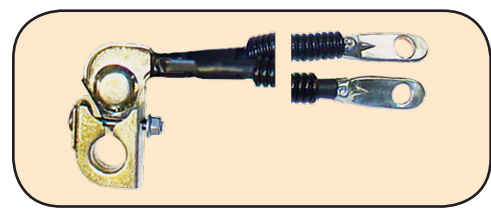

### Suffix "RDF" Ford Type Top Terminal, With Fusible Link

4 Gauge	Aux. Lead 1	Aux. Lead 2
<b>NEW!</b> A55-4RDF	4 Ga. x 37"	4 Ga. x 32" w/ fusible link

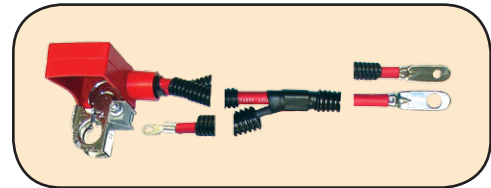

# BATTERY CABLES

## INSULATED BATTERY CABLES (PREFIX "A")

### Suffix "RDN" Ford Type Top Terminal, NEG Without Aux Post

	Gauge	Aux. Lead 1	Aux. Lead 2
<b>NEW!</b> A24-4RDN	4	6 Ga. x 15"	
<b>NEW!</b> A29-4RDN	4	n/a	
<b>NEW!</b> A32-4RDN	4	6 Ga. x 11"	
<b>NEW!</b> A33-4RDN	4	4 Ga. x 9"	
<b>NEW!</b> A49-4RDN	4	6 Ga. x 16"	
<b>NEW!</b> A66-4RDN	4	8 Ga. x 14"	8 Ga. x 43"
<b>NEW!</b> A69-4RDN	4	8 Ga. x 15"	8 Ga. x 9"
<b>NEW!</b> A70-4RDN	4	8 Ga. x 12"	
<b>NEW!</b> A19-2RDN	2	n/a	
<b>NEW!</b> A24-2RDN	2	n/a	
<b>NEW!</b> A37-0RDN	1/0	2 Ga. x 11"	

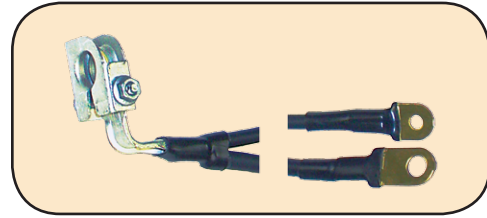

### Suffix "RDP", "RPP" Ford Type Top Terminal, POS

4 Gauge	Aux. Lead 1
<b>NEW!</b> A55-4RDP	4 & 6 Ga. x 62"
<b>NEW!</b> A62-4RPP	4 Ga. x 37"
<b>NEW!</b> A63-4RPP	n/a

Note: Product may be different from photograph

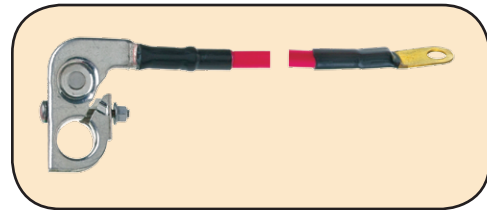

### Suffix "T" Lead-Free Top-Post Terminal, No Auxiliary Leads

6 Gauge	4 Gauge	2 Gauge
<b>NEW!</b> A6-6T	<b>NEW!</b> A10-4T	<b>NEW!</b> A10-2T
A10-6T	A11-4T	A15-2T
<b>NEW!</b> A12-6T	A12-4T	A18-2T
A18-6T	A16-4T	<b>NEW!</b> A40-2T
A24-6T	A22-4T	A43-2T
A30-6T	A30-4T	
A36-6T	A33-4T	
A40-6T	A36-4T	
	A39-4T	
	A42-4T	
	A43-4T	
	A48-4T	
	A56-4T	

Note: Product may be different from photograph

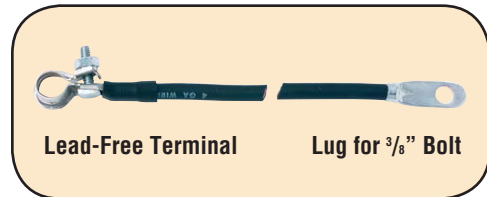

### Suffix "TA" Lead-Free Top-Post Terminal, One Auxiliary Lead 6 Ga. Or Larger

	Gauge	Aux. Lead 1	Aux. Lead 2
<b>NEW!</b> A24-6TA	6	4 Ga. x 16"	
<b>NEW!</b> A30-6TA	6	4 Ga. x 63"	12 Ga. x 72"
<b>NEW!</b> A31-6TA	6	6 Ga. x 10"	
A34-6TA	6	6 Ga. x 14"	
A36-6TA	6	6 Ga. x 24"	4 Ga. x 8"*
A46-6TA	6	6 Ga. x 12"	
A48-6TA	6	6 Ga. x 39"	
A55-6TA	6	6 Ga. x 10"	
<b>NEW!</b> A57-6TA	6	8 Ga. x 12"	
A58-6TA	6	6 Ga. x 19"	
A70-6TA	6	10 Ga. x 10"	12 Ga. x 69"*
<b>NEW!</b> A30-4TA	4	4 Ga. x 13"	
A36-4TA	4	4 Ga. x 8"	
A42-4TA	4	4 Ga. x 22"	
<b>NEW!</b> A45-4TA	4	6 Ga. x 24"	12 Ga. x 10"*
<b>NEW!</b> A47-4TA	4	6 Ga. x 28"	12 Ga. x 10"*
<b>NEW!</b> A49-4TA	4	6 Ga. x 28"	12 Ga. x 10"
<b>NEW!</b> A50-4TA	4	6 Ga. x 21"	12 Ga. x 10"
<b>NEW!</b> A51-4TA	4	6 Ga. x 15"	
<b>NEW!</b> A52-4TA	4	6 Ga. x 13"	
<b>NEW!</b> A56-4TA	4	6 Ga. x 18" w/ fusible link	12 Ga. x 69"
<b>NEW!</b> A57-4TA	4	6 Ga. x 45"	12 Ga. x 67"*
<b>NEW!</b> A58-4TA	4	6 Ga. x 36"	
<b>NEW!</b> A63-4TA	4	6 Ga. x 18" w/ fusible link	12 Ga. x 74"
<b>NEW!</b> A67-4TA	4	6 Ga. x 14"	
<b>NEW!</b> A48-1TA	1	6 Ga. x 28"	

\* Not attached to main cable

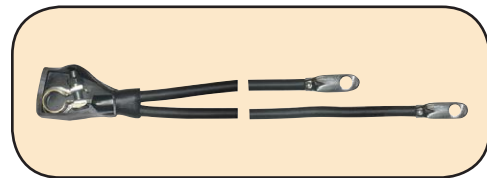

### Suffix "TAF" Lead-Free Top-Post Terminal, Fusible Link In Main Cable, One Or Two Aux Leads

	Gauge	Aux. Lead 1	Aux. Lead 2
<b>NEW!</b> A64-4TAF	4	10 Ga. x 12"	4 Ga. x 37"
<b>NEW!</b> A13-4TAF	4	12 Ga. x 67"	6 Ga. x 55"
<b>NEW!</b> A36-6TAF	6	12 Ga. x 55"	4 Ga. x 49"
<b>NEW!</b> A37-6TAF	6	12 Ga. x 51"	4 Ga. x 45"

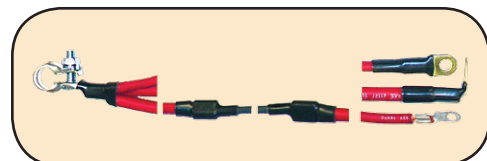

# BATTERY CABLES



BATTERY CABLES

## INSULATED BATTERY CABLES (PREFIX "A")

Suffix "TB" and "TBB" Lead-Free Top-Post Terminal, One Auxiliary Wire 6 Ga. Or Larger

6 Gauge	Aux. Lead	6 Gauge	Aux. Lead
A25-6TB	4 Ga. x 44"	<b>NEW!</b> A40-6TB	4 Ga. x 20"
A27-6TB	6 Ga. x 46"	<b>NEW!</b> A41-6TB	6 Ga. x 32" w/ fusible link
A28-6TB	6 Ga. x 11"	<b>NEW!</b> A41-6TBB	6 Ga. x 15"
A28-6TB2	6 Ga. x 19"	<b>NEW!</b> A49-6TB	6 Ga. x 35"
A32-6TB	6 Ga. x 10"	<b>NEW!</b> A55-6TB	6 Ga. x 20" w/ fusible link
A34-6TB	6 Ga. x 27"	<b>NEW!</b> A59-6TB	4 Ga. x 32"
A37-6TB	4 Ga. x 39"	A60-6TB	6 Ga. x 13"
A38-6TB	6 Ga. x 12"	<b>NEW!</b> A66-6TB	4 Ga. x 32" w/ fusible link

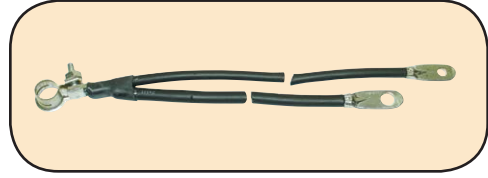

Suffix "TB" and "TBB" Lead-Free Top-Post Terminal, One Auxiliary Wire 6 Ga. Or Larger

4 Gauge	Aux. Lead	4 Gauge	Aux. Lead
<b>NEW!</b> A13-4TB	6 Ga. x 59"	A42-4TB	6 Ga. x 18"
A19-4TB	6 Ga. x 22" w/ fusible link	<b>NEW!</b> A42-4TBB	6 Ga. x 37"
A19-4TB2	6 Ga. x 12" w/ fusible link	A43-4TB	6 Ga. x 33"
A22-4TB	4 Ga. x 13"	<b>NEW!</b> A45-4TB	6 Ga. x 26"
A24-4TB	4 Ga. x 16"	A48-4TB	4 Ga. x 51"
<b>NEW!</b> A25-4TB	6 Ga. x 17"	A51-4TB	4 Ga. x 16"
A26-4TB	6 Ga. x 15"	<b>NEW!</b> A54-4TB	6 Ga. x 26"
A32-4TB	6 Ga. x 15"	<b>NEW!</b> A55-4TB	4 Ga. x 10"
<b>NEW!</b> A35-4TB	6 Ga. x 22"	A58-4TB	6 Ga. x 38"
A36-4TB	4 Ga. x 41"	<b>NEW!</b> A60-4TB	6 Ga. x 17"
A37-4TB	6 Ga. x 10"	A62-4TB	6 Ga. x 14"
A40-4TB	6 Ga. x 26"	<b>NEW!</b> A67-4TB	10 Ga. x 10"
<b>NEW!</b> A40-4TBB	6 Ga. x 27"	A78-4TB	6 Ga. x 27"

Suffix "TB" and "TBB" Lead-Free Top-Post Terminal, One Auxiliary Wire 6 Ga. Or Larger

2 Gauge	Aux. Lead	2 Gauge	Aux. Lead
A24-2TB	6 Ga. x 10"	A36-2TB	6 Ga. x 35"
<b>NEW!</b> A29-2TB	6 Ga. x 59"	A41-2TB	6 Ga. x 7"
<b>NEW!</b> A30-2TB	12 Ga. x 115"	A45-2TB	4 Ga. x 16"
<b>NEW!</b> A30-2TBB	6 Ga. x 89"	<b>NEW!</b> A52-2TB	6 Ga. x 10"
A32-2TB	6 Ga. x 32"		
<b>NEW!</b> A33-2TB	6 Ga. x 16"	<b>1 Gauge</b>	<b>Aux. Lead</b>
<b>NEW!</b> A34-2TB	4 Ga. x 10"	<b>NEW!</b> A20-1TB	6 Ga. x 12"

Suffix "TBC" and "TBCL" Lead-Free Cable

	Gauge	Aux. Lead 1	Aux. Lead 2
<b>NEW!</b> A31-6TBC	6	6 Ga. x 28"	6 Ga. x 10" *
A32-6TBC	6	6 Ga. x 19"	14 Ga. x 10"
<b>NEW!</b> A74-6TBC	6	6 Ga. x 9"	6 Ga. x 52" w/ fusible link
A32-4TBC	4	6 Ga. x 18"	14 Ga. x 10"
<b>NEW!</b> A42-4TBC	4	6 Ga. x 24"	12 Ga. x 10"
<b>NEW!</b> A43-4TBC	4	6 Ga. x 36"	12 Ga. x 10"
<b>NEW!</b> A50-4TBC	4	8 Ga. x 27"	14 Ga. x 63" *
A63-4TBCL	4	4 Ga. x 15"	

\* Not attached to main cable



Suffix "TC" Lead-Free Top-Post Terminal, With Primary Wire Auxiliary Leads

	Gauge	Aux. Lead 1	Aux. Lead 2	Aux. Lead 3
<b>NEW!</b> A26-6TC	6	8 Ga. x 31"	10 Ga. x 11"	
<b>NEW!</b> A38-6TC*	6	8 Ga. x 25"	10 Ga. x 19"	4 Ga. x 47"
A38-6TC2*	6	8 Ga. x 35"	10 Ga. x 19"	4 Ga. x 4"
A30-4TC	4	10 Ga. x 11"	12 Ga. x 8"	12 Ga. x 8"
<b>NEW!</b> A33-4TC	4	8 Ga. x 12"	10 Ga. x 12"	
<b>NEW!</b> A62-4TC	4	10 Ga. x 11"	10 Ga. x 11"	
<b>NEW!</b> A66-4TC	4	6 Ga. x 14"		
A72-4TC	4	14 Ga. x 20"	14 Ga. x 20"	
<b>NEW!</b> A73-4TC	4	10 Ga. x 11"	10 Ga. x 11"	
<b>NEW!</b> A74-4TC	4	10 Ga. x 11"	10 Ga. x 11"	

\* Not attached to main cable

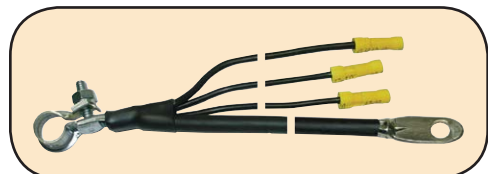

Suffix "TCC" Lead-Free Top-Post Terminal, With Primary Wire Aux Leads, 1 From Lug End Or Center

	Aux. Lead 1	Aux. Lead 2	Aux. Lead 3	Aux. Lead 4
A26-6TCC	8 Ga. x 13"	12 Ga. x 8"	12 Ga. x 13" **	12 Ga. x 13" **
A35-4TCC	10 Ga. x 15"	12 Ga. x 15"	10 Ga. x 15"	
A46-4TCC	10 Ga. x 17"	14 Ga. x 20"	8 Ga. x 12" ***	18 Ga. x 15" *
A49-4TCC	10 Ga. x 15"	12 Ga. x 15"	10 Ga. x 15" *	
A73-4TCC	12 Ga. x 27"			

\* From lug end

\*\* From aux. lead 1

\*\*\* From center lug

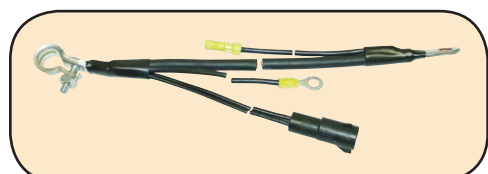

# BATTERY CABLES

## INSULATED BATTERY CABLES (PREFIX "A")

### Suffix "TD" Lead-Free Top-Post Terminal, With One Aux Lead From Lug End 6 Ga.Or Larger

6 Gauge	Aux. Lead
A24-6TD	6 Ga. x 24"
A40-6TD	6 Ga. x 41"

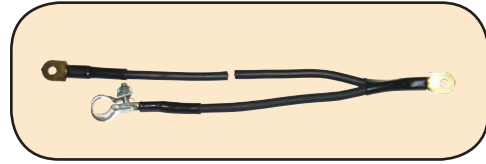

### Suffix "TL" Lead-Free Top-Post Terminal, Terminal Bolts To Lug To Lug Cable With 90° Lug

	Gauge
A26-6TL	6
A11-4TL	4
A20-4TL	4
A25-4TL	4
A34-4TL	4
A39-4TL	4



### Suffix "TLA" Lead-Free Top-Post Terminal, With Aux Lead 6 Ga. Or Larger

	Gauge	Length	Aux. Lead
<b>NEW!</b> A11-6TLA	6	11"	8 Ga. x 28"
<b>NEW!</b> A22-6TLA	6	22"	8 Ga. x 12"
<b>NEW!</b> A25-6TLA	6	25"	8 Ga. x 15"
A26-6TLA	6	26"	6 Ga. x 11"
A32-6TLA	6	32"	6 Ga. x 10"
A39-6TLA	6	39"	6 Ga. x 30"
<b>NEW!</b> A24-4TLA	4	24"	6 Ga. x 34"
<b>NEW!</b> A28-4TLA	4	28"	4 Ga. x 12"
<b>NEW!</b> A33-4TLA	4	33"	4 Ga. x 12"
<b>NEW!</b> A37-4TLA	4	37"	6 Ga. x 14"
<b>NEW!</b> A38-4TLA	4	38"	6 Ga. x 15"
A48-4TLA	4	48"	6 Ga. x 11"
A54-4TLA	4	54"	4 Ga. x 27"

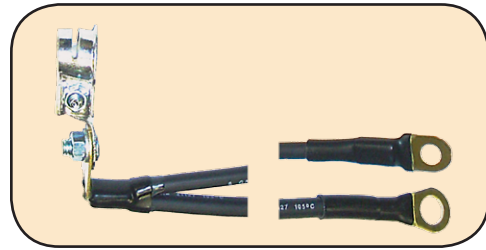

### Suffix "TLCL" Lead-Free Top-Post Terminal, Terminal Bolts To Lug To Lug Cable With 90° Lug, With Center Lug

4 Gauge	Battery To Center Lug	Aux. Lead
A91-4TLCL	54"	6 Ga. x 15"
A47-4TLCL	19"	N/A
A44-4TLCL	19"	N/A
A42-4TLCL	16"	N/A

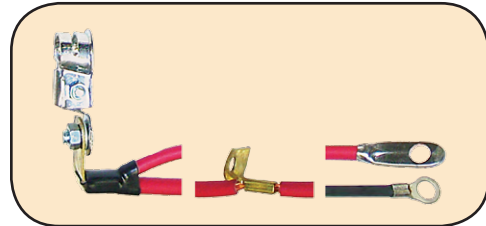

### Suffix "U" Lead Top-Post Terminal, With One Auxiliary Lead

6 Gauge	4 Gauge	4 Gauge	2 Gauge	1/0 Gauge
<b>NEW!</b> A22-6U	A15-4U	<b>NEW!</b> A41-4U	A30-2U	<b>NEW!</b> A34-0U
A28-6U	A19-4U	A45-4U	A47-2U	<b>NEW!</b> A45-0U
A36-6U	A22-4U	A48-4U	A61-2U	
A42-6U	<b>NEW!</b> A25-4U	A53-4U	A65-2U	
A50-6U	A30-4U	A63-4U		
A56-6U	A36-4U	A78-4U		
A67-6U	<b>NEW!</b> A38-4U			
Aux. lead 8 Ga. x 9"	Aux. lead 12 Ga. x 9"		Aux. lead 10 Ga. x 11 1/2"	Aux. lead 10 Ga. x 19 1/2"

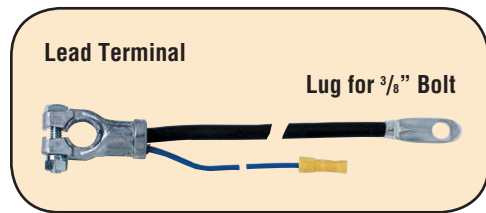

Lead Terminal

Lug for 3/8" Bolt



### Suffix "UA" Lead Top-Post Terminal, With One 8 Ga. Aux Lead. May Also Include Detached starter lead

4 Gauge	Aux. Lead
A42-4UA	8 Ga. x 9"
<b>NEW!</b> A50-4UA	8 Ga. x 20"
A58-4UA	8 Ga. x 9"
A72-4UA*	14 Ga. x 93"
<b>NEW!</b> A82-4UA*	6 Ga. x 45", 12 Ga. x 115" **

\* Lead-free terminal      \*\* Not attached to main cable

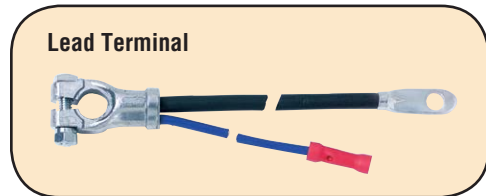

Lead Terminal



### Suffix "UAB" Lead Top-Post Terminal, With Aux Lead With OE Type Aux Lead From Lug End

	Aux. Lead 1	Aux. Lead 2
A42-4UAB	8 Ga. x 9"	14 Ga. x 10" *

\* From auxiliary lead 1

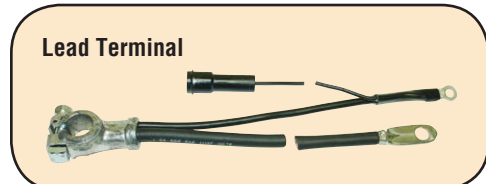

Lead Terminal





# BATTERY CABLES



BATTERY CABLES

## INSULATED BATTERY CABLES (PREFIX "A")

Suffix "UAC" Lead-Free Top-Post Terminal With Aux Lead With OE Type Aux Lead From Lug End

	Gauge	Aux. Lead 1	Aux. Lead 2 *
A27-6UAC	6	8 Ga. x 15"	12 Ga. x 13"
A30-6UAC	6	14 Ga. x 10"	14 Ga. x 20"
A42-6UAC	6	14 Ga. x 25"	14 Ga. x 20"
A43-4UAC	4	14 Ga. x 10"	14 Ga. x 20"
<b>NEW</b> A50-4UAC	4	8 Ga. x 24"	12 Ga. x 7"
A28-2UAC	2	8 Ga. x 15"	12 Ga. x 13"
<b>NEW</b> A54-2UAC	2	8 Ga. x 18"	10 Ga. x 10"

\* From auxiliary lead 1

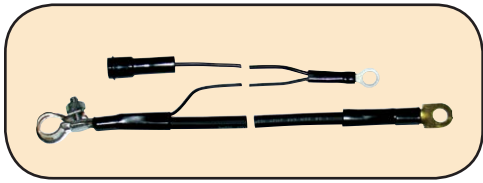

Suffix "UC" Lead-Free Top-Post Terminal 3 Aux Leads, 1 From Terminal And 2 From Center Splice

	Aux. Lead 1	Aux. Lead 2	Aux. Lead 3
A45-4UC	12 Ga. x 14"	8 Ga. x 25"	8 Ga. x 16"
<b>NEW</b> A54-4UC	10 Ga. x 6"	8 Ga. x 12"	

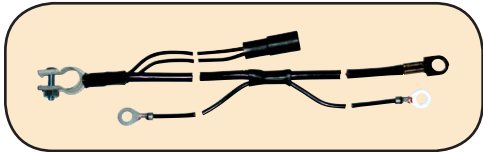

Suffix "UD" Lead-Free Top-Post Terminal With Aux Lead From Both Ends

	Aux. Lead	Lug End Aux. Lead
A26-6UD	8 Ga. x 12"	10 Ga. x 15"
<b>NEW</b> A27-6UD	8 Ga. x 14"	10 Ga. x 10"
<b>NEW</b> A31-6UD	8 Ga. x 14"	10 Ga. x 10"
A32-6UD	8 Ga. x 12"	8 Ga. x 12"
<b>NEW</b> A52-4UD	8 Ga. x 13"	

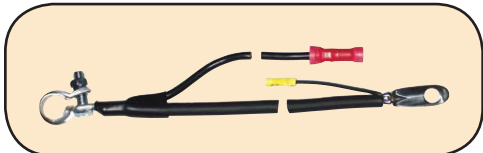

Suffix "UDC" Lead-Free Top-Post Terminal With Aux Lead From Both Ends With Ring Terminals

4 Gauge	Aux. Lead 1	Aux. Lead 2
<b>NEW</b> A49-4UDC	8 Ga. x 16"	8 Ga. x 17"
<b>NEW</b> A53-4UDC	8 Ga. x 16"	8 Ga. x 22"
<b>NEW</b> A66-4UDC	8 Ga. x 14"	36 Ga. x 38"
<b>NEW</b> A69-4UDC	8 Ga. x 14"	36 Ga. x 8"



Suffix "UH" Lead Top-Post Terminal, With One Aux Lead, With 1/2" Lug

6 Gauge	Aux. Lead	6 Gauge	Aux. Lead
A24-6UH	10 Ga. x 5"	A38-6UH	10 Ga. x 5"
A32-6UH	10 Ga. x 5"	A56-6UH	10 Ga. x 5"



Suffix "UHC" Lead-Free Top-Post Terminal, With One Aux Lead, With Ring Terminal, 1/2" Lug

	Gauge	Aux. Lead
A46-2UHC	2	8 Ga. x 21"

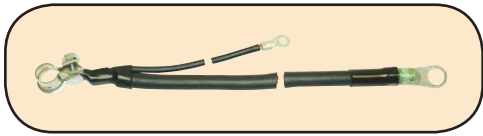

Suffix "UHLC" Lead Top-Post Terminal, With One Aux Lead From Lug End, 1/2" Lug

	Gauge	Aux. Lead
A38-2UHLC	2	8 Ga. x 15"

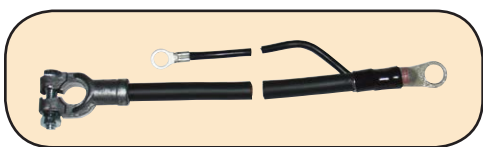

Suffix "UT" Lead-Free Top-Post Terminal, With One Aux Lead With Butt Splice Connector

6 Gauge	Aux. Lead	4 Gauge	Aux. Lead
A14-6UT	10 Ga. x 8"	A22-4UT	8 Ga. x 8"
A16-6UT	8 Ga. x 8"	A32-4UT	8 Ga. x 8"
A22-6UT	8 Ga. x 8"	A36-4UT	8 Ga. x 8"
A25-6UT	8 Ga. x 8"	A38-4UT	10 Ga. x 8"
A27-6UT	8 Ga. x 8"	A42-4UT	8 Ga. x 8"
A28-6UT	10 Ga. x 8"	A48-4UT	8 Ga. x 8"
A30-6UT	8 Ga. x 8"	A52-4UT	8 Ga. x 8"
A36-6UT	8 Ga. x 8"	A57-4UT	8 Ga. x 8"
A37-6UT	10 Ga. x 8"	A72-4UT	8 Ga. x 8"
A42-6UT	8 Ga. x 8"	A73-4UT	10 Ga. x 8"
A48-6UT	8 Ga. x 8"	A78-4UT	8 Ga. x 8"
A54-6UT	8 Ga. x 8"		
A56-6UT	10 Ga. x 8"		

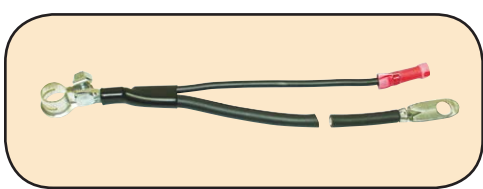

# BATTERY CABLES

## INSULATED BATTERY CABLES (PREFIX "A")

### Suffix "UT" Lead-Free Top-Post Terminal, With One Aux Lead With Butt Splice Connector

2 Gauge	Aux. Lead	1 Gauge	Aux. Lead
A33-2UT	6 Ga. x 35" *	A22-1UT	6 Ga. x 29"
A44-2UT	8 Ga. x 8"		
A55-2UT	8 Ga. x 8"		
<b>NEW!</b> A60-2UT	8 Ga. x 8"		
<b>NEW!</b> A68-2UT	8 Ga. x 8"		

\* With 10 Ga. x 12" aux. lead from lug end

### Suffix "UTC" Lead-Free Top-Post Terminal, With One Aux Lead, With Ring Terminal

6 Gauge	Aux. Lead	4 Gauge	Aux. Lead	Aux. Lead
<b>NEW!</b> A38-6UTC	8 Ga. x 14"	A17-4UTC	10 Ga. x 20"	
<b>NEW!</b> A54-6UTC	8 Ga. x 11"	<b>NEW!</b> A37-4UTC	8 Ga. x 12"	
<b>NEW!</b> A56-6UTC	8 Ga. x 10"	<b>NEW!</b> A40-4UTC	8 Ga. x 30"	12 Ga. x 10" *
		<b>NEW!</b> A42-4UTC	8 Ga. x 30"	12 Ga. x 10" *
		<b>NEW!</b> A46-4UTC	8 Ga. x 10"	
		<b>NEW!</b> A50-4UTC	8 Ga. x 12"	
		<b>NEW!</b> A53-4UTC	8 Ga. x 30"	12 Ga. x 10" *
		<b>NEW!</b> A62-4UTC	8 Ga. x 12"	
		<b>NEW!</b> A67-4UTC	8 Ga. x 17"	

\* Not attached to main cable



## Cable Make-Up Tips

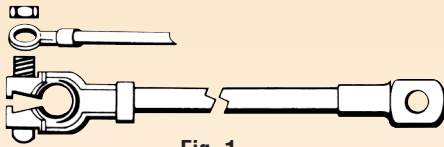

Fig. 1

- A.** To attach auxiliary wires when none are provided on the cable itself, proceed as follows:
1. Terminate the auxiliary wire desired, using a 3/8" I.D. ring terminal.
  2. Attach terminal to the battery terminal bolt as shown (Fig. 1).

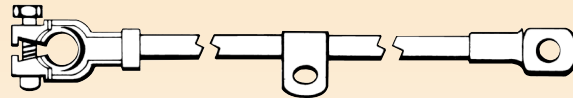
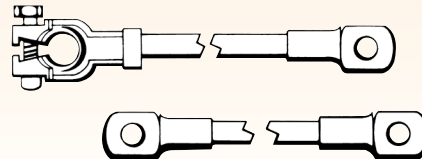

Fig. 2

- B.** To create a center lug cable when one is unavailable use two normal cables proceed as follows:
1. Set up two cables as shown in Fig. 3.
  2. Install.

Fig. 3



# BATTERY CABLES & GROUND STRAPS



## BATTERY CABLE SELF-SERVICE CENTER

Part No.	Description	Std. Pkg.	
BCA-1 SD647	Battery Cable Assortment 14-Hook Display Header	1 4	
<b>Included in the assortment:</b> <ul style="list-style-type: none"> <li>• 14 top-selling cables (1 each)</li> <li>• 2 switch-to-starter cables</li> <li>• 3 conventional cables</li> <li>• 5 cables with auxiliary wire leads</li> <li>• 4 GM-style side terminals</li> <li>• Free 14 hook display header</li> </ul>			
Part No.	Cable Type	Length	Gauge
A10-4	Conventional	10"	4
A16-4	Conventional	16"	4
A12-6	Conventional	12"	6
A19-4U	with auxiliary wire	19"	4
A22-4U	with auxiliary wire	22"	4
A30-4U	with auxiliary wire	30"	4
A36-4U	with auxiliary wire	36"	4
A48-4U	with auxiliary wire	48"	4
A24-4L	Switch-to-starter	24"	4
A40-4L	Switch-to-starter	40"	4
A25-4D	GM-style	25"	4
A30-4D	GM-style	30"	4
A35-4D	GM-style	35"	4
A45-4D	GM-style	45"	4

## GROUND STRAPS

Flat copper braid, tinned without insulation			
Part No.	Gauge	Length	Description
B8G	10	8"	Bonding strap to connect engine block to firewall. Reduces radio noise.
B16G	10	16"	
B20G	10	20"	
<b>NEW</b> B10G	10	9 1/2"	
B9G	4	9"	
B12G	4	12"	
B14G	4	14"	Cable with 2 square lugs.
B14G-5 *	4	14"	* 5/16" lug holes
B18G	4	18"	
B20G-5 *	4	20"	
B26G	4	26"	
B17G2	2	17"	
B9	2	9"	
B14	2	14"	Cable with lead terminal and square lug.
B17	2	17"	
B25E	2	25"	Cable with lead terminal and multiple square lugs.
B29E	2	29"	

## BULK GROUND STRAP

Part No.	Gauge	Std. Pkg.
B2GV	2	25 ft. roll
B4GV	4	25 ft. roll
B10GV	10	25 ft. roll

## STEP-DOWN BUTT CONNECTORS

Part No.	Gauge	Std. Pkg.
SST89	10-12 to 8 Gauge	10
SST90	14-16 to 12-10 Gauge	10

## VINYL INSULATED GROUND LEAD

Part No.	Description	Qty. Per Pkg.
ET2012	12 Gauge Vinyl insulated universal grounding lead. 20" long 5/16" eyelet	1 Display Clam
ET912	12 Gauge Vinyl insulated universal grounding lead. 9" long 3/8" eyelet	1 Display Clam

ET Display Package

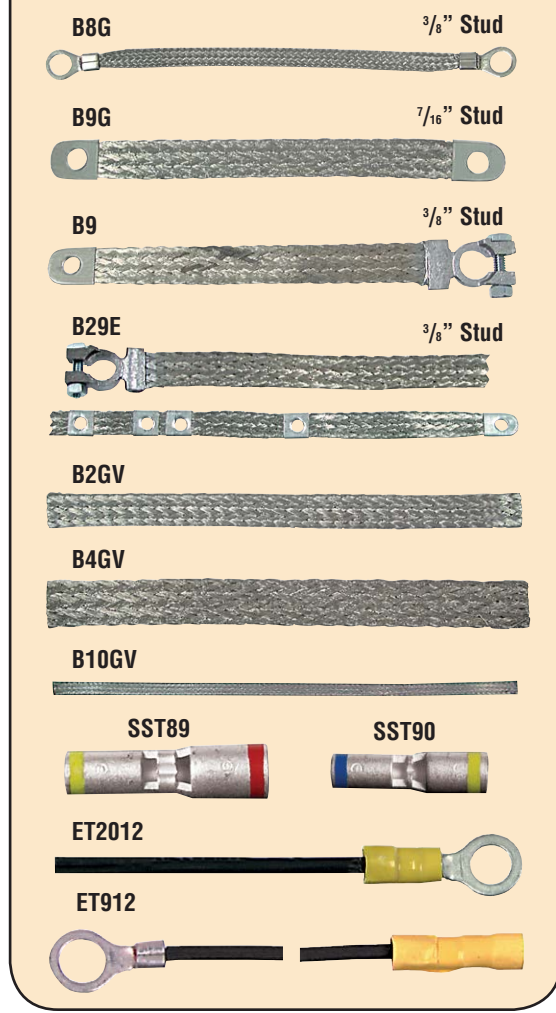

BATTERY CABLES

# BATTERY CABLE REPLACEMENT ENDS

- Ideal for emergency repairs.
- Insulating sleeve protects splice from corrosion and shorts.
- Convenient lengths.
- Carded items are convenient for up-front display.
- Easy-to-install, because the work is always near the battery, no matter how long the cable is.
- No special tools required.
- Universal terminal fits positive and negative battery posts.
- Length 6 1/2".

## LEAD COUPLERS

Part No.	Description	Std. Pkg.
<b>Top Mount</b>		
QC10	Single replacement end; top post battery terminal for 8, 6 & 4 Ga. cable. Includes plastic insulator.	1 card 6 per card
QC16	Double "quick-connect" replacement end; top mount for 6 Ga. cable. Chrysler and import vehicles. Includes plastic insulator	1 per box
<b>Side Mount</b>		
QC14	Side mount battery terminals; for 8, 6 & 4 Ga. cable. Includes plastic insulator (6 black)	1 card 6 per card
QC20	Side mount battery with 2 auxiliary leads.	1 per box
<b>NEW!</b> QC21	Repairs 4 & 6 Ga.	1 per box
<b>NEW!</b> QC23	Repairs 2 & 1 Ga.	1 per box

## LEAD-FREE COUPLERS

Part No.	Description	Std. Pkg.
QC18	Single replacement end; top post cable with 2 auxiliary leads	1 per box
QC19	Double replacement end; 1 auxiliary lead.	1 per box
<b>NEW!</b> QC22	Repairs 2 & 1 Ga.	1 per box

## COMPRESSION ENDS WITH BRASS COUPLERS

Part No.	Description	Std. Pkg.
QC11	Brass coupler for top post battery terminal for 2 & 1 Ga. Includes telescoping insulator	1 card 6 per card
QC12	Brass coupler for top post battery terminal for 2/0 Ga. Includes telescoping insulator	1 card 6 per card (3 red; 3 black)
QC15	Lead terminal conversion end. For adapting conventional (top) post terminal batteries for use with side terminal battery cables. Extra length adapter minimizes strain on posts	1 card 6 per card (3 red; 3black)
QC17	Brass coupler for 3/8" stud or side mount battery, 2 & 1 Ga. Includes telescoping insulator	1 per box

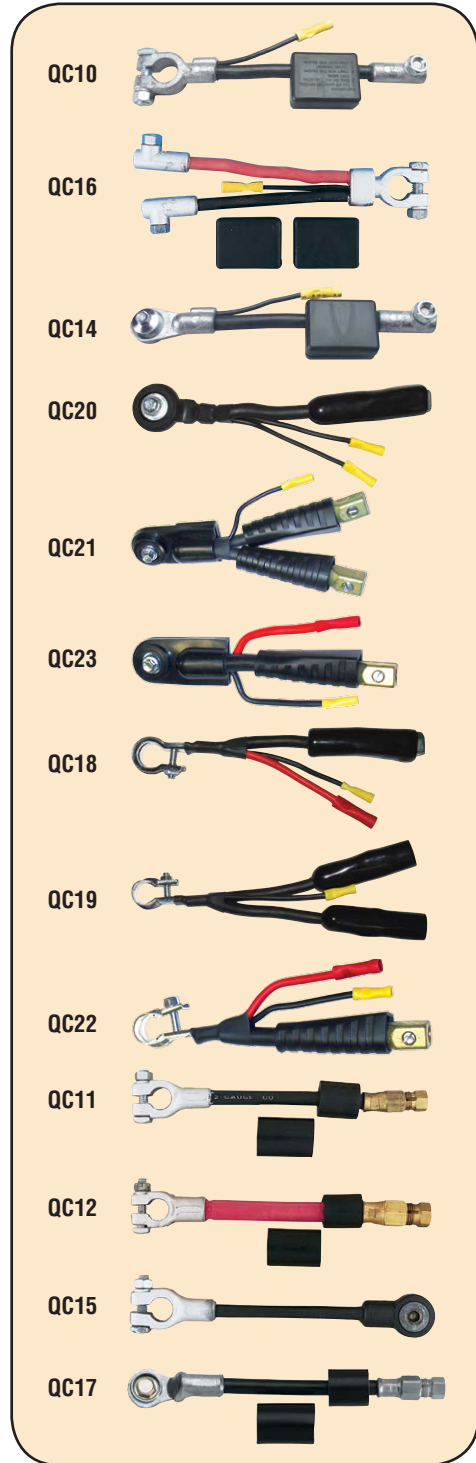

## SPLICING SYSTEMS AND SIDE TERMINAL CONVERSION

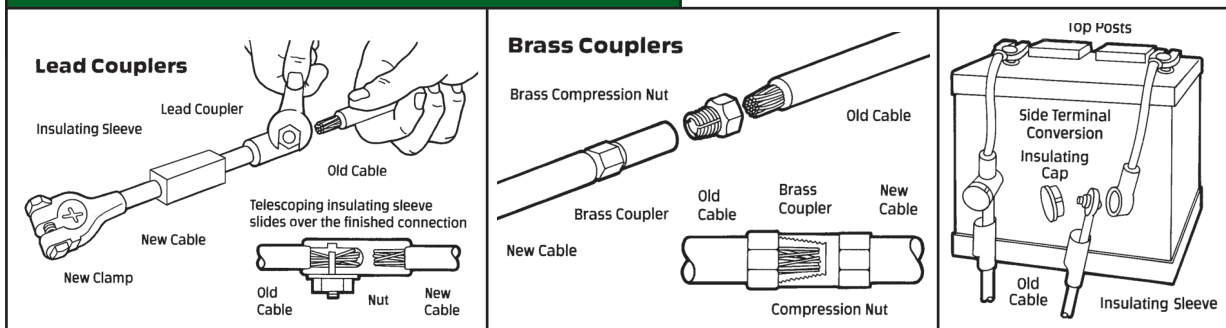

# MULTIPLE BATTERY CABLE HARNESSSES



## TWO AND THREE BATTERY CABLE HARNESS

### Two Battery Harnesses

Top post to power take-off post

Part No.	Length	Gauge	Polarity
A7-00MN	7"	2/0	Neg.
A7-00MP	7"	2/0	Pos.
A8-00MN	7 1/2"	2/0	Neg.
A8-00MP	7 1/2"	2/0	Pos.

### Two Battery Harnesses

Stud to power take-off post

Part No.	Length	Gauge	Polarity
A7-00SN	7"	2/0	Neg.
A7-00SP	7"	2/0	Pos.
A8-00SN	7 1/2"	2/0	Neg.
A8-00SP	7 1/2"	2/0	Pos.

Each stud type harness includes (2) 3/8" flange nuts

### Three Battery Harnesses

Top post to power take-off post

Part No.	Length	Gauge	Polarity
A14-00MN	14"	2/0	Neg.
A14-00MP	14"	2/0	Pos.
A15-00MN	15"	2/0	Neg.
A15-00MP	15"	2/0	Pos.

### Three Battery Harnesses

Stud to power take-off post

Part No.	Length	Gauge	Polarity
A14-00SN	14"	2/0	Neg.
A14-00SP	14"	2/0	Pos.
A15-00SN	15"	2/0	Neg.
A15-00SP	15"	2/0	Pos.

Each stud type harness includes (3) 3/8" flange nuts

Post type

A7-00MN



Post type

A7-00MP



Stud type

A8-00SN



Stud type

A8-00SP



Post type

A14-00MN



Post type

A14-00MP



Stud type

A14-00SN



Stud type

A14-00SP



Power Take-Off Post makes connection simple and fast.

2/0 Gauge wire, PVC insulated.

Steel reinforcing ring cast inside clamps for extra strength.

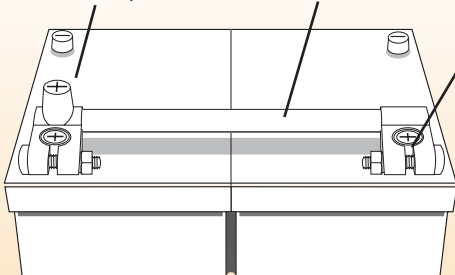

## MULTIPLE BATTERY HARNESSSES

Pre-assembled cables quickly and easily join 2 and 3 batteries together to deliver maximum starting power.

- Factory sealed between cable and clamp reduces effects of corrosive elements.
- Heavy duty 2/0 copper cable is PVC insulated.
- Designed for use on group 31 and other battery sizes where maximum power is needed for truck engines.

# MULTIPLE BATTERY HOOKUPS

## MULTIPLE BATTERY HOOKUPS... TRUCK, FARM & INDUSTRIAL APPLICATIONS

- **Universal application.** Each cable can be used as a “top” or a “bottom”  
Cuts inventory in half . . . without sacrificing coverage
- **Precision-molded insulated end . . . provides a tight, maintenance-free seal**
- **Protective cap protects against electrical shorting, corrosion and contamination**
- **Four-way cable permits 4-battery cluster setups using only one part number: A22-00K**

Four Part Numbers Cover Every Application

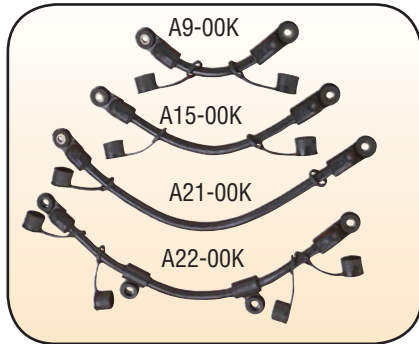

Part No.	Length	Gauge
A9-00K	9"	2/0
A15-00K	15"	2/0
A21-00K	21"	2/0
A22-00K	22" (4 Term.)	2/0



Part No.	Description	Std. Pkg.
BP41B	Black (neg.) protective cap for stackable battery cable	5
BP41R	Red (pos.) protective cap for stackable battery cable	5
BP99	Stainless steel hold down nuts	5
BP101	Black (neg.) nylon stud nuts	5
BP102	Red (pos.) nylon stud nuts	5

### TYPICAL ASSEMBLY AND INSTALLATION TIPS

Cables are factory-assembled for use as “bottoms.” To convert cable for “top” use, pry out insert with a screwdriver.

Use **SST305**, 2/0 gauge butt splice connector to splice into O.E. cable and **HST240B** heat shrink tubing for extra protection.

### CABLE HOOKUPS FOR MULTIPLE BATTERY CLUSTERS

**Legend:** OEM = OEM Starter Cable; BC = Butt Connector; A9 = A9-00K; A15 = A15-00K; A21 = A21-00K; A22 = A22-00K.

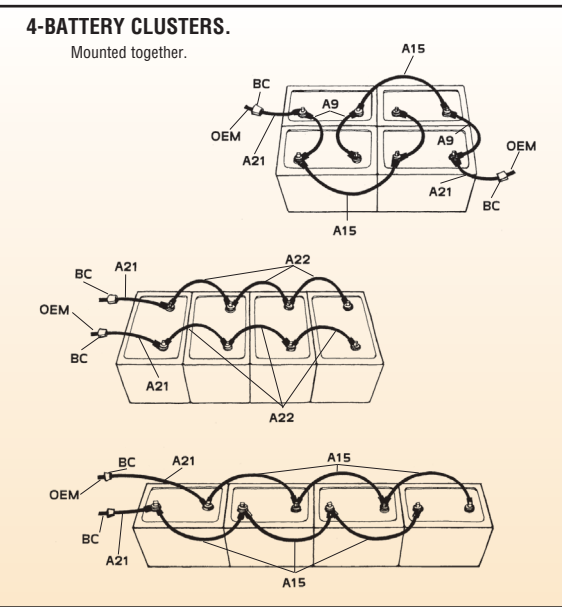
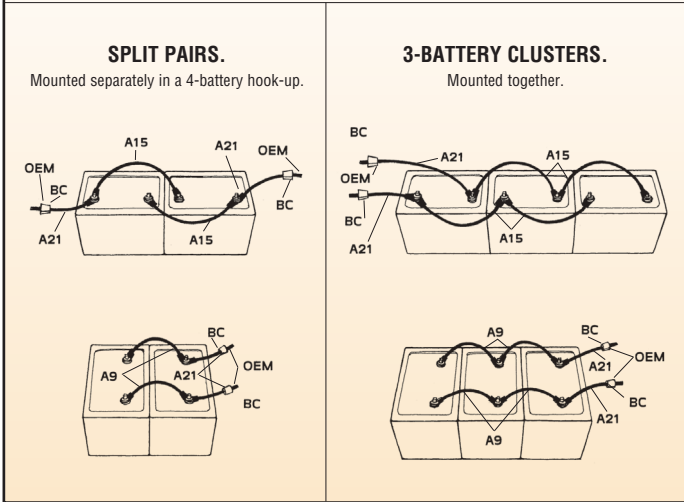

# MULTI-BATTERY ISOLATORS



## MULTIPLE BATTERY ISOLATORS

- Electronically isolates auxiliary battery from main start battery
- One way directional design prevents auxiliary battery from robbing main/start battery
- No matter how drained an accessory battery becomes, the main battery will always have the power to start the engine
- Suitable for all multi-battery systems, including RV and inboard marine
- Multi-battery isolators are designed for alternator systems with negative ground, and batteries of the same nominal voltage. Batteries of differing voltages cannot be used.
- For optimum systems performance batteries labeled “Deep Cycle” should be used in the auxiliary position

**BP42 - 95 AMP Multi-Battery Isolator** – For one main battery, one auxiliary battery, alternator up to 95 amp. output, including GM “CS” series alternator.

**BP43 - 120 AMP Multi-Battery Isolator** – For one main battery, one auxiliary battery, alternator up to 120 amp. output, including GM “CS” series alternator.

**BP44 - Battery Isolator Installation Kit** – Kit includes: 15 feet of 8 gauge primary wire; 50 Amp circuit breaker; Terminal and connector hardware pack; 8 Ga., ring terminals, (2 1/4” stud, 4 5/16” stud, 1 3/8” stud), 1-12-10 Ga. splice, 2 each 1/4” nuts and washers, 2 circuit breaker mounting screws.

**BP45 - Connector Assembly Kit** – For GM & Jeep vehicles with Delcotron “CS” series alternators. Group 2 applications - 1985 and newer. Kit includes: Various 16-14 Ga. terminals, sense wire for “S” position on certain GM “CS” alternator connectors, primary wire.

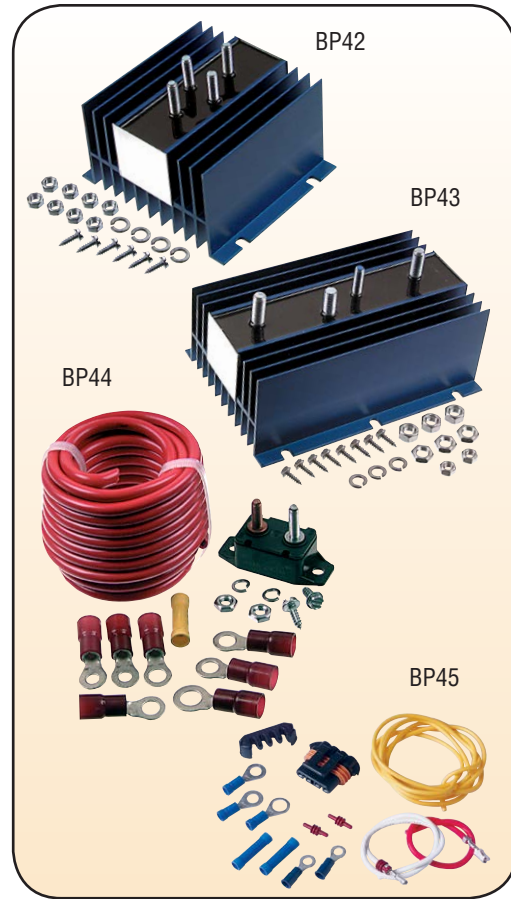

BATTERY CABLES

BATTERY ISOLATOR APPLICATIONS			Recommended Primary Wire Gauge Circuit Breaker or Installation Kit			
Alternator Type	Max Alt. Output	2 Batteries 1 Main, 1 Auxiliary	Wire Length			
			15 ft.	20 ft.	25 ft.	30 ft.
<b>Group #1</b> <b>Delco (GM)</b> , except Delcotron CS series alternators (1984 and earlier) <b>Ford</b> All models through 1997 <b>Chrysler</b> All models, all years, including externally regulated Nippondenso alternators <b>Motorola</b> Load Handler series 8EM remote sense series Japanese Imports with external voltage regulators or external sensing	Up to 95 Amps	<b>BP42*</b>	8 Ga. 50 Amp (1)	6 Ga. 50 Amp	4 Ga. 50 Amp	4 Ga. 50 Amp
<b>Group #2</b> <b>Delco (GM)</b> , with Delcotron CS series alternators (most 1985 and newer)** or CS130D (1993 and newer) <b>Ford</b> - All models 1998 and later <b>Jeep</b> - equipped with Delcotron CS series alternators (1985 and 1990)** <b>Toyota and Honda</b> Nippondenso Alt. with internal regulator	Up to 95 Amps	<b>BP43*</b>	6 Ga. 80 Amp	4 Ga. 80 Amp	2 Ga. 80 Amp	1 Ga. 80 Amp

\*BP45 connector kit is required for Group 2 applications with Delcotron “CS” alternators. Included is a sense wire required for the CS130D alternator. \*\*CS series alternator is identified by the number of holes in the plug-in connector. The CS series has 3 smaller square holes and 1 larger square hole. CS130D alternator has 4 square holes all the same size. Standard series has 2 slotted holes.  
 (1) — 8 Ga. wire, 50 Amp circuit breaker or BP44 connector kit (includes: 15 ft. 8 Ga. wire, 50 Amp CB, terminals and connectors.  
 Refer to detailed assembly instructions included with each Multi-Battery Isolator.

# BULK BATTERY CABLE

## CUSTOMIZE YOUR OWN BATTERY CABLES... AND WELDING CABLES...



Bulk battery and welding cable can help you repair or adapt to a wide range of cable make-ups. Our bulk cable comes in a wide range of gauges and coil lengths. Also available is a complete selection of individual terminals, adapters and other accessories to accommodate any situation: from an emergency hookup to a custom application.

Our **heavy duty cable** exceeds SAE Spec J1127 for Type SGR cable, and exhibits higher levels of heat resistance and resistance to corrosive elements (oil and moisture). That's why our cable works better and lasts longer.

### HEAVY DUTY – TYPE SGR/SAEJ1127

Part No.			Cable		
25 ft. Coil	50 ft. Coil	100 ft. Coil	Gauge	Stranding	O.D.
CS6V	—	C6E	6	133 x 27	.305"
CS4V	CS4L	CS4C	4	61 x 22	.365"
CS2V	CS2L	CS2C	2	133 x 23	.490"
CS1V	CS1L	CS1C	1	399 x 27	.490"
CS0V	CS0L	CS0C	1/0	133 x 21	.535"
CS00V	CS00L	CS00C	2/0	133 x 20	.575"
CS000V	CS000L	CS000C	3/0	361 x 23	.670"
CS0000V	—	—	4/0	323 x 22	.788"

Insulation Temperature Rating 105°C (221°F)



DON'T try this on conventional battery cable! This is what a hot soldering iron does to conventional battery cable jacket after 30 seconds . . .



Our heavy duty battery cable takes the heat. No trace of melting or burning after contact with same hot soldering iron. In some applications, battery cables can make contact with hot engine parts which often reach temperatures as high as a hot soldering iron.

Insulation Temperature Rating 105°C (221°F)



Go to page numbers **C7-C8**, Section C "Primary Wire" for Marine Battery Cable

### HEAVY DUTY RED CABLE – TYPE SGR/SAEJ1127

Part No.			Cable		
25 ft. Coil	50 ft. Coil	100 ft. Coil	Gauge	Stranding	O.D.
CS6RV	—	CS6RC	6	133 x 27	.305"
CS4RV	—	CS4RC	4	61 x 22	.365"
CS2RV	—	CS2RC	2	133 x 23	.490"
CS1RV	—	CS1RC	1	399 x 27	.490"
CS0RV	CS0RL	CS0RC	1/0	133 x 21	.535"
CS00RV	CS00RL	CS00RC	2/0	133 x 20	.575"
CS000RV	CS000RL	CS000RC	3/0	361 x 23	.671"
CS0000RV	—	—	4/0	361 x 22	.788"

#### ORDERING INFORMATION

Suffixes in charts indicate length of coil. (**V** = 25 ft. coil, **L** = 50 ft. coil; **C** = 100 ft. coil.) Cable is sold by the foot, not by the coil. To order, specify total number of feet required, followed by part number and desired coil size (suffix).

**Examples:** To order four-25 ft. coils of 1 gauge battery cable, order 100' **CS1V**. To order one-50 ft. coil of 2 gauge battery cable, order 50' **CS2L**. To order three-25 ft. coils of 2 gauge welding cable, order 75' **WC2V**.



# WELDING CABLE & SOLDER SLUGS



## WELDING CABLE – 600 VOLT RATING

- Protects against abrasion, grease and oil
- Maintains flexibility to -50°C (-60°F)
- Temperature rating 105°C (221°F)

Part No.						Cable	Ga.	Stranding	O.D.
25 ft. Coil		50 ft. Coil		250 ft. Coil					
Black	Red	Black	Red	Black	Red				
WC4V	WC4RV	WC4L	WC4RL	<b>NEW!</b> WCB4	<b>NEW!</b> WCB4R	4	427 x 30	.375	
WC2V	WC2RV	WC2L	WC2RL	<b>NEW!</b> WCB2	<b>NEW!</b> WCB2R	2	651 x 30	.445	
WC1V	WC1RV	WC1L	WC1RL	<b>NEW!</b> WCB1	<b>NEW!</b> WCB1R	1	826 x 30	.506	
WC0V	WC0RV	WC0L	WC0RL	<b>NEW!</b> WCB0	<b>NEW!</b> WCB0R	1/0	1044 x 30	.572	
WC00V	WC00RV	WC00L	WC00RL	<b>NEW!</b> WCB00	<b>NEW!</b> WCB00R	2/0	1308 x 30	.606	



Black Welding Cable - WC00V



Red Welding Cable - WC00RV

## BULK BOOSTER CABLE

- Parallel bonded cable provides tangle free service.
- Maintains flexibility in sub zero temperatures.

Part No.	Qty	Gauge
BC2DL	50'	2 Ga.
BC4DL	50'	4 Ga.
BC6DL	50'	6 Ga.



Bulk Booster Cable

## BATTERY TERMINAL SOLDER SLUGS

Pre-measured solder slugs available in 7 sizes provide the correct amount of solder for the perfect termination. Fast and convenient, this system only needs a propane torch and vise combined with normal safety precautions when using flammable materials.

Part No.	Gauge	Color	Std. Pkg.
BP185	4 Ga.	Gray	10
BP186	2 Ga.	Green	10
BP187	1 Ga.	Pink	10
BP188	1/0 Ga.	Black	10
BP189	2/0 Ga.	Orange	10
BP190	3/0 Ga.	Purple	10
BP191	4/0 Ga.	Yellow	10
BP192	2 oz.	Flux	1

## STA15 SOLDER SLUGS ASSORTMENT

Contains battery terminal solder slugs, flux and heat shrink tubing. (12 pieces of heat shrink tubing in assorted sizes) Std. Pkg. 1 Contents:

Part No.	Qty.	Part No.	Qty.	Part No.	Qty.
STT263	4	BP185	5	BP189	5
STT264	4	BP186	5	BP190	5
STT265	2	BP187	5	BP191	5
STT265R	2	BP188	5	BP192	1

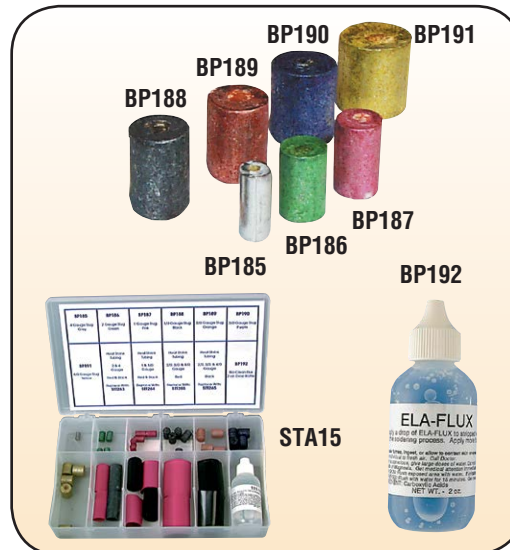

## Instructions For Cable Assembly



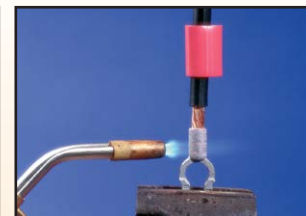





- 1 Strip the insulation from the cable allowing the exposed copper to reach the bottom of the terminal.
- 2 Place the proper size slug into the terminal. Secure the terminal in vise. Slide heat shrink tubing over the cable. Apply several drops of flux (BP192) to the exposed cable. Insert the cable into the terminal.
- 3 Heat the base of the battery terminal with the ignited torch gently pressing downward on the cable. Allow the cable to slide into the terminal until the insulation is snug against the top of the terminal. Remove the heat.
- 4 Slide the heat shrink tubing over the connection; apply heat to the tubing using a heat gun (WTT20). For additional heat shrink instructions see pages B36-B38.



# BATTERY TERMINALS

## HEAVY DUTY SUPER-CRIMP TERMINALS

Super-Crimp terminals are made of pure copper and are lead plated. This combination assures maximum conductivity and corrosion resistance. For best results, use appropriate crimping tool (shown below). These “Heavy Duty” terminals can also be soldered using battery terminal solder slugs (page B23). For added durability, finish every crimping job with double-wall heat shrink tubing. (See pages B36-B38 for complete selection of heat shrink tubing).

	Part No.(+)	Part No.(-)	Gauge	Std. Pkg.		
STRAIGHT	BP90	BP90	4	5	 <p>Straight</p>	 <p>Left Elbow</p>
	BP91	BP92	2 & 1	5		
	BP93	BP94	1/0	5		
	BP95	BP96	2/0	5		
	BP107	BP108	3/0	5		
	BP109	BP110	4/0	5		
LEFT ELBOW	BP123	BP124	1/0	5	 <p>Right Elbow</p>	 <p>Flag Style</p>
	BP125	BP126	2/0	5		
	BP127	BP128	3/0	5		
FLAG STYLE	BP113	BP114	1/0	5	 <p>In-Line Stud</p>	 <p>Stud Top</p>
	BP115	BP116	2/0	5		
	BP117	BP118	3/0	5		
	BP170	BP171	2	5		
	BP172	BP173	1	5		
	BP174	BP175	1/0	5		
IN-LINE STUD	BP135	BP136	2/0	5	 <p>Stud Type*</p>	 <p><sup>13</sup>/<sub>32</sub> Side Mount</p>
	BP137	BP138	3/0	5		
	BP176	BP177	4/0	5		
	BP169	BP169	1/0	1		
STUD TOP	BP164	BP163	2/0	1		
	BP165	BP162	3/0	1		
	BP167	BP168	4/0	1		
STUD TYPE*	BP140	BP144	1/0	1		
	BP142	BP143	4/0	1		
SIDE MOUNT	BP145	BP146	2/0	1		
	BP147	BP148	3/0	1		
	BP160		4	5		
	BP161		2	5		
	BP166		1/0	5		

\*Straight, crimpable battery terminals, featuring anti-rotational tongue. Heat shrink tubing furnished.

How to match crimpable terminals to the proper cable gauge	Gauge	Color Code	Letter Code
Crimping dies are coded by color or by letters (depending on the tool manufacturer) to designate the cable gauge and terminal for which they are designed. Here's how to select the proper crimping die: 1. Match the gauge of the terminal with the cable gauge. 2. Check the chart for the “color” or “letter” key corresponding to the wire gauge. 3. Select the crimping die with the “color” or “letter” code indicated on the chart.	4	Gray	JH
	1 & 2	Pink/Green	HH
	1/0	Black	EA
	2/0	Orange	AC
	3/0	Purple	AB
	4/0	Yellow	AA

### How to get a “super” crimping job...

- Use quality Super-Crimp terminals and quality heavy-duty crimping tools!
- Finish the job with quality heat-shrink tubing ... for the ultimate in protection against moisture, oxidation and wear!



# BATTERY TERMINALS



## COMPRESSION TERMINALS

- Tin plated copper terminals and lugs, for trouble-free terminations
- Quick, dependable assembly with a few simple tools

LUG				
Part No.	Gauge	Color	Std. Pkg.	Lug Hole
BP220	4	Gray	5	3/8"
BP221	2 & 1	Green & Pink	5	3/8"
BP223	1/0	Black	5	3/8"
BP225	2/0	Orange	5	3/8"
BP227	3/0	Purple	5	3/8"
BP229	4/0	Yellow	5	1/2"



Lug

STRAIGHT			
Part No.	Gauge	Color	Std. Pkg.
BP200	4	Gray	5
BP201	2 & 1	Green & Pink	5
BP203	1/0	Black	5
BP205	2/0	Orange	5
BP207	3/0	Purple	5
BP209	4/0	Yellow	5



Straight

90° ELBOW			
Part No.	Gauge	Color	Std. Pkg.
BP211	2 & 1	Green	5
BP213	1/0	Black	5
BP215	2/0	Orange	5
BP217	3/0	Purple	5
BP219	4/0	Yellow	5



90° Elbow

COMPRESSION NUTS			
Part No.	Gauge	Color	Std. Pkg.
BP234*	4	Gray	1
BP236**	4	Gray	1
BP235	2 & 1	Green	1
BP230	1/0	Black	1
BP231	2/0	Orange	1
BP232	3/0	Purple	1
BP233	4/0	Yellow	1

\* 9/16" Nut for flags & elbows only.

\*\* For straights and lugs only.

Compression Nuts



FLAG			
Part No.	Gauge	Color	Std. Pkg.
BP237	4	Gray	5
BP238	2 & 1	Green	5
BP239	1/0	Black	5
BP240	2/0	Orange	5
BP241	3/0	Purple	5



Flag

### Easy Installation Instructions

1 Strip 3/4" of insulation from end of cable.

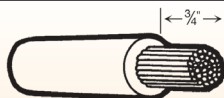

2 Using the proper size compression nut to match the cable size, insert the bare wire into the compression nut until it seats. The copper wire should be flush with, or extend slightly beyond the threaded portion of the compression nut.

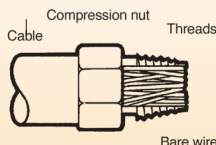

3 Thread the terminal onto the compression nut by hand a few turns to make sure the terminal and the nut are threading properly.

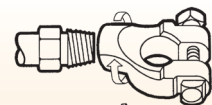

4 Finish tightening the terminal onto the compression nut by gripping the compression nut with a pair of pliers (or wrench), and rotating the terminal with a screwdriver until the nut seats.

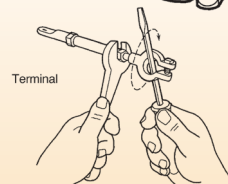

# BATTERY TERMINALS & EMERGENCY BATTERY TERMINALS

## LEAD-FREE TERMINALS

Part No.	Gauge	Std. Pkg.
BP224	6 & 4	5
BP226	6 & 4	5

Use heavy duty dual wall heat shrink tubing for professional finish. See page B36.

### Lead-Free Terminal



BP224

### Lead-Free Terminal Universal with Stud for Bolt on Cable



BP226

- Lead coated brass for extra strength and conductivity

## SOLDERABLE TERMINALS & ADAPTERS

Part No.	Description	Gauge	Std. Pkg.
BP11U	Open neck for bare cable	4-2/0	5
BP21U	Bell type neck for insulated cable	6	5
BP2	Bell type neck for insulated cable	6-4	5
BP25U	Bell type neck for insulated cable, universal	2	5
BP26U	Bell type neck for insulated cable, positive	2-1	5
BP20U	Bell type neck for insulated cable	1/0-2/0	5
BP20N	Bell type neck for insulated cable, negative	1/0-2/0	5
BP20P	Bell type neck for insulated cable, positive	1/0-2/0	5
BP83N	Bell type neck for insulated cable, negative	2/0-3/0	1
BP83P	Bell type neck for insulated cable, positive	2/0-3/0	1

## TOP-MOUNT - 90°

Part No.	Description	Gauge	Std. Pkg.
BP3U	Universal 90° elbow	4-2	5
BP1U	Universal 90° elbow	1/0-2/0	5
BP4U	Universal Split Barrel	4-6	5
BP2U	Universal Split Barrel	1-2	5
BP8P	Split Barrel Positive	1-2	5
BP8N	Split Barrel Negative	1-2	5
BP5U	Universal Split Barrel	1-2/0	5
BP6P	Split-barrel positive	1/0-2/0	5
BP6N	Split-barrel negative	1/0-2/0	5
BP7U	Universal Split Barrel	2/0-3/0	5
BP9P	Split Barrel Positive	3/0-4/0	5
BP9N	Split Barrel Negative	3/0-4/0	5
BP10N	Top post to stud converter, negative 3/8" x 3/4" w/ nut	n/a	5
BP10P	Top post to stud converter, positive 3/8" x 3/4" w/ nut	n/a	5

\* Go to page numbers B35-B38 for crimping tools & heat shrink tubing.

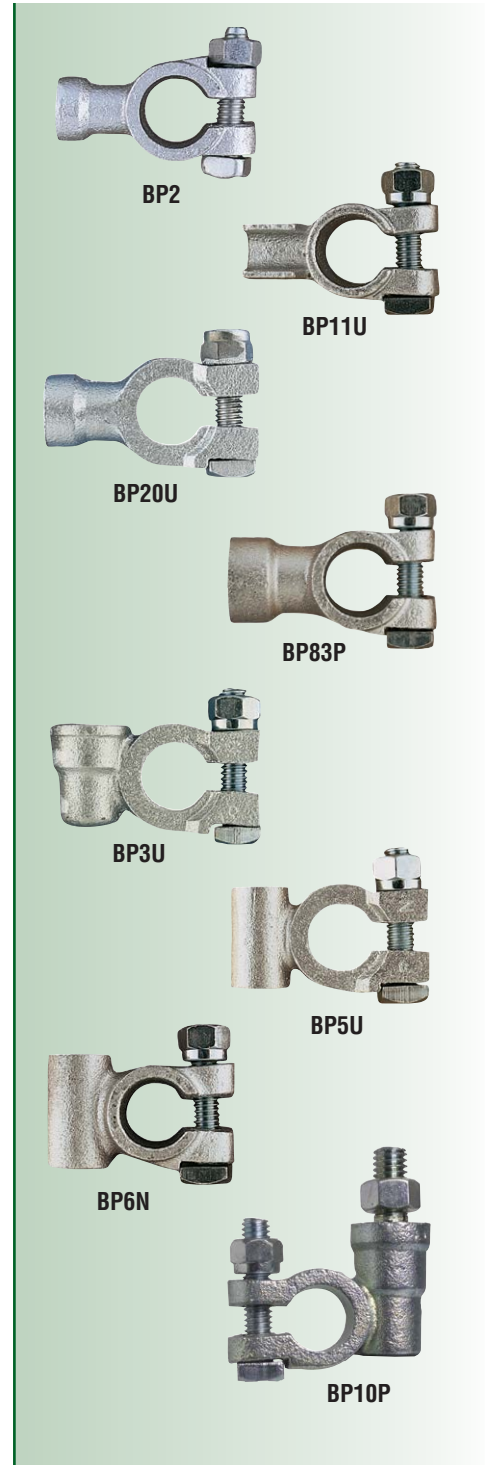

# BATTERY TERMINALS & EMERGENCY BATTERY TERMINALS



- Lead and brass terminals for extra strength and conductivity
- Nickel-plated for extra corrosion resistance

## EMERGENCY SOLDERLESS TERMINALS

Part No.	Description	Gauge	Std. Pkg.
BP17U	Epoxy-coated lead terminals Display packed	6 - 2/0	1 pr./clam (red/black)
BP19U	Universal, nickel-plated brass terminal	6-1	5
BP19C	Card of ten BP19U		2 cards
BP67U	Universal, lead terminal	8 - 4	5
BP67C	Card of ten BP67U	8 - 4	2 cards
BP67UC	Card of ten BP67U	8 - 4	10 cards
BP23U	Universal, solid lead terminal	4	5
BP23C	Card of ten BP23U	4	2 cards
BP23UC	Card of ten BP23U	4	10 cards
BP97U	Universal, heavy-duty solid lead terminal	1/0 - 3/0	1
BP97	Display pkg of BP97U	1/0 - 3/0	2/clam
BP97C	Card of ten BP97U	1/0 - 3/0	2 cards
BP28	Top mount 3-way terminal	2-1/0	1 pr./clam (1 pos., 1 neg)
BP81	Universal side mount, washer included	6-1/0	2/clam
BP81C	Card of 10 BP81	6-1/0	2 cards

## MARINE BATTERY TERMINALS

Part No.	Description	Std. Pkg.
BP22U	Universal, solid lead marine terminal with zinc plated steel $\frac{5}{16}$ " wing nut	5/box
BP22	Display pack of BP22U	2/clam
BP22C	Card of 10 BP22U	2 cards
BP58N	Cast brass negative marine terminal with $\frac{5}{16}$ " wing nut	5/box
BP58P	Cast brass positive marine terminal with $\frac{3}{8}$ " wing nut	5/box
BP58U	Cast brass universal marine terminal with $\frac{5}{16}$ " wing nut	5/box
BP22N	Negative lead marine terminal with zinc-plated steel $\frac{5}{16}$ " wing nut	5/box
BP22P	Positive lead marine terminal with zinc-plated steel with $\frac{3}{8}$ " wing nut	5/box
BP22W	Wing nut for BP22U, BP22N, and BP58N - $\frac{5}{16}$ " thread	10/box
BP22PW	Wing nut for BP22P and BP58P - $\frac{3}{8}$ " thread	10/box

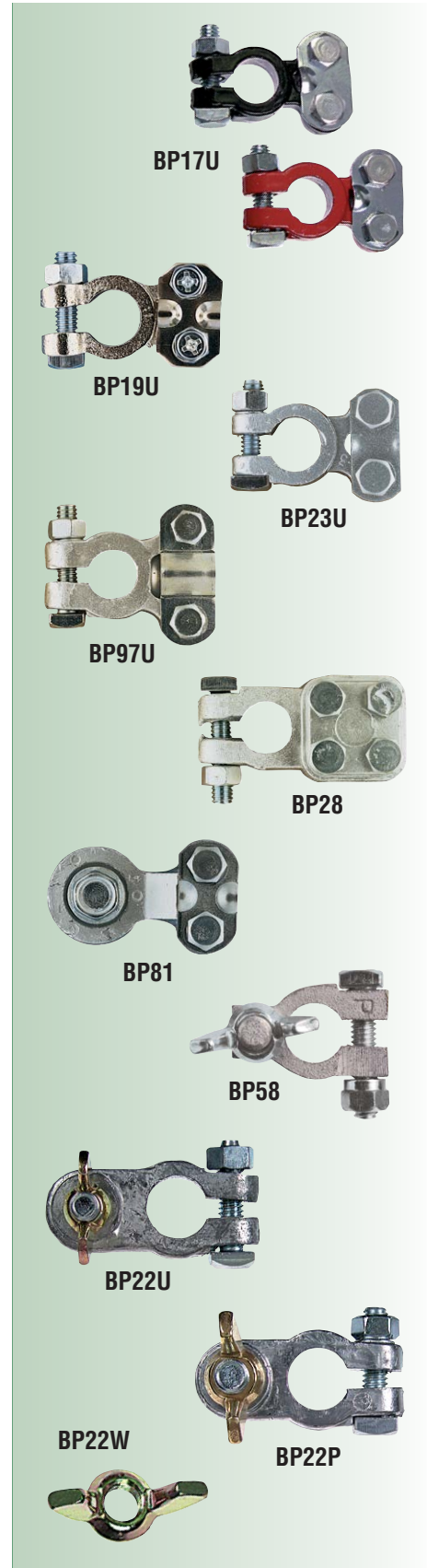

BATTERY CABLES

# BATTERY TERMINAL ADAPTERS

## TERMINAL ADAPTERS

Part No.	Description	Std. Pkg.
BP37	Quick connection with locking twist cap. Ideal for easy removal	1/clam
BP89*	Side Terminal Quick-disconnect battery bolts	1 pr.
BP111	Top Post Quick-disconnect battery bolts	1 pr.
BP112	HD Top Post Quick-disconnect battery bolts	1 pr.
BP77N	For adapting top post battery cable to side terminal battery. $\frac{3}{8}$ " threaded stud screws into negative battery terminal	5
BP77P	Same as BP77N—but for positive terminal	5
BP78	$\frac{3}{8}$ " x $\frac{1}{2}$ " side terminal battery bolt	5
BP78L	$\frac{3}{8}$ " x 1" extra long side terminal battery bolt. Auxiliary screw in end provides accessory hookup. Display pack (2/clam)	5 clams
BP79	For adapting side terminal battery cable to top post batteries. Universal solid lead (Display packed)	1 pos., 1 neg.
BP139	Side terminal battery cable bolt	5
BP141	Stud-to-post conversion. $\frac{3}{8}$ " stud. Display pack (1pos., 1neg./clam)	1 clam
BP182	Charging post, side mount. Display pack (2/clamshell) — install with side terminal cable	1 clam
BP183	Diesel side terminal battery cable bolt. For connecting 2 battery cables. Use with BP184 spacer	5
BP184	Spacer required to connect diesel battery cable. Use with BP183 bolt	5
BP193	Side mount terminal extension bolt. Heavy duty brass construction	5
BP194	Adaptor nut replaces regular $\frac{5}{16}$ " shoulder nut on top post clamps. Has $\frac{5}{16}$ " x $\frac{3}{4}$ " stud for accessory wires	5

## MILITARY BATTERY POST ADAPTERS

Part No.	Description	Std. Pkg.
BP24	Universal, Military type; for tapping auxiliary leads	5
BP36N	Battery post adapter. Meets military specification MS75004-1 (neg.)	5
BP36P	Battery post adapter. Meets military specification MS75004-2 (pos.)	5

## GARDEN TRACTOR BATTERY ADAPTERS

Part No.	Description	Std. Pkg.
BP38	Flag to post terminal adapters. Designed to convert most group U-1 flag terminal batteries to post terminal applications (Display packed)	2/clam
BP39	Carriage nuts and bolts. For utility and garden tractor battery cables. 2 bolts ( $\frac{1}{4}$ " x $\frac{3}{4}$ " ) and 2 nuts (Display packed)	2/clam

\* Available while supplies last

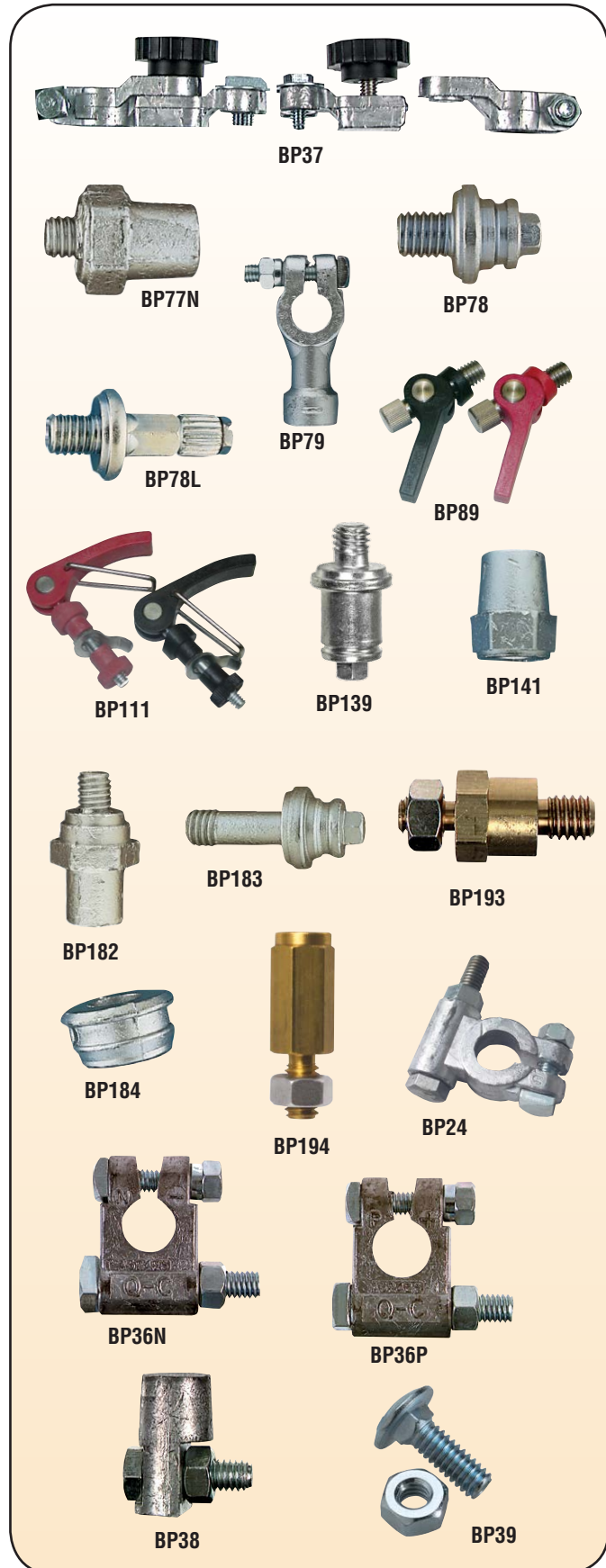

# BATTERY & STARTER CABLE LUGS



BATTERY CABLES

## BATTERY CABLE LUGS

- Solid copper for maximum conductivity
- One-piece seamless construction
- Can be used with battery cable solder slugs (Go to page B23)

Part No.	Gauge	Stud Size	Std. Pkg.	Part No.	Gauge	Stud Size	Std. Pkg.
BP300	8	#10	25	BP330	1	3/8"	10
BP301	8	1/4"	10	BP317*	1	1/2"	10
BP304	8	3/8"	10	BP314	1	1/2"	10
BP305	6	#10	25	BP316	1/0	3/8"	25
BP331	6	1/4"	10	BP327	1/0	1/2"	10
BP302	6	5/16"	10	BP318	2/0	5/16"	10
BP303	6	3/8"	25	BP319	2/0	3/8"	25
BP342	4	1/4"	10	BP320	2/0	1/2"	10
BP332	4	5/16"	10	BP341	2/0	5/8"	10
BP307	4	3/8"	25	BP322	3/0	3/8"	10
BP308	4	1/2"	10	BP323	3/0	1/2"	10
BP329	2	3/8"	10	BP328	4/0	3/8"	2
BP311	2	1/2"	10	BP326	4/0	1/2"	10
BP313	1	5/16"	10				

**NOTE:** The lugs shown are unplated copper. Lugs that are gray in color are tin-plated copper. Both types provide equal conductivity.

\* Extra wide pad

Actual Size



BP307



BP320

## SUPER HEAVY STARTER LUGS

- Heavier wall thickness and wide pads for greater heat sink
- Longer barrels for more crimping area. Can be soldered
- Electro Tin plated for reducing corrosion
- Color coded to identify correct die

Part No.	Gauge	Stud Size	Color	Std. Pkg.
BP347	4	1/4"	Gray	5
BP348	4	5/16"	Gray	5
BP350	4	3/8"	Gray	5
BP349	1-2	5/16"	Pink	5
BP351	1-2	3/8"	Pink	5
BP333	1/0	3/8"	Black	5
BP334	1/0	1/2"	Black	5
BP335	2/0	3/8"	Orange	5
BP336	2/0	1/2"	Orange	5
BP337	3/0	3/8"	Purple	5
BP338	3/0	1/2"	Purple	5
BP339	4/0	3/8"	Yellow	5
BP340	4/0	1/2"	Yellow	5



BP334



BP335



BP352



BP355

## LOCKING LUGS

- Locking Magna Lugs are designed for stud terminal batteries – Tin Plated Copper

Part No.	Gauge	Style	Color	Std. Pkg.	Lug Hole
BP352	1/0	Lug End	Black	5	3/8"
BP353	2/0	Lug End	Orange	5	3/8"
BP354	3/0	Lug End	Purple	5	3/8"
BP355	1/0	Dual Wire	Black	5	3/8"
BP356	2/0	Dual Wire	Orange	5	3/8"
BP357	3/0	Dual Wire	Purple	5	3/8"

# SPLICE CONNECTORS, BOLTS & SHIMS

## FOR PROFESSIONAL WIRE & CABLE INSTALLATIONS

### HEAVY DUTY THICK WALL COPPER LUGS

Copper Alloy for best conductivity, die cast and tin plated

Part No.	Gauge	Stud Size	Color	Std. Pkg.
BP358	6	3/8"	Gray	5
BP359	4	1/2"	Gray	5
BP360	4	3/8"	Gray	5
BP361	2	1/2"	Green	5
BP362	2	3/8"	Green	5
BP363	1	1/2"	Pink	5
BP364	1	3/8"	Pink	5
BP365	1/0	3/8"	Black	5
BP366	1/0	1/2"	Black	5
BP367	2/0	3/8"	Orange	5
BP368	2/0	1/2"	Orange	5
BP369	3/0	3/8"	Purple	5
BP370	3/0	1/2"	Purple	5
BP371	4/0	3/8"	Yellow	5
BP372	4/0	1/2"	Yellow	5

### BUTT SPLICE CONNECTORS

- Made of tinned copper for extra corrosion resistance
- Flared ends permit easy cable insertion

Part No.	Gauge	Std. Pkg.
SST299	8	10
SST300	6	10
SST301	4	10
SST302	2	10
SST303	1	10
SST304	1/0	10
SST305	2/0	10
SST306	3/0	10
SST307	4/0	10

### SUPER HEAVY DUTY BUTT SPLICE CONNECTORS

Part No.	Gauge	Color	Std. Pkg.
BP343	1/0	Black	5
BP344	2/0	Orange	5
BP345	3/0	Purple	5
BP346	4/0	Yellow	5

### STEP-DOWN BUTT CONNECTORS

Part No.	Gauge	Std. Pkg.
SST89	10-12 to 8 Ga.	10
SST90	14-16 to 12-10 Ga.	10

### BATTERY CABLE BOLTS & SHIMS

Part No.	Description	Length	Std. Pkg.
BP40	Blue Di-Chromate Battery bolt	1 7/16"	25
BP40C	5/16" raised shoulder nut Display packaged version of BP40	1 7/16"	4
BP40N	5/16" nut only		25
BP46	Plated nut & bolt 1/4" raised shoulder nut	1 3/8"	25
BP56	Battery post shim Pre-formed soft lead		25
BP56C	Display packaged version of BP56		2
BP57	Plated Flange 5/16" nut		10



BP362



SST304



BP345

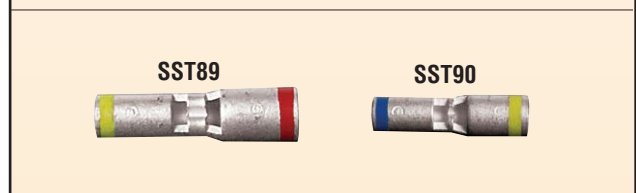

SST89

SST90

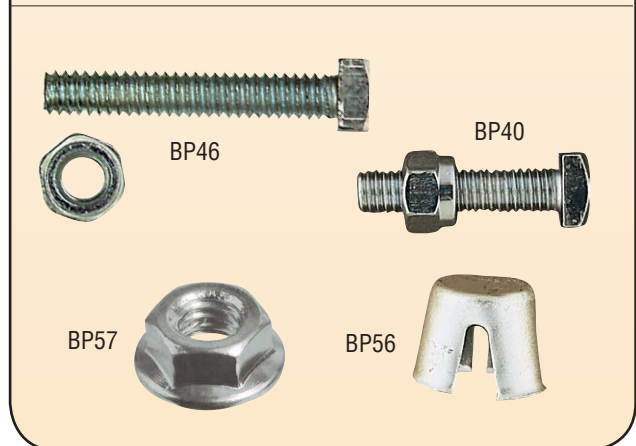

BP46

BP40

BP57

BP56



# BATTERY CORROSION PROTECTION

## PREVENT POWER LOSS BY PREVENTING CORROSIVE BUILD-UP

### BATTERY TERMINAL PROTECTORS

Chemically-impregnated felt gaskets. Installed between the battery and terminal to stop corrosion. Prevents corrosive build-up that interferes with electrical connection and causes engine starting failure.

Part No.	Description	Std. Pkg.
BPP71	Polyester pad protector for post-type battery	1 clam (2 pads)
BPP73	Polyester pad protector for side-mount battery	1 clam (2 pads)
BPP74	Can of 100 BPP71 terminal protectors	1 can (100 pads)



### BATTERY CORROSION PROTECTION

#### SW4 - Self-Fusing Sealing Wrap

This self-fusing sealing wrap is designed for primary wire and battery cable terminals. Heat sealable wrap seals terminal area against corrosion, moisture, abrasion and weather.

Part No.	Description	Size	Std. Pkg.
SW4	Heat sealable sealing wrap (2 1/2" width)	10 ft.	1 box

#### SW4 Sealing Wrap Instructions



Fig. 1 Cut to length. Place connector in center of wrap.



Fig. 2 Fold over joint and squeeze. Heat to seal.

### BATTERY TERMINAL PROTECTORS

- Protects your battery against possible explosion by reducing the chance of sparks
- Color codes battery cables to easily identify polarity
- Reduces battery terminal corrosion

Part No.	Cable Size	Color	Style	Qty.	Std. Pkg.
BP32	4 & 6	1 Red, 1 Black	Straight Clamp Snap-on	2 per bag	5 bags
BP155	1 & 2	1 Red, 1 Black	Straight Clamp Snap-on	2 per bag	5 bags
BP48B	6	Black	Straight Clamp	1	1
BP48R	6	Red	Straight Clamp	1	1
BP49B	4	Black	Straight Clamp	1	1
BP49R	4	Red	Straight Clamp	1	1
BP50B	1 & 2	Black	Straight Clamp	1	1
BP50R	1 & 2	Red	Straight Clamp	1	1
BP51B	1/0 & 2/0	Black	Straight Clamp	1	1
BP51R	1/0 & 2/0	Red	Straight Clamp	1	1
BP159R	3/0 - 4/0	Red	Straight Clamp	1	1
BP159B	3/0 - 4/0	Black	Straight Clamp	1	1
BP55B	1 & 2	Black	Flag Clamp	1	1
BP55R	1 & 2	Red	Flag Clamp	1	1
BP52B	1/0 - 3/0	Black	Flag Clamp	1	1
BP52R	1/0 - 3/0	Red	Flag Clamp	1	1
BP53B	1 & 2	Black	Left Elbow Clamp	1	1
BP53R	1 & 2	Red	Left Elbow Clamp	1	1
BP54B	1/0 - 3/0	Black	Left Elbow Clamp	1	1
BP54R	1/0 - 3/0	Red	Left Elbow Clamp	1	1
BP149B	1 & 2	Black	Right Elbow Clamp	1	1
BP149R	1 & 2	Red	Right Elbow Clamp	1	1
BP150B	1/0 - 3/0	Black	Right Elbow Clamp	1	1
BP150R	1/0 - 3/0	Red	Right Elbow Clamp	1	1
BP151B	1 & 2	Black	Marine Wing Nut Clamp	1	1
BP151R	1 & 2	Red	Marine Wing Nut Clamp	1	1
BP152B	1/0 & 2/0	Black	Marine Wing Nut Clamp	1	1
BP152R	1/0 & 2/0	Red	Marine Wing Nut Clamp	1	1
BP153B	1 & 2	Black	Stud Terminal 3/8"	1	1
BP153R	1 & 2	Red	Stud Terminal 3/8"	1	1
BP154B	1/0	Black	Stud Terminal 3/8"	1	1
BP154R	1/0	Red	Stud Terminal 3/8"	1	1
BP156B	-	Black	Side Terminal	1	1
BP156R	-	Red	Side Terminal	1	1
BP157B	6 & 4	Black	Lug End	5	5
BP158B	10 & 8	Black	Lug End	5	5



SW4



Straight Clamp Snap-On



Straight Clamp



Flag Clamp



Left / Right Elbow Clamp



Marine Wing Nut Clamp



Stud Terminal 3/8"



Side Terminal



Lug End

# QUICK-CONNECT BATTERY COUPLERS

## SAFE-MATE® QUICK-CONNECT BATTERY COUPLERS

- Used for:
- Electric fork-lifts
  - Booster cables on tow trucks
  - Battery connectors on race cars

Safe-Mate® quick-connect couplers plug together instantly, handle high current loads with minimum voltage drop. Popular on electric fork lift trucks: battery cables can quickly be disconnected from system and hooked up to battery charger.

The durable, high impact Lexan™ housing eliminates breakage and withstands rough usage. Heavy contacts are silver-plated copper for high current capacity. Terminals can be crimped (with heavy duty crimping tool) or soldered. Sold in five color-coded sizes, for 12 gauge to 2/0 gauge cables.

Part No.	Description	Color	Gauge	Std. Pkg.
SST309	2 conductor, 50 Amp.	Yellow	12-10	1
SST309T	Contacts only for SST309			2
SST308	2 conductor, 50 Amp.	Blue	6	1
SST308T	Contacts only for SST308			2
SST312	2 conductor, 175 Amp.	Pink	4	1
SST313	2 conductor, Blue Housing, 175 Amp.			4
SST312T	Contacts only for SST312, SST313	Pink	1/0	2
SST310	2 conductor, 175 Amp.			1
SST310T	Contacts only for SST310			2
SST311	2 conductor, 350 Amp.	Orange	2/0	1
SST311T	Contacts only for SST311			2



Standard package: 1 housing, 2 contacts, to make up one side of a quick-connect coupler. Use 2 standard packages for a complete connection.

### Assembly Instructions

1. Match the contact size to the cable size. Strip cable 1/8" longer than barrel length.

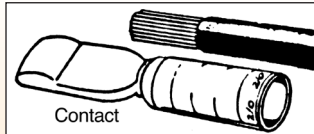

2. Insert stripped cable into contact barrel. Crimp with heavy-duty crimping tool, or solder. Apply heat-shrink tubing to protect the connection.

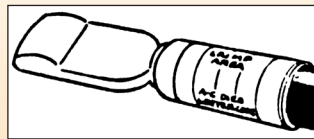

3. Insert crimped contact into housing ("top" up) and push until it locks into place. Repeat with second contact. Be sure to observe cable polarity.

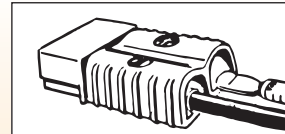

4. Assembly can be mated with another housing of the same gauge and part number.

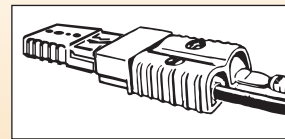

## QUICK-CONNECT BATTERY COUPLER ACCESSORIES

- Protective caps fit over connector mating points for all weather protection
- Durable PVC material rated at 105°C

Part No.	Description	Std. Pkg.
BP47	Handle for Safe-Mate® 50 Amp.	1
BP48	Handle for Safe-Mate® 175 Amp. & 350 Amp.	1
BP33	Cover for SST308/SST309 50 Amp. connector	1
BP34	Cover for SST310/SST312/SST313 175 Amp. connector	1
BP35	Cover for SST311 350 Amp. connector	1

## PLUG-IN 4 GA. INDUSTRIAL BOOSTER CABLES

- BC105 25 ft. overall length. 5 ft. section attaches directly to vehicle. 20 ft. section has heavy duty 800 Amp. clamps and snaps easily into permanently mounted cable. Perfect for tow trucks or fork lifts
- BC106 5 foot section. Ideal where multiple tow trucks or fork lifts are used. Protective cap included

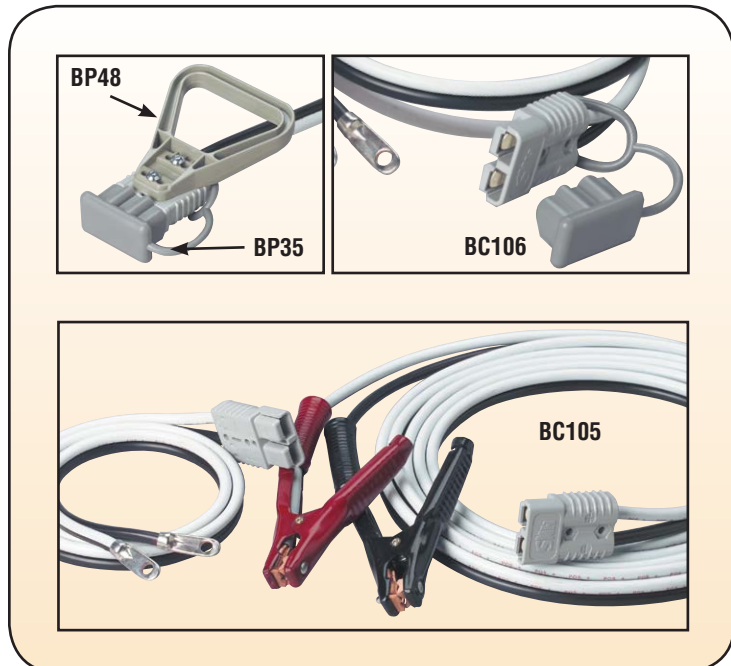

# AUXILIARY STARTING SYSTEM



## AUXILIARY STARTING SYSTEM

### Engineered especially for Fleets and Professional Service!

The fast and effective Auxiliary Starting System provides quick jump starting capability. No manual hook-up to battery. Correct polarity is assured.

#### Instructions:

1. Permanently wire BCS5 Receptacle to vehicle(s) which may require jump starting.
2. Attach BCS4 Protective Dust Cover to BCS5 Receptacle.
3. Permanently wire BCS6 Mating Plug to mobile power source.
4. Use BCS1 Auxiliary Jumper Cables to connect Mobile Power Source to vehicle(s) equipped with BCS5 Receptacle when jump starting is required.

Part No.	Description	Std. Pkg
BCS1	16' Auxiliary Jumper Cable – Connects vehicle to power source	1
BCS2	Optional 32' Auxiliary Jumper Cable	1
BCS3	16' Auxiliary Jumper Cable with 800 Amp. booster clamps	1
BCS4	Protective Dust Cover for Female Receptacle BCS5	1
BCS5	Female Receptacle (Includes BCS4 Dust Cover) – mounts to vehicle	1
BCS6	Male Mating Plug – mounts to power source	1

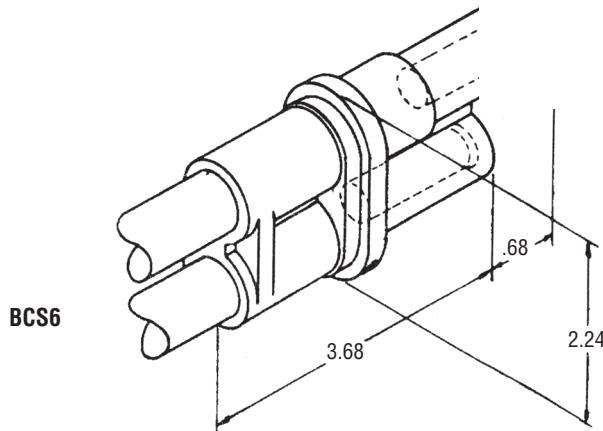
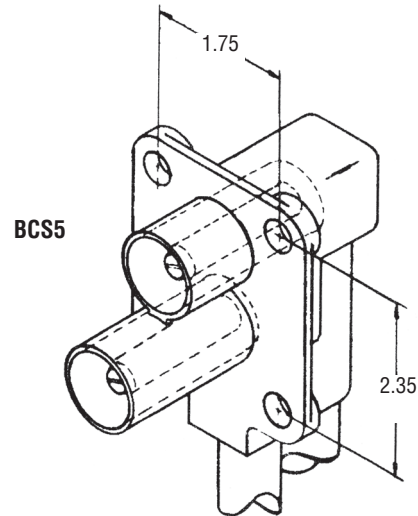
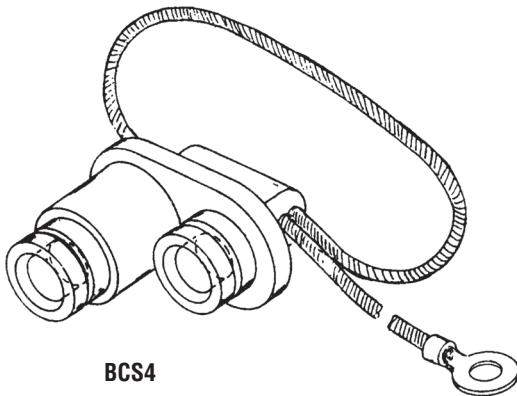
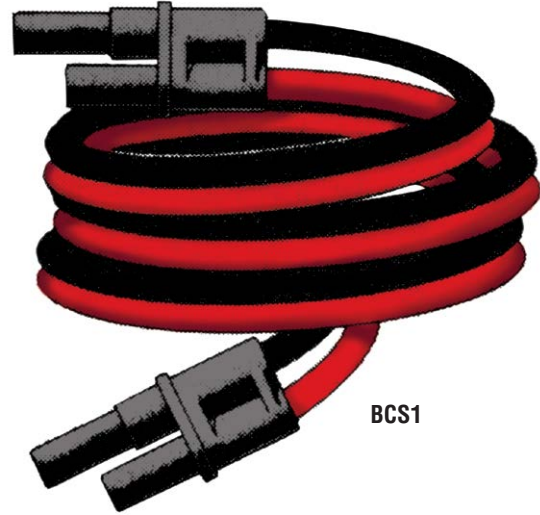

# BATTERY TOOLS, ACCESSORIES & BATTERY HOLD-DOWNS

## BATTERY TEST CLIPS

Part No.	Description	Std. Pkg.
BP60	5 amp. Nickel plated alligator clip- 1 1/2". Opens to 5/16"	10
ET60	Display clam BP60	6
BP80	Vinyl boots for use with BP60 and ET60	5 red, 5 blk
ET57	Display clam BP80	2 red, 2 blk
BP61	10 amp. clip with serrated jaws – 2". Opens to 7/16"	10
ET59	Display clam BP61	4
BP61A	Vinyl boots for BP61 and ET59	5 red, 5 blk
BP62	25 amp. clip with serrated jaws- 2 7/8". Opens to 3/4"	10
ET58	Display clam BP62	2 per clam
BP62A	BP62A Vinyl boots for BP62 and ET58 battery clip	5 red, 5 blk
BP63	50 amp. battery clip- 4". Opens to 1 3/16"	10
BP63A	Vinyl boots for BP63 battery clip	1 pr.
BP69	50 amp. Copper-plated steel test clip- 3". Opens to 3/4"	3 red, 3 blk
ET67	Display Clam BP69	1 pr.
BP65	75 amp. copper- 3". Opens to 3/4"	3 red, 3 blk
BP65C	Display clam BP65	1 pr.
BP73	100 amp battery clip- opens to 1 1/4"	5
BP64	200 amp. copper clip- 6". Opens to 1 5/8"	1 stamped/1 plain
BP64A	Vinyl boots for BP64 & BP73 battery clip	1 pr.
ET70	36" test lead. Un-insulated alligator clips. For test emergency trouble lead.	1 per clam
ET71	Pair of 30" insulated leads.	1 per clam

ET Display Package

## BATTERY SERVICE TOOLS

Part No.	Description	Std. Pkg.
BP31	Cup-type charging connector with 14" wire	10
BP70S	Carrying strap for top post batteries 14" center-to-center)	10
BP70L	Same as above — for long batteries (21" center-to-center)	10

## BATTERY CLEANERS

Part No.	Description	Std. Pkg.
TC1	Trailer Connector Assembly Cleaner	1
BP72C	Battery post & terminal cleaning brush kit	1 per clam
BP72A	Plastic Battery post & terminal cleaning brush kit	1 per clam

## BATTERY BOLTS

Part No.	Description	Style	Std. Pkg.
HD59C	9 3/4" x 5/16" – 3" Thread	J	1 per clam
HD60C	12" x 5/16" – 5" Thread	J	1 per clam
HD61C	8 7/8" x 1/4" – 3" Thread	L	1 per clam
HD62C	8" x 1/4" – 4" Thread	L	1 per clam
HD63C	10" x 1/4" – 3 3/4" Thread	L	1 per clam
HD64C	6" x 5/16" – 1 1/2" Thread	J	1 per clam

Bolts include washers and nuts

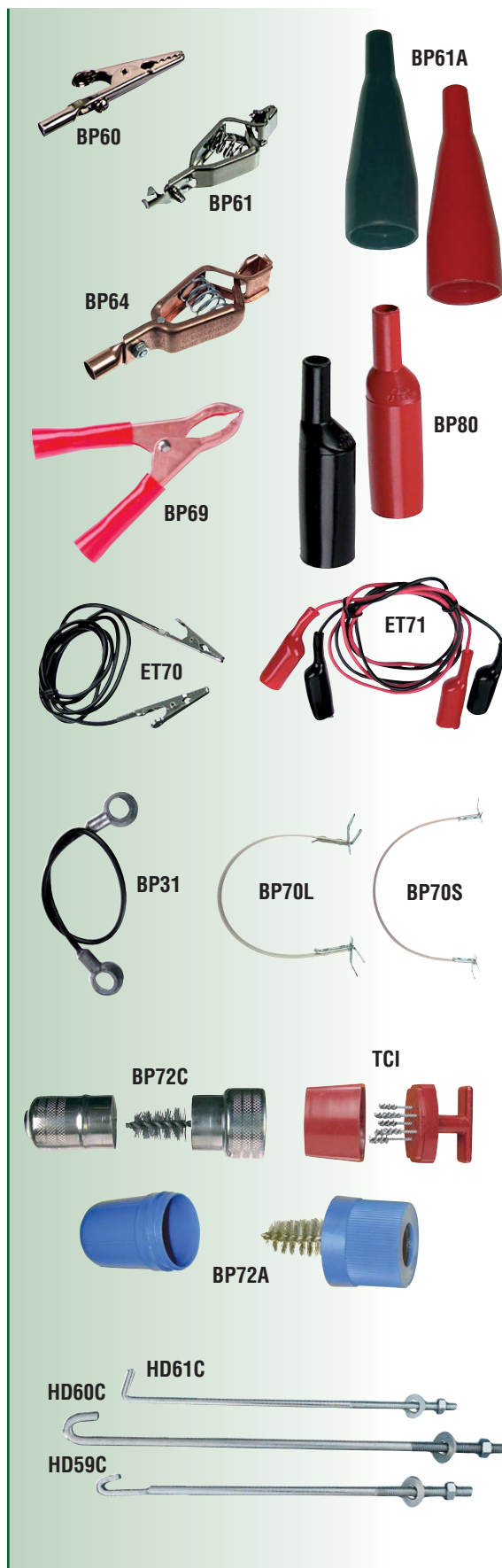

# BATTERY HOLD-DOWNS & TOOLS



## BATTERY HOLD DOWNS

Part No.	Applications	Std. Pkg.
HD56	Rubber hold down. Fits across 6 1/4" battery. Includes 2 J bolts & 2 washers	1/box
HD57*	AABM Groups 22F, 24, 27G, 27H, 60 Permits installation of heavy duty or next larger size battery. No height limitation	1 card

\* Includes 2 mounting brackets

## TOP MOUNT

Part No.	Size L x W	Applications	Std. Pkg.
HD62	Adjustable 8 1/8" min. length, 13 3/8" max. length	For square or rectangular batteries with flush vent covers	1
HD63	Adjustable 5 3/4" min. length, 8 1/2" max. length	For square or rectangular batteries with flush vent covers	1
HD64	Adjustable 4 1/4" min. length, 6 5/8" max. length	For square or rectangular batteries with raised vent covers	1

HD62, HD63, & HD64 - made of polypropylene, corrosion proof and non-conducting, works on cars, trucks, boats, farm commercial and recreational vehicles

## BATTERY HOLD DOWN KITS

Part No.	Applications	Std. Pkg.
HD65	12" L x 6 7/8" W	1
HD66	10 7/8" L x 6 7/8" W	1

## BASE MOUNT

Part No.	Applications	Std. Pkg.
HD58**	For GM; AABM Groups 22C, 22FC, 24, 24C	1

\*\*Includes steel and fiber washer (1 each) & bolt

## BATTERY TOOLS

**WTT7** Crimps solderless terminals to battery cable, welding cable and primary wire . . . from 16 to 4/0 gauge. Use with a hammer or vise. Produces reliable crimps with excellent mechanical strength and electrical integrity. Depth gauge indicates when proper crimp is achieved. V-shaped nest design prevents overcrimping. Std. Pkg. 1.

**WTT8** 7 3/4" long. Ideal for one-hand operation. Designed for fast, easy cutting of multi-conductor cable, battery and welding cable up to 2/0 gauge. Std. Pkg. 1. Display packed.

**WTT10** Professional crimping tool is 26" long. Double lever construction provides extra crimping power for heavy-duty jobs. Ideal for crimping copper terminals, lugs and butt connectors from 6 to 4/0 gauge. Rotatable, multi-die sets eliminate the need to stock extra dies. Diamond-shaped dies compress all strands uniformly to achieve high-integrity crimps. Std. Pkg. 1.

**WTT33** Jr. crimper crimps cables from 8 Ga. to 1 Ga. Designed for medium to heavy duty crimps. Ideal for use where space is limited. Length 16", Std. Pkg. 1.

**WTT11** Large, heavy-duty cutter is 16 1/2" long. Easily cuts through 4/0 gauge battery/welding cable. Blades are tough moly-steel; keep a sharp edge longer. Curved blade makes a clean cut with minimum strand distortion. Std. Pkg. 1.

**WTT16** Battery cable stripper – gauges up to 4/0

**WTT30** Bench mount crimp tool. Same construction and features as WTT10. Inverted crimp head allows direct visual inspection of crimp during operation for more reliable connection.



## Adjustable Top Mount Hold Down

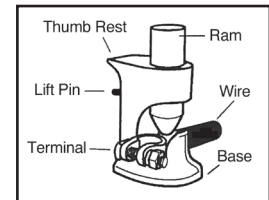
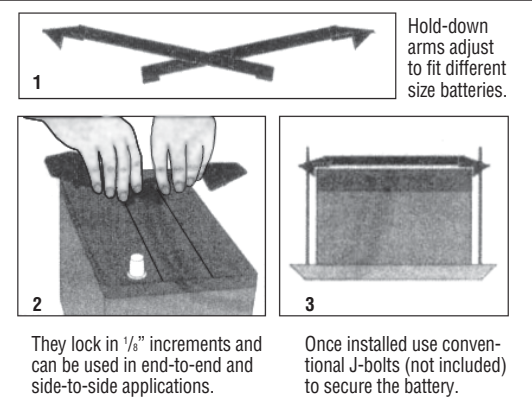

# HEAT SHRINK TUBING

## DUAL WALL, POLYOLEFIN, WITH SEALANT 3-1 SHRINK RATIO

Part No.	Color	Wire Gauge	ID"	Shrinks To"	Length	Shrink Ratio	Std. Pkg.
HST85	Black	30-18	0.125	0.040	1.125"	3-1	20
HST88	Black	20-14	0.187	0.060	6"	3-1	10
HST86	Black	18-10	0.250	0.080	1.25"	3-1	20
HST84	Black	18-10	0.250	0.080	1.5"	3-1	50
HST89	Black	18-10	0.250	0.080	6"	3-1	10
HST87	Black	12-6	0.375	0.125	1.25"	3-1	20
HST91	Black	12-6	0.375	0.125	6"	3-1	10
HST83	Black	8-4	0.500	0.160	1"	3-1	20
HST83R	Red	8-4	0.500	0.160	1"	3-1	20
HST82	Black	8-4	0.500	0.160	6"	3-1	20
HST210	Black	4-2/0	0.750	0.250	1.125"	3-1	20
HST210R	Red	4-2/0	0.750	0.250	1.125"	3-1	20
HST92	Black	4-2/0	0.750	0.250	6"	3-1	10
HST230	Black	2-4/0	1.000	0.320	1.125"	3-1	20
HST230R	Red	2-4/0	1.000	0.320	1.125"	3-1	20
HST93	Black	2-4/0	1.000	0.320	6"	3-1	10

## DUAL WALL, CLEAR POLYOLEFIN, WITH SEALANT 3-1 SHRINK RATIO

Clear dual wall tubing with contamination proof, watertight sealant. Provides strain relief and vibration resistance. Temp. range -55°C to 110°C / -67°F to 230°F.

Part No.	Color	Wire Gauge	ID"	Shrinks To"	Length	Shrink Ratio	Std. Pkg.
HST30	Clear	20-14	0.187	0.060	6"	3-1	10
HST28	Clear	14-8	0.312	0.060	6"	3-1	10
HST21	Clear	8-1	0.500	0.167	6"	3-1	10
ET27	Display Package of 3 HST21						
ET28	Display Package of 3 HST28						
ET29	Display Package of 4 HST30						
ET38	Display Package of Contains: 1 HST21, 1 HST28, 2 HST30						

## HEAVY WALL, POLYOLEFIN WITH SEALANT 3-1 SHRINK RATIO

Flame retardant with contamination proof, watertight sealant. Mil spec, 23053/15 requirements for flame retardancy. UL 468 B & D listed. Temp. range -55°C to 125°C.

Part No.	Color	Wire Gauge	ID"	Shrinks To"	Length	Shrink Ratio	Std. Pkg.
HST146B	Black	14-6	0.400	0.150	6"	3-1	5
HST146R	Red	14-6	0.400	0.150	6"	3-1	5
HST81SB	Black	8-1	0.750	0.220	1.5"	3-1	20
HST81SR	Red	8-1	0.750	0.220	1.5"	3-1	20
HST81B	Black	8-1	0.750	0.220	6"	3-1	5
HST81R	Red	8-1	0.750	0.220	6"	3-1	5
HST240SB	Black	2-4/0	1.100	0.125	1.5"	3-1	20
HST240SR	Red	2-4/0	1.100	0.375	1.5"	3-1	20
HST240B	Black	2-4/0	1.100	0.375	6"	3-1	5
HST240R	Red	2-4/0	1.100	0.375	6"	3-1	5
ET21	Contains 1 each HST81B and HST81R						

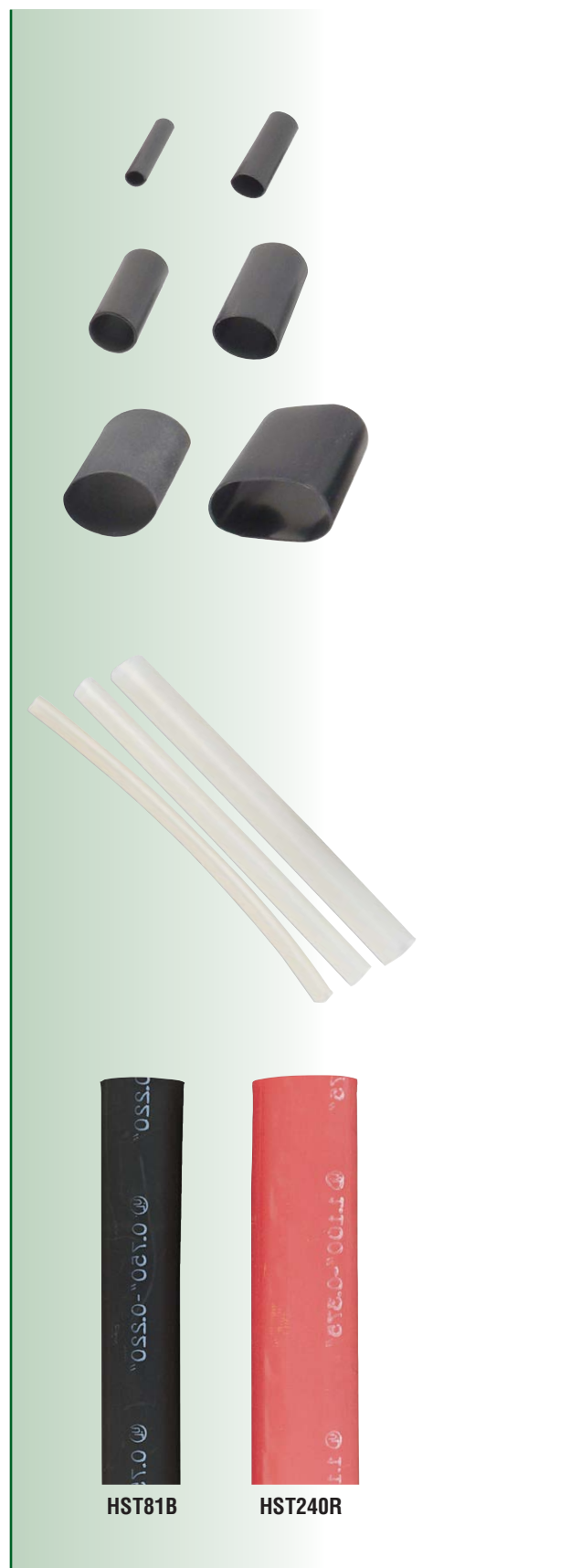

HST81B

HST240R

# HEAT SHRINK TUBING



## SPLICING PATCHES

Adhesive Vinyl splicing patches. 2 1/2" x 2 1/2" provide moisture proof connections. Easier to use than tape. Adds strain relief to splices and protects against abrasion.

Part No.	Std. Pkg.
HST90	25

## HIGH RATIO, HEAVY WALL, WITH SEALANT, 6-1 SHRINK RATIO

Thermoplastic adhesive sealant for a gas-tight, water-tight seal. 6 to 1 shrink ratio - ideal for heavy duty battery cable applications or a variety of connector configurations. Covers wide range of wire and cable gauge sizes. Post-shrink insulation thickness provides for very high tensile strength of 2100 psi. Temperature range -55°C to 110°C / -67°F to 230°F

Part No.	Color	Wire Gauge	ID"	Shrinks To"	Length	Shrink Ratio	Std. Pkg.
HST401	Black	8-4/0	1.300	.200	12"	6-1	2

## THIN WALL, POLYOLEFIN, 2-1 SHRINK RATIO

Provides electrical insulation over splices and terminations. Excellent for bundling and cable identification. Temperature range -55°C to 135°C. Color coded, no sealant.

Part No.	Color	Wire Gauge	ID"	Shrinks To"	Length	Shrink Ratio	Std. Pkg.
HST18	Red	20-18	0.187	0.093	6"	2-1	10
HST18B	Black	20-18	0.187	0.093	6"	2-1	10
HST18H	Red	20-18	0.187	0.093	8'	2-1	1
HST18L	Red	20-18	0.187	0.093	50'	2-1	1
HST14	Blue	16-14	0.250	0.125	6"	2-1	10
HST14H	Blue	16-14	0.250	0.125	8'	2-1	1
HST14L	Blue	16-14	0.250	0.125	50'	2-1	1
HST10	Yellow	12-10	0.312	0.156	6"	2-1	10
HST10H	Yellow	12-10	0.312	0.156	8'	2-1	1
HST10L	Yellow	12-10	0.312	0.156	50'	2-1	1
HST6	Black	8-2	0.500	0.250	6"	2-1	5
HST6H	Black	8-2	0.500	0.250	8'	2-1	1
HST6L	Black	8-2	0.500	0.250	50'	2-1	1
HST3	Black	2-3/0	1.000	0.500	6"	2-1	10

ET18 Display Package of 6 HST18  
 ET14 Display Package of 5 HST14  
 ET12 Display Package of 4 HST10  
 ET2 Display Package of 3 HST6  
 ET20 Display Package Contains: 2 HST18, 2 HST14, 1 HST10

## SINGLE WALL, PVC 2-1 SHRINK RATIO

Part No.	Color	Wire Gauge	ID"	Shrinks To"	Length	Shrink Ratio	Std. Pkg.
STT260	Black	20-18	0.187	0.093	1.5"	2-1	25
STT261	Black	16-14	0.250	0.125	1.5"	2-1	25
STT262	Black	12-10	0.375	0.188	1.5"	2-1	25
STT263	Black	8-2	0.500	0.250	1.5"	2-1	10
STT263R	Red	8-2	0.500	0.250	1.5"	2-1	10
STT264	Black	1-2/0	0.750	0.375	1.5"	2-1	25
STT264R	Red	1-2/0	0.750	0.375	1.5"	2-1	25
STT265	Black	2/0-4/0	1.000	0.500	1.5"	2-1	10
STT265R	Red	2/0-4/0	1.000	0.500	1.5"	2-1	10

ET263 Display Package of 12 STT261  
 ET260 Assortment Contains: 4 STT260, 4 STT261, 4 STT262

HST90

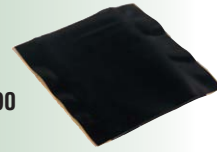

HST401



Pre-Shrink Dia. 1.3"  
Shrink Diameter .222"



HST10H



HST10L

HST18



HST14



HST10

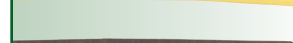

HST6

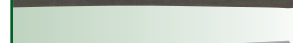

HST3

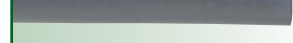

STT260

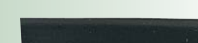

STT263



STT264R



STT265

# HEAT SHRINK GUNS & ASSORTMENTS

## MULTI-PURPOSE HEAT GUN

**WTT20** Multi-purpose hot air gun. Can be hand-held or mounted vertically. 3-position switch: HIGH (1100°F); OFF; LOW (750°F.) 1200 Watts (max) 120 Volts AC. 6-ft. grounded line cord. Recommendation for heat shrink tubing: LOW setting with nozzle-to-work distance about 3". Std. Pkg. 1.

**WTT21** Heat gun deflector for heat shrink tubing. Use with WTT20. Also included with purchase of heat gun WTT20. Std. Pkg. 1.

## MINI BUTANE TORCH

**WTT28\*** Butane torch includes heat deflector and handy carrying case. Piezo ignition system controls for flame intensity and air mixture. Butane not included. Std. Pkg. 1.

**CAUTION:** Do not operate in engine compartment. Recommended for shop use in well ventilated areas.

\* While supplies last

## BUTANE MICRO TORCH

**WTT29** Micro Torch turns readily available disposable butane lighter or included fuel cell into handy powerful micro torch. Piezo electronic ignition system with safety lock. Flame temperature up to 2400°F (1300°C). Wind proof flame and waterproof ignition. Compact size fits most tools kits. Std. Pkg. 1.

**WTT22** Self Igniting Butane. Micro Torch. Butane not included. Std. Pkg. 1.

**CAUTION:** Read instructions before use. Refer to package for complete warnings and cautions. Do not ignite or operate near open flame, heater, furnace, near combustible materials or in engine compartment. Recommended for shop use in well ventilated areas.

## FLAMELESS HEAT TORCH

**WTT31** Flameless Heat Torch. Fuel cell included. Std. Pkg. 1.

**CAUTION:** Read instructions before use. Refer to package for complete warnings and cautions. Do not ignite or operate near open flame, heater, furnace, near combustible materials or in engine compartment. Recommended for shop use in well ventilated areas.

## HEAT SHRINK TUBING ASSORTMENT

**HST1A** – 6" long. Std. Pkg. 1

Contents:

Part No.	Qty.	Part No.	Qty.
HST6	5	HST81B	2
HST10	10	HST81R	2
HST14	10	HST240B	2
HST18	10	HST240R	2

## CLEAR HEAT SHRINK TUBING ASSORTMENT

**HST2A** – 6" long. Std. Pkg. 1

Contents:

Part No.	Qty.	
HST30	10	Dual Wall with water-tight sealant. Temperature range: -55°C to 110°C / -67°F to 230°F
HST28	10	
HST21	10	
WTT31	1	Flameless Heat Torch



## HOW TO USE HEAT SHRINK TUBING

**CAUTION:** Disconnect battery cables before applying heat shrink tubing!

- 1 Select tubing to assure a tight fit after shrinkage. Consider the outside dimension of the terminal when determining tubing diameter. Shrink ratios: 3:1 for double wall tubing; 2:1 for single wall.
- 2 Cover at least 1/2" of the terminal barrel and 1" of the cable.
- 3 Apply heat evenly to all areas of the tubing. When tubing starts to shrink, focus heat at center of tubing and move heat toward ends to eliminate any trapped air.





*Ignition Wires*

*Battery Cables*

## ***Primary Wire***

*Terminals & Connectors*

*Trailer Connectors*

*Sockets, Pigtails & Switches*

*Safety Accessories*

*O.E. Interchanges*

*Index*

# PRIMARY WIRE & ACCESSORIES

**STANDARD® THE NUMBER ONE CHOICE! FOR AUTOMOTIVE & MARINE...**



OE manufacturers have been using TWP (thin wall PVC) wire since the early 1990s in order to save weight without sacrificing functionality. Wire gauge is determined by the total cross sectional area of the copper conductor strands (see listings below). Don't be misled by the thickness of the jacket when selecting wire size.

- Our TWP primary wire is manufactured with the highest stranded copper wire with tough durable vinyl insulation.
- The insulation resists abrasion, grease, oil and battery acid; and won't support combustion.
- Our wire is available in a broad range of sizes, types, and colors for any electrical repair, replacement or customizing job.

## THERMOPLASTIC PRIMARY WIRE

SAEJ1128 Requirement – Type TWP Temperature Max 80°C/176°F									
Wire Ga.	Strands & Gauge	O.D.	Color	Ft.	Display Pack	Part No.			
						Ft.	Display Pack	100 Ft. Spool	1000 Ft. Spool
22	7 x 30	.062	Black Blue Red White	50'	CW22B CW22E CW22R CW22W			C22EB C22E C22ER C22EW	
20	7 x 28	.070	Black Blue Green Red White Yellow	50'	CW20B CW20E CW20G CW20R CW20W CW20Y	40'	<b>NEW!</b> PW20B <b>NEW!</b> PW20E <b>NEW!</b> PW20G <b>NEW!</b> PW20R <b>NEW!</b> PW20W <b>NEW!</b> PW20Y	C20EB C20E C20EG C20ER C20EW C20EY	C20E-10  C20ER-10
18	19 x 31	.078	Black Blue Brown Green Red White Yellow	50'	CW18B CW18E CW18BR CW18G CW18R CW18W CW18Y	35'	<b>NEW!</b> PW18B <b>NEW!</b> PW18E <b>NEW!</b> PW18BR <b>NEW!</b> PW18G <b>NEW!</b> PW18R <b>NEW!</b> PW18W <b>NEW!</b> PW18Y	C18EB C18E C18EBR C18EG C18ER C18EW C18EY	C18EB-10 C18E-10 C18EBR-10 C18EG-10 C18ER-10 C18EW-10 C18EY-10
16	19 x 29	.089	Black Blue Brown Green Orange Pink Purple Red White Yellow	35'	CW16B CW16E CW16BR CW16G CW16T CW16PK CW16P CW16R CW16W CW16Y	30'	<b>NEW!</b> PW16B <b>NEW!</b> PW16E <b>NEW!</b> PW16BR <b>NEW!</b> PW16G <b>NEW!</b> PW16T <b>NEW!</b> PW16PK <b>NEW!</b> PW16P <b>NEW!</b> PW16R <b>NEW!</b> PW16W <b>NEW!</b> PW16Y	C16EB C16E C16EBR C16EG C16ET C16EPK C16EP C16ER C16EW C16EY	C16EB-10 C16E-10 C16EBR-10 C16EG-10 C16ET-10 C16EPK-10 C16EP-10 C16ER-10 C16EW-10 C16EY-10



## **STANDARD** PRIMARY WIRE... THE NUMBER ONE CHOICE!

### BULK WIRE DISPENSER

Designed to help you sell bulk wire from spools by the foot.  
Height – 18", Width – 14", Depth – 12", 3 tiers.

Part No.	Description	Std. Pkg.
SWR1	Primary wire dispenser and header	1

USE ON...

**COUNTER TOP!  
END CAP!  
SHELF!  
PEGBOARD!**



SWR1

### THERMOPLASTIC PRIMARY WIRE

SAEJ1128 Requirement – Type TWP Temperature Max 80°C/176°F

Wire Ga.	Strands & Gauge	O.D.	Color	Ft.	Part No.													
					Display Pack	Ft.	Display Pack	100 Ft. Spool	500 Ft. Spool	1000 Ft. Spool								
14	19 x 27	.103	Black	25'	CW14B	20'	<b>NEW!</b> PW14B	C14EB		C14EB-10								
			Blue		CW14E		<b>NEW!</b> PW14E			C14E	C14E-10							
			Brown		CW14BR		<b>NEW!</b> PW14BR			C14EBR	C14EBR-10							
			Black with Red Stripe		CW14BS		<b>NEW!</b> PW14BS			C14BS	C14BS-10							
			Green		CW14G		<b>NEW!</b> PW14G			C14EG	C14EG-10							
			Orange		CW14T		<b>NEW!</b> PW14T			C14ET	C14ET-10							
			Pink		CW14PK		<b>NEW!</b> PW14PK			C14EPK	C14EPK-10							
			Purple		CW14P		<b>NEW!</b> PW14P			C14EP	C14EP-10							
			Red		CW14R		<b>NEW!</b> PW14R			C14ER	C14ER-10							
			White		CW14W		<b>NEW!</b> PW14W			C14EW	C14EW-10							
			Yellow		CW14Y		<b>NEW!</b> PW14Y			C14EY	C14EY-10							
			12		19 x 25		.142			Black	15'	CW12B	12'	<b>NEW!</b> PW12B	C12EB	<b>NEW!</b> C12EB-5	C12EB-10	
										Blue		CW12E		<b>NEW!</b> PW12E		C12E	<b>NEW!</b> C12E-5	C12E-10
										Brown		CW12BR		<b>NEW!</b> PW12BR		C12EBR	<b>NEW!</b> C12EBR-5	C12EBR-10
Green	CW12G	<b>NEW!</b> PW12G		C12EG		<b>NEW!</b> C12EG-5		C12EG-10										
Red	CW12R	<b>NEW!</b> PW12R		C12ER		<b>NEW!</b> C12ER-5		C12ER-10										
White	CW12W	<b>NEW!</b> PW12W		C12EW		<b>NEW!</b> C12EW-5		C12EW-10										
Yellow	CW12Y	<b>NEW!</b> PW12Y		C12EY		<b>NEW!</b> C12EY-5		C12EY-10										
10	19 x 23	.175		Black		10'		CW10B	8'	<b>NEW!</b> PW10B		C10EB		<b>NEW!</b> C10EB-5		C10EB-10		
				Blue				CW10E		<b>NEW!</b> PW10E				C10E		<b>NEW!</b> C10E-5	C10E-10	
				Brown				CW10BR		<b>NEW!</b> PW10BR				C10EBR		<b>NEW!</b> C10EBR-5	C10EBR-10	
			Green	CW10G	<b>NEW!</b> PW10G		C10EG	<b>NEW!</b> C10EG-5		C10EG-10								
			Red	CW10R	<b>NEW!</b> PW10R		C10ER	<b>NEW!</b> C10ER-5		C10ER-10								
			White	CW10W	<b>NEW!</b> PW10W		C10EW	<b>NEW!</b> C10EW-5		C10EW-10								
			Yellow	CW10Y	<b>NEW!</b> PW10Y		C10EY	<b>NEW!</b> C10EY-5		C10EY-10								
			8	19 x 21	.226		Black	—		—	—		C8EB	—	—			
Blue	—	—				—	C8E	—	—									
Red	—	—				—	C8ER	—	—									
6	—	—	Black	—	—	—	C6E*	—	—									
			Red	—	—	—	C6ER*	—	—									
4	—	—	Red	—	—	—	C4ER*	—	—									

\*SGR cable rated 105°C / 221°F

# PRIMARY WIRE



## SPEAKER WIRE

Wire Gauge	Color	Display Pack	Ft.	Part No.	
				100 Ft. Spool	1000 Ft. Spool
20	Clear	CW20-2	20	CF20-2P	CF20-2P-10
18	Black	CW18-2	20	<b>NEW!</b> CF18-2HD†	CF18-2P-10
18	Clear		20	CF18-2P	
16	Black	CW16-2	15	<b>NEW!</b> CF16-2HD†	CF16-2P
16	Clear		15	CF16-2P	

† Heavy Duty Speaker Wire

## FUSIBLE LINK WIRE

Wire Gauge	Sq. mm	Strands	O.D.	Display Color	Part No.		
					Spool	Ft.	Display Pack
20	0.5	19 x 32	.087"	Grey	CW20F	25	
18	0.8	16 x 30	.110"	Black	CW18F	25	ET31
18				Blue			ET30
18				Red			ET30
16	1.0	19 x 29	.150"	Black	CW16F	20	ET34
16				Black			ET35
16				Orange			ET36
14				Black			ET33
14	2.0	19 x 27	.165"	Grey	CW14F	15	ET37
14				Green			ET32
12	3.0	19 x 25	.200"	Blue	CW12F	10	
10	5.0	19 x 23	.213"	Orange	CW10F	8	

Part No.	Desc.	Gauge	Length	Part No.	Desc.	Gauge	Length
ET30	Ford	18	10½"	ET34	Chrysler	16	8"
ET31	Chrysler	18	8"	ET35	GM	16	9¼"
ET32	Ford	14	10½"	ET36	Ford	16	9½"
ET33	GM	14	9½"	ET37	Chrysler	14	8"

NOTE: Fusible link wire is made to be an exact replacement for the fusible links used by OE on battery cable and other circuits for protection from current overloads. Always replace fusible link with same size and gauge used on original circuit. In general, fusible link is four gauges smaller than the circuit wire. (EXAMPLE: Circuit wire = 10 ga.; fusible link = 14 ga.)

ET Display Package

## ELECTRICAL CABLE – 125/250 VOLT – U.L. LISTED

• For use in rewiring drop lights, extension cords, portable tools and equipment						
Part No.	Gauge & Cond.	UL Type	Stranding	Jacket	O.D.	
<b>NEW!</b> C14-3SRB	14 - 3	SO	41 x 30	Synthetic Rubber/Black	.558	
<b>NEW!</b> C16-2SRB	16 - 2	SO	65 x 34	Synthetic Rubber/Black	.380	
<b>NEW!</b> C16-3SRB	16 - 3	SO	65 x 34	Synthetic Rubber/Black	.400	
<b>NEW!</b> C16-3VB	16 - 3	SJT	36 x 30	Vinyl, Black	.353	
<b>NEW!</b> C18-2SRB	18 - 2	SJO	41 x 34	Synthetic Rubber/Black	.298	
<b>NEW!</b> C18-3VY	18 - 3	SJT	16 x 30	Vinyl, Yellow	.328	

# PRIMARY WIRE



## HEAVY DUTY CROSS LINKED POLYETHYLENE PRIMARY WIRE

SAE J-1128 TYPE SXL 125°C/257°F

Cross-linked polyethylene insulation provides outstanding resistance to heat. It withstands severe conditions which can degrade regular plastic primary wire such as oil, gasoline, and abrasion as well as heat. An overloaded wire will not melt and fuse with other wires in a harness. The damaged wire can be slid from the harness and replaced individually. Recommended for all heavy duty applications including trucks, buses, and fleets.

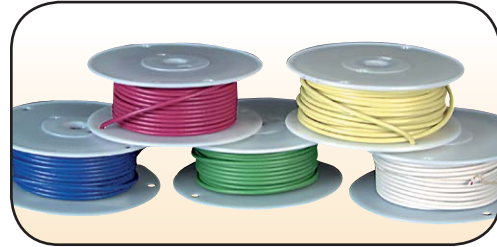

Wire Gauge	Stranding	O.D.	Color	100 Ft. Spool
18	16 x 30	.092	Black	<b>C118EB</b>
			Blue	<b>C118E</b>
			Brown	<b>C118EBR</b>
			Green	<b>C118EG</b>
			Red	<b>C118ER</b>
			White	<b>C118EW</b>
16	19 x 29	.116	Yellow	<b>C118EY</b>
			Black	<b>C116EB</b>
			Blue	<b>C116E</b>
			Brown	<b>C116EBR</b>
			Green	<b>C116EG</b>
			Red	<b>C116ER</b>
14	19 x 27	.138	White	<b>C116EW</b>
			Yellow	<b>C116EY</b>
			Black	<b>C114EB</b>
			Blue	<b>C114E</b>
			Brown	<b>C114EBR</b>
			Green	<b>C114EG</b>
			Red	<b>C114ER</b>
			White	<b>C114EW</b>
Yellow	<b>C114EY</b>			

Wire Gauge	Stranding	O.D.	Color	100 Ft. Spool
12	19 x 25	.160	Black	<b>C112EB</b>
			Blue	<b>C112E</b>
			Brown	<b>C112EBR</b>
			Green	<b>C112EG</b>
			Red	<b>C112ER</b>
			White	<b>C112EW</b>
10	19 x 23	.190	Yellow	<b>C112EY</b>
			Black	<b>C110EB</b>
			Blue	<b>C110E</b>
			Brown	<b>C110EBR</b>
			Green	<b>C110EG</b>
			Red	<b>C110ER</b>
			White	<b>C110EW</b>
			Yellow	<b>C110EY</b>

## FLAT MULTI-CONDUCTOR AUTOMOTIVE CABLE

SAE J1128 Type GPT Temperature Rating for individual conductors 60°C/140°F

### Parallel Insulated

Part No.	Gauge	Cond.	Colors	Stranding	Qty. Per Pkg.
<b>C16-4E</b>	16	4	Red, Green	19 x 29	100
<b>C16-4V</b>	16	4	White, Black	19 x 29	25
<b>C14-4J</b>	14	4		19 x 27	100
<b>C16-3E</b>	16	3	White, Green	19 x 29	100
<b>C14-3J</b>	14	3	Black	19 x 27	100
<b>C12-3J</b>	12	3		19 x 25	100
<b>C16-2E</b>	16	2		19 x 29	100
<b>C14-2E</b>	14	2	Black, Red	19 x 27	100
<b>C12-2E</b>	12	2		19 x 25	100
<b>C10-2E</b>	10	2		19 x 23	100

### Parallel Bonded

<b>C16-4B</b>	16	4		19 x 29	100
<b>ET457</b>	16	4	Brown, Green	19 x 29	25
<b>C14-4E</b>	14	4	Yellow, White	19 x 27	100
<b>C12-4E</b>	12	4		19 x 25	100
<b>C16-3B</b>	16	3		19 x 29	100
<b>C16-3V</b>	16	3	Brown, Green	19 x 29	25
<b>ET458</b>	16	3	Yellow	19 x 29	25
<b>C14-3E</b>	14	3		19 x 27	100

### PARALLEL INSULATED

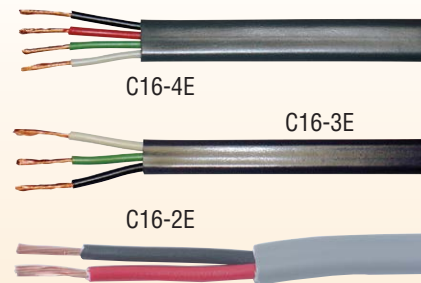

### PARALLEL BONDED

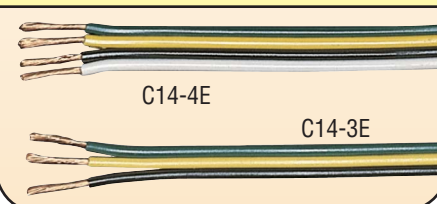

ET Display Package

# PRIMARY WIRE

## AMPERAGE GUIDE

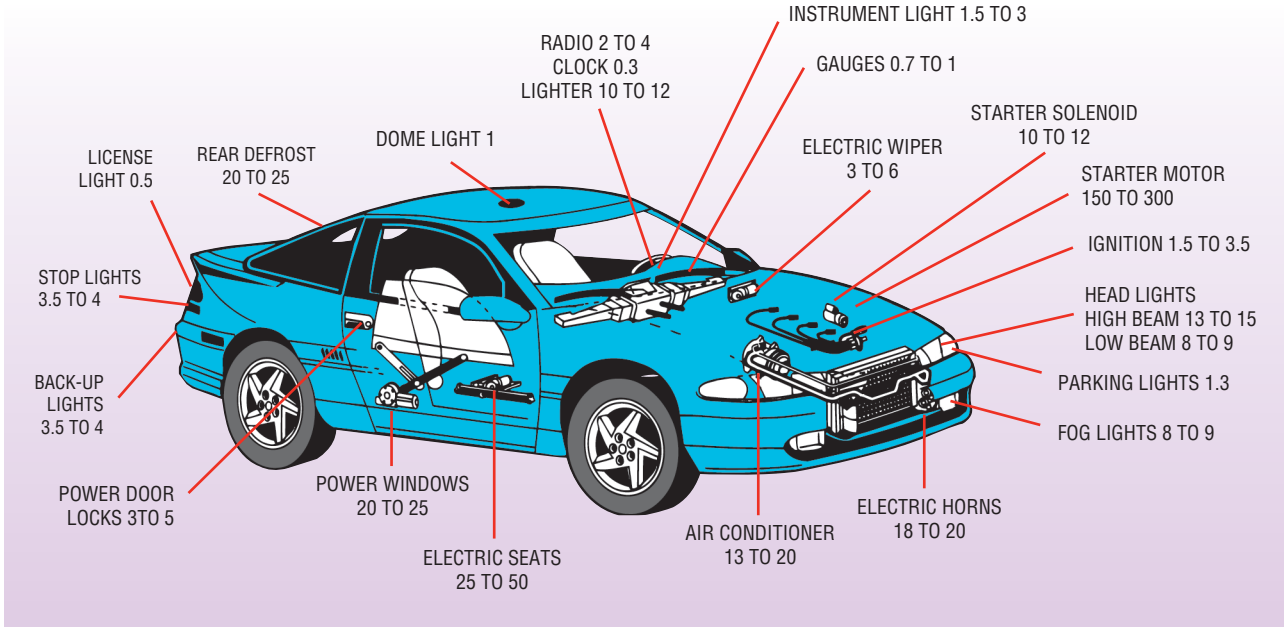

### PRIMARY WIRE LENGTH AND SIZE

Selecting the correct gauge of primary wire for specific applications is very important. Refer to the following chart to help resolve questions about 12 volt systems.

12 Volt System	Total Length of Wire Using Ground Return										
	Amps. Approx.	10'	20'	30'	40'	50'	60'	70'	80'	90'	100'
1	20	20	20	20	20	20	20	20	18	18	18
1.5	20	20	20	20	20	20	20	18	18	18	18
2	20	20	20	20	18	18	18	16	16	16	16
3	20	20	20	18	18	18	16	16	16	14	14
4	20	20	18	16	16	16	14	14	14	14	12
5	20	18	18	16	14	14	14	12	12	12	12
6	20	18	16	16	14	14	14	12	12	12	12
7	18	18	16	14	14	12	12	12	10	10	10
8	18	16	16	14	12	12	12	10	10	10	10
10	18	16	14	12	12	12	10	10	10	10	10
11	18	16	14	12	12	10	10	10	10	8	8
12	18	16	14	12	12	10	10	10	8	8	8
15	18	14	12	12	10	10	10	8	8	8	8
18	16	14	12	10	10	8	8	8	8	8	8
20	16	12	12	10	10	8	8	8	8	6	6
22	16	12	10	10	8	8	8	8	6	6	6
24	16	12	10	10	8	8	8	6	6	6	6
30	14	10	10	8	8	6	6	6	4	4	4
36	14	10	8	8	6	6	4	4	4	4	4
50	12	8	8	6	4	4	4	2	2	2	2
100	8	6	4	4	2	2	1	0	0	2/2	2/2
150	6	4	2	2	1	0	2/0	2/0	3/0	3/0	3/0
200	6	2	2	1	0	2/0	3/0	4/0	4/0	4/0	4/0

Note that as the conductor length increases, so does resistance. For 6 volt systems, use half of the allowable 12 volt lengths, and for 24 volt systems use twice the allowable 12 volt lengths.



## HIGHEST QUALITY... DESIGNED SPECIFICALLY FOR MARINE APPLICATIONS



### Marine Primary Wire – SAE Specification J378/J1128 Type GPT Temperature rating 105°C.

- Tough thermoplastic insulation is heat, oil and abrasion resistant
- Wide range of gauges and colors in convenient 100 ft. spools
- Tinned copper conductor

Protect your boat using products specified by wire industry experts. Use only highest quality products designed specifically for Marine applications. All Standard Wire and Cable Marine products meet Marine industry standards. The requirements as set by the following:

U.S. Coast Guard, CFR 33 Part 183.  
 ABYC (American Boat and Yacht Council)  
 NMMA (National Marine Manufacturers Association)  
 SAE J378/J1128  
 Underwriters Laboratory Inc. UL1426  
 600 Volts requirement.  
 Temperature Rating 105°C/221°F

100' spool Part No.	Wire Gauge	Stranding	O.D.	Color			
C218E	18	16 x 30	.105	Blue			
C218EB				Black			
C218EBR				Brown			
C218EG				Green			
C218ER				Red			
C218EY				Yellow			
C216E	16	26 x 30	.125	Blue			
C216EB				Black			
C216EBR				Brown			
C216EG				Green			
C216EGY				Gray			
C216EP				Purple			
C216EPK				Pink			
C216ER				Red			
C216ES				Tan			
C216ET				Orange			
C216EW				White			
C216EY				Yellow			
C214E				14	41 x 30	.140	Blue
C214EB							Black
C214EBR	Brown						
C214EG	Green						
C214EGY	Gray						
C214EP	Purple						
C214EPK	Pink						
C214ER	Red						
C214ES	Tan						
C214ET	Orange						
C214EW	White						
C214EY	Yellow						

100' spool Part No.	Wire Gauge	Stranding	O.D.	Color			
C212E	12	65 x 30	.158	Blue			
C212EB				Black			
C212EBR				Brown			
C212EG				Green			
C212EGY				Gray			
C212EP				Purple			
C212EPK				Pink			
C212ER				Red			
C212ES				Tan			
C212ET				Orange			
C212EW				White			
C212EY				Yellow			
C210E				10	105 x 30	.182	Blue
C210EB							Black
C210EBR	Brown						
C210EG	Green						
C210EP	Purple						
C210ER	Red						
C210ET	Orange						
C210EW	White						
C210EY	Yellow						
C208EB	8	168 x 30	.272				Black
C208EG				Green			
C208ER				Red			
C208EW				White			

# MARINE WIRE & CABLE

HIGHEST QUALITY... DESIGNED SPECIFICALLY FOR MARINE APPLICATIONS



## MARINE MULTI CONDUCTOR CABLE — SAE SPECIFICATION J1128, TYPE GPT TEMPERATURE RATING 105°C

Flexible Tinned Copper Conductors have a tough PVC Jacket, are run parallel and covered with a Thermoplastic Insulation.

Part No.	AWG	Conductor's Colors	Stranding	Qty. Per Pkg.
C216-3E	16	3 (Black, Green, White)	19 x 29	100 Ft. spool
C214-3E	14		19 x 27	100 Ft. spool
C212-3E	12		19 x 25	100 Ft. spool
C210-3E	10		19 x 23	100 Ft. coil
C208-3E	8		19 x 21	100 Ft. coil
C206-3E	6		37 x 21	100 Ft. coil
C216-2E	16	2 (Red, Yellow)	19 x 29	100 Ft. spool
C214-2E	14		19 x 27	100 Ft. spool
C212-2E	12		19 x 25	100 Ft. spool
C210-2E	10		19 x 23	100 Ft. coil
C208-2E	8		19 x 21	100 Ft. coil
C206-2E	6		37 x 21	100 Ft. coil

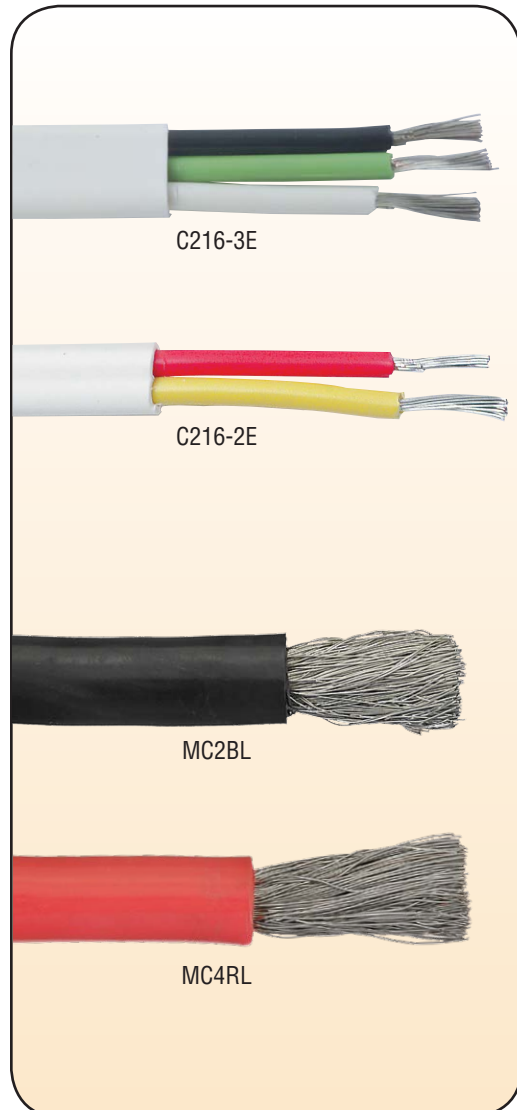

## MARINE BATTERY CABLE — SAE SPECIFICATION J1127, TYPE SGT TEMPERATURE RATING 105°C

- Wide variety of gauges available from 6 to 4/0
- Tinned Copper Conductor
- Tough Thermoplastic Insulation is available in black or red

Part No.	Color	Cable Gauge	Stranding	O.D.	Qty. Per Pkg.
MC6BL	Black	6	266/30	0.340"	50 Ft.
MC6RL	Red	6	266/30	0.340"	50 Ft.
MC4BL	Black	4	420/30	0.395"	50 Ft.
MC4RL	Red	4	420/30	0.395"	50 Ft.
MC2BL	Black	2	665/30	0.465"	50 Ft.
MC2RL	Red	2	665/30	0.465"	50 Ft.
MC1BL	Black	1	833/30	0.521"	50 Ft.
MC1RL	Red	1	833/30	0.521"	50 Ft.
MC0BL	Black	1/0	1064/30	0.561"	50 Ft.
MC0RL	Red	1/0	1064/30	0.561"	50 Ft.
MC00BL	Black	2/0	1330/30	0.616"	50 Ft.
MC00RL	Red	2/0	1330/30	0.616"	50 Ft.
MC000BL	Black	3/0	1672/30	0.666"	50 Ft.
MC000RL	Red	3/0	1672/30	0.666"	50 Ft.
MC0000BL	Black	4/0	2107/30	0.726"	50 Ft.
MC0000RL	Red	4/0	2107/30	0.726"	50 Ft.

For Automotive Battery Cable go to page numbers B22-B23, Section B "Battery Cable"



# AUTOMOTIVE PRIMARY WIRE



## PROTECT & ORGANIZE AUTOMOTIVE & MARINE WIRING WITH WIRE LOOM

### SPIRAL WRAP

Protects cables while permitting wires to lead out from anywhere along the length. Natural white polyethylene. Temperature range: -50°F. to +160°F.

Part No.	Color	Std. Pkg.	Display Pack	Qty. Per Pkg.	O.D.
CL8	Natural	50'	ET8	5'	1/4"
CL7	Natural	50'	ET7	5'	1/2"
—	Yellow	—	ET7Y	5'	1/2"
—	Blue	—	ET7E	5'	1/2"
—	Black	—	ET7B	5'	1/2"
—	Red	—	ET7R	5'	1/2"
CL9	Natural	50'	ET9	5'	3/4"

### CLEAR VINYL

Recommended for truck and trailer applications exposed to weather. Protects against acid, salt and oil. Temperature range: -4°F. to 220°F.

Part No.	I.D.	Std. Pkg.
CL30	1/4"	50 Ft. Coil
CL32	3/8"	50 Ft. Coil
CL33	1/2"	50 Ft. Coil

### BLACK NEOPRENE LOOM

Part No.	I.D.	Std. Pkg.
CL5N	5/16"	50 Ft. Coil

### PVC SPLIT LOOM

Protect your wiring. Split seam allows easy insertion and removal without disconnecting wire or cable. Temperature range: -15°F. to +195°F.

Part No.	Color	Std. Pkg.	Bulk Pkg.	Std. Pkg.	Display Pack	Qty. Per Pkg.	I.D.
CL4S	Black	50'	CLB4	250'	ET3	12'	1/4"
CL5S	Black	50'	CLB5	250'	ET5	12'	3/8"
CL6S	Black	50'	—	—	ET6	12'	7/16"
CL16	Black	50'	CLB16	250'	—	—	1/2"
CL10S	Black	50'	—	—	—	—	5/8"
CL11S	Black	50'	CLB11	250'	ET4	6'	3/4"
CL12S	Black	50'	CLB12	150'	—	—	1"
CL13S	Black	50'	CLB13	150'	—	—	1 1/2"
CL5SE	Blue	50'	—	—	ET5E	12'	3/8"
CL5SY	Yellow	50'	—	—	ET5Y	12'	3/8"
CL5SR	Red	50'	—	—	ET5R	12'	3/8"
CL5SW	White	50'	—	—	ET5W	12'	3/8"

### HIGH TEMPERATURE NYLON SPLIT LOOM

Protection for wire routed near exhaust manifolds or other hot engine parts. Combines abrasion and superior thermal protection. Marked with white stripe. Temperature rating -20°F to 300°F.

Part No.	I.D.	Std. Pkg.	Part No.	I.D.	Std. Pkg.
CL38	1/4"	50 Ft. Coil	NEW CL44	5/8"	50 Ft. Coil
CL39	3/8"	50 Ft. Coil	CL41	3/4"	50 Ft. Coil
CL14S	7/16"	50 Ft. Coil	CL42	1"	50 Ft. Coil
CL40	1/2"	50 Ft. Coil	CL43	1 1/2"	50 Ft. Coil

### HIGH TEMPERATURE REFLECTIVE LOOM

High Temperature Reflective Loom protects up to 450°F / 232°C. Protects cables, harnesses, hoses, etc.

Part No.	I.D.	Length	Std. Pkg.
CL17S	3/4"	15"	1

### ASPHALT-COATED FABRIC LOOM

Seamless, moisture-proof loom for heavy duty service. For temperatures up to 250°F. Meets or exceeds SAE J562A specifications.

Part No.	I.D. (min.)	Std. Pkg.	Bulk Pkg.	Std. Pkg.
CL19	3/16"	50'	—	—
CL20	1/4"	50'	CLB20	250'
CL21	5/16"	50'	—	—
CL22	3/8"	50'	CLB22	250'
CL23	7/16"	50'	—	—
CL24	1/2"	50'	CLB24	250'
CL26	5/8"	50'	—	—
CL28	3/4"	50'	—	—
CL29	1"	50'	—	—

ET Display Package

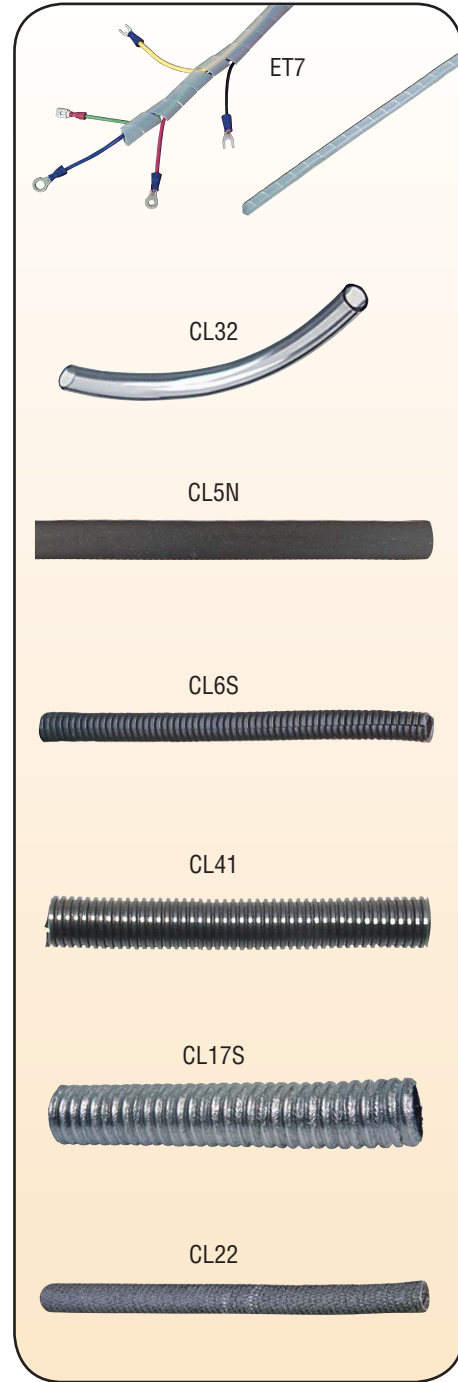

### LOOM INSTALLATION TOOL



**CL15** - Make installing wire loom quick and easy with this handy loom installation tool. Just slip over wire and start loom, tool spreads loom while it feeds over wire. Use with 3/8" to 5/8" ID split loom. **Standard Package 1.**

# WIRING ACCESSORIES

## LOOM TEE CONNECTORS

Connects branch runs to main loom wiring.					
Part No.	Loom	Left I.D.	Center I.D.	Right I.D.	Std. Pkg.
CL34	Use with CL6S & CL16	1/2"	1/2"	1/2"	1
CL35	Use with CL5S	13/32"	23/64"	23/64"	1
CL36	Use with CL5S CL6S, CL11S	3/4"	23/64"	3/4"	1
CL37*	Loom outlet Use with CL5S & CL6S	13/32"	—	13/32"	1

\* Loom outlet — Holds loom tight at breakouts

## ELECTRICAL TAPE

Part No.	Description	Qty. per Pkg.
ET261	Electrical Tape 33 - foot roll	1 roll

## WIRING CLIPS

Part No.	Qty.	Description	Display Pack	Qty. Per Pkg.
ST60	50	Push-on metal wiring clip for flat surfaces	ET290	4
ST61	50	Bolt on wiring clip 5/16" mounting hole		
ST62	50	Adhesive-backed wiring clip 1 1/4" L. x 3/16" I.D.	ET62	4
ST63	50	1 1/2" L. x 1/4" I.D.		
ST64	50	2" L. x 3/8" I.D.		
ST65†	50	2 1/4" L. x 1/2" I.D.		
ST291	50	1/4" I.D.	ET291	6
ST292	50	3/8" I.D.	ET292	4
ST294	50	1/2" I.D.	ET294	4
ST295	50	3/4" I.D.	ET295	3
ST293	50	1 1/2" sq. nylon base	ET293	4
ST69	25	Molded nylon harness bracket 1/4" I.D.		
ST66	25	1/2" I.D.		
ST67	25	3/4" I.D.		
		Asst. of 4 ea. ST66, ST67, ST69	ET270	12
ST70	25	Rubber cushioned steel clamp 1/4" I.D.	ET273	7
ST73	25	3/8" I.D.	ET296	6
ST71	25	1/2" I.D.	ET274	6
ST74	25	5/8" I.D.	ET297	5
ST72	25	3/4" I.D.	ET275	5
ST75	25	1" I.D.	ET298	4
		Asst. of 2 ea. ST70, ST71, ST72	ET272	6
ST296	10	Push-mount wiring clip 1/4" I.D.		
ST297	10	1/2" I.D.		

## COATED METAL CLAMPS

Part No.	I.D.	Hole Diameter	Width	Std. Pkg.
ST80	1/4"	1/4"	3/4"	25
ST81	3/8"	13/32"	3/4"	25
ST85	1/2"	13/32"	3/4"	25
ST82	5/8"	13/32"	3/4"	25
ST83	3/4"	13/32"	3/4"	25
ST84	1"	13/32"	3/4"	25

## VACUUM CAPS

Part No.	Description	Qty. per Pkg.
ET505	Rubber Vacuum Caps, Display Pkg., 8-pcs. with holder	8 per clam
ET506	Vinyl Vacuum Caps, Display Pkg., 35-pcs.	35 per clam

ET Display Package † Available while supplies last



CL34

CL37



3-way  
wire loom  
hook up



ET261



ST60



ST61

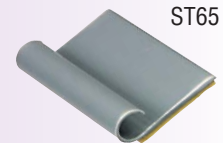

ST65



ST292



ST293



ST66



ST72



ST296



ST80



ET505



ET506

# WIRING ACCESSORIES



## PROTECT YOUR WIRING... KEEP YOUR WIRES NEATLY BUNDLED AND ORGANIZED

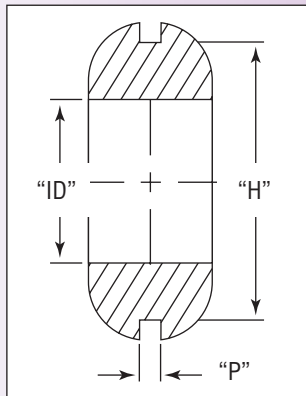

ET40



STA50



ET11

Tie Strap Gun. Included in STA50 Tie Strap Kit.

### VINYL WIRE GROMMETS

Flexible, oil resistant, high dielectric grommets resist harsh engine compartment conditions.

Part No.	ID	Hole	Panel	Std. Pkg.
ET44	1/8"	1/4"	1/16"	33
ET40	1/4"	3/8"	1/16"	20
ET45	3/8"	1/2"	1/16"	26
ET46	5/8"	7/8"	1/16"	12
ET41+	1/4", 3/16", 1/8"	3/8", 5/16", 1/4"	1/16"	21
ET42+	3/8", 5/8", 3/4"	5/8", 7/8", 1"	1/8", 1/16"	8
ET43+	5/8", 3/8", 1/2"	1", 3/4", 5/8", 7/16"	1/8", 1/16"	15
	1/4", 3/16", 1/8"	3/8", 5/16", 1/4"		
GR1	1/8"	1/4"	1/16"	25
GR2	1/4"	3/8"	1/16"	25
GR3	3/8"	1/2"	1/16"	25
GR4	1/2"	13/16"	1/16"	25
GR5	5/8"	7/8"	1/16"	25
GR6	3/4"	1 1/16"	1/16"	25
GR7	7/8"	1 1/4"	1/16"	25
GR8	1"	1 3/8"	1/8"	25

ET Display Package  
+ Assorted Sizes

### WIRE TIE STRAP KIT & ACCESSORIES

Wire tie kit has everything needed to keep wiring neatly bundled and out of the way. The tensioning tool comes as part of the assortment or separate part number.

Part No.	Description	Qty. per Pkg.
STA50	Tensioning Tool Kit	1 kit
ET11	Tie Strap Gun	1

#### STA50 Contents:

- 1 Tensioning Tool
- 50 - 6" white universal tie straps - Re-Order STT273
- 50 - 8" black universal tie straps - Re-Order STT275
- 5 - mounting clips - Re-Order ET293, ST293
- Instruction sheet

### TENSIONING INSTRUCTIONS



1. Loop cable tie around bundle. Thread tail through head of cable tie and hand tighten.

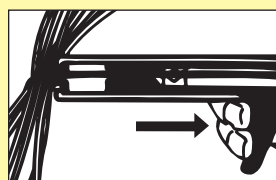

2. Position cable tie in tool and pull trigger to tighten keeping tension on trigger.

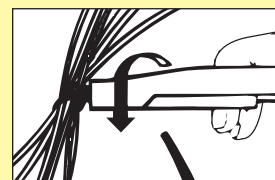

3. A quick twist of the gun in a counter-clockwise direction cuts the excess tail, leaving no sharp edge.

ET Display Package

# WIRING TIE STRAPS







Protect Your Wiring... Keep Your Wires Neatly Bundled And Organized

## NYLON WIRE TIE STRAPS

	Part No.	Length	Tensil Strength	Width	Bundle Dia.	Qty.
Standard - Non Releasable - Natural	ET280L	Asst.; 5 ea. STT253, STT256, STT271 and 2 ea. ST293				
	STT256	4"	18lbs.	.10"	.75"	100
	STT256M					1000
	ET256					15
	STT273	6"	30lbs.	.14"	1.25"	25
	STT273C					100
	STT273M					1000
	STT271	8"	50lbs.	.18"	1.75"	25
	STT271C					100
	STT271M					1000
	ET271L	8.5"	40lbs.	.15"	2.00"	20
	STT252	11.75"	50lbs.	.18"	3.00"	25
	STT252C					100
	STT252M					1000
	ET252L	11.5"	40lbs.	.15"	3.00"	15
	STT253	15.5"	50lbs.	.18"	4.00"	10
	STT253C					100
	STT253M					1000
ET253L	14.5"	40lbs.	.15"	4.00"	12	
STT272	15.25"	120lbs.	.30"	4.00"	10	
STT272C					100	
STT272D					500	
Standard - Non Releasable - Black UV Resistant	STT281C	4"	18lbs.	.10"	.75"	100
	STT281M					1000
	STT282	6"	30lbs.	.14"	1.25"	25
	STT282C					100
	STT275	8"	50lbs.	.18"	1.75"	25
	STT275C					100
	STT275M					1000
	ET279L					20
	STT276	11.75"	50lbs.	.18"	3.00"	25
	STT276C					100
	STT276M					1000
	ET276L					15
STT277	15.5"	50lbs.	.18"	4.00"	10	
STT277C					100	
STT277M					1000	
STT278	15.25"	120lbs.	.30"	4.00"	10	
STT278C					100	
STT278D					500	
Mounting - Non Releasable Natural	STT259	6.5" Stud Size #8	30lbs.	.14"	1.38"	25
	STT250	8.5"	50lbs.	.18"	1.75"	25
	STT250C					100
	STT250M					1000
	ET250	Stud Size #10				8
	ET250L					20
Mounting - Non Releasable U.V. Resistant	STT251	16" Stud Size #10	50lbs.	.18"	4.00"	25
	STT251C					100
	STT251D					500
	ET251L					8
STT274	16.25" Stud Size .25"	120lbs.	.30"	4.00"	25	
STT274C					100	
Releasable - Black U.V. Resistant	STT254	5.5"	50lbs.	.34"	1.375"	25
	ET254					6
	ET254L					20
	STT255	10"	50lbs.	.34"	2.75"	10
	ET255L					10

ET Display Package

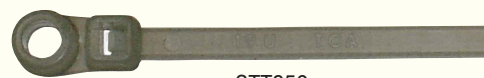
Specialty Tie Straps					
Part No.	Length	Tensil Strength	Width	Bundle Dia.	Qty.
STT270	12"	50lbs.	.18"	1.5"	25
		40lbs.		1.5" Each Loop	
STT279	15.25" Stud Size .25"	120lbs.	.18"	4"	50

<b>Standard - Non Releasable</b>	
	STT252
<b>Standard - Non Releasable U.V. Resistant</b>	
	STT275
<b>Mounting - Non Releasable</b>	
	STT250
<b>Standard - Releasable - U.V. Resistant</b>	
	STT254
<b>Non Releasable - Neutral</b>	
	STT259
<b>Double Headed - Non Releasable</b>	
	STT270
<b>Heavy Duty Stud Mount - Non Releasable</b>	
	STT279

For Multi-Colored Tie Straps go to page number C13

# SPECIALTY ACCESSORIES



## PROTECT YOUR WIRING... KEEP YOUR WIRES NEATLY BUNDLED AND ORGANIZED

### MULTI-COLORED NYLON WIRE TIE STRAPS

	Standard - Non Releasable						
	Part No.	Color	Length	Tensil Strength	Width	Bundle Dia.	Qty.
Standard - Non Releasable	STT256E	Blue	4"	18lbs.	.10"	.75"	100
	ET256E						15
	STT256R	Red	4"	18lbs.	.10"	.75"	100
	ET256R						15
	STT256W	White	4"	18lbs.	.10"	.75"	100
	ET256W						15
	STT256Y	Yellow	4"	18lbs.	.10"	.75"	100
	ET256Y						15
	STT271E	Blue	8"	50lbs.	.18"	1.75"	25
	ET271EL						20
	STT271R	Red	8"	50lbs.	.18"	1.75"	25
	ET271RL						20
	STT271W	White	8"	50lbs.	.18"	1.75"	25
	ET271WL						20
	STT271Y	Yellow	8"	50lbs.	.18"	1.75"	25
	ET271YL						20

ET Display Pack

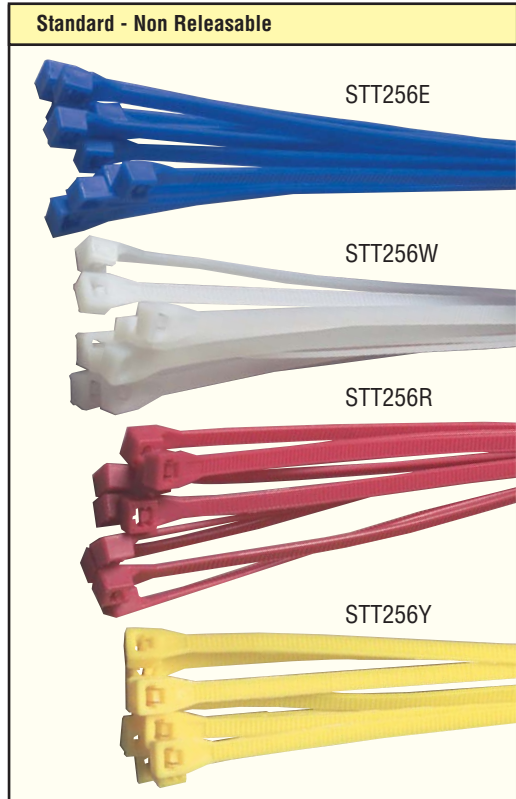

### MULTI-COLORED SPIRAL WRAP

Part No.	Color	Std. Pkg.	O.D.
ET7E	Blue	5'	1/2"
ET7R	Red	5'	1/2"
ET7Y	Yellow	5'	1/2"

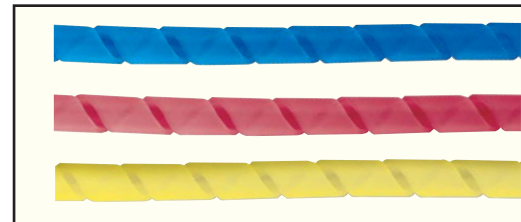

### MULTI-COLORED PVC SPLIT LOOM

Part No.	Color	Std. Pkg.	Display Pack	Qty. Per Pkg.	I.D.
CL5SE	Blue	50'	ET5E	12'	3/8"
CL5SR	Red	50'	ET5R	12'	3/8"
CL5SW	White	50'	ET5W	12'	3/8"
CL5SY	Yellow	50'	ET5Y	12'	3/8"

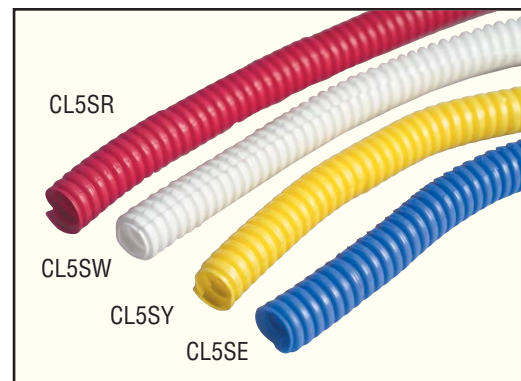

PRIMARY WIRE

# STANDARD<sup>®</sup>

## Primary Wire, Terminals & Accessories



Proper Tools To Do  
The Job Right

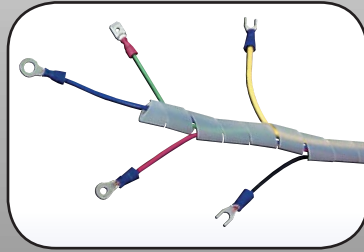

Spiral Wrap & Loom To Neatly  
Bundle Any Wiring Job

### A Comprehensive Source For All Your Wiring Needs



Time Saving Accessories  
To Get The Job Done Fast



Wide Range Of Parts To Fit  
Almost Every Need



Store Your Wiring Products Neatly Into Wire Cabinet AB99W. Organizes Your Wire And Cable Parts So They Are Always At Your Finger Tips.



*Ignition Wires*

*Battery Cables*

*Primary Wire*

## ***Terminals & Connectors***

*Trailer Connectors*

*Sockets, Pigtails & Switches*

*Safety Accessories*

*O.E. Interchanges*

*Index*

## INSULATED SOLDERLESS TERMINALS

- The terminals and connectors product group include both PVC and nylon insulated terminals to satisfy the varying needs of automotive wiring experts.
- Nylon insulated terminals offer both high performance design and rugged construction.

Unlike the PVC equivalent, the nylon terminals have an extended tin plated brass support sleeve that:

- (1) Strengthens the barrel and secures the wire to protect against stress and high vibration.
- (2) Nylon insulating sleeve withstands continuous operating temperatures of  $-10^{\circ}\text{C}$  to  $+105^{\circ}\text{C}$ .
- (3) Both PVC and nylon terminals have funnel entry to prevent wire strand “hang up” for more secure, reliable crimps. In most instances nylon insulated terminals are visually identified as having lighter colored insulation than the equivalent PVC.

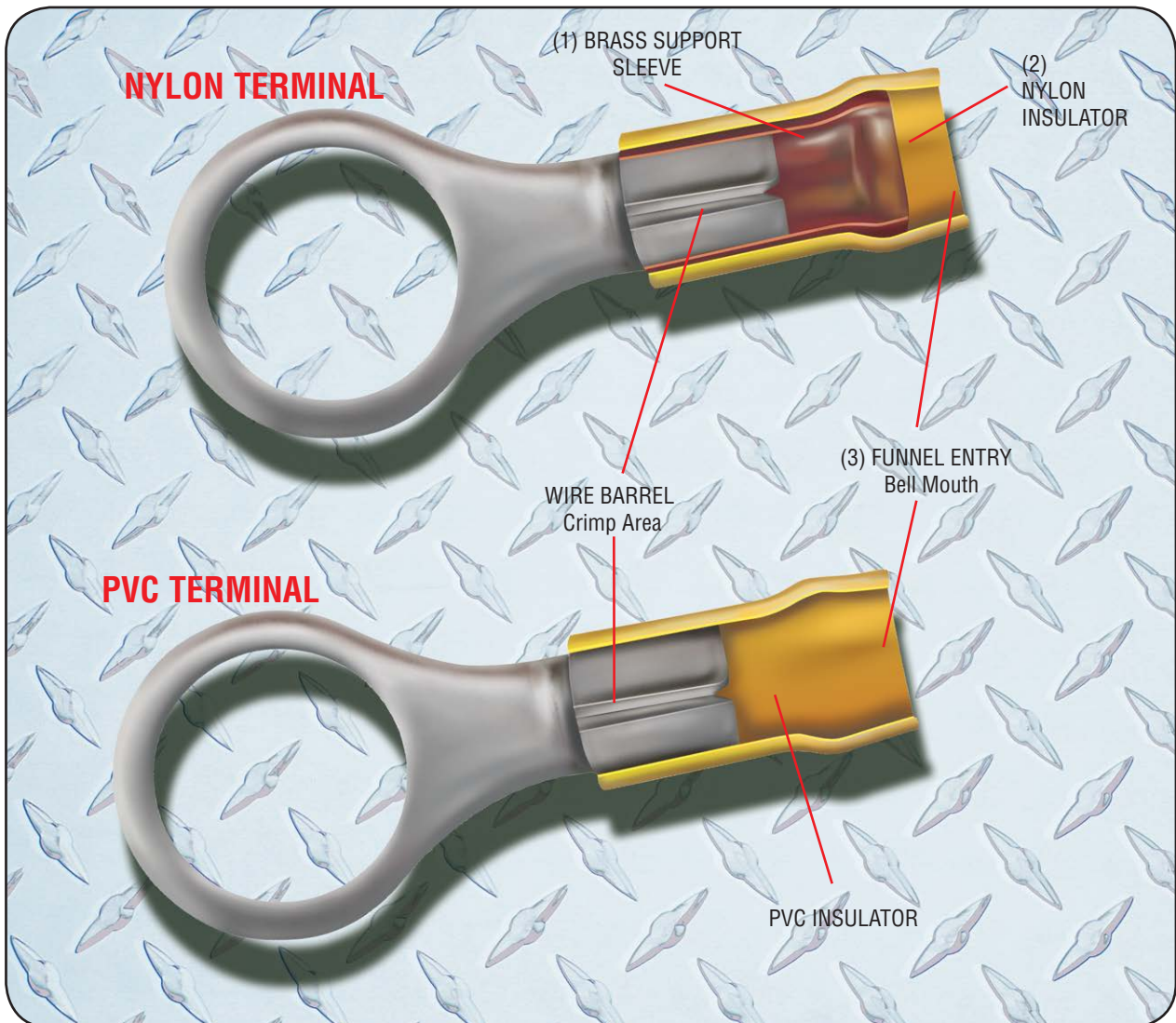



# INSULATED RING TERMINALS



## 22-18 GAUGE

PVC	Part No.	Stud Size	Qty Per Pkg.
	STP151 ET151	#6	100 7
	STP497 ET497	#8	100 7
	STP120 ET120XL ET120L ET120	#10	100 80 20 7
	STP121 ET121	1/4"	100 7
	STP606	5/16"	100
	STP122 ET122	3/8"	100 6

Star PVC	Part No.	Stud Size	Qty Per Pkg.
	STP93 ET93L ET93	#6	50 12 3
	STP92 ET92L ET92	#8	50 12 3
	STP91 ET91L ET91	#10	50 12 3

## 20-18 GAUGE

Crimp Type With Heat Shrink	Part No.	Stud Size	Qty Per Pkg.
	STP151H ET151H	#6	10 3
	STP497H ET497H	#8	10 3
	STP120HL STP120H ET120H	#10	50 10 3
	STP121H ET121H	1/4"	10 3
	STP606H	5/16"	10
	STP122H ET122H	3/8"	10 3

## 20-18 GAUGE

Self Solder Heat Shrink	Part No.	Stud Size	Qty Per Pkg.
	STP354	#6	25
	STP355 ET355	#8	25 3
	STP356 ET356	#10	25 3
	STP357 ET357	1/4"	25 3
	STP475 ET475	5/16"	25 3
	STP476 ET476	3/8"	25 3
Crimp, Solder & Heat Shrink	Part No.	Stud Size	Qty Per Pkg.
	STP556 ET556	#10	5 3

## 16-14 GAUGE

PVC	Part No.	Stud Size	Qty Per Pkg.
	STP498D STP498 ET498	#6	500 100 6
	STP123 ET123L ET123	#8	100 20 6
	STP124D STP124 ET124XL ET124L ET124	#10	500 100 85 20 6
	STP125D STP125 ET125XL ET125L ET125	1/4"	500 100 75 15 5
	STP157C STP157 ET157	5/16"	100 25 4
	STP126 STP302 ET126L ET126	3/8"	100 25 15 5
Star PVC	Part No.	Stud Size	Qty Per Pkg.
	STP96 ET96L ET96	#6	50 12 3
	STP95 ET95L ET95	#8	50 12 3
	STP94 ET94L ET94	#10	50 12 3

Images shown actual size unless indicated otherwise.  
ET Display Package





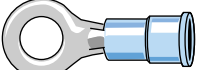
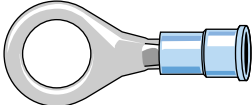
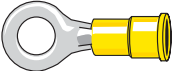
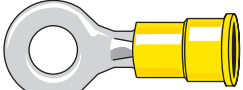
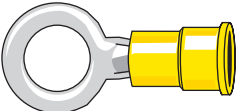
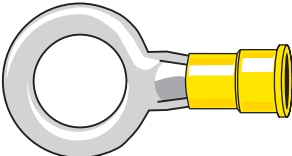
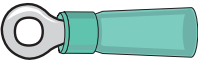
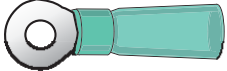
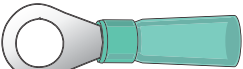
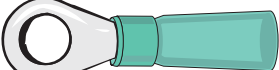
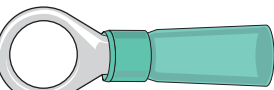
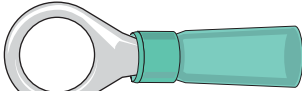



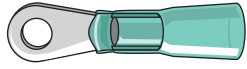
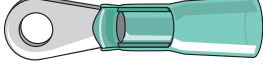

# INSULATED RING TERMINALS

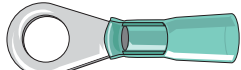
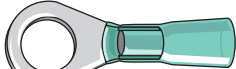
## 16-14 GAUGE

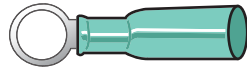
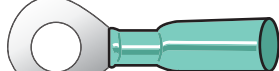
Nylon Extended Barrel	Part No.	Stud Size	Qty Per Pkg.
	STP438	#10	50
	STP439	1/4"	50
	STP440	3/8"	50
Heavy Duty Nylon Extended Barrel *STP602 also suitable for 12 Ga.	Part No.	Stud Size	Qty Per Pkg.
	STP602	#10	50
	STP494 ET494L	1/4"	50 8
	STP495 ET495L	3/8"	50 8
	STP496	1/2"	50
Crimp Type With Heat Shrink	Part No.	Stud Size	Qty Per Pkg.
	STP498H	#6	10
	STP123H	#8	10
	STP124HL STP124H ET124H	#10	50 10 3
	STP125H ET125H	1/4"	10 3
	STP157H ET157H	5/16"	10 3
	STP126H ET126H	3/8"	10 3

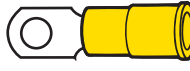
Images shown actual size unless indicated otherwise.

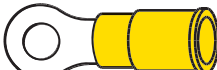
## 16-14 GAUGE

Self Solder Heat Shrink	Part No.	Stud Size	Qty Per Pkg.
	STP477	#6	25
	STP358	#8	25
	STP359C STP359 ET359	#10	100 25 3
	STP360 ET360	1/4"	25 3
	STP478 ET478	5/16"	25 3
	STP361 ET361	3/8"	25 3
Crimp, Solder, Heat Shrink	Part No.	Stud Size	Qty Per Pkg.
	STP559 ET559	#10	5 3
	STP560 ET560	1/4"	5 3
	STP561 ET561	3/8"	5 3
12-10 GAUGE			
PVC	Part No.	Stud Size	Qty Per Pkg.
	STP493 ET493	#6	50 4
	STP524D STP524 ET524	#8	500 50 4
	STP127 ET127XL ET127L ET127	#10	50 60 14 4
	STP128D STP128 ET128XL ET128L ET128	1/4"	500 50 60 14 3
	STP168 ET168L	5/16"	50 9

ET Display Package

# INSULATED RING TERMINALS

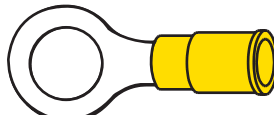
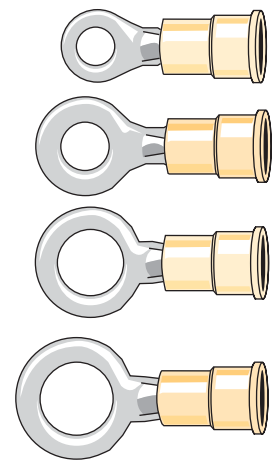
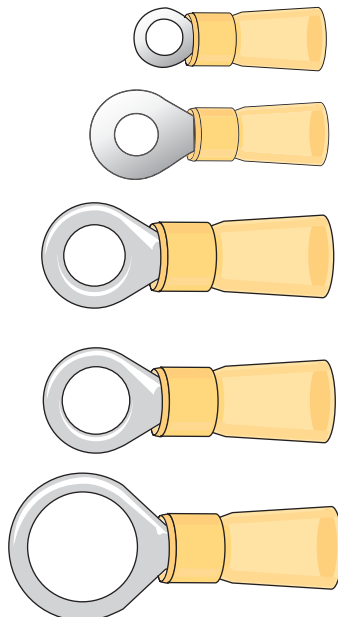

12-10 GAUGE			
<b>PVC</b>	<b>Part No.</b>	<b>Stud Size</b>	<b>Qty Per Pkg.</b>
	STP129 ET129XL ET129L ET129	3/8"	50 60 14 3
	STP159 ET159L	1/2"	25 10
<b>Nylon Extended Barrel</b>	<b>Part No.</b>	<b>Stud Size</b>	<b>Qty Per Pkg.</b>
	STP441	#10	50
	STP442	1/4"	50
	STP443	5/16"	50
	STP444	3/8"	50
<b>Crimp Type With Heat Shrink</b>	<b>Part No.</b>	<b>Stud Size</b>	<b>Qty Per Pkg.</b>
	STP127H ET127H	#10	10 3
	STP128H	1/4"	10
	STP168H	5/16"	10
	STP129H	3/8"	10
	STP159H	1/2"	10

Images shown actual size unless indicated otherwise.  
ET Display Package

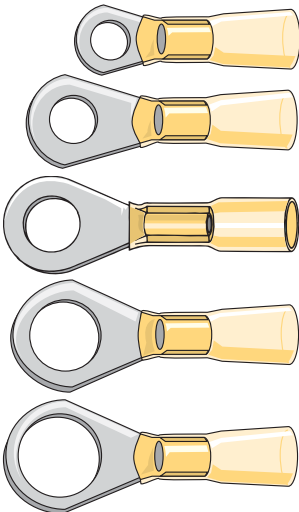
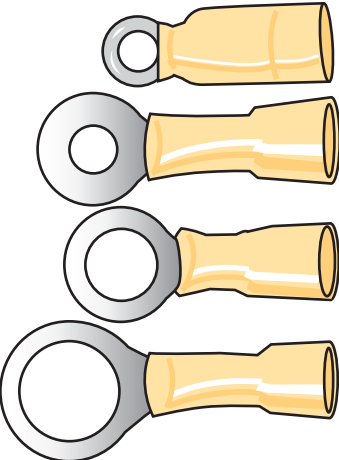
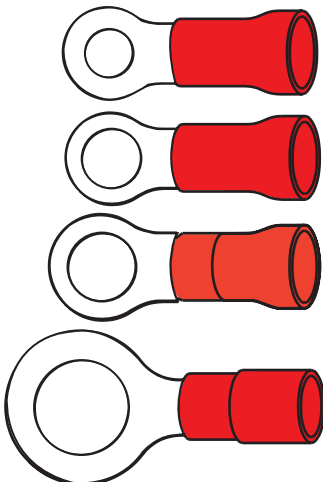
12-10 GAUGE			
<b>Self Solder Heat Shrink</b>	<b>Part No.</b>	<b>Stud Size</b>	<b>Qty Per Pkg.</b>
	STP362	#10	25
	STP363 ET363	1/4"	25 3
	STP479 ET479	5/16"	25 3
	STP364 ET364	3/8"	25 3
	STP365 ET365	1/2"	25 3
<b>Crimp, Solder, Heat Shrink</b>	<b>Part No.</b>	<b>Stud Size</b>	<b>Qty Per Pkg.</b>
	STP562 ET562	#10	5 3
	STP563	1/4"	5
	STP564 ET564	3/8"	5 3
	STP565	1/2"	5
8 GAUGE			
<b>PVC</b>	<b>Part No.</b>	<b>Stud Size</b>	<b>Qty Per Pkg.</b>
	STP188	1/4"	25
	STP192	5/16"	25
	STP177	3/8"	25
	STP175	1/2"	25

# INSULATED RING TERMINALS / TERMINALS & CONNECTORS

## 8 GAUGE

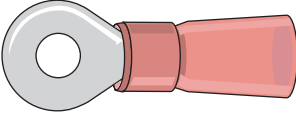
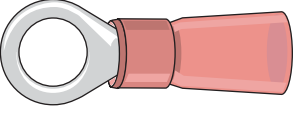
Crimp Type With Heat Shrink	Part No.	Stud Size	Qty Per Pkg.
	STP188H	1/4"	10
	STP177H	3/8"	10

## 6 GAUGE

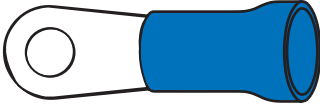
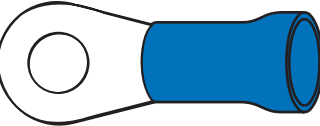
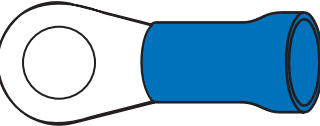
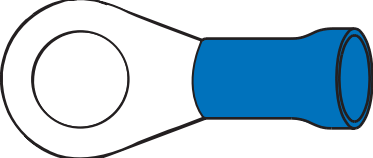

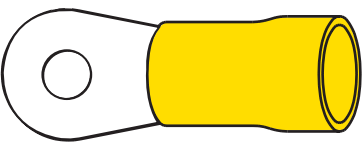
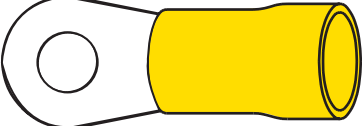
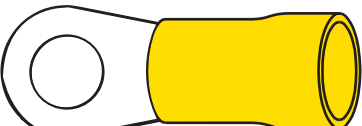
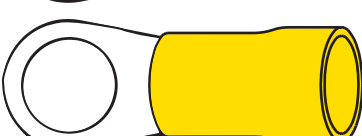

PVC	Part No.	Stud Size	Qty Per Pkg.
	STP187	1/4"	25
	STP194	5/16"	25
	STP301	3/8"	25
	STP174	1/2"	25

## 4 GAUGE

PVC	Part No.	Stud Size	Qty Per Pkg.
	STP193	1/4"	10
	STP191	5/16"	10
	STP190	3/8"	10
	STP189	1/2"	10

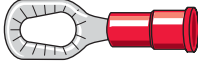

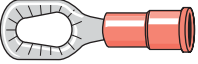
Images shown actual size unless indicated otherwise.

## MULTI-STUD RING TERMINALS

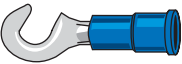

PVC (Stud Size #6-8-10)	Part No.	Gauge	Qty Per Pkg.
	STP388 ET388L	22-18	25 9
	STP389 ET389L	16-14	25 9
	STP390 ET390L	12-10	25 8
Nylon Extended Barrel (Stud Size #6-8-10)	Part No.	Gauge	Qty Per Pkg.
	STP391	22-18	25
	STP392	16-14	25
	STP393	12-10	25

## HOOK TERMINALS

PVC (Stud Size #6)	Part No.	Gauge	Qty Per Pkg.
	STP445	22-18	50
	STP300	16-14	100

PVC (Stud Size #10)	Part No.	Gauge	Qty Per Pkg.
	STP165 ET165	22-18	100 4
	STP155C STP155 ET155	16-14	100 50 3
	STP154 ET154	12-10	25 3

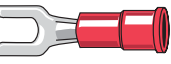
## SPADE TERMINALS

PVC (22-18 Gauge)	Part No.	Stud Size	Qty Per Pkg.
	STP136 ET136XL ET136	#6	100 75 7
	STP486 ET486	#8	100 7
	STP150 ET150	#10	100 7

ET Display Package

# TERMINALS & CONNECTORS



## SPADE TERMINALS

Crimp Type With Heat Shrink Tubing (20-18 Gauge)	Part No.	Stud Size	Qty Per Pkg.
	STP136H	#6	10
	STP499H	#8	10
	STP150H	#10	10
Self Solder Heat Shrink (22-18 Gauge)	Part No.	Stud Size	Qty Per Pkg.
	STP366	#10	25
Crimp Solder Heat Shrink (22-18 Gauge)	Part No.	Stud Size	Qty Per Pkg.
	STP578	#10	5
PVC (16-14 Gauge)	Part No.	Stud Size	Qty Per Pkg.
	STP133D	#6	500
	STP133		100
	ET133		6
	STP134	#8	100
	ET134XL		85
	ET134		6
	STP135D	#10	500
	STP135		100
	ET135XL		65
ET135		6	
Crimp Type With Heat Shrink Tubing (16-14 Gauge)	Part No.	Stud Size	Qty Per Pkg.
	STP133H	#6	10
	STP134H	#8	10
	STP135H	#10	10
	ET135H		3
Heavy Duty Nylon (16-14 Gauge)	Part No.	Stud Size	Qty Per Pkg.
	STP446*	#6	50
	ET446L*		7
	STP394*	#8	50
	ET394L*		7
	STP447*	#10	50
	ET447L*		7
Self Solder Heat Shrink (16-14 Gauge)	Part No.	Stud Size	Qty Per Pkg.
	STP367	#10	25
	ET367		3
Crimp Solder Heat Shrink (16-14 Gauge)	Part No.	Stud Size	Qty Per Pkg.
	STP577	#10	5

Images shown actual size unless indicated otherwise.

ET Display Package

\* Available while supplies last

## SPADE TERMINALS







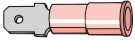

PVC (12-10 Gauge)	Part No.	Stud Size	Qty Per Pkg.
	STP491	#6	50
	ET491		4
	STP492	#8	50
	ET492		4
	STP208	#10	50
	ET208XL		65
	ET208		4
Crimp Type With Heat Shrink (12-10 Gauge)	Part No.	Stud Size	Qty Per Pkg.
	STP208H	#10	10
	STP500H	1/4"	10
Self Solder Heat Shrink (12-10 Gauge)	Part No.	Stud Size	Qty Per Pkg.
	STP368	#10	25
Crimp Solder Heat Shrink (12-10 Gauge)	Part No.	Stud Size	Qty Per Pkg.
	STP576	#10	5

## SLIDE-ON TERMINALS

PVC (22-18 Gauge)	Part No.	Width	Qty Per Pkg.	Male/Female
	STP148	1/4"	100	M
	ET148XL		80	
	ET148L		20	
	ET148		5	
	STP149	1/4"	100	F
	ET149XL		80	
	ET149L		20	
	ET149		5	
	STP480	3/16"	50	M
	ET480L		15	
	STP481	3/16"	50	F
	ET481L		15	
	STP484	7/64"	50	F
	ET484L		12	
Nylon Fully Insulated (22-18 Gauge)	Part No.	Width	Qty Per Pkg.	Male/Female
	STP142	1/4"	100	M
	ET142		3	
	STP143	1/4"	100	F
	ET143		3	
ET528 — Combo Pack includes 2 of each: STP142 and STP143				
	STP600	3/16"	50	M
	ET600L		9	
	STP601	3/16"	50	F
	ET601L		9	

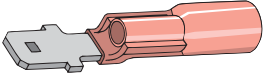
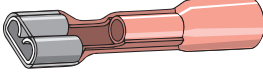
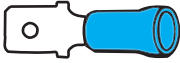
# TERMINALS & CONNECTORS

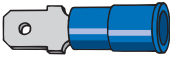



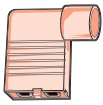
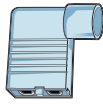

## SLIDE-ON TERMINALS

Nylon Extended Barrel (22-18 Gauge)	Part No.	Width	Qty Per Pkg.	Male/Female
	STP487	3/16"	50	M
	STP488	3/16"	50	F
Nylon Fully Insulated With Heat Shrink (20-18 Gauge)	Part No.	Width	Qty Per Pkg.	Male/Female
	STP142HL STP142H	1/4"	50 10	M
	STP143HL STP143H	1/4"	50 10	F
Self Solder Heat Shrink Fully Insulated (20-18 Gauge)	Part No.	Width	Qty Per Pkg.	Male/Female
	STP469C STP469 ET469	1/4"	100 25 2	M
	STP468C STP468 ET468	1/4"	100 25 2	F
PVC (16-14 Gauge)	Part No.	Width	Qty Per Pkg.	Male/Female
	STP140D STP140 ET140XL ET140L ET140	1/4"	500 100 85 20 5	M
	STP141D STP141 ET141XL ET141L ET141	1/4"	500 100 85 20 5	F
	STP482 ET482L	3/16"	50 17	M
	STP483 ET483L	3/16"	50 17	F
	STP485 ET485L	7/64"	50 11	F

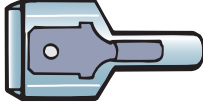
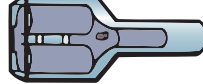
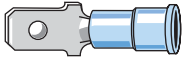
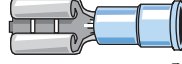
## FLAG TERMINALS

Fully Insulated Nylon (22-18 Gauge)	Part No.	Width	Qty Per Pkg.	Fully Insulated Nylon (16-14 Gauge)	Part No.	Width	Qty Per Pkg.
	STP97 ET97L	1/4"	25 5		STP98 ET98L	1/4"	25 5
	STP430	3/16"	25		STP432	3/16"	25

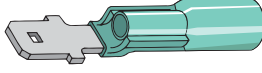
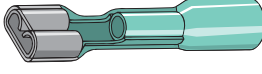
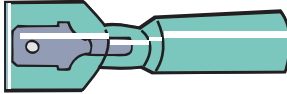
## SLIDE-ON TERMINALS

Nylon Fully Insulated (16-14 Gauge)	Part No.	Width	Qty Per Pkg.	Male/Female
	STP144D STP144 ET144XL ET144L ET144	1/4"	500 100 50 12 3	M
	STP431 STP145D STP145 ET145XL ET145L ET145	3/16" 1/4"	50 500 100 50 12 3	M F
	STP433	3/16"	50	F
ET500 - Includes 2 of each: STP144 and STP145				
Nylon Extended Barrel (16-14 Gauge)	Part No.	Width	Qty Per Pkg.	Male/Female
	STP395 ET395L	1/4"	50 12	M
	STP396 ET396L	1/4"	50 12	F
	STP489	3/16"	50	M
	STP490	3/16"	50	F
Nylon Fully Insulated With Heat Shrink (16-14 Gauge)	Part No.	Width	Qty Per Pkg.	Male/Female
	STP144HL STP144H ET144H	1/4"	50 10 3	M
	STP145HL STP145H ET145H	1/4"	50 10 3	F
Self Solder Heat Shrink Fully Insulated (16-14 Gauge)	Part No.	Width	Qty Per Pkg.	Male/Female
	STP471C STP471 ET471	1/4"	100 25 3	M
	STP470C STP470 ET470	1/4"	100 25 3	F
Crimp, Solder, Heat Shrink Fully Insulated (16-14 Gauge)	Part No.	Width	Qty Per Pkg.	Male/Female
	STP571 ET571	1/4"	5 3	M
	STP570 ET570	1/4"	5 3	F

Images shown actual size unless indicated otherwise.

ET Display Package

# TERMINALS & CONNECTORS



## SLIDE-ON TERMINALS

PVC (12-10 Gauge)	Part No.	Width	Qty Per Pkg.	Male/Female
	STP207 ET207XL ET207	1/4"	25 75 4	M
	STP161 ET161XL ET161L ET161	1/4"	25 60 14 4	F
	STP474 ET474	3/8"	25 7	F
Nylon (12-10 Gauge)	Part No.	Width	Qty Per Pkg.	Male/Female
	STP179 ET179	1/4"	50 4	M
	STP178 ET178	1/4"	50 4	F
Nylon Heat Shrink (12-10 Gauge)	Part No.	Width	Qty Per Pkg.	Male/Female
	STP179H	1/4"	10	M
	STP178H	1/4"	10	F
Fully Insulated Self Solder With Heat Shrink (12-10 Gauge)	Part No.	Width	Qty Per Pkg.	Male/Female
	STP473 ET473	1/4"	25 3	M
	STP472 ET472	1/4"	25 3	F
Crimp, Solder Heat Shrink (12-10 Gauge)	Part No.	Width	Qty Per Pkg.	Male/Female
	STP573	1/4"	5	M
	STP572	1/4"	5	F

## DOUBLE MALE INSULATED - 1/4" BLADE

Mates with STP141 and STP161	Part No.	Qty. Per Pkg.
	SST97 ET512	10 4

Images shown actual size unless indicated otherwise.

## MALE & FEMALE DISCONNECTS

PVC (16-14 Gauge)	Part No.	Qty Per Pkg.
	STP182 ET182	25 3
PVC (22-18 Gauge)	Part No.	Qty Per Pkg.
	STP183 ET183	25 4
Knife Disconnect (12-10 Gauge)	Part No.	Qty Per Pkg.
	STP153	10

## SPLICE CONNECTOR

PVC	Part No.	Gauge	Qty Per Pkg.
Not actual size	STP167 4-way	22-18	10
	STP195 4-way ET195	16-14	25 2
	STP167		
	STP156 4-way ET156	12-10	10 2
	STP158 3-way ET158	22-18	25 3
	STP166 3-way ET166	16-14	10 2
	STP199 3-way	12-10	25
	STP158		
	STP137 3-way ET137	(2)12-10 (1)16-14	25 2
3-Way Crimp With Heat Shrink	Part No.	Gauge	Qty Per Pkg.
Not actual size	STP166H	16-14	10
	STP166H		
	STP137H	12-10	10

ET Display Package

TERMINALS & CONNECTORS

# TERMINALS & CONNECTORS

## BUTT SPLICE CONNECTORS

PVC	Part No.	Gauge	Qty Per Pkg.
	STP130D	22-18	500
	STP130		50
	ET130XL		85
	ET130L		20
	ET130		6
	STP131D	16-14	500
	STP131C		100
	STP131		50
	ET131XL		85
	ET131L		20
	ET131	6	
	STP132D	12-10	500
	STP132		50
	ET132XL		70
	ET132L		15
ET132	5		
STP186	8	10	
STP185	6	10	
STP184	4	10	
Nylon	Part No.	Gauge	Qty Per Pkg.
	STP196D	22-18	500
	STP196		50
	ET196L		12
	ET196		4
	STP197D	16-14	500
	STP197		50
	ET197L		12
	ET197		4
	STP198D	12-10	500
	STP198C		100
	STP198		50
	ET198L		12
	ET198	2	
	STP206	8	10
	STP205	6	10
STP204	4	10	

Images shown actual size unless indicated otherwise.

ET Display Package

\* Display Jar

## BUTT SPLICE CONNECTORS

Crimp With Heat Shrink	Part No.	Gauge	Qty Per Pkg.	
	STP350H	24-22	10	
	STP130HC	20-18	100	
	STP130H		10	
	ET130H		3	
	ET130HJ*		100	
	STP131HC	16-14	100	
	STP131H		10	
	ET131H		3	
	ET131HJ*	100		
	STP132HC	12-10	100	
	STP132H		10	
	ET132H		3	
	ET132HJ*		60	
	STP186H	8	10	
	Self Solder With Heat Shrink	Part No.	Gauge	Qty Per Pkg.
	STP350	24-22	25	
	STP351C	22-18	100	
	STP351		25	
	ET351		3	
	ET351J*		100	
	STP352C	16-14	100	
	STP352		25	
	ET352		3	
	ET352J*		100	
	STP353C	12-10	100	
	STP353		25	
	ET353		3	
	ET353J*		60	
	Crimp, Solder, Heat Shrink	Part No.	Gauge	Qty Per Pkg.
		STP550	24-22	5
ET550			3	
STP551C		20-18	100	
STP551			10	
ET551			3	
ET551J*			100	
STP552D		16-14	500	
STP552C			100	
STP552			10	
ET552			3	
ET552J*		100		
STP553D		12-10	500	
STP553C			100	
STP553			10	
ET553			3	
ET553J*	60			

## PARALLEL SPLICE - PVC

PVC	Part No.	Gauge	Qty Per Pkg.
	STP435	22-18	50
	STP436	16-14	50
	STP437	12-10	50
	ET437L		6
	ET529L Combo Pack Includes:		
STP435	3 pcs.		
STP436	4 pcs.		
STP437	2 pcs.		

Stripped wires lie side by side in the splice and are secured by a single crimp in the middle.









# TERMINALS & CONNECTORS



## STEP DOWN BUTT CONNECTORS

PVC	Part No.	Gauge	Qty Per Pkg.
	STP384	16-14 to 22-18	10
	STP385	12-10 to 16-14	10
	STP386	8 to 12-10	10
	STP387	6 to 8	10





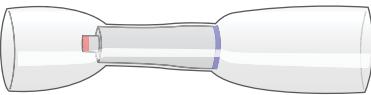
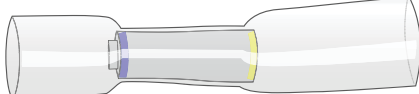
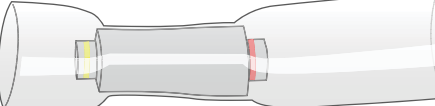

Step down end is color coded with smaller gauge colored stripe.

## SEALED IN-LINE BUTT CONNECTORS

Joins 2 Wires To 1	Part No.	Gauge	Pkg. Qty.
	STP400	20-18 Ga.	10
	STP401	16-14 Ga.	10
	STP402	12-10 Ga.	10











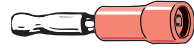

For use when two wires need to be inserted in one end of splice and a single wire in the other end.

## WIRE PIN TERMINALS \*\*

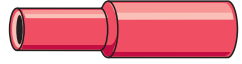
PVC	Part No.	Gauge	Pkg. Qty.
	STP375	22-18 Ga.	25
	STP376	16-14 Ga.	25
	STP377	12-10 Ga.	25
Nylon	Part No.	Gauge	Pkg. Qty.
	STP378	22-18 Ga.	25
	STP379	16-14 Ga.	25
	STP380	12-10 Ga.	25

\*\* For use where set screws or clamps make contact with wire. Simplifies insertion of standard wire into European style terminal blocks by preventing wire strand foldback. Fits all popular pin-type (European) terminal blocks.

## BULLET CONNECTORS .176" FORD APPLICATIONS .156" UNIVERSAL





PVC (22-18 Gauge)	Part No.	Size	Qty Per Pkg.
	STP170 ET170 (Male)	.156"	25 4
	STP171 ET171 (Fem.)	.156"	25 4
	STP172 ET172 (Male)	.176"	25 4
	STP173 ET173 (Fem.)	.176"	25 4
Nylon (22-18 Gauge)	Part No.	Size	Qty Per Pkg.
	STP373 (Male)	.156"	25
	STP371 (Fem.)	.156"	25
	STP374 (Male)	.176"	25
	STP372 (Fem.)	.176"	25
Crimp Type With Heat Shrink (22-18 Gauge)	Part No.	Size	Qty Per Pkg.
	STP171H (Fem.)	.156"	10
	STP170H (Male)	.156"	10
PVC (16-14 Gauge)	Part No.	Size	Qty Per Pkg.
	STP163C STP163 ET163L ET163 (Male)	.156"	100 25 15 4
	STP162C STP162 ET162L ET162 (Fem.)	.156"	100 25 15 4
	STP147 ET147 (Male)	.176"	100 4
	STP164C STP164 ET164 (Fem.)	.176"	100 25 4
ET527L - Combo Pack Includes: STP163 - 7 pcs. STP162 - 7 pcs.			

TERMINALS & CONNECTORS

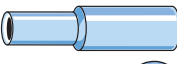

Images shown actual size unless indicated otherwise.  
ET Display Package

# TERMINALS & CONNECTORS



## BULLET CONNECTORS .176" FORD APPLICATIONS .156" UNIVERSAL

Nylon - 16-14 Gauge	Part No.	Size	Qty Per Pkg.
	STP462 (Male)	.156"	25
	STP369 (Fem.)	.156"	25
	STP463 (Male)	.176"	25
	STP370 (Fem.)	.176"	25
Crimp Type With Heat Shrink - 16-14 Gauge	Part No.	Size	Qty Per Pkg.
	STP163H (Male)	.156"	10
	STP162H (Fem.)	.156"	10







## BULLET CONNECTOR COMBO PACK .156" UNIVERSAL

PVC (16-14 Gauge)	Part No.	Contains
	ET527L	7 pcs. STP163 (Male)
		7 pcs STP162 (Female)

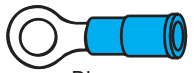
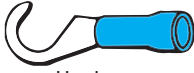

## BUTT SPLICE CONNECTOR COMBO PACK

PVC	Part No.	Contains
	ET503	STP130 - 6 pcs.
		22-18 Ga. STP131 - 5 pcs.
		16-14 Ga. STP132 - 4 pcs.
		12-10 Ga.



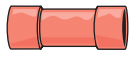

## PVC TERMINAL COMBO PACK

22-18 Gauge Terminals	Part No.	Contains
	ET513	Contains 4 each: STP120 - #10 ring STP130 - splice STP150 - #10 spade STP165 - #10 hook
		
		
		
16-14 Gauge Terminals	Part No.	Contains
	ET514	Contains 4 each: STP124 - #10 ring STP131 - splice STP135 - #10 spade STP155 - #10 hook
		
		
		

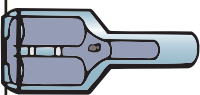

## PARALLEL SPLICE - PVC

PVC Combo Pack	Part No.	Contains
	ET529L	STP435 - 3 pcs. STP436 - 4 pcs. STP437 - 2 pcs.
		
		

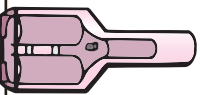
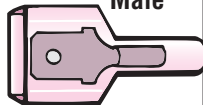
## SLIDE-ON TERMINAL COMBO PACK

16-14 Ga. Terminals 1/4" Fully Insulated Nylon	Part No.	Contains
	ET500	STP144 - 2 pcs. STP145 - 2 pcs.
		
22-18 Ga., 16-14 Ga. & 12-10 Ga. 1/4" Male/Female Slides	Part No.	Contains
	ET504	STP140 - M 3 pcs. STP141 - F 3 pcs. STP148 - M 2 pcs. STP149 - F 2 pcs. STP207 - M 1 pc. STP161 - F 1 pc.
		
22-18 Ga., 16-14 Ga. & 12-10 Ga. All Female 1/4" PVC	Part No.	Contains
	ET526	STP141 - F 4 pcs. STP149 - F 4 pcs. STP161 - F 4 pcs.
22-18 Ga. 1/4" Fully Insulated Nylon	Part No.	Contains
	ET528	STP142 - M 2 pcs. STP143 - F 2 pcs.
		

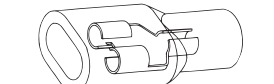
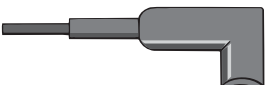
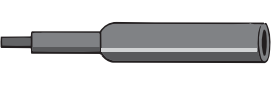
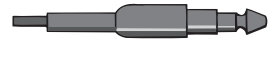
## SPECIAL CONNECTORS

	Part No.	Description	Qty Per Pkg.
	SST95	.156" and .176" Dual Female	50
	ET511		5
	SST96	.156" 3-Wire Female mates with STP163	50
	STL-1	156" Vinyl Female - 90° mates with STP163	1
	STL-2	176" Vinyl Female - Str. mates with STP147	1
	STL-3	176" Vinyl Male - Str. 12' 16 gauge leads	1

Images shown actual size unless indicated otherwise.

# TERMINALS, SPECIALTY TERMINALS & CONNECTORS



## QUICK SPlice CONNECTORS

Parallel Quick Splice	Part No.	Gauge	Qty. Per Pkg.
	STP381 ET381XL ET381	22-18 Ga.	25 30 2
	STP434†	18-14 Ga.	25
	STP139D STP139 ET139XL ET139L ET139	18-14 Ga.	500 25 30 5 2
	STP176 ET176XL ET176	12-10 Ga.	25 12 1
"T" Tap Female	Part No.	Gauge	Qty. Per Pkg.
	STP212 (Red) STP211 (Yellow) STP210 (Blue)	22-18 Ga.	25 2
	STP210D STP210 ET210	18-14 Ga.	500 25 2
	STP211 ET211	12-10 Ga.	25 2
"T" Splice Quick Tap	Part No.	Gauge	Qty. Per Pkg.
See Figure 1 Includes STP210 & STP144	STP138 ET502	18-14 Ga.	25 pairs 4 pairs
Bullet Quick Splice	Part No.	Gauge	Qty. Per Pkg.
See Figure 2	STP146 ET146*	18-14 Ga.	25 pcs. 1 pair

\*Contains STP163 & STP146

†STP434 is double run – both wires extend through connector

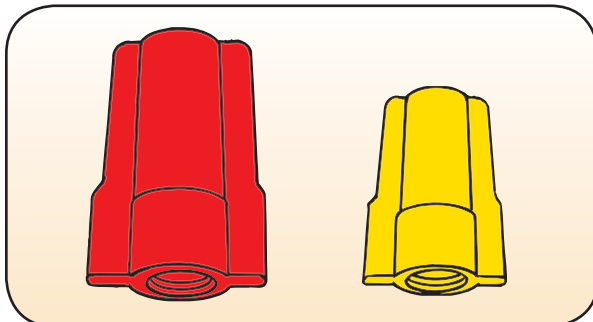
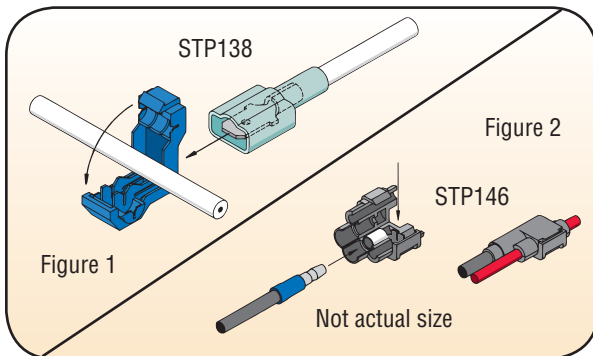

## SELF STRIPPING SPlice CONNECTORS

22-14 Gauge Range	Part No.	Qty. Per Pkg.
	STP525	10
		2 Wire
		3 Wire
<p>Self stripping connector makes a 2 or 3 wire splice with a wire range of 22-14 ga. Maximum voltage: 600V Operating Temp:105°</p> <p>Insert 2 or 3 unstripped wires into the connector. Self stripping action makes the connection as the blue cap is driven into the connector body using a crimping tool or pliers held perpendicular to the wires. Silicone sealant in the connector body makes for a moisture resistant, flame retardant termination.</p>		

## TWIST LOCK CONNECTORS

Part No.	Gauge	Wire Ranges		Qty Per Pkg.
		Min.	Max.	
STP201 ET201	22-14 Ga.	3 #22	3 #16	25 6
STP203 ET203	22-14 Ga.	3 #20	4 #16 w/1 #20	25 5
STP200 ET200	18-10 Ga.	1 #14 w/1 #18	4 #14	25 4
STP202 ET202	18-10 Ga.	2 #14	2 #10 w/2 #12	25 3
ET204*		Various Sizes		12

\*Contains 3-STP200, 4-STP201, 1-STP202, 4-STP203

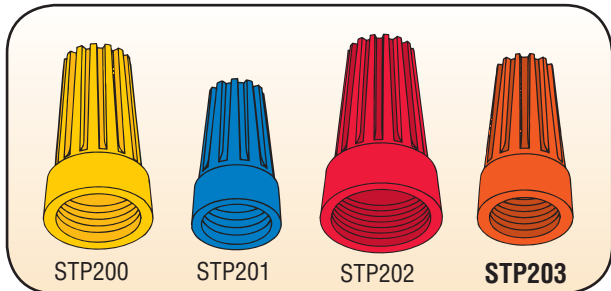

## TWIST LOCK CONNECTORS

Part No.	Gauge	Wire Ranges		Qty Per Pkg.
		Min.	Max.	
STP180 ET180	18-10 Ga.	2 #14	5 #12	25 3
STP181 ET181	18-10 Ga.	2 #18	3 #12	25 3

Images shown actual size unless indicated otherwise.  
ET Display Package

# MULTI-WIRE CONNECTORS & FUSE BLOCK TAPS

## WATERPROOF TWIST CONNECTORS

Part No.	Gauge	Wire Ranges		Qty Per Pkg.
		Min.	Max.	
STP464	22-14 Ga.	3 #20	3 #16	10
STP466	18-12 Ga.	4 #18	2 #12	8
STP467	18-10 Ga.	2 #14	4 #12	8

Silicone filled safety Twist-on Connector should be used where water proofing is a must. Pre-filled sealant provides watertight enclosure.

Maximum Voltage: 600V  
Sealant Temperature: -45°F to 400°F  
Temperature Rating: 167°F (75°C)

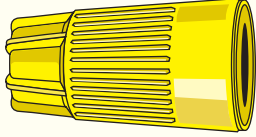

STP466

Silicone sealant protects against sparks, water and corrosion.

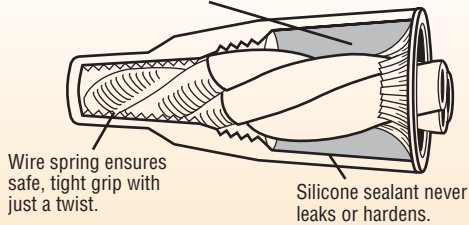

**IMPORTANT:** Once installed, connectors should not be reused. Silicone sealant is ineffective after first use.

## CLOSED END SPLICE

Part No.	Gauge	Possible Wire Combinations	Qty. Per Pkg.
STP382	22-14 1 #18 w/ 2 #20	1 #16 w/ 1 #18	25
STP383 ET383	22-12 2 #22 w/ 2 #12	1 #12 w/ 1 #22	25 4
STP160	18-8 1 #12 w/ 4 #16	1 #8 w/ 1 #16	10
STP152 ET152	16-10 2 #16 w/ 2 #18	1 #12 w/ 1 #16	25 4

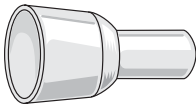

STP160

## CLOSED END SPLICE WITH HEAT SHRINK

Part No.	Description	Gauge	Std. Pkg.
STP397	Joins 2 to 4 wires	22-14	10
STP398	Joins 2 to 4 wires	18-10	10

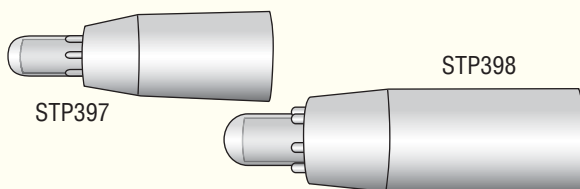

STP398

STP397

## FUSE BLOCKS

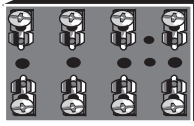
Glass Type	Part No.	Description	Qty Per Pkg.
	ET220	4 - Gang	1
	ET221	5 - Gang	1
	ET222	6 - Gang	1

## FUSE BLOCK TAP

Part No.	Description	Std. Pkg.
ET460	Piggyback for ET461	1
ET461	GM Fuseblock Tap	1

### Installation Instructions:

1. Splice accessory connection to fuseblock tap lead.
2. Plug fuseblock tap connector into fuseblock cavity marked "BAT."
3. When using piggyback, unplug fuseblock tap. Insert piggyback into fuse tap cavity and reinsert tap into fuseblock.

To tap current from the battery – always on clocks, burglar alarms and radios, etc.

For GM fuseblocks when "Bat" cavity is already in use or constant service is required. Extra cavity built into fuseblock tap to piggyback additional accessory connections.

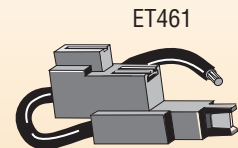
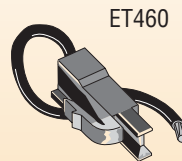

## FUSE TAPS

Part No.	Description	Qty Per Pkg.
ST230 ET230	GM Type Fuse Tap 1/4" Blade	25 8
ST231 ET231	GM Type Mini Fuse Tap 3/16" Blade	25 7

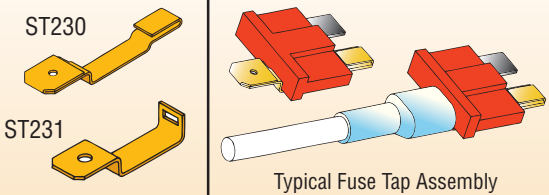

ET Display Package

## FUSE CLIP ADAPTER

Description: 1/4" Male Tab, Taps Into Fuseblock

Part No.	Std. Pkg.	
SST206	25	

# FUSE HOLDERS & FUSE TAPS

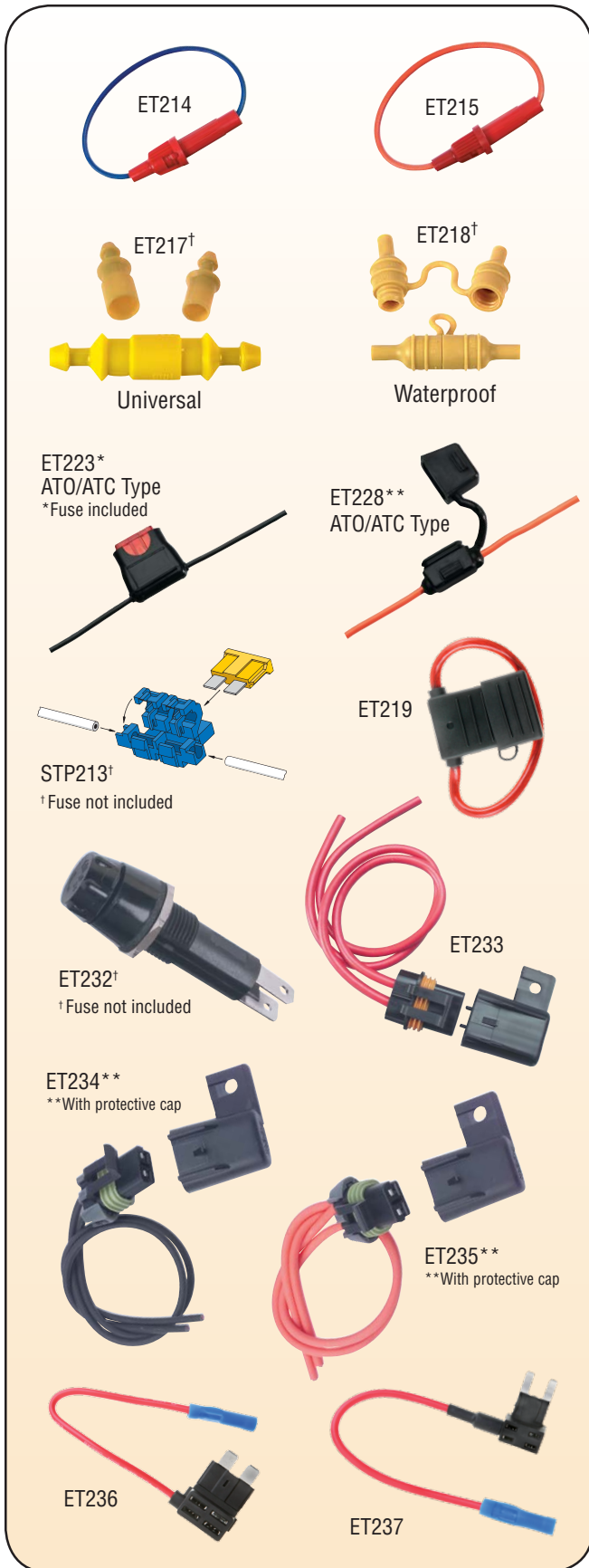

## IN-LINE FUSE HOLDERS

Description: Glass Type			
Part No.	Size	Gauge	Per Pkg.
ET214	20 amp.	14 Ga.	2
ET215	30 amp.	12 Ga.	2
ET217 <sup>†</sup>	30 amp.	18 - 12 Ga.	1
ET218 <sup>†</sup>	30 amp.	18 - 12 Ga.	1
ET232 <sup>†</sup>	Panel Mount Fuse Holder		1
Description: ATO/ATC Type			
STP213 <sup>†</sup>	20 amp.	18 - 14 Ga.	10
ET216			2
ET223*	10 amp.	14 Ga.	1
ET224*	20 amp.	14 Ga.	1
ET225*	30 amp.	12 Ga.	1
ET226**	20 amp.	16 Ga.	1
ET227**	25 amp.	12 Ga.	1
ET228**	30 amp.	12 Ga.	1
ET229**	20 amp.	14 Ga.H.D.	1
ET219**	40 amp.	8 Ga.H.D. Maxi Fuse Holder	1
ET233**	40 amp.	10 Ga. Sealed Fuse Holder	1
ET234**	15 amp.	16 Ga. Sealed Mini Fuse Holder	1
ET235**	30 amp.	12 Ga. Sealed Mini Fuse Holder	1
ET236 <b>NEW!</b>	10 amp.	16 Ga. Add a Circuit ATC/ATO Fuse Holder	1
ET237 <b>NEW!</b>	10 amp.	16 Ga. Add a Circuit Mini Fuse Holder	1

<sup>†</sup> Fuse not included

\* Fuse included

\*\* With protective cap (ET227 & ET229 are Mini® Fuse Holders)

ET Display Package

## 1/4" SLIDE-ON CONNECTORS

20-14 Gauge		Part No.	Std. Pkg.
SST86	SST98	SST86 (M)	50
		SST98 (M)	25
		SST99 (F)	50
SST99	SST100	SST100	25
		ET510	10
	SST102 <sup>‡</sup>	SST102 <sup>‡</sup>	25
	ST68	ST68	10
ST68 COIL ADAPTER	ST110	ST110	50
		ET509	9

<sup>‡</sup> Available while supplies last

# UNINSULATED TERMINALS

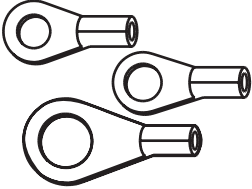
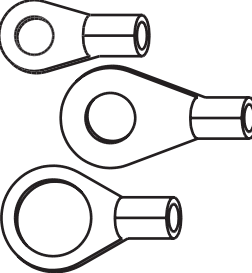
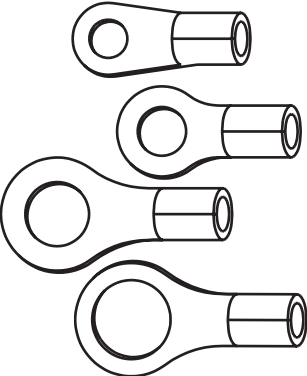
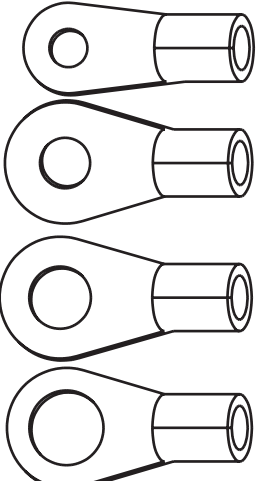

## RING TERMINALS

16-14 Gauge	Part No.	Stud Size	Qty Per Pkg.
	SST73	#6-8	100
	SST71	#10	100
	SST72	1/4"	100
12-10 Gauge	Part No.	Stud Size	Qty Per Pkg.
	SST76	#8-10	100
	SST82	1/4"	50
	SST75	3/8"	50
8 Gauge	Part No.	Stud Size	Qty Per Pkg.
	SST83	#8-10	50
	SST200	1/4"	10
	SST203	5/16"	10
	SST201	3/8"	10
6 Gauge	Part No.	Stud Size	Qty Per Pkg.
	SST84	#8-10	50
	SST205	1/4"	10
	SST202	5/16"	10
	SST88	3/8"	25

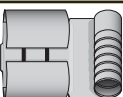
## FLAG TERMINAL

16-14 Gauge	Part No.	Width	Qty Per Pkg.
	SST101	1/4"	25

## SPADE TERMINALS

16-14 Gauge	Part No.	Stud Size	Qty Per Pkg.
	SST74	10	100
12-10 Gauge	Part No.	Stud Size	Qty Per Pkg.
	SST87	#8-10	50

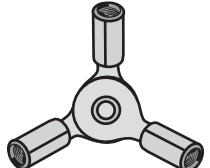

## 3 WAY CONNECTOR

16-14 Gauge	Part No.	Qty Per Pkg.
	SST103	25



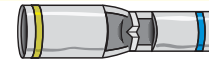

## KNIFE CONNECTOR

16-14 Gauge	Part No.	Std. Pkg.
	SST77	50



## STEP-DOWN BUTT CONNECTORS

	Part No.	Gauge	Std. Pkg.
	SST90	14-16 to 12-10 Gauge	10
	SST89	10-12 to 8 Gauge	10

## BUTT SPLICE CONNECTORS

20-14 Gauge	Part No.	Std. Pkg.
	SST91	100
 SST92 - Sleeve 1 7/8" x 7/32" OD	SST92 SST92A	100 100 ft.
12-10 Gauge	Part No.	Std. Pkg.
	SST80	50
 SST93 - Sleeve 1 7/8" x 1/4" OD	SST93	50
8 Gauge	Part No.	Std. Pkg.
	SST81	50

## STOPLIGHT SWITCH CONNECTOR

16-14 Gauge	Part No.	Size	Std. Pkg.
	ST55 (F)	.156"	100
	SST104 (M)	.156"	100

# POSI-LOCK™ CONNECTORS



## POSI-LOCK™ CONNECTORS

Part No.	Gauge	Qty. Per Pkg.
STP534*†	24-18	25
STP523C† STP523† ET523†	24-18	100 25 2
STP501C† STP501† ET501†	16-14	100 25 2
STP530C† STP530† ET530†	12-10	100 25 2
STP527†	8-6	25



\*Ultra high temperature  
 PATENT No. 5,228,875, 5,695,369  
 and others pending

### EASY AS ①②③

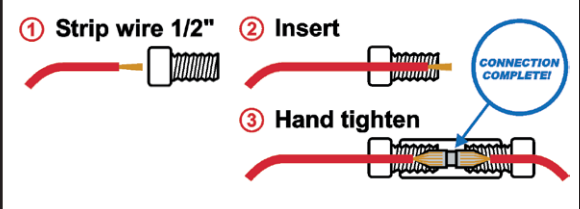

## POSI-TAP™ CONNECTORS

Part No.	Gauge	Qty. Per Pkg.
STP536† ET536†	18-12	25 2

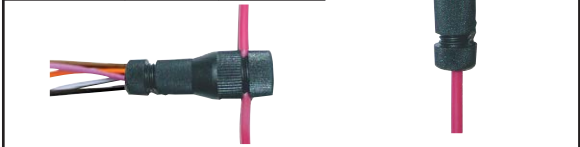

### POSI-TAP LINE TAP CONNECTOR

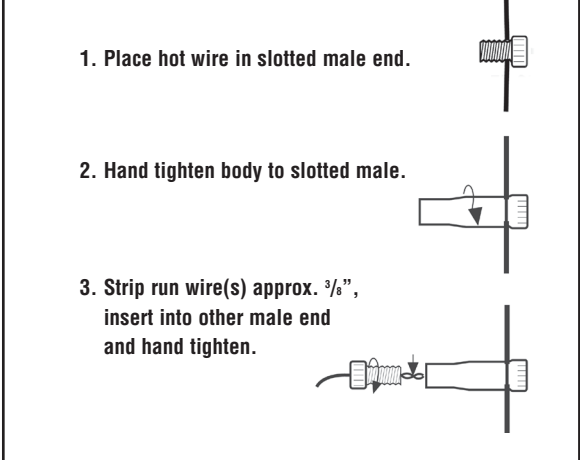

## POSI-SEAL™ CONNECTOR

Part No.	Gauge	Std. Pkg.
STP516	18	10
STP517	16-14	10
STP518†	12	10
STP519	10	10
STP520	8	10

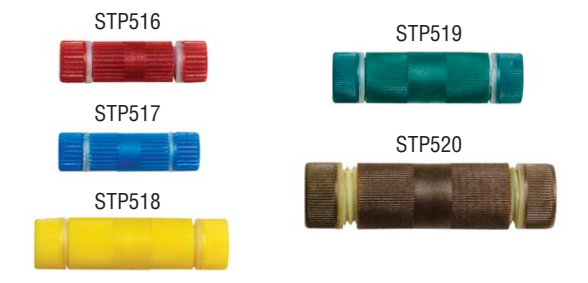

## POSI-PLUG™ QUICK DISCONNECT

Part No.	Gauge	Qty. Per Pkg.
ET535	18	1

### EASY AS ①②③

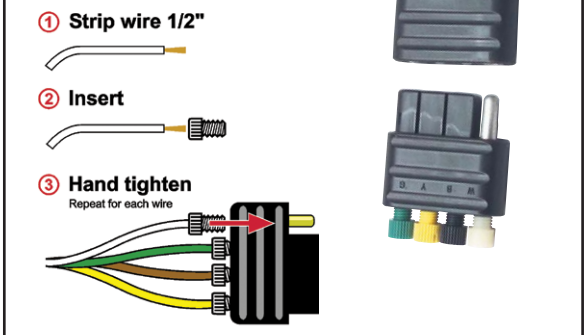

## POSI-FUSE™ CONNECTORS

Part No.	Gauge	Qty. Per Pkg.
ET537	18-12	2 pr.
ET538	18-12	1 pc.

Fuses: 3/4" to 1 1/4"  
 Up to 30 AMP max



## POSI-TWIST™ CONNECTORS

Part No.	Gauge	Qty. Per Pkg.	STP533	STP531	STP532
STP533 ET533	24-14	25 5			
STP531	22-10	25			
STP532	22-10	25			

ET Display Package

† Available while supplies last

TERMINALS & CONNECTORS

# HEAT SHRINK TERMINALS

## HEAT SHRINK TERMINALS FOR ALL WEATHER PROTECTION...

Ideal for marine, automotive, and industrial applications. Tough multiple wall tubing protects splice from moisture and corrosion. Adhesive tubing melts to form waterproof bond. Color-coded for easy identification. Temperature Rating -65°F to 275°F.

### 1. Crimp type heat shrink terminal application is fast and foolproof.

Crimp type heat shrink terminals are ideal for applications where protection from moisture and corrosion is a must. Simply crimp connection as you would any regular terminal. Then heat tubing with a heat gun until shrink tube bonds to primary wire to form a waterproof bond.

### 2. Self solder heat shrink terminals solder and seal each connection in one step.\*

No crimping tools required which risk damage to wire insulation or provide unreliable connection. Solder ring melts when heated with a heat gun and provides superior current flow and tensile strength. Translucent tubing allows visual inspection of connection after termination.

### 3. Crimp, solder and heat shrink terminals offer the ultimate electrical connection.\*

Crimped for reliability, soldered for strength and conductivity, and sealed for moisture protection and durability. Crimp the connection as you would any regular terminal, heat solder ring until melted with a heat gun and then heat the shrink tube until bonded to primary wire.

### \* WARNING

**Battery posts, terminals and related accessories contain lead, lead compounds and *CADMIUM* chemicals known to the State of California to cause cancer and reproductive harm. WASH HANDS AFTER HANDLING!**

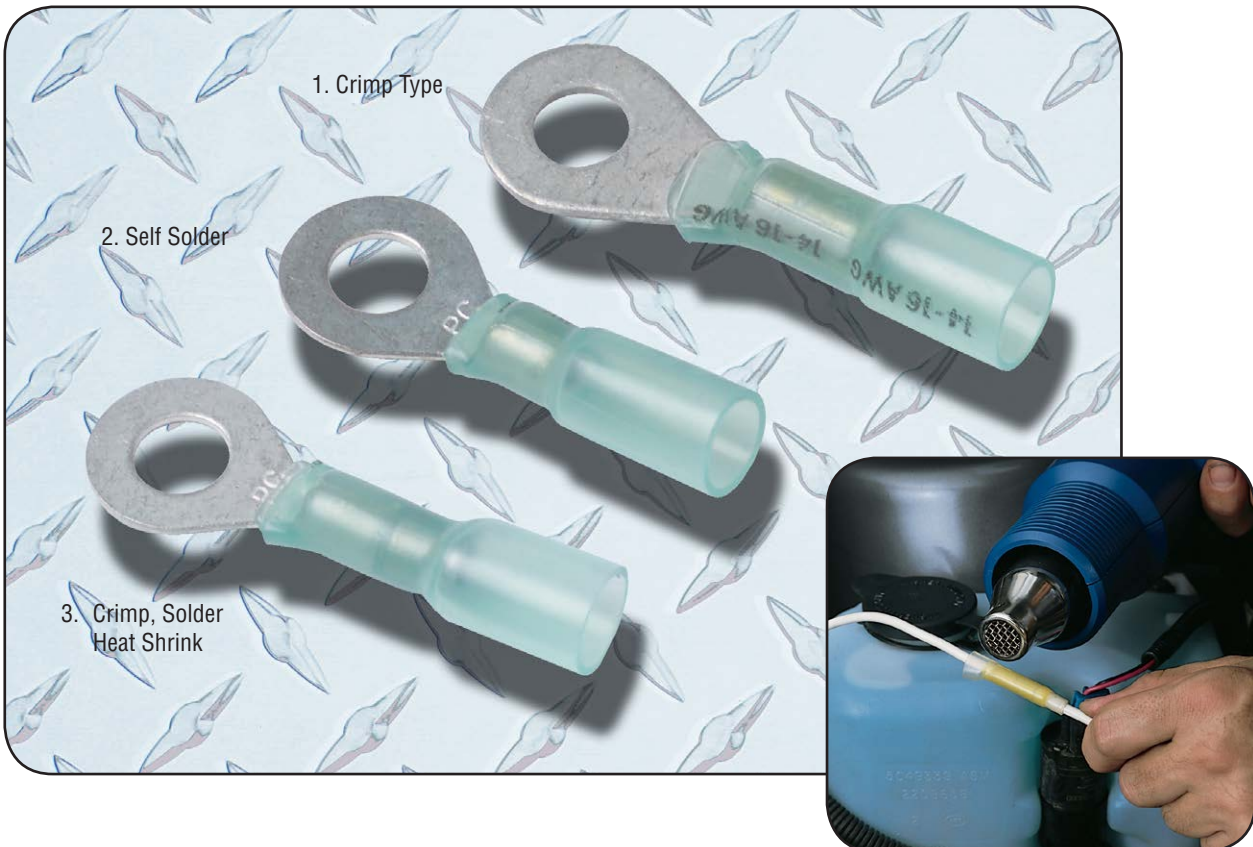



# SPECIALTY TERMINALS & CONNECTORS



## CRIMP TYPE WITH HEAT SHRINK

### How to Use Crimp Type Heat Shrink Terminals...

1. Insert stripped wire.



**Butt Splice Connector**

2. Crimp connector



3. Apply heat evenly across sleeve until shrinkage is complete.



**WTT20 Heat Gun**

### RING TERMINALS

#### 20-18 Gauge

	Part No.	Stud Size	Qty Per Pkg.
	STP151H ET151H	#6	10 3
	STP497H ET497H	#8	10 3
	STP120H ET120H	#10	10 3
	STP121H ET121H	1/4"	10 3
	STP122H ET122H	3/8"	10 3

#### 16-14 Gauge

	Part No.	Stud Size	Qty Per Pkg.
	STP498H	#6	10
	STP123H ET123H	#8	10 3
	STP124H ET124H	#10	10 3
	STP125H ET125H	1/4"	10 3
	STP157H ET157H	5/16"	10 3
	STP126H ET126H	3/8"	10 3

ET Display Package

### RING TERMINALS

#### 12-10 Gauge

	Part No.	Stud Size	Qty Per Pkg.
	STP127H ET127H	#10	10 3
	STP128H	1/4"	10
	STP168H	5/16"	10
	STP129H	3/8"	10
	STP159H	1/2"	10

#### 8 Gauge

	Part No.	Stud Size	Qty Per Pkg.
	STP188H	1/4"	10
	STP177H	3/8"	10

### SPADE TERMINALS

#### 20-18 Gauge

	Part No.	Stud Size	Qty Per Pkg.
	STP136H	#6	10
	STP499H	#8	10
	STP150H	#10	10

#### 16-14 Gauge

	Part No.	Stud Size	Qty Per Pkg.
	STP133H	#6	10
	STP134H	#8	10
	STP135H ET135H	#10	10 3



#### 12-10 Gauge

	Part No.	Stud Size	Qty Per Pkg.
	STP208H	#10	10
	STP500H	1/4"	10



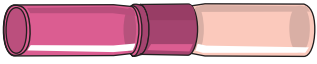

# SPECIALTY TERMINALS & CONNECTORS

## CRIMP TYPE WITH HEAT SHRINK

### BULLET CONNECTORS

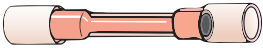
22-18 Gauge	Part No.	Size	Qty Per Pkg.
	STP170H (male)	.156	10
	STP171H (fem.)	.156	10
16-14 Gauge	Part No.	Size	Qty Per Pkg.
	STP163H (male)	.156	10
	STP162H (fem.)	.156	10

### BUTT SPLICE CONNECTORS

	Part No.	Gauge	Qty Per Pkg.
	STP350H	24-22	10
	STP130HC	20-18	100
	STP130H		10
	ET130HJ†		100
	ET130H		3
	STP131HC	16-14	100
	STP131H		10
	ET131HJ†		100
	ET131H		3
	STP132HC	12-10	100
	STP132H		10
	ET132HJ†		60
	ET132H		3
	STP186H	8	10

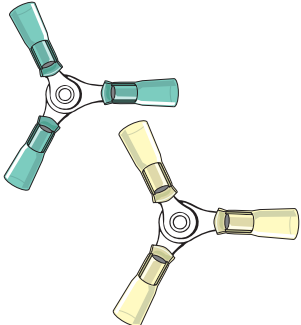

### SPLICE CONNECTORS 3 WAY

	Part No.	Gauge	Qty Per Pkg.
	STP166H*	16-14	10
	STP137H*	12-10	10

\*Not shown in actual size  
ET Display Package

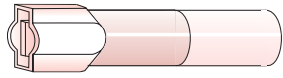

† Display Jar

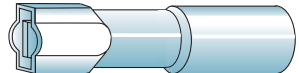
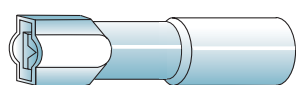
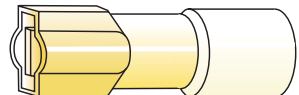
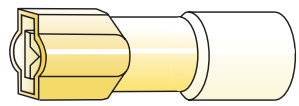
### 1/4" FULLY INSULATED NYLON COUPLERS

	Part No.	Gauge	Qty Per Pkg.
	STP142HL STP142H (male)	20-18	50 10
	STP143HL STP143H (fem.)	20-18	50 10
	STP144HL STP144H ET144H (male)	16-14	50 10 3
	STP145HL STP145H ET145H (fem.)	16-14	50 10 3
	STP179H (male)	12-10	10
	STP178H (fem.)	12-10	10

## SELF SOLDER HEAT SHRINK TERMINALS

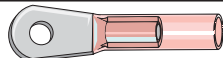
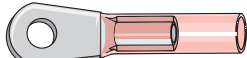
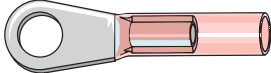
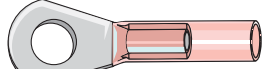
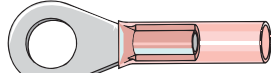
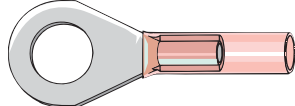
### RING TERMINALS

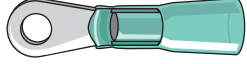
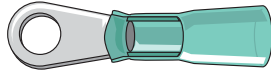
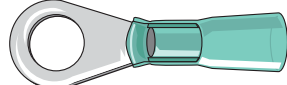
20-18 Gauge	Part No.	Stud Size	Qty Per Pkg.
	STP354	#6	25
	STP355	#8	25
	ET355		3
	STP356	#10	25
	ET356		3
	STP357 ET357	1/4"	25 3
	STP475 ET475	5/16"	25 3
	STP476 ET476	3/8"	25 3
16-14 Gauge	Part No.	Stud Size	Qty Per Pkg.
	STP477	#6	25
	STP358	#8	25
	STP359C	#10	100
	STP359		25
	ET359		3
	STP360 ET360	1/4"	25 3

# SPECIALTY TERMINALS & CONNECTORS



## SELF SOLDER HEAT SHRINK TERMINALS

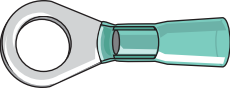
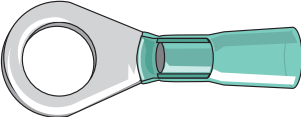
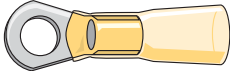
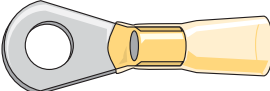
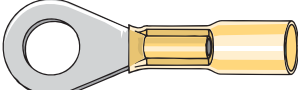
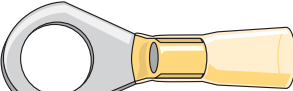
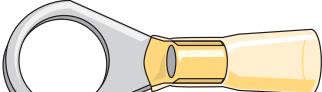

### RING TERMINALS

16-14 Gauge	Part No.	Stud Size	Qty Per Pkg.
	STP478 ET478	5/16"	25 3
	STP361 ET361	3/8"	25 3
12-10 Gauge	Part No.	Stud Size	Qty Per Pkg.
	STP362	#10	25
	STP363 ET363	1/4"	25 3
	STP479 ET479	5/16"	25 3
	STP364 ET364	3/8"	25 3
	STP365 ET365	1/2"	25 3

ET Display Package

† Display Jar

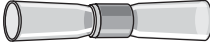
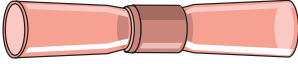
### BUTT CONNECTORS

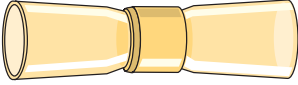
	Part No.	Gauge	Qty Per Pkg.
	STP350	24-22	25
	STP351C STP351 ET351J† ET351	20-18	100 25 100 3
	STP352C STP352 ET352J† ET352	16-14	100 25 100 3
	STP353C STP353 ET353J ET353	12-10	100 25 60 3

### SPADE TERMINALS

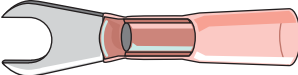
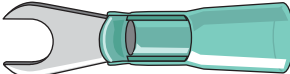
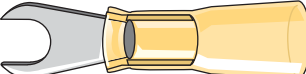
	Part No.	Stud Size	Gauge	Qty Per Pkg.
	STP366	#10	20-18	25
	STP367 ET367	#10	16-14	25 3
	STP368	#10	12-10	25

#### Instructions:

- Strip wires 3/8".
- Slide splice over one end of wire.
- Separate wire strands; push both ends together to mesh wire.
- Slide splice over joined wires; heat tubing from center out to terminal ends; then focus heat on solder until it flows.
- Remove from heat and let cool for a perfect connection.

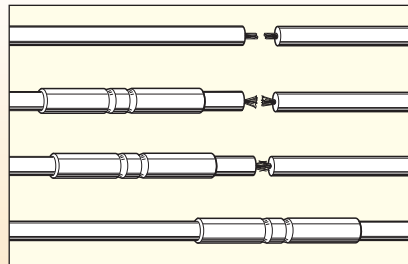

# SPECIALTY TERMINALS & CONNECTORS

## SELF SOLDER HEAT SHRINK TERMINALS

### 1/4" SLIDE-ON TERMINALS

	Part No.	Gauge	Qty Per Pkg.
	STP468C	20-18	100
	STP468		25
	ET468 (Fem.)		2
	STP469C	20-18	100
	STP469		25
	ET469 (Male)		2
	STP470C	16-14	100
	STP470		25
	ET470 (Fem.)		3
	STP471C	16-14	100
	STP471		25
	ET471 (Male)		3
	STP472	12-10	25
	ET472 (Fem.)		3
	STP473	12-10	25
	ET473 (Male)		3

### Crimp, Solder & Heat Shrink

Crimp, solder and heat shrink terminals offer the ultimate electrical connection. Crimped for reliability, soldered for strength and conductivity, and sealed for moisture protection and durability. Crimp the connection as you would any regular terminal, heat solder ring until melted with a heat gun and then heat the shrink tube until bonded to primary wire.

#### CRIMP IT

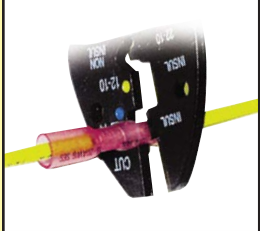

#### SOLDER IT



SEAL IT...SEALED FOR SUPERIOR DURABILITY

## CRIMP, SOLDER & HEAT SHRINK

### BUTT CONNECTORS

	Part No.	Gauge	Qty Per Pkg.
	STP550	24-22	5
	ET550		3
	STP551C	20-18	100
	STP551		10
	ET551J†		100
	ET551		3
	<b>NEW!</b>		
	STP552D	16-14	500
	STP552C		100
	STP552		10
	ET552J†		100
	ET552		3
<b>NEW!</b>			
	STP553D	12-10	500
	STP553C		100
	STP553		10
	ET553J†		60
	ET553		3
<b>NEW!</b>			

† Display Jar

## CRIMP, SOLDER & HEAT SHRINK

### RING TERMINALS

	Part No.	Stud Size	Gauge	Qty Per Pkg.
	STP556	#10	20-18	5
	ET556			3
	STP559	#10	16-14	5
	ET559			3
	STP560	1/4"	16-14	5
	ET560			3
	STP561	3/8"	16-14	5
	ET561			3
	STP562	#10	12-10	5
	ET562			3
	STP563	1/4"	12-10	5
	ET563			
	STP564	3/8"	12-10	5
	ET564			3
	STP565	1/2"	12-10	5
	ET565			

### SLIDE ON TERMINAL

16-14 Gauge	Part No.	Width	Female/Male	Qty Per Pkg.
	STP570	1/4"	F	5
	ET570			3
	STP571	1/4"	M	5
	ET571			3
12-10 Gauge	Part No.	Width	Female/Male	Qty Per Pkg.
	STP572	1/4"	F	5
	ET572			
	STP573	1/4"	M	5
	ET573			

ET Display Package

### SPADE TERMINALS

	Part No.	Stud Size	Gauge	Qty Per Pkg.
	STP578	#10	22-18	5
	ET578			
	STP577	#10	16-14	5
	ET577			
	STP576	#10	12-10	5
	ET576			

# O.E.M. ELECTRONIC TERMINALS



The most popular OE-style terminals for repairing computer wire harness connections. Replacing damaged terminals saves time and money, eliminates the need to change the entire wiring harness.









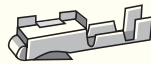

Product Type	Illustration	Part No.	O.E. No.	Gauge	Description	Qty. Per Pkg.
GM Pack-Con		CG1* ET701	6294512 12020346	20-18	Female Mates with CG2, ET702	10 5
		CG2* ET702	6294511	20-18	Male-Tin Plated Mates with CG1, ET701	10 5
		CG5* ET703	8900524 12020320	16-14	Male-Tin Plated Mates with CG6, ET704	10 5
		CG6* ET704	12020347	16-14	Female Mates with CG5, ET703	10 5
		CG19 ET706	8905087	16-14	Female-Tin Plated Heavy Duty Series	10 5
		CG18 ET705	12033817	12-10	Male-Tin Plated Heavy Duty Series	10 5
GM 56 Series		CG7* ET708	2962447	16-14	Female-Unplated Brass Mates with CG8, ET709 Insulated with shell CG45, ET710	10 5
		CG80	2962574	12	Female - Copper Alloy	10
		CG8* ET709	2962987	16-14	Male-Unplated Brass Mates with CG7, ET708 Insulated with CG47, ET712	10 5
		CG45 ET710	2962448	—	Terminal Insulator Mates with CG47, ET712 Insulates CG7, ET708	10 3
		CG46 ET711	6294493	—	Alternator Connector Housing Insulates with CG7, ET703 GM 1973-up	10 2
		CG47 ET712	2962984	—	Terminal Insulator Mates with CG45, ET710 Insulates CG8, ET709	10 3
		ET507	—	—	Combo Pack, Includes CG7, CG45	4 ea.
		ET508	—	—	Combo Pack, Includes CG8, CG47	4 ea.
GM Metri-Pack		CG3* ET713	12015857	18-14	280 Series Female Mates with CG4, ET714	10 4

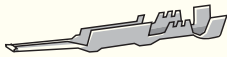
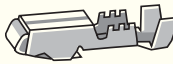
\*Available in CGA1 terminal assortment.

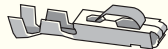
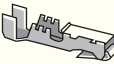
ET Display Package

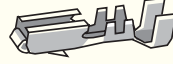
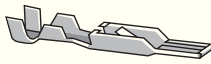
TERMINALS & CONNECTORS

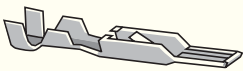
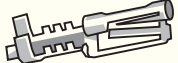
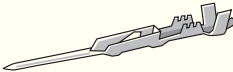
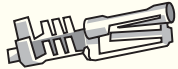
# O.E.M. ELECTRONIC TERMINALS

Product Type	Illustration	Part No.	O.E. No.	Gauge	Description	Qty. Per Pkg.
GM Metri-Pack (Cont'd.)		CG61	12052466	24	150 Series Tin Plated	10
		CG21 ET715	12047680	20-18	150 Series Female Tin Plated—Mates with CG22, ET716	10 5
		CG22 ET716	12047581	20-18	150 Series Male Tin Plated—Mates with CG21, ET715	10 5
		CG24 ET718	12034046	20-18	Tin Plated, Mates with CG25, ET719	10 5
		CG25 ET719	12034047	20-18	280 Series Male, Tin Plated, Mates with CG24, ET718	10 5
		CG63	12052922 12089340	20-18	150 Series	10
		CG23 ET717	12047767 4368618	20-16	150 Series Female Tin Plated	10 5
		CG4* ET714	12020116	18-14	280 Series Male Tin Plated—Mates with CG3, ET713	10 4
		CG26 ET720	12015861	16-14	480 Series Female Tin Plated, Mates with CG27, ET721	10 5
		CG27 ET721	12020120	16-14	480 Series Male Tin Plated, $\frac{3}{16}$ " blade width, Mates with CG26, ET720	10 5
		CG28 ET722	12015870	16-14	630 Series Female Tin Plated Mates with CG62	10 5
		CG62	12020126	16-14	630 Series Male Tin Plated, $\frac{1}{4}$ " blade width, Mates with CG28, ET722	10
	GM Micro Pack Series		CG12* ET723	12020757	20-18	Female Tin Plated
		CG14 ET724	12040902	22	Tin Plated	10 5
		CG15 ET725	12020758	16-14	Tin Plated	10 4
Weather-Pack Series		CG9*	12015323		Silicone Seal for Weather-Pack Terminals Use with CG10, CG11 CG16 and CG17, ET735	10
		ET734				5

\*Available in CGA1 terminal assortment.

ET Display Package

# O.E.M. ELECTRONIC TERMINALS



Product Type	Illustration	Part No.	O.E. No.	Gauge	Description	Qty. Per Pkg.
GM Weather-Pack Series		CG10* ET735	12033674 12089040	20-18	Male Terminal Tin Plated Brass Mates with CG11, ET736	10 5
		CG11* ET736	12034051 12089188	20-18	Female Terminal Tin Plated Brass Mates with CG10, ET735	10 5
		CG64 ET737		20-18	Male Repair Lead 10"-18 ga. Wire with CG9, ET734 Seal and CG10, ET735 Terminal	5 1
		CG65 ET738		20-18	Female Repair Lead 10"-18 ga. Wire with CG9, ET734 Seal and CG11, ET736 Terminal	5 1
		CG13* ET742	12034053 12004610	20-18	GM Electronic Control Module Tin Plated	10 4
		CG16 ET739	12010182 12124580	16-14	Female-Tin Plated Mates with CG17, ET740	10 5
		CG17 ET740	12089305 12010085	16-14	Male-Tin Plated Mates with CG16, ET739	10 5
		CG29 ET741	12010300	—	Silicone Cavity Plug for GM. Weather-Pack & Metri-Pack 280 Series	10 5
		CG38 ET743	12010996	—	Nylon Single Cavity for Male Terminals CG64, ET737 Mates with CG39, ET744	10 1
		CG39 ET744	12015791	—	Nylon Single Cavity for Female Terminals, CG65, ET738 Mates with CG38, ET743	10 1
		CG40 ET745	12010973	—	Nylon Double Cavity for Male Terminals Mates with CG41, ET746	10 1
		CG41 ET746	12015792	—	Nylon Double Cavity for Female Terminals Mates with CG40, ET745	10 1
		CG42 ET747	12010717	—	Nylon Triple Cavity for Male Terminals Mates with CG43, ET748	10 1

† Not Actual Size. \* Available in CGA1 terminal assortment. ET Display Package

# O.E.M. ELECTRONIC TERMINALS

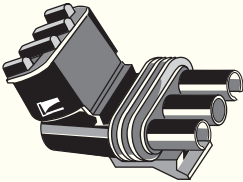
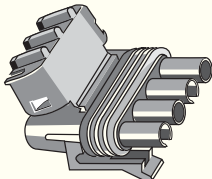
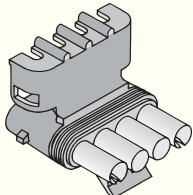
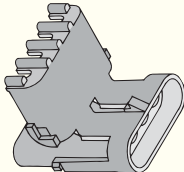
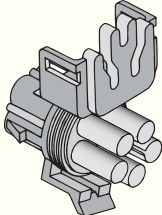
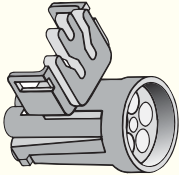
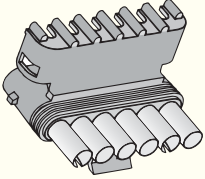
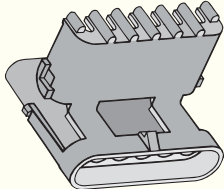
Product Type	Illustration	Part No.	O.E. No.	Gauge	Description	Qty. Per Pkg.
GM Weather-Pack Series (Cont.)		CG43	12015793	—	Nylon Triple Cavity for Female Terminals Mates with CG42, ET747	10
		ET748				1
		CG44	12015387	—	Nylon Four Cavity for Male Connects Wiring Harness to Idle Control Solenoid. GM 1985-up Offset Locking Arm	5
		ET749				1
		CG70	12015797	—	Nylon 4-cavity Flat Male Tower Mates with CG71 Uses CG11 Terminal	5
		CG71	12010974	—		Nylon 4-cavity Flat Female Shroud Mates with CG70 Uses CG10 Terminal
		CG72	12034342	—	Nylon 5-cavity Round Male Tower Mates with CG73	1
		CG73	12065158	—		Nylon 5-cavity Round Female Shroud Mates with CG72
	CG74	12015799	—	Nylon 6-cavity Flat Male Tower Mates with CG75	1	
	CG75	12010975	—		Nylon 6-cavity Flat Female Shroud Mates with CG74	1

Not Actual Size. ET Display Package



# O.E.M. ELECTRONIC TERMINALS



Product Type	Illustration	Part No.	O.E. No.	Gauge	Description	Qty. Per Pkg.
GM Power Window & Door Lock Terminal		CG68	2965880	16-14	Tin Plated	10
Ford Terminals		CG30† ET726	D1AB-14488-CA	20-18	Wedglock Pin Type, Female Terminal, Mates with CG31, ET727	10 4
		CG31† ET727	D1AB-14461-AA	20-18	Wedglock Pin Type, Male Terminal, Mates with CG30, ET726	10 5
		CG32† ET728	D8BB-14474-BA D3AB-14474-DA	20-18	Box Type Female Terminal	10 4
		CG33† ET729	D20B-14421-BB	20-18	Male Terminal $\frac{3}{16}$ " Blade Width	10 4
		CG34 ET730	D5AB-14474-FA D3AZ-14474-G	20-18	Snap-On	10 4
		CG55†	E7EB-14421-EA	20-18	Male Mini Block $\frac{1}{8}$ " Width Mates with CG57	10
		CG57†	E7EB-14474-CA	20-18	Female Mini Block $\frac{1}{8}$ " Width Mates with CG55	10
		CG54†	E8EB-14474-AMA	16-14	Female Micro Terminal $\frac{1}{8}$ " Width	10
		CG56†	E8EB-14421-LA	16-14	Male Mini Block $\frac{1}{8}$ " Blade Mates with CG58	10
		CG58†	E8EB-14474-AJA	16-14	Female Mini Block $\frac{1}{8}$ " Blade Mates with CG56	10
		CG81*	E8EB-14474-AKA	12-10	Mini Terminal Block fits $\frac{1}{8}$ " Blade	10
		CG59†	D20B-14421-CB	16-14	Male Standard Block $\frac{3}{16}$ " Blade Mates with CG60	10
		CG60†	E8EB-14474-VA	16-14	Female Standard Block $\frac{3}{16}$ " Blade Mates with CG59	10

† Available in CGA2 Terminal Assortment.

ET Display Package

\*Available while supplies last

# O.E.M. ELECTRONIC TERMINALS

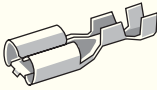
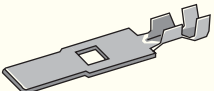
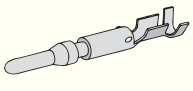
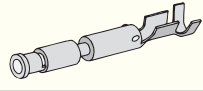
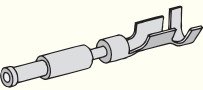
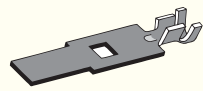
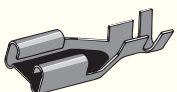
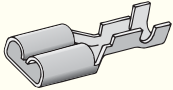
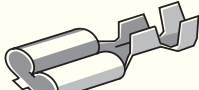
Product Type	Illustration	Part No.	O.E. No.	Gauge	Description	Qty. Per Pkg.
Chrysler Terminals		CG53†	4304729	24-18	Used with P.C. Board Connections and General Purpose	10
		CG36†	3843601	20-18	Center Tab for 1/4" Blade Slide	10
		CG37†	3843386	20-18	Male, Long Tab 1/4" Blade Width	10
		CG50†	7368261	20-18	Male, 3/32" Dia. Pin	10
		CG51†	4368163	20-18	Female, 3/32" Dia. Pin	10
		CG52†	4368960	20-18	Female, 1/16" Dia. Pin	10
		CG48	3843386	16-14	Male, 1/4" Blade	10
		CG49	3843601	16-14	Female, 1/4" Blade	10
Universal Terminals		CG69	GM:2965470 Ford:C5AB-14474-B Chrys:2096466	20-18	1/4" Slide Terminal	10
		CG35† ET733	GM:2965580 Ford:C1SF-14474-A Chrys:2096467	14-12	1/4" Female Slide Terminal	10 5

† Available in CGA2 Terminal Assortment

ET Display Package

# TERMINAL & CONNECTOR ASSORTMENTS



## CGA1-GM COMPUTER TERMINAL ASSORTMENT



CGA1

134-piece assortment contains complete terminal starter kit plus WTT12 crimping tool, WTT13 extractor tool and WTT14 & WTT15 extractor picks.

**CONTENTS:**

Part No.	Qty.	Part No.	Qty.
CG1	10	CG9	10
CG2	10	CG10	10
CG3	10	CG11	10
CG4	10	CG12	10
CG5	10	CG13	10
CG6	10	WTT12	1
CG7	10	WTT13	1
CG8	10	WTT14	1
		WTT15	1

## CGA2-FORD AND CHRYSLER COMPUTER TERMINAL ASSORTMENT



CGA2

130-piece assortment contains complete terminal starter kit.

**CONTENTS:**

Part No.	Qty.	Part No.	Qty.
CG30	10	CG52	5
CG31	10	CG53	5
CG32	10	CG54	5
CG33	10	CG55	5
CG35	10	CG56	5
CG36	5	CG57	5
CG37	5	CG58	5
CG50	10	CG59	5
CG51	10	CG60	10

## O.E.M. COMPUTER TERMINAL MAKE UP TECHNIQUES

### Terminal Extraction

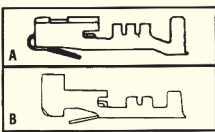

**1. (A) Push-To-Seat Terminals**  
Grasp the lead and push the terminal to the forward most position. Hold lead in this stop position.

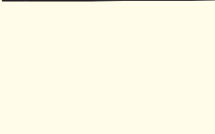

**(B) Pull-To-Seat Terminals**  
Grasp the lead and pull the terminal to the forward most position. Hold lead in this stop position.

2. Locate terminal lock tang in connector canal.

3. Insert pick straight into the connector canal at the mating end of the connector.

4. Depress lock tang to unseat terminal. Never use force to remove terminal from connector.

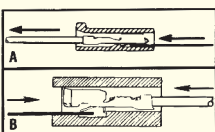

**5. (A) Push-To-Seat Terminals**  
Gently pull the cable to remove the terminal through the back (wire end) of the connector.

**(B) Pull-To-Seat Terminals**  
Gently push the cable to remove the terminal through the front (mating end) of the connector.

6. Look for terminal and connector damage. Replace if necessary.

**Note:** When reseating existing terminal, assure lock tang(s) are to reseat properly.

### Standard Replacement

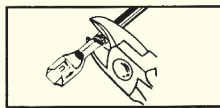

1. Cut off damaged terminal end between core and insulation crimp.

2. Remove insulation. (Make sure you do not cut strands.)

3. Position stripped wire in terminal.

4. Hand crimp core wings first, then insulation wings using crimping tool.

5. Apply solder at all hand crimped locations.

6. Electrically check repaired terminal for continuity using DVOM tool.

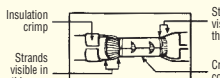

### Sealed Weather Pack and Metri-Pack Replacement

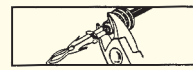

1. Cut off damaged terminal end between core and insulation crimp.

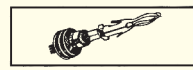

5. Hand crimp core wings first, then insulation wings using crimping tool.



2. Apply correct seal per gauge size of wire and slide back along cable to enable insulation removal. (Make sure you do not cut strands.)



6. Solder all hand crimped terminals.

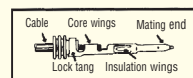

3. Align seal with cable insulation.



7. Electrically check repaired terminal for continuity using DVOM tool.



4. Position stripped wire and seal in terminal.

# TERMINAL & CONNECTOR ASSORTMENTS



STA51



STA10



STA12



STA11

## STA51-INSTALLER TERMINAL KIT

Durable metal cabinet has 28 compartments. Comes with a balanced assortment of insulated terminals, connectors and splices. Also included is handy heat shrink tubing in convenient 1 1/2" pre-cut lengths. Drawer measures 3 1/16" H x 18 3/8" W x 12 7/16" D. Will fit in an AB200 metal cabinet.

**CONTENTS:** 650 pcs.

Part No.	Qty.	Part No.	Qty.	Part No.	Qty.
STP120	10	STP133	10	STP151	10
STP121	10	STP134	25	STP161	10
STP123	25	STP135	25	STP162	10
STP124	50	STP136	10	STP163	10
STP125	25	STP139	25	STP170	10
STP126	25	STP140	50	STP171	10
STP127	10	STP141	50	STP207	10
STP128	10	STP144	25	STP208	10
STP129	25	STP145	25	STT260	5
STP130	10	STP148	10	STT261	10
STP131	50	STP149	10	STT262	5
STP132	25	STP150	10		

## STA10-IGNITION WIRE TERMINAL KIT

Contains ignition wire terminals plus WTT4 Crimpmaster tool.

**CONTENTS:** 126 pcs.

Part No.	Qty.	Part No.	Qty.
ST22	25	ST114	15
ST25	10	ST116	5
ST26	10	ST119	10
ST106	25	TN7	5
ST107	10	WTT4	1
ST113	10		

## STA12-IGNITION/PRIMARY WIRE TERMINAL KIT

**CONTENTS:** 225 pcs.

Part No.	Qty.	Part No.	Qty.
CG49	5	STP124	30
SST71	5	STP125	10
SST86	5	STP130	20
SST91	5	STP131	35
ST22	10	STP132	25
ST25	10	STP139	10
ST106	10	STP140	10
ST107	5	STP141	20
STP123	10		

## STA11-PRIMARY WIRE TERMINAL KIT

Contains insulated terminals plus WTT5 Crimp 'n Cut tool.

**CONTENTS:** 121 pcs.

Part No.	Qty.	Part No.	Qty.
STP123	5	STP134	5
STP124	20	STP135	5
STP125	5	STP139	10
STP127	5	STP140	5
STP130	10	STP141	10
STP131	30	WTT5	1
STP132	10		

# TERMINAL & CONNECTOR ASSORTMENTS

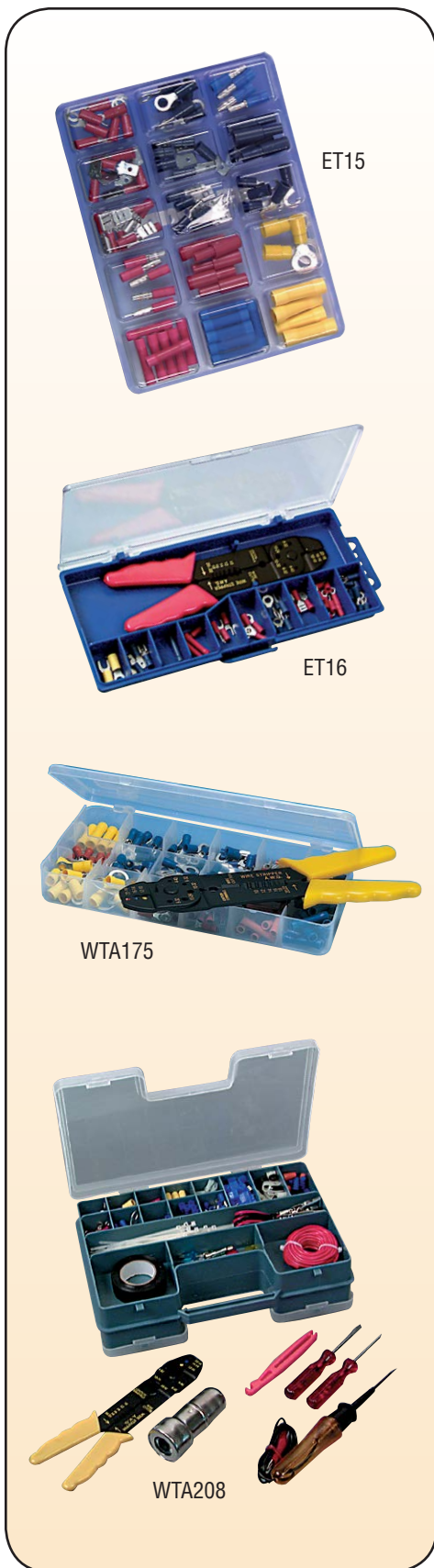

ET15

ET16

WTA175

WTA208

\* Kit contents may vary

## ET15-TERMINAL STARTER KIT

CONTENTS: 80 pcs.

Part No.	Qty.	Part No.	Qty.
STP120	4	STP149	7
STP124	6	STP154	1
STP128	2	STP155	5
STP130	7	STP162	4
STP131	6	STP163	4
STP132	4	STP165	3
STP140	5	STP170	5
STP141	5	STP171	5
STP148	7		

## ET16-TERMINAL STARTER KIT\*

Gauge	Stud Size	Description	Qty.
22-18	#10	Spade Terminal	3
22-18	#10	Ring Terminal	3
22-18	#8	Ring Terminal	7
22-18	#6	Ring Terminal	7
22-18	-	Butt Splice Connector	4
22-18	-	Male 1/4" Slide-on-Terminal	2
22-18	-	Female 1/4" Slide-on-Terminal	2
16-14	#10	Ring Terminal	7
16-14	#8	Spade Terminal	3
16-14	#6	Ring Terminal	7
16-14	#4	Ring Terminal	3
12-10	#10	Ring Terminal	1
12-10	#10	Spade Terminal	1
-	-	Economy Crimping Tool	1

## WTA175-ECONOMY TERMINAL KIT\*

Contains primary wire terminals plus an economy crimping tool for the occasional user.

Gauge	Description	Qty.
22-18 Ga.	#6 stud, Ring Terminal	10
22-18 Ga.	#6 stud, Spade Terminal	10
22-18 Ga.	#8-10 stud, Ring Terminal	10
22-18 Ga.	Male, 1/4" Slide-On Connector	10
22-18 Ga.	Female, 1/4" Slide-On Connector	10
22-18 Ga.	Butt Splice Connector	10
16-14 Ga.	#8 stud, Spade Terminal	10
16-14 Ga.	#10 stud, Spade Terminal	10
16-14 Ga.	#10 stud, Ring Terminal	10
16-14 Ga.	5/16" stud, Ring Terminal	10
16-14 Ga.	1/4" stud, Ring Terminal	10
16-14 Ga.	Male, 1/4" Slide-On Connector	10
16-14 Ga.	Female, 1/4" Slide-On Connector	10
16-14 Ga.	Butt Splice Connector	10
12-10 Ga.	Butt Splice Connector	10
12-10 Ga.	#8-10 stud, Ring Terminal	10
12-10 Ga.	3/8" stud, Ring Terminal	5

## WTA208-ELECTRICAL REPAIR KIT\*

Contains everything you need in an emergency automotive repair kit, plus a set of handy tools—all in a rugged plastic carrying case.

- Blade and glass fuses
- 10 wiring nuts
- 50 tie straps (4", 6", 8")
- 10 pieces heat shrink tubing
- 10 rubber grommets
- 94 insulated terminals and connectors
- 13 nylon clamps
- 1 30-ft. roll of electrical tape
- 1 20-ft. roll of 18-ga. primary wire
- Fuse puller
- Battery brush
- 2 test leads
- Crimping tool
- Voltage tester
- 2 screwdrivers (blade and Phillips head)

# KITS & ASSORTMENTS



STA14



STA17



STA23

## STA14-SELF SOLDER TERMINAL KIT

135-piece assortment includes various sizes of butt connectors, ring terminals, spade terminals and slip-on connectors.

### CONTENTS:

Part No.	Qty.	Part No.	Qty.
STP350	5	STP363	5
STP351	10	STP364	5
STP352	10	STP365	5
STP353	5	STP366	5
STP354	5	STP367	5
STP355	5	STP368	5
STP356	5	STP468	5
STP357	5	STP469	5
STP358	5	STP470	5
STP359	5	STP471	5
STP360	5	STP472	5
STP361	5	STP473	5
STP362	5		

## STA17-CRIMP-TYPE HEAT SHRINK TERMINAL ASSORTMENT

115-piece terminal assortment includes various gauge sizes of ring terminals, spade terminals, butt connectors, fully insulated nylon couplers. All terminals include adhesive lined polyolefin heat shrink tubing for contaminant resistant seal.

### CONTENTS:

Part No.	Qty.	Part No.	Qty.
STP120H	5	STP131H	10
STP122H	5	STP132H	10
STP123H	5	STP135H	5
STP124H	5	STP142H	5
STP125H	5	STP143H	5
STP126H	5	STP144H	5
STP127H	5	STP145H	5
STP128H	5	STP150H	5
STP129H	5	STP151H	5
STP130H	10	STP208H	5

## STA23-CRIMP, SOLDER AND HEAT SHRINK TERMINAL ASSORTMENT

75-piece assortment includes various sizes of butt connectors, ring terminals, spade terminals and slip-on connectors. All terminals include adhesive lined polyolefin heat shrink tubing for contaminant resistant seal.

### CONTENTS:

Part No.	Description	Qty.
STP550	24-22 ga. Butt connector	5
STP551	20-18 ga. Butt connector	10
STP552	16-14 ga. Butt connector	10
STP553	12-10 ga. Butt connector	10
STP556	20-18 ga. #10 ring	5
STP559	16-14 ga. #10 ring	5
STP560	16-14 ga. 1/4" ring	5
STP561	16-14 ga. 3/8" ring	5
STP562	12-10 ga. #10 ring	5
STP564	12-10 ga. 3/8" ring	5
STP570	16-14 ga. 1/4" female slide-on	5
STP571	16-14 ga. 1/4" male slide-on	5



STA15



HST1A



HST2A



STA26



STA27



STA28

### STA15-BATTERY TERMINAL SOLDER SLUG KIT

48-piece assortment contains complete range of pre-measured solder and heat shrink tubing for battery cable make-up or repair. **CONTENTS:** 48 pcs.

Part No.	Gauge	Color	Qty.
BP185	4 ga.	gray	5
BP186	2 ga.	green	5
BP187	1 ga.	pink	5
BP188	1/0 ga.	black	5
BP189	2/0 ga.	orange	5
BP190	3/0 ga.	purple	5
BP191	4/0 ga.	yellow	5
BP192	2 oz.	FLUX	1
Heat Shrink Tubing – 8–2 gauge			4
Heat Shrink Tubing – 1–2/0 gauge			4
Heat Shrink Tubing – 2/0–4/0 gauge			4

### HST1A-HEAT SHRINK TUBING ASSORTMENT

6" Lengths **CONTENTS:** 43 pcs

Part No.	Qty.	Part No.	Qty.
HST6	5	HST81B	2
HST10	10	HST81R	2
HST14	10	HST240B	2
HST18	10	HST240R	2

### HST2A-CLEAR HEAT SHRINK TUBING ASSORTMENT

**CONTENTS:** 31 pcs

Part No.	I.D. Shrinks			Qty.
	From	To	Gauge	
HST21	.500"	.195"	8-1	10
HST28	.312"	.104"	14-08	10
HST30	.187"	.060"	20-14	10
WTT31	Flameless heat torch			1

### STA26-CRIMP, SOLDER & SEAL BUTT CONNECTOR KIT

20-piece assortment contains 3 sizes of butt connectors. All connectors are insulated with a color-coded, adhesive-lined polyolefin heat shrink tubing to provide maximum durability against corrosion and vibration.

Part No.	Gauge	Qty.
STP551	20-18 ga.	5
STP552	16-14 ga.	10
STP553	12-10 ga.	5

### STA27-CRIMP & SEAL BUTT CONNECTOR KIT

30-piece assortment contains 3 sizes of butt connectors. All connectors are insulated with a color-coded, adhesive-lined polyolefin heat shrink tubing to provide maximum durability against corrosion and vibration.

Part No.	Gauge	Qty.
STP130H	20-18 ga.	10
STP131H	16-14 ga.	15
STP132H	12-10 ga.	5

### STA28-SEALED MULTIPLE WIRE CONNECTOR KIT

21-piece assortment contains 3 sizes of in-line butt connectors and 2-sizes of closed end connectors. All connectors are insulated with an active, adhesive-lined polyolefin heat shrink tubing to provide maximum durability against corrosion and vibration.

Part No.	Gauge	Color	Qty.
STP400	20-18 ga.	Red Dashes	5
STP401	16-14 ga.	Blue Dashes	5
STP402	12-10 ga.	Yellow Dashes	5
STP397	22-14 ga.	Blue Dashes	3
STP398	20-18 ga.	Yellow Dashes	3

# WIRING CENTER CABINET



## AB99W — Wiring Center Cabinet

Manufactured for extreme durability with reinforced locking steel doors and a heavy 22 gauge welded steel body. A bonus pack includes exterior cabinet decals, a ruler decal, storage drawer plan-o-grams, helpful product instruction decals, a wire and cable illustrated parts guide, and merchandise certificate. Dimensions are: 39 3/16" H x 32" L x 13 13/16" W. 7 cubic feet storage compartment includes the following:

### CONTENTS:

- 4 Metal drawers to store bulk quantities of terminals and accessories
- 3 Small metal rods used for 100' spools of primary wire
- 1 Large metal rod for bulk battery cable
- Adjustable shelf for wire and cable stock.

## AB10C — Catalog Rack

Mounts onto AB99W cabinet. Rugged steel construction has slots for 9, 2" catalog holders. 3 two inch catalog holders are included in the rack. Merchandise certificate included. Mounting hardware included. Dimensions: 17 1/2" H x 32" L x 12 3/16" W

## AB11C — Catalog Rack Holders

2" Catalog rack holders for use with AB10C catalog rack. Std. Pkg. 3.

## Cabinet & Storage Drawers

Part No.	Std. Description	Pkg.
AB200	Metal Cabinet, 8 5/16" H x 20 1/2" W x 12 3/4" D	1
AB201	Metal Cabinet Drawer, 29 Compartments 3 1/6" H x 18 3/8" W x 12 1/16" D	1
AB202	Plastic Box, 18 Compartments 1 3/4" H x 11" W x 6 1/2" D	1
AB203	Plastic Cabinet Drawer, 12 Adjustable Dividers 3 1/8" H x 18 1/2" W x 12 3/4" D	1
ET904X	4" Peg Hook	100





WIRING TOOLS		
Part No.	Description	Std. Pkg.
ET100	Economy Crimping Tool — Strips or cuts primary wire and crimps terminals from 22 to 10 ga. 7.5" long.	1
WTT4	Crimpmaster — 10" long; boxed; plastic handle grips. For professional crimps on ignition wire terminals (including ST114 and ST116 90° terminals), insulated and uninsulated solderless terminals (including "W" crimps). Stripping notches for 22 to 10 ga. primary wire.	1
WTT5	Crimp 'N Cut — 8" long; boxed; plastic handle grips. Strips wire, crimps terminals, cuts screws. Color-coded crimping notches for insulated solderless terminals. Wire cutter plus stripping notches for 22 to 10 gauge primary wire. Special crimping nest for 7mm ignition wire terminals. Same as carded version ET10.	1
WTT6	Wire Stripper — The original "Miller Stripper." Cuts, strips wire from 24 to 8 gauge, with adjusting set screw. Individually bagged.	5
WTT12	Crimping tool for open barrel Weather-Pack Terminals.	1
WTT13	Extractor tool for Weather-Pack Terminals.	1
WTT14	Terminal extractor pick. Narrow blade, .050".	1
WTT15	Terminal extractor pick. Wide blade, .090".	1
WTT17	Premium crimping tool. 8" long display packaged cuts and strips primary wire 26 to 10 gauge. Crimps insulated and non-insulated terminals. Precision ground. Made in USA.	1
WTT18	Racheting terminal crimper — 8 1/2" long. Forms professional crimps on primary wire insulated terminals. Crimps connectors 22-10 gauge. Adjustable tension. Molded hand grips. Added leverage eases hand fatigue.	1
WTT27	Easy Stripper — Multi-function, self adjusting stripper with cutting and crimping actions. Cuts and strips 26-10 gauge wire. Crimps insulated and non-insulated terminals. Cushion grip handles for comfort.	1
WTT32	Crimping tool for open barrel OE Style Terminals.	1
WTT110	Pro Continuity Tester — tests circuits with power off, use to locate broken wires, bad connections, open circuits, requires 1 AA battery, not included.	1
WTT111	Pro Circuit Tester — finds open circuits, blown fuses, and bad connections. Handle illuminates when circuit is working.	1
WTT112	Continuity Tester — tests circuits with power off, use to locate broken wires, bad connections, open circuits, requires 2 AAA batteries, not included.	1
WTT113	Circuit Tester — finds open circuits, blown fuses, and bad connections. Handle illuminates when circuit is working.	1
WTT114	LED Voltage Tester — LED indicators show normal, low, or flat charge level. Magnetic base for hands-free use. Two leads, one with alligator clip, one with probe.	1
WTT115	Circuit Tester w/ Probe Hook — probe pierces insulation to contact circuit, finds open circuits, blown fuses, and bad connections. Handle illuminates when circuit is working.	1

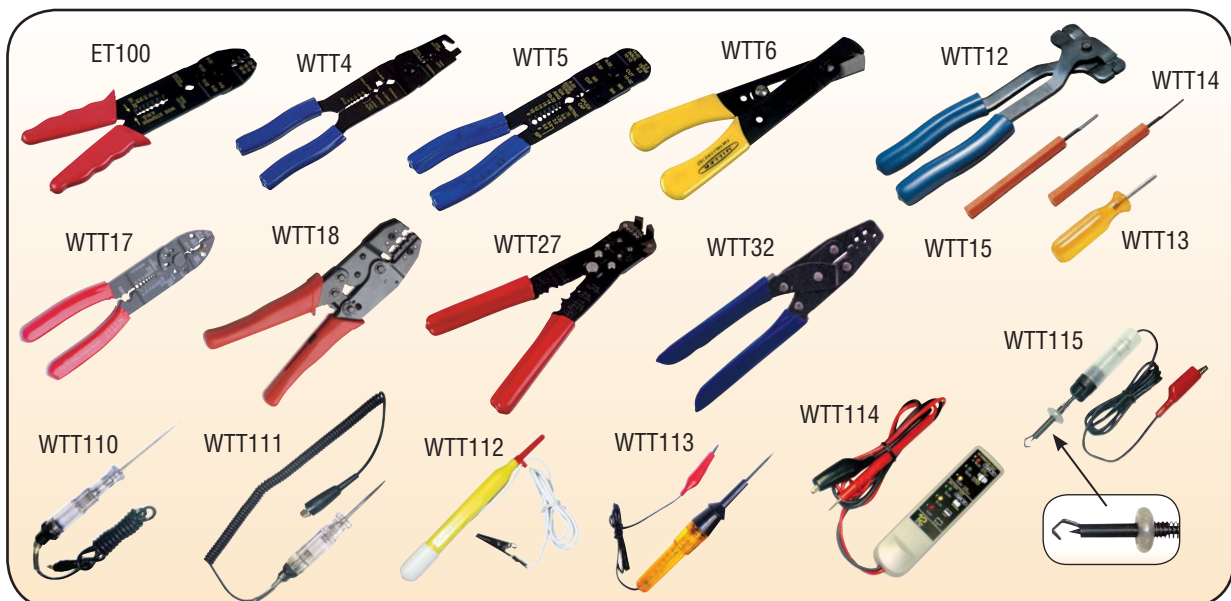

# WHY USE HEAT SHRINK TERMINALS?



## CORROSION

When using a standard crimp terminal, the wire is exposed to moisture and other contaminants. Over time, the wire starts to corrode which reduces the current carrying capacity of the electrical system.

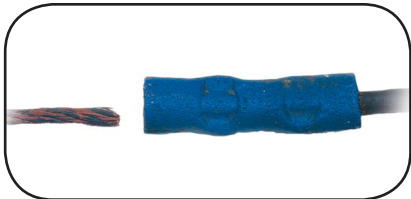

## PULL-OUT

In most cases, electrical connectors must operate in adverse conditions: heat, cold, vibration, strain, etc. These conditions can cause the wire or wires to pull-out of the connector.

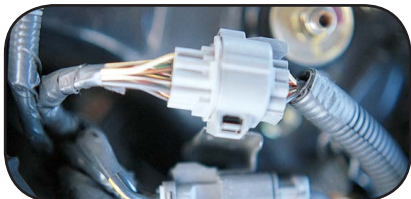

## TECHNOLOGY

Advanced technology and computerization have resulted in OEMs designing sealed and molded components in all types of equipment. The integrity of the electrical system can be compromised when repairs are made with unsealed electrical connections.



## DOWNTIME

Lighting and electrical problems are the most frequent causes of downtime when maintaining a fleet. Often these problems stem from faulty electrical connections. Equipment downtime can result in thousands of dollars in lost opportunities and repair costs.

## SOLUTIONS

Adhesive-lined tubing prevents corrosion on wire.

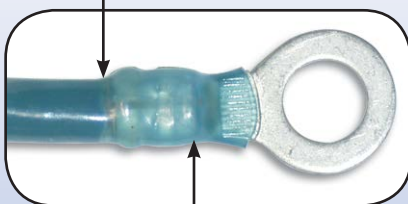

Translucent tubing allows visual inspection of installation.

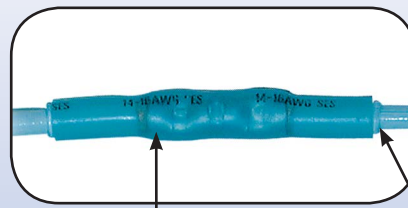

Adhesive-lined heat shrink tubing and solder combine to increase tensile strength.



*Ignition Wires*

*Battery Cables*

*Primary Wire*

*Terminals & Connectors*

## ***Trailer Connectors***

*Sockets, Pigtails & Switches*

*Safety Accessories*

*O.E. Interchanges*

*Index*

## Standard® ... Parts For The Road...To Keep You Driving!



### THE NUMBER ONE CHOICE!

### STANDARD® VEHICLE TO TRAILER WIRING SYSTEM...

Wiring from vehicle to trailer was a big job, it could take hours of cutting, splicing, soldering and stripping. Not to mention getting to the original equipment wire you need to attach to. Now, the “professional installer” or a “do-it-yourself” individual can do a complete vehicle to trailer installation the easy plug in way. This modular wiring adapter is ready made to plug right into the original equipment system.

The adapters plug into a molded connector joining the car and truck body or bed wiring harness to the chassis harness to provide tail, brake and turn signal light wiring to the trailer connector.

### HOOK ME UP!

On some applications you have a choice of a complete one-piece molded unit or two separate connectors. The **1-piece connector** consists of a built-in 4-pole flat extension. The advantage of the **2-piece connector** is the 4-pole extender may be replaced if damaged and the end may be interchangeable for a 6-way or 7-way connector.

If a vehicle connector is not available, use a universal converter. There are three types of converters: 4-wire flat, general purpose and power converter/isolator.

A **4-wire flat** is the most common trailer plug. A **4-wire flat** converter is used with a common bulb standard tail light system. Brake light and turn signal functions work through the same bulbs. The lens at the back of the vehicle will be completely red.

A **converter** changes the tow vehicle’s independent turn signals to the standard wiring found on trailers. Brake/tail lights and turn signal functions work through separate, independent light bulbs. A general purpose converter is designed for small trailers with 2 stop/tail lights and 4 running lights.

If the trailer has a large amount of bulbs, or to prevent damage to the converter or tow vehicle, a **power converter** or an **isolator** is recommended for guaranteed protection. A **power converter** is used to adapt the independent turn signal system found on tow vehicles to the trailer standard or common bulb system. The **power isolator** isolates the trailer lighting functions from all electronics on the vehicle including light circuits, on-board computers, anti-lock brake systems, information centers and lamp outage modules.

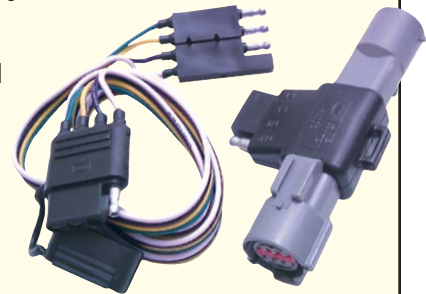
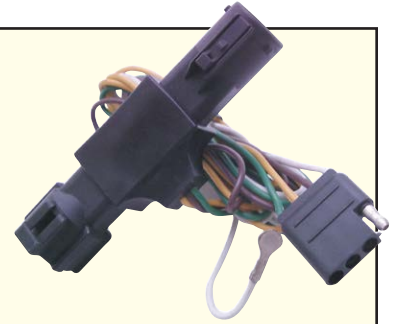

# VEHICLE CONNECTORS



## TRAILER CONNECTORS

Part No.	Type	Description	Illustration	Part No.	Type	Description	Illustration
TC411	Ford	Bronco .....1979-1973 F100 - 350 .....1979-1973 Use with 4-wire flat extension TC427.		TC421 TC421A	Ford	Bronco .....1986-1980 Ranger .....1985 Pickup .....1986-1980 Use with 4-wire flat extension TC427. TC421A one piece molded unit. 36 inches long. Used for TC421 and TC427.	
TC412 TC412A	Chevrolet GMC Cadillac Full Size Pickup (old body style)	Blazer .....2000-1988 Escalade .....1999 Denali .....2001-1999 Jimmy .....1994-1992 Yukon .....1999-1995 Tahoe .....1999-1995 Suburban .....1999-1992 Use with 4-wire flat extension TC427. TC412A one piece molded unit. 36 inches long. Used for TC412 and TC427.		TC422 TC422A	Ford Mazda	Explorer .....1994-1991 Navajo .....1994-1991 Use with 4-wire flat extension TC427. TC422A one piece molded unit. 56 inches long. Use for TC422 and TC427.	
TC413 TC413A	Chevrolet GMC	S-10 Blazer (2 door) ....1991-1984 S-15 Jimmy (2 door) ...1991-1984 Use with 4-wire flat extension TC427. TC413A one piece molded unit. 74 inches long. Used for TC413 and TC427.		TC431 TC431A	Ford	Ranger .....1992-1986 Use with 4-wire flat extension TC427. TC431A one piece molded unit. 38 inches long. Use for TC431 and TC427.	
TC414 TC414A	Dodge	Pickup (full size) .....1994-1987 Cab & Chassies only ....2002-1995 Dakota .....1994-1988 Ram Charger .....1993-1988 Trailduster .....1993-1988 Use with 4-wire flat extension TC427. TC414A one piece molded unit. 44 inches long. Used for TC414 and TC427.		TC436 TC436A	Ford Mazda	Ranger .....1999-1993 Mazda Pickup .....1999-1994 Use with 4-wire flat extension TC427. TC436A one piece molded unit. 60 inches long. Use for TC436 and TC427. Includes Tail Light Converter.	
TC416 TC416A	Ford	F150/250 Light Duty ....1996-1987 F250/350 Heavy Duty...1997 Use with 4-wire flat extension TC427. TC416A one piece molded unit. 36 inches long. Used for TC416 and TC427.		TC437	Jeep	Cherokee .....1996-1991 Use with 4-wire flat extension TC427. Includes Tail Light Converter.	
TC418 TC418A	Ford	Bronco .....1988-1987 Use with 4-wire flat extension TC427. TC418A one piece molded unit. 38 inches long. Use for TC418 and TC427.		TC438	Toyota	Tacoma .....2004-1995 Pickup (except T-100) ...1994-1984 Use with 4-wire flat extension TC427. Includes Tail Light Converter.	
TC419 TC419A	Ford	Bronco .....1991-1989 Use with 4-wire flat extension TC427. TC419A one piece molded unit. 44 inches long. Use for TC419 and TC427.		TC439	Dodge Chrysler Plymouth Mitsubishi	Dakota .....2007-2004 Minivan .....1995-1991 Caravan/Grand Caravan ..1995-1991 Voyager/Grand Voyager. 1995-1991 Town & Country .....1995-1991 Pickup .....2007 Raider .....2007-2006	
TC420 TC420A	Ford	Bronco II .....1991-1987 Use with 4-wire flat extension TC427. TC420A one piece molded unit. 54 inches long. Use for TC420 and TC427.		TC441 TC441A	Chevrolet GMC	Blazer .....1984-1973 Jimmy .....1984-1973 Pickup .....1984-1968 Suburban .....1984-1973 Use with 4-wire flat extension TC427. TC441A one piece molded unit. 36 inches long. Use for TC441 and TC427.	

# VEHICLE CONNECTORS

Part No.	Type	Description	Illustration	Part No.	Type	Description	Illustration
TC451 TC451A	Chevrolet GMC Isuzu	Blazer .....1991-1985 Cyclone .....1992-1991 Jimmy .....1991-1985 Pickup (full size).....1987-1985 Suburban .....1991-1985 S10-S15 Pickup .....1997-1985 Sonoma .....1997-1985 Hombre/Pickup .....1997-1996 Use with 4-wire flat extension TC427. TC412A one piece molded unit. 36 inches long. Used for TC412 and TC427.		TC469 TC469A	Ford	Bronco (full size) .....1996-1992 Use with 4-wire flat extension TC430 TC469A one piece molded unit. 54 inches long. Used for TC469 and TC430.	
TC460	Ford Mazda	Explorer .....1994-1991 Navajo .....1994-1991 For vehicles equipped with a factory tow package.		TC470	Ford	Taurus (sedan only).....1995-1992 Use with 4-wire flat extension TC430. Includes Power Tail Light Converter for electronic protection.	
TC461	Jeep	Cherokee .....1982-1976 Use with 4-wire flat extension TC427.		TC472	Chevrolet GMC Oldsmobile	Astro .....2005-1995 Blazer .....2002-1995 Jimmy .....2001-1995 Envoy .....2001-1999 Safari .....2005-1995 Bravada .....2001-1996	
TC462 TC462A	Dodge	Pickup (full size).....2003-1995 Dakota .....2003-1995 Use with 4-wire flat extension TC427. TC462A one piece molded unit. 52 inches long. Used for TC462 and TC427.		TC473	Chrysler Dodge	Caravan.....2000-1996 Durango .....2003-1998 Town and Country.....2000-1996 Voyager.....2000-1996 Includes Tail Light Converter.	
TC463	Ford Mazda Mercury	Explorer .....2000-1995 Escape .....2003-2001 (without tow package) Mountaineer .....2000-1995 (without tow package) Tribute .....2003-2001 (without tow package) Use with 4-wire flat extension TC430. Includes Power Tail Light Converter for protection on vehicles with lamp outage modules.		TC474	Jeep	Grand Cherokee .....1993 (mfg. 8/92-2/94) Use with 4-wire flat extension TC430. Includes Power Tail Light Converter for protection on vehicles with Lamp Outage Modules.	
TC464	Ford	Windstar.....1998-1995 Includes Tail Light Converter. Use with 4-wire flat extension TC430.		TC475	Jeep	Grand Cherokee .....1994 (without tow package) .....1998-1995 (mfg. 3/94-1998) Use with 4-wire flat extension TC430.	
TC465	Dodge	Van (full size) .....1998-1993 <b>Available while supplies last</b>		TC476	Jeep	Grand Cherokee .....1998-1995 (with tow package) .....1998-1995 Includes Power Tail Light Converter for protection on vehicles with Lamp Outage Modules. Use with 4-wire flat extension TC430.	
				TC477	Acura Honda Isuzu	Accord .....2002-1994 (except station wagon) Element .....2004-2003 Odyssey .....2004-1995 Oasis .....1998-1996 Integra .....2001-1994 Pilot .....2007-2003 CRV .....2006-1997 CL/RL Series.....2003-1995 MDX .....2006-2001 TL .....2004-1996 Includes Tail Light Converter.	

# VEHICLE CONNECTORS



## TRAILER CONNECTORS

Part No.	Type	Description	Illustration	Part No.	Type	Description	Illustration
TC478	Honda Isuzu	Passport .....1997-1994 Rodeo .....1997-1992		TC490	Jeep	Wrangler .....1997-1981	
TC479	Acura Isuzu	SLX .....1999-1996 Trooper .....2002-1992 Includes Tail Light Converter.		TC492	Buick Chevrolet	Roadmaster Sedan .....1996-1990 Caprice .....1996-1991 Impala .....1996-1991	
TC482	Ford Mercury	Mustang (except Cobra) .....2002-1994 Crown Victoria/LTD .....1997-1992 Grand Marquis .....1997-1992 Use with 4-wire flat extension TC430. Includes Power Tail Light Converter for electronic protection.		TC494	Ford Lincoln	F150 .....1997 (mfg. 1/96-10/96) F250 Light Duty .....1997 (mfg. 1/96-10/96) Expedition .....1999-1997 Navigator .....1999-1997	
TC483	Ford Mercury	Taurus .....1999-1996 Sable .....1999-1996 (sedan only) Use with 4-wire flat extension TC430. Includes Power Tail Light Converter for electronic protection.		TC495	Isuzu	Pickup .....1995-1989 Use with 4-wire flat extension TC427. Includes Tail Light Converter.	
TC485	Nissan	Pickup .....1997-1991 Use with 4-wire flat extension TC430. Includes Tail Light Converter.		TC496	Mazda	Pickup .....1993-1985 Use with 4-wire flat extension TC427. Includes Tail Light Converter.	
TC486	Toyota	T-100 Pickup .....1998-1994 Includes Tail Light Converter.		TC498	Ford Mercury	Explorer .....2000-1995 Ranger .....1999-1998 Mountaineer .....2001-1996 (All with tow pkg.) For vehicles equipped with a factory tow package.	
TC487	Chevrolet Buick	Caprice Wagon .....1996-1991 Roadmaster Wagon ....1996-1991		TC499 TC499A	Ford Mercury	Explorer .....1997-1996 Mountaineer .....1997-1996 Use with 4-wire flat extension TC430. TC499A one piece molded unit. 79 inches long. Used for TC499 and TC430.	
TC488	Chevrolet Pontiac Oldsmobile	Lumina APV .....1997-1992 Silhouette .....1997-1992 Transport .....1997-1992		TC500	Nissan Infiniti	Altima .....2001-1997 Pathfinder .....2004-1996 QX4 .....2003-1996 Includes Tail Light Converter.	
TC489	Mitsubishi	Montero .....1997-1991		TC501	Subaru	Forrester .....2007-1998 Outback .....2007-1996 Use with 4-wire flat extension TC430. Includes Power Tail Light Converter for electronic protection.	

# VEHICLE CONNECTORS

Part No.	Type	Description	Illustration	Part No.	Type	Description	Illustration
TC502	Jeep	Cherokee .....2001-1997 Use with 4-wire flat extension TC430. Includes Power Tail Light Converter for vehicles electronic protection.		TC515	Jeep	Renegade .....2003-1998 Wrangler .....2004-1998 Use with 4-wire flat extension TC430.	
TC503	Toyota	4-Runner .....2002-1996 Includes Tail Light Converter.		TC516	Chevrolet GMC	Van (full size) .....1996-1987	
TC504	Chevrolet GMC Isuzu	S10/S15 Pickup .....2004-1998 Hombre/Pickup .....2000-1998 Sonoma.....2004-1998 Use with 4-wire flat extension TC430.		TC517	Chevrolet GMC	Express Van (full size) .....1999-1996 Savannah (new body) .....1999-1996 Use with 4-wire flat extension TC430. Includes Tail Light Converter.	
TC505	Toyota Lexus	Land Cruiser .....1998-1991 LX450 .....1998-1996 Includes Tail Light Converter.		TC518	Dodge	Ram Van (full size).....2000-1999	
TC506	Ford	E150 .....2003-1995 E250 .....2003-1995 Escort .....2001-1997 ZX2 .....2003-1998 (full size vans) Use with 4-wire flat extension TC430.		TC519	Chevrolet GMC Oldsmobile Cadillac	Sierra (1/2 ton) with tow package .....2001-2000 Silverado (1/2 ton) with tow package .....2004-2000 Sierra (3/4 ton) .....2004-2000 Silverado (3/4 ton) .....2004-2000 Suburban .....2004-2000 Tahoe .....2004-2000 Yukon .....2004-2000 Avalanche .....2004-2002 Trail Blazer .....2004-2002 Bravada .....2003-2002 Envoy .....2004-2002 Denali .....2004-2001 Escalade.....2004-2001	
TC510	Chevrolet Oldsmobile Pontiac	Venture .....2005-1997 Transport .....2000-1997 Silhouette .....2004-1997 Montana .....2005-1999 Includes Tail Light Converter.		TC520	Ford	F-150 .....2002-1997 F-250 .....2001-1997 (mfg. 11/96-Present)	
TC511	Toyota	Rav4 .....2000-1996		TC521	Jeep	Grand Cherokee .....2004-1999 Includes Power Tail Light Converter for protection on vehicles with Lamp Outage Modules. Use with 4-wire flat extension TC430.	
TC512	Toyota	Tundra .....2000 Includes Tail Light Converter.		TC522	Ford	F-250 .....2001-1999 F-350 .....2001-1999	
TC513	Nissan	Frontier Pickup .....2004-1998 Includes Tail Light Converter.		TC523	Ford	Windstar .....2003-1999 Includes Negative Input Converter. Use with 4-wire flat extension TC430.	









# VEHICLE CONNECTORS





Part No.	Type	Description	Illustration	Part No.	Type	Description	Illustration
TC524	Chevrolet GMC	Express Van (full size) ..2002-2000 Savannah (full size).....2002-2000 Includes Tail Light Converter. Use with 4-wire flat extension TC430.		TC546	Ford Lincoln Mercury	Explorer (w/tow pkg.) ..2005-2002 Mountaineer .....2005-2002 Aviator .....2005-2003	
TC525	Honda Isuzu	Passport .....2003-1998 Amigo .....2003-1998 Rodeo .....2003-1998 Axiom .....2002 Includes Tail Light Converter.		TC547	Ford	F-250 .....2004-2002 F-350 .....2004-2002	
TC536	Ford Mazda	Escape .....2004-2001 (without tow package) Tribute .....2004-2001 (without tow package)		TC548	Ford Mercury	Taurus Sedan .....2003-2000 Sable Sedan .....2003-2000	
TC537	Nissan	Xterra .....2004-2000		TC549	Toyota	Highlander .....2007-2001 Includes Tail Light Converter for protection on vehicles with Lamp Outage Modules.	
TC538	Toyota	RAV4 .....2005-2001 Includes Tail Light Converter.		TC551	Jeep	Liberty .....2005-2002 Includes Tail Light Converter for protection on vehicles with Lamp Outage Modules.	
TC539	Ford Lincoln	Expedition .....2002-2000 Navigator .....2002-2000 For vehicles equipped with a factory tow package.		TC554	Buick Cadillac Chevrolet Chrysler Dodge Ford GMC Hummer Infiniti Isuzu Lincoln Mercury Nissan Oldsmobile Saab	Provides 7RV blade and 4-wire flat towing. 9-7X .....2006-2005 2500/3500 (new body style) .. 2007-1999 Ascender ..... 2006-2004 Armada ..... 2007-2004 Aspen (w/ factory 7-way) ..2007 Avalanche ..... 2007-2002 Aviator (w/ factory 7-way) 2006-2003 Bravada ..... 2004-2002 Denali ..... 2005-2001 Durango (w/ factory 7-way) 2008-2007 Envoy ..... 2007-2002 Escalade ..... 2007-2000 Escalade EXT ..... 2007-2002 Excursion ..... 2005-2000 Expedition ..... 2007-2000 Explorer (w/ factory 7-way) .. 2007-2002 F-150 (w/ factory 7-way) . 2007-1999 F-250 (w/ factory 7-way) . 2007-1999 F-350 (w/ factory 7-way) . 2007-1999 H2 ..... 2007-2003 H2 SUT ..... 2007-2005 H3 ..... 2007-2006 QX56 ..... 2007-2004 Mark LT ..... 2007-2006 Mountaineer (w/ factory 7-way) 2007-2002 Navigator ..... 2007-2000 Pickup 2500/3500 ..... 2007-1999 Rainier ..... 2007-2004 Sierra ..... 2008-2003 Silverado ..... 2008-2003 Suburban ..... 2008-2000 Tahoe ..... 2008-2000 Titan ..... 2007-2004 Trailblazer ..... 2008-2002 Yukon/Yukon XL ..... 2007-2000	
TC540	Dodge Chrysler	Caravan .....2003-2001 Grand Caravan .....2003-2001 Town & Country .....2003-2001 Voyager .....2003-2001 Grand Voyager .....2003-2001 Includes Tail Light Converter.					
TC542	Toyota	Sequoia .....2002-2001					
TC543	Toyota	Sienna .....2003-1998 Includes Tail Light Converter.					
TC544	Toyota	Tundra .....2002-2001 Includes Power Tail Light Converter for protection on vehicles with Lamp Outage Modules.					
TC545	Dodge	Ram 1500 Pickup .....2006-2002 Ram 2500 Pickup .....2006-2003 Ram 3500 Pickup .....2006-2003 Includes Tail Light Converter.					

# VEHICLE CONNECTORS & POLE CONNECTORS

Part No.	Type	Description	Illustration	Part No.	Type	Description	Illustration
TC555	Buick Cadillac Chevrolet Ford GMC Hummer Infiniti Isuzu Lincoln Mercury Nissan Oldsmobile	Provides 6RV blade and 4-wire flat towing. 2500/3500 (new body style).....2004-2002		TC556	Dodge Jeep Lincoln	7 way RV to 7 way blade.	
		Armada .....2007-2004				Dakota .....2008-1998	
		Ascender .....2006-2004				RAM .....2008-1998	
		Avalanche .....2007-2002				Quad Cab/Club Cab .....2001-1998	
		Aviator (w/ factory 7-way).....2004-2003				Durango .....1999-1998	
		Bravada.....2004-2002				Commando.....2008-2006	
		Denali.....2005-2001				Mini Vans .....2003-2001	
		Envoy .....2007-2002				Liberty .....2007-2002	
		Escalade.....2007-2000				MMC Pickup .....2007-2006	
		Escalade EXT .....2007-2002				Magnum/300.....2008-2005	
		Excursion .....2005-2000					
		Expedition .....2007-2000					
		Explorer (w/ factory 7-way) .....2007-2002					
		F-150 (w/ factory 7-way).....2007-1999					
		F-250 HD (w/ factory 7-way) ...2007-1999					
		F-350 (w/ factory 7-way).....2007-1999					
		H2 .....2007-2003					
		H2 SUT .....2007-2005					
		H3 .....2007-2006					
		Navigator.....2007-2000					
		Mark LT.....2007-2006					
		Mountaineer (w/ factory 7-way) .2007-2003					
		Pickup 2500/3500.....2007-1999					
		QX56 .....2007-2004					
		Rainier.....2008-2004					
		Sierra .....2007-2003					
		Silverado .....2007-2003					
Suburban .....2007-2000							
Tahoe .....2007-2000							
Trailblazer .....2007-2002							
Titan .....2007-2004							
Yukon/Yukon XL.....2007-2000							
				TC558	Chevrolet GMC	Express Van (new body style).....2007-2003 Savannah (new body) .....2007-2003	
				TC559	Buick Pontiac	Aztec .....2005-2001 Rendezvous .....2005-2002	
				TC560	Chevrolet Suzuki	Tracker .....2004-1998 Vitara .....2005-1999 Grand Vitara .....2005-1999	
				TC561	Hyundai	Santa Fe..... 2006-2001	

## 1 POLE CONNECTORS

One pole connectors are used for farm equipment lift gates, plows and similar high current applications.

Part No.	Description	Illustration	Part No.	Description	Illustration
TC10 (Set)	<ul style="list-style-type: none"> <li>• Universal Single Pole Trailer Connector</li> <li>• Accepts up to 0 gauge cable</li> <li>• Also sold separately, order TCP10F receptacle or TCP10MS plug with cable guard</li> </ul>		TC11 (Set)	<ul style="list-style-type: none"> <li>• Universal Heavy Duty Single Pole Trailer Connector Set</li> <li>• Has continuous capacity of 300 amp.</li> <li>• Accepts up to 00 ga. wire and 2 ga. or 4 ga. ground lug adapter</li> <li>• Also sold separately, order TCP11F receptacle or TCP11M plug</li> </ul>	

# POLE CONNECTORS



## 4 POLE CONNECTORS

Four pole round connectors are used in many of the same applications that the four-way flat is used. The pin location of each function varies so be sure to wire by function only.

Part No.	Description	Illustration	Part No.	Description	Illustration
TC41 (Set)	<b>4-Pole Trailer Connector Set</b> <ul style="list-style-type: none"> <li>• Self-locking with coded sockets</li> <li>• Receptacle has concealed terminals</li> <li>• Plug has handle for ease of removing plug</li> <li>• Split clamp for securing cable</li> <li>• Accepts up to 12 ga. wire</li> <li>• Also sold separately, order TCP41F receptacle or TCP41M plug</li> </ul>		TC44	<b>4-Pole Trailer Connector Set</b> <ul style="list-style-type: none"> <li>• Polarized connector for marine and trailer use</li> <li>• Molded interiors</li> <li>• Spring loaded cover holds plug in position</li> <li>• Die-cast plug and socket casing</li> <li>• Heavy brass contacts</li> <li>• Accepts up to 12 ga. wire</li> <li>• Also sold separately, order TCP44F receptacle or TCP44M plug</li> </ul>	
TC41S (Set)	<b>4-Pole Trailer Connector Set</b> <ul style="list-style-type: none"> <li>• Self-locking with coded sockets</li> <li>• Receptacle has concealed terminals</li> <li>• Plug has handle for ease of removing plug</li> <li>• Plug has cable protector</li> <li>• Split clamp for securing Cable</li> <li>• Accepts up to 12 ga. wire</li> <li>• Also sold separately, order TCP41F receptacle or TCP41MS plug</li> </ul>		TC44K (Kit)	<b>4-Pole Round Connector Kit</b> <ul style="list-style-type: none"> <li>• Contains plug and socket, mounting bracket, wire, splice connectors and mounting hardware</li> </ul>	

## 5 POLE CONNECTORS

Five pole round connectors are commonly found on large camping trailers, RV trailers, industrial trailers, horse trailers, and other large trailers. Additional functions provided by the five wire are electric brakes, auxiliary, back-up, etc.

Part No.	Description	Illustration	Part No.	Description	Illustration
TC51 (Set)	<b>Universal 5-Pole Trailer Connector</b> <ul style="list-style-type: none"> <li>• Used with recreational vehicles</li> <li>• Polarized chrome plated housing</li> <li>• Rating: 12-24 volts, 15 amps</li> <li>• Also sold separately, order TCP51F receptacle or TCP51M plug</li> </ul>		TC51K (Kit)	<b>5-Pole Round Connector Kit</b> <ul style="list-style-type: none"> <li>• Contains plug and socket, mounting bracket, wire, splice connectors and mounting hardware</li> </ul>	

## 6 POLE CONNECTORS









Six pole round connectors are used on smaller campers, horse trailers, and car trailers. Added functions provided by a six pole round are electric brakes and an auxiliary power lead.

Part No.	Description	Illustration	Part No.	Description	Illustration
TC61 (Set)	<b>6-Pole Trailer Connector Set</b> <ul style="list-style-type: none"> <li>• Self-locking with coded sockets</li> <li>• Receptacle has concealed terminals</li> <li>• Plug has handle for ease of removing plug</li> <li>• Split clamp for securing cable</li> <li>• Accepts five 12 ga. wires and one 10 ga. wire</li> <li>• Also sold separately, order TCP61F receptacle, or TCP61M plug</li> </ul>		TCP62F	<b>Universal 6-Pole Self-Locking Trailer Connector Socket</b> <ul style="list-style-type: none"> <li>• Used with recreational vehicles</li> <li>• Receptacle has concealed terminals</li> <li>• Split clamp for securing cable</li> <li>• Plastic construction</li> </ul>	
TC61S (Set)	<b>6-Pole Trailer Connector Set</b> <ul style="list-style-type: none"> <li>• Plug has cable protector</li> <li>• Self-locking with coded sockets</li> <li>• Receptacle has concealed terminals</li> <li>• Split clamp for securing cable</li> <li>• Accepts five 12 ga. wires and one 10 ga. wire</li> <li>• Also sold separately, order TCP61F receptacle or TCP61MS plug</li> </ul>		TC62K (Kit)	<b>6-Pole Round Connector Kit</b> <ul style="list-style-type: none"> <li>• Contains plug and socket, mounting bracket, wire, splice connectors and mounting hardware</li> </ul>	

# POLE CONNECTORS

## 7 POLE CONNECTORS

Seven pole connectors are found mostly on the largest trailers, RV campers and industrial. Seven pole connector function provides electric brakes, auxiliary power lead and backup lights.

Part No.	Description	Illustration	Part No.	Description	Illustration
TCP77PM	<b>Universal Heavy Duty 7-Pole Trailer Connector Plug</b> <ul style="list-style-type: none"> <li>Made of high impact glass-filled molded plastic for weather protection</li> <li>Floating pins for ease of alignment and maximum contact</li> <li>Will accept widest range of wire gauges from #16 to #8 ground wire</li> <li>Rating: 6 to 28 volts, 40 amp.</li> </ul>		TCP77PG	<b>Universal 7-Pole Trailer Connector Plug</b> <ul style="list-style-type: none"> <li>Heavy duty, with cable guard</li> <li>Made of high impact glass-filled molded plastic for weather protection</li> <li>Will accept widest range of wire gauges from #16 to #8 ground wire</li> <li>Rating: 6 to 28 volts, 40 amp.</li> <li>Also sold separately, order TCP77M, plug or TCP77G cable guard</li> </ul>	
TCP77F	<b>Universal 7-Pole Trailer Connector Set</b> <ul style="list-style-type: none"> <li>Conforms to federal anti-skid (FMV SS-121) requirements</li> <li>Used with TCP77M</li> </ul>		TCP78F TCP78M	<b>Universal 7-Pole Trailer Connector Receptacle and Plug</b> <ul style="list-style-type: none"> <li>Corrosion resistant plated steel</li> <li>Used with TCP78C bracket</li> <li>Rating: 12-24 volts, 30 amp Sold separately</li> </ul>	
TCP77F-15 TCP77F-20 TCP77F-30	<b>Trailer Connector Socket</b> <ul style="list-style-type: none"> <li>7-pole with built-in replaceable 15, 20, 30 amp. circuit breakers</li> <li>Zinc die-cast body and cover</li> <li>Used with TCP77M</li> </ul>		TCP701F TCP701M	<b>Universal 7-Pole Trailer Connector Receptacle and Plug</b> <ul style="list-style-type: none"> <li>Heavy duty weatherproof designs eliminates corrosion, poor appearance, and difficulty of removal</li> <li>Unique interior design incorporates vinyl inserts to seal out moisture and dirt</li> <li>Safety latch prevents accidental pull-away</li> <li>Color coded to RVI standards</li> <li>Detail instructions permit Used for both 6 and 7-way applications.</li> </ul>	
TCP77M	<b>Universal 7-Pole Trailer Connector Plug</b> <ul style="list-style-type: none"> <li>Conforms to federal anti-skid (FMV SS-121) requirements</li> <li>Accepts six: 12 ga. wires and one 10 ga. wire</li> <li>Used with TCP77F; TCP77F-15, -20, -30 TCP77PF</li> </ul>		TC701K (Kit)	<b>7-Pole Round Connector Kit</b> <ul style="list-style-type: none"> <li>Contains plug and socket, mounting bracket, wire, splice connectors and mounting hardware</li> </ul>	
TCP77PF	<b>Universal 7-Pole Trailer Connector Socket</b> <ul style="list-style-type: none"> <li>Thermoplastic housing</li> <li>Will accept widest range of wire gauges from #16 to #8 ground wire</li> <li>Rating: 6 to 28 volts, 40 amp.</li> </ul>				

## 9 POLE CONNECTORS

Part No.	Description	Illustration
TC91 (Set)	<b>Universal 9-Pole Heavy Duty Trailer Connector Set</b> <ul style="list-style-type: none"> <li>6-24 volts</li> <li>Used with recreational vehicles</li> <li>Also sold separately. Order TCP91F receptacle or TCP91M plug</li> </ul>	

# POLE CONNECTORS & ADAPTERS



## 13 POLE CONNECTORS

Part No.	Description	Illustration	Part No.	Description	Illustration
TCP713M (Plug)	<b>Universal 13-Pole Heavy Duty Trailer Connector Receptacle</b> <ul style="list-style-type: none"> <li>The six small diameter contacts carry up to 25 amps and maintain multiple contact points between the plug and socket</li> <li>The seven standard diameter contacts are "spring grip" design with self adjusting spring band for uniform contact with J560b socket pins</li> <li>Contacts "float" for proper engagement with all mating sockets</li> <li>Surpasses SAE J560b performance standards</li> <li>Conforms to SAE J560b for interchangeability with seven pole sockets and plugs</li> </ul>		TCP713F (socket)	<b>Universal 13-Pole Heavy Duty Trailer Connector Plug</b> <ul style="list-style-type: none"> <li>Rain hood extends beyond socket to protect socket interior</li> <li>Drain channel inside socket with five degree downward angle reduces water retention</li> <li>Gasket sealed door</li> <li>Solid brass contact pins</li> <li>Six crimp on connectors will mate six additional pins</li> <li>Wiring codes embossed on insulator</li> </ul>	

## ADAPTERS

Adapters allow you to tow several other trailers without having to re-wire your tow vehicle.

<b>TC44A</b> <ul style="list-style-type: none"> <li>4-Pole round pin type male and female pre-wired adapter kit</li> </ul>	<b>TC51A</b> <ul style="list-style-type: none"> <li>5-Pole round pin type male and female pre-wired adapter kit</li> </ul>	<b>TC61A</b> <ul style="list-style-type: none"> <li>6-Pole round pin type male and female pre-wired adapter kit</li> </ul>	<b>TC63</b> <ul style="list-style-type: none"> <li>6-Pole round pin type to 4-way flat</li> <li>Flexible wire design</li> </ul>
<b>TC72</b> <ul style="list-style-type: none"> <li>7-way RV blade type to 4-way flat adapter</li> <li>Flexible wire design</li> </ul>	<b>TC73</b> <ul style="list-style-type: none"> <li>7-way round pin heavy duty adapter</li> <li>Optional harness for TC7T test kit</li> </ul>	<b>TC423</b> <ul style="list-style-type: none"> <li>6-Pole 4-wire flat</li> <li>Pre-wire adapter (Plastic)</li> </ul>	<b>TC424</b> <ul style="list-style-type: none"> <li>7-Pole 4-Wire flat RV blade</li> <li>Pre-wired adapter (Plastic)</li> </ul>
<b>TC433</b> <ul style="list-style-type: none"> <li>4-way round pin type to 4-way flat adapter</li> <li>Flexible wire design</li> </ul>	<b>TC456</b> <ul style="list-style-type: none"> <li>6-way round pin type to 4-way flat adapter</li> </ul>	<b>TC457</b> <ul style="list-style-type: none"> <li>7-way RV blade type to 4-way flat adapter</li> </ul>	<b>TC458</b> <ul style="list-style-type: none"> <li>7-way round pin type to 4-way flat adapter</li> </ul>

# ADAPTERS & POWER ADAPTERS

## ADAPTERS

Adapters allow you to tow several other trailers without having to re-wire your tow vehicle.



**TC459**  
• 7-way blade round to 6-pin round adapter



**TC497**  
• 4-wire flat knockout adapter  
(For use w/ 1.25" hole diameter)



**TC534**  
• 6-Pole round to 4-way flat  
• Pre-wired adapter (Metal)



**TC535**  
• 7-Pole RV blade to 4-wire flat  
• Pre-wired adapter (Metal)



**TC541**  
• 4-wire flat to 4-wire and 7 RV round



**TC556**  
• 7-way RV blade to 8-way blade plug



**TC562**  
• 6-way round to 4-wire flat  
(Includes function testing leds)



**TC563**  
• 7-way RV blade to 4-wire flat  
(Includes function testing leds)



**TC564**  
• 7-way RV blade to both 6-round and 4-wire flat  
• Center pin electric brake  
(Center pin can be switched to auxiliary)



**TC565**  
• 7-RV to 6-round  
• Center pin - Auxiliary  
(Center pin can be switched to electric brake)



**TC568**  
• 7-RV blade to 5-flat



**TC569**  
• 7-Pole RV blade to 7 pole pin type

## POWER ADAPTERS

Plug-in 12 volt power adapter supplies 12 volt power from your trailer receptacle. Adapts the trailer connector at the rear of the vehicle to a cigarette lighter plug receptacle. Use for spot lights, car vacuums, electric coolers, air compressors, tailgate parties and more.



**TC65**  
• 6-Pole Round



**TC75**  
• 7-Pole Round RV Adapter



**TC76**  
• 7-Pole Pin Round

# ELECTRONIC BRAKE CONTROL



Electronic trailer brake control for 2 and 4 brake systems. Fits RV'S, Horse, Utility and any trailer with electric brakes. This device controls inertia-activated braking for safe stops. Separate slide controls adjust braking action for different loads. Flexible mounting options and easy to use features. Easy installation includes all mounting hardware. Green lights indicate trailer brakes are connected. The green light changes to red as power to trailer brakes increases.



- TC507**  
**Brake Control Adapter**  
**Ford/Mercury with tow package**
- Excursion .....2008-2003
  - Expedition .....2008-1997
  - Explorer .....2008-2002
  - F-150 .....2008-1994
  - F-250/F-350 .....2004-1994
  - Mountaineer .....2004
  - Van (full size) .....1998-1994
  - Windstar .....2003-1995



- TC508**  
**Brake Control Adapter**  
**Ford with tow package**
- F-Series Pickup .....1993-1992



- TC526**  
**Brake Control Adapter**  
**Dodge with tow package only**
- Ram Full Size Pickup .....2008-1997
  - Durango .....2008-1998



- TC527**  
**Brake Control Connector**  
**CHEVY/GMC/CADILLAC with tow package**
- Denali .....2002-2000
  - Escalade .....2002-2000
  - Sierra .....2002-2000
  - Silverado .....2002-1999
  - Suburban .....2002-2000
  - Tahoe .....2002-2000
  - Yukon .....2002-2000



- TC553**  
**Electronic Brake Control Brake Control Adapter**  
**CHEVY/GMC**
- Avalanche .....2006-2002
  - Denali .....2006-2000
  - Escalade .....2006-2000
  - Hummer H2 .....2006-2003
  - Sierra .....2006-1999
  - Silverado .....2006-1999
  - Suburban .....2006-2000
  - Tahoe .....2006-2000
  - Yukon .....2006-2000













- TC600**  
**Electronic Brake Control**
- Bracket and hardware included

# TRAILER CONNECTORS

## TRAILER CONNECTOR CONVERTERS

### Converters

Universal Converters are designed for vehicles that are not equipped with factory tail light plugs. Power tail light converters completely isolate the tow vehicle from any trailer malfunctions. Power is taken directly from the battery for isolation and brighter tail lights. Each unit can power up to two sets of stop/turn signals on the trailer.

Part No.	Description	Illustration	Part No.	Description	Illustration
TC52	<ul style="list-style-type: none"> <li>• 12 volt negative ground</li> <li>• For all domestic and import cars with separate stop and turn lamps</li> <li>• Converts trailer lights on vehicles with amber turn signals</li> <li>• Complete kit</li> </ul>		TC453	<ul style="list-style-type: none"> <li>• Protects electrical system from self destruction caused by dead shorts from water or wire wear</li> <li>• SMART switch included</li> <li>• CAUTION: You may need TC432 for guaranteed protection. This is for vehicles not designed to handle the additional load created by a trailer-in-tow</li> </ul>	
TC428	<ul style="list-style-type: none"> <li>• Can be used with all cars/trucks/vans with AMBER rear turn signals or with separate bulbs for turn signals and brake lights</li> <li>• Use with 4-wire flat extension TC427</li> </ul>		TC454	<ul style="list-style-type: none"> <li>• Protects sensitive vehicle electrical systems from failure caused by trailer lighting malfunctions</li> </ul>	
TC432	<ul style="list-style-type: none"> <li>• Includes power converter with circuit guardian</li> <li>• Circuit guardian provides protection for vehicles with highly sensitive on-board computers</li> </ul>		TC466	<ul style="list-style-type: none"> <li>• General purpose converter</li> <li>• Tail light converter with (60") input wires</li> <li>• Molded Terminals</li> <li>• For use on cars, vans and trucks with rear AMBER turn signals or with separate bulb for turn signals and lights</li> </ul>	
TC434	<ul style="list-style-type: none"> <li>• T-connector (single plug)</li> <li>• Can be used with all cars/trucks/vans with RED rear turn signal or with "common" bulbs for turn signals and brake lights</li> </ul>		TC528	<ul style="list-style-type: none"> <li>• For Vehicle-To-Vehicle towing. Used on vehicles with common or separate bulbs for the brake lights and turn signals</li> </ul>	
TC452	<ul style="list-style-type: none"> <li>• General purpose converter</li> <li>• CAUTION: You may need TC432 for guaranteed protection. This is for vehicles not designed to handle the additional load created by a trailer-in-tow</li> </ul>		TC550	<ul style="list-style-type: none"> <li>• Short-Proof Power Tail Light Converter</li> <li>• Short Circuit protected</li> <li>• Can power up to 8.0 amps per output</li> <li>• Protects tow vehicle electronics and itself from wiring shorts</li> <li>• Self-resetting</li> </ul>	

## 2-WIRE CONNECTORS

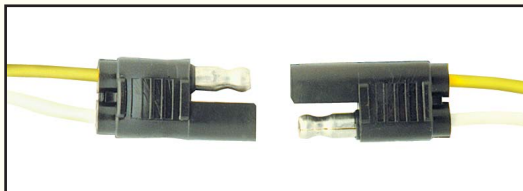

TC23

### 2-Prong Molded Trailer Connector

- 18 gauge pigtails for boats, trailers, etc.
- Requires a single circuit connection
- Plug and receptacle are not sold separately

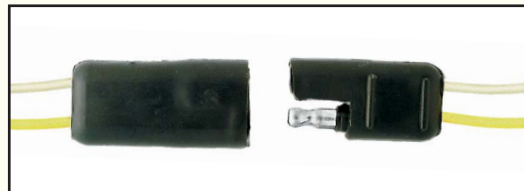

TC23P

### 2-Pole Universal Holder Plug & Receptacle Connector

- Weather resistant protective sleeve
- 18 gauge pigtails
- Plug and receptacle are not sold separately.





### 3-WIRE CONNECTORS

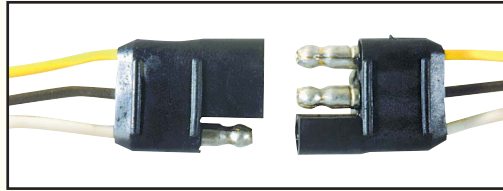

**TC30**  
**3-Pole Molded Trailer Connector**  
 • 18 gauge pigtails for boats, trailers, etc.  
 • Plug and receptacle are not sold separately

### 4-WIRE CONNECTORS

Four wire flat connectors are the most popular trailer plugs available. These plugs are used on small boats, utility, jet ski, snowmobile and/or small campers trailers where right turn/brake, left turn/brake, tail/marker lights and ground are needed.

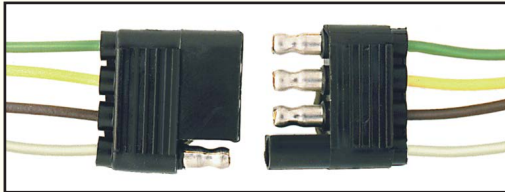

**TC45**  
**12" Tow Vehicle End and 12" Trailer End Set**  
 (Includes 6 quick splice connectors)



**TC45H**  
**29 ft. 4-wire flat connector extension**  
 (Includes 6 splice connectors)

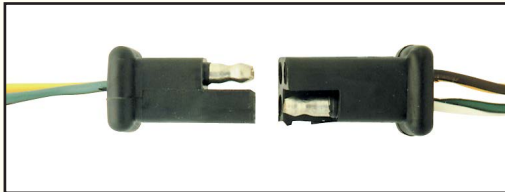

**TC46**  
**Universal 4-Pole Square Type Connector**  
 • 12" leads



**TC48**  
**48" Tow Vehicle End and 12" Trailer End Set**



**TC427**  
**3 ft. long 4-wire trailer extension**  
 • Uses vehicle frame ground  
 • Includes serrated edge ring terminal



**TC430**  
**4 ft. long 4-wire trailer extension**  
 • Passes through vehicle-ground  
 • Color center bonded wire



**TC481**  
**48" Trailer end**

# TRAILER CONNECTORS

## 4-WIRE CONNECTORS (continued)



**TC529**  
12" Tow vehicle end  
(include 3 splice connectors)



**TC530**  
48" Tow vehicle end



**TC531**  
4-Wire flat tow vehicle  
• End knockout connector  
(For use w/1.25" hole diameter)



**TC532**  
12" Trailer end



**TC533**  
10 ft. 4-wire flat extension  
• Ideal for 5th wheel trailers



**TC552**  
48" Tow Vehicle End and 20 ft. Trailer End Y-harness  
• Wishbone design includes 3 splice connectors

## 5-WIRE CONNECTORS

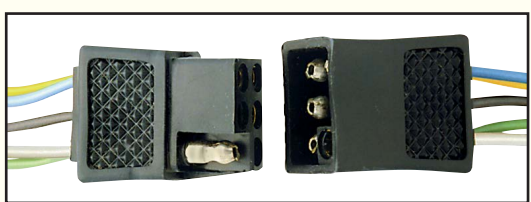

**TC50**  
Universal 5-Pole Trailer Connector  
• Used for vehicles using separate stop light and Directional lamps  
• Plug and receptacle are not sold separately.

## 6-WIRE CONNECTORS



**TC62**  
Universal 6-Pole Trailer Connector  
• Used for trailer requiring a six-circuit connection such as electric brakes

## IN-LINE CONNECTORS

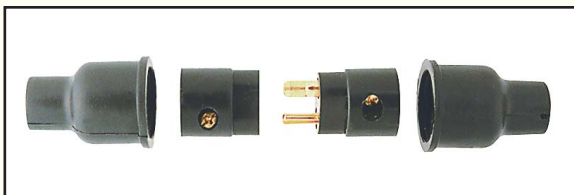

**TC20 (Set)**  
2-Pole Trailer Connector  
• Hard rubber body, soft rubber end caps  
• All brass, metal components, polarized  
• Accepts up to 12 ga. wire



**TC42 (Set)**  
4-Pole Trailer Connector  
• Hard rubber body, soft rubber end caps  
• All brass, metal components, polarized  
• Accepts up to 12 ga. wire

# TRAILER CONNECTOR BRACKETS



## TRAILER CONNECTOR BRACKETS

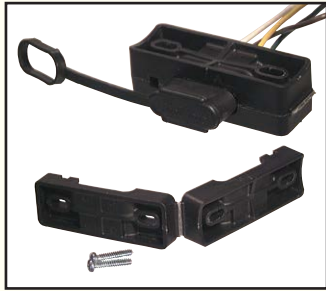

**TCP45C**  
**Vehicle Mounting Bracket**  
 • Used to mount 4-wire trailers



**TCP62C**  
**Universal Trailer Connector Bracket**  
 • 4, 5, 6-Pole mounting bracket  
 • Heavy gauge cadmium plated steel trailer connector bracket

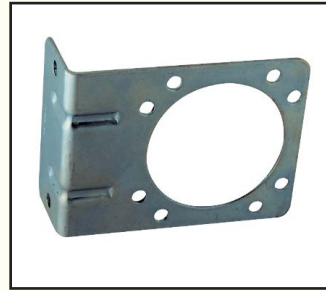

**TCP78C**  
**Universal Trailer Connector Bracket**  
 • 7, 9-Pole mounting bracket  
 • Corrosion-resistant plated steel

## MISCELLANEOUS



**TCP77B**  
**Universal Trailer Connector Socket Boot**  
 • Weatherproof housing  
 • Used with TCP77F

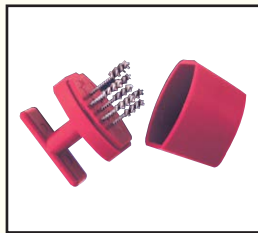

**TC1**  
**Trailer Cable Connector Cleaner - 7 Pin**  
 • Push/pull into plug holes, to clean electrical contact areas  
 • Easy grip handle  
 • Self cover for storage  
 • Sturdy construction



**TC7T**  
**Economy Circuit Tester**  
 • Economy tester finds open circuits, blown fuses, connections quickly and easily. Test lead with alligator clip included

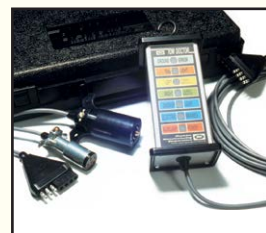

**TC8T**  
**Tow Doctor Vehicle Wire Harness Test Kit**  
 • Tests all tow vehicle functions  
 • Adapts to 4-way flat, 6-way round, 7-way RV blade and 7-way heavy duty pin  
 • Heavy Duty, 20' extension cord  
 • Attractive durable storage case



**TC455**  
**Trailer Connector Sto-Box**  
 • Stores and protects 4-way flat trailer connectors from weather and corrosion  
 • Connects directly onto bumper  
 • Installation looks neat and professional



**TC468**  
**T-connector**  
 • LED 4 pole trailer connector tester



**TC509**  
**Trailer Wiring Circuit Breaker**  
 • Protect vehicle from costly circuit or overload damage  
 • Indicator lights pinpoint location of short

# APPLICATION GUIDE

Vehicle Make/Model	Year	Vehicle Connector	4-Wire Flat	Vehicle Connection Assembly	Universal Converters	Code	Vehicle Make/Model	Year	Vehicle Connector	4-Wire Flat	Vehicle Connection Assembly	Universal Converters	Code
<b>Acura</b>							Regal	04-74	N/A	TC427	N/A	TC434	A
CL	03-97	TC477	NR	N/A	TC432/TC453	B	Rendezvous	07-02	TC559	NR	N/A	TC434	A
Integra	01-94	TC477	NR	N/A	TC428/TC466	B	Riviera	98-86	N/A	TC430	N/A	TC432/TC453	C
Integra	93-86	N/A	TC427	N/A	TC428/TC466	B	Riviera	85-74	N/A	TC427	N/A	TC428/TC466	B
Legend	95-86	N/A	TC430	N/A	TC432/TC453	C	Roadmaster (sedan)	96-91	TC492	NR	N/A	TC434	A
NSX	00-91	N/A	TC430	N/A	TC432/TC453	C	Roadmaster (wagon)	96-91	TC487	TC427	N/A	TC434	A
MDX	06-01	TC477	NR	N/A	TC428/TC466	B	Skyhawk	89-75	N/A	TC427	N/A	TC434	A
RL	03-96	TC477	NR	N/A	TC428/TC466	B	Skylark/Somerset	97-75	N/A	TC427	N/A	TC434	A
SLX	99-96	TC479	NR	N/A	TC428/TC466	B	Terraza	07-05	N/A	TC427	N/A	TC434	A
TL	04-96	TC477	NR	N/A	TC428/TC466	B	<b>Cadillac</b>						
TL	95	N/A	TC430	N/A	TC428/TC466	B	Allante	93-87	N/A	TC430	N/A	TC432/TC453	C
Vigor	94-92	N/A	TC430	N/A	TC432/TC453	C	Calais	84-75	N/A	TC430	N/A	TC432/TC453	C
<b>American Motors</b>							Catera	01-97	N/A	TC430	N/A	TC432/TC453	C
Alliance	87-83	N/A	TC427	N/A	TC428/TC466	B	Cimarron	88-82	N/A	TC427	N/A	TC428/TC466	B
AMX	82-77	N/A	TC427	N/A	TC428/TC466	B	CTS	04-03	N/A	TC427	N/A	TC432/TC453	C
Concord	87-83	N/A	TC427	N/A	TC428/TC466	B	DeVille	00-75	N/A	TC430	N/A	TC432/TC453	C
Eagle	88-80	N/A	TC427	N/A	TC428/TC466	B	Eldorado	00-79	N/A	TC430	N/A	TC432/TC453	C
Matador	78-75	N/A	TC427	N/A	TC434	A	Escalade (provides 6-way or 7RV blade and 4-way towing)	08-01	TC554 or TC555	NR	N/A	TC434	A
Pacer	80-78	N/A	TC427	N/A	TC434	A	Escalade	04-01	TC519	TC427	N/A	TC434	A
Spirit	83-79	N/A	TC427	N/A	TC434	A	Escalade EXT	04-02	TC519	TC427	N/A	TC434	A
<b>Audi</b>							Escalade	00	TC424 <217>	TC427	N/A	TC457 <218>	.....
All models	07-85	N/A	TC430	N/A	TC432/TC453	C	Escalade	99	TC412	TC427	TC412A	TC434	A
<b>BMW</b>							Fleetwood	96-75	N/A	TC430	N/A	TC432/TC453	C
All models	07-85	N/A	TC430	N/A	TC432/TC453	C	Seville	05-98	N/A	TC427	N/A	TC428/TC466	B
<b>Buick</b>							Seville	97-75	N/A	TC430	N/A	TC432/TC453	C
Apollo	75	N/A	TC427	N/A	TC434	A	<b>Chevrolet (includes GEO)</b>						
Century	05-82	N/A	TC427	N/A	TC434	A	Astro	05-95	TC472	TC427	N/A	TC434	A
Century	81-78	N/A	TC427	N/A	TC428/TC466	B	Astro	94-85	N/A	TC427	N/A	TC434	A
Century	77-75	N/A	TC427	N/A	TC434	A	Avalanche (provides 6-way or 7RV blade and 4-way towing)	07-02	TC554 or TC555	NR	N/A	TC434	A
Electra (including Park Avenue)	04-85	N/A	TC430	N/A	TC432/TC453	C	Avalanche	04-02	TC519	TC427	N/A	TC434	A
Enclave	08	TC554 or TC555	NR	N/A	TC434	.....	Beretta	96-88	N/A	TC427	N/A	TC434	A
Electra (including Park Avenue)	84-71	N/A	TC427	N/A	TC434	A	Blazer (ST Series)	02-95	TC472	TC427	N/A	TC434	A
Estate Wagon	96-71	N/A	TC427	N/A	TC434	A	Blazer (full size)	94-92	TC412	TC427	TC412A	TC434	A
Le Sabre	04-90	N/A	TC427	N/A	TC434	A	Blazer (ST Series) (2-door)	94-92	N/A	TC427	N/A	TC434	A
Le Sabre	89-86	N/A	TC430	N/A	TC432/TC453	C	Blazer (ST Series) (4-door)	94-91	N/A	TC427	N/A	TC434	A
Le Sabre	85-75	N/A	TC427	N/A	TC434	A							
Opel	79-76	N/A	TC430	N/A	TC432/TC453	C							
Rainer	07-04	TC554 or TC555	NR	N/A	TC434	.....							

## CHART CODES

- A. 4-Wire Flat
- B. General Purpose Converters
- C. Power Converters

- 217. Vehicle Connector (TC457 also required to service this application)
- 218. Plug Converter (TC424 also required to service this application)
- Note: See Buyers guide for full description and addition link options

# APPLICATION GUIDE



## TRAILER CONNECTORS

Vehicle Make/Model	Year	Vehicle Connector	4-Wire Flat	Vehicle Connection Assembly	Universal Converters	Code	Vehicle Make/Model	Year	Vehicle Connector	4-Wire Flat	Vehicle Connection Assembly	Universal Converters	Code
Blazer (full size)	91-85	TC451	TC427	TC451A	TC434	A	Old Body Style 3/4 ton	00-99	TC412	TC427	TC412A	TC434	A
Blazer (ST Series, 2dr)	91-84	TC413	TC427	TC413A	TC434	A							
Blazer (full size)	84-73	TC441	TC427	TC441A	TC434	A	New Body Style 3/4 ton	04-00	TC519	TC427	N/A	TC434	A
Camaro	02-78	N/A	TC427	N/A	TC428/TC466	B	Pickup (full size)	98-88	TC412	TC427	TC412A	TC434	A
Camaro	77-75	N/A	TC427	N/A	TC434	A	Pickup (full size)	87-85	TC451	TC427	TC451A	TC434	A
Caprice (sedan)	96-91	TC492	NR	N/A	TC434	A	Pickup - including Dual Wheel (full size)	84-75	TC441	TC427	TC441A	TC434	A
Caprice (wagon)	96-91	TC487	NR	N/A	NR	.....							
Caprice/Bel Air	90-75	N/A	TC427	N/A	TC434	A							
Cavalier	03-88	N/A	TC427	N/A	TC434	A	S-10 Pickup	03-98	TC504	TC430	N/A	TC434	A
Cavalier	87-82	N/A	TC427	N/A	TC428/TC466	B	Silverado (New Body Style) - 3/4 ton	01-99	TC519	TC427	N/A	TC434	A
Celebrity	90-85	N/A	TC427	N/A	TC434	A							
Celebrity	84-82	N/A	TC427	N/A	TC428/TC466	B	Silverado (1500/2500 with tow package)	04-00	TC519	TC427	N/A	TC434	A
Chevelle/Malibu	83-75	N/A	TC427	N/A	TC434	A							
Cobalt	08-05	N/A	TC427	N/A	TC434	A	Silverado (1500 w/o tow package)	04-03	TC519	TC427	N/A	TC434	A
Corsica	96-87	N/A	TC427	N/A	TC434	A							
Corvette	01-75	N/A	TC430	N/A	TC432/TC453	C	Silverado (2500 w/o tow package)	04-00	TC519	TC427	N/A	TC434	A
Corvette	04-03	N/A	TC427	N/A	TC434	A	Silverado	08-03	TC554 or TC555	NR	N/A	TC434	.....
El Camino	87-75	N/A	TC427	N/A	TC434	A	Spectrum	96-87	N/A	TC430	N/A	TC432/TC453	C
Express Van	07-03	TC558	NR	N/A	TC428/TC466	B	Storm	96-90	N/A	TC430	N/A	TC432/TC453	C
Express Van (full size)	02-00	TC524	TC427	N/A	TC434	A	Suburban (provides 6-way or 7RV blade and 4-way towing)	07-00	TC554 or TC555	NR	N/A	TC434	A
Express Van (full size)	99-96	TC517	TC427	N/A	TC428/TC466	B							
Impala	03-99	N/A	TC427	N/A	TC434	A	Suburban	04-00	TC519	TC427	N/A	TC434	A
Impala	96-94	TC492	NR	N/A	NR	.....							
Impala	83-75	N/A	TC427	N/A	TC434	A	Suburban	99-92	TC412	TC427	TC412A	TC434	A
Lumina (sedan)	99-90	N/A	TC427	N/A	TC434	A	Suburban	91-85	TC451	TC427	TC451A	TC434	A
Lumina APV	96-93	TC488	NR	N/A	NR	.....	Suburban	84-73	TC441	TC427	TC441A	TC434	A
Lumina APV	92-90	N/A	TC427	N/A	TC434	A	Syclone (ST Series)	92-91	TC451	TC427	TC451A	TC434	A
Malibu	08-97	N/A	TC427	N/A	TC428/TC466	B	Tahoe (provides 6-way or 7RV blade and 4-way towing)	08-00	TC554 or TC555	NR	N/A	TC434	A
Malibu	83-75	N/A	TC427	N/A	TC434	A							
Metro	00-89	N/A	TC430	N/A	TC432/TC453	C	Tahoe	07-00	TC519	TC427	N/A	TC434	A
Monte Carlo	06-00	N/A	TC427	N/A	TC428/TC466	B	Tahoe	99-95	TC412	TC427	TC412A	TC434	A
Monte Carlo	99-95	N/A	TC427	N/A	TC434	A	Tracker	04-99	TC560	NR	N/A	TC428/TC466	B
Monte Carlo	88-75	N/A	TC427	N/A	TC434	A	Tracker	98-89	N/A	TC427	N/A	TC428/TC466	B
Monza	80-75	N/A	TC427	N/A	TC434	A	Trailblazer ST Series (provides 6-way or 7RV blade and 4-way towing)	07-02	TC554 or TC555	NR	N/A	TC434	A
Nova	88-85	N/A	TC430	N/A	TC432/TC453	C							
Nova	79-75	N/A	TC427	N/A	TC434	A	Trailblazer	04-02	TC519	TC427	N/A	TC434	A
Prizm	99-90	N/A	TC427	N/A	TC428/TC466	B							
Pickup (full size) New Body Style, 1/2 ton	00-99	TC424<217>	TC427	N/A	TC457<218>	.....							

### CHART CODES

- A. 4-Wire Flat
- B. General Purpose Converters
- C. Power Converters

- 217. Vehicle Connector (TC457 also required to service this application)
  - 218. Plug Converter (TC424 also required to service this application)
- Note: See Buyers guide for full description and addition link options

# APPLICATION GUIDE

Vehicle Make/Model	Year	Vehicle Connector	4-Wire Flat	Vehicle Connection Assembly	Universal Converters	Code	Vehicle Make/Model	Year	Vehicle Connector	4-Wire Flat	Vehicle Connection Assembly	Universal Converters	Code
Van (full size except Express)	96-87	TC516	TC427	N/A		A	Caravan	95-91	TC439	TC427	N/A	TC434	A
Van (full size)	86-78	N/A	TC427	N/A		A	Caravan	90-84	N/A	TC427	N/A	TC434	A
Van	77-75	N/A	TC427	N/A	TC434	A	Challenger	83-81	N/A	TC427	N/A	TC428/TC466	B
Venture	05-97	TC510	TC427	N/A	TC428/TC466	B	Challenger	81-76	N/A	TC427	N/A	TC434	A
<b>Chrysler</b>							Charger	87-75	N/A	TC427	N/A	TC434	A
300C	07-05	N/A	TC430	N/A	TC432/TC453	C	Colt	95-75	N/A	TC427	N/A	TC428/TC466	B
300M	00-99	N/A	TC430	N/A	TC432/TC453	C	Diplomat	89-77	N/A	TC427	N/A	TC434	A
Cirrus	00-95	N/A	TC430	N/A	TC432/TC453	C	Durango	03-98	TC473	NR	N/A	TC428/TC466	B
Concorde	04-93	N/A	TC430	N/A	TC432/TC453	C	Dynasty	93-88	N/A	TC427	N/A	TC434	A
Cordoba	83-80	N/A	TC427	N/A	TC434	A	Grand Caravan	03-01	TC540	NR	N/A	TC428/TC466	B
Crossfire	06-04	N/A	TC430	N/A	TC432/TC453	C	Grand Caravan	00-96	TC473	NR	N/A	TC428/TC466	B
E-Class	84-83	N/A	TC427	N/A	TC434	A	Grand Caravan	95-91	TC439	TC427	N/A	TC434	A
Fifth Avenue (rear wheel drive)	89-82	N/A	TC427	N/A	TC434	A	Grand Caravan	90-84	N/A	TC427	N/A	TC434	A
Imperial	93-84	N/A	TC430	N/A	TC432/TC453	C	Intrepid	04-93	N/A	TC430	N/A	TC432/TC453	C
Imperial	83-75	N/A	TC427	N/A	TC434	A	Lancer	89-85	N/A	TC427	N/A	TC434	A
Laser	86-84	N/A	TC430	N/A	TC432/TC453	C	Mirada	83-80	N/A	TC427	N/A	TC434	A
LeBaron	95-90	N/A	TC430	N/A	TC432/TC453	C	Neon	03-95	N/A	TC427	N/A	TC434	A
LeBaron	89-77	N/A	TC427	N/A	TC434	A	Omni	90-78	N/A	TC427	N/A	TC434	A
LHS	00-94	N/A	TC430	N/A	TC432/TC453	C	Raider	89-87	N/A	TC427	N/A	TC428/TC466	B
New Yorker	96-88	N/A	TC430	N/A	TC432/TC453	C	Rampage	84-82	N/A	TC427	N/A	TC434	A
New Yorker	87-75	N/A	TC427	N/A	TC434	A	Scamp	83	N/A	TC427	N/A	TC434	A
Pacifica	08-03	N/A	TC430	N/A	TC432/TC453	C	Shadow	94-87	N/A	TC427	N/A	TC434	A
Sebring	08-02	N/A	TC427	N/A	TC428/TC466	B	Spirit	95-89	N/A	TC430	N/A	TC432/TC453	C
Town & Country	03-01	TC540	NR	N/A	TC428/TC466	B	Stealth	96-91	N/A	TC430	N/A	TC432/TC453	C
Town & Country	00-96	TC473	TC427	N/A	TC428/TC466	B	Stratus	99-98	N/A	TC430	N/A	TC432/TC453	C
Town & Country	95-91	TC439	TC427	N/A	TC434	A	Stratus	07-95	N/A	TC430	N/A	TC432/TC453	C
Town & Country	90-84	N/A	TC427	N/A	TC434	A	Viper	00-93	N/A	TC430	N/A	TC432/TC453	C
<b>Daihatsu</b>							Vista	91-84	N/A	TC427	N/A	TC428/TC466	B
Charade	93-89	N/A	TC427	N/A	TC428/TC466		<b>Dodge Trucks</b>						
Rocky	94-90	N/A	TC427	N/A	TC428/TC466		Arrow Pickup	83-79	N/A	TC427	N/A	TC428/TC466	B
<b>Dodge</b>							B Series (full size van)	00-99	TC518	TC427	N/A	TC434	A
400	83-82	N/A	TC427	N/A	TC434	A	B Series (full size van)	98-93	TC465	TC427	N/A	TC434	A
600	88-83	N/A	TC427	N/A	TC434	A	B Series (full size van)	92-75	N/A	TC427	N/A	TC434	A
Aries	89-81	N/A	TC427	N/A	TC434	A	Caravan	03-01	TC540	NR	N/A	TC428/TC466	B
Aspen	80-76	N/A	TC427	N/A	TC434	A	Caravan	00-96	TC473	TC427	N/A	TC428/TC466	B
Avenger	00-95	N/A	TC430	N/A	TC432/TC453	C	Caravan	95-91	TC439	TC427	N/A	TC434	A
Caravan	03-01	TC540	NR	N/A	TC428/TC466	B							
Caravan	00-96	TC473	NR	N/A	TC428/TC466	B							

## CHART CODES

A. 4-Wire Flat

B. General Purpose Converters

C. Power Converters

217. Vehicle Connector (TC457 also required to service this application)

218. Plug Converter (TC424 also required to service this application)

Note: See Buyers guide for full description and addition link options

# APPLICATION GUIDE



Vehicle Make/Model	Year	Vehicle Connector	4-Wire Flat	Vehicle Connection Assembly	Universal Converters	Code	Vehicle Make/Model	Year	Vehicle Connector	4-Wire Flat	Vehicle Connection Assembly	Universal Converters	Code
Caravan	90-84	N/A	TC427	N/A	TC434	A	Crown Victoria/LTD	03-98	N/A	TC427	N/A	TC428/TC466	B
D Series/W Series (Pickup full size)	93-87	TC414	TC427	TC414A	TC434	A	Crown Victoria/LTD	97-94	TC482	TC430	N/A	TC432/TC453	C
D Series/W Series (Ram Pickup)	86-76	N/A	TC427	N/A	TC434	A	Crown Victoria/LTD	93-83	N/A	TC430	N/A	TC432/TC453	C
Dakota	01-95	TC462	TC427	TC462A	TC434	A	Crown Victoria/LTD	82-75	N/A	TC427	N/A	TC434	A
Dakota	94-88	TC414	TC427	TC414A	TC434	A	Escort (sedan)	03-97	TC506	TC430	N/A	TC434	A
Dakota	87	N/A	TC427	N/A	TC434	A	Escort (wagon)	99-97	N/A	TC427	N/A	TC428/TC466	B
Grand Caravan	03-01	TC540	NR	N/A	TC428/TC466	B	Escort	96-81	N/A	TC430	N/A	TC432/TC453	C
Durango	07	TC554	.....	.....	.....	.....	EXP	88-82	N/A	TC430	N/A	TC432/TC453	C
Durango	03-98	TC473	TC427	N/A	TC428/TC466	B	Fairmont/Futura	83-78	N/A	TC427	N/A	TC434	A
Grand Caravan	00-96	TC473	TC427	N/A	TC428/TC466	B	Festiva	93-88	N/A	TC427	N/A	TC428/TC466	B
Grand Caravan	95-91	TC439	TC427	N/A	TC434	A	Focus	00	N/A	TC430	N/A	TC432/TC453	C
Grand Caravan	90-84	N/A	TC427	N/A	TC434	A	Granada	82-75	N/A	TC427	N/A	TC428/TC466	B
Ram Pickup 1500	06-02	TC545	NR	N/A	TC428/TC466	B	LTD II	79-77	N/A	TC427	N/A	TC434	A
Ram Pickup 2500	06-03	TC545	NR	N/A	TC428/TC466	B	Mustang (Cobra only)	00-99	N/A	TC427	N/A	TC428/TC466	B
Ram Pickup 3500 (except Chassis Cab)	06-03	TC545	NR	N/A	TC428/TC466	B	Mustang (except Cobra)	04-94	TC482	TC430	N/A	TC432/TC453	C
Ram Pickup (Cab & Chassis only)	02-87	TC414	TC427	TC414A	TC434	A	Mustang	93-87	N/A	TC430	N/A	TC432/TC453	C
Ram Pickup 2500	02-94	TC462	TC427	TC462A	TC434	A	Mustang	86-75	N/A	TC427	N/A	TC434	A
Ram Pickup 3500 (except Chassis Cab)	02-94	TC462	TC427	TC462A	TC434	A	Pinto	80-75	N/A	TC427	N/A	TC434	A
Ramcharger	93-88	TC414	TC427	TC414A	TC434	A	Probe	97-89	N/A	TC430	N/A	TC432/TC453	C
Ramcharger	87-75	N/A	TC427	N/A	TC434	A	Taurus (sedan)	03-00	TC548	NR	N/A	TC428/TC466	B
Rampage	84-82	N/A	TC427	N/A	TC434	A	Taurus (wagon)	01-96	N/A	TC430	N/A	TC432/TC453	C
Ram 50	93	N/A	TC427	N/A	TC466/TC428	A	Taurus (sedan)	99-96	TC483	TC430	N/A	TC432/TC453	C
Ram 50	92-79	N/A	TC427	N/A	TC428/TC466	B	Taurus (sedan)	95-92	TC470	TC430	N/A	TC432/TC453	C
Trailduster	93-88	TC414	TC427	TC414A	TC434	A	Taurus (wagon)	95-86	N/A	TC427	N/A	TC434	A
Trailduster	87-75	N/A	TC427	N/A	TC434	A	Taurus (sedan)	91-87	N/A	TC430	N/A	TC432/TC453	C
Voyager	03-01	TC540	NR	N/A	TC428/TC466	B	Tempo	94-84	N/A	TC430	N/A	TC432/TC453	C
Voyager	00-96	TC473	TC427	N/A	TC428/TC466	B	E Series - E150, E250	03-95	TC506	NR	N/A	TC434	A
Voyager	95-91	TC439	TC427	N/A	TC434	A	Thunderbird	97-83	N/A	TC430	N/A	TC432/TC453	C
Voyager	90-84	N/A	TC427	N/A	TC434	A	Thunderbird	82-74	N/A	TC427	N/A	TC434	A
<b>Eagle</b>							Torino	76-75	N/A	TC427	N/A	TC434	A
Summit	96-89	N/A	TC427	N/A	TC428/TC466	B	Windstar	00-99	TC523	N/A	N/A	N/A	
Talon	96-92	N/A	TC430	N/A	TC432/TC453	C	Windstar	98-95	TC464	TC427	N/A	TC428/TC466	B
Talon	91-90	N/A	TC427	N/A	TC434	A	ZX2 -Sedan	03-98	TC506	TC430	N/A	TC434	A
Vision	96-93	N/A	TC430	N/A	TC432/TC453	C	<b>Ford Trucks</b>						
<b>Ford</b>							Aerostar	97	TC506	NR	N/A	TC434	A
Aspire	97-94	N/A	TC430	N/A	TC432/TC453	C	Aerostar	96-86	N/A	TC427	N/A	TC428/TC466	B
Contour	00-95	N/A	TC430	N/A	TC432/TC453	C	Bronco	96-92	TC469	TC430	TC469A	TC434	A

## CHART CODES

A. 4-Wire Flat

B. General Purpose Converters

C. Power Converters

217. Vehicle Connector (TC457 also required to service this application)

218. Plug Converter (TC424 also required to service this application)

Note: See Buyers guide for full description and addition link options

# APPLICATION GUIDE

Vehicle Make/Model	Year	Vehicle Connector	4-Wire Flat	Vehicle Connection Assembly	Universal Converters	Code	Vehicle Make/Model	Year	Vehicle Connector	4-Wire Flat	Vehicle Connection Assembly	Universal Converters	Code
Bronco	91-89	TC419	TC427	TC419A	TC434	A	F Series - F250 Light Duty	03-98	TC520	NR	N/A	TC434	A
Bronco	88-87	TC418	TC427	TC418A	TC434	A		03-97	TC520	NR	N/A	TC434	A
Bronco	86-81	TC421	TC427	TC421A	TC434	A		97	TC416	TC427	TC416A	TC434	A
Bronco	80	N/A	TC427	N/A	TC434	A		97	TC494	NR	N/A	TC434	A
Bronco	79-73	TC411	TC427	N/A	TC434	A		97	TC494	NR	N/A	TC434	A
Bronco II	90-87	TC420	TC427	TC420A	TC434	A		97	TC494	NR	N/A	TC434	A
Bronco II	86-84	N/A	TC427	N/A	TC434	A		97	TC494	NR	N/A	TC434	A
Escape (w/o tow package)	03-01	TC463	TC430	N/A	TC432/TC453	C		97	TC494	NR	N/A	TC434	A
Escape (w/ tow package)	04-01	TC536	NR	N/A	TC434	A		97	TC494	NR	N/A	TC434	A
E Series - E150, E250	03-95	TC506	NR	N/A	TC434	A		96-87	TC416	TC427	TC416A	TC434	A
E Series - E150/350	94-92	N/A	TC427	N/A	TC428/TC466	B	86-80	TC421	TC427	TC421A	TC434	A	
E Series - E150/350	91-75	N/A	TC427	N/A	TC434	A	79-75	TC411	TC427	N/A	TC434	A	
Excursion (provides 6-way or 7RV blade and 4-way towing)	05-00	TC554 or TC555	NR	N/A	TC434	A	03	N/A	TC427	N/A	TC434	A	
Expedition (with factory 7-way)	07-00	TC554 or TC555	NR	N/A	TC434	A	03-00	N/A	TC427	N/A	TC428/TC466	B	
Expedition	02-00	TC539	NR	N/A	TC434	A	03-00	N/A	TC427	N/A	TC434	A	
Expedition - tow pkg. replacement adaptor	99-97	TC494	NR	N/A	TC434	A	99-98	TC498	TC427	N/A	TC434	A	
Explorer	07-02	TC546	NR	N/A	TC434	A	99-93	TC436	TC427	TC436A	TC428/TC466	B	
Explorer (with factory 7-way)	04-02	TC554 or TC555	NR	N/A	TC434	A	92-86	TC431	TC427	TC431A	TC434	A	
Explorer (w/o tow pkg.)	00-95	TC463	TC430	N/A	TC432/TC453	C	85	TC421	TC427	TC421A	TC434	A	
Explorer (w/o tow pkg.)	00-95	TC498	TC427	N/A	TC434	A	03-99	TC523	NR	N/A	N/A	.....	
Explorer (vehicle equipped with tow prep only)	97-96	TC499	TC430	TC499A	TC432/TC453	C	98-95	TC464	NR	N/A	TC428/TC466	B	
Explorer (with tow pkg.)	94-91	TC422	TC427	TC422A	TC434	A	<b>GMC</b>						
Explorer Sport Trac	04-01	N/A	TC427	N/A	TC434	A	Astro	03-95	TC472	NR	N/A	TC434	A
F250, F350 Heavy Duty	04-02	TC547	NR	N/A	TC434	A	Astro	94-85	N/A	TC427	N/A	TC434	A
F Series Pickup (with factory 7-way)	07-99	TC554 or TC555	NR	N/A	TC434	A	Blazer (ST Series)	03-95	TC472	NR	N/A	TC434	A
F Series - F250, F350 Heavy Duty	01-99	TC522	NR	N/A	TC434	A	Blazer (full size)	94-92	TC412	TC427	TC412A	TC434	A
							Blazer - 4-door (ST Series)	94-91	N/A	TC427	N/A	TC434	A
							Blazer (full size)	91-85	TC451	TC427	TC451A	TC434	A
							Bravada (provides 6-way or 7RV blade and 4-way towing)	04-02	TC554 or TC555	NR	N/A	TC434	A
							Blazer - 2-door (ST Series)	91-84	TC413	TC427	TC413A	TC434	A
							Blazer (full size)	84-75	TC441	TC427	TC441A	TC434	A
							Bravada (ST Series)	01-95	TC472	NR	N/A	TC434	A

## CHART CODES

- A. 4-Wire Flat
- B. General Purpose Converters
- C. Power Converters

- 217. Vehicle Connector (TC457 also required to service this application)
- 218. Plug Converter (TC424 also required to service this application)
- Note: See Buyers guide for full description and addition link options



# APPLICATION GUIDE



## TRAILER CONNECTORS

Vehicle Make/Model	Year	Vehicle Connector	4-Wire Flat	Vehicle Connection Assembly	Universal Converters	Code	Vehicle Make/Model	Year	Vehicle Connector	4-Wire Flat	Vehicle Connection Assembly	Universal Converters	Code
Bravada - 4-door (ST Series)	94-91	N/A	TC427	N/A	TC434	A	Sierra (1500) (w/o tow package)	04-03	TC519	TC427	N/A	TC434	A
Caballero / El Camino	87-78	N/A	TC427	N/A	TC434	A	Sierra (2500) (w/o tow package)	04-00	TC519	TC427	N/A	TC434	A
Denali (CK Series)	00-99	TC412	TC427	TC412A	TC434	A	Sierra (1500/2500 with tow package)	04-00	TC519	TC427	N/A	TC434	A
Denali (CK Series)	04-01	TC519	TC427	N/A	TC434	A	Sonoma (ST Series)	01-98	TC504	TC430	N/A	TC434	A
Envoy (ST Series) - New Body Style (provides 6-way or 7RV blade and 4-way towing)	07-02	TC554 or TC555	NR	N/A	TC434	A	Sonoma (ST Series)	96-85	TC451	TC427	TC451A	TC434	A
Envoy (ST Series)	04-02	TC519	TC427	N/A	TC434	A	ST Series - Pickup	03-98	TC504	TC430	N/A	TC434	A
Envoy (ST Series)	01-99	TC472	NR	N/A	TC434	A	ST Series - Pickup	97-85	TC451	TC427	TC451A	TC434	A
Express Van - New Body Style (G Series)	00	TC524	TC530	N/A	TC434	A	Suburban (provides 6-way or 7RV blade and 4-way towing)	07-00	TC554 or TC555	NR	N/A	TC434	A
Express Van - New Body Style (G Series)	99-96	TC517	TC430	N/A	TC434	A	Suburban (CK Series)	99-92	TC412	TC427	TC412A	TC434	A
Jimmy (ST Series)	01-95	TC472	NR	N/A	TC434	A	Suburban (CK/RV Series)	91-85	TC451	TC427	TC451A	TC434	A
Jimmy - 4-door (full size)	94-92	TC412	TC427	TC412A	TC434	A	Suburban (CK Series)	84-75	TC441	TC427	TC441A	TC434	A
2-door (full size)		N/A	TC427	N/A	TC434	A	Tahoe (provides 6-way or 7RV blade and 4-way towing)	07-00	TC554 or TC555	NR	N/A	TC434	A
Jimmy (full size)	91-85	TC451	TC427	TC451A	TC434	A	Tahoe (CK Series)	04-00	TC519	TC427	N/A	TC434	A
Jimmy - 2-door (ST Series)	91-84	TC413	TC427	TC413A	TC434	A	Tahoe (CK Series)	99-95	TC412	TC427	TC412A	TC434	A
Jimmy (full size)	84-75	TC441	TC427	TC441A	TC434	A	Tracker	00-98	N/A	TC427	N/A	TC428/TC466	B
Pickup (full size) New Body Style 1/2 ton	00-99	TC424<217>	TC427	N/A	TC457<218>	.....	Tracker	97-89	N/A	TC427	N/A	TC428/TC466	B
Old Body Style 3/4 ton	00-99	TC412	TC427	TC412A	TC434	A	Van - full size (G Series)	96-87	TC516	TC427	N/A	TC434	A
New Body Style 3/4 ton	04-00	TC519	TC427	N/A	TC434	A	Vandura - full size (G Series)	86-71	N/A	TC427	N/A	TC434	A
Pickup (full size)	98-88	TC412	TC427	TC412A	TC434	A	Venture	03-97	TC510	TC427	N/A	TC428/TC466	B
Pickup (full size)	87-85	TC451	TC427	TC451A	TC434	A	Yukon (provides 6-way or 7RV blade and 4-way towing)	07-00	TC554 or TC555	NR	N/A	TC434	A
Pickup - including dual wheel (full size)	84-75	TC441	TC427	TC441A	TC434	A	Yukon (CK Series)	04-00	TC519	TC427	N/A	TC434	A
Safari	03-95	TC472	NR	N/A	TC434	A	Yukon (CK Series)	99-95	TC412	TC427	TC412A	TC434	A
Safari	94-85	N/A	NR	N/A	TC434	A	<b>Honda</b>						
Savana - New Body Style (G Series)	01-00	TC524	TC430	N/A	TC434	A	Accord (sedan)	02-94	TC477	NR	N/A	TC428/TC466	B
Savana	07-03	TC558	NR	N/A	TC428/TC466	B	Accord (wagon)	96-94	TC477	TC427	N/A	TC428/TC466	B
Savana - New Body Style (G Series)	99-96	TC517	TC430	N/A	TC434	A							

### CHART CODES

A. 4-Wire Flat  
 B. General Purpose Converters  
 C. Power Converters

217. Vehicle Connector (TC457 also required to service this application)  
 218. Plug Converter (TC424 also required to service this application)  
 Note: See Buyers guide for full description and addition link options

# APPLICATION GUIDE

Vehicle Make/Model	Year	Vehicle Connector	4-Wire Flat	Vehicle Connection Assembly	Universal Converters	Code	Vehicle Make/Model	Year	Vehicle Connector	4-Wire Flat	Vehicle Connection Assembly	Universal Converters	Code
Accord	93-76	N/A	TC427	N/A	TC428/TC466	B	Pickup	01-98	TC504	TC430	N/A	TC434	A
Civic	02-82	N/A	TC430	N/A	TC432/TC453	C	Pickup	97-96	TC451	TC427	TC451A	TC434	A
Civic - Del Sol	96-93	N/A	TC430	N/A	TC432/TC453	C	Pickup	95-81	TC495	TC427	N/A	TC428/TC466	B
CRV	04-97	TC477	NR	N/A	TC428/TC466	B	Rodeo	02-98	TC525	TC430	N/A	TC428/TC466	B
Element	04-03	TC477	NR	N/A	TC428/TC466	B	Rodeo	97-92	TC478	NR	N/A	TC428/TC466	B
Odyssey	04-95	TC477	NR	N/A	TC428/TC466	B	Stylus	93-91	N/A	TC427	N/A	TC428/TC466	B
Passport	02-98	TC525	TC430	N/A	TC432/TC453	C	Trooper	01-92	TC479	NR	N/A	TC428/TC466	B
Passport	97-94	TC478	NR	N/A	TC428/TC466	B	Trooper	91-88	N/A	TC427	N/A	TC428/TC466	B
Pilot	04-03	TC477	NR	N/A	TC428/TC466	B	Vehicross	01-99	N/A	TC427	N/A	TC428/TC466	B
Prelude	01-83	N/A	TC430	N/A	TC432/TC453	C	<b>Jaguar</b>						
<b>Hummer</b> (provides 6-way or 7RV blade and 4-way towing)	07-03	TC554 or TC555	NR	N/A	TC434	A	All models	00-86	N/A	TC430	N/A	TC432/TC453	C
<b>Hyundai</b>							<b>Jeep</b>						
Accent	03-95	N/A	TC427	N/A	TC428/TC466	B	Cherokee	01-97	TC502	TC430	N/A	TC428/TC466	B
Elantra	03-92	N/A	TC427	N/A	TC428/TC466	B	Cherokee	96-91	TC437	TC427	N/A	TC428/TC466	B
Excel	96-86	N/A	TC427	N/A	TC428/TC466	B	Cherokee	90-84	N/A	TC427	N/A	TC428/TC466	B
Santa Fe	06-01	TC561	NR	N/A	TC428/TC466	B	Cherokee	83-76	TC461	TC427	N/A	TC434	A
Scoupe	96-91	N/A	TC427	N/A	TC428/TC466	B	CJ-5	86-77	N/A	TC427	N/A	TC434	A
Sonata	00-89	N/A	TC427	N/A	TC428/TC466	B	CJ-7	86-77	N/A	TC427	N/A	TC434	A
Tiburon	00-97	N/A	TC427	N/A	TC428/TC466	B	Comanche	92-86	N/A	TC427	N/A	TC434	A
<b>Infiniti</b>							Grand Cherokee	04-99	TC521	TC430	N/A	TC432/TC453	C
FX35	08-05	N/A	TC430	N/A	TC432/TC453	C	Grand Cherokee (with tow pkg.)	98-95	TC476	TC430	N/A	TC432/TC453	C
G20	01-99	N/A	TC430	N/A	TC432/TC453	C	Grand Cherokee (w/o tow pkg.)	98-94	TC475	TC430	N/A	TC432/TC453	C
G20	96-91	N/A	TC430	N/A	TC432/TC453	C	Grand Cherokee	93	TC474	NR	N/A	TC432/TC453	C
I30	01-95	N/A	TC430	N/A	TC432/TC453	C	Grand Wagoneer	91-84	N/A	TC427	N/A	TC428/TC466	B
J30	98-93	N/A	TC430	N/A	TC432/TC453	C	J-10 Truck	88-75	N/A	TC427	N/A	TC434	A
Q45	01-90	N/A	TC430	N/A	TC432/TC453	C	J-20 Truck	88-75	N/A	TC427	N/A	TC434	A
Q56	07-04	TC554 or TC555	NR	N/A	TC434	A	Liberty	07-02	TC551	TC430	N/A	TC432/TC453	C
QX4	03-96	TC500	TC430	N/A	TC428/TC466	B	Scrambler	86-77	N/A	TC427	N/A	TC434	A
<b>Isuzu</b>							Wagoneer (compact)	90-84	N/A	TC430	N/A	TC432/TC453	C
Amigo	01-98	TC525	TC430	N/A	TC428/TC466	B	Wagoneer (full size)	83-75	N/A	TC427	N/A	TC434	A
Amigo	94-89	N/A	TC427	N/A	TC428/TC466	B	Wrangler (including YJ and Renegade)	03-98	TC515	TC430	N/A	TC434	A
Ascender	06-04	TC554 or TC555	NR	N/A	TC434	A	Wrangler (including YJ and Renegade)	97-91	TC490	TC427	N/A	TC434	A
Axion	02	TC525	TC430	N/A	TC428/TC466	B	Wrangler	90-87	N/A	TC427	N/A	TC434	A
Hombre	00-98	TC504	TC430	N/A	TC434	A	<b>Kia</b>						
Hombre	97-96	TC451	TC427	TC451A	TC434	A	Rio	03-01	N/A	TC427	N/A	TC428/TC466	B
I-Mark	89-81	N/A	TC427	N/A	TC428/TC466	B	Sedona	03-02	N/A	TC427	N/A	TC428/TC466	B
Impulse	93-83	N/A	TC430	N/A	TC432/TC453	C	Sephia	02-94	N/A	TC427	N/A	TC428/TC466	B
Oasis	98-96	TC477	NR	N/A	TC428/TC466	B							

## CHART CODES

- A. 4-Wire Flat
- B. General Purpose Converters
- C. Power Converters

- 217. Vehicle Connector (TC457 also required to service this application)
- 218. Plug Converter (TC424 also required to service this application)
- Note: See Buyers guide for full description and addition link options

# APPLICATION GUIDE



## TRAILER CONNECTORS

Vehicle Make/Model	Year	Vehicle Connector	4-Wire Flat	Vehicle Connection Assembly	Universal Converters	Code	Vehicle Make/Model	Year	Vehicle Connector	4-Wire Flat	Vehicle Connection Assembly	Universal Converters	Code
Sorento	03	N/A	TC427	N/A	TC428/TC466	B	Millenia	02-95	N/A	TC430	N/A	TC432/TC453	C
Spectra	03-01	N/A	TC427	N/A	TC428/TC466	B	MX-3	96-92	N/A	TC430	N/A	TC432/TC453	C
Sportage	02-94	N/A	TC427	N/A	TC428/TC466	B	MX-5	97-88	N/A	TC430	N/A	TC432/TC453	C
<b>Lexus</b>							MX-6	97-88	N/A	TC430	N/A	TC432/TC453	C
ES300	01-91	N/A	TC430	N/A	TC432/TC453	C	Navajo (with tow package)	94-91	TC422 TC460	TC427 NR	TC422A N/A	TC434 TC434	A A
GS 300	01-91	N/A	TC430	N/A	TC432/TC453	C	Pickup	03	N/A	TC427	N/A	TC434	A
GS400	01-91	N/A	TC430	N/A	TC432/TC453	C	Pickup (with tow package)	99-98	TC498	NR	N/A	TC434	A
LS400	01-91	N/A	TC430	N/A	TC432/TC453	C	Pickup (w/o tow package)	99-94	TC436	TC427	TC436A	TC428/TC466	B
LX450	97-96	TC505	TC430	N/A	TC432/TC453	C	Pickup	93-85	TC496	TC427	N/A	TC428/TC466	B
LX470	01-91	N/A	TC430	N/A	TC432/TC453	C	Pickup	02-00	N/A	TC427	N/A	TC434	A
RX300	01-91	N/A	TC430	N/A	TC432/TC453	C	Pickup	99-91	N/A	TC430	N/A	TC432/TC453	C
SC300	00-91	N/A	TC430	N/A	TC432/TC453	C	Protege	96-79	N/A	TC430	N/A	TC432/TC453	C
SC400	00-91	N/A	TC430	N/A	TC432/TC453	C	RX-7	03-01	TC463	TC430	N/A	TC432/TC453	C
<b>Lincoln</b>							Tribute (w/o tow package)	04-01	TC536	NR	N/A	TC434	A
Aviator	04	TC546	NR	N/A	TC434	A	Tribute (with tow package)	00-89	N/A	TC430	N/A	TC432/TC453	C
Aviator (w/ factory 7-way)	04-03	TC554 or TC555	NR	N/A	TC434	A	<b>Mercedes Benz</b>						
Continental	01-88	N/A	TC430	N/A	TC432/TC453	C	All models	01-86	N/A	TC430	N/A	TC432/TC453	C
Continental	87-75	N/A	TC427	N/A	TC434	A	<b>Mercury</b>						
Mark IV	76-75	N/A	TC427	N/A	TC434	A	Capri	86-79	N/A	TC427	N/A	TC428/TC466	B
Mark V	79-77	N/A	TC430	N/A	TC432/TC453	C	Cougar	02-99	N/A	TC430	N/A	TC432/TC453	C
Mark VI	83-80	N/A	TC430	N/A	TC432/TC453	C	Cougar	97-89	N/A	TC430	N/A	TC432/TC453	C
Mark VII	92-84	N/A	TC430	N/A	TC432/TC453	C	Cougar	88-75	N/A	TC430	N/A	TC434	A
Mark VIII	98-93	N/A	TC430	N/A	TC432/TC453	C	Cougar XR7	80	N/A	TC430	N/A	TC432/TC453	C
Navigator (provides 6-way or 7RV blade and 4-way towing)	04-00	TC554 or TC555	NR	N/A	TC434	A	Grand Marquis	03-98	N/A	TC430	N/A	TC432/TC453	C
Navigator	02-00	TC539	NR	N/A	TC434	A	Grand Marquis	97-92	TC482	TC430	N/A	TC432/TC453	C
Navigator	00	N/A	TC427	N/A	TC434	A	Grand Marquis	91-83	N/A	TC430	N/A	TC432/TC453	C
Navigator	99-97	TC494	TC430	N/A	TC434	A	LN7	83-82	N/A	TC427	N/A	TC434	A
Town Car	03-80	N/A	TC430	N/A	TC432/TC453	C	Lynx	87-81	N/A	TC430	N/A	TC432/TC453	C
Versailles	80-77	N/A	TC427	N/A	TC434	A	Marauder	03	N/A	TC430	N/A	TC432/TC453	C
<b>Mazda</b>							Marquis	86-75	N/A	TC427	N/A	TC434	A
323	96-87	N/A	TC430	N/A	TC432/TC453	C	Monarch	80-75	N/A	TC427	N/A	TC434	A
626	02-88	N/A	TC430	N/A	TC432/TC453	C	Montego	76-75	N/A	TC427	N/A	TC434	A
626	87-79	N/A	TC427	N/A	TC428/TC466	B	Mountaineer	03-02	TC546	NR	N/A	TC434	A
929	96-88	N/A	TC430	N/A	TC432/TC453	C	Mountaineer (w/ factory 7-way)	03-02	TC554 or TC555	NR	N/A	TC434	A
GLC	86-77	N/A	TC427	N/A	TC428/TC466	B							
Miata	02-93	N/A	TC430	N/A	TC432/TC453	C							

### CHART CODES

- A. 4-Wire Flat
- B. General Purpose Converters
- C. Power Converters

- 217. Vehicle Connector (TC457 also required to service this application)
  - 218. Plug Converter (TC424 also required to service this application)
- Note: See Buyers guide for full description and addition link options

# APPLICATION GUIDE

Vehicle Make/Model	Year	Vehicle Connector	4-Wire Flat	Vehicle Connection Assembly	Universal Converters	Code	Vehicle Make/Model	Year	Vehicle Connector	4-Wire Flat	Vehicle Connection Assembly	Universal Converters	Code
Mountaineer (with tow pkg.)	01-96	TC498	TC427	N/A	TC434	A	Altima	03-02	N/A	TC427	N/A	TC428/TC466	B
Mountaineer (w/o tow pkg.)	00-95	TC463	TC427	N/A	TC428/TC466	B	Altima	01-97	TC500	TC430	N/A	TC428/TC466	B
Mountaineer (with tow prep pkg.)	97-96	TC499	TC430	TC499A	TC432/TC453	C	Altima	96-93	N/A	TC430	N/A	TC432/TC453	C
Mystique	00-95	N/A	TC427	N/A	TC434	A	Axxess	95-90	N/A	TC427	N/A	TC428/TC466	B
Sable (sedan)	03-00	TC548	NR	N/A	TC428/TC466	B	Frontier	03-98	TC513	TC427	N/A	TC428/TC466	B
Sable (wagon)	01-96	N/A	TC430	N/A	TC432/TC453	C	Maxima	03-81	N/A	TC430	N/A	TC432/TC453	C
Sable (sedan)	99-96	TC483	TC430	N/A	TC432/TC453	C	Multi-Van	89-87	N/A	TC430	N/A	TC428/TC466	B
Sable (sedan)	95-86	N/A	TC430	N/A	TC432/TC453	C	NX 1600	93-91	N/A	TC427	N/A	TC428/TC466	B
Sable (wagon)	95-86	N/A	TC427	N/A	TC434	A	NX 2000	93-91	N/A	TC427	N/A	TC428/TC466	B
Topaz	95-88	N/A	TC430	N/A	TC432/TC453	C	Pathfinder	03-96	TC500	NR	N/A	TC428/TC466	B
Topaz	87-84	N/A	TC427	N/A	TC434	A	Pathfinder	95-91	N/A	TC430	N/A	TC432/TC453	C
Tracer	99-88	N/A	TC430	N/A	TC432/TC453	C	Pathfinder	90	N/A	TC427	N/A	TC432/TC453	C
Villager	02-93	N/A	TC427	N/A	TC428/TC466	B	Pathfinder	89-87	N/A	TC430	N/A	TC432/TC453	C
Zephyr	83-78	N/A	TC427	N/A	TC434	A	Pickup	97-91	TC485	TC430	N/A	TC432/TC453	C
<b>Mitsubishi</b>							Pickup	90-86	N/A	TC427	N/A	TC428/TC466	B
3000 GT	99-91	N/A	TC430	N/A	TC432/TC453	C	Pulsar	90-83	N/A	TC427	N/A	TC428/TC466	B
Diamante	02-92	N/A	TC430	N/A	TC432/TC453	C	Quest	00-93	N/A	TC427	N/A	TC428/TC466	B
Eclipse	03-90	N/A	TC430	N/A	TC432/TC453	C	Sentra	03-82	N/A	TC427	N/A	TC428/TC466	B
Expo LRV	94-92	N/A	TC427	N/A	TC428/TC466	B	Stanza	97-90	N/A	TC430	N/A	TC432/TC453	C
Galant	03-85	N/A	TC430	N/A	TC432/TC453	C	Stanza	89-82	N/A	TC427	N/A	TC428/TC466	B
Lancer	03-02	N/A	TC430	N/A	TC432/TC453	C	X-Terra	03-00	TC537	NR	N/A	TC428/TC466	B
Mirage	03-85	N/A	TC430	N/A	TC432/TC453	C	<b>Oldsmobile</b>						
Montero	03-92	TC489	NR	N/A	TC428/TC466	B	88 Series	99-90	N/A	TC430	N/A	TC432/TC453	C
Montero	91	TC489	TC427	N/A	TC434	A	88 Series	89-80	N/A	TC427	N/A	TC428/TC466	B
Montero	90-83	N/A	TC427	N/A	TC434	A	88 Series	79-75	N/A	TC427	N/A	TC434	A
Outlander	03	N/A	TC427	N/A	TC428/TC466	B	98 Series	96-84	N/A	TC430	N/A	TC432/TC453	C
Precis	92-87	N/A	TC430	N/A	TC432/TC453	C	98 Series	83-75	N/A	TC427	N/A	TC434	A
Pickup	96-83	N/A	TC427	N/A	TC428/TC466	B	Achieva	97-92	N/A	TC427	N/A	TC434	A
<b>Nissan</b>							Alero	03-99	N/A	TC430	N/A	TC432/TC453	C
200SX	98-95	N/A	TC427	N/A	TC428/TC466	B	Aurora	02-95	N/A	TC430	N/A	TC432/TC453	C
200SX	83-77	N/A	TC427	N/A	TC428/TC466	B	Bravada (provides 6-way or 7RV blade and 4-way towing)	03-02	TC554 or TC555	NR	N/A	TC434	A
210	82-76	N/A	TC427	N/A	TC428/TC466	B	Bravada	03-02	TC519	TC427	N/A	TC434	A
240SX	98-89	N/A	TC427	N/A	TC428/TC466	B	Bravada	01-96	TC472	TC430	N/A	TC434	A
280Z	83-75	N/A	TC427	N/A	TC428/TC466	B	Bravada	94-92	N/A	TC427	N/A	TC434	A
300ZX	96-84	N/A	TC430	N/A	TC432/TC453	C	Calais	91-89	N/A	TC427	N/A	TC434	A
310	82-79	N/A	TC427	N/A	TC428/TC466	B	Calais	88-86	N/A	TC430	N/A	TC432/TC453	C

## CHART CODES

- A. 4-Wire Flat
- B. General Purpose Converters
- C. Power Converters

- 217. Vehicle Connector (TC457 also required to service this application)
- 218. Plug Converter (TC424 also required to service this application)
- Note: See Buyers guide for full description and addition link options

# APPLICATION GUIDE



## TRAILER CONNECTORS

Vehicle Make/Model	Year	Vehicle Connector	4-Wire Flat	Vehicle Connection Assembly	Universal Converters	Code	Vehicle Make/Model	Year	Vehicle Connector	4-Wire Flat	Vehicle Connection Assembly	Universal Converters	Code
Calais	85-78	N/A	TC427	N/A	TC434	A	Astre	77-75	N/A	TC427	N/A	TC434	A
Custom Cruiser (full size)	92-75	N/A	TC427	N/A	TC434	A	Aztec	05-01	TC559	NR	N/A	TC434	A
Cutlass	97-75	N/A	TC427	N/A	TC434	A	Bonneville	03-87	N/A	TC430	N/A	TC432/TC453	C
Cutlass Ciera	96-82	N/A	TC427	N/A	TC434	A	Bonneville	86-75	N/A	TC427	N/A	TC434	A
Firenza	88-82	N/A	TC427	N/A	TC434	A	Catalina	81-75	N/A	TC427	N/A	TC434	A
Intrigue	02-98	N/A	TC430	N/A	TC428/TC466	B	Firebird	02-89	N/A	TC430	N/A	TC432/TC453	C
Omega	84-75	N/A	TC427	N/A	TC434	A	Firebird	88-75	N/A	TC427	N/A	TC434	A
Silhouette	04-97	TC510	NR	N/A	TC434	A	Grand Am	00-75	N/A	TC427	N/A	TC434	A
Silhouette	96-92	TC488	NR	N/A	TC434	A	Grand LeMans	81-75	N/A	TC427	N/A	TC434	A
Silhouette	91	N/A	TC427	N/A	TC434	A	Grand Prix	08-88	N/A	TC430	N/A	TC432/TC453	C
Starfire	80-75	N/A	TC427	N/A	TC434	A	Grand Prix	87-74	N/A	TC427	N/A	TC434	A
Toronado	92-86	N/A	TC430	N/A	TC432/TC453	C	Grandville	81-75	N/A	TC427	N/A	TC434	A
Toronado	85-79	N/A	TC427	N/A	TC434	A	J2000	84-82	N/A	TC427	N/A	TC434	A
<b>Plymouth</b>							LeMans	93-88	N/A	TC427	N/A	TC434	A
Acclaim	95-89	N/A	TC427	N/A	TC432/TC453	C	LeMans	81-78	N/A	TC427	N/A	TC428/TC466	B
Arrow	80-76	N/A	TC427	N/A	TC428/TC466	B	LeMans	77-75	N/A	TC427	N/A	TC434	A
Breeze	00-96	N/A	TC430	N/A	TC432/TC453	C	Phoenix	84-80	N/A	TC427	N/A	TC434	A
Caravelle	88-85	N/A	TC427	N/A	TC434	A	Safari Wagon	89-83	N/A	TC427	N/A	TC434	A
Colt	94-83	N/A	TC427	N/A	TC428/TC466	B	Sunbird	94-88	N/A	TC427	N/A	TC428/TC466	B
Colt Vista	94-84	N/A	TC427	N/A	TC428/TC466	B	Sunbird	87-85	N/A	TC427	N/A	TC434	A
Duster	94-85	N/A	TC427	N/A	TC428/TC466	B	Sunbird	80-76	N/A	TC427	N/A	TC428/TC466	B
Gran Fury	89-75	N/A	TC427	N/A	TC434	A	Sunfire	05-95	N/A	TC427	N/A	TC434	A
Gr. Voyager	00-96	TC473	NR	N/A	TC428/TC466	B	Trans Sport	03-97	TC510	NR	N/A	TC428/TC466	B
Gr. Voyager	95-84	N/A	TC427	N/A	TC434	A	Trans Sport	96-93	TC488	NR	N/A	TC434	A
Horizon	90-78	N/A	TC427	N/A	TC428/TC466	B	Trans Sport	92-90	N/A	TC427	N/A	TC434	A
Laser	94-90	N/A	TC427	N/A	TC434	A	Ventura	77-75	N/A	TC427	N/A	TC434	A
Neon	01-95	N/A	TC427	N/A	TC434	A	Vibe	08-03	N/A	NR	N/A	TC428/TC466	B
Prowler	00-97	N/A	TC430	N/A	TC432/TC453	C	<b>Porsche</b>						
Reliant	89-81	N/A	TC427	N/A	TC434	A	All models	07-01	See Dealer	See Dealer	See Dealer	See Dealer	.....
Sundance	94-87	N/A	TC427	N/A	TC434	A	<b>Range Rover</b>						
Turismo	87-82	N/A	TC427	N/A	TC434	A	Defender	98-93	N/A	TC430	N/A	TC432/TC453	C
Van (full size)	83-75	N/A	TC427	N/A	TC428/TC466	B	Discovery	00-94	N/A	TC430	N/A	TC432/TC453	C
Volare	80-76	N/A	TC427	N/A	TC434	A	Range Rover	00-87	N/A	TC430	N/A	TC432/TC453	C
Voyager	00-96	TC473	NR	N/A	TC428/TC466	B	<b>Renault</b>						
Voyager	95-91	TC439	TC427	N/A	TC434	A	18i	86-80	N/A	TC427	N/A	TC428/TC466	B
Voyager	90-84	N/A	TC427	N/A	TC434	A	Alliance	87-83	N/A	TC427	N/A	TC428/TC466	B
<b>Pontiac</b>							Fuego	85-82	N/A	TC427	N/A	TC428/TC466	B
6000	91-82	N/A	TC430	N/A	TC432/TC453	C	Medallion	89-88	N/A	TC430	N/A	TC432/TC453	C
							Sportwagon	85-84	N/A	TC427	N/A	TC428/TC466	B

### CHART CODES

A. 4-Wire Flat

B. General Purpose Converters

C. Power Converters

217. Vehicle Connector (TC457 also required to service this application)

218. Plug Converter (TC424 also required to service this application)

Note: See Buyers guide for full description and addition link options

# APPLICATION GUIDE

Vehicle Make/Model	Year	Vehicle Connector	4-Wire Flat	Vehicle Connection Assembly	Universal Converters	Code	Vehicle Make/Model	Year	Vehicle Connector	4-Wire Flat	Vehicle Connection Assembly	Universal Converters	Code
<b>Saab</b>							Land Cruiser	98-91	TC505	NR	N/A	TC432/TC453	C
All models	00-86	N/A	TC430	N/A	TC432/TC453	C	Land Cruiser	90-81	N/A	TC430	N/A	TC432/TC453	C
<b>Saturn</b>							MR2	95-85	N/A	TC427	N/A	TC428/TC466	B
L Series	03-00	N/A	TC427	N/A	TC428/TC466	B	Paseo	98-92	N/A	TC427	N/A	TC428/TC466	B
SC Series	02-91	N/A	TC427	N/A	TC428/TC466	B	Pickup - except T-100	94-84	TC438	TC427	N/A	TC428/TC466	B
SL Series	00-91	N/A	TC427	N/A	TC428/TC466	B	Pickup - except T-100	83-75	N/A	TC427	N/A	TC428/TC466	B
SW Series	00-91	N/A	TC427	N/A	TC428/TC466	B	Previa	97-91	N/A	TC427	N/A	TC428/TC466	B
<b>Subaru</b>							RAV 4	08-06	N/A	TC427	N/A	TC428/TC466	.....
Brat	87-78	N/A	TC427	N/A	TC428/TC466	B	RAV 4	05-01	TC538	TC430	N/A	TC428/TC466	B
Forester	03-98	TC501	TC430	N/A	TC432/TC453	C	RAV 4	00-96	TC511	TC430	N/A	TC428/TC466	B
GL	92-87	N/A	TC430	N/A	TC432/TC453	C	Sequoia	03-01	N/A	TC427	N/A	TC428/TC466	B
GL	86-80	N/A	TC427	N/A	TC428/TC466	B	Sequoia	02-01	TC542	NR	N/A	TC428/TC466	B
Impreza	03-93	N/A	TC430	N/A	TC432/TC453	C	Sienna	03-98	N/A	TC543	N/A	TC428/TC466	B
Justy	93-89	N/A	TC430	N/A	TC432/TC453	C	Solara	03-99	N/A	TC427	N/A	TC428/TC466	B
Legacy	03-90	N/A	TC430	N/A	TC432/TC453	C	Starlet	84-81	N/A	TC427	N/A	TC428/TC466	B
Loyale	93-90	N/A	TC430	N/A	TC432/TC453	C	Supra	98-82	N/A	TC430	N/A	TC432/TC453	C
Outback	03-96	TC501	TC430	N/A	TC432/TC453	C	T100	98-93	TC486	TC427	N/A	TC428/TC466	B
SVX	96-92	N/A	TC430	N/A	TC432/TC453	C	Tacoma	03-95	TC438	TC427	N/A	TC428/TC466	B
<b>Suzuki</b>							Tercel	98-80	N/A	TC427	N/A	TC428/TC466	B
Esteem	01-95	N/A	TC427	N/A	TC428/TC466	B	Tundra	03	N/A	TC427	N/A	TC428/TC466	B
Vitara/Grand Vitara	05-99	TC560	NR	N/A	TC428/TC466	B	Tundra	02-01	TC544	NR	N/A	TC428/TC466	B
Grand Vitara	00-99	N/A	TC427	N/A	TC428/TC466	B	Tundra	00	TC512	TC427	N/A	TC428/TC466	B
Samurai	94-86	N/A	TC427	N/A	TC428/TC466	B	Van Wagon	90-84	N/A	TC427	N/A	TC428/TC466	B
Sidekick	98-89	N/A	TC427	N/A	TC428/TC466	B	<b>Volkswagen</b>						
Swift	01-89	N/A	TC427	N/A	TC428/TC466	B	Beetle	01-98	N/A	TC430	N/A	TC432/TC453	C
X-90	98-96	N/A	TC427	N/A	TC428/TC466	B	Beetle	79-75	N/A	TC427	N/A	TC428/TC466	B
<b>Toyota</b>							Cabriolet	01-85	N/A	TC427	N/A	TC428/TC466	B
4 Runner	08-03	N/A	TC427	N/A	TC428/TC466	B	Corrado	94-89	N/A	TC427	N/A	TC428/TC466	B
4 Runner	02-96	TC503	NR	N/A	TC428/TC466	B	EuroVan	00-83	N/A	TC427	N/A	TC428/TC466	B
4 Runner	95-87	N/A	TC430	N/A	TC432/TC453	C	Fox	93-87	N/A	TC427	N/A	TC428/TC466	B
Avalon	03-95	N/A	TC430	N/A	TC432/TC453	C	Golf	01-85	N/A	TC427	N/A	TC428/TC466	B
Camry	03-87	N/A	TC430	N/A	TC432/TC453	C	GTI	01-85	N/A	TC427	N/A	TC428/TC466	B
Camry	86-83	N/A	TC427	N/A	TC428/TC466	B	Jetta	01-80	N/A	TC427	N/A	TC428/TC466	B
Celica	03-75	N/A	TC427	N/A	TC428/TC466	B	Passat	01-90	N/A	TC427	N/A	TC428/TC466	B
Corolla	03-76	N/A	TC427	N/A	TC428/TC466	B	Quantum	88-82	N/A	TC427	N/A	TC428/TC466	B
Corona	82-75	N/A	TC427	N/A	TC428/TC466	B	Rabbit	84-75	N/A	TC427	N/A	TC428/TC466	B
Cressida	93-81	N/A	TC430	N/A	TC432/TC453	C	Scirocco	88-75	N/A	TC427	N/A	TC428/TC466	B
Echo	03-00	N/A	TC427	N/A	TC428/TC466	B	Vanagon	92-80	N/A	TC427	N/A	TC428/TC466	B
Highlander	04-01	TC549	NR	N/A	TC428/TC466	B	<b>Volvo</b>						
Land Cruiser	06-99	N/A	TC427	N/A	TC428/TC466	B	All models	00-75	N/A	TC430	N/A	TC432/TC453	C

## CHART CODES

A. 4-Wire Flat

B. General Purpose Converters

C. Power Converters

217. Vehicle Connector (TC457 also required to service this application)

218. Plug Converter (TC424 also required to service this application)

Note: See Buyers guide for full description and addition link options

# TRAILER CABLES



## TRAILER WIRE ACCESSORIES

Economy Circuit Tester	
Part No.	Description
TC7T	Economy tester finds open circuits, blown fuses, bad connections quickly and easily. Test lead with alligator clip included.
TC1	Trailer assembly connector cleaner. Self storing cap. 7 Pin.

## MOLDED CONNECTORS

Universal 4-Pole Square Type Trailer Connector	
Part No.	Description
ET450	<ul style="list-style-type: none"> <li>• 12" leads, 18 gauge</li> <li>• Plug and receptacle are not sold separately</li> <li>• Includes 6 quick splice connectors</li> </ul>
4-Pole Molded Trailer Connector	
Part No.	Description
ET456	<ul style="list-style-type: none"> <li>• 18 gauge pigtails</li> <li>• Ideal for utility, boat, camper trailer</li> <li>• Will accommodate stop lights, directional lights, tail lights, and ground. Plug and receptacle not sold separately</li> <li>• Includes 6 quick splice connectors</li> </ul>
Universal 5-Pole Trailer Connector	
Part No.	Description
ET451	<ul style="list-style-type: none"> <li>• Used for vehicles with separate stop light and directional lamps</li> <li>• Plug and receptacle are not sold separately</li> <li>• Includes 6 quick splice connectors</li> </ul>
6-Pole Molded Trailer Connector	
Part No.	Description
ET452	<ul style="list-style-type: none"> <li>• Used for trailers requiring a six-circuit connection such as electric brakes</li> <li>• Plug and receptacle are not sold separately</li> <li>• Includes 6 quick splice connectors</li> </ul>

## POSI-PLUG™ QUICK DISCONNECT

Part No.	Gauge	Qty. Per Pkg.
ET535	18	1

**EASY AS ①②③**

- Strip wire 1/2"**
- Insert**
- Hand tighten**  
Repeat for each wire

ET Display Package

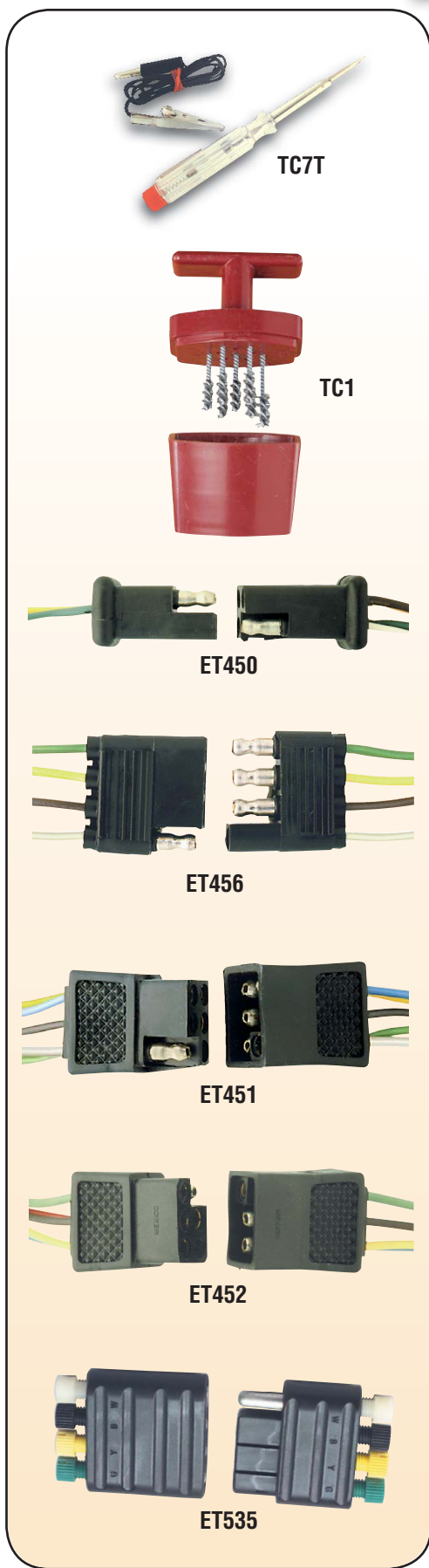

# TRAILER CONNECTORS

# TRAILER CABLES / TRACTOR TRAILER WIRING RECOMMENDATIONS

## TRAILER CABLE ASSEMBLIES COLOR CODED TO ATA STANDARDS AND SAE J2394 SPECIFICATIONS

Part No.	Description	Working Length	Conductor Plugs	Gauges	Color	Std. Pkg.
TC5*	PHILAPRENE® Jacket	12'	Xenoy	1-10 Ga. 6-12 Ga.	Black	1
TC6*	PHILAPRENE® Jacket	15'	Xenoy	1-10 Ga. 6-12 Ga.	Black	1
TC7*	PHILAPRENE® Jacket, w/ 2 40" leads	15'	Xenoy	1-10 Ga. 6-12 Ga.	Black	1
TC8*	PHILAPRENE® Jacket	20'	Xenoy	1-10 Ga. 6-12 Ga.	Black	1
TC9	PHILAPRENE® Jacket for trailers w/ ABS	15'	Xenoy	1-8 Ga. 2-10 Ga. 4-12 Ga.	Green	1
TC12	PHILAPRENE® Jacket for trailers w/ ABS, w/ 2 40" leads	15'	Xenoy	1-8 Ga. 2-10 Ga. 4-12 Ga.	Green	1

**NOTE:** \*Not recommended for vehicles with anti-skid control circuits...Or on tandem trailers where excessive voltage drops are likely to occur.

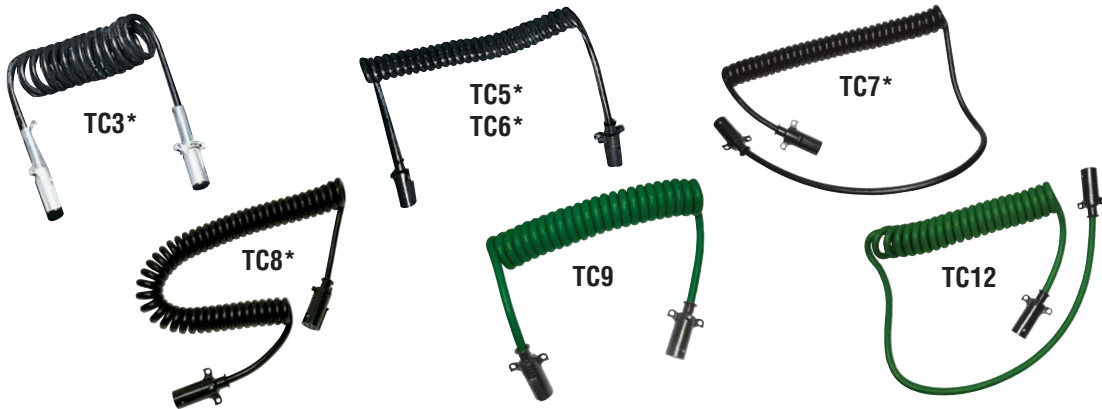

## TRACTOR TRAILER WIRING RECOMMENDATIONS (RCCC & A.T.A.)

- WHITE** — Ground return to towing vehicle (8 AWG)
- BLACK\*** — ICC-required marker identification and clearance lamps (12 AWG)
- YELLOW** — Left-hand directional and hazard signal (12-AWG)
- RED** — Stop lamp and anti-wheel lock devices (10 AWG)
- GREEN** — Right-hand directional and hazard signal (12-AWG)
- BROWN** — Tail, license and clearance lamps (12 AWG)
- BLUE** — ABS Continuous Power (10 AWG)

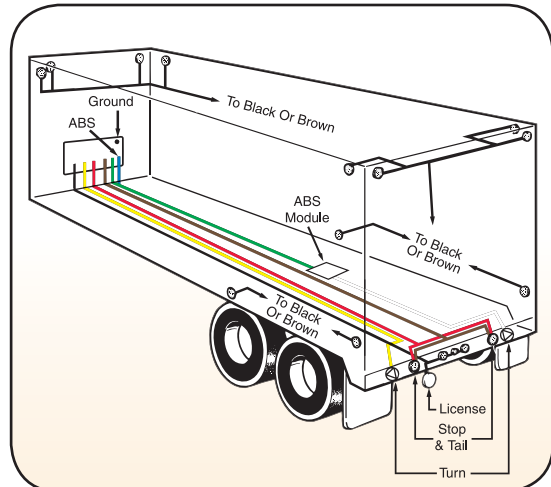



# TRAILER CONNECTORS



TRAILER CONNECTORS

BULK TRAILER CABLE						
Rated at -40°F to +176°F.						
Part No.		Conductors	Gauge	Stranding	O.D.	
50' Coil	100' Coil					
CJ12-4PL	CJ12-4PC	4 (red / brown / green / yellow)	12	19 x 25	.406"	
	<b>NEW!</b> CJ14-2C	2 (red / black)	14	41 x 30	.440"	
CJ14-4L	CJ14-4C	4 (red / brown / black / white)	14	19 x 27	.410"	
<b>NEW!</b> CJ14-4BL	<b>NEW!</b> CJ14-4BC	4 (white / brown / yellow / green)	14	41 x 30	.450"	
CJ16-4L	CJ16-4C	4 (red / brown / black / white)	16	26 x 30	.455"	
<b>NEW!</b> CL16-4BL	<b>NEW!</b> CL16-4BC	4 (white / brown / yellow / green)	16	26 x 30	.390"	
CJ16-5L	CJ16-5C	5 (red / white / green / yellow / brown)	16	26 x 30	.400"	
CJ12-6PL	CJ12-6PC	6 (black / white / red / green / yellow / brown)	12	19 x 25	.500"	
CJ14-6L	CJ14-6C	6 (black / white / red / green / yellow / brown)	14	19 x 27	.500"	
CJ16-6L	CJ16-6C	6 (black / white / red / green / yellow / brown)	16	19 x 29	.435"	
<b>SEVEN - CONDUCTOR TRAILER CABLE</b>						
<b>THERMOPLASTIC PVC INSULATION</b>						
Rated at -40°F to +176°F.						
Meets SAE Specification J1128						
Part No.			Conductors	Gauges	Stranding	O.D.
50' Coil	100' Coil	250' Coil				
CJ12-7AL *	CJ12-7AC		7 (white/red/brown/black/yellow/blue/green)	1-8 Ga. 1-10 Ga. 5-12 Ga.	19 x 21 19 x 23 19 x 25	.695"
CJ12-7BL (ABS)	CJ12-7BC	<b>NEW!</b> CJ12-7BE	7 (white/red/brown/black/yellow/blue/green)	4-12 Ga. 2-10 Ga. 1-8 Ga.	65 x 30 105 x 30 168 x 30	.690"
<b>NEW!</b> CJ12-7DL	<b>NEW!</b> CJ12-7DC	<b>NEW!</b> CJ12-7DE	7 (white/red/brown/black/yellow/blue/green)	1-12 Ga. 6-14 Ga.	65 x 30 41 x 30	.610"
CJ12-7L	CJ12-7C		7 (white/red/brown/black/yellow/blue/green)	1-10 Ga. 6-12 Ga.	19 x 23 19 x 25	.695"

\*For vehicles equipped with electronic anti-skid control devices.

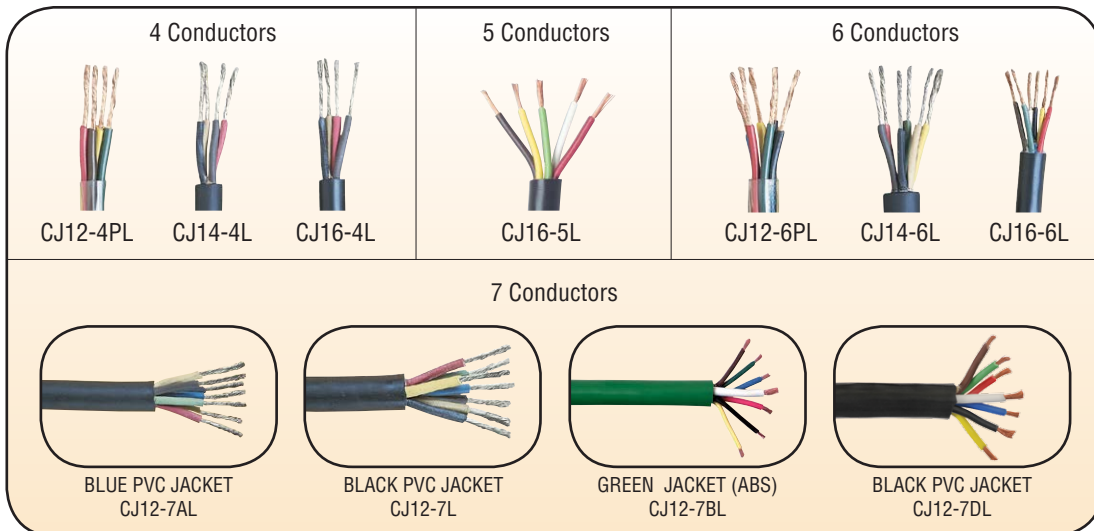

Meets SAE Specification J1128

# CUSTOM REPLACEMENT ENDS

## Alternative to High Priced Complicated Custom Cables

- ❖ Great for OE Harness Repair
- ❖ Saves Customer Time and Money
- ❖ Universal Terminal Fits Positive and Negative Battery Posts

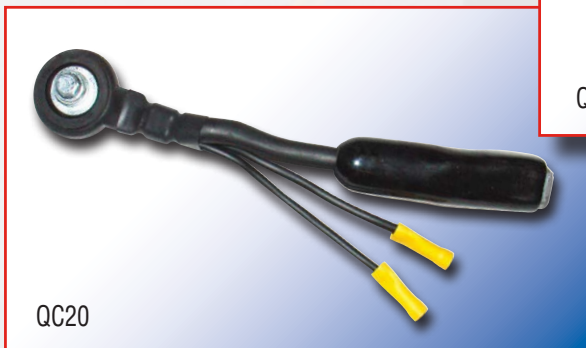
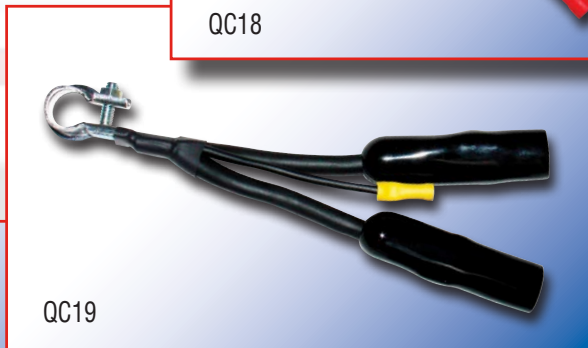
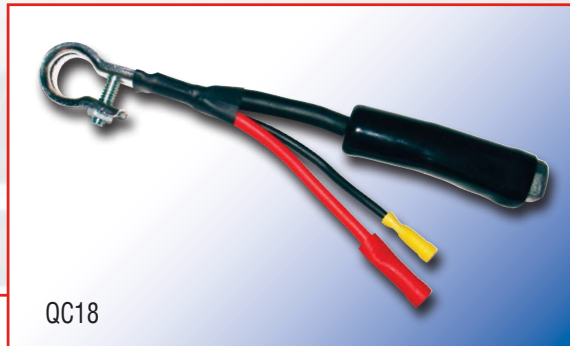

For a complete listing of part numbers and additional information see page B18

Easy-to-install, because the work is always near the battery, no special tools required

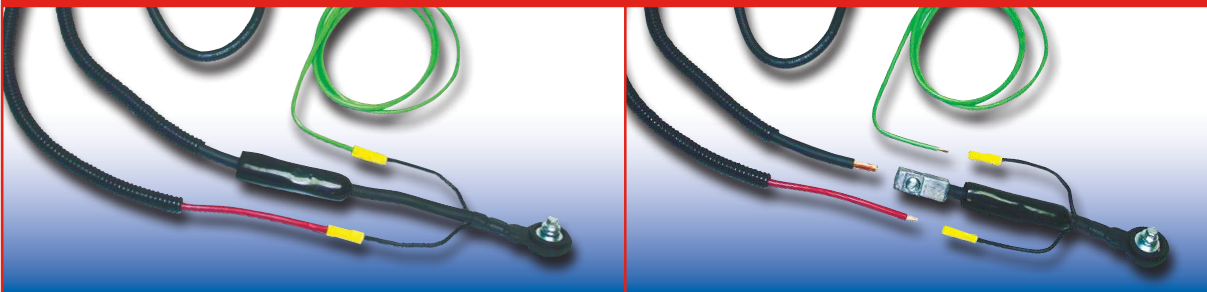

**STANDARD**<sup>®</sup>

[www.StandardBrand.com](http://www.StandardBrand.com)

ST10080



*Ignition Wires*

*Battery Cables*

*Primary Wire*

*Terminals & Connectors*

*Trailer Connectors*

***Sockets, Pigtails & Switches***

*Safety Accessories*

*O.E. Interchanges*

*Index*

# SOCKET ASSEMBLIES

This catalog section contains the sockets, pigtails and universal switches available in the engine controls line. The Socket Assemblies and the Pigtail Assemblies are listed by number of lead wires. The universal switches are listed by type. The Pkg. Qty. column indicates quantity per each package.









## SOCKET ASSEMBLIES WITH SINGLE WIRE LEAD

Part No.	Pkg. Qty.	Description	Illustration	Part No.	Pkg. Qty.	Description	Illustration
S-20	1	Single Contact Miniature Socket and bracket. For dome, map and other applications. Fits lamps No. 51, 53, 55, 57, 1895.		S-43N	1	Single Contact Neoprene Covered Socket Assembly For signal, park, stop and taillight. Fits lamps No. 67, 89, 93, 97, 1003, 1073, 1141, 1156. Universal	
S-21	1	Single Contact Socket For dome, map and other applications. Fits lamps No. 67, 89, 93, 97, 1003, 1073, 1141, 1156. Universal.		S-45N	1	Single Contact Socket Repair Assembly AMC: 4486949, 4489412 Chry.: 3513162, 3780745 Ford: D00Z-15536A GM: 2978302 Fits 1 1/8" hole. Fits lamps No. 67, 89, 93, 97, 1003, 1073, 1141, 1156. American Motors ..... 80-70 Chrysler Corp. .... 85-71 Dodge Trucks ..... 86-71 Ford, Mercury ..... 77-73	
S-22	1	For Replaceable Single Contact Miniature base socket. Pigtail wire assembly complete with terminal attached. Fits lamps No. 53, 55, 57, 1895. Universal.		S-56	1	Socket Bracket Assembly Snap-in-type for instrument panel. Miniature base (5/8" dia.) single contact w/16 gauge wire for instrument panel lights. Fits lamps No. 53, 55, 57, 1985. Universal applications.	
S-23	1	For Replaceable Base Sockets Pigtail wire assembly complete with terminal attached. Fits lamps No. 67, 89, 93, 97, 1003, 1073, 1141, 1156. Universal.		S-57	1	Socket Repair Assembly Single contact w/12" of 16 gauge wire and ceramic disc. Used on most cars, trucks, trailers & boats for courtesy lamps, marker lights, dome lights, taillight, etc. Fits lamps No. 67, 89, 93, 97, 1003, 1073, 1141, 1156.	
S-30N	1	Single Contact Socket Spring clips for snap fit in 7/8" to 1 1/8" openings. Parking and taillight assemblies. Fits lamps No. 67, 89, 93, 97, 1003, 1073, 1141, 1156. Universal.		S-60	1	Socket Repair Assembly Single contact back-up and license lights. Fits lamps No. 67, 89, 93, 97, 1003, 1073, 1141, 1156. Pontiac ..... 78-75	
S-35	1	Single Contact Snap-In Socket Assembly For license plate and instrument light on most cars. Fits lamps No. 67, 89, 93, 97, 1003, 1073, 1141, 1156. Universal.		S-61	1	Socket Repair Assembly Pigtail with ceramic washer. Single contact w/12" of 16 gauge wire. Used on most cars, trucks, trailers, boats for dome light, instrument panel, courtesy lamp, under hood or trunk. Fits lamps No. 53, 55, 57, 1985.	
S-38N	1	Single Contact Socket Assembly Regular base. For signal, park, stop and taillight. Fits lamps No. 67, 89, 93, 97, 1003, 1073, 1141, 1156. Universal.		S-62	1	Socket Repair Assembly With adapter plate and Neoprene boot, for universal single contact applications. Fits lamps No. 67, 89, 93, 97, 1003, 1073, 1141, 1156.	
S-40	1	Single Contact Socket and Pigtail Assembly For shielded license plate and utility lights. Universal applications.					

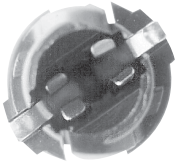





# SOCKET ASSEMBLIES



## SOCKET ASSEMBLIES WITH SINGLE WIRE LEAD

Part No.	Pkg. Qty.	Description	Illustration	Part No.	Pkg. Qty.	Description	Illustration
S-87	1	<b>Socket Repair Assembly</b> Single contact snap in socket. For 3/4" hole. Fits license lamps No. 67, 89, 93, 97, 1003, 1073, 1141, 1156. Universal.		S-703	1	<b>Socket Repair Assembly</b> GM: 10042638. Instrument panel socket w/digital, 1/2" hole. Oldsmobile..... 86-87 Pontiac ..... 87	
S-500A	2	<b>Socket Repair Assembly</b> Chry.: 3744750, 4124104 Ford: C80Z-13711A, B Fits instrument cluster with printed circuit board. 1/2" mounting hole. Fits lamp No. 194. Chrysler Corp. ....90-74 Ford .....96-80 Ford Trucks .....92-80 Lincoln .....89-73 Mercury.....90-78		S-704	1	<b>Socket Repair Assembly</b> GM: 22531065. Instrument panel socket w/o digital, 3/8" hole. Oldsmobile.....86-87 <b>Available While Supplies Last</b>	
				S-771	1	<b>Socket Assembly</b> Socket, board, tail lamps. Chrysler .....00-96 Dodge .....03-96 Jeep .....04-99 Plymouth.....00-96	
S-513	1	<b>Socket Repair Assembly</b> Standard base, 11/16" dia., single contact. Fits lamps No. 67, 89, 93, 97, 1003, 1073, 1141, 1156.		S-865	1	<b>Socket Assembly</b> Single contact, snap-in type, fits 3/2" hole. For stop, tail, turn signal, back-up, license plate, or parking light socket. Buick .....64-55 Cadillac.....61-56 Chevrolet .....63-58 Chrysler .....69-55 Dodge .....69-55 Ford .....67-59 Mercury.....61-56 Oldsmobile.....61-56 Plymouth.....67-50	
S-515	1	<b>Socket Repair Assembly</b> For dome, map and other applications. Fits lamps No. 67, 89, 93, 97, 1003, 1073, 1141, 1156. Standard socket base, 11/16" dia. with flange and two holes on 13/16" centers, single contact.					





## SOCKET ASSEMBLIES WITH 2 WIRE LEAD

Part No.	Pkg. Qty.	Description	Illustration	Part No.	Pkg. Qty.	Description	Illustration
S-24	1	<b>For Replaceable Double Contact Base Sockets</b> Pigtail wire assembly with terminals attached. Fits lamps No. 1034, 1154, 1157, 1158, 1176, 1178.		S-29	1	<b>Flush Mounting Snap-In Double Contact</b> Fits 1 1/8" hole for most double contact applications. Parking, directional, taillight & stoplights. Fits lamps No. 1034, 1154, 1157.	
S-25N	1	<b>Double Contact Base with Socket</b> Fits lamps No. 68, 90, 94, 96, 1004, 1158, 1176, 1178.		S-31N	1	<b>Double Contact Socket</b> Spring clips for snap fit in 7/8" to 1 1/8" openings. For many popular cars and trucks. Parking and taillight assemblies. Fits lamps No. 68, 90, 94, 96, 1004, 1158, 1176, 1178.	
S-26N	1	<b>Double Contact Base with Socket</b> Fits lamps No. 1034, 1154, 1157.		S-32	1	<b>Double Contact Socket Repair Assembly</b> For parking and taillight assemblies. For most cars. Fits lamps No. 1034, 1154, 1157.	
S-27	1	<b>Double Contact Socket</b> Socket clips for snap fit in 7/8" to 1 1/8" openings. For many popular cars and trucks. Parking and taillight assemblies. Fits lamps No. 1034, 1154, 1157.					

SOCKETS, PIGTAILS & SWITCHES

# SOCKET ASSEMBLIES

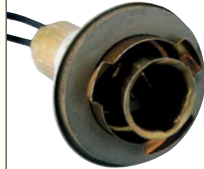
## SOCKET ASSEMBLIES WITH 2 WIRE LEAD

Part No.	Pkg. Qty.	Description	Illustration	Part No.	Pkg. Qty.	Description	Illustration
S-36N	1	<b>Double Contact Weather-Proof</b> Neoprene Covered Socket Assembly Stop, tail & rear turn signal. Ford 72-65. Fits license lamps for Mercury Marquis 76-73. Fits stoplight of American Motors and many universal car and truck applications 80-59. Fits lamps No. 198, 1016, 1034, 1154, 1157		S-58	1	<b>Socket Repair Assembly</b> Pigtail w/ solid brass contacts, w/ weatherproof boots for double contact standard base sockets. Fits lamps No. 1004, 1034, 1154, 1157, 1158, 1176, 1178. Similar to S24.	
S-37N	1	<b>Double Contact Socket</b> Spring clips for snap-in fit. For parking and taillight on most vehicles. Fits lamps No. 1034, 1154, 1157.		S-63	1	<b>Socket Repair Assembly</b> (5963268, 8904437, 8909518) Back-up light. Fits lamp No. 1154. Buick.....90-72 Cadillac.....92-70 Chevrolet.....88-69 GM Light Trucks.....91-86 Oldsmobile.....85-73 Pontiac.....88-76 Saturn.....92-91	
S-39	1	<b>Double Contact Assembly</b> Regular base. For signal, park, stop taillight. Fits lamps No. 67, 89, 93, 97, 1003, 1073, 1141, 1156.		S-67	1	<b>Socket Repair Assembly</b> IHC: 571721C91 Park, stop, tail and turn signal. Fits lamp No. 1156. IHC Trucks.....80-73	
S-44	1	<b>Double Contact Socket Assembly</b> AMC: 448649, 4488908 Chry: 3764747 ; GM: 8909910 Stop, tail and rear signal lights. Fits 1 1/8" hole. Fits lamps No. 1034, 1154, 1157. American Motors.....80-72 Buick, Oldsmobile.....81-64 Dodge.....75		S-70	1	<b>Socket Repair Assembly</b> (D3AZ-13410C, D9AZ-15A434A) Back-up light. Fits lamp No. 1158. Ford.....79, 74-73 Lincoln.....81-77 Mercury.....80 <b>Available While Supplies Last</b>	
S-46N	1	<b>Double Contact Socket Assembly</b> With socket adapter plate and neoprene boot, 30" wire leads. For signal, park, stop and taillight for most cars and trucks. Fits 3/4" hole. Fits lamps No. 1034, 1154, 1157.		S-71	1	<b>Socket Repair Assembly</b> AMC: 3691072 Chrysler: 3764126, 159 Ford: D3AZ-13410A, D80Z-15434A Fits lamp No. 1156. American Motors.....77-76 Chrysler.....78-74 Ford.....80-73 Mercury.....80-73 Plymouth.....74	
S-47N	1	<b>Weatherproof Double Contact</b> Socket Assembly For signal, park, stop and taillight. Fits 1 1/8". Fits lamps No. 1034, 1154, 1157.		S-74	1	<b>Socket Repair Assembly</b> AMC: 4489395 Ford: E1FZ-13410A; D5VY-15A442A. GM: 6298892 IHC: 418977C91 License, side maker, cornering. Fits lamps No. 131, 168, 194, 194A. AMC.....88-70 Ford Cars.....87-73 Ford Trucks.....90-88 GM Cars.....96-70 GM Light Trucks.....92-82 IHC Trucks.....80-57 Renault.....87-72 Older Cars & Trucks	
S-49	1	<b>Double Contact Assembly</b> AMC: 448869478 GM: 8912698 With positive-grip heavy duty plastic housing and sealed-in blade contacts. An exact replacement for the original socket. For park, turn, stop and taillight applications on most cars with 1 1/8" hole. American Motors.....79-69 Cadillac.....73-70 Oldsmobile.....73-70		S-51	1	<b>Socket Repair Assembly</b> Ceramic disc for double contact standard base sockets. Moisture resistant. Pigtail wire assembly with terminals attached. Fits lamps No. 1034, 1154, 1157, 1158, 1176, 1178.	

# SOCKET ASSEMBLIES





## SOCKET ASSEMBLIES WITH 2 WIRE LEAD

Part No.	Pkg. Qty.	Description	Illustration	Part No.	Pkg. Qty.	Description	Illustration
S-75	1	<b>Socket Repair Assembly</b> (D0AZ, D1AZ, D20Z-13410B) Park, stop, tail, turn signal. Fits lamps No. 1034, 1154, 1157. Lincoln .....80-70 Mercury .....79-75		S-97	1	<b>Socket Repair Assembly</b> Chry.: 4274100, GM: 8912750 License, side marker, cornering. Fits lamps No. 161, 168, 194, 194A. Buick.....92-73 Cadillac.....85-76, 73 Chevrolet.....92-74 Chrysler Corp. Cars....86-82 GM Light Trucks.....92-86 Oldsmobile.....92-76 Pontiac.....92-74, 70	
S-80	1	<b>Socket Repair Assembly</b> (8918646) Back-up light. Fits lamp No. 1156. Buick .....77 Mercury .....77-74		S-98	1	<b>Socket Repair Assembly</b> (12003878) Back-up, cornering and turn signal. Fits lamps No. 1156. Buick.....90-77 Cadillac.....89-82, 78-76 Chevrolet.....90-77 Oldsmobile.....90-82, 78-77 Pontiac.....89-81, 79-77	
S-89	1	<b>Socket Repair Assembly</b> GM: 8918525, 12003877 Single contact with ground wire. Fits 1 1/8" hole. For Back-up light. Fits lamps No. 67, 89, 93, 97, 1003, 1073, 1141, 1156. Pontiac.....78-75		S-99	1	<b>Socket Repair Assembly</b> (3513686, 4055028) Fits front and rear side marker. Fits lamps No. 158, 194, 194A. Chrysler Corp. Cars....87-72 Dodge Trucks .....91-72	
S-90	1	<b>Socket Repair Assembly</b> Single contact with ground wire. Fits 1 1/8" hole. Back-up and license lights. Fits lamps No. 67, 89, 93, 97, 1003, 1073, 1141, 1156. Universal applications. <i>Available While Supplies Last</i>		S-100	1	<b>Socket Repair Assembly</b> Chry.: 3588314, 3588650 Ford: E25Y-13410B. Fits front and rear side marker. Fits lamps No. 158, 194, 194A. Chrysler .....98-79 Dodge, Plymouth.....98-72 Dodge Trucks .....98-86, 88-85 Ford, Mercury .....98-83 Ford Trucks .....98-92 Lincoln .....98-82	
S-95	1	<b>Socket Repair Assembly</b> Ford: E0SZ-15A442B GM: 12001470. Tail, stop, turn signal. Fits lamps No. 161, 168, 194, 194A. Cornering, license, park, side marker. Buick .....99-76 Cadillac.....97-76 Chevrolet.....02-76 Ford .....89-88 GM Light Trucks .....99-78 Lincoln .....89-81 Mercury.....80 Oldsmobile.....99-76 Pontiac.....02-76		S-501	1	<b>Socket Repair Assembly</b> (3764865, 3764561, 3764863) Fits front and rear cornering or side marker lamps. Chrysler .....92-79, 75-74 Dodge .....90-79 Plymouth.....90-79	
S-96	1	<b>Socket Repair Assembly</b> Shielded universal underhood & trunk light. Universal Applications.		S-503A	2	<b>Socket &amp; Pigtail Assembly</b> Fits instrument cluster with printed circuit board 5/8" mounting hole. AMC: 8122474, 8126900 Chrysler: 2496279 Ford: E6FZ-13B764A GM: 12004311, 2973932, 5655006 AMC.....77-76 Buick.....77-76 Cadillac.....89-76 Chevrolet .....84-70 GM Trucks .....91-73 Oldsmobile.....84-76 Pontiac.....87-76	

SOCKETS, PIGTAILS & SWITCHES

# SOCKET ASSEMBLIES

## SOCKET ASSEMBLIES WITH 2 WIRE LEAD

Part No.	Pkg. Qty.	Description	Illustration	Part No.	Pkg. Qty.	Description	Illustration
S-506	1	<b>Socket Repair Assembly</b> (12003757) Back-up light. Buick..... 96-81 Cadillac..... 02-86 Chevrolet..... 96-80 Chrysler..... 90-89 Dodge..... 89 GM Light Trucks..... 03-82 Oldsmobile..... 96-81 Pontiac..... 95-81 Renault..... 87-83		S-523	1	<b>Socket Repair Assembly</b> GM: 12101897 (low beam) socket assembly for Halogen bulb headlamp assembly with 2 prong and 9006 bulb. With gray housing, weather-pack seal, two 9 1/2" No. 18 Ga. leads. Buick..... 03-90 Cadillac..... 03-90 Chevrolet..... 03-90 GM Light Trucks..... 03-92 Oldsmobile..... 99-90 Pontiac..... 03-88	
S-508	1	<b>Socket Repair Assembly</b> (D3AZ-13410E, D8BZ-13412A) Fits front, park, and turn signal. Ford..... 77-75 Mercury..... 78-75		S-529	1	<b>2-Wire Socket Assembly</b> Fits domestic and import vehicles with 2-prong headlights. Acura..... 95-86 Audi..... 85-71 Austin..... 80-70 Chrysler Vehicles..... 91-65 De Lorean..... 82-81 Ford Vehicles..... 89-65 GM Vehicles..... 97-63 IHC Light Trucks..... 85-57	
S-509	1	<b>Socket Repair Assembly</b> (D3AZ-13410G) Fits cornering lamps. Ford..... 80-73 Lincoln..... 78-75 Mercury..... 78-75		S-535	1	<b>Socket Repair Assembly</b> Universal dash lamp & socket assembly. Will mount through 1/2" hole in panel up to 3/4" thick. 12 volt non-replacement bulb, 8" coil leads.	
S-514	1	<b>Socket Repair Assembly</b> Universal, weatherproof, double-contact socket assembly. Fits 3/4" base bulb. Fits lamps No. 1034, 1154.		S-540	1	<b>Socket Assembly</b> For 4701 minisealed high beam headlamps for GM vehicles.	
S-517	1	<b>Socket Repair Assembly</b> Universal 2 wire socket to fit all vehicles with 2 prong sealed beam or flasher. Buick..... 95-85 Cadillac..... 00-99, 95-93, 90-85 Chevrolet..... 01, 95-85 GM Light Trucks..... 03-90		S-541	1	<b>Socket Assembly</b> For 4703 minisealed low beam headlamps for GM vehicles.	
S-518	1	<b>Socket Repair Assembly</b> Universal, standard base, 11/16" diameter, double contact socket. Comes with two flange mounting holes on 1 3/16" center.		S-557	1	<b>Socket Repair Assembly</b> (4414184) For license lamps. Chrysler..... 92-89 Dodge, Plymouth..... 92-89	
S-524	1	<b>Socket Repair Assembly</b> GM: 12101898 (high beam) socket assembly for halogen bulb headlamp assembly with 2 prongs and a 9005 bulb. With black housing, weather-pack type seal, two 9 1/2" No. 18 Ga. leads. Buick..... 03-90 Cadillac..... 04-90 Chevrolet..... 03-90 GM Light Trucks..... 03-92 Oldsmobile..... 99-90 Pontiac..... 03-88		S-570	1	<b>Single Contact Socket with External Ground</b> (EOMY, EIDZ-15536A) ID No. EIBB-15A536-BA Ford..... 89-81 Mercury..... 89-80	
				S-571	1	<b>Socket Repair Assembly</b> Rear lamps. (E8PZ-13411D, E9AZ, E9DZ-15A434A) ID No. 20.85 Ford..... 90-86 Lincoln..... 90-87 Mercury..... 87-86	



# SOCKET ASSEMBLIES















## SOCKET ASSEMBLIES WITH 2 WIRE LEAD

Part No.	Pkg. Qty.	Description	Illustration	Part No.	Pkg. Qty.	Description	Illustration
S-572	1	<b>Socket Repair Assembly</b> Side marker. (E1DZ-15A43B; E4DZ, E6AZ, E6DZ-15A43A) ID# E6AB-15A200-AA; E6DB-15A200-AA, AC Ford, Mercury .....89-81 Lincoln .....90-81		S-766	1	<b>Socket Assembly</b> A/T indicator lamp, compartment lamp, courtesy lamp I/P, console front floor, daytime running lamp, ambient light, sensor, malfunction indicator lamp, water and fuel indicator lamps. Buick .....02-90 Cadillac .....96-93 Chevrolet .....01-90 GM Light Trucks .....03, 95-90 GM Med. Duty Trucks 98-93 Oldsmobile .....02-92 Pontiac .....02-90	
S-586	1	<b>Socket Repair Assembly</b> Back-up Lamps. GM: 12085330 Buick .....03-91 Cadillac .....03-94 Chevrolet .....02-90 GM Light Trucks .....03-95 Oldsmobile .....03-90 Pontiac .....03-96		S-767	1	<b>Socket Assembly</b> Back-up lamp, rear fog lamp, rear turn signal lamp. Buick .....03-97 Cadillac .....96-92 Chevrolet .....02-93 GM Light Trucks .....03-94 Oldsmobile .....95-93	
S-589	1	<b>Universal "OFFSET" Mounting Plate</b> Type double contact socket. For signal, park, stop and tail lamps. Fits lamps No. 198, 16, 1034, 1154.		S-768	1	<b>Socket Assembly</b> Back-up lamp, cornering lamp. Buick .....96-83 Cadillac .....02-82 Chevrolet .....96-82 GM Light Trucks .....94-82 Oldsmobile .....96-82 Pontiac .....98-82	
S-591	1	<b>Universal Socket Repair Assembly</b> Double contact standard base, ceramic disc. Contacts at right angle to key. Fits lamps No. 64, 68, 82, 88, 90, 94, 210, 1004, 1074, 1130, 1158, 1176.		S-769	1	<b>Socket Assembly</b> Ford: F32Z-13K371A Hi-Mtd. stop lamp. Ford .....97-93	
S-592	1	<b>Socket Repair Assembly</b> For cornering and marker lamps. (12083007) Chevrolet .....03-84 Oldsmobile .....98-88 Pontiac .....96-87 Saturn .....92-91		S-770	1	<b>Socket Assembly</b> Chrysler: 4636358 Back-up lamp, cornering lamp, turn lamp. Chrysler .....97-91 Dodge .....97-91 Plymouth .....97-91	
S-669	1	<b>Socket Repair Assembly</b> GM: 12037105, 12083460 Front, side and rear marker. Cadillac .....85 Chevrolet .....01-87, 82 GM Light Trucks .....03-82		S-772	1	<b>Socket Assembly</b> Chrysler: 4400899 Hi-Mtd. stop, license plate, side marker, tail lamps. Chrysler .....96-89 Dodge .....96-89 Eagle .....93-93 Plymouth .....96-89	
S-708	1	<b>Foglamp Harness</b> Fits bulbs No. 880, 881, 884, 885, 886, 889, 890, 892, 893, 894, 896, 899. Buick .....97-89 Cadillac .....91-90, 86 Eagle .....94 Ford .....97-90 Ford Light Trucks .....97-93 Oldsmobile .....97-92 Pontiac .....97-92 Saturn .....97-95		S-773	1	<b>Socket Assembly</b> Chrysler: 4864259 Tail stop and turn signal lamps. Chrysler .....89-82 Dodge .....89-82 Dodge Trucks .....89-82 Plymouth .....89-88	





SOCKETS, PIGTAILS & SWITCHES

# SOCKET ASSEMBLIES

## SOCKET ASSEMBLIES WITH 2 WIRE LEAD

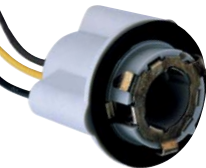
Part No.	Pkg. Qty.	Description	Illustration	Part No.	Pkg. Qty.	Description	Illustration
S-778	1	Socket Assembly Chrysler: 4636363 Back-up lamp. Chrysler ..... 91 Dodge ..... 91 Plymouth ..... 91		S-830	1	Socket Assembly Back-up lamp Buick ..... 96-91	
S-789	1	Socket Assembly License plate, park, side marker, tail lamps. Buick ..... 03-92 Cadillac ..... 04-92 Chevrolet ..... 03-93 GM Light Trucks ..... 04-94 Oldsmobile ..... 03-95 Pontiac ..... 03-93		S-835	1	Socket Assembly Back-up lamp Dodge ..... 88-82	
S-793	1	Socket Assembly Side marker lamp socket. Buick ..... 99-97 Oldsmobile ..... 99-97 Pontiac ..... 99-97 <b>Available While Supplies Last</b> Re-order S789		S-841	1	Socket Assembly Back-up lamp. Ford Truck ..... 03-92 Ford Van ..... 97-96 Lincoln ..... 02-96 Mercury ..... 07-95	
S-806	1	Socket Repair Assembly OEM: F1TZ-13411B Back-up, cornering, parking, turn & stop lamps. Ford Vehicles ..... 04-90		S-842	1	Socket Assembly Back-up lamp. Ford ..... 99-96 Mercury ..... 00-99	
S-807	1	Socket Repair Assembly OEM: F1TZ-13411G Back-up, parking & stop lamps. Ford Vehicles ..... 04-90		S-856	1	Socket Assembly Back-up lamp. Ford ..... 87	
S-810	1	Socket Repair Assembly OEM: F1TZ-13411A Back-up lamp, turn signal. Ford Vehicles ..... 03-96		S-858	1	Socket Assembly Back-up lamp. Acura ..... 95-88 Nissan ..... 92-80	
S-815	1	Socket Repair Assembly OEM: F85Z-13411AA Running board lights. Ford Vehicles ..... 04-98		S-863	1	Socket Assembly Stop, turn & taillight lamps. Chevrolet ..... 61-60	
				S-877	1	Socket Assembly Park, turn signal & taillight Lamps Ford Truck ..... 06-03	







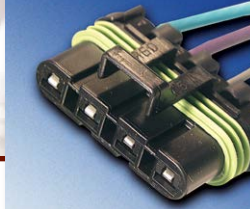





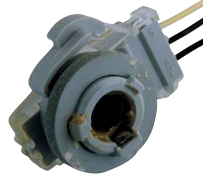



## SOCKET ASSEMBLIES WITH 3 WIRE LEAD

Part No.	Pkg. Qty.	Description	Illustration	Part No.	Pkg. Qty.	Description	Illustration
S-54	1	Socket Repair Assembly (8093203, 9814823) Park, tail, stop, turn signal. Fits lamps No. 1034, 1154, 1157. Buick ..... 90-77 Cadillac ..... 99-77 Chevrolet ..... 90-69 Oldsmobile ..... 90-76 Pontiac ..... 86-76		S-59	1	Socket Repair Assembly. (8902458, 8902487, 8909908, 8907701) Park, tail, stop, turn signal. Fits lamps No. 1034, 1154, 1157. Buick ..... 72-68 Cadillac ..... 73 Oldsmobile ..... 73-70	
S-55	1	Socket Repair Assembly GM: 8903202, 8914822 IHC: 571722C91 Park, tail, stop, turn signal. Fits lamps No. 1034, 1154, 1157. Buick ..... 83-76 Cadillac ..... 86-76 Chevrolet ..... 86-69 GM Light Truck ..... 91-73 Oldsmobile ..... 89-76 Pontiac ..... 83-76		S-65	1	Socket Repair Assembly (8909517) Park, stop, tail, turn signal. Fits lamps No. 1154, 1157. Buick ..... 79-76 Cadillac ..... 93-87, 79-77 Chevrolet ..... 78-77 Oldsmobile ..... 88-71 Pontiac ..... 79-70	

# SOCKET ASSEMBLIES

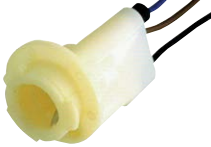

## SOCKET ASSEMBLIES WITH 3 WIRE LEAD

Part No.	Pkg. Qty.	Description	Illustration	Part No.	Pkg. Qty.	Description	Illustration
S-68	1	<b>Socket Repair Assembly</b> (D3AZ-13410D, D40Z-13234A, D40Z-13410A) Park, stop, tail, turn signal. Fits lamp No. 1157. Ford .....79-73 Lincoln .....79-77		S-505	1	<b>Socket Repair Assembly</b> (3513558, 3764561, 3764863) Stop, tail & turn signal. Chrysler .....83-80, 75-80 Dodge .....90-78, 74 Dodge Trucks .....91-82 Plymouth.....90-71	
S-69	1	<b>Socket Repair Assembly</b> AMC: 3690736, 8124663 Chry.: 13588833, 3764123 Ford: D2FZ-13410A, D3AZ-13410B, D5DZ, D5VY-13410A. Park, stop, tail, turn signal. Fits lamp No. 1157. American Motors .....80-77 Ford Motor Co. Cars...80-73 Plymouth-Barracuda...74-73		S-507	1	<b>Socket Repair Assembly</b> (12003757) Stop, tail & rear turn signal lamps. Buick.....96-81 Cadillac.....02-86 Chevrolet .....96-80 GM Light Trucks .....02-82 Oldsmobile.....96-82 Pontiac.....95-81	
S-76	1	<b>Socket Repair Assembly</b> Pair of socket assemblies. (8913503) Park, turn signal and cornering. Bulb No. 1156, 1157. Buick-Rivera .....74-73		S-510	1	<b>Socket Repair Assembly</b> (D3AZ-13410G) Fits stop, tail, & turn signal. Ford .....80-73 Lincoln .....80-77 Mercury.....80-74	
S-77	1	<b>Socket Repair Assembly</b> (8919916, 12013813) Park & turn signal. Fits lamps No. 1034, 1154, 1157. Buick .....96-79 Cadillac.....99-82 Chevrolet .....96-76 GM Light Trucks .....94-79 Oldsmobile.....99-79 Pontiac.....95-92		S-511	1	<b>Socket Repair Assembly</b> (D3MY-13410A, D4DZ-13234A, D54Y-13234A) Fits park and turn signal. Ford .....76-74 Mercury.....77-73	
S-86	1	<b>Socket Repair Assembly</b> Double contact with ground lead. Fits 1 1/16" hole. Park, turn, stop, tail & corner lights. Fits lamps No. 1034, 1154, 1157. Universal applications.		S-512	1	<b>Socket Repair Bracket Assembly</b> (D4LY-13410A) Fits stop, tail & turn signal. Lincoln .....79-73 Mercury.....78-75	
S-91	1	<b>Socket Repair Assembly</b> Double contact with ground wire and mounting plate 1 1/4" by 1 3/4" Stop, tail & turn lights. Fits lamps No. 1034, 1154, 1157. Universal applications.		S-519	1	<b>Socket Repair Assembly</b> For park and turn signal lamps. Ford: D1FZ-13234A, D7FZ-13234C. Used with lamp No. 1157. Ford .....78-73 Ford Trucks .....92-75 Mercury.....78-75	
S-502	1	<b>Socket Repair Assembly</b> Chry.: 4331051, GM: 12003759. Fits back-up, tail, stop and turn signal lamps. Buick .....96-77 Cadillac.....02-77 Chevrolet .....96-77 Chrysler, Dodge.....89-85 GM Light Trucks .....02-78 Oldsmobile.....96-77 Pontiac.....96-77		S-520	1	<b>Socket Repair Assembly</b> Socket assembly for front turn signal or parking lamps. Ford: D40Z-13234A, D7FZ-13234A, D7FZ-13234B, D. Used with lamp No. 1157. Ford .....80-74 Lincoln .....80 Mercury.....80-77	
S-504	1	<b>Socket Repair Assembly</b> (3843245, 3843432, 4163003) Park & front turn signal, side marker, tail, stop or rear turn signal. Chrysler Corp. Cars....92-75 Dodge Trucks .....91-78		S-521	1	<b>Socket Repair Assembly</b> Socket assembly for front turn signal lamps. Ford: D4ZZ-13234A. Used with lamp No. 1157. Ford .....77-74 Ford HD Trucks .....92-89 Mercury.....80	
				S-522	1	<b>Socket Repair Assembly</b> For tail, stoplight or rear turn signal lamps. Ford: D70Z-13410A, E1FZ-13234A, E2VY-13410A, E25Y-13410A. Used with lamp No. 1157. Ford .....90-70	

# SOCKET ASSEMBLIES

## SOCKET ASSEMBLIES WITH 3 WIRE LEAD

Part No.	Pkg. Qty.	Description	Illustration	Part No.	Pkg. Qty.	Description	Illustration
S-525	1	<b>Socket Repair Assembly</b> For halogen bulb headlamp assembly with 3 prongs and 9004/9007 bulb with blue housing, weather-pack seal, three No. 9 1/2" 18 ga. leads. Chry: 4400395; 4414332; 4430976; 4439076.		S-584	1	<b>Socket assembly</b> Park & turn signal, side marker, stop & turn lamps. Buick.....99-91 Cadillac.....03-98, 92-90 Chevrolet.....03-97, 94-90 GM Light Trucks.....03-94 Oldsmobile.....03-93, 91-90 Pontiac.....03-90	
S-526	1	<b>Socket Repair Assembly</b> Fits domestic and import vehicles with 3 prong headlights.		S-585	1	<b>Socket Repair Assembly</b> For back-up, stop, tail and rear turn signal lamps. (12083680) Buick.....96-91 Cadillac.....93-89 Oldsmobile.....94-90	
S-531	1	<b>Socket Repair Assembly</b> For parking lamps. Ford: E1FZ-132234A. Ford.....90-79 Lincoln.....92-82 Mercury.....90-79		S-590	1	<b>Socket Repair Assembly</b> Socket assembly for back-up, stop, tail or rear turn signal lamps. (12076946) Cadillac.....99-94 Chevrolet.....03-00, 96-90 GM Light Trucks.....03-89 Oldsmobile.....96-90 Pontiac.....96-88	
S-532	1	<b>Socket Repair Assembly</b> Chry: 4368264, 4400740 Chrysler Corp. Cars.....89-86		S-600A	1	<b>Socket Assembly</b> For stop, tail, or rear turn signal lamps. (4399576) Chrysler.....89, 84-80 Dodge.....89, 84-81 Dodge Truck.....90-86 Plymouth.....94-81	
S-533	1	<b>Socket Repair Assembly</b> Tail, stop, turn, side marker - rear. Ford: E2SZ-13410A Ford.....91-80 Mercury.....97-70		S-626	1	<b>Socket Repair Assembly</b> Park and turn lamp socket. (3) 18 Gauge, 8" Leads. Ford, Ford Trucks.....94-74 Mercury.....94-74	
S-547	1	<b>Socket Repair Assembly</b> Ford: ESPZ-13411B Ford.....95-83 Lincoln.....90-87 Mercury.....96-86		S-673	1	<b>Socket Repair Assembly</b> GM: 12030055 Repair harness, stop & tail lamps, park & turn lamps. Buick.....96-91 Cadillac.....96-90 Chevrolet.....96-87 GM Light Trucks.....84-82 Oldsmobile.....98-82 Pontiac.....95-92, 88-84	
S-548	1	<b>Socket Repair Assembly</b> Socket assembly. (12083005, 12092377) back-up, front grille, park or turn signal lamps. Buick.....96-88 Chevrolet.....96-95 Oldsmobile.....99-88 Pontiac.....96-88		S-686	1	<b>Repair Harness Seal Beam Lamp</b> No. H4666 and H6545 3-16 Ga. 8" leads GXL. GM, Firebird, Blazer.....97-93 Ford Probe.....97-93 Chrysler, Daytona, Lazer.....91-89	
S-559	1	<b>Socket Repair Assembly</b> (12083006) For stop, tail and rear signal lamps. Buick.....03-93 Chevrolet.....96-90 Oldsmobile.....96-88 Pontiac.....96-90		S-775	1	<b>Socket Assembly</b> Chrysler: 4857327AA Headlamp, turn signal lamp. Chrysler.....04-01 Dodge.....04-01 Plymouth.....04-01	

# SOCKET ASSEMBLIES







## SOCKET ASSEMBLIES WITH 3 WIRE LEAD

Part No.	Pkg. Qty.	Description	Illustration	Part No.	Pkg. Qty.	Description	Illustration
S-776	1	<b>Socket Assembly</b> Park, turn & side lamps, tail, stop, turn signal lamps. Chrysler .....04-90 Dodge .....04-90 Plymouth .....04-90 Wrangler .....03-97		S-844	1	<b>Socket Assembly</b> Headlight and flasher. American Motors .....54-40 Chevrolet Truck .....69-40 Chrysler .....63-40 GMC Truck .....63-54 Jeep .....74-58 Lincoln .....69-58	
S-777	1	<b>Socket Assembly</b> Chrysler: 4773905 Park & turn signal lamps. Dodge Trucks .....02-94 <b>Available While Supplies Last</b> Re-order S532		S-845	1	<b>Socket Assembly</b> Headlight and flasher. Same as S-844 but with mounting bracket.	
S-779	1	<b>Socket Assembly</b> Chrysler: 5288917AA Park & turn signal lamps. Dodge .....03-00 Plymouth .....03-00		S-847	1	<b>Socket Assembly</b> Park & turn signal lamps. Acura .....94-88 Mercury .....96 Nissan .....92-80 Subaru .....93-90 Toyota .....93-80	
S-783	1	<b>Socket Assembly</b> Ford: F1TZ-13411C Turn signal lamp. Ford .....04-00		S-862	1	<b>Socket Assembly</b> Park & turn signal lamps. Chrysler .....95-90 Dodge .....92-89 Dodge Truck .....92-91	
S-786	1	<b>Socket Assembly</b> Front park/turn, rear park/stop/turn, headlamps. Ford .....04-96 Ford Trucks .....04-96 Mercury .....04-96		S-866	1	<b>Socket Assembly</b> Headlight and flasher. 3 wire head light socket for most vehicles using headlamp No. 4002, 4003, 4005, 5040, 5042, 5400, 5402, 5421, 6006, and 6012. Also fits two and three prong flashers.	
S-787	1	<b>Socket Assembly</b> Ford: F1TZ-13411A Front turn/park, rear stop/park/turn Ford .....04-96 Ford Trucks .....01-96		S-868	1	<b>Socket Assembly</b> Stop, turn & taillight lamps. Cadillac .....99-94 Chevrolet .....04-97 Chevrolet Truck .....06-98 GMC Truck .....00-95 Pontiac .....97-93	
S-791	1	<b>Socket Assembly</b> Chrysler: 4636362 Tail, stop, turn signal socket. Chrysler .....94-91 Dodge .....94-91 Plymouth .....94-91		S-872	1	<b>Socket Assembly</b> Park & turn signal lamps. Chrysler .....92-90 Dodge .....05-01	
S-797	1	<b>Socket Assembly</b> Ford: E1AZ-13410A Front turn/park, rear, stop, tail, turn lamps. Ford .....94-81		S-874	1	<b>Socket Assembly</b> Park & turn signal lamps. Ford .....08-05 Ford Truck .....08-03	
S-808	1	<b>Socket Assembly</b> Ford: F3LY-13411 Park & turn lamps. Ford Vehicles .....03-93		S-878	1	<b>Socket Assembly</b> Park & turn signal lamps. Ford .....04-03	
S-809	1	<b>Socket Assembly</b> Ford: F47Z-13411 Side marker, stop, tail & turn lamps. Ford Vehicles .....03-96		S-879	1	<b>Socket Assembly</b> Park & turn signal lamps. Ford .....08 Ford Truck .....08-03 Mercury .....08-04	
S-829	1	<b>Socket Assembly</b> Stop, turn & taillight lamps. Cadillac .....97-92 Chevrolet .....02-93 Chevrolet Truck .....01-96 GMC Truck .....02-95 Oldsmobile .....97-94 Pontiac .....97-93		S-890	1	<b>Socket Assembly</b> Stop, turn & taillight lamps. Ford .....04-00	
				S-891	1	<b>Socket Assembly</b> Stop, turn & taillight lamps. Ford Truck .....03-97	

SOCKETS, PIGTAILS & SWITCHES

# PIGTAIL ASSEMBLIES

PIGTAIL ASSEMBLIES WITH SINGLE WIRE LEAD							
Part No.	Pkg. Qty.	Description	Illustration	Part No.	Pkg. Qty.	Description	Illustration
S-81	1	Voltage Regulator Pigtail Chrysler Corp. Vehicles..... 69-65		S-655	1	Coolant Temp./Oxygen Sensor Repair Harness. Buick.....96-87 Cadillac.....96-87 Chevrolet.....96-87 GM Light Trucks.....96-87 Oldsmobile.....96-87 Pontiac.....96-87 Mates with S554	
S-550	1	Pigtail Assembly GM 12051234: 12102621 For GM radiator fan temperature switch. Special multiple lock, multi-seal connector with 10" 18 Ga. crosslink polyethylene lead. Buick.....95-90, 88-82 Cadillac.....95-93, 85-82 Chevrolet.....01-82 GM Light Trucks.....02-88 Oldsmobile.....92-82 Pontiac.....01-82		S-733	1	Pigtail Assembly Auxiliary engine cooling fan harness, auxiliary fan control switch. Chevrolet.....96-91 GM Light Trucks.....95-91	
S-554	1	Pigtail Assembly Repair For exhaust oxygen sensor with one 18 Ga. lead 8" long. Buick.....98-91 Chevrolet.....98-92 GM Trucks.....98-82 Oldsmobile.....98-91 Pontiac.....98-91 Mates with S655		S-790	1	Pigtail Assembly Plug, cigar lighter (accessory). Chrysler.....98-97 Dodge.....00-95 Dodge Light Trucks.....99-97 Plymouth.....00-95	
S-582	1	Pigtail Repair Assembly For carburetor choke heater. Gray with 7" lead, 18 Ga. Buick.....96-93, 91-82 Cadillac.....88-84 Chevrolet.....96-82 Oldsmobile.....95, 91-82 Pontiac.....90-82		S833	1	Pigtail Repair Assembly Stereo power connector. Chevrolet Truck.....86-73 GMC Truck.....87-73	
S-635	1	Switch and Sensor Connector Fits No. 8 and M4 terminals. Buick.....93-92, 90-82 Chevrolet.....95-94 GM Light Trucks.....95-94 Oldsmobile, Pontiac.....94-82		S839	1	Pigtail Repair Assembly Brake fluid level sensor connector. GMC Truck.....02-90	
S-639	1	Oil Pressure Switch Pigtail For 1 pin switches. GM vehicles. GM: 12085500 Buick.....02, 97, 88-87 Cadillac.....99 Chevrolet.....02, 90, 88-87 GM HD Trucks.....02-92 GM Light Trucks.....02-98 Oldsmobile.....02, 97, 88-87 Pontiac.....02, 97, 88-86		S840	1	Pigtail Repair Assembly Trunk release switch connector. Buick.....96-84 Cadillac.....88-84 Chevrolet.....95-84 Oldsmobile.....95-89	
S-643	1	Repair Harness GM 12117353 Fuel pump instrument panel. Buick.....95-90 Chevrolet.....02-90 GM Light Trucks.....03-89 GM Medium Duty.....02-01 Oldsmobile.....94-90 Pontiac.....02-90		S843	1	Pigtail Repair Assembly Starter relay connector. Ford.....98-89 Lincoln.....97-89 Mercury.....00-90	
				S853	1	Pigtail Repair Assembly A/C compressor clutch relay connector. Dodge.....89-85 Dodge Truck.....87-85 Plymouth.....87-85	

# PIGTAIL ASSEMBLIES



















## PIGTAIL ASSEMBLIES WITH 2 WIRE LEAD

Part No.	Pkg. Qty.	Description	Illustration	Part No.	Pkg. Qty.	Description	Illustration
S-78	1	<b>Alternator Pigtail</b> Fits Delco alternators with integral regulator Buick.....88-70 Cadillac.....85-70 Chevrolet.....85-74 GM Trucks.....86-70 IHC Trucks.....82-70 Oldsmobile.....85-70		S-556	1	<b>Pigtail Repair Assembly</b> For manifold air temperature. (MAT) GM Vehicles.....03-84	
				S-560	1	<b>Pigtail Repair Assembly</b> Radiator fan temperature control switch. 14 Ga. leads 7" long, and gray connector. Fits Ford or Mercury cars with 2.3L. Eng. 91-81.	
S-79	1	<b>Alternator Pigtail Repair Harness</b> Chrysler Vehicles.....88-85		S-562	1	<b>Pigtail Repair Assembly</b> GM ignition coils. Comes with grey plug. Buick.....95-91, 88-85 Cadillac.....95-90, 86-85 Chevrolet.....95-85 GM Light Trucks.....95-85 GM HD Trucks.....98-88 GEO.....93-90 Isuzu.....94-87 Jeep.....86-85 Oldsmobile.....95-90, 88-85 Pontiac.....95-85	
S-84	1	<b>Alternator Pigtail</b> With color coded wires. Delco equipped with external regulator. GM Cars.....73-70 GM Trucks.....86-70 IHC Trucks.....82-70 Older Cars & Trucks		S-563	1	<b>Pigtail Repair Assembly</b> GM ignition coils. Comes with black plug. Buick.....95-91, 88-85 Cadillac.....95-90, 86-85 Chevrolet.....95-85 GM Light Trucks.....95-85 GM HD Trucks.....98-88 GEO.....93-90 Isuzu.....94-87 Jeep.....86-85 Oldsmobile.....95-90, 88-85 Pontiac.....95-85	
S-85	1	<b>Blower and Compressor Relay Pigtail</b> Older Cars & Trucks		S-566	1	<b>Pigtail Repair Assembly</b> Ford engine fan switches. Ford, Mercury.....86-84	
S-536	1	<b>Pigtail Assembly</b> A.C. compressor low pressure switch, A.C. cycling switch, A.C. refrigerant pressure switch. GM vehicles w/V-5 compressor. GM Vehicles.....01-85		S-567	1	<b>Pigtail Repair Assembly</b> Ford air charge temp. sensor. Ford.....95-81 Ford Light Trucks.....01-81 Lincoln.....94-81 Mercury.....95-81	
S-537	1	<b>Pigtail Assembly</b> A.C. clutch field. Ford Vehicles.....89-81		S-568	1	<b>Pigtail Repair Assembly</b> GM cooling fan motors. GM: 22048271, 22074968, 22074969. Replaces GM: 12101906, 917. Buick.....03-90 Cadillac.....02-89 Chevrolet.....03-90 GM Light Trucks.....00-92 Medium Duty.....02-00, 98-90 Oldsmobile.....02-87 Pontiac.....04-86	
S-538	1	<b>Pigtail Assembly A.C. Compressor High Pressure Switch.</b> GM: 12085521 GM vehicles w/V-5 compressor. Buick.....96-86 Cadillac.....93-92, 88-87 Chevrolet.....95-86 GM Trucks.....97-90 Oldsmobile.....95-86 Pontiac.....95-86		S-573	1	<b>Pigtail Repair Assembly</b> For electric voltage regulator. (2983727) Chrysler Vehicles.....95-72	
S-553	1	<b>Pigtail Repair Assembly</b> Repairs GM 12043215, 12085498 For cornering and fog lamps with halogen bulbs. With two 18 Ga. leads 7" long. Buick.....96-87 Cadillac.....02-87 Chevrolet.....02-87 GM Light Trucks.....03-88 Medium Duty.....02-92 Oldsmobile.....03-87 Pontiac.....03-84					

SOCKETS, PIGTAILS & SWITCHES

# PIGTAIL ASSEMBLIES

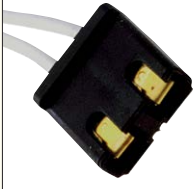
## PIGTAIL ASSEMBLIES WITH 2 WIRE LEAD

Part No.	Pkg. Qty.	Description	Illustration	Part No.	Pkg. Qty.	Description	Illustration
S-575	1	<b>Pigtail Repair Assembly</b> GM: 12102747. For windshield washer pump or low coolant sensor. Buick.....03-87 Cadillac.....04-92 Chevrolet.....03-90 GM Light Trucks.....03-87 Medium Duty.....04-90 Oldsmobile.....03-87 Pontiac.....04-87		S-610	1	<b>Air Conditioning Cycling Switch Harness</b> Ford.....95-83 Ford Trucks.....95-83 Lincoln.....95-83 Mercury.....95-83	
S-576	1	<b>Pigtail Repair Assembly</b> For mixture control solenoid connector. For 2 or 4 barrel Rochester Varajet Carburetors. GM Vehicles.....90-80		S-612	1	<b>Coolant Temperature Sensor Harness</b> Ford.....01-83, 81-80 Ford Light Trucks.....01-79 Lincoln.....01-98, 96-80 Mazda.....94-91 Mercury.....01-83, 81-80 Nissan.....99-96	
S-578	1	<b>Pigtail Repair Assembly</b> For sealed type horn connector. Fits GM 1999161, 10456327, 10456328. Buick.....96-88 Cadillac.....96-91 Chevrolet.....96-88 Oldsmobile.....96-88 Pontiac.....96-88		S-614	1	<b>Power Window Motor Harness</b> GM: 12101914 Buick.....93-90 Cadillac.....93-90 Chevrolet.....95-93 GM Light Trucks.....03-94 Oldsmobile.....96-90 Pontiac.....95-90	
S-581	1	<b>Pigtail Repair Assembly</b> Pigtail and assembly repair with 12" leads. Radiator cooling fan motor 4 cylinder engine and heater blower motors. Ford.....89-79 Ford Trucks.....86-82		S-633	1	<b>A/C Clutch Switch Connector</b> GM Vehicles.....96-82	
S-583	1	<b>Pigtail Repair Assembly</b> For Ford ignition coil. Ford, Mercury.....87-77 Lincoln.....84-75		S634	1	<b>Air Switch Valve Pigtail</b> GM Vehicles.....95-87	
S-587	1	<b>Pigtail Repair Assembly.</b> For throttle body injection. GM cars with direct injection. GM: 12085496 Buick.....96, 93-92, 90-87 Chevrolet.....99, 97-87 GM Light Trucks.....02-87 Medium Duty.....99-90 Oldsmobile.....99, 96, 93-87 Pontiac.....97-96, 93-87		S-636	1	<b>Air Diverter Valve Pigtail</b> GM Vehicles.....96-87	
S-588	1	<b>Pigtail Repair Assembly</b> AC clutch. GM: 12101937 Buick.....03-89 Cadillac.....04-89 Chevrolet.....03-89 GM Light Trucks.....03-87 Medium Duty.....03, 93-90 Oldsmobile.....03-89 Pontiac.....04-89		S-641	1	<b>Oil Pressure Switch Pigtail</b> For 2 pin switches. GM Vehicles.....99-85	
S-596	1	<b>Windshield Washer Pump Repair</b> Harness fits pump No. E3AZ-17664A, E0AZ-17664A. Ford.....94-68 Lincoln.....94-68 Mercury.....94-68		S-647	1	<b>Repair Harness</b> Washer fluid sensor connector, back-up lamp switch connector, A/C compressor switch connector. GM: 12101903 Buick.....93-90, 87-85 Cadillac.....87-85 Chevrolet.....02-91 GM Light Trucks.....95-90 Medium Duty.....02-98 Oldsmobile.....92-85 Pontiac.....02-95, 91-86	
				S-648	1	<b>Repair Harness</b> Diode and leads air conditioner compressor. Buick.....87-85 Cadillac.....89-83 Chevrolet.....87-86 Oldsmobile.....87-86 Pontiac.....87-86	
				S-649	1	<b>Repair Harness</b> Coolant sensor connector. Buick.....95-83 Cadillac.....90-85 Chevrolet.....96-85 Oldsmobile.....94-85 Pontiac.....95-85	



# PIGTAIL ASSEMBLIES



## PIGTAIL ASSEMBLIES WITH 2 WIRE LEAD

Part No.	Pkg. Qty.	Description	Illustration	Part No.	Pkg. Qty.	Description	Illustration
S-650	1	<b>Repair Harness</b> GM: 12085524 Multi-purpose connector. Park lamp, inline-to turn signal lamp, fog lamp, inline-to aux. turn signal, fuel sensor, inline-to rear license plate, inline-to rear body harness, inline-to park and turn signal, inline-to fwd. lamp harness, inline-to front position lamp, side marker lamp. Mate with S751. Buick .....96-88 Cadillac.....03, 01, 99-86 Chevrolet.....03-90 GM Light Trucks .....03-90 Medium Duty.....04-90 Oldsmobile.....03-99, 96-87 Pontiac.....03-99, 97-85		S-683	1	<b>Pigtail Repair Assembly</b> Repair harness windshield washer sensor. Ford Light Trucks .....90-86	
				S-685	1	<b>Pigtail Repair Assembly</b> Repair harness fuel injector. Ford .....96-85 Lincoln .....96-85 Mercury.....96-85	
				S-689	1	<b>Repair Harness</b> Replaces 12101855 Direct ignition, door lock actuator, actuator No. 22144362, 22144363 2-18 Ga. GXL 8" leads. Buick .....03-92 Cadillac .....03-87 Chevrolet .....03-88 GM Light Trucks .....03-87 Medium Duty .....03-90 Oldsmobile.....03-92 Pontiac.....03-90	
S-651	1	<b>Pigtail Repair Assembly</b> GM: 12085489. Cooling fan temp. sensor. Buick .....87-85 Chevrolet .....85 GM Light Trucks .....89-87 Medium Duty .....03-94 Oldsmobile.....87-85 Pontiac.....91, 86-85		S-691	1	<b>Pigtail Repair Assembly</b> Repair harness, air bag 2-22 Ga. 8" leads. Ford .....97-85	
S-653	1	<b>Pigtail Repair Assembly</b> GM: 12101933. Distributorless ignition module repair harness. (Ignition coil harness) Chevrolet .....02-90 GM Light Trucks .....00-95 Pontiac.....02-95, 90-87		S-695	1	<b>Repair Harness</b> Straight lamp socket base for wedge bulb. Green hardshell. 2-18 Ga. TXL 8" leads. Ford Windstar .....99-95	
S-663	1	<b>Pigtail Repair Assembly</b> Repair harness idle air by-pass valve. Ford, Lincoln.....98-84 Mercury.....98-86		S-696	1	<b>Repair Harness</b> Fuel injector 2-18 Ga. 8" leads w/ set index Lucas & Bosch injectors. Domestic & Import Vehicles.	
S-667	1	<b>Pigtail Repair Assembly</b> GM: 12101820 Repair harness body markerlamp switch ground block, cargo lamp switch, wiper motor, power seat-front vertical motor, lumbar pump. Buick .....03-86 Cadillac .....03-86 Chevrolet .....03-93 GM Light Truck .....94-92 Oldsmobile.....03-86 Pontiac.....03-93		S-697	1	<b>Repair Harness</b> Fuel injector 2-18 Ga. 8" leads w/external spring clip retainer. Lucas & Bosch injectors. Domestic & Import Vehicles.	
				S-699	1	<b>Repair Harness</b> Vehicle speed sensor A.B.S. wheel speed sensor 2-18 Ga. GXL 8" leads. Ford .....97-93	
				S-705 ET-411	1	<b>Alternator Pigtail Extender</b> Internal regulator harness. GMC .....95-69 Buick .....95-69 Cadillac .....95-69 Ford HD Trucks .....92 Freight Liner Trucks....92-89, 87-73 Jeep .....92-75 Oldsmobile .....88-70 Pontiac .....87-70	
S-670	1	<b>Pigtail Repair Assembly</b> Ford: F3XY-12A112A Repair harness pick-up or crankshaft sensor. Ford Light Trucks.....95-83 Nissan.....94-82		S-709	1	<b>Speaker Harness</b> GM: 12085520 Buick .....96-88 Cadillac .....88 Chevrolet .....96-88 Oldsmobile.....92-88 Pontiac.....88	
S-681	1	<b>Pigtail Repair Assembly</b> Repair harness lamp socket base 90° Ford Light Trucks.....96-91					

# PIGTAIL ASSEMBLIES







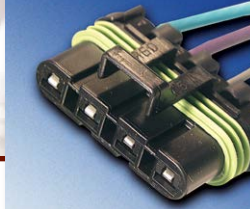

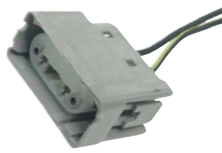

## PIGTAIL ASSEMBLIES WITH 2 WIRE LEAD

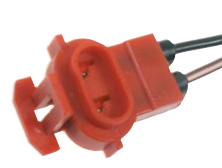
Part No.	Pkg. Qty.	Description	Illustration	Part No.	Pkg. Qty.	Description	Illustration
S-712	1	<b>Pigtail Repair Assembly</b> A/C solenoid, air diverter valve, ambient temperature sensor, back-up alarm, back-up lamp, exhaust oxygen sensor, fog lamp, electronic brake control module, idle air control valve, windshield washer pump motor, speed sensor. GM: 12085485		S-751	1	<b>Pigtail Assembly</b> Inline female 2-way connector used on cars, trucks, stationary engines, farm and industrial equipment. Features: current capacity of 20 Amp., silicone seals, machine crimped terminals, temperature rating of -40°F to 275°F fuel/coolant/brake fluid resistant. Mate with S650.	
S-715	1	<b>Repair Harness</b> Garage door opener. Door opener No. 12344978 GM Vehicles ..... 80		S-757	1	<b>Pigtail Assembly</b> Radiator cooling motor for fan motor No. 4546538, 4546540..... Chrysler ..... 95-91 Dodge ..... 95-91 Plymouth ..... 95-91	
S-717	1	<b>Pigtail Assembly</b> GM: 12085535 Ashtray lamp, fog lamp, floor console, interior lighting, rear view mirror, side marker lamp, van mirror, radio speaker, lumbar switch, door lock switch, parking brake switch, windshield wiper & wiring. Buick ..... 03-86 Cadillac ..... 04-86 Chevrolet ..... 03-87 GM Light Trucks ..... 03-89 Medium Duty ..... 04-92 Oldsmobile ..... 03-87 Pontiac ..... 04-88		S-792	1	<b>Pigtail Assembly</b> GM: 12102921 GM alternator adapter harness converts the new style (CS Series) GM alternators to be used in older GM vehicles (SI Series). Use on vehicles without alternator warning light or if vehicle has gauge. GM Vehicles ..... 95-88	
S-722	1	<b>Repair Harness</b> GM: 25117765 Fuel pump adapts fuel pumps wiring and fuel pump with pin terminals. Cadillac ..... 92-90 Chevrolet ..... 92-88 GM Light Trucks ..... 95-87 Pontiac ..... 93-88		S-799	1	<b>Pigtail Assembly</b> Brake lamp switch. Ford Vehicles ..... 03-98	
S-727	1	<b>Repair Harness</b> Oil pressure switch, vehicle speed sensor switch No. 4707015, 5233397. Sensor No. 4439096, 5227897. Chrysler Vehicles ..... 92-85		S-811	1	<b>Pigtail Assembly</b> GM: 12127120 Inline brakes, engine, lamp, wheel speed sensor. GM Vehicles ..... 04-95	
S-735	1	<b>Pigtail Assembly</b> Parking brake switch, cruise control release switch, cruise control switch. GM Light Trucks ..... 95-92, Medium Duty ..... 94-93		S-812	1	<b>Pigtail Assembly</b> Cam shaft and crank shaft sensors. Ford Vehicles ..... 04-91	
S-737	1	<b>Pigtail Assembly</b> Ford 90 Amp. alternators. Ford ..... 94-74		S-816	1	<b>Pigtail Assembly</b> Running board lights, evaporator solenoids. Ford Vehicles ..... 04-99	
S-740	1	<b>Pigtail Assembly</b> Windshield washer pump. GM Cars & Trucks ..... 91-82		S-818	1	<b>Pigtail Assembly</b> GM: 12126499 ABS wheel, speed sensor. Ford Vehicles ..... 04-92	
S-743	1	<b>Pigtail Assembly</b> Back-up lamp switch. Ford ..... 97-89 Ford Light Trucks ..... 04-80 Ford Med. Trucks ..... 98-94 Mercury ..... 97-89		S-819	1	<b>Pigtail Assembly</b> Ignition Coil. Ford Vehicles ..... 04-99	
				S-820	1	<b>Pigtail Assembly</b> Windshield washer pump. Ford Vehicles ..... 04-97	
				S-823	1	<b>Pigtail Assembly</b> Ford: 1F1Z-14A411BA Brake lamp switch. Ford Vehicles ..... 04-00	



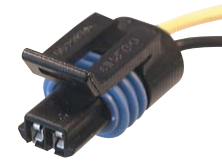

# PIGTAIL ASSEMBLIES



## PIGTAIL ASSEMBLIES WITH 2 WIRE LEAD

Part No.	Pkg. Qty.	Description	Illustration	Part No.	Pkg. Qty.	Description	Illustration
S-824	1	<b>Pigtail Assembly</b> Fuel injectors (with oval injector connectors). Ford Vehicles.....04-99		S-893	1	<b>Pigtail Repair Assembly</b> Backup light connector. Ford Truck .....05 Lincoln .....02-00 Mercury.....06-04	
S-826	1	<b>Pigtail Assembly</b> GM: 12101888 Window lift motors. GM Vehicles .....04-90		S-904	1	<b>Pigtail Repair Assembly</b> Fuel pump connector. Ford .....93-87	
S-827	1	<b>Pigtail Assembly</b> Radiator cooling (motor & resistor) Ford Vehicles.....03-95		SK25	1	<b>Fuel Injector Solenoid</b> Connector Pigtail. Multi-purpose. Replaces GM No. 12085491 Buick.....03-86 Cadillac.....02-92 Chevrolet .....03-87 GM Light Trucks .....03-96 Oldsmobile.....02-86 Pontiac.....03-86	
S-831	1	<b>Pigtail Repair Assembly</b> Stoplight switch connector. Ford .....94-80 Ford Truck .....94-80		SK29	1	<b>Fuel Injection Pump Delivery</b> Valve Wiring. Injector-fuel, In-line-to-fuel injector Solenoid-brake pressure modulate valve. GM Vehicles .....99-86	
S-838	1	<b>Alternator Adapter Harness</b> Used to convert older vehicles with SI Series alternator and with warning light to newer CS series alternator. GM Vehicles .....95-88		TX3A	1	<b>Multi-Purpose Repair Harness</b> AMC: 8983502327 GM: 12046623 Buick .....03-86 Cadillac.....02-92 Chevrolet .....03-87 GM Light Trucks .....03-96 Oldsmobile.....02-86 Pontiac.....03-86	
S-848	1	<b>Pigtail Repair Assembly</b> Cigar lighter connector. Buick .....95-80					
S-849	1	<b>Pigtail Repair Assembly</b> Stereo speaker connector. Ford.....89-88					













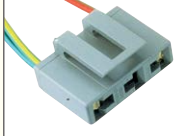
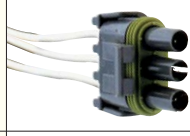



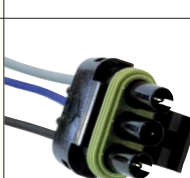

## PIGTAIL ASSEMBLIES WITH 3 WIRE LEAD

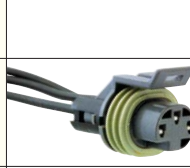
Part No.	Pkg. Qty.	Description	Illustration	Part No.	Pkg. Qty.	Description	Illustration
S-64	1	<b>Pigtail Repair Assembly</b> Fits dimmer switches with 3 12" wire leads. American Motors .....81-67 Chrysler Vehicles.....80-65 Ford Vehicles.....81-65		S-82	1	<b>Pigtail For Manual A.C. Relay</b> Not supplied by O.E.M. American Motors .....80-67 Buick.....88-70 Cadillac.....84-70 Chevrolet .....86-70 Chrysler Vehicles.....91-70 GM Trucks .....86-70 IHC Trucks.....86-70 Oldsmobile.....88-70 Pontiac.....87-70 Older Cars & Trucks	
S-72	1	<b>Pigtail Repair Assembly</b> For floor mounted dimmer switches. Buick .....83-63 Cadillac .....82-63 Chevrolet .....84-63 GM Trucks .....86-63 IHC Trucks.....80-57 Oldsmobile.....81-70 Pontiac.....84-65		S-83	1	<b>Power Servo Pigtail</b> Not supplied by O.E.M. GM Vehicles .....73-63 Older Cars & Trucks	

SOCKETS, PIGTAILS & SWITCHES

# PIGTAIL ASSEMBLIES

## PIGTAIL ASSEMBLIES WITH 3 WIRE LEAD

Part No.	Pkg. Qty.	Description	Illustration	Part No.	Pkg. Qty.	Description	Illustration
S-92	1	Alternator Pigtail Repair Harness With color-coded wires. Ford Vehicles..... 81-65		S-579	1	Pigtail Assembly Repair For 3 terminal heavy duty, thermal or electronic flashers. For cars, trucks, tractors, trailer and industrial applications.	
S-539	1	Pigtail Repair Assembly Ford ignition coil, EEC-IV. Ford Vehicles..... 91-81		S-594	1	A/C Pressure Switch Repair Harness GM: 12085507 Cadillac..... 97-86 Oldsmobile ..... 88-84 Pontiac ..... 88-84	
S-542	1	Pigtail Repair Assembly Alternator pigtail repair. Ford Vehicles..... 89-81		S-595	1	MAP Sensor Repair Harness GM: 12085502 Buick..... 03-82 Chevrolet..... 03-82 GM Light Trucks..... 99-90 Medium Trucks..... 98-90 Oldsmobile ..... 03-82 Pontiac ..... 03-82	
S-545	1	Voltage Regulator Pigtail Ford Vehicles..... 94-81		S-602	1	Ignition Switch Repair Harness AMC ..... 91-69 GM Vehicles ..... 91-69	
S-552	1	Pigtail Assembly Repair GM: 12101895 for voltage regulators of Delco CS type alternators with internal regulators. With two 18 Ga. leads and one 12 Ga. (SXL) wire. Chevrolet ..... 89-87 Oldsmobile..... 89-87 Pontiac..... 89-87		S-613	1	MAP Sensor Repair Harness Ford ..... 91-69 Ford Trucks ..... 91-69 Lincoln ..... 91-69 Mercury ..... 91-69	
S-564	1	Pigtail Repair Harness GM: 12116257 Repair harness for GM throttle position sensors. For GM vehicles with fuel injection. Chevrolet ..... 96-89 GM Light Trucks ..... 98-95 Medium Duty ..... 03, 96-90 Pontiac..... 95-92		S-619	1	Throttle Position Sensor Harness GM: 12102748 Various sensors and switches. Buick..... 03-90 Cadillac..... 04-90 Chevrolet..... 03-90 GM Light Trucks..... 03-90 Medium Duty ..... 03-90 Oldsmobile ..... 03-90 Pontiac ..... 04-89	
S-565	1	Pigtail Repair Harness For Ford EGR sensor. No. E6AZ-9J460A Ford/Mercury ..... 91-88		S-637	1	Oil Pressure Switch Pigtail For 3 pin switches. GM Vehicles..... 99-87	
S-569	1	Pigtail Repair Harness For mass air flow sensor. For GM engines with tuned port injection. GM Cars ..... 88-85		S-640	1	Blower Motor Pigtail (Heavy Duty Applications) Chrysler Trucks ..... 94-85 Ford Trucks ..... 95-86 GM Cars & Trucks ..... 95-86	
S-574	1	Pigtail Repair Harness GM: 12085483 Pigtail repair harness for crankshaft coolant sensor. Also used as a power steering pressure switch connector. Buick..... 96-86 Cadillac..... 94-93, 90-87 Chevrolet ..... 97-90 Oldsmobile..... 95-86 Pontiac..... 96-87		S-656	1	Repair Harness For GM mass airflow sensors. For GM vehicles with fuel injection. Buick..... 96-90 Chevrolet ..... 96-90 Chevrolet Trucks ..... 96-90 Oldsmobile ..... 96-91 Pontiac ..... 95-92	
S-577	1	Pigtail Assembly Repair For camshaft sensor connector. (12085538) Buick..... 90-86 Oldsmobile..... 90-86 Pontiac..... 90-87		S-657	1	Repair Harness Door jamb switch/master cylinder. Ford..... 96-87 Lincoln ..... 96-87 Mercury ..... 96-87	
				S-674	1	Repair Harness Throttle position sensor connector. Ford..... 96-90 Ford Light Trucks ..... 96-91 Mercury ..... 96-90	

# PIGTAIL ASSEMBLIES









## PIGTAIL ASSEMBLIES WITH 3 WIRE LEAD

Part No.	Pkg. Qty.	Description	Illustration	Part No.	Pkg. Qty.	Description	Illustration
S-677	1	<b>Repair Harness</b> Exhaust oxygen sensor. Fits 3 wire O2 sensors. Ford .....90-86 Ford Light Trucks.....90-86 Lincoln.....96-87 Mercury.....96-87		S-725	1	<b>Pigtail Repair Assembly</b> Repair harness, radiator cooling fan motor, fan & shroud assembly No. F4DZ-8C07B, F5CZ-8C607A. Ford Vehicles.....96-90	
S-682	1	<b>Repair Harness</b> Lamp socket base 90°. Ford Light Trucks.....96-91		S-732	1	<b>Pigtail Assembly</b> GM: 12126058 Blower motor resistor connector. Chevrolet .....92 GM Light Trucks .....96-90 GM Med. Trucks.....96-90 Pontiac.....92	
S-688	1	<b>Socket and Pigtail Assembly</b> Replaces 12126444 repair harness electric ride control sensor No. 22076335. 3-22 Ga. GPT 8" lead. Buick.....96, 94-93 Cadillac.....95, 93 Chevrolet .....97-90 Oldsmobile.....99-92 Pontiac.....99-94		S-734	1	<b>Pigtail Assembly</b> GM: 12101851 Cigarette lighter ashtray lamp, Inline-to instrument panel. Buick.....91-87 Cadillac.....04 Chevrolet .....95, 91-89 Oldsmobile.....91 Pontiac.....91	
S-690	1	<b>Repair Harness</b> Inertia fuel shut off switch. Switch No. E8AZ-9341-A, FO2Z-A, FZAZ-A. 2-18 GA. SXL 8" leads. Ford .....97-90		S-738	1	<b>Pigtail Assembly</b> Chrysler: 4897087AA Camshaft, crankshaft sensors. Chrysler .....98-97 Dodge .....00-95 Dodge Light Trucks ....99-97 Plymouth.....00-95	
S-694	1	<b>Repair Harness</b> Repair harness straight lamp socket base for wedge bulb. Brown hardshell 3-18 Ga. TXL 8" leads. Ford Windstar .....97-95		S-745	1	<b>Pigtail Assembly</b> Lamp socket base, power steering pressure, brake master cylinder. Ford .....02-95 Mercury.....02-95	
S-707	1	<b>Pigtail Assembly</b> Voltage regulators. Used Delco 9000590, 9000591 & 9000592, 9000593. Chrysler 2444064 Farm, Industrial & Marine. <b>Available While Supplies Last</b>		S-747	1	<b>Pigtail Assembly</b> Chrysler: 2926502 Neutral safety switch No. 2932820, 3747361, 4057750. AMC.....88-72 Chrysler .....01-69 Dodge .....01-69 Dodge Light Trucks ....01-69 IHC.....80-62 Jeep .....01-80 Plymouth.....01-69	
S-711	1	<b>Pigtail Repair Assembly</b> GM: 12117354 Stop lamp switch, stop lamp, torque converter switch, torque converter clutch switch. Buick.....96-92 Cadillac.....96-93 Chevrolet .....02-91 GM Light Trucks .....99-92 Oldsmobile.....96-91 Pontiac.....02-91		S-750	1	<b>Pigtail Assembly</b> Universal. Inline male 3-way connector used on cars, trucks, stationary engines, farm and industrial equipment. Features: current capacity of 20 Amp., silicone seals, machine crimped terminals, temperature rating of -40° F to 257° F, fuel/coolant/ brake fluid resistant. Mates with S758.	
S-724	1	<b>Pigtail Repair Assembly</b> GM: 12117025 Repair harness, crank position sensor, electric brake module, cooling fan motor, coolant level switch & various sensors. Buick.....03-91 Cadillac.....03-91 Chevrolet .....03-90 GM Light Trucks .....03-91 Oldsmobile.....03-91 Pontiac.....04-91					









SOCKETS, PIGTAILS & SWITCHES

# PIGTAIL ASSEMBLIES

## PIGTAIL ASSEMBLIES WITH 3 WIRE LEAD

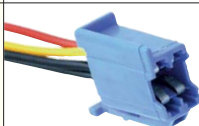
Part No.	Pkg. Qty.	Description	Illustration	Part No.	Pkg. Qty.	Description	Illustration
S-755	1	<b>Pigtail Assembly</b> Distributorless ignition coil. Ford ..... 03-91 Ford Light Trucks..... 01-89 Lincoln ..... 98-91 Mazda..... 01-94 Mercury..... 01-91 Available While Supplies Last		S-785	1	<b>Pigtail Assembly</b> EGR position sensor. Ford ..... 95-85 Ford Light Trucks ..... 96-85 Lincoln ..... 92-86 Mercury ..... 93-85 Medium Duty ..... 03-90	
S-758	1	<b>Pigtail Assembly</b> Inline female 3-way connector used on cars, trucks, stationary engines, farm and industrial equipment. Features: current capacity of 20 Amp., silicone seals, machine crimped terminals, temperature rating of -40° F to 257° F, fuel/coolant/brake fluid resistant. Mates with S750.		S-821	1	<b>Pigtail Assembly</b> Ford: 1U2Z-14S411TA Alternator, brake fluid level sensor. Ford Vehicles ..... 04-96	
S-760	1	<b>Socket Assembly</b> Headlight switch. Ford ..... 94-80 Lincoln ..... 94-90 Mercury..... 94-80		S-855	1	<b>Pigtail Repair Assembly</b> Tailgate window connector. Buick..... 72-64 Chevrolet..... 72-64 Oldsmobile ..... 72-64 Pontiac ..... 72-64	
				S-867	1	<b>Pigtail Repair Assembly</b> Throttle position sensor connector. Ford..... 05-94 Ford Truck..... 05-96	

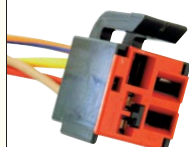
## PIGTAIL ASSEMBLIES WITH 4 WIRE LEAD

Part No.	Pkg. Qty.	Description	Illustration	Part No.	Pkg. Qty.	Description	Illustration
S-93	1	<b>Voltage Regulator Pigtail Repair Harness</b> Delco: 7700 With color coded wires. GM Vehicles ..... 73-61 IHC Trucks..... 80-63		S-555	1	<b>Pigtail Repair Assembly</b> GM: 12085506 For idle air control valve, with four 18 Ga. leads with seal 10" long. Fits GM Vehicles with fuel injection 95-82.	
S-527	1	<b>Pigtail Repair Assembly</b> GM: 12085483 For rear radio speakers. Buick..... 91-86 Chevrolet ..... 92 Oldsmobile..... 91-86 Pontiac..... 91-87		S-558	1	<b>Pigtail Socket Assembly Repair</b> For idle speed control. Fits GM V6, V8 models with carburetor 81-87.	
S-528	1	<b>Pigtail Repair Assembly</b> For rear radio speakers. GM Vehicles ..... 87-78		S-561	1	<b>Connector Kit</b> For fuel pump sending unit of Ford vehicles and also general purpose applications. Comes with 4 wire connector and a set of female 18/20 Ga. terminals and 14/16 Ga. terminals. Ford ..... 90-85	
S-530	1	<b>Pigtail Repair Assembly</b> For GM or Delco radio connectors. GM Cars ..... 82-78		S-598	1	<b>Fuel Pump Relay Repair Harness</b> Ford ..... 96-92 Ford Trucks ..... 96-92 Lincoln ..... 96-82 Mercury ..... 96-82	
S-551	1	<b>Pigtail Assembly Repair Harness</b> (Multi-Purpose) GM Cars ..... 96-85					

# PIGTAIL ASSEMBLIES



## PIGTAIL ASSEMBLIES WITH 4 WIRE LEAD

Part No.	Pkg. Qty.	Description	Illustration	Part No.	Pkg. Qty.	Description	Illustration
S-601	1	Heater Resistor Repair Harness GM Vehicles .....92-70		S-658	1	Repair Harness Mass Airflow Sensor Ford .....92-89 Lincoln .....92-89 Mercury.....92-89	
S-604	1	Voltage Regulator Module Harness GM Vehicles .....95-86		S-660	1	Repair Harness Turn Signal Switch 4 leads. Ford .....93-86	
S-617	1	Fan Speed Switch Harness Buick, Chevrolet .....94-77 GM Trucks .....95-86 Oldsmobile, Pontiac....94-77		S-668	1	Repair Harness GM: 12085530 Repair harness windshield washer motor. Buick.....87-84 Cadillac.....88-85 Chevrolet .....89-84 Oldsmobile.....86-84 Pontiac.....87-84	
S-620	1	Tail Lamp Repair Harness GMC Trucks .....96-88		S-687	1	Pigtail Repair Assembly Replaces 12102677. Repair harness, blower motor switch. For rear compartment switch. No. 14040842. Buick.....98-95, 93-91 Chevrolet .....03-90 GM Light Trucks.....03-98, 95-92 Medium Trucks .....94-90 Oldsmobile.....03-01, 98-90 Pontiac.....03-90 Suburban .....96-84	
S-624	1	Fan Speed Switch Harness For applications: Ford .....93-86 Mercury.....93-86 Ford Trucks .....92		S-698	1	Repair Harness Electronic ignition module. 4-16 Ga. SXL leads. Ford .....97-95	
S-627	1	Oxygen Sensor Pigtail 4 Leads - (3) 18 Gauge, (1) 16 Gauge. Ford .....94-89 Ford Trucks .....94-89 Lincoln .....94-89 Mercury.....94-89		S-700	1	Repair Harness Replaces 12085533 transmission converter clutch. 3-18 Ga. (GPT) 8" leads. Buick.....93-91, 86-84 Cadillac.....90-85 Chevrolet .....93-74 GM Light Trucks .....96-85 Oldsmobile.....92-91, 88-84 Pontiac.....93-85	
S-628	1	Ignition Switch Repair Harness Ford .....94-86 Mercury.....94-86		S-706	1	Relay Harness Audi.....96-93 Chrysler .....96-87	
S-629	1	Ignition Module Repair Harness (Main Wiring Harness) Ford .....85-75 Ford Trucks .....91-75 Mercury.....85-75		S-714	1	Pigtail Repair Assembly GM: 12085487. Heater & A/C control, end gate ajar warning lamp, front side door wiring, seat adjuster motor, power window wiring, power window control wiring, rear compartment lid wiring, rear window defogger switch, windshield wiper switch, windshield wiper motor. Buick.....96-85 Cadillac.....93-85 Chevrolet .....02-85 GM Light Trucks.....03-90 Medium Duty .....03-00 Oldsmobile.....96-85 Pontiac.....02-85	
S-630	1	Blower Motor Resistor Harness (4) 14 Gauge 8" Leads. Ford Trucks .....94-86					
S-631	1	Oxygen Sensor Pigtail (4) Leads - (3) 18 Gauge, (1) 16 Gauge. Ford Trucks .....94-89					
S-638	1	Oil Pressure Switch Pigtail Fits 4 pin switches. Buick.....92-86 Oldsmobile.....89-86 Pontiac.....88-87					

SOCKETS, PIGTAILS & SWITCHES

# PIGTAIL ASSEMBLIES

## PIGTAIL ASSEMBLIES WITH 4 WIRE LEAD









Part No.	Pkg. Qty.	Description	Illustration	Part No.	Pkg. Qty.	Description	Illustration
S-719	1	<b>Repair Harness</b> Blower Motor Switch. Switch No. F5RZ-18578A Ford Contour ..... 98-95 Ford Mystique		S-759	1	<b>Pigtail Assembly</b> GM: 12101871 Glow plug controller No. 12088520. Buick.....93-90, 88-84 Cadillac.....90-88 Chevrolet.....99-84 GMC.....99-85 Oldsmobile .....96-90, 88-84 Pontiac .....96-84	
S-721	1	<b>Pigtail Repair Assembly</b> GM: 12101885, 939, 12126460. A/C compressor clutch wiring, auto. temp. control blower, hazard lamp flasher, blower motor, turn signal flasher, door lock actuator motor, door lock relay, auxiliary fan control relay, brake pressure module valve, various other relays. Buick ..... 93-90 Cadillac ..... 02-88 Chevrolet ..... 03-86 GM Light Trucks ..... 00-90 Medium Duty ..... 96-90 Oldsmobile..... 93-91 Pontiac.....03-96, 94-91		S-761	1	<b>Pigtail Assembly</b> GM: 15305942 Crankshaft position sensor. Buick.....03-96 Chevrolet.....03-96, 94, 93 GM Light Trucks.....03-98 Oldsmobile .....99-96 Pontiac .....04-96, 94	
S-728	1	<b>Repair Harness</b> Starter relay. Relay No. 5227300. Chrysler Vehicles..... 92-90		S-763	1	<b>Pigtail Assembly</b> Universal. Inline male 4-way connector used on cars, trucks, stationary engines, farm and industrial equipment. Features: current capacity of 20 Amp., silicone seals, machine crimped terminals, temperature rating of -40° F to 257° F, fuel/coolant/brake fluid resistant. Mates with S765.	
S-729	1	<b>Repair Harness</b> GM: 12102757. Repair harness, body marker lamp, dimmer switch, headlamp high beam lamp, headlamp switch lamp, dome lamp switch, end gate lock switch, instrument panel switch, stop lamp, torque converter clutch switch. Buick.....96-90 Chevrolet ..... 96-90 Cadillac ..... 96-93 GMC Trucks ..... 96-90 Oldsmobile.....02-90 Pontiac.....96-90		S-765	1	<b>Pigtail Assembly</b> Inline female 4-way connector used on cars, trucks, stationary engines, farm and industrial equipment. Features: current capacity of 20 Amp., silicone seals, machine crimped terminals, temperature rating of -40° F to 257° F, fuel/coolant/brake fluid resistant. Mates with S763.	
S-730	1	<b>Repair Harness</b> Inline To Lighting Ford Vehicles.....97-94		S-784	1	<b>Pigtail Assembly</b> A/C blower switch. Ford.....94-90	
S-754	1	<b>Pigtail Assembly</b> GM:12085537 Neutral & part switch, alternators, wheel/vehicle speed sensors, rear windshield wiper switch. Buick.....98-86 Cadillac.....96-87 Chevrolet ..... 98-90 GM Light Trucks .....02-90 Oldsmobile.....96-86 Pontiac.....98-87		S-795	1	<b>Pigtail Assembly</b> GM: 88987185, 15305925 Park neutral position switch, back-up lamp, inline-to aux. heater rear harness, inline-to back-up lamp & stop lamp, inline-to battery positive cable, inline-to park neutral position switch. Buick.....02-96 Cadillac.....99-96 Chevrolet.....03-95 GM Light Trucks.....03-95 Medium Trucks .....03-00 Oldsmobile .....03-95 Pontiac .....03-95	







# PIGTAIL ASSEMBLIES



## PIGTAIL ASSEMBLIES WITH 4 WIRE LEAD

Part No.	Pkg. Qty.	Description	Illustration	Part No.	Pkg. Qty.	Description	Illustration
S-805	1	<b>Pigtail Assembly</b> Ford: F81Z-19D887AA A/C clutch cycling pressure switch. Ford Vehicles.....02-94		S-850	1	<b>Pigtail Repair Assembly</b> Blower switch connector. Chrysler .....86-84 Dodge .....90-83 Dodge Truck.....95-81	
S-814	1	<b>Pigtail Assembly</b> ABS, air ride compressor, anti skid relays. Ford Vehicles.....02-94		S-857	1	<b>Pigtail Repair Assembly</b> Relay connector. Buick.....90-80	
S-817	1	<b>Pigtail Assembly</b> GM: 15305801 Oxygen sensor. GM Vehicles .....04-95		S-860	1	<b>Pigtail Repair Assembly</b> Multipurpose Connector Buick.....93-91 Cadillac.....91 Oldsmobile.....93-91 Pontiac.....91	
S-825	1	<b>Pigtail Assembly</b> Rear lamp assembly without pickup box. Ford Trucks .....04-90		S-861	1	<b>Pigtail Repair Assembly</b> Blower switch connector. Buick.....90-80	
S-834	1	<b>Pigtail Repair Assembly</b> Ignition control module connector. Chrysler .....95-88 Dodge .....95-88 Dodge Truck.....95-87 Plymouth.....95-89					







## PIGTAIL ASSEMBLIES WITH 5 WIRE LEAD

Part No.	Pkg. Qty.	Description	Illustration	Part No.	Pkg. Qty.	Description	Illustration
S-516	1	<b>Socket Assembly</b> (3588421) Fits Chrysler ignition control unit. Chrysler Vehicles.....83-72		S-605	1	<b>Mass Airflow Sensor Harness</b> GM: 12085497 Buick.....88 Cadillac.....87 Chevrolet .....89-85 GM Light Trucks .....88-85 Oldsmobile.....88-85 Pontiac.....96, 89-85	
S-549	1	<b>Pigtail Assembly Repair</b> (E4FZ-8C290). Engine cooling fan module harness repair kit. Kit contains one 8 position connector, one 10 position connector, and five 4" 12 Ga. terminated solderless leads. Ford, Mercury w/AC.....89-81		S-615	1	<b>Cooling Fan Relay Harness</b> GM Vehicles .....88-85	

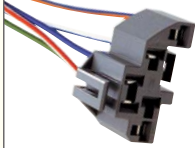
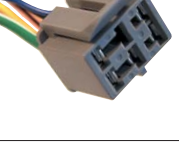
SOCKETS, PIGTAILS & SWITCHES

# PIGTAIL ASSEMBLIES

## PIGTAIL ASSEMBLIES WITH 5 WIRE LEAD

Part No.	Pkg. Qty.	Description	Illustration	Part No.	Pkg. Qty.	Description	Illustration
S-621	1	Turn Signal Switch Harness Ford, Mercury ..... 94-81 Ford Trucks ..... 95-85 Lincoln ..... 94-80		S-742	1	Pigtail Assembly GM: 12085501 Relays, fuel pump, blower motor & daytime running lamps. Buick ..... 92, 90-88 Chevrolet ..... 92-87 Gm Light Trucks ..... 99-98, 96-87 Medium Trucks ..... 96-90 Oldsmobile ..... 92-90	
S-625	1	Heater and A/C Blower Harness (5) 12 Gauge, 5" Leads. Ford, Lincoln, Mercury ..... 94-73		S-752	1	Pigtail Assembly Blower motor switch No. E83Z-19986A. Ford ..... 94-90 Mercury ..... 94-90	
S-652	1	Repair Harness Distributorless ignition modules/data connector. GM: 12101880 Buick ..... 93, 91-87 Cadillac ..... 88-87 Chevrolet ..... 96-87 GM Light Trucks ..... 94 Oldsmobile ..... 96-87 Pontiac ..... 93, 91-87		S-753	1	Pigtail Assembly GM: 12117277 Brake pressure modulator valve solenoid, electronic brake control module, front axle 4WD actuator No. 26060073, stop & tail turn signal. Buick ..... 90 Cadillac ..... 04, 90 GM Light Trucks ..... 00-97 Pontiac ..... 90	
S-654	1	Universal Applications Fits all 4 & 5 terminal relays. Various Cars & Trucks ..... 95-82		S-762	1	Pigtail Assembly A/C blower motor resistor No. 4462978. Chrysler ..... 95-90	
S-659	1	Repair Harness EEC Relay Ford ..... 96-83 Mercury ..... 96-83		S-780	1	Pigtail Assembly Aux. blower switch. Ford ..... 96-95	
S-718	1	Kit, Repair Harness, Horn & Blower Relays Relay No. FOA8-14B193. Ford Cars & Trucks ..... 97-90		S-781	1	Pigtail Assembly Blower motor switch Ford HD Trucks ..... 89-80	
S-726	1	Repair Harness Instrument panel flood lamp, panel and dome lamp switch, fuel sensor, headlamp switch, ignition start switch. GM Light Trucks ..... 96-90 Oldsmobile ..... 96-95 Pontiac ..... 91-90		S-803	1	Pigtail Assembly GM: 15306045 Various relays, fuel pump, headlamp, blower, ABS, horn. GM Vehicles ..... 04-93	
S-736	1	Pigtail Assembly GM: 12102565 Inline-to rear lamp. Chevrolet ..... 96-92		S-897	1	Pigtail Repair Assembly Diesel glow plug relay connector. Ford Truck ..... 97-94	

# PIGTAIL ASSEMBLIES

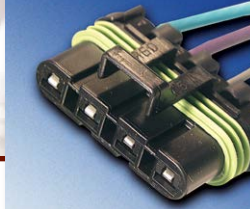

## PIGTAIL ASSEMBLIES WITH 6 WIRE LEAD

Part No.	Pkg. Qty.	Description	Illustration	Part No.	Pkg. Qty.	Description	Illustration
S-94	1	Voltage Regulator Pigtail Repair Harness. With color-coded wires. Ford Vehicles.....81-65		S-713	1	Repair Harness Ford: F2AZ-14489W. Kit repair harness, ignition switches Ford .....01-90 Ford Light Trucks.....01-92 Lincoln .....01-90 Mercury.....01-98, 95-90	
S-544	1	Ignition Module Pigtail (Grey) Ford Vehicles.....91-81		S-716	1	Repair Harness Ignition switch, switch No. DOTZ-11572A, SW944. Ford Trucks .....93-70	
S-546	1	Ignition Module Pigtail (Black) Ford Light Trucks.....91-88		S-749	1	Pigtail Assembly GM: 12102763 Stop lamp switch. GM Light Trucks .....03-94 Medium Duty .....03	
S-606	1	Headlamp Switch Repair Harness GM Vehicles .....95-88		S-764	1	Pigtail Assembly Universal. Inline female 6-way connector used on cars, trucks, stationary engines, farm and industrial equipment. Features: Current capacity of 20 Amp., silicone seals, machine crimped terminals, temperature rating of -40° F to 257° F, fuel/coolant/brake fluid resistant. Mates with S788.	
S-611	1	Ignition Switch Repair Harness Ford .....95-86 Ford Truck .....95-86 Lincoln .....95-86 Mercury.....95-86		S-788	1	Pigtail Assembly Universal. Inline male 6-way connector used on cars, trucks, stationary engines, farm and industrial equipment. Features: Current capacity of 20 Amp., silicone seals, machine crimped terminals, temperature rating of -40° F to 257° F, fuel/coolant/brake fluid resistant. Mates with S764.	
S-679	1	Repair Harness Wiper motor. Ford .....96-87 Ford Light Trucks.....96-87 Lincoln .....96-87 Mercury.....96-87		S-802	1	Pigtail Assembly Blower relays GM Vehicles .....90-70	







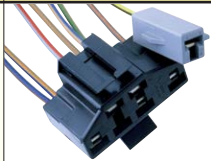

## PIGTAIL ASSEMBLIES WITH 7 WIRE LEAD

Part No.	Pkg. Qty.	Description	Illustration	Part No.	Pkg. Qty.	Description	Illustration
S-665	1	Repair Harness Turn signal switch. Ford Light Trucks.....95-90 Mercury.....98-97		S-796	1	Pigtail Assembly GM: 15305887 Park neutral position switch & back-up lamp. Buick .....02-96 Cadillac .....99-96 Chevrolet .....03-95 GM Light Trucks .....03-95 Medium Duty .....03-00 Oldsmobile.....03-95 Pontiac.....03-95	
S-678	1	Repair Harness Wiper motor. Ford .....96-87 Ford Light Trucks.....96-87 Lincoln .....96-87 Mercury.....96-87					

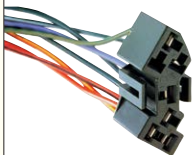

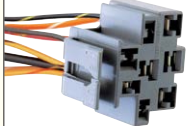
SOCKETS, PIGTAILS & SWITCHES

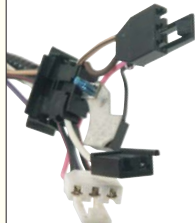
# PIGTAIL ASSEMBLIES

## PIGTAIL ASSEMBLIES WITH 8 WIRE LEAD

Part No.	Pkg. Qty.	Description	Illustration	Part No.	Pkg. Qty.	Description	Illustration
S-609	1	Test Harness EEC-IV test plug harness. Ford ..... 94-83 Ford Trucks ..... 94-83 Lincoln ..... 94-83 Mercury ..... 94-83		S-692	1	Repair Harness Neutral safety switch, back-up, transmission, lever position switches, daytime running lights 8-16 Ga. GPT wire leads. Replaces F2PZ-14A46C ..... F4UB-A Ford ..... 97-90 Ford Light Trucks ..... 97-90	
S-622	1	Turn Signal Switch Harness Ford ..... 94-81 Ford Trucks ..... 95-85 Lincoln ..... 94-80 Mercury ..... 94-81		S-723	1	Repair Harness Manual lever position sensor, used in place of connector. Supplied w/switch for early models and O.E. switch for late models. Switch No. F5TZ-7A247A. Ford Vehicles ..... 97-84	
S-623	1	Headlamp Switch Harness Ford ..... 95-86 Mercury ..... 95-90		S-798	1	Pigtail Assembly Ford: F2PZ-14A464C Daytime running lamp, control module, neutral safety/back-up/lever position switches. Ford Vehicles ..... 94-90	
S-632	1	Headlamp Switch Harness Mercury ..... 89-86		S-846	1	Pigtail Repair Assembly Distributor connector. Chevrolet Trucks ..... 91-85 GMC Trucks ..... 91-85	
S-675	1	Headlamp Switch Harness Headlamp switch. Ford ..... 93-87					

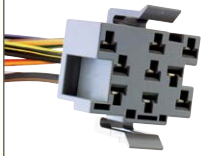
## PIGTAIL ASSEMBLIES WITH 9 WIRE LEAD

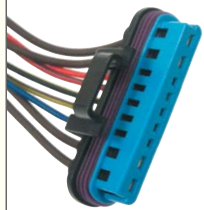
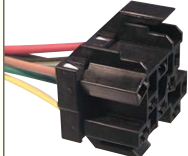
Part No.	Pkg. Qty.	Description	Illustration	Part No.	Pkg. Qty.	Description	Illustration
S-607	1	Headlamp Switch Repair Harness Ford Cars ..... 00-79 Ford Trucks ..... 99-87		S-801	1	Pigtail Assembly Ford: F2PZ-14A464B Transmission solenoid assy (shift & throttle pressure control). Ford Vehicles ..... 94-90	
S-661	1	Repair Harness Turn Signal Switch Ford ..... 93-86		S-896	1	Pigtail Repair Assembly Diesel glow plug relay connector. Ford Trucks ..... 97-94	
S-720	1	Repair Harness Headlamp switch. Switch No. 56007043. Chrysler Vehicles ..... 97-90 Dodge Light Trucks ..... 98-94					

# PIGTAIL ASSEMBLIES



## PIGTAIL ASSEMBLIES WITH 10 WIRE LEAD

Part No.	Pkg. Qty.	Description	Illustration	Part No.	Pkg. Qty.	Description	Illustration
S-662	1	Repair Harness Turn signal switch. Ford .....92-86		S-672	1	Repair Harness Ignition switch. GM Light Trucks .....90-67 GM HD Trucks .....85-67	
S-664	1	Repair Harness EEC Relay Turn signal switch. Ford .....95-90		S-782	1	Pigtail Assembly Blower switch. Ford Light Trucks .....94-90	
S-666	1	Socket and Pigtail Assembly Repair harness HVAC control switch. Ford .....95-88		S-836	1	Pigtail Repair Assembly Stereo power connector. Buick .....95-85 Cadillac .....95-86 Chevrolet .....95-85 Oldsmobile .....95-86 Pontiac .....95-86	

## PIGTAIL ASSEMBLIES WITH 11 WIRE LEAD

Part No.	Pkg. Qty.	Description	Illustration	Part No.	Pkg. Qty.	Description	Illustration
S-804	1	Pigtail Assembly GM: 12101833 Various switches, blower motor, door lock, power window etc., various modules and Inline connector. GM Vehicles .....04-88		S-822	1	Pigtail Assembly Ford: 1U2Z-14S411BXA Headlamp switch. Ford Explorer, Ranger ...04-95	

## PIGTAIL ASSEMBLIES WITH 12 WIRE LEAD

Part No.	Pkg. Qty.	Description	Illustration	Part No.	Pkg. Qty.	Description	Illustration
S-744	1	Pigtail Assembly Ignition control module. Ford Vehicles .....02-92		S-813	1	Pigtail Assembly Transmission lever position sensor. Ford Ranger .....04-95 Ford Explorer .....04-95	
S-800	1	Pigtail Assembly GM: 12167155 Headlamp switch. GM Vehicles .....02-95					

## PIGTAIL ASSEMBLIES WITH 15 WIRE LEAD

Part No.	Pkg. Qty.	Description	Illustration
S-756	1	Pigtail Assembly Ford: F6HZ-14A464FUA Ignition switch No. D7AZ-11572A. Ford .....78-77 Ford Light Trucks .....85-80 Mercury .....78-77	

SOCKETS, PIGTAILS & SWITCHES

# UNIVERSAL SWITCHES

## TOGGLE SWITCHES 2 POSITIONS

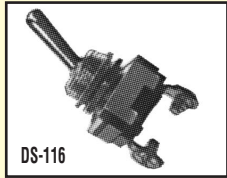

DS-116

### Toggle Switch

Universal 2 position, single pole, single throw. UL approved toggle switch. Furnished with 2 screw terminals. Mounting stem dia.  $\frac{19}{32}$ " length  $\frac{3}{8}$ ". Rating: 125 Volt 10 Amp., 250 Volt 5 Amp.

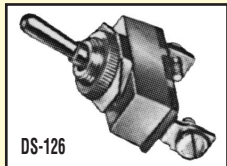

DS-126

### Toggle Switch

Universal heavy duty, 2 position, single pole, single throw, toggle switch. Furnished with "OFF-ON" face plate and 2 screw terminals. Mounting stem dia.  $\frac{19}{32}$ " length  $\frac{3}{8}$ ". Rating: 6 Volt 35 Amp., 12 Volt 20 Amp.

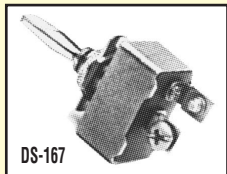

DS-167

### Toggle Switch

Universal heavy duty, zinc diecast. 2 position, single pole, single throw, toggle switch. Furnished with "ON-OFF" face plate and 2 screw terminals. Mounting stem dia.  $\frac{19}{32}$ " length  $\frac{3}{8}$ ". Rating: 12-24 Volt, 50 Amp.

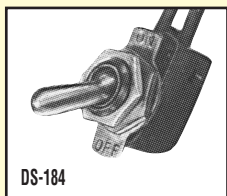

DS-184

### Toggle Switch

Universal 2 position, single pole, single throw, toggle switch. Furnished with 6" lead wires. Mounting stem dia.  $\frac{19}{32}$ " length  $\frac{5}{8}$ ". Rating: 125 Volt 6 Amp., 250 Volt 3 Amp.

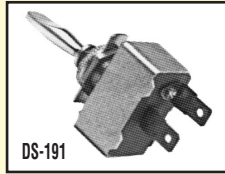

DS-191

### Toggle Switch

Universal 2 position, zinc diecast, single pole, single throw furnished with "OFF-ON" face plate. 2 heavy slide terminals and chrome plated handle.

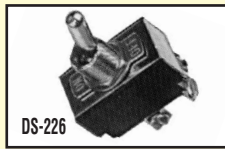

DS-226

### Toggle Switch

2 position, Double Pole, Single Throw, "ON-OFF" toggle switch with 4 screw terminals. Mounting stem dia.  $\frac{5}{16}$ " length  $\frac{15}{16}$ ". Rating: 12 Volt DC 35 Amp., 125 Volt 15 Amp., 250 Volt 10 Amp.



DS-310

### Toggle Switch

2 position plastic toggle switch with 2 slide terminals. Rating: 12 Volt 10 Amp.

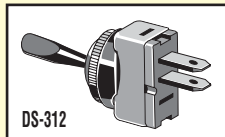

DS-312

### Toggle Switch

Non-illuminated momentary "ON". 12 Volt DC 10 Amp.



DS-322

### Toggle Switch

Universal 2 position, double pole, single throw, toggle switch. Furnished with 6" lead wires. Mounting stem dia.  $\frac{19}{32}$ " length  $\frac{5}{8}$ ". "ON-ON". Rating: 125 Volt 6 Amp., 250 Volt 3 Amp.

## TOGGLE SWITCHES 2 POSITIONS - ILLUMINATED

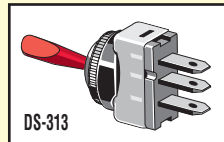

DS-313

### Toggle Switch

"ON-OFF", 12 Volt 20 Amp.  
**DS-313 - Red DS-314 - Amber**  
**DS-315 - Blue DS-316 - Green**

## TOGGLE SWITCHES 3 POSITIONS

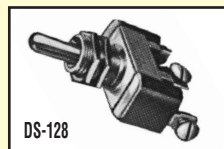

DS-128

### Toggle Switch

Universal 3 position single pole, double throw, "ON-OFF-ON". Underwriters approved toggle switch. With 3 screw terminals. Mounting stem dia.  $\frac{19}{32}$ " length  $\frac{1}{2}$ ". Rating: 125 Volt 15 Amp., 250 Volt 10 Amp., 3/4 H.P. 120-240 Volt, AC.

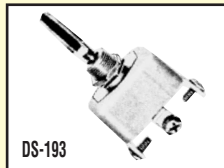

DS-193

### Toggle Switch

Universal 3 position, zinc diecast, single pole, double throw, "ON-OFF-ON" furnished with 3 heavy copper screw terminals and chrome plated handle. Mounting stem dia.  $\frac{19}{32}$ " length  $\frac{15}{32}$ ". Rating: 12-24 Volt 50 Amp.

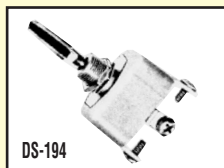

DS-194

### Toggle Switch

Universal 3 position, zinc diecast, single pole, double throw. Momentary "ON", normally "OFF", momentary "ON". Furnished with 3 heavy copper screw terminals and chrome plated handle. Mounting stem dia.  $\frac{3}{32}$ " length  $\frac{15}{32}$ ". Rating: 12-24 Volt 50 Amp.

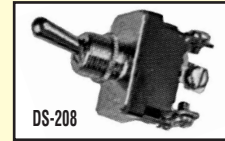

DS-208

### Toggle Switch

Double pole, double throw, 3 position "ON-OFF-ON", 6 heavy duty screw terminals. Mounting stem dia.  $\frac{3}{32}$ ". Rating: 125 Volt 15 Amp., 250 Volt 10 Amp.

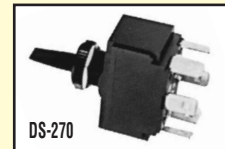

DS-270

### Toggle Switch

Double pole, double throw, 3 position "Momentary ON-OFF-Momentary ON", 6 heavy duty screw terminals. Mounting stem dia.  $\frac{5}{32}$ ". Rating: 125 Volt 15 Amp., 250 Volt 10 Amp.



DS-271

### Toggle Switch

Universal 3 position, "ON-OFF-ON" double pole, double throw toggle switch with 6 terminals. Mounting stem  $\frac{19}{32}$ " diameter,  $\frac{3}{8}$ " long handle. Thermoplastic housing with Neoprene seal. Used for marine and recreational vehicles. Rating: 12 Volt 10 Amp.

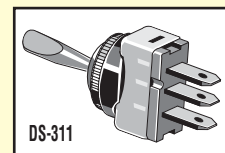

DS-311

### Toggle Switch

3 position non-illuminated toggle switch. 12 Volt DC 10 Amp.

## DUCK BILL TOGGLE SWITCHES



DS-1339

### Toggle Switch

"ON-OFF" black duck bill toggle switch. 20 Amp. "ON-OFF" toggle switch. 20 Amp.

# UNIVERSAL SWITCHES

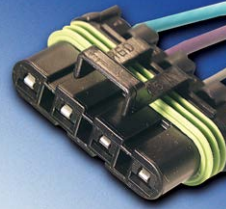

## DUCK BILL TOGGLE SWITCHES



**DS-1340**  
Toggle Switch  
"ON-OFF" chrome duck bill toggle switch. 20 Amp.



**DS-1341**  
Toggle Switch  
"ON-OFF-ON" duck bill toggle switch. 20 Amp. 12 Volt.  
**DS-1341 - Black**



**DS-1342**  
Toggle Switch  
Illuminated, "ON-OFF", 20 Amp. 12 Volt.  
**DS-1342 - Amber Illuminated**  
**DS-1343 - Blue Illuminated**  
**DS-1344 - Green Illuminated**  
**DS-1345 - Red Illuminated**

## ROCKER SWITCHES



**DS-277**  
Rocker Switch  
For trucks, school buses & recreational vehicles, silver contacts, "OFF-ON" SPST. 2 spade terminals UL Listed 15 Amp. 125 VAC, 10 Amp. 250 VAC, 35 Amp. 12V DC.



**DS-280**  
Rocker Switch  
Universal rocker switch for trucks, buses & recreational vehicles, 35A, 12V silver contact, red illuminated rocker, 2 position "OFF-ON", SPST, 2 spade terminal for circuit. 1 spade terminal for built-in 12V bulb. Black body, white rocker. Kenworth: K-301-1572 OMC: 977743

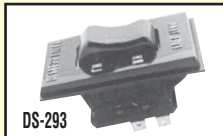

**DS-293**  
Rocker Switch  
Fuel tank selector switch. GM: 14028811; 15591149 GM Trucks..... 88-81



**DS-317**  
Rocker Switch  
Illuminated, 2 position, "ON-OFF", blade terminals. Rating: 12 Volt 20 Amp.  
**DS-317 - Red**  
**DS-318 - Amber**  
**DS-319 - Blue**  
**DS-320 - Green**



**DS-1332**  
Rocker Switch  
"ON-OFF" twin circuit rocker switch, 20 Amp. Black.



**DS-1333**  
Rocker Switch  
Illuminated "ON-OFF" rocker switch, with interchangeable lens and icons. 20 Amp. 12 Volt.



**DS-1334**  
Rocker Switch.  
Oval LED illuminated round hole rocker switch, 16 Amp. 12 Volt.  
**DS-1334 - Amber**  
**DS-1335 - Green**  
**DS-1336 - Red**  
**DS-1337 - Red Spot Illuminated**



**DS-1338**  
Rocker Switch  
Universal rocker switch for trucks, buses & recreational vehicles. Electric window, antenna switch. 5 blade terminals.

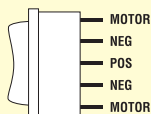

## MINI ROCKER SWITCHES



**DS-1312**  
Mini Rocker Switch  
"ON-OFF" black mini rocker switch, 10 Amp. 12 Volt.



**DS-1313**  
Mini Rocker Switch  
"ON-OFF" LED illuminated mini rocker switch, 10 Amp. 12 Volt.  
**DS-1313 - Amber**  
**DS-1314 - Green**  
**DS-1315 - Red**



**DS-1316**  
Mini Rocker Switch  
"Momentary ON-OFF-Momentary ON", black mini rocker, 10 Amp. 12 Volt.



**DS-1317**  
Mini Rocker Switch  
"ON-OFF" double pole black mini 10 Amp. 12 Volt.



**DS-1318**  
Mini Rocker Switch  
"ON-OFF" illuminated mini rocker switch. 10 Amp. 12 Volt.  
**DS-1318 - Amber**  
**DS-1319 - Red**



**DS-1320**  
Mini Rocker Switch  
"ON-OFF" black round rocker. 10 Amp. 12 Volt.



**DS-1321**  
Mini Rocker Switch  
"ON-OFF" LED illuminated round spot mini rocker switch. 10 Amp., 12 Volt.  
**DS-1321 - Amber**  
**DS-1322 - Green**  
**DS-1323 - Red**

## JUMBO ROCKER SWITCHES

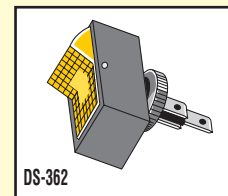

**DS-362**  
Rocker Switch  
Universal, Heavy duty, illuminated rocker switch. Mounting 1/2" round hole, illuminated in "ON" position. Rating: 20 Amp. 12 Volt.  
**DS-362 - Amber Illuminated**  
**DS-364 - Red Illuminated**  
**DS-365 - Non-Illuminated**  
**DS-1821 - Green Illuminated**

## PUSH PULL SWITCHES

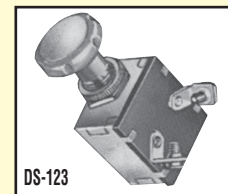

**DS-123**  
Push Pull Switch  
Universal 2 position, single pole, single throw. Pull "ON", push "OFF" switch. Furnished with large plastic knob, and 2 screw terminals. Mounting stem dia 15/32", length 1/2". Rating: 6 volt 20 Amp., 12 Volt, 10 Amp.

# UNIVERSAL SWITCHES

## PUSH PULL SWITCHES (cont.)

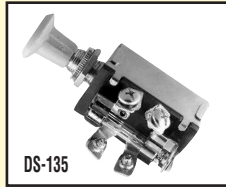

DS-135

**Push-Pull Switch**  
12 Volt, Universal Switch. Push-pull, 3 positions, 5 terminals. Equipped with 15 Amp. fuse. Mounting stem dia.  $\frac{7}{16}$ ".



DS-175

**Push-Pull Switch**  
Heavy duty push-pull switch, 6-28 Volt DC, 75 Amp., single pole, single throw, "OFF-ON". Die-cast body, chrome plated metal knob, copper terminals with brass terminal screws. Mounting stem dia.  $\frac{15}{32}$ ", length  $\frac{5}{8}$ ". Overall dimensions  $3\frac{1}{8}$ " x  $1\frac{1}{8}$ " x  $\frac{9}{16}$ ".

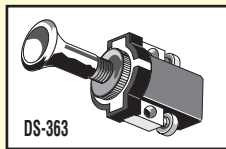

DS-363

**Push-Pull Switch**  
Universal push-pull switch. European styling, black body. Rating: 16 Amp. 12 Volt.



DS-1327

**Push-Pull Switch**  
Long push-pull switch. 16 Amp.



DS-1328

**Push-Pull Switch**  
Illuminated push-pull switch. 16 Amp. 12 Volt.  
**DS-1328 - Amber**  
**DS-1329 - Blue**  
**DS-1330 - Green**  
**DS-1331 - Red**

## PUSH BUTTON SWITCHES



DS-246

**Push Button Switches**  
Universal momentary push button switch. "OFF-momentary ON". Single pole, single throw, with 2 screw terminals. Rating: 125 Volt 6 Amp., 250 Volt 3 Amp.



DS-1307

**Push Button Switches**  
Push ON/ Push OFF switch. 16 Amp. 12 Volt LED.  
**DS-1307 - Non-Illuminated Black**  
**DS-1308 - Illuminated Amber**  
**DS-1309 - Illuminated Green**  
**DS-1310 - Illuminated Red**  
**DS-1791 - Illuminated Blue**

## MISCELLANEOUS SWITCHES



HB-6B

**Horn Button**  
Horn button with mountable bracket.

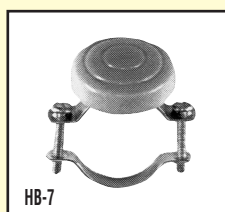

HB-7

**Horn Button**  
Universal Horn button. Furnished with large ivory colored plastic button mounting bracket. Bronze contact spring and rustproof parts. Insulated—cannot short or ground.



HS-98

**Heater Switch**  
Universal heavy duty, 4 position "ON-HI-MED-LOW", illuminated heater switch. Furnished with maroon face, tan knob, bulb, heavy ceramic base, bracket and 2 screw terminals. 12 Volt. Current rating: Lo 2 Amp., Mid 2.5 Amp., Hi 10 Amp.



SSB-2

**Push Button Switch**  
2 screw terminals, "OFF-Momentary ON",  $\frac{5}{16}$ " mounting stem, 12 volt 15Amp.

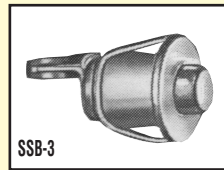

SSB-3

**Push Button Switch**  
Push button, normally open to ground. Rating: 6 Volt 15 Amp., 12 Volt 10 Amp., 24 Volt 6 Amp. Older Cars and trucks.



SSB-5

**Push Button**  
Heavy duty, 2 screw terminals, "OFF-momentary ON", 12 Volt 60 Amp., 24 Volt 40 Amp.



DS-1346

**Battery Cut-Off Switch**  
100 Amp., continuous. For marine, RV, specialty vehicles, farm equipment. Prevent battery drain.

## WARNING LIGHTS



DS-1324

**Indicator Lamp**  
Universal, warning indicator lamp with illuminated lens and long life non-replaceable bulb. Includes wire leads for easy installation. Mounting  $\frac{1}{2}$ " round hole, 12 volt applications.

**DS-366 - Red**  
**DS-367 - Amber**  
**DS-1324 - Blue**  
**DS-1325 - Green**

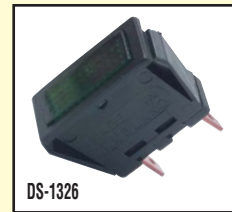

DS-1326

**Rectangular Warning Light**  
12 Volt, Green.

## SWITCH PANELS

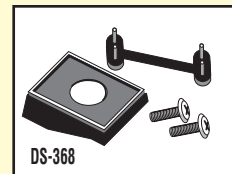

DS-368

**Mounting Panel**  
Switch mounting panel. For  $\frac{1}{2}$ " round hole mounting switches.

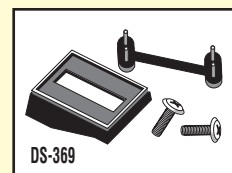

DS-369

**Mounting Panel**  
Switch mounting panel. For  $1\frac{1}{8}$ " x  $\frac{15}{32}$ " rectangular hole.



DS-1311

**Mounting Panel**  
Switch mounting panel. 2 slots. For  $1\frac{1}{8}$ " x  $\frac{15}{32}$ " rectangular hole.





*Ignition Wires*

*Battery Cables*

*Primary Wire*

*Terminals & Connectors*

*Trailer Connectors*

*Sockets, Pigtails & Switches*

***Safety Accessories***

*O.E. Interchanges*

*Index*

# SAFETY ACCESSORIES

SAFETY ACCESSORIES			
Part No.	Description	Part No.	Description
ET515	<b>Headlight on Reminder</b> Prevents drained batteries - buzzer sounds when ignition is turned off and lights are on. Includes fuse taps and adhesive mounting pad.	ET517	<b>Back-up Alarm</b> Pulse alarm sounds when you shift into reverse. Alarm warns anyone behind your car, van or pickup. Simple two wire connection to back-up lights.
ET516	<b>Trunk or Under Hood Light</b> Provides light under hood or in trunk. Includes mount screw, bulb, cadmium plated holder and 6' wire lead.	ET518	<b>9-Volt Adapter</b> Converts Electronic Hazard Light from accessory plug-in to portable 9 volt battery power.
		ET519	<b>Electronic Strobe Hazard Light</b> Emergency flasher plugs into cigarette lighter or portable adapter. Magnetic base mount. High visibility electronic strobe.



# SAFETY ACCESSORIES



## SAFETY ACCESSORIES

Part No.	Description	Part No.	Description
ET400	<b>Temporary Lamp Wiring Connector</b>	ET521	<b>Daytime Running Lights</b> Increase daytime visibility of vehicle. Automatically turns on low beam lights. Shuts off with ignition. Includes daytime running light module, wire leads, splices, fuse taps and mounting screw. Installs by connecting module lead wires to 2 or 3 wire headlight system. Detailed instructions are included—read carefully! Not for vehicles with concealed headlights.
ET448	<b>Cigarette Lighter Plug</b>	ET522	<b>Power Reducer</b> Provides 30% low beam light power reduction. Connects to red wire of daytime running light. Mount away from excessive heat. Includes power reducer, splices and mounting screws.
ET520	<b>Wipers on / Headlights on Reminder</b> Reminds driver to turn lights on when weather conditions require wipers. Increases vehicle visibility in inclement daytime weather. Installs by splicing 2 blue leads to the wiper motor and black leads to the instrument lamps fuse and any other lighting fuse. Includes electronic module, splice connector, fuse taps and adhesive mounting strip. Detailed instructions are included—read carefully!		

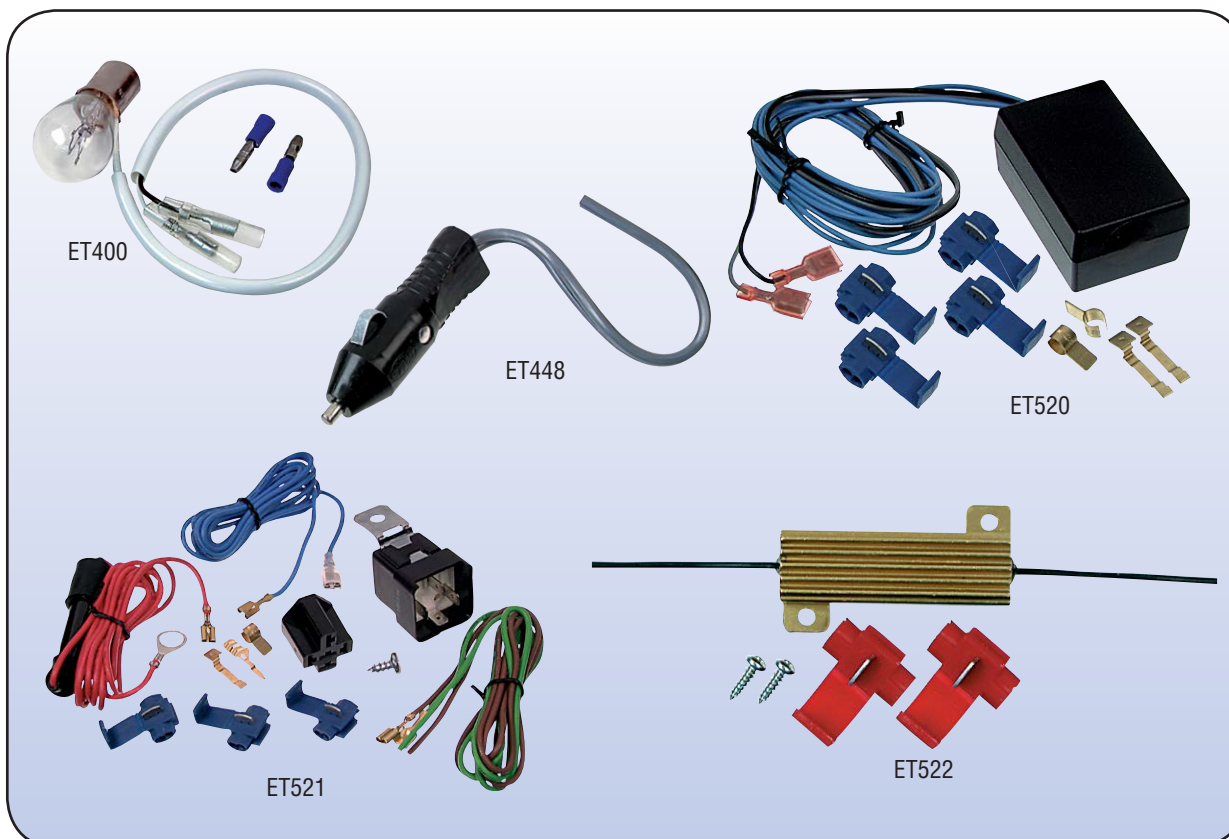

SAFETY ACCESSORIES

# BOOSTER CABLES

## BOOSTER CABLES TO FIT THE NEEDS OF ALL YOUR CUSTOMERS

- 100% copper conductor
- Soft PVC blend maintains flexibility at extreme temperatures
- Available in 200, 400 or 500 Amp. clamps
- Economy – For occasional or emergency use
- Standard Duty – For frequent use on cars and light trucks
- Heavy Duty – For professional service dealers

### ECONOMY

Part No.	Description	Clamp Type	Outer Jacket/ Thermal Rating
BC120	10 gauge 12 ft. 200 Amp.	Utility	Blended PVC
BC128	8 gauge 12 ft. 400 Amp.	Alligator	PVC/ -40° to +140° F

### STANDARD DUTY

Part No.	Description	Clamp Type	Outer Jacket/ Thermal Rating
BC126	6 gauge 12 ft. 400 Amp.	Alligator	PVC/ -40° to +140° F
BC166	6 gauge 16 ft. 400 Amp.	Alligator	PVC/ -40° to +140° F
BC124	4 gauge 12 ft. 400 Amp.	Alligator	PVC/ -40° to +140° F
BC164	4 gauge 16 ft. 400 Amp.	Alligator	PVC/ -40° to +140° F
BC204	4 gauge 20 ft. 400 Amp.	Alligator	PVC/ -40° to +140° F

### HEAVY DUTY

Part No.	Description	Clamp Type	Outer Jacket/ Thermal Rating
BC165	4 gauge 16 ft. 500 Amp.	Parrot	PVC/ -40° to +140° F
BC254	4 gauge 25 ft. 500 Amp.	Parrot	PVC/ -40° to +140° F
BC202	2 gauge 20 ft. 500 Amp.	Parrot	PVC/ -40° to +140° F

### BOOSTER CABLE BAG

Part No.	Description	Qty Per Pkg.
BC100	Booster cable bag	1

Note: Booster cables not available in Canada.

Standard package of 1



# BOOSTER CABLES



SAFETY ACCESSORIES

## BOOSTER CABLE CLAMPS

Part No.	Description	Qty Per Pkg.
BP66	Solid copper clamps with color coded plastic handles. 400 Amp. (1 red, 1 black)	2
BP68	Light-duty clamps with copper-plated steel jaws and color-coded vinyl handles. 200 Amp.	2 (1 red, 1 black)
BP87	Metal clamps with copper-plated steel jaws won't crack or break in sub-zero temperatures. 400 Amp. 6' wire lead.	1 pair
BP98R	Heavy-duty "Marquette" type clamp with serrated steel jaws. 400 Amp. 1 per card.	10 cards
BP98B	Same as BP98R—but with black handles. 400 Amp. 1 per card.	10 cards
BP104	800 Amp. professional booster cable clamps.	1 pair
BP104J	Replacement jaw for BP104.	1 pair

Note: Booster cable clamps not available in Canada.

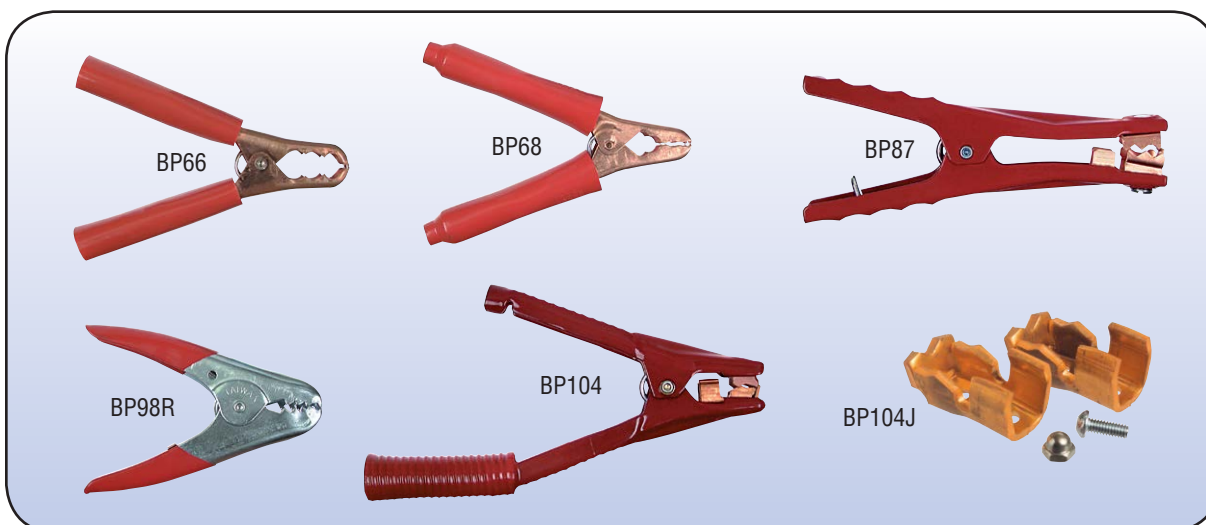

## BULK BOOSTER CABLE

- Parallel bonded cable provides tangle free service.
- Maintains flexibility in sub zero temperatures.

Part No.	Qty	Gauge
BC6DL	50'	6 Ga.
BC4DL	50'	4 Ga.
BC2DL	50'	2 Ga.

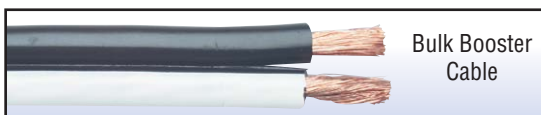

Bulk Booster Cable



BC105

## PLUG-IN 4 GA. INDUSTRIAL BOOSTER CABLES

BC105	25 ft. overall length. 5 ft. section attaches directly to vehicle. 20 ft. section has heavy duty 500 Amp. clamps and snaps easily into permanently mounted cable. Perfect for tow trucks or fork lifts.
BC106	5 foot section. Ideal where multiple tow trucks or fork lifts are used. Protective cap included.

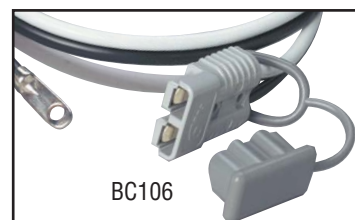

BC106

# TROUBLE LIGHTS

- HEAVY DUTY
- BUILT TO TAKE RUGGED HANDLING
- ALL ITEMS SHOWN MEET OSHA STANDARDS AND ARE UL LISTED

## FLUORESCENT DROPLIGHTS

Make light of the heaviest jobs! Great additions to repair shops, home workshops, basements, garages! Swivel hook. Tough plastic handle. Resists oil, grease, water, chemicals and vapors. Vinyl-coated wire.

Part No.	Description	Watt Rating	Amp. Rating	Cord Length	Qty. Per Pkg.
ZR95	Reel light. 18/2 wire, wall mount.	15	.305	25 ft.	1
ZT31	Droplight. 18/2 wire.	15	.305	25 ft.	1
ZT31A	Repl. bulb for ZT31 & ZR95.	15	.305		1
ZT34	Droplight. 18/2 SJT.	13	.285	15 ft.	1
ZT34A	Repl. bulb for ZT34, ZR96.	13	.285		1
ZR96	Mini no switch reel light 18/2 wire, wall mount.	13	.350	40 ft.	1

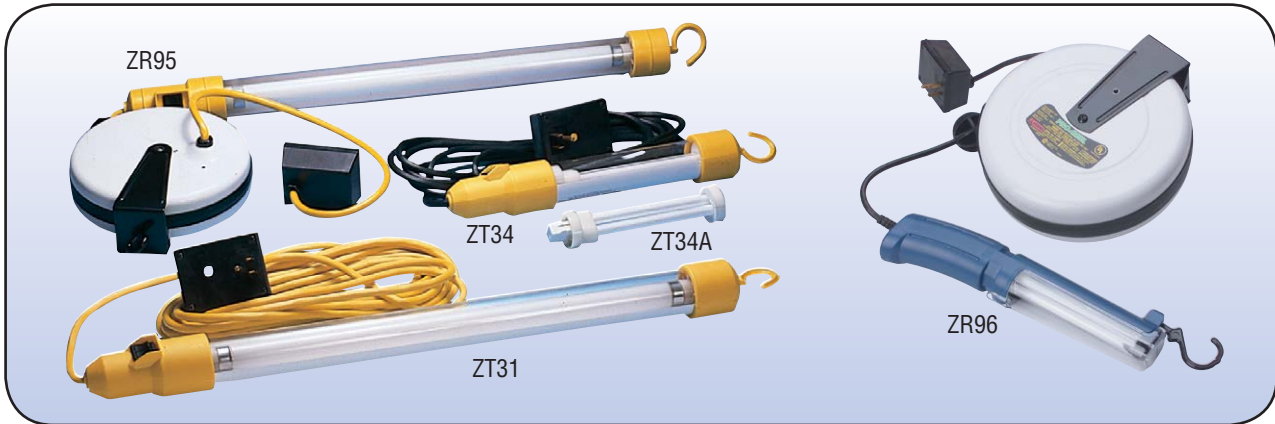

## EMERGENCY DROPLIGHT

Part No.	Wire Gauge	Volt Rating	Cord Length	Description	Qty. Per Pkg.
ZT32	18/2 SPT	12 Volt	15 ft.	w/2pc. Battery Clips	1

## TROUBLE LIGHT - 2 WIRE

- Non-conductive plastic cage
- Switch in handle

Part No.	Wire Type	Watt Rating	Amp. Rating	Cord Length	Qty. Per Pkg.
ZT17	18/2 SJT	75	10	25 ft.	1

## CORDLESS TROUBLE LIGHT

- Rechargeable, 120V, charger included
- Cordless, use anywhere
- LED

Part No.	Qty. Per Pkg.
ZT37	1

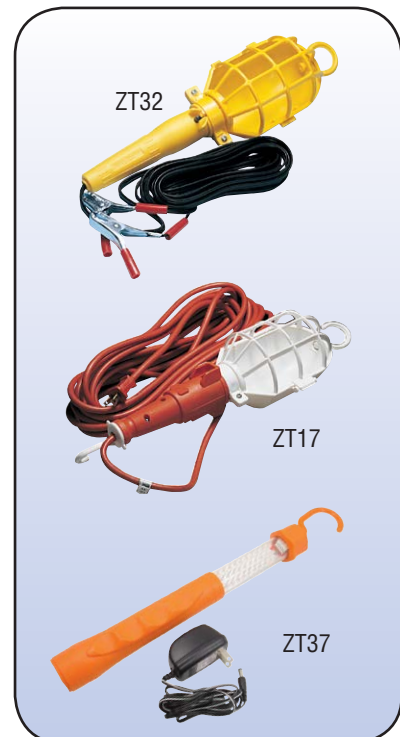

Note: Trouble lights and droplights not available in Canada.

# TROUBLE LIGHTS & ELECTRICAL CABLE



## TROUBLE LIGHT - 3 WIRE

Droplights

- Vinyl cord, Grounded steel cage
- Three-prong extension side outlet

Part No.	Wire Type	Watt Rating	Amp. Rating	Cord Length	Qty. Per Pkg.
ZT11	18/3 SJT	1250	10	25 ft.	1
ZT21	16/3 SJT	1625	13	25 ft.	1
ZT22	16/3 SJT	1625	13	50 ft.	1



ZT11

## NO SWITCH TROUBLE LIGHT - 3 WIRE

- Rubber cord flexible to -50°C
- Solid encapsulating injection molding

Part No.	Wire Type	Watt Rating	Amp. Rating	Cord Length	Qty. Per Pkg.
ZT23	18/3 SJT	1250	10	25 ft.	1



ZT23

## ELECTRICAL CABLE – 125/250 VOLT – U.L. LISTED

- For use in rewiring drop lights, extension cords, portable tools and equipment

Part No.	Gauge & Cond.	UL Type	Stranding	Jacket	O.D.
<b>NEW!</b> C18-2SRB	18 - 2	SJO	41 x 34	Synthetic Rubber/Black	.298
<b>NEW!</b> C16-2SRB	16 - 2	SO	65 x 34	Synthetic Rubber/Black	.380
<b>NEW!</b> C18-3VY	18 - 3	SJT	16 x 30	Vinyl, Yellow	.328
<b>NEW!</b> C16-3SRB	16 - 3	SO	65 x 34	Synthetic Rubber/Black	.400
<b>NEW!</b> C16-3VB	16 - 3	SJT	36 x 30	Vinyl, Black	.353
<b>NEW!</b> C14-3SRB	14 - 3	SO	41 x 30	Synthetic Rubber/Black	.558



C18-3VY



C16-3SRB

# TROUBLE LIGHTS & EXTENSION CORDS

## 3-WIRE REEL LIGHTS

With grounded side outlet. Durable steel cord housing. Fully retractable. Includes wall or ceiling mounting hardware. Includes switch on handle.

Part No.	Wire Type	Outlet Watt Rating	Outlet Amp. Rating	Cord Length	Qty. Per Pkg.
ZR91	16/3 SJT	1150	9.2	30 ft.	1
ZR92	18/3 SVT	775	6.2	50 ft.	1

ZR92 resettable circuit contains breaker in plug.

## NO SWITCH 3-WIRE REEL LIGHTS

With plastic guard housing. Durable steel cord housing. Fully retractable. Includes wall or ceiling mounting hardware.

Part No.	Wire Type	Outlet Watt Rating	Outlet Amp. Rating	Cord Length	Qty. Per Pkg.
ZR97	18/3 SJT	—	—	35 ft.	1

## 3-WIRE INDOOR/OUTDOOR EXTENSION CORDS

- Rounded vinyl cord for outdoor use
- Weather-resistant and flexible
- Three-prong grounded plug and outlet
- 125 Volt Rating

Part No.	Wire Type	Outlet Watt Rating	Outlet Amp. Rating	Cord Length	Qty. Per Pkg.
ZX50	16/3 SJTW-A	1625	13	10 ft.	1
ZX51	16/3 SJTW-A	1625	13	25 ft.	1
ZX52	16/3 SJTW-A	1625	13	50 ft.	1
ZX53	16/3 SJTW-A	1250	10	100 ft.	1
ZT54	12/3 AGW SJEOW-A	1875	15	25 ft.	1

## REPLACEMENT PARTS

Part No.	Description	Qty. Per Pkg.
ZM80	Replacement metal cage for grounded 3-wire lights. Display packaged.	1 bag
ZM81	Replacement plastic cage for ungrounded 2-wire lights Display packaged.	1 bag
ZM82	Replacement handle for 3-wire trouble light. Extended guard ground.	1
ZM85	Replacement socket — 15 Amp. 125 V.	1
ZM86	Replacement plug — 15 Amp. 125 V.	1
ZM87	Replacement push button switch socket. UL Approved.	1

Note: Trouble lights and droplights not available in Canada.







*Ignition Wires*

*Battery Cables*

*Primary Wire*

*Terminals & Connectors*

*Trailer Connectors*

*Sockets, Pigtails & Switches*

*Safety Accessories*

***O.E. Interchanges***

*Index*

# O.E. INTERCHANGES

## OEM TERMINALS

	<b>Boxed Part #</b>
ET507.....	CG7 & CG45
ET508.....	CG8 & CG47
ET701.....	CG1
ET708.....	CG2
ET709.....	CG5
ET704.....	CG6
ET705.....	CG18
ET706.....	CG19
ET707.....	CG20
ET708.....	CG7
ET709.....	CG8
ET710.....	CG45
ET711.....	CG46
ET712.....	CG47
ET713.....	CG3
ET714.....	CG4
ET715.....	CG21
ET716.....	CG22
ET717.....	CG23
ET718.....	CG24
ET719.....	CG25
ET720.....	CG26
ET721.....	CG27
ET722.....	CG28
ET723.....	CG12
ET724.....	CG14
ET725.....	CG15
ET726.....	CG30
ET727.....	CG31
ET728.....	CG32
ET729.....	CG33
ET730.....	CG34
ET731.....	CG36
ET732.....	CG37
ET733.....	CG35
ET734.....	CG9
ET735.....	CG10
ET736.....	CG11
ET737.....	CG64
ET738.....	CG65
ET739.....	CG16
ET740.....	CG17
ET741.....	CG29
ET742.....	CG13
ET743.....	CG38
ET744.....	CG39
ET745.....	CG40
ET746.....	CG41
ET747.....	CG42
ET748.....	CG43
ET749.....	CG44

## TERMINALS & CONNECTORS

	<b>Boxed Part #</b>
ET97L.....	STP97
ET98L.....	STP98
ET120H.....	STP120H
ET120, ET120L.....	STP120
ET120XL.....	STP120
ET121.....	STP121

## TERMINALS & CONNECTORS

	<b>Boxed Part #</b>
ET122.....	STP122
ET123, ET123L.....	STP123
ET124H.....	STP124H
ET124, ET124L.....	STP124
ET124XL.....	STP124
ET125, ET125L.....	STP125
ET126, ET126L.....	STP126
ET127H.....	STP127H
ET127, ET127L.....	STP127
ET127XL.....	STP127
ET128, ET128L.....	STP128
ET129, ET129L.....	STP129
ET129XL.....	STP129
ET130H.....	STP130H
ET130, ET130L.....	STP130
ET130XL.....	STP130
ET131, ET131L.....	STP131
ET131H.....	STP131H
ET131XL.....	STP131
ET132H.....	STP132H
ET132, ET132L.....	STP132
ET132XL.....	STP132
ET133.....	STP133
ET134.....	STP134
ET135.....	STP135
ET135XL.....	STP135
ET136.....	STP136
ET139, ET139L.....	STP139
ET139XL.....	STP139
ET140, ET140L.....	STP140
ET140XL.....	STP140
ET141, ET141L.....	STP141
ET141XL.....	STP141
ET142.....	STP142
ET143.....	STP143
ET143H.....	STP143H
ET144H.....	STP144H
ET144L.....	STP144
ET144XL.....	STP144
ET145H.....	STP145H
ET145L.....	STP145
ET145XL.....	STP145
ET146.....	STP146
	STP163
ET147.....	STP147
ET148, ET148L.....	STP148
ET148XL.....	STP148
ET149, ET149L.....	STP149
ET149XL.....	STP149
ET150.....	STP150
ET151.....	STP151
ET151H.....	STP151H
ET154.....	STP154
ET155.....	STP155
ET157.....	STP157
ET159L.....	STP159
ET161, ET161L.....	STP161
ET161XL.....	STP161
ET162, ET162L.....	STP162
ET163, ET163L.....	STP163
ET164.....	STP164

## TERMINALS & CONNECTORS

	<b>Boxed Part #</b>
ET165.....	STP165
ET166.....	STP166
ET168L.....	STP168
ET170.....	STP170
ET171.....	STP171
ET176.....	STP176
ET176XL.....	STP176
ET178.....	STP178
ET179.....	STP179
ET182.....	STP182
ET183.....	STP183
ET196L.....	STP196
ET197L.....	STP197
ET198L.....	STP198
ET207.....	STP207
ET207XL.....	STP207
ET208.....	STP208
ET208XL.....	STP208
ET210.....	STP210
ET211.....	STP211
ET212.....	STP212
ET351.....	STP351
ET352.....	STP352
ET353.....	STP353
ET357.....	STP357
ET360.....	STP360
ET361.....	STP361
ET363.....	STP363
ET364.....	STP364
ET365.....	STP365
ET381.....	STP381
ET381XL.....	STP381
ET437L.....	STP437
ET470.....	STP470
ET474.....	STP474
ET476.....	STP476
ET480L.....	STP480
ET481L.....	STP481
ET482L.....	STP482
ET483L.....	STP483
ET486.....	STP486
ET492.....	STP492
ET497.....	STP497
ET497H.....	STP497H
ET501.....	STP501
ET502.....	STP144
	STP210
ET503.....	STP130
	STP131
	STP132
ET504.....	STP140
	STP141
	STP148
	STP149
	STP161
	STP207
ET509.....	ST110
ET511.....	SST95
ET512.....	SST97

## TERMINALS & CONNECTORS

	<b>Boxed Part #</b>
ET513.....	STP120
	STP130
	STP150
	STP165
ET514.....	STP124
	STP131
	STP135
	STP155
ET523.....	STP523
ET524.....	STP524
ET526.....	STP149
	STP141
	STP161
ET529L.....	STP435
	STP436
	STP437
ET530.....	STP530
ET550.....	STP550
ET551.....	STP551
ET552.....	STP552
ET553.....	STP553
ET556.....	STP556
ET559.....	STP559
ET560.....	STP560
ET561.....	STP561
ET562.....	STP562
ET564.....	STP564
ET570.....	STP570
ET571.....	STP571
ET600L.....	STP600
ET601L.....	STP601

## CLIPS, STRAPS, LOOM & HEAT SHRINK TUBING

	<b>Boxed Part #</b>
ET3.....	CL4S
ET4.....	CL11S
ET5.....	CL5S
ET6.....	CL6S
ET7.....	CL7
ET12.....	HST10
ET14.....	HST14
ET18.....	HST18
ET20.....	HST10
	HST14
	HST18
ET38.....	HST21
	HST28
	HST30
ET58.....	BP62
ET59.....	BP61
ET60.....	BP60
ET60 & ET57.....	BP80
ET62.....	ST62
ET250L & ET250.....	STT250
ET251L & ET251.....	STT251
ET252L & ET252.....	STT252
ET253L.....	STT253
ET254L & ET254.....	STT254

# O.E. INTERCHANGES



O.E. INTERCHANGES

## CLIPS, STRAPS, LOOM & HEAT SHRINK TUBING

	<b>Boxed Part #</b>
ET256	STT256
ET256E	STT256E
ET256R	STT256R
ET256W	STT256W
ET256Y	STT256Y
ET260	STT260
	STT261
	STT262
ET263	STT261
ET270	ST69
	ST66
	ST67
ET271EL	STT271E
ET271L	STT271
ET271RL	STT271R
ET271WL	STT271W
ET271YL	STT271Y
ET272	ST70
	ST71
	ST72
ET273	ST70
ET274	ST71
ET275	ST72
ET276L	STT276
ET279L	STT275
ET290	ST60
ET292	ST292
ET293	ST293

## MISCELLANEOUS

	<b>Boxed Part #</b>
ET10	WTT5
ET26	ST26
ET40	GR2
ET44	GR1
ET45	GR3
ET100	WTT100
ET113	ST113
ET114	ST114
ET116	ST116
ET200	STP200
ET201	STP201
ET203	STP203
ET204	STP201
	STP203
	STP200
ET214	FH1
ET215	FH2
ET216	STP213
ET223	FH15
ET224	FH12
ET225	FH18
ET230	ST230
ET231	ST231
ET457	C16-4B
ET458	C16-3B

## AMERICAN MOTORS

O.E.#	STD Part #
3690736	S69
3691072	S71
4486948	S49
4486949	S45N
4488908	S44
4489395	S74
4489412	S45N
8122474	S503
8124663	S69
8126900	S503
8983500650	S506

## CHRYSLER

O.E.#	STD Part #
15305803	S-793
202096466	CG69
2096467	CG35
2822196	S-773
2926370	S-75
2926502	S-747
2983727	S-573
302919BK	S844
3032BK	S845
3513162	S-45N
3513558	S-505
3513686	S-99
3588314	S-100
3588421	S-516
3588427	S-69
3588650	S-100
3588883	S-69
3690736	S-69
3691072	S-71
3738020	S-99
3744750	S-500A
3764123	S-69
3764126	S-71
3764561	S-505
3764579	S-71
3764747	S-44
3764863	S-505
3764865	S-501
3780745	S-45N
3843386	CG37
3843386	CG48
3843432	S-504
3843601	CG36
3843601	CG49
4055028	S-99
4124081	S-600A
4124721	S-501
4163003	S-504
4274041	S-99
4274100	S-97
4304282	S-505
4304729	CG53
4331051	S-502
4362012	S1928
4368163	CG51
4368264	S-532
4368960	CG52
4374072	S-500A

## CHRYSLER

O.E.#	STD Part #
4399576	S-600A
4399639	S862
4399900	S-776
4400147	S772
4400216	S-501
4400231	S872
4400396	S-525
4400448	S835
4400588	S-99
4400740	S-532
4400899	S772
4414184	S-557
4414332	S-525
4430976	S-525
4439076	S-525
4450799	S-532
4450807	S2000
4450816	S-502
4450817	S-506
4450820	S872
4450821	S-100
4486948	S-49
4486949	S-45N
4488908	S-44
4488909	S-45N
4489395	S-74
4489412	S-45N
4636358	S-770
4636359	S-532
4636360	S872
4636361	S2000
4636362	S-791
4636363	S-778
4676589	S-771
4773905	S-777
4782204	S-720
4857327AA	S-775
4864259	S-773
4897034AA	S949
4897087AA	S-738
5003316AA	S1936
5013933AA	S1838
5013940AA	S2055
5013942AA	S2056
5013949AA	S1958
5013961AA	S1960
5013971AA	S1933
5013979AB	S949
5014001AA	S2063
5014010AA	S1832
5014010AB	S1832
5016261AA	S1950
5017119AA	S1918
5017124AA	S1768
5017124AB	S1768
5017124AC	S1768
5019923AA	S1837
5019940AA	S2082
5019945AA	S2061
5019959AA	S1918
5102406AA	S1153
5102408AA	S1920

## CHRYSLER

O.E.#	STD Part #
5127710AA	S1957
5161920AA	S1905
5173477AA	S1928
5183448AA	S1895
5288917AA	S-779
5288919AA	S907
55157102AB	S1916
56045501AC	S1956
68003675AA	S1938
68018959AA	S899
68018993AA	S1739
68052586AB	S1759
68052733AA	S1943
7368261	CG50
8122474	S-503A
8124663	S-69
8126900	S-503A
8983500650	S-506
8983501000	S-505
MB898192	S-790
MD611538	S834
MU805823	S-794

## DELCO

O.E.#	STD Part #
8013	SPP33
FP51	S-722
LS101	S-74
LS11	S-548
LS12	S-559
LS13	S-592
LS14	S-590
LS15	S-584
LS17	S-586
LS19	S-95
LS2	S-63
LS25	S-97
LS32	S-669
LS37	S-673
LS39	S-767
LS4	S-55
LS44	S-789
LS5	S-95
LS50	S-768
LS51	S-97
LS53	S-506
LS54	S-585
LS6	S-507
LS63	S-98
LS64	S-766
LS65	S-54
LS7	S-502
LS71	S-766
LS8	S-77
LS82	S-793
PT100	S-639
PT101	S-709
PT1031	S-796
PT107	S-712
PT109	S-714
PT110	S-649
PT111	S-651

# O.E. INTERCHANGES

## DELCO

O.E.#	STD Part #
PT1115.....	S-742
PT113.....	SK25
PT114.....	S-569
PT115.....	S-701
PT117.....	S-656
PT1174.....	S-761
PT118.....	S-587
PT1184.....	S-795
PT119.....	S-605
PT120.....	S-553
PT1205.....	S-803
PT121.....	S-637
PT122.....	S-742
PT123.....	S-595
PT124.....	S-536
PT127.....	S-555
PT128.....	S-594
PT131.....	S-538
PT134.....	S-650
PT1346.....	S-804
PT1350.....	TX3A
PT140.....	S-668
PT143.....	S-700
PT146.....	S-717
PT147.....	S-754
PT148.....	S-577
PT1489.....	S-753
PT151.....	S-652
PT156.....	S-721
PT156.....	S-721
PT159.....	S-826
PT165.....	S-604
PT166.....	S-562
PT167.....	S-523
PT168.....	S-524
PT175.....	S-647
PT179.....	S-648
PT181.....	S-646
PT186.....	S-614
PT189.....	S-568
PT194.....	S-615
PT195.....	S-758
PT199.....	S-726
PT205.....	S-653
PT209.....	S-588
PT212.....	S-667
PT217.....	S-633
PT225.....	S-804
PT243.....	S-734
PT247.....	S-689
PT248.....	S-634
PT249.....	S-636
PT262.....	S-759
PT285.....	SK29
PT292.....	S-527
PT307.....	S-556
PT308.....	S-550
PT331.....	S-708
PT342.....	S-601
PT344.....	S-687
PT363.....	S-654

## DELCO

O.E.#	STD Part #
PT367.....	S-687
PT374.....	S-575
PT375.....	S-619
PT387.....	S-729
PT392.....	S-749
PT404.....	S-635
PT407.....	S-614
PT410.....	S-688
PT419.....	S-578
PT420.....	S-724
PT430.....	S-564
PT433.....	S-525
PT450.....	S-753
PT466.....	S-618
PT486.....	S-643
PT487.....	S-711
PT494.....	S-552
PT516.....	S-735
PT517.....	S-554
PT643.....	S-750
PT656.....	S-733
PT689.....	S-732
PT730.....	S-721
PT743.....	S-619
PT757.....	S-551
PT768.....	S-818
PT782.....	S-574
PT786.....	S-811
PT819.....	S-800
PT919.....	S-817

## FORD

O.E.#	STD Part #
1F1Z14A411BA.....	S-823
1U2Z14S411AA.....	S1094
1U2Z14S411ABA.....	S2036
1U2Z14S411ACA.....	S1859
1U2Z14S411ADA.....	S943
1U2Z14S411AFA.....	S867
1U2Z14S411AFB.....	S867
1U2Z14S411AJA.....	S942
1U2Z14S411AKA.....	S1756
1U2Z14S411AKB.....	S1754
1U2Z14S411AMA.....	S1888
1U2Z14S411AUA.....	S1839
1U2Z14S411AXA.....	S1874
1U2Z14S411AY.....	S1094
1U2Z14S411AYA.....	S1094
1U2Z14S411BBA.....	S1840
1U2Z14S411BCA.....	S1860
1U2Z14S411BDA.....	S898
1U2Z14S411BDB.....	S898
1U2Z14S411BEA.....	S911
1U2Z14S411BEB.....	S911
1U2Z14S411BFA.....	S1869
1U2Z14S411BHA.....	S1779
1U2Z14S411BJA.....	S1868
1U2Z14S411BNA.....	S918
1U2Z14S411BNB.....	S918
1U2Z14S411BRA.....	S1764
1U2Z14S411BRC.....	S1764

## FORD

O.E.#	STD Part #
1U2Z14S411BSA.....	S1085
1U2Z14S411BSB.....	S1085
1U2Z14S411BVA.....	S1851
1U2Z14S411BXA.....	S-822
1U2Z14S411LA.....	S1866
1U2Z14S411PA.....	S1785
1U2Z14S411TA.....	S-821
1U2Z14S411VA.....	S1896
1W3Z14S411AB.....	S1775
2U2Z14S411AA.....	S924
2U2Z14S411AC.....	S924
2U5Z13411AA.....	S875
2U5Z13411BB.....	S878
2U5Z13411CA.....	S876
2U5Z13411DA.....	S879
2U5Z13411FB.....	S2054
2U5Z13411HA.....	S877
2U5Z13411RA.....	S873
2U5Z13411SA.....	S874
3U2Z14S411ACAA.....	S2096
3U2Z14S411ACAB.....	S2096
3U2Z14S411ADA.....	S1897
3U2Z14S411AEA.....	S1789
3U2Z14S411ARA.....	S1850
3U2Z14S411ARB.....	S1850
3U2Z14S411AVA.....	S2051
3U2Z14S411BA.....	S1894
3U2Z14S411BKA.....	S1853
3U2Z14S411BNA.....	S1883
3U2Z14S411BNB.....	S1883
3U2Z14S411BYAA.....	S1795
3U2Z14S411BYAB.....	S1795
3U2Z14S411BYAC.....	S1795
3U2Z14S411CKAA.....	S895
3U2Z14S411CYA.....	S2092
3U2Z14S411DDA.....	S1899
3U2Z14S411DMAA.....	S893
3U2Z14S411DNAA.....	S892
3U2Z14S411DYA.....	S1770
3U2Z14S411DYB.....	S1770
3U2Z14S411EAA.....	S1755
3U2Z14S411EBAA.....	S1754
3U2Z14S411EEA.....	S1018
3U2Z14S411EEB.....	S1018
3U2Z14S411EKA.....	S941
3U2Z14S411EKB.....	S941
3U2Z14S411ERAA.....	S1085
3U2Z14S411EXB.....	S2031
3U2Z14S411EYAA.....	S2095
3U2Z14S411FAA.....	S1831
3U2Z14S411FKA.....	S1849
3U2Z14S411FKAA.....	S899
3U2Z14S411FKAB.....	S899
3U2Z14S411FKAE.....	S899
3U2Z14S411FLA.....	S1873
3U2Z14S411FNA.....	S1086
3U2Z14S411FNB.....	S1086
3U2Z14S411FNB.....	S1086
3U2Z14S411FPB.....	S1873
3U2Z14S411FRA.....	S1857
3U2Z14S411GDA.....	S2050

## FORD

O.E.#	STD Part #
3U2Z14S411GFA.....	S1870
3U2Z14S411GLB.....	S1858
3U2Z14S411GMA.....	S1856
3U2Z14S411GSA.....	S2090
3U2Z14S411GVA.....	S1452
3U2Z14S411GZA.....	S2032
3U2Z14S411HRA.....	S2031
3U2Z14S411HSA.....	S2078
3U2Z14S411HSB.....	S2078
3U2Z14S411HXA.....	S1862
3U2Z14S411HYA.....	S2034
3U2Z14S411HYB.....	S2034
3U2Z14S411HZB.....	S1857
3U2Z14S411JBA.....	S2037
3U2Z14S411JGA.....	S2048
3U2Z14S411JLA.....	S1757
3U2Z14S411JLB.....	S1757
3U2Z14S411JPA.....	S1858
3U2Z14S411JTA.....	S1867
3U2Z14S411JUA.....	S1080
3U2Z14S411JVA.....	S1878
3U2Z14S411JYA.....	S1794
3U2Z14S411JYB.....	S1794
3U2Z14S411JZB.....	S1080
3U2Z14S411KBA.....	S843
3U2Z14S411LEA.....	S1858
3U2Z14S411LKA.....	S1796
3U2Z14S411LXA.....	S1082
3U2Z14S411MFA.....	S843
3U2Z14S411MGA.....	S1834
3U2Z14S411MHA.....	S940
3U2Z14S411MJA.....	S1891
3U2Z14S411MLA.....	S1765
3U2Z14S411MLB.....	S1765
3U2Z14S411PFA.....	S1787
3U2Z14S411PFB.....	S1787
3U2Z14S411PGA.....	S1861
3U2Z14S411RBA.....	S2079
3U2Z14S411RCA.....	S1835
3U2Z14S411RHA.....	S1777
3U2Z14S411RHB.....	S1777
3U2Z14S411RJA.....	S1781
3U2Z14S411RJB.....	S1781
3U2Z14S411RPA.....	S1786
3U2Z14S411RPB.....	S1756
3U2Z14S411RPB.....	S1786
3U2Z14S411SA.....	S1848
3U2Z14S411SJB.....	S1873
3U2Z14S411SRA.....	S1773
3U2Z14S411SVA.....	S1021
3U2Z14S411SVB.....	S1021
3U2Z14S411TKA.....	S1875
3U2Z14S411UA.....	S1784
3U2Z14S411UB.....	S1784
3U2Z14S411UEA.....	S1788
3U2Z14S411USA.....	S1752
3U2Z14S411UZA.....	S2079
3U2Z14S411UZB.....	S2079
3U2Z14S411VA.....	S2034
3U2Z14S411VCA.....	S910
3U2Z14S411VLA.....	S1020

# O.E. INTERCHANGES



O.E. INTERCHANGES

## FORD

O.E. #	STD Part #
3U2Z14S411XA	S831
3U2Z14S411XRA	S1884
3U2Z14S411XUA	S2093
3U2Z14S411XVA	S2094
3U2Z14S411XVB	S2094
3U2Z14S411YBA	S1019
3U2Z14S411YSA	S2080
4U2Z14S411JA	S1771
4U2Z14S411RA	S941
4W7Z14A411A	S1798
4W7Z14A411B	S1798
5U2Z14S411XA	S899
5U2Z14S411YA	S1799
5U2Z14S411YB	S1799
6U2Z14S411AA	S892
6U2Z14S411AA	S895
6U2Z14S411AB	S895
6U2Z14S411BA	S893
6U2Z14S411CA	S892
6U2Z14S411LB	S1772
89FZ14489HB	S1858
906790	S849
998129	S903
998130	S904
998278	S898
998312	S905
998470	S897
998509	S899
998533	S894
998612	S896
9U2Z14S411ASA	S1776
C1SF14474A	CG35
C5AB14474B	CG69
C80Z13711B	S-500A
C80Z13711A	S-500A
D0AZ13410B	S-75
D0DZ15A434B	S-74
D0OZ15536A	S-45N
D1AB14461AA	CG31
D1AB14488CA	CG30
D1AZ13410A	S831
D1AZ13410B	S-75
D1FZ13234A	S-519
D20814421BB	CG33
D20B14421CB	CG59
D2FZ13410A	S-69
D2OZ13410B	S-75
D3AB14474DA	CG32
D3AZ13410A	S-71
D3AZ13410B	S-69
D3AZ13410C	S-70
D3AZ13410D	S-68
D3AZ13410E	S-509
D3AZ13410G	S-510
D3AZ14474G	CG34
D3MY13410A	S-511
D40Z13234A	S-520
D4AZ13412A	S-36N
D4DZ13234A	S-511
D4FZ15536A	S-71
D4LY13410A	S-512
D4OZ13234A	S-520

## FORD

O.E. #	STD Part #
D40Z13410A	S-68
D4SZ13410A	S-68
D4ZZ13234A	S-521
D54Y13234A	S-511
D5AB14474FA	CG34
D5AZ13234A	S-508
D5DZ13410A	S-69
D5UZ13410A	S-519
D5VY13410A	S-69
D5VY15A442A	S-74
D7AZ13412A	S-74
D7DZ13412A	S-74
D7FZ13234A	S-520
D7FZ13234B	S-520
D7FZ13234C	S-519
D7FZ13234D	S-520
D7LY13412A	S-74
D7MY13412A	S-74
D7OZ13410A	S-522
D7OZ13412A	S-74
D7VY13412A	S-74
D8BB14474BA	CG32
D8BZ13412B	S-74
D8HZ13711A	S-500A
D8OZ15A434A	S-71
D8VY15A442A	S-74
D9AZ13412B	S-74
D9AZ15A434A	S-70
D9MY13412A	S-74
D9MY15A442A	S-74
D9ZZ13412A	S-74
D9ZZ13412B	S-74
D9ZZ15A434A	S-74
E0AZ13412A	S-74
E0AZ15536A	S-74
E0BZ13412A	S-74
E0BZ13412B	S-74
E0DZ13412B	S-74
E0FZ13412A	S-74
E0MY13412A	S-74
E0MY13412B	S-74
E0MY15536A	S-570
E0SZ13412A	S-74
E0SZ15A442A	S-74
E0SZ15A442B	S-95
E0TZ13410A	S-533
E0VY13412A	S-74
E0ZZ13412A	S-74
E1AZ13410A	S-797
E1AZ13410A	S-533
E1AZ13410A	S-533
E1BZ13412A	S-74
E1BZ13412B	S-74
E1DZ15536A	S-570
E1DZ15A434B	S-572
E1FZ13234A	S-531
E1FZ13410A	S-74
E1FZ13412A	S-74
E1VY13412A	S-74
E1ZZ15A434A	S-100
E25B14488AC	CG67
E25B14488DA	CG66
E25Y13410A	S-522

## FORD

O.E. #	STD Part #
E25Y13410B	S-100
E25Y15A442	S-95
E25Y15A442A	S-95
E2SZ13410A	S-533
E2SZ15A442A	S-95
E2VY13410A	S-522
E3LY15A442A	S-95
E4DZ15A434A	S-572
E4FZ8C290A	S-549
E5SZ13B765A	S-500A
E6AZ15A434A	S-572
E6DB15A200AA	S-572
E6DB15A200AC	S-572
E6DZ14A411A	S-628
E6DZ15A434A	S-572
E6FZ13B764A	S-503A
E7EB14421EA	CG55
E7EB14474CA	CG57
E83Z13412C	S-100
E89Z13B765A	S-500A
E8EB1114474AMA	CG54
E8EB14421LA	CG56
E8EB14474AJA	CG58
E8EB14474VA	CG60
E8EB14488AGA	CG67
E8EB14488AHA	CG66
E8PZ13411A	S-547
E8PZ13411B	S-547
E8PZ13411C	S-547
E8PZ13411D	S-571
E92Z13B765A	S-500A
E9AZ15A434A	S-571
E9DZ15A434A	S-571
E9TZ13410A	S898
F02Z13K371B	S-36N
F1TZ13411A	S-787
F1TZ13411B	S-806
F1TZ13411C	S-783
F1TZ13411E	S891
F1TZ13411F	S-786
F1TZ13411G	S-807
F24Y13410A	S-547
F2AZ13234A	S-547
F2AZ14489W	S-713
F2DZ13410A	S-547
F2DZ13412B	S-100
F2MY13234A	S-547
F2PZ14A464B	S-801
F2PZ14A464C	S-692
F2PZ14A464C	S-798
F2ZZ13412B	S-100
F32Z13K371A	S-769
F32Z13K371D	S-36N
F37Z13411A	S841
F3LY13411A	S-808
F3XY12A112A	S-670
F3XY13410B	S1091
F42Z13K371D	S-36N
F47Z13411A	S-809
F4UB14A464A	S-692
F4VY14A411S	S843
F57Z13234AA	S898

## FORD

O.E. #	STD Part #
F58Z13411A	S-810
F5RZ13K371A	S-745
F5RZ13K371B	S-745
F6DZ13411A	S890
F6DZ13411B	S842
F6HZ14A464FUA	S-756
F6TZ14489A	S1785
F7PZ14A411AB	S918
F7ZZ13411AB	S2036
F81Z13411AA	S1836
F81Z13411BA	S923
F81Z19D887AA	S-805
F85Z13411AA	S-815
F87Z13411AA	S1091
F8AZ14A411BA	S943
F8ZZ14489DA	S943
F9PZ14A411AB	S918
FOOY14489A	S1775
WPT170	S867
YF1Z14489BA	S1839

## GENERAL MOTORS

O.E. #	STD Part #
06298886	S-74
08901283	S1719
08912750	S-97
08918527	S-74
10042638	S-703
10486240	S1767
12001470	S-95
12003757	S-507
12003758	S-506
12003759	S-502
12003877	S-89
12003878	S-98
12003896	S-97
12004035	S840
12004311	S-500A
12004311	S-503A
12004706	S1134
12004996	CG20
12010085	CG17
12010182	CG16
12010300	CG29
12010717	CG42
12010973	CG40
12010974	CG71
12010975	CG75
12010996	CG38
12013813	S-77
12015323	CG9
12015387	CG44
12015791	CG39
12015792	CG41
12015793	CG43
12015797	CG70
12015798	S1594
12015799	CG74
12015857	CG3
12015861	CG26
12015870	CG28
12020116	CG4

# O.E. INTERCHANGES

## GENERAL MOTORS

O.E. #	STD Part #
12020120.....	CG27
12020126.....	CG62
12020320.....	CG5
12020347.....	CG6
12020757.....	CG12
12020758.....	CG15
12027133.....	S-768
12030055.....	S-673
12033674.....	CG10
12033817.....	CG18
12034046.....	CG24
12034047.....	CG25
12034051.....	CG11
12034053.....	CG13
12034342.....	CG72
12037105.....	S-669
12040902.....	CG14
12043215.....	S-553
12045781.....	CG22
12046623.....	TX3A
12046624.....	S-556
12047680.....	CG21
12047767.....	CG23
12051233.....	S-580
12051234.....	S-550
12052466.....	CG61
12052922.....	CG63
12058478.....	S836
12059800.....	S1399
12065158.....	CG73
12076946.....	S-590
12078187.....	S-95
12083005.....	S-548
12083006.....	S-559
12083007.....	S-592
12083460.....	S-669
12083462.....	S838
12083680.....	S-585
12083689.....	S-584
12085208.....	S974
12085212.....	S1337
12085247.....	S1099
12085330.....	S-586
12085480.....	S840
12085481.....	S1611
12085483.....	S-574
12085484.....	S1596
12085485.....	S-712
12085486.....	S1597
12085487.....	S-714
12085488.....	S-649
12085489.....	S-651
12085491.....	SK25
12085493.....	S-701
12085493.....	S1101
12085495.....	S-656
12085496.....	S-587
12085497.....	S-605
12085498.....	S-553
12085499.....	S-637
12085500.....	S-639

## GENERAL MOTORS

O.E. #	STD Part #
12085501.....	S-742
12085502.....	S-595
12085503.....	S-536
12085504.....	S1606
12085506.....	S-555
12085507.....	S-594
12085520.....	S-709
12085521.....	S-538
12085523.....	S1833
12085524.....	S-650
12085525.....	S-552
12085527.....	S-552
12085528.....	S-552
12085529.....	S956
12085530.....	S-668
12085531.....	S1040
12085532.....	S1614
12085533.....	S-700
12085534.....	S1103
12085535.....	S-717
12085536.....	S1104
12085537.....	S-754
12085538.....	S-638
12085538.....	S-577
12085539.....	S-638
12089040.....	CG10
12089188.....	CG11
12089340.....	CG63
12089347.....	S-506
12089348.....	S-502
12089648.....	S1227
12092209.....	S1622
12092377.....	S-548
12092378.....	S-559
12092512.....	S1170
12101762.....	S1065
12101763.....	S1029
12101820.....	S-667
12101822.....	S1097
12101823.....	S1660
12101824.....	S1659
12101825.....	S-633
12101826.....	S1369
12101827.....	S1105
12101830.....	S1056
12101832.....	S1651
12101833.....	S-804
12101836.....	S1617
12101845.....	S1106
12101847.....	S1107
12101848.....	S1621
12101850.....	S908
12101851.....	S-734
12101852.....	S1747
12101853.....	S1609
12101854.....	S1647
12101855.....	S-689
12101856.....	S-634
12101857.....	S-636
12101858.....	S1350
12101862.....	S1644

## GENERAL MOTORS

O.E. #	STD Part #
12101864.....	S972
12101865.....	S1648
12101866.....	S1108
12101871.....	S-759
12101874.....	S1109
12101875.....	S1658
12101876.....	S1639
12101880.....	S-652
12101880.....	S1099
12101881.....	S860
12101885.....	S-721
12101886.....	S1016
12101887.....	S1650
12101888.....	S-826
12101889.....	S1641
12101894.....	S869
12101895.....	S-552
12101897.....	S-523
12101898.....	S-524
12101899.....	TX3A
12101900.....	S1098
12101901.....	S1110
12101903.....	S-647
12101905.....	S1335
12101906.....	S-568
12101907.....	S-648
12101909.....	S-78
12101910.....	S1046
12101911.....	S1649
12101913.....	S1068
12101914.....	S-614
12101915.....	S1638
12101916.....	S1090
12101917.....	S-568
12101918.....	S1749
12101922.....	S-615
12101923.....	S-564
12101924.....	S1634
12101925.....	S839
12101927.....	S-726
12101928.....	S956
12101930.....	S1111
12101932.....	S1095
12101933.....	S-653
12101935.....	S2062
12101936.....	S1636
12101937.....	S-588
12101938.....	S1635
12101939.....	S-721
12102480.....	S1766
12102481.....	S1637
12102483.....	S1643
12102484.....	S1631
12102485.....	S1112
12102490.....	S1642
12102561.....	S1100
12102565.....	S-736
12102566.....	S1701
12102568.....	SK29
12102602.....	S1113
12102606.....	S1628

## GENERAL MOTORS

O.E. #	STD Part #
12102611.....	S966
12102614.....	S1632
12102616.....	S1640
12102619.....	S1474
12102620.....	S-556
12102621.....	S-550
12102627.....	S1633
12102628.....	S1114
12102629.....	S1115
12102630.....	S1630
12102632.....	S1112
12102635.....	S1117
12102636.....	S1118
12102638.....	S1629
12102639.....	S971
12102660.....	S1119
12102661.....	S982
12102664.....	S-708
12102668.....	S1120
12102670.....	S967
12102677.....	S1044
12102685.....	S1121
12102686.....	S1122
12102690.....	S1646
12102697.....	S1645
12102698.....	S945
12102741.....	S928
12102746.....	S1616
12102747.....	S-575
12102748.....	S-619
12102750.....	S1123
12102754.....	S1605
12102756.....	S1124
12102757.....	S-729
12102759.....	S1125
12102762.....	S1615
12102763.....	S-749
12102768.....	S1652
12102769.....	S1126
12102775.....	S1607
12102776.....	S1339
12102777.....	S1627
12102778.....	S1613
12102900.....	S1051
12110250.....	S944
12112171.....	S-635
12112380.....	S1828
12112768.....	S-592
12116169.....	S-95
12116244.....	S979
12116247.....	S1819
12116251.....	S1127
12116257.....	S-564
12116930.....	S1128
12116958.....	S-578
12117025.....	S-724
12117269.....	S1604
12117270.....	S1129
12117271.....	S1130
12117273.....	S1058
12117277.....	S-753

# O.E. INTERCHANGES



O.E. INTERCHANGES

## GENERAL MOTORS

O.E. #	STD Part #
12117320	S1338
12117321	S1131
12117322	S1132
12117323	S1624
12117324	S1140
12117339	S1133
12117342	S1623
12117344	S984
12117346	S960
12117350	S1603
12117353	S-643
12117354	S-711
12117360	S1134
12117361	S-552
12117369	S1743
12117371	S1625
12117372	S1135
12117379	S1137
12117380	S961
12117381	S1139
12117383	S1626
12117384	S-735
12117387	S1136
12117399	S1138
12121822	S1097
12124634	S1142
12125621	S1826
12125627	S1602
12125631	S1041
12125632	S1602
12125634	S1140
12125635	S916
12125636	S1141
12125641	S1142
12125643	S1143
12125649	S1654
12125653	S1144
12125665	S1699
12125670	S1145
12125675	S1146
12125676	S1147
12125678	S1148
12125682	S1227
12125687	S1150
12125690	S1149
12125691	S1150
12125694	S915
12125695	S1720
12125910	S-97
12125966	S1727
12126011	S1349
12126016	S1176
12126023	S1151
12126025	S-733
12126032	S957
12126033	S1833
12126045	S1600
12126047	S951
12126048	S1599
12126058	S-732
12126059	S1595
12126430	S980

## GENERAL MOTORS

O.E. #	STD Part #
12126432	S1484
12126436	S955
12126438	S1598
12126444	S-688
12126449	S1594
12126452	S1783
12126453	S1593
12126458	S963
12126459	S1152
12126460	S-721
12126461	S1591
12126463	S1590
12126470	S1476
12126475	S1351
12126477	S1054
12126478	S1473
12126480	S932
12126486	S1153
12126487	S-551
12126498	S1622
12126499	S-818
12129427	S1230
12129565	S1352
12129946	S952
12141301	S-767
12141302	S829
12141388	S-789
12141493	S868
12159662	S-585
12159663	S1723
12160491	S1152
12160493	S1199
12160948	S1377
12162414	S1372
12162873	S1444
12166036	S1730
12166325	S1733
12167101	S1656
12167113	S1154
12167120	S-811
12167121	S1099
12167122	S1657
12167123	S1026
12167126	S1620
12167127	S1610
12167129	S1619
12167130	S1618
12167133	S1329
12167136	S1355
12167138	S-766
12167140	S1608
12167144	S1343
12167150	S1320
12167151	S1155
12167154	S912
12167155	S-800
12167156	S1047
12167157	S1008
12187676	S1051
12187678	S1051
12202677	S-687
12335587	S1023

## GENERAL MOTORS

O.E. #	STD Part #
12335631	S1690
12335815	S1728
12456483	S999
12475138	S1156
13355748	S1477
13504128	S1745
13580103	S1491
13580104	S1072
13580107	S1384
13580108	S1801
13580111	S1426
13580112	S1010
13580114	S1717
13580114	S1717
13580115	S1323
13580116	S1048
13580860	S1694
13580864	S1265
13580868	S1216
13580869	S1329
13580871	S1025
13580873	S1445
13580873	S1741
13580874	S1288
13580877	S934
13580880	S1673
13580881	S1394
13580883	S1605
13583923	S1699
13583927	S1344
13584094	S1479
13584095	S1745
13584255	S1664
13584255	S1708
13584311	S1458
13584479	S1469
13585849	S1437
15231500	S1800
15305801	S-817
15305802	S1383
15305839	S929
15305857	S1199
15305872	S1200
15305873	S2001
15305874	S2018
15305876	S912
15305878	S1201
15305880	S1071
15305883	S1202
15305886	S1158
15305887	S-796
15305888	S975
15305889	S1203
15305890	S1157
15305891	S1204
15305896	S1159
15305899	S1370
15305900	S1160
15305910	S1161
15305913	S1162
15305914	S1206
15305916	S1207

## GENERAL MOTORS

O.E. #	STD Part #
15305917	S1163
15305918	S1164
15305919	S1167
15305920	S1165
15305921	S1166
15305923	S1167
15305924	S1168
15305925	S-795
15305927	S1325
15305928	S1169
15305930	S1319
15305931	S1818
15305935	S2004
15305938	S2028
15305942	S-761
15305943	S1170
15305944	S1371
15305946	S1171
15305949	S1372
15305950	S1374
15305951	S1373
15305957	S1172
15305960	S1208
15305965	S1348
15305982	S1416
15305983	S1210
15305984	S1211
15305985	S1167
15305986	S1212
15305988	S1376
15305991	S1377
15305992	S1378
15305995	S1173
15305996	S1059
15305997	S1096
15305998	S1362
15305999	S1174
15306000	S1213
15306002	S-742
15306005	S1175
15306007	S945
15306007	S945
15306008	S1176
15306011	S1355
15306012	S1387
15306013	S1177
15306014	S1385
15306017	S1178
15306018	S1179
15306021	S1388
15306023	S1227
15306024	S1390
15306026	S1375
15306027	S1054
15306028	S1199
15306030	S1389
15306032	S1386
15306036	S1180
15306039	S1181
15306041	S1182
15306042	S1368
15306044	S1341

# O.E. INTERCHANGES

## GENERAL MOTORS

O.E. #	STD Part #
15306045.....	S-802
15306047.....	S1014
15306050.....	S1183
15306052.....	S1184
15306053.....	S1035
15306054.....	S1360
15306059.....	S1007
15306060.....	S1359
15306061.....	S1185
15306063.....	S1361
15306064.....	S1357
15306065.....	S1358
15306067.....	S1351
15306069.....	S1352
15306070.....	S1214
15306071.....	S1215
15306076.....	S1186
15306078.....	S1187
15306079.....	S932
15306080.....	S868
15306082.....	S1372
15306083.....	S1066
15306084.....	S1356
15306086.....	S1482
15306087.....	S1706
15306088.....	S1188
15306090.....	S1354
15306092.....	S1723
15306097.....	S1189
15306098.....	S1190
15306102.....	S1344
15306103.....	S1191
15306105.....	S1345
15306106.....	S1192
15306107.....	S1193
15306114.....	S1704
15306115.....	S1194
15306116.....	S1195
15306117.....	S1196
15306119.....	S1197
15306121.....	S1243
15306125.....	S1815
15306134.....	S1216
15306135.....	S1217
15306138.....	S1218
15306139.....	S1219
15306141.....	S1220
15306142.....	S1221
15306143.....	S1198
15306146.....	S1224
15306147.....	S919
15306148.....	S1225
15306153.....	S1226
15306155.....	S1227
15306156.....	S1717
15306157.....	S1022
15306159.....	S1222
15306160.....	S1014
15306162.....	S1340
15306163.....	S1280
15306164.....	S1344

## GENERAL MOTORS

O.E. #	STD Part #
15306166.....	S1491
15306167.....	S1228
15306168.....	S1229
15306169.....	S1399
15306173.....	S1398
15306174.....	S1793
15306176.....	S1230
15306178.....	S1395
15306181.....	S-804
15306182.....	S1230
15306182.....	S1231
15306185.....	S1823
15306186.....	S1406
15306188.....	S1725
15306189.....	S-804
15306194.....	S829
15306196.....	S1077
15306199.....	S1811
15306300.....	S1233
15306304.....	S1813
15306305.....	S1382
15306306.....	S1234
15306309.....	S1322
15306311.....	S938
15306312.....	S921
15306313.....	S1384
15306314.....	S952
15306316.....	S1411
15306317.....	S1380
15306319.....	S926
15306327.....	S1235
15306329.....	S1236
15306330.....	S1724
15306331.....	S947
15306332.....	S1237
15306334.....	S1238
15306335.....	S1239
15306336.....	S1240
15306338.....	S1241
15306339.....	S1242
15306346.....	S1334
15306348.....	S1243
15306349.....	S1410
15306350.....	S1501
15306351.....	S1244
15306353.....	S1393
15306357.....	S1245
15306358.....	S1721
15306359.....	S1041
15306360.....	S1265
15306361.....	S1381
15306362.....	S1246
15306363.....	S1295
15306364.....	S1247
15306365.....	S927
15306370.....	S1803
15306371.....	S1248
15306372.....	S1223
15306373.....	S1249
15306375.....	S1250
15306376.....	S1214

## GENERAL MOTORS

O.E. #	STD Part #
15306377.....	S1394
15306379.....	S1396
15306380.....	S1694
15306384.....	S1251
15306385.....	S1494
15306386.....	S1252
15306387.....	S1253
15306388.....	S1025
15306389.....	S1321
15306390.....	S1254
15306392.....	S1397
15306393.....	S1400
15306394.....	S1347
15306395.....	S1336
15306396.....	S1074
15306398.....	S1407
15306399.....	S1075
15306401.....	S1408
15306403.....	S1409
15306405.....	S1255
15306406.....	S1256
15306407.....	S990
15306408.....	S1405
15306409.....	S1404
15306411.....	S1402
15306412.....	S1257
15306413.....	S1258
15306414.....	S1366
15306415.....	S1180
15306416.....	S1069
15306417.....	S977
15306418.....	S1259
15306419.....	S1112
15306420.....	S1057
15306422.....	S1260
15306424.....	S1401
15306425.....	S1346
15306426.....	S1364
15306427.....	S1379
15306429.....	S1812
15306430.....	S1318
15306431.....	S953
15306434.....	S1787
15306438.....	S1811
15306439.....	S1261
15306441.....	S1365
15306554.....	S1327
15323418.....	S1051
15326808.....	S1025
15326835.....	S1010
15326924.....	S1793
15336745.....	S947
15383038.....	S1244
15839620.....	S1230
15862656.....	S916
15945363.....	S1489
16513367.....	S-97
16513368.....	S830
16522273.....	S1729
16530707.....	S1735
1893623.....	S1751

## GENERAL MOTORS

O.E. #	STD Part #
19115027.....	S1696
19115594.....	S1745
19115602.....	S1488
19115653.....	S1481
19115666.....	S1493
19115695.....	S1486
19120947.....	S1822
19120997.....	S1472
19121104.....	S1805
19121115.....	S1820
19121149.....	S1820
19138475.....	S835
19149287.....	S1687
19149288.....	S1741
19149289.....	S1499
19149297.....	S1740
19149301.....	S1698
19149302.....	S1710
19149305.....	S1718
19151493.....	S1485
19151498.....	S1262
19151499.....	S1491
19151505.....	S1825
19151506.....	S1712
19151508.....	S1808
19152589.....	S1265
19153187.....	S1744
19153751.....	S1793
19166999.....	S1266
19167001.....	S1804
19167008.....	S1704
19168034.....	S1824
19168035.....	S1713
19178087.....	S958
19178093.....	S1487
19178096.....	S1695
19178174.....	S1692
19178187.....	S1708
19178189.....	S1336
19179273.....	S1709
19179274.....	S1490
19179278.....	S1717
19179278.....	S1717
19179280.....	S1697
19179283.....	S1714
19179748.....	S1801
19180245.....	S1496
19180246.....	S1693
19180278.....	S1694
19180287.....	S1074
19180287.....	S1074
19181247.....	S1793
19208396.....	S1827
19257374.....	S1167
19260871.....	S1181
1989457.....	S846
22531065.....	S-704
22710588.....	S1449
25117765.....	S-722
25851959.....	S1688
25851960.....	S1471



# O.E. INTERCHANGES



O.E. INTERCHANGES

## GENERAL MOTORS

O.E. #	STD Part #
25851961	S1689
2962447	CG7
2962448	CG45
2962984	CG47
2962987	CG8
2965470	CG69
2965580	CG35
2965880	CG68
2973781	S1648
2973932	S-503A
2978302	S-45N
5585157	S861
5585170	S857
5655006	S-503A
5963268	S-63
6270498	S833
6288702	S1143
6294015	S-74
6294493	CG46
6294511	CG2
6294512	CG1
6298886	S-74
6298892	S-74
8077	S838
88952431	S1746
88952434	S1263
88952463	S1746
88952464	S1268
88952774	S1305
88952780	S1244
88952801	S1041
88952807	S1670
88952810	S1057
88952816	S1470
88952817	S1444
88952819	S1263
88952821	S1263
88952831	S1452
88952832	S1264
88952834	S986
88952835	S1446
88952837	S1006
88952838	S1001
88952839	S989
88952841	S1005
88952843	S1004
88952885	S1267
88952886	S1268
88953129	S1269
88953130	S1244
88953131	S1270
88953145	S1672
88953150	S1671
88953152	S1443
88953154	S1673
88953155	S1674
88953157	S935
88953158	S1815
88953199	S1057
88953267	S1676
88953268	S934
88953271	S1677

## GENERAL MOTORS

O.E. #	STD Part #
88953272	S1454
88953273	S1678
88953274	S1711
88953290	S1675
88953299	S1334
88953301	S1470
88953302	S1444
88953303	S1263
88953306	S1452
88953307	S1264
88953308	S986
88953309	S1024
88953310	S1004
88953312	S1038
88953314	S1446
88953315	S989
88953316	S1006
88953319	S1001
88953320	S1005
88953321	S1031
88953345	S1271
88953350	S1272
88953351	S1273
88953352	S1274
88953353	S1669
88953354	S1662
88953355	S1275
88953357	S1726
88953358	S916
88953359	S1663
88953360	S1665
88953361	S1666
88953364	S1661
88953365	S1667
88953366	S1446
88953367	S1668
88953368	S1276
88953370	S1670
88953371	S946
88956482	S1802
88956483	S1748
88972567	S1722
88972568	S1734
88972570	S1732
88973647	S948
88974055	S935
88983300	S1305
88986245	S1500
88986247	S1492
88986251	S1041
88986254	S1501
88986255	S1010
88986257	S1498
88986262	S1480
88986263	S1225
88986264	S1277
88986265	S1502
88986266	S1011
88986268	S1278
88986269	S1279
88986270	S1089
88986417	S1280

## GENERAL MOTORS

O.E. #	STD Part #
88986437	S1503
88986439	S1683
88986447	S1504
88986448	S1505
88986449	S1506
88986452	S1010
88986453	S1507
88986454	S1281
88986455	S1508
88986460	S1282
88986968	S2035
88987182	S1680
88987186	S1262
88987187	S1664
88987188	S1510
88987526	S1516
88987841	S1511
88987842	S1512
88987843	S1073
88987844	S1513
88987845	S1514
88987846	S1515
88987853	S1323
88987855	S1516
88987856	S1517
88987860	S1283
88987863	S1518
88987868	S1519
88987869	S1520
88987881	S1521
88987883	S1522
88987901	S989
88987910	S1523
88987913	S1524
88987916	S1806
88987921	S1324
88987925	S1526
88987927	S1527
88987928	S1528
88987929	S1284
88987940	S1070
88987948	S895
88987963	S1529
88987964	S1530
88987965	S1531
88987967	S1285
88987968	S1532
88987971	S926
88987972	S934
88987973	S1025
88987976	S1286
88987980	S948
88987981	S1287
88987983	S1288
88987985	S1289
88987986	S1290
88987987	S1533
88987988	S1291
88987989	S1292
88987990	S1293
88987991	S1534
88987992	S1535

## GENERAL MOTORS

O.E. #	STD Part #
88987994	S1294
88987995	S1445
88987997	S952
88987998	S1295
88987999	S1536
88988054	S1537
88988055	S1538
88988056	S1342
88988059	S1305
88988060	S1539
88988061	S1540
88988063	S1541
88988064	S1542
88988066	S1544
88988067	S1306
88988104	S1543
88988105	S1545
88988109	S1307
88988111	S1296
88988112	S1546
88988113	S1297
88988114	S1547
88988116	S1475
88988117	S894
88988118	S1469
88988137	S1548
88988138	S1549
88988139	S895
88988140	S1550
88988141	S926
88988142	S1551
88988143	S1302
88988161	S1303
88988162	S1367
88988279	S1304
88988280	S1552
88988297	S1553
88988298	S1554
88988300	S1555
88988308	S1298
88988309	S1684
88988310	S943
88988311	S1299
88988312	S1300
88988314	S1557
88988315	S1324
88988317	S1558
88988320	S1559
88988322	S1684
88988323	S1301
88988337	S1497
88988338	S1308
88988342	S1561
88988343	S1562
88988344	S1563
88988345	S1309
88988346	S1564
88988347	S1565
88988353	S1310
88988357	S1311
88988358	S1566
88988364	S1703

# O.E. INTERCHANGES

## GENERAL MOTORS

O.E. #	STD Part #
88988366.....	S1312
88988374.....	S1821
88988383.....	S1313
88988384.....	S1567
88988385.....	S1314
88988386.....	S1568
88988389.....	S1569
88988391.....	S1570
88988393.....	S1571
88988394.....	S1572
88988395.....	S1315
88988396.....	S1573
88988398.....	S1574
88988399.....	S1575
88988400.....	S1576
88988401.....	S1577
88988402.....	S1682
88988403.....	S1578
88988406.....	S1316
88988407.....	S1317
88988408.....	S1579
88988409.....	S1580
88988410.....	S1412
88988448.....	S1413
88988449.....	S1581
88988451.....	S1467
88988454.....	S1466
88988458.....	S1465
88988459.....	S1463
88988460.....	S1441
88988465.....	S1464
88988466.....	S1440
88988482.....	S1455
88988483.....	S1456
88988497.....	S1700
88988498.....	S1691
88988506.....	S1715
88988507.....	S1353
88988509.....	S1742
88988512.....	S1702
88988582.....	S1582
88988583.....	S1038
88988585.....	S1419
88988586.....	S1414
88988586.....	S1415
88988587.....	S1415
88988588.....	S1716
88988595.....	S1458
88988598.....	S912
88988599.....	S1448
88988600.....	S1583
88988601.....	S1266
88988602.....	S933
88988609.....	S1416
88988610.....	S1418
88988638.....	S1584
88988640.....	S1585
88988641.....	S1420
88988642.....	S1421
88988643.....	S1586
88988644.....	S1587

## GENERAL MOTORS

O.E. #	STD Part #
88988645.....	S1422
88988646.....	S1423
88988648.....	S1424
88988650.....	S1588
88988651.....	S1425
88988652.....	S1426
88988653.....	S1427
88988700.....	S1685
88988702.....	S1353
88988703.....	S1428
88988704.....	S1430
88988705.....	S1429
88988718.....	S1696
88988737.....	S1589
88988739.....	S1449
88988740.....	S1450
88988741.....	S1451
88988742.....	S991
88988744.....	S1477
88988745.....	S1453
88988747.....	S1442
88988764.....	S1431
88988814.....	S1014
88988815.....	S1684
88988815.....	S1684
88988815.....	S1684
88988877.....	S1802
88988878.....	S1748
88988939.....	S1478
88988942.....	S1707
88988944.....	S1479
88988963.....	S1024
8900524.....	CG5
8902485.....	S-59
8902487.....	S-59
89025035.....	S1729
8903202.....	S-55
8903203.....	S-54
8903283.....	S-59
8904437.....	S-63
89046626.....	S1326
89046627.....	S1327
89046628.....	S1328
89046632.....	S1432
89046633.....	S1075
89046634.....	S1330
89046635.....	S1076
89046638.....	S993
89046640.....	S1417
89046642.....	S1331
89046643.....	S1072
89046644.....	S1332
89046645.....	S1433
89046647.....	S1679
89046649.....	S973
89046651.....	S1447
89046652.....	S1681
89046653.....	S1048
89046654.....	S959
89046658.....	S1281
89046731.....	S1434

## GENERAL MOTORS

O.E. #	STD Part #
89046732.....	S1333
89046735.....	S1384
89046742.....	S1435
89046743.....	S1436
89046833.....	S1334
89046834.....	S1462
89046835.....	S1461
89046837.....	S1437
89046839.....	S1683
89046842.....	S1460
89046845.....	S1459
89046846.....	S931
89046849.....	S1438
89046851.....	S1439
89047070.....	S1736
89047243.....	S1415
8905087.....	CG19
8909517.....	S-65
8909518.....	S-63
8909908.....	S-59
8909910.....	S-44
8910685.....	S-74
8912698.....	S-49
8912750.....	S-97
8913503.....	S-76
8914822.....	S-55
8914823.....	S-54
8918525.....	S-89
8918527.....	S-74
8918646.....	S-80
8919916.....	S-77
92143912.....	S930
92147004.....	S1731
94160702.....	S1444

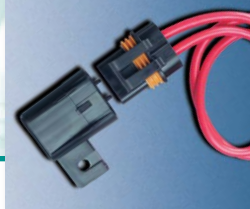

403W.....	A6	724BK.....	A8	745CW.....	A9	828X.....	A11
603W.....	A6	724CD.....	A12	748AL.....	A8	829N.....	A11
605W.....	A6	724CL.....	A9	749M.....	A10	830FW.....	A11
700PLR-1.....	A14	724EE.....	A12	750U.....	A12	831FT.....	A10
700SLA-1.....	A14	724U.....	A12	752AL.....	A8	832AH.....	A10
701PLA-1.....	A14	724US.....	A12	754UW.....	A12	832AK.....	A10
702PLA.....	A15	725BL.....	A8	756AL.....	A8	832P.....	A11
702PLR.....	A15	725CC.....	A12	760US.....	A12	832Q.....	A11
705PLA.....	A14	725HA.....	A13	760UX.....	A12	832R.....	A11
707XD.....	A10	725T.....	A10	801W.....	A6	832X.....	A11
708NS.....	A10	725UW.....	A12	804W.....	A6	834GT.....	A11
710CS.....	A9	726CE.....	A12	806W.....	A6	834XC.....	A11
711CE.....	A12	726CT.....	A9	809W.....	A6	835FW.....	A11
711NS.....	A10	726K.....	A9	812AK.....	A10	836AH.....	A10
712AF.....	A8	726M.....	A10	812CA.....	A13	836P.....	A11
712AK.....	A8	726XA.....	A10	812X.....	A11	836X.....	A11
712AL.....	A8	727CK.....	A8	813FT.....	A10	838AK.....	A10
712CT.....	A9	727CW.....	A9	813HH.....	A13	838R.....	A11
712GG.....	A13	727EE.....	A12	813XC.....	A11	840AH.....	A10
712K.....	A9	727L.....	A9	814CA.....	A13	840GT.....	A11
712XA.....	A10	727XD.....	A10	814CB.....	A13	840P.....	A11
713EE.....	A12	728AK.....	A8	814FW.....	A11	840Q.....	A11
713T.....	A10	728AL.....	A8	814P.....	A11	840X.....	A11
715NT.....	A10	728BK.....	A8	816X.....	A11	844AK.....	A10
716AF.....	A8	728CH.....	A8	817CA.....	A13	844R.....	A11
716AK.....	A8	728JB.....	A9	817FT.....	A10	845FW.....	A11
716AL.....	A8	729CD.....	A12	818AH.....	A10	845P.....	A11
716CC.....	A12	730U.....	A12	818AK.....	A10	845X.....	A11
716CS.....	A9	731K.....	A9	818CB.....	A13	848AH.....	A10
716K.....	A9	731XA.....	A10	818FW.....	A11	848AK.....	A10
716U.....	A12	732AK.....	A8	818N.....	A11	848GT.....	A11
716UW.....	A12	732AL.....	A8	818P.....	A11	848R.....	A11
716XA.....	A10	732BK.....	A8	818Q.....	A11	855AK.....	A10
716XD.....	A10	732M.....	A10	818R.....	A11	855R.....	A11
717CE.....	A12	734CS.....	A9	818XC.....	A11	856GT.....	A11
717CL.....	A9	734CT.....	A9	819DD.....	A13	860UP.....	A12
717T.....	A10	734L.....	A9	820GT.....	A11	3400.....	A6
718BK.....	A8	734U.....	A12	820X.....	A11	3401.....	A6
718EE.....	A12	735K.....	A9	821XC.....	A11	3402.....	A6
718GG.....	A13	735XA.....	A10	822P.....	A11	3403.....	A6
718JB.....	A9	736AK.....	A8	822Q.....	A11	3600.....	A6
718L.....	A9	736AL.....	A8	822R.....	A11	3601.....	A6
718UC.....	A13	736BK.....	A8	822X.....	A11	3602.....	A6
719CH.....	A8	736BL.....	A8	824AK.....	A10	3603.....	A6
719CT.....	A9	736CE.....	A12	824FW.....	A11	3800.....	A6
719HA.....	A13	736US.....	A12	824GT.....	A11	3801.....	A6
720AL.....	A8	736UW.....	A12	824X.....	A11	3802.....	A6
720CE.....	A12	737CW.....	A9	825CB.....	A13	3803.....	A6
720U.....	A12	738U.....	A12	825FT.....	A10	3840.....	A6
722GG.....	A13	739CD.....	A12	826P.....	A11	3850.....	A6
722JB.....	A9	740BL.....	A8	826X.....	A11	3851.....	A6
722K.....	A9	741CK.....	A8	827CA.....	A13	6600R.....	A22
722M.....	A10	741J.....	A9	827XC.....	A11	6800R.....	A22
722XA.....	A10	741M.....	A10	828AH.....	A10	8613.....	A6
722XD.....	A10	742HA.....	A13	828AK.....	A10	8840.....	A6
723L.....	A9	743UW.....	A12	828GT.....	A11	8852.....	A6
724AK.....	A8	744AL.....	A8	828Q.....	A11	9947.....	A4
724AL.....	A8	744U.....	A12	828R.....	A11	9952.....	A4

# INDEX

9961.....	A4	A10-4L.....	B10	A16-4T.....	B12	A23-2L.....	B10
9965.....	A4	A10-4T.....	B12	A16-6LM.....	B11	A23-4DAC.....	B6
9984.....	A4	A10-6T.....	B12	A16-6UT.....	B15	A23-4HD.....	B9
69401.....	A5	A11-4HD.....	B9	A17-1GEN.....	B8	A23-6PN.....	B11
69402.....	A5	A11-4T.....	B12	A17-4UTC.....	B16	A24-00.....	B4
69403.....	A5	A11-4TL.....	B14	A17-6.....	B4	A24-00H.....	B8
69404.....	A5	A11-6TLA.....	B14	A17-6CLT.....	B5	A24-1GEN.....	B8
69405.....	A5	A11-8L.....	B10	A18-00.....	B4	A24-2RDN.....	B12
69406.....	A5	A12-00.....	B4	A18-1H.....	B8	A24-2TB.....	B13
69407.....	A5	A12-00H.....	B8	A18-2DDF.....	B7	A24-4GEN.....	B8
69408.....	A5	A12-1.....	B4	A18-2T.....	B12	A24-4L.....	B10
69409.....	A5	A12-1H.....	B8	A18-4L.....	B10	A24-4LH.....	B11
69410.....	A5	A12-1L.....	B10	A18-6ACP.....	B4	A24-4RDN.....	B12
69411.....	A5	A12-2.....	B4	A18-6DN.....	B8	A24-4TB.....	B13
69412.....	A5	A12-2H.....	B8	A18-6L.....	B10	A24-4TLA.....	B14
69414.....	A5	A12-2LF.....	B10	A18-6T.....	B12	A245-0HD.....	B9
69415.....	A5	A12-4LF.....	B10	A19-00H.....	B8	A24-6.....	B4
69416.....	A5	A12-4T.....	B12	A19-1.....	B4	A24-6CLT.....	B5
69417.....	A5	A12-6.....	B4	A19-1L.....	B10	A24-6L.....	B10
69418.....	A5	A12-6PN.....	B11	A19-2RDN.....	B12	A24-6LM.....	B11
69419.....	A5	A12-6T.....	B12	A19-4.....	B4	A24-6T.....	B12
69420.....	A5	A13-0D.....	B6	A19-4DNCL.....	B8	A24-6TA.....	B12
69421.....	A5	A13-2L.....	B10	A19-4L.....	B10	A24-6TD.....	B14
69422.....	A5	A13-4TAF.....	B12	A19-4TB.....	B13	A24-6UH.....	B15
69423.....	A5	A13-4TB.....	B13	A19-4TB2.....	B13	A25-2D.....	B6
69424.....	A5	A13-6L.....	B10	A19-4U.....	B14	A25-2L.....	B10
69425.....	A5	A14-00MN.....	B19	A19-6L.....	B10	A25-4CLT.....	B5
69426.....	A5	A14-00MP.....	B19	A20-1TB.....	B13	A25-4D.....	B6
69427.....	A5	A14-00SN.....	B19	A20-2D.....	B6	A25-4DA.....	B6
69428.....	A5	A14-00SP.....	B19	A20-4D.....	B6	A25-4DN.....	B8
69429.....	A5	A14-2AEN.....	B4	A20-4HD.....	B9	A25-4DNCL.....	B8
69430.....	A5	A14-2D.....	B6	A20-4L.....	B10	A25-4HD.....	B9
69501.....	A5	A14-2DN.....	B8	A20-4LF.....	B10	A25-4TB.....	B13
69502.....	A5	A14-4.....	B4	A20-4LH.....	B11	A25-4TL.....	B14
A6-6L.....	B10	A14-4L.....	B10	A20-4TL.....	B14	A25-4U.....	B14
A6-6T.....	B12	A14-6L.....	B10	A21-00K.....	B20	A25-6CLT.....	B5
A7-00MN.....	B19	A14-6UT.....	B15	A21-2HD.....	B9	A25-6TB.....	B13
A7-00MP.....	B19	A15-00K.....	B20	A21-4DN.....	B8	A25-6TLA.....	B14
A7-00SN.....	B19	A15-00MN.....	B19	A21-4GEP.....	B8	A25-6UT.....	B15
A7-00SP.....	B19	A15-00MP.....	B19	A21-4HD.....	B9	A26-2DG.....	B7
A8-00H.....	B8	A15-00SN.....	B19	A22-00K.....	B20	A26-2L.....	B10
A8-00MN.....	B19	A15-00SP.....	B19	A22-1UT.....	B16	A26-4.....	B4
A8-00MP.....	B19	A15-1H.....	B8	A22-2L.....	B10	A26-4HD.....	B9
A8-00SN.....	B19	A15-1L.....	B10	A22-4.....	B4	A26-4TB.....	B13
A8-00SP.....	B19	A15-2H.....	B8	A22-4DNCL.....	B8	A26-6C.....	B5
A8-1H.....	B8	A15-2T.....	B12	A22-4HD.....	B9	A26-6KN.....	B10
A8-2H.....	B8	A15-4L.....	B10	A22-4T.....	B12	A26-6TC.....	B13
A8-2DBN.....	B6	A15-4U.....	B14	A22-4TB.....	B13	A26-6TCC.....	B13
A8-6DN.....	B8	A15-6PN.....	B11	A22-4U.....	B14	A26-6TL.....	B14
A8-6LM.....	B11	A16-0HDA.....	B9	A22-4UT.....	B15	A26-6TLA.....	B14
A8-8L.....	B10	A16-1.....	B4	A22-6PP.....	B11	A26-6UD.....	B15
A9-00K.....	B20	A16-2DDF.....	B7	A22-6TLA.....	B14	A27-1.....	B4
A9-6PP.....	B11	A16-2HDA.....	B9	A22-6U.....	B14	A27-2CLT.....	B5
A10-2DN.....	B8	A16-4.....	B4	A22-6UT.....	B15	A27-2L.....	B10
A10-2HD.....	B9	A16-4HD.....	B8	A23-1.....	B4	A27-4DA.....	B6
A10-2T.....	B12	A16-4L.....	B10	A23-2CLT.....	B5	A27-4DG2.....	B7
A10-4.....	B4	A16-4LF.....	B10	A23-2CLTB.....	B5	A27-6L.....	B10
A10-4D.....	B6	A16-4LT.....	B11	A23-2DAC.....	B6	A27-6TB.....	B13

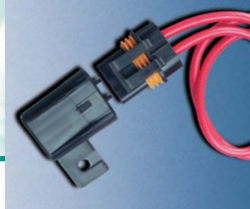

A27-6UAC.....	B15	A31-6TA.....	B12	A35-4D.....	B6	A38-6CLT.....	B5
A27-6UD.....	B15	A31-6TBC.....	B13	A35-4DA.....	B6	A38-6TB.....	B13
A27-6UT.....	B15	A31-6UD.....	B15	A35-4DD.....	B6	A38-6TC.....	B13
A27-8ACN.....	B4	A32-0DAC.....	B6	A35-4DG.....	B7	A38-6TC2.....	B13
A28-ODN.....	B8	A32-1L.....	B10	A35-4DN.....	B8	A38-6UH.....	B15
A28-ORD.....	B11	A32-2DAC.....	B6	A35-4HD.....	B9	A38-6UTC.....	B16
A28-2DAC.....	B6	A32-2TB.....	B13	A35-4HD2.....	B9	A39-4AEP.....	B4
A28-2DG.....	B7	A32-4CLT.....	B5	A35-4HDCL.....	B10	A39-4CLT.....	B5
A28-2DG2.....	B7	A32-4CLTA.....	B5	A35-4HDCL2.....	B10	A39-4HD.....	B9
A28-2UAC.....	B15	A32-4HD.....	B9	A35-4TB.....	B13	A39-4T.....	B12
A28-4DD.....	B6	A32-4HD2.....	B9	A35-4TCC.....	B13	A39-4TL.....	B14
A28-4LH.....	B11	A32-4HDA.....	B9	A35-6CLT.....	B5	A39-6CLT.....	B5
A28-4TLA.....	B14	A32-4RDN.....	B12	A36-00.....	B4	A39-6TLA.....	B14
A28-6CLT.....	B5	A32-4TB.....	B13	A36-00H.....	B8	A40-2D.....	B6
A28-6TB.....	B13	A32-4TBC.....	B13	A36-0HDA.....	B9	A40-2DA.....	B6
A28-6TB2.....	B13	A32-4UT.....	B15	A36-2.....	B4	A40-2DG.....	B7
A28-6U.....	B14	A32-6CLT.....	B5	A36-2CLT.....	B5	A40-2HD.....	B9
A28-6UT.....	B15	A32-6TB.....	B13	A36-2DDC.....	B7	A40-2L.....	B10
A29-2TB.....	B13	A32-6TBC.....	B13	A36-2HD.....	B9	A40-2T.....	B12
A29-2TBC.....	B13	A32-6TLA.....	B14	A36-2TB.....	B13	A40-4CLT.....	B5
A29-4HD.....	B9	A32-6UD.....	B15	A36-4.....	B4	A40-4CLTA.....	B5
A29-4RDN.....	B12	A32-6UH.....	B15	A36-4CLT.....	B5	A40-4CLTB.....	B5
A29-6.....	B4	A33-0C.....	B5	A36-4HD.....	B9	A40-4CLTD.....	B5
A29-6CLT.....	B5	A33-2CLT.....	B5	A36-4LF.....	B10	A40-4D.....	B6
A30-00.....	B4	A33-2DAC.....	B6	A36-4LTF.....	B11	A40-4DA.....	B6
A30-0DAC.....	B6	A33-2DDC.....	B7	A36-4T.....	B12	A40-4DD.....	B6
A30-1.....	B4	A33-2L.....	B10	A36-4TA.....	B12	A40-4DDF.....	B7
A30-2CLT.....	B5	A33-2TB.....	B13	A36-4TB.....	B13	A40-4DE.....	B7
A30-2D.....	B6	A33-2UT.....	B16	A36-4U.....	B16	A40-4DF.....	B7
A30-2DBN.....	B6	A33-4HD.....	B9	A36-4UT.....	B15	A40-4HD.....	B9
A30-2HD.....	B9	A33-4HDA.....	B9	A36-6.....	B4	A40-4L.....	B10
A30-2L.....	B10	A33-4LH.....	B11	A36-6T.....	B12	A40-4LF.....	B10
A30-2TB.....	B13	A33-4LT.....	B11	A36-6TA.....	B12	A40-4LFF.....	B10
A30-2TBB.....	B13	A33-4RDN.....	B12	A36-6TAF.....	B12	A40-4LH.....	B11
A30-2U.....	B14	A33-4T.....	B12	A36-6U.....	B14	A40-4TB.....	B13
A30-4.....	B4	A33-4TC.....	B13	A36-6UT.....	B15	A40-4TBB.....	B13
A30-4CLT.....	B5	A33-4TLA.....	B14	A37-0HD.....	B9	A40-4UTC.....	B16
A30-4D.....	B6	A34-0U.....	B14	A37-0RDN.....	B12	A40-6ACN.....	B4
A30-4DA.....	B6	A34-2HD.....	B9	A37-2HD.....	B9	A40-6L.....	B10
A30-4HD.....	B9	A34-2TB.....	B13	A37-2HD.....	B9	A40-6T.....	B12
A30-4L.....	B10	A34-4CLT.....	B5	A37-4CLT.....	B5	A40-6TB.....	B13
A30-4LF.....	B10	A34-4HD.....	B9	A37-4HD.....	B9	A40-6TD.....	B14
A30-4RD.....	B11	A34-4TL.....	B14	A37-4HDA.....	B9	A41-2CLT.....	B5
A30-4T.....	B12	A34-6CLT.....	B5	A37-4TB.....	B13	A41-2DEF.....	B7
A30-4TA.....	B12	A34-6L.....	B10	A37-4TLA.....	B14	A41-2L.....	B10
A30-4TC.....	B13	A34-6TA.....	B12	A37-4UTC.....	B16	A41-2TB.....	B13
A30-4U.....	B14	A34-6TB.....	B13	A37-6CLT.....	B5	A41-4DDF.....	B7
A30-6CLT.....	B5	A35-0DN.....	B8	A37-6TAF.....	B12	A41-4DE.....	B7
A30-6T.....	B12	A35-1.....	B4	A37-6TB.....	B13	A41-4DF.....	B7
A30-6TA.....	B12	A35-2CLT.....	B5	A37-6UT.....	B15	A41-4DEF.....	B7
A30-6UAC.....	B15	A35-2CLTB.....	B5	A38-2DF.....	B7	A41-4HD.....	B9
A30-6UT.....	B15	A35-2D.....	B6	A38-2HD.....	B9	A41-4HDA.....	B9
A31-1GEN.....	B8	A35-2DA.....	B6	A38-2UHLHC.....	B15	A41-4U.....	B14
A31-2CLT.....	B5	A35-2HD.....	B9	A38-4CLT.....	B5	A41-4U.....	B14
A31-2CLTB.....	B5	A35-2HDD.....	B10	A38-4DE.....	B7	A41-6C.....	B5
A31-2DD.....	B6	A35-2AEN.....	B4	A38-4L.....	B10	A41-6TB.....	B13
A31-4CLT.....	B5	A35-4CLT.....	B5	A38-4TLA.....	B14	A41-6TBB.....	B13
A31-4HD.....	B9	A35-4CLTA.....	B5	A38-4U.....	B14	A42-00.....	B4
				A38-4UT.....	B15	A42-1.....	B4

# INDEX

A42-1GEN.....	B8	A45-4TA.....	B12	A50-2D.....	B6	A56-2DD.....	B6
A42-2.....	B4	A45-4TB.....	B13	A50-4D.....	B6	A56-4.....	B4
A42-2DDF.....	B7	A45-4U.....	B14	A50-4DA.....	B6	A56-4T.....	B12
A42-2HD.....	B9	A45-4UC.....	B15	A50-4TA.....	B12	A56-4TA.....	B12
A42-4.....	B4	A45-6HD.....	B8	A50-4TBC.....	B13	A56-6U.....	B14
A42-4CLT.....	B5	A45-6KP.....	B10	A50-4UA.....	B14	A56-6UH.....	B15
A42-4CLTA.....	B5	A46-0DAC.....	B6	A50-4UAC.....	B15	A56-6UT.....	B15
A42-4DE.....	B7	A46-0HD.....	B9	A50-4UTC.....	B16	A56-6UTC.....	B16
A42-4DEE.....	B7	A46-2DDF.....	B7	A50-6C.....	B5	A57-2AEN.....	B4
A42-4DEF.....	B7	A46-2HD.....	B9	A50-6U.....	B14	A57-2LT.....	B11
A42-4HD.....	B9	A46-2L.....	B10	A5-10L.....	B10	A57-4CLT.....	B5
A42-4HDA.....	B9	A46-2UHC.....	B15	A51-4L.....	B10	A57-4TA.....	B12
A42-4T.....	B12	A46-4CLT.....	B5	A51-4TA.....	B12	A57-4UT.....	B15
A42-4TA.....	B12	A46-4DF.....	B7	A51-4TB.....	B13	A57-6TA.....	B12
A42-4TB.....	B13	A46-4DG.....	B7	A52-2AEP.....	B4	A58-1.....	B4
A42-4TBB.....	B13	A46-4TCC.....	B13	A52-2LT.....	B11	A58-2AEN.....	B4
A42-4TBC.....	B13	A46-4UTC.....	B16	A52-2LTF.....	B11	A58-2DEF.....	B7
A42-4TLCL.....	B14	A46-6CLT.....	B5	A52-2TB.....	B13	A58-4CLT.....	B5
A42-4UA.....	B14	A46-6DN.....	B8	A52-4CLTC.....	B5	A58-4LF.....	B10
A42-4UAB.....	B14	A46-6TA.....	B12	A52-4HD.....	B9	A58-4LTF.....	B11
A42-4UT.....	B15	A47-0DDF.....	B7	A52-4LF.....	B10	A58-4TA.....	B12
A42-4UTC.....	B16	A47-2DC.....	B6	A52-4TA.....	B12	A58-4TB.....	B13
A42-6U.....	B14	A47-2DDF.....	B7	A52-4UD.....	B15	A58-4UA.....	B14
A42-6UAC.....	B15	A47-2U.....	B14	A52-4UT.....	B15	A58-6TA.....	B12
A42-6UT.....	B15	A47-4TA.....	B12	A53-1.....	B4	A59-0FLP.....	B8
A43-2DF.....	B7	A47-4TLCL.....	B14	A53-2DAC.....	B6	A59-6CLT.....	B5
A43-2HD.....	B9	A47-6CLT.....	B5	A53-2DDC.....	B7	A59-6TB.....	B13
A43-2L.....	B10	A47-6KP.....	B10	A53-2LT.....	B11	A60-00.....	B4
A43-2T.....	B12	A48-00.....	B4	A53-4LTF.....	B11	A60-1L.....	B10
A43-4DE.....	B7	A48-00H.....	B8	A53-4U.....	B14	A60-2D.....	B6
A43-4DG.....	B7	A48-1TA.....	B12	A53-4UDC.....	B15	A60-2DA.....	B6
A43-4HD.....	B9	A48-2DC.....	B6	A53-4UTC.....	B16	A60-2UT.....	B16
A43-4L.....	B10	A48-4.....	B4	A53-6L.....	B10	A60-4D.....	B6
A43-4LF.....	B10	A48-4CLT.....	B5	A54-00.....	B4	A60-4DA.....	B6
A43-4T.....	B12	A48-4DE.....	B7	A54-2UAC.....	B15	A60-4L.....	B10
A43-4TB.....	B13	A48-4HD.....	B9	A54-4APP.....	B4	A60-4LF.....	B10
A43-4TBC.....	B13	A48-4LT.....	B11	A54-4DE.....	B7	A60-4TB.....	B13
A43-4UAC.....	B15	A48-4T.....	B12	A54-4LF.....	B10	A60-6C.....	B5
A43-6GEN.....	B8	A48-4TB.....	B13	A54-4TB.....	B13	A60-6HD.....	B8
A44-2DDC.....	B7	A48-4TLA.....	B14	A54-4TLA.....	B14	A60-6TB.....	B13
A44-2HD.....	B9	A48-4U.....	B15	A54-4UC.....	B15	A61-2AEN.....	B4
A44-2HDD.....	B10	A48-4UT.....	B14	A54-6UT.....	B15	A61-2U.....	B14
A44-2KP.....	B10	A48-6TA.....	B12	A54-6UTC.....	B16	A62-4.....	B4
A44-2UT.....	B16	A48-6UT.....	B15	A55-1HD.....	B9	A62-4RPP.....	B12
A44-4CLT.....	B5	A49-1L.....	B10	A55-2D.....	B6	A62-4TB.....	B13
A44-4DE.....	B7	A49-2AEP.....	B4	A55-2HD.....	B9	A62-4TC.....	B13
A44-4TLCL.....	B14	A49-2APN.....	B4	A55-2LT.....	B11	A62-4UTC.....	B16
A44-6L.....	B10	A49-2DEF.....	B7	A55-2UT.....	B16	A63-0DAC.....	B6
A45-0DDF.....	B7	A49-4AEN.....	B4	A55-4APP.....	B4	A63-2HBD.....	B6
A45-0U.....	B14	A49-4CLT.....	B5	A55-4D.....	B6	A63-4RPP.....	B12
A45-2D.....	B6	A49-4HD.....	B9	A55-4DA.....	B6	A63-4TA.....	B12
A45-2HD.....	B9	A49-4LTF.....	B11	A55-4HD.....	B9	A63-4TBCL.....	B13
A45-2TB.....	B13	A49-4RDN.....	B12	A55-4RDF.....	B11	A63-4U.....	B14
A45-4.....	B4	A49-4TA.....	B12	A55-4RDP.....	B12	A64-2DE.....	B7
A45-4D.....	B6	A49-4TCC.....	B13	A55-4TB.....	B13	A64-4TAF.....	B12
A45-4DA.....	B6	A49-4UDC.....	B15	A55-6TA.....	B12	A65-1.....	B4
A45-4DDF.....	B7	A49-6TB.....	B13	A55-6TB.....	B13	A65-2D.....	B6
A45-4DG.....	B7	A50-0DF.....	B7	A56-0D.....	B6	A65-2DB.....	B6

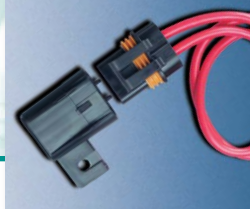

A65-2HBD.....	B6	A78-2AEP.....	B4	B17G2.....	B17	BP22U.....	B27
A65-2U.....	B14	A78-2HDCL.....	B10	B18G.....	B17	BP22W.....	B27
A65-4CLT.....	B5	A78-4TB.....	B13	B20G.....	B17	BP23C.....	B27
A65-4D.....	B6	A78-4U.....	B14	B20G-5.....	B17	BP23U.....	B27
A65-4DN.....	B8	A78-4UT.....	B15	B25E.....	B17	BP23UC.....	B27
A65-4LF.....	B10	A78-6PN.....	B11	B26G.....	B17	BP24.....	B28
A65-4LTF.....	B11	A79-2HDCL.....	B10	B29E.....	B17	BP25U.....	B26
A66-00.....	B4	A80-2DN.....	B8	BC2DL.....	B23,G5	BP26U.....	B26
A66-2HD.....	B9	A82-4UA.....	B14	BC4DL.....	B23,G5	BP28.....	B27
A66-4DN.....	B8	A83-2L.....	B10	BC6DL.....	B23,G5	BP31.....	B34
A66-4RDN.....	B12	A83-6HDA.....	B9	BC100.....	G4	BP32.....	B31
A66-4TC.....	B13	A84-4.....	B4	BC105.....	B32,G5	BP33.....	B32
A66-4UDC.....	B15	A84-6HD.....	B8	BC106.....	B32,G5	BP34.....	B32
A66-6C.....	B5	A84-6PN.....	B11	BC120.....	G4	BP35.....	B32
A66-6TB.....	B13	A85-2DA.....	B6	BC124.....	G4	BP36N.....	B28
A67-2DG.....	B7	A87-0HD.....	B9	BC126.....	G4	BP36P.....	B28
A67-4LF.....	B10	A87-2DB.....	B6	BC128.....	G4	BP37.....	B28
A67-4TA.....	B12	A87-2DBB.....	B6	BC164.....	G4	BP38.....	B28
A67-4TB.....	B13	A87-2DFB.....	B6	BC165.....	G4	BP39.....	B28
A67-4UTC.....	B16	A88-2DFB.....	B6	BC166.....	G4	BP40.....	B30
A67-6U.....	B14	A90-2D.....	B6	BC202.....	G4	BP40C.....	B30
A68-1L.....	B10	A90-2DA.....	B6	BC204.....	G4	BP40N.....	B30
A68-2DE.....	B7	A91-4TLCL.....	B14	BC254.....	G4	BP41B.....	B20
A68-2HD.....	B9	A92-0HD.....	B9	BCA1.....	B17	BP41R.....	B20
A68-2UT.....	B16	A94-0HD.....	B9	BCS1.....	B33	BP42.....	B21
A68-4DE.....	B7	A95-0D.....	B6	BCS2.....	B33	BP43.....	B21
A69-4L.....	B10	A95-2DA.....	B6	BCS3.....	B33	BP44.....	B21
A69-4RDN.....	B12	A95-6DS.....	B8	BCS4.....	B33	BP45.....	B21
A69-4UDC.....	B15	A100-2FLP.....	B8	BCS5.....	B33	BP46.....	B30
A70-ODN.....	B8	A100-6PN.....	B11	BCS6.....	B33	BP47.....	B32
A70-0HD.....	B9	A116-00HP.....	B10	BP1U.....	B26	BP48.....	B32
A70-2D.....	B6	A123-00HP.....	B10	BP2.....	B26	BP48B.....	B31
A70-2DB.....	B6	A136-2HD.....	B9	BP2U.....	B26	BP48R.....	B31
A70-2DDF.....	B7	A137-0HDA.....	B9	BP3U.....	B26	BP49B.....	B31
A70-2DF.....	B7	A152-2HD.....	B9	BP4U.....	B26	BP49R.....	B31
A70-2HD.....	B9	A199-2APP.....	B4	BP5U.....	B26	BP50B.....	B31
A70-2HDA.....	B9	A224-2AEP.....	B4	BP6N.....	B26	BP50R.....	B31
A70-4RDN.....	B12	A272-0HD.....	B9	BP6P.....	B26	BP51B.....	B31
A70-6TA.....	B12	AB10C.....	D34	BP7U.....	B26	BP51R.....	B31
A72-00.....	B4	AB11C.....	D34	BP8N.....	B26	BP52B.....	B31
A72-2DBB.....	B6	AB99W.....	D34	BP8P.....	B26	BP52R.....	B31
A72-4TC.....	B13	AB200.....	D34	BP9N.....	B26	BP53B.....	B31
A72-4UA.....	B14	AB201.....	D34	BP9P.....	B26	BP53R.....	B31
A72-4UT.....	B15	AB202.....	D34	BP10N.....	B26	BP54B.....	B31
A72-6C.....	B5	AB203.....	D34	BP10P.....	B26	BP54R.....	B31
A73-0HD.....	B9	B2GV.....	B17	BP11U.....	B26	BP55B.....	B31
A73-1.....	B4	B4GV.....	B17	BP17U.....	B27	BP55R.....	B31
A73-2HD.....	B9	B8G.....	B17	BP19C.....	B27	BP56.....	B30
A73-4TC.....	B13	B9.....	B17	BP19U.....	B27	BP56C.....	B30
A73-4TCC.....	B13	B9G.....	B17	BP20N.....	B26	BP57.....	B30
A73-4UT.....	B15	B10G.....	B17	BP20P.....	B26	BP58N.....	B27
A73-6C.....	B5	B10GV.....	B17	BP20U.....	B26	BP58P.....	B27
A74-4TC.....	B13	B12G.....	B17	BP21U.....	B26	BP58U.....	B27
A74-6TBC.....	B13	B14.....	B17	BP22.....	B27	BP60.....	B34
A75-2HDCL.....	B10	B14G.....	B17	BP22C.....	B27	BP61.....	B34
A76-2D.....	B6	B14G-5.....	B17	BP22N.....	B27	BP61A.....	B34
A76-2HDCL.....	B10	B16G.....	B17	BP22P.....	B27	BP62.....	B34
A78-1.....	B4	B17.....	B17	BP22PW.....	B27	BP62A.....	B34

# INDEX

BP63	B34	BP123	B24	BP183	B28	BP320	B29
BP63A	B34	BP124	B24	BP184	B28	BP322	B29
BP64	B34	BP125	B24	BP185	B23	BP323	B29
BP64A	B34	BP126	B24	BP186	B23	BP326	B29
BP65	B34	BP127	B24	BP187	B23	BP327	B29
BP65C	B34	BP128	B24	BP188	B23	BP328	B29
BP66	G5	BP135	B24	BP189	B23	BP329	B29
BP67C	B27	BP136	B24	BP190	B23	BP330	B29
BP67U	B27	BP137	B24	BP191	B23	BP331	B29
BP67UC	B27	BP138	B24	BP192	B23	BP332	B29
BP68	G5	BP139	B28	BP193	B28	BP333	B29
BP69	B34	BP140	B24	BP194	B28	BP334	B29
BP70L	B34	BP141	B28	BP200	B25	BP335	B29
BP70S	B34	BP142	B24	BP201	B25	BP336	B29
BP72A	B34	BP143	B24	BP203	B25	BP337	B29
BP72C	B34	BP144	B24	BP205	B25	BP338	B29
BP73	B34	BP145	B24	BP207	B25	BP339	B29
BP77N	B28	BP146	B24	BP209	B25	BP340	B29
BP77P	B28	BP147	B24	BP211	B25	BP341	B29
BP78	B28	BP148	B24	BP213	B25	BP342	B29
BP78L	B28	BP149B	B31	BP215	B25	BP343	B30
BP79	B28	BP149R	B31	BP217	B25	BP344	B30
BP80	B34	BP150B	B31	BP219	B25	BP345	B30
BP81	B27	BP150R	B31	BP220	B25	BP346	B30
BP81C	B27	BP151B	B31	BP221	B25	BP347	B29
BP83N	B26	BP151R	B31	BP223	B25	BP348	B29
BP83P	B26	BP152B	B31	BP224	B26	BP349	B29
BP87	G5	BP152R	B31	BP225	B25	BP350	B29
BP89	B28	BP153B	B31	BP226	B26	BP351	B29
BP90	B24	BP153R	B31	BP227	B25	BP352	B29
BP91	B24	BP154B	B31	BP229	B25	BP353	B29
BP92	B24	BP154R	B31	BP230	B25	BP354	B29
BP93	B24	BP155	B31	BP231	B25	BP355	B29
BP94	B24	BP156B	B31	BP232	B25	BP356	B29
BP95	B24	BP156R	B31	BP233	B25	BP357	B29
BP96	B24	BP157B	B31	BP234	B25	BP358	B30
BP97	B27	BP158B	B31	BP235	B25	BP359	B30
BP97C	B27	BP159B	B31	BP236	B25	BP360	B30
BP97U	B27	BP159R	B31	BP237	B25	BP361	B30
BP98B	G5	BP160	B24	BP238	B25	BP362	B30
BP98R	G5	BP161	B24	BP239	B25	BP363	B30
BP99	B20	BP162	B24	BP240	B25	BP364	B30
BP101	B20	BP163	B24	BP241	B25	BP365	B30
BP102	B20	BP164	B24	BP300	B29	BP366	B30
BP104	G5	BP165	B24	BP301	B29	BP367	B30
BP104J	G5	BP166	B24	BP302	B29	BP368	B30
BP107	B24	BP167	B24	BP303	B29	BP369	B30
BP108	B24	BP168	B24	BP304	B29	BP370	B30
BP109	B24	BP169	B24	BP305	B29	BP371	B30
BP110	B24	BP170	B24	BP307	B29	BP372	B30
BP111	B28	BP171	B24	BP308	B29	BPP71	B31
BP112	B28	BP172	B24	BP311	B29	BPP73	B31
BP113	B24	BP173	B24	BP313	B29	BPP74	B31
BP114	B24	BP174	B24	BP314	B29	C4ER	C3
BP115	B24	BP175	B24	BP316	B29	C6E	B22, C3
BP116	B24	BP176	B24	BP317	B29	C6ER	C3
BP117	B24	BP177	B24	BP318	B29	C8E	C3
BP118	B24	BP182	B28	BP319	B29	C8EB	C3



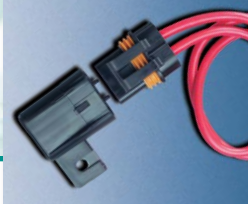

C8ER.....	C3	C14EB-10.....	C3	C18ER-10.....	C2	C208ER.....	C7
C10-2E.....	C5	C14EBR.....	C3	C18EW.....	C2	C208EW.....	C7
C10E.....	C3	C14EBR-10.....	C3	C18EW-10.....	C2	C210-2E.....	C8
C10E-5.....	C3	C14EG.....	C3	C18EY.....	C2	C210-3E.....	C8
C10E-10.....	C3	C14EG-10.....	C3	C18EY-10.....	C2	C210E.....	C7
C10EB.....	C3	C14EP.....	C3	C20E.....	C2	C210EB.....	C7
C10EB-5.....	C3	C14EP-10.....	C3	C20E-10.....	C2	C210EBR.....	C7
C10EB-10.....	C3	C14EPK.....	C3	C20EB.....	C2	C210EG.....	C7
C10EBR.....	C3	C14EPK-10.....	C3	C20EG.....	C2	C210EP.....	C7
C10EBR-5.....	C3	C14ER.....	C3	C20ER.....	C2	C210ER.....	C7
C10EBR-10.....	C3	C14ER-10.....	C3	C20ER-10.....	C2	C210ET.....	C7
C10EG.....	C3	C14ET.....	C3	C20EW.....	C2	C210EW.....	C7
C10EG-5.....	C3	C14ET-10.....	C3	C20EY.....	C2	C210EY.....	C7
C10EG-10.....	C3	C14EW.....	C3	C22E.....	C2	C212-2E.....	C8
C10ER.....	C3	C14EW-10.....	C3	C22EB.....	C2	C212-3E.....	C8
C10ER-5.....	C3	C14EY.....	C3	C22ER.....	C2	C212E.....	C7
C10ER-10.....	C3	C14EY-10.....	C3	C22EW.....	C2	C212EB.....	C7
C10EW.....	C3	C16-2E.....	C5	C110E.....	C5	C212EBR.....	C7
C10EW-5.....	C3	C16-2SRB.....	C4, G7	C110EB.....	C5	C212EG.....	C7
C10EW-10.....	C3	C16-3B.....	C5	C110EBR.....	C5	C212EGY.....	C7
C10EY.....	C3	C16-3E.....	C5	C110EG.....	C5	C212EP.....	C7
C10EY-5.....	C3	C16-3SRB.....	C4, G7	C110ER.....	C5	C212EPK.....	C7
C10EY-10.....	C3	C16-3V.....	C5	C110EW.....	C5	C212ER.....	C7
C12-2E.....	C5	C16-3VB.....	C4, G7	C110EY.....	C5	C212ES.....	C7
C12-3J.....	C5	C16-4B.....	C5	C112E.....	C5	C212ET.....	C7
C12-4E.....	C5	C16-4E.....	C5	C112EB.....	C5	C212EW.....	C7
C12E.....	C3	C16-4V.....	C5	C112EBR.....	C5	C212EY.....	C7
C12E-5.....	C3	C16E.....	C2	C112EG.....	C5	C214-2E.....	C8
C12E-10.....	C3	C16E-10.....	C2	C112ER.....	C5	C214-3E.....	C8
C12EB.....	C3	C16EB.....	C2	C112EW.....	C5	C214E.....	C7
C12EB-5.....	C3	C16EB-10.....	C2	C112EY.....	C5	C214EB.....	C7
C12EB-10.....	C3	C16EBR.....	C2	C114E.....	C5	C214EBR.....	C7
C12EBR.....	C3	C16EBR-10.....	C2	C114EB.....	C5	C214EG.....	C7
C12EBR-5.....	C3	C16EG.....	C2	C114EBR.....	C5	C214EGY.....	C7
C12EBR-10.....	C3	C16EG-10.....	C2	C114EG.....	C5	C214EP.....	C7
C12EG.....	C3	C16EP.....	C2	C114ER.....	C5	C214EPK.....	C7
C12EG-5.....	C3	C16EP-10.....	C2	C114EW.....	C5	C214ER.....	C7
C12EG-10.....	C3	C16EPK.....	C2	C114EY.....	C5	C214ES.....	C7
C12ER.....	C3	C16EPK-10.....	C2	C116E.....	C5	C214ET.....	C7
C12ER-5.....	C3	C16ER.....	C2	C116EB.....	C5	C214EW.....	C7
C12ER-10.....	C3	C16ER-10.....	C2	C116EBR.....	C5	C214EY.....	C7
C12EW.....	C3	C16ET.....	C2	C116EG.....	C5	C216-2E.....	C8
C12EW-5.....	C3	C16ET-10.....	C2	C116ER.....	C5	C216-3E.....	C8
C12EW-10.....	C3	C16EW.....	C2	C116EW.....	C5	C216E.....	C7
C12EY.....	C3	C16EW-10.....	C2	C116EY.....	C5	C216EB.....	C7
C12EY-5.....	C3	C16EY.....	C2	C118E.....	C5	C216EBR.....	C7
C12EY-10.....	C3	C16EY-10.....	C2	C118EB.....	C5	C216EG.....	C7
C14-2E.....	C5	C18-2SRB.....	C4, G7	C118EBR.....	C5	C216EGY.....	C7
C14-3E.....	C5	C18-3VY.....	C4, G7	C118EG.....	C5	C216EP.....	C7
C14-3J.....	C5	C18E.....	C2	C118ER.....	C5	C216EPK.....	C7
C14-3SRB.....	C4, G7	C18E-10.....	C2	C118EW.....	C5	C216ER.....	C7
C14-4E.....	C5	C18EB.....	C2	C118EY.....	C5	C216ES.....	C7
C14-4J.....	C5	C18EB-10.....	C2	C206-2E.....	C8	C216ET.....	C7
C14BS.....	C3	C18EBR.....	C2	C206-3E.....	C8	C216EW.....	C7
C14BS-10.....	C3	C18EBR-10.....	C2	C208-2E.....	C8	C216EY.....	C7
C14E.....	C3	C18EG.....	C2	C208-3E.....	C8	C218E.....	C7
C14E-10.....	C3	C18EG-10.....	C2	C208EB.....	C7	C218EB.....	C7
C14EB.....	C3	C18ER.....	C2	C208EG.....	C7	C218EBR.....	C7

# INDEX

C218EG.....	C7	CG8.....	D23	CG69.....	D28	CL17S.....	C9
C218ER.....	C7	CG9.....	D24	CG70.....	D26	CL19.....	C9
C218EY.....	C7	CG10.....	D25	CG71.....	D26	CL20.....	C9
CBPK100.....	A21	CG11.....	D25	CG72.....	D26	CL21.....	C9
CBPK105.....	A21	CG12.....	D24	CG73.....	D26	CL22.....	C9
CBPK110.....	A21	CG13.....	D25	CG74.....	D26	CL23.....	C9
CBPK120.....	A21	CG14.....	D24	CG75.....	D26	CL24.....	C9
CBPK130.....	A21	CG15.....	D24	CG80.....	D23	CL26.....	C9
CBPK140.....	A21	CG16.....	D25	CG81.....	D27	CL28.....	C9
CBPK200.....	A21	CG17.....	D25	CGA1.....	D29	CL29.....	C9
CBPK205.....	A21	CG18.....	D23	CGA2.....	D29	CL30.....	C9
CBPK210.....	A21	CG19.....	D23	CJ12-4PC.....	E31	CL32.....	C9
CBPK220.....	A21	CG21.....	D24	CJ12-4PL.....	E31	CL33.....	C9
CBPK230.....	A21	CG22.....	D24	CJ12-6PC.....	E31	CL34.....	C10
CBPK240.....	A21	CG23.....	D24	CJ12-6PL.....	E31	CL35.....	C10
CBPK250.....	A21	CG24.....	D24	CJ12-7AC.....	E31	CL36.....	C10
CBPK260.....	A21	CG25.....	D24	CJ12-7AL.....	E31	CL37.....	C10
CBPK300.....	A21	CG26.....	D24	CJ12-7BC.....	E31	CL38.....	C9
CBPK400.....	A21	CG27.....	D24	CJ12-7BE.....	E31	CL39.....	C9
CBPK405.....	A21	CG28.....	D24	CJ12-7BL.....	E31	CL40.....	C9
CBPK410.....	A21	CG29.....	D25	CJ12-7C.....	E31	CL41.....	C9
CBPK420.....	A21	CG30.....	D27	CJ12-7DC.....	E31	CL42.....	C9
CBPK430.....	A21	CG31.....	D27	CJ12-7DE.....	D31	CL43.....	C9
CBPK440.....	A21	CG32.....	D27	CJ12-7DL.....	E31	CL44.....	C9
CBPK450.....	A21	CG33.....	D27	CJ12-7L.....	E31	CLB4.....	C9
CBPK460.....	A21	CG34.....	D27	CJ14-2C.....	E31	CLB5.....	C9
CBPK500.....	A21	CG35.....	D28	CJ14-4BC.....	E31	CLB11.....	C9
CBPK600.....	A21	CG36.....	D28	CJ14-4BL.....	E31	CLB12.....	C9
CBPK700.....	A21	CG37.....	D28	CJ14-4C.....	E31	CLB13.....	C9
CBPK710.....	A21	CG38.....	D25	CJ14-4L.....	E31	CLB16.....	C9
CBPK720.....	A21	CG39.....	D25	CJ14-6C.....	E31	CLB20.....	C9
CC7D.....	A22	CG40.....	D25	CJ14-6L.....	E31	CLB22.....	C9
CC7L.....	A22	CG41.....	D25	CJ16-4BC.....	E31	CLB24.....	C9
CC7M.....	A22	CG42.....	D25	CJ16-4BL.....	E31	CS0C.....	B22
CC7N.....	A22	CG43.....	D26	CJ16-4C.....	E31	CS0L.....	B22
CC7S.....	A22	CG44.....	D26	CJ16-4L.....	E31	CS0RC.....	B22
CC8LC.....	A22	CG45.....	D23	CJ16-5C.....	E31	CS0RL.....	B22
CC8LL.....	A22	CG46.....	D23	CJ16-5L.....	E31	CS0RV.....	B22
CC8M.....	A22	CG47.....	D23	CJ16-6C.....	E31	CS0V.....	B22
CC8S.....	A22	CG48.....	D28	CJ16-6L.....	E31	CS1C.....	B22
CC75C.....	A22	CG49.....	D28	CL4S.....	C9	CS1L.....	B22
CC85C.....	A22	CG50.....	D28	CL5N.....	C9	CS1RC.....	B22
CD7L.....	A22	CG51.....	D28	CL5S.....	C9	CS1RV.....	B22
CD7S.....	A22	CG52.....	D28	CL5SE.....	C9, C13	CS1V.....	B22
CF16-2HD.....	C4	CG53.....	D28	CL5SR.....	C9, C13	CS2C.....	B22
CF16-2P.....	C4	CG54.....	D27	CL5SW.....	C9, C13	CS2L.....	B22
CF18-2HD.....	C4	CG55.....	D27	CL5SY.....	C9, C13	CS2RC.....	B22
CF18-2P.....	C4	CG56.....	D27	CL6S.....	C9	CS2RV.....	B22
CF18-2P-10.....	C4	CG57.....	D27	CL7.....	C9	CS2V.....	B22
CF20-2P.....	C4	CG58.....	D27	CL8.....	C9	CS4C.....	B22
CF20-2P-10.....	C4	CG59.....	D27	CL9.....	C9	CS4L.....	B22
CG1.....	D23	CG60.....	D27	CL10S.....	C9	CS4RC.....	B22
CG2.....	D23	CG61.....	D24	CL11S.....	C9	CS4RV.....	B22
CG3.....	D23	CG62.....	D24	CL12S.....	C9	CS4V.....	B22
CG4.....	D24	CG63.....	D24	CL13S.....	C9	CS6RC.....	B22
CG5.....	D23	CG64.....	D25	CL13S.....	C9	CS6RV.....	B22
CG6.....	D23	CG65.....	D25	CL14S.....	C9	CS6V.....	B22
CG7.....	D23	CG68.....	D27	CL15.....	C9	CS6V.....	B22
				CL16.....	C9	CS00C.....	B22

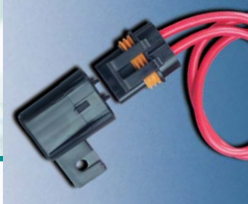

CS00L.....	B22	CW18G.....	C2	DS1310.....	F30	ET14.....	B37
CS00RC.....	B22	CW18R.....	C2	DS1311.....	F30	ET15.....	D31
CS00RL.....	B22	CW18W.....	C2	DS1312.....	F29	ET16.....	D31
CS00RV.....	B22	CW18Y.....	C2	DS1313.....	F29	ET18.....	B37
CS00V.....	B22	CW20-2.....	C4	DS1314.....	F29	ET20.....	B37
CS000C.....	B22	CW20B.....	C2	DS1315.....	F29	ET21.....	B36
CS000L.....	B22	CW20E.....	C2	DS1316.....	F29	ET26.....	A23
CS000RC.....	B22	CW20F.....	C4	DS1317.....	F29	ET27.....	B36
CS000RL.....	B22	CW20G.....	C2	DS1318.....	F29	ET28.....	B36
CS000RV.....	B22	CW20R.....	C2	DS1319.....	F29	ET29.....	B36
CS000V.....	B22	CW20W.....	C2	DS1320.....	F29	ET30.....	C4
CS0000RV.....	B22	CW20Y.....	C2	DS1321.....	F29	ET31.....	C4
CS0000V.....	B22	CW22B.....	C2	DS1322.....	F29	ET32.....	C4
CW10B.....	C3	CW22E.....	C2	DS1323.....	F29	ET33.....	C4
CW10BR.....	C3	CW22R.....	C2	DS1324.....	F30	ET34.....	C4
CW10E.....	C3	CW22W.....	C2	DS1325.....	F30	ET35.....	C4
CW10F.....	C4	DS116.....	F28	DS1326.....	F30	ET36.....	C4
CW10G.....	C3	DS123.....	F29	DS1327.....	F30	ET37.....	C3
CW10R.....	C3	DS126.....	F28	DS1328.....	F30	ET38.....	B36
CW10W.....	C3	DS128.....	F28	DS1329.....	F30	ET40.....	C11
CW10Y.....	C3	DS135.....	F30	DS1330.....	F30	ET41.....	C11
CW12B.....	C3	DS167.....	F28	DS1331.....	F30	ET42.....	C11
CW12BR.....	C3	DS175.....	F30	DS1332.....	F29	ET43.....	C11
CW12E.....	C3	DS184.....	F28	DS1333.....	F29	ET44.....	C11
CW12F.....	C4	DS191.....	F28	DS1334.....	F29	ET45.....	C11
CW12G.....	C3	DS193.....	F28	DS1335.....	F29	ET46.....	C11
CW12R.....	C3	DS194.....	F28	DS1336.....	F29	ET57.....	B34
CW12W.....	C3	DS208.....	F28	DS1337.....	F29	ET58.....	B34
CW12Y.....	C3	DS226.....	F28	DS1338.....	F29	ET59.....	B34
CW14B.....	C3	DS246.....	F30	DS1339.....	F29	ET60.....	B34
CW14BR.....	C3	DS270.....	F28	DS1340.....	F29	ET61.....	A22
CW14BS.....	C3	DS271.....	F28	DS1341.....	F29	ET62.....	C10
CW14E.....	C3	DS277.....	F29	DS1342.....	F29	ET66.....	A22
CW14F.....	C4	DS280.....	F29	DS1343.....	F29	ET67.....	B34
CW14G.....	C3	DS293.....	F29	DS1344.....	F29	ET70.....	B34
CW14P.....	C3	DS310.....	F28	DS1345.....	F29	ET71.....	B34
CW14PK.....	C3	DS311.....	F28	DS1346.....	F30	ET91.....	D3
CW14R.....	C3	DS312.....	F28	DS1791.....	F30	ET91L.....	D3
CW14T.....	C3	DS313.....	F28	DS1821.....	F29	ET92.....	D3
CW14W.....	C3	DS314.....	F28	ET2.....	B37	ET92L.....	D3
CW14Y.....	C3	DS315.....	F28	ET3.....	C9	ET93.....	D3
CW16-2.....	C4	DS316.....	F28	ET4.....	C9	ET93L.....	D3
CW16B.....	C2	DS317.....	F29	ET5.....	C9	ET94.....	D3
CW16BR.....	C2	DS318.....	F29	ET5E.....	C9, C13	ET94L.....	D3
CW16E.....	C2	DS319.....	F29	ET5R.....	C9, C13	ET95.....	D3
CW16F.....	C4	DS320.....	F29	ET5W.....	C9, C13	ET95L.....	D3
CW16G.....	C2	DS322.....	F28	ET5Y.....	C9, C13	ET96.....	D3
CW16P.....	C2	DS362.....	F29	ET6.....	C9	ET96L.....	D3
CW16PK.....	C2	DS363.....	F30	ET7.....	C9	ET97L.....	D8
CW16R.....	C2	DS364.....	F29	ET7B.....	C9	ET98L.....	D8
CW16T.....	C2	DS365.....	F29	ET7E.....	C9, C13	ET100.....	A24, D35
CW16W.....	C2	DS366.....	F30	ET7R.....	C9, C13	ET113.....	A22
CW16Y.....	C2	DS367.....	F30	ET7Y.....	C9, C13	ET114.....	A22
CW18-2.....	C4	DS368.....	F30	ET8.....	C9	ET116.....	A23
CW18B.....	C2	DS369.....	F30	ET9.....	C9	ET120.....	D3
CW18BR.....	C2	DS1307.....	F30	ET10.....	A24	ET120H.....	D3, D19
CW18E.....	C2	DS1308.....	F30	ET11.....	C11	ET120L.....	D3
CW18F.....	C4	DS1309.....	F30	ET12.....	B37	ET120XL.....	D3

# INDEX

ET121.....	D3	ET141.....	D8	ET197.....	D10	ET271L.....	C12
ET121H.....	D3, D19	ET141L.....	D8	ET197L.....	D10	ET271RL.....	C13
ET122.....	D3	ET141XL.....	D8	ET198.....	D10	ET271WL.....	C13
ET122H.....	D3, D19	ET142.....	D7	ET198L.....	D10	ET271YL.....	C13
ET123.....	D3	ET143.....	D7	ET200.....	D13	ET272.....	C10
ET123H.....	D4, D19	ET144.....	D8	ET201.....	D13	ET273.....	C10
ET123L.....	D3	ET144H.....	D8, D20	ET202.....	D13	ET274.....	C10
ET124.....	D3	ET144L.....	D8	ET203.....	D13	ET275.....	C10
ET124H.....	D4, D19	ET144XL.....	D8	ET204.....	D13	ET276L.....	C12
ET124L.....	D3	ET145.....	D8	ET207.....	D9	ET279L.....	C12
ET124XL.....	D3	ET145H.....	D8, D20	ET207XL.....	D9	ET280L.....	C12
ET125.....	D3	ET145L.....	D8	ET208.....	D7	ET290.....	C10
ET125H.....	D4, D19	ET145XL.....	D8	ET208XL.....	D7	ET291.....	C10
ET125L.....	D3	ET146.....	D13	ET210.....	D13	ET292.....	C10
ET125XL.....	D3	ET147.....	D11	ET211.....	D13	ET293.....	C10
ET126.....	D3	ET148.....	D7	ET212.....	D13	ET294.....	C10
ET126H.....	D4, D19	ET148L.....	D7	ET214.....	D15	ET295.....	C10
ET126L.....	D3	ET148XL.....	D7	ET215.....	D15	ET296.....	C10
ET127.....	D4	ET149.....	D7	ET216.....	D15	ET297.....	C10
ET127H.....	D5, D19	ET149L.....	D7	ET217.....	D15	ET298.....	C10
ET127L.....	D4	ET149XL.....	D7	ET218.....	D15	ET351.....	D10, D21
ET127XL.....	D4	ET150.....	D6	ET219.....	D15	ET351J.....	D10, D21
ET128.....	D4	ET151.....	D3	ET220.....	D14	ET352.....	D10, D21
ET128L.....	D4	ET151H.....	D3, D19	ET221.....	D14	ET352J.....	D10, D21
ET128XL.....	D4	ET152.....	D14	ET222.....	D14	ET353.....	D10, D21
ET129.....	D5	ET154.....	D6	ET223.....	D15	ET353J.....	D10, D21
ET129L.....	D5	ET155.....	D6	ET224.....	D15	ET355.....	D3, D20
ET129XL.....	D5	ET156.....	D9	ET225.....	D15	ET356.....	D3, D20
ET130.....	D10	ET157.....	D3	ET226.....	D15	ET357.....	D3, D20
ET130H.....	D10, D20	ET157H.....	D4, D19	ET227.....	D15	ET359.....	D4, D20
ET130HJ.....	D10, D20	ET158.....	D9	ET228.....	D15	ET360.....	D4, D20
ET130L.....	D10	ET159L.....	D5	ET229.....	D15	ET361.....	D4, D21
ET130XL.....	D10	ET161.....	D9	ET230.....	D14	ET363.....	D5, D21
ET131.....	D10	ET161L.....	D9	ET231.....	D14	ET364.....	D5, D21
ET131H.....	D10, D20	ET161XL.....	D9	ET232.....	D15	ET365.....	D5, D21
ET131HJ.....	D10, D20	ET162.....	D11	ET233.....	D15	ET367.....	D7, D21
ET131L.....	D10	ET162L.....	D11	ET234.....	D15	ET381.....	D13
ET131XL.....	D10	ET163.....	D11	ET235.....	D15	ET381XL.....	D13
ET132.....	D10	ET163L.....	D11	ET236.....	D15	ET383.....	D14
ET132H.....	D10, D20	ET164.....	D11	ET237.....	D15	ET388L.....	D6
ET132HJ.....	D10, D20	ET165.....	D6	ET250.....	C12	ET389L.....	D6
ET132L.....	D10	ET166.....	D9	ET250L.....	C12	ET390L.....	D6
ET132XL.....	D10	ET168L.....	D4, D19	ET251L.....	C12	ET394L.....	D7
ET133.....	D7	ET170.....	D11	ET252L.....	C12	ET395L.....	D8
ET134.....	D7	ET171.....	D11	ET253L.....	C12	ET396L.....	D8
ET134XL.....	D7	ET172.....	D11	ET254.....	C12	ET400.....	G3
ET135.....	D7	ET173.....	D11	ET254L.....	C12	ET411.....	F15
ET135H.....	D7, D19	ET176.....	D13	ET255L.....	C12	ET437L.....	D10
ET135XL.....	D7	ET176XL.....	D13	ET256.....	C12	ET446L.....	D7
ET136.....	D6	ET178.....	D9	ET256E.....	C13	ET447L.....	D7
ET136XL.....	D6	ET179.....	D9	ET256R.....	C13	ET448.....	G3
ET137.....	D9	ET180.....	D13	ET256W.....	C13	ET450.....	E29
ET139.....	D13	ET181.....	D13	ET256Y.....	C13	ET451.....	E29
ET139L.....	D13	ET182.....	D9	ET260.....	B37	ET452.....	E29
ET139XL.....	D13	ET183.....	D9	ET261.....	C10	ET456.....	E29
ET140.....	D8	ET195.....	D9	ET263.....	B37	ET457.....	C5
ET140L.....	D8	ET196.....	D10	ET270.....	C10	ET458.....	C5
ET140XL.....	D8	ET196L.....	D10	ET271EL.....	C13	ET460.....	D14

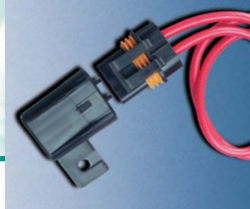

ET461.....	D14	ET535.....	D17, E29	ET739.....	D25	HST81B.....	B36
ET468.....	D8, D22	ET536.....	D17	ET740.....	D25	HST81R.....	B36
ET469.....	D8, D22	ET537.....	D17	ET741.....	D25	HST81SB.....	B36
ET470.....	D8, D22	ET538.....	D17	ET742.....	D25	HST81SR.....	B36
ET471.....	D8, D22	ET550.....	D10, D22	ET743.....	D25	HST82.....	B36
ET472.....	D9, D22	ET551.....	D10, D22	ET744.....	D25	HST83.....	B36
ET473.....	D9, D22	ET551J.....	D10, D22	ET745.....	D25	HST83R.....	B36
ET474.....	D9, D22	ET552.....	D10, D22	ET746.....	D25	HST84.....	B36
ET475.....	D3, D20	ET552J.....	D10, D22	ET747.....	D25	HST85.....	B36
ET476.....	D3, D20	ET553.....	D10, D22	ET748.....	D26	HST86.....	B36
ET478.....	D4, D21	ET553J.....	D10, D22	ET749.....	D26	HST87.....	B36
ET479.....	D5, D21	ET556.....	D3, D22	ET904X.....	D34	HST88.....	B36
ET480L.....	D7	ET559.....	D4, D22	ET912.....	D3	HST89.....	B36
ET481L.....	D7	ET560.....	D4, D22	ET2012.....	B17	HST90.....	B37
ET482L.....	D8	ET561.....	D4, D22	GR1.....	C11	HST91.....	B36
ET483L.....	D8	ET562.....	D5, D22	GR2.....	C11	HST92.....	B36
ET484L.....	D7	ET564.....	D5, D22	GR3.....	C11	HST93.....	B36
ET485L.....	D8	ET570.....	D8, D22	GR4.....	C11	HST146B.....	B36
ET486.....	D6	ET571.....	D8, D22	GR5.....	C11	HST146R.....	B36
ET491.....	D7	ET600L.....	D7	GR6.....	C11	HST210.....	B36
ET492.....	D7	ET601L.....	D7	GR7.....	C11	HST210R.....	B36
ET493.....	D4	ET701.....	D23	GR8.....	C11	HST230.....	B36
ET494L.....	D4	ET702.....	D23	HB6B.....	F30	HST230R.....	B36
ET495L.....	D4	ET703.....	D23	HB7.....	F30	HST240B.....	B36
ET497.....	D3, D20	ET704.....	D23	HD56.....	B35	HST240R.....	B36
ET497H.....	D3, D19	ET705.....	D23	HD57.....	B35	HST240SB.....	B36
ET498.....	D3	ET706.....	D23	HD58.....	B35	HST240SR.....	B36
ET500.....	D8, D12	ET708.....	D23	HD59C.....	B34	HST401.....	B37
ET501.....	D17	ET709.....	D23	HD60C.....	B34	MC0BL.....	C8
ET502.....	D13	ET710.....	D23	HD61C.....	B34	MC0RL.....	C8
ET503.....	D12	ET711.....	D23	HD62.....	B35	MC1BL.....	C8
ET504.....	D12	ET712.....	D23	HD62C.....	B34	MC1RL.....	C8
ET505.....	C10	ET713.....	D23	HD63.....	B35	MC2BL.....	C8
ET506.....	C10	ET714.....	D24	HD63C.....	B34	MC2RL.....	C8
ET507.....	D23	ET715.....	D24	HD64.....	B35	MC4BL.....	C8
ET508.....	D23	ET716.....	D24	HD64C.....	B34	MC4RL.....	C8
ET509.....	D15	ET717.....	D24	HD65.....	B35	MC6BL.....	C8
ET510.....	D15	ET718.....	D24	HD66.....	B35	MC6RL.....	C8
ET511.....	D12	ET719.....	D24	HS98.....	F30	MC00BL.....	C8
ET512.....	D9, D22	ET720.....	D24	HST1A.....	B38, D33	MC00RL.....	C8
ET513.....	D12	ET721.....	D24	HST2A.....	B38, D33	MC000BL.....	C8
ET514.....	D12	ET722.....	D24	HST3.....	B37	MC000RL.....	C8
ET515.....	G2	ET723.....	D24	HST6.....	B37	MC0000BL.....	C8
ET516.....	G2	ET724.....	D24	HST6H.....	B37	MC0000RL.....	C8
ET517.....	G2	ET725.....	D24	HST6L.....	B37	MC1101.....	A5
ET518.....	G2	ET726.....	D27	HST10.....	B37	MC1102.....	A5
ET519.....	G2	ET727.....	D27	HST10H.....	B37	MC1103.....	A5
ET520.....	G3	ET728.....	D27	HST10L.....	B37	MC1104.....	A5
ET521.....	G3	ET729.....	D27	HST14.....	B37	MC1105.....	A5
ET522.....	G3	ET730.....	D27	HST14H.....	B37	MC1106.....	A5
ET523.....	D17	ET731.....	D28	HST14L.....	B37	MC1107.....	A5
ET524.....	D4	ET732.....	D28	HST18.....	B37	MC1108.....	A5
ET526.....	D12	ET733.....	D28	HST18B.....	B37	MC1109.....	A5
ET527L.....	D11, D12	ET734.....	D24	HST18H.....	B37	MC1110.....	A5
ET528.....	D7, D12	ET735.....	D25	HST18L.....	B37	MC1111.....	A5
ET529L.....	D10, D12	ET736.....	D25	HST21.....	B36	MC1112.....	A5
ET530.....	D17	ET737.....	D25	HST28.....	B36	MC1113.....	A5
ET533.....	D17	ET738.....	D25	HST30.....	B37	MC1114.....	A5

# INDEX

MC1115	A5	QC18	B18	S83	F17	S542	F18
MC1116	A5	QC19	B18	S84	F13	S544	F25
MC1117	A5	QC20	B18	S85	F13	S545	F18
PW10B	C3	QC21	B18	S86	F9	S546	F25
PW10BR	C3	QC22	B18	S87	F3	S547	F10
PW10E	C3	QC23	B18	S89	F5	S548	F10
PW10G	C3	S20	F2	S90	F5	S549	F23
PW10R	C3	S21	F2	S91	F9	S550	F12
PW10W	C3	S22	F2	S92	F18	S551	F20
PW10Y	C3	S23	F2	S93	F20	S552	F18
PW12B	C3	S24	F3	S94	F25	S553	F13
PW12BR	C3	S25N	F3	S95	F5	S554	F12
PW12E	C3	S26N	F3	S96	F5	S555	F20
PW12G	C3	S27	F3	S97	F5	S556	F13
PW12R	C3	S29	F3	S98	F5	S557	F6
PW12W	C3	S30N	F2	S99	F5	S558	F20
PW12Y	C3	S31N	F3	S100	F5	S559	F10
PW14B	C3	S32	F3	S500A	F3	S560	F13
PW14BR	C3	S35	F2	S501	F5	S561	F20
PW14BS	C3	S36N	F4	S502	F9	S562	F13
PW14E	C3	S37N	F4	S503A	F5	S563	F13
PW14G	C3	S38N	F2	S504	F9	S564	F18
PW14P	C3	S39	F4	S505	F9	S565	F18
PW14PK	C3	S40	F2	S506	F6	S566	F13
PW14R	C3	S43N	F4	S507	F9	S567	F13
PW14T	C3	S44	F4	S508	F6	S568	F13
PW14W	C3	S45N	F2	S509	F6	S569	F18
PW14Y	C3	S46N	F4	S510	F9	S570	F6
PW16B	C2	S47N	F4	S511	F9	S571	F6
PW16BR	C2	S49	F4	S512	F9	S572	F7
PW16E	C2	S51	F4	S513	F3	S573	F3
PW16G	C2	S54	F8	S514	F6	S574	F18
PW16P	C2	S55	F8	S515	F3	S575	F14
PW16PK	C2	S56	F2	S516	F23	S576	F14
PW16R	C2	S57	F2	S517	F6	S577	F18
PW16T	C2	S58	F4	S518	F6	S578	F14
PW16W	C2	S59	F7	S519	F9	S579	F18
PW16Y	C2	S60	F2	S520	F9	S581	F14
PW18B	C2	S61	F2	S521	F9	S582	F12
PW18BR	C2	S62	F2	S522	F9	S583	F14
PW18E	C2	S63	F4	S523	F6	S584	F10
PW18G	C2	S64	F17	S524	F6	S585	F10
PW18R	C2	S65	F8	S525	F10	S586	F7
PW18W	C2	S67	F4	S526	F10	S587	F14
PW18Y	C2	S68	F9	S527	F20	S588	F14
PW20B	C2	S69	F9	S528	F20	S589	F7
PW20E	C2	S70	F4	S529	F6	S590	F10
PW20G	C2	S71	F4	S530	F20	S591	F7
PW20R	C2	S72	F17	S531	F10	S592	F7
PW20W	C2	S74	F4	S532	F10	S594	F18
PW20Y	C2	S75	F5	S533	F10	S595	F18
QC10	B18	S76	F9	S535	F6	S596	F14
QC11	B18	S77	F9	S536	F13	S598	F20
QC12	B18	S78	F13	S537	F13	S600A	F10
QC14	B18	S79	F13	S538	F13	S601	F21
QC15	B18	S80	F5	S539	F18	S602	F18
QC16	B18	S81	F12	S540	F6	S604	F21
QC17	B18	S82	F17	S541	F6	S605	F23

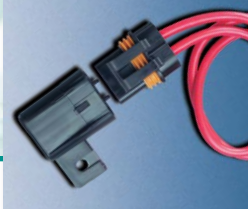

S606	F25	S672	F27	S738	F19	S802	F25
S607	F26	S673	F10	S740	F16	S803	F24
S609	F26	S674	F18	S742	F24	S804	F27
S610	F14	S675	F26	S743	F16	S805	F23
S611	F25	S677	F19	S744	F27	S806	F8
S612	F14	S678	F25	S745	F19	S807	F8
S613	F18	S679	F25	S747	F19	S808	F10
S614	F14	S681	F15	S749	F25	S809	F10
S615	F23	S682	F19	S750	F19	S810	F8
S617	F21	S683	F15	S751	F16	S811	F16
S619	F18	S685	F15	S752	F24	S812	F16
S620	F21	S686	F10	S753	F24	S813	F27
S621	F24	S687	F21	S754	F22	S814	F23
S622	F26	S688	F19	S755	F20	S815	F8
S623	F26	S689	F15	S756	F27	S816	F16
S624	F21	S690	F19	S757	F16	S817	F23
S625	F24	S691	F15	S758	F20	S818	F16
S626	F10	S692	F26	S759	F22	S819	F16
S627	F21	S694	F19	S760	F20	S820	F16
S628	F21	S695	F15	S761	F22	S821	F20
S629	F21	S696	F15	S762	F24	S822	F27
S630	F21	S697	F15	S763	F22	S823	F16
S631	F21	S698	F21	S764	F25	S824	F17
S632	F26	S699	F15	S765	F22	S825	F23
S633	F14	S700	F21	S766	F7	S826	F17
S634	F14	S703	F3	S767	F7	S827	F17
S635	F12	S704	F3	S768	F7	S829	F11
S636	F14	S705	F15	S769	F7	S830	F8
S637	F18	S706	F21	S770	F7	S831	F17
S638	F21	S707	F19	S771	F3	S833	F12
S639	F12	S708	F7	S772	F7	S834	F23
S640	F18	S709	F15	S773	F7	S835	F8
S641	F14	S711	F19	S775	F10	S836	F27
S643	F12	S712	F16	S776	F10	S838	F17
S647	F14	S713	F25	S777	F10	S839	F12
S648	F14	S714	F21	S778	F8	S840	F12
S649	F14	S715	F16	S779	F10	S841	F8
S650	F15	S716	F23	S780	F24	S842	F8
S651	F15	S717	F16	S781	F24	S843	F12
S652	F24	S718	F24	S782	F27	S844	F11
S653	F15	S719	F22	S783	F10	S845	F11
S654	F24	S720	F26	S784	F22	S846	F26
S655	F12	S721	F22	S785	F20	S847	F11
S656	F18	S722	F16	S786	F10	S848	F17
S657	F18	S723	F26	S787	F10	S849	F17
S658	F21	S724	F19	S788	F25	S850	F23
S659	F24	S725	F19	S789	F8	S853	F12
S660	F21	S726	F24	S790	F12	S855	F20
S661	F26	S727	F16	S791	F10	S856	F8
S662	F27	S728	F22	S792	F16	S857	F23
S663	F15	S729	F22	S793	F8	S858	F8
S664	F27	S730	F22	S795	F22	S860	F23
S665	F26	S732	F19	S796	F25	S861	F23
S666	F27	S733	F12	S797	F10	S862	F11
S667	F15	S734	F19	S798	F26	S863	F8
S668	F21	S735	F16	S799	F16	S865	F3
S669	F7	S736	F24	S800	F27	S866	F11
S670	F15	S737	F16	S801	F26	S867	F20

# INDEX

S868	F11	SPP41	A18	SPP70E	A18	SPP100E	A19
S872	F11	SPP41E	A18	SPP71	A18	SPP101	A19
S874	F11	SPP42	A18	SPP71E	A18	SPP101E	A19
S877	F8	SPP42E	A18	SPP72	A18	SPP102	A19
S878	F11	SPP43	A18	SPP72E	A18	SPP102E	A19
S879	F11	SPP44	A18	SPP73	A19	SPP103	A19
S890	F11	SPP44E	A18	SPP73E	A19	SPP103E	A19
S891	F11	SPP45	A18	SPP74	A19	SPP104	A19
S893	F17	SPP45E	A18	SPP74E	A19	SPP104E	A19
S896	F26	SPP46	A18	SPP75	A19	SPP105	A19
S897	F24	SPP46E	A18	SPP75E	A19	SPP105E	A19
S904	F17	SPP47	A18	SPP76	A19	SPP106	A19
SD647	B17	SPP47E	A18	SPP76E	A19	SPP106E	A19
SK25	F17	SPP48	A18	SPP77	A19	SPP107	A19
SK29	F17	SPP48E	A18	SPP77E	A19	SPP107E	A19
SL3	A22	SPP49	A18	SPP78	A19	SPP108	A19
SL4	A22	SPP49E	A18	SPP78E	A19	SPP108E	A19
SPP1	A17	SPP50	A18	SPP79	A19	SPP109	A19
SPP2	A17	SPP50E	A18	SPP79E	A19	SPP109E	A19
SPP3	A17	SPP51	A18	SPP80	A19	SPP110	A19
SPP4	A17	SPP51E	A18	SPP80E	A19	SPP110E	A19
SPP5	A17	SPP52	A18	SPP81	A19	SPP111E	A20
SPP6	A17	SPP52E	A18	SPP81E	A19	SPP112E	A20
SPP7	A16	SPP53	A18	SPP82	A19	SPP113E	A20
SPP8	A16	SPP53E	A18	SPP82E	A19	SPP114E	A20
SPP10	A17	SPP54	A18	SPP83	A19	SPP115E	A20
SPP11	F17	SPP54E	A18	SPP83E	A19	SPP116E	A20
SPP15	A17	SPP55	A18	SPP84	A19	SPP117E	A20
SPP17	A17	SPP55E	A18	SPP85	A19	SPP118E	A20
SPP19	A17	SPP56	A18	SPP85E	A19	SPP119E	A20
SPP20	A16	SPP56E	A18	SPP86	A19	SPP120E	A20
SPP22	A17	SPP57	A18	SPP86E	A19	SPP121E	A20
SPP23	A17	SPP57E	A18	SPP87	A19	SPP122E	A20
SPP24	A17	SPP58	A18	SPP87E	A19	SPP123E	A20
SPP25	A17	SPP58E	A18	SPP88	A19	SPP124E	A20
SPP26	A17	SPP59	A18	SPP88E	A19	SPP125E	A20
SPP27	A18	SPP59E	A18	SPP89	A19	SPP127E	A20
SPP27E	A18	SPP60	A18	SPP89E	A19	SPP128E	A20
SPP27HT	A18	SPP60E	A18	SPP90	A19	SPP129E	A20
SPP27HTE	A18	SPP61	A18	SPP91	A19	SPP130E	A20
SPP28	A17	SPP61E	A18	SPP91E	A19	SPP131E	A20
SPP29	A17	SPP62	A18	SPP92	A19	SPP132E	A20
SPP30	A17	SPP62E	A18	SPP92E	A19	SPP133E	A20
SPP31	A17	SPP63	A18	SPP93	A19	SPP134E	A20
SPP32	A17	SPP63E	A18	SPP93E	A19	SPP135E	A20
SPP33	A16	SPP64	A18	SPP94	A19	SPP136E	A20
SPP34	A16	SPP64E	A18	SPP94E	A19	SPP137E	A20
SPP35	A16	SPP65	A18	SPP95	A19	SPP138E	A20
SPP36	A16	SPP65E	A18	SPP95E	A19	SPP139E	A20
SPP37	A16	SPP66	A18	SPP96	A19	SPP140E	A20
SPP38	A17	SPP66E	A18	SPP96E	A19	SPP141E	A20
SPP39	A18	SPP67	A18	SPP97	A19	SPP142E	A20
SPP39E	A18	SPP67E	A18	SPP97E	A19	SPP143E	A20
SPP39HT	A18	SPP68	A18	SPP98	A19	SPP144E	A20
SPP39HTE	A18	SPP68E	A18	SPP98E	A19	SPP145E	A20
SPP39L	A18	SPP69	A18	SPP99	A19	SPP146E	A20
SPP40	A18	SPP69E	A18	SPP99E	A19	SPP148E	A20
SPP40E	A18	SPP70	A18	SPP100	A19	SPP149E	A20



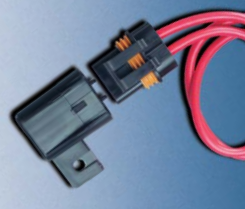

SPP150E.....	A20	SST311T.....	B32	STA12.....	D30	STP132HC.....	D10, D20
SPP151E.....	A20	SST312.....	B32	STA14.....	D32	STP133.....	D7
SSB2.....	F30	SST312T.....	B32	STA15.....	B23, D33	STP133D.....	D7
SSB3.....	F30	SST313.....	B32	STA17.....	D32	STP133H.....	D7, D19
SSB5.....	F30	ST22.....	A23	STA23.....	D32	STP134.....	D7
SST71.....	D16	ST25.....	A23	STA26.....	D33	STP134H.....	D7, D19
SST72.....	D16	ST26.....	A23	STA27.....	D33	STP135.....	D7
SST73.....	D16	ST27.....	A23	STA28.....	D33	STP135D.....	D7
SST74.....	D16	ST28.....	A23	STA50.....	C11	STP135H.....	D7, D19
SST75.....	D16	ST30.....	A23	STA51.....	D30	STP136.....	D6
SST76.....	D16	ST55.....	D16	STL1.....	D12	STP136H.....	D7, D19
SST77.....	D16	ST60.....	C10	STL2.....	D12	STP137.....	D9
SST80.....	D16	ST61.....	C10	STL3.....	D12	STP137H.....	D9, D20
SST81.....	D16	ST62.....	C10	STP91.....	D3	STP138.....	D13
SST82.....	D16	ST63.....	C10	STP92.....	D3	STP139.....	D13
SST83.....	D16	ST64.....	C10	STP93.....	D3	STP139D.....	D13
SST84.....	D16	ST65.....	C10	STP94.....	D3	STP140.....	D8
SST86.....	D15	ST66.....	C10	STP95.....	D3	STP140D.....	D8
SST87.....	D16	ST67.....	C10	STP96.....	D3	STP141.....	D8
SST88.....	D16	ST68.....	D15	STP97.....	D8	STP141D.....	D8
SST89.....	B17, B30, D16	ST69.....	C10	STP98.....	D8	STP142.....	D7
SST90.....	B17, B30, D16	ST70.....	C10	STP120.....	D3	STP142H.....	D8, D20
SST91.....	D16	ST71.....	C10	STP120H.....	D3, D19	STP142HL.....	D8, D20
SST92.....	D16	ST72.....	C10	STP120HL.....	D3	STP143.....	D7
SST92A.....	D16	ST73.....	C10	STP121.....	D3	STP143H.....	D8, D20
SST93.....	D16	ST74.....	C10	STP121H.....	D3, D19	STP143HL.....	D8, D20
SST95.....	D12	ST75.....	C10	STP122.....	D3	STP144.....	D8
SST96.....	D12	ST80.....	C10	STP122H.....	D3, D19	STP144D.....	D8
SST97.....	D9	ST81.....	C10	STP123.....	D3	STP144H.....	D8, D20
SST98.....	D15	ST82.....	C10	STP123H.....	D4, D19	STP144HL.....	D8, D20
SST99.....	D15	ST83.....	C10	STP124.....	D3	STP145.....	D8
SST100.....	D15	ST84.....	C10	STP124D.....	D3	STP145D.....	D8
SST101.....	D16	ST85.....	C10	STP124H.....	D4, D19	STP145H.....	D8, D20
SST102.....	D15	ST106.....	A22	STP124HL.....	D4, D19	STP145HL.....	D8, D20
SST103.....	D16	ST107.....	A22	STP125.....	D3	STP146.....	D13
SST104.....	D16	ST110.....	D15	STP125D.....	D3	STP147.....	D11
SST200.....	D16	ST113.....	A22	STP125H.....	D4, D19	STP148.....	D7
SST201.....	D16	ST114.....	A22	STP126.....	D3	STP149.....	D7
SST202.....	D16	ST115.....	A23	STP126H.....	D4, D19	STP150.....	D6
SST203.....	D16	ST116.....	A23	STP127.....	D4, D19	STP150H.....	D7, D19
SST205.....	D16	ST119.....	A22	STP127H.....	D5, D19	STP151.....	D3
SST206.....	D14	ST120.....	A23	STP128.....	D4	STP151H.....	D3, D19
SST299.....	B30	ST121.....	A23	STP128D.....	D4	STP152.....	D14
SST300.....	B30	ST122.....	A22	STP128H.....	D5, D19	STP153.....	D9
SST301.....	B30	ST131.....	A22	STP129.....	D5	STP154.....	D6
SST302.....	B30	ST230.....	D14	STP129H.....	D5, D19	STP155.....	D6
SST303.....	B30	ST231.....	D14	STP130.....	D10	STP155C.....	D6
SST304.....	B30	ST291.....	C10	STP130D.....	D10	STP156.....	D9
SST305.....	B30	ST292.....	C10	STP130H.....	D10, D20	STP157.....	D3
SST306.....	B30	ST293.....	C10	STP130HC.....	D10, D20	STP157C.....	D3
SST307.....	B30	ST294.....	C10	STP131.....	D10	STP157H.....	D4, D19
SST308.....	B32	ST295.....	C10	STP131C.....	D10	STP158.....	D9
SST308T.....	B32	ST296.....	C10	STP131D.....	D10	STP159.....	D5
SST309.....	B32	ST297.....	C10	STP131H.....	D10, D20	STP159H.....	D5, D19
SST309T.....	B32	ST522.....	A22	STP131HC.....	D10, D20	STP160.....	D14
SST310.....	B32	ST523.....	A22	STP132.....	D10	STP161.....	D9
SST310T.....	B32	STA10.....	A23, D30	STP132D.....	D10	STP162.....	D11
SST311.....	B32	STA11.....	D30	STP132H.....	D10, D20	STP162C.....	D11

# INDEX

STP162H.....	D12, D20	STP205.....	D10	STP390.....	D6	STP487.....	D8
STP163.....	D11	STP206.....	D10	STP391.....	D6	STP488.....	D8
STP163C.....	D11	STP207.....	D9	STP392.....	D6	STP489.....	D8
STP163H.....	D12, D20	STP208.....	D7	STP393.....	D6	STP490.....	D8
STP164.....	D11	STP208H.....	D7, D19	STP394.....	D7	STP491.....	D7
STP164C.....	D11	STP210.....	D13	STP395.....	D8	STP492.....	D7
STP165.....	D6	STP210D.....	D13	STP396.....	D8	STP493.....	D4
STP166.....	D9	STP211.....	D13	STP397.....	D14	STP494.....	D4
STP166H.....	D9, D20	STP212.....	D13	STP398.....	D14	STP495.....	D4
STP167.....	D9	STP213.....	D15	STP400.....	D11	STP496.....	D4
STP168.....	D4, D19	STP300.....	D6	STP401.....	D11	STP497.....	D3
STP168H.....	D5, D19	STP301.....	D6	STP402.....	D11	STP497H.....	D3, D19
STP170.....	D11	STP302.....	D3	STP430.....	D8	STP498.....	D3
STP170H.....	D11, D20	STP350.....	D10	STP431.....	D8	STP498D.....	D3
STP171.....	D11	STP350H.....	D10, D20	STP432.....	D8	STP498H.....	D4, D19
STP171H.....	D11, D20	STP351.....	D10, D21	STP433.....	D8	STP499H.....	D7, D19
STP172.....	D11	STP351C.....	D10, D21	STP434.....	D13	STP500H.....	D7, D19
STP173.....	D11	STP352.....	D10, D21	STP435.....	D10	STP501.....	D17
STP174.....	D6	STP352C.....	D10, D21	STP436.....	D10	STP501C.....	D17
STP175.....	D5	STP353.....	D10, D21	STP437.....	D10	STP516.....	D17
STP176.....	D13	STP353C.....	D10, D21	STP438.....	D4	STP517.....	D17
STP177.....	D5	STP354.....	D3, D20	STP439.....	D4	STP518.....	D17
STP177H.....	D6, D19	STP355.....	D3, D20	STP440.....	D4	STP519.....	D17
STP178.....	D9	STP356.....	D3, D20	STP441.....	D5	STP520.....	D17
STP178H.....	D9, D20	STP357.....	D3, D20	STP442.....	D5	STP523.....	D17
STP179.....	D9	STP358.....	D4, D20	STP443.....	D5	STP523C.....	D17
STP179H.....	D9, D20	STP359.....	D4, D20	STP444.....	D5	STP524.....	D4
STP180.....	D13	STP359C.....	D4, D20	STP445.....	D6	STP524D.....	D4
STP181.....	D13	STP360.....	D4, D20	STP446.....	D7	STP525.....	D13
STP182.....	D9	STP361.....	D4, D21	STP447.....	D7	STP527.....	D17
STP183.....	D9	STP362.....	D5, D21	STP462.....	D12	STP530.....	D17
STP184.....	D10	STP363.....	D5, D21	STP463.....	D12	STP530C.....	D17
STP185.....	D10	STP364.....	D5, D21	STP464.....	D14	STP531.....	D17
STP186.....	D10	STP365.....	D5, D21	STP466.....	D14	STP532.....	D17
STP186H.....	D10, D20	STP366.....	D7, D21	STP467.....	D14	STP533.....	D17
STP187.....	D6	STP367.....	D7, D21	STP468.....	D8, D22	STP534.....	D17
STP188.....	D5	STP368.....	D7, D21	STP468C.....	D8, D22	STP536.....	D17
STP188H.....	D6, D19	STP369.....	D12	STP469.....	D8, D22	STP550.....	D10, D22
STP189.....	D6	STP370.....	D12	STP469C.....	D8, D22	STP551.....	D10, D22
STP190.....	D6	STP371.....	D11	STP470.....	D8, D22	STP551C.....	D10, D22
STP191.....	D6	STP372.....	D11	STP470C.....	D8, D22	STP552.....	D10, D22
STP192.....	D6	STP373.....	D11	STP471.....	D8, D22	STP552C.....	D10, D22
STP193.....	D6	STP374.....	D11	STP471C.....	D8, D22	STP552D.....	D10, D22
STP194.....	D6	STP375.....	D11	STP472.....	D9, D22	STP553.....	D10, D22
STP195.....	D9	STP376.....	D11	STP473.....	D9, D22	STP553C.....	D10, D22
STP196.....	D10	STP377.....	D11	STP474.....	D9, D22	STP553D.....	D10, D22
STP196D.....	D10	STP378.....	D11	STP475.....	D3, D20	STP556.....	D3, D22
STP197.....	D10	STP379.....	D11	STP476.....	D3, D20	STP559.....	D4, D22
STP197D.....	D10	STP380.....	D11	STP477.....	D4, D20	STP560.....	D4, D22
STP198.....	D10	STP381.....	D13	STP478.....	D4, D20	STP561.....	D4, D22
STP198C.....	D10	STP382.....	D14	STP479.....	D5, D21	STP562.....	D5, D22
STP198D.....	D10	STP383.....	D14	STP480.....	D7	STP563.....	D5, D22
STP199.....	D9	STP384.....	D11	STP481.....	D7	STP564.....	D5, D22
STP200.....	D13	STP385.....	D11	STP482.....	D8	STP565.....	D5, D22
STP201.....	D13	STP386.....	D11	STP483.....	D8	STP570.....	D8, D22
STP202.....	D13	STP387.....	D11	STP484.....	D7	STP571.....	D8, D22
STP203.....	D13	STP388.....	D6	STP485.....	D8	STP572.....	D9, D22
STP204.....	D10	STP389.....	D6	STP486.....	D6	STP573.....	D9, D22

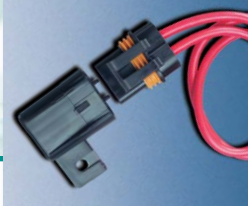

STP576.....	D7, D22	STT276C.....	C12	TC412.....	E3	TC473.....	E4
STP577.....	D7, D22	STT276M.....	C12	TC412A.....	E3	TC474.....	E4
STP578.....	D7, D22	STT277.....	C12	TC413.....	E3	TC475.....	E4
STP600.....	D7	STT277C.....	C12	TC413A.....	E3	TC476.....	E4
STP601.....	D7	STT277M.....	C12	TC414.....	E3	TC477.....	E4
STP602.....	D4	STT278.....	C12	TC414A.....	E3	TC478.....	E5
STP606.....	D3	STT278C.....	C12	TC416.....	E3	TC479.....	E5
STP606H.....	D3	STT278D.....	C12	TC416A.....	E3	TC481.....	E15
STT250.....	C12	STT279.....	C12	TC418.....	E3	TC482.....	E5
STT250C.....	C12	STT281C.....	C12	TC418A.....	E3	TC483.....	E5
STT250M.....	C12	STT281M.....	C12	TC419.....	E3	TC485.....	E5
STT251.....	C12	STT282.....	C12	TC419A.....	E3	TC486.....	E5
STT251C.....	C12	STT282C.....	C12	TC420.....	E3	TC487.....	E5
STT251D.....	C12	SW4.....	B31	TC420A.....	E3	TC488.....	E5
STT252.....	C12	SWR1.....	C3	TC421.....	E3	TC489.....	E5
STT252C.....	C12	TC1.....	B34, E17, E29	TC421A.....	E3	TC490.....	E5
STT252M.....	C12	TC5.....	E30	TC422.....	E3	TC492.....	E5
STT253.....	C12	TC6.....	E30	TC422A.....	E3	TC494.....	E5
STT253C.....	C12	TC7.....	E30	TC423.....	E11	TC495.....	E5
STT253M.....	C12	TC7T.....	E17, E29	TC424.....	E11	TC496.....	E5
STT254.....	C12	TC8.....	E30	TC427.....	E15	TC497.....	E12
STT255.....	C12	TC8T.....	E17	TC428.....	E14	TC498.....	E5
STT256.....	C12	TC9.....	E30	TC430.....	E15	TC499.....	E5
STT256E.....	C13	TC10.....	E8	TC431.....	E3	TC499A.....	E5
STT256M.....	C12	TC11.....	E8	TC431A.....	E3	TC500.....	E5
STT256R.....	C13	TC12.....	E30	TC432.....	E14	TC501.....	E5
STT256W.....	C13	TC20.....	E16	TC433.....	E11	TC502.....	E6
STT256Y.....	C13	TC23.....	E14	TC434.....	E14	TC503.....	E6
STT259.....	C12	TC23P.....	E14	TC436.....	E3	TC504.....	E6
STT260.....	B37	TC30.....	E15	TC436A.....	E3	TC505.....	E6
STT261.....	B37	TC41.....	E9	TC437.....	E3	TC506.....	E6
STT262.....	B37	TC41S.....	E9	TC438.....	E3	TC507.....	E13
STT263.....	B37	TC42.....	E16	TC439.....	E3	TC508.....	E13
STT263R.....	B37	TC44.....	E9	TC441.....	E3	TC509.....	E17
STT264.....	B37	TC44A.....	E11	TC441A.....	E3	TC510.....	E6
STT264R.....	B37	TC44K.....	E9	TC451.....	E4	TC511.....	E6
STT265.....	B37	TC45.....	E15	TC451A.....	E4	TC512.....	E6
STT265R.....	B37	TC45H.....	E15	TC452.....	E14	TC513.....	E6
STT270.....	C12	TC46.....	E15	TC453.....	E14	TC515.....	E6
STT271.....	C12	TC48.....	E15	TC454.....	E14	TC516.....	E6
STT271C.....	C12	TC50.....	E16	TC455.....	E17	TC517.....	E6
STT271E.....	C13	TC51.....	E9	TC456.....	E11	TC518.....	E6
STT271M.....	C12	TC51A.....	E11	TC457.....	E11	TC519.....	E6
STT271R.....	C13	TC51K.....	E9	TC458.....	E11	TC520.....	E6
STT271W.....	C13	TC52.....	E14	TC459.....	E12	TC521.....	E6
STT271Y.....	C13	TC61.....	E9	TC460.....	E4	TC522.....	E6
STT272.....	C12	TC61A.....	E11	TC461.....	E4	TC523.....	E6
STT272C.....	C12	TC61S.....	E9	TC462.....	E4	TC524.....	E7
STT272D.....	C12	TC62.....	E16	TC462A.....	E4	TC525.....	E7
STT273.....	C12	TC62K.....	E9	TC463.....	E4	TC526.....	E13
STT273C.....	C12	TC63.....	E11	TC464.....	E4	TC527.....	E13
STT273M.....	C12	TC65.....	E12	TC465.....	E4	TC528.....	E14
STT274.....	C12	TC72.....	E11	TC466.....	E14	TC529.....	E16
STT274C.....	C12	TC73.....	E11	TC468.....	E17	TC530.....	E16
STT275.....	C12	TC75.....	E12	TC469.....	E4	TC531.....	E16
STT275C.....	C12	TC76.....	E12	TC469A.....	E4	TC532.....	E16
STT275M.....	C12	TC91.....	E10	TC470.....	E4	TC533.....	E16
STT276.....	C12	TC411.....	E3	TC472.....	E4	TC534.....	E12

# INDEX

TC535	E12	TN10	A16	WTT14	D35
TC536	E7	TN11	A17	WTT15	D35
TC537	E7	TN15	A17	WTT16	B35
TC538	E7	TN16	A17	WTT17	A24, D35
TC539	E7	TN17	A16	WTT18	A24, D35
TC540	E7	TN18	A17	WTT20	B38
TC541	E12	TN19	A16	WTT21	B38
TC542	E7	TN20	A16	WTT22	B38
TC543	E7	TN21	A16	WTT27	A27, D35
TC544	E7	TN22	A16	WTT28	B38
TC545	E7	TN23	A16	WTT29	B38
TC546	E7	TN24	A16	WTT30	B35
TC547	E7	TN25	A16	WTT31	B38
TC548	E7	TN26	A16	WTT32	D35
TC549	E7	TN27	A16	WTT33	B35
TC550	E14	TN28	A16	WTT38	A24, D35
TC551	E7	TX3A	F17	WTT39	A24, D35
TC552	E16	WC0L	B23	WTT110	D35
TC553	E13	WC0RL	B23	WTT111	D35
TC554	E7	WC0RV	B23	WTT112	D35
TC555	E8	WC0V	B23	WTT113	D35
TC556	E8, E12	WC1L	B23	WTT114	D35
TC558	E8	WC1RL	B23	WTT115	D35
TC559	E8	WC1RV	B23	ZM80	G8
TC560	E8	WC1V	B23	ZM81	G8
TC561	E8	WC2L	B23	ZM82	G8
TC562	E12	WC2RL	B23	ZM85	G8
TC563	E12	WC2RV	B23	ZM86	G8
TC564	E12	WC2V	B23	ZM87	G8
TC565	E12	WC4L	B23	ZR91	G8
TC568	E12	WC4RL	B23	ZR92	G8
TC569	E12	WC4RV	B23	ZR95	G6
TC600	E13	WC4V	B23	ZR96	G6
TC701K	E10	WC00L	B23	ZR97	G8
TCP45C	E17	WC00RL	B23	ZT11	G6
TCP62C	E17	WC00RV	B23	ZT17	G6
TCP62F	E9	WC00V	B23	ZT21	G6
TCP77B	E17	WCB0	B23	ZT22	G6
TCP77F	E10	WCB0R	B23	ZT23	G6
TCP77F-15	E10	WCB1	B23	ZT31	G6
TCP77F-20	E10	WCB1R	B23	ZT31A	G6
TCP77F-30	E10	WCB2	B23	ZT32	G6
TCP77M	E10	WCB2R	B23	ZT34	G6
TCP77PF	E10	WCB4	B23	ZT34A	G6
TCP77PG	E10	WCB4R	B23	ZT37	G6
TCP77PM	E10	WCB00	B23	ZT54	G8
TCP78C	E17	WCB00R	B23	ZX50	G8
TCP78F	E10	WTA175	D31	ZX51	G8
TCP78M	E10	WTA208	D31	ZX52	G8
TCP701F	E10	WTT4	A24, D35	ZX53	G8
TCP701M	E10	WTT5	A24		
TCP713F	E11	WTT6	A24		
TCP713M	E11	WTT7	B35		
TN7	A17	WTT8	B35		
TN7E	A17	WTT10	B35		
TN8E	A16	WTT11	B35		
TN9	A17	WTT12	D35		
TN9E	A17	WTT13	D35		

# IT'S TIME TO SHAKE UP YOUR HEAT SHRINK TERMINAL SALES WITH GRAB & GO JARS!

## Benefits & Uses of Grab & Go Jars

- Designed for **Most Popular Connectors**
- Ideal for **High and Low Volume Users**
- **Attractive Packaging** for Organization while Providing a **Visual Stock Level**
- **Great for Service Trucks and Satellite Shops**
- Larger Quantity = **Bigger Sales**



Sealed Crimp Connectors



Part #	Qty
ET130J	100
ET131J	100
ET132J	60



Sealed Solder Connectors



Part #	Qty
ET351J	100
ET352J	100
ET353J	60



Sealed Crimp & Solder Connectors



Part #	Qty
ET551J	100
ET552J	100
ET552J	60



Sealed Window Butt Connectors



Part #	Qty
ET700J	100
ET701J	100
ET552J	60

2.75"

4.5"

# STANDARD<sup>®</sup>

## WIRE & CABLE ILLUSTRATED PARTS GUIDE FOR DOMESTIC & IMPORT CARS & TRUCKS



Distributed By

Standard Motor Products, Inc.  
3718 Northern Blvd., Long Island City, NY 11101  
[www.smpcorp.com](http://www.smpcorp.com)

Printed in the USA  
0513.35M.Fry