



# **Safety plus**® **WORLD**



Top Brands • Total Solutions • One World

**2024-25**  
**PRODUCT CATALOG**  
6<sup>TH</sup> EDITION



# WELCOME TO SAFETY PLUS WORLD

Hello and welcome!

As the fresh face at the helm of our vibrant company, I'm excited to present to you our latest Safety Products Catalogue - a collection where cutting-edge meets comfort and where technology shakes hands with practicality.

Gone are the days when safety equipment was just functional. Now, we're talking about gear that's so intuitive, it feels like it's part of your team. Think of it as your silent partner in crime prevention - without the cape and tights, of course.

This catalogue isn't just a list of products; it's a chronicle of progress, a testament to where foresight can take us. Each page introduces solutions designed not only to protect but to impress and innovate. We're not just keeping up with the times; we're playing jazz with the rhythm of technology.

Our offerings are the conversation starters in the safety world, blending seamlessly into your daily grind while standing on the front lines of the 'what's next.' With AI that anticipates more than your next coffee break and sensors that could give a sixth sense a run for its money, we're redefining the meaning of 'safe and sound.'

As we roll out the red carpet on our new catalogue, I invite you to join us in this narrative where every paragraph pledges our unwavering commitment to your well-being. Together, let's set the scene for a future where safety and sophistication go hand in hand.

Here's to the next chapter in our journey, where every product is a promise kept, every innovation is an investment in tomorrow.

**Safety Plus World**  
A Division of Raja Company

*Jay S. Mirchandani*

**JAY MIRCHANDANI**  
Managing Director



# ABOUT US

## **Our Legacy: A Journey of Excellence**

Established in 1961 by the visionary Late Mr. Govind Mirchandani, Raja Company W.L.L. embarked on a journey that transcended the realms of business to become the cornerstone of a diverse and dynamic conglomerate. From its humble beginnings, our organization has evolved into the esteemed Raja Group, comprising various companies and divisions that stand as pillars of excellence across multiple industries.

At the heart of our diverse portfolio is Safety Plus World, a testament to our unwavering commitment to providing unparalleled Personal Protection, Health & Safety solutions. Founded in 1996, Safety Plus World has not only grown but has emerged as the undisputed market leader in Kuwait and the broader Middle East region. Our dedication to excellence and a customer-centric approach have positioned us as the go-to source for safety requirements across a spectrum of industries.

The legacy forged by Mr. Govind Mirchandani lives on in our relentless pursuit of quality, innovation, and customer satisfaction. Today, the Raja Group proudly serves valued customers in fields ranging from Safety and Kitchen Equipment to Restaurants, Web & Software Solutions, Fabrication, Interiors contracting, and Training & other Services.

As we reflect on our journey, we acknowledge the trust and support bestowed upon us by our customers and partners. It is this trust that propels us forward, inspiring us to continually raise the bar and redefine standards in every sector we touch.

Our legacy is not just a chronicle of the past; it is a living testament to our ongoing commitment to excellence, innovation, and service. We invite you to be part of our journey, as we navigate the future with the same passion and dedication that has defined us for over six decades.

Thank you for being an integral part of our legacy

## **Our Mission: Leading the Way in HSE Innovation**

At Safety Plus World, our mission is clear: to be a progressive leader in discovering, professionally developing, and introducing the latest advancements in Health, Safety, and Environment (HSE) technology and solutions to the Middle East Region. We are committed to staying at the forefront of innovation, ensuring that our clients have access to the most cutting-edge tools and strategies to address their day-to-day HSE concerns.

## **Our Vision: Building a Safer World**

Safety is not just a commitment; it is our passion. We aspire to create a world where safety is not merely a consideration but a way of life. In pursuit of this vision, we have brought together some of the best and most reputable manufacturers in the Safety, Health, Environment, and Security industry. Our aim is not only to be a one-stop-shop but to establish a world where individuals in the Safety Arena can find total, easy, and quick solutions to their HSE challenges.

In recent years, our investments have not only expanded our product range by incorporating new brands and categories but have also prioritized a proactive approach to after-sale services. Recognizing the transformative power of Industry 4.0, AI, and IoT, we've dedicated a research team to identify new developments, with a special focus on Safety wearables.

Our commitment to service excellence is evident in the establishment of our Repair and Service workshop – the first of its kind in the State of Kuwait. Specializing in Fall Protection products from renowned brands like 3M Fall protection, our workshop ensures the longevity and reliability of your safety equipment. Additionally, our certified and well-trained personnel provide SCBA servicing and repairs from Interspiro and other brands, along with gas detection instrument repairs and calibration services to Torque wrench calibration and rental of various equipment's.

In the pursuit of a safer world, Safety Plus World is not just a supplier; we are your strategic partner in safeguarding lives and enhancing workplace safety.

### **MEA Regional Thrust: A Commitment to Excellence**

Safety Plus World's commitment to excellence extends beyond borders, and our MEA (Middle East and Africa) Regional Thrust exemplifies our dedication to bringing the very best in safety solutions to the region. We are proud to represent Edelhoff Technologies Germany, a global leader in life support systems, dense loading, and catalyst handling technologies. This partnership ensures that our clients in the MEA region have access to state-of-the-art solutions that redefine safety standards.

In our relentless pursuit of comprehensive safety solutions, we have ventured into HSE Software, covering areas such as Health, Safety, Industrial Hygiene, and Ergonomics. Safety Plus World aims to become the go-to provider for complete safety solutions in the region, combining cutting-edge technology with a deep understanding of industry-specific needs.

Introducing [www.ibuysafety.com](http://www.ibuysafety.com), we are bringing safety directly to your doorstep. This innovative platform not only facilitates convenient access to a wide range of safety products but also reflects our commitment to making safety a seamless and accessible aspect of your daily operations.

At the core of our success is our belief that our people are our assets. We have consistently invested in evolving the knowledge and skill sets of our team, ensuring that they are equipped to enhance and upgrade our service levels continuously. Our commitment to our customers is unwavering, and our energy and responsiveness to the ever-changing work habitat reflect our dedication to providing care at every step.

As Safety Plus World, we take immense pride in bringing you top brands, total solutions, and the promise of one world united by a shared commitment to safety. Join us on this journey as we continue to redefine safety standards and shape a world where safety knows no boundaries.



## HISTORY

When our founder landed at Kuwait in 1952, he immediately conceived it to be truly the land of milk and honey. True to vision, and within the decade, in 1961 Mr. Mirchandani established Raja General Store and Trading Company.

Traditionally hard working and business savvy by nature as well as being well educated, the young Shalesh Mirchandani, popularly known as Rohit, was determined to elevate the family business to the next level.



CSR ACTIVITY



KUWAIT OFFICE



UAE BRANCH



ASSP GCC HSE EXCELLENCE AWARD



SERVICE CENTER



KUWAIT SAFETY CHAMPIONSHIP



FALL PROTECTION TRAINING









OUR TEAM



RAJA COMPANY WAREHOUSE

# INDEX

 Head Protection.....	5-9
 Eye & Face Protection.....	10-21
 Hearing Protection.....	22-25
 Respiratory Protection.....	26-41
 Hand Protection.....	42-69
 Protective Clothing.....	70-103
 Foot Protection.....	104-119
 Fall Protection.....	120-165
 Industrial Hygiene Products.....	166-167
 Thermal Imaging Camera.....	168-169
 Electrical Safety Products.....	170-177
 Weather Meters & Windsocks.....	178-183
 Gas Detection.....	184-201
 Emergency & First Aid.....	202-207
 Beverage for Hydration & Electrolyte Replacement.....	208-209
 Safety of Life at Sea.....	210-213
 Environment Protection.....	214-217
 Road Safety.....	218-219
 Safety Signage.....	220-221
 Industrial Tools.....	222-227
 Lockout / Tagout.....	228-239
 Explosion Proof Products.....	240-251
 Rescue Equipment.....	252-259
 FME (Foreign Material Exclusion).....	260-263
 Engineered Solutions.....	264-271
 Fire Fighting Equipment.....	272-273
 IIOT (Industrial Internet of Things).....	274-279

# HEAD PROTECTION





# Head Protection

K-COMPANY  
APPROVED



## Bullard Standard Series Hard Hat

**Model No.: S61R**

The Bullard standard series hard hats offer excellent protection in a lightweight, low profile design.

Available with 4 Point Flex- Gear Ratchet Suspension with Absorbant. ANSI/ISEA Standards: ANSI/ISEA Z89.1-2014 (R2019) Class E and G.



## Bullard Standard Series Hard Hat

**Model No.: S51R**

S51 offers a low-profile shell design and is loaded with upgraded features and benefits. With its 4-point suspension system, users can choose from a pinlock or upgraded Flex-Gear® ratchet suspension with a pillowed cotton, super-absorbent, poly brow pad. The S51 is ideal for the construction and everyday work environments.

Standards: Z89.1-2014, Type I, Class E & G.



## Desert Gold ANSI Series Hard Hat

**Model No.: SP102AS**

- Material: HDPE
- 6 Point Ratchet suspension
- Smooth Ratchet for Adjustable Fitting
- With Adjustment chin strap
- Available Colors: White, Yellow, Blue, Red & Green
- Standards: ANSI/ISEA Z89.1-14 (R2019)





## Safety Plus World Hard Hat with Vent

**Model No.:** SP100HP-V

- Material: HDPE
- 4 Point Ratchet suspension
- Smooth Ratchet for Adjustable Fitting
- With Adjustment chin strap
- **Standards:** CE EN397:2012 + A1:2012



## uvex airwing B-WR safety hard hat

**Model No.:** 9762030

- New lightweight safety helmet with three variable air vents, one ventilation zone on the forehead and two at the back
- 6-point textile suspension harness, side slots for attaching ear defenders or visors, rotating size adjusters
- Helmet colour: white
- Size: 52-61 cm



## Portwest Height Endurance Hard Hat

**Model No.:** PS53

Designed to be specially used for working at heights. Light, comfortable and compact with a short peak. ABS shell, textile comfort harness 6 points, wheel ratchet adjustment, size 52-63 cm.

- **Standards:**
  - ANSI/ISEA Z89.1 TYPE I (Class E)
  - EN 50365 Class: 0
  - EN 397 (-30°C/+50°C)



# Head Protection



## Bullard Full Brim Hard Hat

**Model No.: S71R**

- A wide brim extends the area of rain and sun protection offered by the Model S71 Hard Hat
- Highly absorbent cotton replaceable brow pad for added comfort
- Four-point suspension has a Flex-Gear® ratchet suspension with a ratchet sizing knob and flex points for a personal fit
- Accessory slots allow for mounting faceshields, welding helmets, earmuffs and headsets
- Standards: ANSI/ISEA Z89.1-2014, Type I, Class E and G



## Portwest Bump Cap

**Model No.: PW59**

- Long peak (7cm) for maximum protection against shock and light
- Durable high density EVA protects and gives comfort to the wearer
- Inner ABS shell and soft pad for shock absorption
- Hook and loop strap for safe and secure fit
- Padded headband for comfort
- Standards: EN 812



## Portwest Bump Cap

**Model No.: PW69**

- Long peak (7cm) for maximum protection against shock and light
- Inner ABS shell and soft pad for shock absorption
- Durable high density EVA protects and gives comfort to the wearer
- Hook and loop strap for safe and secure fit
- Mesh panels for extra ventilation
- Available in multiple colourways
- Standards: EN 812



## Bullard High Heat Series

### Model No.: 911C

The 3-Rib 911C is a cap style hard hat with a 6-point. Flex-Gear® ratchet suspension, designed to protect the head from falling objects and bumps into stationary objects in high heat environments. The 911C includes a suspension which drops below the nape of the head, improving retention. Standards: ANSI/ISEA:Z89.1, Type I, Class E & G



## Bullard LT Series

### Model No.: LTX

LT Series fire helmets are designed Bullard Tough for extreme conditions. Tough shell, lightweight and compact design have been reengineered to offer even more headroom and comfort – making it the comfortable low profile helmet on the market. LT Fire Helmet exceeds the NFPA 1971, Standard on Protective Ensemble for Structural Fire Fighting and Proximity Fire Fighting Pertaining to Structural Fire Helmets



## Safety Plus World Sweat Band

### Model No.: SP101SB

- Material: 100% cotton fabric
- Size: 6 x 12 inch
- Compatible with Bullard, 3M & MSA



## Safety Plus World Chin Strap

**Model No.: SP101CS**

- Hard Hat Chin Strap provides a secure fit and is compatible with all the hard hats
- The hard hat chin straps are constructed from a soft and comfortable material for all day wear
- Adjustable strap
- Soft and comfortable material



# EYE & FACE PROTECTION





# Eye & Face Protection



**uvex**

## uvex pheos cx2

**Model No.: 9198.257 (Clear)**

**Model No.: 9198.237 (Grey)**

- "x"-branded safety spectacles with a modern, sporty design
- Injection moulded forehead and nose piece further enhances wearer comfort
- Twist-arm technology for ultimate non-slip fit, comfort and protection
- Large field of vision with duo-spherical lens
- Innovative uvex duo component technology for maximum wearer comfort
- Standards: EN166 & EN170



**uvex**

## uvex astrospec 2.0

**Model No.: 9164.065 (Clear)**

**Model No.: 9164.387 (Grey)**

- Innovative style and new technology ensure maximum wearer acceptance
- Maximum wearer comfort to all face shapes due to flexible 2k side arms and inclination
- Wraparound side arms ensure perfect fit
- Secure and pressure free fit, even when worn for extended periods
- Standards: EN166 & EN170



**uvex**

## uvex i-3 variomatic

**Model No.: 9190.880**

- Adaptable to every face, with extremely comfortable and outstandingly secure fit
- Self-tinting lenses with uvex supravision variomatic coating: self-tinting lenses
- Frame in black/anthracite
- PC lens, light green
- Standards: EN166 & EN170



## Safety Plus World Platinum X

**Model No.: SPPTX304CL (Clear)**

**Model No.: SPPTX304SM (Smoke)**

- Sporty and full wraparound design provides optimal protection for general use
- Vented frame design for improved airflow
- Slim and pliable co-material temples with ratchet angle adjustable feature for personalized fit
- Cushion-like nose pad made of non-slipting material providing optimal comfort
- 99.9% of harmful UV light can be blocked through the optical class one lens
- Perfect and useful protective eyewear with high velocity impact resistance
- **Standards:** EN166:2001, EN170:2002, EN172:1994 + A2:2001
- **Detailed Characteristics:** 1 FT KN



## Safety Plus World Platinum Plus

**Model No.: SP300CL (Clear)**

**Model No.: SP300SM (Grey)**

- Flexible, rubber tip temples provide a secure fit and release pressure points Lightweight, frameless design provides user all day comfort
- Soft rubber bridge design with a ribbed nose-piece for comfort
- Provide 99.9% protection against harmful UV rays
- **Standards:** EN166:2001, EN170:2002, EN172:1994 + A2:2001
- **Detailed Characteristics:** 1 FT KN





# Eye & Face Protection



## Safety Plus World Platinum

**Model No.: S-801CLAFGP (Clear)**

**Model No.: S-801SMAFGP (Grey)**

- Poly Carbonate lens w/grip nose pads
- 8 Based curvature standard Hard coated
- Foam for extra protection
- Angle adjustment for universal fitting
- Arm grips for extra comfort and secure
- Standards: ANSI Z87.1-2015



## Safety Plus World Premium X

**Model No.: Clear SPPX303CL**

**Model No.: Smoke SPPX303SM**

- High curvature of single-piece lens offers wide and unobstructed vision
- Soft nosepiece and temple pad for cushion fit
- Light, resilient & durable protective eyewear for all day wear
- Lens inclination for different users
- Fashionable design that meets safety standard
- Scratch-resistant coated polycarbonate lens filters out more than 99.9% of harmful UV light
- Standards: EN166:2001, EN170:2002 & EN 172:1994 + A2:2001
- Detailed Characteristics: 1 FT KN





## Safety Plus World Premium

**Model No.: S-801CLAF (Clear)**

**Model No.: S-801SMAF (Grey)**

- Poly Carbonate lens w/grip nose pads
- 8 Based curvature standard Hard coated
- Angle adjustment for universal fitting
- Arm grips for extra comfort and secure
- Standards: ANSI Z87.1-2015



## Safety Plus World OTG

**Model No.: Clear SPOTG305CL**

**Model No.: Smoke SPOTG305SM**

- All new light-weight OTG style with 1.7mm lens thickness and wraparound 2.5 base lens with integral extension of side shield can be worn over most prescription glasses
- Metal free hinge structure suitable for di-electric applications
- 3-position angle & length adjustment function for personalized fit
- Co-injected frame increasing the dust protection
- Dual-material temples with ultra soft TPR tip for all day comfort
- Filters out 99.9% of all harmful UV light
- Standards: EN166:2001, EN170:2002 & EN 172:1994 + A2:2001
- Detailed Characteristics: 1 FT KN



# Eye & Face Protection



## Safety Plus World Basic

**Model No.: S-968 CLAS (Clear)**

**Model No.: S-968 GYAS (Grey)**

- Lightweight, frameless protection
- Superior comfort and fit
- Polycarbonate lens provides 99% UVA/B/C protection
- Standards: ANSI Z87.1.2015



## Safety Plus World Chemical Splash Goggle

**Model No.: SPCSG306GLCL (Clear)**

**Model No.: SPCSG306GLSM (Smoke)**

- Wide vision crystal clear polycarbonate lens
- Indirect vents allow airflow and reduce fogging
- Elastic headband is easily adjustable with optional quick-release clip for ease of use
- Specific design on the sides of the goggle body for fitting over prescription glasses
- Impact resistance against flying particles
- Splash and Dust protection
- Anti-Fog & Anti-Scratch lenses filter out more than 99.9% of harmful UV light
- Standards: EN166:2001, EN170:2002 & EN 172:1994 + A2:2001
- Detailed Characteristics: 1 BT 3459 KN



**uvex**

## uvex pheos cx2 sonic goggle

**Model No.: 9309.275 (Clear)**

**Model No.: 9309.286 (Grey)**

- uvex's lightest compact wide-vision goggles (34 grams)
- High mechanical strength B (120 m/s)
- Designation 3 (liquids), 4 (coarse dust) and T (extreme temperatures)
- Comfortable protection thanks to soft forehead and nose piece moulded directly onto the lens
- uvex supravision coating technology
- Very soft, light textile headband for secure and comfortable fit
- Standards: DIN EN 166, DIN EN 170

## uvex u-sonic goggle

**Model No.: 9308.248**



**uvex**

- Innovative ventilation system ensures comfortable internal goggle environment lens replacement possible
- 9308.04 add on lens grey 14% and magnetic headband
- Compact design – just 69g (without additional lens)
- Low profile, wraparound design fits a wide range of facial shapes
- Soft seal frame technology adapts to your face for a customised fit – protects against liquid droplets/splash large dust particles
- Permanent anti-fog on the inside of the lens, scratch resistant on the outside
- Wide fully adjustable head strap-secure, pressure free fit
- Standards: DIN EN 166, DIN EN 170, DIN EN 172



# Eye & Face Protection



**uvex**

## uvex ultrasonic goggle

**Model No.: 9302.245 (Clear)**

**Model No.: 9302.286 (Grey)**

- Wide panoramic field of vision
- No pressure problems with long-term wear thanks to combination of hard and soft components
- Supravision anti-fog/anti-scratch lens
- Can be worn comfortably over most prescription spectacles
- The outstanding ventilation ensures a pleasant interior environment, whilst protecting against splash and dust
- Optical class 1 polycarbonate lens
- Liquid (chemical) splash, large dust particles, molten metals and solids
- **Standards: EN166 & EN170**



**uvex**

## uvex ultravision goggle

**Model No.: 9301.105**

- Anatomical shape and soft material allow close, yet comfortable fit
- Fits comfortably over most prescription spectacles
- Nose bridge works well with respirators
- Frosted top to reduce glare
- High-quality, easily adjustable headband
- Optically correct lens (EN 166 class 1) does not distort view or cause headaches
- Large goggle body, can also comfortably be worn as overspecs
- Optimum wearability due to cleverly designed ventilation system
- Chemical resistant outside, antifog inside of lens
- **Standards: EN 166:2001/EN 170:2002**



**uvex**

## uvex ultrasonic flip-up goggle

**Model No.: 9302.043 Shade 3**

**Model No.: 9302.045 Shade 5**

- Sporty design and wide panoramic field of vision
- High level of protection for professional welders
- Permanent anti-fog on the inside
- Available in Welding Shade No. 3 and 5
- Standards: EN172



**uvex**

## uvex i-vo welding

**Model No.: 9160.041 Shade 1.7**

**Model No.: 9160.043 Shade 3**

**Model No.: 9160.045 Shade 5**

- Fashionable safety spectacles with adjustable side arms
- New filter technology combines UV and IR radiation protection
- Minimum damage from welding sparks
- Reliable protection provided by customised fit: multi-level side arm inclination and different side arm lengths allow the wearer to adjust the spectacles to suit their facial shape
- The shape of the lenses offers unrestricted peripheral vision
- Standards: DIN EN 166



# Eye & Face Protection

## Univet Prescription Safety Spectacle

All Univet prescription glasses are tailor-made. Starting from the needs and preferences of each user the production department creates a specific product with all the assurance of "Made in Italy". On all Univet frames can be mounted monofocal, bifocal and progressive lenses made of polycarbonate or CR39. These products are recognised as II Category PPE and certified according to EN166 standard.



 **UNIVET**  
OPTICAL TECHNOLOGIES



**uvex**

## uvex prescription safety spectacle

**Model No.: 6109.217**

- Plastic frame with a sporty wraparound design
- Anatomically shaped soft nose pads
- Protective functions integrated in the frame design
- Sporty temple arms with a combination of soft and hard components ensure increased comfort and a pressure-free fit
- Curved anatomic lenses



**uvex**

## uvex eyewear cord

**Model No.: 9959.002**

uvex eyewear cords for all uvex spectacles



**uvex**

## uvex eyewear cleaning station

**Model No.: 9970.005**

Contains:

9971000: Cleaning tissues (2x approx. 700 sheets)

9972100: uvex cleaning fluid (0.5 l)

9973100: Plastic pump



## Bullard Face Shield Visor

**Model No.: Carrier 300B**

**Model No.: Visor 640**

- Stylish, sleek, cohesive look throughout the line
- Ergonomic design with easy-to-grip knobs
- Flexibility to accommodate all Bullard Hard Hats and the Bullard Bump Cap
- Band-mounted brackets that fit competitor models
- Visor retainer system that securely locks visor in place





# Eye & Face Protection



## Arc-Flash Helmet Class 2, Arc LIM 25Cal/cm<sup>2</sup>, White

**Model No.: TC403B**

Full face protection against thermal effect from an electric Arc: Class 2 / Box Test (7kA for 0,5 sec at 30cm), and ARC LIM 25Cal/cm<sup>2</sup>

Safety Helmet: EN 397, EN 50365 (Class 0), ANSI Z89.1 (Class E)

Face shield: EN 166, EN 170, ASTM F2178 (ATPV 36Cal/cm<sup>2</sup>), GS-ET-29 (Class 2)



## E-Shark Helmet with Face Shield

**Model No.: TC42ES**

**Helmet:** Polyethylene outer and inner shells

**Screen:**

- Polycarbonate material, thickness: 1.5 mm
- Optical quality class 1: Distortion free for permanent wear
- Protection against high speed particles
- Protection against liquid splashes
- Protection against electric arc from short circuit
- Anti-fog treated • Anti-scratching treated
- Marking: 2-1, 2 SFE 1 B 8-1-0-K 3

**Standards:**

- Helmet: EN397, EN50365 1000 V
- Screen: EN166-EN167-EN168-EN170, GS-ET-29



## Portwest BizWeld Plus Welding Helmet

**Model No.: PW65**

- Auto-darkening, switches from light to dark when the welding process starts
- Solar cell power with two built-in lithium back-up batteries and a working time of over 5000 hours
- Superior optical quality LCD filter
- Wheel ratchet size adjustment for easy fitting
- Suitable to be worn with disposable respirators
- Suitable for a wide range of applications
- CE certified



# HEARING PROTECTION





# Hearing Protection

## MARKINGS AND STANDARDS

The PPE Regulation (EU 2016/425 has a risk approach which defines harmful noise as a risk that may cause very serious hearing injuries. As a result, the regulation has recategorized hearing protection from category 2 RISK PPE (Intermediate) to Category 3 Risk (Complex)

### The Control of Noise at Work Regulations 2005

The Noise Regulation 2005 requires employers to prevent or reduce risks to health and safety from exposure to noise at work. It asks to take specific actions and defines action levels and limit values of exposure to noise:

	Daily / Weekly average exposure to noise	Peak Sound Pressure
Lower Exposure Action Values	80dB	135dB
Upper Exposure Action Values	85dB	137dB
Levels of Noise Exposure that must be exceeded	87dB	140dB

## DECIBEL SCALE (dBA)

### How To Protect Yourself?

4 Steps To Choose The Appropriate Hearing Protection

- Identify the nature of the noise: stable, fluctuating, intermittent or pulse
- Measure the noise at the working station: intensity (dB) and volume (Hz)
- Determine the exposure time
- Calculate the required attenuation needed. The attenuation level offered by the hearing protector should bring the noise to a level that is not harmful to health whilst avoiding over-protection which would isolate the worker. Hearing protectors that reduce the level at the ear to below 70 dB should be avoided

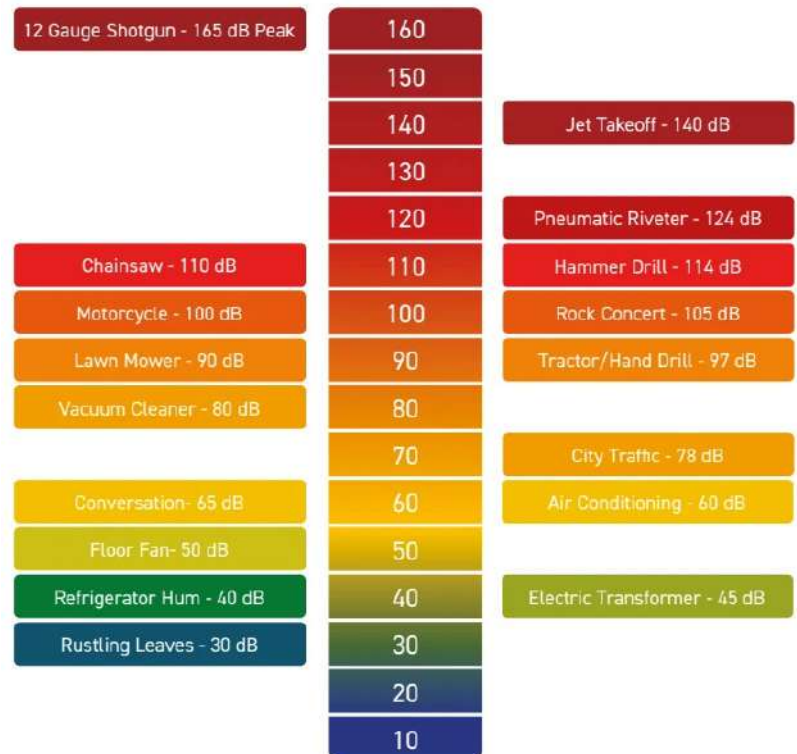



## Earsafe Earplugs

**Model No.: SP201-EPC (with cord)**

- PU Foam Bullet shape Earplugs
- Comfortable for wide range of ear sizes
- Bright fluorescent yellow for visibility
- Can be used with other personal protective equipment
- Standards: ANSI S3.19-1974 & EN 352-2:2002
- SNR 37dB | NRR 31dB | Class 5



## uvex whisper supreme

**Model No.: 2111.235 (in a hygiene box)**

- Reusable earplugs with high sound absorption
- Long ridges for high noise insulation
- Soft, smaller earplug stem ensures optimum wearer comfort
- Storage in earplug box
- Signal recognition: W
- Standards: EN 352-2
- SNR 30dB



## Earsafe Helmet Mounted Earmuff

**Model No.: SP-202-EM**

- Dielectric (no metal parts)
- Comfortable Style
- Helmet mouted Earmuff
- Bright fluorescent yellow for visibility
- Materials: ABS
- Standards: ANSI S3.19-1974 & EN 352-3:2002
- SNR 30dB | NRR 25dB | Class 5



# Hearing Protection



**PORTWEST**

## Portwest HV Extreme Ear Defenders High

**Model No: PS43**

- Excellent attenuation rate
- Padded headband for comfort
- Reflective trim for increased visibility and safety
- Adjustable dual pin system provides multiple positioning for better fit
- Contrast colouring for added style
- **Standards:**
  - EN 352-1:2002 SNR 36dB
  - ANSI S3.19 NRR 30dB



**PORTWEST**

## Portwest Ear Defenders

**Model No: PW73**

- Colour coded cups for easy identification
- Padded headband for comfort
- Reflective trim for increased visibility and safety
- Adjustable dual pin system provides multiple positioning for better fit
- **Standards:** EN 352-1 SNR 28DB

# RESPIRATORY PROTECTION





# Respiratory Protection



## Newlison foldable mask with Valve

**Model No.: 1105V**

- Ultra-wide knitted headband, good elasticity, suitable for long-term wear
- One-way exhalation valve, low resistance when wearing
- The filter efficiency is as high as 95 or more, Composite FFP2 NR D test requirements
- Standards: EN149:2001+A1:2009



## Newlison foldable mask without Valve

**Model No.: 1206**

- The product comes standard with an ear buckle, which can be worn on the head and in the ear
- 5 layers of material, the filter efficiency is as high as 95 or more, Composite FFP2 NR test requirements
- The built-in bridge of the nose is not easy to deform
- Standards: EN149:2001+A1:2009



## Venus N95 Dust Mask

**Model No.: CN95+**

Venus CN95+ (N95) NIOSH approved convex style disposable respirator, Stapled rubber headbands. Protection against solid dust and non oil based liquid mist.





## uvex silv-Air 7320 FFP3 preformed mask

**Model No.: 8707.320**

Particle-filtering cup shape mask with exhalation valve - protection level FFP3

- Soft material edges for increased comfort
- Soft sealing lip guarantees a secure, comfortable sealed position of the mask
- Integrated, flexible, adjustable nose clip
- 4-point headband attachment allows an individual and secure fit
- Exhalation valve reduces breathing resistance and build-up of heat moisture in the mask
- Activated carbon filter for odours, gases and vapors below limit value
- Mask fulfils the requirements of reusability (R) and the dolomite dust test (D)
- Packing: 5 pieces/box
- Standards: DIN EN 149:2001 + A1:2009



**uvex**



RESPIRATORY  
PROTECTION  
PRODUCTS

## BLS Half Face Mask

**Model No.: 4000R**

BLS 4000R half mask respirators with twin bayonet filter connection have an ease of maintenance and are available with ready to use premounted kits with filters.

- Standards: EN 140:1998 + AC:1998



# Respiratory Protection

## BLS Half Respiratory Mask with RD 40 filter connection

**Model No.: SGE46**

The BLS SGE 46 half mask can be used with filters from the BLS 400 series. These are antigas, antiparticle and combined filters with a standard threaded connection for protection against organic gases and vapours as well as harmful dusts, smoke and aerosols. The filters are screwed directly onto the threaded connection of the mask.

### Fields of Application

- Chemical and pharmaceutical processes
- Shipbuilding
- Aviation
- Automotive Industry
- Agriculture
- Standards:

Meets the requirements of standard EN 140:1998

CE Marked

BLS Management System is ISO 9001:2008 Certified



## BLS Full Face Mask

**Model No.: 5600**

- Face seal available in soft thermoplastic rubber or silicone rubber
- Antifog System designed to avoid fogging on the visor through the control of the cold & hot air flows inside the mask instead of using surface treatments
- Standards: EN 136:2000







RESPIRATORY  
PROTECTION  
PRODUCTS

## BLS Gas & Vapor Cartridges

BLS211 A2	Organic Gases & Vapours
BLS213 ABE1	Organic/Inorganic/Acid Gases & Vapours
BLS244 K2	Ammonia & Derivatives
BLS214 ABEK1	Organic/Inorganic/Acid/Gases & Vapours + Ammonia
BLS201-3	Particulate Filters

## DPI Poliblitz ABEK Emergency Escape

**Model No.: 43390230**

Multipurpose gas filter type A-B-E-K allows protection against organic and inorganic vapours (including chlorine, cyanidric acid, and hydrogen sulphide), sulphur dioxide, ammonia and derived substances. Lasts at least 15 minutes as per according to the DIN 58647-7.

Carrying case is impact resistant and perfectly sealed by adhesive strap with a belt carrying clip in steel. Instructions for use and pictogram are printed on the box.

**Standards: EN 140:1989 & EN 141:1990**



## Bullard Clean Air Boxes (CAB)

**Model No.: CAB50**

The Bullard Clean Air Box is supplied with up to 8 quick-disconnect fittings. The actual number of respirators that may be connected to the CAB is dependent on the inlet pressure to the Bullard air filtration system and the air flow and pressure requirements of the respirator being worn. Air supply pressure ranges and approved hose lengths for a respirator can be found in the manufacturer's User Instructions for the respirator.





# Respiratory Protection

## GVS Elipse® P3 Respirator with Filters

**Model No.: SPR299 (S/M) & SPR501 (M/L) Mask with P3 Filter**

**Model No.: SPR337 (S/M) & SPR502 (M/L) Mask with P3 Nuisance Odour Filter**

Compact, lightweight and flexible design which adapts and fits perfectly to the face and offers a full range of vision without interfering with other eye or ear protection which users are required to wear. Elipse come in two sizes: S/M and M/L.

### Storage Life

- Elipse P3 R D: & Elipse P3 Nuisance Odour R D: 5 year

### Applications

- Welding and Grinding (Metal fumes and Dust)
- Construction (Silica Dust, Abestos, Concrete Dust, Stone Dust, Aggregate Dust, Wood Dust, Cement Dust, Mold)
- Manufacturing (Glass Fibres, Composite Fibres, Lead Fumes)
- Pharmaceutical (Powders, Viruses)

### Certifications

- Mask conforms to EN 140:1998
- Filters conform to EN 143:2000+A1:2006
- Masks and filters are CE certified



**SPR316 (P3)**



**SPR336 (P3 Nuisance Odour)**





## GVS Eclipse® Integra Combined Eye & Respiratory Protection

**Model No.: SPR407 (S/M) & SPR406 (M/L) Mask with P3 Filter**

**Model No.: SPR404 (S/M) & SPR405 (M/L) Mask with P3 Nuisance Odour Filter**

Compact, lightweight and flexible design which adapts and fits perfectly to the face and offers a unique and innovative combined protection, reducing risks of non-compatibility, non-conformity and mist build-up. Eclipse® Integra come in 2 sizes S/M and M/L.

### Storage Life

- 3 years, for mask & filters for gases
- 5 years, for mask & filters for particulates
- 3 years, for mask & filters for particulates with nuisance odour

### Applications

- A organic gases & vapours with a boiling point above 65°C
- B inorganic gases & vapours (excluding carbon monoxide)
- E sulphur dioxide and other acidic gases and vapours
- K ammonia and organic ammonia derivatives
- AX certain organic gases and vapours with a boiling point  $\leq 65$  °C. For single use only

### Certifications

- Integra Mask (Goggle combined) conforms to EN 140:1998
- Integra Mask (Goggle combined) conforms to EN 166:2002
- Particulate filters conform to EN 143:2000+A1:2006
- Gas and combined gas & particulate filters conform to EN 14387:2004+A1:2008
- Integra Masks and filters are CE certified



**SPR316 (P3)**



**SPR336 (P3 Nuisance Odour)**





# Respiratory Protection

## IEVAC Smoke Fire Hood

### Model No.: EBP-900 (Hood)

The iEvac® Protects against:

- **Carbon Monoxide**
- **Hydrogen Sulfide**
- **Additional Toxic Gases:**  
Sarin, smoke, hydrogen cyanide, chlorine, ammonia, sulfur dioxide, tear gas, OC and more.
- **Harmful Particulates:**  
Soot, fumes, aerosols and others
- Contains a HEPA P100 filter that removes sub-micron particles such as ebola, anthrax, ricin, smallpox and radioactive particles.
- **Life-Threatening Physical Hazards:**  
Flammability and radiant heat

The first and only hood Certified to the American National Standard for Smoke Escape Devices

- Maintenance-free
- Latex-free
- At 9.5 in. (240mm) can withstand up to 1700°F (927°C) in radiant heat
- Twin filters for easier breathing
- Improved field of view compared with single filter in front
- Hood is a clear material resulting in an unobstructed field of view
- High visibility reflective strips for easy recognition
- Highest level of protection maintained by silicone neck dam
- Protects lungs, head, eyes and face
- Can be used with eyeglasses, beards and long hair
- Packaged in puncture and water-proof laminate barrier
- Quick and easy donning
- One universal size
- **Tested & Certified to ASTM E2952**



**iEvac®**



## Powered Air Purifying Respirators (PAPRs)

### Respiratory Protection Reimagined

The RPB PX5 changes the way people experience clean filtered air across multiple industries – from medical and chemical settings, through to the profoundly harsh environments of foundries. Weighing just 1.16 Kg with the HEPA cartridge/filter fitted, and between 1.65 Kg and 1.7 Kg with a gas cartridge/filter fitted, the PX5 allows you to get more out of your day by reducing the effects of fatigue.



## PX5 PAPR Industrial Starter Pack

### Model No.: 03-801-FR-EUU

- PX5® PAPR blower
- Rechargeable battery and charging bank (EU and UK plug)
- Flame Retardant Belt
- Flow Tester
- 1 x HEPA (P3) filter
- 1 x spark arrestor
- 1 x pack of pre-filters (10pcs)



### Pre-filter (pk 10)

Model No.: 03-890



### Spark Arrestor

Model No.: 03-891



### HEPA P3/Filter

Model No.: 03-892-P



### Complete Charger Kit

Model No.: 03-851-DC-EUUK



### Combination HEPA A2P3 Gas Filter

Model No.: 03-893-A2

### Combination HEPA ABEKP3 Gas Filter

Model No.: 03-895-ABEK





# Respiratory Protection

**Easy Clean Backpack Assembly**  
Model No.: 03-822-DC



**Flame Retardant Back**  
Model No.: 03-822-FR



**Short Breathing Tube for Backpack Assembly**    **Battery**  
Model No.: 03-855  
Model No.: 04-841



## Z4 Respirator Weld / Grind Starter Pack

Model No.: 17-110-12-CE

- 1.1.1 ADF lens
- Flame Retardant face seal
- Slim-line ear muffs
- PX5® Breathing tube
- PX5® PAPR blower
- Rechargeable battery & charging bank (EU and UK plug)
- Flame Retardant belt
- 1 x HEPA (P3) filter
- 1 x spark arrestor
- 1 x pack of pre-filters (10pcs)



## T-Link Respirator, Bump Cap

Model No.: 17-110-12-CE

- Bump Cap
- Tychem® 2000 Hood
- PX5® Breathing Tube



## Z-Link Respirator - Zytec® FR Shoulder Cape

Model No.: 16-010-21-CE

- Safety Lens
- Zytec FR Shoulder Cape
- PX5 Breathing Tube



## Z-Link Radiant Heat Respirator

Model No.: 16-010-24-CE

- Safety Lens
- Aluminized shoulder cape, top rear & breathing tube cover
- PX5 breathing tube



## Z-Link Respirator - Zytec® FR Chin Seal

Model No.: 16-010-31-CE

- Safety Lens
- Chin Seal Zytec FR
- PX5 Breathing Tube





## Interspiro Spiroscape EEBD



Spiroscape is a very simple unit to use. Once donned, the user is able to focus on escape. This is made possible with the unique ambient air valve which automatically opens when the cylinder is depleted. The automatic ambient air valve eliminates the risk of suffocation inside the hood and eliminates the need to waste breathing air on a low air warning alarm. The patented air distribution system expels Carbon Dioxide from the hood, thus optimizing air usage from the cylinder. The air flow is activated by pulling the quick start strap, which simultaneously opens the zipper on the carrying bag and gives the user access to the hood. The CE approved unit has a 200-bar, 3 L steel cylinder rated for 15 minutes' escape time.

## Interspiro Spiromatic 90U



The Spiromatic 90U is a robust breathing apparatus for firefighting, excellent also for industrial and maritime environments. The configurations are CE approved according to European product Standards and approved according to the Marine Equipment Directive ("ship wheel mark").

Spiromatic 90U is built upon the proven and reliable S-facemask and breathing valve and the plug-in regulator system, delivering Interspiro performance at a competitive price. The harness is equipped with padded shoulder straps and easy-to-adjust waist belt buckle

- Open back plate for good ventilation and low weight
- Easy to handle and adjustable cylinder strap
- Small and light warning whistle placed on chest
- Carrying handle integrated in backplate
- Well-proven and robust pneumatics
- Mask and breathing valve in a compact design



# Respiratory Protection



## Interspiro Spiroguide II

A close cooperation with firefighters and experts in the field of ergonomics has been a defining feature when developing the Spiroguide II harness. The ergonomic design of all the components and the many integrated smart features make the harness highly versatile. Each component is carefully selected to ensure that the harness is robust enough to handle the extreme environment for which it is intended.

The Spiroguide II has an ergonomic and easy-to-read display with powerful backlight and two big buttons. It is designed and built to work, whatever the conditions.

The digital display can be configured to show one or more of these screens:

- Cylinder pressure in bar
- Cylinder pressure symbol
- Remaining air time based on actual breathing rate
- Absorbed temperature



## Air Quality Monitoring System

Airtrack™ is a unique product designed to test the air quality of compressed air in line with breathing air requirements.

The Airtrack™ works in real time constantly monitoring air quality, and contains a built in alarm and separate audible alarm output which can be used to integrate with a remote alarm or compressor shut down system. A test function allows the unit to perform an average over 5 minutes and built in logging facility records data from each channel which can be downloaded.

Model No.	20030	20031	20030
	Portable	Fixed	Lite





## Airstar Lite & Pro

Premium airline breathing apparatus combining improved user comfort and versatility with enhanced ease of maintenance. Offering unique versatility of wearing styles for different working environments, the Airstar™ is supplied in either a Lite or Pro version. The Lite consists of a belt which the cylinder and apparatus are mounted on, and the Pro consists of an approved full body harness, with front and rear attachment points, which can be used for fall protection, and also provides the option of wearing the cylinder on either leg mounted or back mounted position - this can be switched in seconds utilizing the unique Quickmount™ buckles.

- Harness / Belt Material: Polyester webbing, padded belt
- Cylinder durations: 2L 200bar (10min) or 300bar (13min) composite, locking handwheel
- Standards: EN 14593-1, EN 402, EN 136



## Micro Breathing Air Trailer

Maximum manoeuvrability and convenience for shorter duration breathing air tasks. Designed to make small works requiring breathing air simple the Micro Trailer delivers up to 9.7 hours of air, with a 1 hour emergency air supply. Trailer construction is designed for harsh industrial environments, comprising galvanised steel frame, powder coated stainless steel panels, stainless steel fittings and pipework. 2 hose reels accommodate 50m airlines fed to the user by a roller guide and a further 2 airlines can be connected to the main control panel. Being lightweight and well balanced 1 user can easily manoeuvre the trailer, and its narrow width means it is ideal for accessing congested areas of a plant.



# Respiratory Protection



## BAC 1000 Series Compressor

A trailer mounted compressor providing continuous, reliable and quality breathing air for long duration works that require breathing air. Based on a diesel engine with direct drive to the compressor, all units are automatically fitted with a chalywn valve and spark arrestor as standard, for automatic shutdown and explosion protection. Constructed to meet the requirements of EN14593/ EN14594 for Airline Breathing Apparatus, units will produce high purity air to the EN12021 standard.

In addition to the compressed air, a high pressure 200 bar cylinder bank provides a secondary air supply which automatically operates in the event of the main supply failing. If the main supply should fail, there is an alarm which simultaneously activates giving an audible and visual warning.

Unique to these compressors is the control panel, which can be removed from the trailer and positioned remotely to at the point of entry to the work zone, and provides means of entry control for the users. All units are supplied Airtrack ready, so that they can easily integrate continuous air quality monitoring.

With Airtrack integrated, the compressor will shut down and automatically activate emergency air if there is any compromise to the air quality. The compressor will provide consistent breathing air to up to 4 users of positive pressure breathing apparatus and supply an appropriate number of constant flow respirators or air supplied suits, providing they fit within its design flow requirements.



Food grade compressor oil removes concerns of contamination to BA



Raised Air intake draws air in away from exhaust fume and other potential contamination



Control panel



Direct drive compressor gives class leading reliability



Airtrack ready - allowing for easy integration of live air quality monitoring, shutting down the compressor if air quality is compromised



Filtration and Drying system ensures continuous quality breathing air



Connection for external emergency air where required



## ATS 1 Trolley System

Robust, simple trolley system for extended duration breathing air tasks where space is at a premium.

High pressure air is fed to a regulator which reduces the pressure to under 10 bar, where it is fed to a hose reel holding 50 metres of hose. A Y-Piece and 2 x 15 M hoses can then be connected which will supply the 2 user's breathing apparatus.

- Material: Main trolley - powder coated steel.  
Hose reels band and control panel - SS
- Working Duration:
  - 2 x 9L cylinders - 1.8 hours
  - 2 x 20L cylinders - 4.5 hour
- Cylinder Capacity: 2 x 9L 300 Bar
- Standards: EN 14593



## ATS 2 Trolley System

Large portable trolley system with integrated handling aids for extended duration breathing apparatus tasks.

High pressure air is fed to a regulator which reduces the pressure to under 10 bar, where it is fed to 2 hose reels which will each hold 50 metres of hose for each user. The user's breathing apparatus is connected to the end of the airline. The control panel can be supplied optionally with a whistle for audible warning of depleted cylinders, which will activate at 35 bar.

- Material: Main trolley - powder coated steel.  
Hose reels band and control panel - SS
- Working Duration: 2 x 50L cylinders - 11 hours
- Cylinder Capacity: 2 x 50L
- Standards: EN 14593



# Respiratory Protection

## Sibata Mask Tester Pro

**Model No.: MT-05U**



- With a single detector (particle counter), MT-05U measures the number of particles in the room (outside the mask) and inside the mask alternately to quantify how tightly the mask fits the face. As a result, errors due to differences in detector characteristics are reduced
- There are four modes: Daily Check mode, Fit Test mode, Fit Check mode and Training mode, that enable a user to use according to the application
- Measurements can be made using a test guide (non-destructive mask test) or a tube joint set (open a mask hole)
- Automatic recording function for measurement results (Daily Check mode, Fit Test mode, and Fit Check mode)
- MT-05U communicates with PC using a USB cable
- Leakage rate can be measured while the fitting of the mask is checked by using attached mirror
- **Standards: CE, FDA, Code 95R-EN and not explosion proof**

Intended Measurement	Mask-to-face fit evaluation
Measurement items	± (3%+0.2)
Principle of Measurement	Particle count concentration measurement by laser beam scattering (determination of dust particle count ratio between indoor air and in-mask air)
Measurement Ranges	Counting range: 0 to 9999999 counts • Leakage percentage: 0 to 100% • Fit factor: 1 to 1000000
Suction Flow Rate	1 L/min
Built-in Functions	Leakage percentage and Fit factor calculation functions; heating tube temperature control function; dryer function; RS-232C output function; USB communication function; and logging function (up to 200 logs for each of Fit Check, Fit Test, and Daily Check)
Usage Environment	0 to 40°C, 30 to 90% RH (no condensation)
Power Supply	100 to 240 ±10% VAC, 50/60 Hz, approx. 0.5 A
Main Unit Dimensions	210 (W) x 240 (D) x 232 (H) mm (excluding protrusions)
Main Unit Mass	Approx. 3 kg
Accessories	One AC adapter (fitted with a plug; supplied with four spare plugs) Two pcs of Sampling tube (pair tube) 1.5 m • One USB cable (A-mini B) One strap clip • One high-performance zero check filter One Tube joint set type M 100 pairs/set • One Soft case One Tube joint attachment tool type M • Two suction port caps One external output connector cap • One USB connector cap One CD-ROM (Communication software, USB driver, Operation manuals) One Manufacturer's inspection and calibration certificate

# HAND PROTECTION





# Hand Protection



EN388:2016  
+A1:2018



4X43C



ISHIELDU

## ISU Cut-Shield

**Model No.: ISU4X42CT**

- Touchscreen compatible fingertips
- Polyurethane coated palm for great abrasion resistance
- Elasticated knitted wrist provides secure & comfortable fit
- Seamless liner offers increased comfort & breathability

### Ideal Applications

- Glass Handling
- Automatic Manufacturing
- Construction
- Sharp Materials Handling
- Component Handling



EN388:2016  
+A1:2018



4131A



ISHIELDU

## ISU Air-Shield

**Model No.: ISU4131AS**

- Breathable back of hand to reduce perspiration
- Polyurethane coating offers excellent grip & extra durability
- Perfect for handling small components & carrying out precision works

### Ideal Applications

- Loading and unloading Items
- Accessories & spare parts Items
- Maintenance works
- Equipment Handling
- Precision Handling



EN388:2016



3111B

**Ansell**

## Ansell Oceanic®

**Model No.: 48-913**

Cost-effective hand protection for heavy handling  
The glove is the smart choice when you want an economical heavy-duty glove solution with quality features

### Ideal Applications

- Raw material extraction
- Masonry
- Public works
- Foundry die casting
- Primary assembly
- Warehouse work



EN388:2016



3111A

**Ansell**

## Ansell Hylite™

**Model No.: 47-400**

A versatile alternative to cotton, light leather and PVC gloves

- Special nitrile formulation provides an excellent combination of flexibility, mechanical resistance and oil repellency
- Natural hand shape - easier to wear for long periods
- Silicone-free. Ensures cleanliness of metal sheets: important in steel and motor industries

### Ideal Applications

- Handling metal sheets & panels
- Chassis assembly, body trimming
- Final assembly
- Inspection (picking, checking and marking)
- Cutting glasses, sheets, panels
- Fabricating metal parts, glass sheets
- Assembly & inspection of components



# Hand Protection

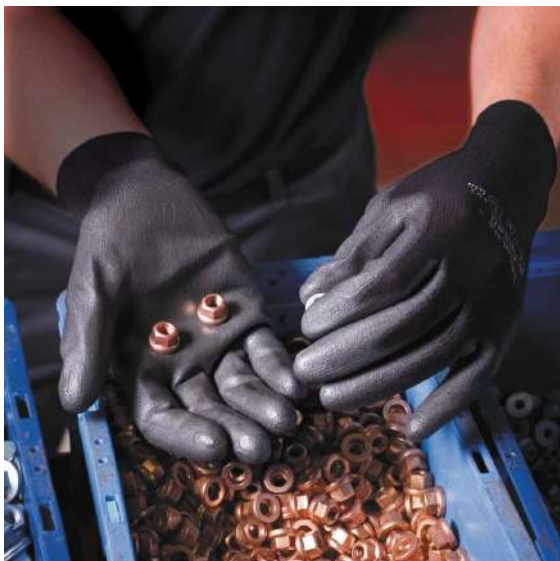

EN388:2016



4131A

**Ansell**

## Ansell Sensilite®

**Model No.: 48-101**

Black PU-coated multi-purpose gloves, designed for comfortable light-duty handling

- Ansell's SensiLite® range of industrial gloves are designed for light applications that require good levels of comfort and abrasion resistance
- Offering precise handling of small objects in dry or light oily environments
- SensiLite® provides enhanced safety, dexterity and durability compared to other glove options often used in the same applications

### Ideal Application

- Assembly and disassembly of equipment
- Equipment repair & maintenance
- Chassis assembly, body trimming
- Loading and unloading rough parts or boxes



EN388:2016



3121X

**Ansell**

## Ansell HyFlex®

**Model No.: 11-618**

Ultra-thin polyurethane gloves, with superb tactility and dexterity, for delicate handling

- Ansell's thinnest glove for most delicate handling
- Light duty 18 gauge liner offers outstanding comfort and sensitivity
- Extra-thin 0.8mm polyurethane coating provides high dexterity with high abrasion resistance
- Dark liner and glove mask dirt and reduce glove waste

### Ideal Applications

- Light assembly requiring high degree of precision
- Picking and fitting small pieces
- Finishing works





EN388:2016



4X42C

**Ansell**

## Ansell HyFlex®

**Model No.: 11-561**

The thinnest, lightest EN ISO C/ANSI A3-level industrial gloves, offering 100% greater durability

- Hyflex® 11-561 industrial safety gloves are 100% more durable than nearest competitors, with FORTIX™ Abrasion Resistance Technology
- The 11-561's palm-dipped coating improves grip, while a reinforced thumb crotch defends against rapid wear
- HyFlex® 11-561 industrial working gloves are also light and thin, making them flexible, yet protective

### Ideal Applications

- Handling metal sheets & panels
- Handling parts with sharp, rough edges
- Handling materials with sharp or rough edges
- Assembly & inspection of components
- Applying finish to materials, products



EN388:2016



4X42B

**Ansell**

## Ansell HyFlex®

**Model No.: 11-939**

Ultralight, palm-coated cut-resistant and oil-repellent work gloves

- HyFlex® 11-939 PPE gloves' ultralight 18-gauge design and ERGOFORM™ Technology deliver superb dexterity
- FORTIX™ Abrasion Resistance foam coating makes these HyFlex® gloves 12x more abrasion-resistant
- ANSELL GRIP™ coating treatment reduces the force needed to maintain grip, preventing workplace injuries

### Ideal Applications

- Assembly & inspection of components
- Oil, fluids and filter change
- Adjusting parts, systems
- Equipment repair & maintenance



# Hand Protection



EN388:2016



4342B

**Ansell**

## Ansell HyFlex®

**Model No.: 11-727**

Ultralight abrasion-resistant gloves that offer barehanded comfort, dexterity and protection

- The Ansell HyFlex® 11-727's light, barehanded feel, tailored fit and breathable fabric make for consistently comfortable PPE gloves
- HyFlex® 11-727 safety gloves also benefit from secure grip, for handling dry or slightly oily components

### Ideal Applications

- Handling metal sheets & panels
- Handling parts with sharp, rough edges
- Handling materials with sharp or rough edges
- Maintenance



EN388:2016



4131A

**Ansell**

## Ansell HyFlex®

**Model No.: 11-840**

Durable industrial gloves, offering 2x more grip and up to 20% greater abrasion protection

- Ansell FORTIX™ Abrasion Resistance Technology
  - Provides longer continuous wear times in abrasive environments
  - 20% more breathable vs standard safety gloves for cooler, drier hands
- Form-fitting liner offers a secure and comfortable fit to optimize worker performance

### Ideal Applications

- Assembly of small and medium parts
- Feeding the lines
- Screwing and unscrewing
- General handling
- Raw materials reception



## Ansell

EN388:2016



4121A



## Ansell Edge®

**Model No.: 48-126**

A good level of abrasion resistance & grip, as well as high tactility in dry to slightly oily environments

- Good level of abrasion and tear resistance, good grip, improved productivity
- Black glove shows dirt less, gloves are discarded less quickly
- Seamless structure; ensures comfort and encourages safety and glove usage

### Ideal Applications

- Assembly of small parts
- General handling
- Quality control
- Packaging

## Ansell HyFlex®

**Model No.: 11-800**

Improved design delivers up to 30% more breathability

- More durability vs the original design
- Benefits from proprietary washing process that efficiently extracts impurities to deliver a cleaner, more comfortable glove
- The improved coating offers improved grip in dry and slightly oily environments along with an extended durability compared to its previous formulation

### Ideal Applications

- Picking, fastening components
- Adjusting systems and screwing
- Fastening components, parts
- Loading and unloading trucks and vehicles
- Loading trucks & vehicles
- Product shipping, transport and delivery
- Lock smith



## Ansell

EN1149 EN388:2016



3131A



# Hand Protection



EN1149 EN388:2016



3131A

**Ansell**

## Ansell Hyflex®

**Model No.: 11-920**

**High performance grip and oil repellence**

- Multi-layer coating provides high abrasion resistance and increases wear life
- Ergonomic, natural fit along with superior dry and oil grip for high productivity
- Durable material is machine launderable for extended life and reduced replacement costs

### Ideal Applications

- Assembly & inspection of components
- Production line support & maintenance
- Seizing structural parts
- Fabricating metal parts, glass sheets
- Applying finish to materials, products



**Ansell**

EN1149 EN388:2016



3131A

## Ansell HyFlex®

**Model No.: 11-801**

**Industrial safety gloves with 30% greater breathability and a dirt-masking dark liner**

- A highly versatile solution for precision assembly and general handling, it provides the perfect balance between comfort, dexterity and protection
- Advanced Knitting Technology allows increased stretch and flexibility in high-stress areas: the hand operates more freely, improving comfort and reducing hand fatigue

### Ideal Applications

- Picking, fastening components
- Adjusting systems and screwing
- Fastening components, parts
- Loading and unloading trucks and vehicles
- Loading trucks & vehicles
- Product shipping, transport and delivery
- Lock smith



EN388:2016



4X21B

**Ansell**

## Ansell HyFlex®

**Model No.: 11-550**

Versatile abrasion-resistant gloves, designed with nitrile coating for enhanced grip

- Increased durability
- Enhanced grip
- Heightened defenses
- Specialized protection
- Elevated comfort
- Considered aesthetics

### Ideal Applications

- General maintenance
- Maintenance inspection
- Handling of glass sheets, sharp edged objects
- Plastic injections
- Molding



EN388:2016



4X42C

**Ansell**

## Ansell HyFlex®

**Model No.: 11-738**

Highly durable cut-resistant gloves, with strong blended fibers and reinforced thumb crotch

- Unique combination of INTERCEPT Technology® yarn, Nylon, Lycra® and glass fiber
- Ultra strong fibers provide extreme resistance against cuts and burrs
- Reinforced thumb crotch for increased protection & extended use life

### Ideal Applications

- Handling of sharp-edged objects, pre-assembling, cutting of small dry or lightly oiled parts and maintenance
- Handling of glass sheets, sharp edged objects
- Handling of metal sheets, cutting of dry, painted or galvanised pieces



# Hand Protection



EN388:2016



4X43C

**Ansell**

## Ansell Edge®

**Model No.: 48-706**

Cost effective solution for medium weight applications requiring high level of cut performance in dry or slightly oily environments

- High durability Nitrile foam coating
- Excellent comfort and dexterity
- High level of cut performance EN ISO level C cut performance
- Excellent abrasion resistance
- In compliance with the standards
- Breathable liner that allow very high level of comfort for end users
- Good level of grip in dry and slightly oily environments

### Ideal Applications

- General Maintenance • Hardware assembly
- Machining / Stamping / Cutting
- Raw material handling

## Safety Plus World High Quality Leather

**Model No.: SP600HP**

'A' Grade Split High Quality Leather Gloves

- 8 Oz. Cotton drill backing
- Leather knuckle strap for extra protection
- Rubberized Safety Cuff Protects wrists
- Handling: The Gloves should be thoroughly checked before use to ensure there is no damage
- CE Certified 4.2.3.3.X
- EN388:2016 + A1:2018 & EN ISO 21420:2020
- Color: Yellow/Grey

### Ideal Applications

- Mechanical Works • Assembling • Rigging
- Inspection • Construction
- Pipe Fitting • Iron & Steel Works
- Other General Purpose Works



**K-COMPANY  
APPROVED**





EN388:2016



4342B

**Ansell**

## Ansell Edge®

**Model No.: 48-701**

Cost effective solution for medium weight applications requiring cut and abrasion resistance in dry environment

- Good dexterity and flexibility
- High cut protection and abrasion level
- Good grip in dry environments
- Palm dipping for good protection against oil compared to a knitted or cut and sew glove

### Ideal Applications

- Aeronautics
- Assembly line
- Assembling metal parts and components
- Handling sharp or irregular metal pieces



EN388:2016



4X43C

**Ansell**

## Ansell HyFlex®

**Model No.: 11-425**

Whatever industry, the HyFlex indicator system helps the wearer to select the right protection for the job

- Water-based process is environmentally friendly, and has an innovative coating
- Silicone-free and DMF-free
- Excellent abrasion resistance
- 11-425 is a seamless knitted glove, made with INTERCEPT technology

### Ideal Applications

- Applying sealers, touching up
- Handling metal sheets & panels
- Handling parts with sharp, rough edges
- Loading and unloading trucks and vehicles
- Opening furnaces draining pumps valves or lines and crackers BTX process
- Product shipping, transport and delivery
- Production line support & maintenance



# Hand Protection



## Insulating Latex Gloves

### Model No.: GLB

- Insulation of hands by class and according to the nominal supply voltage
- Must be used with a pair of leather overgloves for a mechanical protection
- **Standards:**  
EN 60903: 2003 / IEC 60903: 2002 PPE  
Category III = Irreversible risks

Model No.	Class	Max operating voltage	Sizes
GLB00-36	00	500V AC	7 to 12
GLB0-36	0	1000V AC	7 to 12
GLB1-36	1	7500V AC	7 to 12
GLB2-36	2	17000V AC	8 to 12
GLB2-36	3	26500V AC	8 to 12
GLB4-41	4	36000V AC	8 to 12



## Pneumatic Insulating Glove Tester

### Model No.: TV10

This pneumatic tester enables you to check that insulating gloves are intact before using them.

Moulded plastic body with:

- Tapered end piece with two grooves where the glove to be tested is fitted
- Central piston at the base of the device
- Flexible valve situated at the bottom of the upper chamber
- Two elastic bands to hold the glove in place while it is inflated





EN388:2016 EN407  
4133B 413X4X

**Ansell**



## Ansell Edge®

**Model No.: 48-216**

High levels of durability, control and protection from heat, flame, sparks and puncture

- Edge® Glove is CE certified and complying with REACH European regulation
- Glove total length of 36 cm provide a full forearm protection
- Can be ideally combined with Ansell Welding Sleeve 59-416, made of Lenzing FR® and Kevlar®

### Ideal Applications

- Brazing
- Handling hot parts with spark
- Metal grinding
- Stick and MIG welding
- Torch cutting



EN388:2016 EN407  
3243B 413X4X

**Ansell**

## Ansell WorkGuard®

**Model No.: 43-216**

High levels of durability, control and protection from heat, flame, sparks and puncture

- ActivArmr WorkGuard 43-216 is a heavy-duty special purpose glove offering high levels of molten splash resistance. Ideal for many different applications requiring thermal protection, It also provides superior durability and good protection from cuts, heat, punctures and abrasions
- With a soft inner jersey palm lining and a cotton denim cuff, ActivArmr® WorkGuard™ 43-216 is comfortable to wear

### Ideal Applications

- Welding
- Loading & unloading with risk of heat or molten splash



# Hand Protection

**Ansell**

EN388:2016

EN407



2111A



41XX4X



## Ansell ActivArmr®

**Model No.: 43-217**

ActivArmr® 43-217 work gloves satisfy EN 12477 Type B standards, ensuring effective protection from heat, flames, sparks and weld spatter and making them ideal for welding and thermal applications, as well as grinding, brazing, metal fabrication and maintenance

### Ideal Applications

- Grinding
- Welding
- Brazing
- Metal Fabrication
- Maintenance
- Welding, bonding, riveting
- Equipment repair & maintenance
- Metal working & assembly operations



EN388:2016  
+A1:2018



4X44FP



## ISU Rig Shield Anti-Impact

**Model No.: ISU4544EP**

- Sandy Nitrile finish with extra padding for Excellent grip in wet, dry & oily condition
- Black TPR chips on back for super anti impact protection
- Velcro hook & loop closure at the wrist to provide a snug custom fit
- Reinforced thumb crotch for extended glove life, enhanced comfort, increased abrasion resistance
- High Visibility for increased safety
- Touchscreen compatible fingertips

### Ideal Applications

- Oil & Gas Industry
- Heavy Construction Work
- Handling Heavy Duty Tools



## Ansell Edge®

**Model No.: 48-205**

**Robust protection for demanding extraction jobs in oil, gas and mining industry**

- High-performance fibres used in the construction of the palm protect the hands from cut injuries
- Back of hand PVC bumpers significantly reduce the risk of crush, pinch and impact injuries
- Excellent grip performance is provided in both dry, wet and oily environments thanks to the unique material used on the palm
- Reinforcement patches in between the thumb crotch as well as the palm area improve the longevity of the most valuable areas
- The wide cuff with a pull strap allows easy donning and doffing

### Ideal Applications

- Drilling/Extraction
- Exploration
- Heavy-duty maintenance
- Production/Processing
- Roughneck & Roustabout tasks



EN388:2016



**Ansell**

4X44EP

## Ringers R-065

**Innovative impact and cut protection combined with superior dexterity for ultimate comfort in a variety of end uses.**

- Breathable knit shell with excellent dexterity for all working conditions
- Half-dipped nitrile in sandy finish for enhanced grip
- TPR impact protection on top of hand and full length of fingers and thumb
- Certified and rated for CE EN388 level 5 cut resistance and EN ISO13997 level C cut resistance
- Tested & rated for ANSI/ISEA 105-2016 level A3 cut resistance
- High visibility colors for increased safety awareness
- Touchscreen compatible



4X43DP





# Hand Protection



2121XP



## Ringers R-161

Impact protection with synthetic red leather padded palm and touchscreen compatibility for comfort and ease-of-use.

- Finger and top-of-hand protection
- Enhanced durability and improved grip
- Lesser glove removal, greater hand safety



4X44FP



## Ringers R-068

Fully coated safety gloves designed for impact, cut and liquid protection.

- For PPE gloves with strong impact protection
- Liquid resistance and hand protection
- Liquid resistance and hand protection



4X41CP



## Ringers R-074

PVC-coated short gauntlet-style impact gloves, offering waterproof chemical resistance.

- Top-of-hand and finger-length impact protection
- Waterproof chemical resistance against various hazards\*
- For 360° cut protection



## Ringers R-259B

Heavy duty impact technology combined with high cut resistance & a waterproof barrier to keep hands safe, warm & dry in the harshest environments.

- TPR impact protection on top of hand and full length of fingers
- Durable synthetic leather palm for enhanced grip
- Additional palm layer for enhanced cut resistance
- Waterproof barrier to keep hands dry
- Best in class construction provides a durable bond between layers, eliminating glove separation when doffing
- Liquid resistant coating on top of hand
- Extended neoprene wrist closure with TPR pull tab
- Kevlar™ stitched palm
- High visibility and reflective cuff piping for increased safety



4X44FP



## Ansell Vibraguard®

Model No.: 07-112

Minimize the risks and effects of harsh vibrations on the job

- Gelfôm padding reduces vibration while nitrile coating provides snag, puncture and abrasion resistance
- Matches the contours of the hand, enhancing flexibility and reducing hand fatigue
- Silicone-free and launderable

### Ideal Applications

- Carpentry, drywall, roofing
- Operating chain saws and grinders
- Forestry, logging and lumber operations
- Grinding, sanding and polishing tool operation
- Handling tools, air guns and small parts
- Operating machinery and equipment



EN388  
3221B

**Ansell**



# Hand Protection



4243BP



## Ringers R-267

Heavy-duty, oil-resistant impact gloves with a Silicone Dot® palm for enhanced grip

- TPR impact protection on top of hand and full length of fingers
- High Visibility for Increased Safety
- CE Rated for EN388 Level 2 Cut and Puncture Resistance
- TefLoc Grip System on Palm & Fingers Resists Oil & Enhances Grip
- Kevlar Stitched Palm



4343CP



## Ringers R-297

Heavy-duty impact protection gloves, ensuring hand safety with added cut resistance

- TPR impact protection on top of hand and full length of fingers
- High visibility for increased safety
- CE rated for EN388 level 3 cut & puncture resistance
- ANSI/ISEA rated for level 2 cut resistance
- KevLoc grip system on palm & fingers enhances grip
- Kevlar stitched with padding on palm



4X41CP



## Ringers R-075

Waterproof PVC-coated long gauntlet-style impact gloves, for advanced chemical protection

- TPR impact protection on top of hand for maximum coverage
- Proprietary PVC coating for waterproof and chemical resistance
- Durable textured palm coating for enhanced grip
- CE rated for EN388 cut resistance level 5 and abrasion resistance level 4
- ANSI/ISEA rated for level 3 cut resistance
- CE rated for EN374: A (Methanol) J (n-Heptane) K (Sodium Hydroxide 40%) L (Sulfuric Acid 96%)
- ANSI/ISEA rated for level 3 cut resistance
- High visibility colors for increased safety



## Ringers R-299

Heavy duty impact technology combined with high cut resistance and the ultimate grip for harsh environments

- TPR impact protection on top of hand and full length of fingers
- High visibility colors for increased safety
- CE rated for EN388 level 5 cut and level 4 puncture resistance
- ANSI/ISEA rated for level 4 cut resistance
- KevLoc grip system on palm & fingers enhances grip
- Kevlar stitched palm



4X44FP



## Ringers R-259

Heavy-duty impact gloves with an additional palm layer, for advanced cut resistance

- TPR impact protection on top of hand and full length of fingers
- Durable synthetic leather palm for enhanced grip
- Additional palm layer for enhanced cut resistance
- Kevlar stitched palm
- High visibility for increased safety
- Extended neoprene wrist closure with TPR pull tab



4X44EP



## Kong High Abrasion Dexterity Gloves

Model No.: SDX2-HAD

- Patented "pinch protection" on the fingertips
- Patented maximum coverage impact protection on fingers, thumb, knuckles and metacarpal bones
- High dexterity and Abrasion, most comfortable impact glove
- IVE™ patent pending optical technology that extends the field of visual recognition



EN388:2016



4331BP





# Hand Protection



## Kong Deck Crew Gloves

**Model No.: KDC5**

- Armortex® High Abrasion Palm
- Cut Resistant Palm Liner Made with DuPont™ Kevlar®
- Teflon® Coated Nylon Back of Hand
- Patented KONG® Impact Protection
- Armortex® Reinforced Thumb Saddlen

EN388:2016



4X44EP



## Kong Original Impact Gloves

**Model No.: SDX2**

- Double Layer Synthetic Leather Dotted Palm
- Breathable Nylon Back of Hand
- Patented KONG® Impact Protection

EN388:2016



4242AP



## Kong Knit Cut A5 Impact Gloves

**Model No.: KKCA5**

- Sandy Nitrile Coated Palm
- 13 Gauge HPPE Blended Knit
- Patented IVE™ Full TPR
- Duraclad® Reinforced Thumb Saddle

EN388:2016



4X43EP







EN388  
133XC



EN407  
X1XXXX

**Ansell**

## Ansell Gold Knit Kevlar® Sleeve

**Model No.: 70-118**

Superior mechanical protection and cut-resistance

- Range of sleeves providing protection to the arms from cuts and heat
- 100% knitted Kevlar® sleeve
- Offers high cut-resistant to weight ratio
- Comfort and sure grip. Constructed from high-tech 100% Kevlar® para-aramid short fibers
- Approved to BS EN 388:1994 and EN 407:2004



EN388:2016



1X42C

**Ansell**

## Ansell HyFlex®

**Model No.: 11-200**

High-visibility protective arm sleeves, with an adjustable forearm for peerless comfort

- HyFlex® 11-200 protective sleeves' ergonomic design and ample, adjustable sleeve space make for sweat- and itch-free everyday wear
- Their high-visibility fabric makes these arm protection sleeves particularly safe in varying work environments

**Ideal Applications**

- Handling structural and body components
- Inspection, selecting, checking parts
- Body panel repair and replacement



## Chainex

**Model No.: 582-A515MD**

- Works when using knives or cutting and/or punching tools
- Gloves made of SS chainmail with textile straps
- Protected area: Hand
- Fastening by textile strap with press-button and adjustable buckle
- Available Sizes: Medium, Large & X-Large



# Hand Protection



EN374



EN388  
4101A



EN374  
JKLOPT

**Ansell**

## Ansell AlphaTec®

**Model No.: 58-335**

Less sweat equals greater comfort and performance

- New, proprietary AQUADRI® technology delivers the properties of a sponge with an unrivalled moisture absorption capacity: on average 10 times more than traditional cotton flocked linings

### Ideal Applications

- Changing oil, fixing pumps
- Chemicals mixing/handling/transferring/pouring/blending
- Cleaning
- Opening, draining pumps/valves
- Painting, applying sealants
- Sampling/Testing



EN374



EN388  
3122A



EN374  
JKL

**Ansell**

## Ansell Alphatec®

**Model No.: 58-535**

Unique combination of grip and chemical resistance

### Ideal Applications

- Chemical handling
- Printing industry
- Mining
- Aerospace
- Emergency services
- Maintenance
- Agrochemicals
- Refining - Oil & Petrol
- Chemical handling, especially caustics and solvents
- Handling objects coated in grease and oils
- Handling paints, inks, dyes, glues and adhesives



EN374 EN374 EN407 EN388:2016



JKLOPT



JKL



X1XXXX



4101X

**Ansell**

## Ansell Solvex®

**Model No.: 37-675**

The Ansell Solvex® nitrile glove is designed to deliver optimal results in wet or dry work environments where chemical resistance is crucial. Fully reusable, with an unequalled abrasion resistance, it provides superb comfort for the wearer

- Solvex nitrile gloves are the ideal choice for safe handling in a wide range of work environments where harsh chemicals are present

### Ideal Applications

- Chemical processing and preparation
- Refining - Oil & Petrol
- Agrochemicals
- Printing Industry



**Ansell**

## Ansell Solvex®

**Model No.: 37-695**

Comfortable chemical-resistant gloves, delivering highly durable personal protection

- Material: Nitrile • AQL is 0.65 (Cat. III)
- Resistant to solvents, oils, fats, acids and alcohols
- High resistance to snags and punctures
- 15"/38 cm long, Flocked, Reversed Lozenge, 0.425 mm thick
- Approved to EN388:4101A1, EN374 (Bio), EN374 (Chem AJL)

EN374-5:2016

Type A



AJKLPT



EN388:2016

4101A



EN374-5:2016



# Hand Protection



**Ansell**

EN388:2016



3121B



EN374  
AKLMNOPT



EN374  
AKL

## Ansell AlphaTec®

**Model No.: 08-354**

A good level of abrasion resistance & grip, as well as high tactility in dry to slightly oily environments

- 100% liquid proof
- Soft stretchy knit liner
- Excellent wet grip. Safer handling means increased productivity
- These Neoprene liquid-proof industrial gloves are extremely comfortable to wear

### Ideal Applications

- Transferring liquids and solids
- Supervision of running operation
- Cleaning furnaces, distillation pumps, valves or lines and crackers BTX process



EN388:2016



3122B



EN374  
AKLMPT



EN374  
AKL

**Ansell**

## Ansell AlphaTec®

**Model No.: 19-024**

Neoprene-dipped coating on a double insulating liner for improved resistance in hot conditions

- The glove combines the flexibility and chemical resistance of neoprene with the comfort and heat resistance of a soft thermal liner
- The glove is designed to protect the users in applications where thermal and chemical risks are present

### Ideal Applications

- Handling materials with sharp or rough edges
- Production line support & maintenance
- Charging and blending raw materials
- Unexpected leakages spills or other releases



EN ISO 374-2016

Type B



JKPT

EN ISO

374-5



**Ansell**

## Ansell Touch N Tuff®

**Model No.: 92-600**

Disposable Nitrile Glove with Enhanced Chemical Splash Protection

- Made of 100% nitrile
- Offers three times the puncture resistance of standard latex or vinyl gloves
- Combines excellent fingertip sensitivity with exceptional durability
- Gives a high level of protection against grease and oil
- Lightweight and comfortable to wear
- Touch N Tuff® gloves comply with FDA food handling requirements (21 CFR 177.2600)

**Ideal Applications**

- Industrial Production
- Maintenance
- Chemical Handling



**K-COMPANY APPROVED**

EN ISO 374-1-2016

Type B



JKT

EN ISO

374-5



**Ansell**

## Ansell Touch N Tuff®

**Model No.: 92-670**

Robust protection for food processing and heavy-duty jobs

- Made from an innovative nitrile compound which offers outstanding chemical and mechanical properties, comfort and dexterity
- Three times the puncture resistance of latex or PVC disposable. Lighter and cooler, yet safer and more durable; better value for money
- 100% nitrile; no waxes, silicone or plasticizers
- Powder-free. No risk of contaminating food with corn starch used to powder gloves

**Ideal Applications**

- Equipment, maintenance and repair
- Transferring liquids and solids
- Automotive
- Laboratory analysis



# Hand Protection



## Chem Tough Green Nitrile Powder Free Gloves

Model No.: X2260GR

CHEMTOUGH Green Nitrile Powder Free Glove is well known for its superior protection against chemical splashes or hazardous substances. The glove offers good resistance to chemotherapy drugs and it is suitable for heavy chemical industries. The proprietary nitrile formulation provides better durability and comfortable wear and is fully textured for excellent gripping in both wet and dry conditions.

- Ultra-Soft fit that provides easy comfort
- Latex free, reducing potential allergens
- Protection against chemical & dangerous substance
- Full textured for excellent grip
- **Standards:**
  - EN ISO 374-1:2016+A1:2018/Type B
  - EN ISO 374-5:2016

Chemo Drug Tested ✓



### Physical Properties

ASTM Standard ( Before Aging)  
Elongation of Break (%) : Min. 500  
Tensile Strength (Mpa) : Min. 14

EN Standard (Before Aging)  
Force at Force (N) : Min. 6

ASTM Standard ( After Aging)  
Elongation of Break (%) : Min. 400  
Tensile Strength (Mpa) : Min. 14



Chemical Resistance



Ambidextrous



Superior Grip & Fit

**CHEMTOUGH**





## Push & Pull Stick

Push-pull operations are often carried out in production and life on land or offshore. Ishieldu high-strength insulated push-pull sticks are mainly used in docks, mines, power, oil and gas energy and offshore petrochemical industries.

- High-strength non-slip insulation rod;
- D Shape comfortable insulated grips
- High-strength tool head
- Anti-falling and non-slip hand guards are installed on the pole
- SGS Certified

Available Sizes:

21" | 42" | 50" | 72" | 90"



## Drill Pipe Handling Tool D Grip Handle

Model No.: ISU-DRP-15M

- Heavy duty insulated Handle
- D grip handle • Length: 1300mm, 1500mm
- Push test - 1650N / Pull test - 2800N
- Drill Pipe Handling tool is an insulated safety tool, it is made of Heavy duty insulated Fiberglass Yellow handle and D grip handles. The handle has a reflective strip, which can be clearly seen when working at night. U shaped attachment for forward facing and one rear facing (Push and Pull)
- Fitted with hand protector and durable Foam/rubber hand grip. ISU handling tools providing excellent load control of up to 5 1/2-inch pipes
- It can also be used for the safe handling of bulk hoses and the installation and removal of BOP service lines



# Hand Protection



## Finger Shield

- The Finger Shields are designed to hold / support large
- Spanners/wrench in place during the removal of bolts and nuts

### Material

- Body: high-impact Poly Propylene
- Internal Strap: Nitrile (Black) / Poly Propylene webbing (Black)

### Size / Diameter / Weight

- 850 mm / 33.5 mm / 680 grams
- 375 mm / 33.5 mm / 230 grams
- 295 mm / 33.5 mm / 194 grams



# PROTECTIVE CLOTHING





# Protective Clothing



K-COMPANY  
APPROVED

PORTWEST

## Portwest Nomex IIIA (IFR) Coverall

### Model No.: NX51

The NX51 uses Nomex fabric which provides the wearer with natural, inherent flames resistance. Kelvar in the fabric gives outstanding strength, ensuring both the durability & longevity of the garment. Carbon fibre woven into the fabric gives the garment it's inherent anti-static properties.

- Nomex IIIA 153g
- 93% Nomex, 5% Kelvar & 2% Carbon Fibre
- Available colors: Navy Blue & Royal Blue
- Available Sizes: 34-56
- Standards:
  - EN ISO 11612 A1+A2, B1, C1, F1
  - EN 1159-5



K-COMPANY  
APPROVED

PORTWEST

## Portwest Nomex Comfort (IFR) Coverall

### Model No.: NX53

The garments are constructed with a 93% Nomex, 5% Kevlar, 2% Carbon 153g/m2 fibre woven fabric in Royal or Navy. The garments feature a brass zip front fastening, and are available in 12 nominal sizes. The garments have side pockets, rear hip pockets. The Nomex Coverall offers comfort & protection in a variety of working environment

- Colors: Navy Blue, Khaki & Royal Blue
- Available Sizes: 34-56
- Standards:
  - EN ISO 11612 A1 A2 B1 C1 F1
  - EN 1149-5:2008 (EN 1149-3)



K-COMPANY  
APPROVED

 PORTWEST

## Portwest Araflame Silver (IFR) Coverall

**Model No.: AF73**

This super lightweight coverall offers outstanding flame resistant protection. The Araflame fabric is soft and breathable but provides excellent tear and tensile strength. Ideal for a variety of industries including oil and gas, petrochemical and many more.

- Shell Fabric: Araflame Plus™ 150g
- Available Colors: Khaki, Royal & Navy Blue
- Size: 36-54
- Standards:  
EN ISO 11612 (A1 + A2, B1, C1, F1), EN 1149 -5  
ASTM F1959/F1959M-12 (ATPV 5.9 CAL/CM2 (HAF 63.1%))  
Fabric confirms to NFPA 2112



 PORTWEST

## Portwest Araflame NFPA 2112 (IFR) Coverall

**Model No.: UAF73**

- Inherent flame resistant qualities will not diminish with washing
- Protection against radiant, convective and contact heat
- 8 pockets for ample storage
- Durable, strong and long lasting brass zips
- Sew on flame resistant industrial wash tape
- Two-way front durable brass zip for easy access
- Triple-stitched seams for extra durability
- Sleeve pocket
- Radio loops for easy clipping of a radio
- Radio loops for easy clipping of a radio
- Adjustable hook and loop fastening for flexible sizing
- Standards: NFPA 2112-2018 (UL)



## Arc Guard GDI32 Classic (IFR) Coverall

### Model No.: GDI32-OVL

- Modacrylic based Inherent FR
- Weight: 180 GSM
- 8 integrated pockets for user utility
- 360° Reflective Coverage for better visibility
- Heavy Duty brass zipper for rapid undressing
- Special crotch joint for maximum comfort
- Unique no metal part exposed to skin design
- Adjustable cuffs and action-back design for freedom of movement
- Standards: EN 11612, EN 1149, EN 13688, CE, NFPA 2112, HRC 1



## Arc Guard GDI49 Classic (IFR) Coverall

### Model No.: GDI49-OVL

- Modacrylic based Inherent FR
- Weight: 230 GSM
- Inherent FR for lifelong FR properties
- 8 integrated pockets for user utility
- 360° Reflective Coverage for better visibility
- Heavy Duty brass zipper for rapid undressing
- Special crotch joint for maximum comfort
- Unique no metal part exposed to skin design
- Optional quilted / insulated winter coverall available with PES lining
- Adjustable cuffs and action-back design for freedom of movement
- Standards: EN 11612, EN 1149, EN 13688, EN 61482, CE, NFPA 2112, UL



## Arc Guard GDI32 Classic Winter (IFR) Coverall

### Model No.: GDI32-WOVL

- Modacrylic based Inherent FR
- Weight: 180 GSM • FR Type: Inherent
- Inherent FR for lifelong FR properties
- 8 integrated pockets for user utility
- 360° Reflective Coverage for better visibility
- Heavy Duty brass zipper for rapid undressing
- Special crotch joint for maximum comfort
- Optional quilted winter coverall available
- Adjustable cuffs and action-back design for freedom of movement
- Optional Insulated Quilting:
  - Middle: Non-Woven Padding, 150 GSM
  - Lining: 100% Polyester, 60 GSM
- Standards: EN 11612, EN 1149, EN 13688, CE, NFPA 2112, HRC 1



## Arc Guard GDI49 Classic Winter (IFR) Coverall

### Model No.: GDI49-WOVL

- Modacrylic based Inherent FR
- Outer Layer: 230 GSM
- Middle Layer: 100% Polyester Non woven wadding, 140 GSM
- Inner Layer: 100% Polyester taffeta, 60 GSM
- Garment Specifications:-
  - Two chest pocket, flap closure with VT-5 snaps
  - Two side cross vent pkt closure with VT-5 snaps
  - Two back pkt flap closure with velcro
  - Tool / Utility Pkt in right back leg
  - Front placket closure with Two way 5 No GDI Brass Zipper
  - 50mm Silver Color FR reflective tape on shoulder, both sleeves and legs with double stitched
- Standards: EN 11612, EN 1149, EN 13688, EN 61482, CE, NFPA 2112, UL



# Protective Clothing



**PORTWEST**

## Portwest Super Light Weight Anti-Static (FR) Coverall

**Model No.: FR21**

This coverall is perfect for the extra warm weather demands of the offshore industry. Constructed with a lighter weight highly innovative flame-retardant twill fabric.

### Features

- Fabric: BIZFLAME PLUS-99%, Cotton 1% Carbon Fibres 210g
- Sizes: M, L, XL, XXL & 3XL
- Available Colors: Navy Blue & Orange
- Standards: EN ISO 11612 A1+A2, B1, C1, F1, EN1149-5



**PORTWEST**

## Portwest Iona Cotton Coverall

**Model No.: C814**

- Made from 100% cotton fabric for added comfort and breathability
- Two-way zip for quick and easy access
- 8 pockets for ample storage
- Lightweight and comfortable
- Moisture wicking fabric helping to keep the body cool and dry
- Reflective tape for increased visibility
- 40+ UPF rated fabric to block 98% of UV rays
- Phone pocket • Zipped pockets
- Action back for extra freedom of movement
- Side elastic waist for ultimate wearer comfort
- Concealed zip opening for added security
- Radio loop for easy clipping of a radio
- Hammer loop for secure storage of work tools
- Back patch pocket • Rule pocket
- Standards: EN 17353 Type B2



**TAESAN**  
Industrial Corporation

## Taesan IFR Coverall

**Model No.: TS-CVR-1708**

- Fabric : Aramid / Lenzing FR / Anti-Static (150gsm)
- Loop above breast pocket on both side
- Left breast pocket with a snap and pen pocket
- Right breast pocket with a snap and zipper
- Two side pockets • Two rear pockets with a snap
- Pen slot on left sleeve • Utility pocket on left leg
- Heavy-duty & Two-way metal zipper (Fire resistant)
- Concealed metallic snap button (front)
- Elasticized waistband on the back
- Action back pleats
- Adjustable cuffs with snap closure
- Two-line silver reflective tape on sleeves and legs



**TAESAN**  
Industrial Corporation

## Taesan IFR Shirt & Pant

**Model No.: TS-ST-1702**

Fabric: Aramid 49%, Lenzing FR 49%, Anti-static 2% (150 gsm)

### Shirt

- Loop above breast pocket on both side
- Left breast pocket with a snap and pen pocket
- Right breast pocket with a snap and zipper
- Pen slot on left sleeve
- Adjustable cuffs with snap closure
- Two-line silver reflective tape on sleeves

### Pant

- Two side pockets
- Two rear pockets with a snap
- Utility pocket on left leg
- Elasticized waistband on both side
- Two-line silver reflective tape on legs





# Protective Clothing



**TAESAN**  
Industrial Corporation

## Taesan IFR Jacket

**Model No.: TS-JK-1704**

- Outshell: Lenzing FR 49% Aramid 49%, Anti-Static 2% ( 150 gsm )
- Inner: shell Lenzing FR 49% Aramid 49%, Anti-Static 2% ( 150 gsm )
- Padding: Modacrylic FR Fabric, 140 gsm
- Pen slot on left sleeve
- Reflective tape on both sleeves & side pockets
- Elastic band on waist
- Loop above the both breast pockets



## Safety Plus World Platinum Cotton Coverall

**Model No.: 1783PT**

- Pre Shrunken 100% cotton 200gsm
- Front closure with YKK zip and snap buttons
- Two Chest pockets with YKK zip and flap closure
- 2 back pockets with flaps and velcro closure
- 50mm reflective tape on the shoulders sleeves & legs
- One ruler pocket on the right leg and tool pocket on the left leg
- Elasticated waist & flexi back for comfortable fit







## Safety Plus World Premium Cotton Coverall

**Model No.: S-1782C**

- Pre-shrunk 100% cotton or 65% polyester & 35% cotton, 200 gsm
- Bi-swing action back for ease of motion
- Two zippered chest pockets with flap closure
- Two-way front zipper w/snap-over fly
- Double lined swing pockets & hip pocket
- Two front swing pockets w/side entry
- **Available Colors: Navy Blue, Khaki, Red & Light Grey**



## Safety Plus World Cotton Coverall

**Model No.: S-1781C**

- 100% cotton, 200 gsm
- Two chest pockets with flap & snap button
- Pen slot on the left hand sleeve
- 2 side & 2 back patch pockets, with one rule pocket on right leg side
- Self locking, 2 way nylon zipper front under placket
- Elasticed waist
- **Available Colors: Navy Blue, Light Blue & Khaki**



# Protective Clothing



## Safety Plus World Winter (Insulated) Coverall

- 65% Polyester & 35% cotton woven
- Long sleeves winter coverall with quilted lining
- 2 Chest pockets with flap & snap button closure
- 2 side & 2 back patch pockets
- One tool pocket on right leg side
- Front opening with 2-way nylon zipper
- Elastic waist at back
- **Available Color: Navy Blue**



**PORTWEST**

## Portwest Softshell (3L) Jacket

### Model No.: TK50

- Made of durable breathable, windproof and water resistant fabric
- Micro polar fleece lined and bonded with shell
- Generous fit for wearer comfort
- Waterproof zips to prevent water penetration
- Hook and loop cuffs for a secure fit
- Chin guard for added comfort and stability
- Extremely water resistant fabric finish, water beads away from fabric surface
- 6 pockets for ample storage
- Phone pocket
- Multiple utility pockets providing ample storage
- Fleece lined collar to trap the heat and increase warmth



## Arc Guard GDI32 Winter Jacket

### Model No.: GDI32-WJKT

- Modacrylic based Inherent FR

### Specs:

- Pocket Style: Triangle Style
- Placement of Pockets:
  - 2 Chest Pockets
  - 2 Abdominal Pockets
  - 1 Pen Pocket on left sleeve

### Composition:

- Shell: GDI32 (MOD: COT : PA: AS)
- Middle Layer: Non Woven Padding
- Lining: 100% Polyester

### Weight:

- Shell: 180 GSM
- Middle: 150 GSM • Lining: 60 GSM
- Standards: EN 11612, EN 1149, EN 13688, CE, NFPA 2112, HRC 1



## Arc Guard GDI49 Winter Jacket

### Model No.: GDI49-WJKT

- Modacrylic based Inherent FR

### Specs:

- Pocket Style: Triangle Style
- Placement of Pockets:
  - 2 Chest Pockets
  - 2 Abdominal Pockets
  - 1 Pen Pocket on left sleeve

### Composition:

- Shell: GDI49 (TENCEL: MOD : PA: AS)
- Middle Layer: Non Woven Padding
- Lining: GDI49 (TENCEL: MOD: PA: AS)

### Weight:

- Shell: 230 GSM
- Middle: 150 GSM • Lining: 230 GSM
- Standards: EN 11612, EN 1149, EN 13688, EN 61482, CE, NFPA 2112, UL





# Protective Clothing



**PORTWEST.**

## Portwest ColdStore Jacket

**Model No.: CS10**

The CS10 3/4 length freezer jacket offers unrivalled protection. The heavy-duty two-way zipper allows maximum wearer flexibility and the extra long knitted cuffs with thumb holes provide extra warmth. The jacket includes reflective tape around the chest and back for extra visibility. Features also include a chest pocket with a clear ID pocket for security and personalization.  
**Standards: EN 342 0.454M<sup>2</sup>. K/W (B), 2, X**



**PORTWEST.**

## Portwest ColdStore Trousers

**Model No.: CS11**

These expertly designed ColdStore Trousers come with a high front and back to provide extra warmth around the body. The heavy-duty buckles with wide elastic suspenders are height adjustable to ensure a comfortable fit for the wearer. 5cm reflective tape around the leg increases wearer visibility and safety. Knee patches are reinforced for increased durability. Oversized pockets allow for access without removing gloves.  
**Standards: EN 342 0.454M<sup>2</sup>. K/W (B), 2, X**



**Gold Freeze**  
The Extreme Temperature Specialists

## Goldfreeze® Hi-Glo 40 Xtreme® Freezer Jacket

**Model No.: 3905340**

- Designed for use in cold working conditions, such as cold storage and general handling in cold environments
- Extremely durable, warm and comfortable
- Soft, waterproof and breathable 100% polyester outer fabric
- Heatsealed reflective chevron tape around body, and reflective piping around yoke and sleeves for excellent visibility in low light
- High neck with fully enclosed fleece-lined collar
- Two internal pockets
- Breast pockets and bellows hip pockets with handwarmer access on both sides of front, plus pencil pocket on left sleeve
- **Compliance: EN 342:2017 – Certified to -49°C**



**Gold Freeze**  
The Extreme Temperature Specialists

## Goldfreeze® Hi-Glo 40 Xtreme® Freezer Trouser

**Model No.: 3926340**

- Designed for use in cold working conditions, such as cold storage and general handling in cold environments
- Extremely durable, warm and comfortable
- Soft, waterproof and breathable 100% polyester outer fabric
- High back for kidney protection.
- Adjustable elasticated braces for support
- Heatsealed reflective chevron tape around ankles for excellent visibility in low light
- Two large hip pockets
- **Compliance: EN 342:2017 – Certified to -49°C**



# Protective Clothing



**Gold Freeze**  
The Extreme Temperature Specialists

## Goldfreeze® Hi-Glo 40 Xtreme® Freezer Coverall

**Model No.: 3955340**

- Designed for use in cold working conditions, such as cold storage and general handling in cold environments
- Extremely durable, warm and comfortable
- Soft, waterproof and breathable 100% polyester twill outer fabric
- Red cut-resistant nylon reinforcement to knee area.
- Heatsealed reflective chevron tape around body and ankles, and reflective piping around yoke and sleeves for excellent visibility in low light High neck with fully enclosed fleece-lined collar
- Two internal pockets
- Breast pockets and hip pockets with flaps on both sides of front, plus pencil pocket on left sleeve.
- Knitted nylon cuffs
- **Compliance: EN 342:2017 – Certified to -49°C**



**Gold Freeze**  
The Extreme Temperature Specialists

## Goldfreeze® Alaskan Trapper Hat

**Model No.: 3101030**

- High-performance faux fur-lined hat for use in cold environments
- Thermal hat to protect head and ears
- Comfortable fit with adjustable velcro chin strap
- Ear flaps can be secured to top of head when required
- Available in 4 sizes, S-XL (fits head sizes 58cm (S), 60cm (M), 62cm (L) & 64cm (XL))



**INDUTEX** S.p.A.

## Gasguard® T1 Fully Encapsulated Suit

- Ventilated suit made with external and internal hot over taped seams
- Cat. 3 type 1a-B-ET with NBC (nuclear, biological and chemical protection in orange colour)
- CATEGORIA 3 TYPE 1a-B-ET - All the garments are in conformity with the following norms:
  - EN 340 Protection Garments: General requirements
  - EN 943-1:2002 Protective clothing against liquid and gaseous chemicals, including liquid aerosols and solid particles - Performance requirements for ventilated and non-ventilated "gas-tight" (Type 1) & "non-gas-tight" (Type 2) chemical protective suits
  - EN 943-2:2002 Performance requirements for "gas-tight" (Type 1) chemical protective suits for emergency teams (ET)



**Ansell**

## Ansell AlphaTec® 4000 CFR Coverall

**Model No.: 111**

Comfortable, anti-static chemical protective suit with exceptional multi-hazard solutions.

- Coverall with 2 piece hood, elasticated hood, waist, wrists, ankles, double zip flap closure
- Hazmat response
- Contaminated Environments
- Chemical Handling
- Filling, blending and charging of raw materials
- Transferring liquids and solids
- Opening and draining pumps valves or lines
- Loading and unloading of proces equipment
- Raw material sample collection
- Concentration mixing and palletisation
- Assembly and disassembly of large pipes



CE EN ISO 13688:2013

EN 1073-2

EN 14126

EN ISO 14188



# Protective Clothing



## Safety Plus World Disposable Coverall

**Model No.: 81100**

- 100% polypropylene
- With the hood and boot cover
- Single use coverall suit which offers light protection from dirt and grease
- Weight/gsm: 50 gsm
- Available Color: White



**K-COMPANY APPROVED**



## Safety Plus World Type 5/6 Chemical Disposable Coverall

**Model No.: SP700CP**

- Style: With hood, elastic wrist/ankle, Elasticated waist for optimum fit to body, zipper with flap over & adhesive tape
- Weight/gsm: 63 gsm
- Certified as per CE, Type5, Type6, EN1073, EN 14126, EN1149-5

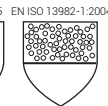

TYPE 5

TYPE 6





## Arc flash Sibille Safe Class 1, ATPV 12 cal/cm<sup>2</sup> Jacket and Trousers or Coverall

**Model No.: AFSIB**

AFSIB12 garments offer protection from the thermal effects of short circuit electrical arcs, with an ATPV that does not exceed 12 cal/cm<sup>2</sup>.

**Fabric**

- Composition: 79% cotton, 20% polyester, 1% antistatic fibre, 300 g/m<sup>2</sup>
- Flame retardant and antistatic
- **Colour: Navy Blue**
- **Sizes: XS to 3XL**



IEC  
61482-2



EN ISO  
11612



EN ISO  
11611



EN  
1149-5



EN  
13034



## Arc Flash Sibille Safe Class 2, ATPV 25 cal/cm<sup>2</sup> Jacket & Trousers or Coverall

**Model No.: AFSIB 25**

AFSIB25 garments offer protection from the thermal effects of short circuit electrical arcs, with an ATPV that does not exceed 25 cal/cm<sup>2</sup>.

**Fabric**

- Double layer fabric 410 g/m<sup>2</sup>
- Composition: 35% modacrylic, 30% cotton, 20% viscose, 14% para-aramid, 1% antistatic fibre
- Flame retardant and antistatic
- **Available Colors: Orange/Navy Blue**
- **Sizes: XS to 3XL**



IEC  
61482-2



EN ISO  
11612



EN ISO  
11611



EN  
1149-5



EN  
13034



# Protective Clothing



IEC  
61482-2



EN ISO  
11612



EN  
1149-5

## Arc Flash Sibille Safe, ATPV 40 cal/cm<sup>2</sup> Jacket, Bib & Brace Overalls & Hood

### Model No.: ARC40

ARC40 garments offer protection from the thermal effects of short circuit electrical arcs, with an ATPV that does not exceed 40 cal/cm<sup>2</sup>.

- Double layer Indura Ultrasoft® fabric 88% cotton and 12% nylon
- **Model No.:**
  - **ARCVES40:** Arc flash jacket, ATPV 40 cal/cm<sup>2</sup> (XS to 2XL)
  - **ARCSAL40:** Arc flash bib and brace overalls, ATPV 40 cal/cm<sup>2</sup> (XS to 2XL)
  - **ARCGAN40:** Arc flash gloves, ATPV 40 cal/cm<sup>2</sup> (XS to 2XL)
  - **ARCCOI40:** Arc flash hood, ATPV 40 cal/cm<sup>2</sup> (1 size fits all)



## Arc Flash Sibille Safe ATPV 53 cal/cm<sup>2</sup> Jacket, Bib & Brace Overalls & Hood

### Model No.: ARC53

ARC53 garments offer protection from the thermal effects of short circuit electrical arcs, with an ATPV that does not exceed 53 cal/cm<sup>2</sup>.

- Double layer Indura Ultrasoft® fabric 88% cotton and 12% nylon
- **Model No.:**
  - **ARCVES53:** Arc flash jacket, ATPV 53 cal/cm<sup>2</sup> (XS to 2XL)
  - **ARCSAL53:** Arc flash bib and brace overalls, ATPV 53 cal/cm<sup>2</sup> (XS to 2XL)
  - **ARCGAN53:** Arc flash gloves, ATPV 53 cal/cm<sup>2</sup> (XS to 2XL)
  - **ARCCOI53:** Arc flash hood, ATPV 53 cal/cm<sup>2</sup> (1 size fits all)



## Portwest Hi-Vis FR Vest

**Model No.:** FR75

- Premium sew on flame resistant reflective tape
- Hook and loop closure for easy access
- 100% metal free
- Lightweight and comfortable
- Generous fit for wearer comfort
- CE certified
- Available Colors: Red & Yellow
- Standards: EN ISO 20471 Class 2



## Portwest Hi-Vis Band and Brace Vest

**Model No.:** C470

- 2cm x 14cm velcro fastening
- 5cm HiVisTex reflective tape
- 100% warp knit polyester
- Available Colors: Red, Yellow & Orange
- Standards: EN ISO 20471 Class 2



## Portwest Berlin Hi-Vis Executive Vest

**Model No.:** S476

- Light flexible comfortable fit
- Executive features & styling
- Available Colors: Red, Yellow & Orange
- Standards: EN ISO 20471 Class 2



# Protective Clothing



## Safety Plus World Basic Vest

**Model No.:** SP400BVY

- 10% knitted polyester, 120gsm
- Velcro for closure
- Available Colors: Lime & Orange



## Safety Plus World Technical Vest

**Model No.:** SP401TVY

- 10% knitted polyester, 120gsm
- Resin zipper for the closure
- Available Color: Lime
- Available Size: L to 3XL



**PORTWEST**

## Portwest Bizflame Rain Hi-Vis Multi-Protection Jacket

**Model No.:** S779

Portwest Bizflame Rain Hi-Vis Multi-Protection Jacket is a waterproof, breathable garment that offers protection against multiple risks. A detachable FR fleece liner makes this jacket suitable for use in all weather conditions.

**Available Colors:** Orange/Navy (S-3XL) & Yellow Navy (S-2XL)



## Portwest Sealtex Flame FR Hi-Vis Jacket

**Model No.: FR41**

This lightweight waterproof and windproof jacket offers excellent protection. Features include a studded storm flap, front flapped pockets and adjustable cuffs. Heat sealed EN ISO 20471 reflective tape for added visibility. Constructed from a flame resistant, PU coated, polyester fabric 260g, the lightweight and durable Sealtex Flame suit is designed to offer full protection against adverse weather conditions and flame hazards.

- Available Colors: Orange (S-3XL) & Yellow (S-4XL)
- Standards:
  - ANSI/ISEA 107-2015 TYPE R CLASS 3
  - EN 1149 -5 • EN ISO 14116 Index 1 (/5H/40)
  - EN 13034 Type 6 • EN ISO 20471 Class 3
  - EN 343 Class 3:1



**PORTWEST**

## Portwest Sealtex Flame FR Hi-Vis Trouser

**Model No.: FR43**

Portwest trousers offer excellent protection against harsh elements, they are waterproof and windproof. Heat sealed EN ISO 20471 reflective tape for added visibility. Constructed from a flame resistant, PU coated, polyester fabric 260g, the lightweight and durable Sealtex Flame suit is designed to offer full protection against adverse weather conditions and flame hazards.

- Available Colors: Orange & Yellow
- Sizes: S-3XL
- Standards:
  - ANSI/ISEA 107-2015 SUPPLEMENTAL CLASS E
  - EN 1149 -5
  - EN ISO 14116 Index 1 (/5H/40) • EN 13034 Type 6
  - EN ISO 20471 Class 1 • EN 343 Class 3:1



**PORTWEST**



# Protective Clothing

## Portwest Hi-Vis Rain Jacket

### Model No.: H440

Designed to keep the wearer visible, safe and dry in foul weather conditions, the H440 is extremely practical and waterproof. It offers exceptional value for money and can be perfectly matched with the H441 Hi-Vis Rain Trousers. This garment can be easily rolled up and stored when not in use. It is made with 190T plain weave 100% polyester yarn this is a durable, hard wearing fabric for tough conditions.

- Available Colors: Orange & Yellow
- Sizes: XS-4XL
- Standards:
  - ANSI/ISEA 107-2015 TYPE R CLASS 3
  - AS/NZS 4602.1:2011 Class D/N
  - EN ISO 20471 Class 3
  - EN 343 Class 3:1



**PORTWEST.**

## Portwest Hi-Vis Rain Trousers

### Model No.: H441

Trousers are lightweight and extremely practical. They can be layered over the wearers own trousers for complete waterproof protection. It is made with 190T plain weave 100% polyester yarn this is a durable, hard wearing fabric for tough conditions.

- Available Colors: Orange (S-3XL) & Yellow (S-4XL)
- Standards:
  - ANSI/ISEA 107-2015 SUPPLEMENTAL CLASS E
  - AS/NZS 1906.4:2010
  - EN ISO 20471 Class 1
  - EN 343 Class 3:1



**PORTWEST.**



## Portwest Hi-Vis Rain Lite Traffic Jacket

### Model No.: S160

Portwest offers high quality at an unbeatable price, the S160 includes features such as a zipped front with Hook & Loop storm flap, jetted hip pockets and stud adjustable cuffs. The extensive range of High-Visibility clothing meets stringent requirements in both design and construction, to ensure compliance with the latest EN ISO 20471 & ANSI standards. Innovative and technical, our High Visibility range is ideal for those who will not compromise on style, comfort, protection and performance.

- Available Colors: Orange & Yellow
- Sizes: XS-3XL
- Standards:
  - ANSI/ISEA 107-2015 TYPE R CLASS 3
  - EN ISO 20471 Class 3
  - EN 343 Class 3:1



## Portwest Iona Lite Traffic Jacket

### Model No.: S433

Portwest Iona Lite Jacket offers added visibility in dull conditions. Features include two large pockets, an easily accessible external mobile phone/radio pocket to the chest and a drawcord hood and hem for a snug fit.

- Available Colors: Forest Green (S-3XL), Black (XS-3XL), Navy (XS-3XL), Royal Blue (XS-4XL)
- Standards:
  - EN 343 Class 3:1
  - EN 342 (0.503M2. K/W(B), X, 3, 2)





# Protective Clothing



**PORTWEST**

## Portwest Classic Rain Jacket

**Model No.: S440**

Portwest Classic rain jacket Designed to be worn in foul weather conditions, the Classic Rain Jacket is not only practical and durable, it offers exceptional value for money. Tested to withstand the rigours of everyday wear, each garment has been designed and manufactured with care to ensure total satisfaction wear after wear.

- Available Colors: Grey (S-3XL), Royal (S-3XL), Olive Green (S-4XL), Orange (S-4XL), Yellow (S-4XL), Black (XS-4XL), Navy (XS-5XL)
- Standards: EN 343 Class 3:1



**PORTWEST**

## Portwest Classic Rain Trousers

**Model No.: S441**

Lightweight and easily packable for convenience, these trousers provide comfort and protection in any weather. Designed to be worn in foul weather conditions, the Classic rainwear range is not only practical and durable, it offers exceptional value for money. Clever styling and taped seams guarantee maximum comfort and protection.

- Available Colors: Royal (S-3XL), Olive Green (S-4XL), Orange (S-4XL), Yellow (S-4XL), Black (XS-4XL), Navy (XS-5XL)
- Standards: EN 343 Class 3:1





## Portwest Bizflame Rain Hi-Vis Antistatic FR Jacket

**Model No.: S778**

Combination of 98% polyester & 2% anti-static carbon fibre 250g. This breathable fabric offers maximum protection with superb breathable and water resistant properties, means this garment meets the necessary stringent European standards.

• **Available Colors:** Yellow (XS-6XL), Orange (XS-4XL)

• **Standards:**

AS/NZS 4602.1:2011 Class D/N

EN ISO 14116 Index 3 (/12H/40)

EN 1149 -5

EN 14058 Class 3

ISO 13688

EN 13034 Type 6

EN ISO 20471 Class 3

EN 343 Class 3:1



**PORTWEST**

## Portwest Bizflame Rain Hi-Vis Antistatic FR Bomber Jacket

**Model No.: S773**

- Flame resistant treated waterproof fabric prevents water penetration
- Anti-static • Internal chest pocket
- Ribbed cuffs for added comfort
- Fully lined and padded to trap the heat and increase warmth
- Premium sew on flame resistant reflective tape
- Breathable fabric to draw moisture away from the body keeping the wearer cool, dry and comfortable
- Taped seams to provide additional protection
- 4 pockets for ample storage
- Phone pocket • Two-way zip for quick and easy access
- Concealed detachable hood
- Print access for corporate branding
- Side elastic waist for ultimate wearer comfort



**PORTWEST**



# Protective Clothing

K-COMPANY  
APPROVED



## Safety Plus World PVC/ Polyester Rain Coat

**Model No.: SIR7602**

- Fabric: 0.35mm PVC/Polyester
- Attached hood with drawstring and stoppers
- Storm front with plastic snaps closure
- Ventilated cape back and underarm air vents
- 2 Pockets with flap in front
- Cuffs adjusted by snaps
- Available Color: Yellow



## Portwest Classic Adult Rain Coat

**Model No.: S438**

- The S438 offers unbeatable protection with its longer length while matching perfectly with the S441 Rain Trousers for ultimate protection
- 100% Polyester, PVC Coated, 210g
- Available Colors: Yellow (S-3XL), Navy (S-4XL)



**Ansell**

## Ansell AlphaTec Apron

**Model No.: 56-100**

- Thickness: 0.508 mm (20 mil)
- Size: 84 x 112 cm (33 x 44 inch)
- Ties: Nylon • Grommets: PVC
- Color: Green
- Medium-to-heavy-duty splash protection
- Resistant to a wide range of chemicals
- Provides superior flexibility and resistance to chemicals, fats, oils, grease, punctures & abrasion while at the same time offers easy cleaning



## Portwest Leather Welding Apron

**Model No.: SW10**

- CE Certified
- Class 2 welding protection
- Ergonomic quick release buckle
- Adjustable straps for a secure fit
- Kevlar® stitching throughout for extra durability
- Concealed hook and loop fastening for easy closure
- Designed to be worn in a tough work environment
- **Standards: EN ISO 11611 Class 2 A1**

 **PORTWEST**



## Portwest Leather Welding Sleeve

**Model No.: SW20**

- CE Certified
- Class 2 welding protection
- Elasticated cuffs for a secure fit
- Designed to be worn in a tough work environment
- Designed with a comfort fit
- **Standards: EN ISO 11611 Class 2 A1**

 **PORTWEST**



## Portwest Leather Hood

**Model No.: SW33**

Providing vital protection for the head and neck area this premium quality hood is made of split cowhide leather. The strong material is suitable for the toughest welding jobs.

**Standards: EN ISO 11611 Class 2 A1**

 **PORTWEST**



## Portwest Leather Welding Boot Cover

**Model No.: SW32**

Premium quality boot covers made of split cowhide leather. The strong material protects the feet and lower legs when welding and is designed to last in the toughest environments.

**Standards: EN ISO 11611 Class 2 A1**

 **PORTWEST**



## Velocity Fire Protective Gear

Velocity's ergonomic design is engineered to provide fire-fighters with an unrestricted full range of motion. Ultra FlexKnee triple pleated trousers provide unsurpassed comfort. Velocity's Ultra FlexWing Expanded Back coat delivers a bind free reach. The FlexElbow adds outer shell pleats combined with liner darts to provide a natural contour at the elbow while complementing the integrated seamless underarm bellows. Engineered with minimal seams for maximum durability

**Standards: UL certified to meet or exceed current edition of NFPA 1971**



## PROTECSAFE Fire Proximity Suits

- Outer shell: Nomex®IIIA
- Moisture Barrier: PTFE Membrane
- Thermal Barrier: FR Non woven (Nomex® / Kevlar) Quilted to face Cloth
- Jacket and Trousers manufactured with inherent flame retardant threads
- FR Zipper + FR Velcro + HR Buckles + HR Buttons
- Nomex®IIIA Extra Additional Layer of outer shell fabric is provided at the knee portion as the best reinforcement to enhance the life of the garment during kneeling or any such operation
- Size: S to XXXL (The size of Jacket and Trousers confirming to EN 13688:2013 harmonized)
- Available Colors: Navy Blue, Red & Yellow
- Certified to EN469:2005/A1:2006 + AC:2006





# Protective Clothing



**PORTWEST.**

## Portwest FR Anti-Static Balaclava Hood

**Model No.: FR20**

FR20 is inherently flame resistant and anti-static. The fabric provides ARC2 protection against the thermal hazard of an electric arc and the high cotton content gives maximum comfort against the skin. Ideal when extra warmth and protection are required. Constructed from an inherently fire resistant yarn of 60% Modacrylic, 39% Cotton and 1% Carbon Fibre

**Colors: Navy Blue**

**Standards: EN 1149 -5, EN ISO 11612 (A1, B1, C1, F1) IEC 61482-2 IEC 61482-1-2 Class 1**



## Arc Flash Balaclava

**Model No.: ARCCAG12 – ARCCAG24**

Arc flash balaclava for use along with an electrician helmet with face shield

ARCCAG10: ATPV 12.1 cal/cm<sup>2</sup>

ARCCAG24: ATPV 24 cal/cm<sup>2</sup>



## Cooling Beanie

**Model No.: 6522**

- Made with NEW 100% Polyester Cool Mesh for enhanced performance
- Rear elastic panel ensures a comfortable fit for all
- Provide 5-10 hours of cooling relief per soaking; lightweight and durable
- Comfortable, polyester mesh with CoolBar™ fabric inner
- **Colors: Blue & Black**



## Crown Cooler with Neck Shade

**Model No.: 6521**

- Protects the head and neck from dangerous heat and sun while on the job; easily attaches to hard hat liner (hard hat not incl.)
- Comfortable quilted Hi-Viz Lime polyester outer, TechCool™ fabric inner, water repellent nylon liner and black poly-cotton trim; elastic straps w/hook and loop attachments
- Provide 5-10 hours of cooling relief per soaking
- Colors: Lime, Blue & Orange



## Cooling Lockdown Reversible Headband

**Model No.: 6520**

- Cooler heads prevails in revitalizing lockdown reversible headband
- It drops to 30 degrees below average body temperatures when soaked with water, wrung out and snapped
- Sounds simple to activate because it is built for you to look good and feel better doing all-things-summer
- Colors: Black & Green



## Endura Cooling Towel

**Model No.: 103702**

90% polyester, 10% nylon. The Instant Cooling Towel is made from a proprietary performance fabric that instantly cools when soaked with water, wrung out, and then snapped in the air to activate the cooling properties.



# Protective Clothing



## Evaporative Cooling Vest

**Model No.: 6529**

Garments are made of a special fabric which holds the cooling energy for an extended period of time. Water causes a naturally cooling effect as it evaporates. Simply submerge in water for 1 to 3 minutes, or until garment reaches the desired level of hydration. Gently wring out excess water and it's ready to wear! No freezers or cold packs necessary. Once activated, the vest will provide many hours of cooling relief in low-humidity climates.



## Radians Arctic Radwear® Cooling Vest

- Adjustable Waist
- Zipper Closure
- Unique 3-Layer Fabric System
- Cools Body Temperature
- Safe and Reusable, Jobsite Proven
- Anti-Microbial treated to help prevent mold build-up and unwanted smells
- Heat stress safety management
- Sizing: S/M, L/XL, 2X/3X, 4X/5X



## Portwest Cooling Evaporative Vest

**Model No.: CV09**

- Lightweight and comfortable
- Cooling mesh fabric for increased breathability
- Keeps wearer cool for up to 8 hours
- Wicking, cooling and drying capabilities
- Soak in water to activate
- Standards
  - CE Certified
  - EN 17353 Type A







## Radians Arctic Radwear® Cooling Wrap XT

- Secure around neck by pulling through slot opening
- Reusable Packaging Design
- Safe and reusable, jobsite proven
- Anti-Microbial treated to help prevent mold build-up and unwanted smells
- Heat stress safety management
- Lasts up to 5 hours, depending on humidity levels
- 100% Polyester Microfiber
- Dimensions: 32.5" x 12"



## Radians Arctic Radwear® Cooling Towel

- Reusable Packaging Design
- Safe and reusable, jobsite proven
- Anti-Microbial treated to help prevent mold build-up and unwanted smells
- Heat stress safety management
- Lasts up to 5 hours, depending on humidity levels
- Dimensions: 26" x 17"



## Radians Arctic Radwear® Headband

- Patent pending stretch-fit design allows for better blood circulation and comfort
- Safe and reusable, jobsite proven
- Anti-Microbial treated to help prevent mold build-up and unwanted smells
- Heat stress safety management
- Lasts up to 5 hours, depending on humidity levels
- One size fits all
- PATENT: D712094



# Protective Clothing



## Radians Arctic Radwear® Head Shade

- Patent pending stretch-fit design allows for better blood circulation and comfort
- Safe and reusable, jobsite proven
- Anti-Microbial treated to help prevent mold build-up and unwanted smells
- Heat stress safety management
- Lasts up to 5 hours, depending on humidity levels
- **One size fits all**



## Radians Arctic Radwear® Hard Hat Cooling Sweatband

- Easy Installation
- Soak in water for 2-3 Minutes
- Wave in the air for 10 to 15 seconds activating ADVANCED ARCTIC® material
- Reactivate your SWEATBAND in extreme heat or humid conditions by soaking again in water and twirling/waving in the air for 10 to 15 seconds
- Hand Wash Only, using Mild Detergent. Do NOT bleach
- Safe and reusable, Job-Site Proven
- Anti-microbial treated to help prevent mold build-up and unwanted smells
- Heat Stress Safety Management - Cools Body Temperature
- Lasts up to 5 hours, depending on humidity levels
- Hard hat and suspension sold separately

# FOOT PROTECTION





# Foot Protection

## BASIC REQUIREMENTS



## ADDITIONAL REQUIREMENTS



scuff cap

sole resistance  
o hydrocarbons

toe cap impact  
(200J + 15kN)

slip resistance  
(ceramic floor +  
sodium lauryl  
sulphate)

slip resistance  
(ceramic floor + glycerine)

energy absorption  
of seat reagon

antistatic  
footwear

water resistant upper



water  
resistant shoe

metallic nail  
(ø 4,5 mm)

non metallic nail  
(ø 4,5 mm)

non metallic nail  
(ø 3 mm)

antiperforation midsole

-17°C

cold insulation of sole complex

-30°C

outsole resistant  
to hot contact

heat insulation  
of sole complex

ladder grip



## STANDARDS EN ISO 20345:2022

SB=



S1=SB+E+A  
CLOSED HEEL AREA



**NEW** S1P=SB+E+A+P



**NEW** S1PL=SB+E+A+PL



**NEW** S1PS=SB+E+A+PS



S2=S1+WPA



S3=S2+P+  
CLEATED OUTSOLE



**NEW** S3L=S2+PL+  
CLEATED OUTSOLE



**NEW** S3S=S2+PS+  
CLEATED OUTSOLE



**NEW** S6=S2+WR



**NEW** S7=S3+WR



**NEW** S7L=S3L+WR



**NEW** S7S=S3S+WR





# Foot Protection



## Puma Condor Mid Safety Shoes

**Model No.: 630122**

The Puma Condor Mid is a water-resistant modern brown safety boot with steel toe caps and a flexible FAP® midsole. This boot is durable with its leather upper. Inside the boot is a breathable lining and the Evercushion footbed giving you enhanced comfort.

- Protection: Steel cap and flexible FAP® midsole
- Plus: ESD
- Upper: Oiled nubuck leather
- Lining: BreathActive functional lining
- Footbed: Evercushion® pro ESD
- Sole: REBOUND - extremely cushioning and slip resistant
- Standards: EN ISO 20345:2022 S3 ESD SRC



## Puma FRONTCOURT BLK/WHT/RED MID Safety Shoes

**Model No.: 630050**

- Protection: Fibreglass toe cap and flexible FAP® penetration protection
- Plus: idCELL, ROTATION POINT
- Lining: BreathActive functional lining
- Footbed: Evercushion® RELIEF
- Sole: HERITAGE sole - 300°C heat-resistant rubber outsole, non-slip with special herringbone pattern and rotation point
- Applications: Agricultural, construction, craftsmen, industry, production, Warehouse / Logistics
- Material: Smooth leather
- Standards: EN ISO 20345:2022 S3L ESD, HRO



## Puma CROSSTWIST MID Safety Shoes

**Model No.: 633140**

- Protection: Composite-fiberglass toe cap, metalfree, flexible FAP® midsole
- Plus: DGVU 112-191, injected protection in the toe and heel area
- Upper: Functional leather, textile
- Lining: BreathActive functional lining
- Footbed: Evercushion® BA
- Sole: 300°C heat resistant, IdCell, rotation point, rubber sole URBAN
- Applications: Craftsmen, industry, production, Warehouse / Logistics
- Material: Funktionsleder, Textil
- Standards: EN ISO 20345:2022 S3 HRO



## Albatros UltraTrail Olive CTX Mid Safety Shoes

**Model No.: 636220**

- Protection: Fiberglass toe cap and flexible FAP® midsole
- Plus: Water resistant and breathable COA.TEX® membrane, bumper of rubber in the toe area
- Upper: Leather with abrasion resistant textile inserts
- Lining: Breathable functional lining
- Footbed: Anatomically formed comfit® AIR footbed
- Sole: XTS TRAIL high quality, 300°C heat and slip resistant, rubber outsole with IMPULSE. FOAM® midsole or optimal cushioning, stability and comfort
- Standards: EN ISO 20345:2022 S3 ESD WR HRO SRC





# Foot Protection

## Albatros TARAVAL BLACK/ BLUE MID Safety Shoes

**Model No.: 638040**

- Protection: Fiberglass toe cap and flexible FAP® midsole
- Upper: Durable microfibre
- Plus: Heel & Arch Support, two width system , extremely lightweight
- Lining: BreathActive functional lining
- Footbed: Evercushion® RELIEF<sup>T</sup>
- Sole: FLEXLITE slip resistant DUO PU and TPU outsole with midsole of continuously high performance EFFECT.FOAM® for excellent cushioning and energy return
- Standards: EN ISO 20345:2022 S3L ESD FO SR



 **albatros**

## Cofra Leimen S3 SRC

- Upper: Water repellent full grain leather and breathable fabric
- External Lining: Breathable Fabric
- Internal Lining: DRYTHERM 100% polyamide fabric, ladder proof, breathable, it absorbs and releases the moisture, abrasion resistant
- Footbed: EVANIT, made of EVA and nitrile special compound, with high bearing capacity and variable thickness (12mm - 8mm - 3,8mm). Thermoformed, anatomic, punched and coated with highly breathable fabric. Antistatic thanks to a specific treatment on the surface and to seams made of conductive yarns
- Sole: Polyurethane/TPU
- Toe Cap: Non-metallic Top Return resistant to 200 J
- Midsole: Non-metallic Apt Plate - Zero Perforation
- Standards: EN ISO 20345:2011



 **COFRA**  
BORN TO WORK





K-COMPANY  
APPROVED

## Cofra Funk Black S3 ESD SRC

- Upper: Water repellent full grain leather
- External Lining: Breathable leather
- Internal Lining: 100% polyamide fabric, ladder-proof, breathable, it absorbs and releases the moisture, abrasion resistant
- Sole: Polyurethane/TPU with low electrical resistance
- Toe Cap: Non metallic TOP RETURN resistant to 200 J
- Midsole: Non metallic APT PLATE - Zero Perforation with low electrical resistance
- Standards: EN ISO 20345:2011



**COFRA**  
BORN TO WORK



K-COMPANY  
APPROVED

## Giasco Oxford Kube S3 SRC

**Model No.: KU068D**

- TOECAP 200J polymeric composite non-thermic according to EN 12568
- MIDSOLE flexible antiperforation composite fabric according to EN 12568
- SOLE KUBE bidensity polyurethane antistatic, resistant to hydrolysis ISO 5423:92, to hydrocarbons and to abrasion, anti-shock and anti-slipping SRC
- Standards: CE UNI EN ISO 20345:2012 S3 SRC



**GIASCO**  
ITALY



K-COMPANY  
APPROVED

## Bicap Safety Shoes S3 SRC

**Model No.: OS 6294/9K S3 SRC**

- Upper: Water resistant and Oil resistant leather
- Lining: Smocking fabric, breathable, high scratch resistance
- Toe cap: Composite material
- Midsole: Non metal Flex Textile Plate Zero Perforation System
- Sole: OS - double density PU
- Sizes: 36-47
- Standards: EN ISO 20345:2011



**BICAP**  
ABSOLUTELY SAFE



# Foot Protection



## Desert Gold Premium S3 SRC Shoes

**Model No.: SP-816PSH**

- Upper: Beige embossed leather
- Sole: Dual density PU outsole
- Composite toe & kevlar mid sole
- Slip resistance as per SRC standard
- Size: 39-47
- Standards: EN ISO 20345:2011



## Bicap Safety Shoes S1P

**Model No.: 2012**

- Upper: Printed leather, black color
- Lining: Absorbent, breathable, high scratch resistance, anti-bacterial
- Fussbett: Micro perforated, anatomic, breathable
- Sole: Double density polyurethane, anti-static, non-slip, oil resistant
- Crush-proof toe cap and steel pierce proof layer
- Size: 35-48
- Standards: EN ISO 20345:2011



## Dapro Noble S3 SRC

**Model No.: FNOBS3C-BL/BL**

- Water resistant buffalo split leather
- PU/PU sole for comfort and light weight
- Heat resistant sole up to 200 degrees Celsius
- Oil resistant sole
- Slip resistant as per SRC standard
- Antistatic inner and outer sole
- Energy absorption in the heel
- Steel toe cap
- Coated steel mid plate
- PU cuff nose • EVA insole
- Standards: CE EN ISO 20345:2011 S3 SRC



## Desert Gold High Ankle S3 SRC Shoes

**Model No.: SP800FW**

- Upper: Black embossed leather
- Sole: Single density, black PU for comfort & light weight
- Steel toe cap & steel mid plate
- Slip resistance as per SRC standard
- Size: 39-47
- Standards: EN ISO 20345:2022 S3 SR CI FO



## Puma CROSSTWIST LOW Safety Shoes

**Model No.: 643100**

Classic design elements combined with modern incision. The distinctive CROSSTWIST LOW with fiberglass and flexible, metal free FAP® anti-perforation protection satisfies all criteria of a safety boot in sneaker-style. Technically, the sole construction with custom-fit lasts provides new standards..

- Protection: Composite-fiberglass toe cap, metalfree, flexible FAP® midsole
- Plus: DGUV 112-191, injected protection in the toe and heel area
- Upper: Functional leather, textile
- Lining: BreathActive functional lining
- Footbed: Evercushion® BA
- Sole: 300°C heat resistant, IdCell, rotation point
- Applications: Craftsmen, industry, production, Warehouse / Logistics
- Material: Oiled smooth full leather with textile inserts
- Standards: EN ISO 20345:2022 S3 HRO



# Foot Protection



**albatros**

## Albatros Ultratrail Black Low Safety Shoes

**Model No.: 646200**

- Protection: Fiberglass toe cap and flexible FAP® midsole
- Upper: Leather with abrasion resistant textile inserts
- Lining: Breathable functional lining
- Footbed: Anatomically formed comfit® AIR footbed
- Sole: XTS TRAIL high quality, 300 C heat and slip resistant, rubber outsole with IMPULSE. FOAM® midsole or optimal cushioning, stability and comfort
- Standards: EN ISO 20345:2022 S3 ESD HRO SRC



**PUMA**

## Puma FrontCourt Safety Shoes

**Model No.: 640200**

- Penetration protection: Flexible FAP penetration protection
- Insole: Evercushion® RELIEF
- Lining: BreathActive functional lining
- Outsole: HERITAGE sole
- Upper material: Smooth full-grain cowhide
- Protective toe cap: Fibreglass cap
- Standards: EN ISO 20345:2022 S3L



## Portwest Steelite Slip On Safety Shoe S2 FO SR

**Model No.: FW81**

Lightweight safety clog with a perforated upper for added breathability. 100% non metallic with plastic stud fastener. Suitable for use in ESD environments. Complies with EN 61340-5-1.



**PORTWEST**

- Slip-on silhouette
- Adjustable elastic heel strap
- Perforated upper aiding air circulation in hot environments
- Wipe clean upper
- Self-cleaning outsole preventing cross contamination
- Composite toecap for added protection
- Anti-static footwear
- Energy absorbing seat region
- SRC - Slip resistant outsole to prevent slips and trips on ceramic and steel surfaces
- Fuel and oil resistant outsole
- Dual density sole unit
- 100% non-metallic
- Suitable for use in ESD environments
- **Standards: EN ISO 20345:2022 S2**



**MADE IN ITALY**

**COFRA**  
BORN TO WORK

## Cofra Worthing S3 SRC

- Upper: Water repellent full grain leather
- External Lining: Breathable leather
- Internal Lining: Breathable and abrasion resistant leather
- Sole: Slip resistant dual-density polyurethane
- Toe Cap: Non-metallic Top Return resistant to 200 J
- Midsole: Non-metallic Apt Plate - Zero Perforation
- **Standards: EN ISO 20345:2011**



# Foot Protection



**K-COMPANY  
APPROVED**



**COFRA**  
BORN TO WORK

## Cofra Yard S3 ESD SRC

- Upper: TECHSHELL, innovative and extremely sturdy fabric, abrasion and tear resistant, water repellent and breathable and suede-like microfiber
- External Lining: Breathable leather
- Internal Lining: SANY-DRY® 100% polyester fabric, three-dimensional, breathable, it absorbs and releases the moisture, abrasion resistant
- Sole: Polyurethane/TPU with low electrical resistance
- Toe Cap: ALUMINIUM 200 J
- Midsole: Non metallic APT PLATE - Zero Perforation even with a 3 mm diameter nail, with low electrical resistance
- Standards: EN ISO 20345:2011



## Desert Gold Low Ankle S3 SRC Shoes

**Model No.: SP801FW**

- Upper: Black embossed leather
- Sole: Single density, black PU for comfort & light weight
- Steel toe cap & steel mid plate
- Slip resistance as per SRC standard
- Size: 39-47
- Standards: EN ISO 20345:2022 S3 SR CI FO



## Gaston Mille Safety Overshoe

**Model No.: MLPCK**

- Component: Waterproof & Washable PU
- Upper: Protective Tongue
- Toe cap: Composite (fiberglass)
- Midsole: Without Penetration Resistant
- Sole: Waterproof & Washable TPU
- Sizes: 35-48
- Features: Adjustable Strap
- Standards: EN ISO 20345:2011



**Gaston // MILLE**



Gaston MILLE®

## Gaston Mille Safety Overshoe

### Model No.: MFPU

- Component: Waterproof & Washable PU
- Upper: Fore foot protection
- Toe cap: Steel
- Midsole: Penetration Resistant midsole: Steel
- Sole: Abrasion & hydrocarbon resistant PU outsole
- Sizes: 35-48
- Features: Adjustable Strap
- Standards: EN ISO 20345:2011

## Portwest Compositelite ESD Perforated Safety Clog SB AE

### Model No.: FC03

Lightweight safety clog with a perforated upper for added breathability. 100% non metallic with plastic stud fastener. Suitable for use in ESD environments. Complies with EN 61340-5-1.



PORTWEST

- Adjustable elastic heel strap
- Perforated upper aiding air circulation in hot environments
- Composite toecap for added protection
- Anti-static footwear
- Energy absorbing seat region
- SRC - Slip resistant outsole to prevent slips and trips on ceramic and steel surfaces
- Fuel and oil resistant outsole
- Dual density sole unit
- 100% non-metallic
- Suitable for use in ESD environments
- Standards: EN ISO 20345: 2011 SB IEC 61340-5-1:2016



# Foot Protection



## Bicap Rigger Boot

**Model No.: PS6060/6E | K4 S3 CI SRC**

- Upper: Waterproof oiled nubuck
- Toe cap: Composite ITS SAFE
- Midplate: Anti-perforation textile "0 perforation"
- Sole: Double density polyurethane
- Size: 39-48
- Standards: EN ISO 20345:2011



## Gaston Mille Master Black

**Model No.: MON03**

- Full grain leather, water & oil resistant (2 to 2.2mm thickness)
- Reinforced padding protection of Achilles tendon
- Waterproof tongue & gusset
- Side Zip: Easy slip on/off
- Non metallic 200J safety toe (fiberglass)
- High performance grip: SRC rating
- Auto-cleaning studs
- Standards: EN ISO 20345 : 2022  
S3L HI CI HRO FO LG SC SR





**dapro**<sup>®</sup>

## Dapro Interpid Rigger Boot

**Model No.: FINTS3C-BR/BR**

- Water resistant buffalo split leather
- PU/PU sole for comfort and light weight
- Heat resistant sole up to 160 degrees Celsius
- Oil resistant sole
- Slip resistant as per SRC standard
- Antistatic sole
- Energy absorption in the heel
- Steel toe cap
- Coated steel mid plate
- PU bump cap
- EVA insoles
- Standards: CE EN ISO 20345 : 2011 S3 SRC



**PORTWEST**

## Portwest Wellington Rigger Boot

**Model No.: FW95**

- Dual density PVC/Nitrile construction
- Chemical resistant
- Protective steel toecap
- Pierce resistant steel midsole
- Anti-static footwear
- Energy Absorbing Seat Region
- 100% Waterproof to keep feet dry
- SRC - Slip resistant outsole to prevent slips and trips on ceramic and steel surface
- Size: 39-47
- Standards: EN ISO 20345: 2022



# Foot Protection



GIASCO  
ITALY

## Giaco Edison Electrical Insulated Safety Shoes

**Model No.:** HRD060D

- High safety shoe, WRU back leather and heel in anti-scratch leather
- Thickness 1,8-2,0 mm, with refracting fabric insert
- Perspiring and abrasion resistant fabric lining
- Soft, lined and padded tongue
- COMPLETELY METAL FREE SHOE
- Standards: CE UNI EN ISO 20345:2012 SB FO E P CI HI WRU HRO SRC

# FALL PROTECTION

**We do it all for one reason: you.**

Every day, thousands of people around the world go to work and perform tasks at heights most would never dream of climbing to—a dangerous calling that results in thousands of injuries every year.

Whether you're reaching for the sky or crawling into tight confined spaces, our commitment to you remains the same: outfitting you with quality, comfortable 3M Fall Protection, backed by science and designed to help you get the job done and get home safely.

## Fall Protection Portfolio

- Anchors
- Body Harnesses
- Connecting Devices
- Descent and Rescue
- Fall Protection for Tools
- Confined Space
- Engineered Systems





# Fall Protection

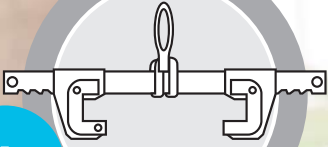

A

## Anchorage

Anchorage is a secure point of attachment. Anchorage connectors vary by industry, job, type of installation and structure. They must be able to hold fast under surge load of a fall, working in suspension or a rescue.



## 3M DBI-SALA® Sliding Beam Anchor

**Model No.: 2104710**

- Hands-free Mobility 360-degree swiveling D-ring optimizes your mobility on the beam
- Visible adjustability dual ratcheting adjustment buttons are accessible above the beam, while locking mechanism is located on the side to reduce accidental engagement
- Versatile size ranges to fit a variety of beams
- Replaceable wear pads
- 360-degree swiveling D-ring anchor point
- Integrated dual ratcheting system
- High-strength, lightweight steel and aluminium construction
- 5,000 lb. (22 kN) strength and up to 420 lb. (189 kg) capacity
- **Standards:** OSHA 1910.140, OSHA 1926.502

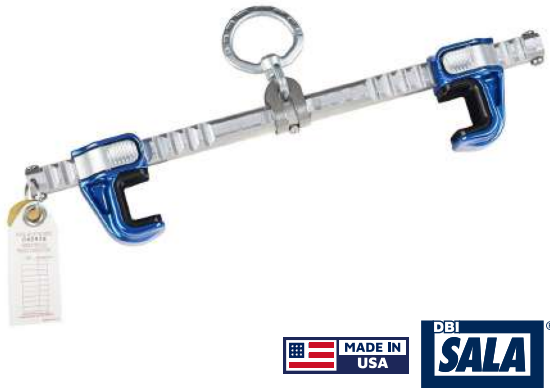

## 3M DBI-SALA® Trolley for I-Beam

**Model No.: 2103143**

- Installs onto 3 in. to 8 in. wide I-beam flange (7.6-20.3 cm) up to 11/16" thick (1.7 cm)
- Complete hands-free horizontal mobility
- Ideal for use with self retracting lifeline
- Easy to use dual adjustment dials
- High strength steel construction
- Extremely rugged and corrosion resistant
- Rotating D-ring tie-off point is fixed in center
- Double-shielded wheel bearings
- Built-in guards protect wheels
- Fall Arrester to be ordered separately
- **Standards:** OSHA 1910.140, OSHA 1926.502



## 3M DBI-SALA® Tandem Pulley

**Model No.: 8800023**

- 3/8 in. to 1/2 in. rope or cable

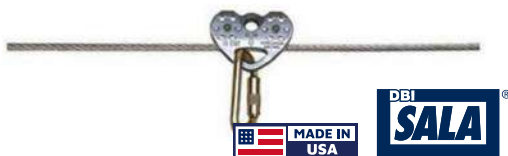



# Fall Protection

## 3M DBI-SALA® Fixed Beam

**Model No.: 2108406**

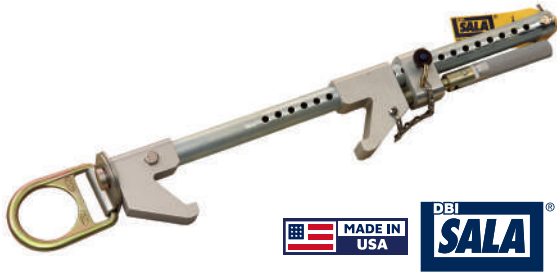

- Installs onto 2-1/2 in. to 12 in. wide I-beam flange (6.3-30.5 cm) up to 1-1/2" thick (3.8 cm)
- High strength steel and aluminium construction
- Extremely rugged and corrosion resistant
- Swivelling D-ring tie-off point
- Detent style attachment with built-in tightening handle
- Standards: OSHA 1910.140, OSHA 1926.502

## 3M DBI-SALA® Steel Plate Anchor

**Model No.: 2104550**



- Set-screw design installs onto 3/8in. to 1in. thick (9.5-25.4mm) plate steel
- User friendly compact and lightweight design
- Integral D-ring tie-off point
- High strength steel construction
- Extremely rugged and corrosion resistant
- Steel plate anchor with D-ring fits 3/8in. to 1 in. thick (9.5-25.4mm) plate steel
- Standards: OSHA 1910.140, OSHA 1926.502

## 3M DBI-SALA® D-ring Anchorage Plate

**Model No.: 2101630**



- Bolt or weld to structure for fall arrest anchor point
- Compact 1/4" x 2" x 4-1/2" (6 x 51 x 114 mm) 304 stainless steel plate
- Pre-drilled 1/2" (12.7 mm) holes
- Zinc plated steel D-ring for compatible tie-off point
- High strength steel construction
- Extremely rugged and corrosion resistant
- Standards: OSHA 1910.140, OSHA 1926.502



## 3M DBI-SALA® Concrete Detent Anchor

**Model No.: 2101004**

- Use vertically in wall or horizontally in ceiling (both components)
- Swiveling D-ring tie-off point
- Push button operation for fast & easy operation
- Socket cover cap included
- Standards: OSHA 1910.140, OSHA 1926.502



## 3M DBI-SALA® Web Tie-Off Adaptor

**Model No.: 1003000**

- 3 ft. (0.9 m) pass-thru type tie-off adaptor
- Durable polyester construction
- Abrasion resistant polyester wear pad
- High strength steel hardware
- Standards: ANSI Z359.18, OSHA 1910.140, OSHA 1926.502



## 3M DBI-SALA® Scaffold Choker

**Model No.: 1201390**

- 1.4 ft. (0.4 m) choker style anchor
- Durable polyester construction
- Ideal anchorage device for scaffolding or piping
- High strength steel D-ring
- Standards: ANSI Z359.18, OSHA 1910.140, OSHA 1926.502



# Fall Protection



## 3M DBI-SALA® Saflok™ Carabiner

**Model No.: 2000112**

- 11/16 in. (17.5 mm) gate opening steel carabiner
- Self closing and locking gate for added safety
- Highly corrosion resistant plated hardware
- High strength steel construction
- User friendly compact and lightweight design
- Standards: OSHA 1910.140, OSHA 1926.502



## 3M DBI-SALA® Saflok™ Carabiner

**Model No.: 2000113**

- 1-3/16 in. (30 mm) gate opening steel carabiner
- Self closing and locking gate for added safety
- Highly corrosion resistant plated hardware
- High strength steel construction
- User friendly compact and lightweight design
- Standards: OSHA 1910.140, OSHA 1926.502



## 3M DBI-SALA® Self-Closing/Locking Carabiner

**Model No.: 2000041**

- Zinc Plated Steel, 2 1/8 in Gate
- Hook Type: Self-Locking
- Tensile Strength: 3600 lb
- Load Capacity: 420 lb



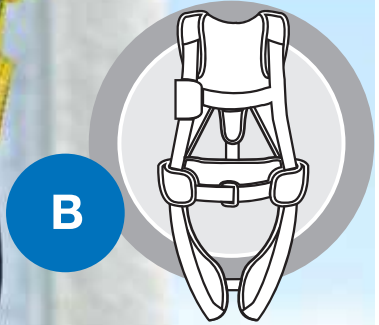
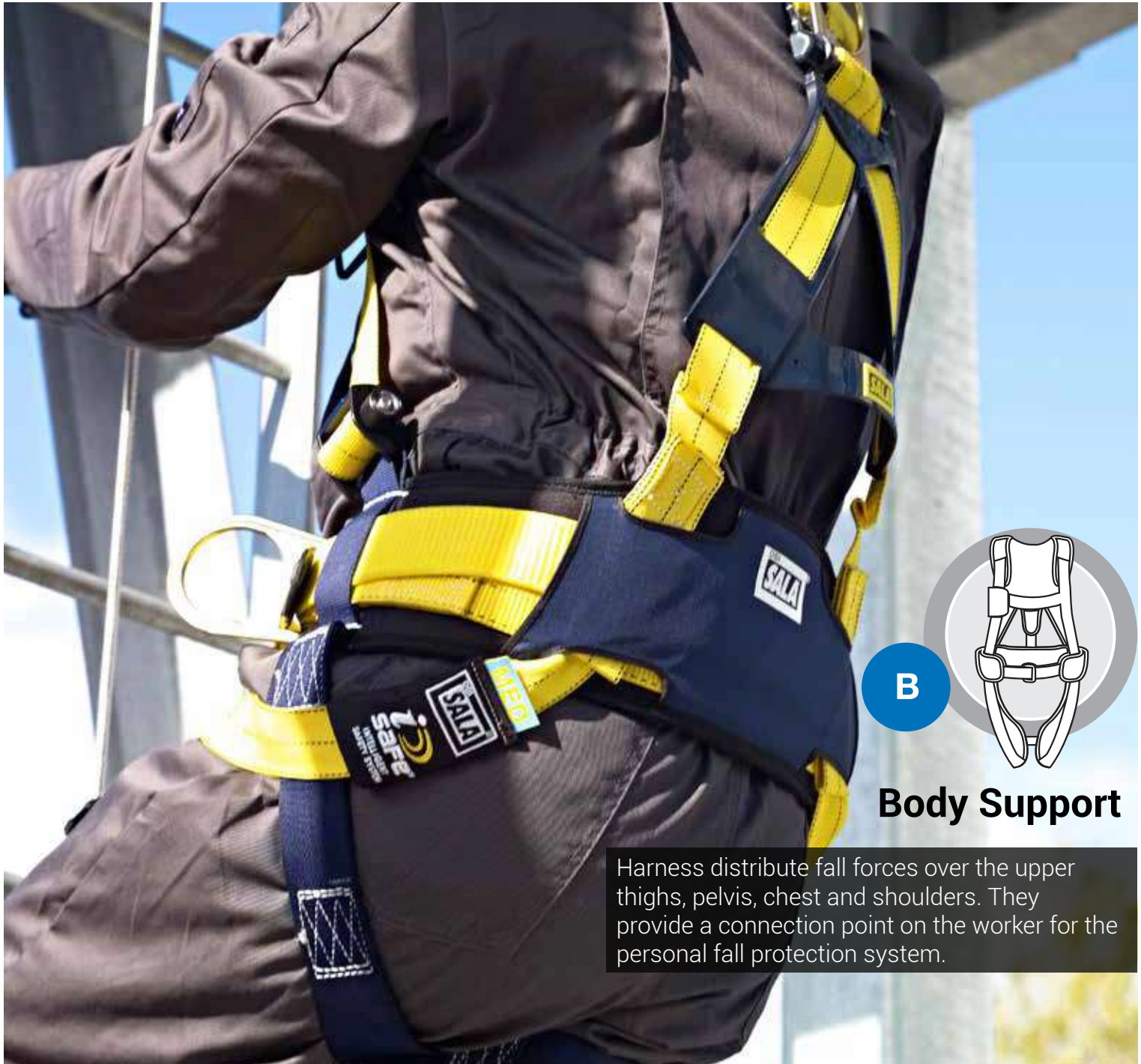

## Body Support

Harness distribute fall forces over the upper thighs, pelvis, chest and shoulders. They provide a connection point on the worker for the personal fall protection system.



## Harnesses

Whether you are 6' or 60' off the ground, your harness is more than just your safety connection – it's everything.

The right safety harness provides comfort and confidence, and could benefit the user's productivity, as well as gives them versatility to do what needs to be done on the job site.

3M™ DBI-SALA® Harnesses are designed for those who refuse to compromise. The new ExoFit™ X-Series harnesses are outfitted with components that have been developed to help enhance the safety, convenience, and performance for working at height on your jobsite.

We have launched innovations such as the Automatic stand-up dorsal D-ring, Revolving torso adjusters, locking quick-connect buckles, personal SRL adapter, anti-slide dorsal D-ring pad, weight distribution system, suspension trauma straps, and connected safety ID. While many of our harnesses can be used on most jobs, we also manufacture harnesses for specific uses within different industries, like Construction, Oil and Gas, Transportation, Utilities/Telecommunications and Wind Energy.





## 3M DBI-SALA® ExoFit™ Rope Access/Rescue Harness

- Features hybrid shoulder, back, and leg comfort padding
- Lightweight aluminum D-rings
- Web-locking quick-connect chest and leg straps
- Includes integrated auto-setting lanyard keepers
- Features revolving torso adjusters
- Available in multiple styles, configurations, and leg and chest connection options
- **Standards:** ANSI A10.32, ANSI Z359.1, ANSI Z359.3, ANSI Z359.4, NFPA 1983, NFPA 1983-06, OSHA 1910.66, OSHA 1926.502

Model No.	1113345	1113346	1113347	1113348
Length	SM	MED	LG	X-LG



## 3M DBI-SALA® Delta™ Vest - Style Climbing Harness

- No-tangle design
- Stand-up back D-ring
- Front D-ring
- Tongue buckle leg straps
- Repel™ webbing
- Built-in lanyard keepers
- Revolver™ vertical torso adjusters
- Impact Indicator
- **Standards:** ANSI Z359.1, OSHA 1910.66, OSHA 1926.502

Model No.	1107806	1107807
Length	SM	MED



# Fall Protection



## 3M DBI-SALA® Delta™ Vest - Style Climbing Harness

**Model No.: 1102090**

- Universal Size
- No-tangle design
- Stand-up back D-ring
- Front D-ring
- Tongue buckle leg straps
- Repel™ webbing
- Built-in lanyard keepers
- Revolver™ vertical torso adjusters
- Impact Indicator
- **Standards:** ANSI Z359.1, OSHA 1910.66, OSHA 1926.502



## 3M DBI-SALA® Delta™ Cross-Over Climbing/Positioning Safety Harness, Universal

**Model No.: 1103270**

- Delta™ no-tangle design for comfort & easy donning
- Spring loaded stand-up D-ring for fast & easy-safe connections
- Patented cross-over design for added comfort / versatility
- Adjustable front D-Ring
- Side D-Rings for work positioning
- Parachute buckles on lower shoulder straps for quick adjustment
- Pass-thru buckle leg straps - easy donning
- Polyester webbing for durability
- Universal sized
- Weight Capacity: 420 lbs. (190 kg)
- **Standards:** OSHA, ANSI and ANSI Z359



## 3M™ DBI-SALA® ExoFit™ X100 Comfort Vest Safety Harness

**Model No.: 1401001, Medium**

The 3M DBI-SALA ExoFit X100 is designed with high-quality components that have been developed to enhance the harnesses safety and comfort while working at height on your job site.

- Equipped with anti-sliding dorsal D-ring pad to help greatly reduce dorsal D-ring slide
- Suspension trauma relief straps with low-profile design included
- Integrated SRL adapter lets you quickly and easily connect and disconnect personal SRLs
- **Standards:** ANSI Z359.11, OSHA 1910.140, OSHA 1926.502



## 3M DBI-SALA® Delta™ Vest-Style Welder's Harness

**Model No.: 1105475**

- Universal Size (Medium / Large size in 1)
- No-tangle design
- PVC coated back D-ring
- PVC coated pass-thru buckle leg straps
- PVC coated pass-thru torso buckles
- Loops for body belt
- Nomex®/Kevlar® webbing
- **Standards:** ANSI A10.32, ANSI Z359.1, ANSI Z359.4, OSHA 1910.66, OSHA 1926.502



# Fall Protection



Model No.	1100727	1100725	1100726
Length	MED	LG	X-LG

## 3M DBI-SALA® Delta™ II Multi-Purpose Harness

**Model No.: 1100727**

- Delta II Multi-purpose harness with back, front, shoulders and side D-rings, integrated belt for back lumbar and positioning work support, Repel technology webbing (water proof and chemical resistance), pass-thru buckles
- Back, front, shoulder and side D-rings with integrated belt for lumbar support
- No-tangle design • Stand-up back D-ring
- Front D-ring • Tongue buckle leg straps
- Repel™ webbing • Built-in lanyard keepers
- Revolver™ vertical torso adjusters
- Impact Indicator
- **Standards:** OSHA 1910.66, OSHA 1926.502, ANSI Z359.1



## 3M DBI-SALA® Delta™ Vest-Style Retrieval Harness

- Stand-up back D-ring
- Tongue buckle leg straps
- Low-profile suspension trauma straps integrated between harness webbing
- Includes integrated auto-setting lanyard keepers
- Features revolving torso adjusters
- Impact indicators provide ease of inspection for webbing integrity
- **Standards:** ANSI A10.32, ANSI Z359.1, ANSI Z359.4, OSHA 1910.66, OSHA 1926.5021

Model No.	1101254	1101257
Length	UNIVERSAL	X-LG



## 3M DBI-SALA® Delta™ Bosun Chair Harness with Rigid Seat

- No-tangle design
- 18" back D-ring extension
- Front D-ring
- Body belt/hip pad with side D-rings
- Seat sling with rigid board and positioning D-rings
- Tongue buckle leg straps
- Revolver™ vertical torso adjusters
- Built-in lanyard keepers
- High visibility Repel™ webbing
- Option webbing seat available
- **Standards: ANSI Z359.1, OSHA 1910.66, OSHA 1926.502**

Model No.	1108126	1108125	1108128	1108129
Length	SM	LG	X-LG	XXLG



Model No.	1402115	1402116	1402117	1402118
Length	SM	MED	LG	X-LG



## 3M DBI-SALA® ExoFit™ X200 Safety Harness

- Revolving Torso Adapters help to adjust harness fit with ease and speed, & lock webbing into place to maintain a comfortable & safe harness fit
- Equipped with anti-sliding dorsal D-ring pad to help greatly reduce dorsal D-ring slide
- Dual-locking quick connect buckles lock to harness webbing & helps prevent adjustments from slipping
- Low-profile suspension trauma strap design integrated between harness webbing
- Equipped with auto-resetting lanyard keepers to help with faster & easier parking of snap hooks & carabiners
- 3M™ Connected Safety ID (RFID) integrated for simplified inventory, inspection, & record management
- **Standards: CSA Z259.10-18**



# Fall Protection



## 3M DBI-SALA® ExoFit™ Derrick Harness

- No-tangle design • Stand-up back D-ring
- Lifting D-rings • Tongue buckle leg straps
- Parachute torso buckles
- Integrated derrick belt connection (shown with 1000545 derrick belt - must order separately)
- Protected labels, equipped with 3M™ Connected Safety ID (CSID)
- Standards: ANSI Z359.1, ANSI Z359.3, OSHA 1910.66, OSHA 1926.502

Model No.	1105826	1105827	1105825	1105828
Length	SM	MED	LG	X-LG

## Desert Gold ANSI Full Body Harness & Shock Absorbing Lanyard



### Model No.: SP708ASH

- Full Body Harness with 3 points adjustment
- Material - Polyester, breaking strength 22kN
- Design - Dorsal D-ring for fall arrest
- Adjustable leg straps
- Breakaway lanyard keepers
- Leg pad and shoulder pad
- Standards: ANSI Z359.11.2021



### Model No.: SP709ASL

- Lanyard 6ft. Shock Absorber, Rebar Hook and Double leg
- Design: Double Y shaped lanyard with shock absorber
- One end of absorber equipped with snap hook and other sides of the lanyard are equipped with rebar hooks
- Length: 6 ft. • Width: 30 mm
- Standards: ANSI Z359.13.2013 (R2022)





K-COMPANY  
APPROVED

  
GUARDIAN

## Guardian® Fall Protection Series 5 Harness

**Model No.: 37301**

The Guardian Series 5 full-body harness incorporates premium features for even greater performance. Series 5 harnesses feature durable water-repellant, contrasting core webbing that makes any damage easy to see, greatly improving the inspection process. Removeable shoulder and leg pads offer expanded coverage for increased comfort and are removable for washing.



K-COMPANY  
APPROVED

  
GUARDIAN

## Guardian® 6 Foot Double Leg Shock Absorbing Lanyard with Rebar Hooks

**Model No.: 01231**

The Guardian 01231 6 Foot Double Leg Shock Absorbing Lanyard with Rebar Hooks meets all the ANSI Z359.13-2009 regulations. This twin leg lanyard features 1" nylon webbing and steel rebar hooks at each leg end with a snaphook at the middle connection point. The integrated shock absorbing component limits average arresting forces to 900 pounds or less.

**Features:**

- 6' Length
- 1" Nylon Webbing
- Rebar hooks at each leg end
- Clear shock absorbing pack for easy inspection
- Always ANSI compliant 3,600 lb.
- 100% of the lanyards meet the ANSI Z359.13-2009 requirements



# Fall Protection



## 3M DBI-SALA® ShockWave™ 2 100% Tie-Off Shock Absorbing Lanyard

**Model No.: 1246129**

- Exclusive Vectran™ energy absorption system
- Extremely compact and lightweight
- Abrasion-resistant webbing
- Available in a wide range of web styles & designs
- User-friendly self-locking snap hooks
- Built-in impact indicator
- Ideal for the following applications: Construction, General Industrial and Oil & Gas
- **Standards:** ANSI A10.32, ANSI Z359.1, ANSI Z359.13, ASTM F887, OSHA 1910.66, OSHA 1926.502



## 3M DBI-SALA ShockWave™ 2 100% Tie-Off Shock Absorbing Lanyard

**Model No.: 1244409**

- 6 ft. (1.8m) double-leg 100% tie-off lanyard
- Stretches in reaction to your movements
- Abrasion resistant polyester tubular webbing
- Self-locking aluminium rebar hooks at leg ends
- Energy absorbing design limits fall arrest forces
- **Standards:** ANSI Z359.13, OSHA 1926.502, OSHA 1910.140



## 3M DBI-SALA® Force2™ 100% Tie-Off Shock Absorbing Lanyard

**Model No.: 1246159**

- 6 ft. (1.8m) double-leg 100% tie-off lanyard
- Force2™ 12 ft. free fall (3.6m) and dual capacity rated
- Extremely compact and lightweight
- Exclusive Vectran™ energy absorption system
- Abrasion resistant polyester webbing
- User friendly self locking snap hook at center
- Self-locking gate/nose steel rebar hook at leg ends
- **Standards:** ANSI Z359.13



## 3M DBI-SALA® EZ-Stop™ Adjustable Shock Absorbing Lanyard

**Model No.: 1246234**

- 6 ft. (1.8m) adjustable single-leg lanyard
- Extremely compact and lightweight
- Exclusive Vectran™ energy absorption system
- Abrasion resistant polyester webbing
- User friendly self locking snap hook at center
- Standards: ANSI Z359.13



## 3M DBI-SALA® Rope Positioning Lanyard - Nylon

**Model No.: 1232354**

- 6 ft. (1.8 m) single-leg lanyard (Other lengths available)
- Ideal for work positioning or restraint
- 1/2 in. (1.3 cm) three-strand filament nylon rope
- Standards: ANSI A10.32, ANSI Z359.3, OSHA 1910.66, OSHA 1926.502
- Size: Incremental per foot



## 3M DBI-SALA® Rope Adjustable Restraint Lanyard - Polyester

**Model No.: 1232210**

- 6 ft. (1.8m) adjustable single-leg lanyard
- Ideal for work positioning or restraint
- 1/2 in. (1.3cm) three-strand filament polyester rope
- User friendly self locking snap hooks at each end
- Size: Incremental per foot
- Standards: ANSI A10.32, OSHA 1910.66, OSHA 1926.502



# Fall Protection



## 3M DBI-SALA® 6 ft. Class 1 Nano-Lok SRL with Anchor Hook

**Model No.: 3100522**

- Swiveling anchorage loop with carabiner
- Quick activating speed sensing brake system
- Self-locking snap hook on lifeline
- Compact & lightweight design
- Durable thermoplastic housing
- Standards: 29 CFR OSHA 1926.502



## 3M DBI-SALA® Sealed-Blok SRL

- Critical SRL components sealed from environmental exposure
- Swiveling self-locking snap hook with impact indicator
- Pivoting anchorage connector loop
- Durable Construction
- Galvanized & stainless steel cable options
- Quick activating speed-sensing locking system
- Standards: 29 CFR OSHA 1910.140, 29 CFR OSHA 1926.502, ANSI/ASSP Z359.14-2021



Stainless Steel - Model No.	3400131	3400133	3400135	3400169	3400172	3400173
Galvanised - Model No.	3400130	3400132	3400134			
Length	15ft.	30ft.	50ft.	85ft.	130ft.	175ft.



Stainless Steel - Model No.	3400149	3400167
Galvanised - Model No.	3400148	
Length	50ft.	85ft.

## 3M DBI-SALA® Sealed-Blok™ SRL, Retrieval with Bracket

### Model No.: 3400148

The 3M™ DBI-SALA® Sealed-Blok™ Self-Retracting Lifeline is one of the most critical parts of a rescue system as it provides the means to retrieve an incapacitated worker to safety.

- ANSI Class Level: Class 1
  - Anchor Connection Type: Swivel Snap Hook
  - Anchor Hook Material: Zinc Plated Steel
  - Anchor Hook Material: Stainless Steel
- Average Arrest Force (Imperial): 1125 lbf (ANSI), 1125 lbf (OSHA 130 lb - 310 lb)
- **Standards:** 29 CFR OSHA 1910.140, 29 CFR OSHA 1926.502, ANSI/ASSP Z359.14-2021



Galvanised - Model No.	3503872	3503874
Length	20ft.	30ft.
Stainless Steel - Model No.	3503875	3503879
Length	25ft.	40ft.

## 3M DBI-SALA® Smart Lock Self-Retracting Lifelines

3M™ DBI-SALA® Smart Lock Self-Retracting Lifeline are our smartest SRLs yet. From reducing nuisance lockups, to simplifying inspections, every detail of the new 3M™ DBI-SALA® Smart Lock Self-Retracting Lifeline is designed with helping workers perform with safety and convenience. Using advanced motion capture technology, we studied the forces applied to the SRL during typical at-height tasks. This data helped us engineer a new arrest mechanism that can more easily detect the difference between a fall and normal work motion, tailoring a SRL for your work application.



# Fall Protection



## 3M DBI-SALA® Rollgliss Descender - Controlled Emergency Escape Device

The Rollgliss® Descent Device will get personnel down safely from high places when quick escape is vital. Either vertical or sloped descent models are available to provide complete versatility and flexibility for any job site or work environment.

Stainless Steel - Model No.	3303016
Galvanised Steel - Model No.	3303015

## 3M DBI-SALA® Horizontal Systems

### Model No.: 7605060

- 60ft. (18.3m) retractable system can be set at any length
- Rugged 1/4" (6.3mm) 7 x 19 galvanized cable lifeline
- Built-in winch, pre-tension and impact indicators
- Durable construction will stand up to tough jobsites
- Single and multi-span (with SecuraSpan™ stanchion) system configurations
- Flexible system capacity
- Equipped with i-Safe™
- Use with any 5,000lb. (22.2 kN) anchorage device
- Standards: OSHA 1926.502





## 3M DBI-SALA® Advanced 5-Piece Hoist System

### Model No.: 8518000

- 5-piece davit hoist system
- Integrated 5,000lbs. (22 kN) mast anchorage point
- Fall arrest rated in all davit offset mast positions
- Adjustable offset upper davit mast (model 8518001)
- Telescoping reach of 11-1/2in. to 27-1/2in. (29.2 to 69.8cm)
- Adjustable vertical height of 33in. to 43in. (83.8 to 109.2cm)
- Built-in primary and secondary pulleys
- Quick mount winch/SRL bracket
- Detent and knob style adjustment
- 33in. (83.8cm) lower davit mast extension (model 8518002)
- 3-piece adjustable portable base (model 8518005)
- Base width adjusts from 37 in. to 64 in. (94 to 162.6cm)
- Standards: ANSI Z359.1, OSHA 1926.502



## 3M DBI-SALA® Advanced™ Pole Hoist System

### Model No.: 8530253

- Extendable pole hoist system
- Extends 6-10ft. (1.8-3m)
- Built-in pulley for lifeline
- Swivel head rotates 360 degrees
- Quick mount winch bracket
- Adjustable stabilizer T-bar
- Set-up and dismantle without tools
- Order mechanical winch/SRL device(s) separately
- Standards: OSHA 1926.502, OSHA 1910.140



# Fall Protection



## 3M DBI-SALA® Advanced Aluminium Tripod

Advanced Tripods are constructed of lightweight tubular aluminium with a rugged steel head assembly. The tripods can be combined with up to three pulleys to accommodate a variety of winches and fall arrest devices to meet a wide range of confined space entry/retrieval and rescue requirements.

### Kits Tripod + Winch:

- 7ft. tripod + Winch 60ft. Stainless Steel Cable 8300031
- 7ft. tripod + Winch 90ft. Stainless Steel Cable 8300033
- 7ft. Tripod + Winch 120ft. Stainless Steel Cable 8300035

### Kit Tripod + Sealed Blok Fall Arrester with integrated Retrieval:

- 7ft. Tripod + 50ft. Sealed Blok Fall Arrester Stainless Steel 8301001
- 7ft. Tripod + 85ft. Sealed Blok Fall Arrester Stainless Steel Cable 8301003
- 7ft. Tripod + 130ft. Sealed Blok Fall Arrester Stainless Steel Cable 8301007

- **Standards:** ANSI Z117.1, ANSI Z117.1-1995, OSHA 1910.146, OSHA 1910.66, OSHA 1926.502



## 3M DBI-SALA® Advanced Side Entry Tank Mount System

### Model No.: 8530254

- Capacity 450lbs. • Side entry system for tanks
- Multiple pivot point arm assembly
- Rotating and adjustable mechanical device base
- Extentable arm up to 6ft. (1.8m)
- Adjustable height range of 3.2ft. to 4.4ft. (0.9 to 1.3m)
- Built-in pulley for lifeline • Quick mount winch bracket
- Adjustable external tank collar
- Lightweight, corrosion resistant aluminum construction
- Order mechanical winch/SRL device(s) separately
- **Standards:** ANSI Z117.1-1995, OSHA 1910.146





## 3M DBI-SALA® Advanced™ Portable Fall Arrest Post

### Model No.: 8516691

- Portable fall arrest post
- 360 degrees of protection for 3 workers
- Telescoping design
- Built-in levelling system
- Anchor ring for horizontal lifeline system
- Integral carrying handle
- Lightweight, corrosion resistant aluminium construction
- Order base, lanyard or SRL separately
- Portable, telescoping fall arrest post with three independent 360 degree swiveling anchor points
- Standards: OSHA 1910.66, OSHA 1926.502

## 3M DBI-SALA® Advanced™ Davit Arm

### Model No.: 8516693

- Davit arm for portable fall arrest post
- Adjustable offset upper davit mast (model 8518001)
- Built-in primary and secondary pulleys
- Quick mount winch/SRL bracket
- Detent and knob style adjustment
- Built-in secondary fall arrest anchor point
- Includes cable stabiliser strap
- Lightweight, corrosion resistant aluminum construction
- Order 8516691 fall arrest post and winch/SRL separately
- Davit arm for portable, telescoping fall arrest post with adjustable 71 in. (180.3cm) height & 34 in. (86.4cm) offset
- Standards: OSHA 1926.502, OSHA 1910.140





# Fall Protection



## 3M DBI-SALA® Salalift® II Winch

Winch with 60ft. (18m) of 1/4in. (6.3mm) stainless steel wire rope and swivel snap hook, mounting bracket and carrying bag

- Manually operated winch
- Quick mount bracket
- Free-wheel mode
- Built-in fall protection
- Overload clutch
- Durable corrosion resistant construction
- Level wind system
- Reserve lifeline retention system
- Swivelling snap hook with impact indicator
- Includes mounting bracket and carrying bag
- Standards: ANSI Z117.1, ANSI Z117.1-1995, OSHA 1910.146

Stainless Steel - Model No.	8102003	8102011	8102007
Galvanised - Model No.	8102001	8102009	8102005
Length	60ft./18m	90ft./27.5m	120ft./36.5m

## 3M DBI-SALA® Advanced™ Digital 100 Series Winch

The Digital 100 Series winch includes a removable aluminium crank handle to utilize both our 9:1 and 4:1 drives. These two drives offer the capability of retrieval/descent at average speeds from 13 ft./min up to 30 ft./min. The UCL Advanced Digital Series winches are rated for a maximum working load of 450 lbs with an 11:1 safety factor. Comes with 60 ft. of 3/16in. stainless steel cable with a locking snap hook. Power Drive System with drilling device can be used for lowering ascending carrying bag for advanced digital winch.

- Winch Sizes: 8518558 60ft. / 8518559 90ft.
- Power Drive: 8518565 60ft. / 8518566 90ft.
- Standards: ANSI Z117.1, ANSI Z117.1-1995, OSHA 1910.146





## 3M Engineered Systems

The 3M™ DBI-SALA® Permanent Horizontal Lifeline System can be used for either work restraint or fall arrest and is suitable for multiple applications. It allows users complete freedom of movement to carry out their work uninterrupted, in a continuous straight line and around corners, provided a suitable structure is available for connection of the lifeline.

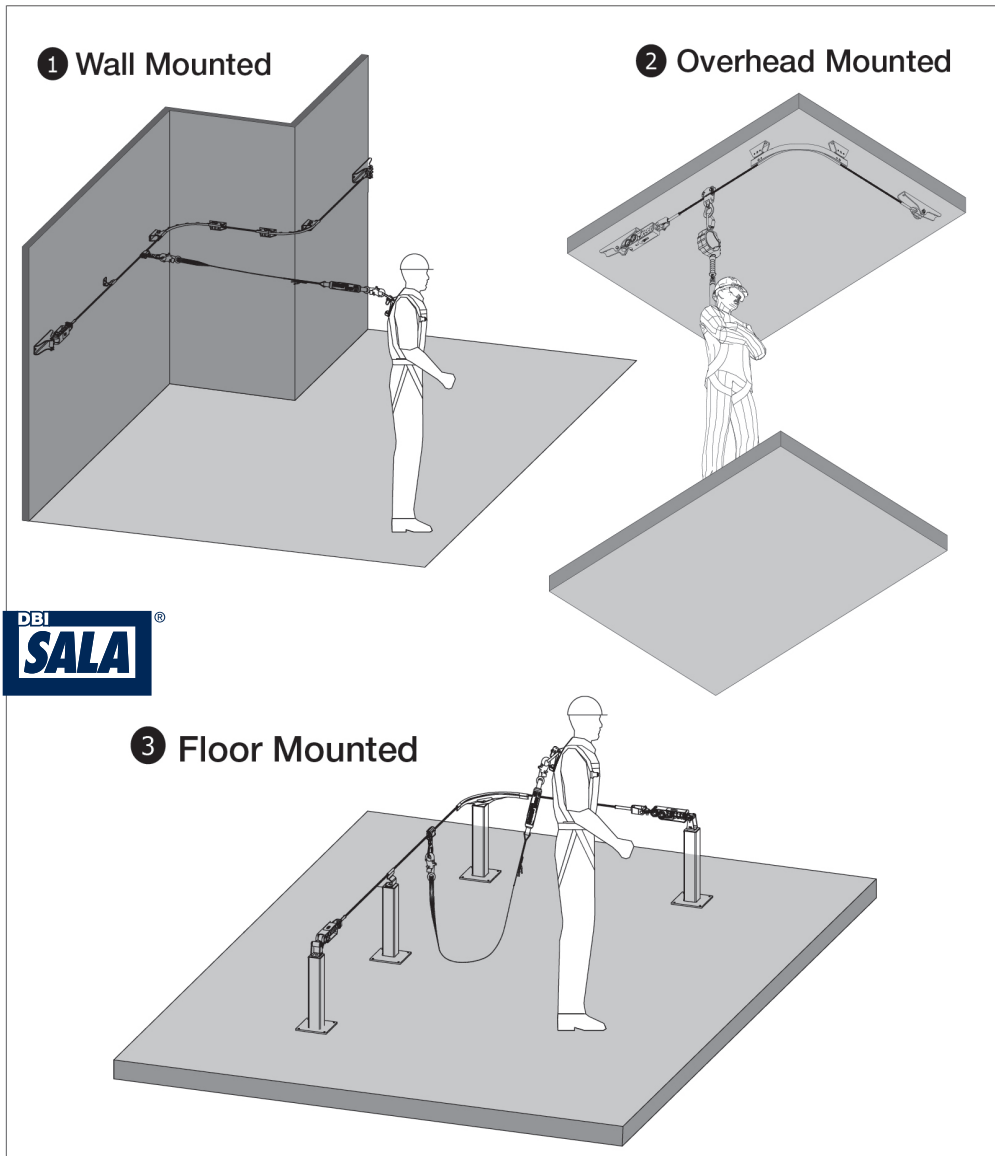



# Fall Protection

## Wall & Floor Applications

- Ideally suited to modern building projects, refurbishments and industrial safety applications
- Can be fitted to steel beams, concrete and brickwork
- Suitable for use on older roof constructions in conjunction with fabricated anchor posts
- Allows up to 15 m spans between support brackets for multiple users.



**Model No.: 7241412**  
8 mm intermediate bracket



**Model No.: 7241413**  
8 mm variable bracket



**Model No.: 7241408**  
90 degree post mount corner



**Model No.: 7241415**  
8 mm 45 deg  
intermediate bracket



**Model No.: 7241424**  
19 kN peak force, 0.8 kN system  
tension energy absorber



**Model No.: 7240211**  
8 mm, 7 X 7 & 1 X 19  
Stainless Steel Cable



**Model No.: 7241406**  
90 degree internal corner



**Model No.: 7241409**  
45 degree internal corner



**Model No.: 7234011**  
8 mm hex swage toggle



**Model No.: 7241417**  
Multi fix anchor plate



**Model No.: 7240122**  
8 mm straight eye



**Model No.: 7234012**  
8 mm Hex Swage Joiner



**Model No.: 7241420**  
8 mm Detachable Traveller



**Model No.: 7241422**  
11 kN peak force, 0.8 kN system  
tension energy absorber





## Overhead Applications

- Specifically designed to meet the needs of transport and industrial customers
- Enables safe work at height to be carried out on trucks, trains and aircraft, crane walkways and loading bays
- Solves access and safety problems within the entertainment and arena industry
- Can support Self-Retracting Lifelines and controlled rate descent devices up to 15 kg
- Allows up to 60 m single span for 1 user and up to 30 m single span for multiple users
- Corner brackets available for overhead applications.



**Model No.: 7240122**  
8 mm straight eye



**Model No.: 7241067**  
8 mm overhead bracket



**Model No.: 7241432**  
Stop Ball



**Model No.: 7241425**  
19 kN peak force, 5 kN system  
tension energy absorber



**Model No.: 7234012**  
8 mm Hex Swage  
Joiner



**Model No.: 7240211**  
8 mm, 7 X 7 & 1 X 19  
Stainless Steel Cable



**Model No.: 7241417**  
Multi fix anchor plate



**Model No.: 7241421**  
8 mm Overhead Traveller



**Model No.: 7234011**  
8 mm hex swage toggle





# Fall Protection

## Roofsafe Lifeline Multiple Roof Systems

The RoofSafe anchor can be used to facilitate the installation of a horizontal lifeline system that allows continuous uninterrupted access to all areas of a roof or alternatively can be used as a single point of anchor for maintenance tasks in localised areas.



### SpiraTech Force Management Technology

In the event of a fall, the RoofSafe anchor breaks open, deploying the unique and patented SpiraTech Force Management Technology absorbing system, which reduces the forces generated on the roof structure to less than 6 kN, the lowest of any of its kind on the market. This enables the anchor to be installed on a wide variety of old and new roof types with less risk to structural integrity.

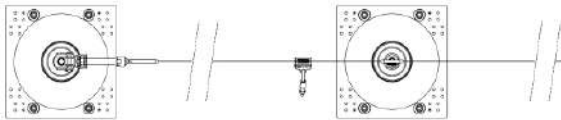
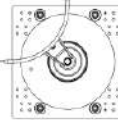
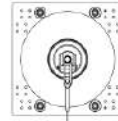

**Model No.: 7241141**

RoofSafe Anchor Module  
End/Corner Top Fix



**Model No.: 7241136**

RoofSafe Anchor Baseplate  
Multi Sizes



**Model No.: 7241161**

RoofSafe Anchor  
System Eye & Pin



**Model No.: 7241143**

RoofSafe Anchor Module  
End / Corner Bitumen



**Model No.: 7241145**

RoofSafe Anchor Module  
End/Corner PVC



## UniRail™ Horizontal System

UniRail™ is a quality extruded aluminum rail system, which provides a high level of user safety combined with an aesthetically pleasing appearance. The product can span up to 10ft (3m) between support brackets. It offers excellent functionality through its free flowing attachment carriage, the user's experience with the system is truly hands free. The system is also capable of navigating corners and contours in the building or structure to provide complete design flexibility. UniRail™ can be fitted to a wide range of structures and can support multiple workers for both fall arrest and fall restraint work applications. UniRail's strength and functional characteristics make it very suitable for use as an anchorage system for rope access and abseil work tasks where the structure requires inspection and light to medium duty tasks.

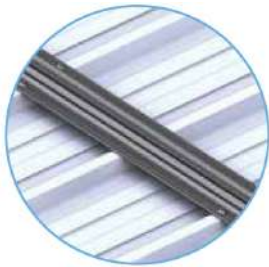

### Rail Profile

The one piece base plate's unique profile facilitates ease of installation and directs water away from fixing points. Each length is joined with a spigot pin to provide additional strength and to help with alignment. Standard lengths is 10 feet (3 meters).



### Spreader Plates

The spreader plates incorporate the same fixing features as the base plate and facilitate attachment of the system 'upslope' to a variety of wider roof profiles.



### Corners

The RoofSafe™ System is available with 90° and 45° corners as standard and ridge and valley rail joints can be formed to allow continuous attachment.





## Lad-Saf™ Fixed Ladder Safety System

### 6116632 (SS)

#### Top & Bottom Bracket System

- Spacing: 9"-12.25" (230mm-310mm)
- Cylindrical rung: 0.5"-1.6" (13mm-40mm) diameter
- Square rung: 0.5"-1.6" (13mm-40mm)
- Diamond rung: 0.5"-1.6" (13mm-40mm) height
- Angle Iron: 0.5"-1.6" (13mm-40mm) leg height
- Rectangular rung: 0.5"-1.6" (13mm-40mm) height, 0.5"-1.9" (13mm-48mm) width



## Lad-Saf™ Flexible Cable Sleeve

The Lad-Saf™ sleeve is globally recognized and preferred because of its user friendly and reliable design. The sleeve is easily attached or removed anywhere along the cable and automatically follows you as you climb or descend. In the event of a fall, the device locks onto the cable lifeline allowing you to regain your footing and continue to climb.

### 6110000

#### Cable Lifeline

Galvanized cable, 3/8" (9.5 mm) diameter, 1 x 7 type. Last 3 digits in part number indicate length in feet.

### 6100400

#### Cable Guide

Non-metallic cable guide with mounting hardware. For systems up to 199 ft. (60.6 m), fits up to 1-1/8" (2.85 cm) rung diameter. Must have 1 every 25 ft. (7.6 m).

### 6160030

#### Lad-Saf™ Detachable Cable Traveller

Sleeve with carabiner, cam and inertial locking, fits 3/8" (9.5 mm) and 5/16" (8 mm) diameter 1 x 7 or 7 x 19 solid core cable





**3511063**

**SSB Safety Block**  
Climb assist main  
block pulley assembly.

**3512000**

**Lifeline Assembly**  
Galvanized 1/4" (6.3 cm) 7 x 19  
cable assembly with rung and  
belt hook last 3 digits in part  
number indicate length in feet.

**3530000**

Stainless steel lifeline assembly.

**3511783**

**Mountain Bracket**  
Attaches safety block to structure.  
Fits round rungs up to 3/4" (1.9  
cm) diameter or square rungs up  
to 9/16" (1.4 cm) per side.

**3511785**

Mounting Bracket, fits round rungs  
over 3/4" (1.9 cm) up to 1-1/2" (3.8 cm)  
diameter or square rungs over 9/16"  
and up to 1-1/2" (3.8 cm) per side.

**3511598**

**Counterweight Assembly**  
80 lb. (36.3 kg) counterweight with  
integrated runaway brake system.

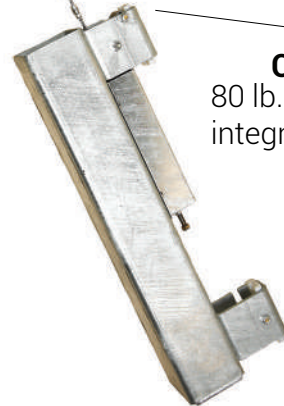

## SSB Climb Assist System

The DBI-SALA® SSB Climb Assist System, with external counterweight, aids workers and provides fall protection while climbing lengthy ladders and towers. It's ideal for use on land based and offshore drilling platforms, where environmental and work conditions can make climbing ladders hazardous.

- Counterweight includes a runaway brake for added safety
- No limit to length of system for ultimate flexibility
- Durable aluminium housing and steel drum for durability and corrosion resistance
- Takes 25-55 kg of your weight for very easy climbing
- Fall arrest system integrated

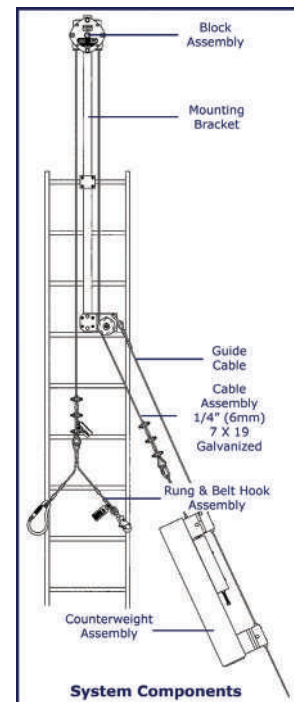



# Fall Protection

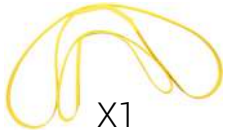

X1



X2



## Rollgliss R550 Rescue & Descent Device with Soft Bag

Includes carabiner (2), 4 ft., (1.22 m) anchor sling and rope bag.

Part#	Length
3327050	50 ft.
3327075	75 ft.
3327100	100 ft.
3327150	150 ft.
3327200	200 ft.
3327250	250 ft.
3327275	275 ft.
3327300	300 ft.
3327325	325 ft.
3327350	350 ft.
3327400	400 ft.



## Rollgliss R550 Rescue & Descent Device with sealed case

Fully sealed case provides 10 years minimum storage life. External humidity indicator allows user to inspect the seal without opening case. Includes edge protector, 4 ft. (1.22 m) anchor sling (2), 2.5 ft. (0.76 m) anchor sling, pulley, rope grab, carabiner (3), rope bag and humidity case.

Model No.	3326100	3326300	3326350
Length	100 ft./31m	300 ft./92 m	350 ft./105m
Weight	35.3lbs/16.01 kg	42.9lbs/19.46 kg	44.8lbs/20.32 kg

## Accessories

**3320003**

Edge Protector w/Carabiner



**8900298**

Rescue Pole



**3321014**

Ladder Bracket





## 3M DBI-SALA® Suspension Trauma Safety Straps

**Model No.: 9501403**

- Suspension trauma safety strap
- Allows user to stand in harness after a fall
- Attaches to almost any harness
- Fast and easy installation
- Extremely compact and lightweight design
- Simple and fast zipper style deployment
- Continuous loop design
- In-field resettable design



## 3M DBI-SALA® Cable Tie-Off Adaptor

**Model No.: 5900551**

- 6 ft. (1.8 m) pass-thru type tie-off adaptor
- Durable 3/8" (9.5 mm) 7 x 19 stainless steel cable construction
- High strength steel O-ring hardware
- Compact and lightweight design
- **Standards: ANSI Z359.18, OSHA 1910.140, OSHA 1926.502**



## 3M DBI-SALA® Concrete Detent Socket & Cap

**Model No.: 2101000**

- Installs into 7/8" (22 mm) concrete hole with adhesive
- Use vertically in wall or horizontally in ceiling
- Order reusable detent D-ring assembly separately - model 2101002
- Socket cover cap included
- Compact and lightweight design
- High strength steel construction
- Rugged and corrosion resistant material
- **Standards: ANSI Z359.1, OSHA 1910.66, OSHA 1926.502**



# Fall Protection



## 3M DBI-SALA® Vinyl Bucket

**Model No.: 1500140**

- Six built in connection points with 10 lb. (4.5 kg) load rating each
- 250 lb. (113.4 kg) load rating
- Puncture resistant plating sewn into the base of the bucket
- Carabiner and Hoisting Strap
- Innovative hook and loop closure system
- Heavy-duty vinyl is easy to clean



## 3M DBI-SALA® Hard Body Safe Bucket Insert with Pockets

**Model No.: 1500141**

- Hard body safe bucket insert
- Reusable insert
- Four inner pockets



## 3M DBI-SALA® Python Safety® Extra Deep Tool Pouch & D-Ring

**Model No.: 1500127**

- Tool pouch is 8.75 in. wide × 13 in. high (22.2 cm x 33 cm) and has multiple inner pockets
- Belt loops provided on rear of pouch
- Two internal retractor pockets, allowing 3M™ DBI-SALA® Steel Cable Retractors to be installed
- Made from 18 oz. duck canvas with inner lining to help prevent punctures
- Inside the pouch are two retractor pockets to allow cable retractors to be installed
- Integrated D-rings load-rated for 5 lbs. (2.3 kg) makes tethering tools easy



## 3M DBI-SALA® Adjustable Radio Holster with Clip2Loop Coil and Micro D-Ring

**Model No.: 1500089**

- Adjusts to the size of virtually any portable radio or cell phone
- D-Ring connection point
- Can be used from a belt or harness
- Ergonomic quick-cinch ergonomic cord lock
- Includes Python Safety Clip2Loop Coil Tether and Micro D-Ring



## 3M DBI-SALA® Dual Tool Holster For Belt

**Model No.: 1500106**

- Net Weight (Metric): 0.22 kg
- Weight (Metric): 0.22 kg
- Weight Capacity: 5 lb (2.3 kg)
- Standards: ANSI / ISEA 121-2018



## 3M DBI-SALA® Hook2Hook Tether w/Swivel

**Model No.: 1500159**

- Stretches from 4" to 62" in length
- Aluminum lockable carabiner
- Vinyl-coated steel coil
- 5 lb. capacity





# Fall Protection



## 3M DBI-SALA® Adjustable Wristband - 5 lb.

**Model No.: 1500082**

- Adjustable wristband, elastic strap with hook and loop
- Sewn-in ballistic nylon D-Ring connection point
- Adjusts to virtually any wrist size



Model No.	1500111	1500112
Sizes	LG/XL	2XL/3XL



## 3M DBI-SALA® Comfort Tool Belt

**Model No.: 1500110 Small-Medium (28"-36")**

DBI-SALA® Comfort Tool Belts were designed with a modular approach allowing the user to customize their own personal holster and pouch setup.

- Modular design for tool carrying flexibility
- Unique design that provides both strength and comfort
- Extra padding for comfort
- Fits 28-36 in. (71-91 cm) waist size



## 3M DBI-SALA® Quick Wrap Tape - Yellow

**Model No.: 1500176 (Pack of 120 rolls)**

**Model No.: 1500175 (Pack of 10 rolls)**

Quick-wrap tape II, yellow, 1 in. x 9ft. (2.54cm x 2.74m) length, used with 3M™ DBI-SALA® D-Rings and Tool Cinches to create instant tethering points on virtually any tool.

- Creates instant tethering points
- Redesigned Quick-Wrap Tape II helps deliver long-lasting tool attachment performance
- Resists tears better
- Stretches further
- Quick and easy installation
- Stays out of the way
- Reduces tool downtime



## 3M DBI-SALA® Quick Spin

- Reusable design
- Tangle-resistant spin top

Model No.	1500028	1500029	1500030
Sizes	Medium	Large	X-Large
Capacity	0.8in. (2cm)	1in. (2.5cm)	1.2in. (3.1cm)

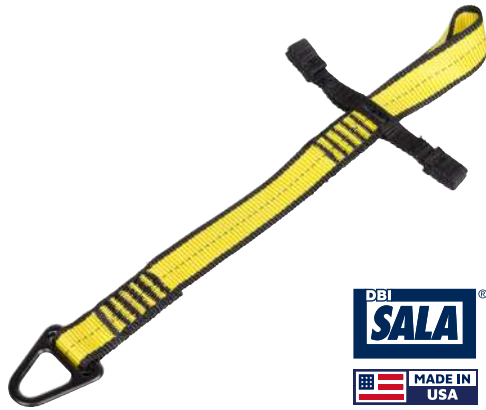

## 3M DBI-SALA® Dual Wing Cinch Tool Attachment Point

**Model No.: 1500015**

Tool Cinch - Dual Wing - Medium Duty Attachment Point features a unique cinch design that allows users to quickly secure even the most difficult to tether tools, and continue their work.

- 35 lb. (15.9 kg) capacity
- Stabilization wings can be used to secure cinch in place
- Simple cinch design



## 3M DBI-SALA® D-ring Attachment 1" x 3.5"

**Model No.: 1500008 (50 Ea/Pack)**

- Creates instant attachment points
- 1 in. x 3.5 in. (2.54 cm x 8.89 cm)  
D-Ring attachment point
- 5 lb. (2.3 kg) capacity
- Use our Quick-Wrap Tape II to attach D-ring to your tool
- Standards: ANSI / ISEA 121-2018



## 3M DBI-SALA® D Ring Attachment 0.5" x 2.25"

**Model No.: 1500003 (Pack of 10)**

- Creates instant attachment points
- 0.5" D-Ring attachment point
- Heavy-duty dual bar tack stitch with nylon twist multi-filament bonded thread
- 2lb. (0.9kg) capacity
- Triple fold tab sewn on end of webbing creates a unique "catch point"
- Heavy-duty welded d-ring allows for easy connection to a variety of extension lanyards for use in the field
- Use Quick-Wrap Tape II to attach D-ring to your tool
- Standards: ANSI / ISEA 121-2018



## 3M DBI-SALA® Hook2Loop Bungee Tether

**Model No.: 1500048 (Pack of 10)**

- 10 lb. (4.5 kg) capacity
- 5/8" tubular webbing
- Self-Locking carabiner







## Quick-Switch® Tool Tethers

Cutting-edge products like quick-switch®  
Make dropping equipment a thing of the past

### The first tool switching tether system in the world

Quick-Switch® tool tethers are a revolutionary system used to connect tools when working at heights. The system is designed to keep tools connected at all times (including during tool transfers) & reduce the risk of tools being dropped on people or property below.



### Key features and benefits of the Quick-Switch® system

- Fast and easy use
- No more dangling tool tethers
- Reduced swinging tool hazard
- Low profile for snag resistance
- Hands-free tool switching
- Lightweight and comfortable
- Switch from place to place while maintaining 100% tie-off
- Impact, chemical and corrosion resistant material
- US Patent No. 9,351,558

### How it works





# Fall Protection



## Quick-Switch Tool Lanyard System 1 Docking Station & 1 Switch

### Model No.: QSS

- Quick-Switch® Switch & Dock Pack (1 Switch, 1 Dock)
- Patent No. 9,351,558



## Quick-Switch Rotating Dock

### Model No.: BRKTPCHDK-R

- No more dangling tool tethers
- Reduced impact force in a drop
- Hands-free tool switching
- Tapered for easy alignment
- 360-degree rotation
- Reduced swing and snag hazard
- Maximum tool weight 2.7kg (6lb)



## Quick-Switch Retracting Tether With Key On End

### Model No.: RET648RQS-R

- Max Tool Weight: 6 lb
- Ends: Quick-Switch Link & Stainless Steel Screw-Gate, Type: Quick-Switch
- Anchor Options: Tool Pocket|Waist/Belt
- Quantity: Single



## Quick-Switch Wrist Strap Cinch Style

### Model No.: QSWSCNCH

QUICK-SWITCH WRIST CUFF (Single) - The patented Quick Switch wrist strap is the heart of the Quick Switch system. Just secure the strap to your wrist (or ideally, both wrists) for 100% tie-off to reduce the risk of dropped tools.



  
**GUARDIAN**

## Quick-Switch Bungee Tether

**Model No.: QSBNGEXT**

- Internal bungee cord with nylon outer sheathing
- QS Key installed on one end to negate need for QS wrist cuff
- Made for the Quick Switch product line
- Quickly attaches to waist belts using the carabiner
- Carabiner attaches to D-Ring Attachments or factory attachment points
- Connect to fixed anchor points with ease
- Meets ANSI/ISEA 121-2018

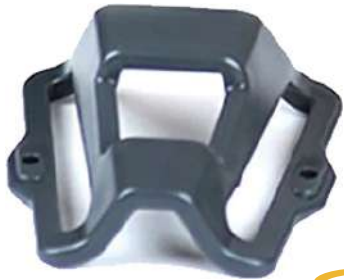

  
**GUARDIAN**

## Quick-Switch Docking Station

**Model No.: QSDOCK**

- Quick-Switch® Dock (Package of 2)
- Patent No. 9,351,558
- Meets ANSI/ISEA 121-2018



  
**GUARDIAN**

## Quick-Switch Starter Kit

**Model No.: QSSTRTKT**

Quick-Switch® is the first and only tool transfer system on the market that lets you switch tools from one location to another without ANY possibility for a drop



# Fall Protection



**PROTECTA**

**MADE IN FRANCE**

## 3M Protecta® E200 Standard Vest Style Fall Arrest Harness

**Model No.: 1161601**

- Modern look at an affordable price
- Conveniently placed front D-ring
- Auto-resetting lanyard keeper
- Impact indicators
- Easy and clear identification of fall arrest anchorage points
- No loose web ends
- Stain and water resistant webbing



**MADE IN FRANCE**

**PROTECTA**

## 3M Protecta® Sanchoc™ Shock Absorbing Lanyard

**Model No.: AE532/31**

- Energy-absorbing fall arrest lanyard safely arrests your fall
- Tear web energy absorber reduces the forces on your body to <math><6\text{kN}</math> in the event of a fall
- 10.5 mm durable kernmantle rope leg material for long product service life
- Twin leg with 2 x AJ595 steel scaffold hooks, 50 mm opening



**MADE IN FRANCE**

**PROTECTA**

## 3M Protecta® Energy Absorber Lanyard

**Model No.: AE5320WAF**

2mtrs. lanyard, 25mm webbing, energy absorber, high strength polyamide thread, individual serially numbered, impact force reduction to less than 6 kN, system breaking strength 1500 daN.



## 3M DBI-SALA® ExoFit NEX Suspension Harness

**Model No.: 1113961**

ExoFit NEX™ will provide the freedom and confidence to function at your maximum potential. Innovative safety devices and ground breaking design features—such as Duo-Lok™ quick-connect buckles, Tech-Lite™ aluminium D-rings and Hybrid comfort padding—permit the wearer to work smarter, faster and safer.



Model No.	1113961	1113962
Sizes	Medium	Large



## 3M Protecta® E200 Comfort Belt Style Fall Arrest Harness

**Model No.: 1161631**

- Back, Front Sides and Lower Front D Rings
- Auto-resetting lanyard keeper
- Impact indicators
- No loose web ends
- Easy and clear identification of fall arrest anchorage points
- Stain and water resistant webbing



## 3M Protecta® Work Positioning Lanyard - Trigger

**Model No.: 1200314**

- Trigger™ adjustment device
- 10.5mm Kernmantle rope material
- Snap hook connecting hook
- Triple action carabiner connection to Trigger™ device





# Fall Protection



## 3M Protecta® Twin Leg SRL with Steel Rebar Hooks 6 ft.

**Model No.: 3100512**

- Capacity 310 lbs. (141 kgs)
- Twin-leg 100% tie-off design
- Triple locking carabiner connects SRL's to form twin-leg system
- 6 ft. (1.8m) twin-leg lifelines with 1" (2.5cm) polyester web
- Self-locking steel rebar hook on each lifeline
- Compact, lightweight design
- Tough and impact resistant thermoplastic housing
- Swiveling anchorage loops
- Quick activating speed sensing brake systems



## 3M Protecta® 6 ft. SRL, Web, Carabiner Anchor & Steel Rebar Hook

**Model No.: 3100508**

- Swiveling anchorage connector loop and carabiner
- Aluminum or thermoplastic housing design
- Self-locking snap hook on lifeline
- Compact, lightweight design
- Quick activating speed-sensing locking system
- Features impact-indicating external energy absorber (for models with external shock pack)
- Corrosion resistant components



## 3M DBI-SALA® FlexiGuard C-Frame System

**Model No.: 8517709**

- 12.5 ft. to 19 ft. (3.8-5.8 m) adjustable height overhead rail
- 20 ft. (6.1 m) fixed width for horizontal mobility
- Heavy duty 16 in. (0.4 m) pneumatic wheels
- Requires some clearance under equipment being accessed
- Durable aluminium and steel construction
- Maintenance free extruded aluminium rail
- C-Frame rail fall arrest system
- Provides overhead sliding anchor points for two personnel
- Rigid rail design reduces fall clearance requirements
- Heavy duty levelling jacks



## 3M DBI-SALA® Mobi-Lok™ Vacuum Anchor with Air Bottle Attachment

**Model No.: 2200108**

- Provides tie-off point on smooth, non-porous surfaces via vacuum technology
- Fall arrest rated for ultimate safety
- Self contained with on-board air bottle attachment (order air bottle 2200078 separately)
- Compatible with external air power options
- Audible and visual alarms for complete safety
- Built-in check valves provide safety during accidental air loss
- EPDM rubber seals are Skydrol resistant and won't damage surface
- Approved for horizontal lifeline use
- Mobi-Lok™ aviation industry self contained vacuum anchor system with attachment for air bottle and carrying case
- **Standards: OSHA 1910.140, OSHA 1926.502**





# Fall Protection



## Mode Escape Descend Device

### Model No.: Drill Powered Rescue Model

- Lifting Capacity: 250 kg
- Descending Capacity: 125 kg
- Handwheel located on the top of the unit

## Mode Smart Spider Pro Ascender

### Model No.: Smart Spider Pro

- Material: Aluminum alloy body
- Battery: 5000mAh power battery
- Charging Duration: 140 minutes
- Protection Level: IP65 • Safe Load: 200 kg





# INDUSTRIAL HYGIENE PRODUCTS





# Industrial Hygiene Products



**Cirrus**  
Research plc  
dedicated to noise measurement

## Cirrus Sound Level Meter

### Model No.: CK1720 Measurement Kit

- IEC 61672-1:2013 Class 1 & Class 2
- LNE, PTB & APplus+ Type Approval
- Simultaneous measurement & data logging of all available parameters
- Simultaneous A, C & Z Frequency Weightings
- Simultaneous F, S & I Time Weightings
- Real-time 1:1 & 1:3 Octave Band Filters
- High resolution colour OLED display and back-lit keypad for night-time measurements
- 4GB memory capable of storing over 10,000 measurements (expandable up to 32GB)
- Measure up to 170dB with the optional MV:200EH microphone system



**K-COMPANY  
APPROVED**

Critical  
Environment  
Technologies™

## YES AIR 8-Channel IAQ Monitor

- Capacity for 1 temperature sensor, 1 relative humidity sensor and 5 internal gas sensors, plus 1 external particulate sensor
- More than 30 plug & play sensors to choose from, including electrochemical, catalytic, infrared & PID
- Multi-function, easy to use menu
- Light weight, contoured & comfortable to hold
- LCD displays readings for all sensors, battery level and logging status
- Sampling with an internal sample draw pump or by diffusion

# THERMAL IMAGING CAMERA





# Thermal Imaging Camera

## Bullard Thermal Imaging Camera

The XT Series, featuring the NFPA 1801-2018 Certified NXT and the QXT, is equipped with Bullard's X Factor image clarity technology and the industry's longest battery run time of more than eight hours of continuous use. The NXT and QXT are designed not only for long-lasting service on the front line but also the low total cost of ownership in the back office. They are purpose-built for today's fire service and offer firefighters the following features:

- Longest battery run time
- Best image quality
- Most desired form factor
- First wireless charging systems
- Most proven durability
- Industry's only five-year imager and battery warranty

### Model No.: EcoX

EcoX is the economical solution for budget constrained departments to put more Bullard Tough thermal imagers in the hands of firefighters.



### Model No.: LDX

LDX is a sleek, compact thermal imager enhanced with the newest infrared engine technology and image processing techniques with a price that accommodates any budget.



### Model No.: T3X

Bullard's T3X is a handheld favorite thermal imager equipped with the latest X Factor engine technology and image processing techniques.



### Model No.: NXT

The Bullard NXT is designed not only for long-lasting service on the front line but also low total cost of ownership in the back office. It is purpose-built for today's fire service including NFPA.



### Model No.: T4X

The T4X combines advanced features and the industry's largest widescreen display with the newest state-of-the-art infrared engine technology for the ultimate in thermal imaging performance.



# ELECTRICAL SAFETY PRODUCTS





## Electrical Insulating Mats

### Model No.: TTCL

Insulating mats isolate the worker from the ground so that the electrical current does not pass through his body if he directly touches an energised part or in the case of step voltage.

The CLASS of mat will be chosen according to the maximum nominal voltage of the network.

Instructions for use and maintenance are marked on each mat.

- Made of elastomer
- Non-slip surface

Available in sizes: 0.6 x 0.6 m – 0.6 x 1 m – 1 x 1 m (other sizes available on request)

Reference	Class	Max. Operating Voltage AC	Max. Operating Voltage DC
TTCL0	0	1,000 V	1,500 V
TTCL2	2	17,000 V	25,500 V
TTCL3	3	26,500 V	39,750 V
TTCL4	4	36,000 V	54,000 V



## Canvas Carry Bag for Insulating Mat

### Model No.: TS707 – TS711

- Blue polyamide canvas
- Carry handle and drawstring closure

Reference	Length	Diameter	Weight
TS707	700 mm	110 mm	290 g
TS711	1,100 mm	110 mm	450 g



## Low Voltage Short-Circuiting & Earthing Device for Panels & Cabinets

**Model No.:** DMTBTT

IEC 61230

Portable device for short-circuiting and earthing a panel or cabinet in a LV network equipped with NH00, NH1, 2, 3 or NH4a fuse links

Trifurcation kit with crimped central connector sealed by heat shrinkable sleeving consisting of:

- 3 phase cables L1, L2, L3 fitted with screw connections at the ends
- 1 earth cable with a lug with a stud hole  $\varnothing$  10 mm at the end
- 2 x 00 fuse links with M10 thread
- 2 x 123 fuse links with M12 thread
- 1 insulated handle
- 1 earth clamp

Optional storage case

Reference	Cable Section	Max. ICC	Short-Circuit & Earth Cable L1	Short-Circuit & Earth Cable L2	Short-Circuit & Earth Cable L3	Short-Circuit & Earth Cable LE	Cable Type
DMTBTT1601	16 mm <sup>2</sup>	3,5 kA/1s	300 mm	500 mm	700 mm	800 mm	CEI61138
DMTBTT2501	25 mm <sup>2</sup>	5,5 kA/1s	300 mm	500 mm	700 mm	800 mm	CEI61138
DMTBTT3501	35 mm <sup>2</sup>	7 kA/1s	300 mm	500 mm	700 mm	800 mm	CEI61138
DMTBTT5001	50 mm <sup>2</sup>	9 kA/1s	300 mm	500 mm	700 mm	800 mm	CEI61138

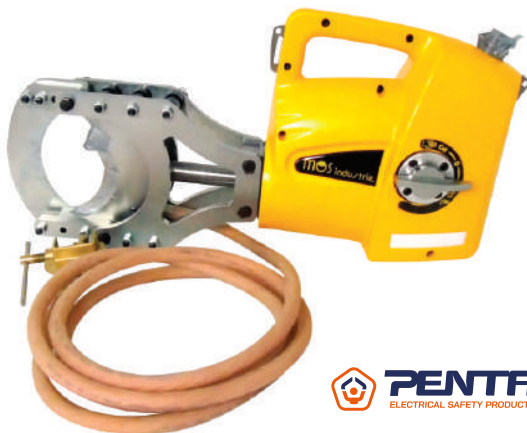

## Hydraulic Spiking & Cutting Tool

**Model No.:** Picoup 400

- Spiking cable to check and ensure the absence of voltage on LV and MV underground cables
- Cutting after spiking operation in full safety
- Total Security for the USER According to NFC 18510

**Specifications**

- Cutting capacity: Diameter 140 mm
- Cutting force: 21000 kg



# Electrical Safety Products

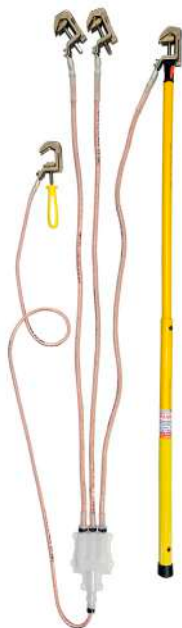

## Complete MV Earthing & short-circuiting Device

**Model No.: CORATRIF**

IEC 61230

For fixed ball points, diameters 20 and 25 mm, flat and cylindrical bars. Suitable for fitting E240 lug barrels.

- 1 trifurcation
- 3 phase clamps, hexagonal end fittings, 12 mm
- 1 earth clamp with ergonomic handle
- 1 2-part telescopic insulating stick, length when extended 2 m
- 1 metal storage case

Clamp capacity:

Cylindrical conductors: 7 / 37 mm

Flat conductor: 37 mm

Fixed earth point: 20 and 25 mm

Reference	Max. ICC	Section of 3 Short-Circuit Cables	Lenhth of 3 Short-Circuit Cables	Earth Cable Section	Earth Cable Length
CORATRIF	18,5 kA/1s	70 mm <sup>2</sup>	1.5 m	35 mm <sup>2</sup>	2 m
CORATRIF01	25 kA/1s	95 mm <sup>2</sup>	0.8 m	95 mm <sup>2</sup>	3 m
CORATRIF02	18,5 kA/1s	70 mm <sup>2</sup>	0.8 m	35 mm <sup>2</sup>	5 m
CORATRIF03	18,5 kA/1s	70 mm <sup>2</sup>	0.8 m	35 mm <sup>2</sup>	10 m



## Non-Metallic Textile Belt 80/125

**Model No.: CTI-125**

Textile belt in non-metallic strapping, 40 mm wide. Closure and adjustment with automatic plastic buckle



## PPE Carry Bag in Rigid Canvas

**Model No.: S510**

Carry bag designed especially for transporting PPE. Special side pocket for shoes, so as to leave the rest of the equipment clean.





## Electrical Safety Kit

### VES25-VES36

This case contains everything you need to rescue persons in a situation where there is an electrical hazard from networks up to 25kV (model VES25) or 36kV (model VES36).

Kit contains:

- Insulating stool: 25,000V or 36,000V models available
- Class 3 insulating gloves for model VES25 or class 4 for model VES36
- Insulating boots
- Insulating stick with hook
- AC voltage detector
- Insulated 36,000V cable cutter
- Talc shaker
- Fabric glove case
- Safety adhesive tape
- Instructions for use



Reference	Description
VES25	Electrical emergency kit 25 kV
VES36	Electrical emergency kit 36 kV



## Aladin Individual Voltage Alarm with Headlamp

### Aladin

ALADIN is equipped with an integrated high-performance LED headlamp and professional lenses for excellent light quality and will adapt to any requirements.

ALADIN is fitted with two light beams, suitable for all uses.

- Wide Voltage Detection Range from 2KV to 400KV
- 360° Detection around the wearer
- Smart Mute Feature
- Long Range Beam & Broad Beam



# Electrical Safety Products



## Earthing and short-circuiting Device for MV Substations

**Model No.: PIMT**

IEC 61230

Standard composition:

- A set of 3 identical clamps with AP end fitting (reference of choice)
- A TRIFURCATION kit: set of extra flexible sheathed copper jumper cables with sealed cable lugs, connected by a junction block
- Length of short-circuit cables: 0.8 m
- Length of earth cable: 2 m
- An earth clamp, capacity : Ø 6 to 27 mm / flat surface 0 to 25 mm / hexagonal 19 mm
- 1 2-part telescopic insulating stick, length when extended 2 m
- A metal case

Reference	Clamp Set Capacity	ICC	Triffurcation: Short Circuit Section & Earth Cable Section
PIMT66	Cylindrical conductors Ø 5-35 mm	8 kA/1s	35 mm <sup>2</sup>
PIMT76	Cylindrical conductors Ø 5-35 mm Flat conductors 16-40 mm and 5-40 mm	8 kA/1s	35 mm <sup>2</sup>
PIMT610	Cylindrical conductors Ø 5-35 mm	13 kA/1s	50 mm <sup>2</sup>
PIMT710	Cylindrical conductors Ø 5-35 mm Flat conductors 16-40 mm and 5-40 mm	13 kA/1s	50 mm <sup>2</sup>
PIMT49	Cylindrical conductors Ø 5-35 mm	14.5 kA/1s	sc: 70 mm <sup>2</sup> / earth: 35 mm <sup>2</sup>
PIMT48	Cylindrical conductors Ø 5-35 mm Flat conductors 16-40 mm and 5-40 mm	8 kA/1s	35 mm <sup>2</sup> (lgth sc cable = 2 m, earth = 5 m)



## Voltage Detector

**Model No.: TAG780**

- A revolutionary IP2X system (retractable sleeve) trigger in back of device
- Incomparable display quality provided by encapsulated LED technology
- Very strong and ultra flexible cable
- Special protection adapted to field use
- 780V Simple Voltage Detector
- 780R with Phase Rotation



## Multi Purpose Telescopic Insulating Stick

### PENTA-POLE

The Penta-Pole insulating stick is Fameca's new telescopic stick for Medium Voltage overhead networks. Its new pentagonal shape combines ergonomics & effectiveness in use. Infact, with its new fibre structure, its mechanical strength is 15% greater than other types of stick. This makes it more rigid, & therefore easier to handle. Made up of between 2 & 9 segments, this stick adapts to all types of uses & can reach great heights, up to 12 metres.

Reference	No. of Sections	Length when extended		Length when retracted		Average Weight
		m	ft"	m	ft"	
PPOL3/035U	3	3,80 m	12'5"	1,45 m	4'9"	1,89 kg
PPOL4/050U	4	5,00 m	16'4"	1,54 m	5'0"	2,48 kg
PPOL5/060U	5	6,40 m	21'0"	1,60 m	5'2"	3,16 kg
PPOL6/075U	6	7,80 m	25'7"	1,67 m	5'5"	3,96 kg
PPOL7/090U	7	9,20 m	30'2"	1,74 m	5'8"	4,70 kg
PPOL8/0105U	8	10,60 m	34'9"	1,80 m	5'10"	5,52 kg
PPOL9/0120U	9	12,00 m	39'4"	1,84 m	6'0"	6,89 kg



## MV Voltage Detector Vector

### VECTOR

IEC 61243-1 2009

- Use: Device designed to test for the absence of voltage on MV system. (indoor & outdoor)
- Its multiple sensor technology and microcomputer enable it to read the same voltage, whatever the network configuration and regardless of changes in temperature
- Indicator lights on the side allow for easy reading in any configuration
- Adjusted to true voltage
- AC voltage range: can be adjusted 3 to 80 kV
- Comes in a shoulder bag, with 40 mm V-shaped electrodes and 40 mm straight electrodes

Reference	Voltage Range
VEC0310	3 kV to 10 kV
VEC1036	10 kV to 36 kV



## Low Voltage Tool Kit

### Kit contains:

- Pozidriv screwdriver with non-flush blade tip, 5 x 80 mm
- Pozidriv screwdriver with non-flush blade tip, 6 x 100 mm
- Flat screwdrivers with non-flush blade tip, 3 x 75 mm
- Flat screwdrivers with non-flush blade tip, 4 x 100 mm
- Flat screwdrivers with non-flush blade tip, 5.5 x 125 mm
- Flat screwdrivers with non-flush blade tip, 8 x 175 mm
- Electrician's knife with sheath
- 200 mm universal composite pliers with ceramic blades
- Side cutting pliers, 175 mm
- Stripping pliers, 175 mm
- Junior extension, 3/8" drive, 140 mm
- Junior ratchet spanner, 3/8" drive, 185 mm
- 5 insulating caps, Ø 10 mm, length 60 mm
- Silicone treated leather gloves, size 9
- Electrician's latex gloves, 500 V, class 00, size 9
- Insulating sheet with Velcro, 0.66 x 0.36 m
- Electrician's faceshield on a headband with forehead protector
- Clips for insulating sheet
- Canvas bag for gloves, with pocket
- Black leather bag
- Insulating mat, 0.6 x 1 m class 3
- LV voltage detector, with phase rotation and IP2X test probes
- Ratchet wrench set, 3/8" drive, 17 sockets



# WEATHER METERS & WINDSOCKS



# Weather Meters & Windsocks

## Kestrel Wind Meter

### Model No.: 1000

Here's the one that started it all! Measuring wind is a breeze with the Kestrel 1000. We developed the Kestrel 1000 Pocket Wind Meter in 1995 when NK's co-founder, Richard Kellerman, needed a reliable wind meter for flying his glider. The Kestrel 1000 can easily be switched between mph, km/h, ft/min, m/s, knots and Beaufort.

- Wind Speed
- 3-Button Control
- CR2032 Coin Cell Battery (Average Life 300 Hours)
- Data Hold Function • Easy-To-Read Display
- Drop-Tested, MIL-STD-810G • Neck Lanyard
- Patented Impeller and Sensor Technology
- Slip-On Protective Cover
- User-Replaceable Batteries
- User-Replaceable Impeller • Waterproof & Floats



## Kestrel Pocket Wind Meter

### Model No.: 2000

For those of you who like to know just how cold and windy it really is, the Kestrel 2000 Pocket Wind Meter is your reality check. Winter sports enthusiasts around the world love Kestrel Meters.

- Temperature • Wind Chill • Wind Speed
- Backlight
- CR2032 Coin Cell Battery (Average Life 300 Hours)
- Data Hold Function • Drop-Tested, MIL-STD-810G
- Easy-To-Read Display • IP67 Waterproof
- Minimum and Maximum Values • Neck Lanyard
- Patented Impeller and Sensor Technology
- Slip-On Protective Cover
- User-Replaceable Batteries
- User-Replaceable Impeller • Waterproof & Floats



## Kestrel Pocket Weather Meter

**Model No.: 3000**

The Kestrel 3000 keeps you from working past your limits. From the Kestrel 3000's accurate relative humidity readings, it also calculates the dewpoint and heat stress index—important information to know when working or playing outdoors in hot and humid conditions.

- Dew Point • Heat Stress Index
- Relative Humidity • Temperature
- Wind Chill • Wind Speed
- 3-Button Control • Backlight
- Easy-To-Read Display • Neck Lanyard
- CR2032 Coin Cell Battery (Average Life 300 Hours)
- Data Hold Function • Drop-Tested, MIL-STD-810G
- Patented Impeller and Sensor Technology
- Slip-On Protective Cover • Time of Day
- User-Replaceable Batteries
- User-Replaceable Impeller
- Waterproof & Floats



## Kestrel Delta-T Pocket Weather Meter

**Model No.: 3500**

It is critical to measure relative humidity, wind speed and wind direction in order to minimize waste and maximize safety when spraying.

- Altitude • Barometric Pressure
- Delta T
- Dew Point
- Heat Stress Index
- Relative Humidity
- Temperature
- Wet Bulb Temperature (Psychometric)
- Wind Chill
- Wind Speed





**Kestrel®**

## Kestrel Environmental Meter

### Model No.: 5000

The Kestrel 5000 Environmental Meter is a remarkably powerful measuring and data logging tool, yet remarkably compact. The Kestrel 5000 provides the same trusted accuracy, reliability, and usability as the original Kestrel 4000. Use it for research, safety, expeditions, agriculture and any other profession or activity where accurate on-the-spot conditions monitoring is the key.

### Kestrel 5000 Environmental Meter Overview

- Used in firefighting, agriculture, hazardous materials response, meteorology, military, law enforcement, research, education, scientific & mountaineering expeditions and more
- Handheld, portable environmental meter with onboard data logging and graphing
- Measures wind speed / air speed, temperature, humidity and pressure and displays over 10 total environmental parameters on large, hi-res, hi-contrast, graphic display
- Optional Link connectivity powered by Bluetooth® low energy provides wireless communication to mobile devices and computers
- Rugged (drop tested to MIL-STD-810G standards), waterproof (sealed to IP67 standards)
- Protective pouch, neck lanyard and Lithium AA battery included
- 5-year warranty





## Kestrel Professional Environmental Meter

**Model No.: 5200**

Kestrel 5200 provides the same trusted accuracy, reliability, and usability as the original Kestrel 4200 and 4300. With its complete suite of environmental measurements plus special features designed to aid HVAC technicians, construction and agriculture professionals, the Kestrel 5200 outperforms the competition as the most compact and complete environmental meter and data logger for all professional uses.

### Kestrel 5200 Professional Environmental Meter Overview

- Measures evaporation rate, air velocity, air flow, air density, relative air density, delta T, and much more. 17 measurements in all!
- Large, hi-res, hi-contrast, graphic display is perfectly readable in the brightest sunlight and is backlit for use in low-light conditions
- Handheld, portable, data logger with on-screen graphing and measurement statistics
- Optional Link connectivity powered by Bluetooth® low energy provides wireless communication to mobile devices and computers
- Rugged (drop tested to MIL-STD-810G standards), waterproof (sealed to IP67 standards)
- Protective pouch, neck lanyard and Lithium AA battery included
- 5-year warranty



## Kestrel Weather Meter

**Model No.: 5500**

The Kestrel 5500 provides the same trusted accuracy, reliability, and usability as the original Kestrel 4500. Measure every environmental condition plus wind direction, crosswind and headwind/tailwind. Use it golfing, sailing, flying, spraying, shooting and more. Drop-proof, dust-proof, waterproof and able to withstand extreme environments without damage, your Kestrel weather meter travels with you anywhere you dare to go. A range of carry pouch options makes it even easier to take your Kestrel meter with you.



## Safety Plus World Windsocks

Windsocks are high-visibility indicators of wind direction and speed. We have a variety of sizes available suitable for industrial applications and aviation. All windsocks are made from high-quality international orange PVC over nylon, which is incredibly durable and stays colorfast longer than other materials.

**Available Sizes: 10 & 18 Inch**

# GAS DETECTION





# Gas Detection



## Gas Sensor options

H2S (hydrogen sulphide)

LEL combustible

CO (carbon monoxide)

O2 (oxygen, lead-free)

NH3 (ammonia)

SO2 (sulphur dioxide)

Cl2 (chlorine)

COSH (CO + H2S) – coming soon

CO2 (carbon dioxide)

PID (photoionization detector)

## Safety Certifications:

SAR, RoHS, CE, RCM

FCC ID: XPY1CGM5NNN

IC ID: 8595A-1CGM5NNN

Canada and USA: Class I Division 1 Gr A, B, C, D T4;

Class I Zone 0 AEx ia IIC T4; Ex ia IIC T4 Ga Ⓢ

IECEX: Ex ia IIC T4 Ga

ATEX: Ex ia IIC T4 Ga   II 1 G

LEL-NDIR: -20°C to 45°C; CSA C22.2 No.152;

ISA 12.13.01

LEL-Pellistor: Ex ia IIB T4 Ga; Ex ib IIC T4 Gb

## Blackline Safety G7C

Blackline Safety's G7c uses 3G cellular networks to wirelessly connect your team to real people. Should a gas leak, injury or health event occur, G7c confidently accounts for everyone's wellbeing and whereabouts in real-time to equip live monitoring personnel when someone needs a hand.

G7c automatically watches over workers and calls for help, even when the employee can't. All safety incidents are communicated to 24/7 monitoring personnel who can mobilize responders to an employee's exact location or trigger an evacuation in real-time. With a two-way speakerphone, monitoring personnel can communicate with the worker. Constant connectivity and incident alerting provide critical insights and situational awareness for optimized emergency responses.

## Features

Fall detection and No-motion detection: Tri-axis accelerometer, tri-axis gyro, software processing, configurable sensitivity, configurable time window (1-30 mins, or off) for no-motion detection.

Additional gas cartridge features

- Time-weighted average (TWA)
- Short-term exposure limit (STEL)
- High & Low gas alert
- Bump test and calibration notification

## Warranty

G7: Two years

Cartridges: Lifetime

G7 complete plan: Three years

**blacklinesafety**





## Blackline Safety G7 EXO

Blackline revolutionised personal gas monitoring with the introduction of G7c, the world's only detector with integrated cellular communications and two-way voice calling to a live monitoring team. Delivering a broad range of gas detection and real-time safety features, G7c is the most connected gas detection instrument on the market.

### Features

- 100+ day battery life
- Diffusion and combination diffusion / pump model options
- Internal 4G/2G wireless works in 100+ countries
- Works globally with optional Iridium satellite communication
- Call for help using the SOS latch
- Works seamlessly with Blackline Live cloud-hosted software
- Communicates all data to the Blackline Safety Cloud – no need to collect data from the field
- Blackline Live automates configuration changes, plus firmware updates automatically
- Uses the same plug-and-play gas sensor cartridges as G7c
- Blackline Analytics automates compliance reporting
- Internal GPS and beacon location technology
- Manage G7 Exo area monitors in Blackline Live alongside G7c personal monitors

### Power & Battery

- Rechargeable battery capacity: 144 Ah (LiFePO4)
- Battery life in diffusion mode:
  - 100 days at 20°C (68°F), LEL-IR, H2S, CO and O2 config.
- Battery life in pump mode:
  - 30 days at 20°C (68°F), LEL-IR, H2S, CO and O2 config.
- Charge time: 12 hr (preliminary)
- Intrinsically safe trickle-charging port: Yes, supports G7 EXO continuous operation

### Warranty

G7 EXO area monitor: three-year hardware warranty

### Safety Certifications:

RoHS, CE, RCM

Canada & USA: Class I Division 1

Group A, B, C, D T4; Ⓢ

Class I Zone 0 AEx da ia IIC T3; Ex da ia IIC T4 Ga

IECEX: Ex da ia IIC T4 Ga

ATEX: Ex da ia IIC T4 Ga   II 1 G

LEL: CSA C22.2 No.152; ISA 12.13.01

**blacklinesafety**





# Gas Detection



## mPower UNI 321RT

### 3, 2 and 1-Year Maintenance-Free Single Gas Detectors

- Real-time Readings
- Hibernation Mode up to 1 year for 2 years detectors model
- Weight: 4.4 oz. & size: 3.46 x 2.44 x 1.30 in
- Gases: 3 Selections (H<sub>2</sub>S, CO & O<sub>2</sub>)
- Display: Large LCD • Protection: IP 67
- Battery: Replaceable (3.6V, 2700mAh, AA Lithium)
- Event log: Up to 50 alarm events
- Docking Station for calibration and event download
- **Manufactured by Mpower Electronics (USA)**

### Safety Certifications:

Class I, Div 1, Group ABCD

 Class II, Div 1, Group EFG

Class III, Div 1

T<sub>4</sub>, -20°C ≤ T<sub>amb</sub> ≤ +50°C

 Ex ia IIC T4 Ga

II 1G

 Ex ia IIC T4 Ga



## mPower Disposable Gas Detector

### Model No.: MP112

MP112 is a disposable or maintenance-free version of carbon monoxide (CO) & hydrogen sulfide (H<sub>2</sub>S) single gas detectors up to 2 years continual operation.

### Features

- Simple one-button GO, NO-GO!
- Large LCD • 4-size CO and H<sub>2</sub>S sensors
- 50 events logging
- IP rating: IP-67 • Low & High alarms
- Six bright red flashing LEDs
- 2/3 AA Lithium battery
- No maintenance or part replacement

### Safety Certifications:

 Ex ia IIC T4 Ga

 Ex ia IIC T4



## T40 II Rattler™ Portable Single Gas Monitor and T-Dock™

The T40 II Rattler single gas detector is primarily used to keep personnel safe by detecting the presence of hydrogen sulfide (H<sub>2</sub>S) or carbon monoxide (CO), in a serviceable, maintainable, compliance instrument. The T40 II Rattler is the easiest gas detector to service while still making compliance easy and cost effective with a confidence flash.

- Robust, compact, and light
- Ultra-Fast sensor response
- Automatic Self-Test
- Data and Event Logging
- Configurable Low and High alarm settings
- Optional TWA and STEL Alarm
- Multiple sensor range options with high accuracy
- Replaceable battery with 2-years run-time
- One Year Shelf Life

### Safety Certifications:

#### International:

IECEX: Ex ia IIC T4 Ga; Ex ia I Ma

#### North America:

UL: Class I, Division 1, Groups A, B, C, D

T4 Class I, Zone 0, AEx ia IIC T4 Ga

CSA: Ex ia IIC T4

Class I, Division 1, Groups A, B, C, D T4

#### Europe:

ATEX: Ex ia IIC T4 Ga; Ex ia I Ma

CE: Directive 2014/30/EU, EN50270

Directive 2011/65/EU and 2015/863/EU



**INDUSTRIAL  
SCIENTIFIC**



*mPower Electronics*

Making Powerful Senses

## mPower UNI MP100

### Single Gas Detectors

- Real-time Readings
- Weight: 4.4 oz.
- Widest choice of sensors in the market
- Smart Sensor
- Size: 3.46 x 2.44 x 1.30 in
- Gases: 19 Selections (H<sub>2</sub>S, CO, O<sub>2</sub>, NH<sub>3</sub>, Cl<sub>2</sub>, ClO<sub>2</sub>, H<sub>2</sub>, HCl, HF, HCN, NO, NO<sub>2</sub>, O<sub>3</sub>, PH<sub>3</sub>, SO<sub>2</sub>, C<sub>2</sub>H<sub>4</sub>O, ETO, CH<sub>3</sub>SH, THT)
- Display: Large LCD
- Battery: Replaceable, AA size Lithium battery, 3 years typical operation
- Event Log: Up to 50 alarm events
- Low, High, TWA & STEL Alarms
- Protection: IP 67
- Docking Station for calibration and event download
- **Warranty: 2 years on O<sub>2</sub>, CO, H<sub>2</sub>S, SO<sub>2</sub> HCN, NO, NO<sub>2</sub> & PH<sub>3</sub> units including sensor & 1 year on all others**
- **Manufactured by Mpower Electronics (USA)**

### Safety Certifications:

Class I, Div 1, Group ABCD

 Class II, Div 1, Group EFG

Class III, Div 1

T<sub>4</sub>, -20°C ≤ T<sub>amb</sub> ≤ +50°C



Ex ia IIC T4 Ga

II 1G

 Ex ia IIC T4 Ga





## mPower Resusable Gas Detector



### Model No.: MP110

MP110 offers a cost-effective solution for personal monitoring toxic gases of carbon monoxide (CO) and hydrogen sulfide (H<sub>2</sub>S).

#### Features

- Large LCD, 30% larger than most
- 4-size CO and H<sub>2</sub>S sensors
- 50 events logging
- IP rating: IP-67 • Password protection
- Adjustable Low, High, TWA & STEL alarms
- Six bright red flashing LEDs
- Two-point field calibration
- 2/3 AA Lithium battery replaceable

#### Safety Certifications:

-  Ex ia IIC T4 Ga
-  Ex ia IIC T4



## mPower MUNI MP420

### Compact & Lightweight 4-Gas Monitor

- Auto backlit LCD with large numeric digits
- Easy-to-navigate menu with two buttons
- Battery operation 24 hours with pellistor LEL sensor extended time with low power infrared LEL sensor
- Tri-color status indicators on regular self-diagnosis of sensor, battery & circuit
- Wide angle LED alarms • 1000 Events log
- **Manufactured by Mpower Electronics (USA)**

#### Safety Certifications:

 Class I, Div 1, Group ABCD

 T4, -20°C ≤ T<sub>amb</sub> ≤ +50°C

 II 1G Ex da ia IIC T4 Ga 4

 European Conformity

#### Warranty:

2 years on including sensors

3 years with CH<sub>4</sub>, (NDIR)/O<sub>2</sub> (Lead-Free)/H<sub>2</sub>S/CO



## mPower MP400/MP400P/MP400S

### POLI Multi-Gas Detectors

The POLI multi-gas detectors (MP400/MP400P/MP400S) offer 4- or 5- gas monitoring of oxygen (O<sub>2</sub>), combustibles (LEL), toxic gases, carbon dioxide (CO<sub>2</sub>), and volatile organic compounds (VOCs). The MP400 and MP400P are basic models with O<sub>2</sub>, LEL, carbon monoxide (CO) and hydrogen sulfide (H<sub>2</sub>S) configuration in both diffusion or pumped versions, for confined space entry compliance. The MP400S adopts a full range of sensor selection, e.g. electrochemical (EC), pellistor, non-dispersive infrared (NDIR) and photo-ionization detector (PID) in a pumped model. Use of a combined CO/H<sub>2</sub>S sensor in the MP400S allows up to five gases to be monitored. An option of wireless communication enables real-time monitoring of gas readings and alarm status including man down alarm from remote locations for better visibility and faster response.



#### Safety Certifications:

 Class I, Div 1, Group ABCD

T4,  $-20^{\circ}\text{C} \leq T_{\text{amb}} \leq +50^{\circ}\text{C}$

 Ex ia IIC T4 Ga

 II 1G Ex ia IIC T4 Ga

 European Conformity

#### • Warranty:

2 years on instruments

2 years on sensors for LEL,

LEL/Vol, O<sub>2</sub>, CO, CO<sub>2</sub>, H<sub>2</sub>S,

SO<sub>2</sub>, HCN, NO, NO<sub>2</sub> and PH<sub>3</sub>

1 year on other sensors

- Available in diffusion or pump version
- Man Down Alarm with real-time remote wireless notification
- IP-65/67 water and dust resistant case
- Real-time gas concentration readings and alarm status enabled by state-of-the-art wireless technology
- Large graphical display icon-driven user interface through intuitive, simple-to-operate two-button user interface
- Easy access to pump, sensor, filter and battery
- Over 30 interchangeable sensor options, including PID for VOC, NDIR and catalytic for combustibles, and NDIR for CO<sub>2</sub>
- Intelligent sensors store calibration data, so they can be swapped in the field
- **Manufactured by Mpower Electronics (USA)**



## Ventis® MX4 4-Gas Monitor

The Ventis® MX4 is a four-gas monitor with the portability and size of a single-gas monitor. Eliminate the need for extra monitors and transition seamlessly from personal monitoring to confined space entry with the Ventis® Slide-on Pump— ideal for operators who wear their gas monitors primarily for personal protection but occasionally require a pump for confined space entries.

- Detect up to four gases with a wide range of sensor options
- Select alarm set points, set latch alarms, disable instrument shutdown while in alarm, and more
- Save time and reduce human error with maintenance and usage data available from iNet Control software
- Available with or without an integral pump, or with the Ventis Slide-on Pump for ultimate flexibility
- Non-pumped instruments compatible with 12-hour, 18-hour, or 20-hour batteries

### Safety Certifications:

ATEX: Ex ia IIC T4 Ga and Ex ia I Ma; Equipment Group and Category II 1G/I M1

IECEX: Ex ia IIC T4 Ga

UL: Cl I, Div 1, Groups A-D, T4; Zone 0, AEx ia IIC T4; Cl II, Gr F-G (Carbonaceous and Grain dust)

INGRESS PROTECTION IP66/67



**INDUSTRIAL  
SCIENTIFIC**



## Ventis® Pro5: The Most Flexible Connected 5-Gas Monitor

Detect up to five gases simultaneously with the rugged, wireless, Ventis® Pro5 Multi-Gas Monitor. With Ventis Pro5, safety goes beyond the gas detector whether you need team-based alarm sharing, remote monitoring with location details, or both. The monitor is also backed by a Guaranteed for Life™ warranty.



**INDUSTRIAL  
SCIENTIFIC**

- Eliminate the need for two pieces of equipment by using Ventis Pro5 for personal monitoring and confined space entry
- Train workers on one, multi-purpose gas monitor and reduce the risk and investment of having different devices in the field
- Improve team and site safety by locally sharing alarms and gas readings between wirelessly connected Ventis Pro5 monitors
- Get real-time location and alarm data directly from Ventis Pro5 gas monitors to a designated safety contact with the optional cellular or wi-fi battery pack
- Reinforce safe behavior with programmable alarm action messages like "EVACUATE" or "VENTILATE" based on alarm level
- Simplify the user experience with the ability to hide unnecessary screens based on user needs, role, industry, or site

### Safety Certifications:

ATEX: Equipment Group and Category II 1G, Ex ia IIC, Ga, T4

IECEX: Cl I, Zone 0, Ex ia IIC, Ga, T4; Cl I, Zone 1, Ex d ia IIC, Gb, T4, IR sensor

UL: Cl I, Div 1, Gr A-D, T4; Cl II, Div 1, Gr E-G, T4

Cl I, Zone 0, AEx ia IIC, T4; Cl I, Zone 1, AEx d ia II C, T4, IR sensor

INGRESS PROTECTION IP68



**INDUSTRIAL  
SCIENTIFIC**

## MX6 iBrid® Six-Gas Monitor

- 24 "Plug-and-Play" field-replaceable sensors including PID and Infrared options
- Up to 6 gases monitored simultaneously
- Simple, user-friendly, customizable, menu-driven navigation • Five-way navigation button
- Powerful, 95 dB audible alarm
- Durable, concussion-proof overmold
- Optional integral sampling pump with strong 30.5 meter (100 feet) sample draw
- Full-color graphic LCD is highly visible in a variety of lighting conditions
- **Safety Certifications:**
  - ATEX: Ex ia IIC T4 Ga; II 1G (or Ex d ia IIC T4 Gb IR sensor);
  - Ex ia I; Equipment Group and Category: I M1/II 1G
  - IECEx: Ex ia I (Ex ia d I IR sensor); Ex ia IIC T4 Ga; Ex d ia IIC T4 Gb
  - UL: Cl I, Div 1, Gr A-D, T4; Cl II, Groups F G; Cl I, Zone LEL 0, AEx ia d IIC T4 (or AEx ia d IIC T4 IR sensor)



**K-COMPANY  
APPROVED**

**TELEDYNE  
TECHNOLOGIES**  
Everywhere you look™

## BM25 Area Gas Monitor

BM25 portable area gas monitor is designed for team protection or area surveillance where fixed detection systems are not suitable. The unit is most suitable in applications for perimeter monitoring, rig overhauls, & plant shutdowns for use by maintenance teams. BM25 is capable of monitoring 6 gases choosing from 32 interchangeable "smart" sensor available including a PID sensor for VOCs, an IR sensor for CO<sub>2</sub> & combustible gases, electrochemical sensors for toxic gas and oxygen detection, & a catalytic sensor for combustible gas detection.

**Safety Certifications:**

- ATEX:
  - II 1 G / EEx ia IIC T4; I M1 / EEx ia I
  - or (when used with IR flameproof sensor)
  - II 2 G / EEx ia d IIC T4; I M2 / EEx ia d I



## Portable Infrared Gas Detector

**Model No.: GS 700**

**All-in-one detection solution for Natural Gas and Hydrogen**

This upgraded model incorporates the capability to detect hydrogen (H<sub>2</sub>), in addition to its existing ability to detect natural gas. This integration of natural gas and H<sub>2</sub> detection within a single instrument enhances versatility and performance across various gas utility applications.

The GS700 is a configurable combination instrument that fully meets the needs of gas utilities. The large display simplifies operation and allows the user to access multiple functions.

### Features

- LEL & Volume Gas (infrared)
- Optional sensors including: PPM, O<sub>2</sub>, CO, H<sub>2</sub>S
- Barhole Mode - configurable
- Soft-key Operation
- 360° Alarms
- Communication: IrDA & Bluetooth (optional)

### Safety Certifications:

IECEX / ATEX II 2G (T<sub>a</sub> = -20°C to +50°C)

Ex db ia IIC T4 Gb or

Ex db ia IIB T3 Gb (when fitted with a PPM gas sensor)

CSA

Class I Div.1 Groups A, B, C, D T4 or

Class I Div.1 Groups C, D T3 (when fitted with a PPM gas sensor)





## iTrans2 - Universal multi-sensor transmitter

The iTrans2 infrared gas detector employs an intelligent electronics platform to provide one or two points of detection from a single head for maximum flexibility, superior performance & lower installation costs. With the optional HART Communication Protocol, the iTrans2 offers remote diagnostics, set-up or calibration by superimposing a high-frequency current across the industry standard 4-20mA analog line.

- Large Sensor Offering – Electrochemical, Catalytic and Infrared
- Non-Intrusive Calibration
- Smart Sensor
- HART (optional)
- RS-485 Modbus
- Programmable Relays (optional)
- Dual Gas Sensing (optional)



## MX 43 Gas Detection Controller

Fully scalable, and designed to functional safety performance level 1 standards, the MX 43 is an analog and digital controller that continuously measures and controls gases in the atmosphere. The MX 43 gas detector manages both digital lines and analog channels, and covers all needs for a wide variety of gas monitoring applications. The MX 43 digital technology allows up to 32 detectors to be distributed on 8 lines for increased cost savings.

The MX 43 digital technology allows up to 32 detectors to be distributed on 8 lines for increased cost savings.

### Features:

- Analog and digital controller
- 4 or 8 lines / 16 to 32 detectors max
- Highly versatile controller
- SIL 1 reliability



## mPower NEO Photo-ionization Detectors



- Smaller and lighter weight than comparable PIDs
- Most stable ppb-level PID on the market
- Outstanding linearity over full measurement range
- Easy charging on laptop or other USB port
- USB Micro Charger; combination USB-m charging and communications cable
- Powerful battery (run time 24 hours)
- Bluetooth Low Energy (BLE) connectivity standard
- SM Wireless communication at longer distances and with no subscription fees
- Large backlight graphic display
- Lamp glow indicator
- Rugged, stainless-steel housing with rubber outer boot

### Safety Certifications:

- Class I, Div 1, Group ABCD
- Class II, Div 1, Group EFG
- Class III, Div 1
- T4,  $-20^{\circ}\text{C} \leq T_{\text{amb}} \leq +50^{\circ}\text{C}$
- Ex ia IIC T4 Ga
- II 1G Ex ia IIC T4 Ga
- European Conformity

Model Number	VOC Range (ppm)	Part No.
MP181 (NEO PPM)	0.01-5,000	M011-0004-000
MP182 (NEO EXT)	0.01-15,000	M011-0005-000
MP184 (NEO PPB)	0.001-15,000	M011-0006-000
MP185 (NEO SEMI) (w/o MicroUSB)	0.001-15,000	Special Order
MP186 (NEO BENZ)* (w/9.8 eV Lamp & Tube Holder)	0.05-200 Benzene 0.005-10,000 VOC	M011-0013-000





**INDUSTRIAL  
SCIENTIFIC**

## Radius BZ1

- Detect up to seven gases using 22 sensor options including PID
- Longest running area monitor with a typical run time of 7 days (168 hours)
- Extended Run Time Power Supply can extend battery to over 1 month
- Ultra-bright blue and red lights and attention-grabbing alarms with distinctive tones
- Audible alarms sound at 108 dB at 1 m to cut through high-noise environments
- Largest display of any area monitor on the market
- Intuitive text-based navigation and configuration
- Customizable alarm action messages such as "EVACUATE" or "VENTILATE"
- LENS™ Wireless enables communication between area monitors and Ventis® Pro5 personal monitors
- All-weather sensor deployment and 360-degree gas path for more accurate detection
- DualSense® Technology increases worker safety by using two sensors to detect the same gas

### Warranty

Two-year warranty, including sensors and battery

### Safety Certifications:

ATEX: Ex da ia IIC T4 Ga, Equipment Group and Category II 1G

IECEX: Ex da ia IIC T4 Ga

UL: Cl I, Div 1, Gr A-D, T4; Cl 1 Zone 0

AEx da ia IIC T4 Ga1



# Gas Detection

## Uniphos Multi Channel Controller

Model No.: UNIPHOS-500HA(8) / UNIPHOS-500HA(16)



Display	7" TFT, Touchscreen HMI
No. of Channels	3303015
Channels/Screen	8
Screen Scrolling	Auto/Manual
Remote Panel Supported	Yes*
Input signal	Industrial Standard 4-20mA signal
Output signal	MODBUS RTU Slave over RS-485, 2 Wire
Alarms	4 Potential free relays. viz. Alarm-1, Alarm-2, Alarm-3 & FLT
Data logging	Yes, with an option to "export to .csv" format in USB Stick
Input Power	110 - 240 V AC, 50/60 Hz
Output Power	24VDC (for transmitters only)



## Uniphos KwikSense LITE Digital Gas Transmitter

KwikSense LITE is the latest transmitter coming from Uniphos Envirotronic which is designed in order to meet the various needs of our customers. The Digital transmitter is housed in an explosion proof ("Exd" certified) wall mountable enclosure and is virtually maintenance-free.

- Fixed single gas sensors
- Sensor Technology – Comes in all the four technologies ie, EC/PEL/NDIR/PID/SS
- Tri-Color LEDs have been provided to signal the alarm condition
- **Safety Certifications:**

ATEX Certified by SGS BASEEFA Certificate No: Baseefa 14ATEX 0304X

IECEX Certified Certificate No: IECEX BAS 14.0148X



## Uniphos KwikSense RD Remote Transmitter

KwikSense RD is a remote transmitter which bridges the detector and controller. It consists of an OLED display to indicate the gas concentration detected by the detector on field.

The Remote transmitter is housed in an explosion proof ("Exd" certified) wall mountable enclosure.

- Configuration via Non-intrusive magnetic wand
- Industrial standard RS-485 Modbus/ 4-20 mA output and input is available to connect controller as well as the detector
- Tri-Color LEDs have been provided to signal the alarm condition



## Uniphos 499 Flammable Gas Leak Detector

The Uniphos 499 Flammable Gas Monitoring System is a novel state of the art leak detection system. Designed for permanent installation, the unit is able to monitor the presence of combustible gases such as LPG, CNG, LNG etc. in a variety of applications.

- Microprocessor based system with in-built self-test facility & RS 485 digital data communication link
- Exd IIC T6, IP66 Certified gas Leak Detector heads continuously monitors the presence of flammable gases
- Local & optional Remote Alarm Indicator console provides audio-visual alarm status from all detector heads
- Relay output for automatic activation of exhaust fan, hooter, solenoid valve etc.
- Alarm acknowledgement / reset and mute keys on both local and remote consoles
- **Safety Certifications:**  
ATEX & IECEx certified:  
Ex d IIC T6 Gb (Tamb -20°C to + 40°C)  
Ex d IIC T5 Gb (Tamb -20°C to + 55°C)





## Calibration Gases & Regulators

**Calibration Gases:** We carry a complete range of calibration gas cylinders to calibrate all instruments. The gas mixture in calibration gas cylinders is certified to be prepared gravimetrically, using NIST traceable weights. The lot number and nominal value of the gas constituents in volume, percent by mass, PPM, or volume is specified on the cylinder.

**Regulators:** The regulator, or gas delivery system, is crucial in providing the correct amount of gas to the instrument. This ensures an accurate bump testing and calibration.



## Precision Gas Detector Tubes

Detector tubes are available to measure more than 200 different kinds of gases and vapours. For many gases and vapours, there are several concentration ranges available giving you the flexibility to measure both low and high concentrations without sacrificing precision.

# EMERGENCY & FIRST AID





# Emergency & First Aid



## ISU First Aid Kits

General Purpose First Aid Kits, Plastic - Designed for everyday use. Good for the home, office, auto, camping or the workshop. These plastic kits are waterproof and portable and are completely latex free. General Purpose First Aid Kits, Soft-Sided - Designed for everyday use.

- Contents meet or exceed those required items from ANSI Z308.1-2009
- Contents exceed requirements of ANSI Standard Z308.1-2009
- Available in different size as 10, 25 and 50 persons – also available in metal cabinets with 2 or 3 shelf



## Focus Emergency Eyewash Station

**Model No.: 5022**

Focus Emergency Eyewash Station inc Bracket (Double) - Complete



## Focus Emergency Eyewash Station

**Model No.: 5020**

Focus Emergency Eyewash Station inc Bracket (Single) - Complete



## Focus Saline Eye Wash

**Model No.: 5999**

Focus Saline Eye Wash, 500ml  
Sterile - Including Eyebath Cap



## Radians Eyewash Station

**Model No.: REW01116**

To effectively and quickly clean debris from the eye, the Radians® 16 gallon REW01116 gravity fed Eyewash Station has a one second, one-step activation to deliver up to 15 minutes of non-injurious flow. It complies with ANSI Z358.1-2014 standards for portable eyewash stations.

- Wall mounted 16 gallon gravity fed eyewash station
- Quick one-step activation for instantaneous flow
- Delivers at least 15 minutes of non-injurious flow
- High visibility green color is easily recognizable if an injury occurs
- Includes an easy-to-mount wall bracket, portable water preservative, test log card and drainage hose
- **Standards: ANSI Z358.1**



## Combination Eyewash & Shower

**Model No.: 15031500**

- Suitable for mounting on floor by its own base
- Shower bowl, head & pipes are produced from galvanized steel material
- Body shower activation: Pull rod & push handle
- Eye/Face wash activation: Pull rod
- Water Inlet: 1"
- Water Outlet: 1"
- Body: 1 ¼"
- Standards: EN 15154-1, EN 15154-2, EN 15154-5, ANSI/ISEA Z358.12014 Certified







## Encon Combination Shower & Eye/Facewash

### Model No.: 01050231 with Strainer Tee

The combination shower and eyewash shall deliver 30 gpm (113.6 lpm) @ 30/70 psi (206.8/482.6 kPa) of flowing pressure from the shower head and 2.4 gpm (9.1 lpm) @ 30/70 psi (206.8/482.6 kPa) of flowing pressure from the eyewash. Unit shall provide a non-injurious stream of water for 15 minutes or longer.

- Piping: Schedule 80 hot dip galvanized steel
- Valves: Chrome plated bronze stay open ball valves with chrome plated balls, stainless steel valve stems, stainless steel push plate with actuation graphic (eyewash) and stainless steel pull rod with actuation graphic (shower)
- Valve sizes: shower 1", eyewash 1/2"
- Shower Head: Yellow ABS plastic shower head
- Eyewash Head: Acetal plastic dual stream heads with integral hinged covers and chrome plated brass wye assembly
- Bowl: Type 304 stainless steel
- Regulator: Self adjusting 30 gpm (113.6 lpm) shower and (2) 1.2 gpm (4.5 lpm) eyewash regulators
- Supply: 1 1/4" NPT
- Waste: 1 1/4" NPT
- Weight: 60 lbs (27.21 kgs)



**Encon**<sup>®</sup>  
SAFETY PRODUCTS

## Encon Pedestal Mounted Eye/Facewash - ABS heads /Wye, Yello-Bowl<sup>®</sup>

### Model No.: 01035402

- Bowl Type: ABS Plastic Yello-Bowl<sup>®</sup>
- Mounting: Pedestal Mount
- Fountain Type: 3.2 gpm ABS EW Heads & Wye
- Special Features: ABS Float-Off Head Covers with SS Bead Chain, Hi-Viz Bowl - 10.8" Diameter



**Encon**<sup>®</sup>  
SAFETY PRODUCTS



# Emergency & First Aid



## Progetti Rescue Sam AED

RESCUE SAM is a semi-automatic external defibrillator designed for providing simple and direct voice prompts and indications for a straightforward rescue operation. It is lightweight and battery powered for maximum portability. RESCUE SAM is designed to treat Ventricular Fibrillation (VF) and Fast Ventricular Tachycardia (VT).



## Progetti Rescue Life 9

Rescue Life 9 guarantees a user friendly interface, an impact-proof 8.4" LCD display and a powerful battery up to 10 hours to ensure continuous monitoring.

Standard set includes:

- Defibrillator unit 1 EA,
- Reusable adult and pediatric paddles 1 SET,
- Power cord 1 EA,
- Built-in printer 1 EA,
- Lithium battery 1 EA,
- ECG cable 5-leads 1 EA,
- User's manual 1 EA,
- AED/Advisory module with voice prompts and internal memory 2Gb,
- One adapter cable and one set of disposable adult pads 1 SET,
- 12 leads module included (specification working with 10 leads patient cable only),
- TEMP module included (working only with TEMP sensor),
- Predisposition for EtCO2 integration
- Including ECG cable 3-leads 1 EA,
- Paper roll 2 EA,
- ECG disposable electrodes 50 pcs

# BEVERAGE FOR HYDRATION & ELECTROLYTE REPLACEMENT





## Super Hydrate

Super Hydrate is the world's first Hydration Drink that has been developed especially for Industry. It contains the right balance of electrolytes and carbohydrates to ensure your workers are optimally hydrated throughout the day and helps avoid cases of Heat Stress and Heat Related accidents. It tastes great too and only contains 1% sugar when mixed so its safe to be consumed throughout the day over a prolonged period. In extensive trials, more than 95% of participants preferred Super Hydrate over other hydration products.

### Available Sizes

345 gm bag Orange & Lemon

17 gm Sachet Orange & Lemon

# SAFETY OF LIFE AT SEA





# Safety of Life At Sea



**LALIZAS**  
Simply life saving

## Lalzas Oceano SOLAS Life Rafts

- Insulated floor for low temperature conditions
- High visibility canopy with SOLAS reflective tapes
- Fully operational at temperatures from -30°C up to +65°C
- Lalzas Oceano SOLAS Life Rafts' capacity from 6 to 35 persons
- Lalzas Oceano SOLAS Life Rafts are designed to be store on-board on every vessel worldwide



**K-COMPANY  
APPROVED**

**LALIZAS**  
Simply life saving

## Lalzas Foam Lifejacket

**Model No.: 71086 (50-70 kg.)**

**Model No.: 71087 (70-90 kg.)**

**Model No.: 71088 > 90 kg.)**

A new design of a superior for safety. Designed to keep an unconscious face up and saves person from drowning. These vests are provided with a strap between legs, in the case of a child support too. Include a strap with buckle, plastic zipper and reflective tape. Approved to the latest European standards for vests 150 Newton, ISO 12402-3. All components certified according to ISO 12402-7 and ISO 12402 -8.



**LALIZAS**  
Simply life saving

## Lalzas Lifejacket LED Flash Light

**Model No.: 72348**

- Water-Activated LED Flashlight Technology
- Extra powerful LED light
- ON-OFF button operation
- Durable plastic body
- Universal size clamp
- Inspection friendly label
- Alkaline battery



K-COMPANY  
APPROVED

**LALIZAS**  
Simply life saving

## Lalizas Lifejacket Sigma 150N CE ISO 12402-3

**Model No.: 71094 upto 71097**

The Sigma lifejacket is an economic lifejacket available in auto and manual version. The ultra-lightweight design makes Sigma comfortable to wear and its webbing system makes it a user-friendly lifejacket. This cost effective lifejacket is available, in red and its transparent area allows the user to check the operating head function. The inflatable bladder, which is made of High Visibility Yellow fabric, is folded into a nylon red valise with Velcro closure and it is also equipped with Lalizas retro reflective tapes (70180) and whistle (70010, certified per ISO 12402-7 & 8). They are provided with lifting loop and heavy duty D-ring for easier rescue.



**LALIZAS**  
Simply life saving

## Lalizas SOLAS Lamda Inflatable Jacket

**Model No.: 71216**

- Certified per SOLAS, for ultimate safety while on board
- Certified according to the specifications of the HSE Compatibility Test Protocol for Lifejackets & Immersion suits on Offshore installations (when combined with LALIZAS Immersion suit with rubber gloves)
- Twin chambers as per SOLAS requirements
- Lamda 330N goes above and beyond the standard regulations of 275N
- It is the only SOLAS lifejacket in its category with two stainless steel buckles, on the center and side of the waist harness, in order to be easily removed even inflated, when needed & features a crotch strap
- Available in one adult size, which can be easily adjusted to passengers with chest size up to 175cm or more, with the use of the LALIZAS Waist Belt Extender (71161)



**LALIZAS**  
Simply life saving

## LALIZAS Immersion Suit "Neptune", Insulated, SOLAS/MED

**Model No.: 70454**

- Exceeds the latest SOLAS specifications for hypothermia protection
- Ideal for use on board ferries, offshore drilling rigs, rescue boats, man-overboard boats and for general commercial use
- Protects you in situations where the danger of hypothermia is great, increasing your chances of survival
- Made of reinforced neoprene material (5mm thickness)
- Ergonomic design • Thermally insulated
- Diesel, oil & flame resistant • Easy & quick donning
- Successfully submitted to water ingress, jump & leak tests
- Should be worn in conjunction with an approved lifejacket



**K-COMPANY  
APPROVED**

**LALIZAS**  
Simply life saving

## Lalizas SOLAS Lifebuoy Ring

**Model No.: 70090**

Lifebuoy ring Lalizas 70090 features an orange, rack hard, cross-linked polyethylene outer shell that will not deteriorate and is unaffected by extreme weather conditions CE approved to SOLAS (L.S.A Code).



# ENVIRONMENT PROTECTION



CAUTION  
ATTENTION



ACHTUNG  
OPGELET

SPC





# Environment Protection



**PORTWEST**

## PW Spill 20 Litre Chemical Kit

**Model No.: SM90**

New chemical control response kit. Smaller size allows conventional storage and easy portability to all areas that may need spill control. Excellent chemical and fluid retention for easy displacement of hazardous chemicals. Kit contains:

- 2 x Sock • 20 x Pads • 1 x Bag Ties
- 1 x Yellow Disposable Bag
- 1 x Clear Clip Handle Bag
- 1 x Instruction & Contents Sheet



**SYSBEL**<sup>®</sup>

## Flammable Cabinet (Self-Closing)

**Model No.: SD60227F – 227L**

Double-wall construction with 38mm insulating air space for fire resistance. Over 1.2mm thick, fully welded, construction holds squareness for longer life, offering greater protection in a fire with 5.3cm leak tight sump at the bottom of cabinet's maximally catching incidental drips.



**Encon**<sup>®</sup>  
SAFETY PRODUCTS

## Encon Air Purified Respirator Wall Case

**Model No.: 01338007**

- Chemical and corrosion resistant materials of construction
- Rugged oversized hinges
- Bulb rubber door gasket
- Quarter turn handle and internal dual latch
- Highly visible graphics

Size	Color	Graphics	Accessories
Mini	Yellow door, black case	Air Purified	Windows in door



## Encon Single SCBA Wall Case

**Model No.: WC11Y10B**

- Chemical and corrosion resistant materials of construction
- Rugged oversized hinges
- Bulb rubber door gasket
- Quarter turn handle and internal dual latch
- Highly visible graphics

Shelving	Equipment Retainer	Color	Graphics	Accessories
Molded Top Shelf	Strap	Yellow	Self Contained Breathing Apparatus	Window - Air Gauge Viewer

**Encon**<sup>®</sup>  
SAFETY PRODUCTS



## Encon ESCBA Wall Case (Dual)

**Model No.: 01339001**

- Chemical resistant ABS plastic thermoformed construction
- Corrosion resistant external components
- Rugged oversized low friction hinges
- Bulb rubber gasket provides virtual air tight seal
- Stay clear acrylic window(s)
- Available in single or dual unit models
- Internal dual latch closure allows for two points of contact to help ensure door seal
- Quart turn handle provides for quick and easy access to case contents
- High visibility black graphics
- UV inhibitors to assure long lasting color
- Compatible with virtually every available ESCBA equipment

**Encon**<sup>®</sup>  
SAFETY PRODUCTS

Shelving	Equipment Retainer	Color	Graphics	Accessories
Two Unit	Strap	Yellow door, black case	Escape Respirator	Windows in door



## Chemical Spill Kit

- Capacity: 65 Gallon
- Absorbent Color: Yellow
- Technical Specification: Hydrophilic Absorbent
- Bin Type: Weather resistant HDPE Container
- Bin Size & Color: 240Ltr., Yellow.
- Bin Size: L74 x W58 x H108 cms.
- Total Weight (Gross): ≤ 20kg.



## Oil Spill Kit

- Spill Cleanup Capacity: 220 to 260 Liters
- Absorbent Color: White
- Technical Specification: Hydrophobic Oil-Only Absorbent
- Bin Type: Weather resistant HDPE Container
- Bin Size & Color: 240 Ltr., Yellow.
- Bin Size: L74 x W58 x H108 cms.
- Total Weight (Gross): ≤ 10kg.

# ROAD SAFETY





# Road Safety



## Caution & Warning Tapes

Caution and warning tapes provide a visual barricade to block off designated areas. These caution and warning tapes block off potential hazards and are ideal for temporary use outdoors or permanent indoor warning.



## Traffic Cones

Traffic cones are used to indicate, demarcate, warn or delineate an area. Road cones are also widely used for construction, mining, industry, traffic, police and military and in various sports as a training tool. Traffic cones are manufactured from flexible high visibility plastic material and a heavy base to keep the traffic cone upright and on the road.



## Plastic Barricade

**Strong polypropylene construction**

- Never requires painting
- Will not rust, chip, dent or corrode like metal barriers

**Available in six high visibility colors**

- Different colors can be mixed to match corporate, team or school colors
- Custom colors available

**Multiple units can be interlinked to create a modular barrier**

- Units stay connected together on flat or uneven surfaces
- Holes in the base for permanent anchoring

# SAFETY SIGNAGE





# Safety Signage

## ✓ SITE SAFETY



**WARNING**  
Construction  
work in progress



All visitors must  
report to the  
site office



Safety helmets  
must be worn



Unauthorised  
access strictly  
prohibited



## Safety Signs

We carry in stock all kinds of Signs for Safety, Maintenance and facility identification for you to use in your work environment. These can be made on normal or reflective stickers for high visibility. We have our own Fabrication unit that can custom make metal poles and stands if required.



PassivHaus  
RECOGNISED BY CASB Telephone: 0800 055 6887

### SITE SAFETY

Under the Health and Safety at Work Act 1974 all persons entering this site must comply with all regulations under this act. All visitors must report to the site office and obtain permission to proceed onto the site or any work areas. Safety signs and procedures must be observed and personal protection and safety equipment must be used at all times.



Construction work in progress. Parents are advised to warn children of the dangers of entering this site.



Safety helmets must be worn



High visibility jackets must be worn



Unauthorised entry to this site is strictly forbidden





**INDUSTRIAL TOOLS**

**EGA** *Master*

**ART IN INNOVATION**

*BE SAFE...BE EFFICIENT*





# Industrial Tools

## Premium Industrial Tools



Industrial Tools



Pipe Tools & Machines



Slogging Ring Wrench



Slogging Ring Wrench Thin Wall



ESD Tools



Controlled Tightening

## Safety Tools



Insulated 1000V



ATEX



Antidrop



Underwater



Non-Magnetic Titanium

## Workshop & Tool Control Solutions



Storage Solutions



Personalized Foam Trays



Tool Marking



## Digital Torque Wrenches

Quality control  
Mini for confined spaces  
With interchangeable heads  
(9x12, 14x18)  
Torque screwdriver



## Analogic Torque Wrenches

Mini for confined spaces  
With interchangeable heads  
(9x12, 14x18, 24x32,  
27x36, Ø16, Ø22)  
Preset torque  
Dial torque wrenches  
Insulated 1000V



## Hydraulic & Battery Torque Wrenches

Ease of use  
High tightening torques





# Industrial Tools

## Non Sparking Tools

Safe to use in explosive environments

Required by Directive 1999/92/CE

EN 1127-1 requirement

### Alloy Type

Al-Bron, Cu-be or Acetilex

Cu-Be safest option and more durable if used frequently

### Alloy Marking

The alloy should be marked on the tool to ensure a safe choice of tool and use

### Certificated

Request certificates of the material against Directive 1999/92/CE, not of the tool quality (e.g. ISO or DIN)

### Valid Certificates

Certificates that explicitly state compliance of the material against the Directive 1999/92/CE  
Issued by EU approved laboratory (e.g. BAM main EU approved laboratory)





## Antidrop Tools

EGA Master manufactures a whole range of ANTIDROP products and solutions that have been designed to control and prevent object dropping when working at height. These products have been designed to allow a comfortable, productive and efficient use of tools while assuring workers' and equipment safety against object dropping. Ideal for many manufacturing, construction, installation and maintenance activities, both onshore and offshore. Some applications: oil rigs, wind turbines, power lines, cranes, buildings, scaffoldings, bridges, telecom towers, airplane maintenance, speleology, mining...

### Lanyards Antidrop

Designed for maximum safety, as well as optimum working freedom, the various systems provide all required solutions for a comfortable and safe use on heights, while assuring best shock absorption.



### Heat Shrink System

EGA Master ANTIDROP tools have been carefully designed not only to avoid accidental dropping, but also to ensure maximum safety. All tools are equipped with heat shrink system which offer superior safety compared to other systems, such as directly holding tools with a knot. Of course, all tools keep the original and well-known EGA Master industrial tools features: safety, resistance, durability, efficient and comfortable use.

### Safety Belts

Designed to fit the worker's body, enable user freedom and provide maximum tool fixing points. Internal hooks safely retain tools while the operator is climbing or moving location.





# Industrial Tools

## Customise your kits

1

Select the tools among the more than 25.000 references that we manufacture



2

Choose among our wide range of roller cabinets and/or cases



3

The foam trays will be designed with the highest efficiency and the best use of the space\*

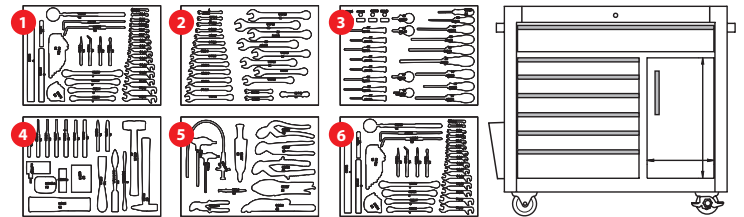

4

The user's logo will be engraved by laser on each tool\*



5

Receive your customised kit



# LOCKOUT / TAGOUT





# Lockout / Tagout



## Brady Lockout Tagout Tags, Labels & Signs

Lockout tagout tags, labels and signs will help you communicate safety and lockout information at the point of need. These tags, labels and signs come in a variety of materials and are available in OSHA-compliant Lockout/tagout (LOTO) formats. It is a great way to visually provide warnings and instructions for preventing unexpected machine start ups, and alert equipment operators about proper lockout procedures during maintenance and repair.



## Brady Safety Padlocks - Compact

With this Brady Safekey Padlock, you get up to 700% more unique key possibilities than a standard safety padlock. The unique cylinder is insulated to protect workers from shocks when the key is inserted. Its all in the forward-thinking design of the locking mechanism and unique key blade that gives you more precision and control in your lockout program.

- Easy operation with extra smooth key insertion and removal - even wearing gloves!
- Fast identification with the color-matched key and lock body
- Years of use with the low friction locking mechanism that helps maintain key integrity
- Excellent durability in every industrial environment

Locks are compact and lightweight and resist impact, temperature, chemicals, and corrosion. Their non-conductive, non-sparking body features a ribbed design for easier gripping and handling. 1 key supplied with each lock. Key retaining (Key won't release until the padlock shackle is securely closed)  
**Available Shackle Heights: 25mm, 38mm, 50mm & 75mm**





BRADY

## Brady Labels for Safety Padlocks

**Model No.: 051379**

Safety padlock labels help send a clear message to workers when a machine is down for service or maintenance. Labels are designed to fit Brady Safety Padlocks and are supplied with text in English, French and Spanish as standard.



BRADY

## Brady Portable Padlock Station

**Model No.: 811218**

- Holds up to 10 padlocks, 6 lockout hasps and 10 tags
- Made from polypropylene: light and rustproof
- Pre-drilled holes: easy to mount on wall
- Station is supplied without contents



BRADY

## Brady Butterfly Valve Lockout

Can be used to lock a butterfly valve in the OFF position by clamping down on the handle so that it may not be engaged or moved.

- Available in two sizes
- 121504 Small Butterfly Lockout For valve handle
- 121505 Large Butterfly Lockout For valve handle



# Lockout / Tagout

## Brady Miniature Circuit Breaker

A safe and effective method for locking out European circuit breakers as it fits most of their existing types.

Miniature Breaker Lockout unique in its kind = requires NO TOOLS to install

- The lockout easily installs with the aid of a Push Button
- The Tie-Bar Style Lockout has a convenient thumb wheel for quick application
- Suitable for single and multi-pole breakers
- Made from glass-filled nylon
- Available in single or six pack
- 1 padlock can be applied
- 090847 Miniature Circuit Breaker Lockouts - Pin-In
- 090844 Miniature Circuit Breaker Lockouts - Pin-Out
- 090850 Miniature Circuit Breaker Lockouts - Pin-Out
- 090853 Miniature Circuit Breaker Lockouts - Tie-Bar



 **BRADY**

## Brady Combined Lockout & Lock Box Station (Box Only)

**Model No.: 099708**

- Powder-coated metal yellow cabinet
- Lockout safety tips printed on inside of door
- Lock Box attaches to bottom of cabinet, accommodates 8-10 locks (depending on size)
- Comes with one adjustable shelf (extra shelves available)
- Lockout cabinet is capable of being locked closed and can easily be wall mounted using pre-drilled holes in back
- Cabinet dimensions: (H) 406 x (W) 355 x (D) 152 mm
- Lock box dimensions: (H) 152 x (W) 381 x (D) 76 mm



 **BRADY**



## Brady Safelex™ Universal Cable Lockout Device

**Model No.: 145554**



BRADY

- Secure Multiple Energy Disconnects with Versatile Group Lockout Hasp
- Safety hasp-shaped body clearly identifies the equipment lockout application
- Lightweight for easy handling, carrying, operation and storage
- Versatile to lock out multiple electrical or valve energy isolation points
- Effectively lock out diverse shutoff configurations
- Complete the lockout by securing 1 to 6 safety padlocks to the locking body
- Cable can be tightened to remove slack even when locked
- Designed to withstand a wide range of environmental conditions



BRADY

## Brady Original Cable Lockout

Brady's original, patented cable lockout device is perfect for your difficult lockout situations such as large gate valves or oversized devices.

- Simply squeeze device to tighten cable, insert your padlock to secure the handle and you're done
- Body is made of impact modified nylon
- Available in several colors
- Comes with galvanized steel cable (non-coated)

**045191 Original Cable Lockout Blue**

**045192 Original Cable Lockout Yellow**

**065318 Original Cable Lockout Red**



# Lockout / Tagout



## Brady Pro-Lock II Cable Lockout Device

This is a complete isolation safety system, ideal for securing valves or industrial machinery and can only be opened and locked by using a special operating tool (to be ordered separately).

- Polypropylene Moulding & Stainless Steel
- UV Stabilised
- Temperature resistance range: -50 °C to 55 °C
- Vinyl coated cable

225203 Pro-Lock device with cable Red

225204 Pro-Lock device with cable Green

225205 Pro-Lock device with cable Yellow



## Brady Lockout Satchel

**Model No.: 806200**

- Made of 1000 denier red cordura nylon with a 95 cm shoulder strap
- Includes latchable front pocket and two side mesh holders



## Brady Lock Boards

Brady's high visibility lock boards make your locks, tags and lockouts easy to find and use. Built for the toughest conditions, these lock boards are made of durable plastic material.

- 050989 5-Lock Board
- 050990 10-Lock Board
- 050991 20-Lock Board
- 050992 36-Lock Board





## Brady Ultimate Lockout Kit

**Model No.: 806178**

This is our most extensive Lockout Tagout kit and includes everything a larger company might need for their Lockout Tagout programme as well as training material.



 BRADY

## Brady Portable Metal Group Lockout Boxes

**Model No.: 065699**

For group lockout situations involving a large number of workers and equipment, lock boxes can offer a number of advantages over hasps. 13 lock holes on lid and can also be used as a lock storage box holding up to 40 padlocks. Slot in front allows keys to be inserted when box is locked.



 BRADY



# Lockout / Tagout

## Brady Coloured Nylon Ties

Coloured nylon ties provide you with an option of colour coded application.

- 622647 Natural • 622680 Blue • 622681 Green
- 622682 Orange • 622683 Violet • 622684 Red
- 622685 Yellow • 622613 Black • 622647 Natural
- 229956 Blue • 229957 Red • 229958 Orange
- 229959 Yellow • 229960 Green • 229961 Violet



BRADY

## Brady Personal Padlock Kit

**Model No.: 873872**

Convenient way to carry padlocks (2 in kit), hasps and keys.

- The pouch has a clear plastic face to display identification
- The heavy duty retractable key holder features a Kevlar cord with split ring attachment, and is extendable to 1200 mm
- Key holder can be attached to the pouch or can be used on its own!



BRADY

## Brady Label Printer 300 dpi

**Model No.: BBP™12**

The BBP™12 Label Printer is an entry level benchtop label printer for cable, component, product and laboratory sample identification that offers great value for money. The compact BBP12 offers a high print speed of 100 mm/second and can handle a wide range of highly durable and specialised Brady identification labels.



BRADY

Article No.	Order Reference
198600	BBP12-UK with Unwinder and Brady Workstation PWID Suite
198599	BBP12-UK with Cutter, Unwinder and Brady Workstation PWID Suite



## Brady Industrial Label Printer with Wi-Fi

**Model No.: i3300**



- Mid-volume industrial label printer ideal for identification throughout your facility, including everything from wires and panels to safety and facility labels
- Print smart technology allows the printer to print on the first label – even sleeves and small labels
- Changeovers in a flash – foolproof drop-in label rolls and ribbons snap into place in 20 seconds
- Talk about options, this printer prints on more than 825 parts and 70 material options for facility-wide identification
- Add one of the Brady Workstation Software Suites to your solution and make label creation even easier
- Setup is stress free – Contact our Brady Technical Support Team and we will schedule a free phone setup appointment

## Brady Portable Label Printer

**Model No.: BMP41**



The BMP®41 portable Label Printer is a mid-range handheld labelling solution that can print up to 300 labels per day. Not only that, but it can print die-cut or continuous labels up to 1" wide.

This printer is a rugged device that withstands harsh conditions. Whether it is sweltering or frigid, it will get the job done where you need it. Also, it is built with additional protection to survive falls of up to six feet high.

With an ergonomic design, long rechargeable battery life and easy-to-use features, this printer is engineered for the worker on-the-go.

41 Label Printer Part #BMP41



# Lockout / Tagout



## BradyJet Colour Label Printer

**Model No.: J2000**

The BradyJet J2000 prints on Brady's reliable indoor sign, tag and label materials that stay attached and remain legible when exposed to liquids, alcohol and indoor lighting. They can be counted on to warn coworkers about hazards, or to instruct them on the optimal use or maintenance of machinery.



## Brady Covers Confined Space

**Model No.: 151063**

Visually identifying your confined spaces will keep you compliant, but it may leave gaps in safety. Add another level of safety with this Confined Space Safety Cover to keep your crew safe. Get the complete safety package – unlike signs and tapes this cover provides a sign and an unavoidable boundary in one easy-to-use product. Elastic covers are ideal for quick protection needs and provide ventilation for areas that require it. Make it last – unlike wasteful warning tape, these covers are designed to be reused for multiple projects. The size of the sign on the cover is 355.60 mm width x 254.00 mm height



## Brady Mobile Label Printer

**Model No.: M611**

The M611 Mobile Printer announces a new chapter in the ongoing evolution of identification. Easily design the most complex labels in the field using only your smartphone and Brady's free Express app before printing on reliable, industrial grade label materials with the M611 Mobile Printer.





## Brady Sign & Label Printer

**Model No.: S3100**

With the S3100 Sign & Label Printer, you can print a wide range of signs and labels to increase safety and efficiency in any workplace. Safety signs, floor marking, 5S labels, lean labels, labels to identify racks, doors, stairs, bins, desks and chairs and CLP-labels to identify chemicals can all be printed with the S3100 at your location whenever you need them.

- Label making made easy
- Automatic label setup
- 20-second material changeovers
- 76.2 mm per second print speed
- Weight: 8.8kg
- Size: 22.5H x 30.5W x 28D cm
- Keyboard Type: Full size fold down keyboard  
QWERTY, AZERTY, QWERTZ, CYRILLIC
- Min. Label Width: 1.27cm
- Max. Label Width: 10.1cm
- Internal Memory Capacity: 300 MB

**Includes: S3100 Printer, Power Cord, USB Cable, Cleaning Kit, Cutter Cleaning Tool, Quick Start Guide, Stylus and Mouse**



## Brady Adjustable Gate Valve Lockout

**Model No.: 064057**

The adjustable Gate Valve Lockout adjusts to fit gate valves from 2.5 to 16.5 cm and can replace up to 3 conventional gate valve lockouts therefore reducing costs



# Lockout / Tagout



 BRADY

## Brady 4-Legged Ball Valve Lockout

**Model No.: 800110**

The two halves of the device encompass the ball valve lever to secure it from inadvertent activation of the valve. Locks out pipes from 12.70 - 31.75 mm in open and 12.70 - 63.50 mm closed position



 BRADY

## Brady Pipe Blind Flange Lockout Device

**Model No.: 149228**

The pipe blind lockout device can be applied to the widest range of pipes to easily and temporarily avoid the release of gas, steam and hazardous liquids while pipe maintenance is still ongoing. Padlocks with shackle diam 6.50 mm to 7.00mm can only be used on this lockout

# EXPLOSION PROOF PRODUCTS





# Explosion Proof Products



K-COMPANY  
APPROVED



**NIGHTSTICK**  
Life Depends on Light

## Nightstick Intrinsically Safe Permissible Flashlight - Zone 0

**Model No.: XPP-5420GA**

This flashlight is cETLus, ATEX, IECEx, INMETRO and MSHA listed Intrinsically Safe Permissible. It uses a LED rated at 140 lumens that works in conjunction with a high-efficiency deep parabolic reflector to create a usable flashlight beam rated at 180 meters.

- Momentary or constant-on flashlight
- Sharp focused beam for distance illumination
- Engineered polymer housing
- Dustproof / Waterproof
- Impact & chemical resistant
- Built-in pocket/belt clip
- Includes removable lanyard



K-COMPANY  
APPROVED



**NIGHTSTICK**  
Life Depends on Light

## Nightstick X-Series Intrinsically Safe Flashlight - Zone 0

**Model No.: XPP-5420GXA**

This flashlight is cETLus, ATEX, IECEx and INMETRO listed Intrinsically Safe for use in both above and below ground hazardous locations where explosive gases and dusts may be present. The XPP-5420GX uses a LED rated at 210 lumens that works in conjunction with a high-efficiency deep parabolic reflector to create a usable flashlight beam rated at 187 meters.

- Momentary or constant-on flashlight
- Sharp focused beam for distance illumination
- Engineered polymer housing
- Dustproof / Waterproof
- Impact & chemical resistant
- Built-in pocket/belt clip
- Includes removable lanyard



**NIGHTSTICK**  
Life Depends on Light

## Intrinsically Safe Permissible Dual-Light™ Flashlight - Zone 0

**Model No.: XPP-5422GA**

This 3 AA Dual-Light™ Flashlight is cETLus, ATEX, IECEx, INMETRO and MSHA listed Intrinsically Safe Permissible. It uses a LED rated at 120 lumens that works in conjunction with a high-efficiency deep parabolic reflector to create a usable flashlight beam rated at 170 meters.

- Flashlight – Floodlight – Dual-Light™
- Momentary or constant-on flashlight
- Sharp focused flashlight beam for distance illumination • Built-in pocket/belt clip
- Unfocused wide-beam floodlight for close-up illumination • Includes removable lanyard
- Dual-light (flashlight & floodlight at same time) for maximum versatility • Dual body switches



**NIGHTSTICK**  
Life Depends on Light

## Nightstick X-Series Intrinsically Safe Flashlight - Zone 0

**Model No.: XPP-5418GX**

This Flashlight is cETLus, ATEX, IECEx, and INMETRO-certified Intrinsically Safe for use in both above and below ground hazardous locations where explosive gases and dust may be present. The XPP-5418GX uses a LED rated at 200 lumens that works in conjunction with a high-efficiency deep parabolic reflector to create a usable flashlight beam rated at 143 meters.

- LED technology – 50,000 + hours LED life
- Momentary or constant-on flashlight
- Sharp focused beam for distance illumination
- Polymer housing
- Tail switch
- Dustproof / Waterproof
- Impact & chemical resistant
- Meets requirements of NFPA-1971-8.6 (2013)



# Explosion Proof Products

## INTRANT™ Intrinsically Safe Dual-Light™ Angle Light - Zone 0

**Model No.: XPP-5566GX**

The INTRANT™ Intrinsically Safe Angle Light is a Flashlight, a Floodlight and a Dual-Light Angle Light. The INTRANT's flashlight pivots 90 degrees up and down with a 45 degree downward angled floodlight. The flashlight setting offers user-selectable brightness settings of 200, 110 and 60 Lumens with a 401-meter beam distance.

- cULus, UKCA, ATEX, IECEx, and INMETRO listed Intrinsically Safe
- LED technology
- 8 User-selectable brightness settings for the Flashlight and Floodlight including a 20 Lumen Survival Mode
- High-efficiency deep parabolic reflector creating a sharp focused flashlight beam
- Heavy-duty stainless-steel pocket clip
- IP-67 Dustproof/Waterproof
- 3 AA batteries (included)
- Meets requirements of NFPA-1971-8.6 (2013)



## Nightstick Intrinsically Safe Dual-Light LED flashlight - Zone 0

**Model No.: XPP5414GX**

This Intrinsically Safe (cETLus, UKCA, ATEX Zone 0 and IECEx) Dual-Light LED flashlight offers peak performance in hazardous work environments.

- cULus, UKCA, ATEX, IECEx, and INMETRO listed Intrinsically Safe
- LED technology
- Momentary or constant beams of light
- Integrated magnet on base and reversible pocket clip
- IP-67 Dustproof/Waterproof
- 2 AA batteries
- Meets requirements of NFPA-1971-8.6 (2013)



## Nightstick IS Rechargeable Dual-Light™ Flashlight w/ Dual Magnets - Zone 0

**Model No.: XPR-5522GMX**

The XPR-5522GMX Rechargeable Dual-Light™ Flashlight w/Dual Magnets is cETLus, ATEX, IECEx, and MSHA listed Intrinsically Safe Permissible for use in both above and below ground hazardous locations where explosive gases and dusts may be present. It uses an LED rated at 240 lumens that work in conjunction with a high-efficiency deep parabolic reflector to create a usable flashlight beam rated at 178 meters. A 175-lumens unfocused floodlight is integrated into the housing which is perfect for close-up illumination. cETLus, ATEX, IECEx and MSHA listed Intrinsically Safe Permissible



**K-COMPANY  
APPROVED**

**NIGHTSTICK**  
*Life Depends on Light*



- Flashlight / Floodlight / Dual-Light™
- Momentary or constant-on flashlight
- Sharp focused flashlight beam for distance illumination
- High-efficiency deep parabolic reflector
- Effective beam distance of 178 meters
- Unfocused wide-beam floodlight for close-up illumination
- Dual-Light (flashlight & floodlight on at the same time) for maximum versatility & user safety
- Powerful integrated magnets built into the base and pocket clip for multiple hands-free options
- Engineered polymer housing • Non-slip grip
- Dual body switches • Built-in pocket/belt clip
- IP-67 Dustproof / Waterproof
- Impact & chemical resistant
- Includes wall/vehicle mountable charger, AC/DC power supplies & removable lanyard
- Integrated Lithium-ion rechargeable battery (included)



## INTRANT® Intrinsically Safe Rechargeable Dual-Light Angle Light - Zone 0

### Model No.: XPR-5568GX

The INTRANT® Intrinsically Safe rechargeable angle light is a flashlight, a floodlight, and a Dual-Light angle light.

The flashlight rotates 90 degrees up and down with a 45 degree downward angled floodlight.

Multiple settings offer user-selectable brightness of 200, 110, and 60 lumens with a 401 meter beam distance.



**NIGHTSTICK**  
Life Depends on Light

- cULus, KOSHA, UKCA, ATEX, IECEx and INMETRO listed Intrinsically Safe
- Flashlight – Floodlight – Dual-Light
- LED technology
- 8 User-selectable brightness settings for the Flashlight and Floodlight including a 20 Lumen Survival Mode
- High-efficiency deep parabolic reflector creating a sharp focused flashlight beam
- Dual-light (both the flashlight & floodlight on at the same time) provides for maximum lighting versatility and user safety
- Glass-filled Nylon Polymer housing
- Dual body switches
- Heavy-duty stainless-steel pocket clip
- Battery charge status indicator (for use only with rechargeable battery)
- IP-67 Dustproof / Waterproof
- Impact & chemical resistant
- Meets requirements of NFPA-1971-8.6 (2013)
- Powered by a Rechargeable Lithium-ion Battery (included)
- Serialized for personal identification
- Includes a AA Battery Carrier for backup power if needed
- Charge Input: 24VDC max.



## Nightstick Intrinsically Safe Multi-Function Dual-Light™ Headlamp - Zone 0

**Model No.: XPP-5454G**

This 3 AAA Multi-Function Dual-Light™ Headlamp is cETLus, ATEX, INMETRO and IECEx listed Intrinsically Safe. This headlamp features a multi-position tilt-head design and includes an elastic head strap with a non-slip lining and a heavy-duty rubber head strap for use on a hard hat.

- High/low-brightness spotlight, high/low-brightness floodlight & Dual-Light™
- Focused spotlight beam for distance illumination
- Wide unfocused floodlight beam for close-up illumination
- Dual switches located on top of light
- Adjustable ratchet tilt head



**NIGHTSTICK**  
Life Depends on Light

## Nightstick X-Series Intrinsically Safe Low-Profile Dual-Light™ Headlamp - Zone 0

**Model No.: XPP-5460GX**

This X-Series Intrinsically Safe Low-Profile Dual-Light™ Headlamp is cULus, ATEX and IECEx listed Intrinsically Safe and is designed specifically to work on fire helmets and hard-hats that have a flip-up face shield.

- Focused high/low-brightness spotlight beam for distance illumination
- Unfocused high/low-brightness wide-beam floodlight for close-up illumination
- Dual-Light™ (spotlight and floodlight on at the same time) for maximum versatility
- Dual switches located on front of light
- Adjustable tilt head
- 3 AAA batteries (included)



**NIGHTSTICK**  
Life Depends on Light



# Explosion Proof Products

## Nightstick USB Intrinsically Safe Dual-Light Headlamp - Zone 0

**Model No.: XPR-5554G**

Rated at 160 lumens, this Magmate™ USB Rechargeable Dual-Light headlamp is cULus, ATEX, INMETRO, KOSHA, and IECEx Zone 0, listed as Intrinsically Safe for hazardous environments.

- cULus, ATEX, INMETRO, KOSHA and IECEx listed Intrinsically Safe
- LED technology
- IP-67 Dustproof / Waterproof
- Unfocused high/low-brightness wide-beam floodlight for close-up illumination
- Heavy-duty rubber strap for fire helmets and hard hat applications
- Dual-Light™ (spotlight and floodlight on at the same time) for maximum versatility



**NIGHTSTICK**  
Life Depends on Light

## Nightstick Intrinsically Safe Dual-Function Headlamp - Zone 0

**Model No.: XPP-5450G**

This 3 AAA dual-function headlamp is cETLus, ATEX, INMETRO and IECEx listed Intrinsically Safe. This headlamp features a multi-position tilt head design and includes an elastic head strap with a non-slip lining and a heavy-duty rubber head strap for use on a hard hat.

- High-brightness spotlight, low-brightness spotlight
- Focused spotlight beam for distance illumination
- Single switch located on top of light
- Adjustable ratchet tilt head
- Dustproof / Waterproof
- 3 AAA alkaline batteries (included)



**NIGHTSTICK**  
Life Depends on Light

## Nightstick Viribus™ Intrinsically Safe Dual Light Lantern - Zone 0

**Model No.: XPR-5580G**

The VIRIBUS™ Intrinsically Safe Dual-Light™ Rechargeable Lantern is a Flashlight, a Floodlight and a Dual-Light that is cULus, ATEX, and IECEx certified intrinsically safe. The flashlight setting offers 3 user-selectable brightness settings of 210, 100 and 30 lumens with a 635-meter beam distance.

- LED Technology • Dual body switches
- cULus, ATEX, and IECEx certified Intrinsically Safe
- Dual-light (both the flashlight & floodlight on at the same time) provides for maximum lighting versatility and user safety
- IP-67 Dustproof / Waterproof
- Impact & chemical resistant
- Lithium-ion battery (included)
- **Meets requirements: NFPA-1971-8.6 (2013)**



## Nightstick NTEGRITAS™ 84 IS Rechargeable Lantern - Zone 0

**Model No.: XPR-5592GX**

The INTEGRITAS™ 84 Intrinsically Safe Rechargeable Lantern generates a scene-filling 600 lumens for an ultra-long 13 hours from four separate LEDs housed in a 180-degree articulating head for maximum versatility. Holding down the switch enables a battery-saving 250-lumen low mode.

- Adjustable tilting head • Low battery indicator
- cULus, ATEX, and IECEx certified Intrinsically Safe
- Rear-mounted rubber base with a powerful rare earth magnet
- Integrated rechargeable lithium-ion battery
- IP-67 Dustproof / Waterproof
- **Meets requirements of NFPA-1971-8.6 (2013)**





# Explosion Proof Products



**NIGHTSTICK**  
Life Depends on Light

## Nightstick Rechargeable LED Scene Light with Magnetic Base - Zone 0

**Model No.: XPR-5592GX (without Tripod)**

**Model No.: XPR-5592GCX (with Tripod)**

The XPR-5592GX/GCX Rechargeable LED Scene Light is ideal for use when portability is important. cULus, ATEX, INMETRO, and IECEx-certified Intrinsically safe for use in hazardous environments, the array of 5 floodlight LEDs perfectly emit an impressive 1,200 lumens on high for 6 hours, or 650 lumens on low for 12 hours.

- LED Technology
- cULus, ATEX, and IECEx certified Intrinsically Safe
- Rechargeable integrated lithium ion battery
- Multi-angle tilt and swivel fixture design
- IP-67 Dustproof / Waterproof
- Meets requirements: NFPA-1971-8.6 (2013)



**PORTWEST**

## Portwest L.E.D Head Light

**Model No.: PA50**

Head Light with tilt control so you can aim the light where it is needed most. Ideal for keeping your hands free for work. New and improved brightness now with 8 L.E.D's. The ideal utility head light.

- Brightness: 40 Lumens
- Run time: 10 hours
- Batteries: Included AAA x 3
- Function: High-Medium-Low



## Ex Shield Intrinsically Smart Phone

### Model No.: EX-Z1SP

- Intrinsically Safe ATEX ZONE 1/21
- RAM/ROM: 4GB/64GB Micro SD support upto 256GB
- Battery Capacity: 8580 mAh
- OS: Android 10.0
- Water & Dust Resistance IP68
- Camera/s: 16MP Front & 8MP Back
- Display: 5.7 inch, Resolution 720 x 1440



## Realix REx1.1 Mobile Phone

The REx1.1 IS mobile especially designed to work in a potentially explosive area and the waterproof feature, It's a powerful mobile phone for Zone 1/21 with Android operating system, 4G LTE, Wi-Fi, LED-torch, amplified loudspeaker and SOS-key.

- Available with 2MP rear camera or without camera
- Processor MTK6739 (1.5GHz) quad core
- Android 8.0 with touchscreen and keypad / 2.4" Screen
- Internal memory 8GB ROM and 1GB RAM
- 2800mAh Lithium-ion battery
- Standards:
  - ATEX Zone 1 / 21
  - II 2G Ex ib IIC T4 Gb IP68
  - II 2D Ex ib IIIC T135°C Db IP68
  - Ta: -20°C +60°C





# Explosion Proof Products



## Realix RxIS201 IS Mobile

The RxIS201 IS mobile especially designed to work in a potentially explosive area and the waterproof feature, It's a powerful mobile phone for Zone 1/21 with Android operating system, 4G LTE, Wi-Fi, SOS-key.

- Android 9.0 / 6" Screen
- Processor - MTK6763 (2.5GHz) Octa core
- Internal memory 128GB ROM and 6GB RAM
- 13MP rear camera & 5MP front camera
- 8000mAh Lithium-Ion Battery
- **Standards:**

ATEX

II 2G Ex ib IIC T4 Gb IP68

II 2D Ex ib IIIC T135°C Db IP68

Ta: -20°C +60°C



## Realix RxAltitude IS Tablet

RxAltitude, an IS Tablet especially built to be used in hazardous areas. With special focus given to ease of use while making it fully functional under most challenging environment providing maximum safety in the field.

- Available with 13MP Rear camera with autofocus & a flashlight, 5MP Front camera
- Processor MSM8953 (2.0GHz) Octa core
- Android 10
- Internal memory 64GB ROM & 4GB RAM
- 8500mAh Lithiumion battery
- **Standards:**

ATEX

II 2G Ex ib IIC T4 Gb IP68

II 2D Ex ib IIIC T135°C Db IP68

Ta: -20°C +60°C



# RESCUE EQUIPMENT





## Spencer Evacuation/ Transport Chair

**Model No.: SK10001E**

Pro Skid – E is an evacuation chair ideal for transfers on stairs thanks to the front and rear handles which allow lifting, and slides that allow easy movement on stairs. 4 wheels allow movement on flat surfaces.

- PVC Sheet easy to clean
- Slide allow easy movement & control going down & upstairs
- Telescopic front handles make handling easier
- Footrest
- Front wheels pivoting with brake
- Large diameter rear wheels increase sliding action
- Headrest sheet is movable making the device suitable for patient of different heights
- Height opened: 1580 mm • Height folded: 1060 mm
- Length with handles closed: 1110 mm
- Length with handles opened: 1340 mm
- Width: 550 mm • Weight: 15 kg
- Thickness folded: 355 mm
- Materials: Al, PVC, PE, PU
- **Standards: Class I Med.Device according to Dir. 93/42/CEE**



## Spencer Foldable Stretcher

**Model No.: ST00598A**

Foldable stretcher with ground supports for patient recovery and transfer to a main stretcher or other transport device.

- Extremely lightweight and durable structure
- Very low storage space required
- Lengthwise foldable • Easy to clean sheet
- The handles offer a firm grip
- Load capacity: 170 kg • Weight: 5,4 ± 0,1 kg
- Measurements: 2010 x 550 x 140 mm
- **Standards: Class I Med. Dev. according to Dir. 93/42/CEE**





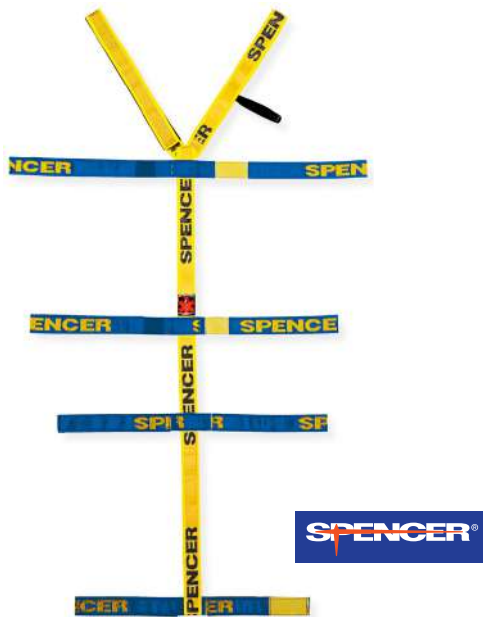

## Spencer Rock Straps

**Model No.: ST02035A**

Retention system for the immobilization of patients to be used on spinal boards.

- Extremely resistant and robust system
- Strap closures to make rescue operations faster
- Sliding transversal bands for greater versatility
- No. of fixing point: 10
- Central belt length: 1230 mm
- Minimum Length: "V" belts 270 mm
- Maximum Length: "V" belts 540 mm
- Minimum Width: 720 mm
- Maximum Width: 1350 mm
- Material: Nylon • Weight: 460 ± 20 g
- Standards: Class I Med.Device according to Dir. 93/42/CEE

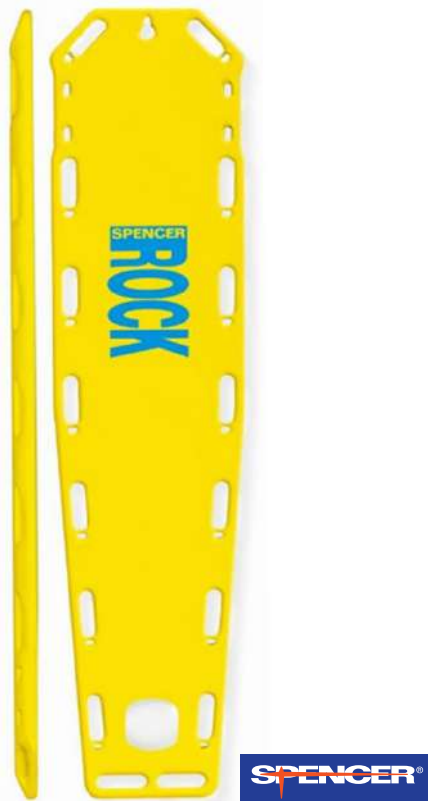

## Spencer Rock Pin Spinal Board

**Model No.: ST02010B**

The Spinal Board Spencer Rock is a device for recovery, immobilization, and transfer to the stretcher of patient with suspected spinal injuries.

- The number of handles, their positioning and their shape, allow a firm grip even in difficult conditions
- The tapered shape allows to save space and to place the device inside Spencer basket stretchers
- Dedicated holes and pins to fix belts and Spencer head immobilizers
- Smooth and filleted surfaces to allow easy cleaning
- Robust and lightweight structure to ensure impact resistances
- Dimensions: 1840 x 445 x 50 ± 10 mm
- Materials: PE, PU • N° of handles: 16
- N° of pins: 14 • Loading Capacity: 200 kg
- Weight: 6,5 ± 0,5 kg
- Standards: Class I Med.Device according to Dir. 93/42/CEE

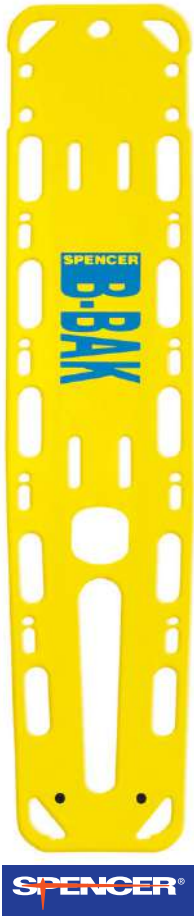

## Spencer Spinal Board with Pin

### Model No.: ST02061B

The spinal board Spencer B-Bak Pin is a device for recovery, immobilization and transfer to a main stretcher of patients with suspected spinal injuries

- The number of handles, their placing and their shape offer an easy grip even in difficult conditions
- The tapered shape allows place the device inside Spencer basket stretchers
- Smooth and rounded surfaces ensure an effective sanitation
- Robust and light structure to ensure high resistance
- Slides on the lower side to minimize sliding resistance during the application
- The low thickness makes the application and storage easier
- Equipped with Pins to allow easy fixing of belts with snap hook
- Dimensions: 1840 x 405 x 45 mm
- Materials: PE
- No. Handles: 14
- No. PIN: 8
- Loading capacity: 180 kg
- Weight: 6 ± 0,3 kg
- Standards: Class I Med.Device according to Dir. 93/42/CEE

## Spencer Shell Universal Basket Stretcher

**Model No.: ST04000A**

Spencer Shell is a basket stretcher intended for recovery of patients where other devices would be difficult to use. Typical uses are water rescue, recovery by ground hoisting, fast recoveries and transfers that require side impact protection.

- The single shell body makes it extremely safe and easy to handle
- The perimetral frame provides rigidity and allows to have a firm grip on the handles
- Equipped with rings for hooks fixing
- Perimetral rope to fix belts or accessories
- The shape of the inferior part reduces friction during ground dragging procedures
- Mattress to increase patient comfort
- L x W x H: 2150 x 650 x 200 ± 10 mm
- Materials: PE, PP, Al
- Weight (without standard equipment): 12.5 ± 0.5 kg
- Loading capacity: 280 kg
- **Standards:** Class I Med. Dev. according to Dir. 93/42/CEE

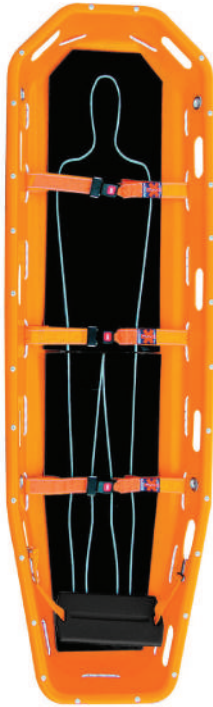

**SPENCER®**

## Spencer Foldable Stretcher

**Model No.: ST30100A**

Foldable stretcher with ground supports for patient recovery and transfer to a main stretcher or other transport device.

- Extremely lightweight and durable structure
- Very low storage space required
- Lengthwise foldable • Easy to clean sheet
- The handles offer a firm grip
- Load capacity: 170 kg
- Measurements: 2010 x 480 x 140 mm
- **Standards:** Class I Med. Dev. according to Dir. 93/42/CEE



**SPENCER®**



# Rescue Equipment



## Spencer Pickup Stretcher

**Model No.: ST05002A**

Spencer SX is a pickup stretcher with two blades for lifting & loading of patients on immobilising or transport devices such as spinal boards, vacuum mattresses or transport stretchers.

- Extremely light and resistant structure
- The possibility to adjust the length confers high versatility
- Smooth surfaces easy to clean
- Foldable to save space when stored
- The numerous handles make the transport easier
- Aluminum joints for maximum resistance
- Adjustable lengths: 1660mm, 1780mm, 1900mm, 2050mm
- Weight: 7,6 ± 0,4 kg
- Load capacity: 170 kg
- **Standards: Class I Med.Device according to Dir. 93/42/CEE**

## Spencer Total Recovery Stretcher

**Model No.: ST04090**

Total is the strongest versatile and compact rescue stretcher on the market. It is made with a particularly robust & durable plastic on which has undergone a special thermal treatment that improves the elastic memory feature.

- Belts for towing and lifting
- A system of belts for the assembling of the stretcher & subsequently folding before replacing it in the bag
- A system of additional handles for the transport of heavy patients by four or eight operators
- Aluminium hook to allow for lifting
- Transport bag in nylon Ripstop
- Hoisting harness in nylon • Material: Polyethylene
- Dimensions: 2430 x 920 x 3 mm
- Weight: 6 Kg +/- 0.5 kg • Load capacity: 200 kg
- **Standards: Class I Med. Dev. according to Dir. 93/42/CEE**





## Spencer Evacuation Chair

### Model No.: SK20003E

SKID-OK is an evacuation chair ideal for transfers on descending stairs thanks to the handle on the rear side & slide system with belts. The four wheels also allow the transport on the plane surface.

- PVC sheet easily cleanable equipped with quick release buckles to adjust the tension
- Rear wheels of large diameter to increase the sliding
- Reduced storage dimensions • Footrest
- Height with extracted handle 1540 ± 10 mm
- Height with handle closed 1040 ± 10 mm
- Length: 900 ± 10 mm • Width: 520 ± 10 mm
- Thickness folded: 175 ± 10 mm • Weight: 10 ± 1 kg
- Loading capacity: 150 kg • Material: Al, PVC, PE, PU
- Front wheels ø 100 mm • Rear wheels ø 150 mm
- **Standards: Class I Med. Dev. according to Dir. 93/42/CEE**



## Spencer Compact Universal Head Immobilizer

### Model No.: SH00110C

Device for head immobilization intended to be used with Spencer spinal boards or pickup stretchers. It can be used along with other immobilization devices like SED and all Spencer cervical collars.

- The padding of the base increase patient comfort
- Wide strap surfaces make the headblock positioning easier
- Adjustable frontal & chin straps with soft & high adhesion paddings to optimize the immobilization
- Base dim. (buttonhole excluded) 365 x 260 x 20 mm
- Pillow dim. (1 piece) 255 x 85 x 160 mm
- Hole for ear inspection ø70 mm
- Base weight: 360 ± 10g • Pillow weight: 500 ± 10g
- Overall weight 1,46 ± 0,07 kg
- Materials: PE, PVC, Nylon
- **Standards: Class I Med. Device according to Dir. 93/42/CEE**





## Spencer 10G Fastener for Stretcher

**Model No.: ST42707**

Fastener for 10g certified stretchers, created to ensure their safe anchorage inside medical vehicles.

- The linearity of the structure avoids unnecessary bulk when the stretcher is not loaded on the ambulance
- Release of the stretcher requires a minimum effort thanks to the leverages integrated in the main structure
- The release system is protected against accidental operation
- The device acts simultaneously both on frontal and rear part of the stretcher and, thanks to the integral structure, allows a simple installation without alignment difficulties between the frontal and rear part of the fastener
- S-MAX can achieve maximum integration levels if used together with the optional system SHARP that, once installed on the stretcher, allows to carry out the unlocking through a drive mechanism strategically placed on the control group of the stretcher
- Dimensions: 1790 x 190 x 80 ± 5mm • Weight: 5,2 ± 0,1 kg
- **Standards: Class I Med.Device according to Dir. 93/42/CEE**



**SPENCER®**

## Spencer Carrera T Tec Chrome Frame Black Board 10G

**Model No.: CA70037**

Spencer Carrera T Tec is a compact and lightweight self-loading stretcher for transport of patients. It can be used for rescue operations on road and sanitary vehicles. The legs fold independently operating the specific commands and open automatically when unloading.

- Polyethylene board easy to clean
- Frame material Stainless Steel
- Color coded commands • Adjustable backrest
- 2 fixed wheels & 2 pivoting with large diameter to make movement easier
- Brakes on rear wheels • Foldable side bars Safe bar
- Board with Trendelenburg antishock position • Weight: 37 kg
- Length x Width: 1980 x 580 mm • Loading capacity: 170 kg
- **Standards: Class I Med.Device according to Dir. 93/42/CEE**



**SPENCER®**

# FOREIGN MATERIAL EXCLUSION



**FME**  
230 mm  
2-12-0





# Foreign Material Exclusion



## FME Zone Tape

**Model No.: BT1KS**

- 3" x 1000', 3mil
- Markers every foot for tracking
- Deters loitering
- Warns workers that an FME Zone is present
- BT1K-S is orange with white stripes
- Available Color: Orange



## FME Vinyl Magnetic Sheet

**Model No.: MAGSHT2436**

- Easily cut to any size
- Orange comes with black text
- Red/Pink comes with white text
- Custom print available
- Small sections of sheet can also be used in signs
- When custom manufactured covers just aren't fast enough, these vinyl magnets provide an instant solution; just cut and stick
- Used in: Diesel generators, manway openings, breaker openings, turbine maintenance and more...



## FME Covers

**Model No.: CBFRR SERIES**

- Round bottom for custom fit
- Adjustable drawstring with metal-free cord lock
- NFPA-701 fire retardant
- Water repellent





  
**GUARDIAN**

## Basic FME Cabinets

### Model No.: CBFR SERIES

- Contains a variety of the most common FME products
- Each model specifically tailored for the most common setups
- A popular option for new FME programs
- Contents available on request
- **Available Colors: Orange, Red, Pink & Green**

Part No.	Description	Dimensions
Basic	Standard Basic FME Cabinet	36"W x 24"D x 78"H
Basic-T	Basic Cabinet Training Setup	36"W x 24"D x 78"H
Basic-WH	Basic Cabinet Warehouse Setup	36"W x 24"D x 78"H



  
**GUARDIAN**

## Auxiliary FME Cabinets

- Contains a variety of the most common FME products
- Each model specifically tailored for the most common setups
- A popular option for new FME programs
- Rolling casters for mobility
- Contents available on request
- **Available Colors: Orange, Red, Pink & Green**

Part No.	Description	Dimensions
AUX-1	Auxiliary Cabinet Configuration 1	36"W x 24"D x 42"H
AUX-2	Auxiliary Cabinet Configuration 2	36"W x 24"D x 42"H
AUX-T	Auxiliary Cabinet Training Setup	36"W x 24"D x 42"H
AUX-XL	Extra Width Auxiliary Cabinet	48"W x 24"D x 42"H
AUX-XL-T	Extra Width Auxiliary Cabinet Training Setup	48"W x 24"D x 42"H



# Foreign Material Exclusion



  
**GUARDIAN**

## Supreme FME Cabinets

- Stocked with a massive number of FME Products
- Fork-lift pockets for transportation
- Great for high traffic FME zones
- Contents available on request
- **Available Colors: Orange, Red, Pink & Green**

Part No.	Description	Dimensions
EXTREME	Standard Extreme Cabinet	52"W x 30"D x 78"H

Part No.	Description	Dimensions
SUPREME	Standard Supreme FME Cabinet	60"W x 36"D x 78"H
SUPREME-NPT	Supreme Cabinet NPT Setup	60"W x 36"D x 78"H
SUPREME-MAX	Supreme w/Expanded Contents	60"W x 36"D x 78"H
SUPREME-MAX-NPT	Supreme NPT w/Expanded Contents	60"W x 36"D x 78"H
SUPREME-FLG	Supreme Cabinet Flange Setup	64"W x 38"D x 78"H
SUPREME-REF	Supreme Cabinet Refinery Setup	60"W x 36"D x 78"H

# ENGINEERED SOLUTIONS





More than 25 years Edelhoff-Technologies got known worldwide as a specialized manufacturer of components for catalyst handling. Edelhoff is part of a traditional family-run group of companies owned by Klaus-Union Group with their headquarter in Iserlohn / Germany.

In 2019, ERI Technical Services was founded as a joint venture with Raja International General Trading from Kuwait to provide service companies with a rental fleet of our advanced technologies and our own qualified, trained, and experienced catalyst personnel at shutdowns peaks. ERI is based in Dubai and strongly positioned in the MENA region.

In April 2021, Klaus Union Group became the sole stakeholder of Edelhoff-Technologies. Klaus Union Group is a traditional, family-owned organization that operates internationally. The group has over 1,000 employees worldwide. Klaus-Union Group is one of the world's leading supplier of pumps and valves, especially for the chemical and petrochemical industry.

## Life Support System (LSS)

Life support systems have been used worldwide for more than 40 years. LSS are needed whenever people must be supplied with breathable air. Three independent supply lines including voice radio, and a breathing protection helmet which cannot be removed uncontrollably – this is the safety concept of NASA. We offer you all components as a complete system CE-certified from one source.

In the context of customer requirements for increased safety, we have further developed and partially digitized our LSS technology in the field of breathing air control and gas measurement monitoring, including recording and data storage systems. Additional monitoring cameras increase safety at the various workplaces of an LSS team. This is the new safety and quality generation 2020 – Advanced technology for the next 10 years!

Breathing console components - CE certified and partially digitized are:

- Manual air supply control system
- Digital recording, evaluation and warning systems
- Integrated voice communication and multiple camera monitoring
- Anti-panic respirator helmet





Integral anti-panic breathing air helmet with redundant primary & secondary & egress air supply and full communication

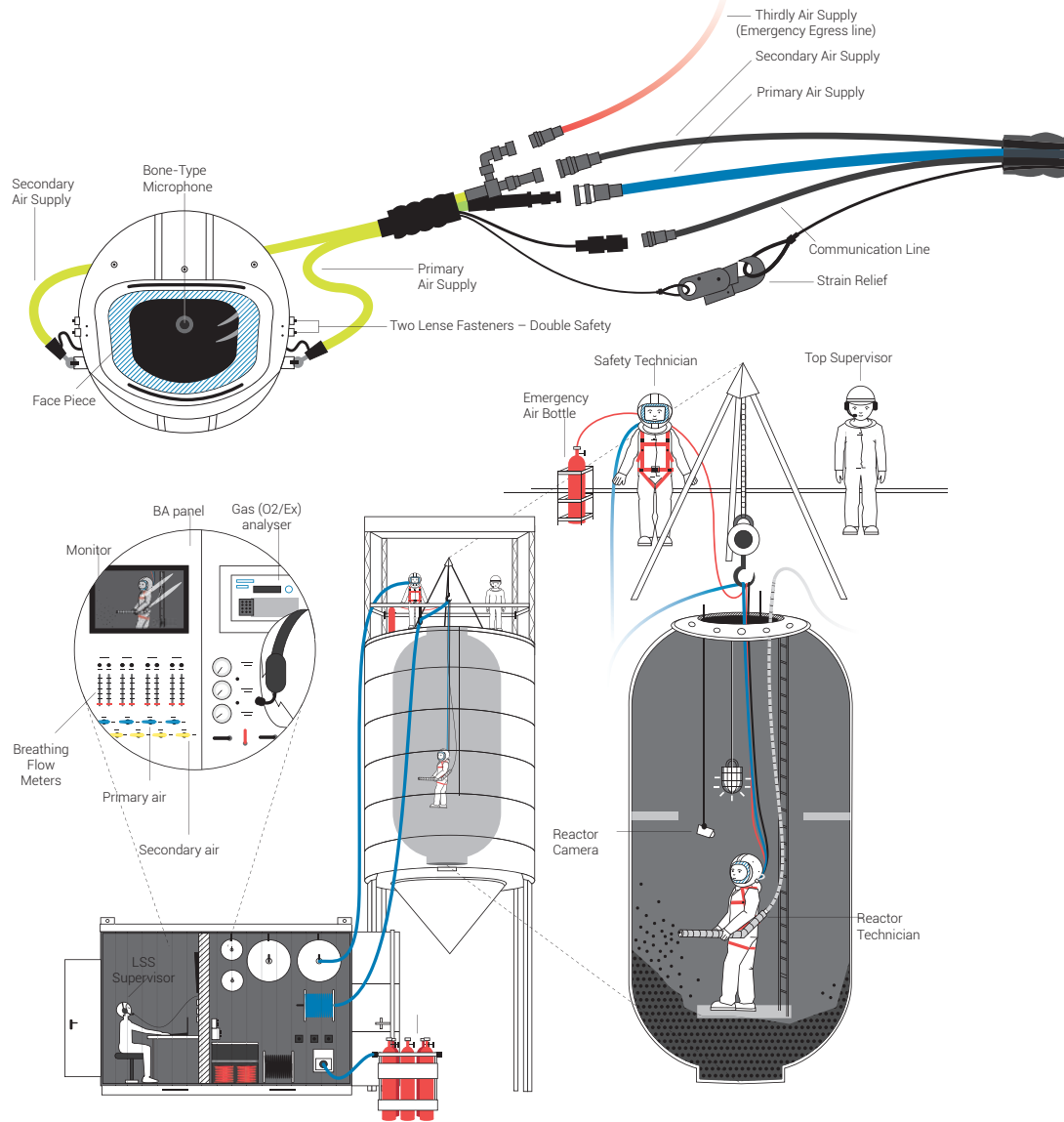

**Edelhoff**



## Mobile High-Performance Vacuum Units

### Technical Information

Edelhoff was the first enterprise to develop high performance vacuum suction units in container design.

Our mobile systems are incorporated in 20" containers. They have permission to be transported on the road, by rail, by sea and by air. Optionally they are available on a swap trailer, as a trailer, or as a fixed superstructure.

Edelhoff vacuum units are equipped with fine filters, discharge lock, nitrogen recirculation and cooling for works accomplished under nitrogen conditions.

### Flexible Application:

Our mobile vacuum units are being designed and developed for the flexible and independent use at a wide variety of locations. Fitted with the very latest type of low-emission diesel engines with a drive power of up to 200 kW Lionair vacuum units perform to your requirements most reliable, even under the most difficult working conditions.

The particular advantages are:

- Multi-stage blower, depending on its size also executed as pre-initial inlet blower
- Compact and powerful filter separator; expandable and height-adjustable
- Integrated, vacuum-tight bulk solids sluice – ideal for continuous discharging of the aspirated product, especially during the active vacuum process



**Edelhoff**



## Mobile vacuum unit Type - Lionair Vac 8000 Ex

Diesel drive

Drive power 200 kW

Volume flow 9600 m<sup>3</sup>/h

With dust explosion-proof in accordance to VDI 2263-3/3673 – in application for the safe removal of substances including coal dust within power plants

## Mobile Container vacuum unit Type - Lionair Vac 8000 C2

Diesel Drive

Drive Power 200 kW

Volume Flow 9600 m<sup>3</sup>/h

In application for dedusting of diverse industrial catalyst materials at refineries and for disposal of waste substances for general industrial cleaning purposes

### Special Feature:

Extremely robust and compact design, built into a 20" Euro-Container incl. CSC-approval for road, rail, sea and air transport

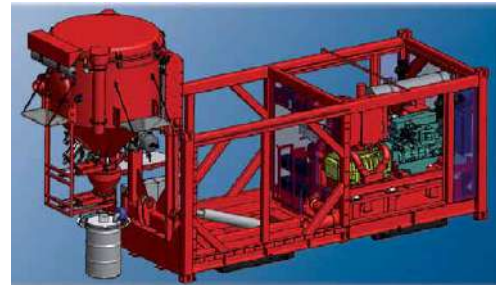

**Edelhoff**



## Edelhoff Dense Loading System 2020

### Technical Information

You can now make use of our technically optimized and job tested new generation of Edelhoff Dense Loading Machines (DLM) for your reactor loading! It preserves your valuable catalyst better than ever and thus extends the material's period of use.

Our tried and tested DLM, which has been continuously developed since 2002, ensures that the catalyst material is distributed evenly, smoothly and dust-free in the reactor. It results in the desired homogeneous and tight sealing of the individual catalyst particles with a significantly higher filling volume.

The continuous control of the inflow quantity and rotary speed of the filling motor as well as the length and shape of the flexible, star-shaped product deflector which is arranged over several layers guarantee a sparing and economic loading for each reactor bed size.



**Edelhoff**

### Benefit from experience!

All practical application experiences are incorporated into the DLM Generation 2020:

- Our customers have carried out globally-successful reactor loadings with Edelhoff Dense Loading Systems for almost ten years
- The Edelhoff Dense Loading Technology was constantly reviewed and further developed in cooperation with the customers
- The qualitative high-grade theoretical education and the practical on-the-job training for operators were implemented thoroughly
- Not to forget, our name stands for more than 50 years of technical experience in handling diverse bulk goods. As a result, the DLM Generation 2020 offers you an individual system which:
- Is even better protected against breakdowns through dust and damage in transit
- Can be installed even quicker
- Can be technically adapted even more flexibly to the on-site conditions without the need for reconstruction
- Ensures the catalyst is distributed even more evenly the catalyst material is handled even more sparingly
- Regulates the material flow in a more controlled way





## Rent your DLM 2020

You have three options as regards introducing DLM systems:

- Three year lease contract
- Three year lease contract including
- Full-Service Package “servicing and technological upgrading”
- Lease contract on a daily basis (as an addition for three years contract on request)

No other licence-fee accrues for you!

On request, we also arrange for a DLM qualified member of service staff from our cooperation partner to implement your catalyst loading.



## Take a closer look at the development of the DLM 2020!

### • Central product supply:

The volumetric exhaust flow of the catalyst is solely defined by the central product supply. An uncontrolled product discharge is therefore absolutely excluded

### • Quick release system for the flow quantity control:

The Material Flow Control discs graded in 5 mm diameter steps which regulate the inlet quantity of the catalyst on the rotating strips can now be changed externally while the device is assembled in less than 10 seconds. Time saving is around 20 minutes/change

### • Arrangement of strips:

Flexible strips arranged on four levels with different numbers of each level guarantee the catalyst is distributed almost dust-free and smoothly in the distributor

### • Fine alignment of the inflow quantity:

The use of facing discs on the strip rotary blades allows the inflow quantity which is pre-aligned by the Material-Flow-Control discs to channel to the requested distribution levels and thus improve the loading structure in the reactor

### • Balanced three point adjustment:

A balanced three point adjustment was mounted onto the DLM with screw-on extensions, whereby a time-consuming and expensive installation of auxiliary constructions on the reactor entrance is not necessary

### • Stub wings on the ends of the shaft (alternative):

According to the type of catalyst and reactor, the catalyst material flowing through the Strip Holder discs reaches a so-called “stub wing” at the end of the shaft which also distributes the material smoothly and evenly at this point for an optimal loading result

### • Control unit protection:

The control unit (for compressed air and motor rotating speed) is built into a switch box which protects the aggregate against dust and damage in transit

### • Compact unities construction system:

The entire system is mounted into an aluminium container, the internal design of which makes it easy to test the completeness of all construction components

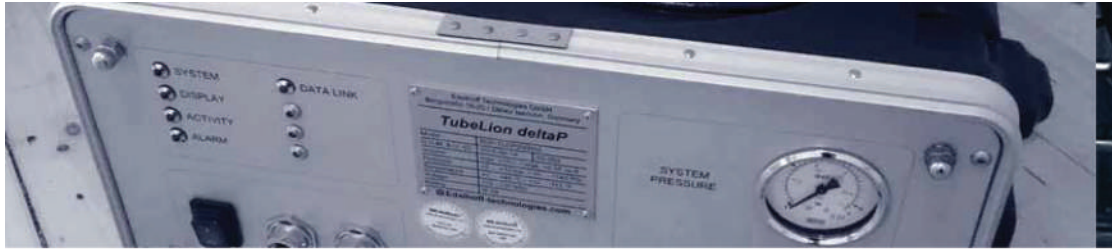

## ..... Tubular Technologies .....



- Belt Conveyor Machine
- Vibration Machine
- MULTIDENSE™ Technology
- Orifice Loading
- Funnel Loading
- Dedusting Hopper
- Final Deduster
- Air Lancing
- Air Drilling
- Fish Tapping
- Brush Cleaning Machine
- Drilling Equipment
- DeltaP Single Tube Technology
- DeltaP Multi Tube Technology



**Edelhoff**

# FIRE FIGHTING EQUIPMENT





## 3% Alcohol-Resistant Aqueous Film Forming Foam Concentrate

### Model No.: AR-AFFF

- Single 3% Proportioning Rate on both Class B Hydrocarbon and Polar Solvent Fuels
- Suitable for Use with Fresh or Salt Water
- Superior Knockdown Performance on Hydrocarbon fires
- Excellent wetting characteristics on Class A Fuel Fires
- Use with both Aspirating foam Nozzles and Inline Eductors
- Use with Fixed Foam Discharge Outlets
- Suitable for Storage in Carbon Steel, Fibreglass, Polyethylene or Stainless Steel tanks but is not compatible with galvanised pipe or fittings in an undiluted form
- U.L. Listed







## Introduction

The Internet of Things (IoT) is a network of physical objects or people called "things" that are embedded with software, electronics, network, and sensors which allows these objects to collect and exchange data.

Industrial IoT connects machines, vehicles, and devices in industries such as transportation, power generation, and oil and gas, and is set apart from other IoT applications by its daily effects on human safety.

## Why Industrial IoT

Industrial IoT collects and analyzes data to deliver insights that help industrial companies become nimbler, making better informed business decisions more quickly than ever before. Also, through the use of equipment and product data points, such as location data, industrial IoT is helping companies transform their manufacturing and industrial processes.

Raja Company and Safety Plus World have been working and investing for more than a year to bring IOT solutions into the Kuwait Market.

We aim to bring high-performance devices that can operate in real time and challenging environments. This means better quality control, sustainable and green practices, and more efficient, streamlined supply chain management.

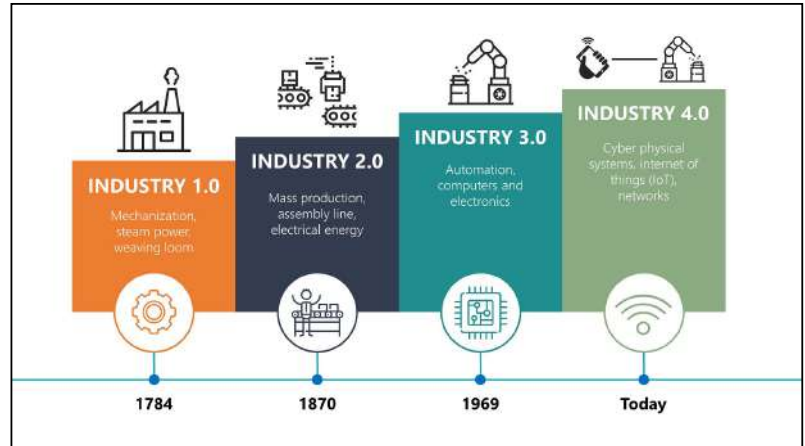

## BRADY SAFETRAK INSEPECTION

Safetrak is a digital system that supports businesses with inspection planning, equipment inspections and inspection reporting to maximize safety, improve resource performance and minimize costs.

- Eliminate paper based inspections and reporting and substantially reduce administration
- Manage equipment inspections, maintenance work, asset identification and location
- Comply with legislation by providing a clear auditable trails of inspections and actions taken
- Generate reports for equipment that is due inspection, has passed, failed, been commissioned & decommissioned by date

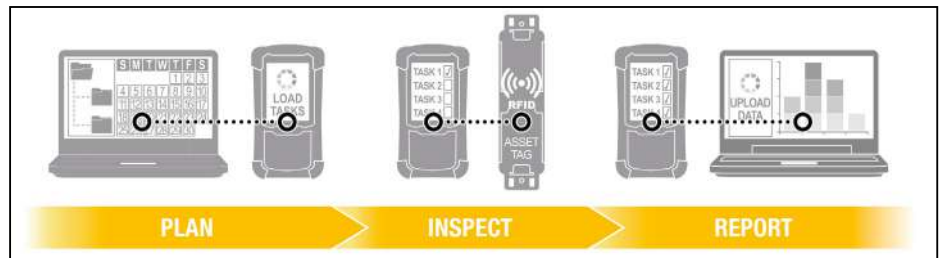



## Helmet Mounted Tablet

The RealWear™ HMT 1™ provides the foundation for Connected Worker programs. Use it in wet, dusty, hot, dangerous and loud industrial environments. A fully rugged head mounted device, it optionally snaps into safety helmets or attaches to bump caps and can be used with safety glasses or corrective eyewear.



## Heat Stress & Personal Monitoring

- An intuitive, edge-based system that collects, transmits, and alerts on critical data in real-time
- Specifically designed to be easy-to-use with large groups of people
- Key metrics in real-time including: Exertion, Heart Rate, Core Temperature, GPS and SOS TapAlert
- Use cases such as: Heat Stress and Overexertion prevention, Lone Worker, Confined Space and more
- Configurable alerts with vibration and LEDs for low severity, high severity and return to work.

## blacklinesafety



## Smart Gas Detectors

Detect. Connect. Analyze. It's a simple concept and one that makes us, and keeps us, uniquely positioned in the connected safety market. Blackline products are designed to detect anything from a gas leak to a man down incident, health event and more. To ensure no call for help ever goes unanswered, our direct to cloud technology with integrated connectivity connects workers to live monitoring teams.



## Nevada Nano MethaneTrack

NevadaNano's MethaneTrack™ is a low cost, close proximity network of rugged monitoring points to measure methane emissions and report leak location and size to the operator. Utilizing an Industrial IoT (IIoT) network to detect methane in the air, MethaneTrack™ detects fugitive and operational emissions from a site and immediately alerts the operator of the location and volume of the emissions, facilitating rapid response and repair. Autonomous, continuous monitoring enables up to 99% reduction in emissions while reducing operational costs and boosting profits.



## Polludrone Multiparameter Air Quality Monitoring System

Polludrone® is a Continuous Ambient Air Quality Monitoring System (CAAQMS). It is capable of monitoring various environmental parameters related to air quality, noise, odour, weather, radiation.

It measures the particulate matter and gaseous concentrations in the ambient air in real-time. Using external probes, it can also monitor other auxiliary parameters like traffic, disaster & weather monitoring.

Polludrone® is an ideal choice for smart cities as well as urban infrastructure applications like roads and highways, tunnels, smart campus and airport monitoring. It is easily integrable with a Smart Pole / Intelligent Pole.



The first one is by using our Air Quality Software – Envizom. It is equipped with below features:

- User-friendly interface
- Smart alerts and reports
- Easy to set up
- Real-time data
- Set thresholds to automate the integrated systems





## AQBot Empowering Through Technology and Convenience

AQBot, with its innovative single-parameter monitoring system, reimagines this essential need with a unique blend of technology and cost efficiency.

AQBot allows industries to tailor their monitoring to just what's crucial for them. Whether it's Methane (CH<sub>4</sub>), PM<sub>2.5</sub>, or any other toxic gas, industries can now invest in monitoring just that specific parameter, thereby making significant savings.

But the beauty of AQBot goes beyond just cost savings. It promises real-time, accurate data. Imagine a sudden surge in Carbon Monoxide (CO) levels in an industrial site. With AQBot, there's no lag—industries receive immediate alerts, enabling them to act promptly and ensure safety.

AQBot comes with an on-device display of data without computer dependency.

If the AQBot Series is connected to Oizom cloud, the data is also available in the Air Quality Software. The platform has essential features like...

- Data Overview
- Micro-analysis Dashboard
- Historical Data Analytics
- Data Report
- Smart Alerts
- Historical Data-set Download



## Oizom Dustroid Pro Air Particulate Monitor

Oizom Dustroid Pro Air Particulate Monitor is an Online Particulate Monitoring system to measure the dust particles in the ambient air. The outdoor air particle is capable of monitoring various particulate size ranging from 1 micron to 100 microns. It can measure different kinds of dust pollution like Suspended Particulate Matter (SPM), Respiratory Particulate Matters (RPM), and Total Suspended Particulates (TSP).

Applications: Road Dust, Sea Ports Monitoring, Construction Sites Monitoring, Quarry Activity Monitoring, Mines Monitoring



## Oizom Weathercom Pro IoT Based Weather Monitoring Device

Oizom Weathercom Pro IoT Based Weather Monitoring Device is an automatic weather station that measures wind speed, wind direction, rainfall, flood, temperature, humidity, pressure, light intensity, and UV radiations. The aim is to monitor meteorological parameters to take timely decisions in case of extreme weather conditions through warnings and alerts. Weathercom is an ideal choice for comprehensive meteorological monitoring.

Applications: Agriculture Monitoring, Disaster Prevention Monitoring, Road Safety Monitoring, Air Ports Monitoring, Sea Ports Monitoring

# Health, Safety Environment Training Courses

## Internationally Accredited Safety Training

### National Examination Board in Occupational Safety and Health (NEBOSH)

- NEBOSH IGC (International General Certificate- Both Arabic and English)
- NEBOSH IOGC (International Technical Certificate in Oil & Gas Operational Safety)
- NEBOSH HSW (Health & Safety at Work- Both Arabic and English)
- NEBOSH IDip (International Diploma in Occupational Health & Safety)

### Institution of Occupational Safety and Health (IOSH)

- IOSH Accident Investigation
- IOSH Managing Safely
- IOSH Managing Safely in Schools
- IOSH Working Safely
- IOSH Managing Safely in Construction

### IADC

- Wellcap - Introductory, Fundamental & Supervisory Levels

---

## Specialized Safety Training

### Lifting Operations

- Lifting Operations – Best Practices
- Lifting Equipment Examination
- Tower Crane Safety & Rescue
- Mobile Crane Examination
- Mobile Crane Operator • Slinger/ Signaller
- Counter Balance Forklift Truck Operator
- Safe Use of Overhead Cranes
- Basic Safe Slings & Lifting
- LOLER & PUWER
- Safe Lifting Operation for Safety Personnel
- Lifting Equipment Examination
- Wire Rope Examination • Rigging Loft Management
- Container Inspection • Mobile Crane Examination
- Socketing of Steel Wire Ropes
- Counter Balance Forklift Examination
- General Fire Prevention under Qatari Regulations
- Strategies & Tactics for Fire Prevention in Commercial Buildings
- Fire Safety Strategy
- Fire Inspection & Code Enforcement

# Health, Safety Environment Training Courses

## General Safety Training

- Authorized Gas Testing (AGT) Training Course
- Behavioural Based Safety • Chemical Safety
- Confined Space Safety & Rescue
- Crane Operator Certification: Safe Operation of Cranes for a Competent Person Training Course
- Crane Safety • Cutting & Grinding Safely
- Defensive Driving • Demolition Safety
- Electrical Safety & Lock Out / Tag Out
- Emergency Evacuation Preparedness
- Environmental safety
- Ergonomics • Evacuation Procedures
- Fire Fighting Training Course
- First Aid / CPR Training Course Fork lifting Safe Operation
- Forklift Operator Certification: Safe Operation of Forklift for a Competent Person Training Course
- General Office Hygiene and Safety
- H2S Safety Awareness SCBA Training Course
- Hands & Finger Safety • Hazardous Goods Safety
- HAZCOM & MSDS • Heat Stress
- Heavy Equipment Operator Assessment Heavy Machineries
- Height Work • Hierarchy of control measures
- Hot Work • HSE Induction
- Incidents & Accidents Investigation Report Job Safety Analysis
- Lifting and Hoisting
- LOCKOUT – TAGOUT (LOTO)
- Manual Handling • Masonry and Form Work
- Mechanical Operations / Erection
- Occupational Health & Safety Training
- Permit to Work Training Course Personal Protective Equipment (PPE)
- Rigger Safety: Inspection Rigging Equipment & Hand Risk Assessment
- Safety Leadership & Skills
- Scaffolding Competent Person  
Welding and Gas Cutting
- Work Permit System  
Working at Heights Safety and Falling Objects

# EHS, Sustainability & Risk Management Solutions

## One Stop Solution To Achieve Industry 4.0 Goals



### Climb The Ladder Of Safety Culture Using Arresto Connect+ Digital Platform

- ✓ DIGITIZE
- ✓ COMPLY
- ✓ ANALYSE

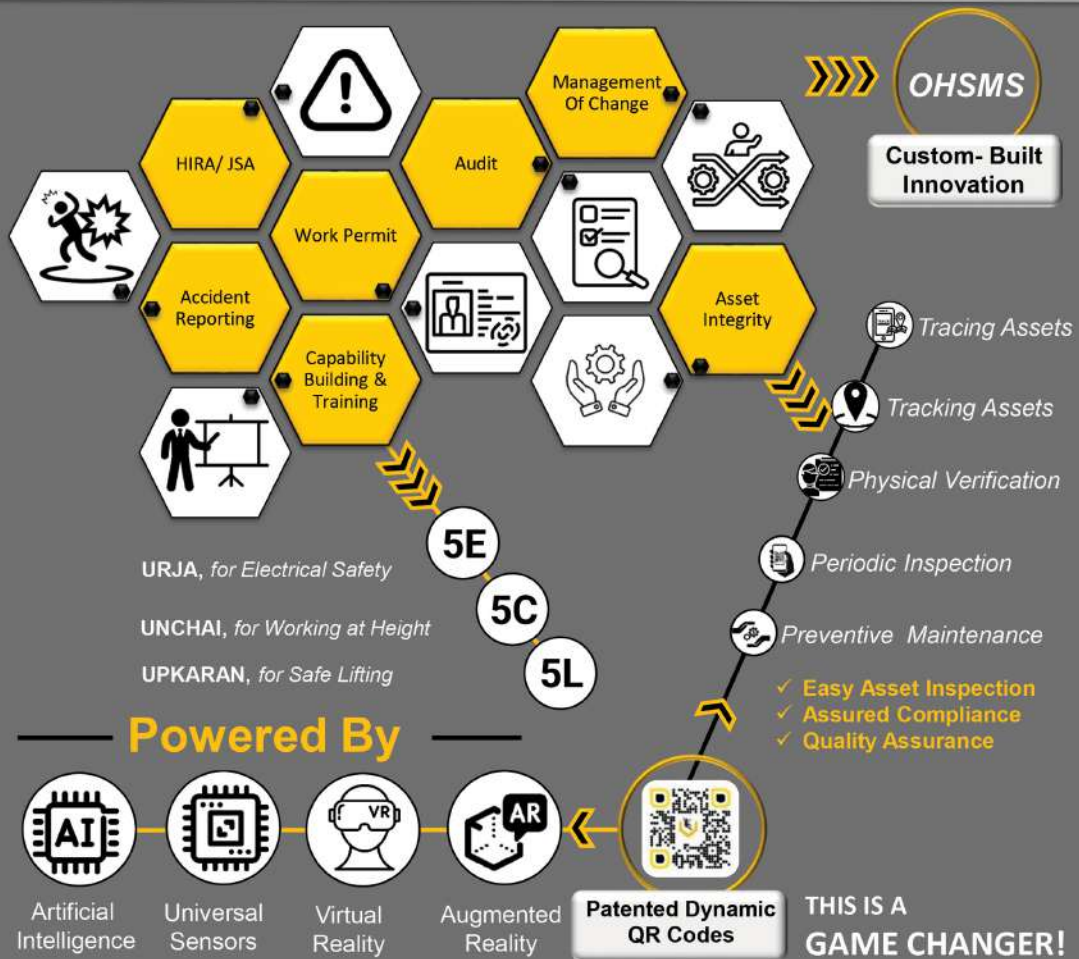

# EHS, Sustainability & Risk Management Solutions



Enablers Are Independent, Interdependent And Interrelated With Core Processes



## OHSMS

### Occupational Health & Safety Management System

Arresto Connect+ introduces cloud-based Custom-Built innovation which allows user to customize business processes as per requirements and relieves the user from a mountain of paper records.

Identify And Mitigate Safety Risks  
To Protect Your People And Organization



**Powered By**

<b>ARTIFICIAL INTELLIGENCE</b>	<b>UNIVERSAL SENSORS</b>	<b>VIRTUAL REALITY</b>	<b>AUGMENTED REALITY</b>	<b>DYNAMIC QR CODE</b>
PPE & Hazard Detection Traffic Management Illumination Management	Work At Height Sensors Make Your Own Sensor	Work At Height VR Programs Make Your Own VR Program	Work At Height AR Programs Electrical Safety AR Programs Make Your Own AR Program	Asset Integrity OHSMS Physical Verification (PV-FAR)

PLANS	MODULES	USERS	LOCATION	QR STICKERS	ADD-ONS
SILVER	1	100	1	1500	
GOLD	3	100	1	3500	
DIAMOND	5	100	1	5000	
PLATINUM	10	100	1	7500	
ENTERPRISE	ALL	100	1	15000	



## A Dynamic QR Code Is All You Need To Digitize Safety



## Asset Integrity

The Dynamic QR code are powered by Arresto Connect+, a cloud-based asset integrity software. This unique 360° digital platform reminds a user of a pending competent person inspection, generates inspection reports with proof of evidence and monitors closure of non-conformity.

## Integration of Product, People, Process



**IN-form**  
Track and trace assets. Suitable for physical verification for fixed asset reconciliation.

**PER-form**  
Perform quick inspection with geofencing feature to ensure presence of inspector while performing inspection.

**TRANS-form**  
Perform a comprehensive and periodic inspection of critically vulnerable components along with proof of evidence (images) and geofencing.

**CON-form**  
360° monitoring of inspection and maintenance. Assign non-conformities for rectifications to the repair team and monitor closure.

**UNI-form**  
360° monitoring of inspection and maintenance of heavy machines with large number of components and checkpoints.

- ✓ Easy Asset Inspection
- ✓ Assured Compliance
- ✓ Quality Assurance

**Dynamic QR Code**

- ✓ Provides real time information.
- ✓ Records last scan location.
- ✓ Makes your occupational health & safety management system interdependent and interrelated.

**Dynamic RFID Tags**

- ✓ Non-contact, water, heat and abrasion resistant.
- ✓ Read by smart phones, do not need expensive RFID readers.
- ✓ Available in different size and shape.
- ✓ Some tags are compatible to metal.

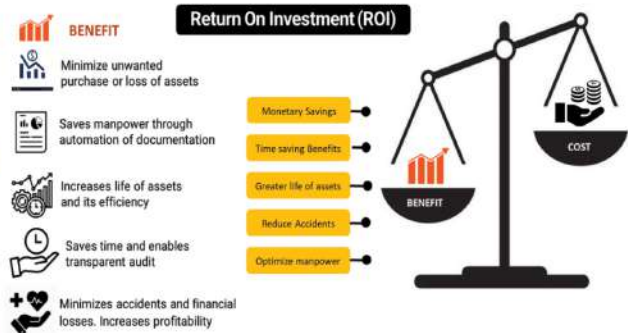



Redefine Reality, Immersive Experience And Data-driven Insights



## Augmented Reality Application

Personalized Immersive Learning Experience in your own Environment and Assets.

- ✓ Create digital twin of your workplace.
- ✓ Select industrial assets from Arresto vast library of 3D images.
- ✓ Link images to a story board in quick time.
- ✓ Link AR programs to OHSMS modules for interactive learning.



- Enhanced Training And Induction
- Real-time Information Overlay
- Risk Visualization
- Maintenance Support
- Emergency Response Improvement
- Low Downtime and High Productivity

## Virtual Reality Application

A virtual tour of inaccessible or dangerous workplace and experience the consequences of accidents in a safe virtual environment.

- ✓ Enhance industrial safety by providing realistic training, mitigating risks, improving emergency preparedness.



- Behavioral Safety Training
- Risk-Free Learning
- Hazard Visualization
- Customizable Training Scenarios
- Remote Training and Collaboration
- Equipment Familiarization

## Universal Sensors

Continuously monitor compliances and ensure predictive maintenance of assets in your occupational health & safety management system.



- Scalability
- Flexibility
- Data Transmission
- Over The Air (OTA) Updation
- Arresto Connect+ Sensor Module
- Dashboard



## Artificial Intelligence

- ✓ Fully automated the hazard and incident report system.
- ✓ Unsafe activities detection with 98% accuracy.
- ✓ Time-to-action reduction of 80%



- Real time Alerts
- Plug and Play
- Compliance
- AI Dashboard
- Daily/Weekly Reporting
- KPI Tracking



# EHS, Sustainability & Risk Management Solutions



## The Arresto SMART Safety Culture Campaign



### Capability Building & Training

Enhance organization's safety culture with adaptive training methodology in line with Industry 4.0 using digital aids (AR, VR, AI). Assessment/Knowledge retention through cloud-based mobile application.

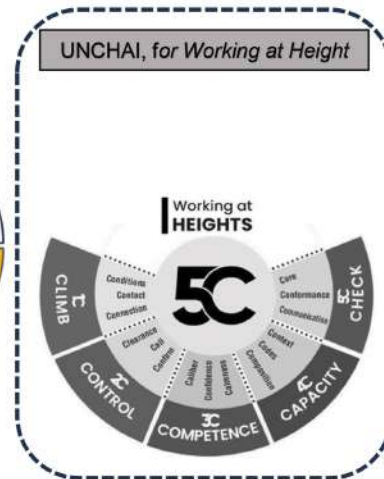
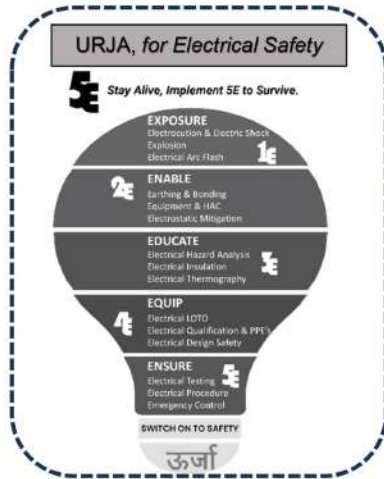

**UNCHAI**

The 5C's of Unchai is a 360° program to maximize safety during working at height. Follow 5C's to eliminate Work at Height accidents. This campaign helps to understand how each C's impact the effectiveness of our fall protection program.

**URJA**

This campaign helps you to understand 5E's of electrical safety at work. Emphasize the recognition for the safety of those who must work around and with electricity. It ensures the safety of human beings as well as equipment.

**UPKARAN**

This campaign helps to ensure that operators have the knowledge and skills needed to safely operate the equipment. Includes understanding the capabilities and limitations of the equipment, how to inspect and maintain it, and how to properly rig and lift loads.

**UDAAN**

This campaign prioritize safety and help to mitigate risks and limit liability for airports, by ensuring that proper safety procedures and practices are followed. Airports can minimize the likelihood of accidents, which can have severe legal and financial consequences.

**RESCUE**

This campaign enables the participants to assess the workplace hazards and create an effective rescue plan considering site conditions, hazards, access situations and safety of the rescuer and the victim.

# Operational & Consulting Services



# Operational & Consulting Services

## Joint Venture Announcement

### **Raja Company Kuwait and Sunbelt Services Forge a Strategic Joint Venture**

Raja Company W.L.L. Kuwait, a distinguished business entity celebrating 64 years of successful operations, proudly announces a strategic joint venture with Sunbelt Safety Services, a key player in the H2S equipment and services industry, and part of the London-listed Lamprell Group.

#### **About Raja Company Kuwait:**

Raja Company W.L.L. Kuwait, with a rich history dating back to 1960, has evolved into a diverse conglomerate encompassing various divisions and activities. From Industrial Safety & Contracting, Rig Supplies Division, to Kitchen Equipment, Restaurants, and beyond, Raja Company Kuwait has been a trailblazer in offering comprehensive solutions across multiple sectors.

#### **About Sunbelt Services:**

As part of the renowned Lamprell Group, Sunbelt Services specializes in providing state-of-the-art H2S safety equipment and services to the energy industry. With over 40 years of expertise, Sunbelt's commitment to fostering a robust safety culture within worksites is unparalleled. The team of skilled professionals at Sunbelt tailors various solutions to meet the unique needs of each customer, covering equipment rental, recertification, installation, and maintenance, as well as offering specialized professionals and training services.

#### **Key Highlights of the Joint Venture:**

**Diversification of Services:** The joint venture leverages Raja Company Kuwait's diversified business portfolio, market knowledge and customer coverage to enhance and showcase Sunbelt's specialized expertise in H2S equipment and services, Air Cascade System, Fire Fighting system and Explosion proof cameras. This collaboration will result in a comprehensive suite of offerings to cater to a broader range of client needs.

**Enhanced Safety Solutions:** Sunbelt's extensive experience in H2S safety equipment and services complements Raja Company Kuwait's commitment to safety across various sectors. Together, they aim to provide cutting-edge solutions, equipment, and training to the oil and gas industry in Kuwait.

**Geographical Impact:** With a strategic presence in Kuwait, the joint venture aims to strengthen its footprint in the region, offering a combined array of services that align with the evolving requirements of the energy industry.

**Shared Commitment to Excellence:** Both entities share a common commitment to excellence, safety, and client satisfaction. The joint venture embodies these values and strives to set new benchmarks in safety standards and service quality.

This joint venture marks a significant milestone for both Raja Company Kuwait and Sunbelt Services, uniting diverse strengths to deliver unparalleled solutions and services to the Kuwait market.

# Steel & Aluminium Fabrication Services

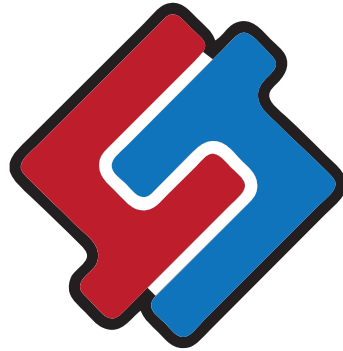

**WORX INTERNATIONAL Co. W.L.L.**  
**FOR ALUMINIUM & STEEL**

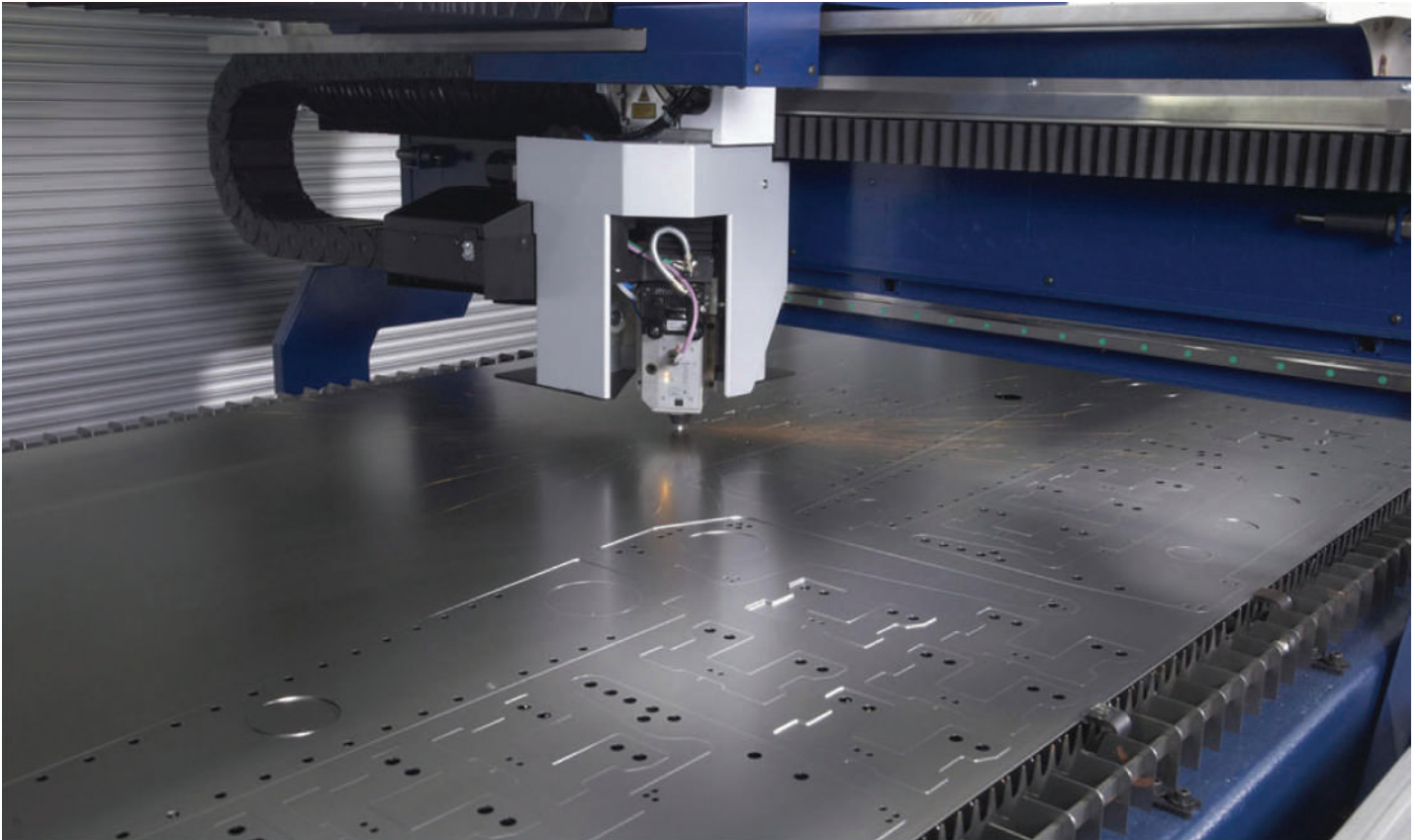

# Steel & Aluminium Fabrication Services

## About Worx International

Since its establishment in 2000, Worx International has grown to be recognized by its clients as a reliable and professional contracting team that takes its profession seriously and executes the contracts on time.

Worx International was set up as the contracting Division of Raja Company W.L.L. in the year 2000 and has since then committed to surpassing the expectations of our professionalism, and service which yields the highest quality construction projects.

## Our Services

- Sheet Metal Fabrication • SS Kitchen Furniture
- Mechanical Fabrication • Drainage Systems / Solutions
- Laser Cutting • Cutting & Punching
- Folding • Welding Finishing & Powder Coating



# Technical Services Division



**VY TALTEC**  
Pin, Point, Precision.



**TECHNICAL  
SERVICES  
DIVISION**

[www.safetyplusworld.com](http://www.safetyplusworld.com)

## WHO WE ARE

Our certified team aims to give the best service in the shortest time possible with pin point precision to set a new standard for Engineering at its finest

## WHAT WE DO

Certification Training – Demonstration  
Engineering Design • Installation  
Site Surveys • Risk Assessments  
Inspection • Maintenance • Consultancy

## WHAT WE SPECIALIZE IN

- Gas Detectors
- Vertical – Horizontal Life Line
- Retractable Tieback Systems (Blocks)
- Self Contained Breathing Apparatus
- Fall Protection Equipment
- Life Support Systems



# Technical Services Division

## SCOPE OF WORK

### Gas Detectors

Inspection, Calibration and Recertification

### Vertical – Horizontal Life Line

Calculation, Design, Supply & Install, Inspect, Repair & Certify

### Retractable Fall Arrest Systems (Blocks)

Full System Inspection, Cable Replacement Cleaning, Consumable Replacement & Certifying

### Self Contained Breathing Apparatus

Inspection, Repair, Calibration, Leak Control & Test, Recertification, Refilling of Air Cylinder, Air Quality Test

### Fall Protection Equipment

Harness inspection, Recertification  
Lanyard Inspection, Recertification, Anchor Point Consultancy

### Life Support Systems (LSS)

Helmet Cleaning, Leak Test, Airflow Test, Communication Control





# Technical Services Division

## EGATORK TORQUE CALIBRATION MACHINES

### PRECISION MATTERS:

Trust Our Expert Torque Wrench Calibration Services

*Regular torque tool calibration ensures repeatable accuracy and adherence to international standards.*

*Torque calibration also guarantees the equipment is operating at peak performance and can highlight potential tooling problems before they arise due to tool wear or broken components.*

**Range: 0-2000N.m**



### TYPE I

Model No.: 57665 & 57666

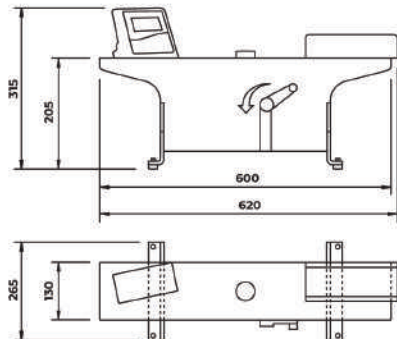

### TYPE II

Model No.: 57664

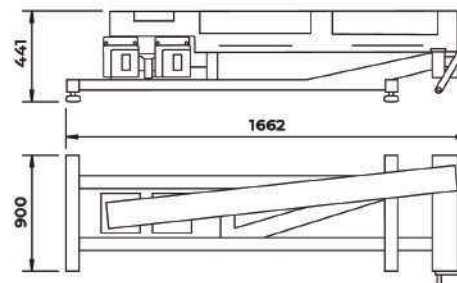

**EGA Master**  
ART IN INNOVATION  
BE SAFE...BE EFFICIENT

# Safety Plus World Cricket Team

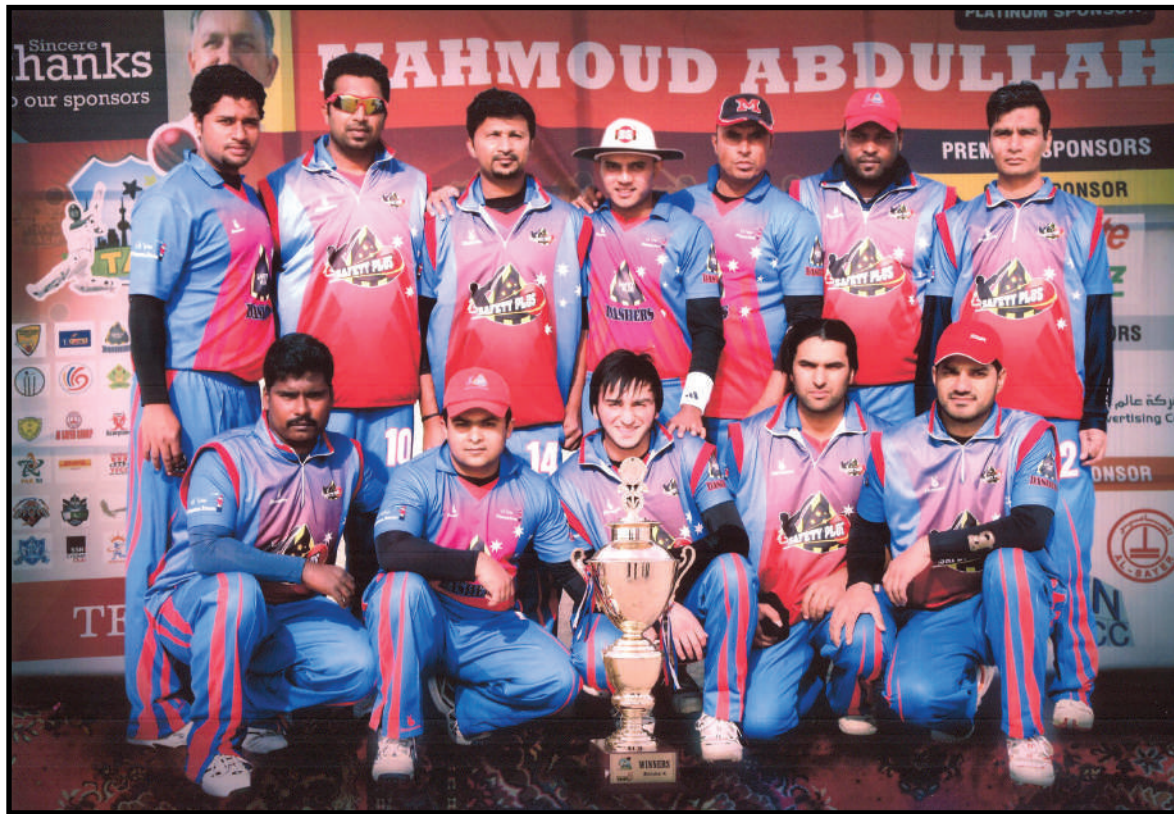

Safety Plus World Cricket Team, sponsored by Raja Company started participating in the Professional cricket leagues organized by TACK, Kuwait Cricket, Kuwait Oil Company, Gulf Consult & Other private bodies in Kuwait Since 2006. Since then, the team had participated in almost all the cricket tournaments around Kuwait.

Safety Plus World Cricket Team has thrived on a precise aim of promoting the game as an equal opportunity for all its players to demonstrate their skills, and developing the sport by contributing in utmost ways that may lead towards the betterment of cricket in Kuwait. In pursuit of such promotion and development, Raja Company has taken the initiative of selecting players from Kuwait and India, enabling them to demonstrate their skills both on and off the field, and more importantly, making the cricketing environment in Kuwait a lot more exciting and competitive. In order to encourage the efforts, hard work, and mental determination of these players and all the other players, Raja Company Management has also taken the initiative to provide incentives in the form of monetary value, whereby the performances of the best batsmen and the best bowler for each match are fully acknowledged with great enthusiasm. In doing so, Raja Company Management encourages other clubs to pursue a similar path as it guarantees the everlasting promotion, competition, and development of cricket in Kuwait.

Safety Plus World Cricket team over the years have bagged some great victories and championships and Team stand under Top three teams of Kuwait.

# Our Brands



# SAFETY PLUS WORLD®

www.safetyplusworld.com

KUWAIT | ABU DHABI | DUBAI | SHARJAH

BUY OUR PRODUCTS ONLINE



 **buysafety.com**  
YOUR ONLINE SAFETY STORE

Mobile  
+965 - 6632 3117

Phone  
+965 - 2484 4799

Fax  
+965 - 2484 4798

Email Address  
enquiries@safetyplusworld.com

A Division Of



شركة راجا للتجارة العامة ذ.م.م.  
Raja General Trading Company W.L.L.

