



Sarin your diamonds, everyone else does.

THIS DOCUMENT IS IMPORTANT. IF YOU ARE IN ANY DOUBT AS TO THE ACTION YOU SHOULD TAKE, YOU SHOULD CONSULT YOUR STOCKBROKER, BANK MANAGER, SOLICITOR, ACCOUNTANT OR OTHER PROFESSIONAL ADVISER.

We have applied to the Singapore Exchange Securities Trading Limited (the "SGX-ST") for permission to deal in, and for quotation of, all our ordinary shares ("Shares") in the capital of Sarin Technologies Ltd (the "Company") already issued (including the Vendor Shares as defined herein), and the new Shares ("New Shares") which are the subject of this Invitation (as defined herein), the Shares which may be provided by the Vendors upon the exercise of the over-allotment option (the "Over-Allotment Option") (the "Additional Shares") and the new Shares ("Option Shares") to be issued under the Sarin 2003 Share Option Plan and under the Sarin 2005 Share Option Plan (the "Plan"). Such permission will be granted when we have been admitted to the Official List of the SGX-ST. The dealing in and quotation of the Shares will be in Singapore dollars.

Acceptance of applications will be conditional upon permission being granted by the SGX-ST to deal in, and for quotation of, all our existing issued Shares, the New Shares, the Additional Shares and the Option Shares. If permission is not granted for any other reason, monies paid in respect of any application accepted will be returned to you at your own risk, without interest or any share of revenue or other benefit arising therefrom, and you will not have any claims whatsoever against us, the Vendors or the Manager.

In connection with the Invitation, the Vendors have granted the Manager an Over-Allotment Option exercisable by the Manager, in whole or in part, during the period commencing on the date of commencement of trading of our Shares on the SGX-ST (the "Commencement Date") and expiring on the date falling 30 days after the Commencement Date. The Manager may purchase and/or procure purchasers for the Additional Shares, representing in aggregate not more than 15% of the Invitation Shares (before the exercise of the Over-Allotment Option), at the Invitation Price (as defined herein), solely for the purpose of covering over-allotments (if any) made in connection with the Invitation. The Manager may over-allot and effect transactions which stabilize or maintain the market price of our Shares at levels which may not otherwise prevail in the open market, subject to compliance with the laws of Singapore. Such stabilization, if commenced, may be discontinued by the Manager at any time at the Manager's discretion, in accordance with the laws of Singapore.

The SGX-ST assumes no responsibility for the correctness of any of the statements made, opinions expressed or reports contained in this Prospectus. Admission to the Official List of SGX-ST is not to be taken as an indication of the merits of the Invitation, the Sarin 2003 Share Option Plan, the Plan, our Company, our subsidiaries, our Shares, the New Shares, the Additional Shares or the Option Shares.

A copy of this Prospectus together with a copy of the Application Forms, has been lodged with and registered by the Monetary Authority of Singapore (the "Authority"). The Authority assumes no responsibility for the contents of this Prospectus. Registration of this Prospectus by the Authority does not imply that the Securities and Futures Act (Chapter 289), or any other legal or regulatory requirements, have been complied with. The Authority has not, in any way, considered the merits of our Shares, the New Shares, the Additional Shares or the Option Shares, as the case may be, being offered or in respect of which an invitation is made, for investment.

No Shares shall be allotted or allocated on the basis of this Prospectus later than six months after the date of registration of this Prospectus.

Investing in our Shares involves risks which are described in the section entitled "Risk Factors" on pages 41 to 49 of this Prospectus.

PROSPECTUS DATED 31 MARCH 2005 (registered with the Monetary Authority of Singapore on 31 March 2005)



SARIN TECHNOLOGIES LTD

(Incorporated in Israel on 8 November 1988)
(Israel Registration No. 51 1332207)

Invitation in respect of 62,200,000 ordinary shares, comprising 52,000,000 New Shares and 10,200,000 Vendor Shares as follows:

- (1) 6,220,000 Offer Shares at S\$0.355 for each Offer Share by way of public offer; and
- (2) 55,980,000 Placement Shares at S\$0.355 for each Placement Share by way of placement,

payable in full on application (subject to the Over-Allotment Option as defined herein)

Manager, Underwriter and Placement Agent



Primary Sub-Underwriters and Primary Sub-Placement Agents



31 MARCH 2005

A leading Israeli company with proprietary technology for the diamond industry

Polishing Discs

CORPORATE PROFILE

Established in Israel in 1988, we develop, manufacture and sell precision technology products that use 3-D geometric measurements and apply advanced software algorithms to the processing of diamonds and gems

Our systems provide smart solutions for every stage and aspect of diamond design and manufacturing, from determining the optimal yield from a rough stone, to laser markings for cutting rough stones, measuring and analysing polished diamonds, inscription of polished diamonds and technology that assists sales in jewellery stores

The diamond industry deals with extremely costly rough stones, where even single digit percentage savings translate to significant actual profit. Our products increase the profit margins at various stages of the diamond trade between the initial purchase price of rough stones and the end price of polished diamonds

Over the years, we have established a brand name in the diamond industry, and the systems we have developed, produced and marketed have:-

- ◆ changed the way polished diamonds are bought and sold
- ◆ changed the manner in which rough stones are processed into polished ones
- ◆ increased the level of automation in diamond manufacturing
- ◆ contributed to the geographic shift of the diamond industry to new centres of manufacture such as India, PRC and Russia

Our customers include major industry participants and opinion leaders spanning the entire value chain of the global diamond industry - from wholesale traders, to manufacturers, gemological laboratories and major retailers



DiaVision Software

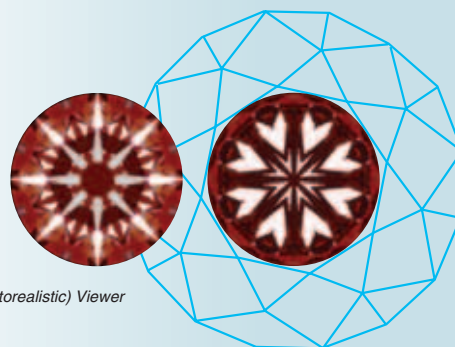

Hearts & Arrows (Photorealistic) Viewer

PROPRIETARY PRODUCTS

We combine our core computer software with various hardware technologies to create proprietary technological solutions:-

COMPUTER SOFTWARE

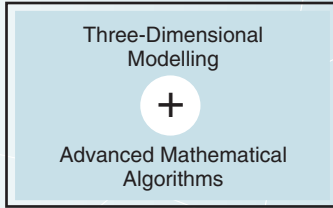

HARDWARE TECHNOLOGIES

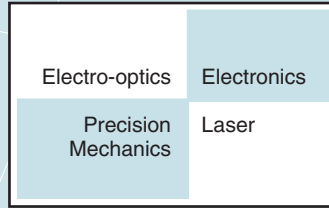

Smart solutions for every stage and aspect of diamond design and manufacturing

Our products provide diamond dealers with technological solutions for three main areas in the diamond industry:-

Technological solutions for three main areas:-	Functions:-	Products:-
Planning the optimal use of rough stones	<p>Explore different methods of utilization of the rough stone and propose the possible ways of processing the stones into polished diamonds</p> <p>Assess the grading of the proposed cut according to the preferred method of grading</p>	<p>DiaExpert™ DiaMark™ DiaScan "S" Series</p>
Measurement of the parameters of polished diamonds to determine their value	Measure the quality of the colour and cut of polished diamonds	<p>DiaMension™ DiaVision™ Brilliant Eye DC 3000 Colorimeter</p>
Inscribing on polished diamonds	<p>Branding tool to enhance ownership</p> <p>Inscribe on polished diamonds with distinctive marks for identification and security purposes such as:-</p> <ul style="list-style-type: none"> - Serial numbers, - Owner's name, - Logo of retailers, etc. 	DiaScribe

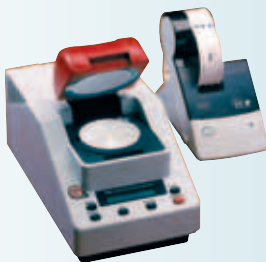

DC 3000 Colorimeter



DiaScan "S" Series



DiaMobile™



Obverse of modified polish wheel



DiaExpert™

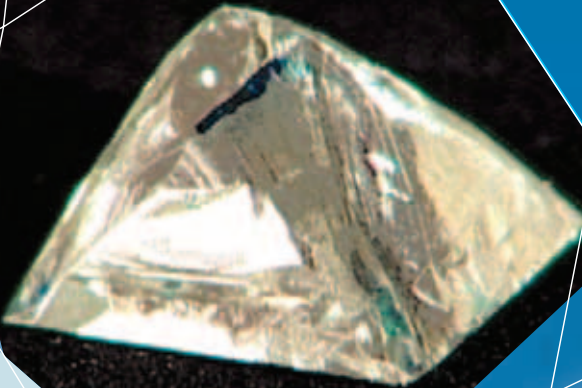

Rough Stone

COMPETITIVE STRENGTHS

- We understand the needs of our customers
 - ◆ Keen understanding of customers' business and in-depth knowledge about the diamond industry enable us to provide solutions to meet customers' needs
- We have an established track record for innovation and strong brand name
 - ◆ Major industry participants use our products which strengthens our ability to market our products and services to new customers
- Opinion leaders in the industry mainly use our products
 - ◆ Our products are used almost exclusively by the major gemological laboratories worldwide – an endorsement of our products as perceived by the other industry players
- Our products are modular and are "add-ons" to our existing product platforms
 - ◆ Our products are easily upgradeable to meet the changing needs of our customer's business and keep them abreast of the newest technologies in the diamond industry
- We focus on quality products and services
 - ◆ We implement stringent quality controls in our development and production processes and our development and production staff are provided with on-going training
- We have highly experienced and dedicated management and development teams
 - ◆ Our CEO, Executive Directors and Executive Officers have extensive working experience and in-depth knowledge of the industry
 - ◆ Our development team possesses a high level of technical know-how, allowing us to develop products that meet the requirements of our customers
- We own proprietary rights to our products
 - ◆ The intellectual property on which our products are based, has been developed and is owned by us

FINANCIAL HIGHLIGHTS (in US\$)

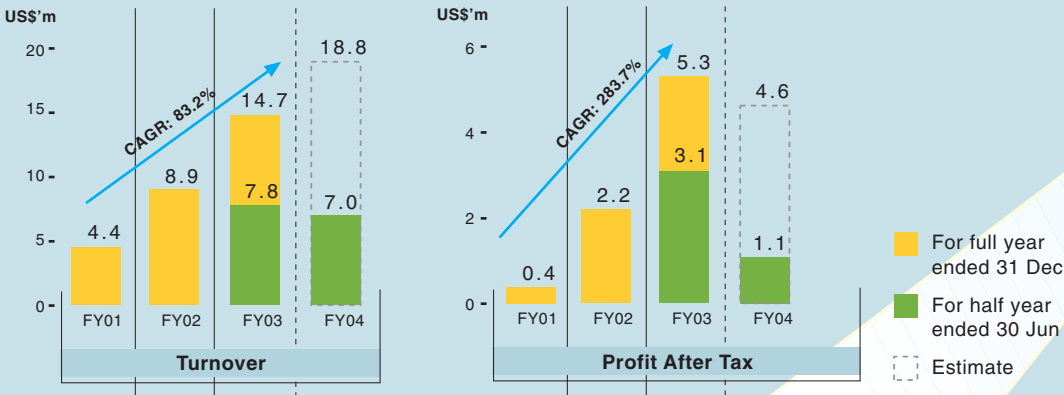

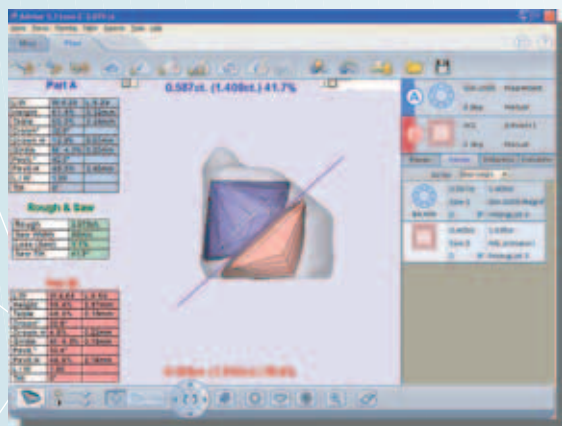

Advisor™ Planning Screen



Laser Marking

PROSPECTS

We expect our business to be driven primarily by the following trends:-

- ◆ Increasing use of automation throughout the factories and the streamlining of the process flow from planning to production due to increased pressure on profit and yield margins
- ◆ Emerging new diamond manufacturing centres, such as PRC and Russia
- ◆ Increasing use of other cost-saving technologies in order to achieve better profit and yield margins
- ◆ Increasing use of branding by the manufacturers as a means of differentiation of their products
- ◆ Increasing consumer demand for certification of the diamonds' quality
- ◆ Increasing demand for equipment to enable identification of natural and untreated diamonds over the counter prior to purchase

Brilliance: G

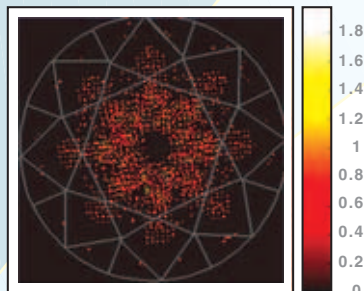

CutGrade Analyzer™

Brilliance: Exc.

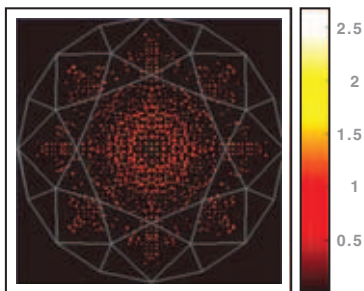

CutGrade Analyzer™

BUSINESS STRATEGIES AND FUTURE PLANS

Our business strategy is to enhance our market presence in existing and emerging markets, and to position ourselves as a "one-stop shop" in the diamond industry. To this end, our future plans include the following:-

- ◆ Increase our sales to existing customers while enhancing our market penetration to attract new customers worldwide and obtaining annual renewable service contracts
- ◆ Develop innovative high-end products with high returns on investment
- ◆ Offer lower cost products for smaller manufacturers and in-line quality control
- ◆ Introduce advanced laser-based cutting and bruting system
- ◆ Penetrate the consumables market with disposable polishing discs and cleaning fluids which are environmentally friendly
- ◆ Introduce light performance systems (software upgrades to grade brilliance, fire and scintillation of polished diamonds)
- ◆ Leverage continued trend towards branding to drive demand for our inscription products
- ◆ Develop diamond identification systems
- ◆ Explore potential scalability of our technology to other industries

DIVIDEND

We intend to recommend a dividend to our Shareholders of approximately S\$4.125 million (or US\$2.5 million) be paid out of profits from FY2004. This translates to S\$0.017 per share.



TABLE OF CONTENTS

	Page
CORPORATE INFORMATION	4
DEFINITIONS	6
GLOSSARY OF TECHNICAL TERMS	11
CAUTIONARY NOTE REGARDING FORWARD-LOOKING STATEMENTS	19
SELLING RESTRICTIONS	20
PURCHASE BY OUR COMPANY OF OUR OWN SHARES	21
ATTENDANCE AT GENERAL MEETINGS AND VOTING POWERS	22
TAKE-OVERS	23
DETAILS OF THE INVITATION	
Listing on the SGX-ST	25
Indicative Timetable for Listing	28
PLAN OF DISTRIBUTION	29
OVER-ALLOTMENT AND STABILIZATION	31
PROSPECTUS SUMMARY	
Overview of our Group	32
Our Invitation	38
EXCHANGE RATE	40
RISK FACTORS	41
INVITATION STATISTICS	50
USE OF PROCEEDS	52
DIVIDEND POLICY	53
CAPITALISATION AND INDEBTEDNESS	54
DILUTION	55
GROUP STRUCTURE	56
SHARE CAPITAL	57

TABLE OF CONTENTS

	Page
GENERAL INFORMATION ON OUR COMPANY	
Our Market	63
Our History	68
Our Business	71
Our Products	72
Research and Development	78
Intellectual Property	78
Our Production Process	81
Our Production Capacity	82
Our Inventory Management Policy	82
Seasonality	82
Sales, Marketing and Business Development	82
Quality Assurance	83
Government Regulations	84
Credit Management	84
Staff Training and Development	85
Major Suppliers	85
Major Customers	86
Competition	86
Competitive Strengths	86
Properties and Fixed Assets	88
Insurance	90
PROSPECTS, BUSINESS STRATEGIES AND FUTURE PLANS	
Prospects	91
Business Strategies and Future Plans	91
SELECTED CONSOLIDATED FINANCIAL INFORMATION	95
MANAGEMENT'S DISCUSSION AND ANALYSIS OF FINANCIAL CONDITION AND RESULTS OF OPERATIONS	
Overview	98
Profit Estimate	107
Review of Financial Position	108
Liquidity and Capital Resources	112
Capital Expenditures, Acquisitions, Divestment and Commitment	114

TABLE OF CONTENTS

	Page
DIRECTORS, MANAGEMENT AND STAFF	
Directors	118
Management	123
Management Reporting Structure	127
Staff	128
Compensation	129
Service Agreements	131
Term of Office	132
Sarin 2005 Share Option Plan	132
INTEREST OF MANAGEMENT AND OTHERS IN CERTAIN TRANSACTIONS	
Interested Person Transactions	137
Guidelines for Future Interested Person Transactions	139
Review Procedures for Future Interested Person Transactions	140
Potential Conflict of Interest	141
Corporate Governance	141
GENERAL AND STATUTORY INFORMATION	146
INDEPENDENT AUDITORS' REPORT AND FINANCIAL STATEMENTS	F1 - F34
ANNEX A	
Diamond Grading and Certificates	A-1
ANNEX B	
Amended and Restated Articles of Association of Sarin Technologies Ltd	B-1
ANNEX C	
Rules of Sarin Technologies Ltd 2005 Share Option Plan	C-1
ANNEX D	
Description of Singapore and Israeli Law and Regulations Relating to Taxation	D-1
ANNEX E	
Comparison between the Companies Act and the Israeli Companies Law	E-1
ANNEX F	
Summary of Certain Provisions of Israeli Law	F-1
ANNEX G	
Terms and Conditions and Procedures for Application and Acceptance	G-1

CORPORATE INFORMATION

BOARD OF DIRECTORS	:	Daniel Benjamin Glinert Hanoh Stark Ehud Harel Eyal Mashiah Israel Zeev Eliezri Aharon Shapira Yehezkel Pinhas Blum Chan Kam Loon Valerie Ong Choo Lin	<i>Chairman and Executive Director</i> <i>Executive Director</i> <i>Non-Executive Director</i> <i>Non-Executive Director</i> <i>Non-Executive Director</i> <i>Non-Executive Director</i> <i>Independent Director</i> <i>Independent Director</i> <i>Independent Director</i>
JOINT COMPANY SECRETARIES	:	Amir Jacob Zolty (Adv.) Chang Sow Kuen (ACIS)	
REGISTERED OFFICE	:	4 Hahilazon Street, Ramat Gan 52522 Israel	
ISRAEL REGISTRATION NUMBER	:	51 1332207	
REGISTRAR FOR THE INVITATION AND SINGAPORE SHARE TRANSFER AGENT	:	M & C Services Private Limited 138 Robinson Road #17-00, The Corporate Office Singapore 068906	
MANAGER, UNDERWRITER AND PLACEMENT AGENT	:	UOB Asia Limited 80 Raffles Place UOB Plaza Singapore 048624	
PRIMARY SUB-UNDERWRITERS AND PRIMARY SUB-PLACEMENT AGENTS	:	United Overseas Bank Limited 80 Raffles Place UOB Plaza Singapore 048624 UOB Kay Hian Private Limited 80 Raffles Place #30-01, UOB Plaza 1 Singapore 048624	
RECEIVING BANK	:	United Overseas Bank Limited 80 Raffles Place UOB Plaza Singapore 048624	
JOINT AUDITORS AND REPORTING ACCOUNTANTS	:	KPMG Singapore Certified Public Accountants 16 Raffles Quay #22-00 Hong Leong Building Singapore 048581 Partner-in-charge : Paul Barley Somekh Chaikin Certified Public Accountants (Isr.) Member firm of KPMG International KPMG Millennium Tower 17 Haarbaa Street Tel-Aviv 64739, Israel Partner-in-charge : Roger I Lavender	

CORPORATE INFORMATION

Chaikin, Cohen, Rubin and Gilboa
Certified Public Accountants (Isr.)
Kiriati Atidim Building No. 4
P.O. Box 58143
Tel-Aviv 61580, Israel
Partner-in-charge : Ilan Chaikin

SOLICITORS TO THE INVITATION :

Drew & Napier LLC
20 Raffles Place #17-00
Ocean Towers
Singapore 048620

**SOLICITORS TO THE MANAGER,
UNDERWRITER AND
PLACEMENT AGENT :**

Allen & Gledhill
One Marina Boulevard #28-00
Singapore 018989

**LEGAL ADVISORS TO THE
COMPANY ON ISRAELI LAW :**

Eyal Khayat, Zolty & Co.
9 Hamenofim Street
Ackerstein Towers PO Box 2136
Herzliya Pituach 46120, Israel

**LEGAL ADVISORS TO THE
COMPANY ON INDIAN LAW :**

Vaish Associates Advocates
No. 5B, 5th Floor, Diamond House
No. 515, 35th Road, Bandra (West)
Mumbai – 400 050, India

PRINCIPAL BANKER :

Bank Igud (Union Bank of Israel)
Ramat-Gan Branch
Elite Square, Diamond Exchange Building
P.O. Box 3006
Ramat-Gan 52130, Israel

VENDORS :

Sarin Research & Development Ltd
Bezalel 52
Ramat Gan 52521, Israel

Interhightech (1982) Ltd
c/o Daniel Benjamin Glinert
Meshek 41
Moshav Ben Shemen 73115, Israel

DEFINITIONS

In this Prospectus and the accompanying Application Forms, the following definitions apply throughout where the context so admits:

Our Group Companies

<i>"GCI"</i>	:	Gran Computer Industries (1992) Ltd
<i>"Romedix"</i>	:	Romedix Ltd
<i>"Sarin" or "Company"</i>	:	Sarin Technologies Ltd
<i>"Sarin Group" or "Group"</i>	:	Our group of companies comprising Sarin, GCI, Romedix and Sarin India
<i>"Sarin India"</i>	:	Sarin Technologies India Private Limited

Other Companies

<i>"Interhightech"</i>	:	Interhightech (1982) Ltd
<i>"Sarin R&D"</i>	:	Sarin Research & Development Ltd
<i>"Zannex"</i>	:	Zannex Capital Development Ltd

General

<i>"Additional Shares"</i>	:	Up to 9,330,000 issued and fully paid-up Shares held by the Vendors to be sold upon the exercise of the Over-Allotment Option
<i>"Application Forms"</i>	:	The official printed application forms to be used for the purpose of the Invitation, which form part of this Prospectus
<i>"Application List"</i>	:	The list of applications to subscribe for and/or purchase the Invitation Shares
<i>"Articles of Association"</i>	:	The articles of association of our Company, as amended, supplemented or modified from time to time
<i>"Associate"</i>	:	(a) in relation to any director, chief executive officer, substantial shareholder or controlling shareholder (being an individual) means:- <ul style="list-style-type: none">(i) his immediate family;(ii) the trustees of any trust of which he or his immediate family is a beneficiary or, in the case of a discretionary trust, is a discretionary object; and(iii) any company in which he and his immediate family together (directly or indirectly) have an interest of 30% or more

DEFINITIONS

	(b)	in relation to a substantial shareholder or a controlling shareholder (being a company) means any other company which is its subsidiary or holding company or is a subsidiary of such holding company or one in the equity of which it and/or such other company or companies taken together (directly or indirectly) have an interest of 30% or more
<i>"ATM"</i>	:	Automated teller machine of a Participating Bank
<i>"Audit Committee"</i>	:	The audit committee of our Company
<i>"Authority" or "MAS"</i>	:	Monetary Authority of Singapore
<i>"Board" or "Board of Directors"</i>	:	The board of Directors of our Company
<i>"CDP"</i>	:	The Central Depository (Pte) Limited
<i>"CEO"</i>	:	Chief Executive Officer
<i>"CFO"</i>	:	Chief Financial Officer
<i>"Companies Act"</i>	:	Companies Act (Chapter 50) of Singapore
<i>"Controlling Shareholder"</i>	:	a person who:- (a) holds directly or indirectly 15% or more of the nominal amount of all voting shares in the company. The Exchange may determine that a person who satisfies this paragraph is not a controlling shareholder; or (b) in fact exercises control over a company
<i>"Directors"</i>	:	The directors of our Company as at the date of this Prospectus
<i>"Electronic Applications"</i>	:	Applications for the Offer Shares made through an ATM of a Participating Bank or through internet websites in accordance with the terms and conditions of this Prospectus
<i>"EPS"</i>	:	Earnings per Share
<i>"Executive Directors"</i>	:	Our executive Directors as at the date of this Prospectus
<i>"Executive Officers"</i>	:	The key executive officers of our Company as at the date of this Prospectus
<i>"FY"</i>	:	Financial year ended or ending 31 December, as the case may be
<i>"1H03"</i>	:	Six months ended 30 June 2003
<i>"1H04"</i>	:	Six months ended 30 June 2004
<i>"2H04"</i>	:	Six months commencing 1 July 2004 and ending 31 December 2004

DEFINITIONS

<i>"Independent Directors"</i>	:	Yehezkel Pinhas Blum, Chan Kam Loon and Valerie Ong Choo Lin, who will be nominated as independent directors of our Company in accordance with Israeli Law within three months of the listing of our Shares on the SGX-ST
<i>"Invitation"</i>	:	The invitation by our Company and the Vendors to the public to subscribe for and/or purchase the Invitation Shares, subject to and on the terms and conditions of this Prospectus
<i>"Invitation Price"</i>	:	S\$0.355 for each Invitation Share
<i>"Invitation Shares"</i>	:	The 62,200,000 Shares which are the subject of the Invitation comprising 52,000,000 New Shares and 10,200,000 Vendor Shares (subject to the Over-Allotment Option)
<i>"Israeli Companies Law"</i>	:	The Companies Law, 5759-1999, and the Companies Ordinance (New Version) 1983 of Israel, or any statutory modification, amendment or re-enactment thereof for the time being in force, and any reference to any provision of the said law is to that provision as so modified, amended or re-enacted or contained in any such subsequent act or acts
<i>"Israel Securities Law"</i>	:	The Israel Securities Law, 5728-1968
<i>"Latest Practicable Date"</i>	:	23 February 2005, being the latest practicable date prior to the printing of this Prospectus
<i>"Listing Manual"</i>	:	The listing manual of the SGX-ST
<i>"Market Day"</i>	:	A day on which the SGX-ST is open for trading in securities
<i>"New Shares"</i>	:	The 52,000,000 new Shares for which our Company invites applications to subscribe for pursuant to the Invitation, subject to and on the terms and conditions of this Prospectus
<i>"Non-Executive Directors"</i>	:	Our non-executive Directors as at the date of this Prospectus
<i>"NTA"</i>	:	Net tangible assets
<i>"Offer"</i>	:	The offer by our Company and the Vendors to the public to subscribe for and/or purchase the Offer Shares at the Invitation Price, subject to, and on the terms and conditions of, this Prospectus
<i>"Offer Shares"</i>	:	The 6,220,000 Invitation Shares which are the subject of the Offer
<i>"Option Shares"</i>	:	The new Shares which may be allotted and issued under the Sarin 2003 Share Option Plan and the Plan
<i>"2003 Options"</i>	:	The share options granted pursuant to the Sarin 2003 Share Option Plan

DEFINITIONS

<i>“Over-Allotment Option”</i>	:	The option granted by the Vendors to the Manager to purchase and/or procure purchasers for the Additional Shares, representing in aggregate not more than 15% of the Invitation Shares (before the exercise of the Over Allotment Option), pursuant to the Invitation, upon the terms and conditions set out in the Prospectus and referred to in the section entitled “Over-Allotment and Stabilization” in this Prospectus. Unless we indicate otherwise, all information in this Prospectus assumes that the Manager does not exercise the Over-Allotment Option
<i>“Participating Banks”</i>	:	United Overseas Bank Limited and its subsidiary, Far Eastern Bank Limited (“UOB Group”), DBS Bank Ltd (including POSB) and Oversea-Chinese Banking Corporation Ltd (“OCBC”)
<i>“PER”</i>	:	Price earnings ratio
<i>“Placement”</i>	:	The placement of the Placement Shares at the Invitation Price, subject to, and on the terms and conditions of, this Prospectus
<i>“Placement Shares”</i>	:	The 55,980,000 Invitation Shares which are the subject of the Placement
<i>“Plan” or “Sarin 2005 Share Option Plan”</i>	:	The share option plan as described under the section entitled “Directors, Management and Staff” under the subheading “Sarin 2005 Share Option Plan” in this Prospectus and the rules of which are more particularly set out in Annex C on pages C-1 to C-20 of this Prospectus
<i>“PRC”</i>	:	The People’s Republic of China
<i>“R&D”</i>	:	Research and development
<i>“Sarin 2003 Share Option Plan”</i>	:	The share option plan as described under the section entitled “General and Statutory Information” under the subheading “Share Capital” on pages 149 to 152 of this Prospectus
<i>“SCCS”</i>	:	Securities Clearing & Computer Services (Pte) Ltd
<i>“Securities Account”</i>	:	Securities account maintained by a Depositor with CDP, not including a securities sub-account
<i>“Securities and Futures Act”</i>	:	Securities and Futures Act (Chapter 289) of Singapore
<i>“SGX-ST”</i>	:	Singapore Exchange Securities Trading Limited
<i>“Shareholders”</i>	:	Shareholders of our Company
<i>“Shares”</i>	:	Ordinary shares of no par value in the share capital of our Company
<i>“Singapore Code”</i>	:	The Singapore Code on Take-Overs and Mergers
<i>“Substantial Shareholder”</i>	:	A person who holds, directly or indirectly, 5% or more of the total issued share capital of the Company

DEFINITIONS

“TASE”	:	Tel-Aviv Stock Exchange
“UOB”	:	United Overseas Bank Limited
“UOB Asia”, “Manager”, “Underwriter” or “Placement Agent”	:	UOB Asia Limited
“UOB KayHian”	:	UOB Kay Hian Private Limited
“USA”	:	The United States of America
“Vendor Shares”	:	The 10,200,000 issued and fully paid-up Shares for which the Vendors invite applications to purchase pursuant to the Invitation, subject to and on the terms and conditions of this Prospectus
“Vendors”	:	Interhightech and Sarin R&D
Currencies, Units and Others		
“NIS”	:	New Israeli Shekels, the lawful currency of Israel
“Rs”	:	Indian rupees, the lawful currency of India
“S\$” or “SGD” or “cents”	:	Singapore dollars and cents, respectively, the lawful currency of Singapore
“USD” or “US\$” or “U.S. dollars”	:	United States dollars, the lawful currency of the USA
“sq m”	:	Square metre
“%” or “per cent.”	:	Per centum or percentage

The terms “Depositor”, “Depository Agent” and “Depository Register” shall have the same meanings ascribed to them respectively in Section 130A of the Companies Act.

Words importing the singular shall, where applicable, include the plural and *vice versa* and words importing the masculine gender shall, where applicable, include the feminine and neuter genders and *vice versa*. References to persons shall include corporations.

Any reference in this Prospectus and the Application Forms to any statute or enactment is a reference to that statute or enactment for the time being amended or re-enacted. Any word defined in the Companies Act, Securities and Futures Act or any statutory modification thereof and used in this Prospectus and the Application Forms shall, where applicable, have the meaning ascribed to it under the Companies Act, Securities and Futures Act (as the case may be) or any statutory modification thereof.

Any reference in this Prospectus or the Application Forms to our Shares being allotted or allocated to an applicant includes allotment or allocation to CDP for the account of that applicant.

Any reference to a time of day in this Prospectus or the Application Forms shall be a reference to Singapore time unless otherwise stated.

Any reference to “we”, “us”, “our” and “ourselves” or other grammatical variations in this Prospectus is a reference to our Company or the Group, as the case may be.

GLOSSARY OF TECHNICAL TERMS

A

American Gem Society (AGS): An educational institution for gemological studies. The AGS Laboratories were created primarily to develop and promote universally-accepted standards for grading cut.

Artificial stone: A gem material that is either a man-made imitation or a synthetic. (See **Synthetic**).

B

Bezel: A facet on the Crown, or the upper part of the Diamond above the Girdle.

Blemish: A clarity characteristic that occurs on the surface of a diamond. Though some blemishes are inherent to the original rough diamond, most are the result of the environment the diamond has encountered since it was unearthed.

Brilliance: The brightness that seems to come from the very heart of a diamond. It is the effect that makes diamonds unique among all other gemstones. While other gemstones also display brilliance, none has the power to equal the extent of a diamond's light-reflecting power. Brilliance is created primarily when light enters through the table, reaches the pavilion facets, and is then reflected back out through the table, where the light is most visible to your eye.

Brilliant Cut: One of three styles of faceting arrangements. In this type of arrangement, all facets appear to radiate out from the center of the diamond toward its outer edges. It is called a brilliant cut because it is designed to maximize brilliance. Round diamonds, ovals, radiants, princesses, hearts, marquises, and pears all fall within this category of cut.

C

Carat: The unit of weight by which a diamond is measured. One carat equals 200 milligrams, or 0.2 grams. The word comes from the carob bean, whose consistent weight was used in times past to measure gemstones.

Clarity: A stone's relative position on a flawless to imperfect scale. Clarity characteristics are classified as inclusions (internal) or blemishes (external). The size, number, position, nature, and colour or relief of characteristics determine the clarity grade. Very few diamonds are flawless, that is, showing no inclusions or blemishes when examined by a skilled grader under 10X magnification. If other factors are equal, flawless stones are most valuable.

Clarity Enhanced: A gemstone that has been treated to improve its appearance by filling fissures or fractures with a transparent substance. Also called "fracture filled."

Coated Diamond: A diamond coloured by a surface coating which masks the true body-colour. The coating may be extensive (entire pavilion, for example), but is more often limited to one or two pavilion facets or a spot on the girdle.

Colour Grading: A system of grading diamond colours based on their colourlessness (for white diamonds) or their spectral hue, depth of colour and purity of colour (for fancy colour diamonds). For white diamonds, GIA and AGS use a grading system which runs from D (totally colourless) to Z (light yellow).

Colour Origin: A determination of the cause of colour in fancy coloured diamonds. Diamonds that are naturally coloured are very rare and expensive. Two common ways of enhancing the colour of diamonds are irradiation and the high pressure high temperature (HPHT) processes.

Crown: The upper portion of a cut gemstone, which lies above the girdle. The crown consists of a table facet surrounded by either star and bezel facets (on round diamonds and most fancy cuts) or concentric rows of facets reaching from the table to the girdle (on emerald cuts and other step cuts).

GLOSSARY OF TECHNICAL TERMS

Crown Angle: The angle at which a diamond's bezel facets (or, on emerald cuts, the row of concentric facets) intersect the girdle plane. This gentle slope of the facets that surround the table is what helps to create the dispersion, or fire, in a diamond. White light entering at the different angles is broken up into its spectral hues, creating a beautiful play of colour inside the diamond. The crown angle also helps to enhance the brilliance of a diamond.

Crown Height: The part of the diamond that is above the girdle.

Crown Height Percentage: The crown height expressed as a percentage of the average girdle diameter.

Culet: A tiny flat facet that diamond cutters sometimes add at the bottom of a diamond's pavilion. Its purpose is to protect the tip of the pavilion from being chipped or damaged. However, once a diamond is set in jewellery the setting itself generally provides the pavilion with sufficient protection from impact or wear. Large or extremely large culets were common in diamonds cut in the early part of this century, such as the Old European or Old Mine Cut. However, such large culets are rarely seen today. Most modern shapes have either no culet at all, or a small or very small culet.

Cut: This refers both to the proportions and finish of a polished diamond. As one of "the four Cs" of diamond value, it is the only man-made contribution to a diamond's beauty and value.

D

Depth: The height of a diamond from the culet to the table. The depth is measured in millimeters.

Depth Percentage: On a diamond grading report, you will see two different measurements of the diamond's depth—the actual depth in millimeters (under "measurements" at the top of the report) and the depth percentage, which expresses how deep the diamond is in comparison to how wide it is. This depth percentage of a diamond is important to its brilliance and value, but it only tells part of the story. Where that depth lies is equally important to the diamond's beauty; specifically, the pavilion should be just deep enough to allow light to bounce around inside the diamond and be reflected out to the eye at the proper angle. Keep in mind, also, that a depth percentage that might be excessive for one diamond cut might be necessary for another type of cut. For example, a 75% or 78% depth in a princess cut diamond would be typical and quite attractive. However, a depth of even 65% would be unnecessary and even detrimental to a round diamond's beauty.

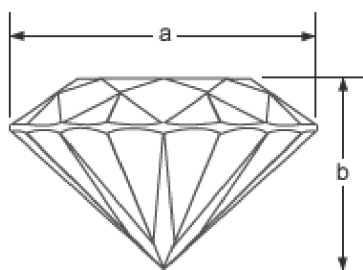

$$b/a \times 100 = \text{total depth \% in rounds}$$

Diamond: A crystal made up of 99.95% pure carbon atoms arranged in an isometric, or cubic, crystal arrangement. It is this unique arrangement of the carbon atoms that makes a diamond look and behave differently from other pure carbon minerals such as graphite (the soft black material used to make pencils).

Diamond Cutting: The method by which a rough diamond that has been mined from the earth is shaped into a finished, faceted stone. As a first step, cleaving or sawing is often used to separate the rough into smaller, more workable pieces that will each eventually become an individual polished gem. Next, bruting grinds away the edges, providing the outline shape (for example, heart, oval or round) for the gem. Faceting is done in two steps: during blocking, the table, culet, bezel and pavilion main facets are cut;

GLOSSARY OF TECHNICAL TERMS

afterward, the star, upper girdle and lower girdle facets are added. Once the fully faceted diamond has been inspected and improved, it is boiled in hydrochloric and sulfuric acids to remove dust and oil. The diamond is then considered a finished, polished gem.

Diamond Gauge: An instrument that is used to measure a diamond's length, width and depth in millimeters.

Dispersion: Arranged around the table facet on the crown are several smaller facets (bezel and star facets) angled downward at varying degrees. These facets, and the angles at which they are cut, have been skillfully designed to break up white light as it hits the surface, separating it into its component spectral colours (for example, red, blue and green). This effect, which appears as a play of small flashes of colour across the surface of the diamond as it is tilted, is what we refer to as the diamond's dispersion (also called "fire"). This play of colour should not be confused with a diamond's natural body colour (normally white, though sometimes yellow, brown, pink or blue in the case of fancy colour diamonds) which is uniform throughout the entire diamond and is constant, regardless of whether it is being tilted or not.

Durability: A combination of hardness, toughness and stability that describes a specific gemstone's ability to resist wear.

E

European Gemological Laboratory (EGL): EGL has franchises in a number of cities around the world which grade diamonds and offer a diamond grading certificate.

Extra Facet: A facet placed without regard for symmetry and not required by the cutting style.

F

Facet: The smooth, flat faces on the surface of a diamond. They allow light to both enter a diamond and reflect off its surface at different angles, creating the wonderful play of colour and light for which diamonds are famous. The table below shows all the facets on a round brilliant cut diamond. A round brilliant has 58 facets (or 57 if there is no culet). The shape, quantity, and arrangement of these facets will differ slightly among other fancy shapes.

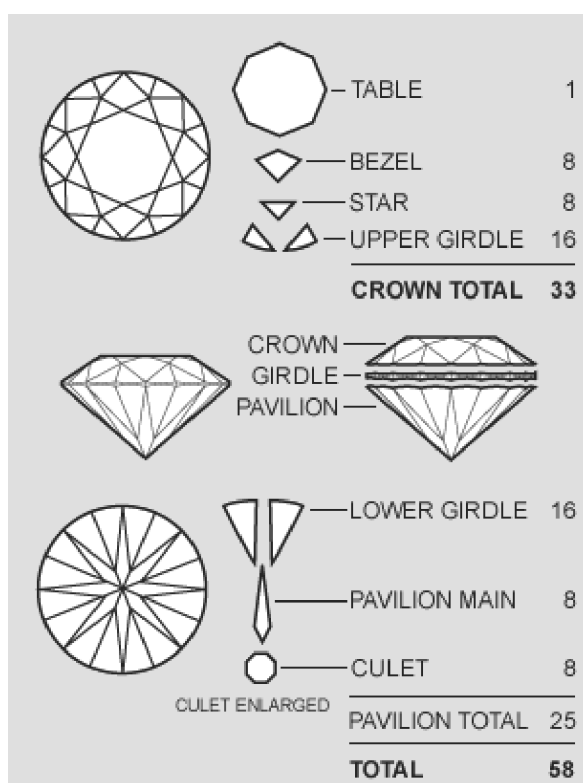

GLOSSARY OF TECHNICAL TERMS

Faceted Girdle: Sometimes cutters polish the girdle into 32 facets.

Fancy Shape: Any diamond shape other than round.

Fancy Diamond: A diamond with an attractive natural body-colour other than light yellow or light brown.

Finish: This term refers to the qualities imparted to a diamond by the skill of the diamond cutter. The term “finish” covers every aspect of a diamond’s appearance that is not a result of the diamond’s inherent nature when it comes out of the ground. The execution of the diamond’s design, the precision of its cutting details, and the quality of its polish are all a consideration when a gemologist is grading finish. If you examine a diamond’s grading report, you will see its finish graded according to two separate categories: polish and symmetry.

Fire: See “Dispersion”.

Flaw: An imperfection in a stone.

Fluorescence: An effect that is seen in some gem-quality diamonds when they are exposed to long-wave ultraviolet light (such as the lighting frequently seen in dance clubs). Under most lighting conditions, this fluorescence is not detectable to the eye. However, if a diamond is naturally fluorescent, it will emit a soft coloured glow when held under an ultraviolet lamp or “black light.” Fluorescence is not dangerous to the diamond or to the wearer; it is a unique and fascinating quality that occurs naturally in a number of gems and minerals.

Full Cut Diamond: A description of a brilliant cut, round stone with 57-58 facets.

G

Gemological Institute of America (GIA): Founded in 1931 by Roger Shipley, this non-profit organization upholds the highest standards for grading diamonds and other precious gems. GIA has one of the most-respected and well-regarded gemological laboratories in the world. GIA was responsible for developing and standardizing the diamond grading system that is used today by nearly all other gem labs.

Girdle: The outer edge, or outline, of the diamond’s shape. The girdle is not graded, but rather it is described by its appearance at its thinnest and thickest points. The descriptions of girdle thickness range as follows: extremely thin; thin; medium; slightly thick; thick; extremely thick. While it is less desirable for a round diamond to display an extremely thin or extremely thick girdle, such girdle widths are more common and acceptable in fancy shapes.

Girdle Thickness: The measurement describing the percentage of the diamond’s average girdle diameter.

Grading Report: Sometimes called a “certificate”, although laboratories do not “certify” diamonds. The grading report, issued by an independent laboratory, should accurately describe the proportions, weight, and colour, clarity, symmetry, polish and possible fluorescence seen in the diamond being evaluated.

H

Hardness: Mineral’s resistance to scratching on a smooth surface. Mohs scale of relative hardness consists of 10 minerals, each scratching all those below it in scale and being scratched by all those above it.

High-Pressure High-Temperature (HPHT): HPHT treatments are used to improve the colour grade of diamonds. It was first used in the 1970s to produce yellow and green diamonds.

GLOSSARY OF TECHNICAL TERMS

Today, the HPHT process is used to turn cheap brown diamonds into more expensive colourless diamonds. General Electric has patented a variation on the technique - such diamonds are sold as Bellataire ® diamonds.

In the case of colourless diamonds, this treatment is effective only on very rare Type IIa or Type Ia/b diamonds.

The HPHT process is a form of diamond treatment, so such diamonds should be disclosed to the buyer. Diamonds treated in this manner are becoming more widespread, as it allows lesser colour grades of diamonds to be sold at higher prices.

Detecting diamonds treated by the HPHT process takes special equipment and skills. The best way is to obtain a report from a gem laboratory. If the report states that the diamond is “enhanced”, it means the diamond has been treated.

Hoge Raad voor Diamant or The Diamond High Council (HRD): HRD is a laboratory that offers a grading report.

Hue: Pure, spectral (prismatic) colour. Hues include gradations and mixtures of red, orange, yellow, green, blue, violet and purple.

I

International Gemological Institute (IGI): A laboratory that offers a grading report. IGI also produces written appraisals.

Inclusion: A clarity characteristic found within a diamond. Most inclusions were created when the gem first formed in the earth.

Irradiated Diamond: A diamond which has been exposed to radiation.

L

Loupe: Magnifying glass usually of 10X.

M

Mohs Scale: The ten-point scale of mineral hardness, keyed arbitrarily to the minerals talc, gypsum, calcite, fluorite, apatite, orthoclase, quartz, topaz, corundum, and diamond.

P

Pavilion: The lower portion of the diamond, below the girdle.

Pavilion Angle: The angle measured between the girdle and the pavilion main facet.

Pavilion Main Facet: The eight facets found on the pavilion of a round brilliant diamond. Their points touch the girdle.

Point: A unit of measurement used to describe the weight of diamonds. One point is equivalent to one-hundredth of a carat.

Polish: Refers to any blemishes on the surface of the diamond which are not significant enough to affect the clarity grade of the diamond. Examples of blemishes that might be considered as ‘polish’ characteristics are faint polishing lines and small surface nicks or scratches. Polish is regarded as an indicator of the quality of a diamond’s cut. It is graded as either Ideal, Excellent, Very Good, Good, Fair or Poor.

GLOSSARY OF TECHNICAL TERMS

Polish Lines: Tiny parallel lines left by polishing. Fine parallel ridges confined to a single facet, caused by crystal structure irregularities, or tiny parallel polished grooves produced by irregularities in the scaife surface.

Polish Mark: Surface clouding caused by excessive heat (also called burn mark, or burnt facet), or uneven polished surface resulting from structural irregularities.

R

Ratio: A comparison of how much longer a diamond is than it is wide. It is used to analyze the outline of fancy shapes only; it is never applied to round diamonds. There's really no such thing as an 'ideal' ratio; it's simply a matter of personal aesthetic preferences. For example, while many people are told that a 2 to 1 ratio is best for a marquise, most people actually tend to prefer a ratio of around 1.80 to 1 when they actually look at marquises. And though the standard accepted range for the length-to-width ratio of a marquise generally falls between 1.70 to 1 and 2.05 to 1, there are customers who insist on having 'fatter' marquises of about 1.60 to 1 and other customers who want longer, thinner marquises of 2.25 to 1.

Reflection: The return of light that strikes the surface of a stone.

Refraction: The change in direction of a ray of light as it enters a gemstone.

Rough: Any uncut or unpolished gem material.

Rough Girdle: A grainy or pitted girdle surface, often with nicks.

S

Saturation: A colour's position on a neutral to vivid scale.

Scintillation: Mirror-like reflections from the facets of a gemstone as it turns in the light.

Shape:



➤ **Round Brilliant Diamonds**

This shape has set the standard for all other diamond shapes, and accounts for more than 75% of diamonds sold today. Its 58-facet cut, divided among its crown (top), girdle (widest part) and pavilion (base), is calibrated through a precise formula to achieve the maximum in fire and brilliance.



➤ **Oval Diamonds**

An even, perfectly symmetrical design popular among women with small hands or short fingers. Its elongated shape gives a flattering illusion of length to the hand or fingers.



➤ **Marquise Diamonds**

An elongated shape with pointed ends inspired by the fetching smile of the Marquise de Pompadour and commissioned by the Sun King, France's Louis XIV, who wanted a diamond to match it.



➤ **Pear Shaped Diamonds**

A hybrid cut, combining the best of the oval and the marquise, it is shaped like a sparkling teardrop. It also belongs to that category of diamond whose design most complements a hand with small or average-length fingers.



➤ **Heart Shaped Diamonds**

This is essentially a pear-shaped diamond with a cleft at the top. The skill of the cutter determines the beauty of the cut.

GLOSSARY OF TECHNICAL TERMS



➤ **Emerald Cut Diamond**

This is a rectangular shape with cut corners. It is known as a step cut because its concentric broad, flat planes resemble stair steps.



➤ **Princess Cut Diamond**

This is a square or rectangular cut with numerous sparkling facets. It is a relatively new cut and often finds its way into solitaire engagement rings. Flattering to a hand with long fingers, it is often embellished with triangular stones at its sides. Because of its design, this cut requires more weight to be directed toward the diamond's depth in order to maximize brilliance. Depth percentages of 70% to 78% are not uncommon.



➤ **Trilliant Diamond**

This is a spectacular wedge of brittle fire. First developed in Amsterdam, the exact design can vary depending on a particular diamond's natural characteristics and the cutter's personal preferences. It may be a traditional triangular shape with pointed corners or a more rounded triangular shape with 25 facets on the crown, 19 facets on the pavilion, and a polished girdle.



➤ **Radiant Diamond**

This square or rectangular cut combines the elegance of the emerald shape diamond with the brilliance of the round, and its 70 facets maximize the effect of its colour refraction. Because of its design, this cut requires more weight to be directed toward the diamond's depth in order to maximize brilliance. Depth percentages of 70% to 78% are not uncommon.

➤ **Cushion Cut Diamond**

An antique style of cut that looks like a cross between an Old Mine Cut (a deep cut with large facets that was common in the late 19th and the early 20th centuries) and a modern oval cut.

The shape of things to come in diamonds has already produced other fanciful and innovative styles such as the flower, cloverleaf, triangle and kite. Nor does it stop there. Some cuts are variations on standard shapes, others are a spin off of the natural crystal formation of the stone, and still others take the idea of shape to revolutionary new heights. Individuality and taste determine the fashion, and the magic of the gem cutter transforms each stone into a unique work of art.

Star Facets: The eight triangular facets that surround the table facet of a round, brilliant-cut diamond.

GLOSSARY OF TECHNICAL TERMS

Symmetry: Refers to variations in a diamond's symmetry. The small variations can include misalignment of facets or facets that fail to point correctly to the girdle (this misalignment is completely undetectable to the naked eye). Symmetry is regarded as an indicator of the quality of a diamond's cut. It is graded as either Ideal, Excellent, Very Good, Good, Fair or Poor.

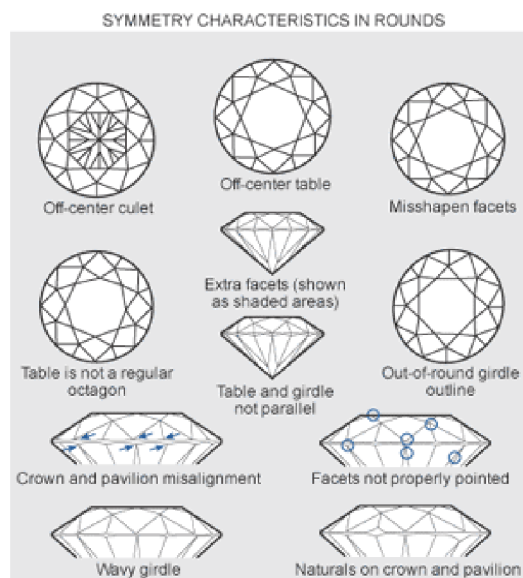

Synthetic: A man-made gem material that has essentially the same physical, optical and chemical properties as that of its natural counterpart.

T

Table: The flat facet on the top of the diamond. It is the largest facet on a cut diamond.

Table Percentage: The value which represents how the diameter of the table facet compares to the diameter of the entire diamond. A diamond with a 60% table has a table which is 60% as wide as the diamond's outline. For a round diamond, gemologists calculate table percentage by dividing the diameter of the table, which is measured in millimeters (this millimeter measurement does not appear on diamond grading reports) by the average girdle diameter (an average of the first two millimeter measurements on the top left-hand side of a diamond grading report). For a fancy shape diamond, table percentage is calculated by dividing the width of the table, at the widest part of the diamond, by the millimeter width of the entire stone (this total width measurement is the second of the three millimeter values in the top left-hand corner of the diamond grading report). Contrary to popular misconception, having a small table percentage (53% to 57%) does not make a round diamond any more brilliant than a diamond with a larger table.

Transparency: The ability of a substance to transmit light.

Treated Diamonds: A general term used to describe gemstones that have been artificially modified to improve their colour or clarity. Techniques include, fracture filling (clarity enhancement), high pressure high temperature (HPHT) annealing, irradiation and surface colouration. Gemological laboratories have the equipment and experience to detect the more difficult treatments.

U

Upper-Girdle Facet: One of the 15 facets found on the lower crown portion of the diamond (abutting the girdle).

CAUTIONARY NOTE REGARDING FORWARD-LOOKING STATEMENTS

All statements contained in this Prospectus, statements made in press releases and oral statements that may be made by the Vendors, us or our officers, Directors or employees that are not statements of historical fact constitute “forward-looking statements”. Some of these statements can be identified by forward-looking terms such as “expect”, “believe”, “plan”, “intend”, “estimate”, “anticipate”, “may”, “will”, “would” and “could” or similar words. However, these words are not the exclusive means of identifying forward-looking statements. All statements regarding our expected financial position, business strategy, plans and prospects are forward-looking statements. These forward-looking statements including statements as to our revenue and profitability, cost measures, planned strategy and any other matters discussed in this Prospectus regarding matters that are not historical fact are only predictions. These forward-looking statements involve known and unknown risks, uncertainties and other factors that may cause our actual results, performance or achievements to be materially different from any future results, performance or achievements expected, expressed or implied by such forward-looking statements.

Given the risks and uncertainties that may cause our actual future results, performance or achievements to be materially different from that expected, expressed or implied by the forward-looking statements in this Prospectus, we advise you not to place undue reliance on those statements. None of our Company, the Vendors, the Manager, our advisors or any other person represents or warrants that our actual future results, performance or achievements will be as discussed in those statements. Our actual results may differ materially from those anticipated in those forward-looking statements as a result of the risks faced by us.

Investors are, in particular, advised not to place reliance on any forward-looking statements made outside the context of, and which had not been made in connection with the preparation of, this Prospectus. Such forward-looking statements may have been overtaken by events and may not be representative of our actual future results, performance or achievements. Investors are advised that their investment decisions should be made solely on the basis of the information contained in this Prospectus. None of our Company, the Vendors, the Manager, our advisors or any other person represents or warrants that our actual future results, performance or achievements will be as discussed in any forward-looking statements made outside the context of, and which had not been made in connection with the preparation of, this Prospectus.

Further, our Company, the Vendors and the Manager disclaim any responsibility to update any of those forward-looking statements or publicly announce any revisions to those forward-looking statements to reflect future developments, events or circumstances. We are, however, subject to the provisions of the Securities and Futures Act and the Listing Manual regarding corporate disclosure. In particular, pursuant to Section 241 of the Securities and Futures Act, if after this Prospectus is registered but before the close of the Offer, our Company becomes aware of (a) a false or misleading statement or matter in this Prospectus; (b) an omission from this Prospectus of any information that should have been included in it under Section 243 of the Securities and Futures Act; or (c) a new circumstance that has arisen since this Prospectus was lodged with the Authority and would have been required by Section 243 of the Securities and Futures Act to be included in this Prospectus, if it had arisen before this Prospectus was lodged and that is materially adverse from the point of view of an investor, the Company may lodge a supplementary or replacement prospectus with the Authority.

SELLING RESTRICTIONS

Singapore

This Prospectus does not constitute an offer, solicitation or invitation to subscribe for and/or purchase the Invitation Shares in any jurisdiction in which such offer, solicitation or invitation is unlawful or is not authorised or to any person to whom it is unlawful to make such offer, solicitation or invitation. No action has been or will be taken under the requirements of the legislation or regulations of, or of the legal or regulatory authorities of, any jurisdiction, except for the lodgement and/or registration of this Prospectus in Singapore in order to permit a public offering of the Invitation Shares and the public distribution of this Prospectus in Singapore. The distribution of this Prospectus and the offering of the Invitation Shares in certain jurisdictions may be restricted by the relevant laws in such jurisdictions. Persons who may come into possession of this Prospectus are required by us, the Vendors, the Manager, the Underwriter and the Placement Agent to inform themselves about, and to observe and comply with, any such restrictions. Persons to whom a copy of this Prospectus has been issued shall not circulate to any other person, reproduce or otherwise distribute this Prospectus or any information herein for any purpose whatsoever nor permit or cause the same to occur.

Israel

In the State of Israel, this Prospectus is being distributed only to, and is directed at, investors listed in the first addendum (the "Addendum") to the Israel Securities Law, mainly, joint investment funds, provident funds, insurance companies, banks, portfolio managers, investment advisors, members of the TASE purchasing for themselves, underwriters, venture capital funds and corporations with a shareholders equity in excess of NIS250,000,000, each as defined in the Addendum (collectively, "Institutional Investors"). Institutional Investors may be required to submit written authorization that they fall within the scope of the Addendum. In addition, the Company, the Vendors and/or any third parties may distribute and direct this Prospectus, at their sole discretion, to investors who do not fall within one of the definitions in the Addendum, provided that the number of such investors shall be no greater than 35 in any 12-month period.

India

This Prospectus has not been and will not be registered with the Registrar of Companies in India and accordingly, this document may not be issued, circulated or distributed in India. This Prospectus may also be issued in a manner which does not constitute an offer, solicitation or invitation to the public in India to acquire or subscribe for and/or purchase the Invitation Shares.

Hong Kong

The Manager has represented and agreed that (i) it has not offered or sold and will not offer or sell in Hong Kong, by means of any document, any Shares other than (a) to "professional investors" as defined in the Securities and Futures Ordinance (Cap. 571) of Hong Kong (the "Securities and Futures Ordinance") and any rules made thereunder; (b) to persons whose ordinary business is to buy or sell shares or debentures, whether as principal or agent, or (c) in circumstances which do not result in the document being a "prospectus" as defined in the Companies Ordinance (Cap. 32) of Hong Kong (the "Companies Ordinance") or which do not constitute an offer to the public within the meaning of the Companies Ordinance; and (ii) it has not issued or had in its possession for the purposes of issue, and will not issue or have in its possession for the purposes of issue, any advertisement, invitation or document relating to the Shares, which is directed at, or the contents of which are likely to be accessed or read by, the public of Hong Kong (except if permitted to do so under the securities laws of Hong Kong) other than with respect to Shares which are intended to be disposed of only to persons outside Hong Kong or only to "professional investors" as defined in the Securities and Futures Ordinance and any rules made thereunder.

PURCHASE BY OUR COMPANY OF OUR OWN SHARES

Under the laws of Israel, a company may purchase its own shares, subject to certain conditions. The Israeli Companies Law treats a repurchase of shares by a company as a distribution to the company's shareholders. A distribution may be paid only out of profits and other surplus, as defined in the Israeli Companies Law, as of the date of the most recent financial statements or as accrued over a period of two years, whichever is higher. Alternatively, if the company does not have sufficient profits or other surplus, then permission to effect a distribution can be granted by order of an Israeli court. Prior to granting such an order, the company is required to give notice of the proposed distribution to its creditors, who are entitled to file objections with the court. In any event, a distribution is permitted only if there is no reasonable concern that the distribution will prevent the company from satisfying its existing and foreseeable obligations as they become due. Pursuant to our Company's Articles of Association, the Directors are authorized to approve distributions, including a repurchase of shares, subject to the provisions of the Israeli Companies Law. Any shares repurchased by a company lose their rights and are referred to as "dormant shares."

For further details, please see Annex E on pages E-1 to E-18 of this Prospectus entitled "Comparison between the Companies Act and Israeli Companies Law" under the subheading "Powers of Issuer to purchase its own Shares".

Our Company presently has no intention of purchasing our Shares after the listing. However, if we decide to do so later, we will do so in accordance with the applicable Israeli laws and the rules of the SGX-ST.

ATTENDANCE AT GENERAL MEETINGS AND VOTING POWERS

Under the Israeli Companies Law, only those persons whose names appear in the shareholders' register of a company are considered shareholders, with rights to vote at general meetings. However, a company is entitled to operate an additional shareholders' register outside Israel. Our Directors have appointed a share registrar to administer a shareholders' register in Singapore with respect to our Shares that are listed for trading on the SGX-ST. Accordingly, Depositors whose names are shown in the records of the CDP will be recognised as shareholders of our Company and, among other things, will have a right to vote at general meetings of our Company. Shareholders (including Depositors) who cannot attend a meeting personally may enable their nominees to attend as their proxies, provided that they supply a written proxy form to our Company (at its registered address, or at its principal place of business or at the offices of its registrar and/or transfer agent or at such places as the Directors may specify) at least 24 hours prior to the time of the relevant general meeting.

A corporate entity being a Shareholder (including a Depositor) may, by resolution of its directors or any other managing body thereof, authorize any person to be its representative at any general meeting of the Company. Any person so authorized shall be entitled to exercise on behalf of such Shareholder all the powers that the latter could have exercised if it were an individual shareholder. Upon the request of the chairman of the general meeting, written evidence of such authorization (in a form acceptable to the Chairman) shall be delivered to him.

Most of the general meetings of our Company are envisaged to be held at our offices in Ramat Gan, Israel.

TAKE-OVERS

Mandatory Take-Over Offers, Voluntary Offers and Partial Offers under the Singapore Code

Although the Israeli Companies Law contains certain provisions on mandatory tender offers for our Shares that are applicable to us (as described below), our Israeli legal counsel has opined that the provisions of the Israeli Companies Law, including the regulations made under the Israel Securities Law prescribing the procedures for tender offers, do not apply to us as our Shares are not listed on the TASE or offered to the public in Israel, and as they were advised by our Singapore legal counsel that the laws and rules in Singapore have provisions covering the acquisitions of interests in shares in a public listed company and the obligations to make a compulsory offer of shares in the company in certain situations (it should also be noted, as stated in the following paragraph, that we have incorporated the provisions of the Singapore Code and of section 140 of the Securities and Futures Act in our Company's Articles of Association). It should be noted however, that certain provisions of the Israeli Companies Law, concerning the conduct of compulsory tender offers with regard to a shareholder holding 90% or more of a company's issued share capital, do apply to our Company - as further described on page 24 of this Prospectus.

The Singapore Code does not apply to companies incorporated outside Singapore. As we are incorporated in Israel, the Singapore Code does not ordinarily apply to take-over offers for our Company.

In order to overcome the absence of an applicable code on take-overs, we have adopted the Singapore Code provisions by incorporating the provisions of the Singapore Code and section 140 of the Securities and Futures Act in our Company's Articles of Association. Hence, in addition to observing the mandatory tender offer requirements under the Israeli Companies Law, our Shareholders must also observe the requirements for mandatory take-over offers, voluntary offers and partial offers under the Singapore Code.

Under the Singapore Code, any person who (i) acquires whether by a series of transactions over a period of time or not, shares which (taken together with shares held or acquired by persons acting in concert with him) carry 30% or more of the voting rights of a company; or (ii) together with persons acting in concert with him (if any), holds not less than 30% but not more than 50% of the voting rights and such person, or any person acting in concert with him, acquires in any period of six months additional shares carrying more than 1% of the voting rights, must make a mandatory take-over offer in compliance with Rule 14 of the Singapore Code. In addition, a person, who has not incurred an obligation to make a mandatory offer, may in accordance with Rule 15 of the Singapore Code, make a voluntary offer conditional upon him receiving acceptances in respect of voting rights which, together with voting rights acquired or agreed to be acquired before or during the offer, will result in him and persons acting in concert with him (if any) holding more than 50% of the voting rights. Rule 16 of the Singapore Code also allows for partial offers that result in the offeror and persons acting in concert holding (i) less than 30%; or (ii) more than 50% of the voting rights in the company to be made if certain conditions are met.

Although our Company has presently adopted the Singapore Code provisions in addition to the mandatory tender offer requirements under the Israeli Companies Law, our Company may in the future seek an exemption from the substantive provisions of the Singapore Code described in the paragraph above.

Article 62 of our Company's Articles of Association (as described below) will, due to its binding effect on our Shareholders (including Depositors), require our Shareholders who make take-over offers in respect of our Shares to comply with the Singapore Code. Article 62 only binds our Shareholders. A person (including a corporation) who is not our Shareholder will not be bound to comply with the Singapore Code by virtue of the Articles of Association. We have provided in Article 63 that any Shares acquired in violation of the take-over obligations will be deemed to be dormant Shares with no rights whatsoever for as long as they are held by the acquirer of such Shares. However, it is uncertain whether this will be effective in securing compliance with the Singapore Code. This may affect you because, even if a take-over offer is made for our Shares, either because it is required by the Israeli Companies Law or otherwise, the take-over offer may not be made entirely in accordance with the procedures stipulated in the Singapore Code. Article 62 provides that for so long as the Shares are listed on the SGX-ST, the provisions of section 140 of the Securities and Futures Act and the provisions of the Singapore Code shall apply, *mutatis mutandis*, to the Company.

TAKE-OVERS

Mergers and Tender Offers under Israeli Companies Law

The Israeli Companies Law provides for mergers between two Israeli companies, provided that each party to the transaction obtains the approval of its board of directors and shareholders.⁽¹⁾ Following the approval by the board of directors of each of the merging companies, each company is required to file a merger proposal with the Israeli Registrar of Companies. For purposes of the shareholder vote of each company, unless a court rules otherwise, the merger will not be deemed approved if a majority of the shares not held by the other company (or by any person who holds 25% or more of the shares or the right to appoint 25% or more of the directors of the other company, including their relatives and entities controlled thereby) and represented at the general meeting held in this regard, voted against the merger (the calculation of such majority shall not include abstaining shareholders). Upon the request of a creditor of either company to the proposed merger, the court may delay or prevent the merger if it concludes that there exists a reasonable concern that as a result of the merger, the surviving company will be unable to satisfy the obligations of that party. Finally, a merger may not be completed unless at least 30 days from the date of receipt of the shareholders' resolution in each of the merging companies and 50 days from the time that the requisite merger proposals have been filed with the Israeli Registrar of Companies have passed.

In addition, provisions of the Israeli Companies Law that deal with "arrangements" between a company and its shareholders may be used to effect squeeze-out transactions and other arrangements, including mergers. These provisions generally require that the arrangement be approved by a majority of the participating shareholders holding at least 75% of the shares who voted on the matter. In addition to shareholder approval, court approval of the arrangement is required, which may entail further delay.

The Israeli Companies Law also provides that an acquisition of shares in a public company must be made by means of a tender offer if, as a result of the acquisition, a person would become a holder of 25% or more of the company, unless there is already another holder of 25% of the company. Similarly, the Israeli Companies Law provides that an acquisition of shares in a public company must be made by means of a tender offer if, as a result of the acquisition, the purchaser would become a holder of 45% or more of the company, unless there is already another holder of 45% or more of the company. This requirement does not apply: (i) if the acquisition is made in a private placement (provided that such private placement has been approved by the shareholders meeting as a private placement intended to grant the offeree 25% or more of the company, where no other person holds 25% or more of the company, or 45% or more of the company, where no other person holds 45% or more of the company); or (ii) if a person purchases 25% or more of the company from a shareholder who already holds 25% or more of the company, or if a person purchases 45% or more of the company from a shareholder who already holds 45% or more of the company; or (iii) if a regulatory exemption applies. The tender offer must be extended to all shareholders, but the offeror is not required to purchase less than 5% of the company's outstanding shares, regardless of how many shares are tendered by shareholders. The tender offer may be consummated only if (i) at least 5% of the company's outstanding shares will be acquired by the offeror; and (ii) the number of shares tendered in the offer exceeds the number of shares whose holders objected to the offer (the votes of the controlling shareholder in the offeror, of shareholders who hold 25% or more of the company, or any person acting on their behalf, including relatives thereof, or corporations controlled by any of the above, shall not be taken into account in the calculation of this majority). Shares that are acquired in violation of this requirement will be deemed "dormant shares" and will have no rights whatsoever for so long as they are held by the acquirer.

However, and as specified on page 23 of this Prospectus, our Israeli legal counsel has opined that the aforementioned provisions do not apply to us as our Shares are not listed on the TASE or offered to the public in Israel.

If, as a result of an acquisition of shares the acquirer will hold more than 90% of a company's outstanding shares, the Israeli Companies Law requires that the acquisition be made by means of a tender offer for all of the outstanding shares. If less than 5% of the outstanding shares are not tendered in the tender offer, all the shares that the acquirer offered to purchase will be transferred to it. The Israeli Companies Act also provides for appraisal rights if any shareholder files a request in court within three months following the consummation of a full tender offer. If more than 5% of the outstanding shares are not tendered in the tender offer, then the acquirer may not acquire shares in the tender offer that will cause his shareholding to exceed 90% of the outstanding shares.

Note:

- (1) However, the approval of the shareholders of the target company will not be required where the target company is a fully-owned subsidiary of the surviving company, and the approval of the shareholders of the surviving company shall not be required if (i) the proposed merger does not necessitate the amendment of the surviving company's Memorandum or Articles of Association; (ii) the surviving company does not issue, as part of the merger, more than 20% of the voting rights in the surviving company, and no person shall become the controlling shareholder of the surviving company's securities held by such person are to be measured on an "as converted" basis; and (iii) no person holds 25% or more of the shares or the right to appoint 25% or more of the directors of both companies.

DETAILS OF THE INVITATION

LISTING ON THE SGX-ST

We have applied to the SGX-ST for permission to deal in, and for quotation of, all our Shares already issued (including the Vendor Shares), the New Shares, the Additional Shares and the Option Shares on the Official List of the SGX-ST. Such permission will be granted when we have been admitted to the Official List of the SGX-ST. No Shares shall be allotted on the basis of the Prospectus later than six months after the date of registration of this Prospectus.

Acceptance of applications for the Invitation Shares will be conditional upon permission being granted to deal in, and for quotation of, all our issued Shares (including the Vendor Shares), the New Shares, the Additional Shares and the Option Shares. If permission is not granted for any reason, monies paid in respect of any application accepted will be returned to you at your own risk, without interest or any share of revenue or other benefit arising therefrom, and you will not have any claims whatsoever against us, the Vendors or the Manager.

In connection with the Invitation, the Vendors have granted the Manager an Over-Allotment Option exercisable by the Manager, in whole or in part, during the period commencing on the date of commencement of trading of our Shares on the SGX-ST (the "Commencement Date") and expiring on the date falling 30 days after the Commencement Date. The Manager may purchase and/or procure purchasers for the Additional Shares, representing in aggregate not more than 15% of the Invitation Shares (before the exercise of the Over Allotment Option), at the Invitation Price, solely for the purpose of covering over-allotments (if any) made in connection with the Invitation. The Manager may over-allot and effect transactions, which stabilize or maintain the market price of the Shares, subject to compliance with the laws of Singapore. Such stabilization, if commenced, may be discontinued by the Manager at any time at the Manager's discretion in accordance with the laws of Singapore.

The SGX-ST assumes no responsibility for the correctness of any of the statements made, opinions expressed or reports contained in this Prospectus. Admission to the Official List of the SGX-ST is not to be taken as an indication of the merits of the Invitation, our Company, our subsidiaries, our Shares, the New Shares, the Additional Shares or the Option Shares.

A copy of this Prospectus, together with a copy of the Application Forms, has been lodged with and registered by the Authority. The Authority assumes no responsibility for the contents of this Prospectus. Registration of this Prospectus by the Authority does not imply that the Securities and Futures Act, or any other legal or regulatory requirements, have been complied with. The Authority has not, in any way, considered the merits of the Shares, the New Shares, the Additional Shares or the Option Shares, as the case may be, being offered or in respect of which an invitation is made, for investment.

We are subject to the provisions of the Securities and Futures Act and the Listing Manual regarding corporate disclosure. In particular, pursuant to Section 241 of the Securities and Futures Act, if after this Prospectus is registered but before the close of the Offer, we become aware of:

- (a) a false or misleading statement or matter in this Prospectus;
- (b) an omission from this Prospectus of any information that should have been included in it under Section 243 of the Securities and Futures Act; or
- (c) a new circumstance that has arisen since this Prospectus was lodged with the Authority and which would have been required by Section 243 of the Securities and Futures Act to be included in this Prospectus, if it had arisen before the Prospectus was lodged,

and that is materially adverse from the point of view of an investor, we will lodge a supplementary or replacement prospectus with the Authority.

Where the Authority issues a stop order pursuant to Section 242 of the Securities and Futures Act, and applications to subscribe for and/or purchase the Invitation Shares have been made prior to the stop order, then:

DETAILS OF THE INVITATION

- (a) in the case where the Invitation Shares have not been issued and/or sold to you, your application pursuant to the Invitation shall be deemed to have been withdrawn and cancelled and our Company shall (as well as on behalf of the Vendors), within 14 days from the date of the stop order, refund the application monies to you; or
- (b) in the case where the Invitation Shares have been issued and/or sold to you but trading has not commenced, the issue and/or sale of the Invitation Shares pursuant to the Invitation shall be deemed to be void and
 - (i) in the case where the Invitation Shares have been issued, our Company shall within 14 days from the date of the stop order, refund you all application monies you have paid; or
 - (ii) in the case where the Invitation Shares have been sold, (a) we will, on behalf of the Vendors, inform you to return such documents to our Company within 14 days from the date of the stop order; and (b) we will, on behalf of the Vendors, refund the application monies to you within 7 days from the receipt of those documents (if applicable) or the date of the stop order, whichever is later.

Monies paid in respect of your application will be returned to you at your own risk, without interest or any share of revenue or other benefit arising therefrom, and you will not have any claims whatsoever against us, the Vendors or the Manager.

No person is authorised to give any information or to make any representation not contained in this Prospectus in connection with the Invitation and, if given or made, such information or representation must not be relied upon as having been authorised by us, our Directors, our Vendors or the Manager. Neither the delivery of this Prospectus and the Application Forms nor the Invitation shall, under any circumstances, constitute a continuing representation or create any suggestion or implication that there has been no change in the affairs of our Company or in any statement of fact or information contained in this Prospectus since the Latest Practicable Date. Where material changes occur, we will promptly make an announcement of the same to the SGX-ST and the public and, if required, lodge a supplementary or replacement document pursuant to Section 241 of the Securities and Futures Act and take immediate steps to comply with the requirements of Section 241 of the Securities and Futures Act. All applicants should take note of any such announcement and, upon the release of such announcement and/or documents, shall be deemed to have notice of such changes.

Save as expressly stated in this Prospectus, nothing herein is, or may be relied upon as, a promise or representation as to our future performance or policies. This Prospectus has been prepared solely for the purpose of the Invitation and may not be relied upon by any person other than the applicants in connection with their applications for Invitation Shares, or any other purpose. This Prospectus does not constitute an offer, invitation or solicitation, to subscribe for and/or purchase the Invitation Shares in any jurisdiction in which such offer, invitation or solicitation is unauthorised or unlawful, nor does it constitute an offer, invitation or solicitation to any person to whom it is unlawful to make such an offer, invitation or solicitation.

Copies of this Prospectus and the Application Forms and envelopes may be obtained on request, subject to availability, during office hours from:

**UOB Asia Limited
1 Raffles Place #13-01
OUB Centre
Singapore 048616**

and members of the Association of Banks in Singapore, members of the SGX-ST and merchant banks in Singapore.

DETAILS OF THE INVITATION

A copy of this Prospectus is also available on:

- (a) the SGX-ST website <http://www.sgx.com>; and
- (b) the Authority's website at <http://masnet.mas.gov.sg/operasdrprosp.nsf>

The Application List will open at 10.00 a.m. on 6 April 2005 and will remain open until 12.00 noon on the same day or until such other date and/or time or such other period or periods as our Company and the Vendors may, in consultation with the Manager, decide subject to any limitation under all applicable laws. Where a supplementary document or replacement document has been lodged with the Authority, the Application List shall be kept open for at least 14 days after the lodgement of the supplementary document or replacement document. Where an applicant has notified our Company and the Vendors within 14 days from the date of lodgement of the supplementary document or replacement document of his wish to exercise his option under the Securities and Futures Act to withdraw his application, our Company and the Vendors (as the case may be) shall pay to him all monies paid by him on account of his application for the Invitation Shares pursuant to the Invitation without interest or any share of revenue or other benefit arising therefrom and at the applicant's risk within 7 days from the receipt of such notification.

Where applications have been made for the Invitation Shares prior to the lodgement of the supplementary or replacement prospectus, we shall (and shall on behalf of the Vendors), within seven days from the date of lodgement of the supplementary or replacement prospectus, either:

- (a) **provide the applicants with a copy of the supplementary or replacement prospectus, as the case may be, and provide the applicants with an option to withdraw their applications, or**
- (b) **treat the applications as withdrawn and cancelled and return all monies paid, without interest or any share of revenue or other benefit arising therefrom, in respect of any application accepted within seven days from the date of lodgement of the supplementary or replacement prospectus.**

Any applicant who wishes to exercise his option to withdraw his application shall, within 14 days from the date of lodgement of the supplementary or replacement prospectus, notify us whereupon we shall, within seven days from the receipt of such notification, return the application monies without interest or any share of revenue or other benefit arising therefrom and at the applicant's own risk.

Details of the procedures for application of the Invitation Shares are set out in Annex G on pages G-1 to G-18 of this Prospectus.

DETAILS OF THE INVITATION

INDICATIVE TIMETABLE FOR LISTING

In accordance with the SGX-ST's News Release of 28 May 1993 on the trading of initial public offering shares on a "when issued" basis, an indicative timetable is set out below for the reference of applicants:

Indicative Date and Time	Event
6 April 2005, 12.00 noon	: Close of Application List
7 April 2005	: Balloting of applications, if necessary (in the event of over-subscription for the Offer Shares)
8 April 2005, 9.00 a.m.	: Commence trading on a "when issued" basis
21 April 2005	: Last day of trading on a "when issued" basis
22 April 2005, 9.00 a.m.	: Commence trading on a "ready" basis
27 April 2005	: Settlement date for all trades done on a "when issued" basis and for all trades done on a "ready" basis on 22 April 2005

The above timetable is only indicative as it assumes that the closing of the Application List takes place on 6 April 2005, the date of admission of our Company to the Official List of the SGX-ST will be 8 April 2005, the SGX-ST's shareholding spread requirement will be complied with and the New Shares will be issued and fully paid-up prior to 8 April 2005. The actual date on which our Shares will commence trading on a "when issued" basis will be announced when it is confirmed by the SGX-ST.

The above timetable and procedure may be subject to such modifications as the SGX-ST may, in its absolute discretion decide, including the decision to permit trading on a "when issued" basis and the commencement date of such trading. **All persons trading in our Shares on a "when issued" basis, do so at their own risk. In particular, persons trading in our Shares before their Securities Accounts with CDP are credited with the relevant number of Shares do so at the risk of selling Shares which neither they nor their nominees, if applicable, have been allotted and/or allocated with or are otherwise beneficially entitled to. Such persons are exposed to the risk of having to cover their net sell positions earlier if "when issued" trading ends sooner than the indicative date mentioned above. Persons who have net sell positions traded on a "when issued" basis should close their positions on or before the first day of "ready" basis trading.**

The Invitation will be open from 1 April 2005 to 6 April 2005.

In the event of an early or extended closure of the Application List or the shortening or extension of the time period during which the Invitation is open, we will publicly announce the same:

- (i) through a SGXNET announcement to be posted on the Internet at the SGX-ST website <http://www.sgx.com>; and
- (ii) in a local newspaper.

We will provide details of the results of the Invitation through the channels described in (i) and (ii) above.

Investors should consult the SGX-ST announcement on the "ready" trading date on the Internet (at the SGX-ST website <http://www.sgx.com>) or newspapers or check with their brokers on the date on which trading on a "ready" basis will commence.

PLAN OF DISTRIBUTION

The Invitation Price was arrived at after consultations between ourselves, the Vendors and the Manager and after taking into consideration, *inter alia*, prevailing market conditions and estimated market demand for our Shares. The Invitation Price is the same for all the Invitation Shares and is payable in full on application.

Offer Shares

The Offer Shares are made available to members of the public in Singapore for subscription and/or purchase at the Invitation Price.

In the event of an under-subscription for the Offer Shares as at the close of the Application List, the number of Offer Shares not subscribed for and/or purchased shall be made available to satisfy applications for the Placement Shares to the extent that there is an over-subscription for the Placement Shares as at the close of the Application List.

In the event of an over-subscription of the Offer Shares as at the close of the Application List and the number of Placement Shares are fully subscribed or over-subscribed as at the close of the Application List, the successful applications for the Offer Shares will be determined by ballot or otherwise as determined by our Directors and the Vendors, after consultation with the Manager, and approved by the SGX-ST.

Pursuant to the terms and conditions contained in the Management and Underwriting Agreement as disclosed in the section entitled "General and Statutory Information" under the subheading "Management, Underwriting and Placement Arrangements" on pages 159 and 160 of this Prospectus, our Company has appointed UOB Asia to manage the Invitation and underwrite the Offer Shares. In the event of under-subscription for the Offer Shares, UOB Asia will be committed to subscribe for and/or purchase and pay for all the unsubscribed or unsold Offer Shares. However, UOB Asia may, at its absolute discretion, appoint one or more sub-underwriters.

Placement Shares

In the event of an under-subscription for the Placement Shares as at the close of the Application List, the number of Placement Shares not subscribed for and/or purchased shall be made available to satisfy applications for the Offer Shares to the extent that there is an over-subscription for the Offer Shares as at the close of the Application List.

Pursuant to the terms and conditions contained in the Placement Agreement as disclosed in the section entitled "General and Statutory Information" under the subheading "Management, Underwriting and Placement Arrangements" on pages 159 and 160 of this Prospectus, UOB Asia has agreed to subscribe for and/or purchase or procure subscriptions and/or purchasers for the Placement Shares. In the event of under-subscription for the Placement Shares, UOB Asia will be committed to subscribe for and/or purchase and pay for all the unsubscribed or unsold Placement Shares. However, UOB Asia may, at its absolute discretion, appoint one or more sub-placement agents.

Subscribers or purchasers of Placement Shares may be required to pay brokerage (and if so required, such brokerage will be up to 1.0% of the Invitation Price), stamp duties and other similar charges. The terms and conditions and procedures for applications and acceptance are described in Annex G on pages G-1 to G-18 of this Prospectus.

PLAN OF DISTRIBUTION

To the Company's best knowledge none of the members of our Company's management or employees intend to subscribe for and/or purchase Shares amounting to more than 5% of the Invitation Shares.

As at the date of this Prospectus, we are not aware of any person who intends to subscribe for and/or purchase more than 5% of the Invitation Shares. However, through a book-building process to assess market demand for our Shares, there may be person(s) who may indicate an interest to subscribe for and/or purchase more than 5% of the Invitation Shares. If such person(s) were to make an application amounting to more than 5% of the Invitation Shares and are subsequently allotted and/or allocated such number of Shares, we will make the necessary announcements at the appropriate time. The final allotment of Shares will be in accordance with the shareholding spread and distribution guidelines as set out in Rule 210 of the Listing Manual.

No Shares shall be allotted and/or allocated on the basis of this Prospectus later than six months after the date of registration of this Prospectus.

OVER-ALLOTMENT AND STABILIZATION

In connection with the Invitation, the Vendors have granted the Manager an Over-Allotment Option exercisable by the Manager, in whole or in part, during the period commencing on the date of commencement of trading of our Shares on the SGX-ST (“Commencement Date”) and expiring on the date falling 30 days after the Commencement Date, to purchase from the Vendors the Additional Shares, representing in aggregate not more than 15% of the Invitation Shares (before the exercise of the Over Allotment Option), at the Invitation Price, solely for the purpose of covering over-allotments (if any) made in connection with the Invitation.

The total number of issued and existing Shares immediately after the Invitation will be 243,132,000 Shares. The exercise of the Over-Allotment Option will not increase this total number of issued and existing Shares immediately after the Invitation.

In addition, the Vendors have entered into a securities lending agreement with the Manager to lend up to 9,330,000 Shares to the Manager for the purpose of effecting the over-allotment or price stabilization activities in connection with the Invitation. As disclosed in the section “Share Capital” under the subheading “Moratorium” on page 62 of this Prospectus, the Vendors’ entire shareholding of 174,738,000 Shares, excluding the Vendor Shares to be disposed of, will be subject to a moratorium, save for the 9,330,000 Shares to be lent to the Manager pursuant to the securities lending agreement. At the conclusion of the price stabilization activities, Shares lent to the Manager that are returned to the Vendors will thereafter be subject to the moratorium undertaking.

In connection with the Invitation, the Manager may over-allot or effect transactions which stabilize or maintain the market price of our Shares, at levels which might not otherwise prevail in the open market, subject to compliance with the laws of Singapore. Such transactions may be effected on the SGX-ST and in other jurisdictions where it is permissible to do so, in each case in compliance with all applicable laws and regulations. Such stabilization, if commenced, may be discontinued by the Manager at any time and shall not be effected after the earlier of (a) the date falling 30 days from the Commencement Date; or (b) the date when the over-allotment of our Shares which are subject to the Over-Allotment Option has been fully covered (either through the purchase of our Shares on the SGX-ST or the exercise of the Over-Allotment Option by the Manager, or through both).

None of our Company, the Vendors and the Manager, makes any representation or prediction as to the magnitude of any effect that the transactions described above may have on the price of our Shares. In addition, none of our Company, the Vendors and the Manager makes any representation that the Manager will engage in these transactions or that these transactions, once commenced, will not be discontinued without notice (unless such notice is required by law). The Manager, being the stabilizing manager, will be required to make a public announcement through the SGX-ST on the cessation of stabilization activities and the amount of the Over-Allotment Option that has been exercised.

PROSPECTUS SUMMARY

The information contained in this summary is derived from, and should be read in conjunction, with the full text of this Prospectus. Terms defined elsewhere in this Prospectus have the same meanings when used herein. Prospective investors should carefully consider the information presented in this Prospectus, particularly the matters set out under "Risk Factors", before buying our Shares.

OVERVIEW OF OUR GROUP

Our Market

The major wholesale diamond trading and manufacturing centres in the world were historically in Israel and Belgium. Today, India is by far the leading manufacturing centre, accounting for over 80% of all stones manufactured worldwide. PRC is already the second most important manufacturing centre, with many plants being set up by international players, primarily from Belgium, the USA and India. Russia, due to legislation enacted to limit the export of rough stones from Russia, is emerging as a manufacturing centre.

Based on information available relating to the Israeli diamond bourse, we believe there are approximately 2,500 active members in the Israeli diamond bourse (including wholesalers and manufacturers). Of these, there are over 200 active manufacturers in Israel.

From information available regarding the Antwerp diamond trade, we are able to estimate that there are approximately 1,000 active members in the Belgian diamond bourse (including wholesalers and manufacturers).

Based on information available relating to the Indian Gem & Jewellery Export Promotion Council, we believe there are over 2,750 active listed members in the diamond panel of the Indian Gem & Jewellery Export Promotion Council (including wholesalers and manufacturers). It is estimated that there are additional non-listed manufacturers of some 750 in number, most of whom are small scale manufacturers. Based on information available on the diamond industry in India, the Company believes that there are over 1 million people employed in the diamond manufacturing and trading industry in India, of which approximately one-third are in the labor-intensive polishing phases of manufacturing, as described below.

Though labour intensive in the end facet-polishing phase, the modern Indian (and other) diamond manufacturing facility is an advanced high technology plant, utilizing computerized systems and automation throughout and housed in modern office buildings. In the past, diamond planning and cutting expertise was passed down through the generations in a family and was thus limited to a relatively small and select group of individuals. The introduction of automation and computerized systems made this knowledge available to non-expert users and thus enabled the establishment of large-scale diamond processing plants.

Based on information available on the diamond manufacturing industry in PRC, the Company estimates that there are over 20,000 persons in the diamond manufacturing industry in PRC, although many of them work in small factories processing very small diamonds and that the PRC is now the second largest producer of diamonds in the world, after India, producing approximately 3 million carats annually.

PROSPECTUS SUMMARY

There are essentially fewer than 50 major gemological laboratories worldwide. The leading laboratories that have the most influence on the diamond industry today, all of whom are our clients, utilizing our products, are:

- Gemological Institute of America (GIA) – USA & worldwide
- American Gem Society (AGS) – USA
- The Diamond High Council (HRD) – Belgium
- International Gemological Institute (IGI) – Worldwide
- European Gemological Institute (EGL) – Worldwide
- Zenhokyo, of the Association of Gem Labs of all Japan (AGL) – Japan
- Central Gemological Laboratory (CGL) – Japan
- National Gem Testing Center (NGTC) – PRC

Our Company

Our Company was incorporated on 8 November 1988 in Israel under the Israeli Companies Ordinance (New Version) 1983 of Israel, as a private limited liability company. We were formerly known as Borimer Ltd. On 21 September 1989, we changed our name to Sarin Research, Development and Manufacture (1988) Ltd and on 31 December 1994, we changed our name to Sarin Technologies Ltd.

Our first product in 1988 was the Robogem™, an automated production system for producing polished gemstones from rough gemstones. Robogem™ captured images of a rough gemstone, determined the maximum yield achievable and cut it into its final shape.

In 1992, we introduced a pioneering grading product for measuring the cut of polished diamonds, the DiaMension™. The product was an automated computerized product for accurately measuring a diamond's cut, thus reducing variances in results previously obtained from manual and visual means of assessment. In 1995, we introduced another innovative product called the DiaExpert™, which was an automated computerized planning system which allowed for the rapid determination of various possibilities of placing, shaping and sizing polished diamonds from the rough stone, hence providing its user with optimal and maximized yields from his valuable rough stones. In 1999, we introduced the use of laser scanning in order to create, for the first time, a three-dimensional model of rough stones revealing both convex and concave surfaces, which increased the effectiveness of our DiaExpert™ product by providing a complete and accurate model of the rough stone. In 2000, we introduced the DiaMark™, a laser-marking product which allowed the DiaExpert™ to automatically inscribe, using laser markings on the rough stone's surface, the optimal sawing plane suggested by the system and accepted by the user. With this new product, we were able to link the planning and production phases by accurately conveying information from the planning stage directly to the production floor.

These products, together with the strategic acquisition of new technologies from third parties, the acquisition of GCI and the incorporation of Sarin India, have entrenched our position in the market as a leading company with proprietary technology specifically applied to the diamond and gemstone industries.

For further details of the milestones of our Group, please refer to the section entitled "General Information on our Company" under the subheading "Our History" on pages 68 to 71 of this Prospectus.

Our Business and Products

We are involved in the development, manufacture and sale of precision technology products that use three-dimensional geometric measurement (metrology) for the processing of diamonds and gems. Our products combine various hardware technologies, mainly electro-optics, electronics, precision mechanics and lasers. The heart of our products is the computer software that combines three-dimensional modelling and advanced mathematical algorithms. Our systems provide smart solutions for every stage and aspect of diamond design and manufacturing, from determining the optimal yield from a rough stone,

PROSPECTUS SUMMARY

to laser markings for cutting rough stones, measuring and analysing polished diamonds, inscription of polished diamonds and technology that assists sales in jewellery stores. Hence, our systems increase the profit margins at various stages of the diamond trade between the purchase price of rough stones and the price of polished diamonds. We believe that over the years, the systems we have developed, produced and marketed have changed the manner in which rough stones are processed into polished ones, in comparison to manual processes previously used by experienced experts, and have established a brand name for ourselves in the diamond industry.

Our products provide diamond dealers with technological solutions for three main areas in the diamond industry:

- (a) Planning the optimal utilization of the rough stones in order to cut the rough stones so as to achieve the maximum yield and value;
- (b) Measurement of two (Colour and Cut) of the four parameters of the polished diamond (Colour, Cut, Clarity and Carat) in order to help determine the value of the diamond, based on the quality grade of its colour and cut; and
- (c) Inscribing on polished diamonds with distinct marks like text, numerals and symbols.

For more details, please refer to the section entitled “General Information on our Company” under the subheading “Our Business” on pages 71 to 77 of this Prospectus.

Our Competitive Strengths

We believe that our competitive strengths are as follows:

- (a) We understand the needs of our customers;
- (b) We have an established track record for innovation and a strong brand name;
- (c) Opinion leaders in the industry use mainly our products;
- (d) Our product improvements are modular and are “add-ons” to our existing product platforms;
- (e) We focus on quality products and services;
- (f) We have highly experienced and dedicated management and development teams; and
- (g) We own proprietary rights to our products.

Further details are set out under the section entitled “General Information on Our Company” under the subheading “Competitive Strengths” on pages 86 to 88 of this Prospectus.

Prospects

The diamond industry is estimated to have an annual sales turnover of approximately US\$9.0 billion for rough stones and US\$16.0 billion for polished diamonds. The cost of the rough stones is high and hence, it is vital that rough stones are used wisely and are processed optimally in order to achieve maximum yield. The price of diamonds is influenced to a considerable extent by the specific physical parameters of each diamond. These parameters are the Carat (weight), Clarity (internal defects of the crystal), Colour and quality of the Cut, collectively known as the four Cs. Therefore, our prospects are dependent on our ability to provide the industry players (from factories which process rough stones, through the traders at various levels and to the final retailer) with products to enable them to measure precisely and objectively these parameters of the diamond in order to increase the profit margins between the initial purchase price of rough stones and the end price of polished diamonds.

PROSPECTUS SUMMARY

We expect our business to be driven primarily by the following trends:

- (i) emerging new diamond manufacturing centres, such as PRC and Russia;
- (ii) increasing use of automation throughout the factories and the streamlining of the process flow from planning through production due to increased pressure on profit and yield margins;
- (iii) increasing use of other cost-saving technologies in order to achieve better profit and yield margins;
- (iv) increasing use of branding by the manufacturers as a means of differentiation of their products from others in the eyes of the consumers;
- (v) increasing consumer demand for certification of the diamonds' quality; and
- (vi) increasing demand for equipment to enable identification of natural and untreated diamonds over the counter prior to purchase.

Our Business Strategies and Future Plans

Our business strategy is to consolidate our position as a market leader for the provision of high technology solutions in the diamond and gemstone industries. To fully leverage the market trends mentioned above, our business strategies are as follows:

1. Enhancing our market presence in existing and emerging markets
2. "One-stop-shop" philosophy

Hence, our future plans focus on the following:

- (a) Increasing our sales to existing customers while attracting new customers worldwide;
- (b) Innovative high-end products with high returns on investment;
- (c) Laser-based cutting and bruting systems to achieve better yield from rough stones, easier production of fancy shapes and enhanced ability to process a wider variety of stones;
- (d) Lower cost products for smaller manufacturers and in-line quality control;
- (e) Penetrating the consumables market with cost-saving technologies;
- (f) Light performance systems (brilliance, fire and scintillation);
- (g) Inscription products;
- (h) Diamond identification systems;
- (i) Recurring income from service contracts; and
- (j) Potential scalability of our technology to other industries.

Further details are set out under the section entitled "Prospects, Business Strategies and Future Plans" under the subheading "Business Strategies and Future Plans" on pages 91 to 94 of this Prospectus.

PROSPECTUS SUMMARY

Our Financial Performance

The following tables present a summary of the financial highlights of our Group and should be read in conjunction with the sections entitled “Management’s Discussion and Analysis of Financial Condition and Results of Operations” and “Independent Auditors’ Report and Financial Statements” on pages 98 to 117 and pages F1 to F34 respectively of this Prospectus.

Selected Items from the Operating Results of our Group

(US\$'000)	FY2001	Audited FY2002	FY2003	Unaudited 1H03	Audited 1H04
Revenue	4,376	8,909	14,694	7,778	7,047
Gross profit	2,677	5,910	10,222	5,408	4,583
Profit from ordinary activities before taxation	609	2,654	5,919	3,464	1,623
Net profit for the year/period	362	2,158	5,329	3,147	1,097
Basic earnings per share (“EPS”) (in Singapore Cents per Share)	0.3	2.0	4.9	2.9	1.0
Diluted EPS (in Singapore Cents)	0.3	2.0	4.9	2.9	0.9
(Weighted average) Number of Shares in computing EPS (Basic)	92,800	92,800	93,300	93,300	93,926
(Weighted average) Number of Shares in computing EPS (Diluted)	92,800	92,800	93,300	93,300	101,115
(Weighted average, post-Invitation subdivision of Shares) Number of Shares in computing EPS (Basic)	185,600,000	185,600,000	186,600,000	186,600,000	187,852,000
(Weighted average, post-Invitation subdivision of Shares) Number of Shares in computing EPS (Diluted)	185,600,000	185,600,000	186,600,000	186,600,000	202,230,000

PROSPECTUS SUMMARY

Selected items from the Financial Position of our Company

	Audited			
	(as at the end of)			
(US\$'000)	FY2001	FY2002	FY2003	1H04
Current assets	1,464	3,313	7,389	8,226
Current liabilities	(1,821)	(2,589)	(2,265)	(3,748)
Non current assets	490	637	758	1,200
Non current liabilities	(74)	(46)	(73)	(97)
Capital and reserves	(59)	(1,315)	(5,809)	(5,581)
NTA per Share (Singapore Cents)	(0.3)	0.8	4.7	4.4
Number of shares, pre-Invitation subdivision of Shares (as of the end of the FY/period) in computing NTA per Share	191,132,000	191,132,000	191,132,000	191,132,000

Cashflow statement data

	Audited			
	(as at the end of)			
(US\$'000)	FY2001	FY2002	FY2003	1H04
Cash flow generated from operating activities	253	2,120	3,852	2,844
Cash flow used in investing activities	(8)	(163)	(100)	(430)
Cash flow used in financing activities	(476)	(995)	(1,157)	(1,352)

Our Contact Details

Our headquarters are located in Ramat Gan, Israel. Our telephone and fax numbers are +972 3 751 5490 and +972 3 751 5485 respectively.

Our website address is www.sarin.com.

Information contained on the website does not constitute part of this Prospectus.

PROSPECTUS SUMMARY

OUR INVITATION

- Size** : 62,200,000 Invitation Shares, comprising 52,000,000 New Shares and 10,200,000 Vendor Shares (subject to the Over-Allotment Option). The Invitation Shares will, upon allotment and issue or transfer (as the case may be), rank *pari passu* in all respects with the existing issued Shares.
- Invitation Price** : S\$0.355 for each Invitation Share.
- The Offer** : The Offer comprises an offering of 6,220,000 Offer Shares to members of the public in Singapore.
- The Placement** : The Placement comprises an offering of 55,980,000 Placement Shares at S\$0.355 for each Placement Share.
- Purpose of our Invitation** : Our Directors consider that the listing and quotation of our Shares on the SGX-ST will enhance our public image locally and internationally and enable us to tap the capital markets to fund our business growth. It will also provide members of the public, our employees and our business associates an opportunity to participate in the equity of our Company. The Invitation will also be beneficial to the growth of our business.
- Use of Proceeds** : The net proceeds from the issue of the New Shares (after deducting our share of the estimated issue expenses to be borne by us) is estimated to be S\$16.0 million (or US\$9.4 million). We intend to utilise the net proceeds from the issue of the New Shares as follows:
- (i) approximately S\$3.4 million (or US\$2.0 million) for our expansion plans, including potential mergers and acquisitions, acquisition of intellectual property rights and establishing offices in new markets (for further details, please refer to paragraphs (a), (c) and (f) in the section entitled “Business Strategies and Future Plans” on pages 92 to 93 of this Prospectus);
 - (ii) approximately S\$4.3 million (or US\$2.5 million) for investment in product development and our infrastructure, of which approximately US\$1.75 million has been allocated for product development in 2005 (for further details, please refer to paragraphs (b), (c), (d), (g) and (h) in the section entitled “Business Strategies and Future Plans” on pages 92 to 94 of this Prospectus);
 - (iii) approximately S\$3.4 million (or US\$2.0 million) for expansion of production facilities for disposable polishing discs; and
 - (iv) the balance of approximately S\$4.9 million (or US\$2.9 million) to be used for general working capital purposes.

The Company has no specific targets for mergers and acquisitions currently. Pending the above specific deployment of funds, we may use the funds as working capital or invest in interest bearing instruments as our Directors may, in their absolute discretion, deem fit.

PROSPECTUS SUMMARY

Over-Allotment Option : In connection with the Invitation, the Vendors have granted to the Manager the Over-Allotment Option exercisable in full or in part by the Manager within 30 days from the date of commencement of trading of our Shares on the SGX-ST (“Commencement Date”), to purchase from the Vendors and/or procure purchasers for the Additional Shares, representing in aggregate not more than 15% of the Invitation Shares (before the exercise of the Over-Allotment Option), at the Invitation Price, solely for the purpose of covering over-allotments (if any) made in connection with the Invitation.

Unless we indicate otherwise, all information in this Prospectus assumes that the Manager does not exercise the Over-Allotment Option.

Listing Status : Prior to the Invitation, there has been no public market for our Shares. Our Shares will be quoted on the Main Board of the SGX-ST, subject to the admission of our Company to the Official List of the SGX-ST and permission for dealing in, and for quotation of, our Shares being granted by the SGX-ST.

EXCHANGE RATE

The exchange rate between the S\$ and the USD as at the Latest Practicable Date was USD1.00 to S\$1.6278.

The exchange rate between the NIS and the USD as at the Latest Practicable Date was USD1.00 to NIS4.363.

The table below sets out the high and low exchange rates between the S\$ and USD for each month for the six months prior to the Latest Practicable Date. The table below indicates how many US\$ can be bought with one S\$.

	S\$/USD Rate	
	High	Low
September 2004	0.594	0.586
October 2004	0.601	0.591
November 2004	0.611	0.600
December 2004	0.613	0.605
January 2005	0.6133	0.6045
February 2005	0.6158	0.6053

The following table sets forth, for each of the financial periods indicated, the average exchange rates between the S\$ and USD calculated by using the average of the exchange rates on the last day of each month during each financial period.

	S\$/USD Rate	
	Average	Closing
FY2001	0.557	0.542
FY2002	0.560	0.576
FY2003	0.574	0.588
FY2004	0.589	0.613
1H03	0.571	0.568
1H04	0.589	0.582

There are no exchange control restrictions in Singapore. In certain parts of the Prospectus, we have converted USD amounts into S\$ for the convenience of our potential investors of our Company. Unless otherwise indicated, the exchange rates used for conversion of USD to S\$ is 0.5820, which was the exchange rate as at 30 June 2004. No representation is made that the S\$ amounts could have been, or could be converted into US\$ at that rate or any other certain rate on 30 June 2004 or any other certain date. Fluctuations in the exchange rate between the S\$ and the USD will affect the USD equivalent of the S\$ price of our Shares on the SGX-ST and cash dividends paid by us in S\$.

RISK FACTORS

Prospective investors should carefully consider and evaluate each of the following considerations and all other information set forth in this Prospectus before deciding to invest in our Shares. To the best of our Directors' knowledge and belief, all risk factors that are material to investors in making an informed judgement have been set out below. If any of the following considerations and uncertainties develops into actual events, our business, financial conditions, results of operations and prospects could be materially and adversely affected. In such cases, the trading price of our Shares could decline and you may lose all or part of your investment in our Shares.

This Prospectus also contains forward-looking statements having direct and/or indirect implications on our future performance. Our actual results may differ materially from those anticipated by these forward-looking statements due to certain factors, including the risks and uncertainties faced by us, as described below and elsewhere in this Prospectus.

RISK FACTORS WHICH APPLY SPECIFICALLY TO THE INDUSTRY AND OUR COMPANY

We operate in a competitive environment

The market for our products is competitive. We are subject to competition from existing and new competitors. If we are unable to achieve product and price differentiation in our products from those of our competitors, our sales volume may be materially and adversely affected. If we are unable to provide new and innovative products to address the needs of the market, or if our competitor's pricing policies change, it could significantly affect the price we charge for our products in the future and our market share. Competition could also lead to a decrease in the size of our customer base as existing or potential customers choose to use products from our competitors. In the event that we are unable to compete effectively, our business and financial conditions may be materially and adversely affected.

We may not be able to continually enhance our products

Our industry is characterised by changes due to changing market trends, evolving industry standards and the introduction of new technologies. The development and commercialisation of new products can render existing products and services obsolete or less marketable. Our future success depends, to a significant extent, on our ability to enhance our existing products and to introduce new ones to meet the requirements of our customers in an evolving and developing market. Our present and/or future products may not be able to satisfy the needs of the market. If we are unable to anticipate and respond quickly and adequately to such demands either due to resource, technological or other constraints, our business and financial position would be materially and adversely affected. Our Group produces and develops a number of systems, each of which answers different needs in the diamond and gemstone industry. The development of a competing product, which might answer all of the needs of the diamond and gemstone industry, might materially and adversely affect the business of our Group.

We are dependent on a limited number of key suppliers

We purchased approximately 66% and 57% of our purchases in FY2003 and 1H04 respectively from our major suppliers as set out in the section entitled "General Information on our Company" under the subheading "Major Suppliers" on page 85 of this Prospectus. The involuntary or unexpected loss of any of our major suppliers may temporarily disrupt our supplies and will have a material and adverse impact on our business. Furthermore, there is no assurance that our major suppliers will be able to continue to fulfil our needs and expectations in terms of cost, product quality and technical specifications. In the event that our major suppliers are unable to fulfil our requirements or cease to supply our key components to us, this could result in disruptions to our business and we may incur higher costs in sourcing from new suppliers. This could result in a material and adverse impact on our financial results.

We may not be able to develop and/or maintain long-term relationships with our customers

It is important for our future success that we develop new long-term relationships with successful diamond dealers and manufacturers globally, and primarily in emerging markets such as PRC and Russia, while maintaining the current relationships with our existing customers. Our failure to attract new customer relationships or the failure of existing relationships may have a material and adverse impact on our business and our financial results.

RISK FACTORS

We are reliant on R&D personnel

Our industry is one that is highly dependent on R&D personnel. One of the key elements of our success is the continued service of our core team of R&D engineers and technicians. The process of attracting, training and successfully integrating such personnel into our operations can be lengthy and expensive. We may not be able to compete effectively for the R&D personnel we need. A high turnover of such R&D personnel without suitable and/or timely replacements would have a material and adverse effect on our competitiveness and business.

We are dependent on our Executive Directors and senior management team for our continued growth

Our success depends on the continued efforts of our Executive Directors and senior management team, comprising our CEO and Executive Officers. Our Executive Directors and senior management team have been instrumental in our growth and expansion since our inception. They have made significant contributions in the formulation of our business strategy and are responsible for our marketing efforts. They are expected to continue to play important roles in the continuing development and growth of our Company. Accordingly, the loss of any of our Executive Directors and any member of our senior management team without a timely replacement or the inability to attract and retain qualified personnel will have a material and adverse impact on our operations.

We may be required to indemnify our Directors and Executive Officers

We had, on 8 March 2005, approved the issuance of letters of indemnification to our Directors and Executive Officers, according to which the Company undertakes, subject to the applicable provisions of the Israeli Companies Law and of the Company's Articles, to indemnify our Directors and Executive Officers prospectively up to the amount of US\$2 million, but in no event more than 25% of the Company's equity, in respect of an act performed in their capacity as Directors or Executive Officers. A claim under such letters of indemnification could materially and adversely affect our operations. For details on the letters of indemnification, please refer to the section entitled "Share Capital" on page 58 of this Prospectus.

We may be unable to protect our proprietary technology

Our success and ability to compete are substantially dependent on our proprietary technology. The steps that we have taken to protect our proprietary rights (as set out in the section entitled "General Information on our Company" under the subheading "Intellectual Property" on pages 78 to 81 of this Prospectus) may not be adequate and we might not be able to prevent others from using what we regard as our technology. Existing trade secret, copyright and trademark laws and non-disclosure agreements only offer limited protection and in addition, the laws in certain countries in which we operate may not protect our proprietary technology to the same extent. Other companies could independently develop similar or superior technology without violating our proprietary rights. Any misappropriation of our technology or the development of competitive technology may seriously harm our business and financial position. Policing unauthorized use of our products is difficult and costly. If we have to resort to legal proceedings to enforce our proprietary rights, the proceedings could be costly and we may not be able to recover our expenses.

Save as disclosed in the section entitled "General and Statutory Information" under the subheading "Litigation" on pages 155 to 158 of this Prospectus, our Company is not aware of any infringement or attempted infringement by a third party of our proprietary rights or technology.

We may be subject to claims by others regarding infringement of their proprietary technology

Litigation over intellectual property rights exists in the industry. In addition to our outstanding legal proceedings as set out in the section entitled "General Information on our Company" under the subheading "Intellectual Property" on pages 78 to 81 of this Prospectus, we may in future be subject to other claims. Any claim of infringement by a third party against us may cause us to incur substantial costs even if the claim is invalid and if an injunction or any other court order, even if temporary, is obtained against us, we may be disrupted or prevented from selling our products and this would materially and adversely affect our turnover and profits. In the event that we need to seek a licence from third parties for their intellectual property or to develop non-infringing technology, we may not be able to obtain such licenses on commercially reasonable terms and/or our efforts to develop non-infringing technology could be unsuccessful.

RISK FACTORS

There is no assurance that our future plans will be commercially successful

As part of our business plan, we intend to develop new product lines, new products in existing product lines and to expand in key geographical markets, including India, PRC and Russia. Details of our future plans are disclosed under the section entitled “Prospects, Business Strategies and Future Plans” under the subheading “Business Strategies and Future Plans” on pages 91 to 94 of this Prospectus. There is no assurance that such expansion plans will be commercially successful. If we fail to achieve a sufficient level of revenue or if we fail to manage our production costs effectively, we will not be able to recover our costs and our future financial position and performance may be materially and adversely affected.

We are dependent on the political, economic, regulatory and social conditions in the countries that we operate or intend to expand our businesses

Our business and future growth are dependent on the political, economic, regulatory and social conditions in the countries in which we operate and sell our products. Any changes in policies implemented by the governments in these countries, currency and interest rates fluctuations, exchange controls, and changes in duties and taxation or general changes in the economic or social environment that are detrimental to our business could materially and adversely affect our operations, financial performance and future growth.

We may be adversely affected by changes in demand for diamonds

Our continued growth and success is indirectly dependent on the popularity of and consumer demand for diamonds. Shifts in consumer preferences away from diamonds will in turn affect our business and profitability. In addition, our continued success depends on trends in consumer spending. Factors which cause decrease in discretionary consumer spending may also adversely affect our sales. For example, deterioration in economic conditions globally or in major diamond retail centres and/or changes in governmental policies such as the implementation of or an increase in taxation on luxury goods may reduce the level of disposable income which consumers spend on non-essential and luxury items such as diamonds and gems. A material and sustained reduction in consumer demand would have a material and adverse effect on our operations, financial performance and future growth.

RISKS RELATED TO OUR LOCATION IN ISRAEL

Potential political, economic and military instability in Israel may materially and adversely affect our results of operations

Our principal offices are located in Israel. Accordingly, political, economic and military conditions in Israel directly affect our operations. Since the establishment of the State of Israel in 1948, a number of armed conflicts have taken place between Israel and its Arab neighbours. A state of hostility, varying in degree and intensity, has led to security and economic problems for Israel. Since October 2000, there has been an increase in hostilities between Israel and the Palestinian Arabs, which has adversely affected the peace process and has negatively influenced Israel’s relationship with its Arab citizens and several Arab countries. Such ongoing hostilities may hinder Israel’s international trade relations and may limit the geographic markets where we can sell our products. Any hostilities involving Israel or threatening Israel, or the interruption or curtailment of trade between Israel and its present trading partners, could materially and adversely affect our operations.

Civil unrest may materially and adversely affect our business

Israel has recently experienced civil unrest within its own borders, such as labour disputes which have resulted in workforce strikes at our ports, airports, customs and other governmental offices. As a result, we have experienced delays in the import of capital equipment and materials and in the export of our finished goods. Such ongoing civil unrest could materially and adversely affect our operations.

Non-competition clauses in our employment contracts may not be enforceable

Non-competition clauses in employment agreements are difficult to enforce in Israel, especially with respect to non-senior management employees. Israeli courts have required employers seeking to enforce non-compete undertakings against former employees to demonstrate that the former employee breached an obligation to the employer and thereby caused harm to one of a limited number of legitimate

RISK FACTORS

interests of the employer recognized by the courts, such as the confidentiality of certain commercial information or a company's intellectual property or trade secrets. We currently have non-competition clauses in the employment agreements with most of our employees. The provisions of such clauses prohibit our employees, if they cease working for us, from directly competing with us or working for our competitors. However, in the event that any of our employees (especially with respect to non-senior management employees) chooses to work for one of our competitors, we may be unable to prevent such employment.

We are subject to foreign exchange risks

We are exposed to foreign exchange risk arising from currency exposure primarily with respect to the NIS and Rs as some of our operating expenses are denominated in NIS and Rs. Our sales are denominated in USD. Our costs are mainly denominated in USD, Rs and NIS. Where possible, we will match our sales and purchases in USD to achieve a natural hedge. We currently do not have a policy for using derivative instruments for hedging purposes. To the extent that we may be unable to fully match the sales and purchases in any country, and to the extent that we transact in currencies other than USD, Rs and NIS, we may be exposed to fluctuations in foreign exchange rates. This may adversely affect our profitability.

We currently participate in or receive tax benefits from Israeli government programs. These programs require us to meet certain conditions and these programs and benefits could be terminated or reduced in the future, which could harm our results of operations

We receive tax benefits under the Israeli Law for Encouragement of Capital Investments, 1959, in respect of our production facility that is designated as an "Approved Enterprise", the cessation of which could adversely affect our results of operations. Our cumulative tax benefits resulting from our Approved Enterprise for the years 2002 and 2003, net of other tax effects, were approximately US\$1.7 million and US\$4.2 million, respectively. For more information on this law and our Approved Enterprise, see Annex D under the caption "Israel - Taxation of the Company—Law for the Encouragement of Capital Investments, 1959" on pages D-5 and D-6 of this Prospectus. To maintain our eligibility for these tax benefits, we must continue to meet several conditions, including, making required investments in fixed assets and preserving the manufacturing base in Israel. If we fail to comply with these conditions in the future, the tax benefits we receive could be cancelled and we could be required to pay the amounts of the benefits received. The Israeli government has reduced the benefits available under this program in recent years and has indicated that it may reduce or eliminate these benefits in the future. These tax benefits may not continue in the future at their current levels or at any level. From time to time, we submit requests for expansion of our Approved Enterprise programs or for new programs. These requests might not be approved. The Law for Encouragement of Capital Investments, 1959, will expire on 31 March 2005 (however, a ministerial committee with the approval of the parliamentary finance committee can approve a further extension of up to no later than 30 June 2005). Accordingly, requests for new programs or expansions that are not approved by 31 March 2005 will not confer any tax benefits, unless the term of the law is extended. The termination or reduction of these tax benefits would increase the amount of tax payable by us and, accordingly, reduce our net profit after tax.

It could be difficult to enforce a Singapore judgment against our officers and directors and us

We are incorporated in the State of Israel. All of our Executive Officers and Directors (with the exception of two Independent Directors as at the date of this Prospectus) are non-residents of Singapore, and substantially all of our assets and the assets of these persons are located outside Singapore. Therefore, it could be difficult to serve process in Singapore on, or to enforce a judgment obtained in Singapore against, us or any of these persons.

RISK FACTORS

We have been informed by our legal counsel in Israel that there is doubt concerning the enforceability of civil liabilities under Singapore law in original actions instituted in Israel. However, subject to specified time limitations, Israeli courts may enforce a final executory judgment in a civil matter rendered by a court in Singapore that enforces similar Israeli judgments, including a monetary or compensatory judgment in a non-civil matter, obtained after due process before a court of competent jurisdiction according to the laws of Singapore and the rules of private international law currently prevailing in Israel. The rules of private international law currently prevailing in Israel do not prohibit the enforcement of a judgment by Israeli courts provided that:

- (i) the judgment is enforceable in the state in which it was given;
- (ii) adequate service of process has been effected and the defendant has had a reasonable opportunity to present his arguments and evidence;
- (iii) the judgment and the enforcement of the judgment are not contrary to the law, public policy, security or sovereignty of the State of Israel;
- (iv) the judgment was not obtained by fraud and does not conflict with any other valid judgment in the same matter between the same parties; and
- (v) an action between the same parties in the same matter is not pending in any Israeli court at the time the lawsuit is instituted in the foreign court.

Provisions of Israeli law may delay, prevent or make more difficult a merger or other business combination.

The Israeli Companies Law provides for mergers between two Israeli companies, provided that each company obtains the approval of its board of directors and shareholders. Upon the request of a creditor of either company to the proposed merger, the court may delay or prevent the merger if it concludes that there exists a reasonable concern that as a result of the merger the surviving company will be unable to satisfy the obligations of that company. Finally, a merger may not be completed unless at least 70 days have passed from the time that the requisite merger proposals have been filed with the Israeli Registrar of Companies by each of the merging companies.

Moreover, provisions of the Israeli Companies Law that deal with “arrangements” between a company and its shareholders may be used to effect squeeze-out transactions and other arrangements, including mergers. These provisions generally require that the arrangement be approved by a majority of the participating shareholders holding at least 75% of the shares voted on the matter. In addition to shareholder approval, court approval of the arrangement is required, which may entail further delay.

If, as a result of an acquisition of shares, the acquirer will hold more than 90% of a company’s shares, the Israeli Companies Law requires that the acquisition be made by means of a tender offer for all of the outstanding shares. If more than 95% of the outstanding shares are tendered in a tender offer, all the shares that the acquirer offered to purchase will be transferred to it. The law provides for appraisal rights if any shareholder files a request in court within three months following the consummation of a full tender offer.

The Israeli Companies Law also contains provisions requiring partial take-overs in certain circumstances. For details, please refer to section entitled “Take-overs” on pages 23 and 24 of this Prospectus.

RISK FACTORS

The listing of our Shares on the SGX-ST may impose greater restraints on our Directors and Shareholders in approving interested person transactions

The listing of our Shares on the SGX-ST subjects our Company to, *inter alia*, the provisions of Chapter 9 of the Listing Manual. Hence, while Israeli law allows Directors, in some cases, to participate and vote in Board resolutions concerning transactions in which they, or their associates, have personal interest, such participation and voting shall not be allowed in our Company if and to the extent that the provisions of the Listing Manual provide otherwise. Moreover, while Israeli law allows Directors and any associates thereof to vote in shareholders meetings with regard to interested persons' transactions which concern such Directors, the Directors and Shareholders may be precluded from voting at such meetings due to the provisions of the Listing Manual.

For details on approval procedures of interested person transactions by our Company, please refer to section entitled "Interest of Management and Others in Certain Transactions" under the subheading "Review Procedures for Future Interested Person Transactions" on pages 140 and 141 of this Prospectus.

In the event of a take-over, protection under applicable laws is limited.

Since we are incorporated in Israel, the Singapore Code does not ordinarily apply to take-over offers for our Company. At the same time, since our Shares are not listed on the TASE or offered to the public in Israel, the provisions of the Israeli Companies Law and the Israel Securities Law, including the regulations thereunder prescribing the procedures for tender offers, do not apply to tender offers for our Shares. We have partially addressed this lacuna by adding provisions to our Company's Articles of Association requiring our Shareholders who make take-over offers in respect of our Shares to comply with the provisions of the Singapore Code and that Shares acquired in violation of take-over obligations would be deemed dormant Shares with no rights whatsoever attached to them for as long as they are held by the acquirer. However, it is uncertain whether this will be effective in securing compliance with the Singapore Code. Hence, even if a take-over offer is made for our Shares, either because it is required by the Israeli Companies Law or otherwise, the take-over offer may not be made in accordance with the Singapore Code or any other laws or regulations prescribing procedures for such offers.

For details on the take-over obligations of our Company, please refer to section entitled "Take-overs" on pages 23 and 24 of this Prospectus.

RISKS RELATED TO OUR LOCATION IN INDIA

Social and civil unrest and regional hostilities may materially and adversely affect our business

India has, from time to time, experienced civil unrest within its own borders and hostilities with neighbouring countries. Such ongoing civil unrest and hostilities may hinder India's international trade relations and may limit the geographic markets where we can sell our products. Any civil unrest and hostilities involving India or threatening India, or the interruption or curtailment of trade between India and its present trading partners, could materially and adversely affect our operations.

Furthermore, we may not be able to foresee events that could have an adverse effect on our business or your investment, as the consequences of any armed conflicts are unpredictable.

Political instability or a change in economic liberalisation and deregulation policies could seriously harm business and economic conditions in India generally and our business in particular

Since 1991, the Indian government has pursued policies of economic liberalisation, including significantly relaxing restrictions on the private sector. The present Indian government consists of a coalition of political parties. The withdrawal of one or more of these parties from the coalition government can result in political instability. Any political instability could delay the reform of the Indian economy and could have a material and adverse effect on our business operations. We cannot assure you that these economic liberalisation policies, including existing specific laws and policies affecting foreign investment and currency exchange rates, will continue under the newly elected government or future governments.

RISK FACTORS

Protests against privatisation could slow down the pace of liberalisation and deregulation. Such changes in India's economic liberalisation and deregulation policies could disrupt business and economic conditions in India and thereby affect our business.

Indian court proceedings may be lengthy

India has a parliamentary democracy with a common law system. The court processes in India may be lengthy. We are currently engaged in a dispute with our previous distributor in India, as detailed hereunder and in the section entitled "General and Statutory Information" under the subheading "Litigation" on pages 155 to 158 of this Prospectus. As such, delays in the legal processes in the Indian courts with respect to this current litigation and any other future litigation could potentially affect our operations and business, which will in turn affect our overall financial performance.

Our legal proceedings and disputes with our previous distributor in India may not have an outcome favourable to us

We are defending and contesting a claim by Sahajanand Technologies P. Ltd ("Sahajanand") in India who distributed our products up until March 2004. Sahajanand has filed a civil suit in the District Court of Surat, India, against our Company and some of the employees of Sarin India, who had previously been Sahajanand's own employees. There is no assurance that the ongoing legal proceedings and disputes will not have a material and adverse impact on our business. If the outcome of the resolution of these legal proceedings and disputes are unfavourable to us, our operations and business may be materially and adversely affected. For details on this litigation, please refer to the section entitled "General and Statutory Information" under the subheading "Litigation" on pages 155 to 158 of this Prospectus.

Service charge payable by our Company to Sarin India may not be accepted as an arm's length price by the authorities in India

Pursuant to a service agreement entered into between our Company and Sarin India ("Agreement"), Sarin India provides pre-sale assistance, installation, training, repairs, after sales services and other related services ("Services") to our Company during the warranty period in respect of the sale of our products to our customers in India, Sri Lanka and such other territories as may be agreed between our Company and Sarin India. As consideration for the Services, our Company is paying Sarin India a service charge at the rate of total cost of Sarin India for the Services plus 10% ("Service Charge"). The Service Charge may be reviewed by the authorities in India in the course of assessment proceedings consequent to the filing of return of income by Sarin India to determine if it is an arm's length price. There is no assurance that the authorities in India may accept the Service Charge as an arm's length price or would not impose any tax on the Service Charge. If it is not accepted as such, our operations and business may be materially and adversely affected.

Sarin India has a limited operating history

Sarin India was established in 2004 and therefore has a limited operating history upon which investors may evaluate its business. There can be no assurance that our Indian operations will continue to be successful. In addition, as a result of our limited operating experience, some degree of uncertainty exists in connection with whether and how a wide variety of national and state laws, including, without limitation, those relating to import and export, foreign exchange, tax and labour may apply to us and whether and how we comply with them.

RISKS RELATING TO AN INVESTMENT IN OUR SHARES

Future sales or issuance of our Shares could adversely affect our Share price

Any future sale or issuance or availability of our Shares in the public market may have a downward pressure on our Share price. The sale of a significant amount of our Shares in the public market after the Invitation, or the perception that such sale may occur, could materially and adversely affect the market price of our Shares. These factors also affect our ability to sell additional equity securities. Save as disclosed under the section entitled "Share Capital" under the subheading "Moratorium" on page 62 of this Prospectus, there will be no restriction on the ability of our Substantial Shareholders to sell their Shares either on the SGX-ST or otherwise.

RISK FACTORS

Negative publicity, including those relating to any of our Substantial Shareholders or key personnel, may adversely affect our Share price

Any negative publicity or announcement relating to any of our Substantial Shareholders or key personnel may materially and adversely affect the performance of our Share price, whether or not this is justifiable. Such negative publicity or announcement may include involvement in insolvency proceedings, failed attempts in takeovers, joint ventures, etc.

There has been no prior market for our Shares, and the Invitation may not result in an active or liquid market for our Shares

Prior to the Invitation, there has been no public market for our Shares. Therefore, we cannot assure investors that an active public market will develop or be sustained after the Invitation. The Invitation Price was arrived at after consultation between ourselves, the Vendors and the Manager and after taking into consideration, *inter alia*, prevailing market conditions and estimated market demand for the Invitation Shares. The Invitation Price may not be indicative of prices that may prevail in the trading market after the Invitation and investors may not be able to sell their Shares at or above the Invitation Price. The volatility in the trading price of our Shares may be caused by factors beyond our control and may be unrelated or disproportionate to our financial results.

The market price of our Shares may be significantly affected by, amongst others, the following factors:

- (i) actual or anticipated results of operations of our Group;
- (ii) new services or products offered by us or our competitors;
- (iii) announcements by us or our competitors of significant contracts, acquisitions, partnerships, joint ventures or capital commitments;
- (iv) the loss of a major customer or supplier;
- (v) additions or departures of key personnel;
- (vi) changes in, or our failure to meet, securities analysts' expectations;
- (vii) changes in market valuations of other similar companies;
- (viii) legislative and regulatory developments affecting the diamond industries;
- (ix) investor perception of investments relating to Israel;
- (x) broad share price fluctuations;
- (xi) involvement in litigation; and
- (xii) general market conditions and other factors beyond our control.

Control by existing Substantial Shareholders may limit your ability to influence the outcome of decisions requiring the approval of Shareholders

Immediately after the Invitation, Sarin R&D and Interhightech will own approximately 46.3% and 21.3% of our issued share capital respectively. Please refer to the section entitled "Share Capital" under the subheading "Shareholders" on pages 60 and 61 of this Prospectus for further details. These Shareholders may be able to significantly influence our corporate actions such as mergers or take-over attempts in a manner that could conflict with the interests of our public Shareholders.

RISK FACTORS

Our Share price may be volatile, which could result in substantial losses for investors acquiring our Shares pursuant to the Invitation

The market price of our Shares could be subject to significant fluctuations in response to various factors and events, including the liquidity of the market for our Shares, differences between our actual financial operating results and those expected by investors and analysts, changes in analysts' recommendations or projections, changes in general market conditions and broad market fluctuations.

Such fluctuations could result in substantial losses for investors acquiring our Shares pursuant to the Invitation.

In addition, our Share price may be under downward pressure if certain of our Directors, management staff or employees sell their Shares immediately after the Invitation or upon the expiry of the moratorium period, as the case may be.

Future dilution due to future capital requirements

Our working capital and capital expenditure needs may vary materially from those presently planned, depending on numerous factors including the rate of market acceptance of our products, strategic alliances, marketing and distribution strategies, levels and results of research and development and other factors which cannot be foreseen. If we do not meet our goals with respect to revenues, or if costs are higher than anticipated, substantial additional funds may be required. Even if we exceed our goals, our success may introduce new opportunities that may have to be fulfilled quickly and this could also result in the need for substantial new capital. To the extent that funds generated from operations together with the proceeds from this Invitation have been exhausted, we may have to raise additional funds to meet the new capital requirements. These additional funds may be raised by way of a limited placement or by a rights offering or through the issuance of new Shares. In all such events, if any Shareholder is unable or unwilling to participate in this additional round of fund raising, such Shareholder may suffer dilution in their investment.

INVITATION STATISTICS

Invitation Price	S\$ 0.355
Net Tangible Assets	
NTA per Share based on the audited balance sheet of our Company as at 30 June 2004:	
(a) before adjusting for the estimated net proceeds of the New Shares and based on the pre-Invitation share capital of 191,132,000 Shares	4.4 cents
(b) after adjusting for the estimated net proceeds of the New Shares and based on the post-Invitation share capital of 243,132,000 Shares	10.0 cents
Premium of Invitation Price per Share over the NTA per Share as at 30 June 2004:	
(a) before adjusting for the estimated net proceeds of the New Shares and based on the pre-Invitation share capital of 191,132,000 Shares	706.8 per cent.
(b) after adjusting for the estimated net proceeds of the New Shares and based on the post-Invitation share capital of 243,132,000 Shares	255.0 per cent.
Earnings	
Historical net EPS of our Company for FY2003 based on the weighted average number of shares of 186,600,000 Shares	4.9 cents
Historical net EPS of our Company for FY2003 had the Service Agreements set out on pages 131 and 132 of this Prospectus been in effect for FY2003 and based on the weighted average number of shares of 186,600,000 Shares	5.0 cents
Estimated net EPS of our Company for FY2004 based on pre-Invitation share capital of 191,132,000 Shares	3.9 cents
Price Earnings Ratio	
Historical price earnings ratio based on the historical net EPS of our Company for FY2003 based on weighted average number of shares of 186,600,000 Shares	7.2 times
Historical price earnings ratio based on the historical net EPS of our Company for FY2003 had the Service Agreements set out on pages 131 and 132 of this Prospectus been in effect for FY2003	7.1 times
Estimated price earnings ratio based on the estimated net EPS of our Company for FY2004 based on pre-Invitation share capital of 191,132,000 Shares	9.1 times
Net Operating Cash Flow⁽¹⁾	
Historical net operating cash flow per Share of our Company for FY2003 based on pre-invitation share capital of 191,132,000 Shares	4.9 cents
Price To Net Operating Cash Flow⁽¹⁾	
Historical price to net operating cash flow ratio based on the historical net operating cash flow per Share for FY2003 based on pre-invitation share capital of 191,132,000 Shares	7.2 times

INVITATION STATISTICS

Market Capitalisation

Market capitalisation based on Invitation Price of S\$ 0.355 per Share and post- S\$86.3 million
Invitation share capital of 243,132,000 Shares

Note:

- (1) Net operating cash flow is defined as net profit attributable to our Shareholders with total depreciation and amortisation expenses of US\$149,000 respectively added back.

USE OF PROCEEDS

The net proceeds from the issue of the New Shares (after deducting our share of the estimated issue expenses to be borne by us) is estimated to be S\$16.0 million (or US\$9.4 million). The net proceeds represent the amount we will receive after payment of underwriting commissions and other transaction expenses related to the Invitation. We intend to utilise the net proceeds from the issue of the New Shares as follows:

- (i) approximately S\$3.4 million (or US\$2.0 million) for our expansion plans, including potential mergers and acquisitions, acquisition of intellectual property rights and establishing offices in new markets (for further details, please refer to paragraphs (a), (c) and (f) in the section entitled “Business Strategies and Future Plans” on pages 92 to 93 of this Prospectus);
- (ii) approximately S\$4.3 million (or US\$2.5 million) for investment in product development and our infrastructure, of which approximately US\$1.75 million has been allocated for product development in 2005 (for further details, please refer to paragraphs (b), (c), (d), (g) and (h) in the section entitled “Business Strategies and Future Plans” on pages 92 to 94 of this Prospectus);
- (iii) approximately S\$3.4 million (or US\$2.0 million) for expansion of production facilities for disposable polishing discs; and
- (iv) the balance of approximately S\$4.9 million (or US\$2.9 million) to be used for general working capital purposes.

The Company has no specific targets for mergers and acquisitions currently. Pending the above specific deployment of funds, we may use the funds as working capital or invest in interest bearing instruments as our Directors may, in their absolute discretion, deem fit.

There is no minimum amount, which in the reasonable opinion of the Directors, must be raised by the Invitation.

Please refer to the section entitled “Prospects, Business Strategies and Future Plans” on pages 91 to 94 of this Prospectus for further details.

DIVIDEND POLICY

In 2002, 2003 and 2004, our Company paid dividends amounting to approximately S\$1.8 million (or US\$1.0 million), S\$1.4 million (or US\$0.8 million) and S\$2.2 million (or US\$1.4 million) out of profits in FY2000 and FY2002, FY2002 and FY2003 respectively. Our Company also paid an interim dividend in FY2004 of approximately S\$3.2 million (or US\$1.9 million) out of profits from 1H04 and retained earnings.

In a Board Meeting held on 8 March 2005, the Board decided to recommend that at the next annual general meeting (which is scheduled to be held within 90 days from the listing of our Shares on the SGX-ST) a dividend of approximately S\$4,125,000 (or US\$2.5 million) be paid out of profits from FY2004.

We currently do not have a fixed dividend policy. We have over the past three years, distributed dividends as noted above and the Board's policy is to continue distributing a portion of the profits (as defined below) to the shareholders so that they may benefit from their investment in the Company, save that we do not and will not pay out dividends derived from the portion of our income which is tax exempt as per the approved enterprise statuses discussed in detail at Annex D on pages D-1 to D-9 of this Prospectus. Any dividend paid in the past is not reflective or indicative of our future dividend payments or future dividend policy.

We may, by ordinary resolution at a general meeting of our Company declare annual dividends but the amount of such dividends shall not exceed the amount recommended by the Directors. The form, frequency and amounts of future dividends on our Shares will depend on our earnings, financial position, results of operations, capital needs, plans for expansion and other factors, which the Directors may deem appropriate. Our Directors may also declare an interim dividend without seeking Shareholder's approval in a general meeting.

Our Company may pay dividends only out of profits.

Profits are defined, under the Israeli Companies Law, as the greater of:

- (i) retained surplus; or
- (ii) surplus accumulated during the preceding two years,

in accordance with the last adjusted financial reports (audited or reviewed) prepared by the Company, provided that the date of those financial reports is no earlier than six months prior to distribution. "Surplus" refers to the sums included in the equity of the Company which are derived from its net profits as determined in accordance with generally accepted accounting principles and other sums included in the equity in accordance with generally accepted accounting principles, which are not share capital or premium, that the Israeli Minister of Justice has provided that such shall be deemed as surplus, provided always that there is no reasonable concern that such distribution of dividend shall not prevent the company from performing its obligations when such become due.

For information relating to taxes payable on dividends, please refer to Annex D on pages D-1 to D-9 of this Prospectus.

Our Company will declare dividends, if any, in US\$. Shareholders whose Shares are held through CDP will receive their dividends in S\$. CDP will make the necessary arrangements to convert the dividends received from the Company in US\$ into S\$ equivalent at such foreign exchange rate as CDP may determine for onward distribution to such Shareholder entitled thereto. Neither our Company nor CDP will be liable for any loss howsoever arising from the conversion of the dividend entitlement of Shareholders holding their Shares through CDP from US\$ into S\$ equivalent.

CAPITALISATION AND INDEBTEDNESS

The following information should be read in conjunction with the Independent Auditors' Report and Financial Statements set out in the section entitled "Independent Auditors' Report and Financial Statements" on pages F1 to F34 of this Prospectus.

Our Company's capitalisation and indebtedness as at 31 January 2005, on an actual and adjusted basis were as follows:

(US\$'000)	As at 31 January 2005	As adjusted for the net proceeds from the issue of the New Shares
Cash and cash equivalents	4,873	14,307
Finance lease creditor	0	0
Total indebtedness	0	0
Shareholders' Equity		
Share capital	0	0
Share premium	497	9,931
Retained earnings	6,970	6,970
Total shareholders' equity	7,467	16,901
Total Capitalisation & Indebtedness	7,467	16,901

Contingent Liabilities

As at the Latest Practicable Date, our Group does not have any material contingent liabilities outstanding. We have no other borrowings or indebtedness in the nature of borrowings including bank overdrafts and liabilities under acceptances (other than normal trading bills) or acceptances credits, mortgages, charges, hire purchase commitments, guarantees or other material contingent liabilities.

Please refer to the section entitled "Management's Discussion and Analysis of Financial Condition and Results of Operations" under the subheading "Commitments" on page 115 of this Prospectus for details relating to our commitments.

DILUTION

Dilution is the amount by which the Invitation Price to be paid by the applicants for our New Shares in the Invitation exceeds the NTA per Share after the Invitation. The NTA per Share as at 30 June 2004 but before adjusting for the net proceeds from the issue of the New Shares and based on the pre-Invitation issued and paid-up share capital of 191,132,000 Shares was 4.4 cents (or US 2.6 cents).

Based on the issue of 52,000,000 New Shares at the Invitation Price for each New Share pursuant to the Invitation and after deducting the estimated issue expenses, the adjusted NTA of our Company as at 30 June 2004 would have been 10.0 cents per Share based on the post-Invitation issued and paid-up share capital of 243,132,000 Shares. This represents an immediate increase in NTA of 5.6 cents per Share to our existing Shareholders and an immediate dilution of 25.5 cents per Share to our new investors pursuant to the Invitation ("New Investors"). The following table illustrates such dilution on a per Share basis:

Invitation Price	S\$ 0.355
	Cents
NTA per Share as at 30 June 2004 before adjusting for the net proceeds from the Invitation)	4.4 cents
Increase in NTA per Share contributed by New Investors	5.6 cents
NTA per Share after the Invitation	10.0 cents
Dilution per Share to New Investors	25.5 cents

The following table summarises the total number of Shares issued by us to our substantial Shareholders during the period of three years prior to the date of this Prospectus, the total consideration paid by them and the effective cash cost per Share to our substantial Shareholders. The following table also sets out the total number of Shares acquired by New Investors pursuant to the Invitation, the total consideration paid and the effective cash cost per Share to them. Save as disclosed in the foregoing, no shares in the share capital of our Company has been acquired by any of our Directors or substantial Shareholders or any of their associates at any time during the three years before the date of this Prospectus.

	Number of Shares acquired (Sub-division)	Total Consideration US\$	Effective cash cost per Share US\$
Sarin R&D	642,000	32,060	0.05
Interhightech	296,000	14,765	0.05
Zannex	62,000	3,173	0.05
New Investors	52,000,000	10,858,824	0.21

GROUP STRUCTURE

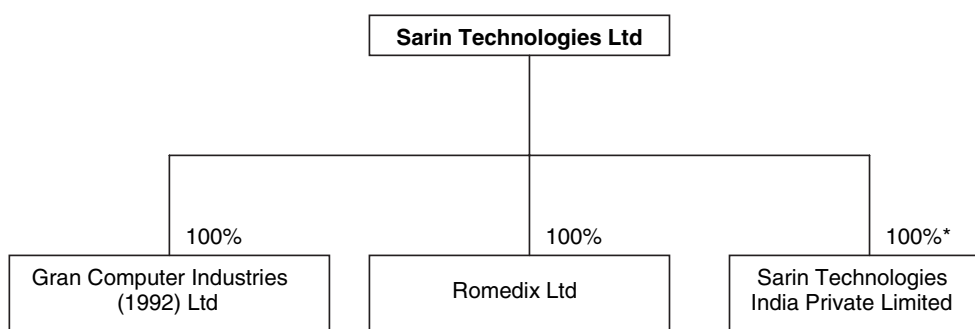

* The issued and paid-up share capital of Sarin India is 10,001 shares of Rs10 each, of which 10,000 shares is held by our Company and 1 share is held by GCI as a nominee for our Company.

We currently have three subsidiaries, the details of which are as follows:

Name	Date and place of incorporation	Principal place of business	Principal business	Authorised, Issued and paid up share capital
Gran Computer Industries (1992) Ltd	16 January 1992, Israel	Israel	Development, manufacture and marketing of instruments for assessing the colour of diamonds.	NIS17,600 divided into 17,600 ordinary shares of NIS1.00 each of which 10,000 ordinary shares have been issued to and fully paid-up by our Company
Romedix Ltd	21 December 1995, Israel	Israel	In the past, Romedix concentrated mainly on the manufacturing and marketing of devices for the imaging and documentation of features in general and nevi (size and colour) in particular on human skin for use in medical and aesthetic treatments. Since May 2004, Romedix has been concentrating mainly on the development, manufacture and marketing of disposable polishing discs for diamonds and gemstones.	NIS30,000 divided into 3,000,000 ordinary shares of NIS0.01 each of which 1,824,643 shares have been issued to and fully paid-up by our Company
Sarin Technologies India Private Limited	22 March 2004, India	India	(a) Provision of pre- and post-sales and technical support for our Group's products that are sold in India and Sri Lanka and such other territories as may be agreed to in writing by our Company and Sarin India from time to time. (b) Trading operations in computer systems and accessories for sale to our customers with machinery sourced from our Group.	Rs500,000 divided into 50,000 shares of Rs10 each, of which 10,001 shares have been issued to and fully paid-up by our Company (10,000 shares) and GCI (1 share) as a nominee of our Company

SHARE CAPITAL

SHARE CAPITAL

Our Company was incorporated on 8 November 1988 in Israel under the Israeli Companies Ordinance (New Version) 1983 of Israel, as a private limited liability company. We were formerly known as Borimer Ltd. On 21 September 1989, we changed our name to Sarin Research, Development and Manufacture (1988) Ltd and on 31 December 1994, we changed our name to Sarin Technologies Ltd.

On 26 December 2002, we converted each ordinary share of par value NIS1.00 each in the share capital of our Company to 100 ordinary shares of par value NIS0.01 each and our authorised share capital was NIS10,000 divided into 1,000,000 ordinary shares of NIS0.01 each. On 18 November 2003, we converted our authorised share capital into 990,000 ordinary shares of NIS0.01 each and 10,000 ordinary B shares of NIS0.01 each due to the adoption of the Sarin 2003 Share Option Plan, as described in the section entitled "General and Statutory Information" under the subheading "Share Capital" on pages 149 to 152 of this Prospectus.

Our issued share capital was NIS955.66 divided into 93,300 ordinary shares and 2,266 ordinary B shares of NIS0.01 each immediately prior to the Extraordinary General Meeting referred to below.

At the Extraordinary General Meeting held on 8 March 2005, our Shareholders approved, *inter alia*, the following:

- (a) the conversion of all ordinary and ordinary B shares of NIS0.01 each into ordinary shares with no par value (the "Conversion");
- (b) the division of each ordinary share of no par value, into 2,000 ordinary shares of no par value (the "Sub-division");
- (c) the adoption of the new Articles of Association of our Company;
- (d) the issue of up to 52,000,000 New Shares pursuant to the Invitation. The New Shares, when fully paid, allotted and issued, will rank *pari passu* in all respects with our existing issued Shares;
- (e) that authority be given to our Directors to issue and allot Shares in our Company whether by way of rights, bonus or otherwise (including but not limited to the issue and allotment of Shares at any time, whether during the continuance of such authority or thereafter, pursuant to offers, agreements or options made or granted by our Company while this authority remains in force) by our Directors, or otherwise disposal of Shares (including making and granting offers, agreements and options which would or might require Shares to be issued, allotted or otherwise disposed of, whether during the continuance of such authority or thereafter) by our Directors at any time to such persons (whether or not such persons are Shareholders), upon such terms and conditions and for such purposes as our Directors may in their absolute discretion deem fit PROVIDED THAT:
 - (i) the aggregate number of Shares to be issued shall not exceed 50% of the issued share capital of our Company; and
 - (ii) where Shareholders are not given the opportunity to participate in the same on a *pro rata* basis, then the Shares to be issued under such circumstances shall not exceed 20% of the issued share capital of our Company,

and the percentage of the issued share capital shall be calculated based on the maximum potential share capital post-Invitation (taking into account the conversion or exercise of any convertible securities and employee share options issued at the time this resolution is passed, which were issued pursuant to any previous Shareholders' approval), adjusted for any subsequent consolidation or subdivision of our Shares. Unless revoked or varied by our Company in a general meeting, such authority to continue in full force until the conclusion of the next annual general meeting of our Company or the date by which the next annual general meeting of our Company is required by law to be held whichever is the earlier;

SHARE CAPITAL

- (f) to approve the Board resolution of 8 March 2005 to
- (I) issue letters of indemnification to the Directors and Executive Officers of the Company, according to which letters, the Company undertakes, subject to the provisions of the Israeli Companies Laws and of the Company's Articles, to indemnify its Directors and Executive Officers prospectively up to the amount of US\$2 million, but in no event more than 25% of the Company's equity, in respect of an act performed in their capacity as Directors or Executive Officers in connection with the Invitation, with regard to the following:
 - (i) a financial obligation imposed on any and all of the Directors and/or Executive Officers in favour of another person by a court judgment, including a compromise judgment or an arbitrator's award approved by court; and
 - (ii) reasonable litigation expenses, including attorneys' fees, expended by any and all of the Directors or Executive Officers or charged to the Directors or Executive Officers by a court, in a proceeding instituted against any and all of the Directors and/or Executive Officers by the Company or on its behalf or by another person, or in a criminal charge from which the Director or Executive Officer was acquitted, or in a criminal proceeding in which the Director or Executive Officer was convicted of an offense that does not require proof of criminal intent; and
 - (II) to authorize the management of our Company to procure Directors' and Officers' liability insurance for the directors and officers of our Company and our subsidiaries, subject to the provisions of applicable laws and of our Articles of Association. The maximum amount covered by such insurance shall not exceed US\$10 million.
- (g) the establishment of the Plan, which comprises share options that may be granted in respect of such number of new Shares representing in aggregate not more than 15% of the total issued share capital of our Company from time to time, the rules of which are set out in Annex C of this Prospectus.

The issuance of letters of indemnification is common and customary with public companies in Israel. The scope of such letters of indemnification is set out in Article 60 of the Articles of Association of our Company on pages B-23 to B-24 of this Prospectus. As at the date of this Prospectus, our Company has only one class of Shares, being ordinary shares. The rights and privileges of our Shares are stated in the Articles of Association of our Company. There are no founder, management or deferred Shares.

Upon the allotment and issue of the New Shares which are the subject of the Invitation, the resultant number of issued and paid-up shares of our Company will be 243,132,000 Shares.

Details of the changes to the issued and paid-up share capital of our Company as at 30 June 2004, being the date of the last audited accounts of our Company, and our issued and paid-up share capital immediately after the Invitation are as follows:

	Number of Shares	NIS
Issued and fully paid-up ordinary and ordinary B shares as at 30 June 2004	94,135	941.35
Issued and fully paid-up ordinary shares after adjusting for the Sub-division and the Conversion	191,132,000	(no par value)
Pre-Invitation share capital	191,132,000	(no par value)
New Shares to be issued pursuant to the Invitation	52,000,000	(no par value)
Post-Invitation share capital	<u>243,132,000</u>	<u>(no par value)</u>

The authorised share capital and the shareholders' equity of our Company as at 30 June 2004, before and after adjustments to reflect the increase in authorised share capital and the Invitation are set forth below. These statements should be read in conjunction with the Independent Auditors' Report and Financial Statements in this Prospectus.

SHARE CAPITAL

	30 June 2004	
	Before Invitation	After Invitation
Authorised Number of Shares		
Ordinary and ordinary B shares	1,000,000	–
Ordinary shares each with no par value after adjusting for Sub-division and Conversion	–	2,000,000,000
	<hr/> <hr/>	<hr/> <hr/>
	US\$'000	US\$'000
Shareholders' Equity		
Issued and paid-up share capital	0	0
Share premium	449	9,884
Retained earnings	5,132	5,132
	<hr/>	<hr/>
Total Shareholders' Equity	5,581	15,016
	<hr/> <hr/>	<hr/> <hr/>

The changes in the issued share capital of our Company and our subsidiaries over the last three years preceding the date of this Prospectus is set out in the section entitled “General and Statutory Information” under the subheading “Share Capital” on pages 149 to 152 of this Prospectus.

SHARE CAPITAL

SHAREHOLDERS

Our Shareholders and their respective shareholdings in our Company immediately before and after the Invitation are set out below:

	Pre-Invitation				Post-Invitation ¹			
	Direct Shares	%	Deemed Shares	%	Direct Shares	%	Deemed Shares	%
Directors								
Daniel Benjamin Glinert ⁷	–	–	55,096,000	28.83	–	–	51,883,000	21.34
Aharon Shapira ⁸	–	–	55,096,000	28.83	–	–	51,883,000	21.34
Ehud Harel ⁹	–	–	119,642,000	62.60	–	–	112,655,000	46.33
Hanoh Stark ¹⁰	–	–	119,642,000	62.60	–	–	112,655,000	46.33
Israel Zeev Eliezri	–	–	–	–	–	–	–	–
Eyal Mashiah	–	–	–	–	–	–	–	–
Yehezkel Pinhas Blum	–	–	–	–	–	–	–	–
Chan Kam Loon	–	–	–	–	–	–	–	–
Valerie Ong Choo Lin	–	–	–	–	–	–	–	–
Persons holding more than 5% of our Shares								
Sarin R&D ²	119,642,000	62.60	–	–	112,655,000	46.33	–	–
Interhightech ³	55,096,000	28.83	–	–	51,883,000	21.34	–	–
Zannex ⁴	11,862,000	6.21	–	–	11,862,000	4.88	–	–
Sara Harel ⁹	–	–	119,642,000	62.60	–	–	112,655,000	46.33
Uzi Lev-Ami ¹¹	–	–	55,096,000	28.83	–	–	51,883,000	21.34
Gilad Moran ¹²	–	–	55,096,000	28.83	–	–	51,883,000	21.34
Persons holding less than 5% of our Shares								
Employees ⁵	4,532,000	2.374	–	–	4,532,000	1.86	–	–
Public – Vendor Shares	–	–	–	–	10,200,000	4.20	–	–
Public ⁶ – New Shares	–	–	–	–	52,000,000	21.39	–	–
Total	191,132,000	100.00	–	–	243,132,000	100.00	–	–

Notes:

1. Assuming that the Over-Allotment Option is not exercised.
2. Sarin R&D is offering 6,987,000 Shares as part of the Invitation. These Shares form part of the Vendor Shares and represent 3.66% of our pre-invitation share capital. Sarin R&D is a private Israeli company, which has been our Shareholder since 1989 and whose shares are held as follows:
 - (a) **25.36%** of the capital and the rights to appoint directors are held by **Hargem Ltd** (a private Israeli company whose shares are held by Sara Harel (75.0%), and her son Ehud Harel, (25.0%) (who is a Director of our Company and is also a brother-in-law of Hanoh Stark, who is also a Director of our Company).
 - (b) **24.34%** of the capital and rights to appoint directors are held by **Hanoh Stark Holdings, Ltd**, wholly-owned by Hanoh Stark (who is a Director of our Company, the brother-in-law of Ehud Harel - an indirect Shareholder and a Director of our Company, and brother-in-law of Ilan Weisman, an indirect Shareholder of our Company);
 - (c) **12.09%** of the capital and the rights to appoint directors are held by **Fabulous Ltd** (a private Israeli company held by Kugler Yehuda (1%) and Precious Stones Ltd (99%) - a private Panamanian company owned and controlled by Alfio Harari);
 - (d) **13.52%** of the capital and rights to appoint directors are held by **Gemstar Ltd** (a private Israeli company owned by Avraham Eshed (99%) and his spouse, Mrs. Nitzza Eshed (1%));
 - (e) **14.54%** of the capital and rights to appoint directors are held by **Ramgem Ltd** (a private Israeli company owned by Eyal Mashiah (who is a Director of our Company) (25%), his father, Albert Mashiah (15.5%), his siblings, Oz Mashiah (15%) and Ifat Oved (15%) and Ram Investments Ltd, a company wholly-owned by Eyal Mashiah (29.5%); Eyal Mashiah also holds all of the issued preferred A shares of Ramgem Ltd;
 - (f) **4.06%** of the capital and the rights to appoint directors are held by **Ilan Weisman and Co. Ltd** (a private Israeli company owned by Ilan Weisman and his spouse; and

SHARE CAPITAL

- (g) **6.09%** of the capital and of the rights to appoint directors are held by **Colgem EI 97 Ltd** (a private Israeli company held by Oren Eliezri (20%) and Israel Zeev Eliezri (80%)), who is a Director of our Company and the father of Oren Eliezri).

The directors of Sarin R&D are Hanoh Stark, Ehud Harel, Avraham Eshed, Eyal Mashiah and Ilan Weisman.

3. Interhightech is offering 3,213,000 Shares as part of the Invitation. These Shares form part of the Vendor Shares and represent 1.68% of our pre-invitation share capital. Interhightech is a private Israeli company (previously known as TICI Software Systems Ltd), which has been our Shareholder since 1994 and whose shares are held as follows:
- (a) 24.25% by Daniel Benjamin Glinert, who is our Chairman of the Board of Directors, via a company controlled by him, **D. Glinert Holdings, Ltd**;
 - (b) 24.25% by Aharon Shapira, who is our Director, via a company controlled by him, **A. Shapira 2000 Systems, Ltd**;
 - (c) 24.25% by Uzi Lev-Ami, via a company controlled by him, **U Lev-Ami Holdings, Ltd**;
 - (d) 24.25% by Gilad Moran, via a company controlled by him, **Moran Hightech, Ltd**; and
 - (e) 3% by Eitan Kenneth, via a trustee.

The directors of Interhightech are Daniel Benjamin Glinert, Aharon Shapira, Gilad Moran, Eitan Kenneth and Uzi Lev- Ami.

4. A private Israeli company (previously known as Klali Capital Development Ltd), which has been our Shareholder since 1995 and whose shares are wholly-owned by Ephraim Shpitalni and his spouse, Odelia Shpitalni.
5. Employees comprise our CEO, certain employees (excluding Directors) and consultants who have, prior to the Invitation, been granted share options under the 2003 Share Option Plan as described in the section entitled "General and Statutory Information" under the subheading "Share Capital" on pages 149 to 152 of this Prospectus. These Shares are held in trust for these employees by Eyal Khayat (Adv.), pursuant to Israeli tax regulations.
6. Public shareholders comprise new investors.
7. Daniel Benjamin Glinert is a director of, and indirectly holds 24.25% of the shares (through D. Glinert Holdings Ltd) in, Interhightech, which in turn holds 28.83% (pre-Invitation) or 21.34% (post-Invitation) of the Shares in our Company. Accordingly, Daniel Benjamin Glinert is deemed to be interested in the 28.83% (pre-Invitation) or 21.34% (post-Invitation) of the Shares in our Company held by Interhightech.
8. Aharon Shapira is a director of, and indirectly holds 24.25% of the shares (through A. Shapira 2000 Systems, Ltd) in, Interhightech, which in turn holds 28.83% (pre-Invitation) or 21.34% (post-Invitation) of the Shares in our Company. Accordingly, Aharon Shapira is deemed to be interested in the 28.83% (pre-Invitation) or 21.34% (post-Invitation) of the shares in our Company held by Interhightech.
9. Ehud Harel is a director of Sarin R&D and holds 25% of the shares in Hargem Ltd, which in turn holds 25.36% of the shares in Sarin R&D, which in turn holds 62.6% (pre-Invitation) or 46.33% (post-Invitation) of the Shares in our Company. Accordingly, Ehud Harel is deemed to be interested in the 62.6% (pre-Invitation) or 46.33% (post-Invitation) of the Shares in our Company held by Sarin R&D. Sara Harel, who holds 75% of the shares in Hargem Ltd, which in turn holds 25.36% of the shares in Sarin R&D, which in turn holds 62.6% (pre-Invitation) or 46.33% (post-Invitation) of the Shares in our Company. Accordingly, Sara Harel is deemed to be interested in the 62.6% (pre-Invitation) or 46.33% (post-Invitation) of the Shares in our Company held by Sarin R&D.
10. Hanoh Stark is a director of and indirectly holds 24.34% of the shares (through Hanoh Stark Holdings, Ltd), in Sarin R&D, which in turn holds 62.6% (pre-Invitation) or 46.33% (post-Invitation) of the Shares in our Company. Accordingly, Hanoh Stark is deemed to be interested in the 62.6% (pre-Invitation) or 46.33% (post-Invitation) of the Shares in our Company held by Sarin R&D.
11. Uzi Lev-Ami indirectly holds 24.25% of the shares (through U Lev-Ami Holdings, Ltd) in, Interhightech, which in turn holds 28.83% (pre-Invitation) or 21.34% (post-Invitation) of the Shares in our Company. Accordingly, Uzi Lev-Ami is deemed to be interested in the 28.83% (pre-Invitation) or 21.34% (post-Invitation) of the Shares in our Company held by Interhightech.
12. Gilad Moran indirectly holds 24.25% of the shares (through Moran Hightech, Ltd) in, Interhightech, which in turn holds 28.83% (pre-Invitation) or 21.34% (post-Invitation) of the Shares in our Company. Accordingly, Gilad Moran is deemed to be interested in the 28.83% (pre-Invitation) or 21.34% (post-Invitation) of the Shares in our Company held by Interhightech.

The Shares held by our Substantial Shareholders do not carry different voting rights from the New Shares which are subject of the Invitation.

To the best knowledge of our Directors and save as disclosed above, our Company is not directly or indirectly owned or controlled by another corporation, any government or other natural or legal person whether severally or jointly.

SHARE CAPITAL

MORATORIUM

To demonstrate their commitment to our Company, each of the Vendors, who in aggregate own 164,538,000 Shares, representing approximately 67.67% of our enlarged issued share capital immediately after the Invitation, have undertaken not to realise, dispose of or transfer any part of their respective shareholding in our Company (save for the Additional Shares which may be sold pursuant to the Over-Allotment Option) for a period of six months commencing on the date of our admission to the Official List of the SGX-ST and in the six months thereafter not to realise, transfer or otherwise dispose of more than 50% of their respective shareholdings in the Company.

The shareholders of Sarin R&D (namely Hargem Ltd, Hanoh Stark Holdings Ltd, Fabulous Ltd, Gemstar Ltd, Ramgem Ltd, Ilan Weisman and Co. Ltd, Colgem EI 97 Ltd.) and Interhightech (namely D. Glinert Holdings, Ltd., A. Shapira 2000 Systems, Ltd., U Lev-Ami Holdings, Ltd., Moran Hightech, Ltd. and Mr Eitan Kenneth), have each undertaken not to realise, dispose of, or transfer any part of their respective shareholdings in Sarin R&D and Interhightech for a period of six months, commencing from the date of our admission to the Official List of the SGX-ST and in the six months thereafter, not to realise, dispose of, or transfer more than 50% of their respective shareholdings in Sarin R&D and Interhightech.

In addition, the respective shareholders in each of Hargem Ltd, Hanoh Stark Holdings Ltd, Fabulous Ltd (save for Kugler Yehuda, who owns 1% of Fabulous Ltd), Gemstar Ltd (save for Mrs Nitza Eshed, who owns 1% of Gemstar Ltd), Ramgem Ltd, Ilan Weisman and Co. Ltd, Colgem EI 97 Ltd., have each undertaken not to realise, dispose of, or transfer any part of their respective shareholdings in these companies for a period of six months, commencing from the date of our admission to the Official List of the SGX-ST and in the six months thereafter, not to realise, dispose of, or transfer more than 50% of their respective shareholdings in these companies.

In addition, the respective shareholders in each of D. Glinert Holdings, Ltd., A. Shapira 2000 Systems, Ltd., U Lev-Ami Holdings, Ltd., Moran Hightech, Ltd., have each undertaken not to realise, dispose of, or transfer any part of their respective shareholdings in these companies for a period of six months, commencing from the date of our admission to the Official List of the SGX-ST and in the six months thereafter, not to realise, dispose of, or transfer more than 50% of their respective shareholdings in these companies.

GENERAL INFORMATION ON OUR COMPANY

OUR MARKET

The global diamond industry can be segmented into five major segments – mines, wholesale traders, manufacturers, gemological laboratories and retailers.

1. Mines

Diamonds are primarily found in a relatively limited number of areas, accounting for their relative scarcity and the resulting high price of the rough stones. The most significant areas in which diamonds are found and exploited on a commercial basis are Africa (South Africa, Namibia, Angola, the Congo and Sierra Leone, in particular), Australia, Canada and Russia. With the exception of Russia, which has enacted specific legislature to encourage the processing of the rough stones within its boundaries, the diamonds extracted from the mines in these countries are passed on to wholesalers and manufacturers in other centres in the world. The total dollar value of diamonds mined on an annual basis is approximately US\$9.0 billion.

2. Wholesale Traders

Diamonds are traded in two forms, namely, rough and polished.

The most well-known of the rough stone wholesalers in the diamond industry is De Beers, in London. De Beers concentrates approximately 60% of all the rough diamonds in the world and tightly controls their supply to the market, thus being the primary source of rough diamonds in the industry. De Beers markets their diamonds through a tightly controlled and limited list of approved wholesale dealers and manufacturers, referred to as sight holders. There are a few dozen sight holders that meet ten times a year at De Beers' trading subsidiary – the Diamond Trading Company (DTC) in London. These trading meets are referred to as "sights". The diamonds are traded at these sights in large packages according to the buyers' needs and requests, but more often according to the seller's availability and interests.

The sight holders can then sell the diamonds to rough diamond dealers and manufacturers, but are also expected (required) to utilize part of their rough stone allocation in their own manufacturing facilities.

The rough diamonds are priced by the wholesale traders based on the expected yield from the final polished diamond(s), after carefully planning and polishing the rough stone, according to its unique size, shape, colour and quality (clarity) and other characteristics. Rough diamond traders and manufacturers often use automated diamond planning systems (e.g., our DiaExpert™) to assist them in their assessment of the true value of the diamond they are buying or selling and to help plan its optimal utilization.

Polished diamonds are traded on both the wholesale and retail levels. The wholesale market is dominated by large companies, many of which have their own manufacturing plants. These large wholesale traders sell their diamonds to retailers, including large chain stores (e.g., Tiffany, Zales and WalMart, all at different levels of the quality chain in the USA). A polished diamond is evaluated and priced according to the four C's – Carat weight, Colour, Clarity, and Cut. Sellers and buyers alike employ computerized diamond grading systems to evaluate several of the diamond's characteristics, like colour (e.g., our DC3000 Colorimeter) and cut (e.g., our DiaVision™).

3. Manufacturers

The major wholesale diamond trading and manufacturing centres in the world were historically in Israel and Belgium. Today, India is by far the leading manufacturing centre, accounting for over 80% of all stones manufactured worldwide. PRC is already the second most important manufacturing centre, many plants being set up by international players, primarily from Belgium, the USA and India. Russia as well, due to legislation enacted to limit the export of rough stones from Russia, is emerging as a manufacturing centre.

GENERAL INFORMATION ON OUR COMPANY

Many companies are both wholesalers and manufacturers, so it is difficult to entirely differentiate between these two sectors.

Based on information available relating to the Israeli diamond bourse, we believe that there are approximately 2,500 active members in the Israeli diamond bourse (including wholesalers and manufacturers). Of these, there are just over 200 active manufacturers in Israel.

From information available regarding the Antwerp diamond trade, we are able to estimate that there are approximately 1,000 active members in the Belgian diamond bourse (including wholesalers and manufacturers).

Based on information available relating to the Indian Gem & Jewellery Export Promotion Council, we believe there are over 2,750 active listed members in the diamond panel of the Indian Gem & Jewellery Export Promotion Council (including wholesalers and manufacturers). It is estimated that there are additional non-listed manufacturers of some 750 in number, most of whom are small scale manufacturers. Based on information available on the diamond industry in India, the Company believes that there are over 1 million people employed in the diamond manufacturing and trading industry in India, of which approximately one-third are in the labor-intensive polishing phases of manufacturing, as described below.

Though labour intensive in the end facet-polishing phase, the modern Indian (and other) diamond manufacturing facility is an advanced high technology plant, utilizing computerized systems and automation throughout and housed in modern office buildings. The use of automation has been one of the key factors in India's ascendance as the world's leading diamond manufacturing centre. In the past, diamond planning and cutting expertise was passed down through the generations in a family and was thus limited to a relatively small select group of individuals. The introduction of automation and computerized systems made this knowledge available to non-expert users and thus enabled the establishment of large scale diamond processing plants.

Based on information available on the diamond manufacturing industry in PRC, the Company estimates that there are over 20,000 persons in the diamond manufacturing industry in PRC, although many of them work in small factories processing very small diamonds, and that the PRC is now the second largest producer of diamonds in the world, after India, producing approximately 3 million carats annually.

The manufacturing process is described in more detail below.

4. Gemological Laboratories

The gemological labs set standards for the entire diamond industry on how diamonds should be graded, and hence manufactured and traded.

There are essentially fewer than 50 major gemological laboratories worldwide.

The leading laboratories that have the most influence on the diamond industry today, all of whom are our clients, utilizing our products, are:

➤ Gemological Institute of America (GIA)	– USA & worldwide
➤ American Gem Society (AGS)	– USA
➤ The Diamond High Council (HRD)	– Belgium
➤ International Gemological Institute (IGI)	– Worldwide
➤ European Gemological Institute (EGL)	– Worldwide
➤ Zenhokyo, of the Association of Gem Labs of all Japan (AGL)	– Japan
➤ Central Gemological Laboratory (CGL)	– Japan
➤ National Gem Testing Center (NGTC)	– PRC

GENERAL INFORMATION ON OUR COMPANY

The various laboratories' grading procedures vary slightly, but the basic process, common to all of them, follows the following steps:

Registration & Carat Weight

At this stage the diamond is given a tracking or serial number and its carat weight is measured using an electronic balance (1 diamond carat = 0.2 grams).

Optional: Synthetics & Treatments Detection

Only the larger laboratories have the expensive equipment needed to perform this stage, where the diamonds are scanned for colour and clarity enhancement treatments and for their being of synthetic origin. Synthetic diamonds are real diamonds (hence their detection is problematic) but are man-made, and are not to be confused with other diamond-appearing synthetic crystals, such as Cubic Zirconia, Maissanite and similar commercially available gems. As noted later, an area of future development for our Group is the proposed introduction of cost-effective and inexpensive products for the identification of these synthetic or treated stones, as the need for such products is not only at the laboratory level, but at all levels of the wholesale and retail trade in polished diamonds.

Colour & Fluorescence

The grading of the colour and fluorescence, if any, is usually performed by comparing the polished diamond with a set of master stones. The colour grades for white diamonds are from D ("pure" white), through E, F to Z, specifying darkening shades of colour, with J and K already denoting a distinct yellow tint. In addition, there are fancy coloured diamonds of many colours – most commonly real yellow (not to be confused with yellowish white diamonds), green, orange, red and blue all of varying degrees of scarcity and value. Fancy coloured diamonds are graded by the intensity of their colour and its hue (deep, vivid, etc.).

Two human graders grade each polished diamond with a third one casting the deciding vote between two possibly different grades. This exemplifies the subjectivity of the process and demonstrates the need for objective tools to perform this evaluation. Automatic computerized colorimeters are also used to perform this function in a more objective way (e.g., our DC3000 Colorimeter).

Clarity

Clarity grading is determined by the size and proliferation of inclusions, of many varied types, observed in the diamond. The grades range from flawless (F) and internally flawless (IF), through very very slightly (VVS) included, very slightly (VS) included, slightly included (SI) to included (I), all typically split into two sub-grades (e.g., VS1 and VS2). The definition of each grade is related to the ease of identification of the inclusions with a 10x loupe.

Again, clarity, like colour grading is performed by two human graders, with a third one casting the deciding vote between two possibly different grades. There is currently no cost-effective automated system to grade the clarity of a diamond and the need for such a product is acute for both rough stones, to aid in the process of evaluating the rough stones and planning its optimal utilization at the wholesale and manufacturing level, and polished diamonds, at the wholesale and retail trade levels, as well as at the laboratories.

Cut

The cut is defined by the following parameters:

Proportions – Proportions of the polished diamond, which are always checked with an automatic scanner (e.g., our DiaMension™, DiaVision™ or DiaScan).

GENERAL INFORMATION ON OUR COMPANY

Symmetry – Symmetry of the polished diamond, which may be checked by a combination of human inspection and automatic scanning (e.g., our DiaMension™, DiaVision™ or DiaScan).

Polish – the polish of the facets is always examined by human observation and grades the quality of the finishing craftsmanship performed on the diamond.

Optional: Laser Inscription

Laboratories that offer this service will usually inscribe the serial number they gave the diamond plus a differentiating mark or logo the client requests on the girdle of the diamond. For example, “Tiffany 17263”. There are various laser inscribers available to accomplish this task (e.g., our DiaScribe).

Certificate Generation

At this stage all the accumulated grading data from the previous stages are fed into a central database and a diamond report or certificate is issued with all the relevant information. This report is the only output the client will receive.

5. Retailers

The largest market for retail diamonds is the USA, accounting for approximately 50% of the global diamond retail market. We estimate that there are approximately 25,000 jewellery-only companies in the USA, as of 2002. Many of these jewellers, but not all, deal with diamonds.

The retail stores sell diamonds to consumers, either in their loose state or mounted in jewellery. Most diamonds are sold mounted, as most consumers know too little about diamonds to be able to evaluate their quality when not mounted. The diamond retailer will often use sales tools to educate his clients and show them the superior quality of his diamonds. These sales tools may show the diamond's colour (e.g., our DC3000 Colorimeter), the diamond's cut (e.g., our DiaMension™, DiaVision™ or DiaScan), or other characteristics.

6. Diamond Manufacturing

The diamond manufacturing process is different for different shapes of diamonds. The Round Brilliant Cut that includes 57 facets (and the culet facet) is one of the most popular shapes for polished diamonds. The manufacturing process for a Round Brilliant Cut diamond is as follows:

Planning

This stage encompasses the process of deciding how to best utilize the rough stone in order to achieve the maximum yield possible as polished diamonds of the best size (carat) and quality (clarity, colour and cut) possible. The various steps employed are:

- Manual inspecting and planning. May occasionally require “opening” windows into the opaque diamond for detecting inclusions and making decisions about them.
- Inclusion marking on the surface of the rough diamond.
- Planning on an automatic system (e.g., our DiaExpert™). At this point the planner wants the machine's opinion to either confirm his own expert opinion, if any, or to offer (better) alternatives.
- Laser marking on the rough diamond of the initial sawing plane for the table and other key shaping lines for the remainder of diamond. Automatic systems may again be employed at this stage (e.g., our DiaMark™).

GENERAL INFORMATION ON OUR COMPANY

Sawing and Bruting

The stone is sawed according to the marked lines. Sawing cuts the diamond along its cubic surface using either a thin copper disc, coated in diamond dust and oil, or an automated laser cutting system. Cleaving, an alternative process, less commonly used today, cuts the diamond along the octahedron surface by hitting it with a sharp metal tool. The initial sawing process is then followed by a number of possible steps, according to the shape to be realized. Bruting is used for round diamonds, the most common shape produced.

- Blocking is a process that cuts away unnecessary parts of the rough diamond, leaving the diamond in the general shape to which it will be polished.
- Table blocking – this is where the approximate shape and location of the polished diamond's table is fashioned.
- Pre-centering for initial bruting – this process involves positioning of the rough stone on a special tool ("dop") which is then inserted in a centering machine that makes sure the rough stone is centred and ready for the bruting process.
- Barrel bruting – this process grinds one rough stone against another while rotating them at high speeds (similar to a lathe) to create a barrel shape on both of them, indicating the outer surface of the girdle of the polished round diamonds-to-be.

Re-planning & Final Bruting

This is an iterative step employed to ensure maximal yield and quality. This steps encompasses:

- Re-planning on an automated system to decide the final table tilt (e.g., our DiaExpert™).
- Table tilting – this is where the diamond's table facet is polished to its final tilt angle.
- Blocking 8 + 8 – this is where the diamond's crown's (top) main facets and pavilion's (bottom) main facets are polished.
- Final bruting – this puts the finishing touches on the girdle outline of the diamond.

Parameter Distribution

This accomplishes additional faceting, by polishing the diamond manually on a high speed polishing wheel coated with diamond powder, known as a "scaife". As these scaifes are used, their surfaces are worn down and require periodic (monthly or more frequently) resurfacing. A potential alternative, which has been developed by us, is the utilization of disposable polishing discs to fit on the surface of the scaifes. The utilized steps are as follows:

- Quality assurance ("parameter distribution") is performed on an automatic system (e.g., our DiaMension™, DiaVision™ or DiaScan).
- Final table polishing – finishing touches are polished on the diamond's table.
- Girdle marking for top and bottom girdle lines. This can be done with an automatic marker (e.g., our DiaMark™).
- Bottom 16 + 8 – at this point all the pavilion facets are polished.

GENERAL INFORMATION ON OUR COMPANY

Polishing

The final stage of polishing involves the following:

- Confirmation of pavilion angles on the automated system and their correction (e.g., our DiaMension™, DiaVision™ or DiaScan).
- Top 8 – the crown's main facets are polished.
- Confirmation of the crown's eight main facets and correction if required. This is again done with an automatic scanner (e.g., our DiaMension™, DiaVision™ or DiaScan).
- Girdle finishing and polishing – the diamond's girdle is finished by either polishing it, faceting it, or leaving it bruted, as per the manufacturer's choice.
- Halves – the crown's halve facets (16) are polished.

Finishing

The final quality assurance process. Final measurements and the Cut grade are confirmed. This is, once again, accomplished on an automatic system (e.g., our DiaMension™, DiaVision™ or DiaScan).

OUR HISTORY

Our Company was incorporated in Israel on 8 November 1988 as a private company limited by shares under the Companies Ordinance (New Version) 1983 of Israel, under the name of Borimer Ltd. On 21 September 1989, we changed our name to Sarin Research, Development and Manufacture (1988) Ltd and on 31 December 1994, our name was changed to Sarin Technologies Ltd.

We are a company with proprietary technology specifically applied to the diamond and gemstone industries.

Our Company has, to date, been conducting our business out of the Diamond Exchange District in Ramat Gan, Israel. Our Company currently conducts its business at our offices comprising approximately 1,500 sq m leased on the ground (approximately 180 sq m), 3rd, 4th and 5th (approximately 440 sq m each) floors of a contemporary office building situated at 4 Hahilazon Street, in Ramat Gan 52522, Israel. Prior to this location, our Company leased approximately 725 sq m at 8 Hataas Street, Ramat Gan (from 2000 to December 2004) and approximately 250 sq m at 7 Habonim Street, Ramat Gan 52462, Israel (from 1997 to 1999). Our Company also leases a store, where we showcase our products, in the Diamond Exchange Yahalom (Diamond) Tower. GCI, since its acquisition, has been sharing office premises with our Company.

In addition, Romedix leases approximately 100 sq m at 6 Hasadna Street, in the Kiryat Arie industrial area of Petach Tikva, Israel. The area is being utilized for the pilot production line of disposable polishing discs as described below.

Our first product

Our first product in 1988 was the Robogem™, an automated production system for producing polished gemstones from rough gemstones. Robogem™ captured images of a rough gemstone, determined the maximum polished yield achievable and finally cut the stone into its final shape, all in a production line environment, leaving only the final facet polishing to be done manually. Robogem™ was sold in limited numbers to semi-precious gemstone manufacturers in Israel, Europe and the Far East (namely India and Myanmar). The primary cause for the limited success of Robogem™ was its relatively high cost (over US\$100,000 each), which, together with the relatively low costs of the rough material being optimized (semi-precious stones) and the manpower being saved, negatively impacted the system's returns on investment.

GENERAL INFORMATION ON OUR COMPANY

Following the development of Robogem™, we switched our primary focus to the diamond industry, where the high cost of the rough stones created the necessary environment for favorable returns on investment. The diamond industry deals with extremely costly rough stones, where even single digit percentage savings translate to significant actual profit. The massive promotion budgets allocated create a continuous market demand for diamonds as symbols of love, commitment and eternity. This continuous consumer market drives a stable industry of mining, processing, certification and trading, on which we decided to capitalize.

The value of a diamond – The four Cs

A diamond's value is determined by four parameters, also known as the four C's – Carat, Colour, Clarity and Cut. Its carat weight is determined by weighing the gem on an electronic scale. Its colour, clarity and cut were historically assessed manually, by various subjective visual means like comparison to a key set of colour stones and inspection under various levels of magnification. Often, the results obtained from such means varied, depending on the expert conducting the evaluation. Of the four parameters, the cut was the most difficult to measure manually, resulting in the largest variances in results against the accepted standards set by gemological institutes. For a more in-depth understanding of diamond grading, please refer to Annex A on pages A-1 to A-5 of this Prospectus.

Introduction of innovative products and our subsidiaries

Cut-grading technology

In 1992, we introduced a pioneering grading product for assessing the cut (proportion and symmetry) of polished diamonds, the DiaMension™. The product was an automated computerized product for assessing a diamond's proportion and symmetry, key parameters in the grading of a diamond's cut. Our introduction of the DiaMension™ was a significant advancement for the diamond industry, allowing accurate, uniform and repeatable measurement of the cut, regardless of where, when and by whom the gem was measured. Today, leading gemological labs like the Gemological Institute of America (GIA) and the Hoge Raad voor Diamant or the Diamond High Council (HRD) use the DiaMension™ as a tool for cut grading, and we believe the DiaMension™ has changed the way polished diamonds are bought and sold in the diamond industry by providing accurate means of measuring the proportion and symmetry, thereby deriving the cut, one of the four Cs in determining the value of a polished diamond.

Automated computerized planning system

A key stage in the manufacture of diamonds is the evaluation of the rough stone and the decision on what to produce from it, for example, how many polished diamonds of what size and shape and how to cut them out of the rough stone. Historically, this has been an art known by few and typically passed down within the family. We believe that the diamond industry was again advanced significantly in 1995 when our Company developed the DiaExpert™, which is an automated computerized planning system for the maximum utilization of rough stones. The product is able to rapidly assess various possibilities of placing, shaping and sizing polished diamonds within the volume of the rough stone, thereby allowing the user to optimally maximize the yield from his valuable rough stones. Though the yield benefit varies, the system typically provides for a commercially significant increase in yield. We believe that the introduction of this new technology in the DiaExpert™ has contributed to the geographic shift of the diamond industry to new centres of manufacture such as India, PRC and Russia, which otherwise lacked the diamond expertise traditionally passed down through the generations.

Laser scanning

In 1999, we introduced the use of laser scanning in order to create three-dimensional concave modelling of rough stones. The ability to accurately complement our modelling with the rough stone's concavities provided the user with a complete and accurate model of the rough stone. This feature was complementary to, and increased the effectiveness of, the DiaExpert™, hence enhancing its appeal in the market.

GENERAL INFORMATION ON OUR COMPANY

Inscribing on diamonds

In 2000, the DiaMark™ was introduced. This product allows the DiaExpert™ product to automatically inscribe, using laser markings on the rough stone's surface, the optimal sawing plane that was suggested by the DiaExpert™ and accepted by the user. This effectively links the planning and production phases and allows the diamond manufacturer's planning personnel to accurately, unequivocally and without error, convey to the production personnel on the production floor the information necessary for the initial sawing phase, which is key to the actual realization of additional yield benefit.

Colour assessment

In May 2001, we acquired the entire share capital of GCI, a private company incorporated in Israel. GCI deals in the development, manufacture and marketing of devices for the identification and classification of diamond colour. By acquiring GCI, we were able to provide the market with an automated assessment of another of the polished diamond's four C's – Colour.

Laser cutting technology

We also increased the level of automation in diamond manufacturing by introducing a direct computer-to-computer link to laser cutting tools for diamonds. Laser cutting technology provides the manufacturer with higher accuracy in diamond cutting, additional utilization of the rough stone (as the volumes neatly cut off by the laser can be processed into additional smaller stones, compared to non-laser cutting, during which the volumes cut off would become diamond dust due to the continual abrasive action of non-laser cutting). In addition, laser cutting technology provides the possibility of processing more types of stones, including problematic crystals, which tend to shatter when processed by conventional abrasion methods. By enabling the automatic transfer of the designated cutting from our DiaExpert™ to the laser cutting machine, we provided an additional level of automation and isolated another area of possible human error. The automated interface between the planning and cutting systems is an important link in connecting the planning and production phases, which is critical to the diamond manufacturer.

Diversification of products

On 21 December 1995, our Company, along with another company, Rodata Investments Ltd, incorporated a private company subsidiary called Romedix. In the ensuing years, additional investment brought in other minority shareholders. In 2002, Rodata sold its share in Romedix to our Company and in June 2004, we acquired the remaining share capital of Romedix (amounting to approximately 9%) from the other minority shareholders. As a result, Romedix became our wholly-owned subsidiary. Since its incorporation, Romedix dealt in the development, manufacture and marketing of devices for inspecting and documenting skin afflictions in general and in particular, the colour and size of skin lesions. The sales of these products have been and are limited.

In May 2004, Romedix purchased from a third party know-how and technology used in the development and manufacture of disposable polishing discs for diamonds and gemstones. Use of these discs is expected to enable factories to renew their polishing scaifes (or wheels) quickly, with minimal effort, and without the need to send them to be reworked at special workshops. This enables diamond manufacturers to save considerable time and expense. Using the goodwill, our existing customer base and the marketing channels that we have generated in the diamond and gemstone market, we believe that adding these polishing discs to our product line is another step towards establishing our Group as a "one-stop-shop" for technology and automation in the diamond industry while also establishing a recurring source of income from the sale of these disposable goods.

GENERAL INFORMATION ON OUR COMPANY

Strengthening our presence in India

Through Aerodiam Software Ltd in Mumbai (from 1995 to 1997) and via Sahajanand Technologies P. Ltd in Mumbai and Surat (from 1997 to early 2004), we were dependent on various local distributors for our sales activities in India. In order to reduce our dependency on distributors in light of the increasing role of India as the primary worldwide production centre in the diamond industry, we saw fit to establish a wholly-owned subsidiary in India. On 22 March 2004, we incorporated Sarin India as our wholly owned subsidiary in India. Sarin India deals in the provision of pre-sale, post-sale and technical support services to our Group's customers in India, Sri Lanka and such other territories as may be agreed upon by our Company and Sarin India. These services include identification of business opportunities and sales promotion and technical support, from installation and training through provision of maintenance services, during and after the warranty period. In addition, Sarin India also trades in computer systems and accessories for sale to customers with machinery sourced from our Group. Sarin India commenced operations in the two main trading and manufacturing regions in Mumbai and Surat at the beginning of the second quarter of 2004.

OUR BUSINESS

Our Group deals in the development, manufacture and sale of precision technology products based mainly on automated three-dimensional geometric measurement (metrology) for the processing of diamonds and gems. Our systems also combine various hardware technologies, like electro-optics, electronics, precision mechanics and lasers. The heart of the systems is the computer software that combines three-dimensional modelling and advanced mathematical algorithms. Our products provide smart solutions for every stage and aspect of diamond design and manufacturing, from determining the optimal yield from a rough stone, laser markings for cutting rough stones, measuring and analysing polished diamonds, inscription on polished diamonds and technology that assists sales in jewellery stores. Hence, our products increase the profit margins at all stages of the trade between the purchase price of rough stones and the price of polished diamonds. We believe that over the years, our products have changed the manner in which rough stones are processed into polished ones and have established a brand name for ourselves in the diamond industry.

Our DiaMension™ and DiaVision™ products (as detailed in the section entitled "General Information on our Company" under the subheading "Our Products") are used in most of the gemological institutes (like the Gemological Institute of America (GIA), the American Gem Society (AGS), the International Gemological Institute (IGI), the Hoge Raad voor Diamant or the Diamond High Council (HRD), the Central Gemological Laboratory (CGL) and the European Gemological Laboratory (EGL) for the qualification and grading of a polished diamond's cut.

Our products provide diamond dealers with technological solutions for three main areas in the diamond industry:

(a) *Planning the optimal use of the rough stones*

We have developed computerized electro-optical products, which assist the diamantaire (that is, the expert planner tasked with planning the utilization of the rough stones) in considering various options for utilizing the rough stones. Our products explore thousands of different possible methods of utilization of the rough stone and propose, using a visual three-dimensional representation on a computer screen, the possible ways of processing the stone into polished diamonds. This can be done according to each individual diamantaire's preferences where the parameters are set according to the preferred cuts and valuations. The product also assesses the grading of the proposed cut according to the diamantaire's preferred method of grading (as per various grading institutes). In addition, in order to assist in implementing the recommendations presented by our products, we have also developed laser marking products which allow the diamantaire to mark the sawing plane, as proposed by our system's recommendations for the optimal cut, onto the rough stone. In addition, the product is designed by us to interface with various automated diamond processing (for bruting and cutting) machines (of other manufacturers) and significantly facilitates the processing of the diamond ensuring that the exploitation of the expensive rough stones yields the maximum results.

GENERAL INFORMATION ON OUR COMPANY

(b) *Measurement of the parameters of polished diamonds to determine their value*

We have also developed electro-optical computerized products that measure the specific parameters on the basis of which a diamond is graded (that is, the quality of its colour and cut) to assist in determining the value of polished diamonds.

(c) *Inscribing on polished diamonds*

We have developed a product, which inscribes text and symbols on a polished diamond, enabling diamond manufacturers to mark their diamonds with logos, serial numbers and other distinctive marks. It also allows gemological institutes in the diamond industry to provide individual diamonds with a certificate bearing the institute's mark and an exclusive certificate number and inscribes this certificate number onto the diamond for identification and security purposes.

OUR PRODUCTS

Diagram A: The DiaMension™ / DiaExpert™ Platform



GENERAL INFORMATION ON OUR COMPANY

Diagram B : The DiaVision™ Software Screen Layout

The screenshot displays the DiaVision Professional Edition software interface. The title bar shows 'DiaVision Professional Edition Stone Name: Round'. The menu bar includes 'Stone', 'View', and 'Tools', with 'Help' also visible. The main toolbar contains buttons for 'Measure', 'Data', 'Recut', 'Properties', 'Print Current', 'Print & Finish', 'Open [database]', 'Save [database]', and 'Shape Wizard'. Below the toolbar is a navigation bar with a '3D' view indicator and a 'VIDEO' section with playback controls. The central area is divided into a data table on the left, a 3D diamond model on the right, and a sidebar on the far right.

AGL	Stone ID: Round		Symmetry	
Weight	0.612 ct.			
Diameter	5.490 mm (5.47 - 5.51)			
Diameter Dev	0.7%		Ex	VG
Total Depth	61.4%	3.37 mm	Ex	
Table Size	54% (54.10)	2.97 mm	Ex	VG
Crown Angle	34.5	(34.0 - 34.6)	Ex	VG
Crown Height	15.8%	0.87 mm		VG
Pavilion Angle	40.7	(40.6 - 40.9)		VG
Pavilion Depth	42.6%	2.34 mm	Ex	VG
Culet Size	0.7%	Very Small	Ex	VG
Girdle Min	1.09%	Thin	Ex	
Girdle Max	1.64%	Medium	Ex	
Girdle Deduction		0	Ex	VG
Star/Upper Ratio	51.49		Ex	
Proportion Grade	EXCELLENT		VERY GOOD	

The 3D model shows a diamond with the following dimensions: diameter 5.49mm, table size 2.97mm (54%), crown angle 34.3°, crown height 0.87mm (15.8%), pavilion angle 40.7°, pavilion depth 2.34mm (42.6%), and culet size 0.04mm (0.7%). The top-down view shows eight facets with angles ranging from 34.0° to 34.6°.

The sidebar on the right includes sections for 'Views', 'Reports', 'Labels', '3D Symmetry', 'Video', 'AGL', and 'AGS'. The bottom status bar indicates 'Current shape: Round-P8-P8'.

Diagram C: The DiaMark™ / DiaScribe Platform (being the DiaMension™/DiaExpert™ platform with a laser add-on module)

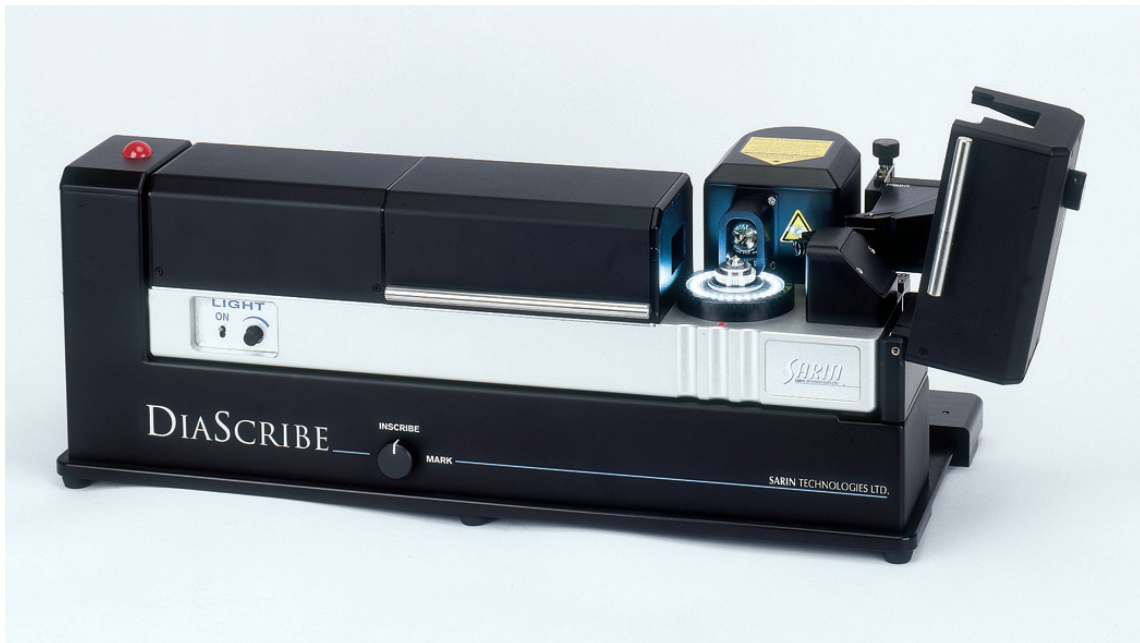

GENERAL INFORMATION ON OUR COMPANY

Diagram D: The DiaExpert™ Screen Page

The screenshot shows the DiaExpert software interface. At the top, the title bar reads "Advisor 1.1 Lens 1 gak203415 3.352 ct." and the menu bar includes "Stone", "Planes", "Planning", "Polish", "Reports", "Tools", and "Help". Below the menu bar are tabs for "Map", "Plan", and "Mark". A toolbar with various icons is visible. The main area is divided into several sections:

Part A (1.179ct. (1.560ct.) 75.6%)

L:W	W:5.84	L:5.84
Height	75.0%	4.38mm
Table	75.0%	4.38mm
Crown°	13.7°	
Crown H	5.3%	0.31mm
Girdle	M: 4.0%	0.23mm
Pavil.°	52.7°	
Pavil.H	65.7%	3.84mm
L / W	1.00	
Tilt	0°	

Rough & Saw

Rough	3.352ct.
Saw Width	120mic.
Loss (Saw)	2.9%
Saw Tilt	55.7°

Part B (1.211ct. (1.694ct.) 71.5%)

L:W	W:5.85	L:6.00
Height	75.0%	4.39mm
Table	75.0%	4.39mm
Crown°	13.7°	
Crown H	5.3%	0.31mm
Girdle	M: 3.8%	0.22mm
Pavil.°	52.8°	
Pavil.H	65.9%	3.86mm
L / W	1.02	
Tilt	0°	

The right side of the interface shows a "Results" table with columns for "Planes", "Results", "Inclusions", and "Calculator". The "Results" column is expanded, showing a list of diamonds with their weights and saw types. The "Sort by" dropdown is set to "Best Weight".

Icon	Weight 1	Weight 2
	1.179ct Saw 0	1.560ct
	1.211ct Saw 0	1.694ct
	1.281ct Saw 1	2.623ct
	0.398ct Saw 1	0.660ct
	0.449ct Saw 1	0.660ct

Diagram E : The DiaScan S Series



GENERAL INFORMATION ON OUR COMPANY

Diagram F : The DC 3000 Colorimeter



Our products can be segregated for use in three areas, namely (a) products for analysing and planning the use of rough stones, (b) products for measuring and grading polished diamonds and (c) products for inscribing on polished diamonds.

(a) *Products for analysing and planning the use of rough stones*

(i) DiaExpert™

DiaExpert™ (see Diagrams A and D above) is a product which maps complicated stones with convex and concave geometries of up to approximately 28 mm (equivalent to more than 100 carats) using patented technology implementing cutting edge optical imaging and laser scanning systems. A new model of this product, the DiaExpert™ XL, which handles stones of up to 65 mm (equivalent, depending on the shape of the stone, in theory to 800 carats and more) will be marketed in the first quarter of 2005. It assists the diamond manufacturer in the most crucial step in the processing of rough stones – deciding how to cut the rough stones while achieving the maximum yield possible. It takes into account different shape possibilities, proportions and internal flaws while giving the optimal solution. It calculates thousands of polished diamond allocation options in seconds and is user-driven when recommending the optimal shape selection by providing interactive indications of sawing and other planes. The newest version of the software to run on the DiaExpert™ platform (and the DiaScan series described below) was introduced in January 2005 and is called the Advisor. It offers many new enhancements, including better planning functionality for fancy shapes in general and square fancy shapes (Princess, Radiant, Rectangle (Emerald) etc.) in particular and an enhanced graphic user interface.

GENERAL INFORMATION ON OUR COMPANY

Introduced in 1995, the DiaExpert™ is commonly used in the diamond trading and manufacturing process. We have realized significant sales volumes of DiaExpert™ in all the major diamond trading and manufacturing centres worldwide, including the USA, Belgium, India, Israel, South Africa and Thailand. With the opening of additional diamond cutting and polishing centres in PRC and Russia, and the introduction of new models of the DiaExpert™ aimed at small manufacturing facilities, we expect our sales volumes of these products to continue into the foreseeable future.

(ii) DiaMark™

DiaMark™ (see Diagram C above) is an automatic laser marking system which is an add-on unit to the DiaExpert™. Using a laser beam, it etches non-erasable markings of the rough stone's sawing plane according to the recommendations by the DiaExpert™, hence eliminating possible discrepancies between the planning stage and the production process. It is a simple one-step operation and since it uses a low power laser, constitutes no risk to the diamond or the user.

(iii) DiaScan "S" Series

DiaScan "S" Series (see Diagram E above), consisting of four models, is a cost-effective analysis tool, similar to the DiaExpert™, but its use is limited to specific ranges of stones of smaller sizes and it does not link to the DiaMark™. It is a single lens unit and is not designed to be upgraded to do laser marking, unlike the DiaExpert™. It was developed as a strategic product to expand our market, for use on production floors as in-line quality assurance and by companies with smaller budgets, as it is relatively inexpensive. DiaScan "S" Series is based on the same technology and software as the DiaExpert™. DiaScan "S" Series is also available as a mobile carry-on configuration (known as the DiaMobile) which includes a laptop computer and is sold in a hard-case for portability.

(b) *Products for measuring and grading of polished diamonds*

(i) DiaMension™

DiaMension™ (see Diagram A above) is an assessment system for the cut of the polished diamond. It enhances diamond manufacturing and diamond grading efficiency in all phases of production by combining computerized machine vision and advanced three-dimensional image processing technologies to evaluate and display geometric properties of stones and present accurate on-screen proportion and symmetry measurements.

DiaMension™ was introduced in 1992 and many gemological institutes worldwide, such as the GIA, have acquired the DiaMension™ for use in their certification process. Successive generations of the DiaMension™ have incorporated additional features, such as more accurate imaging and measuring, recut software which is used to evaluate the potential benefits of re-cutting and re-polishing a polished diamond, and "finger-printing" software. Subsequent models also address the varying needs of different market segments (manufacturing, wholesale trading, retail) such as portability, stone sizes and pricing.

(ii) DiaVision™

DiaVision™ (see Diagram B above) is an enhanced version of the software in the DiaMension™, which enables the measurement of the cut of the polished diamond by analysing the proportion and symmetry of the polished diamond. It is able to measure virtually any shape (round or fancy), a wide range of sizes (up to 70 carats) and accurately quantifies all the angles and facets of the polished diamond. The software can be set to grade the various cuts according to major gemological laboratories' grading standards and provides reports of the grades. It incorporates enhanced modelling accuracy and proprietary software, enabling both inspection and documentation of previously unattainable data, as well as the simulated quantification of new parameters defining the beauty of the polished

GENERAL INFORMATION ON OUR COMPANY

diamond by the brilliancy, scintillation and fire. It also offers the user a realistic three-dimensional model of the diamond cut and has a photorealistic viewer for assessing the light performance of the measured diamond. It includes a new visual editor for quickly customizing on-screen views of the diamond's appearance, labels and full-sized reports for printing. It is an add-on software module and is compatible with all our hardware platforms including our DiaMension™ series of diamond grading machines, DiaScan and Brilliant Eye.

(iii) Brilliant Eye

Brilliant Eye is designed to increase the consumer confidence in the quality of the stone, providing the consumer with information on the stone (including an animated three-dimensional display of the stone) and generating an accurate measurement report endorsed by major gemological laboratories worldwide. This system assists the diamond merchants and jewellers in sales to the end customers. It is based on the same technology as the DiaMension™.

(iv) DC 3000 Colorimeter

This product (see Diagram F above) is a computerized colour measuring system for polished diamonds up to 20 carats in size. It is able to measure all grades from a D (optimal colour) to a Z (inferior colour) and provides an accuracy of up to a half grade.

(v) Sarin – A3DM Modeler (“SAM”)

The SAM software allows the user to scan a gemstone and save its data as a standard stereo-lithographic file using our machine. This enables the user to incorporate the exact stone dimensions into a three-dimensional CAD program for the jewellery designer, thus aiding its incorporation into the final jewellery design. It is capable of measuring virtually any shape (round and fancy), in a wide range of sizes and measures all the angles and facets, including the upper and lower girdle of the stone. It has an easy to use graphical interface and is a simple two-step operation (scan and save). It is compatible for use with our DiaExpert™, DiaMension™ and DiaScan hardware platforms.

(vi) Sarin Web Viewer

The Sarin Web Viewer is a freely distributed program for viewing Sarin files, which may contain stone reports, measurements and three-dimensional stone models without the need for our machines. It enables users to inspect the stone in detail without actually physically holding the stone. It is designed as an aid for our customers to market their stones on the Internet. Our web viewer can be operated using standard software programs, like Microsoft Windows™.

(c) *Products for inscribing on polished diamonds*

(i) DiaScribe

DiaScribe (see Diagram C above) is a laser inscription system which allows users to create inscriptions of virtually any text (in almost any language and font) or logo on the girdle of a polished diamond. By inscribing microscopic characters on the diamond, it can be used for (i) identifying and protecting diamonds by inscribing their unique serial number; (ii) branding the diamond with the relevant company's name; and (iii) allowing end-customers to personalise their diamonds with individual messages.

GENERAL INFORMATION ON OUR COMPANY

RESEARCH AND DEVELOPMENT

In order to accommodate the rapidly changing needs of our end customers, we engage in on-going product development activities and place considerable emphasis on research and development projects designed to create new proprietary software for use in our products, improving our existing products, developing new products and customizing our products to meet our end customers' needs. This includes improving the functionality and enhancing the use of our products. Our research and development policy is an integral part of our initiative and strategy to stay competitive with cutting edge technology. We work closely with our end customers, our agents and distributors who provide significant feedback for product development and innovation.

We have created a structured process for undertaking research and product development. We believe that the method that we use for our product development and testing is well suited for identifying market needs, addressing the activities required to release new products and bringing development projects to the market successfully. Our product development activities also include the release from time to time of new versions of our software for our existing hardware platforms. Although we expect to develop new products internally, we may, from time to time, and based upon timing and cost considerations, acquire or license technologies or products from third parties.

Our research and development programs are led by our Vice President of R&D, Dan Ilan Bar-El, and our Chief Technology Officer, Abraham Meir Kerner, who, together with their team, execute the development of our products. These developments are financed, mainly by shareholders' equity and in part by grants from the Israeli government. Our Group paid royalties to the Israeli government in the approximate sums of US\$15,000, US\$20,000, US\$16,000, US\$9,000 and US\$9,000 in FY2001, FY2002, FY2003, 1H04 and 2H04 respectively. Research and development expenses for FY2001, FY2002, FY2003, 1H04 and 2H04 were US\$757,000, US\$709,000, US\$1,370,000, US\$725,000 and US\$834,000 respectively. We expect to continue to commit the required resources to research and development in the future.

INTELLECTUAL PROPERTY

The products we develop are proprietary in nature. Hence, our ability to remain competitive in the market is dependent in part on our ability to protect our proprietary software and the technology accompanying it. In protecting these proprietary rights, we have registered the following patents and trademarks:

Patents

The following patents are either owned by our Group or are pending:

Name of Invention and Owner of Patent	Country of Registration	Date of Application	Date of Expiry of Registration
Registered Patents:			
Laser Marking on Diamonds (our Company)	Israel*	3 September 2000	In opposition ¹
	India*	1 June 2001	Pending
	USA	2 August 2001	2 August 2021 ²
	Belgium	24 June 2001	24 June 2021 ²
An Apparatus and Method of Examining the Shape of Gemstones (our Company)	Israel	29 October 1998	29 October 2018 ³
	India*	10 July 2000	Pending
	USA	31 August 2000	31 August 2020
	Belgium	1 September 2000	1 September 2006
Keypad (our Company)	Israel*	13 February 2003	Pending
Method and System for Gemstone Colour Prediction (GCI)	Israel and international procedure (PCT)*	7 July 2003 and 6 July 2004	Pending
Method for Working Gemstones (Romedix)	Israel*	14 June 2004	Pending

GENERAL INFORMATION ON OUR COMPANY

* Pending patents

1. Our patent attorney in Israel, Gilat, Bareket & Co Attorneys at Law, has informed us on 13 September 2004 that the opposition proceedings initiated by OGI Systems Ltd ("OGI") in Israel against our patent application are taking place before the Israel Patent Office. On 15 June 2004, OGI filed with the Israel Patent Office a petition to amend its statement of claims. On 20 December 2004, the Company filed its reply to OGI's claim, and OGI now needs to submit its evidential documentation by 20 March 2005.
2. We have also recently learned that OGI may be infringing our patent for this product in the USA and Belgium (where patents have been granted) and we have instructed our patent and IP attorneys to pursue this issue.
3. This patent was originally also subject to an opposition by OGI. However, on 28 July 2003, a settlement agreement was signed by OGI and us, pursuant to which OGI agreed to withdraw its objection to the patent application. Further, OGI agreed not to claim against or challenge the validity of any applications which may be submitted by us all over the world with regard to this invention and that OGI will neither manufacture nor market any appliance for the modelling of diamonds, which combines the taking of pictures of the silhouettes of the diamond with the exercise of laser mapping of concave surfaces.

The know-how purchased by Romedix regarding the production of the disposable polishing discs ("A Method of Working Gemstones") has not yet been registered as a patent, but an application for registration of it as a patent has been submitted on 14 June 2004 with the Patent Office of the State of Israel. For further information on this pending patent, please refer to the section entitled "General and Statutory Information" under the subheadings "Material Contracts" on pages 153 and 154 and "Litigation" on pages 155 to 158 of this Prospectus.

As at the date of this Prospectus, we have two disputes with regards to intellectual property. We opposed two Israeli Patent Applications (No. 124034 and No. 140512), both with respect to "Laser Marking Systems for Gemstones and Method of Authenticating Marking" in the name of Lazare Kaplan International, Inc ("LKI"). Opposition proceedings are taking place before the Israel Patent Office and we are awaiting the filing of counter-evidence by LKI (with regard to Patent Application No. 124034), which was to be filed by 28 February 2005. However LKI filed a petition on 30 December 2004 to amend its claims and our Company has to file our objection to the said amendment by 2 March 2005. With regards to Patent Application No. 140512, our Company had filed our opposition claims on 13 January 2005 and LKI now has to file its counter-claim no later than 13 April 2005.

Trademarks

Our Group either owns or has applied for the registration of the following trade names and trade marks:

Trade Mark/Name	Country of Registration	Date of Expiry of Registration (where applicable)
ADVISOR	Israel*	Pending
	USA*	Pending
	Benelux*	Pending
	PRC*	Pending
	India*	Pending
BRILLIANT EYE	Israel*	Pending
	USA*	Pending
	Benelux*	Pending
	PRC*	Pending
	India*	Pending
DIACENTER	Israel	23 November 2015
	USA*	Pending
	Benelux*	Pending
	PRC*	Pending
	India*	Pending

GENERAL INFORMATION ON OUR COMPANY

Trade Mark/Name	Country of Registration	Date of Expiry of Registration (where applicable)
DIAEXPERT	Israel	28 January 2017
	USA*	Pending
	Benelux*	Pending
	PRC*	Pending
	India*	Pending
DIAMARK	Israel	19 November 2007
	USA*	Pending
	Benelux*	Pending
	PRC*	Pending
	India*	Pending
DIAMENSION	Israel	23 November 2015
	USA*	Pending
	Benelux*	Pending
	PRC*	Pending
	India*	Pending
DIAMOBILE	Israel*	Pending
	USA*	Pending
	Benelux*	Pending
	PRC*	Pending
	India*	Pending
DIAPORT	Israel	28 January 2017
DIAPRO	Israel	28 January 2017
DIASCAN	Israel*	Pending
	USA*	Pending
	Benelux*	Pending
	PRC*	Pending
	India*	Pending
DIASCRIBE	Israel*	Pending
	USA*	Pending
	Benelux*	Pending
	PRC*	Pending
	India*	Pending
DIASIGN	Israel	28 January 2017
	USA*	Pending
	Benelux*	Pending
	PRC*	Pending
	India*	Pending
DIAVISION	Israel	21 January 2013
	Benelux	22 January 2013
	USA*	Pending
	PRC*	Pending
	India*	Pending
ROBOGEM	Israel	23 November 2015
SARIN	Israel	24 January 2016

GENERAL INFORMATION ON OUR COMPANY

Trade Mark/Name	Country of Registration	Date of Expiry of Registration (where applicable)
SARIN TECHNOLOGIES	Israel*	24 January 2016
	USA*	Pending
	Benelux*	Pending
	PRC*	Pending
	India	Pending
SARIN (SARIN TECHNOLOGIES LTD.) & DEVICE	Israel*	Pending
	USA*	Pending
	Benelux*	Pending
	PRC*	Pending
	India*	Pending

* Pending trademarks

Other Protection

In addition to patents and trademarks, we also employ internal controls such as the use of confidentiality and non-disclosure agreements with our employees, strategic partners and customers who may have access to sensitive design software and technology and may also rely on a combination of copyright, trademark and trade secret laws in order to protect our proprietary rights. As a matter of policy we do not provide our product source codes to customers. In addition, our proprietary technology incorporates processes, methods, algorithms and software that are results of long-term in-house experience and expertise and thus we believe our technology cannot be easily copied.

OUR PRODUCTION PROCESS

Our products are assembled from three main technological components: laser sources, optical systems, including lenses and charged coupled device (CCD) cameras, and software, which implements the applications of the various systems. In addition, our products comprise electronic cards and various mechanical components, such as vacuum pumps and motors.

The software in these products is embedded in part on electronic cards that are integrated into our products and installed in part on computers running on any Microsoft Windows™ operating system. The source code for the software is confidential and protected against piracy by using a HASP™.

The laser sources, the CCD cameras, some of the electronic cards, the pumps and the motors are off-the-shelf products chosen especially to comply with the technical requirements of our products. Most of the lenses, some of the electronic cards and other electro-optical components are manufactured in accordance with our specifications as per the requirements of our products. However, most manufacturers of such components can manufacture the parts in accordance with such specifications.

Assembly of the parts takes place in our facilities. Calibration, quality control and burn-in processes are performed at the end of the production process, before the product is sent out to end customers and/or distributors. All parts of our products are manufactured or supplied by suppliers and sub-contractors.

GENERAL INFORMATION ON OUR COMPANY

OUR PRODUCTION CAPACITY

Our production facilities are located in Israel. The average production capacity and extent of utilization for FY2002, FY2003 and FY2004 are as follows:

	Maximum Production Capacity* (hours)	Actual Utilization** (hours)	Utilization Rate (%)
FY2002	16,100	11,000	68.0
FY2003	19,300	15,800	80.0
FY2004	23,500	21,700	92.3

* The maximum production capacity is calculated based on the number of production employees multiplied by the standard number of hours in a standard work year based on one shift with 30% overtime.

** The actual utilization is calculated based on the actual number of hours worked.

Our production capacity varies with market needs. We operate five days a week, one shift with overtime if necessary. Over the years, our production capacity has increased in FY2003, by 20% compared to FY2002. This was accomplished through the investment in additional production means (for example, assembly and test benches, calibration and test equipment) and the recruitment of additional employees. In FY2004, our production capacity increased by a further 22% compared to FY2003 as we continued to invest in equipment and personnel. Utilization rates increased in FY2004 as more machines were produced and those produced were more complex. Notwithstanding the aforesaid, our human resource requirements are adjusted periodically for varying levels of needs.

In FY2002, FY2003 and FY2004, the output of our facilities, in units, was 850, 1,000 and 1,250 respectively.

OUR INVENTORY MANAGEMENT POLICY

Our inventory of products in process, like subsystems and components is typically for a supply period of one to three months (depending on the availability and cost of the items). We strive to maintain inventory of final products for a supply period of about four weeks. Since it takes a relatively short time to assemble our products, we have a policy of keeping minimal inventory. Our Group also holds inventory of products and spare parts on consignment with our agents and distributors, so as to enable the provision of fast and professional services by our distributors and agents to our customers who purchase the various systems. We have established inventory management control directives to track incoming and outgoing inventory. Our management closely monitors inventory levels to ensure we do not carry quantities in excess of our requirements. Our inventory turnover for finished goods was 26 days for FY2001, 63 days for FY2002, 53 days for FY2003 and 45 days for 1H04. For further information on our inventory turnover, please refer to the section entitled "Management's Discussion and Analysis of Financial Condition and Results of Operations" under the subheading "Review of Financial Position" on pages 108 to 112 of this Prospectus.

SEASONALITY

There is no seasonality observed for our business over the financial years and period under review.

SALES, MARKETING AND BUSINESS DEVELOPMENT

We market either directly from Israel (including into India), or through our distributors and agents in 14 locations covering the major centres of diamond manufacturing and trading worldwide. We provide technical support for our products through our subsidiary in India as well as through our distributors and agents located worldwide. The products manufactured by our Group are sold to manufacturers, dealers, retailers, gemological institutes and laboratories in the diamond and gem industry.

GENERAL INFORMATION ON OUR COMPANY

Our products are sold in four main geographical areas, namely (i) India (approximately 58.2% of sales as at 30 June 2004); (ii) Western Europe (approximately 11.5% of sales as at 30 June 2004); (iii) North America (approximately 9.7% of sales as at 30 June 2004); and (iv) the rest of the world (including sales to Israel, PRC, Hong Kong and Russia), constituting 20.7% of sales, as at 30 June 2004. Our Group has no framework agreements with end customers (as distinct from distributors) because the amount of products purchased by individual customers is usually limited.

As at 30 June 2004, we had a total of 14 agents and distributors, and a team of internal sales personnel (who are employees of our Group). We have agent and distribution agreements, mostly on an exclusive basis. Our agents and distributors are not required to hold product inventory, but do undertake to provide installation and warranty services to customers. The distributors purchase our Group's products at a discount of between 20% and 30% of the list price for our Group's products. The agents are entitled to a sales commission at the rate of between 10% and 20%.

Since 1999, India has become the primary market for our products. Prior to the end of 2003, sales to India were almost exclusively channelled via the local distributor in India. In the beginning of 2004, our relationship with our previous distributor was terminated. For more details, please refer to the section entitled "General and Statutory Information" under the subheading "Litigation" on pages 155 to 158 of this Prospectus. We commenced direct marketing and distribution in India in April 2004. Sarin India provides pre-sale, post-sale and technical support services to our Group's customers in India, Sri Lanka and such other territories as may be agreed by our Company and Sarin India. These services include identification of business opportunities and sales promotion and technical support, from installation and training through provision of maintenance services, during and after the warranty period. We pay Sarin India for the pre-sale and post-sale services provided during the warranty period. Our Group's customers who wish to receive technical support and maintenance services after the warranty period are entitled to contract with Sarin India directly. In addition, Sarin India also trades in computer systems and accessories for sale to customers with machinery sourced from our Group.

QUALITY ASSURANCE

We believe that the quality of our products is key to our continued growth. We have a dedicated quality assurance team that is responsible for ensuring that our products are in compliance with our specifications. We accord high priority to quality control and have adopted the following measures as part of our quality assurance and control system:

Quality assurance during development

Upon completion of the product development, the development team conducts quality assurance according to a written procedure tailored for the particular product. The finished product is first tested in-house. This is known as the alpha site testing. Our quality assurance team tests the products to ensure that they comply with the functional requirements specified. After the product passes the alpha site testing, it is sent for beta site testing. For the beta site testing, we provide the products to selected customers to be used at various representative sites where the products are put to test in the real world environment for a period of one to three months, depending on the type of product and scope of new development. After the product passes the beta site testing, it is ready for mass production and distribution.

In-coming quality control

We maintain an updated list of suppliers with whom we have good business experience, particularly in respect of product specification compliance, payment terms and price. Our preferred suppliers are evaluated on an annual basis. Upon discovery of any non-conforming incoming components, the defects are rectified either by repair or replacement by the supplier.

In-process / outgoing quality control

During the production phase, every sub-assembly is inspected and tested to ensure that it conforms to the specifications. When the production process is completed, each product is tested again according to a set of written procedures for technical, functional and visual inspections, to verify compliance with specifications before delivery to our customers. The completed testing checklist is attached to the product and passed on to our customers.

GENERAL INFORMATION ON OUR COMPANY

Warranties

In general, we provide a one-year warranty for our products, commencing upon acceptance of the product. Our warranty generally provides that our product will be free from defects in materials and workmanship under normal use for one year from purchase. In the event our products fail during the warranty period, we will provide our customers with free repair or replacement services, at our discretion. The total number of products repaired or replaced over the years by our Group during the warranty period has not been significant.

Support and maintenance

Following the expiration of the warranty period, we continue to provide support and maintenance services, subject to fees, either on a contract basis or on demand, which include fault diagnosis, localization of problems, corrections and preventive maintenance. To date, income from support and maintenance services has not been significant.

GOVERNMENT REGULATIONS

Romedix, in its production of the disposable polishing discs, uses hazardous materials, including various acids. According to municipal and state government regulations for the protection of the environment, these are to be removed by an authorized contractor for the disposal of such materials and delivered to an authorized repository. Romedix has signed an appropriate contract with such a contractor and has submitted documentary proof of the same to the pertinent local authorities.

Save as disclosed above, we are not aware of any governmental regulations which will have a material impact on our business operations.

CREDIT MANAGEMENT

Most of our sales are carried out on a cash-against-documents ("CAD") basis. In all other cases (primarily for sales to our distributor in Belgium and customers in North America), our Group grants credit of between 30 to 60 days from the date of the invoice. The actual credit terms granted to our customers are determined on a case-by-case basis, taking into account, *inter alia*, their creditworthiness (based on informal checks), financial background, payment history, length of past business relationship and nature and size of the transactions.

We recorded trade receivables (net) balances of US\$0.4 million, US\$0.6 million, US\$1.6 million and US\$1.1 million in FY2001, FY2002, FY2003 and 1H04 respectively. Our Group secures, in most cases, the consideration due for its sales by setting CAD mechanisms or requiring letters of credit ("LC"). The balance of sales is effected on open credit terms. Our allowance for doubtful receivables and write-offs of bad debts have not been significant during FY2001, FY2002 and FY2003. In 1H04, the allowance for doubtful receivables increased substantially due to the refusal of our previous Indian distributor to pay the outstanding balance.

Our debtor turnover days for FY2001, FY2002, FY2003 and 1H04 were 27 days, 21 days, 27days and 34 days respectively.

We monitor credit risk on an ongoing basis. Save as disclosed above, we have not experienced any material debt collection difficulties in FY2001, FY2002, FY2003 and 1H04. Our provision for doubtful debts is computed in a manner which takes into account all specific debts whose collection is doubtful in the opinion of the management.

The analysis of our debtor turnover days is discussed in further details in the section entitled "Management's Discussion and Analysis of Financial Condition and Results of Operations" under the subheading "Review of Financial Position" on pages 108 to 112 of this Prospectus.

GENERAL INFORMATION ON OUR COMPANY

STAFF TRAINING AND DEVELOPMENT

We believe that continual staff training is important in ensuring that we keep ourselves abreast of the technological advancements and the changing needs of our customers. It also enables us to keep ourselves effective and efficient in our work. Some of the internal and external training sessions that we regularly organise for our staff include the following:

Software development tools

The development of our proprietary software requires, amongst others, the use of third party software development tools. It is our practice to recruit experienced programmers that have several years of experience working with the relevant software development tools. In addition, we also provide training to our development staff whenever a new version of the software development tools is available to keep them updated with the latest technology available.

Development methodology

Our development methodology is based on internal procedures established based on several years of product development by us. We provide training on our development methodology for every new staff joining our research and development department and also conduct periodic refresher training for the entire development staff.

Testing methodology

Our testing methodology is based on industry standard procedures. We provide training for our testing methodology for every new quality assurance person joining our Company and also conduct periodic refresher training for the entire quality assurance staff.

The amount incurred in relation to staff training for the past three financial years has not been significant.

MAJOR SUPPLIERS

The suppliers (including sub-contractors) accounting for 5% or more of our total purchases are as follows:

Supplier	For purchases of	FY2001	FY2002	FY2003	1H04
JDS Uniphase GmbH (formerly known as Nanolase Ltd) ¹	Lasers	36%	38%	47%	37%
Sela Electronic Systems, Inc. ²	Electronic cards	6%	9%	7%	1%
Oplatka Automatic Milling Plant, Ltd	Metal parts	2%	7%	5%	5%
Legamat Automatic Milling Ltd	Metal parts	6%	6%	5%	5%
Aerotech Computers and Software ³ (2002), Ltd	Computers and peripherals	3%	4%	2%	9%

Notes:

1. The Company's supplier-buyer relationship with JDS Uniphase GmbH is based on a general OEM agreement executed by and between the said parties in March 2003, and on periodic orders and purchase forecasts issued by the Company, currently through to the end of 2005. However, from 2H04, JDS Uniphase GmbH is not the sole supplier of lasers to the Company, which had, on 11 February 2004, signed a Purchase Order Agreement with V-gen Ltd., currently through to mid-2006.
2. In respect of the decrease in purchases from Sela Electronic Systems, Inc. this was because we were able to buy better quality products at a lower price from another company.
3. In respect of the increase in purchases from Aerotech Computers and Software (2002), Ltd, we established our Indian subsidiary in 2004 and thus purchased more computers so as to supply the computers directly to our Indian customers through our Indian subsidiary.

None of our Directors or Substantial Shareholders has any interest, direct or indirect, in any of the above major suppliers (including sub-contractors).

GENERAL INFORMATION ON OUR COMPANY

MAJOR CUSTOMERS

The customers accounting for 5% or more of our total revenue are as follows:

Customer	Percentage of total revenue (%)			
	FY2001	FY2002	FY2003	1H04
Sahajanand Technologies P. Ltd ¹	51%	61%	67%	13%
Aerodiam Antwerp NV ²	17%	13%	8%	5%

Notes:

1. Sahajanand Technologies P. Ltd ("Sahajanand") served as the Group's sole distributor in India until November 2003. The purchases made by Sahajanand during this period were governed by annual purchase agreements, the last of which was mutually terminated in November 2003. The termination of the distributorship arrangement with Sahajanand led to the decrease in sales to Sahajanand.
2. The decrease in sales to Aerodiam Antwerp NV (the Group's Belgium distributor) was caused mainly because of the shifting of sales to other markets such as India, Russia and the PRC.

None of our Directors or Substantial Shareholders has any interest, direct or indirect, in any of the above customers.

COMPETITION

Our Group operates in a competitive market. Among other things, we have to compete on product quality, service quality, timeliness in delivering our products and services, and the pricing of our products and services. There is a small number of manufacturers of similar systems in the diamond industry around the world. We believe that we are one of the leading players in the international market, both in terms of the quality of our products and the amount of units sold by us. Our Group has three main competitors, namely OGI Systems Ltd of Israel, Lexus Group and Sahajanand Laser Technology Ahmedabad of India.

We believe that our Group has a relative advantage over most of our competitors, which is mainly based on our ability to provide a solution to the changing demands of the market, to evolve our products to meet the needs of our end customers, our cumulative experience of 15 years in the field, the level, quality and reliability of our products, the reputation accompanying our products and the professional back-up given to each of our products.

We expect continued competition in the industry and the entrance of new competitors into the market in the future.

COMPETITIVE STRENGTHS

Despite the competition we face from the companies described above, we believe that we are able to differentiate ourselves from our competitors. Our Directors believe that our competitive strengths are as follows:

(a) We understand the needs of our customers

We believe that our customers value our ability to provide solutions to meet their needs. Our keen understanding of our customers' business and our in-depth knowledge about the diamond industry help keep us ahead of our competitors. We have dedicated product managers, customer service teams and a network of overseas sale and marketing offices to better identify and serve the technical needs of our customers.

We have good working relationships with our customers. We work closely with our customers to find out their needs and to resolve the technical issues they face. Our management and sales teams keep abreast of the latest trends and technological developments in the diamond industry in order to provide suitable advice and services to our customers. This has enabled us to retain our customers for many years.

GENERAL INFORMATION ON OUR COMPANY

(b) We have an established track record for innovation and a strong brand name

We have an established track record. Our products are used by major industry participants such as GIA, HRD, EGL, Tiffany & Co. Ltd, Karp Index Limited, Venus Jewels, Overseas Diamonds Bvba, Lazare Kaplan Nv and Rosy Blue Nv. We believe our proven track record strengthens our ability to market our products and services to new customers.

We have successfully established a strong brand identity within the diamond industry. We believe that our brand development approach enables our products to penetrate rapidly in the diamond industry markets. Our approach involves branding and positioning, marketing and brand extension. This has allowed us to develop and build up goodwill rapidly in our brand, which increases the sales of our products. We believe that such a strategy has proven effective as our turnover has constantly increased over the past three years.

(c) Opinion leaders in the industry mainly use our products

Our products are used, almost exclusively, by the major gemological laboratories worldwide including GIA, AGS, HRD, IGI, EGL, AGL, CGL and NGTC. These leading gemological laboratories use our products as their primary measuring systems for the diamond's proportion and, in some instances, the symmetry as well. This is a strategic advantage over our competitors, as their selection of our products as their measuring equipment effectively endorses them, as perceived by the other industry players.

(d) Our products are modular and are “add-ons” to our existing product platforms

Our new products in our existing product lines have historically been either improvements to existing software, or hardware that is designed to be modular add-ons to existing hardware platforms. The modular nature of our products enables our customers to upgrade their existing products with additional functionality by simply upgrading the software of the machine (for software improvements), or by affixing the new modular component (for new hardware products with a different yet complementary function) to their existing hardware platform, without a need to completely replace the existing product.

For example, the DiaExpert™ and DiaMark™ are hardware add-ons to the same DiaMension™ hardware platform and hence our customers, who originally had the measurement system for the cut of the polished diamond, the DiaMension™, can now enjoy the benefits of scanning, planning and marking of the rough stones afforded by the DiaExpert™ and DiaMark™ by simply affixing the new hardware onto their existing DiaMension™ platform.

We believe that this modular feature gives our products a competitive edge. Our products are easily upgradeable to meet the changing needs of our customer's business and keep them abreast of the newest technologies in the diamond industry, hence encouraging customer loyalty to our products. Moreover, this enhances our market potential by ensuring that our existing customers (in addition to new customers) continue to be a market for our new products.

(e) We focus on quality products and services

We are dedicated to delivering quality products and services to our customers. We have implemented stringent quality controls in our development and production processes and our development and production staff are provided with on-going training.

(f) We have highly experienced and dedicated management and development teams

Our business activities are managed by our experienced and dedicated management and development teams. In particular, our development team possesses a high level of technical know-how, allowing us to develop products that meet the requirements of our customers. Our employees are regularly trained and updated on new programming languages, trends and products. Our CEO, Executive Directors and Executive Officers have extensive working experience and in-depth knowledge of the industry. The qualifications and work experience of our CEO, Executive Directors and Executive Officers are set out in the section entitled “Directors, Management and Staff” under the subheadings “Directors” and “Management” on pages 118 to 126 of this Prospectus.

GENERAL INFORMATION ON OUR COMPANY

(g) We own proprietary rights to our products

The intellectual property on which our products are based has been developed and owned by us. Details on our patent and trademark registrations are set out in the section entitled "General Information on our Company" under the subheading "Intellectual Property" on pages 78 to 81 of this Prospectus.

PROPERTIES AND FIXED ASSETS

We currently lease/license the following properties:

Lessor/ Licensor	Lessee/ Licensee	Property Location	Description and Usage	Tenure	Gross Built -in Area (sq m)	Monthly Rental
Levin Z.H Ltd. and A. Netanel-Nun Ltd.	Our Company	4 Hahilazon Street, Ramat Gan 52522, Israel	Office and assembly facility	Until 16 January 2008 with two one- year extension options	1,610 ⁽¹⁾	US\$11,270 Monthly rental to increase by approximately 5% in each of the ensuing years, adjusted for inflation in Israel
Ophir Tours Ltd.	Our Company	Diamond Tower, 54 Bezalel Street, Ramat Gan 52521, Israel	Shop	Until 14 January 2005, renewed for an additional three years until 14 January 2008	24	US\$1,550 until 14 January 2005, then to be increased to US\$1,750 until 14 January 2006, then to be increased to US\$2,000 until 14 January 2008
Aharon Liebmann	Romedix	6 Hasadna Street, Kiryat Arie, Petach Tikva	Workshop	12 months commencing on 4 April 2004 with an option to renew for a further term of 4 years, 1 year at a time	approximately 100	US\$400, to be increased by 5% at the beginning of the third year and fourth year. Rent for the fifth year shall be negotiated in good faith, provided it shall not exceed 105% of the rent paid in the preceding year
Sanghi Oxygen (B) Private Ltd.	Sarin India	Sanox Centre, Ground Floor, Mani Mahal, 11/21 Mathew Road, Opera House, Mumbai 400 004, Maharashtra, India	Office	Commences from 23 March 2004 until 28 February 2006, with an option to renew for a further period of two years	approximately 172	Rs120,900, to be increased by 10% if option to renew is exercised

GENERAL INFORMATION ON OUR COMPANY

Lessor/ Licensor	Lessee/ Licensee	Property Location	Description and Usage	Tenure	Gross Built -in Area (sq m)	Monthly Rental
Charulata Satish Jariwala & Others	Sarin India	89, A-1-D, Plot No. 432, Brink's Arya House, Vastadevdi Road, Katargam, Surat 395008, India	Office	3 years from 5 April 2004 with an option to renew for a further 3 years	approximately 200	Rs14,000, to be increased by 10% if option to renew is exercised
Dr Dilip G. Sampat and Mrs Kumudini Dilip Sampat	Sarin India	Residential apartment in Mumbai, India	Residence for senior executive of Sarin India	11 months from 13 July 2004	approximately 65	Rs26,000
Sarmishtha M. Jariwala	Sarin India	Residential apartment in Surat, India	Residence for visiting engineers from Mumbai office	Verbal agreement, from 22 May 2004 with no fixed term	approximately 46	Rs3,500

(1) Inclusive of 110 sq m of common area.

As set out in the tables below, our fixed assets consist primarily of machinery, motor vehicles, computers, office equipment and improvements in leasehold; the aggregate net book value of these fixed assets as at 30 June 2004 amounted to US\$0.5 million. Details of our fixed assets can be found in the section entitled "Independent Auditors' Report and Financial Statements" under subheading "Property, Plant and Equipment" on page F18 of this Prospectus. Details of our operating lease commitments are set out under the section entitled "Management's Discussion and Analysis of Financial Condition and Results of Operations" under the subheading "Capital Expenditure, Acquisitions, Divestment and Commitment" on pages 114 and 115 of this Prospectus.

US\$'000 (As at 30 June 2004)	Machinery And Equipment	Demonstration Equipment	Motor Vehicles	Computers And Office Equipment	Improvements In Leasehold	Total
Cost	385	204	132	121	61	903
Accumulated Depreciation	205	37	41	31	61	375
Net book value	180	167	91	90	0	528
\$'000 (As at 30 June 2004)	Machinery And Equipment	Demonstration Equipment	Motor Vehicles	Computers And Office Equipment	Improvements In Leasehold	Total
Cost	662	351	227	208	105	1,553
Accumulated Depreciation	352	64	70	53	105	644
Net book value	310	287	157	155	0	909

GENERAL INFORMATION ON OUR COMPANY

INSURANCE

Our Group is insured under a number of policies, some of which are joint policies with subsidiaries, and others which are separate policies. Our Group is insured under the following policies:

- (a) Expanded fire insurance - buildings and contents including break-in, earthquake, natural damage and riot and strike damage, in the sum of NIS11.9 million;
- (b) Property in transit (in Israel) in the sum of NIS100,000;
- (c) Insurance for computer systems and databases in the sum of NIS230,000;
- (d) Liability insurance:
 - (i) third party insurance – liability ceiling for damage for the term in the sum of NIS4.5 million
 - (ii) employers' liability at a liability ceiling of NIS6.885 million per employee and NIS22.95 million for the term;
 - (iii) product liability insurance at a liability ceiling of NIS2.25 million; and
 - (iv) vehicles insured under comprehensive insurance;
- (e) Insurance for Directors and Executive Officers of our Group limited to US\$10 million per annum; and
- (f) Loss of revenue insurance limited to NIS40 million per annum.

The insurance policies are renewed annually.

In addition, Sarin India is insured for public liability amounting to Rs55,000 and Rs34,000 for their business operations in Mumbai and Surat respectively. Sarin India's premises in Mumbai and Surat are insured against fire, burglary and glass breakage for a total amount of approximately Rs6.9 million and Rs3.1 million respectively.

The aggregate monthly insurance payment by our Group is US\$10,200.

Our Directors believe that the above insurance policies are adequate in managing our day-to-day operational risks.

PROSPECTS, BUSINESS STRATEGIES AND FUTURE PLANS

PROSPECTS

The diamond industry is estimated to have an annual sales turnover of approximately US\$9 billion for rough stones and US\$16 billion for polished diamonds. The cost of the rough stones is high and hence, it is vital that rough stones be used wisely and processed optimally in order to achieve maximum yield. The price of diamonds is influenced to a considerable extent by the specific physical parameters of each diamond, namely the carat (weight), clarity (internal defects of the crystal), colour and quality of the cut. Therefore, our prospects are dependent on our ability to provide the industry players (from factories which process rough stones, through the traders at various levels and to the final retailer) with products to enable them to measure precisely and objectively these parameters of the diamond in order to increase the profit margins between the initial purchase price of rough stones and the end price of polished diamonds.

We expect our business to be driven primarily by the following trends:

- (i) emerging new diamond manufacturing centres, such as PRC and Russia;
- (ii) increasing use of automation throughout the factories and the streamlining of the process flow from planning through production due to increased pressure on profit and yield margins;
- (iii) increasing use of other cost-saving technologies in order to achieve better profit and yield margins;
- (iv) increasing use of branding by the manufacturers as a means of differentiation of their products from others in the eyes of the consumers;
- (v) increasing consumer demand for certification of the diamonds' quality; and
- (vi) increasing demand for equipment to enable identification of natural and untreated diamonds over the counter prior to purchase.

BUSINESS STRATEGIES AND FUTURE PLANS

Our business strategy is to become the leader for the provision of high technology solutions in the diamond and gemstone industries. To fully leverage the above market trends, our business strategies are as follows:

1. *Enhancing our market presence in existing and emerging markets*

We will continue to enhance our market presence in existing and emerging markets, by either establishing a direct presence where needed, through the incorporation of wholly owned subsidiaries for the provision of pre-and post-sales support, or through the appointment of additional distributors and agents, in order to fully leverage the opportunities existing in India and emerging in PRC, Russia and elsewhere.

2. *"One-stop shop" philosophy*

We will continue to endeavour to become the "one-stop shop" for high technology and automation in the diamond and gemstone industries. Currently, we offer products for the assessment of the cut and colour of polished diamonds and the optimal utilization of rough stones. We intend to broaden our offerings so that a product sold by us will answer any technological need in the diamond industry, including those evolving from the market trends identified above. Whether through internal research and development, acquisition or licensing of appropriate intellectual property or selling third-party products, we are positioning ourselves as the solution provider for the industry, so as to realise our motto, "Sarin your diamonds, everyone else does", in the market.

PROSPECTS, BUSINESS STRATEGIES AND FUTURE PLANS

Following our business strategies and the market trends above, we have future plans as follows:

(a) *Increase our sales to existing customers while attracting new customers worldwide*

Our existing customers presently employ our products at various levels of their planning and manufacturing process. Our customers are constantly striving to streamline their processes and we intend to leverage this trend by selling more of the existing high-end products for use in their planning offices as well as the introduction of lower-cost systems specifically designed for use on their production floors. All these efforts are in parallel to our on-going efforts to enhance our presence in existing and emerging markets by attracting new customers to buy our products. For example, we believe that we have currently penetrated approximately one-quarter of the manufacturers in India. These typically have several of their planning personnel utilize one of our DiaExpert™ or DiaScan planning products. It is our intent to continue the market penetration in India by addressing the yet untapped potential of both the manufacturers who have not yet acquired our systems as well as the need for additional products, and annual renewable service contracts, by those who have and are constantly striving to enhance the productivity of their operations. The Company believes the overall potential in India alone for its existing planning products is still substantial.

(b) *Innovative high-end products with high returns on investment*

Our Group is in the process of negotiating marketing and sales rights for a product which estimates the colour of the rough diamond. There are currently competing products that perform this function with various degrees of accuracy. We believe that the product we intend to offer is better and will provide more accurate and repeatable results at a lower price.

In addition, we intend to address the last of the four C's – Clarity. There is currently no practical cost effective automated solution for the assessment of the clarity of the stone and inclusion mapping. We are planning to develop a product to address this problem, and thereby provide a comprehensive solution to the rough stone utilization planning process. To this end, we have negotiated for a worldwide exclusive license for a unique and patented technology, which preliminary results have indicated may provide the ability to automatically identify and map the inclusions in a rough or polished diamond. If we are able to successfully complete the development of our project, this will be an important step forward for the entire industry and we expect to realize substantial sales potential as we believe, based on our discussions with our existing clients, that the price which the manufacturers are willing to pay for such a product is a multiple of the existing DiaExpert™/DiaMark™ combination system's price (typically US\$25,000 to US\$50,000) and quantities will be significant.

(c) *Laser-based cutting and bruting system*

The diamond manufacturing industry is adopting laser-cutting tools for diamonds, as this technology provides the manufacturer with added benefits (more accuracy, better utilization of rough stones and the ability to process more varied types of stones) and hence more profits. In August 2004, our Company entered into a memorandum of understanding for the acquisition of the intellectual property in relation to advanced laser cutting systems for diamonds. We intend to introduce in 2005 a laser cutting machine which will be linked by computer software to the DiaExpert™, thus providing an automated solution, linking both the planning and production phases. Our proposed product will utilize advanced laser technology which is expected to both decrease the loss of raw material during the cutting process, thus increasing the yield and profit margin realized by the manufacturer, and reduce the risk of breakage associated with the use of lasers for cutting diamonds. The Company intends to offer this high-end laser at a price comparable to other high-end laser cutting products (US\$100,000+) and expects to be a player in this market due to the proposed product's advantageous characteristics.

PROSPECTS, BUSINESS STRATEGIES AND FUTURE PLANS

(d) *Lower cost products for smaller manufacturers and in-line quality control*

There is a need to preserve the additional yield and profitability margins provided by the DiaExpert™ and DiaMark™ products during the production phase. This requires a solution to ensure proper adherence to the designated cutting during the production phase. To provide the customers with the ability to do this, we plan to offer low cost products in the DiaScan series, which will be placed on the production floor as in-line quality assurance and test systems. These systems will also allow smaller manufacturers with more limited resources to acquire our products.

(e) *Penetrate the consumables market*

We have identified several technologies, which should enable us to offer alternatives to current consumable products utilized during the production process, that are aimed at reducing costs and increasing productivity in order to provide the manufacturers with better profit margins.

(i) Disposable polishing discs

We have acquired (and are in the process of applying for a patent for) unique know-how for the production of innovative disposable diamond polishing discs. Currently, diamonds are polished using diamond-coated wheels, which, when worn down, need to be stripped, reworked, recoated and realigned, at a substantial cost to the manufacturer. Our new technology precludes the need for these processes by allowing the manufacturer to simply and quickly replace the used disposable polishing disc, with virtually no downtime. Furthermore, its implementation will not require significant retooling by the manufacturers. We expect this will not only save both money and time, but will also be a superior product with superior polishing qualities and a longer working life. We believe the overall worldwide recurring sales potential of this product is over US\$75 million annually (based on the estimated number of existing personnel employed in the polishing stage of the diamonds, the estimated number of scaifes (high-speed polishing wheels) presently utilized, the expected replacement rate, and the projected pricing of the disposable polishing disc, so as to be competitively attractive to the manufacturers).

(ii) Cleaning fluids which are environmentally friendly

We are also developing a cleaning fluid, which is environmentally friendly, as well as significantly more cost-effective for use. Its application is in the cleaning of the polished diamonds during the final stages of the diamond processing cycle, which is currently accomplished using other more costly and environmentally problematic processes.

(f) *Diamond identification systems*

A severe problem facing the industry, primarily at the wholesale trading and retail business levels, is the introduction of new technologies that allow for the manufacture of synthetic diamonds and the artificial alteration of the appearance of inferior diamonds, using high pressure and high temperature treatments (referred to collectively as HPHT processes). Although considered legal if fully disclosed, there is an acute need for a product that will allow the quick and simple differentiation between natural diamonds and others (synthetic or treated). It is one of our longer term goals to provide such a product, in accordance with our “one-stop shop” philosophy, which will allow such quick and automated differentiation.

(g) *Light performance systems (brilliancy, fire and scintillation)*

In addition to the four Cs, new parameters are being defined and will be introduced with the aim of grading the appearance of the polished diamond. Currently, three parameters are being defined, namely brilliancy, fire and scintillation. These parameters are to be derived by the simulation of light ray path through the diamond after it has been modelled on a platform such as our DiaMension™. We intend to implement the necessary software upgrades in order to provide our customers, past and future, with this added functionality. This add-on software, along with the increasing consumer demand for certification of diamonds, will continue to drive the market for our DiaVision™ software for the DiaMension™ and DiaScan platforms.

PROSPECTS, BUSINESS STRATEGIES AND FUTURE PLANS

(h) *Inscription Products*

The continued trend towards branding, as a means for differentiation by diamond manufacturers, dealers and retailers, will continue to be a market driver for our DiaScribe inscription product

(i) *Recurring income from service contracts*

We expect to realise recurring income from the service contracts.

(j) *Potential scalability of our technology to other industries*

We believe that the technologies we have developed may be applied with appropriate modifications to other industries.

In this regard, we have ventured into the industrial quality assurance market by applying our existing technology to a quality control application in the plastics industry. By slightly modifying the software used for our DiaMension™ product, we have developed a prototype that is specifically tailored for a manufacturer of injection moulded parts for medical infusion kits, including valves, tubes and connectors.

SELECTED CONSOLIDATED FINANCIAL INFORMATION

SELECTED CONSOLIDATED FINANCIAL INFORMATION

The following selected financial information should be read in conjunction with the full text of this Prospectus, including the Independent Auditors' Report and Financial Statements set out on pages F1 to F34 of this Prospectus.

INCOME STATEMENT DATA:

<i>US\$'000</i>	FY2001	Audited FY2002	FY2003	Unaudited 1H03	Audited 1H04
Revenue	4,376	8,909	14,694	7,778	7,047
Cost of sales	(1,699)	(2,999)	(4,472)	(2,370)	(2,464)
Gross profit	2,677	5,910	10,222	5,408	4,583
Research and development costs	(757)	(709)	(1,370)	(542)	(725)
Selling and marketing expenses	(684)	(1,199)	(1,521)	(838)	(1,221)
General and administrative expenses	(872)	(1,155)	(1,305)	(562)	(964)
Other income / (expenses)	212	(132)	(20)	1	(19)
Profit from operations	576	2,715	6,006	3,467	1,654
Net finance income / (costs)	33	(61)	(87)	(3)	(31)
Profit from ordinary activities before taxation	609	2,654	5,919	3,464	1,623
Income tax expense	(247)	(496)	(590)	(317)	(526)
Net profit for the year/period	362	2,158	5,329	3,147	1,097
Basic earnings per share ("EPS") (in Singapore Cents per Share)	0.3	2.0	4.9	2.9	1.0
Diluted EPS (in Singapore Cents)	0.3	2.0	4.9	2.9	0.9
(Weighted average) Number of Shares in computing EPS (Basic)	92,800	92,800	93,300	93,300	93,926
(Weighted average) Number of Shares in computing EPS (Diluted)	92,800	92,800	93,300	93,300	101,115
(Weighted average, post-Invitation subdivision of Shares) Number of Shares in computing EPS (Basic)	185,600,000	185,600,000	186,600,000	186,600,000	187,852,000
(Weighted average, post-Invitation subdivision of Shares) Number of Shares in computing EPS (Diluted)	185,600,000	185,600,000	186,600,000	186,600,000	202,230,000

SELECTED CONSOLIDATED FINANCIAL INFORMATION

BALANCE SHEET DATA:

<i>US\$'000</i>	← As at 31 December →			As at 30 June 2004
	2001	2002	2003	
Non-current assets				
Property, plant and equipment	139	223	230	528
Intangible assets	212	164	116	140
Deferred tax assets	139	250	412	532
	490	637	758	1,200
Current assets				
Inventories	494	1,113	1,486	1,625
Trade receivables	399	620	1,584	1,070
Other receivables	79	196	86	276
Short-term investments	0	0	268	264
Cash and cash equivalents	492	1,384	3,965	4,991
	1,464	3,313	7,389	8,226
Current liabilities				
Trade payables	471	791	415	1,360
Other payables	510	944	1,174	1,693
Short term loans and bank overdraft	461	352	36	–
Current tax payable	330	433	540	591
Provision	49	69	100	104
	1,821	2,589	2,265	3,748
Net current (liabilities)/assets	(357)	724	5,124	4,478
Non-current liabilities				
Long-term loans	(27)	0	0	0
Liability for employee severance benefits	(47)	(46)	(73)	(97)
	(74)	(46)	(73)	(97)
Net assets	59	1,315	5,809	5,581
Capital and reserves				
Share capital	0	0	0	0
Reserves	59	1,315	5,809	5,581
	59	1,315	5,809	5,581
NTA per Share (Singapore Cents)	(0.3)	0.8	4.7	4.4
Number of shares, pre-Invitation subdivision of Shares in computing NTA per Share	191,132,000	191,132,000	191,132,000	191,132,000

SELECTED CONSOLIDATED FINANCIAL INFORMATION

CASH FLOW STATEMENT DATA:

<i>US\$'000</i>	FY2001	Audited FY2002	FY2003	Unaudited 1H03	Audited 1H04
Cash flows generated from / operating activities	253	2,120	3,852	2,665	2,844
Cash flows used in investing activities	(8)	(163)	(100)	(77)	(430)
Cash flows used in financing activities	(476)	(995)	(1,157)	(1,162)	(1,352)

MANAGEMENT'S DISCUSSION AND ANALYSIS OF FINANCIAL CONDITION AND RESULTS OF OPERATIONS

The following discussion of our results of operations for the past three financial years ended 31 December 2001, 2002 and 2003 and for the two periods ended 30 June 2003 ("1H03") and 30 June 2004 ("1H04") should be read in conjunction with the Independent Auditors' Report and Financial Statements and the related notes elsewhere in this Prospectus. This discussion contains forward-looking statements that involve risks and uncertainties. Our actual results may differ significantly from those projected in the forward looking-statements. Factors that might cause future results to differ significantly from those projected in the forward-looking statements include, but not limited to, those discussed below and elsewhere in this Prospectus, particularly in "Risk Factors".

OVERVIEW

We are principally involved in the development, manufacture and sale of precision technology products that use three-dimensional geometric measurement (metrology) for the processing of diamonds and gemstones. Our products combine various hardware technologies, mainly electro-optics, electronics, precision mechanics and lasers designed to assist in the planning of rough stones in order to increase the percentage exploitation of raw materials. Our Group also develops products that measure various parameters of polished diamonds in accordance with industry requirements.

Our products are mainly sold to manufacturers, dealers, retailers and gemological institutes and laboratories in the diamond and gemstones industry. As at the Latest Practicable Date, sales to our customers are effected via a total of 14 representatives, agents and distributors, and via a team of internal sales personnel. The latter are our employees, who keep in constant contact with existing customers, while striving, at the same time, to look for new customers. We have agents and distribution agreements, mostly on an exclusive basis.

GCI and Romedix

Our subsidiary, GCI deals in the development, manufacture and marketing of devices for the identification and classification of diamond color. We derived revenue from GCI of approximately US\$0.4 million, US\$0.6 million, US\$0.5 million, US\$0.2 million and US\$0.3 million for FY2001, FY2002, FY2003, 1H03 and 1H04 respectively, accounting for 8.4%, 6.6%, 3.2%, 2.6% and 3.6% respectively of our Group's income. The management believes that the income derived from GCI in the forthcoming years will increase at a higher rate than the increase in our Group's income, due to the expected introduction of the colour prediction product for rough stones commencing in FY2005 and gaining in sales in FY2006 and thereafter.

Our revenue derived from Romedix was not significant during the past three financial years ended 31 December 2001, 2002 and 2003, and 1H04. The management believes that the income derived from Romedix in the forthcoming years will increase at a higher rate than the increase in our Group's income, due to the expected introduction of the disposable polishing discs commencing in 2005 and gaining in sales in FY2006 and thereafter.

Our sales to India contributed most significantly to our revenue, accounting for approximately 50.0%, 69.3%, 67.2%, 74.4% and 58.2% of our total sales for FY2001, FY2002, FY2003, 1H03 and 1H04 respectively. Since 1999, India has become the primary market for our Group's products. Until the end of 2003, sales to India were mostly channelled via the local distributor in India, on whom our Group was dependent. The annual framework contract with this local distributor in India was mutually terminated in November 2003. We set up a subsidiary in India in March 2004 to act as our pre-sale lead identifier and to provide after sales services to our customers located in India, Sri Lanka and such other territories as may be agreed upon by our Company and Sarin India. We issue sales invoices to these customers. The setting up of our Indian subsidiary has eliminated our dependence on our previous local distributor in India and was a strategic move as our management recognises that in the recent years, India has become the primary worldwide production centre in the diamond industry.

We also derived revenue from other geographical regions such as Europe and North America, where our operations contributed most significantly to our revenue, accounting for approximately 9.8% and 8.0% of our total sales for FY2003 respectively.

MANAGEMENT'S DISCUSSION AND ANALYSIS OF FINANCIAL CONDITION AND RESULTS OF OPERATIONS

Based on our management's experience in the industry and the track record of our Group for the past three financial years and 1H04, we believe that the market in India will continue to be the most important market in the future. However, there is a definite trend whereby the PRC and Russia are emerging as centres of diamond manufacturing of growing importance and we believe that this will have a positive impact on our Group's sales in these areas in the upcoming years.

We recorded compounded annual growth rate ("CAGR") of 83.2% for our revenue from FY2001 to FY2003. We also recorded CAGR of 211.8% for our profit before tax and CAGR of 283.7% for our profit after tax from FY2001 to FY2003. Our gross profit margin improved from 61.2% in FY2001 to 66.3% in FY2002. We recorded gross profit margin of 69.6% and 65.0% for FY2003 and 1H04 respectively. We have improved our gross margin during FY2001 to FY2003, mainly as we manage our fixed costs amid an increase in revenue. The gross margin declined in 1H04, due to (i) increase in our cost of direct components costs, caused by incremental modifications in our products' configurations, implemented as part of our on-going efforts to further improve our products, as we continue to preserve our qualitative edge over our competitors and (ii) increase in direct labor costs during 1H04. The sharp increase in deliveries to India in May and June 2004 and quotations issued for the rest of the year necessitated the addition of manpower and the use of costly overtime in order to meet delivery schedules.

Revenue from the sale of goods is recognised in the profit and loss account when the significant risks and rewards of ownership have been transferred to purchasers of our products. We do not recognise revenue if there are significant uncertainties regarding recovery of the consideration due, associated costs or the possible return of goods, or when the amount of revenue and costs incurred or to be incurred in respect of the transaction cannot be measured reliably. We provide a one-year product warranty to our customers. The total number of products repaired or replaced by us during the warranty period were not significant for the last past three financial years ended 31 December 2001, 2002 and 2003, and 1H04.

The demand for our products is dependent primarily on the following trends:

- (i) Emerging new diamond manufacturing centres, such as PRC and Russia;
- (ii) Increasing use of automation throughout the planning and production processes due to increased pressure on profit and yield margins;
- (iii) Increasing use of other cost-saving technologies in order to achieve better profit and yield margins;
- (iv) Increasing use of branding by manufacturers as a means of differentiating their products in the eyes of the consumers;
- (v) Increasing demand for certification of diamonds by consumers; and
- (vi) Increasing demand for equipment to enable identification of natural and untreated diamonds over the counter prior to purchase.

Our revenue is dependent on the following factors:

- (i) Our ability to obtain a constant and adequate supply of our key components, such as the lasers utilized in our DiaMark™ product, and our ability to successfully negotiate with our suppliers on the volume and price of these components and to retain them for future purchases will also affect our revenue.
- (ii) Our ability to achieve quality and price differentiation in our products from those of our competitors and our ability to enhance our existing products and to introduce new ones to meet the requirements of our customers in an evolving and developing market.
- (iii) Our ability to develop new long-term relationships with successful diamond dealers and manufacturers globally, and primarily in emerging markets such as PRC and Russia, while maintaining the current relationships with our existing customers.

MANAGEMENT'S DISCUSSION AND ANALYSIS OF FINANCIAL CONDITION AND RESULTS OF OPERATIONS

For 1H04, approximately 50% of our total sales were carried out on a "cash against documents" ("CAD") basis. Approximately 20% of our sales were made to distributors in Belgium and customers in Israel and North America, to whom we grant credit of between 30 to 60 days from the date of invoice. The remaining sales are made on a cash basis (prepaid before delivery). The distributors purchase our products at a discount of between 20% to 30% of the list price, while our agents are entitled to a sale commission at the rate of between 10% to 20%.

Our cost of sales includes primarily direct components costs. Direct components costs formed approximately 73.5%, 78.1%, 85.1%, 86.3% and 82.0% of our cost of sales for FY2001, FY2002, FY2003, 1H03 and 1H04 respectively. Our direct components costs comprised mainly (i) lasers used for the marking of the optimal saw plane on the rough diamond by the DiaMark™ product, and for the inscription of text on polished diamonds by the DiaScribe product and for our laser mapping add-on to our DiaExpert™; (ii) optical components including lenses and electronic CCD cameras, used for the acquisition and measurement of the rough and polished diamonds geometrical characteristics by the DiaMension™, DiaScan and Brilliant Eye hardware platforms; and (iii) mechanical parts (motors, controllers, vacuum pumps) used for the assembly of the motion subsystems of all of our products. Lasers, our single most costly component, comprised approximately 39.5%, 50.4%, 55.3%, 52.5% and 48.0% of our cost of materials consumed for FY2001, FY2002, FY2003, 1H03 and 1H04 respectively. These components are used for the assembly of our products at our facilities in Israel. We do not manufacture these components in-house but source from our suppliers and sub-contractors. Some of the laser sources, the electronic CCD cameras, some of the electronic cards, the pumps and the motors are off-the-shelf products that are chosen especially to comply with our system's technical requirements. Other laser sources, most of the lenses, some of the electronic cards and other electro-optical components are manufactured in accordance with our systems' specifications.

For the financial years and periods under review, we have not experienced any material volatility in the prices of the components, except that we have experienced increases in the cost of our laser components during 1H04, incurred as part of our on-going efforts to further improve our products by using sealed lasers and fiber-optic lasers.

Other components of our cost of sales comprised depreciation, other assembly overheads and direct labor costs. Our direct labor charge when expressed as a percentage of cost of sales has declined from 17.3% in FY2001 to 15.4% in FY2002 to 9.3% in FY2003 (9.0% in 1H03) and increased to 13.4% in 1H04 due to increased labor costs (more employees and overtime and bonuses) in 1H04 as we organized for the increase in orders and deliveries as the sales to India picked up. Depreciation is charged for machinery directly used in the assembly of our products. Our depreciation charge when expressed as a percentage of cost of sales fell from 1.9% in FY2001 to 1.3% in FY2002 to 1.5% in FY2003 to 1.3% in 1H04 (2.2% in 1H03). Our depreciation charge was not significant as it constituted less than 5.0% of total cost of sales for FY2001, FY2002, FY2003, 1H03 and 1H04. Other assembly overheads consist mainly of sub-contractor costs, electricity, rent, shipping and maintenance expenses. Other assembly overheads when expressed as a percentage of cost of sales declined from 7.3% in FY2001 to 5.1% in FY2002 to 4.1% in FY2003 (2.4% in 1H03) to 3.3% in 1H04 mainly due to growth in sales and cost of sales between the years. Our Group holds inventory of products and spare parts on consignment with our agents and distributors, so as to enable the provision of fast and professional services by these distributors and agents to our end customers who purchase our products.

Our operating expenses comprise research and development costs, selling and marketing expenses, general and administrative expenses and other expenses/income. These expenses accounted for 36.0%, 32.6%, 41.5% and (10.1%) respectively of our total operating expenses during FY2001. These expenses accounted for 22.2%, 37.5%, 36.2% and 4.1% respectively of our total operating expenses during FY2002. These expenses respectively accounted for approximately 32.5%, 36.1%, 31.0% and 0.5% of our total operating expenses during FY2003. These expenses accounted for 27.9%, 43.2%, 29.0% and (0.1%) respectively of our total operating expenses during 1H03. These expenses accounted for 24.8%, 41.7%, 32.9% and 0.6% respectively of our total operating expenses during 1H04. Our research and development costs comprised mainly of wages and salaries and payments to subcontractors. We

MANAGEMENT'S DISCUSSION AND ANALYSIS OF FINANCIAL CONDITION AND RESULTS OF OPERATIONS

subcontract out the development of certain subsystems, which are not perceived by us to be our key core competencies. Examples of this subcontracting are the design and development of prototype optical subsystems and the assembly of prototype mechanical subassemblies. Our selling and marketing expenses comprised mainly of wages and salaries and commissions to our agents, as well as travelling and exhibitions and others. Our general and administrative expenses comprised mainly wages and salaries, rent, office expenses, depreciation and professional fees.

Net finance (costs)/income

Our net finance (costs)/income for the financial years and periods under review related to interest charges for our short term loans and bank overdrafts, our interest income from our cash and cash equivalents and our loss/(gain) derived from trading investments being debt securities held for interest acquired by us during FY2003, all of which are subject to net foreign exchange loss/(gain).

Foreign exchange exposure

We are mainly exposed to movement in exchange rates of the US\$ in relation to NIS with regards to salaries paid in NIS. Our subsidiaries' financial statements are also maintained in US\$. The exchange losses we incurred during FY2001, FY2002, FY2003 and 1H04 were not significant.

Taxes on income

(a) Measurement of results for tax purposes under the Income Tax Law (Adjustments for Inflation) – 1985 (the “Adjustments Law”)

- (i) In accordance with the Adjustments Law, the results for tax purposes are measured in real terms, based on the changes in the Customer Price Index.
- (ii) On 29 June 2004, the Knesset approved the Income Tax Ordinance Amendment (No. 140 and Temporary Order), 2004 (the “Amendment”).

The Amendment prescribes a gradual reduction in the corporate tax rate, from 36% (in 2001 to 2003) to 30%, in the following manner: in the 2004 tax year, a tax rate of 35% will be imposed, in the 2005 tax year, a tax rate of 34% will be imposed, in the 2006 tax year, a tax rate of 32% will be imposed, and from the 2007 tax year and thereafter, the tax rate will be 30%.

The current taxes for 2004 (other than on “Approved Enterprise” related income) and the deferred tax balances at 30 June 2004 are calculated based on the new tax rates, as prescribed in the Amendment.

(b) Tax benefits under the Law for the Encouragement of Industry (Taxes), 1969

The Company currently qualifies as an “Industrial Company” under the above law. As such, it is entitled to certain tax benefits, mainly the right to deduct share issuance costs for tax purposes in the event of a public offering, and to amortise know-how acquired from third parties.

(c) Tax benefits under the Law for the Encouragement of Capital Investments, 1959 (the “Law”)

The Company has been granted “Approved Enterprise” status in respect of part of its property, plant and equipment under the Law, according to programs that were approved in 1994 (“first program”) and 2002 (“second program”). Income of the Company derived from the Approved Enterprise is tax-exempt for a period of two years and is subject to a reduced tax rate of 25% for an additional five years. The seven-year period of benefits commences in the year during which the Approved Enterprise first generates taxable income, provided that 14 years have not elapsed since the year in which the approval was granted, and 12 years have not elapsed since the year in which the Approved Enterprise was put into operation.

MANAGEMENT'S DISCUSSION AND ANALYSIS OF FINANCIAL CONDITION AND RESULTS OF OPERATIONS

The first program was enacted in 1999 and the second program was enacted in 2002. Dividends distributed from the "Approved Enterprise" income will be liable to a 15% withholding tax rate. The last year of benefits relating to the first program is 2005 and with respect to the second program, is 2008.

The Investment Center of the Ministry of Industry and Commerce confirmed the execution of the first program in August 2001 and the second program in November 2004.

The Company's request to approve an expansion plan ("third program") of its Approved Enterprise was granted by the Investment Center in January 2005. The plan comprises an investment in fixed assets of US\$138,500. Subject to meeting the conditions of the letter of approval, the Company will be entitled to taxation benefits on the taxable income generated from the third program during a period of seven years commencing with the first year in which it generates taxable income from the third program, at tax rates similar to the two existing programs, as described above.

The benefits from the Company's investment programs are dependent upon the Company fulfilling the conditions stipulated by the Law and the regulations published thereunder, as well as the criteria set forth in the approval for the specific investment in the Company's Approved Enterprise.

If the Company does not comply with these conditions, the tax benefits may be cancelled, and the Company may be required to refund the amount of the cancelled benefits, with the addition of linkage differences and interest.

In the event of distribution of cash dividends from tax-exempt income attributed to the "Approved Enterprise", the reduced tax rate of 25% in respect of the amount distributed would have to be paid.

(d) Final tax assessments

The Company and its consolidated subsidiaries have received final tax assessments (including assessments which are considered final under the tax laws) for all tax years up to 31 December 1999.

Further information on Taxes on Income is set out in Note 6 of the Independent Auditors' Report and Financial Statements on pages F15 to F17 of this Prospectus.

Inflation

The financial impact of inflation over the financial years and periods under review was not significant.

Segment Reporting

Our management considers that we have only one business segment being the development, assembly and sale of precision technology products that use three-dimensional geometric measurement (metrology) for the processing of diamonds and gemstones. We have also presented information on the basis of our secondary geographical segments.

MANAGEMENT'S DISCUSSION AND ANALYSIS OF FINANCIAL CONDITION AND RESULTS OF OPERATIONS

The breakdown of our revenue for the past three financial years ended 31 December 2003, 1H03 and 1H04 are set out below:

US\$' 000	Audited						Unaudited		Audited	
	FY2001	%	FY2002	%	FY2003	%	1H03	%	1H04	%
TURNOVER										
India	2,190	50.0	6,178	69.4	9,878	67.2	5,782	74.4	4,098	58.2
Europe	908	20.8	1,250	14.0	1,435	9.8	789	10.1	807	11.4
North America	561	12.8	615	6.9	1,181	8.0	536	6.9	685	9.7
Other ⁽¹⁾	717	16.4	866	9.7	2,200	15.0	671	8.6	1,457	20.7
	4,376	100.0	8,909	100.0	14,694	100.0	7,778	100	7,047	100.0

Note:

- (1) "Other" comprised countries such as Israel, PRC (including Hong Kong), Taiwan, Japan, South Korea, Thailand, the Philippines, Russia, Armenia, Australia, New Zealand, South Africa and Argentina.

Results of Operations

FY2002 vs FY2001

Revenue

Revenue increased by 103.6% or US\$4.5 million, from US\$4.4 million in FY2001 to US\$8.9 million in FY2002 mainly due to an increase in sales of US\$4.0 million in India. Revenue from India increased 182.1% from US\$2.2 million in FY2001 to US\$6.2 million in FY2002, mainly due to an increase in sales volumes arising from increased diamond manufacturing activity in India and continued acceleration of investment by Indian entities in technology to reduce costs and increase profit margins. Our customers' increased acceptance of the DiaMark™ (which is sold as a combined system with the DiaExpert™), resulted in increased sales volume and higher unit price. Revenue from Europe increased by 37.7% or US\$0.3 million from US\$0.9 million in FY2001 to US\$1.2 million in FY2002, and was mainly due to an increase in demand for our products in Belgium. Revenue increases from North America and Other were not significant during FY2002. Sales by units were approximately 300 in FY2001 and 600 in FY2002.

Cost of sales and gross profit

Though cost of sales increased 76.5% or US\$1.3 million from US\$1.7 million in FY2001 to US\$3.0 million in FY2002, due to an increase in revenue by 103.6%, gross profit margin improved by 5.1% from 61.2% in FY2001 to 66.3% in FY2002. The improvement was mainly due to an increase in our productivity, as manifested by an increase in direct labor costs of only 57.1% as compared to an increase in revenue of 103.6% during FY2002. This was achieved as we managed our fixed costs amid an increase in revenue.

Research and development costs

The decrease of 6.3% during FY2002 in our research and development costs was mainly due to reduction of such expenses incurred by our subsidiary, Romedix. The decrease was not significant in quantum.

Selling and marketing costs

Selling and marketing costs increased 75.3% or US\$0.5 million from US\$0.7 million in FY2001 to US\$1.2 million in FY2002 mainly attributable to an increase in wages and salaries (US\$0.2 million) and others (US\$0.3 million). The increase in wages and salaries of US\$0.2 million was due to an increase in sales commissions. The increase in others of US\$0.3 million was due to an increase in various marketing operations such as printing of new brochures, participation in exhibitions and advertising.

MANAGEMENT'S DISCUSSION AND ANALYSIS OF FINANCIAL CONDITION AND RESULTS OF OPERATIONS

General and administrative expenses

General and administrative expenses increased by 32.5% or US\$0.3 million from US\$0.9 million in FY2001 to US\$1.2 million in FY2002 mainly due to an increase in wages and salaries (US\$0.2 million). The increase in wages and salaries of US\$0.2 million was due to an increase in bonus payments to our CEO.

Other expenses/(income)

We recorded other income during FY2001 of approximately US\$0.2 million being a write-back, due to the cancellation of an amount payable to the Israeli Diamond Institute. In FY2002, we reversed the other income previously recognised in FY2001 as "other expenses" as an agreement was finally reached with the Israeli Diamond Institute.

Net finance costs/(income)

We recorded finance income during FY2001 and we incurred finance costs during FY2002. These amounts were not significant.

Profit from ordinary activities before taxation

In FY2002, we recorded profit before tax of approximately US\$2.7 million as compared to approximately US\$0.6 million in FY2001, representing an increase of 335.8% or US\$2.0 million. The increase was primarily due to (i) increase in Revenue as discussed under "Revenue"; (ii) improvement in gross profit margins as discussed under "Cost of sales and gross profit"; and (iii) a decrease in research and development as discussed above.

Income tax expenses

Taxes on income increased by 100.8% or US\$0.3 million from US\$0.2 million in FY2001 to US\$0.5 million in FY2002. Though we recorded an increase in profit before tax of 410.4%, our taxation was offsetted by the effect of lower tax rates arising from our "Approved Enterprise" status. The statutory tax rate for FY2001 and FY2002 is 36%.

Net profit

For FY2002, we recorded net profit of approximately US\$2.2 million as compared to approximately US\$0.4 million in FY2001, representing an increase of 496.1% or US\$1.8 million, due to the increases in profit before tax and lower tax rates, as discussed above.

FY2003 vs FY2002

Revenue

Revenue increased by 64.9% or US\$5.8 million from US\$8.9 million in FY2002 to US\$14.7 million in FY2003. The increase in sales was mainly due to an increase from India of US\$3.7 million, from "Other" of US\$1.3 million, from North America of US\$0.6 million and from Europe of US\$0.2 million. Revenue from India increased by 59.9% or US\$3.7 million from US\$6.2 million in FY2002 to US\$9.9 million in FY2003. Our increase in sales from India was primarily due to our introduction of the DiaExpert™ SL (Single Lens), a single lens, non-configurable version with a reduced price tag especially developed for the Indian market. Revenue from Other increased by 154.0% or US\$1.3 million from US\$0.9 million in FY2002 to US\$2.2 million in FY2003. Our increase in sales from Other was mainly due to increased sales in markets on which we have not previously focused, such as the PRC, Hong Kong, Korea, South Africa and Thailand. We recruited a new Vice President of Sales, who was (and is) able to dedicate his sales efforts to all markets outside India. Revenue from North America increased by 92.0% or US\$0.6 million from US\$0.6 million in FY2002 to US\$1.2 million in FY2003. Our increase in sales from North America was mainly due to a general increase in sales to both retail and manufacturing customers. The increase of revenue from Europe during FY2003 was not significant.

MANAGEMENT'S DISCUSSION AND ANALYSIS OF FINANCIAL CONDITION AND RESULTS OF OPERATIONS

Cost of sales and gross profit

Cost of sales increased 49.1% or US\$1.5 million from US\$3.0 million in FY2002 to US\$4.5 million in FY2003 due to an increase in revenue of 64.9% during FY2003. Our gross profit margin improved by 3.3% from 66.3% in FY2002 to 69.6% in FY2003. The improvement was mainly due to a decrease in direct labor costs as a percentage of cost of sales from 15.4% to 9.3% and a lower rate of increase of our assembly overheads by 27.8% as compared to the increase in revenue of 64.9% during FY2003. This was achieved as we manage our fixed costs amid an increase in revenue.

Research and development costs

Research and development costs increased 93.2% or US\$0.7 million from US\$0.7 million in FY2002 to US\$1.4 million in FY2003 mainly attributable to the increases in wages and salaries (US\$0.3 million) and sub-contractors costs (US\$0.3 million). The increases in wages and salaries and sub-contractor costs were mainly due to an increase in our R&D activities.

Selling and marketing costs

Selling and marketing costs increased 26.9% or US\$0.3 million from US\$1.2 million in FY2002 to US\$1.5 million in FY2003 mainly attributable to increases in wages and salaries (US\$0.1 million), commissions to agents (US\$0.1 million) and other (US\$0.1 million). The respective increases were not significant.

General and administrative expenses

General and administrative expenses increased by 13.0% or US\$0.2 million from US\$1.1 million in FY2002 to US\$1.3 million in FY2003. The increase was not significant.

Other expenses

Decrease in Other expenses of US\$0.1 million during FY2003 was not significant.

Net Finance costs/(Income)

Increase in net finance costs during FY2003 was not significant.

Profit from ordinary activities before taxation

In FY2003, we recorded profit before tax of US\$5.9 million as compared to US\$2.7 million in FY2002, representing an increase of 123.0% or US\$3.3 million. The increase was primarily due to an increase in revenue as discussed under "Revenue" and an improvement in gross profit margins as discussed under "Cost of sales and gross profit", offset mainly by the increases in selling and marketing and general and administrative expenses.

Taxes on income

Taxes on income increased by 19.0% or US\$0.1 million from US\$0.5 million in FY2002 to US\$0.6 million in FY2003. Though we recorded an increase in profit before tax of 123.0%, our taxation was offset by the effect of lower tax rates arising from our "Approved Enterprise" status. The statutory tax rate for FY2002 and FY2003 is 36%.

Net profit

For FY2003, we recorded net profit of US\$5.3 million as compared to US\$2.2 million in FY2002, representing an increase of 146.9% or US\$3.1 million, due to the increase in profit before tax and lower tax rates as discussed above.

MANAGEMENT'S DISCUSSION AND ANALYSIS OF FINANCIAL CONDITION AND RESULTS OF OPERATIONS

1H04 vs 1H03

Revenue

Revenue decreased by 9.4% or US\$0.7 million from US\$7.7 million in 1H03 to US\$7.0 million in 1H04 mainly due to a decrease in sales to India, following the termination of our distribution agreement with our previous Indian distributor which affected our sales during the first few months of 1H04. The decrease in sales from India of US\$1.7 million was offset by the increases in sales in Other of US\$0.8 million and North America of US\$0.2 million (increase in sales in Europe was insignificant). Revenue from India decreased by 29.1% or US\$1.7 million from US\$5.8 million in 1H03 to US\$4.1 million in 1H04. Revenue from "Other" increased by 117.1% or US\$0.8 million from US\$0.7 million in 1H03 to US\$1.5 million in 1H04. Sales from various countries classified under Other did not record material increases individually. Revenue from North America increased by 27.8% or US\$0.2 million from US\$0.5 million in 1H03 to US\$0.7 million in 1H04.

Cost of sales and gross profit

Cost of sales increased insignificantly (4.0% or US\$0.1 million) from US\$2.4 million in 1H03 to US\$2.5 million in 1H04 due to improvements in our products (mainly improved laser components) driven by our strive for quality. Our gross profit margin decreased by 4.5% from 69.5% in 1H03 to 65.0% in 1H04. The decrease was due mainly to (i) more costly components as we moved to sealed lasers and fiber-optic lasers and other refinements in our cost of direct components, and (ii) increase in direct labor costs of 63.4%.

Research and development costs

Research and development costs increased 33.8% or US\$0.2 million from US\$0.5 million in 1H03 to US\$0.7 million in 1H04 mainly attributable to an increase in our research and development salaries and sub-contractor costs due to our R&D activities.

Selling and marketing costs

Selling and marketing costs increased 45.7% or US\$0.4 million from US\$0.8 million in 1H03 to US\$1.2 million in 1H04 mainly attributable to expenses related to our newly incorporated Indian subsidiary. These expenses comprised salaries of new employees, office rent and travelling expenses of approximately US\$0.3 million.

General and administrative expenses

General and administrative expenses increased by 71.5% or US\$0.4 million from US\$0.6 million in 1H03 to US\$1.0 million in 1H04 due to an increase in allowances for doubtful debts of US\$0.2 million arising from the refusal of our previous Indian distributor to pay our outstanding balance. In addition, we also incurred professional services and other expenses related to incorporating our subsidiary in India during 1H04.

Other expenses

Decrease in Other expenses was insignificant during 1H04.

Finance costs

Increase in other finance costs was insignificant during 1H04.

Profit from ordinary activities before taxation

In 1H04, we recorded profit before tax of US\$1.6 million as compared to US\$3.5 million in 1H03, representing a decrease of 53.1% or US\$1.9 million. The decrease was primarily due to (i) decrease in revenue as discussed under "Revenue"; (ii) decrease in gross profit margins as discussed under "Cost of sales and gross profit"; and (iii) increases in operating costs as discussed under "Research and development costs", "Selling and marketing costs" and "General and administrative expenses" as described above.

MANAGEMENT'S DISCUSSION AND ANALYSIS OF FINANCIAL CONDITION AND RESULTS OF OPERATIONS

Income tax expenses

Income tax for 1H04 was 32.4% or US\$0.5 million on pre-tax profit of US\$1.6 million compared to 9.2% or US\$0.3 million on pre-tax profit of US\$3.5 million in 1H03 due to expiration of the zero-tax rate associated with our Approved Enterprise status granted in FY2002. The statutory tax rate for 1H03 is 36% and for 1H04 is 35%.

Net profit

For 1H04, we recorded net profit of US\$1.1 million as compared to US\$3.2 million in 1H03 representing a decrease of 65.1% or US\$2.1 million due to the decrease in profit before tax and the increase in our tax rate as discussed above.

PROFIT ESTIMATE

Barring any unforeseen circumstances, our Directors estimate that our Group will achieve revenue of approximately US\$18.8 million, profit before tax of approximately US\$6.4 million and profit after tax of approximately US\$4.6 million for FY2004. Our Directors believe that our Group will be able to achieve the profit estimate as our estimated revenue is based on actual sales and revenue through December 2004. Based on the consolidated audited financial statements for 1H04, our Group achieved revenue, profit before tax and profit after tax of US\$7.0 million, US\$1.6 million and US\$1.1 million respectively. These represented approximately 37%, 25% and 24% of our respective estimates.

For 1H04, our Group has achieved profit before taxation of US\$1.6 million. Our profit before taxation is estimated to be approximately US\$4.8 million in 2H04, representing an increase in profit before tax margin from 23% in 1H04 to 41% in 2H04. The higher profit before tax in 2H04 is due mainly to the estimated increase in our sales volume, primarily in India, and our operating expenses being estimated to have increased at a lower rate than the rate of increased revenue.

Investors should be aware that there is no assurance that the profit estimate set out above can be achieved, as there are risks and uncertainties that may cause our actual results and performance (after completion of the entire audit process) to be materially different from the profit estimate set out above. The factors that may affect our business and operations are mainly set out under the section "Risk Factors" on pages 41 to 49 of this Prospectus.

Bases and assumptions underlying the profit estimate

The profit estimate, for which our Directors are solely responsible, has been prepared on a basis consistent with the accounting policies normally adopted by our Group in the preparation of our financial statements.

The general principal assumptions underlying the profit estimate are set out below:

- (a) Based on the prevailing conditions, the Directors are not aware of any changes to the existing political, economic, legal and social conditions, and regulatory and fiscal measures in the countries in which the Group operates that may adversely affect the Group's operations.
- (b) There will be no material changes in the bases of exchange rates from those prevailing as at the date 30 June 2004.
- (c) The effective tax rate for 1H04 and 2H04 are 32.4% and 27.8% respectively due to the effect of the tax incentives under the Law for the Encouragement of Capital Investments, 1959 as described on pages 101, F16, D-5 and D-6 of this Prospectus.
- (d) There will be no exceptional circumstances or events which will materially affect the market that we operate in.
- (e) There will be no exceptional circumstances, which will require provisions to be made by our Group in respect of any contingent liability or arbitration threatened or otherwise, abnormal bad debts and other assets.

MANAGEMENT'S DISCUSSION AND ANALYSIS OF FINANCIAL CONDITION AND RESULTS OF OPERATIONS

REVIEW OF FINANCIAL POSITION

Non-current assets

Non-current assets comprised mainly property, plant and equipment, intangible assets and deferred taxes. Property, plant and equipment consist mainly of machinery and equipment, motor vehicles, computers and office equipment, demonstration equipment and improvements in leasehold. Depreciation is calculated by the straight-line method over the useful lives of the assets as estimated by management.

Annual rates of depreciation are as follows:

Machinery and equipment	15%
Motor vehicles	15%
Computers and office equipment	6-33%
Demonstration equipment	12-20%
Leasehold improvements	According to the leasing contract period

Intangible assets relate to the cost of acquisition of technical know-how arising from the acquisition of GCI in June 2001 which are amortised at the annual rate of 20.0%. We also recorded intangible assets relating to cost of acquisition of know how regarding the development of diamond polishing discs arising from our acquisition of Romedix, which will be amortised at the annual rate of 12.5%.

Non-current assets as at the end of FY2001 increased by 30.0% or US\$0.1 million from US\$0.5 million to US\$0.6 million as at the end of FY2002. The increase in quantum was not significant.

Non-current assets as at the end of FY2002 increased by 19.0% or US\$0.2 million from US\$0.6 million to US\$0.8 million as at the end of FY2003. The increase in quantum was not significant.

Non-current assets as at the end of FY2003 increased by 58.3% or US\$0.4 million from US\$0.8 million to US\$1.2 million as at the end of 1H04. The increase was mainly due to increase in property, plant and equipment (US\$0.3 million) during 1H04 arising from capital expenditure incurred for our Indian subsidiary.

Current assets

Current assets comprised inventories, trade receivables, other receivables, short-term investments and cash and cash equivalents.

Inventories comprised mainly raw materials and consumables, work in progress and finished goods (including goods in transit and inventories held by customers on sale or return) and they each form 44.7%, 18.8% and 36.5% respectively of our inventories as at 30 June 2004.

Trade and other receivables are stated at their cost less allowance for doubtful receivables. The allowance for doubtful receivables is provided based on the evaluation of the recoverability of these receivables at the balance sheet date. The allowance for doubtful receivables for the past three financial years were not significant. During 1H04, the allowance for doubtful debts increased substantially due to the failure of our previous Indian distributor to pay us the outstanding balance.

Other receivables relate mainly to (i) amount owing to us by the tax authorities relating to value-added tax recoverable; (ii) advances to suppliers; and (iii) prepaid expenses.

Short term investments relates to debt securities held for trading.

MANAGEMENT'S DISCUSSION AND ANALYSIS OF FINANCIAL CONDITION AND RESULTS OF OPERATIONS

Current assets increased by 126.3% or US\$1.8 million from US\$1.5 million as at the end of FY2001 to US\$3.3 million as at the end of FY2002 due to an increase in cash and cash equivalent (US\$0.9 million), an increase in inventories (US\$0.6 million), an increase in trade receivables (US\$0.2 million) and an increase in other receivables (US\$0.1 million). The increase in inventories of US\$0.6 million was due to an increase in the finished goods components. This increase is primarily due to products delivered to India on CAD terms and not cleared through customs by year end and an increase in our inventory of finished DiaMarks, which was to meet orders in the first quarter of FY2003. The increase in trade receivables of US\$0.2 million and increase on other receivables of US\$0.1 million were not significant.

Current assets increased by 123.0% or US\$4.1 million from US\$3.3 million as at the end of FY2002 to US\$7.4 million as at the end of FY2003 mainly due to an increase in cash and cash equivalents (US\$2.6 million), an increase in inventories (US\$0.4 million), an increase in short-term investments (US\$0.3 million), and an increase in trade receivables (US\$1.0 million) offset by a decrease in other receivables (US\$0.1 million). The increase in inventories of US\$0.4 million was due to an increase in the raw materials component due to the termination of our distribution agreement with our former India distributor. The local distributor in India did not fulfil its undertaking to purchase the full amount of systems ordered from us, although, we continued to fulfil our purchase orders with suppliers (primarily lasers and laser power supplies). For more information on the termination of our distributorship with this local distributor in India, please refer to the section entitled "General and Statutory Information" under the subheading "Litigation" on pages 155 to 158 of this Prospectus. We purchased debt securities held for trading of US\$0.3 million during FY2003. The increase in trade receivables of US\$1.0 million or 155.5% was mainly due to an increase in our revenue of 64.9% during FY2003. The decrease in other receivables (US\$0.1 million) during FY2003 was not significant.

Current assets increased by 11.3% or US\$0.8 million from US\$7.4 million as at the end of FY2003 to US\$8.2 million as at 30 June 2004 mainly due to an increase in cash and cash equivalent (US\$1.0 million), an increase in inventories (US\$0.1 million), and an increase in other receivables (US\$0.2 million) offset by a decrease in trade receivables (US\$0.5 million). The increase in inventories of US\$0.1 million was primarily due to products delivered to India on CAD terms and not cleared through customs by period end. The decrease in trade receivables of US\$0.5 million was due to higher sales made on CAD or cash terms to our various Indian customers instead of providing credit terms to our previous distributor. In addition, we also made a higher allowance for doubtful receivables of US\$0.2 million, most of which related to our previous Indian distributor. The increase in other receivables was not significant.

We recorded average inventory turnover (for Finished Goods only) of 26 days and 63 days in FY2001 and FY2002 respectively. The increase in inventories turnover for FY2001 to FY2002 was mainly due to increase in inventory at year end, as noted above. We recorded average inventory turnover of 63 days, 53 days and 45 days in FY2002, FY2003 and 1H04 respectively. The improvement in average inventory turnover was mainly due to our management effort to maintain minimal inventory level.

Our management established inventory management and control directives to track incoming and outgoing inventory. Provision for stock obsolescence is made on a quarterly basis for obsolete, slow moving and defective inventory. Our management, based on the estimated realized value of the inventory, determine the provisions. We did not make any provisions for stock obsolescence and write-offs of inventory during FY2001, FY2002, FY2003 and 1H04.

MANAGEMENT'S DISCUSSION AND ANALYSIS OF FINANCIAL CONDITION AND RESULTS OF OPERATIONS

We have a credit policy in place and the exposure to credit risk is monitored on an ongoing basis. At balance sheet date, cash and cash equivalents were held with only two financial institutions, thereby exposing us to significant concentrations of credit risks. However, we consider that the high credit rating of the counter-parties reduces our risk to an acceptable level. We recorded trade debtors turnover of 27 days, 21 days, 27 days and 34 days in FY2001, FY2002, FY2003 and 1H04 respectively. Our Belgian distributor exceeded his agreed terms of payment in June 2004 resulting in the higher trade debtors turnover of 34 days during 1H04. The allowances for doubtful receivables and the write offs of bad debts for the past three financial years were not significant. In 1H04, the allowance for doubtful receivables increased substantially due to the failure of our previous Indian distributor to settle our outstanding balance.

Current liabilities

Current liabilities comprised mainly trade payables, other payables and short term loans and bank overdraft, current tax payable and warranty provision. Our short term bank loans and bank overdraft were secured by personal guarantees from related parties.

The short term bank loans were secured and repayable within six months. The effective interest rate was 6.75% and 3.28% per annum for FY2001 and FY2002 respectively. Interest was repriceable as and when notified by the bank.

The bank overdraft was secured and had no fixed terms of repayment. The effective interest rate (with regards to debts in NIS) as at 31 December 2003 was 12.5% per annum, as at 31 December 2002 was 7.29% per annum and as at 31 December 2001 was 9.79% per annum. Interest rate was repriceable as and when notified by the bank.

Our provision for warranty is based on estimates from historical warranty data associated with our similar products. We expect to incur the liability over the next year. The provision for warranty for the past three financial years ended 31 December 2001, 2002 and 2003 and 1H04 were not significant.

Other payables relate mainly to (i) amount owing to employees and related institutions, (ii) advances from customers; (iii) accrued expenses; and (iv) bonus to our CEO.

Our amount owing to employees and related institutions relates to outstanding balance owing to employees at year (period) end, pending actual pay of net salary on 1 January (July) of the following financial year (period), and to tax and social insurance authorities, as well as insurance policies and other benefits.

We often receive payments on account from customers against ordered products, in order to guarantee fixed product price and delivery time.

Accrued expenses relate to operating expenses incurred during the respective financial years and period but not paid.

Outstanding balances owing to related parties at the respective financial year ends and as at 30 June 2004 relate to amounts owing to one of our Controlling Shareholders, Sarin R&D for the services of Mr Hanoh Stark as an Executive Director of our Company and for bonuses owed to our CEO. The amounts payable to related parties are unsecured, interest free and have no fixed terms of repayment.

Current liabilities increased by 42.2% or US\$0.8 million from US\$1.8 million as at the end of FY2001 to US\$2.6 million as at the end of FY2002. This was mainly due to increases in other payables (US\$0.4 million), trade payables (US\$0.3 million), current tax payable (US\$0.1 million) offset by decreases in short term loans and bank overdraft (US\$0.1 million). The increase in other payables of US\$0.4 million was mainly due to increases of amount owing to related parties (US\$0.2 million) and amount owing to employees and related institutions (US\$0.2 million). The payroll to employees increased (in line with growth in operations) and also our CEO's bonus due to the increase in revenue and profitability. The increase in trade payables of US\$0.3 million was mainly due to increase in purchases of components

MANAGEMENT'S DISCUSSION AND ANALYSIS OF FINANCIAL CONDITION AND RESULTS OF OPERATIONS

(primarily lasers), in line with increased sales, resulting in higher outstanding balance as at 31 December 2002. The increase in current tax payable and decrease in short term loans and bank overdraft during FY2002 were not significant.

Current liabilities decreased by 12.5% or US\$0.3 million from US\$2.6 million as at the end of FY2002 to US\$2.3 million as at the end of FY2003. This was mainly due to the decreases in trade payables (US\$0.4 million), short term loans and bank overdraft (US\$0.3 million) offset by increases in other payables (US\$0.2 million) and tax payables (US\$0.1 million). The decrease in trade payables of US\$0.4 million was mainly due to our reduced purchases leading up to year end due to our gradual cessation of sales through our previous Indian distributor. The decrease in short-term bank loans and bank overdraft of US\$0.3 million was due to our repayment of balances during FY2003. The increase in other payables of US\$0.2 million was mainly due to the increase in amount owing to related parties (US\$0.2 million). This increase relates to an increase in our CEO's ongoing bonus balance as he chose not to redeem the amount owed to him at that time. The increase in current tax payable during FY2003 was not significant.

Current liabilities increased by 65.5% or US\$1.5 million from US\$2.3 million as at the end of FY2003 to US\$3.8 million as at 30 June 2004. This was mainly due to the increase in trade payables (US\$0.9 million) and other payables (US\$0.5 million). The increase in trade payables of US\$0.9 million was mainly due to an increase in purchases of direct components due to an increase in sales and deliveries of systems in June and July 2004. The increase in other payables of US\$0.5 million was mainly due to (i) advances from customers and (ii) our CEO's bonus as he continued not to redeem the amount owed to him. The increase in current tax payable and provision for warranty and decrease in short term loans and bank overdraft during 1H04 were not significant.

We recorded trade creditors turnover of 112 days, 90 days, 53 days and 74 days in FY2001, FY2002, FY2003 and 1H04 respectively. The decrease from FY2001 to FY2003 was due to our improvement of cashflow from operating activities which enabled our accelerated payment to suppliers. In particular, during FY2003, the decrease in trade creditors turnover was primarily due to an overall decrease in purchases leading up to year end, as described above. We recorded trade creditors turnover of 74 days for 1H04. This increase was due to the increase in purchases of components to meet the increase in our order book for deliveries of systems in June and July 2004.

Non-current liabilities

Non-current liabilities comprised (i) long term loan in FY2001; and (ii) liability for employee severance benefits.

The unsecured and interest-free long term loan represented an amount due to a related party. We have fully repaid our long-term loans as at the end of 31 December 2002. The increases in liability for employee severance benefit over the past three financial years ended 31 December 2001, 2002 and 2003 and 1H04 were not significant.

Liability for employee severance benefits

- (a) Israeli labor laws and agreements require the Company to pay severance pay to dismissed or retiring employees (including those leaving their employment under certain other circumstances). The calculation of the severance pay liability was made in accordance with labor agreements in force and based on salary components, which, in management's opinion, create entitlement to severance pay.
- (b) The Company's severance pay liabilities to their Israeli employees are funded partially by regular deposits with recognised pension and severance pay funds in the employees' names and by purchase of insurance policies.
- (c) The Group makes contributions to various external defined benefit plans as mentioned in (b) above that provide pension benefits for employees upon retirement. The Company has no control over the assets of these funds.

MANAGEMENT'S DISCUSSION AND ANALYSIS OF FINANCIAL CONDITION AND RESULTS OF OPERATIONS

For more information on Liability for Employee Severance Benefits, please refer to page F22 of the Independent Auditors' Report and Financial Statements, Note 20.

Capital and reserves

Capital and reserves comprised mainly share premium and retained earnings. Our share capital is immaterial.

Capital and reserves increased by US\$1.2 million during FY2002 mainly due to profit generated for FY2002 of US\$2.2 million, offset by a distribution of a dividend of US\$1.0 million. There was an increase in share premium of approximately US\$0.1 million due to issuance of shares.

Capital and reserves increased by 341.7% or US\$4.5 million during FY2003 from US\$1.3 million as at 31 December 2002 to US\$5.8 million as at 31 December 2003 mainly due to profit generated for FY2003 of US\$5.3 million, offset by a distribution of a dividend of US\$0.8 million.

Capital and reserves decreased by US\$0.2 million mainly due to profit generated for 1H04 of US\$1.1 million, offset by a distribution of a dividend of US\$1.3 million.

LIQUIDITY AND CAPITAL RESOURCES

US\$' 000	Condensed Summary of Our Cashflow			
	FY2001	FY2002	FY2003	1H04
Operating profit before working capital changes	617	2,767	6,080	1,740
Net Cash generated from Operating Activities	253	2,120	3,852	2,844
Net Cash used in Investing Activities	(8)	(163)	(100)	(430)
Net Cash used in Financing Activities	(476)	(995)	(1,157)	(1,352)

Our Group has financed our growth through a combination of shareholders' equity, retained profits, short term loans and overdraft and loans from related parties. As at the date of this Prospectus, our Group had no outstanding related parties' loans as we fully repaid the loans during FY2001 and FY2002.

As at the Latest Practicable Date, our principal source of liquidity comprised cash and cash equivalents of US\$4.7 million. The effective interest rate relating to bank deposits as at the Latest Practicable Date was 3.8% per annum. The effective interest rate relating to bank deposits was 8.7% and 4.6% per annum in FY2002 and FY2003 respectively. Interest rates are re-priced on a weekly basis. Our Directors are of the opinion that our Group has adequate working capital for our requirements.

MANAGEMENT'S DISCUSSION AND ANALYSIS OF FINANCIAL CONDITION AND RESULTS OF OPERATIONS

Operating Activities

FY2002

Net cash generated from operating activities amounted to US\$2.1 million for FY2002. For FY2002, our positive sales growth of 103.6% contributed to the operating cash flow as we achieved profit after tax of US\$2.2 million. Cash flow generated from operating activities before working capital changes amounted to US\$2.8 million. Our cash flow from operating activities was further increased from an increase in trade payables (\$0.3 million) and an increase in other payables (US\$0.4 million). Net cash generated from operating activities was reduced by an increase in trade receivables (US\$0.2 million), an increase in other receivables (US\$0.1 million), an increase in inventory (\$0.6 million) and our payment of income taxes of US\$0.5 million during FY2002. For further information on the variance analysis of the current assets and current liabilities, please refer to "Review of Financial Position" on pages 108 to 112 of this Prospectus

FY2003

Net cash generated from operating activities amounted to US\$3.9 million for FY2003. For FY2003, our positive sales growth of 64.9% contributed to the operating cash flow as we achieved profit after tax of US\$5.3 million. Cash flow generated from operating activities before working capital changes amounted to US\$6.1 million. Our cash flow from operating activities was further increased from a decrease in other receivables (US\$0.1 million) and an increase in other payables (US\$0.3 million).

Net cash generated from operating activities was reduced by an increase in trade receivables (US\$1.0 million), an increase in inventory (\$0.4 million), a decrease in trade payables (US\$0.4 million), acquisition of short-term investments (US\$0.3 million) and our payment of income taxes of US\$0.7 million during FY2003. For further information on the variance analysis of the current assets and current liabilities, please refer to "Review of Financial Position" on pages 108 to 112 of this Prospectus

1H04

Net cash generated from operating activities amounted to US\$2.8 million for 1H04. For 1H04, we achieved profit after tax of US\$1.1 million. Cash flow generated from operating activities before working capital changes amounted to US\$ 1.7 million. Our cash flow from operating activities was further increased by an increase in trade payables (US\$0.9 million) and an increase in other payables (US\$0.5 million) and a decrease in trade receivables of US\$0.5 million. Net cash generated from operating activities was reduced by an increase in inventories (US\$0.1 million), an increase in other receivables (US\$0.2 million) and our payment of income taxes of US\$0.6 million during 1H04. For further information on the variance analysis of the current assets and current liabilities, please refer to "Review of Financial Position" on pages 108 to 112 of this Prospectus

Investing Activities

FY2002 and FY2003

Net cash used for investing activities during FY2002 and FY2003 related mainly to investments made to expand our production facilities and to replace old equipment, as part of the "approved enterprise" plan.

1H04

Net cash used for investing activities amounted to US\$0.4 million for 1H04 mainly for the acquisition of equipment for our Indian subsidiary and our Israeli facilities.

MANAGEMENT'S DISCUSSION AND ANALYSIS OF FINANCIAL CONDITION AND RESULTS OF OPERATIONS

Financing Activities

FY2002

Net cash used for financing activities amounted to US\$1.0 million for FY2002. This corresponded mainly to a payment of a dividend of US\$1.0 million and, to a lesser extent, to the repayment of short and long term loans and bank overdrafts.

FY2003

Net cash used for financing activities totalled US\$1.2 million for FY2003. This corresponded mainly to a payment of a dividend of US\$0.8 million and, to a lesser extent, to the repayment of short-term loans and bank overdrafts of US\$0.3 million.

1H04

Net cash used for financing activities totalled US\$1.4 million for 1H04. This corresponded mainly to a payment of a dividend of US\$1.4 million.

Bank Loans and Credit Facilities

As at 30 June 2004 and as at the Latest Practicable Date, we have no bank borrowings. We have a good banking relationship with our principal banker.

CAPITAL EXPENDITURES, ACQUISITIONS, DIVESTMENT AND COMMITMENT

Capital Expenditure

Our major capital expenditure comprises mainly additions of machinery and equipment, demonstration machines, motor vehicle, computers and office equipment and improvements in leasehold ("Property, Plant and Equipment"). The purchases of such assets, which are based in Israel, are financed mainly by funds generated from operations and short-term loans and overdrafts. The details for such expenditure for each of the last three financial years and 1H04 are set out below:

US\$'000	FY2001	FY2002	FY2003	1H04
Machinery and equipment	19	94	88	110
Demonstration machines	0	0	56	148
Motor vehicle	0	0	0	84
Computers and office equipment	9	29	5	40
Improvements in leasehold	5	21	4	0
<i>Total</i>	33	144	153	382

Acquisitions

In May 2001, we acquired all the shares in GCI for US\$5,000. The acquisition was accounted for using the purchase method.

In November 2002, we acquired, from a third party, 22% of Romedix in return for US\$41,000. In February 2004 the Company acquired from related parties the remaining 9% of Romedix. in return for US\$18,000. As at February 2004, the Company holds 100% of Romedix.

MANAGEMENT'S DISCUSSION AND ANALYSIS OF FINANCIAL CONDITION AND RESULTS OF OPERATIONS

Divestment

We did not have any material capital divestment during the past three financial years ended 31 December 2001, 2002 and 2003 and during 1H04 and we do not have any material capital divestment in progress.

Commitments

(a) Operating lease commitments

The total future minimum lease payments under operating leases in respect of properties and motor vehicles are payable as follows:

	As at 31 December			
	2001 US\$'000	2002 US\$'000	2003 US\$'000	2004 US\$'000
Payable within:				
- 1 year	100	159	118	352
- 2 to 5 years	76	87	42	570
- after 5 years	-	-	-	-
	176	246	160	922
	176	246	160	922

(b) The Group is committed to pay royalties at the rate of 3.5% to the Chief Scientist's Office of the Ministry of Trade and Industry (the "Chief Scientist") on sales proceeds from products for which the Company and a subsidiary received grants up to an amount not exceeding the grants received (linked to the exchange rate of the US dollar). The total grants received, net of royalties paid to the Chief Scientist were approximately US\$1.1 million as at 30 June 2004.

(c) The Company has a contractual obligation with a director who is a shareholder (indirectly), whereby the Company pays management fees of US\$1,000 per month.

(d) In May 2004, a subsidiary signed an agreement for the acquisition of know-how regarding the development of diamond polishing discs for a consideration of US\$50,000 and a commitment to pay royalties in the amount of 2% of the net sales proceeds of the subsidiary from these products in the 5-year period beginning 1 January 2005 up to 31 December 2009.

(e) The Company has given guarantees of up to US\$20,000 for liabilities of a subsidiary to a bank.

The above commitments are expected to be funded by positive cash flow generated by the Company in its ordinary course of business.

Subsequent events

Subsequent to 30 June 2004, the following events took place:

(i) In August 2004, the Company signed an agreement for the acquisition of know-how regarding the development of a laser diamond cutting machine for a consideration of US\$500,000 and a commitment to pay royalties for six years or the total amount of US\$2 million, whichever occurs first. Furthermore, the Company undertook to receive management and marketing services from the vendor of the know-how for a consideration of US\$100,000 a year subject to certain terms and conditions. All the payments are contingent upon the successful development and testing of the new machine.

(ii) On 9 September 2004, the Company's Board of Directors decided to distribute a cash dividend to its shareholders in the amount of US\$1.89 million, representing US\$19.78 per share. This dividend was paid at the end of September 2004.

MANAGEMENT'S DISCUSSION AND ANALYSIS OF FINANCIAL CONDITION AND RESULTS OF OPERATIONS

- (iii) During September 2004, 1431 ordinary B shares were issued upon the exercise of options granted under the Sarin 2003 Share Option Plan.
- (iv) According to a protocol of a meeting of the Board of Directors held on 18 October 2004, it was resolved as follows:
- The Company's Board of Directors resolved to cancel the agreement with a company, which is a Shareholder, and sign a new agreement instead, with one of the directors, for services as a member of the executive committee starting September 2004 for a consideration of US\$1,000 per month and reimbursement of reasonable expenses.
 - The Company's Board of Directors resolved to sign an agreement with the Chairman of the Board for his services as Chairman and a member of the executive committee starting September 2004 for a consideration of US\$2,500 per month and reimbursement of reasonable expenses.
 - The Company's Board of Directors approved the amendments to the agreement with the CEO for three years with effect from 1 September 2004. In addition to his base salary of US\$11,000 per month plus social benefits and a company vehicle, the CEO is entitled to an annual bonus. In the year 2004, the bonus will equal to 1.5% of the annual profit before tax and 2% of the annual increase in the Group's turnover. In the year 2005 and thereafter, the annual bonus will equal to 1% of the annual profit before tax of the Group and 3% of the annual increase in the profit before tax.
 - The Company's Board of Directors approved a rental agreement dated 16 August 2004 for the Company's new offices for a monthly rental of approximately US\$11,270 for a period of 41 months up to 16 January 2008 with further renewal options of up to two years.
 - The Company's Board of Directors resolved to accelerate the vesting period on some of the options granted to the Group's employees and to re-issue 515 options that were previously cancelled.
- (v) According to the protocol of a meeting of the Company's Board of Directors held on 23 December 2004, it was resolved to accelerate the vesting period on certain options granted to the Group's employees and to grant 460 additional options to employees. In addition 103 options were cancelled such that the total stock options outstanding and unexercised at the date of issue of these financial statements are 7,731.
- (vi) At a Board of Directors meeting held on 8 March 2005, the Company's Board of Directors decided to recommend that at the next annual general meeting (which is scheduled to be held within 90 days from the listing of our shares on the SGX-ST) a dividend of approximately S\$4,125,000 (or US\$2.5 million) be paid out of profits from the year ended 31 December 2004.
- (vii) At the Extraordinary General Meeting of the Company held on 8 March 2005, the Shareholders approved, *inter alia*, the following:
- (a) The conversion of all ordinary and ordinary B shares of NIS0.01 each into ordinary shares with no par value (the "Conversion");
 - (b) The division of each ordinary share of no par value, into 2,000 ordinary shares of no par value (the "Sub-division");
 - (c) The adoption of the New Articles of Association of the Company;

MANAGEMENT'S DISCUSSION AND ANALYSIS OF FINANCIAL CONDITION AND RESULTS OF OPERATIONS

- (d) The issue of up to 52,000,000 New Shares pursuant to the Prospectus of the Company. The New Shares, when fully paid, allotted and issued, will rank *pari passu* in all respects with the existing issued Shares;
 - (e) To approve the Board resolution of 8 March 2005 to issue letters of indemnification to the Directors and Executive Officers of the Company, according to which letters, the Company undertakes, subject to the provisions of the Israeli Companies Law and of the Company's Articles, to indemnify its Directors and Executive Officers prospectively up to the amount of US\$2 million, but in no event more than 25% of the Company's equity, in respect of an act performed in their capacity as Directors or Executive Officers;
 - (f) The establishment of the Company's 2005 Share Option Scheme, which comprises share options that may be granted in respect of such number of new Shares representing in aggregate not more than 15% of the total issued share capital of the Company from time to time;
 - (g) Approval and ratification of service agreements with the Chairman and a director who is a member of the executive committee.
- (viii) The Company's request to approve an expansion plan ("third program") of its Approved Enterprise was granted by the Investment Center in January 2005. The plan comprises an investment in fixed assets of US\$138,500. Subject to meeting the conditions of the letter of approval, the Company will be entitled to taxation benefits on the taxable income generated from the third program during a period of seven years commencing with the first year in which it generates taxable income from the third program, at tax rates similar to the two existing programs, as described in Note 6 (c) to the financial statements.

DIRECTORS, MANAGEMENT AND STAFF

DIRECTORS

Our Board of Directors is entrusted with the responsibility for the overall management of our Company.

The particulars of our Directors are as follows:

Name	Age	Address	Principal Occupation	Directorship in Company and Group
Daniel Benjamin Glinert	54	4 Hahilazon Street, Ramat Gan 52522 Israel	Chairman of our Board of Directors, Director of Sarin India, Romedix, GCI, Interhightech, D. Glinert Holdings, Ltd and High Tech Lipids Ltd.	Chairman of our Board of Directors and Director in Sarin India, GCI and Romedix
Hanoh Stark	64	4 Hahilazon Street, Ramat Gan 52522 Israel	President of H. Stark & Co., Ltd., Chairman and Director of Sarin R&D, Chairman of Turbofan Ltd. and of Hanoh Stark Holdings Ltd, Director of Romedix, GCI and Sarin India	Executive Director of our Company and Director of Romedix, GCI and Sarin India
Ehud Harel	44	4 Hahilazon Street, Ramat Gan 52522 Israel	Executive Vice President of Hargem Ltd	Non- Executive Director of our Company
Eyal Mashiah	44	4 Hahilazon Street, Ramat Gan 52522 Israel	Executive Director of Ramgem Ltd., Biram Diamonds Ltd and Ram Investment Ltd	Non-Executive Director of our Company
Israel Zeev Eliezri	71	4 Hahilazon Street, Ramat Gan 52522 Israel	President of Colgem EI 97 Ltd and of Coldiam Ltd.	Non-Executive Director of our Company
Aharon Shapira	53	4 Hahilazon Street, Ramat Gan 52522 Israel	Chief Technological Officer of Orsan Medical Equipment Ltd, Director of A. Shapira 2000 Systems Ltd and of Interhightech.	Non-Executive Director of our Company
Yehezkel Pinhas Blum*	51	4 Hahilazon Street, Ramat Gan 52522 Israel	President of Yarmuch Investments Ltd and Blum-Gem, Ltd	Independent Director
Chan Kam Loon*	44	18 Cross Street, #08-03 Marsh & McLennon Center, Singapore 048423	Director of Philip Chan Consulting Pte Ltd	Independent Director
Valerie Ong Choo Lin*	40	80 Raffles Place, #33-00 UOB Plaza I, Singapore 048624	Partner of Rodyk & Davidson	Independent Director

* Under Israeli law, the Company is required to appoint two external directors to the Board. In compliance with such requirement, the Company intends to propose two external directors (Yehezkel Pinhas Blum and Valerie Ong Choo Lin) from among our independent directors, Yehezkel Pinhas Blum, Chan Kam Loon and Valerie Ong Choo Lin. Israeli law also requires external directors to be nominated at a general meeting of the shareholders to be held within three months of the company's shares being listed. Such a general meeting will be convened by our Company within three months following the listing of our Shares on the SGX-ST. Please refer to the section entitled "Interest of Management and Others in Certain Transactions" under the subheading "Independent Directors under Israeli Law" on pages 142 and 143 of this Prospectus for further details on independent directorship under Israeli laws.

DIRECTORS, MANAGEMENT AND STAFF

Information on the business and working experience of our Directors is set out below:

Daniel Benjamin Glinert is the Chairman of our Board of Directors and is also our Executive Director. He was appointed to our Board in 1993 and continued until 1996 when he left Israel, and was re-appointed in 1999 when he returned. He is primarily responsible for the oversight of the management of our Company and he holds a bachelor's degree in Computer Sciences (Cum Laude) from the Technion - Israel Institute of Technology. He is also the Director of our subsidiaries, Romedix, Sarin India and GCI, and was the Chief Executive Officer in Romedix from 2000 to 2003. In addition, he was also the Chief Executive Officer of Interhightech, a software development house which specialises in real time systems, from 1982 to 1995 and is its Managing Director from 2000 to date. From 1996 to November 2004, he was also the Chief Executive Officer of InterTICI Inc., a company dealing in pre-and post-sales support for US customers in the semiconductor industry, which is a wholly-owned US subsidiary of Interhightech and was wound up voluntarily in November 2004. His company, D. Glinert Holdings Ltd, is an investment holding company and is also involved in real estate. He is also a director of High Tech Lipids Ltd. He was also a member of the Municipal Committee of Moshav Ben Shemen from 2000 to 2004. From 1977 to 1982, he was a software engineer at E-Systems in Greenville, Texas USA. From 1972 to 1977, he served in the Israeli Air Force and was honorably discharged with the rank of Major.

Hanoh Stark is our Executive Director. He was appointed to our Board on 30 August 1989. He is also the director of our subsidiaries, Romedix, GCI and Sarin India. He studied Electrical Engineering at the Technion in Milan, Italy. He is the President of H. Stark & Co. Ltd and is the Chairman and Director of Sarin R&D. He is also the Chairman of Turbofan Ltd and Hanoh Stark Holdings Ltd. He is a Member of the Israeli Diamond & Colored Stone Bourse and also a Member of I.C.A International Colored Gemstone Association. From 1969 to 1995, he was also the Chief Executive Officer of Hargem Ltd. From 1963 to 1969, he was a radio officer in the Israeli commercial navy and from 1961 to 1963, he was an electronic technician for R&D with the Israel Defence Forces.

Ehud Harel is our Non-Executive Director. He was appointed to our Board in July 2004. He completed his high school education and has been with Hargem Ltd, which deals in the evaluation and purchase of rough stones, as well as wholesale and worldwide distribution of polished gemstones since 1982. From 1982 to 1995, he was the managing director of Hargem Ltd and was promoted to his current position of executive vice president in 1995. He is also the managing director of Hart Trade & Investments Ltd, director of Gem Trading Centre Ltd and Director of Sarin R&D. From 1979 to 1982, he was a mechanical engineer with the Israeli Navy.

Eyal Mashiah is our Non-Executive Director. He was appointed to our Board on 17 December 1994. He completed his secondary level education and is currently an executive director of Biram Diamonds Ltd, a diamond manufacturer and dealer, as well as an executive director of Ram Investment Ltd, an investment holding company. Prior to joining our Group, he was involved in manufacturing of precious stones in Icam-Gems Ltd (1982-1983) and marketing of precious stones in Algem Ltd (1983-1987). From 1987 to 2001, he was with Ramgem Ltd, a company involved in cutting and dealing with precious stones, and was promoted to become its executive director in 1990. Since 1995, he is also the executive director of Ram Investments Ltd, an investment holding company. He is also the executive director, since 1992, of Biram Diamonds Ltd, a diamond manufacturing company.

Israel Zeev Eliezri is our Non-Executive Director. He was appointed to our Board in July 2004. He holds a Master's degree in Science (Geology) and a Master's degree in business administration, both from the Hebrew University, Israel and is currently the President of Colgem EI 97 Ltd and Coldiam Ltd, which cuts and exports diamonds and coloured gemstones. He was also the President of the International Colored Gemstones Association (ICA) from 1999 to 2003 and is currently the Chairman of the Geological Museum Foundation, Ramat Hasharon in Israel. From 1994 to 1999, he was the President of the Israel Emerald Cutters Association and from 1994 to 1999, he was the Chairman of the Gemological Institute of Colourstones and Diamonds. From 1999 to 2003, he was the President of the International Coloured Gemstones Association. From 1978 to 1996, he was a partner in Colgem Ltd which mines, cuts and exports coloured gemstones.

DIRECTORS, MANAGEMENT AND STAFF

Aharon Shapira is our Non-Executive Director. He was appointed to our Board on 30 August 1989. He holds a Bachelor's degree in Electrical Engineering (Cum Laude) from the Technion - Israel Institute of Technology and also a Master's degree in Computer Science from the Weizman Institute of Science in Rehovot, Israel. He is the founder and Chief Technological Officer of Orsan Medical Equipment Ltd, which was established in 2004 and the founder and previously the Chief Technological Officer, from 2000 to 2002, of Voicesense Ltd, a company dealing in stress/emotion recognition through voice analysis for call centres. He was also a lecturer at Systematic Inventive Thinking, Ltd., a company specializing in the training of organizations and individuals in a methodology for inventive thinking. He is also a director of A. Shapira 2000 Ltd, an investment holding company and of Interhightech. From 1984 to 1993, he was a partner in charge of R&D at Shalev Ltd (which merged in 1993 into TICl Software Systems Ltd, a software and systems engineering company, now known as Interhightech). From 1980 to 1984, he was a software engineer in the R&D department in Compulite Ltd, a company that developed and marketed computerised lighting systems. From 1973 to 1980, he was a Captain in the Israel Defence Forces.

Yehezkel Pinhas Blum is our Independent Director. He was appointed to our Board on 8 March 2005. He holds a Bachelor's degree in Economics and Business Administration from the Bar-Ilan University in Ramat Gan, Israel. Since 1988, he has been the President of Yarmuch Investments Ltd, a company dealing with initiation and management of real estate investments and the provision of economic analysis services. In addition, he has been, since 1990, the President of Blum-Gem Ltd, which deals with cutting and export of precious stones and diamonds. From 1983 to 1990, he was the Chief Executive Officer of Gem Star, Ltd, which deals with cutting and export of precious stones and diamonds. From 1980 to 1983, he was an economist with the United Mizrahi Bank Ltd and was responsible for managing the bank's economic research unit and advising the bank's management with regard to new investments and business opportunities. From 1978 to 1980, he was an analyst engaged in economic research and analysis of financial reports. He is currently a Major (Reserve) in the Israel Defence Forces, a Senior Member of the Israel Diamond Exchange and a member of the Board of the Israel Diamond Exchange in Ramat Gan, Israel.

Chan Kam Loon is our Independent Director. He was appointed to our Board on 8 March 2005. He holds a degree in accountancy from the London School of Economics and is a qualified Chartered Accountant with the Institute of Chartered Accountants in England and Wales (ICAEW) and is a member of the Institute of Chartered Accountants in England and Wales. He articulated with KPMG in London before returning to Singapore to practice with Price Waterhouse in Singapore. He currently runs his own management and consulting firm, Philip Chan Consulting Pte Ltd. From July 2001 to July 2004, he headed the Listings Function of Markets Group at the Singapore Exchange Ltd. From 1996 to 2001, he was a director of investments at a private equity fund, Suez Asia Holdings Pte Ltd where he was responsible for originations, structuring and executing investments within the ASEAN region and in South Asia. Between 1990 to 1996, he worked at Morgan Grenfell Asia Ltd and HG Asia Securities Ltd in their corporate finance teams where he worked on various regional financial advisory and equity fund raising exercises for listed corporates and also executed a number of private equity mandates within the ASEAN region. From 1989 to 1990, he was an assistant audit manager in Price Waterhouse. He was a member of the Singapore's Accounting Standards Committee, Singapore Zhejiang Business Council and also Singapore Shandong Business Council.

Valerie Ong Choo Lin is our Independent Director. She was appointed to our Board on 8 March 2005. She graduated with a Bachelor of Laws (Honours) from the National University of Singapore in 1987 and obtained a Masters in Law (Distinction) from the London School of Economics in 1991. She heads the Corporate Finance Practice in Rodyk & Davidson and is also a member of the firm's Executive Committee. She has been a practicing lawyer since 1988, specializing in corporate finance (including initial public offerings) and mergers and acquisitions. Ms Ong is a member of the Income Tax Board of Review.

DIRECTORS, MANAGEMENT AND STAFF

Save as disclosed below and in the section entitled “Share Capital” under the subheading “Shareholders” on pages 60 to 61 of this Prospectus, none of our Directors is related by blood or marriage to one another or to any of our Substantial Shareholders.

- Ehud Harel, our Non-Executive Director, is the brother-in-law of Hanoh Stark, who is also our Executive Director. Both Ehud Harel and Hanoh Stark are also directors and indirect shareholders of Sarin R&D, our Substantial Shareholder. Ehud Harel’s mother, Hanoh Stark’s mother-in-law, Sara Harel, is also a director and shareholder of Hargem Ltd, a controlling shareholder of Sarin R&D.
- Hanoh Stark, who is our Executive Director is also the brother-in-law of Ilan Weisman, who is a director and shareholder (through Ilan Weisman Holdings Ltd) in Sarin R&D, our Substantial Shareholder.
- Eyal Mashiah, our Non-Executive Director, is a director and an indirect shareholder of Sarin R&D, our Substantial Shareholder.
- Israel Zeev Eliezri, our Non-Executive Director, is the father of Mr Oren Eliezri, who is an indirect shareholder of Sarin R&D, our Substantial Shareholder.
- Daniel Benjamin Glinert, our Chairman and Executive Director, is a director and an indirect shareholder of Interhightech, our Substantial Shareholder.
- Aharon Shapira, our Non-Executive Director, is a director and an indirect shareholder of Interhightech, our Substantial Shareholder.

The list of present and past directorships of each of our Directors held in the last five years preceding the date of this Prospectus can be found in the section entitled “General and Statutory Information” under the subheading “Information on Directors and Executive Directors” on pages 146 to 149 of this Prospectus.

Save as disclosed below, there are no arrangements or understandings with any of our Substantial Shareholders, customers, suppliers or other person pursuant to which any of our Directors was appointed:

- (a) Pursuant to a shareholders’ agreement entered into in 1995 (the “1995 Agreement”) by our Company, Interhightech, Sarin R&D and Zannex, each of Sarin R&D and Interhightech was entitled to appoint one director for each 14% of the shares in our Company held by it. Hence, Interhightech was entitled to appoint two directors and Sarin R&D was entitled to appoint four directors to our Board of Directors. Currently, Daniel Benjamin Glinert and Aharon Shapira are appointed by Interhightech (although there is no personal agreement between either Daniel Benjamin Glinert or Aharon Shapira with Interhightech or our Company pursuant to which they were so appointed), whilst Hanoh Stark, Ehud Harel, Israel Zeev Eliezri and Eyal Mashiah are appointed by Sarin R&D (although there is no personal agreement between either Hanoh Stark, Ehud Harel, Israel Zeev Eliezri or Eyal Mashiah with Sarin R&D or our Company pursuant to which they were so appointed).
- (b) In 2005, Sarin R&D and Interhightech entered into another shareholders’ agreement (the “2005 Agreement”) which superseded the 1995 Agreement. Under the 2005 Agreement, Sarin R&D and Interhightech have agreed, *inter alia*, that :
 - (i) they will co-operate in appointing six Directors, up to four of whom may be proposed by Sarin R&D and up to two may be proposed by Interhightech;

DIRECTORS, MANAGEMENT AND STAFF

- (ii) Sarin R&D shall have the right to propose one of the three Independent Directors (who is a non-Singaporean Independent Director) and Interhightech shall support such proposal;
- (iii) neither Sarin R&D nor Interhightech shall initiate or support an attempt to remove a Director, who was appointed based on the other party's proposal;
- (iv) if a Director retires or is removed before his term ends, the party appointing such Director may propose another person and such person shall be appointed for the remainder of the term of office of the out-going or retiring Director;
- (v) if Interhightech's shareholding in our Company at any time falls below 50% of its shareholding at the time the 2005 Agreement was signed, Interhightech shall have the right to propose only one Director;
- (vi) the allocation of seats in the Board of Directors shall be reviewed and adjusted on a pro-rata basis every three years, according to the respective shareholdings of Sarin R&D and Interhightech;
- (vii) neither party shall initiate or support the amendment of our Articles of Association without the consent of the other party, or the consent of the holders of at least 75% of our Shares held by both Sarin R&D and Interhightech;
- (viii) both parties shall have a mutual first right of refusal with regard to the sale of shares by the other party other than on the SGX-ST; and
- (ix) the 2005 Agreement shall be for a term of six years and may be renewed unless terminated earlier in accordance with the terms and conditions therein.

On 8 March 2005, the Board resolved, subject to the approval of the Company's Shareholders' Meeting to:

- (I) issue letters of indemnification to the Directors and Executive Officers of the Company, pursuant to which the Company undertakes, subject to the provisions of the Israeli Companies Laws and of the Company's Articles of Association, to indemnify its Directors and Executive Officers prospectively, up to the amount of US\$2 million, but in no event more than 25% of the Company's equity, in respect of an act performed in their capacity as Directors or Executive Officers in connection with the Invitation, with regard to the following:
 - (i) a financial obligation imposed on any and all of the Directors and/or Executive Officers in favour of another person by a court judgment, including a compromise judgment or an arbitrator's award approved by court;
 - (ii) reasonable litigation expenses, including attorneys' fees, expended by any and all of the Directors or Executive Officers or charged to the Directors or Executive Officers by a court, in a proceeding instituted against any and all of the Directors and/or Executive Officers by the Company or on its behalf or by another person, or in a criminal charge from which the Director or Executive Officer was acquitted, or in a criminal proceeding in which the Director or Executive Officer was convicted of an offense that does not require proof of criminal intent; and
- (II) to authorize the management of our Company to procure Directors and Officers' liability insurance for the directors and officers of our Company and our subsidiaries, subject to the provisions of applicable laws and of our Articles of Association. The maximum amount covered by such insurance shall not exceed US\$10 million.

DIRECTORS, MANAGEMENT AND STAFF

MANAGEMENT

Our Executive Directors are assisted by our team of Executive Officers whose particulars are as follows:

Name	Age	Address	Principal Occupation
Zeev Leshem	58	4 Hahilazon Street, Ramat Gan 52522 Israel	Chief Executive Officer of our Company and Chief Executive Officer of GCI Director of GCI, Romedix and Sarin India
Zvi Halperin	50	4 Hahilazon Street, Ramat Gan 52522 Israel	Chief Financial Officer of our Company
Avraham Dali	59	4 Hahilazon Street, Ramat Gan 52522 Israel	Vice President for Sales and Marketing of our Company
Abraham Meir Kerner	49	4 Hahilazon Street, Ramat Gan 52522 Israel	Chief Technological Officer of our Company
Dan Ilan Bar-El	50	4 Hahilazon Street, Ramat Gan 52522 Israel	Vice President of R&D of our Company
Yosef Vax	43	4 Hahilazon Street, Ramat Gan 52522 Israel	Vice President for Production
Udi Lederer	30	4 Hahilazon Street, Ramat Gan 52522 Israel	Product Manager – Retail and Gemological Laboratories
David Sydney Block	30	4 Hahilazon Street, Ramat Gan 52522 Israel	Product Manager – Manufacturing
Shemiau Cassorla	56	Sanox Centre, Ground Floor, Mani Mahal, 11/21 Mathew Road, Opera House, Mumbai 400 004, Maharashtra	Chief Executive Officer of Sarin India
Saraf Sajjan Lal	54	Sanox Centre, Ground Floor, Mani Mahal, 11/21 Mathew Road, Opera House, Mumbai 400 004, Maharashtra	Chief Operating Officer of Sarin India
Rajeshwari H. Mehta	29	Sanox Centre, Ground Floor, Mani Mahal, 11/21 Mathew Road, Opera House, Mumbai 400 004, Maharashtra	Vice President of Sarin India

DIRECTORS, MANAGEMENT AND STAFF

Information on the business and working experience of our Executive Officers is set out below:

Zeev Leshem, our Chief Executive Officer, is in charge of overseeing the overall management and expansion of our Company's operations and business. He holds a bachelor's degree in Electrical Engineering from the Ben-Gurion University in Israel. He joined our Company as our CEO on 27 December 1994. Prior to becoming our CEO, he was a consultant with our Company from 1992 to 1994 and was involved in project work. From 1990 to 1992, he was a self-employed consultant involved in medical instrumentation projects with Medoc Ltd and in a project with Naztec Ltd for a product to analyse the best direction for polishing of diamonds. From 1988 to 1990, he was the Vice President of New Business in Orpak Ltd and was responsible for leading new projects relating to computerised signs.

Zvi Halperin is our Chief Financial Officer and was appointed in 2004. He holds a bachelor's degree in Accounting and Economics from the Tel-Aviv University in Israel and is a member of the Institute of Certified Public Accountants in Israel. He is responsible for all the financial aspects of our Company. Prior to joining us, he spent 10 years, from 1994 to 2004, as the Chief Financial Officer of Optibase Ltd, an Israeli company traded on the NASDAQ. Before that, he spent 10 years, from 1984 to 1994, as the comptroller and financial manager of Oshap Technologies Ltd., also an Israeli company traded on the NASDAQ. Between 1983 and 1984, he acted as a comptroller of one of the subsidiaries of Delta Galil Industries Ltd.

Avraham Dali is our Vice President for Sales and Marketing and has been with us since 30 March 2003. He is responsible for managing our Company's sales and marketing operations. He holds a bachelor's degree in Computer Engineering and Electronics Engineering (with a major in Computers) from the Ben Gurion University in Israel and also a Masters of Business Administration from the Northeastern University in Boston, Massachusetts, USA. He has over 30 years of experience in the fields of marketing, sales, technical and operational support. Prior to joining us, he was a customer support manager in Verint Systems Ltd (used to be known as Comverse Infosys Ltd) from 2000 to 2003 and was responsible for managing the worldwide support group of the company, as well as developing and implementing business and operational strategies in the company. From 1992 to 1999, he was the Vice President of Marketing, Sales and Support in Cubital Ltd and was in charge of managing all the sales, marketing and support aspects in the company. From 1990 to 1991, he was a technical marketing manager in Indigo Graphic Systems (IGS) Ltd and worked with the company to establish sale distribution channels for promoting and selling the company's products in Europe. From 1975 to 1989, he worked in various management positions in Scitex Corporation Ltd. From 1973 to 1975, he was an electronic design engineer with Elisra Ltd, a company dealing with computer systems for military and commercial use.

Abraham Meir Kerner is our Chief Technological Officer and is primarily responsible for determining the development of products and technology. He has been with our Company since July 1995. He holds a bachelor's degree in Electrical Engineering from the Technion - Israel Institute of Technology. Before his appointment as Chief Technological Officer in September 2004, he was the R&D manager in our Company from 1994 to 2004, (for the initial two years with us, he was on loan from our shareholder TICI Software Systems Ltd., now known as Interhightech). Prior to joining us, he was a senior engineer in Shalev Ltd (which merged in 1993 into TICI Software Systems Ltd, a software and systems engineering company, now known as Interhightech) from 1986 to 1996 where he was involved in the development of motion control systems and accurate measuring machines for diamonds. From 1980 to 1986, he was a senior engineer with Compulite Ltd, a company that developed and marketed computerized lighting systems, where he was involved in developing hardware and software for light controls.

Dan Ilan Bar-El is our Vice President for R&D. He joined our Company in 2004 and is responsible for overseeing the research and development processes in our Company. He has a bachelor's degree in Electronics and Computer Engineering from the Technion - Israel Institute of Technology and also holds a diploma in business management from the Israeli Institute of Management. Prior to joining us, he was, from 2002 to 2004, a consultant with expertise in product management and operations and an academic manager at the Israeli Centre for Continuing Education where he developed, managed and lectured on

DIRECTORS, MANAGEMENT AND STAFF

project management courses. From 1999 to 2000, he was the Vice President of R&D in charge of managing the R&D department (including product development, quality assurance and engineering) in Comview Visual Systems Ltd, a company that developed and marketed large display systems for control rooms and visualization markets but was placed under receivership in 2001. From 1994 to 1999, he co-founded and was the Vice President of R&D in charge of market studies, product development and business development at Scidel Technologies Ltd, a company involved in the development and marketing of real-time insertion of advertising during live television broadcasts. From 1980 to 1994, he was the hardware engineer and team leader, before being promoted as manager of the R&D department at Scitex Corp Ltd, where he was in charge of development of hardware and software infrastructure for interactive graphic workstations.

Yosef Vax is our Vice President for Production and is also in charge of quality control in our Company. He has been with us since 2001 and is responsible for production lines, quality, logistics, purchasing of supplies and ensuring the quality of our products. He is an electronics practical engineer from the Tel-Aviv College in Israel and also is a Certified Quality Manager from the A.L.D College for Certified Managers for Quality in Rishon le Zion in Israel. Prior to joining us, he was with NICE Systems Ltd, a company in Israel dealing with Voice-over Internet Protocol ("VoIP") from 1995 to 2001 where he was a quality control manager in charge of quality control processes and customer care. From 1984 to 1995, he was with Scitex Corporation Ltd where he was a team leader for incoming inspection for eletro-optics, electronics and mechanics as well as optic and mechanics laboratories.

Udi Lederer is our Product Manager for Retail and Gemological Laboratories. He is primarily responsible for writing product requirements, conducting market research, customer support and management of product releases. He has been with us since March 2001. He holds a bachelor's degree in business and a Masters of Business Administration from the College of Management in Israel. Prior to joining us, he was a product technologist from 2000 to 2001 and a help desk manager from 1998 to 2000 in ClickSoftware Technologies Ltd, a company in Israel which leads the provision of niche service resource optimization software. He was responsible for initiating and developing product prototypes, integrating diverse technologies, presenting recommendations to senior management and participating in multi-company technology development consortiums. From 1997 to 1998, he was a simulator specialist in Tetra Technologies Ltd, a company in Israel dedicated to developing sophisticated technical simulators for large military systems. He was responsible for developing artillery-related simulators and wrote technical product specifications.

David Sydney Block is our Product Manager for Manufacturing Markets. He has been with us since 2002 and is primarily responsible for defining products related to the manufacturing field. His scope of work includes determining the needs of the market and producing specifications to meet such market needs for our R&D department. He holds a bachelor's degree in Computer Science from the Tel-Aviv-Jaffa Academic College in Israel and is also a qualified electrical technician from the 'Ort Shapira Technical College in Israel. Prior to joining us, from 2001 to 2002, he was a programmer in CastUp Inc., a company dealing with internet video streaming and he was responsible for quality assurance. In 2001, he was responsible for establishing the quality control department in Pango Systems B.V., a company in Israel. From 1999 to 2000, he was a technical writer responsible for establishing and developing the multimedia department in R.O.R. Ltd and also managed large-scale projects for several major Israeli high-tech companies.

Shemiau Cassorla is the Chief Executive Officer of Sarin India. He was appointed in 2004 and is in charge of overall management of the operations and business in Sarin India. He graduated as a practical electronic engineer from Ort Singalovsky in Israel. Prior to his appointment to Sarin India, he was with our Company from 1993 to 2003 where he started in sales and was promoted over the years to become our Vice President for Marketing in India. He was with Sarin R&D from 1988 to 1993, where he worked as a product manager. From 1985 to 1988, he was a technical advisor on R&D in ES Engineering Ltd, a company dealing with computerised industrial systems. From 1981 to 1985, he was self-employed, dealing with R&D and maintenance of motor vehicle electronic fuel injection and ABS systems. From 1974 to 1981, he was an electronics maintenance manager with Helfor Ltd, a steel processing company where he maintained control systems for company production equipment. From 1969 to 1973, he was a member in the R&D team of the military systems division in Motorola Ltd. From 1966 to 1969, he was a sergeant with the Israeli Air Force.

DIRECTORS, MANAGEMENT AND STAFF

Saraf Sajjan Lal is the Chief Operating officer of Sarin India. He was appointed in 2004 and is responsible for administration, accounts and finance in Sarin India. He holds a bachelor's degree in Commerce from the University of Rajasthan, India, and is a F.C.A. from the Institute of Chartered Accountants of India. Prior to joining us, he was practicing as an accountant in his own firm, S.L. Saraf & Co. from 1998 to 2003. From 1988 to 1997, he was the finance manager in charge of administration, accounts, taxation and finance in Indexo International & Mondial India Pvt Ltd. From 1985 to 1988, he was the Vice President of Futura Packaging Inds. Ltd and from 1983 to 1985, he was the Vice President of Sunrise Soaps and Chemicals Pvt Ltd. From 1978 to 1983, he was the chief accountant in Bombay Potteries & Tiles Ltd. From 1975 to 1978, he was an accountant at Mypak Plastics India Pvt Ltd and from 1974 to 1975, he was an accountant at Unicorn Tyres Ltd.

Rajeshwari H. Mehta is the Vice President of Sarin India. She was appointed in 2004 and is responsible for all pre-sale and post-sale activities concerning the sale of products by our Company in India. She holds a Master's degree in Organic Chemistry and a Masters in Business Administration from the South Gujarat University, India. Prior to joining Sarin India, she was employed by our Company from 2002 to 2004 and was in charge of doing the initial market surveys for our Company in India. From 1999 to 2002, she was the Vice President of Marketing in Sahajanand Technologies P. Ltd (then known as Sahajanand Laser Technology P. Ltd) where she was responsible for the marketing team in charge of sales with our Company. In 1999, she was a customer care executive in Mahindra Holidays & Resorts India Ltd where she was in charge of customer support for the Surat division.

None of our Executive Officers is related by blood or marriage to one another, our Directors or to our Substantial Shareholders.

The list of present and past directorships of each of our Executive Officers held in the last 5 years preceding the date of this Prospectus can be found in the section entitled "General and Statutory Information" and under the subheading "Information on Directors and Executive Directors" on pages 146 to 149 of this Prospectus.

DIRECTORS, MANAGEMENT AND STAFF

MANAGEMENT REPORTING STRUCTURE

Our management reporting structure is set out below:

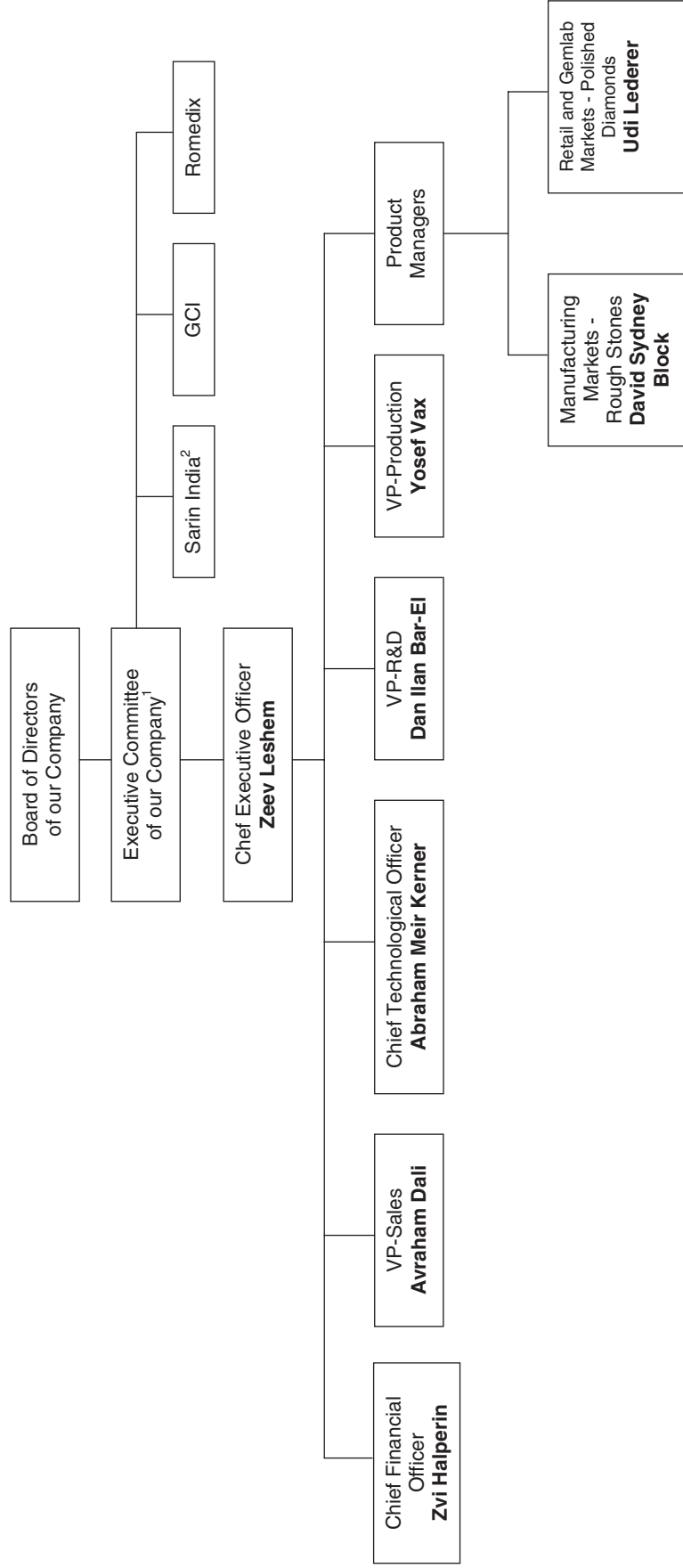

1. Executive Committee comprising our Executive Directors, Daniel Benjamin Glinert and Hanoh Stark; and our CEO, Zeev Leshem. The Executive Committee of our Company is also the Board of Directors of our subsidiaries, namely Sarin India, GCI and Romedix.

2. The Chief Executive Officer of Sarin India is Shemiau Cassorla. Saraf Sajjan Lal is the Chief Operating Officer and Rajeshwari Mehta is the Vice President.

DIRECTORS, MANAGEMENT AND STAFF

STAFF

As at 23 February 2005, a total of 123 persons are employed by our Group, as per the following table:

Name of Company	R&D	Sales and Marketing	Production	Management and Administration	Customer Support	Total
Our Company	17	6	17	7	4	51
GCI	1	–	–	–	–	1
Romedix	1	–	1	1	–	3
Sarin India	–	16	–	20	32	68
Total Employees of our Group	19	22	18	28	36	123

A breakdown of our Group's staff strength at the end of each of the three financial years ended 31 December 2001, 2002 and 2003, 1H04 and up to the Latest Practicable Date are as follows:

Corporate Divisions	FY2001	FY2002	FY2003	1H04	23 February 2005
Administration	4	4	4	15	28
Sales and Marketing	4	5	5	15	22
Development and Engineering	7	11	14	18	19
Production	8	12	12	17	18
Customer Support	2	3	3	25	36
Total number of full-time employees	25	35	38	90	123

Our employees with Sarin India were all employed in 2004. Our Group's employee count has been moderately increasing over the years leading up to 1H04 due to expansion of existing operations, primarily in research and development and production staff. In particular, our Group's employee count substantially increased in 1H04 due to the establishment of our subsidiary, Sarin India.

No collective agreements apply to employees of our Group. However, a number of industrial expansion orders and general expansion orders, which apply to all employers and employees in the Israeli labour force, do apply to them. None of our employees are represented by a labour union and we have not experienced any labour disputes or any work stoppage.

We have not employed a significant number of temporary staff in the last three financial years and during 1H04. However, from time to time, when the need arises, we may employ contract workers to help us to handle the increased workload. Competition for highly-qualified technical and engineering personnel in Israel is intense. We believe we have been able to attract talented engineering and other technical personnel.

Israeli labour laws and regulations apply to all of our employees in Israel. The laws principally concern matters such as paid vacation, paid sick days, length of the workday, payment for overtime and severance payments upon the retirement or death of an employee or termination of employment under specified circumstances. The severance payments may be funded, in whole or in part, through managers' insurance fund or a pension fund. The payments to the managers' insurance fund or pension

DIRECTORS, MANAGEMENT AND STAFF

fund toward severance amount to 8.3% of wages, 5% provident fund (matched by the employee) and between 1% to 2.5% of disability insurance. Such payments are covered in full by our Group on a monthly basis. Furthermore, Israeli employees and employers are required to pay predetermined sums to the National Insurance Institute of Israel. Since 1 January 1995, these amounts also include payments for health insurance. The payments to the National Insurance Institute amount to approximately 14.5% of wages, of which the employee contributes 66% and the employer contributes 34%.

Indian labour laws and regulations apply to all employees employed by Sarin India. The laws principally concern matters such as paid vacation, paid sick leave, the length of workdays, payment of overtime and severance payments upon retirement or death of an employee or termination of employment under specified circumstances. All employees who have completed five years of service, irrespective of their salary, are eligible for Gratuity. Indian laws provide for Gratuity at the rate of 15 days' wages for every year of completed service, subject to a maximum of Rs350,000.

Sarin India is registered with the Regional Provident Fund Commissioner of India and is contributing 12% of basic salary of employees (except Shemiau Cassorla, CEO of Sarin India and Rajeshwari Mehta, Vice President of Sarin India). An equal amount is being contributed by the employees concerned. The Provident Fund accumulation is payable to the employee by the Regional Provident Fund at the time of leaving or retiring from their service.

Out of the employer's share of Provident Fund contributions, 8.33% of the total basic salary, subject to a maximum of Rs6,500 per month, is credited to the Employees' Pension Fund. Sarin India contributes to Employees State Insurance for employees drawing salary up to Rs7,500 per month. The employees contribute at the rate of 1.75% of their salary and Sarin India contributes at the rate of 4.75% of the salary. Sarin India shall be liable to pay bonus as per the Payment of Bonus Act to employees drawing remuneration of less than Rs3,500 per month. The Payment of Bonus Act provides for payment of bonus of between 8.33% to 20.00% of their annual salary, provided that, for the first five accounting years of Sarin India's business, such bonus shall be payable only in respect of accounting years in which Sarin India derives profit.

COMPENSATION

Directors

It has not been our Company's practice to compensate our Non-Executive Directors for their services rendered.

The compensation paid to Daniel Benjamin Glinert and Hanoh Stark for services rendered to us in all capacities for FY2003 and FY2004 and the estimated compensation for FY2005 in bands of S\$250,000 per annum, were as follows:

Name	FY2003	FY2004	FY2005 (Estimated)
Daniel Benjamin Glinert*	Band 1	Band 1	Band 1
Hanoh Stark**	–	Band 1	Band 1

Notes:

Band 1: compensation up to S\$250,000 per annum.

* Daniel Benjamin Glinert, who was also the Chief Executive Officer of Romedix until 31 December 2003, was entitled to a monthly fee of up to US\$10,000 (depending on time spent) for the period from December 1999 to December 2003. As at 31 December 2002, the total salary due to him that remained unpaid amounted to US\$68,000. However, in 2002, he waived his rights to these amounts due to him.

** Although Hanoh Stark did not receive any direct compensation in FY2002 and FY2003 for his services to us, Sarin R&D (of which he is a director and controlling shareholder) received US\$1,000 per month as remuneration for his services. In FY2004 part of Hanoh Stark's remuneration was still paid to Sarin R&D and he was paid directly only from September 2004. Please refer to the section entitled "Interest of Management and Others in Certain Transactions" on page 138 of this Prospectus.

DIRECTORS, MANAGEMENT AND STAFF

As described below, the Israeli Companies Law requires public companies to have two external directors, as defined in said law, who are entitled to remuneration in accordance with regulations promulgated thereunder (the "Remuneration Regulations").

According to the Remuneration Regulations, based on our Company's consolidated shareholders' equity, our external directors are entitled to an annual fee not exceeding a certain annual amount and a certain amount per meeting. The maximum amounts payable to our external directors shall be set according to our Company's equity immediately following the Invitation. Assuming that our Company's equity following the Invitation shall be less than US\$15,900,000 (but more than US\$8 million), then the external Directors shall be entitled to an annual fee ranging between approximately US\$3,181 and US\$5,766 and to a meeting attendance fee in an amount between US\$150 and US\$300. Assuming that the Company's equity following the Invitation shall be more than US\$15,900,000, then the external directors shall be entitled to an annual fee ranging between approximately US\$4,500 and US\$6,053 and to a meeting attendance fee in an amount between US\$224 and US\$400.

The attendance fees paid for participation in a Directors' meeting through the phone, or through any other means of communication shall be 60% of the ordinary attendance fees. The attendance fees paid with regard to signing of a resolution in writing shall be 50% of the ordinary attendance fees. External directors shall be also entitled to reimbursement for their expenses incurred in connection with their participation in Directors' meetings.

A company may also grant to external directors securities of the company in addition to the fees payable to them, as set forth above, as part of remuneration plan applicable to all other directors of the company (or to all other directors, who are not controlling shareholders of the company).

A company may adopt an alternative arrangement, according to which an external director shall be entitled to fees in an amount which shall be no less than the lowest amount paid to any other director (who is neither an external director, nor a director who is a controlling shareholder of the Company, an office holder in a controlling shareholder or who provides other services to the Company on an on-going basis, hereinafter "Other Director") and no more than the average fees paid to Other Directors.

It should be noted, however, that a company may not adopt such a method unless there are at least two Other Directors.

The amounts set forth above are based on the NIS amounts specified in the Remuneration Regulations, converted into US Dollars based on an exchange rate of NIS4.5 to US\$1. Actual amounts may vary in accordance with the prevailing exchange rate.

Companies listed outside Israel are entitled to pay higher limit fees (up to US\$24,500 per year and up to US\$730 per meeting) if the foreign law imposes additional obligations on external directors. The actual fees are determined at the Company's discretion. In this case as well, attendance in a meeting via means of communication entitles the external directors to 60% of a full meeting attendance fee, and a resolution taken in writing entitles the external directors to 50% of the full attendance fee.

Each external director is also entitled to reimbursement of his or her travel expenses incurred in connection with attending meetings outside such director's residential area, and of all direct expenses incurred in connection with attending meetings outside such external director's home country, provided that the said reimbursement is based on the same criteria as the reimbursement paid by the company to its non-independent, non-resident directors.

The Remuneration Regulations exempts fees payable to external directors from the regular corporate approvals required pursuant to the Israeli Companies Law if the amount of such fees equals the average between the minimum and maximum fees set forth in the regulations.

DIRECTORS, MANAGEMENT AND STAFF

Alternatively, the Remuneration Regulations allow a company to pay its external directors a relative remuneration. In addition to a relative remuneration or to the fixed remuneration described above, the Remuneration Regulations allow a company to pay its external directors remuneration in securities. Such relative remuneration and remuneration in securities must be in proportion to the remuneration paid by the company to its non-independent, non-controlling directors and require the approval of the company's audit committee, board of directors and shareholders.

Employees

The compensation paid by us and our subsidiaries to each of our top five (in terms of amount of compensation) employees (not being Directors) for services rendered to us in all capacities for FY2003 and FY2004 and the estimated compensation for FY2005 in bands of S\$250,000 per annum, were (or are) as follows:

Name	FY2003	FY2004	FY2005 (Estimated)
Zeev Leshem	Band 3	Band 3	Band 3
Shemiau Cassorla	Band 3	Band 4	Band 5
Abraham Meir Kerner	Band 2	Band 2	Band 2
Avraham Dali	Band 1	Band 1	Band 1
Udi Lederer	Band 1	Band 1	Band 1

Notes:

Band 1: compensation up to S\$250,000 per annum.

Band 2: compensation of between S\$250,001 to S\$500,000 per annum.

Band 3: compensation of between S\$500,001 to S\$750,000 per annum.

Band 4: compensation of between S\$750,001 to S\$1,000,000 per annum.

Band 5: compensation of between S\$1,000,001 to S\$1,250,000 per annum.

SERVICE AGREEMENTS

We have entered into service agreements with our Executive Directors, Daniel Benjamin Glinert and Hanoh Stark. The service agreements each have a fixed term of three years with effect from 1 September 2004. Either party to the service agreement may terminate the agreement by giving six months' written notice of termination to the other party.

We also entered into a service agreement with our Chief Executive Officer, Zeev Leshem. Following the Extraordinary General Meeting of the Company held on 8 March 2005, the service agreement has an initial term of 18 months with effect from 1 January 2005. Either party to the service agreement may terminate the agreement by giving six months' written notice of termination to the other party. His base salary is currently US\$11,000 per month. It was agreed in principle that such salary will be increased to US\$12,500 per month on the date of admission of our Company to the Official List of the SGX-ST. In addition to his base salary, he is entitled to a year-end performance-linked bonus. In the year 2004, the bonus will amount to 1.5% of annual profit before tax and 2.0% of annual increase in our Group's turnover. In the year 2005 and thereafter, the annual bonus will amount to 1.0% of the annual profit before tax and 3% of the annual increase in the profit before tax of our Group respectively.

Mr. Zeev Leshem was also granted with 2,750 options according to the Sarin 2003 Option Plan, all of which are already vested as of the Latest Practicable Date. The exercise price for each of such options is NIS 135 (approximately US\$30). So far Mr. Leshem has exercised 500 options.

Upon the termination of the aforementioned service agreements (except if the termination is due to the misconduct or neglect of duties), the salary and profit sharing incentive (if any) accrued to the date of termination shall be payable. In addition, severance pay, equal to one month's pay for every year of employment is payable to Zeev Leshem in accordance with the provisions of the Israeli Severance Pay Law. Save as disclosed above, the relevant persons above shall not be entitled to any other payment or compensation in respect of the termination.

DIRECTORS, MANAGEMENT AND STAFF

All the aforementioned service agreements contain confidentiality clauses which are effective during and at any time after the termination of their employment. In addition, there are non-solicitation clauses under the service agreements which are effective during their employment and for a further period of 24 months from the termination of their employment.

Our Company has also previously entered into various employment agreements with all our Executive Officers. Such agreements typically provide for the salary payable to the Executive Officers, their appointments and duties, working hours, annual leave, grounds of termination and certain restrictive covenants.

Save as disclosed above and in the section entitled "Directors, Management and Staff" under the subheading "Staff" on pages 128 and 129 of this Prospectus, there are no existing or proposed service contracts entered or to be entered into by our Directors or Executive Officers with our Company or any of our subsidiaries which provide for benefits upon termination of employment.

Had the service agreements for our Executive Directors and our Chief Executive Officer been effected on 1 January 2003, the total remuneration payable to our Directors and Executive Officers for FY2003 would have been US\$415,000 (approximately 6.4% of our profit before tax) instead of US\$571,000 (approximately 8.8% of our profit before tax) and the profit before tax would have been US\$6.1 million instead of US\$5.9 million.

TERM OF OFFICE

Each Director shall, subject to the Articles of Association, retire from office once every three years and a retiring Director shall be eligible for re-election.

SARIN 2005 SHARE OPTION PLAN

Our Company has also adopted the Sarin 2005 Share Option Plan (the "Plan"), which was approved by the Shareholders at an Extraordinary General Meeting held on 8 March 2005. The Plan will provide an opportunity for employees and directors (both Israeli and non-Israeli) of the Company, or any subsidiary or affiliate thereof to participate in the equity of our Company. The rules of the Plan are set out in Annex C of this Prospectus. The Plan conforms with the requirements as set out in Chapter 8, Part VIII of the Listing Manual.

Capitalised terms used herein bear the same meanings as defined in Annex C of this Prospectus.

As of the date of this Prospectus, no options have been granted under the Plan.

Purpose of the Plan

The purpose of the Plan is to provide incentives to Grantees by providing them with opportunities to purchase ordinary Shares, of no par value, in the Company. The Plan is designed to allow Grantees to benefit from the provisions of either Section 102 or Section 3(9) of the Ordinance, as applicable, and the rules and regulations promulgated thereunder or any other tax ruling provided by the tax authorities to the Company, or with respect to non-Israeli residents, the applicable laws relevant in their respective country of residence.

Summary of the Plan

The following is a summary of the rules of the Plan:

Administration

The Board may appoint a Share Incentive Committee or other committee of the Board (the "Committee"), which will consist of such number of Directors of the Company, as may be fixed from time to time by the Board. The Plan will be administered by such committee or by the Board. No member of the Committee shall participate in any deliberation or decision in respect of the Options granted to him or held by him.

DIRECTORS, MANAGEMENT AND STAFF

The Committee and/or the Board (as the Israel Companies Law shall allow) shall have full authority in its discretion, from time to time and at any time to determine, *inter alia*, the following:

- (a) the persons to whom the Options shall be granted;
- (b) the schedule and conditions on which such Options may be exercised and on which such Shares shall be paid for;
- (c) rules and provisions as may be necessary or appropriate to permit eligible Grantees who are not Israeli residents to participate in the Plan and/or to receive preferential tax treatment in their country of residence, with respect to the Options granted hereunder; and
- (d) such rules and regulations for carrying out the Plan, as it may deem necessary.

Eligible Grantees

The Committee and/or the Board (as the Israel Companies Law shall allow) may grant Options to any employee or director of the Company or any subsidiary or affiliate thereof.

All grants of Options to employees, directors and office holders of the Company, other than a Controlling Shareholder of the Company, shall be made only pursuant to the provisions of Section 102 of the Ordinance, the 102 Rules and any other regulations, rulings, procedures or clarifications promulgated thereunder.

All grants of Options to Controlling Shareholders of the Company shall be made only pursuant to the provisions of Section 3(9) of the Ordinance and the rule and regulations promulgated thereunder and shall further be subject to any approval required by applicable law, including the Listing Manual.

Plan Size

The aggregate number of Shares over which the Committee may grant Options on any date, when added to the number of Shares issued and issuable in respect of all Options granted under the Plan and any other share option schemes of our Company, shall not exceed 15% of the issued share capital of our Company on the date preceding the date of the relevant grant.

Our Company believes that the 15% limit set by the Listing Manual gives our Company sufficient flexibility to decide upon the number of Option Shares to offer to its existing and new employees. The number of eligible participants is expected to grow over the years. Our Company, in line with our goal of ensuring sustainable growth, is constantly reviewing its position and considering the expansion of its talent pool, which may involve employing new employees. The employee base, and thus the number of eligible participants will increase as a result. If the number of Options available under the Plan is limited, our Company may only be able to grant a small number of Options to each eligible participant which may not be a sufficiently attractive incentive. Our Company is of the opinion that it should have a sufficient number of Options to offer to new employees as well as to existing ones. The number of Options offered must also be significant enough to serve as a meaningful reward for contribution to our Company or any subsidiaries or affiliates. However, it does not indicate that the Committee and/or the Board (as the case may be) will definitely issue Option Shares up to the prescribed limit. The Committee shall exercise its discretion in deciding the number of Option Shares to be granted to each employee which will depend on the performance and value of the employee to our Company or any subsidiaries or affiliates.

DIRECTORS, MANAGEMENT AND STAFF

Options, Exercise Period and Exercise Price

The Options that are granted under the Plan may have exercise prices that are, at the Committee's discretion, set out at a discount to a price ("Market Price") equal to the average of the last dealt price for one Share on the SGX-ST over the five consecutive trading days immediately preceding the date of grant of the relevant Option (subject to a maximum discount of 20%), in which event, such Options may be exercised after the second anniversary date of the grant of the Option ("Incentive Option"), or fixed at the Market Price ("Market Price Option"). Market Price Options may be exercised after the first anniversary of the date of grant of that Option. The Options shall be valid for a term of six years from the date of grant and thereafter expire.

Grant of Options

The granting of any Option under the Plan shall be subject to the Company's procurement of all approvals and permits required by applicable law or regulatory authorities having jurisdiction over the Company, the Plan, the Options granted under it and the Shares subject thereto, including the Listing Manual of the SGX-ST.

Termination of Options

Special provisions in the rules of the Plan deal with the lapse or earlier exercise of Options in circumstances which include the termination of or, the participant's cessation of employment in our Company or any subsidiaries or affiliates; the liquidation of our Company; and the consummation of a Corporate Transaction by our Company.

Acceptance of Options

If a grant of an Option is not accepted by the Grantee within 30 days from the date of grant of that Option and, in any event, not later than 5.00 p.m. on the 30th day from such date of grant, such grant shall, upon the expiry of the 30 day period, automatically lapse. The Grantee shall not be required to pay any consideration for the Grant of an Option.

Rights of Shares

Shares arising from the exercise of Options are subject to the provisions of the Plan and the provisions of the Articles of Association of the Company. The Shares shall entitle the Grantee to full Shareholder rights, including voting and dividend rights, with respect to such Shares

Duration of the Plan

The Plan shall come into force following its adoption by the Shareholders. The Plan shall terminate upon the earliest of the expiration of the 10-year period measured from the date it was adopted by the Shareholders, or the termination of all outstanding Options in connection with a Corporate Transaction.

Grant of Options with a Discounted Exercise Price

The ability to offer Options to participants of the Plan with exercise prices set at a discount to the prevailing market price of our Shares will operate as a means to recognise participants for their outstanding performance, motivate them to continue to improve and excel while encouraging them to improve the profitability and return of our Company above a certain level which will benefit all Shareholders when these are eventually reflected through share price appreciation. Discounted options would be perceived more positively by the participants, inspiring them to work hard and produce results in order to be offered Options at a discount as only employees who have made outstanding contributions to the success and development of our Company or any subsidiaries or affiliates would be granted Options at a discount.

DIRECTORS, MANAGEMENT AND STAFF

The flexibility to grant Options with discounted exercise prices is also intended to cater to the situations where the stock market performance has overrun the general market conditions. In such cases, the Committee or the Board (as the case may be) will have the absolute discretion to:

- (a) grant Options with a discount to the Market Price of a Share (subject to the maximum limit of twenty per cent. (20%)); and
- (b) determine the participants to whom, and the Options to which, such reduction in exercise prices will apply.

In determining whether to give a discount and the quantum of such discount, the Committee or the Board (as the case may be) shall be at liberty to take into consideration factors including the performance of our Company or any subsidiaries or affiliates, the years of service and the performance of the participant concerned, the contribution of the participant to the success and development of our Company or any subsidiaries or affiliates, and the prevailing market conditions.

It is envisaged that our Company may consider granting Options with exercise prices set at a discount to the Market Price of our Shares prevailing at the time of grant under circumstances including (but not limited to) the following:

- (a) where, due to speculative forces in the stock market resulting in an overrun of the market, the market price of the Shares at the time of the grant of Options is not a true reflection of the financial performance of our Company or any subsidiaries or affiliates;
- (b) to enable our Company or any subsidiaries or affiliates to offer competitive remuneration packages in the event that the practice of granting Options with exercise prices that have a discount element becomes a general market norm. As share options become more significant components of executive remuneration packages, a discretion to grant Options with discounted prices will provide our Company or any subsidiaries or affiliates with a means to maintain the competitiveness of our Company's or any subsidiaries' or affiliates' compensation strategy; and/or
- (c) where our Company or any subsidiaries or affiliates needs to provide more compelling motivation for specific business units to improve their performance, grants of share options with discounted exercise prices will help to align the interests of employees to those of the Shareholders by encouraging them to focus more on improving the profitability and return of our Company above a certain level which will benefit all Shareholders when these are eventually reflected through share price appreciation, as such the Options granted at a discount would be perceived more positively by the employees who receive such Options.

The Committee will determine on a case-by-case basis whether a discount will be given, and if so, the quantum of the discount, taking into account the objective that is desired to be achieved by our Company or any subsidiaries or affiliates and the prevailing market conditions. As the actual discount given will depend on the relevant circumstances, the extent of the discount may vary from one case to another, subject to a maximum discount of twenty per cent. (20%) of the Market Price of a Share, as described above.

The discretion to grant Options to subscribe for shares at an exercise price set at a discount to the market price will, however, be used judiciously. The amount of the discount may vary from one offer to another, and from time to time, subject to a limit of twenty per cent. (20%) on the quantum of discount in respect of Options granted under the Plan.

Such flexibility in determining the quantum of discount would enable the Committee and/or the Board (as the case may be) to tailor the incentives in the grant of Options to be commensurate with the performance and contribution of each individual participant. By individually recognising the degree of performance and contribution of each participant, the granting of Options at a commensurate discount would enable the Committee to provide incentives for better performance, greater dedication and loyalty of the participants.

DIRECTORS, MANAGEMENT AND STAFF

Our Company may also grant Options without any discount to the market price. Additionally, our Company may, if it deems fit, impose conditions on the exercise of the Options (whether such Options are granted at the Market Price or at a discount to the Market Price), such as restricting the number of Shares for which the Option may be exercised during the initial years following its vesting.

Participants in the Plan

The extension of the Plan to Executive and Non-Executive Directors and employees of our Company or any subsidiaries or affiliates, allows us to have a fair and equitable system to reward Directors and employees who have made and who continue to make significant contributions to the long-term growth of our Company, subsidiaries or affiliates. In the event that a Non-Executive Director is selected by the Committee to participate in the Plan, the total number of Options granted to such Non-Executive Director will not be of such a significant amount as to cause his independence to be compromised.

We believe that the Plan will also enable us to attract, retain and provide incentives to its participants to produce higher standards of performance as well as encourage greater dedication and loyalty by enabling our Company, subsidiaries or affiliates to give recognition to past contributions and services as well as motivating participants generally to contribute towards the long-term growth of our Company, subsidiaries or affiliates.

Financial effects of Options granted under the Plan

The Company currently applies International Accounting Standard #19 ("IAS 19") – Employee Benefits. This standards requires the Company to make certain disclosures relating to compensation benefits (including stock options) but does not specify recognition and measurement requirements.

As at 1 January 2005, the Company will apply International Financial Reporting Standard #2 "Share-based Payment" ("IFRS 2") in respect of its Share Option Plan. Under IFRS 2, equity-settled share based payment made to employees shall be measured at the fair value and reported as an expense over the vesting period of those payments based on the best available estimate of the number of equity instruments expected to vest. IFRS 2 would be applied to grants of shares, share options or other equity instruments that were granted after 7 November 2002 and had not yet vested at the effective date of the IFRS (that is, 1 January 2005). For all grants of equity instruments to which this IFRS is applied, the Company will restate the comparative information.

INTEREST OF MANAGEMENT AND OTHERS IN CERTAIN TRANSACTIONS

INTERESTED PERSON TRANSACTIONS

Save as disclosed below, no Director, Executive Officer or Controlling Shareholder or associate of any such Director, Executive Officer or controlling Shareholder was or is interested in any material transaction or loan undertaken by our Company in the past three financial years ended 31 December 2001, 2002 and 2003 and up to the Latest Practicable Date.

Past Interested Person Transactions

1. *Joint Guarantee Agreement*

A joint guarantee agreement dated 1 February 2001 ("Agreement") was entered into between our Company, Interhightech (a shareholder of our Company) and another guarantor (collectively "Guarantors") in support of a line of credit granted to Romedix amounting to US\$40,000 by the First International Bank ("Bank"). Pursuant to the Agreement, each of the Guarantors, severally agreed to guarantee (as a continuing guarantee) the line of credit and to execute any forms required for that purpose by the Bank. The guarantee by our Company and Interhightech amounted to US\$20,000 (or 50% of the total credit amount) and US\$10,000 (or 25% of the total credit amount) respectively.

Romedix undertook to repay the Guarantors, within 30 days of demand, any sum paid by them to the Bank and bearing interest at the rate of 5% ("Debt"), and to indemnify them for any damage, expense or monetary loss incurred by them due to the guarantee.

Without prejudice to any other rights of the Guarantors under the Agreement, the Agreement also provides them the right, at their discretion, upon Romedix's default, to convert the Debt (either partially or in full) into shares in the capital of Romedix, at a price equal to that paid by the latest third party investor in Romedix, provided that such an investment amounted to at least US\$100,000. In the event that no such investment was made, the conversion rate would be determined according to the values of the receivables received by Romedix pursuant to the investment of Romedix's shareholders in the share capital of the Company, until the date of the conversion. The Guarantors agreed and undertook that in the event any of them would be required by the Bank to pay an amount which is not pro rata to the sums provided for in the Agreement, then the others would reimburse him accordingly.

The Agreement was entered into on commercial terms and at arm's length. The line of credit was terminated by Romedix in December 2003 without any guarantee being exercised against any Guarantor.

2. *Continuing Guarantee*

In December 2002, in support of a line of credit granted to our Company amounting to US\$300,000 by the Union Bank of Israel Ltd ("Bank"), certain shareholders of Sarin R&D ("Guarantors") severally agreed to guarantee (as a continuing guarantee) the line of credit and to execute any forms required for that purpose by the Bank ("Guarantee"). The Guarantee was rescinded in February 2004, without being exercised. The Guarantee was entered into to replace another guarantee which was granted by the same parties to the Bank for a line of credit amounting to US\$400,000 and which expired in December 2002 without being exercised.

3. *Purchase of Shares in Romedix*

A share purchase agreement was entered into on 3 February 2004 pursuant to which Hargem Ltd, Alessia Investment S.A., Bilbao Trade and Investment Ltd, Ilan Weisman and Sarin R&D ("Romedix Vendors") sold all the shares held by them (amounting to 151,400 ordinary shares) in the share capital of Romedix to our Company in consideration for a total sum of NIS82,975, which was paid in full by our Company to the Romedix Vendors. The consideration for this transaction was based on the same mechanism used in the transaction in which we purchased Romedix's shares from Rodata Ltd., a non-related entity in September 2002. The transaction was entered into on commercial terms and at arm's length.

INTEREST OF MANAGEMENT AND OTHERS IN CERTAIN TRANSACTIONS

4. *Provision of services by Sarin R&D*

Since January 2002, our Company has been paying Sarin R&D a monthly sum of US\$1,000 for the services of Mr Hanoh Stark as an executive Director of our Company. The services were provided on commercial terms and at arm's length.

This arrangement was terminated on 18 October 2004. A service agreement was signed by Mr Hanoh Stark directly with our Company as stated in the section entitled "Directors, Management and Staff" under the subheading "Service Agreements" on pages 131 and 132 of this Prospectus.

5. *Lease of Property*

Pursuant to a sub-lease arrangement, Romedix sub-leased part of a property at 10 Plaut St., Rehovot, Israel with an approximate area of 50 sq. m area, from Interhightech (1982) Ltd (who leased the property from another unrelated third party) on 1 November 2002 up to the end of November 2003. The sub-lease arrangement was on a back-to-back basis with Interhightech and on a pro-rata basis (computed by the ratio of the area leased by Romedix from Interhightech out of the total area leased by Interhightech from the third party). In total, Romedix paid Interhightech NIS7,000 in FY2002 (for two months only), and NIS17,000 in FY2003. The transaction was entered into on commercial terms and at arm's length.

6. *Payment of fee to Ilan Weisman*

In 2004, our Group entered into an agreement with an unrelated third party for the purchase of machines. We were informed that Mr Ilan Weisman, our Director at that time, was entitled to a fee (amounting to 15% of the sales by the third party to our Company, which fee amounted to approximately US\$13,000) to which he is entitled as partial owner of the rights of the product which fee was paid to him regardless of the fact that the sale was made to us. This fee was paid by the third party from the proceeds of the sale of the machines. Nevertheless, the transaction was entered into at market price, on commercial terms and at arm's length.

7. *Purchase of software development services*

In 2001, Romedix entered into an agreement with Taldor-TICI, Ltd ("Software Agreement") pursuant to which Romedix purchased software development services from Taldor-TICI Ltd. Interhightech, a shareholder of our Company was entitled to receive 45% of the gross profit of Taldor-TICI for the four-year period from 2000 to 2003 (irrespective of the services provided to Romedix). Romedix paid the sum of US\$134,000, US\$32,000 and US\$3,300 for FY2001, FY2002 and FY2003 respectively for said software services.

The Software Agreement, including the term requiring payment to Interhightech, was entered into on commercial terms and at arm's length and payment to Interhightech was terminated on 31 December 2003.

8. *Royalties paid by Romedix to a company (whose shares are held by Hanoh Stark and others) with respect to technological know-how for disposable polishing discs*

On 20 May 2004, Romedix entered into an agreement pursuant to which Romedix purchased the technological know-how from a third party with regards to disposable polishing discs for diamonds and other gems. Hanoh Stark, our Director and indirect shareholder via Sarin R&D, claimed that the technology that we bought overlaps with the know-how protected under registered patents registered under the name of Turbofan Ltd. (a company whose shares are held by Hanoh Stark and others). It was agreed between Hanoh Stark and Romedix that the claims relating to the said know-how and patents will be referred to arbitration. The arbitrator ruled, on 3 August 2004 that, though there was no infringement of Turbofan's patents, Romedix should pay Turbofan Ltd, due to partial overlap of the technologies involved, royalties amounting to 2% of the actual receivables derived from the sale of such disposable polishing discs, up to and until 31 December 2009. As the payments are directed to be paid by an impartial arbitrator, we are of the view that the payments are at arm's length. For further details, please refer to the section entitled "General and Statutory Information" under the subheadings "Material Contracts" and "Litigation" on pages 153 and 154 and pages 155 to 158 of this Prospectus respectively.

INTEREST OF MANAGEMENT AND OTHERS IN CERTAIN TRANSACTIONS

9. *Payment of fees to Philip Chan Consulting Pte Ltd*

Our Independent Director, Chan Kam Loon, is a director of Philip Chan Consulting Pte Ltd. Philip Chan Consulting Pte Ltd has provided consulting services to our Company prior to our Invitation and we paid a consultancy fee amounting to US\$30,000 to Philip Chan Consulting Pte Ltd in this regard. This consultancy fee, which was paid in 2005 is a one-time non-recurring fee and does not constitute Director's fees. The transaction was entered into on commercial terms and at arm's length. We do not intend to continue with this arrangement with Philip Chan Consulting Pte Ltd. The Directors, taking into account the services rendered and the fees to be paid, are of the view that this is not a relationship which will interfere or be reasonably perceived to interfere with the exercise of Chan Kam Loon's independent business judgement in the best interests of our Company.

Save for the aforesaid, there are no other material interested person transactions.

GUIDELINES FOR FUTURE INTERESTED PERSON TRANSACTIONS

We anticipate that we may, in the ordinary course of business, enter into certain transactions with interested persons. It is likely that such transactions will occur with some degree of frequency and could arise at any time and from time to time. Such transactions include, but are not limited to the transactions described above.

All future transactions with interested persons shall comply with the requirements of the Listing Manual and the Israeli Companies Law. As required by the Listing Manual and the Israeli Companies Law, our Articles of Association requires a Director to abstain from voting in any contract or arrangement in which he has a personal material interest (although, according to the Israeli Companies Law, when the majority (or all) of the Directors have a personal material interest in any contract or arrangement, they will be allowed to vote on such contact or transaction – but their resolution shall be subject to the approval of the Shareholders in general meeting. Our Company shall act in accordance with the Listing Manual, and therefore, our Directors and their Associates shall refrain, at all times from voting on any contract or transaction in which the Directors have a personal interest).

According to the Israeli Companies Law, a transaction with an office holder or in which an office holder has a personal interest is permitted only if it does not harm the company's welfare and is subject to certain approvals. Such approvals are the Board of Directors' approval and, in the event of an extraordinary transaction (as defined in the Israeli Companies Law, being a transaction which is not made in a company's ordinary course of business, or which is not made under ordinary market terms, or which may materially affect the company's profitability, property or undertakings), the Audit Committee's approval and/or the approval of the Shareholders in general meeting, as well. If a majority of the directors have a personal interest in a transaction, then approval of the Shareholders in general meeting is required. If the matter involves the compensation of a Director for his services to the company as a Director or officer, the approval of the Audit Committee, Board of Directors and of the Shareholders in general meeting will be required, in that order.

Our internal control procedures will ensure that all interested person transactions, including the aforementioned interested person transactions involving companies related to our Company are conducted at arm's length and on commercial terms. Such internal controls include the following:

- (a) when purchasing from interested persons, our Directors shall (where circumstances permit) take into account the prices and terms of at least two other comparative offers from independent third parties, contemporaneous in time. The purchase price shall not be higher than the most competitive price of the two comparative offers from such third parties;
- (b) in determining the most competitive purchase price, our Directors shall take into consideration the nature of the project, the cost and the experience and expertise of the supplier;

INTEREST OF MANAGEMENT AND OTHERS IN CERTAIN TRANSACTIONS

- (c) when selling to interested persons, our Directors shall take into account the prices and terms of at least two other successful sales to independent third parties, contemporaneous in time. The sale price shall not be lower than the lowest sale price of the other two successful sales to such third parties;
- (d) when renting from interested persons, our Directors shall take into account the rental and terms of two other comparative premises, contemporaneous in time. The rental paid shall not be higher than the most competitive rental of the two comparative premises; and
- (e) should any future interested party transaction be on less preferred terms than as determined in steps (a) to (c), our Board of Directors must grant prior approval.

The considerations in paragraphs (a) to (e) above will allow for variation from the prices and terms of the comparative offers or sales so long as the volume of trade, creditworthiness of the buyer, differences in service, reliability or other relevant factors justify the variation and so long as the contemporaneous comparative offer or sale incorporates modifications that account for volatility of the market for the goods and services in question.

Each such interested party transaction will be properly documented and submitted quarterly to our Audit Committee for its review to ensure that all interested person transactions are conducted at arm's length and on normal commercial terms. In the event that a member of our Audit Committee is interested in any interested person transaction, he will abstain from reviewing that particular transaction. Our Audit Committee will include the review of all such interested person transactions as part of the standard procedures while examining the adequacy of internal controls of our Company.

Our Audit Committee will ensure that all provisions and disclosure requirements on all such interested person transactions, including those required by prevailing legislation, the Listing Manual and accounting standards, as the case may be, are complied with.

Our Board of Directors will ensure that all disclosure requirements on interested person transactions, including those required by prevailing legislation will be subject to Shareholders' approval in general meeting if deemed necessary by the Listing Manual. We will disclose in our annual report the aggregate value of interested person transactions conducted during the financial year.

REVIEW PROCEDURES FOR FUTURE INTERESTED PERSON TRANSACTIONS

Our Directors, our Audit Committee (when formed) and/or our Shareholders in a general meeting (as may be required under the Israeli Companies Law and/or Listing Manual) will review and approve all interested person transactions as defined by the Listing Manual ("Interested Person Transactions") prior to entry of such transactions to ensure they are on arms' length basis, that is, the transactions are transacted on terms and prices not more favourable to the interested person than if they were transacted with an independent third party and we have not been disadvantaged in any other way.

Any contracts to be made with an interested person shall not be approved unless the pricing is:

- (a) determined in accordance with our usual business practices and policies;
- (b) consistent with the usual margin given or price received by us for the same or substantially similar type of transactions between us and unrelated parties; and
- (c) the terms are no more favourable to the interested person than those extended to or received from unrelated parties.

For the purposes of the above, contracts for the same or substantially similar types of transactions entered into between us and unrelated third parties, if any, will be used as a basis for comparison to determine whether the price and terms offered to or received from the interested person are no more favourable than those extended to unrelated third parties.

INTEREST OF MANAGEMENT AND OTHERS IN CERTAIN TRANSACTIONS

We will prepare relevant information to assist our Audit Committee in its review.

Before any agreement or arrangement that is not in the ordinary course of business of our Company is transacted, prior approval must be obtained from our Audit Committee. In the event that a member of our Audit Committee is interested in any of the Interested Person Transaction, he will abstain from reviewing that particular transaction. Any decision to proceed with such an agreement or arrangement would be recorded for review by our Audit Committee.

We will also comply with the provisions in Chapter 9 of the Listing Manual in respect of all future Interested Person Transactions, and if required under the Israeli Companies Law, the Articles of Association, the Listing Manual, the Companies Act or the SFA, we will seek our Shareholders' approval in general meeting for such transactions. Should the above statutes or regulations require that any of the Directors (or any of their associates) refrain from voting in any Shareholder's resolutions, then such Directors (and their Associates) shall refrain from voting.

POTENTIAL CONFLICT OF INTEREST

As at the date of this Prospectus:

- (a) no Director, Executive Officer, or Controlling Shareholder or Associate of any such Director, Executive Officer or Controlling Shareholder has an interest, direct or indirect, in any material transaction subsisting as at the Latest Practicable Date to which our Company is a party and which is significant in relation to the business of our Company taken as a whole;
- (b) no Director, Executive Officer, or Controlling Shareholder or Associate of any such Director, Executive Officer or Controlling Shareholder has any material interest, direct or indirect, in any enterprise or Company carrying out the same business as our Company or dealing in similar products as our Company; and
- (c) no Director, Executive Officer, or Controlling Shareholder or Associate of any such Director, Executive Officer or Controlling Shareholder has any material interest, direct or indirect, in any enterprise or company that is our Company's major customer or supplier of goods or services.

CORPORATE GOVERNANCE

Board Practices

According to the Israeli Companies Law and our Articles of Association, the oversight of the management of our business is vested in our Board of Directors. The Board of Directors may exercise all powers and may take all actions that are not specifically granted to our Shareholders. As part of its powers, our Board of Directors may cause us to borrow or secure payment of any sum or sums of money for our purposes, at times and upon terms and conditions as it thinks fit, including the grant of security interests in all or any part of our property.

According to the Israeli Companies Law, the general manager, or chief executive officer, is responsible for the day-to-day operations of a company's affairs within the bounds of the policies determined by the board of directors and subject to its directions. A company's chairman of the board may not serve as its chief executive officer, unless otherwise approved by the shareholders from time to time, which approval shall be valid, once given, for a period of up to three years. The required shareholder approval is either: (i) a majority of the shares voted on the matter (excluding abstentions), including at least two-thirds of the shares of non-controlling shareholders voted on the matter; or (ii) less than 1% of the shares of the Company opposed such approval. The chairman of our Board is Daniel Benjamin Glinert and our Chief Executive Officer is Zeev Leshem.

INTEREST OF MANAGEMENT AND OTHERS IN CERTAIN TRANSACTIONS

Our Directors may be elected at annual meetings of our Shareholders by a vote of the holders of a majority of the ordinary shares voting thereon, or by our Board of Directors. Generally, Directors appointed by the Company at a general meeting hold office until the third annual general meeting immediately following the date on which they were elected and directors appointed by the Board of Directors hold office until the first annual general meeting immediately following the date on which they were so appointed. Pursuant to the Israeli Companies Law, independent directors, which are referred to in the Israeli Companies Law as “external directors”, are required to be elected by shareholders for a three-year term and may be re-elected by shareholders for one additional three-year term.

Unless otherwise unanimously decided by our Directors, and except as set forth below, a quorum at a meeting of the Board of Directors is constituted by the presence of at least one-half of the Directors then in office who are lawfully entitled to participate in the meeting, but not less than two Directors. A resolution proposed at a meeting of the Board of Directors is deemed adopted if approved by a majority of the Directors present and voting on the matter.

However, the following resolutions shall be deemed adopted only if approved by at least two-thirds (2/3) of the Directors of our Company:

- (a) listing of any of our Shares on any stock exchange other than the SGX-ST;
- (b) issuance of securities of our Company (including, without limitation, options and warrants) which (i) shall form more than five per cent of our Company's issued share capital (on a fully diluted basis) immediately following such issuance; or (ii) together with any securities issued the 12 months period preceding the date of such issuance, shall form more than five per cent. of the Company's issued share capital (on a fully diluted basis) immediately following such issuance; and
- (c) appointment and removal of the CEO.

Our Directors recognise the importance of corporate governance and the maintenance of a high standard of accountability to our Shareholders.

Independent Directors under Israeli Law

Under the Israeli Companies Law, public companies are required to appoint two independent directors (to be nominated within three months following the listing of the Company).

The Israeli Companies Law provides that a person may not be appointed as an independent director of a company if the person or the person's relative (as defined under the Israeli Companies Law), partner, employer or any entity under the person's control has, as of the date of the person's appointment to serve as an independent director, or had, during the two years preceding that date any affiliation with:

- the company;
- any entity controlling the company; or
- any entity controlled by the company or by its controlling entity.

The term affiliation includes:

- an employment relationship;
- a business or professional relationship maintained on a regular basis;
- control; and
- service as an office holder.

INTEREST OF MANAGEMENT AND OTHERS IN CERTAIN TRANSACTIONS

The Israeli Companies Law defines the term “office holder” of a company to include a director, the chief executive officer, the chief business manager, a vice president and any officer that reports directly to the chief executive officer. No person can serve as an independent director if the person’s position or other business creates, or may create conflict of interests with the person’s responsibilities as an independent director or may otherwise interfere with the person’s ability to serve as an independent director. Until the lapse of two years from termination of office, a company may not engage an independent director to serve as an office holder and cannot employ or receive services from that person, either directly or indirectly, including through a corporation controlled by that person.

Independent directors are to be elected by a majority vote at a shareholders’ meeting, provided that either:

- at least one-third of the shares of non-controlling shareholders voted at the meeting vote in favour of the election; or
- the total number of shares voted against the election of the independent director does not exceed one per cent. of the aggregate voting rights in the company.

The initial term of an independent director is three years and may be extended for an additional three years. Independent directors may be removed from office only by the same percentage of shareholders as is required for their election, or by a court, and then only if the independent directors cease to meet the statutory qualifications for their appointment or if they violate their duty of loyalty to the company. Each committee of a company’s board of directors that is authorized to exercise a power of the board of directors is required to include at least one independent director, except for the audit committee, which is required to include all independent directors.

Audit Committee

Under the Israeli Companies Law, the board of directors of a public company is required to appoint an audit committee, which must comprise at least three directors and include all of the independent directors, but may not include:

- the chairman of the board of directors;
- any controlling shareholder or any relative of a controlling shareholder; and
- any director employed by the company or providing services to the company on a regular basis.

Our Audit Committee comprises Yehezkel Pinhas Blum, Chan Kam Loon and Valerie Ong Choo Lin. The chairman of our Audit Committee is Yehezkel Pinhas Blum.

Our Audit Committee will assist our Board in discharging its responsibility to safeguard our assets, maintain adequate accounting records, and develop and maintain effective systems of internal control, with the overall objective of ensuring that our management creates and maintains an effective control environment in our Company, in consultation with the internal auditor. Our Audit Committee will provide a channel of communication between our Board, our management and our external auditors on matters relating to audit.

The Audit Committee shall meet periodically and perform the following functions:

- (a) review with the external and internal auditors the audit plan, their findings on their evaluation of the system of internal accounting controls, their letter to management and the management’s response;
- (b) Review the scope and results of the internal audit procedures;

INTEREST OF MANAGEMENT AND OTHERS IN CERTAIN TRANSACTIONS

- (c) review the quarterly and annual financial statements and balance sheet and profit and loss accounts before submission to our Board for approval, focusing in particular on changes in accounting policies and practices, major risk areas, significant adjustments resulting from the audit, compliance with accounting standards and compliance with the Listing Manual and any other relevant statutory or regulatory requirements;
- (d) review the internal control procedures and ensure co-ordination between the external and internal auditors and our management, and review the assistance given by our management to the external and internal auditors, and discuss problems and concerns, if any, arising from the interim and final audits, and any matters which the external and internal auditors may wish to discuss (in the absence of our management, where necessary);
- (e) review and discuss with the external auditors any suspected fraud or irregularity, or suspected infringement of any relevant laws, rules or regulations, which has or is likely to have a material impact on our Company's operating results or financial position, and our management's response;
- (f) consider and recommend to the Board to appoint and re-appoint the external auditors and matters relating to the resignation or dismissal of the auditors;
- (g) review interested person transactions (if any) falling within the scope of Chapter 9 of the Listing Manual or within the scope of those interested persons transactions that require the approval of the audit committee pursuant to Israeli Companies Law;
- (h) review potential conflicts of interest, if any;
- (i) review the remuneration packages of employees who are related to our Directors and/or Substantial Shareholders, if any;
- (j) undertake such other reviews and projects as may be requested by our Board, and will report to our Board its findings from time to time on matters arising and requiring the attention of our Audit Committee; and
- (k) generally undertake such other functions and duties as may be required by statute or the Listing Manual, or by such amendments as may be made thereto from time to time.

Apart from the duties listed above, our Audit Committee shall communicate and review the findings of internal investigation into matters where there is any suspected fraud or irregularity, or failure of internal controls or infringement of any law, rule or regulation which has or is likely to have a material impact on our Company's operating units and/or financial position. In the event that a member of our Audit Committee is interested in any matter being considered by our Audit Committee, he will abstain from reviewing that particular transaction or voting on that particular resolution.

Nominating Committee

Our Nominating Committee comprises Yehezkel Pinhas Blum, Chan Kam Loon, Valerie Ong Choo Lin, Hanoh Stark and Daniel Benjamin Glinert. The chairman of our Nominating Committee is Chan Kam Loon. Our Nominating Committee will be responsible for the:

- (a) re-nomination of Directors (including Independent Directors of our Company) taking into consideration each director's contribution and performance;
- (b) determining on an annual basis whether or not a Director is independent; and
- (c) deciding whether or not a Director is able to and has been adequately carrying out his duties as a Director.

INTEREST OF MANAGEMENT AND OTHERS IN CERTAIN TRANSACTIONS

Our Nominating Committee will decide how the board's performance is to be evaluated and propose objective performance criteria, subject to the approval of the Board, which addresses how the board has enhanced long-term Shareholder's value. The performance evaluation will also include consideration of our Share price performance over a five year period vis-à-vis the Straits Times Index. The Board will also implement a process to be carried out by our Nominating Committee for assessing the effectiveness of the Board as a whole and for assessing the contribution of each individual Director to the effectiveness of the Board. Each member of our Nominating Committee shall abstain from voting on any resolution in respect of the assessment of his performance, independence or re-nomination as Director.

Remuneration Committee

Our Remuneration Committee comprises Aharon Shapira, Eyal Mashiah, Yehezkel Pinhas Blum, Chan Kam Loon and Valerie Ong Choo Lin. The chairman of our Remuneration Committee is Yehezkel Pinhas Blum. Our Remuneration Committee will recommend to our Board of Directors a framework of remuneration for our Directors and key executives, and determine specific remuneration packages for each Executive Director. The recommendations of our Remuneration Committee shall be submitted for endorsement by our entire Board of Directors. All aspects of remuneration, including but not limited to Directors' fees, salaries, allowances and bonuses, options and benefits in kind shall be covered by our Remuneration Committee. Each member of our Remuneration Committee shall abstain from voting on any resolutions in respect of his remuneration package.

Internal Auditor

Under the Israeli Companies Law, our Board of Directors is also required to appoint an internal auditor proposed by the Audit Committee. The role of the internal auditor is to examine, among other things, whether our activities comply with the law and orderly business procedure. If there are any defects in the company's business administration, the internal auditor in consultation with the Audit Committee, is responsible for proposing ways of correcting the defects. In addition, the internal auditor is in-charge of submitting a proposal for annual or periodical work program to the Audit Committee for its approval. The internal auditor may not be an interested party or office holder, or a relative of any interested party or office holder, nor a member or representative of our independent accounting firm. The Israeli Companies Law defines the term "interested party" to include a person who holds 5% or more of the company's outstanding share capital or voting rights, a person who has the right to appoint one or more directors or the general manager, or any person who serves as a director or as the general manager.

GENERAL AND STATUTORY INFORMATION

INFORMATION ON DIRECTORS AND EXECUTIVE OFFICERS

1. The particulars and information on business and working experience of our Directors and Executive Officers are set out in the section entitled “Director, Management and Staff” under the subheadings “Directors” and “Management” on pages 118 to 126 of this Prospectus.
2. The interests of our Substantial Shareholders in our Shares as at the date of this Prospectus (prior to the Invitation) and as recorded in the Register of Shareholders maintained under the Israeli Companies Act, are described in the section entitled “Share Capital” under the subheading “Shareholders” on pages 60 and 61 of this Prospectus.
3. The list of present and past directorships of each of our Directors, **excluding** those held in our Company, over the past five years preceding the date of this Prospectus, are as follows:

Directors	List of Other Directorships	List of Past Directorships
Daniel Benjamin Glinert	<i>Group Companies</i> Romedix GCI Sarin India	<i>Group Companies</i> NA
	<i>Other Companies</i> Interhightech (1982) Ltd D. Glinert Holdings, Ltd High Tech Lipids Ltd	<i>Other Companies</i> InterTICI, Inc.
Ehud Harel	<i>Group Companies</i> NA	<i>Group Companies</i> NA
	<i>Other Companies</i> Hargem, Ltd. Hart Trade & Investment Ltd Gem Trading Centre Ltd Sarin R&D	<i>Other Companies</i> NA
Hanoh Stark	<i>Group Companies</i> Romedix GCI Sarin India	<i>Group Companies</i> NA
	<i>Other Companies</i> H. Stark & Co. Ltd Sarin R&D Turbofan Ltd Hanoh Stark Holdings, Ltd	<i>Other Companies</i> NA
Eyal Mashiah	<i>Group Companies</i> NA	<i>Group Companies</i> NA
	<i>Other Companies</i> Biram Diamonds Ltd Ram Investment Ltd Ram Crescent Ltd I.F. Jewellery Ltd Pam-Ram Ltd Sarin R&D Ramgem Ltd	<i>Other Companies</i> NA
Israel Zeev Eliezri	<i>Group Companies</i> NA	<i>Group Companies</i> NA
	<i>Other Companies</i> Sarin R&D	<i>Other Companies</i> NA

GENERAL AND STATUTORY INFORMATION

Directors	List of Other Directorships	List of Past Directorships
Aharon Shapira	<i>Group Companies</i> NA	<i>Group Companies</i> NA
	<i>Other Companies</i> A. Shapira 2000 Systems Ltd Interhightech (1982) Ltd	<i>Other Companies</i> NA
Yehezkel Pinhas Blum	<i>Group Companies</i> NA	<i>Group Companies</i> NA
	<i>Other Companies</i> Blum-Gem Ltd Yarmuch Investments Ltd	<i>Other Companies</i> NA
Chan Kam Loon	<i>Group Companies</i> NA	<i>Group Companies</i> NA
	<i>Other Companies</i> Philip Chan Consulting Pte Ltd Midas Holdings Limited	<i>Other Companies</i> KarenSoft Technology Berhad Salcon Engineering Sdn. Bhd. WRP Sinetimed Sdn. Bhd.
Valerie Ong Choo Lin	<i>Group Companies</i> NA	<i>Group Companies</i> NA
	<i>Other Companies</i> Rodyk Services Private Limited	<i>Other Companies</i> MTQ Equipment Rental Pte. Ltd. ICO Worldwide Tubular Services Pte Ltd Source Programming Services Pte Ltd Big Trumpet Ltd

4. Save as disclosed below, none of our Executive Officers currently holds directorships or held any past directorships for the last five years preceding the date of this Prospectus:

Executive Officer	List of Directorships	List of Past Directorships
Zeev Leshem	<i>Group Companies</i> Romedix GCI Sarin India	<i>Group Companies</i> NA
	<i>Other Companies</i> Naztec Ltd	<i>Other Companies</i> NA
Zvi Halperin	<i>Group Companies</i> NA	<i>Group Companies</i> NA
	<i>Other Companies</i> NA	<i>Other Companies</i> VBOX Communication Ltd Mobixcell Communication Ltd

5. Save as disclosed under the section entitled “Director, Management and Staff” under the subheadings “Directors” and “Management” and under the section entitled “Share Capital” under the subheading “Shareholders” on pages 118 to 126 and pages 60 to 61 of this Prospectus respectively, none of our Directors, Executive Officers and substantial Shareholders of our Company are related to one another by blood or marriage. Save as disclosed under the section on “Interested Person Transactions” on pages 137 to 149 of this Prospectus, none of our Directors has any professional relationship with our Company and our other Directors and substantial Shareholders.

GENERAL AND STATUTORY INFORMATION

6. Save as disclosed under the section on “Interested Person Transactions” on pages 137 to 149 of this Prospectus, none of our Directors and Executive Officers, Substantial Shareholders or experts is interested, directly or indirectly, in the promotion of, or in any assets which have been acquired or disposed of by, or leased to, our Company within the two years preceding the date of this Prospectus, or are proposed to be acquired or disposed of by, or leased to, our Company.
7. Save as disclosed under the section entitled “Directors, Management and Staff” under the subheading “Service Agreements” as set out on pages 131 and 132 of this Prospectus, there are no existing or proposed service agreements between our Directors or our Executive Officers and our Company or any of our subsidiary companies.
8. There is no shareholding qualification for our Directors under the Articles of Association of our Company.
9. The aggregate remuneration and emoluments paid to the then existing Directors for services in all capacities to our Group for FY2001, FY2002, FY2003 and FY2004 amounted to approximately US\$77,000, US\$77,000, US\$122,000 and US\$92,000 respectively.
10. Save as disclosed under Annex C and the section entitled “Directors, Management and Staff” under the subheading “Sarin 2005 Share Option Plan” on pages 132 to 136 of this Prospectus and the section entitled “General Statutory Information” under the subheading “Share Capital” on pages 149 to 152 of the Prospectus, no option to subscribe for shares in, or debentures of our Company or our subsidiary companies has been granted to, or has been exercised by, any of our Directors or Executive Officers within the last four financial years ended 31 December 2001, 2002 and 2003 and 2004.
11. No sum or benefit has been paid or has been agreed to be paid to any Director, or to any firm in which such Director is a partner or any corporation in which such Director holds shares or debentures, in cash or shares or otherwise, by any person to induce him to become, or to qualify him as, a Director, or otherwise for services rendered by him or by such firm or corporation in connection with the promotion or formation of our Company.
12. Dan Ilan Bar-El, our Vice President for R&D, was previously the Vice President for R&D in Comview Visual Systems Ltd, which was placed under receivership in 2001.

Save as disclosed above, none of our Directors, Executive Officers or Controlling shareholders:

- (a) has at any time during the last 10 years, had a petition under any bankruptcy laws of any jurisdiction filed against him or against a partnership of which he was a partner;
- (b) has at any time during the last 10 years, had a petition under any law of any jurisdiction filed against a corporation of which he was a director or key executive for the winding up of that corporation on the ground of insolvency;
- (c) has had any unsatisfied judgment against him;
- (d) has been convicted of any offence, in Singapore or elsewhere, involving fraud or dishonesty which is punishable with imprisonment for three months or more, or has been the subject of any criminal proceedings (including any pending criminal proceedings which he is aware of) for such purpose;
- (e) has ever been convicted of any offence, in Singapore or elsewhere, involving a breach of any law or regulatory requirement that relates to the securities or futures industry in Singapore or elsewhere, or been the subject of any criminal proceedings (including any pending criminal proceedings which he is aware of) for such breach;

GENERAL AND STATUTORY INFORMATION

- (f) has at any time during the last 10 years, had judgment entered against him in any civil proceedings in Singapore or elsewhere involving a breach of any law or regulatory requirement that relates to the securities or futures industry in Singapore or elsewhere, or a finding of fraud, misrepresentation or dishonesty on his part, or the subject of any civil proceedings (including any pending civil proceedings which he is aware of) involving an allegation of fraud, misrepresentation or dishonesty on his part;
- (g) has been convicted in Singapore or elsewhere of any offence in connection with the formation or management of any corporation;
- (h) has been disqualified from acting as a director of any corporation, or from taking part directly or indirectly in the management of any corporation;
- (i) has been the subject of any order, judgment or ruling of any court, tribunal or governmental body, permanently or temporarily enjoining him from engaging in any type of business practice or activity; and
- (j) has, to his knowledge, been concerned with the management or conduct, in Singapore or elsewhere, of the affairs of:
 - (i) any corporation which has been investigated for a breach of any law or regulatory requirement governing corporations in Singapore or elsewhere; or
 - (ii) any corporation or partnership which has been investigated for a breach of any law or regulatory requirement that relates to the securities or futures industry in Singapore or elsewhere,

in connection with any matter occurring or arising during the period when he was so concerned with the corporation or partnership.

13. Save as disclosed in this Prospectus, there is no arrangement or understanding with a Substantial Shareholder, customer or supplier of our company or any other persons, pursuant to which that person was selected as a Director or Executive Officer of our Company.

SHARE CAPITAL

14. As at the date of this Prospectus, there is only one class of shares in the capital of our Company. The rights and privileges of the Shares are stated in the Articles of Association of our Company. There is no founder, management, deferred or issued share reserved for any purpose.
15. Our Directors and Substantial Shareholders are not entitled to any different voting rights from other Shareholders.
16. As at the date of this Prospectus, to the best of the knowledge of our Directors, our Directors are not aware of any arrangements, the operation of which may at a subsequent date result in the change in the control of our Company.
17. As at the date of this Prospectus, to the best of the knowledge and belief of our Directors, our Directors are not aware of, nor have they received any indications of, public take-over offers by third parties in respect of our Shares.
18. Save as disclosed herein, there were no changes in the issued share capital of our Company and our subsidiary companies* within the three years preceding the date of this Prospectus. Save as disclosed below, there has been no significant change in the percentage of ownership of our Company held by our Substantial Shareholders during the last three years prior to the Latest Practicable Date.

GENERAL AND STATUTORY INFORMATION

Our Company

Date of issue	Number of ordinary shares issued	Issue price	Purpose of issue	Consideration	Resultant paid-up capital
26 December 2002	500 ordinary shares	Approximately US\$100 each per ordinary share	Infusion of additional funds into the equity of our Company as per the requirements of the Investments Centre in connection with an Approved Enterprise plan submitted by our Company at that time	US\$50,000	NIS933 divided into 93,300 ordinary shares
12 February 2004	835 Ordinary B Shares	NIS135 per Ordinary B Share	Exercise of share options pursuant to the Sarin 2003 Share Option Plan	NIS112,725	NIS941.35 divided into 93,300 ordinary shares and 835 Ordinary B Shares
20 September 2004	1,431 Ordinary B Shares	NIS137 per each Ordinary B Shares (for 1,302 Ordinary B Shares) and NIS274 per each Ordinary B Share (for the remaining 129 Ordinary B Shares)	Exercise of share options pursuant to the Sarin 2003 Share Option Plan	NIS213,720	NIS955.66 divided into 93,300 ordinary shares and 2,266 Ordinary B Shares

Sarin India

Date of issue	Number of ordinary shares issued	Issue price	Purpose of issue	Consideration	Resultant paid-up capital
22 March 2004	10,001	Rs10 for each ordinary share	Subscriber shares	Rs10 for each ordinary share	Rs100,010 divided into 10,001 ordinary shares of Rs10 each

* There were no changes in issued share capital of GCI and Romedix in the past three years.

19. Save as disclosed above, no shares in or debentures of our Company or any of our subsidiaries have been issued or are agreed to be issued by our Company or any of our subsidiaries, as fully or partly paid-up and whether for cash or for a consideration other than cash, within the three years preceding the Latest Practicable Date.

GENERAL AND STATUTORY INFORMATION

20. Save as disclosed below, no person has been, or is entitled to be, granted an option to subscribe for shares in or debentures of our Company or any of our subsidiary companies.

In 2003, our Company adopted a share option plan ("Sarin 2003 Share Option Plan") and granted options to 25 persons at no consideration (including our CEO as disclosed in the section entitled "Directors, Management and Staff" under the subheading "Compensation" on pages 129 to 131 of this Prospectus). As at 18 October 2004, a total of 9,640 options (before Sub-division) exercisable into 9,640 ordinary shares (before Sub-division) of par value NIS0.01 each in the capital of our Company, at an exercise price of either NIS135 (approximately US\$30) or NIS270 (approximately US\$60) per option (before Sub-division) (adjusted by the change in the Cost of Living Index in Israel from December 2003 to the date of exercise) were granted under the Sarin 2003 Share Option Plan ("2003 Options"). On 23 December 2004, another 460 options (before sub-division) (out of which 100 options were re-granted following the expiry of 103 previously granted options) exercisable into 460 ordinary B shares (before Sub-division) of par value NIS 0.01 each in the capital of our Company, at an exercise price of US\$ 250 (adjusted by the change in the Cost of Living Index in Israel from December 2004 to the date of exercise) were granted to two more employees of our Company. The original vesting periods of the 2003 Options were between the date of grant to four years. As at the date of this Prospectus, 2,266 options (before Sub-division) have been exercised. The exercise period for the 2003 Options is six years from the date of issuance.

The Company currently applies International Accounting Standard #19 ("IAS 19") – Employee Benefits. This standard requires the Company to make certain disclosures relating to compensation benefits (including stock options) but does not specify recognition and measurement requirements.

As at 1 January 2005, the Company will apply International Financial Reporting Standard #2 "Share-based Payment" ("IFRS 2") in respect of its Share Option Plan. Under IFRS 2, equity-settled share based payment made to employees shall be measured at the fair value and reported as an expense over the vesting period of those payments based on the best available estimate of the number of equity instruments expected to vest. IFRS 2 would be applied to grants of shares, share options or other equity instruments that were granted after 7 November 2002 and had not yet vested at the effective date of the IFRS (that is, 1 January 2005). For all grants of equity instruments to which this IFRS is applied, the Company will restate comparative information.

Accordingly, the Company will be required to restate the results of 1H04 in respect of non-vested share options at 1 January 2005 under the Sarin 2003 Share Option Plan.

The amount of compensation expense to be recorded as a result of the restatement of the above financial statements and the reduction of the profit from ordinary activities before taxation, are estimated to be for 1H04 US\$101,000.

In 1998, Romedix adopted an employee share option plan ("Romedix Employee Option Plan"). 70,000 options ("Employee Options") under the Romedix Employee Option Plan were granted to three employees of Romedix at no consideration. Of the 70,000 Employee Options, 30,000 were granted to Daniel Benjamin Glinert, a deemed Controlling Shareholder of our Group, and these were subsequently waived. The exercise price was NIS0.01 per Employee Option, exercisable into one ordinary share of par value NIS0.01 each in the capital of Romedix. Of the 70,000 Employee Options, only 10,938 Employee Options were exercised and the rest either expired or were waived by the grantee. Save as disclosed, no further Employee Options were granted and the Romedix Employee Option Plan was terminated on 1 November 2004.

GENERAL AND STATUTORY INFORMATION

In addition, Romedix also granted options to three consultants, who were not employees but have contributed to the business of Romedix. 12,800 options ("Consultant Options") were granted to two consultants at no consideration, exercisable at a price of NIS0.01 per Consultant Option into 12,800 ordinary shares of par value NIS0.01 each in the capital of Romedix. Such Consultant Options expired. 10,000 additional Consultant Options were issued to a third consultant at no consideration, exercisable at a price of US\$0.10 per Consultant Option into 10,000 ordinary shares of par value NIS0.01 each in the capital of Romedix. Only 5,000 Consultant Options remain (the rest have expired) and Consultant Options that are not exercised by 15 August 2005 will expire. Save as disclosed above, no other Consultant Options was granted as at the Latest Practicable Date.

Save as disclosed above, none of the above options was granted to Controlling Shareholders of our Group.

ARTICLES OF ASSOCIATION

21. Our Company is registered in Israel with the Companies Registrar in Israel, and our Company's registration number is 51 1332207. The main objects of our Company are to deal in any legal activities, including marketing, sale, purchase, export, import, agency, enterprise, development, management and performance of commercial and business activities of any kind or type.
22. Our Articles of Association providing for, *inter alia*, transferability of Shares, directors' voting rights, borrowing powers of directors and dividend rights are set out in Annex B to this Prospectus. The Articles of Association of our Company is available for inspection at our registered office as stated in this Prospectus.

BANK BORROWINGS AND WORKING CAPITAL

23. As at the Latest Practicable Date, there were no other borrowings or indebtedness in the nature of borrowings including bank overdrafts and liabilities under acceptances (other than normal trading bills) or acceptance credits, mortgages, charges, hire purchase commitments, guarantees or other material contingent liabilities.
24. In the opinion of our Directors, there are no minimum amounts which must be raised by the issue of the New Shares in order to provide for the following items:
 - (a) any estimated preliminary and issue expenses (including underwriting commission and brokerage) for this Invitation payable by our Company;
 - (b) the repayment of any money borrowed by our Company in respect of any of the foregoing matters; and
 - (c) working capital.

Although no minimum amount must be raised by the Invitation in order to provide for the items set out above, the estimated expenses to be borne by us in connection with the Invitation are approximately S\$2.4 million (excluding underwriting and placement fees). Such amount is proposed to be provided out of the proceeds of the Invitation or, in the event the Invitation is cancelled, out of the existing funds generated from our Company's operations.

25. Our Directors are of the opinion that, after taking into account cash generated from our operations and our existing banking facilities, our Group has adequate working capital for its present working capital requirements.

GENERAL AND STATUTORY INFORMATION

FINANCIAL CONDITION AND OPERATIONS OF THE COMPANY

26. Save as disclosed in this Prospectus, our Directors are not aware of any material information including trading factors or risks which are unlikely to be known or anticipated by the general public and which could materially affect the profits of our Company.
27. Save as disclosed in this Prospectus, the financial condition and operations of our Company are not likely to be affected by any of the following:
- (a) known trends or known demands, commitments, events or uncertainties that will result in or are reasonably likely to result in our Company's liquidity increasing or decreasing in any material way;
 - (b) material commitments for capital expenditure;
 - (c) unusual or infrequent events or transactions or any significant economic changes that will materially affect the amount of reported income from operations; and
 - (d) known trends or uncertainties that have had or that our Company expects to have a material favourable or unfavourable impact on revenue or operating income.
28. Save as disclosed herein, the Directors are not aware of any event that has occurred since 30 June 2004 which may have a material effect on the financial position and results provided under the Independent Auditors' Report and Financial Statements of our Group for FY2001, FY2002, FY2003 and 1H04.

MATERIAL CONTRACTS

29. The dates of, parties to, and general nature of contracts, not being contracts entered into in the ordinary course of business of our Company and its subsidiaries within the two years preceding the date of lodgement of this Prospectus which are or may be material are as follows:
- (a) Share purchase agreement entered into on 24 September 2002 pursuant to which Rodata Investments Ltd ("Rodata") sold all the shares held by them (amounting to 399,059 ordinary shares of par value NIS0.01 each) in the share capital of Romedix to our Company in consideration for a total sum of NIS200,000 payable by our Company to Rodata;
 - (b) Lease agreement dated 9 December 2002 entered into between our Company and Ophir Tours Ltd (the "Landlord") with regards to the lease of our showroom at Diamond Tower, 54 Bezalel Street, Ramat Gan, Israel for a monthly rental of approximately US\$1,550. The original term of the lease expired on 14 January 2004 and we exercised the option to extend the lease for a period of one year until 14 January 2005. Although we had another option to extend the lease for a further period until 14 January 2006, we were informed on 19 September 2004 that the Landlord had exercised its rights under the lease to terminate the lease by giving a three-month notice period. After renegotiations, the lease has been renewed for an additional two years commencing 15 January 2005 and will be automatically extended for an additional period of one year until 14 January 2008 at an increased rent of US\$1,750 until 14 January 2006 and thereafter, at US\$2,000 until 14 January 2008;
 - (c) Share purchase agreement entered into on 3 February 2004 pursuant to which Hargem Ltd, Alessia Investment S.A., Bilbao Trade and Investment Ltd, Ilan Weisman and Sarin R&D (collectively the "Romedix Vendors") sold all the shares held by them (amounting to 151,400 ordinary shares of par value NIS0.01 each) in the share capital of Romedix to our Company in consideration for a total sum of NIS82,975 payable by our Company to the Romedix Vendors;

GENERAL AND STATUTORY INFORMATION

- (d) Agreement for purchase of shares in Romedix entered into on 17 February 2004 pursuant to which Dr. Tuvia Kutcher ("TK") sold 10,938 ordinary share of par value NIS0.01 each in the share capital of Romedix to our Company in consideration for NIS547 payable by our Company to TK;
- (e) Business Centre Agreement dated 23 March 2004 entered into between Sarin India and Sanghi Oxygen (B) Private Ltd with regards to the lease of Sarin India's premises at Sanox Centre, Ground Floor, Mani Mahal, 11/21 Mathew Road, Opera House, Mumbai 400 004, Maharashtra, India for a monthly rental of approximately Rs120,900. The Agreement expires on 28 February 2006 and is renewable at the option of Sarin India for a further period of two years at an increased rent of 10%;
- (f) Lease agreement dated 13 April 2004 entered into between Romedix and Aharon Leibmann with regards to the lease of Romedix's premises at 6 Hasadna Street, Kiryat Arie, Petach-Tikva, Israel for a monthly rental of approximately US\$400. The lease is for 12 months, commencing on 4 April 2004 and ending on 3 April 2005 with an option for extension by four consecutive 12 month periods at an increased rent;
- (g) Leave and License Agreement dated 23 April 2004 entered into between Sarin India and Charulata Satish Jariwala & Others with regards to the lease and license of the office premises of Sarin India at 89, A-1-D, Plot No. 432, Brink's Arya House, Vastadevdi Road, Katargam, Surat 395008, India for a monthly rental of approximately Rs14,000. The leave and license is for a period of three years commencing 5 April 2004 with an option to renew for a further period of three years at an increased rent of 10%;
- (h) Agreement entered into on 20 May 2004 pursuant to which Romedix acquired the know-how and technology relating to the development and manufacture of disposable polishing discs for diamonds and gemstones from a third party, namely Genadi Kazanovitz. Pursuant to the Agreement, the know-how and technology were purchased in consideration of Romedix paying a sum of US\$ 50,000 (US\$20,000 prior to the execution of the Agreement and the balance US\$30,000 in 12 consecutive monthly instalments) as well as payment of royalties by Romedix from the sale of the polishing discs commencing from 1 January 2005 until 31 December 2014. For further details on this, please refer to the section entitled "General and Statutory Information" under the subheading "Litigation" on pages 155 to 158 of this Prospectus;
- (i) Leave and License Agreement dated 13 July 2004 entered into between Sarin India and Dr Dilip G. Sampat and Mrs Kumudini Dilip Sampat with regards to the leave and license of a residential apartment in Mumbai, India, as residence for 11 months for the senior executive of Sarin India for a rent of Rs286,000 for the complete lease and license period;
- (j) Verbal agreement entered into between Sarmistha M Jariwala and Sarin India for the leave and license of a residential apartment for visiting engineers from Sarin India's Mumbai office for a monthly rental of Rs3,500 from 22 May 2004 for no fixed term; and
- (k) Lease agreement dated 16 August 2004 entered into between our Company and Levin Z.H. Ltd, and A. Netanel-Nun Ltd, with regards to the lease of our office premises at 4 Hahilazon Street, Ramat Gan 52522, Israel for a monthly rental of approximately US\$11,270 at the end of the fifth month after delivery of possession and a management fee for the period commencing at the date of the delivery of possession. The lease commences on 19 August 2004 and continues for a period of 41 months until 16 January 2008 with two options for extensions for two additional one-year periods at an increased rent.

GENERAL AND STATUTORY INFORMATION

LITIGATION

30. Save as disclosed below, our Company is not engaged in any legal or arbitration proceedings, including those relating to bankruptcy, receivership or similar proceedings and those involving any third party in respect of any claims or amounts which are material in the context of the Invitation and our Directors have no knowledge of any proceedings pending or threatened against our Company or any facts likely to give rise to any litigation, claims or proceedings which might materially affect the financial position or the business of our Company.

(i) *Dispute with distributor*

A local Indian distributor, Sahajanand Technologies P. Ltd ("Sahajanand"), who distributed our products up until March 2004 filed legal proceedings in the District Court of Surat in India, against our Company and some of the employees of Sarin India, who had previously been Sahajanand's own employees.

The claim is summarized as follows:

1. Sahajanand distributed our Company's products in India. In fulfilling this task, Sahajanand has acted in order to adjust our software and to translate it into Gujarati, and therefore Sahajanand has acquired copyrights in the bilingual software (in English and in Gujarati) used by us in India.
2. Sahajanand assisted us in customizing our products (software and hardware), in accordance with the needs and preferences of the Indian market, and thus has acquired copyrights in modifications and updates made by us.
3. We unlawfully terminated our distributorship agreement with Sahajanand and therefore are precluded from making any use of the translation of the software, the improvements and the modifications, which are Sahajanand's intellectual property.
4. The five additional defendants (who are now employed by us, including Ms Rajeshwari Mehta, Vice President of Sarin India), were Sahajanand's former employees, who were exposed, during their employment with Sahajanand, to Sahajanand's commercial secrets – with regards to Sahajanand's clients' base.

Based on the aforementioned assertions, Sahajanand asked that the Court:

1. Issue a declaratory judgment, according to which our Company and the additional defendants have no legal right to sell and to market in India any equipment and software which were updated and modified based on Sahajanand's original and innovative contribution.
2. Issue a declaratory judgment, according to which the remaining defendants, other than our Company, are precluded from revealing commercial secrets or confidential information of Sahajanand.
3. Issue an order, preventing the defendants, their employees, managers, etc. from making any use in the know-how and information, which are the subject matters of Sahajanand's copyrights.
4. Issue an order, instructing the defendants, their employees, dealers, distributors etc to deliver to Sahajanand all of the equipment and software in their possession, which include know-how or information, which are the subject matters of Sahajanand's copyrights.

GENERAL AND STATUTORY INFORMATION

5. Issue an order, instructing the defendants to submit to Sahajanand all the financial documents concerning the sale of equipment and software, which comprise of the know-how and information, which are the subject matters of Sahajanand's copyrights, and also to forward to Sahajanand all the profits generated due to such sales.
6. Issue a declaratory judgment, according to which the defendants (except our Company) are precluded from working for our Company and/or for any other entity competing with Sahajanand for a period of three years.
7. Issue a restraining order, instructing the defendants (except our Company) to refrain from working for our Company and/or for any other entity competing with Sahajanand for a period of three years.
8. Issue such other orders as may be necessary in the interest of justice.
9. Issue an order for the cost of the suit in favour of Sahajanand.

The Court has, on 21 April 2004, rejected Sahajanand's motion asking for an *ex parte* interim injunction. The Court has ruled that there was no original creation on the part of Sahajanand as the original hardware and software of the machine was innovated and prepared by our Company and hence, the question of copyright does not arise. According to our Indian legal counsel, Mr Bomi Daruwala of Vaish Associates Advocates, the Court has made the following observations, which will be detrimental to Sahajanand in the subsequent stage of the legal proceedings:

- (i) From the documents produced on record, it appears that the laser machine was supposed to be used by semi-skilled persons in the area of Surat and hence, to make it viable to the local market, some modifications were suggested by Sahajanand to our Company. These modifications were inclusive of Gujarati translation and some minor alteration in the software. These modifications were suggested by Sahajanand in writing and were accepted by our Company and suitable change was made by our Company in the software. Thus, these circumstances clearly *prima facie* establish that there was no original creation on part of Sahajanand. The original hardware of the laser machine and software of laser machine was innovative and prepared by our Company. Moreover, at the most, it can be said that some idea was supplied by Sahajanand, and because of only idea has been supplied by Sahajanand, it cannot be said that it is original creation. Therefore, the question of copyright does not arise. This view is fortified by the Gujarat High Court case where the Gujarat High Court observed to the effect that the object of the Copyright Act (of India) is to protect authors and artists from being exploited. No copyright exists in ideas, and, as such, no infringement of the alleged copyright by taking ideas from the data pads of the appellant.
- (ii) The knowledge of Ms Rajeshwari Mehta about customer base cannot be treated as business secret and confidential matter of Sahajanand. From the documents produced on record, it appears that, in 2002, she has already resigned and has joined our Company.
- (iii) From the distributorship agreement dated 13 August 1997 between our Company and Sahajanand ("Agreement"), it appears that both parties mutually agreed that legal proceedings brought by either party under this Agreement shall be exclusively referred and instituted in the Court at Israel. Therefore, this is nothing but ouster of jurisdiction of the Surat Court.

As at the Latest Practicable Date, our Indian legal counsel has opined that we have a very good case and it is highly unlikely that relief would be granted to Sahajanand, in view of the observations in the initial order.

GENERAL AND STATUTORY INFORMATION

Following the submission of the aforementioned claim, Sahajanand has submitted a motion to amend its claim, by substituting our Company with our subsidiary, Sarin India. The Court has not ruled yet in such motion. Subsequently, Sahajanand submitted a second motion to amend its claim by joining our Company with our subsidiary, Sarin India, as co-defendants. Our Indian legal counsel has also informed us that Sahajanand is withdrawing the first amendment application and is pressing for the second amendment application. So far the Court had not made any additional substantial decisions with regard to Sahajanand's claim. The next hearing is scheduled for 16 April 2005.

- (ii) *Arbitration arising out of the agreement entered into on 20 May 2004 by Romedix to acquire the know-how relating to the manufacture of disposable polishing discs for diamonds and gemstones from a third party*

Hanoh Stark, one of our Directors, claimed that the said know-how purchased by Romedix ("Product") overlaps with know-how protected under a patent registered in Israel (and several parallel patents in other countries) under the name of Turbofan Ltd (a company which shares are held by Hanoh Stark and other third parties) ("Patent"). It was agreed, with the consent of our Company, Romedix and Hanoh Stark, to arbitrate on this matter.

The arbitrator has ruled, on 3 August 2004, that the Product did not infringe the Patents and accordingly, Turbofan Ltd's claim against Romedix should be dismissed. However, the arbitrator added that due to the goodwill and amicable relations between the parties, and since the parties had at the start of the arbitration requested that the arbitrator not rule only according to the strict letter of the law, hence, the arbitrator ruled that since a central feature of the Product was described in the Patent (although it did not constitute the main gist of the Patent and was not set out as novel in the Patent and hence was not strictly an infringement of the Patent), Romedix should pay Turbofan Ltd, due to partial overlap of the technologies involved, royalties amounting to 2% of the receipts actually collected by it from the sale of such Product, up to and until 31 December 2009 and royalties are to be paid 30 days after the end of each calendar half year in respect of receipts collected during the preceding half-year.

- (iii) *Objections to register patent*

Our Company filed two objections to applications by Lazare Kaplan International Inc., as described in the section entitled "General Information on our Company" under the subheading "Intellectual Property" on pages 78 to 81 of this Prospectus. The objections are currently being heard by the Registrar of Patents in Jerusalem. Our management is of the view that if the Company's objections are rejected, it will not have a significantly adverse effect on our Group's business.

- (iv) *Objection filed by OGI Systems Ltd*

In addition, an objection was filed by OGI Systems Ltd against our Company's application to register a patent for a system for marking diamonds by laser as described in the section entitled "General Information on our Company" under the subheading "Intellectual Property" on pages 78 to 81 of this Prospectus. This objection is currently being heard by the Registrar of Patents in Jerusalem. Our management is of the view that if this objection is upheld, it will not have a significantly adverse effect on our Group's business.

- (v) *Potential litigation against OGI Systems Ltd in Belgium*

We also recently learned that OGI Systems Ltd may be infringing our patent for the laser marking on diamonds in Belgium and USA (where patents have been granted to us). We have instructed our patent and IP attorneys, Gilat, Bareket & Co Attorneys at Law to, through a correspondent Belgian attorney, file a request for a temporary injunction against OGI and a writ allowing the seizure of infringing equipment at his distributor's offices and his customers. Please refer to the section entitled "General Information on our Company" under the subheading "Intellectual Property" on pages 78 to 81 of this Prospectus.

GENERAL AND STATUTORY INFORMATION

(vi) *Potential litigation against the Lexus Group in India*

In 2004, our Company discovered that our competitor in India, Lexus Soft Mac of the Lexus Group, India (“Lexus”), is copying verbatim the description of our product, the DiaMension™ (taken from our website), substituted our trademark for their “Helium” mark and is using the same in Lexus’ website. On 21 September 2004, our legal counsel in India, Vaish Associates Advocates, issued a legal warning to Lexus and demanding that (i) an unconditional apology is tendered and an undertaking not to infringe any of our intellectual property rights in future; and (ii) remove the copied contents from Lexus’ website. If Lexus fails to comply with the demands made, we may consider commencing appropriate civil and criminal actions against Lexus. Lexus, through their lawyers, has notified our lawyers in India that they have agreed to remove the infringing web page from their website, without admitting to any of our allegations. As at the date of this Prospectus, the web page has been removed.

(vii) *Potential litigation against Sahajanand Technologies P. Ltd (“Sahajanand”)*

We intend to commence legal action against Sahajanand, our former distributor in India, with regards to several matters, including the outstanding debt of approximately US\$140,000 owing to our Company for systems delivered.

(viii) *Dispute over union fees*

In 2004, a claim was submitted against our Company in the Labor Tribunal of the Tel-Aviv District by the Association of Craft and Industry in Israel (“Association”). We are required, under the said claim, to pay to the Association an amount of NIS23,940 (approximately US\$5,500) (plus linkage differentials and interest) as compulsory union fees, allegedly due from our Company. We have consulted our Israeli legal counsel, Rubin-Shmuelevich, who specializes in labor law. At this stage Rubin- Shmuelevich is acting to resolve this matter amicably. A pre-trial conference has been scheduled for 15 May 2005.

(ix) *Cease and Desist Letter from the American Gem Society (“AGS”)*

On March 2004, we received a cease and desist letter from AGS regarding the use of AGS’ trademark. We referred this matter to our US counsel, who approached AGS’ counsel for an amicable resolution of this matter. In June 2004, our US counsel delivered to AGS’ counsel a proposal which does not involve any payment by us. As at the date of this Prospectus, we have not heard from AGS or its counsel.

(x) *Cease and Desist Letter to Benelux Laser Systems NV (“BLS”)*

The above named company, BLS, is using Sarin’s registered trademark DiaScribe on its web site. In addition, it is selling overseas (including into India and China), and its distributors therein are infringing on Sarin’s trademark on their web sites (even though there the trademark has not yet been registered). A letter to cease and desist was sent to BLS on December 23, 2004 by our patent and IP attorney’s Belgian correspondent office, Nauta Dutilh, and on January 10, 2005 a response was received, to which a response will be sent shortly. Following the delivery of this letter, BLS notified our Belgian lawyers that it has agreed to refrain from using our DiaScribe™ logo in the future and that they will see to it that their worldwide distributors, namely in China (Hitai Instruments) and India (Lexus) will cease from doing so, as well. BLS have already taken action and removed the infringing trademark from their web site.

(xi) *Cease and Desist Letter to Sahjanad Amdabhad (“SA”)*

The above named company, SA, is selling planning systems which apparently use Sarin’s patent-pending technology. We have instructed the Indian law firm, Kan and Krishme, to send a cease and desist letter to SA, based on copyright infringement and other common law causes of action. As at the date of this Prospectus, we have not heard from SA.

GENERAL AND STATUTORY INFORMATION

MANAGEMENT, UNDERWRITING AND PLACEMENT ARRANGEMENTS

31. (a) Pursuant to the management and underwriting agreement dated 31 March 2005 ("Management and Underwriting Agreement"), our Company and the Vendors appointed UOB Asia as the Manager to manage the Invitation, and as the Underwriter to underwrite the Offer Shares. The Manager and Underwriter will receive a fee for its services in connection with the Invitation.
- (b) Pursuant to the Management and Underwriting Agreement, the Underwriter agreed to underwrite the Offer Shares for a commission of 2.5% of the Invitation Price for each Offer Share, payable by our Company and the Vendors in the proportion in which the number of Invitation Shares offered by each of them pursuant to the Invitation bears to the total number of Invitation Shares.
- (c) Pursuant to the placement agreement dated 31 March 2005 ("Placement Agreement"), the Placement Agent agreed to subscribe for, and/or procure the subscription for, the Placement Shares for a placement commission of 1.75% of the Invitation Price for each Placement Share, to be paid by our Company and the Vendors in the proportion in which the number of Invitation Shares offered by each of them pursuant to the Invitation bears to the total number of Invitation Shares.
- (d) Brokerage will be paid by our Company and the Vendors, in the proportion in which the number of Offer Shares offered by each of them pursuant to the Invitation bears to the total number of Invitation Shares, to the Manager and the Underwriter, the Participating Banks, members of the SGX-ST, merchant banks in Singapore and members of the Association of Banks in Singapore in respect of all successful applications for the Offer Shares pursuant to the Invitation (whether on Application Forms bearing an endorsement or stamp of their respective names or made pursuant to an Electronic Application in accordance with the terms of the Prospectus), at the rate of 0.25% of the Invitation Price for each Offer Share and at the rate of 1.0% of the Invitation Price for each Placement Share. Subscribers and/or purchasers of the Placement Shares may be required to pay a commission of up to 1.0% of the Invitation Price to the Placement Agent.
- (e) The Management and Underwriting Agreement may be terminated by the Manager and the Underwriter at any time on or prior to the close of the Application List on the occurrence of certain events including, *inter alia*, the following:
- (1) there shall come to the knowledge of the Manager and Underwriter any breach of the warranties or undertakings in Clause 6 of the Management and Underwriting Agreement or that any of the warranties by the Company and the Vendors in Clause 6 of the Management and Underwriting Agreement is untrue or incorrect;
 - (2) any event or circumstance occurring after the date of the Management and Underwriting Agreement and prior to 12.00 noon of the date of the close of the Application List which if it had occurred before the date of the Management and Underwriting Agreement, would have rendered any of the warranties or representations in the Management and Underwriting Agreement untrue or incorrect in any respect comes to the knowledge of the Manager or the Underwriter; or
 - (3) if there shall have been, since the date of the Management and Underwriting Agreement:
 - (i) any material adverse change, or any development involving a prospective material adverse change, in the condition (financial or otherwise) of the Company and/or its subsidiaries; or

GENERAL AND STATUTORY INFORMATION

- (ii) any introduction or prospective introduction of or any change or prospective change in any legislation, regulation, order, policy, rule, guideline or directive in Singapore or elsewhere (whether or not having the force of law and including, without limitation, any directive or request issued by the Authority, the Securities Industry Council of Singapore or the SGX-ST) or in the interpretation or application thereof by any court, government body, regulatory authority or other competent authority; or
- (iii) any change, or any development involving a prospective change, in local, national, regional or international financial (including stock market, foreign exchange market, inter-bank market or interest rates or money market), political, industrial, economic, legal or monetary conditions, taxation or exchange controls (including, without limitation, the imposition or any moratorium, suspension or material restriction on trading in securities generally on the SGX-ST due to exceptional financial circumstances or otherwise); or
- (iv) any imminent threat and new threat or occurrence of any local, national or international outbreak or escalation of hostilities, insurrection, terrorist attacks or armed conflict (whether or not involving financial markets); or
- (v) any other occurrence of any nature whatsoever,

which event or events shall in the opinion of the Manager (1) result or be likely to result in a material adverse fluctuation or material adverse conditions in the stock market in Singapore or overseas, or (2) be likely to materially prejudice the success of the subscription or offer or sale of the Invitation Shares (whether in the primary market or in respect of dealings in the secondary market), or (3) make it impracticable, inadvisable or inexpedient to proceed with any of the transactions contemplated in the Management and Underwriting Agreement, or (4) be likely to have a material adverse effect on the business, trading position, operations or prospects of the Company or of the Group as a whole, or (5) be such that no reasonable underwriter would have entered into the Management and Underwriting Agreement, or (6) result or be likely to result in the issue of a stop order by the Authority pursuant to the Securities and Futures Act, or (7) make it uncommercial or otherwise contrary to or outside the usual commercial practices of underwriters in Singapore for the Underwriter to observe or perform or be obliged to observe or perform the terms of the Agreement.

- (f) The Placement Agreement is conditional upon the Management and Underwriting Agreement not having been terminated or rescinded pursuant to the provisions of the Management and Underwriting Agreement.
- (g) In the event that the Management and Underwriting Agreement is terminated for any reason, our Company and Vendors reserve the right to cancel the Invitation.

32. Save as disclosed in this Prospectus, we do not have any material relationships with our Manager, Underwriter and Placement Agent.

MISCELLANEOUS

- 33. The nature of the business of our Company is stated in the section entitled “General Information on Our Company” under the subheading “Our Business” on pages 71 to 77 of this Prospectus. Corporations which are deemed to be related to our Company by virtue of Section 4 of the Securities and Futures Act, are as set out in the section entitled “General and Statutory Information” under the subheading “Related Corporations” on page 162 of this Prospectus.
- 34. The time of opening of the Application List is set out in the section entitled “Details of the Invitation” under the subheading “Listing on the SGX-ST” on pages 25 to 27 of this Prospectus.

GENERAL AND STATUTORY INFORMATION

35. The amount payable on application is S\$0.355 for each Offer and Placement Share. There has been no previous issue of shares by our Company or offer for subscription of our Shares to the public within the two years preceding the date of this Prospectus.
36. Application monies received by our Company in respect of successful applications (including successfully balloted applications which are subsequently rejected) will be placed in a separate non-interest bearing account with the Receiving Bank. In the ordinary course of business, the Receiving Bank will deploy these monies in the inter-bank money market. All profits derived from the deployment of such monies will accrue to Receiving Bank. Any refund of all or part of the application moneys to unsuccessful Applicants will be made without any interest or share of revenue or other benefit arising therefrom.
37. No expert is employed on a contingent basis by our Company, has a material interest, whether direct or indirect, in the shares of our Company or our subsidiaries, or has a material economic interest, whether direct or indirect, in our Company, including an interest in the success of the Offer.
38. No property has been purchased or acquired or proposed to be purchased or acquired by our Group which is to be paid for, wholly or partly, out of the proceeds of the Invitation or the purchase or acquisition of which has not been completed at the date of this Prospectus, other than property which the contract for the purchase or acquisition of was entered into in the ordinary course of business of our Company, such contract not being made in contemplation of the Invitation nor the Invitation in consequence of the contract.
39. The estimated expenses payable by our Company and the Vendors in connection with the Invitation, including placement commission, brokerage, management fee, auditors' fee, solicitors' fee, listing fee and all other incidental expenses in relation to this Invitation are estimated to amount to approximately S\$2.5 million which may be broken down as follows:

	S\$'000
Listing fees	25
Professional fees	1,058
Underwriting and Placement commission and brokerage	607
Others and miscellaneous expenses (including taxes)	829
Total estimated expenses	2,519

Of the total sum as stated above, approximately S\$2.4 million will be borne by our Company and approximately S\$0.1 million will be borne by the Vendors.

40. Save as disclosed under the sections entitled "Directors, Management and Staff" on pages 118 to 136 and "Interested Person Transactions" on pages 137 to 139 of this Prospectus, no amount of cash or securities or benefit has been paid or given to any promoter within the two years preceding the date of this Prospectus or is proposed or intended to be paid or given to any promoter at any time.
41. This Prospectus is dated 31 March 2005. No Shares will be allotted on the basis of this Prospectus later than six months after the date of this Prospectus.
42. Our Company currently intends to continue to appoint Somekh Chaikin (Member firm of KPMG International) and Chaikin, Cohen, Rubin and Gilboa as joint auditors of our Group after the listing of our Company on the Official List of the SGX-ST.

Our Company currently intends to appoint KPMG India as the auditor of our Indian subsidiary commencing FY2005.

GENERAL AND STATUTORY INFORMATION

43. Details including the names, addresses and professional qualifications (including membership in a professional body) of the auditors of our Company since incorporation to date are as follows:

Period	Name, Membership and Address	Professional Body Membership	Partner in Charge Professional Qualification
1998-1995	Aharanovitz & Heisler	Institute of CPAs in Israel	Haim Heisler (CPA, Israel)
1996-1998	Kost Forer & Gabay, member firm of Ernst & Young	Institute of CPAs in Israel	Yoram Titz (CPA, Israel)
1999-2003	Chaikin, Cohen, Rubin and Gilboa	Institute of CPAs in Israel	Ilan Chaikin (CPA, Israel)
2004	Chaikin, Cohen, Rubin and Gilboa	Institute of CPAs in Israel	Ilan Chaikin (CPA, Israel)
	Somekh Chaikin (Member firm of KPMG International)	Institute of CPAs in Israel	Roger I Lavender (FCA, UK, CPA, Israel)

44. Each of the Manager, Underwriter and Placement Agent, the Solicitors to the Invitation and the Solicitors to the Manager, Underwriter and Placement Agent do not make, or purport to make, any statement in this Prospectus or any statement upon which a statement in this Prospectus is based and, to the maximum extent permitted by law, expressly disclaim and take no responsibility for any liability to any person which is based on, or arises out of, the statements, information or opinions in this Prospectus.

RELATED CORPORATIONS

45. As at the date of this Prospectus, the subsidiaries of the Company are:
- (a) Gran Computer Industries (1992) Ltd., our wholly owned subsidiary located at 4 Hahilazon Street, Ramat Gan 52522, Israel;
 - (b) Romedix Ltd, our wholly owned subsidiary located at 4 Hahilazon Street, Ramat Gan 52522, Israel; and
 - (c) Sarin Technologies India Private Limited, our wholly owned subsidiary located at Sanox Centre, Ground Floor, Mani Mahal, 11/21 Mathew Road, Opera House, Mumbai 400 004, Maharashtra, India.

CONSENTS

46. The Auditors and Reporting Accountants have given and have not withdrawn their written consent to the issue of this Prospectus with the inclusion herein of their Report on examination of consolidated financial information and references to their name in the form and context in which it appears in this Prospectus and to act in such capacity in relation to this Prospectus.
47. Vaish Associates Advocates has given and has not withdrawn its written consent to the issue of this Prospectus with the inclusion herein of certain statements in the form and context in which they are included and references to its name in the form and context in which they appear in this Prospectus and to act in such capacity in relation to this Prospectus.
48. Eyal Khayat, Zolty & Co. has given and has not withdrawn its written consent to the issue of this Prospectus with the inclusion herein of certain statements in the form and context in which they are included and references to its name in the form and context in which they appear in this Prospectus and to act in such capacity in relation to this Prospectus.

GENERAL AND STATUTORY INFORMATION

49. Drew & Napier LLC has given and has not withdrawn its written consent to the issue of this Prospectus with the inclusion herein of certain statements in the form and context in which they are included and references to its name in the form and context in which they appear in this Prospectus and to act in such capacity in relation to this Prospectus.

RESPONSIBILITY STATEMENT BY OUR DIRECTORS AND THE VENDORS

50. This Prospectus has been seen and approved by our Directors and our Vendors and they collectively and individually accept full responsibility for the accuracy of the information given in this Prospectus and confirm, having made all reasonable enquiries, that to the best of their knowledge and belief, the facts stated and the opinions expressed in this Prospectus are fair and accurate in all material respects as at the date thereof and that there are no other material facts the omission of which would make any statements herein misleading, and that this Prospectus constitutes full and true disclosure of all material facts about the Invitation, the Vendors and our Company.

DOCUMENTS FOR INSPECTION

51. Copies of the following documents may be inspected at 138 Robinson Road, #17-00, The Corporate Office, Singapore 068906 during normal business hours for a period of six months from the date of this Prospectus:
- (a) the Memorandum and Articles of Association of our Company;
 - (b) the material contracts referred to in the section entitled "General and Statutory Information" under the subheading "Material Contracts" on pages 153 and 154 of this Prospectus;
 - (c) the letters of consent referred to in the section entitled "General and Statutory Information" under the subheading "Consents" on page 162 of this Prospectus;
 - (d) the audited financial statements of our Group for the financial years ended 31 December 2001, 2002, and 2003;
 - (e) the Independent Auditors' Report and Financial Statements as set out on pages F1 to F34 of this Prospectus; and
 - (f) the service agreements referred to in the section entitled "Directors, Management and Staff" under the subheading "Service Agreements" on pages 131 and 132 of this Prospectus.

INDEPENDENT AUDITORS' REPORT AND FINANCIAL STATEMENTS

INDEPENDENT AUDITORS' REPORT

The Board of Directors
Sarin Technologies Ltd
Ramat Gan
Israel

Dear Sirs

We have audited the consolidated financial statements of Sarin Technologies Ltd (the "Company") and its subsidiaries (the "Group"), as set out on pages F2 to F34, comprising the consolidated balance sheets as at 31 December 2001, 2002, 2003 and 30 June 2004, consolidated profit and loss accounts, consolidated statements of changes in equity and consolidated statements of cash flows for the three years ended 31 December 2001, 2002 and 2003, and the six months ended 30 June 2004 and the notes thereto. These financial statements, which have been prepared in accordance with International Financial Reporting Standards, are the responsibility of the Company's directors. Our responsibility is to express an opinion on these financial statements based on our audits. The financial information of the Group for the six months ended 30 June 2003 has not been audited or reviewed and has been presented for comparative purposes only.

We conducted our audits in accordance with International Standards on Auditing. An audit includes examination, on a test basis, of evidence relevant to the amounts and disclosures in the financial statements. It also includes an assessment of the significant estimates and judgements made by the directors in the preparation of the financial statements, and of whether the accounting policies are appropriate to the Company's circumstances, consistently applied and adequately disclosed. We planned and performed our audits so as to obtain all the information and explanations which we considered necessary in order to provide us with sufficient evidence to give reasonable assurance as to whether the financial statements are free from material misstatement. In forming our opinion, we also evaluated the overall adequacy of the presentation in the financial statements. We believe that our audits provide a reasonable basis for our opinions.

In our opinion, the consolidated financial statements of the Group, present fairly, in all material respects, the state of affairs of the Group as at 31 December 2001, 2002, 2003 and 30 June 2004, and the results, changes in equity and cash flows of the Group for the three years ended 31 December 2001, 2002 and 2003 and the six months ended 30 June 2004 and have been properly prepared in accordance with International Financial Reporting Standards.

This report has been prepared for inclusion in the Prospectus of Sarin Technologies Ltd. No audited financial statements of the Company or its subsidiaries have been prepared for any period subsequent to 30 June 2004.

Yours faithfully

KPMG
Certified Public Accountants
Singapore

8 March 2005

Paul Barley
Partner

Somekh Chaikin
Certified Public Accountants
Tel Aviv, Israel
Member Firm of KPMG International
8 March 2005

Roger I Lavender
Partner

Chaikin, Cohen, Rubin and Gilboa
Certified Public Accountants
Tel Aviv, Israel

8 March 2005

Ilan Chaikin
Partner

INDEPENDENT AUDITORS' REPORT AND FINANCIAL STATEMENTS

SARIN TECHNOLOGIES LTD AND ITS SUBSIDIARIES PROFIT AND LOSS ACCOUNTS FOR THE YEARS ENDED 31 DECEMBER 2001, 2002, AND 2003 AND SIX MONTHS ENDED 30 JUNE 2004

	Note	Audited			Unaudited	Audited
		Year ended 31 December			Six months ended	Six months ended
		2001	2002	2003	30 June	30 June
		US\$'000	US\$'000	US\$'000	2003	2004
		US\$'000	US\$'000	US\$'000	US\$'000	US\$'000
Revenue	3	4,376	8,909	14,694	7,778	7,047
Cost of sales		(1,699)	(2,999)	(4,472)	(2,370)	(2,464)
Gross profit		2,677	5,910	10,222	5,408	4,583
Research and development costs		(757)	(709)	(1,370)	(542)	(725)
Selling and marketing expenses		(684)	(1,199)	(1,521)	(838)	(1,221)
General and administrative expenses		(872)	(1,155)	(1,305)	(562)	(964)
Other income/(expenses)		212	(132)	(20)	1	(19)
Profit from operations	4	576	2,715	6,006	3,467	1,654
Net finance income/(costs)	5	33	(61)	(87)	(3)	(31)
Profit from ordinary activities before taxation		609	2,654	5,919	3,464	1,623
Income tax expense	6	(247)	(496)	(590)	(317)	(526)
Net profit for the year/period		362	2,158	5,329	3,147	1,097
Earnings per share (in US\$ per share)	7					
Basic		0.002	0.012	0.029	0.017	0.006
Diluted		0.002	0.012	0.029	0.017	0.005

The accompanying notes form an integral part of these financial statements.

INDEPENDENT AUDITORS' REPORT AND FINANCIAL STATEMENTS

SARIN TECHNOLOGIES LTD AND ITS SUBSIDIARIES CONSOLIDATED BALANCE SHEETS AS AT 31 DECEMBER 2001, 2002, 2003 AND 30 JUNE 2004

	Note	Audited			30 June 2004 US\$'000
		2001 US\$'000	31 December 2002 US\$'000	2003 US\$'000	
Non-current assets					
Property, plant and equipment	8	139	223	230	528
Intangible assets	9	212	164	116	140
Deferred tax assets	10	139	250	412	532
		490	637	758	1,200
Current assets					
Inventories	11	494	1,113	1,486	1,625
Trade receivables	12	399	620	1,584	1,070
Other receivables	13	79	196	86	276
Short term investments	14	–	–	268	264
Cash and cash equivalents	15	492	1,384	3,965	4,991
		1,464	3,313	7,389	8,226
Current liabilities					
Trade payables		471	791	415	1,360
Other payables	16	510	944	1,174	1,693
Short term loans and bank overdraft	17	461	352	36	–
Current tax payable		330	433	540	591
Provision	18	49	69	100	104
		1,821	2,589	2,265	3,748
Net current (liabilities)/assets		(357)	724	5,124	4,478
Non-current liabilities					
Long term loan	19	(27)	–	–	–
Liability for employee severance benefits	20	(47)	(46)	(73)	(97)
		(74)	(46)	(73)	(97)
Net assets		59	1,315	5,809	5,581
Capital and reserves					
Share capital*	21	–	–	–	–
Reserves	23	59	1,315	5,809	5,581
		59	1,315	5,809	5,581

* Less than one thousand dollars

The accompanying notes form an integral part of these financial statements.

INDEPENDENT AUDITORS' REPORT AND FINANCIAL STATEMENTS

SARIN TECHNOLOGIES LTD AND ITS SUBSIDIARIES CONSOLIDATED STATEMENTS OF CASH FLOWS FOR THE YEARS ENDED 31 DECEMBER 2001, 2002, AND 2003 AND SIX MONTHS ENDED 30 JUNE 2004

	Note	Audited			Unaudited	Audited
		Year ended 31 December			Six months ended	Six months ended
		2001	2002	2003	30 June 2003	30 June 2004
		US\$'000	US\$'000	US\$'000	US\$'000	US\$'000
Operating activities						
Net profit for the year/period		362	2,158	5,329	3,147	1,097
Adjustments for:						
Income tax expense		247	496	590	317	526
Amortisation and depreciation		79	108	149	83	110
(Gain)/Loss on sale of property, plant and equipment		(7)	—	20	—	—
Interest expenses		35	27	20	12	27
Interest income		(10)	(22)	(28)	(16)	(20)
Minority interest		(89)	—	—	—	—
Operating profit before working capital changes		617	2,767	6,080	3,543	1,740
Changes in working capital:						
Inventories		(78)	(619)	(373)	(382)	(139)
Trade receivables		(223)	(221)	(964)	(370)	515
Other receivables		13	(117)	110	41	(190)
Short term investments		—	—	(268)	—	4
Trade payables		107	320	(376)	222	945
Other payables and provision		(112)	495	261	7	540
Employee severance benefits		17	(1)	27	14	24
Cash generated from operations		341	2,624	4,497	3,075	3,439
Income taxes paid		(88)	(504)	(645)	(410)	(595)
Cash flows generated from operating activities		253	2,120	3,852	2,665	2,844
Investing activities						
Purchase of property, plant and equipment		(33)	(144)	(153)	(93)	(382)
Proceeds from sale of property, plant and equipment		14	—	25	—	—
Acquisition of intangible asset		—	—	—	—	(50)
Acquisition of a subsidiary	27	1	—	—	—	—
Acquisition of minority shares in a subsidiary	27	—	(41)	—	—	(18)
Interest received		10	22	28	16	20
Cash flows used in investing activities		(8)	(163)	(100)	(77)	(430)
Balance carried forward		245	1,957	3,752	2,588	2,414

INDEPENDENT AUDITORS' REPORT AND FINANCIAL STATEMENTS

**SARIN TECHNOLOGIES LTD AND ITS SUBSIDIARIES
CONSOLIDATED STATEMENTS OF CASH FLOWS
FOR THE YEARS ENDED 31 DECEMBER 2001, 2002, AND 2003
AND SIX MONTHS ENDED 30 JUNE 2004**

	Note	Audited			Unaudited	Audited
		Year ended 31 December			Six months ended	Six months ended
		2001	2002	2003	30 June 2003	30 June 2004
		US\$'000	US\$'000	US\$'000	US\$'000	US\$'000
Balance brought forward		245	1,957	3,752	2,588	2,414
Financing activities						
Proceeds from issue of shares		–	53	–	–	25
Repayment of long term bank loans		(415)	(27)	–	–	–
Repayment of short term bank loan		(26)	(39)	(302)	(315)	–
Interest paid		(35)	(27)	(20)	(12)	(27)
Dividends paid		–	(955)	(835)	(835)	(1,350)
Cash flows used in financing activities		(476)	(995)	(1,157)	(1,162)	(1,352)
Net (decrease)/increase in cash and cash equivalents		(231)	962	2,595	1,426	1,062
Cash and cash equivalents at beginning of the year/period		603	372	1,334	1,334	3,929
Cash and cash equivalents at end of the year/period	15	372	1,334	3,929	2,760	4,991

The accompanying notes form an integral part of these financial statements.

INDEPENDENT AUDITORS' REPORT AND FINANCIAL STATEMENTS

SARIN TECHNOLOGIES LTD AND ITS SUBSIDIARIES CONSOLIDATED STATEMENTS OF CHANGES IN EQUITY FOR THE YEARS ENDED 31 DECEMBER 2001, 2002, AND 2003 AND SIX MONTHS ENDED 30 JUNE 2004

	Share capital US\$'000	Share premium US\$'000	Accumulated (losses)/profits US\$'000	Total US\$'000
At 1 January 2001	–	371	(674)	(303)
Net profit for the year	–	–	362	362
At 31 December 2001	–	371	(312)	59
Net profit for the year	–	–	2,158	2,158
Issue of shares	–	53	–	53
Dividends paid of US\$10.24 per share	–	–	(955)	(955)
At 31 December 2002	–	424	891	1,315
Net profit for the period (unaudited)	–	–	3,147	3,147
Dividends paid of US\$8.95 per share	–	–	(835)	(835)
At 30 June 2003	–	424	3,203	3,627
Net profit for the period (unaudited)	–	–	2,182	2,182
At 31 December 2003	–	424	5,385	5,809
Net profit for the period	–	–	1,097	1,097
Issue of shares	–	25	–	25
Dividends paid of US\$14.34 per share	–	–	(1,350)	(1,350)
At 30 June 2004	–	449	5,132	5,581

The accompanying notes form an integral part of these financial statements.

INDEPENDENT AUDITORS' REPORT AND FINANCIAL STATEMENTS

SARIN TECHNOLOGIES LTD AND ITS SUBSIDIARIES NOTES TO THE FINANCIAL STATEMENTS 31 DECEMBER 2001, 2002, AND 2003 AND 30 JUNE 2004

These notes form an integral part of the financial statements.

These financial statements were authorised for issue by the directors on 8 March 2005, and have been prepared for inclusion in the Prospectus of SARIN TECHNOLOGIES LTD (the "Company").

1. Background

1.1 Introduction

Sarin Technologies Ltd, an Israeli corporation, was incorporated on 8 November 1988. The Company and a wholly owned consolidated subsidiary, Gran Computer Industries (1992) Ltd. ("GCI") are engaged in the development, assembly and marketing of technology intensive products for the diamond, precious stone and associated industries. Romedix Ltd. ("Romedix"), a wholly owned consolidated subsidiary is engaged in the development, manufacturing and marketing of technology intensive products for examining lightweight skin illumination. In May 2004, Romedix purchased from a third party know-how and technology used in the development and manufacture of disposable polishing disks for diamonds and gemstones.

During 2004, the Company established a wholly owned consolidated subsidiary in India, Sarin Technologies India Private Ltd. ("Sarin India"), whose main activity is to market and distribute the Company's products in India and Sri-Lanka.

1.2 Subsidiaries

The Group has the following subsidiaries:

Name of subsidiary	Place of incorporation	Effective equity interest held by the Group			
		As at 31 December 2001	As at 31 December 2002	As at 31 December 2003	As at 30 June 2004
		%	%	%	%
Gran Computer Industries (1992) Ltd.	Israel	100	100	100	100
Romedix Ltd.	Israel	69	91	91	100
Sarin Technologies India Private Ltd.	India	—	—	—	100

1.3 Auditors

The statutory audited financial statements of the companies in the Group as of and for the three financial years ended 31 December 2001, 2002 and 2003 were audited by Chaikin, Cohen, Rubin and Gilboa ("CCR&G"), a firm of Israeli Certified Public Accountants whose partners are registered with the Israel Auditor's Council. The statutory audited financial statements of the Group for the relevant periods have been prepared in accordance with generally accepted accounting principles in Israel.

Sarin India was incorporated in 2004 with a 31 December financial year end. No statutory audit has been performed to date.

INDEPENDENT AUDITORS' REPORT AND FINANCIAL STATEMENTS

SARIN TECHNOLOGIES LTD AND ITS SUBSIDIARIES NOTES TO THE FINANCIAL STATEMENTS 31 DECEMBER 2001, 2002, AND 2003 AND 30 JUNE 2004

1. Background (cont'd)

1.3 Auditors (cont'd)

For the purpose of the Company's proposed listing on the Singapore Exchange Securities Trading ("SGX"), the audited consolidated financial statements of the Group as of and for the three years ended 31 December 2001, 2002 and 2003 and as of and for the six months ended 30 June 2004 have been prepared in accordance with International Financial Reporting Standards and jointly audited by CCR&G, Somekh Chaikin and KPMG Singapore in accordance with International Standards on Auditing.

Somekh Chaikin and KPMG Singapore are member firms of KPMG International, a Swiss cooperative.

The financial information of the Group for the six months ended 30 June 2003 has not been audited or reviewed and has been included for comparative purposes only.

The audit reports on the statutory financial statements of the Company and the Group as of and for the financial year ended 31 December 2001 were subject to qualifications relating to non-inclusion of inflationary disclosures as required under Israel GAAP. In addition, the audit reports on the statutory financial statements of Romedix for the financial years ended 31 December 2001, 2002 and 2003 included an emphasis of matter statement relating to a capital deficit and losses.

2. Significant Accounting Policies

(a) *Basis of Preparation*

The financial statements have been prepared in accordance with International Financial Reporting Standards ("IFRS") adopted by the International Accounting Standards Board.

The financial statements are presented in United States dollars, rounded to the nearest thousand. They are prepared on the historical cost basis except that short term investments are stated at their fair value.

(b) *Measurement Currency*

Items included in the financial statements of each company in the Group are measured using the currency that best reflects the economic substance of the underlying events and circumstances relevant to that company (the "measurement currency"). The financial statements of the Group are presented in United States dollars, which is the measurement currency of the Group. For statutory reporting purposes the Israeli companies also maintain their records in New Israeli Shekels ("NIS"), the lawful currency of Israel.

(c) *Basis of Consolidation*

(i) *Subsidiaries*

Subsidiaries are those enterprises controlled by the Company. Control exists when the Company has the power, directly or indirectly, to govern the financial and operating policies of an enterprise so as to obtain benefits from its activities.

The financial statements of subsidiaries are included in the consolidated financial statements from the date that control commences until the date that control ceases.

The acquisitions of subsidiaries are accounted for using the purchase method of accounting.

INDEPENDENT AUDITORS' REPORT AND FINANCIAL STATEMENTS

SARIN TECHNOLOGIES LTD AND ITS SUBSIDIARIES NOTES TO THE FINANCIAL STATEMENTS 31 DECEMBER 2001, 2002, AND 2003 AND 30 JUNE 2004

2. Significant Accounting Policies (cont'd)

(c) *Basis of Consolidation (cont'd)*

(ii) **Transactions eliminated on consolidation**

Intra-group balances and transactions, and any unrealised gains arising from intra-group transactions, are eliminated in preparing the consolidated financial statements. Unrealised losses are eliminated in the same way as unrealised gains, but only to the extent that there is no evidence of impairment.

(d) *Foreign Currency Transactions*

Monetary assets and liabilities in foreign currencies are translated into United States dollars at rates of exchange approximate to those ruling at the balance sheet date. Transactions in foreign currencies are translated at rates ruling on transaction dates. Exchange differences are recognised in the profit and loss account.

(e) *Property, Plant and Equipment*

(i) **Owned assets**

Items of property, plant and equipment are stated at cost less accumulated depreciation and impairment losses.

Where an item of property, plant and equipment comprises major components having different useful lives, they are accounted for as separate items of property, plant and equipment.

(ii) **Subsequent expenditure**

Subsequent expenditure relating to property, plant and equipment that has already been recognised is added to the carrying amount of the asset when it is probable that future economic benefits, in excess of the originally assessed standard of performance of the existing asset, will flow to the Group. All other subsequent expenditure is recognised as an expense in the period in which it is incurred.

(iii) **Disposals**

Gains or losses arising from the retirement or disposal of property, plant and equipment are determined as the difference between the estimated net disposal proceeds and the carrying amount of the asset and are recognised in the profit and loss account on the date of retirement or disposal.

(iv) **Depreciation**

No depreciation is provided on assets under construction. Depreciation is provided on a straight-line basis so as to write off the cost, net of estimated residual values of property, plant and equipment, and major components, that are accounted for separately over their estimated useful lives. The annual rates of depreciation are as follows:

Machinery and equipment	15%
Motor vehicles	15%
Demonstration equipment	12%-20%
Computers and office equipment	6-33%
Leasehold improvements	According to the leasing contract period

INDEPENDENT AUDITORS' REPORT AND FINANCIAL STATEMENTS

SARIN TECHNOLOGIES LTD AND ITS SUBSIDIARIES NOTES TO THE FINANCIAL STATEMENTS 31 DECEMBER 2001, 2002, AND 2003 AND 30 JUNE 2004

2. Significant Accounting Policies (cont'd)

(f) *Intangible Assets*

(i) *Know-how*

Know-how is stated at cost less accumulated amortisation and impairment losses.

(ii) *Subsequent Expenditure*

Subsequent expenditure on capitalised intangible assets is capitalised only when it increases the future economic benefits embodied in the specific asset to which it relates. All other expenditure is expensed as incurred.

(iii) *Amortisation*

Amortisation is charged to the profit and loss account on a straight-line basis over the estimated useful lives of intangible assets from the date the asset is available for use. The estimated useful life of the know-how is 5 to 8 years.

(g) *Financial Assets*

Short term investments held for trading are stated at fair value, with any resulting gain or loss recognised in the profit and loss account. The fair values of quoted investments are based on current bid prices.

(h) *Inventories*

Inventories are stated at the lower of cost and net realisable value. Net realisable value is the estimated selling price in the ordinary course of business, less the estimated costs of completion and selling expenses.

The cost of inventories is calculated based on the first in, first out costing method and includes expenditure incurred in acquiring the inventories and bringing them to their existing location and conditions. In the case of manufactured inventories and work in progress, cost includes an appropriate share of overheads based on normal operating capacity.

When inventories are sold, the carrying amount of those inventories is recognised as an expense in the period in which the related revenue is recognised. The amount of any allowance for write-down of inventories to net realisable value and all losses of inventories are recognised as an expense in the period the write-down or loss occurs. The amount of any reversal of any allowance for write-down of inventories, arising from an increase in net realisable value, is recognised as a reduction in the amount of inventories recognised as an expense in the period in which the reversal occurs.

(i) *Trade and Other Receivables*

Trade and other receivables are stated at cost less allowance for doubtful receivables. An allowance for doubtful receivables is provided based on the evaluation of the recoverability of these receivables at the balance sheet date.

(j) *Cash and Cash Equivalents*

Cash and cash equivalents comprise cash balances and bank deposits. Bank overdrafts that are repayable on demand and form an integral part of the Group's cash management are included as a component of cash and cash equivalents for the purpose of the consolidated statements of cash flows.

INDEPENDENT AUDITORS' REPORT AND FINANCIAL STATEMENTS

SARIN TECHNOLOGIES LTD AND ITS SUBSIDIARIES NOTES TO THE FINANCIAL STATEMENTS 31 DECEMBER 2001, 2002, AND 2003 AND 30 JUNE 2004

2. Significant Accounting Policies (cont'd)

(k) Impairment

The carrying amounts of the Group's assets are reviewed at each balance sheet date to determine whether there is any indication of impairment. If any such indication exists, the asset's recoverable amount is estimated.

An impairment loss is recognised whenever the carrying amount of an asset or its cash-generating unit exceeds its recoverable amount. Impairment losses are recognised in the profit and loss account.

(i) Calculation of recoverable amount

The recoverable amount is the greater of the asset's net selling price and value in use. In assessing value in use, the estimated future cash flows are discounted to their present value using a pre-tax discount rate that reflects current market assessment of the time value of money and the risks specific to the asset. For an asset that does not generate cash inflows largely independent of those from other assets, the recoverable amount is determined for the cash-generating unit to which the asset belongs.

(ii) Reversal of impairment loss

An impairment loss is reversed if there has been a change in the estimates used to determine the recoverable amount. An impairment loss is reversed only to the extent that the asset's carrying amount does not exceed the carrying amount that would have been determined, net of depreciation or amortisation, if no impairment loss had been recognised. Reversals of impairment losses are recognised in the profit and loss account.

(l) Dividends

Dividends are recognised as a liability in the period in which they are declared.

(m) Liabilities and Interest-bearing Liabilities

Trade and other payables and interest-bearing liabilities are stated at cost.

(n) Provisions

A provision is recognised in the balance sheet when the Group has a legal or constructive obligation as a result of a past event, and it is probable that an outflow of economic benefits will be required to settle the obligation. If the effect is material, provisions are determined by discounting the expected future cash flows at a pre-tax rate that reflects current market assessments of the time value of money and, where appropriate, the risks specific to the liability.

When it is not probable that an outflow of economic benefits will be required, or the amount cannot be estimated reliably, the obligation is disclosed as a contingent liability, unless the probability of outflow of economic benefits is remote. Possible obligations, whose existence will only be confirmed by the occurrence or non-occurrence of one or more future events are also disclosed as contingent liabilities unless the probability of outflow of economic benefits is remote.

INDEPENDENT AUDITORS' REPORT AND FINANCIAL STATEMENTS

SARIN TECHNOLOGIES LTD AND ITS SUBSIDIARIES NOTES TO THE FINANCIAL STATEMENTS 31 DECEMBER 2001, 2002, AND 2003 AND 30 JUNE 2004

2. Significant Accounting Policies (cont'd)

(o) *Employee Benefits*

(i) *Post employment benefits*

The liabilities of the Group arising from defined benefit obligations, and the related current service cost, are determined using the projected unit credit method. Valuations are carried out annually for the plan. Actuarial advice is provided by an external consultant.

Such a plan is externally funded, with the assets of the schemes held separately from those of the Group in independently administered insurance policies.

Actuarial gains and losses arise mainly from changes in actuarial assumptions and differences between actuarial assumptions and what has actually occurred. They are recognised in the profit and loss account in their full amount in the periods they occur.

For defined benefit plans the actuarial cost charged to the income statement consists of current service cost, interest cost, expected return on plan assets as well as actuarial gains or losses that are recognised.

(ii) *Bonuses*

The Group recognises a liability and an expense for bonuses, based on a formula that takes into consideration the profit attributable to the Company's shareholders after certain adjustments. The Group recognises a liability where contractually obliged or where there is a past practice that has created a constructive obligation.

(p) *Deferred Tax*

Deferred tax is provided in full, using the liability method, on temporary differences arising between the tax bases of assets and liabilities and their carrying amount in the financial statements. Temporary differences are not recognised for the initial recognition of assets or liabilities that affect neither accounting nor taxable profit. The amount of deferred tax provided is based on the expected manner of realisation or settlement of the carrying amount of assets and liabilities, using tax rates enacted or substantively enacted at the balance sheet date.

A deferred tax asset is recognised only to the extent that it is probable that future taxable profits will be available against which the asset can be utilised. Deferred tax assets are reduced to the extent that it is no longer probable that the related tax benefit will be realised.

(q) *Revenue Recognition*

(i) *Sale of goods*

Revenue from the sale of goods is recognised in the profit and loss account when the significant risks and rewards of ownership have been transferred to the buyer. No revenue is recognised if there are significant uncertainties regarding recovery of the consideration due, associated costs or the possible return of goods, or when the amount of revenue and costs incurred or to be incurred in respect of the transaction cannot be measured reliably.

INDEPENDENT AUDITORS' REPORT AND FINANCIAL STATEMENTS

SARIN TECHNOLOGIES LTD AND ITS SUBSIDIARIES NOTES TO THE FINANCIAL STATEMENTS 31 DECEMBER 2001, 2002, AND 2003 AND 30 JUNE 2004

2. Significant Accounting Policies (cont'd)

(q) *Revenue Recognition (cont'd)*

(ii) *Interest income*

Interest income from bank deposits is accrued on a time-apportioned basis on the principal outstanding and at the rate applicable.

(r) *Research and Development Costs*

Expenditure on research activities, undertaken with the prospect of gaining new scientific or technical knowledge and understanding, is recognised in the income statement as an expense as incurred.

Expenditure on development activities, whereby research findings are applied to a plan or design for the production of new or substantially improved products and processes, is capitalised if the product or process is technically and commercially feasible and the Group has sufficient resources to complete development. The expenditure capitalised includes the costs of materials, direct labour and an appropriate proportion of overheads. Other development expenditure is recognised in the income statement as an expense as incurred. Capitalised development expenditure is stated at cost less accumulated amortisation and impairment losses.

In the event that the Group cannot distinguish a research phase from the development phase of an internal project, the Group treats the expenditure on that project as if it were incurred in the research phase only.

(s) *Operating Lease Payments*

Payments made under operating leases are recognised in the profit and loss account on a straight-line basis over the term of the lease. Lease incentives received are recognised in the profit and loss account as an integral part of the total lease expense.

(t) *Equity and Equity Related Compensation Benefits*

The stock option program allows group employees to acquire shares of the Company. Certain options are granted at an exercise price, which is lower than the market price of the underlying shares at the date of the grant and no compensation cost and obligation is recognised.

When the options are exercised, equity is increased by the amount of the proceeds received.

(u) *Finance Costs*

Interest expense and similar charges are expensed in the profit and loss account in the period in which they are incurred.

(v) *Segment Reporting*

A segment is a distinguishable component of the Group that is engaged either in providing products or services (business segment), or in providing products or services within a particular economic environment (geographical segment), which is subject to risks and rewards that are different from those of other segments.

INDEPENDENT AUDITORS' REPORT AND FINANCIAL STATEMENTS

SARIN TECHNOLOGIES LTD AND ITS SUBSIDIARIES NOTES TO THE FINANCIAL STATEMENTS 31 DECEMBER 2001, 2002, AND 2003 AND 30 JUNE 2004

3. Revenue

Revenue of the Group is primarily derived from the assembly and sales of technology intensive products for the diamond, precious stone and associated industries.

Revenue represents the net invoiced value of goods sold, after trade discounts and exclusion of value added and other sales taxes.

4. Profit from Operations

Profit from operations includes the following:

	Year ended 31 December			Six months ended 30 June 2003	Six months ended 30 June 2004
	2001	2002	2003	US\$'000	US\$'000
	US\$'000	US\$'000	US\$'000	US\$'000	US\$'000
(a) Staff costs					
Salaries and allowances	1,420	2,135	2,521	1,310	1,710
Defined benefit retirement plan expense	64	51	106	53	72
	1,484	2,186	2,627	1,363	1,782
				Six months ended 30 June 2003	Six months ended 30 June 2004
	2001	2002	2003		
Number of staff at year/period end	25	35	38	37	90
				Six months ended 30 June 2003	Six months ended 30 June 2004
	2001	2002	2003	US\$'000	US\$'000
(b) Other operating expenses					
Amortisation of intangible assets	28	48	48	24	26
Allowance for doubtful trade receivables	21	65	(9)	(18)	188
Depreciation of property, plant and equipment	51	60	101	59	84
Operating lease charges	149	151	223	76	128
Warranty provision, net	26	20	31	17	4
	26	20	31	17	4

INDEPENDENT AUDITORS' REPORT AND FINANCIAL STATEMENTS

SARIN TECHNOLOGIES LTD AND ITS SUBSIDIARIES NOTES TO THE FINANCIAL STATEMENTS 31 DECEMBER 2001, 2002, AND 2003 AND 30 JUNE 2004

5. Net Finance Income/(Costs)

	— Year ended 31 December —			Six months ended	Six months ended
	2001	2002	2003	30 June 2003	30 June 2004
	US\$'000	US\$'000	US\$'000	US\$'000	US\$'000
Interest income	10	22	28	16	20
Interest expenses	(35)	(27)	(20)	(12)	(27)
Net foreign exchange gain/(loss)	58	(56)	(93)	(7)	(20)
Changes in fair values of trading investments	—	—	(2)	—	(4)
	<u>33</u>	<u>(61)</u>	<u>(87)</u>	<u>(3)</u>	<u>(31)</u>

6. Income Taxes

	— Year ended 31 December —			Six months ended	Six months ended
	2001	2002	2003	30 June 2003	30 June 2004
	US\$'000	US\$'000	US\$'000	US\$'000	US\$'000
Current tax	267	607	752	399	646
Deferred tax					
– Origination and reversal of temporary differences	(20)	(111)	(162)	(82)	(120)
Total income tax expense in profit and loss account	<u>247</u>	<u>496</u>	<u>590</u>	<u>317</u>	<u>526</u>

	— Year ended 31 December —			Six months ended	Six months ended
	2001	2002	2003	30 June 2003	30 June 2004
	US\$'000	US\$'000	US\$'000	US\$'000	US\$'000
Reconciliation of effective tax rate					
Profit from ordinary activities before taxation	<u>609</u>	<u>2,654</u>	<u>5,919</u>	<u>3,464</u>	<u>1,623</u>
Income tax using Israel tax rate of:					
2004: 35% (2001 – 2003: 36%)	219	955	2,131	1,247	568
Non-deductible expenses for tax purposes	16	45	49	11	12
Losses for which deferred tax assets were not recognised	86	59	8	15	22
Effects of lower tax rates arising from “Approved Enterprise” status	(45)	(566)	(1,578)	(930)	(105)
Others	(29)	3	(20)	(26)	29
	<u>247</u>	<u>496</u>	<u>590</u>	<u>317</u>	<u>526</u>

INDEPENDENT AUDITORS' REPORT AND FINANCIAL STATEMENTS

SARIN TECHNOLOGIES LTD AND ITS SUBSIDIARIES NOTES TO THE FINANCIAL STATEMENTS 31 DECEMBER 2001, 2002, AND 2003 AND 30 JUNE 2004

6. Income Taxes (cont'd)

(a) Measurement of results for tax purposes under the Income Tax Law (Adjustments for Inflation) – 1985 (the “Adjustments Law”)

- (i) In accordance with the Adjustments Law, the results for tax purposes are measured in real terms, based on the changes in the Customer Price Index.
- (ii) On 29 June 2004, the Knesset approved the Income Tax Ordinance Amendment (No. 140 and Temporary Order), 2004 (“the Amendment”).

The Amendment prescribes a gradual reduction in the corporate tax rate, from 36% (in 2001 to 2003) to 30%, in the following manner: in the 2004 tax year, a tax rate of 35% will be imposed, in 2005, a tax rate of 34% will be imposed, in 2006, a tax rate of 32% will be imposed, and from the 2007 tax year and thereafter, the tax rate will be 30%.

The current taxes for 2004 (other than on “Approved Enterprise” related income) and the deferred tax balances at 30 June 2004 are calculated based on the new tax rates, as prescribed in the Amendment.

(b) Tax benefits under the Law for the Encouragement of Industry (Taxes), 1969

The Company currently qualifies as an “Industrial Company” under the above law. As such, it is entitled to certain tax benefits, mainly the right to deduct share issuance costs for tax purposes in the event of a public offering, and to amortise know-how acquired from third parties.

(c) Tax benefits under the Law for the Encouragement of Capital Investments, 1959 (hereafter – “the Law”)

The Company has been granted “Approved Enterprise” status in respect of part of its property, plant and equipment under the Law, according to programs that were approved in 1994 (“first program”) and 2002 (“second program”). Income of the Company derived from the Approved Enterprise is tax-exempt for a period of two years and is subject to a reduced tax rate of 25% for an additional five years. The seven-year period of benefits commences in the year during which the Approved Enterprise first generates taxable income, provided that 14 years have not elapsed since the year in which the approval was granted, and 12 years have not elapsed since the year in which the Approved Enterprise was put into operation.

The first program was enacted in 1999 and the second program was enacted in 2002. Dividends distributed from the “Approved Enterprise” income will be liable to a 15% withholding tax rate. The last year of benefits relating to the first program is 2005 and with respect to the second program, is 2008.

The Investment Center of the Ministry of Industry and Commerce confirmed the execution of the first investment program in August 2001 and the second program in November 2004.

See Note 30(viii) – Subsequent Events.

The benefits from the Company's investment programs are dependent upon the Company fulfilling the conditions stipulated by the Law and the regulations published thereunder, as well as the criteria set forth in the approval for the specific investment in the Company's Approved Enterprise.

INDEPENDENT AUDITORS' REPORT AND FINANCIAL STATEMENTS

SARIN TECHNOLOGIES LTD AND ITS SUBSIDIARIES NOTES TO THE FINANCIAL STATEMENTS 31 DECEMBER 2001, 2002, AND 2003 AND 30 JUNE 2004

6. Income Taxes (cont'd)

(c) Tax benefits under the Law for the Encouragement of Capital Investments, 1959 (hereafter – “the Law”) (cont'd)

If the Company does not comply with these conditions, the tax benefits may be cancelled, and the Company may be required to refund the amount of the cancelled benefits, with the addition of linkage differences and interest.

In the event of distribution of cash dividends from tax-exempt income attributed to the “Approved Enterprise”, the reduced tax rate of 25% in respect of the amount distributed would have to be paid.

(d) Final tax assessments

The Company and its consolidated subsidiaries have received final tax assessments (including assessments which are considered final under the tax laws) for all tax years up to 31 December 1999.

7. Earnings Per Share

Earnings per share is calculated on the profit attributable to shareholders of US\$362,000, US\$2,158,000, US\$5,329,000, US\$3,147,000 and US\$1,097,000 for the years ended 31 December 2001, 2002, 2003 and the six months ended 30 June 2003 and 2004 respectively, applied to the weighted average number of shares.

The weighted average number of shares during each of the years and periods was calculated as follows:

	Number of Shares in Thousands				
	31 December			30 June	
	2001	2002	2003	2003	2004
Issued ordinary shares at beginning of the year/period	185,600	185,600	186,600	186,600	186,600
Weighted average number of shares issued under employee stock option plan:					
Issue of new shares	–	– *	–	–	1,252
Weighted average number of shares issued used in calculation of basic earnings per share	185,600	185,600	186,600	186,600	187,852
Dilutive effect of stock options	–	–	–	–	14,378
Weighted average number of shares used in calculation of diluted earnings per share	185,600	185,600	186,600	186,600	202,230

* The Company issued 500 ordinary shares on 29 December 2002.

There were no dilutive potential ordinary shares in existence for the years ended 31 December 2001, 2002 and 2003. The calculation of earnings per share for the relevant period is based on the assumption that the Company will convert all its ordinary shares of NIS 0.01 each into ordinary shares with no par value and sub-divide each such converted ordinary share with no par value into 2,000 ordinary shares with no par value prior to the Invitation.

INDEPENDENT AUDITORS' REPORT AND FINANCIAL STATEMENTS

SARIN TECHNOLOGIES LTD AND ITS SUBSIDIARIES NOTES TO THE FINANCIAL STATEMENTS 31 DECEMBER 2001, 2002, AND 2003 AND 30 JUNE 2004

8. Property, Plant and Equipment

	Machinery and equipment US\$'000	Demonstration equipment US\$'000	Motor vehicles US\$'000	Computers and office equipment US\$'000	Leasehold improvements US\$'000	Total US\$'000
Cost						
At 1 January 2001	260	–	80	42	31	413
Additions	19	–	–	9	5	33
Disposals	–	–	(32)	–	–	(32)
At 31 December 2001	279	–	48	51	36	414
Additions	94	–	–	29	21	144
Disposals	(138)	–	–	(4)	–	(142)
At 31 December 2002	235	–	48	76	57	416
Additions	88	56	–	5	4	153
Disposals	(48)	–	–	–	–	(48)
At 31 December 2003	275	56	48	81	61	521
Additions	110	148	84	40	–	382
At 30 June 2004	385	204	132	121	61	903
Accumulated depreciation						
At 1 January 2001	194	–	46	8	1	249
Depreciation charge for the year	35	–	8	4	4	51
Disposals	–	–	(25)	–	–	(25)
At 31 December 2001	229	–	29	12	5	275
Depreciation charge for the year	43	–	5	8	4	60
Disposals	(138)	–	–	(4)	–	(142)
At 31 December 2002	134	–	34	16	9	193
Depreciation charge for the year	49	–	3	9	40	101
Disposals	(3)	–	–	–	–	(3)
At 31 December 2003	180	–	37	25	49	291
Depreciation charge for the period	25	37	4	6	12	84
At 30 June 2004	205	37	41	31	61	375
Carrying amount						
At 31 December 2001	50	–	19	39	31	139
At 31 December 2002	101	–	14	60	48	223
At 31 December 2003	95	56	11	56	12	230
At 30 June 2004	180	167	91	90	–	528

INDEPENDENT AUDITORS' REPORT AND FINANCIAL STATEMENTS

SARIN TECHNOLOGIES LTD AND ITS SUBSIDIARIES NOTES TO THE FINANCIAL STATEMENTS 31 DECEMBER 2001, 2002, AND 2003 AND 30 JUNE 2004

9. Intangible Assets

	As at 31 December			As at
	2001 US\$'000	2002 US\$'000	2003 US\$'000	30 June 2004 US\$'000
Acquisition of know-how				
Cost	240	240	240	290
Amortisation				
At 1 January	—	28	76	124
Amortisation during the year/period	28	48	48	26
At 31 December/30 June	28	76	124	150
Carrying amount	212	164	116	140

10. Deferred Tax

Recognised deferred tax assets are attributable to the following:

	As at 31 December			As at
	2001 US\$'000	2002 US\$'000	2003 US\$'000	30 June 2004 US\$'000
Deferred tax assets				
Research and development costs	97	169	324	364
Other payables and liability for employee severance benefits	36	57	58	81
Allowance for doubtful receivables	6	24	20	75
Other	—	—	10	12
Total	139	250	412	532

Deferred tax assets have not been recognised in respect of the following:

	As at 31 December			As at
	2001 US\$'000	2002 US\$'000	2003 US\$'000	30 June 2004 US\$'000
Tax losses (Note 6)	2,656	2,820	2,842	2,986

Deferred tax assets have not been recognised because the Group does not currently have sufficient information to determine the probability that future taxable profits will be available against which the Group can utilise the benefits. The above tax losses are available for offsetting against future taxable income of the Company's Israeli subsidiaries subject to compliance with the relevant tax regulations and agreement by the tax authorities.

The tax losses do not expire under current tax legislation.

INDEPENDENT AUDITORS' REPORT AND FINANCIAL STATEMENTS

SARIN TECHNOLOGIES LTD AND ITS SUBSIDIARIES NOTES TO THE FINANCIAL STATEMENTS 31 DECEMBER 2001, 2002, AND 2003 AND 30 JUNE 2004

11. Inventories

	As at 31 December			As at
	2001 US\$'000	2002 US\$'000	2003 US\$'000	30 June 2004 US\$'000
At cost:				
Raw materials and consumables	350	378	772	726
Work-in-progress	41	32	321	306
Finished goods, including goods in transit and inventories held by customers on sale or return	103	703	393	593
	<u>494</u>	<u>1,113</u>	<u>1,486</u>	<u>1,625</u>

12. Trade Receivables

	As at 31 December			As at
	2001 US\$'000	2002 US\$'000	2003 US\$'000	30 June 2004 US\$'000
Trade receivables	420	706	1,661	1,335
Allowance for doubtful receivables	(21)	(86)	(77)	(265)
	<u>399</u>	<u>620</u>	<u>1,584</u>	<u>1,070</u>

13. Other Receivables

	As at 31 December			As at
	2001 US\$'000	2002 US\$'000	2003 US\$'000	30 June 2004 US\$'000
Value added tax recoverable	31	153	37	137
Advances to suppliers	13	8	16	31
Prepaid expenses	8	13	22	100
Amount recoverable from a related party	13	14	—	—
Others	14	8	11	8
	<u>79</u>	<u>196</u>	<u>86</u>	<u>276</u>

The amount recoverable from a related party was unsecured and bore interest at Israeli Customer Price Index plus 4% for 2001 and 2002.

14. Short Term Investments

	As at 31 December			As at
	2001 US\$'000	2002 US\$'000	2003 US\$'000	30 June 2004 US\$'000
Investments held for trading	—	—	268	264

INDEPENDENT AUDITORS' REPORT AND FINANCIAL STATEMENTS

SARIN TECHNOLOGIES LTD AND ITS SUBSIDIARIES NOTES TO THE FINANCIAL STATEMENTS 31 DECEMBER 2001, 2002, AND 2003 AND 30 JUNE 2004

15. Cash and Cash Equivalents

	As at 31 December			As at
	2001 US\$'000	2002 US\$'000	2003 US\$'000	30 June 2004 US\$'000
Cash at banks and in hand	492	754	3,724	3,582
Bank deposits	—	630	241	1,409
	492	1,384	3,965	4,991
Bank overdraft	(120)	(50)	(36)	—
Cash and cash equivalents in the consolidated statements of cash flows	<u>372</u>	<u>1,334</u>	<u>3,929</u>	<u>4,991</u>

The effective interest rate relating to bank deposits at 30 June 2004 is 3.80% (2003: 4.60%; 2002: 8.70%) per annum. Interest rates reprice on a weekly basis.

16. Other Payables

	As at 31 December			As at
	2001 US\$'000	2002 US\$'000	2003 US\$'000	30 June 2004 US\$'000
Employees and related institutions	220	406	431	647
Advances from customers	23	14	153	454
Accrued expenses	177	209	175	168
Amounts payable to related parties	17	217	405	422
Other	73	98	10	2
	510	944	1,174	1,693

The amounts payable to related parties are unsecured, interest-free and have no fixed terms of repayment.

17. Short Term Loans and Bank Overdraft

	As at 31 December			As at
	2001 US\$'000	2002 US\$'000	2003 US\$'000	30 June 2004 US\$'000
Short term bank loans	341	302	—	—
Bank overdraft	120	50	36	—
	<u>461</u>	<u>352</u>	<u>36</u>	<u>—</u>

The short term bank loans were secured by personal guarantees from related parties and repayable within 6 months. The effective interest rate was 6.75% and 3.28% per annum for 2001 and 2002 respectively. Interest rates repriced as and when notified by the bank.

INDEPENDENT AUDITORS' REPORT AND FINANCIAL STATEMENTS

SARIN TECHNOLOGIES LTD AND ITS SUBSIDIARIES NOTES TO THE FINANCIAL STATEMENTS 31 DECEMBER 2001, 2002, AND 2003 AND 30 JUNE 2004

17. Short Term Loans and Bank Overdraft (cont'd)

The bank overdraft was secured by personal guarantees from related parties and has no fixed terms of repayment. The effective interest rate was 9.79%, 7.29% and 12.50% per annum for 2001, 2002 and 2003 respectively. Interest rates repriced as and when notified by the bank.

18. Provision

The movement in the warranty provision is as follows:

	As at 31 December			As at 30 June 2004
	2001	2002	2003	2004
	US\$'000	US\$'000	US\$'000	US\$'000
At 1 January	23	49	69	100
Provision made, net	26	20	31	4
	49	69	100	104
At 31 December/30 June	49	69	100	104

Warranty provision is based on estimates made from historical warranty data associated with the Group's similar products. The Group expects to incur this liability over the next year.

19. Long Term Loan

The unsecured and interest-free long term loan represented an amount due to a related party.

20. Liability for Employee Severance Benefits, Net

- (a) Israeli labor laws and agreements require the Group to pay severance pay to dismissed or retiring employees (including those leaving their employment under certain other circumstances). The calculation of the severance pay liability was made in accordance with labor agreements in force and based on salary components, which, in management's opinion, create entitlement to severance pay.
- (b) The Group's severance pay liabilities to their Israeli employees are funded partially by regular deposits with recognised pension and severance pay funds in the employees' names and by purchase of insurance policies.
- (c) Employees benefits consist of the following:

	As at 31 December			As at 30 June 2004
	2001	2002	2003	2004
	US\$'000	US\$'000	US\$'000	US\$'000
Present value of defined benefit obligations	208	241	406	445
Fair value of plan assets (see (b) above)	161	195	333	348
	47	46	73	97
Recognised liability for defined benefit obligations	47	46	73	97

INDEPENDENT AUDITORS' REPORT AND FINANCIAL STATEMENTS

SARIN TECHNOLOGIES LTD AND ITS SUBSIDIARIES NOTES TO THE FINANCIAL STATEMENTS 31 DECEMBER 2001, 2002, AND 2003 AND 30 JUNE 2004

20. Liability for Employee Severance Benefits, Net (cont'd)

Liability for defined benefit obligations

The Group makes contributions to various external defined benefit plans as mentioned in (b) above that provide pension benefits for employees upon retirement. The Company has no control over the assets of these funds.

Movements in the net liability recognised in the balance sheet

	As at 31 December			As at
	2001	2002	2003	30 June
	US\$'000	US\$'000	US\$'000	2004
				US\$'000
Net liability at 1 January	30	47	46	73
Contributions paid	(47)	(52)	(79)	(48)
Expense recognised in the profit and loss account	64	51	106	72
Net liability at 31 December/30 June	47	46	73	97

Expenses recognised in the profit and loss account

	As at 31 December			As at
	2001	2002	2003	30 June
	US\$'000	US\$'000	US\$'000	2004
				US\$'000
Current service costs	49	56	94	52
Interest on obligation	8	8	13	15
Expected return on plan assets	(13)	(15)	(23)	(21)
Net actuarial loss	20	2	22	26
	64	51	106	72

The expense is recognised in the following line items in the profit and loss account:

	As at 31 December			As at
	2001	2002	2003	30 June
	US\$'000	US\$'000	US\$'000	2004
				US\$'000
Cost of sales	9	13	19	12
Research and development costs	24	25	52	32
Selling and marketing expenses	10	8	15	16
General and administrative expenses	21	5	20	12
	64	51	106	72
Actual return on plan assets	21	(3)	34	(3)

INDEPENDENT AUDITORS' REPORT AND FINANCIAL STATEMENTS

SARIN TECHNOLOGIES LTD AND ITS SUBSIDIARIES NOTES TO THE FINANCIAL STATEMENTS 31 DECEMBER 2001, 2002, AND 2003 AND 30 JUNE 2004

20. Liability for Employee Severance Benefits, Net (cont'd)

Principal actuarial assumptions:

- (a) The calculations are based on the following demographic assumptions about the future characteristics of current employees who are eligible for benefits:
- (i) Mortality rates are based on the pension circular 2000/1 of the Ministry of Finance, including 0.5% improvement per annum, as specified in that document.
 - (ii) Disability rates are based upon the aforementioned document.
 - (iii) The leave rate assumed is conservative and derived from experience of comparable companies as the Group is considered too small to have credible experience. It is assumed that for employees with up to 10 years service, the leave rate will be 2.5% p.a. with entitlement to post-employment benefits, and 5% p.a. without such entitlement. For employees with 10 years service and more it is assumed that the leave rate will be 2% p.a. with entitlement to benefits and 2% p.a. without entitlement.
- (b) The calculations are based on the following financial assumptions:
- (i) The discount rate used is based on the yield of fixed-interest Israeli government bonds with duration equal to the duration of the gross liabilities:

<u>Valuation Date</u>	<u>Discount Rate</u>
31 December 2000	5.84%
31 December 2001	4.39%
31 December 2002	5.69%
31 December 2003	4.17%
30 June 2004	4.31%

- (ii) The future real salary increase is assumed to fall linearly from 12% p.a. at age 20 to 3% p.a. from age 40 onwards.
 - (iii) The rate of growth of the accrued balance in individual savings plans is assumed to be 3.0% p.a. This reflects 4.0% expected market return after the deduction of 1.0% management fees.
- (c) In view of the small size of the Group and the limited number of years experience currently available, these assumptions were felt to be reasonable. With the progress of time and the consequent accumulation of experience, these assumptions will be periodically reviewed.

INDEPENDENT AUDITORS' REPORT AND FINANCIAL STATEMENTS

SARIN TECHNOLOGIES LTD AND ITS SUBSIDIARIES NOTES TO THE FINANCIAL STATEMENTS 31 DECEMBER 2001, 2002, AND 2003 AND 30 JUNE 2004

21. Share Capital – The Company

	2001 No. of shares	As at 31 December 2002 No. of shares	2003 No. of shares	As at 30 June 2004 No. of shares
Authorised:				
Ordinary shares of NIS 0.01 each	1,000,000	1,000,000	–	–
Ordinary Shares A of NIS 0.01 each	–	–	990,000	990,000
Ordinary Shares B of NIS 0.01 each	–	–	10,000	10,000
Total	<u>1,000,000</u>	<u>1,000,000</u>	<u>1,000,000</u>	<u>1,000,000</u>
Issued and fully paid:				
Ordinary shares of NIS 0.01 each	92,800	93,300	–	–
Ordinary Shares A of NIS 0.01 each	–	–	93,300	93,300
Ordinary Shares B of NIS 0.01 each	–	–	–	835
Total	<u>92,800</u>	<u>93,300</u>	<u>93,300</u>	<u>94,135</u>

The paid up share capital is less than US\$1,000 as at 31 December 2001, 2002, 2003 and as at 30 June 2004.

- (a) Holders of the Ordinary shares B of NIS 0.01 par value each have no voting rights or the rights to appoint directors (other rights are identical to those of the Ordinary Shares A).
- (b) On 18 November 2003, the general assembly of the shareholders decided to amend the authorised share capital from 1,000,000 Ordinary Shares of NIS 0.01 par value each to 990,000 Ordinary Shares A of NIS 0.01 par value each and 10,000 Ordinary Shares B of NIS 0.01 par value each.
- (c) On 12 February 2004, 835 Ordinary Shares B were issued upon exercise of options for cash.

22. Employee Stock Option Plan

In November 2003, the Company's Board of Directors approved a stock option plan to allot options to directors, officers, and employees of the Company and its subsidiaries. Under this plan, the Board of Directors is authorised to grant to its employees and managers share options to a total of 10,000 Ordinary Shares B of NIS 0.01 par value.

The shares provide their holders the right to receive dividends, the right to participate in the distribution of the Company's assets upon liquidation, but shall not provide voting rights in the Company's General assemblies and/or the right to appoint directors.

The vesting period of the option ranges from immediate vesting to ratable vesting over a period of four years.

The said options shall expire at the end of six years commencing on the date of grant or on cessation of employment, at the earlier of the two. Unexercised vested options can generally be exercised within 60 days of cessation of employment.

INDEPENDENT AUDITORS' REPORT AND FINANCIAL STATEMENTS

SARIN TECHNOLOGIES LTD AND ITS SUBSIDIARIES NOTES TO THE FINANCIAL STATEMENTS 31 DECEMBER 2001, 2002, AND 2003 AND 30 JUNE 2004

22. Employee Stock Option Plan (cont'd)

The employee shall not be entitled to transfer or sell shares without the Board of Directors approval. In case the employment of the employee is terminated while holding shares of the Company, the employee shall be restricted from transferring and/or selling the shares for a period of one year from the date of termination ("blocking period") and the Company shall have the right, during the blocking period, to instruct the employee to sell the shares to whom it shall decide (including the Company), for the price that shall be calculated on the basis of the Company's valuation, that shall be determined by multiplying the average net profit of the Company in the last three previous years prior to the said Company's instructions, by four. According to a resolution of the board of directors dated 18 October 2004, this paragraph will be cancelled upon filing of a prospectus with the SGX and subject to a public offering of the Company's shares.

The Income Tax authorities have recognised the option plan as "share allotment by a trustee" according to Section 102 to the Tax Ordinance "Capital gain track". As a result, the benefit from the option plan shall not be recognised for deduction for income tax purposes.

Movements in the number of share options outstanding and their related weighted average exercise prices are as follows:

	2001		As at 31 December 2002		2003		As at 30 June 2004	
	Average exercise price in US\$ per share	Options	Average exercise price in US\$ per share	Options	Average exercise price in US\$ per share	Options	Average exercise price in US\$ per share	Options
At 1 January	-	-	-	-	-	-	41	9,125
Granted	-	-	-	-	42	9,640	-	-
Cancelled	-	-	-	-	31	(515)	-	-
Exercised	-	-	-	-	-	-	30	(835)
At 31 December/ 30 June		-		-		9,125		8,290

The number of stock options vested at 31 December 2003 is 3,570 and at 30 June 2004 is 2,735. See Note 30 – Subsequent Events.

Share options outstanding at the end of the year/period have the following expiry date and exercise prices:

	Exercise price US\$ per share	As at 31 December			As at 30 June
		2001 '000	2002 '000	2003 '000	2004 '000
29 December 2009	30 – 60	-	-	9,125	8,290

INDEPENDENT AUDITORS' REPORT AND FINANCIAL STATEMENTS

SARIN TECHNOLOGIES LTD AND ITS SUBSIDIARIES NOTES TO THE FINANCIAL STATEMENTS 31 DECEMBER 2001, 2002, AND 2003 AND 30 JUNE 2004

23. Reserves

	As at 31 December			As at
	2001 US\$'000	2002 US\$'000	2003 US\$'000	30 June 2004 US\$'000
Share premium	371	424	424	449
Accumulated (losses)/profits	(312)	891	5,385	5,132
	<u>59</u>	<u>1,315</u>	<u>5,809</u>	<u>5,581</u>

24. Significant Related Party Transactions

For the purposes of these consolidated financial statements, parties are considered to be related to the Group if the Group has the ability, directly or indirectly, to control the party or exercise significant influence over the party in making financial and operating decisions, or vice versa, or where the Group and the party are subject to common control or common significant influence. Related parties may be individuals or entities.

In addition to the related party information disclosed elsewhere in the financial statements, there were the following significant related party transactions between the Group and parties which are subject to common control or common significant influence during the year/period carried out in the normal course of business on terms agreed between the parties:

	Year ended 31 December			Six months ended	Six months ended
	2001 US\$'000	2002 US\$'000	2003 US\$'000	30 June 2003 US\$'000	30 June 2004 US\$'000
Sales to shareholders	78	2	5	3	–
Remuneration of key management personnel	305	439	507	276	196
	<u>305</u>	<u>439</u>	<u>507</u>	<u>276</u>	<u>196</u>

Remuneration of key management personnel

In addition to salary of US\$11,500 per month, the Group also provides to the CEO an annual bonus at the rate of 2% of the annual increase in the Company's turnover and an annual bonus of 2% of the Company's annual profit before tax. See Note 30 – Subsequent Events.

In December 2003, the Company granted to the CEO 2,750 share options at an exercise price of NIS 135 (US\$30.02) per share. Half of the options vested immediately, one quarter will vest on 30 December 2004 and the balance will vest on 30 December 2005. In September 2004, the CEO exercised 500 share options.

The Company had contracted with an interested party who serves as Chairman of the Board of Directors (hereinafter – “the Chairman”). The Chairman had been the CEO of a subsidiary until 31 December 2003 for a monthly fee of up to US\$10,000 (depending on time spent) for the period from December 1999 to December 2003. As at 31 December 2002, the total salary due to the Chairman that remained unpaid amounted to US\$68,000, however in 2002, the Chairman waived his rights to those amounts due to him and to 30,000 options in Romedix that he was also entitled to. See Note 30 – Subsequent Events.

INDEPENDENT AUDITORS' REPORT AND FINANCIAL STATEMENTS

SARIN TECHNOLOGIES LTD AND ITS SUBSIDIARIES NOTES TO THE FINANCIAL STATEMENTS 31 DECEMBER 2001, 2002, AND 2003 AND 30 JUNE 2004

24. Significant Related Party Transactions (cont'd)

Remuneration of key management personnel (cont'd)

A shareholder who serves as a director of the Company and a subsidiary is entitled to royalties in the amount of 2% per year from certain sales of Romedix up to 31 December 2009.

Other related party transaction

The Company has a contractual obligation with a company, which is a shareholder, whereby the Company pays management fees of US\$1,000 per month. With effect from 1 September 2004, the obligation of the Company was transferred so it is directly with an individual, who is a director of the Company and includes the reimbursement of reasonable expenses.

Balances with related parties are disclosed in notes 13, 16 and 19.

25. Segment Reporting

(a) Business segment

The Group is engaged in only one business segment, which is development, assembly and marketing of technology intensive products for the diamond, precious stone and associated industries.

(b) Geographical segment

The Group's secondary segment is based on geographical segments. These are India, Europe, North America and Other.

In presenting information geographically, segment revenue is based on the geographical location of the production, services or assets. Segment assets are based on the geographical location of the assets. Unallocated assets comprise deferred tax assets, other receivables and cash and cash equivalents held principally with banks in Israel.

Segment capital expenditure is the total cost incurred during the period to acquire segment assets that are expected to be used for more than one period.

	India US\$'000	Europe US\$'000	North America US\$'000	Other US\$'000	Total US\$'000
Year ended 31 December 2001					
Revenue from external customers	2,190	908	561	717	4,376
Segment assets	384	310	299	162	1,155
Unallocated assets					799
Total assets					1,954
Capital expenditure incurred during the year	6	2	1	2	11

INDEPENDENT AUDITORS' REPORT AND FINANCIAL STATEMENTS

SARIN TECHNOLOGIES LTD AND ITS SUBSIDIARIES NOTES TO THE FINANCIAL STATEMENTS 31 DECEMBER 2001, 2002, AND 2003 AND 30 JUNE 2004

25. Segment Reporting (cont'd)

(b) Geographical segment (con't)

	India US\$'000	Europe US\$'000	North America US\$'000	Other US\$'000	Total US\$'000
Year ended 31 December 2002					
Revenue from external customers	6,178	1,250	615	866	8,909
Segment assets	1,148	444	298	157	2,047
Unallocated assets					1,903
Total assets					3,950
Capital expenditure incurred during the year	67	14	6	10	97
Year ended 31 December 2003					
Revenue from external customers	9,878	1,435	1,181	2,200	14,694
Segment assets	1,378	589	514	866	3,347
Unallocated assets					4,800
Total assets					8,147
Capital expenditure incurred during the year	48	7	33	32	120
Six months ended 30 June 2003 (Unaudited)					
Revenue from external customers	5,782	789	536	671	7,778
Six months ended 30 June 2004					
Revenue from external customers	4,098	807	685	1,457	7,047
Segment assets	1,417	413	527	1,012	3,369
Unallocated assets					6,057
Total assets					9,426
Capital expenditure incurred during the period	262	10	28	38	338

INDEPENDENT AUDITORS' REPORT AND FINANCIAL STATEMENTS

SARIN TECHNOLOGIES LTD AND ITS SUBSIDIARIES NOTES TO THE FINANCIAL STATEMENTS 31 DECEMBER 2001, 2002, AND 2003 AND 30 JUNE 2004

26. Financial Instruments

The Group's financial assets comprise mainly cash and cash equivalents, trade receivables, other receivables and short term investments. The Group's financial liabilities comprise mainly short term bank loans, trade and other payables and liability for employee severance benefits. Except for the short term investments, the Group does not hold or issue financial instruments for trading purposes. The Group had no positions in derivative contracts as at 31 December 2001, 2002, 2003 and 30 June 2004. Exposure to credit, interest rate and currency risk arise in the normal course of the Group's business.

(a) Credit risk

Management has a credit policy in place and the exposure to credit risk is monitored on an ongoing basis. The Group does not require collateral in respect of financial assets.

The Group has established credit limits for customers and monitor their balances regularly. Cash and deposits are placed with banks and financial institutions, which are regulated.

At the balance sheet date, cash and cash equivalents were held with only one bank, thereby exposing the Group to significant concentrations of credit risk. However, management consider that the high credit rating of the bank reduces the risk to the Group to an acceptable level.

(b) Interest rate risk

The Group's exposure to market risk for changes in interest rates relates primarily to cash and cash equivalents and debt obligations. The Group does not use derivative financial instruments to hedge its debt obligations.

The interest rates of the cash and cash equivalents are disclosed in Note 15. The interest rates and terms of repayment of short term bank loans are disclosed in Note 17.

(c) Foreign currency risk

The Group is mainly exposed to movement in exchange rates of the US dollar in relation to the NIS with regards to salaries paid in NIS.

(e) Fair values

The fair values of cash and cash equivalents, trade and other receivables, trade and other payables and short term bank loans are not materially different from their carrying amounts because of the immediate or short term maturity of these instruments.

INDEPENDENT AUDITORS' REPORT AND FINANCIAL STATEMENTS

SARIN TECHNOLOGIES LTD AND ITS SUBSIDIARIES NOTES TO THE FINANCIAL STATEMENTS 31 DECEMBER 2001, 2002, AND 2003 AND 30 JUNE 2004

27. Acquisitions of Subsidiaries

In May 2001, the Group acquired all the shares in Gran Computer Industries (1992) Ltd. for US\$5,000. The acquisition was accounted for using the purchase method. In the 7 months to 31 December 2001, the subsidiary contributed a net profit of US\$4,000 to the consolidated net profit for the year.

The effect of acquisition of the subsidiary is set out below:

	Year ended 31 December 2001 US\$'000
Working capital	175
Long term loan	(410)
Know-how	240
	5
Net identifiable assets and liabilities	5
Satisfied by:	
Cash consideration paid	(5)
Cash acquired	6
	1
Net cash inflow	1

In November 2002, the Company acquired from a third party 22% of Romedix for US\$41,000. In February 2004 the Company acquired from related parties the remaining 9% of Romedix in return for US\$18,000. As of February 2004 the Company holds 100% of Romedix.

28. Commitments

(a) Operating lease commitments

The total future minimum lease payments of the Group, under operating leases in respect of properties and motor vehicles, are payable as follows:

	As at 31 December			As at 30 June 2004
	2001	2002	2003	2004
	US\$'000	US\$'000	US\$'000	US\$'000
Payable within:				
– 1 year	100	159	118	222
– 2 to 5 years	76	87	42	98
– after 5 years	–	–	–	–
	176	246	160	320
	176	246	160	320

- (b) The Group is committed to pay royalties at the rate of 3.5% to the Chief Scientist's Office of the Ministry of Trade and Industry (hereinafter – the Chief Scientist) on sales proceeds from products for which the Company and a subsidiary received grants up to an amount not exceeding the grants received (linked to the exchange rate of the US dollar). The total grants received, net of royalties paid to the Chief Scientist were approximately US\$1.1 million as at 30 June 2004.

INDEPENDENT AUDITORS' REPORT AND FINANCIAL STATEMENTS

SARIN TECHNOLOGIES LTD AND ITS SUBSIDIARIES NOTES TO THE FINANCIAL STATEMENTS 31 DECEMBER 2001, 2002, AND 2003 AND 30 JUNE 2004

28. Commitments (cont'd)

- (c) The Company has a contractual obligation with a director who is a shareholder (indirectly), whereby the Company pays management fees of US\$1,000 per month. See Note 30 – Subsequent Events.
- (d) In May 2004 a subsidiary signed an agreement for the acquisition of know-how regarding the development of diamond polishing discs for a consideration of US\$50,000 and a commitment to pay royalties in the amount of 2% of the net sales proceeds of the subsidiary from these products in the 5 year period beginning on 1 January 2005 up to 31 December 2009.
- (e) The Company has given guarantees of up to US\$20,000 for the liabilities of a subsidiary to a bank.

29. Holding Company

The immediate and ultimate holding company is Sarin Research & Development Ltd., a private Israeli company.

30. Subsequent Events

Subsequent to 30 June 2004, the following events took place:

- (i) In August 2004 the Company signed an agreement for the acquisition of know-how regarding the development of a laser diamond cutting machine for a consideration of US\$500,000 and a commitment to pay royalties for six years or the total amount of US\$2 million, whichever occurs first. Furthermore, the Company undertook to receive management and marketing services from the vendors for a consideration of US\$100,000 a year subject to certain terms and conditions. All the payments are contingent upon the successful development and testing of the new machine.
- (ii) On 9 September 2004, the Company's Board of Directors decided to distribute a cash dividend to its shareholders in the amount of US\$1.89 million, representing US\$19.78 per share. This dividend was paid at the end of September 2004.
- (iii) During September 2004, 1431 ordinary B shares were issued upon exercise of options.
- (iv) According to a protocol of a meeting of the Board of Directors held on 18 October 2004, it was resolved as follows:
 - The Company's Board of Directors resolved to cancel the agreement with a company, which is a shareholder, and sign a new agreement instead, with one of the directors, for services as a member of the executive committee starting September 2004 for a consideration of US\$1,000 per month and reimbursement of reasonable expenses.
 - The Company's Board of Directors resolved to sign an agreement with the Chairman of the Board for his services as Chairman and a member of the executive committee starting September 2004 for a consideration of US\$2,500 per month and reimbursement of reasonable expenses.

INDEPENDENT AUDITORS' REPORT AND FINANCIAL STATEMENTS

SARIN TECHNOLOGIES LTD AND ITS SUBSIDIARIES NOTES TO THE FINANCIAL STATEMENTS 31 DECEMBER 2001, 2002, AND 2003 AND 30 JUNE 2004

30. Subsequent Events (cont'd)

- The Company's Board of Directors approved the amendments to the agreement with the CEO for three years with effect from 1 September 2004. In addition to his base salary of US\$11,000 per month plus social benefits and a company vehicle, the CEO is entitled to an annual bonus. In the year 2004, the bonus will equal to 1.5% of the annual profit before tax and 2% of the annual increase in the Group's turnover. In the year 2005 and thereafter, the annual bonus will equal to 1% of the annual profit before tax of the Group and 3% of the annual increase in the profit before tax.
 - The Company's Board of Directors approved a rental agreement dated 16 August 2004 for the Company's new offices for a monthly rental of approximately US\$11,270 for a period of 41 months up to 16 January 2008 and further renewal options of up to two years.
 - The Company's Board of Directors resolved to accelerate the vesting period on some of the options granted to the Group's employees and to re-issue 515 options that were previously cancelled.
- (v) According to the protocol of a meeting of the Company's Board of Directors held on 23 December 2004, it was resolved to accelerate the vesting period on certain options granted to the Group's employees and to grant 460 additional options to employees. In addition 103 options were cancelled such that the total stock options outstanding and unexercised at the date of issue of these financial statements are 7,731.
- (vi) At a Board of Directors meeting held on 8 March 2005, the Company's Board of Directors decided to recommend that at the next annual general meeting (which is scheduled to be held within 90 days from the listing of our shares on the SGX-ST) a dividend of approximately S\$4,125,000 (or US\$2.5 million) be paid out of profits from the year ended 31 December 2004.
- (vii) At the Extraordinary General Meeting of the Company held on 8 March 2005, the Shareholders approved, *inter alia*, the following:
- (a) The conversion of all ordinary and ordinary B shares of NIS0.01 each into ordinary shares with no par value (the "Conversion");
 - (b) The division of each ordinary share of no par value, into 2,000 ordinary shares of no par value (the "Sub-division");
 - (c) The adoption of the New Articles of Association of the Company;
 - (d) The issue of up to 52,000,000 New Shares pursuant to the Prospectus of the Company. The New Shares, when fully paid, allotted and issued, will rank *pari passu* in all respects with the existing issued Shares;
 - (e) To approve the Board resolution of 8 March 2005 to issue letters of indemnification to the Directors and Executive Officers of the Company, according to which letters, the Company undertakes, subject to the provisions of the Israeli Companies Laws and of the Company's Articles, to indemnify its Directors and Executive Officers prospectively up to the amount of US\$2 million, but in no event more than 25% of the Company's equity, in respect of an act performed in their capacity as Directors or Executive Officers;

INDEPENDENT AUDITORS' REPORT AND FINANCIAL STATEMENTS

SARIN TECHNOLOGIES LTD AND ITS SUBSIDIARIES NOTES TO THE FINANCIAL STATEMENTS 31 DECEMBER 2001, 2002, AND 2003 AND 30 JUNE 2004

30. Subsequent Events (cont'd)

- (f) The establishment of the Company's 2005 Share Option Scheme, which comprises share options that may be granted in respect of such number of new Shares representing in aggregate not more than 15% of the total issued share capital of the Company from time to time;
 - (g) Approval and ratification of service agreements with the Chairman and a director who is a member of the executive committee.
- (viii) The Company's request to approve an expansion plan ("third program") of its Approved Enterprise was granted by the Investment Center in January 2005. The plan comprises an investment in fixed assets of US\$138,500. Subject to meeting the conditions of the letter of approval, the Company will be entitled to taxation benefits on the taxable income generated from the third program during a period of seven years commencing with the first year in which it generates taxable income from the third program, at tax rates similar to the two existing programs, as described in Note 6 (c) to the financial statements.

DIAMOND GRADING AND CERTIFICATES

Diamond grading covers numerous aspects of each individual diamond's qualities, but there are four grades which are critical to understand: cut, clarity, colour, and carat weight. There are additional ratings and measurements noted on a diamond certificate, but they generally fall under the diamond's grade in one of the **Four Cs**. For example, measurements listed such as "depth" and "table" are part of the description of the diamond's cut

1st "C" – Diamond Cut

First, it is important not to confuse diamond "cut" with "shape." Shape refers to the general outward appearance of the diamond. When a diamond jeweler (or a diamond certificate) says "cut," that's a reference to the diamond's reflective qualities, not the shape.

Diamond cut is perhaps the most important of the four Cs, so it is important to understand how this quality affects the properties and values of a diamond. A good cut gives a diamond its brilliance, which is that brightness that seems to come from the very heart of a diamond. The angles and finish of any diamond are what determine its ability to handle light, which leads to brilliance.

As shown in the images below, when a diamond is well-cut, light enters through the table and travels to the pavilion where it reflects from one side to the other before reflecting back out of the diamond through the table and to the observer's eye. This light is the brilliance we mentioned, and it's this flashing, fiery effect that makes diamonds so mesmerizing.

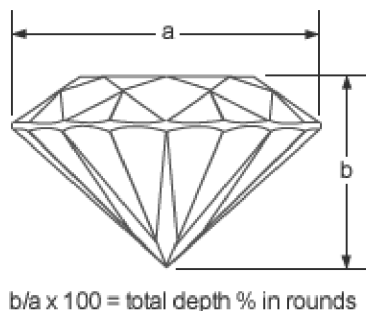

In a poorly cut diamond, the light that enters through the table reaches the facets and then 'leaks' out from the sides or bottom of the diamond rather than reflecting back to the eye. Less light reflected back to the eye means less brilliance.

Good Proportions are Key

Most gemologists agree that the best cut diamonds are those that follow a set of formulae calculated to maximize brilliance. These formulae can be seen in a diamond's proportions, most importantly how the depth compares to the diameter, and how the diameter of the table compares to the diameter of the diamond.

However, the variance in the **proportions** between an **Ideal Cut** and a **Poor Cut** can be difficult to discern by the casual observer.

Because cut is so important, several grading methods have been developed to help consumers determine the cut of a particular diamond. In general, these grades are:

- Ideal
- Premium

ANNEX A

- Very Good
- Good
- Fair & Poor

The descriptions below are general guidelines for Cut grades.

Ideal Cut

This cut is intended to maximize brilliance, and the typically smaller table sizes of these diamonds have the added benefit of creating a great deal of dispersion or 'fire' as well. This category applies only to round diamonds.

Premium

In the case of round diamonds, many Premium Cut diamonds have cuts that are the equal of any Ideal Cut diamond, though they often can be purchased at slightly lower prices than Ideal Cuts. They are intended to provide maximum brilliance and fire.

Very Good

These diamonds reflect most of the light that enters them, creating a good deal of brilliance. With these diamonds, the cutters have chosen to stray slightly from the preferred diamond proportions in order to create a larger diamond. The result is that these diamonds fall slightly outside of some customers' preferences in terms of, for example, table size or girdle width, though, in many cases many of the parameters of diamonds in this range will overlap with certain parameters of diamonds in the Ideal or Premium ranges.

Good

Diamonds that reflect much of the light that enters them. Their proportions fall outside of the preferred range because the cutter has chosen to create the largest possible diamond from the original rough crystal, rather than cutting extra weight off to create a smaller Premium quality diamond. Diamonds in this range offer an excellent cost-savings to customers who want to stay in a budget without sacrificing quality or beauty.

Fair & Poor

A diamond graded as fair or poor reflects only a small proportion of the light that enters it. Typically these diamonds have been cut to maximize the carat weight over most other considerations.

Diamond Anatomy - The graphic and supporting text below explain the various "parts" of a diamond.

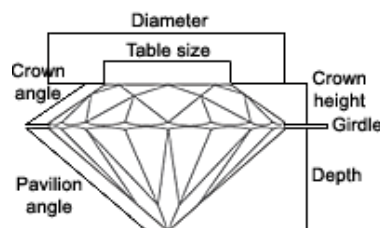

- **Diameter**
The width of the diamond as measured through the girdle.
- **Table**
This is the large, flat top facet of a diamond.

ANNEX A

- **Crown**
The upper portion of a cut gemstone, above the girdle.
- **Girdle**
The narrow rim of a diamond that separates the crown from the pavilion. It is the largest diameter to any part of the stone.
- **Pavilion**
The lower portion of the diamond, below the girdle. It is sometimes referred to as the base.
- **Culet**
The tiny facet on the pointed bottom of the pavilion, which is the portion of a cut gem below the girdle.
- **Depth**
The height of a gemstone, from the culet to the table.

2nd “C” – Diamond Clarity

When we speak of a diamond's clarity, we are referring to the presence of identifying characteristics on (blemishes) and within (inclusions) the stone.

If you think about the incredible amount of pressure it takes to create a diamond and the fact that natural diamonds are not grown in a sterile laboratory, it is no surprise that **most** diamonds have flaws.

Basically there are two types of flaws: inclusions and blemishes. Inclusions refer to internal flaws and blemishes refer to surface flaws. However, in the diamond grades listed below, you will note that none of the grades include the term “blemish” – for the purposes of grading diamonds, **all** flaws are called “inclusions.”

Inclusions include flaws such as air bubbles, cracks, and non-diamond minerals found in the diamond. Blemishes include scratches, pits, and chips. Some blemishes occur during the cutting processes (most often at the girdle). Diamonds with no or few inclusions and blemishes are more highly valued than those with less clarity because they are rarer.

How are diamonds graded for clarity?

Diamonds are graded for clarity under 10x loupe magnification. Grades range from Flawless (diamonds which are completely free of blemishes and inclusions), to Included 3 (diamonds which possess large, heavy blemishes and inclusions that are visible to the naked eye).

- **F**
Flawless: No internal or external flaws. Extremely rare.
- **IF**
Internally Flawless: no internal flaws, but some surface flaws. Very rare.
- **VVS1-VVS2**
Very Very Slightly Included (two grades). Minute inclusions very difficult to detect under 10x magnification by a trained gemologist.
- **VS1-VS2**
Very Slightly Included (two grades). Minute inclusions seen only with difficulty under 10x magnification.
- **S11-S12**
Slightly Included (two grades). Minute inclusions more easily detected under 10x magnification.

ANNEX A

- **I1-I2-I3**

Included (three grades). Inclusions visible under 10x magnification AS WELL AS to the human eye. We do not recommend buying diamonds in any of these grades.

While the presence of these clarity characteristics (inclusions and blemishes) do lower the clarity grade of a diamond, they can also be viewed as proof of a diamond's identity. GIA certificates include what is known as a "plot" of a diamond's inclusions – think of it as a "diamond fingerprint". Since no two diamonds are exactly the same, comparing the uniqueness of your diamond's clarity characteristics with the plot provided on the diamond certificate offers assurance that the diamond you pay for is the same diamond you receive.

3rd "C" – Diamond Colour

When jewelers speak of a diamond's colour, they are usually referring to the presence or absence of colour in white diamonds. Colour is a result of the composition of the diamond, and it never changes over time.

Because a colourless diamond, like a clear window, allows more light to pass through it than a coloured diamond, colourless diamonds emit more sparkle and fire. The formation process of a diamond ensures that only a few, rare diamonds are truly colourless. Thus the whiter a diamond's colour, the greater its value.

NOTE: Fancy colour diamonds do not follow this rule. These diamonds, which are very rare and very expensive, can be any colour from blue to green to bright yellow. They are actually more valuable for their colour.

To grade 'whiteness' or colourlessness, most jewelers refer to GIA's professional colour scale that begins with the highest rating of D for colourless, and travels down the alphabet to grade stones with traces of very faint or light yellowish or brownish colour. The colour scale continues all the way to Z.

Which Colour Grade Should I Choose?

Diamonds graded D through F are naturally the most valuable and desirable because of their rarity. Such diamonds are a treat for the eyes of anyone. But you can still obtain very attractive diamonds that are graded slightly less than colourless. **And diamonds graded G through I show virtually no colour that is visible to the untrained eye.**

And while a very, very faint hint of yellow will be apparent in diamonds graded J through M, this colour can often be minimized by carefully selecting the right jewelry in which to mount your diamond. Keep in mind that, while most people strive to buy the most colourless diamond they can afford, there are many people who actually prefer the warmer glow of lower-colour diamonds.

What is Fluorescence?

Fluorescence is an effect that is seen in some gem-quality diamonds when they are exposed to long-wave ultraviolet light (such as the lighting frequently seen in dance clubs). Under most lighting conditions, this fluorescence is not detectable to the eye. While most gemologists prefer diamonds without this effect, some people enjoy it. It's really just a matter of aesthetics.

4th "C" – Carat Weight

A carat is a unit of measurement, it is the unit used to weigh a diamond. One carat is equal to 200 milligrams, or 0.2 grams.

The word "carat" is taken from the carob seeds that people once used in ancient times to balance scales. So uniform in shape and weight are these little seeds that even today's sophisticated instruments cannot detect more than three one-thousandths of a difference between them.

NOTE: Do not confuse "carat weight" with "karat," the method of determining the purity of gold.

ANNEX A

The process that forms a diamond happens only in very rare circumstances, and typically the natural materials required are found only in small amounts. That means that larger diamonds are uncovered less often than smaller ones. Thus, large diamonds are rare and have a greater value per carat. For that reason, the price of a diamond rises exponentially to its size.

Diamond's Certificates

What are gemological laboratory certified diamonds? Loose diamonds (not pre-set in a ring or other setting) that have been certified by a gemological laboratory.

A certificate is a “blueprint” of a diamond, it tells you the diamond’s exact measurements and weight, as well as the details of its cut and quality. It precisely points out all the individual characteristics of the stone. Certificates also serve as proof of the diamond’s identity and value

A certificate is not the same thing as an appraisal. A certificate describes the quality of a diamond, but it does not place a monetary value on the gem. An appraisal places a monetary value on your diamond, but does not certify the quality of the diamond.

Who Issues Certificates?

There are many diamond labs that issue certificates, but the leading ones, such as the well-known Gemological Institute of America (GIA) and the American Gem Society (AGS) in the USA are the more widely regarded and recognized diamond grading labs in the world.

Why Do I Need a Certificate?

Shopping for certified diamonds allows you to make an informed choice about your selections, and to comparison-shop. You can compare one diamond of a particular weight and quality with other diamonds of similar weight and quality to determine which is the better value.

ANNEX B

A COMPANY LIMITED BY SHARES

AMENDED AND RESTATED ARTICLES OF ASSOCIATION OF SARIN TECHNOLOGIES LTD (the “Company”)

GENERAL PROVISIONS

1. Object and Purpose of the Company

- (a) The object and purpose of the Company shall be as set forth in the Company’s Memorandum of Association, as the same shall be amended from time to time in accordance with applicable law.
- (b) In accordance with Section 11(a) of the Israeli Companies Law, the Company may contribute a reasonable amount to a worthy cause. The Board of Directors may determine the amounts of the contributions, the purpose or category of purposes for which the contribution is to be made, and the identity of the recipient of any such contribution.

2. Limitation of Liability

The liability of the shareholders is limited to the payment of the respective amount, if any, that they have undertaken to the Company to pay for the shares in the Company allotted to them and which remains unpaid, and only to that amount.

3. Interpretation; Amendment

- (a) Unless the subject or the context otherwise requires, words and expressions defined in the Israeli Companies Law in force on the date when these Articles of Association (these “Articles”) or any amendment thereto, as the case may be, first became effective shall have the same meanings herein; words and expressions importing the singular shall include the plural and vice versa; words and expressions importing the masculine gender shall include the feminine gender; and words and expressions importing persons shall include bodies corporate.
- (b) The captions in these Articles are for convenience only and shall not be deemed a part hereof or affect the construction of any provision hereof.
- (c) The approval of a resolution adopted in a General Meeting approved by a simple majority of the voting power represented at the meeting in person or by proxy and voting thereon (a “Shareholders Resolution”) is required to approve any amendment to these Articles, except as otherwise required by applicable law.
- (d) In these Articles, if not inconsistent with the subject or context, the words standing in the first column below shall bear the meanings set opposite to them respectively:

“account holder” means a person who has an account directly with the Depository and not through a Depository Agent;

“Alternate Director” includes any natural person appointed by a Director pursuant to these Articles of the Company as that Director’s alternate;

ANNEX B

“book-entry securities”	means the documents evidencing title to listed securities which are deposited by a Depositor with the Depository and are registered in the name of the Depository or its nominee, and which are transferable by way of book-entry in the Depository Register and not by way of an instrument of transfer;
“Director”	includes any person who is a Director of the Company and includes any person duly appointed and acting for the time being as an Alternate Director;
“Depositor”	means an account holder or a Depository Agent but does not include a sub-account holder;
“Depository”	means the Central Depository (Pte) Limited and, where applicable, its successors in title;
“Depository Agent”	means a member company of the Exchange, a trust company (registered under the Singapore Trust Companies Act (Cap. 336)), a banking corporation or merchant bank (approved by the Monetary Authority of Singapore under the Monetary Authority of Singapore Act (Cap. 186)) or any other person or body approved by the Depository who or which performs services as a depository agent for sub-account holders in accordance with the terms of a depository agent agreement entered into between the Depository and the depository agent; deposits book-entry securities with the Depository on behalf of the sub-account holders and establishes an account in its name with the Depository;
“Depository Register”	means a register maintained by the Depository in respect of book-entry securities;
“Exchange” or “SGX-ST”	means The Singapore Exchange Securities Trading Limited and, where applicable, its successors in title;
“Israeli Companies Law”	means the Companies Law, 5759-1999, of Israel or any statutory modification, amendment or re-enactment thereof for the time being in force, and any reference to any provision of said law is to that provision as so modified, amended or re-enacted or contained in any such subsequent act or acts;
“Ordinary Shares”	means ordinary shares, of no nominal value, in the share capital of the Company;
“Register of Shareholders”	means the register of registered Shareholders of the Company kept in accordance with the Israeli Companies Law;
“securities”	means the documents evidencing title to listed securities which are deposited by a Depositor with the Depository and are registered in the name of the Depository or its nominee, and which are transferable by way of book-entry in the Depository Register and not by way of an instrument of transfer;

ANNEX B

“Securities Accounts”	means the securities account maintained by a Depositor with a Depository;
“Shareholder” or “holder of shares”	means a registered shareholder for the time being of the Company or if the registered shareholder is the Depository, a Depositor named in the Depository Register (for such period as shares are entered in the Depositor’s Securities Account);
“Singapore Companies Act”	means the Companies Act (Cap. 50) of Singapore or any statutory modification, amendment or re-enactment thereof for the time being in force, and any reference to any provision of said code is to that provision as so modified, amended or re-enacted or contained in any such subsequent code or codes;
“Singapore Take-over Code”	means the Singapore Code on Take-overs and Mergers or any statutory modification, amendment or re-enactment thereof for the time being in force, and any reference to any provision of said act is to that provision as so modified, amended or re-enacted or contained in any such subsequent act or acts;
“Special Resolution”	means a resolution passed by the holders of a three-fourths majority of the shares of such class present, in person or by proxy, and voting;
“sub-account holder”	means the holder of an account maintained with a Depository Agent; and
“writing”	includes printing, lithography, typewriting and any other mode of representing or reproducing words in a visible form.

SHARE CAPITAL

4. Share Capital

The registered share capital of the Company is 2,000,000,000 Ordinary Shares, with no par/nominal value.

5. Increase of Share Capital

- (a) The Company may, from time to time, by a Shareholders Resolution, whether or not all the shares then authorized have been issued, and whether or not all the shares theretofore issued have been called up for payment, increase its share capital by the creation of new shares. Any such increase shall be in such amount and shall be divided into shares of such nominal amounts (or no nominal amounts if the Company so decides), and such shares shall confer such rights and preferences, and shall be subject to such restrictions, as such resolution shall provide.
- (b) Except to the extent otherwise provided in such resolution, such new shares shall be subject to all the provisions applicable to the shares of the original share capital.

ANNEX B

6. Rights of the Ordinary Shares

The Ordinary Shares confer upon the holders thereof all rights accruing to a shareholder of a Company, as provided in these Articles, including, *inter alia*, the right to receive notices of, and to attend meetings of shareholders; for each share held, the right to one vote at all meetings of shareholders; and to share equally, on a per share basis, in such dividends as may be declared by the Board of Directors in accordance with these Articles and the Israeli Companies Law, and upon liquidation or dissolution of the Company, in the assets of the Company legally available for distribution to shareholders after payment of all debts and other liabilities of the Company, in accordance with the terms of these Articles and applicable law. All Ordinary Shares rank *pari passu* in all respects with each other.

7. Special Rights; Modifications of Rights

- (a) Without prejudice to any special rights previously conferred upon the holders of existing shares in the Company, the Company may, from time to time, by Shareholders Resolution, provide for shares with such preferred or deferred rights or rights of redemption or other special rights and/or such restrictions, whether in regard to dividends, voting, repayment of share capital or otherwise, as may be stipulated in such resolution provided always that:
- (i) the total nominal value, if any, of issued preference shares shall not exceed the total nominal value, if any, of issued Ordinary Shares at any time;
 - (ii) the rights attaching to shares of a class other than Ordinary Shares shall be expressed in the resolution creating the same;
 - (iii) preference shareholders shall have the same rights as ordinary shareholders as regards receiving notices, reports and balance sheets, attending and voting at General Meetings. Preference shareholders shall also have the right to vote at any meeting convened for the purpose of reducing the capital or winding up or sanctioning a sale of the assets of the Company or where the proposal to be submitted to the meeting directly affects their rights and privileges or when the dividend on the preference shares is more than six months in arrears; and
 - (iv) the Company has power to issue further preference capital ranking equally with, or in priority to, preference shares from time to time already issued.
- (b) (i) If at any time the share capital is divided into different classes of shares, the rights attached to any class, unless otherwise provided by these Articles, may be modified or abrogated by the Company, by Shareholders Resolution, subject to the sanction of a resolution passed by the holders of a majority of the shares of such class present and voting at a separate General Meeting of the holders of the shares of such class
- (ii) The repayment of preference capital other than redeemable preference capital, or any alteration of preference shareholders rights, may only be made by way of a Special Resolution of the preference shareholders concerned, provided always that where the necessary majority for such a Special Resolution is not obtained at the General Meeting, consent in writing obtained from the holders of three-fourths of the preference shares concerned within two months of the General Meeting, shall be as valid and effectual as a Special Resolution carried at the General Meeting.
 - (iii) The provisions of these Articles relating to General Meetings shall, *mutatis mutandis*, apply to any separate General Meeting of the holders of the shares of a particular class.

ANNEX B

- (iv) Unless otherwise provided by these Articles, the enlargement of an existing class of shares, the creation of a new class of shares, or the issuance of additional shares thereof, shall not be deemed, for purposes of this Article 7(b), to modify or abrogate the rights attached to the previously issued shares of such class or of any other class.

8. Consolidation, Subdivision, Cancellation and Reduction of Share Capital

- (a) The Company may, from time to time, by Shareholders Resolution (subject, however, to the provisions of Article 7(b) hereof and to applicable law):
 - (i) consolidate and divide all or any of its issued or unissued share capital into shares of larger nominal value than its existing shares,
 - (ii) subdivide its shares (issued or unissued) or any of them, into shares of smaller nominal value than is fixed by these Articles (subject, however, to the provisions of the Israeli Companies Law), and the Shareholders Resolution whereby any share is subdivided may determine that, as among the holders of the shares resulting from such subdivision, one or more of the shares may, as compared with the others, have any such preferred or deferred rights or rights of redemption or other special rights, or be subject to any such restrictions, as the Company has power to attach to unissued or new shares,
 - (iii) cancel any shares which, at the date of the adoption of such resolution, have not been taken or agreed to be taken by any person, and diminish the amount of its share capital by the amount of the shares so cancelled, or
 - (iv) reduce its share capital in any manner, and subject to any consent required by law.
- (b) With respect to any consolidation of issued shares into shares of larger nominal value, and with respect to any other action which may result in fractional shares, the Board of Directors may settle any difficulty which may arise with regard thereto, as it deems fit, including, *inter alia*, resort to one or more of the following actions:
 - (i) determine, as to the holder of shares so consolidated, which issued shares shall be consolidated into each share of larger nominal value;
 - (ii) allot, in contemplation of or subsequent to such consolidation or other action, such shares or fractional shares sufficient to preclude or remove fractional share holdings;
 - (iii) redeem, in the case of redeemable preference shares, and subject to applicable law, such shares or fractional shares sufficient to preclude or remove fractional share holdings;
 - (iv) cause the transfer of fractional shares by certain shareholders of the Company to other shareholders thereof so as to most expediently preclude or remove any fractional shareholdings, and cause the transferees to pay the transferors the fair value of fractional shares so transferred, and the Board of Directors is hereby authorized to act as agent for the transferors and transferees with power of substitution for purposes of implementing the provisions of this sub-Article 8(b)(iv).
- (c) Notwithstanding the foregoing, if a class of shares has no nominal value, then any of the foregoing actions may be taken with respect to such class without regard to nominal value.

ANNEX B

SHARES

9. Issuance of Share Certificates; Replacement of Lost Certificates

- (a) Share certificates shall be issued under the seal or stamp of the Company and shall bear the signature of two Directors, or of one Director and of the Secretary of the Company, or of any other person or persons authorized thereto by the Board of Directors.
- (b) Each holder of shares shall be entitled to one numbered certificate for all the shares of any class registered in his name, and if reasonably requested by such Shareholder, to several certificates, each for one or more of such shares. Every Shareholder shall be entitled to receive share certificates in reasonable denominations for his holding and where a charge is made for certificates, such charge shall not exceed S\$2 (or such other fee as the Directors may determine having regard to any limitation thereof as may be prescribed by any stock exchange upon which the shares of the Company may be listed). Where a Shareholder transfers part only of the shares comprised in a certificate or where a Shareholder requires the Company to cancel any certificate or certificates and issue new certificates for the purpose of subdividing his holding in a different manner the old certificate or certificates shall be cancelled and a new certificate or certificates for the balance of such shares issued in lieu thereof and the Shareholder shall pay a fee not exceeding S\$2 (or such other fee as the Directors may determine having regard to any limitation thereof as may be prescribed by any stock exchange upon which the shares of the Company may be listed) for each such new certificate as the Directors may determine.
- (c) A share certificate registered in the names of two or more persons shall be delivered to the person first named in the Registrar of Shareholders in respect of such co-ownership.
- (d) Subject to the provisions of the Israeli Companies Law and the Singapore Companies Act, if a share certificate is defaced, worn out, destroyed, lost or stolen, it may be replaced or renewed on such evidence being produced and a letter of indemnity (if required) being given by the shareholder, transferee, person entitled, purchaser, member firm or member company of the Exchange or on behalf of its or their client or clients as the Directors of the Company shall require, and (in case of defacement or wearing out) on delivery of the old certificate and in any case on payment of such sum not exceeding S\$2 (or such other fee as the Directors may determine having regard to any limitation thereof as may be prescribed by any stock exchange upon which the shares of the Company may be listed) as the Directors may from time to time require. In the case of destruction, loss or theft, a shareholder or person entitled to whom such renewed certificate is given shall also bear the loss and pay to the Company all expenses incidental to the investigations by the Company of the evidence of such destruction or loss.

10. Allotment of Shares; Registered Holders of Shares

- (a) Subject to Article 10(b) below, the unissued shares from time to time shall be under the control of the Board of Directors, who shall have the power to allot shares or otherwise dispose of them to such persons, on such terms and conditions (including *inter alia* terms relating to calls as set forth in Article 11(f) hereof), and either at par or at a premium, or, subject to the provisions of the Israeli Companies Law, at a discount, and at such times, as the Board of Directors may deem fit, and the power to give to any person the option to acquire from the Company any shares, either at par or at a premium, or, subject as aforesaid, at a discount, during such time and for such consideration as the Board of Directors may deem fit.
- (b) Subject to any direction to the contrary that may be given by the Company in General Meeting or except as permitted under the Exchange's listing rules, all new shares shall before issue be offered to the such persons who as at the date of the offer are entitled to receive notices from the Company of General Meetings in proportion, as far as circumstances admit, to the amount of the existing shares to which they are entitled. The

ANNEX B

offer shall be made by notice specifying the number of shares offered, and limiting a time within which the offer, if not accepted, will be deemed to be declined, and, after the expiration of the aforesaid time, or on the receipt of an intimation from the person to whom the offer is made that he declines to accept the shares offered, the Directors may dispose of those shares in such manner as they think most beneficial to the Company. The Directors may likewise so dispose of any new shares which (by reason of the ratio which the new shares bear to shares held by persons entitled to an offer of new shares) cannot, in the opinion of the Directors, be conveniently offered under this Article.

- (c) Except as otherwise provided in these Articles, the Company shall be entitled to treat the registered holder of any share as the absolute owner thereof, and, accordingly, shall not, except as ordered by a court of competent jurisdiction, or as required by statute, be bound to recognize any equitable or other claim to, or interest in such share on the part of any other person.
- (d) The Board of Directors may elect to maintain one or more Registers of Shareholders outside of Israel in addition to its principal Register of Shareholders, and each such register shall be deemed a Register of Shareholders for purposes of these Articles. The depositary, registrar or transfer agent maintaining such an additional Register of Shareholders on behalf of the Company shall not be deemed a shareholder of the Company solely by virtue thereof, but the individuals or entities appearing as shareholders therein, including without limitation, Depositary Agents, shall be deemed shareholders of the Company for all intents and purposes. Notwithstanding anything to the contrary in the Israeli Companies Law, transfers of shares on any such additional Register of Shareholders shall be effected in accordance with the procedures customary in the jurisdiction of the applicable depositary, registrar or transfer agent.

11. Calls on Shares

- (a) The Board of Directors may, from time to time, make such calls as it may deem fit upon holders of shares in respect of any sum unpaid in respect of shares held by such holders which is not, by the terms of allotment thereof or otherwise, payable at a fixed time, and each such holder shall pay the amount of every call so made upon him (and of each instalment thereof if the same is payable in instalments), to the person(s) and at the time(s) and place(s) designated by the Board of Directors, as any such time(s) may be thereafter extended and/or such person(s) or place(s) changed. Unless otherwise stipulated in the resolution of the Board of Directors (and in the notice hereafter referred to), each payment in response to a call shall be deemed to constitute a pro rata payment on account of all shares in respect of which such call was made.
- (b) Notice of any call shall be given in writing to the holder(s) in question not less than fourteen (14) days prior to the time of payment, specifying the time and place of payment, and designating the person to whom such payment shall be made, provided, however, that before the time for any such payment, the Board of Directors may, by notice in writing to such holder(s), revoke such call in whole or in part, extend such time, or alter such person and/or place. In the event of a call payable in instalments, only one notice thereof need be given.
- (c) If, by the terms of allotment of any share or otherwise, any amount is made payable at any fixed time, every such amount shall be payable at such time as if it were a call duly made by the Board of Directors and of which due notice had been given, and all the provisions herein contained with respect to such calls shall apply to each such amount.
- (d) The joint holders of a share shall be jointly and severally liable to pay all calls in respect thereof and all interest payable thereon.

ANNEX B

- (e) Any amount unpaid in respect of a call shall bear interest from the date on which it is payable until actual payment thereof, at such rate (not exceeding the then prevailing debitory rate charged by leading commercial banks in Israel), and at such time(s) as the Board of Directors may prescribe.
- (f) Upon the allotment of shares, the Board of Directors may provide for differences among the allottees of such shares as to the amount of calls and/or the times of payment thereof.

12. Prepayment

With the approval of the Board of Directors, any holder of shares may pay to the Company any amount not yet payable in respect of his shares, and the Board of Directors may approve the payment of interest on any such amount until the same would be payable if it had not been paid in advance, at such rate and time(s) as may be approved by the Board of Directors. Capital paid on shares in advance shall not, whilst carrying interest, confer a right to participate in profits and until appropriated towards satisfaction of any call shall be treated like a loan to the Company and not part of the capital. Accordingly, the Board of Directors may at any time cause the Company to repay all or any part of the money so advanced, without premium or penalty. Nothing in this Article 12 shall derogate from the right of the Board of Directors to make any call before or after receipt by the Company of any such advance.

13. Forfeiture and Surrender

- (a) If any holder fails to pay any amount payable in respect of a call, or interest thereon as provided for herein, on or before the day fixed for payment of the same, the Company, by resolution of the Board of Directors, may at any time thereafter, so long as the said amount or interest remains unpaid, forfeit all or any of the shares in respect of which said call had been made. Any expense incurred by the Company in attempting to collect any such amount or interest, including, *inter alia*, attorneys' fees and costs of suit, shall be added to, and shall, for all purposes (including the accrual of interest thereon), constitute a part of the amount payable to the Company in respect of such call.
- (b) Upon the adoption of a resolution of forfeiture, the Board of Directors shall cause notice thereof to be given to such holder, which notice shall state that, in the event of the failure to pay the entire amount so payable within a period stipulated in the notice (which period shall not be less than fourteen (14) days and which may be extended by the Board of Directors), such shares shall be ipso facto forfeited, provided, however, that, prior to the expiration of such period, the Board of Directors may nullify such resolution of forfeiture, but no such nullification shall estop the Board of Directors from adopting a further resolution of forfeiture in respect of the non-payment of the same amount.
- (c) Whenever shares are forfeited as herein provided, all dividends theretofore declared in respect thereof and not actually paid shall be deemed to have been forfeited at the same time.
- (d) The Company, by resolution of the Board of Directors, may accept the voluntary surrender of any share.
- (e) Any share forfeited or surrendered as provided herein shall become the property of the Company, and the same, subject to the provisions of these Articles, may be sold, re-allotted or otherwise disposed of as the Board of Directors deems fit, provided that in the case of a forfeiture, the net proceeds of any sale, after payment of the costs thereof, shall be applied in or toward satisfaction of the unpaid calls and accrued interest and expenses, residue (if any) shall be paid to the holder, his executors, administrators or assignees or as he directs.

ANNEX B

- (f) Any holder whose shares have been forfeited or surrendered shall cease to be a holder in respect of the forfeited or surrendered shares, but shall, notwithstanding, be liable to pay, and shall forthwith pay, to the Company, all calls, interest and expenses owing upon or in respect of such shares at the time of forfeiture or surrender, together with interest thereon from the time of forfeiture or surrender until actual payment, at the rate prescribed in Article 11(e) above, and the Board of Directors, in its discretion, may enforce the payment of such moneys, or any part thereof, but shall not be under any obligation to do so. In the event of such forfeiture or surrender, the Company, by resolution of the Board of Directors, may accelerate the date(s) of payment of any or all amounts then owing by the holder in question (but not yet due) in respect of all shares owned by such holder, solely or jointly with another, and in respect of any other matter or transaction whatsoever.
- (g) The Board of Directors may at any time, before any share so forfeited or surrendered shall have been sold, re-allotted or otherwise disposed of, nullify the forfeiture or surrender on such conditions as it deems fit, but no such nullification shall estop the Board of Directors from re-exercising its powers of forfeiture pursuant to this Article 13.

14. Lien

- (a) The Company shall have a first and paramount lien upon all the shares (not being a fully paid share) registered in the name of each shareholder (whether solely or jointly with others and without regard to any equitable or other claim or interest in such shares on the part of any other person) and upon the proceeds of the sale thereof and upon all dividends from time to time declared or payable in respect of such shares, provided such lien is restricted to unpaid calls and instalments upon the specific shares in respect of which such monies are due and unpaid, and to such amounts as the Company may be called upon by law to pay in respect of the shares of the Shareholder or deceased Shareholder. Unless otherwise provided, the registration by the Company of a transfer of shares shall be deemed to be a waiver on the part of the Company of the lien (if any) existing on such shares immediately prior to such transfer.
- (b) The Board of Directors may cause the Company to sell any shares subject to such lien in such manner as the Board of Directors may deem fit, but no such sale shall be made unless such unpaid calls and instalments upon the specific shares in respect of which such monies are due and unpaid have not been satisfied within fourteen (14) days after written notice of the intention to sell shall have been served on such holder, his executors or administrators.
- (c) The net proceeds of any such sale, after payment of the costs thereof, shall be applied in or toward satisfaction of the unpaid calls and accrued interest and expenses, and the residue (if any) shall be paid to the holder, his executors, administrators or assignees or as he directs.

15. Sale after Forfeiture or Surrender or in Enforcement of Lien

Upon any sale of shares after forfeiture or surrender or for enforcing a lien, the Board of Directors may appoint some person to execute an instrument of transfer of the shares so sold and cause the purchaser's name to be entered in the Register of Shareholders in respect of such shares, and the purchaser shall not be bound to see to the regularity of the proceedings, or to the application of the purchase money, and after his name has been entered in the Register of Shareholders in respect of such shares, the validity of the sale shall not be impeached by any person, and the remedy of any person aggrieved by the sale shall be in damages only and against the Company exclusively.

16. Redeemable Shares

The Company may, subject to applicable law, issue redeemable shares and redeem the same.

ANNEX B

TRANSFER OF SHARES

17. Effectiveness and Registration

- (a) No transfer of shares shall be registered or transferred by any shareholder unless a proper instrument of transfer (in form and substance satisfactory to the Board of Directors and the Exchange) has been submitted to the Company or its agent, together with any share certificate(s) and such other evidence of title as the Board of Directors may reasonably require. Until the transferee has been so registered in the Register of Shareholders in respect of the shares so transferred, the Company may continue to regard the transferor as the owner thereof. The Board of Directors may, from time to time, prescribe a fee not exceeding S\$2 for the registration of each transfer.
- (b) There shall be no restriction on the transfer of fully paid securities except where required by law or by the rules, bye-laws or listing rules of the Exchange but the Board of Directors shall be entitled to refuse to recognize a transfer deed until the certificate of the transferred share is attached to it together with any other evidence which the Board of Directors shall require as proof of the transferor's right to transfer the share and payment of any transfer fee determined by the Board of Directors. Registered transfer deeds shall remain with the Company, but any transfer deed which the Board of Directors refused to register shall be returned to the transferor upon demand.

18. Record Dates

- (a) Notwithstanding any provision to the contrary in these Articles, for the determination of the holders entitled to receive notice of and to participate in and vote at a General Meeting or to express consent to or dissent from any corporate action in writing, the Board of Directors may fix, in advance, a record date, which, subject to applicable law, shall not be earlier than forty (40) days prior to the General Meeting or other action, as the case may be, nor later than four (4) days prior to the General Meeting or other action, as the case may be. No persons other than holders of record of Ordinary Shares as of such record date shall be entitled to notice of and to participate in and vote at such General Meeting, or to exercise such other right, as the case may be. A determination of holders of record with respect to a General Meeting shall apply to any adjournment of such meeting, provided that the Board of Directors may fix a new record date for an adjourned meeting.
- (b) Subject to the applicable law, the holders entitled to receive payment of any dividend or other distribution or allotment of any rights, shall be the shareholders on the date upon which it was resolved to distribute the dividends or at such later date as shall be determined by, or pursuant to a resolution of, the Board of Directors.

TRANSMISSION OF SHARES

19. Decedents' Shares

- (a) In case of a share registered in the names of two or more holders, the Company may recognize the survivor(s) as the sole owner(s) thereof unless and until the provisions of Article 19(b) have been effectively invoked.
- (b) Any person becoming entitled to a share in consequence of the death of any person, upon producing evidence of the grant of probate or letters of administration or declaration of succession (or such other evidence as the Board of Directors may reasonably deem sufficient that he sustains the character in respect of which he proposes to act under this Article or of his title), shall be registered as a holder in respect of such share, or may, subject to the regulations as to transfer herein contained, transfer such share.

ANNEX B

20. Receivers and Liquidators

- (a) The Company may recognize the receiver or liquidator of any corporate shareholder in winding-up or dissolution, or the receiver or trustee in bankruptcy of any shareholder, as being entitled to the shares registered in the name of such shareholder.
- (b) The receiver or liquidator of a corporate shareholder in winding-up or dissolution, or the receiver or trustee in bankruptcy of any shareholder, upon producing such evidence as the Board of Directors may deem sufficient that he sustains the character in respect of which he proposes to act under this Article or of his title, shall with the consent of the Board of Directors (which the Board of Directors may grant or refuse in its absolute discretion), be registered as a shareholder in respect of such shares, or may, subject to the regulations as to transfer herein contained, transfer such shares.

GENERAL MEETINGS

21. Annual General Meeting

An Annual General Meeting shall be held once in every calendar year at such time (within a period of not more than fifteen (15) months after the last preceding Annual General Meeting) and at such place either within or outside the State of Israel as may be determined by the Board of Directors. The Board of Directors shall cause to be prepared and laid before the Company in the Annual General meeting such profit and loss accounts, balance sheets, group accounts (if any) and reports as may be required by applicable law. The interval between the close of a financial year of the Company and the date of the Annual General Meeting shall not exceed four months (or such other period as may be prescribed by the bye-laws and listings rules of the Exchange).

22. Special Meetings

All General Meetings other than Annual General Meetings shall be called "Special Meetings". The Board of Directors may, whenever it deems fit, convene a Special Meeting at such time and place, within or without the State of Israel, as may be determined by the Board of Directors, and shall be obliged to do so upon a requisition in writing in accordance with Sections 63(b)(1) or (2) and 63(c) of the Israeli Companies Law.

23. Notice of General Meetings

- (a) The Company is not required to give notice under Section 69(b) of the Israeli Companies Law. The Company is required to give such prior notice of a General Meeting as required by applicable law or applicable stock exchange rules. The notices convening meetings shall specify the place, day, hour and agenda of the meeting, and shall be given to all Shareholders (by advertisement in an English daily newspaper in Singapore) and to each stock exchange on which the Company is listed in writing at least fourteen (14) days before the General Meeting. Where notices contain Special Resolutions, they must be given to Shareholders at least twenty-one (21) days before the General Meeting. The accidental omission to give notice of a meeting to any shareholder or the non-receipt of notice by any of the shareholders shall not invalidate the proceedings at any meeting.
- (b) Any notice of a General Meeting called to consider special business (which is any business other than routine business) shall be accompanied by a statement regarding the effect of any proposed resolutions in respect of such businesses. All business shall be deemed special that is transacted at any Special Meeting, and all that is transacted at an Annual General Meeting shall also be deemed special, with the exception of sanctioning a dividend, the consideration of the accounts and balance sheet and the reports of the Directors, if any, and Auditors, and any other documents required to be annexed to the balance sheet, electing Directors in place of those retiring by rotation or otherwise and the fixing of the Directors' remuneration and the appointment and fixing of the remuneration of the Auditors or determining the manner in which such remuneration is to be fixed.

ANNEX B

- (c) A shareholder desiring to request that the Board of Directors include a certain item on the agenda of the meeting pursuant to Section 66(b) of the Israeli Companies Law, shall, as a condition to such proposal being considered by the Board of Directors, make such request to the Company in writing at least eight (8) weeks prior to the date of the meeting (or such shorter period as determined by the Board of Directors).

PROCEEDINGS AT GENERAL MEETINGS

24. Quorum

- (a) Two or more holders of Ordinary Shares (not in default in payment of any sum referred to in Article 30(a) hereof), present in person or by proxy and holding shares conferring in the aggregate at least 25% of the voting power of the Company (subject to rules and regulations, if any, applicable to the Company), shall constitute a quorum at General Meetings. No business shall be transacted at a General Meeting, or at any adjournment thereof, unless the requisite quorum is present when the meeting proceeds to business.
- (b) If within an hour from the time set for the meeting a quorum is not present, in person or by proxy, the meeting shall stand adjourned to the same day in the next week, at the same time and place, or, if not set forth in the notice of the meeting, to such day and at such time and place as the Chairman may determine with the consent of the holders of a majority of the voting power represented at the meeting in person or by proxy and voting on the question of adjournment. No business shall be transacted at any adjourned meeting except business which might lawfully have been transacted at the meeting as originally called. At such adjourned meeting, if a quorum is not present, in person or by proxy, within a half hour from the time set, any two (2) holders of Ordinary Shares (not in default as aforesaid) present in person or by proxy, shall constitute a quorum (subject to rules and regulations, if any, applicable to the Company). Notwithstanding anything in this Article 24 to the contrary, if the meeting was convened upon requisition pursuant to Section 63 or 64 of the Israeli Companies Law, the quorum requirement at any adjournment thereof shall be governed by the provisions of the Israeli Companies Law.
- (c) The Board of Directors may determine, in its discretion, the matters that may be voted upon at the meeting by proxy or written ballot in addition to the matters listed in Section 87(a) to the Israeli Companies Law.

25. Chairman

The Chairman, if any, of the Board of Directors shall preside as chairman at every General Meeting of the Company. If there is no such chairman, or if at any meeting he is not present within fifteen (15) minutes after the time fixed for holding the meeting or is unwilling to act as chairman or has notified the Company that he will not attend such meeting, the holders of Ordinary Shares present (or their proxies) shall choose someone else to be chairman. The office of chairman shall not, by itself, entitle the holder thereof to vote at any General Meeting nor shall it entitle such holder to a second or casting vote (without derogating, however, from the rights of such chairman to vote as a holder of Ordinary Shares or proxy of a shareholder if, in fact, he is also a shareholder or such proxy).

26. Adoption of Resolutions at General Meetings

- (a) Unless otherwise indicated herein, a Shareholders Resolution shall be deemed adopted if approved by the holders of a majority of the voting power represented at the meeting in person or by proxy and voting thereon.
- (b) A Shareholders Resolution approving a merger (as defined in the Israeli Companies Law) of the Company shall be deemed adopted if approved by the majority required under Section 320 of the Israeli Companies Law.

ANNEX B

- (c) Every question submitted to a General Meeting shall be decided by a show of hands, but if a written ballot is demanded by any holder of Ordinary Shares present in person or by proxy and entitled to vote at the meeting, the same shall be decided by such ballot. A written ballot may be demanded before the proposed resolution is voted upon or immediately after the declaration by the Chairman of the results of the vote by a show of hands. If a vote by written ballot is taken after such declaration, the results of the vote by a show of hands shall be of no effect, and the proposed resolution shall be decided by such written ballot. The demand for a written ballot may be withdrawn at any time before the same is conducted, in which event another holder of Ordinary Shares may then demand such written ballot. The demand for a written ballot shall not prevent the continuance of the meeting for the transaction of business other than the question on which the written ballot has been demanded.
- (d) A declaration by the Chairman of the meeting that a resolution has been carried unanimously, or carried by a particular majority, or lost, and an entry to that effect in the minute book of the Company, shall be conclusive evidence of the fact without proof of the number or proportion of the votes recorded in favour of or against such resolution.

27. Resolutions in Writing

A resolution in writing signed by all holders of Ordinary Shares of the Company then entitled to attend and vote at General Meetings or to which all such holders of Ordinary Shares have given their written consent (by letter, facsimile, telegram, telex or otherwise), or their oral consent by telephone (provided that a written summary thereof has been approved and signed by the Chairman of the Board of Directors of the Company) shall be deemed to have been unanimously adopted by a General Meeting duly convened and held.

28. Power to Adjourn

- (a) The Chairman of a General Meeting at which a quorum is present may, with the consent of the holders of a majority of the voting power represented in person or by proxy and voting on the question of adjournment (and shall if so directed by the meeting), adjourn the meeting from time to time and from place to place, but no business shall be transacted at any adjourned meeting except business which might lawfully have been transacted at the meeting as originally called.
- (b) It shall not be necessary to give any notice of an adjournment, whether pursuant to Article 24(b) or Article 28(a), unless the meeting is adjourned for twenty-one (21) days or more in which event notice thereof shall be given in the manner required for the meeting as originally called.

29. Voting Power

Subject to the provisions of Article 30(a) and subject to any provision hereof conferring special rights as to voting, or restricting the right to vote, every holder of Ordinary Shares shall have one vote for each share held by him of record, on every resolution, without regard to whether the vote hereon is conducted by a show of hands, by written ballot or by any other means.

30. Voting Rights

- (a) No holder of Ordinary Shares shall be entitled to vote at any General Meeting (or be counted as a part of the quorum thereat), unless all calls and other sums then payable by him in respect of his shares in the Company have been paid, but this Article shall not apply to separate General Meetings of the holders of a particular class of shares pursuant to Article 7(b).

ANNEX B

- (b) A company or other corporate body being a holder of Ordinary Shares of the Company may, by resolution of its directors or any other managing body thereof, authorize any person to be its representative at any meeting of the Company. Any person so authorized shall be entitled to exercise on behalf of such holder all the power which the latter could have exercised if it were an individual shareholder. Upon the request of the Chairman of the meeting, written evidence of such authorization (in form acceptable to the Chairman) shall be delivered to him.
- (c) Any holder of Ordinary Shares entitled to vote may vote either personally or by proxy (who need not be a holder of shares in the Company), or, if the Shareholder is a company or other corporate body, by a representative authorized pursuant to Article 30(b).
- (d) If two or more persons are registered as joint holders of any Ordinary Share, any one of such persons may vote, but if more than one of such persons is present at a General Meeting, the vote of the senior who tenders a vote, in person or by proxy, shall be accepted to the exclusion of the vote(s) of the other joint holder(s); and for this purpose seniority shall be determined by the order in which the names stand in the Register of Shareholders.
- (e) Provided always that a proxy shall be entitled to vote on a show of hands on any matter at any General Meeting, the Board of Directors may determine, in its discretion, the matters, if any, that may be voted upon by written ballot to the Company (without attendance in person or by proxy), as shall be permitted, at a General Meeting, in addition to the matters listed in Section 87(a) of the Israeli Companies Law.

PROXIES

31. Instrument of Appointment

- (a) The instrument appointing a proxy shall be in any usual or common form or in such other form as may be approved by the Board of Directors. It shall be duly signed by the appointer or his duly authorized attorney or, if such appointer is a company or other corporate body, under its common seal or stamp or the hand of its duly authorized agent(s) or attorney(s). An instrument of proxy shall be deemed to include the authority to demand or join in demanding a poll on behalf of the appointor.
- (b) The instrument appointing a proxy (and the power of attorney or other authority, if any, under which such instrument has been signed) shall be delivered to the Company (at its registered office, or at its principal place of business or at the offices of its registrar and/or transfer agent or at such place as the Board of Directors may specify) not less than twenty-four (24) hours before the time fixed for the meeting at which the person named in the instrument proposes to vote, unless otherwise determined by the Chairman of the meeting.

32. Effect of Death of Appointor or Revocation of Appointment

A vote cast pursuant to an instrument appointing a proxy shall be valid notwithstanding the previous death of the appointing holder (or of his attorney-in-fact, if any, who signed such instrument), or the revocation of the appointment or the transfer of the share in respect of which the vote is cast, provided no written intimation of such death, revocation or transfer shall have been received by the Company or by the Chairman of the meeting before such vote is cast and provided, further, that the appointing holder, if present in person at said meeting, may revoke the appointment by means of a writing, oral notification to the Chairman, or otherwise.

ANNEX B

BOARD OF DIRECTORS

33. Powers of Board of Directors

(a) In General

The oversight of the management of the business of the Company shall be vested in the Board of Directors, which may exercise all such powers and do all such acts and things as the Company is authorized to exercise and do, and are not hereby or by law required to be exercised or done by the Company in a General Meeting. The authority conferred on the Board of Directors by this Article 33 shall be subject to the provisions of the Israeli Companies Law, of these Articles and any regulation or resolution consistent with these Articles adopted from time to time by the Company in General Meeting, provided, however, that no such regulation or resolution shall invalidate any prior act done by or pursuant to a decision of the Board of Directors which would have been valid if such regulation or resolution had not been adopted.

(b) Borrowing Power

The Board of Directors may from time to time, in its discretion, cause the Company to borrow or secure the payment of any sum or sums of money for the purposes of the Company, and may secure or provide for the repayment of such sum or sums in such manner, at such times and upon such terms and conditions in all respects as it deems fit, and, in particular, by the issuance of bonds, perpetual or redeemable debentures, debenture stock, or any mortgages, charges, or other securities on the undertaking or the whole or any part of the property of the Company, both present and future, including its uncalled or called but unpaid capital for the time being.

(c) Reserves

The Board of Directors may, from time to time, set aside any amount(s) out of the profits of the Company as a reserve or reserves for any purpose(s) which the Board of Directors, in its absolute discretion, shall deem fit, and may invest any sum so set aside in any manner and from time to time deal with and vary such investments, and dispose of all or any part thereof, and employ any such reserve or any part thereof in the business of the Company without being bound to keep the same separate from other assets of the Company, and may subdivide or redesignate any reserve or cancel the same or apply the funds therein for another purpose, all as the Board of Directors may from time to time deem fit.

(d) Protective Measures

The Board of Directors may, at any time in its sole discretion, adopt protective measures to prevent or delay a coercive takeover of the Company, including without limitation the adoption of a "Shareholder Rights Plan".

34. Exercise of Powers of Directors

(a) A meeting of the Board of Directors at which a quorum is present (in person, by means of a conference call or any other device allowing each Director participating in such meeting to hear all the other Directors participating in such meeting) shall be competent to exercise all the authorities, powers and discretions vested in or exercisable by the Board of Directors.

(b) A resolution proposed at any meeting of the Board of Directors shall be deemed adopted if approved by a majority of the Directors present when such resolution is put to a vote and voting thereon. The Directors may meet together for the despatch of business, adjourn or otherwise regulate their meetings as they think fit. Unless otherwise determined, a majority of the Directors for the time being appointed to the Board of Directors shall be a quorum. Questions arising at any meeting shall be determined by a majority of votes and in case of an equality of votes the Chairman of the meeting shall have a second or casting vote provided always that the Chairman of a meeting at which only two Directors are competent to vote on the question at issue shall not have a second or casting vote.

ANNEX B

- (c) Notwithstanding the provision of Article 34(b) above, the following resolutions shall be deemed adopted only if approved by at least two-thirds (2/3) of the Directors of our Company:
- (i) listing of any of our Shares on any stock exchange other than the SGX-ST;
 - (ii) issuance of securities of our Company (including without limitation, options and warrants) which (i) shall form more than five per cent of our Company's issued share capital (on a fully diluted basis) immediately following such issuance; or (ii) together with any securities issued the 12 months period preceding the date of such issuance, shall form more than five per cent of the Company's issued share capital (on a fully diluted basis) immediately following such issuance; and
 - (iii) appointment and removal of the General Manager.
- (d) A resolution in writing signed by all Directors then in office and lawfully entitled to vote thereon (as conclusively determined by the Chairman of the Audit Committee ("Va'adat Bikoret"), and in the absence of such determination - by the Chairman of the Board of Directors) or to which all such Directors have given their consent (by letter, telegram, telex, facsimile or otherwise), or their oral consent by telephone (provided that a written summary thereof has been approved and signed by the Chairman of the Board of Directors of the Company) shall be deemed to have been unanimously adopted by a meeting of the Board of Directors duly convened and held.

35. Delegation of Powers

- (a) The Board of Directors may, subject to the provisions of the Israeli Companies Law, delegate any or all of its powers to committees, each consisting of two or more persons (all of whose members must be Directors), and it may from time to time revoke such delegation or alter the composition of any such committee. Any Committee so formed (in these Articles referred to as a "Committee of the Board of Directors"), shall, in the exercise of the powers so delegated, conform to any regulations imposed on it by the Board of Directors. The meetings and proceedings of any such Committee of the Board of Directors shall, mutatis mutandis, be governed by the provisions herein contained for regulating the meetings of the Board of Directors, so far as not superseded by any regulations adopted by the Board of Directors under this Article. Unless otherwise expressly provided by the Board of Directors in delegating powers to a Committee of the Board of Directors, such Committee shall not be empowered to further delegate such powers.
- (b) Without derogating from the provisions of Article 48, the Board of Directors may, subject to the provisions of the Israeli Companies Law, from time to time appoint a Secretary to the Company, as well as officers, agents, employees and independent contractors, as the Board of Directors may deem fit, and may terminate the service of any such person. The Board of Directors may, subject to the provisions of the Israeli Companies Law, determine the powers and duties, as well as the salaries and emoluments, of all such persons, and may require security in such cases and in such amounts as it deems fit.
- (c) The Board of Directors may from time to time, by power of attorney or otherwise, appoint any person, company, firm or body of persons to be the attorney or attorneys of the Company at law or in fact for such purpose(s) and with such powers, authorities and discretions, and for such period and subject to such conditions, as it deems fit, and any such power of attorney or other appointment may contain such provisions for the protection and convenience of persons dealing with any such attorney as the Board of Directors may deem fit, and may also authorize any such attorney to delegate all or any of the powers, authorities and discretions vested in him.

ANNEX B

36. Number of Directors

Unless and until the general meeting of the Company provides otherwise, by a Shareholders Resolution, the Board of Directors shall consist of such number of Directors (not less than four (4) and not more than nine (9)), all of whom shall be natural persons.

37. Election and Removal of Directors

- (a) The members of the Board of Directors shall be called Directors, and they shall be elected and removed in accordance with the provisions of this Article, provided, however, that to the extent that any provisions in these Articles of Association relating to Directors conflict with the provisions of the Israeli Companies Law (or the regulations promulgated thereunder) relating to External Directors (as such term is defined in the Israeli Companies Law), the provisions of the Israeli Companies Law shall apply to External Directors.
- (b) Directors shall be elected at the Annual General Meeting by the vote of the holders of a majority of the voting power represented at such meeting in person or by proxy and voting on the election of Directors, or by the Board of Directors. In the event that any Directors are appointed by the Board of Directors, such appointment of Directors shall be subject to ratification by Shareholders Resolution at the first Annual General Meeting of the shareholders following the date upon which the Director was appointed by the Board of Directors.
- (c) Each Director shall serve, subject to Articles 39 and 40 hereof, and unless the Annual General Meeting appointing him provides otherwise, until the third Annual General Meeting following the Annual General Meeting at which such Director was appointed, or his earlier removal pursuant to this Article 37. A Director who has completed his term of service or has been removed as aforesaid (a "retiring Director") shall be eligible for re-election. The shareholders shall be entitled to remove any Director(s) from office, all subject to applicable law. In addition, any Director appointed by the Board of Directors may be subsequently removed by the Board of Directors.
- (d) At any General Meeting, a person who is not a retiring Director shall be eligible for election to office of Director if a Shareholder intending to propose him has, at least eleven (11) clear days before the meeting, left at the office of the Company a notice in writing duly signed by the nominee, giving his consent to the nomination and signifying his candidature for the office, or the intention of such Shareholder to propose him. In the case of a person recommended by the Directors for election, nine (9) clear days' notice only shall be necessary. Notice of each and every candidature for election to the Board of Directors shall be served on the Shareholders at least seven (7) days prior to the Meeting at which the election is to take place.
- (e) Notwithstanding anything to the contrary herein, the term of a Director may commence as of a date later than the date of the Shareholder Resolution electing said Director, if so specified in said Shareholder Resolution.

38. Qualification of Directors

No person shall be disqualified to serve as a Director by reason of his not holding shares in the Company.

39. Continuing Directors in the Event of Vacancies

In the event of one or more vacancies in the Board of Directors, the continuing Directors may continue to act in every matter, and may temporarily fill any such vacancy until the next Annual General Meeting, whereupon any Director so appointed shall cease holding office and then be eligible for re-election, provided, however, that if they number less than the minimum number provided for pursuant to Article 36 hereof, they may, except in an emergency, act only for the

ANNEX B

purpose of increasing the number of Directors to such minimum number or to call a General Meeting of the Company for, *inter alia*, the purpose of electing Directors to fill any or all vacancies, so that at least a majority of the number of Directors provided for pursuant to Article 36 hereof are in office as a result of said meeting.

40. Vacation of Office

- (a) The office of a Director shall be vacated, *ipso facto*, upon his death, or if he be found lunatic or becomes of unsound mind, or if he becomes bankrupt.
- (b) The office of a Director shall be vacated by his written resignation. Such resignation shall become effective on the date fixed therein, or upon the delivery thereof to the Company, whichever is later.

41. Remuneration of Directors

- (a) No Director shall be paid any remuneration by the Company for his services as Director except as may be approved pursuant to the provisions of the Israeli Companies Law, provided that the fees payable to Directors shall not be increased except pursuant to a resolution passed at a General Meeting where notice of the proposed increase has been given in the notice convening such meeting. Salaries to Executive Directors may not include a commission on or a percentage of turnover of the Company.
- (b) The fees in the case of Non-Executive Directors shall be payable by a fixed sum and shall not at any time be by a commission on or percentage of profits or turnover. Subject to the foregoing, reimbursement of expenses incurred by a Director in carrying out his duties as such shall be made pursuant to the policy of the Board of Directors in effect from time to time.

42. Conflict of Interests

Subject to the provisions of the Israeli Companies Law, the Company may enter into any contract or otherwise transact any business with any Director in which contract or business such Director has a personal interest, directly or indirectly; and may enter into any contract or otherwise transact any business with any third party in which contract or business a Director has a personal interest, directly or indirectly, provided always that no Director shall vote in regard to any contract or proposed contract or arrangement in which he has directly or indirectly a personal material interest.

43. Alternate Directors

- (a) A Director may, by written notice to the Company, appoint a natural person who is approved by a majority of his co-Directors as an alternate for himself, remove such Alternate Director and appoint another Alternate Director in place of any Alternate Director appointed by him whose office has been vacated for any reason whatsoever. Unless the appointing Director, by the instrument appointing an Alternate Director or by written notice to the Company, limits such appointment to a specified period of time or restricts it to a specified meeting or action of the Board of Directors, or otherwise restricts its scope, the appointment shall be for an indefinite period, but will expire upon the expiration of the appointing Director's term, and shall be for all purposes. Any fee paid by the Company to an Alternate Director shall be deducted from the remuneration otherwise payable to his appointor.
- (b) Notwithstanding Article 43(a), (i) no person shall be appointed the Alternate Director for more than one Director, (ii) no Director may act as an Alternate Director and (iii) except as otherwise specifically permitted by the Israeli Companies Law, no External Director may appoint an Alternate Director.

ANNEX B

- (c) Any notice given to the Company pursuant to Article 43(a) shall become effective on the date fixed therein, or upon the delivery thereof to the Company, whichever is later.
- (d) An Alternate Director shall have all the rights and obligations of the Director who appointed him, provided, however, that he may not in turn appoint an alternate for himself (unless the instrument appointing him otherwise expressly provides), and provided further that an Alternate Director shall have no standing at any meeting of the Board of Directors or any committee thereof while the Director who appointed him is present.
- (e) Without derogating from the provisions of the Israeli Companies Law, an Alternate Director shall be responsible for his own acts and defaults, and he shall not be deemed the agent of the Director(s) who appointed him.
- (f) The office of an Alternate Director shall be vacated under the circumstances, *mutatis mutandis*, set forth in Article 40, and such office shall ipso facto be vacated if the Director who appointed such Alternate Director ceases to be a Director.

PROCEEDINGS OF THE BOARD OF DIRECTORS

44. Meetings

- (a) The Board of Directors may meet and adjourn its meetings and otherwise regulate such meetings and proceedings as the Board of Directors deems fit, provided, however, that the Board of Directors must meet at least once every three (3) months. Notice of the meetings of the Board of Directors shall be sent to each Director at the last address that the Director provided to the Company, or via telephone, facsimile or e-mail message.
- (b) Any Director may at any time, and the Secretary, upon the request of such Director, shall, convene a meeting of the Board of Directors, but not less than four (4) days written notice shall be given of any meeting so convened, provided, that the Board of Directors may convene a meeting without such prior notice with the consent of all of the Directors. The notice of a meeting of the Board of Directors shall describe the agenda for such meeting in reasonable detail.
- (c) Directors may participate in a meeting of the Board of Directors by means of a conference telephone, videoconferencing, audio visual, or other similar communications equipment by means of which all persons participating in the meeting can hear one another, without a Director being in the physical presence of another Director or Directors, and participation in a meeting pursuant to this provision shall constitute presence in person at such meeting. A Director participating in a meeting in the manner aforesaid may also be taken into account in ascertaining the presence of a quorum at the meeting. Such a meeting shall be deemed to take place where the largest group of Directors present for the purpose of the meeting is assembled or, if there is no such group, where the Chairman of the meeting is present.

45. Quorum

Unless otherwise decided by the Board of Directors, a quorum at a meeting of the Board of Directors shall be constituted by the presence of at least one-half of the Directors then in office who are lawfully entitled to participate in the meeting (as conclusively determined by the Chairman of the Board of Directors), but shall not be less than two (2).

ANNEX B

46. Chairman of the Board of Directors

The Company may, by a Shareholders' Resolution, from time to time appoint one of its Directors to be the Chairman of the Board of Directors, remove such Chairman from office and appoint another in its place. The Chairman of the Board of Directors shall preside at every meeting of the Board of Directors, but if there is no such Chairman, or if at any meeting he is not present within fifteen (15) minutes of the time fixed for the meeting, or if he is unwilling to take the chair, the Directors present shall choose one of their number to be the chairman of such meeting.

47. Validity of Acts Despite Defects

Subject to the provisions of the Israeli Companies Law, all acts done bona fide at any meeting of the Board of Directors, or of a Committee of the Board of Directors, or by any person(s) acting as Director(s), shall, notwithstanding that it may afterwards be discovered that there was some defect in the appointment of the participants in such meetings or any of them or any person(s) acting as aforesaid, or that they or any of them were disqualified, be as valid as if there were no such defect or disqualification.

GENERAL MANAGER

48. General Manager

- (a) The Board of Directors may from time to time appoint one or more persons, whether or not Directors, as General Manager(s) of the Company and may confer upon such person(s), and from time to time modify or revoke, such title(s) (including Managing Director, President, Chief Executive Officer, Director General or any similar or dissimilar title) and such duties and authorities of the Board of Directors as the Board of Directors may deem fit, subject to such limitations and restrictions as the Board of Directors may from time to time prescribe. A General Manager (or person holding an equivalent position) shall be subject to the control of the Board of Directors.
- (b) Where such appointment(s) is for a fixed term, such term shall not exceed five years and the Board of Directors may from time to time (subject to the provisions of the Israeli Companies Law and of any contract between any such person and the Company) fix his or their salaries and emoluments, remove or dismiss him or them from office, or assume his or their authorities with respect to a specific matter or period of time.
- (c) A General Manager may hire, fix the salaries and emoluments of, remove or dismiss other officers of the Company, all subject to the policies adopted by the Board of Directors from time to time, provided always that the appointment or removal of senior officers of the Company shall be made in consultation with the Board of Directors or a committee of the Board.

MINUTES

49. Minutes

- (a) Minutes of each General Meeting and of each meeting of the Board of Directors shall be recorded and duly entered in books provided for that purpose. Such minutes shall, in all events, set forth the names of the persons present at the meeting and all resolutions adopted thereat.
- (b) Any minutes as aforesaid, if purporting to be signed by the chairman of the meeting or by the chairman of the next succeeding meeting, shall constitute *prima facie* evidence of the matters recorded therein.

ANNEX B

DIVIDENDS

50. Declaration and Payment of Dividends

- (a) Subject to these Articles, the Company, at a General Meeting and upon the recommendation of the Board of Directors, may declare a dividend to be paid to the shareholders, according to their rights and benefits in the profits, and to decide the time of payment. A dividend may not be declared in excess of that recommended by the Board of Directors, although the Company at a General Meeting may declare a smaller dividend.
- (b) Subject to these Articles, the Board of Directors may from time to time pay to the shareholders, on account of a forthcoming dividend, such interim dividend as shall be deemed by it just with regard to the condition of the Company.

51. Amount Payable by Way of Dividends

Subject to the rights of the holders of shares with special rights as to dividends, any dividend paid by the Company shall be allocated among the shareholders entitled thereto in proportion to their respective holdings of the shares in respect of which such dividend is being paid.

52. Interest

No dividend shall carry interest as against the Company.

53. Retention of Dividends

The Board of Directors may retain any dividend or other moneys payable or property distributable in respect of a share in respect of which any person is, under Articles 19 or 20, entitled to become a Shareholder, or which any person is, under said Articles, entitled to transfer, until such person shall become a Shareholder in respect of such share or shall transfer the same.

54. Unclaimed Dividends

All unclaimed dividends or other moneys payable in respect of a share may be invested or otherwise made use of by the Board of Directors for the benefit of the Company until claimed. The payment by the Directors of any unclaimed dividend or such other moneys into a separate account shall not constitute the Company a trustee in respect thereof, and any dividend unclaimed after a period of seven (7) years from the date of declaration of such dividend, and any such other moneys unclaimed after a like period from the date the same were payable, shall be forfeited and shall revert to the Company, provided, however, that the Board of Directors may, at its discretion, cause the Company to pay any such dividend or such other moneys, or any part thereof, to a person who would have been entitled thereto had the same not reverted to the Company.

55. Mechanics of Payment

Any dividend or other moneys payable in cash in respect of a share may be paid by check or warrant sent through the post to, or left at, the registered address of the person entitled thereto or by transfer to a bank account specified by such person (or, if two or more persons are registered as joint holders of such share or are entitled jointly thereto in consequence of the death or bankruptcy of the holder or otherwise, to any one of such persons or to his bank account), or to such person and at such address as the person entitled thereto may by writing direct. Every such check or warrant shall be made payable to the order of the person to whom it is sent, or to such person as the person entitled thereto as aforesaid may direct, and payment of the check or warrant by the banker upon whom it is drawn shall be a good discharge to the Company. Every such check or warrant shall be sent at the risk of the person entitled to the money represented thereby.

ANNEX B

AUDITORS

56. Outside Auditor

The outside auditor of the Company shall be elected by Shareholders Resolution and shall serve until the Annual General Meeting held in the third year following such election or its earlier removal or replacement by Shareholders Resolution. The appointment, authorities, rights and duties of the auditor of the Company, shall be regulated by applicable law, provided, however, that the Board of Directors shall have the authority to fix, in its discretion, the remuneration of the auditor for any services or to delegate such authority to a committee thereof.

57. Internal Auditor

The internal auditor of the Company shall present all its proposed work plans to the Audit Committee of the Board of Directors, which shall have the authority to approve them subject to any modifications in its discretion.

RIGHTS OF SIGNATURE

58. Rights of Signature

The Board of Directors shall be entitled to authorize any person or persons (who need not be Directors) to act and sign on behalf of the Company, and the acts and signature of such person(s) on behalf of the Company shall bind the Company insofar as such person(s) acted and signed within the scope of his or their authority.

NOTICES

59. Notices

- (a) Any written notice or other document may be served by the Company upon any shareholder either personally, or by facsimile transmission, or by sending it by prepaid mail (airmail or overnight air courier if sent to an address on a different continent from the place of mailing) addressed to such shareholder at his address as described in the Register of Shareholders or such other address as he may have designated in writing for the receipt of notices and other documents. Any written notice or other document may be served by any shareholder upon the Company by tendering the same in person to the Secretary or the General Manager of the Company at the principal office of the Company, or by facsimile transmission, or by sending it by prepaid registered mail (airmail or overnight air courier if posted outside Israel) to the Company at its registered office. Any such notice or other document shall be deemed to have been served (i) in the case of mailing, three (3) business days after it has been posted, or when actually received by the addressee if sooner than three (3) days, after it has been posted; (ii) in the case of overnight air courier, on the next business day following the day sent, with receipt confirmed by the courier; (iii) in the case of personal delivery, on the date such notice was actually tendered in person to such shareholder (or to the Secretary or the General Manager); (iv) in the case of facsimile transmission, on the date on which the sender receives automatic electronic confirmation by the recipient's facsimile machine that such notice was received by the addressee. The mailing or publication date and the date of the meeting shall be counted as part of the days comprising any notice period. If a notice is, in fact, received by the addressee, it shall be deemed to have been duly served, when received, notwithstanding that it was defectively addressed or failed, in some respect, to comply with the provisions of this Article 65(a). Notwithstanding the foregoing, the accidental omission to give notice of a meeting to any shareholders, or the non-receipt of notice sent to such shareholder, shall not invalidate the proceedings at such meeting.

ANNEX B

- (b) All notices to be given to the shareholders shall, with respect to any share to which persons are jointly entitled, be given to whichever of such persons is named first in the Register of Shareholders, and any notice so given shall be sufficient notice to the holders of such share.
- (c) Any shareholder whose address is not described in the Register of Shareholders, and who shall not have designated in writing an address for the receipt of notices, shall not be entitled to receive any notice from the Company.
- (d) Notwithstanding anything to the contrary herein, notice by the Company of a General Meeting which is published in two (2) daily newspapers in the State of Israel, if at all, shall be deemed to have been duly given on the date of such publication to any shareholder whose address as registered in the Register of Shareholders (or as designated in writing for the receipt of notices and other documents) is located in the State of Israel.
- (e) Notwithstanding anything to the contrary herein, notice by the Company of a General Meeting or any other matter which is published in one (1) daily newspaper in Singapore or via one international wire service shall be deemed to have been duly given on the date of such publication to any Shareholder whose address as registered in the Register of Shareholders (or as designated in writing for the receipt of notices and other documents) is located outside the State of Israel.

EXCULPATION, INSURANCE AND INDEMNITY

60. Exculpation, Indemnity and Insurance

- (a) For purposes of these Articles, the term "Office Holder" shall mean every Director and every officer of the Company, including, without limitation, each of the persons defined as "*Nosei Misra*" in the Israeli Companies Law.
- (b) Subject to the provisions of the Israeli Companies Law, the Company may exculpate an Office Holder in advance from all or some of the Office Holder's responsibility for liability resulting from the Office Holder's breach of the Office Holder's duty of care to the Company.
- (c) Subject to the provisions of the Israeli Companies Law, the Company may indemnify an Office Holder in respect of an obligation or expense specified below imposed on the Office Holder in respect of an act performed in his capacity as an Office Holder, as follows:
 - (i) a financial obligation imposed on him in favour of another person by a court judgment, including a compromise judgment or an arbitrator's award approved by court;
 - (ii) reasonable litigation expenses, including attorneys' fees, expended by an Office Holder or charged to the Office Holder by a court, in a proceeding instituted against the Office Holder by the Company or on its behalf or by another person, or in a criminal charge from which the Office Holder was acquitted, or in a criminal proceeding in which the Office Holder was convicted of an offense that does not require proof of criminal intent.

The Company may undertake to indemnify an Office Holder as aforesaid, (aa) prospectively, provided that the undertaking is limited to categories of events which in the opinion of the Board of Directors can be foreseen when the undertaking to indemnify is given, and to an amount set by the Board of Directors as reasonable under the circumstances, but in no event more than 25% of the Company's equity, and (bb) retroactively.

ANNEX B

- (d) Subject to the provisions of the Israeli Companies Law, the Company may enter into a contract for the insurance of all or part of the liability of any Office Holder imposed on the Office Holder in respect of an act performed in his capacity as an Office Holder, in respect of each of the following:
- (i) a breach of his duty of care to the Company or to another person;
 - (ii) a breach of his duty of loyalty to the Company, provided that the Office Holder acted in good faith and had reasonable cause to assume that such act would not prejudice the interests of the Company; or
 - (iii) a financial obligation imposed on him in favour of another person.
- (e) The provisions of Articles 66(a), 66(b) and 66(c) above are not intended, and shall not be interpreted, to restrict the Company in any manner in respect of the procurement of insurance and/or in respect of indemnification (i) in connection with any person who is not an Office Holder, including, without limitation, any employee, agent, consultant or contractor of the Company who is not an Office Holder, and/or (ii) in connection with any Office Holder to the extent that such insurance and/or indemnification is not specifically prohibited under law; provided that the procurement of any such insurance and/or the provision of any such indemnification shall be approved by the Audit Committee of the Company.

WINDING UP

61. Winding Up

- (a) A Special Resolution is required to approve the winding up of the Company.
- (b) If the Company be wound up, then, subject to applicable law and to the rights of the holders of shares with special rights upon winding up, the assets of the Company available for distribution among the shareholders shall be distributed to them in proportion to the nominal value of their respective holdings of the shares in respect of which such distribution is being made, provided, however, that if a class of shares has no nominal value, then the assets of the Company available for distribution among the members shall be distributed to them in proportion of their respective holdings of the shares in respect of which such distribution is made.

TAKE-OVER REGULATION

62. For so long as the shares of the Company are listed on the Exchange, the provisions of section 140 of the Singapore Securities and Futures Act and the provisions of the Singapore Take-over Code shall apply, *mutatis mutandis*, to the Company and its Shareholders.
63. Any shares acquired in violation of the aforementioned take-over obligations will be deemed to be dormant shares with no rights whatsoever attached to them for as long as they are held by the acquirer of such shares.

ANNEX C

RULES OF SARIN TECHNOLOGIES LTD 2005 SHARE OPTION PLAN

A. NAME AND PURPOSE

1. **Name:** This plan, as amended from time to time, shall be known as "Sarin Technologies Ltd 2005 Share Option Plan" (the "Plan").
2. **Purpose:** The purpose and intent of the Plan is to provide incentives to employees, executive directors as well as non-executive directors (both Israeli and non-Israeli) of Sarin Technologies Ltd., a company incorporated under the laws of the State of Israel (the "Company"), or any subsidiary or affiliate (as defined herein) thereof (where applicable in this Plan, the term "Company" shall include any subsidiary or affiliate of the Company), by providing them with opportunities to purchase Ordinary Shares, of no par value, of the Company (the "Shares"). The Plan, approved by the Board of Directors of the Company (the "Board") and the shareholders of the Company (the "Shareholders"), is designed to allow Grantees (as defined below) to benefit from the provisions of either Section 102 or Section 3(9) of the Israeli Income Tax Ordinance (New Version), 1961 (as may be amended from time to time, the "Ordinance"), as applicable, and the rules and regulations promulgated thereunder or any other tax ruling provided by the tax authorities to the Company, or with respect to non-Israeli residents, the applicable laws relevant in their respective country of residence. The Plan will also give Grantees an opportunity to have a personal equity interest in the Company at not direct cost to its profitability and will help achieve positive objectives like motivating each Grantee to optimise his performance standards and efficiency and to maintain a high level of contribution to the Group, retention of key employees of the Company whose contributions are essential to the long-term growth and profitability of the Company and to align the interests of the Grantees with the interests of the Shareholders.

For the purposes of this Plan the term "affiliate" shall mean an "associated company" (i.e. a company at least 20% but not more than 50% of whose shares are held by the Company and which is controlled by the Company) over which the Company has control.

B. GENERAL TERMS AND CONDITIONS OF THE PLAN

3. **Administration:**
 - 3.1 The Board may appoint a Share Incentive Committee or other committee of the Board, which will consist of such number of Directors of the Company, as may be fixed from time to time by the Board. The Board shall appoint the members of such committee, may from time to time remove members from, or add members to, such committee and shall fill vacancies in such committee however caused. The Plan will be administered by such committee, or by the Board (including, but not limited to, actions which the Share Incentive Committee is not permitted to take according to Section 112 of the Israeli Companies Law, 1999 (the "Companies Law")) (the Board or its committee, as applicable - the "Committee"). Provided always that no member of the Committee shall participate in any deliberation or decision in respect of the options granted to him or held by him.
 - 3.2 The Committee shall select one of its members as its Chairman and shall hold its meetings at such times and places, as it shall determine. Actions taken by a majority of the members of the Committee, at a meeting at which a majority of its members is present, or acts reduced to, or approved in, writing by all members of the Committee, shall be the valid acts of the Committee. The Committee may appoint a Secretary, who shall keep records of its meetings and shall make such rules and regulations for the conduct of its business, as it shall deem advisable.

ANNEX C

- 3.3 Subject to the general terms and conditions of this Plan and applicable law and regulations, and in particular, the Listing Manual of the Singapore Exchange Securities Trading Limited (and any other stock exchange on which the Shares are quoted or listed) (“SGX-ST”), the Committee shall have the full authority in its discretion, from time to time and at any time to determine (i) the persons (“Grantees”) to whom options to purchase Shares (the “Options”) shall be granted, (ii) the time or times at which the same shall be granted, (iii) the schedule and conditions on which such Options may be exercised and on which such Shares shall be paid for, (iv) rules and provisions as may be necessary or appropriate to permit eligible Grantees who are not Israeli residents to participate in the Plan and/or to receive preferential tax treatment in their country of residence, with respect to the Options granted hereunder, and/or (v) any other matter which is necessary or desirable for, or incidental to, the administration of the Plan. Unless otherwise determined by the Committee for a specific grant or grants of Options, each Option will be exercisable, under the terms of this Plan, into one Share of the Company.
- 3.4 Subject to the general terms and conditions of the Plan and the Ordinance, the Committee shall have the full authority in its discretion, from time to time and at any time, to determine:
- (a) with respect to the grant of 102 Options (as defined in Section 5.1(a)(i) below) - whether the Company shall elect the “Ordinary Income Route” under Section 102(b)(1) of the Ordinance (the “Ordinary Income Route”) or the “Capital Gains Route” under Section 102(b)(2) of the Ordinance (the “Capital Gains Route”) (each of the Ordinary Income Route or the Capital Gains Route - a “Taxation Route”) for the grant of 102 Options, and the identity of the trustee who shall be granted such 102 Options in accordance with the provisions of this Plan and the then prevailing Taxation Route.
- Unless otherwise permitted by the Ordinance, in the event the Committee determines that the Company shall elect one of the Taxation Routes for the grant of 102 Options, the Company shall be entitled to change such election only following the lapse of one year from the end of the tax year in which 102 Options are first granted under the then prevailing Taxation Route; and
- (b) with respect to the grant of 3(9) Options (as defined in Section 5.1(a)(ii) below) - whether or not 3(9) Options shall be granted to a trustee in accordance with the terms and conditions of this Plan, and the identity of the trustee who shall be granted such 3(9) Options in accordance with the provisions of this Plan.
- 3.5 Notwithstanding the aforesaid, the Committee may, from time to time and at any time, grant 102 Options that will not be subject to a Taxation Route, as detailed in Section 102(c) of the Ordinance (“102(c) Options”).
- 3.6 The Committee may, from time to time, adopt such rules and regulations for carrying out the Plan, as it may deem necessary. No member of the Board or of the Committee shall be liable for any act or determination made in good faith with respect to the Plan or any Option granted thereunder. Subject to the Company’s Articles of Association and the Company’s decision, and to all approvals legally required, including, but not limited to the provisions of the Israeli Companies Law, each member of the Board or the Committee shall be indemnified and held harmless by the Company against any cost or expense (including counsel fees) reasonably incurred by him, or any liability (including any sum paid in settlement of a claim with the approval of the Company) arising out of any act or omission to act in connection with the Plan unless arising out of such member’s own fraud or bad faith, to the extent permitted by applicable law. Such indemnification shall be in addition to any rights of indemnification the member may have as a director or otherwise under the Company’s Articles of Association, any agreement, any vote of shareholders or disinterested directors, insurance policy or otherwise.

ANNEX C

3.7 The interpretation and construction by the Committee of any provision of the Plan or of any Option thereunder shall be final and conclusive and binding on all parties who have an interest in the Plan or any Option or Share issuance thereunder unless otherwise determined by the Board.

4. **Eligible Grantees:**

4.1 The Committee, at its discretion, may grant Options to any employee or director of the Company or any subsidiary or affiliate thereof. Anything in this Plan to the contrary notwithstanding, all grants of Options to office holders (i.e., "Nosei Misra", as such term is defined in the Israeli Companies Law) shall be authorized and implemented in accordance with the provisions of the Israeli Companies Law and the regulations promulgated thereunder.

4.2 The grant of an Option to a Grantee hereunder, shall neither entitle such Grantee to participate, nor disqualify him from participating, in any other grant of Options pursuant to this Plan or any other share option plan of the Company.

4.3 Subject to Rule 5.1, persons who are qualified under Rule 4.1 above and who are also Controlling Shareholders (defined below) or their associates may be granted Options if their participation and actual number of Shares to be issued to them and the terms of any Options to be granted to them have been approved by independent shareholders in general meeting in separate resolutions for each such person and in respect of each such person, in separate resolutions for each of his (i) participation and (ii) the actual number of Shares to be issued to him and the terms of any Option to be granted to him provided always that it shall not be necessary to obtain the approval of the independent shareholder of the Company for the participation of this Plan of a Controlling Shareholder or an associate to a Controlling Shareholder who is, at the relevant time, already a Grantee. For the purposes of obtaining such approval from the independent shareholders, the Company shall procure that the circular, letter or notice to the shareholders in connection herewith shall set out (a) clear justifications for the participation of such Controlling Shareholders and/or their associates, (b) clear rationale for number and terms (including the Exercise Price) of the Options to be granted to such Controlling Shareholders and/or their associates, and (c) where Incentive Options (defined below) are proposed to be granted to Controlling Shareholders and/or their associates the discount to the Market Price applicable to the Exercise Price of such Options as determined in accordance with Rule 8.

5. **Taxation Routes, Trust, Dividends and Shareholder Rights:**

5.1 Taxation Routes and Trust.

(a) Subject to the provisions of the Ordinance and applicable law, including the Listing Manual of the SGX-ST, (it being understood that, unless otherwise determined by the Committee, the following shall not apply to Options granted to non-Israeli Grantees),

(i) all grants of Options to employees, directors and office holders of the Company, other than to a Controlling Shareholder of the Company, shall be made only pursuant to the provisions of Section 102 of the Ordinance, the Income Tax Rules (Tax Relief in Issuance of Shares to Employees), 2003 (the "102 Rules") and any other regulations, rulings, procedures or clarifications promulgated thereunder ("102 Options"), or any other section of the Income Tax Ordinance that will be relevant for such issuance in the future; and

(ii) all grants of Options to Controlling Shareholders of the Company shall be made only pursuant to the provisions of Section 3(9) of the Ordinance and the rules and regulations promulgated thereunder ("3(9) Options"), or any other section of the Ordinance that will be relevant for such issuance in the future, and shall further be subject to any approval required by applicable law, including the Listing Manual of the SGX-ST.

ANNEX C

For the purposes of this Plan the term “Controlling Shareholder” shall mean a person holding, directly or indirectly, solely or jointly with his relative (i.e. spouse, brother, sister, parent, parent of parent, offspring or spouse of offspring, and the spouse of each of the foregoing), one of the following:

- (A) at least 10% of the outstanding share capital of the Company or at least 10% of the voting rights in the Company;
 - (B) the right(s) to hold or purchase at least 10% of the outstanding share capital of the Company or at least 10% of the voting rights in the Company;
 - (C) the right(s) to receive at least 10% of the profits of the Company;
 - (D) the right(s) to appoint a director of the Company.
- (iii) Notwithstanding the aforesaid in Sections 5.1(a)(i) and 5.1 (a)(ii), the Committee, at its discretion, may grant Options to any employee or director of the Company pursuant to the provisions of any tax ruling provided to the Company with respect to such Options by the Israeli Commissioner of Income Tax.
- (b) Subject to Sections 7.1 and 7.2 hereof, the effective date of the grant of an Option (the “Date of Grant”) shall be the date the Committee resolves to grant such Option, unless specified otherwise by the Committee in its determination relating to the award of such Option. The Committee shall promptly give the Grantee written notice substantially in the form set out in Schedule A to this Plan (the “Notice of Grant”) of the grant of an Option.
- (c) Trust. In the event Options are deposited under the Plan with a trustee designated by the Committee in accordance with the provisions of Section 3.4 hereof and, with respect to Options under a Taxation Route, approved by the Israeli tax authorities (the “Trustee”), the Trustee shall hold each such Option and the Shares issued upon exercise thereof in trust (the “Trust”) for the benefit of the Grantee in respect of whom such Option was granted (the “Beneficial Grantee”).

In accordance with Section 102, the tax benefits afforded to 102 Options (and any Shares issued upon exercise thereof) in accordance with the Ordinary Income Route or Capital Gains Route, as applicable, shall be contingent upon the Trustee holding such 102 Options for a period (the “Trust Period”) of at least (i) one year from the end of the tax year in which the 102 Options are granted, if the Company elects the Ordinary Income Route, or (ii) two years from the end of the tax year in which the 102 Options are granted, if the Company elects the Capital Gains Route, or (iii) such other period as shall be prescribed by the Ordinance or approved by the Israeli tax authorities.

In accordance with Section 102 and the 102 Rules, with respect to 102 Options granted to the Trustee, the following shall apply:

- (i) Upon receipt of granted 102 Options and as precondition to any entitlement thereof, the Grantee will sign an undertaking to release the Trustee from any liability in respect of any action and/or decision bona fide taken and executed in relation with the Plan, or any granted 102 Option or Share granted to him thereunder;
- (ii) A Grantee granted 102 Options shall not be entitled to sell the Shares issued upon exercise thereof or to transfer such Shares (or such 102 Options) from the Trust prior to the lapse of the Trust Period;

ANNEX C

- (iii) Any and all rights issued in respect of the Shares, including bonus shares but excluding cash dividends ("Rights"), shall be deposited with the Trustee and held thereby until the lapse of the Trust Period, and such Rights shall be subject to the Taxation Route which is applicable to such Shares.
- (iv) Notwithstanding the aforesaid, Shares or Rights may be sold or transferred, and the Trustee may release such Shares (or 102 Options) or Rights from Trust, prior to the lapse of the Trust Period, provided, however, that tax is paid or withheld in accordance with Section 102(b)(4) of the Ordinance and Section 7 of the 102 Rules.

All certificates representing Exercised Shares held in Trust under the Plan shall be deposited with the Trustee, and shall be held by the Trustee until such time that such Shares are released from the Trust as herein provided.

- (d) Subject to the terms hereof and specifically the provisions of Section 9 herein, at any time after the Options have vested, with respect to any Options or Shares the following shall apply: Upon the written request of any Beneficial Grantee, the Trustee shall release from the Trust the Options granted, and/or the Shares issued, on behalf of such Beneficial Grantee, by executing and delivering to the Company such instrument(s) as the Company may require, giving due notice of such release to such Beneficial Grantee, provided, however, that the Trustee shall not so release any such Options and/or Shares to such Beneficial Grantee unless the latter, prior to, or concurrently with, such release, provides the Trustee with evidence, satisfactory in form and substance to the Trustee, that all taxes, if any, required to be paid upon such release have, in fact, been paid.

- 5.2 Guarantee. In the event a 102(c) Option is granted to a Grantee who is an employee at the time of such grant, if the Grantee's employment is terminated, for any reason, such Grantee shall provide the Company with a guarantee or collateral securing the payment of all taxes required to be paid upon the sale of the Shares issued upon exercise of such 102(c) Option.
- 5.3 Dividend. All Shares issued upon the exercise of Options granted under this Plan shall entitle the Grantee thereof to receive dividends with respect thereto. For so long as Shares are held in the Trust, the dividends paid or distributed with respect thereto shall be distributed directly to such Beneficial Grantee, subject to applicable withholding tax requirements, and the Company shall provide appropriate notification to the Trustee of such distribution.
- 5.4 Shareholder Rights. Unless otherwise provided herein, the holder of an Option shall have no shareholder rights with respect to the Shares underlying such Option until such person shall have exercised the Option, paid the exercise price and become the record holder of the purchased Shares. Without derogating from the generality of the aforesaid, it is hereby acknowledged that the holder of Options shall not be deemed to be a class of shareholders or creditors of the Company for purpose of the operation of sections 350 and 351 of the Israeli Companies Law or any successor to such section, until registration of the Grantee as holder of such Shares in the Company's register of shareholders upon exercise of the Option in accordance with the provisions of the Plan. Subject to the provisions of the Plan and the provisions of the Articles of Association of the Company, the Shares shall entitle the Grantee thereof to full shareholder rights, including voting and dividend rights, with respect to such Shares. As long as the Shares are registered in the name of the Trustee, the voting rights at the Company's general meeting attached to such Shares will remain with the Trustee. However, the Trustee shall not be obligated to exercise such voting rights at general meetings, and may, in its sole discretion, empower another person, including the respective Beneficial Grantee, to vote in name and in place of the Trustee according to such Beneficial Grantee's instructions, if provided.

ANNEX C

6. **Reserved Shares:** Subject to adjustments as provided in Section 11 hereof, the aggregate number of new Shares for which the Committee may grant Options on any date, when added to the number of new Shares issued and issuable in respect of (a) all Options granted under the Plan, and (b) all awards granted under any other share option, share incentive, performance share or restricted share plan implemented by the Company and for the time being in force, shall not exceed fifteen percent (15%) of the issued share capital of the Company on the day preceding that date. Without derogating from the foregoing, the Committee shall have full authority in its discretion to determine that the Company may issue, for the purposes of the Plan, previously issued Shares that are held by the Company, from time to time, as Dormant Shares (as such term is defined in the Israeli Companies Law). All Shares under the Plan, in respect of which the right of an option holder to purchase the same shall, for any reason, terminate, expire or otherwise cease to exist, shall again be available for grant through Options under the Plans.

Without deviating from the generality of the foregoing, (1) the aggregate number of Shares for which the Committee may grant Options to Controlling Shareholders and their associates shall not exceed 25% of the Shares available under the Plan; and (2) the number of Shares for which the Committee may grant Options to each Controlling Shareholder or his associate shall not exceed 10% of the Shares available under the Plan.

7. **Grant of Options:**

- 7.1 The implementation of the Plan and the granting of any Option under the Plan shall be subject to the Company's procurement of all approvals and permits required by applicable law or regulatory authorities having jurisdiction over the Company, the Plan, the Options granted under it and the Shares subject thereto, including the Listing Manual of the SGX-ST.
- 7.2 The Notice of Grant shall state, *inter alia*, the number of Shares subject to each Option, the vesting schedule, the dates when the Options may be exercised, the exercise price, whether the Options granted thereby are 102 Options or 3(9) Options or other type of Options, and such other terms and conditions as the Committee at its discretion may prescribe, provided that they are consistent with this Plan. Each Notice of Grant evidencing a 102 Option shall, in addition, be subject to the provisions of the Ordinance applicable to such Options.
- 7.3 The grant of an Option hereunder shall be accepted by the Grantee within 30 days from the Date of Grant of that Option and, in any event, not later than 5.00 p.m. on the 30th day from such Date of Grant by completing, signing and returning the Acceptance Notice substantially in the form of Schedule B. The Grantee shall not be required to pay any consideration for the Grant of an Option hereunder.
- 7.4 If a grant of an Option is not accepted in the manner as provided in Section 7.3, such grant shall, upon the expiry of the 30 day period, automatically lapse and become null, void and of no effect.
- 7.5 Validity and Vesting. Without derogating from the rights and powers of the Committee under this Section 7.3, unless otherwise specified by the Committee, the Options shall be valid for a term of six (6) years from the Date of Grant and thereafter expire. Subject to Section 10 hereof, the Vesting Period (as defined below) pursuant to which an Option shall vest, and the Grantee thereof shall be entitled to pay for and acquire the Shares subject thereto, shall be determined in each case by the Committee, provided, however, that no Option granted hereunder will be exercisable prior to (i) the first anniversary of the Date of Grant; or (ii) in the case of Incentive Options (as defined below), the second anniversary of the Date of Grant.

ANNEX C

“Vesting Period” of an Option means, for the purpose of the Plan and its related instruments, the period between the Date of Grant and the date on which the Grantee may exercise the rights awarded pursuant to the terms of the Option. Unless otherwise determined by the Committee, any period in which the Grantee shall not be employed by the Company (or, in the case of directors, shall not be in the service of the Company) or in which the Grantee shall have taken an unpaid leave of absence (excluding maternity leave and military reserves), shall not be included in the Vesting Period.

“Incentive Options” means an Option granted with an Exercise Price (as defined in Section 8 herein) set at a discount from the Market Price (as defined in Section 8 herein).

- 7.6 Acceleration of Vesting. Subject to applicable law and regulations, including the Listing Manual of the SGX-ST, the Committee shall have full authority to, at any time, determine any provisions regarding the acceleration of the Vesting Period of any Option or the cancellation of all or any portion of any outstanding restrictions with respect to any Option or Share upon certain events or occurrences, and to include such provisions in the Notice of Grant on such terms and conditions as the Committee shall deem appropriate.
- 7.7 Repricing. Subject to applicable law and regulations, including the Listing Manual of the SGX-ST, the Committee shall have full authority to, at any time and from time to time, (i) grant in its discretion to the holder of an outstanding Option, in exchange for the surrender and cancellation of such Option, a new Option having an exercise price lower than provided in the Option (and related Notice of Grant) so surrendered and cancelled and containing such other terms and conditions as the Committee may prescribe in accordance with the provisions of the Plan, or (ii) effectuate a decrease in the Exercise Price of outstanding Options.
8. **Exercise Price:** The exercise price per Share subject to each Option shall be determined by the Committee in its sole and absolute discretion, subject to applicable law and regulations, including the Listing Manual of the SGX-ST, and may or may not be equal to the Market Price, provided, however, that in each case the maximum discount from the Market Price shall not exceed twenty percent (20%) of the Market Price (or such other percentage or amount as may be determined by the Committee and permitted by the SGX-ST). The criteria that the Committee can take into consideration when determining the quantum of such discounts include (but is not limited to) the performance of the Company, the individual performance of the Grantee and the contribution of the Grantee to the success and development of the Company. All discounts must have been approved beforehand by the shareholders of the Company in a separate resolution.

“Market Price” means a price equal to the average of the last dealt price for one Share on the SGX-ST over the five (5) consecutive trading days immediately preceding the Date of Grant, as determined by the Committee by reference to the daily official list or any other publication published by the SGX-ST, rounded to the nearest whole cent in the event of fractional prices.

9. **Exercise of Options:**
- 9.1 Options shall be exercisable pursuant to the terms under which they were awarded and subject to the terms and conditions of the Plan.
- 9.2 The exercise of an Option shall be made by a written notice of exercise substantially in the form set out in Schedule C (the “Notice of Exercise”) delivered by the Grantee (or, with respect to Options held in the Trust, by the Trustee upon receipt of written instructions from the Beneficial Grantee) to the Company at its principal executive office, specifying the number of Shares to be purchased and accompanied by the payment therefor, and complying with such other terms and conditions as the Committee shall prescribe from time to time.

ANNEX C

- 9.3 Anything herein to the contrary notwithstanding, but without derogating from the provisions of Section 10 hereof, if any Option has not been exercised and the Shares subject thereto not paid for within six (6) years after the Date of Grant (or any shorter period set forth in the Notice of Grant), such Option and the right to acquire such Shares shall terminate, all interests and rights of the Grantee in and to the same shall *ipso facto* expire, and, in the event that in connection therewith any Options are still held in the Trust as aforesaid, the Trust with respect thereto shall *ipso facto* expire, and the Shares underlying such Options shall again be available for grant through Options under the Plan, as provided for in Section 6 herein, provided the Plan shall be in force at such time.
- 9.4 Each payment for Shares shall be in respect of a whole number of Shares, and shall be effected in cash or by a bank's check payable to the order of the Company, or such other method of payment acceptable to the Company.
- 9.5 Notwithstanding the provisions of Section 9.4 above, the Company will be entitled in its sole discretion on a case-by-case basis and subject to any applicable law, to allow payment of the Exercise Price out of the proceeds from the sale of the Shares subject to Options, provided that the Company has ascertained the Grantee's ability to pay the exercise price at that time. Grantees are not entitled to demand that the Company, and the Company shall not be required to, act as described in this Section 9.5.

10. Termination of Employment:

10.1 Employees. In the event that a Grantee who was an employee of the Company on the Date of Grant of any Options to him or her ceases, for any reason, to be employed by the Company (the "Cessation of Employment"), unless otherwise determined by the Committee, all Options theretofore granted to such Grantee when such Grantee was an employee of the Company shall terminate as follows:

- (a) The date of the Grantee's Cessation of Employment shall be the date on which the employee-employer relationship between the Grantee and the Company ceases to exist (the "Date of the Cessation").
- (b) Subject to Section 10.1(c) below, all such Options that are not vested at the Date of Cessation shall terminate immediately.
- (c) If the Grantee's Cessation of Employment is by reason of such Grantee's death or "Disability" (as hereinafter defined), such Options shall be exercisable (to the extent vested) by the Grantee or the Grantee's guardian, legal representative, estate or other person to whom the Grantee's rights are transferred by will or by laws of descent or distribution, at any time until 12 months from the Date of Cessation, and shall thereafter terminate.

For purposes hereof, "Disability" shall mean the inability to engage in any substantial gainful occupation for which the Grantee is suited by education, training or experience, by reason of any medically determinable physical or mental impairment that is expected to result in such person's death or to continue for a period of six (6) consecutive months or more.

- (d) If the Grantee's Cessation of Employment is due to any reason other than those stated in Sections 10.1(c), 10.1(e) and 10.1(f) herein, such Options (to the extent vested at the Date of Cessation) shall be exercisable at any time until 90 days after the Date of Cessation, and shall thereafter terminate; provided, however, that if the Grantee dies within such period, such Options (to the extent vested at the Date of Cessation) shall be exercisable by the Grantee's legal representative, estate or other person to whom the Grantee's rights are transferred by will or by laws of descent or distribution at any time until 12 months from the Date of Cessation, and shall thereafter terminate.

ANNEX C

- (e) Notwithstanding the aforesaid, if the Grantee's Cessation of Employment is due to (i) breach of the Grantee's duty of loyalty towards the Company, or (ii) breach of the Grantee's duty of care towards the Company, or (iii) the commission of any flagrant criminal offense by the Grantee, or (iv) the commission of any act of fraud, embezzlement or dishonesty towards the Company by the Grantee, or (v) a material breach of the Grantee's employment contract, or (vi) any unauthorized use or disclosure by the Grantee of confidential information or trade secrets of the Company, or (vii) any act constituting business competition with the Company or enabling, in the past, present or future, another party to compete with the Company, or (viii) any other intentional misconduct by the Grantee (by act or omission) adversely affecting the business or affairs of the Company in a material manner, or (ix) any act or omission by the Grantee which would allow for the termination of the Grantee's employment without severance pay, according to the Israeli Severance Pay Law, 1963, all the Options whether vested or not shall *ipso facto* expire immediately and be of no legal effect.
 - (f) Whether the Cessation of Employment of a particular Grantee is by reason of "Disability" for the purposes of paragraph 10.1(c) hereof, or is a termination of employment other than by reason of such Disability or retirement, or is for reasons as set forth in paragraph 10.1(e) hereof, shall be finally and conclusively determined by the Committee in its absolute discretion.
 - (g) Notwithstanding the aforesaid, under no circumstances shall any Option be exercisable after the specified expiration of the term of such Option.
- 10.2 Directors. In the event that a Grantee, who is a director of the Company, ceases, for any reason, to serve as such, the provisions of Sections 10.1(b), 10.1(c), 10.1(d), 10.1(e), and 10.1(g) above shall apply, *mutatis mutandis*. For the purposes of this Section 10.2, "Date of Cessation" shall mean the date on which the director ceases to serve as a director of the Company.
- 10.3 Notwithstanding the foregoing provisions of this Section 10, the Committee shall have the discretion, exercisable either at the time an Option is granted or thereafter, to:
- (a) extend the period of time for which the Option is to remain exercisable following the Date of Cessation to such greater period of time as the Committee shall deem appropriate, but in no event beyond the specified expiration of the term of the Option;
 - (b) permit the Option to be exercised, during the applicable exercise period following the Date of Cessation, not only with respect to the number of Shares for which such Option is exercisable at the Date of Cessation but also with respect to one or more additional instalments in which the Grantee would have vested under the Option had the Grantee continued in the employ or service of the Company.
- 11. Bonus Shares and Other Adjustments**
- 11.1 Bonus Shares.
- (a) If the Company distributes bonus shares, whose date of distribution is earlier than the actual date of exercise of Options (the "Exercise Date"), Shares in the number and kind that the Grantee would have been entitled to as bonus shares had he/she exercised the Options before the record date determining the right to receive bonus shares, will be added to the Shares to which the Grantee is entitled upon exercising the Options (the "Option Shares").
 - (b) The Exercise Price of each Option will not change as a result of the addition of such bonus shares, while other terms referring to the Option Shares will also apply to the bonus shares added to the Option Shares, *mutatis mutandis*.

ANNEX C

- (c) If the Company distributes bonus shares for which the record date for distribution and the date of distribution fall during the period in which Option Shares are registered in the name of the Trustee for Beneficial Grantees, the Company will transfer to the Trustee an amount of bonus shares according to the number of Option Shares registered in his name at the time of distribution, and the Trustee will hold them in Trust for the Beneficial Grantees. In the event Option Shares have been transferred from the Trustee to a Beneficial Grantee and/or sold by the Trustee at the Beneficial Grantee's request between the record date for distribution and the date of distribution, the Company will transfer bonus shares in respect of these Option Shares directly to such Beneficial Grantee. Each such Grantee will be entitled to bonus shares in the same number and kind to which he would have been entitled, had the Option Shares been held by him prior to the record date for the right to receive the bonus shares.
- 11.2 Adjustments. Without deviating from the aforesaid in this Section 11, subject to any required action by the Shareholders, the number of Option Shares, and the number of Shares which have been authorized for issuance under the Plan but as to which no Options have yet been granted or which have been returned to the Plan upon cancellation or expiration of an Option, as well as the Exercise Price for each outstanding Option, shall be proportionately adjusted for any increase or decrease in the number of issued Shares resulting from a stock split, reverse stock split, combination or reclassification of the Shares or any other increase or decrease in the number of issued Shares effected without receipt of consideration by the Company; provided, however, that conversion of any convertible securities of the Company shall not be deemed to have been "effected without receipt of consideration". Such adjustment shall be made by the Committee, whose determination in that respect shall be final, binding and conclusive. The issue of Shares as consideration for an acquisition would normally not be regarded as a circumstance requiring adjustment.
- 11.3 Notwithstanding the provisions of Sections 11.1 and 11.2 above:
- (a) no such adjustment shall be made if as a result the Grantee receives a benefit that a Shareholder does not receive; and
- (b) any adjustment (except in relation to a capitalization issue) must be confirmed in writing by the auditors of the Company (acting only as experts and not as arbitrators) to be in their opinion, fair and reasonable.
- 11.4 Except as expressly provided in this Section 11, no issuance by the Company of shares of any class, or securities convertible into shares of any class, shall affect, and no adjustment by reason thereof shall be made with respect to, the number or Exercise Price of Option Shares subject to an Option.
- 11.5 Except as expressly provided in this Section 11, the grant of Options under the Plan shall in no way affect the right of the Company to distribute bonus shares, to offer rights to purchase its securities, to distribute cash dividends, or to adjust, reclassify, reorganize or otherwise change its capital.
12. **Liquidation and Corporate Transaction:**
- 12.1 Definitions:
- "Corporate Transaction" means the occurrence, in a single transaction or in a series of related transactions, of any one or more of the following events:
- (i) a sale or other disposition of all or substantially all, as determined by the Board in its discretion, of the consolidated assets of the Company and its subsidiaries;
- (ii) a sale or other disposition of at least eighty percent (80%) of the outstanding securities of the Company;

ANNEX C

- (iii) a merger, consolidation or similar transaction following which the Company is not the surviving corporation; or
- (iv) a merger, consolidation or similar transaction following which the Company is the surviving corporation but the Ordinary Shares of the Company outstanding immediately preceding the merger, consolidation or similar transaction are converted or exchanged by virtue of the merger, consolidation or similar transaction into other property, whether in the form of securities, cash or otherwise.

12.2 Liquidation. Unless otherwise provided by the Board, in the event of the proposed dissolution or liquidation of the Company, all outstanding Options will terminate immediately prior to the consummation of such proposed action. In such case, the Committee may declare that any Option shall terminate as of a date fixed by the Committee and give each Grantee the right to exercise his Option, including any Option that would not otherwise be exercisable.

12.3 Corporate Transaction.

- (a) In the event of a Corporate Transaction, immediately prior to the effective date of such Corporate Transaction, the Committee may, at its sole and absolute discretion, take any action with respect to any outstanding Options which it deems advisable to effectuate the Corporate Transaction, including among others, resolving that each Option shall:
 - (i) be substituted for an option to purchase securities of any successor entity (the "Successor Entity Option") such that the Grantee may exercise the Successor Entity Option for such number and class of securities of the successor entity which would have been issuable to the Grantee in consummation of such Corporate Transaction, had the Option been exercised immediately prior to the effective date of such Corporate Transaction, given the exchange ratio or consideration paid in the Corporate Transaction, the vesting of the Options and such other terms and factors that the Committee determines to be relevant for purposes of calculating the number of Successor Entity Options granted to each Grantee; and/or
 - (ii) be assumed by any successor entity such that the Grantee may exercise the Option for such number and class of securities of the successor entity which would have been issuable to the Grantee in consummation of such Corporate Transaction, had the Option been exercised immediately prior to the effective date of such Corporate Transaction; given the exchange ratio or consideration paid in the Corporate Transaction, the vesting of the Options and such other terms and factors that the Committee determines to be relevant for purposes of calculating the number of Options granted to each Grantee.

In the event of a clause (i) or clause (ii) action, appropriate adjustments shall be made to the exercise price per Share to reflect such action.

- (b) Immediately prior to the consummation of the Corporate Transaction, all outstanding Options shall terminate and cease to be outstanding, except to the extent assumed by a successor entity.
- (c) Notwithstanding the foregoing, and without derogating from the power of the Committee pursuant to the provisions of this Plan, the Committee shall have full authority and sole discretion to determine that any of the provisions of Sections 12.3(a)(i) and/or 12.3(a)(ii) above shall apply in the event of a Corporate Transaction in which the consideration received by the shareholders of the Company is not solely comprised of securities of a successor entity, or in which such consideration is solely cash or assets other than securities of a successor entity.

ANNEX C

- 12.4 Sale. Subject to any provision in the Articles of Association of the Company and to the Committee's sole and absolute discretion, in the event that all or substantially all of the issued and outstanding share capital of the Company is to be sold (the "Sale"), each Grantee shall be obligated to participate in the Sale and sell his or her Shares and/or Options in the Company, provided, however, that each such Share or Option shall be sold at a price equal to that of any other Share sold under the Sale (minus the applicable exercise price), while accounting for changes in such price due to the respective terms of any such Option.

With respect to Shares held in Trust the following procedure will be applied: The Trustee will transfer the Shares held in Trust and sign any document in order to effectuate the transfer of Shares, including share transfer deeds, provided, however, that the Trustee receives a notice from the Board, specifying that: (i) all or substantially all of the issued outstanding share capital of the Company is to be sold, and therefore the Trustee is obligated to transfer the Shares held in Trust; (ii) the Company is obligated to withhold at the source all taxes required to be paid upon release of the Shares from the Trust and to provide the Trustee with evidence, satisfactory to the Trustee, that such taxes indeed have been paid; (iii) the Company is obligated to transfer the consideration for the Shares directly to the Grantees.

- 12.5 The grant of Options under the Plan shall in no way affect the right of the Company to change its capital or business structure or to merge, consolidate, dissolve, liquidate or sell or transfer all or any part of its business or assets.

13. **Limitations on Transfer:** No Option shall be assignable or transferable by the Grantee to whom granted otherwise than by will or the laws of descent and distribution, and an Option may be exercised during the lifetime of the Grantee only by such Grantee or by such Grantee's guardian or legal representative. The terms of such Option shall be binding upon the beneficiaries, executors, administrators, heirs and successors of such Grantee.

14. **Term and Amendment of the Plan:**

- 14.1 The Plan shall come into force following its adoption by the Shareholders. The Plan shall terminate upon the earliest of (i) the expiration of the ten (10)-year period measured from the date it was adopted by the Shareholders, or (ii) the termination of all outstanding Options in connection with a Corporate Transaction. All Options outstanding at the time of a clause (i) termination event shall continue to have full force and effect in accordance with the provisions of the Plan and the documents evidencing such Options.

- 14.2 Subject to applicable laws and regulations, including the Listing Manual of the SGX-ST, the Board in its discretion may, at any time and from time to time, amend or modify this Plan, except that:

- (a) no amendment or modification shall adversely affect any rights and obligations with respect to Options at the time outstanding under the Plan, unless the applicable Grantee consents to such amendment or modification;
- (b) provisions of Rules 3 (Administration), 4 (Eligible Grantees), 5.2 (Guarantee), 5.3 (Dividend), 5.4 (Shareholder Rights), 7 (Grant of Options), 8 (Exercise Price), 9 (Exercise of Options), 11 (Bonus Shares and other Adjustments), 12 (Liquidation and Corporate Transaction), 13 (Limitations on Transfer) and this Rule shall not be amended or modified to the advantage of Grantees under the Plan except with the prior approval of the Shareholders; and
- (c) no amendment or modification shall be made without the prior approval of the SGXST and such other regulatory authorities as may be necessary.

ANNEX C

15. **Withholding and Tax Consequences:** The Company's obligation to deliver Shares upon the exercise of any Options granted under the Plan shall be subject to the satisfaction of all applicable income tax and other compulsory payments withholding requirements. All tax consequences and obligations regarding any other compulsory payments arising from the grant or exercise of any Option, from the payment for, or the subsequent disposition of, Shares subject thereto or from any other event or act (of the Company, of the Trustee or of the Grantee) hereunder, shall be borne solely by the Grantee, and the Grantee shall indemnify the Company and/or the Trustee, as applicable, and hold them harmless against and from any and all liability for any such tax or other compulsory payment, or interest or penalty thereon, including without limitation, liabilities relating to the necessity to withhold, or to have withheld, any such tax or other compulsory payment from any payment made to the Grantee.
16. **Disclosure in Annual Report:** The following disclosures (as applicable) will be made by the Company in its annual report for so long as the Plan continues in operation:
- (a) the names of the members of the Committee administering the Plan;
 - (b) the information in respect of Options granted to the following Grantees in the table set out below:
 - (i) Directors of the Company; and
 - (ii) Grantees who are Controlling Shareholders and their associates; and
 - (iii) Grantees, other than those in (i) and (ii) above, who receive five percent (5%) or more of the total number of Shares available under the Plan.

Name of Grantee	Number of Shares comprised in Options granted during financial year under review (including terms)	Aggregate number of Shares comprised in Options granted since commencement of Plan to end of financial year under review	Aggregate number of Shares comprised in Options exercised since commencement of Plan to end of financial year under review	Aggregate number Shares comprised in Options outstanding at as end of financial year under review
[●]	[●]	[●]	[●]	[●]

- (c) the number of Incentive Options during the financial year under review in the following bands:

Discount to the Market Price %	Aggregate number of Incentive Options granted during the financial year under review	Proportion of Incentive Options to Market Price Options granted during the financial year under review
0-10	[●]	[●]
11-20	[●]	[●]

In the event that the disclosure of any of the aforementioned information is not applicable, an appropriate negative statement will be included in the Annual Report.

17. **Miscellaneous:**

- 17.1 Continuance of Employment. Neither the Plan nor the grant of an Option thereunder shall impose any obligation on the Company to continue the employment or service of any Grantee. Nothing in the Plan or in any Option granted thereunder shall confer upon any Grantee any right to continue in the employ or service of the Company for any period of specific duration, or interfere with or otherwise restrict in any way the right of the Company to terminate such employment or service at any time, for any reason, with or without cause.

ANNEX C

- 17.2 Requirement of Law. Notwithstanding anything to the contrary in this Plan, the grant of Options and the issuance of Shares under the Plan to Grantees who are non Israeli residents, shall not be governed by Section 102 or Section 3(9) and shall be subject to all applicable laws, rules and regulations, including the Listing Manual of the SGX-ST, and to such approvals as may be required by any governmental agency of the country of residence of such Grantees.
- 17.3 Governing Law. The Plan and all instruments issued thereunder or in connection therewith, shall be governed by, and interpreted in accordance with, the laws of the State of Israel.
- 17.4 Use of Funds. Any proceeds received by the Company from the sale of Shares pursuant to the exercise of Options granted under the Plan shall be used for general corporate purposes of the Company.
- 17.5 Multiple Agreements. The terms of each Option may differ from other Options granted under the Plan at the same time, or at any other time. The Committee may also grant more than one Option to a given Grantee during the term of the Plan, either in addition to, or in substitution for, one or more Options previously granted to that Grantee. The grant of multiple Options may be evidenced by a single Notice of Grant or multiple Notices of Grant, as determined by the Committee.
- 17.6 Non-Exclusivity of the Plan. Unless expressly stated herein, the adoption of the Plan by the Board and the Shareholders shall not be construed as amending, modifying or rescinding any previously approved incentive arrangement or as creating any limitations on the power of the Board or Shareholders to adopt such other incentive arrangements as it may deem desirable, including, without limitation, the granting of stock options otherwise than under the Plan, and such arrangements may be either applicable generally or only in specific cases.

ANNEX C

Schedule A

SARIN TECHNOLOGIES LTD 2005 SHARE OPTION PLAN

NOTICE OF GRANT

Serial No.: _____

Date: _____

To: [Name]
[Designation]
[Address]

Private and Confidential

Dear Sir/Madam

1. We have the pleasure of informing you that you have been nominated to participate in the Sarin Technologies Ltd 2005 Share Option Plan (the "Plan") by the Board of Directors (the "Board") of Sarin Technologies Ltd (the "Company") to administer the Plan. Terms as defined in the Plan shall have the same meaning when used in this Notice of Grant.
2. Accordingly, an offer is hereby made to grant you [●] [102 / 3(9) / Incentive]* Options (the "Options"), each to subscribe for and be allotted one (1) Share at the Exercise Price of S\$[●]. The Options awarded to you should you accept this offer will be held in trust to secure performance of Israeli tax requirements (see discussion in Section 7 below).
3. The Options are exercisable no later than 10 years after the date hereof. The Options shall vest over a period of _____ years, according to the following vesting schedule:

[{Insert vesting schedule}].

4. The Options are personal to you and shall not be transferred, charged, pledged, assigned or otherwise disposed of by you, in whole or in part, except with the prior approval of the Company.
5. The Options shall be subject to the terms of the Plan, a copy of which is available for inspection at the business address of the Company.
6. Section 102 of the Income Tax Ordinance and its Regulations:
 - 6.1 Should you accept this offer, the award of Options will be subject to the provisions of Section 102 of the Israeli Income Tax Ordinance [New version] 1961 (the "Ordinance" and "Section 102", respectively), as well as the rules, which were promulgated thereunder - the Income Tax Rules (Tax Relief in Issuance of Shares to Employees), 2003 (the "102 Rules"). The complete version of Section 102 and the 102 Rules is available for inspection at the business address of the Company.

ANNEX C

- 6.2 Accordingly, the Company elected the Capital Gains Route in Section 102(b)(2) of the Ordinance for the purpose of the taxation of income attributed to you as a result of the grant of Options (the "Capital Gains Route"). In general and subject to the provisions of the Ordinance and/or any other applicable law, taxable income that should be attributed to you as a result of the grant of the Options will be tax-free on the date of grant, but will be taxed on the sale of Shares or transfer of Shares from the Trustee in your name. In accordance with the Capital Gains Route, if the Options or the Shares received upon exercise of the Options are held in trust by the Trustee until **31 December 2006 (for grants made in 2005)]** (the "Trust Period"), gains derived from such Options or Shares shall be classified as capital gains and taxed at a rate of only 25% (as apposed to marginal tax rates, social security and national health insurance payments). However, if the Shares are sold (or if the Shares or Options are released from Trust) prior to the lapse of the Trust Period, in accordance with Section 102(b)(4) of the Ordinance and Section 7 of the 102 Rules, gains derived from such sale shall be deemed ordinary income and subject to tax at marginal tax rates (currently up to 50%), social security and national health insurance payments.
- 6.3 At the time of sale of the Shares or the transfer of the Options and/or the Shares from the Trustee to you, you shall be subject to tax that will be calculated according to the difference between the market price (or the actual sale price) of the Shares at that time and the Exercise Price (as set forth in Section 2 above). You shall solely bear all tax consequences and compulsory payments under applicable law, which may arise in connection with the Options. The Company or the Trustee shall withhold at the source any tax required by applicable law to be withheld with respect to the Options. The transfer of Shares to you is conditioned upon the payment of all taxes as aforesaid. **YOU ARE ADVISED YOU ARE ADVISED TO CONSULT A TAX ADVISER WITH RESPECT TO THE TAX CONSEQUENCES OF RECEIVING OR EXERCISING THIS OPTION OR DISPOSING OF THE SHARES.**
7. Trust:
- 7.1 To secure performance of tax requirements, the Options awarded to you should you accept this offer will be held in trust by Eyal Khayat, Adv. (the "Trustee") that was approved for this purpose by the Israeli tax authorities, and shall be released to you only upon full compliance with the legal requirements and the terms of the Plan. For this purpose, a Trust Instrument was signed between the Company and the Trustee, a copy of which is attached hereby as **Exhibit "A"**. The conditions under the Trust Instrument are also imposed upon the Options awarded to you; thus, you are required to read carefully the provisions of the said Trust Instrument.
- 7.2 You shall not be entitled to sell the Shares allotted upon exercise of Options or to transfer such Shares or the Options from the Trust prior to the Trust Period.
- 7.3 Any and all rights issued in respect of the Shares, including bonus shares but excluding cash dividends ("Rights"), shall be issued to the Trustee and held thereby until the lapse of the Trust Period, and such Rights shall be subject to the Capital Gains Route.
- 7.4 Notwithstanding the aforesaid, Shares or Rights may be sold or transferred, and the Trustee may release such Shares or Options or Rights from Trust, prior to the lapse of the Trust Period, provided however, that tax is paid or withheld in accordance with Section 102(b)(4) of the Ordinance and Section 7 of the 102 Rules, as described in Section 7 hereinabove.
8. It is hereby clarified that reading this notice is not, and cannot be, a substitute for the full and thorough reading of the Plan. The Plan and the Trust Instrument include important details that you should know and understand. In any case of contradiction between the aforesaid in this notice and the Plan, or in any case of dispute on any of the issues discussed in this notice, the Plan shall prevail.

ANNEX C

9. If you wish to accept the offer of the Option on the terms of this notice, please sign and return the enclosed Acceptance Form no later than 5.00 p.m. on [●]. **This offer will lapse if you fail to return the Acceptance Form until such time.**

Yours faithfully,
for and on behalf of
SARIN TECHNOLOGIES LTD

By: _____

Name:

Designation:

ANNEX C

Schedule B

SARIN TECHNOLOGIES LTD 2005 SHARE OPTION PLAN

ACCEPTANCE NOTICE

Serial No.: _____

Date: _____

To: Sarin Technologies Ltd
4 Hahilazon Street,
Ramat Gan 52522
Israel

Closing Date for Acceptance of Offer :
Number of Share Offered :
Exercise Price for each Share : S\$

I have read your Notice of Grant dated _____ and agree to be bound by the terms of the Notice of Grant and the Plan referred to therein as well as the terms of the Trust Instrument, and I declare that I am familiar with the provisions of Section 102 and the Capital Gains Route. Terms defined in your Notice of Grant shall have the same meanings when used in this Acceptance Notice.

I hereby accept the offer to be granted _____ Options each to subscribe for one (1) Share.

I understand that I am not obliged to exercise the Options.

I confirm that my acceptance of the Options will not result in the contravention of any applicable law regulation in relation to the ownership of Shares in the Company or options to subscribe for such Shares.

I hereby agree to indemnify the Company and/or its affiliates and/or the Trustee and hold them harmless against and from any and all liability for any such tax or interest or penalty thereon, including without limitation, liabilities relating to the necessity to withhold, or to have withheld, any such tax from any payment made to me.

I agree to keep all information pertaining to the grant of the Options to me confidential.

I further acknowledge that you have not made any representation to induce me to accept the offer and that the terms of the Notice of Grant, the Plan and this Acceptance Notice constitute the entire agreement between us relating to the offer.

I hereby undertake not to sell or transfer the Options and/or the Shares prior to the lapse of the Trust Period, unless I pay all taxes that may arise in connection with such sale and/or transfer of Options and/or Shares.

Name in full : _____

Designation : _____

Address : _____

Nationality : _____

*NRIC/Passport No. : _____

Signature : _____

Note: * Delete accordingly

ANNEX C

Schedule C

SARIN TECHNOLOGIES LTD 2005 SHARE OPTION PLAN

NOTICE OF EXERCISE

Total number of Ordinary Shares ("Shares") :
offered at [S\$] _____ for each
Share (the "Exercise Price") under the Plan on
_____ (the "Date of Grant").

Number of Shares previously allotted thereunder :

Outstanding balance Shares to be allotted thereunder :

Number of Shares now to be subscribed :

To: Sarin Technologies Ltd
4 Hahilazon Street,
Ramat Gan 52522
Israel

1. Pursuant to your Notice of Grant dated _____ and my acceptance thereof, I hereby exercise [] [102 / 3(9) / Incentive]* Options to subscribe for _____ Shares in Sarin Technologies Ltd. (the "Company") at [S\$] _____ for each Share.
2. I enclose a *cheque cashier's order/banker's draft/postal order no. _____ for [S\$] _____ by way of subscription for the total number of the said Shares.
3. I agree to subscribe for the said Shares subject to the terms of the Notice of Grant, the Sarin Technologies Ltd 2005 Share Option Plan and the Memorandum and Articles of Association of the Company.
4. I declare that I am subscribing for the said Shares for myself and not as a nominee for any other person.
5. I request the Company to allot and issue the Shares in the name of The Central Depository (Pte) Limited (CDP) for credit of the Trustee's *Securities Account with CDP/Sub Account with the Depository Agent specified below to be held in trust for me and I hereby agree to bear such fees or other charges as may be imposed by CDP in respect thereof.

ANNEX C

Please print in block letters

Name in full : _____

Designation : _____

Address : _____

Nationality : _____

*NRIC/Passport No. : _____

Name of Depository Agent : _____

Signature : _____

Date : _____

Note:* *Delete accordingly*

cc: **[●] TRUSTS**
 Tel Aviv _____
 Israel

ANNEX D

DESCRIPTION OF SINGAPORE AND ISRAELI LAW AND REGULATIONS RELATING TO TAXATION

SINGAPORE

The following is a summary of certain tax matters arising under the current tax laws in Singapore and is not intended to be and does not constitute legal or tax advice. While this discussion is considered to be a correct interpretation of existing laws in force as at the date of this Prospectus, no assurance can be given that courts or fiscal authorities responsible for the administration of such laws will agree with this interpretation or that changes in such laws (which may be retrospective) will not occur. The summary is limited to a general description of certain tax consequences in Singapore with respect to ownership of our Shares by Singapore investors, and does not purport to be a comprehensive nor exhaustive description of all of the tax considerations that may be relevant to a decision to purchase our Shares.

Prospective investors should consult their tax advisors regarding Singapore tax and other tax consequences of owning and disposing our Shares. It is emphasised that neither our Company, our Directors nor any other persons involved in the Invitation accept responsibility for any tax effects or liabilities resulting from the subscription for, purchase, holding or disposal of our Shares.

General

Singapore tax residents are subject to Singapore income tax on income that is accrued in or derived from Singapore and on foreign income received or deemed received in Singapore, subject to certain exceptions.

Non-resident corporate taxpayers are subject to income tax on income that is accrued in or derived from Singapore, and on foreign income received or deemed received in Singapore. Non-resident individuals are subject to income tax on the income accrued in or derived from Singapore.

For Singapore tax resident corporate taxpayers, all foreign-sourced dividends, branch's profits and services income received/remitted on or after 1 June 2003 will be tax exempt in Singapore subject to certain prescribed conditions. The exemption applies to income earned from jurisdictions with "headline" tax rate of at least 15% and the income must be taxed in the foreign jurisdiction from which the income is received.

For Singapore tax resident individuals, all foreign-sourced income received in Singapore are exempt from Singapore tax with effect from Year of Assessment 2005 unless the said income is received through a partnership in Singapore (subject to certain exceptions).

A company is tax resident in Singapore if the control and management of its business is exercised in Singapore. Normally, control and management of the company is vested in the board of directors and the company is resident in the country where the directors meet. An individual is tax resident in Singapore in a year of assessment if, in the preceding year, he was physically present in Singapore or exercised an employment in Singapore (other than as a director of a company) for 183 days or more, or if he resides in Singapore.

The corporate tax rate in Singapore is currently 20% after allowing for tax exemption on 75% of the first \$10,000 and 50% of the next \$90,000 of a company's chargeable income. The above partial tax exemption will not apply to Singapore dividends received by companies.

For a Singapore tax resident individual, the rate of tax will vary according to the individual's chargeable income but is subject to a maximum marginal rate of 22% for the year of assessment 2005. In the 2005 Budget announced on 18 February 2005, the Prime Minister and Minister for Finance proposed to reduce the top personal income tax rate to 20% in two stages - first from 22% to 21% in the year of assessment 2006 and then to 20% in the year of assessment 2007. This proposal has not been promulgated as a law yet.

ANNEX D

Dividend Distributions

As the Company was incorporated in Israel and will be non-tax resident in Singapore, dividends paid by the Company would be considered as sourced outside Singapore.

Foreign sourced income is subject to Singapore income tax when remitted or deemed remitted to Singapore by corporate taxpayers in Singapore. As dividends on the Shares will be paid through the CDP the dividends will be regarded as remitted to Singapore.

Corporate taxpayers in Singapore will be liable to tax in Singapore on these dividends.

For tax resident corporate taxpayers, the foreign-sourced dividends will be tax exempt if the prescribed conditions for exemption of specified foreign income are met. Where the foreign dividends do not qualify for tax exemption for specified foreign income and are deemed to be business income sourced in Singapore, the dividends will be liable to tax in Singapore, regardless of whether they are received in Singapore or elsewhere.

Where the investors are foreign companies and have activities in Singapore, foreign dividends received in Singapore through the CDP by such investors may be subject to tax in Singapore if the dividends are in respect of investments made through their Singapore-based activities or the dividends are otherwise connected with their Singapore-based activities.

Foreign-sourced dividends received or deemed received in Singapore by an individual whether resident or not resident in Singapore is exempt from Singapore income tax.

Gains on Disposal of our Shares

Singapore does not impose tax on capital gains. There are no specific laws or regulations which deal with the characterisation of capital gains. Gains may be construed to be of an income nature and subject to tax especially if they arise from activities which the Inland Revenue Authority of Singapore regards as the carrying on of a trade or business in Singapore.

Any profits from the disposal of our Shares are not taxable in Singapore unless the seller is regarded as having derived gains from the carrying on of a trade or business in Singapore or the gains are regarded as gains of an income nature, in which case, the disposal profits would be taxable.

Stamp Duty

There is no stamp duty payable on the subscription of our Shares.

Stamp duty is payable on the instrument of transfer of our Shares at the rate of \$2.00 for every \$1,000 of the consideration for, or market value of our Shares whichever is higher.

The purchaser is liable for stamp duty, unless there is an agreement to the contrary. No stamp duty is payable if no instrument of transfer is executed or the instrument of transfer is executed outside Singapore. However, stamp duty may be payable if the instrument of transfer which is executed outside Singapore is received in Singapore.

The above stamp duty is not applicable to electronic transfers of our Shares through the CDP.

Estate Duty

Singapore estate duty is imposed on the value of immovable property situated in Singapore owned by individuals who at the time of death are not domiciled in Singapore, subject to specific exemption limits. Movable assets of individuals domiciled outside Singapore will be exempt from estate duty. Our shares are considered to be movable property.

ANNEX D

Our Shares held by an individual domiciled in Singapore are subject to Singapore estate duty upon such individual's death. Singapore estate duty is payable to the extent that the value of our Shares aggregated with any other assets subject to Singapore estate duty exceeds \$600,000. Unless other exemptions apply to the other assets, for example, the separate exemption limit for residential properties, any excess beyond \$600,000 will be taxed as follows:

First \$12,000,000	5%
Excess over \$12,000,000	10%

Individuals should consult their own tax advisors regarding the Singapore estate duty consequences of their ownership of our Shares.

Goods and Services Tax ("GST")

The sale of our Shares by a GST-registered investor belonging in Singapore through a SGX-ST member or to another person belonging in Singapore is an exempt sale not subject to GST. Any GST (for example, GST on brokerage) incurred by the investor in respect of the shares sold by him will become an additional cost to the investor.

Where our Shares are sold by a GST-registered investor in the course of or furtherance of a business carried on by him to a person belonging outside Singapore, the sale is a taxable supply subject to GST at zero rate. Any GST incurred by the GST-registered investor in the making of this supply in the course of or furtherance of a business may be recovered from the Comptroller of GST.

Services such as brokerage, handling and clearing services rendered by a GST-registered person to an investor belonging in Singapore in connection with the investor's purchase, sale or holding of the shares will be subject to GST at the current rate of 5%. Similar services rendered to and for an investor belonging outside Singapore are subject to GST at zero rate.

ISRAEL

The following is a discussion of certain tax matters arising under the current tax laws in Israel and is not intended to be and does not constitute legal or tax advice. While this discussion is considered to be a correct interpretation of existing laws in force as at the date of this Prospectus, no assurance can be given that courts or fiscal authorities responsible for the administration of such laws will agree with this interpretation or that changes in such laws will not occur. The discussion is limited to a general description of certain tax consequences in Israel with respect to companies, with special reference to its effect on us, and ownership of our Shares by investors, and does not purport to be a comprehensive nor exhaustive description of all of the tax considerations that may be relevant to a decision to purchase our Shares.

Prospective investors should consult their tax advisors regarding Israeli tax and other tax consequences of owning and disposing our shares. It is emphasised that neither our Company, our directors nor any other persons involved in the invitation accepts responsibility for any tax effects or liabilities resulting from the subscription for, purchase, holding or disposal of our Shares.

General – Tax Reform

- On 1 January 2003, the Law for Amendment of the Income Tax Ordinance (Amendment No. 132), 5762-2002, as amended, known as the "Tax Reform," came into effect. The Tax Reform, aimed at broadening the categories of taxable income and reducing the tax rates imposed on employment income, introduced the following, among other things:
- Imposition of Israeli tax on all income of Israeli residents, individuals and corporations, regardless of the territorial source of income, including income derived from passive sources such as interest, dividends and royalties;

ANNEX D

- Imposition of capital gain tax on capital gains, realized by individuals resident in Israel beginning 1 January 2003, from the sale of shares of publicly traded companies on the Tel Aviv Stock Exchange (such gain was previously exempt from capital gains tax in Israel) and from the sale of shares of publicly traded Israeli companies on certain other stock exchanges. For information with respect to the applicability of Israeli capital gains taxes on the sale of our Shares, see "Taxation of Investors Owning our Shares-Capital Gains Tax in Israel" below;
- Reduction of the tax rate levied on capital gains (other than gains deriving from the sale of listed securities) derived after 1 January 2003, to a general rate of 25% (with certain exceptions) for both individuals and corporations. In addition, the tax reform enables a carry-forward of capital losses generated in 1996 and onwards without any time restrictions;
- Introduction of controlled foreign corporation (CFC) rules into the Israeli tax structure. Generally, under such rules, an Israeli resident who holds, directly or indirectly, 10% or more of the rights in a foreign corporation whose shares are not publicly traded (or which has offered less than 30% of its shares or any rights to its shares to the public), in which more than 50% of the rights are held directly or indirectly by Israeli residents, and a majority of its income in a tax year is considered passive income (which was taxed at a rate of less than 20%), will be liable for tax on the portion of such income attributed to his/her holdings in such corporation, as if such income were distributed to him/her as a dividend;
- Effectuation of a new regime for the taxation of shares and options issued to employees, officers and directors; and
- Introduction of tax at a rate of 25% on dividends paid by one Israeli company to another (which are generally not subject to tax), if the source of such dividends is income that was derived outside of Israel.

Taxation of the Company

Corporate Tax

Most Israeli companies were subject to corporate tax at the rate of 36%, up to the tax year 2003, of their taxable income (and are subject to capital gains tax at a rate of 25% for capital gains derived after 1 January 2003, other than gains deriving from the sale of listed securities). However, as in our case, the rate is effectively reduced for income derived from an "Approved Enterprise", as set forth below.

On 29 June 2004, the Israeli parliament passed a new tax law reducing the corporate tax rate from 36% to 35% for the 2004 tax year, 34% for the 2005 tax year, 32% for the 2006 tax year and 30% for the 2007 tax year and thereafter.

Special Provisions Relating to Taxation Under Inflationary Conditions

The Income Tax Law (Inflationary Adjustments), 1985, generally referred to as the Inflationary Adjustments Law, represents an attempt to overcome the problems presented to a traditional tax system by an economy undergoing rapid inflation. The Inflationary Adjustments Law is highly complex. The features that are material to us can be described as follows:

- Where a company's equity, as calculated under the Inflationary Adjustments Law, exceeds the depreciated cost of its Fixed Assets (as defined in the Inflationary Adjustments Law), a deduction from taxable income is permitted equal to the excess multiplied by the applicable annual rate of inflation. The maximum deduction permitted in any single tax year is 70% of taxable income, with the unused portion permitted to be carried forward.
- Where a company's depreciated cost of Fixed Assets exceeds its equity, then the excess multiplied by the applicable annual rate of inflation is added to taxable income.
- Subject to specified limitations, depreciation deductions on Fixed Assets and losses carried forward are adjusted for inflation based on the increase in the consumer price index.

ANNEX D

However, the Israel Minister of Finance may, with the approval of the Finance Committee of the Knesset (the Israeli parliament), determine by order, during a certain fiscal year (or until February 28th of the following year) in which the rate of increase of the price index would not exceed or shall not have exceeded, as applicable, 3%, that all or some of the provisions of this Law shall not apply to such fiscal year, or, that the rate of increase of the price index relating to such fiscal year shall be deemed to be 0%, and to make the adjustments required to be made as a result of such determination.

Law for the Encouragement of Capital Investments, 1959

The Law for Encouragement of Capital Investments, 1959 (the "Investments Law"), provides that capital investments in a production facility (or other eligible assets) may, upon approval by the Investment Center of the Israel Ministry of Industry and Trade (the "Investment Center"), be designated as an Approved Enterprise. The Investments Law will expire on 31 March 2005 (however, a ministerial committee with the approval of the parliamentary finance committee can approve a further extension up to no later than 30 June 2005). Accordingly, requests for new programs or expansions that are not approved on or before 31 March 2005 will not confer any tax benefits, unless the term of the law will be extended. Each certificate of approval for an Approved Enterprise relates to a specific investment program, delineated both by the financial scope of the investment and by the physical characteristics of the facility or the asset. The tax benefits from any such certificate of approval relate only to taxable profits attributable to the specific Approved Enterprise. An Approved Enterprise is entitled to benefits, including Israeli Government cash grants, which are made available if it is located in a government designated development area, and/or tax benefits. As discussed below, our production facilities have been granted Approved Enterprise status.

Taxable income derived from an Approved Enterprise within the benefit period, and subject to compliance with the conditions for approval as described below is subject to a reduced corporate tax rate of 25% rather than the usual rate of 36% up to 2003 and lower rates from 2004 as described above. The benefit period is ordinarily seven years, or ten years for a company whose foreign investment level as defined below exceeds 25%, commencing with the year in which the Approved Enterprise first generates taxable income, and is limited to twelve years from the commencement of production or fourteen years from the date of approval, whichever is earlier.

That income is eligible for further reductions in tax rates if the company qualifies as a foreign investors' company. A foreign investors' company is a company in which more than 25% of its combined share capital including loans from shareholders (in terms of shares, rights to profits, voting and appointment of directors) is owned by non-Israeli residents. The tax rate is reduced to 20% if the foreign ownership of the foreign investors' company is 49% or more but less than 74%; 15% if the foreign ownership of the foreign investors' company is 74% or more but less than 90%; and 10% if the foreign ownership of the foreign investors' company is 90% or more. The determination of foreign ownership is made on the basis of the lowest level of foreign ownership during the tax year.

In the event that a company is operating under more than one approval, or that not all of its capital investments are approved, its effective corporate tax rate is the result of a weighted combination of the various applicable rates. A company may elect to forego entitlement to the grants otherwise available under the Investments Law and, in lieu thereof, participate in an alternative benefits program, referred to as the Alternative Benefits Program, under which the undistributed income from the Approved Enterprise is fully exempt from corporate tax for a period of between two and ten years, depending upon the geographic location within Israel and the type of the Approved Enterprise. Upon expiration of the exemption period, the Approved Enterprise is eligible for beneficial tax rates under the Investments Law for the remainder, if any, of the applicable benefit period. We participate in the Alternative Benefits Program. There can be no assurance that this benefit program will continue to be available or that we will continue to qualify for benefits under the current program.

Dividends paid by a company that owns an Approved Enterprise and that are attributable to income derived from that Approved Enterprise during the applicable benefits period, are subject to withholding tax at a rate of 15%, if the dividends are paid during the benefit period or no more than twelve years thereafter; or, if the company qualifies as a foreign investors' company, without any time limitations. This tax must be withheld at source by the company paying the dividend.

ANNEX D

A dividend paid from income derived from an enterprise owned by a company that has elected the Alternative Benefits Program during the period in which it is exempt from tax causes the company to be liable for corporate tax on the amount distributed which for this purpose includes the amount of the corporate tax at the rate that would have been applicable had the company not elected the Alternative Benefits Program, of up to 25%. In addition, the company would be required to withhold at source, for the account of the dividend recipient, 15% of the amount actually distributed as a dividend, as described above.

The Investments Law also provides that an Approved Enterprise is entitled to accelerated depreciation on its property and equipment that are included in an approved investment program.

In respect of its production facilities in Ramat Gan the Company has been granted Approved Enterprise status under the Investments Law. In respect of income derived from our Approved Enterprise, we are entitled to reduced tax rates during a period of seven years from the year in which such enterprises first earn taxable income (limited to 12 years from commencement of production or 14 years from the date of approval, whichever is earlier). We have an approved expansion program of our existing facilities which received approval in 1994 ("First Expansion") and we also received approval in 2002 for an additional expansion program ("Second Expansion"). Income derived from our two expansion programs was tax exempt during the first two years of each seven-year tax benefit period mentioned above, and is subject to a reduced tax rate of 25% (depending on our foreign investment level, as defined above) during the remaining years of benefits.

The First Expansion was enacted in 1999 (performance approval was given in 2001) and the Second Expansion was enacted in 2002 (performance approval for the Second Expansion was given in 2004). The last year of benefits relating to our First Expansion is in 2005 and, with respect to the Second Expansion is 2008.

The Company's request to approve an expansion plan ("third expansion") of its Approved Enterprise was granted by the Investment Center in January 2005. The plan comprises an investment in fixed assets of US\$138,500. Subject to meeting the conditions of the letter of approval, the Company will be entitled to taxation benefits on the taxable income generated from third expansion during a period of seven years commencing with the first year in which it generates taxable income from the third expansion at tax rates similar to the two existing expansions, as described above.

Since we participate in the Alternative Benefits Program, in the event we distribute a dividend from income that is tax exempt, as described above, we would have to pay a tax of up to 25% (depending on our foreign investment level, as defined above) in respect of the amount distributed.

The benefits available to an Approved Enterprise are conditioned upon terms stipulated in the Investment Law and the regulations thereunder (including in respect of the Second Expansion receiving final performance approval) and the criteria set forth in the applicable certificate of approval. In the event that we do not fulfil these conditions in whole or in part, the benefits can be cancelled and we may be required to refund the amount of the benefits, with the addition of the Israeli consumer price index linkage differences and interest. We believe that our Approved Enterprise currently operates in compliance with all applicable conditions and criteria, but there can be no assurance that they will continue to do so.

Law for the Encouragement of Industry (Taxes), 1969

We believe that we currently qualify as an "Industrial Company" within the meaning of the Law for the Encouragement of Industry (Taxes), 1969, or the Industry Encouragement Law. According to the Industry Encouragement Law, an "Industrial Company" is a company resident in Israel, 90% or more of the income of which in any tax year, other than of income from government loans, capital gains, interest and dividends, is derived from an "Industrial Enterprise" owned by it. An "Industrial Enterprise" is defined as an enterprise whose major activity in a given tax year is industrial production.

ANNEX D

The following corporate tax benefits are available to Industrial Companies, among others:

- amortization of the cost of purchased know-how and patents over an eight-year period for tax purposes;
- accelerated depreciation rates on equipment and buildings;
- under specified conditions, an election to file consolidated tax returns with additional related Israeli Industrial Companies; and
- deduction for Israel tax purposes of the cost of a public share offering on a recognized stock exchange, over a three-year period in equal instalments.

Eligibility for the benefits under the Industry Encouragement Law is not subject to receipt of prior approval from any governmental authority. No assurance can be given that we qualify or will continue to qualify as an Industrial Company or that the benefits described above will be available in the future.

Taxation of Investors Owning our Shares

Capital Gains Tax in Israel

Israeli law generally imposes a capital gains tax on the sale of any capital assets by residents of Israel, as defined for Israeli tax purposes, and on the sale of assets located in Israel, including shares in Israeli companies, by both residents and non-residents of Israel, unless a specific exemption is available or unless a tax treaty between Israel and the shareholder's country of residence provides otherwise. The law distinguishes between real gain and inflationary surplus. The inflationary surplus is equal to the increase in the purchase price of the relevant asset attributable to the increase in the Israeli consumer price index or, in certain circumstances, a foreign currency exchange rate, between the date of purchase and the date of sale. The real gain is the excess of the total capital gain over the inflationary surplus.

Pursuant to the tax reform, generally, capital gains tax is imposed on Israeli residents at a rate of 15% on real gains derived on or after 1 January 2003, from the sale of shares in (i) companies publicly traded on the Tel Aviv Stock Exchange ("TASE"), (ii) Israeli companies publicly traded on a recognized stock exchange or regulated market in a country that has a treaty for the prevention of double taxation with Israel, or (iii) companies dually traded on both the TASE and a recognized stock exchange or a regulated market outside of Israel. This tax rate is contingent upon the shareholder not claiming a deduction for financing expenses in connection with such shares, and does not apply to: (i) the sale of shares to a relative (as defined in the tax reform); (ii) the sale of shares by dealers in securities; (iii) the sale of shares by shareholders (mostly companies) that report in accordance with the Inflationary Adjustment Law; or (iv) the sale of shares by shareholders who acquired their shares prior to an initial public offering (that are subject to a different tax arrangement).

Non-Israeli residents are exempt from Israeli capital gains tax on any gains derived from the sale of shares publicly traded on the Tel Aviv Stock Exchange, except when assets are attributable to an Israeli permanent establishment of the foreign resident, and are exempt from Israeli capital gains tax on any gains derived from the sale of shares of Israeli companies publicly traded on a recognized stock exchange or a regulated market outside of Israel, provided that such capital gains are not derived by a permanent establishment of the foreign resident in Israel. However, non-Israeli corporations will not be entitled to such exemption if an Israeli resident (1) has a controlling interest of 25% or more in such non-Israeli corporation, or (2) is the beneficiary of or is entitled to 25% or more of the revenues or profits of such non-Israeli corporation, whether directly or indirectly.

The Convention Between the State of Israel and the Republic of Singapore for the Avoidance of Double Taxation and the Prevention of Fiscal Evasion with Respect to Taxes (the "Israel-Singapore Tax Treaty") is silent with respect to capital gains on the sale or disposition of Israeli assets, such as our Shares, by a person who qualifies as a resident of Singapore under such treaty. Under the Israel-Singapore Tax Treaty a "resident of Singapore" is any person (including an individual or a company) who under the laws

ANNEX D

of Singapore is liable to taxation in Singapore by reason of his domicile, residence, place of management or any other criterion of a similar nature. The Israel-Singapore Tax Treaty also contains certain “tie-breaker” provisions in cases where a person may be considered both a resident of Singapore and a resident of Israel.

In some instances where our shareholders may be liable to Israeli tax on the sale of our Shares, the payment of the consideration may be subject to the withholding of Israeli tax at the source.

The Israel-Singapore Tax Treaty was revamped by the parties, in 2004, (the “New Israel-Singapore Tax Treaty”). The New Israel-Singapore Tax Treaty has been initialed, at this stage and it is expected that it will be ratified and become effective during 2005, but as at the date of this Prospectus, there can be no assurance about the timing of the ratification.

According to the New Israel-Singapore Tax Treaty, only the state of residence has the right to impose tax on capital gains from the alienation of shares (not including the alienation of non-traded shares deriving at least fifty per cent of their value directly or indirectly from immovable property). An extract of the Capital Gains clause of the New Israel-Singapore Tax Treaty is as follows:

- “1. Gains derived by a resident of a Contracting State from the alienation of immovable property referred to in Article 6 and situated in the other Contracting State may be taxed in that other State.
2. Gains derived by a resident of a Contracting State from the alienation of shares, other than shares traded on a recognized Stock Exchange, deriving at least fifty per cent. of their value directly or indirectly from immovable property situated in the other Contracting State may be taxed in that other State.
3. Gains from the alienation of movable property forming part of the business property of a permanent establishment which an enterprise of a Contracting State has in the other Contracting State or of movable property pertaining to a fixed base available to a resident of a Contracting State in the other Contracting State for the purpose of performing independent personal services, including such gains from the alienation of such a permanent establishment (alone or with the whole enterprise) or of such fixed base, may be taxed in that other Contracting State.
4. Gains derived by a resident of a Contracting State from the alienation of ships or aircraft operated in international traffic, or movable property pertaining to the operation of such ships or aircraft, shall be taxable only in that State.
5. Gains derived by a resident of a Contracting State from the alienation of any property other than that referred to in paragraphs 1, 2, 3 and 4, shall be taxable only in the Contracting State of which the alienator is a resident, if that resident is the beneficial owner of the property from which the capital gains are derived.”

It should be noted that until the ratification of the New Israel-Singapore Tax Treaty takes place, the provisions of the current Israel-Singapore Tax Treaty are in force.

Stamp Duty

There is no stamp duty payable in Israel by investors purchasing our Shares. Israeli stamp duty does not apply to the transfer of our Shares, electronically through the CDP, or otherwise.

Estate Tax

No estate tax or duty currently exists under Israeli tax laws.

ANNEX D

Dividend Distributions

Non-residents of Israel will be subject to Israeli income tax on the receipt of dividends paid on our Shares at the rate of 25%, which tax will be withheld at source, unless the dividends are paid from income derived from an Approved Enterprise during the applicable benefit period, then the tax will be 15%, or a different rate if provided in a treaty between Israel and the shareholder's country of residence.

Pursuant to the existing Israel-Singapore Tax Treaty, dividends paid on our Shares to a holder of our Shares who qualifies as a resident of Singapore under such treaty and is subject to tax in Singapore in respect of such dividend will not be subject to tax in Israel, unless such resident of Singapore has a Permanent Establishment in Israel that is effectively connected to his right to receive such dividends.

It should be noted that if the withholding tax exemption would not apply, due to the fact that the recipient is not subject to tax in Singapore on such dividend, a withholding tax would be applied according to the Israeli domestic law.

According to the New Israel-Singapore Tax Treaty, dividends paid on our shares to a holder of our Shares who is the beneficial owner of the dividends in Singapore, would be subject to a withholding tax in Israel at the following rates:

- (a) 5 per cent. of the gross amount of the dividends if the beneficial owner holds directly at least 10 per cent. of the capital of the company paying the dividends; and
- (b) 10 per cent. of the gross amount of the dividends in all other cases.

It should be noted that until the ratification of the New Israel-Singapore Tax Treaty takes place, the current Israel-Singapore Tax Treaty is in force.

ANNEX E

COMPARISON BETWEEN THE COMPANIES ACT AND THE ISRAELI COMPANIES LAW

Any person wishing to have a detailed summary of Israeli corporate law or advice on the differences between it and the laws of any jurisdiction with which he is more familiar (including, without limitation, Singapore law), is strongly advised to seek independent legal advice.

Israeli corporate law is governed by the Israeli Companies Law, 5759 – 1999 (the “Law”) and, with respect to certain matters set forth in the Law, by the Companies Ordinance (New Version), 5743-1983 (the “Ordinance”).

Section references below are to the Act or the Law, as the case may be, unless otherwise specified.

SINGAPORE COMPANIES ACT (the “Act”)	SUMMARY	ISRAELI COMPANIES LAW	<u>SUMMARY AND DIFFERENCES</u>
<i>Power of Directors to Allot and Issue Shares</i>			
161	<ul style="list-style-type: none"> The power to issue shares is usually vested with the directors of a company subject to any restrictions in the articles. However, notwithstanding anything in the memorandum or articles of a company, prior approval of the company at a general meeting is required, or the share issue is void. Such approval need not be specific but may be general and will continue to be in force until the conclusion of the next annual general meeting or expiration of the period within which the next annual general meeting is to be held. 	92, 286, 288	<ul style="list-style-type: none"> The power to issue shares is vested with the board of directors of a company, subject to any restrictions in the articles. The board of directors may issue shares up to the limit of the company's authorized share capital. The authority to increase the company's authorized share capital belongs to the general meeting of the company.
<i>Power of Directors to dispose of the Issuer's or any of its Subsidiaries' Assets</i>			
Fourth Schedule 160	<ul style="list-style-type: none"> The articles of a company usually provide for the business of the company to be managed by its directors. Notwithstanding anything to the contrary in the memorandum or articles of a company, the prior approval of the company in general meeting is needed before directors can dispose the whole or substantially the whole of the company's undertaking or property. 	92, 120, 121, 314, 350 - 351	<ul style="list-style-type: none"> The board of directors is authorized to determine the company's policies and supervise the performance and actions of the general manager. The general manager is responsible for the day-to-day operation of the company's affairs within the bounds of the policies determined by the board of directors and subject to its directions. The Law does not contain specific requirements to approve the disposal of all or substantially all of the assets of the company, except in the context of a merger, which requires the approvals of the board of directors and the general meeting, or in the context of an arrangement among shareholders, which requires, inter alia, the approval of the general meeting by special majorities and a court order.

ANNEX E

SINGAPORE COMPANIES ACT (the "Act")	SUMMARY	ISRAEL COMPANIES LAW	SUMMARY AND DIFFERENCES
			<ul style="list-style-type: none"> The authority to dispose of the assets of a subsidiary belongs to the board of directors or the general manager of the subsidiary, as the case may be.
<i>Loans to Directors</i>			
162	<ul style="list-style-type: none"> s.162 prohibits a company from making loans to directors of the company or directors of related companies (or to the director's spouse or children (natural; step or adopted)), or giving a guarantee or providing security in connection with such a loan. <p style="text-align: center;">Exceptions to s.162:</p> <p>(a) (subject to the approval of the company in a general meeting) the provision of funds to a director to meet expenditure incurred or to be incurred for the purposes of the company or for the purpose of carrying out his duties as an officer of the company;</p> <p>(b) (subject to the approval of the company in a general meeting) advances to director in full time employment of the company or a related company for expenditure in purchasing or acquiring a home occupied or to be occupied by that director. Not more than one such loan may be outstanding at any one time</p> <p>(c) advances to a director in full time employment of the company or a related company pursuant to an employee loan scheme approved in general meeting; and</p> <p>(d) a loan made in ordinary course of business by bank, finance company or insurance company.</p>	270 - 284, 244	<ul style="list-style-type: none"> The making by a company of loans to an officer or director thereof, to his relative (defined as spouse, siblings, parents, grandparents, descendants, spouse's descendants and the spouses of any of the foregoing) or to a company in which he or his relative is considered an interested party (defined as a company in which the officer or director (or his relative) is the holder of 5% or more of the issued share capital or of its voting rights, a director or general manager or in which he has the right to appoint at least one director or the general manager) is a transaction with an office holder or in which an office holder has a personal interest. A transaction with an office holder or in which an office holder has a personal interest is permitted only if it does not harm the company's welfare and is subject to certain approvals. Said approvals are the board of directors' approval and, in the event of an extraordinary transaction (as defined in the Law), the audit committee's approval, as well. If a majority of the directors have a personal interest in an extraordinary transaction, then approval of the general meeting is required. If the matter involves the compensation of a director for his services to the company as a director or officer, the approval of the audit committee, directors and general meeting will be required, in that order. The authority to dispose of the assets of a subsidiary belongs to the board of directors or the general manager of the subsidiary, as the case may be.

ANNEX E

SINGAPORE COMPANIES ACT (the "Act")	SUMMARY	ISRAEL COMPANIES LAW	SUMMARY AND DIFFERENCES
163	<p>● s.163 prohibits making of loans to connected persons i.e. lending company may not make loans to borrowing company if the directors of the lending company have an interest of 20% or more of the shares of the borrowing company.</p> <p>Exceptions to s.163:</p> <p>(a) exempt private companies;</p> <p>(b) loans to related companies;</p> <p>(c) loans by bank, finance or insurance companies in ordinary course of business.</p>		
<i>Giving of Financial Assistance to purchase the Issuer's or any of its Subsidiaries' Shares</i>			
76	<p>● A company is prohibited from giving financial assistance to any person (directly or indirectly) for purpose of, or in connection with the acquisition of that company's shares or shares in its holding company.</p> <p>● Financial assistance includes loans, guarantees, provision of security, release of debt or obligation.</p> <p>● Certain transactions are specifically provided by the Act not to be prohibited. These include transactions carried out in good faith and those carried out in the ordinary course of commercial dealing.</p> <p>● s. 76(10) provides that the company can give financial assistance if it complies with certain procedural requirements and a special resolution is passed approving the provision of the financial assistance.</p>	1, 301 - 305, 309	<ul style="list-style-type: none"> ● Provision of financing, directly or indirectly, by a company, its subsidiary or other entity under its control, for the purpose of acquiring the company's shares is considered a "distribution". ● A company may make a distribution only out of its profits (as defined in the Law; "the Profit Criterion") on condition that there is no reasonable concern that the distribution will prevent the company from satisfying its existing and foreseeable obligations when they become due (the "Solvency Criterion"). However, the court may permit a company to make a distribution that does not satisfy the Profit Criterion, provided that it satisfies the Solvency Criterion. ● Provision of financing by a subsidiary for purchasing the parent company's shares is considered a distribution by the parent company. See below under the caption "Power for any Subsidiary of the Issuer to Own Shares in its Parent."

ANNEX E

SINGAPORE COMPANIES ACT (the "Act")	SUMMARY	ISRAEL COMPANIES LAW	SUMMARY AND DIFFERENCES
<i>Disclosure of interest in contracts with the Issuer</i>			
156	<ul style="list-style-type: none"> ● Nature of a director's or any other member of his family's interest in any contract with the company must be disclosed at a meeting of the directors, as well as the nature, character and extent of any possible conflict by virtue of the director holding any office in another company or owning any property. 	269	<ul style="list-style-type: none"> ● If an officer or director of the company knows that he or his relative (as such term is defined in the Law) has a personal interest in a transaction of the company, then - without delay and not later than the directors meeting at which the transaction is first discussed - he must disclose to the company the nature of his personal interest and any material fact or document (such officer or director is not required to disclose the personal interest of his relative in a transaction which is not an extraordinary transaction – as such term is defined in the law).
<i>Remuneration</i>			
169	<ul style="list-style-type: none"> ● The method for remuneration of a director is usually provided for in the articles. ● Subject to the articles of the company, its directors are usually empowered to fix the remuneration of the officers and employees in the company. ● s.169 prohibits the provision or improvement of a director's emoluments unless approved by a resolution that is not related to other matters. 	270, 250 - 251, 244, 92	<ul style="list-style-type: none"> ● The remuneration of a director is subject to the approval of the company's audit committee, board of directors and general meeting, in that order. ● An external director is entitled to compensation and reimbursement of expenses from the company only pursuant to strict provisions of the Law and the regulations promulgated thereunder. It is forbidden for an external director to receive other payments, directly or in directly, as consideration for his service as a director. ● Unless the articles of the company provide otherwise, the board of directors appoints the general manager, and the general manager appoints the other officers and employees. ● The board of directors is authorized to determine the company's compensation policies. The articles of a company may authorize the general manager to determine the compensation of the other officers, subject to policies determined by the board. The compensation of the general manager is subject to approval of the board of directors.

ANNEX E

SINGAPORE COMPANIES ACT (the "Act")	SUMMARY	ISRAEL COMPANIES LAW	SUMMARY AND DIFFERENCES
<p><i>Retirement, Appointment, Removal</i></p> <p>145-148, 150, 152, 153, 154, 155, 170</p>	<ul style="list-style-type: none"> ● The first directors of a company are named in the articles of the company. For appointment of directors in a public company, any appointment of such directors must generally be voted on individually. ● Every company shall have at least one director who is ordinarily resident in Singapore and, where the company has only one member, that sole director may also be the sole member of the company. ● The Act provides that a person may be disqualified from being a director by the court for several reasons (e.g. an undischarged bankrupt, unfit directors of insolvent companies) or disqualified by virtue of certain events (e.g. attaining the age of 70 while appointed a director of a public company unless reappointed on a yearly basis by an ordinary resolution passed at an annual general meeting, on conviction for certain offences, persistent default in relation to delivery of documents to the Registrar of Companies). ● A director of a public company may be removed before the expiration of his period of office by an ordinary resolution of the shareholders, notwithstanding anything in the company's memorandum or articles or in any agreement between the company and the director. ● A director appointed to represent a particular class of shareholders or debenture holders may only be removed if his successor has been appointed. ● In the case of a public company, any assignment of office by a director or manager of the company has no effect until approved by a special resolution of the company. 	<p>220, 219, 115, 94, 226, 227, 228, 232, 233, 7, 54, 239 - 249, 59, 230, 237</p>	<ul style="list-style-type: none"> ● The first directors of a company are appointed by the founders. ● The number of directors, or the minimum and maximum numbers of directors, is required to be set forth in the articles. The Law requires a public company to have at least two external directors, a third independent director to serve on the audit committee and a chairman of the board (who may not serve as a member of the audit committee). ● An external director ordinarily must be an Israeli resident, but there is an exemption for companies listed on a non-Israeli stock exchange. An individual qualified to serve as a director (see below) and who meets certain independence criteria set forth in the Law is qualified to serve as an external director. ● A person is disqualified from serving as a director in a public company if: (a) he was convicted of one of several offenses set forth in the Law, unless five years have passed since the conviction; (b) he was declared bankrupt and has not been relieved; (c) a court rules that he is permanently unable to exercise his duties; or (d) a court disqualifies him from serving as a director for up to five years after ordering to "pierce the corporate veil" thereby attributing to him the rights and obligations of a company in which he served as an officer, director or shareholder. ● According to the Third Amendment to the Law (passed on 7 March, 2005) (the "Amendment"), at least one of the external directors should possess financial and accounting expertise, and the other external directors should possess professional expertise. The Amendment further provides that the board of directors of a public company should also set the number of directors (other than the external directors) who should possess financial and accounting expertise. However, the definition of "financial and accounting expertise" and of "professional expertise", is yet to be promulgated by the Minister of Justice, and such requirements shall enter into force only following the issuance of specific regulations in this regard. ● Directors are appointed by the annual general meeting, unless the articles provide otherwise. Unless the articles provide otherwise, the general meeting may remove a director from office. If there is a provision in the articles according to which a director is appointed otherwise than by the general meeting, then he can be removed from office only by whoever is entitled to appoint him, unless the articles provide otherwise. A director may be removed from office by court or the board of directors in certain events of disqualification.

ANNEX E

SINGAPORE COMPANIES ACT (the "Act")	SUMMARY	ISRAEL COMPANIES LAW	SUMMARY AND DIFFERENCES
			<ul style="list-style-type: none"> ● An external director may be removed from office only by court or the general meeting if he fails to satisfy the requisite qualifications for such office or if he has breached his duty of loyalty to the company.
<p>Alterations to Constitutional Documents</p> <p>18, 26, 33, 34, 37, 71, 73, 74</p>	<ul style="list-style-type: none"> ● Subject to the Act, the memorandum of a company may be altered and the company shall within 14 days lodge with the Registrar, a copy of the resolution together with the memorandum as altered. ● Objects clause(s) in the memorandum may be amended by a special resolution. ● Share capital may be altered by the company in general meeting if so authorised by its articles ● Share capital may be reduced by the company by way of special resolution if so authorised by its articles. This is subject to a confirmation by the court. ● Articles may be freely altered or added to (subject to the Act and to the company's memorandum and articles) by way of special resolution. ● There are no specific provisions in the Act relating to the amendment of directors' powers. 	<p>20, 21, 24, 40, 31, 286 - 287, 50 (and ss.25, 37 and 144 of the Ordinance)</p>	<ul style="list-style-type: none"> ● The articles of a company may be altered by way of an ordinary resolution (simple majority) of the general meeting, unless the articles require another majority. For a company established before February 1, 2000, the alteration of the articles requires the approval of the general meeting by 75% of the votes cast on the matter, unless the articles provide for a different majority or have been altered by said 75% majority to provide for another majority. ● Notice of any alterations of a private company's articles is required to be filed with the Israeli Registrar of Companies (the "Registrar") within 14 days. A public company whose shares are listed only on a stock exchange outside Israel or offered to the public only outside Israel is required to file notices with the Register as though it were a private company. The effectiveness of alterations of the company's name or objectives is subject to the registration by the Registrar. ● Alterations of the articles that prejudice the rights of a class of shares also require the approval of a separate meeting of the holders of that class, unless the articles provide otherwise. ● Share capital may be altered by the company in the general meeting (in accordance with the majority set forth above). The general meeting may cancel authorized share capital that has not yet been allocated (in accordance with the majority set forth above), provided that there is no obligation of the company, including a contingent obligation, to allocate the unissued shares.

ANNEX E

SINGAPORE COMPANIES ACT (the "Act")	SUMMARY	ISRAEL COMPANIES LAW	SUMMARY AND DIFFERENCES
			<ul style="list-style-type: none"> ● <u>With respect to a memorandum of a company:</u> (a) Companies established on or after February 1, 2000 (when the Israeli Companies Law came into effect) have articles only and not a memorandum. (b) Companies established before said date may: (i) terminate or alter their memorandum by approval of the shareholders by special majorities and a court order; (ii) alter their memorandum pursuant to the Ordinance (<i>i.e.</i>, only certain items may be altered (<i>viz.</i>, the company's name and objectives and certain changes to the share capital), with the approval of the general meeting by a majority of 75% of the votes cast (notwithstanding abstentions); or (iii) add to their memorandum, by a resolution adopted by the general meeting by a majority of 75% of the votes cast, a provision offsetting forth the majority required to alter the memorandum's provisions that the general meeting is authorized to alter. ● There is no blanket provision that all shares (whether or not carrying the right to vote) will carry the right to vote in respect of such extraordinary transactions.
<p><i>Extraordinary Transaction</i></p> <p>160, 216</p>	<ul style="list-style-type: none"> ● Directors shall not carry into effect any proposals for disposing of the whole or substantially the whole of the company's undertaking or property unless those proposals have been approved by the company in a general meeting. ● Notwithstanding any provision in the Act or in the memorandum or articles of the company, holders of equity shares in a public company having a share capital (defined to be any share which is not a preference share) shall have the right at a poll at any general meeting to 1 vote per share. ● There is no blanket provision that all shares (whether or not carrying the right to vote) will carry the right to vote in respect of such extraordinary transactions. 	<p>314, 350 - 351, 275, 82</p>	<ul style="list-style-type: none"> ● The Law does not contain specific requirements to approve the disposal of all or substantially all of the assets of the company, except in the context of a merger, which requires, <i>inter alia</i>, the approvals of the board of directors and the general meeting, or in the context of an arrangement among shareholders, which requires the approval of the general meeting by special majorities and a court order. ● An extraordinary transaction with a controlling shareholder or in which a controlling shareholder has a personal interest requires approval of the audit committee, the board of directors and the general meeting, in that order. The required approval of the general meeting is a simple majority of the votes cast, provided that either (i) at least one-third of the shares of shareholders who

ANNEX E

SINGAPORE COMPANIES ACT (the "Act")	SUMMARY	ISRAEL COMPANIES LAW	SUMMARY AND DIFFERENCES
			have no personal interest in the transaction and that voted on the matter, voted in favour or (ii) the shares of the shareholders who have no personal interest in the transaction who voted against the transaction do not represent more than one per cent. of the voting rights in the company.
<i>Variation of Rights of Existing Shares or Classes of Shares</i>			
26	<ul style="list-style-type: none"> If class rights are contained in the memorandum of the company, they cannot be varied as the memorandum cannot be altered except in accordance with the Act. 	20, 24	<ul style="list-style-type: none"> If class rights are contained in the articles of the company, they may be altered in the way the articles may be altered (see above). Alterations of the articles that prejudice the rights of a class of shares also require the approval of a separate meeting of the holders of that class, unless the articles provide otherwise.
37	<ul style="list-style-type: none"> If class rights are contained in the articles of the company, they can be altered (subject to the memorandum and the Act) by special resolution. 		<ul style="list-style-type: none"> If class rights are contained in the memorandum of the company, they cannot be varied as the memorandum cannot be altered except in respect of specific issues (see above). However, they may be altered by approval of the general meeting by special majorities and a court order pursuant to s.350 of the Law.
74	<ul style="list-style-type: none"> If class rights are to be varied or abrogated the approval of the specified majority (in the articles) of the affected class must be obtained. However, the holder(s) of at least 5% of the issued shares of that class may apply to court to disallow the variation or abrogation. 		
<i>Special Resolutions - Majority Required</i>			
84	<ul style="list-style-type: none"> Require at least a 3/4 majority of votes of such members as being entitled to vote, cast at a meeting for which in the case of a private company, not less than 14 days' written notice or in the case of a public company, not less than 21 days' written notice has been given. May be passed at a meeting convened at short notice if agreed to by a minimum 95% majority of members having the right to attend and vote at the meeting. 	20, 24, 85 (and ss.25 and 319 of the Ordinance)	<ul style="list-style-type: none"> Decisions at the general meeting may generally be approved by a simple majority, except as provided otherwise in the Law or the articles (see above for the respective majorities required for altering the articles or memorandum or for approving extraordinary transactions with a controlling shareholder or in which a controlling shareholder has a personal interest). Liquidations and certain alterations to the memorandum are governed by the Ordinance and require the adoption of a special resolution thereunder, <i>i.e.</i>, approval of the general meeting by 75% of the votes cast at a meeting of which prior notice of 21 days has been given. All the shareholders entitled to vote may waive the requirement for 21days' prior notice.

ANNEX E

SINGAPORE COMPANIES ACT (the "Act")	SUMMARY	ISRAEL COMPANIES LAW	SUMMARY AND DIFFERENCES
Voting Rights (generally, on a poll and right to demand a poll)			
178-181	<ul style="list-style-type: none"> ● Subject to the articles of the company ● Each equity share entitles the holder to 1 vote at a poll. ● The right to demand a poll is generally set out in the articles, but notwithstanding the articles, a poll may be demanded by: <ul style="list-style-type: none"> (a) any 5 or more members (or proxies) having the right to vote at the meeting; (b) member(s) (or proxies) representing at least 10% of the total voting rights of all the members having the right to vote at the meeting; or (c) member(s) (or proxies) holding voting shares totalling not less than 10% of total paid up amount on such shares. 	82, 63	<ul style="list-style-type: none"> ● Unless otherwise provided in the articles, each share entitles the holder thereof to one vote at a general meeting. ● The board of directors is authorized to convene a general meeting. ● A convention of a general meeting in a public company may be demanded by: <ul style="list-style-type: none"> (a) two directors or one-fourth of the directors; (b) one or more shareholders representing at least 5% of the issued share capital and 1% of the voting rights in the company; or (c) one or more shareholders representing at least 5% of the voting rights in the company.
Requirements for Annual General Meetings			
175	<ul style="list-style-type: none"> ● Held (in addition to any other meeting) once in every calendar year and not more than 15 months after the holding of the last preceding annual general meeting. ● The Registrar of Companies may, on application of company, extend the time limit for special reasons. ● There is no provision for signed written resolutions in lieu of a general meeting for a public company. 	60	<ul style="list-style-type: none"> ● Held (in addition to any other meeting) once in every calendar year and not more than 15 months after the holding of the last preceding annual general meeting. ● There is no provision in the Law for signed written resolutions in lieu of a general meeting for a public company.

ANNEX E

SINGAPORE COMPANIES ACT (the "Act")	SUMMARY	ISRAEL COMPANIES LAW	SUMMARY AND DIFFERENCES
<i>Accounts and Audit</i>			
203	<ul style="list-style-type: none"> Members must be sent copies of last audited profit and loss account, balance sheet and consolidated accounts (if the company is a holding company) accompanied by a copy of the auditor's report, not less than 14 days before the general meeting at which such accounts to be presented or not less than 28 days if, in the case of a private company, where the holding of an annual general meeting is dispensed with. 	142, 155	<ul style="list-style-type: none"> The reporting obligations of a public company are governed by the applicable laws and regulations of the jurisdiction in which its shares are listed. The board of directors is authorized to appoint the initial auditors, who serve until the conclusion of the first annual general meeting. Thereafter, auditors are appointed at each annual general meeting. However, the articles may provide that the general meeting may appoint an auditor for a longer period, which shall not extend beyond the end of the third annual general meeting following the one at which they were appointed.
205	<ul style="list-style-type: none"> The directors of all companies must appoint auditors within 3 months of incorporation to be the company's auditor until the conclusion of the first annual general meeting. Thereafter auditors are appointed at each annual general meeting. 		
<i>Notice of Meetings and Business to be conducted thereat</i>			
177, 180, 181, 184, 207	<ul style="list-style-type: none"> Unless the articles provide for a longer period of notice, at least 14 days' notice of each meeting must be given to every member entitled to attend and speak at the meetings, and 21 days' notice for any meeting to pass a special resolution. An annual general meeting may be called at short notice with unanimous consent of all members entitled to attend and vote, and for any other meeting, with consent of a majority holding at least 95% in nominal value of the shares giving a right to attend and vote thereat. The method of service of notice is set out in the articles but in the event that the articles do not so provide, notice shall be served in the manner provided in s.177(4) and in the Fourth Schedule of the Act (i.e. sent personally or by post) and in the case of special business, the general 	69	<ul style="list-style-type: none"> A notice of a general meeting of a public company is required to be delivered to every shareholder registered in the company's shareholders register at least 21 days before it is convened, unless the articles provide that a notice shall not be delivered. Under applicable regulations, notice of a general meeting generally must be published at least 21 days before it is convened. Under applicable regulations, a public company whose shares are listed only on a stock exchange outside Israel or offered to the public only outside Israel is required to publish notice of a general meeting in accordance with the laws of the applicable jurisdiction, and if there are no such laws, in the manner determined by the company.

ANNEX E

SINGAPORE COMPANIES ACT (the "Act")	SUMMARY	ISRAEL COMPANIES LAW	SUMMARY AND DIFFERENCES
	<p>nature of that business shall be given to such persons as are entitled to receive such notices from the company.</p> <ul style="list-style-type: none"> All such notices must state member's right to appoint a proxy. 		
<i>Transfer of Shares</i>			
126-130	<ul style="list-style-type: none"> Shares are transferred by the execution and delivery of a proper instrument of transfer to the company, which will be registered by the company. Every company shall within 1 month after the date on which a transfer is lodged with the company, complete and have ready for delivery all the appropriate certificates and debentures in connection with the transfer The articles will normally provide certain rights and restrictions (where applicable) in relation to the members' transfer of shares and will set out the procedure for such transfer. 	299	<ul style="list-style-type: none"> Under the Law, a company is required to alter the ownerships records in its shareholders register if (i) it receives a proper instrument of transfer signed by the transfer or and the transferee and the requirements for transfer set forth in the articles, if any, have been fulfilled, (ii) it receives a court order to alter the shareholders register, (iii) it is demonstrated to the company that the legal conditions for assignment of the shares have been fulfilled or (iv) other conditions are fulfilled which, under the articles, suffice for the alteration of the shareholders register. The articles will normally provide certain rights and restrictions (where applicable) in relation to the shareholders' transfer of shares and will set out the procedure for such transfer.
<i>Powers of Issuer to purchase its own Shares</i>			
70, 76, 76A, 76B - 76E	<ul style="list-style-type: none"> There is a general prohibition against the acquisition (whether directly or indirectly) by a company of its own shares, or shares in its holding company. 	301 - 303, 308, 309A, 312	<ul style="list-style-type: none"> An acquisition by a company of its own shares is considered a "distribution" of the company and subject to certain limitations. For said limitations, see above under the caption "Giving of Financial Assistance to purchase the Issuer's or any of its Subsidiaries' Shares."

ANNEX E

SINGAPORE COMPANIES ACT (the "Act")	SUMMARY	ISRAEL COMPANIES LAW	SUMMARY AND DIFFERENCES
	<ul style="list-style-type: none"> Exceptions include purchase under sanction of court order, redemption of redeemable preference shares and shareholder repurchases in accordance with s. 76B - s.76E. 		<ul style="list-style-type: none"> However, purchase of securities convertible into shares shall not be deemed as distribution – to the extent that the amount of such conversion was included in the most recent adjusted financial reports of the company as a short term or long term undertaking, due to the issuance of such securities – up to such amount. If the articles permit the issuance of redeemable securities, the company may issue and redeem such securities without regard to the limitations applicable to distributions. The shares of a company purchased by the company are deemed dormant shares and have no rights whatsoever for so long as they are held by the company.
<i>Power for any Subsidiary of the Issuer to own Shares in its Parent</i>			
21, 76	<ul style="list-style-type: none"> Generally there is a prohibition on the purchase of shares in a holding company by its subsidiary and a prohibition on a subsidiary being a member of its holding company. 	301-303, 309	<ul style="list-style-type: none"> An acquisition by a subsidiary (or other entity controlled by the parent company) of the parent company's shares or of securities convertible into shares of the parent company is considered a "distribution" by the parent company and is permitted to the extent the parent company would be permitted to effect such acquisition. The shares of a company purchased by its subsidiary or controlled company have no voting rights for so long as they are held by the subsidiary or the controlled corporation, as the case may be.
<i>Dividends and Other Methods of Distribution</i>			
403, 69	<ul style="list-style-type: none"> Subject to the company's articles, dividends may be payable in cash, shares or by way of distribution of specific assets. No dividends are payable except out of profits or pursuant to s.69 (that is, by way of the share premium account, if such dividends are satisfied by the issue of shares). 	1, 301 - 307, 190	<ul style="list-style-type: none"> Subject to the company's articles, dividends may be payable in cash or shares, or by way of distribution of other assets. Allocation of dividend (other than shares of the company) is a "distribution" and subject to the limitations described above under the caption "Giving of Financial Assistance to purchase the Issuer's or any of its Subsidiaries' Shares".

ANNEX E

SINGAPORE COMPANIES ACT (the "Act")	SUMMARY	ISRAEL COMPANIES LAW	SUMMARY AND DIFFERENCES
	<ul style="list-style-type: none"> No unconditional right of members to receive dividends, unless specified in articles, and how and when dividends are to be declared is decided by the articles. 		<ul style="list-style-type: none"> Any shareholder is entitled to receive dividends declared by the company, in accordance with the rights attached to the applicable class of shares. The board of directors is authorized to declare dividends, unless the articles provide otherwise. In any event, the board of directors must determine whether the proposed dividend is permitted under the Law and the general meeting may not allocate an amount of dividends which exceeds the amount set by the board of directors.
<i>Proxies</i>			
178, 181	<ul style="list-style-type: none"> Unless specified otherwise in the articles, proxies may only vote on a poll, and a proxy may demand such a poll. A member may appoint a proxy by written instrument in a form usually specified by the articles. <p>Although there are no specific provisions in the Act, the articles generally provide as follows:</p> <ul style="list-style-type: none"> The proxy may be instructed as to how to vote, or given a discretion to vote. The appointment of a proxy is revocable. 	83, 87	<ul style="list-style-type: none"> A shareholder may vote in person or through a proxy. There are no specific provisions in the Law regarding the appointment of proxies, and the articles generally contain said provisions. The Law requires a public company to send written ballots to its shareholders, who may indicate their votes thereon and return them to the company. The types of matters on which shareholder may vote by written ballot are those listed in the Law, applicable regulations or in the articles. However, the provisions in the Law regarding voting by written ballot will come into effect only after regulations on the matter are promulgated. In any event, under applicable regulations, a company listed on a stock exchange outside Israel is not required to send ballots to shareholders who reside outside Israel if the company sends them ballots or proxies in accordance with the laws of the applicable jurisdiction.
<i>Calls on Shares and Forfeiture of Shares</i>			
71	<ul style="list-style-type: none"> The power to forfeit shares for non-payment of calls is usually prescribed in the articles, and the company may cancel those shares and diminish the amount of share capital accordingly. 	181	<ul style="list-style-type: none"> A company is entitled to set forth in its articles or a share allotment agreement provisions authorizing the board of directors to forfeit shares for non-payment of all or a part of the applicable consideration on the terms set forth in the articles or the agreement.

ANNEX E

SINGAPORE COMPANIES ACT (the "Act")	SUMMARY	ISRAEL COMPANIES LAW	SUMMARY AND DIFFERENCES
	<ul style="list-style-type: none"> The procedure and the rights of the company to forfeit such shares are usually set out in the articles. 		<ul style="list-style-type: none"> The shares forfeited and not yet sold by the company are deemed dormant shares and have no rights whatsoever. The procedure and the rights of the company to forfeit such shares are usually set out in the articles.
<i>Inspection of Register of Members</i>			
192	<ul style="list-style-type: none"> A member has the right to inspect the register of members free of charge. Inspection of the register of members is open to public on payment of \$1.00 or such less sum as the company requires. 	129, 125 - 126	<ul style="list-style-type: none"> The shareholders register of a company is open for inspection by any person. The company is authorized to charge a fee (not to exceed the Company's cost of producing such copy) to receive a copy of the shareholders register. Maximum fees may be set forth in the regulations.
<i>Quorum for Meetings and Separate Class Meetings</i>			
179	<ul style="list-style-type: none"> Shareholders' meeting - if the articles do not specify otherwise, 2 members personally present constitute a quorum. Directors' meeting - subject to the articles. 	78 -79, 81, 104	<ul style="list-style-type: none"> Shareholders' meeting - if the articles do not specify otherwise, two shareholders present (personally or by proxy) holding at least 25% of the voting rights constitute a quorum. If a quorum is not obtained within one-half hour of the time set for the meeting, the meeting will be adjourned to a later time, and if a quorum is not obtained within one-half hour of the time set for such meeting, such meeting may be held with any number of participants, unless otherwise provided in the articles. Directors' meeting - a majority of the directors constitute a quorum, unless otherwise specified in the articles.
<i>Rights of the Minorities in Relation to Fraud or Oppression thereof</i>			
216	<ul style="list-style-type: none"> Any member or holder of a debenture of a company may apply to the court for relief on the ground of oppression resulting from the manner of conduct of the affairs of the company or the manner of exercise of the powers of the directors or on the ground that some act of the company 	191, 194 - 206	<ul style="list-style-type: none"> If any of the affairs of the company were conducted in a manner that discriminates against some or all its shareholders or if there is a significant suspicion that they will be so conducted, then the court may, upon the request of a shareholder, issue instructions it deems appropriate to eliminate or prevent the discrimination.

ANNEX E

SINGAPORE COMPANIES ACT (the "Act")	SUMMARY	ISRAEL COMPANIES LAW	SUMMARY AND DIFFERENCES
216A	<p>has been done or is threatened or some resolution has been passed or is proposed which unfairly discriminates against or is otherwise prejudicial to one or more of the members or holders of debentures including himself.</p> <ul style="list-style-type: none"> Any member of a company may apply to court for leave to bring an action in the name and on behalf of the company, or intervene in an action involving the company. 		<ul style="list-style-type: none"> Any shareholder or director may bring a derivative claim in the name and on behalf of the company, subject to court approval, pursuant to the provisions set forth in the Law. In the event of an unlawful distribution, the right to bring a derivative claim is also conferred upon a creditor of the company. If an action was brought against a company, any shareholder or director may defend in the name of the company, subject to court approval, pursuant to the provisions set forth in the Law.
<i>Procedures on Liquidation</i>			
247-354	<ul style="list-style-type: none"> The winding up of a company may be done in 3 ways. <ul style="list-style-type: none"> members' voluntary winding up creditors' voluntary winding up court compulsory winding up The directors of the company must make a statutory declaration of solvency (i.e. that the company is able to pay its debts within 12 months of the winding up) for a members' voluntary winding up and lodge it with the Registrar of Companies. After that, a shareholders' meeting to approve a resolution winding up the company will have to be convened where at least 75% of the shareholders approve the special resolution for winding up and appoint a liquidator. A copy of this resolution will have to be lodged with the Registrar of Companies. 	ss. 244 - 382 of the Ordinance	<ul style="list-style-type: none"> The winding up of a company may be done in 3 ways: <ul style="list-style-type: none"> Voluntary winding up, which can be a shareholders' voluntary winding up or a creditors' voluntary winding up; Compulsory winding up by court; and Voluntary winding up under supervision of the court. The majority of the directors of the company must make a statutory declaration of solvency (i.e., that the company is able to pay its debts within 12 months of the winding up) for a shareholders' voluntary winding up and file it with the Registrar. After that, a shareholders' meeting to approve a resolution winding up the company will have to be convened where at least 75% of the votes cast approve the special resolution for winding up and appoint a liquidator. The liquidator is responsible for collecting the assets of the company, determining its liabilities and distributing its assets among its creditors and the surplus to the shareholders. A notice of

ANNEX E

SINGAPORE COMPANIES ACT (the "Act")	SUMMARY	ISRAEL COMPANIES LAW	SUMMARY AND DIFFERENCES
	<p>● A statutory declaration of insolvency needs to be made by directors of a company for a creditors' voluntary winding up and lodged with the Registrar of Companies. Thereafter a provisional liquidator will be appointed. A meeting of shareholders needs to be called within a month of the declaration and a special resolution for winding up passed. A meeting of creditors will also need to be held on the same day and a liquidator appointed. All creditors need to be informed by post of this meeting 7 days in advance. A newspaper advertisement also needs to be made 7 days in advance. The creditors' voluntary winding up is deemed to have commenced the date the statutory declaration of insolvency is lodged with the Registrar of Companies.</p> <p>● Persons permitted to petition to the court for winding up by the court, include the company's creditors, contributories, the liquidator of the company and a duly appointed judicial manager.</p> <p>● Among the grounds available to wind up the company are <i>inter alia</i> the following:</p> <p>(a) the company does not commence business within a year from its incorporation or suspends its business for a whole year;</p> <p>(b) the company has by special resolution resolved that it be wound up by the court;</p> <p>(c) the number of members is reduced below 2;</p> <p>(d) the company is unable to pay its debts; and public company, reduced below seven);</p> <p>(e) the court is of the opinion that it is just and equitable that the company be wound up</p>		<p>the shareholder resolution must be published within seven days in Reshumot (the official Israeli governmental publication). The liquidator must notify the Registrar of his appointment within 21 days.</p> <p>● If a company is insolvent and a declaration of solvency cannot be sworn, a creditors' voluntary winding up may occur, provided that the shareholders approve a special resolution to voluntary wind up the company. A meeting of creditors will also need to be held on the same day (or the day after) and a liquidator appointed. All creditors need to be notified of this meeting at the time the shareholders are notified of the shareholders' meeting. A newspaper advertisement and publication in <i>Reshumot</i> (the official Israeli governmental publication) are also required.</p> <p>● Voluntary winding up (by creditors or shareholders) is deemed to have commenced the date the resolution to voluntary winding up of the company is adopted in the shareholders' general meeting.</p> <p>● Persons permitted to petition to the court for winding up by the court, include the company or a creditor or shareholder of the company.</p> <p>● Among the grounds available to wind up the company by court order are the following:</p> <p>(a) the company does not commence business within a year from incorporation or suspends its business for a whole year;</p> <p>(b) the company has, by special resolution, resolved that it be up by the court;</p> <p>(c) the company is insolvent; and</p> <p>(d) the court is of the opinion that it is just and equitable that the company be wound up.</p>

ANNEX E

SINGAPORE COMPANIES ACT (the "Act")	SUMMARY	ISRAEL COMPANIES LAW	SUMMARY AND DIFFERENCES
	<ul style="list-style-type: none"> The petitioner must prove to the satisfaction of the court the reasons for winding up the company. 		<ul style="list-style-type: none"> Application for the winding up by court order may be made also by the Attorney General, the Official Receiver or the Registrar in certain circumstances. Winding up under the supervision of the court: When a company decides voluntarily to wind up, the court may order that the winding up be continued under the supervision of the court according to instructions and on general conditions prescribed by it, and that the creditors, shareholders and others shall be entitled to apply to the court, all as the court deems just. If the court orders a winding up under its supervision, it may appoint an additional liquidator. In a winding up under supervision, the liquidator may, subject to any restriction imposed by court, make use of his powers without approval or intervention of the court, as if the company were winding up voluntarily. However, an order for winding up under supervision is, for all intents and purposes, equivalent to an order for winding up by the court, except for several differences set forth in the Ordinance.
<p><i>Procedures on Dissolution</i></p> <p>212, 275, 276, 308, 343-349</p> <p>are</p>	<ul style="list-style-type: none"> Two types of dissolution - by merger or amalgamation of 2 companies, or by the Registrar striking a defunct company off the register after publication of the prescribed notice in the Government Gazette. When the liquidator of a company has resigned or has been removed from his office, he may apply for an order that he be released and that the company be dissolved. A copy of the order and an office copy of the order shall, within 14 days after the making thereof, be lodged by the liquidator with the Registrar and the Official Receiver. 	<p>350, 314 (and ss.338, 339, 327 and 315 of the Ordinance)</p>	<ul style="list-style-type: none"> The types of dissolution - by merger, arrangement among shareholders and creditors or winding up. In a voluntary winding up, as soon as the affairs of the company fully wound up, the liquidator will make a final account showing how the winding up was conducted and how property was disposed of. The final general meeting must be called for the purpose of laying the account before it (and in the event of a creditors' voluntary winding up, the account must be laid also in the creditors' meeting), and within seven days thereafter, the liquidator must file a copy of the account with the Registrar. The company is dissolved three months after the Registrar registered said account in its records.

ANNEX E

SINGAPORE COMPANIES ACT (the "Act")	SUMMARY	ISRAEL COMPANIES LAW	SUMMARY AND DIFFERENCES
	<ul style="list-style-type: none"> In a voluntary winding up, as soon as the affairs of the company are fully wound up, the liquidator will make a final account showing how the winding up was conducted and how property was disposed of. The Final Meeting of the company must be called for the purpose of laying the account before it and within 7 days thereafter, the liquidator must lodge the prescribed return of the holding of the meeting and of its date with a copy of the account attached to such return with the Registrar and the Official Receiver and the company is dissolved 3 months after lodging of this return. 		<ul style="list-style-type: none"> In a compulsory winding up by court, as soon as the company's affairs have been completely wound up, upon the request of the liquidator, the court orders that the company be dissolved, and the company is deemed dissolved as of the date of the order. A copy of the order shall, within 14 days, be filed by the liquidator with the Registrar.

SUMMARY OF CERTAIN PROVISIONS OF ISRAELI LAW

Our Company is incorporated under the laws of the State of Israel and, therefore, operates subject to Israeli law. Set forth below is a summary of provisions of Israeli law relating to (i) Fiduciary duties of Office Holders, (ii) Duties of Shareholders; and (iii) Exculpation, Insurance and Indemnification of Office Holders. This summary does not purport to contain all applicable qualifications and exemptions and does not purport to be a complete review of all matters of Israeli law or a comparison of provisions that may differ from the laws of other jurisdictions, with which interested parties may be more familiar. For a summary comparison of Israeli corporate laws to corresponding Singapore corporate laws, see Annex E of this Prospectus. For a summary of Israeli tax laws, see Annex D of this Prospectus.

Fiduciary duties of Office Holders

The Israeli Companies Law codifies the fiduciary duties that office holders owe to their company. An “office holder” is defined by the Israeli Companies Law as a director, general manager, managing director, chief executive officer, executive vice president, vice president, other managers who are directly subordinated to the general manager and any other person fulfilling or assuming any of the foregoing positions regardless of such person’s title. An office holder’s fiduciary duties consist of a duty of care and a duty of loyalty.

The duty of care generally requires an office holder to act with the level of care with which a reasonable office holder in the same position would act under the same circumstances. The duty of care includes a duty to use reasonable means to obtain information on the advisability of a given action brought for his approval or performed by him by virtue of his position and all other important information pertaining to these actions.

The duty of loyalty generally requires an office holder to act in good faith and for the benefit of the company. It requires an office holder to: (i) refrain from any conflict of interest between the performance of his duties in the company and the performance of his other duties or his personal affairs; (ii) refrain from any activity that is competitive with the company; (iii) refrain from exploiting any business opportunity of the company to receive a personal gain for himself or others; and (iv) disclose to the company any information or documents relating to a company’s affairs which the office holder has received due to his position as an office holder.

The Israeli Companies Law requires that an office holder of a company disclose to the company, promptly and in any event no later than the board of directors meeting in which the transaction is first discussed, any personal interest that he may have and all related material information known to him, in connection with any existing or proposed transaction by the company. A personal interest of an office holder includes an interest of a company in which the office holder is, directly or indirectly, the holder of 5% or more of a company’s issued share capital or of its voting rights, a director or general manager or in which the office holder has the right to appoint at least one director or the general manager. In the case of an extraordinary transaction (as defined in the Israeli Companies Law), the office holder’s duty to disclose applies also to a personal interest of the office holder’s relative, which term is defined in the act as the person’s spouse, siblings, parents, grandparents, descendants, spouse’s descendants and the spouses of any of the foregoing.

Duties of Shareholders

Under the Israeli Companies Law, each shareholder has a duty to act in good faith in exercising his rights and fulfilling his or her obligations towards the company and other shareholders and to refrain from abusing his or her power in the company, such as in shareholder votes on the following matters: (i) any alteration of the articles; (ii) an increase of the company’s registered share capital; (iii) a merger; or (iv) approval of certain actions and transactions that require shareholder approval. Each shareholder also has the general duty to refrain from depriving other shareholders of their rights.

ANNEX F

In addition, specified shareholders have a duty of fairness towards the company. These shareholders include any controlling shareholder, any shareholder who knows that it possesses the power to determine the outcome of a shareholder vote in a general meeting or in a class meeting and any shareholder who, pursuant to the provisions of the articles, has the power to appoint or to prevent the appointment of an office holder or any other power with respect to the company. The Israeli Companies Law further provides that a breach of such duty shall be subject, *mutatis mutandis*, to the laws applicable to breach of contract, given the standing of the aforementioned entities in the company.

Under the Israeli Companies Law, the disclosure requirements that apply to an office holder (described above) also apply to a controlling shareholder of a public company. A controlling shareholder, for this purpose, is a shareholder who has the ability to direct the activities of a company, including a shareholder that holds 25% or more of the voting rights of the company where no other shareholder holds more than 50% of the voting rights, but excluding a shareholder whose power derives solely from his or her position on the board of directors or any other position within the company.

Extraordinary transactions (as defined in the Israeli Companies Law) with a controlling shareholder of a public company or with another person in which a controlling shareholder has a personal interest, and the engagement of a controlling shareholder as an office holder or employee, require the approval of the audit committee, the board of directors and the shareholders of the company, in that order.

Exculpation, Insurance and Indemnification of Office Holders

The Israeli Companies Law allows a company to provide exculpation or indemnification of, or insurance coverage for, its office holders, as summarized below, provided that (i) the articles authorize the company to do so and (ii) it has been approved by the company's audit committee and board of directors and, if the beneficiary is a director, also by the general meeting.

Exculpation of Office Holders

A company may not exempt an office holder from liability with respect to a breach of his duty of loyalty, but may exempt in advance an office holder from his liability to the company, in whole or in part, with respect to a breach of his duty of care.

Insurance of Office Holders

A company may enter into a contract for the insurance of the liability of any of its office holders with respect to an act performed in his capacity of an office holder, for: (i) a breach of his duty of care to the company or to another person; (ii) a breach of his duty of loyalty to the company, provided that the office holder acted in good faith and had reasonable cause to assume that his act would not prejudice the company's interests; or (iii) a financial liability imposed upon him in favor of another person.

Indemnification of Office Holders

A company may indemnify an office holder with respect to an act performed in his capacity of an office holder against: (i) a financial liability imposed on him, and/or incurred by him in favor of another person by any judgment, including a settlement or an arbitration award approved by a court; (ii) reasonable litigation expenses, including attorneys' fees, expended by the office holder or charged to him by a court, in proceedings the company instituted against him or were instituted on its behalf or by another person, a criminal charge from which he was acquitted, or a criminal charge in which he was convicted of a criminal offence that does not require proof of criminal intent; and (iii) reasonable litigation expenses, including attorneys' fees, expended by the office holder or charged to him, due to investigation or other similar proceeding initiated by a competent governmental agency, which investigation did not result in criminal charges, or a payment of a fine in lieu of criminal proceedings.

A company may also grant in advance an undertaking to indemnify an office holder, provided that the undertaking is limited to types of events which the board of directors deems to be foreseeable at the time of the undertaking, in view of the Company's activities at that time and limited to an amount determined by the board of directors to be reasonable under the circumstances.

ANNEX F

Limitations on Exculpation, Insurance and Indemnification

The Israeli Companies Law provides that a company may not exculpate or indemnify an office holder nor enter into an insurance contract which would provide coverage for any monetary liability incurred as a result of any of the following: (i) a breach by the office holder of his duty of loyalty, unless, with respect to insurance coverage, the office holder acted in good faith and had a reasonable basis to believe that the act would not prejudice the company; (ii) a breach by the office holder of his duty of care if the breach was done intentionally or recklessly (but not solely in a negligent manner); (iii) any act or omission done with the intent to derive an unlawful personal benefit; or (iv) any fine levied against the office holder.

Any person wishing to have detailed summary of Israeli company law or advice on the differences between it and the laws of any jurisdiction with which he is more familiar, is recommended to seek independent legal advice.

ANNEX G

TERMS AND CONDITIONS AND PROCEDURES FOR APPLICATION AND ACCEPTANCE

You are invited to apply for the Invitation Shares at the Invitation Price for each Invitation Share subject to the following terms and conditions:

- 1. YOUR APPLICATION MUST BE MADE IN LOTS OF 1,000 INVITATION SHARES AND INTEGRAL MULTIPLES THEREOF. YOUR APPLICATION FOR ANY OTHER NUMBER OF INVITATION SHARES WILL BE REJECTED.**
- 2. Your application for the Offer Shares may be made by way of printed Offer Shares Application Forms or by way of Electronic Applications through Automated Teller Machines (“ATMs”) of the Participating Banks (“ATM Electronic Applications”) or through Internet Banking (“IB”) websites of the relevant Participating Banks (“Internet Electronic Applications”, which together with ATM Electronic Applications, shall be referred to as “Electronic Applications”). Your application for the Placement Shares may only be made by way of printed Placement Shares Application Forms. YOU MAY NOT USE CENTRAL PROVIDENT FUND (“CPF”) FUNDS TO APPLY FOR THE INVITATION SHARES.**
- 3. You are allowed to submit only one application in your own name for either the Offer Shares or the Placement Shares. If you submit an application for Offer Shares by way of an Application Form, you MAY NOT submit another application for Offer Shares by way of an Electronic Application and vice versa. If you submit an application for Offer Shares by way of an ATM Electronic Application, you MAY NOT submit another application for Offer Shares by way of an Internet Electronic Application. Such separate applications shall be deemed to be multiple applications and will be liable to be rejected at the discretion of our Company and the Vendors, except in the case of applications by approved nominee companies, where each application is made on behalf of a different beneficiary.**

If you, being other than an approved nominee company, have submitted an application for Offer Shares in your own name, you should not submit any other application for Offer Shares, whether by way of an Application Form or by way of an Electronic Application, for any other person. Such separate applications shall be deemed to be multiple applications and will be liable to be rejected at the discretion of our Company and the Vendors.

If you have made an application for Placement Shares, you should not make any application for Offer Shares either by way of an Application Form or through an Electronic Application and vice versa. Such separate applications shall be deemed to be multiple applications and will be liable to be rejected at the discretion of our Company and the Vendors.

Conversely, if you have made an application for Offer Shares either by way of an Application Form or through an Electronic Application, you may not make any application for Placement Shares. Such separate applications shall be deemed to be multiple applications and will be liable to be rejected at the discretion of our Company and the Vendors.

Joint applications shall be rejected. If you submit or procure submissions of multiple share applications (whether for Offer Shares, Placement Shares or both Offer Shares and Placement Shares), you may be deemed to have committed an offence under the Penal Code, Chapter 224 of Singapore and the Securities and Futures Act, Chapter 289 of Singapore, and your applications may be referred to the relevant authorities for investigation. Multiple applications or those appearing to be or suspected of being multiple applications will be liable to be rejected at the discretion of our Company and the Vendors.

ANNEX G

4. We will not accept applications from any person under the age of 21 years, undischarged bankrupts, sole proprietorships, partnerships, chops or non-corporate bodies, joint Securities Account holders of CDP and from applicants whose addresses (as furnished in their Application Forms or, in the case of Electronic Applications, contained in the records of the relevant Participating Banks, as the case may be) bear post office box numbers.
5. We will not recognise the existence of a trust. Any application by a trustee or trustees must be made in his/her/their own name(s) and without qualification or, where the application is made by way of an Application Form by a nominee, in the name(s) of an approved nominee company or approved nominee companies after complying with paragraph 6 below.
6. **WE WILL NOT ACCEPT APPLICATIONS FROM NOMINEES EXCEPT THOSE MADE BY APPROVED NOMINEE COMPANIES ONLY.** Approved nominee companies are defined as banks, merchant banks, finance companies, insurance companies, licensed securities dealers in Singapore and nominee companies controlled by them. Applications made by nominees other than approved nominee companies shall be rejected.
7. **IF YOU ARE NOT AN APPROVED NOMINEE COMPANY, YOU MUST MAINTAIN A SECURITIES ACCOUNT WITH CDP IN YOUR OWN NAME AT THE TIME OF YOUR APPLICATION.** If you do not have an existing Securities Account with CDP in your own name at the time of your application, your application will be rejected (if you apply by way of an Application Form), or you will not be able to complete your Electronic Application (if you apply by way of an Electronic Application). If you have an existing Securities Account with CDP but fail to provide your Securities Account number or provide an incorrect Securities Account number in Section B of the Application Form or in your Electronic Application, as the case may be, your application is liable to be rejected. Subject to paragraph 9 below, your application shall be rejected if your particulars such as name, NRIC/passport number, nationality and permanent residence status, and CDP Securities Account number provided in your Application Form or, in the case of an Electronic Application, contained in the records of the relevant Participating Bank at the time of your Electronic Application, as the case may be, differ from those particulars in your Securities Account as maintained with CDP. If you have more than one individual direct Securities Account with CDP, your application shall be rejected.
8. **If your address stated in the Application Form or, in the case of an Electronic Application, contained in the records of the relevant Participating Bank, as the case may be, is different from the address registered with CDP, you must inform CDP of your updated address promptly, failing which the notification letter on successful allotment and/or allocation and other correspondences from CDP will be sent to your address last registered with CDP.**
9. **Our Company and the Vendors reserve the right to reject any application which does not conform strictly to the instructions set out in the Application Forms and in this Prospectus or which does not comply with the instructions for Electronic Applications or with the terms and conditions of this Prospectus or, in the case of an application by way of an Application Form, which is illegible, incomplete, incorrectly completed or which is accompanied by an improperly drawn remittance or improper form of remittance. We further reserve the right to treat as valid any applications not completed or submitted or effected in all respects in accordance with the instructions set out in the Application Forms or the instructions for Electronic Application or the terms and conditions of this Prospectus and also to present for payment or other processes all remittances at any time after receipt and to have full access to all information relating to, or deriving from, such remittances or the processing thereof.**
10. Our Company and the Vendors reserve the right to reject or accept, in whole or in part, or to scale down or ballot any application without assigning any reason therefor, and no enquiry and/or correspondence on our decision with regards hereto will be entertained. This right applies to applications made by way of Application Forms and by way of Electronic Applications. In deciding

ANNEX G

the basis of allotment and/or allocation which shall be at our discretion, due consideration will be given to the desirability of allotting and/or allocating the Invitation Shares to a reasonable number of applicants with a view to establishing an adequate market for the Shares.

11. Share certificates will be registered in the name of CDP and will be forwarded only to CDP. It is expected that CDP will send to you, at your own risk, within 15 Market Days after the close of the Application List, a statement of account stating that your Securities Account has been credited with the number of Invitation Shares allotted and/or allocated to you, if your application is successful. This will be the only acknowledgement of application monies received and is not an acknowledgement by us. You irrevocably authorise CDP to complete and sign on your behalf as transferee or renounee any instrument of transfer and/or other documents required for the issue or transfer of the Invitation Shares allotted and/or allocated to you. This authorisation applies to applications made by way of Application Forms and by way of Electronic Applications.
12. In the event that our Company lodges a supplementary or replacement prospectus ("Relevant Document") pursuant to the SFA or any applicable legislation in force from time to time prior to the close of the Invitation, and the Invitation Shares have not been issued, we will (as required by law) at our Company's sole and absolute discretion either:
 - (i) within seven days of the lodgement of the Relevant Document give you a copy of the Relevant Document and provide you with an option to withdraw your application; or
 - (ii) treat your application as withdrawn and cancelled, in which case the applications shall be deemed to have been withdrawn and cancelled and we shall refund your application monies (without interest or any share of revenue or other benefit arising therefrom) to you within seven days from the lodgement of the Relevant Document.

When you have notified us within 14 days from the date of lodgement of the Relevant Document of your wish to exercise your option under the SFA to withdraw your application, we shall pay to you all monies paid by you on account of your application for the Invitation Shares without interest or any share of revenue or other benefit arising therefrom and at your own risk, within seven days from the receipt of such notification.

In the event that at the time of the lodgement of the Relevant Document, the Invitation Shares have already been issued but trading has not commenced, we will (as required by law) either:

- (i) within seven days of the lodgement of the Relevant Document give you a copy of the Relevant Document and provide you with an option to return the Shares; or
- (ii) treat the issue of the Invitation Shares as void, in which case the issue shall be deemed to be void and we shall refund your application monies (without interest or any share of revenue or other benefit arising therefrom) to you within seven days from the lodgement of the Relevant Document.

Where you have notified us within 14 days from the date of lodgement of the Relevant Document of your wish to exercise your option under the SFA to return the Invitation Shares issued or sold to you, you shall return all documents, if any, purporting to be evidence of title to those Invitation Shares, whereupon we shall pay to you all monies paid by you on account of your application for the Invitation Shares without interest or any share of revenue or other benefit arising therefrom and at your own risk, within seven days from the receipt of such notification and documents.

Additional terms and instructions applicable upon the lodgement of the Relevant Document, including instructions on how you can exercise the option to withdraw, may be found in such supplementary or replacement prospectus.

ANNEX G

13. In the event of an under-subscription for the Offer Shares as at the close of the Application List, that number of Offer Shares not subscribed for and/or purchased shall be made available to satisfy applications for Placement Shares to the extent that there is an over-subscription for Placement Shares as at the close of the Application List.

In the event of an under-subscription for the Placement Shares as at the close of the Application List, that number of Placement Shares not subscribed for and/or purchased shall be made available to satisfy applications for Offer Shares to the extent that there is an over-subscription for Offer Shares as at the close of the Application List.

In the event of an over-subscription for Offer Shares as at the close of the Application List and the Placement Shares are fully subscribed or over-subscribed as at the close of the Application List, the successful applications for Offer Shares will be determined by ballot or otherwise as determined by our Directors and approved by the SGX-ST.

In all of the above instances, the basis of allotment and/or allocation of the Invitation Shares as may be decided upon by our Directors in ensuring a reasonable spread of shareholders of our Company, shall be made public, as soon as practicable, via an announcement through the SGX-ST and through a paid advertisement in a local English newspaper.

14. You irrevocably authorise CDP to disclose the outcome of your application, including the number of Invitation Shares allotted and/or allocated to you pursuant to your application, to our Company, the Vendors, the Manager, the Underwriter, the Placement Agent and any other parties so authorised by the forgoing persons.
15. Any reference to “you” or the “applicant” in this section shall include an individual, a corporation, an approved nominee and trustee applying for the Offer Shares by way of an Application Form or by way of an Electronic Application and a person applying for the Placement Shares through the Placement Agents.
16. By completing and delivering an Application Form or by making and completing an Electronic Application (in the case of an ATM Electronic Application by pressing the “Enter” or “OK” or “Confirm” or “Yes” or any other relevant key on the ATM (as the case may be) or in the case of an Internet Electronic Application by clicking “Submit” or “Continue” or “Yes” or “Confirm” or any other relevant button on the IB website screen (as the case may be) of the relevant Participating Banks) in accordance with the provisions of this Prospectus, you:
- (a) irrevocably offer, agree and undertake to subscribe for and/or purchase the number of Invitation Shares specified in your application (or such smaller number for which the application is accepted) at the Invitation Price for each Invitation Share and agree that you will accept such Invitation Shares as may be allotted and/or allocated to you, in each case on the terms of, and subject to the conditions set out in, this Prospectus and the Memorandum and Articles of Association of our Company;
 - (b) warrant the truth and accuracy of the information contained, and representations and declarations made, in your application, and acknowledge and agree that such information, representations and declarations will be relied on by our Company and the Vendors in determining whether to accept your application and/or whether to allot and/or allocate any Invitation Shares to you;
 - (c) agree that in the event of any inconsistency between the terms and conditions for application set out in this Prospectus and those set out in the IB websites or ATMs of the relevant Participating Banks, the terms and conditions set out in this Prospectus shall prevail;
 - (d) agree that the aggregate Invitation Price for the Invitation Shares applied for is due and payable to the Company and the Vendors upon application; and

ANNEX G

- (e) agree and warrant that, if the laws of any jurisdictions outside Singapore are applicable to your application, you have complied with all such laws and none of our Company, the Vendors, the Manager, the Underwriter, the Placement Agent, the Primary Sub-Underwriter and/or the Primary Sub-Placement Agent will infringe any such laws as a result of the acceptance of your application.
17. Our acceptance of applications will be conditional upon, *inter alia*, us being satisfied that:
- (a) permission has been granted by the SGX-ST to deal in and for quotation of all our existing Shares (including the Vendor Shares), the New Shares and the Option Shares on the Official List of the SGX-ST;
 - (b) the Management and Underwriting Agreement and the Placement Agreement referred to in paragraph 31, in “General and Statutory Information” have become unconditional and have not been terminated; and
 - (c) the Authority has not served a stop order which directs that no or no further shares to which this Prospectus relates be allotted and/or allocated.
18. In the event that a stop order in respect of the Invitation Shares is served by the Authority or other competent authority, and:
- (a) the Invitation Shares have not been issued, we will (as required by law) deem all applications withdrawn and cancelled and our Company shall refund the application monies (without interest or any share of revenue or other benefit arising therefrom) to you within 14 days of the date of the stop order; or
 - (b) if the Invitation Shares have already been issued but trading has not commenced, the issue will (as required by law) be deemed void, and
 - (i) if documents purporting to evidence title had been issued to you, our Company shall inform you to return such documents to our Company within 14 days from that date; and
 - (ii) we will refund the application monies (without interest or any share of revenue or other benefit arising therefrom) to you within seven days from the date of receipt of those documents (if applicable) or the date of the stop order, whichever is later. This shall not apply where only an interim stop order has been served.
19. In the event that an interim stop order in respect of the Invitation Shares is served by the Authority or other competent authority, no Invitation Shares shall be issued to you during the time when the interim stop order is in force.
20. The Authority is not able to serve a stop order in respect of the Invitation Shares if the Invitation Shares have been issued and listed on a securities exchange and trading in them has commenced.
21. In the event of any changes in the closure of the Application List or the time period during which the Invitation is open, we will publicly announce the same through a MASNET announcement to be posted on the Internet at the SGX-ST website <http://www.sgx.com> and through a paid advertisement in a local English newspaper.
22. We will not hold any application in reserve.
23. We will not allot and/or allocate Shares on the basis of this Prospectus later than six months after the date of registration of this Prospectus.

ANNEX G

24. Additional terms and conditions for applications by way of Application Forms are set out on pages G-6 to G-9 of this Prospectus.
25. Additional terms and conditions for applications by way of Electronic Applications are set out on pages G-9 to G-14 of this Prospectus.

ADDITIONAL TERMS AND CONDITIONS FOR APPLICATIONS USING APPLICATION FORMS

You shall make an application by way of an Application Form made on and subject to the terms and conditions of this Prospectus, including, but not limited to, the terms and conditions appearing below as well as those set out under the section on “TERMS AND CONDITIONS AND PROCEDURES FOR APPLICATION AND ACCEPTANCE” beginning on page G-1 of this Prospectus, as well as the Memorandum and Articles of Association of our Company.

1. Your application must be made using the **WHITE** Application Forms and **WHITE** official envelopes “A” and “B” for Offer Shares, or the **BLUE** Application Forms for Placement Shares accompanying and forming part of this Prospectus. We draw your attention to the detailed instructions contained in the respective Application Forms and this Prospectus for the completion of the Application Forms which must be carefully followed. **Our Company and the Vendors reserve the right to reject applications which do not conform strictly to the instructions set out in the Application Forms and this Prospectus or to the terms and conditions of this Prospectus or which are illegible, incomplete, incorrectly completed or which are accompanied by improperly drawn remittances or improper form of remittances.**
2. Your Application Forms must be completed in English. Please type or write clearly in ink using **BLOCK LETTERS**.
3. All spaces in the Application Forms, except those under the heading “FOR OFFICIAL USE ONLY”, must be completed and the words “NOT APPLICABLE” or “N.A.” should be written in any space that is not applicable.
4. Individuals, corporations, approved nominee companies and trustees must give their names in full. You must make your application, in the case of individuals, in your full names as they appear in your identity card (if you have such identification documents) or in your passport and, in the case of corporations, in your full names as registered with a competent authority. If you are not an individual, you must complete the Application Form under the hand of an official who must state the name and capacity in which he signs the Application Form. If you are a corporation completing the Application Form, you are required to affix your Common Seal (if any) in accordance with your Memorandum and Articles of Association or equivalent constitutive documents. If you are a corporate applicant and your application is successful, a copy of your Memorandum and Articles of Association or equivalent constitutive documents must be lodged with our Company’s Share Registrar and Share Transfer Office. Our Company and the Vendors reserve the right to require you to produce documentary proof of identification for verification purposes.
5.
 - (a) You must complete Sections A and B and sign on page 1 of the Application Form.
 - (b) You are required to delete either paragraph 7(a) or 7(b) on page 1 of the Application Form. Where paragraph 7(a) is deleted, the applicants must also complete Section C of the Application Form with particulars of the beneficial owner(s).
 - (c) If you fail to make the required declaration in paragraph 7(a) or 7(b), as the case may be, on page 1 of the Application Form, your application is liable to be rejected.
6. You (whether an individual or corporate applicant, whether incorporated or unincorporated and wherever incorporated or constituted) will be required to declare whether you are a citizen or permanent resident of Singapore or a corporation in which citizens or permanent residents of Singapore or any body corporate constituted under any statute of Singapore have an interest in the aggregate of more than 50 per cent. of the issued share capital of or interests in such

ANNEX G

corporations. If you are an approved nominee company, you are required to declare whether the beneficial owner of the Invitation Shares is a citizen or permanent resident of Singapore or a corporation, whether incorporated or unincorporated and wherever incorporated or constituted, in which citizens or permanent residents of Singapore or any body corporate whether incorporated or unincorporated and wherever incorporated or constituted under any statute of Singapore have an interest in the aggregate of more than 50 per cent. of the issued share capital of or interests in such corporation.

7. You may apply for the Invitation Shares using only cash. Your application must be accompanied by a remittance in Singapore currency for the full amount payable, in respect of the number of Invitation Shares applied for, in the form of a BANKER'S DRAFT or CASHIER'S ORDER drawn on a bank in Singapore made out in favour of "**SARIN SHARE ISSUE ACCOUNT**" crossed "**A/C PAYEE ONLY**", with the name and address of the applicant written clearly on the reverse side. WE WILL NOT ACCEPT APPLICATIONS NOT ACCOMPANIED BY ANY PAYMENT OR ACCOMPANIED BY ANY OTHER FORM OF PAYMENT. We will reject remittances bearing "NOT TRANSFERABLE" or "NON TRANSFERABLE" crossings. No acknowledgement of receipt will be issued by our Company, the Vendors or the Manager for applications and application monies received.
8. Monies paid in respect of unsuccessful applications are expected to be returned (without interest or any share of revenue or other benefit arising therefrom) to you by ordinary post within 24 hours of balloting at your own risk. Where your application is rejected or accepted in part only, the full amount or the balance of the application monies, as the case may be, will be refunded (without interest or any share of revenue or other benefit arising therefrom) to you by ordinary post at your own risk within 14 days after the close of the Application List provided that the remittance accompanying such application which has been presented for payment or other processes has been honoured and the application monies have been received in the designated share issue account. In the event that the Invitation is cancelled by our Company and the Vendors following the termination of the Management and Underwriting Agreement and/or the Placement Agreement, the application monies received will be refunded (without interest or any share of revenue or any other benefit arising therefrom) to you by ordinary post or telegraphic transfer at your own risk within five Market Days of the termination of the Invitation. In the event that the Invitation is cancelled by our Company and the Vendors following the issuance of a stop order by the Authority, the application monies received will be refunded (without interest or any share of revenue or other benefit arising therefrom) to you by ordinary post or telegraphic transfer at your own risk within 14 days from the date of the stop order.
9. Capitalised terms used in the Application Forms and defined in this Prospectus shall bear the meanings assigned to them in this Prospectus.
10. In consideration of our Company and the Vendors having distributed the Application Form to you and agreeing to close the Application List at **12.00 noon on 6 April 2005** or such other time or date as our Directors and the Vendors may, in consultation with the Manager, decide and by completing and delivering the Application Form, you agree that:
 - (a) your application is irrevocable;
 - (b) your remittance will be honoured on first presentation and that any application monies returnable may be held pending clearance of your payment without interest or any share of revenue or other benefit arising therefrom;
 - (c) all applications, acceptances and contracts resulting therefrom under the Invitation shall be governed by and construed in accordance with the laws of Singapore and that you irrevocably submit to the non-exclusive jurisdiction of the Singapore courts;

ANNEX G

- (d) in respect of the Invitation Shares for which your application has been received and not rejected, acceptance of your application shall be constituted by written notification by or on behalf of our Company and the Vendors and not otherwise, notwithstanding any remittance being presented for payment by or on behalf of our Company and the Vendors;
- (e) you will not be entitled to exercise any remedy of rescission for misrepresentation at any time after acceptance of your application;
- (f) in making your application, reliance is placed solely on the information contained in this Prospectus and that none of our Company, the Vendors, the Manager, the Underwriter, the Placement Agent, the Primary Sub-Underwriters and the Primary Sub-Placement Agents or any other person involved in the Invitation shall have any liability for any information not so contained;
- (g) you consent to the disclosure of your name, NRIC/passport number, address, nationality, permanent resident status, CDP Securities Account number, and share application amount to our Share Registrar, CDP, SCCS, SGX-ST, our Company, the Vendors, the Manager, the Underwriter, the Placement Agent or other authorised operators; and
- (h) you irrevocably agree and undertake to subscribe for and/or purchase the number of Invitation Shares applied for as stated in the Application Form or any smaller number of such Invitation Shares that may be allotted and/or allocated to you in respect of your application. In the event that our Company and the Vendors decide to allot and/or allocate a smaller number of Invitation Shares or not to allot and/or allocate any Invitation Shares to you, you agree to accept such decision as final.

Applications for Offer Shares

1. Your application for Offer Shares **MUST** be made using the **WHITE** Offer Shares Application Forms and **WHITE** official envelopes "A" and "B". **ONLY ONE APPLICATION** should be enclosed in each envelope.
2. You must:
 - (a) enclose the **WHITE** Offer Shares Application Form, duly completed and signed, together with your correct remittance in accordance with the terms and conditions of this Prospectus in the **WHITE** envelope "A" provided;
 - (b) in the appropriate spaces on **WHITE** envelope "A":
 - (i) write your name and address;
 - (ii) state the number of Offer Shares applied for; and
 - (iii) affix adequate Singapore postage;
 - (c) SEAL THE **WHITE** ENVELOPE "A";
 - (d) write, in the special box provided on the larger **WHITE** envelope "B" addressed to **SARIN TECHNOLOGIES LTD, C/O UOB ASIA LIMITED, 1 RAFFLES PLACE #13-01, OUB CENTRE, SINGAPORE 048616**, the number of Offer Shares for which the application is made; and

ANNEX G

- (e) insert **WHITE** envelope “A” into **WHITE** envelope “B”, seal **WHITE** envelope “B” and thereafter **DESPATCH BY ORDINARY POST OR DELIVER BY HAND**, at your own risk, to **SARIN TECHNOLOGIES LTD, C/O UOB ASIA LIMITED, 1 RAFFLES PLACE #13-01, OUB CENTRE, SINGAPORE 048616** to arrive by **12.00 noon on 6 April 2005 or such other time as our Directors and the Vendors may, in consultation with the Manager, decide. Local Urgent Mail or Registered Post must NOT be used.** No acknowledgement of receipt will be issued for any application or remittance received.
3. Applications that are illegible, incomplete or incorrectly completed or accompanied by improperly drawn remittances or improper form of remittance or which are not honoured upon their first presentation are liable to be rejected.
4. **ONLY ONE APPLICATION** should be enclosed in each envelope. No acknowledgement of receipt will be issued for any application or remittance received.

Applications for Placement Shares

1. Your application for Placement Shares **MUST** be made using the **BLUE** Placement Shares Application Forms. **ONLY ONE APPLICATION** should be enclosed in each envelope.
2. The completed and signed **BLUE** Placement Shares Application Form and your remittance in full in respect of the number of Placement Shares applied for in accordance with the terms and conditions of this Prospectus, with your name and address written clearly on the reverse side, must be enclosed and sealed in an envelope to be provided by you. The sealed envelope must be **DESPATCHED BY ORDINARY POST OR DELIVERED BY HAND**, at your own risk, to **SARIN TECHNOLOGIES LTD, C/O UOB ASIA LIMITED, 1 RAFFLES PLACE #13-01, OUB CENTRE, SINGAPORE 048616** to arrive by **12.00 noon on 6 April 2005 or such other time as our Directors and the Vendors may, in consultation with the Manager, decide. Local Urgent Mail or Registered Post must NOT be used.** No acknowledgement of receipt will be issued for any application or remittance received.
3. Applications that are illegible, incomplete or incorrectly completed or accompanied by improperly drawn remittances or improper form of remittance or which are not honoured upon their first presentation are liable to be rejected.
4. **ONLY ONE APPLICATION** should be enclosed in each envelope. No acknowledgement of receipt will be issued for any application or remittance received.

ADDITIONAL TERMS AND CONDITIONS FOR ELECTRONIC APPLICATIONS

The procedures for Electronic Applications are set out on the ATM screens (in the case of ATM Electronic Applications) and the IB website screens (in the case of Internet Electronic Applications) of the relevant Participating Banks. Currently, UOB Group and DBS are the only Participating Banks through which Internet Electronic Applications can be made. For illustration purposes, the procedures for Electronic Applications through the ATMs and the IB website of UOB Group are set out, respectively, in the “Steps for an ATM Electronic Application through the ATMs of UOB Group” and the “Steps for an Internet Electronic Application through the IB website of UOB Group” (collectively, the “Steps”) appearing on pages G-14 to G-18 of this Prospectus. Please read carefully the terms of this Prospectus, the Steps and the terms and conditions for Electronic Applications set out below before making an Electronic Application. Any reference to “you” or the “applicant” in the “Additional Terms and Conditions for Electronic Applications” and the Steps shall refer to you making an application for Offer Shares through an ATM or the IB website of a relevant Participating Bank.

You must have an existing bank account with, and be an ATM cardholder of, one of the Participating Banks before you can make an ATM Electronic Application at the ATMs of that Participating Bank. An ATM card issued by one Participating Bank cannot be used to apply for Offer Shares at an ATM belonging to other Participating Banks. For an Internet Electronic Application, you must have an existing bank account with and an IB User Identification (“User ID”) and a Personal Identification

ANNEX G

Number/Password (“PIN”) given by a relevant Participating Bank. The Steps set out the actions that you must take at ATMs or the IB website of UOB Group to complete an Electronic Application. The actions that you must take at ATMs or the IB websites of other Participating Banks are set out on the ATM screens or the IB website screens of the relevant Participating Banks. Upon the completion of your ATM Electronic Application transaction, you will receive an ATM transaction slip (“Transaction Record”), confirming the details of your ATM Electronic Application. Upon completion of your Internet Electronic Application, through the IB website of UOB Group, there will be an on-screen confirmation (“Confirmation Screen”) of the application which can be printed out for your record. The Transaction Record or your printed record of the Confirmation Screen is for your retention and should not be submitted with any Application Form.

You must ensure that you enter your own Securities Account number when using the ATM card issued to you in your own name. If you fail to use an ATM card issued in your own name or do not key in your own Securities Account number, your application will be rejected. If you operate a joint bank account with any of the Participating Banks, you must ensure that you enter your own Securities Account number when using the ATM card issued to you in your own name. Using your own Securities Account number with an ATM card which is not issued to you in your own name will render your ATM Electronic Application liable to be rejected.

You must ensure, when making an Internet Electronic Application, that your mailing address for the purpose of the application is in Singapore and the application is being made in Singapore and you will be asked to declare accordingly. Otherwise, your application is liable to be rejected.

Your Electronic Application shall be made on the terms, and subject to the conditions of, this Prospectus, including, but not limited to, the terms and conditions appearing below and those set out under the section on “TERMS AND CONDITIONS AND PROCEDURES FOR APPLICATION AND ACCEPTANCE” on pages G-1 to G-18 of this Prospectus as well as the Memorandum and Articles of Association of our Company.

1. In connection with your Electronic Application for Offer Shares, you are required to confirm statements to the following effect in the course of activating the Electronic Application:
 - (a) **that you have received a copy of this Prospectus (in the case of ATM Electronic Applications only) and have read, understood and agreed to all the terms and conditions of application for Offer Shares and this Prospectus prior to effecting the Electronic Application and agree to be bound by the same;**
 - (b) **that you consent to the disclosure of your name, NRIC/passport number, address, nationality, permanent resident status, CDP Securities Account number and application details (the “Relevant Particulars”) maintained with the relevant Participating Bank to our Share Registrar, SGX-ST, CDP, CPF, SCCS, our Company, the Manager or other authorised operators (the “Relevant Parties”); and**
 - (c) **that this is your only application for Offer Shares and it is made in your own name and at your own risk.**

Your application will not be successfully completed and cannot be recorded as a completed transaction at the ATM or on the IB website unless you press the “Enter” or “OK” or “Confirm” or “Yes” key or any other relevant key on the ATM or click “Confirm” or “OK” or Submit” or “Continue” or “Yes” or any other relevant button on the IB website screen. By doing so, you shall be treated as signifying your confirmation of each of the above three statements. In respect of statement 1(b) above, your confirmation shall signify and shall be treated as your written permission, given in accordance with the relevant laws of including Section 47(2) of the Banking Act, Chapter 19 of Singapore, to the disclosure by the relevant Participating Bank of the Relevant Particulars to the Relevant Parties.

ANNEX G

2. **BY MAKING AN ELECTRONIC APPLICATION, YOU CONFIRM THAT YOU ARE NOT APPLYING FOR OFFER SHARES AS NOMINEE FOR ANY OTHER PERSON AND THAT ANY ELECTRONIC APPLICATION THAT YOU MAKE IS THE ONLY APPLICATION MADE BY YOU AS BENEFICIAL OWNER.**

YOU SHALL MAKE ONLY ONE ELECTRONIC APPLICATION FOR OFFER SHARES AND SHOULD NOT MAKE ANY OTHER APPLICATION FOR OFFER SHARES OR PLACEMENT SHARES, WHETHER AT THE ATMS OF ANY PARTICIPATING BANKS OR THE IB WEBSITES (IF ANY) OF THE RELEVANT PARTICIPATING BANKS OR ON THE APPLICATION FORMS. IF YOU HAVE MADE AN APPLICATION FOR OFFER SHARES OR PLACEMENT SHARES ON AN APPLICATION FORM, YOU SHALL NOT MAKE AN ELECTRONIC APPLICATION FOR OFFER SHARES AND VICE VERSA.

3. You must have sufficient funds in your bank account with your Participating Bank at the time you make your Electronic Application, failing which your Electronic Application will not be completed or accepted. **Any Electronic Application which does not conform strictly to the instructions set out in this Prospectus or on the screens of the ATM or the IB website of the relevant Participating Bank through which your Electronic Application is being made shall be rejected.**

You may make an ATM Electronic Application at the ATM of any Participating Bank or an Internet Electronic Application at the IB website of a relevant Participating Bank for Offer Shares, using cash only by authorising such Participating Bank to deduct the full amount payable from your account with such Participating Bank.

4. You irrevocably agree and undertake to subscribe for and/or purchase and to accept the number of Offer Shares applied for as stated on the Transaction Record or the Confirmation Screen or any lesser number of Offer Shares that may be allotted and/or allocated to you in respect of your Electronic Application. In the event that our Company and the Vendors decide to allot and/or allocate any lesser number of such Offer Shares or not to allot and/or allocate any Offer Shares to you, you agree to accept such decision as final. If your Electronic Application is successful, your confirmation (by your action of pressing the "Enter" or "OK" or "Confirm" or "Yes" key or any other relevant key on the ATM or clicking "Confirm" or "OK" or "Submit" or "Continue" or "Yes" or any other relevant button on the IB website screen) of the number of Offer Shares applied for shall signify and shall be treated as your acceptance of the number of Offer Shares that may be allotted and/or allocated to you and your agreement to be bound by the Memorandum and Articles of Association of our Company.

5. **We will not keep any applications in reserve.** Where your Electronic Application is unsuccessful, the full amount of the application monies will be refunded in Singapore currency (without interest or any share of revenue or other benefit arising therefrom) to you by being automatically credited to your account with your Participating Bank within 24 hours of balloting provided that the remittance in respect of such application which has been presented for payment or other processes has been honoured and the application monies have been received in the designated share issue account. **Trading on a "WHEN ISSUED" basis, if applicable, is expected to commence after such refund has been made.**

Where your Electronic Application is rejected or accepted in part only, the full amount or the balance of the application monies, as the case may be, will be refunded in Singapore currency (without interest or any share of revenue or other benefit arising therefrom) to you by being automatically credited to your account with your Participating Bank within 14 days after the close of the Application List provided that the remittance in respect of such application which has been presented for payment or other processes has been honoured and the application monies have been received in the designated share issue account.

ANNEX G

Responsibility for timely refund of application monies from unsuccessful or partially successful Electronic Applications or otherwise lies solely with the respective Participating Banks. Therefore, you are strongly advised to consult your Participating Bank on the status of your Electronic Application and/or the refund of any monies to you from an unsuccessful or partially successful Electronic Application, to determine the exact number of Invitation Shares allotted and/or allocated to you, if any, before trading the Shares on SGX-ST. You may also call CDP Phone at 6535 7511 to check the provisional results of your application by using your T-pin (issued by CDP upon application for the service) and keying in the stock code (that will be made available together with the results of the allotment and/or allocation via announcement through SGX-ST and by advertisement in a generally circulating daily press). To sign up for the service, you may contact CDP Customer Service Officers. Neither SGX-ST, the CDP, the SCCS, the Participating Banks, our Company, the Vendors nor the Manager assumes any responsibility for any loss that may be incurred as a result of you having to cover any net sell positions or from buy-in procedures activated by the SGX-ST.

6. If your Electronic Application is unsuccessful, no notification will be sent by the relevant Participating Banks.

If you make an ATM Electronic Application through the ATM or IB website of the following Participating Banks, you may check the provisional results of your Electronic Application as follows:

Bank	Telephone	Available at ATM/Internet	Operating Hours	Service expected from
UOB Group	1800 222 2121	ATM (Other Transactions – “IPO Enquiry”) ⁽¹⁾ http://www.uobgroup.com ⁽¹⁾⁽²⁾	ATM/Phone Banking – 24 hours a day Internet Banking 24 hours a day	Evening of balloting day Evening of balloting day
DBS	1800 339 6666 (for POSB Account holders) 1800 111 1111 (for DBS Account holders)	Internet Banking http://www.dbs.com ⁽²⁾	24 hours a day	Evening of balloting day
OCBC	1800 363 3333	ATM	ATM/Phone Banking – 24 hours a day	Evening of the balloting day

Notes:

- (1) If you have made your Electronic Application through the ATMs or IB website of UOB Group, you may check the results of your application through UOB Personal Internet Banking, UOB Group ATMs or UOB PhoneBanking Services.
- (2) If you have made your Internet Electronic Application through the IB websites of UOB Group or DBS, you may check the results through the same channels listed in the table above in relation to ATM Electronic Applications made at ATMs of the UOB Group or DBS.
7. Electronic Applications shall close at **12.00 noon on 6 April 2005** or such other time as our Directors and the Vendors may, in consultation with the Manager, decide. Subject to paragraph 9 below, an Internet Electronic Application is deemed to be received only upon its completion, that is, when there is an on-screen confirmation of the application.

ANNEX G

8. You are deemed to have irrevocably requested and authorised our Company and the Vendors to:
 - (a) register the Offer Shares allotted and/or allocated to you in the name of CDP for deposit into your Securities Account;
 - (b) send the relevant Share certificate(s) to CDP;
 - (c) return or refund (without interest or any share of revenue or other benefit arising therefrom) the application monies in Singapore currency, should your Electronic Application be rejected, by automatically crediting your bank account with your Participating Bank with the relevant amount within 24 hours of balloting; and
 - (d) return or refund (without interest or any share of revenue or other benefit arising therefrom) the balance of the application monies in Singapore currency, should your Electronic Application be accepted in part only, by automatically crediting your bank account with your Participating Bank with the relevant amount within fourteen (14) Market Days after the close of the Application List.
9. You irrevocably agree and acknowledge that your Electronic Application is subject to risks of electrical, electronic, technical and computer-related faults and breakdowns, fires, acts of God and other events beyond the control of the Participating Banks, our Company, the Vendors, and the Manager and if, in any such event, our Company, the Vendors, the Manager and/or the relevant Participating Bank does not receive your Electronic Application, or data relating to your Electronic Application or the tape or any other devices containing such data is lost, corrupted, destroyed or not otherwise accessible, whether wholly or partially for whatever reason, you shall be deemed not to have made an Electronic Application and you shall have no claim whatsoever against our Company, the Vendors, the Manager, the Underwriter and the Placement Agent and/or the relevant Participating Bank for Offer Shares applied for or for any compensation, loss or damage.
10. We do not recognise the existence of a trust. Any Electronic Application by a trustee must be made in his own name and without qualification. We will reject any application by any person acting as nominee, except those made by approved nominee companies only.
11. All your particulars in the records of your Participating Bank at the time you make your Electronic Application shall be deemed to be true and correct and your Participating Bank and the Relevant Parties shall be entitled to rely on the accuracy thereof. If there has been any change in your particulars after the time of the making of your Electronic Application, you shall promptly notify your Participating Bank.
12. **You should ensure that your personal particulars as recorded by both CDP and the relevant Participating Bank are correct and identical, otherwise, your Electronic Application is liable to be rejected.** You should promptly inform CDP of any change in address, failing which the notification letter on successful allotment and/or allocation and other correspondence from the CDP will be sent to your address last registered with CDP.
13. By making and completing an Electronic Application, you are deemed to have agreed that:
 - (a) In consideration of our Company and the Vendors making available the Electronic Application facility, through the Participating Banks acting as our agents, at the ATMs and the IB websites (if any):
 - (i) your Electronic Application is irrevocable; and
 - (ii) your Electronic Application, the acceptance by our Company and the Vendors and the contract resulting therefrom under the Invitation shall be governed by and construed in accordance with the laws of Singapore and you irrevocably submit to the non-exclusive jurisdiction of the Singapore courts;

ANNEX G

- (b) neither our Company, the Vendors, the Manager nor the Participating Banks shall be liable for any delays, failures or inaccuracies in the recording, storage or in the transmission or delivery of data relating to your Electronic Application to us or CDP due to breakdowns or failure of transmission, delivery or communication facilities or any risks referred to in paragraph 9 above or to any cause beyond their respective controls;
- (c) in respect of Offer Shares for which your Electronic Application has been successfully completed and not rejected, acceptance of your Electronic Application shall be constituted by written notification by or on behalf of our Company and the Vendors, and not otherwise, notwithstanding any payment received by or on behalf of our Company and the Vendors;
- (d) you will not be entitled to exercise any remedy of rescission or misrepresentation at any time after acceptance of your application; and
- (e) in making your application, reliance is placed solely on the information contained in this Prospectus and that none of our Company, the Vendors, the Manager, the Underwriter, the Placement Agent, the Primary Sub-Underwriters and the Primary Sub-Placement Agents or any other person involved in the Invitation shall have any liability for any information not so contained.

INSTRUCTIONS FOR ELECTRONIC APPLICATIONS THROUGH ATMS AND THE IB WEBSITE OF THE UOB GROUP

The instructions for Electronic Applications will appear on the ATM screens and the IB website screens of the respective Participating Banks. For illustration purposes, the steps for making an Electronic Application through the ATMs or the IB website of UOB Group are shown below. Instructions for Electronic Applications on the ATM screens and the IB website screens (if any) of the relevant Participating Banks (other than UOB Group) may differ from that represented below. Due to space constraints on UOB Group's ATM screen, the following terms will appear in abbreviated form:

"&"	:	AND
"A/C" and "A/Cs"	:	ACCOUNT AND ACCOUNTS, respectively
"ADDR"	:	ADDRESS
"AMT"	:	AMOUNT
"APPLN"	:	APPLICATION
"CDP"	:	THE CENTRAL DEPOSITORY (PTE) LIMITED
"CPF"	:	CENTRAL PROVIDENT FUND
"CPFINVT A/C"	:	CPF INVESTMENT ACCOUNT
"ESA"	:	ELECTRONIC SHARE APPLICATION
"IC/PSSPT"	:	NRIC OR PASSPORT NUMBER
"NO" or "NO."	:	NUMBER
"PERSONAL NO"	:	PERSONAL IDENTIFICATION NUMBER
"REGISTRARS"	:	SHARE REGISTRARS
"SCCS"	:	SECURITIES CLEARING & COMPUTER SERVICES (PTE) LTD
"UOB/ICB CPFIS"	:	UOB OR ICB CPF INVESTMENT SCHEME
"YR"	:	YOUR

Steps for an ATM Electronic Application through the ATMs of UOB Group

- STEP 1 : Insert your personal Unicard, Uniplus card, Multi Account or UOB VISA/MASTER card and key in your personal identification number.
- 2 : Select "CASHCARD OR OTHER TRANSACTIONS".
- 3 : Select "SECURITIES APPLICATION".
- 4 : Select "ESA-FIXED".

ANNEX G

- 5 : Select the share counter which you wish to apply for.
- 6 : Read and understand the following statements which will appear on the screen:
- **THIS OFFER OF SECURITIES (OR UNITS OF SECURITIES) WILL BE MADE IN, OR ACCOMPANIED BY, A COPY OF THE PROSPECTUS/DOCUMENT OR SUPPLEMENTARY DOCUMENTS. ANYONE WISHING TO ACQUIRE THESE SECURITIES (OR UNITS OF SECURITIES) WILL NEED TO MAKE AN APPLICATION IN THE MANNER SET OUT IN THE PROSPECTUS/DOCUMENT OR SUPPLEMENTARY DOCUMENTS**
- (Press "Enter" to continue)
- PLEASE CALL 1800-22-22-121 IF YOU WOULD LIKE TO FIND OUT WHERE YOU CAN OBTAIN A COPY OF THE PROSPECTUS/DOCUMENT OR SUPPLEMENTARY DOCUMENT**
- **WHERE APPLICABLE, A COPY OF THE PROSPECTUS/DOCUMENT OR SUPPLEMENTARY DOCUMENT HAS BEEN LODGED WITH AND REGISTERED BY THE MONETARY AUTHORITY OF SINGAPORE WHO ASSUMES NO RESPONSIBILITY FOR THE CONTENTS OF THE PROSPECTUS/DOCUMENT OR SUPPLEMENTARY DOCUMENT**
- (Press "ENTER" to continue and to confirm that you have read and understood the above statements)
- 7 : Read and understand the following terms which will appear on the screen:
- **YOU HAVE READ UNDERSTOOD & AGREED TO ALL TERMS OF THE PROSPECTUS/DOCUMENT/SUPPLEMENTARY DOCUMENT & THIS ELECTRONIC APPLICATION**
- (Press "ENTER" to continue)
- **YOU CONSENT TO DISCLOSE YOUR NAME IC/PSSPT NATIONALITY ADDR APPLN AMT CPF INVT A/C NO & CDP A/C NO FROM YOUR A/CS TO CDP, CPF, SCCS, REGISTRARS, SGX-ST & ISSUER/VENDOR(S)**
 - **THIS IS YOUR ONLY FIXED PRICE APPLN & IS IN YOUR NAME AND AT YOUR RISK**
- (Press "ENTER" to confirm)
- 8 : Screen will display:
- **NRIC/Passport No. XXXXXXXXXXXX IF YOUR NRIC NO/PASSPORT NO. IS INCORRECT, PLEASE CANCEL THE TRANSACTION AND NOTIFY THE BRANCH PERSONALLY.**
- (Press "Cancel" or "Confirm")
- 9 : Select mode of payment i.e. "CASH ONLY". You will be prompted to select Cash A/c type to debit (ie, Current A/c or Saving A/c). Should you have a few a/cs linked to this ATM card, a list of linked A/cs Number will be displayed for you to select.

ANNEX G

- 10 : After you have selected ACCOUNT, CDP A/c No. will be displayed for you to confirm or change (This screen with CDP A/c No. will be shown for applicants whose CDP No. is already stored in our UOB Group's ATM system). For applications using UOB Group's ATM for the first time to apply for IPO, CDP A/c No. will not be stored in UOB Group's ATM system, hence below screen will be displayed to customers for their input of CDP No. Read and understand the following terms which will appear on the screen:
- **PLEASE DO NOT APPLY FOR YOUR JOINT A/C HOLDER OR OTHER THIRD PARTIES**
 - **PLEASE USE YOUR OWN ATM CARD**
 - **DO NOT KEY IN THE CDP A/C NO OF YOUR JOINT A/C HOLDER OR OTHER THIRD PARTIES**
 - **KEY IN YOUR CDP A/C NO. (12 DIGITS) 1681-XXXX-XXXX**
 - **PRESS ENTER KEY**
- 11 : Key in your CDP Securities Account number (12 digits) and press the "ENTER" key.
- 12 : Select your nationality status.
- 13 : Key in the number of Shares you wish to apply for and press the "ENTER" key.
- 14 : Check the details of your Electronic Application on the screen and press the "ENTER" key to confirm your Electronic Application.
- 15 : Select "NO" if you do not wish to make any further transactions and remove the Transaction Record. You should keep the Transaction Record for your own reference only.

Owing to space constraints on UOB Group's IB website screen, the following terms will appear in abbreviated form:

"CDP"	:	The Central Depository (Pte) Limited
"CPF"	:	The Central Provident Fund
"NRIC" or I/C"	:	National Registration Identity Card
"PR"	:	Permanent Resident
"SGD" or "\$"	:	Singapore Dollars
"SCCS"	:	Securities Clearing & Computer Services (Pte) Ltd
"SGX-SESDAQ"	:	The SGX-ST Dealing and Automated Quotation System
"SGX-ST"	:	Singapore Exchange Securities Trading Limited

Steps for an Internet Electronic Application through the IB website of UOB Group

- STEP 1 : Connect to UOB website at <http://www.uobgroup.com>
- 2 : Locate the Login icon at the top title bar of the Home Page (locate the Login icon on the left hand side next to Internet Banking).
- 3 : Click on Login and at drop list select "UOB Personal Internet Banking"
- 4 : Enter your Username and Password and click "Submit"

ANNEX G

- 5 : Select "Investment Services" ("IPO" Application should be the default transaction that appears, if not click IPO Application)
- 6 : Read the IMPORTANT notice and complete the declaration found on the bottom of the page by answering Yes/No to the questions
- 7 : Click "Continue"
- 8 : Select your country of residence (you must be residing in Singapore to apply) and click "Continue"
- 9 : Select the IPO counter from the drop list (if there are concurrent IPOs) and click "Continue"
- 10 : Select the IPO type and payment mode if multiple options are available:
 - (a) Check the share counter
 - (b) Select "Fixed price" or "Tender price"
 - (c) Select the mode of payment and account to debit
 - (d) Click "Continue"
- 11 : Read the IMPORTANT instructions and click on "Confirm" to confirm that:
 - (a) You have read, understood and agreed to all the terms and conditions of this application and the Prospectus/Document or Supplementary Document;
 - (b) You consent to disclose your name, I/C or passport number, address, nationality, CDP Securities Account number, CPF Investment Account number, and application details to the share registrars, CDP, SGX-ST, CPF Board, issuer/vendor(s);
 - (c) This application is made in your own name and at your own risk. For FIXED/MAX price share application, this is your only application. For TENDER price share application, this is your only application for this share at the selected tender price
 - (d) For Foreign currency securities, subject to the terms of the issue, please note the the following: The application monies will be debited from your bank account in S\$, based on the Bank's prevailing board rates at the time of application. The different prevailing board rates at the time of application and at the time of refund of application monies may result in either a foreign exchange profit or loss, or application monies may be debited and refunds credited in S\$ at the same exchange rate.
 - (e) For 1st-come-1st serve securities, the number of securities applied for may be reduced, subject to the availability at the point of application.

ANNEX G

- 12 : Check your personal details, details of the share counter you wish to apply for and account to debit.
- Select (a) "Nationality";
- Enter (b) your CDP securities account number; and
- (c) the number of shares applied for.
- 13 : Check your personal particulars (name, NRIC/passport number and nationality), details of the share counter you wish to apply for, CDP securities account number, account to debit and number of shares applied for.
- 14 : Click "Confirm", "Edit" or "Cancel".
- 15 : Print the Confirmation Screen (optional) for your own reference.

This page has been intentionally left blank.

This page has been intentionally left blank.