

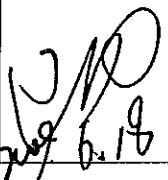
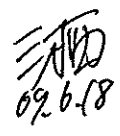

Document No. RD1-309055

**CG400 series  
Command Specifications**

Model name	Dev. code
CG408DT	57017
CG408TT	57017
CG412DT	57017
CG412TT	57017

Approved	Checked	Prepared
	 09.6.18 蔵智 09.6.18	 09.06.18

First edition: March 31, 2009

Edition	Date	Page	Item	Contents
DR00	2008. 2. 1			
DR01	2008. 2. 7			
DR02	2008. 2.13			
DR03	2008. 6.19	208	ESC+CS	Deleted print speed 5(inch/sec)
		225	ESC+#E	Set the default value of print darkness to [A]
		238	ESC+I2	Deleted [57600] and [115200] from baud rate
DR05	2008.8.11	221	ESC+PG	Added I-mark sensor [CX-compatible]
		224	ESC+PC	Added I-mark sensor [CX-compatible]
		229	ESC+IG	Added I-mark sensor [CX-compatible]
		-	ESC+#	Deleted the command
	2008.11.19	225	ESC+PG	Added the default value Changed [Nonsepa mode: Motion 2] from cutter position to tear off position
		222	ESC+PC	Added the default value Changed [Nonsepa mode: Motion 2] from cutter position to tear off position
	2008.11.28	244	ESC+DI	Added scanner and smart keyboard
	2008.11.30	-	ESC+YE	Deleted
		-	ESC+K1,K2(Card)	Deleted
	2008.12. 1	222	ESC+PG	Changed No. l [Media] to [Reserved: 00H Fixed]
		225	ESC+PC	Changed No.m [Media] to [Reserved: 0 Fixed]
DR06	2008.12.08	236	ESC+TP	Added [3: Factory test print for adjustment] in parameter
	2008.12.12	9		Added the restriction on sample program
		213	ESC+#E	Deleted [Darkness range: B] in parameter
		4		Added the list of commands
DR07	2008.12.13	-	ESC+T1,T2	Deleted <T1> and <T2> commands
	2009. 1.15	255,258		Corrected sample program
		257,260		Deleted the description of <Xnn> font
		126		Corrected parameter description
		58		Corrected parameter description
	2009. 1.27	226		Deleted [*1]
DR08		Cover		Added RD number
		1	Introduction	Changed description
			Default Settings	Changed [4-inch] to [3-inch]
		2	Font List	Changed description
		9	Command category	Added [Memory Card] and [Calendar]
		29	Format	Changed description
		31	Notes	Added the description on logo printing
		32,34,36, 38,40,42, 44,61,63, 65,67	Valid commands	Added the <BL><d> commands

Edition	Page	Item	Contents
DR08	61,63,65, 67,69		Added [Closed to end users]
	71	Notes	Changed [Cartridge] to [Download]
	99		Corrected code range
	101		Corrected description, Added the <BM><BL> commands
	103,104,1 05,106,10 7,108,109 ,115		Changed [JAN-xx/EAN-xx] to [JAN/EANxx]
	112	Code Table	Deleted [SP]
	122		Changed [UPC add-on code] to [BOOKLAND]
	122	Notes	Corrected the number of digits to be entered
	126,127,1 28	Parameter	Min. bar width → Narrow bar width
	129,131,1 32		Guide bar → Guard bar
	129,130,1 31,132		Narrow bar → Narrow bar
	134		Added the description on print position
	208		Changed the range from [01h~] to [20h~]
	212	Default value, specified range	Added [DT/TT]. Changed the default value [4]→ [3]
	214	Specified range	Added [DT/TT]
	215	Format	Changed the dots to [0 to 792]
	217	Notes No.6	Added <CT>
	218,219		Added [Closed to end users]
	229	Label size	Added [Decimal number]
	231	Notes	Changed [LINE] to [FEED/LINE]
			Corrected description
	235	Notes	Changed [Nonesepa mode: Motion 2] to tear off position
	236		Added [Closed to end users]
	243	Notes	Changed [command] to [this command]
	248,249,2 50		Changed [stored] to [retained]
	248	Notes	Changed [next power on] to [rebooting]
	256	Notes No. 7	Deleted memory card information
	257,260	Command	Added [Closed to end users]
270,271		Changed [IC] to [Calendar IC]	
226,229		Corrected description on the validity of setting	
236	Parameter	Deleted [8: Print of barcode]	
2009.03.13	226	ESC+PG	Changed the setting value of sensor type Changed the setting to [Reflective sensor (CX-compatible)]
	229	ESC+PC	Changed the setting value of sensor type Changed the setting to [Reflective sensor (CX-compatible)]



# Contents

<b>1. Introduction</b> .....	<b>1</b>
<b>2. Default Settings</b> .....	<b>1</b>
<b>3. Font List</b> .....	<b>2</b>
<b>4. Command List</b> .....	<b>4</b>
<b>5. How to Read the Command Manual</b> .....	<b>8</b>
<b>6. Control Command</b> .....	<b>10</b>
ESC+A Start data transfer .....	10
ESC+Z End data transfer .....	11
ESC+Q Number of pages .....	12
ESC+ID Job ID number .....	13
ESC+WK Job name .....	14
<b>7. Print Position Command</b> .....	<b>15</b>
ESC+H Horizontal print position .....	15
ESC+V Vertical print position .....	16
<b>8. Edit Command</b> .....	<b>17</b>
ESC+P Character pitch .....	17
ESC+L Character expansion .....	18
ESC+PS Proportional pitch .....	19
ESC+PR Release proportional pitch .....	20
ESC+% Rotation .....	21
ESC+F Sequential number .....	22
ESC+FW Rule / Grid print .....	23
ESC+( Inversed color print .....	24
ESC+KC Kanji code .....	25
ESC+& Store Form overlay .....	26
ESC+/ Recall Form overlay .....	27
ESC+0 Partial edit .....	28
ESC+WD Partial copy .....	29
ESC+J Journal print .....	30

ESC+RF	Recall font & logo .....	31
ESC+RL	Print Direction .....	32
<b>9. Font Command.....</b>		<b>33</b>
ESC+XU	XU font .....	33
ESC+XS	XS font .....	35
ESC+XM	XM font .....	37
ESC+XB	XB font .....	39
ESC+XL	XL font .....	41
ESC+OA	OCR-A font .....	43
ESC+OB	OCR-B font .....	45
ESC+\$	Outline font design .....	47
ESC+\$=	Outline font print.....	48
ESC+RD	CG font .....	51
ESC+T1	Store 16×16 dots external character.....	54
ESC+T2	Store 24x24 dots external character .....	56
ESC+K1 (K2)	Recall horizontally oriented external character .....	58
ESC+k1 (k2)	Recall vertically oriented external character .....	60
ESC+U	U font (Closed to end users).....	62
ESC+S	S font (Closed to end users).....	64
ESC+M	M font (Closed to end users).....	66
ESC+WB	WB font (Closed to end users).....	68
ESC+WL	WL font (Closed to end users).....	70
ESC+K2	Horizontally oriented Chinese font (Basic size 24x24 dots).....	72
ESC+K9	Horizontally oriented Chinese font with 1-byte chr (Basic size 24x24 dots) .....	73
ESC+k2	Vertically oriented Chinese font (Basic size 24x24 dots) .....	74
ESC+k9	Vertically oriented font with 1-byte chr (Basic size 24x24 dots) .....	75
ESC+K1	Horizontally oriented Korean font (Basic size 16x16 dots) .....	84
ESC+K2	Horizontally oriented Korean font (Basic size 24x24 dots) .....	85
ESC+K8	Horizontally oriented Korean font with 1-byte chr (16x16 dots).....	86
ESC+K9	Horizontally oriented Korean font with 1-byte chr (Basic size 24x24 dots).....	87

ESC+k1	Vertically oriented Korean font (Basic size 16x16 dots).....	88
ESC+k2	Vertically oriented Korean font (Basic size 24x24 dots).....	89
ESC+k8	Vertically oriented Korean font with 1-byte chr (Basic size 16x16 dots).....	90
ESC+k9	Vertically oriented Korean font with 1-byte chr (Basic size 24x24 dots).....	91
ESC+B	Barcode (Ratio 1:3) .....	102
ESC+D	Barcode (Ratio 1:2) .....	104
ESC+D~ESC+d	Barcode (HRI font).....	106
ESC+BD	Barcode (Ratio 2:5).....	107
ESC+BT	Barcode ratio .....	109
ESC+BW	Barcode print by specified ratio .....	110
ESC+BI	GS1-128 (UCC/EAN128).....	113
ESC+BC	CODE93.....	115
ESC+BG	CODE128 (128A, 128B, 128C).....	117
ESC+BF	UPC add-on barcode (BOOKLAND) .....	121
ESC+BP	POSTNET .....	123
ESC+EU	Composite symbol .....	125
ESC+BL	UPC-A barcode (No HRI) .....	128
ESC+BL~ESC+d	UPC-A Barcode (Font designation).....	129
ESC+BM	UPC-A Barcode (with HRI) .....	131
<b>11. 2D Code Command</b>	<b>.....</b>	<b>132</b>
ESC+2D10	PDF417 .....	132
ESC+2D12	Micro PDF .....	135
ESC+2D20	MAXI code.....	138
ESC+2D30	QR code (Model 2) .....	140
ESC+2D31	QR code (Model 1).....	144
ESC+2D32	Micro QR .....	147
ESC+2D50	GS1 DataMatrix (ECC200).....	172
ESC+BQ	QR code.....	174
ESC+BV	MAXI code.....	199
ESC+BK	PDF417 .....	201

ESC+BX	GS1 DataMatrix.....	204
ESC+DC	GS1 DataMatrix (Data) .....	205
ESC+FX	GS1 DataMatrix (Sequential number) .....	206
<b>12. Graphic Command .....</b>		<b>208</b>
ESC+G	Graphic print.....	208
ESC+GM	BMP file print.....	209
ESC+GP	PCX file print.....	210
<b>13. System Command.....</b>		<b>211</b>
ESC+CS	Print speed.....	211
ESC+#E	Print darkness.....	212
ESC+A1	Media size .....	213
ESC+A3	Base reference point .....	214
ESC+EP	Print end position .....	215
ESC+~(NULL)	Multi cut.....	216
ESC+CT	Cut number unit.....	217
ESC+NC (EJ)	Eject and Cut.....	218
ESC+~A	Cut number unit.....	219
ESC+~B	Eject and Cut.....	220
ESC+*	Clear memory .....	221
ESC+@	Offline .....	222
ESC+C	Reprint.....	223
ESC+PG	Register Printer operation .....	224
ESC+PC	Register Printer operation .....	227
ESC+E	Auto line feed.....	229
ESC+LD	User download .....	230
ESC+PO	Offset .....	231
ESC+IG	Sensor type .....	232
ESC+PH	Print method.....	233
ESC+PM	Print mode .....	234
ESC+TP	Test print (Closed to end users) .....	235



Media feed control (Closed to end users) .....	236
ESC+I1 IEEE1284 .....	239
ESC+I2 Serial interface .....	240
ESC+I3 LAN interface .....	241
ESC+W1 IP address .....	242
ESC+W2 Subnet mask.....	243
ESC+W3 Default gateway.....	244
ESC+W1 IP address setup.....	245
ESC+WM RARP .....	246
ESC+DI Interface .....	247
ESC+TW Option waiting time.....	248
ESC+TK Forced Tear off.....	249
<b>14. Memory Card Commands.....</b>	<b>250</b>
ESC+CC Card slot .....	250
ESC+FM Format Memory card.....	251
ESC+FP Print Memory card status .....	252
ESC+&S Store Form overlay.....	253
ESC+&R Recall Form overlay.....	255
ESC+YS Store Format .....	256
ESC+/N Store Field .....	259
ESC+YR Recall Format.....	260
ESC+/D Print Field .....	261
ESC+GI Store Graphic .....	262
ESC+GR Recall Graphic.....	263
ESC+GT Store BMP file .....	264
ESC+GC Recall BMP file .....	265
ESC+* Clear (Memory card).....	266
<b>15 Calendar Commands .....</b>	<b>268</b>
ESC+WT Calendar setting .....	268
ESC+WP Calendar increment.....	269

ESC+WA Calendar print.....270

# 1. Introduction

This document includes the command specifications of the CG400 series.

- (1) CG408DT: Head density 203(dpi) / Direct thermal printer
- (2) CG408TT: Head density 203(dpi) / Thermal transfer & Direct thermal printer
- (3) CG412DT: Head density 305(dpi) / Direct thermal printer
- (4) CG412TT: Head density 305(dpi) / Thermal transfer & Direct thermal printer

Command language used in this document is based on the SBPL(SATO Barcode Printer Language).

# 2. Default Settings

Default setting of the printers are listed below.

CG400 series

Item	Default
Print speed	3ips (Range: 2, 3, 4)
Darkness range	A
Print darkness	3 (Range: 1, 2, 3, 4, 5)
Offset	+0
Zero font switching	NO
Kanji code	JIS
Proportional pitch	Fixed pitch

### 3. Font List

Built-in fonts for the CG400 series are as follows.

#### Built-in fonts

Font	Font type	Command	Pitch
OCR-A ( 8dot/mm)	Bitmap 15×22 dots	OA	Fixed
OCR-B ( 8dot/mm)	Bitmap 20×24 dots	OB	Fixed
OCR-A (12dot/mm)	Bitmap 22×33 dots	OA	Fixed
OCR-B (12dot/mm)	Bitmap 30×36 dots	OB	Fixed
XU	Bitmap 5×9 dots [Helvetica]	XU	Fixed/Proportional
XS	Bitmap 17×17 dots [Univers Condensed Bold]	XS	Fixed/Proportional
XM	Bitmap 24×24 dots [Univers Condensed Bold]	XM	Fixed/Proportional
XB	Bitmap 48×48 dots [Univers Condensed Bold]	XB	Fixed/Proportional
XL	Bitmap 48×48 dots [Sans Serif]	XL	Fixed/Proportional
U	Bitmap 5×9 dots	U	Fixed
S	Bitmap 8×15 dots	S	Fixed
M	Bitmap 13×20 dots	M	Fixed
WB	Bitmap 18×30 dots	WB	Fixed
WL	Bitmap 28×52 dots	WL	Fixed
Outline	Outline font	\$(Designation of shape) \$=(Designation of print)	Fixed/Proportional
CG Times	True Type font	RD	Fixed/Proportional
CG Triumvirate	True Type font	RD	Fixed/Proportional

The following are the optional fonts provided for the CG400 series. These fonts can be used once you download them to the user memory area of the printer unit. Select either [Chinese font] or [Korean font] for the optional font. You cannot use both fonts at the same time.

#### 1) Chinese font

Font	Font type	Symbol set	Command	Pitch
K2 Simplified Chinese	Bitmap 24×24 dots	GB2312(GL)	K2, k2	Fixed
K9 Simplified Chinese	Bitmap 24×24 dots, 1 & 2-byte chr.	GB2312(GL)	K9, k9	Fixed

- Printable character codes are A1A1H~A9FEH, ADA1H~ADFEH, and B0A1H~F7FEH. Null characters are included within the range of these codes.
- Make sure to include the Kanji Code specification command <KC>1 (Shift JIS Kanji Code) in print data.
- Once you download the Chinese font, the user memory area will be occupied by the Chinese font.

#### 2) Korean font

Font	Font type	Symbol set	Command	Pitch
K1 Korean	Bitmap 16×16 dots	KSC5601(KSX1001)	K1, k1	Fixed
K2 Korean	Bitmap 24×24 dots	KSC5601(KSX1001)	K2, k2	Fixed
K8 Korean	Bitmap 16×16 dots, 1 & 2-chr.	KSC5601(KSX1001)	K8, k8	Fixed
K9 Korean	Bitmap 24×24 dots, 1 & 2-chr.	KSC5601(KSX1001)	K9, k9	Fixed

- Some parts are different from the code system of KS X1001. Refer to each command information for more details.
- Printable character codes are A1A1H~A6FEH, ADA1H~ADFEH, and B0A1H~CFFEH. Null characters are included within the range of these codes.
- C9A5H ~ CFFEH in 16 x 16 dots will be blacked out.
- Make sure to include the Kanji Code specification command <KC>1 (Shift JIS Kanji Code) in print data.
- When you download the Korean font, free user memory area will be smaller than 1MB.

## Expanded font

Built-in fonts can be expanded by a factor of 1 to 12.

Internal bitmap fonts can also be expanded with a factor of 1 to 12.

Example: A font in a size of 5 dots in width and 9 dots in height is expanded by a factor of 3. The resulting font has a width of 15 dots and a height of 27 dots.

The following are the input methods of width and height parameters.

Width x Expansion factor = Width parameter setting value

Height x Expansion factor = Height parameter setting value

The command <L> controls the font expansion factor, and the parameter is specified by the magnification.

Example: If setting the factor to: <L>0304, the character is expanded by a factor of 3 in horizontal direction (width) and a factor of 4 in vertical direction (height).

If the command <L> is specified, the pitch between characters becomes wider as well.

## Fixed pitch / Proportional pitch

As for XU~XL font, outline font and CG font, either fixed pitch or proportional pitch can be selected. Use the Proportional Pitch command <PS> and the Proportional Pitch Release command <PR> for the settings of proportional pitch.

Depending on the font, the width of the proportional pitch differs. Katakana is not affected by the proportional pitch. On the other hand, the width of alphanumeric becomes narrow by specifying the proportional pitch.

As for the fixed pitch, the character width is according to the relevant font size selected.

## Difference between outline font and bitmap font

The height and the width of bitmap font are predefined. The height of the bitmap font is a little bit larger than the width.

The bitmap font is the largest one in the font matrix.

For the font type and size, refer to the font list on the previous page.

As for the outline font, if setting the height and the width of the font properly, the smooth scaling algorithm of the printer allows you to create a well balanced font. It is also possible to select some style options such as gray scale and shadow settings.

## 4. Command List

Category	Command		Restriction
Control	Start Code	<A>	
	Stop Code	<Z>	
	Print Quantity	<Q>	
	Job ID Number	<ID>	
	Job name	<WK>	
Print position	Horizontal Print Position	<H>	
	Vertical Print Position	<V>	
Modification	Character Pitch	<P>	
	Character Expansion	<L>	
	Proportional Pitch	<PS>	
	Release Proportional Pitch	<PR>	
	Rotation (Fixed Base Reference Point)	<%>	
	Rotation (Base Reference Point Shift)	<R>	
	Sequential Numbering	<F>	
	Rule / Grid print	<FW>	
	Inversed Color Print	<(>	
	Kanji Code	<KC>	
	Store Form Overlay	<&>	
	Recall Form Overlay	</>	
	Partial Edit	<O>	
	Partial Copy	<WD>	
	Journal Print	<J>	
	Recall Font & Logo	<RF>	
	Print Direction	<RL>	
	Font	XU Font	<XU>
XS Font		<XS>	
XM Font		<XM>	
XB Font		<XB>	
XL Font		<XL>	
OCR-A Font		<OA>	
OCR-B Font		<OB>	
Outline Font design		<\$>	
Outline Font print		<\$=>	
CG Font		<RD>	CG Times, CG Triumvirate only
Store 16x16 dots external Character		<T1>	
Store 24x24 dots external Character		<T2>	

Category	Command	Restriction	
Font	U Font	<U> Closed to end users	
	S Font	<S> Closed to end users	
	M Font	<M> Closed to end users	
	WB Font	<WB> Closed to end users	
	WL Font	<WL> Closed to end users	
	24x24 dots horizontally oriented Chinese	<K2>	
	24x24 dots horizontally oriented Chinese with 1 byte character	<K9>	
	24x24 dots vertically oriented Chinese	<k2>	
	24x24 dots vertically oriented Chinese with 1 byte character	<k9>	
	16x16 dots horizontally oriented Korean	<K1>	
	24x24 dots horizontally oriented Korean	<K2>	
	16x16 dots horizontally oriented Korean with 1 byte character	<K8>	
	24x24 dots horizontally oriented Korean with 1 byte character	<K9>	
	16x16 dots vertically oriented Korean	<k1>	
	24x24 dots vertically oriented Korean	<k2>	
	16x16 dots vertically oriented Korean with 1 byte character	<k8>	
	24x24 dots vertically oriented Korean with 1 byte character	<k9>	
	Store 40x40 dots external character	<T5>	
	Barcode	Barcode (Ratio 1:3)	<B>
		Barcode (Ratio 1:2)	<D>
Barcode (HRI)		<D> ~ <d>	
Barcode (Ratio 2:5)		<BD>	
Barcode Ratio		<BT>	
Barcode Ratio by Specified Ratio		<BW>	
GS1-128 (UCC/EAN128)		<BI>	
CODE93		<BC>	
CODE128		<BG>	
UPC Add-on Barcode		<BF>	
POSTNET		<BP>	
GS1 DataBar Composite Symbol		<EU>	
UPC-A Barcode (No HRI)		<BL>	
UPC-A Barcode (with HRI)		<BL> ~ <d>	
UPC-A Barcode (with HRI)		<BM>	
2D code		PDF417	<2D10>
	Micro PDF	<2D12>	
	MAXI code	<2D20>	
	QR Code (Model 2)	<2D30>	
	QR Code (Model 1)	<2D31>	
	Micro QR	<2D32>	
	GS1 DataMatrix (ECC200)	<2D50>	
	QR code	<BQ>	
	MAXI code	<BV>	
	PDF417	<BK>	
	GS1 DataMatrix	<BX>	
	GS1 DataMatrix (Data)	<DC>	
	GS1 DataMatrix (Sequential number)	<FX>	

Category	Command		Restriction
Graphic	Graphic print	<G>	
	BMP File print	<GM>	
	PCX File print	<GP>	Closed to end users
System	Print Speed	<CS>	
	Print Darkness	<#E>	
	Media Size	<A1>	
	Base Reference Point	<A3>	
	Print End Position	<EP>	
	Multi cut	<~>	
	Cut Number Unit	<CT>	
	Eject and Cut	<NC>	
	Cut Number Unit	<~A>	
	Eject and Cut	<~B>	
	Clear	<*>	
	Offline	<@>	
	Reprint	<C>	
	Register Printer Operation	<PG>	
	Register Printer Operation	<PC>	
	Line Feed	<E>	
	User Download	<LD>	
	Offset	<PO>	Tear-off Offset: -60 to +99 dots
	Sensor Type	<IG>	
	Print Method	<PH>	
	Print Mode	<PM>	
	Test Print	<TP>	Closed to end users
	Media Feed Control	<IK>	
	IEEE1284	<I1>	
	Serial Interface	<I2>	
	LAN Interface	<I3>	
	IP Address	<W1>	
	Subnet Mask	<W2>	
	Default Gateway	<W3>	
	IP Address	<WI>	
	RARP	<WM>	
	Interface	<DI>	
	Option Waiting Time	<TW>	
Forced Tear Off	<TK>		



Category	Command		Restriction
Memory card	Card Slot	<CC>	
	Format Memory Card	<FM>	
	Print Memory Card Status	<FP>	
	Store Form Overlay	<&S>	
	Recall Form Overlay	<&R>	
	Store Format	<YS>	
	Store Field	</N>	
	Recall Format	<YR>	
	Print Field	</D>	
	Store Graphic	<GI>	
	Recall Graphic	<GR>	
	Store BMP File	<GT>	
	Recall BMP File	<GC>	
	Clear (Memory card)	<*>	
Calendar	Calendar Configuration	<WT>	
	Calendar Increment	<WP>	
	Calendar Print	<WA>	

## 5. How to Read the Command Manual

	<b>7.2 Modification</b>									
Available for	CG400 series									
<b>Font Expansion</b>					<b>ESC+L</b>					
5) Hex code	ESC <1B> <sub>16</sub>	L <4C> <sub>16</sub>	Parameter aabb							
7) Initial setting	aa=01, bb=01									
8) Persistence of the command	When printer is powered-off	Set parameter will not be retained								
	Validity in a job	Parameter set will be retained until next valid setting								
	Validity after a job	Parameter set will be the initial value for the next job								
9) [Function]	Specifying the print expansion factor.									
10) [Format]	<L>aabb • Parameter a            [Horizontal expansion factor (width)]            =    validity range    :    01 to 12 b            [Vertical expansion factor (height)]            =    validity range    :    01 to 12									
11) [Coding example]	Horizontal expansion factor (width): 4, Vertical expansion factor (height): 3 <A> <V>100<H>200<P>3<L> <b>0403</b> <OA>ABCD <Q>2 <Z>									
12) [Notes]	1. The pitch between the characters is equally enlarged. When setting the inter character pitch <P>, the preset horizontal expansion factor <L> will be valid for the inter character pitches <P> thereafter. 2. If enlarging graphics, put in expansion factor <L> just before the graphic print command.									
13) [Tips]	1. When using the expansion function, be careful not to fall out of the printing range. Therefore, select a correct print format.									
14) [Valid command]	CG400 series									
Font	<X20> <K8>	<X21> <K9>	<X22> <k1>	<X23> <k2>	<X24> <k3>	<OA> <k8>	<OB> <k9>	<K1>	<K2>	<K3>
Modification	<P>	<RF>								
Graphic	<G>	<GM>								

- 1) Command identification.  
[Control], [Print position], [Modification], [Font], [Barcode], [2D code], [Graphic], [System], [Memory card] and [Calendar].
- 2) Command availability depending on printer model.  
[ ] indicates unavailable commands.

Example) Commands only available for the CG400 series as shown below.

Available for	CG400DT series			
	CG400TT series			

- 3) Command name
- 4) Command code
- 5) Command as HEX code
- 6) Command describing parameters. () indicates that omission is possible
- 7) Default command value
- 8) Persistence of the Command
  - When printer is powered off
    - (1) Set Parameter will be retained
    - (2) Set parameter will not be retained (Set parameter will not be retained)
    - (3) Command settings will not be retained (Command setting will not be retained)
  - Validity in a job
    - (1) Retained until next valid setting
    - (2) Set parameter will be retained
    - (3) Becomes invalid after execution
  - Valid after a job
    - (1) Set parameter will be the default value for the next job<a>.
    - (2) Set parameter will be retained until next valid setting
    - (3) Becomes invalid after execution
    - (4) Becomes invalid after execution
- 9) Command function outline
- 10) Command, necessary parameter  
<L>aabb indicates the ESC+L (<1B><sub>16</sub><4C><sub>16</sub>) command with the parameters aa and bb
- 11) Example for command input  
If putting out a code via RS-232C to a printer connected, the programming will be done in BASIC language:
 

```

10 ESC$=CHR$( &H1B)
20 OPEN "COM1: 9600, N, 8, 1, RS, BIN" FOR OUTPUT AS #1
30 PRINT #1, ESC$: "A";
40 PRINT #1, ESC$: "V100"; ESC$: "H200";
50 PRINT #1, ESC$: "P3"; ESC$: "L0403";
60 PRINT #1, ESC$: "OAABCD";
70 PRINT #1, ESC$: "Q2";
80 PRINT #1, ESC$: "Z";
90 CLOSE #1
100 END

```
- 12) Explanation of commands and parameters
- 13) Tips when using the command
- 14) Other commands which will be influenced by using the specific command

\* A part of sample program is using Japanese font; therefore, it may not work on the CG400.

## 6. Control Command

Control			
Available for	CG400 series		
<b>Start data transfer</b>		<b>ESC+A</b>	
Hex code	ESC <1B> <sub>16</sub>	A <41> <sub>16</sub>	Parameter None
Default setting	None		

Persistence of the command	When printer is powered off	Command setting will not be retained.
	Validity in a job	Becomes invalid after execution
	Validity after a job	Becomes invalid after the job

### [Function]

Start code. Data transfer defaultized.

### [Format]

<A>

### [Coding example]

<A>  
 <V>100<H>200<P>2<L>0202<OA>ABCD  
 <Q>2  
 <Z>

### [Notes]

1. Defaultizes item. Command is used always at beginning of an item.
2. Always use data transfer start <A> and data transfer end <Z> as a set.

### [Important]

1. Except for some system commands, all command settings will be set to default value.
2. If not starting data transfer with <A>, the print will not be executed.

Control			
Available for	CG400 series		
<b>End data transfer</b>		<b>ESC+Z</b>	
Hex code	ESC <1B> <sub>16</sub>	Z <5A> <sub>16</sub>	Parameter None
Default setting	None		
Persistence of the command	When printer is powered off	Command settings will not be retained.	
	Validity in a job	Becomes invalid after execution	
	Validity after a job	Becomes invalid after the job	

[Function]

Stop code. Data transfer terminated.

[Format]

<Z>

[Coding example]

<A>  
 <V>100<H>200<P>2<L>0202<OA>ABCD  
 <Q>2  
<Z>

[Notes]

1. Terminates item. Command is used always at the end of an item.
2. Always use data transfer start <A> and data transfer end <Z> as a set.

[Important]

1. If not ending data transfer with <Z>, the print will not be executed.

Control			
Available for	CG400 series		
<b>Number of pages</b>		<b>ESC+Q</b>	
Hex code	ESC <1B> <sub>16</sub>	Q <51> <sub>16</sub>	Parameter aaaaaa
Default setting	aaaaaa=1		
Persistence of the command	When printer is powered off	Set parameter will not be retained	
	Validity in a job	Becomes invalid after execution	
	Validity after a job	Becomes invalid after the job	

[Function]

Defines number of pages to be printed.

[Format]

<Q>aaaaaa

• Parameter

a [Number of pages] = Valid range : 1 - 999999

[Coding example] 2 pages to be print

<A>

<V>100<H>200<P>2<L>0202<OA>ABCD

<Q>2

<Z>

[Notes]

1. The data between start data transfer <A> and end data transfer <Z> is regarded as one page. <Q> defines how many pages of the same content shall be printed out.
2. Command is put in before the end data transfer <Z> command.

[Important]

1. Print out of the same information will be done for pages specified. If the appearance of a serial number is set <F>, then this number will be of consecutive order.
2. If specifying with a multi-cut <~>, the defined number of pages will be multiplied by cut number.

Control			
Available for	CG400 series		
<b>Job ID number</b>		<b>ESC+ID</b>	
Hex code	ESC <1B> <sub>16</sub>	ID <49> <sub>16</sub> <44> <sub>16</sub>	Parameter aa
Default setting	aa=<20> <sub>16</sub>		
Persistence of the command	When printer is powered off	Set parameter will not be retained	
	Validity in a job	Set parameter will be retained until next valid setting	
	Validity after a job	Becomes invalid after the job	

[Function]

Defines job ID for status return

[Format]

<ID>aa

• Parameter

a [Job ID number] = Valid range : 00 - 99

[Coding example] Job ID number: 01

<A>

**<ID>01**

<V>200<H>100<P>0<\$>B,100,100,6

<\$>SATOPRINTER

<Q>2

<Z>

[Notes]

1. If using a status return in the transfer protocol, the job ID number can be set in the telegram.
2. The status can be confirmed by putting out a status request (ENQ).
3. This command is set within the item, between start data transfer <A> and end data transfer <Z>.

[Important]

1. Activates when status return transfer protocol is used and status request (ENQ) is received during printing (incl. QTY≠0, offline, error).
2. If status return transfer protocol is used, and status request is received while not printing (QTY=0, start up, no data received), space (20H) will be set and returned as status.
3. If defining a job ID number several times during one item (between start data transfer <A> and end data transfer <Z>), the last definition will be valid.
4. For more details, refer to the "Interface Specifications".

Control			
Available for	CG400 series		
Job name		ESC+WK	
Hex code	ESC <1B> <sub>16</sub>	WK <57> <sub>16</sub> <4B> <sub>16</sub>	Parameter aaaaaaaaaaaaaaaa
Default setting	aaaaaaaaaaaaaaaa=<20> <sub>16</sub>		
Persistence of the command	When printer is powered off	Set parameter will not be retained	
	Validity in a job	Set parameter will be retained until next valid setting	
	Validity after a job	Becomes invalid after the job	

[Function]

Defines job name for status return

[Format]

<WK>aaaaaaaaaaaaaaaa

• Parameter

a [Job name] = ASCII-CODE 16 digits, Shift JIS Kanji 8 digits

[Coding example] Job name: SATO

```
<A>
<WK>SATO
<V>200<H>100<P>0<$>B,100,100,6
<$>SATOPRINTER
<Q>2
<Z>
```

[Notes]

1. If using the status 4 as transfer protocol, the job name can be set in the telegram.
2. The status can be confirmed by putting out a status request (ENQ).
3. This command is set within the item, between start data transfer <A> and end data transfer <Z>.
4. This command can be used together with Define job ID number <ID>.

[Tips]

1. Activates when status return transfer protocol is used and status request (ENQ) is received during printing (incl. QTY≠0, offline, error).
2. If status return transfer protocol is used, and status request is received while not printing (QTY=0, start up, no data received), space (20H) will be set and returned as status.
3. If defining a job ID name several times during one item (between start data transfer <A> and end data transfer <Z>), the last definition will be valid.
4. For particulars, refer to the [Interface Specification].



## 7. Print Position Command

Print Position			
Available for	CG400 series		
<b>Horizontal print position</b>		<b>ESC+H</b>	
Hex code	ESC <1B>16	H <48> <sub>16</sub>	Parameter aaaa
Default setting	aaaa=1		
Persistence of the command	When printer is powered off	Command settings will not be retained	
	Validity in a job	Set parameter will be retained until next valid setting	
	Validity after a job	Set parameter will be the default value for the next job <A>.	

### [Function]

Specifies horizontal print position in dots from the origin position

### [Format]

<H>aaaa

#### • Parameter

a [Horizontal print position] = Valid range : refer to table below

### [Coding example] Horizontal print position: 200 dots (from origin)

```
<A>
<V>100<H>200<P>2<L>0202<OA>ABCD
<Q> > 2
<Z>
```

### [Notes]

1. Defines starting position of print for the following: Characters, barcodes, ruled lines, graphics, etc.

### [Tips]

1. Data outside of the print range (such as characters, barcodes and graphics) will be clipped.

### [Parameter default setting and validity range]

Model	Default	Range (dots)
CG408	1	1 ~ 832
CG412	1	1 ~ 1248

### [Valid commands]

CG400 series

Font	<XU>	<XS>	<XM>	<XB>	<XL>	<U> <sup>*1</sup>	<S> <sup>*1</sup>	<M> <sup>*1</sup>	<WB> <sup>*1</sup>	<WL> <sup>*1</sup>
	<OA>	<OB>	<RD>	<\$>						
Barcode	<B>	<BC>	<BG>	<BI>	<BF>	<BP>	<D>	<D><d>	<BD>	<BT>
	<BW>									
2D code	<BK>	<BQ>	<BV>	<BX>						
	<2D10>	<2D12>	<2D20>	<2D30>	<2D31>	<2D32>	<2D50>			
Modification	<WD>	<FW>	<I>	<RF>						
Graphic	<G>	<GM>	<GP>							

\*1. Closed to end users.

Print Position			
Available for	CG400 series		
<b>Vertical print position</b>		<b>ESC+V</b>	
Hex code	ESC <1B> <sub>16</sub>	V <56> <sub>16</sub>	Parameter aaaa
Default setting	aaaa=1		

Persistence of the command	When printer is powered off	Command settings will not be retained
	Validity in a job	Set parameter will be retained until next valid setting
	Validity after a job	Set parameter will be the default value for the next job <A>

[Function]

Specifies vertical print position in dots from the origin position

[Format]

<V>aaaa

• Parameter

a [Vertical print position] = Valid range : refer to table below

[Coding example] Vertical print position: 100 dots

<A>

<V>100<H>200<P>2<L>0202<OA>ABCD

<Q>2

<Z>

[Notes]

1. Defines starting position of print for the following: Characters, barcodes, ruled lines, graphics, etc.

[Parameter, default setting and validity range]

Model	Default	Range (dots)
		Standard printable area
CG408	1	1 ~ 2400
CG412	1	1 ~ 3600

[Tips]

1. Data outside of the print range (such as characters, barcodes and graphics) will be clipped.

[Valid commands]

CG400 series

Font	<XU>	<XS>	<XM>	<XB>	<XL>	<U>*1	<S>*1	<M>*1	<WB>*1	<WL>*1
	<OA>	<OB>	<RD>	<\$>						
Barcode	<B>	<BC>	<BG>	<BI>	<BF>	<BP>	<D>	<D><d>	<BD>	<BT>
	<BW>									
2D code	<BK>	<BQ>	<BV>	<BX>						
	<2D10>	<2D12>	<2D20>	<2D30>	<2D31>	<2D32>	<2D50>			
Modification	<WD>	<FW>	<I>	<RF>						
Graphic	<G>	<GM>	<GP>							

\*1 Closed to end users.

## 8. Edit Command

Modification			
Available for	CG400 series		
<b>Character pitch</b>		<b>ESC+P</b>	
Hex code	ESC <1B> <sub>16</sub>	P <50> <sub>16</sub>	Parameter aa
Default setting	aa=02		
Persistence of the command	When printer is powered off	Set parameter will not be retained	
	Validity in a job	Set parameter will be retained until next valid setting	
	Validity after a job	Set parameter will be the default value for the next job <A>	

### [Function]

Defines character pitch in dots

### [Format]

<P>aa

- Parameter

a [Inter-character pitch] = Valid range : 00 to 99 dots

### [Coding example] Inter-character pitch: 10

```
<A>
<V>100<H>200<P>10<L>0202<OA>ABCD
<Q>2
<Z>
```

### [Notes]

1. The character pitch is the distance between characters, fonts when selecting barcode / font print.
2. The character pitch is enlarged according to the expansion factor <L>, if specified.
3. Even if automatic line feed is selected <E> and line feed code [CR] is set, the character pitch remains valid (saved) and the setting does not return to default. Only if Start data transfer <A> is selected, the setting returns to default.
4. When setting the character pitch <P> directly before specifying a barcode print, the pitch command for the barcode module becomes valid.  
Applicable barcodes: CODABAR (NW-7), CODE39, Industrial 2of5, Matrix 2of5  
For details, refer to the [9. Barcode settings outline (3) inter-character gap].
5. If incorrect values are specified, the settings will return to default.

### [Valid commands]

CG400 series

Font	<XU>	<XS>	<XM>	<XB>	<XL>	<U> <sup>*1</sup>	<S> <sup>*1</sup>	<M> <sup>*1</sup>	<WB> <sup>*1</sup>	<WL> <sup>*1</sup>
Modification	<OA>	<OB>	<RD>	<\$=>						
Barcode	<B>	<D>	<D><d>	<BD>	<BT>	<BW>				

\*1 Closed to end users.

Modification			
Available for	CG400 series		
<b>Character expansion</b>		<b>ESC+L</b>	
Hex code	ESC <1B> <sub>16</sub>	L <4C> <sub>16</sub>	Parameter aabb
Default setting	aa=01, bb=01		
Persistence of the command	When printer is powered off	Set parameter will not be retained.	
	Validity in a job	Set parameter will be retained until next valid setting.	
	Validity after a job	Set parameter will be the default value for the next job<A>.	

[Function]

Defines font expansion setting

[Format]

<L>aabb

• Parameter

a [Horizontal expansion factor] = Valid range : 01 to 12  
 b [Vertical expansion factor] = Valid range : 01 to 12

[Coding example]

Horizontal expansion factor: 4 times, Vertical expansion factor: 3 times

<A>  
 <V>100<H>200<P>3<L>0403<OA>ABCD  
 <Q>2  
 <Z>

[Notes]

1. The character pitch is equally enlarged. If setting the character pitch with <P>, the horizontal expansion factor specified with <L> will affect (enlarge) the character pitch.
2. When enlarging graphics, put in the expansion factor <L> just before the graphic print command.

[Tips]

1. Select the format so that the enlarged print does not go out of the printable area.

[Valid commands]

CG200 series

Font	<XU>	<XS>	<XM>	<XB>	<XL>	<U> <sup>*1</sup>	<S> <sup>*1</sup>	<M> <sup>*1</sup>	<WB> <sup>*1</sup>	<WL> <sup>*1</sup>
	<OA>	<OB>								
Modification	<P>	<RF>								
Graphic	<G>	<GM>	<GP>							

\*1 Closed to end users.

Modification			
Available for	CG400 series		
<b>Proportional pitch</b>		<b>ESC+PS</b>	
Hex code	ESC <1B> <sub>16</sub>	PS <50> <sub>16</sub> <53> <sub>16</sub>	Parameter None
Default setting	None		
Persistence of the command	When printer is powered off	Command settings will not be retained	
	Validity in a job	Will be retained until next valid setting	
	Validity after a job	Will be retained after the job	

[Function]

Defines proportional pitch

[Format]

<PS>

[Coding example]

<A>

<PS>

<V>100<H>200<P>2<L>0202<XU>ABCD

<Q>2

<Z>

[Notes]

1. When setting proportional pitch <PS>, in case of Katakana the proportional pitch function will be unavailable. When printing alphanumeric, the pitch will be narrower than if not specified.
2. If the setting is done outside of the possible range, the proportional print will not be performed.
3. The default setting is set to [Proportional pitch].

[Valid commands]

CG400 series

Font	<XU>	<XS>	<XM>	<XB>	<XL>	<RD>	<S=>			
Modification	<RF>									

Modification			
Available for	CG400 series		
<b>Release proportional pitch</b>		<b>ESC+PR</b>	
Hex code	ESC <1B> <sub>16</sub>	PR <50> <sub>16</sub> <52> <sub>16</sub>	Parameter None
Default setting	None		
Persistence of the command	When printer is powered off	Command settings will not be retained	
	Validity in a job	Command set are valid until setting is changed	
	Validity after a job	Will be retained after the job	

[Function]

Releases proportional pitch

[Format]

<PR>

[Coding example]

<A>

<PR>

<V>100<H>200<P>2<L>0202<XM>ABCD

<Q>2

<Z>

[Notes]

1. The default setting is set to [Proportional pitch].

[Valid commands]

CG400 series

Font	<XU>	<XS>	<XM>	<XB>	<XL>	<RD>	<\$=>			
Modification	<RF>									

Modification			
Available for	CG400 series		
<b>Rotation</b>		<b>ESC+%</b>	
Hex code	ESC <1B> <sub>16</sub>	% <25> <sub>16</sub>	Parameter a
Default setting	a=0		
Persistence of the command	When printer is powered off	Set parameter will not be retained	
	Validity in a job	Set parameter will be retained until next valid setting	
	Validity after a job	Set parameter will be the default value for the next job<A>	

[Function]

Rotates font / barcodes in a counterclockwise direction.

[Format]

<%>a

• Parameter

a [Rotation direction] = 0 : Parallel 1 (0 deg)      1 : Serial 1 (90 deg)  
 2 : Parallel 2 (180 deg)      3 : Serial 2 (270 deg)

[Coding example] Font rotation: Parallel 2, Barcode rotation: Serial 1

<A>

<%>2

<V>100<H>400<P>3<L>0403<OA>ABCD

<%>1

<V>400<H>200<BD>103160\*123\*

<Q>2

<Z>

[Notes]

1. The vertical print position and the horizontal print position are absolute values from the origin.
2. If the parameter setting is outside of the specification (4 to 9), the command will get an error. If non numeric values included, the print will be executed with 0 degree rotation.
3. There is a possibility of incorrect print, when printing barcodes in serial 1 or serial 2 mode. Confirm print-out in those cases. Reduce print speed when printing in serial 1 or serial 2 mode.

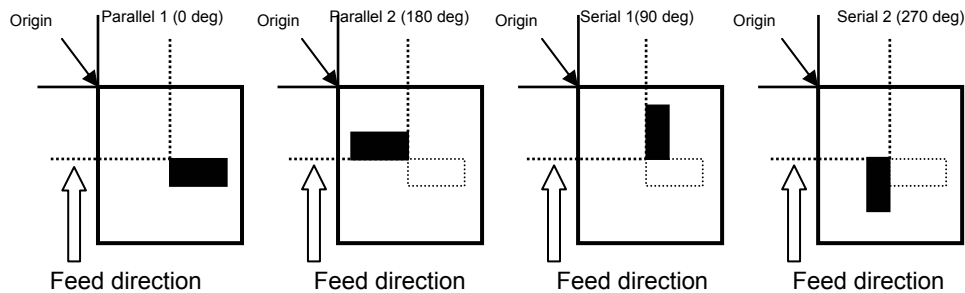

[Valid commands]

CG400 series

Font	<XU>	<XS>	<XM>	<XB>	<XL>	<U> <sup>-1</sup>	<S> <sup>-1</sup>	<M> <sup>-1</sup>	<WB> <sup>-1</sup>	<WL> <sup>-1</sup>
Barcode	<OA>	<OB>	<RD>	<\$=>						
	<B>	<BC>	<BG>	<BI>	<BF>	<BP>	<D>	<D><d>	<BD>	<BT>
2D code	<BW>									
	<BK>	<BQ>	<BV>	<BX>						
Graphic	<2D10>	<2D12>	<2D20>	<2D30>	<2D31>	<2D32>	<2D50>			
System	<G>	<GM>	<GP>							
Modification	<E>									
	<RF>									

\*1. Closed to end users.

Modification			
Available for	CG400 series		
<b>Sequential number</b>		<b>ESC+F</b>	
Hex code	ESC <1B> <sub>16</sub>	F <46> <sub>16</sub>	Parameter aaaabcccc(,dd,ee,f)
Default setting	None		
Persistence of the command	When printer is powered off	Set parameter will not be retained	
	Validity in a job	Becomes invalid after execution	
	Validity after a job	Becomes invalid after the job	

[Function]

Sets before the font / barcode data is specified. Assigns the specified data a serial number (consecutive) and adds it to the print.

[Format]

<F>aaaabcccc (,dd,ee,f)

• Parameter

a	[Print copies]	=	Valid range	:	1 to 9999	
b	[Increase/Decrease]	=	+	:	Increase	
			-	:	Decrease	
c	[Starting number]	=	Valid range	:	1 to 9999	
d	[Range of numeration (digits)]	=	Valid range	:	1 to 99	when omitted: 8
e	[Minimum downward count (digits)]	=	Valid range	:	0 to 99	when omitted: 0
f	[Decimal/ hexadecimal numeration]	=	Valid range	:	0 to 99	when omitted: 0
			0	:	Decimal	when omitted: 0
			1	:	Hexadecimal	

[Coding example] Pages of print: 1, Increase/Decrease: +, Starting number: 1,  
Range of numeration: 5 digits, Minimum downward count: 0

```
<A>
<V>100<H>100<P>2<L>0202
<F>1+1.5.0<OA>10000
<Q>2
<Z>
```

[Notes]

- Up to 8 serial numbers can be specified for one format.
- The inverse color setting <(> is not available for this function.
- The automatic line feed <E> is not available.
- To use this function, you need to print font or barcode together with serial number.
- Digit number of font or barcode command should be the same with the one of [Range of numeration]. If it exceeds the digit number of font or barcode command, serial number will not be printed.

[Valid commands]

CG200 series

Font	<XU>	<XS>	<XM>	<XB>	<XL>	<U> <sup>*1</sup>	<S> <sup>*1</sup>	<M> <sup>*1</sup>	<WB> <sup>*1</sup>	<WL> <sup>*1</sup>
	<OA>	<OB>	<\$=>	<RD>						
Barcode	<B>	<BC>	<BG>	<BI>	<BF>	<BP>	<D>	<D><d>	<BD>	<BT>
	<BW>	<BL>	<BM>							

\* 1 Closed to end users.



Modification			
Available for	CG400 series		
<b>Rule / Grid print</b>		<b>ESC+FW</b>	
Hex code	ESC <1B> <sub>16</sub>	FW <46> <sub>16</sub> <57> <sub>16</sub>	Parameter Rule aabcccc Grid aabbVccccHdddd
Default setting	None		

Persistence of the command	When printer is powered off	Set parameter will not be retained
	Validity in a job	Becomes invalid after execution
	Validity after a job	Becomes invalid after the job

[Function]

Prints rule / grid

[Format]

<FW>aabcccc

Rule print

• Parameter

a	[Line width]	=	Valid range	:	02 to 99 dots
b	[Horizontal / vertical setting]	=	H	:	Horizontal
			V	:	Vertical
c	[Length]	=	Valid range	:	Refer to table below

<FW>aabbVccccHdddd

Grid print

• Parameter

a	[Vertical line width]	=	Valid range	:	02 to 99 dots
b	[Horizontal line width]	=	Valid range	:	02 to 99 dots
c	[Vertical line length]	=	Valid range	:	Refer to table below
d	[Horizontal line length]	=	Valid range	:	Refer to table below

[Coding example] Ruled line: Line width: 4, Horizontal setting, Length: 400

Grid: V. line width: 8, H. line width: 8, V. line length: 300, H. line length: 400

<A>

<V>100<H>200<FW>**04H400**

<V>300<H>200<FW>**0808V300H400**

<Q>2

<Z>

[Notes]

1. If the print start position is outside of the printable area, it will not print due to a command error.

[Valid range]

Model	Horizontal line length in dots	Vertical line length in dots
CG408DT/TT	1 to 832	1 to 2400
CG412DT/TT	1 to 1248	1 to 3600

Modification			
Available for	CG400 series		
<b>Inversed color print</b>		<b>ESC+(</b>	
Hex code	ESC <1B> <sub>16</sub>	( <28> <sub>16</sub>	Parameter aaaa,bbbb
Default setting	None		
Persistence of the command	When printer is powered off	Set parameter will not be retained	
	Validity in a job	Becomes invalid after execution	
	Validity after a job	Becomes invalid after the job	

[Function]

Sets reversed color print (black/white)

[Format]

<(>aaaa,bbbb

• Parameter

- a [Valid range in horizontal direction] = Valid range : Refer to table below
- b [Valid range in vertical direction] = Valid range : Refer to table below

[Coding example] Valid range in horizontal direction: 200, Valid range in vertical direction: 70

```
<A>
<V>50<H>50<P>2<L>0202<OA>ABC
<V>50<H>50<(>200,70
<Q>2
<Z>
```

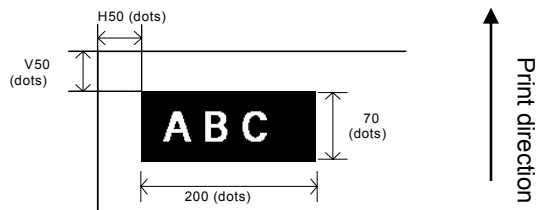

[Notes]

1. The horizontal and vertical print positions <H>, <V> are set before the inversed printing color setting <(>.
2. If the print start position is outside of the printable area, it will not print due to a command error.

[Tips]

1. Make sure the black print does not exceed 30% of the entire label.

[Valid range]

Model	Horizontal line length in dots	Vertical line length in dots
CG408DT/TT	1 to 832	1 to 2400
CG412DT/TT	1 to 1248	1 to 3600

8.9 Modification			
Available for	CG400 series		
<b>Kanji code</b>		<b>ESC+KC</b>	
Hex code	ESC <1B> <sub>16</sub>	KC <4B> <sub>16</sub> <43> <sub>16</sub>	Parameter a
Default setting	a=0		
Persistence of the command	When printer is powered off	Set parameter will not be retained.	
	Validity in a job	Set parameter will be retained until next valid setting.	
	Validity after a job	Set parameter will be the default value for the next job<A>.	

[Function]

Defines Kanji character code (Kanji code)  
Allows temporary switch-over between Kanji codes

[Format]

<KC>a

• Parameter

a [Kanji code selection] = 0 : JIS code  
1 : Shift JIS code

[Coding example 1] Shift JIS code selected

```
<A>
<KC>1
<V>100<H>200<P>2<L>0202
<K1>H81698A94816A83548367815B
<Q>2
<Z>
```

[Coding example 2] JIS code selected

```
<A>
<KC>0
<V>100<H>200<P>2<L>0202
<K1>H214A3374214B25352548213C
<Q>2
<Z>
```

[Notes]

1. It is not necessary to specify this command when printing labels normally.
2. It is possible to specify several Kanji codes within 1 item.
3. To print in Chinese or Korean, select Shift JIS code.

Modification			
Available for	CG400 series		
<b>Store Form overlay</b>		<b>ESC+&amp;</b>	
Hex code	ESC <1B> <sub>16</sub>	& <26> <sub>16</sub>	Parameter None
Default setting	None		
Persistence of the command	When printer is powered off	Command settings will not be retained	
	Valid range	Will be retained until next valid setting	
	Validity after a job	Will be retained until next valid setting	

[Function]

Registers form-overlay

[Format]

<&>

[Coding example]

```
<A>
<V>100<H>50<FW>1010V800H750
<V>100<H>50<FW>0505V760H710
<V>150<H>100<OA>MODEL
<&>
<Z>
```

[Notes]

1. After having registered a specific form overlay <&>, this format can be loaded by </> and applied to any print data.
2. The form overlay register function is set at the end of a format specification. The form overlay is valid over the entire print range.
3. Only one format can be registered.
4. If willing to change the format, first clear the form overlay with <\*&> before setting the form overlay another time.
5. The registered format can be loaded with </>.
6. If selecting a label size according to <A1> the registered form overlay will be expanded.

[Valid commands]

CG400 series

Print position	<V>	<H>								
Modification	<WD>	<FW>	</>	<RF>						
Font	<XU>	<XS>	<XM>	<XB>	<XL>	<U> <sup>*1</sup>	<S> <sup>*1</sup>	<M> <sup>*1</sup>	<WB> <sup>*1</sup>	<WL> <sup>*1</sup>
	<OA>	<OB>	<RD>	<\$=>						
Barcode	<B>	<BC>	<BG>	<BI>	<BF>	<BP>	<D>	<D><d>	<BD>	<BT>
	<BW>									
2D code	<BK>	<BQ>	<BV>	<BX>						
	<2D10>	<2D12>	<2D20>	<2D30>	<2D31>	<2D32>	<2D50>			
Graphic	<G>	<GM>	<GP>							

\*1 Closed to end users.

<b>Modification</b>			
Available for	CG400 series		
<b>Recall Form overlay</b>		<b>ESC+/ /</b>	
Hex code	ESC <1B> <sub>16</sub>	/ <2F> <sub>16</sub>	Parameter None
Default setting	None		
Persistence of the command	When printer is powered off	Command settings will not be retained	
	Validity in a job	Will be retained until next valid setting	
	Validity after a job	Will be retained until next valid setting	

[Function]

Specifies to invoke form overlay

[Format]

</>

[Coding example]

<A>

</>

<V>200<H>100<P>0<S>B,100,100,6

<S>SATOPRINTER

<V>720<H>150<B>102100\*95000012345\*

<Q>2

<Z>

[Notes]

1. This command invokes the form-overlay, saved by the form-overlay registration <&> command.
2. If detecting this command in a normal print data, this data will be combined with a graphic saved in the form overlay for printing out.

Modification			
Available for	CG400 series		
<b>Partial edit</b>		<b>ESC+0</b>	
Hex code	ESC <1B> <sub>16</sub>	0 <30> <sub>16</sub>	Parameter None
Default setting	None		
Persistence of the command	When printer is powered off	Command settings will not be retained	
	Valid range	Becomes invalid after execution	
	Validity after a job	Becomes invalid after the job	

[Function]

Specifies to edit the latest printed data partially

[Format]

<0>

[Coding example] Print data [DEF] is modified into [123]

```

<A>
<V>100<H>200<P>2<L>0202<XM>ABC
<V>200<H>200<P>2<L>0202<XM>DEF
<Q>1
<Z>
} 1st data

<A>
<0>
<V>200<H>200<P>2<L>0202<XM>123
<Q>1
<Z>
} 2nd data

```

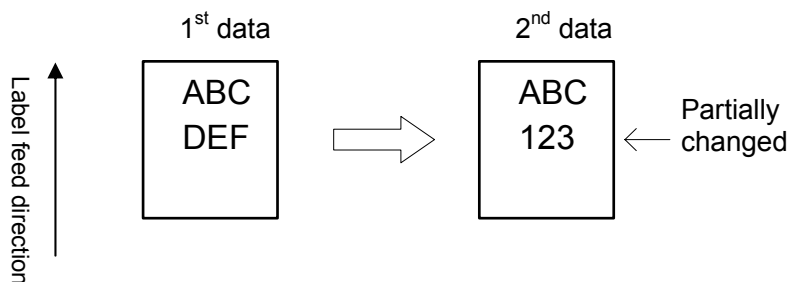

[Notes]

1. Used when data of print does only differ partially from latest printed data.
2. Invoke the last printed data with the command <0> to edit this data partially and to print out. Specify the data to be changed and send a new data to be replaced with it.
3. The original data (1<sup>st</sup> data shown above) will be cleared.
4. If the rotation command <%> is specified for the old data, this rotation will also be maintained for the new data.
5. Use the partial modifications command <0> with fixed pitch, same font and same number of digits.

Modification			
Available for	CG400 series		
<b>Partial copy</b>		<b>ESC+WD</b>	
Hex code	ESC <1B> <sub>16</sub>	WD <57> <sub>16</sub> <44> <sub>16</sub>	Parameter VaaaaHbbbbYccccXdddd
Default setting	None		
Persistence of the command	When printer is powered off	Set parameter will not be retained	
	Validity in a job	Becomes invalid after execution	
	Validity after a job	Becomes invalid after the job	

[Function]

Copies data from one place to another destination.

[Format]

<WD>VaaaaHbbbbYccccXdddd

• Parameter

a	[Vertical position of origin]	=	Valid range	:	Refer to the below
b	[Horizontal position of origin]	=	Valid range	:	Refer to the below
c	[Vertical dot number of origin]	=	Valid range	:	Refer to the below
d	[Horizontal dot number of origin]	=	Valid range	:	Refer to the below

[Coding example] Vertical position of origin: 50, Horizontal position of origin: 50, Vertical dot number of origin: 200, Horizontal dot number of origin: 400

```
<A>
<V>50<H>50<P>2<L>0202<XU>ABCD
<V>300<H>100<WD>V50H50Y200X400
<Q>2
<Z>
```

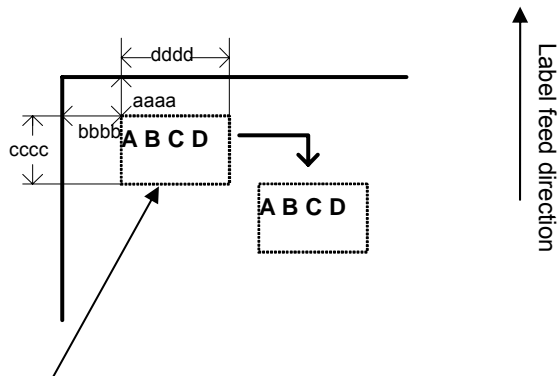

The dotted line indicates the copy range.  
The actual print is limited to ABCD.

[Notes]

1. Specify the print position by vertical position <V> and horizontal position <H> before performing data copy <WD>.
2. Do not place the print position within the range of the origin.
3. If the print start position of copy area is outside of the printable area, it will not print due to a command error.

[Valid range]

Model	Valid range in dots	
	Horizontal position of origin Horizontal dot number	Vertical position of origin Vertical dot number
CG408DT/TT	1 to 832	1 to 2400
CG412DT/TT	1 to 1248	1 to 3600

Modification			
Available for	CG400 series		
<b>Journal print</b>		<b>ESC+J</b>	
Hex code	ESC <1B> <sub>16</sub>	J <4A> <sub>16</sub>	Parameter a~a+CR<0D> <sub>16</sub>
Default setting	None		
Persistence of the command	When printer is powered off	Set parameter will not be retained	
	Validity in a job	Becomes invalid after execution	
	Validity after a job	Becomes invalid after the job	

[Function]

Specifies journal print

[Format]

<J>a~a+CR

• Parameter

a                    [Column of journal print]                    =    Print data  
CR                    [Control code (0DH)]

[Coding example]

<A>  
<J>  
ABCD+CR  
EFGH+CR  
<Z>

[Notes]

1. Journal print is executed from 2 dots vertical position and 2 dots horizontal position.
2. Inter character pitch is fixed to 2 dots. The inter-line pitch is fixed to 16 dots.
3. The data will be printed in XS font, factor 2 x 2.
4. Setting the journal print command cancels all other commands, except from the re-issuing command <C> and the inversed color printing command <(>.



Modification			
Available for	CG400 series		
<b>Recall font &amp; logo</b>		<b>ESC+RF</b>	
Hex code	ESC <1B> <sub>16</sub>	RF <52> <sub>16</sub> <46> <sub>16</sub>	Parameter aabbbb,n~n
Default setting	aa=01, bbbb=1		
Persistence of the command	When printer is powered off	Set parameter will not be retained	
	Validity in a job	Becomes invalid after execution	
	Validity after a job	Becomes invalid after the job	

[Function]

Invokes and print out fonts and logos downloaded by a specific tool

[Format]

<RF>aabbbb,n - n

• Parameter

a [Font ID Number] = Valid range : 01 to 99  
 b [Digits to be printed] = Valid range : 1 to 9999  
 n [Print data]

[Coding example 1] When calling the font with this command and printing "AB" in 1 byte character.

[Font ID No.: 01, Digits to be printed: 4]  
 (Unicode is A: <0041><sub>16</sub>, B: <0042><sub>16</sub>)

```
<A>
<PS>
<V>100<H>100<L>0101
<RF>010004,<0041>16<0042>16
<Z>
```

[Coding example 2] When calling the logo with this command and printing [Font ID No.: 02, Digits: 2]

```
<A>
<V>100<H>100<L>0101<RF>020002,<826B>16
<Z>
```

[Notes]

1. Specify the Unicode value for print data.
2. When printing logos, specify [Digits to be printed: 0002] and [Print data: <826BH>].

Modification			
Available for	CG400 series		
<b>Print Direction</b>		<b>ESC+RL</b>	
HEX code	ESC	EX0	Parameter
	<1B> <sub>16</sub>	<52> <sub>16</sub> <4C> <sub>16</sub>	a
Default setting	a=0		
Persistence of the command	When printer is powered off	Set parameter will not be retained.	
	Validity in a job	Set command will be retained until next valid setting.	
	Validity after a job	Set parameter becomes invalid.	

[Function]

Specifies print direction.

[Format]

<RL>a

• Parameter

- |   |                   |     |   |  |
|---|-------------------|-----|---|--|
| a | [Print direction] | = 0 | : | Normal direction (prints from left to right)   |
|   |                   | 1   | : | Opposite direction (prints from right to left) |

[Coding example]

<A>

**<RL>1**

<V>100<H>300<L>0202<P>1<XM>ABCD

<Q>1

<Z>

[Notes]

1. The print command is retained unless this print direction command is specified between <A> and <Z>.
2. The designation of print direction is effective between <A> and <Z> only. The print command when <Z> is executed becomes the default value (a=0).
3. This command is ignored when it is specified outside the memory range.
4. When [Print direction] is set to the opposite direction (RL1), sequential number printing and format registration cannot be performed. Make sure to select the normal print direction (RL0) with this command for sequential number printing and format registration.
5. This command is available when using Hebrew font.

## 9. Font Command

Font			
Available for	CG400 series		
<b>XU font (Basic size 5x9 dots)</b>		<b>ESC+XU</b>	
Hex code	ESC <1B> <sub>16</sub>	XU <58> <sub>16</sub> <55> <sub>16</sub>	Parameter n~n
Default setting	None		
Persistence of the command	When printer is powered off	Set parameter will not be retained	
	Validity in a job	Becomes invalid after execution	
	Validity after a job	Becomes invalid after the job	

### [Function]

Font with the basic size of: width 5 dots, height 9 dots is specified.

### [Format]

<XU> n~n

- Parameter

n [Print data] = Data

### [Coding example]

```
<A>
<V>100<H>200<P>2<L>0304<XU>ABCDE
<Q>2
<Z>
```

### [Notes]

1. The XU font allows the setting of a fixed pitch or the setting of a proportional pitch.
2. The setting of the fixed / proportional pitch is done in the command settings.

### [Valid commands]

Print position	<V>	<H>								
Modification	<P>	<L>	<%>	<PS>	<PR>	<F>	<&>	</>	<0>	<WD>
Barcode	<D><d>	<BL><d>								

# XU font character set

Basic size is 5 x 9 dots (width x height)

	2	3	4	5	6	7	8	9	A	B	C	D	E	F
0	ø	ø	P	`	p	ç	é	á			ø	ó	-	
1	!	1	A	Q	a	q	ü	æ	í			ð	þ	±
2	"	2	B	R	b	r	é	æ	ó			é	ó	=
3	#	3	C	S	o	s	á	ó	ú			ë	ò	æ
4	\$	4	D	T	d	t	ä	ö	ñ			ë	ó	
5	%	5	E	U	e	u	ä	ö	ñ	á		€	ç	£
6	&	6	F	V	f	v	ä	ú	æ	á	ä	é	µ	÷
7	'	7	G	W	g	w	ç	ú	æ	á	æ	é		
8	<	8	H	X	h	x	é	ý	ó	ø		í		°
9	>	9	I	Y	i	y	ë	ö					ó	~
A	*	:	J	Z	j	z	è	ü	~				ó	*
B	+	;	K	[	k	{	í	ø	æ				ó	!
C	,	<	L	\	l		í	æ	æ				ý	æ
D	-	=	M	]	m	}	í	æ	í	æ			ý	æ
E	.	>	N	^	n	~	æ	x	æ	¥			æ	~
F	/	?	O	_	o		á	f	æ				'	

The print sample shown above is issued with a head density of 12 dots/mm and a expansion factor of 3 (vertical/horizontal).

Font			
Available for	CG400 series		
<b>XS font (Basic size 17x17 dots)</b>		<b>ESC+XS</b>	
Hex code	ESC <1B> <sub>16</sub>	XS <58> <sub>16</sub> <53> <sub>16</sub>	Parameter n~n
Default setting	None		
Persistence of the command	When printer is powered off	Set parameter will not be retained	
	Validity in a job	Becomes invalid after execution	
	Validity after a job	Becomes invalid after the job	

[Function]

Font with the basic size of: width 17 dots, height 17 dots is specified.

[Format]

<XS>n~n

• Parameter

n [Print data] = Data

[Coding example]

<A>

<V>100<H>200<P>2<L>0304<XS>ABCDE

<Q>2

<Z>

[Notes]

1. The XS font allows the setting of a fixed pitch or the setting of a proportional pitch.
2. The setting of the fixed / proportional pitch is done in the command settings.

[Valid commands]

Print position	<V>	<H>								
Modification	<P>	<L>	<%>	<PS>	<PR>	<F>	<&>	</>	<0>	<WD>
Barcode	<D><d>	<BL><d>								

## XS font character set

Basic size is 17 x 17 dots (width x height)

	2	3	4	5	6	7	8	9	A	B	C	D	E	F
0	ø	@	P	'	p	ç	É	á	ø	ð	ó	-		
1	!	1	A	Q	a	q	ü	æ	í		ø	β	±	
2	"	2	B	R	b	r	é	Æ	ó		É	ó	=	
3	#	3	C	S	c	s	â	ô	ú		É	ó	%	
4	\$	4	D	T	d	t	ä	ö	ñ		É	ö	¶	
5	%	5	E	U	e	u	à	ò	Ñ	À	€	ö	§	
6	&	6	F	V	f	v	â	û	ä	Å	ã	í	μ	÷
7	'	7	G	W	g	w	ç	ù	ø	À	Ä	Í	þ	-
8	(	8	H	X	h	x	ê	ÿ	¿	©	ÿ	þ	°	
9	)	9	I	Y	i	y	ë	ü	®			ü	..	
A	*	:	J	Z	j	z	è	0	¬			0	.	
B	+	;	K	[	k	{	ï	ø	½			ü	'	
C	,	<	L	\	l	!	í	£	¼			ý	²	
D	-	=	M	]	m	}	ï	ø	í	ø	!	ÿ	²	
E	.	>	N	^	n	~	Ä	x	«	¥	!	~		
F	/	?	0	_	o		Ä	f	»			~		

The print sample shown above is issued with a head density of 12 dots/mm and an expansion factor of 2 (vertical/horizontal).

Font			
Available for	CG400 series		
<b>XM font (Basic size 24x24 dots)</b>		<b>ESC+XM</b>	
Hex code	ESC <1B> <sub>16</sub>	XM <58> <sub>16</sub> <4D> <sub>16</sub>	Parameter n~n
Default setting	None		
Persistence of the command	When printer is powered off	Set parameter will not be retained	
	Validity in a job	Becomes invalid after execution	
	Validity after a job	Becomes invalid after the job	

[Function]

Font with the basic size of: width 24 dots, height 24 dots is specified.

[Format]

<XM>n~n

• Parameter

n [Print data] = Data

[Coding example]

```
<A>
<V>100<H>200<P>2<L>0304<XM>ABCDE
<Q>2
<Z>
```

[Notes]

1. The XM font allows the setting of a fixed pitch or the setting of a proportional pitch.
2. The setting of the fixed / proportional pitch is done in the command settings.

[Valid commands]

Print position	<V>	<H>								
Modification	<P>	<L>	<%>	<PS>	<PR>	<F>	<&>	</>	<0>	<WD>
Barcode	<D><d>	<BL><d>								

## XM font character set

Basic size is 24 x 24 dots (width x height)

	2	3	4	5	6	7	8	9	A	B	C	D	E	F
0	0	@	P	`	p	Ç	É	á	ø	Ó	-			
1	!	1	A	Q	a	q	ü	æ	í			Ð	β	±
2	"	2	B	R	b	r	é	Æ	ó			É	Ö	=
3	#	3	C	S	c	s	â	ô	ú			È	Ò	¾
4	\$	4	D	T	d	t	ä	ö	ñ			Ê	õ	¶
5	%	5	E	U	e	u	à	ò	Ñ	À		€	Ö	§
6	&	6	F	V	f	v	ä	û	ä	Ã	ã	í	μ	÷
7	'	7	G	W	g	w	ç	ù	º	À	Ã	î	þ	-
8	(	8	H	X	h	x	ê	ÿ	ÿ	©		Ï	þ	°
9	)	9	I	Y	i	y	ë	Ö	®			Ú	--	
A	*	:	J	Z	j	z	è	Ü	¬			Ó	-	
B	+	;	K	[	k	{	ï	ø	½			■	Ü	¹
C	,	<	L	\	l	!	î	£	¼				ý	³
D	-	=	M	]	m	}	ï	Ø	ï	¢		!	ÿ	²
E	.	>	N	^	n	~	Ä	x	<<	¥		!	-	
F	/	?	O	_	o		Ä	f	>>				'	

The print sample shown above is issued with a head density of 12 dots/mm and a expansion factor of 2 (vertical/horizontal).



Font			
Available for	CG400 series		
<b>XB font (Basic size 48x48 dots)</b>		<b>ESC+XB</b>	
Hex code	ESC <1B> <sub>16</sub>	XB <58> <sub>16</sub> <42> <sub>16</sub>	Parameter an~n
Default setting	a=0		
Persistence of the command	When printer is powered off	Set parameter will not be retained	
	Validity in a job	Becomes invalid after execution	
	Validity after a job	Becomes invalid after the job	

[Function]

Font with the basic size of: width 48 dots, height 48 dots is specified.

[Format]

<XB>an~n

• Parameter

a	[Smoothing]	=	0: Smoothing OFF 1: Smoothing ON (Valid for expansion factors <L> between 3 and 12)
n	[Print data]	=	Data

[Coding example]

```
<A>
<V>100<H>200<P>2<L>0304<XB>0ABCDE
<Q>2
<Z>
```

[Notes]

1. The XB font allows the setting of a fixed pitch or the setting of a proportional pitch.
2. The setting of the fixed / proportional pitch is done in the command settings.
3. If setting the smoothing option, and the expansion <L> command is set to 1 or 2, the smoothing function will be ignored.

[Valid commands]

Print position	<V>	<H>								
Modification	<P>	<L>	<%>	<PS>	<PR>	<F>	<&>	</>	<0>	<WD>
Barcode	<D><d>	<BL><d>								

## XB font character set

Basic size is 48 x 48 dots (width x height)

	2	3	4	5	6	7	8	9	A	B	C	D	E	F
0	ø	@	P	`	p	Ç	É	á	ø		ø	ó	-	
1	!	1	A	Q	a	q	ü	æ	í			ø	β	±
2	"	2	B	R	b	r	é	Æ	ó			É	ó	=
3	#	3	C	S	c	s	â	ô	ú			É	ó	¼
4	\$	4	D	T	d	t	ä	ö	ñ			È	ö	†
5	%	5	E	U	e	u	à	ò	Ñ	Á		€	Ö	§
6	&	6	F	V	f	v	á	û	ä	Å	ã	í	μ	÷
7	'	7	G	W	g	w	ç	ù	ø	À	Ä	í	þ	·
8	(	8	H	X	h	x	ê	ÿ	¿	©		ÿ	þ	°
9	)	9	I	Y	i	y	ë	ö	®				ü	..
A	*	:	J	Z	j	z	è	Ü	¬				ü	·
B	+	;	K	[	k	{	ï	ø	½				ü	¹
C	,	<	L	\	l		î	£	¼				ý	³
D	-	=	M	]	m	}	ï	ø	í	ø			!	Ý²
E	.	>	N	^	n	~	Ä	×	«	¥			í	-
F	/	?	o	_	o		Å	f	»				í	-

The print sample shown above is issued with a head density of 12 dots/mm and a expansion factor of 1 (vertical/horizontal).

Font			
Available for	CG400 series		
<b>XL font (Basic size 48x48 dots)</b>		<b>ESC+XL</b>	
Hex code	ESC <1B> <sub>16</sub>	XL <58> <sub>16</sub> <4C> <sub>16</sub>	Parameter an~n
Default setting	None		
Persistence of the command	When printer is powered off	Set parameter will not be retained	
	Validity in a job	Becomes invalid after execution	
	Validity after a job	Becomes invalid after the job	

[Function]

Font with the basic size of: width 48 dots, height 48 dots is specified.

[Format]

<XL>an~n

• Parameter

a	[Smoothing]	=	0: Smoothing OFF 1: Smoothing ON (Valid for expansion factors <L> between 3 and 12)
n	[Print data]	=	Data

[Coding example]

```
<A>
<V>100<H>200<P>2<L>0304<XL>0ABCDE
<Q>2
<Z>
```

[Notes]

1. The XL font allows the setting of a fixed pitch or the setting of a proportional pitch.
2. The setting of the fixed / proportional pitch is done in the command settings.
3. If setting the smoothing option, and the expansion <L> command is set to 1 or 2, the smoothing function will be ignored.

[Valid commands]

Print position	<V>	<H>								
Modification	<P>	<L>	<%>	<PS>	<PR>	<F>	<&>	</>	<0>	<WD>
Barcode	<D><d>	<BL><d>								

## XL font character set

Basic size is 48 x 48 dots (width x height)

	2	3	4	5	6	7	8	9	A	B	C	D	E	F
<b>0</b>	0	@	P	'	p	Ç	É	á	Ø	ø	Ó	-		
<b>1</b>	!	1	A	Q	a	q	ü	æ	í			Ð	β	±
<b>2</b>	"	2	B	R	b	r	é	Æ	ó			Ê	Ô	=
<b>3</b>	#	3	C	S	c	s	â	ô	ú			Ë	Ò	¾
<b>4</b>	\$	4	D	T	d	t	ä	ö	ñ			È	õ	¶
<b>5</b>	%	5	E	U	e	u	à	ò	Ñ	Á		€	Õ	§
<b>6</b>	&	6	F	V	f	v	â	û	ª	Â	ã	Í	μ	÷
<b>7</b>	'	7	G	W	g	w	ç	ù	º	Ã	ä	î	þ	-
<b>8</b>	(	8	H	X	h	x	ê	ÿ	¿	©		Ï	þ	°
<b>9</b>	)	9	I	Y	i	y	ë	ÿ	®				Ú	••
<b>A</b>	*	:	J	Z	j	z	è	Ü	¬				Û	•
<b>B</b>	+	;	K	[	k	{	ï	φ	½			■	Ü	¹
<b>C</b>	,	<	L	\	l		î	£	¼			▒	ý	³
<b>D</b>	-	=	M	]	m	}	ï	Φ	ι	¢			ÿ	²
<b>E</b>	.	>	N	^	n	~	Ä	x	«	¥			ÿ	-
<b>F</b>	/	?	O	_	o		Å	f	»				ÿ	'

The print sample shown above is issued with a head density of 12 dots/mm and a expansion factor of 1 (vertical/horizontal).

Font			
Available for	CG400 series		
<b>OCR-A font</b>		<b>ESC+OA</b>	
Hex code	ESC <1B> <sub>16</sub>	OA <4F> <sub>16</sub> <41> <sub>16</sub>	Parameter n~n
Default setting	None		
Persistence of the command	When printer is powered off	Set parameter will not be retained	
	Validity in a job	Becomes invalid after execution	
	Validity after a job	Becomes invalid after the job	

[Function]  
Specifies OCR-A font.

[Format]  
<OA>n~n  
 • Parameter  
 n [Print data] = Data

[Coding example]  
 <A>  
 <V>100<H>100<P>2<L>0202<OA>ABC  
 <Q>2  
 <Z>

[Font size table]

Model	Font size in dots
CG408DT/TT	W15 x H22
CG412DT/TT	W22 x H33

[Valid commands]

Print position	<V>	<H>							
Modification	<P>	<L>	<%>	<F>	<&>	</>	<0>	<WD>	
Barcode	<D><d>	<BL><d>							

## OCR-A font character set

OCR-A font settings.

	2	3	4	5	6	7	8	9	A	B	C	D	E	F
0		0		P										
1		1	A	Q										
2		2	B	R										
3		3	C	S										
4	4	4	D	T										
5		5	E	U										
6		6	F	V										
7		7	G	W										
8		8	H	X										
9		9	I	Y										
A			J	Z										
B			K											
C			L											
D			M											
E	.	>	N											
F	/		o											

The print sample shown above is issued with a head density of 12 dots/mm, a font size of 22x33, and a expansion factor of 1 (vertical/horizontal).

Font			
Available for	CG400 series		
<b>OCR-B font</b>		<b>ESC+OB</b>	
Hex code	ESC <1B> <sub>16</sub>	OB <4F> <sub>16</sub> <42> <sub>16</sub>	Parameter n~n
Default setting	None		
Persistence of the command	When printer is powered off	Set parameter will not be retained	
	Validity in a job	Becomes invalid after execution	
	Validity after a job	Becomes invalid after the job	

[Function]  
Specifies OCR-B font.

[Format]  
<OB>n~n  
• Parameter  
n [Print data] = Data

[Coding example]  
<A>  
<V>100<H>100<P>2<L>0202<OB>ABC  
<Q>2  
<Z>

[Font size table]

Model	Font size in dots
CG408DT/TT	W20 x H24
CG412DT/TT	W30 x H36

[Valid commands]

Print position	<V>	<H>							
Modification	<P>	<L>	<%>	<F>	<&>	</>	<0>	<WD>	
Barcode	<D><d>	<BL><d>							

## OCR-B font character set

OCR-B font settings.

	2	3	4	5	6	7	8	9	A	B	C	D	E	F
0	0	@	P											
1	!	1	A	Q										
2	"	2	B	R										
3	#	3	C	S										
4	\$	4	D	T										
5	%	5	E	U										
6	&	6	F	V										
7	'	7	G	W										
8	(	8	H	X										
9	)	9	I	Y										
A	*	:	J	Z										
B	+	;	K	¥										
C	,	<	L	¥										
D	-	=	M											
E	.	>	N											
F	/	?	O											

The print sample shown above is issued with a head density of 12 dots/mm, a font size of 30x36, and a expansion factor of 1 (vertical/horizontal).



Font			
Available for	CG400 series		
<b>Outline font design</b>		<b>ESC+\$</b>	
Hex code	ESC <1B> <sub>16</sub>	\$ <24> <sub>16</sub>	Parameter a,bbb,ccc,d
Default setting	None		
Persistence of the command	When printer is powered off	Set parameter will not be retained.	
	Validity in a job	Set parameter will be retained until next valid setting.	
	Validity after a job	Set parameter will be the default value for the next job <A>.	

[Function]

Specifies type, design, size of outline font

[Format]

<\$>a,bbb,ccc,d

• Parameter

a	[Font type selection]	=	A	:	Helvetica Bold (Proportional)
			B	:	Helvetica Bold (Inter-character pitch fixed)
b	[Font width]	=	Valid range	:	24 to 999 dots
c	[Font height]	=	Valid range	:	24 to 999 dots
d	[Font design]	=	0	:	Normal font (Black)
			1	:	White characters on black background
			2	:	Grey font (Pattern 1)
			3	:	Grey font (Pattern 2)
			4	:	Grey font (Pattern 3)
			5	:	Font with shadow
			6	:	White characters with shadow on black background
			7	:	Mirrored font
			8	:	Normal italic font
			9	:	White italic characters with shadow on black background

[Coding example] Font type: A, font width: 100 dots, font height: 100 dots, font design: 1

```
<A> >
<V> > 100<H>100<P>2
<$>A,100,100,1<=$>SATO
<Q>2
<Z>
```

[Notes]

1. The outline font printing command <\$=> shall be executed after the outline font design selection <\$>.
2. Font height includes both ascender and descender area. For proportional pitch, the character width of outline font differs depending on the font to be used.
3. Use character pitch command <P> to specify font pitch.
4. Italic characters are tilt in an angle of 15-degree, within their specified width. As for the height specification, both ascender and descender area are included.
5. For the font design 1 thru 9, if the specified dot setting is irregularly small, the font can not be identified.
6. If the font width / height are very small, there can be cases that the font is squeezed.

[Valid commands]

Modification	<\$=>								
--------------	-------	--	--	--	--	--	--	--	--

Font			
Available for	CG400 series		
<b>Outline font print</b>		<b>ESC+\$=</b>	
Hex code	ESC <1B> <sub>16</sub>	\$= <24> <sub>16</sub> <3D> <sub>16</sub>	Parameter n~n
Default setting	None		
Persistence of the command	When printer is powered off	Set parameter will not be retained	
	Validity in a job	Becomes invalid after execution	
	Validity after a job	Becomes invalid after the job	

[Function]

Specifies printing command of outline font

[Format]

<\$=>n~n

•Parameter

n [Print data] = Data

[Coding example] Print data: SATO

<A>

<V>100<H>100<P>2

<\$>A,100,100,1<\$=>**SATO**

<Q>2

<Z>

[Notes]

1. The outline font printing commando <\$=> shall be executed after the outline font design selection <\$>.

[Valid commands]

Print position	<V>	<H>								
Modification	<P>	<%>	<\$>	<F>						

## Outline font character set

Outline font settings

	2	3	4	5	6	7	8	9	A	B	C	D	E	F
0	ø	@	P	'	p	Ç	É	á			ø	Ó	-	
1	!	1	A	Q	a	q	ü	æ	í			Ð	β	±
2	"	2	B	R	b	r	é	Æ	ó			Ê	Ô	=
3	#	3	C	S	c	s	â	ô	ú			Ë	Ò	‰
4	\$	4	D	T	d	t	ä	ö	ñ			È	õ	
5	%	5	E	U	e	u	à	ò	Ñ	Á		€	Ö	
6	&	6	F	V	f	v	á	ó	a	Â	ã	Í	μ	+
7	'	7	G	W	g	w	ç	ù	ø	À	Ã	Î	þ	.
8	(	8	H	X	h	x	é	ý	¿	©		Ï	ρ	°
9	)	9	I	Y	i	y	ë	Ö	®			Ú	"	
A	*	:	J	Z	j	z	è	Ü	¬			Û	.	
B	+	;	K	[	k	{	ı	ø	½			Ü	'	
C	.	<	L	\	l		ı	£	¼			Ý	•	
D	-	=	M	]	m	}	ı	ø	ı	¢		Ý	•	
E	.	>	N	^	n	~	À	×	«	¥		ı	¯	
F	/	?	O	_	o		Á	f	»					

The print sample shown above is issued with a head density of 12 dots/mm, normal font, and a font size of 50x50 (vertical/horizontal).

## Outline font character set

Characters consists of Helvetia Bold (Inter-character pitch fixed), 40×40 dots, Normal font (Black)

	0	1	2	3	4	5	6	7	8	9	A	B	C	D	E	F
0				Ø	@	P	'	p	Ç	É	á			ø	Ó	-
1			!	1	A	Q	a	q	ü	æ	í			Ð	β	±
2			"	2	B	R	b	r	é	Æ	ó			Ê	Ô	=
3			#	3	C	S	c	s	â	ô	ú			Ë	Ò	¾
4			\$	4	D	T	d	t	ä	ö	ñ			È	õ	
5			%	5	E	U	e	u	à	ò	Ñ	Á		€	Õ	
6			&	6	F	V	f	v	â	û	a	Â	ã	Í	μ	÷
7			'	7	G	W	g	w	ç	ù	ø	À	Ã	Î	þ	·
8			(	8	H	X	h	x	ê	ÿ	¿	©		Ï	ƒ	°
9			)	9	I	Y	i	y	ë	Ö	®			Ú	”	
A			*	:	J	Z	j	z	è	Ü	¬			Û	•	
B			+	;	K	[	k	{	ï	ø	½			Ü	´	
C			,	<	L	\	l	!	í	£	¼			Ý	³	
D			-	=	M	]	m	}	ì	Ø	¡	¢		Ý	²	
E			.	>	N	^	n	~	Ä	×	«	¥		ÿ	ˆ	
F			/	?	O	_	o		Å	f	»			'		

The print sample shown above is issued with a head density of 8 dots/mm.

Font			
Available for	CG400 series		
CG font		ESC+RD	
Hex code	ESC <1B> <sub>16</sub>	RD <52> <sub>16</sub> <44> <sub>16</sub>	Parameter abb,ccc,ddd,n~n
Default setting	None		
Persistence of the command	When printer is powered off	Set parameter will not be retained	
	Validity in a job	Becomes invalid after execution	
	Validity after a job	Becomes invalid after the job	

[Function]

Specifies CG font type, font style, font size and print data

[Format]

<RD>abb,ccc,ddd,n~n

• Parameter

a	[Font type]	=	A [CG Times] B [CG Triumvirate]
b	[Font style]	=	00 Fixed
c	[Horizontal size (width)]	=	Valid range : 004 to 999 dots. Refer to the table below Valid range : P02 to P99 points
d	[Vertical size (height)]	=	Valid range : 004 to 999 dots. Refer to the table below Valid range : P02 to P99 points
n	[Print data]	=	Data

[Coding example]

```
<A>
<V>100<H>100<P>2
<RD>A00,P10,P10,SATO
<Q>2
<Z>
```

[Notes]

1. The font size is set by [dot number] or [point number].
2. The dot size does vary with printer type. (Refer to the table below)
3. 1 point is 0.35mm.

[Dot size]

Printer	1 dot size (mm)
CG408DT/TT	0.125
CG412DT/TT	0.083

[Range of font size]

Printer	Valid range: Horizontal (dots)	Valid range: Vertical (dots)
CG408DT/TT	4 to 832	4 to 999
CG412DT/TT	4 to 1248	4 to 999

[Valid commands]

Print position	<V>	<H>								
Modification	<P>	<%>	<PS>	<PR>	<F>					

## CG Times font character set

CG Times font settings

	2	3	4	5	6	7	8	9	A	B	C	D	E	F
<b>0</b>	0	@	P	`	p	Ç	É	á	0		ø	Ó	-	
<b>1</b>	!	1	A	Q	a	q	ü	æ	í			Ð	ß	±
<b>2</b>	"	2	B	R	b	r	é	Æ	ó			Ê	Ô	_
<b>3</b>	#	3	C	S	c	s	â	ô	ú			Ë	Ò	<sup>3</sup> / <sub>4</sub>
<b>4</b>	\$	4	D	T	d	t	ä	ö	ñ			È	õ	¶
<b>5</b>	%	5	E	U	e	u	à	ò	Ñ	Á			Õ	§
<b>6</b>	&	6	F	V	f	v	á	û	<sup>a</sup>	Â	ã	í	μ	÷
<b>7</b>	'	7	G	W	g	w	ç	ù	°	À	Ã	î	þ	,
<b>8</b>	(	8	H	X	h	x	ê	ÿ	ı	©		İ	Ɔ	°
<b>9</b>	)	9	I	Y	i	y	ë	Ö	®				Ú	”
<b>A</b>	*	:	J	Z	j	z	è	Ü	¬				Û	·
<b>B</b>	+	;	K	[	k	{	ï	ø	<sup>1</sup> / <sub>2</sub>				Ù	<sup>1</sup>
<b>C</b>	,	<	L	\	l		î	£	<sup>1</sup> / <sub>4</sub>				Ý	<sup>3</sup>
<b>D</b>	-	=	M	]	m	}	ì	Ø	ı	ç			Ý	<sup>2</sup>
<b>E</b>	.	>	N		n		Ä	×	«	¥		ì	-	
<b>F</b>	/	?	O	_	o		Å	f	»				'	

The print sample shown above is issued with a head density of 12 dots/mm, and a font size of 48x48 (vertical/horizontal).

# CG Triumvirate font character set

CG Triumvirate font settings

	2	3	4	5	6	7	8	9	A	B	C	D	E	F
<b>0</b>		0	@	P	`	p	Ç	É	á	0		ö	Ó	-
<b>1</b>		!	1	A	Q	a	q	ü	æ	í		Đ	ß	±
<b>2</b>		"	2	B	R	b	r	é	Æ	ó		Ê	Ô	
<b>3</b>		#	3	C	S	c	s	â	ô	ú		Ë	Ò	¾
<b>4</b>		\$	4	D	T	d	t	ä	ö	ñ		È	õ	¶
<b>5</b>		%	5	E	U	e	u	à	ò	Ñ	Á		Õ	§
<b>6</b>		&	6	F	V	f	v	å	û	ª	Â	ã	í	µ ÷
<b>7</b>		'	7	G	W	g	w	ç	ù	º	À	Ã	î	þ
<b>8</b>		(	8	H	X	h	x	ê	ÿ	¿	©		Ï	°
<b>9</b>		)	9	I	Y	i	y	ë	Ö	®			Ú	¨
<b>A</b>		*	:	J	Z	j	z	è	Ü	¬			Û	·
<b>B</b>		+	;	K	[	k	{	ï	ø	½			Ü	¹
<b>C</b>		,	<	L	\	l		î	£	¼			Ý	³
<b>D</b>		-	=	M	]	m	}	ì	Ø	ì	¢		ÿ	²
<b>E</b>		.	>	N	^	n	~	Ä	×	«	¥		ì	
<b>F</b>		/	?	O	_	o		Å	f	»				'

The print sample shown above is issued with a head density of 12 dots/mm, and a font size of 48x48 (vertical/horizontal).

Font			
Available for	CG400 series		
<b>Store 16x16 dots external character</b>		<b>ESC+T1</b>	
Hex code	ESC <1B> <sub>16</sub>	T1 <54> <sub>16</sub> <31> <sub>16</sub>	Parameter abbn~n
Default setting	None		

Persistence of the command	When printer is powered off	Set parameter will not be retained
	Validity in a job	Becomes invalid after execution
	Validity after a job	Becomes invalid after the job

[Function]

Stores external character of W16 x H16 dots

[Format]

<T1>abbn~n

• Parameter

- a [Select type of data to be stored] = H : HEX characters  
B : Binary code characters
- b [Font code address to be registered]
  - <JIS code>
    - H : Max. 95 letters in the range of 21 and 7F
    - B : Max. 95 letters in the range of 21H and 7FH
  - <Shift JIS>
    - H : Max. 95 letters in the range of 40 and 9E
    - B : Max. 95 letters in the range of 40H and 9EH
- n [Data to be stored]

[Coding example 1] HEX character letters of JIS code

```

<A>
<T1>H21
00FF-----FF00
<Z>

<A>
<V>100<H>200<K1>H9021
<Q>2
<Z>

```

[Coding example 2] Registered data by binary code of Shift JIS

```

<A>
<T1>B<40>16
<00FF-----FF00>16
<Z>

<A>
<V>100<H>200<K1>B<F0>16<40>16
<Q>2
<Z>

```



[Notes]

1. Saves external fonts of W16 x H16 size to the internal memory
2. Concerning the font code address to be registered, specify a font according to the [Kanji code mode] of the printer- JIS code or Shift JIS code.
3. Data can be rewritten
4. Data registration is done according to the schematic below
5. If storing the data to the printer memory, the data will be lost when the power supply is turned off. In such cases, register the data again.

External characters file [16×16]

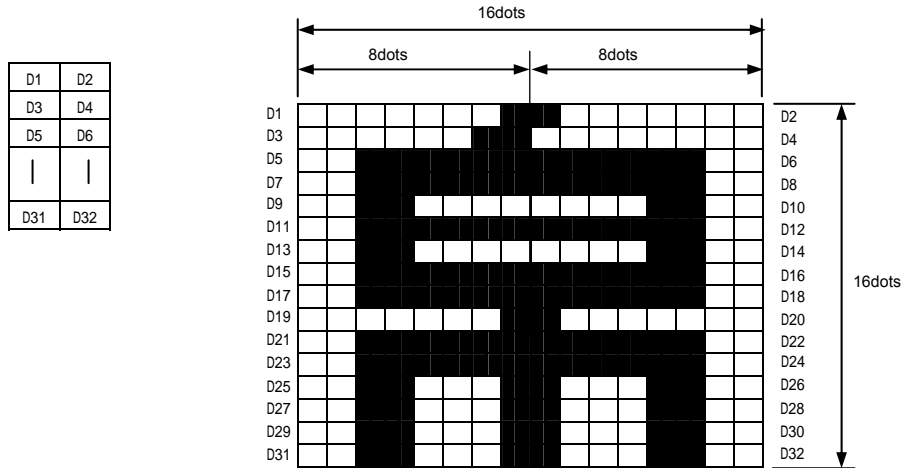

For putting in data according to the schematic above, D1 has to be set to [00000001] while D2 has to be set to [10000000]. In HEX this <01><sub>16</sub> for D1 and <80><sub>16</sub> for D2.

The same applies to all odd and even numbers up to D32.

D3: <03><sub>16</sub>, D4: <00><sub>16</sub>, D5: <3F><sub>16</sub>, D6: <FC><sub>16</sub>,... D32: <018003003FFC.....>

Font			
Available for	CG400 series		
<b>Store 24x24 dots external character</b>		<b>ESC+T2</b>	
Hex code	ESC <1B> <sub>16</sub>	T2 <54> <sub>16</sub> <32> <sub>16</sub>	Parameter abbn~n
Default setting	None		

Persistence of the command	When printer is powered off	Set parameter will not be retained
	Validity in a job	Becomes invalid after execution
	Validity after a job	Becomes invalid after the job

[Function]

Stores external character of W24 x H24 dots

[Format]

<T2>abbn~n

• Parameter

a [Select type of data to be stored]

= H : HEX characters  
B : Binary code characters

b [Font code address to be registered]

<JIS code>

H : Max. 95 letters in the range of 21 and 7F  
B : Max. 95 letters in the range of 21H and 7FH

<Shift JIS>

H : Max. 95 letters in the range of 40 and 9E  
B : Max. 95 letters in the range of 40H and 9EH

n [Data to be stored]

[Coding example 1] HEX character letters of JIS code

<A>

<T2>H21

00FF..... FF00

<Z>

<A>

<V>100 <H>200 <K2>H9021

<Q>2

<Z>

[Coding example 2] Registered data by binary code of Shift JIS

<A>

<T2>B<40><sub>16</sub>

00FF..... FF00

<Z>

<A>

<V>100 <H>200 <K2>B<F0><sub>16</sub><40><sub>16</sub>

<Q>2

<Z>

[Notes]

1. Saves external fonts of W24 x H24 size to the internal memory
2. Concerning the font code address to be registered, specify a font according to the [Kanji code mode] of the printer- JIS code or Shift JIS code.
3. Data can be rewritten
4. Data registration is done according to the schematic below
5. If storing the data to the printer memory, the data will be lost when the power supply is turned off. In such cases register the data another time.

External character file [24x24]

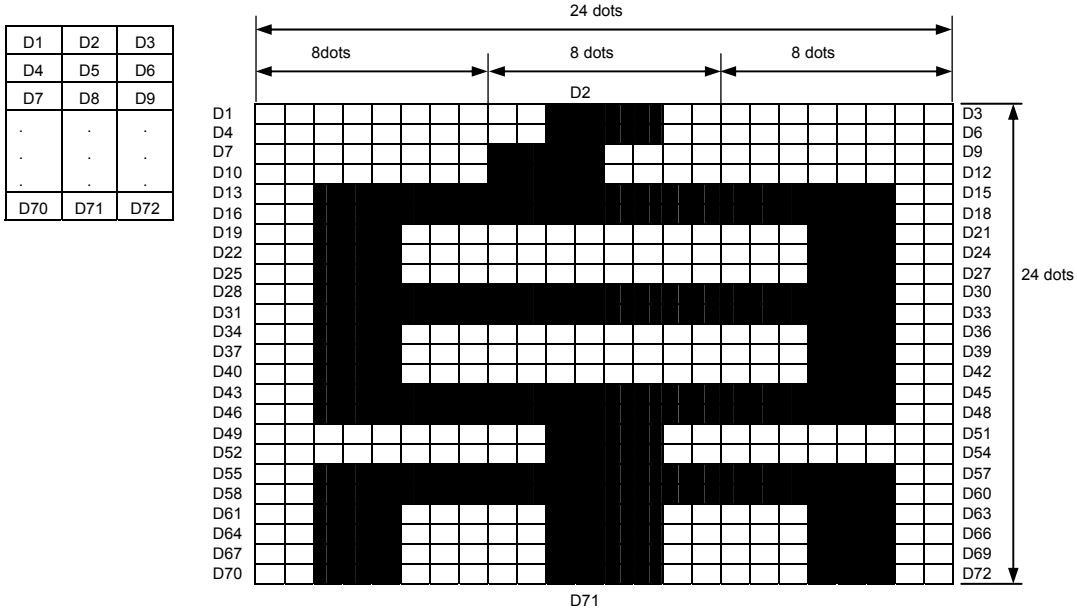

For putting in data according to the schematic above, D1 has to be set to [00000000], D2 has to be set to [00111100] and D3 to [00000000]. In HEX this <00><sub>16</sub> for D1 and <3C><sub>16</sub> for D2 and <00><sub>16</sub> for D3.  
 The same principle applies to all numbers up to D72.  
 D4: <00><sub>16</sub>, D5: <3C><sub>16</sub>, D6: <00><sub>16</sub>, D6: <FC><sub>16</sub>,... D72: <003C00003C00.....>

Font			
Available for	CG400 series		
<b>Recall horizontally oriented external character</b>		<b>ESC+K1 (K2)</b>	
Hex code	ESC <1B> <sub>16</sub>	K1 (K2) <4B> <sub>16</sub> <31> <sub>1</sub> ( <4B> <sub>16</sub> <32> <sub>16</sub> )	Parameter ab~b
Default setting	None		

Persistence of the command	When printer is powered off	Set parameter will not be retained
	Validity in a job	Becomes invalid after execution
	Validity after a job	Becomes invalid after the job

[Function]

Invokes horizontal external characters saved in the printer memory to print out

[Format]

<K1>ab~b

<K2>ab~b

• Parameter

- |   |                       |            |  |
|---|-----------------------|------------|--|
| a | [Print specification] | =          | H : HEX characters<br>B : Binary code<br>I : HEX characters with smoothing function<br>C : Binary code with smoothing function<br>J : HEX characters with highlighting function<br>D : Binary code with highlighting function<br>K : HEX characters with smoothing and highlighting functions<br>E : Binary characters with smoothing and highlighting functions |
| b | [Registration code]   | <JIS code> | H, I, J, K : 9021 to 907F<br>B, C, D, E : 9021H to 907FH<br><Shift JIS code><br>H, I, J, K : F040 to F09E<br>B, C, D, E : F040H to F09EH   |

[Coding example 1] Invokes 16x16 dots external character; Registered data by HEX character of JIS

```

<A>
<T1>H21
00FF..... FF00
<Z>
<A>
<V>100<H>200<K1>H9021
<Q>2
<Z>

```

[Coding example 2] Invokes 24x24 dots external character; Registered data by binary code of Shift JIS

```

<A>
<T2>B<40>16
00FF..... FF00
<Z>
<A>
<V>100<H>200<K2>B<F0>16<40>16
<Q>2
<Z>

```

[Notes]

1. If the print out is not executed properly, register the data another time.
2. Applicable range of smoothing function = horizontal/vertical range: factor 3 to 12
3. Applicable range of highlighting function = horizontal/vertical range: factor 1 to 5

[Tips]

1. With the highlighting function, the character width enlarges proportional with the expansion factor.
2. Using the highlighting function, in some cases, depending on the type of font, characters become squeezed.

[Valid commands]

Print position	<V>	<H>								
Modification	<P>	<L>	<%>	<&>	</>	<0>	<WD>			

Font			
Available for	CG400 series		
<b>Recall vertically oriented external character</b>		<b>ESC+k1 (k2)</b>	
Hex code	ESC <1B> <sub>16</sub>	k1 ( k2 ) <6B> <sub>16</sub> <31> <sub>16</sub> ( <6B> <sub>16</sub> <32> <sub>16</sub> )	Parameter abbn~b
Default setting	None		

Persistence of the command	When printer is powered off	Set parameter will not be retained
	Validity in a job	Becomes invalid after execution
	Validity after a job	Becomes invalid after the job

[Function]

Invokes horizontal external characters saved in the printer memory to print out

[Format]

<K1>abbn~b

<K2>abbn~b

• Parameter

- a [Print specification] =
- H : HEX characters
  - B : Binary code
  - I : HEX characters with smoothing function
  - C : Binary code with smoothing function
  - J : HEX characters with highlighting function
  - D : Binary code with highlighting function
  - K : HEX characters with smoothing and highlighting functions
  - E : Binary characters with smoothing and highlighting functions
- b [Registration code]
- <JIS code>
- H, I, J, K : 9021 to 907F
  - B, C, D, E : 9021H to 907FH
- <Shift JIS code>
- H, I, J, K : F040 to F09E
  - B, C, D, E : F040H to F09EH

[Coding example 1] Invokes 16x16 dots external character; Registered data by HEX character of JIS

```
<A>
<T1>H21
00FF..... FF00
<Z>
<A>
<V>100<H>200<K1>H9021
<Q>2
<Z>
```

[Coding example 2] Invokes 24x24 dots external character; Registered data by binary code of Shift JIS

```
<A>
<T2>B<40>16
00FF..... FF00
<Z>
<A>
<V>100<H>200<K2>B<F0>16<40>16
<Q>2
<Z>
```

[Notes]

1. If the print out is not executed properly, register the data another time.
2. Applicable range of smoothing function = horizontal/vertical range: factor 3 to 12
3. Applicable range of highlighting function = horizontal/vertical range: factor 1 to 5

[Tips]

1. With the highlighting function, the character width enlarges proportional with the expansion factor.
2. Using the highlighting function, in some cases, depending on the type of font, characters become squeezed.

[Valid commands]

Print position	<V>	<H>								
Modification	<P>	<L>	<%>	<&>	</>	<0>	<WD>			

Font			
Available for	CG400 series		
<b>U font (Closed to end users) (Basic size 5x9 dots)</b>		<b>ESC+U</b>	
Hex code	ESC <1B> <sub>16</sub>	U <55> <sub>16</sub>	Parameter n~n
Default setting	None		

Persistence of the command	When printer is powered off	Set parameter will not be retained
	Validity in a job	Becomes invalid after execution
	Validity after a job	Becomes invalid after the job

[Function]

Font with the basic size of: width 5 dots, height 9 dots is specified.

[Format]

<U>n~n

- Parameter

n [Print data] = data

[Coding example]

<A>

<V>100<H>200<P>2<L>0304<U>ABCDE

<Q>2

<Z>

[Notes]

1. The U font only allows the setting of a fixed pitch.
2. This font is to obtain compatibility with old printer models and shall not disclose to end users.

[Valid commands]

Print position	<V>	<H>								
Modification	<P>	<L>	<%>	<F>	<&>	</>	<0>	<WD>		
Barcode	<D><d>	<BL><d>								



## U font character set

Basic size is 5 x 9 dots (width x height)

	2	3	4	5	6	7	8	9	A	B	C	D	E	F
0	ø	ø	P	`	p	ç	é	á			ø	ó	-	
1	!	1	A	Q	a	q	ú	æ	í			ø	β	±
2	"	2	B	R	b	r	é	Æ	ó			é	ó	=
3	#	3	C	S	c	s	á	ó	ú			é	ó	≠
4	\$	4	D	T	d	t	á	ó	ñ			é	ó	
5	%	5	E	U	e	u	á	ó	ñ	á		é	ó	≠
6	&	6	F	V	f	v	á	ó	ñ	á	á	é	ó	÷
7	'	7	G	W	g	w	ç	ú	ø	á	á	é	ó	
8	<	8	H	X	h	x	é	ý	ó	ø		í		°
9	>	9	I	Y	i	y	é	ó				ú		ˆ
A	*	:	J	Z	j	z	ø	ú	ˆ			ó		+
B	+	;	K	[	k	{	í	ø	ø			ú		!
C	,	<	L	\	l		í	ø	ø			ý		≠
D	-	=	M	]	m	}	í	ø	ø			ý		≠
E	.	>	N	^	n	ˆ	ñ	x	ø	ø		í		ˆ
F	/	?	O	_	o		ñ	f	ø					ˆ

The print sample shown above is issued with a head density of 12 dots/mm and a expansion factor of 3 (vertical/horizontal).

Font			
Available for	CG400 series		
<b>S font (Closed to end users) (Basic size 8x15 dots)</b>		<b>ESC+S</b>	
Hex code	ESC <1B> <sub>16</sub>	S <53> <sub>16</sub>	Parameter n~n
Default setting	None		

Persistence of the command	When printer is powered off	Set parameter will not be retained
	Validity in a job	Becomes invalid after execution
	Validity after a job	Becomes invalid after the job

[Function]

Font with the basic size of: width 8 dots, height 15 dots is specified.

[Format]

<S>n~n

• Parameter

n [Print data] = data

[Coding example]

<A>

<V>100<H>200<P>2<L>0304<S>ABCDE

<Q>2

<Z>

[Notes]

1. The S font only allows the setting of a fixed pitch.
2. This font is to obtain compatibility with old printer models and shall not disclose to the users.

[Valid commands]

Print position	<V>	<H>							
Modification	<P>	<L>	<%>	<F>	<&>	</>	<0>	<WD>	
Barcode	<D><d>	<BL><d>							

## S font character set

Basic size is 8 x 15 dots (width x height)

	2	3	4	5	6	7	8	9	A	B	C	D	E	F
<b>0</b>	ø	@	P	'	p	ç	é	á				ð	ó	-
<b>1</b>	!	1	A	Q	a	q	ú	æ	í			ð	β	±
<b>2</b>	"	2	B	R	b	r	é	Æ	ó			ê	ó	=
<b>3</b>	#	3	C	S	c	s	â	ø	ú			ë	ò	‰
<b>4</b>	\$	4	D	T	d	t	ä	ö	ñ			è	õ	
<b>5</b>	%	5	E	U	e	u	à	ò	Ñ	á		€	ö	§
<b>6</b>	&	6	F	V	f	v	á	ú	ä	ã	ä	í	μ	÷
<b>7</b>	'	7	G	W	g	w	ç	ü	ø	à	ã	î		
<b>8</b>	(	8	H	X	h	x	ê	ÿ	¿	©		ï		°
<b>9</b>	)	9	I	Y	i	y	ë	ö	®			ú		¨
<b>A</b>	*	:	J	Z	j	z	è	ü	™			û		•
<b>B</b>	+	;	K	L	k	l	í	ø	½			ü		'
<b>C</b>	,	<	L	\	l	l	î	£	¼			ý		³
<b>D</b>	-	=	M	J	m	)	ï	ø	i	ø		ÿ		²
<b>E</b>	.	>	N	^	n	~	ä	x	«	¥		ì		ˆ
<b>F</b>	/	?	O	_	o		á	f	»					'

The print sample shown above is issued with a head density of 12 dots/mm and a expansion factor of 2 (vertical/horizontal).

Font			
Available for			
	CG400 series		
<b>M font (Closed to end users) (Basic size 13x20 dots)</b>			<b>ESC+M</b>
Hex code	ESC <1B> <sub>16</sub>	M <4D> <sub>16</sub>	Parameter n~n
Default setting	None		

Persistence of the command	When printer is powered off	Set parameter will not be retained
	Validity in a job	Becomes invalid after execution
	Validity after a job	Becomes invalid after the job

[Function]

Font with the basic size of: width 13 dots, height 20 dots is specified.

[Format]

<M>n~n

• Parameter

n [Print data] = Data

[Coding example]

<A>  
 <V>100<H>200<P>2<L>0304<M>ABCDE  
 <Q>2  
 <Z>

[Notes]

1. The M font only allows the setting of a fixed pitch.
2. This font is to obtain compatibility with old printer models and shall not disclose to the users.

[Valid commands]

Print position	<V>	<H>							
Modification	<P>	<L>	<%>	<F>	<&>	</>	<0>	<WD>	
Barcode	<D><d>	<BL><d>							

## M font character set

Basic size is 13 x 20 dots (width x height)

	2	3	4	5	6	7	8	9	A	B	C	D	E	F
<b>0</b>	ø	@	P	'	p	ç	É	á			ö	ó	-	
<b>1</b>	!	1	A	Q	a	q	ü	æ	í			Ð	β	±
<b>2</b>	"	2	B	R	b	r	é	Æ	ó			ê	ô	=
<b>3</b>	#	3	C	S	c	s	â	ô	ú			È	ò	¼
<b>4</b>	\$	4	D	T	d	t	ä	ö	ñ			è	ö	
<b>5</b>	%	5	E	U	e	u	à	ò	Ñ	Á		€	ö	§
<b>6</b>	&	6	F	V	f	v	ä	û	ä	Ä	ã	í	μ	÷
<b>7</b>	'	7	G	W	g	w	ç	ù	ë	À	Ã	î		
<b>8</b>	(	8	H	X	h	x	ê	ÿ	ç	©		ï		°
<b>9</b>	)	9	I	Y	i	y	ë	ö	®				ú	¨
<b>A</b>	*	:	J	Z	j	z	è	ü	¬				ó	·
<b>B</b>	+	;	K	[	k	{	ï	ø	½				ù	¹
<b>C</b>	,	<	L	\	l		î	£	¼				ý	³
<b>D</b>	-	=	M	]	m	}	ì	ø	ì	ø			ÿ	²
<b>E</b>	.	>	N	^	n	~	À	x	«	¥		ì	˘	
<b>F</b>	/	?	O	_	o		Å	f	»				´	

The print sample shown above is issued with a head density of 12 dots/mm and a expansion factor of 2 (vertical/horizontal).

Font			
Available for	CG400 series		
<b>WB font (Closed to end users) (Basic size 18x30 dots)</b>		<b>ESC+WB</b>	
Hex code	ESC <1B> <sub>16</sub>	WB <57> <sub>16</sub> <42> <sub>16</sub>	Parameter an~n
Default setting	None		

Persistence of the command	When printer is powered off	Set parameter will not be retained
	Validity in a job	Becomes invalid after execution
	Validity after a job	Becomes invalid after the job

[Function]

Font with the basic size of: width 18 dots, height 30 dots is specified.

[Format]

<WB>an~n

• Parameter

a [Smoothing] = 0: Smoothing OFF  
1: Smoothing ON (Valid for expansion factors <L> between 3 and 12)

n [Print data] = Data

[Coding example]

<A>  
<V>100<H>200<P>2<L>0304<WB>0ABCDE  
<Q>2  
<Z>

[Notes]

1. The WB font only allows the setting of a fixed pitch.
2. If setting the smoothing option, and the expansion <L> command is set to 1 or 2, the smoothing function will be ignored.
3. This font is to obtain compatibility with old printer models and shall not disclose to the users.

[Valid commands]

Print position	<V>	<H>							
Modification	<P>	<L>	<%>	<F>	<&>	</>	<0>	<WD>	
Barcode	<D><d>	<BL><d>							

## WB font character set

Basic size is 18 x 30 dots (width x height)

	2	3	4	5	6	7	8	9	A	B	C	D	E	F
0	ø	@	P	'	p	ç	é	á			ð	ó	-	
1	!	1	A	Q	a	q	ü	æ	í			Ð	β	±
2	"	2	B	R	b	r	é	Æ	ó			É	ó	=
3	#	3	C	S	c	s	â	ô	ú			È	ò	¼
4	\$	4	D	T	d	t	ä	ö	ñ			È	ö	
5	%	5	E	U	e	u	â	ô	Ñ	Á		é	ö	§
6	&	6	F	V	f	v	à	Q	ä	Å	ä	í	μ	÷
7	'	7	G	W	g	w	ç	ù	ë	Å	Å	í		
8	(	8	H	X	h	x	ê	ÿ	ç	©		Ï		°
9	)	9	I	Y	i	y	ë	ö	®				Ú	¨
A	*	:	J	Z	j	z	è	Ü	¬				Ö	·
B	+	;	K	[	k	{	ÿ	ø	¼				Ü	l
C	,	<	L	\	l		í	É	¼				ý	³
D	-	=	M	]	m	}	ï	Ø	l	ø			Ý	²
E	.	>	N	^	n	~	Ä	X	«	¥			î	-
F	/	?	O	_	o		À	f	»				í	-

The print sample shown above is issued with a head density of 12 dots/mm and a expansion factor of 1 (vertical/horizontal).

Font			
Available for	CG400 series		
<b>WL font (Closed to end users) (Basic size 28x52 dots)</b>		<b>ESC+WL</b>	
Hex code	ESC <1B> <sub>16</sub>	WL <57> <sub>16</sub> <4C> <sub>16</sub>	Parameter an~n
Default setting	None		

Persistence of the command	When printer is powered off	Set parameter will not be retained
	Validity in a job	Becomes invalid after execution
	Validity after a job	Becomes invalid after the job

[Function]

Font with the basic size of: W28 x H52 dots is specified.

[format]

<WL>an~n

• Parameter

a [Smoothing] = 0: Smoothing OFF  
1: Smoothing ON (Valid for expansion factors <L> between 3 and 12)

n [Print data] = Data

[Coding example]

<A>  
<V>100<H>200<P>2<L>0304<WL>0ABCDE  
<Q>2  
<Z>

[Notes]

1. The WL font only allows the setting of a fixed pitch.
2. If setting the smoothing option, and the expansion <L> command is set to 1 or 2, the smoothing function will be ignored.
3. This font is to obtain compatibility with old printer models and shall not disclose to the users.

[Valid commands]

Print position	<V>	<H>							
Modification	<P>	<L>	<%>	<F>	<&>	</>	<0>	<WD>	
Barcode	<D><d>	<BL><d>							



## WL font character set

Basic size is 28 x 52 dots (width x height)

	2	3	4	5	6	7	8	9	A	B	C	D	E	F
0	0	@	P	'	p	Ç	É	á		ø	ó	-		
1	!	1	A	Q	a	q	ü	æ	í			Ð	β	±
2	"	2	B	R	b	r	é	Æ	ó			é	ô	=
3	#	3	C	S	c	s	â	ô	ú			È	ò	¼
4	\$	4	D	T	d	t	ä	ö	ñ			È	õ	
5	%	5	E	U	e	u	à	ò	Ñ	Á		€	ö	§
6	&	6	F	V	f	v	å	Q	a	Â	ã	Í	μ	÷
7	'	7	G	W	g	w	ç	ù	ø	À	Ã	î		
8	(	8	H	X	h	x	ê	ý	¿	©		ÿ		°
9	)	9	I	Y	i	y	ë	ö	®				Ú	¨
A	*	:	J	Z	j	z	è	Ü	™				Ó	·
B	+	;	K	[	k	{	ï	ø	½				Ü	¹
C	,	<	L	\	l	;	î	£	¼				Ý	³
D	-	=	M	]	m	}	ì	Ø	ì	ø			Ý	²
E	.	>	N	^	n	~	Ä	x	«	¥			ÿ	´
F	/	?	O	_	o		À	f	»				˘	

The print sample shown above is issued with a head density of 12 dots/mm and an expansion factor of 1 (vertical/horizontal).

Font			
Available for	CG400 series		
Horizontally oriented Chinese font (Basic size 24x24 dots)		ESC+K2	
HEX code	ESC <1B> <sub>16</sub>	K2 <4B> <sub>16</sub> <32> <sub>16</sub>	Parameter an~n
Default setting	None		

Persistence of the command	When printer is powered off	Set parameter will not be retained.
	Validity in a job	Set parameter becomes invalid.
	Validity after a job	Set parameter becomes invalid.

[Function]

Specifies horizontally oriented Chinese Kanji font in W24 x H24 dots.

[Format]

<K2>an~n

• Parameter

- |                         |   |   |
|-------------------------|---|---|
| a [Code selection mode] | = | H : HEX characters  |
|                         |   | B : Binary code   |
|                         |   | I : HEX characters with smoothing function                      |
|                         |   | C : Binary code with smoothing function                         |
|                         |   | J : HEX characters with highlighting function                   |
|                         |   | D : Binary code with highlighting function                      |
|                         |   | K : HEX characters with smoothing and highlighting functions    |
|                         |   | E : Binary characters with smoothing and highlighting functions |
| n [Data]                | = | Refer to the table of Chinese Kanji code (GB2312).              |

\* If the number of data is increased/decreased, the data might not be printed correctly.

[Coding example] HEX character code    Magnification in horizontal direction: Twofold  
Magnification in vertical direction: 3 times

```
<A>
<V>100<H>100<P>8<L>0203
<K2>HB0A1B0A2B0A3B0A4B0A5
<Q>1
<Z>
```

[Notes]

1. It is necessary to download simplified Chinese font to use this command.
2. HEX character code = Chinese Kanji code 4-byte ASCII / 1 character
3. Binary code = Chinese Kanji code 2-byte / 1 character
4. Magnification of smoothing function = Horizontal and vertical direction: 3 to 12 times
5. Magnification of highlighting function = Horizontal and vertical direction: 1 to 5 times

[Tips]

1. With the highlighting function, the character width enlarges proportional with the expansion factor.
2. Using the highlighting function, in some cases, depending on the type of font, characters become squeezed.

[Valid commands]

Print position	<V>	<H>	<%>	<&>	</>	<O>	<WD>			
Modification	<P>	<L>	<%>	<&>	</>	<O>	<WD>			

Font			
Available for			
	CG400 series		
Horizontally oriented Chinese font with 1-byte chr (Basic size 24x24 dots)			ESC+K9
HEX code	ESC <1B> <sub>16</sub>	K9 <4B> <sub>16</sub> <39> <sub>16</sub>	Parameter an~n
Default setting	None		

Persistence of the command	When printer is powered off	Set parameter will not be retained.
	Validity in a job	Set parameter becomes invalid.
	Validity after a job	Set parameter becomes invalid.

[Function]

Specifies horizontally oriented Chinese Kanji font in W24 x H24 dots and 1 byte character in W12 x H24 dots at the same time.

[Format]

<K9>an ~ n

• Parameter

- a [Code selection mode] = H : HEX characters  
 B : Binary code  
 I : HEX characters with smoothing function  
 C : Binary code with smoothing function  
 J : HEX characters with highlighting function  
 D : Binary code with highlighting function  
 K : HEX characters with smoothing and highlighting functions  
 E : Binary characters with smoothing and highlighting functions
- n [Data] = Refer to the table of Chinese Kanji code (GB2312).

\* If the number of data is increased/decreased, the data might not be printed correctly.

\* 1 byte character code from 20h to 7Fh are available.

[Coding example]HEX character code Magnification in horizontal direction: Twofold  
 Magnification in vertical direction: 3 times

```
<A>
<V>100<H>100<P>8<L>0203
<K9>HB0A1B0A2B0A3B0A4B0A5303132
<Q>1
<Z>
```

[Notes]

1. HEX character code = Chinese Kanji code 4-byte ASCII / 1 character
2. Binary code = Chinese Kanji code 2-byte / 1 character
3. Magnification of smoothing function = Horizontal and vertical direction: 3 to 12 times
4. Magnification of highlighting function = Horizontal and vertical direction: 1 to 5 times

[Tips]

1. With the highlighting function, the character width enlarges proportional with the expansion factor.
2. Using the highlighting function, in some cases, depending on the type of font, characters become squeezed.

[Valid commands]

Print position	<V>	<H>								
Modification	<P>	<L>	<%>	<&>	</>	<O>	<WD>			

Font			
Available for	CG400 series		
Vertically oriented Chinese font (Basic size 24x24 dots)		ESC+k2	
HEX code	ESC <1B> <sub>16</sub>	k2 <6B> <sub>16</sub> <32> <sub>16</sub>	Parameter an~n
Default setting	None		

Persistence of the command	When printer is powered off	Set parameter will not be retained.
	Validity in a job	Set parameter becomes invalid.
	Validity after a job	Set parameter becomes invalid.

[Function]  
Specifies vertically oriented Chinese Kanji font in W24 x H24 dots.

[Format]  
<k2>an ~ n  
• Parameter

- a [Code selection mode] = H : HEX characters  
B : Binary code  
I : HEX characters with smoothing function  
C : Binary code with smoothing function  
J : HEX characters with highlighting function  
D : Binary code with highlighting function  
K : HEX characters with smoothing and highlighting functions  
E : Binary characters with smoothing and highlighting functions
- n [Data] = Refer to the table of Chinese Kanji code (GB2312).

\* If the number of data is increased/decreased, the data might not be printed correctly.

[Coding example] HEX character code Magnification in horizontal direction: Twofold  
Magnification in vertical direction: 3 times

```
<A>
<V>100<H>100<P>8<L>0203
<k2>HB0A1B0A2B0A3B0A4B0A5
<Q>1
<Z>
```

- [Notes]
1. HEX character code = Chinese Kanji code 4-byte ASCII / 1 character
  2. Binary code = Chinese Kanji code 2-byte / 1 character
  3. Magnification of smoothing function = Horizontal and vertical direction: 3 to 12 times
  4. Magnification of highlighting function = Horizontal and vertical direction: 1 to 5 times

- [Tips]
1. With the highlighting function, the character width enlarges proportional with the expansion factor.
  2. Using the highlighting function, in some cases, depending on the type of font, characters become squeezed.

[Valid commands]

Print position	<V>	<H>								
Modification	<P>	<L>	<%>	<&>	</>	<O>	<WD>			

Font			
Available for	CG400 series		
Vertically oriented Chinese font with 1-byte chr (Basic size 24x24 dots)		ESC+k9	
HEX code	ESC <1B> <sub>16</sub>	k9 <6B> <sub>16</sub> <39> <sub>16</sub>	Parameter an~n
Default setting	None		

Persistence of the command	When printer is powered off	Set parameter will not be retained.
	Validity in a job	Set parameter becomes invalid.
	Validity after a job	Set parameter becomes invalid.

[Function]

Specifies vertically oriented Chinese Kanji font in W24 x H24 dots and 1 byte character in W12 x H24 dots at the same time.

[Format]

<k9>an~n

• Parameter

- a [Code selection mode] = H : HEX characters  
 B : Binary code  
 I : HEX characters with smoothing function  
 C : Binary code with smoothing function  
 J : HEX characters with highlighting function  
 D : Binary code with highlighting function  
 K : HEX characters with smoothing and highlighting functions  
 E : Binary characters with smoothing and highlighting functions
- n [Data] = Refer to the table of Chinese Kanji code (GB2312).

\* If the number of data is increased/decreased, the data might not be printed correctly.  
 \* 1 byte character code from 20h to 7Fh are available.

[Coding example] HEX character code Magnification in horizontal direction: Twofold  
 Magnification in vertical direction: 3 times

```
<A>
<V>100<H>100<P>8<L>0203
<k9>HB0A1B0A2B0A3B0A4B0A5303132
<Q>1
<Z>
```

[Notes]

1. HEX character code = Chinese Kanji code 4-byte ASCII / 1 character
2. Binary code = Chinese Kanji code 2-byte / 1 character
3. Magnification of smoothing function = Horizontal and vertical direction: 3 to 12 times
4. Magnification of highlighting function = Horizontal and vertical direction: 1 to 5 times

[Tips]

1. With the highlighting function, the character width enlarges proportional with the expansion factor.
2. Using the highlighting function, in some cases, depending on the type of font, characters become squeezed.

[Valid commands]

Print position	<V>	<H>								
Modification	<P>	<L>	<%>	<&>	</>	<O>	<WD>			

# Chinese font character set

## (1) A1A1H ~ B2FEH

A1A0		、	。	・	-	∨	∞	∞	々	一	~		...	'	'	
A1B0	“	”	[	]	<	>	《	》	「	」	『	』	【	】	[	]
A1C0	±	×	÷	:	∧	∨	Σ	Π	U	∩	∪	∩	∪	∩	∪	∩
A1D0	^	⊙	∫	∫	≡	≡	≈	≈	α	≠	≠	≠	≠	∞	∞	∞
A1E0	∴	♠	♀	°	'	°	°	°	°	°	°	°	°	°	°	°
A1F0	○	●	◎	◐	◑	◒	◓	◔	◕	◖	◗	◘	◙	◚	◛	◜
A2A0	i	ii	iii	iv	v	vi	vii	viii	ix	x						
A2B0	1.	2.	3.	4.	5.	6.	7.	8.	9.	10.	11.	12.	13.	14.	15.	
A2C0	16.	17.	18.	19.	20.	(1)	(2)	(3)	(4)	(5)	(6)	(7)	(8)	(9)	(10)	(11)
A2D0	(12)	(13)	(14)	(15)	(16)	(17)	(18)	(19)	(20)	①	②	③	④	⑤	⑥	⑦
A2E0	⑧	⑨	⑩		(一)	(二)	(三)	(四)	(五)	(六)	(七)	(八)	(九)	(十)		
A2F0	I	II	III	IV	V	VI	VII	VIII	IX	X	XI	XII				
A3A0	!	"	#	¥	%	&	'	(	)	*	+	,	-	.	/	
A3B0	0	1	2	3	4	5	6	7	8	9	:	;	<	=	>	?
A3C0	@	A	B	C	D	E	F	G	H	I	J	K	L	M	N	O
A3D0	P	Q	R	S	T	U	V	W	X	Y	Z	[	\	]	^	_
A3E0	`	a	b	c	d	e	f	g	h	i	j	k	l	m	n	o
A3F0	p	q	r	s	t	u	v	w	x	y	z	{		}	~	
A4A0	あ	あ	い	い	う	う	え	え	お	お	か	か	が	が	き	き
A4B0	く	け	げ	こ	ご	さ	ざ	し	じ	ず	ぜ	そ	ぞ	た		
A4C0	だ	ち	ぢ	っ	つ	づ	て	で	と	ど	な	に	ぬ	ね	の	は
A4D0	ば	ば	ひ	び	び	ぶ	ぶ	べ	べ	ほ	ほ	ぼ	ま	み		
A4E0	む	め	も	や	や	ゆ	ゆ	よ	よ	ら	り	る	れ	ろ	わ	わ
A4F0	ゐ	ゑ	を	ん												
A5A0	ア	アイ	イ	ウ	ウ	エ	エ	オ	オ	カ	ガ	キ	ギ	ク		
A5B0	グ	ケ	ゲ	コ	ゴ	サ	ザ	シ	ジ	ス	ズ	セ	ゼ	ソ	タ	
A5C0	ダ	チ	ツ	ツ	ツ	テ	デ	ト	ド	ナ	ニ	ヌ	ネ	ノ	ハ	
A5D0	バ	パ	ヒ	ビ	ピ	フ	ブ	ヘ	ベ	ホ	ボ	ポ	マ	ミ		
A5E0	ム	メ	モ	ヤ	ユ	ユ	ヨ	ラ	リ	ル	レ	ロ	ワ			
A5F0	キ	キ	ン	ヴ	カ	ケ										
A6A0	A	B	Γ	Δ	E	Z	H	Θ	I	K	Λ	M	N	Ξ	O	
A6B0	Π	P	Σ	T	Υ	Φ	X	Ψ	Ω							
A6C0	α	β	γ	δ	ε	ζ	η	θ	ι	κ	λ	μ	ν	ξ	ο	
A6D0	π	ρ	σ	τ	υ	φ	χ	ψ	ω							
A6E0																
A6F0																
A7A0	A	B	B	Γ	Δ	E	E	Ж	З	И	Й	К	Л	М	Н	
A7B0	О	П	Р	С	Т	У	Ф	Х	Ц	Ч	Ш	Щ	Ъ	Ы	Ь	Э
A7C0	Ю	Я														

A7D0	a	б	в	г	д	e	ё	ж	з	и	й	к	л	м	н	
A7E0	о	п	р	с	т	у	ф	х	ц	ч	ш	щ	ъ	ы	ь	э
A7F0	ю	я														
A8A0	ā	á	ǎ	ǎ	ē	é	ě	è	ī	í	ï	ì	ō	ó	ö	
A8B0	ò	û	ü	ÿ	ÿ	ÿ	ÿ	ÿ	ÿ	ÿ	ÿ	ÿ	ÿ	ÿ	ÿ	ÿ
A8C0	g				ウ	文	門	口	勿	去	了	カ	《	》	厂	
A8D0	4	<	丁	世	行	尸	回	下	方	厶	丫	乙	志	世	秀	へ
A8E0	么	又	乃	与	尢	厶	儿	丨	乂	凵						
A8F0																
A9A0					—	—			---	---			---	---		
A9B0	Г	Г	Г	Г	Г	Г	Г	Г	Г	Г	Г	Г	Г	Г	Г	Г
A9C0	ト	ト	ト	ト	ト	ト	ト	ト	ト	ト	ト	ト	ト	ト	ト	ト
A9D0	ト	ト	ト	ト	ト	ト	ト	ト	ト	ト	ト	ト	ト	ト	ト	ト
A9E0	ト	ト	ト	ト	ト	ト	ト	ト	ト	ト	ト	ト	ト	ト	ト	ト
A9F0																
ADA0	①	②	③	④	⑤	⑥	⑦	⑧	⑨	⑩	⑪	⑫	⑬	⑭	⑮	
ADB0	⑯	⑰	⑱	⑲	⑳	I	II	III	IV	V	VI	VII	VIII	IX	X	XI
ADC0	シ	キ	キ	キ	キ	キ	キ	キ	キ	キ	キ	キ	キ	キ	キ	キ
ADD0	mm	cm	km	mg	kg	cc	m <sup>2</sup>	cm <sup>2</sup>	Hz							
ADE0	Ⓜ	Ⓜ	No.	KK	TEL					(株)	(有)	(代)				
ADF0	(社)	(資)	(財)	xi	xii	i	ii	iii	iv	v	vi	vii	viii	ix	x	
B0A0	啊	阿	埃	挨	哎	唉	哀	皑	癌	藹	矮	艾	碍	爰	隘	
B0B0	鞅	氣	安	俺	按	暗	岸	胺	案	肮	昂	盎	凹	敖	熬	翱
B0C0	袄	傲	奥	懊	澳	芭	捌	扒	叭	吧	芭	八	疤	巴	拔	跋
B0D0	靶	把	靶	坝	霸	罢	爸	白	柏	百	摆	佰	败	拜	裨	斑
B0E0	班	搬	扳	般	颁	板	版	扮	拌	伴	瓣	半	办	绊	邦	帮
B0F0	梆	榜	膀	绑	棒	磅	蚌	镑	傍	谤	苞	胞	包	褒	剥	
B1A0	薄	雹	保	堡	饱	宝	抱	报	暴	豹	鲍	爆	杯	碑	悲	
B1B0	卑	北	辈	背	贝	钡	倍	狈	惫	焙	被	奔	笨	本	笨	
B1C0	崩	绷	甯	泵	蹦	迸	遍	鼻	比	鄙	笔	彼	碧	蓖	蔽	毕
B1D0	髭	髭	币	庇	痹	闭	敝	弊	必	辟	壁	臂	避	陛	鞭	边
B1E0	编	贬	扁	便	变	卞	辨	辩	辨	遍	标	彪	膘	表	鳖	憋
B1F0	别	瘰	彬	斌	濒	滨	宾	摈	兵	冰	柄	丙	乘	饼	炳	
B2A0	病	并	玻	菠	播	拨	钵	波	博	勃	搏	铂	箔	伯	帛	
B2B0	舶	膊	膊	渤	泊	驳	捕	卜	哺	补	埠	不	布	步	簿	部
B2C0	怖	擦	猜	裁	材	才	财	睬	睬	采	彩	菜	蔡	餐	蚕	
B2D0	残	惭	惨	灿	苍	舱	仓	沧	藏	操	糙	槽	曹	草	厕	策
B2E0	侧	册	测	层	蹭	插	叉	茬	茶	查	碴	察	岔	差	诧	
B2F0	拆	柴	豺	搀	掺	蝉	馋	谗	缠	铲	产	阐	颤	昌	猖	

(2) B3A1H ~ BFFEH

B3A0	场	尝	常	长	偿	肠	厂	敞	畅	唱	倡	超	抄	钞	朝
B3B0	嘲	潮	巢	炒	车	扯	撤	掣	彻	澈	郴	臣	辰	尘	晨
B3C0	忱	沉	陈	趁	衬	称	橙	成	呈	乘	程	逞	澄	诚	
B3D0	承	逞	骋	秤	吃	痴	匙	池	迟	弛	耻	齿	侈	尺	
B3E0	赤	翘	斥	炽	充	冲	崇	宠	抽	畴	踌	稠	愁	筹	
B3F0	仇	绸	瞅	丑	臭	初	橱	厨	踰	锄	雏	滁	除	楚	
B4A0		础	储	矗	搐	触	处	揣	川	穿	椽	船	喘	串	疮
B4B0	窗	幢	床	闯	创	吹	炊	捶	垂	春	椿	醇	唇	淳	纯
B4C0	蠢	戳	绰	疵	茨	磁	雌	辞	慈	瓷	词	此	刺	赐	聪
B4D0	葱	囱	匆	丛	从	凑	粗	醋	簇	促	蹙	篡	摧	崔	催
B4E0	脆	瘁	粹	淬	翠	村	存	寸	磋	撮	挫	错	搭	达	
B4F0	答	瘩	打	大	呆	歹	傣	戴	带	殆	代	袋	待	逮	
B5A0		怠	耽	担	丹	单	郸	掸	胆	旦	氮	但	惮	淡	诞
B5B0	蛋	当	挡	党	荡	档	刀	捣	蹈	倒	岛	祷	导	稻	悼
B5C0	道	盗	德	得	的	蹬	灯	登	等	瞪	邓	堤	低	滴	迪
B5D0	敌	笛	狄	涤	翟	嫡	抵	底	地	蒂	弟	递	缔	颠	颠
B5E0	掂	滇	碘	典	颠	垫	电	佃	甸	店	惦	奠	淀	殿	殿
B5F0	叮	雕	凋	刁	掉	吊	钓	调	跌	爹	碟	迭	谍	叠	
B6A0		丁	叮	叮	钉	顶	鼎	锭	定	订	丢	冬	董	懂	动
B6B0	栋	侗	冻	洞	兜	抖	斗	陡	豆	逗	痘	都	督	毒	牍
B6C0	独	读	堵	睹	杜	肚	度	渡	妒	端	短	锻	段	断	断
B6D0	缎	堆	兑	队	对	墩	吨	敦	囤	钝	盾	遁	撮	哆	哆
B6E0	多	夺	垛	躲	朵	躲	舵	剝	惰	堕	蛾	峨	俄	额	讹
B6F0	娥	恶	厄	扼	遏	鄂	饿	恩	而	儿	耳	尔	洱	二	
B7A0		贰	发	罚	筏	伐	乏	阙	法	珐	藩	帆	番	翻	樊
B7B0	钒	繁	凡	烦	反	返	范	贩	犯	饭	泛	坊	芳	方	房
B7C0	防	妨	仿	访	纺	放	菲	非	啡	飞	肥	匪	啡	吠	废
B7D0	沸	费	芬	酚	吩	氛	分	纷	坟	焚	汾	粉	奋	份	愤
B7E0	羹	丰	封	枫	蜂	锋	风	疯	烽	逢	冯	缝	讽	奉	凤
B7F0	佛	否	夫	敷	肤	孵	扶	拂	辐	幅	氟	符	伏	俘	服
B8A0		浮	涪	福	袱	弗	甫	抚	辅	俯	釜	斧	脯	腑	腐
B8B0	赴	副	覆	赋	复	傅	付	阜	父	腹	负	富	讣	附	缚
B8C0	咐	噻	嘎	该	改	概	钙	盖	溉	干	甘	杆	柑	竿	赶
B8D0	感	秆	敢	赣	冈	刚	钢	缸	肛	纲	岗	杠	管	赶	高
B8E0	膏	羔	糕	搞	搞	稿	告	哥	歌	搁	戈	鸽	胳	疙	革
B8F0	葛	格	蛤	阁	隔	个	各	给	根	跟	耕	更	庚	羹	
B9A0		埂	耿	梗	工	攻	功	恭	龚	供	躬	公	宫	弓	汞
B9B0	拱	贡	共	钩	勾	沟	苟	狗	垢	构	够	辜	菇	咕	固
B9C0	估	沽	孤	姑	鼓	古	骨	骨	骨	骨	骨	骨	骨	骨	骨

B9D0	刚	寡	挂	褂	乖	拐	怪	棺	关	官	冠	观	管	馆	罐
B9E0	灌	贯	光	广	逛	瑰	规	圭	硅	归	龟	闰	轨	鬼	惯
B9F0	桂	柜	跪	贵	刽	滚	棍	锅	郭	国	果	裹	过	哈	癸
BAA0		骸	孩	海	亥	害	骇	酣	憨	汗	邯	韩	含	涵	函
BAB0	喊	罕	翰	撼	旱	憾	悍	焊	汗	汉	夯	杭	航	壕	豪
BAC0	豪	毫	郝	好	耗	浩	呵	喝	荷	菏	核	禾	和	何	合
BAD0	盒	貉	阖	河	涸	赫	鹤	贺	嘿	黑	痕	很	狠	恨	哼
BAE0	亨	横	衡	恒	轰	哄	虹	鸿	洪	宏	弘	红	候	猴	
BAF0	吼	厚	候	后	呼	乎	忽	壶	葫	胡	蝴	狐	糊	湖	
BBA0		弧	虎	唬	护	互	沪	户	花	桦	华	滑	画	划	化
BBB0	话	槐	徊	怀	淮	坏	欢	环	桓	还	缓	换	唤	痪	鞅
BBC0	焕	涣	宦	幻	荒	慌	黄	蝗	蝗	皇	凰	惶	煌	晃	幌
BBD0	恍	慌	灰	挥	辉	恢	徊	回	毁	悔	混	混	混	混	混
BBE0	秽	会	烩	汇	讳	悔	绘	莘	昏	婚	浑	混	混	混	混
BBF0	火	获	或	惑	霍	货	祸	击	圾	基	畸	稽	积	箕	
BCA0		肌	饥	迹	激	讥	鸡	姬	绩	缉	吉	极	辑	籍	集
BCB0	及	急	疾	汲	即	嫉	级	挤	几	脊	己	薜	技	伎	伎
BCC0	祭	剂	悸	济	寄	寂	计	记	既	忌	际	妓	继	纪	嘉
BCD0	夹	佳	家	加	荚	颊	贾	甲	钾	假	稼	价	架	嫁	歼
BCE0	监	坚	尖	笺	间	煎	兼	肩	艰	奸	奸	茧	检	碱	硷
BCF0	拣	捡	简	俭	剪	减	荐	槛	鉴	践	贱	见	键	箭	
BDA0		健	舰	剑	饯	渐	溅	涧	建	僵	姜	将	浆	江	蒋
BDB0	浆	讲	匠	匠	酱	降	蕉	椒	礁	焦	胶	交	郊	浇	娇
BDC0	嚼	搅	皎	矫	侥	脚	狡	角	皎	缴	剿	教	酵	轿	较
BDD0	叫	窖	揭	接	皆	秸	街	阶	截	劫	桔	杰	捷	睫	谒
BDE0	洁	结	解	姐	戒	藉	芥	界	借	介	疥	诫	届	巾	筋
BDF0	金	今	津	襟	紧	锦	仅	谨	进	靳	晋	禁	近	烬	漫
BEA0		尽	劲	荆	兢	茎	睛	晶	鲸	京	惊	精	经	井	警
BEB0	景	颈	静	境	敬	镜	径	痉	靖	竟	竟	净	净	净	净
BEC0	纠	玖	韭	久	灸	九	酒	厥	救	旧	臼	舅	拒	据	鞠
BED0	拘	狙	疽	居	驹	菊	局	咀	矩	沮	聚	拒	据	巨	具
BEE0	距	踞	锯	俱	句	惧	炬	剧	捐	娟	倦	眷	卷	绢	据
BEF0	攫	抉	掘	倔	爵	觉	决	诀	绝	均	菌	钧	君	峻	
BFA0		俊	竣	浚	郡	骏	喀	咖	卡	咯	开	揩	楷	凯	刊
BFB0	堪	勘	坎	砍	看	康	慷	糠	扛	抗	亢	炕	考	拷	靠
BFC0	坷	苛	柯	棵	磕	颗	壳	咳	可	渴	克	刻	客	课	肯
BFD0	啃	垦	恳	坑	吭	空	恐	控	抠	窟	扣	寇	枯	哭	窟
BFE0	苦	酷	库	裤	夸	垮	跨	跨	跨	跨	跨	跨	跨	跨	跨
BFF0	筐	狂	框	矿	眶	况	况	况	况	况	况	况	况	况	况

(3) C0A1H ~ CCFEH

C0A0	馈	愧	溃	坤	昆	捆	困	括	扩	廓	阔	垃	拉	喇	蜡
C0B0	腊	辣	啦	莱	赖	蓝	婪	栏	拦	篮	阑	兰	澜	澜	老
C0C0	览	懒	揽	烂	琅	榔	狼	廊	郎	朗	浪	捞	劳	牢	老
C0D0	佬	姥	酪	烙	勒	乐	雷	雷	雷	磊	累	儡	垒	播	肋
C0E0	类	泪	棱	楞	冷	厘	梨	犁	黎	离	漓	理	李	例	里
C0F0	鲤	礼	莉	荔	吏	栗	丽	厉	励	砾	历	利	例	例	里
C1A0	痢	立	粒	沥	隶	力	璃	哩	俩	联	莲	连	镰	廉	怜
C1B0	涎	帘	敛	脸	链	恋	炼	练	粮	凉	梁	良	两	辆	量
C1C0	晾	亮	凉	撩	聊	僚	疗	燎	辽	僚	了	撩	僚	廖	料
C1D0	列	裂	烈	劣	猎	琳	林	磷	霖	临	邻	淋	凛	赁	吝
C1E0	列	玲	菱	零	龄	铃	伶	凌	灵	陵	岭	领	另	令	溜
C1F0	琉	榴	硫	榴	留	刘	瘤	流	柳	六	漏	陋	庐	庐	炉
C2A0	隆	垄	拢	陇	楼	娄	搂	篓	漏	陋	卢	卢	庐	庐	炉
C2B0	虏	鲁	麓	碌	露	路	鹿	鹿	禄	录	陆	戮	驴	李	李
C2C0	吕	铝	侣	旅	履	缕	虑	律	率	绿	绿	绿	罗	罗	罗
C2D0	漆	卵	乱	掠	略	抡	伦	仑	沦	论	萝	螺	罗	罗	罗
C2E0	锣	萝	骡	裸	落	洛	络	妈	玛	码	蚂	马	骂	骂	嘛
C2F0	吗	埋	买	麦	卖	迈	脉	瞒	满	蔓	曼	慢	漫	漫	漫
C3A0	谩	芒	茫	盲	氓	忙	莽	茅	锚	毛	矛	柳	卯	茂	茂
C3B0	冒	帽	貌	贸	么	玫	枚	梅	霉	煤	没	眉	媒	镁	每
C3C0	美	昧	寐	妹	媚	门	闷	们	萌	蒙	檬	盟	猛	梦	孟
C3D0	眯	昧	糜	糜	迷	谜	弥	米	秘	觅	泌	蜜	密	幕	棉
C3E0	绵	冕	免	勉	娩	緬	面	苗	描	瞄	藐	秒	秒	庙	妙
C3F0	灭	民	抿	皿	敏	悯	闽	明	螟	鸣	铭	名	命	谬	摸
C4A0	摹	磨	模	膜	靡	摩	魔	抹	末	莫	墨	默	沫	漠	寞
C4B0	陌	谋	牟	某	拇	牡	亩	姆	母	暮	幕	募	慕	木	目
C4C0	睦	牧	穆	拿	哪	呐	纳	那	娜	纳	氛	乃	奶	耐	奈
C4D0	男	难	囊	挠	脑	恼	闹	淖	呢	馁	内	嫩	能	妮	倪
C4E0	泥	尼	拟	你	匿	腻	逆	溺	焉	沾	年	碾	撵	捻	念
C4F0	酿	鸟	尿	捏	聂	孽	啮	镊	镍	涅	您	柠	泞	凝	宁
C5A0	拧	泞	牛	扭	钮	纽	脓	浓	农	弄	奴	努	怒	女	暖
C5B0	虐	挪	懦	糯	诺	哦	欧	鸥	殴	藕	呕	偶	沓	啪	趴
C5C0	爬	帕	怕	琶	拍	排	牌	湃	派	攀	潘	盘	磐	盼	畔
C5D0	判	叛	乓	庞	旁	磅	抛	咆	刨	袍	袍	跑	泡	坯	胚
C5E0	培	裴	赔	陪	配	佩	沛	喷	盆	砰	抨	烹	澎	彭	蓬
C5F0	硼	篷	膨	朋	鹏	捧	碰	坯	砒	霹	批	披	劈	毗	毗
C6A0	啤	脾	疲	皮	匹	痞	僻	屁	譬	篇	偏	片	骗	瓢	漂
C6B0	瓢	粟	撇	瞥	拼	频	贫	品	聘	乒	坪	苹	萍	平	凭
C6C0	评	屏	坡	泼	颇	婆	破	魄	迫	粕	剖	扑	铺	仆	葡

C6D0	菩	蒲	埔	朴	圃	浦	浦	谱	曝	瀑	期	欺	栖	戚	妻	七
C6E0	凄	漆	柒	沔	圃	奇	岐	岐	岐	崎	脐	齐	旗	祈	祁	骑
C6F0	起	岂	乞	企	启	砌	器	气	迄	弃	谦	乾	讫	钱	钳	
C7A0	怡	洽	牵	扞	钎	铅	干	迁	签	仟	腔	羌	墙	蔷	强	
C7B0	前	潜	遣	浅	遣	嵌	欠	歉	枪	呛	鞘	翘	峭	俏	窍	
C7C0	抢	攫	揪	敲	悄	桥	乔	侨	巧	鞘	撬	翘	峭	俏	窍	
C7D0	切	茄	且	怯	窃	钦	亲	秦	琴	勤	芹	擒	禽	寝	沁	
C7E0	青	轻	氢	倾	卿	清	睛	区	蛆	曲	躯	屈	驱	渠	渠	
C7F0	丘	邱	球	求	囚	酋	囚	趋	区	蛆	曲	屈	驱	渠	渠	
C8A0	取	娶	龌	趣	去	圃	权	权	雀	裙	群	然	冉	染	认	
C8B0	劝	缺	缺	却	却	确	确	雀	雀	雀	雀	雀	雀	雀	雀	
C8C0	劝	缺	缺	却	却	确	确	雀	雀	雀	雀	雀	雀	雀	雀	
C8D0	刃	妊	纫	扔	仍	戎	茸	蓉	荣	融	溶	容	绒	冗	冗	
C8E0	揉	柔	肉	茹	儒	孺	如	辱	乳	汝	入	褥	阮	阮	阮	
C8F0	瑞	锐	闰	润	若	弱	洒	萨	腮	鳃	塞	赛	叁	叁	叁	
C9A0	伞	伞	散	桑	桑	丧	搔	扫	嫂	瑟	涩	森	僧	莎	莎	
C9B0	砂	杀	刹	沙	纱	傻	啥	煞	筛	晒	珊	商	商	上	上	
C9C0	衫	闪	陕	擅	膳	膳	勺	韶	少	哨	邵	绍	韶	蛇	蛇	
C9D0	尚	裳	梢	稍	稍	烧	芍	韶	少	哨	邵	绍	韶	蛇	蛇	
C9E0	舌	舍	赦	摄	射	慑	涉	社	设	呻	申	伸	身	深	深	
C9F0	绅	神	沈	审	婢	甚	肾	慎	失	师	施	尸	虱	石	石	
CAA0	省	盛	剩	胜	圣	师	失	师	施	尸	虱	虱	虱	虱	虱	
CAB0	拾	时	什	食	蚀	实	识	史	矢	使	屎	始	式	示	示	
CAC0	世	柿	事	拭	誓	逝	势	是	嗜	噬	适	侍	释	饰	氏	
CAD0	市	恃	室	视	试	收	手	首	守	寿	授	售	瘦	蔬	蔬	
CAE0	枢	梳	殊	抒	输	舒	淑	疏	书	书	赎	孰	暑	暑	暑	
CAF0	署	蜀	黍	鼠	属	术	述	束	束	束	竖	竖	竖	竖	竖	
CBA0	恕	刷	耍	摔	表	甩	帅	栓	拴	霜	双	爽	谁	水	睡	
CBB0	税	吮	瞬	顺	舜	说	硕	朔	烁	斯	嘶	思	私	司	丝	
CBC0	死	肆	寺	嗣	四	伺	似	伺	已	松	耸	颂	送	宋	讼	
CBD0	诵	搜	艘	撒	嗽	苏	酥	俗	速	速	粟	粟	溯	宿	诉	
CBE0	肃	酸	蒜	算	虽	隋	随	绥	髓	碎	岁	穗	隧	孙	孙	
CBF0	损	笋	笋	梭	梭	缩	琐	索	锁	所	塌	他	她	塔	塔	
CCA0	勤	拮	拮	跼	踏	苔	抬	台	泰	汰	汰	汰	汰	摊	摊	
CCB0	贪	瘫	滩	坛	檀	痰	潭	谈	坦	毯	炭	探	叹	炭	炭	
CCC0	汤	塘	搪	堂	棠	膛	唐	糖	倘	淌	趟	烫	掏	滔	滔	
CCD0	绦	萄	桃	逃	淘	陶	讨	套	特	藤	腾	疼	梯	剔	剔	
CCE0	绦	萄	桃	逃	淘	陶	讨	套	特	藤	腾	疼	梯	剔	剔	
CCF0	甜	恬	舔	腆	挑	挑	挑	挑	挑	挑	挑	挑	挑	挑	挑	



(4) CDA1H ~ D9FEH

CDA0	汀	廷	停	亭	庭	挺	艇	通	桐	酮	瞳	同	铜	彤	童
CDB0	桶	捅	筒	统	痛	偷	投	透	凸	秃	突	囤	徒	途	涂
CDC0	属	土	吐	兔	湍	团	颓	腿	蜕	褪	退	屯	臀	拖	
CDD0	托	脱	陀	驮	驼	橛	妥	拓	唾	挖	蛙	洼	娃	瓦	
CDE0	袜	歪	外	腕	弯	湾	玩	顽	丸	烷	完	碗	挽	晚	惋
CDF0	宛	婉	万	腕	汪	王	亡	枉	网	往	旺	望	忘	妄	威
CEA0	巍	微	危	韦	违	桅	围	唯	惟	为	淮	维	苇	萎	委
CEB0	伟	伪	尾	纬	未	蔚	味	畏	胃	喂	魏	位	渭	谓	尉
CEC0	卫	瘟	温	蚊	文	闻	纹	吻	稳	紊	问	吻	瓮	挝	蜗
CED0	涡	窝	我	斡	卧	握	沃	巫	舞	伍	侮	坞	戊	雾	芜
CEE0	梧	吾	吴	毋	武	五	捂	午	舞	伍	侮	坞	戊	雾	芜
CEF0	勿	务	悟	误	昔	熙	析	西	晒	砂	晰	汐	犀	锡	牺
CFA0	稀	息	希	悉	膝	夕	惜	熄	烯	溪	汐	犀	锡	牺	席
CFB0	习	媳	喜	洗	系	隙	戏	细	瞎	匣	咸	贤	衔	舷	峡
CFC0	侠	狭	下	厦	吓	掀	掀	鲜	纤	咸	宪	陷	限	线	
CFD0	闲	涎	弦	嫌	显	险	现	献	县	腺	馅	羡	陷	限	线
CFE0	相	厢	镶	香	箱	襄	湘	乡	翔	祥	详	响	享	项	巷
CFF0	橡	像	象	萧	硝	霄	削	哮	嚣	销	宵	消	宵	晓	
D0A0	小	孝	校	肖	啸	笑	效	楔	些	歇	蝎	鞋	协	挟	携
D0B0	邪	斜	肋	谐	写	械	卸	蟹	懈	泄	泻	谢	屑	薪	锌
D0C0	欣	辛	新	忻	心	信	衅	腥	猩	惺	兴	刑	型	邢	邢
D0D0	行	醒	幸	杏	性	姓	兄	凶	胸	匈	汹	雄	休	修	羞
D0E0	朽	嗅	锈	秀	袖	绣	墟	戊	需	虚	嘘	徐	许	蓄	酗
D0F0	叙	旭	序	畜	絮	婿	绪	续	轩	喧	宣	悬	旋	玄	
D1A0	选	癣	眩	绚	薛	学	穴	雪	血	勋	薰	循	旬	询	
D1B0	寻	驯	巡	殉	讯	讯	逊	迅	压	押	鸦	鸭	呀	芽	
D1C0	牙	蚜	崖	衙	涯	雅	亚	讶	焉	咽	阉	烟	淹	盐	严
D1D0	研	蜒	岩	延	言	颜	阎	炎	沿	奄	掩	衍	演	艳	堰
D1E0	燕	厌	砚	雁	唁	彦	焰	宴	谚	验	殃	央	鸯	秧	扬
D1F0	佯	痒	羊	洋	氧	仰	痒	养	漾	邀	腰	妖	瑶		
D2A0	摇	尧	遥	窑	谣	姚	咬	舀	药	要	耀	椰	曜	爷	爷
D2B0	野	冶	也	页	掖	业	叶	曳	腋	夜	液	壹	医	揖	铤
D2C0	依	伊	衣	颐	夷	遗	移	仪	胰	疑	沂	宜	姨	彝	椅
D2D0	倚	已	乙	矣	以	艺	抑	易	邑	屹	亿	役	臆	逸	肄
D2E0	亦	裔	意	毅	忆	义	益	溢	诣	议	谊	译	异	翼	绎
D2F0	茵	荫	因	殷	音	阴	姻	吟	银	淫	寅	饮	尹	引	隐
D3A0	印	英	樱	婴	鹰	应	纓	莹	莹	营	荧	蝇	迎	赢	盈
D3B0	影	颖	硬	映	哟	拥	佣	庸	雍	雍	踊	蛹	咏	泳	涌
D3C0	永	愿	勇	用	幽	悠	忧	尤	由	邮	邮	犹	油	游	酉

D3D0	有	友	右	佑	釉	诱	又	幼	迂	淤	于	孟	榆	虞	愚
D3E0	余	俞	逾	鱼	愉	渝	渔	隅	迂	娱	雨	与	屿	禹	宇
D3F0	羽	玉	域	芋	郁	吁	遇	喻	峪	御	愈	欲	狱	育	誉
D4A0		浴	寓	裕	预	豫	驭	苑	愿	怨	院	曰	约	越	跃
D4B0	园	员	圆	猿	源	缘	远	邕	匀	陨	允	运	蕴	酝	晕
D4C0	岳	粤	月	悦	阅	耘	云	郢	载	再	在	咱	攒	赞	脏
D4D0	孕	匝	砸	杂	栽	哉	灾	宰	早	澡	蚤	躁	噪	造	灶
D4E0	脏	葬	遭	糟	凿	藻	枣	增	憎	曾	赠	扎	渣	札	轧
D4F0	贲	择	则	泽	贼	怎	增	憎	曾	赠	扎	渣	札	轧	
D5A0		铡	闸	眨	栅	榨	乍	炸	诈	摘	斋	宅	窄	债	寨
D5B0	瞻	毡	詹	沾	沾	沾	斩	崭	崭	展	蘸	栈	占	战	站
D5C0	绽	樟	彰	彰	漳	张	掌	杖	丈	帐	杖	仗	胀	瘴	障
D5D0	招	昭	找	沼	赵	照	兆	肇	召	遮	折	哲	蛰	辙	者
D5E0	锺	蔗	这	浙	珍	斟	真	甄	征	狰	争	怔	整	拯	疹
D5F0	震	振	镇	阵	蔗	挣	睁	征	狰	争	怔	整	拯	疹	
D6A0		帧	症	郑	证	芝	枝	支	歧	蜘	知	肢	脂	汁	织
D6B0	职	直	殖	殖	执	值	侄	址	指	止	趾	只	旨	纸	志
D6C0	挪	至	致	置	帜	峙	制	智	秩	稚	质	炙	痔	滞	窒
D6D0	中	盅	忠	钟	衷	终	种	肿	重	仲	众	舟	周	洲	洎
D6E0	粥	轴	肘	帚	咒	皱	宙	昼	辍	珠	株	朱	猪	诸	诛
D6F0	逐	竹	烛	煮	拄	瞩	瞩	主	著	柱	助	蛀	贮	铸	筑
D7A0		住	注	祝	驻	抓	爪	拽	专	砖	撰	赚	篆	桩	庄
D7B0	装	妆	撞	壮	状	椎	锥	追	赘	坠	辍	准	捉	拙	卓
D7C0	桌	琢	茁	酌	啄	着	灼	油	兹	咨	姿	滋	淄	孜	紫
D7D0	仔	籽	滓	子	自	渍	字	紫	踪	组	钻	钻	钻	钻	钻
D7E0	妻	揍	租	足	卒	族	祖	诅	阻	组	钻	钻	钻	钻	钻
D7F0	尊	遵	昨	左	佐	柞	做	作	坐	座					
D8A0	孑	丌	兀	丐	卅	卅	丕	亓	丞	高	豸	豸	豸	豸	豸
D8B0	匕	乇	天	攴	厄	氏	凶	廌	廌	廌	廌	廌	廌	廌	廌
D8C0	乚	元	半	李	番	般	仄	厶	厶	厶	厶	厶	厶	厶	厶
D8D0	匚	匚	匚	匚	匚	匚	匚	匚	匚	匚	匚	匚	匚	匚	匚
D8E0	劊	劊	劊	劊	劊	劊	劊	劊	劊	劊	劊	劊	劊	劊	劊
D8F0	仞	仞	仞	仞	仞	仞	仞	仞	仞	仞	仞	仞	仞	仞	仞
D9A0		佟	佗	佗	伽	佞	佞	佞	佞	佞	佞	佞	佞	佞	佞
D9B0	侑	侑	侑	侑	侑	侑	侑	侑	侑	侑	侑	侑	侑	侑	侑
D9C0	侑	侑	侑	侑	侑	侑	侑	侑	侑	侑	侑	侑	侑	侑	侑
D9D0	侑	侑	侑	侑	侑	侑	侑	侑	侑	侑	侑	侑	侑	侑	侑
D9E0	侑	侑	侑	侑	侑	侑	侑	侑	侑	侑	侑	侑	侑	侑	侑
D9F0	侑	侑	侑	侑	侑	侑	侑	侑	侑	侑	侑	侑	侑	侑	侑







Chinese (GB2312) code range

A1A1H	A1A2H	A1A3H	.....	.....	A1FBH	A1FCH	A1FDH	A1FEH
A2A1H	A2A2H	A2A3H	.....	.....	A2FBH	A2FCH	A2FDH	A2FEH
A3A1H	A3A2H	A3A3H	.....	.....	A3FBH	A3FCH	A3FDH	A3FEH
⋮								
F5A1H	F5A2H	F5A3H	.....	.....	F5FBH	F5FCH	F5FDH	F5FEH
F6A1H	F6A2H	F6A3H	.....	.....	F6FBH	F6FCH	F6FDH	F6FEH
F7A1H	F7A2H	F7A3H	.....	.....	F7FBH	F7FCH	F7FDH	F7FEH

Font			
Available for	CG400 series		
Horizontally oriented Korean font (Basic size 16x16 dots)		ESC+K1	
HEX code	ESC <1B> <sub>16</sub>	K1 <4B> <sub>16</sub> <31> <sub>16</sub>	Parameter an~n
Default setting	None		

Persistence of the command	When printer is powered off	Set parameter will not be retained.
	Validity in a job	Set parameter becomes invalid.
	Validity after a job	Set parameter becomes invalid.

[Function]

Specifies horizontally oriented Korean font in W16 x W16 dots.

[Format]

<K1>an~n

• Parameter

- a [Code selection mode] = H : HEX characters  
 B : Binary code  
 I : HEX characters with smoothing function  
 C : Binary code with smoothing function  
 J : HEX characters with highlighting function  
 D : Binary code with highlighting function  
 K : HEX characters with smoothing and highlighting functions  
 E : Binary characters with smoothing and highlighting functions
- n [Data] = Refer to the table of KS X1001 code.

\* If the number of data is increased/decreased, the data might not be printed correctly.

[Coding example] HEX character code Magnification in horizontal direction: Twofold  
 Magnification in vertical direction: 3 times

```
<A>
<V>100<H>100<P>8<L>0203
<K1>HB0A1B0A2B0A3B0A4B0A5
<Q>1
<Z>
```

[Notes]

1. HEX character code = KS X1001 code 4-byte ASCII / 1 character
2. Binary code = KS X1001 code 2-byte / 1 character
3. Magnification of smoothing function = Horizontal and vertical direction: 3 to 12 times
4. Magnification of highlighting function = Horizontal and vertical direction: 1 to 5 times

[Tips]

1. With the highlighting function, the character width enlarges proportional with the expansion factor.
2. Using the highlighting function, in some cases, depending on the type of font, characters become squeezed.

[Valid commands]

Print position	<V>	<H>								
Modification	<P>	<L>	<%>	<&>	</>	<O>	<WD>			

Font			
Available for	CG400 series		
Horizontally oriented Korean font (Basic size 24x24 dots)		ESC+K2	
HEX code	ESC <1B> <sub>16</sub>	K2 <4B> <sub>16</sub> <32> <sub>16</sub>	Parameter an~n
Default setting	None		

Persistence of the command	When printer is powered off	Set parameter will not be retained.
	Validity in a job	Set parameter becomes invalid.
	Validity after a job	Set parameter becomes invalid.

[Function]

Specifies horizontally oriented Korean font in W24 x H24 dots.

[Format]

<K2>an~n

• Parameter

- a [Code selection mode] = H : HEX characters  
 B : Binary code  
 I : HEX characters with smoothing function  
 C : Binary code with smoothing function  
 J : HEX characters with highlighting function  
 D : Binary code with highlighting function  
 K : HEX characters with smoothing and highlighting functions  
 E : Binary characters with smoothing and highlighting functions
- n [Data] = Refer to the table of KS X1001 code.

\* If the number of data is increased/decreased, the data might not be printed correctly.

[Coding example] HEX character code Magnification in horizontal direction: Twofold  
 Magnification in vertical direction: 3 times

```
<A>
<V>100<H>100<P>8<L>0203
<K2>HB0A1B0A2B0A3B0A4B0A5
<Q>1
<Z>
```

[Notes]

1. HEX character code = KS X1001 code 4-byte ASCII / 1 character
2. Binary code = KS X1001 code 2-byte / 1 character
3. Magnification of smoothing function = Horizontal and vertical direction: 3 to 12 times
4. Magnification of highlighting function = Horizontal and vertical direction: 1 to 5 times

[Tips]

1. With the highlighting function, the character width enlarges proportional with the expansion factor.
2. Using the highlighting function, in some cases, depending on the type of font, characters become squeezed.

[Valid commands]

Print position	<V>	<H>								
Modification	<P>	<L>	<%>	<&>	</>	<O>	<WD>			

Font			
Available for	CG400 series		
<b>Horizontally oriented Korean font with 1-byte (Basic size 16x16 dots)</b>		<b>ESC+K8</b>	
HEX code	ESC <1B>16	K8 <4B>16<38>16	Parameter an~n
Default setting	None		

Persistence of the command	When printer is powered off	Set parameter will not be retained.
	Validity in a job	Set parameter becomes invalid.
	Validity after a job	Set parameter becomes invalid.

[Function]

Specifies horizontally oriented Korean font in W16 x H16 dots and 1 byte character in W8 x H16 dots at the same time.

[Format]

<K8>an~n

• Parameter

- a [Code selection mode] = H : HEX characters  
 B : Binary code  
 I : HEX characters with smoothing function  
 C : Binary code with smoothing function  
 J : HEX characters with highlighting function  
 D : Binary code with highlighting function  
 K : HEX characters with smoothing and highlighting functions  
 E : Binary characters with smoothing and highlighting functions
- n [Data] = Refer to the table of KS X1001 code.

\* If the number of data is increased/decreased, the data might not be printed correctly.

\* 1 byte character code from 20h to 7Fh are available.

[Coding example] HEX character code Magnification in horizontal direction: Twofold  
 Magnification in vertical direction: 3 times

```
<A>
<V>100<H>100<P>8<L>0203
<K8>HB0A1B0A2B0A3B0A4B0A5303132
<Q>1
<Z>
```

[Notes]

1. HEX character code = KS X1001 code 4-byte ASCII / 1 character
2. Binary code = KS X1001 code 2-byte / 1 character
3. Magnification of smoothing function = Horizontal and vertical direction: 3 to 12 times
4. Magnification of highlighting function = Horizontal and vertical direction: 1 to 5 times

[Tips]

1. With the highlighting function, the character width enlarges proportional with the expansion factor.
2. Using the highlighting function, in some cases, depending on the type of font, characters become squeezed.

[Valid commands]

Print position	<V>	<H>							
Modification	<P>	<L>	<%>	<&>	</>	<O>	<WD>		



Font			
Available for	CG400 series		
<b>Horizontally oriented Korean font with 1-byte chr (Basic size 24x24 dots)</b>		<b>ESC+K9</b>	
HEX code	ESC <1B> <sub>16</sub>	K9 <4B> <sub>16</sub> <39> <sub>16</sub>	Parameter an~n
Default setting	None		

Persistence of the command	When printer is powered off	Set parameter will not be retained.
	Validity in a job	Set parameter becomes invalid.
	Validity after a job	Set parameter becomes invalid.

[Function]

Specifies horizontally oriented Korean font in W24 x H24 dots and 1 byte character in W12 x H24 dots at the same time.

[Format]

<K9>an~n

• Parameter

- a [Code selection mode] = H : HEX characters  
 B : Binary code  
 I : HEX characters with smoothing function  
 C : Binary code with smoothing function  
 J : HEX characters with highlighting function  
 D : Binary code with highlighting function  
 K : HEX characters with smoothing and highlighting functions  
 E : Binary characters with smoothing and highlighting functions
- n [Data] = Refer to the table of KS X1001 code.

\* If the number of data is increased/decreased, the data might not be printed correctly.  
 \* 1 byte character code from 20h to 7Fh are available.

[Coding example] HEX character code Magnification in horizontal direction: Twofold  
 Magnification in vertical direction: 3 times

```
<A>
<V>100<H>100<P>8<L>0203
<K9>HB0A1B0A2B0A3B0A4B0A5303132
<Q>1
<Z>
```

[Notes]

1. HEX character code = KS X1001 code 4-byte ASCII / 1 character
2. Binary code = KS X1001 code 2-byte / 1 character
3. Magnification of smoothing function = Horizontal and vertical direction: 3 to 12 times
4. Magnification of highlighting function = Horizontal and vertical direction: 1 to 5 times

[Tips]

1. With the highlighting function, the character width enlarges proportional with the expansion factor.
2. Using the highlighting function, in some cases, depending on the type of font, characters become squeezed.

[Valid commands]

Print position	<V>	<H>							
Modification	<P>	<L>	<%>	<&>	</>	<O>	<WD>		

Font			
Available for	CG400 series		
<b>Vertically oriented Korean font (Basic size 16x16 dots)</b>		<b>ESC+k1</b>	
HEX code	ESC <1B> <sub>16</sub>	k1 <6B> <sub>16</sub> <31> <sub>16</sub>	Parameter an~n
Default setting	None		

Persistence of the command	When printer is powered off	Set parameter will not be retained.
	Validity in a job	Set parameter becomes invalid.
	Validity after a job	Set parameter becomes invalid.

[Function]  
specifies vertically oriented Korean font in W16 x H16 dots.

[Format]

<k1>an~n

• Parameter

- a [Code selection mode] = H : HEX characters  
 B : Binary code  
 I : HEX characters with smoothing function  
 C : Binary code with smoothing function  
 J : HEX characters with highlighting function  
 D : Binary code with highlighting function  
 K : HEX characters with smoothing and highlighting functions  
 E : Binary characters with smoothing and highlighting functions
- n [Data] = Refer to the table of KS X1001 code.

\* If the number of data is increased/decreased, the data might not be printed correctly.

[Coding example] HEX character code Magnification in horizontal direction: Twofold  
 Magnification in vertical direction: 3 times

<A>  
 <V>100<H>100<P>8<L>0203  
<k1>HB0A1B0A2B0A3B0A4B0A5  
 <Q>1  
 <Z>

[Notes]

1. HEX character code = KS X1001 code 4-byte ASCII / 1 character
2. Binary code = KS X1001 code 2-byte / 1 character
3. Magnification of smoothing function = Horizontal and vertical direction: 3 to 12 times
4. Magnification of highlighting function = Horizontal and vertical direction: 1 to 5 times

[Tips]

1. With the highlighting function, the character width enlarges proportional with the expansion factor.
2. Using the highlighting function, in some cases, depending on the type of font, characters become squeezed.

[Valid commands]

Print position	<V>	<H>								
Modification	<P>	<L>	<%>	<&>	</>	<O>	<WD>			

Font			
Available for	CG400 series		
<b>Vertically oriented Korean font (Basic size 24x24 dots)</b>		<b>ESC+k2</b>	
HEX code	ESC <1B> <sub>16</sub>	k2 <6B> <sub>16</sub> <32> <sub>16</sub>	Parameter an~n
Default setting	None		

Persistence of the command	When printer is powered off	Set parameter will not be retained.
	Validity in a job	Set parameter becomes invalid.
	Validity after a job	Set parameter becomes invalid.

[Function]

Specifies vertically oriented Korean font in W24 x H24 dots.

[Format]

<k2>an~n

• Parameter

- a [Code selection mode] = H : HEX characters  
 B : Binary code  
 I : HEX characters with smoothing function  
 C : Binary code with smoothing function  
 J : HEX characters with highlighting function  
 D : Binary code with highlighting function  
 K : HEX characters with smoothing and highlighting functions  
 E : Binary characters with smoothing and highlighting functions
- n [Data] = Refer to the table of KS X1001 code.

\* If the number of data is increased/decreased, the data might not be printed correctly.

[Coding example] HEX character code Magnification in horizontal direction: Twofold  
 Magnification in vertical direction: 3 times

<A>  
 <V>100<H>100<P>8<L>0203  
<k2>HB0A1B0A2B0A3B0A4B0A5  
 <Q>1  
 <Z>

[Notes]

1. HEX character code = KS X1001 code 4-byte ASCII / 1 character
2. Binary code = KS X1001 code 2-byte / 1 character
3. Magnification of smoothing function = Horizontal and vertical direction: 3 to 12 times
4. Magnification of highlighting function = Horizontal and vertical direction: 1 to 5 times

[Tips]

1. With the highlighting function, the character width enlarges proportional with the expansion factor.
2. Using the highlighting function, in some cases, depending on the type of font, characters become squeezed.

[Valid commands]

Print position	<V>	<H>								
Modification	<P>	<L>	<%>	<&>	</>	<O>	<WD>			

Font			
Available for	CG400 series		
Vertically oriented Korean font with 1-byte (Basic size 16x16 dots)		ESC+k8	
HEX code	ESC <1B>16	k8 <6B>16<38>16	Parameter an~n
Default setting	None		

Persistence of the command	When printer is powered off	Set parameter will not be retained.
	Validity in a job	Set parameter becomes invalid.
	Validity after a job	Set parameter becomes invalid.

[Function]

Specifies vertically oriented Korean font in W16 x H16 dots and 1 byte character in W8 x H16 dots at the same time.

[Format]

<k8>an~n

• Parameter

- a [Code selection mode] = H : HEX characters  
 B : Binary code  
 I : HEX characters with smoothing function  
 C : Binary code with smoothing function  
 J : HEX characters with highlighting function  
 D : Binary code with highlighting function  
 K : HEX characters with smoothing and highlighting functions  
 E : Binary characters with smoothing and highlighting functions
- n [Data] = Refer to the table of KS X1001 code.

\* If the number of data is increased/decreased, the data might not be printed correctly.  
 \* 1 byte character code from 20h to 7Fh are available.

[Coding example] HEX character code Magnification in horizontal direction: Twofold  
 Magnification in vertical direction: 3 times

```
<A>
<V>100<H>100<P>8<L>0203
<k8>HB0A1B0A2B0A3B0A4B0A5303132
<Q>1
<Z>
```

[Notes]

1. HEX character code = KS X1001 code 4-byte ASCII / 1 character
2. Binary code = KS X1001 code 2-byte / 1 character
3. Magnification of smoothing function = Horizontal and vertical direction: 3 to 12 times
4. Magnification of highlighting function = Horizontal and vertical direction: 1 to 5 times

[Tips]

1. With the highlighting function, the character width enlarges proportional with the expansion factor.
2. Using the highlighting function, in some cases, depending on the type of font, characters become squeezed.

[Valid commands]

Print position	<V>	<H>							
Modification	<P>	<L>	<%>	<&>	</>	<O>	<WD>		

Font			
Available for	CG400 series		
Vertically oriented Korean font with 1-byte chr (Basic size 24x24 dots)		ESC+k9	
HEX code	ESC <1B>16	k9 <6B>16<39>16	Parameter an~n
Default setting	None		

Persistence of the command	When printer is powered off	Set parameter will not be retained.
	Validity in a job	Set parameter becomes invalid.
	Validity after a job	Set parameter becomes invalid.

[Function]

Specifies vertically oriented Korean font in W24 x H24 dots and 1 byte character in W12 x H24 dots at the same time.

[Format]

<k9>an~n

• Parameter

- a [Code selection mode] = H : HEX characters  
 B : Binary code  
 I : HEX characters with smoothing function  
 C : Binary code with smoothing function  
 J : HEX characters with highlighting function  
 D : Binary code with highlighting function  
 K : HEX characters with smoothing and highlighting functions  
 E : Binary characters with smoothing and highlighting functions
- n [Data] = Refer to the table of KS X1001 code.

\* If the number of data is increased/decreased, the data might not be printed correctly.  
 \* 1 byte character code from 20h to 7Fh are available.

[Coding example] HEX character code Magnification in horizontal direction: Twofold  
 Magnification in vertical direction: 3 times

```
<A>
<V>100<H>100<P>8<L>0203
<k9>HB0A1B0A2B0A3B0A4B0A5303132
<Q>1
<Z>
```

[Notes]

1. HEX character code = KS X1001 code 4-byte ASCII / 1 character
2. Binary code = KS X1001 code 2-byte / 1 character
3. Magnification of smoothing function = Horizontal and vertical direction: 3 to 12 times
4. Magnification of highlighting function = Horizontal and vertical direction: 1 to 5 times

[Tips]

1. With the highlighting function, the character width enlarges proportional with the expansion factor.
2. Using the highlighting function, in some cases, depending on the type of font, characters become squeezed.

[Valid commands]

Print position	<V>	<H>							
Modification	<P>	<L>	<%>	<&>	</>	<O>	<WD>		

# Korean font character set

1) 16 × 16 dots

(1) A0A0H ~ AFFFH

	0	1	2	3	4	5	6	7	8	9	A	B	C	D	E	F
A0A0																
A0B0																
A0C0																
A0D0																
A0E0																
A0F0																
A1A0		,	.	..	...	....	..	-	-		/	~	'			
A1B0	"	"	[ ]	< >	《 》	「 」	『 』	【 】	±	×						
A1C0	÷	≠	≤	≥	∞	∴	∵	∶	∷	∸	∹	∺	∻	∼	∽	∾
A1D0	∠	⊥	∧	∅	∇	≡	≅	≈	※	☆	★	○	●	◎	◇	◆
A1E0	□	■	△	▲	▽	▼	→	←	↑	↓	↔	⇒	⇐	⇓	⇔	⊞
A1F0	∞	∴	∵	∶	∷	∸	∹	∺	∻	∼	∽	∾				
A2A0	⇒	⇐	⇓	⇔												
A2B0	:	∫	∑	∏	∏	∏	∏	∏	∏	∏	∏	∏	∏	∏	∏	∏
	0	1	2	3	4	5	6	7	8	9	A	B	C	D	E	F
A2E0	No	Co	TM	a.m.	p.m.	Tel										
A2F0																
A3A0	!	"	#	\$	%	&	'	( )	*	+	,	-	.	/		
A3B0	0	1	2	3	4	5	6	7	8	9	:	;	<	=	>	?
A3C0	@	A	B	C	D	E	F	G	H	I	J	K	L	M	N	O
A3D0	P	Q	R	S	T	U	V	W	X	Y	Z	[	W	]	^	_
A3E0	`	a	b	c	d	e	f	g	h	i	j	k	l	m	n	o
A3F0	p	q	r	s	t	u	v	w	x	y	z	{		}		
A4A0	~	π	π	π	π	π	π	π	π	π	π	π	π	π	π	π
A4B0	π	π	π	π	π	π	π	π	π	π	π	π	π	π	π	π
A4C0	π	π	π	π	π	π	π	π	π	π	π	π	π	π	π	π
A4D0	π	π	π	π	π	π	π	π	π	π	π	π	π	π	π	π
A4E0	π	π	π	π	π	π	π	π	π	π	π	π	π	π	π	π
A4F0	π	π	π	π	π	π	π	π	π	π	π	π	π	π	π	π
A5A0	i	ii	iii	iv	v	vi	vii	viii	ix	x						
A5B0	I	II	III	IV	V	VI	VII	VIII	IX	X						
	0	1	2	3	4	5	6	7	8	9	A	B	C	D	E	F
A5C0	A	B	Γ	Δ	E	Z	H	Θ	I	K	Λ	M	N	Ξ	O	
A5D0	Π	P	Σ	T	Υ	Φ	X	Ψ	Ω							
A5E0	α	β	γ	δ	e	ζ	η	θ	ι	κ	λ	μ	ν	ξ	ο	
A5F0	π	ρ	σ	τ	υ	φ	χ	ψ	ω							
A6A0	-		Γ	Γ	Γ	Γ	Γ	Γ	Γ	Γ	Γ	Γ	Γ	Γ	Γ	Γ
A6B0	Γ	Γ	Γ	Γ	Γ	Γ	Γ	Γ	Γ	Γ	Γ	Γ	Γ	Γ	Γ	Γ
A6C0	Γ	Γ	Γ	Γ	Γ	Γ	Γ	Γ	Γ	Γ	Γ	Γ	Γ	Γ	Γ	Γ
A6D0	Γ	Γ	Γ	Γ	Γ	Γ	Γ	Γ	Γ	Γ	Γ	Γ	Γ	Γ	Γ	Γ
A6E0	Γ	Γ	Γ	Γ	Γ	Γ	Γ	Γ	Γ	Γ	Γ	Γ	Γ	Γ	Γ	Γ
A6F0																
A7A0	μl	ml	dl	l	kl	cc	mm <sup>3</sup>	cm <sup>3</sup>	m <sup>3</sup>	km <sup>3</sup>	fm	nm	μm	mm	cm	
A7B0	km	mm <sup>2</sup>	cm <sup>2</sup>	m <sup>2</sup>	km <sup>2</sup>	ha	μg	mg	kg	kt	cal	kcal	dB	m/s	m/s <sup>2</sup>	ps
A7C0	ns	μs	ms	pV	nV	μV	mV	kV	MV	pA	nA	μA	mA	kA	pW	nW
A7D0	μW	mW	kW	MW	Hz	kHz	MHz	GHz	THz	Ω	kΩ	MΩ	pF	nF	μF	mol
A7E0	cd	rad	sr	Pa	kPa	MPa	GPa	Wb	lm	lx	Bq	Gy	Sv	q/kg		
A7F0																

	0	1	2	3	4	5	6	7	8	9	A	B	C	D	E	F		
A8A0	Æ	Ð	Š	Ŧ		Ů		Ł	Ł	Ø	Œ	Ɔ	Ɔ	Ɔ	Ɔ	Ɔ		
A8B0	⊙	⊙	⊙	⊙	⊙	⊙	⊙	⊙	⊙	⊙	⊙	⊙	⊙	⊙	⊙	⊙		
A8C0	Ⓛ	Ⓛ	Ⓛ	Ⓛ	Ⓛ	Ⓛ	Ⓛ	Ⓛ	Ⓛ	Ⓛ	Ⓛ	Ⓛ	Ⓛ	Ⓛ	Ⓛ	Ⓛ		
A8D0	Ⓛ	Ⓛ	Ⓛ	Ⓛ	Ⓛ	Ⓛ	Ⓛ	Ⓛ	Ⓛ	Ⓛ	Ⓛ	Ⓛ	Ⓛ	Ⓛ	Ⓛ	Ⓛ		
A8E0	Ⓛ	Ⓛ	Ⓛ	Ⓛ	Ⓛ	Ⓛ	Ⓛ	Ⓛ	Ⓛ	Ⓛ	Ⓛ	Ⓛ	Ⓛ	Ⓛ	Ⓛ	Ⓛ		
A8F0	Ⓛ	Ⓛ	Ⓛ	Ⓛ	Ⓛ	Ⓛ	Ⓛ	Ⓛ	Ⓛ	Ⓛ	Ⓛ	Ⓛ	Ⓛ	Ⓛ	Ⓛ	Ⓛ		
A9A0	æ	ð	š	ŧ		ů		ł	ł	ø	œ	ɔ	ɔ	ɔ	ɔ	ɔ		
A9B0	h	(	)	(	)	(	)	(	)	(	)	(	)	(	)	(	)	
A9C0	(	)	(	)	(	)	(	)	(	)	(	)	(	)	(	)	(	)
A9D0	(	)	(	)	(	)	(	)	(	)	(	)	(	)	(	)	(	)
A9E0	(	)	(	)	(	)	(	)	(	)	(	)	(	)	(	)	(	)
A9F0	(	)	(	)	(	)	(	)	(	)	(	)	(	)	(	)	(	)
AAA0	あ	い	う	え	お	か	が	き	ぎ	く								
AAB0	く	け	げ	こ	さ	ざ	し	じ	ず	ぜ	そ	ぞ	た					
	0	1	2	3	4	5	6	7	8	9	A	B	C	D	E	F		
AAE0	む	め	も	や	や	ゆ	ゆ	よ	よ	ら	り	る	れ	ろ	わ	わ		
AAF0	ゑ	え	を	ん														
ABA0	ア	イ	ウ	エ	オ	カ	ガ	キ	ク									
ABB0	グ	ケ	ゲ	コ	ゴ	サ	ザ	シ	ジ	ス	ズ	セ	ゼ	ソ	ゾ	タ		
ABC0	ダ	チ	ヂ	ツ	ヅ	テ	デ	ト	ド	ナ	ニ	ネ	ノ	ハ				
ABD0	バ	ビ	ブ	ヒ	フ	ヘ	ベ	ホ	ボ	マ	ミ							
ABE0	ム	メ	モ	ヤ	ユ	ヨ	ラ	リ	ル	レ	ロ	ワ						
ABF0	ヰ	ヱ	ヲ	ン	ヰ	ヱ	ヲ	ン										
ACA0	A	B	B	Г	Д	Е	Ж	З	И	Й	К	Л	М	Н				
ACB0	О	П	Р	С	Т	У	Ф	Х	Ц	Ч	Ш	Щ	Ъ	Ы	Ь	Э		
ACC0	Ю	Я																
ACD0	a	b	B	Г	Д	e	ê	Ж	э	и	й	К	Л	М	Н			
ACE0	О	П	Р	С	Т	У	Ф	Х	Ц	Ч	Ш	Щ	Ъ	Ы	Ь	Э		
ACF0	Ю	Я																
ADA0																		
ADB0																		
	0	1	2	3	4	5	6	7	8	9	A	B	C	D	E	F		
ADC0																		
ADD0																		
ADB0																		
ADF0																		
AEA0																		
AEB0																		
AEC0																		
AED0																		
AEE0																		
AEF0																		
AFAM																		
AFB0																		
AFC0																		
AFD0																		
AFE0																		
AFF0																		







2)24x24 dots

(1) A0A0H ~ AFFFH

	0	1	2	3	4	5	6	7	8	9	A	B	C	D	E	F
A0A0																
A0B0																
A0C0																
A0D0																
A0E0																
A0F0																
A1A0		,	.	°	′	″	…	”	”	”	”	”	”	”	”	”
A1B0	-	+	(	)	<	>	《	》	『	』	『	』	{	}	±	×
A1C0	÷	≈	≤	≥	∞	∴	∵	∶	∷	∸	∹	∺	∻	∼	∽	∿
A1D0	∠	⊥	∧	∅	∇	≡	≅	§	※	☆	★	○	●	◎	◇	◆
A1E0	□	■	△	▲	▽	▼	→	←	↑	↓	↔	↔	↔	↔	↔	↔
A1F0	∝	∴	∵	∶	∷	∸	∹	∺	∻	∼	∽	∿	∿	∿	∿	∿
A2A0	⇒	⇐	∇	∇	∇	∇	∇	∇	∇	∇	∇	∇	∇	∇	∇	∇
A2B0	:	∑	∏	∏	∏	∏	∏	∏	∏	∏	∏	∏	∏	∏	∏	∏
A2C0	☉	☽	☾	☾	☾	☾	☾	☾	☾	☾	☾	☾	☾	☾	☾	☾
A2D0	☾	☾	☾	☾	☾	☾	☾	☾	☾	☾	☾	☾	☾	☾	☾	☾

	0	1	2	3	4	5	6	7	8	9	A	B	C	D	E	F
A5A0	ア	イ	ウ	エ	オ	カ	キ	ク	ケ	コ	サ	シ	ス	セ	ソ	タ
A5B0	チ	ツ	テ	ト	ナ	ニ	ノ	ハ	ヒ	フ	ブ	ペ	ホ	ボ	マ	ミ
A5C0	ム	メ	モ	ヤ	ユ	ヨ	ラ	リ	ル	レ	ロ	ワ	ヰ	ヱ	ヰ	ヱ
A5D0	ヰ	ヱ	ヰ	ヱ	ヰ	ヱ	ヰ	ヱ	ヰ	ヱ	ヰ	ヱ	ヰ	ヱ	ヰ	ヱ
A5E0	ヰ	ヱ	ヰ	ヱ	ヰ	ヱ	ヰ	ヱ	ヰ	ヱ	ヰ	ヱ	ヰ	ヱ	ヰ	ヱ
A5F0	ヰ	ヱ	ヰ	ヱ	ヰ	ヱ	ヰ	ヱ	ヰ	ヱ	ヰ	ヱ	ヰ	ヱ	ヰ	ヱ
A6A0	ア	イ	ウ	エ	オ	カ	キ	ク	ケ	コ	サ	シ	ス	セ	ソ	タ
A6B0	チ	ツ	テ	ト	ナ	ニ	ノ	ハ	ヒ	フ	ブ	ペ	ホ	ボ	マ	ミ
A6C0	ム	メ	モ	ヤ	ユ	ヨ	ラ	リ	ル	レ	ロ	ワ	ヰ	ヱ	ヰ	ヱ
A6D0	ヰ	ヱ	ヰ	ヱ	ヰ	ヱ	ヰ	ヱ	ヰ	ヱ	ヰ	ヱ	ヰ	ヱ	ヰ	ヱ
A6E0	ヰ	ヱ	ヰ	ヱ	ヰ	ヱ	ヰ	ヱ	ヰ	ヱ	ヰ	ヱ	ヰ	ヱ	ヰ	ヱ
A6F0	ヰ	ヱ	ヰ	ヱ	ヰ	ヱ	ヰ	ヱ	ヰ	ヱ	ヰ	ヱ	ヰ	ヱ	ヰ	ヱ
A7A0	μl	ml	dl	l	kl	cc	ml	cl	ml	cl	ml	cl	ml	cl	ml	cl
A7B0	km	ml	cl	ml	cl	ba	μg	mg	kg	kt	cal	kal	dB	%	%	ps
A7C0	ne	μs	ms	μV	mV	μV	mV	kV	MV	PA	NA	μA	mA	KA	μW	mW
A7D0	μW	mW	kW	MW	Hz	MHz	MHz	GHz	THz	Ω	kΩ	MΩ	pF	nF	μF	mol
A7E0	cd	rad	%	%	er	Pa	Pa	Pa	Pa	Wb	lm	lx	Bq	Gy	Sv	%e
A7F0																

	0	1	2	3	4	5	6	7	8	9	A	B	C	D	E	F
A2E0	No	Ca	TM	as	pa	tel										
A2F0																
A3A0	!	"	#	\$	%	&	'	(	)	*	+	.	-	.	/	
A3B0	0	1	2	3	4	5	6	7	8	9	:	:	<	=	>	?
A3C0	⊙	A	B	C	D	E	F	G	H	I	J	K	L	M	N	O
A3D0	P	Q	R	S	T	U	V	W	X	Y	Z	[	W	]	-	-
A3E0	a	b	c	d	e	f	g	h	i	j	k	l	m	n	o	
A3F0	p	q	r	s	t	u	v	w	x	y	z	{		}	-	-
A4A0	т	т	т	т	т	т	т	т	т	т	т	т	т	т	т	т
A4B0	т	т	т	т	т	т	т	т	т	т	т	т	т	т	т	т
A4C0	т	т	т	т	т	т	т	т	т	т	т	т	т	т	т	т
A4D0	т	т	т	т	т	т	т	т	т	т	т	т	т	т	т	т
A4E0	т	т	т	т	т	т	т	т	т	т	т	т	т	т	т	т
A4F0	т	т	т	т	т	т	т	т	т	т	т	т	т	т	т	т
A5A0	I	II	III	IV	V	VI	VII	VIII	IX	X						
A5B0	I	II	III	IV	V	VI	VII	VIII	IX	X						

	0	1	2	3	4	5	6	7	8	9	A	B	C	D	E	F
A6A0	む	め	も	や	ゆ	よ	ら	り	る	れ	ろ	わ	わ			
A6B0	ゐ	ゑ	を	ん												
A6C0	ア	イ	ウ	エ	オ	カ	キ	ク	ケ	コ	サ	シ	ス	セ	ソ	タ
A6D0	チ	ツ	テ	ト	ナ	ニ	ノ	ハ	ヒ	フ	ブ	ペ	ホ	ボ	マ	ミ
A6E0	ム	メ	モ	ヤ	ユ	ヨ	ラ	リ	ル	レ	ロ	ワ	ヰ	ヱ	ヰ	ヱ
A6F0	ヰ	ヱ	ヰ	ヱ	ヰ	ヱ	ヰ	ヱ	ヰ	ヱ	ヰ	ヱ	ヰ	ヱ	ヰ	ヱ
A7A0	ア	イ	ウ	エ	オ	カ	キ	ク	ケ	コ	サ	シ	ス	セ	ソ	タ
A7B0	チ	ツ	テ	ト	ナ	ニ	ノ	ハ	ヒ	フ	ブ	ペ	ホ	ボ	マ	ミ
A7C0	ム	メ	モ	ヤ	ユ	ヨ	ラ	リ	ル	レ	ロ	ワ	ヰ	ヱ	ヰ	ヱ
A7D0	ヰ	ヱ	ヰ	ヱ	ヰ	ヱ	ヰ	ヱ	ヰ	ヱ	ヰ	ヱ	ヰ	ヱ	ヰ	ヱ
A7E0	ヰ	ヱ	ヰ	ヱ	ヰ	ヱ	ヰ	ヱ	ヰ	ヱ	ヰ	ヱ	ヰ	ヱ	ヰ	ヱ
A7F0	ヰ	ヱ	ヰ	ヱ	ヰ	ヱ	ヰ	ヱ	ヰ	ヱ	ヰ	ヱ	ヰ	ヱ	ヰ	ヱ

	0	1	2	3	4	5	6	7	8	9	A	B	C	D	E	F
A5C0	A	B	Γ	Δ	E	Z	H	Θ	I	K	A	M	N	Π	Ο	
A5D0	Π	P	Σ	T	Υ	Φ	X	Ψ	Ω							
A5E0	α	β	γ	δ	ε	ζ	η	θ	ι	κ	λ	μ	ν	ξ	ο	
A5F0	π	ρ	σ	τ	υ	φ	χ	ψ	ω							
A6A0	-		Γ	Γ	Γ	Γ	Γ	Γ	Γ	Γ	Γ	Γ	Γ	Γ	Γ	Γ
A6B0	Γ	Γ	Γ	Γ	Γ	Γ	Γ	Γ	Γ	Γ	Γ	Γ	Γ	Γ	Γ	Γ
A6C0	Γ	Γ	Γ	Γ	Γ	Γ	Γ	Γ	Γ	Γ	Γ	Γ	Γ	Γ	Γ	Γ
A6D0	Γ	Γ	Γ	Γ	Γ	Γ	Γ	Γ	Γ	Γ	Γ	Γ	Γ	Γ	Γ	Γ
A6E0	Γ	Γ	Γ	Γ	Γ											
A6F0																
A7A0	μl	ml	dl	l	kl	cc	ml	cl	ml	cl	ml	cl	ml	cl	ml	cl
A7B0	km	ml	cl	ml	cl	ba	μg	mg	kg	kt	cal	kal	dB	%	%	ps
A7C0	ne	μs	ms	μV	mV	μV	mV	kV	MV	PA	NA	μA	mA	KA	μW	mW
A7D0	μW	mW	kW	MW	Hz	MHz	MHz	GHz	THz	Ω	kΩ	MΩ	pF	nF	μF	mol
A7E0	cd	rad	%	%	er	Pa	Pa	Pa	Pa	Wb	lm	lx	Bq	Gy	Sv	%e
A7F0																

	0	1	2	3	4	5	6	7	8	9	A	B	C	D	E	F
A6A0																
A6B0																
A6C0																
A6D0																
A6E0																
A6F0																
A7A0																
A7B0																
A7C0																
A7D0																
A7E0																
A7F0																

(2) B0A0H ~ BFFFH

	0	1	2	3	4	5	6	7	8	9	A	B	C	D	E	F
B8A0	外	夕	心	古	夕	夕	夕	夕	夕	夕	夕	夕	夕	夕	夕	夕
B8B0	記	心	心	天	天	天	天	天	天	天	天	天	天	天	天	天
B8C0	心	心	天	天	天	天	天	天	天	天	天	天	天	天	天	天
B8D0	天	天	天	天	天	天	天	天	天	天	天	天	天	天	天	天
B8E0	天	天	天	天	天	天	天	天	天	天	天	天	天	天	天	天
B8F0	天	天	天	天	天	天	天	天	天	天	天	天	天	天	天	天
B1A0																
B1B0																
B1C0																
B1D0																
B1E0																
B1F0																
B2A0																
B2B0																
B2C0																
B2D0																

	0	1	2	3	4	5	6	7	8	9	A	B	C	D	E	F
B8A0																
B8B0																
B8C0																
B8D0																
B8E0																
B8F0																
B9A0																
B9B0																
B9C0																
B9D0																
B9E0																
B9F0																
BAA0																
BAB0																
BAC0																
BAD0																

	0	1	2	3	4	5	6	7	8	9	A	B	C	D	E	F
B2E0																
B2F0																
B3A0																
B3B0																
B3C0																
B3D0																
B3E0																
B3F0																
B4A0																
B4B0																
B4C0																
B4D0																
B4E0																
B4F0																
B5A0																
B5B0																

	0	1	2	3	4	5	6	7	8	9	A	B	C	D	E	F
BAE0																
BAF0																
BBA0																
BBB0																
BBC0																
BBD0																
BBE0																
BBF0																
BBA0																
BBB0																
BBC0																
BBD0																
BBE0																
BBF0																
BBA0																
BBB0																
BBC0																
BBD0																
BBE0																
BBF0																

	0	1	2	3	4	5	6	7	8	9	A	B	C	D	E	F
B5C0																
B5D0																
B5E0																
B5F0																
B6A0																
B6B0																
B6C0																
B6D0																
B6E0																
B6F0																
B7A0																
B7B0																
B7C0																
B7D0																
B7E0																
B7F0																

	0	1	2	3	4	5	6	7	8	9	A	B	C	D	E	F
BDC0																
BDD0																
BDE0																
BDF0																
BEA0																
BEB0																
BEC0																
BED0																
BEF0																
BEA0																
BEB0																
BEC0																
BED0																
BEF0																
BEA0																
BEB0																
BEC0																
BED0																
BEF0																

(3) C0A0H ~ CFFFH

	0	1	2	3	4	5	6	7	8	9	A	B	C	D	E	F
C8A0		취	산	삽	만	삽	송	취	취	천	삽	만	삽	취	삽	취
C8B0	속	산	술	술	술	술	술	이	속	은	술	술	술	술	술	술
C8C0	응	웃	웃	웃	웃	웃	웃	의	인	원	원	원	원	이	의	인
C8D0	위	임	임	임	임	잇	잇	잇	인	자	좌	잔	잔	잔	잔	잔
C8E0	잡	잡	잡	잡	잡	잡	잡	잡	잡	잡	잡	잡	잡	잡	잡	잡
C8F0	자	작	잔	잔	잔	잔	잔	잔	잔	잔	잔	잔	잔	잔	잔	잔
C1A0		점	점	점	점	점	점	점	점	점	점	점	점	점	점	점
C1B0	절	점	점	점	점	점	점	점	점	점	점	점	점	점	점	점
C1C0	줄	줄	좌	좌	좌	좌	좌	좌	좌	좌	좌	좌	좌	좌	좌	좌
C1D0	짓	징	조	조	조	조	조	조	조	조	조	조	조	조	조	조
C1E0	괴	괴	죄	죄	죄	죄	죄	죄	죄	죄	죄	죄	죄	죄	죄	죄
C1F0	근	름	름	름	름	름	름	름	름	름	름	름	름	름	름	름
C2A0		성	성	성	성	성	성	성	성	성	성	성	성	성	성	성
C2B0	제	제	전	전	전	전	전	전	전	전	전	전	전	전	전	전
C2C0	침	침	침	침	침	침	침	침	침	침	침	침	침	침	침	침
C2D0	풍	풍	부	부	부	부	부	부	부	부	부	부	부	부	부	부

	0	1	2	3	4	5	6	7	8	9	A	B	C	D	E	F
C8A0		형	형	호	호	호	호	호	호	호	호	호	호	호	호	호
C8B0	활	활	활	활	활	활	활	활	활	활	활	활	활	활	활	활
C8C0	흔	흔	흔	흔	흔	흔	흔	흔	흔	흔	흔	흔	흔	흔	흔	흔
C8D0	징	징	징	징	징	징	징	징	징	징	징	징	징	징	징	징
C8E0	흔	흔	흔	흔	흔	흔	흔	흔	흔	흔	흔	흔	흔	흔	흔	흔
C8F0	활	활	활	활	활	활	활	활	활	활	활	활	활	활	활	활
C9A0																
C9B0																
C9C0																
C9D0																
C9E0																
C9F0																
CAA0																
CAB0																
CAC0																
CAD0																

	0	1	2	3	4	5	6	7	8	9	A	B	C	D	E	F
C2E0	근	름	름	름	름	름	름	름	름	름	름	름	름	름	름	름
C2F0	진	침	침	침	침	침	침	침	침	침	침	침	침	침	침	침
C3A0	잔	잔	잔	잔	잔	잔	잔	잔	잔	잔	잔	잔	잔	잔	잔	잔
C3B0	잡	잡	잡	잡	잡	잡	잡	잡	잡	잡	잡	잡	잡	잡	잡	잡
C3C0	침	침	침	침	침	침	침	침	침	침	침	침	침	침	침	침
C3D0	웃	웃	좌	좌	좌	좌	좌	좌	좌	좌	좌	좌	좌	좌	좌	좌
C3E0	죽	죽	죽	죽	죽	죽	죽	죽	죽	죽	죽	죽	죽	죽	죽	죽
C3F0	짓	징	조	조	조	조	조	조	조	조	조	조	조	조	조	조
C4A0		지	진	진	진	진	진	진	진	진	진	진	진	진	진	진
C4B0	갑	갑	갑	갑	갑	갑	갑	갑	갑	갑	갑	갑	갑	갑	갑	갑
C4C0	적	적	적	적	적	적	적	적	적	적	적	적	적	적	적	적
C4D0	징	징	징	징	징	징	징	징	징	징	징	징	징	징	징	징
C4E0	웃	웃	좌	좌	좌	좌	좌	좌	좌	좌	좌	좌	좌	좌	좌	좌
C4F0	활	활	활	활	활	활	활	활	활	활	활	활	활	활	활	활
C5A0		침	침	침	침	침	침	침	침	침	침	침	침	침	침	침
C5B0	기	기	기	기	기	기	기	기	기	기	기	기	기	기	기	기

	0	1	2	3	4	5	6	7	8	9	A	B	C	D	E	F
CAE0																
CAF0																
CBA0																
CBB0																
CBC0																
CBD0																
CBE0																
CBF0																
CCA0																
CCB0																
CCC0																
CCD0																
CCE0																
CCF0																
CDA0																
CE00																

	0	1	2	3	4	5	6	7	8	9	A	B	C	D	E	F
C5C0	웃	웃	웃	웃	웃	웃	웃	웃	웃	웃	웃	웃	웃	웃	웃	웃
C5D0	활	활	활	활	활	활	활	활	활	활	활	활	활	활	활	활
C5E0	흔	흔	흔	흔	흔	흔	흔	흔	흔	흔	흔	흔	흔	흔	흔	흔
C5F0	죄	죄	죄	죄	죄	죄	죄	죄	죄	죄	죄	죄	죄	죄	죄	죄
C6A0		죄	죄	죄	죄	죄	죄	죄	죄	죄	죄	죄	죄	죄	죄	죄
C6B0	근	름	름	름	름	름	름	름	름	름	름	름	름	름	름	름
C6C0	침	침	침	침	침	침	침	침	침	침	침	침	침	침	침	침
C6D0	패	패	패	패	패	패	패	패	패	패	패	패	패	패	패	패
C6E0	활	활	활	활	활	활	활	활	활	활	활	활	활	활	활	활
C6F0	침	침	침	침	침	침	침	침	침	침	침	침	침	침	침	침
C7A0		좌	좌	좌	좌	좌	좌	좌	좌	좌	좌	좌	좌	좌	좌	좌
C7B0	음	음	음	음	음	음	음	음	음	음	음	음	음	음	음	음
C7C0	송	송	송	송	송	송	송	송	송	송	송	송	송	송	송	송
C7D0	학	학	학	학	학	학	학	학	학	학	학	학	학	학	학	학
C7E0	형	형	형	형	형	형	형	형	형	형	형	형	형	형	형	형
C7F0	침	침	침	침	침	침	침	침	침	침	침	침	침	침	침	침

	0	1	2	3	4	5	6	7	8	9	A	B	C	D	E	F
CDC0																
CDE0																
CE00																
CE10																
CE20																
CE30																
CE40																
CE50																
CE60																
CE70																
CE80																
CE90																
CEA0																
CEB0																
CEC0																
CED0																
CEE0																
CEF0																
CEA0																
CEB0																
CEC0																
CED0																
CEE0																
CEF0																
CEA0																
CEB0																
CEC0																
CED0																
CEE0																
CEF0																



## 10. Barcode Command

The barcode setting is done by inputting the relevant parameter for B, D, BD after ESC. This enables the selection of the barcode type, the barcode ratio and the print out of guard bars or Human-readable characters, and etc.

Please carefully study the following pages for barcode setting specifications.

Please find the description of parameters B, D, BD below.

[Barcode ratio]

Parameter	Barcode	<B>	<D>	<BD>
0	CODABAR (NW-7)	1 : 3	1 : 2	2 : 5
1	CODE39	1 : 3	1 : 2	2 : 5
2	ITF	1 : 3	1 : 2	2 : 5
5	Industrial 2of5	1 : 3	1 : 2	2 : 5
6	Matrix 2of5	1 : 3	1 : 2	2 : 5

### (1) Barcode ratio

Barcodes consist of narrow bars, wide bars, narrow spaces and wide spaces. The barcode ratio is specified as the ratio between one wide bar and one narrow bar.

Barcode ratio: Parameter <B>, Ratio: 1:3

Narrow bar width [1] stands against wide bar width [3]

Barcode ratio: Parameter <D>, Ratio: 1:2

Narrow bar width [1] stands against wide bar width [2]

Barcode ratio: Parameter <BD>, Ratio: 2:5

Narrow bar width [2] stands against wide bar width [5]

If an other barcode ratio shall be chosen, this can be done by specifying an user-defined ratio, using command <BT> and printing that registered ratio by command <BW>.

### (2) Narrow bar width and barcode height

The width of the narrow bar is set through the thickness of the bar. The barcode height is set by the height of the bar.

For example, if printing a narrow bar with a width of 1 dot with a print head of 12 dots/mm (305dpi) the width of the narrow bar will be 0.083 mm, which could cause problems when reading the barcode with a scanner. Setting the narrow bar width to 2 dots (0.166 mm) will enable a trouble free reading by the barcode scanner.

When specifying the narrow bar it is necessary to consider the print head density and the ability of the barcode scanner.

The barcode ratio and the width of the narrow bar specify the actual thickness of the bar.

For example: Barcode ratio 1:3. Narrow bar width: 3 dots. The actual barcode ratio (in dots) will be 3:9.

The Barcode height shall be adjusted to the specifications of the barcode scanner.

### (3) Inter-character gap

The inter-character gap is the space between each barcode characters.

The inter-character gap shall be put in directly in front of the barcode ratio parameters <B>, <D>, <BD> or in front of the printing command for user specified ratios <BW>. The inter-character gap is set by command <P>. If no gap is specified, the default value of 2 dots is chosen.

Barcodes which allow the specification of an inter-character gap are as follows:

- 1) CODABAR (NW-7)
- 2) CODE39
- 3) Industrial 2of5
- 4) Matrix 2of5

The actual inter-character gap is specified by the multiplication of the character pitch <P> and the width of the narrow bar.

For example: Inter-character pitch <P>: 3, Narrow bar width: 2 dots

$$\text{Inter-character gap} = 3 \times 2 = 6 \text{ dots}$$

**(4) Human Readable Interpretation and Guard bars**

For UPC-A, JAN/EAN-8/13 column barcodes it is possible to specify the print of guard bars or human-readable interpretation.

Parameter	Barcode	<B>	<D>	<BD>	<BM>	<BL>
3	JAN/EAN-13	HRI OFF Guard bar OFF	HRI OFF Guard bar ON	HRI ON Guard bar ON		
4	JAN/EAN-8	HRI OFF Guard bar OFF	HRI OFF Guard bar ON	HRI ON Guard bar ON		
H	UPC-A	HRI OFF Guard bar OFF	HRI OFF Guard bar ON	HRI ON Guard bar ON	HRI ON The 1 <sup>st</sup> and last guard bars are long	HRI OFF The 1 <sup>st</sup> and last guard bars are long

**1) When selecting <B> (Human-readable interpretation: OFF, Guard bars: OFF)**



**2) When selecting <D> (Human-readable interpretation: OFF, Guard bars: ON)**

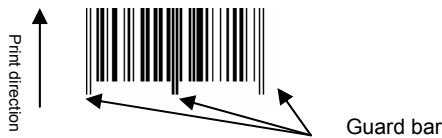

[Notes] By specifying font data after having set the guard bars <D>, it is possible to print human readable interpretation. Refer to barcode specifications (Selecting Human-readable interpretation) <D>~<d>.

**3) When selecting <BD> (Human-readable interpretation: ON, Guard bars: ON)**



**4) When selecting <BM> (Human-readable interpretation: ON, The first and the last guard bars are long.)**

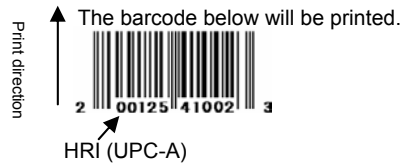

**5) When selecting <BL> (Human-readable interpretation: OFF, The first and the last guard bars are long.)**

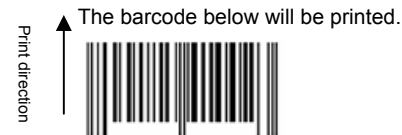

[Specifying barcode only]

Parameter	Barcode	Parameter <B>
C	CODE93	Barcode only
E	UPC-E	Barcode only
G	CODE128 (128A, 128B, 128C)	Barcode only
I	GS1-128 (UCC/EAN128) for standard carton ID	Barcode only
Z	Customer barcode	Barcode only

[Important]

- Above are barcodes with no specified barcode ratio or human-readable interpretation.

**(5) Check digits**

Check digits available for each type of barcode are listed below.

[C/D]

Parameter	Barcode	Input digits	Digits printed, information included
3	JAN/EAN13	12	13 digits (barcode input+C/D) Calculation of C/D is done in modulus 10 (automatic)
		13	13 digits (Complying to barcode input. C/D is not executed/printed)
4	JAN/EAN8	7	8 digits (barcode input+C/D) Calculation of C/D is done in modulus 10 (automatic)
		8	8 digits (Complying to barcode input. C/D is not executed/printed)
C	CODE93	Max. 99	Calculation of C/D is done in modulus 47 (automatic)
E	UPC-E	6 (fixed)	Calculation of C/D is done in modulus 10 (automatic)
G	CODE128 (128A,128B, 128C)	-	Calculation of C/D is done in modulus 103 (automatic)
H	UPC-A	11 (fixed)	12 digits (barcode data + C/D) Calculation of C/D is done in modulus 10 (automatic)
I	GS1-128 (UCC/EAN128) for standard carton ID	17 (fixed)	Calculation of C/D is done in modulus 103 (automatic)

\* C/D stands for check digits

**Barcode rotation**

Print direction of barcodes can be changed. However, if having selected serial 1 or serial 2, depending on the expansion factor, the barcode print might be blurred.

Parallel 1 : Forward printing

Parallel 2 : Rotating 180° in respect to parallel 1

Serial 1 : Rotating 90° in respect to parallel 1

Serial 2 : Rotating 270° in respect to parallel 1

**\* Forward printing: picket fence barcode**

- 1) If printing in parallel 1 or parallel 2 mode, specify the bar width expansion factor so that when using a 8 dots/mm or 12 dots/mm head the width of the narrow bar is at least 2 dots.

(L shows the applicable expansion factor in relevance to the bar ratio)

	Head density	
	8 dots/mm	12 dots/mm
Bar ratio 1:2	More than 2L	More than 2L
Bar ratio 1:3	More than 2L	More than 2L
Bar ratio 2:5	More than 1L	More than 1L
UPC-A/JAN/EAN	More than 2L	More than 2L

- 2) If printing in serial 1 or serial 2 mode, specify the bar width expansion factor so that when using a 8 dots/mm or 12 dots/mm head the width of the narrow bar is at least 3 dots.

- 3) If printing in serial 1 or serial 2 mode, reduce the print speed

	Head density	
	8 dots/mm	12 dots/mm
Bar ratio 1:2	More than 3L	More than 3L
Bar ratio 1:3	More than 3L	More than 3L
Bar ratio 2:5	More than 2L	More than 2L
UPC-A/JAN/EAN	More than 3L	More than 3L

Barcode			
Available for	CG400 series		
<b>Barcode (Ratio 1:3)</b>		<b>ESC+B</b>	
Hex code	ESC <1B> <sub>16</sub>	B <42> <sub>16</sub>	Parameter abbcccn~n
Default setting	None		

Persistence of the command	When printer is powered off	Set parameter will not be retained
	Validity in a job	Becomes invalid after execution
	Validity after a job	Becomes invalid after the job

[Function]

Specifies a barcode with a ratio of 1:3 between narrow bar and wide bar.

[Format]

<B>abbcccn~n

• Parameter

a	[Barcode type]	=	Refer to table below
b	[Narrow bar width]	=	Valid range : 01 to 12 dots
c	[Barcode height]	=	Valid range : 001 to 999 dots
n	[Print data]	=	Data

Barcode type (Depending on the barcode type, there might be the case that there is no ratio specified for the module draw up)

a	Barcode type	Information	Ratio
0	CODABAR (NW-7)	Always include start and stop characters in print data. Start/stop characters are [A, B, C, D, E, N, T, a, b, c, d, e, n, t] Example) In case of barcode data [123]: [A123A] Inter-character pitch of barcode is valid. For print data specifications, refer to table of CODABAR (NW-7) code	1:3
1	CODE39	Always include start and stop characters in print data. Start/stop characters are [*] Example) In case of barcode data [12345]: [*12345*] Inter-character pitch of barcode is valid. For print data specifications, refer to table of CODE39 code	1:3
2	ITF	Put the print data in even digit numbers If putting the print data in odd digit numbers "0" will be added on the head of the print data. For print data specifications, refer to table of ITF code	1:3
3	JAN/EAN-13	This barcode does not include guard bars or human-readable characters For print data specifications, refer to table of JAN/EAN13 code	Fixed
4	JAN/EAN-8	This barcode does not include guard bars or human-readable characters For print data specifications, refer to table of JAN/EAN8 code	Fixed
5	Industrial 2of5	Inter-character pitch of the barcode is valid For print data specifications, refer to table of Industrial 2of5 code	1:3
6	Matrix 2of5	Print data can be specified up to 13 digits For print data specifications refer to table of Matrix 2of5 code	1:3
A	MSI	Print data input is possible for up to 13 characters For print data specifications, refer to table of MSI code	Fixed
C	CODE93	Refer to CODE93 <BC>	Fixed
E	UPC-E	Specify 6-digit numbers for print data For print data specifications, refer to table of UPC-E code	Fixed
F	BOOKLAND	Refer to BOOKLAND specifications <BF>	Fixed
G	CODE128 (128A, 128B, 128C)	Refer to CODE128 (128A, 128B, 128C) <BG>	Fixed
H	UPC-A	This barcode does not include guard bars or translation For print data specifications, refer to table of Interleaved UPC-A code	Fixed
I	GS1-128 (UCC/EAN128)	Refer to GS1-128 (UCC/EAN128) <BI>	Fixed
P	POSTNET	Refer to POSTNET <BP>	Fixed





Barcode			
Available for	CG400 series		
<b>Barcode (Ratio 1:2)</b>		<b>ESC+D</b>	
Hex code	ESC <1B> <sub>16</sub>	D <44> <sub>16</sub>	Parameter abbcccn~n
Default setting	None		

Persistence of the command	When printer is powered off	Set parameter will not be retained
	Validity in a job	Becomes invalid after execution
	Validity after a job	Becomes invalid after the job

[Function]

Specifies a barcode with a ratio of 1:2 between narrow bar and wide bar.

[Format]

<D>abbcccn~n

• Parameter

a	[Barcode type]	=	Refer to table below
b	[Narrow bar width]	=	01 to 12 dots
c	[Barcode height]	=	001 to 999 dots
n	[Print data]	=	Data

Barcode type (Depending on the barcode type, there might be the case that there is no ratio specified for the module draw up)

a	Barcode type	Information	Ratio
0	CODABAR (NW-7)	Always include start and stop characters in print data. Start/stop characters are [A, B, C, D, E, N, T, a, b, c, d, e, n, t] Example) In case of barcode data [123]: [A123A] Inter-character pitch of barcode becomes valid. For print data specifications, refer to table of CODABAR (NW-7) code	1:2
1	CODE39	Always include start and stop characters in print data. Start/stop character is [*] Example) In case of barcode data [12345]: [*12345*] Inter-character pitch of barcode is valid. For print data specifications, refer to table of CODE39 code	1:2
2	ITF	Put the print data in even-number digits If putting the print data in odd-number digits "0" will be added on the head of the print data. For print data specifications, refer to table of ITF code	1:2
3	JAN/EAN-13	Guard bars: On, Human-readable interpretation: Off For print data specifications, refer to table of JAN/EAN13 code	Fixed
4	JAN/EAN-8	Guard bars: On, Human-readable interpretation: Off For print data specifications, refer to table of JAN/EAN-8 code	Fixed
5	Industrial 2of5	Inter-character pitch of the barcode is valid For print data specifications, refer to table of Industrial 2of5 code	1:2
6	Matrix 2of5	Inter-character pitch of the barcode is valid For print data specifications, refer to table of Matrix 2of5 code	1:2
H	UPC-A	Guard bars: On, Human-readable interpretation: Off For print data specifications, refer to table of UPC-A code	Fixed

[Coding example 1] Barcode type: CODABAR (NW-7), Narrow bar width: 03, Barcode height: 120, Print data: A1234A

```
<A>
<V>100<H>100<D>003120A1234A
<Q>2
<Z>
```



Barcode			
Available for	CG400 series		
<b>Barcode (HRI font)</b>		<b>ESC+D ~ ESC+d</b>	
Hex code	ESC <1B> <sub>16</sub>	D~+ ESC+d <44> <sub>16</sub> ~<1B> <sub>16</sub> char. type	Parameter abbcccn~n+<d>n~n
Default setting	None		
Persistence of the command	When printer is powered off	Set parameter will not be retained	
	Validity in a job	Becomes invalid after execution	
	Validity after a job	Becomes invalid after the job	

[Function]

Specifies character type of human readable interpretation (HRI) for barcode.

[Format]

<D>abbcccn~n + <d>n~n

• Parameter

a	[Barcode type]	=	3 4 H	:	JAN/EAN13 JAN/EAN8 UPC-A
b	[Narrow bar width]	=	Valid range :		01 to 12 dots
c	[Barcode height]	=	Valid range :		001 to 999 dots
n	[Print data]	=	Barcode data		
d	[Character type]	=	XU XS XM XB XL OA OB U* S* M* WB* WL*		

\* Compatible fonts for old models and shall not be disclosed to end users.

n [Print data] = HRI data

[Coding example] Barcode type: JAN/EAN-13, Narrow bar width: 02, Barcode height: 120,  
Barcode data: 4902471006795, Character type: XS, HRI data: 4902471006795

```
<A>
<V>100<H>200<D>3021204902471006795
<XS>4902471006795
<Q>2
<Z>
```

[Notes]

1. Adds HRI characters in specified font.
2. When the data other than specified value is set, printing will not be performed. When barcode enlargement ratio is small and character type is large, HRI text may be overlapped with each other.
3. Printer will lay out HRI properly.
4. The barcode translation of following codes will be restricted to conditions below: JAN/EAN8, JAN/EAN13, UPC-A
  - In case of 8 dots/mm (203dpi) : Appropriate Narrow bar width is [02], [03]
  - In case of 12 dots/mm (305dpi) : Appropriate Narrow bar width is [03], [04]

Barcode			
Available for			
	CG400 series		
Barcode (Ratio 2:5)		ESC+BD	
Hex code	ESC	BD	Parameter
	<1B> <sub>16</sub>	<42> <sub>16</sub> <44> <sub>16</sub>	abbcccn~n
Default setting	None		

Persistence of the command	When printer is powered off	Set parameter will not be retained
	Validity in a job	Becomes invalid after execution
	Validity after a job	Becomes invalid after the job

[Function]

Specifies a barcode with a ratio of 2:5 between narrow bar and wide bar.

[Format]

<BD>abbcccn~n

• Parameter

a	[Barcode type]	=	Refer to table below
b	[Narrow bar width]	=	01 to 12 dots
c	[Barcode height]	=	001 to 999 dots
n	[Print data]	=	Data

Barcode type (Depending on the barcode type, there might be the case that there is no ratio specified for the module draw up)

a	Barcode type	Information	Ratio
0	CODABAR (NW-7)	Always include start and stop characters in print data. Start/stop characters are [A, B, C, D, E, N, T, a, b, c, d, e, n, t] Example) In case of barcode data [123]: [A123A] Inter-character pitch of barcode becomes valid. For print data specifications, refer to table of CODABAR (NW-7) code	2:5
1	CODE39	Always include start and stop characters in print data. Start/stop character is [*] Example) In case of barcode data [12345]: [*12345*] Inter-character pitch of barcode is valid. For print data specifications, refer to table of CODE39 code	2:5
2	ITF	Put the print data in even-number digits If putting the print data in odd-number digits "0" will be added on the head of the print data. For print data specifications, refer to table of ITF code	2:5
3	JAN/EAN-13	Guard bars: On, Human-readable interpretation: On For print data specifications, refer to table of JAN/EAN13 code	Fixed
4	JAN/EAN-8	Guard bars: On, Human-readable interpretation: On For print data specifications, refer to table of JAN/EAN8 code	Fixed
5	Industrial 2of5	Inter-character pitch of the barcode is valid For print data specifications, refer to table of Industrial 2of5 code	2:5
6	Matrix 2of5	Inter-character pitch of the barcode is valid For print data specifications, refer to table of Matrix 2of5 code	2:5
H	UPC-A	Guard bars: On, Human-readable interpretation: On For print data specifications, refer to table of UPC-A code	Fixed

[Coding example1] Barcode type: CODABAR (NW-7), Narrow bar width: 03, Barcode height: 120, Print data: A1234A

```
<A>
<V>100<H>100<BD>003120A1234A
<Q>2
<Z>
```

[Coding example 2] Barcode type: ITF, Narrow bar width: 04, Barcode height: 240, Print data: 98002345678163  
<A>  
<V>100<H>100<BD>20424098002345678163  
<Q>2  
<Z>

[Coding example 3] Barcode type: UPC-A, Narrow bar width: 02, Barcode height: 120, Print data: 20123948573  
<A>  
<V>240<H>100<BD>H0212020123948573  
<Q>2  
<Z>

[Notes]

1. For CODABAR (NW-7), CODE39, Industrial 2of5 and Matrix 2of5, the inter-character pitch of the barcode can be specified. The barcode inter-character pitch is set by specifying the character pitch <P> immediately before.

If not set, the inter-character pitch will be of the same size as a space command.

Example) Inter-letter pitch (Not specified / 0 / 2)	x	Narrow bar width (2 dots) =	Inter-character pitch (4 dots)
Inter-letter pitch (1)	x	Narrow bar width (3 dots) =	Inter-character pitch (3 dots)
Inter-letter pitch (3)	x	Narrow bar width (3 dots) =	Inter-character pitch (9 dots)

2. HRI text of JAN/EAN8, JAN/EAN13, UPC-A will be printed properly in following conditions.

8 dots/mm (203dpi) - Narrow bar width: [02], [03]

12 dots/mm (305dpi) - Narrow bar width: [03], [04]

[Tips]

1. When the value other than valid range is set, command error will occur and barcode will not be printed.
2. Increasing narrow bar width may exceed the print area.
3. Scanner may not read the barcode with valid character pitch when the Character Pitch <P> command is increased. Also, increasing the narrow bar width may cause the same type of problem. For more information, refer to the documentation of your scanner.
4. For specifying the narrow bar width, consider the reading compatibility of scanner beforehand.
5. Adjust the Print Speed <CS> or Print Darkness <#E> commands in case of scanner reading problem.
6. If Start/Stop characters are not included in print data in the specification of CODABAR(NW-7) or CODE39, barcode will be printed; however, scanner can not read it.
7. If sending the print data including check digit in the specification of JAN/EAN-13 or JAN/EAN-8, set the correct calculated value. Barcode will be printed even when the data includes improper check digit; however, scanner can not read it.

Barcode			
Available for	CG400 series		
Barcode ratio		ESC+BT	
Hex code	ESC <1B> <sub>16</sub>	BT <42> <sub>16</sub> <54> <sub>16</sub>	Parameter abbccddee
Default setting	None		
Persistence of the command	When printer is powered off	Set parameter will not be retained	
	Validity in a job	Becomes invalid after execution	
	Validity after a job	Becomes invalid after the job	

[Function]

Specifies the ratio of the narrow gap in regard to the wide gap.

[Format]

<BT>abbccddee

• Parameter

a	[Barcode type]	=	0	:	CODABAR (NW-7)
			1	:	CODE39
			2	:	ITF
			5	:	Industrial 2of5
			6	:	Matrix 2of5
b	[Narrow space]	=	Valid range	:	01 to 99 dots
c	[Wide space]	=	Valid range	:	01 to 99 dots
d	[Narrow bar]	=	Valid range	:	01 to 99 dots
e	[Wide bar]	=	Valid range	:	01 to 99 dots

[Coding example 1] Barcode type: CODE39, Narrow space: 03, Wide space: 06, Narrow bar: 03, Wide bar: 06

<A>

**<BT>103060306**

<V>100<H>200<BW>01233\*ABCD\*

<Q>2

<Z>

[Notes]

1. To print barcode with specified ratio, insert "Barcode print by specified ratio" command <BW> after this command.
2. When <BW> and the Print Quantity <Q> command are not specified, only the registration of bar width ratio of narrow and wide bars will be performed.
3. Only one ratio can be registered.
4. If the data other than specified is set, this will not be registered due to command error.

Barcode			
Available for	CG400 series		
<b>Barcode print by specified ratio</b>		<b>ESC+BW</b>	
Hex code	ESC <1B> <sub>16</sub>	BW <42> <sub>16</sub> <57> <sub>16</sub>	Parameter aabbbn~n
Default setting	None		
Persistence of the command	When printer is powered off	Set parameter will not be retained	
	Validity in a job	Becomes invalid after execution	
	Validity after a job	Becomes invalid after the job	

[Function]

Specifies barcode ratio, saved by <BT>

[Format]

<BW>aabbbn~n

• Parameter

a [Narrow bar width] = Valid range : 01 to 12 dots  
b [Barcode height] = Valid range : 001 to 999 dots  
n [Print data] = Barcode data

[Coding example] Narrow bar width: 02, Barcode height: 120

```
<A>
<BT>103060306
<V>100<H>200<BW>02120*ABCD*
<Q>2
<Z>
```

[Notes]

- Barcode character pitch is available for CODABAR(NW-7), CODE39, Industrial 2of5 and Matrix 2of5. To specify barcode character pitch, insert the Character Pitch <P> command right before barcode symbology.  
When <P> is omitted, character pitch will be equal to narrow space width.  
  
e.g.1) When the narrow space value that was specified at <BT> is [3]:  
Character pitch specification (None or 0, 3) x Narrow bar width (2dots) = Character pitch (6dots)  
e.g.2) When the character pitch is specified:  
Character pitch specification (2) x Narrow bar width (3dots) = Character pitch (6dots)
- If there is no registration of Bar width ratio <BT> command, barcode based on pre-registered bar width ratio of narrow and wide bars will be printed. Note that specification of <BT> is required beforehand to print.
- For print data of barcode symbology, refer to the code table of each barcode.

[Tips]

- If the value other than valid range is set, command error will occur and barcode will not to be printed.
- Increasing narrow bar width may exceed the print area.
- Scanner may not read the barcode with valid character pitch when the Character Pitch <P> command is increased.  
Also, increasing the narrow bar width may cause the same type of problem. For more information, refer to the documentation of your scanner.
- For specifying the narrow bar width, consider the reading compatibility of scanner beforehand.
- Adjust the Print Speed <CS> or Print Darkness <#E> commands in case of scanner reading problem.
- If Start/Stop characters are not included in print data in the specification of CODABAR(NW-7) or CODE39, the print of barcode will be performed; however, scanner cannot read it.



CODABAR (NW-7) code table

					S				I				S				O						
					b8	0	0	0	0	0	0	0	0	1	1	1	1	1	1	1	1	1	
					b7	0	0	0	0	1	1	1	1	0	0	0	0	1	1	1	1	1	
					b6	0	0	1	1	0	0	1	1	0	0	1	1	0	0	1	1	1	
					b5	0	1	0	1	0	1	0	1	0	1	0	1	0	1	0	1	0	1
b4	b3	b2	b1		0	1	2	3	4	5	6	7	8	9	A	B	C	D	E	F			
0	0	0	0	0				0															
0	0	0	1	1				1	A		a												
0	0	1	0	2				2	B		b												
0	0	1	1	3				3	C		c												
0	1	0	0	4			\$	4	D	T	d	t											
0	1	0	1	5				5	E		e												
0	1	1	0	6				6															
0	1	1	1	7				7															
1	0	0	0	8				8															
1	0	0	1	9				9															
1	0	1	0	A			*	:															
1	0	1	1	B			+																
1	1	0	0	C																			
1	1	0	1	D			-																
1	1	1	0	E			.		N		n												
1	1	1	1	F			/																

CODE39 code table

					S				I				S				O					
<b>b8</b>					0	0	0	0	0	0	0	0	0	1	1	1	1	1	1	1	1	
<b>b7</b>					0	0	0	0	1	1	1	1	0	0	0	0	1	1	1	1	1	
<b>b6</b>					0	0	1	1	0	0	1	1	0	0	1	1	0	0	1	1	1	
<b>b5</b>					0	1	0	1	0	1	0	1	0	1	0	1	0	1	0	1	0	1
<b>b4</b>	<b>b3</b>	<b>b2</b>	<b>b1</b>		<b>0</b>	<b>1</b>	<b>2</b>	<b>3</b>	<b>4</b>	<b>5</b>	<b>6</b>	<b>7</b>	<b>8</b>	<b>9</b>	<b>A</b>	<b>B</b>	<b>C</b>	<b>D</b>	<b>E</b>	<b>F</b>		
0	0	0	0	<b>0</b>			SP	0		P												
0	0	0	1	<b>1</b>				1	A	Q												
0	0	1	0	<b>2</b>				2	B	R												
0	0	1	1	<b>3</b>				3	C	S												
0	1	0	0	<b>4</b>			\$	4	D	T												
0	1	0	1	<b>5</b>			%	5	E	U												
0	1	1	0	<b>6</b>				6	F	V												
0	1	1	1	<b>7</b>				7	G	W												
1	0	0	0	<b>8</b>				8	H	X												
1	0	0	1	<b>9</b>				9	I	Y												
1	0	1	0	<b>A</b>			*		J	Z												
1	0	1	1	<b>B</b>			+		K													
1	1	0	0	<b>C</b>					L													
1	1	0	1	<b>D</b>			-		M													
1	1	1	0	<b>E</b>			.		N													
1	1	1	1	<b>F</b>			/		O													

Barcode			
Available for	CG400 series		
<b>GS1-128 (UCC/EAN128)</b> <b>&lt;For standard carton ID&gt;</b>		<b>ESC+BI</b>	
Hex code	ESC <1B>16	BI <42>16<49>16	Parameter aabbbcn~n
Default setting	None		
Persistence of the command	When printer is powered off	Set parameter will not be retained	
	Validity in a job	Becomes invalid after execution	
	Validity after a job	Becomes invalid after the job	

[Function]

Specifies GS1-128 (UCC/EAN128) for standard carton ID.

[Format]

<BI>aabbbcn~n

●Parameter

- a Narrow bar width = Valid range : 01 to 12 dots
- b Barcode height = Valid range : 001 to 999 dots
- c Font of barcode interpretation =
  - 0 : No interpretation
  - 1 : Above barcode
  - 2 : Below barcode
- n Print data = Barcode data (17 digits fixed)

See code table GS-1128 (UCC/EAN128).

EAN128 (for standard carton ID)18 digits fixed

- Identifier of a continuous code for freight packaging
- Type of packaging
- Country, manufacturer code
- Serial number for shipping container
- C/D

\* Check digit is automatically added, therefore, specify data in 17 digits excluding check digit.

[Coding Example] Narrow bar width: 03, Barcode height: 150, HRI characters: Below barcode,  
Print data: 12345678901234567

```
<A>
<V>100<H>200<BI>03150012345678901234567
<Q>2
<Z>
```

[Notes]

1. This command is used only for UCC128 standard carton ID. If EAN128 used for other applications, such as pharmaceutical, horticultural application, use the command <BG> with appropriate application identifier and delimiters.
2. Start character code /Function character/ End character code, and identifier "00" will be automatically added.
3. Check digit Modulus 10 and Modulus 103 will be automatically generated.
4. Sequential numbering by barcode data is possible.
5. Both character pitch of Barcode and HR interpretation is fixed at 10 dots.
6. In case HR interpretation is longer than the barcode's width, the translation will be left-aligned to the start of barcode.
7. In case HR interpretation is shorter than the barcode's width, the translation will be center-aligned.
8. HR interpretation will be printed in OCR-B font.
9. If HR interpretation is out of the printable area, it will not be printed. Consider the output image when determining the vertical<V> and horizontal<H> print position.

ITF  
 Matrix2of5  
 Industrial2of5  
 UPC-A,JAN/EAN-8  
 JAN/EAN-13,UPC-E  
 GS1-128 (UCC/EAN128)  
 MSI Code table

					S				I				S				0					
<b>b8</b>					0	0	0	0	0	0	0	0	0	1	1	1	1	1	1	1	1	
<b>b7</b>					0	0	0	0	1	1	1	1	0	0	0	0	1	1	1	1	1	
<b>b6</b>					0	0	1	1	0	0	1	1	0	0	1	1	0	0	1	1	1	
<b>b5</b>					0	1	0	1	0	1	0	1	0	1	0	1	0	1	0	1	0	1
<b>b4</b>	<b>b3</b>	<b>b2</b>	<b>b1</b>		0	1	2	3	4	5	6	7	8	9	A	B	C	D	E	F		
0	0	0	0	0				0														
0	0	0	1	1				1														
0	0	1	0	2				2														
0	0	1	1	3				3														
0	1	0	0	4				4														
0	1	0	1	5				5														
0	1	1	0	6				6														
0	1	1	1	7				7														
1	0	0	0	8				8														
1	0	0	1	9				9														
1	0	1	0	A																		
1	0	1	1	B																		
1	1	0	0	C																		
1	1	0	1	D																		
1	1	1	0	E																		
1	1	1	1	F																		

Barcode			
Available for	CG400 series		
<b>CODE93</b>		<b>ESC+BC</b>	
Hex code	ESC <1B> <sub>16</sub>	BC <42> <sub>16</sub> <43> <sub>16</sub>	Parameter aabbccn~n
Default setting	None		
Persistence of the command	When printer is powered off	Set parameter will not be retained	
	Validity in a job	Becomes invalid after execution	
	Validity after a job	Becomes invalid after the job	

[Function]

Specifies CODE93 Barcode.

[Format]

<BC>aabbccn~n

●Parameter

a Narrow bar width = Valid range : 01 to 12 dots  
 b Barcode height = Valid range : 001 to 999 dots  
 c Data length (digits) = Valid range : 01 to 99  
 n Print data = Barcode data (See CODE93 code table)

[Coding Example] Narrow bar width: 02, Barcode height: 120, Data length: 12, Print data: ABCD123456xy

```
<A>
<V>100<H>200<BC>0212012ABCD123456xy
<Q>2
<Z>
```

[Notes]

1. Check digit is automatically generated and added.
2. The maximum data length is 99 digits.
3. Data length (number of digits) and quantity of actual input data shall be the same.
4. If the input data is not consistent with the specified data length, a command error will occur.

CODE93 code table

					S				I				S				O							
					b8	0	0	0	0	0	0	0	0	0	1	1	1	1	1	1	1	1	1	
					b7	0	0	0	0	1	1	1	1	1	0	0	0	0	1	1	1	1	1	
					b6	0	0	1	1	0	0	1	1	1	0	0	1	1	0	0	1	1	1	1
					b5	0	1	0	1	0	1	0	1	1	0	1	0	1	0	1	0	1	0	1
b4	b3	b2	b1		0	1	2	3	4	5	6	7	8	9	A	B	C	D	E	F				
0	0	0	0	0			SP	0	@	P	`	p												
0	0	0	1	1			!	1	A	Q	a	q												
0	0	1	0	2			"	2	B	R	b	r												
0	0	1	1	3			#	3	C	S	c	s												
0	1	0	0	4			\$	4	D	T	d	t												
0	1	0	1	5			%	5	E	U	e	u												
0	1	1	0	6			&	6	F	V	f	v												
0	1	1	1	7				7	G	W	g	w												
1	0	0	0	8			(	8	H	X	h	x												
1	0	0	1	9			)	9	I	Y	i	y												
1	0	1	0	A			*	:	J	Z	j	z												
1	0	1	1	B			+	;	K	[	k	{												
1	1	0	0	C			,	<	L	\	l													
1	1	0	1	D			-	=	M	]	m	}												
1	1	1	0	E			.	>	N	^	n	~												
1	1	1	1	F			/	?	O	_	o	DEL												

Selectable range is 00H thru 7FH for CODE93.

Barcode			
Available for	CG400 series		
<b>CODE128 (128A, 128B, 128C)</b>		<b>ESC+BG</b>	
Hex code	ESC <1B>16	BG <42>16<47>16	Parameter aabbbn~n
Default setting	None		
Persistence of the command	When printer is powered off	Set parameter will not be retained	
	Validity in a job	Becomes invalid after execution	
	Validity after a job	Becomes invalid after the job	

[Function]

Specifies CODE128 (128A, 128B, 128C) barcode.

[Format]

<BG>aabbbn~n

●Parameter

a Narrow bar width = Valid range : 01 to 12 dots  
b Barcode height = Valid range : 001 to 999 dots  
n Print data = Barcode data (see code table on the next page)

[Coding Example] Narrow bar width: 02, Barcode height: 120, Print data: ABCD123456 (START CODE A)

<A>  
<V>100<H>200<BG>02120<G>ABCD123456  
<Q>2  
<Z>

[Notes]

- Add valid start code respectively for Type(A,B,C).  
(1)START CODE A = [>G]  
(2)START CODE B = [>H]  
(3)START CODE C = [>I]
- C/D will be automatically added.
- To use CODE128 (128A, 128B, 128C) START CODE C, length of the print data (number of digits) shall be even.
- In case data length(number of digits) is only an odd number for START CODE C, you may first select START CODE A or B, and add one digit, then switch to code set character C to make the total data length even. (Example below)  
e.g.1) 15 digits [123456789012345] : <B>1<C>23456789012345  
e.g.2) 9 numeric/6 alphanumeric 123456789ABC123 : <C>12345678<B>9ABC123
- If data length is an odd number for START CODE C, "0" will be automatically added to the end of the data.
- If START CODE is omitted, the data will be printed with START CODE B.

GS1-128 (128A, 128B, 128C) code table

Value	Code A	Code B	Code C
0	SP	SP	00
1	!	!	01
2	"	"	02
3	#	#	03
4	\$	\$	04
5	%	%	05
6	&	&	06
7			07
8	(	(	08
9	)	)	09
10	*	*	10
11	+	+	11
12	,	,	12
13	-	-	13
14	.	.	14
15	/	/	15
16	0	0	16
17	1	1	17
18	2	2	18
19	3	3	19
20	4	4	20
21	5	5	21
22	6	6	22
23	7	7	23
24	8	8	24
25	9	9	25
26	:	:	26
27	;	;	27
28	<	<	28
29	=	=	29
30	> (See Note 4)	> (See Note 4)	30
31	?	?	31
32	@	@	32
33	A	A	33
34	B	B	34
35	C	C	35
36	D	D	36
37	E	E	37
38	F	F	38
39	G	G	39
40	H	H	40
41	I	I	41
42	J	J	42
43	K	K	43
44	L	L	44
45	M	M	45
46	N	N	46
47	O	O	47
48	P	P	48



Value	Code A	Code B	Code C
49	Q	Q	49
50	R	R	50
51	S	S	51
52	T	T	52
53	U	U	53
54	V	V	54
55	W	W	55
56	X	X	56
57	Y	Y	57
58	Z	Z	58
59	[	[	59
60	\	\	60
61	]	]	61
62	^	^	62
63	—	—	63
64	NUL >SP	>SP	64
65	SOH >!	a >!	65
66	STX >"	b >"	66
67	ETX >#	c >#	67
68	EOT >\$	d >\$	68
69	ENQ >%	e >%	69
70	ACK >&	f >&	70
71	BEL >	g >	71
72	BS >(	h >(	72
73	HT >)	i >)	73
74	LF >*	j >*	74
75	VT >+	k >+	75
76	FF >,	l >,	76
77	CR >-	m >-	77
78	SO >.	n >.	78
79	SI >/	o >/	79
80	DLE >0	p >0	80
81	DC1 >1	q >1	81
82	DC2 >2	r >2	82
83	DC3 >3	s >3	83
84	DC4 >4	t >4	84
85	NAK >5	u >5	85
86	SYN >6	v >6	86
87	ETB >7	w >7	87
88	CAN >8	x >8	88
89	EM >9	y >9	89
90	SUB >:	z >:	90
91	ESC >;	{ >;	91
92	FS ><	><	92
93	GS >=	} >=	93
94	RS >>	~ >>	94
95	US >?	DEL >?	95
96	FNC3 >@	FNC3 >@	96
97	FNC2 >A	FNC2 >A	97

Value	Code A	Code B	Code C
98	SHIFT >B	SHIFT >B	98
99	Code-C >C	Code-C >C	99
100	Code-B >D	FNC4 >D	Code-B >D
101	FNC4 >E	Code-A >E	Code-A >E
102	FNC1 >F	FNC1 >F	FNC1 >F
103	START CODE A >G		
104	B >H		
105	C >I		

**(Notes)**

1. If START CODE is not specified, the data will be printed by START CODE B.
2. STOP CODE is automatically added inside the printer.
3. In Code A and B, specify the codes more than Value64 as a two-digit code with ">".
4. The code ">" is described as ">J".

Barcode			
Available for	CG400 series		
<b>BOOKLAND</b>		<b>ESC+BF</b>	
Hex code	ESC <1B> <sub>16</sub>	BF <42> <sub>16</sub> <46> <sub>16</sub>	Parameter aabbbn~n
Default setting	None		
Persistence of the command	When printer is powered off	Set parameter will not be retained	
	Validity in a job	Becomes invalid after execution	
	Validity after a job	Becomes invalid after the job	

[Function]

Specifies BOOKLAND barcode.

[Format]

<BF>aabbbn~n

•Parameter

a Narrow bar width = Valid range : 01 to 03 dots  
b Barcode height = Valid range : 001 to 999 dots  
n Print data = Barcode data (See BOOKLAND code table)

[Coding Example] Narrow bar width: 03, Barcode height: 130, Print data: 21826

```
<A>
<V>725<H>325<BD>3031504902471000739
<V>760<H>640<BF>0313021826
<Q>2
<Z>
```

[Notes]

1. Only numeric can be specified for print data.
2. Valid data length is 2 and 5 digits.

BOOKLAND Code table

					S				I				S				O					
<b>b8</b>					0	0	0	0	0	0	0	0	0	1	1	1	1	1	1	1	1	
<b>b7</b>					0	0	0	0	1	1	1	1	0	0	0	0	1	1	1	1	1	
<b>b6</b>					0	0	1	1	0	0	1	1	0	0	1	1	0	0	1	1	1	
<b>b5</b>					0	1	0	1	0	1	0	1	0	1	0	1	0	1	0	1	0	1
<b>b4</b>	<b>b3</b>	<b>b2</b>	<b>b1</b>		<b>0</b>	<b>1</b>	<b>2</b>	<b>3</b>	<b>4</b>	<b>5</b>	<b>6</b>	<b>7</b>	<b>8</b>	<b>9</b>	<b>A</b>	<b>B</b>	<b>C</b>	<b>D</b>	<b>E</b>	<b>F</b>		
0	0	0	0	<b>0</b>				0														
0	0	0	1	<b>1</b>				1														
0	0	1	0	<b>2</b>				2														
0	0	1	1	<b>3</b>				3														
0	1	0	0	<b>4</b>				4														
0	1	0	1	<b>5</b>				5														
0	1	1	0	<b>6</b>				6														
0	1	1	1	<b>7</b>				7														
1	0	0	0	<b>8</b>				8														
1	0	0	1	<b>9</b>				9														
1	0	1	0	<b>A</b>																		
1	0	1	1	<b>B</b>																		
1	1	0	0	<b>C</b>																		
1	1	0	1	<b>D</b>																		
1	1	1	0	<b>E</b>																		
1	1	1	1	<b>F</b>																		

Barcode			
Available for	CG400 series		
<b>POSTNET</b>		<b>ESC+BP</b>	
Hex code	ESC <1B> <sub>16</sub>	BP <42> <sub>16</sub> <50> <sub>16</sub>	Parameter n~n
Default setting	None		
Persistence of the command	When printer is powered off	Set parameter will not be retained	
	Validity in a job	Becomes invalid after execution	
	Validity after a job	Becomes invalid after the job	

[Function]

Specifies POSTNET barcode.

[Format]

<BP>n~n

●Parameter

n

= Print data (See POSTNET Code table in next page)

\* Follow the rule of the data length for each format.

- 5 digits (for Postnet-32 format)

- 6 digits (for Postnet-37 format)

- 9 digits (for Postnet-52 format)

- 11 digits (for Postnet-62 Delivery Point format)

[Coding Example] Postal code 11 digits : 01234567890

<A>

<V>100<H>200<BP>**01234567890**

<Q>2

<Z>

[Notes]

1. Data length other than 5, 6, 9, and 11 digits will be invalid.
2. Only numeric can be specified for print data.

POSTNET Code table

					S				I				S				O					
<b>b8</b>					0	0	0	0	0	0	0	0	0	0	1	1	1	1	1	1	1	1
<b>b7</b>					0	0	0	0	1	1	1	1	0	0	0	0	1	1	1	1	1	1
<b>b6</b>					0	0	1	1	0	0	1	1	0	0	1	1	0	0	1	1	1	1
<b>b5</b>					0	1	0	1	0	1	0	1	0	1	0	1	0	1	0	1	0	1
<b>b4</b>	<b>b3</b>	<b>b2</b>	<b>b1</b>		<b>0</b>	<b>1</b>	<b>2</b>	<b>3</b>	<b>4</b>	<b>5</b>	<b>6</b>	<b>7</b>	<b>8</b>	<b>9</b>	<b>A</b>	<b>B</b>	<b>C</b>	<b>D</b>	<b>E</b>	<b>F</b>		
0	0	0	0	<b>0</b>				0														
0	0	0	1	<b>1</b>				1														
0	0	1	0	<b>2</b>				2														
0	0	1	1	<b>3</b>				3														
0	1	0	0	<b>4</b>				4														
0	1	0	1	<b>5</b>				5														
0	1	1	0	<b>6</b>				6														
0	1	1	1	<b>7</b>				7														
1	0	0	0	<b>8</b>				8														
1	0	0	1	<b>9</b>				9														
1	0	1	0	<b>A</b>																		
1	0	1	1	<b>B</b>																		
1	1	0	0	<b>C</b>																		
1	1	0	1	<b>D</b>																		
1	1	1	0	<b>E</b>																		
1	1	1	1	<b>F</b>																		

Barcode			
Available for	CG400 series		
<b>Composite symbol</b>		<b>ESC+EU</b>	
Hex code	ESC <1B> <sub>16</sub>	EU <45> <sub>16</sub> <55> <sub>16</sub>	Parameter aabb(ccc)n~n
Default setting	None		
Persistence of the command	When printer is powered off	Set parameter will not be retained	
	Validity in a job	Becomes invalid after execution	
	Validity after a job	Becomes invalid after the job	

[Function]

Specifies composite symbol.

[Format 1]

<EU>aabbccn~n

●Parameter

- |   |                  |  |
|---|------------------|--|
| a | Barcode type     | = 01: GS1 DataBar Composite(CC-A/CC-B)<br>02: GS1 DataBar Truncated Composite(CC-A/CC-B)<br>03: GS1 DataBar Stacked Composite(CC-A/CC-B)<br>04: GS1 DataBar Stacked Omni-Directional Composite(CC-A/CC-B)<br>05: GS1 DataBar Limited Composite (CC-A/CC-B)<br>06: GS1 DataBar Expanded & Expanded Stacked (CC-A/CC-B)<br>07: UPC-A Composite (CC-A/CC-B)<br>08: UPC-E Composite (CC-A/CC-B)<br>09: EAN-13 Composite (CC-A/CC-B)<br>10: EAN-8 Composite (CC-A/CC-B) |
| b | Narrow bar width | = 01 to 12 (dots)  |
| c | Segment width    | = 02 to 22 (even number only)<br>* Supporting GS1 DataBar Expanded Composite (CC-A/CC-B) only  |
| n | Print data       | = Barcode data   |

Max. number of digit for linear barcode

GS1 DataBar Composite(CC-A/CC-B)	13 digits
GS1 DataBar Truncated Composite(CC-A/CC-B)	13 digits
GS1 DataBar Stacked Composite(CC-A/CC-B)	13 digits
GS1 DataBar Stacked Omni-Directional Composite(CC-A/CC-B)	13 digits
GS1 DataBar Limited Composite (CC-A/CC-B)	13 digits
GS1 DataBar Expanded Composite(CC-A/CC-B)	74 digits
UPC-A Composite(CC-A/CC-B)	11 digits
UPC-E Composite(CC-A/CC-B) Specify linear data in the form of "XX00000XXX"(X is variable)	10 digits (fixed)
EAN-13 Composite(CC-A/CC-B)	12 digits
EAN-8 Composite(CC-A/CC-B)	7 digits

\* Check digit will be automatically calculated and added.

\* To specify the print of composite symbol, delimit 1D data and 2D data with ' | '(7CH).

Data = 1D data | 2D data

\* Specify GS1 DataBar Composite(CC-A/CC-B) data between 1st - 16th digit of GS1 DataBar Expanded Composite(CC-A/CC-B).

\* For GS1 DataBar Expanded Composite(CC-A/CC-B), up to 74-digit of numeric / 41-digit of alphabet can be entered, including GS1 DataBar Composite(CC-A/CC-B) data. (Up to 41-digit of alphanumeric can be entered including GS1 DataBar Composite(CC-A/CC-B) data)

\* If a specified digit number is smaller than the maximum one of 1D data, this value will be zero filled at the front end.

\* In 2D data, up to 338-digit can be entered. Maximum digit number may vary depending on barcode symbologies.

[Format 2]

<EU>aabbcccn~n

• Parameter

a	[1D code type]	=	11:GS1-128 (UCC/EAN128) with CC-A/B 12:GS1-128 (UCC/EAN128) with CC-C
b	[Narrow bar width]	=	01 to 12 (dots)
c	[Barcode height]	=	001 to 500 (dots)
		*	Specify barcode height supposing narrow bar width is 01. When narrow bar width is 03, and bar height is 100, the barcode height becomes 300 dots.
n	[Print data]	=	Barcode data

Maximum number of digits for 1 and 2D data (Restriction on the max. number of digits for 1D data)

GS1-128 (UCC/EAN128) with CC-A/B	338 digits
GS1-128 (UCC/EAN128) with CC-C	2361 digits

Maximum number of digits for 1D data

GS1-128 (UCC/EAN128) with CC-A/B	48 digits
GS1-128 (UCC/EAN128) with CC-C	48 digits

\* To specify the print of composite symbol, delimit 1D data and 2D data with ' | '(7CH).

Data = 1D data | 2D data

\* To specify FNC1(GS) of CC-A/B(Micro PDF) and CC-C(PDF41) as data, make sure to use #'(23H).

\* In 2D data of GS1-128(UCC/EAN128) with CC-A/B, up to 338-digit can be entered.

[Coding example 1] GS1 DataBar Composite(CC-A/CC-B)

<A>  
<V>100<H>100  
<EU>01040361234567890 | 11990102  
<Q>1  
<Z>



[Coding example 2] GS1 DataBar Truncated Composite(CC-A/CC-B)

<A>  
<V>100<H>100  
<EU>02040361234567890 | 11990102  
<Q> 1  
<Z>



[Coding example 3] DataBar Stacked Composite(CC-A/CC-B)

<A>  
<V>100<H>100  
<EU>03040341234567890 | 17010200  
<Q>1  
<Z>



[Coding example 4] DataBar Stacked Omni-Directional Composite(CC-A/CC-B)

<A>  
<V>100<H>100  
<EU>04040341234567890 | 17010200  
<Q>1  
<Z>



[Coding example 5] DataBar Limited Composite (CC-A/CC-B)

<A>  
<V>100<H>100  
<EU>05040351234567890 | 21abcdefghijklmnopqrstuv  
<Q>1  
<Z>



[Coding example 6] UPC-A Composite(CC-A/CC-B)

<A>  
<V>100<H>100  
<EU>0704331234567890 | 991234-abcd  
<Q>1  
<Z>





[Coding example 7] UPC-E Composite(CC-A/CC-B)

<A>  
<V>100<H>100  
<EU>08041200000123|15021231  
<Q>1  
<Z>



[Coding example 8] EAN-13 Composite(CC-A/CC-B)

<A>  
<V>100<H>100  
<EU>0904331234567890|991234-abcd  
<Q>1  
<Z>



[Coding example 9] EAN-8 Composite(CC-A/CC-B)

<A>  
<V>100<H>100  
<EU>10041234567|21A12345678  
<Q>1  
<Z>



[Coding example 10] GS1-128 (UCC/EAN128) with CC-A/B

<A>  
<V>100<H>100  
<EU>11040260103212345678906|21A1B2C3D4E5F6G7H8  
<Q>1  
<Z>



[Coding example 11] GS1-128 (UCC/EAN128) with CC-C

<A>  
<V>100<H>100  
<EU>1204026000030123456789012340|02130123456789  
093724#101234567ABCDEFG  
<Q>1  
<Z>



[Note]

1. Parameter feature varies depending on 1D barcode symbologies.  
Only GS1 DataBar Expanded Composite(CC-A/CC-B)(EU06) is designable for segment width.  
Parameter for height of barcode can be specified for GS1-128 (UCC/EAN128)(EU11,EU12) only.
2. If the invalid value for 1D barcode symbology is set in the data portion, composite symbol will not be printed.
3. The sum of 1D and 2D data up to 2361-digit can be set for the print data parameter. As for 2D data, when 1D barcode symbology and alphanumeric are mixed, the number of designable data may vary.  
If specifying the data exceeding the maximum digit number, barcodes may not be printed properly.
4. Entire size of composite symbol changes depending on the specification of narrow bar width.
5. If composite symbol exceeds the printable area, only the portion within the area will be printed; however, a scanner might read the value of such composite symbol occasionally.
6. In the specification of composite symbol, 1D barcode data affects the width and height of 2D barcode. When the 1D barcode width is very small, specifying the data with the valid digit number will not print anything.
7. Print of HRI cannot be designated with this command.
8. The Rotate <%> command is available, but not the Character Expansion <L> command.
9. When specifying 11 (production date), 12 (due date for payment), 13 (packaging date), 15 (sell by date), or 17 (expiration date) for Application Identifier (AI), specify the valid values to the date (YYMMDD). There is no guarantee for print result if invalid values are specified.
10. When barcode type is GS1 DataBar, the 2D code data of it should be based on the format of Application Identifier.

Barcode			
Available for	CG400 series		
UPC-A barcode (No HRI)		ESC+BL	
Hex code	ESC <1B>16	BL <42>16<4C>16	Parameter abbcccn~n
Default setting	None		
Persistence of the command	When printer is powered off	Set parameter will not be retained	
	Validity in a job	Becomes invalid after execution	
	Validity after a job	Becomes invalid after the job	

[Function]

Specifies UPC-A Barcode with start/end bar in the same length with guard bar.

[Format]

<BL>abbcccn~n

●Parameter

a	Barcode type	= H	: UPC-A("H"Fixed)
b	Narrow bar width	= Valid range	: 01 to 12 dots
c	Barcode height	= Valid range	: 001 to 999 dots
n	Print data	= Data	: 11 digits fixed

[Coding Example] Barcode type: UPC-A, Narrow bar width: 03, Barcode height: 120, Print data: 01234567890

```
<A>
<V>100<H>100<BL>H0312001234567890
<Q>2
<Z>
```

[Notes]

1. This command supports UPC-A. Selecting barcode type other than "H" will result in a command error.
2. Refer to the following settings.

Barcode setting		
Guard bar	HRI	Ratio
Yes	No	Fixed

3. If a parameter is specified out of the range, its behavior will not be supported.
4. When using command <D> to print UPC-A, the character bars will be all in the same length. The command <BL> will print the start bar and end bar in the same length as that of guard bars



Print result of UPC-A by command <D>



Print result of UPC-A by command <BL>

Barcode			
Available for	CG400 series		
<b>UPC-A barcode (HRI font designation)</b>		<b>ESC+BL ~ ESC+d</b>	
Hex code	ESC <1B>16	BL~d <42>16<4C>16 -Font type	Parameter abbcccn~n~<d>n~n
Default setting	None		
Persistence of the command	When printer is powered off	Set parameter will not be retained	
	Validity in a job	Becomes invalid after execution	
	Validity after a job	Becomes invalid after the job	

[Function]

Specifies font type of UPC-A (with HRI characters)

[Format]

<BL>abbcccn~n ~ <d>n~n

●Parameter

a	Barcode type	=	H	:	UPC-A ("H" fixed)
b	Narrow bar width	=		:	Valid range : 01 to 12 dots
c	Barcode height	=		:	Valid range : 001 to 999 dots
n	Print data	=		:	Barcode data : 11 digits fixed
d	Font	=	XU XS XM XB XL OA OB U* S* M* WB* WL*		

\*Compatible fonts for old models and shall not be disclosed to end users.

n	Print data	=	HRI data	:	12 digits fixed
---	------------	---	----------	---	-----------------

[Coding Example]

Barcode type : UPC-A, Narrow bar width : 02, Barcode height : 120  
Barcode data : 01234567890, Font type : X21, Translation data : 012345678905

```
<A>
<V>100<H>200<BL>H0212001234567890
<X21>012345678905
<Q>2
<Z>
```

[Notes]

1. This command supports UPC-A only. Selecting barcode type other than "H" will be a command error.
2. Recommended narrow bar width for UPC-A with HRI:
  - 8 dot/mm resolution [02], [03]
  - 12 dot/mm resolution [03], [04]
3. Calculate the 12<sup>th</sup> check digit of HRI data by using Modulus 10.
4. Refer to the following settings.

Barcode setting

Guard bar	HRI	Ratio
Yes	Yes	Fixed

5. If a parameter is specified out of the range, its behavior will not be supported.
6. The command <D> with specifying font type to print UPC-A will print the character bars all in the same length. On the other hand, the command <BL> with font type selection will print the start bar and end bar in the same length as that of guard bars. When printing UPC-A with command<D> followed by <font type> data, its HRI can be printed from under the start/end bar, because the length of them is short. When printing UPC-A with command <BL> followed by <font type> data, character spacing of the HRI will be smaller than command <BL> because the length of start and end bars is longer.

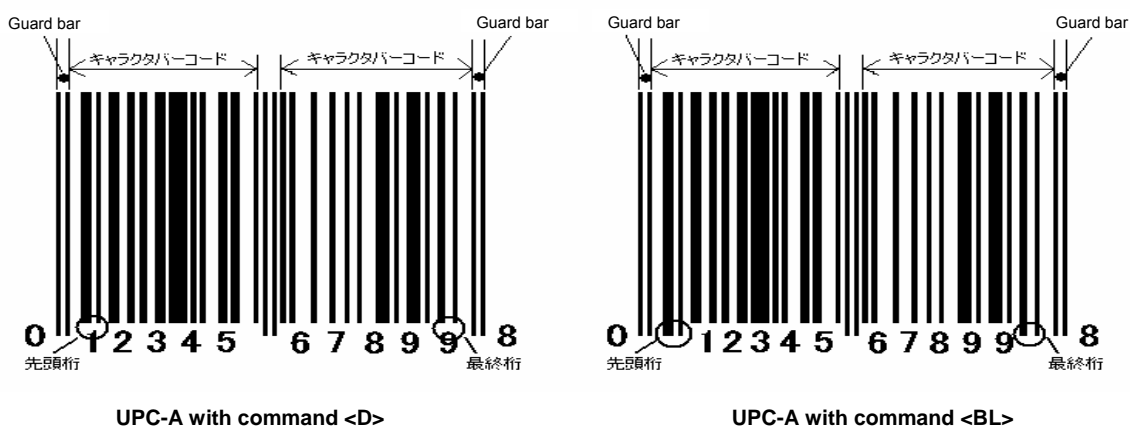

Barcode			
Available for	CG400 series		
UPC-A barcode (with HRI)		ESC+BM	
Hex code	ESC <1B>16	BM <42>16<4D>16	Parameter abbcccn~n
Default setting	None		
Persistence of the command	When printer is powered off	Set parameter will not be retained	
	Validity in a job	Becomes invalid after execution	
	Validity after a job	Becomes invalid after the job	

[Function]

Specifies UPC-A barcode with HRI characters. The start and end bar height will be the same length as that of guard bars.

[Format]

<BM>abbcccn~n

●Parameter

a	Barcode type	= H	:	UPC-A ("H" fixed)
b	Narrow bar width	= Valid range	:	01 to 12 dots
c	Barcode height	= Valid range	:	001 to 999 dots
n	Print data	= Data	:	11 digits fixed

[Coding Example] Barcode type : UPC-A, Narrow bar width : 02, Barcode height : 120, Print data : 20123948573

```
<A>
<V>240<H>100<BM>H0212020123948573
<Q>2
<Z>
```

[Notes]

1. This command supports UPC-A only. Selecting barcode type other than "H" will be a command error.
2. Recommended narrow bar width for UPC-A with HRI characters:
  - 8 dots/mm resolution [02], [03]
  - 12 dots/mm resolution [03], [04]

3. Refer to the following settings.

Barcode setting

Guard bar	HRI	Ratio
Yes	Yes	Fixed

4. If a parameter is specified out of the range, its behavior will not be supported.
5. The command <BD> with specifying font type to print UPC-A will print the character bars all in the same length. On the other hand, the command <BM> will print the start bar and end bar in the same length as that of guard bars. When printing UPC-A with command <BD>, its HRI can be printed from under the start/end bar, because the length of them is short. When printing UPC-A with command <BM>, character spacing of the HRI will be smaller than command <BD>

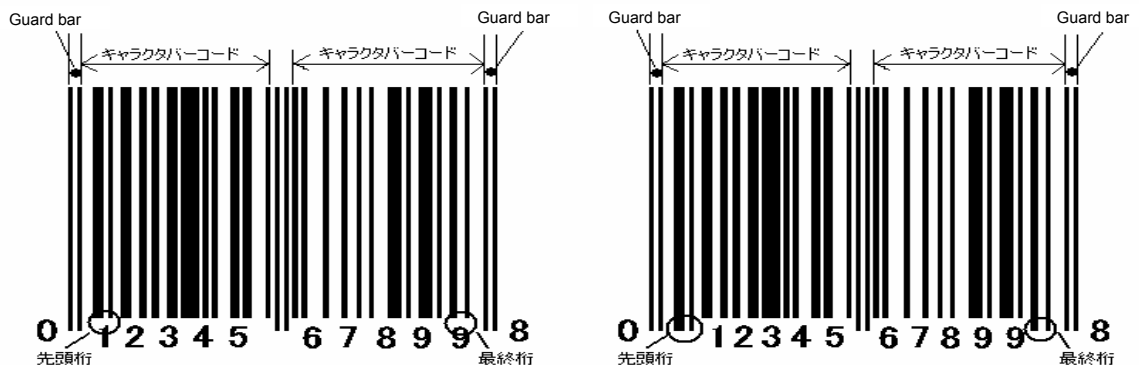

UPC-A with command <BD>

UPC-A with command <BM>

# 11. 2D Code Command

11.1 2D Code			
Available for	CG400 series		
<b>PDF417</b>		<b>ESC+2D10</b>	
Hex code	ESC <1B>16	2D10 <32>16<44>16<31>16<30>16	Parameter ,aa,bb,c,dd,ee,(f)
Default setting	None		
Persistence of the command	When printer is powered off	Set parameter will not be retained	
	Validity in a job	Becomes invalid after execution	
	Validity after a job	Becomes invalid after the job	

[Function]

Specifies 2D Code PDF417.

[Format]

<2D10>,aa,bb,c,dd,ee,(f)

•Parameter

a	Minimum module width	= Valid range	: 01 to 09 dots
b	Minimum module height	= Valid range	: 01 to 24 dots
c	Security level	= Valid range	: 0 to 8
d	Code words per line	= Valid range	: 01 to 30
e	Rows per symbol	= Valid range	: 03 to 90
		00	: Auto (Module width auto-justified according to data quantity)
f	Code type (Omissible)	= 0	: Normal (when omitted)
		1	: Truncated

[Format](Data part)

<DN>mmmm,n~n

•Parameter

m	Quantity of data	= Valid range	: 1 to 2681 bytes
n	Print data	= Data	

[Coding Example1]

Min.module width : 03 dots, Min. module height : 09 dots  
Security level : 3, Data code words per line : 03  
Rows per symbol : 18

<A>  
<V>100<H>200<2D10>.03.09.3.03.18  
<DN>0010,0123456789  
<Q>2  
<Z>



[Coding Example2]

Min.module width : 03 dots, Min. module height : 09 dots  
Security Level : 3, Data code words per line : 03  
Rows per symbol : 18, Code type : Truncated

<A>  
<V>100<H>200<2D10>.03.09.3.03.18,1  
<DN>0010,0123456789  
<Q>2  
<Z>



[Notes]

1. By command <V>(Vertical print position) and <H>(Horizontal print position) print start position can be specified.

<V>100<H>200<2D10>\*\*\* . . . . . \*\*

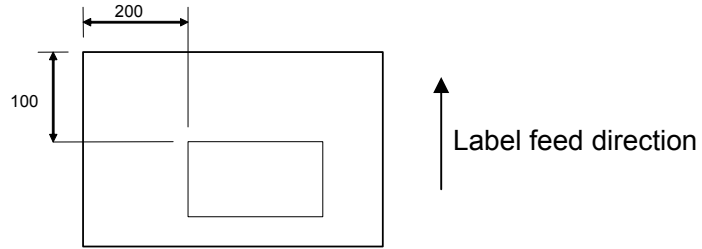

2. In case the both parameter d=e=00, aspect ration will be 1:2.
3. Parameters and data size being inconsistent may not be printed properly.
4. Higher Security Level will require larger numbers for parameter "d" or "e".
5. Min. module width 01,02dot are not recommendable with a risk of lower scanner-readability.
6. Min. module height 01,02,03 dots are not recommendable with a risk of lower scanner-readability.

[Tips]

1. No sequential numbering is possible for PDF417.
2. No print position setting is possible by auto-CR.
3. 00H - FFH can be specified as print data.
4. Increase minimum module dimensions for better quality, as necessary.
5. Increase Security Level for better scanner-readability, as necessary.
6. Height of print image will differ for alphabet, numeric, and alpha-numeric data.

PDF417 Code table

					S				I				S				O					
<b>b8</b>					0	0	0	0	0	0	0	0	0	0	1	1	1	1	1	1	1	1
<b>b7</b>					0	0	0	0	1	1	1	1	0	0	0	0	1	1	1	1	1	1
<b>b6</b>					0	0	1	1	0	0	1	1	0	0	1	1	0	0	1	1	1	1
<b>b5</b>					0	1	0	1	0	1	0	1	0	1	0	1	0	1	0	1	0	1
<b>b4</b>	<b>b3</b>	<b>b2</b>	<b>b1</b>		<b>0</b>	<b>1</b>	<b>2</b>	<b>3</b>	<b>4</b>	<b>5</b>	<b>6</b>	<b>7</b>	<b>8</b>	<b>9</b>	<b>A</b>	<b>B</b>	<b>C</b>	<b>D</b>	<b>E</b>	<b>F</b>		
0	0	0	0	<b>0</b>			SP	0	@	P	`	p										
0	0	0	1	<b>1</b>			!	1	A	Q	a	q										
0	0	1	0	<b>2</b>			"	2	B	R	b	r										
0	0	1	1	<b>3</b>			#	3	C	S	c	s										
0	1	0	0	<b>4</b>			\$	4	D	T	d	t										
0	1	0	1	<b>5</b>			%	5	E	U	e	u										
0	1	1	0	<b>6</b>			&	6	F	V	f	v										
0	1	1	1	<b>7</b>			'	7	G	W	g	w										
1	0	0	0	<b>8</b>			(	8	H	X	h	x										
1	0	0	1	<b>9</b>			)	9	I	Y	i	y										
1	0	1	0	<b>A</b>			*	:	J	Z	j	z										
1	0	1	1	<b>B</b>			+	;	K	[	k	{										
1	1	0	0	<b>C</b>			,	<	L	¥	l											
1	1	0	1	<b>D</b>			-	=	M	]	m	}										
1	1	1	0	<b>E</b>			.	>	N	^	n	~										
1	1	1	1	<b>F</b>			/	?	O	_	o	DEL										

Selectable range is 00H thru FFH for PDF417



2D Code			
Available for	CG400 series		
<b>Micro PDF</b>		<b>ESC+2D12</b>	
Hex code	ESC <1B>16	2D12 <32>16<44>16<31>16<32>16	Parameter ,aa,bb,c,dd,(e)
Default setting	None		
Persistence of the command	When printer is powered off	Set parameter will not be retained	
	Validity in a job	Becomes invalid after execution	
	Validity after a job	Becomes invalid after the job	

[Function]

Specifies Micro PDF.

[Format] (Setting portion)

<2D12>,aa,bb,c,dd,(e)

●Parameter

a	Minimum module width	= Valid range : 01 to 09 (dots)
b	Minimum module height	= Valid range : 01 to 24 (dots)
c	Code words per line (Cols)	= Valid range : 1 to 4
d	Rows per symbol (Rows)	= Valid range : 2 digits
e	Binary mode (Omissible)	= 0 : Normal (when omitted) 1 : Binary mode

[Format] (Data portion)

<DN>mmmm,n~n : When Binary mode is set to [1]  
<DS>n~n : When Binary mode is set to [0]

●Parameter

m	Quantity of data	= Valid range : 0001 to 0366 (bytes)
n	Print data	= Data

[Coding Example] Module width: 02 dots, Module height: 04 dots  
Code words per line: 1, Rows per symbol: 14

<A>  
<V>100<H>200<2D12>02.04.1.14  
<DN>0010,0123456789  
<Q>2  
<Z>



[Note]

1. Rows per symbol is subject to the number of data code word per line. See table in next page for symbol size and data quantity.

\* Symbol size and Max. data quantity (Byte) of Micro PDF (Only the following 34 types are available)

Micro PDF Symbol size and data quantity

Symbol size		Max. Data quantity (Byte)		
Cols(c)	Rows(d)	Numeric (A to Z)only	Numeric	Binary
1	11	6	8	3
	14	12	17	7
	17	18	26	10
	20	22	32	13
	24	30	44	18
	28	38	55	22
2	8	14	20	8
	11	24	35	14
	14	36	52	21
	17	46	67	27
	20	56	82	33
	23	64	93	38
	26	72	105	43
3	6	10	14	6
	8	18	26	10
	10	26	38	15
	12	34	49	20
	15	46	67	27
	20	66	96	39
	26	90	132	54
	32	114	167	68
	38	138	202	82
	44	162	237	97
4	4	14	20	8
	6	22	32	13
	8	34	49	20
	10	46	67	27
	12	58	85	34
	15	76	111	45
	20	106	155	63
	26	142	208	85
	32	178	261	106
	38	214	313	128
	44	250	366	150

\* Combination of alphabet (Upper/Lower case), numeric and control code varies depending on the number of characters.

Micro PDF Code table

					S				I				S				O					
<b>b8</b>					0	0	0	0	0	0	0	0	0	0	1	1	1	1	1	1	1	1
<b>b7</b>					0	0	0	0	1	1	1	1	0	0	0	0	1	1	1	1	1	1
<b>b6</b>					0	0	1	1	0	0	1	1	0	0	1	1	0	0	1	1	1	1
<b>b5</b>					0	1	0	1	0	1	0	1	0	1	0	1	0	1	0	1	0	1
<b>b4</b>	<b>b3</b>	<b>b2</b>	<b>b1</b>		<b>0</b>	<b>1</b>	<b>2</b>	<b>3</b>	<b>4</b>	<b>5</b>	<b>6</b>	<b>7</b>	<b>8</b>	<b>9</b>	<b>A</b>	<b>B</b>	<b>C</b>	<b>D</b>	<b>E</b>	<b>F</b>		
0	0	0	0	<b>0</b>			SP	0	@	P	`	p										
0	0	0	1	<b>1</b>			!	1	A	Q	a	q										
0	0	1	0	<b>2</b>			"	2	B	R	b	r										
0	0	1	1	<b>3</b>			#	3	C	S	c	s										
0	1	0	0	<b>4</b>			\$	4	D	T	d	t										
0	1	0	1	<b>5</b>			%	5	E	U	e	u										
0	1	1	0	<b>6</b>			&	6	F	V	f	v										
0	1	1	1	<b>7</b>			'	7	G	W	g	w										
1	0	0	0	<b>8</b>			(	8	H	X	h	x										
1	0	0	1	<b>9</b>			)	9	I	Y	i	y										
1	0	1	0	<b>A</b>			*	:	J	Z	j	z										
1	0	1	1	<b>B</b>			+	;	K	[	k	{										
1	1	0	0	<b>C</b>			,	<	L	¥	l											
1	1	0	1	<b>D</b>			-	=	M	]	m	}										
1	1	1	0	<b>E</b>			.	>	N	^	n	~										
1	1	1	1	<b>F</b>			/	?	O	_	o	DEL										

Selectable range is 00H thru FFH for Micro PDF Code.

2D Code			
Available for	CG400 series		
<b>MAXI code</b>		<b>ESC+2D20</b>	
Hex code	ESC <1B>16	2D20 <32>16<44>16<32>16<30>16	Parameter ,a(,bbb,ccc,d~d)
Default setting	None		

Persistence of the command	When printer is powered off	Set parameter will not be retained
	Validity in a job	Becomes invalid after execution
	Validity after a job	Becomes invalid after the job

[Function]  
Specifies MAXI Code.

[Format] (Setting portion)  
<2D20>,a(,bbb,ccc,d~d)

- Parameter
- a Mode = 2 : Delivery (Numeric only)
- 3 : Delivery (Alphanumeric)
- 4 : Standard symbol
- 6 : for Reader device only

The following parameters shall be specified when mode [2] or [3] is selected. Omit the following if selection is [4] or [6].

- b Service class = Valid range : 001 to 999 (Numeric)
  - c Country code = Valid range : 001 to 999 (Numeric)
  - d Postal code = Valid range : 0 to 999999999 (Mode2)  
000000 to 999999 (Mode3)
- Mode 2 accepts max. 9digits numeric only  
Mode 3 accepts 6digits only (Upper case only for alphabet)

[Format] (Data portion)  
<DN>mmmm,n~n

- Parameter
  - m Quantity of data = Valid range : 1 to 138
  - n Print data = Data
- \* 00H cannot be specified

Mode	Service class	Country code	Postal code	Max. data quantity	
				Numeric	Alphanumeric.
2	3digits Fixed (Numeric only)	3digits Fixed (Numeric only)	Max. 9 digits	123	84
3			6 digits fixed (Alphanumeric)		
4	Omitted			138	93
6	Omitted				

[Coding Example] Mode: Delivery (Numeric only), Service Class: 003, Country code: 081  
Postal code: 123456789

```
<A>
<V>100<H>200<2D20>,2,003,081,123456789
<DN>0010,0123456789
<Q>2
<Z>
```

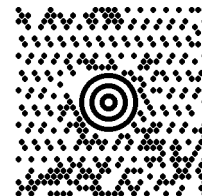

[Notes]

- The size of the symbol printed is not subject to data volume. (Quantity of data)
- Any other parameters specified or settings being inconsistent with each other will result in no printing.
- In case mode [4] or [6] is selected, be sure to have data size (in byte) larger than 12 (bytes), smaller data volume will result in failure of scanner-reading.

**MAXI code Code table**

					S				I				S				O						
					b8	0	0	0	0	0	0	0	0	1	1	1	1	1	1	1	1	1	
					b7	0	0	0	0	1	1	1	1	0	0	0	0	1	1	1	1	1	
					b6	0	0	1	1	0	0	1	1	0	0	1	1	0	0	1	1	1	
					b5	0	1	0	1	0	1	0	1	0	1	0	1	0	1	0	1	0	1
b4	b3	b2	b1		0	1	2	3	4	5	6	7	8	9	A	B	C	D	E	F			
0	0	0	0	0			SP	0	@	P	`	p											
0	0	0	1	1			!	1	A	Q	a	q											
0	0	1	0	2			"	2	B	R	b	r											
0	0	1	1	3			#	3	C	S	c	s											
0	1	0	0	4			\$	4	D	T	d	t											
0	1	0	1	5			%	5	E	U	e	u											
0	1	1	0	6			&	6	F	V	f	v											
0	1	1	1	7			'	7	G	W	g	w											
1	0	0	0	8			(	8	H	X	h	x											
1	0	0	1	9			)	9	I	Y	i	y											
1	0	1	0	A			*	:	J	Z	j	z											
1	0	1	1	B			+	;	K	[	k	{											
1	1	0	0	C			,	<	L	¥	l												
1	1	0	1	D			-	=	M	]	m	}											
1	1	1	0	E			.	>	N	^	n	~											
1	1	1	1	F			/	?	O	_	o	DEL											

Selectable range is 01H thru FFH for MAXI Code.

2D Code			
Available for	CG400 series		
<b>QR code (Model 2)</b>		<b>ESC+2D30</b>	
Hex code	ESC	2D30	Parameter
	<1B>16	<32>16<44>16<33>16<30>16	,a,bb,c,d(,ee,ff,gg)
Default setting	None		
Persistence of the command	When printer is powered off	Set parameter will not be retained	
	Validity in a job	Becomes invalid after execution	
	Validity after a job	Becomes invalid after the job	

[Function]

Specifies QR code (Model2).

[Format] (Setting portion)

<2D30>,a,bb,c,d(,ee,ff,gg)

●Parameter

- a Error correction level = L : 7%  
M : 15%  
Q : 25%  
H : 30%
- b Size of one side of cell = Valid range : 01 to 32 dots
- c Data setting mode = 0 : Manual  
1 : Auto
- \* Note that the way of print data setting is different in each setting mode.
- d Concatenation mode = 0 : Normal mode  
1 : Concatenation mode

In case [concatenation mode] is selected, the following settings are mandatory. If normal mode is selected, omit the settings below.

- e Quantity of partitions by concatenation mode = Valid range : 01 to 16  
(How many partitioned QR codes are concatenated.)
- f Sequential number partitioned by concatenation = Valid range : 01 to 16  
(Sequential numbering to each partitioned symbol)
- g Concatenation parity data = Valid range : 00 to FF  
(Parity data is a result of XOR calculation of entire data of QR Code expressed in Hexadecimal character)

[Format] (Data portion)

<DS>k,n~n

<DN>mmmm,n~n

●Parameter

- k Input character mode = 1 : Numeric mode  
2 : Alphanumeric mode  
3 : Kanji (Shift JIS Kanji code)

This setting is only required when manual data setting is selected.  
Use command <DN> for binary data input.

- m Quantity of data = Valid range : 1 to 2953  
When auto data setting is selected, or binary data input is selected, Quantity of data shall be specified.
- n Print data = Data

[Coding Example] Error correction level: 7%, Size of one side of cell: 05  
Data setting mode: manual, Concatenation mode: Normal

<A>  
<V>100<H>200<2D30>L.05.0.0  
<DS>1,012345  
<Q>2  
<Z>



[Notes]

1. In case any other parameters than above are specified, or parameters and quantity of data are not consistent with each other, the symbol will not be printed correctly.
2. Note that data part use two different commands <DS> and <DN> according to input mode.

**Auto setting (Data setting mode)**

<DN>mmmm,n~n

[Tips 1]

1. When Kanji is to be specified, quantity of data shall be twice as many as number of total Kanji characters.
2. The address 80H~9FH, E0H~FFH cannot be used for binary data input, since these characters are only handled in Kanji mode.

**Binary input in manual data setting mode**

<DN>mmmm,n~n

**Other input mode**

<DS>1,n~n (Numeric)  
<DS>2,n~n (Alphanumeric)  
<DS>3,n~n (Kanji)

**Mixture of different data input mode**

Different data input mode can be used in the same command string. See example below.

<A>  
<V>100<H>100  
<2D30>a,bb,c,d  
<DS>3,n~n  
<DN>mmmm,n~n  
<DS>1,n~n  
<Q>1  
<Z>

[Tips 2]

1. Data part shall follow directly symbol format part , or a data part and other data part shall follow successively without interval. Otherwise printed result may be incorrect.
2. Quantity of data shall no exceed the maximum 7000 bytes. Also the maximum number of data block, which can be used in one symbol is 200.

QR data size table (Model 2)

Version	Error correction	Numeric	Alphanum	Kanji	Binary
1 21x21	L	41	25	10	17
	M	34	20	8	14
	Q	27	16	7	11
	H	17	10	4	7
2 25x25	L	77	47	20	32
	M	63	38	16	26
	Q	48	29	12	20
	H	34	20	8	14
3 29x29	L	127	77	32	53
	M	101	61	26	42
	Q	77	47	20	32
	H	58	35	15	24
4 33x33	L	187	114	48	78
	M	149	90	38	62
	Q	111	67	28	46
	H	82	50	21	34
5 37x37	L	255	154	65	106
	M	202	122	52	84
	Q	144	87	37	60
	H	106	64	27	44
6 41x41	L	322	195	82	134
	M	255	154	65	106
	Q	178	108	45	74
	H	139	84	36	58
7 45x45	L	370	224	95	154
	M	293	178	75	122
	Q	207	125	53	86
	H	154	93	39	64
8 49x49	L	461	279	118	192
	M	365	221	93	152
	Q	259	157	66	108
	H	202	122	52	84
9 53x53	L	552	335	141	230
	M	432	262	111	180
	Q	312	189	80	130
	H	235	143	60	98
10 57x57	L	652	395	167	271
	M	513	311	131	213
	Q	364	221	93	151
	H	288	174	74	119

Version	Error correction	Numeric	Alphanum	Kanji	Binary
11 61x61	L	772	468	198	321
	M	604	366	155	251
	Q	427	259	109	177
	H	331	200	85	137
12 65x65	L	883	535	226	367
	M	691	419	177	287
	Q	489	296	125	203
	H	374	227	96	155
13 69x69	L	1022	619	262	425
	M	796	483	204	331
	Q	580	352	149	241
	H	427	259	109	177
14 73x73	L	1101	667	282	458
	M	871	528	223	362
	Q	621	376	159	258
	H	468	283	120	194
15 77x77	L	1250	758	320	520
	M	991	600	254	412
	Q	703	426	180	292
	H	530	321	136	220
16 81x81	L	1408	854	361	586
	M	1082	656	277	450
	Q	775	470	198	322
	H	602	365	154	250
17 85x85	L	1548	938	397	644
	M	1212	734	310	504
	Q	876	531	224	364
	H	674	408	173	280
18 89x89	L	1725	1046	442	718
	M	1346	816	345	560
	Q	948	574	243	394
	H	746	452	191	310
19 93x93	L	1903	1153	488	792
	M	1500	909	384	624
	Q	1063	644	272	442
	H	813	493	208	338
20 97x97	L	2061	1249	528	858
	M	1600	970	410	666
	Q	1159	702	297	482
	H	919	557	235	382



Version	Error correction	Numeric	Alphanum	Kanji	Binary
21 101x101	L	2232	1352	572	929
	M	1708	1035	438	711
	Q	1224	742	314	509
	H	969	587	248	403
22 105x105	L	2409	1460	618	1003
	M	1872	1134	480	779
	Q	1358	823	348	565
	H	1056	640	270	439
23 109x109	L	2620	1588	672	1091
	M	2059	1248	528	857
	Q	1468	890	376	611
	H	1108	672	284	461
24 113x113	L	2812	1704	721	1171
	M	2188	1326	561	911
	Q	1588	963	407	661
	H	1228	744	315	511
25 117x117	L	3057	1853	784	1273
	M	2395	1451	614	997
	Q	1718	1041	440	715
	H	1286	779	330	535
26 121x121	L	3283	1990	842	1367
	M	2544	1542	652	1059
	Q	1804	1094	462	751
	H	1425	864	365	593
27 125x125	L	3517	2132	902	1465
	M	2701	1637	692	1125
	Q	1933	1172	496	805
	H	1501	910	385	625
28 129x129	L	3669	2223	940	1528
	M	2857	1732	732	1190
	Q	2085	1263	534	868
	H	1581	958	405	658
29 133x133	L	3909	2369	1002	1628
	M	3035	1839	778	1264
	Q	2181	1322	559	908
	H	1677	1016	430	698
30 137x137	L	4158	2520	1066	1732
	M	3289	1994	843	1370
	Q	2358	1429	604	982
	H	1782	1080	457	742

Version	Error correction	Numeric	Alphanum	Kanji	Binary
31 141x141	L	4417	2677	1132	1840
	M	3486	2113	894	1452
	Q	2473	1499	634	1030
	H	1897	1150	486	790
32 145x145	L	4686	2840	1201	1952
	M	3693	2238	947	1538
	Q	2670	1618	684	1112
	H	2022	1226	518	842
33 149x149	L	4965	3009	1273	2068
	M	3909	2369	1002	1628
	Q	2805	1700	719	1168
	H	2157	1307	553	898
34 153x153	L	5253	3183	1347	2188
	M	4134	2506	1060	1722
	Q	2949	1787	756	1228
	H	2301	1394	590	958
35 157x157	L	5529	3351	1417	2303
	M	4343	2632	1113	1809
	Q	3081	1867	790	1283
	H	2361	1431	605	983
36 161x161	L	5836	3537	1496	2431
	M	4588	2780	1176	1911
	Q	3244	1966	832	1351
	H	2524	1530	647	1051
37 165x165	L	6153	3729	1577	2563
	M	4775	2894	1224	1989
	Q	3417	2071	876	1423
	H	2625	1591	673	1093
38 169x169	L	6479	3927	1661	2699
	M	5039	3054	1292	2099
	Q	3599	2181	923	1499
	H	2735	1658	701	1139
39 173x173	L	6743	4087	1729	2809
	M	5313	3220	1362	2213
	Q	3791	2298	972	1579
	H	2927	1774	750	1219
40 177x177	L	7089	4296	1817	2953
	M	5596	3391	1435	2331
	Q	3993	2420	1024	1663
	H	3057	1852	784	1273

2D Code			
Available for	CG400 series		
<b>QR code (Model 1)</b>		<b>ESC+2D31</b>	
Hex code	ESC	2D31	Parameter
	<1B> <sub>16</sub>	<32> <sub>16</sub> <44> <sub>16</sub> <33> <sub>16</sub> <31> <sub>16</sub>	,a,bb,c,d(,ee,ff,gg)
Default setting	None		
Persistence of the command	When printer is powered off	Set parameter will not be retained	
	Validity in a job	Becomes invalid after execution	
	Validity after a job	Becomes invalid after the job	

[Function]

Specifies QR code (Model1)

[Format]

<2D31>,a,bb,c,d(,ee,ff,gg)

●Parameter

- a Error correction level = L : 7%  
M : 15%  
Q : 25%  
H : 30%
- b Size of one side of cell = Valid range : 01 to 32 dots
- c Data setting mode = 0 : Manual  
1 : Auto
- Note that two different data setting modes above are available.
- d Concatenation mode = 0 : Normal mode  
1 : Concatenation mode

In case concatenation mode is selected, the following settings are mandatory. If normal mode is selected, omit the settings below.

- e Quantity of partitions by concatenation mode = Valid range : 01 to 16  
(How many partitioned QR codes are concatenated.)
- f Sequential number partitioned by concatenation = Valid range : 01 to 16  
(Sequential numbering to each partitioned symbol)
- g Concatenation parity data = Valid range : 00 to FF  
(Parity data is a result of XOR calculation of entire data of QR Code expressed in Hexadecimal character.)

[Format] (Data portion)

<DS>k,n~n  
<DN>mmmm,n~n

●Parameter

- k Input character mode = 1 : Numeric mode  
2 : Alphanumeric mode  
3 : Kanji mode (ShiftJIS Kanji code)

This setting is only required when manual data setting is selected.  
Use command <DN> for binary data input.

- m Quantity of data = Valid range : 1 to 486  
When auto data setting is selected, or binary data input is selected, Quantity of data shall be specified.
- n Print data = Data

[Coding Example]

Error correction level: 7%,  
Data setting mode: manual,

Size of one side of cell: 05  
Concatenation mode: Normal

<A>  
<V>100<H>200  
<2D31>,L,05,0,0  
<DS>1,012345  
<Q>2  
<Z>



[Notes]

1. In case any other parameters than above are specified, or parameters and quantity of data are not consistent with each other, the symbol will not be printed correctly.
2. Note that data part use two different commands <DS> and <DN> according to input mode.

**Auto setting (Data setting mode)**

<DN>mmmm,n~n

[Tips 1]

1. When Kanji is to be specified, quantity of data shall be twice as many number as total Kanji characters.
2. The address 80H~9FH and E0H~FFH cannot be used for binary data input, since these characters are only handled in Kanji mode.

**Binary input in manual data setting mode**

<DN>mmmm,n~n

**Other input mode**

<DS>1,n~n (Numeric)  
<DS>2,n~n (Alphanumeric)  
<DS>3,n~n (Kanji)

**Mixture of different data input mode**

Different data input mode can be used in the same command string. See example below.

<A>  
<V>100<H>100  
<2D31>,a,bb,c,d  
<DS>3,n~n  
<DN>mmmm,n~n  
<DS>1,n~n  
<Q>1  
<Z>

[Tips 2]

1. Data part shall follow directly symbol format part , or a data part and other data part shall follow successively without interval. Otherwise printed result may be incorrect.

QR data size table (Model 1)

Version	Error correction	Numeric	Alphanum	Kanji	Binary
1 21x21	L	40	24	10	17
	M	33	20	8	14
	Q	25	15	6	11
	H	16	10	4	7
2 25x25	L	81	49	20	34
	M	66	40	17	28
	Q	52	31	13	22
	H	33	20	8	14
3 29x29	L	131	79	33	55
	M	100	60	25	42
	Q	81	49	20	34
	H	52	31	13	22
4 33x33	L	186	113	48	78
	M	138	84	35	58
	Q	114	69	29	48
	H	76	46	19	32
5 37x37	L	253	154	65	106
	M	191	116	49	80
	Q	157	95	40	66
	H	105	63	27	44
6 41x41	L	321	194	82	134
	M	249	151	64	104
	Q	201	122	51	84
	H	133	81	34	56
7 45x45	L	402	244	103	168
	M	311	188	80	130
	Q	253	154	65	106
	H	167	101	43	70
8 49x49	L	493	299	126	206
	M	378	229	97	158
	Q	301	183	77	126
	H	203	123	52	85
9 53x53	L	585	354	150	244
	M	441	267	113	184
	Q	369	223	94	154
	H	239	145	61	100
10 57x57	L	690	418	177	287
	M	526	319	135	219
	Q	433	262	111	180
	H	291	176	74	121

Version	Error correction	Numeric	Alphanum.	Kanji	Binary
11 61x61	L	800	485	205	333
	M	608	368	156	253
	Q	493	299	126	205
	H	342	207	87	142
12 65x65	L	915	555	234	381
	M	694	421	178	289
	Q	579	351	148	241
	H	390	236	100	162
13 69x69	L	1030	624	264	429
	M	790	479	202	329
	Q	656	398	168	273
	H	454	275	116	189
14 73x73	L	1167	707	299	486
	M	877	531	225	365
	Q	738	447	189	307
	H	498	302	127	207

2D Code			
Available for	CG400 series		
<b>Micro QR</b>		<b>ESC+2D32</b>	
Hex code	ESC <1B> <sub>16</sub>	2D32 <32> <sub>16</sub> <44> <sub>16</sub> <33> <sub>16</sub> <32> <sub>16</sub>	Parameter ,a,bb,c
Default setting	None		
Persistence of the command	When printer is powered off	Set parameter will not be retained	
	Validity in a job	Becomes invalid after execution	
	Validity after a job	Becomes invalid after the job	

[Function]

Print Micro QR Code.

[Format] (Setting portion)

<2D32>,a,bb,c

●Parameter

a	Error correction level	=	L	:	7%
			M	:	15%
			Q	:	25%
b	Size of one side of cell	=	Valid range	:	01 to 32 dots
c	Data setup mode	=	0	:	Manual setting
			1	:	Auto setting

[Format] (Data portion)

<DS>k,n~n

<DN>mmmm,n~n

●Parameter

k	Input mode	=	1	:	Numeric mode
			2	:	Alphanumeric mode
			3	:	Kanji mode (Shift JIS Kanji)

\* Use command <DN> for binary data input.

m	Quantity of data	=	Valid range	:	1 to 15
---	------------------	---	-------------	---	---------

\* This setting is only required for binary data input.

n	Print data	=	Data
---	------------	---	------

[Coding Example] Error correction level: 7%, Size of one side of cell: 04, Data mode: 1

<A>

<V>100<H>200<2D32>.L.04.1

<DS>1.012345

<Q>2

<Z>



[Notes]

1. In case any other parameters than above are specified, or parameters and quantity of data are not consistent with each other, the symbol will not be printed correctly.
2. Use correct data command <DS> or <DN> according to the different format settings and content of the print data.

**Auto-setting (Data setup mode)**

&lt;DN&gt;mmmm,n~n

## [Tips 1]

1. When Kanji is to be specified, quantity of data shall be twice as many number as total Kanji characters.
2. The address 80H~9FH and E0H~FFH cannot be used for binary data input, since these characters are only handled in Kanji mode.

**Binary data input**

&lt;DN&gt;mmmm,n~n

**Other data input mode**

&lt;DS&gt;1,n~n (Numeric)

&lt;DS&gt;2,n~n (Alphanumeric)

&lt;DS&gt;3,n~n (Kanji)

**Mixture of different data input mode**

Different data input mode can be used in the same command string. See example below.

&lt;A&gt;

&lt;V&gt;100&lt;H&gt;100

<2D32>,a,b<DS>3,n~n<DN>mmmm,n~n<DS>1,n~n

&lt;Q&gt;1

&lt;Z&gt;

## [Tips 2]

1. Data part shall follow directly symbol format part, or a data part and other data part shall follow successively without interval. Otherwise printed result may be incorrect.

Micro QR Code data size table

Version	Error correction	Numeric	Alphanum.	Kanji	Binary
M1 (11×11)	L (error detection only)	5	—	—	—
M2 (13×13)	L	10	6	—	—
	M	8	5	—	—
M3 (15×15)	L	23	14	6	9
	M	18	11	4	7
M4 (17×17)	L	35	21	9	15
	M	30	18	8	13
	Q	21	13	5	9

QR Code (Numeric mode) table

					S				I				S				O					
<b>b8</b>					0	0	0	0	0	0	0	0	0	1	1	1	1	1	1	1	1	1
<b>b7</b>					0	0	0	0	1	1	1	1	0	0	0	0	1	1	1	1	1	1
<b>b6</b>					0	0	1	1	0	0	1	1	0	0	1	1	0	0	1	0	1	1
<b>b5</b>					0	1	0	1	0	1	0	1	0	1	0	1	0	1	0	1	0	1
<b>b4</b>	<b>b3</b>	<b>b2</b>	<b>b1</b>		<b>0</b>	<b>1</b>	<b>2</b>	<b>3</b>	<b>4</b>	<b>5</b>	<b>6</b>	<b>7</b>	<b>8</b>	<b>9</b>	<b>A</b>	<b>B</b>	<b>C</b>	<b>D</b>	<b>E</b>	<b>F</b>		
0	0	0	0	<b>0</b>				0														
0	0	0	1	<b>1</b>				1														
0	0	1	0	<b>2</b>				2														
0	0	1	1	<b>3</b>				3														
0	1	0	0	<b>4</b>				4														
0	1	0	1	<b>5</b>				5														
0	1	1	0	<b>6</b>				6														
0	1	1	1	<b>7</b>				7														
1	0	0	0	<b>8</b>				8														
1	0	0	1	<b>9</b>				9														
1	0	1	0	<b>A</b>																		
1	0	1	1	<b>B</b>																		
1	1	0	0	<b>C</b>																		
1	1	0	1	<b>D</b>																		
1	1	1	0	<b>E</b>																		
1	1	1	1	<b>F</b>																		

QR Code (Alphanumeric mode) table

					S				I				S				O					
<b>b8</b>					0	0	0	0	0	0	0	0	0	0	1	1	1	1	1	1	1	1
<b>b7</b>					0	0	0	0	1	1	1	1	0	0	0	0	1	1	1	1	1	1
<b>b6</b>					0	0	1	1	0	0	1	1	0	0	1	1	0	0	1	1	1	1
<b>b5</b>					0	1	0	1	0	1	0	1	0	1	0	1	0	1	0	1	0	1
<b>b4</b>	<b>b3</b>	<b>b2</b>	<b>b1</b>		<b>0</b>	<b>1</b>	<b>2</b>	<b>3</b>	<b>4</b>	<b>5</b>	<b>6</b>	<b>7</b>	<b>8</b>	<b>9</b>	<b>A</b>	<b>B</b>	<b>C</b>	<b>D</b>	<b>E</b>	<b>F</b>		
0	0	0	0	<b>0</b>			SP	0		P												
0	0	0	1	<b>1</b>				1	A	Q												
0	0	1	0	<b>2</b>				2	B	R												
0	0	1	1	<b>3</b>				3	C	S												
0	1	0	0	<b>4</b>			\$	4	D	T												
0	1	0	1	<b>5</b>			%	5	E	U												
0	1	1	0	<b>6</b>				6	F	V												
0	1	1	1	<b>7</b>				7	G	W												
1	0	0	0	<b>8</b>				8	H	X												
1	0	0	1	<b>9</b>				9	I	Y												
1	0	1	0	<b>A</b>			*	:	J	Z												
1	0	1	1	<b>B</b>			+		K													
1	1	0	0	<b>C</b>					L													
1	1	0	1	<b>D</b>			-		M													
1	1	1	0	<b>E</b>			.		N													
1	1	1	1	<b>F</b>			/		O													



QR Code (Binary mode) table

					S				I				S				O					
<b>b8</b>					0	0	0	0	0	0	0	0	0	0	1	1	1	1	1	1	1	1
<b>b7</b>					0	0	0	0	1	1	1	1	0	0	0	0	1	1	1	1	1	1
<b>b6</b>					0	0	1	1	0	0	1	1	0	0	1	1	0	0	1	1	1	1
<b>b5</b>					0	1	0	1	0	1	0	1	0	1	0	1	0	1	0	1	0	1
<b>b4</b>	<b>b3</b>	<b>b2</b>	<b>b1</b>		<b>0</b>	<b>1</b>	<b>2</b>	<b>3</b>	<b>4</b>	<b>5</b>	<b>6</b>	<b>7</b>	<b>8</b>	<b>9</b>	<b>A</b>	<b>B</b>	<b>C</b>	<b>D</b>	<b>E</b>	<b>F</b>		
0	0	0	0	<b>0</b>			SP	0	@	P	`	p										
0	0	0	1	<b>1</b>			!	1	A	Q	a	q										
0	0	1	0	<b>2</b>			"	2	B	R	b	r										
0	0	1	1	<b>3</b>			#	3	C	S	c	s										
0	1	0	0	<b>4</b>			\$	4	D	T	d	t										
0	1	0	1	<b>5</b>			%	5	E	U	e	u										
0	1	1	0	<b>6</b>			&	6	F	V	f	v										
0	1	1	1	<b>7</b>			'	7	G	W	g	w										
1	0	0	0	<b>8</b>			(	8	H	X	h	x										
1	0	0	1	<b>9</b>			)	9	I	Y	i	y										
1	0	1	0	<b>A</b>			*	:	J	Z	j	z										
1	0	1	1	<b>B</b>			+	;	K	[	k	{										
1	1	0	0	<b>C</b>			,	<	L	¥	l											
1	1	0	1	<b>D</b>			-	=	M	]	m	}										
1	1	1	0	<b>E</b>			.	>	N	^	n	-										
1	1	1	1	<b>F</b>			/	?	O	_	o	DEL										

The address can be specified in the range [00H~7FH] and [A0H~DFH] for QR Code (Binary mode).

QR Code (Kanji mode) Table

	ShiftJIS	0	1	2	3	4	5	6	7	8	9	A	B	C	D	E	F
Symbol	813F		SP	、	。	、	・	・	：	；	？	！	、	。	、	、	、
	814F	^		—	、	、	、	、	、	全	々	々	〇	—	—	□	/
	815F	\	~	□		…	□	、	、	“	”	(	)	[	]	[	]
	816F	{	}			《	》	「	」	『	』	【	】	+	-	±	×
	8180	÷	=	≠	<	>	□	□	∞	□	♂	♀	。	、	”	□	¥
	8190	\$	¢	£	%	#	&	*	@	§	□	□	。	●	□	□	
	819E		□	□	■	□	▲	□	▼	□	〒	→	←	↑	↓	=	
Alphanumeric	824F	0	1	2	3	4	5	6	7	8	9						
	825F		A	B	C	D	E	F	G	H	I	J	K	L	M	N	O
	826F	P	Q	R	S	T	U	V	W	X	Y	Z					
	8280		a	b	c	d	e	f	g	h	i	j	k	l	m	n	o
	8290	p	q	r	s	t	u	v	w	x	y	z					
Hiragana	829E		あ	あ	い	い	う	う	え	え	お	お	か	が	き	ぎ	く
	82AE	ぐ	け	げ	こ	こ	さ	ざ	し	じ	す	ず	せ	が	そ	ぞ	た
	82BE	だ	ち	ぢ	っ	っ	づ	て	で	と	ど	な	に	が	ぬ	ね	は
	82CE	ば	ぱ	ひ	び	び	ふ	ぶ	ぶ	へ	べ	り	ほ	が	ぼ	ぼ	ま
	82DE	む	め	も	ゃ	ゃ	ゆ	ゆ	よ	よ	ら	り	る	が	ろ	ろ	わ
	82EE	ゐ	ゑ	を	ん												
Katakana	833F		ア	ア	イ	イ	ウ	ウ	エ	エ	オ	オ	カ	ガ	キ	ギ	ク
	834F	グ	ケ	ゲ	コ	ゴ	サ	ザ	シ	ジ	ス	ズ	セ	ガ	ソ	ゾ	タ
	835F	ダ	チ	ヂ	ッ	ツ	ツ	テ	デ	ト	ド	ナ	ニ	ガ	ヌ	ノ	ハ
	836F	バ	パ	ヒ	ビ	ピ	フ	ブ	プ	ヘ	ベ	リ	ホ	ガ	ボ	ポ	マ
	8380	ム	メ	モ	ャ	ヤ	ユ	ユ	ヨ	ヨ	ラ	リ	ル	ガ	ロ	ロ	ワ
	8390	ヰ	ヱ	ヲ	ン	ヴ	カ	ケ									
Greek	839E		A	B	Γ	Δ	E	Z	H	Θ	I	K	Λ	M	N	Ξ	O
	83AE	Π	Ρ	Σ	T	Υ	Φ	X	Ψ	Ω	ι	κ	λ	μ	ν	ξ	ο
	83BE		α	β	Υ	δ	ε	ζ	η	θ	ι	κ	λ	μ	ν	ξ	ο
	83CE	π	ρ	σ	τ	υ	φ	χ	ψ	ω							
Russian	843F		A	B	B	Г	Д	Е	Е	Ж	З	И	Й	К	Л	М	Н
	844F	О	П	Р	С	Т	У	Ф	Х	Ц	Ч	Ш	Щ	Ъ	Ы	Ь	Э
	845F	Ю	Я														
	846F		а	б	в	г	д	е	ё	ж	з	и	й	к	л	м	н
	8480	о	п	р	с	т	у	ф	х	ц	ч	ш	щ	ъ	ы	ь	э
	8490	ю	я														

	ShiftJIS	0	1	2	3	4	5	6	7	8	9	A	B	C	D	E	F
ア	889E		亜	唾	娃	阿	哀	愛	挨	始	逢	葵	茜	穉	惡	握	渥
	88AE	旭	葦	芦	鮎	梓	庄	幹	扱	宛	姐	虻	飴	絢	綾	鮎	或
	88BE	粟	裕	安	庵	按	暗	案	闇	鞍	杏						
イ	88BE											以	伊	位	依	偉	困
	88CE	夷	委	威	尉	惟	意	慰	易	椅	為	畏	異	移	維	緯	胃
	88DE	萎	衣	謂	違	遣	医	井	亥	域	育	郁	磯	一	忝	溢	逸
	88EE	稻	茨	芋	鱒	允	印	咽	員	因	姻	引	飲	淫	蔭		
	893F		院	陰	隱	韻	吋										
ウ	893F							右	宇	烏	羽	迂	雨	卯	鷓	窺	丑
	894F	碓	白	渦	噓	唄	鬱	蔚	鱧	姥	廐	浦	瓜	閏	嘑	云	運
	895F	雲															
エ	895F		荏	餌	叡	嘗	嬰	影	映	曳	榮	永	泳	洩	瑛	盈	穎
	896F	穎	英	衛	詠	銳	液	疫	益	馱	悅	謁	越	閱	榎	厭	円
	8980	園	堰	奄	宴	延	怨	掩	援	沿	演	炎	焰	煙	燕	猿	縁
	8990	艶	苑	園	遠	鉛	鴛	塩									
オ	8990								於	汚	甥	凹	央	奧	往	忝	億
	899E		押	旺	橫	欧	殴	王	翁	襖	鶯	鷗	黃	岡	沖	荻	
	89AE	屋	憶	臆	桶	牡	乙	俺	卸	恩	温	穩	音				
カ	89AE													下	化	飯	何
	89BE	伽	伽	佳	加	可	嘉	夏	嫁	家	寡	科	暇	果	架	歌	河
	89CE	火	珂	禍	禾	稼	箇	花	苛	茄	荷	華	菓	蝦	課	嘩	貨
	89DE	迦	過	霞	蚊	俄	峨	我	牙	画	臥	芽	蛾	賀	雅	餓	駕
	89EE	介	會	解	回	塊	壞	迴	快	怪	悔	恢	懷	戒	拐	改	
	8A3F		魁	晦	械	海	灰	界	皆	給	芥	蟹	開	階	貝	凱	幼
	8A4F	外	咳	害	崖	慨	概	涯	碍	蓋	街	該	開	骸	淫	凱	蛙
	8A5F	垣	柿	蛎	鈎	劃	嚇	各	廓	蓋	攪	蟹	格	骸	獲	確	穫
	8A6F	覺	角	赫	較	郭	閣	隔	革	學	岳	該	格	核	殼	筮	榿
	8A80	檀	梶	鯁	漚	割	喝	恰	括	活	渴	滑	滑	額	掛	筮	榿
	8A90	叶	椴	樺	鞆	株	兜	竈	蒲	釜	鎌	滑	滑	葛	轄	筮	榿
	8A9E		粥	刈	苜	瓦	乾	侃	冠	寒	刊	滑	滑	鴨	轄	筮	榿
	8AAE	完	官	寬	干	幹	患	感	慣	憾	換	滑	滑	勸	轄	筮	榿
	8ABE	汗	漢	澗	灌	環	甘	監	看	竿	管	滑	滑	柑	桓	款	肝
	8ACE	莞	觀	諫	貫	還	鑑	間	閑	閏	陷	滑	滑	館	缶	含	岸
8ADE	巖	玩	癌	眼	岩	翫	贖	雁	頑	顏	願	願					

	ShiftJIS	0	1	2	3	4	5	6	7	8	9	A	B	C	D	E	F	
キ	8ADE													企	伎	危	喜	器
	8AEE	基	奇	嬉	寄	岐	希	幾	忌	揮	机	旗	企	伎	危	喜	器	
	8B3F	機	機	歸	毅	氣	汽	畿	祈	季	稀	紀	既	期	棋	棄		
	8B4F	軌	輝	飢	騎	鬼	龜	偽	儀	妓	宜	戲	徽	規	記	貴	疑	
	8B5F	祇	義	蟻	誼	議	掬	菊	鞠	吉	吃	喫	技	擬	欺	犧	杵	
	8B6F	祿	却	客	脚	虐	逆	丘	久	仇	休	及	桔	橘	詰	砧	救	
	8B80	黍	求	汲	泣	灸	球	究	窮	笈	級	吸	給	宮	弓	急	居	
	8B90	朽	拒	拋	拳	渠	虛	許	距	鋸	漁	糾	魚	旧	牛	去		
	8B9E		供	俠	僑	兇	競	共	凶	協	匡	卿	叫	亨	喬	峽	強	
	8BAE	彊	怯	恐	恭	挾	教	橋	況	狂	狹	矯	胸	喬	興	蕎	鄉	
	8BBE	鏡	響	饗	驚	仰	凝	堯	曉	業	局	曲	極	玉	桐	秆	僅	
8BCE	勤	均	巾	錦	斤	欣	欽	琴	禁	禽	筋	緊	芹	菌	衿	襟		
8BDE	謹	近	金	吟	銀													
ク	8BDE						九	俱	句	区	狗	玖	矩	苦	軀	驅	駟	
	8BEE	駒	具	愚	虞	喰	空	偶	寓	遇	隅	串	櫛	釧	屑	屈	君	
	8C3F		掘	窟	沓	靴	轡	窪	熊	隈	彖	栗	縹	桑	歛	勲		
	8C4F	薰	訓	群	軍	郡												
ケ	8C4F						卦	袈	祁	係	傾	刑	兄	啓	圭	珪	型	
	8C5F	契	形	徑	患	慶	慧	憩	揭	携	敬	景	桂	溪	畦	稽	系	
	8C6F	經	繼	繫	罨	荃	荊	蚩	計	詣	警	輕	頸	鷄	芸	迎	鯨	
	8C80	劇	戟	擊	激	隙	桁	傑	欠	詣	潔	穴	結	血	訣	月	鯨	
	8C90	儉	倦	健	兼	券	斫	喧	圈	決	嫌	建	憲	懸	拳	捲	鯨	
	8C9E		檢	權	牽	券	劍	喧	圈	堅	嫌	建	憲	謙	拳	捲	鯨	
	8CAE	鍵	險	權	牽	犬	獻	元	硯	絹	臬	肩	見	玄	賢	軒	鯨	
	8CBE	言	諺	限	驗	齧	元		敵	幻	弦	減	源	玄	現	絃		
コ	8CBE				乎	個	古	呼	固	姑	孤	己	庫	弧	戸	故	枯	
	8CCE	湖	狐	糊	袴	股	胡	菰	虎	誇	跨	鈷	雇	顧	鼓	互		
	8CDE	伍	午	吳	吾	娛	後	御	悟	梧	檣	瑚	暮	語	誤	翻		
	8DEE	乞	鯉	交	佼	侯	候	倖	光	公	功	効	勾	厚	口	康		
	8D3F		后	喉	坑	垢	好	孔	孝	宏	工	巧	巷	幸	庾	洪		
	8D4F	弘	恒	慌	抗	拘	控	攻	昂	晃	更	杭	校	梗	江	肱		
	8D5F	浩	港	溝	甲	皇	硬	稿	糠	紅	紘	絞	網	耕	肯	降		
	8D6F	腔	膏	航	荒	行	衡	講	貢	購	郊	醇	鉞	砘	閤	刻		
	8D80	頂	香	高	鴻	剛	劫	号	合	壕	拷	濠	豪	轟	克			

	ShiftJIS	0	1	2	3	4	5	6	7	8	9	A	B	C	D	E	F
コ	8D90 8D9E 8DAE	告 紺	国 此 良	穀 頃 魂	酷 今	鵠 困	黒 坤	獄 壘	漉 婚	腰 恨	甌 懇	忽 昏	惚 昆	骨 根	狛 梱	込 混	痕
サ	8DAE 8DBE 8DCE 8DDE 8DEE 8E3F 8E4F 8E5F	袞 歳 材 咋 三 酸	坐 濟 罪 搾 察 傘 餐	座 災 財 昨 拶 參 斬	些 挫 采 冴 朔 撮 山 暫	佐 債 犀 坂 柵 擦 慘 殘	又 催 碎 阪 窄 札 撒	峻 再 砦 堺 策 殺 散	嵯 最 祭 榊 索 薩 棧	左 哉 齋 肴 錯 雜 燦	差 塞 細 咲 桜 阜 珊	查 妻 菜 崎 鮭 鯖 産	沙 宰 裁 埼 筭 捌 算	磋 彩 載 碕 匙 鑄 纂	砂 才 際 鷺 冊 鮫 蚕	詐 採 削 作 刷 皿 讚	鎖 裁 在 削 晒 贊
シ	8E5F 8E6F 8E80 8E90 8E9E 8EAE 8EBE 8ECE 8EDE 8EEE 8F3F 8F4F 8F5F 8F6F 8F80 8F90 8F9E 8FAE 8FBE 8FCE 8FDE 8FEE 903F	姉 死 諮 式 疾 斜 酌 腫 衆 柔 出 準 署 尚 樟 笑 鉦 情	姿 氏 資 次 識 質 煮 积 趣 宗 襲 汁 術 潤 書 勝 庄 樵 粧 鍾 擾 拭	子 獅 賜 滋 鳴 実 社 錫 酒 就 警 洪 述 盾 薯 匠 床 沼 紹 鐘 条 植	屍 祉 雌 治 竺 蔀 紗 若 首 州 蹴 獸 俊 純 諸 升 廠 消 肖 障 杖 殖	市 私 飼 爾 軸 篠 者 寂 儒 修 輯 縱 峻 巡 諸 召 彰 涉 莒 鞘 淨 燭	仕 師 糸 齒 事 痔 零 柴 車 惹 呪 拾 酋 銃 瞬 春 遵 助 哨 承 湘 蒋 上 状 織	仔 志 紙 事 痔 零 柴 車 惹 呪 拾 酋 銃 瞬 春 遵 助 哨 承 湘 蒋 上 状 織	伺 思 紫 似 磁 七 芝 遮 主 寿 洲 酬 叔 竣 順 女 唱 招 焦 衝 丞 穰 色	使 指 肢 侍 示 叱 屢 蛇 取 授 秀 集 夙 舜 処 序 嘗 掌 照 裳 乘 蒸 触	刺 支 脂 兒 而 執 蕊 邪 守 樹 秋 醜 宿 駿 初 徐 獎 捷 症 訟 冗 讓 食	司 孜 至 字 耳 失 縞 借 手 綬 終 什 淑 准 所 恕 妾 昇 省 証 剩 釀 蝕	史 斯 視 寺 自 嫉 舍 勺 朱 需 繡 住 祝 循 暑 鋤 媚 昌 硝 詔 城 錠 辱	嗣 施 詞 慈 蒔 室 写 尺 殊 囚 習 充 縮 旬 曙 除 宵 昭 礁 詳 場 囑 冗	四 旨 詩 持 辞 悉 射 杓 狩 収 臭 十 肅 楯 渚 傷 將 晶 祥 象 壤 埴 伸	士 枝 試 時 夕 湿 捨 灼 珠 周 舟 從 塾 殉 庶 償 小 松 称 賞 壤 節 信	始 止 誌 鹿 漆 赦 爵 種 蒐 戎 熟 淳 緒 少 梢 章 醬 常 侵

	ShiftJIS	0	1	2	3	4	5	6	7	8	9	A	B	C	D	E	F
シ	904F	唇	娠	寢	審	心	慎	振	新	晋	森	榛	浸	深	申	疹	真
	905F	神	秦	紳	臣	芯	薪	親	診	身	辛	進	針	震	人	仁	刃
	906F	塵	壬	尋	甚	尽	腎	訊	迅	陣	韌						
ス	906F																
	9080	逗	吹	垂	帥	推	水	炊	睡	粹	翠	筍	諏	須	酢	凶	厨
	9090	瑞	髓	崇	嵩	数	枢	趨	離	据	杉	袁	遂	醉	錐	錘	隨
	909E		澄	摺	寸							相	菅	頗	雀	裾	
セ	909E					世	瀨	畝	是	淒	制	勢	姓	征	性	成	政
	90AE	整	星	晴	棲	栖	正	清	牲	生	盛	精	聖	声	製	西	誠
	90BE	誓	請	逝	醒	青	静	齐	税	脆	隻	席	惜	戚	斥	昔	析
	90CE	石	積	籍	績	脊	責	赤	跡	蹟	碩	切	拙	接	撰	折	設
	90DE	窃	節	説	雪	絶	舌	蝉	仙	先	千	占	宣	専	尖	川	設
	90EE	扇	撰	栓	梅	泉	浅	洗	染	潜	煎	煽	旋	穿	箭	線	設
	913F		織	羨	腺	舛	船	薦	詮	賤	踐	選	遷	穿	箭	線	設
914F	前	善	漸	然	全	禅	繕	膳	糶				錢	銑	閃	鮮	
ソ	914F																
	915F	狙	疏	疎	礎	祖	租	粗	素	組	噌	塑	岨	措	曾	曾	楚
	916F	双	叢	倉	喪	壯	奏	爽	宋	層	蘇	訴	阻	迦	鼠	僧	創
	9180	操	早	曹	巢	槍	槽	漕	燥	争	匠	忽	想	搜	掃	挿	搔
	9190	草	莊	葬	蒼	藻	装	走	送	遭	瘦	相	宥	糶	総	綜	唼
	919E		臆	蔵	贈	造	促	側	則	即	鎗	霜	騷	像	増	憎	俗
	91AE	属	賊	族	統	卒	袖	其	揃	存	息	捉	束	測	足	速	
タ	91AE																
	91BE	太	汰	訖	唾	墮	妥	惰	打	柁	舵	梢	陀	馱	駢	他	多
	91CE	对	耐	岱	帶	待	怠	態	戴	替	泰	滯	胎	腿	苔	体	堆
	91DE	退	逮	隊	黛	鯛	代	台	大	第	醜	題	鷹	淹	瀧	袋	貸
	91EE	宅	托	扞	拓	沢	濯	琢	託	鐸	濁	諾	茸	夙	卓	啄	
	923F		叩	但	達	辰	奪	脱	異	豎	迪	棚	苒	狸	只	誰	
	924F	丹	单	嘆	坦	担	探	旦	歎	淡	湛	炭	谷	端	樽	孰	
925F	胆	蛋	誕	鍛	団	壇	彈	断	暖	檀	段	短	端	綻	耽		
チ	925F																
	926F	弛	恥	智	池	痴	稚	置	致	蚰	遲	馳	築	畜	竹	知	地
	9280	逐	秩	窒	茶	嫡	着	中	仲	宙	忠	抽	昼	柱	注	筑	蓄
	9290	註	耐	鑄	駐	樗	瀦	猪	苧	著	貯	丁	兆	涸	喋	虫	衷

	ShiftJIS	0	1	2	3	4	5	6	7	8	9	A	B	C	D	E	F	
チ	929E 92AE 92BE	帖 聽 沈	帳 脹 珍	庁 蝶 賃	疋 調 陳	弔 張 陳	彫 超	徵 跳	懲 鈔	挑 長	暢 頂	朝 鳥	潮 勅	牒 抄	町 直	眺 朕		
ツ	92BE 92CE 92DE	槻 釣	佃 鶴	漬 柘	辻	津 蔦	墜 綴	椎 鏑	槌 椿	追 潰	鎚 坪	痛 壺	通 孀	塚 紬	柁 爪	掴 吊		
テ	92DE 92EE 933F 934F 935F	悌 徹 点	抵 邸 撤 伝	亭 挺 鄭 轍 殿	低 提 釘 迭 澗	停 梯 鼎 鉄 田	偵 汀 泥 典 電	剃 碇 摘 填	貞 禎 擢 天	呈 程 敵 展	堤 締 滴 店	定 艇 的 添	帝 訂 笛 纏	底 諦 適 甜	庭 蹄 箇 貼	廷 逋 溺 轉	弟 哲 顛	
ト	935F 936F 9380 9390 939E 93AE 93BE 93CE	登 凍 盜 動 得 鳶	菟 刀 淘 董 同 德 苦	賭 唐 湯 蕩 堂 洩 寅	途 塔 涛 藤 導 特 西	都 塘 灯 討 懂 督 瀨	兔 砥 宕 当 豆 洞 篤 屯	吐 砺 島 痘 踏 瞳 毒 惇	堵 努 嶋 禱 逃 童 独 敦	塗 度 悼 等 透 胴 読 沌	妬 土 投 答 鏡 萄 析 豚	屠 奴 搭 筒 陶 道 橡 遁	徒 怒 東 糖 頭 銅 凸 頓	斗 倒 桃 統 騰 峠 突 吞	杜 党 袴 到 鬪 鴉 椀 曇	渡 冬 棟 働 匿 届 鈍		
ナ	93DE 93EE	奈 軟	那 難	内 汝	乍	凧 薙	謎 灘			捺 鍋		槽 馴	繩 罨	南 楠				
ニ	93EE 943F		如 尿	二 菲		尼 任	弑 妊	迓 忍	匂 認	賑 肉	虹 廿			日 乳	入			
ヌ	943F									濡								
ネ	943F 944F		念 捻	撚 燃		粘					襦 祢 寧			葱 猫 熱	年			
ノ	944F 945F		農 覗	蚤			乃 迺	之		埜 囊 惱 濃			納 能 腦	膿				
ハ	945F 946F 9480 9490 949E 94AE	俳 楳 柏 醜	廢 煤 泊 函 髮	拝 狽 白 箱 箱 伐	巴 排 買 箔 裕 筥 罰	把 敗 売 粕 箸 拔	播 杯 賠 舶 肇 箬 筏	霸 盃 陪 薄 箬 罈 閥	杷 牌 這 迫 櫨 鳩	波 背 蠅 曝 幡 嘶	派 肺 秤 漠 肌 塙	琶 輩 矧 爆 焮 焮 隼	破 配 菽 縛 畠 隼	婆 倍 伯 莫 八 伴	罵 培 剥 駁 鉢 判	芭 媒 博 麥 澆 澆 半	馬 梅 拍 發 反	

	ShiftJIS	0	1	2	3	4	5	6	7	8	9	A	B	C	D	E	F
ハ	94BE 94CE	叛采	帆煩	搬頒	斑飯	板挽	汎晩	汎番	版盤	犯磐	班蕃	畔蛮	繁	般	藩	販	範
ヒ	94CE 94DE 94EE 953F 954F 955F 956F	彼誹 桧廟 賓	悲費 鼻姬 描頻	扉避 柎媛 病敏	批非 稗紐 秒瓶	披飛 匹百 苗	斐樋 疋謬 錨	比簸 髭儀 鉾	泌備 彦彪 蒜	疲尾 膝標 蛭	皮微 菱冰 鱗	碑枇 肘漂 品	匪秘 毘弼 瓢彬	卑緋 毚必 票斌	否罷 眉畢 表浜	妃肥 美筆 評瀕	庇被 逼豹 貧
フ	956F 9580 9590 959E 95AE	斧武 憤	普舞 福扮	浮葡 腹焚	父蕪 複奮	不符 部覆 粉	付腐 封淵 糞	埠膚 楓弗 紛	夫芙 風弘 霧	婦譜 葦沸 文	富負 蒞伏 物	富賦 佻物	布赴 副鮒	府阜 復分	怖附 幅吻	扶侮 服噴	敷撫 墳
ヘ	95AE 95BE 95CE	弊偏	柄变	並片	蔽篇	閉編	陛辺	米返	頁遍	僻便	壁勉	癖嬾	併碧 弁	兵別 鞭	塀警	幣蔑	平篋
ホ	95CE 95DE 95EE 963F 964F 965F 966F	圃俸 飽棒 撲	捕包 法鳳 冒朴	步呆 泡鵬 紡牧	甫報 烹乏 肪睦	補奉 砲亡 穆	輔宝 縫傍 謀卸	穗峰 胞剖 貌勃	募峯 芳坊 貿没	墓崩 萌妨 銛殆	慕庖 蓬帽 防堀	戊抱 蜂忘 吠幌	暮捧 褒忙 類奔	母放 訪房 北本	保簿 方豐 暴僕 翻	舖菩 朋邦 望卜 凡	鋪做 鋒某 墨盆
マ	9680 9690 969E	摩鱒	磨榭 漫	魔亦 蔓	麻俣	埋又	妹抹	昧末	枚沫	每迄	哩俛	楨繭	幕磨	膜万	枕慢	縮滿	枉
ミ	969E 96AE	耗	民眠	味	未	魅	巳	箕	岬	密	蜜	湊	蓑	稔	脈	妙	
ム	96AE			務	夢	無	牟	矛	霧	鷓	棕	婿	娘				
メ	96AE 96BE	明	盟迷	銘	鳴	姪	牝	滅	免	棉	綿	緬	面	冥	名	命	
モ	96BE 96CE	茂	妄	孟	毛	猛	盲	網	耗	蒙	儲	木	默	目	空	摸	模 餅



	ShiftJIS	0	1	2	3	4	5	6	7	8	9	A	B	C	D	E	F
モ	96DE	尤	戾	勅	蕘	問	悶	紋	門	刃							
ヤ	96DE 96EE	矢	厄	役	約	藥	訊	躍	靖	柳	也	冶	夜	爺	耶	野	弥
ユ	96EE 973F 974F		諭	輸	唯	佑	優	勇	友	宥	幽	悠	愉	愈	油	癒	湧
ヨ	974F 975F 976F 9780	誉	輿	預	傭	幼	妖	容	庸	揚	揺	擁	曜	楊	樣	余	与
ラ	9780 9790	乱	卵	嵐	欄	濫	羅	螺	裸	来	莱	頼	雷	洛	絡	落	酪
リ	9790 979E 97AE 97BE 97CE		痢	裏	裡	里	離	陸	律	利	吏	履	李	梨	理	璃	溜
ル	97CE 97DE	類												瑠	罌	淚	累
レ	97DE 97EE 983F	齡	令	伶	例	冷	勵	嶺	怜	玲	礼	苓	鈴	隸	零	靈	麗
ロ	983F 984F 985F	樓	榔	浪	漏	呂	魯	櫓	炉	賂	路	露	勞	婁	廊	弄	朗
ワ	985F 986F	椀	倭	和	話	歪	賄	脇	惑	梓	鷲	互	亘	鰐	詫	藁	蕨

	ShiftJIS	0	1	2	3	4	5	6	7	8	9	A	B	C	D	E	F
一	989E		弌	𠂇	丕												
丨	989E					个	𠂇										
丶	989E							、	井								
丿	989E									丿	乂	乖	乘				
乙	989E													亂			
丿	989E														丿	豫	爭
	98AE	舒															
二	98AE		弌	于	亞	亟											
一	98AE					一	亢	京		毫	亶						
人	98AE											从	仍	仄	仆	仂	仗
	98BE	仞	仞	仞	价	伉	侏	估	佛	佝	佗	佇	佖	仄	侏	佗	佻
	98CE	佩	佰	侑	佯	來	侑	儘	倪	佞	俎	俘	佻	侑	俚	侑	佻
	98DE	俚	倚	倨	倔	倪	侗	倅	倅	倅	倡	倩	倅	倅	倅	侑	佻
	98EE	偃	假	會	偕	修	偈	做	偕	偕	偕	偕	僂	僂	僂	僂	僂
	993F		僉	僂	僂	僂	僂	僂	僂	僂	僂	僂	僂	僂	僂	僂	僂
	994F	監	儕	儕	儕	儕	儕	儕	儕	儕	儕	儕	儕	儕	儕	儕	儕
儿	994F										儿	兀	兒	兌	兔	兢	競
入	995F	兩	兪														
八	995F			兮	冀												
冂	995F					冂	回	册	冉	冂	冂	冂	冕				
冂	995F													冂	冤	冠	冢
	996F	寫	冃														
冫	996F			冫	决	冫	冲	冰	况	冫	冫	凉	凜				
几	996F													几	處	凵	凭
	9980	凰															
凵	9980		凵	凵													
刀	9980				刃	刊	刂	刂	刂	刪	刮	刮	剝	剝	剝	剝	剝
	9990	劊	剔	剪	劊	剩	劊	劊	劊	劊	劊	劊	劊	劊	劊	劊	劊
	999E		辦														
力	999E			劬	劬	劬	劬	劬	劬	劬	勞	勸	勸	飭	勸	勸	勸
	99AE	勸															
勹	99AE		勹	匆	匆	匍	匍	匍	匍								
匕	99AE									匕							
匚	99AE										匚	匚	匚	匚	匚	匚	匚

	ShiftJIS	0	1	2	3	4	5	6	7	8	9	A	B	C	D	E	F
匸	99AE																匸 區
十	99BE	𠂇	卅	卅	卉	卂	準										
卜	99BE								𠂇								
𠂇	99BE									𠂇	𠂇	𠂇	𠂇				
𠂇	99BE 99CE													𠂇	𠂇	𠂇	𠂇
厶	99CE				厶	參	纂										
又	99CE							雙	叟	曼	變						
口	99CE 99DE 99EE 9A3F 9A4F 9A5F 9A6F 9A80 9A90	呀 咒 啞 啞 噫 噫	听 呻 咫 唯 啞 噫	吭 咀 晒 啞 啞 嘔 嘔	吼 嗽 咤 啞 喘 嗽 嘔 嘔	吮 咄 咄 咄 嘔 嘔 嘔	呐 附 咄 咄 啞 啞 啞	吩 咆 啞 啞 啞 啞 啞	吝 哇 哥 啞 啞 啞 啞	呖 咏 呖 哦 啞 啞 啞	咏 咸 唏 啞 啞 啞 啞	叮 呵 啞 咬 啞 啞 啞	叨 咎 咬 啞 啞 啞 啞	叭 咳 哄 哮 喙 嗅 嚙	叭 呱 哈 哭 喀 嗟 嘶	吁 呷 咨 哺 咯 嗝 嘸	咩 咩 咩 咩 咩 咩 咩
口	9A90 9A9E									口	囧	囧	囧	囧	囧	囧	囧
土	9A9E 9AAE 9ABE 9ACE 9ADE	坩 埤 埤 壘 壘	垂 埤 壘 壘 壘	垓 垓 壘 壘 壘	坡 埤 壘 壘 壘	坩 坩 壘 壘 壘	垓 垓 壘 壘 壘	垓 垓 壘 壘 壘	垓 垓 壘 壘 壘	坩 埤 壘 壘 壘	坩 埤 壘 壘 壘	坩 埤 壘 壘 壘	坩 埤 壘 壘 壘	坩 埤 壘 壘 壘	坩 埤 壘 壘 壘	坩 埤 壘 壘 壘	坩 埤 壘 壘 壘
士	9ADE				壯	壺	壹	壺	壺	壽							
夕	9ADE									夕							
夕	9ADE										夕	𠂇					
夕	9ADE													夕	𠂇	𠂇	𠂇
大	9ADE 9AEE	天	卒	夸	夾	奇	奕	奂	奎	奚	奘	奢	莫	奧	獎	奘	夫
女	9B3F 9B4F 9B5F 9B6F	娑 媽 孃	奸 娜 媽 孃	妁 娉 媼 孃	妝 娉 媼 孃	佞 媼 媼 孃	佞 媼 媼 孃	妁 媼 媼 孃	妁 媼 媼 孃	姆 娶 嬌	姨 婢 嬋	姜 婪 嬋	妍 媚 嬋	妊 媼 嬋	姚 媼 嬋	娥 媼 嬋	娟 媼 嬋

	ShiftJIS	0	1	2	3	4	5	6	7	8	9	A	B	C	D	E	F
子	9B6F				子	孕	孚	孛	孛	孩	孰	孳	孵	學	孳	孺	
宀	9B6F 9B80 9B90	它 寶	宦	宸	寃	寇	崔	寔	寐	寤	實	寢	寔	寥	寫	寔	寶
寸	9B90		尅	將	專	對											
小	9B90						尔	尠									
尢	9B90							尢	尢								
尸	9B90 9B9E		屨	屏	屨	屬				尸	尹	屨	屨	屨	屨		
屮	9B9E					屮											
山	9B9E 9BAE 9BBE 9BCE	岬	岷	岷	岷	岷	岷	岷	岷	岷	岷	岷	岷	岷	岷	岷	岷
巛	9BCE																巛
工	9BDE	巫															
巳	9BDE		巳	卮													
巾	9BDE 9BEE	幟	幟	幣	幣	帛	帛	帛	帛	帶	帷	幄	幃	幃	幃	幃	幃
干	9BEE					开	并										
么	9BEE						么	麼									
广	9BEE 9C3F		廖	廣	廝	廚	廛	廢	廡	广	庠	廁	廂	廡	廡	廡	廡
廴	9C3F																廴 廴
廾	9C4F	廾	弃	廾	廾	廾											
弋	9C4F						弋	弋									
弓	9C4F							弓		弩	弭	弭	弭	彈	彌	彎	彎
彳	9C5F	彳	彳	彳	彳												
彳	9C5F					彳	彭										
彳	9C5F 9C6F	徙	徙	徠	徠	徠	徠	徠	徠	徠	徠	徠	徠	徠	徠	徠	徠
心	9C6F 9C80 9C90	怙	恂	恂	恂	恂	恂	恂	恂	恂	恂	恂	恂	恂	恂	恂	恂

	ShiftJIS	0	1	2	3	4	5	6	7	8	9	A	B	C	D	E	F	
心	9C9E		悄	悛	悖	悗	悛	悛	悛	惡	悛	惠	悛	悛	悛	悛	悛	
	9CAE	悛	悛	悛	悛	悛	悛	悛	悛	悛	悛	悛	悛	悛	悛	悛	悛	
	9CBE	悛	悛	悛	悛	悛	悛	悛	悛	悛	悛	悛	悛	悛	悛	悛	悛	
	9CCE	悛	悛	悛	悛	悛	悛	悛	悛	悛	悛	悛	悛	悛	悛	悛	悛	悛
	9CDE	悛	悛	悛	悛	悛	悛	悛	悛	悛	悛	悛	悛	悛	悛	悛	悛	悛
	9CEE	悛	悛	悛	悛	悛	悛	悛	悛	悛	悛	悛	悛	悛	悛	悛	悛	悛
戈	9CEE									戈	戊	戊		戊	戔	戔		
	9D3F		戔	戔	戔													
尸	9D3F									扁								
手	9D3F										扎	扞	扣	扞	扞	扞	扞	
	9D4F	扞	扞	扞	扞	扞	扞	扞	扞	扞	扞	扞	扞	扞	扞	扞	扞	
	9D5F	扞	扞	扞	扞	扞	扞	扞	扞	扞	扞	扞	扞	扞	扞	扞	扞	
	9D6F	扞	扞	扞	扞	扞	扞	扞	扞	扞	扞	扞	扞	扞	扞	扞	扞	
	9D80	扞	扞	扞	扞	扞	扞	扞	扞	扞	扞	扞	扞	扞	扞	扞	扞	
	9D90	扞	扞	扞	扞	扞	扞	扞	扞	扞	扞	扞	扞	扞	扞	扞	扞	
	9D9E	扞	扞	扞	扞	扞	扞	扞	扞	扞	扞	扞	扞	扞	扞	扞	扞	
	9DAE	扞	扞	扞	扞	扞	扞	扞	扞	扞	扞	扞	扞	扞	扞	扞	扞	
支	9DAE														支	支	支	
	9DBE	收	攸	攸	攸	攸	攸	攸	攸	攸	攸	攸	攸	攸	攸	攸	攸	
斗	9DBE																斛	
	9DCE	斛																
斤	9DCE		斫	斫														
方	9DCE				旃	旃	旃	旃	旃	旃	旃	旃	旃					
无	9DCE												无	无				
日	9DCE															旱	昊	
	9DDE	昊	昊	昊	昊	昊	昊	昊	昊	昊	昊	昊	昊	昊	昊	昊	昊	
	9DEE	昊	昊	昊	昊	昊	昊	昊	昊	昊	昊	昊	昊	昊	昊	昊	昊	
	9E3F	昊	昊	昊	昊	昊	昊	昊	昊	昊	昊	昊	昊	昊	昊	昊	昊	
日	9E3F									日	日	日						
月	9E3F													肫	肫	肫	肫	
	9E4F	肫	肫															
木	9E4F			朮	朮	朮	朮	朮	朮	杆	杞	杠	杙	杙	杙	杙	杰	
	9E5F	杙	杙	杙	杙	杙	杙	杙	杙	杙	杙	杙	杙	杙	杙	杙	杰	
	9E6F	杙	杙	杙	杙	杙	杙	杙	杙	杙	杙	杙	杙	杙	杙	杙	杰	

	ShiftJIS	0	1	2	3	4	5	6	7	8	9	A	B	C	D	E	F	
木	9E80	梳	柁	柁	档	桷	梲	梲	梲	梲	梭	梲	條	柳	梲	梲	桴	
	9E90	梳	柁	柁	档	桷	梲	梲	梲	梲	梭	棘	梲	梲	梲	梲	桴	
	9E9E																	
	9EAE	榎	榎	榎	榎	榎	榎	榎	榎	榎	榎	榎	榎	榎	榎	榎	榎	榎
	9EBE	榎	榎	榎	榎	榎	榎	榎	榎	榎	榎	榎	榎	榎	榎	榎	榎	榎
	9ECE	榎	榎	榎	榎	榎	榎	榎	榎	榎	榎	榎	榎	榎	榎	榎	榎	榎
	9EDE	榎	榎	榎	榎	榎	榎	榎	榎	榎	榎	榎	榎	榎	榎	榎	榎	榎
	9EEE	榎	榎	榎	榎	榎	榎	榎	榎	榎	榎	榎	榎	榎	榎	榎	榎	榎
	9F3F																	
	9F4F																	
欠	9F4F								歛	歛	盜	歛	飲	歛	歛	歛	歛	
	9F5F	歛	歛	歛	歛	歛												
止	9F5F						歸											
歹	9F5F						歹	歹		歹	歹	歹	歹	歹	歹	歹	歹	
	9F6F	歹	歹	歹	歹	歹												
殳	9F6F						殳	殳	殳	殳								
毋	9F6F										毋	毓						
毛	9F6F												髦	髦	髦	髦	髦	
	9F80	髦	髦															
氐	9F80			氐														
气	9F80			气	气	气	气	气										
水	9F80								汞	汕	汙	汪	沂	沔	沔	沔	沔	
	9F90	汾	汨	汨	沒	沐	泄	決	泓	沽	泗	汪	沂	沔	沔	沔	沔	
	9F9E																	
	9FAE	洌	洌	洌	沒	沐	泄	決	泓	沽	泗	汪	沂	沔	沔	沔	沔	
	9FBE	洌	洌	洌	沒	沐	泄	決	泓	沽	泗	汪	沂	沔	沔	沔	沔	
	9FCE	洌	洌	洌	沒	沐	泄	決	泓	沽	泗	汪	沂	沔	沔	沔	沔	
	9FDE	洌	洌	洌	沒	沐	泄	決	泓	沽	泗	汪	沂	沔	沔	沔	沔	
	9FEE	洌	洌	洌	沒	沐	泄	決	泓	沽	泗	汪	沂	沔	沔	沔	沔	
	E03F	洌	洌	洌	沒	沐	泄	決	泓	沽	泗	汪	沂	沔	沔	沔	沔	
	E04F	洌	洌	洌	沒	沐	泄	決	泓	沽	泗	汪	沂	沔	沔	沔	沔	
E05F	洌	洌	洌	沒	沐	泄	決	泓	沽	泗	汪	沂	沔	沔	沔	沔		
E06F	洌	洌	洌	沒	沐	泄	決	泓	沽	泗	汪	沂	沔	沔	沔	沔		
火	E06F						炙	炒	炯	炯	炬	炸	炳	炮	烟	然	蒸	

	ShiftJIS	0	1	2	3	4	5	6	7	8	9	A	B	C	D	E	F
火	E080 E090 E09E	烙 煩	焉 熨 爇	烽 熬 燿	焜 爛 爍	焙 熹 爐	煥 熾 爛	熙 燒 爨	熙 燉	煦 燂	煢 燎	煌 燠	煖 燬	煬 燧	熏 燧	燻 燼	熄
爪	E09E								爭	爬	爰	爲					
爻	E09E												爻	俎			
爿	E09E E0AE	牋	牘												爿	牀	牆
牛	E0AE			牴	牯	犁	犁	犇	犒	犖	犢	犢					
犬	E0AE E0BE E0CE	狎 猥	狒 狒	狝 獒	狝 獒	狝 獒	狝 獒	狝 獒	狝 獒	狝 獒	狝 獒	狝 獒	狝 獒	狝 獒	狝 獒	狝 獒	狝 獒
王	E0CE E0DE E0EE	玢 瑁	珀 瑜	珥 瑩	珥 瑰	珥 瑛	珥 瑪	珥 瑤	珥 瑾	琥 璋	珉 璞	珉 璧	珉 瓊	瑕 瓏	玳 瑁	玳 瑁	玳 瑁
瓜	E13F		瓠	瓣													
瓦	E13F E14F	甍	甍	甍	甍	甍	甍	甍	甍	甍	甍	甍	甍	甍	甍	甍	甍
甘	E14F			嘗													
生	E14F					甦											
用	E14F					甬											
田	E14F E15F	畧	畫	畧	畧	當	疆	疇	疇	畋	畋	畋	畋	畋	畋	畋	畋
疒	E15F E16F E180 E190 E19E	痲	疔	痲	痲	疔	疔	痲	痲	痲	痲	痲	痲	痲	痲	痲	痲
火	E19E		火	癸		發											
白	E19E					皂	兒	飯		皐	皎	皖	皓	皙	皚		
皮	E19E E1AE	鞞	輝	皸											皸	皸	
皿	E1AE			孟	盍	盍	盒	盞		盞	盞	盞	盞	盞			
目	E1AE E1BE	眇	眩	眇	眞	眇	眇	眇	眇	眇	眇	眇	眇	眇	眇	眇	眇

	ShiftJIS	0	1	2	3	4	5	6	7	8	9	A	B	C	D	E	F	
目	E1CE E1DE	睽 轟	睽 矚	瞎 矚	矚 矚	矚 矚	矚 矚	矚 矚	矚 矚	矚 矚	矚 矚	矚 矚	矚 矚	矚 矚	矚 矚	矚 矚	矚 矚	
矛	E1DE			矚														
矢	E1DE			矚	矚	矚	矚	矚	矚									
石	E1DE E1EE E23F	矚 矚	矚 矚	矚 矚	矚 矚	矚 矚	矚 矚	矚 矚	矚 矚	矚 矚	矚 矚	矚 矚	矚 矚	矚 矚	矚 矚	矚 矚	矚 矚	
示	E23F E24F	矚 矚	矚 矚	矚 矚	矚 矚	矚 矚	矚 矚	矚 矚	矚 矚	矚 矚	矚 矚	矚 矚	矚 矚	矚 矚	矚 矚	矚 矚	矚 矚	
禺	E24F												矚	矚				
禾	E24F E25F E26F	矚 矚	矚 矚	矚 矚	矚 矚	矚 矚	矚 矚	矚 矚	矚 矚	矚 矚	矚 矚	矚 矚	矚 矚	矚 矚	矚 矚	矚 矚	矚 矚	
穴	E26F E280	矚 矚	矚 矚	矚 矚	矚 矚	矚 矚	矚 矚	矚 矚	矚 矚	矚 矚	矚 矚	矚 矚	矚 矚	矚 矚	矚 矚	矚 矚	矚 矚	
立	E280 E290	矚 矚	矚 矚	矚 矚	矚 矚	矚 矚	矚 矚	矚 矚	矚 矚	矚 矚	矚 矚	矚 矚	矚 矚	矚 矚	矚 矚	矚 矚	矚 矚	
竹	E290 E29E E2AE E2BE E2CE E2DE	矚 矚 矚 矚 矚 矚	矚 矚 矚 矚 矚 矚	矚 矚 矚 矚 矚 矚	矚 矚 矚 矚 矚 矚	矚 矚 矚 矚 矚 矚	矚 矚 矚 矚 矚 矚	矚 矚 矚 矚 矚 矚	矚 矚 矚 矚 矚 矚	矚 矚 矚 矚 矚 矚	矚 矚 矚 矚 矚 矚	矚 矚 矚 矚 矚 矚	矚 矚 矚 矚 矚 矚	矚 矚 矚 矚 矚 矚	矚 矚 矚 矚 矚 矚	矚 矚 矚 矚 矚 矚	矚 矚 矚 矚 矚 矚	矚 矚 矚 矚 矚 矚
米	E2DE E2EE	矚 矚	矚 矚	矚 矚	矚 矚	矚 矚	矚 矚	矚 矚	矚 矚	矚 矚	矚 矚	矚 矚	矚 矚	矚 矚	矚 矚	矚 矚	矚 矚	
糸	E2EE E33F E34F E35F E36F E380 E390	矚 矚 矚 矚 矚 矚 矚	矚 矚 矚 矚 矚 矚 矚	矚 矚 矚 矚 矚 矚 矚	矚 矚 矚 矚 矚 矚 矚	矚 矚 矚 矚 矚 矚 矚	矚 矚 矚 矚 矚 矚 矚	矚 矚 矚 矚 矚 矚 矚	矚 矚 矚 矚 矚 矚 矚	矚 矚 矚 矚 矚 矚 矚	矚 矚 矚 矚 矚 矚 矚	矚 矚 矚 矚 矚 矚 矚	矚 矚 矚 矚 矚 矚 矚	矚 矚 矚 矚 矚 矚 矚	矚 矚 矚 矚 矚 矚 矚	矚 矚 矚 矚 矚 矚 矚	矚 矚 矚 矚 矚 矚 矚	矚 矚 矚 矚 矚 矚 矚
缶	E390 E39E	矚 矚	矚 矚	矚 矚	矚 矚	矚 矚	矚 矚	矚 矚	矚 矚	矚 矚	矚 矚	矚 矚	矚 矚	矚 矚	矚 矚	矚 矚	矚 矚	



	ShiftJIS	0	1	2	3	4	5	6	7	8	9	A	B	C	D	E	F
网	E39E							网	罕	罔	罟	罟	罟	罟	罟	罟	罟
	E3AE	罟	罟	罟	罟	罟											
羊	E3AE							羌	羔	羴	羴	羴	羴	羴	羴	羴	羴
	E3BE	羴	羴														
羽	E3BE			翅	翠	翊	翕	翔	翦	翦	翦	翦	翦	翦	翦	翦	翦
老	E3BE														耆	耆	耆
耒	E3CE	耒	耘	耜	耜	耒	耒										
耳	E3CE							耿	耻	聊	聆	聒	聘	聚	聒	聒	聒
	E3DE	聒	聒	聒	聒	聒	聒										
聿	E3DE							聿	聿	聿	聿						
肉	E3DE					胄	胚	胖	脉	胯	肱	肱	肱	肱	肱	肱	肱
	E3EE	胄	胄	胄	胄	胄	胄	胄	胄	胄	胄	胄	胄	胄	胄	胄	胄
	E43F	胄	胄	胄	胄	胄	胄	胄	胄	胄	胄	胄	胄	胄	胄	胄	胄
	E44F	胄	胄	胄	胄	胄	胄	胄	胄	胄	胄	胄	胄	胄	胄	胄	胄
	E45F	胄	胄	胄	胄	胄	胄	胄	胄	胄	胄	胄	胄	胄	胄	胄	胄
臣	E45F									臧							
至	E45F										臺	臻					
白	E45F													臾	臾	春	舅
	E46F	與	舊														
舌	E46F			舍	舐	舖											
舟	E46F					舩	舩	舩		舩	舩	舩	舩	舩	舩	舩	舩
	E480	舩	舩	舩	舩	舩	舩	舩	舩	舩	舩	舩	舩	舩	舩	舩	舩
艮	E480					艮											
艸	E480								艸	艾	芍	芒	芫	芫	芫	芫	芫
	E490	芫	芫	芫	芫	芫	芫	芫	芫	艾	芍	芒	芫	芫	芫	芫	芫
	E49E	芫	芫	芫	芫	芫	芫	芫	芫	艾	芍	芒	芫	芫	芫	芫	芫
	E4AE	芫	芫	芫	芫	芫	芫	芫	芫	艾	芍	芒	芫	芫	芫	芫	芫
	E4BE	芫	芫	芫	芫	芫	芫	芫	芫	艾	芍	芒	芫	芫	芫	芫	芫
	E4CE	芫	芫	芫	芫	芫	芫	芫	芫	艾	芍	芒	芫	芫	芫	芫	芫
	E4DE	芫	芫	芫	芫	芫	芫	芫	芫	艾	芍	芒	芫	芫	芫	芫	芫
	E4EE	芫	芫	芫	芫	芫	芫	芫	芫	艾	芍	芒	芫	芫	芫	芫	芫
	E53F	芫	芫	芫	芫	芫	芫	芫	芫	艾	芍	芒	芫	芫	芫	芫	芫
	E54F	芫	芫	芫	芫	芫	芫	芫	芫	艾	芍	芒	芫	芫	芫	芫	芫

	ShiftJIS	0	1	2	3	4	5	6	7	8	9	A	B	C	D	E	F
艸	E55F	蘋	蕓	藺	蘆	龍	薜	縷	蘿								
虍	E55F									虍	虍	虍	虍	虍			
虫	E55F														虱	蛆	蚣
	E56F	蚩	蚪	蚋	蚌	蚶	蚯	蛄	蛆	蚰	蛉	螞	蛇	蛔	蛞	蚓	蚣
	E580	蛟	蛛	蛭	蛭	蛭	蜈	蜀	履	蛭	蛭	蛭	蛭	蛭	蛭	蛭	蛭
	E590	蝮	蜻	蜥	蝮	蜥	蝠	蝮	蝮	蝮	蝮	蝮	蝮	蝮	蝮	蝮	蝮
	E59E	蝮	蝮	蝮	蝮	蝮	蝮	蝮	蝮	蝮	蝮	蝮	蝮	蝮	蝮	蝮	蝮
	E5AE	蝮	蝮	蝮	蝮	蝮	蝮	蝮	蝮	蝮	蝮	蝮	蝮	蝮	蝮	蝮	蝮
	E5BE	蝮	蝮	蝮	蝮	蝮	蝮	蝮	蝮	蝮	蝮	蝮	蝮	蝮	蝮	蝮	蝮
血	E5BE									衄	衄						
行	E5BE											衞	衞	衞	衞		
衣	E5BE															衫	袁
	E5CE	衾	衾	衾	衾	衾	衾	衾	衾	衾	衾	衾	衾	衾	衾	衾	衾
	E5DE	衾	衾	衾	衾	衾	衾	衾	衾	衾	衾	衾	衾	衾	衾	衾	衾
	E5EE	衾	衾	衾	衾	衾	衾	衾	衾	衾	衾	衾	衾	衾	衾	衾	衾
	E63F	衾	衾	衾	衾	衾	衾	衾	衾	衾	衾	衾	衾	衾	衾	衾	衾
西	E63F									西	覃	覈	羈				
見	E63F													覓	覓	覓	覓
	E64F	覓	覓	覓	覓	覓	覓	覓	覓								
角	E64F									觚	觚	觚	觚	觚	觚		
言	E64F															訃	訃
	E65F	訃	訃	訃	訃	訃	訃	訃	訃	訃	訃	訃	訃	訃	訃	訃	訃
	E66F	訃	訃	訃	訃	訃	訃	訃	訃	訃	訃	訃	訃	訃	訃	訃	訃
	E680	訃	訃	訃	訃	訃	訃	訃	訃	訃	訃	訃	訃	訃	訃	訃	訃
	E690	訃	訃	訃	訃	訃	訃	訃	訃	訃	訃	訃	訃	訃	訃	訃	訃
	E69E	訃	訃	訃	訃	訃	訃	訃	訃	訃	訃	訃	訃	訃	訃	訃	訃
谷	E69E															𪗇	𪗇
	E6AE	𪗇															
豆	E6AE		豈	豈	豈	豈	豈	豈	豈								
豕	E6AE					豕	豕	豕	豕								
豸	E6AE									豸	豸	豸	豸	豸	豸	豸	豸
	E6BE	豸	豸	豸										豸	豸	豸	豸
貝	E6BE				賤	賤	賤	賤	賤	貳	貳	貳	賈	賈	賈	賈	賈
	E6CE	賈	賈	賈	賈	賈	賈	賈	賈	賈	賈	賈	賈	賈	賈	賈	賈

	ShiftJIS	0	1	2	3	4	5	6	7	8	9	A	B	C	D	E	F	
赤	E6CE E6DE	赭															赧	
走	E6DE	走	起	趁		趙												
足	E6DE E6EE E73F E74F	跟 踏	跣 躅	跣 躅	踳 躅	跟 踏	跣 躅	踳 躅	踳 躅	跣 躅	跣 躅	跣 躅	跣 躅	跣 躅	跣 躅	跣 躅	跣 躅	跣 躅
身	E74F E75F	躄	躄										躬	躄	躄	躄	躄	
車	E75F E76F E780	輟 輟 輟	輟 輟 輟	輟 輟 輟	輟 輟 輟	輟 輟 輟	輟 輟 輟	輟 輟 輟	輟 輟 輟	輟 輟 輟	輟 輟 輟	輟 輟 輟	輟 輟 輟	輟 輟 輟	輟 輟 輟	輟 輟 輟	輟 輟 輟	
辛	E780			辜		辟	辣	辭	辯									
亻	E780 E790 E79E E7AE	迨	迹 遏 避	迨 遏 避	迨 遏 避	迨 遏 避	迨 遏 避	迨 遏 避	迨 遏 避	迨 遏 避	迨 遏 避	迨 遏 避	迨 遏 避	迨 遏 避	迨 遏 避	迨 遏 避	迨 遏 避	迨 遏 避
邑	E7AE E7BE	郤	鄙	郢	鄰				邨	邨	邨	邨	邨	邨	邨	邨	邨	邨
酉	E7BE E7CE	醫	醢	醢	醢	醢	醢	醢	醢	醢	醢	醢	醢	醢	醢	醢	醢	醢
采	E7CE									糶	釋							
里	E7CE												釐					
金	E7CE E7DE E7EE E83F E84F E85F E86F	釵 鈹 鎔 鑄 鑄	鈹 鈹 鎔 鑄 鑄	鈹 鈹 鎔 鑄 鑄	鈹 鈹 鎔 鑄 鑄	鈹 鈹 鎔 鑄 鑄	鈹 鈹 鎔 鑄 鑄	鈹 鈹 鎔 鑄 鑄	鈹 鈹 鎔 鑄 鑄	鈹 鈹 鎔 鑄 鑄	鈹 鈹 鎔 鑄 鑄	鈹 鈹 鎔 鑄 鑄	鈹 鈹 鎔 鑄 鑄	鈹 鈹 鎔 鑄 鑄	鈹 鈹 鎔 鑄 鑄	鈹 鈹 鎔 鑄 鑄	鈹 鈹 鎔 鑄 鑄	鈹 鈹 鎔 鑄 鑄
門	E86F E880 E890	閨 關	閨 關	閨 關	閨 關	閨 關	閨 關	閨 關	閨 關	閨 關	閨 關	閨 關	閨 關	閨 關	閨 關	閨 關	閨 關	閨 關
阜	E890					阡	阨	阮	阨	陂	陌	陌	陌	陷	陝	陞		

	ShiftJIS	0	1	2	3	4	5	6	7	8	9	A	B	C	D	E	F
卓	E89E		陝	陟	陟	陞	陞	陞	陞	隕	隗	險	隧	隱	隲	隲	隲
叟	E8AE	隶	隸														
佳	E8AE		佳	睢		雋	雉	雍	襍	雜	霍	雕					
雨	E8AE E8BE	霽	霽	霽	霖	霽	雷	霽	霽	霹	霽	霽	霽	霄	霆	霽	霽
青	E8CE	靜															
非	E8CE	靠															
面	E8CE		匏	靦		曆											
革	E8CE E8DE	鞅	鞅	鞅	鞅	鞅	鞅	鞅	鞅	鞅	鞅	鞅	鞅	鞅	鞅	鞅	鞅
韋	E8DE											韋	韋				
韭	E8DE													韭	齏	齏	
音	E8DE E8EE	韶	韻														竟
頁	E8EE E93F		頡	頡	頡	頡	頡	頡	頡	頡	頡	頡	頡	頡	頡	頡	頡
風	E93F					風	颯	颯	颯	飄	颯	颯					
食	E93F E94F E95F	餽	餽	餽	餽	餽	餽	餽	餽	餽	餽	餽	餽	餽	餽	餽	餽
首	E95F					馮	馮										
香	E95F					馮	馮										
馬	E95F E96F E980	馮	馮	馮	馮	馮	馮	馮	馮	馮	馮	馮	馮	馮	馮	馮	馮
骨	E980 E990	體	體	體	體									體	體	體	體
高	E990					髡											
影	E990 E99E		髡	髡	髡	髡	髡	髡	髡	髡	髡	髡	髡	髡	髡	髡	髡
鬥	E99E									鬥	鬥	鬥	鬥	鬥	鬥		
鬯	E99E																鬯
鬼	E9AE	魄	魑	魏	魑	魑	魑	魑	魑								

	ShiftJIS	0	1	2	3	4	5	6	7	8	9	A	B	C	D	E	F	
魚	E9AE E9BE E9CE E9DE	鮓 鮓 鮓 鮓	鮓 鮓 鮓 鮓	鮓 鮓 鮓 鮓	鮓 鮓 鮓 鮓	鮓 鮓 鮓 鮓	鮓 鮓 鮓 鮓	鮓 鮓 鮓 鮓	鮓 鮓 鮓 鮓	鮓 鮓 鮓 鮓	鮓 鮓 鮓 鮓	鮓 鮓 鮓 鮓	鮓 鮓 鮓 鮓	鮓 鮓 鮓 鮓	鮓 鮓 鮓 鮓	鮓 鮓 鮓 鮓	鮓 鮓 鮓 鮓	鮓 鮓 鮓 鮓
鳥	E9DE E9EE EA3F EA4F EA5F	鳩 鳩 鳩 鳩	鳩 鳩 鳩 鳩	鳩 鳩 鳩 鳩	鳩 鳩 鳩 鳩	鳩 鳩 鳩 鳩	鳩 鳩 鳩 鳩	鳩 鳩 鳩 鳩	鳩 鳩 鳩 鳩	鳩 鳩 鳩 鳩	鳩 鳩 鳩 鳩	鳩 鳩 鳩 鳩	鳩 鳩 鳩 鳩	鳩 鳩 鳩 鳩	鳩 鳩 鳩 鳩	鳩 鳩 鳩 鳩	鳩 鳩 鳩 鳩	鳩 鳩 鳩 鳩
鹵	EA5F				鹵	鹵	鹽											
鹿	EA5F						鹿	麁		麁	麁	麁	麁	麁	麁			
麥	EA5F EA6F																麥	麩
麻	EA6F				麻													
黃	EA6F					黃												
黍	EA6F						黍	黏	黏									
黑	EA6F EA80	黠	黠	黠						黠	黠	黠	黠	黠	黠	黠	黠	黠
滂	EA80				滂	滂	滂											
黽	EA80						黽	黽		黽								
鼓	EA80									鼓	鼗							
鼠	EA80											鼠	鼠					
鼻	EA80														鼻			
齊	EA80															齊		
齒	EA80 EA90	齒	齒	齒	齒	齒	齒	齒	齒	齒	齒	齒	齒					齒
龍	EA90													龍				
龜	EA90														龜			
禽	EA90																禽	

2D Code			
Available for	CG400 series		
<b>GS1 DataMatrix (ECC200)</b>		<b>ESC+2D50</b>	
Hex code	ESC <1B> <sub>16</sub>	2D50 <32> <sub>16</sub> <44> <sub>16</sub> <35> <sub>16</sub> <30> <sub>16</sub>	Parameter ,aa,bb,ccc,ddd
Default setting	None		
Persistence of the command	When printer is powered off	Set parameter will not be retained	
	Validity in a job	Becomes invalid after execution	
	Validity after a job	Becomes invalid after the job	

[Function]

Prints GS1 DataMatrix code (ECC200).

[Format] (Setting portion)

<2D50>,aa,bb,ccc,ddd

•Parameter

a	[Cell width]	=	Valid range	: 01 to 16 dots
b	[Cell height]	=	Valid range	: 01 to 16 dots
c	[Number of cell per line]	=	Valid range	: 000 (fixed)
d	[Number of line per symbol]	=	Valid range	: 000 (fixed)

[Format] (Data portion)

<DN>m m m m,n~n

•Parameter

m    Quantity of data            =    Valid range : 1 to 3116  
 \* Only required when data is input in binary

n    Print data                      =    Data

\* In case any other parameters than above are specified, or parameters and quantity of data are not consistent with each other, the symbol will not be printed correctly.

[Coding Example]    Cell width : 3 dots    Cell height : 3 dots

<A>  
 <V>100<H>200<2D50>03.03.000.000  
 <DN>0010.0123456789  
 <Z>



[Notes]

1. In case any other parameters than above are specified, or parameters and quantity of data are not consistent with each other, the symbol will not be printed correctly.
2. Make sure to leave 2mm margin of each side of the symbol for good scanner-readability.
3. To specify the code address [7EH], write [7EH, 7EH]. Quantity of data is [0002].

	Data format	Quantity of data
Data format	Numeric	3116
	Alphanumeric	2335
	Binary (01H to FFH)	1556

**GS1 DataMatrix (ECC200) code table**

				S				I				S				O				
				b8	0	0	0	0	0	0	0	0	1	1	1	1	1	1	1	1
				b7	0	0	0	0	1	1	1	1	0	0	0	0	1	1	1	1
				b6	0	0	1	1	0	0	1	1	0	0	1	1	0	0	1	1
				b5	0	1	0	1	0	1	0	1	0	1	0	1	0	1	0	1
b4	b3	b2	b1	0	1	2	3	4	5	6	7	8	9	A	B	C	D	E	F	
0	0	0	0	0			SP	0	@	P	`	p								
0	0	0	1	1			!	1	A	Q	a	q								
0	0	1	0	2			"	2	B	R	b	r								
0	0	1	1	3			#	3	C	S	c	s								
0	1	0	0	4			\$	4	D	T	d	t								
0	1	0	1	5			%	5	E	U	e	u								
0	1	1	0	6			&	6	F	V	f	v								
0	1	1	1	7			'	7	G	W	g	w								
1	0	0	0	8			(	8	H	X	h	x								
1	0	0	1	9			)	9	I	Y	i	y								
1	0	1	0	A			*	:	J	Z	j	z								
1	0	1	1	B			+	;	K	[	k	{								
1	1	0	0	C			,	<	L	¥	l									
1	1	0	1	D			-	=	M	]	m	}								
1	1	1	0	E			.	>	N	^	n	~								
1	1	1	1	F			/	?	O	_	o	DEL								

Address can be selected in the range 01H thru FFH for GS1 Data Matrix (ECC200).  
 To specify 7EH, write [7EH, 7EH].

2D Code			
Available for	CG400 series		
<b>QR code</b>		<b>ESC+BQ</b>	
Hex code	ESC <1B> <sub>16</sub>	BQ <42> <sub>16</sub> <51> <sub>16</sub>	Parameter Manual setup abcc,(ddeeff),g(hhhh)n Auto-setup abcc,(ddeeff),n
Default setting	None		
Persistence of the command	When printer is powered off	Set parameter will not be retained	
	Validity in a job	Becomes invalid after execution	
	Validity after a job	Becomes invalid after the job	

[Function]  
Specifies QR code

[Format]  
Manual setup <BQ>abcc,(ddeeff),g(hhhh)n  
Auto-setup <BQ>abcc,(ddeeff),n

- Parameter
  - a Error correction level = 1 : 7% High density (L)  
2 : 15% Standard (M)  
3 : 30% Ultrahigh reliability (H)  
4 : 25% High reliability (Q)
  - b Concatenation mode = 0 : Normal mode  
1 : Concatenation mode
  - c Size of one side of cell = Valid range : 01 to 32 dots  
Example) cc=04

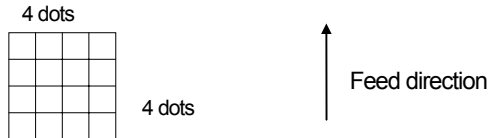

- d Quantity of partitions by concatenation mode = Valid range : 01 to 16
- e Sequential number partitioned by concatenation = Valid range : 01 to 16
- f Concatenation mode parity data = Valid range : 00 to FF
- g Input character mode = 1 : Numeric  
2 : Alphanumeric  
3 : Binary  
4 : Kanji
- h Quantity of data = Valid range : 0001 to 7366
- n Print data = Data

[Coding Example] Error correction level: 30%, concatenation mode: standard, size of one side of cell: 10  
<A>  
<V>100<H>200<BQ>3010,112345  
<Q>2  
<Z>

[Notes]  
1. Parity data is a result of XOR calculation of entire data of QR Code expressed in Hexadecimal character.  
2. Quantity of data is not required to specify unless character mode is set to binary.



QR code data size table (Model1)

Version	Error correction	Numeric	Alpha-Num	Kanji	Binary
1 21x21	L	40	24	10	17
	M	33	20	8	14
	Q	25	15	6	11
	H	16	10	4	7
2 25x25	L	81	49	20	34
	M	66	40	17	28
	Q	52	31	13	22
	H	33	20	8	14
3 29x29	L	131	79	33	55
	M	100	60	25	42
	Q	81	49	20	34
	H	52	31	13	22
4 33x33	L	186	113	48	78
	M	138	84	35	58
	Q	114	69	29	48
	H	76	46	19	32
5 37x37	L	253	154	65	106
	M	191	116	49	80
	Q	157	95	40	66
	H	105	63	27	44
6 41x41	L	321	194	82	134
	M	249	151	64	104
	Q	201	122	51	84
	H	133	81	34	56
7 45x45	L	402	244	103	168
	M	311	188	80	130
	Q	253	154	65	106
	H	167	101	43	70
8 49x49	L	493	299	126	206
	M	378	229	97	158
	Q	301	183	77	126
	H	203	123	52	85
9 53x53	L	585	354	150	244
	M	441	267	113	184
	Q	369	223	94	154
	H	239	145	61	100
10 57x57	L	690	418	177	287
	M	526	319	135	219
	Q	433	262	111	180
	H	291	176	74	121

Version	Error correction	Numeric	Alpha-Num	Kanji	Binary
11 61x61	L	800	485	205	333
	M	608	368	156	253
	Q	493	299	126	205
	H	342	207	87	142
12 65x65	L	915	555	234	381
	M	694	421	178	289
	Q	579	351	148	241
	H	390	236	100	162
13 69x69	L	1030	624	264	429
	M	790	479	202	329
	Q	656	398	168	273
	H	454	275	116	189
14 73x73	L	1167	707	299	486
	M	877	531	225	365
	Q	738	447	189	307
	H	498	302	127	207

QR Code (Numeric mode) table

					S				I				S				O					
<b>b8</b>					0	0	0	0	0	0	0	0	0	1	1	1	1	1	1	1	1	
<b>b7</b>					0	0	0	0	1	1	1	1	0	0	0	0	1	1	1	1	1	
<b>b6</b>					0	0	1	1	0	0	1	1	0	0	1	1	0	0	1	1	1	
<b>b5</b>					0	1	0	1	0	1	0	1	0	1	0	1	0	1	0	1	0	1
<b>b4</b>	<b>b3</b>	<b>b2</b>	<b>b1</b>		<b>0</b>	<b>1</b>	<b>2</b>	<b>3</b>	<b>4</b>	<b>5</b>	<b>6</b>	<b>7</b>	<b>8</b>	<b>9</b>	<b>A</b>	<b>B</b>	<b>C</b>	<b>D</b>	<b>E</b>	<b>F</b>		
0	0	0	0	<b>0</b>				0														
0	0	0	1	<b>1</b>				1														
0	0	1	0	<b>2</b>				2														
0	0	1	1	<b>3</b>				3														
0	1	0	0	<b>4</b>				4														
0	1	0	1	<b>5</b>				5														
0	1	1	0	<b>6</b>				6														
0	1	1	1	<b>7</b>				7														
1	0	0	0	<b>8</b>				8														
1	0	0	1	<b>9</b>				9														
1	0	1	0	<b>A</b>																		
1	0	1	1	<b>B</b>																		
1	1	0	0	<b>C</b>																		
1	1	0	1	<b>D</b>																		
1	1	1	0	<b>E</b>																		
1	1	1	1	<b>F</b>																		

QR Code (alphanumeric) table

					S				I				S				O						
					b8	0	0	0	0	0	0	0	0	1	1	1	1	1	1	1	1	1	
					b7	0	0	0	0	1	1	1	1	0	0	0	0	1	1	1	1	1	
					b6	0	0	1	1	0	0	1	1	0	0	1	1	0	0	1	1	1	
					b5	0	1	0	1	0	1	0	1	0	1	0	1	0	1	0	1	0	1
b4	b3	b2	b1		0	1	2	3	4	5	6	7	8	9	A	B	C	D	E	F			
0	0	0	0	<b>0</b>			SP	0		P													
0	0	0	1	<b>1</b>				1	A	Q													
0	0	1	0	<b>2</b>				2	B	R													
0	0	1	1	<b>3</b>				3	C	S													
0	1	0	0	<b>4</b>			\$	4	D	T													
0	1	0	1	<b>5</b>			%	5	E	U													
0	1	1	0	<b>6</b>				6	F	V													
0	1	1	1	<b>7</b>				7	G	W													
1	0	0	0	<b>8</b>				8	H	X													
1	0	0	1	<b>9</b>				9	I	Y													
1	0	1	0	<b>A</b>			*	:	J	Z													
1	0	1	1	<b>B</b>			+		K														
1	1	0	0	<b>C</b>					L														
1	1	0	1	<b>D</b>			-		M														
1	1	1	0	<b>E</b>			.		N														
1	1	1	1	<b>F</b>			/		O														

QR Code (Binary mode) table

				S				I				S				O			
<b>b8</b>				0	0	0	0	0	0	0	0	1	1	1	1	1	1	1	1
<b>b7</b>				0	0	0	0	1	1	1	1	0	0	0	0	1	1	1	1
<b>b6</b>				0	0	1	1	0	0	1	1	0	0	1	1	0	0	1	1
<b>b5</b>				0	1	0	1	0	1	0	1	0	1	0	1	0	1	0	1
<b>b4</b>	<b>b3</b>	<b>b2</b>	<b>b1</b>	<b>0</b>	<b>1</b>	<b>2</b>	<b>3</b>	<b>4</b>	<b>5</b>	<b>6</b>	<b>7</b>	<b>8</b>	<b>9</b>	<b>A</b>	<b>B</b>	<b>C</b>	<b>D</b>	<b>E</b>	<b>F</b>
0	0	0	0	<b>0</b>			SP	0	@	P	`	p							
0	0	0	1	<b>1</b>			!	1	A	Q	a	q							
0	0	1	0	<b>2</b>			"	2	B	R	b	r							
0	0	1	1	<b>3</b>			#	3	C	S	c	s							
0	1	0	0	<b>4</b>			\$	4	D	T	d	t							
0	1	0	1	<b>5</b>			%	5	E	U	e	u							
0	1	1	0	<b>6</b>			&	6	F	V	f	v							
0	1	1	1	<b>7</b>			'	7	G	W	g	w							
1	0	0	0	<b>8</b>			(	8	H	X	h	x							
1	0	0	1	<b>9</b>			)	9	I	Y	i	y							
1	0	1	0	<b>A</b>			*	:	J	Z	j	z							
1	0	1	1	<b>B</b>			+	;	K	[	k	{							
1	1	0	0	<b>C</b>			,	<	L	\	l								
1	1	0	1	<b>D</b>			-	=	M	]	m	}							
1	1	1	0	<b>E</b>			.	>	N	^	n	-							
1	1	1	1	<b>F</b>			/	?	O	_	o	DEL							

The address can be selectable in the range 00H thru 7FH, A0H thru DFH for QR Code (Binary mode).

QR code (Kanji mode) table

	Shift JIS	0	1	2	3	4	5	6	7	8	9	A	B	C	D	E	F	
Symbol	813F		SP	、	。	、	・	・	：	；	？	！	、	。	、	、	、	
	814F	^		—	、	、	、	、	、	全	々	々	〇	—	—	□	/	
	815F	\	~	□		…	□	、	、	“	”	(	)	[	]	[	]	
	816F	{	}			《	》	「	」	『	』	【	】	+	-	±	×	
	8180	÷	=	≠	<	>	□	□	∞	□	♂	♀	°	、	”	□	¥	
	8190	\$	¢	£	%	#	&	*	@	§	□	□	○	●	□	□		
	819E		□	□	■	□	▲	□	▼	□	〒	→	←	↑	↓	≡		
Alphanumeric	824F	0	1	2	3	4	5	6	7	8	9			L	M	N	O	
	825F		A	B	C	D	E	F	G	H	I	J	K					
	826F	P	Q	R	S	T	U	V	W	X	Y	Z						
	8280		a	b	c	d	e	f	g	h	i	j	k	l	m	n	o	
	8290	p	q	r	s	t	u	v	w	x	y	z						
Hiragana	829E		あ	い	う	え	お	か	が	き	ぎ	く						
	82AE	ぐ	け	こ	さ	し	す	せ	げ	そ	ぞ	た						
	82BE	だ	ち	っ	つ	て	ず	な	ぬ	ね	の	は						
	82CE	ば	ぱ	び	ふ	ぶ	べ	に	ぼ	ね	ま	み						
	82DE	む	め	も	ゆ	よ	ら	ほ	れ	ろ	わ	わ						
	82EE	ゐ	ゑ	を	ん													
Katakana	833F		ア	イ	ウ	エ	オ	カ	ガ	キ	ギ	ク						
	834F	グ	ケ	コ	サ	シ	ス	セ	ゲ	ソ	ゾ	タ						
	835F	ダ	チ	ッ	ツ	テ	ド	ナ	ネ	ノ	ハ	ミ						
	836F	バ	パ	ヒ	フ	ブ	ヘ	ベ	ポ	ポ	マ	ミ						
	8380	ム	メ	モ	ユ	ヨ	ラ	リ	ロ	ワ	ワ							
	8390	ヰ	ヱ	ヲ	ヴ	カ	ケ											
Greek	839E		Α	Β	Γ	Δ	Ε	Ζ	Η	Θ	Ι	Κ	Λ	Μ	Ν	Ξ	Ο	
	83AE	Π	Ρ	Σ	Τ	Υ	Φ	Χ	Ψ	Ω								
	83BE		α	β	γ	δ	ε	ζ	η	θ	ι	κ	λ	μ	ν	ξ	ο	
	83CE	π	ρ	σ	τ	υ	φ	χ	ψ	ω								
Russian	843F		А	Б	В	Г	Д	Е	Ж	З	И	Й	К	Л	М	Н		
	844F	О	П	Р	С	Т	У	Ф	Ц	Ч	Ш	Щ	Ъ	Ы	Ь	Э		
	845F	Ю	Я															
	846F		а	б	в	г	д	е	ё	ж	з	и	й	к	л	м	н	
	8480	о	п	р	с	т	у	ф	х	ц	ч	ш	щ	ъ	ы	ь	э	
	8490	ю	я															

	Shift JIS	0	1	2	3	4	5	6	7	8	9	A	B	C	D	E	F
ア	889E		垂	唾	娃	阿	哀	愛	挨	始	逢	葵	茜	穉	惡	握	渥
	88AE	旭	葦	芦	鮎	梓	压	幹	扱	宛	姐	虻	飴	絢	綾	鮎	或
	88BE	粟	裕	安	庵	按	暗	案	闇	鞍	杏						
イ	88BE											以	伊	位	依	偉	困
	88CE	夷	委	威	尉	惟	意	慰	易	椅	為	畏	異	移	維	緯	胃
	88DE	萎	衣	謂	違	遣	医	井	亥	域	育	郁	磯	一	老	溢	逸
	88EE	稻	茨	芋	翳	允	印	咽	員	因	姻	引	飲	淫	胤	蔭	
	893F		院	陰	隱	韻	吋										
ウ	893F							右	宇	烏	羽	迂	雨	卯	鷓	窺	丑
	894F	碓	白	渦	嘘	唄	鬱	蔚	鰻	姥	廐	浦	瓜	閏	樽	云	運
	895F	雲															
エ	895F		荏	餌	叡	嘗	嬰	影	映	曳	栄	永	泳	洩	瑛	盈	穎
	896F	穎	英	衛	詠	銳	液	疫	益	馱	悦	謁	越	閱	榎	厭	円
	8980	園	堰	奄	宴	延	怨	掩	援	沿	演	炎	焰	煙	燕	猿	縁
	8990	艶	苑	園	遠	鉛	鴛	塩									
オ	8990								於	汚	甥	凹	央	奧	往	忝	億
	899E		押	旺	横	欧	殴	王	翁	襖	鶯	鷗	黄	岡	沖	荻	
	89AE	屋	憶	臆	桶	牡	乙	俺	卸	恩	温	穩	音				
カ	89AE													下	化	飯	何
	89BE	伽	伽	佳	加	可	嘉	夏	嫁	家	寡	科	暇	果	架	歌	河
	89CE	火	珂	禍	禾	稼	箇	花	苛	茄	荷	華	菓	蝦	課	嘩	貨
	89DE	迦	過	霞	蚊	俄	峨	我	牙	画	臥	芽	蛾	賀	課	餓	駕
	89EE	介	會	解	回	塊	壞	迴	快	怪	悔	恢	懷	戒	拐	改	
	8A3F		魁	晦	械	海	灰	界	皆	怪	芥	蟹	開	階	貝	凱	幼
	8A4F	外	咳	害	崖	慨	概	涯	碍	蓋	街	該	鎧	骸	隄	凱	蛙
	8A5F	垣	柿	蚌	鉤	劃	嚇	各	廓	蓋	攪	格	核	殼	獲	確	穫
	8A6F	覺	角	赫	較	郭	閣	隔	革	学	岳	樂	額	顎	掛	笠	榎
	8A80	檀	梶	鯁	瀉	割	喝	恰	括	活	渴	滑	葛	謁	轄	且	鯉
	8A90	叶	椀	樺	鞆	株	兜	竈	蒲	釜	鎌	嚙	鴨	栢	茅	萱	姦
	8A9E		粥	刈	苳	瓦	乾	侃	冠	寒	刊	勘	勸	卷	喚	堪	姦
	8AAE	完	官	寬	干	幹	患	感	慣	憾	換	敢	柑	桓	棺	款	歡
	8ABE	汗	漢	濶	淮	環	甘	監	看	竿	管	簡	柑	缶	翰	肝	岸
8ACE	莞	觀	諫	貫	還	鑑	間	閑	閑	陷	韓	館	丸	含			
8ADE	巖	玩	癩	眼	岩	翫	贖	雁	頑	顏	願						

	ShiftJIS	0	1	2	3	4	5	6	7	8	9	A	B	C	D	E	F	
キ	8ADE													企	伎	危	喜	器
	8AEE	基	奇	嬉	寄	岐	希	幾	忌	揮	机	旗	企	伎	危	喜	器	
	8B3F		機	歸	毅	氣	汽	畿	祈	季	稀	紀	既	規	棋	棄		
	8B4F	軌	輝	飢	騎	鬼	龜	偽	儀	妓	宜	戲	微	擬	記	貴		
	8B5F	祇	義	蟻	誼	議	掬	菊	鞠	吉	吃	喫	技	橘	詰	儀		
	8B6F	黍	却	客	脚	虐	逆	丘	久	仇	休	及	桔	宮	詰	儀		
	8B80	朽	求	汲	泣	灸	球	究	窮	笈	級	糾	給	旧	詰	儀		
	8B90	巨	拒	拋	拳	渠	虛	許	距	筮	漁	及	魚	亨	詰	儀		
	8B9E		供	俠	僑	兇	競	共	凶	協	匡	卿	叫	喬	詰	儀		
	8BAE	彊	怯	恐	恭	挾	教	橋	況	狂	狹	矯	胸	喬	詰	儀		
	8BBE	鏡	響	饗	驚	仰	凝	堯	曉	業	局	曲	極	玉	詰	儀		
8BCE	勤	均	巾	錦	斤	欣	欽	琴	禁	禽	筋	緊	芹	詰	儀			
8BDE	謹	近	金	吟	銀									芹	詰	儀		
ク	8BDE						九	俱	句	区	狗	玖	矩	苦	軀	驅	駮	
	8BEE	駒	具	愚	虞	喰	空	偶	寓	遇	隅	串	櫛	釧	屑	屈	君	
	8C3F		掘	窟	沓	靴	轡	窪	熊	隈	彖	栗	線	桑	歛	勲		
	8C4F	薰	訓	群	軍	郡												
ケ	8C4F						卦	袈	祁	係	傾	刑	兄	啓	圭	珪	型	
	8C5F	契	形	徑	患	慶	慧	憩	揭	携	敬	景	桂	溪	畦	稽	系	
	8C6F	經	繼	繫	罴	荳	荊	蚩	計	詣	警	輕	頸	鷄	芸	迎	鯨	
	8C80	劇	戟	擊	激	隙	桁	傑	欠	詣	潔	穴	結	血	訣	月	鯨	
	8C90	儉	倦	健	兼	券	劍	喧	圈	決	嫌	建	憲	懸	拳	捲	鯨	
	8C9E		檢	權	牽	券	劍	喧	圈	堅	嫌	建	憲	懸	拳	捲	鯨	
	8CAE	鍵	險	顯	驗	鯨	元	原	嚴	絹	臬	肩	見	源	謙	軒	鯨	
8CBE	言	諺	限						幻	弦	減	源	玄	現	絃	鯨		
コ	8CBE				乎	個	古	呼	固	姑	孤	己	庫	弧	戸	故	枯	
	8CCE	湖	狐	糊	袴	股	胡	菰	虎	誇	跨	鈷	雇	顧	鼓	五	互	
	8CDE	伍	午	吳	吾	娛	後	御	悟	梧	檣	瑚	暮	語	誤	護	翻	
	8DEE	乞	鯉	交	佼	侯	候	倖	光	公	功	効	勾	厚	口	向	康	
	8D3F		后	喉	坑	垢	好	孔	孝	宏	工	巧	巷	幸	庾	庚	洪	
	8D4F	弘	恒	慌	抗	拘	控	攻	昂	晃	更	杭	校	梗	構	江	肱	
	8D5F	浩	港	溝	甲	皇	硬	稿	糠	紅	紘	絞	綱	耕	考	肯	降	
	8D6F	腔	膏	航	荒	行	衡	講	貢	購	郊	醇	鉞	砧	閤	閤	刻	
	8D80	頂	香	高	鴻	剛	劫	号	合	壕	拷	濠	豪	轟	克	克	刻	

	ShiftJIS	0	1	2	3	4	5	6	7	8	9	A	B	C	D	E	F
コ	8D90 8D9E 8DAE	告 紺	国 此 艮	穀 頃 魂	酷 今	鵠 困	黒 坤	獄 壘	漉 婚	腰 恨	甌 懇	忽 昏	惚 昆	骨 根	狛 梱	込 混	痕
サ	8DAE 8DBE 8DCE 8DDE 8DEE 8E3F 8E4F 8E5F	袞 歳 材 咋 三 酸	坐 濟 罪 搾 察 傘 餐	座 災 財 昨 拶 搽 參 斬	些 挫 采 冚 朔 撮 山 暫	佐 債 犀 坂 柵 擦 慘 残	又 催 碎 阪 窄 札 撒	峻 再 砦 堺 策 殺 散	嵯 最 祭 榊 索 薩 棧	左 哉 斎 肴 錯 雜 燦	差 塞 細 咲 桜 阜 珊	查 妻 菜 崎 鮭 鯖 産	沙 宰 裁 埼 筵 捌 算	瑳 彩 載 碇 匙 鏘 纂	砂 才 際 鷺 冊 鮫 蚕	詐 採 劑 作 刷 皿 讚	鎖 裁 在 削 晒 贊
シ	8E5F 8E6F 8E80 8E90 8E9E 8EAE 8EBE 8ECE 8EDE 8EEE 8F3F 8F4F 8F5F 8F6F 8F80 8F90 8F9E 8FAE 8FBE 8FCE 8FDE 8FEE 903F	姉 死 諮 式 疾 斜 酌 腫 衆 柔 出 準 署 尚 樟 笑 鉦 情	姿 氏 資 次 識 質 煮 積 趣 宗 襲 汁 術 潤 書 勝 匠 床 沼 紹 鐘 擾 拭	屍 祉 雌 治 竺 部 紗 若 首 州 蹴 獸 俊 純 諸 升 廠 消 肖 障 杖 殖	市 私 飼 爾 軸 篠 者 寂 儒 修 輯 縱 峻 巡 諸 召 彰 涉 莒 鞘 淨 燭	仕 師 糸 齒 事 痔 零 柴 車 惹 呢 拾 酋 銃 瞬 醇 叙 商 抄 燒 蕉 丈 疊 職	仔 志 紙 事 痔 零 柴 車 惹 呢 拾 酋 銃 瞬 醇 叙 商 抄 燒 蕉 丈 疊 職	伺 思 紫 似 磁 七 芝 遮 主 寿 洲 酬 叔 竣 順 女 唱 招 焦 衝 丞 穰 色	使 指 肢 侍 示 叱 屢 蛇 取 授 秀 集 夙 舜 処 序 嘗 掌 照 裳 乘 蒸 触	刺 支 脂 兒 而 執 蕊 邪 守 樹 秋 醜 宿 駿 初 徐 獎 捷 症 訟 冗 讓 食	司 攷 至 字 耳 失 縞 借 手 綬 終 什 淑 准 所 恕 妾 昇 省 証 剩 釀 蝕	史 斯 視 寺 自 嫉 舍 勺 朱 需 繡 住 祝 循 暑 鋤 娼 昌 硝 詔 城 錠 辱	嗣 施 詞 慈 蒔 室 写 尺 殊 囚 習 充 縮 旬 曙 除 宵 昭 礁 詳 場 囑 尻	四 旨 詩 持 辞 悉 射 杓 狩 収 臭 十 肅 楯 渚 傷 將 晶 祥 象 壤 埴 伸	士 枝 試 時 汐 湿 捨 灼 珠 周 舟 從 塾 殉 庶 償 小 松 称 象 壤 埴 伸	始 止 誌 鹿 漆 赦 爵 種 蒐 戎 熟 淳 緒 少 梢 章 醬 常 侵	



	ShiftJIS	0	1	2	3	4	5	6	7	8	9	A	B	C	D	E	F
シ	904F	唇	娠	寝	審	心	慎	振	新	晋	森	榛	浸	深	申	疹	真
	905F	神	秦	紳	臣	芯	薪	親	診	身	辛	進	針	震	人	仁	刃
	906F	塵	壬	尋	甚	尽	腎	訊	迅	陣	勃						
ス	906F											笥	諏	須	酢	凶	厨
	9080	逗	吹	垂	帥	推	水	炊	睡	粹	翠	衰	遂	醉	錐	錘	隨
	9090	瑞	髓	崇	嵩	数	枢	趨	難	据	杉	相	菅	頗	雀	裾	
	909E		澄	摺	寸												
セ	909E					世	瀬	畝	是	凄	制	勢	姓	征	性	成	政
	90AE	整	星	晴	棲	栖	正	清	牲	生	盛	精	聖	声	製	西	誠
	90BE	誓	請	逝	醒	青	静	齐	税	脆	隻	席	惜	戚	斥	昔	析
	90CE	石	積	籍	績	脊	責	赤	跡	蹟	碩	切	拙	接	撰	折	設
	90DE	窃	節	説	雪	絶	舌	蝉	仙	先	千	占	宣	専	尖	川	戦
	90EE	扇	撰	栓	梅	泉	浅	洗	染	潜	煎	煽	旋	穿	箭	線	鮮
	913F		織	羨	腺	舛	船	薦	詮	賤	踐	選	遷	穿	銑	閃	
914F	前	善	漸	然	全	禅	繕	膳	糶								
ソ	914F										噌	塑	岨	措	曾	曾	楚
	915F	狙	疏	疎	礎	祖	租	粗	素	組	蘇	訴	阻	迦	鼠	僧	創
	916F	双	叢	倉	喪	壯	奏	爽	宋	層	匠	惣	想	搜	掃	挿	搔
	9180	操	早	曹	巢	槍	槽	漕	燥	争	瘦	相	恣	槽	総	綜	聰
	9190	草	莊	葬	蒼	藻	装	走	送	遭	鎗	霜	騷	像	増	憎	俗
	919E		臆	蔵	贈	造	促	側	則	即	息	捉	束	測	足	速	
91AE	属	賊	族	統	卒	袖	其	揃	存	孫	尊	損	村	遜			
タ	91AE															他	多
	91BE				唾	墮	妥	惰	打	柁	舵	楯	陀	馱	駢	体	堆
	91CE	太	汰	詫	帶	待	怠	態	戴	替	泰	滯	胎	腿	苔	袋	貸
	91DE	对	耐	岱	黛	鯛	代	台	大	第	醜	題	鷹	淹	瀧	卓	啄
	91EE	退	逮	隊	拓	沢	濯	琢	託	鐸	濁	諾	茸	夙	只	誰	耽
	923F		叩	但	達	辰	奪	脱	巽	豎	汕	柵	苜	狸	樽	誰	
	924F	丹	单	嘆	坦	担	探	旦	歎	淡	湛	炭	谷	端	綻		
925F	胆	蛋	誕	鍛	団	壇	彈	断	暖	檀	炭	短	談				
チ	925F														值	知	地
	926F	弛	恥	智	池	痴	稚	置	致	蚰	遲	馳	策	畜	竹	筑	蓄
	9280	逐	秩	窒	茶	嫡	着	中	仲	宙	忠	抽	昼	柱	注	虫	衷
	9290	註	耐	鑄	駐	樗	瀦	猪	苧	著	貯	丁	兆	凋	喋	龍	

	ShiftJIS	0	1	2	3	4	5	6	7	8	9	A	B	C	D	E	F
チ	929E		帖	帳	庁	弔	張	彫	徵	懲	挑	暢	朝	潮	牒	町	眺
	92AE	聽	脹	腸	蝶	調	謀	超	跳	鈔	長	頂	鳥	勅	抄	直	朕
	92BE	沈	珍	賃	鎮	陳											
ツ	92BE						津	墜	椎	槌	追	鎚	痛	通	塚	梅	摑
	92CE	槻	佃	漬	柘	辻	蔦	綴	鍔	椿	潰	坪	壺	嬢	紬	爪	吊
	92DE	釣	鶴														
テ	92DE			亭	低	停	偵	剃	貞	呈	堤	定	帝	底	庭	廷	弟
	92EE	悌	抵	挺	提	梯	汀	碇	禎	程	締	艇	訂	諦	蹄	遞	哲
	933F		邸	鄭	釘	鼎	泥	摘	擢	敵	滴	的	笛	適	適	溺	顛
	934F	徹	撤	鞞	迭	鉄	典	填	天	展	店	添	纏	甜	貼	轉	
	935F	点	伝	殿	澱	田	電										
ト	935F							兔	吐	堵	塗	妬	屠	徒	斗	杜	渡
	936F	登	菟	賭	途	都	鍍	砥	砺	努	度	土	奴	怒	倒	党	冬
	9380	凍	刀	唐	塔	塘	套	宕	島	嶋	悼	投	搭	東	桃	袴	棟
	9390	盜	淘	湯	涛	灯	燈	当	痘	禱	等	答	筍	糖	統	到	
	939E		董	蕩	藤	討	騰	豆	踏	逃	透	鏡	陶	頭	騰	鬪	働
	93AE	動	同	堂	導	懂	撞	洞	瞳	童	胴	苟	道	銅	峠	鴉	匿
	93BE	得	德	澆	特	督	禿	篤	毒	独	読	析	橡	凸	突	椀	届
	93CE	鷲	苦	寅	酉	滯	噸	屯	惇	敦	沌	豚	遁	頓	吞	曇	鈍
ナ	93DE	奈	那	内	乍	凧	薙	謎	灘	捺	鍋	櫛	馴	縄	啜	南	楠
	93EE	軟	難	汝													
ニ	93EE				二	尼	弍	迤	勻	賑	肉	虹	廿	日	乳	入	
	943F		如	尿	菲	任	妊	忍	認								
ヌ	943F									濡							
ネ	943F										襦	祢	寧	葱	猫	熱	年
	944F	念	捻	撚	燃	粘											
ノ	944F						乃	迺	之	埜	囊	惱	濃	納	能	腦	膿
	945F	農	覗	蚤													
ハ	945F				巴	把	播	霸	杷	波	派	琶	破	婆	罵	芭	馬
	946F	俳	糜	拝	排	敗	杯	盃	牌	背	肺	輩	配	倍	培	媒	梅
	9480	椈	煤	狽	買	売	賠	陪	這	蠅	秤	矧	萩	伯	剥	博	拍
	9490	柏	泊	白	箔	粕	舶	薄	迫	曝	漠	爆	縛	莫	駁	麥	
	949E		函	箱	砒	箸	肇	箒	櫨	幡	肌	焮	阜	八	鉢	澆	癸
	94AE	醜	髮	伐	罰	拔	筏	閥	鳩	嘶	塙	蛤	隼	伴	判	半	反

	ShiftJIS	0	1	2	3	4	5	6	7	8	9	A	B	C	D	E	F
ハ	94BE 94CE	叛 采	帆 煩	搬 頒	斑 飯	板 挽	汜 晚	汎 番	版 盤	犯 罄	班 蕃	畔 蛮	繁	般	藩	販	範
ヒ	94CE 94DE 94EE 953F 954F 955F 956F	彼 誹 桧 廟 竇	悲 費 鼻 姬 描 頻	扉 避 柎 媛 病 敏	批 非 稗 紐 秒 瓶	披 飛 匹 百 苗	斐 樋 疋 謬 錨	比 簸 髭 佞 鋌	泌 備 彦 彪 蒜	疲 尾 膝 標 蛭	皮 微 菱 冰 鱗	碑 枇 肘 漂 品	匪 秘 毘 弼 瓢 彬	卑 緋 毘 必 票 斌	否 罷 眉 畢 表 浜	妃 肥 美 筆 評 瀕	庇 被 逼 豹 貧
フ	956F 9580 9590 959E 95AE	斧 武 憤	普 舞 福 扮	浮 葡 腹 焚	父 蕪 複 奮	不 符 部 覆 粉	付 腐 封 淵 糞	埠 膚 楓 弗 紛	夫 芙 風 弘 霧	婦 譜 葦 沸 文	富 負 落 仏 聞	富 賦 伏 物	布 赴 副 鮒	府 阜 復 分	怖 附 幅 吻	扶 侮 服 噴	敷 撫 墳
ヘ	95AE 95BE 95CE	弊 偏	柄 变	並 片	蔽 篇	閉 編	陛 辺	米 返	頁 遍	僻 便	壁 勉	丙 癖 婉	併 碧 弁	兵 別 鞭	塀 警	幣 蔑	平 篋
ホ	95CE 95DE 95EE 963F 964F 965F 966F	圃 俸 飽 棒 撲	捕 包 法 鳳 冒 朴	步 呆 泡 鵬 紡 牧	甫 報 烹 乏 肪 睦	補 奉 砲 亡 膨 穆	輔 宝 縫 傍 謀 釦	穗 峰 胞 剖 貌 勃	募 峯 芳 坊 貿 没	墓 崩 萌 妨 銖 殆	慕 庖 蓬 帽 防 堀	戊 抱 蜂 忘 吠 幌	暮 捧 褒 忙 類 奔	母 放 訪 房 北 本	保 簿 方 豐 暴 僕 翻	舖 菩 朋 邦 望 卜 凡	鋪 做 鋒 某 墨 盆
マ	9680 9690 969E	摩 鱒	磨 枿 漫	魔 亦 蔓	麻 俣	埋 又	妹 抹	昧 末	枚 沫	每 迄	哩 俛	禎 繭	幕 磨	膜 万	枕 慢	鮪 滿	枉
ミ	969E 96AE	耗 民 眠		味	未 魅 巳 箕					岬 密 蜜 湊			蓑 稔 脈 妙				
ム	96AE			務	夢 無 牟 矛					霧 鷓 棕 婿			娘				
メ	96AE 96BE	明 盟 迷 銘			鳴 姪 牝 滅					免 棉 綿 緬			冥 麵	名 命			
モ	96BE 96CE	茂 妄 孟 毛			猛 盲 網 耗					蒙 儲 木 默			目 空	摸 勿	模 餅		

	ShiftJIS	0	1	2	3	4	5	6	7	8	9	A	B	C	D	E	F
モ	96DE	尤	戾	勑	貫	問	悶	紋	門	刃							
ヤ	96DE 96EE	矢	厄	役	約	藥	訊	躍	靖	柳	也	冶	夜	爺	耶	野	弥
ユ	96EE 973F 974F	涌	諭	輸	唯	佑	優	勇	友	宥	幽	悠	愉	愈	油	癒	湧
ヨ	974F 975F 976F 9780	誉	輿	預	傭	幼	妖	容	庸	揚	搖	擁	曜	楊	樣	洋	欲
ラ	9780 9790	乱	卵	嵐	欄	濫	羅	螺	裸	来	莱	賴	雷	洛	絡	落	酪
リ	9790 979E 97AE 97BE 97CE	琉	痲	裏	裡	里	離	陸	律	利	吏	履	李	梨	理	璃	溜
ル	97CE 97DE	類	寮	料	涼	淋	龍	瞭	稜	率	立	了	略	亮	僚	流	凌
レ	97DE 97EE 983F	齡	令	伶	例	冷	勵	嶺	伶	玲	礼	苓	鈴	隸	零	靈	麗
ロ	983F 984F 985F	楼	榔	浪	漏	呂	魯	櫓	炉	賂	路	露	勞	婁	廊	弄	朗
ワ	985F 986F	椀	倭	和	話	歪	賄	脇	惑	梓	鷺	互	巨	鱒	詫	藁	蕨

	ShiftJIS	0	1	2	3	4	5	6	7	8	9	A	B	C	D	E	F	
一	989E		弋	丐	丕													
丨	989E					个	卯											
丶	989E							、	井									
丿	989E									丿	乂	乖	乘					
乙	989E													亂				
丿	989E 98AE	舒													丿	豫	爭	
二	98AE		式	于	亞	亟												
亠	98AE					亠	亢	京		毫	亠							
人	98AE 98BE 98CE 98DE 98EE 993F 994F	仞 佩 俾 偃 儼	仞 佰 倚 假 僉 儕	仞 侑 侏 會 僂 儔	价 佯 偃 偕 僂 儔	伉 來 倪 修 儂 儻	伉 侖 侗 倜 儂 儻	估 儂 倜 倜 儂 儻	佛 倪 倜 倜 儂 儻	佻 俎 俎 俎 儂 儻	佻 俎 俎 俎 儂 儻	仍 佻 俎 俎 儂 儻	仍 佻 俎 俎 儂 儻	仄 侈 侑 俎 儂 儻	仆 侑 俎 俎 儂 儻	仞 侑 俎 俎 儂 儻	仗 佻 俎 俎 儂 儻	
儿	994F									儿	兀	兒		兌	兔	兢	競	
入	995F	兩	兪															
八	995F			兮	冀													
冂	995F					冂	回	册	冉	冂	冂	冂	冂					
冂	995F 996F	寫	冂											冂	冤	冠	冂	
冂	996F			冂	决	冂	冲	冰	况	冂	冂	冂	冂					
几	996F 9980														几	處	冂	凭
冂	9980		冂	冂														
刀	9980 9990 999E	劊	剔	剪	劊	刊	劊	劊	劊	刪	刮	劊	劊	劊	劊	劊	劊	
力	999E 99AE	勸		劊	劊	劊	劊	劊	劊	劊	劊	劊	劊	劊	劊	劊	劊	
勹	99AE		勹	勹	冂	冂	冂	冂	冂									
匕	99AE									匕								
匚	99AE										匚	匚	匚	匚	匚	匚		

	ShiftJIS	0	1	2	3	4	5	6	7	8	9	A	B	C	D	E	F
匸	99AE																匸 區
十	99BE	卅	卅	卅	卅	卅	卅	卅	卅								
卜	99BE								卜								
卩	99BE								卩	卮	卮	卮	卮				
厂	99BE 99CE													厂	厖	厖	厦
厶	99CE				厶	参	篡										
又	99CE							雙	叟	曼	變						
口	99CE 99DE 99EE 9A3F 9A4F 9A5F 9A6F 9A80 9A90	呀 咒 啞 喟 噫 噫	听 呻 咫 唯 啞 噤	吭 咀 晒 啣 啣 嘔 嘔	吼 嗽 咤 啞 喘 嗽 嘔 嘔	吮 咄 佬 售 啣 嘔 嘔	呐 咐 局 啣 單 啞 啞	吩 咆 啣 啞 啞 啞 啞	吝 哇 哥 啞 啞 啞 啞	呖 咏 呖 哦 啞 啞 啞	咏 咸 唏 唸 唸 噎 噎	呵 啞 唔 啞 啞 噎 噎	叮 咎 咬 哽 啞 啞 啞	叭 呖 哄 哮 喙 嗅 嚙 嚙	叭 呱 哈 哭 喀 嗟 嚙 嚙	吁 呖 咨 哭 喀 嗟 嚙 嚙	咩 咩 咩 咩 咩 咩 咩 咩
口	9A90 9A9E									口	囧	囧	囧	囧	囧	囧	囧
土	9A9E 9AAE 9ABE 9ACE 9ADE	坩 埧 墅 壘	垂 埧 壘 壘	垚 垚 墟 壘	坡 埧 埧 壘	坩 埧 埧 壘	垚 埧 埧 壘	垚 埧 埧 壘	垚 埧 埧 壘	坩 埧 壘 壘	坩 埧 壘 壘	坩 埧 壘 壘	坩 埧 壘 壘	坩 埧 壘 壘	坩 埧 壘 壘	坩 埧 壘 壘	坩 埧 壘 壘
士	9ADE				壯	壺	壹	壻	壺	壽							
女	9ADE									女							
女	9ADE										女	𡇗					
夕	9ADE													夕	𡇗	𡇗	
大	9ADE 9AEE	夭	𡇗	夸	夾	奇	奕	奂	奎	奚	奘	奢	奠	奧	獎	奘	夫
女	9B3F 9B4F 9B5F 9B6F	娑 媽 孃	奸 娜 媽 孃	妁 娉 嫗 孃	妝 娉 嫗 孃	佞 姍 嫩	佞 姍 嫗	妁 姍 嫗	妁 姍 嫗	姆 娶 嬌	姨 婢 嬋	姜 婪 嬋	妍 媚 嬋	妊 媪 嬋	姚 媪 嬋	娥 媪 嬋	娟 嫂 嬋

	ShiftJIS	0	1	2	3	4	5	6	7	8	9	A	B	C	D	E	F
子	9B6F				子	孕	孚	孛	孛	孩	孰	孳	孵	學	孛	孺	
宀	9B6F 9B80 9B90	它 寶	宦	宸	寃	寇	宦	寔	寐	寤	實	寢	寔	寥	寫	寰	寶
寸	9B90		尅	將	專	對											
小	9B90						尔	尠									
尢	9B90							尢	尢								
尸	9B90 9B9E		屐	屏	屨	屬				尸	尹	屮		屮	屎	屮	
屮	9B9E					屮											
山	9B9E 9BAE 9BBE 9BCE	岬	岷	岷	岷	岷	岷	岷	岷	岷	岷	岷	岷	岷	岷	岷	岷
巛	9BCE																巛
工	9BDE	巫															
巳	9BDE		巳	卮													
巾	9BDE 9BEE	幟	幟	幣	幣	帛	帛	帛	帛	帶	帷	幄	幃	幃	幃	幃	幃
干	9BEE					干	并										
么	9BEE						么	麼									
广	9BEE 9C3F		廖	廣	廝	廚	廛	廢	廡	广	庠	廁	廂	厦	廡	廡	
廴	9C3F																廴 廴
廴	9C4F	廴	弃	廴	廴	廴											
弋	9C4F						弋	弋									
弓	9C4F							弓		弩	弭	弭	弭	彈	彌	彎	彎
彳	9C5F	彳	彳	彳	彳												
彳	9C5F					彳	彭										
彳	9C5F 9C6F	徙	徙	徠	徠	徠	徠	徠	徠	徠	徠	徠	徠	徠	徠	徠	徠
心	9C6F 9C80 9C90	怙	恂	怩	恚	怙	怙	怙	怙	忤	忤	忤	忤	惠	恚	怡	恚





	ShiftJIS	0	1	2	3	4	5	6	7	8	9	A	B	C	D	E	F	
木	9E80	梳	栲	杵	档	桷	梲	梟	梏	梭	梔	條	椰	梃	檣	梔	桴	
	9E90	梵	栎	杵	桠	梲	梲	梲	梲	栲	棘	栲	椰	桐	控	棍		
	9E9E		栲	棧	棕	櫻	椒	接	棗	棗	柳	棗	棠	棧	梲	桠	桠	
	9EAE	棟	櫛	櫛	櫛	櫛	櫛	櫛	櫛	櫛	櫛	櫛	櫛	櫛	櫛	櫛	櫛	櫛
	9EBE	榆	櫛	棟	櫛	櫛	櫛	櫛	櫛	櫛	櫛	櫛	櫛	櫛	櫛	櫛	櫛	櫛
	9ECE	榻	櫛	櫛	櫛	櫛	櫛	櫛	櫛	櫛	櫛	櫛	櫛	櫛	櫛	櫛	櫛	櫛
	9EDE	榻	櫛	櫛	櫛	櫛	櫛	櫛	櫛	櫛	櫛	櫛	櫛	櫛	櫛	櫛	櫛	櫛
	9EEE	榻	櫛	櫛	櫛	櫛	櫛	櫛	櫛	櫛	櫛	櫛	櫛	櫛	櫛	櫛	櫛	櫛
	9F3F		櫛	櫛	櫛	櫛	櫛	櫛	櫛	櫛	櫛	櫛	櫛	櫛	櫛	櫛	櫛	櫛
	9F4F	櫛	櫛	櫛	櫛	櫛	櫛	櫛	櫛	櫛	櫛	櫛	櫛	櫛	櫛	櫛	櫛	櫛
欠	9F4F								欸	欸	盜	欸	飲	歇	歇	歉	歐	
	9F5F	欸	欸	欸	欸	歡												
止	9F5F					歸												
歹	9F5F						歹	殳	殳	殳	殳	殳	殳	殳	殳	殳	殳	
	9F6F	殳	殳	殳	殳	殳												
殳	9F6F					殳	殳	殳	殳	殳								
毋	9F6F									毋	毓							
	9F80	麾	氈									笔	毳	毫	毳	毳		
氏	9F80			氓														
气	9F80			气	氛	氫	氣											
水	9F80							汞	汕	汕	汪	沂	沔	沔	沁	沛		
	9F90	汾	汨	汨	沒	沐	泄	決	沽	泗	泗	沂	沂	沔	沔	沔		
	9F9E		汨	汨	沒	沐	泄	決	沽	泗	泗	沂	沂	沔	沔	沔	沔	
	9FAE	洌	洌	洌	沒	沐	泄	決	沽	泗	泗	沂	沂	沔	沔	沔	沔	
	9FBE	洌	洌	洌	沒	沐	泄	決	沽	泗	泗	沂	沂	沔	沔	沔	沔	
	9FCE	洌	洌	洌	沒	沐	泄	決	沽	泗	泗	沂	沂	沔	沔	沔	沔	沔
	9FDE	洌	洌	洌	沒	沐	泄	決	沽	泗	泗	沂	沂	沔	沔	沔	沔	沔
	9FEE	洌	洌	洌	沒	沐	泄	決	沽	泗	泗	沂	沂	沔	沔	沔	沔	沔
	E03F	澎	溇	溇	溇	溇	溇	溇	溇	溇	溇	溇	溇	溇	溇	溇	溇	溇
	E04F	濱	溇	溇	溇	溇	溇	溇	溇	溇	溇	溇	溇	溇	溇	溇	溇	溇
E06F	瀾	瀾	瀾	瀾	瀾	瀾	瀾	瀾	瀾	瀾	瀾	瀾	瀾	瀾	瀾	瀾	瀾	
火	E06F					炙	炒	炯	炯	炬	炸	炳	炳	炮	烟	然	烝	

	ShiftJIS	0	1	2	3	4	5	6	7	8	9	A	B	C	D	E	F
火	E080 E090 E09E	烙 煩	焉 熨	烽 熬 燿	焜 爛 爍	焙 熏 爐	煥 熾 爛	熙 燒 爨	熙 燉	煦 燔	煢 燎	煌 燠	煖 煨	煬 燧	熏 燧	燻 燼	熄
爪	E09E								爭	爬	爰	爲					
爻	E09E												爻	俎			
爿	E09E E0AE														爿	牀	牆
牛	E0AE			牝	牯	犁	犁	犛	犒	犖	犖	犖					
犬	E0AE E0BE E0CE	狎 猥	狒 狒	狒 獒	狼 獾	狡 默	狹 獺	狷 獾	倏 獨	猗 猗	猊 獸	猜 獵	狷 獻	豺 獾	狃 獾	狃 獾	狄 猓
王	E0CE E0DE E0EE	玻 瑁	珀 瑜	珥 瑩	珮 瑰	珞 瑣	璠 瑪	琅 瑤	瑯 瑾	琥 璋	瑀 璞	琲 璧	珙 瓊	瑕 瓏	玳 瓊	玳 瓊	玳 瓊
瓜	E13F		瓠	瓣													
瓦	E13F E14F		甕	甕	甕	甗	瓮	甗	甗	甗	甗	甗	甗	甗	甗	甗	甗
甘	E14F				嘗												
生	E14F					甦											
用	E14F					甬											
田	E14F E15F	畧	畫	畎	畸	當	疆	𡇗	𡇗	畎	畎	畎	畎	畎	畎	畎	畎
疒	E15F E16F E180 E190 E19E	痲 癩	疔 瘁 癩	痲 癩	疔 癩	疔 癩	疔 癩	疔 癩	疔 癩	疔 癩	疔 癩	疔 癩	疔 癩	疔 癩	疔 癩	疔 癩	疔 癩
火	E19E			火	癸	發											
白	E19E					皂	兒	飯		皋	皎	皖	皓	皙	皚		
皮	E19E E1AE															皸	皸
皿	E1AE				孟	盍	盍	盍	盍	盍	盍	盍	盍	盍			
目	E1AE E1BE	眇	眩	昵	眞	眇	眇	眇	眇	眇	眇	眇	眇	眇	眇	眇	眇

	Shift JIS	0	1	2	3	4	5	6	7	8	9	A	B	C	D	E	F	
目	E1CE E1DE	睽 轟	睹 矚	瞎 矜	瞋	瞑 瞠	瞞	瞰		瞶 瞷	瞸	瞹	瞽	瞾	瞿	瞿	瞿	
矛	E1DE			矜														
矢	E1DE			矣	矮													
石	E1DE E1EE E23F	砗 砑	砒 砑	砒 砑	砒 砑	砒 砑	砒 砑	砒 砑	砒 砑	礦 砒	砒 砑	砒 砑	砒 砑	碎 砒	砒 砑	砒 砑	砒 砑	
示	E23F E24F	祕 祕	祕 祕	祕 祕	祕 祕	禊 禊	禊 禊	禊 禊	禊 禊	禪 禪	禪 禪	禪 禪	祀	祠 祇	祇 崇	崇 祚	祚	
禺	E24F												禹	禺				
禾	E24F E25F E26F	秬 稗	秬 稗	秬 稗	稗 稗	稍 稗	稗 稗	稗 稗	稗 稗	稗 稗	稗 稗	稗 稗	稗 稗	稗 稗	稗 稗	稗 稗	稗 稗	稗 稗
穴	E26F E280	窶 窶	窶 窶	窶 窶	窶 窶	邃 竇	竇 竇	竇 竇	竇 竇	窈 窈	窈 窈	窈 窈	窈 窈	窈 窈	窈 窈	窈 窈	窈 窈	窈 窈
立	E280 E290	竝 竝	竝 竝	竝 竝				竝		竝 竝	竝 竝	竝 竝	竝 竝	竝 竝	竝 竝	竝 竝	竝 竝	
竹	E290 E29E E2AE E2BE E2CE E2DE	筊 筊	筊 筊	筊 筊	筊 筊	筊 筊	筊 筊	筊 筊	筊 筊	筊 筊	筊 筊	筊 筊	筊 筊	筊 筊	筊 筊	筊 筊	筊 筊	
米	E2DE E2EE	糝 糝	糝 糝	糝 糝	糝 糝	粿 粿	粿 粿	粿 粿	粿 粿	粿 粿	粿 粿	粿 粿	粿 粿	粿 粿	粿 粿	粿 粿	粿 粿	
糸	E2EE E33F E34F E35F E36F E380 E390	絨 絨	絨 絨	絨 絨	絨 絨	絨 絨	絨 絨	絨 絨	絨 絨	絨 絨	絨 絨	絨 絨	絨 絨	絨 絨	絨 絨	絨 絨	絨 絨	
缶	E390 E39E	罇 罇	罇 罇	罇 罇	罇 罇	罇 罇	罇 罇	罇 罇	罇 罇					缸 缸	缸 缸	缸 缸	缸 缸	

	ShiftJIS	0	1	2	3	4	5	6	7	8	9	A	B	C	D	E	F	
网	E39E						网	罕		罔	罟	罟	罟	罟	罟	罟	罟	
	E3AE	罟	罟	罟	罟	罟												
羊	E3AE						羌	羔	羞	羝	羚	羣	羯	羴	羴	羴	羴	
	E3BE	羴	羴															
羽	E3BE			翅	翠	翊	翕	翔	翡	翦	翮	翮	翹	翹				
老	E3BE														耆	耄	耄	
耒	E3CE	耒	耘	耙	耜	耒	耨											
耳	E3CE						耿	耻		聊	聆	聒	聘	聚	聒	聒	聒	
	E3DE	聒	聒	聒	聒	聒	聒	聒										
聿	E3DE						聿	肄		肆	肅							
肉	E3DE										肱	肱	肱	肱	肱	肱	肱	
	E3EE	胛	胛	胛	胛	胛	胛	胛	胛	胛	胛	胛	胛	胛	胛	胛	胛	
	E43F		胛	胛	胛	胛	胛	胛	胛	胛	胛	胛	胛	胛	胛	胛	胛	
	E44F	胛	胛	胛	胛	胛	胛	胛	胛	胛	胛	胛	胛	胛	胛	胛	胛	
	E45F	胛	胛	胛	胛	胛	胛	胛	胛	胛	胛	胛	胛	胛	胛	胛	胛	
臣	E45F									臧								
至	E45F										臺	臻						
白	E45F													臽	舛	舛	舛	
	E46F	臽	舛															
舌	E46F			舍	舐	舖												
舟	E46F						舩	舩	舩	舩	舩	舩	舩	舩	舩	舩	舩	
	E480	舩	舩	舩	舩	舩	舩	舩	舩	舩	舩	舩	舩	舩	舩	舩	舩	
艮	E480						艮											
色	E480						艷											
艸	E480							艸	艾	芍	芒	芫	芫	芫	芫	芫	芫	
	E490	芫	芫	芫	芫	芫	芫	芫	艾	芍	芒	芫	芫	芫	芫	芫	芫	
	E49E	芫	芫	芫	芫	芫	芫	芫	艾	芍	芒	芫	芫	芫	芫	芫	芫	
	E4AE	芫	芫	芫	芫	芫	芫	芫	艾	芍	芒	芫	芫	芫	芫	芫	芫	
	E4BE	芫	芫	芫	芫	芫	芫	芫	艾	芍	芒	芫	芫	芫	芫	芫	芫	
	E4CE	芫	芫	芫	芫	芫	芫	芫	艾	芍	芒	芫	芫	芫	芫	芫	芫	芫
	E4DE	芫	芫	芫	芫	芫	芫	芫	艾	芍	芒	芫	芫	芫	芫	芫	芫	芫
	E4EE	芫	芫	芫	芫	芫	芫	芫	艾	芍	芒	芫	芫	芫	芫	芫	芫	芫
	E53F	芫	芫	芫	芫	芫	芫	芫	艾	芍	芒	芫	芫	芫	芫	芫	芫	芫
	E54F	芫	芫	芫	芫	芫	芫	芫	艾	芍	芒	芫	芫	芫	芫	芫	芫	芫

	Shift JIS	0	1	2	3	4	5	6	7	8	9	A	B	C	D	E	F
艸	E55F	蘋	蕓	蘭	蘆	蘆	蘆	蘆	蘆								
虍	E55F									虍	虍	虍	虍	虍			
虫	E55F														虱	虱	虱
	E56F	蚩	蚪	蚋	蚌	蚶	蚯	蚯	蚯	蚰	蚰	蚰	蚰	蚰	蚰	蚰	蚰
	E580	蛟	蛛	蛸	蛸	蛸	蛸	蛸	蛸	蛸	蛸	蛸	蛸	蛸	蛸	蛸	蛸
	E590	蝮	蜻	蜥	蜥	蜥	蜥	蜥	蜥	蜥	蜥	蜥	蜥	蜥	蜥	蜥	蜥
	E59E		蚰	蚰	蚰	蚰	蚰	蚰	蚰	蚰	蚰	蚰	蚰	蚰	蚰	蚰	蚰
	E5AE	蝮	蝮	蝮	蝮	蝮	蝮	蝮	蝮	蝮	蝮	蝮	蝮	蝮	蝮	蝮	蝮
	E5BE	蝮	蝮	蝮	蝮	蝮	蝮	蝮	蝮	蝮	蝮	蝮	蝮	蝮	蝮	蝮	蝮
血	E5BE									衄	衄						
行	E5BE											衞	衞	衞	衞		
衣	E5BE															衫	袁
	E5CE	衾	衾	衾	衾	衾	衾	衾	衾	衾	衾	衾	衾	衾	衾	衾	衾
	E5DE	袂	袂	袂	袂	袂	袂	袂	袂	袂	袂	袂	袂	袂	袂	袂	袂
	E5EE	袂	袂	袂	袂	袂	袂	袂	袂	袂	袂	袂	袂	袂	袂	袂	袂
	E63F	襦	襦	襦	襦	襦	襦	襦	襦	襦	襦	襦	襦	襦	襦	襦	襦
冫	E63F									冫	冫	冫	冫				
見	E63F													覓	覓	覓	覓
	E64F	覓	覓	覓	覓	覓	覓	覓	覓	覓	覓	覓	覓	覓	覓	覓	覓
角	E64F									觚	觚	觚	觚	觚	觚		
言	E64F															訃	訃
	E65F	訃	訃	訃	訃	訃	訃	訃	訃	訃	訃	訃	訃	訃	訃	訃	訃
	E66F	訃	訃	訃	訃	訃	訃	訃	訃	訃	訃	訃	訃	訃	訃	訃	訃
	E680	訃	訃	訃	訃	訃	訃	訃	訃	訃	訃	訃	訃	訃	訃	訃	訃
	E690	訃	訃	訃	訃	訃	訃	訃	訃	訃	訃	訃	訃	訃	訃	訃	訃
	E69E	訃	訃	訃	訃	訃	訃	訃	訃	訃	訃	訃	訃	訃	訃	訃	訃
谷	E69E															𪗇	𪗇
	E6AE	𪗇															
豆	E6AE		豈	豈	豈	豈	豈	豈	豈								
豕	E6AE						豕	豕	豕								
豸	E6AE									豸	豸	豸	豸	豸	豸	豸	豸
	E6BE	豸	豸	豸										豸	豸	豸	豸
貝	E6BE				賤	賤	賤	賤	賤	貳	貳	貳	賈	賈	賈	賈	賈
	E6CE	賈	賈	賈	賈	賈	賈	賈	賈	賈	賈	賈	賈	賈	賈	賈	賈

	ShiftJIS	0	1	2	3	4	5	6	7	8	9	A	B	C	D	E	F
赤	E6CE E6DE	赭															赧
走	E6DE	支	赳	赳	趙												
足	E6DE E6EE E73F E74F	跟	跣	跣	跣	跟	跣	跣	跣	跣	跣	跣	跣	跣	跣	跣	跣
身	E74F E75F	軀	軀										躬	軀	軀	軀	軀
車	E75F E76F E780	輟	輟	輟	輟	輟	輟	輟	輟	輟	輟	輟	輟	輟	輟	輟	輟
辛	E780				辜	辟	辣	辭	辯								
亾	E780 E790 E79E E7AE	迨	迹	迨	迨	迨	迨	迨	迨	亾	迨	迨	迨	迨	迨	迨	迨
邑	E7AE E7BE	鄒	鄒	鄒	鄒				邨	邨	邨	邨	邨	邨	邨	邨	邨
酉	E7BE E7CE	醫	醢	醢	醢	醢	醢	醢	醢	醢	醢	醢	醢	醢	醢	醢	醢
采	E7CE									糶	釋						
里	E7CE												釐				
金	E7CE E7DE E7EE E83F E84F E85F E86F	釵	鉞	鉞	鉞	鈔	鈔	鈔	鈔	鈔	鈔	鈔	鈔	鈔	鈔	鈔	鈔
門	E86F E880 E890	閨	閨	閨	閨	閨	閨	閨	閨	閨	閨	閨	閨	閨	閨	閨	閨
阜	E890					阡	阡	阡	阡	阡	阡	阡	阡	阡	阡	阡	阡

	Shift JIS	0	1	2	3	4	5	6	7	8	9	A	B	C	D	E	F
阜	E89E		陝	陟	陟	陞	陞	隍	隘	隕	隗	險	隧	隱	隲	隳	隴
隶	E8AE	隶	隸														
佳	E8AE			佳	睢	雋	雉	雍	襍	雜	霍	雕					
雨	E8AE												霄	霽	霽	霽	霽
	E8BE	霽	霽	霽	霖	霽	霽	霽	霽	霽	霽	霽	霽	霽	霽	霽	霽
青	E8CE	靜															
非	E8CE		靠														
面	E8CE			鮑	覲	曆											
革	E8CE						勒	鞞	鞞	鞞	鞞	鞞	鞞	鞞	鞞	鞞	鞞
	E8DE	鞞	鞞	鞞	鞞	鞞	鞞	鞞	鞞	鞞	鞞	鞞	鞞	鞞	鞞	鞞	鞞
韋	E8DE											韋	韋				
韭	E8DE													韭	韭	韭	
音	E8DE																竟
	E8EE	韶	韻														
頁	E8EE			頤	頤	頤	頤	頤	頤	頤	頤	頤	頤	頤	頤	頤	頤
	E93F		頤	頤	頤												
風	E93F					風	颯	颯	颯	飄	颯	颯					
食	E93F												餽	餽	餽	餽	餽
	E94F	餽	餽	餽	餽	餽	餽	餽	餽	餽	餽	餽	餽	餽	餽	餽	餽
	E95F	餽	餽	餽	餽												
首	E95F					馮	馮										
香	E95F																
馮	E95F									馮	馮	馮	馮	馮	馮	馮	馮
	E96F	馮	馮	馮	馮	馮	馮	馮	馮	馮	馮	馮	馮	馮	馮	馮	馮
	E980	馮	馮	馮	馮	馮	馮	馮	馮	馮	馮	馮	馮	馮	馮	馮	馮
骨	E980													馮	馮	馮	馮
	E990	馮	馮	馮	馮												
高	E990					馮											
影	E990						髟	髟	髟	髟	髟	髟	髟	髟	髟	髟	髟
	E99E		髟	髟	髟	髟	髟	髟	髟	髟	髟	髟	髟	髟	髟	髟	髟
鬥	E99E									鬥	鬥	鬥	鬥	鬥	鬥		
鬯	E99E																鬯
鬯	E99E																鬯
鬼	E9AE	魄	魃	魏	魃	魃	魃	魃	魃								

	Shift JIS	0	1	2	3	4	5	6	7	8	9	A	B	C	D	E	F
魚	E9AE								魴	魴	鯉	鮑	鮎	鮎	鮎	鮎	鮎
	E9BE	鮎	鮎	鮎	鮎	鮎	鮎	鮎	鮎	鮎	鮎	鮎	鮎	鮎	鮎	鮎	鮎
	E9CE	鮎	鮎	鮎	鮎	鮎	鮎	鮎	鮎	鮎	鮎	鮎	鮎	鮎	鮎	鮎	鮎
	E9DE	鮎	鮎	鮎	鮎	鮎	鮎	鮎	鮎	鮎	鮎	鮎	鮎	鮎	鮎	鮎	鮎
鳥	E9DE											鳧	鳧	鳧	鳧	鳧	鳧
	E9EE	鳧	鳧	鳧	鳧	鳧	鳧	鳧	鳧	鳧	鳧	鳧	鳧	鳧	鳧	鳧	鳧
	EA3F		鳧	鳧	鳧	鳧	鳧	鳧	鳧	鳧	鳧	鳧	鳧	鳧	鳧	鳧	鳧
	EA4F	鳧	鳧	鳧	鳧	鳧	鳧	鳧	鳧	鳧	鳧	鳧	鳧	鳧	鳧	鳧	鳧
	EA5F	鳧	鳧	鳧	鳧	鳧	鳧	鳧	鳧	鳧	鳧	鳧	鳧	鳧	鳧	鳧	鳧
鹵	EA5F				鹵	鹵	鹽										
鹿	EA5F						鹿	麁						麁	麁		
麥	EA5F															麥	麩
	EA6F	麩	麩	麩													
麻	EA6F				麻												
黃	EA6F					覺											
黍	EA6F						黍	黏	黍								
黑	EA6F									黠	黠	黠	黠	黠	黠	黠	黠
	EA80	黠	黠	黠													
滂	EA80				滂	滂	滂										
黽	EA80						黽	黽		黽							
鼓	EA80									鼓	鼗						
鼠	EA80											鼠		鼠			
鼻	EA80														鼻		
齊	EA80															齊	
齒	EA80																齒
	EA90	齒	齒	齒	齒	齒	齒	齒	齒	齒	齒	齒	齒				
龍	EA90													龍			
龜	EA90														龜		
禽	EA90															禽	



2D Code			
Available for	CG400 series		
<b>MAXI code</b>		<b>ESC+BV</b>	
Hex code	ESC <1B> <sub>16</sub>	BV <42> <sub>16</sub> <56> <sub>16</sub>	Parameter a,b,c,ddddddddd,eee,fff,n~n
Default setting	None		
Persistence of the command	When printer is powered off	Set Parameter will not be retained	
	Validity in a job	Becomes invalid after execution	
	Validity after a job	Becomes invalid after the job	

[Function]

Specifies to print MAXI code.

[Format]

<BV>a,b,c,ddddddddd,eee,fff,n~n

●Parameter

a	[Symbol number]	=	Valid range	:	1 to 8
b	[Digit of symbol]	=	Valid range	:	1 to 8
c	[Mode]	=	2	:	Delivery
			3	:	Delivery
			4	:	Standard symbol
			6	:	for reader device only
d	Postal code	=	Valid range	:	0 to 999999999 (Mode 2) 000000 to 999999 (Mode 3)
					* Mode 2 accepts max. 9 digits (numeric only) * Mode 3 accepts 6digits fixed (only upper case for alphabet)
e	Country code	=	Valid range	:	001 to 999
f	Service class	=	Valid range	:	001 to 999
n	Low priority message	=	Alphanumeric + symbols		

Mode	Service class	Country code	Postal code	Max. data size	
				Numeric	Alphanum.
2	3 digits Fixed (Numeric only)	3 digits Fixed (Numeric only)	Max.9digits	123	84
3			6 digits fixed(Alpha-num.)		
4	Omitted			138	93
6					

[Coding Example]

```
<A>
<V>100<H>200<BV>1,1,2,123456789,001,002,SAHTHA
<Q>2
<Z>
```

[Notes]

1. The size of the symbol printed is not subject to data volume. (Quantity of data)
2. Any other parameters specified or settings being inconsistent with each other will result in no printing.
3. In case mode [4] or [6] is selected, the data size shall be larger than 12 (bytes), otherwise the symbol can not be read by scanners.

MAXI Code table

					S				I				S				O								
					<b>b8</b>	0	0	0	0	0	0	0	0	1	1	1	1	1	1	1	1	1	1	1	1
					<b>b7</b>	0	0	0	0	1	1	1	1	0	0	0	0	1	1	1	1	1	1	1	1
					<b>b6</b>	0	0	1	1	0	0	1	1	0	0	1	1	0	0	1	1	0	0	1	1
					<b>b5</b>	0	1	0	1	0	1	0	1	0	1	0	1	0	1	0	1	0	1	0	1
<b>B4</b>	<b>b3</b>	<b>b2</b>	<b>b1</b>		<b>0</b>	<b>1</b>	<b>2</b>	<b>3</b>	<b>4</b>	<b>5</b>	<b>6</b>	<b>7</b>	<b>8</b>	<b>9</b>	<b>A</b>	<b>B</b>	<b>C</b>	<b>D</b>	<b>E</b>	<b>F</b>					
0	0	0	0	<b>0</b>			SP	0	@	P	`	p													
0	0	0	1	<b>1</b>			!	1	A	Q	a	q													
0	0	1	0	<b>2</b>			"	2	B	R	b	r													
0	0	1	1	<b>3</b>			#	3	C	S	c	s													
0	1	0	0	<b>4</b>			\$	4	D	T	d	t													
0	1	0	1	<b>5</b>			%	5	E	U	e	u													
0	1	1	0	<b>6</b>			&	6	F	V	f	v													
0	1	1	1	<b>7</b>			'	7	G	W	g	w													
1	0	0	0	<b>8</b>			(	8	H	X	h	x													
1	0	0	1	<b>9</b>			)	9	I	Y	i	y													
1	0	1	0	<b>A</b>			*	:	J	Z	j	z													
1	0	1	1	<b>B</b>			+	;	K	[	k	{													
1	1	0	0	<b>C</b>			,	<	L	\	l														
1	1	0	1	<b>D</b>			-	=	M	]	m	}													
1	1	1	0	<b>E</b>			.	>	N	^	n	~													
1	1	1	1	<b>F</b>			/	?	O	_	o	DEL													

Selectable range is 01H thru FFH for MAXI code.

2D Code			
Available for	CG400 series		
<b>PDF417</b>		<b>ESC+BK</b>	
Hex code	ESC <1B> <sub>16</sub>	BK <42> <sub>16</sub> <4B> <sub>16</sub>	Parameter aabbcddeefffg~g,(h)
Default setting	None		
Persistence of the command	When printer is powered off	Set parameter will not be retained	
	Validity in a job	Becomes invalid after execution	
	Validity after a job	Becomes invalid after the job	

[Function]

Specifies to print PDF417.

[Format]

<BK>aabbcddeefffg~g,(h)

●Parameter

a	[Minimum module width]	=	Valid range :	01 to 09 dots
b	[Minimum module height]	=	Valid range :	01 to 24 dots
c	[Security level]	=	Valid range :	0 to 8
d	[Code words per line] (cols)	=	Valid range :	01 to 30
			00	: Auto (Width auto-justified according to data quantity)
e	[Rows per symbol](rows)	=	Valid range :	03 to 90
			00	: Auto (Height auto-justified according to data quantity)
f	[Number of data digits to encode]	=	Valid range :	0001 to 2681
g	[Data to be printed]	=	Data	
h	[PDF code type]	=	Not specified :	PDF417
			T	: Truncated PDF417
			M	: Micro PDF417

[Coding Example] Min. Module width: 03(dot), Min.Module height: 09(dot), Security level: 3,  
Code words per line: 03, Rows per symbol : 18

```
<A>
<V>100<H>200-<BK>0309303180010PDF1234567
<Q>2
<Z>
```

[Notes]

1. Min. module width 01, 02 dot are not recommendable with a risk of lower scanner-readability.
2. Min. module height 01, 02, 03dot are not recommendable with a risk of lower scanner-readability.
3. When both "data codeword per line" and "number of data digit" are set to 00, aspect ratio (V x H) will be set automatically to 1:2.
4. Higher Security Level will require larger numbers for "rows per symbol" or "data codeword per line".
5. Maximum number of data digit is 2681. However, the number of data digit is also restricted by and subject to minimum module size, security code level and type of print data.
6. Parameters and data size being inconsistent will not print.
7. When Micro PDF is specified, "line per symbol" is subject to "data codeword per line", and thus, maximum number of data digit will be automatically defined. Consult the table in next page for details.
8. Security level setup is disabled for Micro PDF.

[Tips]

1. No sequential numbering is possible for PDF417.
2. No print position setting is possible by auto-CR.
3. 00H~FFH can be specified as print data.
4. Increase minimum module dimensions for better quality, as necessary.
5. Increase Security Level for better scanner-readability, as necessary.
6. Height of print image will differ for alphabet, numeric, and alpha-numeric data.

Symbol size and Max. data digits of Micro PDF (Only the following 34 types are available)

Symbol size		Max. Data digits	
cols(d)	rows(e)	Alphabet (A to Z) only	Numeric only
1	11	6	8
	14	12	17
	17	18	26
	20	22	32
	24	30	44
	28	38	55
2	8	14	20
	11	24	35
	14	36	52
	17	46	67
	20	56	82
	23	64	93
3	6	10	14
	8	18	26
	10	26	38
	12	34	49
	15	46	67
	20	66	96
	26	90	132
	32	114	167
	38	138	202
44	162	237	
4	4	14	20
	6	22	32
	8	34	49
	10	46	67
	12	58	85
	15	76	111
	20	106	155
	26	142	208
	32	178	261
	38	214	313
44	250	366	

\* Alphabet (Upper/Lower case), Numeric, Control code may be mixed for valid combination.

PDF417 code table (including Micro PDF)

					S				I				S				O							
					b8	b7	b6	b5	0	1	2	3	4	5	6	7	8	9	A	B	C	D	E	F
0	0	0	0	0	0	0	0	0	0	0	0	0	0	0	0	1	1	1	1	1	1	1	1	1
0	0	0	1	0	0	0	0	1	1	1	1	1	0	0	0	0	0	1	1	1	1	1	1	1
0	0	1	0	0	0	0	1	0	0	1	1	1	0	0	1	1	0	0	1	1	0	0	1	1
0	1	0	1	0	0	1	0	1	0	1	0	1	0	1	0	1	0	1	0	1	0	1	0	1
b4	b3	b2	b1		0	1	2	3	4	5	6	7	8	9	A	B	C	D	E	F				
0	0	0	0	0			SP	0	@	P	`	p												
0	0	0	1	1			!	1	A	Q	a	q												
0	0	1	0	2			"	2	B	R	b	r												
0	0	1	1	3			#	3	C	S	c	s												
0	1	0	0	4			\$	4	D	T	d	t												
0	1	0	1	5			%	5	E	U	e	u												
0	1	1	0	6			&	6	F	V	f	v												
0	1	1	1	7			'	7	G	W	g	w												
1	0	0	0	8			(	8	H	X	h	x												
1	0	0	1	9			)	9	I	Y	i	y												
1	0	1	0	A			*	:	J	Z	j	z												
1	0	1	1	B			+	;	K	[	k	{												
1	1	0	0	C			,	<	L	\	l													
1	1	0	1	D			-	=	M	]	m	}												
1	1	1	0	E			.	>	N	^	n	~												
1	1	1	1	F			/	?	O	_	o	DEL												

Selectable range is 00H thru FFH for PDF417 (including Micro PDF).

2D Code			
Available for	CG400 series		
<b>GS1 DataMatrix</b>		<b>ESC+BX</b>	
Hex code	ESC <1B> <sub>16</sub>	BX <42> <sub>16</sub> <58> <sub>16</sub>	Parameter aabbccddeeffghh
Default setting	None		
Persistence of the command	When printer is powered off	Set parameter will not be retained	
	Validity in a job	Becomes invalid after execution	
	Validity after a job	Becomes invalid after the job	

[Function]

Specifies to print GS1 DataMatrix

[Format]

<BX>aabbccddeeffghh

●Parameter

a	[Format ID]	= Valid range	: 01 to 06
b	[Error correction level]	=	00 : (ECC000)
			05 : (ECC050)
			08 : (ECC080)
			10 : (ECC100)
			14 : (ECC140)
			20 : (ECC200)
c	[Cell width]	= Valid range	: 01 to 16 (dot/Cell)
d	[Cell height]	= Valid range	: 01 to 16 (dot/Cell)
e	[Number of cells per line]	= Valid range	: 008 to 148
			000 : (auto-setup)
f	[Number of cell lines]	= Valid range	: 008 to 148
			000 : (auto-setting)
g	[Mirror image]	=	0 : Normal image (Normal print)
			1 : Mirror image
h	[Guide cell thickness]	= Valid range	: 01 to 15

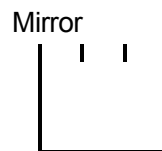
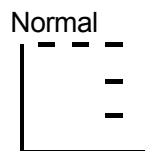

Table of Format ID

Error correction	Format ID					
	01	02	03	04	05	06
00 (ECC000)	500	452	394	413	310	271
05 (ECC050)	457	333	291	305	228	200
08 (ECC080)	402	293	256	268	201	176
10 (ECC100)	300	218	190	200	150	131
14 (ECC140)	144	105	91	96	72	63

20 (ECC200)	Numeric	3116
	Alphanumeric	2335
	Binary (01H~FFH)	1556

\* The above values are the maximum data volume which the 2D code can handle for a valid coding.

[Notes]

- When error correction level is set to 20, other three settings : Format ID, Mirror image, Guide cell thickness will be ignored.
- Cell width, Cell height can be set to 01, 02, however may result in low scanner-read rate. 00 will cause an error.
- When 000 is specified for "the number of cells per line", or "number of cell lines", the size of the code is auto-justified according to the data to accommodate.
- Guide cell thickness for normal type code is 01.

2D Code			
Available for	CG400 series		
<b>GS1 DataMatrix (Data)</b>		<b>ESC+DC</b>	
Hex code	ESC <1B> <sub>16</sub>	DC <44> <sub>16</sub> <43> <sub>16</sub>	Parameter n~n
Default setting	None		
Persistence of the command	When printer is powered off	Set parameter will not be retained	
	Validity in a job	Becomes invalid after execution	
	Validity after a job	Becomes invalid after the job	

[Function]

Specifies data for GS1 DataMatrix

[Format] (Data portion)

<DC>n~n

●Parameter

n            [Print data]            =    Data

[Coding Example]

Format ID: 01, Error correction level: 10 (ECC100), Cell width: 02, Cell height: 02,  
Number of the cell in one line: 000, Number of lines: 000, Mirror image: 0 (Normal),  
Thickness of the guide-cell: 01, Print data: 1234567890

<A>

<V>100<H>200

<BX>01100202000000001

**<DC>1234567890**

<Q>2

<Z>

2D Code			
Available for	CG400 series		
<b>GS1 DataMatrix (Sequential number)</b>		<b>ESC+FX</b>	
Hex code	ESC <1B> <sub>16</sub>	FX <46> <sub>16</sub> <58> <sub>16</sub>	Parameter aaabccdddeee
Default setting	None		
Persistence of the command	When printer is powered off	Set parameter will not be retained	
	Validity in a job	Becomes invalid after execution	
	Validity after a job	Becomes invalid after the job	

[Function]

Specifies sequential numbering for GS1 DataMatrix

[Format] (sequential numbering)

<FX>aaabccdddeee

●Parameter

a	[Number of duplicate labels]	=	Valid range : 001 to 999
b	[Increment / decrement]	= +	: Increment
		= -	: Decrement
c	[Increment/decrement steps]	=	Valid range : 001 to 999
d	[Sequential numbering start position (digit)]	=	Valid range : 001 to 999 from left side.
e	[Incremented data length (digit number)]	=	Valid range : 001 - 999

[Coding Example] Number of duplicate labels: 001, Increment/decrement: +, Increment/decrement steps: 001, Sequential number start position: 005, Digit number: 003

<A>

<V>100<H>200

**<FX>001+001005003**

<BX>01100202000000001

<DC>00006000

<Q>2

<Z>



Data matrix code table

					S				I				S				O					
<b>b8</b>					0	0	0	0	0	0	0	0	1	1	1	1	1	1	1	1	1	
<b>b7</b>					0	0	0	0	1	1	1	1	0	0	0	0	1	1	1	1	1	
<b>b6</b>					0	0	1	1	0	0	1	1	0	0	1	1	0	0	1	1	1	
<b>b5</b>					0	1	0	1	0	1	0	1	0	1	0	1	0	1	0	1	0	1
<b>B4</b>	<b>b3</b>	<b>b2</b>	<b>b1</b>		<b>0</b>	<b>1</b>	<b>2</b>	<b>3</b>	<b>4</b>	<b>5</b>	<b>6</b>	<b>7</b>	<b>8</b>	<b>9</b>	<b>A</b>	<b>B</b>	<b>C</b>	<b>D</b>	<b>E</b>	<b>F</b>		
0	0	0	0	<b>0</b>			SP	0	@	P	`	p										
0	0	0	1	<b>1</b>			!	1	A	Q	a	q										
0	0	1	0	<b>2</b>			"	2	B	R	b	r										
0	0	1	1	<b>3</b>			#	3	C	S	c	s										
0	1	0	0	<b>4</b>			\$	4	D	T	d	t										
0	1	0	1	<b>5</b>			%	5	E	U	e	u										
0	1	1	0	<b>6</b>			&	6	F	V	f	v										
0	1	1	1	<b>7</b>			'	7	G	W	g	w										
1	0	0	0	<b>8</b>			(	8	H	X	h	x										
1	0	0	1	<b>9</b>			)	9	I	Y	i	y										
1	0	1	0	<b>A</b>			*	:	J	Z	j	z										
1	0	1	1	<b>B</b>			+	;	K	[	k	{										
1	1	0	0	<b>C</b>			,	<	L	\	l	!										
1	1	0	1	<b>D</b>			-	=	M	]	m	}										
1	1	1	0	<b>E</b>			.	>	N	^	n	~										
1	1	1	1	<b>F</b>			/	?	O	_	o	DEL										

GS1 DataMatrix can be specified in the range 20H thru FFH.  
 To specify 7EH, write [7EH,7EH].

## 12. Graphic Command

Graphic			
Available for	CG400 series		
Graphic print		ESC+G	
Hex code	ESC <1B> <sub>16</sub>	G <47> <sub>16</sub>	Parameter abbcccn~n
Default setting	None		
Persistence of the command	When printer is powered off	Set parameter will not be retained	
	Validity in a job	Becomes invalid after execution	
	Validity after a job	Becomes invalid after the job	

### [Function]

Specifies graphic printing.

### [Format]

<G>abbcccn~n

#### •Parameter

- a [Specifies data in hexadecimal/binary]
  - H: Hexadecimal 8bit data divided into 2 blocks of 4bit and output in a ASCII-based Hexadecimal code.
  - B: \*Binary 8bit data is handled as 1font data and output in a chunk.
- b [Width of the graphic area] = see table below for valid range
- c [Height of the graphic area] = see table below for valid range
- n [Graphic data]

### [Coding Example]

```
<A>
<V>50<H>50<G>H02000288888888...8888
<Q>2
<Z>
```

### [Notes]

- "B" Binary format is advantageous to "H" in terms of total data length being 1/2, though it needs prolix programming.
- The rotation command<%>, expansion command<L> can be used in combination with this command.

### [Valid range]

Model	Max. width (byte)	Max. height (byte)
CG408DT/TT	104	600
CG412DT/TT	156	400

Graphic			
Available for	CG400 series		
<b>BMP file print</b>		<b>ESC+GM</b>	
Hex code	ESC <1B> <sub>16</sub>	GM <47> <sub>16</sub> <4D> <sub>16</sub>	Parameter aaaaa,n~n
Default setting	None		
Persistence of the command	When printer is powered off	Set parameter will not be retained	
	Validity in a job	Becomes invalid after execution	
	Validity after a job	Becomes invalid after the job	

[Function]

Specifies to print BMP File (Created on Windows Paint, for example).

[Format]

<GM>aaaaa,n~n

•Parameter

a [Total number of bytes of BMP file]  
n [Data]

[Coding Example]

```
<A>
<V>50<H>50<GM>04500,200028888888...8888
<Q>2
<Z>
```

[Notes]

1. The data is transmitted in binary (8bit/1font data). Actual size of BMP file is the value to parameter "a".
2. BMP file consists of the header part (the first 62 byte) and compressed graphic data.
3. If the total number of bytes of a BMP file is not consistent with actual send data, it may result in an operation failure.
4. The total number of bytes is displayed in the property of the file.
5. BMP file can be used only in black/white mode. A BMP file in color mode will result in a command error and no printing.  
The command does not support compressed type of the BMP file. Make sure that file extension is BMP before printing.
6. Rotation<%>, Expansion<L> can be used in combination with this command.
7. Expansion command <L> shall be specified just before command<GM>.

Graphic			
Available for	CG400 series		
<b>PCX file print</b>		<b>ESC+GP</b>	
Hex code	ESC <1B> <sub>16</sub>	GP <47> <sub>16</sub> <50> <sub>16</sub>	Parameter aaaaa,n~n
Default setting	None		
Persistence of the command	When printer is powered off	Set parameter will not be retained	
	Validity in a job	Becomes invalid after execution	
	Validity after a job	Becomes invalid after the job	

[Function]

Specifies to print PCX file (Created on Windows Paint, for example).

[Format]

<GP>aaaaa,n~n

•Parameter

a [Total number of bytes of PCX file]

n [Data]

[Coding Example]

<A>

<V>50<H>50<GP>04500,XXXXXXXXXXXXX...XXXX

<Q>2

<Z>

[Notes]

1. The data is transmitted in binary (8bit/1font data). Actual size of PCX file is the value to parameter "a".
2. PCX file consists of the header part (the first 128 byte) and compressed graphic data.
3. If the total number of bytes of a PCX file is not consistent with actual send data, it may result in an operation failure.
4. The total number of bytes is displayed in the property of the file.
5. PCX file can be used only in black/white mode. A PCX file in color mode will result in a command error and no printing.  
The command does not support compressed type of the PCX file. Make sure that file extension is PCX before printing.
6. Rotation<%>, Expansion<L> can be used in combination with this command.

### 13. System Command

System			
Available for	CG400 series		
<b>Print speed</b>		<b>ESC+CS</b>	
Hex code	ESC <1B> <sub>16</sub>	CS <43> <sub>16</sub> <53> <sub>16</sub>	Parameter a
Default setting	See table below		
Persistence of the command	When printer is powered off	Set parameter will not be retained	
	Validity in a job	Retained until next valid setting	
	Validity after a job	Retained until next valid setting	

**[Function]**

Specifies print speed.

**[Format]**

<CS>a

•Parameter

a [Print speed] = see table below.

**[Coding Example]**

<A>

**<CS>3**

<Z>

**[Note]**

1. The setting by this command will not persist after powering off the printer. When the printer restarted, either the printer' default value, or original values set by the command <PG> will be valid.

**[Tips]**

1. Invalid range being selected will result in a command error and the setting will not be changed.
2. The default values are available by the operation of the printer side.

**[Parameter default value and valid range]**

Model	Default value	Parameter range	Parameter: Printer speed
CG408DT/TT	3	2, 3, 4	2 : 2 inch/sec (50mm/sec)
CG412DT/TT			3 : 3 inch/sec (75mm/sec)
			4 : 4 inch/sec (100mm/sec)

System			
Available for	CG400 series		
<b>Print darkness</b>		<b>ESC+#E</b>	
Hex code	ESC <1B> <sub>16</sub>	#E <23> <sub>16</sub> <45> <sub>16</sub>	Parameter a(b)
Default setting	See table below		
Persistence of the command	When printer is powered off	Set parameter will not be retained	
	Validity in a job	Retained until next valid setting	
	Validity after a job	Retained until next valid setting	

[Function]

Specifies print darkness.

[Format]

<#E>a(b)

•Parameter

- |   |                  |   |   |
|---|------------------|---|---|
| a | [Darkness level] | = | See table below.  |
| b | [Darkness range] | = | A (Omissible)<br>Use [A] for darkness range under normal conditions |

[Coding Example]

```
<A>
<#E>3
<Z>
```

[Note]

- The setting by this command will not persist after powering off the printer. When the printer restarted, either the printer' default value, or original values set by the command <PG> will be valid.

[Tips]

- Invalid range being selected will result in a command error and the setting will not be changed.
- The default values are available by the operation of the printer side.

[Default value and valid range]

Model	Parameter	Default	Range
CG408DT/TT CG412DT/TT	a	3 : Normal	1: Light 2: Slightly light 3: Normal 4: Slightly dark 5: Dark
	b	A	A

System			
Available for	CG400 series		
<b>Media size</b>		<b>ESC+A1</b>	
Hex code	ESC <1B> <sub>16</sub>	A1 <41> <sub>16</sub> <31> <sub>16</sub>	Parameter aaaabbbb
Default setting	None		
Persistence of the command	When printer is powered off	Set parameter will not be retained	
	Validity in a job	Retained until next valid setting	
	Validity after a job	Retained until next valid setting	

[Function]

Specifies media size.

[Format]

<A1>aaaabbbb

•Parameter

a [Label height] = see table in next page  
 b [Label width] = see table in next page

[Coding Example]

<A>  
<A1>08000240  
 <Z>

[Notes]

1. This command is useful when you use a label in a smaller size than the print head width, and need to optimize the base reference point accordingly.
2. Backing paper should be included in the label size.

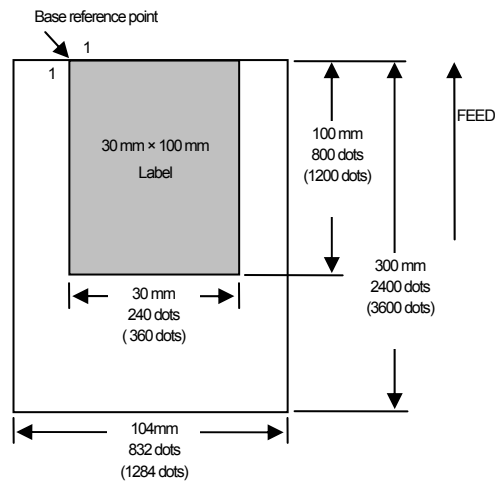

The values in ( ) are for 12 dots/mm

[Valid range]

Model	Label width (dot)	Label height (dot)
CG408DT/TT	1 to 832	1 to 2400
CG412DT/TT	1 to 1248	1 to 3600

System			
Available for	CG400 series		
Base reference point		ESC+A3	
Hex code	ESC <1B> <sub>16</sub>	A3 <41> <sub>16</sub> <33> <sub>16</sub>	Parameter VabbbbHcdddd
Default setting	None		
Persistence of the command	When printer is powered off	Set parameter will not be retained	
	Validity in a job	Retained until next valid setting	
	Validity after a job	Retained until next valid setting	

[Function]

Specifies a new base reference point

[Format]

<A3>VabbbbHcdddd

•Parameter

a	Plus / Minus sign for vertical position correction	= +, - (Omissible)
b	Vertical position shift (dots)	= 0 to 792 (dots)
c	Plus / Minus sign for horizontal position correction (omissible)	= +, - (Omissible)
d	Horizontal position shift (dots)	= 0 to 792 (dots)

[Coding Example]

<A>

<A3>V10H10

<Z>

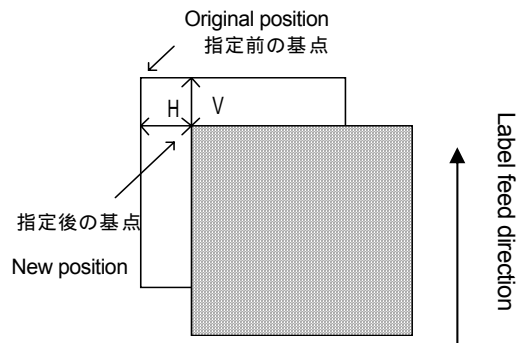

[Notes]

1. The new position set outside printable area, will result in no printing.
2. The new position will be applied to all the label formats. Pay attention to it when you run multiple formats.

[Tips]

1. The values set by this command <A3> is not persistent after powering off the printer.

[Valid range]

Model	Horizontal offset (dots)	Vertical offset (dots)
CG408DT/TT	-792 to 792	-792 to 792
CG412DT/TT	-792 to 792	-792 to 792



System			
Available for	CG400 series		
<b>Print end position</b>		<b>ESC+EP</b>	
Hex code	ESC <1B> <sub>16</sub>	EP <45> <sub>16</sub> <50> <sub>16</sub>	Parameter None
Default setting	None		
Persistence of the command	When printer is powered off	Set Parameter will not be retained	
	Validity in a job	Becomes invalid after execution	
	Validity after a job	Becomes invalid after the job	

[Function]

Specifies the label stop position in the sensor-disabled mode.

[Format]

<EP>

[Coding Example]

```

<A>
<A1>14240832
<Z>
<A>
<V>100<H>200<P>2<L>0202<OA>ABCD
<Q>2
<EP>
<Z>

```

Example)

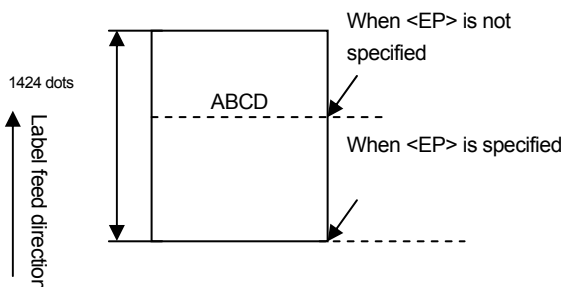

Base reference point

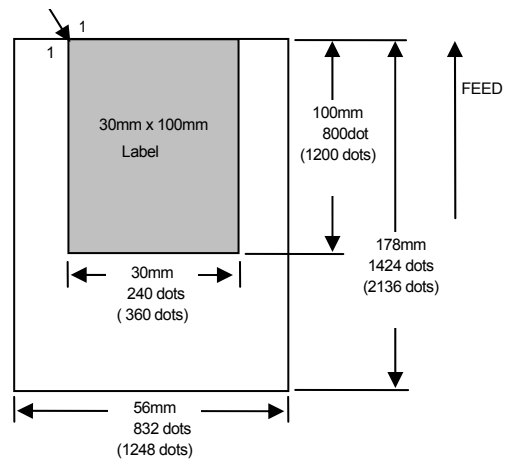

The values in ( ) are for 12 dots/mm

[Notes]

1. This command is valid when sensor is disabled.
2. Use this command in combination with size setting command <A1>.

System			
Available for	CG400 series		
Multi cut		ESC+~(NULL)	
Hex code	ESC <1B>16	~ (NULL) <7E> <sub>16</sub> (<00> <sub>16</sub> )	Parameter aaaa
Default setting	aaaa=1		
Persistence of the command	When printer is powered off	Set Parameter will not be retained	
	Validity in a job	Set Parameter will be retained until next valid setting	
	Validity after a job	Set parameter will be the default value for the next job<A>.	

[Function]

Specifies the number of labels to print between each cut.

[Format]

<~(NULL)>aaaa

•Parameter

a [Number of prints before cutting] = Valid range : 0 to 9999

[Coding Example]

```
<A>
<V>100<H>200<P>2<L>0202<OA>ABC
<Q>4
<~>2
<Z>
```

(1) Normal cut mode

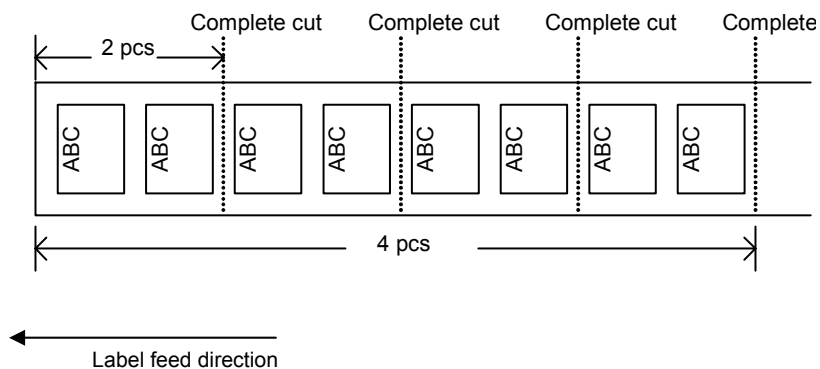

1. Valid only for Cutter models.
2. If this command is not specified in Cutter mode, each label will be cut off after printed.
3. In case the parameter "a" is set to 0, no label will be cut.
4. The product of Qty and value of "aaaa" shall not exceed the maximum number "999999".
5. This command <~> shall be put after Qty<Q>. <Q>, in this case, is to specify number of sheets to be cut.
6. This command may not be used in combination with other cut commands, <CT> or <~A>.

System			
Available for	CG400 series		
Cut number unit		ESC+CT	
Hex code	ESC <1B> <sub>16</sub>	CT <43> <sub>16</sub> <54> <sub>16</sub>	Parameter aaaa
Default setting	aaaa=1		
Persistence of the command	When printer is powered off	Set Parameter will not be retained.	
	Validity in a job	Retained until next valid setting.	
	Validity after a job	Set Parameter will be an default value for the next job<A>.	

[Function]

Cuts label at a specified interval in a print job.

[Format]

<CT>aaaa

●Parameter

a [Number of labels between each cut] = Qty range : 0 to 9999

[Coding Example]

<A>

<V>100<H>200<P>2<L>0202<X22>,ABC

**<CT>2**

<Q>7

<Z>

(1) Normal (complete) cut mode

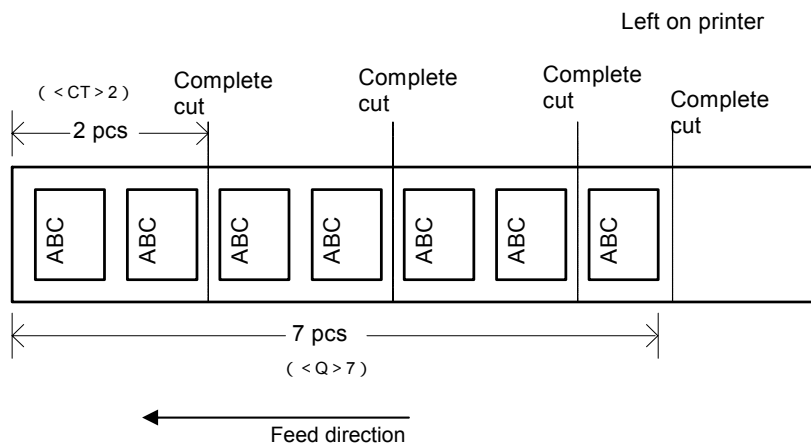

[Notes]

1. Valid only for cutter-mounted models.
2. If the parameter is not specified by this command <CT>, each label will be cut after printed.
3. In case the parameter "a" is set to 0, no label will be cut.
4. Set this command before <Q> command.
5. This command can not be used in combination with other cut commands <-> or <~A>.

[Important]

1. This command is closed to end users.

System			
Available for	CG400 series		
<b>Eject and Cut (Closed to end users)</b>		<b>ESC+NC</b>	
Hex code	ESC <1B> <sub>16</sub>	NC (EJ) <4E> <sub>16</sub> <43> <sub>16</sub>	Parameter None
Default setting	None		
Persistence of the command	When printer is powered off	Set Parameter will not be retained	
	Validity in a job	Becomes invalid after execution	
	Validity after a job	Becomes invalid after the job	

[Function]

Cuts any printed labels that remain in the printer.

[Format]

<NC>

[Coding example]

<A>

<NC>

<Z>

(1) Label stop position

- A: Printed
- B: Not printed
- C: Not printed
- D: Not printed

(2) Command received

(3) Label is fed to the cut position.

(4) Label is cut off.

(5) Label is back fed to the head position.

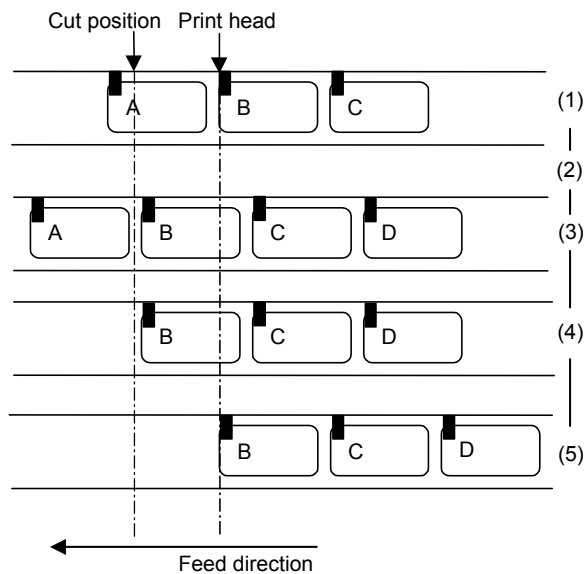

[Notes]

1. Valid only for cutter models.
2. This command is used to cut the last label remaining in the printer.
3. This command should be used by differentiating between Start code<A> and Stop code<Z>.
4. This command <NC> may not be used in combination with other commands.
5. This command <NC> is valid while the printer is not working after printed and finished cutting operation.

[Tips]

1. This command is used to cut remaining label in printer after the commands <CT>0 or <->0 is executed.

[Important]

1. This command is closed to end users.

System			
Available for	CG400 series		
<b>Cut number unit</b>		<b>ESC+~A</b>	
Hex code	ESC <1B>16	~A <7E>16<41>16	Parameter aaaa
Default setting	aaaa=1		
Persistence of the command	When printer is powered off	Set parameter will not be retained	
	Validity in a job	Retained until next valid setting	
	Validity after a job	Set Parameter will be an default value for the next job<A>.	

[Function]

Cuts labels at a specified interval in a print job.

[Format]

<~A>aaaa

•Parameter

a [Number of labels between each cut] = Qty range : 0 to 9999

[Coding Example]

<A>

<V>100<H>200<P>2<L>0202<XM>ABC

<~A>2

<Q>7

<Z>

(1) Normal (complete) cut mode

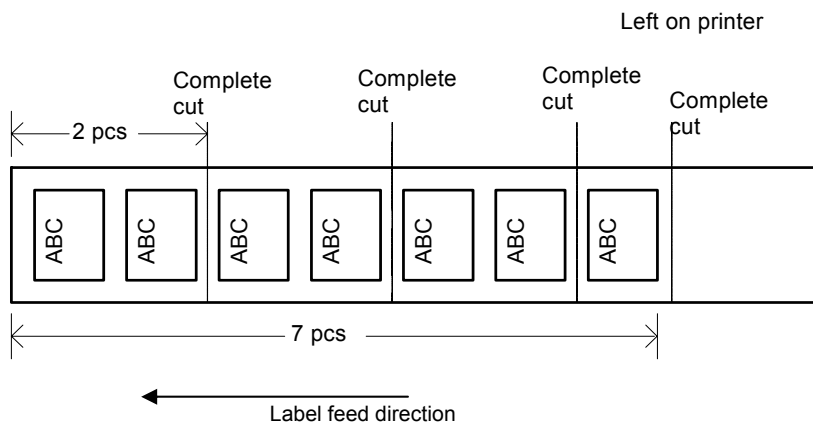

[Notes]

1. Valid only for cutter models.
2. If the parameter is not specified by this command <~A>, each label will be cut after being printed.
3. In case the parameter "a" is set to 0, no label will be cut.
4. Set this command before <Q>.
5. This command may not be used in combination with other cut commands<~>.

System			
Available for	CG400 series		
<b>Eject and Cut</b>		<b>ESC+~B</b>	
Hex code	ESC <1B>16	~B <7E>16<42>16	Parameter None
Default setting	None		
Persistence of the command	When printer is powered off	Set command will not be retained.	
	Validity in a job	Becomes invalid after execution	
	Validity after a job	Becomes invalid after the job	

[Function]

Specifies eject and cut operation

[Format]

<~B>

[Coding Example]

<A>

<~B>

<Z>

(1) Label stop position

- A: Printed
- B: Not printed
- C: Not printed
- D: Not printed

(2) Command received

(3) Label is fed to the cut position.

(4) Label is cut off.

(5) Label is back fed to the print position.

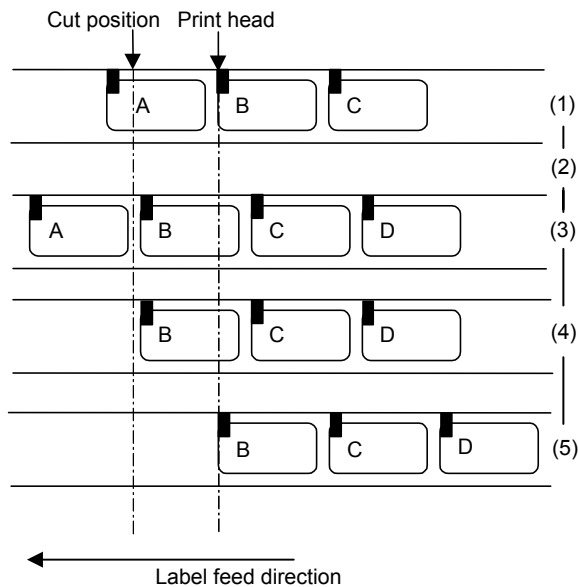

[Notes]

1. Valid only for cutter models.
2. This command is used to cut the last label remaining in the printer.
3. This command <~B> should be used by differentiating between Start code<A> and Stop code<Z>.
4. This command <~B> may not be used in combination with other commands.
5. This command <~B> is valid when the printer still holds the label which has not been cut after being printed.

[Tips]

1. This command is used to cut remaining label in the printer after the commands <~A>0 or <~>0 is executed.

System			
Available for	CG400 series		
<b>Clear memory</b>		<b>ESC+*</b>	
Hex code	ESC <1B> <sub>16</sub>	* <2A> <sub>16</sub>	Parameter a
Default setting	None		
Persistence of the command	When printer is powered off	Set Parameter will not be retained	
	Validity in a job	Becomes invalid after execution	
	Validity after a job	Becomes invalid after the job	

[Function]

Clears print jobs and specific item in memory.

[Format]

<\*>a

•Parameter

a	[Item to be cleared] =	Not specified	: Single item buffer, Edit buffer (reprint is not possible)
		T	: Multi item buffer, Edit buffer (Clears job which is in parsing)
		&	: User defined characters
		X	: Form overlay
			: All clear

(Receive buffer, Edit buffer, User defined characters, form overlay)  
 \* The job ,which is currently in progress, will not be cleared

[Coding Example1] Clear receive and edit buffer

<A>  
<\*>  
 <Z>

[Coding Example2] All clear

<A>  
<\*>X  
 <Z>

[Coding Example3] Clear user-defined characters

<A>  
<\*>T  
 <Z>

[Notes]

1. Set this command between Start code<A> and Stop code<Z>.
2. This command<\*>(a=X) will clear all the data sent before the command. However, the data which is completely parsed before the command will not be cleared. X will also clear user-defined characters and form overlay.

[Tips]

1. After the command <\*> is executed, have an interval of more than 100ms before sending next print data.
2. The job in printing will not be terminated by the command <\*>.

<b>System</b>			
Available for	CG400 series		
<b>Offline</b>		<b>ESC+@</b>	
Hex code	ESC <1B> <sub>16</sub>	@ <40> <sub>16</sub>	Parameter None
Default setting	None		
Persistence of the command	When printer is powered off	Set Parameter will not be retained	
	Validity in a job	Becomes invalid after execution	
	Validity after a job	Becomes invalid after the job	

[Function]

Set printer to offline.

[Format]

<@>

[Coding Example]

<A>

<@>

<Z>

[Notes]

1. Set this command between Start code<A> and Stop code<Z>.
2. Select single-item-buffer for data transmission mode.



System			
Available for	CG400 series		
<b>Reprint</b>		<b>ESC+C</b>	
Hex code	ESC <1B> <sub>16</sub>	C <43> <sub>16</sub>	Parameter None
Default setting	None		
Persistence of the command	When printer is powered off	Set Parameter will not be retained	
	Validity in a job	Becomes invalid after execution	
	Validity after a job	Becomes invalid after the job	

[Function]

Specifies to reprint the last label.

[Format]

<C>

[Coding Example]

<A>

**<C>**

<Z>

[Note]

1. Since the last print data will be cleared by powering off, reprint operation will not be available after the printer rebooted.

[Tips]

1. In case the print data contains sequential numbering by command <F>, the same number will be printed.

System			
Available for	CG400 series		
<b>Register Printer operation</b>		<b>ESC+PG</b>	
Hex code	ESC <1B> <sub>16</sub>	PG <50> <sub>16</sub> <47> <sub>16</sub>	Parameter abcdefghijklmnopqrrstuvwxyz
Default setting	See table in next page		
Persistence of the command	When printer is powered off	Set parameter will be retained	
	Validity in a job	Retained until next valid setting	
	Validity after a job	Retained until next valid setting	

[Function]

Registers printer settings in EEPROM.

[Format]

<PG>abcdefghijklmnopqrrstuvwxyz

•Parameter

See table in next page for parameter details.

[Coding Example]

<A>

**<PG><00 00 02 00 00 00 00 41 01 00 00 00 00 00 0C 80 03 40 00 00 00 00 00 00 00 00 00><sub>16</sub>**

<Z>

Parameter shall be given in HEX <00H><sub>16</sub><00H><sub>16</sub><02H><sub>16</sub> . . . . . <00H><sub>16</sub>

[Notes]

1. This command is not necessary to be specified in normal use.
2. The settings by this command will persist after turning off the printer .

No	Item	Valid selection	
a	Print method (CG408TT/CG412TT only) Default value: 01H	00H	Direct thermal
		01H	Thermal transfer
b	Reserved	00H	Fixed
c	Print speed 203dpi Default value: 02H 305dpi Default value: 02H	00H	2ips
		01H	3ips
		02H	4ips
d	Print mode (Default value: 01H)	00H	Continuous
		01H	Tear off
		02H	Cutter
		03H	Dispenser
		04H	Nonesepea (Linerless)
e	Cutter mode (Default value: 00H)	00H	Motion 1 (Head position)
		01H	Motion 2 (Cut position)
		02H	Motion 3 (No backfeed)
f	Dispenser mode (Default value: 00H)	00H	Motion 1 (Head position)
		01H	Motion 2 (Dispense position)
g	Nonesepea mode (Default value: 00H)	00H	Motion 2 (Tear off position)
		01H	Motion 3 (No backfeed)
h	Print darkness: (Default value: 41H)	41H	A
h	Print darkness level (Default value: 03H)	01H	Level 1
		02H	Level 2
		03H	Level 3
		04H	Level 4
		05H	Level 5
i	Sensor type (Default value: 01H)	00H	Reflective
		01H	Transmissive
		02H	Sensor off
		04H	Transmissive sensor (CX compatible)
j	0 Slash (Default value: 01H)	00H	Disabled
		01H	Enabled
k	Kanji code (Default value: 00H)	00H	JIS Code
		01H	Shift JIS code
l	Reserved	00H	Fixed
m	Initial feed (Default value: 00H)	00H	Disabled
		01H	Enabled
n	Character pitch (Default value: 01H)	00H	Fixed
		01H	Proportional
o	Label height (dot) 203dpi Default value: 0960H 305dpi Default value: 0E10H	CG408	[0001H ~ 0960H] (1 to 2400)
		CG412	[0001H ~ 0E10H] (1 to 3600)
p	Label width (dot) 203dpi Default value: 0340H 305dpi Default value: 04E0H	CG408	[0001H ~ 0340H] (1 to 832)
		CG412	[0001H ~ 04E0H] (1 to 1248)
q	Vertical base point correction (dot) (specifying in 2 bytes) (Default value: 000H)	[0000H - 012CH]	(0 to 300)
		[FFFFH - FED4H]	(-1 to -300)
r	Horizontal base point correction (dot) (specifying in 2 bytes) (Default value: 000H)	[0000H - 012CH]	(0 to 300)
		[FFFFH - FED4H]	(-1 to -300)
s	Vertical pitch offset (dot) (Default value: 00H)	[00H - 63H]	(0 to 99)
		[FFH - 9DH]	(-1 to -99)
t	TearOff position offset(dot) (Default value: 00H)	[00H - 63H]	(0 to 99)
		[FFH - 9DH]	(-1 to -99)
u	Cut position offset (dot) (Default value: 00H)	[00H - 63H]	(0 to 99)
		[FFH - 9DH]	(-1 to -99)
v	Dispensing position offset (dot) (Default value: 00H)	[00H - 63H]	(0 to 99)
		[FFH - 9DH]	(-1 to -99)
w	Control code (Default value: 00H)	00H	Standard code
		01H	Non-standard code
x	Gap between labels (dot) 203dpi Default value: 18H 305dpi Default value: 24H	[08H - 40H]	(8 to 64) 203dpi
		[0CH - 60H]	(12 to 96) 305dpi

(continued from previous page)

No.	Item	Valid selection	
y	Buzzer (Default value : 00H)	00H	Enabled
		01H	Disabled
z	Reserved	00H	Fixed

System			
Available for	CG400 series		
<b>Register Printer operation</b>		<b>ESC+PC</b>	
Hex code	ESC <1B> <sub>16</sub>	PC <50> <sub>16</sub> <43> <sub>16</sub>	Parameter 1) [a, b, c, d, ..., y, z, a1], 2) [aa, b]
Default setting	See the next page		
Persistence of the command	When printer is powered off	Set Parameter will be retained	
	Validity in a job	Retained until next valid setting	
	Validity after a job	Retained until next valid setting	

[Function]

Registers printer settings in EEPROM

[Format1] When all settings are newly registered

<PC>a,b,c,d,e,f,g,h,i,j2,j,k,l,m,n,o,pppp,qqqq,rrrr,ssss,t,u,v,w,x,y,z,a1

•Parameter

a [Item No.] = F : All items  
 b . . . a1 [Setting details] = See table in next page for individual parameters

[Format2] When specific item are needed to be registered

<PC>aa,b

•Parameter

a [Item No.] = 1 to 27  
 b [Setting details] = See table in next page for individual Parameters

[Coding Example1] all items

<A>

<PC>F,2,A,4,1,0,1,1,3000,2400,1

<Z>

[Coding Example2] specific item

<A>

<PC>26,1

<Z>

[Notes]

1. The settings done by the command <PC> will persist after turning off the printer.
2. The entire or partial parameter entities is omissible by using commas. However, commas are not omissible. Current valid setting will be applied to comma “,” position.

No	Item No.	Item	Valid selection
b	1	Print method (CG408TT/CG412TT only)	0 Thermal Transfer 1 Direct Thermal
c	2	Reserved	0 Fixed
d	3	Print speed 203dpi Default value: 2 305dpi Default value: 2	0 2ips 1 3ips 2 4ips
e	4	Print mode (Default value: 1)	0 Continuous 1 Tear Off 2 Cutter 3 Dispenser 4 Noneseпа (Linerless)
f	5	Cutter mode	00 Motion 1 (Head position) 01 Motion 2 (Cut position) 02 Motion 3 (No backfeed)
g	6	Dispenser mode	00 Motion 1 (Head position) 01 Motion 2 (Dispense position)
h	7	Noneseпа mode	00 Motion 2 (Tear off position) 01 Motion 3 (No backfeed)
i1	8	Print darkness (Default value: A)	A
i2	9	Print darkness level (Default value: 3)	1 Level 1 2 Level 2 3 Level 3 4 Level 4 5 Level 5
j	10	Sensor type (Default value: 1)	0 Reflective 1 Transmissive 2 Sensor off 4 Transmissive sensor (CX compatible)
k	11	0 Slash (Default value: 1)	0 Disabled 1 Enabled
l	12	Kanji code (Default value: 0)	0 JIS Code 1 Shift JIS code
m	13	Reserved	0 Fixed
n	14	Initial feed (Default value: 0)	0 Disabled 1 Enabled
o	15	Character pitch (Default value: 1)	0 Fixed pitch 1 Proportional pitch
p	16	Label height (dot) 203dpi Default value: 2400(Decimal number) 305dpi Default value: 3600(Decimal number)	CG408DT/TT 1 to 2400
			CG412DT/TT 1 to 3600
q	17	Label width (dot) 203dpi Default value: 832(Decimal number) 305dpi Default value: 1248(Decimal number)	CG408DT/TT 1 to 832
			CG412DT/TT 1 to 1248
r	18	Vertical base point correction (dot) (Default: 0)	-300 to 300
s	19	Horizontal base point correction (dot) (Default: 0)	-300 to 300
t	20	Vertical pitch offset (dot) (Default: 0)	-99 to 99
u	21	Tear Off position offset(dot) (Default: 0)	-99 to 99
v	22	Cut position offset (dot) (Default: 0)	-99 to 99
w	23	Dispense position offset (dot) (Default: 0)	-99 to 99
x	24	Control code (Default value: 0)	0 Standard code 1 Non-standard code
y	25	Gap between labels (dot) 203dpi Default value: 24 305dpi Default value: 36	8 to 64 203dpi 12 to 96 305dpi
z	26	Buzzer (Default value: 0)	0 On 1 Off
a1	27	Reserved	0 Fixed

System			
Available for	CG400 series		
<b>Auto line feed</b>		<b>ESC+E</b>	
Hex code	ESC <1B> <sub>16</sub>	E <45> <sub>16</sub>	Parameter aaa
Default setting	aaa=0		
Persistence of the command	When printer is powered off	Set Parameter will not be retained	
	Validity in a job	Becomes invalid after execution	
	Validity after a job	Becomes invalid after the job	

[Function]

Specifies amount of line spacing and CR (Line feed)

[Format]

<E>aaa

•Parameter

a [Line spacing] = valid range : 0 to 999 dots

[Coding Example]

```
<A>
<E>10
<V>100<H>200<P>2<L>0304<OA>ABCDE+CR
FGHIJ+CR
<Q>2
<Z>
```

[Notes]

1. Put "CR(ODH)" where the CR needs to be executed in specified line spacing by this command.
2. Rotation command <%> can be used in combination with this command.
3. Line spacing pitch can be changed by this command <E> within the item.
3. The command <E> may be used in a job and change the line spacing as necessary.
4. The command will execute auto CR in the specified line spacing. Horizontal print position shall be specified by the command <H> to directly after the vertical print position is thus (by specified line spacing) specified.  
In case different horizontal positions are specified by the command <H> in multiple times, the last specified position will remain valid for Further CR(ODH) to follow.

System				
Available for				
	CG400 series			
User download			ESC+LD	
Hex code	ESC <1B> <sub>16</sub>	LD <4C> <sub>16</sub> <44> <sub>16</sub>	Parameter , a, b, c, d, e, f, g, h, i, j	
Default setting	See table below			
Persistence of the command	When printer is powered off		Set Parameter will be retained	
	Validity in a job		Retained until next valid setting	
	Validity after a job		Retained until next valid setting	

[Function]

Settings of : Auto-online, zero slash(Enable/Disable), protocol code, Euro code

[Format]

<LD>,a,b,c,d,e,f,g,h,i,j

• Parameter

See the table below.

Function	Parameter	Description	Default	
			Standard	Non-standard
Protocol code	a(HEX)	STX	02H	{(7BH)
	b(HEX)	ETX	03H	}(7DH)
	c(HEX)	ESC	1BH	^(5EH)
	d(HEX)	ENQ	05H	@(40H)
	e(HEX)	CAN	18H	!(21H)
	f(HEX)	NULL	00H	~(7EH)
	g(HEX)	Offline		@(40H)
Auto-online	h(ASCII)	0: YES 1: NO	0(30H)	0(30H)
Zero slash	i(ASCII)	0: YES 1: NO	0(30H)	0(30H)
Euro code	j(HEX)	D5H	D5H	D5H

[Coding Example]

```
<A>
<LD>,{,},%,&,=-,0,0,<FF>16
<Z>
```

[Notes]

1. Place this command between Start code<A> and Stop code<Z>.
2. The command <LD> may be received while printer is in online mode.
3. Certain parameters may be omitted by giving “,” as place holder. Current valid setting will be applied to “,” position.
4. If more or less than 10 commas “,” is used, or specified code is used in other commands or in print data, the result may not be guaranteed.
5. After the setting by this command <LD> is successfully completed, setting information will be printed.  
After the printing is completed, press the FEED/LINE key once and repower the printer to make the new settings valid. If the printer is powered off without FEED/LINE key pressed, the setting information will not be saved.
6. Non-standard code set by this command <LD> will be enabled by the command <PG> or <PC>.



System			
Available for	CG400 series		
<b>Offset</b>		<b>ESC+PO</b>	
Hex code	ESC <1B> <sub>16</sub>	PO <50> <sub>16</sub> <4F> <sub>16</sub>	Parameter abcc
Default setting	a=0,b=+,cc=00		
Persistence of the command	When printer is powered off	Set parameter will not be retained	
	Validity in a job	Retained until next valid setting	
	Validity after a job	Retained until next valid setting	

[Function]

Gives offset to media's stop position on the fly.

[Format]

<PO>abcc

●Parameter

a	[Offset]	=	0	:	Cutter
			1	:	Dispenser
			2	:	Tear-off
			3	:	Continuous
b	[Offset direction]	=	+	:	Feed forward
			-	:	Backward
c	[Amount of offset]	=	Valid range	:	00 to 99 (dots)

[Coding Example]

<A>

<PO>3+08

<Z>

[Notes]

1. This command does not need to be specified in normal use.
2. The command is to fine-tune media position when it is required by specific application.

System			
Available for	CG400 series		
<b>Sensor type</b>		<b>ESC+IG</b>	
Hex code	ESC <1B> <sub>16</sub>	IG <49> <sub>16</sub> <47> <sub>16</sub>	Parameter a
Default setting	a=0		
Persistence of the command	When printer is powered off	Set parameter will not be retained	
	Validity in a job	Retained until next valid setting	
	Validity after a job	Retained until next valid setting	

[Function]

Changes sensor type temporarily

[Format]

<IG>a

•Parameter

a	Sensor type	=	0	:	Reflective (I-Mark)
			1	:	Transmissive (Gap)
			2	:	Sensor off
			4	:	Transmissive (I-mark CX compatible)

[Coding Example]

<A>

**<IG>0**

<Z>

[Notes]

1. The setting by this command is normally not needed.
2. The setting is valid until the printer is powered off and printer's internal setting becomes valid after rebooting.

System			
Available for	CG400 series		
<b>Print method</b>		<b>ESC+PH</b>	
Hex code	ESC <1B> <sub>16</sub>	PH <50> <sub>16</sub> <48> <sub>16</sub>	Parameter a
Default setting	a=0		
Persistence of the command	When printer is powered off	Set parameter will not be retained	
	Validity in a job	Retained until next valid setting	
	Validity after a job	Retained until next valid setting	

[Function]

Changes print method temporarily.

[Format]

<PH>a

●Parameter

a	[Print method]	=	0	:	Thermal transfer
			1	:	Direct Thermal

[Coding Example]

<A>

<PH>0

<Z>

[Notes]

1. The setting by this command is normally not needed.
2. The setting is valid until the printer is powered off and printer's internal setting becomes valid after rebooting.

System			
Available for	CG400 series		
<b>Print mode</b>		<b>ESC+PM</b>	
Hex code	ESC <1B> <sub>16</sub>	PM <50> <sub>16</sub> <4D> <sub>16</sub>	Parameter a
Default setting	a=0		
Persistence of the command	When printer is powered off	Set parameter will not be retained	
	Validity in a job	Retained until next valid setting	
	Validity after a job	Retained until next valid setting	

[Function]

Specifies print mode temporarily.

[Format]

<PM>a

•Parameter

a	Print mode	=	0	:	Continuous
			1	:	Tear-off
			2	:	Cutter (Motion 1: Head position)
			3	:	Cutter (Motion 2: Cutter position)
			4	:	Cutter (Motion 3: No backfeed)
			5	:	Noneseпа (Motion 2: Tear off position)
			6	:	Noneseпа (Motion 3: No backfeed)
			7	:	Dispenser (Motion 1: Head position)
			8	:	Dispenser (Motion 2: Dispense position)

[Coding Example]

<A>  
<PM>0  
 <Z>

[Notes]

1. The selection by this command is valid until printer is powered off. Printer's internal setting becomes valid after rebooting.
2. The selection shall be consistent with the print mode specified by command <PM>.  
 e.g.) In case of cutter mode: print mode (2), (3) and (4) are valid, while other modes are invalid.

General description of each mode :

(1) Tear-off

The media will be fed up to the tear-off edge after printed. Then the printer, after receiving next print data, will back feed the next label to the print head position.

(2) Cutter (Motion 1: Head position)

The printer back feed the label up to the print head position immediately after the last label is cut.

(3) Cutter (Motion 2: Cutter position)

The printer, after receiving the next print data, will back feed the media to the print head position. The label is cut after printing.

(4) Cutter (Motion 3: No back feed)

No backfeed.

(5) Noneseпа (Motion 2: Tear off position)

The printer back feeds the label to the print head position immediately after receiving next print data. Then the printer feeds the label to the tear off position after print job is completed.

(6) Noneseпа (Motion 3: No backfeed)

No backfeed.

(7) Dispenser (Motion 1: Head position)

The printer back feeds the label up to the print head position immediately after the last label is dispensed.

(8) Dispenser (Motion 2: Dispense position)

The printer, after receiving the next print data, will back feed the media to the print head position.

<b>System</b>			
Available for	CG400 series		
<b>Test print (Closed to end users)</b>		<b>ESC+TP</b>	
Hex code	ESC <1B> <sub>16</sub>	TP <54> <sub>16</sub> <50> <sub>16</sub>	Parameter ,a
Default setting	None		
Persistence of the command	When printer is powered off	Set parameter will not be retained	
	Validity in a job	Becomes invalid after execution	
	Validity after a job	Becomes invalid after the job	

[Function]

Specifies to issue Test print

[Format]

<TP>,a

•Parameter

a	Test print	=	0	:	Factory test print (ALL)
			1	:	Factory test print (only first page)
			2	:	User test print (ALL)
			3	:	Factory test print for adjustment (All: printed in reverse order for Head check as the last item)
			4	:	Interface configuration print

[Coding Example]

<A>

<TP>,1

<Z>

[Note]

1. Place this command between <A>Start code and <Z>Stop code.

[Important]

1. This command shall not be disclosed to end users.
2. Make sure that the test print is completely finished before sending any new print data.

System			
Available for	CG400 series		
<b>Media feed control (Closed to end users)</b>		<b>ESC+IK</b>	
HEX code	ESC <1B> <sub>16</sub>	IK <49> <sub>16</sub> <4B> <sub>16</sub>	parameter a,(bbbb)
Default setting	None		
Persistence of the command	When printer is powered off	Set parameter will not be retained.	
	Validity in a job	Set parameter becomes invalid.	
	Validity after a job	Set parameter becomes invalid.	

[Function]

Feeds the label forward or backward according to the specified feed length.

[Format]

<IK>a,bbbb

• Parameter

a [Feed motion] = 0 : Feeds the label forward  
1 : Feeds the label backward

b [Feed length] = Valid range : Refer to [Notes]

<IK>a

• Parameter

a [Feed motion] = 0 : Feeds the single label forward  
2 : Feeds the label forward from print head position to tear off position  
3 : Feeds the label backward from tear off position to print head position  
4 : Feeds the label backward from print head position to cutter position  
5 : Feeds the label backward from cutter position to print head position

[Coding example 1] Feeds the label forward for 120 dots

<A>  
<IK>0,120  
<Z>

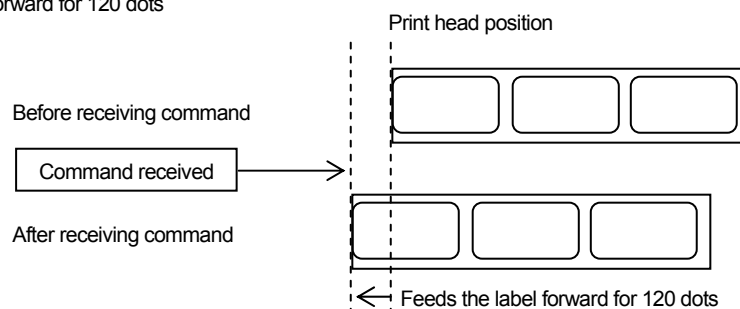

If receiving the print data without returning the label to the original position by <IK>1,120, the print job will start from the current stop position.

[Coding example 2] Feeds the single label

<A>  
<IK>0  
<Z>

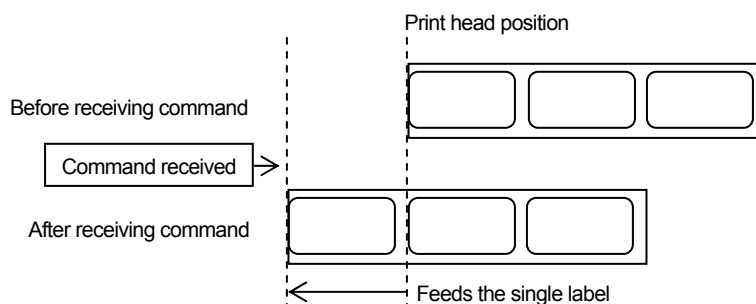

[Coding example 3] Feeds the label forward to tear off position

<A>  
<IK>2  
<Z>

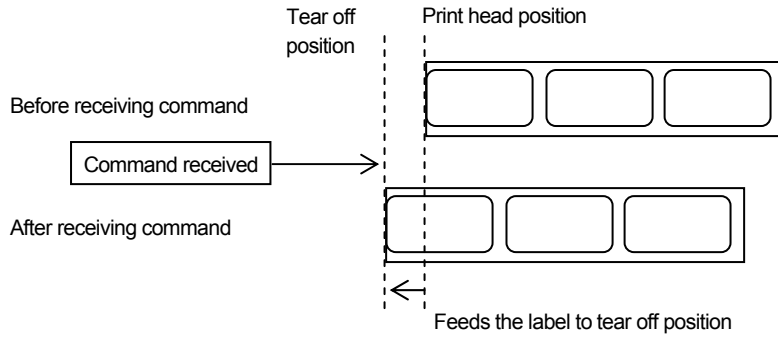

If receiving the print data without returning the label to the original position by <IK>3, the print job will start from the current stop position.

[Coding example 4] Feeds the label backward from tear off position to print head position

<A>  
<IK>3  
<Z>

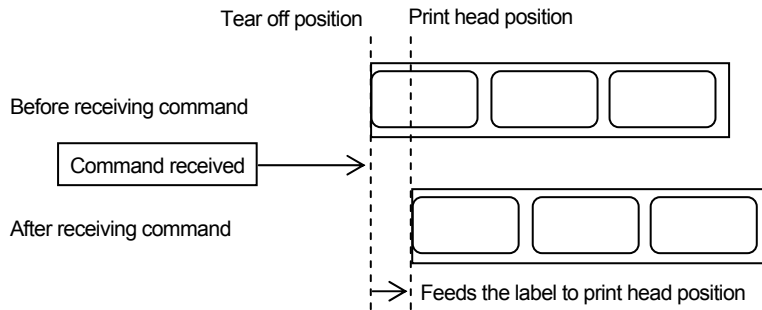

[Coding example 5] Feeds the label forward to cutter position

<A>  
<IK>4  
<Z>

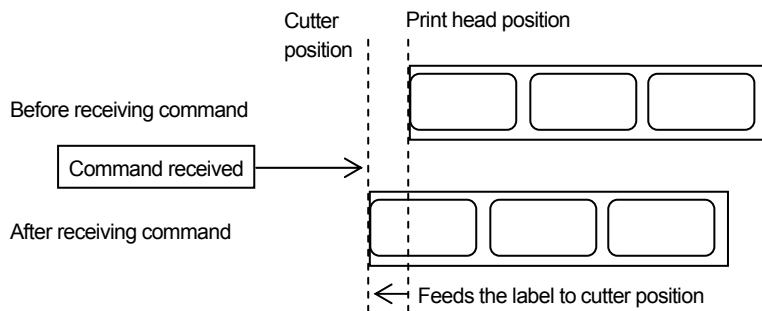

If receiving the print data without returning the label to the original position by <IK>5, the print job will start from the current stop position.

[Coding example 6] Feeds the label backward from cutter position to print head position

<A>  
<IK>5  
<Z>

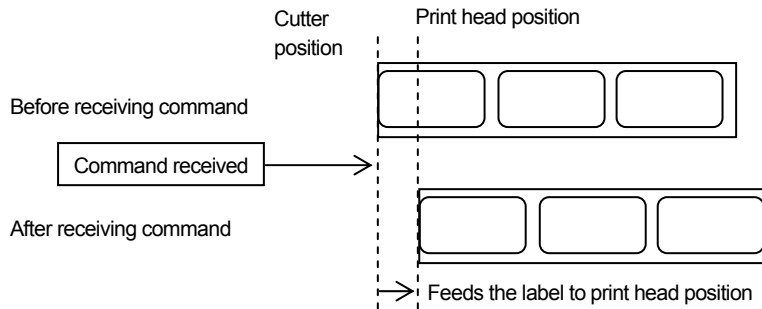

[Notes]

- 1 . Place this command between start code <A> and stop code <Z>. If specifying this command in the item with print data, this command will be ignored.
- 2 . When setting the label feed direction in the reverse direction, make sure the label feed length does not become too long. The print data may appear overlapped with each other or the printer may wrongly detect a paper end error because of the label coming off the platen. Also, there is a possibility that the label would come off the platen in the same way if feeding the label to the tear off position or to the cutter position in the reverse direction.
- 3 . Do not feed the label backward right after cutting the label in cutter mode or dispensing the label in dispenser mode.
- 4 . When omitting the feed distance in the forward direction, label feeding motion will be exactly the same as when pressing the key in offline state.
- 5 . Label feeding motion specified with this command will be performed in online state.
- 6 . Omitting the feed distance in the reverse direction may result in command error and the label will not be fed.
- 7 . When the sensor is disabled in continuous mode, the label cannot be fed by <IK>0 (feed distance omitted).
- 8 . Specifying the feed length outside the valid range may result in command error and the label will not be fed.

[Valid range]

Head density	Valid range (dot)
8 dot/mm	48 to 1600
12 dot/mm	72 to 2400



System			
Available for	CG400 series		
<b>IEEE1284</b>		<b>ESC+I1</b>	
HEX code	ESC	I1	Parameter
	<1B> <sub>16</sub>	<49> <sub>16</sub> <31> <sub>16</sub>	abbb
Default setting	a=0, b=010		
Persistence of the command	When printer is powered off	Set parameter will be retained.	
	Validity in a job	Set parameter will not be retained.	
	Validity after a job	Set parameter will not be retained.	

[Function]

Specifies the receive mode and ACK width of IEEE1284.

[Format]

<I1>abbb

• Parameter

a	[Receive mode (Default: 0)]	=	0	:	Multi item buffer
			1	:	Single item buffer
b	[ACK width]	=	Valid range	:	010 to 200 (1=50ns)

[Coding example]

<A>

**<I1>0010**

<Z>

[Notes]

1. It is not necessary to use this IEEE1284 <I1> command under normal conditions.
2. The set parameter by this command will become valid after rebooting.

System			
Available for	CG400 series		
<b>Serial interface</b>		<b>ESC+I2</b>	
Hex code	ESC	I2	Parameter
	<1B> <sub>16</sub>	<49> <sub>16</sub> <32> <sub>16</sub>	abcde
Default setting	a=1,b=0,c=0,d=0,e=1		
Persistence of the command	When printer is powered off	Set parameter will be retained	
	Validity in a job	Becomes invalid after execution	
	Validity after a job	Becomes invalid after the job	

[Function]

Specifies the setting of serial Interface.

[Format]

<I2>abcde

•Parameter

a	[Baud rate]	:	0 = 9600bps 1 = 19200bps 2 = 38400bps
b	[Data bit]	:	0 = 8bit 1 = 7bit
c	[Parity]	:	0 = No parity 1 = Odd 2 = Even
d	[Stop bit]	:	0 = 1bit 1 = 2bit
e	[Control]	:	0 = READY/BUSY control (Single item buffer) 1 = READY/BUSY control (Multi item buffer) 2 = XON/XOFF 3 = Driver protocol (STATUS4) 4 = STATUS3

[Coding Example]

<A>

**<I2>10003**

<Z>

[Notes]

1. The set parameter by this command will become valid after rebooting.

System			
Available for	CG400 series		
<b>LAN interface</b>		<b>ESC+I3</b>	
Hex code	ESC	I3	Parameter
	<1B> <sub>16</sub>	<49> <sub>16</sub> <33> <sub>16</sub>	a
Default setting	a=0		
Persistence of the command	When printer is powered off	Set parameter will be retained.	
	Validity in a job	Becomes invalid after execution	
	Validity after a job	Becomes invalid after the job	

[Function]

Specifies the setting of LAN Interface.

[Format]

<I3>a

•Parameter

- a [LAN mode] = 0 : 2 port connection/unsolicited (for driver protocol (STATUS4))  
 1 : 2 port connection /solicited by ENQ (for driver protocol (STATUS4))  
 2 : 1 port connection /solicited by ENQ (STATUS3)

[Coding Example]

<A>  
<I3>0  
 <Z>

[Notes]

1. The set parameter by this command will become valid after rebooting.

System			
Available for	CG400 series		
<b>IP address</b>		<b>ESC+W1</b>	
Hex code	ESC	W1	Parameter
	<1B> <sub>16</sub>	<57> <sub>16</sub> <31> <sub>16</sub>	a~a
Default setting	a~a=000000000000		
Persistence of the command	When printer is powered off		Set Parameter will be retained
	Validity in a job		Becomes invalid after execution
	Validity after a job		Becomes invalid after the job

[Function]

Sets IP address.

[Format]

<W1>a~a

•Parameter

a~a [IP address] = 12 digit fixed

[Coding Example]

<A>

**<W1>123220000040**

<Z>

[Notes]

1. Place this command between start code<A> and stop code<Z>.
2. This command may not be used in combination with other commands.
3. Setting can be printed on the factory test print.
4. The set parameter will become valid after rebooting.
5. Default setting of IP address is as follows:

IP address	000000000000
------------	--------------

System			
Available for	CG400 series		
<b>Subnet mask</b>		<b>ESC+W2</b>	
Hex code	ESC <1B> <sub>16</sub>	W2 <57> <sub>16</sub> <32> <sub>16</sub>	Parameter a~a
Default setting	a~a=000000000000		
Persistence of the command	When printer is powered off	Set Parameter will be retained	
	Validity in a job	Becomes invalid after execution	
	Validity after a job	Becomes invalid after the job	

[Function]

Sets Subnet mask

[Format]

<W2>a~a

•Parameter

a~a [Subnet mask] = 12 digits fixed

[Coding Example]

<A>

<W2>255255255000

<Z>

[Notes]

1. Place this command between <A>start code and <Z> stop code.
2. This command may not be used in combination with other commands.
3. Setting can be printed on the factory test print.
4. The set parameter will become valid after rebooting.
5. Default setting of Subnet mask is as follows:

Subnet mask	000000000000
-------------	--------------

System			
Available for	CG400 series		
<b>Default gateway</b>		<b>ESC+W3</b>	
Hex code	ESC <1B> <sub>16</sub>	W3 <57> <sub>16</sub> <33> <sub>16</sub>	Parameter a~a
Default setting	a~a=000000000000		
Persistence of the command	When printer is powered off	Set Parameter will be retained	
	Validity in a job	Becomes invalid after execution	
	Validity after a job	Becomes invalid after the job	

[Function]

Sets Default gateway.

[Format]

<W3>a~a

•Parameter

a~a [Default gateway] = 12 digits fixed

[Coding Example]

<A>

**<W3>128220001001**

<Z>

[Notes]

1. Place this command between <A>start code and <Z> stop code.
2. This command may not be used in combination with other commands.
3. Setting can be printed on the factory test print.
4. The set parameter will become valid after rebooting.
5. Default setting of Default gateway is as follows:

Default gateway	000000000000
-----------------	--------------

[Important]

Use the valid subnet address (=consistent to the IP address currently used) for the default gateway.

System			
Available for	CG400 series		
<b>IP address setup</b>		<b>ESC+WI</b>	
Hex code	ESC <1B> <sub>16</sub>	WI <57> <sub>16</sub> <49> <sub>16</sub>	Parameter a
Default setting	a=1		
Persistence of the command	When printer is powered off	Set Parameter will be retained	
	Validity in a job	Becomes invalid after execution	
	Validity after a job	Becomes invalid after the job	

[Function]

Specifies IP address setup method.

[Format]

<WI>a

•Parameter

a [IP address setup] = 0 : Manual setup  
1 : DHCP

[Coding Example]

<A>  
<WI>1  
<Z>

[Notes]

1. Place this command between start code<A> and stop code<Z>.
2. This command may not be used in combination with other commands.
3. Setting can be printed on the factory test print.
4. The set parameter will become valid after rebooting.
5. Default setting of IP address is as follows:

IP address setup	1 (DHCP)
------------------	----------

System			
Available for	CG400 series		
<b>RARP</b>		<b>ESC+WM</b>	
Hex code	ESC <1B> <sub>16</sub>	WM <57> <sub>16</sub> <4D> <sub>16</sub>	Parameter a
Default setting	a=1		
Persistence of the command	When printer is powered off	Set Parameter will be retained	
	Validity in a job	Becomes invalid after execution	
	Validity after a job	Becomes invalid after the job	

[Function]

Specifies if RARP is disabled/enabled. When enabled, RARP will automatically obtain IP address at the time of startup.

[Format]

<WM>a

•Parameter

a [RARP] = 0 : Disabled  
1 : Enabled

[Coding Example]

<A>

<WM>1

<Z>

[Notes]

1. Place this command between <A>start code and <Z>stop code.
2. This command may not be used in combination with other commands.
3. Setting can be printed on the factory test print.
4. The set parameter will become valid after rebooting.
5. Default setting is as follows:.

IP Address	1 (RARP Enabled)
------------	------------------



System			
Available for	CG400 series		
<b>Interface</b>		<b>ESC+DI</b>	
Hex code	ESC <1B> <sub>16</sub>	DI <44> <sub>16</sub> <49> <sub>16</sub>	Parameter a
Default setting	a=0		
Persistence of the command	When printer is powered off	Set parameter will be retained	
	Validity in a job	Retained until next valid setting	
	Validity after a job	Retained until next valid setting	

[Function]

Specifies the interface used to connect with the host computer.

[Format]

<DI>a

●Parameter

a [Interface] = 0: USB  
1: RS-232C / LAN / IEEE1284  
2: Keypad  
3: Scanner / Smart keyboard

[Coding example]

<A>  
<DI>0  
<Z>

[Notes]

1. Set this command between start code<A> and stop code<Z>.
2. This command will be valid after rebooting.
3. Set <DI>2 to use Keypad. Only in this case, connection with Keypad will be checked and supplied with power. While powering to Keypad, connection check will be executed at fixed intervals and the printer stops supplying power when disconnected. Connection check will not be done after that.

System			
Applicable for	CG400 series		
<b>Option waiting time</b>		<b>ESC+TW</b>	
Hex code	ESC	TW	Parameter
	<1B> <sub>16</sub>	<54> <sub>16</sub> <57> <sub>16</sub>	aaa
Default setting	aaa = 010(1000ms)		
Persistence of the command	When printer is powered off		Set parameter will be retained
	Validity in a job		Retained until next valid setting
	Validity after a job		Retained until next valid setting

[Function]

Specifies waiting time for options.

[Format]

<TW>aaa

●Parameter

aaa [Waiting time] = Valid range: 005 to 200 (unit: 100ms)

[Coding example] (waiting time = 1.5 seconds)

<A>

<TW>015

<Z>

[Notes]

1. This command specifies, in Tear-off mode, the waiting time between print completion and Tear-off motion.
2. The set parameter becomes valid soon after receiving the command and will be in effect after power off.

<b>System</b>			
Applicable for	CG400 series		
<b>Forced Tear off</b>		<b>ESC+TK</b>	
Hex code	ESC	TK	Parameter
	<1B> <sub>16</sub>	<54> <sub>16</sub> <4B> <sub>16</sub>	None
Default setting	None		
Persistence of the command	When printer is powered off	Set parameter will be retained	
	Validity in a job	Retained until next valid setting	
	Validity after a job	Retained until next valid setting	

[Function]

Executes Tear off compulsory.

[Format]

<TK>

[Coding example]

<A>  
<TK>  
 <Z>

[Notes]

1. This command can be specified only in Tear off mode.
2. With this command, the printer executes Tear off motion without waiting the time set by command <TW>. If the next data is received before Tear off motion, Tear off is executed compulsory.
3. This command can not be used in combination with other commands.

[Tips]

1. This command can be used to save the time set by command <TW>, if it is sure that there is no following item.

## 14. Memory Card Commands

Memory Card			
Available for	CG400 series		
<b>Card slot</b>		<b>ESC+CC</b>	
HEX code	ESC <1B> <sub>16</sub>	CC <43> <sub>16</sub> <43> <sub>16</sub>	Parameter a
Default setting	a=0		
Persistence of the command	When printer is powered off	Set parameter will not be retained	
	Validity in a job	Retained until next valid setting	
	Validity after a job	Retained until next valid setting	

**[Function]**

Specifies the card slot number to be used.

**[Format]**

<CC>a

•Parameter

a [Slot number] = 1 : Fixed

**[Example]**

<A>

**<CC>1**

<GI>H003003001FF000000~000000FF

<Z>

**[Note]**

1. This command must be used when command specification is need for a memory card.

Memory Card			
Available for	CG400 series		
<b>Format Memory card</b>		<b>ESC+FM</b>	
HEX code	ESC <1B> <sub>16</sub>	FM <46> <sub>16</sub> <4D> <sub>16</sub>	Parameter aaaaaaaa
Default setting	None		
Persistence of the command	When printer is powered off	Set parameter will not be retained	
	Validity in a job	Becomes invalid after execution	
	Validity after a job	Becomes invalid after the job	

[Function]

Specifies the format (initialization) of memory card.

[Format]

<FM>aaaaaaaa

• Parameter

a [User ID] = Up to 8 bytes in alphanumeric and symbols

[Coding example]

<A>

<CC>1

**<FM>SATO**

<Z>

[Note]

1. Make sure to specify the card slot number to be used for the <CC> command before the <FM> command.
2. The <FM> command is used for initializing a memory card and this command cannot be used in combination with other commands.
3. Care should be exercised when using this command as it destroys any data previously written to the card. SATO is not liable for any data loss.

Memory Card			
Available for	CG400 series		
<b>Print memory card status</b>		<b>ESC+FP</b>	
HEX code	ESC <1B> <sub>16</sub>	FP <46> <sub>16</sub> <50> <sub>16</sub>	Parameter None
Default setting	None		
Persistence of the command	When printer is powered off	Set parameter will not be retained	
	Validity in a job	Becomes invalid after execution	
	Validity after a job	Becomes invalid after the job	

[Function]

Prints the status of memory card.

[Format]

<FP>

[Example]

<A>

<CC>1

**<FP>**

<Z>

[Note]

1. This command is used to print the memory card status and cannot be used in combination with other commands.
2. The status can be checked with the media of W56mm and H90mm.

Memory Card			
Available for	CG400 series		
<b>Store form overlay</b>		<b>ESC+&amp;S</b>	
HEX code	ESC <1B> <sub>16</sub>	&S <26> <sub>16</sub> <53> <sub>16</sub>	Parameter ,aa,(bbbb,cccc)
Default setting	None		
Persistence of the command	When printer is powered off	Set parameter will be retained	
	Validity in a job	Retained until next valid setting	
	Validity after a job	Retained until next valid setting	

[Function]

Stores fixed print contents to memory card.

[Format]

<&S>,aa,(bbbb,cccc)

• Parameter

- a [Registration number] = Valid range: 1 to 99
- b [Horizontal size of window] = See the table in the next page (Omissible)
- c [Vertical size of window] = See the table in the next page (Omissible)

[Coding example]

```
<A>
<V>100<H>100<XM>OMODEL
<CC>1
<&S>1
<Z>
```

[Note]

1. The Card Slot <CC> command must be sent prior to this command.
2. Place the format to be stored between the Start Code <A> and the Stop Code <Z> commands.
3. Registration of identical store number is invalid.
4. The data of Graphics<G> and BMP File <GM> can be also stored.
5. This command allows up to 99 registries. Note that the capacity of registry may vary depending on the memory card to be used.
6. The data stored by this command are cleared by the Clear <\*>R command.

[Valid Commands]

CG400 series

Font	<XU>	<XS>	<XM>	<XB>	<XL>	<U> <sup>*1</sup>	<S> <sup>*1</sup>	<M> <sup>*1</sup>	<WB> <sup>*1</sup>	<WL> <sup>*1</sup>
Barcode	<OA>	<OB>	<RD>	<\$=>						
	<B>	<BC>	<BG>	<BI>	<BF>	<BP>	<D>	<D><d>	<BD>	<BT>
2D code	<BW>									
	<BK>	<BQ>	<BV>	<BX>						
Modification	<2D10>	<2D12>	<2D20>	<2D30>	<2D31>	<2D32>	<2D50>			
	<WD>	<FW>	<(>	<RF>						
Graphic	<G>	<GM>	<GP>							

\* Closed to end users.

In general, this command is used for registration number only. By specifying the horizontal and vertical window sizes, the label image can be moved by using the <V> and <H> position commands when recalling the label image. If the repositioned label image exceeds the printable area, the image will be truncated.

See the following examples.

(1) Normal operation

```
<A>
<V>100<H>100<P>2<L>0202
<XM>0ABCD
<V>60<H>60
<FW>0808V800H400
<V>320<H>60
<FW>04H400
<CC>1
<&S>,1
<Z>
```

Stored label image

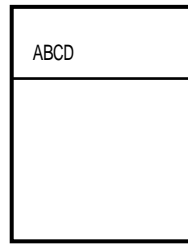

(2) When print is specified after the <&S> command.

```
<A>
<V>100<H>100<P>2<L>0202
<XM>0ABCD
<V>60<H>60
<FW>0808V800H400
<V>320<H>60
<FW>04H400
<CC>1
<&S>,1
<V>200<H>100<OB>12345
<Z>
```

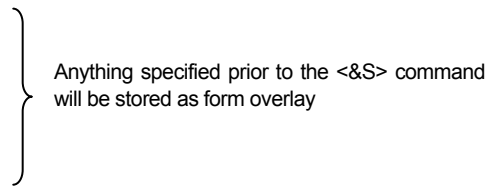

← Will be printed.

(3) When window size is specified.

Media size specification <A1>08000400, Horizontal size of window: 200, Vertical size of window: 200

```
<A>
<A1>08000400
<V>100<H>00<P>2<L>0202
<XM>0ABCD
<CC>1
<&S>,1,200,200
<Z>
```

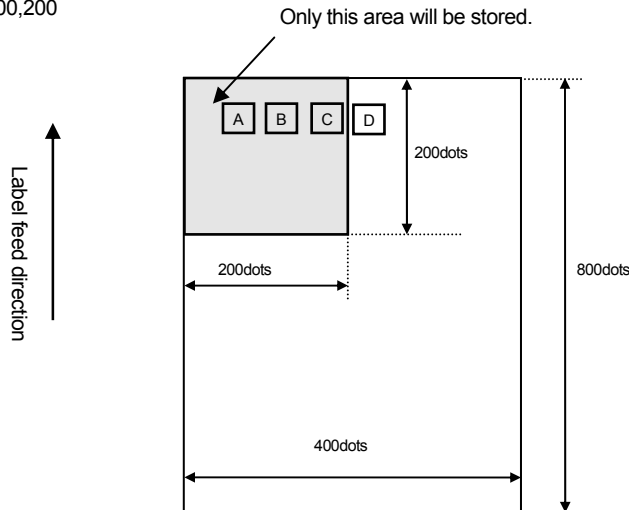

[Range for horizontal size of window]

[Range for vertical size of window]

Resolution	Valid range (dots)
8 dots/mm	1 to 832
12 dots/mm	1 to 1248

Resolution	Valid range (dots)
8 dots/mm	1 to 2400
12 dots/mm	1 to 3600



Memory Card			
Available for	CG400 series		
<b>Recall Form overlay</b>		<b>ESC+&amp;R</b>	
HEX code	ESC <1B> <sub>16</sub>	&R <26> <sub>16</sub> <52> <sub>16</sub>	Parameter ,aa
Default setting	None		
Persistence of the command	When printer is powered off	Set parameter will not be retained	
	Validity in a job	Becomes invalid after execution	
	Validity after a job	Becomes invalid after the job	

[Function]

Recalls the tag or label image from memory card saved by command <&S>.

[Format]

<&R>,aa

• Parameter

a [Registration number] = 1 to 99

[Example]

<A>

<CC>1

<&R>,1

<Z>

[Note]

1. The Card Slot <CC> command must be sent prior to this command.
2. Several images stored under different registration numbers can be printed with this command.
3. If no registration number is specified, this command will be ignored.
4. A read/write error will occur if an unused registration number is specified.
5. If a tag or label image is stored without specifying a window size, the <V> and <H> position commands will be ignored, and the image will be expanded from V1 and H1 (start position of drawing area).
6. The tag or label image can be moved by using the <V> and <H> position commands when it is stored along with a window size. If it exceeds the printable area by being moved, the tag or label image will be truncated.

[Valid commands]

Print position	<V>	<H>								
----------------	-----	-----	--	--	--	--	--	--	--	--

Memory Card			
Available for	CG400 series		
<b>Store Format</b>		<b>ESC+YS</b>	
HEX code	ESC <1B> <sub>16</sub>	YS <59> <sub>16</sub> <53> <sub>16</sub>	Parameter ,aaa
Default setting	None		
Persistence of the command	When printer is powered off	Set parameter will be retained	
	Validity in a job	Retained until next valid setting	
	Validity after a job	Retained until next valid setting	

[Function]

Stores a format field description.

[Format]

<YS>,aaa

• Parameter

a [Format number to be stored] = Valid range: 1 to 999

[Coding example]

<A>

<CC>1

**<YS>,1**

</N>,3,3

<%>0<V>100<H>200<P>2<L>0101<XM>ABC

<Z>

[Notes]

1. When storing multiple formats, each format shall be placed between enter the Start Code <A> and the Stop Code <Z> commands.
2. The Card Slot <CC> command must be sent prior to this command.
3. Use this command in conjunction with the Store Field command </N>.
4. Attempts to store using a predefined field number will result in an error and the target content will be printed.

[Valid commands]

CG400 series

Print position	<V>	<H>								
Font	<XU>	<XS>	<XM>	<XB>	<XL>	<U>*1	<S>*1	<M>*1	<WB>*1	<WL>*1
	<OA>	<OB>	<K1>	<K2>		<K8>	<K9>	<k1>	<k2>	<k8>
	<k9>									
Barcode	<B>	<BC>	<BG>	<BI>	<BZ>	<D>	<D><d>	<BD>	<BT>	<BW>
Modification	<P>	<L>	<PS>	<PR>	<%>	<FW>	<(>	<WD>		
System	<A1>	<A3>								
Memory card	<&R>	</N>	<GR>	<GC>						

\* Closed to end users.

[Tip]

1. Details on the registration of format

A group of commands can be registered to a memory card (option). Once registered, it saves time to specify the identical command group. The registration also allows a change of print data when recalling the format. Such function is called "Registration of Format". One item consists of different command groups necessary for printing, and such groups are called "Field". Note that multiple fields make a format.

Commands for the registration of format:

One format consists of a set of commands from the Start Code <A> command to the Stop Code command <Z>, and specify the Store Format <YS> command right after the <A> command. For the <YS> command, specify [Format number to be stored] between 1 and 999. And then, insert the Store Field <N> command after the <YS> command to specify [Field number] and [Print digit number].

After [Field number] and [Print digit number] are entered, specify print position, character type, barcode, and so on.

[Registration Example]

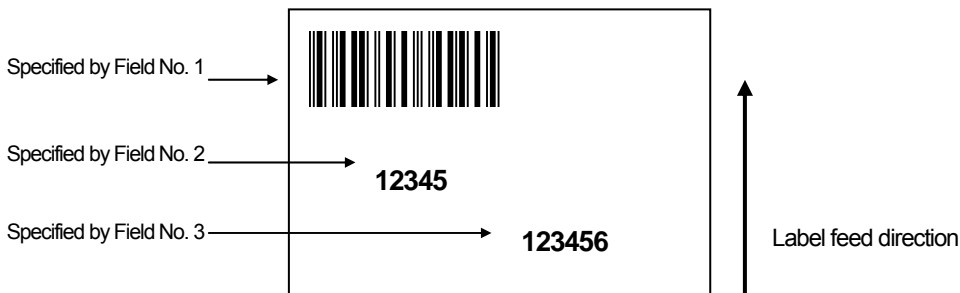
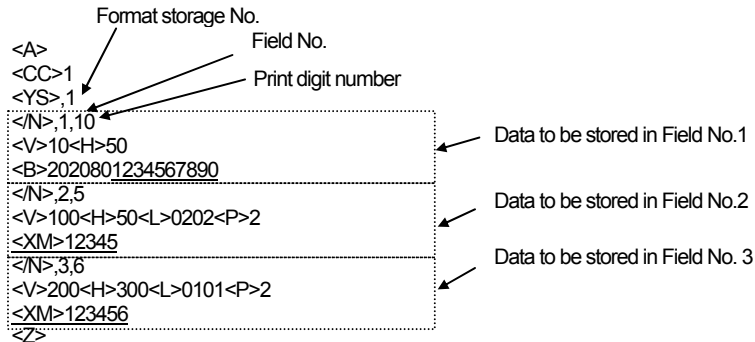

Recalling the stored print contents:

Up to 999 stored formats can be specified by the Recall Format <YR> command.

To change print data, use the Print Field <D> command to specify [Field No.] to be changed, and continuously specify the changed print data.

Note that the underlined parts in the [Registration Example] are changeable.

[Example of recalling]

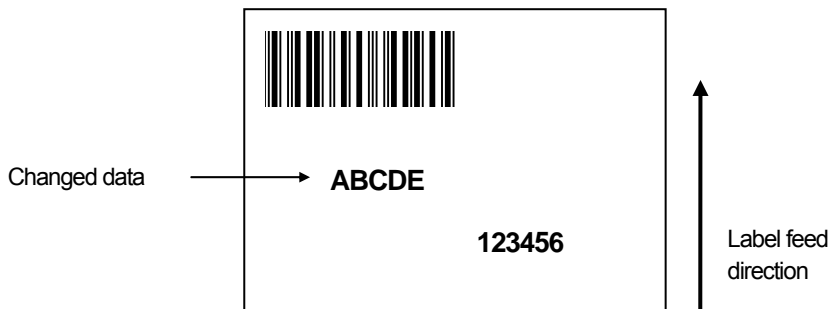
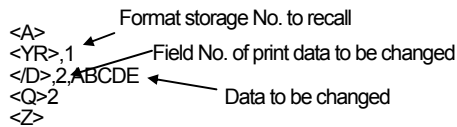

The followings are the invalid commands for storing formats.

Category	Command	Command name
Control	<Q>	Print Quantity
	<ID>	Job Store ID
	<WK>	Job Name
Modification	<&>	Store Form Overlay
	<F>	Sequential Numbering
	<O>	Replace Data (Partial Edit)
Font	<T1>	Registration of 16x16 dots external character
	<T2>	Registration of 24x24 dots external character
Barcode	<BT>	Variable Ratio Barcodes
2D code	<BK>, <2D10>	PDF417
	<2D12>	MicroPDF
	<BV>, <2D20>	MAXI code
	<2D30>	QR code (model 2)
	<BQ>, <2D31>	QR code (model 1)
	<2D32>	MicroQR
Graphic	<BX>, <2D50>	GS1 DataMatrix (ECC200)
	<G>	Custom Graphics
System	<GM>	BMP File
	<CS>	Print Speed
	<#E>	Print Darkness
	<~>	Multiple Cuts
	<C>	Repeat Label
	<+>	Clear
	<@>	Offline
Memory card	<FM>	Format Memory Card
	<GI>	Store Graphic
	<GT>	Store BMP File
	</D>	Print Field
	<FP>	Print Memory card status
	<T1>	Registration of 16x16 dots external character
<T2>	Registration of 24x24 dots external character	

Memory Card			
Available for	CG400 series		
Store Field		ESC+/N	
HEX code	ESC <1B> <sub>16</sub>	/N <2F> <sub>16</sub> <4E> <sub>16</sub>	Parameter ,aa,bb
Default setting	None		
Persistence of the command	When printer is powered off	Set parameter will be retained	
	Validity in a job	Retained until next valid setting	
	Validity after a job	Retained until next valid setting	

[Function]

Stores a format field description in the Store Format <YS> command.

[Format]

</N>,aa,bb

•Parameter

a [Field number] = 1 to 99  
 b [Print digit number] = 1 to 99

[Coding example]

```
<A>
<CC>1
<YS>,1
</N>,1,3
<%>0<V>100<H>200<P>2<L>0101<XM>,ABC
</N>,2,5
<%>0<V>200<H>200<P>2<L>0101<OA>12345
</N>,3,8
<%>0<V>300<H>40<B>40208049123456
<Z>
```

[Notes]

- Specify the field number in ascending order.
- Specify the <V> and <H> position commands for each field. If not, default value will be set.
- Specification of digit number when printing external characters.  
 For an external character code "H", 1 external character has 4 digits; thus, the print of 3 characters will be 12 digits.  
 For an external character code "B", 1 external character has 2 digits; thus, the print of 3 characters will be 6 digits.
- Use this command in conjunction with the Store Format <YS> command.
- Due to the memory capacity limit, it may not save up to 99 registries.

[Valid Commands for the Change of Print]

CG400 series

Font	<XU>	<XS>	<XM>	<XB>	<XL>	<U>*1	<S>*1	<M>*1	<WB>*1	<WL>*1
	<OA>	<OB>	<K1>	<K2>		<K8>	<K9>	<k1>	<k2>	
	<k8>	<k9>								
Barcode	<B>	<BC>	<BG>	<BI>	<BZ>	<D>	<D><d>	<BD>	<BT>	<BW>

\* Closed to end users.

Memory Card			
Available for	CG400 series		
<b>Recall Format</b>		<b>ESC+YR</b>	
HEX code	ESC <1B> <sub>16</sub>	YR <59> <sub>16</sub> <52> <sub>16</sub>	Parameter ,aaa
Default setting	None		
Persistence of the command	When printer is powered off	Set parameter will not be retained	
	Validity in a job	Retained until next valid setting	
	Validity after a job	Retained until next valid setting	

[Function]

Recalls and prints the format stored by the Store Format <YS> command.

[Format]

<YR>,aaa

●Parameter

a [Format registration number] = 1 to 999

[Coding example]

```
<A>
<CC>1
<YR>,01
</D>,1,DEF
</D>,2,78901
</D>,3,49000238
<Q>2
<Z>
```

[Notes]

1. The Recall Format <YR> command cannot recall multiple formats between the Start Code <A> and the Stop Code <Z> commands.
2. Use this command in conjunction with the Print Field </D> command.

Memory Card			
Available for	CG400 series		
<b>Print Field</b>		<b>ESC+/D</b>	
HEX code	ESC <1B> <sub>16</sub>	/D <2F> <sub>16</sub> <44> <sub>16</sub>	Parameter ,aa,n~n
Default setting	None		
Persistence of the command	When printer is powered off	Set parameter will not be retained	
	Validity in a job	Retained until next valid setting	
	Validity after a job	Retained until next valid setting	

[Function]

Recalls the field specified by the Store Field <N> command and selects the data.

[Format]

</D>,aa,n~n

•Parameter

a [Field No.] = Valid range: 1 to 99  
n [Data] = Data to be changed

[Coding example]

```
<A>
<CC>1
<YR>,1
</D>,1,DEF
</D>,2,78901
</D>,3,49000238
<Q>2
<Z>
```

[Note]

1. Print digit number is valid within the Store Field <N> command.
2. When digit number of this command is longer than the one specified with the Store Field <N> command, only the defined digit number will be available for printing.
3. Use this command in conjunction with the Recall Format <YR> command.

Memory Card			
Available for	CG400 series		
<b>Store Graphic</b>		<b>ESC+GI</b>	
HEX code	ESC <1B> <sub>16</sub>	GI <47> <sub>16</sub> <49> <sub>16</sub>	Parameter abbbccddn~n
Default setting	None		
Persistence of the command	When printer is powered off	Stored data will be retained	
	Validity in a job	Becomes invalid after execution	
	Validity after a job	Becomes invalid after the job	

[Function]

Stores the graphic pattern data.

[Format]

<GI>abbbccddn~n

• Parameter

- |   |   |                                |
|---|---|--------------------------------|
| a | [Selects and sends Hexadecimal or Binary data]  | = H : HEX data<br>B : BIN data |
|   | HEX data (8 bits data is divided into 4 bits, and outputs as a HEX code corresponding to ASCII.)<br>Binary data (Outputs 8 bits as 1 character data is all at once) |                                |
| b | [Specifies the horizontal graphic area in byte]   | = See the table below          |
| c | [Specifies the vertical graphic area in byte]   | = See the table below          |
| d | [Registration number] (identification number to recall)   | = Valid range: 1 to 999        |
| n | [Data]  | = Graphic data                 |

[Coding example]

```
<A>
<CC>1
<GI>H003003001n~n
<Z>
```

[Note]

1. Specify the storage data only.
2. To change the stored content, clear it with the Clear <\*> command and store it again.
3. The data stored with this command can be printed with the Recall Graphic <GR> command.
4. If the graphic data is not stored properly, a print error may occur. Refer to the Custom Graphics <G> command for the data form.
5. Attempts to store using a predefined storage number will result in an error and the targeted content will be printed.
6. The Card Slot <CC> command must be sent prior to this command.

[Validity]

Model	Max. bytes in horizontal direction	Max. bytes in vertical direction
CG408DT/TT	104	400
CG412DT/TT	156	600



Memory Card			
Available for	CG400 series		
<b>Recall Graphic</b>		<b>ESC+GR</b>	
HEX code	ESC <1B> <sub>16</sub>	GR <47> <sub>16</sub> <52> <sub>16</sub>	Parameter aaa
Default setting	None		
Persistence of the command	When printer is powered off	Set parameter will not be retained	
	Validity in a job	Becomes invalid after execution	
	Validity after a job	Becomes invalid after the job	

[Function]

Recalls and prints the graphic image stored by the Store Graphic <GI> command.

[Format]

<GR>aaa

• Parameter

a [Registration number] = 1 to 999

[Example]

<A>

<V>100<H>100

<CC>1

**<GR>1**

<Q>1

<Z>

[Note]

1. The Start Point Correction <A3> command will be ignored.
2. The Rotate <%> and the Character Expansion <L> commands can be used for the recalled graphic image.
3. The Card Slot <CC> command must be sent prior to this command.

Memory Card			
Available for	CG400 series		
<b>Store BMP file</b>		<b>ESC+GT</b>	
HEX code	ESC <1B> <sub>16</sub>	GT <47> <sub>16</sub> <54> <sub>16</sub>	Parameter aaa,bbbb,n~n
Default setting	None		
Persistence of the command	When printer is powered off	Set parameter will not be retained	
	Validity in a job	Becomes invalid after execution	
	Validity after a job	Becomes invalid after the job	

[Function]

Stores a graphic file of BMP format.

[Format]

<GT>aaa,bbbb,n~n

• Parameter

- a [Registration number] = 1 to 999
- b [Size of BMP file in bytes] = 1 to 99999  
Specify the BMP file size for total number of bytes.
- n [Data] = BMP file data  
Send Binary data (outputs 8 bits as 1 font data).

[Coding example]

```
<A>
<CC>1
<GT>1,12345,n~n
<Z>
```

[Note]

1. Data must be sent in binary format (outputs 8 bits as 1 font data). (BMP file size is "total bytes", BMP file data is "data")
2. The first 62 bytes of the BMP file is used for the header and the remainder is the BMP image data.
3. If the total bytes of BMP file does not match the transfer data, an error may occur.
4. Total bytes is the file size indicated in the properties.
5. Only black and white non-compressed BMP files can be stored. Color BMP files will cause an error. Make sure to check the file extension is [BMP] before printing.
6. The Card Slot <CC> command must be sent prior to this command.

Memory Card			
Available for	CG400 series		
<b>Recall BMP file</b>		<b>ESC+GC</b>	
HEX code	ESC <1B> <sub>16</sub>	GC <47> <sub>16</sub> <43> <sub>16</sub>	Parameter aaa
Default setting	None		
Persistence of the command	When printer is powered off	Set parameter will not be retained	
	Validity in a job	Becomes invalid after execution	
	Validity after a job	Becomes invalid after the job	

[Function]

Recalls and prints a graphic file previously stored by the Store BMP File <GT> command.

[Format]

<GC>aaa

• Parameter

a [Registration number] = 1 to 999

[Coding example]

<A>

<V>100<H>100

<CC>1

**<GC>1**

<Q>2

<Z>

[Note]

1. The Rotate <%> and the Character Expansion <L> commands can be used for the recalled graphic file.
2. The Card Slot <CC> command must be sent prior to this command.

Memory Card			
Available for	CG400 series		
<b>Clear (Memory card)</b>		<b>ESC+*</b>	
HEX code	ESC <1B> <sub>16</sub>	* <2A> <sub>16</sub>	Parameter a,(bbb)
Default setting	None		
Persistence of the command	When printer is powered off	Set parameter will not be retained	
	Validity in a job	Becomes invalid after execution	
	Validity after a job	Becomes invalid after the job	

[Function]

Clears the entire contents in a memory card (option).

[Format]

<\*>a

• Parameter

a [Item to be cleared] = T : External characters  
(Clears all data of external characters stored with command <T1>, <T2>.)

[Format]

<\*>a,bbb

• Parameter

a [Item to be cleared] = G : SATO Graphic  
(Clears graphic registered with Store Graphic <GI>)  
M : BMP file  
(Clears BMP file registered with Store BMP File <GT>)  
F : Format  
(Clears format registered with Store Format <YS>)  
R : Form Overlay  
(Clears form overlay registered with Store Form Overlay <&S>)

b [Registration number] = Valid range : 000 to 999 (Omissible)  
(When omitting Registration number, all the registered data will be cleared.)

[Coding example 1] Clearing external character

<A>  
<CC>1  
<\*>T  
<Z>

[Coding example 2] Clearing SATO graphic 001

<A>  
<CC>1  
<\*>G,001  
<Z>

[Coding example 3] Clearing all BMP files

<A>  
<CC>1  
<\*>M  
<Z>

[Coding example 4] Clearing format 001

```
<A>  
<CC>1  
<*>F,001  
<Z>
```

[Coding example 5] Clearing all form overlay

```
<A>  
<CC>1  
<*>R  
<Z>
```

[Note]

1. Place this command between the Start Code <A> and the Stop Code <Z> commands.
2. Make sure to specify the slot number with the command <CC> prior to this command.

[Tip]

1. To clear all data of memory card, use the Format Memory Card <FM> command.

# 15 Calendar Commands

Calendar			
Available for	CG400 series		
<b>Calendar setting</b>		<b>ESC+WT</b>	
HEX code	ESC <1B> <sub>16</sub>	WT <57> <sub>16</sub> <54> <sub>16</sub>	Parameter aabbccdde
Default setting	None		

Persistence of the command	When printer is powered off	Set parameter will be retained.
	Validity in a job	Retained until next valid setting
	Validity after a job	Retained until next valid setting

**[Function]**

Sets the printer's internal calendar.

**[Format]**

<WT>aabbccdde

• Parameter

- a [Year] = 00 to 99
- b [Month] = 01 to 12
- c [Day] = 01 to 31
- d [Hour] = 00 to 23
- e [Minute] = 00 to 59

**[Coding example]** 2020, January 1, 13:13

```
<A>
<WT>2001011313
<Z>
```

**[Notes]**

1. This command requires optional calendar IC. Note that the command can not be used without the calendar IC.

Calendar			
Available for	CG400 series		
Calendar increment		ESC+WP	
HEX code	ESC <1B> <sub>16</sub>	WP <57> <sub>16</sub> <50> <sub>16</sub>	Parameter abbb
Default setting	None		
Persistence of the command	When printer is powered off	Set parameter will not be retained..	
	Validity in a job	Retained until next valid setting	
	Validity after a job	Retained until next valid setting	

[Function]

Adds a value to the printer's current date and/or time, which may be printed on the label.

[Format]

<WP>abbb

• Parameter

- |   |                         |   |
|---|-------------------------|---|
| a | [Date and time]         | = Y (Year)<br>M (Month)<br>D (Day)<br>h (Hour)<br>W (week number)   |
| b | [Increment calculation] | = Validity for Y : 0 to 9<br>Validity for M : 00 to 99<br>Validity for D : 000 to 999<br>Validity for h : 000 to 999<br>Validity for W : 00 to 99 |

[Coding example] Prints the date three months from today

```
<A>
<WP>M03
<V>100<H>200
<XM><WA>DD/MM/YY
<Q>2
<Z>
```

[Notes]

1. This command requires optional calendar IC. Note that the command can not be used without the calendar IC.
2. This command adds certain period of time to the specified year/month/date/time. As shown in the above example, three months from today can be set.
3. When there are several <WP> in a single item, the one specified last will be valid.

Calendar			
Available for	CG400 series		
Calendar print			ESC+WA
HEX code	ESC <1B> <sub>16</sub>	WA <57> <sub>16</sub> <41> <sub>16</sub>	Parameter a
Default setting	None		
Persistence of the command	When printer is powered off	Set parameter will not be retained.	
	Validity in a job	Set parameter becomes invalid.	
	Validity after a job	Set parameter becomes invalid.	

[Function]

Specifies the printing of a date and/or time field from the printer's internal clock.

[Format]

<WA>Parameter

• Parameter

a [Calendar configuration] =

YYYY (Year)	:	1981 to 2080
YY (Year)	:	00 to 91
MM (Month)	:	01 to 12
DD (Day)	:	01 to 31
HH (Hour)	:	00 to 11
hh (Hour)	:	00 to 23
mm (Minute)	:	00 to 59
ss (seconds)	:	00 to 59
TT (AM or PM)	:	AM/PM
JJJ (Julian date)	:	001 to 366
WW (Week)	:	00 to 53
ww (Week)	:	01 to 54

[Coding example] Specifies the print of date three months from today

```
<A>
<WP>M03
<V>100<H>200
<XM><WA>DD/MM/YYhh:mm
<Q>2
<Z>
```

[Notes]

1. This command requires optional calendar IC. Note that the command can not be used without the calendar IC.
2. When setting QTY to 2 or more, real time print will be performed on each tag/label.
3. Up to six commands can be used within one form.
4. Up to 16 characters can be used for printing the time and date data.
5. When counting the beginning of WW(Week) as "0" week, the beginning of ww(Week) will be "1".

Indication of week using [WW/ww]

e.g. 1) January 2008, and the year starts from Monday, Tuesday and Thursday.

Mon	Tue	Wed	Thu	Fri	Sat	Sun	WW	ww
31	1	2	3	4	5	6	0 week	1 <sup>st</sup> week
7	8	9	10	11	12	13	1 <sup>st</sup> week	2 <sup>nd</sup> week
14	15	16	17	18	19	20	2 <sup>nd</sup> week	3 <sup>rd</sup> week
21	22	23	24	25	26	27	3 <sup>rd</sup> week	4 <sup>th</sup> week
28	29	30	31	1	2	3	4 <sup>th</sup> week	5 <sup>th</sup> week

- For [2007/12/31], WW(Week) prints out [0 week]. (ww(Week) prints out [1<sup>st</sup> week])
- For [2008/01/25], WW(Week) prints out [3<sup>rd</sup> week]. (ww(Week) prints out [4<sup>th</sup> week])
- For [2008/01/28], WW(Week) prints out [4<sup>th</sup> week]. (ww(Week) prints out [5<sup>th</sup> week])
- For [2008/02/03], WW(Week) prints out [4<sup>th</sup> week]. (ww(Week) prints out [5<sup>th</sup> week])



e.g. 2) January 2010, and the year starts from Friday, Saturday and Sunday.

Mon	Tue	Wed	Thu	Fri	Sat	Sun	WW	ww
28	29	30	31	1	2	3	52 <sup>nd</sup> week	53 <sup>rd</sup> week
4	5	6	7	8	9	10	0 week	1 <sup>st</sup> week
11	12	13	14	15	16	17	1 <sup>st</sup> week	2 <sup>nd</sup> week
18	19	20	21	22	23	24	2 <sup>nd</sup> week	3 <sup>rd</sup> week
25	26	27	28	29	30	31	3 <sup>rd</sup> week	4 <sup>th</sup> week

- For [2010/1/1], WW(Week) prints out [52<sup>nd</sup> week]. (ww(Week) prints out [53<sup>rd</sup> week])
- For [2010/1/4], WW(Week) prints out [0 week]. (ww(Week) prints out [1<sup>st</sup> week])

\* As for the year starts from Friday, Saturday and Sunday, the 2<sup>nd</sup> week of January is counted as 0 week (ww(Week) becomes 1<sup>st</sup> week).