

TABLE OF CONTENTS

INSTALLATION SECTION

PART	DESCRIPTION	PAGE
<u>1</u>	<u>PRE-INSTALLATION INFORMATION</u>	
1.1	<u>SITE REQUIREMENTS</u>	<u>1.1</u>
1.2	<u>GROUNDING CONDITIONS</u>	<u>1.2</u>
1.3	<u>POWER CONDITIONS</u>	<u>1.4</u>
1.4	<u>UNPACKING AND INSPECTION</u>	<u>1.4</u>
<u>2</u>	<u>INSTALLING CABINETS</u>	
2.1	<u>SYSTEM INSTALLATION PROCEDURE</u>	<u>2.1</u>
2.2	<u>SELECTING INSTALLATION METHOD</u>	<u>2.1</u>
2.3	<u>INSTALLING IN A RACK</u>	<u>2.1</u>
2.4	<u>INSTALLING ON A WALL</u>	<u>2.4</u>
2.5	<u>CONNECTING GROUND WIRES</u>	<u>2.8</u>
<u>3</u>	<u>INSTALLING AND REPLACING BOARDS</u>	
3.1	<u>CABINET CONFIGURATION</u>	<u>3.1</u>
3.2	<u>MP10 PROCESSOR CARD</u>	<u>3.2</u>
3.3	<u>INTERFACE CARDS</u>	<u>3.8</u>
3.4	<u>CONNECTING DAUGHTER CARD MODULES</u>	<u>3.12</u>
3.5	<u>OTHER INTERFACE CARDS</u>	<u>3.17</u>
3.6	<u>CONNECTING POWER FAIL TRANSFER</u>	<u>3.29</u>
<u>4</u>	<u>CONNECTING EXTERNAL BATTERIES</u>	
4.1	<u>CONNECTING EXTERNAL BATTERIES</u>	<u>4.1</u>
<u>5</u>	<u>CONNECTING POWER</u>	
5.1	<u>BEFORE CONNECTING POWER</u>	<u>5.1</u>
5.2	<u>PROCEDURE FOR CONNECTING POWER</u>	<u>5.1</u>

<u>6</u>	<u>CONNECTING C.O. LINES</u>	
6.1	<u>SAFETY PRECAUTIONS</u>	<u>6.1</u>
6.2	<u>CONNECTING C.O. LINES</u>	<u>6.1</u>
<u>7</u>	<u>CONNECTING STATIONS AND ADDITIONAL EQUIPMENT</u>	
7.1	<u>CONNECTING STATIONS</u>	<u>7.1</u>
7.2	<u>CONNECTING ADDITIONAL EQUIPMENT</u>	<u>7.13</u>
<u>8</u>	<u>POWER UP PROCEDURES</u>	
8.1	<u>PRE-CHECK</u>	<u>8.1</u>
8.2	<u>STARTING THE SYSTEM.....</u>	<u>8.1</u>
8.3	<u>NUMBERING EXTENSIONS AND C.O. LINES</u>	<u>8.2</u>
<u>9</u>	<u>SOFTWARE AND DATABASE MANAGEMENT.....</u>	<u>9.1</u>
9.1	<u>SOFTWARE MANAGEMENT</u>	<u>9.1</u>
9.2	<u>DATABASE MANAGEMENT</u>	<u>9.1</u>
<u>10</u>	<u>ADDING CARDS TO THE SYSTEM</u>	
10.1	<u>ADDING STATIONS AND TRUNKS</u>	<u>10.1</u>

FIGURES

- [Figure 2.1 Tools Required for Rack Installation](#)
- [Figure 2.2 Rack Installation \(1\)](#)
- [Figure 2.3 Rack Installation \(2\)](#)
- [Figure 2.4 Rack Installation \(3\)](#)
- [Figure 2.5 Required Tools for the installation on a Wall](#)
- [Figure 2.6 Installation on a Wall \(1\)](#)
- [Figure 2.7 Installation on a Wall \(2\)](#)
- [Figure 2.8 Installation on a Wall \(3\)](#)
- [Figure 2.9 Installation on a Wall \(4\)](#)
- [Figure 2.10 Installation on a Wall \(5\)](#)
- [Figure 2.11 Installation on a Wall \(6\)](#)
- [Figure 2.12 Installation on a Wall \(7\)](#)

[Figure 2.13 Grounding](#)

[Figure 3.1 Front/Rear View of OfficeServ 7100 Cabinet](#)

[Figure 3.2 Switch Setting](#)

[Figure 3.3 Mounting a Modem Card on the MP10 Card](#)

[Figure 3.4 Mounting a 4SWM or 4DLM on the MP10 Card](#)

[Figure 3.5 Mounting the MP10 into Slot 0](#)

[Figure 3.6 Secure the MP10 into Slot](#)

[Figure 3.7 Front View of the MP10 Card](#)

[Figure 3.8 Installing Interface Cards](#)

[Figure 3.9 Inserting Interface Card into Slot 1/2](#)

[Figure 3.10 Turning the Cabinet Power Off](#)

[Figure 3.11 Removing a Card](#)

[Figure 3.12 Replacing a Card](#)

[Figure 3.13 Installing the UNI Card](#)

[Figure 3.14 Front View of UNI Card](#)

[Figure 3.15 4SWM Card](#)

[Figure 3.16 Modem Card](#)

[Figure 3.17 4TRM Card](#)

[Figure 3.18 4DLM Card](#)

[Figure 3.19 4SLM Card](#)

[Figure 3.20 Setting Switches on the TEPRI/TEPRIa Card](#)

[Figure 3.21 Front View of the TEPRI/TEPRIa](#)

[Figure 3.22 Front View of the 8TRK Card](#)

[Figure 3.23 Front View of the 16DLI2 Card](#)

[Figure 3.24 Front View of the 8DLI Card](#)

[Figure 3.25 Front View of the 8COMBO](#)

[Figure 3.26 Front View of the 16MWSLI Card](#)

[Figure 3.27 Front View of the 8SLI Card](#)

[Figure 3.28 Front View of the MGI16 Card](#)

[Figure 3.29 Example of Power Fail Transfer Connection to 8SLI](#)

[Figure 4.1 Connecting an External Battery](#)

[Figure 5.1 Connecting Power](#)

[Figure 6.1 8TRK Card Ports \(P1~P8\) or 4TRM port \(P1~P4\)](#)

[Figure 6.2 RJ-45 Port of TEPRI/TEPRIa Card](#)

[Figure 7.1 RJ-45 Port of the 8SLI Card](#)

[Figure 7.2 RJ-45 port of the 16MWSLI Card](#)

[Figure 7.3 RJ-45 Port of the 8COMBO Card \(For Analog Phone\)](#)

[Figure 7.4 RJ-45 4SLM port on the UNI card](#)

[Figure 7.5 RJ-45 4DLM Port on UNI Card](#)

[Figure 7.6 RJ-45 Port of the 8DLI Card \(For Digital Phone\)](#)

[Figure 7.7 RJ-45 Port of the 16DLI2 Card \(For Digital Phone\)](#)

[Figure 7.8 RJ-45 Port of the 8COMBO Card \(For Digital Phone\)](#)

[Figure 7.9 RJ-45 EthernetPort](#)

[Figure 7.10 RJ-45 Digital Ports of the cards mentioned above
\(For Door Phone Connection\)](#)

[Figure 7.11 Adding an iDCS KDBF Keypad Daughtercard Module](#)

[Figure 7.12 Wall-Mounting an iDCS Keypad](#)

[Figure 7.13 Wall-Mounting DS 5000, ITP-5121D and ITP-5107S Keypads](#)

[Figure 7.14 Attaching iDCS 64 Button Module to an iDCS Keypad](#)

[Figure 7.15 Attaching iDCS 14 Button Module to an iDCS Keypad](#)

[Figure 7.16 Attaching DS 64 Button Modules to a DS 5021D or a DS 5014D Keypad](#)

[Figure 7.17 Connecting MOH/BGM Sources](#)

[Figure 7.18 Connecting External/Additional Page Equipment](#)

[Figure 7.19 Connecting Common Bells](#)

[Figure 7.20 Installation Tool Connection to LAN Port](#)

[Figure 7.21 Installation Tool and LAN Connection](#)

[Figure 7.22 Installation Tool and Modem Connection](#)

[Figure 7.23 Connecting SMDR](#)

[Figure 7.24 Connecting Printers](#)

TABLES

[Table 1.1 Power Specifications](#)

[Table 3.1 Card installation Configuration](#)

[Table 3.2 Parts on the Rear Panel of the Cabinet](#)

[Table 3.3 Ports and LEDs of the MP10 Card](#)

[Table 3.4 UNI card Ports and LEDs](#)

[Table 3.5 Ports and LEDs of the TEPRI/TEPRIa](#)

[Table 3.6 Ports and LEDs of the 8TRK Card](#)

[Table 3.7 Ports of the 16DLI2 Card](#)

[Table 3.8 Ports and LEDs of the 8DLI Card](#)

[Table 3.9 16MWSLI Card Ports](#)

[Table 3.10 Ports and LEDs of the 8SLI Card](#)

[Table 3.11:MGI16 Front Panel Components](#)

[Table 6.1 OfficeServ 7100 Line Conditions](#)

[Table 7.1 Distance Between Stations and the System](#)

[Table 7.2 Installation Tool Specification](#)

PART 1. PRE-INSTALLATION INFORMATION

1.1 SITE REQUIREMENTS

Select a location that satisfies the following conditions for safety, temperature, humidity, power and grounding.

1.1.1 Safety Conditions

- The OfficeServ 7100 system should not be installed near materials that can cause a fire, such as explosive gas and inflammables. The OfficeServ 7100 system should not be near equipment that generate electromagnetic waves, such as monitors or copying machines.
- The installation location should be convenient for distributing trunk lines and extension lines, for connecting power and grounding wires, and for maintenance and repair.
- The OfficeServ 7100 system should not be installed in aisles or passageways that are populated or used for moving equipment.
- Always maintain cleanliness to prevent dust from damaging the card connectors of the cabinet.
- Before installing the OfficeServ 7100 system, check items such as the electrical wiring status, grounding status, voltage and frequency.
- Do not expose equipment to direct sun light, corrosive fumes, and constant vibrations.
- Do not install in close proximity to a fire sprinkler or other sources of water.
- A dedicated commercial AC power outlet is required. Do not use extension cords.
- Ensure that all wires and cables to and from the OfficeServ 7100 do not cross fluorescent lights or run in parallel with AC wires.
- This equipment is to be installed only in restricted access areas (dedicated, equipment closets, etc.) in accordance with articles 110-16, 110-17, 110-18 of the National Electric Code, ANSI/NFPA 70.

1.1.2 Temperature/Humidity Conditions

The conditions for temperature and humidity are as follows:

- Operation temperature: 32°F~113 °F
- Storage temperature: 14°F~122 °F
- Humidity: 10~90 %

1.2 GROUNDING CONDITIONS

An equipment grounding conductor that is not smaller in size than the ungrounded branch-circuit supply conductors is to be installed as part of the circuit that supplies the product or system. Bare, covered, or insulated grounding conductors are acceptable. Individually covered or insulated equipment grounding conductors shall have a continuous outer finish that is either green or green with one or more yellow stripes. The equipment grounding conductor is to be connected to ground at the service equipment.

The attachment-plug receptacles in the vicinity of the product or system are all to be of a grounding type, and the equipment grounding conductors serving these receptacles are to be connected to earth ground at the service equipment.

WARNING: HIGH LEAKAGE CURRENT! Earth connection is essential before connecting supply.

The OfficeServ 7100 system requires that a supplementary earth ground be connected to the system. This is the preferred method of grounding the OfficeServ 7100. It should be noted that when the third wire ground becomes inferior it may prevent the digital data bus from canceling out noise. This may result in erratic operation of the OfficeServ 7100. Another problem that has occurred is that some UPS battery systems do not pass the ground through to the power cord resulting in no ground to the system. The ground lug in the back of the cabinet must be connected to one of the following: bonded building steel, cold water pipe or a ground rod using at least #16 AWG copper wire. The third wire AC ground or Field Ground is connected to the system frame via the ground strap from the ground connector on the AC socket.

A supplementary equipment grounding conductor shall be installed between the system and ground that is in addition to the equipment grounding conductor in the power supply cord.

The supplementary equipment grounding conductor shall not be smaller in size than the ungrounded branch-circuit supply conductors. The supplementary equipment grounding conductor shall be connected to the product at the terminal provided, and shall be connected to ground in a manner that will retain the ground connection when the product is unplugged from the receptacle. The connection to ground of the supplementary equipment grounding conductor shall be in compliance with the rules for terminating bonding jumpers in Part K of Article 250 of the National Electrical Code ANSI/NFPA 70 and Article 10 of Part 1 of the Canadian Electrical Code, Part 1, C22.1. Termination of the supplementary equipment grounding conductor is permitted to be made to building steel, to a metal electrical raceway system, or to any grounded item that is permanently and reliably connected to the electrical service equipment ground.

Bare, covered, or insulated grounding conductors are acceptable. A covered or insulated grounding conductor shall have a continuous outer finish that is either green or green with one or more yellow stripes.

Failure to provide an adequate ground may cause a safety hazard, confusing trouble symptoms or even circuit card failure.

WARNING: Unplug the power cord from the AC outlet before attempting to connect the ground. Hazardous voltage may cause death or injury. Observe extreme caution when working with AC power. Remove lines from trunk cards.

What the above paragraphs mean is that when conventional analog telephone circuits are connected to the OfficeServ 7100 system, under fault conditions (i.e., the tip and/or ring conductor is crossed with a power line, or the circuit is affected by lightning during a storm), it is possible for hazardous potentials to appear across the tip and ring wiring coming into the OfficeServ 7100 cabinet from the outside plant (i.e., overhead cables, buried cables, cable head pedestal). These circuits are provided with both primary and secondary protection circuitry which will attempt to drain off these high voltages and currents to earth ground. Obviously, it is important to have a good source of ground connected to the OfficeServ 7100 system to drain this energy off. Again, a good earth ground source is required by the OfficeServ 7100 system.

The OfficeServ 7100 system has two ground reference points. One point is via the green wire in the power cord connected to the AC power outlet. This ground connection is provided to meet local electrical codes when the AC ground is required to be common with the earth ground. However, this can be disconnected either intentionally or unintentionally. Consequently, a more permanent ground connection is required by connecting a high current/voltage capacity ground wire which is bonded to ground at the electric service power entrance or via some other method approved by the National Electrical Code to the OfficeServ 7100 system ground lug. This is a more secure ground connection, which can only be disconnected intentionally. These precautions are taken for safety reasons to protect personnel working on the Office Serv 7100 system and also for operational reasons to accommodate ground return and/or ground-referenced analog telephone circuits, which require this solid earth ground connection for normal functioning.

1.3 POWER CONDITIONS

The power supply card of the OfficeServ 7100 system receives AC input power or battery power, and supplies -48 V, -5 V, +5 V, +3.3 V, +12 V, and -54V (Battery Backup) to the system cabinet.

The rating is as follows:

- RATING: AC 110-120 V; 3 A; 50/60 Hz or DC -48 V 3 A

Table 1.1 Power Specifications

Power Supply Unit(PSU)		Specification
PSU	Input power	AC 110 V DC 48V (-48VDC, 3A for battery backup ONLY)
	Output power	- DC -54V, 1.1 A - DC +5 V, 5.0 A - DC -5.3 V, 0.3 A - DC +3.3 V, 5 A - DC +12 V, 0.4 A - DC -54V, 0.25 A (for battery backup)
Power Consumption	105 Watts	

1.4 UNPACKING AND INSPECTION

The OfficeServ 7100 can only be configured as a single cabinet system.

After unpacking the cabinet, inspect for signs of physical damage. If any damage is detected, do not attempt to install the system. Contact Samsung Telecommunications America Technical Support Department.

Check to see that each cabinet carton includes the following:

- OfficeServ 7100 cabinet
- AC Power Cable
- Wall mount plate
- Screw Pack
- Battery Cable Assembly
- Blanking Plates (1)

PART 2. INSTALLING CABINETS

This section describes how to install an OfficeServ 7100 cabinet on a table/desktop in a data rack or on a wall, depending on the installation environment.

2.1 SYSTEM INSTALLATION PROCEDURE

The procedure of system installation is as follows.

- 1) Install the OfficeServ 7100 cabinet on a table, inside a data rack or on the wall depending on the installation environment.
- 2) Connect the ground to the ground lug located in the back of the cabinet.
- 3) Install the MP10 card into slot 0 of the cabinet.
- 4) Install interface cards or UNI cards (with the required daughter cards modules installed on them) into universal slots (slots 1 or 2) of the cabinet.
- 5) Connect an external battery with proper capacity if required.
- 6) Connect AC 110 V input power.

2.2 SELECTING INSTALLATION METHOD

The OfficeServ 7100 cabinet can be installed on a table, inside a 19-inch rack or on a wall depending on the installation environment or customer requirements.

2.3 INSTALLING IN A RACK

2.3.1 Cautions for Installation

Take the following precautions when installing the OfficeServ 7100 cabinet inside a rack:

- The 19-inch rack should be a standard equipment rack.
- When using an enclosed-type rack, check if the rack is properly ventilated. Vents should be equipped on the side of the rack and fans should be attached to ventilate cool air into the rack.
- Take special caution when using an enclosed-type rack that has vents on top of the rack since hot air coming out of the vent may enter the intake vent of a system installed above the rack.
- When using an open rack, do not block the entrance of a port or the OfficeServ 7100 fan.

2.3.2 Required Tools

- A mid-sized Phillips screwdriver
- Two brackets and six screws for attaching rack
- Two clamp screws

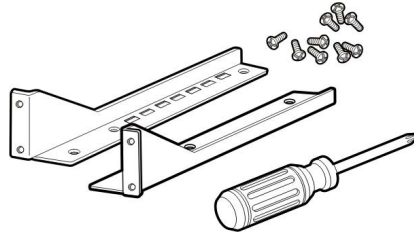

Figure 2.1 Tools Required for Rack Installation

2.3.3 Installing in a Rack

The procedure for installing the OfficeServ 7100 cabinet inside a 19-inch rack is as follows (The optional rack mount kit is required for this method. This kit is sold separately):

- 1) Attach the cabinet bracket to the bottom surface of the OfficeServ 7100 cabinet and fasten the bracket firmly with the two screws.

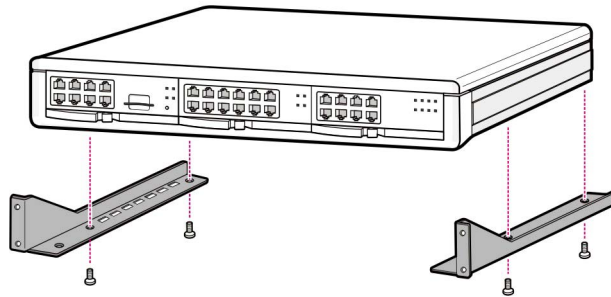

Figure 2.2 Rack Installation (1)

- 2) Slide the cabinet attaching the bracket in Step 1.

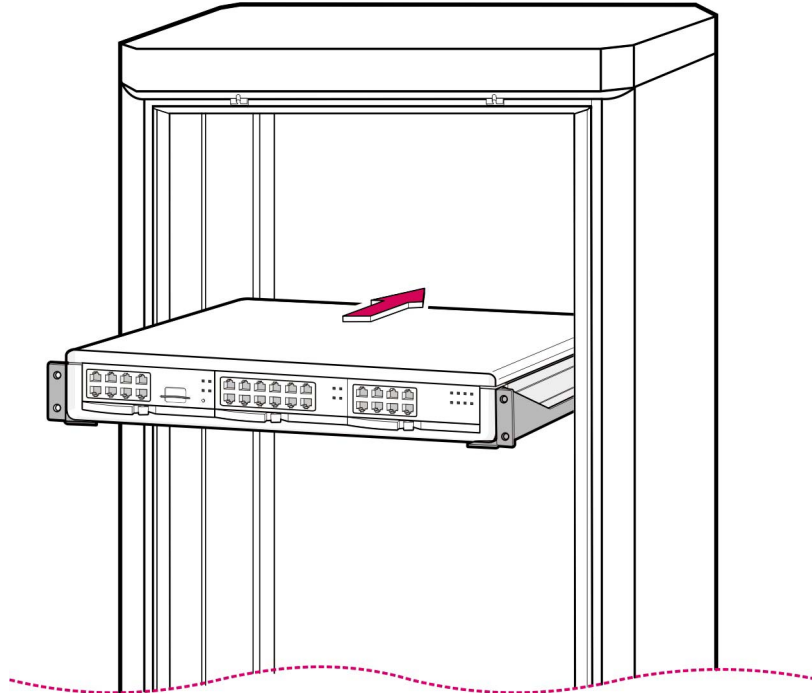

Figure 2.3 Rack Installation (2)

- 3) Align the two holes of the cabinet bracket and the holes of the rack brackets, and fasten the cabinet to the rack with the two screws.

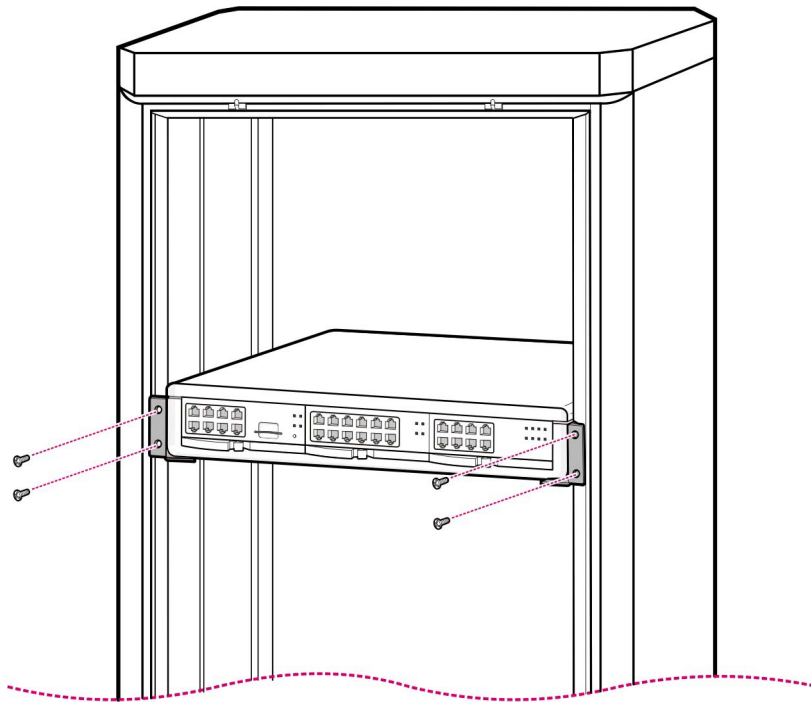

Figure 2.4 Rack Installation (3)

2.4 INSTALLING ON A WALL

This section describes how to install the OfficeServ 7100 cabinet on a wall. The OfficeServ 7100 wall mount bracket is required (included with the cabinet).

2.4.1 Required Tools

- Mid-sized Phillips screw driver
- Electric drill
- Hammer
- Wall-mount bracket
- Four plastic anchors
- Four cross-type screws
- Four Mount locking screws

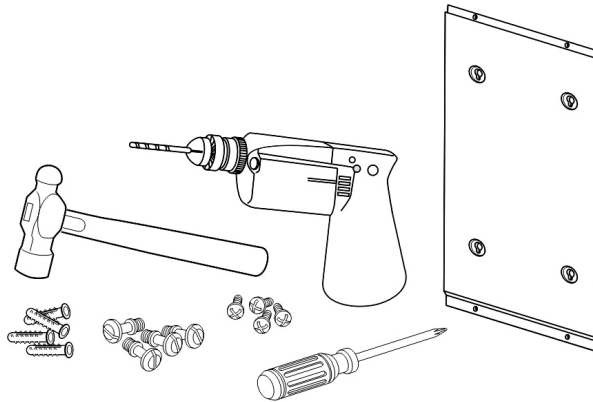

Figure 2.5 Required Tools for the installation on a Wall

2.4.2 Wall Installation

CAUTION: Only mount OfficeServ 7100 onto a wall capable of supporting the 7100 cabinet, associated blocks, cables and peripheral equipment.

- 1) There are four holes for the screws on the top/bottom of the bracket (see positions marked 'A' in the figure below). Mark four holes on a desired wall by using the bracket.

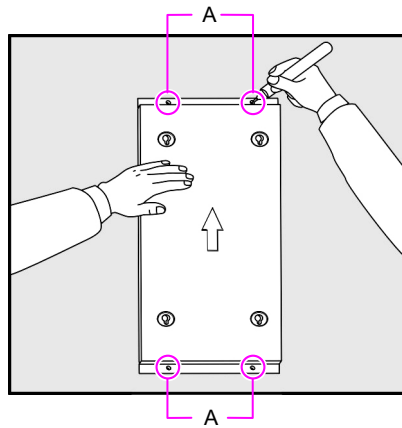

Figure 2.6 Installation on a Wall (1)

- 2) Make holes on the marked positions of the wall mount bracket. Make the depths and the diameters of the holes more than 35 mm and around 5.5 mm such that the plastic anchors can be inserted.

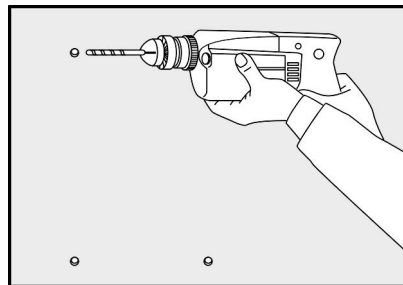

Figure 2.7 Installation on a Wall (2)

- 3) With a hammer, drive plastic anchors into the drilled holes.

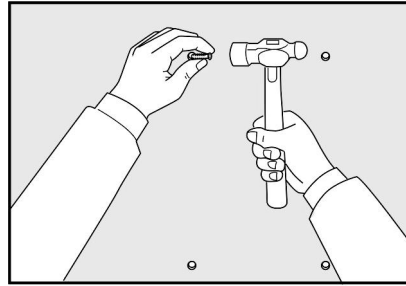

Figure 2.8 Installation on a Wall (3)

- 4) Align the screw holes of the wall mount bracket to the position that the plastic anchors are driven. Insert screws to each hole and tighten the screws with a Phillips screw driver.

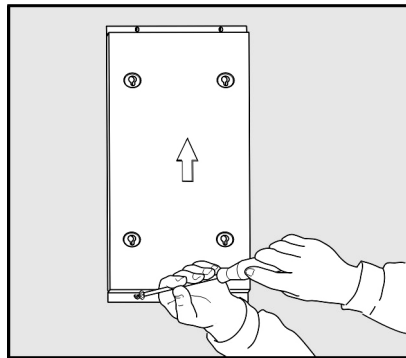

Figure 2.9 Installation on a Wall (4)

- 5) Two screws exist in the two screw holes among the four screw holes on the bottom side of the OfficeServ 7100 cabinet. Unscrew the two screws to a height of about 2 mm.

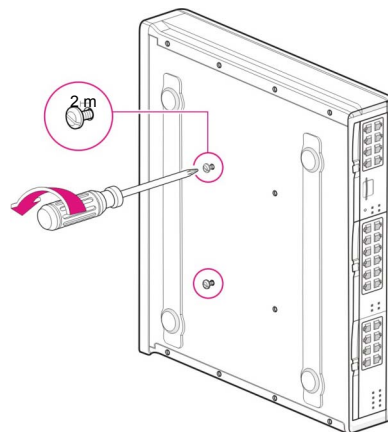

Figure 2.10 Installation on a Wall (5)

- 6) Tighten the mount locking screws into the remaining two holes among the four screw holes on the bottom of the OfficeServ 7100 cabinet. At this point, do not tighten completely, but keep the screws out about 2 mm.

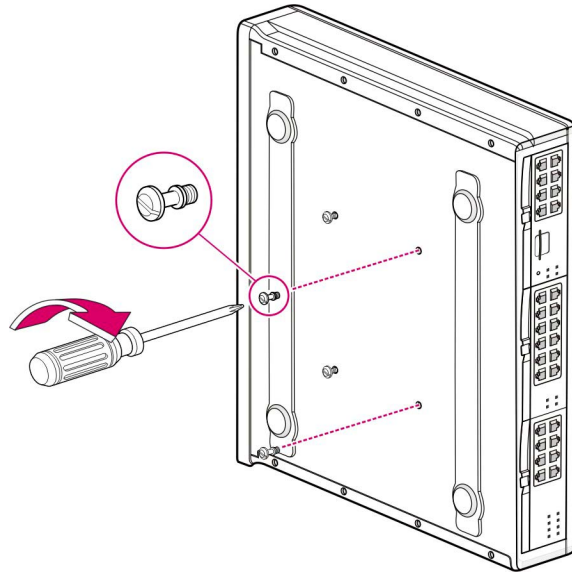

Figure 2.11 Installation on a Wall (6)

- 7) Align the screws on the bottom of the OfficeServ 7100 cabinet to the bracket holes, then pull down the cabinet to lock the cabinet securely.

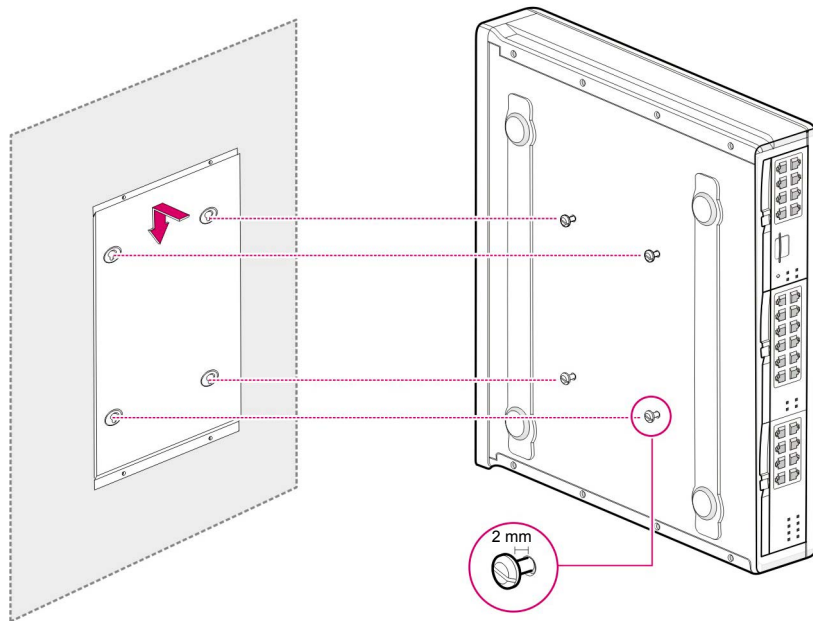

Figure 2.12 Installation on a Wall (7)

2.5 CONNECTING GROUND WIRES

This section describes how to connect an external grounding wire to the OfficeServ 7100 system.



External Grounding

External grounding is required to prevent human injuries and system damage caused by lightning, static electricity, or voltage surge. The OfficeServ 7100 must be grounded with a grounding wire that has a thickness more than 4.0mm^2

As shown in the figure below, connect an earth ground to the ground lug behind the OfficeServ 7100.

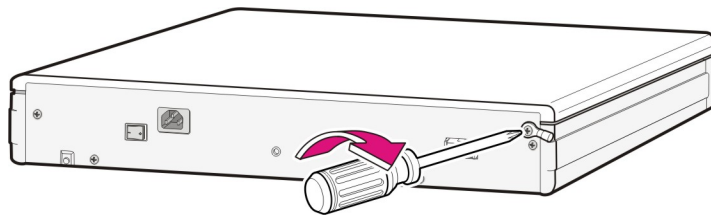

Figure 2.13 Grounding

IMPORTANT: Follow the grounding requirements described in section 1.2 (Grounding Conditions) when connecting a ground to the system.

PART 3. INSTALLING AND REPLACING CARDS

This section describes how to install and replace various cards of the OfficeServ 7100 system.

3.1 CABINET CONFIGURATION

The OfficeServ 7100 system has 3 slots (slots 0 ~ 2). Slot 0 is a processor slot only used for either the MP10 processor card. Slots1 and 2 are universal slots for station and trunk interface cards as described below.

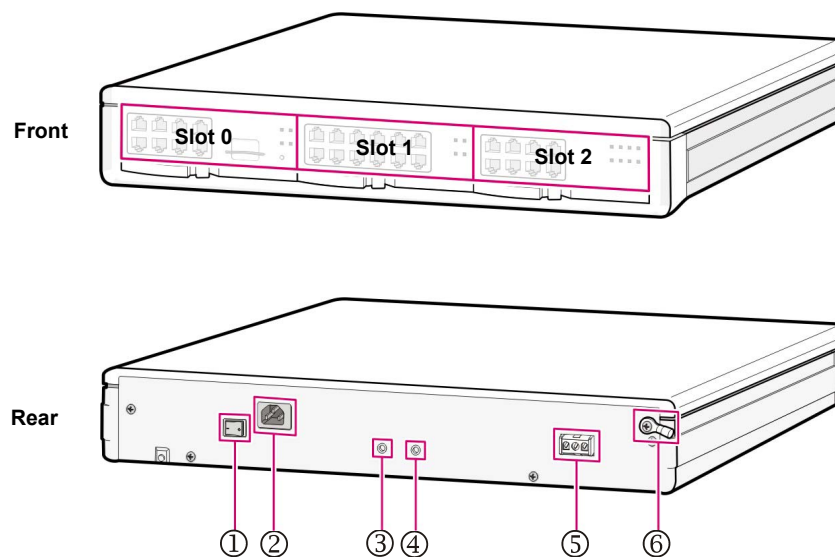

Figure 3.1 Front/Rear View of OfficeServ 7100 Cabinet

Following cards are allowed to be installed in the 7100 as shown below:

Note: (ONLY THESE CARDS ARE ALLOWED IN THE SPECIFIED SLOTS. ALL OTHER CARDS ARE NOT ALLOWED IN THE OS7100 SYSTEM)

Table 3.1 Card installation Configuration

Slot	Cards Allowed
Slot 0 (processor slot)	MP10 ONLY

Slot	Cards Allowed
Slot 1 and Slot 2 (universal slots)	- OS 7100 Card allowed: UNI cards - OS 7200/OS7400 Cards allowed: 8DLI, 16DLI2, 8SLI, 16MWSLI, 8COMBO, 8TRK, TEPRIa, MGI-16

NOTE: The OfficeServ 7100 only supports PRI service and does not support T1 service even though the TEPRI and TEPRIa cards support both.

The descriptions about each part on the rear of the cabinet are listed in the table below.

Table 3.2 Parts on the Rear Panel of the Cabinet

Part	Function
① Power Switch	Power on/off switch for the OfficeServ 7100 system.
② AC Power connector	Connector for the power cable connection
③ AC LED	The LED indicates the input of AC power.
④ DC LED	The LED indicates the normal output of DC power.
⑤ Battery Socket	Connector for an external battery
⑥ Ground Lug	Connection for system ground cable.

3.2 MP10 PROCESSOR CARD

This section describes the procedures for setting switches and installing optional daughter cards on the MP10 as well as installing the MP cards in the processor slot.

The OfficeServ 7100 MP10 (Main Control Processor) controls the system operation. The MP10 is required for all configurations and goes only in slot 0 of the cabinet.

The MP10 comes standard with a built-in 4 port Voice Mail/Auto Attendant and 8 VoIP MGI (Media gateway Interface) channels. The MGI features and capacities are controlled by license keys entered in system programming.

3.2.1 Setting Switches

On the MP10 set the switches for the required configuration. The description for the settings is described below.

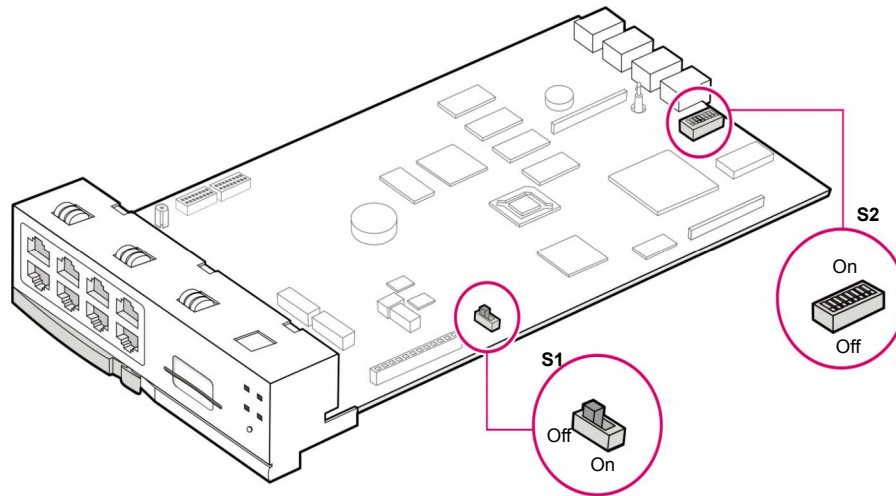

Figure 3.2 Switch Setting

- **Memory Backup Switch (S1):** When set to ON, all system programming is saved in SRAM even when system is rebooted or powered OFF. This will be saved in SRAM until the Super Capacitor has been drained of all charge (this charge will last only up to 24 hours with system power OFF). At that point all programming will be lost. It is recommended that all programming is saved to the MMC+ card or to a PC using the OfficeServ Installation Tool application. Turning the switch (S1) OFF will set the system to DEFAULT. To default the system, keep this switch (S1) in the OFF position for 30 seconds. Switch to ON position before powering up the system.

Note: The S2 dip switches are set properly by the factory for a 3 digit numbering plan and the country of USA. These dip switches should be left at default and should never be changed. If a 4 digit numbering plan is required the numbering plan should be changed in the software by using MMC 724.

DIP SWITCH USE (S2)

ON (left)	SW	OFF (right)
4 DIGIT STATION NUMBERS	SW8	3 DIGIT STATION NUMBERS
4 DIGIT STATION GROUPS	SW7	3 DIGIT STATION GROUPS
4 DIGIT TRUNK NUMBERS	SW6	3 DIGIT TRUNK NUMBERS
RESERVED	SW5	RESERVED
COUNTRY SELECT	SW4	COUNTRY SELECT
COUNTRY SELECT	SW3	COUNTRY SELECT
COUNTRY SELECT	SW2	COUNTRY SELECT
COUNTRY SELECT	SW 1	COUNTRY SELECT

- Switches 1 through 4 select the country the system is installed in.

4	3	2	1	Country
OFF	OFF	OFF	OFF	Korea
OFF	OFF	OFF	ON	USA
OFF	OFF	ON	OFF	UK
OFF	OFF	ON	ON	Italy
OFF	ON	OFF	OFF	Australia
OFF	ON	OFF	ON	New Zealand
OFF	ON	ON	OFF	Holland
OFF	ON	ON	ON	Denmark

- Switch 5 reserved.
- These DIP switches will not take effect unless the switches are set in the wanted position and the system memory is cleared manually by using the Memory Backup switch.

3.2.2 Installing Optional Daughter Cards on the MP10

Three (3) types of optional daughter cards can be installed on the MP10:

- 1) Optional Modem daughter card can be installed in the connector located towards the back of the MP10.
- 2) The optional 4SWM PoE LAN daughter card (installed in the connector located towards the front of the MP10)
- 3) The optional 4DLM daughter card (installed in the connector located towards the front of the MP10)

The optional modem daughter card is mounted to connector P7 of the MP10 card. This modem daughter card allows remote dial up connection to the system for system administration and configuration. This is an alternative method for connecting to the system when a LAN/WAN connection is unavailable. The MODEM board has the following functions:

- The MP10 board supports a 2-Wire Full Duplex modem board. This is the same modem used on the OfficeServ 500 system.
- The Modem board operates in OfficeServ 7100 via V.24 interface. In addition, the Modem board supports V.90 protocol. OfficeServ 7100 controls the Modem board via serial communication using standard AT commands. When mounting a modem card, the holes on the corners of the modem should be aligned such that the spacer fits in the hole in the following figure.

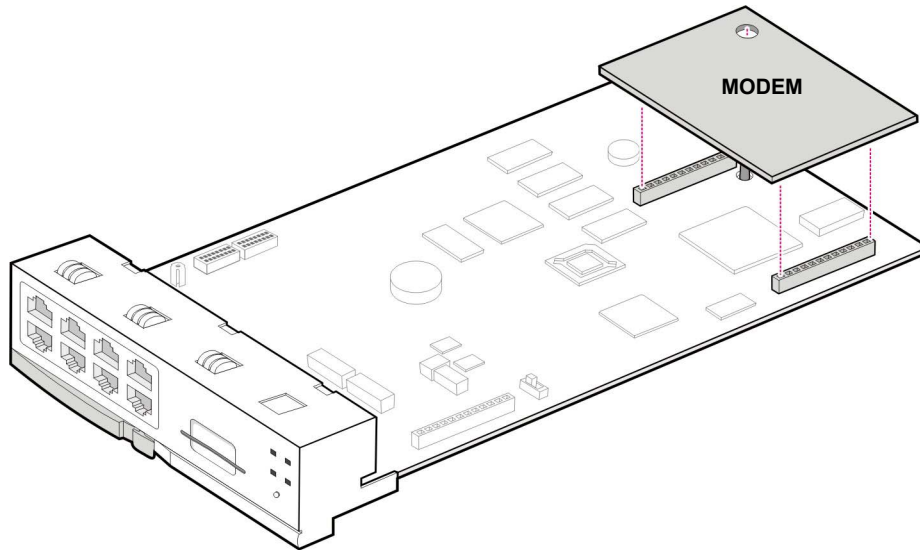

Figure 3.3 Mounting a Modem Card on the MP10 Card

The 4SWM (optional 4 port POE LAN module) or 4DLM (optional 4 port Digital Line module) daughter cards can be mounted to connector P11, P12 and P13 of the MP10 card. A screw is installed to the support located next to connector P13. Remove this screw, install the daughter card and install the screw to secure the card as shown below.

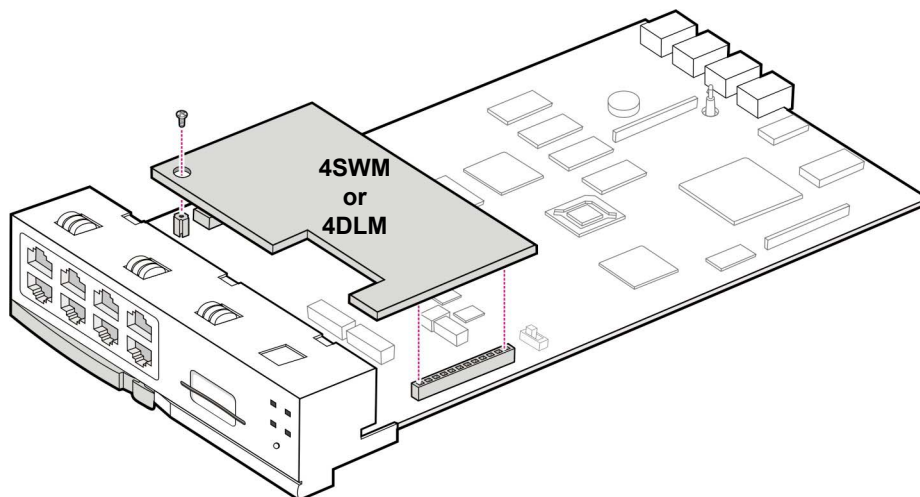

Figure 3.4 Mounting a 4SWM or 4DLM on the MP10 Card

3.2.3 Installing MP10

Install processor card (MP10) in Slot 0. The locations of Slot 0 through slot 2 are described in figure 3.1.

- 1) Check the exterior of the MP10 card for any damage. If damage is found, do not proceed with installation. Contact Samsung Technical Support.



Power the system OFF when installing or removing cards. POWER TO THE CABINET MUST BE TURNED OFF. Failure to do so will damage the card, cabinet and/or corrupt the data moving along the data bus.

- 2) Align the MP10 card to the guardrail of slot 0 and carefully slide it in.

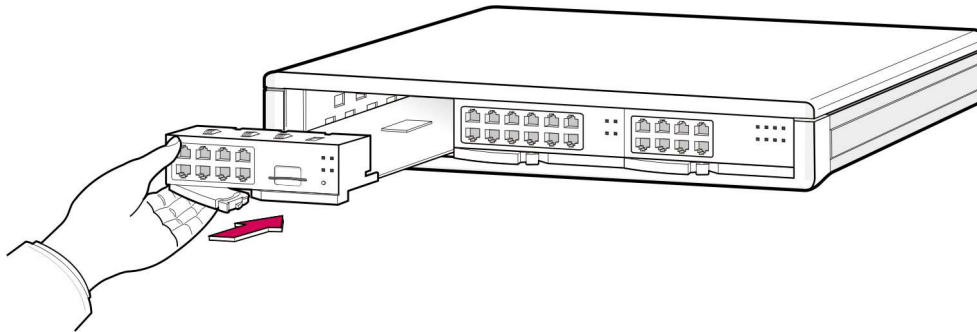

Figure 3.5 Mounting the MP10 into Slot 0

- 3) Press and lock the lever to fully insert into the slot.

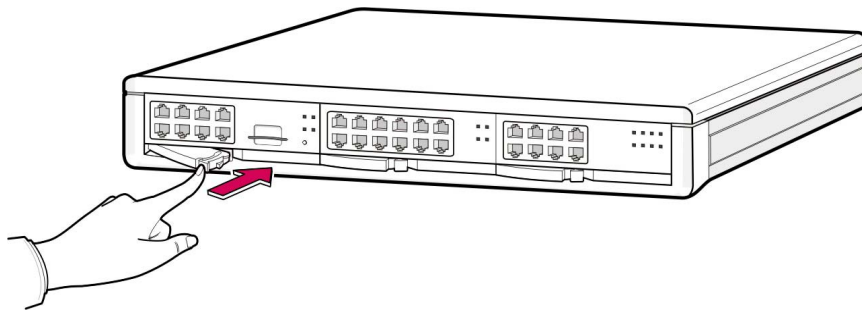

Figure 3.6 Secure the MP10 into Slot

3.2.4 MP10 LEDs

The front view of the MP10 card is shown in the picture below.



Figure 3.7 Front View of the MP10 Card

The MCP front panel components have the functions below:

Table 3.3 Ports and LEDs of the MP10 Card

Ports & LEDs	Function Description
P1~P4 Ports	Connection ports for the 4DLM or 4SWM daughter cards when installed on the MP10.
MISC Port	Port that connects external MOH/BGM sources, paging device, loud bell or common bell.
Media Card	Slot for installing the MMC+ media storage card. This card contains the main system software, system configuration database, and voicemail greetings and messages.
LAN Port	Port for establishing the 10 Base-T/100 Base-Tx Ethernet connection. This allows the MP to be connected to a data network.
SIO port	Serial port (Samsung Use ONLY).
RST button	Button for resetting the MP10 card.
RUN LED	This LED indicates the status of the Main CPU operation. - Off: Power is not connected. - On (green): Booting, reset - Blink (green): The Program is operating properly
LAN LED	This LED indicates the status of the connection to LAN. - Off: MP is not connected to LAN. - On (green): MP is connected LAN. - Blink (green): MP is transmitting or receiving Data through LAN port.

Ports & LEDs	Function Description
MC LED	This LED indicates the status of the MMC+ card access. - Off: The MMC+ card is not installed. - On: The MMC+ card is installed, however, is not being accessed. - Blink: The MMC+ card is installed and is being accessed.

3.3 INTERFACE CARDS

This section describes how to set jumpers and switches of an interface card, how to install optional daughter cards to an interface card, and how to install interface cards into slots.

3.3.1 Installing Interface Cards

Interface cards are installed in slot 1 and slot 2 of the cabinet. [Refer to table 3.1](#) for slot/card configuration rules.

The Procedure for installing interface cards is as follows:

- 1) Check the exterior of the interface card for damage. Do not install if damaged.
- 2) Align each Interface card to the guardrail of the universal slot and slide it in.

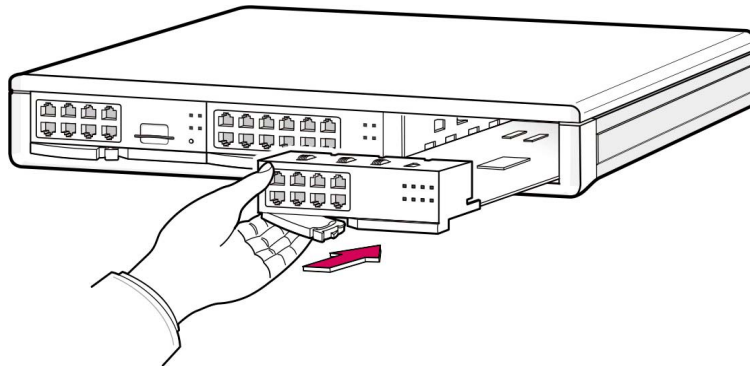

Figure 3.8 Installing Interface Cards

3) Press and lock the lever to fully insert.

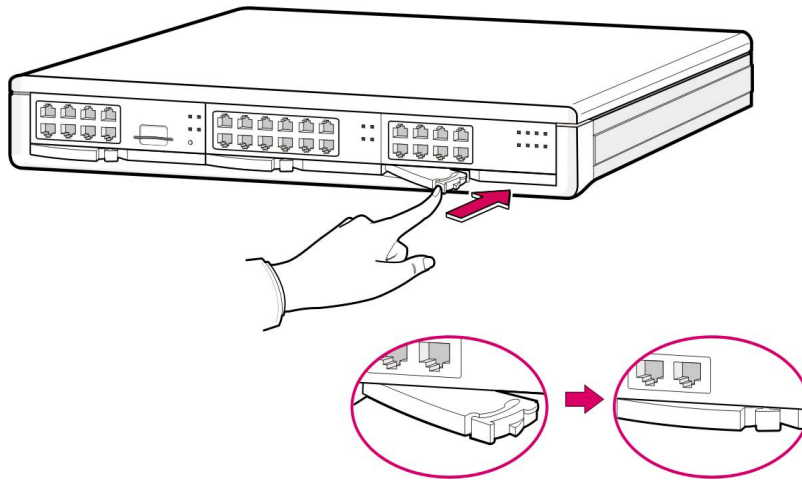

Figure 3.9 Inserting Interface Card into Slot 1/2

3.3.2 Replacing Cards

	<p>Removing Cables Replace a card after removing all cables connected to the card.</p>
--	---------------------------------------------------------------------------------------------------

The procedure for replacing a card is as follows:

	<p>POWER TO THE CABINET MUST BE TURNED OFF BEFORE REMOVING CARDS. Failure to do so will damage the card, cabinet and/or corrupt the data moving along the data bus.</p>
--	--------------------------------------------------------------------------------------------------------------------------------------------------------------------------------

1) Turn off system power using the power switch in the back of the system.

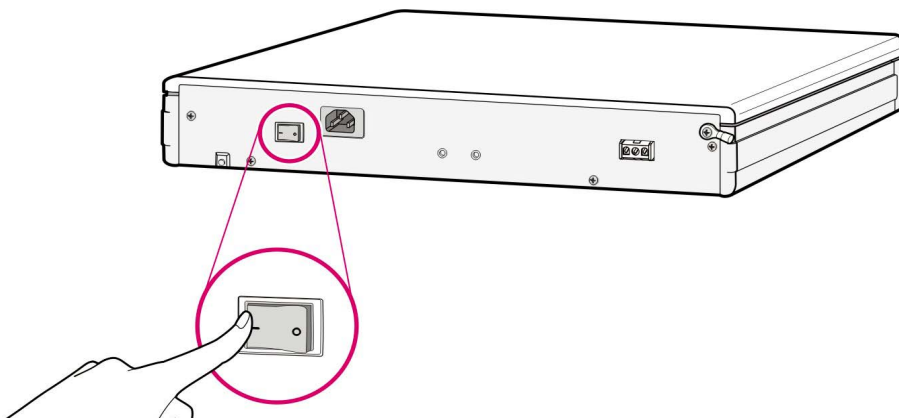

Figure 3.10 Turning the Cabinet Power Off

- 2) Extract the card by pulling the lever of the card carefully.

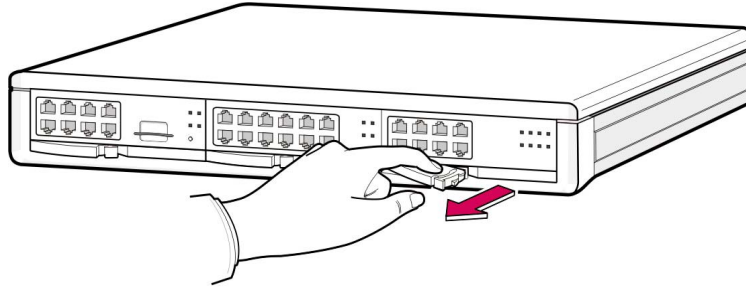

Figure 3.11 Removing a Card

- 3) Align the new card to the guardrail of the slot, and slide the new card into the slot. Then lock the lever in the front panel of the card to fully secure into the connector of the OfficeServ 7100 main card.

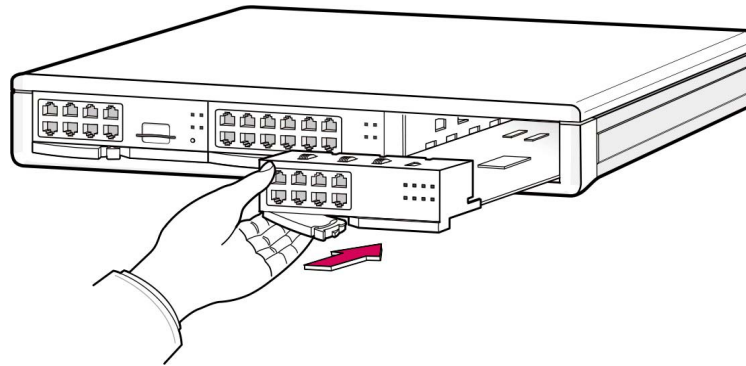

Figure 3.12 Replacing a Card

3.3.3 Installing UNI Cards and Daughter Card Modules

The UNI card is a universal base carrier card that can accommodate up to 3 optional daughter cards. The UNI card by itself serves no function. The UNI card can be installed in slot 1 and/or slot2.

The UNI card has three positions to mount optional daughter card modules. The mountable daughter card modules are 4TRM, 4DLM and 4SLM. Up to three modules can be mounted regardless of the option module type. Any of these daughter cards can go into any of these 3 positions. The interface ports for each card are located on the front panel of the UNI card and are labeled accordingly.

Align the module to be mounted to the top connector (16-pin connector). After that, match the bottom connector (100-pin connector). Push the daughter card in carefully until the card is fully seated into the connectors. Lock the supporter between the grooves and the top of each option card with screws.

Remove screws from UNI card before mounting the daughter cards then re-screw them in to lock down the daughter cards.

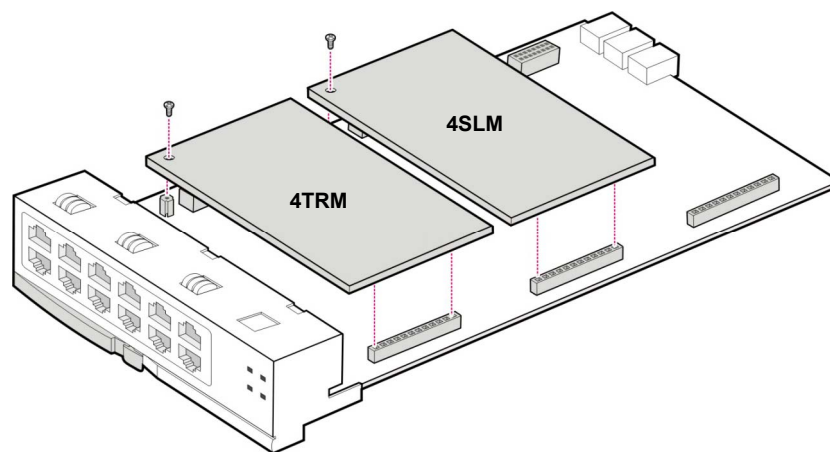

Figure 3.13 Installing the UNI Card

The front view of the UNI card is shown in the picture below.

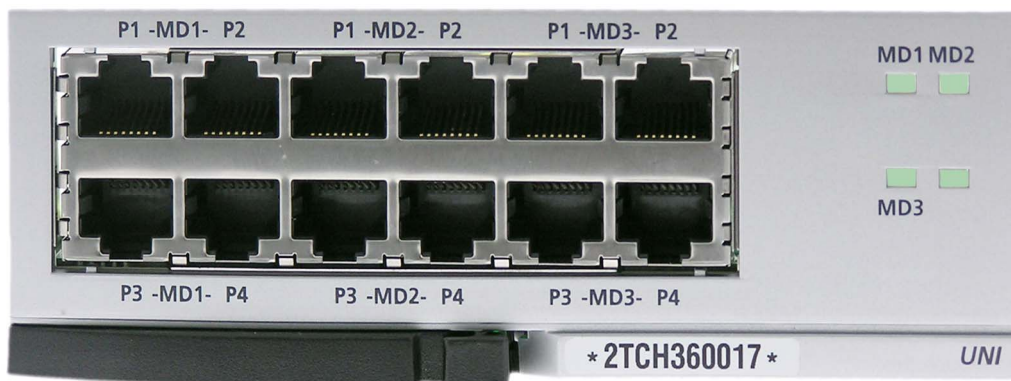

Figure 3.14 Front View of UNI Card

Table 3.4 UNI card Ports and LEDs

Port, LED	Function Description
MD1 P1~P4 MD2 P1~P4 MD3 P1~P4	Ports that correspond with the daughter card modules installed in the specific MD1, MD2 and MD3 connectors on the UNI card.
MD (1~3) LED's	Shows the status of each daughter board connector (MD1, MD2, and MD3) on the UNI card: - Off : No-module mounted - On (Green): TRM Module mounted. - On (Red): DLM Module mounted. - On (Amber): SLM Module mounted.

3.4 DAUGHTER CARD MODULES

There are 5 different daughter cards available on the OfficeServ 7100:

- 1) **4SWM** (installed on MP10 only): 4 port PoE layer 2 LAN switch
- 2) **MODEM Daughter card** (Installed on MP10 only): Provides modem communication for the OS7100 system.
- 3) **4TRM** (installed on UNI card only): 4 port loop start trunk interface module.
- 4) **4DLM** (installed on UNI card or MP10): 4 port digital phone interface module.
- 5) **4SLM** (installed on UNI card only): 4 port Single Line Analog telephone interface.

3.4.1 4SWM (4 Port PoE LAN Switch Daughter Card)

THIS DAUGHTER CARD CAN ONLY BE INSTALLED ON THE MP10 MAIN PROCESSOR BOARD ([refer to section 3.2.3 "Installing the MP10"](#)). This daughter card CANNOT be installed on the UNI card. Only one 4SWM can be mounted per system. The 4SWM is a 4

port LAN Switch that receives/transmits data from/to Intranet or Internet. The 4SWM provides four 10/100 BASE-T Ethernet ports and performs the Layer 2 Switching function. These four ports support Power Over Ethernet (PoE) and are IEEE 802.3af compliant.

Power constraints must be taken into consideration when plugging ITP phones and WAP devices into the 4SWM PoE module.

- The OS 7100 power supply supports a maximum of 24 TDM phones or SEPU (Samsung equivalent power units). One power unit is equal to one (2 line TDM phone).
- A maximum of 4 ITP phones or 4 WAPs can be supported by the 4SWM PoE module.
- Each time an ITP phone is plugged into the 4SWM PoE port, the system capacity for TDM phones is decreased by 5.
- Each time a WAP is plugged into the 4SWM PoE port, the system capacity for TDM phones is decreased by 6.
- External power can be used to power the ITP phones and WAPs. If external power is used to supply power to the ITP phones or WAPs, no SEPU are used from the OS 7100 4SWM PoE module.

POWER CONSUMPTION

OS7100 Samsung Equivalent Power Units (SEPU)		
Devices	KSU Power Units	Optional Power
iDCS Phones	1	n/a
DS 5000 Phones	1	n/a
ITP Phones	5	AC adapter or External PoE Switch
SMT 5000 WAPs	6	AC adapter or External PoE Switch

If you need more than 4 ethernet ports, you can uplink this to an external layer 2 data switch providing additional ports.

The main functions of the 4SWM board are as follows:

- Auto-sensing 10/100 BASE-T and Full/Half duplex Ethernet switch
- Layer 2 LAN Switch function

The 4SWM is shown in the figure below:

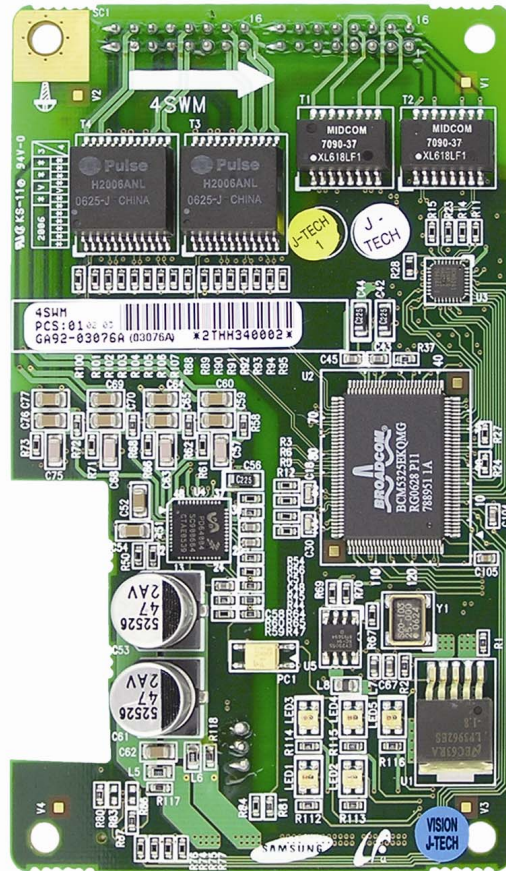

Figure 3.15 4SWM Card

3.4.2 MODEM Daughter Card

The optional modem daughter card is mounted to connector P7 of the MP10 card. This modem daughter card allows remote dial up connection to the system for system administration and configuration. This is an alternative method for connecting to the system when a LAN/WAN connection is unavailable. The MODEM board has the following functions:

The Modem board operates in OfficeServ 7100 via V.24 interface. In addition, the Modem board supports the V.90 protocol. The OfficeServ 7100 controls the Modem board via serial communication using standard AT commands.

[See section 3.2.3 “Installing MP10”](#)

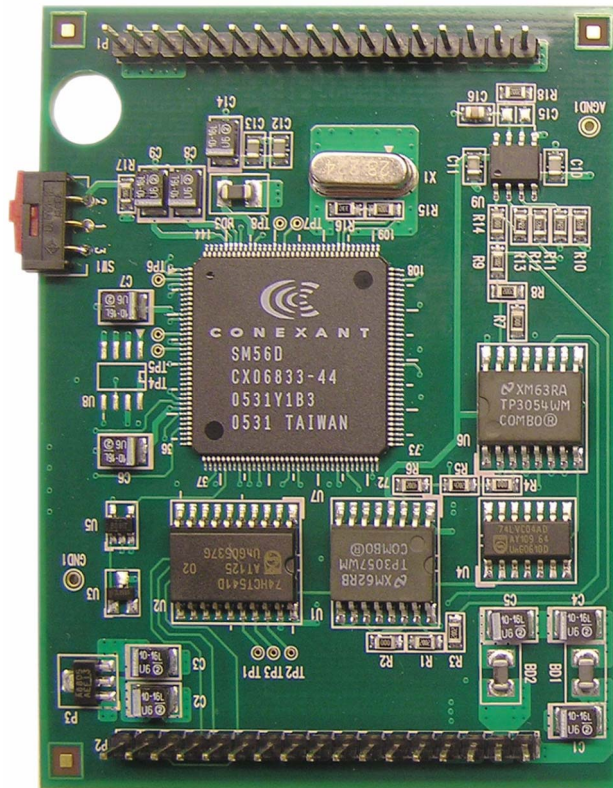

Figure 3.16 Modem Card

3.4.3 4TRM (4 Port Loop Start Trunk Interface Module)

This daughter card provides 4 loop start trunk interface ports to connect to loop start analog trunk lines with Caller ID. This card provides analog trunks for your system. This daughter card can only be installed on the UNI card. It can be installed in any of the 3 positions on the UNI card. This daughter card cannot be installed on the MP10. Add as many as needed.

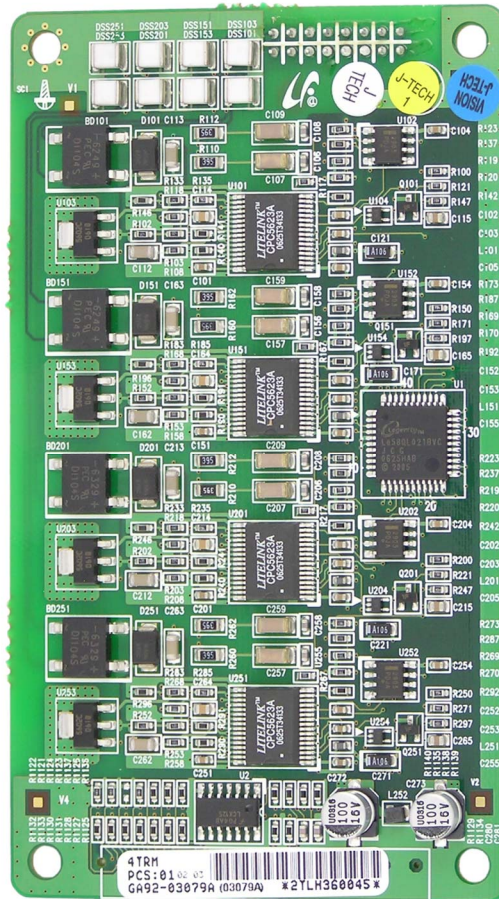

Figure 3.17 4TRM Card

3.4.4. 4DLM (4 Port Digital Phone Interface Module):

This daughter card provides 4 ports for connecting Samsung Digital Key Sets. It can be installed on the MP10 card and any UNI card in any of the UNI card daughter card positions. Add as many as needed.

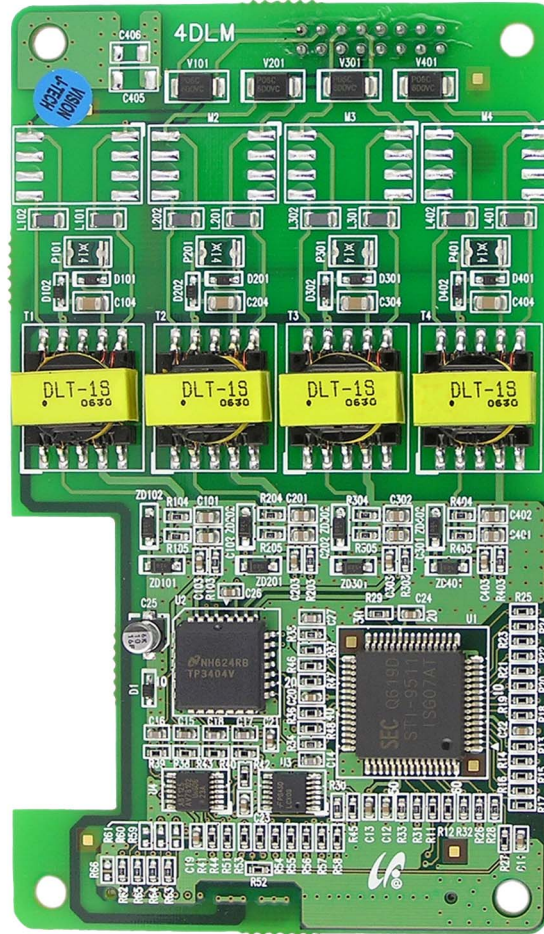

Figure 3.18 4DLM Card

3.4.5 4SLM (4 port Single Line Telephone Interface Module):

This daughter card provides 4 ports for connecting analog telephones. It also provides the message waiting lamp functionality for phones supporting this feature. It can ONLY be installed on the UNI card in any of the UNI card daughter card positions. THIS DAUGHTER CARD CANNOT BE INSTALLED ON THE MP10. Add as many as needed.

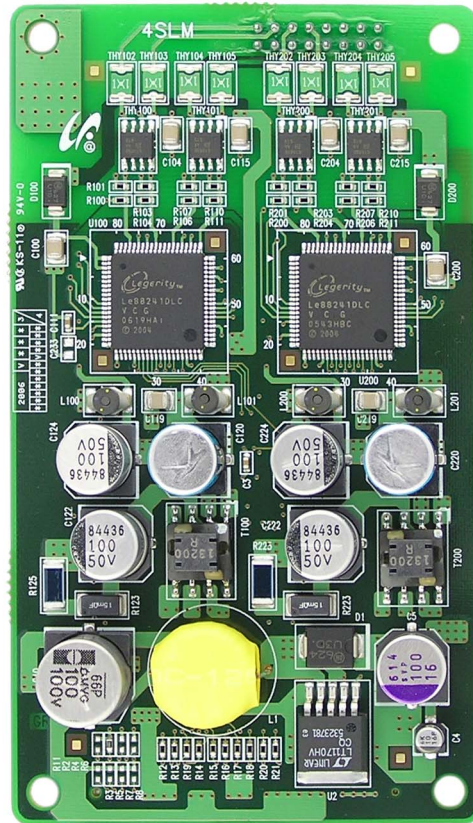

Figure 3.19 4SLM Card

3.5 OTHER INTERFACE CARDS

3.5.1 TEPRI and TEPRIa

The TEPRI(TEPRI/TEPRIa) card is a digital trunk interface that supports either T1 or ISDN PRI service. It also supports Q-Sig/PRI signalling required for networking multiple systems.

NOTE: The OfficeServ 7100 only supports PRI and does not support T1 service even though the TEPRI and TEPRIa cards support both.

The TEPRI/TEPRIa card can be installed in slots 1 and/or 2. The first four LEDs on the front of the card provide the status of the service (Sync, AIS, Loss and Layer 2 Active

states). The second four LED's on the front of the card display the type of service. The first TEPRI/TEPRIa card installed in the OfficeServ 7100 is the primary source of external clocking. The second TEPRI/TEPRIa installed is the secondary source of external clocking. Default clock selection is left to right in the cabinet. The clock priority can be changed by using MMC 826. Regardless of position, a CO PRI circuit should always be given clocking priority over T1 circuits. There are two RJ45 modular jacks on the face of the card. The settings for T1 or PRI service are selected by a bank of dip switches as defined below. The PRI supports NI1, NI2, AT&T No. 5 ESS, and DMS 100 offices. A maximum of 2 TEPRI/TEPRIa cards can be provided per system. **NOTE: Do not insert this card with system power ON.**

TEPRI/TEPRIa Card Dip Switch

Switch No.	ON	OFF
1	T1	E1
2	PRI	T1
3	NFAS (24B)	NFAS (23B + D)
4	NETWORK*	USER
5	AFT	NORMAL
6	**	**
7	**	**
8	**	**

*If this TEPRI/TEPRIa card is to be the master of a pair of TEPRI/TEPRIa cards that are used to connect two systems together via PRI networking then this DIP switch, DIP switch 4 must be set to ON.

**Do not change the settings of DIP switches 3, 5, 6, 7, and 8. Switches 3, 5, 6, and 7 must remain OFF and 8 must be ON.

See the S1 switch and jumpers of the TEPRI/TEPRIa card as shown below.

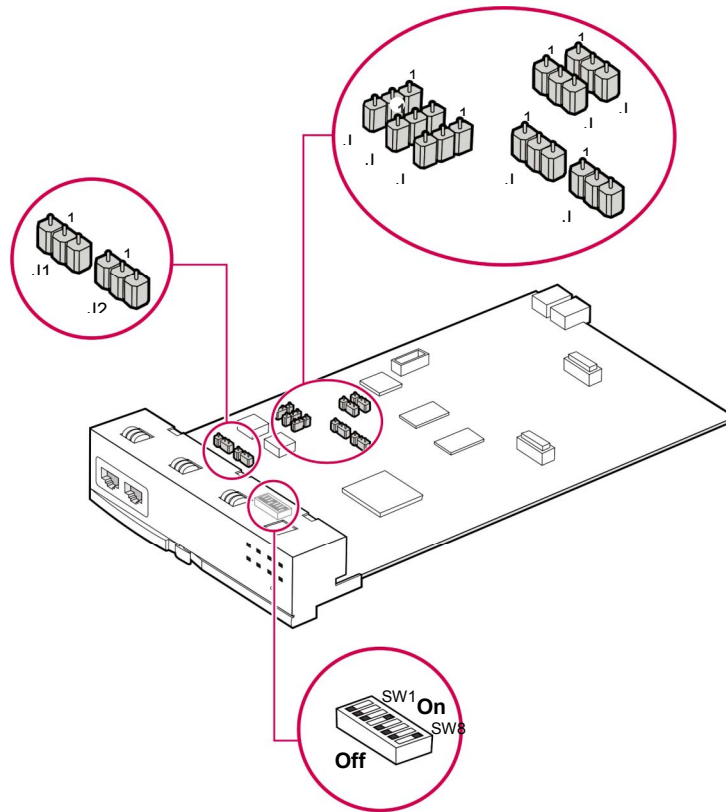

Figure 3.20 Setting Switches on the TEPRI/TEPRIa Card

JUMPER SETTING

The TEPRI/TEPRIa card comes from the factory with the following jumper settings. **These settings should NOT be changed.**

- J1 & J2: Pins 2 & 3 connected
- J3: Pins 2 & 3 connected
- J4~J9: Pins 1 & 2 connected
- Pin 1 is labeled on the card for each jumper.

FRONT VIEW OF TEPRI/TEPRIa CARD

The front view of the TEPRI/TEPRIa card is shown in the picture below.



Figure 3.21 Front View of the TEPRI/TEPRIa

Front panel components of the TEPRI/TEPRIa:

Table 3.5 Ports and LEDs of the TEPRI/TEPRIa

Ports & LEDs	Function Description
T1/E1/PRI	Ports that connect the T1/E1/PRI cable.
SIO	Serial port (for Samsung Use ONLY)
RST	Button for resetting the TEPRI/TEPRIa card.
SYNC LED	Clock synchronization. - On: Indicates loss of framing (Error Condition). - Off: Clocks are synchronized when they inter-work with the counterpart station (Normal).
LOS LED	This LED indicates loss of signal. - On: Signals have been lost, no PCM clocking is being received. - Off: Signals being received (Normal).
AIS LED	This LED indicates whether the T1 remote alarm has been generated. - On: The remote alarm has been generated. All one's are being received (Error) - Off: The remote alarm has not been generated (Normal).
L2 LED	This LED indicates the operation status of Layer 2 - On: The PRI Layer2 is operating properly. PRI message is being received. - Off: The PRI Layer2 is operating abnormally.

Ports & LEDs	Function Description
IPC LED	This LED indicates that this card is inter-working with the higher-level module. - On: The card is inter-working with the MP10. - Off: The card is not inter-working with the MP10.
CLK LED	This LED indicates whether this card is a master or slave. - On: The card has received the synchronization clock from the counterpart station. - Off: Using synchronous clock for internal clock.
TP1 LED	This LED indicates whether the T1 is established. - This LED turns on once the T1 is established.
TP2 LED	This LED indicates whether the PRI is connected. - This LED turns on once the PRI is connected.

[Refer to section 6.2.2 for Port Pinout and Wiring.](#)

3.5.2 8TRK

The 8TRK card provides 8 ports for analog trunk lines with Caller ID capabilities. This card can go into any universal slot (1 ~ 2). Add as many as needed.

FRONT VIEW OF 8TRK CARD

The front view of the 8TRK card is shown in the picture below.

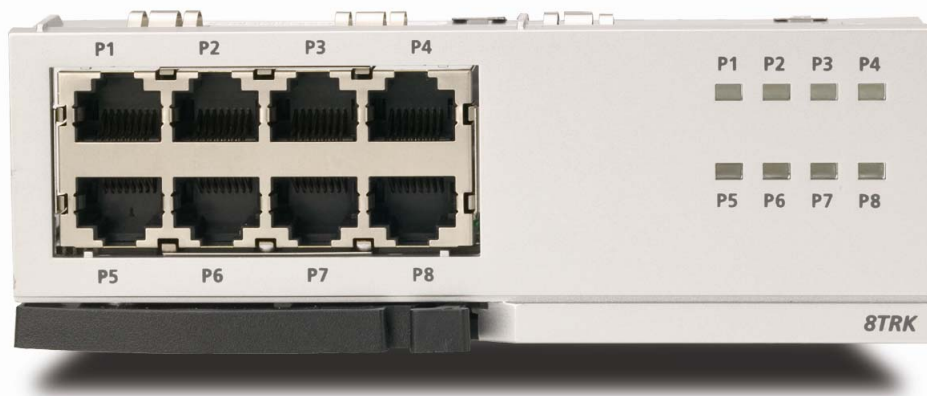

Figure 3.22 Front View of the 8TRK Card

The components on the front panel of the 8TRK have the functions below:

Table 3.6 Ports and LEDs of the 8TRK Card

Ports & LEDs	Function Description
P1~P8	Trunk ports.
P1~P8 LED	These LEDs indicate the status of the ports. - Off: The trunk line is not being used. - On: The trunk line is being used.

[Refer to section 6.2.1 for Port Pinout and Wiring.](#)

3.5.3 16DLI2

This card provides 16 ports for connecting Samung Digital Keysets. Each port provides 1B+D. This means only one station/one voice channel per port. This card can go into slots 1 and/or 2. Add as many as needed.

FRONT VIEW OF 16DLI2 CARD

The front view of the 16DLI2 card is shown in the picture below.

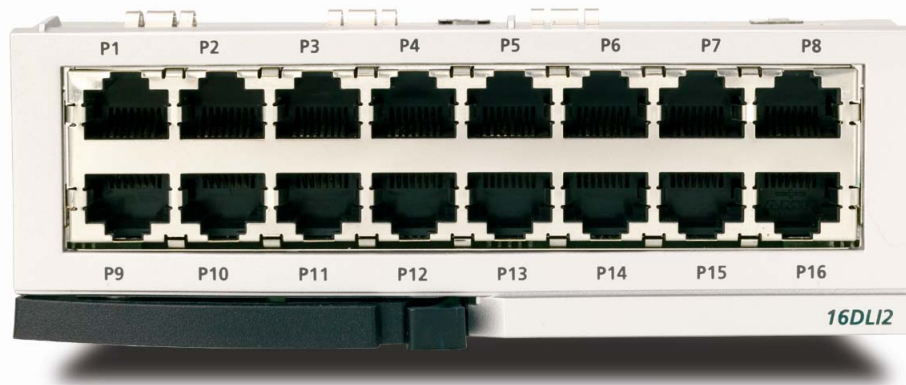

Figure 3.23 Front View of the 16DLI2 Card

16DLI2 front panel components:

Table 3.7 Ports of the 16DLI2 Card

Ports	Function Description
P1~P16	Samsung Digital Telephone Extension Port

[Refer to Section 7.1.3 \(Connecting a Digital Phone\) for port Pinout and Wiring.](#)

3.5.4 8DLI CARD

This card provides 8 ports for connecting Samsung Digital Key sets. This card can go into slots 1 and/or 2. Add as many as needed.

SPECIFICATIONS

The specifications of the 8DLIcard are as follows:

- 8 station ports

NOTE: KDB-D or KDB-S adapters are not supported on the OfficeServ 7100 system.

FRONT VIEW OF 8DLI CARD

The front view of the 8DLI card is shown in the picture below.

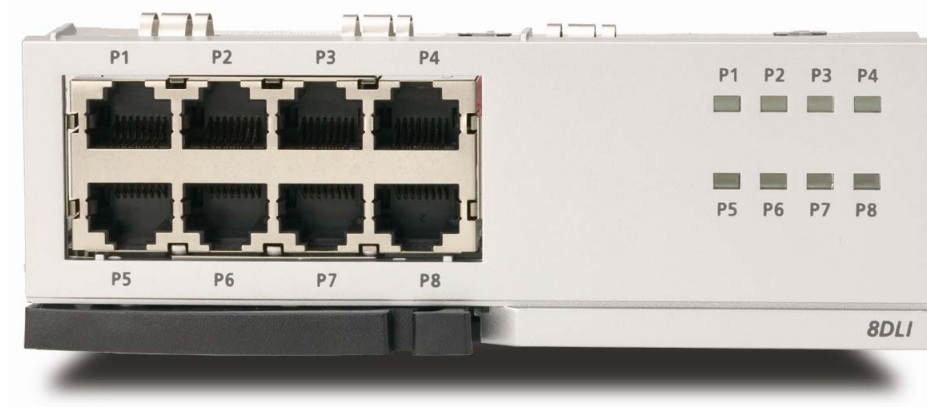

Figure 3.24 Front View of the 8DLI Card

Front panel components of the 8DLI card have the functions below:

Table 3.8 Ports and LEDs of the 8DLI Card

Ports	Function Description
P1~P8	Station ports of Samsung Digital Phones.
P1~P8 LED	These LEDs indicate the status of the ports. -Off: The station is not being used. -On: The station is being used.

[Refer to section 7.1.3 for Port Pinout and Wiring.](#)

3.5.5 8COMBO

This card provides 8 ports for connecting analog stations and 8 ports for connecting Samsung Digital Key sets. This card can go into slots 1 and/or 2. Add as many as needed.

FRONT VIEW OF 8COMBO CARD

The front view of the 8COMBO card is shown in the picture below.

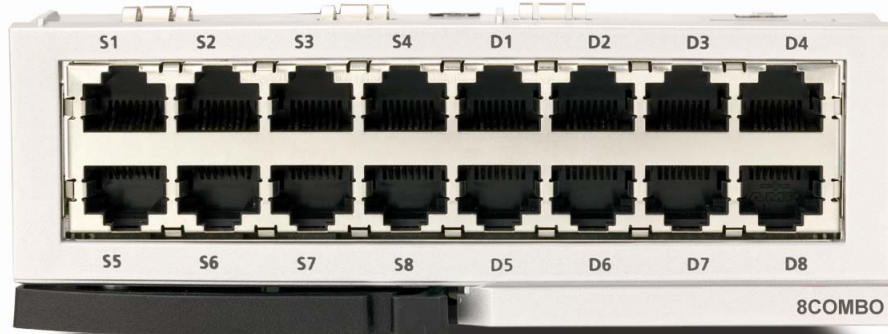

Figure 3.25 Front View of the 8COMBO

- Ports S1 ~ S8 are for analog stations only.
- Ports D1 ~ D8 are for Samsung Digital Stations only.

[See sections 7.1.2 and 7.1.3 for port Pinout/wiring.](#)

3.5.6 16MWSLI

This card provides 16 ports for connecting analog stations. It can go into slots 1 and/or 2. Add as many as needed. This card automatically detects DTMF or dial pulse signals from the SLT. This card has no DTMF receiver. It will share the system resources.

FRONT VIEW OF 16MWSLI CARD

The front view of the 16MWSLI card is shown in the picture below.

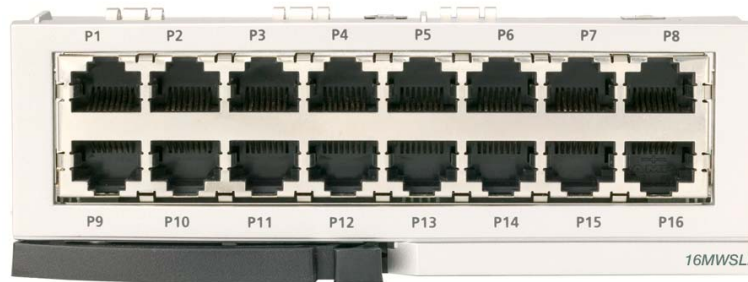

Figure 3.26 Front View of the 16MWSLI Card

Front panel components of the 16MWSLI:

Table 3.9 16MWSLI Card Ports

Ports & LEDs	Function Description
P1~P16	Analog Extension Ports

- The 16MWSLI supports Message Waiting Lamp functionality for analog stations that have this capability.
- Port 1 (Pins 7 & 8) supports Power Failure Transfer function ([Refer to Section 3.4](#)).
- [See Section 7.1.2 for port Pinout/Wiring.](#)
- Do not connect devices with a total REN greater than 5.0 to this card.

3.5.7 8SLI

This card provides 8 ports for connecting analog stations. It can go into slots 1 and/or 2. Add as many as needed. This card automatically detects DTMF or dial pulse signals from SLT. This card does not have any DTMF receivers; it uses system resources.

FRONT VIEW OF 8SLI CARD

The front view of the 8SLI card is shown in the figure below:

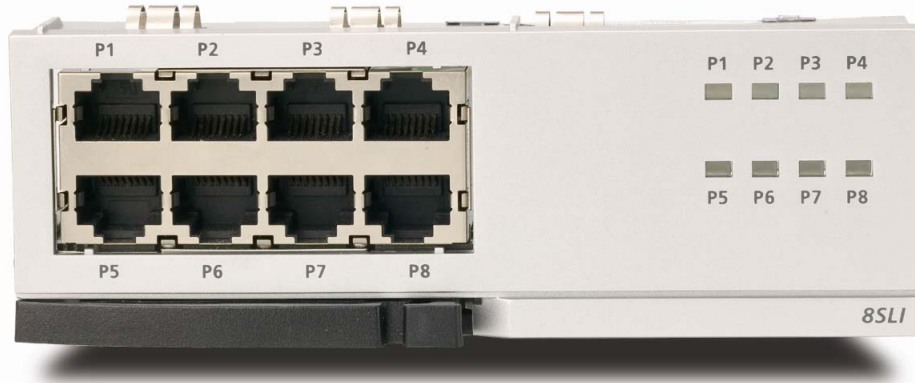

Figure 3.27 Front View of the 8SLI Card

Front panel components of the 8SLI:

Table 3.10 Ports and LEDs of the 8SLI Card

Ports & LEDs	Function Description
P1~P8	Station ports for analog phones.
P1~P8 LED	These LEDs indicate the operation status of the ports. - Off: The station is not active on a call. - On: The station is active on a call.

- Port 1 (Pins 1 & 2) supports Power Failure Transfer function ([Refer to Section 3.4](#)).
- [See Section 7.1.2 for port Pinout/Wiring](#).
- Do not connect devices with a total REN greater than 5.0 to this card.

3.5.8 MGI-16

The MGI-16 is a 16 channel Media Gateway Card. The MGI-16 card provides a variety of Voice over IP (VoIP) services for the OfficeServ 7100. This card is used for ITP phones, IP networking, IP trunking or any application that require VoIP functionality.

NOTE: *The MP10 processor cards have 8 MGI channels built-in. However, these channels have to be activated with the appropriate license key entered in mmc 841. Refer to the [OfficeServ 7100 Programming Manual](#) for details. The MGI16 does **NOT** require any licenses to operate.*

SPECIFICATIONS

- The MGI16 does not require any daughter cards. It offers 16 VoIP channels (respectively) on board.
- The MGI16 can be installed in slot 1 or 2.



Figure 3.28 Front View of the MGI16 Card

Table 3.11: MGI16 Front Panel Components

Ports & LEDs	Function Description
LAN	Port that connects the Ethernet.
SIO	Serial Port (for Samsung Use ONLY)
RST	Button for resetting the MGI.
PWR LED	This LED indicates the power supply status. - Off: Power is not being supplied. - On: Power is being supplied properly.
RUN LED	This LED indicates MP10 status. - Off: Power is not being supplied. - On: Booting. - Blink: The RAM program is operating.

Ports & LEDs	Function Description
LAN Tx LED	This LED indicates the transmit status of the LAN port. - Off: Data is not being transmitted. - On or blink: Data is being transmitted.
LAN Rx LED	This LED indicates the receive status of the LAN port. - Off: Data is not being received. - On or blink: Data is being received.
SVC LED	This LED indicates if the service is being offered. - This LED blinks when program is being modified or configuration is being loaded.
DSP LED	This LED indicates if the VoIP DSP is operating. - This LED blinks when the VoIP channels are engaged.
RTPT LED	This LED indicates if the voice packets are being forwarded. - This LED turns on when the voice packets are forwarded.
RTPR LED	This LED indicates if the voice packets are being received. - This LED turns on when the voice packets are received.

HARDWARE CAPACITIES

Interface Card	Location	Maximum per System
UNI card	Slots 1 & 2	2
4SWM	MP10 only	1
4DLM	UNI card & MP10	6
4SLM	UNI card	6
4TRM	UNI card	5
8TRK	Slots 1 & 2	2
8COMBO	Slots 1 & 2	1
8SLI	Slots 1 & 2	2
8DLI	Slots 1 & 2	2
16DLI2	Slots 1 & 2	1
16MWSLI	Slots 1 & 2	1
TEPR1a	Slots 1 & 2	1
MGI16	Slots 1 & 2	1

3.6 CONNECTING POWER FAIL TRANSFER

The OfficeServ 7100 offers a Power Fail Transfer feature for analog single line telephones that are connected to port 1 (pins 1 & 2) on the 8SLI or port 1 (pins 7 & 8) on the 16MWSLI cards.

In case the OfficeServ 7100 loses power from its AC source, and no battery backup is available, this feature is automatically activated. The SLT connected to Port 1 of the SLI will get C.O. dial tone (direct C.O. line access) activated by an internal relay. For this feature to work, the SLI ports must be wired as shown in [Figure 3.29](#) Pin 4 (TIP) and Pin 5 (Ring) from a port on the 8TRK card (or a port of the 4TRM module) must be connected to Pin 1 (TIP) and Pin 2 (RING) on port 1 (pins 1 & 2) of an 8SLI card or port 1 (pins 7 & 8) of 16MWSLI card.

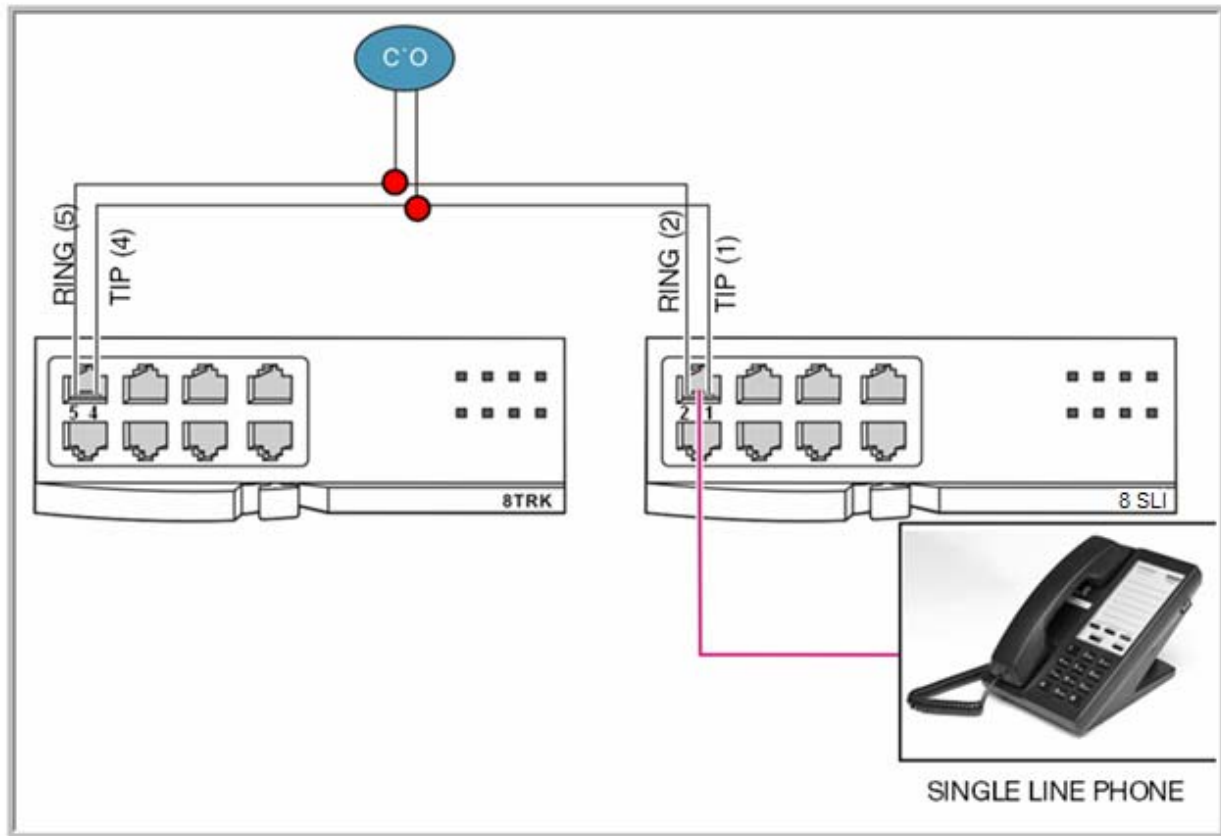

Figure 3.29 Example of Power Fail Transfer Connection to 8SLI

PART 4. CONNECTING EXTERNAL BATTERIES

This section describes how to connect external batteries to the OfficeServ 7100 system.

4.1 CONNECTING EXTERNAL BATTERIES

CAUTIONS FOR CONNECTING EXTERNAL BATTERIES

External batteries are required to maintain stable operation of the OfficeServ 7100 system in case a power failure occurs. The capacity for this battery should be rated at DC 48 V. A fuse (125 VAC, 5 Amp) should be positioned between the output terminal of the battery and the cabinet.



Cautions for connecting external batteries

Do not connect external AC power to the system before completing the connection between batteries and the system. If so, it may cause electric shock. Check the specified polarity (+ or -) to connect external batteries.



To reduce risk of fire and injury, use only a sealed nickel cadmium or lead-acid battery supply capable of handling a charge current of 0.25A, a charge voltage of —54 V DC, and a discharge rate of 26 Ah.

Observe the following precautions when installing batteries:

- Make sure the batteries you install conform to local building, fire and safety codes. Some battery types emit hydrogen gas during the charging state and may require venting to fresh air.
- Do not place batteries directly on a concrete floor. This causes them to discharge very quickly.
- Follow the battery manufacturer's recommended installation and maintenance procedures.

PROCEDURE FOR CONNECTING EXTERNAL BATTERY

The procedure for using a battery cable to connect an external battery to the OfficeServ 7100 system is as follows:

- 1) Use the battery cable that was provided with the OfficeServ 7100 system. The battery cable consists of a white wire and a black wire.

- 2) Connect the white wire of the battery cable to the (+) terminal, and the black wire to the (-) terminal of the battery. Connect the other end of the battery cable to the external battery socket on the rear panel of the OfficeServ 7100 cabinet.

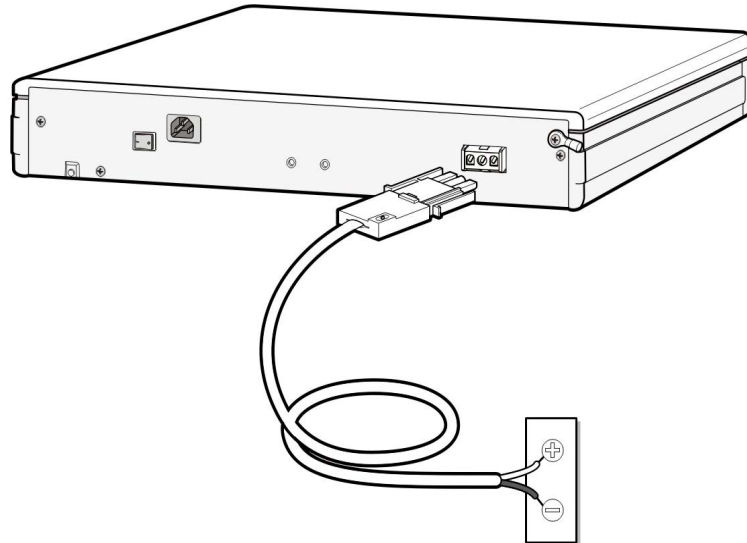

Figure 4.1 Connecting an External Battery

PART 5. CONNECTING POWER

This section describes how to connect power to the OfficeServ 7100 system.

5.1 BEFORE CONNECTING POWER

When input power is normally supplied, the AC power is supplied to the Power Supply Unit (PSU), which charges the external battery. If the input power is interrupted, the system can be operated using the charged power of the external battery.

- System supports only 110V AC power connections.
- A single AC outlet should be used solely for the system's AC power. Sharing the AC power with other devices can cause noise or a voltage drop, resulting in a system malfunction or fire.
- Use a stable power source that can always supply AC power since instantaneous power failures can cause malfunctions or battery failures.
- [System should be grounded as described in Part 1.2 and Part 2.5.](#)

5.2 PROCEDURE FOR CONNECTING POWER

Use the power cable provided with the OfficeServ 7100 system to connect the input power terminal on the back panel to a grounded outlet.

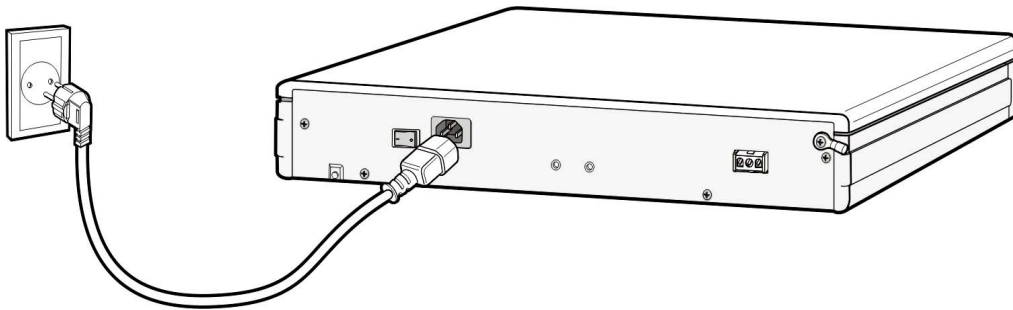

Figure 5.1 Connecting Power

PART 6. CONNECTING C.O. LINES

This section describes how to connect C.O. lines to the OfficeServ 7100 system after installation.

6.1 SAFETY PRECAUTIONS

To reduce the risk of personal injury, follow these precautions before connecting TELCO circuits:

- Wires with AWG #24 or AWG #26 width should be used as subscriber lines.
- Never touch non-insulated telephone wires or terminals unless the telephone line has been disconnected at the Network Interface.
- When wiring cables in high-humidity areas, remove moisture before wiring.
- Never install telephone jackets in a wet location unless the jack is specifically designed for wet locations.
- Wires should be handled carefully to prevent any changes or damages.
- Subscriber lines should be kept indoors if possible.
- High voltage power lines should not be wired near a subscriber line.
- Never install telephone wiring during a lightning storm.

Leak resistance for C.O. lines connected to the OfficeServ 7100 system is as follows:

Table 6.1 OfficeServ 7100 Line Conditions

Line Condition	Leak Resistance
Leak Resistance Between Lines	20 k Ω or higher
Leak Resistance Between Grounds	20 k Ω or higher

6.2 CONNECTING C.O. LINES

6.2.1 Connecting Common C.O. Lines

Use a twisted pair of wires with AWG #24(or AWG #26) width to connect a common C.O. line to the terminal pin of a terminal box connected to the OfficeServ 7100 system equipped with an 8TRK card or the ports of the 4TRM daughter card.

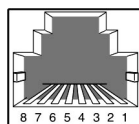

P1-P8 Port
(RJ-45)

Pin No.	1	2	3	4	5	6	7	8
Function	-	-	-	C.O. TIP	C.O. RING	-	-	-

Figure 6.1 8TRK Card Ports(P1~P8) or 4TRM port(P1~P4)

6.2.2 Connecting PRI

TEPRI/TEPRIa cards can be connected to a PRI C.O. line through a RJ-45 port. As shown below, connect a PRI C.O. line to the T1/E1/PRI port of the OfficeServ 7100 system.

Using a standard, straight through eight conductor data cable or straight through eight conductor line cord to connect the customer provided Channel Service Unit (CSU) to the TEPRI/TEPRIa card as shown in [Figure 6.2](#).

NOTES:

1. It may be necessary to cut off the CSU end of the cable and attach a different connector to match that of the CSU. If possible, this connection should be soldered because good connections are critical.
2. It is recommended that the CSU be connected to the network interface with a cable supplied by the CSU manufacturer. If this is not possible or practical, a custom cable has to be made up. This cable should be made from 22 gauge two pair cable with each pair individually shielded. It is recommended that the connections on this cable be soldered wherever possible to ensure good connections. The shielding of the cable should be connected to ground at the CSU end only to prevent a ground loop.

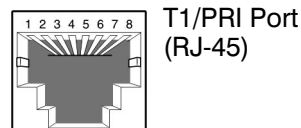

Pin No.	1	2	3	4	5	6	7	8
T1 Function	Rx+	Rx-	-	Tx+	Tx-	-	-	-
PRI Function	-	-	-	Tx+	Tx-	-	Rx+	Rx-

Figure 6.2 RJ-45 Port of TEPRI/TEPRIa Card

PART 7. CONNECTING STATIONS AND ADDITIONAL EQUIPMENT

This section describes how to connect various stations and additional equipment, such as analog/digital phones, door phones and door locks, to the OfficeServ 7100 system.

7.1 CONNECTING STATIONS

7.1.1 Safety Precautions

To reduce the risk of personal injury, follow these precautions before connecting telephone circuits:

- Never install telephone wiring during a lightening storm.
- Never install telephone jacks in a wet location unless the jack is specifically designed for wet locations.
- Do not connect stations in a humid area.
- Never touch non-insulated telephone wires or terminals unless the telephone line has been disconnected at the network interface.
- Connect stations using #24 AWG or #26 AWG cables.

The maximum distance between stations and the OfficeServ 7100 are as follows:

Table 7.1 Distance Between Stations and the System

Station	Distance
Digital phone	Maximum 400 m/1312 ft (for AWG #24)
Analog phone	Maximum 1 km/3280 ft (for AWG #24)
Door phone	Maximum 400 m/1312 ft (for AWG #24)
AOM	Maximum 400 m/1312 ft (for AWG #24)

7.1.2 Connecting an Analog Phone

Connect an analog phone to the 8SLI, 16MWSLI, 8COMBO (analog ports only) cards or the 4SLM (mounted on UNI card) installed in the OfficeServ 7100 system.

CONNECTING TO THE 8SLI CARD

Connect an analog phone to the 8SLI card by using a twisted pair of AWG #24 or AWG #26 wire.

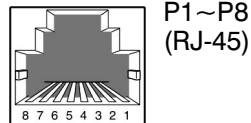

P1~P8
(RJ-45)

P1 port

Pin No.	1	2	3	4	5	6	7	8
Function	PFT TIP	PFT RING	-	SLI 1 TIP	SLI 1 RING	-	-	-

P2-P8 port

Pin No.	1	2	3	4	5	6	7	8
Function	-	-	-	SLI TIP	SLI RING	-	-	-

Figure 7.1 RJ-45 Port of the 8SLI Card

CONNECTING TO THE 16MWSLI CARD

Connect an analog phone to the 16MWSLI card by using a twisted pair of AWG #24 or AWG #26 wires.

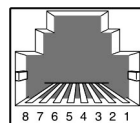

P1-P16
port
(RJ-45)

P1 Port

Pin No.	1	2	3	4	5	6	7	8
Function			-	SLI 1 TIP	SLI 1 RING	-	PFT TIP	PFT RING

P2-P16 Port

Pin No.	1	2	3	4	5	6	7	8
Function	-	-	-	SLI TIP	SLI RING	-	-	-

Figure 7.2 RJ-45 port of the 16MWSLI Card

CONNECTING TO THE 8COMBO CARD

Connect an analog phone to the 8COMBO card by using a twisted pair of AWG #24 or AWG #26 wires.

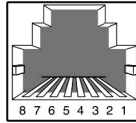

S1-S8 Port
(RJ-45)

S1-S8 Port

Pin No.	1	2	3	4	5	6	7	8
Function	-	-	-	SLI TIP	SLI RING	-	-	-

Figure 7.3 RJ-45 Port of the 8COMBO Card (For Analog Phone)

CONNECTING TO THE 4SLM port on a UNI Card

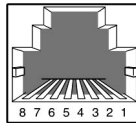

Pin No.	1	2	3	4	5	6	7	8
Function	-	-	-	SLI TIP	SLI RING	-	-	-

Figure 7.4 RJ-45 4SLM port on the UNI card

7.1.3 Connecting a Digital Phone

Connect a digital phone to 8DLI, 16DLI2, 8COMBO (digital ports only) or 4DLM (mounted on a UNI Card) card.

CONNECTING TO 4DLM MOUNTED ON A UNI CARD

Connect a digital phone to the 4DLM port by using a twisted pair AWG #24 or AWG #26 wires.

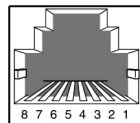

P1~P4
(RJ-45)

Pin No.	1	2	3	4	5	6	7	8
Function	-	-	-	DLI TIP	DLI RING	-	-	-

Figure 7.5 RJ-45 4DLM Port on UNI Card

CONNECTING TO 8DLI CARD

Connect a digital phone to the 8DLI card by using a twisted pair AWG #24 or AWG #26 wires.

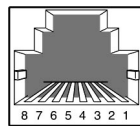

P1~P8
(RJ-45)

Pin No.	1	2	3	4	5	6	7	8
Function	-	-	-	DLI TIP	DLI RING	-	-	-

Figure 7.6 RJ-45 Port of the 8DLI Card (For Digital Phone)

CONNECTING TO 16DLI2 CARD

Connect a digital phone to the 16DLI2 card by using a twisted pair of AWG #24 or AWG #26 wires.

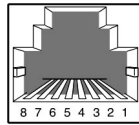

P1-P16
 Port
 (RJ-45)

Pin No.	1	2	3	4	5	6	7	8
Function	-	-	-	DLI TIP	DLI RING	-	-	-

Figure 7.7 RJ-45 Port of the 16DLI2 Card (For Digital Phone)

CONNECTING TO 8COMBO CARD

Connect a digital phone to the 8COMBO card by using a twisted pair of AWG #24 or AWG #26 wires.

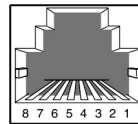

D1~D8
 Port
 (RJ-45)

Pin No.	1	2	3	4	5	6	7	8
Function	-	-	-	DLI TIP	DLI RING	-	-	-

Figure 7.8 RJ-45 Port of the 8COMBO Card (For Digital Phone)

7.1.4 Connecting an IP Phone

[Refer to the ITP-5121D Keyset User Guide, ITP-5112L Keyset User Guide, and ITP-5107S Keyset User Guide for information on connecting IP keysets.](#)

Note: If using the on-board MGI resources of the MP10, you must activate the MGI license key in system programming to enable the specific number of MGI channels.

7.1.5 Connecting Cards to Ethernet

4SWM (P1~P4), MGI-16, and MP-10 (LAN port) cards can be connected to Ethernet by using an Ethernet cable.



Pin No.	1	2	3	4	5	6	7	8
Function	Tx+	Tx-	Rx+	-	-	Rx-	-	-

Figure 7.9 RJ-45 EthernetPort

7.1.6 Connecting to a Door Phone and a Door Lock

Connect a door phone and a door lock to the OfficeServ 7100 system by using a Door Phone Interface Module (DPIM).

- 1) Connect a twisted pair of #24 AWG or #26 AWG wires to the LINE port of DPIM and to P1 through P8 of 8DLI/16DLI2/8COMBO cards or 4DLM (mounted on UNI card P1~P4) of the OfficeServ 7100 system.

CONNECTING TO THE 8DLI, 16DLI2, 8COMBO, 4DLM (mounted on UNI Card)

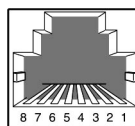

Pin No.	1	2	3	4	5	6	7	8
Function	-	-	-	DLI TIP	DLI RING	-	-	-

Figure 7.10 RJ-45 Digital Ports of the cards mentioned above (For Door Phone Connection)

- 1) Connect the Door Box port of the DPIM to the Line port of the door phone.
- 2) When using an automatic door lock, connect the Lock port of the DPIM and the door phone contact point to the door lock.
- 3) The door lock contact point is designed to control low-voltage relay and uses 24 VDC and 100 mA. Do not attempt to connect commercial AC power to these contact.



MMC

[MMC 211](#) is used to assign call numbers to door phones. Use [MMC 501](#) to program duration of contact closure. [For detailed instruction on the MMC program, refer to OfficeServ 7100 Programming Section.](#)

7.1.7 Connecting KDBF

Keypad Daughter Board module installed on a speakerphone connected to the OfficeServ 7100 system. The module enhances the function to full-duplex functionality.

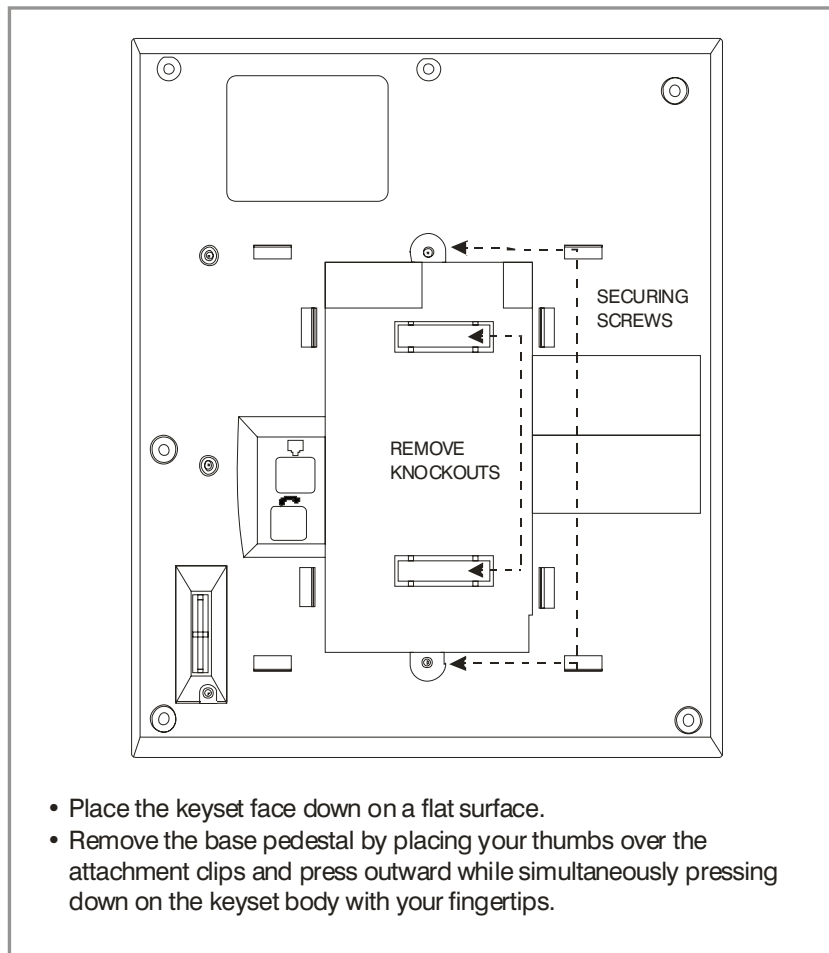

Figure 7.11 Adding an iDCS KDBF Keypad Daughtercard Module

iDCS KDB-FULL DUPLEX (FKDBF)

This daughter card can only be installed in the iDCS 28 and iDCS 18 button phones. The standard speakerphone mode of operation for a iDCS keypad is “half duplex”. This means that you cannot transmit and receive speech at the same time. Adding a FKDBF to your keypad will convert the speakerphone into full duplex mode enhancing its

operation. In addition the FKDBF may have up to 3 external microphones attached to it for conference room type applications. These microphones require an “EXTMIC” key programmed on the keyset to activate or deactivate them. [See Figure 7.11.](#)

DS KDB-FULL DUPLEX (KDBF)

This is a daughter card that can only be installed in the 21D or 14D button keysets. The standard speakerphone mode of operation for a DS keyset is “half duplex”. This means that you cannot transmit and receive speech at the same time. Adding a KDBF to your keyset will convert the speakerphone into full duplex mode enhancing its operation. In addition the KDBF may have up to 3 external microphones attached to it for conference room type applications. These microphones require an “EXTMIC” key programmed on the keyset to activate or deactivate them.

The KDB-D/KDB-S daughter boards are not supported on the iDCS and DS keysets when connected to the OfficeServ 7100 system.

7.1.8 Wall-Mounting Keysets

WALL-MOUNTING iDCS KEYSETS

iDCS keysets come equipped with a reversible base wedge. To wall-mount a keyset, remove the wedge from the keyset and mount the wedge to the wall using one of the methods below ([see Figure 7.12](#)).

Use screw holes 1 and 2 to attach the base wedge to a standard electrical outlet box.

OR

Use screw holes 1 and 3 to attach to a standard telephone wall-mount plate with locking pins. This method can cause the keyset to wobble as the keyset feet do not fit securely to the mounting surface.

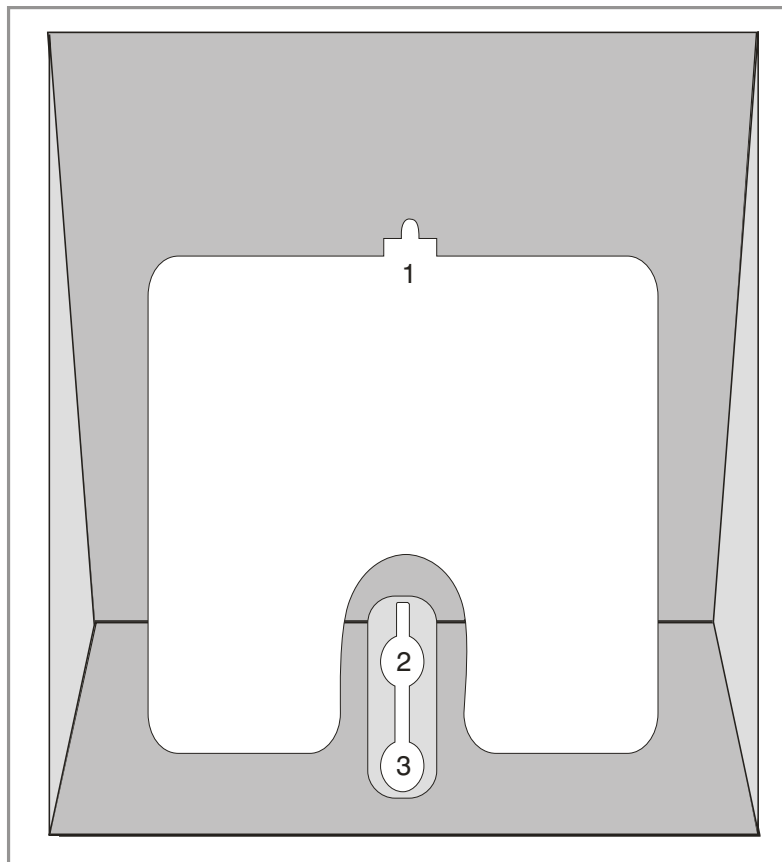

Figure 7.12 Wall-Mounting an iDCS Keyset

WALL-MOUNTING DS, ITP-5121D and ITP-5107S KEYSETS

DS, ITP 5121D and ITP 5107S keysets come equipped with a reversible base stand. To wall-mount a keyset, remove the base stand, reverse it, and attach stand in the bottom slots of the keyset. Use screw holes 1 and 2 to attach the keysets to the wall ([see Figure 7.13](#)).

To secure the handset once you wall-mounted your keyset you must remove the handset retaining clip reverse it such that the extended clip is facing the top of the phone ([see Figure 7.13](#)).

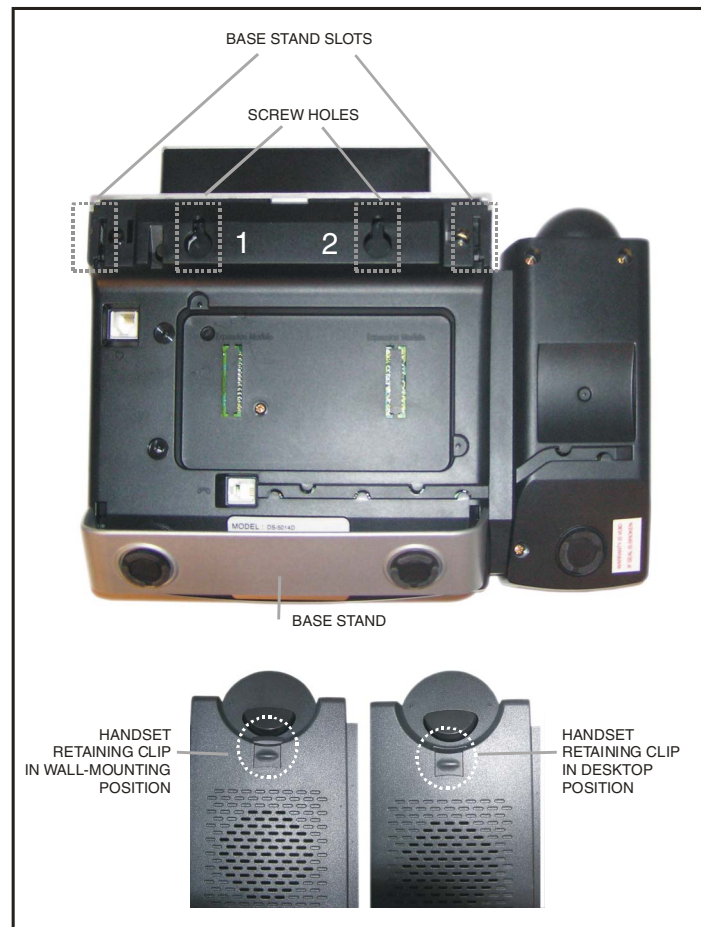

Figure 7.13 Wall-Mounting DS 5000, ITP-5121D and ITP-5107S Keysets

7.1.9 Attaching Add-On-Modules to Keysets

ATTACHING iDCS 64 BUTTON MODULES TO AN iDCS KEYSET

First remove the base wedge from the iDCS 64 Button Module and attach the bracket to it with two of the screws provided ([see Figure 7.14](#)).

Remove the base wedge of the keyset and place it to the right of the 64 Button Module and attach the bracket/64 BM to the keyset with the remaining two screws.

The base wedge can now be replaced.

NOTE: If you wish to attach two 64 button modules to a keyset, connect the 64 button modules together first and then attach them to the keyset.

ATTACHING iDCS 14 BUTTON MODULES TO AN iDCS KEYSSET

To add an iDCS 14 Button Key Strip to your iDCS keyset follow these steps: ([see Figure 7.15](#))

- 1) Place the keyset face down on a flat surface.
- 2) Remove the base pedestal by placing your thumbs over the attachment clips and press outward while simultaneously pressing down on the keyset body with your fingertips.
- 3) Remove the ribbon cable knockout from the bottom of the keyset.
- 4) Clip the 14 button strip to the side of the keyset.
- 5) Plug one end of the ribbon cable into the keyset and the other end into the 14 button strip.
- 6) Place the support bracket over the ribbon cable and secure with the six screws provided.
- 7) Reattach the base pedestal.

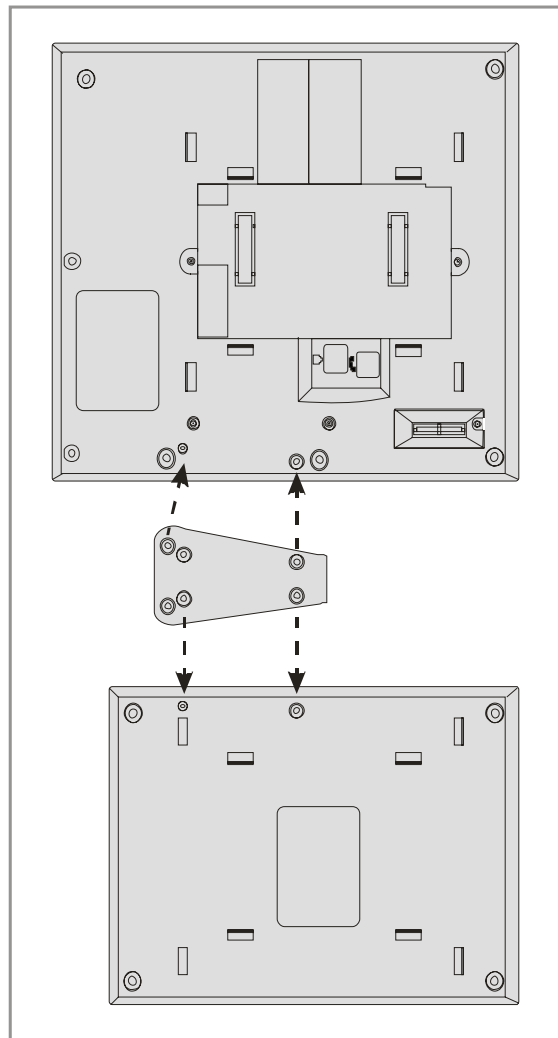

Figure 7.14 Attaching iDCS 64 Button Module to an iDCS Keyset

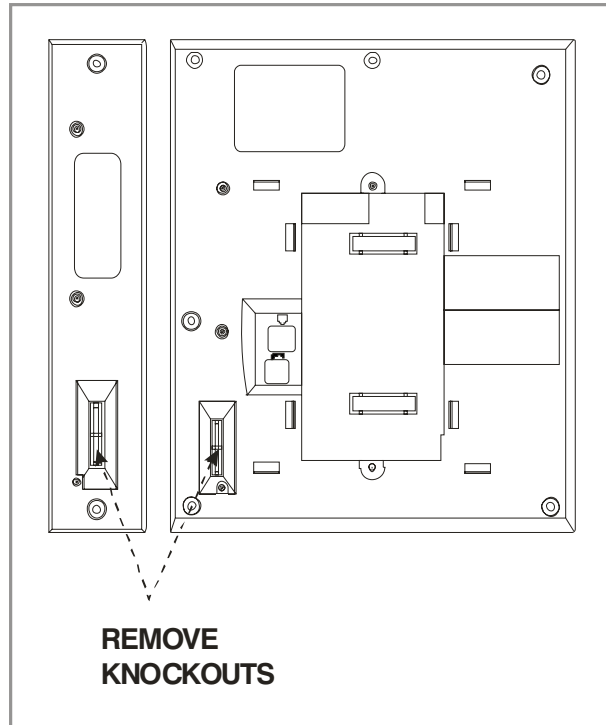

Figure 7.15 Attaching iDCS 14 Button Module to an iDCS Keyset

ATTACHING DS 64 BUTTON MODULES TO a DS 5021D or a DS 5014D KEYSSET

First attach the bracket to the keyset with two of the screws provided. Then attach the 64 button add-on module to the bracket with the remaining two screws. ([see Figure 7.16](#)).

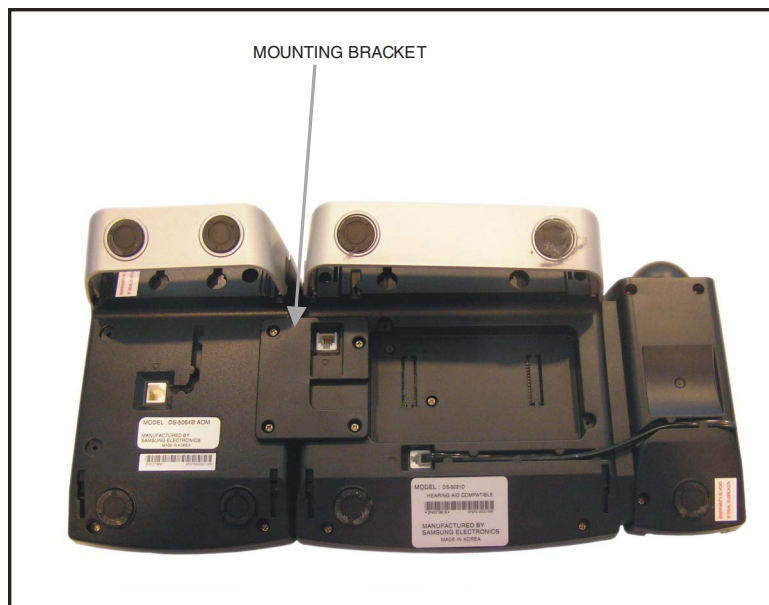

Figure 7.16 Attaching DS 64 Button Modules to a DS 5021D or a DS 5014D Keyset

7.2 CONNECTING ADDITIONAL EQUIPMENT

This section describes how to connect optional equipment, such as Music on Hold (MOH)/Background Music (BGM) sources, external page devices, common bells, and PCs for **OSM/SMDR/CTI**, to the OfficeServ 7100 system.

The following table lists the default MISC Numbering Plan defined in MMC 724.

MISC FUNCTION # IN MMC 724	DEFAULT DN	HARDWARE ITEM
01	371	MOH/BGM
02	361	Page Tip and Ring
03	362	Dry Contact
04	363	Dry Contact
05	3999	Internal Modem

7.2.1 Connecting MOH/BGM Equipment

The OfficeServ 7100 system offers music on hold. The system provides internal tone/music and external music sources per C.O. or extension lines as the music source.

One external MOH source connection is provided on the MP10 MISC port. Connect the music source to this MISC port of the MP10 card.



NOTE

IMPORTANT NOTICE: In accordance with US copyright law, a license may be required from the American Society of Composers, Authors and Publishers (ASCAP) or another similar organization if copyrighted music is transmitted through the Music on Hold feature. Samsung Telecommunications America hereby disclaims any liability arising out of failure to obtain such a license.

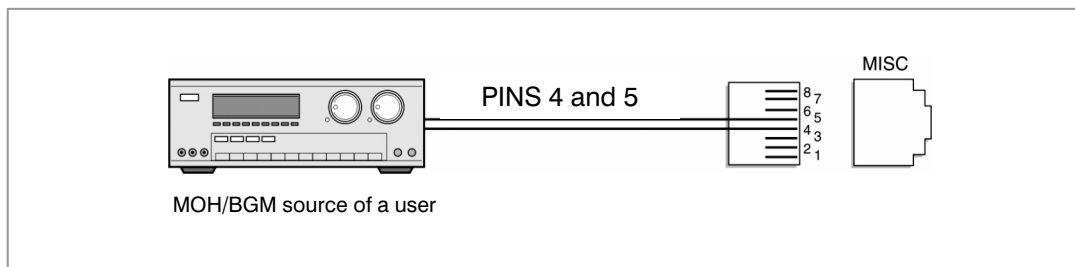

Figure 7.17 Connecting MOH/BGM Sources

- The MISC port located on the front panel of the MP10.



NOTE

MMC

Select music sources for C.O. lines in MMC 408 and music sources for extensions in MMC 308. For detailed instructions on the MMC programs, [refer to OfficeServ 7100 Programming Manual.](#)

The following ports are assigned to the external MOH inputs on the MIS daughter card:

HARDWARE ITEM	MISC FUNCTION # in MMC 724	DEFAULT DN (Ports)
MOH/BGM Ext. Source	01	371

7.2.2 Connecting External/Additional Page Equipment

Instead of an internal speaker, external broadcasting equipment, such as amps or speakers, and additional equipment that can broadcast page ring) signals outside a building can be connected to the OfficeServ 7100 system.

Connect external/additional paging equipment to the MP10 MISC port. The power of the external/additional paging equipment should be connected separately.

The MP10 MISC port provides a voice pair and a one dry contact to be used with customer-provided paging equipment. Connect the customer-provided paging equipment to the page output pins of the MISC port ([see Figure 7.18](#)).

The Page Zone Relay ports assigned to the dry contact pair are listed in the following table. Assign the DN number to the selected page zone using Default DN (Ports).

HARDWARE ITEM	MISC FUNCTION # in MMC 724	DEFAULT DN (Ports)
Page Tip & Ring (600 ohms)	02	361
Contact Pair #1	03	362
Contact Pair #2	04	363

- MISC port is located on the front panel of the MP10.

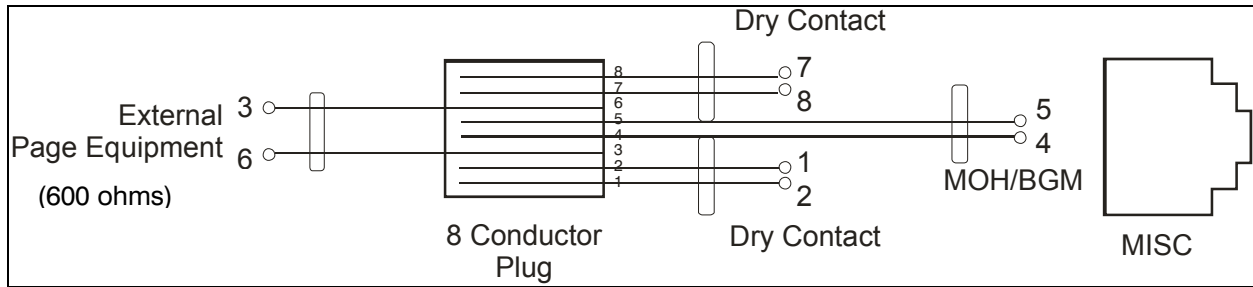

Figure 7.18 Connecting External/Additional Page Equipment



Dry Contact

Dry Contact is a switch that can connect or cut the power or line to external equipment.

7.2.3 Loud Bell Interface

When a station requires loud ringing, assign or pair that station to an audible ring tone output on the MISC port using MMC 205. Relay type can be assigned to Loud Bell in MMC 218.

MISC FUNCTION # in MMC 724	DEFAULT DN
03~04	362 or 363

Next connect the output MISC port to a customer provided paging system or other suitable customer provided speaker, [see Figure 7.18](#).

7.2.4 Connecting Common Bell

A customer-provided loud ringing device can be controlled using a dry contact pair on the MP10 MISC port.

Common bell connections should be wired to the MP10 MISC port.

By using MMC 204 programming allows for interrupted or continuous operation of the contacts. The interrupted selection follows the CO ring cadence, 1 sec ON/3 sec OFF. Relay type can be assigned to Common Bell in MMC 218.

MISC FUNCTION # in MMC 724	DEFAULT DN
03 or 04	362 or 363

The OfficeServ 7100 system supports only one dry contact for the common bell. The MISC port is located on the front panel of the MP10.



Figure 7.19 Connecting Common Bells

WARNING: Do not attempt to connect commercial AC power to these contacts.

- 1) After connecting a common bell, you must assign it in MMC 601 to a group as a ring destination by using the code for common bell.
- 2) After wiring to the contact pair, set contacts for continuous or steady operation.
- 3) Next, program hunt group to include the common bell.
- 4) Assign the trunk to ring the hunt group containing the common bell. Common bell control can be used with station hunt groups, individual stations and universal answer.

7.2.5 Ring Over Page

When a customer-provided paging system is installed, incoming calls can be assigned to ring over page. Program the C.O. line or C.O. lines to ring a hunt group. Using MMC 601 assign the DN number of the Page Output (voice) for the MISC port being used as a member of the group or as the NEXT PORT for the overflow destination. Other stations may be assigned to the same group to provide ringing to phones and the paging system at the same time.

MISC FUNCTION # in MMC 724	DEFAULT DN
02	361

7.2.6 Connecting OfficeServ Installation Tool

Installation Tool is a computer application that provides various maintenance and management functions for the OfficeServ 7100. The minimum requirements for a PC running Installation Tool are as follows:

Table 7.2 Installation Tool Specification

Category	Specification
Platform	IBM PC
CPU	Pentium III or higher
OS	Windows 2000 or higher
Main memory	64 Mbytes or higher
Hard disk	1 Gbytes or higher

CONNECTING INSTALLATION TOOL TO LAN PORT

The IS Tool application can communicate to the OfficeServ 7100 system via the LAN or MODEM connection. The Installation Tool can connect to the MP10 via LAN connection using a customer provided LAN switch or using the 4SWM module as shown in [Figure 7.20](#).

- Set up the MP10 LAN parameters in MMC 830.
- If an MP10 is behind a firewall and the IS Tool is outside the firewall, ports 5090, 5003 must be open to the private IP address of the MP10.

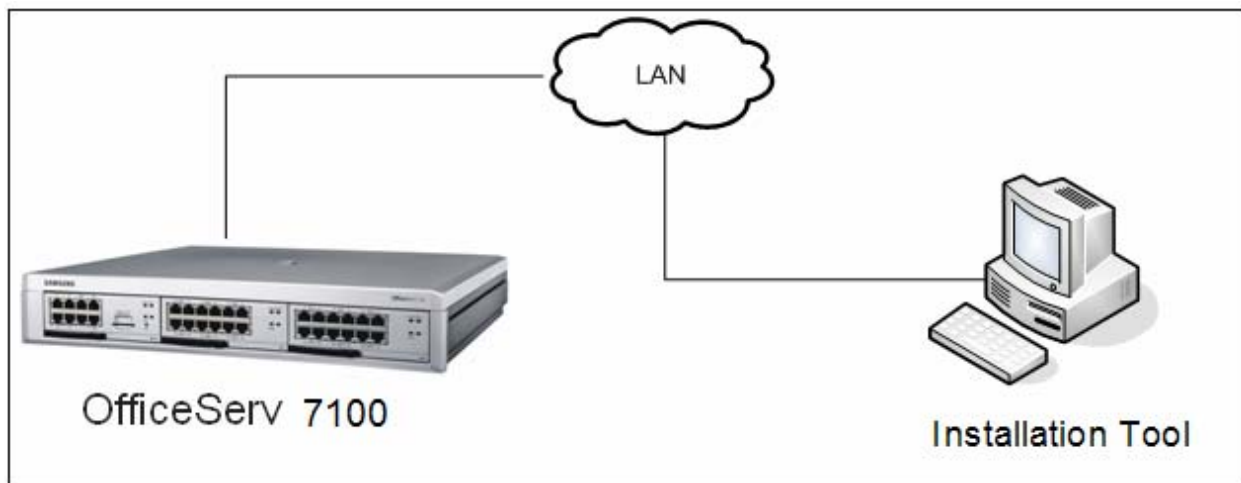

Figure 7.20 Installation Tool Connection to LAN Port

Detail procedures for each of the steps above are as follows:

SETTING NETWORK PARAMETERS THROUGH MMC 830

Set the network parameters of the system. Contact the network manager when setting values for the network parameters.

- 1) Set the IP address of the system.

- 2) Set the subnet.
- 3) Set the gateway address.
- 4) Reset the MP10.



MP10 Reset

New settings are applied only after the card is reset. The system may malfunction if the card is not properly initialized.

INSTALLATION TOOL AND LAN CONNECTION

1. Execute IS tool
2. Click [System] -> [Link Control] menu to set the communications link.

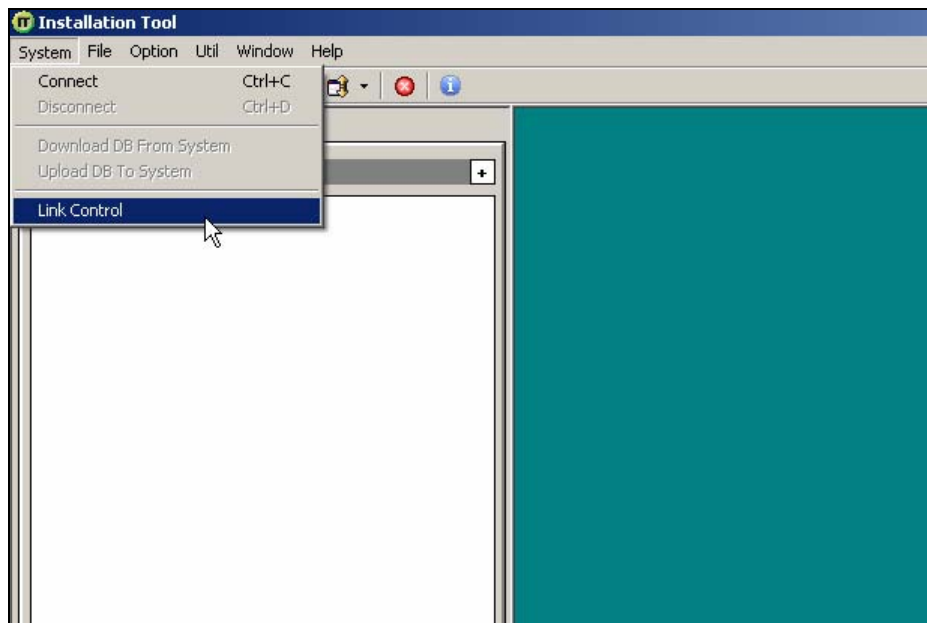

Figure 7.21 Installation Tool and LAN Connection

3. Enter System name (eg; ABC Company).
4. Select the <link type> (eg; LAN).
5. Input the IP address (eg; 192.169.9.209).
6. Click [Apply].
7. Dialog box show: “Do you want to apply new setting value?”
8. Click [Yes].
9. Dialog box shows: “The new setting value is applied.”
10. Click [OK]; Click [Close].
11. Click [System]; Click [Connect].
12. Enter Password [Samsung]; then [OK].

INSTALLATION TOOL AND MODEM CONNECTION VIA TELCO LINE

This example is based on a PC using an internal modem card. Connect Telephone line cord from internal modem connection of PC directly to loop start telco line.

1. Execute IS tool
2. Click [System] -> [Link Control] menu to set the communications link.
3. Enter System Name (eg; ABC Company).
4. Select the <link type> (eg; MODEM).

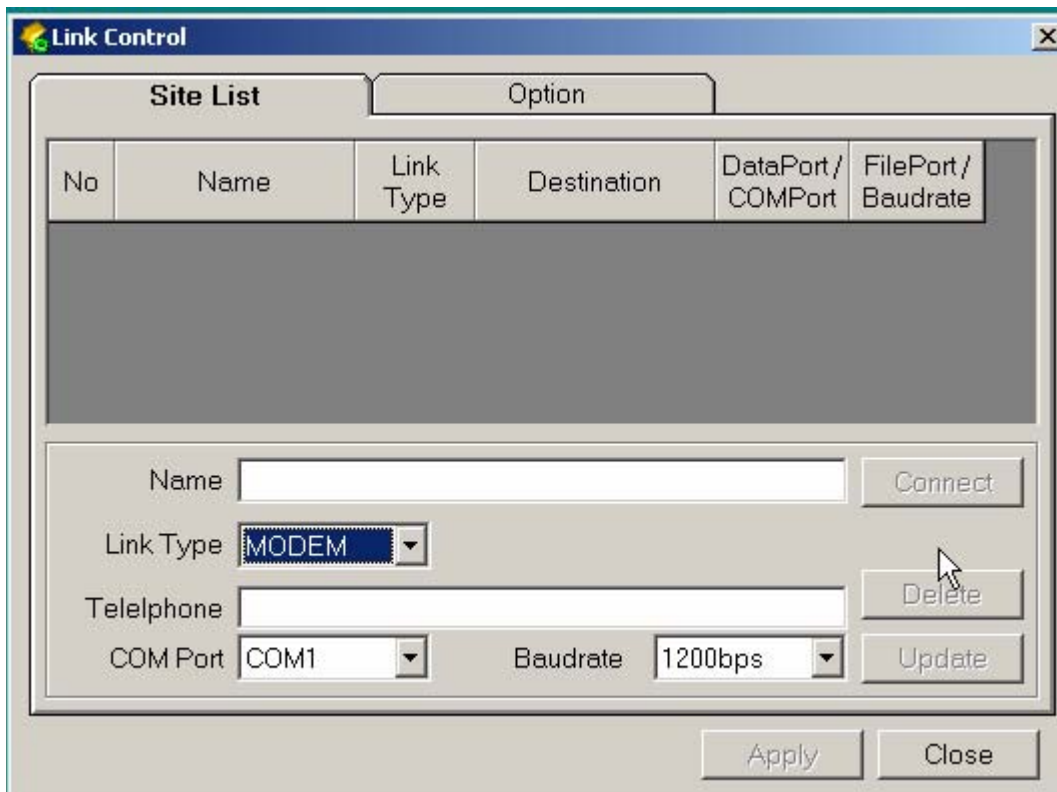

Figure 7.22 Installation Tool and Modem Connection

5. Input the Telephone number (eg; 972-372-4812).
6. Input the Com Port (eg; COM1).
7. Input the Baud Rate (eg; 38400bps).
8. Click [Apply].
9. Dialog box show: "Do you want to apply new setting value?"
10. Click [Yes].
11. Dialog box shows: "The new setting value is applied."
12. Click [OK]; Click [Close].
13. Click [System]; Click [Connect].
14. Enter Password [Samsung]; then [OK].

Note: Internal modem card must be installed for the connection to work. The incoming telco line may need to be programmed to ring directly to modem port of OS 7100 system in MMC 406 (eg. Trunk 701 ring to port 3999).

7.2.7 SYSTEM DATA/ACTIVITY REPORTS

The following type of reports can be output to a PC or LAN printer that is connected to the same network as the MP10: SMDR (Station Message Detail Records), UCD Reports, Traffic Reports, Alarm Reports and much more. [Refer to MMC 829](#) to configure the report type and data output network configuration ([See OfficeServ 7100 Programming Manual](#)). This MMC can also configure the reports to be sent to PCs running 3rd party applications (i.e. SMDR Reporting Packages, etc.).

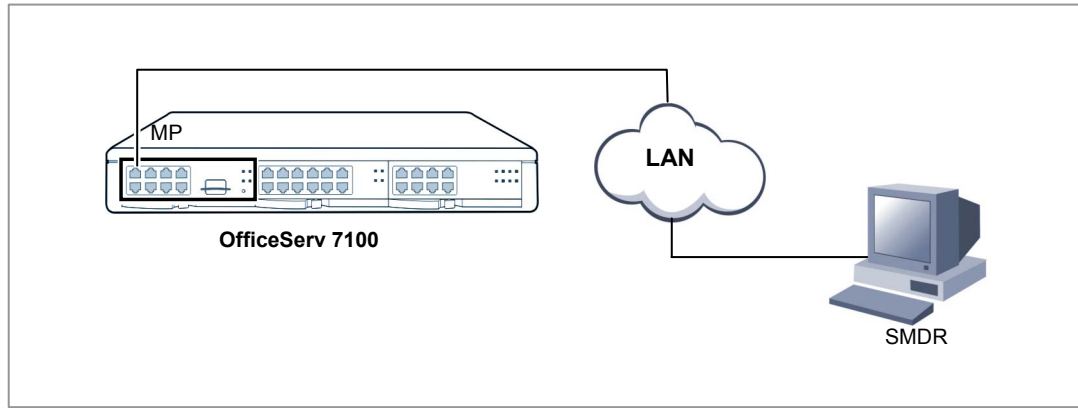

Figure 7.23 Connecting SMDR

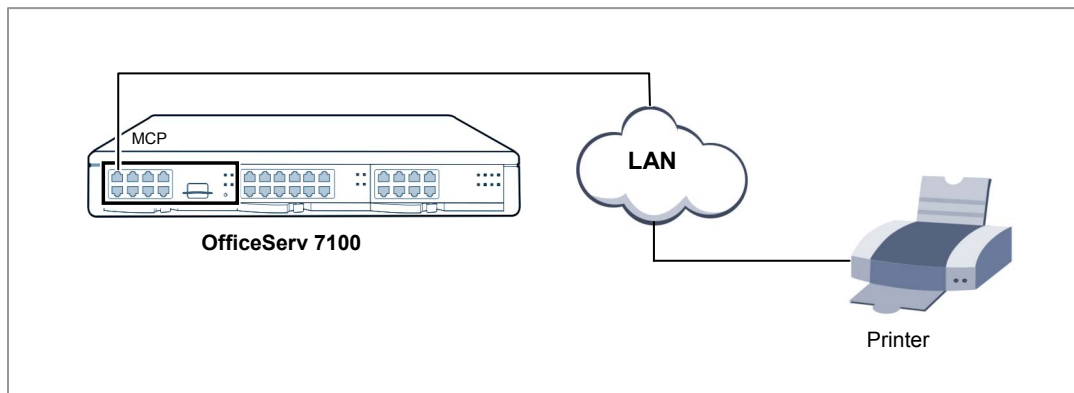

Figure 7.24 Connecting Printers

PART 8. POWER UP PROCEDURES

This section describes items to check before starting the OfficeServ 7100 system and the procedure for starting the system.

8.1 PRE-CHECK

This section describes items to check before starting the OfficeServ 7100 system.

8.1.1 Safety Precautions

- **Temperature:** Check if the temperature of the room where the system is installed is between 32°F and 113°F. If the room temperature is higher or lower than the normal operation temperature, install a heating/cooling device to maintain normal temperature.
- **Humidity:** Check if the room humidity where the system is installed is between 10 % and 90 %. Take special caution since humidity affects the electrical components and connectors of the system.
- **Direct sunlight and dust:** The room where the OfficeServ 7100 system is installed should be protected from direct sunlight and should have ventilation systems to prevent the system from malfunctioning due to dust.

8.1.2 Safety Conditions

The building where the OfficeServ 7100 system is installed should have lightning rods and grounding to protect the system against lightning and electric leakage.

- Check if the OfficeServ 7100 system is not inclined and is maintained horizontally.
- Do not place devices that may cause electromagnetic interference near the system.
- Place a fire extinguisher near the system.
- Check if the AC voltage switch of the PSU is properly set to 110 VAC power.
- Check if the grounding terminal on the rear panel of the system is properly connected to the external grounding.

8.2 STARTING THE SYSTEM

The procedure for starting the OfficeServ 7100 system is as follows:

- 1) Check if the cards and cables are properly mounted and connected to the OfficeServ 7100 cabinet.
- 2) Make sure the MMC+ Card with system software is in the Media slot.
- 3) Make sure the memory backup switch on MP10 is in the ON position.
- 4) Turn on the power of the OfficeServ 7100 cabinet.
- 5) Check the LEDs of the MP10.

- 6) The RUN LED of the MP10 card lights green and the MC LED flashes when the system normally starts the booting process.
- 7) Once the booting is complete, the RUN LED of the MP10 card flashes green, and the MC LED stops flashing and remains lit. (It takes approximately 2 ½ to 3 minutes to boot up).
- 8) Enable MGI channels by entering the appropriate license key in system programming (if MGI services are required).



If the MMC+ card is not detected

If the system cannot detect the MMC+ card, the MC LED might not light or flash. In such cases, turn off the power, replace the MMC+ card and turn the power on again. If the MMC+ card is still not detected, turn off the power and replace the MP10.

- 9) Check if the LED status of other interface cards are normal.

If the LED status of the MP10, or interface card is abnormal, turn off system power and turn the power on again.

8.3 PRECONFIGURED NUMBERING OF EXTENSION AND CO LINES AND STATIONS

The OfficeServ 7100 has been designed as plug-n-play to operate right out of the box with minimum programming and little installation time required. The office server 7100 comes prepackaged with hardware to support 4 CO lines and 8 digital stations (Only 6 iDCS 28 button keyset are provided), and 4 ports of embedded voicemail. Other types of iDCS, DS and ITP series phones can be connected if necessary.

When the system is powered up, it will read the hardware components and self configure a default database to support the following:

- iDCS 28 button phones (pre-labeled) in a squared 4 lines X 8 stations configuration.
 - CO lines 701 through 704
 - Stations 201 through 208
 - Direct station select key (DSS) keys 201 through 208
 - Speed dial keys 01 through 05
 - Feature keys (Directory, Call Log, Group Listen, Intercom, DND)
 - 50 CID review blocks per station
 - 50 Call Log blocks per station
 - 50 Station speed dial buffers per station
- 500 System speed dial buffers.
- Operator group 500(normal) with members 201 through 208,
- Voicemail group (BI-VMS) 519 with member 301 through 304

Six iDCS 28 button keyset are packaged with the OS7100 system and the line keys are preset and pre-labeled to support the OS7100 default configuration. If the iDCS 18 button keysets are connected to the OS7100 system they will also come up pre-configured to support the default line key layout. Please see the following diagram for the iDCS 28 and 18 button line key defaults.

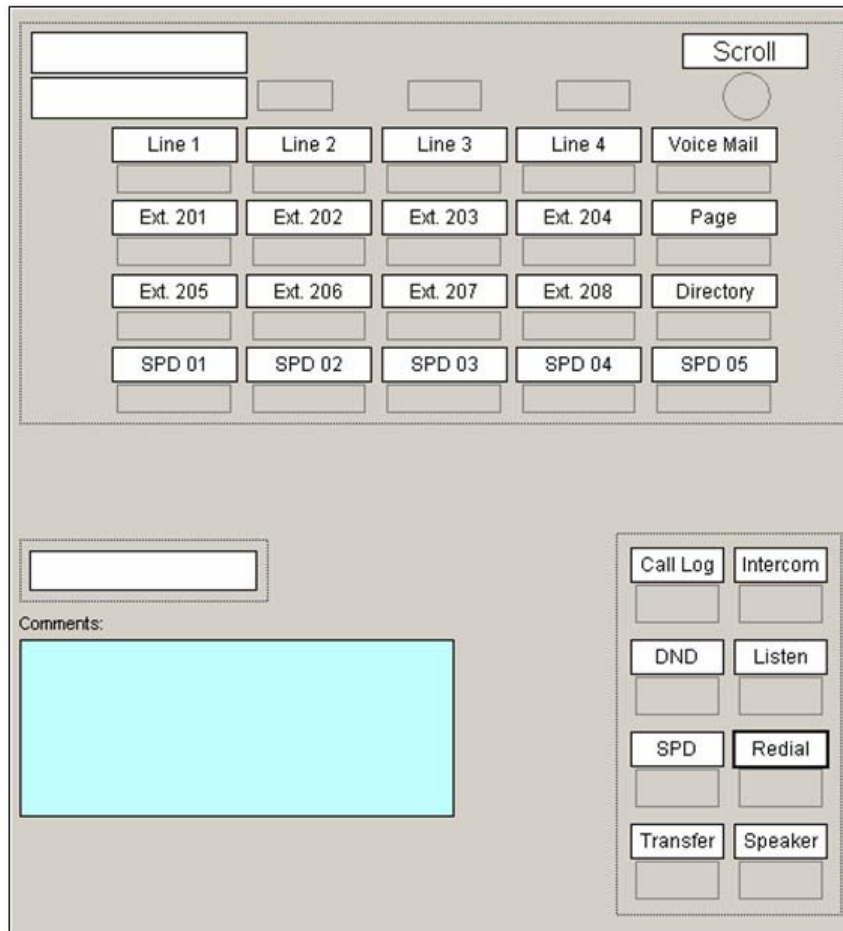

iDCS 28 Button Line Key Default

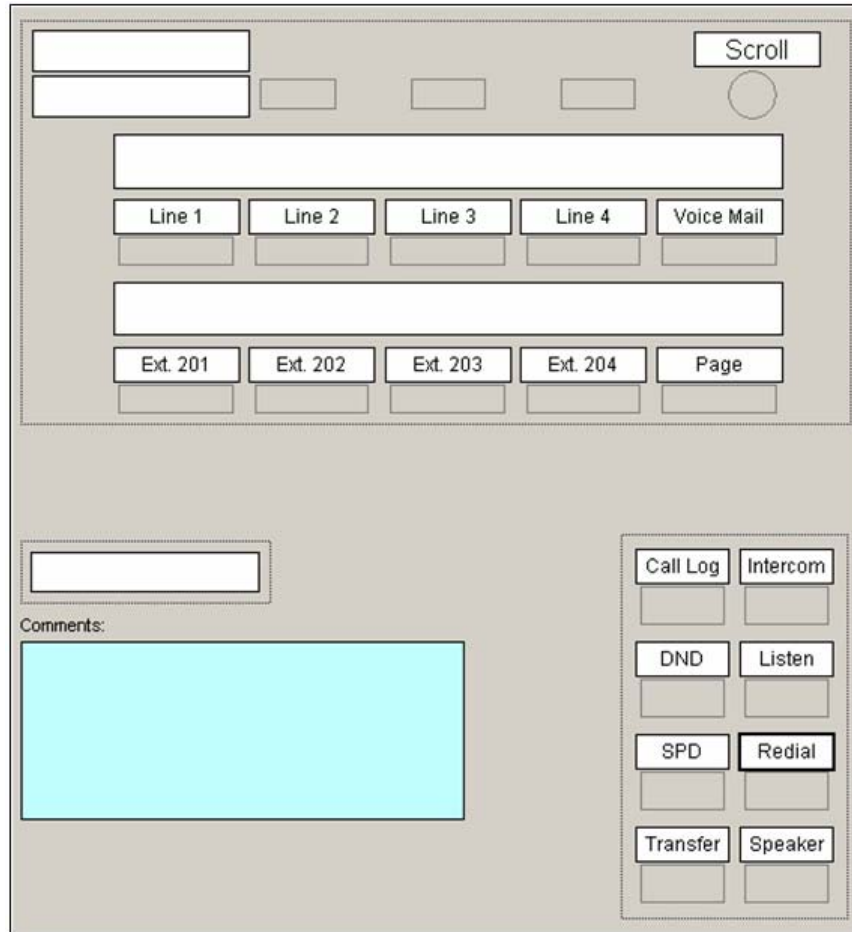

iDCS 18 Button Line Key Default

Note: Other types of iDCS, DS and ITP phones can be connected however the line keys will have a different default button configuration.

Once the OfficeServ 7100 system is booted, the MP10 card verifies the cards mounted on each slot and saves this information as the default configuration of the system. At default, the OfficeServ 7100 system assigns 3 digits to Co lines, extensions, and extension groups. Refer to Sections 3. Installing and Replacing cards of this manual for details on switch 2.

CO line numbers from 701 through 7XX are sequentially assigned (by default) to the first CO line card installed in the system from left to right and following numbers are continuously assigned to the next CO line card of the next slot.

Extension numbers from 201 through 2XX are sequentially assigned to the first station type card mounted in the system from left to right (starting from 4DLM if mounted on the MP10) and following numbers are continuously assigned to the next extension card of the next slot. This numbering process continues until the extension numbers are assigned to all extensions.

The first 8 ports are assigned to the operator group as default. Group 500 with members 201 through 208, and Voicemail Group 519 with members 301 through 304. The numbering plan of CO lines, extensions, and extension groups can also be changed in the database at any time using MMC 724 (STATION NUMBERING PLAN).

PART 9. SOFTWARE AND DATABASE MANAGEMENT

9.1 SOFTWARE MANAGEMENT

The OfficeServ 7100 operating software, Voicemail/Auto Attendant software, and all saved messages and greetings are stored on the MMC+ card which is inserted into the Media Card slot on the MP10. The MMC+ card has 256 Megabytes of NAND flash memory and is formatted, with a custom format to allow faster loading, in a similar manner to a hard disk. The MMC+ card also has the capability to store a backup copy of the system database in addition to the operating software files.

Software can be downloaded from the MMC+ card to the cards listed above using MMC 818 and will be stored in those cards on-card flash memory. The cards will automatically reboot, load and run the new software when the download process is complete. Files can be deleted using MMC 819, File Control. This is necessary to manage files on the MMC+ card.

Using Installation Tool over a LAN connection to the system, the software files can be uploaded to the MMC+ card. The files are first uploaded to the MP10 card and then transferred to the MMC+ card. Once the files are loaded onto the MMC+ card they can be manipulated with MMC 818.

9.2 DATABASE MANAGEMENT

The Customer database can be saved to the MMC+ card using MMC 815 where it is stored as a single file. This save can be performed manually or the system can be programmed to save the database automatically at a designated time every day. Using Installation Tool, the database can be downloaded from the system and stored on the PC or it can be uploaded from the PC to the system. The database uploaded from Installation Tool is not stored on the MMC+ card but is loaded directly into active memory.

PART 10. ADDING CARDS TO THE SYSTEM

10.1 ADDING STATIONS AND TRUNKS

- 1) Power the OfficeServ 7100 OFF before adding a new card. Locate a suitable empty card slot. Having located a suitable slot, insert the new card into the slot and push firmly in the middle of the card to ensure that it is fully inserted into the back plane connector.
- 2) After the new cards are inserted, the system must be told to recognize the new cards. This is done through the use of MMC 806 Card Pre-Install. Use this MMC for each new card that is installed.
- 3) The new cards must be assigned directory numbers according to the system numbering plan in MMC 724. The technician must know the software port assignments of the new cards so the ports can be assigned correct numbers.