

Republic of Iraq Ministry of Higher Education  
and Scientific Research  
University of Baghdad  
College of Science  
Department of Biology



# Physiology of Parasites 2020-2021

دكتوراه  
الفصل الدراسي الثاني

مدرس المادة  
ا.م.د. انتصار جبار صاحب

## **Introduction**

### **What is a parasite? Historical perspective, Importance of parasitology to man**

Parasites present a continual and unacceptable threat to the well-being of millions of people in the tropics and subtropics and to domesticated animals in all parts of the world and the cost of harboring parasites in terms of human misery and economic loss are incalculable.

Parasitology is the study of parasites and their interactions with their hosts. The science of parasitology has a long history and has its roots in zoology, with its emphasis on the identification and classification of parasites and the elucidation of the life cycle and tropical and veterinary medicine with their concern for the diseases caused by parasites. However, the subject is now so intertwined with microbiology, immunology, cell biology, molecular biology and other aspects of biology and medicine that its limits have become increasingly indistinct.

### **Parasitic Protozoa**

There are over 45000 named species of protozoa of which nearly 10000 are parasitic in invertebrates and in almost every species of vertebrate. It is, therefore, hardly surprising those humans and their domesticated animals should act as hosts to protozoa, but the diseases thus caused are out of all proportion to the number of species involved. The protozoa that infect humans range from forms that are never pathogenic to those that cause malaria, sleeping sickness, Chagas disease and leishmaniasis, now regarded as being among the major diseases of tropical countries, and which together threaten over one quarter of the population of the world. In domesticated animals, nagana and theileriosis take a major roll of cattle in Africa and coccidiosis, in its various forms, presents a continual threat to poultry and cattle throughout the world, particularly under conditions of intensive rearing. Even fish and invertebrates suffer from a variety of protozoan infections which create major problems for those trying to raise these animals for food.

Protozoa lie between the prokaryotic and higher eukaryotic organisms and share some of the characteristics of each. They are small, have short generation times, high rates of reproduction and a tendency to induce immunity to reinfection in those hosts that survive. These are features of infections with microparasites such as bacteria. On the other hand, protozoa are undoubtedly eukaryotic cells with organelles and metabolic pathways akin to those of the host. They have also evolved numerous adaptations that allow them to survive in their host and, in particular, to counteract or evade the immune response. For this reason, infections with parasitic protozoa are not short-lived as with most bacteria.

## **Structure and function of protozoa**

Protozoa are unicellular eukaryotic cells measuring 1-150 $\mu$ m. Structurally, each protozoan is the equivalent of a single metazoan cell with its plasma membrane, nucleus, nuclear membrane, chromosomes, endoplasmic reticulum, mitochondria, Golgi apparatus, ribosomes and various specialized structures adapted to meet particular needs. Parasitic protozoa are in no way simple or degenerate forms, and their particular adaptations frequently include complex life cycles and specialized ways of entering their hosts and maintaining themselves therein. Their nutrition, physiology and biochemistry are largely geared to the parasitic habit and are specialized rather than degenerate. Sexual reproduction also occurs in some protozoa and, in the parasitic forms, is particularly important in the sporozoans in which it provides for apparently limitless variation and adaptability.

## **Parasitic Helminths**

The vast majority of metazoan parasites of vertebrates are representatives of two phyla - the acoelomate Platyhelminthes and the pseudocoelomate Nematoda. 'Helminth' is a practically useful, but imprecisely defined, term which includes all the cestodes and digeneans in the former group and all the parasitic members of the latter. It is as the causative agents of a terrible list of debilitating, deforming and killing diseases of humans and their agricultural animals that helminths are principally studied.

Some helminth infections are numbered among the major human infectious diseases. Schistosomiasis (bilharzia) caused by digeneans of the genus *Schistosoma* which inhabit blood vessels, is the most important cause of morbidity with over 200 million infected persons in Africa, South America and the Far East. Even more sufferers exist in nontropical and subtropical zones with the major nematode diseases. It is quite conceivable that one billion are infected with both ascariases caused by *Ascaris lumbricoides* and Trichuriasis whose causative agent is *Trichuris trichiura*. Insect vector-transmitted filarial nematodes like *Wuchereria bancrofti*, *Brugia malayi* and *Onchocerca volvulus* cause highly pathogenic forms of filariasis that harm hundreds of millions of patients. Human cestode disease is a relatively nonpathogenic affliction although two types of larval cestodiasis- hydatid disease and cysticercosis - can both be highly injurious.

## **Structure and function of helminths**

Helminths are very diverse in their structure, physiology and behavior. This diversity results from their varying taxonomic origins, and partly from their multiple adaptations for their particular one-, two- or three-host life cycles.

Digenean and cestode platyhelminths share a solid triploblastic acoelomate body plan, with complex reproductive organs embedded in mesenchymal tissue, and a gut where present, possessing only a single, oral opening. The reproductive system is almost always hermaphroditic. All these worms possess a living syncytial body wall whose outer surface and secretory activity is differently modified in the two groups.

Nematodes possess a pseudocoelomate body cavity which plays an important hydrostatic skeletal role in locomotion. Most nematodes are dioecious, with the male and female reproductive organs located in the body cavities of the separate sexes. These worms have a body wall consisting of a syncytial hypodermis surrounded by an apparently non-living, mainly collagenous cuticle and underlain by groups of longitudinal muscles. In almost all species there is a functional gut with a mouth and anus.

Helminths use many different life cycle modes, and some like the nematode *Strongyloides stercoralis* and the cestode *Hymenolepis nana*, can use more than one mode. Direct life-cycle strategies, with only a single host species involved, are used by many gut-dwelling nematodes and also by *H. nana* in one of its life-cycle modes. Indirect life cycles are those in which more than one host species is used in order to complete one circuit of the parasites life history. In such cycles, the final or definitive host, that is the host in which parasitic sexual reproduction takes place, is almost always a vertebrate. The intermediate hosts, those in which development, growth, encystment or asexual multiplication occurs, can be vertebrates or invertebrates. Indirect life cycles with two or three hosts are the rule among digeneans and the vast majority of cestodes. Among the nematodes, filarial worms and *Dracunculus medinensis* (the guinea worm) utilize two-host indirect cycles). In the dioecious schistosomes and nematodes, sperm transfer between the sexes is obligatory. In the hermaphroditic digeneans and cestodes self-fertilization is sometimes possible but unidirectional or reciprocal cross-fertilization is nearly always favored. Parthenogenesis is rare, but is used by both the nematode *Strongyloides stercoralis* and the lung-inhabiting digenean *Paragonimus*.

Transmission of helminth infections from host to host is achieved by eggs or larvae. Eggs are usually directly ingested by a host. Larvae may be similarly ingested, consumed while attached to a plant or eaten while located in an intermediate host which acts as a prey item for the next host in the life cycle. Free-living mobile larval forms such as digenean miracidia and cercariae and LJ larval nematodes are often able to find, recognize and invade new hosts.

## **Classification of the protozoa**

The small size of protozoa coupled with the fact that they consist of single cells with few obvious morphological features means that their classification has had to be based on a wide range of characteristics including variations in life cycles, details of fine structure and, increasingly at the species level, biochemical and molecular differences.

At one time the protozoa were regarded as a phylum within the kingdom Animalia but protozoologists now believe that the group contains members that could be classified with animals, plants or fungi. Accordingly, the concept of Protozoa as a taxon has disappeared and the term is applied to the animal like members of the kingdom Protista.

Traditionally, the protozoa have been divided into four major groups distinguished by their mode of locomotion: the flagellates, which move by means of flagella; the amoebae, by pseudopodia; the ciliates, by cilia; and the sporozoans lacking any obvious means of locomotion. An abbreviated outline classification of the protozoa is given in Table 1.1.

**Table 1.1** An outline classification of the parasitic protozoa

---

**KINGDOM PROTISTA** (Single-celled eukaryotic organisms)

**Group 1** The flagellated protozoa (Locomotion by flagella)

**PHYLUM KINETOPLASTA** (1–2 flagella, kinetoplast present)

Order Trypanosomatida, e.g. *Leishmania*, *Trypanosoma*

**PHYLUM METAMONADA**

Order Retortamonadida, e.g. *Chilomastix*, *Retortamonas*

Order Diplomonadida, e.g. *Enteromonas*, *Giardia*

**PHYLUM PARABASALIA**

Order Trichomonadida, e.g. *Dientamoeba*, *Histomonas*, *Trichomonas*

**Group 2** The amoeboid protozoa (Locomotion by pseudopodia)

**PHYLUM RHIZOPODA**

Order Euamoebida, e.g. *Entamoeba*

**Group 3** The spore forming protozoa (No obvious means of locomotion)

**PHYLUM SPOROZOA** (= Apicomplexa)

Order Eimeriida, e.g. *Eimeria*, *Isospora*, *Sarcocystis*, *Toxoplasma*

Order Haemosporidida, e.g. *Plasmodium*

Order Piroplasmida, e.g. *Babesia*, *Theileria*

**PHYLUM MICROSPORIDIA**

Order Microsporidida, e.g. *Encephalitozoon*, *Noxema*

**Group 4** The ciliated protozoa (Locomotion by cilia)

**PHYLUM CILIOPHORA**

Order Trichostomatida e.g. *Balantidium*

---

### Kinetoplastid Flagellates

The kinetoplastid flagellates are characterized by the possession of a unique organelle called the kinetoplast which contains DNA and is an integral part of the mitochondrial system. The kinetoplast is situated near the base of the flagellum and is easily seen in stained preparations. Kinetoplastid flagellates are found in invertebrates and vertebrates, the genera in mammals being *Leishmania*, *Trypanosoma* and *Endotrypanum* which are transmitted by insects. The typical form is an elongated organism, called a promastigote, with a kinetoplast and a flagellum at the anterior end. Variations of this form are brought about by the migration of the kinetoplast-flagellum complex within the body of the flagellate associated with changes in the mitochondrial system. The forms in the life cycle of a kinetoplastid flagellate are shown in Fig. 1.1.

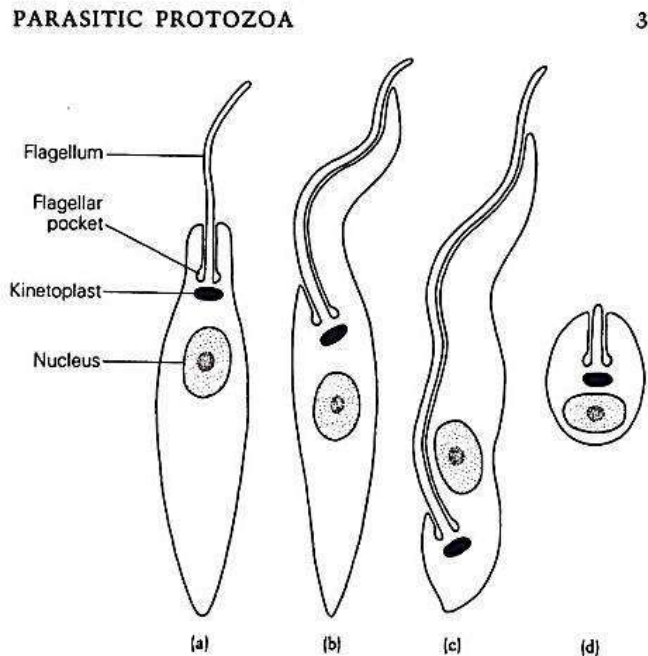

**Fig. 1.1** Forms in the life cycle of a kinetoplastid flagellate.  
 (a) Promastigote. (b) Epimastigote.  
 (c) Trypomastigote.  
 (d) Amastigote.

### Trypanosomes of humans in South America

*Trypanosoma cruzi* (Figs 1.2a, 1.3a) infects 11- 12 million people in South and Central America and is infective to about 100-150 species of wild and domesticated mammals. The vectors are bugs belonging to the family Reduviidae of which three genera are important in the spread of the human disease. When the bug takes up infected blood the trypanosomes multiply in the epimastigote form in the hind gut and infective or metacyclic forms are passed out with the faeces. These infect the human host if they are rubbed into the bite another wound or the

conjunctiva of the eye. Within the human host, the trypanosomes enter various cells, particularly macrophages, muscle and nerve cells, where they round up and multiply in the amastigote form. The amastigotes develop into trypomastigotes that either enter new cells or are taken up when a vector feeds.

The disease is called Chagas disease and takes various forms depending on where the amastigotes develop, the most serious consequences being cardiac failure due to parasites in the heart muscles or the loss of the nervous control of the alimentary canal due to parasites in the nervous system.

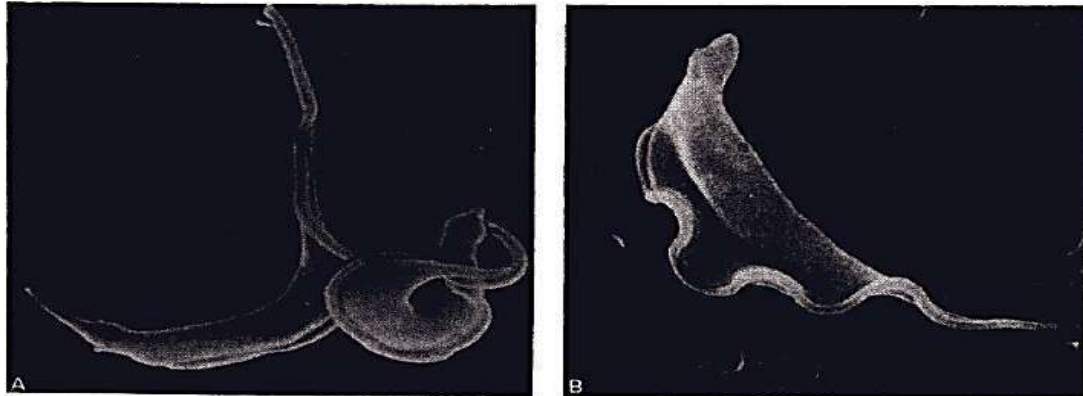

Fig. 1.2 Scanning electronmicrographs of (A): *Trypanosoma cruzi* and (B): *T. brucei*.  $\times 2340$ . (Photograph (A) kindly given by Dr. D. Snary and (B) by Professor K. Vickerman.)

## Trypanosomes of humans in Africa

In contrast to the American trypanosomes the African trypanosomes typically develop in the midgut of the vectors, which are tsetse flies belonging to the family Glossinidae, and are injected from the salivary glands when the fly feeds. Two subspecies infect humans, *T. brucei gambiense* and *T.b. rhodesiense* (Fig. 1.3b-d) the former in riverine conditions in West and Central Africa where it causes chronic sleeping sickness, and the latter in the savanna of East Africa where it causes acute sleeping sickness, although the distinctions between these two forms of the disease are blurred. Both *T.b. gambiense* and *T.b. rhodesiense* can infect a range of mammalian hosts and some of these are important reservoirs of *T.b. rhodesiense*. Natural reservoirs of *T.b. gambiense* seem to be less important because the infection is essentially a human-human one although pigs may be a source of human infection in some places. The vector of human sleeping sickness is the tsetse fly, *Glossina*; the wet flies of the *G. palpalis* group transmit *T.b. gambiense* and dry flies of the *G. morsitans* group transmit *T.b. rhodesiense* but, again, these distinctions are not absolute. The life cycles of these parasites are the same as that of *T.b. brucei*. The main cause of sleeping sickness as a disease is the invasion of the nervous system by the trypanosomes.



## Leishmania

The leishmanial parasites exhibit only two forms in their life cycles; amastigotes (Fig. 1.5a) in macrophages of the mammalian host and promastigotes (Fig. 1.5b) in the gut of the vector which is a sandfly (Diptera, Psychodidae). *Leishmania* species cause serious diseases in humans.

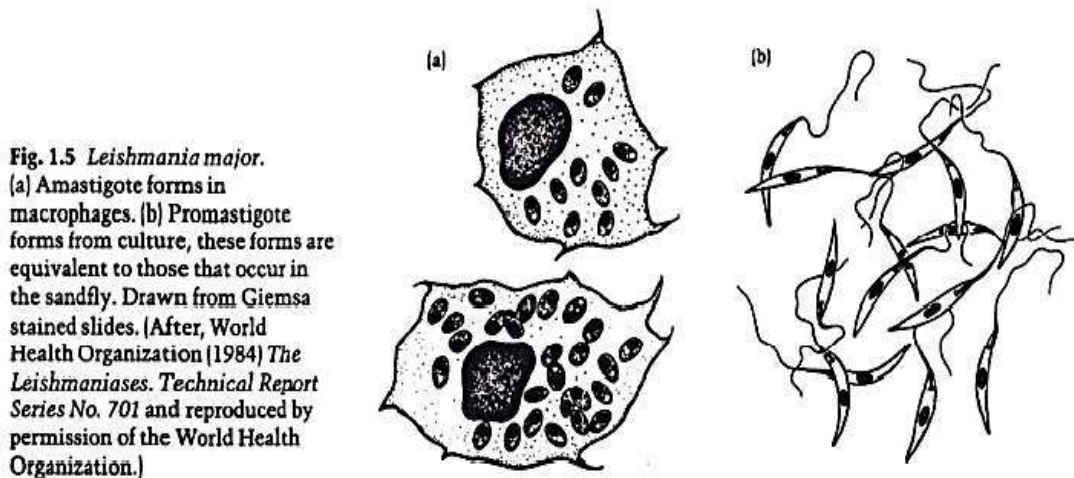

The typical infection is cutaneous but in many species, and in particular individuals, the parasites may invade subcutaneous or deeper tissues causing hideous and permanent disfiguration. The most serious disease, kala-azar, involves the macrophages of organs such as the liver. Leishmaniasis is now known to be caused by a complex of species and subspecies. As the morphology of all these parasites is similar, the identification of species and subspecies tends to be based on isoenzyme and DNA techniques. The classification of these parasites is still in a state of flux following a change of emphasis away from morphological and disease-associated characteristics towards biochemical and molecular criteria. The most widely used scheme is summarized in Table 1.3. In the Old World, the main species causing cutaneous leishmaniasis are *L. tropica* and *L. maior* and the species causing visceral leishmaniasis is *L. donovani*. In the New World *L. chagasi* causes visceral leishmaniasis but cutaneous and mucocutaneous leishmaniasis are caused by several species including *L. braziliensis*, *L. mexicana* and *L. peruviana*.

**Table 1.3** The main species of *Leishmania* that cause human disease

Species	Disease	Distribution	Reservoir	Vector
<b>OLD WORLD</b>				
<i>L. tropica</i>	Dry cutaneous; urban	Europe, Asia, N. Africa	Dogs	<i>Phlebotomus</i>
<i>L. major</i>	Wet cutaneous; rural	Asia, Africa	Rodents	<i>Phlebotomus</i>
<i>L. aethiopica</i>	Dry cutaneous; diffuse	Ethiopia, Kenya	Hyrax	<i>Phlebotomus</i>
<i>L. donovani</i>	Visceral (kala-azar)	Africa, Asia	–	<i>Phlebotomus</i>
<i>L. infantum</i>	Infantile visceral	Mediterranean	Dogs, foxes	<i>Phlebotomus</i>
<b>NEW WORLD</b>				
<i>L. mexicana</i>	Cutaneous	Central America	Rodents	<i>Lutzomyia</i>
<i>L. amazonensis</i>	Cutaneous	Brazil	Rodents, etc.	<i>Lutzomyia</i>
<i>L. pifanoi</i>	Cutaneous	Venezuela	Rodents	<i>Lutzomyia</i>
<i>L. venezuelensis</i>	Cutaneous	Venezuela	?	<i>Lutzomyia</i>
<i>L. braziliensis</i>	Mucocutaneous	Brazil	Rodents	<i>Lutzomyia</i>
<i>L. guyanensis</i>	Cutaneous	S. America	?	<i>Lutzomyia</i>
<i>L. panamensis</i>	Cutaneous	Panama	Sloths, etc.	<i>Lutzomyia</i>
<i>L. peruviana</i>	Cutaneous	S. America	Dogs	<i>Lutzomyia</i>
<i>L. chagasi</i>	Visceral	S. America	Foxes	<i>Lutzomyia</i>

### Intestinal and related flagellates

A number of flagellates occur in the alimentary canals of humans and domesticated animals and similar species are found in laboratory animals. In most cases, the life cycles are very simple and involve the ingestion of food or water contaminated with encysted forms which excyst in the intestine where multiplication by binary fission takes place. Large infestations can build up but the infections are seldom harmful although some may cause gastro-intestinal disorders. Flagellates similar to those in the intestine can occur in other parts of the body, such as the urinogenital system, and these may cause more serious infections.

### Intestinal and related forms in humans

Eight species of flagellate are ubiquitous and common parasites of the human gastro-intestinal tract or urinogenital system (Table 1.4). Few do any real harm but some occasionally give rise to unpleasant symptoms which can usually be easily treated. *Giardia duodenalis* (Fig. 1.6a) which is also known as *G. lamblia*, *G. intestinalis*, is found in the upper part of the small intestine where large infestations may cause malabsorption particularly in children. The overall prevalence is usually 1-30% but can reach 70% in unsanitary institutions.

Three species of *Trichomonas* are common in all parts of the world: *T. hominis* occurs in the caecum and large intestine, *T. tenax* in the mouth and *T. vaginalis* [Fig. 1.6b) in the vagina and urethra of women and in the urethra, seminal vesicles and prostate of men. *Trichomonas vaginalis* may cause inflammation and discharge and is an increasingly important venereal disease afflicting some 180 million women. These trichomonads do not form cysts: *T. hominis* forms rounded

resistant stages while *T. vaginalis* and *T. tenax* are transmitted by direct contact. *Chilomastix mesnili* is rare and harmless. *Dientamoeba fragilis* is transmitted through the eggs of the pinworm *Enterobius vermicularis* and may cause diarrhoea.

**Table 1.4** Intestinal amoebae and flagellates and related forms in humans

Species	Cysts	Site	Pathology
<i>Entamoeba histolytica</i>	[C]	Colon/liver	Ulceration, diarrhoea
<i>E. hartmanni</i>	[C]	Colon	None
<i>E. coli</i>	[C]	Colon	None
<i>E. gingivalis</i>	–	Mouth	Gingivitis
<i>Endolimax nana</i>	[C]	Colon/caecum	None
<i>Iodamoeba buetschlii</i>	[C]	Colon/caecum	None
<i>Trichomonas vaginalis</i>	–	Vagina/urethra	Vaginitis, urethritis
<i>T. tenax</i>	–	Mouth	None
<i>T. hominis</i>	–	Colon	None
<i>Dientamoeba fragilis</i>	–	Colon/caecum	None
<i>Giardia duodenalis</i>	[C]	Duodenum	Diarrhoea
<i>Retortamonas intestinalis</i>	[C]	Colon/caecum	None
<i>Enteromonas hominis</i>	[C]	Colon/caecum	None
<i>Chilomastix mesnili</i>	[C]	Colon/caecum	None

**Fig. 1.6** Scanning electronmicrographs of (a) *Giardia duodenalis* and (b) *Trichomonas vaginalis*. The sucking disc of *Giardia* and the undulating membrane of *Trichomonas* are characteristic features. (a)  $\times 2520$ , (b)  $\times 1260$ . (Both photographs kindly given by Professor V. Zaman.)

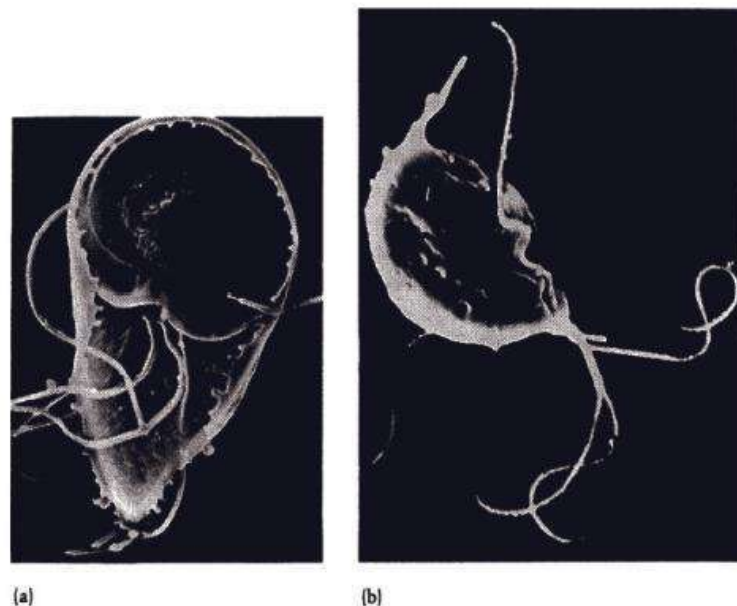

## Parasitic Amoebae

Six species of amoebae are common in humans in most parts of the world but only one, *Entamoeba histolytica*, is an important pathogen.

### *Entamoeba histolytica*

This parasite occurs throughout the world in humans, apes, monkeys, dogs, cats and rats. The trophozoite, or feeding stage (Fig. 1.7a) inhabits the lower small intestine and colon where it multiplies by binary fission and forms characteristic four-nucleated cysts (Fig. 1.7b) which are passed out and subsequently ingested in contaminated food or water. Sometimes the amoebae invade the mucosa and submucosa and may be carried via the portal vein to the liver and other parts of the body. Considerable damage may be caused in the wall of the bowel or in the liver. In most people, there is no tissue invasion and the parasite causes no harm. The symptoms following the invasion of the tissues are variable but usually include diarrhoea or dysentery with the loss of blood (amoebic dysentery).

### Other intestinal amoebae of humans

There are four other amoebae commonly found all over the world. *Entamoeba hartmanni*, once regarded as a small form of *E. histolytica*, resembles the pathogenic form but has smaller cysts. *Entamoeba coli* (Fig. 1.7c) is the most common amoeba in humans and has cysts with eight nuclei. *Endolimax nana* inhabits the upper part of the colon and has four-nucleate cysts. *Iodamoeba buetschlii* has cysts with a single nucleus. None of these four parasites is pathogenic.

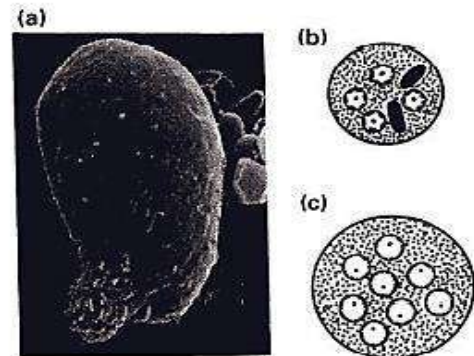

Fig. 1.7 Parasitic amoebae. (a) Trophozoite of *Entamoeba histolytica*  $\times 1325$  (scanning electronmicrograph kindly given by Professor V. Zaman). (b) *Entamoeba histolytica* cyst and (c) *E. coli* cyst drawn from stained slides.

### Facultative amoebae of humans

There have been occasional reports of free-living amoebae infecting humans, sometimes with fatal results. Several species of *Acanthamoeba* can cause upper respiratory tract infections in immunocompromised individuals. *Naegleria fowleri* and other *Naegleria* species have been implicated in primary meningoencephalitis in otherwise healthy individuals.

## **Coccidia**

The coccidia are very common parasites mainly of the intestinal tracts of vertebrates. Some are major pathogens of domesticated animals and losses attributed to them run into millions of pounds or dollars each year. The life cycle usually involves one host and is shown in fig. 1.8. There are a number of minor variations to this basic pattern mainly relating to the site of the infection and the number of schizogonic generations. The genera are identified on the morphology of the infective stage or oocyst. Each oocyst contains a number of sporocysts each containing sporozoites. In the two most important genera, the oocysts of *Eimeria* contain four sporocysts while those of *Isospora* contain two.

## **Toxoplasma and related coccidia**

Until 1970, all coccidians with two sporocysts in the oocyst were classified as *Isospora* species and it was assumed that all had simple life cycles in a single host like that of *Eimeria*. Since 1970, it has become clear that many of these isosporans develop in an intermediate host which may or may not be obligatory. In such life cycles, the oocysts or sporocysts are passed out from the definitive host and are ingested by an intermediate host within which multiplication in various organs occurs and eventually cysts are formed which, when ingested by the definitive host, initiate the typical coccidian life cycle once again. The problem has been that the parasites in the intermediate hosts were all well-known and had been given valid names. The various parts of each life cycle have now been put together and it is possible to identify each parasite from the stages in either the definitive or the intermediate host. The most important species are given in Table 1.6. This group now includes seven genera, whose characteristics are summarized below. *Isospora* is classified on the basis of stages in the definitive host while all the others are classified by stages in the intermediate host.

- *Isospora*. Direct life cycle.
- *Toxoplasma*. Intermediate host not essential. Development in the lymphoid macrophage system. Cysts thin-walled containing many organisms.
- *Cystoisospora*. Intermediate host not essential. Similar to *Toxoplasma* but thin-walled cyst contains only one infective organism.
- *Sarcocystis*. Septate cysts in muscle of intermediate host.
- *Besnoitia*. Thick-walled cysts in connective tissue of intermediate host.

If, however, the oocysts are ingested by other warm-blooded animals, multiplication occurs in various cells of the body and eventually cysts are formed. If the intermediate host is eaten by a definitive host, the parasite enters the cells of the gut and reverts to a normal eimerian life cycle. If, on the other hand, the intermediate



host is eaten by another potential intermediate host disseminated infections occur as before. The infection may cause no symptoms or it may kill the intermediate host. Most humans acquire their infections from undercooked meat or from cats. Infections are normally symptomless but in the unborn fetus or immunosuppressed patients they may be very serious and occasionally in healthy individuals they may cause ocular damage. Toxoplasmosis can also cause serious infections in puppies and lambs.

## **Cryptosporidium**

The genus *Cryptosporidium* is relatively common parasites in the intestinal and respiratory tract of mammals, birds and reptiles. Two species occur in mammals, *C. muris* and *C. parvum*, the latter causing gastrointestinal disorders in cattle, sheep and humans. The life cycle is typically coccidian and is confined to a single host. The oocysts, which contain four sporozoites, are long-lived and are extremely resistant to normal water purification procedures so contaminated drinking water constitutes the main source of infection. In recent years there has been an increasing number of epidemics of cryptosporidiosis. The infection is unpleasant but not normally dangerous except in immunocompromised individuals, such as AIDS sufferers, in which it can be fatal. There is no effective drug against this organism.

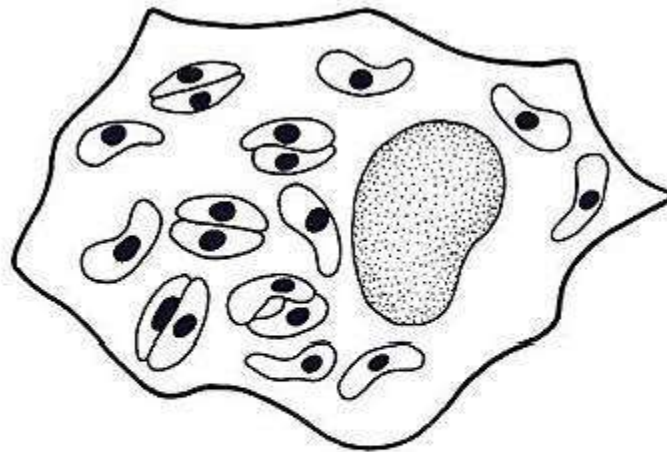

**Fig. 1.9** *Toxoplasma gondii* zoites in a macrophage of an experimentally infected mouse. Drawn from a Giemsa stained slide. (The large stippled structure is the host cell nucleus.)

**Fig. 1.10** The life cycle of *Toxoplasma*. The life cycle begins when oocysts are swallowed by a cat and the sporozoites are released in the gut. A typical eimerian life cycle with schizogony and the formation of gametocytes occurs and eventually oocysts are formed and the cycle is repeated if these are swallowed by cats. If the oocysts are swallowed by mice, schizogony occurs in various parts of the body but no oocysts are formed. Instead cysts are produced that lie dormant until the host is eaten. If eaten by a cat the normal eimerian life cycle follows. If eaten by another host an infection similar to that in mice occurs. This may occur in a variety of mammals including herbivores. Man becomes infected either by oocysts from cats or by eating infected meat. Congenital transmission in this alternative cycle also occurs.

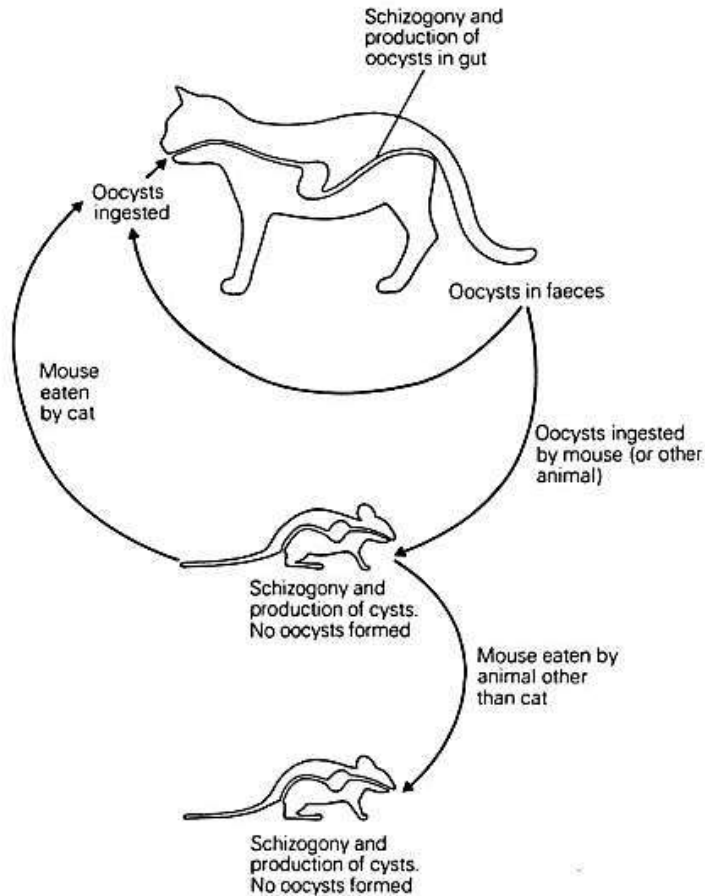

## Malaria Parasites

The malaria parasites belong to the same phylum as the coccidians but to a different order, the Haemosporidida, members of which, as the name implies, are parasitic in the blood of vertebrates. All use dipteran insects as their vectors. The malaria parasites of mammals all belong to the genus *Plasmodium*, the life cycle of which is shown in Fig. 1.11, and are transmitted by female mosquitoes belonging to the genus *Anopheles*.

## Malaria parasites of humans

Human malaria is one of the most important diseases in the world with over 500 million people at risk in tropical and subtropical parts of the world especially Africa. Malaria is caused by four species of *Plasmodium*: *P. falciparum*, *P. vivax*, *P. ovale* and *P. malariae* (Table 1.7). The disease is characterized by periodic fevers coinciding with the liberation of merozoites during the erythrocytic phase of the infection; these fevers occur every 72 hours in the case of *P. malariae* and every 48

hours in the other species. In all species, there is a single phase of exoerythrocytic schizogony and in *P. falciparum* and *P. malariae* this phase lasts for 5-15 days. After this, the only parasites in the body are those in the blood and subsequent bouts of fever are caused by recrudescences of these blood forms. In *P. vivax* and *P. ovale* some of the parasites in the liver lie dormant for several years and subsequent infections due to the maturation of these forms are called relapses.

*Plasmodium falciparum* causes malignant tertian malaria and is the most common and serious of all the forms of malaria. The infection is acute and the parasites tend to stick to endothelial cells causing blockage and cerebral damage, often resulting in death. *Plasmodium vivax* causes benign tertian malaria and is the second most serious infection. *Plasmodium ovale* causes ovale tertian malaria and is concentrated in West Africa. *Plasmodium malariae* causes quartan malaria and infections may last 30 years or more. Infections with these last three parasites, although debilitating are seldom fatal in themselves.

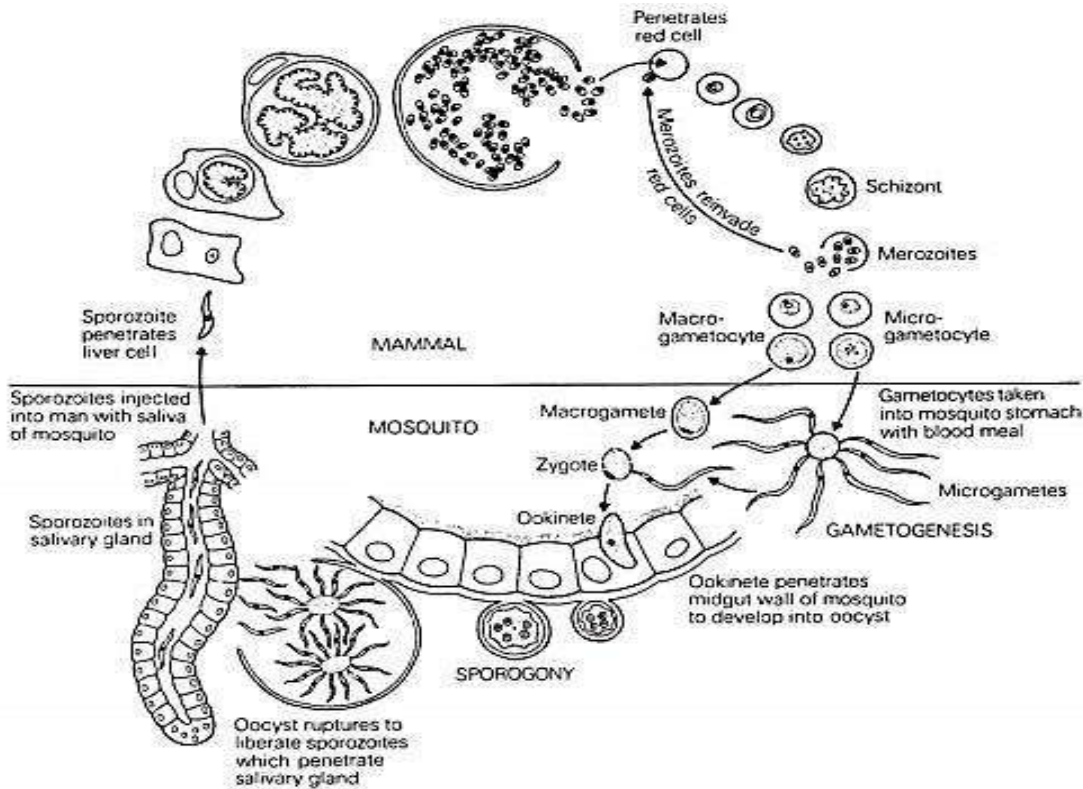
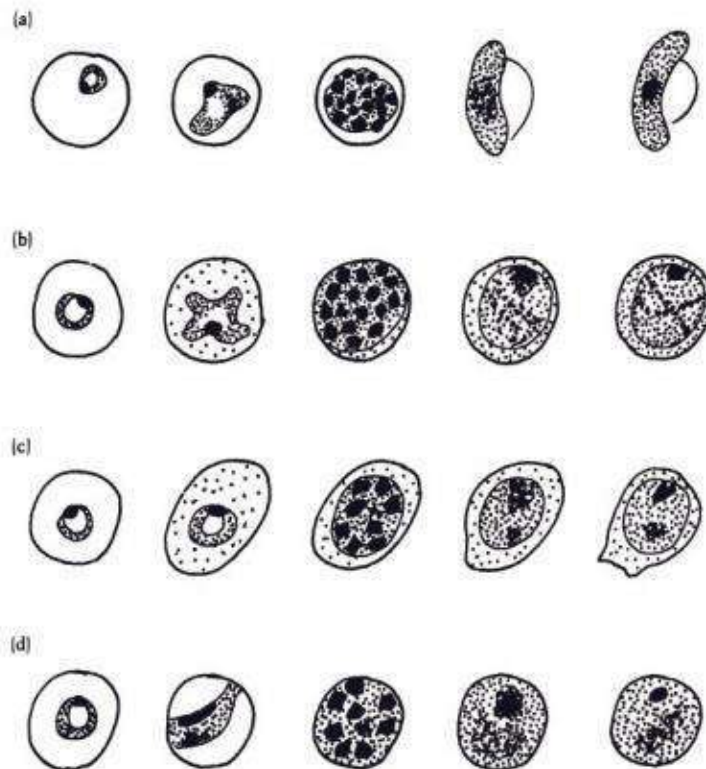

**Fig. 1.11** The life cycle of *Plasmodium* spp. in mammals. The infection begins when sporozoites are injected directly into the bloodstream from the salivary glands of a mosquito. The sporozoites enter liver cells where they begin a phase of multiplication called 'exoerythrocytic schizogony', during which thousands of uninucleate merozoites are formed. These enter red blood cells in which they undergo a second phase of multiplication or erythrocytic schizogony, during which fewer than 24 merozoites are formed. These merozoites invade new red blood cells and the cycle may be repeated many times. Some of the merozoites are capable of developing into sexual stages or gametocytes. These are taken up by a mosquito. In the gut of the mosquito microgametes are produced and these fertilize the macrogametes and the resulting zygote or ookinete bores through the gut wall to come to lie on the outer surface where it forms an oocyst. Within the oocyst a third stage of multiplication occurs resulting in the formation of sporozoites that enter the salivary glands of the mosquito. [After K. Vickerman and F.E.G. Cox, 1967, *The Protozoa*, John Murray, London.]



**Table 1.7** Malaria parasites affecting humans

Species	Disease	Periodicity (hours)	Distribution
<i>P. vivax</i>	Benign tertian	48	Cosmopolitan, between summer isotherms 16°N and 20°S
<i>P. ovale</i>	Ovale tertian	48	Mainly tropical W. Africa
<i>P. falciparum</i>	Malignant tertian	48	Cosmopolitan, mainly tropics and subtropics
<i>P. malariae</i>	Quartan	72	Cosmopolitan but patchy



**Fig. 1.12** Malaria parasites from human blood. (a) *Plasmodium falciparum*. (b) *P. vivax*. (c) *P. ovale*. (d) *P. malariae*. From left to right: ring stage, trophozoite, mature schizont, microgametocyte and macrogametocyte. In the case of *P. falciparum* only the ring stage and gametocytes appear in the peripheral blood. All drawn from Giemsa stained slides.

## Ciliophora

The Ciliophora is a distinct phylum, considered by some to be a subkingdom, containing 4700 free living and 2500 parasitic species. Parasitic ciliates occur in most groups of vertebrates and invertebrates and those in amphibians and earthworms are frequently encountered in elementary biology classes. Few of the parasitic ciliates are of any economic importance.

### Balantidium coli

*Balantidium coli* (Fig. L16) is a common parasite of pigs in all parts of the world and has also been recorded in rats, dogs, monkeys, apes and humans. It is difficult to know how many human cases there have been but about 1000 have been recorded, mainly in the tropics. The ciliate lives in the lumen of the large intestine and may invade the gut wall where it produces ulcers resembling those caused by *Entamoeba histolytica* although the majority of cases are asymptomatic. Transmission is by cysts and epidemiological evidence suggests that most human infections are acquired from pigs.

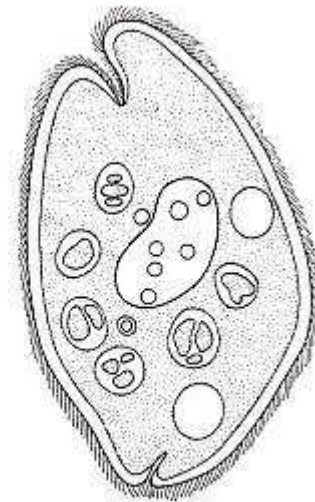

Fig. 1.16 *Balantidium coli* from *in vitro* culture.  
Drawn from a haematoxylin stained slide.

## Classification of parasitic helminths (Platyhelminth, Nematoda)

Table 2.I provides a working outline classification for the helminth groups.

**Table 2.1** An outline classification of helminths parasitic in vertebrates

---

**PHYLUM: PLATYHELMINTHES**

**Class 1 Monogenea**

**Class 2 Cestoda** (*Diphyllobothrium, Taenia, Echinococcus*)\*

**Class 3 Aspidogastrea**

**Class 4 Digenea** (*Schistosoma, Fasciolopsis, Fasciola, Paragonimus*)

**PHYLUM: NEMATODA**

**Order 1 Rhabditida** (*Strongyloides*)

**Order 2 Strongylida** (*Necator, Ancylostoma, etc.*)

**Order 3 Ascaridida** (*Ascaris, Toxocara, etc.*)

**Order 4 Oxyurida** (*Enterobius*)

**Order 5 Spirurida** (*Dracunculus, Wuchereria, Brugia, Loa, Onchocerca*)

**Order 6 Enoplida** (*Trichinella, Trichuris*)

---

\* Important genera which infect man are listed after the appropriate taxa.

### Platyhelminth Parasites of Vertebrates

Of the four classes of entirely parasitic platyhelminths, only two, the Cestoda and Digenea, cause important diseases in humans or agricultural animals, although monogeneans of fish can cause serious losses in stocks kept under high density fish farming conditions.

### Cestodes

With very few exceptions they all share two remarkable attributes: (1) they possess no gut; and (2) they have a very elongated body, often hundreds of times longer than broad. One small subclass, the Cestodaria, have compact non-segmented bodies, but members of the principal subclass, the Eucestoda, have a

characteristically segmented adult body made up of a string of proglottids each of which contains in time a complete set of reproductive organs (Fig. 2.1). A mature adult eucestode may consist of several thousand proglottids behind an anterior attachment organ - the scolex - which is equipped with muscular grooves or suckers and sometimes also with hooks (Fig. 2.1). The serial multiplication of hermaphroditic reproductive organ sets which the segmented body represents is an extraordinary modification for enhanced reproductive capacity. It avoids the production constraints of a single reproductive system and enables individual cestodes to sustain daily egg outputs of hundreds of thousands or even millions of eggs.

The body wall of a cestode is a living syncytial tegument, the outer plasma membrane of which is thrown into a regular array of specialized microvilli termed microtriches, each surrounded by an electron-dense spine. Microtriches produce a large amplification of surface area, operating in a digestive absorptive manner in these gutless helminths to acquire external nutrients. Organic molecules of low molecular weight are absorbed by diffusion and active transport mechanisms across the plasma membrane. The latter also bears intrinsic phosphohydrolases which probably play a role in nutrient uptake. There is evidence that the tegument can also absorb macromolecules such as proteins by endocytosis. This repertoire of nutrient uptake techniques seems to restrict adult eucestodes to nutrient-rich internal locations within their vertebrate final hosts. The vast majority are found in the lumen of the small intestine attached to its mucosa by their scoleces. Except for *Hymenolepis nana*, all eucestodes exhibit only an indirect life cycle with larval (metacestode) development and or asexual multiplication occurring in one or two intermediate hosts. Figure 2.2 illustrates a selection of cestode larvae.

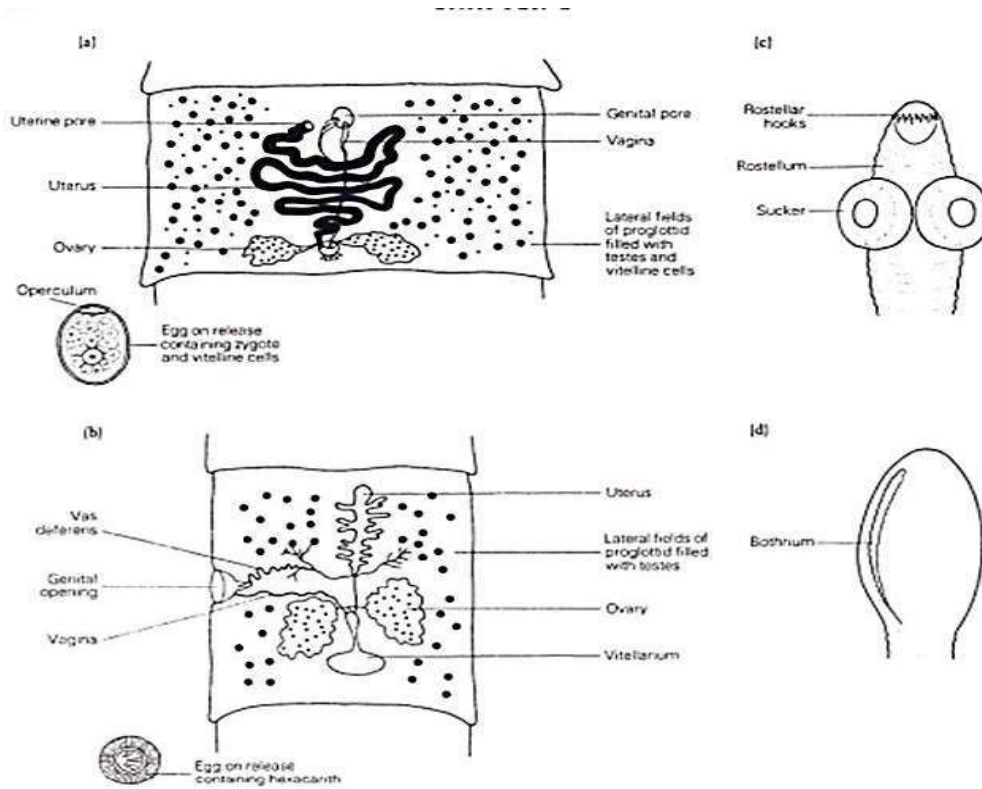

**Fig. 2.1** Proglottids, eggs and scoleces of pseudophyllidean and cyclophyllidean cestodes. (a) Proglottid of *Diphylllobothrium latum*, a pseudophyllidean, demonstrating extensive areas of vitelline cells, genital openings on the ventral proglottid surface, and a uterine pore through which the gravid uterus can communicate with the outside world. The egg of *D. latum* when released is unembryonated. The egg of *D. latum* when released in human faeces contains a fully formed hexacanth larva. (b) Mature proglottid of *Taenia saginata* or *T. solium*, demonstrating a lateral genital opening and a uterus which does not directly communicate with the outside world. The egg of *T. saginata* or *T. solium* when released in human faeces contains a fully formed hexacanth larva. (c) The scolex of the cyclophyllidean *Echinococcus granulosus* from the dog gut, with four suckers and a hooked rostellum.

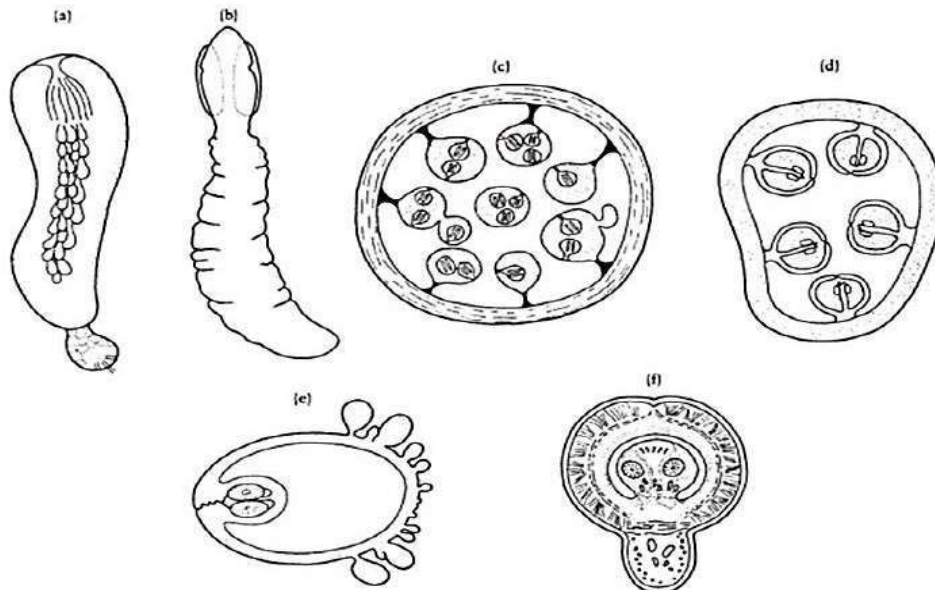

**Fig. 2.2** Cestode larval stages. (a) Procercoid larva of *Diphylllobothrium latum* with a central core of gland cells and retained hooks from the hexacanth stage. (b) Plerocercoid larva of *D. latum* with anterior bothria present. (c) Hydatid cyst of *Echinococcus granulosus* with an outer laminated layer and proliferative brood capsules within it containing infective protoscoleces. (d) Coenurus larva of *Multiceps multiceps* with infective protoscoleces budding directly from a germinal membrane. (e) Cysticercus larva of *Taenia crassiceps* with scolex invaginated into wall of bladder. The posterior portions of the external bladder produce new cysticerci by exogenous budding. Such budding does not occur from the otherwise similar cysticerci of *T. saginata* and *T. solium*. (f) Cysticercoid larva of *Hymenolepis nana* with the invaginated scolex housed within an anterior vesicle.



## Human cestodiasis

**Table 2.2** An outline classification of pseudophyllidean and cyclophyllidean cestodes

**Class: Cestoda**

**Subclass: Eucestoda**

**Order 1: Pseudophyllidea.** Scolex with two long superficial bothria. Mainly gut-dwelling parasites of non-clasmobranch fish, fish-eating mammals including man and birds. Proglottids dorso – ventrally flattened, usually bearing the uterine pore and genital apertures medially on the ventral surface. Each egg hatches in water to release a ciliated coracidium larva containing a hexacanth. Indirect life cycles including proceroid and plerocercoid larvae, e.g. *Spirometra*, *Diphyllobothrium*

**Order 2: Cyclophyllidea.** Scolex typically with four large suckers surmounted with a muscular rostellum normally armed with hooks. Gut-dwelling parasites of amphibians, reptiles, birds and mammals including man. Eggs contain non-ciliated hexacanth larvae. Genital apertures marginal on proglottids. Posterior gravid proglottids often shed containing eggs. Indirect life cycles include a variety of nonproliferative and proliferative larval forms in vertebrate and invertebrate intermediate hosts, e.g. *Taenia*, *Echinococcus*

The species that cause human disease all fall within two well-recognized and orders the Pseudophyllidea and the Cyclophyllidea. Table 2.2 outlines the major differences between these two groups.

Table 2.3 lists the main examples of human cestodiasis and Fig. 2.3 describes the life cycles of a typical pseudophyllidean and cyclophyllidean - *Diphyllobothrium latum* and *Taenia saginata*.

**Table 2.3** Human cestodiasis

Parasite*	Disease	Adult (A) or larval (L)	Location of worms in man	Geographical distribution	Typical pathology
<b>PSEUDOPHYLLIDEANS</b>					
<i>Diphyllobothrium latum</i>	Diphyllobothriasis	A	Lumen of small intestine	Finland, Central Europe, Italy, France, Ireland, Japan, Siberia, Argentina, Great Lakes area of USA and Canada	Very rarely pernicious megaloblastic anaemia
<i>Spirometra</i> spp.	Sparganosis	L	A variety of deep tissues	Tropical and subtropical regions of Africa, N. and S. America, Europe, Far East and Australasia	Mild, various
<b>CYCLOPHYLLIDEANS</b>					
<i>Taenia saginata</i>	Beef tapeworm infection	A	Lumen of small intestine	Cosmopolitan	Very infrequently gut obstruction or perforation
<i>T. solium</i>	Pork tapeworm infection	A	Lumen of small intestine	Cosmopolitan	Very infrequently gut obstruction or perforation; risk of cysticercosis
<i>T. solium</i>	Cysticercosis	L	A variety of deep tissues including the brain	Cosmopolitan, but particularly in S. and Central America, USSR, India and S. and E. Africa	A range of brain pathologies are produced by larvae in the CNS, including epilepsiform attacks
<i>Hymenolepis nana</i>	Dwarf tapeworm infection	A	Lumen of small intestine	Cosmopolitan especially in children	Usually none, diarrhoea and abdominal pain in heavy infections
<i>Echinococcus granulosus</i>	Echinococcosis: hydatid disease	L	A variety of deep tissue sites with liver and lungs predominating	Most sheep and cattle farming areas of the world	Various, depending on the site of the hydatid cysts

\*A number of other cestodes occasionally infect man, namely *Bertiella stuederi*, *Dipylidium caninum* and *Hymenolepis diminuta* (adult cestodiasis); *Echinococcus multilocularis*, *Mesocostoides* spp. and *Multiceps* spp. (larval cestodiasis).

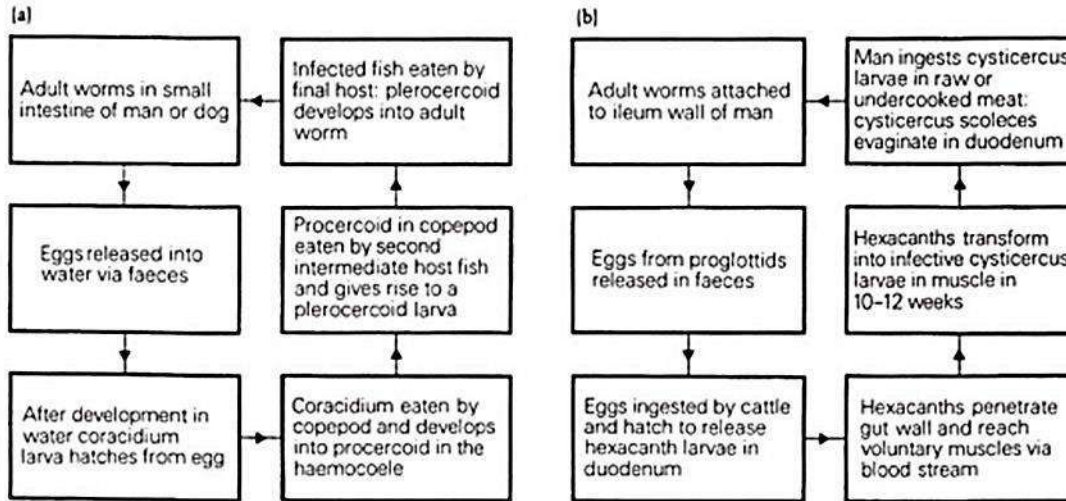

Fig. 2.3 Outline life cycles of cestodes. (a) A pseudophyllidean, *Diphyllobothrium latum*. (b) A cyclophyllidean, *Taenia saginata*.

### Larval cestodiasis

There are three main types of human larval cestodiasis: sparganosis caused by plerocercoids [spargana] of diphylobothriid tapeworms in the genera *Diphyllobothrium* and *Spirometra*; cysticercosis caused by cysticercus stage larvae of *T. solium*; and hydatid disease resulting from the proliferative hydatid cyst larvae of *Echinococcus granulosus*. In none of these cases are humans' obligate hosts for the parasites- they contribute very little to parasitic reproductive success being so rarely consumed by the relevant final hosts. A variety of carnivores are the normal final hosts for sparganosis-producing *Diphyllobothrium* and *Spirometra* species. Eggs in their faeces hatch to produce coracidia which develop into procercooids in copepods of freshwater habitats. The crustaceans are eaten by a wide range of amphibians, reptiles and mammals, in which plerocercoids develop. Spargana are wandering plerocercoids in human tissues. Persons become infected in a number of ways. They may ingest copepods containing procercooids when drinking untreated water from streams and lakes. They may also acquire infections by eating raw poultry, frogs and snakes or by poulticing inflamed eyes or abscesses with fresh frog or snake skin. Such poultices enable the plerocercoids to migrate directly into human tissues. Spargana may wander slowly within the body causing short-lived lumps to appear. Ultimately the spargana die, are calcified and surrounded with a thin fibrous capsule. Most infections occur in Japan, Korea, China and Vietnam.

Adult worms of the pork tapeworm *T. solium* inhabit the human intestine while the larval stages normally develop in pig muscles. Human cysticercosis occurs when people eat *T. solium* eggs, and cysticercus larvae, each about 10 mm long, subsequently become lodged in a variety of tissues. Symptoms are particularly

severe if the parasites occur and then die in the human central nervous system. The commonest mode of human infection is probably human faecal contamination of food, but it is possible that direct autoinfection occurs in patients harbouring adult worms, if segments containing eggs are regurgitated from the small intestine into the stomach so that egg activation begins.

Hydatid disease or echinococcosis is one of the most harmful cestodiasis. It is a complex disease from the point of view of parasite taxonomy. Most human infections are with the endogenously budding hydatid larvae of several strains of *E. granulosus* which has discrete spherical cysts. Humans can act as accidental intermediate hosts for *E. granulosus* in its domestic cycle {where it is transmitted between dogs as final hosts and sheep or cattle as intermediate hosts or in one of its feral cycles utilizing wild carnivores and herbivores. Less frequently, humans become infected by strains of *E. multilocularis* whose irregularly expanding cysts are intensely pathogenic. The latter disease is always feral, with foxes acting as final hosts and rodents as intermediate hosts. In all instances, human infection occurs because of contact with faecally contaminated material from infected canine hosts. The highest community prevalences of hydatid disease around the world are always in cattle or sheep herding populations with high levels of human-dog contact.

### **Adult cestodiasis**

The common adult cestodiasis of human hosts are generally less pathogenic than cysticercosis or hydatid disease. Adult cestodes at low densities in the human gut often cause no symptoms. Only rarely, when parasite densities are high, do problems due to gut-wall damage or intestinal obstruction occur. The only other serious consequences of adult cestodiasis are the increased risk of cysticercosis in carriers of adult *T. solium*, and the geographically restricted risk of pernicious anaemia in those infected with *D. latum*.

In global terms only four adult cestodiasis are at all common, namely those caused by *D. latum*, *T. saginata*, *T. solium* and *Hymenolepis nana*.

*Diphyllobothrium latum* {Figs 2.1, 2.2 & 2.3} is a pseudophyllidean tapeworm whose transmission is due to consumption of raw, undercooked or lightly smoked fish containing viable plerocercoids. It uptake vitamin B12 by the worms which restricts the amount of dietary B12 available for the human host.

*Taenia Saginata* (Figs 2.1, 2.2 & 2.31) the beef tapeworm can sometimes reach 20 m in length but 5 m is more usual. It has a cosmopolitan distribution due to the practice of eating raw or undercooked beef. In this way infective cysticercus larvae (about 8 mm in length) in the muscles of a cow are ingested. Larvae evert their unhooked scoleces in the duodenum and subsequent growth occurs in the duodenum.



*Taenia solium* is very similar in morphology and life-cycle characteristics to *T. saginata*. It differs mainly in having a hooked rather than an unarmed adult scolex and fewer lateral branches in the gravid proglottid uterus. Human consumption of undercooked or raw pork is the route of infection.

*Hymenolepis nana* is only 15-40mm in length. It can occur at high densities in an infected person's small intestine. Children and young adults are particularly at risk especially those in institutions. Low density infections produce few or no symptoms, but at higher infection levels of more than 2000 worms, vomiting, diarrhoea, loss of appetite and abdominal pain have been recorded. Transmission of the parasite is mainly by a method which is extremely unusual among cestodes, that is the ingestion of eggs which complete Larval then adult development in the same human host.

### Digeneans

Adult digeneans are flattened or cylindrical platyhelminths that in humans and agricultural animals always inhabit endoparasitic locations. The vast majority of species live in the gut or its developmental offshoots such as the bile duct and lungs. Externally, adult digenean worms are characterized by an oral sucker around the anterior mouth and often an additional ventral sucker or acetabulum. The oral sucker is an important feeding while both sucker types are involved in attachment to internal host surfaces and locomotion. The outer surface of the body is a living syncytial tegument, the distal cytoplasm of which contains spines. The internal organization of a typical hermaphroditic digenean (only schistosomes are dioecious) is described in fig. 2.4. A basic taxonomy of digeneans is in Table 2.5, with special emphasis on those groups that contain species that infect humans.

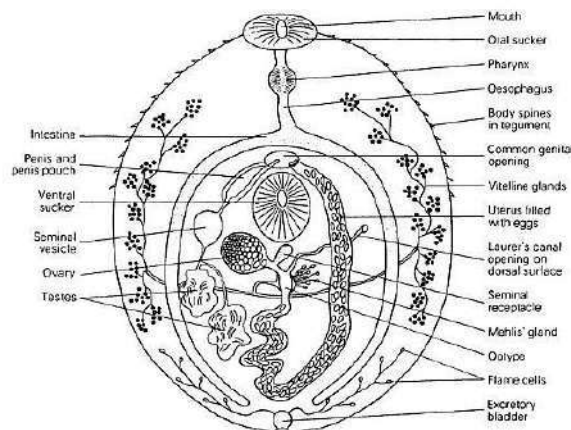

Fig. 2.4 A hypothetical adult digenean demonstrating the main morphological features.

**Table 2.5** An outline classification of digeneans  
(several families excluded)

---

**CLASS: DIGENEA**

**Superorder 1: Anepitheliocystida.** In the cercaria the bladder wall of the excretory system is the retained wall of the primitive bladder formed from the fusion of the two main lateral excretory canals

**Order 1: Strigeatida.** Cercariae fork-tailed

**Family (i) Bucephalidae** (e.g. *Bucephalus*)

**Family (ii) Strigeidae** (e.g. *Alaria*, *Cotylurus*)

**Family (iii) Schistosomatidae.** The schistosomes: adults parasitic in the blood vessels of birds and mammals. Dioecious with males and females occurring in *in-copulo* pairs with the female held in the gynaecophoric canal of the male (e.g. *Schistosoma*)

**Order 2: Echinostomida.** Cercariae with cyst-producing gland cells. Encystation of cercariae occurs on vegetation or in molluscs

**Family (i) Echinostomatidae.** The echinostomes: adults parasitic in the intestine, bile ducts or ureters of reptiles, birds and mammals. Elongate forms with a raised collar behind the oral sucker carrying large backwards pointing spines. (e.g. *Echinostoma*)

**Family (ii) Fasciolidae.** Large, flattened, spinose leaf-shaped worms of mammals. (commonly herbivores) (e.g. *Fasciola*, *Fasciolopsis*)

**Family (iii) Paramphistomatidae.** The amphistomes: gut parasites of mammals (commonly herbivores). Large, thick-bodied digeneans with an anterior oral sucker and a ventral sucker at the extreme posterior end of the worms (e.g. *Paramphistomum*, *Gastrodiscoides*)

---

The life cycles of the great majority of digeneans display a remarkable and highly characteristic alternation of asexual and sexual reproductive phases, in molluscan and vertebrate hosts respectively. The basic life-cycle patterns employed by digeneans and examples of their larval stages are shown in Fig. 2.5. Hermaphroditic adults which normally cross-inseminate, utilize sexual reproduction in the final host, and tanned eggs are produced. These leave the host in faeces, urine or sputum and the zygote within the egg develops or has already developed by this stage into a ciliated larva - the miracidium. The miracidium then infects gastropod mollusca either by direct penetration by a free-swimming hatched miracidium or by the ingestion of the egg by a snail. Within the molluscan host the miracidium transforms into a sporocyst which is a tegument covered, gutless germinal sac, containing germinal cells. These develop into either a second generation of sporocysts or into a new larval type with a gut - the redia. Rediae can often produce further generations of rediae but eventually rediae or daughter sporocysts begin, again asexually, to produce cercariae, which are the larval stages that leave the molluscan host. A cercaria is a tailed, actively swimming larval form, the head of which will develop into an adult worm and often already possesses partially developed reproductive organs. Cercariae leave the snail, the first intermediate host, often with a marked circadian periodicity, and they or the metacercariae which develop from them, infect the final host. The sequence of asexually reproducing larval stages in the mollusc is often able to sustain very high overall reproductive rates for this part of the life cycle. Ultimately many thousands of cercariae may develop from a single miracidial infection of a snail.

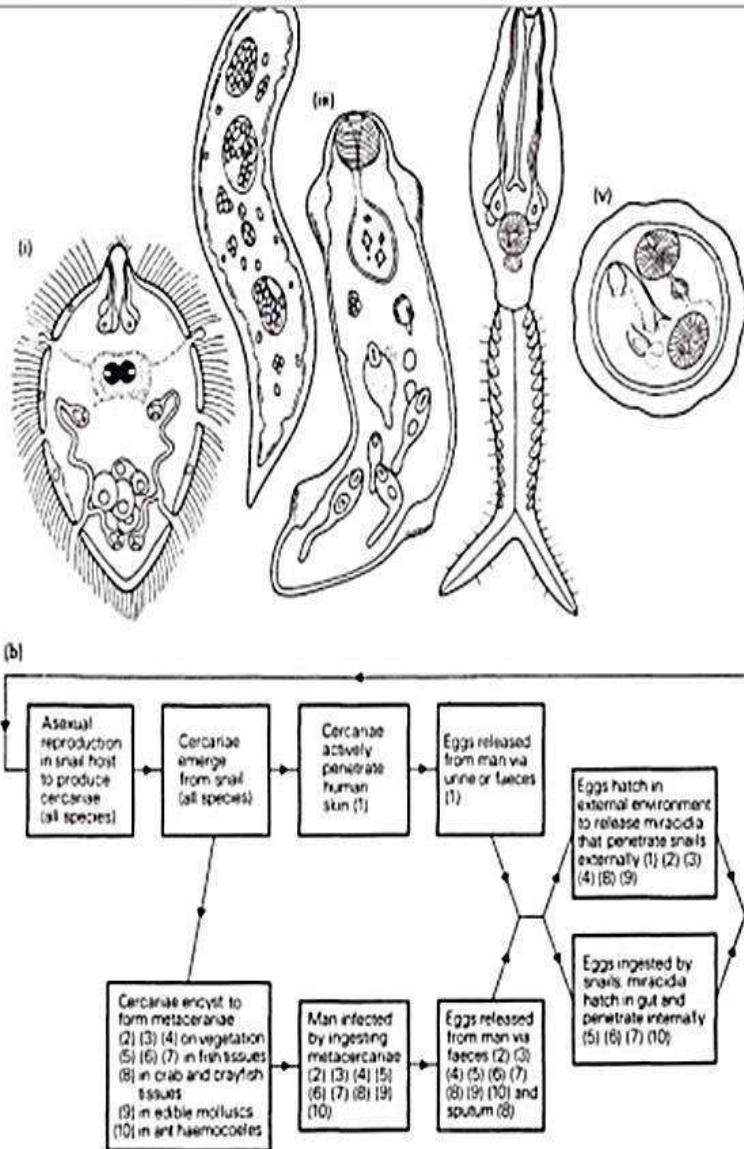

**Fig. 2.5** (a) Diagrammatic representation of digenean larval stages. The larvae illustrated are completely schematic and do not represent an actual developmental sequence. (i) Miracidium: with tiers of epithelial ciliated cells, anterior gland cells, central 'eye spot' consisting of two pigment cup ocelli overlying a nervous cerebral ganglion, flame cells and posteriorly positioned germinal cells. (ii) Sporocyst: a sac shaped larval stage with no gut and a central cavity containing clusters of dividing germinal cells. (iii) Redia: with a large oral sucker and a simple gut, muscular processes in the body wall and a central cavity containing developing larval stages. (iv) Cercaria: a larva with a muscular propulsive tail and a head with gut, oral and ventral suckers and often penetration glands and cystogeneus glands. (v) Metacercaria: a transformed cercarial head surrounded by a secreted cyst wall. The cercarial head usually shows some development of somatic and reproductive characteristics towards the adult state. (b) Diagrammatic flow-chart of the basic organization of the life cycles of medically important digeneans that infect man. Species identities: 1: *Schistosoma*, 2: *Fasciolopsis*, 3: *Fasciola*, 4: *Gastrodiscoides*, 5: *Opisthorchis*, 6: *Heterophyes*, 7: *Metagonimus*, 8: *Paragonimus*, 9: *Echinostoma*, 10: *Dicrocoelium*.

**Table 2.6** Some features of non-schistosome digenean diseases of humans

Name	Site of adult worms in man	Route of egg emergence	Snail [first intermediate] host and mode of snail infection	Mode of human infection	Geographical distribution
<i>Fasciolopsis buski</i>	Small intestinal mucosa, rarely in stomach or colon	Faeces	<i>Segmentina</i> (external miracidial invasion)	Metacercarial cysts on water plants, such as water caltrop and water chestnut: eaten	China, Taiwan, India, Thailand, Laos, Kampuchea and Bangladesh
<i>Heterophyes heterophyes</i>	In crypts of jejunum and upper ileum	Faeces	<i>Pironella</i> and <i>Cerithidia</i> (egg ingestion)	Metacercarial cysts in fish, such as mullet and <i>Tilapia</i> : eaten	Egypt, Israel, Romania, Greece, Japan, China, Taiwan, Philippines
<i>Metagonimus yokogawai</i>	Mucosal folds of jejunum	Faeces	<i>Semisulcospira</i> (egg ingestion)	Metacercarial cysts in fish, such as carp and trout: eaten	Japan, Korea, China, Taiwan, Siberia
<i>Gastrodiscoides hominis</i>	Mucosal lining of caecum and ascending colon	Faeces	<i>Helicobis</i> (external miracidial invasion)	Probably by ingestion of metacercarial cysts on water plants such as water caltrop	India, Bangladesh, Vietnam, Philippines
<i>Opisthorchis sinensis</i>	Bile duct	Faeces	<i>Bulinus</i> , <i>Parafossarulus</i> , <i>Alocima</i> (egg ingestion)	Metacercarial cysts in freshwater fish: eaten. Juvenile flukes migrate directly up bile duct from gut	China, Taiwan, Korea, Japan, Vietnam
<i>Fasciola hepatica</i>	Bile duct	Faeces	<i>Lymnaea</i> (external miracidial invasion)	Metacercarial cysts on watercress or lettuce: eaten. Juvenile flukes penetrate gut wall then liver from the perivisceral cavity	Central and S. America, Cuba, France, UK, N. Africa
<i>Paragonimus westermani</i>	In cysts in lungs, rarely in a variety of extra-pulmonary sites	Sputum and faeces	<i>Semisulcospira</i> , <i>Thiara</i> and <i>Oncomelania</i> (external miracidial invasion)	Metacercarial cysts in freshwater crabs and crayfish: eaten	China, Taiwan, Korea, Japan, Philippines, India, Malaysia, Indonesia

### Human schistosomiasis

Four species of the digenean genus *Schistosoma* are important human parasites. Of these *S. mansoni*, *S. haematobium* and *S. japonicum* have widespread distributions. *Schistosoma haematobium* causes urinary schistosomiasis whereas the other three species are the causative agents of the intestinal form of the disease. Adult worms live in the lumina of blood vessels and feed directly on the cellular and plasma fractions of blood. The species causing intestinal schistosomiasis live in the mesenteric veins of the gut while *S. haematobium* occupies the vesical veins of the bladder wall. They are also dioecious and the male and female worms show considerable sexual dimorphism [Fig. 2.6].

Cylindrical elongate females live permanently in an extensive ventral groove, the gynaecophoric canal, stouter males. In most schistosomes, female sexual maturity only follows successful pairing with a male worm. Living as they do in a host location in which immunological defenses might be expected to be both rapidly engendered and effective. Pairs of adult worms produce eggs which are laid into the lumina of the venules in which they live. There is no direct, non-pathological route by which these eggs can reach the outside world from this location. In fact, most schistosome eggs possess a sharp shell spine which helps to provide a means of escape. Spines lodge in the intima of the venule and impede the movement of eggs by blood flow. Small blood vessels packed with eggs may rupture, enabling them to move into surrounding connective tissue. A proportion of these eggs eventually reach the outside world via the lumen of the gut or bladder in faeces or urine. This



necessarily unusual exit route for schistosome eggs is at the heart of their considerable pathogenicity. Many eggs become lodged in the tissues all over the body. In these locations, living and then moribund or dead eggs become immobilized in spherical granulomatous lesions. It is these progressively accumulating lesions in many different organs which give rise to most chronic schistosome-induced pathology. The eggs which do leave an infected person in urine or faeces hatch on contact with freshwater and the emergent miracidia infect a range of aquatic and amphibious snails in which infective cercariae are produced. All human digenean infections other than schistosomiasis is initiated when people eat metacercarial cysts. Schistosome transmission is quite different. Free cercariae emerging from the snails survive on average for about a day at 20°C, swimming tail first through the water. During this brief, free swimming and non-feeding existence fueled by endogenous glycogen reserves, they are directly infective to people entering the water in which they are swimming. Aided by small backward pointing tegumental spines and cytolytic secretions a cercaria rapidly penetrates bare human skin, often down the side of a hair shaft and sheds its tail in the process. The penetrant cercaria head can now be considered as an immature adult schistosome or schistosomulum. Schistosomula enter the peripheral blood system and are carried eventually to the lungs, usually within a week of skin penetration. From the lungs the worms migrate to the liver where they pair up and mature. Pairs of worms then move to their final egg producing sites. Figure 2.7 illustrates the general organization of human schistosome life cycles while Table 2.7 outlines specific information on the four major species.

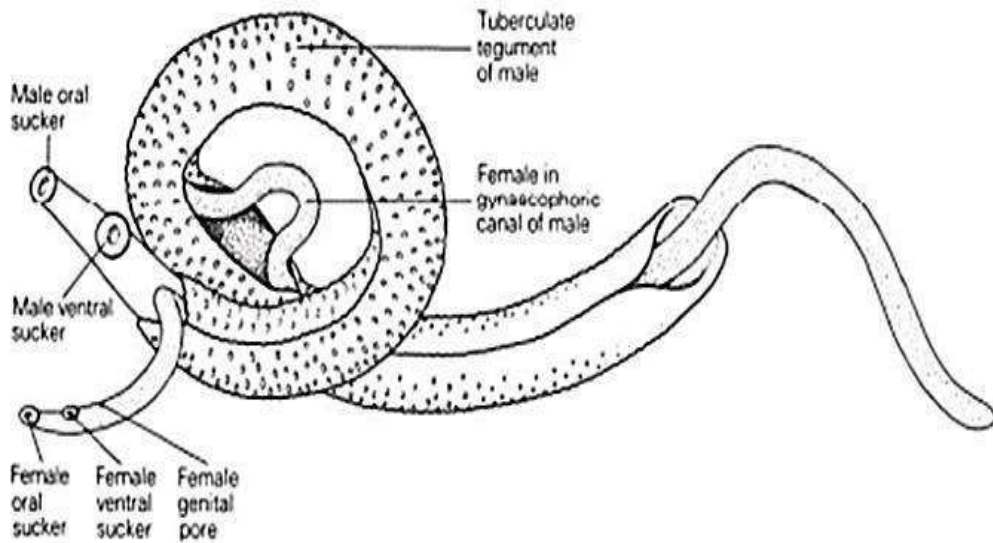

Fig. 2.6 In copulo pair of adult schistosomes (based on *S. mansoni*).

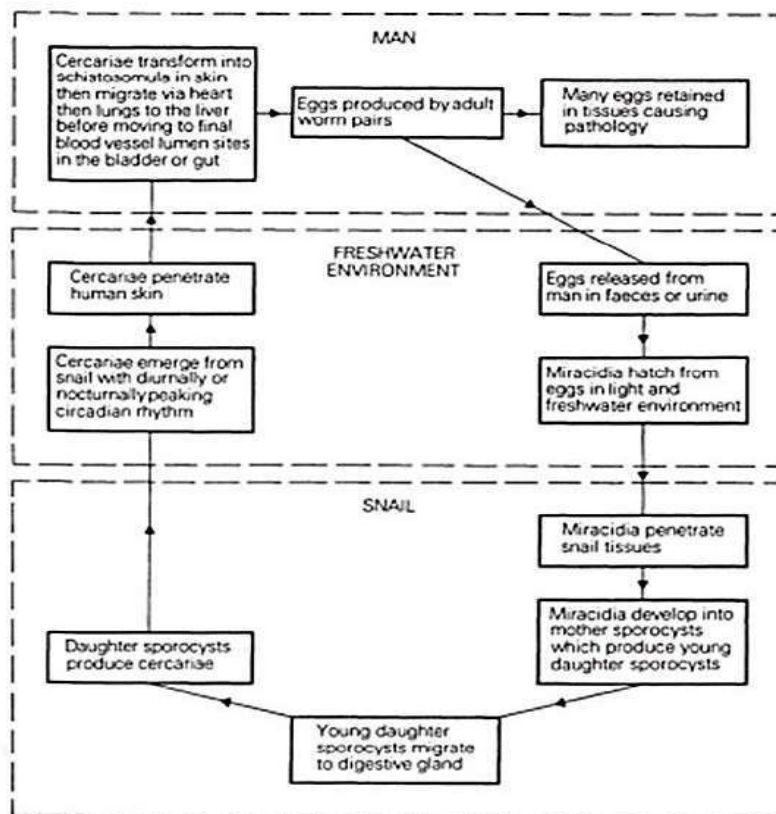

Fig. 2.7 Diagrammatic flow-chart of the main features of the life cycles of human schistosomes.

Table 2.7 Some features of human schistosomes

Name	Site in man	Route of egg emergence	Intermediate hosts	Geographical distribution	Reservoir hosts
<i>Schistosoma mansoni</i>	Mesenteric veins	Faeces	<i>Biomphalaria</i> spp.	Egypt, Middle East, W. Central and S.E. Africa, Malagasy, Brazil, Venezuela and some Caribbean islands	Probably not important except in S. America where some rodents are infected
<i>Schistosoma haematobium</i>	Vesical veins of the bladder	Urine	<i>Bulinus</i> spp.	Africa, Malagasy and Middle East	No important reservoir hosts
<i>Schistosoma japonicum</i>	Mesenteric veins	Faeces	<i>Oncomelania</i> spp.	China, Philippines, Japan, Vietnam, Thailand, Laos and Kampuchea	Important throughout range dogs, rats, pigs, cattle, etc
<i>Schistosoma intercalatum</i>	Mesenteric veins	Faeces	<i>Bulinus</i> spp.	Limited distribution in Zaire, Central African Republic, Cameroon and Gabon	No important reservoir hosts

### Nematode Parasites of Vertebrates

The nematodes are the most successful group among the pseudocoelomic, Aschelminthes. The relative lack of interspecific morphological variation among nematodes belies their ecological diversity. They are almost all unsegmented, spindle-shaped roundworms with bilateral symmetry (Fig. 2.9). This starts when dioecious adults sexually produce eggs that hatch to release L1 larvae, which with intervening cuticular moults and size increases; develop through three more larval phases (L2 L3 and L4) before attaining full sexual maturity after the final L4 moult. The cuticle which is repeatedly moulted, secreted anew and rearranged during development is a central element in the structural organization of all nematodes. It is a multi-layered covering of the nematode body consisting of collagen and other components. A number of surface invaginations of the body wall [buccal cavity, pharynx, excretory pore, vulva, chemosensory pits called amphids and phasmids, rectum, cloaca and spicule pouches) are also cuticle-lined. Stylets, teeth and cutting blades in the buccal cavity and the copulatory spicules are essentially cuticular structures. Table 2.8 outlines a classification of nematodes that are parasitic in vertebrates itemizing species that infect humans.

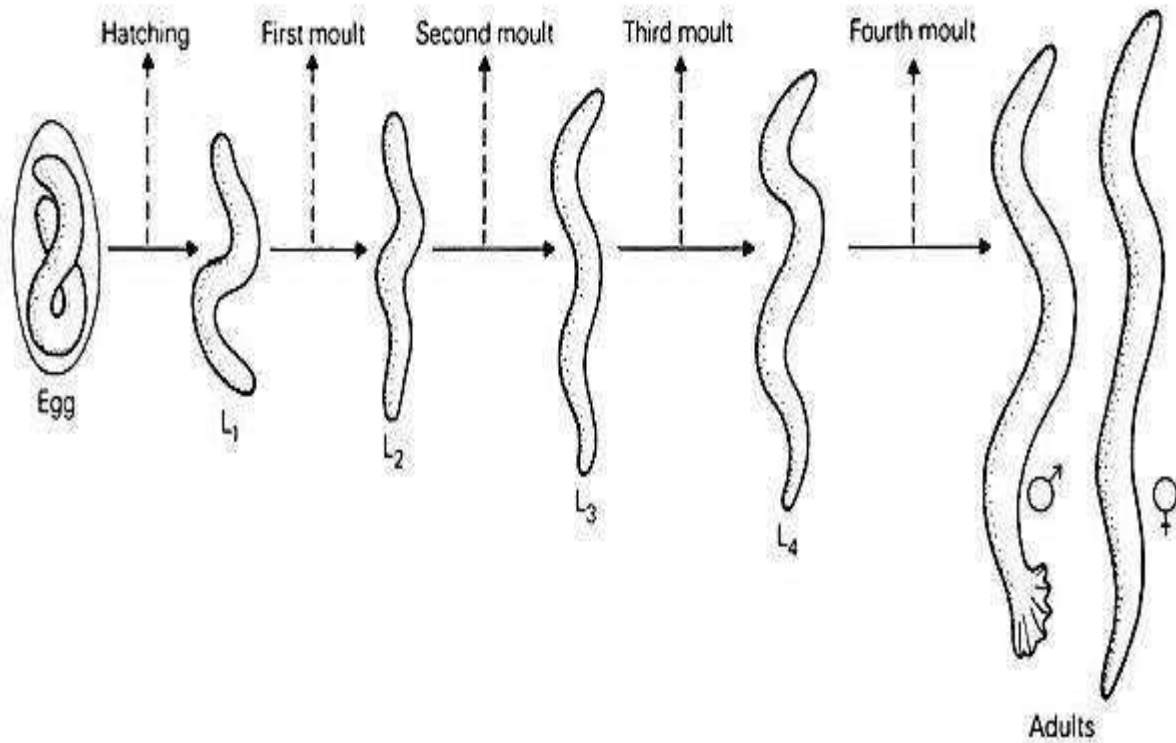

Fig. 2.9 A typical nematode developmental sequence.



Fig. 2.9 A typical nematode developmental sequence.

**Table 2.8** Outline classification of the nematode parasites of vertebrates with particular emphasis on orders and superfamilies containing important human parasites

**PHYLUM: NEMATODA**

**Subclass 1: Secernentea** [Posterior phasmid chemoreceptive organs present]

**Order 1: Rhabditida.** Parasitic female adults parthenogenetic, pharynx often possesses prominent posterior muscular bulb (e.g. *Strongyloides*)

**Order 2: Strongylida.** Adult males possess copulatory bursa with supporting rays. L<sub>1</sub> and L<sub>2</sub> larvae often free living

**Superfamily 1: Ancylostomatoidea.** Prominent buccal capsule often with cuticular teeth or cutting plates – ‘hookworms’ (e.g. *Ancylostoma*, *Necator*)

**Superfamily 2: Strongyloidea**

**Superfamily 3: Trichostrongyloidea**

**Superfamily 4: Metastrongyloidea**

**Order 3: Ascaridida.** Large intestinal nematodes, three-lipped mouth, simple pharynx (e.g. *Ascaris*, *Toxocara*)

**Order 4: Oxyurida.** Pharynx possesses posterior bulb with valves. Adult female has long pointed post-anal tail (e.g. *Enterobius*)

**Order 5: Spirurida.** Pharynx divided into two sections, a shorter anterior muscular portion and a longer glandular posterior one

**Superfamily 1: Filarioidea.** Very elongate adults; usually viviparous; intermediate hosts blood sucking arthropods – ‘filarial worms’ (e.g.

**Table 2.8 Continued**

*Wuchereria*, *Brugia*, *Loa*, *Onchocerca*, *Dipetalonema*, *Mansonella*)

**Superfamily 2: Dracunculoidea.** Very elongate adults with extreme sexual dimorphism – females much longer than males. Mature female vulva nonfunctional; viviparous; intermediate hosts copepods (e.g. *Dracunculus*)

**Superfamily 3: Gnathostomatoidea**

**Superfamily 4: Thelazoidea**

**Superfamily 5: Habronematoidea**

**Superfamily 6: Physalopteroidea**

**Subclass 2: Adenophorea** [Phasmids absent; pharynx usually forms a stichosome]

**Order 1: Enoplida**

**Superfamily 1: Trichuroidea.** Adult body divided into slim anterior region and broader posterior section. Female possesses only a single ovary and uterus; males have single or absent spicule (e.g. *Trichinella*, *Trichuris*).

**Superfamily 2: Dioctophymatoidea**

epidemiologically into three subsets (Table 2.9). Direct life cycle intestinal forms and insect vector-transmitted filarial species are two homogeneous groupings. The remaining species are a heterogeneous mixture of larval and adult infections that are neither insect transmitted nor have

*continued*

Fig. 2.9 A typical nematode developmental sequence.

Table 2.8 Outline classification of the nematode parasites of vertebrates with particular emphasis on orders and superfamilies containing important human parasites

---

**PHYLUM: NEMATODA**  
**Subclass 1: Secernentea** [Posterior phasmid chemoreceptive organs present]  
**Order 1: Rhabditida.** Parasitic female adults parthenogenetic, pharynx often possesses prominent posterior muscular bulb (e.g. *Strongyloides*)  
**Order 2: Strongylida.** Adult males possess copulatory bursa with supporting rays. L<sub>1</sub> and L<sub>2</sub> larvae often free living  
     **Superfamily 1: Ancylostomatoidea.** Prominent buccal capsule often with cuticular teeth or cutting plates – ‘hookworms’ (e.g. *Ancylostoma*, *Necator*)  
     **Superfamily 2: Strongyloidea**  
     **Superfamily 3: Trichostrongyloidea**  
     **Superfamily 4: Metastrongyloidea**  
**Order 3: Ascaridida.** Large intestinal nematodes, three-lipped mouth, simple pharynx (e.g. *Ascaris*, *Toxocara*)  
**Order 4: Oxyurida.** Pharynx possesses posterior bulb with valves. Adult female has long pointed post-anal tail (e.g. *Enterobius*)  
**Order 5: Spirurida.** Pharynx divided into two sections, a shorter anterior muscular portion and a longer glandular posterior one  
     **Superfamily 1: Filarioidea.** Very elongate adults; usually viviparous, intermediate hosts blood sucking arthropods – ‘filarial worms’ (e.g.

---

### Human intestinal nematodes

All the six important species (Table 2.9) have direct life cycles and, apart from *Enterobius vermicularis*, they are all soil-transmitted in the sense that the eggs or larvae responsible for transmission normally become infective during a period of development in the soil. They are sometimes termed geohelminths because of this characteristic.

### **Ascaris lumbricoides**

(Fig. 2.10), is the largest human intestinal nematode and probably one of the most prevalent with between 800 million and a billion persons infected globally. Transmission potential is determined largely by human faecal disposal practices contaminated with faeces. Migrating larvae cause allergic bronchopneumonia in previously infected and sensitized patients along with bronchitis, bronchospasm and urticaria. Adult worms in the small intestine in high density can cause obstruction and worms can migrate out of the gut into the bile duct, pancreatic duct, oesophagus, mouth and occasionally the liver. Worms may also perforate the intestine inducing peritonitis.

**Trichuris trichiura** (Fig. 2.11), the causative agent of trichuriasis or whipworm infection, is an unusually shaped worm about 4 cm long with an extremely long, thin pharyngeal region and a wider posterior section containing the rest of the gut and the reproductive organs. The buccal cavity has a small stylet with which the worms disrupt the caecal mucosa. Low density *Trichuris* infections can be without symptoms but higher density infections, especially in undernourished children can be highly pathogenic and result in chronic bloody diarrhoea, colic, anaemia and rectal prolapse.

**Ancylostoma duodenale and Necator americanus** (Fig. 2.12), two morphologically and developmentally similar blood-feeding nematodes, cause human hookworm disease (ancylostomiasis). Hookworms are transmitted to humans by skin penetrating L3 larvae that develop in faecally contaminated soil. Adult worms attach themselves to gut villi and use cutting blades or teeth in their buccal capsules to abrade the mucosal surface. They then feed on blood so that anaemia is a prominent symptom in many cases of hookworm disease. The disease induces three quite distinct types of pathology. Invading L3 larvae cause an allergic dermatitis with a papular and sometimes vesicular rash that is termed ground itch. Lung pathology - focal haemorrhages and allergic pneumonia - can be provoked by migrating larvae. The most important damage, though, is caused by the blood-feeding adults. Up to 200 ml of blood per day may be lost due to this cause by a patient with a heavy infection although some of the iron in this deficit is reabsorbed. The final degree of anaemia and associated protein loss in a particular patient is a complex resultant of hookworm species, worm load and host nutritional status. Larvae of a number of non-human hookworm species can penetrate human skin and cause irritating 'cutaneous larval migrans' as they move laterally in the skin.

**Enterobius vermicularis** (Fig. 2.13), the causative agent of enterobiasis or pinworm disease affects some 500 million individuals, mainly children, globally and is more

common in temperate than tropical countries. It is of only minor pathogenic significance and the mode of infection can be considered contaminative as the eggs are infective almost immediately after release onto the perianal skin. Infective eggs are found in clothing and bedding and children can reinfect themselves by transferring eggs from anus to mouth with the fingers. This is facilitated by the **pruritus ani** which is the commonest symptom of infections to become apparent.

**Strongyloides stercoralis** (Fig. 2.14) infections (strongyloidiasis) occur either when La larvae penetrate the skin or develop directly within the gut. The life-cycle organization of this parasite is further complicated by the existence in some circumstances of an entirely free-living cycle of sexually reproducing adults and their larvae in the soil. This alternative route can produce La larvae that are infective. The pathology associated with this disease can be divided into larval and adult-generated phases. The larvae give rise to dermatitis at their sites of invasion. They then migrate to the lungs where they cause allergic pneumonia. High densities of egg-laying adult females in the gut cause mucosal inflammation and malabsorption. Some larvae can re-enter the gut mucosa or penetrate the perianal skin to maintain a chronic infection status. In immunosuppressed hosts this autoinfection route can be amplified to produce a considerable and sometimes life-threatening larval invasion of many organ systems.

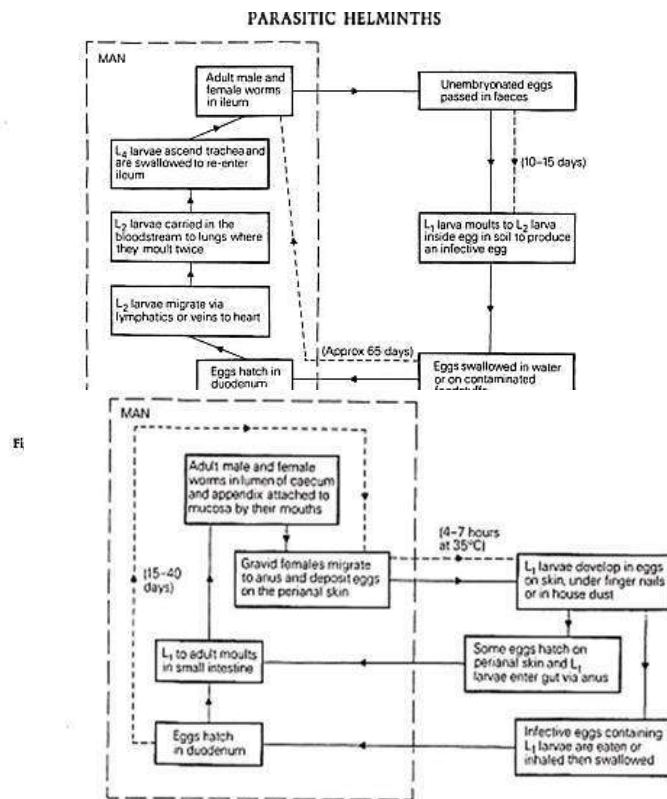

Fig. 2.13 The life cycle of *Enterobius vermicularis*.

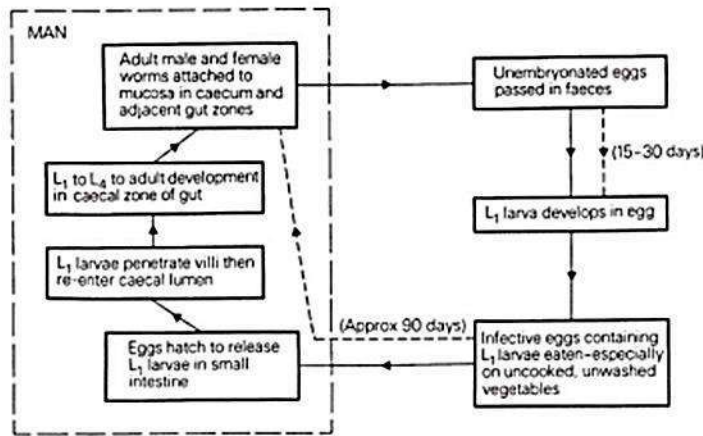

Fig. 2.11 The life cycle of *Trichuris trichiura*.

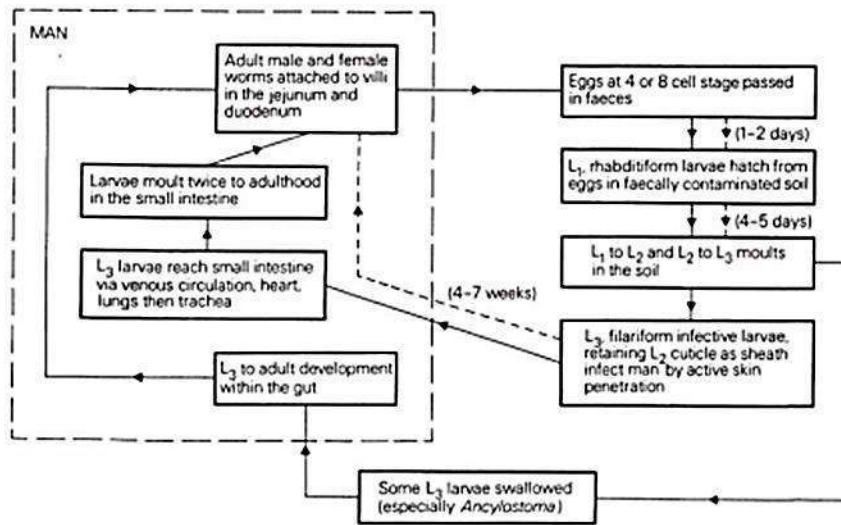

Fig. 2.12 The life cycle of human hookworms.

## Human filariasis

Filarial worms are long-lived nematodes that all require a period of larval development (L1 to L4) in a blood-sucking insect host. These biting vectors initiate new human infections. Table 2.9 lists the seven major filarial species and Fig. 2.15 outlines the basic features of their essentially similar life cycles. Of the seven, *Wuchereria bancrofti* which causes lymphatic filariasis and *Onchocerca volvulus* which induces river blindness and onchodermatitis are widespread and extremely damaging infections. *Brugia malayi*; and *Loa loa*, although pathogenic, are much more restricted in distribution. Adult filarial worms are rarely seen diagnostically. Diagnosis depends on collection and microscopical identification of L1 larvae, termed microfilariae, in either the peripheral blood or skin. Filarial species are divided into geographical subspecies or strains which may utilize different vector



species, display differing circadian periodicity of microfilarial density in the blood be associated with distinctive human pathological syndromes.

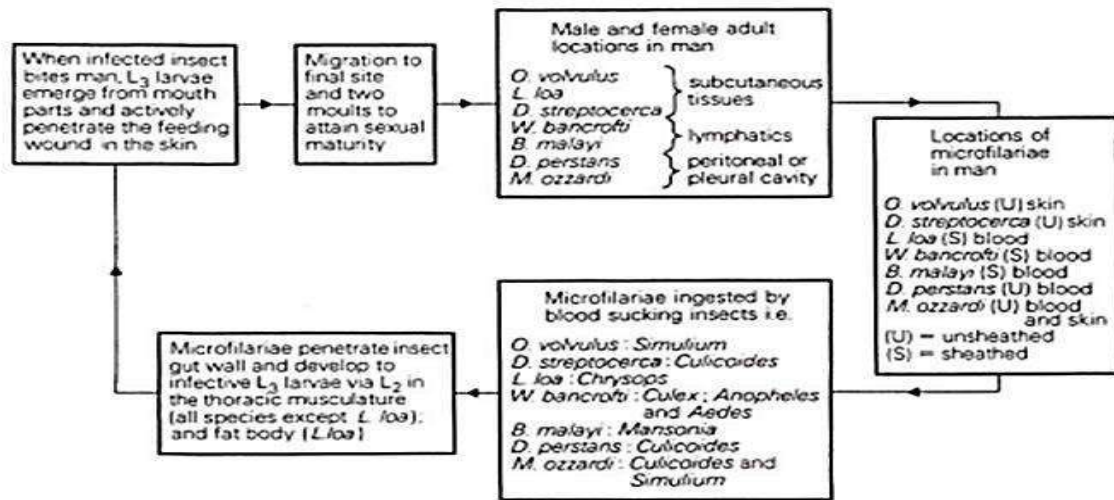

Fig. 2.15 The life-cycle organization of the seven most important human filarial parasites.

### Lymphatic filariasis

Two filarial species *Wuchereria bancrofti* and *Brugia malayi*, which are very similar morphologically, live as adults in the afferent lymphatic vessels of the human host and **produce blood dwelling sheathed microfilariae**. The clinical course of pathogenesis is strongly linked with inflammatory and immunological host responses to the adults and commonly passes through three phases. The first or incubation phase - the time between infection and the first appearance of blood microfilariae - is rarely associated with symptoms although there may be some lymphatic inflammation and fever. The second phase of indeterminate duration is associated with adult worms producing microfilariae and is termed the acute inflammatory phase. It is marked by intermittent bouts of lymphatic inflammation and pain along with fever. When it occurs, the final or obstructive phase displays irreversible lymphatic centred damage with both filarial species. The most disfiguring aspect of these changes is the condition termed elephantiasis. This can occur to the legs, arms, scrotum, vulva and breasts. It is a chronic lymphoedema associated with very extensive fibrous infiltration and thickening of the skin. *Wuchereria* cases, transmitted by *Culex*, *Anopheles* and *Aedes* mosquitoes, are predominantly found in India, the Far East, Polynesia and East Africa.

## **Onchocerciasis**

*Onchocercus volvulus* causes human infections and considerable morbidity across Africa and in minor pockets in South and Central America and in Yemen. Parasite suains exist, transmitted with its own species of blackfly in the genus *Simulium*. The disease causes two types of severe pathology-ocular changes including blindness (river blindness) and onchodermatitis. Both are the result of immune responses to microfilariae, in contrast to the damage caused in lymphatic filariasis where adult worms are responsible. The unsheathed microfilariae of *Onchocerca* are found in the skin rather than the blood system and arise from groups of copulating adult worms located in fibrous nodules in subcutaneous tissues. These nodules, which may be several centimetres in diameter, can often be seen externally as rounded elevations of the skin.

Other human filarial infections *Loa loa* causes loiasis in the rainforest zones of West and Central Africa and is transmitted by large day feeding tabanid flies in the genus *Chrysops*. Adult worms live subcutaneously but do not form permanent nodules. They move around inducing transient 'calabar swellings' and sometimes visibly cross the front of the eye under the conjunctiva.

## **Other human nematode diseases**

### **Dracunculiasis**

This disease which is also called guinea worm disease, is caused by *Dracunculus medinensis*, the mature females of which may reach almost a metre in length. Dracunculiasis is widespread in much of India as well as parts of West and Central Africa, with more restricted foci in Pakistan, Iraq, Iran and Saudi Arabia. The parasites have an indirect life cycle and human infections occur when people drink water contaminated with copepods containing infective L3 larvae of the nematode. Ingested larvae penetrate the human gut wall and spend about 12 weeks growing, molting to adulthood and mating in the subcutaneous tissues. After copulating, female worms move down through the body reaching a lower extremity like the ankle or foot about 8-10 months after the original infection. Here the mature female, with its uterus filled with about one million L1 larvae, induces a blister in the host's skin which subsequently bursts. This enables large numbers of actively swimming L1 larvae to leave the lesion each time it is immersed in water, over a period of 3-4 weeks. Copepods then ingest larvae which develop into L3 larvae in these intermediate hosts. **Blister formation** can be an extremely painful process and the open wound of the blister often becomes serondarily infected. Adult female worm infections closely associated with bony joints can lead to arthritis.

**Trichinosis**, caused by *Trichinella spiralis*, is a cosmopolitan disease which demonstrates very low vertebrate host specificity. Short-lived adult infections in the guts of a wide range of carnivorous and omnivorous mammals give rise to large numbers of invasive L1 larvae which migrate to voluntary muscles throughout these same hosts. Here they encyst. The cysts are the infective stages which can be transmitted to any new host when infected fish is eaten. In domestic cycles throughout the world, human hosts become infected by eating cyst-containing pork from pigs. In feral cycles meat from wild boar, bears, bush pigs or warthogs can give rise to infections. Although adult worms in the small intestine do give rise to some gut damage, the main pathogenic phase of the infection in humans is the population of migrating and encysting larvae. Usually no symptoms occur until the Larvae reach the muscles and then, in heavy infections.



## Survival Outside the Host

### Introduction

Parasites possess unique physiological attributes that are a consequence of living in a hostile and ever-changing environment, the body of the host, with the associated necessity of passing through the external environment, possibly on more than one occasion in a single life cycle.

### Survival outside the body of the host

Many parasites release stages of their life cycles into the external environment, these include eggs, cysts and larvae. Such transmission phases are sometimes short-lived but they may possess considerable longevity and the ability to resist environmental degradation. Parasite transmission between hosts is accomplished in one of three ways:

1. The host ingests eggs, cysts, larvae or an intermediate host containing infective stages of the parasite.
2. The host is inoculated with infective parasites during blood feeding activities of the intermediate (vector).
3. The host is actively penetrated or settled by invasive parasite (Table 7.1).

**Table 7.1** Transmission stages of parasites: a synopsis

	Parasite eaten by host	Arthropod vector transmits parasite	Parasite actively locates host
Protozoa	Coccidian cysts Amoebic cysts	Babesias Trypanosomes Malaria	—
Monogenea	—	—	Oncomiracidium
Digenea	Metacercaria Cercaria [some]	—	Miracidium Cercaria
Cestoda	Egg Cysticercoid Cysticercus Coenurus Hydatid cyst Coracidium Proceroid Plerocercoid	—	—
Acanthocephala	Egg Cystacanth	—	—
Nematoda	Egg Larvae [L <sub>3</sub> ] [ensheathed or free]	Larvae (microfilariae)	Larvae (e.g. hookworms)

### **Cystic stages of parasites**

Protozoa parasitic in the alimentary canal, such as *Entamoeba histolytica*, *Giardia duodenalis* and *Balantidium coli*, commonly produce cysts that contain quiescent, infective forms which are passed into the external environment with host faeces and await ingestion by the next individual host. *Naegleria fowleri* is a free-living organism which can cause human amoebic meningitis. It is acquired during bathing in or by contact with warm natural freshwaters. This organism, an opportunistic parasite, but in this case, the trophozoite and not the cyst is the infective stage, entering the human body via the nasal mucosa and migrating to the brain. Coccidian protozoans form resistant, infective cysts. Species of economic importance, such as *Eimeria* in poultry and *Toxoplasma* in cats, produce oocysts containing sporocysts which are voided in host faeces and are acquired by a new host during feeding.

Amongst the helminth parasites, encysted stages concerned with transmission are common. In the Digenea, cysts containing the metacercarial stage may be found either in the external environment (e.g. on vegetation in the liver fluke, *Fasciola hepatica*) or within the body of an intermediate host (e.g. *Opisthorchis sinensis* in freshwater fish). These cysts are complex in structure and serve as resistant hypobiotic stages in the parasite life cycle.

The encysted larvae of tapeworms are found only within the body of an intermediate host animal. These cysts may contain a single parasite larva (e.g. cysticercus) or contain an increasing number of larval worms produced by asexual internal budding of germinal tissue within the cyst itself (e.g. hydatid cyst of *Echinococcus granulosus*).

Several genera of nematode parasites form cysts involved in transmission. *Trichinella spiralis* larvae encyst in mammalian muscle.

## **Helminth eggs**

The shelled egg of helminth parasites is ideally suited as a transmission stage and, by virtue of the physico-chemical properties of its resistant shell, is able to withstand the rigors of the external environment for considerable periods of time.

The digenean egg is formed from 30 to 40 vitelline cells and a fertilized ovum surrounded by a protein shell. The phenol oxidase system of enzymes carries out complex cross-linking of these proteins in a process known as tanning. Early studies on *Fasciola* led to the suggestion that all digenean eggshells comprised tanned sclerotin formed by quinone tanning. More recent information, however, indicates that a variety of structural cross-linked proteins may confer upon the egg its rigidity and resistant properties, including sclerotin, keratin and elastin. Vitelline proteins are rich in certain amino acids (lysine, tyrosine, aspartic acid, lysine and histidine) agreeing with amino acid analysis data for the shell itself. The vitelline peptides of *Fasciola* are rich in dihydroxyphenylalanine (DOPA), tyrosine, aspartate or asparagine, glycine and lysine or arginine. Therefore, the mechanical strength of the eggshell derives from tanning of the tyrosine-rich vitelline proteins, involving DOPA formation and subsequent quinone production by phenol oxidase to yield cross-linked proteins. DOPA-rich proteins are common components of biological 'glues' in a variety of free-living animals.

The eggshells of parasitic nematodes are different from those of platyhelminth parasites, being generally more complex in construction and containing non-proteinaceous structural components like chitin. This polymer of N-acetyl glucosamine is structurally important in fungi and in the exoskeleton of many invertebrates. Nematode eggshells are typically triple-layered comprising an inner lipid layer, a middle chitinous layer and an outer proteinaceous vitelline layer. Some nematodes, including the filarial nematodes, are ovoviviparous and do not release

the egg from the uterus; even in these forms, with a much diminished eggshell, chitin is still present but its role is in doubt.

### **Mechanisms for locating the host**

Active location of the intermediate or definitive host is carried out by a variety of larval helminth parasites including monogenean oncomiracidia, digenean miracidia and cercariae, cestode coracidia and infective L3 nematode larvae. All of these different larvae actively seek out and either attach to or penetrate the next host in the life cycle. The physiological mechanisms underlying the processes of finding a suitable host remain largely mysterious.

### **Digenea**

Two distinct types of larva are involved in active location of the host in the Digenea - the miracidium and the cercaria. The miracidium emerges from the egg in water as a ciliated free-swimming stage of limited life expectancy whose endeavor is to locate and penetrate a suitable mollusc. The cercaria, also short-lived, is released from the snail and may either crawl or swim in water to locate and establish in the next host, as in the schistosomes, or it may encyst on vegetation and await ingestion (e.g. *Fasciola hepatica*).

Experimental studies on these larval stages have failed to reveal the nature of host-finding mechanisms.

- Many miracidia have sense organs, such as eye-spots and surface papillae, which may help to orientate the larva in its environment so as to bring it in close proximity to its host mollusc.
- Accordingly, miracidia react in various ways to environmental stimuli such as light, temperature, gravity, water currents and changes in carbon dioxide tension (CO<sub>2</sub>).

- Chemotactic recognition of the host may occur but is controversial and while some evidence supposes miracidial attraction to chemicals released from snails, possibly in mucus or faeces, other data favors the hypothesis that miracidia locate snails by a random, trial-and-error process. Chemo attraction may also be important for host finding by cercariae but, again, data are both limited and controversial.

The ability of cercariae to establish in the next host is clearly affected by water flow, a fact that may have important medical and commercial implications. Cercariae of *Schistosoma mansoni* are adversely affected by water turbulence. Whether it is host finding or attachment to the host that is altered remains to be discovered, but the data strongly suggest that one way of reducing the transmission of aquatic parasites with free-swimming larvae is to increase water velocity where practicable.

### **Cestoda**

Pseudophyllidean tapeworms possess a free-swimming ciliated larva, the coracidium. This larva hatches from the egg in freshwater and is eaten by copepods.

### **Nematoda**

Chemical attraction is probably an important component of host-finding in many plant and animal parasitic nematodes. The infective L3 larvae are well-provided with sensory structures and reveal a complex behavioral capacity associated with locating their hosts.

### **Entry mechanisms**

Many parasites gain entry to their hosts by active penetration through the epidermis (cercariae, miracidia and some nematode larvae, such as hookworms). Penetration of a suitable snail by the digenean miracidium is brought about by secretions from the complex of apical glands at the anterior end of the larva. These secretions contain both lubricants and lytic enzymes. During the process of snail penetration some miracidia shed their epidermal ciliated plates (e.g. *F. hepatica*) while in others cilia are retained.

The penetration of mammalian skin by schistosome cercariae is initiated by surface lipids of the host. Some non-essential fatty acids and complex skin lipids will induce the 'penetration response' in cercariae whereby the tail is shed and transformation to the schistosomulum stage commences. Experimentally, these effects can be inhibited by topical application of eicosanoids and eicosanoid like substances, related to the prostaglandins. Both cercariae and mammalian skin can produce eicosanoids and these compounds may interact during the process of skin penetration. Moreover, it is postulated that cercarial eicosanoids may act as immunomodulators and protect the penetrating larvae from host attack. The infective larvae of hookworms and related nematodes actively penetrate host skin probably using lytic enzymes to aid in the process.

### **Heat shock proteins**

A great many parasites experience, during the passage of their life cycle, dramatic changes in ambient temperature. Such changes may occur during the process of host entry, as when an egg or cyst is ingested, an active larva penetrates the skin or when an invertebrate or other coldblooded animal introduces the infective parasite to the host bird or mammal. Such temperature changes will tend to be metabolically and physiologically harmful to the invading parasite. Accordingly,



parasites can synthesize heat shock proteins (HSP) in response to temperature changes in much the same way as do free-living organisms. Heat shock protein production may be prolific, and in schistosomes HSP-70 represents more than 1% of the total protein synthesized by adult worms and is even more abundant in the transfecting schistosomulum.

As a group, HSP are highly conserved molecules of diverse function, classified according to molecular weight and encoded by multigene families. In parasites, they are highly immunogenic and may not always be produced in response to temperature change. Increase in temperature induces HSP synthesis in *Leishmania* promastigotes, *Giardia* trophozoites, *Trypanosoma* trypomastigotes, *Naegleria* trophozoites, infective larvae of *Brugia* and schistosomula of *Schistosoma*. By contrast, schistosome cercariae placed in mammalian cell culture media at 23°C produce high levels of HSP when all other protein synthesis has been down-regulated. The physiological function of the schistosome HSP-70 is unknown but it may be involved in the reshaping of the macromolecular architecture of the parasite as it moves from one environment to another. Heat shock proteins are also involved in the repair of faulty protein synthesis associated with the ageing process and in this way may be responsible for the considerable longevity typical of some parasites.

### **Circadian rhythms and parasite transmission**

Transmission of some parasites to a new host may be associated with daily or circadian (i.e. around 24 hours) cycles. These can be classified as follows:

1. synchronous cell division (e.g. malaria parasites)
2. release of infective stages from:
  - (a) final host (e.g. coccidia, pinworms),
  - (b) intermediate host (e.g. schistosome, cercariae)
3. migratory patterns (e.g. trypanosomes, microfilariae)

### **Synchronous cell division**

Asexual reproduction, termed schizogony, is profoundly periodic in occurrence in malaria parasites. Cell division within the red blood cell takes place every 48 hours in *P. vivax* or 72 hours in *P. malariae*. This periodicity is related to the production of gametocytes in the blood, which are infective to the mosquito vector. Maturation of gametocytes appears to occur at a time of day coincident with the feeding activities of the appropriate species of mosquito. Circadian rhythms of this type are possibly entrained to the daily cycle in body temperature of the homoiothermic hosts; experimentally induced hypothermia in monkeys will disrupt the circadian pattern of malarial development.

### **Circadian release of infective parasites**

There are several examples of the circadian release of infective parasites, timed so as to optimize transmission. Amongst the Protozoa, *Isospora* oocysts are released from the gut of infected birds at roosting time each day (i.e. late afternoon). This may greatly increase the chances of uninfected birds acquiring the oocysts during feeding.

Mammalian pinworms (e.g. *Syphacia muris* in rats and *Enterobius vermicularis* in humans) migrate diurnally from the rectum to the perianal region to lay their eggs. This migration by female worms is related to a lowering of rectal temperature during sleep and it enables the inadvertent 'hand-to-mouth' transmission of parasite eggs to occur without faecal contamination.

The cercariae of many digeneans are released into water from snails at specific times of the day coinciding with the presence of the appropriate new host. This phenomenon has been well studied for schistosomes, where each species exhibits unique characteristics in the chronology of cercarial shedding. The majority of schistosome species are strictly circadian in their behavior having a single peak of

release each day. *Schistosoma mansoni*, *S. haematobium*, and certain strains of *S. japonicum* and *S. bovis*, all release cercariae during the day, while *S. rodhaini* and other strains of *S. japonicum* release cercariae at night. Of the factors that may influence the periodicity of cercarial shedding from snails, the most important are environmental light and temperature cycles. This has been confirmed by experimental manipulations of light period and temperature: reversal of photoperiod rapidly causes a reversal of the pattern of cercarial shedding and, while alterations of the relative lengths of light and dark periods may be influential, the emission wavelength of light is unimportant. Thermoperiod plays a less significant role than does photoperiod. Human schistosomes tend to shed cercariae during the day, *S. Iodhaini*, a parasite of wild rodents, sheds cercariae at night.

### **Circadian migratory activities**

Some parasites that inhabit deep internal tissues of the host and are transmitted by surface-biting invertebrate vectors are faced with the problem of enabling their infective stages to reach superficial tissues at the time when the vector is present and feeding. As a consequence, we see amongst certain parasites elegant physiological adaptations to facilitate transmission under such circumstances. The microfilarial larvae of the filarial nematodes are well-researched examples of this phenomenon. The adult worms reside in the lymphatic system (e.g. *Wuchereria bancrofti*) or in thick nodules in the skin and subdermal regions (e.g. *Onchocerca volvulus*) while their larvae are transmitted by mosquitoes or simuliid blackflies respectively, both of which feed on peripheral blood. To optimize infection of the vector, many filarial nematodes have developed diurnal rhythms in migration of their larvae. These patterns can be classified accordingly and are related to the feeding activities of the insect species consumed with transmission:

1- microfilariae numerous in host peripheral blood at night only, absent by day (e.g. *W. bancrofti*, *Brugia malayi*)

2- microfilariae numerous in peripheral blood by day only, absent by night (e.g. the eye worm, *Loa loa*)

3- microfilariae more numerous in peripheral blood during the evening (e.g. the heart worm, *Dirofilaria immitis*)

4- microfilariae present in peripheral blood for entire 24-hour period, but more numerous in the afternoon (e.g. Pacific form of *W. bancrofti*).

When the microfilariae are not in the peripheral blood they accumulate within the pulmonary circulation at the capillary junctions of arterioles and venules. The difference in oxygen tension ( $CO_2$ ) between arterial and venous blood at these junctions is the initiating trigger for the diurnal migration of the larvae. When the  $CO_2$  is in excess of 55 mmHg the larvae of *W. bancrofti* accumulate in the pulmonary circulation; they emerge and migrate to the peripheral circulation when the  $CO_2$  decreases to 47 mm Hg or below (Fig. 7.2 & Table 7.2).

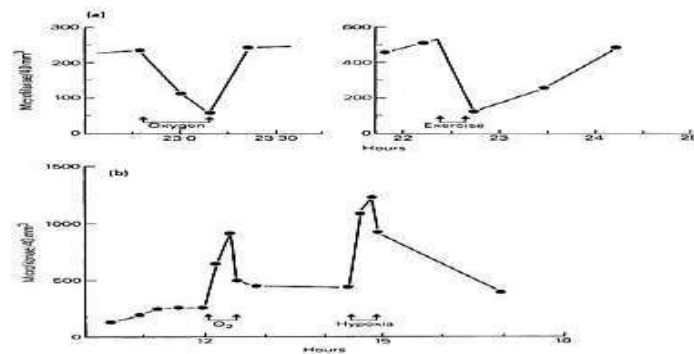

Fig. 7.2 The distribution of microfilariae in the host according to the state of oxygenation. (a) *Wuchereria bancrofti* in humans - both breathing oxygen and vigorous exercise produce a high venous-arterial difference in blood oxygen tension and microfilariae migrate away from the peripheral circulation. (b) *Dirofilaria repens* in dogs. In all graphs, the curves represent the microfilarial counts in peripheral blood obtained by conventional skin-bleeping and direct counting. [Data from Hawking, 1975].

## Establishment and survival within the host

After locating and gaining entry into a suitable host, the parasite has to become established in a physiologically suitable microhabitat in order to grow, either to sexual maturity or to an intermediate stage, such as another larva, whose continued development occurs in the next host. Parasite establishment and growth require that a complex series of physiological conditions are met. These are summarized in Fig. 7.3.

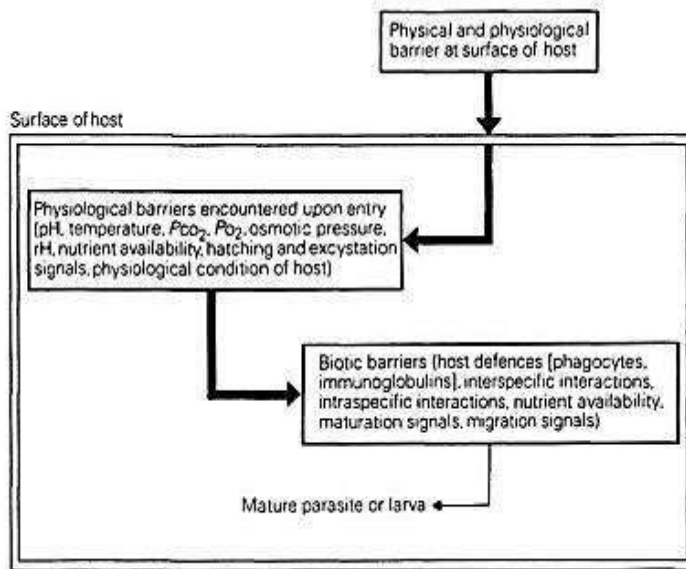

Fig. 7.3 Barriers to establishment encountered by invading parasites.

## Transformation of digenean cercariae

During attachment and subsequent penetration of the host epidermis, cercariae undergo a physiological transfusion in which they rapidly become adapted to the conditions within the host body. Transformation has been studied in some detail in schistosomes but in few other digenean parasites. The schistosome cercaria is adapted for an existence in freshwater at 25°C in which it swims vigorously, gaining motility from its tail. Once attached to mammalian skin, the tail is lost and penetration commences. It was thought that tail-loss signaled cercarial

transformation to the schistosomulum. On skin contact, the cercaria secretes a powerful protease from its preacetabular glands and morphological changes in its tegument are initiated. Over a period of just a few hours the schistosome cercaria transforms into a migratory larva, the schistosomulum. These two larvae are metabolically distinct, the cercaria is aerobic and the schistosomulum produces lactate anaerobically they possess morphologically and antigenically diverse surfaces; and they show osmotic restriction in their tolerance. The dramatic modifications to the worm surface reflect the need for the parasite to defend itself against host immune attack, to which end it can bind host molecules to effect immunological disguise, and also acquire the ability to transport nutrients transtegumentally. The major features that accompany schistosome transfusion are summarized in Table 7.3 and it is probable that these events are common to many species of digenean. Differences that occur may depend on whether the host invaded is a poikilotherm or a homoiotherm.

**Table 7.3 Transformation of the schistosome cercaria. [Data from Wilson, 1987.]**

Condition	Cercaria	Schistosomulum
Habitat	Freshwater	Body of bird or mammal
Temperature	25°C	37–41°C
Motility	Swims using tail	Crawling or burrowing
Glands	Pre-, postacetabular and head glands full; secrete contents on skin contact	Glands empty
Tegument	Trilaminar surface membrane; extensive glycocalyx	Heptalaminar surface membrane; reduced glycocalyx
Permeability	Impermeable to nutrients	Permeable to nutrients
Osmotic tolerance	Survives in water, dies in complex media	Intolerant of freshwater
Energy metabolism	Oxidative, cyanide-sensitive	Anaerobic, cyanide-insensitive
End-products	CO <sub>2</sub> + H <sub>2</sub> O	Lactate (after 24 hours)
Surface immunochemistry	Antigenically simple	Antigenically complex



**Hatching and excystation**

Many parasites enter their hosts encapsulated either within cyst or within egg membranes. Such parasites inevitably enter the host via the alimentary canal, within which they become activated and then liberated from these capsules prior to further development. Not all parasites that gain entry to their host by being eaten are encapsulated; for instance, many helminth larvae reside in the tissues of an intermediate host free from a cyst [e.g. metacercariae of some strigeid digeneans, pseudophyllidean proand plerocercoids and many nematode larvae). It is not clear why some intermediate stages of parasites form cysts and others do not; in part, it may reflect the nature of the host response to the parasite since many cysts are made up of contributions from both parasite and host. Protozoa Activation and excystation of protozoan cysts has been examined *in vitro* for a relatively small number of species (Table 7.4).

**Table 7.4** Conditions for *in vitro* excystation of some protozoan parasites. (Data from Lackie, 1975.)

Species	Temperature [°C]	pH	Gas phase	Enzymes added	Bile	Host
<i>Entamoeba histolytica</i>	37	-	Air or anaerobic	Reducing agents	-	Man
<i>E. invadens</i>	8-24	-	-	-	-	Reptiles
<i>Eimeria bovis</i>	40	7.5-8.5	Air or 50% Air/CO <sub>2</sub>	Trypsin + reducing agents	1%	Cattle
<i>E. tenella</i>	37-41	7.6	Air or CO <sub>2</sub>	Trypsin, HCO <sub>3</sub> <sup>-</sup> , pancreatin	Present	Poultry
<i>Cystoisospora canis</i>	22-37	-	Air or CO <sub>2</sub>	Trypsin	0.5%	Dogs

Optimum experimental conditions include temperature increase, if the parasite is invading a homoiotherm, neutral pH, low PO<sub>2</sub>, high PCO<sub>2</sub>). Activation of the parasite within the cyst may be distinct from excystation, the former depending upon high PCO<sub>2</sub> and the latter requiring proteolytic enzyme action. In the Coccidia, for example *Eimeria* and *Isospora*, excystation of the sporocyst after its release from the oocyst can involve the breakdown of a localized region of the cyst wall by the action of bile salts and trypsin.

## **Digenean**

The eggs of the majority of digeneans hatch in water under suitable environmental conditions of light, salinity and temperature. The eggs of some other digeneans are ingested by molluscs and hatch in the snail gut. The operculate eggs of *Fasciola hepatica* hatch under the influence of light, and in fact, specific wavelength may be important\_ Light appears to stimulate activity in the miracidium resulting in permeability changes to the viscous cushion just below the operculum, the hydration of which may force off the operculum allowing the parasite to escape. Schistosome eggs do not have an operculum and the larval parasite emerges on rupture of the eggshell; osmotic pressure is the major physiological effector for the hatching of schistosome eggs, such that a rapid decrease in osmotic pressure, as would be experienced when the egg is passed into freshwater, triggers hatching. The influence of light and ambient temperature are of less significance. In some digeneans, activation may involve the production of lytic enzymes that contribute to the process of excystation.

The metacercariae of many digeneans are enclosed within cysts whose walls vary in specific architecture and dimension. For those species that invade birds or mammals and whose cysts are thin-walled, excystation is initiated by the elevation of ambient temperature alone. Excystation in the laboratory of the more complex metacercarial cysts requires the action of serial treatment with pepsin followed by trypsin as well as temperature changes; bile salts may also play an important role in this process (e.g. *F. hepatica*). Within the Digenea, excystation initiators vary according to species; often certain of these factors activate the encysted larva itself and then a combination of external and internal factors contributes to the final emergence of the parasite. The initiators for digenean excystation include temperature, pH, redox potential,  $PO_2$ ,  $PCO_2$ , osmotic pressure, bile salts and inorganic ions.

## **Cestoda**

The eggs of many tapeworm species hatch in the external environment upon receipt of, and in response to, suitable stimuli. By contrast, the eggs of the Cyclophyllidea hatch in the gut after ingestion by the invertebrate or vertebrate host. The cyclophyllidean egg has a thin outer capsule but the oncosphere larva is enclosed within a thick, protective embryophore. Hatching of the eggs of taeniid tapeworms is a biphasic process whereby the hexacanth larva is first activated, bringing about disruption of the onchospherical membrane, and digestion of the outer capsule is completed by the action of host proteolytic enzymes.

In nontaeniid cyclophyllideans, hatching is largely a mechanical process due to the action of the host mouthparts on the eggshell. Hatching of these eggs can be accomplished *in vitro* in simple physiological saline. In *Hymenolepis* species, however, onchosphere activation requires high PCO<sub>2</sub> and the presence of bicarbonate ions and digestive enzymes. Hatching of the taeniid egg requires exogenous pepsin (e.g. *Taenia saginata*) and activation of the encapsulated larva is influenced by host bile salts.

## **Nematoda**

The eggs of many nematodes hatch in the external environment to release either infective larvae or larvae that develop to the infective stage (e.g. *Ancylostoma*). Upon receipt of the appropriate environmental stimuli, including water, and changes in temperature or oxygen, the enclosed larva liberates lytic hatching enzymes whose action may increase water uptake into the egg. Hatching may be induced therefore by increased turgor pressure within the egg (e.g. *Trichostrongylus*).

The eggs of other parasitic nematodes hatch only after ingestion by a suitable host (e.g. *Toxocara*). *Ascaris* eggs hatch *in vitro* at 37°C in media with high PCO<sub>2</sub>,

and neutral pH containing bicarbonate ions and reducing factors. The larva within the egg is activated to produce a hatching fluid comprising enzymes capable of digesting the ascaroside and chitinous layers of the eggshell.

Trichostrongyle L3 larvae are enclosed within a sheath formed from the cuticle of the second larva; exsheathment takes place within the gut of a suitable host under the influence of carbon dioxide, bicarbonate ions, reducing agents at neutral pH and at the appropriate temperature. The larval parasite is induced, by these environmental stimuli, to produce an exsheathing fluid that contains enzymes for disruption of the sheath to allow the infective larva to emerge (Fig. 7.4).

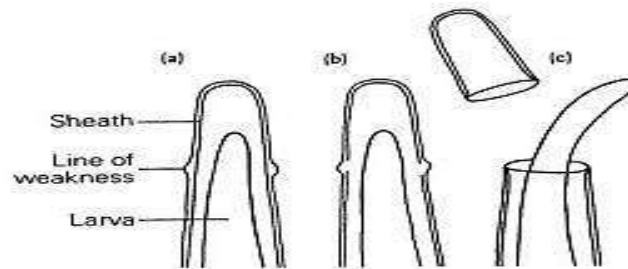

**Fig. 7.4 Exsheathment in infective trichostrongyle larvae [e.g. *Haemonchus*]. (a) A line of cuticular weakness is developed by localized anterior swelling of sheath. (b) Digestion of inner layers of line of weakness. (c) Rupture of sheath along line of weakness and release of larva. (After Lee & Atkinson, 1976.)**

### **The role of bile salts in parasite establishment**

Bile, a complex mixture of organic acids, is released into the upper duodenum of vertebrates via the bile duct. Bile contains bile salts, which are steroid-like molecules based on cholic acid, bile acids, which are the degradation products of red blood cells, and bicarbonate ions. Bile salts can be of considerable significance in determining host specificity of many parasites. They affect parasites in a number of ways including: (1) membrane permeability; (2) activation of encysted forms; (3) lysis of parasite surface membranes; (4) synergism with host digestive enzymes; and (5) metabolic action.

One way in which bile salts may act as determinants of host specificity in parasitism is exemplified by studies on the hydatid organism, *Echinococcus*

granulosus (Table 7.5). Larval protoscoleces, removed from the hydatid cyst, respond in various ways to bile from different animals in vitro: bile rich in deoxycholic acid is lytic to the protoscoleces whereas bile from dogs or other carnivores, the natural hosts for *E. granulosus*, is low in this particular bile acid. The lytic action of bile salts from unsuitable hosts provides a possible mechanism of host specificity at the physiological level. Additionally, bile salts can affect both establishing and established parasites. Experimental cannulation of the bile duct of rats infected with the tapeworm *Hymenolepis diminuta* brings about a reduction in size and fecundity of the worm whereas cannulation prior to infection inhibits establishment. Bile salts activate and initiate excystation in many parasites including protozoans, digeneans (e.g. *Fasciola*), cestodes (e.g. *Taenia pisiformis*). The physiology of these events is not well-understood.

### **Hypobiosis**

The condition under which animals may become quiescent during their development is termed hypobiosis. Periods of arrested development may occur in free living animals that inhabit arid or otherwise intemperate regions and the hypobiotic state is therefore adopted in response to climatic extremes. In the case of parasites, hypobiosis occurs not infrequently; immature stages, encapsulated within eggs or cysts or free within host tissues, are hypobiotic states whereby the parasite becomes arrested in its development and awaits a suitable trigger to initiate the continuation of its development to adulthood. Hypobiosis may represent a serious problem in commercial terms when we consider some of the nematode parasites of cattle. Arrested larval development (ALD) is a feature of many of the major parasitic diseases of cattle including *Haemonchus contortus*. Sheep or cattle become infected with these parasites by ingesting the LJ larvae during grazing; the larvae enter the gut and develop to adults within 21 days, either in the lungs, abomasum or small

intestine, depending upon the species. This pattern of development can become disrupted under certain conditions and populations of arrested early LJ larvae occur, usually within the abomasal glands of the stomach. The factors that trigger ALD in these parasites have not been identified but, host immunity, season of the year and parasite population size may all be involved. Arrested larvae will begin to develop in conditions of experimental or natural immunodepression (e.g. during parturition).

There is a wealth of evidence that ALD in trichostrongyles occurs on a seasonal basis, being prevalent in autumn in the northern hemisphere' and spring in the southern hemisphere. Arrested larvae resume their development and become adult worms at the next grazing season. Artificial induction of ALD has been accomplished by conditioning parasite L3 larvae in a climatic chamber; a large proportion of these 'autumn conditioned' L3s become hypobiotic in naive calves. Chilling parasite larvae to 4°C for 5-10 weeks achieves similar effects.

Arrested larval development external environmental stimuli, such as lowering of ambient temperature or the onset of a hot dry summer period, or to host-mediated stimuli, such as immunocompetence. Moreover, these hypobiotic larvae may also be drug resistant and many anthelmintic drugs are ineffective against them.

Nematodes also exhibit a variety of additional quiescent states. Anabiosis is an extreme state of arrest which may last for considerable periods of time: some nematodes stored dry for over 20 years can then develop normally. In the anabiotic state the parasite has no detectable metabolism and the process of ageing is suspended. Desiccation, low temperatures, osmotic stress can all induce specific anabiotic responses in stages of nematode parasites that occur external to the body of the host.



## **Migration and light selection**

From the point of entry into the host body, the majority of parasites undergo a migration of varying complexity that will take them to their final site of residence. This may be highly specific, as in human schistosomes, cattle lung worms or fish eye- or brain-flukes, or be rather more generalized, as with hydatid cysts that settle in a variety of different sites. Migrations of this type are commonly accompanied by growth and development of the parasite and are thus referred to as ontogenetic migrations. These migratory events, which may be of short or long duration, may culminate in a sexually mature parasite or a larval or cystic stage that exhibits hypobiosis, as described above, until ingested by the final host. Usually the migration will take place over a fixed route if normal parasite development is to occur. The physiological triggers and determinants that orchestrate these migrations are not understood but are clearly important facts of host specificity.

Aberrant migratory patterns can occur if a parasite enters an unsuitable host in which normal and complete development cannot be accomplished. This has been widely documented in strongyloid and ascaridoid nematodes where larval worms invading the wrong host, in this case humans, can cause serious damage. These are the migratory larva migrans which are typical of hookworms, *Ancylostoma braziliense* and some ascaridoids, such as *Toxocara canis*. On invasion, these parasite larvae undertake what is presumably an inadequately signposted migration either in the superficial tissues (e.g. cutaneous larva migrans, *Ancylostoma*) or in deeper tissues (e.g. visceral larva migrans, *Toxocara*).

Since the physiological triggers for normal migration and development are lacking in the incorrect host, these parasites eventually die in an ectopic site, therefore they can cause disease that is often difficult to diagnose. Some common patterns of ontogenetic migration are depicted, but in no case do we understand the

physiological mechanisms that are involved. Some parasites undergo migrations within the host body that are not related to growth and development. These include diurnal migrations associated with transmission. The complex and varied nature of site selection and pattern of migration seen within parasites, especially helminths, argue compellingly that these parasites possess sophisticated sensory capacity to enable them to recognize and respond to the appropriate stimuli emanating from the tissues of the host body. This aspect of parasite physiology has proved to be a difficult area of research to establish and the sensory biology of parasites remains a topic of ignorance and neglect.

### **Invasion of tissues**

During the process of establishment many parasites invade specific cells in host tissues where they reside either temporarily or for long periods of time. The physiology of cell recognition and adherence in parasitology is of interest since many intracellular parasites are responsible for causing major diseases of both humans and animals. Examples of tissue-invading parasites include malarias and babesias (red blood cells), leishmanias (macrophages), coccidians, cestodes and nematodes (muscularis mucosa of the gut), schistosomes (circulatory system), trypanosomes (nervous system) and larval digeneans, cestodes and nematodes (body musculature). The physiology of cell recognition, cell adhesion and penetration is complex and poorly understood and is best described for malaria parasites.

### **Cell invasion in malaria**

Two essentially unrelated features of the cell biology of malaria parasites have attracted considerable attention: red blood cell recognition and invasion and cytoadherence of the parasitized red cell to the endothelial lining of host blood vessels. Invasion of the red cell by Plasmodium is a specific, sequentially-defined

process which involves: (1 cell recognition by the merozoite; (2 orientation of the parasite with respect to the red cell surface and apposition of the apical complex; (3) formation of a junction between the invading merozoite and red cell surface at 'the point of contact, (4) induction of invagination of the red cell membrane by secretions from the merozoite; and (5) entry of the parasite through extensive invagination of the red cell surface membrane forming the parasitophorous vacuole (Fig. 7.7a).

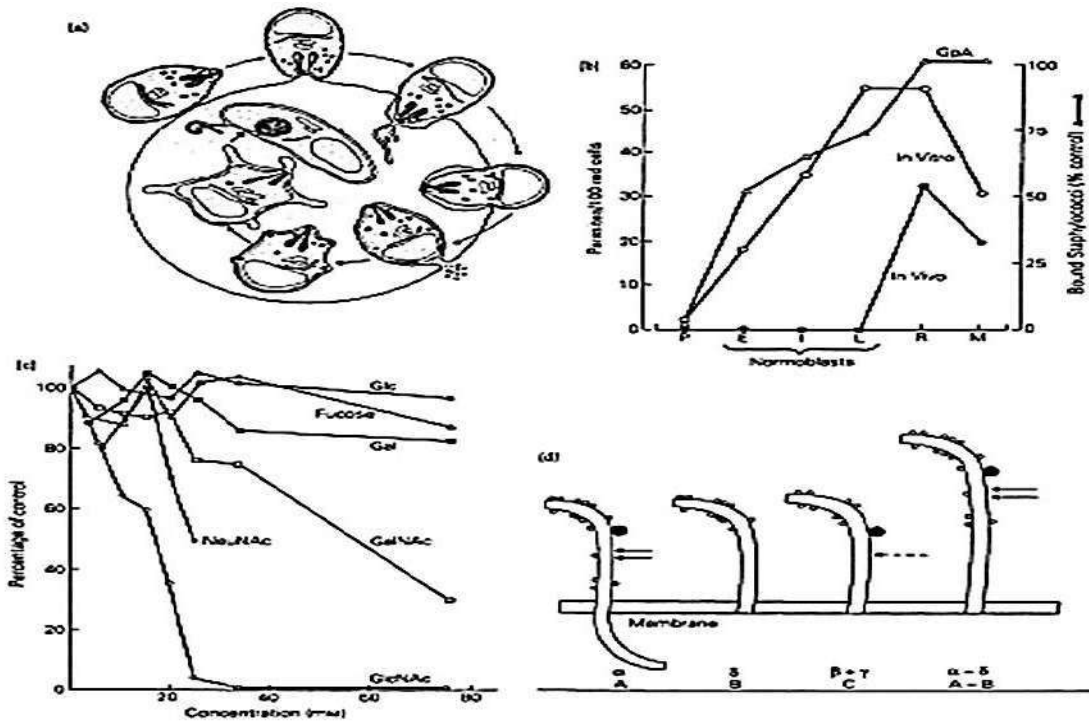

Fig. 7.7 Red cell invasion by *Plasmodium*. [a] Invasion sequence by merozoites of *P. knowlesi* [after Eanister, 1977]. [b] Invasion of red blood cells by *P. falciparum* *in vitro* (○—○) and *in vivo* (●—●) relative to appearance of glycophorin A (GpA): P, proconoblasts, E, early, I, intermediate, L, late normoblasts, R, reticulocyte, and M, mature erythrocyte. [c] Red cell invasion by *P. falciparum* related to the presence of various sugars. Data expressed as a percentage of control invasion: Glc, glucose, Gal, galactose, GalNAc, N-acetyl-D-galactosamine, NeuNAc, N-acetyl-neuraminic acid, GlcNAc, N-acetyl-D-glucosamine. [d] Glycophorins A, B and C schematically represented on the red cell surface. The small circles are O-glycosidically linked oligosaccharides and the large circles are N-glycosidically linked oligosaccharides. Arrows indicate sites of tryptic cleavage. A-B is a hybrid molecule. [b]—[d] from Pasvol & Jungery, 1983.]

Recognition of the red cell by the merozoite depends on specific surface receptors and varies according to age of cell, blood group antigens, and host specificity. Invasion of human red cells is diminished in races lacking Duffy antigens (e.g. in *P. vivax*); treatment with N-acetyl'D-glucosamine, trypsin or neuraminidase blocks cell invasion by *P. falciparum*. Recent evidence implicates surface

glycophorins as major determinants of invasion. Red cell surface glycophorins are sialic acid-rich glycoproteins comprising four subgroups (a, b, c, and d) and their role as surface receptors for *P. falciparum* merozoites is now well-established. Cells lacking either glycophorin or glycophorin resist merozoite invasion to a significant extent and this resistance can be enhanced by tryptic removal of remaining glycophorin molecules. Glycophorins represent a significant component of the red cell membrane and yet they have no clear role, since they can be absent without any red cell dysfunction. *Plasmodium falciparum* will develop normally within glycophorin-deficient cells and will invade young red cells, in which it cannot develop, relative to the progressive appearance of glycophorins on the cell surface (Fig. 7.7b, c & d).

Although the exact role of red cell glycophorins as receptors for merozoites is unknown and the evidence that they contribute to the initiation of erythrocyte invasion is convincing. other factors are also involved. Once recognition of the cell is accomplished, the invasion continues by the formation of a junction of about 10nm, containing fine fibrils that extend between the thickened red cell membrane and the apical protuberance of the merozoite: Duffy-negative, invasion resistant cells do not form this junction but trypsin treatment of these cells renders them permissive to invasion by *P. knowlesi* merozoites and a typical host cell-parasite junction is formed. The apical organelles of the merozoite, the ribosomes and micronemes, initiate the actual invasion of the red cell by releasing secretions which include a histidine-rich protein. During invasion, the red cell membrane invaginates progressively to enclose the merozoite and the junction moves so that its position is maintained at the mouth of the development parasitophorous vacuole. This mobility of the junction may be related to membrane Acidity, since treatment of merozoites with cytochalasin B inhibits invasion despite the formation of a junction on attachment of the merozoite; here no junctional migration occurs. On completion of

normal invasion, the junction seals up behind the merozoite which now lies completely enclosed within the parasitophorous vacuole. This vacuole is made of original red cell membrane which has undergone molecular reorganization. Not only does the intracellular malarial parasite induce molecular changes within the membrane of the parasitophorous vacuole, but it also affects the red cell surface itself. Under certain conditions, surface electron-dense knobs appear on the red cell membrane and caveola-vesicle complexes may also be formed.

One major feature of *P. falciparum* infections is the sequestration of infected red cells through cytoadherence to endothelial cells of the host circulatory system, mediated through erythrocyte surface knobs. Sequestration is an important adaptation by which the parasite may avoid circulation through the spleen where host defense is active. Pathologically, sequestration may contribute to obstructed blood flow typical of cerebral malaria. *falciparum* malaria differs from other human malarias in that only red cells containing young ring Stages of the parasite circulate freely, while cells infected with more mature parasites become sequestered.

The surface knob, which is the functional unit of cytoadherence of *P. falciparum*-infected red cells, comprises a cup-shaped membranous structure and associated protrusion of the red cell surface membrane (Fig. 7.8). These knobs contain a unique protein of Mr 80000, rich in histidine and proline which is lacking in knobless strains of the parasite. Its role in mediating cytoadherence remains unexplained but, since antibody has been shown to inhibit cytoadherence in a strain specific way, it suggests that additional molecules may also be involved.

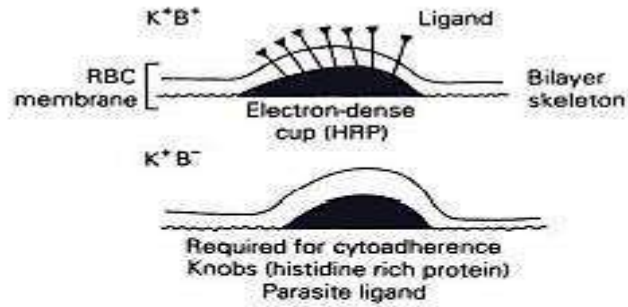

**Fig. 7.8** Model for knobs on the red cell surface induced by infection with *Plasmodium falciparum*.  $K^+B^+$ , knobby parasite able to bind to blood vessel endothelium;  $K^+B^-$ , knobby parasite incapable of endothelial binding due to absence of putative cytoadherence factor. [After Leech *et al.*, 1984.]

### Cell invasion in other parasites

Many other protozoan parasites adopt an intracellular habit and therefore invade host cells. Like malaria parasites, these also may reside within a parasitophorous vacuole and enter by invagination of the cell surface rather than by penetration of the membrane itself. This pattern of invasion occurs in the Coccidia (e.g. *Eimeria* invading gut cells and *Toxoplasma* invading macrophages). The parasitophorous vacuole may be temporary (e.g. *Babesia*) and regresses shortly after entry is accomplished. *Toxoplasma*, *Eimeria* and *Leishmania* all invade host cells by inducing their own phagocytosis. Treatment of host cells with drugs that inhibit phagocytosis, such as colchicine or cytochalasin B, alters the pattern of invasion.

In vitro studies on cell invasion by *Leishmania* parasites suggests a degree of induction and specificity in the mechanisms involved. Promastigotes of various species of *Leishmania* induce phagocytosis by host macrophages and these cells respond to the presence of live parasites by producing pseudopodial whorls or lamellar sheaths killed parasites are also taken up but at a reduced rate. Cytochalasin B inhibits macrophage invasion by these promastigotes, which will also invade non-phagocytic cells in culture. After invasion, *Leishmania* parasites reside within a parasitophorous vacuole formed from host cell membranes. Survival of the parasite



within a cell, whose role is to ingest and kill invaders, is both of considerable interest and applied significance.

*Trypanosoma cruzi*, the causative agent of Chagas disease in the Americas, is an obligate intracellular protozoan. In cell culture, trypomastigotes invade fibroblasts by mechanisms that involve interaction between the surface membranes of the host cell and the parasite. The parasite produces a lectin-like protein responsible for cytoadherence aided by a proteolytic activating system; penetration is effected by a tunicamycin-sensitive glycoprotein. The host cell contributes to these events by producing glycoproteins that are active in adherence and also penetration.

In some cases, host cell invasion by protozoan parasites is the major pathophysiological event. In *Entamoeba histolytica*, secreted products, such as 'amoebapore' (a parasite-derived, pore-forming protein), cytotoxin and proteolytic enzymes all contribute to invasion of the host intestinal cells and to the severe intestinal and liver pathology associated with this phase of amoebiasis. While several species of helminth parasite invade host cells (e.g. *Trichinella spiralis* in muscle cells) little information on mechanisms of entry is available.

## **Reproductive Physiology**

Many parasites have complex life cycles which involve stages that reproduce by sexual processes in one host and by asexual proliferation in another host. These mechanisms ensure that genetic information is varied and becomes widely disseminated and also that infective parasite stages are produced in sufficient numbers to favor successful transmission in a hostile environment.

### **Asexual mechanisms**

Asexual splitting, or budding occurs in many parasitic Protozoa, all of the Digenea and in some Cestoda. Asexual reproduction in the Protozoa involves binary or multiple fission, schizogony, eoadyogeny or single budding, while in helminth parasites individual numbers are dramatically increased by internal budding (polyembryony).

During the life cycle of the Digenea, an asexual phase occurs exclusively within the molluscan intermediate host. Normally two distinct asexual generations are passed within the snail, mother sporocyst to daughter sporocysts or sporocyst to rediae, the net result being that from a single miracidium entering a snail many hundreds of thousands of cercariae may subsequently emerge. Each of these individuals will be genetically identical.

The majority of cestodes produce only a single larva from the egg but proliferative external budding occurs in the urocytis and urocytidium larvae and internal budding occurs within the polycercus, coenurus and hydatid larvae of the Taeniidea. The hydatid cyst of Echinococcus can generate several million protoscoleces by asexual budding. while the coenurus rarely produces more than a few hundred larval tapeworms.

## **Sexual reproduction**

Many protozoans reproduce by a form of sexual reproduction but it is not always easy to distinguish between the fusion of individual parasites and the fusion of gametes. In some species the gametes are morphologically distinct, such as male microgametes and female macrogametes, and sexual processes may alternate with asexual reproduction, each taking place in a different host. In malaria parasites, asexual schizogony increases numbers of merozoites in the host blood but sexual gametocytes are also formed which are transmitted to mosquitoes in which host gamete fusion and sexual proliferation takes place. The stimulus which controls the formation of gametocytes has interested malariologists for a long time; current thinking favors the view that trophozoites are directed towards sexual reproduction by environmental factors associated with host cell lysis or degeneration. Here gametocytogenesis can be regarded as an escape mechanism from unfavourable conditions by means of the genomic variation conferred by random fusion of gametes in the mosquito.

The sexuality of trypanosomes is a topic of current interest and the traditional opinion that these parasites reproduce only by asexual binary fission has been challenged. Sexual stages in the life cycle of trypanosomes may occur either within the mammalian host in an extravascular location or within the tsetse fly vector. In support of the latter contention, giant forms of trypanosomes, which are capable of liberating large numbers of new trypanosomes, have been isolated from midgut cells of flies; these giant forms are apparently the product of fusion of two individuals and this represents a mechanism by which genetic interchange might occur. Natural populations of African trypanosomes demonstrate considerable electrophoretic variability which perhaps indicates the importance of sexual mechanisms in increasing genomic variability in the wild.

All monogeneans are hermaphrodites and asexual mechanisms are unknown. Cross fertilization usually takes place between adjacent individuals but self-fertilization may also occur. The majority of digeneans are hermaphrodite and both self- and cross-fertilization have been recorded; the schistosomes have separate sexes and cross-fertilization is therefore mandatory. The physiology of egg production is well understood; eggs are released from the mature ovary and enter the oviduct. Spermatozoa from the partner are stored, after copulation, in a seminal receptacle. These are then released along with a small number of vitelline cells and they make their way to the ootype where the ova are fertilized. During development the egg shell becomes tanned in utero and on release the egg is fully protected by the rigid shell.

Almost all tapeworms are hermaphrodites and each proglottids (segment) contains a full complement of male and female apparatus. Both cross and self-fertilization occur. Cestodes mature posteriorly such that the terminal segments are the oldest and, when gravid, contain ripe eggs that are either shed independently or within the liberated proglottis itself. The tapeworm egg is not tanned like that of the Digenea, but is surrounded by a capsule comprising various constituent layers.

The majority of parasitic nematodes are sexually dimorphic and reproduce sexually; a small number of species reproduce either hermaphroditically or parthenogenetically but no somatic asexual processes have been described. The male nematode generally possesses a single testis and accessory structures, such as a copulatory bursa or paired spicules, which are used during copulation. The female nematode may have one or two sets of gonads; sperm are stored in a seminal receptacle and these fertilize mature oocytes in situ. Egg shell formation is initiated by the process of fertilization and continues during egg maturation. In some groups, such as the filarial nematodes, egg hatching takes place in utero and the egg shell is accordingly reduced in size and chemical complexity.

Almost all parasites are characterized by their enormous reproductive capacity and they produce, either by sexual or asexual mechanisms, or sometimes both, extremely large numbers of offspring. Physiologically this strategy is demanding in terms of nutrients and energetic commitment to reproduction.

### **Reproductive synchrony**

Reproductive events in a small number of parasite species are synchronized to host sexual cycles and breeding patterns/ this relationship serves to liberate infective parasites into the environment simultaneously with susceptible juvenile hosts. The best known examples come from the flagellated protozoans of amphibians and arthropods.

The release of opalinid (protozoans found in the intestinal tracts of amphibians and some other animals) gametes from the amphibian gut is initiated by host sex hormones. The *Hypermastigina* that inhabit the gut of arthropods can be stimulated to reproduce sexually under the influence of host moulting hormones. Flagellates of termites are lost with each successive moult since they inhabit the insect hindgut which is lined with cuticle. Here, synchrony of sexual processes in the parasite with moulting in the host ensures reinfection, which in this example is a mandatory phenomenon since the parasite is the source of essential digestive cellulases.

### **Chemical Communication**

Chemical communication between animals of the same species or of different species has long been the subject of intensive research interest. Among the insects, the topic of communication via pheromones has had considerable commercial significance in the field of insect pest control. Surprisingly, little is known about chemical communication between parasites, yet this information could prove to be

invaluable in the quest for novel strategies with which to control the world's major parasitic diseases.

Pheromones are probably produced by many helminth parasites and they may serve as sexual attractants: there is considerable indirect, but little direct, evidence to support this contention.

Laboratory identification of parasite pheromones is normally made using in vitro bioassays whereby movement of individual worms in aqueous or semi-solid media is assessed within choice chambers of various design. Less frequently, supporting data has been obtained from in vivo observations on mate location by parasitic worms, but such information has proved more difficult to interpret unambiguously.

Solubility, enzyme and chromatographic studies on putative pheromones from helminths have all provided indirect evidence for the types of chemical messengers involved in sexual attraction, but no parasite pheromone has yet been identified or characterized chemically. Sterols and peptides have both been implicated as candidate pheromones in parasitic nematodes (e.g. *Nippostrongylus brasiliensis*) and digeneans (e.g. *Echinostoma*). However, detailed biochemical analyses of pheromones of *N. brasiliensis* suggest a more complex picture in which the worms produce a mixture of lipidoidal and hydrophilic substances which can variously attract either the same or the opposite sex. The site of pheromone production appears to be highly varied in helminth parasites. In nematodes, the copulatory organs themselves and the body surface are the apparent source of attractant molecules, while in the digeneans, the tegument, alimentary canal and excretory system all produce unidentified chemoattractants. Studies on sensory receptors of helminths that may detect chemical messengers released into the environment have failed to provide unequivocal evidence on location and precise function of these organelles.

Schistosomes present an interesting and somewhat unusual picture in terms of sexual attraction: they possess separate sexes that show varying degrees of interdependence for growth and development and in which processes chemoattractants must play an important but undisclosed role. Males of *Schistosoma mansoni* will grow and develop to maturity in the absence of females whereas female worms lacking males grow poorly and never reach sexual maturity although they have the potential to do so if males are experimentally introduced even as much as a year later. Other schistosome species show a lesser degree of sexual dependence. Laboratory studies reveal that adult male and female schistosomes attract one another by chemical means involving lipid-based pheromones; homosexual attraction and pairing can occur and under these conditions partial sex-reversal of the smaller male partners has been observed. Females of *S. mansoni* will only grow to sexual maturity after a period of residence within the gynaecophoral groove of the male, implying tactile as well as chemical stimuli as controlling mechanisms. The receptors involved in interpreting this complex array of signals have not been described. In a parasitic disease whose pathogenesis is directly related to sexual activity of the parasite, pheromones that initiate worm pairing, growth and maturation would represent ideal and novel drug targets.

Aside from chemical aspects of parasite reproductive biology, the general endocrinology of helminths is little understood. Hormones concerned with regulation of parasite growth and development have been examined for only a small number of species and their role remains a matter for some speculation. Parasitic nematodes, like their free-living relatives and arthropods, grow by a series of moults in which the old cuticle is shed and replaced by a new structure. These events are controlled by juvenile, ecdysteroid and neuropeptide hormones in insects and, by analogy, they should also function similarly in nematodes. Biochemical identification of these hormones from parasite tissues has been confirmed but



experimental verification of their biological function has not yet been made, nor has their biosynthesis been demonstrated unequivocally. Therefore, despite the presence of ecdysteroids (ecdysone and 20-hydroxyecdysone) in nematodes and platyhelminths, their function remains elusive, particularly since moulting only occurs in the nematodes. It may be that the complex surface biology of helminth parasites is regulated by conserved families of developmental hormone but this has yet to be established.

## **Neurophysiology of Helminth Parasites**

Parasite neurobiology has long been a 'Cinderella' topic with parasitologists but it should be apparent that, with their relatively sophisticated patterns of host-finding, site-location, mate finding and reproductive biology, parasites are more complex than many textbooks would admit and their neurobiology will be accordingly complicated. Furthermore, a great many antiparasite drugs act on the neuromuscular system of helminths. Thus parasite neurophysiology is gaining in importance as a topic of considerable applied significance.

### **Helminth nervous systems**

The nervous system of platyhelminth parasites comprises an anterior complex of cerebral ganglia with, posteriorly, a bilaterally symmetrical series of nerves serving the body. The system is formed of a nerve network containing unmyelinated fibers, the majority of which have motor function. The acanthocephalan nervous system is comparably undeveloped and contains a cerebral ganglion from which arise single and paired nerves; the male worm has a second ganglion associated with the reproductive system.

Information of the nervous system of parasitic nematodes derives from early studies on ascarids and more recent work on free-living forms such as *Caenorhabditis elegans*. A nerve ring, containing the main concentration of neurons, is associated with the esophagus, from which motor nerves are directed to the head; sensory nerves connect the nerve ring to anterior sense organs. A paired, ganglionated, ventral nerve cord extends posteriorly and connects with a dorsal nerve via a series of commissures. There is a posterior nerve ring which contains ganglia connecting with both motor and sensory neurons. The pattern of the nervous system tends to be consistent throughout the phylum.

### **Sense organs and sensory biology**

The functioning of helminth sense organs has been determined primarily from morphological and behavioral studies and little direct information has been obtained. The major areas of sensory physiology that have been examined are photoreception in free living larval helminths, chemoreception in host-, site- and mate location, and sensory recognition of and responses to temperature gradients and gravity.

Many larval helminths respond to light in their environment, utilizing these responses to come into juxtaposition with a suitable host for invasion. Eye-spots are present in some helminth larvae, including most monogenean oncomiracidia and some digenean miracidia. Larval forms lacking such sense organs may nevertheless respond either positively or negatively to light but it is often difficult to distinguish between one stimulus and another in an experimental arena. Photosensitivity is undoubtedly important for orientation of invasive helminth larvae with respect to host finding and often also for the initiation of hatching of helminth eggs.

Response to a thermal gradient may be necessary to accomplish infection of a warm-blooded host (e.g. larval hookworms in a terrestrial environment and schistosomes in an aquatic environment). It is not known what sensory apparatus is involved in these responses.

Similarly, parasites may respond to gravity, chemical gradients including oxygen or carbon dioxide, and to the presence of other individual parasites, but the sensory organelles involved here have also yet to be identified. Surface receptors include ciliated sensillae (Monogenea), ciliated pits and papillae (Digenea), tegumental protrusions (Cestoda) and amphids, papillae and ciliated pits in the Nematoda.

### Neurotransmission and neurosecretion

Helminth parasites synthesize a number of putative neurotransmitter substances including adrenalin, noradrenalin, acetylcholine, DOPA, dopamine, GABA (gamma-aminobutyric acid) and serotonin (5-HTI). Cholinergic synapses are widely distributed throughout the helminths and acetylcholinesterase has been located histochemically in many species. The neuromuscular junctions of nematodes are cholinergic: acetylcholine decreases muscle resting potential while substances like physostigmine increase sensitivity to acetylcholine; piperazine, a widely used nematocidal drug, inhibits the stimulatory effects of acetylcholine. The major inhibitory neurotransmitter in nematodes is GABA (Fig. 7.9) and its action at the synapse is thought to be the focus of activity of the anthelmintic ivermectin. Platyhelminth neurotransmitters include acetylcholine, 5-HT, noradrenalin and dopamine; GABA is presumed to be unimportant since ivermectin has no effect on platyhelminth parasites.

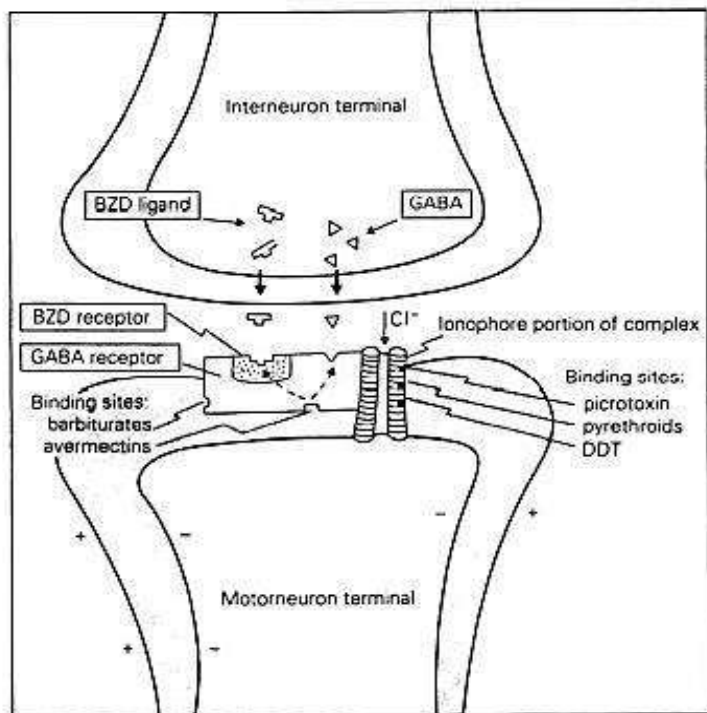
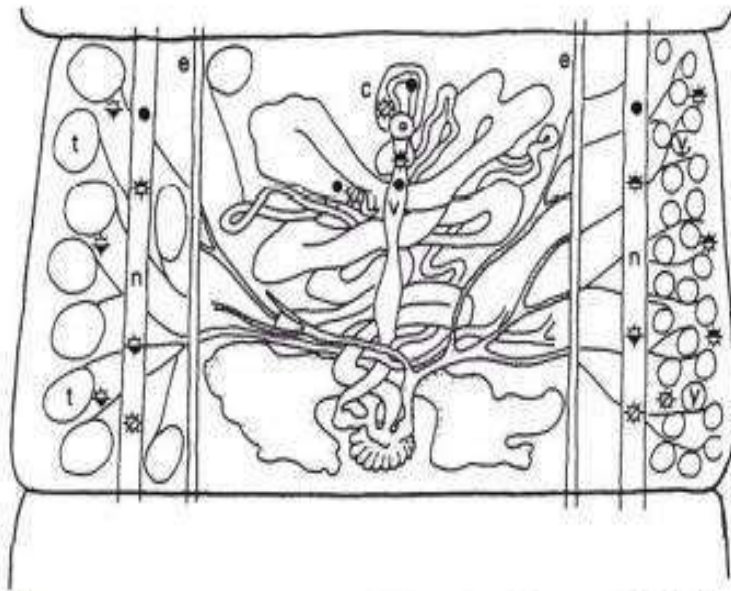

Fig. 7.9 Interaction between the nematode synapse and the drug ivermectin. Potentiation of GABA and benzodiazepine binding [dotted lines] cause Cl<sup>-</sup> influx and motorneuron hyperpolarization. Ivermectin [avermectins] also potentiate GABA release, which may explain their anthelmintic mode of action in causing worm paralysis. (After Campbell, 1985.)

Chemical messengers within the nervous system, such as neuropeptides, amines, amino acids and acetylcholine, are the focus of growing attention since they may differ in parasite and host and thus present chemotherapeutic potential. The complexity of this topic has been revealed in recent studies; for instance, in tapeworms, aminergic, cholinergic and peptidergic neurones have been identified (Fig. 7.10). At least 29 neuropeptides have been detected by immunoreactivity with specific antisera to mammalian peptide hormones including bovine pancreatic polypeptide, growth hormone releasing factor, peptide histidine isoleucine, gastrin, gastrin releasing peptide, leuencephalin, neurotensin, vasotocin, oxytocin and FMRF-amide. Nothing is known of the function of this complex of neuropeptides in cestodes but once disclosed the possibility exists for the development of novel drug targets at the neurophysiological level.



**Fig. 7.10** Aminergic and peptidergic nervous elements in the proglottid of a mature cestode [*Diphyllobothrium dendriticum*]. All four types of immunoreactivity are present in the two main nerve cords [n]. [After Gustafsson, 1985.]

●, fibres immunoreactive to peptide histidine isoleucine surrounding testicular follicles; ○, immunoreactivity to FMRF- amide (Phe-Met-Arg-Phe-NH<sub>2</sub>) in cirrus sac (c); ★, immunoreactivity to growth hormone releasing factor in vaginal wall (v) and vitelline glands (y); ●, immunoreactivity to serotonin in vaginal wall, uterine pore and cirrus sac.

The products of some parasites are capable of causing what appear to be endocrinological lesions in their hosts via the production and release of substances that mimic host hormone action. This occurs in larval helminth infections of snails, such as bird schistosome which induces host gonadal regression via a substance called 'schistosomin'; this substance is synthesized by the snail itself under the influence of the parasite. Many larval digeneas cause profound growth and sexual changes in molluscs, some of which may be mediated endocrinology. Plerocercoids of the tapeworm, *Spirometra mansonioides*, release a platelet growth factor IPGFI which is a remarkable mimic of mammalian growth hormone (Table 7.7). The plerocercoid stage shows little host specificity, infecting a wide range of animals, including humans, causing the condition known as sparganosis. The similarities between PGF and human growth hormone have led to speculation that this parasite has acquired the human gene for growth hormone which it is able to express in the plerocercoid stage. Viral transduction is one possible method by which this proposed genetic exchange may have occurred.

**Table 7.7** Comparison of plerocercoid growth factor (PGF) of *Spirometra mansonioides* with mammalian growth hormone (MGH). (Data from Phares, 1987.)

Parameter	PGF	MGH
Weight gain	Increase	Increase
Skeletal growth	Increase	Increase
Somatomedin activity	Increase	Increase
Endogenous GH	Decrease	Decrease
Insulin-like in:		
Normal rats	Yes	No
Hypophysectomized rats	Yes	Yes
Antiinsulin-like in: Diabetogenic	No	Yes
Binding to rabbit and rodent GH and Prolactin receptors	Yes	Yes
Lactogenic in pigeon crop-sac assay	Yes	Yes
Primate GH-activity	Yes	Yes
Molecular weight	24 000	22 000
Isoelectric point	pH 4.7	pH 4.9
Reaction with monoclonal antibody to human GH (%)	61	100

### **The neuromuscular junction in helminths**

The muscle cells of nematodes, as revealed by studies on *Ascaris*, are unusual in that they contain both nervous and contractile elements: the muscle arm synapses with motoneurons of the nerve cord. The contractile portion contains regular arrangements of thick and thin myofilaments, typical of striate muscle, in which H, A and I, but not Z bands are apparent. The neuromuscular junction of other helminth parasites is poorly understood.

### **Locomotory Physiology**

Almost all parasites are capable of movement and some stages in the life cycle, especially those concerned with active transmission in the external environment, are highly motile. Even adult parasites can be highly active when viewed after host autopsy, but this may not necessarily reflect their natural state *in vivo*.

Information in locomotory physiology is largely restricted observations on the effects of various external stimuli upon activity and speed of movement. Amongst the Protozoa, ciliary, flagellar and amoeboid movement have all been described; parasites appear to be no different in this regard from free-living forms. Members of the Apicomplexa, such as *Eimeria* and *Plasmodium*, exhibit gliding movements during which the parasite undergoes no alteration in body shape. The physiological mechanisms underlying this process are unknown but the motion of a 'linear motor', powered by interactions between actin and myosin filaments in the parasite surface membranes, has been proposed (Fig. 7.11).



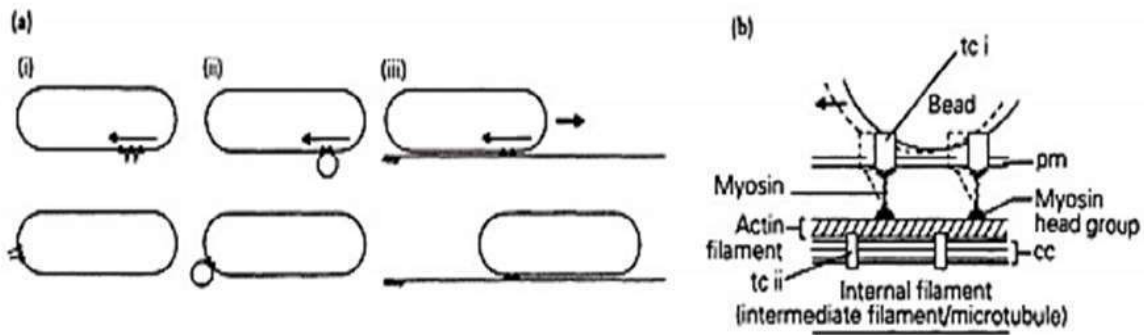
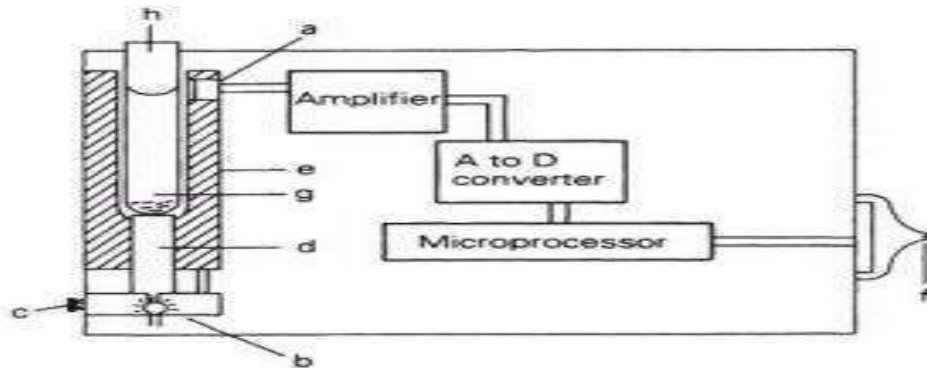

**Fig. 7.11** Biomechanics of locomotion in sporozoan (apicomplexan) protozoans. (a) Gliding movement with associated capping and bead translocation; (i) antibody [Y] interacts with cell surface components forming a cluster which may activate the proposed 'linear motor' sweeping complexes to rear of cell; (ii) beads and cell surface interact to initiate 'linear motor' that moves bead to end of cell; (iii) substrate interacts with cell surface to activate motor, since substrate cannot move, cell is moved forwards. (b) Model for proposed 'linear motor', based on interactions of surface actin and myosin: tc i and tc ii, transmembrane components; cc, cortical cytomembranes; pm, plasma membrane. Interaction of myosin head group with ATP and actin filaments leads to conformational changes associated with release of ADP. Addition of further ATP would cause release of myosin head group from actin filament and the bead illustrated would move to the left. [After King, 1988.]

Ciliary locomotion occurs in some helminth parasites, including oncomiracidia, miracidia and coracidia. In other larval stages and adult helminths, locomotion takes the form of swimming, crawling or burrowing brought about by muscular action. Nematode parasites, like their free-living relatives, move in a characteristic undulatory manner which is the net product of their cylindrical body shape, with opposing dorsal and ventral musculature and a fluid-filled pseudocoelom which acts as a hydrostatic skeleton. Additionally, the pattern of muscle innervation aids the generation of sine waves in the body shape to bring about movement. The resting pseudocoelomic hydrostatic pressure of *Ascaris* is approximately 70mmHg and it can vary between 16 and 225 mmHg during wave-form production by posteriad contraction of the body musculature; these waves are dorsoventral in plane and the animal lies on its side during locomotion. The three underlying mechanisms associated with nematode locomotion, spontaneous myogenic depolarization, neuromuscular coordination and local changes of hydrostatic pressure, are controlled by serotonin and epinephrine.

### Helminth locomotion for drug assays

One of the most common determinants of the efficacy of antiparasite drugs in laboratory screening tests concerns the action of the compound on parasite motility. While this is perhaps a debatable criterion for in vitro drug screening, it does have a proven track record in distinguishing potentially useful drugs from those of little value. Naturally, effects on motility can only be one of many parallel facets of compound evaluation. The so called 'micro-motility meter' has been devised as a relatively simple instrument for determining the effects of putative drug substances on helminth movement in vitro and it provides an attempt at objectivity in this potentially highly subjective assay procedure (Fig. 7.12). Many drugs will depress parasite motility in this system which is an inexpensive and rapid primary screen. However, the majority of new compounds are still tested on conventional model parasite systems as the motility screen has a predilection for drugs that influence the parasite neuromuscular system and may not identify compounds that are specific for alternative targets.



**Fig. 7.12** Diagram of a micromotility meter for quantification of helminth movement in the presence of drugs and other substances. Medium is placed in a tube (g) and light from a lamp (b) passes to the meniscus (h) through a plastic light pipe (d); part of the light is deflected to the photodiode (a), the signal amplified, digitized and microprocessed. Addition of a motile worm will result in fluctuations in the digitized signal and worm movement can be compared statistically under different conditions. [After Bennett & Pax, 1987].

## **Nutrition of Parasites**

There are certain conditions under which the nutritional demands of a parasite may result in physiological stress to the host, such as the acquisition of vitamin B12 by *Diphyllobothrium latum* in the gut of humans and anaemia in hookworm disease, but in general there is little evidence to support the notion that parasites cause disease by their nutritional activities, although the act of feeding itself may be physically damaging. In truth, we are rather ignorant of the nutritional physiology of most parasites and are not in a position to define the nutrient requirements of more than the small handful of species investigated. We must be careful not to imply a lack of metabolic dependence of the parasite on its host, but within the established, stable host parasite relationship, physiological excesses by the parasite tend to be eliminated in favour of activities that lead to a benign association. Moreover, most parasites inhabit sites in the host body where nutrients are themselves often in excess supply.

### **Nutrient requirements and in vitro culture**

A widely adopted approach study of parasite nutrition involves either short-term maintenance or long-term culture in vitro. However, since it is virtually impossible to gather meaningful nutritional facts from in vivo studies due to the complexity of the host-parasite interaction, we must continue to rely on in vitro cultivation to provide us with answers to fundamental questions on parasite nutrition. Relatively few parasites have been cultured in vitro under axenic and chemically-defined conditions. Defined media have been developed for some protozoans (e.g. *Crithidia fasciculata*, *Leishmania donovani* and *L. brasiliensis*, *Trypanosoma cruzi*, *Trichomonas vaginalis*) but this has not yet proved to be possible for helminth parasites.

### **Nutrient acquisition by parasites**

In addition to feeding in the conventional sense, employing mouth and associated alimentary apparatus, many parasites obtain both dissolved and macromolecular nutrients by uptake across the body surface (membrane transport). In some groups of parasite (e.g. Protozoa, Cestoda, Acanthocephala) no mouth or alimentary canal is present so that the body surface forms the major system for molecular exchange.

### **Alimentary systems**

The Monogenea, Digenea and Nematoda all possess a recognizable alimentary system and mouth with which are often associated structures that relate to the particular pattern of feeding. In some protozoan parasites (e.g. sporozoans) a permanent or sometimes temporary oral structure is developed, the cytostome. This is a specialized region concerned with nutrient uptake, such as haemoglobin acquisition by intracellular forms of Plasmodium, at which location food vacuoles, surrounded by cytostomal membrane, are formed. Digestion takes place entirely within the vacuole by chronologically distinct acid and alkaline phases.

The Monogenea and Digenea have well developed alimentary systems comprising a mouth surrounded by a sucker, a muscular and often glandular pharynx, an esophagus which may have associated glands, and two blind-ending digestive caeca (Fig. 7.13); only rarely is an anus present. Among the Monogenea, two patterns of feeding predominate: blood feeding and feeding on tissues and mucus. There are physiological adaptations associated with these different types of nutrition: in the majority of blood feeders, the gastrodermal lining of the digestive caeca is shed following each meal, whereas the gastrodermis is non-deciduous in tissue feeders. Similarly, amongst the Digenea, blood and tissue feeders are found. Different species of digenean have evolved distinct approaches to the physiological

problems associated with haematophagy: schistosomes are exclusively sanguivorous and they digest haemoglobin extracellularly, removing waste metallic iron by periodic regurgitation through the mouth. The liver fluke, *Fasciola hepatica*, by contrast, feeds on both tissue and blood and completes digestion of the blood meal intracellularly in the gastrodermis, passing waste iron to the excretory canals to be voided. In *Fasciola*, a curious gastrodermal cell cycle has been identified, which is related to the various phases of ingestion and digestion of food.

The gut of parasitic nematodes differs little from that of free-living relatives. Significant morphological modifications are developed anteriorly around the mouth and these reflect the diet, taking the form of teeth, jaws and penetrating stylets for engaging host tissues during feeding. The alimentary canal of nematodes comprises an anterior mouth and associated structures, a muscular and sometimes glandular pharynx, esophagus, intestine in which both digestion and nutrient absorption take place, and a posterior rectum and anus.

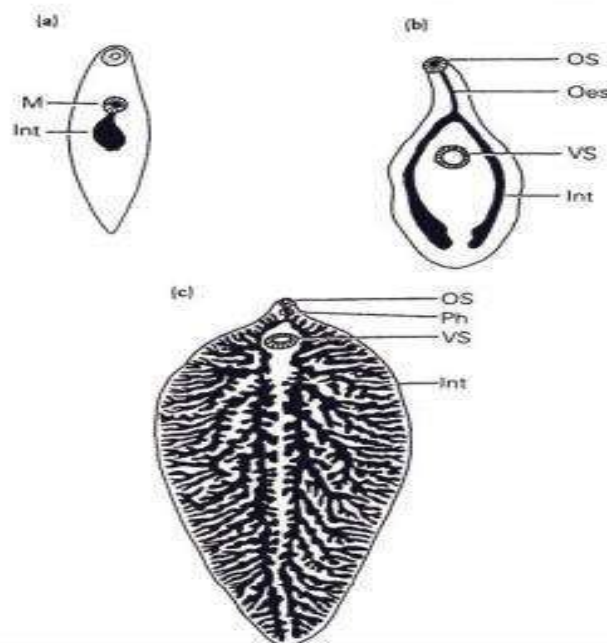

**Fig. 7.13** Morphological types of digenean alimentary canal: Int, intestinal caeca; M, mouth; Oes, oesophagus; OS, oral sucker; Ph, pharynx; VS, ventral sucker. [From Chappell, 1980: after Dawes, 1968.]

## The parasite surface and its role in nutrition

### Morphological adaptations

The surface {plasma} membrane and its associated glycoprotein coat forms, in all parasites, at least one facet of the nutritional interface with the host, and in some parasites, where the surface assumes a major nutritional function, there are marked morphological adaptations at this interface. These are most clearly seen in the platyhelminths and acanthocephalans, in which the surface architecture typifies a digestive absorptive epithelium with its enormous increase in surface area. This is achieved by the development of surface folds and microvilli (e.g. Monogenea, Digenea, Cestoda), tubercles and spines [e.g. Digenea] or surface pores with

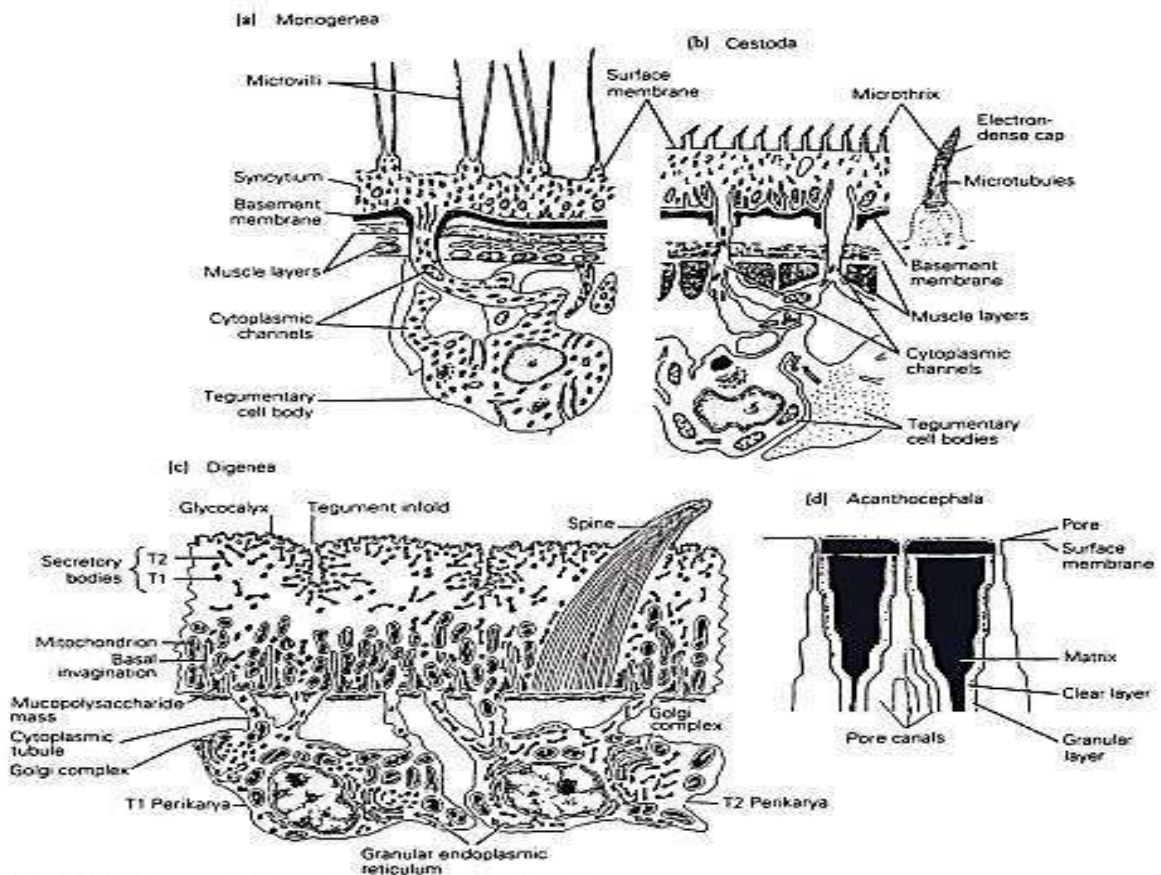

Fig. 7.14 Surface morphology in platyhelminth and acanthocephalan parasites. (From Chappell, 1980: after Lyons, 1970; Smyth & Halton, 1983; Threadgold, 1984; Crompton, 1970.)

branching invaginated canals (e.g. Acanthocephala), all of which are illustrated in Fig. 7.14.

In the Protozoa, a part from the cytostome referred to above, the surface of parasites differs little from free-living forms in its nutrition-related morphology. However, in the intracellular Protozoa, the nutritional interface additionally includes the surface membrane of the host cell, perhaps in the form of the parasitophorous vacuole, and thus there may be two or more distinct barriers to nutrient acquisition.

Early light microscopy suggested that platyhelminth parasites were enclosed in a protective cuticle, presumed to be a defensive structure against host digestive and immunological attack. Electron microscopy has revealed the true picture and we now know that these parasites possess a metabolically active, non-cuticular surface, termed the tegument. This entire tissue system includes the external glycoprotein glycocalyx, the surface membrane, and beneath it, but above the basement membrane, the nucleate syncytium (Fig. 7.14a, h, c). The syncytial layer is replete with organelles of metabolic function and replacement membrane material. Morphological study thus implicates the helminth surface as an active participant in nutrition as well as its apparent role in defense by active surface renewal. The acanthocephalan surface is physiologically comparable although morphologically quite different from the platyhelminths (Fig. 7.14d). Only in the nematodes does a true cuticle occur, but even in this group recent evidence suggests that the cuticle may be permeable to low molecular weight nutrients and to water.

### **Membrane transport mechanisms in parasites**

Transport of nutrient molecules into parasites occurs by one, or a combination of simple diffusion, carrier-mediated transport (facilitated diffusion, active transport, exchange diffusion or macromolecular transport endo- or exocytosis). These



transport mechanisms can be distinguished kinetically and biochemically may be determined in laboratory studies using in vitro methods.

Simple diffusion obeys Fick's law, which states that the rate absolute movements directly related to the concentration difference of that solute on either side of a semi-permeable membrane; it therefore displays linear kinetics (Fig. 7.15a) is independent of metabolic energy and temperature and does not respond to interference by competitive inhibitors. Simple diffusion involves movement of molecules down a concentration gradient.

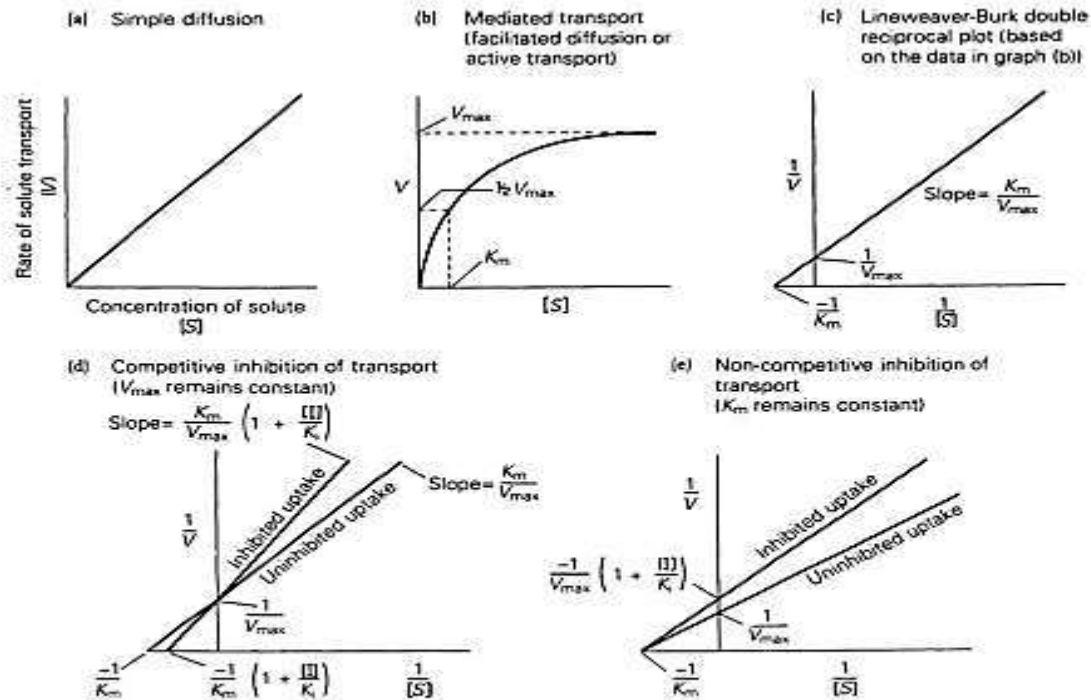

Fig. 7.15 Kinetics of membrane transport mechanisms. Often, nutrient uptake patterns follow a combination of (a) and (b) in which mediated transport is more important at low solute concentrations with diffusion assuming greater significance at higher values. The inhibitor constant [ $K_i$ ] is determined experimentally as shown in (c) and (d); [ $I$ ] concentration of inhibition;  $K_m$ , transport or Michaelis constant;  $V_{max}$ , maximum rate of transport; NB [ $K_m = 1/2 V_{max}$ ].

Carrier-mediated transport requires that the nutrient molecules bind specifically to, and complex with, carriers (transporters, transport sites or loci) in the membrane; these complexes have intramembrane mobility and translocate nutrients

to the opposing side of the membrane where complexes are dissociated and nutrients released. This type of transport displays saturation kinetics (Fig. 7.I5b, e) is temperature and energy-dependent (e.g. active transport but not facilitated diffusion) responds to inhibition both competitively and non-competitively (Fig. 7.I5 d-e) and can be either uphill in terms of solute concentration (e.g. active transport) or down an electrochemical gradient facilitated diffusion). Saturable transport systems (i.e. carrier-mediated) can be examined kinetically by application of the Michaelis-Menten {enzyme} equations from which can be derived the transport constant,  $K_t$  defining the affinity of the substrate for the carrier, and  $V_{max}$  which is the maximum velocity of the transport process.

Thus transport systems of different parasites may be compared kinetically and their substrate specificities determined by inhibitor studies. The applied importance of such work lies in the potential for the development of drugs that target specific transport systems in parasites thereby denying entry of essential nutrients. At present, very few antiparasite drugs operate in this way, but the area is rich with potential for rational chemotherapy. The nutrient transport systems of relatively few parasites have been examined in critical detail. Below are described, in summary, data collected for four groups of parasite about which a reasonable quantity of information is available.

### **Plasmodium**

Malaria parasites transport carbohydrates, amino acids, purine nucleosides, fatty acids, complex lipids, anions and cations and the presence of the parasite confers upon the infected red cell pathological alterations in nutrient transport that may favour the development of the parasite (Fig. 7.16).

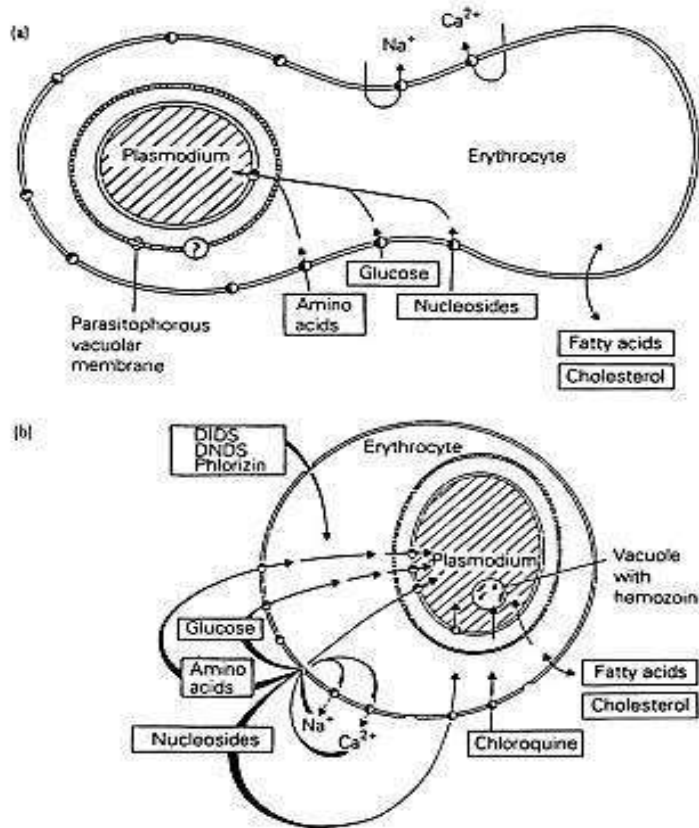

Fig. 7.16 Nutrient transport in the malaria-infected red cell before (a) and after (b) parasite-induced changes in membrane permeability. Carriers are represented as circles, exchange is shown as a double-headed arrow. After induction of permeability changes, the red cell membrane becomes leaky towards the disulphonic stilbenes DIDDS and DNDS, and phlorizin. The drug Chloroquine accumulates via a membrane carrier and becomes concentrated within food vacuoles. (After Sherman, 1988.)

The asexual stages of the parasite within the red cell lack stored carbohydrate but require considerable quantities of glucose to fuel their active metabolism and division. Infected erythrocytes use between 10 and 50 times more glucose than uninfected cells and the parasite appears to induce permeability changes in the red cell membrane which facilitate the passage of host glucose and amino acids into the erythrocyte.

The nutritional source of amino acids for intracellular stages of malaria is not fully understood; haemoglobin digestion undoubtedly provides significant amounts, but the infected red cell also shows increased transport of free amino acids in culture. In *P. falciparum*, these changes in amino acid transport rates are first seen 15 hours after invasion and the infected erythrocyte loses energy-coupled transport systems in favour of diffusion; whether these amino acids enter the parasite itself by carrier

mediated transport or by diffusion remains to be determined and awaits the development of methods permitting culture of the asexual stages of the parasite outside the red cell.

Malaria parasites transport exogenous purine nucleosides but not pyrimidines. This may be related to their inability to synthesize the purine ring. Parasites liberated from red cells may accumulate certain purines [e.g. adenosine, guanosine and hypoxanthine) and can incorporate radioactivity from labelled adenosine, AMP and ATP. Once again, however, studies on liberated parasites produce questionable data. Several studies have demonstrated that lipids (i.e. free fatty acids, cholesterol and phospholipid) are readily incorporated into malaria parasites resident within the red cell but the transport processes involved are unknown.

### **Trypanosomes**

The extracellular habit of trypanosomes makes it relatively easy to examine the transport of nutrients. Carbohydrates are transported by specific carriers, some of which are capable of moving more than one species of nutrient molecule. *Trypanosoma lewisj* has two carriers that transport glucose, mannose, fructose, galactose and glucosamine. *T. equiperdum* has three carriers for monosaccharide transport, a glucose transporter, and two distinct systems for glycerol. These carriers have been defined by the use of inhibitors of transport in Vitro. Amino acid transport into trypanosomes is complicated and several distinct carriers have been described using kinetic and inhibitor studies. *Trypanosoma cruzi* transports basic amino acids (e.g. arginine, lysine) by multiple carriers that possess unusual specificities in terms of substrates carried. Here, both neutral and acidic amino acids inhibit basic amino acid transport, a situation not encountered in mammalian transport systems. By contrast, arginine transport in *T. equiperdum*, a species with at least four distinct amino acid carrier systems, is remarkably substrate specific. *Trypanosoma brucei*

gambiense transports amino acids by a mixture of carrier-mediated and nonspecific (diffusion) mechanisms. Similarly, in *T. equiperdum* and *T. lewisi*, simple diffusion may assume greater significance than saturable processes when amino acids are present at higher concentrations, although it is not easy to extrapolate from these in vivo studies to what may happen in the blood stream of a mammal. Lipid acquisition by trypanosomes is complex and is associated with membrane-bound enzymes [acetyltransferase and phospholipase A<sub>2</sub>, while 3'-nucleotidase/nuclease] has been implicated in the uptake of purines.

### **Tapeworms**

Much of the pioneering work on membrane transport of low molecular weight nutrient molecules in parasites was carried out on tapeworms, in particular *Hymenolepis diminuta*, the rat tapeworm, at Rice University (Texas). This parasite has proved to be an ideal model since it can be obtained readily in large quantities in the laboratory, is non-pathogenic both to the rat and to humans, and having no gut, absorbs all of its nutrients across the tegument. The tapeworm transports carbohydrates by both carrier-mediated systems and by diffusion - glycerol and glucose enter by separate carriers but both depend on sodium ion concentration. Amino acid and purine/pyrimidine transport are complex processes: there are six separate amino acid carriers; four transporting neutral amino acids, one for acidic and one for basic amino acids; and at least three purine/pyrimidine carriers with multiple binding capacity. Fatty acid transport is similarly complicated and separate systems, transporting short-chain and long-chain moieties, have been described.

### **Digenean**

Transport of nutrients across the digenean tegument is complicated by the presence of an alimentary canal and undoubtedly, in vivo, the gut plays a major role

in nutrition, aided to an unknown extent by tegumental transport systems. Study of the latter can be carried out in vitro either by ligation of the pharynx or by using short-term studies in which oral ingestion of nutrients assumes an insignificant role. Both *Schistosoma mansoni* and *Fasciola hepatica* transport monosaccharides by carrier-mediated mechanisms of substrate specificities and while schistosomes transport amino acids also by tegumental carriers, *Fasciola* appears to lack these, absorbing amino acids by simple diffusion only. No explanation for this difference is available but it might relate to the differential dependence on the worm gut as a source of nutrients.

### **Digestive enzymes**

The digestive enzymes of most parasites have been little studied, thus there is a paucity of information on their characteristics, substrate specificities, pH optima, secretory regulation and location. Digestive enzymes occur in the food vacuoles of protozoan parasites and in both the alimentary canal and the body surface of helminths.

The alimentary protease of *S. mansoni* has become a topic of considerable research interest, ironically primarily because of its serodiagnostic potential rather than because of its digestive role. Schistosomes ingest large quantities of host blood via the mouth and digest haemoglobin readily; the schistosome gut is typically delineated by the presence of the black pigment, haematin, which is the result of this digestion. A single proteolytic enzyme (haemoglobinase) occurs in the gut of *S. mansoni*, this being a thiol-protease with a pH optimum of around 3 and which hydrolyses globin to peptides but not to individual amino acids. It is not known whether these peptides are further hydrolysed intracellularly within the gastrodermis or if the tegumental carrier provides the major source of free amino acids from host serum. Other alimentary peptidases have recently been located histochemically,

suggesting that haemoglobin digestion could be completed in the schistosome gut. The proteases of schistosomes vary in their occurrence during the life cycle and may thus have stage-specific functions; the haemoglobinase itself is only expressed in the developing schistosomulum and adult worm, in which stages hematophagy becomes physiologically important (Fig. 7.17). This adult protease is big highly antigenic and is useful in the diagnosis of schistosomes in subclinical human cases as a prelude to chemotherapy.

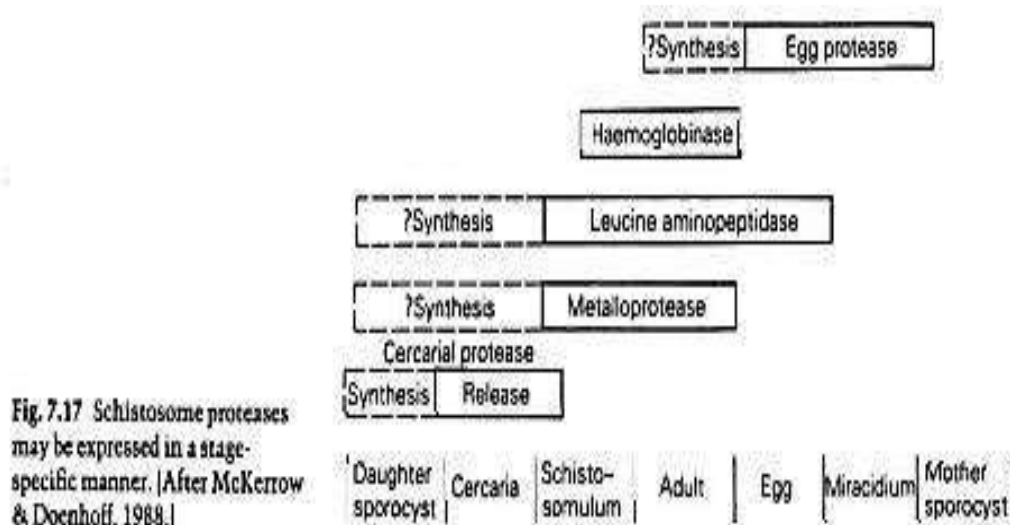

Several helminths possess surface enzymes, either of parasite origin or derived from the host, that may have a digestive function. *Hymenolepis diminuta* synthesizes digestive phosphohydrolases, hydrolysing phosphate esters, monoglyceride hydrolases and ribonucleases, all of which function in a digestive capacity at the tegumental surface. The tapeworm can also bind host digestive enzymes, such as amylases, where upon enzyme activity may become enhanced, although the mechanism of this so called 'contact digestion' is open to interpretation. Conversely, tapeworms can bind and inhibit host enzymes (e.g. trypsin,

chymotrypsin) and this is possibly one adaptation for parasite survival in an enzymatically hostile environment.

Surface membrane-bound enzymes have also been described in some protozoans. *Leishmania* spp, and other trypanosomatids, for instance, possess a 3'-nucleotidase/nuclease complex in their surface membranes which can hydrolyse 3'-nucleotides and nucleic acids. The hydrolytic activity of this complex is implicated in the acquisition of purines associated, perhaps, with the inability of the parasite to synthesize the purine ring. The membrane-bound acyltransferase of African trypanosomes may also play a part in nutrient acquisition, in this case in the uptake and internalization of lipid, particularly phospholipids.



## **Excretory physiology**

Since the life histories of many parasites are complex, involving alternation of free-living and parasitic stages, it might be expected that the processes of regulation of water and ion content and removal of toxic excretory products would reflect such complexity. Little information, however, is available. In parasites, two types of excretory system are found:

- (1) the contractile vacuole of protozoans
- (2) the protonephridial system of platyhelminths

Contractile vacuoles are present in many ciliates, but are absent from amoebae and sporozoans. It seems likely that these vacuoles are involved in both osmoregulation and excretion of nitrogenous waste. The protonephridial system of platyhelminth parasites comprises numerous blind-ending tubules that interconnect and open to the outside at a single nephridiopore. Each tubule has at its terminus a flame cell or cluster of cells, so called because the wave-like beating of the flagella is reminiscent of a flickering candle. Each 'flame' contains between 50 and 100 flagella whose beat regulates fluid flow in the excretory tubule and possibly draws solutes into the terminal organ of the protonephridial system from the surrounding parenchyma. Ultrafiltration may occur at this stage and it has been demonstrated experimentally that a sufficiently high filtration pressure could be developed by the flagellar beat of the flame cell.

Excretion of nitrogenous waste (e.g. ammonia) may take place via diffusion or via the protonephridial system. Detailed analysis of the protonephridial canal fluid of the tapeworm *H. diminuta* reveals the occurrence of inorganic ions (sodium, potassium, chloride, carbonate, ammonia, amino acid, urea, and lactic acid). This analysis accounts for 90% of dry matter and the pH of the canal fluid is 4.5 with a

PCO<sub>2</sub> of 120 mmHg. These data imply an excretory role but the key elements of ultrafiltration and active transport within the system have yet to be demonstrated.

The excretory systems in acanthocephalans and nematodes are poorly understood and there is little physiological evidence for either group to substantiate what is inferred on morphological grounds alone.

### **Parasite Physiology in a Wider Context**

There are many areas of physiology which clearly reflect the unique and often remarkably complex life styles adopted by parasites. The inherent multi-faceted nature of the parasitic life cycle suggests an enormous adaptability, ultimately residing within the genome, which must surely convince the student of the sophisticated status of the parasitic animal. As more information accrues, we come to realize that there are more targets for chemical, immunological or environmental attack upon which we may effect parasite control, but at the same time we discover that the subtleties of parasite evolution have conferred upon these organisms a considerable buffer against the types of onslaught we can currently mobilize.