

CANADA VERSION

# POLARIS *RANGER*

## 2022

ACCESSORIES + APPAREL





# HARDEST WORKING.

SMOOTHEST RIDING.



For the past two decades, RANGER has set the standard through unrivaled strength, unmatched capability and next-level comfort, making it the number one utility side-by-side for over 10-years running.

## 2022 LINEUP

SEE THE FULL LINEUP AT [POLARIS.COM/RANGER](https://www.polaris.com/ranger)

### 2022 PACKAGES & LIMITED EDITIONS

P. 2

SEE P. 2-5 FOR DETAILS

### XP 1000 / XP KINETIC / 1000

P. 16



### SP 570 / 500 MIDSIZE

P. 70



### 570 FULL-SIZE

P. 90

### 150 EFI

P. 92



## CONTENTS

<b>2022 PACKAGES &amp; LIMITED EDITIONS</b>	<b>2</b>
<b>XP 1000 / XP KINETIC / 1000</b>	<b>16</b>
ROOFS	20
WINDSHIELDS	22
REAR PANELS	24
DOORS	26
CAB COMFORT & CONVENIENCE	28
WINCHES	30
PROTECTION	32
AUDIO	34
STORAGE	40
<b>COMMON ACCESSORIES</b>	<b>44</b>
CONNECTED TECHNOLOGY	44
ELECTRICAL ACCESSORIES	46
COOLERS	48
HUNT	50
COLD WEATHER	52
PLOWS	54
LIGHTING	58
WHEELS & TIRES	60
<b>SP 570</b>	<b>70</b>
ROOFS & DOORS	72
WINDSHIELDS & REAR PANELS	74
AUDIO & CONVENIENCE	76
PROTECTION & WINCHES	77
STORAGE	78
<b>500/EV/570</b>	<b>80</b>
ROOFS & DOORS	82
WINDSHIELDS & REAR PANELS	84
CONVENIENCE & PROTECTION	86
WINCHES	87
STORAGE	88
<b>570</b>	<b>90</b>
<b>150 EFI</b>	<b>92</b>
<b>PARTS &amp; GARAGE</b>	<b>94</b>
MAINTENANCE	94
OIL & LUBRICANTS	96
MAINTENANCE FLUIDS	98
BATTERIES & GARAGE ACCESSORIES	100
HD PARTS	102
SERVICE PARTS	104
TIRE SEALANT & TRAILERING	106
POLARIS POWER	110
<b>APPAREL</b>	<b>112</b>
RIDING GEAR	114
HELMETS & GOGGLES	118
MEN'S APPAREL	120
WOMEN'S APPAREL	126
MERCHANDISE	128



# RANGER XP 1000 & SP 570 NORTHSTAR OFF-ROAD CLIMATE CONTROL

Be in control of your comfort with standard Pro Shield Cab System, heat, air conditioning (RANGER XP 1000 models), and more. Polaris RANGER NorthStar Editions help you finish whatever task you set out to do, no matter the weather conditions. Take your NorthStar to the next level with hundreds of accessories to choose from based on your riding needs.



## DO MORE:

### PROTECTION

Protect the front and rear of your RANGER from whatever obstacles you may encounter off-road.

**XP 1000** P. 32  
**SP 570** P. 77

### AUDIO

Customize your audio system to listen to your favorite songs on the trails.

**XP 1000** P. 34  
**SP 570** P. 76

### LIGHTING

Extend the day and work longer with easy-to-install powerful lighting.

P. 58

### WHEELS & TIRES

Select wheels and tires custom built for your riding style and the terrain you ride in.

P. 60

### STORAGE

Leave nothing behind with the limitless customization of Lock & Ride storage.

**XP 1000** P. 38  
**SP 570** P. 78

## UPGRADE YOUR NORTHSTAR XP 1000 & SP 570 FAMILIES

You've got the essentials straight from the factory—but why stop there? Get the most out of your NorthStar with additional Polaris Engineered accessories to fit your riding needs. Add the **MUST HAVES** for top-selling accessories or **UTILITY** to optimize for the toughest outdoor jobs. Or, pick and choose your favorite accessories to make it your own.



### NORTHSTAR ULTIMATE COMES STANDARD WITH:

Heating & Air Conditioning HVAC System  
7" Display Powered by RIDE COMMAND  
Pro Shield Full Glass Tip-Out Windshield with Wiper/Washer System  
Power Window Doors  
Polaris HD 4,500 lb. Winch with Auto-Stop  
Sport Roof with Premium Liner & Dome Light  
Lock & Ride Glass Panel  
LED Headlights  
29" Tires



### NORTHSTAR PREMIUM COMES STANDARD WITH:

Heating & Air Conditioning HVAC System  
Polaris HD 4,500 lb. Winch with Auto-Stop  
Sport Roof with Premium Liner & Dome Light  
Lock & Ride Glass Windshield with Wiper/Washer System  
Lock & Ride Glass Rear Panel  
Premium Manual Crank Window Doors



### RANGER SP 570 NORTHSTAR COMES STANDARD WITH:

Heating & Ventilation System  
Polaris HD 3,500 lb. Winch with Auto-Stop  
Sport Roof with Premium Liner  
Lock & Ride Glass Windshield  
Lock & Ride Glass Rear Panel  
Premium Manual Crank Window Doors

	PRODUCT NAME	XP 1000	PRICE	PAGE	SP 570	PRICE	PAGE
<b>MUST HAVES</b>	Upper Front Brushguard	2882531	\$354 <sup>99</sup>	P. 32	2885084	\$324 <sup>99</sup>	P. 77
	Rear Brushguard	2882529	\$344 <sup>99</sup>	P. 32	2885087	\$299 <sup>99</sup>	P. 77
	Front Hood Storage Rack	2882690	\$499 <sup>99</sup>	P. 40	2885088	\$454 <sup>99</sup>	P. 79
	Lock & Ride Storage Box	2883279	\$459 <sup>99</sup>	P. 43	2889199	\$409 <sup>99</sup>	P. 78
	Polaris PULSE Wiring Harness - 1 Light Bar	2883230	\$124 <sup>99</sup>	P. 47	2889161	\$124 <sup>99</sup>	P. 47
	Pro Armor 33" - Combo LED Light Bar	2882077	\$539 <sup>99</sup>	P. 59	2882077	\$539 <sup>99</sup>	P. 59
			<b>\$2,324<sup>94</sup></b>			<b>\$2,154<sup>94</sup></b>	
<b>UTILITY</b>	Side View Mirrors - Door Mounted	2889241	\$229 <sup>99</sup>	P. 29	2889241	\$229 <sup>99</sup>	P. 76
	Lock & Ride Bed Extender/Divider	2882752	\$344 <sup>99</sup>	P. 40	2889183	\$344 <sup>99</sup>	P. 78
	Electronic Cargo Box Lift	2884141	\$844 <sup>99</sup>	P. 42	N/A	N/A	N/A
			<b>PLUS \$1,419<sup>97</sup></b>			<b>PLUS \$574<sup>98</sup></b>	

**TAKE ADVANTAGE**  
of your off-road climate control with winter and plow accessories on P. 54





TAKE YOUR  
**2022 RANGER**  
**SPECIAL EDITION**  
 TO THE NEXT LEVEL

You've already elevated your off-road experience with an industry-exclusive package. Don't stop there! Customize your experience by adding key accessories.

**TRAIL BOSS**  
 RANGER XP 1000 / NORTHSTAR

**RECOMMENDED  
 ADD-ONS**

PROTECTION	P. 32
STORAGE	P. 38
LIGHTING	P. 58
WHEELS & TIRES	P. 60



**TEXAS EDITION**  
 RANGER XP 1000

**RECOMMENDED  
 ADD-ONS**

WINDSHIELDS	P. 22
PROTECTION	P. 32
STORAGE	P. 38
LIGHTING	P. 58



**HIGH LIFTER**  
 RANGER XP 1000

**RECOMMENDED  
 ADD-ONS**

ROOFS	P. 20
AUDIO	P. 34
COOLERS	P. 48
LIGHTING	P. 58





## DESIGNED



Designed by the same people who designed your vehicle.

## TESTED



Extensively tested in the field so you ride with 100% confidence.

## TRUSTED



ACCESSORIES  
BACKED BY A



WARRANTY

65 years in the business.  
The #1 name in Off-Road.

## INTRODUCING OUR NEWEST PARTNER



# RHINO-RACK®

Introducing an industry exclusive — Rhino-Rack® storage solutions designed specifically for Polaris RANGER. From opposite sides of the globe, the most capable machines in the off-road world meet a trusted outdoor adventure brand to deliver industry-exclusive, purpose-built roof racks, bed racks and accessories to help Polaris RANGER users have more fun and get more done. Designed for perfect integration and tested to off-road standards, a Rhino-Rack®-equipped RANGER will help you get more storage capacity out of your machine — so you can stay prepared for whatever they day may bring.



## WE HOLD OUR PARTNERS TO THE SAME STANDARDS



WHEELS, TIRES & LIGHTING DESIGNED WITH POLARIS TO MAXIMIZE PERFORMANCE  
P. 58 & 60



IGNITE AND FUEL YOUR PASSION FOR PRECISE QUALITY SOUND REPRODUCTION  
P. 36



PRODUCTS SO GOOD THEY REPLACE OR REPAIR THEM FOR LIFE  
P. 58



DARE TO LISTEN  
P. 76



MAKING PRODUCTS FOR AVID SPORTSMEN SINCE 1943  
P. 50



DIGITAL GAUGES FOR POWERSPORTS RIDERS  
P. 45



BRING IT ALL. BRING IT ON.  
P. 38





INTRODUCING THE NEW INDUSTRY-EXCLUSIVE  
RHINO-RACK® STORAGE SOLUTIONS

BRING IT ALL.  
BRING IT ON.

SEE RHINO-RACK® PRODUCTS ON P. 38



INTRODUCING THE NEW  
RANGER SP 570

GET MORE DONE.  
HAVE MORE FUN.



NEXT-LEVEL COMFORT

LEVERAGE THE FULL  
CAPABILITIES OF YOUR  
MACHINE YEAR-ROUND.

RANGER

PRO SHIELD  
CAB SYSTEM



SUPERIOR INTEGRATION

MAKE WORK EASIER WITH YOUR  
VEHICLE BUILT TO ADD ESSENTIAL  
ACCESSORIES FOR ANY JOB.

PRO PRO HEAVY DUTY SERIES

WINCHES

GLACIER

PLOW SYSTEM

POLARIS  
PULSE  
Electrical System



DO MORE

TACKLE ANY JOB AND  
LEAVE NOTHING BEHIND.

LOCK & RIDE

RHINO-RACK





# ENGINEERED FOR MORE

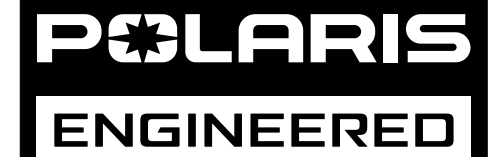

## HARDEST WORKING, SMOOTHEST RIDING.

RANGER is a trusted, most capable, work partner. Developed and tested along with the vehicle, Polaris Engineered Accessories are designed for seamless integration and simple installation to get more done, year-round.

## SUPERIOR INTEGRATION

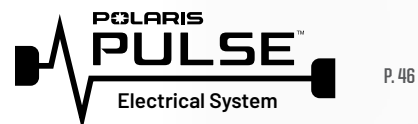

### PLUG AND PLAY ELECTRICAL

A revolution in electrical accessory integration, the Polaris PULSE Electrical System allows for a simple plug and play approach for adding power to Polaris Engineered Accessories.

PRO PRO HEAVY DUTY SERIES

### WINCHES

RANGER XP 1000/1000 P.30  
RANGER SP 570 P.77

### INTEGRATED WINCH MOUNT & PRE-WIRED

Designated mounting points and pre-wired connectors ensure a perfect fit and the strongest place to attach the Polaris Engineered winch - the most dependable winch for your RANGER. With wiring built right into the vehicle, we made this the easiest RANGER winch ever to install.



### PLOW SYSTEM

### INTEGRATED PLOW MOUNT\*

The attachment points for the Glacier Plow System are integrated right at the factory and feature an innovative drive-up and go installation process.

\*Integrated Plow Mount not included on RANGER SP 570 Non-Premium/Non-NorthStar Models



## DO MORE

### LOCK & RIDE™

### CARGO BOX VERSATILITY

Lock & Ride mounting locations allow for limitless customization to let you work the way you want.

RANGER XP 1000/1000 P.40  
RANGER SP 570 P.78

## BRING IT ALL. BRING IT ON.



### STORAGE VERSATILITY

Rhino-Rack® roof rack and bed rack solutions offer 40% more storage capacity so you never have to leave tools or gear behind.

RANGER XP 1000/1000 P.38

## NEXT-LEVEL COMFORT

### OUR BEST SEALING CAB

With the profile channels engineered into the roll cage, body plastics molded to seal and cab accessories designed to keep the elements out, the RANGER Pro Shield Cab System offers a new level of interior comfort.



RANGER XP 1000/1000 P.20  
RANGER SP 570 P.72





# NEXT-LEVEL COMFORT

Look for the RANGER PRO SHIELD Logo for the four components to customize your RANGER with our best sealing cab.

## BUILD YOUR CAB SYSTEM

**1 CHOOSE YOUR ROOF**  
RANGER XP 1000 P.20  
RANGER SP 570 P.72

**2 CHOOSE YOUR WINDSHIELD**  
RANGER XP 1000 P.22  
RANGER SP 570 P.74

**3 CHOOSE YOUR REAR PANEL**  
RANGER XP 1000 P.24  
RANGER SP 570 P.75

**4 CHOOSE YOUR DOORS**  
RANGER XP 1000 P.26  
RANGER SP 570 P.73



- ULTIMATE CLARITY**  
Tempered safety glass, clear to see through and shatterproof.
- COLOR MATCHED**  
Key color matched accent panels available.
- PROTECTION**  
Inner and outer shells are made from high-quality, injection-molded plastics using a state-of-the-art process to shield from the elements and more.
- DURABLE CONSTRUCTION**  
With a 2.5 cm tube steel frame, these doors can handle the rigors of the off-road.



### A FRAME DESIGNED FOR A CAB

All RANGER cab components fit perfectly to the contours of the profile tube cab frame, floor and body panels, allowing for a 360° gasket seal, seamless fit and installation providing unprecedented protection from the elements.

## INCREASED RIDER COMFORT

Add a new level of interior comfort by adding a RANGER Pro Shield Cab System – tested to military standards. Seal out dust, water, and noise by selecting a roof, windshield, rear panel, and set of doors. Extend your work day or trail ride while protecting you and your passengers from the elements.



### RAIN

Rest assured that you and your passengers will stay dry and comfortable on rainy days.



### SNOW

Keep cold wind and snow out in winter months.

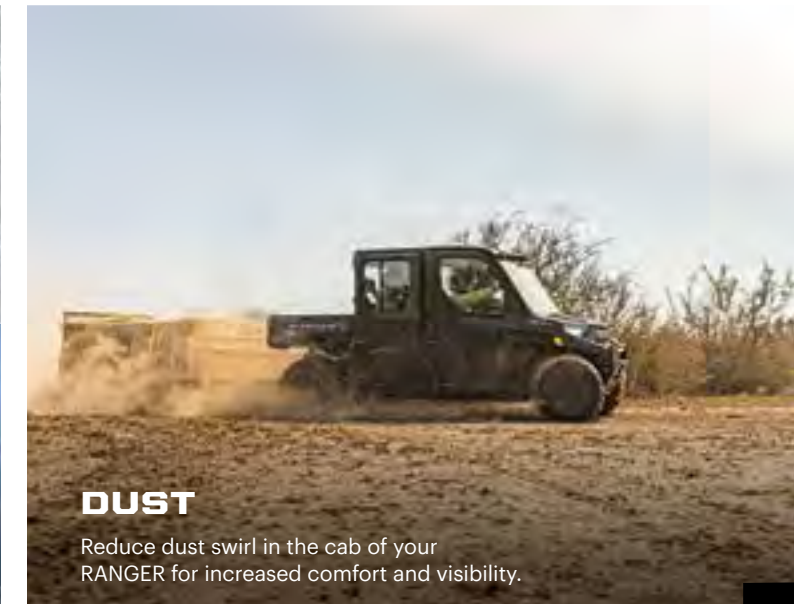

### DUST

Reduce dust swirl in the cab of your RANGER for increased comfort and visibility.



# SUPERIOR INTEGRATION

**PRO** PRO HEAVY DUTY SERIES

**HD** HEAVY DUTY SERIES



RANGER XP 1000/1000 P.30  
RANGER SP 570 P.77

## POLARIS ENGINEERED WINCH FEATURES



Tested **1,200+** pulls at max load, it works when you need it to



Built to withstand **-20° F** temperatures



Sealed motor & heavy duty gears  
**OPERATE FULLY SUBMERGED UNDERWATER**

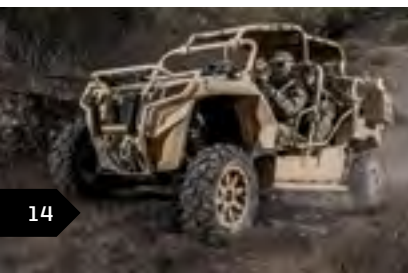

**MILITARY** tested & approved

Right from the factory, your vehicle is built to make essential accessories like winches and plows easy to use day-in and day-out. Mounting brackets are designed into the oversized factory bumper and wiring is routed securely and properly. When it comes to RANGER, Polaris Engineered Accessories make work easier so you can get more done.

**POLARIS**  
**ENGINEERED**

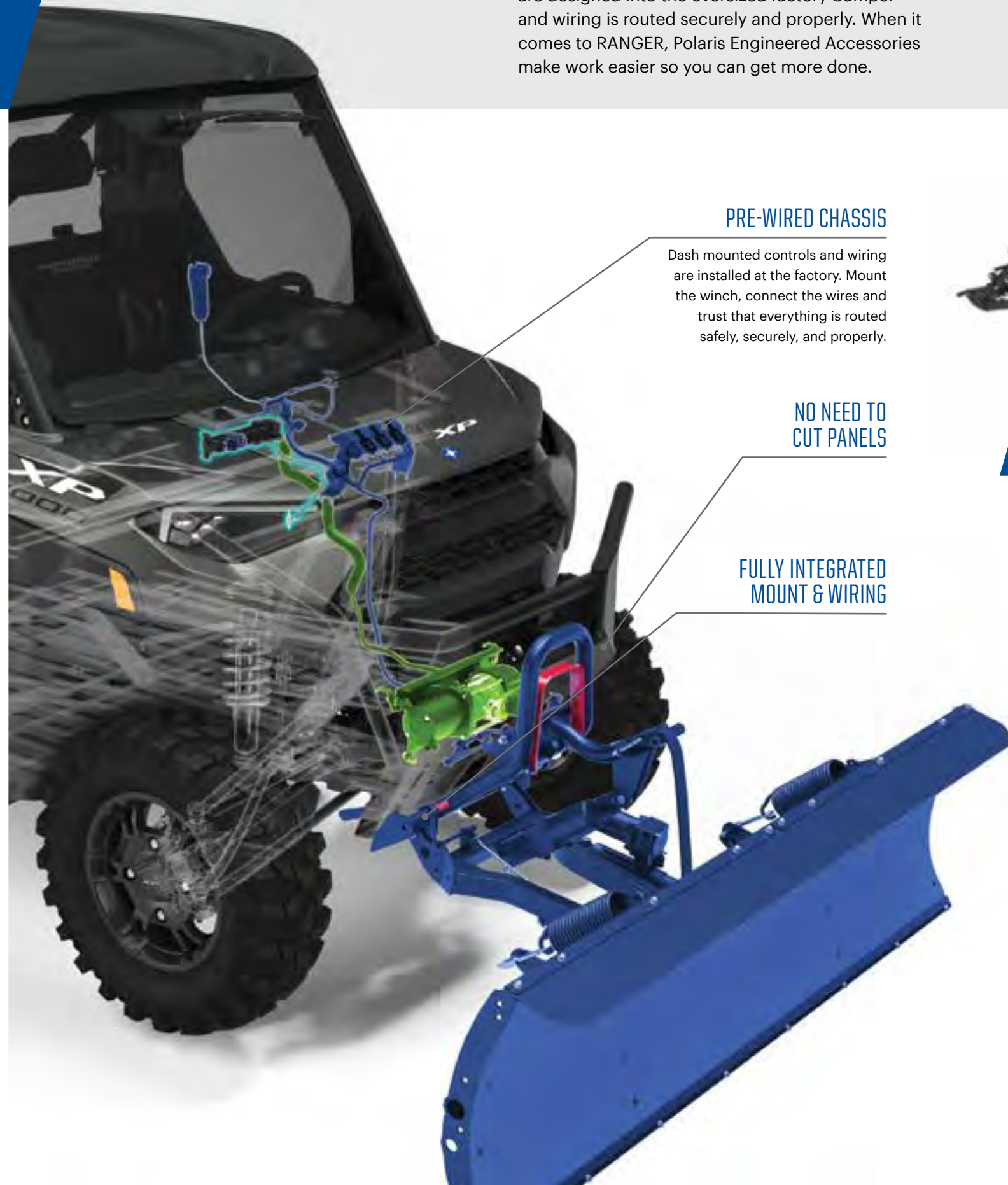

### PRE-WIRED CHASSIS

Dash mounted controls and wiring are installed at the factory. Mount the winch, connect the wires and trust that everything is routed safely, securely, and properly.

### NO NEED TO CUT PANELS

### FULLY INTEGRATED MOUNT & WIRING

## GLACIER<sup>®</sup> PLOW SYSTEM

P.54



### GLACIER FEATURES



To install the plow, simply lift the mount lock handle and pull forward



No loss of factory ground clearance when not plowing



Don't have to crawl under the machine to release the plow blade from the vehicle



No trimming of vehicle plastic or fascia required to mount plow or winch

Angle your blade right from your seat

**25°**

LEFT AND RIGHT





# INTRODUCING THE RANGER XP KINETIC

# THE POWER TO DO MORE



Do more than ever before with the new, full-size electric RANGER. Unmatched horsepower and instant torque means more power than ever before to precisely pull, haul more, and get more done. The industry's strongest drivetrain delivers lower maintenance costs and more uptime to get the job done. Plus, the quiet electric powertrain enables easy conversations while riding and stealthy trips to hunting spots.



## NEW RIDE COMMAND FRONT CAMERA

- Provides additional vantage point
- Front-mounted camera to help with plowing and other tasks

» 2889662 • \$169<sup>99</sup> SUMMER AVAILABILITY  
XP KINETIC '23



## NEW DUAL CHARGER HARNESS

- Required for installation of a 3kW On-Board Charger on XP Kinetic Premium trims

» 2889704 • \$779<sup>99</sup> SUMMER AVAILABILITY  
XP KINETIC '23



## NEW IN-CAB HEATER AND DEFROST KIT

- Easily control the climate inside your cab in any season with this UTV cab heater
- Helps defrost windshields and keep you warm or cool
- Three different fan speeds
- Heat and fan dash-mounted controls
- Manual vents
- A Polaris Pulse Ready Accessory

» 2889449 • \$1,999<sup>99</sup> SUMMER AVAILABILITY  
XP KINETIC '23

## NEW HIGH VOLTAGE BUSBAR

- Required for adding heater or other high voltage accessories such as upgraded chargers

» 2889667 • \$389<sup>99</sup> SUMMER AVAILABILITY  
XP KINETIC '23



## NEW ACCESSORY BUMPER HARDWARE

- Required when using a front camera as well as an upper front bumper or hood rack

» 2889659 • \$51<sup>99</sup> SUMMER AVAILABILITY  
XP KINETIC '23



## NEW TRIPLE CHARGER HARNESS

- Required for installation of a 3kW On-Board Charger on XP Kinetic Ultimate trims

» 2889486 • \$1,169<sup>99</sup> SUMMER AVAILABILITY  
XP KINETIC '23



## NEW 3kW ON-BOARD CHARGER

- Provides additional 3kW charge so you can save time and get more done with your RANGER
- Increases charge rate while decreasing charge time when connected to appropriate in home charger for more efficiency
- Maximum charge of 6kW on Premium trims and 9kW on Ultimate trims
- Upgraded Level 2 EVSE + 240V outlet required for optimal charging for Ultimate trim with 9kW upgrade

» 2889661 • \$1,034<sup>99</sup> SUMMER AVAILABILITY  
XP KINETIC '23





# MAKE IT YOURS

## WORK HARD AND GET IT DONE

with Polaris Engineered Accessories for your RANGER. Start with the ultimate in all-season performance and comfort with the best cab components in the industry. Find everything you need to outfit your RANGER for the task at hand.

RANGER XP 1000 / RANGER 1000

# RANCH

2882910	Dual Bin Under Seat Dry Storage Box	P. 28	2882529	Rear Brushguard	P. 32
2882753	8-Vent Heater & Defrost System	P. 28	2882752	<b>LOCK &amp; RIDE</b> Bed Extender/Divider	P. 40
2883265	Work Beacon LED Light	P. 29	2881531	<b>LOCK &amp; RIDE</b> Tip-Down Headache Rack	P. 40
2882710	Polaris Pro HD 6,000 Lb. Winch with Rapid Rope Recovery	P. 31	2883121	Rigid® SR-Series 10" Spot LED Light	P. 58
2882531	Upper Front Brushguard	P. 32	2883148	Pro Armor Wheel & Tire Set: Dual Threat & 4202	P. 67



RANGER XP 1000 / RANGER 1000

# WATERFOWL

2883265	Work Beacon LED Light	P. 29	2883263	In-Cab Gun Mount	P. 51
2882711	Polaris Pro HD 4,500 Lb. Winch with Rapid Rope Recovery	P. 31	2882076	Pro Armor 2"x2" Cube - LED Spot Light (x2)	P. 58
2882690	Front Hood Storage Rack	P. 40	2884271	Pro Armor Wheel & Tire Set: Mud XC & 4204	P. 66
2882177	<b>LOCK &amp; RIDE</b> CargoMax System	P. 40			



RANGER XP 1000 / RANGER 1000

# BIG GAME

2882753	8-Vent Heater & Defrost System	P. 28	2884107	<b>LOCK &amp; RIDE</b> Kolpin Rhino Grip Pro	P. 51
2883265	Work Beacon LED Light	P. 29	2882077	Pro Armor 33" - Combo LED Light Bar	P. 59
2882710	Polaris Pro HD 6,000 Lb. Winch with Rapid Rope Recovery	P. 31	2883157	Pro Armor Wheel & Tire Set: Attack 2.0 & 5202	P. 66
2882690	Front Hood Storage Rack	P. 40			



RANGER XP 1000 / RANGER 1000

# CRAFTSMAN

2882711	Polaris Pro HD 4,500 Lb. Winch with Rapid Rope Recovery	P. 31	2881533	<b>LOCK &amp; RIDE</b> Tool Rack	P. 43
2882752	<b>LOCK &amp; RIDE</b> Bed Extender/Divider	P. 40	2882077	Pro Armor 33" - Combo LED Light Bar	P. 59
2882751	Cargo Bed Mat	P. 42	2882384	Wheel & Tire Set: Pro Armor Harvester & 4202	P. 66
2879354	<b>LOCK &amp; RIDE</b> Chainsaw Mount	P. 42			
2883279	<b>LOCK &amp; RIDE</b> Storage Box	P. 43			

SHOP ALL RANGER ACCESSORIES AT  
[POLARIS.COM/ShopRANGER](https://www.polaris.com/ShopRANGER)

COMPLETE LIGHTING WITH REQUIRED  
LIGHT BAR HARNESSSES

SEE P. 58



# ROOFS

## POLY FEATURES

- Water run-off
- Polaris PULSE plug and play
- Liner ready
- Lightweight



PREMIUM FINISH AND QUIETER RIDE

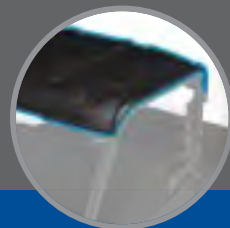

SEALED COVERAGE

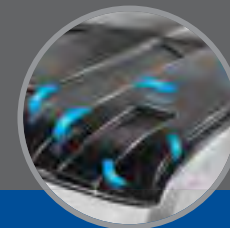

REDUCE STANDING WATER



EASY AND FAST INSTALLATION

### POLARIS ENGINEERED ADVANTAGES

### TO SHIELD AGAINST DRIVING RAIN OR THE BLISTERING SUN,

a roof is the first must-have of the Polaris Engineered cab components. Choose from poly or steel, and get on your way with protective peace of mind.



## PREMIUM & SPORT ROOF FEATURES

SEE AUDIO OPTIONS P.34



\* PREMIUM AND SPORT FEATURES NOT AVAILABLE ON STEEL ROOFS

MULTI-FUNCTION LIGHT READY

WINDSHIELD WIPER & WASHER SYSTEM WIRING READY

POLARIS PULSE INTEGRATION

AUDIO READY

SOUND ABSORBING LINER

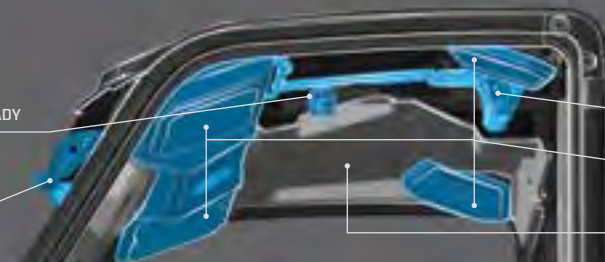

## POLY

Lightweight, durable and impact-resistant. A poly roof can take the abuse of a tough trail and still protect.

### PREMIUM ROOF - POLY

» POLARIS PURSUIT CAMO • 2882913 • \$989<sup>99</sup>

» TOP SELLER BLACK • 2882912 • \$764<sup>99</sup>

XP 1000 '17-22, 1000 '20-22, XP KINETIC '23  
INCLUDES ROOF LINER



### SPORT ROOF - POLY TOP SELLER

» BLACK • 2882911 • \$484<sup>99</sup>

XP 1000 '17-22, 1000 '20-22, XP KINETIC '23



### PREMIUM ROOF LINER

» 2882914 • \$284<sup>99</sup>

XP 1000 '17-22, 1000 '20-22, XP KINETIC '23  
WORKS WITH 2882911, 2882912, 2882913



### PREMIUM ROOF CREW - POLY

» POLARIS PURSUIT CAMO • 2883277 • \$1,684<sup>99</sup>

CREW XP 1000 '19-22, CREW 1000 '20-22  
ROOF LINER INCLUDED WITH CAMO



### SPORT ROOF CREW - POLY TOP SELLER

» BLACK • 2883274 • \$709<sup>99</sup>

CREW XP 1000 '19-22, CREW 1000 '20-22



### PREMIUM ROOF LINER - CREW TOP SELLER

» 2883457 • \$354<sup>99</sup>

CREW XP 1000 '18-22, CREW 1000 '20-22



## PLUG AND PLAY

ADD POWER TO PREMIUM & SPORT ROOFS P. 46



# WINDSHIELDS

## GLASS VS POLY

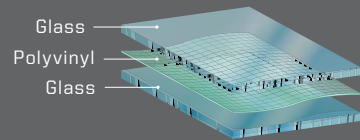

- Superior optical clarity (automotive level)
- Scratch-resistant
- Curved to fit, seals tight
- Cold weather / heavy duty
- Wiper ready

## VS POLY

- Lightweight, flexible, easy to store/remove
- Impact-resistant
- 360° seal keeps out rain and dust

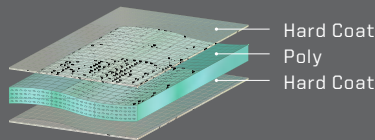

### TIP-OUT FULL WINDSHIELD - GLASS

- Tip-out design offers three positions: open, closed and vented
- Gas shocks assist in easy opening and closing
- 360° gasket for reliable protection and comfort
- Scratch-resistant automotive-style curved glass

» 2889020 • \$1,684<sup>99</sup>  
 XP 1000 '18-22, CREW XP 1000 '19-22, CREW 1000 '20-22, 1000 '20-22, XP KINETIC '23



### FULL GLASS WINDSHIELD - CLEAR

- Scratch-resistant, curved laminate safety glass
- Protects against wind, rain and other debris
- UV-blocking interlayer and 360° gasket seal

» 2889021 • \$984<sup>99</sup>  
 XP 1000 '18-22, CREW XP 1000 '19-22, CREW 1000 '20-22, 1000 '20-22, XP KINETIC '23

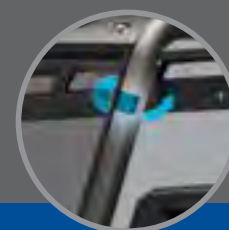

**LOCK & RIDE**  
 EASY AND FAST  
 INSTALLATION



**AIRTIGHT  
 GASKET SEAL**

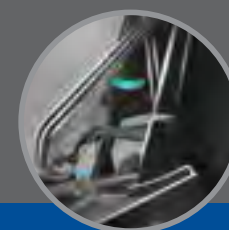

**MULTI-FUNCTION  
 FEATURES**

## POLARIS ENGINEERED ADVANTAGES

## HARD COAT POLY | 30x MORE SCRATCH-RESISTANT



### LOCK & RIDE FULL WINDSHIELD VENTED - HARD COAT POLY **TOP SELLER**

- Frameless design for maximum visibility
- Added vents for airflow on a hot day or defrosting on a cold day
- Requires Wiper Install Kit, 2207624

» 2883266 • \$814<sup>99</sup>  
 XP 1000 '17-22, CREW XP 1000 '18-22, CREW 1000 '20-22, 1000 '20-22, XP KINETIC '23



### LOCK & RIDE FULL WINDSHIELD - HARD COAT POLY **TOP SELLER**

- Frameless design for maximum visibility
- Requires Wiper Install Kit, 2207624

» 2883300 • \$699<sup>99</sup>  
 XP 1000 '17-22, CREW XP 1000 '18-22, CREW 1000 '20-22, 1000 '20-22, XP KINETIC '23



### LOCK & RIDE FLIP-DOWN WINDSHIELD - HARD COAT POLY **TOP SELLER**

- Two venting options: fully sealed, flip-down or remove upper half for some protection with maximum ventilation

» 2884139 • \$774<sup>99</sup>  
 XP 1000 '18-22, CREW XP 1000 '19-22, CREW 1000 '20-22, 1000 '20-22, XP KINETIC '23



### LOCK & RIDE FULL WINDSHIELD - POLY **TOP SELLER**

- Frameless design for maximum visibility

» 2883278 • \$574<sup>99</sup>  
 XP 1000 '17-22, CREW XP 1000 '18-22, CREW 1000 '20-22, 1000 '20-22, XP KINETIC '23



### LOCK & RIDE HALF WINDSHIELD - POLY **TOP SELLER**

- Deflects air flow from straight on, but still provides air flow in the cab

» 2883301 • \$329<sup>99</sup>  
 XP 1000 '17-22, CREW XP 1000 '18-22, CREW 1000 '20-22, 1000 '20-22, XP KINETIC '23



### LOCK & RIDE HARD COAT POLY WINDSHIELD WIPER & WASHER MOUNTING BRACKET

- Required to use wiper on 2883266 or 2883300

» 2207624 • \$79<sup>99</sup>  
 XP 1000 '17-22, CREW XP 1000 '18-22, CREW 1000 '20-22, 1000 '20-22, XP KINETIC '23





# REAR PANELS

## GLASS VS POLY

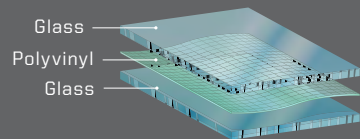

- Superior optical clarity (automotive level)
- Scratch-resistant
- Curved to fit, seals tight
- Cold weather / heavy duty
- Wiper ready (windshield only)

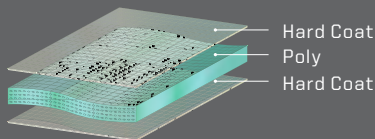

- Lightweight, flexible, easy to store/remove
- Impact-resistant
- Tight seal keeps out rain and dust



**LOCK & RIDE**  
EASY AND FAST  
INSTALLATION



**AIRTIGHT  
GASKET SEAL**



**VENTING  
OPTIONS**

### POLARIS ENGINEERED ADVANTAGES



**REDUCE IN-CAB DUST SWIRL  
BY ADDING A REAR PANEL**  
With a windshield and roof installed, turbulent air develops behind the cab. Add a rear panel to reduce dust intrusion from this swirl.

**HARD COAT POLY | 30x MORE SCRATCH-RESISTANT**

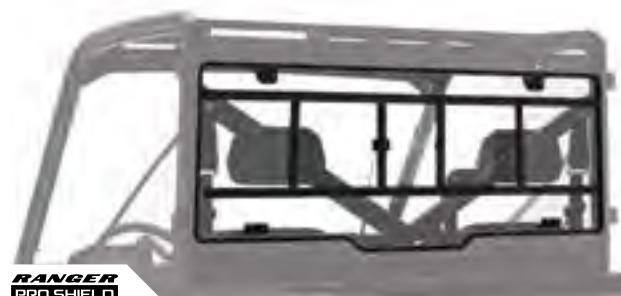

**LOCK & RIDE**  
**REAR PANEL - SLIDING GLASS**

- Sliding window provides ventilation, cab comfort and access to cargo in rear box

» 2879015 • \$989<sup>99</sup>  
XP 1000 '17-22, CREW XP 1000 '18-22, CREW 1000 '20-22, 1000 '20-22, XP KINETIC '23



**LOCK & RIDE**  
**REAR PANEL - GLASS** TOP SELLER

» 2879013 • \$539<sup>99</sup>  
XP 1000 '17-22, CREW XP 1000 '18-22, CREW 1000 '20-22, 1000 '20-22, XP KINETIC '23



**LOCK & RIDE**  
**REAR PANEL - POLY POLARIS PURSUIT CAMO**

- Strong, thick polycarbonate provides outstanding impact and scratch resistance
- Installs in contours of cab frame with 360° gasketing for outstanding protection, comfort, fit and finish
- Dot matrix screen printing allows for rear visibility

» 2883774 • \$574<sup>99</sup>  
XP 1000 '17-22, CREW XP 1000 '18-22, CREW 1000 '20-22, 1000 '20-22, XP KINETIC '23



**LOCK & RIDE**  
**REAR PANEL - POLY - CLEAR** TOP SELLER

- Strong, thick polycarbonate provides outstanding impact and scratch resistance
- Installs in contours of cab frame with 360° gasketing for outstanding protection, comfort, fit and finish

» 2883773 • \$499<sup>99</sup>  
XP 1000 '17-22, CREW XP 1000 '18-22, CREW 1000 '20-22, 1000 '20-22, XP KINETIC '23



# DOORS

## THE BEST CAB

## COMPLETED



SEE WHAT PEOPLE ARE SAYING ABOUT THESE DOORS  
[YOUTUBE.COM/POLARISORV](https://www.youtube.com/polarisorv)  
 SEARCH "DOORS"

KEY FEATURES	PREMIUM POLY DOORS			POLY DOORS		CANVAS DOORS
	POWER WINDOW DOORS	MANUAL CRANK WINDOW DOORS	HALF DOORS	RANGER HUNTER DOORS	RANGER CLEARVIEW DOORS	ZIP WINDOW DOORS
RANGER PRO SHIELD CAB SYSTEM						
WINDOW TYPE / VENTILATION	GLASS / POWER	GLASS / MANUAL CRANK	NA / OPEN TOP	GLASS / HINGED	GLASS / HINGED	CLEAR POLY / ZIPPED
VISIBILITY	UPPER	UPPER	UPPER	UPPER	UPPER + LOWER	UPPER + PARTIAL LOWER
STORAGE COMPARTMENT	STANDARD	STANDARD	STANDARD			
AUDIO-READY / SPEAKER MOUNT	STANDARD, PRE-WIRED	STANDARD				
PREMIUM TPE LINER	STANDARD	STANDARD	STANDARD			
SPECIAL FEATURES	BUILT-IN FLOOR LIGHT, COLORED ACCENT PANELS AVAILABLE	COLORED ACCENT PANELS AVAILABLE	COLORED ACCENT PANELS AVAILABLE	DURABLE POLY CONSTRUCTION, POLARIS PURSUIT CAMO	DURABLE POLY CONSTRUCTION	AVAILABLE IN POLARIS PURSUIT CAMO
	<ul style="list-style-type: none"> <li>The ultimate door offering power windows, switches mounted on the door and built-in floor light.</li> </ul>	<ul style="list-style-type: none"> <li>A premium, door offering manual crank windows for airflow adjustment in the cab.</li> </ul>	<ul style="list-style-type: none"> <li>Provides lower protection from the off-road with an open-air experience.</li> </ul>	<ul style="list-style-type: none"> <li>Tough clear poly shell extends from the bottom of the door until it meets the upper-hinged glass window.</li> <li>Premium Polaris Pursuit Camo pattern offers extensive camo coverage.</li> </ul>	<ul style="list-style-type: none"> <li>Deliver nearly uninterrupted visibility and maximum ambient lighting inside the cab.</li> <li>Tough clear poly shell extends from the bottom of the door until it meets the upper-hinged glass window.</li> </ul>	<ul style="list-style-type: none"> <li>Lightweight, durable protection with adjustable zipper ventilation and see-through bottom panel.</li> </ul>

Front and Rear Doors are required to complete a cab on CREW RANGER models.

Premium Doors come with Gloss Black Exterior Door Accent Panels, images shown with optional Exterior Door Accent Panels.

<b>FRONT DOORS (SET OF 2)</b> XP 1000 '18-'22, CREW XP 1000 '19-'22, CREW 1000 '20-'22, 1000 '20-'22, XP KINETIC '23	 <b>TOP SELLER</b> Power Window Doors - Poly - Black 2884338 • \$4,604 <sup>99</sup>	 <b>TOP SELLER</b> Manual Crank Window Doors - Poly - Black 2882561 • \$3,684 <sup>99</sup>	 Half Doors - Poly 2882559 • \$2,144 <sup>99</sup>	 RANGER Hunter Doors - Polaris Pursuit Camo 2883229 • \$3,159 <sup>99</sup>	 RANGER ClearView Doors 2882901 • \$2,959 <sup>99</sup>	 <b>TOP SELLER</b> Zip Window Doors - Canvas - Polaris Pursuit Camo 2882903 • \$1,724 <sup>99</sup>	 <b>TOP SELLER</b> Zip Window Doors - Canvas - Black 2882902 • \$1,314 <sup>99</sup>
	<b>REAR DOORS (SET OF 2)</b> CREW XP 1000 '19-'22, CREW 1000 '20-'22	 <b>TOP SELLER</b> Manual Crank Window Doors - Rear - Poly 2883437 • \$3,684 <sup>99</sup>	 Half Doors - Rear - Poly 2883438 • \$2,144 <sup>99</sup>	 RANGER Hunter Doors - Rear - Polaris Pursuit Camo 2883633 • \$3,009 <sup>99</sup>	 RANGER ClearView Doors - Rear 2883632 • \$2,959 <sup>99</sup>	 Zip Window Doors - Rear - Canvas - Black 2883634 • \$1,314 <sup>99</sup>	

**EXTERIOR DOOR ACCENT PANELS** // Replace stock gloss black accent panels

// Painted plastic and clear-coated for UV

protection // Install easily with a single screw

// Comes as a pair

FRONT REAR	 Solar Red 2883499-342 • \$79 <sup>99</sup>	 Sunset Red Metallic 2882870-520 • \$79 <sup>99</sup> 2883829-520 • \$79 <sup>99</sup>	 Sand Metallic 2882870-555 • \$79 <sup>99</sup> 2883829-555 • \$79 <sup>99</sup>	 Sage Green 2883843-560 • \$79 <sup>99</sup>	 Pearl White 2882870-566 • \$79 <sup>99</sup> 2883829-566 • \$59 <sup>99</sup>	 Suede Metallic 2882870-577 • \$79 <sup>99</sup>	 Polaris Pursuit Camo 2882870-587 • \$139 <sup>99</sup> 2883829-587 • \$139 <sup>99</sup>	 Magnetic Gray 2882870-603 • \$79 <sup>99</sup>	 Burgundy Metallic 2882870-629 • \$79 <sup>99</sup> 2883829-629 • \$79 <sup>99</sup>
FRONT REAR	 Matte Titanium 2882870-632 • \$79 <sup>99</sup> 2883829-632 • \$79 <sup>99</sup>	 Black Pearl 2882870-666 • \$79 <sup>99</sup> 2883829-666 • \$79 <sup>99</sup>	 Matte Sunset Red 2882870-669 • \$79 <sup>99</sup>	 Matte Sagebrush Green 2882870-685 • \$79 <sup>99</sup> 2883829-685 • \$79 <sup>99</sup>	 Military Tan 2882870-686 • \$79 <sup>99</sup>	 Matte Navy 2882870-726 • \$79 <sup>99</sup> 2883829-726 • \$79 <sup>99</sup>	 Orange Rust 2882870-750 • \$79 <sup>99</sup>	 Maroon Metallic 2882870-754 • \$79 <sup>99</sup> 2883829-754 • \$79 <sup>99</sup>	 Black Cherry 2882870-756 • \$79 <sup>99</sup> 2883829-756 • \$79 <sup>99</sup>
FRONT REAR	 Steel Blue 2882870-765 • \$79 <sup>99</sup> 2883829-765 • \$79 <sup>99</sup>	 Ghost White Metallic 2882870-774 • \$79 <sup>99</sup> 2883829-774 • \$79 <sup>99</sup>	 Polaris Blue 2882870-795 • \$79 <sup>99</sup> 2883829-795 • \$79 <sup>99</sup>	 Stealth Gray 2882870-804 • \$79 <sup>99</sup> 2883829-804 • \$79 <sup>99</sup>	 Onyx Black 2882870-866 • \$79 <sup>99</sup>	 Icy White Pearl 2882870-911 • \$109 <sup>99</sup> SUMMER AVAILABILITY			

**REQUIRED POLARIS PULSE INSTALLATION ITEMS**

GET SUPERIOR PERFORMANCE AND OUR BEST SEAL with the RANGER Pro Shield Cab System door line

360° GASKET SEAL

EASY TO CLEAN TPE LINER

BUILT-IN STORAGE

AUDIO-READY

VENTILATION OPTIONS



# CAB COMFORT & CONVENIENCE



## 8-VENT HEATER & DEFROST SYSTEM



- Easily control the climate inside your cab in any season
- Helps defrost windshields and keeps you warm or cool
- Heat and fan dash-mounted controls
- Manual vents

» **TOP SELLER** 2882753 • \$1,449 <sup>99</sup> **XP 1000 ONLY**

XP 1000 '18-22, CREW XP 1000 '19-22

» **TOP SELLER** 2884066 • \$1,449 <sup>99</sup> **1000 ONLY**

CREW 1000 '20-22, 1000 '20-22  
NEED ADAPTER: 2884163 ON CREW 1000

» **CREW HEATER ADAPTER KIT** **1000 ONLY**  
2884163 • \$139 <sup>99</sup>

CREW 1000 '20-22



## WINDSHIELD WIPER & WASHER SYSTEM



» 2883974 • \$774 <sup>99</sup>

XP 1000 '18-22, CREW XP 1000 '19-22,  
CREW 1000 '20-22, 1000 '20-22, XP KINETIC '23

REQUIRES MOUNT KIT 2207624 FOR POLY WINDSHIELDS

## HARD COAT POLY WINDSHIELD WIPER & WASHER SYSTEM MOUNTING BRACKET

» 2207624 • \$79 <sup>99</sup>

XP 1000 '17-22, CREW XP 1000 '18-22,  
CREW 1000 '20-22, 1000 '20-22, XP KINETIC '23

REQUIRED TO USE WIPER ON 2883266 OR 2883300



## NEW IN-CAB HEATER AND DEFROST KIT

- Easily control the climate inside your cab in any season with this UTV cab heater
- Helps defrost windshields and keep you warm or cool
- Three different fan speeds
- Heat and fan dash-mounted controls
- Manual vents
- A Polaris Pulse Ready Accessory

» 2889449 • \$1,999 <sup>99</sup> **SUMMER AVAILABILITY**

XP KINETIC '23



## FLOOR MATS - 3 SEAT

» 2882780 • \$169 <sup>99</sup> **XP 1000 ONLY**

XP 1000 '18-22, CREW XP 1000 '19-22, XP KINETIC '23  
CREW: FITS FRONT SEATS ONLY

» 2884247 • \$169 <sup>99</sup> **1000 ONLY**

CREW 1000 '20-22, 1000 '20-22  
CREW: FITS FRONT SEATS ONLY

## NOISE REDUCTION SYSTEM

» 2883489 • \$369 <sup>99</sup>

XP 1000 '18-22, CREW XP 1000 '19-22,  
1000 '20-22, CREW 1000 '20-22, XP KINETIC '23

DESIGNED TO ATTACH TO THE REAR CLOSURE PANEL OF YOUR RANGER CAB, THE SOUND ABSORBING MATERIAL REDUCES UNWANTED NOISE FOR A QUIETER CAB

## UNDER SEAT DRY STORAGE

» 2882910 • \$284 <sup>99</sup> **XP 1000 ONLY**

XP 1000 '18-22, CREW XP 1000 '19-22, XP KINETIC '23

WILL NOT WORK WITH SUBWOOFER 2882890 & 2884233



## MULTI-FUNCTION CAB LIGHT



- LED dome light provides white, red, green and blue lighting options
- Battery-operated. Recharges when the vehicle is on
- Can be removed to use as a flashlight in and around your vehicle

- Red light is great for reading maps
- Green light is perfect for navigating in the dark
- Blue light is ideal for night riding

» 2882871 • \$144 <sup>99</sup>

XP 1000 '18-22, CREW XP 1000 '19-22, CREW 1000 '20-22, 1000 '20-22, XP KINETIC '23  
REQUIRES ROOF PULSE: 2882904

## REMOTE GARAGE DOOR OPENER BY HOMELINK®

- HomeLink® technology allows you to control up to two garage doors



» 2882892 • \$199 <sup>99</sup>

XP 1000 '18-22, CREW XP 1000 '19-22,  
CREW 1000 '20-22, 1000 '20-22, XP KINETIC '23



## POLARIS RANGER XP FULL-SIZE SEATSAVER - SPLIT BENCH SEAT

**XP 1000 ONLY**

- Covers the back and bottom of seat

» **POLARIS PURSUIT CAMO** • 2883244-587 • \$309 <sup>99</sup>

» **CARHARTT® BROWN** • 2883244-218 • \$284 <sup>99</sup>

» **CARHARTT® GRAVEL** • 2883244-458 • \$284 <sup>99</sup>

XP 1000 '18-21, CREW XP 1000 '19-21, XP KINETIC '23  
CREW: FITS FRONT SEATS ONLY

NO REAR SEAT COVERS AVAILABLE



SEAT CONFIGURATION

## NEW SIDE VIEW MIRRORS

- Mounts on any RANGER vehicle that is equipped with doors
- Fully adjustable to accommodate riders of all sizes and can fold in to prevent being struck

» **DOOR MOUNTED (shown)** • 2889241 • \$229 <sup>99</sup>

» **ROPS-MOUNTED** • 2889243 • \$229 <sup>99</sup>

XP 1000 '18-22, CREW XP 1000 '19-22, CREW 1000 '20-22,  
1000 '20-22, XP KINETIC '23



## WORK BEACON LED LIGHT

- 50 ft. of illumination 360° around your vehicle
- Ideal for plowing, hunting and nighttime utility work
- Break-away construction protects the light in areas with tight clearance
- Mounted to the vehicle on the rear of the ROPS
- Easily hinge the light up during use and hinge it down when in transit
- Add LED Headlights for more light

» 2883265 • \$329 <sup>99</sup>

XP 1000 '18-22, CREW XP 1000 '19-22, CREW 1000 '20-22, 1000 '20-22, XP KINETIC '23  
REQUIRES LIGHT BAR HARNESS/EXTENSION 2883230 AND 2883854

## LED HEADLIGHTS

**XP 1000 ONLY**

- LED Headlights offer improved brightness and illumination vs stock halogen lights
- Designed with styling specific to RANGER

» 2889072 • \$679 <sup>99</sup>

XP 1000 '18-22, CREW XP 1000 '19-22, XP KINETIC '23



## REVERSE WARNING ALERT

» 2883246 • \$79 <sup>99</sup>

XP 1000 '18-22, CREW XP 1000 '19-22, CREW 1000 '20-22, 1000 '20-22, XP KINETIC '23  
AUTOMATICALLY ACTIVATED WHENEVER THE VEHICLE IS PUT IN REVERSE

## HORN

**TOP SELLER**



» 2882764 • \$94 <sup>99</sup>

XP 1000 '18-22, CREW XP 1000 '19-22, CREW 1000 '20-22, 1000 '20-22, XP KINETIC '23

## LARGE REAR VIEW MIRROR

**TOP SELLER**

» 2879969 • \$99 <sup>99</sup>

XP 1000 '17-22, CREW XP 1000 '18-22, CREW 1000 '20-22, 1000 '20-22, XP KINETIC '23

## WIDE ANGLE REAR VIEW MIRROR

- Large 2.5" x 14" adjustable convex mirrored surface gives you a full-spectrum view

» 2881439 • \$184 <sup>99</sup>

XP 1000 '17-22, CREW XP 1000 '18-22, CREW 1000 '20-22, 1000 '20-22, XP KINETIC '23

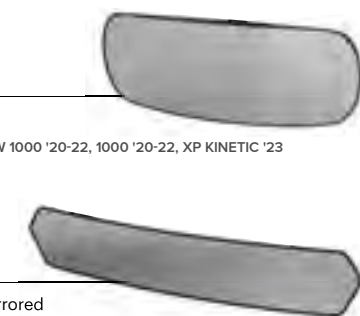



# WINCHES

## DEPENDABLE. TOUGH. BUILT FOR THE OFF-ROAD.

A Polaris Engineered winch is designed to help you get the job done right, get you on your way faster and prepare you for the unexpected.

### WHY POLARIS?

Polaris off-road vehicles are engineered with designated mounting points and wiring for seamless install of Polaris Engineered winches.

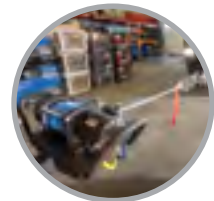

TESTED **1,200+** PULLS AT MAX LOAD



BUILT TO WITHSTAND **-20° F** TEMPERATURES



OPERATES **FULLY SUBMERGED**



**MILITARY TESTED & APPROVED**



ADD A PLOW  
P. 54

### FEATURES & BENEFITS

#### ALL POLARIS ENGINEERED WINCHES COME WITH:



1 YR WARRANTY

- ✓ INTEGRATED WIRING, MOUNT, PREASSEMBLED
- ✓ HOOK WITH STRAP
- ✓ CUT STEEL GEARS & SEALED DRIVETRAIN
- ✓ SEALED PERMANENT MAGNET MOTOR

MODEL	6,000 LB.	4,500 LB.	4,500 LB.
<b>XP 1000</b> '18-22 <b>CREW XP 1000</b> '19-22 <b>1000</b> '20-22 <b>CREW 1000</b> '20-22 <b>XP KINETIC</b> '22 <small>NON EPS RANGER 1000 REQUIRES FRONT BUMPER</small>	<p><b>TOP SELLER</b></p> <p><b>2882710</b></p> <p>\$1,289.99</p>	<p><b>TOP SELLER</b></p> <p><b>2882711</b></p> <p>\$1,149.99</p>	<p><b>TOP SELLER</b></p> <p><b>2882714</b></p> <p>\$844.99</p>
<p><b>RAPID ROPE RECOVERY</b> <b>5X FASTER</b></p> <p>Retrieve cable 5x as fast as standard mode on other Polaris winches. Get back to riding or complete your task quicker.</p> <ol style="list-style-type: none"> <li>Set winch dial to N (Neutral) to manually pull the rope out and secure the hook to your anchor point</li> <li>Set winch dial to L (Low) for maximum pulling power while winching your load</li> <li>Set winch dial to H (High) for retrieving the rope 5x faster with Rapid Rope Recovery</li> </ol>	✓	✓	NOT AVAILABLE
<p><b>AUTO STOP TECHNOLOGY</b></p> <p>Winch stops when fairlead detects collar</p> <p>Auto Stop technology protects and extends the life of your winch by automatically stopping the winch at the end of pull to prevent over-spooling. While plowing, it prevents the plow frame from bending by stopping the winch once the plow has been lifted.</p>	✓	✓	<p>ADD AUTO STOP UPGRADE</p> <p><b>2884702 • \$129.99</b></p> <p>WORKS WITH 2882714</p> <p>SYNTHETIC ROPE REQUIRED</p>
<p><b>PREMIUM SYNTHETIC ROPE</b></p> <p>With its lightweight, yet extremely strong, design and superior flexibility, this 50 ft long synthetic rope is easy to handle and can stand up to any tough job.</p>	✓	✓	<p>ADD SYNTHETIC ROPE</p> <p><b>2879187 • \$184.99</b></p>
<p><b>WIRELESS REMOTE</b></p> <p>This convenient remote operates your Polaris winch wirelessly from within 50 ft of the vehicle. Operate your winch safely outside your vehicle while on the job site or trails.</p>	✓	✓	<p>ADD WIRELESS REMOTE</p> <p><b>TOP SELLER 2883455 • \$184.99</b></p> <p>WORKS WITH 2882714</p>

### UPGRADE YOUR CONTROLS

#### NEW DASH WINCH SWITCH KIT

- Allows user to add a dash switch as an additional means to control winch
- Can be used with all winches and are compatible with other control methods (wireless/wired)

» 2889050 • \$99.99

XP 1000 '18-22, CREW XP 1000 '19-22, CREW 1000 '20-22, 1000 '20-22, XP KINETIC '23

TOP SELLER

#### POWER CONTROLLER



- Control winch/plow hydraulics from shift knob

» 2883247 • \$284.99

XP 1000 '18-22, CREW XP 1000 '19-22, CREW 1000 '20-22, 1000 '20-22, XP KINETIC '23

REQUIRES WINCH ADAPTER 2884159 WHEN USING A WINCH FOR LIFTING DEVICE

#### WIRED REMOTE CONTROL

- Handle and socket both required

» REMOTE HANDLE • 4013466 • \$90.99

» SOCKET • 4017102 • \$86.99

WORKS WITH ALL MODELS

### REPLACEMENT PARTS

#### SYNTHETIC ROPE

6,000 LB. » 2879188 • \$244.99    4,500 LB. » 2879187 • \$184.99





# PROTECTION

PERFECT FOR: **INCREASED PROTECTION AROUND LIGHTING AND FENDERS**

## STANDARD BRUSHGUARDS



FRONT

## HD BRUSHGUARDS



**1 3/4" DIAMETER**  
STEEL TUBE CONSTRUCTION

REAR



• To use Front Bumper with RIDE COMMAND and Front Camera, RIDE COMMAND Bumper Adapter (2207941) is required

» **TOP SELLER** FRONT • 2882531 • **\$354<sup>99</sup>** » **TOP SELLER** REAR • 2882529 • **\$344<sup>99</sup>**

XP 1000 '18-22, CREW XP 1000 '19-22, CREW 1000 '20-22, 1000 '20-22, XP KINETIC '23  
FRONT BRUSHGUARD DOES NOT FIT HIGH LIFTER MODELS  
1000 NON-EPS VEHICLES REQUIRE FRONT BUMPER: 2884123

» RIDE COMMAND BUMPER ADAPTER • 2207941 • **\$48<sup>79</sup>**  
FOR USE ON VEHICLES WITH RIDE COMMAND AND FRONT CAMERA

• Increased protection over stock bumper with integrated mounting locations for accessories and lights (sold separately) with a durable matte black finish

• Easy installation with included mounting hardware

• Additional 36" storage area for recovery equipment

» FRONT • 2885105 • **\$949<sup>99</sup>** » REAR • 2884217 • **\$609<sup>99</sup>**

XP 1000 '18-22, CREW XP 1000 '19-22, CREW 1000 '20-22, 1000 '20-22, XP KINETIC '23  
FRONT BRUSHGUARD DOES NOT FIT HIGH LIFTER MODELS  
REAR: RECOMMENDED WITH RIGID® OR PRO ARMOR® POD LIGHTS FOR UPGRADED LIGHTING

## **NEW** HIGH-MOUNTED FRONT BRUSHGUARD



## FRONT BRUSHGUARD **1000 ONLY**



• Increased protection over stock bumper

• Offers a higher winch mounting position which allows for easier access when used in deep mud

• Not compatible with Polaris Plow Systems

» 2889271 • **\$814<sup>99</sup>**

XP 1000 '18-22, CREW XP 1000 '19-22, CREW 1000 '20-22, 1000 '20-22, XP KINETIC '23

## **NEW** HIGH-MOUNTED HD 4,500 LB. WINCH **WINTER AVAILABILITY**

• Provides outstanding performance and versatile pulling power

• The elevated mounting position allows for easier access when used in deep mud

» 2889272 • **\$969<sup>99</sup>**

XP 1000 '18-22, CREW XP 1000 '19-22, CREW 1000 '20-21, 1000 '20-22, XP KINETIC '23



• Increased protection over stock bumper

• Sturdy stamped steel and tube construction

• Integrated mounting positions for plow and winch accessories

» 2889330 • **\$539<sup>99</sup>**

CREW 1000 '20-22, 1000 '20-22  
REQUIRED TO INSTALL WINCH/PLOW ON NON EPS RANGER 1000

## **NEW** ACCESSORY BUMPER HARDWARE

• Required when using a front camera as well as an upper front bumper or hood rack

» 2889659 • **\$51<sup>99</sup>** **SUMMER AVAILABILITY**

XP KINETIC '23



## ROCK GUARDS



3-SEAT



CREW

### ROCK GUARD WITH STEP

- Reliable, hard-working protection for edges of vehicle
- Integrated step with boot scraper helps keep interior clean
- Mounts directly to the frame, instead of underneath, for maximum ground clearance
- Steel construction with black e-coat and durable black powder-coated finish

» **TOP SELLER** 3-SEAT • 2882530 • **\$344<sup>99</sup>** » CREW • 2883398 • **\$539<sup>99</sup>**

XP 1000 '18-22, 1000 '20-22, XP KINETIC '23 CREW XP 1000 '19-22, CREW 1000 '20-22

## A-ARMS



### **NEW** HIGH CLEARANCE A-ARMS

• Valuable, reliable protection for vital front suspension components exposed to the rigors of off-road environments

• Strong, durable, lightweight polyethylene construction withstands off-road impacts to protect the A-Arms

» FRONT • 2889269 • **\$484<sup>99</sup>** » REAR • 2889270 • **\$484<sup>99</sup>**

XP 1000 '18-22, CREW XP 1000 '19-22, CREW 1000 '20-22, 1000 '20-22, XP KINETIC '23 XP 1000 '18-22, CREW XP 1000 '19-22, CREW 1000 '20-22, 1000 '20-22, XP KINETIC '23



### HMW A-ARM GUARDS

• Strong, 1/4" thick, durable, lightweight HMW (high molecular weight) polyethylene construction helps protect against off-road impacts

• Molded specifically for the RANGER XP 1000 & 1000 front suspension for a sure fit and low-profile presence

• Easy bolt-on design with mounting hardware included

» FRONT • 2882784 • **\$284<sup>99</sup>** » REAR • 2882787 • **\$284<sup>99</sup>**

XP 1000 '18-22, CREW XP 1000 '19-22, CREW 1000 '20-22, 1000 '20-22, XP KINETIC '23 XP 1000 '18-22, CREW XP 1000 '19-22, CREW 1000 '20-22, 1000 '20-22, XP KINETIC '23  
WILL NOT FIT ARCHED A-ARM MODELS WILL NOT FIT ARCHED A-ARM MODELS



# AUDIO

BUILD YOUR AUDIO SYSTEM

## OFF-ROAD GRADE AUDIO

When you research audio solutions, you'll see manufacturers bragging about how their audio equipment is "Marine Grade". Or worse yet, you'll discover they are repackaged components built for automotive applications. MB Quart®, combined with Polaris, engineers Off-Road Grade Audio equipment that's proven to deliver the loudest, crispest sound in the harshest conditions. Rain, snow, mud, heat, cold, dust—

**ANY PLACE YOUR RANGER EXCELS, SO WILL YOUR AUDIO.**

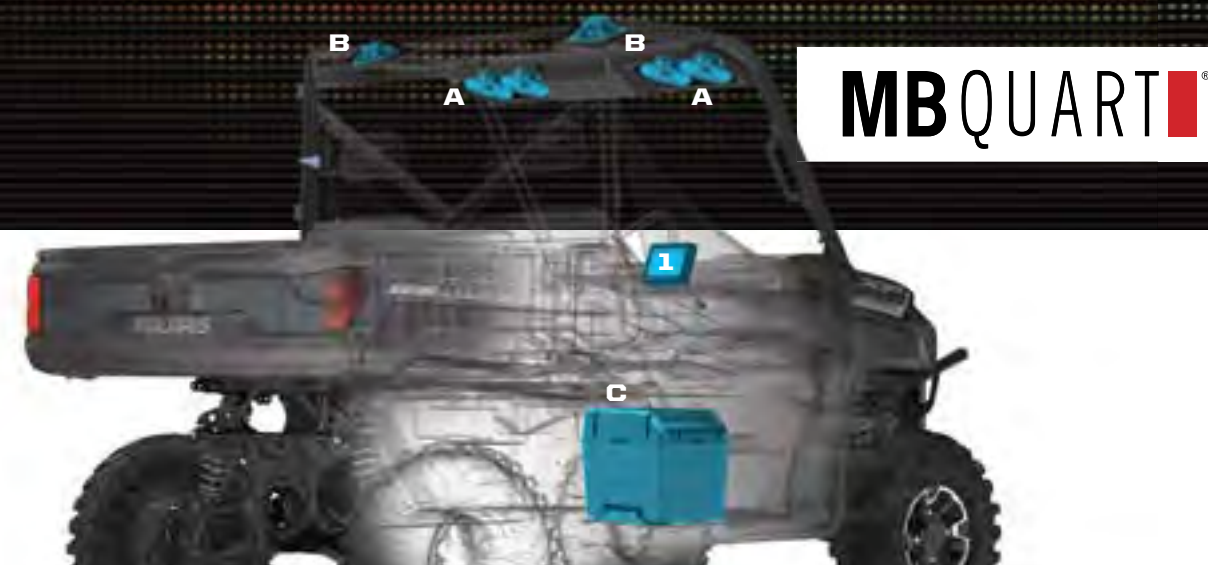

### BUILD YOUR SOUND WITH RIDE COMMAND

<b>STEP 1</b> <b>ADD HEAD UNIT</b> <b>7" DISPLAY POWERED BY RIDE COMMAND</b> 2884072 • <b>\$2,099<sup>99</sup></b> <small>SEE P. 44 FOR MORE INFORMATION</small>	<b>STEP 2</b> <b>ADD MOUNT</b> <b>NEW</b> 2889309 • <b>\$679<sup>99</sup></b> <small>XP 1000 '22, CREW XP 1000 '22, CREW 1000 '22, 1000 '22, XP KINETIC '23 FOR NORTHSTAR AND ALL OTHER MODELS WITHOUT 900 WATT</small>	<b>OR</b>	<b>NEW</b> 2889310 • <b>\$679<sup>99</sup></b> <small>XP 1000 '22, CREW XP 1000 '22, 1000 '22, XP KINETIC '23 FOR 900 WATT STATOR</small>
--	--	-----------	--

### STEP 3 UPGRADE AUDIO BY ADDING VISOR OR DASH AUDIO

**OPTION 1 VISOR AUDIO**

<b>A. OVERHEAD VISOR SPEAKERS</b> 2882891 • <b>\$844<sup>99</sup></b> <b>HARNES REQUIRED</b> <small>TOP SELLER 2882904 • \$139<sup>99</sup></small> <small>CREW MODELS REQUIRE ADDITIONAL 2883231</small>	+	<b>B. REAR OVERHEAD SPEAKERS</b> <small>TOP SELLER</small> 2882876 • <b>\$284<sup>99</sup></b> <small>XP 1000 '18-22, CREW XP 1000 '19-22, CREW 1000 '20-22, 1000 '20-22, XP KINETIC '23</small>	+	<b>C. 10" MAXBOOST SUBWOOFER</b> 2884233 • <b>\$844<sup>99</sup></b> <small>XP 1000 '18-22, CREW XP 1000 '19-22, XP KINETIC '23 WITH 900 WATT STATOR</small>
---	---	--	---	--

**OPTION 2 DASH AUDIO**

<b>AUDIO DASH SPEAKERS</b> <small>TOP SELLER</small> 2883956 • <b>\$609<sup>99</sup></b> <small>XP 1000 '19-22, CREW XP 1000 '19-22, CREW 1000 '20-22, 1000 '20-22, XP KINETIC '23</small>	+	<b>B. REAR OVERHEAD SPEAKERS</b> <small>TOP SELLER</small> 2882876 • <b>\$284<sup>99</sup></b> <small>XP 1000 '18-22, CREW XP 1000 '19-22, CREW 1000 '20-22, 1000 '20-22, XP KINETIC '23</small>	+	<b>C. 10" MAXBOOST SUBWOOFER</b> 2884233 • <b>\$844<sup>99</sup></b> <small>XP 1000 '18-22, CREW XP 1000 '19-22, XP KINETIC '23 RANGER MODELS WITH RIDE COMMAND PACKAGE REQUIRE 2883232 ADAPTER HARNES</small>
--	---	--	---	--

AUDIO DASH SPEAKERS INCLUDE BUILT-IN FOUR CHANNEL AMPLIFIER (40-WATTS) AND TWO OFF-ROAD GRADE 5.25" SPEAKERS

VISIT [POLARIS.COM/SHOPRANGER](https://www.polaris.com/shopranger) FOR FITMENT FOR YOUR SPECIFIC MODEL & YEAR

DOWNLOAD THE RIDE COMMAND MOBILE APP

CHECK FOR FEATURE ENHANCEMENTS & UPDATES AT [POLARIS.COM/RIDECOMMAND](https://www.polaris.com/ridecommand)

XP 1000 / XP KINETIC / 1000

ROOFS

WINDSHIELDS

REAR PANELS

DOORS

CAB COMFORT & CONVENIENCE

WINCHES

PROTECTION

AUDIO

STORAGE



# AUDIO

BUILD YOUR AUDIO SYSTEM

## OFF-ROAD GRADE AUDIO

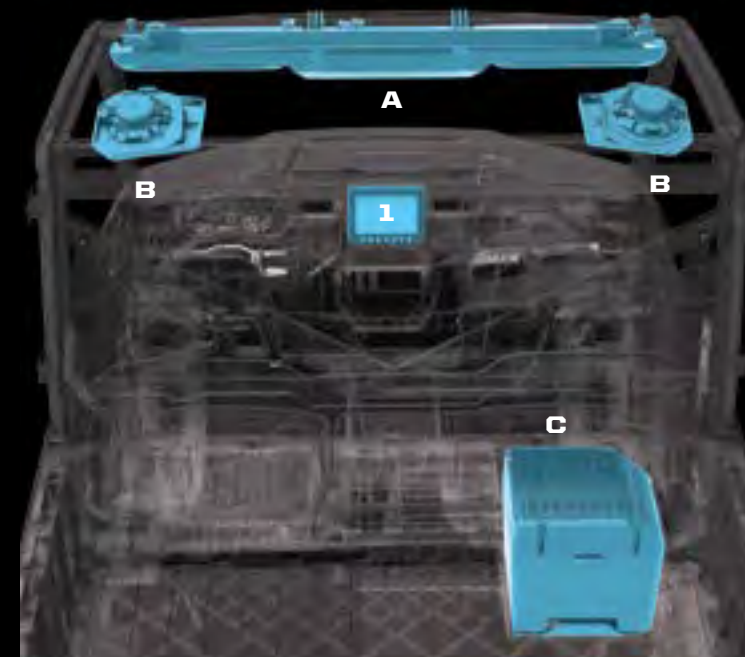

### 1 CHOOSE A HEAD UNIT Control all aspects of your sound system. Choose what to listen to and how loud.



DASH STEREO

#### 160 WATT, WATERPROOF AM/FM BLUETOOTH® AUDIO SYSTEM TOP SELLER



- All-in-one solution for giving your vehicle a performance-ready sound system
- USB input, Bluetooth® 4.0 compatible, Apple® Control, AM/FM tuner
- Built-in four channel amplifier (40-watts x 4)
- Two off-road grade 5.25" speakers with titanium dome tweeters and polypropylene cones

» 2882750 • \$844 <sup>99</sup>  
 XP 1000 '18-22, CREW XP 1000 '19-22, CREW 1000 '20-22, 1000 '20-22, XP KINETIC '23

USE AS IS OR ADD ADDITIONAL SPEAKERS



VISOR STEREO

#### 300 WATT AM/FM, BLUETOOTH® AUDIO VISOR WITH FOUR 6.5" WATERPROOF SPEAKERS TOP SELLER



- One-step solution for off-road audio
- USB input, Bluetooth® 4.0 compatible, Apple® Control, AM/FM tuner
- 300-Watt four channel amplifier (75 watts x 4)
- Four 6.5" coaxial speakers with titanium dome tweeters and polypropylene cones
- Audio outputs to drive additional speakers
- Four Accessory knock outs
- Polaris PULSE Electrical System

» 2882888 • \$1,124 <sup>99</sup>  
 XP 1000 '18-22, CREW XP 1000 '19-22, CREW 1000 '20-22, 1000 '20-22, XP KINETIC '23  
 NOT COMPATIBLE WITH 7" DISPLAY POWERED BY RIDE COMMAND

COMES WITH OVERHEAD VISOR SPEAKERS (AT RIGHT) USE AS IS OR ADD ADDITIONAL SPEAKERS

### 2 ADD SPEAKERS - MIX AND MATCH

Your RANGER is ready for work, but is it ready to entertain? From a simple two-speaker setup to a complete system - add speakers to BUILD IT YOUR WAY.



A VISOR SPEAKERS

#### STANDARD WITH VISOR STEREO

#### 300 WATT OVERHEAD AUDIO VISOR SPEAKERS

- Built-in 300-Watt amplifier (75-watt x 4 channels)
- Four 6.5" speakers located in the overhead
- Waterproof system for reliable power and sound quality

» 2882891 • \$844 <sup>99</sup>  
 XP 1000 '18-22, CREW XP 1000 '19-22, CREW 1000 '20-22, 1000 '20-22, XP KINETIC '23



B OVERHEAD SPEAKERS

#### REAR OVERHEAD SPEAKERS TOP SELLER

- Two 6.5" rear roof mounted speakers with titanium dome tweeters and polypropylene cones
- Easy install
- Waterproof system for reliable power and sound quality

» 2882876 • \$284 <sup>99</sup>  
 XP 1000 '18-22, CREW XP 1000 '19-22, CREW 1000 '20-22, 1000 '20-22, XP KINETIC '23



C SUBWOOFER

#### MAX BOOST 10" 250 WATT SUBWOOFER XP 1000 ONLY

- Built-in 250-watt amplifier powering 10" waterproof subwoofer
- Fits RANGER XP 1000 with flip-up passenger seat

» 2882890 • \$844 <sup>99</sup>  
 XP 1000 '18-22, CREW XP 1000 '19-22, XP KINETIC '23  
 NOT COMPATIBLE WITH 7" DISPLAY POWERED BY RIDE COMMAND, WILL NOT FIT WITH 2882910 STORAGE INSTALLED

### 3 MAKE IT WORK

#### VISOR STEREO HEAD UNIT

#### VISOR SPEAKERS

#### POLARIS PULSE ROOF 6

- Required with Visor Stereo (2882888)
- Required to add Visor Speakers (2882891)

» TOP SELLER 2882904 • \$139 <sup>99</sup>  
 XP 1000 '18-22, CREW XP 1000 '19-22, CREW 1000 '20-22, 1000 '20-22, XP KINETIC '23

#### CREW MODELS

#### CREW EXTENSION

- Required for all Crew models where Polaris PULSE Roof 6 Harness (2882904) is required

» 2883231 • \$34 <sup>99</sup>  
 CREW XP 1000 '19-22, CREW 1000 '20-22

#### NEW GEOFENCING KIT 1000 ONLY

- Keep vehicle operators safe by quickly setting and controlling ride boundaries such as speed limits within and outside the geofenced area
- Ensure operators are riding at the appropriate speed for their experience and terrain by setting a max speed from your RIDE COMMAND app
- Activate passcode protection and to have full control of who and when the vehicle is being operated

» 2884779 • \$409 <sup>99</sup>  
 CREW 1000 '20-22, 1000 '20-22



# STORAGE



## BRING IT ALL. BRING IT ON.

From opposite sides of the globe, the most capable machines in the off-road world meet a trusted outdoor adventure brand to deliver industry-exclusive, purpose-built roof racks, bed racks and accessories to help Polaris RANGER users have more fun and get more done. Increase storage capacity so you can go where you want with everything you need, organized to succeed.



### MAXIMIZE YOUR RIDE

For decades, Rhino-Rack® has built some of the world's highest quality racks, accessories and mounts for the widest variety of uses and conditions. So whether you use your machine for hard work, hunting, fishing, and more, you can bring it all — and bring it on!



### BUILD THE ULTIMATE UTILITY VEHICLE

Transform your vehicle for work, play or anything in between with durable and easy-to-use roof and bed racks, load securing accessories and the latest in carrier technology.



### BUILT FOR THE LONG HAUL

Rhino-Rack® designs and builds award-winning racks, accessories and mounts to endure the most extreme uses and conditions.

## PICK YOUR RACK



### NEW REAR BED RACK / 3-SEAT ROOF RACK

- Can be used as Bed Rack or Roof Rack on 3-Seat models, depending on which mount is purchased. Bed Rack only on Crew models.

- Bed Rack and Roof Rack can be used together if both mounts are purchased

» 2889236 • \$679<sup>99</sup>  
XP 1000 '18-22, 1000 '20-22, XP KINETIC '23



### NEW ROOF RACK - CREW

» 2889237 • \$679<sup>99</sup>  
CREW XP 1000 '19-22, CREW 1000 '20-22

## PICK YOUR MOUNT



### NEW REAR BED RACK MOUNT

» 2889235 • \$539<sup>99</sup>  
XP 1000 '18-22, 1000 '20-22, CREW XP 1000 '19-22, CREW 1000 '20-22, XP KINETIC '23

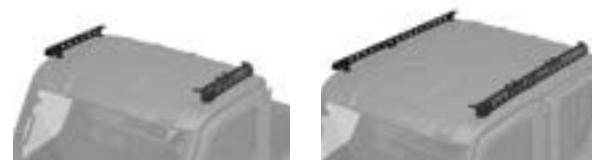

### NEW ROOF RACK MOUNT

» 3-SEAT • 2889233 • \$539<sup>99</sup>  
XP 1000 '18-22, 1000 '20-22, XP KINETIC '23

» CREW • 2889234 • \$539<sup>99</sup>  
CREW XP 1000 '19-22, CREW 1000 '20-22

## ACCESSORIZE IT



### NEW GUN MOUNTING BRACKET

- Bracket used to mount Kolpin Stronghold Gun Boots to Rhino-Rack® systems when paired with Auto-Latch Mount (2884106), sold separately

» 2889327 • \$74<sup>99</sup>  
XP 1000 '18-22, CREW XP 1000 '19-22, CREW 1000 '20-22, 1000 '20-22, XP KINETIC '23



### NEW EYELET TIE-DOWNS

- Includes one set and hardware (straps not included) and attaches in multiple places on the platform to use as additional tie-down points
- Anti-corrosive galvanized steel for heavy-duty strength and long life

» 2889527 • \$73<sup>00</sup>  
XP 1000 '18-22, CREW XP 1000 '19-22, CREW 1000 '20-22, 1000 '20-22, XP KINETIC '23



### NEW MULTI-PURPOSE TOOL HOLDER

- Carry and protect tools, paddles, and more during your ride
- Ratchet-locking mechanism for quick release with rubber inserts to secure accessories into place

» 2889528 • \$145<sup>99</sup>  
XP 1000 '18-22, CREW XP 1000 '19-22, CREW 1000 '20-22, 1000 '20-22, XP KINETIC '23



### NEW SPARE TIRE HOLDER

- Transport your spare tire outside your vehicle
- Easily mounts to your Rhino-Rack® Rear Bed Rack

» 2889529 • \$63<sup>00</sup>  
XP 1000 '18-22, CREW XP 1000 '19-22, CREW 1000 '20-22, 1000 '20-22, XP KINETIC '23



### NEW TRACTION BOARD MOUNT

- Strong, durable mount is easy to attach to the Rhino-Rack® platform
- Traction board not included

» 2889530 • \$235<sup>00</sup>  
XP 1000 '18-22, CREW XP 1000 '19-22, CREW 1000 '20-22, 1000 '20-22, XP KINETIC '23



### NEW CARGO CORNER BRACKET

- Bring your Polaris Northstar cooler along while saving space inside your vehicle
- Unique anti-rotation nut for maximum cargo security

» 2889531 • \$170<sup>00</sup>  
XP 1000 '18-22, CREW XP 1000 '19-22, CREW 1000 '20-22, 1000 '20-22, XP KINETIC '23



### NEW HIGH-LIFTING JACK MOUNT

- Installs simply and quickly with durable brackets
- Rugged, non-corrosive powder-coated steel stands up to the harshest conditions

» 2889533 • \$147<sup>00</sup>  
XP 1000 '18-22, CREW XP 1000 '19-22, CREW 1000 '20-22, 1000 '20-22, XP KINETIC '23



# STORAGE

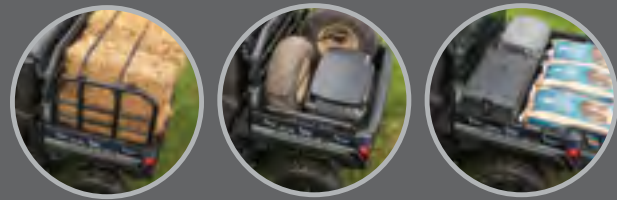

## LOCK & RIDE

Exclusive to Polaris, Lock & Ride accessories let you quickly change from one task to another with hundreds of options.

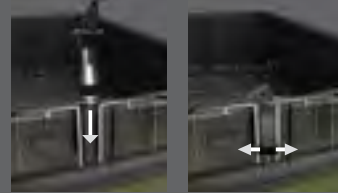

WITH THE FLIP OF A LEVER, LOCK & RIDE PLUNGERS USE OUTWARD PRESSURE TO EXPAND FOR A SECURE FIT.



### CARGO BED REAR WINCH



- Assists lifting heavy objects like hay bales or big game up into rear cargo bed
- 300 lb. winch mounts high on rear cab frame
- Equipped with 15 ft. of premium synthetic rope

» 2884215 • \$789<sup>99</sup>

XP 1000 '18-22, CREW XP 1000 '19-22, CREW 1000 '20-22, 1000 '20-22, XP KINETIC '23  
REQUIRES ROOF PULSE: 2882904



### LOCK & RIDE FRONT BRUSHGUARD STORAGE RACK

- Allows extra storage space in front of your vehicle
- Accommodates a Polaris Northstar 30 Quart Cooler or similar sized items
- Attaches and removes easily
- Mounts to existing plow mounting points

» 2883971 • \$409<sup>99</sup>

XP 1000 '18-22, CREW XP 1000 '19-22, CREW 1000 '20-22, 1000 '20-22, XP KINETIC '23

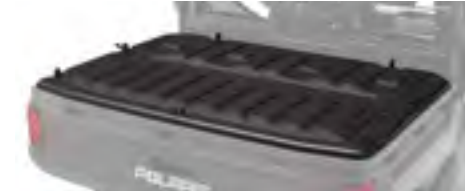

### LOCK & RIDE TONNEAU COVER

- Protects items stored in cargo bed from the elements
- HDPE construction on steel sub-frame can support up to 100 lbs. on top of cover
- Molded storage area for Polaris Northstar 30 Quart Cooler
- Convenient hinged middle panel for easy access
- Easy installation with Lock & Ride

» 2884218 • \$789<sup>99</sup>

XP 1000 '18-22, CREW XP 1000 '19-22, CREW 1000 '20-22, 1000 '20-22, XP KINETIC '23



### LOCK & RIDE TIP-DOWN HEADACHE RACK

- Rack tips down for additional storage solutions with space below and multiple tie-down points
- Lightweight and heavy-duty rack protects the cab of your RANGER and lets you haul even more

» 2881531 • \$499<sup>99</sup>

XP 1000 '17-22, CREW XP 1000 '18-22, CREW 1000 '20-22, 1000 '20-22, XP KINETIC '23



### LOCK & RIDE CARGOMAX SYSTEM

- Comes standard with a support bar that ties the two sides together for a sturdy cargo hold
- Designed to attach to the Lock & Ride Tip-Down Headache Rack for additional support and three-sided containment
- Adjustable utility hooks provide more options for hanging tools, cords or gear

» 2882177 • \$744<sup>99</sup>

XP 1000 '17-22, CREW XP 1000 '18-22, CREW 1000 '20-22, 1000 '20-22, XP KINETIC '23



### FRONT HOOD STORAGE RACK

- Front curve helps keep cargo in place when traveling
- Provides additional protection
- Fully integrated pivots to gain under-hood access
- Requires Bumper Adapter 2207941 when used with 7" Display powered by RIDE COMMAND

» 2882690 • \$499<sup>99</sup>

XP 1000 '18-22, CREW XP 1000 '19-22, CREW 1000 '20-22, 1000 '20-22, XP KINETIC '23  
DOES NOT FIT WITH BUMPER 2882531, REQUIRES 2207941 TO WORK WITH FRONT CAMERA



### LOCK & RIDE BED EXTENDER/DIVIDER

- Extend or divide the cargo box
- Installs in any location in the box
- Multiple tie-down points available to secure cargo

» 2882752 • \$344<sup>99</sup>

XP 1000 '18-22, CREW XP 1000 '19-22, CREW 1000 '20-22, 1000 '20-22, XP KINETIC '23



### CANVAS STORAGE - CREW

- Attaches easily to the rear of the front seat in your crew vehicle
- Provides storage pockets for a variety of items, ensuring they're always within reach

» 2889268 • \$409<sup>99</sup>

CREW XP 1000 '18-22, CREW '20-22

## 75+ COMBINATIONS TO MAKE IT YOUR OWN

With a full line of Lock & Ride accessories, you can haul more and do more. Use the chart below to see what combinations work together.

POLARIS RANGER STORAGE MATRIX XP 1000 / 1000 / XP KINETIC 570 FULL-SIZE	LOCK & RIDE Tip-Down Headache Rack	LOCK & RIDE CargoMax System	LOCK & RIDE Bed Extender/Divider	LOCK & RIDE Storage Box	LOCK & RIDE Tool Rack	LOCK & RIDE Chainsaw Mount	LOCK & RIDE 60 Gallon Boomless Utility Sprayer	Cargo Bed Rear Winch	LOCK & RIDE Front Brushguard Storage Rack	LOCK & RIDE Tonneau Cover	Cargo Bed Mat	NEW RHINO-RACK Roof Rack - 3-Seat	NEW RHINO-RACK Bed Rack - 3-Seat & Crew	NEW RHINO-RACK Roof Rack - Crew
	2881531	2882177	2882752	2883279	2881533	2879354	2879799	2884215	2883971	2884218	2882751	2889236	2889236	2889237
LOCK & RIDE Tip-Down Headache Rack <b>TOP SELLER</b>	✓	✓	✓	✓	✓	✓	✓	✓	✓	✓	✓	✓	✓	✓
LOCK & RIDE CargoMax System	✓	✓	✓	✓ <sup>2</sup>	✓	✓	✓	✓	✓	✓	✓	✓	✓	✓
LOCK & RIDE Bed Extender/Divider	✓	✓	✓	✓	✓	✓	✓	✓	✓	✓	✓	✓	✓	✓
LOCK & RIDE Storage Box	✓	✓ <sup>1</sup>	✓	✓	✓	✓	✓	✓	✓	✓	✓	✓	✓	✓
LOCK & RIDE Tool Rack	✓	✓	✓	✓	✓	✓	✓	✓	✓	✓	✓	✓	✓	✓
LOCK & RIDE Chainsaw Mount	✓	✓	✓	✓	✓	✓	✓	✓	✓	✓	✓	✓	✓	✓
LOCK & RIDE 60 Gallon Boomless Utility Sprayer	✓	✓	✓	✓	✓	✓	✓	✓	✓	✓	✓	✓	✓	✓
Cargo Bed Rear Winch	✓	✓	✓	✓	✓	✓	✓	✓	✓	✓	✓	✓	✓	✓
LOCK & RIDE Front Brushguard Storage Rack	✓	✓	✓	✓	✓	✓	✓	✓	✓	✓	✓	✓	✓	✓
LOCK & RIDE Tonneau Cover	✓	✓	✓	✓	✓	✓	✓	✓	✓	✓	✓	✓	✓	✓
Cargo Bed Mat	✓	✓	✓	✓	✓	✓	✓	✓	✓	✓	✓	✓	✓	✓
NEW RHINO-RACK Roof Rack - 3-Seat	✓	✓	✓	✓	✓	✓	✓	✓	✓	✓	✓	✓	✓	✓
NEW RHINO-RACK Bed Rack - 3-Seat & Crew	✓	✓	✓	✓	✓	✓	✓	✓	✓	✓	✓	✓	✓	✓
NEW RHINO-RACK Roof Rack - Crew	✓	✓	✓	✓	✓	✓	✓	✓	✓	✓	✓	✓	✓	✓

<sup>1</sup> Storage box at front of cargo box if not used with Tip-down Headache Rack

<sup>2</sup> Storage box at front of cargo box

### LOCK & RIDE QUICKSTRAP

- The quickest and most secure way to mount Polaris accessories
- Sold as a pair

» 2882187 • \$59<sup>99</sup>

ALL COOLERS, RANGER CARGO BOXES



### LOCK & RIDE D-RINGS

- The most versatile Lock & Ride accessory - add as many as you need to secure your cargo with bungee cords or straps

» 2881545 • \$44<sup>99</sup>

ALL RANGER CARGO BOXES



### 1.5" x 15' 5,500 LB RATCHET STRAP

- Heavy-duty webbing
- 5,500 lb. Maximum Load / 1,833 lb. Working Load
- 2 Pack

» 2884031 • \$59<sup>99</sup>

### 2" x 20' 10,000 LB RATCHET STRAP

- Heavy-duty webbing
- 10,000 lb. Maximum Load / 3,300 lb. Working Load
- Floating D-Rings and Double J-Hooks

» 2884032 • \$44<sup>99</sup>



# STORAGE

## LOCK & RIDE CHAINSAW MOUNT

- Can be secured to the outside of the bed wall so your chainsaw is within reach at all times

» 2879354 • \$184<sup>99</sup>

XP 1000 '17-22, CREW XP 1000 '18-22, CREW 1000 '20-22, 1000 '20-22, XP KINETIC '23



## LOCK & RIDE 60 GALLON BOOMLESS UTILITY SPRAYER

» 2879799 • \$1,264<sup>99</sup>

XP 1000 '17-22, CREW XP 1000 '18-22, CREW 1000 '20-22, 1000 '20-22, XP KINETIC '23



## BED ESSENTIALS

### FIRE EXTINGUISHER HOLDER

- Only holds a 3.25" diameter extinguisher
- Quick release strap allows for easy use

» 2882158 • \$119<sup>99</sup>

XP 1000 '17-22, CREW XP 1000 '18-22, CREW 1000 '20-22, 1000 '20-22, XP KINETIC '23



### ELECTRONIC CARGO BOX LIFT

» 2884141 • \$844<sup>99</sup>

XP 1000 '18-22, CREW XP 1000 '19-22, CREW 1000 '20-22, 1000 '20-22, XP KINETIC '23



### RISE & REPAIR ESSENTIALS KIT

» 2881207 • \$144<sup>99</sup>

XP 1000 '17-22, CREW XP 1000 '18-22, CREW 1000 '20-22, 1000 '20-22, XP KINETIC '23



### CARGO BED MAT

- Non-slip surface to better secure loads and keep cargo bed clean

» 2882751 • \$184<sup>99</sup>

XP 1000 '18-22, CREW XP 1000 '19-22, CREW 1000 '20-22, 1000 '20-22, XP KINETIC '23



## TOW & HAUL



### TRAILER BALLS

» 2" WITH 3/4" SHANK  
2877603 • \$19<sup>99</sup>

» 1 7/8" WITH 3/4" SHANK  
2877602 • \$19<sup>99</sup>



### 2" BALL MOUNT

» 2" RECEIVER  
2875320 • \$59<sup>99</sup>



### 3:1 HITCHES

» 2" x 2" RECEIVER  
2830522 • \$48<sup>79</sup>

ALL RANGER MODELS  
» 1 3/4" x 1 3/4" RECEIVER  
2830523 • \$48<sup>79</sup>  
ALL RANGER MODELS



» 1 7/8" REPLACEMENT BALL  
2830524 • \$12<sup>19</sup>

ALL RANGER MODELS



## TASK-SPECIFIC TOOLS

### LOCK & RIDE TOOL RACK

- Attach on the inside or outside of the cargo bed

» 2881533 • \$344<sup>99</sup>

XP 1000 '17-22, CREW XP 1000 '18-22, CREW 1000 '20-22, 1000 '20-22, XP KINETIC '23



## ORGANIZE & PROTECT

### LOCK & RIDE STORAGE BOX

- Enough room to store all the tools you need to get the job done
- Internal organizational dividers keep gear from rolling around
- Easily detaches from vehicle

» 2883279 • \$459<sup>99</sup>

XP 1000 '17-22, CREW XP 1000 '18-22, CREW 1000 '20-22, 1000 '20-22, XP KINETIC '23



## DO MORE:



**COOLERS**  
P. 48



**HUNT**  
P. 50



**COLD WEATHER**  
P. 52



**LIGHTING**  
P. 58



# CONNECTED TECHNOLOGY

## POLARIS RIDE COMMAND



### PLAN. TRACK. SHARE. CONNECT.

#### PLAN YOUR RIDE

Plan an epic ride with stops along the way, customize and adjust your path to maximize your route or follow turn-by-turn directions. You can even share your planned route with friends.

#### INDUSTRY'S ONLY PLOW MODE

Allows for quicker snow removal with an adjusting plow position. When gear is in low, the plow automatically drops. When put in reverse, the plow automatically lifts.

#### WAYPOINTS

Follow user-defined locations to keep track of important locations like hunting stands or blinds, food plots, needed maintenance around the farm or ranch, and so much more.

#### BACK UP TO A TRAILER

The back-up camera now makes it easier and faster than ever to hook up a trailer, and automatically turns on when put in reverse.

## TRAIL TECH



## VOYAGER PRO

#### ADD ANY VEHICLE TO YOUR POLARIS GROUP RIDES

The Trail Tech Voyager Pro GPS seamlessly connects with 2020-2022 Polaris RIDE COMMAND 7" Displays. Join the group and ride.

#### THE CONNECTED RIDER'S GPS

Featuring Polaris Group Ride compatibility, custom maps, Bluetooth®, a 4" color touchscreen and full vehicle integration with gauges. Model-specific kits available for all UTV, ATV, snow and motorcycle brands.

#### AVAILABLE ON RIDE COMMAND MODELS & AS AN ACCESSORY

##### 7" DISPLAY POWERED BY RIDE COMMAND

- **Bright, 7" touchscreen** visible in all conditions
- **GPS Navigation & Pre-Loaded Maps**  
Available offline on the in-dash display so you always know where you are.
- **Route Planning**  
Add points of interest and waypoints to make the most of your off-road adventure.
- **Group Ride**  
"Follow the Leader" lets you set and follow the group leader on your display. Group Ride Messaging, lets you send messages to your group with or without a cellular signal.
- **Camera Integration**  
Navigate with full view of your surroundings. Use the integrated rear camera to see others behind you while riding.
- **Personalized Audio Experience**  
Seamlessly pair your display via Bluetooth® to wirelessly stream music and stay connected with call and text alerts.
- **Configurable Gauges**  
Customize your ride experience with elevation, travel direction and more to create relevant screens for you.
- **Plow Mode**  
Included on XP 1000 '18-20 and CREW XP 1000 '19-20 models (see P. 52 for details).

» 2884072 • \$2,099<sup>99</sup>  
XP 1000 '19-22, CREW XP 1000 '19-22, CREW 1000 '20-22, 1000 '20-22, XP KINETIC '23  
SPEAKERS NOT INCLUDED. MUST CHOOSE AUDIO PACKAGE FOR AUDIO OUTPUT.



##### NEW RIDE COMMAND INSTALL MOUNT

- Necessary mount for your 7" Display Powered by RIDE COMMAND
- Seamless fit and finish
- Includes necessary wiring harness and reverse camera kits

» 2889309 • \$679<sup>99</sup>  
XP 1000 '22, CREW XP 1000 '22, CREW 1000 '22, 1000 '22, XP KINETIC '23  
FOR NORTHSTAR AND ALL OTHER MODELS WITHOUT 900 WATT

» 2889310 • \$679<sup>99</sup>  
XP 1000 '22, CREW XP 1000 '22, CREW 1000 '22, 1000 '22, XP KINETIC '23  
FOR 900 WATT STATOR

» 2889163 • \$649<sup>99</sup>  
SP 570 '22

##### NEW RIDE COMMAND FRONT CAMERA

» 2889662 • \$169<sup>99</sup>  
XP KINETIC '23, SEE FULL DETAILS ON P. 17



##### VOYAGER PRO KIT, UTV

- Bright, 4" touchscreen visible in all conditions
- **Pre-Loaded Base Maps**  
The map screen is enabled with base maps, topography lines, hill shading and select trails. Record or load GPS trails/riding areas and transfer to a PC.
- **Buddy Tracking**  
Track up to 20 group members no matter what type of vehicle they are riding.
- **Bluetooth® Enabled**  
Bluetooth® enabled for intercom, phone and media controls. Play songs from your phone or MicroSD card using a Bluetooth® headset, speaker or intercom. Two phones and two headsets can be connected at the same time.

» 922-125 • \$779<sup>99</sup>  
AVAILABLE AT YOUR LOCAL DEALER OR ONLINE AT TRAILTECH.NET



LEARN MORE AND DOWNLOAD AT  
[RIDECOMMAND.POLARIS.COM](https://ridecommand.polaris.com)



LEARN MORE AT  
[TRAILTECH.NET](https://trailtech.net)







# ELECTRICAL ACCESSORIES

Polaris PULSE is a revolutionary way to provide additional power locations on your vehicle, and makes adding electrical accessories a snap. Electrical accessories are easier to install on the roof, with designated routing areas and plug and play connections.

Look for to identify Polaris Pulse ready accessories.



## ADD ELECTRICAL SYSTEM ACCESSORIES IN 4 EASY STEPS

STEP 1				
CHOOSE A POLARIS PULSE READY ROOF	XP 1000 / XP KINETIC / 1000	CREW XP 1000/1000	SP 570	CREW SP 570
Premium Roof - Poly - Polaris Pursuit Camo	2882913 \$989 <sup>99</sup>	2883277 \$1,684 <sup>99</sup>	N/A	N/A
Premium Roof - Poly - Black	2882912 \$764 <sup>99</sup>	N/A	N/A	N/A
Sport Roof - Poly - Black	2882911 \$484 <sup>99</sup>	2883274 \$709 <sup>99</sup>	2885077 \$409 <sup>99</sup>	2885078 \$679 <sup>99</sup>

### THE FOLLOWING ACCESSORIES EASILY PLUG INTO THE FACTORY INSTALLED POLARIS PULSE UNDER THE HOOD:

	XP 1000/1000	SP 570
8-Vent Heater & Defrost System	P. 28	P. 76
Horn	P. 29	P. 76
Plow Controller	P. 30	P. 77
160 Watt, Waterproof AM/FM Bluetooth* Audio System	P. 34	P. 76
Light Bars	P. 58	P. 58



### POLARIS PULSE UNDERHOOD BUS BAR - 6 POSITION 1000 ONLY

• If upgrading to more than three accessories attaching to the underhood PULSE location, replace 3-Position Bus Bar with the Polaris PULSE Underhood Bus Bar - 6 Position

» 2884183 • \$59<sup>99</sup>  
CREW 1000 '20-'22, 1000 '20-'22

### POLARIS FRONT PULSE BAR AND HARNESS

• This kit is required to install any electrical accessories on a base RANGER SP 570

» 2889185 • \$109<sup>99</sup>  
SP 570 '22

### POLARIS PULSE BATTERY TENDER ADAPTER

• Connects your BatteryMINDER® or trickle charger to your vehicle

» 2884297 • \$34<sup>99</sup>  
XP 1000 '18-'21, CREW XP 1000 '19-'22, CREW 1000 '20-'22, 1000 '20-'22, SP 570 '22, CREW SP 570 '22, XP KINETIC '23

STEP 2				
ADD THE POLARIS PULSE ROOF 6	XP 1000 / XP KINETIC / 1000	CREW XP 1000/1000	SP 570	CREW SP 570
Polaris PULSE Roof 6	2882904 \$139 <sup>99</sup>			
Polaris PULSE Wiring Harness - Crew Extension	N/A		2889185 \$109 <sup>99</sup>	

### POLARIS PULSE READY ROOF WIRING EXAMPLE

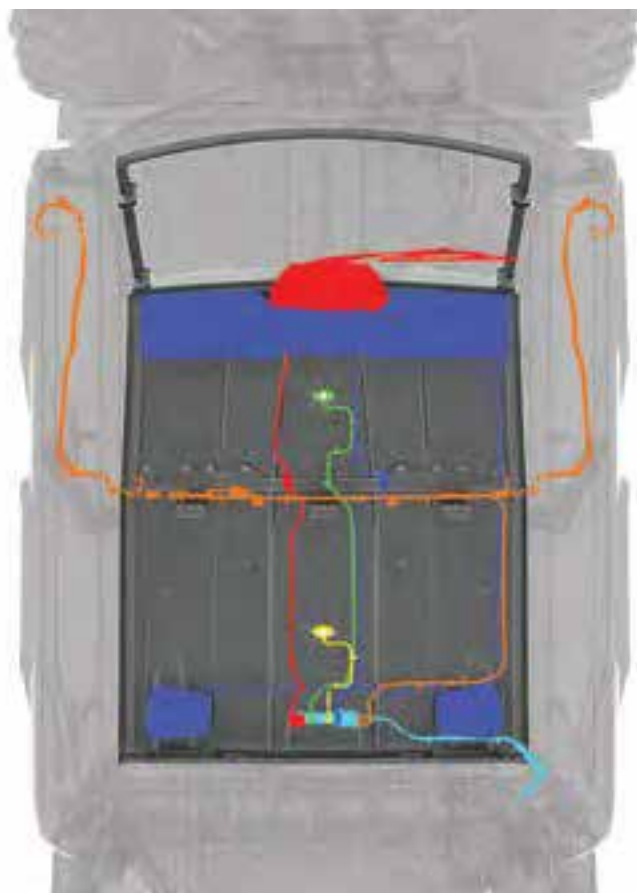

CREW XP 1000 POLARIS PULSE WIRING SHOWN

STEP 3 ADD ACCESSORIES*				
POWER WINDOW DOORS	XP 1000 / XP KINETIC / 1000	CREW XP 1000/1000	SP 570	CREW SP 570
Power Window Doors - Poly - Black	2884338 \$4,604 <sup>99</sup>		N/A	N/A
Polaris PULSE Wiring Harness - Crew Extension	N/A	2883231 \$34 <sup>99</sup>	N/A	N/A
WINDSHIELD WIPER & WASHER SYSTEM	XP 1000 / XP KINETIC / 1000	CREW XP 1000/1000	SP 570	CREW SP 570
Windshield Wiper & Washer System	2883974 \$774 <sup>99</sup>		2885083 \$679 <sup>99</sup>	
Polaris PULSE Wiring Harness - Crew Extension	N/A	2883231 \$34 <sup>99</sup>	2889185 \$109 <sup>99</sup>	
AUDIO: VISOR AUDIO + REAR SPEAKERS	XP 1000 / XP KINETIC / 1000	CREW XP 1000/1000	SP 570	CREW SP 570
300 Watt AM/FM, Bluetooth* Audio Visor with Four 6.5" Waterproof Speakers	2882888 \$1,124 <sup>99</sup>		N/A	
Rear Overhead Speakers	2882876 \$284 <sup>99</sup>		N/A	
Polaris PULSE Wiring Harness - Crew Extension	N/A	2883231 \$34 <sup>99</sup>	N/A	
AUDIO: DASH RADIO & VISOR SPEAKERS	XP 1000 / XP KINETIC / 1000	CREW XP 1000/1000	SP 570	CREW SP 570
160 Watt, Waterproof AM/FM Bluetooth* Audio System	2882750 \$844 <sup>99</sup>		N/A	
300 Watt Overhead Audio Visor Speakers	2882891 \$844 <sup>99</sup>		N/A	
JBL® Dash Audio Kit	N/A		2885081 \$899 <sup>99</sup>	
Polaris PULSE Wiring Harness - Crew Extension	N/A	2883231 \$34 <sup>99</sup>	2889185 \$109 <sup>99</sup>	
MULTI-FUNCTION DOME LIGHT	XP 1000 / XP KINETIC / 1000	CREW XP 1000/1000	SP 570	CREW SP 570
Multi-Function Cab Light (Front) †	2882871 \$144 <sup>99</sup>		2889159 \$144 <sup>99</sup>	
Polaris PULSE Wiring Harness - Crew Extension	N/A	2883231 \$34 <sup>99</sup>	2889185 \$109 <sup>99</sup>	

\*Add accessories to models without 7" Display Powered by RIDE COMMAND  
†To add a Multi-Function Dome Light for rear passengers, add an additional 2882871

STEP 4 FINISHING TOUCH				
CONCEAL WIRING FOR A FINISHED, COMFORTABLE LOOK	XP 1000 / XP KINETIC / 1000	CREW XP 1000/1000	SP 570	CREW SP 570
Premium Roof Liner	2882914 \$284 <sup>99</sup>	2883457 \$354 <sup>99</sup>	2885093 \$254 <sup>99</sup>	2885094 \$679 <sup>99</sup>



### EASILY ADD LIGHTING

With Polaris PULSE it's easy to add RIGID® and Pro Armor lighting to your RANGER. All LED Light bars listed on P. 58-59 are Polaris PULSE ready, making installation that much easier.

### POLARIS PULSE LIGHT BAR WIRING LOCATIONS

FRONT BUMPER // ROOF - FRONT MOUNTED // ROOF - REAR MOUNTED // \*CREW ROOF - REAR MOUNTED

\*Requires Extension

RANGER XP 1000 / XP KINETIC / 1000	RANGER SP 570
1 LIGHT WITH 1 SWITCH	
TOP SELLER Polaris PULSE Wiring Harness - 1 LED Light Bar - 2883230 • \$124 <sup>99</sup>	Polaris PULSE Wiring Harness - 1 LED Light Bar - 2889161 • \$124 <sup>99</sup>
2 LIGHTS WITH 1 SWITCH	
TOP SELLER Polaris PULSE Wiring Harness - 1 LED Light Bar - 2883230 • \$124 <sup>99</sup> Y-Harness - 2879860 • \$24 <sup>99</sup>	N/A
2 LIGHTS WITH 2 SWITCHES	
TOP SELLER Polaris PULSE Wiring Harness - 1 LED Light Bar - 2883230 • \$124 <sup>99</sup>	Polaris PULSE Wiring Harness - 1 LED Light Bar - 2889161 • \$124 <sup>99</sup>
TOP SELLER Polaris PULSE Wiring Harness - 1 LED Light Bar - 2883230 • \$124 <sup>99</sup>	Polaris PULSE Wiring Harness - 1 LED Light Bar - 2889161 • \$124 <sup>99</sup>
EXTENSIONS FOR CREW	
Polaris PULSE Wiring Harness - 1 LED Light Bar - Crew Extension 2883231 • \$34 <sup>99</sup>	N/A



KEEP IT  
**ICE COLD**

**GRIZZLY TESTED.**  
**POLARIS APPROVED.**



This cooler is IGBC-approved, meaning it withstands the power expended by a typical grizzly bear if it was trying to get inside.

Seriously, there are experts who know what a grizzly is capable of doing, and they certify our coolers can take it.



**30, 60 & 105**  
QUART FEATURES



ComfortCarry Handles



TravelLock System



EasyOut Drain System



NoSlip Rubber Feet



PolarWall Insulation



IceLock Seal

**POLARIS NORTHSTAR COOLERS CAN SURVIVE JUST ABOUT ANYTHING - FROM EXTREME HEAT TO A NASTY TUMBLE OFF A VEHICLE.**



105 QUART

- » GRAPHITE • 2883426 • **\$509<sup>99</sup>**
- » DESERT • 2883392 • **\$509<sup>99</sup>**



60 QUART

- » GRAPHITE • 2883425 • **\$409<sup>99</sup>**
- » DESERT • 2881259 • **\$409<sup>99</sup>**



30 QUART

- » GRAPHITE • 2883424 • **\$309<sup>99</sup>**
- » DESERT • 2881315 • **\$309<sup>99</sup>**



15 QUART

- » GRAPHITE • 2883968 • **\$249<sup>99</sup>**



**NEW**  
20 QUART SOFT-SIDED COOLER

- » 2889285 • **\$229<sup>99</sup>**

HOLDS ICE  
**30+**  
HOURS  
LONGER  
THAN YETI<sup>®\*</sup>

\*YETI<sup>®</sup> is a registered trademark of YETI COOLERS, LLC

**ESSENTIAL ACCESSORIES SO YOUR COOLER WORKS AS HARD AS YOU DO**

COOLER ACCESSORIES	105 QUART	60 QUART	30 QUART	DON'T FORGET THESE ACCESSORIES		
<p><b>WIRE BASKET</b></p>	2883648 • <b>\$59<sup>99</sup></b>	2882185 • <b>\$43<sup>99</sup></b>	2882438 • <b>\$36<sup>99</sup></b>	<p><b>TUMBLERS</b></p> <ul style="list-style-type: none"> <li>» 30 OZ (shown) • 2883394 • <b>\$39<sup>99</sup></b></li> <li>» 20 OZ • 2883393 • <b>\$34<sup>99</sup></b></li> </ul>	<p><b>LOCK &amp; RIDE QUICKSTRAP</b></p> <ul style="list-style-type: none"> <li>» 2882187 • <b>\$59<sup>99</sup></b></li> <li>ALL COOLERS AND POLARIS RANGER CARGO BOXES</li> </ul>	<p><b>BOTTLE OPENER</b></p> <ul style="list-style-type: none"> <li>» 2882183 • <b>\$19<sup>99</sup></b></li> <li>ALL COOLERS</li> </ul>
<p><b>DIVIDERS</b> Doubles as cutting board</p>	2883468 • <b>\$44<sup>99</sup></b> COMES WITH ONE DIVIDER  1 way to partition	2882184 • <b>\$59<sup>99</sup></b> COMES WITH TWO DIVIDERS  2 ways to partition	2882186 • <b>\$34<sup>99</sup></b> COMES WITH ONE DIVIDER  1 way to partition			
<p><b>SEAT CUSHION</b></p>	NOT AVAILABLE	2882179 • <b>\$119<sup>99</sup></b>	2882507 • <b>\$94<sup>99</sup></b>			
<p><b>WHEELS</b></p>	2883967 • <b>\$124<sup>99</sup></b>	2882180 • <b>\$129<sup>99</sup></b>	NOT AVAILABLE			



## PROTECTING YOUR ESSENTIAL GEAR SINCE 1943

### KOLPIN STRONGHOLD SYSTEM

Polaris is proud to partner with Kolpin Outdoors, an industry leader in off-road accessories and the premier name in gun boots and mounts. If you need to secure a firearm while riding, simply attach the auto-latch mount and choose your Gun Boot.

### IDEAL FOR SECURE TRANSPORT OF SCOPED RIFLES AND SHOTGUNS

#### STEP 1 CHOOSE YOUR MOUNT



**LOCK & RIDE** KOLPIN STRONGHOLD  
AUTO-LATCH DOUBLE BOOT MOUNT

- Precision angle adjustable for a custom fit
- Provides a quick and secure attachment point

» **DOUBLE BOOT MOUNT** • 2883970 • **\$244<sup>99</sup>**  
» **SINGLE BOOT MOUNT** • 2884106 • **\$84<sup>99</sup>**

#### **LOCK & RIDE** GUN RACK 6

- Adjustable to store guns at an angle or vertical (shown at angle)
- Holds six rifles or shotguns securely with soft rubber v-grips
- Stock is secured in place with a soft molded rubber inlay along the bottom of the rack
- Rack can be adjusted into three positions based on firearm height

» **2882159** • **\$574<sup>99</sup>**

XP 1000 '17-22, CREW XP 1000 '18-22, CREW 570  
FULL SIZE '18-22, CREW 1000 '20-22, 570 FULL SIZE  
'17-22, 1000 '20-22



#### RHINO-RACK<sup>®</sup>



**NEW** RHINO-RACK<sup>®</sup> -  
GUN BOOT MOUNT

- Bracket used to mount Kolpin Stronghold Gun Boots to Rhino-Rack<sup>®</sup> systems when paired with Auto-Latch Mount (2884106), sold separately

» **2889327** • **\$74<sup>99</sup>**

XP 1000 '18-22, CREW XP 1000 '19-22,  
CREW 1000 '20-22, 1000 '20-22  
REQUIRES AUTO-LATCH MOUNT 2884106 TO  
MOUNT TO VEHICLE  
SEE P. 38 FOR MORE RHINO-RACK<sup>®</sup> PRODUCTS

#### STEP 2 CHOOSE YOUR BOOTS



KOLPIN STRONGHOLD  
GUN BOOT XL

- Lockable and TSA approved
- Includes padded, zippered internal protective liner
- 52" L x 3 3/4" W x 10 1/2" H

» **2882036** • **\$109<sup>99</sup>**

REQUIRES AUTO-LATCH MOUNT  
2883970 OR 2884106 TO MOUNT  
TO VEHICLE

KOLPIN STRONGHOLD  
GUN BOOT L

- 52" L x 4 3/4" W x 9 1/4" H

» **2882426** • **\$84<sup>99</sup>**

REQUIRES AUTO-LATCH MOUNT  
2883970 OR 2884106 TO MOUNT  
TO VEHICLE



CARGO BED  
REAR WINCH

- Assists lifting heavy objects like hay bales or big game up into rear cargo bed
- 300 lb. winch mounts high on rear cab frame
- Equipped with 15 ft. of premium synthetic rope

» **2884215** • **\$789<sup>99</sup>**

XP 1000 '18-22, CREW XP 1000 '19-22,  
CREW 1000 '20-22, 1000 '20-22



### KOLPIN RHINO GRIPS IDEAL FOR CARRYING RIFLES, SHOTGUNS, BOWS AND CROSSBOWS

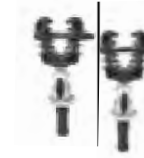

**LOCK & RIDE**  
RHINO GRIP PRO

» **2884107** • **\$109<sup>99</sup>**  
ALL RANGER MODELS (EXCEPT 150 EFI)



**LOCK & RIDE**  
RATCHETING RHINO GRIP

» **2881575** • **\$94<sup>99</sup>**  
ALL RANGER MODELS (EXCEPT 150 EFI)



**LOCK & RIDE**  
RHINO GRIP XLR

» **2881574** • **\$62<sup>99</sup>**  
ALL RANGER MODELS (EXCEPT 150 EFI)



**LOCK & RIDE**  
RHINO GRIP XLR DOUBLES

» **2889166** • **\$99<sup>99</sup>**  
ALL RANGER MODELS (EXCEPT 150 EFI)



RHINO GRIP  
PRO REPLACEMENT  
RUBBER STRAPS (2)

» **2884109** • **\$14<sup>99</sup>**  
RHINO GRIP PRO



RHINO GRIP  
XLR REPLACEMENT  
RUBBER STRAPS (2)

» **2889204** • **\$14<sup>99</sup>**  
RHINO GRIP XL



#### IN-CAB GUN MOUNT

- Gives you instant gun access in the field
- Mounts securely to the floor and adjusts up to 45° forward
- Robust, molded gun butt holder at base
- Quick-release barrel straps
- Easily removable
- Accommodates scope-equipped rifles

» **2883263** • **\$219<sup>99</sup>**

XP 1000 '18-22, CREW XP 1000 '19-22,  
CREW 1000 '20-22, 1000 '20-22  
NORTHSTAR EDITION REQUIRES 2208023  
HWD KIT TO INSTALL ON THE 2019 AND  
NEWER MODELS



#### POLARIS PURSUIT CAMO SxS FIELD COVER

- Full-coverage camo print cover hides your side-by-side while in the field
- Lightweight material protects your RANGER from inclement weather

» **2882160** • **\$169<sup>99</sup>**

XP 1000 '18-22, EV '11-22, 570 FULL SIZE '17-22, 570  
'14-21, SP 570 '22, 500 '11-22, 1000 '20-22



# COLD WEATHER

GET READY FOR WINTER WITH PLOWS AND TRACKS.  
SEE P. 54 FOR PLOW DETAILS

## POLARIS PLOW MODE

EXCLUSIVE TO RANGER XP 1000 RIDE COMMAND FOR 2020-2022

7" DISPLAY POWERED BY RIDE COMMAND

» 2884072 • \$2,099<sup>99</sup>

XP 1000 '19-22, CREW XP 1000 '19-22, CREW 1000 '20-22, 1000 '20-22

SEE P. 44

Plow mode functionality does not control hydraulic lift and angle



PLOW IS AUTOMATICALLY LOWERED WHEN SHIFTING INTO LOW



PLOW IS AUTOMATICALLY RAISED WHEN SHIFTING INTO REVERSE



BACK DRAG MODE ALLOWS FOR PULLING SNOW AWAY FROM BUILDINGS



### PROSPECTOR PRO TRACK MOUNT KIT

• Install this track system mounting hardware in place of tires and wheels. Tracks sold separately.

» **NI-VI** 2889425 • \$679<sup>99</sup>

XP 1000 '21-22, CREW XP 1000 '21, CREW 1000 '20-22, 1000 '21-22. FITS MODELS WITH NON-HIGH CLEARANCE A-ARMS

» **NI-VI** 2889426 • \$679<sup>99</sup>

XP 1000 '21-22, CREW XP 1000 '21-22. FITS MODELS WITH HIGH CLEARANCE A-ARMS

» 2882783 • \$679<sup>99</sup>

XP 1000 '18-21, CREW XP 1000 '19-21, CREW 1000 '20-21, 1000 '20-21

» 2880071 • \$679<sup>99</sup>

CREW 570-4 '15-21, 570 '14-21, 500 '17-22

» 2889196 • \$679<sup>99</sup>

SP 570 '22

### PROSPECTOR PRO TRACK

» 2880758 • \$6,774<sup>99</sup>

570 '14-21 WITH EPS, CREW 570 '14-21 WITH EPS, SP 570 '22, CREW SP 570 '22

» 2880757 • \$6,774<sup>99</sup>

CREW 570-4 '14-21, 570 '14-21, 500 '17-22

If using Glacier Pro Plow System with tracks, Track Plow Extension is required (2889267)

For year-round use, Polaris recommends the use of Intake Update Kit (2880673) on any RANGER XP 1000 '17, RANGER XP 1000 CREW '14-18 with tracks installed. To keep intake system working optimally, this kit pre-filters out fine snow and dust.

### POLARIS-SPECIFIC GEARING PROVIDES 1:1 RATIO TO:

- Minimize track slip, providing better climbing ability and improved traction in deep snow
- Improve top speed over prior models by approximately 5%
- Reduce operating RPM for a quieter ride
- Improve driveline durability, which allows vehicle to run at a lower RPM, decreasing engine wear

New front dual stabilizer for improved stability

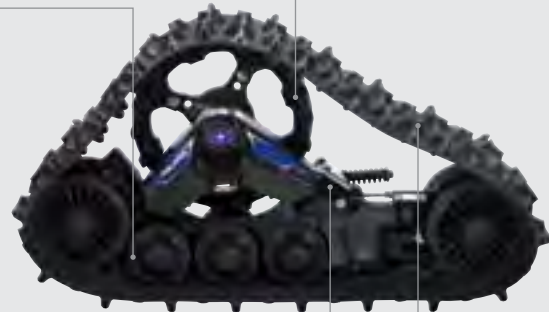

Polaris Exclusive optimized hub geometry that minimizes feedback and eases steering effort

Lightweight design provides for better flotation, eases steering effort, and provides better vehicle control

# Otter®



### FEATURES

- Fits 1-2 people
- 26.5 square ft.
- Set up dimensions: 67" L x 59½" W x 78½" H
- Cover included
- 2 top sealable vents
- Front entry door with dual coil zippers
- 2 sewn-in TPU crack resistant windows
- Insulated corners for complete coverage
- Interior draft skirt with extra-long perimeter



WARRANTY

### POLARIS RANGER COMPATIBLE MODELS



XP 1000 '15-22, CREW XP 1000 '16-22, CREW 1000 '20-22, 1000 '20-22



CREW 570 FULL SIZE '18-22, 570 FULL SIZE '17-22

### LOCK & RIDE

Polaris XT Pro Lodge by Otter

» 2882199 • \$1,354<sup>99</sup>

VEHICLE WITH TRACKS WILL REDUCE SITTING SPACE IN HOUSE SLIGHTLY

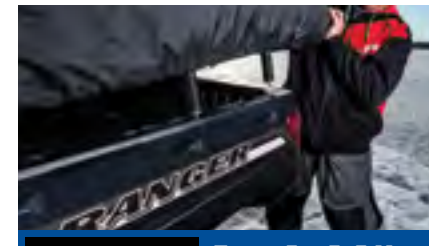

LOCK & RIDE Easy On & Off



Room for Ice Fishing Gear



Comfortable Fishing for 2  
Seating not included

### EASY SET UP

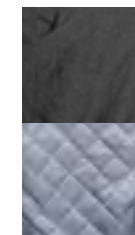
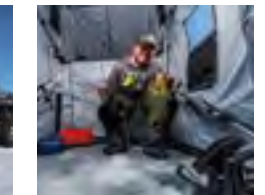
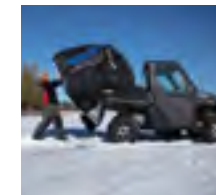

**OUTER SHELL**  
Provides outstanding wind and light blocking capabilities

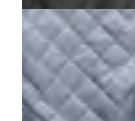

**INNER LINING**  
The full thermal quilted inner shell provides higher lofting while locking in heat and virtually eliminating condensation

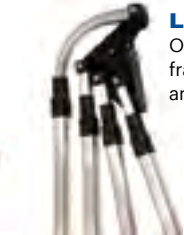

**LIGHTWEIGHT**  
Oversized square tube aluminum frame with anodized receiver tubes and ultra-glide operation

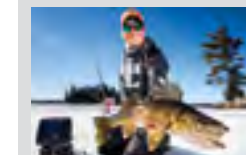

"The full-thermal Otter® Ice House from Polaris sets up in minutes, is spacious enough for two anglers to fish in comfort and stows quickly on the back of your RANGER. It is the premium shelter solution for ice anglers that rely on their Polaris RANGER for mobility out on the ice."

- James Holst, InDepth Outdoors

Otter® is a registered trademark of Otter Outdoors, LLC

### REAR 27" TIRE CHAINS

- Improve traction in deep snow and icy terrain
- Designed to fit on the 11" wide rear tires of the RANGER XP 1000

» 2889242 • \$199<sup>99</sup>



# GLACIER PRO HD PLOW SYSTEM

## HYDRAULIC CONTROL FOR EXTREME SNOW REMOVAL

A robust frame and tough blades, combined with a convenient hydraulic angle system, allow your Glacier Pro HD to move serious snow while you remain comfortable. Thanks to Lock & Ride technology, the Pro HD comes standard with a convenient kickstand attachment to the plow frame, giving you the easiest attachment.

### XP 1000/1000 PLOW SYSTEMS (REQUIRES WINCH, SOLD SEPARATELY)

Choose a Glacier Pro HD Plow System, designed to help you get the most out of your RANGER during snowy months. Select a system based on your plowing needs with premium add-ons including a hydraulic lift system or additional plow accessories.

#### NEW GLACIER PRO HD PLOW SYSTEM WITH HYDRAULICS & ACCESSORIES

- System includes:
- Frame (2883255)
  - 72" Poly Plow (2879317)
  - Hydraulic Angle (2889209)
  - Hydraulic Controller (2883247)
  - Plow Markers (2872726)
  - Back Drag Bar (2889329)
  - Plow Extensions (2889328)

» 3880002 • \$3,954<sup>99</sup>  
 XP 1000 '18-22, CREW XP 1000 '19-22, CREW 1000 '20-22, 1000 '20-22  
 REQUIRES LIFT METHOD: SEE WINCHES

#### NEW GLACIER PRO HD PLOW SYSTEM WITH HYDRAULICS

- System includes:
- Frame (2883255)
  - 72" Poly Plow (2879317)
  - Hydraulic Angle (2889209)
  - Hydraulic Controller (2883247)
  - Plow Markers (2872726)

» 3880003 • \$3,489<sup>99</sup>  
 XP 1000 '18-22, CREW XP 1000 '19-22, CREW 1000 '20-22, 1000 '20-22  
 REQUIRES LIFT METHOD: SEE WINCHES

#### NEW GLACIER PRO HD PLOW SYSTEM

- System includes:
- Frame (2883255)
  - 72" Steel Plow (2879874)

» 3880004 • \$2,254<sup>99</sup>  
 XP 1000 '18-22, CREW XP 1000 '19-22, CREW 1000 '20-22, 1000 '20-22  
 REQUIRES LIFT METHOD: SEE WINCHES

### BUILD YOUR XP 1000/1000 PLOW SYSTEM

» 72" Blades

» Choice of poly or steel

» Hydraulic lift & angle system option

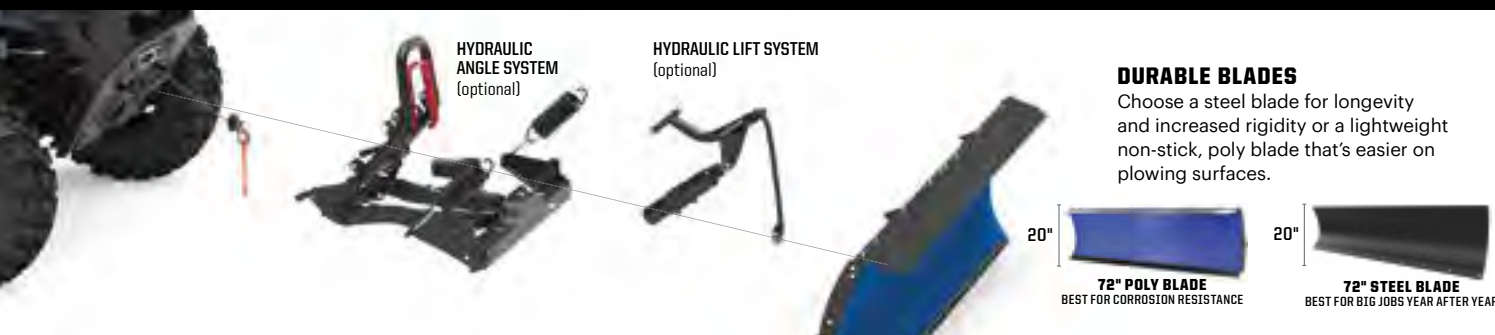

HYDRAULIC ANGLE SYSTEM (optional)

HYDRAULIC LIFT SYSTEM (optional)

**DURABLE BLADES**  
 Choose a steel blade for longevity and increased rigidity or a lightweight non-stick, poly blade that's easier on plowing surfaces.



72" POLY BLADE  
 BEST FOR CORROSION RESISTANCE

72" STEEL BLADE  
 BEST FOR BIG JOBS YEAR AFTER YEAR

BUILD YOUR PLOW SYSTEM	STEP 1 SELECT A MOUNT	STEP 2 SELECT A FRAME	STEP 3 SELECT PLOW CONFIGURATION		STEP 4 SELECT A BLADE
MODELS	MOUNT	FRAME	HYDRAULICS	WINCHES	BLADES
XP 1000 '18-22 CREW XP 1000 '19-22 1000 '20-22 CREW 1000 '20-22	<b>Not Required</b> Integrated into Factory Bumper  NON EPS RANGER 1000 REQUIRES FRONT BUMPER	<b>NEW</b> 2889308   \$1,419 <sup>99</sup> <b>Track Extension</b> 2879871   \$639 <sup>99</sup> <b>Replacement T Shear Pin</b> 2204829   \$14 <sup>99</sup> <b>Glacier Pro HD Kickstand System</b> 2207382   \$34 <sup>99</sup>	<b>Hydraulic Lift System</b> 2883410   \$639 <sup>99</sup> <b>Glacier Pro HD Plow Hydraulic Angle System</b> 2889209   \$669 <sup>99</sup> <b>TOP SELLER</b> <b>Power Controller</b> Required for hydraulic components 2883247   \$284 <sup>99</sup>	<b>Polaris Pro HD 6,000 lb. Winch</b> 2882710   \$1,289 <sup>99</sup> <b>TOP SELLER</b> <b>Polaris Pro HD 4,500 lb. Winch</b> 2882711   \$1,149 <sup>99</sup> <b>Power Controller Winch Adapter</b> 2884159   \$74 <sup>99</sup>	<b>72" Poly</b> 2879317   \$644 <sup>99</sup> <b>TOP SELLER</b> <b>72" Steel</b> 2879874   \$644 <sup>99</sup>

### SELECT ACCESSORIES

#### PLOW BLADE SNOW DEFLECTOR

- » 72" • 2858541 • \$94<sup>99</sup>
- » 66" • 2879866 • \$119<sup>99</sup>
- » 60" • 2871808 • \$94<sup>99</sup>

#### HEAVY-DUTY SNOW PLOW DEFLECTOR

- » 72" • 2884160 • \$204<sup>99</sup>

#### QUICK RELEASE SKID SHOES

- Helps prevent blade wear
- Hardened steel for industrial strength
- » 2205223 • \$44<sup>99</sup>

#### COIL SPRING SPACER

- Keep the front end of the vehicle up and improve ride quality when using a plow on strut or A-Arm vehicles
- » 2872655 • \$24<sup>99</sup>

#### NEW WINTER AVAILABILITY GLACIER 6" PLOW EXTENSIONS

- 6" steel plow extensions that attach to the side of 66" and 72" Glacier Pro HD plows
- » 2889328 • \$324<sup>99</sup>

#### WEAR BARS

- Protect your plow blade and minimize wear on the actual blade
- » 72" • 2204976 • \$79<sup>99</sup>
- » 66" • 2879867 • \$79<sup>99</sup>
- » 60" • 2877243 • \$54<sup>99</sup>
- » HD 72" • 2879875 • \$149<sup>99</sup>
- » HD 66" • 2879868 • \$144<sup>99</sup>

#### NEW PLOW BACK DRAG BAR

- Has a hinged, rear facing cutting edge that improves back dragging performance and allows the bar to float when plowing forward to reduce wear and tear
- » 2889329 • \$139<sup>99</sup>

#### QUICK RELEASE SKID SHOES

- Helps prevent blade wear
- Hardened steel for industrial strength
- » 2208864 • \$39<sup>99</sup>

#### PLOW MARKER

- Helps driver monitor plow blade position
- Sold in pairs
- » 2872726 • \$44<sup>99</sup>

#### PLOW LINK

- » 2204974 • \$24<sup>99</sup>

### POLARIS SP 570 PLOW SYSTEMS (REQUIRES WINCH, SOLD SEPARATELY)

#### NEW GLACIER PRO HD PLOW SYSTEM WITH HYDRAULICS

- System includes:
- Frame (2880260)
  - 72" Steel Plow (2880270)
  - Hydraulic Angle (2885104)
  - Hydraulic Controller (2889162)
  - Plow Markers (2872726)

» 3880006 • \$2,854<sup>94</sup>  
 SP 570 '22 & CREW SP 570 '22  
 REQUIRES LIFT METHOD: SEE WINCHES

#### NEW GLACIER PRO HD PLOW SYSTEM (NON BASE MODELS)

- System includes:
- Frame (2880260)
  - 66" Poly Plow (2880269)

» 3880007 • \$1,424<sup>97</sup>  
 SP 570 '22 & CREW SP 570 '22  
 REQUIRES LIFT METHOD: SEE WINCHES AND HYDRAULIC LIFT OPTION

#### NEW GLACIER PRO HD PLOW SYSTEM (BASE MODELS ONLY)

- System includes:
- Mount (2880261)
  - Frame (2880260)
  - 66" Poly Plow (2880269)

» 3880008 • \$1,574<sup>97</sup>  
 SP 570 '22 & CREW SP 570 '22  
 REQUIRES LIFT METHOD: SEE WINCHES AND HYDRAULIC LIFT OPTION

### BUILD YOUR SP 570/570/500/570 FULL-SIZE PLOW SYSTEM

» 72" or 66" Blades

» Choice of poly or steel

» Hydraulic angle system option



HYDRAULIC ANGLE SYSTEM (optional)



66" POLY BLADE  
 BEST FOR CORROSION RESISTANCE



66" STEEL BLADE  
 BEST FOR BIG JOBS YEAR AFTER YEAR

BUILD YOUR PLOW SYSTEM	STEP 1 SELECT A MOUNT	STEP 2 SELECT A FRAME	STEP 3 SELECT PLOW CONFIGURATION		STEP 4 SELECT A BLADE
MODELS	MOUNT	FRAME	HYDRAULICS	WINCH	BLADES
570 FULL-SIZE '16-22 CREW 570 FULL-SIZE '16-22 500 '10-22 570/CREW 570 '10-21 LI-ION EV & EV '15-22	2880261   \$354 <sup>99</sup>	<b>TOP SELLER</b> 2880260   \$639 <sup>99</sup> <b>Track Extension</b> 2880267   \$354 <sup>99</sup>	<b>Glacier Pro HD Plow Hydraulic Angle System</b> 2885104   \$799 <sup>99</sup> <b>Power Controller</b> 2879227   \$59 <sup>99</sup> NO SHIFTER TO MOUNT CONTROLLER ON EV REQUIRED FOR HYDRAULIC COMPONENTS	<b>Polaris Pro HD 4,500 lb. Winch</b> 2882238   \$1,149 <sup>99</sup>	<b>TOP SELLER</b> <b>72" Steel</b> 2880270   \$644 <sup>99</sup> <b>66" Poly</b> 2880269   \$579 <sup>99</sup> <b>TOP SELLER</b> <b>66" Steel</b> 2880268   \$514 <sup>99</sup>
SP 570/CREW SP 570 '22	<b>NEW</b> 2889577   \$209 <sup>99</sup> <b>NEW</b> 2889195   \$209 <sup>99</sup> <b>WINTER AVAILABILITY</b> NOT REQUIRED ON PREMIUM AND NORTHSTAR EDITION MODELS	<b>Replacement Shear Pin</b> 2205527   \$14 <sup>99</sup>		<b>Polaris Pro HD 4,500 lb. Winch</b> 2885096   \$1,099 <sup>99</sup>	

BUILD A PLOW SYSTEM

CHOOSE A PLOW SYSTEM

COMMON ACCESSORIES

CONNECTED TECHNOLOGY

ELECTRICAL ACCESSORIES

COOLERS

HUNT

COLD WEATHER

PLOWS

LIGHTING

WHEELS & TIRES



# GLACIER<sup>®</sup> HD PLOW SYSTEM

## MAKE QUICK WORK OF THE SMALLER JOBS

Move some snow with the sturdy and capable Glacier HD plow system, and discover why a major snowfall can be the highlight of your week. With a robust frame, beefy poly and steel blade options, convenient Lock & Ride mounting and dismounting and amazing value, Glacier HD is a great choice in the dead of winter.



### 3-SEAT & CREW

» 72" or 66" Blades

» Choice of poly or steel

» Manual angle system standard

### 2-SEAT & CREW 570 FULL-SIZE & CREW

» 66" Blades

» Choice of poly or steel

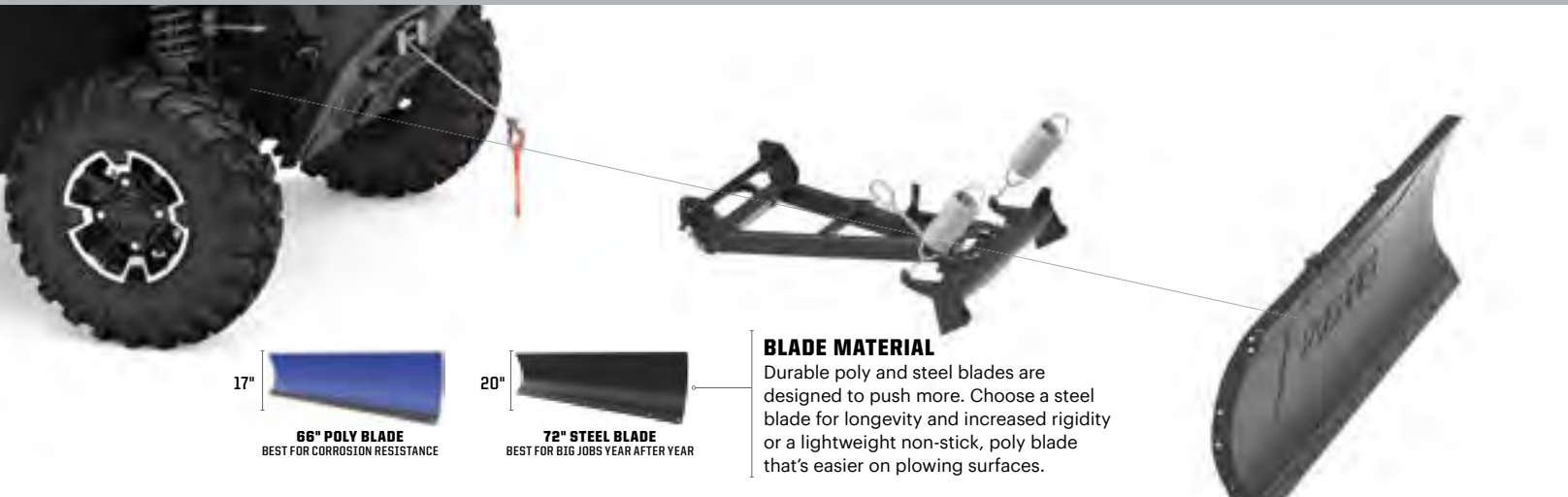

**BLADE MATERIAL**  
Durable poly and steel blades are designed to push more. Choose a steel blade for longevity and increased rigidity or a lightweight non-stick, poly blade that's easier on plowing surfaces.



BUILD A PLOW SYSTEM				
	STEP 1 SELECT A MOUNT	STEP 2 SELECT A FRAME	STEP 3 SELECT A LIFT METHOD	STEP 4 SELECT A BLADE
MODELS	MOUNT	FRAME	WINCHES	BLADES
<b>XP 1000 '18-22</b> <b>CREW XP 1000 '19-22</b> <b>1000 '20-22</b> <b>CREW 1000 '20-22</b>  <small>NOT COMPATIBLE WITH 29" OR LARGER TIRES</small>	<b>Not Required</b> Integrated into Factory Brushguard  <small>NON EPS RANGER 1000 REQUIRES FRONT BUMPER</small>	<b>NEW</b> 2889307   \$609 <sup>99</sup>  <b>Replacement Shear Pin</b> 2205527   \$14 <sup>99</sup>	<small>TOP SELLER</small> <b>Polaris HD 4,500 lb. Winch</b> 2882714   \$844 <sup>99</sup>  <b>66" Poly</b> 2880269   \$579 <sup>99</sup>  <small>TOP SELLER</small> <b>66" Steel</b> 2880268   \$514 <sup>99</sup>	<small>TOP SELLER</small> <b>72" Steel</b> 2880270   \$644 <sup>99</sup>  <b>66" Poly</b> 2880269   \$579 <sup>99</sup>  <small>TOP SELLER</small> <b>66" Steel</b> 2880268   \$514 <sup>99</sup>

**BUY A PLOW SYSTEM**

**NEW GLACIER HD PLOW SYSTEM**

System includes:  
 • Frame (2882927)  
 • 72" Steel Plow (2880270) | \$644<sup>99</sup>  
 » 3880005 • \$1,284<sup>99</sup>

XP 1000 '18-22, CREW XP 1000 '19-22, CREW 1000 '20-22, 1000 '20-22  
 REQUIRES LIFT METHOD: SEE WINCHES AND HYDRAULIC LIFT OPTION

BUILD A PLOW SYSTEM				
	STEP 1 SELECT A MOUNT	STEP 2 SELECT A FRAME	STEP 3 SELECT A LIFT METHOD	STEP 4 SELECT A BLADE
MODELS	MOUNT	FRAME	WINCHES	BLADES
<b>570 FULL-SIZE '16-22</b> <b>CREW 570 FULL-SIZE '16-22</b> <b>500/ETX '10-22</b> <b>570/CREW 570 '10-21</b> <b>LI-ION EV &amp; EV '15-22</b>  <b>SP 570/CREW SP 570 '22</b>	2879105   \$219 <sup>99</sup>  <b>NEW</b> 2889577   \$209 <sup>99</sup> <b>NEW</b> 2889195   \$209 <sup>99</sup> <small>WINTER AVAILABILITY</small> NOT REQUIRED ON PREMIUM AND NORTHSTAR EDITION MODELS	<b>NEW</b> 2889307   \$609 <sup>99</sup>  <b>Replacement Shear Pin</b> 2205527   \$14 <sup>99</sup>	<small>TOP SELLER</small> <b>Polaris HD 3,500 lb. Winch</b> 2881669   \$639 <sup>99</sup>  <b>Polaris Pro HD 4,500 lb. Winch</b> 2885096   \$1,099 <sup>99</sup>	<b>66" Poly</b> 2880269   \$579 <sup>99</sup>  <small>TOP SELLER</small> <b>66" Steel</b> 2880268   \$514 <sup>99</sup>

**BUY A PLOW SYSTEM**

**NEW GLACIER HD PLOW SYSTEM**

System includes:  
 • Frame (2882927)  
 • 66" Steel Plow (2880268)  
 » 3880009 • \$1,154<sup>99</sup>

SP 570 '22 & CREW SP 570 '22  
 REQUIRES LIFT METHOD: SEE WINCHES

### SELECT ACCESSORIES

#### WEAR BARS

- Protect your plow blade and minimize wear on the actual blade
- » 72" • 2204976 • \$79<sup>99</sup>
- » 66" • 2879867 • \$79<sup>99</sup>
- » 60" • 2877243 • \$54<sup>99</sup>
- » HD 72" • 2879875 • \$149<sup>99</sup>
- » HD 66" • 2879868 • \$144<sup>99</sup>

#### PLOW BLADE SNOW DEFLECTOR

- » 72" • 2858541 • \$94<sup>99</sup>
- » 66" • 2879866 • \$119<sup>99</sup>
- » 60" • 2871808 • \$94<sup>99</sup>

#### HEAVY-DUTY SNOW PLOW DEFLECTOR

- » 72" • 2884160 • \$204<sup>99</sup>

#### QUICK RELEASE SKID SHOES

- Helps prevent blade wear
- Hardened steel for industrial strength
- » 2208864 • \$39<sup>99</sup>

#### COIL SPRING SPACER

- Keep the front end of the vehicle up and improve ride quality when using a plow on strut or A-Arm vehicles
- » 2872655 • \$24<sup>99</sup>

#### QUICK RELEASE SKID SHOES

- Helps prevent blade wear
- Hardened steel for industrial strength
- » 2208864 • \$39<sup>99</sup>

#### PLOW MARKER

- Helps driver monitor plow blade position
- Sold in pairs
- » 2872726 • \$44<sup>99</sup>

#### GLACIER PLOW LINK

- » 2204974 • \$24<sup>99</sup>

COMMON ACCESSORIES

CONNECTED TECHNOLOGY

ELECTRICAL ACCESSORIES

COOLERS

HUNT

COLD WEATHER

PLOWS

LIGHTING

WHEELS & TIRES





**POLARIS ENGINEERED ADVANTAGES**

**MOUNTS PERFECTLY**  
Designed for your Polaris Engineered bumper, roof or other mounting point.

**MAX PERFORMANCE**  
Validated to work as hard as your machine does.

**DOESN'T OVERTAX**  
Trust it to work when you need it to.

**PRO ARMOR**



**ADVANCED TECH**

RIGID® lights are driven by Aluminum PCB Smart Boards™, 6063-T5 aircraft aluminum extruded housings and Tiger Drylac® UV protection polyester powder-coating.

**EXCLUSIVE OPTICS**

RIGID® lights feature impact-resistant polycarbonate lenses for a 100% water/dust proof seal.

**RIGID® LIMITED LIFETIME WARRANTY**

If you own a RIGID® light and it breaks, we will replace or repair it for life.\*

**RUGGED CONSTRUCTION**

Pro Armor lights are designed to be big and beefy with an aggressive style all their own, and housed in IP67 marine-grade rated UV polyester powder coating.

**MASSIVELY BRIGHT**

Pro Armor builds bright lights designed for any riding experience. All that power is directed through heat dissipating aluminum for streamlined heat management.

**LIGHT BAR TYPES**



**SR-SERIES PRO**

Sleek, powerful, low-profile (under 2" tall). Lights extreme distances with low energy usage.

Available in 10" & 32"



**D-SERIES PRO**

Compact to fit almost anywhere with high output and low energy usage.

Available in Driving, Flood & Spot



**DUAL-ROW LED LIGHT BARS**

The most spread and farthest illumination downrange. Easy to mount.

Available in Cube, 10", 20" & 30"



**SINGLE-ROW LED LIGHT BARS**

Powerful, compact, low-profile light bars with sleek look.

Available in 11", 33" & 40"



**CUBE LED LIGHTS**

Small size allows mounting in strategic locations for added lighting.

Available in Flood & Spot

**LIGHT BAR OPTIONS**

FOR COMPATIBILITY VISIT [POLARIS.COM/ShopRANGER](http://POLARIS.COM/ShopRANGER)

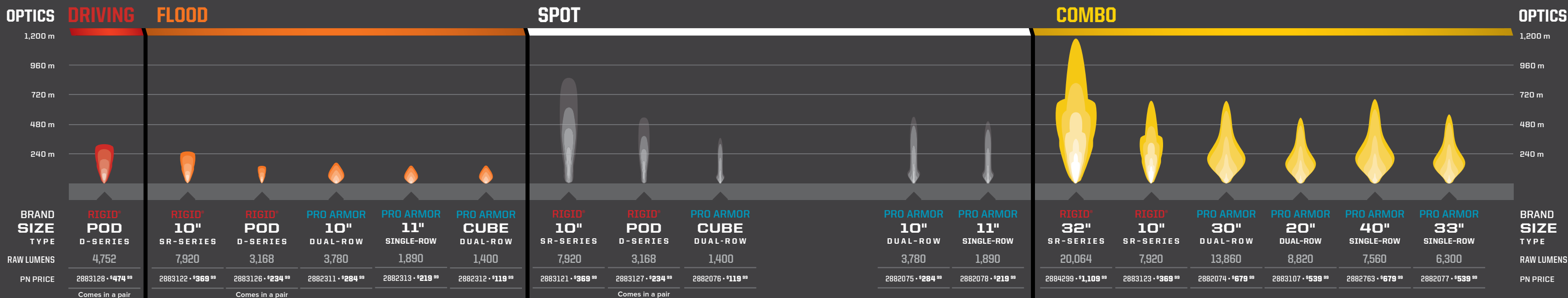

**BUILD YOUR VISION**

Consider the optics, angle & how you will use your vehicle to choose the right light or set of lights.

OPTICS LIGHT ANGLE	ACCENT	DRIVING (45°)	FLOOD (25°)	SPOT (10°)	COMBO (25°/10°)
DRIVING SPEED	All	Slow	Medium	Fast	Medium to fast
BEAM	Diffused glow	Extra-wide	Wide/Shorter	Concentrated/Long	Inner spot & outer flood
RECOMMENDED MOUNTING	Low/Wheel well	All points	Low &/or rear	High points	All points
TERRAIN & RIDING STYLE	Added style & personalization in any terrain	All riding & utility	Wide-open terrain or trails & utility	Trail & tight conditions	All riding & utility

**COMPARE LIGHTS IN A REAL WORLD SETTING AT [POLARIS.COM/LIGHTING](http://POLARIS.COM/LIGHTING)**

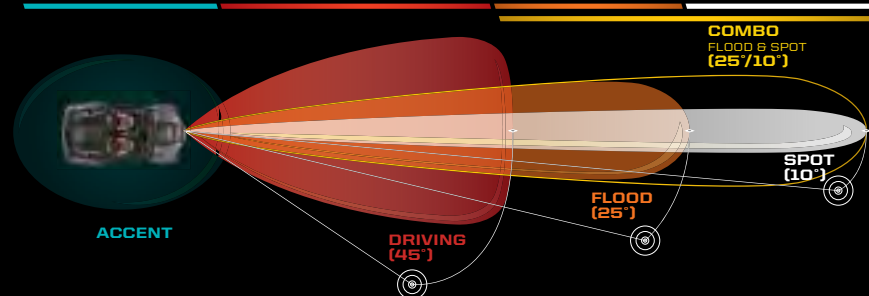

\* If RIGID® determines, in its sole discretion, that your product is defective in material or workmanship, RIGID® will honor your warranty claim. In some cases the product will be replaced, depending on the specific time frame of the purchase. If the product is repaired, all parts, labor, and return shipping may be covered by RIGID®.

**ADD A HARNESS TO MOUNT YOUR LIGHTS**

MODEL	LIGHT BAR SET-UPS		
	1 LIGHT IN 1 LOCATION ON 1 SWITCH	2 LIGHTS IN 2 LOCATIONS ON 1 SWITCH	2 LIGHTS IN 2 LOCATIONS ON 2 SWITCHES
EV '15-22, CREW 570-4 '15-21, CREW 570 FULL SIZE '18-22, 570 FULL SIZE '17-22, 570 '15-21, 500 '17-22	Requires Battery Connection Cable <b>TOP SELLER</b> LIGHT BAR HARNESS 2882209 • \$119 <sup>99</sup>	Requires Battery Connection Cable <b>TOP SELLER</b> LIGHT BAR HARNESS 2882209 • \$119 <sup>99</sup> Y-HARNESS 2879860 • \$24 <sup>99</sup>	Requires Battery Connection Cable <b>TOP SELLER</b> LIGHT BAR HARNESS (x2) 2882209 • \$119 <sup>99</sup>
SP 570 '22 NON-PREMIUM AND NON-NORTHSTAR MODELS REQUIRE BATTERY CONNECTION CABLE	SEE P. 46 FOR PULSE WIRING CONNECTIONS		
XP 1000 '18-21, CREW XP 1000 '19-21, 1000 '20-21 & CREW 1000 '20-21			

If installing Rear Facing Light on Crew models, use 2883854

**1 LED LIGHT BAR WIRING HARNESS - REAR FACING CREW EXTENSION**

» 2883854 • \$34<sup>99</sup>  
XP 1000 '20-22, CREW XP 1000 '19-22, CREW 1000 '20-22

**BATTERY CONNECTION CABLES 3-SEAT & CREW 2-SEAT & CREW**

» 3-SEAT • 2879388 • \$54<sup>99</sup>  
XP 1000 '17

» CREW • 2879685 • \$79<sup>99</sup>  
CREW XP 1000 '17-18

» **TOP SELLER** 2-SEAT • 2879990 • \$54<sup>99</sup>  
EV '15-22, 570 '15-21, 500 '17-22

» CREW • 2880929 • \$79<sup>99</sup>  
CREW 570-4 '15-21

» 570 • 2881684 • \$44<sup>99</sup>  
EV '15-22, 570 '15-21, 500 '17-22

» SP 570 • 2889185 • \$109<sup>99</sup>  
SP 570 SPORT '22, CREW SP 570 SPORT '22

**ADD A BEACON LIGHT FOR 360° ILLUMINATION**

P. 29

COMMON ACCESSORIES

CONNECTED TECHNOLOGY

ELECTRICAL ACCESSORIES

COOLERS

HUNT

COLD WEATHER

PLANS

LIGHTING

WHEELS & TIRES



# KNOW YOUR TERRAIN



- Tread patterns optimized for extreme traction
- Ideal for both hard pack and loose trail



- Flexible "grippy" tread
- Aggressive side bite



- Provides traction and durability
- Built to perform in hard sand, jagged rocks or any other extreme terrain



- Extra deep treads
- Self-cleaning lugs



- Paddles provide traction and durability in soft sand
- Built to float on top of sand



- Triple-belted sidewalls to resist puncture
- Purpose-built, long lasting tread patterns



- Handles extreme cold
- Holds shape and provides traction

# SUPERIOR PERFORMANCE & DURABILITY

# WAYS TO SHOP WHEELS & TIRES

## PRO ARMOR



## LIFELONG PERFORMANCE

- Every tire is designed and constructed with longevity in mind
- 3,000+ mile rated ((4,828 kilometers))

## PREMIUM PROTECTION

- Pro Armor makes tires with extra protection exactly where it's needed most — the sidewall
- Triple-belted sidewalls keep your tires more resistant so you can keep going

## TOUGH TIRES

- Higher ply ratings mean added protection
- Pro Armor builds 8 or 10-ply rated tires for higher puncture-resistance



## KNOW YOUR TIRES

DIMENSIONS			TREAD DEPTH	TIRE WEIGHT	PLY RATING	SIDEWALL BELTS	LOAD RATING
TIRE HEIGHT	TIRE WIDTH	WHEEL DIAMETER					
<b>32" x 9"</b>	<b>R15</b>	<b>FRONT/REAR</b>	<b>30 mm</b>	<b>41 lbs</b>	<b>10</b>	<b>3</b>	<b>1,320 lbs</b>
Part Number • Price							
<b>USAGE</b> Where can you use the tire			<b>TREAD DEPTH</b> Deeper treads have more grip in all conditions	<b>TIRE WEIGHT</b> A lighter tire makes for improved vehicle performance	<b>PLY RATING</b> Indicates tire puncture-resistance	<b>SIDEWALL BELTS</b> Increase your resistance to sidewall punctures	<b>LOAD RATING</b> How much weight can the tire handle

## TIRES BY SIZE

26"	27"	28"	29"
PRESERVE	PRESERVE	HARVESTER	HD-K
HARVESTER	HARVESTER	CRAWLER XR	MUD XC
XD-K	MUD XC	CRAWLER XG	DUAL-THREAT
DUAL-THREAT		ATTACK 2.0	
ATTACK			

## TIRES BY TERRAIN

TRAIL	ROCK	DESERT	MUD	UTILITY	SNOW
HARVESTER	CRAWLER XR	CRAWLER XR	MUD XC	HARVESTER	HARVESTER
PRESERVE	CRAWLER XG	CRAWLER XG		PRESERVE	XD-K
XD-K	DUAL-THREAT	ATTACK		XD-K	ATTACK
CRAWLER XR		ATTACK 2.0		HD-K	ATTACK 2.0
CRAWLER XG		DUAL-THREAT			HD-K
MUD XC					
ATTACK					
ATTACK 2.0					
DUAL-THREAT					
HD-K					

## WHEELS BY SIZE

14"	15"
40-SERIES (7 TIRE OPTIONS)	50-SERIES (2 TIRE OPTIONS)
4201	5201
4202	5202
4203 BEADLOCK	5203 BEADLOCK
4204	5204
4205	5301 BEADLOCK
4301 BEADLOCK	
HD DUAL BEADLOCK	

## KNOW YOUR WHEELS

### STEP 1: SELECT YOUR SERIES

4 = 40-SERIES    5 = 50-SERIES

### STEP 2: CHOOSE YOUR LOAD RATING

1 = <800 lbs    2 = 801 - 1,300 lbs    3 = 1,301 - 1,600+ lbs

### STEP 3: PICK YOUR STYLE

OFFSET / BEADLOCK / COLOR

INCREASE OFFSET FROM STOCK = NARROWER STANCE  
DECREASE OFFSET FROM STOCK = WIDER STANCE



# TIRES

## THE RIGHT TIRES

**FOR WORK.** Pro Armor Utility Tires are built to provide exactly what you need for your application. Looking for a high-kilometer work horse? We've got it. How about a turf-friendly tire with low-impact? We've got those too. Wanting the most extreme puncture resistance? Check.

"We use our RANGER every day around the farm. We put the Pro Armor HARVESTER Tires on last fall and love them! We have received better traction as well as a gentler and quieter ride compared to the stock tires, whether around the yard or out to the fields. They are so gentle on the lawn; we don't worry about driving the kids anywhere around the farm. We've had them on for a year and can't even see wear and tear. These are the best tires for my RANGER."

Bob S. - Barron, Wisconsin

### PICKING THE RIGHT UTILITY TIRE

UTILITY FEATURE	PRESERVE	HARVESTER	XD-K	HD-K
<b>5,000 Mile / 8,047 Kilometer Rated</b> Long life and performance	X	X		
<b>10-Ply Rated</b> Higher ply ratings means added protection	X	X	X	X
<b>Low Impact Tread</b> Easy on soil	X			
<b>Heavy-Duty Tread</b> Aggressive tread pattern for all day work on farms or ranches		X	X	X
<b>Turf-Friendly</b> Easy on grass and farm yard	X	X		
<b>Aramid Fiber Belt</b> 5x times stronger than steel and lighter			X	X
<b>Size Options</b> For exactly how you want to use your machine	26", 27"	26", 27", 28"	26"	29"



### PRO ARMOR PRESERVE

- Turf-friendly for areas where low-impact from tire tread is needed
- Rounded profile and special tread pattern to limit footprint

	TREAD DEPTH	TIRE WEIGHT	PLY RATING	SIDEWALL BELTS	LOAD RATING
12" 26" x 8" R12 5416403 • \$249 <sup>99</sup>	FRONT	24 lbs			855 lbs
12" 26" x 10" R12 5416402 • \$264 <sup>99</sup>	REAR	28 lbs	10	3	1,320 lbs
14" 27" x 10" R14 5416348 • \$264 <sup>99</sup>	FRONT/REAR	28 lbs			1,390 lbs

WHEEL SIZE



### PRO ARMOR HARVESTER

- All-around work horse with tread life of 5,000 miles / 8047 km
- Tread pattern designed to withstand anything from the farmyard to the pastures and the trail
- With 10-ply, it can carry the load day in and day out

	TREAD DEPTH	TIRE WEIGHT	PLY RATING	SIDEWALL BELTS	LOAD RATING
12" 26" x 8" R12 5416396 • \$249 <sup>99</sup>	FRONT	24 lbs			855 lbs
12" 26" x 10" R12 5415966 • \$264 <sup>99</sup>	REAR	32 lbs	10	3	855 lbs
14" 27" x 10" R14 5415965 • \$264 <sup>99</sup>	FRONT/REAR	32 lbs			1,320 lbs
14" 28" x 10" R14 5416347 • \$289 <sup>99</sup>	FRONT/REAR	34 lbs			1,320 lbs

WHEEL SIZE



### PRO ARMOR XD-K

- 26" Aramid fiber-belted tire to tackle any terrain
- Unique full-face tread design
- Harder durometer lugs promotes extended wear, increasing tire life

	TREAD DEPTH	TIRE WEIGHT	PLY RATING	SIDEWALL BELTS	LOAD RATING
12" 26" x 9" R12 5415756 • \$299 <sup>99</sup>	FRONT	28 lbs	10	3/1 Aramid Fiber Belt	855 lbs
12" 26" x 11" R12 5415757 • \$313 <sup>99</sup>	REAR	32 lbs			1,100 lbs

WHEEL SIZE



### PRO ARMOR HD-K

- Designed to provide a smooth ride and aggressive traction in all riding terrains
- Triple-belted sidewall provides extreme protection and extends the tire life
- Quad belt tread core offers superior protection and longer tread life

	TREAD DEPTH	TIRE WEIGHT	PLY RATING	SIDEWALL BELTS	LOAD RATING
14" 29" x 10" R14 5417507 • \$455 <sup>99</sup>	FRONT/REAR	40 lbs	10	3/1 Aramid	1,320 lbs

WHEEL SIZE





# TIRES



## PRO ARMOR CRAWLER XR

- Premium grip for all terrains, from the trail to the rocks
- Square block profile for even surface contact
- A tougher durometer than the XG to take on the toughest the trail has to offer

	TREAD DEPTH	TIRE WEIGHT	PLY RATING	SIDEWALL BELTS	LOAD RATING
14" 28" x 10" R14 5415536 • \$274 99	FRONT/REAR 16 mm	32 lbs	8	3	1,140 lbs



### XR

#### SINGLE DUROMETER

- Smaller lug height, added rigidity and lateral stability when cornering
- Unique lug design excels in hard pack, fast terrain



## PRO ARMOR DUAL-THREAT

- Dual-compound technology and radial construction offer performance in all terrains
- Softer durometer rubber on outer edge for overall superior grip and feel
- Harder durometer rubber in the middle for increased traction during acceleration and longer tread life

	TREAD DEPTH	TIRE WEIGHT	PLY RATING	SIDEWALL BELTS	LOAD RATING
14" 26" x 9" R14 5416340 • \$234 99	FRONT	27 lbs	10	3	910 lbs
14" 26" x 11" R14 5416341 • \$249 99	REAR	30 lbs			1,110 lbs
14" 29" x 9" R14 5416342 • \$289 99	FRONT	30 lbs			1,110 lbs
14" 29" x 11" R14 5416343 • \$304 99	REAR	35 lbs			1,320 lbs



### DUAL-COMPOUND = MORE GRIP + LONGER LIFE

Firmer Durometer Rubber = Longer Life

Softer Durometer Rubber = More Grip



## PRO ARMOR CRAWLER XG

- Built to crawl over all obstacles, both large and small
- A soft, sticky compound makes this tire ideal for both rock crawling and desert running
- 8-ply, triple-belted ballistic sidewalls resist punctures

	TREAD DEPTH	TIRE WEIGHT	PLY RATING	SIDEWALL BELTS	LOAD RATING
15" 28" x 10" R15 5416346 • \$289 99	FRONT/REAR 20 mm	32 lbs	8	3	1,110 lbs



### WHAT CRAWLER ARE YOU?

### XG

#### DUAL-DUROMETER

- Taller lug height and dual-durometer construction
- Perfect balance between high-speed performance, durability and flex in order to grip slick rock



## PRO ARMOR ATTACK 2.0

- Engineered for excellent hard pack performance
- Dual-compound technology and radial construction offer performance in all terrains.
- Tight tread pattern for quieter ride

	TREAD DEPTH	TIRE WEIGHT	PLY RATING	SIDEWALL BELTS	LOAD RATING
15" 28" x 10" R15 5416344 • \$289 99	FRONT/REAR 25 mm	32 lbs	10	3	1,110 lbs

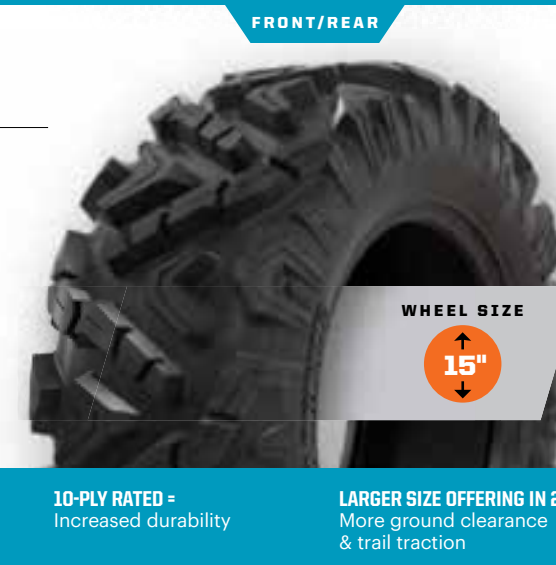

TIGHTER TREAD PATTERN = Better traction in hard pack

DUAL-DUROMETER LUG = Increased grip & traction in rough terrain, smoother ride in all terrain

10-PLY RATED = Increased durability

LARGER SIZE OFFERING IN 28" = More ground clearance & trail traction



## PRO ARMOR MUD XC

- Designed as the perfect mud-trail crossover for a smooth ride on the trail and aggressive traction in the mud
- Dual-compound technology with harder durometer lugs promote extended wear, increasing tire life
- 10-ply construction means added protection in the toughest terrain

	TREAD DEPTH	TIRE WEIGHT	PLY RATING	SIDEWALL BELTS	LOAD RATING
14" 27" x 9" R14 5416947 • \$264 99	FRONT	30 lbs	10	3	1,170 lbs
14" 27" x 11" R14 5416948 • \$274 99	REAR	32 lbs			1,320 lbs
14" 29" x 10" R14 5416946 • \$289 99	FRONT/REAR	39 lbs			3



## PRO ARMOR ATTACK

- The best all-purpose tire for all-season traction in any terrain
- Unique, full-face tread design
- Harder durometer lugs promote extended wear, increasing tire life
- Wider spaced lugs provide more grip in softer terrain

	TREAD DEPTH	TIRE WEIGHT	PLY RATING	SIDEWALL BELTS	LOAD RATING
14" 26" x 9" R14 5415613 • \$204 99	FRONT	28 lbs	8	3	910 lbs
14" 26" x 11" R14 5415614 • \$224 99	REAR	32 lbs			1,320 lbs

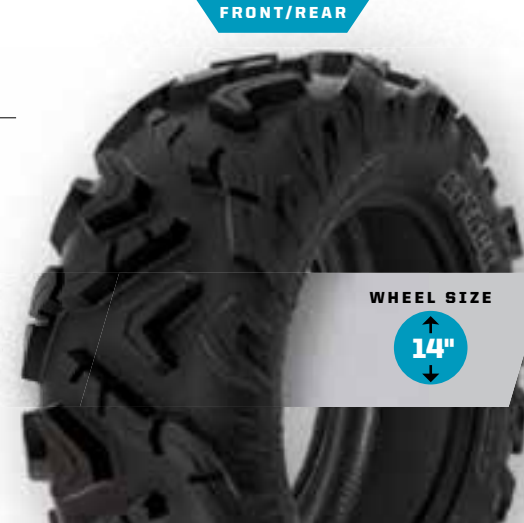



# KNOW YOUR TERRAIN



- Tread patterns optimized for extreme traction
- Ideal for both hard pack and loose trail



- Flexible "grippy" tread
- Aggressive side bite



- Provides traction and durability
- Built to perform in hard sand, jagged rocks or any other extreme terrain



- Extra deep treads
- Self-cleaning lugs



- Paddles provide traction and durability in soft sand
- Built to float on top of sand



- Triple-belted sidewalls to resist puncture
- Purpose-built, long lasting tread patterns



- Handles extreme cold
- Holds shape and provides traction

# WHEEL & TIRE SETS

↑  
14"  
↓

## 40-SERIES

### UTILITY

	HARVESTER 27" 5,000 Mi/8,047 km	HARVESTER 28" 5,000 Mi/8,047 km	PRESERVE 27" 5,000 Mi/8,047 km
4201 Accent	2882388 \$1,849 <sup>99</sup>	2883225 \$2,004 <sup>99</sup>	2883208 \$1,849 <sup>99</sup>
4201 Matte Black	2882389 \$1,709 <sup>99</sup>	2883226 \$1,849 <sup>99</sup>	2883209 \$1,709 <sup>99</sup>
4202 Accent	2882383 \$1,849 <sup>99</sup>	2883220 \$2,004 <sup>99</sup>	2883203 \$1,849 <sup>99</sup>
4202 Matte Black	2882384 \$1,709 <sup>99</sup>	2883221 \$1,849 <sup>99</sup>	2883204 \$1,709 <sup>99</sup>
4203 BEADLOCK Matte Black BEADLOCKS SOLD SEPARATELY			
4204 Accent	2882385 \$1,849 <sup>99</sup>	2883222 \$2,004 <sup>99</sup>	2883205 \$1,849 <sup>99</sup>
4204 Matte Black	2882386 \$1,709 <sup>99</sup>	2883223 \$1,849 <sup>99</sup>	
4205 Luster			
4205 Matte Black	2882387 \$1,709 <sup>99</sup>	2883224 \$1,849 <sup>99</sup>	2883207 \$1,709 <sup>99</sup>
4301 BEADLOCK Accent BEADLOCKS PRE-MOUNTED			
4301 BEADLOCK Matte Black BEADLOCKS PRE-MOUNTED			

### DESERT/ROCK

CRAWLER XR 28" 3,000 Mi/4,828 km	MUD XC 27" 3,000 Mi/4,828 km	MUD XC 29" 3,000 Mi/4,828 km
2882394 \$1,849 <sup>99</sup>	2884272 \$1,869 <sup>99</sup>	2884265 \$1,974 <sup>99</sup>
2882395 \$1,709 <sup>99</sup>	2884273 \$1,724 <sup>99</sup>	2884266 \$1,834 <sup>99</sup>
2881343 \$1,849 <sup>99</sup>	2884267 \$1,869 <sup>99</sup>	2884260 \$1,974 <sup>99</sup>
2881344 \$1,709 <sup>99</sup>	2884268 \$1,724 <sup>99</sup>	2884261 \$1,834 <sup>99</sup>
2881386 \$2,144 <sup>99</sup>		
2881355 \$1,849 <sup>99</sup>	2884270 \$1,869 <sup>99</sup>	2884263 \$1,934 <sup>99</sup>
2881356 \$1,709 <sup>99</sup>	2884271 \$1,724 <sup>99</sup>	2884264 \$1,799 <sup>99</sup>
2881371 \$1,849 <sup>99</sup>		
2881372 \$1,709 <sup>99</sup>	2884269 \$1,709 <sup>99</sup>	2884262 \$1,799 <sup>99</sup>
2883213 \$2,284 <sup>99</sup>		
2883212 \$2,144 <sup>99</sup>		

### BACKCOUNTRY/TRAIL

DUAL-THREAT 26" 3,000 Mi/4,828 km	DUAL-THREAT 29" 3,000 Mi/4,828 km	ATTACK 26" 3,000 Mi/4,828 km
2883138 \$1,784 <sup>99</sup>	2883146 \$2,004 <sup>99</sup>	2882390 \$1,709 <sup>99</sup>
2883139 \$1,644 <sup>99</sup>	2883147 \$1,849 <sup>99</sup>	2882391 \$1,574 <sup>99</sup>
2883140 \$1,784 <sup>99</sup>	2883148 \$2,004 <sup>99</sup>	2881335 \$1,709 <sup>99</sup>
2883141 \$1,644 <sup>99</sup>	2883149 \$1,849 <sup>99</sup>	2881336 \$1,574 <sup>99</sup>
		2881381 \$1,784 <sup>99</sup>
2883142 \$1,784 <sup>99</sup>	2883150 \$2,004 <sup>99</sup>	2881347 \$1,709 <sup>99</sup>
2883143 \$1,644 <sup>99</sup>	2883151 \$1,849 <sup>99</sup>	2881348 \$1,574 <sup>99</sup>
		2881359 \$1,709 <sup>99</sup>
2883144 \$1,644 <sup>99</sup>	2883152 \$1,849 <sup>99</sup>	2881360 \$1,574 <sup>99</sup>
2883217 \$2,209 <sup>99</sup>	2883219 \$2,434 <sup>99</sup>	
2883216 \$2,074 <sup>99</sup>	2883218 \$2,284 <sup>99</sup>	

↑  
15"  
↓

## 50-SERIES

### TRAIL

	ATTACK 2.0 28" 3,000 Mi/4,828 km	CRAWLER XG 28" 3,000 Mi/4,828 km
5201 Accent	2883160 \$1,934 <sup>99</sup>	2883188 \$1,934 <sup>99</sup>
5201 Matte Black	2883159 \$1,784 <sup>99</sup>	2883187 \$1,784 <sup>99</sup>
5202 Accent	2883158 \$1,934 <sup>99</sup>	2883186 \$1,934 <sup>99</sup>
5202 Matte Black	2883157 \$1,784 <sup>99</sup>	2883185 \$1,784 <sup>99</sup>
5203 BEADLOCK Accent BEADLOCKS SOLD SEPARATELY	2883154 \$2,209 <sup>99</sup>	2883182 \$2,209 <sup>99</sup>
5204 Matte Black	2883155 \$1,784 <sup>99</sup>	2883183 \$1,784 <sup>99</sup>
5301 BEADLOCK Accent BEADLOCKS PRE-MOUNTED	2883162 \$2,349 <sup>99</sup>	2883190 \$2,349 <sup>99</sup>
5301 BEADLOCK Matte Black BEADLOCKS PRE-MOUNTED	2883161 \$2,209 <sup>99</sup>	2883189 \$2,209 <sup>99</sup>

## 2 WAYS TO PURCHASE

INDIVIDUAL WHEELS & TIRES  
- OR -  
COMPLETE SETS AS LISTED

visit [Polaris.com/ProArmorRANGER](http://Polaris.com/ProArmorRANGER)  
TO BUILD YOUR CUSTOM SET & VERIFY FITMENT

Exclusively at Polaris Authorized Dealers  
or [Polaris.com/ProArmorRANGER](http://Polaris.com/ProArmorRANGER)



### TIRE SEALANT

- » 946 mL • 2830484 • \$25<sup>99</sup>
- » 3.8 LITERS • 2830485 • \$89<sup>99</sup>

### P. 106

- » 19 LITERS • 2830486 • \$364<sup>99</sup>
- » 19 LITERS, PUMP • 2830487 • \$163<sup>99</sup>

## REPLACEMENT CAPS

### POLARIS CAPS

LUSTER	ALL WHEELS EXCEPT 5204 & 5203 BEADLOCK	1521509-410 • \$19 <sup>99</sup>
MATTE BLACK		1521509-521 • \$19 <sup>99</sup>
LUSTER	5203 BEADLOCK	1522243-410 • \$34 <sup>99</sup>
MATTE BLACK		1522243-458 • \$34 <sup>99</sup>
HD MATTE BLACK	ALL WHEELS	5457498-458 • \$29 <sup>99</sup>

### PRO ARMOR CAPS

LUSTER	ALL WHEELS EXCEPT 5204 & 5203 BEADLOCK	5453209-410 \$19 <sup>99</sup>
MATTE BLACK		5453209-458 • \$19 <sup>99</sup>
MATTE BLACK	5204	1523063-458 • \$19 <sup>99</sup>
LUSTER	5203 BEADLOCK	1523015-410 • \$19 <sup>99</sup>
MATTE BLACK		1523015-458 • \$19 <sup>99</sup>

## LUG NUTS

○ LUG NUTS REQUIRED

### 12mm x 1.5 SPLINED LUG NUTS

16 LUG NUTS WITH WRENCH		2879332 • \$54 <sup>99</sup>
4 LUG NUTS WITHOUT WRENCH	ALL POLARIS RANGER 3-SEAT & CREW MODELS	2879331 • \$19 <sup>99</sup>
SPLINED LUG WRENCH		2204966 • \$14 <sup>99</sup>

### 3/8" - 24 HEX LUG NUTS

16 HEX LUG NUTS	ALL POLARIS RANGER 570 '20-21 MODELS	2877409 • \$44 <sup>99</sup>
4 HEX LUG NUTS		2876754 • \$19 <sup>99</sup>





# WHEELS

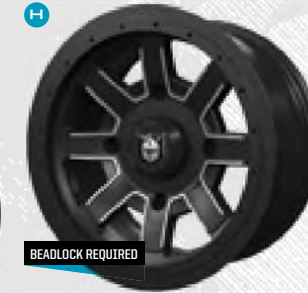

15"

## 50-SERIES

**A 5201**

**WEIGHT:** 17.1 lbs | **LOAD RATING:** 1,300 lbs | **OFFSET:** +4

ACCENT:	FRONT/REAR	15" x 7"	1523184-266	\$184 <sup>99</sup>
MATTE BLACK:	FRONT/REAR	15" x 7"	1523184-458	\$159 <sup>99</sup>

**B 5202**

**WEIGHT:** 17.8 lbs | **LOAD RATING:** 1,300 lbs | **OFFSET:** +4

ACCENT:	FRONT/REAR	15" x 7"	1523102-266	\$184 <sup>99</sup>
MATTE BLACK:	FRONT/REAR	15" x 7"	1523102-458	\$159 <sup>99</sup>

**C 5203 BEADLOCK**

**WEIGHT:** 16 lbs | **LOAD RATING:** 1,300 lbs | **OFFSET:** +38

MATTE BLACK:	FRONT/REAR	15" x 7"	1522435-458	\$329 <sup>99</sup>
--------------	------------	----------	-------------	---------------------

**D 5204**

**WEIGHT:** 13.5 lbs | **LOAD RATING:** 1,300 lbs | **OFFSET:** +55

MATTE BLACK:	FRONT/REAR	15" x 7"	1522550-458	\$264 <sup>99</sup>
--------------	------------	----------	-------------	---------------------

**E 5301 BEADLOCK**

**WEIGHT:** 17 lbs | **LOAD RATING:** 1,600 lbs | **OFFSET:** +38

ACCENT:	FRONT/REAR	15" x 7"	1523282	\$314 <sup>99</sup>
MATTE BLACK:	FRONT/REAR	15" x 7"	1523266	\$289 <sup>99</sup>

### LUG NUTS

○ LUG NUTS REQUIRED

SEE P. 67



14"

## 40-SERIES

**F 4201**

**FRONT WEIGHT:** 13 lbs | **LOAD RATING:** 900 lbs | **OFFSET:** +4

**REAR WEIGHT:** 14 lbs | **LOAD RATING:** 1,300 lbs | **OFFSET:** -9

ACCENT:	FRONT	14" x 7"	1522956-266	\$204 <sup>99</sup>
	REAR	14" x 8"	1522957-266	\$224 <sup>99</sup>
MATTE BLACK:	FRONT	14" x 7"	1522956-458	\$169 <sup>99</sup>
	REAR	14" x 8"	1522957-458	\$184 <sup>99</sup>

**G 4202**

**FRONT WEIGHT:** 12.75 lbs | **LOAD RATING:** 900 lbs | **OFFSET:** +4

**REAR WEIGHT:** 13.5 lbs | **LOAD RATING:** 1,300 lbs | **OFFSET:** -9

ACCENT:	FRONT	14" x 7"	1522544-266	\$204 <sup>99</sup>
	REAR	14" x 8"	1522545-266	\$224 <sup>99</sup>
MATTE BLACK:	FRONT	14" x 7"	1522544-458	\$169 <sup>99</sup>
	REAR	14" x 8"	1522545-458	\$184 <sup>99</sup>

**H 4203 BEADLOCK**

**FRONT WEIGHT:** 13 lbs | **LOAD RATING:** 900 lbs | **OFFSET:** +4

**REAR WEIGHT:** 14.5 lbs | **LOAD RATING:** 1,300 lbs | **OFFSET:** -9

MATTE BLACK:	FRONT	14" x 7"	1522238-458	\$304 <sup>99</sup>
	REAR	14" x 8"	1522239-458	\$304 <sup>99</sup>

**I 4204**

**FRONT WEIGHT:** 13 lbs | **LOAD RATING:** 900 lbs | **OFFSET:** +4

**REAR WEIGHT:** 14 lbs | **LOAD RATING:** 1,300 lbs | **OFFSET:** -9

ACCENT:	FRONT	14" x 7"	1522546-266	\$204 <sup>99</sup>
	REAR	14" x 8"	1522547-266	\$204 <sup>99</sup>
MATTE BLACK:	FRONT	14" x 7"	1522546-458	\$169 <sup>99</sup>
	REAR	14" x 8"	1522547-458	\$169 <sup>99</sup>

**J 4205**

**FRONT WEIGHT:** 10.5 lbs | **LOAD RATING:** 900 lbs | **OFFSET:** +4

**REAR WEIGHT:** 12.5 lbs | **LOAD RATING:** 1,300 lbs | **OFFSET:** -9

MATTE BLACK:	FRONT	14" x 7"	1521507-521	\$159 <sup>99</sup>
	REAR	14" x 8"	1521508-521	\$169 <sup>99</sup>
LUSTER:	FRONT	14" x 7"	1521507-410	\$204 <sup>99</sup>
	REAR	14" x 8"	1521508-410	\$209 <sup>99</sup>

**K 4301 BEADLOCK**

**WEIGHT:** 16 lbs | **LOAD RATING:** 1,600 lbs | **OFFSET:** +38

ACCENT:	FRONT/REAR	14" x 7"	1523284	\$289 <sup>99</sup>
MATTE BLACK:	FRONT/REAR	14" x 7"	1523283	\$274 <sup>99</sup>

**L HD DUAL BEADLOCK**

**WEIGHT:** 40 lbs | **LOAD RATING:** 1,600 lbs | **OFFSET:** +38

MATTE BLACK:	FRONT/REAR	14" x 7"	1524022-458	\$373 <sup>99</sup>
--------------	------------	----------	-------------	---------------------

## KNOW YOUR WHEELS

### STEP 1: SELECT YOUR SERIES

- 4 = 40-SERIES
- 5 = 50-SERIES

### STEP 2: CHOOSE YOUR LOAD RATING

- 1 = <800 lbs
- 2 = 801 - 1,300 lbs
- 3 = 1,301 - 1,600+ lbs

### STEP 3: PICK YOUR STYLE

- OFFSET / BEADLOCK / COLOR**
- INCREASE OFFSET FROM STOCK**  
= **NARROWER STANCE**
- DECREASE OFFSET FROM STOCK**  
= **WIDER STANCE**

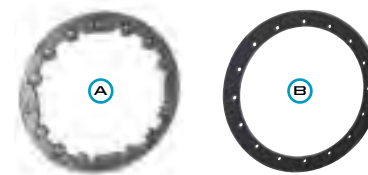

### 14" FORGED BEADLOCK RINGS

<b>A</b> Machined Only used on 4203 Beadlock & HD Dual Beadlock	1522244-266	\$119 <sup>99</sup>
<b>B</b> Matte Black - Replacement Only used on 4301 Beadlock & HD Dual Beadlock	1523146-458	\$79 <sup>99</sup>

### 15" FORGED BEADLOCK RINGS

<b>A</b> Machined Only used on 5203 Beadlock	1522240-266	\$144 <sup>99</sup>
<b>B</b> Matte Black - Replacement Only used on 5301 Beadlock	1523147-458	\$84 <sup>99</sup>

HD PARTS  
P. 102

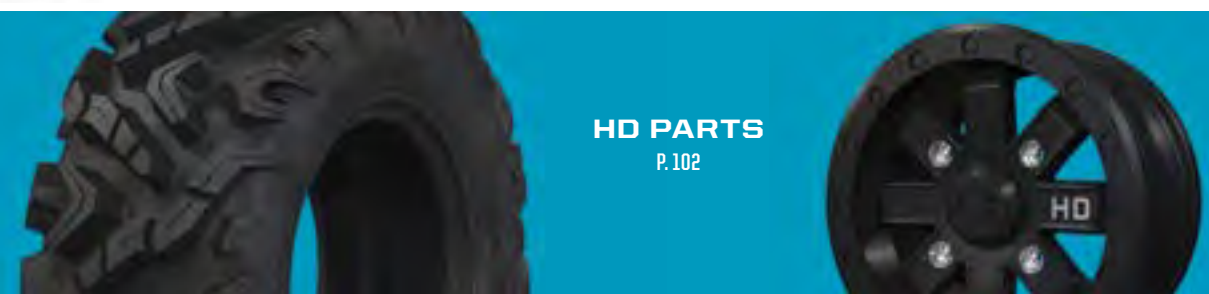



# MAKE IT YOURS

**CUSTOMIZE YOUR ALL-NEW RANGER SP 570 AND GET MORE DONE** with Polaris Engineered Accessories. Outfit your RANGER based on your riding preferences for added comfort, maximized storage, and more.

SHOP ALL RANGER ACCESSORIES AT [POLARIS.COM/ShopRANGER](https://www.polaris.com/ShopRANGER)

## RANGER SP 570 HUNT

2884106	<b>LOCK &amp; RIDE</b> Kolpin Stronghold Auto-Latch Boot Mount	P. 50
2882430	Gun Boot - XL	P. 50
2882077	Pro Armor 33" Combo LED Light Bar	P. 59
2881348	Pro Armor Wheel & Tire Set: Attack & 4204	P. 67
2885078	Poly Crew Sport Roof	P. 72

2889181	Rock Guard with Step - Crew	P. 77
2885087	Rear Brushguard	P. 77
2889056	Polaris Pro HD 4,500 lb. Winch with Rapid Rope Recovery	P. 77
2885088	Front Hood Storage Rack	P. 79



## RANGER SP 570 LANDOWNER

2883144	Pro Armor Wheel & Tire Set: Dual-Threat & 4205	P. 67
2885077	Poly 2-Seat Sport Roof	P. 72
2889187	Convex Weatherproof Rear View Mirror	P. 76
2889243	Side View Mirrors - ROPS-Mounted	P. 76

2889056	Polaris Pro HD 4,500 lb. Winch with Rapid Rope Recovery	P. 77
2889189	Cargo Bed Mat	P. 78
2889199	<b>LOCK &amp; RIDE</b> Storage Box	P. 78



## RANGER SP 570 FARM

2883140	Pro Armor Wheel & Tire Set: Dual-Threat & 4202	P. 67
2885077	Poly 2-Seat Sport Roof	P. 72
2889187	Convex Weatherproof Rear View Mirror	P. 76
2889243	Side View Mirrors - ROPS-Mounted	P. 76

2885084	Upper Front Brushguard	P. 77
2885087	Rear Brushguard	P. 77
2885095	Polaris HD 3,500 lb. Winch	P. 77
2889182	<b>LOCK &amp; RIDE</b> Tip-Down Headache Rack	P. 78
2889189	Cargo Bed Mat	P. 78



## RANGER CREW SP 570 TRAIL

2882077	Pro Armor 33" Combo LED Light Bar	P. 59
2883143	Pro Armor Wheel & Tire Set: Dual-Threat & 4204	P. 67
2885078	Poly Crew Sport Roof	P. 72
2885080	<b>LOCK &amp; RIDE</b> Full Glass Windshield	P. 74
2879965	<b>LOCK &amp; RIDE</b> Rear Panel - Glass	P. 75
2885083	Windshield Wiper & Washer Kit	P. 76

2889187	Convex Weatherproof Rear View Mirror	P. 76
2889243	Side View Mirrors - ROPS-Mounted	P. 76
2889181	Rock Guard with Step - Crew	P. 77
2885084	Upper Front Brushguard	P. 77
2885087	Rear Brushguard	P. 77
2889183	<b>LOCK &amp; RIDE</b> Bed Extender/Divider	P. 78



# ROOFS



SEALED COVERAGE

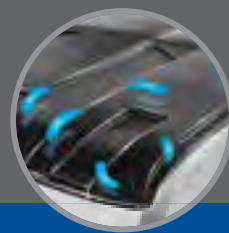

REDUCE STANDING WATER



LOCK & RIDE  
EASY AND FAST INSTALLATION

POLARIS ENGINEERED ADVANTAGES

## GLASS VS POLY

- Water run-off
- Mounting features: easily add accessories & lighting
- Liner ready
- Lightweight

- Heavy duty/durable
- Low profile
- Unique style

### SHIELD AGAINST DRIVING RAIN OR THE BLISTERING SUN.

Choose from poly or steel and know that you are protected from the elements with a seamless integrated roof.

## POLY

Lightweight, durable and impact-resistant. A poly roof can take the abuse of a tight trail and still protect.



### SPORT ROOF - POLY

- Offers reliable protection from the sun and rain
- Lightweight, durable polyethylene construction
- Simple one-time installation

- » **NEW** 2-SEAT BLACK • 2885077 • **\$409<sup>99</sup>** SP 570 '22
- » **NEW** CREW BLACK • 2885078 • **\$679<sup>99</sup>** CREW SP 5770 '22

### NEW PREMIUM ROOF LINER

- Cut in-cab noise by 60% at idle and by 40% at 20 mph
- One-piece liner attaches quickly and securely using push darts
- Adds premium comfort and quieter cab ride
- » 2-SEAT (shown) • 2885093 • **\$254<sup>99</sup>** SP 570 '22
- » CREW • 2885094 • **\$679<sup>99</sup>** CREW SP 570 '22

## STEEL

For the ultimate in strength and protection.

### HD ROOF - STEEL

- Stout 12-gauge steel construction
- Powder-coated finish for scratch and corrosion resistance
- Interior fabric liner provides sound reduction

- » 2-SEAT • 2879954 • **\$809<sup>99</sup>** SP 570 '22



# DOORS



PREMIUM FEATURES



UNPRECEDENTED VENTILATION OPTIONS



EASY AND FAST INSTALLATION

POLARIS ENGINEERED ADVANTAGES

	POLY DOORS	CANVAS DOORS
FRONT DOORS (SET OF 2) SP 570 '22, CREW SP 570 '22	<p><b>CRANK WINDOW</b> Has manual crank windows for airflow adjustment in the cab with a fully finished black interior and exterior panels. Has a steel tube frame with a full 360 degree seal to keep out dust and rain.</p> <p><b>RANGER PRO SHIELD CAB SYSTEM</b> <b>NEW</b> Manual Crank Window Doors 2885073 • <b>\$3,389<sup>99</sup></b> SHOWN WITH EXTERIOR DOOR ACCENT PANEL 2889389-795</p>	<p><b>ZIP WINDOW</b> Heavy-duty 23-oz durable protection with adjustable zipper ventilation and see-through bottom panel. Powder-coated steel rod door frames provide strength and enhance fit and finish.</p> <p><b>NEW</b> Zip Window Doors 2885075 • <b>\$1,099<sup>99</sup></b></p>
REAR DOORS (SET OF 2) CREW SP 570 '22	<p><b>RANGER PRO SHIELD CAB SYSTEM</b> <b>NEW</b> Manual Crank Window Doors 2885074 • <b>\$3,389<sup>99</sup></b> SHOWN WITH EXTERIOR DOOR ACCENT PANEL 2889390-795</p>	<p><b>NEW</b> Zip Window Doors 2885076 • <b>\$1,099<sup>99</sup></b></p>

### NEW EXTERIOR DOOR ACCENT PANELS

- Replace stock gloss black accent panels
- Painted plastic and clear-coated for UV protection
- Install easily with a single screw
- Comes as a pair
- Compatible with Poly doors only

**Sagebrush Green Non-Metallic**  
2889389-560 • **\$74<sup>99</sup>**  
2889390-560 • **\$74<sup>99</sup>**

**Polaris Pursuit Camo**  
2889391-587 • **\$139<sup>99</sup>**  
2889392-587 • **\$139<sup>99</sup>**

**Polaris Blue Non-Metallic**  
2889389-795 • **\$74<sup>99</sup>**  
2889390-795 • **\$74<sup>99</sup>**





# WINDSHIELDS & REAR PANELS

## GLASS VS POLY

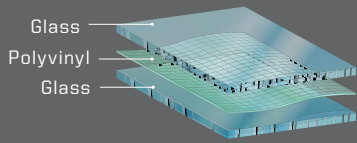

- Superior optical clarity (automotive level)
- Scratch-resistant
- Curved to fit, seals tight
- Cold weather / heavy duty
- Wiper ready (windshield only)

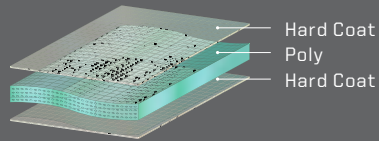

- Lightweight, flexible, easy to store/remove
- Impact-resistant
- Tight seal keeps out rain and dust

### LOCK & RIDE

#### REVOLUTIONARY INSTALLATION



#### AIRTIGHT GASKET SEAL



#### VENTING OPTIONS



#### MULTI-FUNCTION FEATURES



### POLARIS ENGINEERED ADVANTAGES

## WINDSHIELDS



Open



### NEW FULL TIP-OUT WINDSHIELD - GLASS

- Tip-out design offers three positions: open, closed and vented
- Gas shocks assist in easy opening and closing
- 360° gasket for reliable protection and comfort
- Scratch-resistant automotive-style curved glass
- Interior sound dampening and optimized visibility

» 2885079 • \$1,339<sup>99</sup>  
SP 570 '22, CREW SP 570 '22



WIPER AVAILABLE  
P. 74



### NEW FULL GLASS WINDSHIELD - CLEAR

- Scratch-resistant, curved laminate safety glass
- Protects against wind, rain and other hazardous debris
- UV-blocking interlayer and 360° gasket seal

» 2885080 • \$949<sup>99</sup>  
SP 570 '22, CREW SP 570 '22



### LOCK & RIDE FULL WINDSHIELD - POLY TOP SELLER

- Durable, optical-grade, .236"-thick polycarbonate offers outstanding rider protection and visibility
- Windshield has minimal perimeter framework for full visibility

» 2883318 • \$499<sup>99</sup>  
SP 570 '22, CREW SP 570 '22



### LOCK & RIDE HALF WINDSHIELD - POLY

- Strong, durable polycarbonate half windshield delivers a combination of protection and airflow into the cab
- Half windshield offers protection from rain, sleet, spray, and off-road hazards

» 2883320 • \$264<sup>99</sup>  
SP 570 '22, CREW SP 570 '22



### LOCK & RIDE VENTED WINDSHIELD - HARD COAT POLY

- Frameless design for maximum visibility
- Added vents for airflow on a hot day or defrosting on a cold day

» 2883342 • \$744<sup>99</sup>  
SP 570 '22, CREW SP 570 '22



### LOCK & RIDE FULL WINDSHIELD - HARD COAT POLY TOP SELLER

- Durable, optical-grade, .236"-thick polycarbonate offers outstanding rider protection and visibility
- Windshield has minimal perimeter framework for full visibility

» 2883319 • \$639<sup>99</sup>  
SP 570 '22, CREW SP 570 '22

## REAR PANELS



### LOCK & RIDE REAR PANEL - GLASS TOP SELLER

- Durable, tempered laminate glass provides a high level of scratch resistance

» 2879965 • \$434<sup>99</sup>  
SP 570 '22, CREW SP 570 '22



### LOCK & RIDE REAR PANEL - POLY TOP SELLER

- Strong, .236"-thick polycarbonate provides outstanding impact and scratch resistance

» 2879812 • \$354<sup>99</sup>  
SP 570 '22, CREW SP 570 '22

## HARD COAT POLY | 30x MORE SCRATCH-RESISTANT



### REDUCE IN-CAB DUST SWIRL BY ADDING A REAR PANEL

With a windshield and roof installed, turbulent air develops behind the cab. Add a rear panel to reduce dust intrusion from this swirl.



# AUDIO

**NEW**  
JBL® DASH AUDIO KIT

- System mounts into pre-designated locations in the vehicle dash
- Complete UTV audio solution gives your vehicle a performance-ready sound system
- Includes four off-road grade, water- and dust-proof speakers, and one head unit
- Head unit features AM/FM tuner, USB input and Bluetooth® compatibility for wireless streaming



» 2885081 • **\$899<sup>99</sup>**  
SP 570 '22

**POLARIS RIDECOMMAND** SEE P. 44 FOR MORE INFORMATION

7" DISPLAY POWERED BY RIDE COMMAND

» 2884072 • **\$2,099<sup>99</sup>**  
SP 570 '22  
SPEAKERS NOT INCLUDED



## CONVENIENCE FEATURES

**NEW CAB SEAL KIT**

- Seal out dust from your UTV cab
- Reduces dust from getting on dash and seat

» 2889201 • **\$144<sup>99</sup>**  
SP 570 '22, CREW SP 570 '22  
(INCLUDED WITH PREMIUM DOORS)

**NEW FRONT PULSE BAR AND HARNESS**

- This kit is needed to install any electrical accessories to a base vehicle

» 2-SEAT • 2889185 • **\$109<sup>99</sup>**  
SP 570 '22, CREW SP 570 '22  
» CREW • 2889568 • **\$109<sup>99</sup>**  
CREW SP 570 '22

**NEW HORN KIT**

- Adds a warning horn to console area of vehicle

» 2889160 • **\$94<sup>99</sup>**  
SP 570 '22, CREW SP 570 '22  
SP 570 NON-PREMIUM AND NON-NORTHSTAR MODELS REQUIRE FRONT PULSE BAR AND HARNESSES 2889185

**NEW DOME LIGHT**

- LED Dome light provides optimal visibility in the cab
- Easy to install

» 2889159 • **\$144<sup>99</sup>**  
SP 570 '22, CREW SP 570 '22  
SP 570 NON-PREMIUM AND NON-NORTHSTAR MODELS REQUIRE FRONT PULSE BAR AND HARNESSES 2889185

**NEW FLOOR MATS - FRONT**

- Protects floors from dirt and wear
- Textured, non-slip surface

» 2889186 • **\$164<sup>99</sup>**  
SP 570 '22, CREW SP 570 '22

**SPEEDKEY**

» 2879988 • **\$419<sup>99</sup>**  
SP 570 '22, CREW SP 570 '22

# CONVENIENCE FIELD TESTED INTERIOR

**ADD SUPERIOR ALL-WEATHER FUNCTIONALITY**

and comfort to your Ranger with premium Polaris Engineered Accessories. Keep warm on the coldest of days with a heater kit and improve visibility with a Windshield Wiper and Washer System or Large Rear View Mirror.



**NEW HEATER KIT**

- Climate control for the cab of your off-road vehicle
- Total of four dash mounted vents with two positioned for defrosting the windshield and the other two for heating the cab
- Simple, dash-mounted controls
- Manually operated vents for airflow control

» 2885082 • **\$1,289<sup>99</sup>**  
SP 570 '22, CREW SP 570 '22  
SP 570 SPORT MODELS REQUIRES FRONT PULSE BAR AND HARNESSES 2889185



**NEW WINDSHIELD WIPER & WASHER KIT**

- Helps clear hazardous dirt, rain and debris from your windshield

» 2885083 • **\$679<sup>99</sup>**  
SP 570 '22, CREW SP 570 '22  
SP 570 SPORT MODELS REQUIRES FRONT PULSE BAR AND HARNESSES 2889185



**NEW CONVEX WEATHERPROOF REAR VIEW MIRROR**

- Convex design for a broader view of traffic
- Durable, weatherproof construction
- Mount the bolts into your choice of pre-designated mounting locations
- Compatible with roof, windshield, and other accessories

» 2889187 • **\$90<sup>99</sup>**  
SP 570 '22, CREW SP 570 '22



**NEW SIDE VIEW MIRRORS**

» DOOR MOUNTED (shown) • 2889241 • **\$229<sup>99</sup>**  
» ROPS-MOUNTED • 2889243 • **\$229<sup>99</sup>**  
SP 570 '22, CREW SP 570 '22

# PROTECTION



**NEW UPPER FRONT BRUSHGUARD**

- Made from tubular steel and provides additional protection for front fenders and headlights
- Attaches to stock front bumper
- Durable, scratch-resistant, black powder-coat finish

» 2885084 • **\$324<sup>99</sup>**  
SP 570 '22, CREW SP 570 '22

**NEW REAR BRUSHGUARD**

- Made from tubular steel and provides additional protection for taillights
- Durable, scratch-resistant, black powder-coat finish
- Reliably enhances back-end protection of vehicle

» 2885087 • **\$299<sup>99</sup>**  
SP 570 '22, CREW SP 570 '22

**NEW ROCK GUARD WITH STEP**

- Reliable, hard-working protection for edges of vehicle
- Mounts directly to the frame, instead of underneath, for maximum ground clearance

» 2-SEAT (shown) • 2889180 • **\$409<sup>99</sup>**  
SP 570 '22  
» CREW • 2889181 • **\$539<sup>99</sup>**  
CREW SP 570 '22

**NEW A-ARM GUARDS**

- Valuable, reliable protection for vital front suspension components exposed to the rigors of off-road environments
- Strong, durable, lightweight polyethylene construction withstands off-road impacts to protect the A-Arms

» **WINTER AVAILABILITY**  
FRONT (shown) • 2885097 • **\$269<sup>99</sup>**  
» REAR • 2880551 • **\$269<sup>99</sup>**  
SP 570 '22, CREW SP 570 '22

# WINCHES

FEATURES & BENEFITS

**PRO** PRO HEAVY DUTY SERIES

**HD** HEAVY DUTY SERIES

**RAPID ROPE RECOVERY**  
Retrieve cable 5x as fast as standard mode on other Polaris winches. Get back to riding or complete your task quicker.



NOT AVAILABLE

**AUTO STOP TECHNOLOGY**  
Auto Stop technology protects and extends the life of your winch by automatically stopping the winch at the end of pull to prevent over-spooling.



ADD AUTO STOP UPGRADE  
2881693 • **\$144<sup>99</sup>**  
SYNTHETIC ROPE REQUIRED

**SYNTHETIC ROPE**  
Lightweight, extremely strong and flexible 50 ft long rope stands up to any tough job.



ADD SYNTHETIC ROPE  
2878888 • **\$109<sup>99</sup>**



**WARRANTY**

MODEL	4,500 LB.	3,500 LB.	ADD REQUIRED CABLES
SP 570 '22 CREW SP 570 '22	2885096 \$1,099 <sup>99</sup>	TOP SELLER 2885095 \$609 <sup>99</sup>	2-SEAT & CREW MODELS: 2889185 \$109 <sup>99</sup>

**UPGRADE YOUR CONTROLS**  
HD OR PRO HD WINCHES

**WIRED REMOTE CONTROL**

• Must order remote handle and socket together  
» REMOTE HANDLE 4013466 • **\$90<sup>99</sup>**  
» SOCKET 4014228 • **\$64<sup>99</sup>**

**POWER CONTROLLER**

• Control your winch and plow hydraulics directly from the shift knob  
» 2879227 • **\$59<sup>99</sup>**  
SP 570 '22





# STORAGE



## LOCK & RIDE®

Exclusive and available on all Polaris vehicles, Lock & Ride accessories let you quickly change from one task to another with hundreds of options.

WITH THE FLIP OF A LEVER, LOCK & RIDE PLUNGERS USE OUTWARD PRESSURE TO EXPAND FOR A SECURE FIT.



### NEW LOCK & RIDE STORAGE BOX

- Provides enough room to store all the tools you need to get the job done
- Internal organizational dividers keep gear from rolling around
- Easily detaches from vehicle

» 2889199 • \$409<sup>99</sup>  
SP 570 '22, CREW SP 570 '22



### NEW LOCK & RIDE TIP-DOWN HEADACHE RACK

- Provides extreme cargo versatility to your UTV
- Strong steel tube construction for maximum durability
- Installs and removes easily utilizing Lock & Ride technology

» 2889182 • \$514<sup>99</sup>  
SP 570 '22, CREW SP 570 '22



### NEW LOCK & RIDE BED EXTENDER/DIVIDER

- Increase your cargo capacity and UTV storage
- Extend the cargo bed or divide cargo within the bed
- Lock & Ride technology for easy install without tools
- Made from durable steel and powder-coated finish

» 2889183 • \$344<sup>99</sup>  
SP 570 '22, CREW SP 570 '22



### NEW LOCK & RIDE CARGO BED MAT

- Protects cargo box, reduces drivetrain noise, and keeps cargo more secure with non-slip design
- Thick (3.18 mm) rubber mat construction

» 2889189 • \$164<sup>99</sup>  
SP 570 '22, CREW SP 570 '22



### NEW LOCK & RIDE FRONT HOOD STORAGE RACK

- Increases load-carrying capacity and protects against brush and debris
- Steel construction with a durable powder-coated finish
- Lock & Ride functions for easy install, on and off maneuvering of the basket, and under-hood access
- Weight Capacity: 100 lbs.

» 2885088 • \$454<sup>99</sup>  
SP 570 '22, CREW SP 570 '22

### FIRE EXTINGUISHER HOLDER

- Quick-release strap allows for easy access

» 2882158 • \$119<sup>99</sup>  
SP 570 '22, CREW SP 570 '22



### RIDE & REPAIR ESSENTIALS KIT

» 2881207 • \$144<sup>99</sup>  
SP 570 '22, CREW SP 570 '22



### LOCK & RIDE D-RINGS TOP SELLER

- The most versatile Lock & Ride accessory - add as many as you need to secure your cargo with bungee cords or straps

» 2881545 • \$44<sup>99</sup>  
SP 570 '22, CREW SP 570 '22



### LOCK & RIDE CHAINSAW MOUNT

» 2879354 • \$184<sup>99</sup>  
SP 570 '22, CREW SP 570 '22



### LOCK & RIDE TOOL RACK

- Attach on the inside or outside of the cargo bed

» 2881533 • \$344<sup>99</sup>  
SP 570 '22, CREW SP 570 '22

## STRAPS

### 1.5" x 15' 5,500 LB. RATCHET STRAP

- Heavy-duty webbing
- 2 Pack

» 2884031 • \$59<sup>99</sup>



### LOCK & RIDE QUICKSTRAP

- The quickest and most secure way to mount Polaris accessories
- Sold as a pair

» 2882187 • \$59<sup>99</sup>

ALL COOLERS, RANGER CARGO BOXES



### 2" x 20' 10,000 LB. RATCHET STRAP

- Heavy-duty webbing

» 2884032 • \$44<sup>99</sup>



## DO MORE:



**COOLERS**  
P. 48



**HUNT**  
P. 50



**COLD WEATHER**  
P. 52



**LIGHTING**  
P. 58



# MAKE IT YOURS

## WORK HARD AND GET IT DONE

with Polaris Engineered Accessories for your RANGER. Start with the ultimate in all-season performance and comfort with the best cab components in the industry. Find everything you need to outfit your RANGER for the task at hand.

### RANGER 570 HUNT

2882430	Kolpin Stronghold Gun Boot XL Transport	P. 50
2885077	Poly 2-Seat Sport Roof	P. 82
2881784	<b>LOCK &amp; RIDE</b> Full Tip-Out Windshield - Glass	P. 84
2882238	Polaris Pro HD 4,500 lb. Winch	P. 87



### RANGER 570 WORK

2885077	Poly 2-Seat Sport Roof	P. 82
2882247	Hinged Window Doors - Poly	P. 83
2881784	<b>LOCK &amp; RIDE</b> Full Tip-Out Windshield - Glass	P. 84
2882238	Polaris Pro HD 4,500 lb. Winch	P. 87
2881485	Cargo Bed Mat	P. 88



### RANGER CREW 570-4 EPS RANCH

2883424	Polaris Northstar Cooler - 30 Quart	P. 48
2885078	Poly Sport Roof - Crew	P. 82
2879963	<b>LOCK &amp; RIDE</b> Canvas Door Set	P. 83
2881783	Glass Full Windshield, Clear	P. 84
2881533	<b>LOCK &amp; RIDE</b> Tool Rack	P. 89



### RANGER 500 TRAIL

2883425	Polaris Northstar Cooler - 60 Quart	P. 48
2885077	Poly 2-Seat Sport Roof	P. 82
2883320	<b>LOCK &amp; RIDE</b> Half Windshield - Poly	P. 85



# ROOFS



SEALED  
COVERAGE

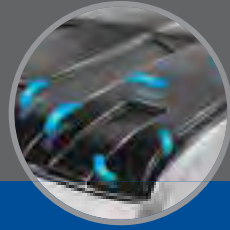

REDUCE  
STANDING  
WATER



LOCK & RIDE  
EASY AND FAST  
INSTALLATION

POLARIS ENGINEERED  
ADVANTAGES

## POLY FEATURES

- Water run-off
- Mounting features: easily add accessories & lighting
- Liner ready
- Lightweight

### SHIELD AGAINST DRIVING RAIN OR THE BLISTERING SUN.

Know that you are protected from the elements with a seamless integrated roof. Poly is lightweight, durable and impact-resistant. A poly roof can take the abuse of a tight trail and still protect.



#### NEW SPORT ROOF - POLY

- Provides shade, superior overhead protection
- Tough injection-molded design resists distortion from the elements
- Polaris Pursuit Camo offers effective visual camouflage in the field

» 2-SEAT BLACK • 2885077 • \$409<sup>99</sup>  
EV '15-22, 570 '15-21, 500 '17-22

» CREW BLACK • 2885078 • \$679<sup>99</sup>  
CREW 570-4 '15-21

# DOORS



PREMIUM  
FEATURES



UNPRECEDENTED  
VENTILATION  
OPTIONS



EASY AND FAST  
INSTALLATION

POLARIS ENGINEERED  
ADVANTAGES

## POLY DOORS

## CANVAS DOORS

### HINGED WINDOW

A premium, door offering hinged window for customizable ventilation in the cab.

### ZIP WINDOW

Lightweight, durable protection with adjustable zipper ventilation and see-through bottom panel.

FRONT DOORS (SET OF 2)  
EV '15-22, CREW 570-4 '15-21, 570 '15-21, 500 '17-22



Hinged Window -  
Poly Doors - Black  
2882247 • \$2,959<sup>99</sup>



TOP SELLER

Zip Window Doors -  
Canvas - Black  
2879963 • \$1,314<sup>99</sup>

REAR DOORS (SET OF 2)  
CREW 570-4 '15-21



Zip Window Doors -  
Rear - Canvas - Black  
2879964 • \$1,314<sup>99</sup>





# WINDSHIELDS & REAR PANELS

## GLASS VS POLY

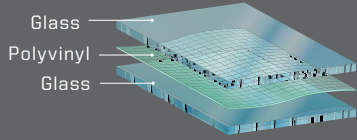

- Superior optical clarity (automotive level)
- Scratch-resistant
- Curved to fit, seals tight
- Cold weather / heavy duty
- Wiper ready (windshield only)

- Lightweight, flexible, easy to store/remove
- Impact-resistant
- Tight seal keeps out rain and dust

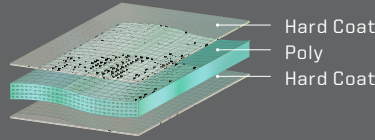

### LOCK & RIDE

#### REVOLUTIONARY INSTALLATION



#### AIRTIGHT GASKET SEAL

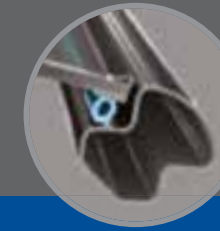

#### VENTING OPTIONS



#### MULTI-FUNCTION FEATURES



### POLARIS ENGINEERED ADVANTAGES

## WINDSHIELDS



### LOCK & RIDE TIP-OUT WINDSHIELD - GLASS

- Made of strong, optical-grade laminate safety glass
- Provides optimal visibility and the best protection from wind, inclement weather and off-road hazards
- Minimal perimeter framework for a low profile and full visibility
- Tip-out feature adjusts the windshield to an open position to enjoy airflow in the cab

» 2881784 • \$1,394<sup>99</sup>  
EV '15-22, CREW 570-4 '15-21, 570 '15-21, 500 '17-22

### FULL WINDSHIELD - GLASS TOP SELLER

- Provides the highest level of scratch resistance

» 2881783 • \$854<sup>99</sup>  
EV '15-22, CREW 570-4 '15-21, 570 '15-21, 500 '17-22

### LOCK & RIDE FULL WINDSHIELD - POLY TOP SELLER

- Durable, optical-grade, .236"-thick polycarbonate offers outstanding rider protection and visibility
- Windshield has minimal perimeter framework for full visibility

» 2883318 • \$499<sup>99</sup>  
EV '15-22, CREW 570-4 '15-21, 570 '15-21, 500 '17-22

### LOCK & RIDE HALF WINDSHIELD - POLY

- Strong, durable polycarbonate half windshield delivers a combination of protection and airflow into the cab
- Half windshield offers protection from rain, sleet, spray, and off-road hazards

» 2883320 • \$264<sup>99</sup>  
EV '15-22, CREW 570-4 '15-21, 570 '15-21, 500 '17-22

## REAR PANELS



### FLIP-DOWN WINDSHIELD - HARD COAT POLY TOP SELLER

- Two venting options: fully sealed or flip-down/remove upper half for some protection with maximum ventilation

» 2882178 • \$679<sup>99</sup>  
EV '15-22, CREW 570-4 '15-21, 570 '15-21, 500 '17-22

### LOCK & RIDE VENTED WINDSHIELD - HARD COAT POLY

- Frameless design for maximum visibility
- Added vents for airflow on a hot day or defrosting on a cold day

» 2883342 • \$744<sup>99</sup>  
EV '15-22, CREW 570-4 '15-21, 570 '15-21, 500 '17-22

### LOCK & RIDE FULL WINDSHIELD - HARD COAT POLY TOP SELLER

- Durable, optical-grade, .236"-thick polycarbonate offers outstanding rider protection and visibility
- Windshield has minimal perimeter framework for full visibility

» 2883319 • \$639<sup>99</sup>  
EV '15-22, CREW 570-4 '15-21, 570 '15-21, 500 '17-22

### LOCK & RIDE REAR PANEL - GLASS TOP SELLER

- Durable, tempered laminate glass provides a high level of scratch resistance

» 2879965 • \$434<sup>99</sup>  
EV '15-22, CREW 570-4 '15-21, 570 '15-21, 500 '17-22

### LOCK & RIDE REAR PANEL - POLY TOP SELLER

- Strong, .236"-thick polycarbonate provides outstanding impact and scratch resistance

» 2879812 • \$354<sup>99</sup>  
EV '15-22, CREW 570-4 '15-21, 570 '15-21, 500 '17-22

## HARD COAT POLY | 30x MORE SCRATCH-RESISTANT



### REDUCE IN-CAB DUST SWIRL BY ADDING A REAR PANEL

With a windshield and roof installed, turbulent air develops behind the cab. Add a rear panel to reduce dust intrusion from this swirl.



# CONVENIENCE & PROTECTION



## CONVENIENCE FEATURES

### CAB SEAL SYSTEM

» 2-SEAT • 2880508 • **\$164**<sup>99</sup>  
EV '15-22, CREW 570-4 '15-21, 570 '15-21, 500 '17-22  
(INCLUDED WITH PREMIUM DOORS)

### EPS SYSTEM (ELECTRIC POWER STEERING)

- Enjoy smooth, easy, precise, responsive automotive-quality power steering
- EPS provides a light steering feel in all situations, including low-speed maneuvering through challenging terrain

» 2879970 • **\$1,814**<sup>99</sup>  
CREW 570-4 '15-21, 570 '15-21  
1824163 REQUIRED FOR 2016 AND NEWER 570 MODELS

### HORN

» 2879273 • **\$94**<sup>99</sup>  
EV '15-22, CREW 570-4 '15-21, 570 '15-21, 500 '17-22

### AUXILIARY BATTERY KIT

» 2880555 • **\$419**<sup>99</sup>  
EV '15-22  
REQUIRED FOR 12V ACCESSORIES ON EV

### REVERSE WARNING ALERT

» 2880631 • **\$109**<sup>99</sup>  
CREW 570-4 '15-21, 570 '15-21, 500 '17-22

### SPEEDKEY

» 2879988 • **\$419**<sup>99</sup>  
CREW 570-4 '15-21, 570 '15-21

### EV QUICK CHARGING SYSTEM

» 2880556 • **\$844**<sup>99</sup>  
EV '15-22

# FIELD TESTED INTERIOR

**ADD SUPERIOR ALL-WEATHER FUNCTIONALITY** and comfort to your Ranger with premium Polaris Engineered Accessories. Keep warm on the coldest of days with a heater kit and improve visibility with a Windshield Wiper and Washer System or Large Rear View Mirror.



### WINDSHIELD WIPER & WASHER SYSTEM

• Use with Full Glass Windshield 2881783 only  
» 2879968 • **\$774**<sup>99</sup>  
EV '15-22, CREW 570-4 '15-21, 570 '15-21, 500 '17-22  
⚠ Requires Battery Connection Cable



### LARGE REAR VIEW MIRROR **TOP SELLER**

» 2879969 • **\$99**<sup>99</sup>  
EV '15-22, CREW 570-4 '15-21, 570 '15-21, 500 '17-22

### STANDARD BRUSHGUARDS

PERFECT FOR: **INCREASED PROTECTION AROUND LIGHTING AND FENDERS**

FRONT



1 3/4" DIAMETER  
STEEL TUBE CONSTRUCTION

REAR



» FRONT • 2879973 • **\$354**<sup>99</sup>  
EV '15-22, CREW 570-4 '15-21, 570 '15-21, 500 '17-22  
DOES NOT WORK WITH FLIP-DOWN POLY WINDSHIELD 2881919

» REAR • 2879972 • **\$344**<sup>99</sup>

### ROCK GUARDS WITH STEP



- Durable, stamped plate steel construction
- Provides additional protection for side of vehicle
- Integrated boot scraper helps keep interior clean

» 2 SEAT • 2879974 • **\$269**<sup>99</sup>  
EV '15-22, 570 '15-21, 500 '17-22

# WINCHES

FEATURES	PRO PRO HEAVY DUTY SERIES	HD HEAVY DUTY SERIES
RAPID ROPE RECOVERY	STANDARD	NOT AVAILABLE
AUTO STOP TECHNOLOGY	STANDARD	OPTION
WINCH LINE	SYNTHETIC ROPE	STEEL CABLE
CONTROL	WIRELESS STANDARD, WIRED OPTION	WIRED STANDARD, WIRELESS OPTION
MODEL	4,500 LB.	3,500 LB.
570 '15-21 CREW 570-4 '15-21 500 '17-22 EV '19-22 EV REQUIRES AUXILIARY BATTERY KIT 2880555	<b>2882238</b> \$1,149 <sup>99</sup>	<b>2881669</b> \$639 <sup>99</sup>



### WARRANTY

ADD REQUIRED CABLES

2-SEAT MODELS: **2879990** \$54<sup>99</sup>

CREW MODELS: **2880929** \$79<sup>99</sup>

### UPGRADE YOUR HD WINCH WITH THESE ACCESSORIES

#### WIRELESS REMOTE

- Up to 50 ft. range, with LED indicator
  - Direct plug and play operation
- » 2879316 • **\$184**<sup>99</sup>  
Works with 2881669

#### SYNTHETIC ROPE

- 4,500 LB.  
» 2879187 • **\$184**<sup>99</sup>
- 3,500 LB.  
» 2878888 • **\$109**<sup>99</sup>

#### AUTO STOP UPGRADE

- Billeted aluminum
  - Replaces stock fairlead
- » 2881693 • **\$144**<sup>99</sup>  
Works with 2881669  
SYNTHETIC ROPE REQUIRED

### UPGRADE YOUR CONTROLS HD OR PRO HD WINCHES

#### WIRED REMOTE CONTROL

- Must order remote handle and socket together
- » REMOTE HANDLE 4013466 • **\$90**<sup>99</sup>
- » SOCKET 4014228 • **\$64**<sup>99</sup>

#### POWER CONTROLLER

- Control your winch and plow hydraulics directly from the shift knob
- » 2879227 • **\$59**<sup>99</sup>  
CREW 570-4 '14-21, 570 FULL SIZE '17-22, 570 '14-21, 500 '11-22



# STORAGE



## LOCK & RIDE®

Exclusive and available on all Polaris vehicles, Lock & Ride accessories let you quickly change from one task to another with hundreds of options.

WITH THE FLIP OF A LEVER, LOCK & RIDE PLUNGERS USE OUTWARD PRESSURE TO EXPAND FOR A SECURE FIT.



## LOCK & RIDE CARGOMAX SYSTEM

- Comes standard with a support bar that ties the two sides together for a sturdy cargo hold
- Adjustable utility hooks provide more options for hanging tools, cords or gear
- Two sides and a support bar included

» 2882177 • \$744<sup>99</sup>

EV '15-22, CREW 570-4 '15-21, 570 '15-21, 500 '17-22



## CARGO BED MAT

- Non-slip surface to better secure loads
- Protect the cargo bed from scratches and scuffs
- Lifts out and is easy to clean
- Can be cut to access factory tie-down cleats

» 2881485 • \$144<sup>99</sup>

EV '11-22, CREW 570-4 '14-21, 570 '14-21, 500 '11-22

## LOCK & RIDE STORAGE BOX

- Rugged roto-molded construction locks for security and is water-resistant
- Low-profile design retains additional hauling capacity on top of vault
- Sliding drawer features foam padding and adjustable dividers
- Fits perfectly in the bed of your RANGER, pickup box or full-size SUV

» 2877033 • \$459<sup>99</sup>

EV '11-22, CREW 570-4 '14-21, 570 '14-21, 500 '11-22



## LOCK & RIDE TOOL RACK

- Attach on the inside or outside of the cargo bed

» 2881533 • \$344<sup>99</sup>

EV '11-22, CREW 570-4 '14-21, CREW 570 FULL SIZE '18-22, 570 FULL SIZE '17-22, 570 '14-21, 500 '11-22



## RIDE & REPAIR ESSENTIALS KIT

» 2881207 • \$144<sup>99</sup>

EV '11-22, CREW 570-4 '14-21, CREW 570 FULL SIZE '18-22, 570 FULL SIZE '17-22, 570 '14-21, 500 '11-22

## STRAPS



## 1.5" x 15' 5,500 LB. RATCHET STRAP

- Heavy-duty webbing
- 2 Pack

» 2884031 • \$59<sup>99</sup>



## FIRE EXTINGUISHER HOLDER

- Quick-release strap allows for easy access

» 2882158 • \$119<sup>99</sup>

EV '15-22, CREW 570-4 '15-21, 570 '15-21, 500 '17-22



## LOCK & RIDE D-RINGS TOP SELLER

- The most versatile Lock & Ride accessory - add as many as you need to secure your cargo with bungee cords or straps

» 2881545 • \$44<sup>99</sup>

EV '11-22, CREW 570-4 '14-21, CREW 570 FULL SIZE '18-22, 570 FULL SIZE '17-22, 570 '14-21, 500 '11-22



## LOCK & RIDE QUICKSTRAP

- The quickest and most secure way to mount Polaris accessories
- Sold as a pair

» 2882187 • \$59<sup>99</sup>

ALL COOLERS, RANGER CARGO BOXES



## UNDER SEAT STORAGE BOX

» 2880046 • \$144<sup>99</sup>

EV '15-22, CREW 570-4 '15-21, 570 '15-21, 500 '17-22



## LOCK & RIDE CHAINSAW MOUNT

» 2879354 • \$184<sup>99</sup>

EV '11-22, CREW 570-4 '14-21, CREW 570 FULL SIZE '18-22, 570 FULL SIZE '17-22, 570 '14-21, 500 '11-22



## 2" x 20' 10,000 LB. RATCHET STRAP

- Heavy-duty webbing

» 2884032 • \$44<sup>99</sup>

## DO MORE:



**COOLERS**  
P. 48



**HUNT**  
P. 50



**COLD WEATHER**  
P. 52



**LIGHTING**  
P. 58



# PERFORMANCE & COMFORT

THE RANGER 570 FULL-SIZE builds on its legendary reputation for getting the job done. With the industry's most complete lineup of Polaris Engineered Accessories, it's ready for anything your work demands.



## ROOFS



### SPORT ROOF

- Lightweight, rugged polyethylene construction
- Offers protection from sun and rain
- Does not work with Full Doors

» **TOP SELLER** 3-SEAT • 2877946 • **\$459<sup>99</sup>**  
570 FULL SIZE '17-21

» CREW • 2878755 • **\$749<sup>99</sup>**  
CREW 570 FULL SIZE '17-22



### BIMINI SOFT TOP

- Tight-fitting canvas soft top with easy on/off design
- Lightweight 600 denier, solution-dyed polyester construction

» 2876963-067 • **\$144<sup>99</sup>**  
570 FULL SIZE '17-22

## ROOF/REAR PANEL



### CANVAS ROOF/REAR PANEL

- Constructed from premium, mold-resistant polyester with UV stabilizers
- Durable, heat-sealed vinyl window for crack resistance

» 2883471 • **\$499<sup>99</sup>**  
570 FULL SIZE '17-22

## DOORS



### RANGER CANVAS DOORS

- Constructed from premium, mold-resistant polyester with UV stabilizers
- Durable, heat-sealed vinyl window for crack resistance
- Zip-down windows for adjustable ventilation

» 2876962-067 • **\$649<sup>99</sup>**  
570 FULL SIZE '17-22  
REQUIRES 2883471 CANVAS ROOF/REAR PANEL  
DOES NOT FIT WITH 2877946 OR 2876963-067

## WINDSHIELDS



### POLY WINDSHIELD

- Optical-grade, .236"-thick polycarbonate for outstanding protection and visibility

» **HARD COAT** • 2879489 • **\$704<sup>99</sup>**  
CREW 570 FULL SIZE '18-22, 570 FULL SIZE '17-22

» **TOP SELLER** **GENERAL PURPOSE** • 2876958 • **\$574<sup>99</sup>**  
CREW 570 FULL SIZE '18-22, 570 FULL SIZE '17-22



### LOCK & RIDE HALF WINDSHIELD

- Durable, optical-grade, .177"-thick polycarbonate for impact-resistance
- Half-height design delivers improved airflow for hot/dusty conditions
- Retains sporty, rugged look

» 2878756 • **\$304<sup>99</sup>**  
CREW 570 FULL SIZE '18-22, 570 FULL SIZE '17-22

## REAR PANEL



### POLY REAR PANEL

- Constructed from thick, impact resistant polycarbonate
- Delivers protection from the elements and a quieter ride
- Scratch-resistant for years of clear vision
- Contoured design eliminates perimeter framework for full rearward visibility

» 2878165 • **\$354<sup>99</sup>**  
CREW 570 FULL SIZE '18-22, 570 FULL SIZE '17-22

**LOCK & RIDE** ADD STORAGE TO YOUR RANGER 570 P. 78

## DO MORE:



**COOLERS**  
P. 48

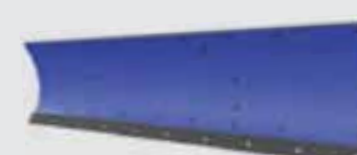

**COLD WEATHER**  
P. 52



**HUNT**  
P. 50



**LIGHTING**  
P. 58

## PROTECTION



### BRUSHGUARDS

- Provides front impact resistance and headlight protection
- Durable, scratch-resistant black powder-coated finish

» FRONT • 2881662 • **\$309<sup>99</sup>**  
CREW 570 FULL SIZE '18-22, 570 FULL SIZE '17-22



### HORN

- Can be used with accessory winch or plow system
- Does not interfere with rear cargo drop gate

» 2875048 • **\$104<sup>99</sup>**  
570 FULL SIZE '17-22

### REVERSE BEEPER

» 2880631 • **\$109<sup>99</sup>**  
CREW 570-4 '15-21, 570 '15-21, 500 '17-22

## WINCHES

FEATURES	PRO PRO HEAVY DUTY SERIES	HD HEAVY DUTY SERIES
RAPID ROPE RECOVERY	STANDARD	NOT AVAILABLE
AUTO STOP TECHNOLOGY	STANDARD	OPTION
WINCH LINE	SYNTHETIC ROPE	STEEL CABLE
CONTROL	WIRELESS STANDARD, WIRED OPTION	WIRED STANDARD, WIRELESS OPTION
MODEL	4,500 LB.	3,500 LB.
570 FULL-SIZE '16-22 CREW 570 FULL-SIZE '16-22	<b>2882238</b> \$1,149 <sup>99</sup>	<b>2881669</b> \$639 <sup>99</sup>



### WARRANTY

#### ADD REQUIRED CABLES

3-SEAT MODELS:  
**2881684** \$44<sup>99</sup>

CREW MODELS:  
**2880929** \$79<sup>99</sup>

### UPGRADE YOUR HD WINCH WITH THESE ACCESSORIES

#### WIRELESS REMOTE

- Up to 50 ft. range with LED indicator
- Direct plug and play operation

» 2879316 • **\$184<sup>99</sup>**  
WORKS WITH 2881669

#### SYNTHETIC ROPE

- 3,500 LB.
- » 2878888 • **\$109<sup>99</sup>**
- 4,500 LB.
- » 2879187 • **\$184<sup>99</sup>**

#### STEEL CABLE

- 3,500 LB.
- » 2878890 • **\$59<sup>99</sup>**

#### AUTO STOP UPGRADE

- Billeted aluminum
- Replaces stock fairlead

» 2881693 • **\$144<sup>99</sup>**

WORKS WITH 2881669  
SYNTHETIC ROPE REQUIRED

### UPGRADE YOUR CONTROLS HD OR PRO HD WINCHES

#### WIRED REMOTE CONTROL

- Must order remote handle and socket together

» REMOTE HANDLE 4013466 • **\$90<sup>99</sup>**

» SOCKET 4014228 • **\$64<sup>99</sup>**

#### POWER CONTROLLER

- Control your winch and plow hydraulics directly from the shift knob

» 2879227 • **\$59<sup>99</sup>**

EV '11-22, CREW 570-4 '14-21, 570 FULL SIZE '17-22, 570 '14-21, 500 '11-22



# HIT THE TRAILS RANGER 150 EFI ACCESSORIES



**NEW**  
**HALF DOOR** WINTER AVAILABILITY

- Steel half doors protect your cab from rocks and debris
- Added comfort with padded elbow guards

» **BLACK • 2889022 • \$519<sup>99</sup>**  
150 EFI '18-22



**FRONT & REAR  
BRUSHGUARD - SET**

- Includes front and rear bumper
- Durable, E-coated steel construction

» **BLACK • 2883287 • \$144<sup>99</sup>**  
150 EFI '18-22



**SPORT ROOF - POLY**

- Shields you from rain, snow, sun
- Easy install

» **BLACK • 2883289 • \$284<sup>99</sup>**  
150 EFI '18-22

**YOUTH CRAWLER TIRE**

- Upgraded youth tire for added durability
  - Increased ground clearance and performance
- 150 EFI '18-22

	TREAD DEPTH	TIRE WEIGHT	PLY RATING	SIDEWALL BELTS	LOAD RATING
12" ↑ 22" x 8" R12 5416945 • \$139 <sup>99</sup>	FRONT/ REAR 13 mm	18 lbs	6	3	910 lbs
12" ↓ 22" x 10" R12 5416944 • \$149 <sup>99</sup>					



**YOUTH BUCKLE - BLACK**

- » FRONT • 12" x 7" • 1524114 • \$124<sup>99</sup>
  - » REAR • 12" x 8" • 1524115 • \$139<sup>99</sup>
- 150 EFI '18-22



**PRO ARMOR WHEEL & TIRE KIT:  
YOUTH CRAWLER & BUCKLE**

» 2885154 • \$1,004<sup>99</sup>  
150 EFI '18-22



**FULL-WINDSHIELD - POLY**

- .125" clear poly carbonate
- Mounts with four simple P-clamps

» 2883288 • \$219<sup>99</sup>  
150 EFI '18-22



**HALF-WINDSHIELD - POLY**

- 13" tall
- .125" clear poly carbonate
- Mounts with four simple P-clamps

» 2883298 • \$144<sup>99</sup>  
150 EFI '18-22



# FOR THE LIFE OF YOUR RIDE

**PARTS THAT PUSH THE LIMITS WITHOUT SACRIFICING STRENGTH AND DURABILITY.**  
We build our products so anyone with the right tools can maintain their vehicle.

**POLARIS**  
**ENGINEERED PARTS & LUBRICANTS**

PARTS & GARAGE

MAINTENANCE

OIL & LUBRICANTS

MAINTENANCE FLUIDS

BATTERIES & GARAGE ACCESSORIES

HD PARTS

SERVICE PARTS

TIRE SEALANT & TRAILERING

POLARIS POWER

95

## MAINTENANCE TIP

### BREAK-IN PERIOD

The break-in period for your new RANGER is the first 25 hours of operation, or the time it takes to use the first two tanks of fuel. No single action on your part is as important as a proper break-in period. Careful treatment of a new engine will result in more efficient performance and longer life for the engine.

**NOTICE:** Excessive heat build-up during the first three hours of operation will damage close-fitted engine parts. Do not operate at full throttle or high speeds for extended periods during the first three hours of use.

SEE OUR LATEST MAINTENANCE TIPS AT [RANGER.POLARIS.COM/EN-CA/SELF-HELP](http://RANGER.POLARIS.COM/EN-CA/SELF-HELP)

### AIR FILTER

A clogged air filter can restrict air flow to the engine leading to reduced engine performance, engine life or catastrophic failure.

### BRAKE PADS

Maintaining and/or replacing brakes are critical to the safety and functionality of a vehicle. Brake pads should be checked for wear and oil or grease (petroleum products) contamination and brake discs should be checked for cracks, excessive corrosion or warping.

### HALF SHAFT

Check for tears and punctures in the boot, which can lead to CV joint wear that can contribute to axle failure.

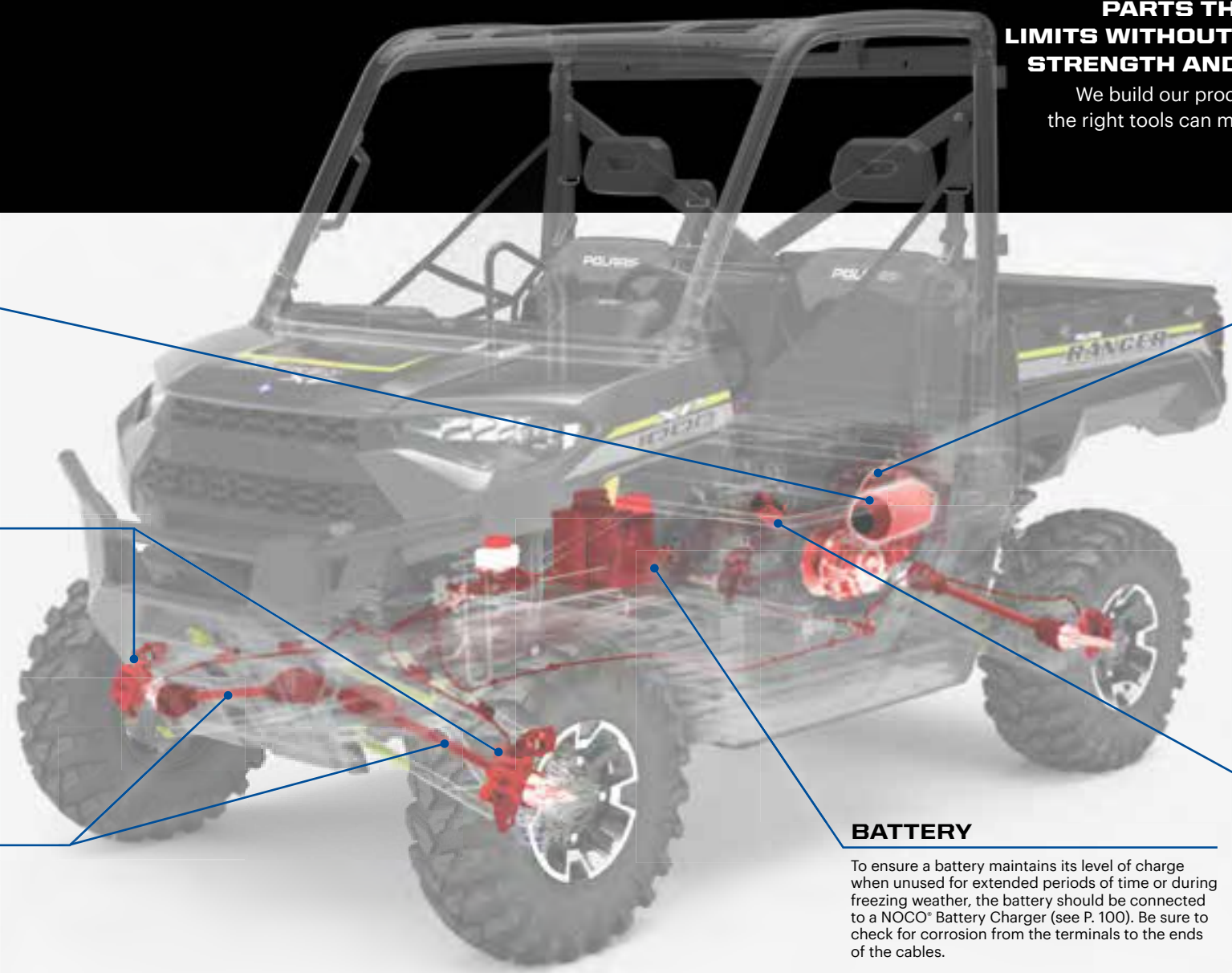

### DRIVE BELT

Polaris Engineered belts deliver unmatched performance for your off-road vehicle. Developed and tested on all our engines for all environments and conditions. Check your belt for delamination, hour glassing and glazing.

#### BREAK-IN PERIOD

- Use lower gear (if available) while varying speeds and avoid wide open throttle for 5-10 miles / 8-16 km
- If no low gear is available, vary at moderate speeds while avoiding wide open throttle for 50 miles / 80 km

#### OUR INVESTMENT

- 40,000+ miles / 32,187 km of field testing
- Thousands of dyno hours
- 18+ months of development (13,000+ design hours) per belt
- 1,500+ vehicle validation hours
- Collaboration with powertrain and clutch engineers

#### YOUR ADVANTAGE

- No clutch recalibration
- Less wear and tear due to heat
- Ensure maximum vehicle performance
- More time riding, less time wrenching
- Produced in collaboration with powertrain and clutch engineers to ensure a perfect fit, maximum performance and ultimate durability

### OIL FILTER

Change oil filters with every oil change to provide the best engine protection and keep the engine operating at peak performance.

### BATTERY

To ensure a battery maintains its level of charge when unused for extended periods of time or during freezing weather, the battery should be connected to a NOCO® Battery Charger (see P. 100). Be sure to check for corrosion from the terminals to the ends of the cables.

**FOLLOW RECOMMENDED SERVICE INTERVALS IN THE OWNER'S MANUAL**

# MAINTENANCE SCHEDULE

25 HRS / 250 Mi / 400 km

## BREAK-IN MAINTENANCE

**ENGINE OIL & OIL FILTER:** CHANGE

**GENERAL LUBRICATION:** ALL FITTINGS, PIVOTS, CABLES, ETC.

**AIR FILTER:** INSPECT & REPLACE AS NEEDED

**EXHAUST SYSTEM:** INSPECT & CLEAN  
INSPECT FOR LEAKAGE OR CARBON BUILD UP AT JOINTS  
INSPECT & CLEAN SCREEN TYPE SPARK ARRESTOR

50 HRS / 500 Mi / 800 km

## 6 MONTHS

**EXHAUST SYSTEM:** INSPECT & CLEAN  
INSPECT FOR LEAKAGE OR CARBON BUILD UP AT JOINTS  
INSPECT & CLEAN SCREEN TYPE SPARK ARRESTOR

**GENERAL LUBRICATION:** ALL FITTINGS, PIVOTS, CABLES, ETC.

100 HRS / 1,000 Mi / 1,600 km

## 12 MONTHS

**ENGINE OIL & OIL FILTER:** CHANGE

**DRIVE BELT:** INSPECT & ADJUST  
REPLACE AS NEEDED

**TRANSMISSION FLUID:** CHANGE

**FRONT DRIVE FLUID:** CHANGE

**DRIVE BELT:** INSPECT & ADJUST  
REPLACE AS NEEDED

**EXHAUST SYSTEM:** INSPECT & CLEAN  
INSPECT FOR LEAKAGE OR CARBON BUILD UP AT JOINTS  
INSPECT & CLEAN SCREEN TYPE SPARK ARRESTOR

150 HRS / 1,500 Mi / 2,400 km

## 18 MONTHS

**ENGINE OIL & OIL FILTER:** CHANGE

**BATTERY:** TEST, CLEAN & REPLACE AS NEEDED

**DRIVE BELT:** INSPECT & ADJUST  
REPLACE AS NEEDED

**TIRES:** INSPECT CONDITION & PRESSURE

**EXHAUST SYSTEM:** INSPECT & CLEAN  
INSPECT FOR LEAKAGE OR CARBON BUILD UP AT JOINTS  
INSPECT & CLEAN SCREEN TYPE SPARK ARRESTOR

200 HRS / 2,000 Mi / 3,200 km

## 24 MONTHS

**ENGINE OIL & OIL FILTER:** CHANGE

**BRAKE PADS & FLUID:** INSPECT & CLEAN  
REPLACE AS NEEDED

**SPARK PLUGS:** INSPECT  
REPLACE AS NEEDED

**EXHAUST SYSTEM:** INSPECT & CLEAN  
INSPECT FOR LEAKAGE OR CARBON BUILD UP AT JOINTS  
INSPECT & CLEAN SCREEN TYPE SPARK ARRESTOR

250 HRS / 2,500 Mi / 4,023 km

## 30 MONTHS

**ENGINE OIL & OIL FILTER:** CHANGE

**BATTERY:** TEST, CLEAN & CHECK FLUID LEVEL  
REPLACE AS NEEDED

**DRIVE BELT:** INSPECT & ADJUST  
REPLACE AS NEEDED

**GENERAL LUBRICATION:** ALL FITTINGS, PIVOTS, CABLES, ETC.

**EXHAUST SYSTEM:** INSPECT & CLEAN  
INSPECT FOR LEAKAGE OR CARBON BUILD UP AT JOINTS  
INSPECT & CLEAN SCREEN TYPE SPARK ARRESTOR

300 HRS / 3,000 Mi / 4,828 km

## 36 MONTHS

**ENGINE OIL & OIL FILTER:** CHANGE

**AIR FILTER:** INSPECT & REPLACE AS NEEDED

**GEARCASES:** CHECK OIL LEVEL

**EXHAUST SYSTEM:** INSPECT & CLEAN  
INSPECT FOR LEAKAGE OR CARBON BUILD UP AT JOINTS  
INSPECT & CLEAN SCREEN TYPE SPARK ARRESTOR

**CHECK YOUR OWNER'S MANUAL FOR ADDITIONAL RECOMMENDED SERVICE ITEMS AND VEHICLE-SPECIFIC TIMING**



# OIL



## NEW PS-4 FORMULATIONS BEST PROTECTION, BEST PERFORMANCE

Our new PS-4 5W-50 formulation and PS-4 Extreme Synthetic 0W-50 have been designed to provide the best fluid technologies for long lasting wear protection. These formulations include a new Polaris exclusive additive system to keep the engine cleaner from deposit build-up to maximize power and powersports-grade synthetic base stocks that provide the ultimate in engine protection.

### PS-4 5W-50 FULL-SYNTHETIC OIL

Optimal for ambient operating temperatures of -40° F to 100° F

- » 1 Quart 2876244
- » 1 Gallon 2876245
- » 16 Gallons 2876247
- » 55 Gallon Drum 2876246
- » 330 Gallon Tote 2878814

### PS-4 0W-50 EXTREME FULL-SYNTHETIC OIL

Optimal for ambient operating temperatures of -45° F to 130° F

- » 1 Quart 2889395
- » 1 Gallon 2889396
- » 16 Gallons 2889397
- » 55 Gallon Drum 2889398
- » 330 Gallon Tote 2889399

PS-4 5W-50 OIL CHANGE KITS		PS-4 (EXTREME DUTY) 10W-50	
PART NUMBER	VEHICLE FITMENT	PART NUMBER	
2202166	RANGER/RZR/SPORTSMAN 570, TWIN 600, TWIN 700, TWIN 800	2879004	
2879323	RANGER, POLARIS GENERAL 900-1000, RZR 900-1000, RS1	2879324	
2877473	RANGER/SPORTSMAN 300-500, SPORTSMAN/SCRAMBLER 500/850/1000	2878924	
2881696	RZR TURBO	2881697	

### ENGINE WEAR TEST LOWER NUMBER = LESS WEAR OF CRITICAL ENGINE PARTS LESS WEAR MEANS LONGER ENGINE LIFE

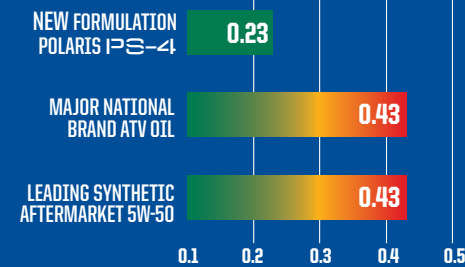

ASTM D4172. In 3rd party against 11 competitive products Polaris had 40% or better wear protection compared to all of the test products.

#### THE BEST PROTECTION

- At least 40% improved wear protection compared to previous Polaris PS-4 formulation and all aftermarket oils tested

Best engine protection against wear for the longest engine life.

### DEPOSIT TEST LOWER DEPOSITS = MAXIMUM POWER

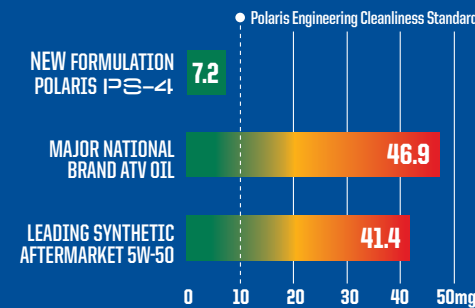

ASTM D6395. In 3rd party against 9 competitive products Polaris PS-4 had less than half the deposits compared to the next closest product. No other tested products met Polaris Engineering standards for deposit cleanliness.

#### MAXIMUM PERFORMANCE

- New improved PS-4 formulation provides 33% less deposits than previous PS-4 formula

- At least 50% less deposits than all aftermarket oils tested

The cleanest engine for maximum power and performance!

## POLARIS EXTREME SYNTHETICS

Our new PS-4 Extreme Synthetic 0W-50 formulation applies only to the **absolute highest performance** products we sell, for ultimate protection and performance in the most extreme conditions.



- Our best extreme high temp formulation, excellent for severe high temperatures and for racing, even at temps over 54°C.

- Provides easier starting and cold temperature protection, even to extreme cold temps of below -42°C.

- Latest in premium synthetic PAO and Ester base stocks along with careful balance of moly and ZDDP additives for ultimate long lasting wear protection.

- Polaris exclusive clean engine additive system reduces deposits and carbon build-up for peak performance and power.



POLARIS INVESTS IN EACH OIL AT AND ABOVE THESE LEVELS

12+ DEDICATED  
TEAM MEMBERS

FOCUSED ON  
POLARIS OIL

18+  
MONTHS

DEVELOPMENT  
& TESTING

76,000+  
HOURS

DYNO  
TESTING

1.9 MILLION  
MILES (3,057,753 KM)

FIELD  
TESTING



# MAINTENANCE FLUIDS



## ENGINE OIL

Maximum protection for your 4-cycle engine.  
NOT COMPATIBLE WITH XP KINETIC



## AGL

Protect gears, drive chain and bearings from scoring and wear.

- » 1 QT • 2878068
- » 1 GALLON • 2878069
- » 2.5 GALLONS • 2878070
- » 55 GALLONS • 2879594



## ORV MAINTENANCE KITS

Everything you need, in the correct fluid volumes, to maintain your drive train and keep your vehicle in top operating condition

- Includes: 1.5 quarts AGL, 1 quart Angle Drive Fluid, 1 pint Demand Drive Fluid, 1-3 OZ tube of All-Season Grease
- » 2880425  
ALL MODELS
- Includes: 2.5 quarts of PS-4, 2 Spark Plugs, 1 Air Filter, 2 quarts of AGL, 1 pint Demand Drive Fluid & 1 Paper Oil Funnel
- » 2830555  
'13-19 XP 900



## DOT 4 BRAKE FLUID

A high-quality brake fluid designed for use in Polaris hydraulic brakes.  
» 12 OZ • 2872189



## ANTI-FREEZE

Prevent corrosion on metal components, eliminate scaling and maximize cooling system performance.

- » 1 QT • 2880514
- » 1 GALLON • 2880513
- » 55 GALLONS • 2880512



## DEMAND DRIVE FLUID

Provide positive 4WD engagement in extreme cold or high heat conditions and protect internal components under heavy loads.

- » 1 QT • 2877922
- » 2.5 GALLONS • 2877923



## PREMIUM GAS SHOCK OIL

- » 1 QT • 2874124  
WALKER EVANS RACING® REBUILDABLE SHOCKS
- » 1 QT PREMIUM • 2870995
- » 2.5 GALLONS PREMIUM • 2872279  
FOX® REBUILDABLE SHOCKS

NOT COMPATIBLE WITH XP KINETIC



## SUSPENSION/ U-JOINT GREASE

- » 3 OZ • 2871515
- » 14 OZ • 2871551



## CHAIN LUBRICANT

Provides superior anti-wear and shock protection

- » 16 OZ AEROSOL 2872348  
NOT COMPATIBLE WITH XP KINETIC



## ALL-SEASON GREASE TUBE

Specialized water-resistant lubricant

- » 3 OZ • 2871322
- » 14 OZ • 2871423



## ANGLE DRIVE FLUID

Extreme pressure, anti-wear and high viscosity film lubrication for maximum protection

- » 1 QT • 2876160
- » 2.5 GALLONS • 2872276

RANGER ANGLE DRIVE GEAR CASE SYSTEMS. NOT COMPATIBLE WITH XP KINETIC



## GENERATOR OIL

4-cycle engine oil

- » 1 QT • 2879383



## CARBON CLEAN

Ultimate fuel and injection system cleaner

- » 12 OZ • 2881413

NOT COMPATIBLE WITH XP KINETIC



## ADVANCED FUEL TREATMENT

Dual antioxidant formula protects jets and fuel system from gum and varnish

- » 12 OZ • 2881416

NOT COMPATIBLE WITH XP KINETIC



# BATTERY CHARGERS



**NEW**  
NOCO® BATTERY CHARGER - 1 AMP

- Ensure your battery is charged with the NOCO Battery Charger 1 Amp
  - Includes Boost Eyelet Cable with X-Connector Adapter (2830546)
- » 2830567 • \$79<sup>99</sup>



**NEW**  
NOCO® BATTERY CHARGER - 2 AMP

- Ensure your battery is charged with the NOCO Battery Charger 2 Amp
  - Includes Boost Eyelet Cable with X-Connector Adapter (2830546)
- » 2830568 • \$121<sup>99</sup>



**NEW**  
1,000 AMP ULTRASAFE LITHIUM JUMP PACK

- Delivers 1,000 amps for jump starting a dead battery in seconds
- » 2830547 • \$169<sup>99</sup>



**NEW**  
JUMP PACK PROTECTION CASE

- Lightweight, durable and rugged custom exterior
- » 2830548 • \$26<sup>99</sup>

## BatteryMINDER® ACCESSORIES



BatteryMINDER® 12' CABLE

- Made with heavy-duty, 16-gauge black zip cord featuring automotive SAE bullet connectors
- » 2830410 • \$15<sup>99</sup>



BatteryMINDER® VPP-12/24 VOLT VEHICLE POWER PLUG

- Allows easy connection to vehicle battery through lighter or 12/24 V power port with replaceable 15 amp fuse
- » 2830518 • \$16<sup>99</sup>



BatteryMINDER® SPLITTER

- Connect two batteries simultaneously for easy battery maintenance
  - Cap includes a set of ring terminals
- » 2830409 • \$45<sup>99</sup>



BatteryMINDER® RING TERMINAL

- Features 24" long 18-gauge wire
  - Plug has standard 5/16" negative and 3/8" positive terminals
  - Replaceable 15 amp in-line fuse for circuit protection
- » 2830437 • \$12<sup>99</sup>



BatteryMINDER® EZ CONNECT

- Allows for quick, easy connecting and disconnecting of your BatteryMINDER®
  - Includes a set of ring terminals
- » 2830411 • \$32<sup>99</sup>

# GARAGE ACCESSORIES



FLUID FUNNEL

- Easily add oil with high accuracy
- » 2830552 • \$17<sup>99</sup>



GREASE GUN

- Enables easy application of grease
- » 2871312 • \$44<sup>99</sup>  
FITS 2871322 ALL-SEASON AND 2871515 U-JOINT 3 OZ



FLEX SPOUT

- Fits all Polaris quart, gallon and 2.5 gallon bottles
- » 2871285 • \$3<sup>99</sup>



FLUID TRAY

- Holds up to 8 quarts of fluid
- » 2830551 • \$26<sup>99</sup>



PUMP

- Fits 1 and 2.5 gallon bottles
- » 2870465 • \$9<sup>99</sup>



OIL FILTER WRENCH

- Remove Polaris ORV oil filters with ease
- » 2830550 • \$10<sup>99</sup>



POLARIS SHOP TOWELS

- » 200 CT WITH DISPENSER (SHOWN) 2830402 • \$28<sup>99</sup>
- » 200 CT REFILL • 2830403 • \$19<sup>99</sup>
- » 64 CT REFILL • 2830440 • \$6<sup>99</sup>



POLARIS HEAVY-DUTY SCRUBBER WIPES

- » 90 CT • 2830441 • \$24<sup>99</sup>



**NEW**  
PREMIUM MAINTENANCE TOOL KIT

- Includes everything you need to work on and repair Polaris vehicles
  - Lifetime warranty on select tools
- » 2830565 • \$659<sup>99</sup>



2D BATTERY-OPERATED SIPHON PUMP

- Liquid transfer pumps 5-6 quarts/min suctioning power
- » 2830513 • \$20<sup>99</sup>



FLUID SYRINGE

- Easily add and remove fluid from your vehicle
- » 2830553 • \$39<sup>99</sup>



POLARIS MAGNETIC PARTS TRAY

- » SILVER • 2830432 • \$15<sup>99</sup>



POLARIS 33" TELESCOPIC MAGNET

- » BLACK • 2830435 • \$6<sup>99</sup>



POLARIS 12" HI-TORQUE RATCHETING DRIVER

- » BLACK / BLUE • 2830434 • \$24<sup>99</sup>



POLARIS LED POCKET FLASHLIGHT

- » BLACK • 2830436 • \$30<sup>99</sup>



# HD HEAVY DUTY PARTS

All Polaris parts are developed and tested to help you get the most out of your ride. We're taking the passion of our riders, workers and outdoor enthusiasts to the next level with HD Parts.

Engineered and designed for:

- Greater durability
- Enhanced performance
- Greater wear and tear capabilities
- All weather conditions

## NEW OIL FILTERS

The advanced synthetic material built into these filters offers the highest debris holding capacity, maintains oil flow and maximizes performance.

OE	HD HEAVY DUTY PARTS
2540086	2522485

## WHEEL BEARINGS

Fully sealed for added protection against intrusions. Made of a higher grade steel for extended life in extreme conditions.

LOCATION	OE	HD HEAVY DUTY PARTS
FRONT WHEEL BEARINGS	3514924	3515090
	3514634	3515088
REAR WHEEL BEARINGS	3514924	3515090
	3514917	3515087
	3514635	3515087

## WHEELS & TIRES

Class leading durability for off-road performance and traction for confident driving in extreme conditions.

- » 1524022-458 • HD WHEEL - 14x7\*
- » 5417507 • PRO ARMOR HD-K - 29x10R14\*
- » 5457498-458 • HD WHEEL CENTER CAP\*
- » 5415756 • PRO ARMOR XD-K FRONT
- » 5415757 • PRO ARMOR XD-K REAR

\* SHOWN

## NEW DRIVE BELTS

The enhanced rubber material compound in these belts keep them cool in extreme heat, while our patented cord treatment process maximizes the transfer of horsepower to the ground for those customers hauling heavy loads.

OE	HD HEAVY DUTY PARTS
3211149	
3211169	3212326
3211196	
3211113	3212328

## BUSHINGS

The advanced material compound of the bushings enables tighter tolerances to reduce overall wear on the system, while the superior triple lip sealing prevents intrusion of the elements.

LOCATION	OE	HD HEAVY DUTY PARTS
FRONT UPPER BUSHINGS	5439874	1543367
	5439730	1543326
FRONT LOWER BUSHINGS	5439874	1543367
	5439730	1543326
REAR UPPER BUSHINGS	5439874	1543367
	5439730	1543326
REAR LOWER BUSHINGS	5439874	1543367
	5439730	1543326
UPPER HUB BUSHINGS	5439270	1543326
LOWER HUB BUSHINGS	5439270	1543326

## NEW BRAKES

Engineered to provide longer life and better stopping power while riding in extreme conditions.

OE	HD HEAVY DUTY PARTS
2205949	2208933
2202413	2208934
2203318	2208936

## BUSHING KITS

Easily update the entire front and rear suspension.

- » 2830560  
XP 900 '13-'19, XP 900 CREW '14-'19, XP 1000 '17, XP 1000 CREW '17, 570 FULL SIZE '15-'20, 570 FULL SIZE CREW '15-'20
- » 2830561 (SHOWN)  
570 EFI '14-'20, 570 EFI CREW '14-'20

Claims made based off testing and performance of Polaris HD Parts against standard OEM parts made by Polaris and competitor brands under normal use.

For more information regarding Polaris HD parts including vehicle compatibility, installation and maintenance, please contact your authorized Polaris ORV dealer.

VISIT [POLARIS.COM/HDPARTS](https://www.polaris.com/hdparts) TO LEARN MORE

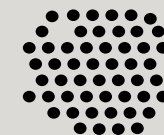

SAND



MUD



WATER



EXTREME COLD



EXTREME HEAT UP TO 130° F



HEAVY PAYLOADS



EXTENDED LIFE

PARTS & GARAGE

MAINTENANCE

OIL & LUBRICANTS

MAINTENANCE FLUIDS

BATTERIES & GARAGE ACCESSORIES

HD PARTS

SERVICE PARTS

TIRE SEALANT & TRAILERING

POLARIS POWER



# SERVICE PARTS

Polaris Engineered service parts deliver unmatched performance and fit for your off-road vehicle.

All service parts are engineered specifically for your machine. Which means everything is designed, tested and perfected to maximize the life of your ride. Getting Polaris Engineered parts is a decision that pays off in the long run, because it ensures there is a long run.



**SHOP FOR SERVICE PARTS ONLINE  
OR VISIT YOUR POLARIS DEALER.**

OVER  
100,000  
PARTS  
AVAILABLE!



## CHECK OUT OUR PARTS FINDER ON POLARIS.COM

FOR EASY PARTS LOOK-UP, PARTS IDENTIFICATION, VIEWS OF ASSEMBLIES & MORE!



### STEP 1

Visit **Polaris.com/RANGER**  
Click the **"Accessories & Parts"** tab  
Click **"Parts & Maintenance"**



### STEP 2

Enter **vehicle year/model**  
or shop by **part number**



### STEP 3

Clearly see what parts  
are required and **order**





# CV BOOT REPAIR KIT\*

FIX ON THE GO | TEMPORARY COVERAGE

- A quick trail-side fix to increase trail time
- The flexible and durable boot material expands over a cone tool for CV boot repairs, without disassembling CV axles
- Universal fit – works as a temporary fix for most powersports axles
- All components fit inside the cone, and a cover is provided for compact durable storage
- Easily fits in a cargo box, attached to the roll cage, in the glovebox or many other storage locations



Items shown are contained inside cone

## UTV CV BOOT REPAIR KIT

Kit includes the following items:

- (1) Expandable XL CV Boot
- (1) Reusable Cone Tool
- (2) CV Boot Clamps
- (1) Tube of Silicone Lube
- (1) Grease Packet
- (1) Cone Cover

» 2830526 • \$36<sup>99</sup>

## UTV TRAIL BOOT ONLY

» 2830527 • \$18<sup>99</sup>

## ATV

- CV REPAIR KIT 2830528 • \$31<sup>79</sup>
- TRAIL BOOT ONLY 2830529 • \$18<sup>99</sup>

SEE HOW THE CV BOOT REPAIR KIT WORKS AT [POLARIS.COM/MAINTENANCE-VIDEOS](http://POLARIS.COM/MAINTENANCE-VIDEOS)



## HOW TO INSTALL

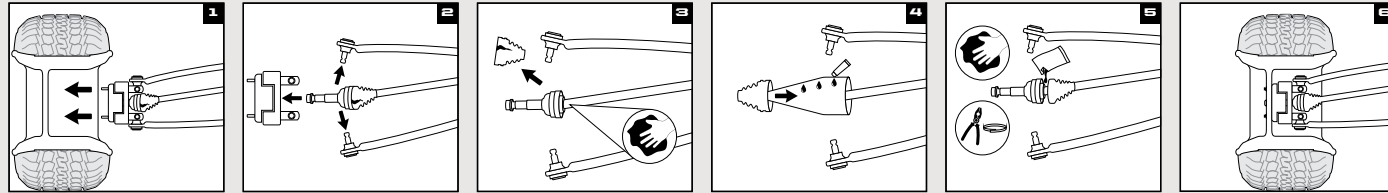

1 Remove wheel and axle nut.

2 Remove brake caliper, hub, tie rod and upper and lower ball joints.

3 Remove old boot and clean joint.

4 Spread silicone lube on entire cone tool. Slide boot over cone tool, large end first. See package for outer boot instructions.

5 Empty the bag of grease into the CV joint/boot, clean sealing points and install clamps.

6 Reassemble tie rod, ball joints, brake caliper, axle nut, tire and wheel.

Refer to your service manual for further instructions and torque specifications.  
\*Designed for temporary CV boot repair. Purchase the OEM CV Boot for a permanent repair.

# TIRE SEALANT



Once a leak occurs, the tire sealant rushes out of the tire and quickly creates a permanent solid plug.

The plug maintains the pressure of the tire so you can continue your ride.

## HOW IT WORKS

Tire sealant remains liquefied inside the tire until a leak develops in the tire or wheel.

## HOW MUCH TIRE SEALANT DO YOU NEED?

$$\begin{array}{r} \text{TIRE HEIGHT (IN.)} \times \text{TIRE WIDTH (IN.)} / 5 = \text{OUNCES REQUIRED PER TIRE} \\ | \qquad \qquad | \qquad \qquad | \\ 27" \times 10" / 5 = 54 \text{ oz} \end{array}$$

FOR A FULL APPLICATION CHART, VISIT [POLARIS.COM/TIRESEALANTCHART](http://POLARIS.COM/TIRESEALANTCHART)

## PREMIUM TIRE SEALANT

- Instantly seals and repairs rim, bead leaks and punctures up to .25" on standard tires and .75" on heavy ply tires
- Helps maintain air pressure for the life of the tire
- Helps seal the tire bead against the wheel
- 100% water soluble for easy cleanup
- Will not rust, corrode or pit wheels
- Creates permanent repair
- Remains fluid and effective in temperatures down to -45° F
- Easily installed through existing tire valve stem with valve core removed

» 32 OZ • 2830484 • \$25<sup>99</sup>

» 1 GALLON • 2830485 • \$89<sup>99</sup>

» 5 GALLONS • 2830486 • \$364<sup>99</sup>

» 5 GALLONS, PUMP • 2830487 • \$163<sup>99</sup>

» 55 GALLONS • 2830489

» 275 GALLONS • 2830488

## TRAILERING



### CALIBER® RAMP PRO

- Designed for ATVs and UTVs up to 50" wide
  - Integrated grip glides for ultimate traction
  - Folding sides for easy transportation and storing
- » 52" x 90" • 2884576 • \$519<sup>99</sup>



### ALUMINUM ARCHED LOADING RAMPS

- Capacity for up to 3,000 lbs
- » 76" x 12" • 2,000 lb • 2875384 • \$419<sup>99</sup>  
» 88" x 12" • 3,000 lb • 2875386 • \$679<sup>99</sup>

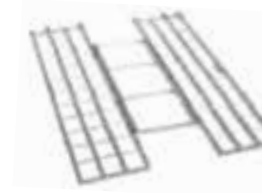

### LIGHTWEIGHT TRI-FOLD RAMPS

- Ramp folds up for transport
  - Capacity for up to 1,500 lbs
  - Safety straps included
- » 72" x 51" • 2875385 • \$409<sup>99</sup>  
» 82" x 51" • 2875860 • \$419<sup>99</sup>

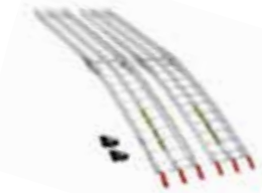

### FOLDING ALUMINUM ARCHED RAMPS

- Ramp folds up for transport
  - Up to 1,500 lbs total capacity, per individual ramp
  - Safety straps included
- » 88" x 12" • 2875387 • \$599<sup>99</sup>

## HITCHES

### 3:1 HITCHES VERSATILE 3 IN 1 FUNCTIONALITY

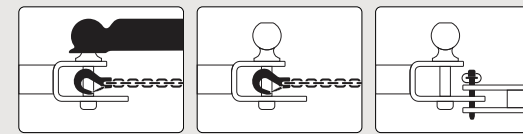

- Ball, hook and pin design
- Durable, rust resistant steel with black powdercoated finish
- Removable ball
- HD 5/8" pin and clip



### HITCH WITH 2" BALL

- 2" x 2" RECEIVER 2830522 • \$48<sup>79</sup>
- 1 1/4" x 1 1/4" RECEIVER 2830523 • \$48<sup>79</sup>



### 1 7/8" BALL

- 1 7/8" replacement ball for hitch
  - Designed to work with 3:1 Hitch
- » 2830524 • \$12<sup>19</sup>



### 2" HITCH BALL MOUNT

- 2" RECEIVER TONGUE 2875320 • \$59<sup>99</sup>



### TRAILER BALL 3/4" SHANK

- 2" BALL • 2877603 • \$19<sup>99</sup>
- 1 7/8" BALL • 2877602 • \$19<sup>99</sup>



### RECOVERY STRAP

- 2" x 30'
  - 18,000 lb maximum load / 9,000 lb maximum vehicle weight
  - Built in strap wrap - easy storage
  - Loops sewn in to webbing
  - 1 Strap bag
- » 2884033 • \$79<sup>99</sup>



### RATCHET STRAP

- 1.5" x 15' straps, 2 Pack
  - Heavy duty webbing
  - 5,500 lb maximum load / 1,833 lb working load
  - 2 Pack
- » 2884031 • \$59<sup>99</sup>



### RATCHET STRAP

- 2" x 20' Ratchet Straps with heavy duty webbing
  - 10,000 lb Maximum Load / 3,300 lb Working Load
  - Floating D-Rings
  - Double J-Hooks
- » 2884032 • \$44<sup>99</sup>



### SHOCK STRAPS

- 1.5" 3,000 lb breaking strength
  - Keeps tension on tie-down straps to secure load
  - 2 Pack
- » 2883296 • 1.5" x 15' 1.5" • \$109<sup>99</sup>  
» 2883295 • 1.5" x 7' 1.5" • \$99<sup>99</sup>

## COVERS

### 2-SEAT & CREW TRAILERING COVERS

- 2880632 • 570/500/EV • \$449<sup>99</sup>  
EV '15-21, 570 '15-22, 500 '17-22
- 2880633 • 570 CREW • \$584<sup>99</sup>  
CREW 570-4 '15-22



### 3-SEAT & CREW TRAILERING COVERS

- 2883419 • XP 1000 • \$449<sup>99</sup>  
XP 1000 '15-22, 1000 '20-22
- 2883840 • CREW XP 1000/900/DIESEL • \$584<sup>99</sup>  
XP 1000 '18-22, CREW XP 1000 '17-22, CREW 1000 '20-22
- 2882160 • POLARIS PURSUIT CAMO SxS FIELD COVER • \$169<sup>99</sup>  
XP 1000 '14-22, EV '11-22, 570 FULL-SIZE '17-22, 570 '14-22, 500 '11-22, 1000 '20-22

PARTS & GARAGE

MAINTENANCE

OIL & LUBRICANTS

MAINTENANCE FLUIDS

BATTERIES & GARAGE ACCESSORIES

HD PARTS

SERVICE PARTS

TIRE SEALANT & TRAILERING

POLARIS POWER



# POLARIS POWER

FOR THE WORKERS, PLAYERS  
AND SAVE-THE-DAYERS.



## THE POWER TO EMPOWER

At Polaris Power, we are committed to powering more.  
We proudly donate 3% of our profits by providing portable power to areas affected by natural disasters and the organizations providing relief in North America.

PARTS & GARAGE

MAINTENANCE

OIL & LUBRICANTS

MAINTENANCE  
FLUIDS

BATTERIES & GARAGE  
ACCESSORIES

HD PARTS

SERVICE PARTS

TIRE SEALANT  
& TRAILERING

POLARIS POWER





## P2000i

Inverter Generator

2830532

**\$899 99**

**1600**

Running Watts

**2000**

Starting Watts

**16.7**

Max Amps at 120V

**7.6**

Run Time at 25% Load w/ Smart Throttle (hrs)

**62**

Noise Level at 25% Load (dBA)

### FEATURES



Extension Cord Management

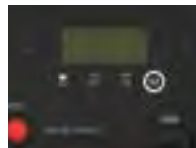

Multi Functional Digital Display

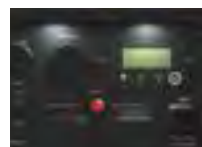

Illuminated Control Panel

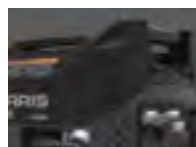

Multi Handle Design



Parallel Capable

### BEST USED FOR



Tailgating



Off-Grid



Camping



### ACCESSORIES

2830536  
2830540

INVERTER PARALLEL KIT  
ALL WEATHER COVER

2884865  
2879383

HIGH ALTITUDE MODIFICATION KIT  
GENERATOR OIL

## P3200iE

Inverter Generator

2830533

**\$1,899 99**

**2800**

Running Watts

**3200**

Starting Watts

**23.3**

Max Amps at 120V

**10.1**

Run Time at 25% Load w/ Smart Throttle (hrs)

**67**

Noise Level at 25% Load (dBA)

### FEATURES



Key Fob Remote Start

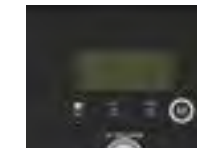

Multi Functional Digital Display



Fuel Gauge

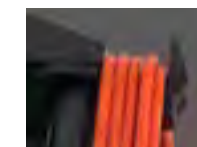

Extension Cord Management



Parallel Capable

### BEST USED FOR



DIY Remodeling



One Room Backup



Camping



### ACCESSORIES

2830536  
2830541

INVERTER PARALLEL KIT  
ALL WEATHER COVER

2884866  
2879383

HIGH ALTITUDE MODIFICATION KIT  
GENERATOR OIL





## P5500

Open Frame Generator

2830534

**\$1,799** 99

**5000**  
Running  
Watts

**5500**  
Starting  
Watts

**20/30**  
Max Amps  
at 120/240V

**5**  
Run Time  
(hrs)

**75**  
Noise Level  
(dBA)

### FEATURES



Extension Cord Management



Fuel Gauge



Electric Start

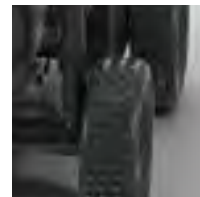

Rough Terrain Wheel

### BEST USED FOR



Construction



Home Backup



RV'ing



### ACCESSORIES

2830542  
2884867

ALL WEATHER COVER  
HIGH ALTITUDE MODIFICATION KIT

2879383 GENERATOR OIL

## P6500

Open Frame Generator

2830535

**\$1,999** 99

**6000**  
Running  
Watts

**6500**  
Starting  
Watts

**20/30**  
Max Amps  
at 120/240V

**5**  
Run Time  
(hrs)

**75**  
Noise Level  
(dBA)

### FEATURES



Extension Cord Management



Fuel Gauge



Electric Start



Rough Terrain Wheel

### BEST USED FOR



Construction



Home Backup



RV'ing



### ACCESSORIES

2830542  
2884867

ALL WEATHER COVER  
HIGH ALTITUDE MODIFICATION KIT

2879383 GENERATOR OIL





# APPAREL

Take your pick from our wide assortment of comfortable and stylish riding gear and casual wear. You'll find jerseys, t-shirts, sweatshirts, jackets, ballcaps and more that reflect your unique style for work or play.







**NEW**  
OFF-ROAD RIDING JERSEYS

\$43<sup>99</sup>

Mesh ventilated panels for maximum airflow  
Elastic sleeves with non-restrictive cuffs

**NEW**  
OFF-ROAD RIDING GLOVES

\$30<sup>99</sup>

Adjustable wrist closure for a custom fit  
Silicon finger grips and neoprene knuckle protection



TEKVEST® FREESTYLE

\$433<sup>99</sup>

Black | S-3XL | 2862577



BLACK  
JERSEY | S-3XL | 2862718  
GLOVE | S-3XL | 2862726

YOUTH JERSEY  
\$37<sup>99</sup>  
S-XL | 2862723

ORANGE  
JERSEY | S-3XL | 2862719  
GLOVE | S-3XL | 2862729

TEAL  
JERSEY | S-3XL | 2862720  
GLOVE | S-3XL | 2862727

YOUTH JERSEY  
\$37<sup>99</sup>  
S-XL | 2862724

GREEN  
JERSEY | S-3XL | 2862721  
GLOVE | S-3XL | 2862730

BLUE  
JERSEY | S-3XL | 2862722  
GLOVE | S-3XL | 2862728

YOUTH JERSEY  
\$37<sup>99</sup>  
S-XL | 2862725



SHORT SLEEVE

\$45<sup>99</sup>

Men's | S-3XL | 2860634  
Women's | S-3XL | 2860636



LONG SLEEVE

\$58<sup>99</sup>

Men's | S-3XL | 2860638  
Women's | S-3XL | 2860640

COOLING SHIRTS

FABRIC TECHNOLOGY DESIGNED  
TO KEEP YOU COOL

- Chemical-free fabric, Coolcore® reduces the surface temperature up to 30% so you don't overheat
- Carries a 50 Ultraviolet Protection Factor rating, blocking 98% of harmful UV rays



RAIN JACKET

\$129<sup>99</sup>

Gray | S-3XL | 2869527



RAIN PANTS

\$109<sup>99</sup>

Gray | S-3XL | 2869528

RAIN JACKET & PANTS

PACKABLE WATERPROOF PROTECTION AGAINST  
UNPREDICTABLE WEATHER

- 100% waterproof, lightweight and packable nylon
- YKK® zippers
- Rain jacket has removable hood



# HELMETS

**FOR POLARIS**

**NEW**  
TAN  
XS-4XL  
2862472



# ALTITUDE

## 509 ALTITUDE 2.0 HELMET

LIGHTWEIGHT DESIGN, PERFORMANCE-INFUSED STYLE AND FEATURES WITH ALL-DAY COMFORT

### SHELL

- Strong, lightweight construction of carbon fiber or fiberglass

### WEIGHT

- Composite as low as 1,260g
- Carbon fiber as low as 1,150g

### FEATURES

- Superior fit for all-day comfort
- Removable Pro Series breath box provides excellent ventilation and air flow
- One-piece eyepoint creates draft-free seal with 509 goggles
- Magnetic Fidlock® chin-strap technology and integrated GoPro® mount
- DOT- and ECE 22.05-approved

**\$371<sup>95</sup>**

**FIDLOCK**



BLACK  
XS-4XL  
2861469

BLACK/RED  
XS-4XL  
2861472

RED/BLACK  
XS-4XL  
2861470

**\$495<sup>95</sup>**  
CARBON FIBER  
BLACK/LIME  
XS-4XL | 2861473

**FOR POLARIS**

RED/BLACK  
XS-4XL  
2862467



# TACTICAL

## **NEW** TACTICAL 2.0 HELMET

BUILT FROM THE GROUND UP WITH INNOVATIVE FEATURES FOR ULTIMATE COMFORT AND CONTROL

### SHELL

- Shock-resistant, injection-molded thermoplastic

### FEATURES

- Venturi vent system generates negative pressure at velocity and pulls moist air from the breath box
- Integrated eyepoint seal is co-integrated with the breath box and creates a draft-free seal with 509 goggles for unparalleled warmth and clear field of view
- Magnetic Fidlock® chin-strap technology
- DOT- and ECE 22.06-approved

**\$272<sup>95</sup>**

**FIDLOCK**



MATTE BLACK  
XS-4XL  
2862468

GRAY  
XS-4XL  
2862469

LIME  
XS-4XL  
2862470

ORANGE  
XS-4XL  
2862471

# TENACITY

## TENACITY 4.0 HELMET

COMBINATION OF MODERN STYLE AND PREMIUM PROTECTION WITH INCREDIBLE VALUE

### SHELL

- Shock-resistant, injection-molded thermoplastic

### WEIGHT

- 1,500g

### FEATURES

- Through-flow, full-helmet ventilation
- ProClip quick release chin strap allows you to fasten the chin strap in seconds
- Removable breath box
- Tool-less adjustable roost shield
- Removable, washable liner
- DOT- and ECE 22.05-approved

**\$173<sup>99</sup>**



LIME  
XS-2XL  
2861559



BLACK  
XS-2XL  
2861557

BLACK/GRAY  
XS-2XL  
2861558

BLACK/WHITE  
XS-2XL  
2861560

WHITE/RED  
XS-2XL  
2861561

PINK  
XS-2XL  
2861562

# GOGGLES

**FOR POLARIS**



ORANGE  
2862561



LIME  
2862559

## **NEW** 509 KINGPIN OFF-ROAD GOGGLE

PREMIUM MATERIALS, ATTRACTIVE PRICE **\$61<sup>95</sup>**

### FEATURES

- Oversized spherical lens delivers optimal peripheral vision
- Metal tear-off posts provide strength and durability
- Quick-change technology allows you to run the best lens tint for conditions



BLUE  
2862562



STEALTH  
2862560

## **NEW** 509 MX6 OFF-ROAD GOGGLE

SUPER WIDE FIELD OF VIEW, ENGINEERED FOR DIRT **\$123<sup>95</sup>**

### FEATURES

- PC outer lens with anti-scratch coating, and internal anti-fog coating
- Outriggers with latch system for quick lens change
- 45mm strap with silicone to hold strap in place



BLACK  
2862557



RED/BLACK  
2862558

APPAREL

RIDING GEAR

HELMETS & GOGGLES

MEN'S APPAREL

WOMEN'S APPAREL

MERCHANDISE



# MEN'S APPAREL

BLACK  
S-3XL | 2862569



NAVY  
S-3XL | 2862570



NEW  
RED  
S-3XL | 2862451



BLACK  
S-3XL | 2861434

GRAY  
S-3XL | 2861435

## NEW WORK VEST

RUGGED AND DURABLE VEST THAT'S  
IDEAL AS AN OUTDOOR LAYER

- Coated with Durable Water Repellency (DWR) to provide water-resistance
- 3M® Thinsulate® for added warmth with brushed flannel trim
- Three outer pockets for storage

\$123<sup>99</sup>

## SOFTSHELL JACKET

VERSATILE LIGHTWEIGHT JACKET THAT'S SURPRISINGLY  
WARM AND PERFECT FOR EVERYDAY WEAR

- Casual jacket armed with rugged and warm features for everyday wear
- Superior DWR prevents precipitation from saturating the jacket's exterior
- Lined with 280g of soft fleece for warmth
- Removable hood and underarm venting, three external pockets and one internal chest pocket

\$161<sup>99</sup>



CHARCOAL  
S-3XL | 2860865



BRONZE  
S-3XL | 2860864



FOREST GREEN  
S-3XL | 2860862



GRAY  
S-3XL | 2860863



BLACK  
S-3XL | 2861608

## FLANNEL JACKET

SHERPA FLEECE LINED JACKET DELIVERS  
EXCEPTIONAL WARMTH AND COMFORT

- Warm sherpa lined fleece material
- Insulation to keep you warm
- Plenty of storage for your valuables

\$123<sup>99</sup>

## WORK JACKET

WARM AND RUGGED JACKET THAT'S TOUGH  
FOR WORK AND STYLISH FOR PLAY

- Coated with Durable Water Repellency (DWR) to provide water-resistance
- Built in action back for increased range of motion
- 80g 3M® Thinsulate® for added warmth with brushed flannel trim
- One inner and four outer pockets for storage

\$198<sup>99</sup>

## NEW REVOLVE VEST

REVERSIBLE

DURABLE AND WARM REVERSIBLE VEST  
OFFERS TWO STYLES IN ONE

- Durable windbreak outer fabric helps protect from the elements
- 140g 3M® Thinsulate® insulation keeps you warm in cold weather
- Reversible vest offers two unique styles in one

\$123<sup>99</sup>



BLUE/ORANGE  
S-3XL | 2862566

BLACK/GRAY  
S-3XL | 2862565



## NEW WINDBREAKER JACKET

LIGHTWEIGHT, WINDPROOF JACKET THAT  
PROVIDES PROTECTION WHILE RIDING

- 100% polyester windproof fabric
- Lightweight construction makes it easy to pack
- Three external pockets allow for maximum storage

\$132<sup>99</sup>

Black | S-3XL | 2861541



## FORCE JACKET

PACKABLE JACKET OFFERS LIGHTWEIGHT  
PROTECTION, IDEAL FOR ANY ACTIVITY

- 140g 3M® Thinsulate®
- Plenty of storage with two external hand pockets and one internal media pocket
- Rugged YKK® zippers
- Great for travel, compacts into pocket

\$173<sup>99</sup>

Black | S-3XL | 2861432





**NEW**  
**TITAN MID-LAYER**

EXTREMELY WARM YET BREATHABLE  
MID-LAYER, PERFECT FOR RIDING

- 319g Polartec® Thermal Pro® rib sweater provides great warmth
- Quick drying moisture wicking helps keep you dry
- Breathable material moves sweat to the outer surface
- Nylon overlay is comfortable and light

**\$111.99**

BLACK  
S-3XL | 2862568

BLUE/ORANGE  
S-3XL | 2862567



**NEW**  
TAN  
S-3XL | 2862450

RED/BLACK  
S-3XL | 2862490



**NORTHSTAR MID-LAYER**

VERSATILE MID-LAYER CAN BE WORN  
ALONE OR AS AN EXTRA LAYER

- 280g of breathable fleece for added warmth
- Offers durable protection against the elements with a wear-resistant polyester face and wind-block layer on chest
- Designed to fit under outer shell when riding

**\$111.99**

BLACK/RED  
S-3XL | 2862616

BLACK/GRAY  
S-3XL | 2869925

**NEW**  
**JOURNEY HOODIE**

DURABLE HOODIE DESIGNED FOR EVERY DAY WEAR

- Keeps the elements out with snug, rib-knit waist and cuffs
- Mock neck collar provides added protection and warmth
- Durable blended material made of 80% cotton, 20% polyester

**\$86.99**

BLACK  
S-3XL | 2862489



**TECH FULL-ZIP HOODIE**

**\$80.99**

**NEW** Tan | S-3XL | 2862486  
Gray | S-3XL | 2861493  
Black/Blue | S-3XL | 2861494



**CREW SWEATSHIRT**

**\$61.99**

**NEW** Black | S-3XL | 2862488  
Green | S-3XL | 2861498  
Navy | S-3XL | 2861497



**ICON HOODIE**

**\$68.99**

**NEW** Gray | S-3XL | 2862487  
Green | S-3XL | 2861495  
Black | S-3XL | 2861496



**ICON LONG SLEEVE**

**\$37.99**

**NEW** Gray/Red | S-3XL | 2862505  
Black | S-3XL | 2861584  
Blue | S-3XL | 2861585



**DASH LONG SLEEVE**

**\$37.99**

**NEW** Gray | S-3XL | 2862504  
Navy | S-3XL | 2861583  
Black | S-3XL | 2861582



**CHECKERED LONG SLEEVE**

**\$37.99**

**NEW** Red | S-3XL | 2862506  
Gray | S-3XL | 2861587  
Black | S-3XL | 2861586



**ICON TEE**

**\$30.99**

**NEW** Green | S-3XL | 2862501  
Black | S-3XL | 2861570  
Blue | S-3XL | 2861571



**STAMP TEE**

**\$30.99**

**NEW** Black | S-3XL | 2862496  
Gray | S-3XL | 2861565  
Green | S-3XL | 2861564



**CORE TEE**

**\$30.99**

**NEW** Red | S-3XL | 2862502  
Black | S-3XL | 2861572  
Blue | S-3XL | 2861573



# MEN'S CAMO

## STEALTH CAMO HAT

\$32<sup>99</sup>

Camo | One Size | 2861527

## NORTHSTAR MID LAYER

\$119<sup>99</sup>

Camo | S-3XL | 2861542

## CAMO SOFTSHELL JACKET

\$172<sup>99</sup>

Camo | S-3XL | 2861543

# MEN'S BALL CAPS

## ELLIPSE PATCH TRUCKER HAT

\$32<sup>99</sup>

**NEW** Light Gray | One Size | 2862539  
 Gray | One Size | 2861531  
 Black | One Size | 2861533  
 Navy | One Size | 2861532

## HIGHLAND CAP

\$30<sup>99</sup>

Tan | One Size | 2860893  
 Gray | One Size | 2862544



**NEW**

## CAMO REVOLVE VEST

\$123<sup>99</sup>

Camo | S-3XL | 2862572



**NEW**

## PURSUIT HOODIE

\$61<sup>99</sup>

Camo | S-3XL | 2862494



## CAMO NECK GAITER

\$16<sup>99</sup>

Camo | One Size | 2861948



## CORE CAP

\$32<sup>99</sup>

**NEW** Gray | One Size | 2862594  
 Navy | One Size | 2861523  
 Black | One Size | 2861524



## TONAL HAT

\$32<sup>99</sup>

Black/Red | One Size | 2861526  
 Navy | One Size | 2861525



## CLASSIC CAP

\$30<sup>99</sup>

Gray | One Size | 2862543  
 Navy | One Size | 2862597



## CAMO TRUCKER HAT

\$32<sup>99</sup>

Black | One Size | 2860613



## HUNTER ORANGE HAT

\$30<sup>99</sup>

Orange | S/M | 2860892  
 Orange | L/XL | 2862545



## HUNTER ORANGE BEANIE

\$24<sup>99</sup>

Orange | One Size | 2862595



## CHECKERED HAT

\$32<sup>99</sup>

Blue | One Size | 2861520  
 Black | One Size | 2861522  
 Gray | One Size | 2861521



## RETRO CAP

\$30<sup>99</sup>

**NEW** Navy | One Size | 2862538  
 Gray/Red | One Size | 2869542  
 Gray/Orange | One Size | 2861536



**NEW**  
BLUE  
S-3XL | 2862460



BLACK  
S-3XL | 2862563

BLACK  
S-3XL | 2861437

GRAY/BLUE  
S-3XL | 2861439

## SOFTSHELL JACKET

LIGHTWEIGHT PERFORMANCE THAT'S SURPRISINGLY WARM AND PERFECT FOR EVERYDAY WEAR

- Superior DWR prevents precipitation from saturating the jacket's exterior
- Lined with 280g of soft fleece for warmth
- Removable hood and underarm venting, three external pockets and one internal chest pocket

**\$161<sup>99</sup>**



BLACK  
S-3XL | 2862457

DUSTY ROSE  
S-3XL | 2862456

## NEW REVOLVE VEST

DURABLE AND WARM REVERSIBLE VEST OFFERS TWO STYLES IN ONE

- Durable windbreak outer fabric protects you from the elements
- 140g 3M™ Thinsulate™ insulation keeps you warm in cold weather
- Reversible vest offers two unique styles in one

**\$123<sup>99</sup>**

## FORCE JACKET

PACKABLE JACKET OFFERS LIGHTWEIGHT PROTECTION, IDEAL FOR ANY ACTIVITY

- 140g 3M™ Thinsulate™
- Plenty of storage with two external hand pockets and one internal media pocket
- Rugged YKK® zippers
- Great for travel, compacts into pocket

**\$173<sup>99</sup>**



BLACK  
S-3XL | 2861433

## NEW WORK JACKET

WARM AND RUGGED JACKET THAT'S TOUGH FOR WORK AND STYLISH FOR PLAY

- Coated with DWR to provide water-resistance
- Built-in action back for increased range of motion
- 80g 3M™ Thinsulate™ for added warmth with brushed flannel trim
- One inner and four outer pockets for storage

**\$198<sup>99</sup>**



BLACK/GRAY  
S-3XL | 2862458

DUSTY ROSE  
S-3XL | 2862459

## NEW TITAN MID-LAYER

EXTREMELY WARM YET BREATHABLE MID-LAYER, PERFECT FOR RIDING

- 319g Polartec™ Thermal Pro® rib sweater provides great warmth
- Quick drying moisture wicking helps keep you dry
- Breathable material moves sweat to the outer surface
- Nylon overlay is comfortable and light

**\$111<sup>99</sup>**



**NEW**  
PURSUIT HOODIE  
~~\$61<sup>99</sup>~~  
Camo | S-3XL | 2862517



**NEW**  
JOURNEY HOODIE  
~~\$86<sup>99</sup>~~  
Black | S-3XL | 2862515  
Blue | S-3XL | 2862516



TECH FULL-ZIP HOODIE  
~~\$80<sup>99</sup>~~  
Maroon | S-3XL | 2861509  
Gray | S-3XL | 2861508



ICON HOODIE  
~~\$68<sup>99</sup>~~  
**NEW** White | S-3XL | 2862512  
Black | S-3XL | 2861506  
Maroon | S-3XL | 2861507



**NEW**  
ADVENTURE CREW  
~~\$61<sup>99</sup>~~  
Dusty Rose | S-3XL | 2862513  
Black | S-3XL | 2862514



**NEW**  
ADVENTURE TEE  
~~\$30<sup>99</sup>~~  
Teal | S-3XL | 2862629  
Black Frost | S-3XL | 2862628



THINK OUTSIDE TEE  
~~\$30<sup>99</sup>~~  
**NEW** Pink | S-3XL | 2862518  
Black | S-3XL | 2861590  
Blue | S-3XL | 2861591



# MERCHANDISE



**STEEL SIGN**  
14" x 36" | 2860868  
\$168<sup>99</sup>



**ALUMINUM SIGN**  
22" | 2860867  
\$168<sup>99</sup>



**WOOD SIGN**  
10.5" x 24" | 2860866  
\$97<sup>99</sup>



**PINT GLASSES (SET OF 2)**  
2860815 | \$25<sup>99</sup>



**12oz CAMPER MUG**  
2861612 | \$39<sup>99</sup>



**17oz WATER BOTTLE**  
2861611 | \$32<sup>99</sup>



**NEW**  
**23oz WATER BOTTLE**  
2862685 | \$30<sup>99</sup>



**15oz CAMPFIRE MUG**  
2861613 | \$26<sup>99</sup>



**KEYCHAIN**  
2861614 | \$8<sup>99</sup>



**LEATHER LOOP KEYCHAIN**  
2861615 | \$19<sup>99</sup>



**NEW**  
**LICENSE PLATE HOLDER**  
2862687 | \$24<sup>99</sup>



**NEW**  
**KICKBACK ROCKER**  
2862626 | \$68<sup>00</sup>



**NEW**  
**FREESTYLE ROCKER**  
2862625 | \$81<sup>00</sup>



**NEW**  
**EASY CHAIR**  
2862627 | \$56<sup>00</sup>



**NEW**  
**QUICK-E-SEAT**  
2862624 | \$43<sup>00</sup>



**NEW**  
**FOLDING TABLE**  
2861620 | \$66<sup>99</sup>



**NEW**  
**POLARIS PARKING SIGN**  
2869934 | \$24<sup>99</sup>



**NEW**  
**POLARIS FLAG**  
3' x 5' | 2869928 | \$30<sup>99</sup>



**NEW**  
**HITCH COVER**  
2861623 | \$43<sup>99</sup>



APPAREL

RIDING GEAR

HELMETS & GOGGLES

MENS APPAREL

WOMENS APPAREL

MERCHANDISE



THE MOST CAPABLE UTV.  
**GET MORE DONE.**

Trusted by farmers, ranchers, hunters and homeowners for more than a decade.





# HARDEST WORKING.

## SMOOTHEST RIDING.

### GET THE BEST OWNER EXPERIENCE OUT THERE

Our goal is to make every day of ownership a smooth ride. Sign in for access to everything you need, plus exclusive offers and more.

[OFFROAD.POLARIS.COM/ACCOUNT](http://OFFROAD.POLARIS.COM/ACCOUNT)



#### MY GARAGE

- Vehicle Profile & Accessory Details
- Maintenance Schedules
- Schedule Service
- Manuals & Warranty Info



#### MY RIDES & COMMUNITY

- My Tracked Rides
- My Planned Routes & POIs
- My Community Activities & Events
- Explore Polaris Adventures



#### MY SHOPPING

- Recommended Accessories
- Purchase History
- My Dealer
- Access to Polaris Pros



CONNECT ONLINE  
SEARCH "PolarisDRV"



# DOMINATE

## ANY ENVIRONMENT

**1** CHOOSE MODEL

**2** CHOOSE TRIM

**3** CHOOSE COLOR

**4** CHOOSE ACCESSORIES

**VISIT POLARIS.COM/RANGER**  
TO SEE VEHICLE OPTIONS AND VIEW ACCESSORIES  
ON YOUR NEW MACHINE FROM EVERY ANGLE!



**POLARIS**

MY22 RGR APP ACC CAN **9948143**

Warning: Polaris off-road vehicles can be hazardous to operate and are not intended for on-road use. Driver must be at least 16 years old with a valid driver's license to operate. All riders should always wear helmets, eye protection and protective clothing and footwear. Read, understand and follow your owner's manual. Ride within the limits of your own abilities and never engage in stunt or exhibition driving. Never ride under the influence of drugs or alcohol. All riders should take a safety training course. Call 800-342-3764 for additional information.

Unless noted, trademarks are the property of Polaris Industries Inc. 3M® and Thinsulate® are registered trademarks of 3M Company, 509® is a registered trademark of Teton Outfitters, LLC. Apple® and App Store® are registered trademarks of Apple Inc. BatteryMinder® is a registered trademark of VDC Electronics Inc. Bluetooth® is a registered trademark of Bluetooth Sig, Inc. Caliber® is a trademark of Caliber, Inc. Carhartt® is a registered trademark of Carhartt, Inc. COOLCORE® is a registered trademark of COOLCORE LLC. Facebook® is a registered trademark of Facebook, Inc. Fidlock® is a registered trademark of Fidlock GmbH. Google Play® is a registered trademark of Google, Inc. GoPro® is a registered trademark of GoPro Inc. Homelink® is a registered trademark of Gentex Corporation. Instagram® is a registered trademark of Instagram, LLC. KOLPIN® and KOLPIN STRONGHOLD® are registered trademarks of Polaris Industries Inc. MB Quart® is a registered trademark of Maxxsonics USA Inc. Otter® is a registered trademark of Otter Outdoors, LLC. Polartec® is a registered trademark of MMI-IPCO, LLC. Rhino Grip® is a registered trademark of Polaris Industries Inc. RHINO-RACK® is a registered trademark of Rhino Rack Australia Pty Limited. RIGID® is a trademark of JST Performance, LLC d/b/a Rigid Industries LLC. SMART BOARD® is a registered trademark of MART TECHNOLOGIES ULC UNLIMITED LIABILITY CORPORATION CANADA. Tiger Drylac® is a registered trademark of Tiger Coatings GMBH & CO. KG. TEKVEST® is a registered trademark of 1181676 ONTARIO INC. Twitter® is a registered trademark of Twitter, Inc. WALKER EVANS RACING® is a registered trademark of Walker Evans Enterprises Incorporated. Yeti® is a registered trademark of Yeti Coolers, LLC. YKK® is a registered trademark of YKK Corporation. YouTube® is a registered trademark of Google Inc. Prices, Fitment and Availability are subject to change at any moment. Copyright © 2021 Polaris Industries Inc. All rights reserved.