

TEST & MEASUREMENT CATALOG 2020

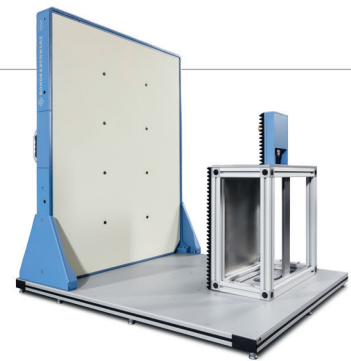

R&S®ZNA VECTOR NETWORK ANALYZER

It features exceptional stability, low trace noise and excellent raw data, making it a perfect choice for development and production applications that require high accuracy, e.g. for developing and producing components and modules for A&D and satellite applications.



R&S®QAR Quality Automotive Radome Tester



R&S®CMX500 Radio Communication Tester



R&S®NGM200 Power Supply Series

ROHDE & SCHWARZ



TEST & MEASUREMENT CATALOG 2020

Chapter	Contents	Page
	Company profile	2
1	Wireless communications testers and systems	6
	<ul style="list-style-type: none"> ▶ Radio testers ▶ Protocol testers ▶ Conformance and preformance testers ▶ Analog radio testers ▶ System accessories 	
2	Oscilloscopes	41
	<ul style="list-style-type: none"> ▶ Oscilloscopes, probes ▶ Hardware and software options, accessories 	
3	Signal and spectrum analyzers	62
	<ul style="list-style-type: none"> ▶ Top class, general purpose, handheld ▶ Accessories for R&S®FSx analyzers ▶ Application-specific solutions ▶ Modulation analyzers for avionics 	
4	Signal generators	96
	<ul style="list-style-type: none"> ▶ RF vector signal generators ▶ RF analog signal generators ▶ Baseband signal generators ▶ Application-specific solutions ▶ Software solutions 	
5	Network analyzers	129
	<ul style="list-style-type: none"> ▶ Vector network analyzers ▶ Converters ▶ Accessories for network analysis 	
6	Mobile network testing	153
	<ul style="list-style-type: none"> ▶ Drive and walk test scanners ▶ Benchmarking ▶ Optimization ▶ Service quality monitoring ▶ Software 	
7	EMC and field strength test solutions	176
	<ul style="list-style-type: none"> ▶ EMI precompliance/compliance ▶ EMS/EMF measurements ▶ TEMPEST measurements ▶ EMC software ▶ Broadband amplifiers ▶ RF test chambers ▶ EMC accessories 	
8	Power meters and power sensors	215
	<ul style="list-style-type: none"> ▶ Power meters, power sensors ▶ Over-the-air (OTA) power measurement solution 	
9	Audio analyzers	226
	<ul style="list-style-type: none"> ▶ Audio analyzers, audio switcher 	
10	Automotive test, modular instruments	230
	<ul style="list-style-type: none"> ▶ Automotive test solutions, open test platform 	
11	Broadcasting test and multimedia	249
	<ul style="list-style-type: none"> ▶ RF signal generation ▶ RF signal analysis ▶ Audio/video generation ▶ Audio/video analysis 	
12	Power supplies	266
	<ul style="list-style-type: none"> ▶ Power supplies 	
13	Meters and counters	275
	<ul style="list-style-type: none"> ▶ Multimeter, LCR meter ▶ Frequency counter, power analyzer 	
14	System components	280
	<ul style="list-style-type: none"> ▶ Open switch and control platform ▶ I/Q data recorder ▶ Step attenuator ▶ Test executive software 	
	Appendix	288
	<ul style="list-style-type: none"> ▶ Service and support, trademarks 	
	Index	296
	<ul style="list-style-type: none"> ▶ Index by type 	

Thanks to its industry-leading technological expertise, Rohde & Schwarz is a reliable partner for shaping the future of communications, information and security.

Rohde & Schwarz develops, produces and markets a wide range of electronic capital goods for industry, infrastructure operators and government customers.

The independent group is among the technology and market leaders in all of its business fields, including wireless communications and RF test and measurement, broadcast and media, air traffic control and military radiocommunications, cybersecurity and network technology.

A worldwide service and support network safeguards customer investments.



Our business fields

Test and measurement

T&M instruments and systems for wireless communications, aerospace and defense, automotive, research and industrial electronics applications.

Broadcast and media

Broadcast, post production and T&M equipment for network operators, broadcasters, studios, the film industry and manufacturers of entertainment electronics.

Aerospace | defense | security

Communications and signal monitoring technology for armed forces and air traffic control, security products for critical infrastructures as well as T&M equipment for A&D applications.

Networks and cybersecurity

Network technology for professional users as well as IT security products to protect communications and information.

TEST AND MEASUREMENT

Test and measurement solutions for the wireless market, automotive applications, aerospace and defense, industrial electronics, research and education

No industrial sector can do without electronics. Test and measurement solutions from Rohde&Schwarz are there every step of the way, from R&D to quality assurance to manufacturing and service. Our portfolio includes all types of RF T&M equipment and systems as well as complementary products.

We focus on the requirements of the mobile and wireless communications market, a market we have been closely involved with for decades, on the requirements of the automotive industry, whose added value is increasingly based on vehicles' electronic features, and on the T&M requirements of the aerospace and defense industry. Manufacturers of entertainment electronics, power electronics, RF components, IT and network equipment as well as medical technology companies and other sectors also benefit from our wide range of products.

Research and education also require an extensive portfolio of T&M equipment in various performance classes. From basic testers for training to submillimeterwave analyzers and high-power RF amplifiers for particle accelerators, the Rohde&Schwarz portfolio meets all of these requirements.

Our test and measurement portfolio

Wireless market

- ▶ Basic RF T&M instruments such as signal generators and analyzers with standard-specific T&M options
- ▶ Wireless device RF and protocol testers for all common cellular and non-cellular wireless communications standards
- ▶ Conformance and preformance test systems
- ▶ Products for measuring quality in mobile networks
- ▶ System equipment, e.g. shielded chambers
- ▶ ITU-compliant radiomonitoring solutions for regulators

Automotive industry

- ▶ T&M equipment for infotainment, mobile communications and wireless connectivity components
- ▶ T&M equipment for driver assistance systems (radar, V2X, navigation, eCall/ERA-GLONASS)
- ▶ T&M equipment for onboard data buses
- ▶ EMC T&M equipment
- ▶ T&M equipment for testing the connection security of telematics systems

Aerospace and defense

- ▶ Wide range of RF and microwave T&M instruments for lab and field measurements
- ▶ Catalog systems and customer-specific solutions
- ▶ Test and measurement solutions for radar, avionics, navigation, satellite communications and military radiocommunications
- ▶ Full range of EMC measuring equipment
- ▶ Millimeterwave and submillimeterwave components

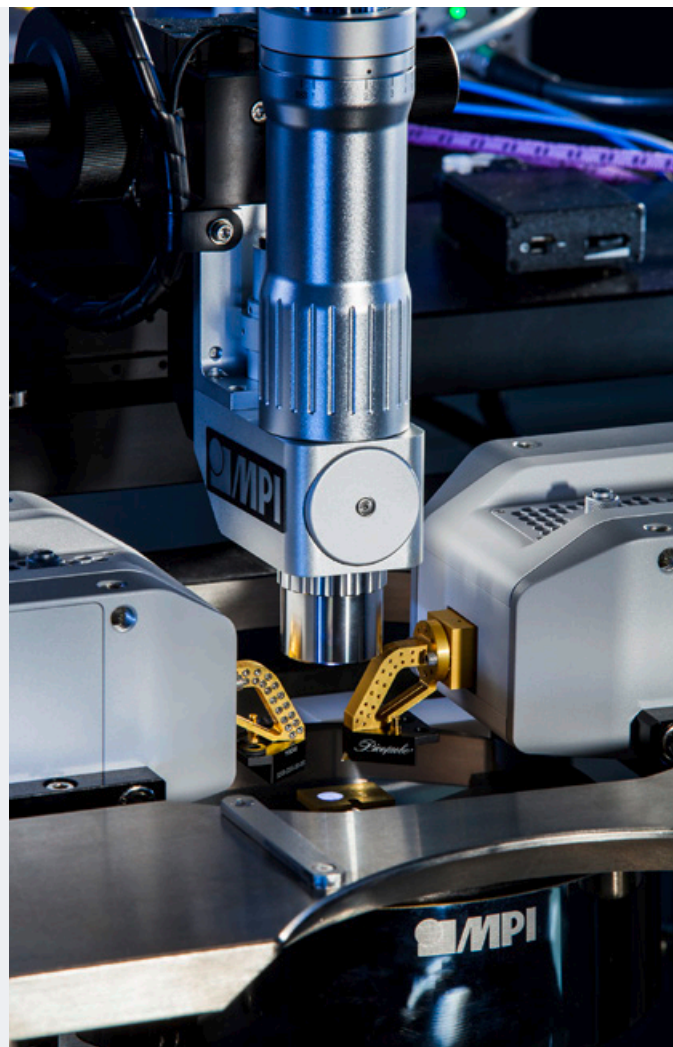

BROADCAST AND MEDIA

Solutions for the production, processing, broadcasting, measurement and quality control of audiovisual signals

Like many industries, broadcast and media has to keep pace with ongoing digitization and the shift towards internet based solutions. Rohde&Schwarz, an innovator in the field of broadcasting for more than 70 years, supports this transformation with groundbreaking solutions. Today, the entire signal processing chain, from camera output to transmission via the various broadcast channels, can be realized with Rohde&Schwarz products. The Rohde&Schwarz portfolio includes T&M equipment for the development, production and quality assurance of consumer electronics devices and infrastructure components as well as monitoring products for broadcast networks.

AEROSPACE – DEFENSE – SECURITY

Security products for critical infrastructures

At a time when crises, violent conflicts and cyberattacks regularly make the headlines, critical infrastructures and public areas need more protection than ever. Rohde&Schwarz addresses this need with products from all its different business fields. Air traffic controllers in 80 countries and at more than 200 airports and traffic management centers use our radio systems to ensure smooth air traffic. Rohde&Schwarz security scanners also provide protection in the form of efficient security checks at airports and other high-security locations.

Drones are opening up new possibilities in logistics, aerial photography and recreation. However, they can also easily be used for illegal purposes such as for industrial espionage or even violent crime. The Rohde&Schwarz drone detection system reliably detects these unwelcome on-lookers so that countermeasures can be taken.

And finally, our IT security products protect IT infrastructures such as the signal lines in railway networks and control systems in supply engineering against tampering and tapping.

Our broadcast and media portfolio

- ▶ TV and radio transmitters in all power classes and for all common worldwide standards
- ▶ Hardware and software for professional film and video post production
- ▶ Broadcast and video T&M and monitoring solutions

Security products for critical infrastructures

- ▶ Radio systems for air traffic control
- ▶ Security scanners
- ▶ Radiomonitoring and direction finding systems, also specifically for drones
- ▶ IT security solutions

Broadcast and media



Radio systems for air traffic control

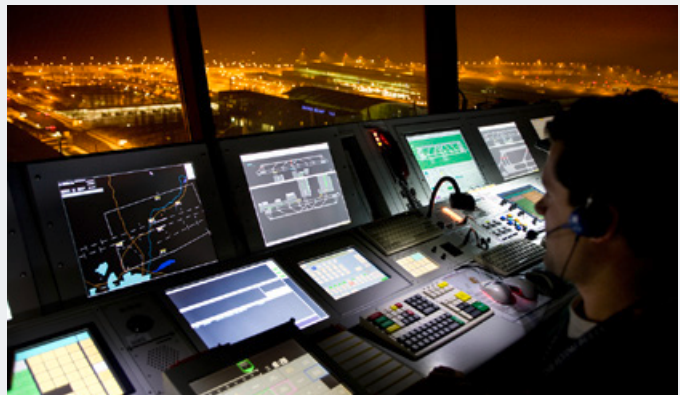

NETWORKS AND CYBERSECURITY

Solutions for business and government authorities

High-performance data networks and IT components are the backbone of business and society. The volume of dormant and transmitted data is growing exponentially, driven by the digitization of all business processes, the increasing outsourcing of IT services to the cloud and the emerging internet of things.

Highly interconnected networks attract unwanted attention. According to the estimates of reliable organizations, cyberattacks (especially theft of intellectual property) cost the global economy hundreds of billions of dollars each year. But intangible assets are not the only assets that need protection. The large quantities of sensitive public sector data as well as personal data generated by the financial sector, the health care system and online commerce also need to be protected. Manufacturers of network components and IT security technology have to provide secure, high-performance solutions for the transmission and storage of this data.

Rohde&Schwarz offers a wide range of infrastructure components for WAN, LAN and WLAN networking as well as cybersecurity products.

SERVICES

Rohde & Schwarz operates a global service network to safeguard the investments of its customers

The following services are offered locally worldwide:

- ▶ Calibration
- ▶ Maintenance and repair
- ▶ Product updates and upgrades
- ▶ Remote service over secure internet channels

Rohde&Schwarz regional service centers, plants and specialized subsidiaries provide a wide range of additional services:

- ▶ System integration
- ▶ System support
- ▶ Installation and commissioning
- ▶ Application support
- ▶ Development of customized modules, equipment and systems
- ▶ Software development
- ▶ Mechanical and electrical design
- ▶ Manufacturing to order
- ▶ Technical documentation
- ▶ Logistics concepts

Secure radiocommunications systems

- ▶ Communications intelligence systems
- ▶ Radar intelligence systems
- ▶ Satellite monitoring systems
- ▶ Signal and IP analysis system

Our network and cybersecurity portfolio

- ▶ All components for secure WAN, LAN and WLAN networking
- ▶ Network security products, e.g. firewalls
- ▶ Products to protect web and cloud applications
- ▶ Products to protect desktop applications
- ▶ Secure products for mobile communications
- ▶ Tools for network traffic and use analysis

Inspection of terrestrial air navigation facilities



Networks and cybersecurity



CHAPTER 1

WIRELESS COMMUNICATIONS TESTERS AND SYSTEMS

To keep the backbone of mobile communications running, powerful mobile networks and mobile devices are needed. Rohde & Schwarz offers a full portfolio of wireless communications testers and systems for the complex measurements involved. The multistandard, modular and highly flexible wireless communications test solutions from Rohde & Schwarz support all main cellular communications, wireless connectivity, GNSS and broadband standards in one box.

They can easily be extended to cover the latest standard enhancements. Benefit from high-speed, high-precision and exceptional flexible testing solutions – Rohde & Schwarz is the right partner to satisfy your test requirements.



Type	Designation	Description	Page	
Radio testers				
	5G NR one-box solutions from Rohde&Schwarz	Overview	8	
New	R&S®CMX500	Radio communication tester	Universal test platform extension for 5G NR	10
New	R&S®CMPQ	Compact solution for 5G mmWave RF testing	Optimized for production applications	11
New	R&S®CMP200	Radio communication tester	Non-signaling solution for 5G mmWave RF parametric testing	12
New	R&S®CMPHEAD30	Remote radio head	Up/downconverter for IF ↔ mmWave	12
New	R&S®CMQ200	Shielding cube	Compact shielding solution for 5G mmWave RF parametric testing	12
	R&S®CMW100	Communication manufacturing test set	The compact RF tester for production	13
	R&S®CMW500	Wideband radio communication tester	All-in-one test platform for wireless devices	14
	R&S®CMW290	Functional radio communication tester	The compact RF tester for service and IoT functional tests	16
	R&S®CMW270	Wireless connectivity tester	The non-cellular expert covering WLAN, Bluetooth®, GNSS and various broadcast technologies	18
	R&S®CMW Callbox	Signaling tester	Efficient signaling tester for the requirements of tomorrow	18
	R&S®CMWrun	Sequencer software tool	Ready-to-use solution for configuring RF and data application test sequences by remote control	19
Protocol testers				
	R&S®CMW500	Protocol tester	One tester for all phases of development	20
	R&S®CMWcards	Signaling and application tester	Smart network emulation for all wireless device tests	21
	R&S®CMWmars	Multifunctional logfile analyzer	Powerful message analyzer for all R&S®CMW applications and use cases	22
	R&S®CMW-ATE	Terminal testing solution for IMS, VoLTE and RCS	Powerful test solution for network operator specific IMS services such voice over LTE (VoLTE), video over LTE (IR94) and rich communication services (RCS)	23
	R&S®CMW-PQA	Test system for performance quality analysis	Automated performance quality analysis (PQA) test solution	24
Preconformance, conformance and acceptance testers and test systems				
	R&S®TS8980	RF/RRM test system for LTE, WCDMA and GSM	Platform for testing needs, from development to conformance testing	25
	R&S®TS-RRM	LTE, WCDMA and 5G RRM test system	Standalone platform for radio resource management (RRM) testing of wireless devices in line with 3GPP LTE, 3GPP WCDMA, 3GPP 5G and operator test plans	26
	R&S®TS-LBS	Test system for location based services	Comprehensive test solution for network and satellite-based location technology testing of wireless devices and chipsets	27
	R&S®TS8991	OTA performance test system	CTIA-compliant OTA measurements – LTE and MIMO inside	29
	R&S®TS8996	RSE test system	Fully automatic emission measurements on wireless communications equipment required for R&D and quality assurance	30
	R&S®TS8997	Regulatory test system for wireless devices	ETSI EN 300328 V1.8.1/V1.9.1 in 2.4 GHz band, ETSI EN 301893 V1.7.1/V1.8.1 in 5 GHz band and FCC §15.247, FCC §15.407	31
Analog radio testers				
	R&S®CMA180	Radio test set	The reference in radio testing	32
	R&S®CTH	Portable radio test set	Always on duty	33
System accessories				
	R&S®AMS32	OTA performance measurement software	Over-the-air (OTA) measurements on mobile phones; intermediate sensitivity and desense tests on mobile phones	34
	R&S®ATS800B/R	CATR benchtop/rack antenna test system	5G antenna characterization in a small footprint	35
	R&S®ATS1000	Antenna test system	5G antenna characterization with small footprint	36
New	R&S®ATS1800C	CATR based 5G NR mmWave test chamber	Device test and antenna characterization in a small footprint	37
	R&S®DST200	RF diagnostic chamber	Accurate radiated testing of wireless devices from 400 MHz to 18 GHz	38
	R&S®CMW-Z10/-Z11	RF shielding box and antenna coupler	Excellent shielding effectiveness and superior coupling characteristics	39
	R&S®TS712x	Shielded RF test chambers	Reliable RF tests on devices with radio interface	39
	R&S®RT-ZVC0xA	Multi-channel power probe	Two-port model and four-port model	39

5G NR ONE-BOX SOLUTIONS FROM ROHDE & SCHWARZ

The challenges associated with 5G NR require high flexibility, end-to-end data testing solutions and reliable measurement methods. As a long-term partner of the mobile radio communications industry, Rohde & Schwarz offers a comprehensive portfolio of innovative 5G NR test solutions.



Rohde & Schwarz radio communication tester portfolio

	LTE Advanced (plus legacy) 5G NR sub6	5G NR mmWave (plus IF)
Non-signaling (RF analyzer and generator)	<p>R&S[®]CMW100</p>	<p>R&S[®]CMQ200</p> <p>R&S[®]CMP200</p> <p>R&S[®]CMPHEAD30</p>
Signaling (network emulation)	<p>R&S[®]CMWflexx</p>	<p>R&S[®]CMX500</p> <p>R&S[®]CMXHEAD30</p>



For most mobile network operators, fifth generation (5G) of mobile communications will initially be an additional data service for transmission rates up to 20 Gbit/s. To allow developers to test their mobile devices in 5G NR non-standalone and standalone mode in line with 3GPP specifications, the test solution must work seamlessly in both LTE and 5G NR networks.

5G signaling solutions

The R&S®CMX500 radio communication tester adds 5G NR signaling to existing LTE test and measurement solutions. Users who already have an R&S®CMW500 or R&S®CMWflexx test system for LTE measurements can continue using it and simply add an R&S®CMX500 as an extension box to perform 5G NR signaling tests. This allows them to test 5G NR use cases in non-standalone (NSA) and standalone (SA) mode in FR1 and FR2 in accordance with 3GPP Option 3x and Option 2. For pure 5G NR test environments in FR2, all that is needed is an R&S®CMX500 radio communication tester (plus remote radio head and a shielded environment).

5G non-signaling solutions

For 5G NR FR2 testing (mmWave), Rohde&Schwarz offers the R&S®CMPQ. The R&S®CMPQ is a compact solution based on the R&S®CMP200 radio communication tester in combination with the R&S®CMPHEAD30 remote radio head (RRH) and the R&S®CMQ200 shielding cube. The instruments are matched to each other. Together they form an easy-to-use, cutting-edge test solution with a

wide variety of combination options. The FR1 sub6 solution consists of the well-known R&S®CMW100 communications manufacturing test set and corresponding measurement software (see R&S®CMPQ product brochure)

One-platform strategy

Just like the R&S®CMW platform for LTE, Rohde&Schwarz is sticking to the proven one-platform strategy for 5G NR. Both the R&S®CMP200 and R&S®CMX500 are based on this strategy. The principle of the one-platform strategy is to use the same technology, comparable hardware and the same software in all test solutions and test stages. This makes the test results comparable. The different test configurations (signaling/non-signaling) must deliver reproducibility and validated test results. Rohde&Schwarz fulfills this requirement.

The test results must provide conclusive information about the characteristics of the DUTs without – figuratively speaking – also testing the test solution. Rohde&Schwarz systems deliver accurate and consistently reproducible test results.

With the Rohde&Schwarz one-platform strategy users ensure, that they when they finally bring their mature product to production state using R&S®CMP200 non-signaling test setup, they can expect same results as during R&D stages when R&S®CMX500 signaling tester was the test equipment.

One-platform strategy

Signaling: sub6 + IF + mmWave

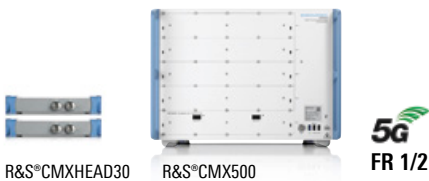

Technology reuse

- ▶ Same test concept
- ▶ Result traceability
- ▶ Synergy effects

Non-signaling: IF + mmWave

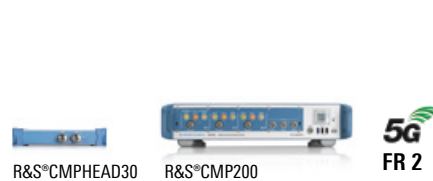

Identical measurements

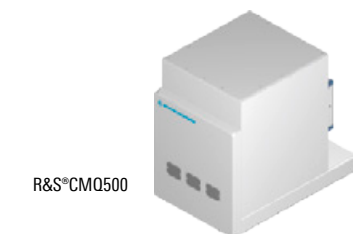

Identical OTA environment



R&S® CMX500 RADIO COMMUNICATION TESTER

New



5G NR extension box to R&S®CMWflexx systems for NSA and SA modes

The R&S®CMX500 hardware and software is designed to address all signaling use cases that are encountered during the lifecycle of a 5G NR mobile communications device – from the early R&D design stage to final integration, verification/performance testing, final product validation in a test house, quality assurance and repair.

The modular hardware architecture allows configurations ranging from basic use cases such as RF parametric measurements to measurements under fading conditions and performance measurements with maximum data rates. The user always has access to all signaling events and logs.

The R&S®CMX500 has eliminated the traditional separation between RF tester, application tester and protocol tester. It is a signaling tester that allows seamless transition between all use cases required to bring a mobile cellular device from the basic layout/design stage to the production stage. In previous tester generations, dedicated instruments were needed to address all this.

The R&S®CMX500 hardware modules are designed for versatile tasks. Users enjoy great flexibility when it comes to addressing different measurement tasks with the same test station because there are no dedicated boards for dedicated measurement tasks. With just a basic configuration, users are all set for signaling, fading and data E2E applications.

Its 7 HU design provides plenty of space for future extension modules – a true one-box tester.

R&S®CMsquares – the powerful control center for 5G NR tests

With R&S®CMsquares, users can access each measurement task in a separate measurement square. In R&S®CMsquares, the DUT is always in focus. This DUT centric approach makes it very easy to keep track of even complex test scenarios, test environments and measurement tasks. The next change is just one mouse click away.

R&S®CMsquares includes as many squares as you need: for measurements, graphical outputs and statistical views, network layout and configuration, RF connection, message analyzer, test sequencer, scripting – you name it. The R&S®CMsquares layout can always be configured to your personal preferences.

Basic/Medium/Xpert – the new signaling concept

With its Basic, Medium and Xpert signaling concept, R&S®CMX500 breaks with the traditional separation between use cases for protocol testing, RF testing and data/performance testing. Unlike in the past where the signaling environments of e.g. RF testing and protocol testing were separated from each other and could not be accessed by the other, Basic, Medium and Xpert sit on top of each other and can be upgraded cost efficiently.

The GUI dynamically adjusts parameter access based on the signaling option – many more parameters can be accessed with Xpert signaling than with Medium or Basic.

The Basic/Medium/Xpert signaling options build on top of each other – Xpert needs Medium, Medium needs Basic.

The name of the option for an application indicates the signaling type required to operate it. For example, the “X” in the R&S®CMX-KC601X protocol conformance test package indicates that it requires the Xpert signaling functionality. Similar applications are available for “B” (Basic) and “M” (Medium) signaling.

Use cases

The R&S®CMX500 is designed to cover all test requirements that may come up during the entire product lifecycle of a mobile communications device. The many components of a mobile communications device need to be independently tested on various interfaces step by step – in development, during integration when components need to work together, and in the final device. The R&S®CMX500 gives users the flexibility and versatility they need for test solutions throughout the entire product lifecycle.

R&S®CMPQ**COMPACT SOLUTION FOR 5G mmWave RF TESTING IN PRODUCTION****New**

To meet the measurement challenges of 5G device testing in the mmWave (mmW) frequency spectrum Rohde & Schwarz offers the R&S®CMPQ, a fully integrated solution from a single supplier. The R&S®CMPQ consists of the R&S®CMP200 radio communication tester, the R&S®CMPHEAD30 remote radio head and the R&S®CMQ200 shielding cube. The R&S®CMPQ provides accurate and reliable measurement results under radiated conditions.

The system concept of the R&S®CMPQ is completely flexible. The user can configure the individual devices and the system constellation independently of each other to create customized solutions for individual requirements.

The R&S®CMPQ is ideal for use in all phases of the product life cycle – from development to validation and quality assurance to production. The system is optimized for production applications. It is ultrafast, robust, reliable, cost efficient and flexible.

Validation of DUTs needs to be done in an OTA environment. All system components have to be matched exactly to get a reliable and efficient test setup. Rohde & Schwarz manufactures all system components, including the antennas, cables, feedthroughs, power sensors, remote radio head and non-signaling tester. This ensures optimal system parameters.

The split concept is a key feature of the one-box tester. The R&S®CMP200 can generate and analyze IF frequencies from 6 GHz to 20 GHz directly at the output. In higher frequency ranges, R&S®CMPHEAD30 seamlessly takes over this function.

The R&S®CMPQ is a future-proof investment. Rohde & Schwarz continually enhances the R&S®CMPQ solution with new hardware and software to meet present and future requirements and specifications.

System software**R&S®CMsquares**

The R&S CMsquares is a new unified test software solution with a browser-based user experience combining everything that is required for 5G NR testing. From test configuration, parameterization, measurements as well as test execution in a single environment, with a dashboard style and quick access to different types of applications, it can control all new 5G radio communication testers via a standardized GUI for a unified experience.

General purpose (GPRF) generator

The ARB generator function allows users to play predefined waveforms and CW signals. Any 5G NR FR2 signals can easily be generated.

General purpose (GPRF) TX measurements

A generic set of RF measurements, such as frequency selective power, FFT spectrum analyzer, I/Q versus slot, I/Q recorder and power measurement with R&S®NRPM module.

5G NR FR2 TX measurements

Multi-evaluation measurement covers the full set of 5G NR FR2 measurements required by 3GPP, e.g. EVM, frequency error, equalizer spectrum flatness, in-band emission, spectrum ACLR and spectrum emission mask.



Product site

R&S®CMP200 RADIO COMMUNICATION TESTER AND R&S®CMPHEAD30 REMOTE RADIO HEAD

New



R&S®CMP200 with R&S®CMPHEAD30 on top

Non-signaling solution for 5G mmWave RF parametric testing

The R&S®CMP200 is an IF tester that combines vector signal analyzer and ARB based generator functionality. The compact integrated solution can be customized with up to three R&S®CMPHEAD30 remote radio heads (RRH), for up/downconverting signals to 5G FR2 frequencies.

Key facts of the R&S®CMP200

- ▶ Ultrafast measurement speed
- ▶ Parallel testing of multiple DUTs
- ▶ IF range from 6 GHz to 20 GHz
- ▶ Fully automated path correction concept



Product site
R&S®CMP200



Product site
R&S®CMPHEAD30

The separate one-box tester and the R&S®CMPHEAD30 RRH concept allow short RF cable lengths for an optimal link budget in radiated test environments. This approach enables testing of fully assembled FR2 devices and RFICs with both IF and mmWave RF interfaces. The multi-band R&S®CMPHEAD30 covers all important FR2 bands.

Key facts of the R&S®CMPHEAD30

- ▶ Up/downconverter for IF ↔ mmWave
- ▶ Integrated mmWave RF switch matrix provides two mmWave RF paths
- ▶ Compact size of 250 mm × 190 mm × 30 mm
- ▶ Connection of up to two mmWave single-polarized antennas
- ▶ Frequency range from 24.25 GHz to 31.80 GHz and from 37.00 GHz to 43.50 GHz

R&S®CMQ200 SHIELDING CUBE

New



Compact shielding solution for 5G mmWave RF parametric testing

The R&S®CMQ200 is a compact and fully integrated solution to cover most 5G devices in various applications. The drawer concept enables fully automated handling in manufacturing environments. The robust mechanical design ensures millions of test cycles for reliable mass production environments. The flexible cube design covers applications for smart devices, CPEs, RFIC and prototypes. R&S®CMQ200 is ready for 5G and other technologies in the frequency range from 20 GHz to 77 GHz.

Key facts

- ▶ Ready for 5G and other technologies
- ▶ Reduced floor space: fits into 19" racks
- ▶ Cost-efficient for large production lot sizes: layouts with simplified geometry
- ▶ Specially designed compact antennas available
- ▶ Antennas with special mounts and swivel heads cover all positions of DUT antenna arrays
- ▶ Power sensors with CW source available



R&S® CMW100 COMMUNICATION MANUFACTURING TEST SET

1



The R&S®CMW100 together with the R&S®TS7124 RF shielded box for device testing

Production and R&D solutions for multi-DUT testing

The R&S®CMW100 communication manufacturing test set is a new trendsetting product for calibrating and verifying wireless devices. This follow-up to the R&S®CMW500 focuses on production and development needs. The device can be used in different phases of the R&D process (e.g. board level testing, engineering and design verification).

The R&S®CMW100 can perform receiver and transmitter tests for cellular and non-cellular technologies. Like the R&S®CMW500, the R&S®CMW100 features high measurement accuracy. The R&S®CMW100 offers parallel testing and can be used to optimize test time and capacity utilization.

The R&S®CMW100 provides high flexibility in a minimum of space. Based on a new eco-friendly hardware concept, it features extremely low energy consumption and a very compact size. The R&S®CMW100 reduces testing costs and is ideal for use in fully automated robotic production lines.

Small cell production testing

The R&S®CMW500 and R&S®CMW100 can be used to calibrate and verify transceivers in small cell production lines. The use of one production line for both mobile devices and small cells provides the greatest possible flexibility.

Key facts

- ▶ Turnkey R&S®CMWrun based production solution for different chipset suppliers
- ▶ Continuous frequency range up to 6 GHz
- ▶ Multitechnology solution up to 5G NR
- ▶ Parallel testing on up to eight RF ports
- ▶ High measurement performance
- ▶ High measurement accuracy
- ▶ Support of a wide range of methods for reducing test time and maximizing capacity utilization
- ▶ Minimum space requirements and footprint
- ▶ Low weight
- ▶ Noise protection
- ▶ Dust protection
- ▶ High MTBF



Videos



Product site

R&S® CMW500 WIDEBAND RADIO COMMUNICATION TESTER



All-in-one test platform for wireless devices

The R&S®CMW wideband radio communication tester offers universal, efficient test solutions for all modern cellular and non-cellular standards. The R&S®CMW is the world's most widely used T&M platform for development, production and service. It meets all of the requirements for a state-of-the-art wireless communication tester. The R&S®CMW can also emulate network operation under realistic conditions for protocol and RF tests.

The R&S®CMW platform offers the very latest LTE enhancements and all legacy technologies in a single compact tester, making it ideal for testing mobile devices such

as smartphones and tablets as well as base stations. It is also an excellent platform for testing the diverse requirements of networked products in the automotive, health-care, smart home and other IoT segments.

The R&S®CMW500 can handle the following:

- ▶ LTE-A up to Cat. 20 (2 Gbps)
- ▶ Wireless standards and broadcast technologies, e.g. LTE (incl. MIMO), WLAN or DVB-T and associated inter-RAT measurements
- ▶ All phases of development, verification and production
- ▶ All protocol layers, from RF tests and protocol tests to end-to-end application tests
- ▶ Module tests, system and integration tests, regression tests, conformance tests and production tests
- ▶ Multi-CMW solution for testing more complex LTE-A requirements

To adapt the R&S®CMW500 to the requirements of the application, the user simply has to select the appropriate hardware and software components.

Platform overview – preconfigured models



R&S®CMW500

The all-in-one test platform

The R&S®CMW500 wideband radio communication tester is the universal test platform for RF integration and protocol development. The R&S®CMW500 includes a fully integrated end-to-end (E2E) data solution that permits comprehensive IP throughput and quality measurements. The R&S®CMW500 can be used in all phases – from product development to production to service. It is the solution with the widest range of supported technologies.



R&S®CMW270

The expert for all non-cellular technologies

The R&S®CMW270 wireless connectivity tester is a cost-effective alternative for development, production and service. The non-cellular specialist offers features comparable to those of the R&S®CMW500. It supports Bluetooth®, WLAN and broadcast technologies.



R&S®CMX500

The 5G NR signaling tester

The R&S®CMX500 radio communication tester is the test platform for signaling tests in all 5G frequency bands: sub6 GHz (FR1) and mmWave (FR2). In non-standalone (NSA) mode, the R&S®CMW500 supports legacy technologies in mixed operation with LTE.



R&S®CMW290

The compact RF tester for basic functional tests

The R&S®CMW290 functional radio communication tester is the cost-effective compact version of the R&S®CMW500. The tester is the right instrument for users who need to measure fundamental RF characteristics or verify the functionality of wireless devices. The R&S®CMW290 provides service companies with a high-quality, customized, automated test environment for functional input and output tests. Powerful network emulation allows IoT/M2M system integrators to functionally test module integration and custom IP applications.



R&S®CMW100

The sub6 GHz (FR1) RF tester for production

The R&S®CMW100 communications manufacturing test set is based on the R&S®CMW platform. The flexible RF interface permits simultaneous testing of up to eight RF ports. The R&S®CMW100 remote control and measurement concepts are compatible with the R&S®CMW500. Both testers use the same methods for optimizing test time and capacity utilization. The R&S®CMW100 can be used to cost-effectively calibrate and verify wireless devices in non-signaling mode (analyzer/generator).



R&S®CMP200

The mmWave (FR2) production tester

The R&S®CMP200 radio communication tester consists of a vector signal analyzer and a generator for RF frequencies from 4 GHz to 20 GHz. Together with the R&S®CMPHEAD30 remote radio head up/downconverter for the higher frequency ranges (mmWave), it forms a compact non-signaling test platform for production testing of 5G FR2 products.



One tester for the entire product lifecycle

The modular R&S®CMW platform covers all test requirements in all phases of the product lifecycle. With just one basic investment, a wireless device can be tested over its

entire lifecycle – from development to certification and network optimization to production and service. An existing configuration can easily be modified to handle other T&M tasks.

R&S®CMW platform covering the entire lifecycle of wireless devices

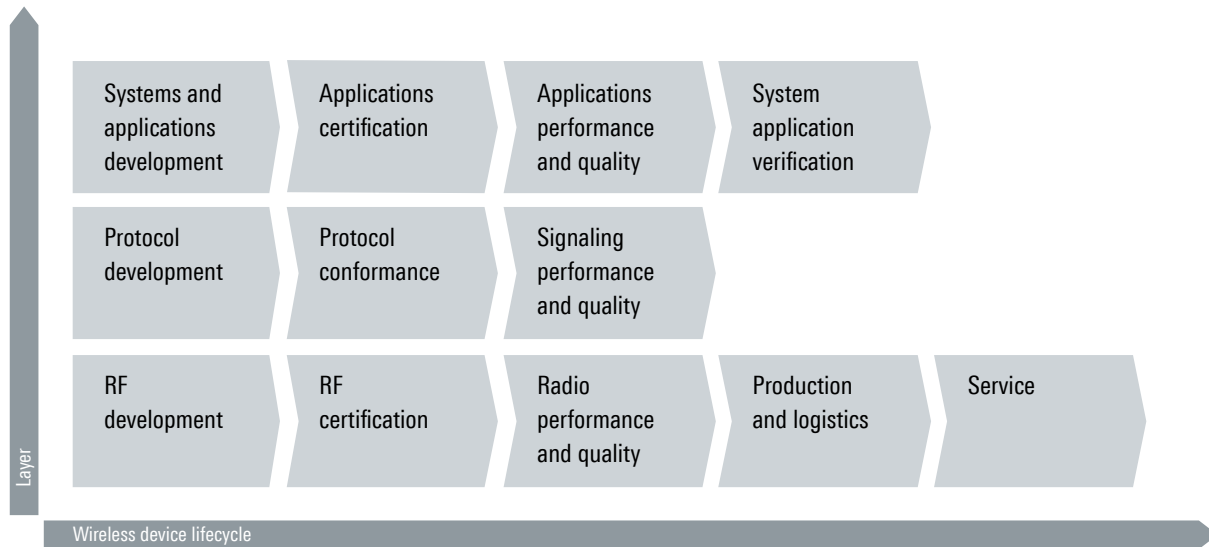

Use of the R&S®CMW platform for wireless technologies						
Technology	RF generator	RF analyzer	Network emulation	Protocol testing	End-to-end application testing	Fading support
Cellular technologies						
5G NR FR1	•	•				
LTE-A pro/LTE MTC	•	•	•	•	•	•
NB-IoT	•	•	•	•	•	
WCDMA/HSPA+	•	•	•	•	•	•
GSM/GPRS/EGPRS	•	•	•	•	•	•
CDMA2000® 1xRTT, CDMA2000® 1xEV-DO	•	•	•	• (inter-RAT LTE)	•	•
TD-SCDMA	•	•				
C-V2X	•	•	•	• ¹⁾		
Non-cellular technologies						
WLAN IEEE 802.11a/b/g/n/ac/ax	•	•	•	• (offloading use cases)	•	
WLAN IEEE 802.11p	•	•				
Bluetooth® Classic/Low energy	•	•	•			
IEEE 802.15.4 (ZigBee)	•	•				
SigFox	•	• (GPRF measurement)				
LoRa	•	• (GPRF measurement)				
Broadcast technologies						
GNSS (GPS, GLONASS, Beidou)	•					
DVB-T/DAB	•					
T-DMB	•					
CMMB	•					

¹⁾ Requires additional external software from partner.

R&S® CMW290 FUNCTIONAL RADIO COMMUNICATION TESTER

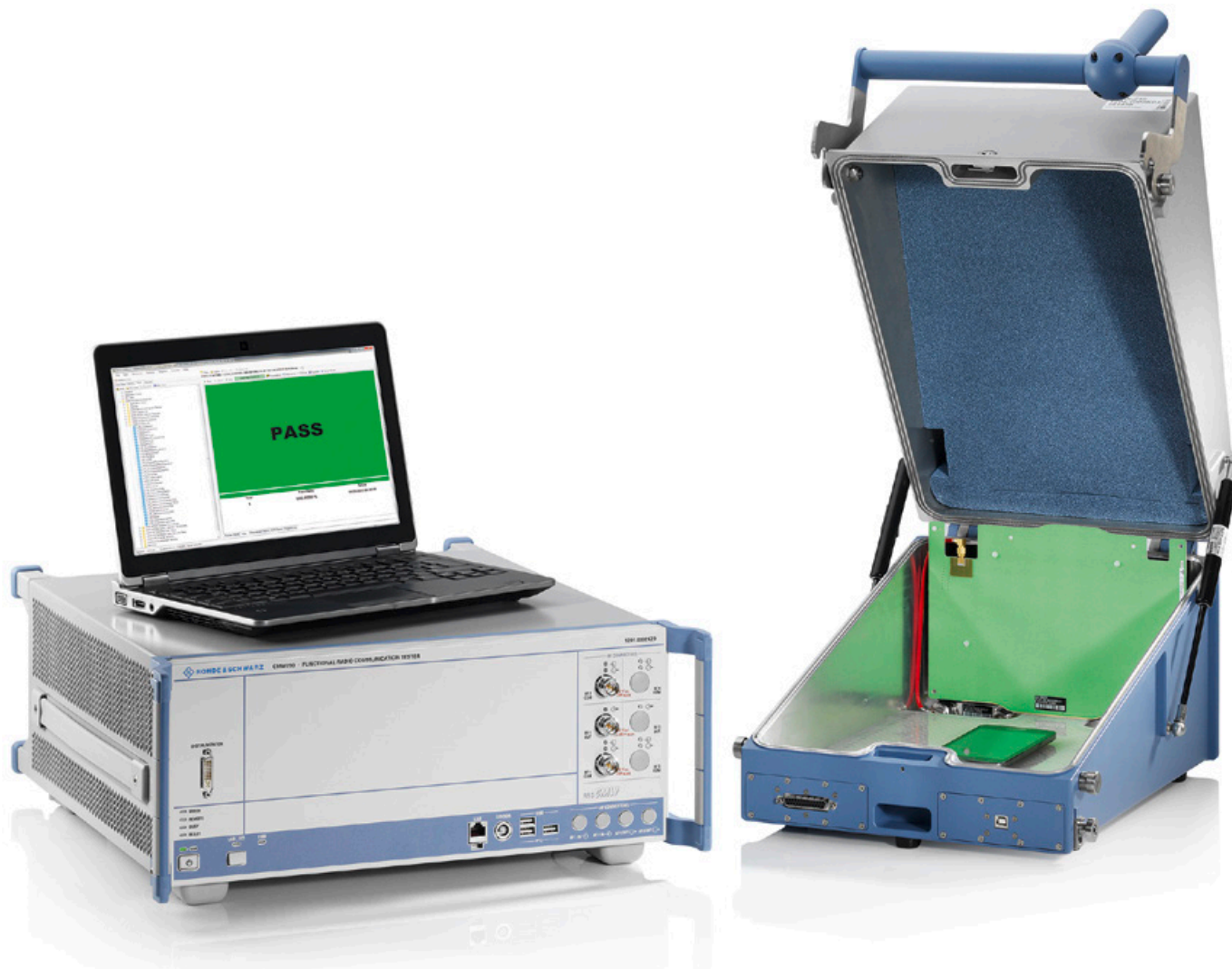

The compact RF tester for service and IoT functional tests

The R&S®CMW290 is the right instrument for users who measure fundamental RF characteristics or perform Go/NoGo checks in line with communications standards. It verifies that the frequencies and levels of the DUTs comply with specifications to ensure proper operation and that they do not interfere with other electronic devices. Since the tester supports all common cellular and non-cellular standards, both handover and coexistence tests can be performed.

The R&S®CMW290 is also the ideal solution for network emulation and functional testing of integrated wireless modules in IoT communications. Not only can users verify that the RF module was correctly installed in the system, they can also verify that the IP-based applications were correctly configured by connecting the devices client software to built-in server software or forwarding IP traffic to external servers.

Use cases

- ▶ Functional tests of cellular and non-cellular devices in IoT services, reverse logistics and module assembly
- ▶ Calibration of cellular devices in service and reverse logistics

Key facts

- ▶ Simultaneous support of all common wireless communications standards – cellular and non-cellular up to 6 GHz on up to two channels
- ▶ Basic RF measurements with/without signaling and pure functional tests
- ▶ Configurable, simple R&S®CMWrun user interface (R&S®CMW-KT050) for efficient test sequence execution
- ▶ Optional: integration of manufacturer software to adjust RF modules
- ▶ Proven R&S®CMW quality, developed for long-term use in production environments



R&S® CMW270 WIRELESS CONNECTIVITY TESTER



The non-cellular expert covering WLAN, Bluetooth®, GNSS, IEEE 802.15.4 and various broadcast technologies

The R&S®CMW270 is a cost-effective alternative for the development and production of equipment outside conventional cellular networks, and is specifically designed for the test requirements of internet of things (IoT) market. It is a tailored subset within the R&S®CMW500 product family. In addition to WLAN IEEE802.11a/b/g/n/ac/ax network emulation and Bluetooth® Classic/Low Energy signaling support, the R&S®CMW270 includes IEEE 802.15.4 non-signaling support plus generator and analyzer functionality.

The R&S®CMW270 was developed to meet the specific requirements of R&D, production, quality assurance, service and network interoperability testing (IOT) – with a single, tailorable instrument. It is an ideal choice for demanding performance tests and measurements in labs and production – from IP application testing under fully controlled network conditions with a MIMO base station emulator to high-speed RF and baseband alignment with dual-tester configuration.

Key facts

- ▶ Continuous frequency range up to 6 GHz
- ▶ Multiple standard RF measurements for WLAN and Bluetooth®
- ▶ WLAN IEEE802.11a/b/g/n/ac/ax network emulation
- ▶ IP-based end-to-end test for WLAN
- ▶ Simultaneous uplink burst measurements during signaling connection, PER/BER and message analyzer
- ▶ Bluetooth® BR/EDR/LE test mode support for preformance tests
- ▶ Bluetooth® Classic and Bluetooth® Low Energy signaling support for OTA tests
- ▶ Bluetooth® audio characteristic for HFP and A2DP
- ▶ General-purpose ARB generation for WLAN, Bluetooth®, GNSS and broadcast technologies
- ▶ Dual-tester concept with R&S®Multi-Evaluation list mode for speed and cost-optimized production

R&S®CMW270 wireless connectivity tester

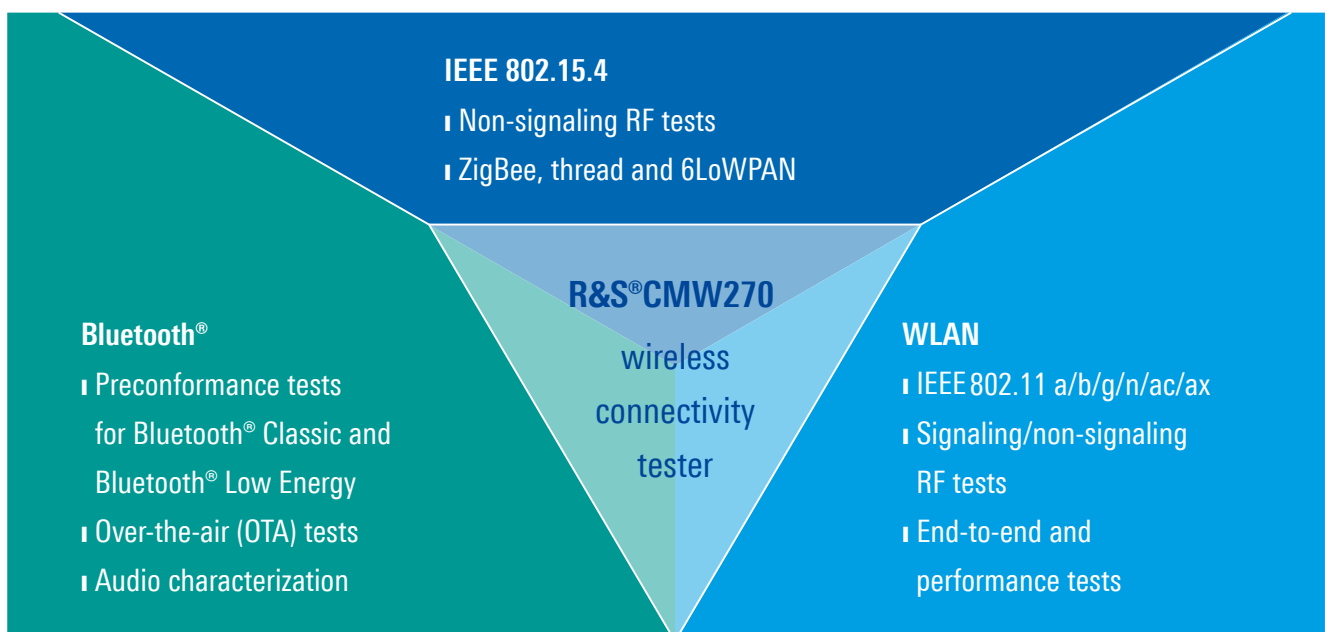

Videos



Product site

R&S®CMW CALLBOX



RF parametric tests including fading at the user's fingertips

Efficient signaling tester for the requirements of tomorrow

Short time to market and cost reduction are the perpetual goals of every developer – from chipset development to module integration. The rapid implementation of the latest wireless technologies makes the R&S®CMW callbox a must-have for every R&D lab. Complex tests can be performed easily and with high accuracy with just one contact point thanks to multi-RAT capability, including Bluetooth® and WLAN, the integrated application server and fading simulator.

R&S®CMW callbox for complex functional, mobility and IP throughput tests

When it is necessary to test wireless devices under realistic conditions, examine physical RF parameters and E2E behavior or verify standard-compliant behavior of a DUT, the R&S®CMW callbox is the right solution. The R&S®CMW callbox is a base station emulator. It generates the signaling messaging and connects directly to the DUT. Depending on which technologies are emulated, a wide range of functional, mobility and fading tests can be performed on the DUT, primarily on the physical layer. Add-ons are available for the R&S®CMW callbox for complex IP throughput tests

Leading in LTE – always a step ahead

A single R&S®CMW setup is all that is needed to easily and economically analyze 2CC up to 8CC setups. All CA scenarios can be used in either FDD or TDD or in FDD/TDD joint operation. The R&S®CMW500 is highly flexible. LTE enhancements such as LTE-U, LTE-D, LTE-MTC and PS-LTE can be rapidly deployed. To quickly develop the latest devices up to Cat21, Rohde & Schwarz offers R&S®CMWflexx, an extremely flexible high-end solution. The intuitive user interface supports users, e.g. when testing 8 DL CA up to 4x4 MIMO, including internal fading. In combination with the R&S®CMX500, even 5G NR signaling tests in non-standalone mode with LTE and other legacy technologies can be supported.

Uplink carrier aggregation is supported for up to four carriers with 16QAM, 64QAM or 256QAM.

Supported 3GPP/3GPP2 RF TRX functional tests

Technology	TX, RX and performance measurements
5G NR (EN-DC)	3GPP TS 38.521-3, chapters 6, 7
LTE/LTE-A (FDD, TDD)	3GPP TS 36.521-1, chapters 6, 7, 8, 9
NB-IoT/eMTC	3GPP TS 36.521-1
WCDMA (HSPA/HSPA+)	3GPP TS 34.121-1, chapters 5, 6, 7, 9, 10
GSM (GPRS/EGPRS)	3GPP TS 51.010-1, chapters 12, 13, 14
TD-SCDMA (HSPA, HSPA+)	3GPP TS 34.122-1, chapters 5, 6
CDMA2000® 1xRTT, CDMA2000® 1xEV-DO	3GPP2 C.S0011-D, chapters 3, 4 3GPP2 C.S0033-B, chapters 3, 4

Comprehensive complex RF signaling tests based on Bluetooth® and WLAN

The R&S®CMW is the only platform to deliver all defined Bluetooth® SIG RF signaling tests in combination with other cellular technologies such as LTE-A, WCDMA, GSM, CDMA2000® and non-cellular technologies such as WLAN and GNSS. The R&S®CMWrun automation tool offers solutions for Bluetooth® BR, EDR and LE prequalification tests.

Easy testing of non-ideal signaling using the internal fading simulator

To simulate fading scenarios, 3GPP has defined various fading profiles (pedestrian, vehicular, typical urban, high-speed train, etc.). Using the R&S®CMW platform's integrated fading simulator, the user can dynamically and individually apply 3GPP profiles for the various technologies. This one-box solution makes it easy to assess receiver performance under non-ideal conditions. These tests can be fully automated with the R&S®CMWrun software to check the devices' MIMO performance under fading conditions.



R&S® CMWrun SEQUENCER SOFTWARE TOOL

Ready-to-use solution for configuring RF and data application test sequences by remote control – for all standards supported by the R&S®CMW family

The R&S®CMWrun sequencer software tool meets all requirements for executing remote-control test sequences on the R&S®CMW500 in R&D, quality assurance, production and service for both current and future wireless equipment. Typical applications are RF pre-conformance tests according to 3GPP, IP throughput test, battery life tests, video and audio (VoLTE) performance tests, coexisting tests and many more.

The software engine is based on the execution of test DLLs (plug-in assemblies). This architecture not only allows easy and straightforward configuration of test sequences without knowledge of specific remote programming of the instrument, it also provides full flexibility in configuring parameters and limits of the test items provided in the R&S®CMWrun package options for the different standards.







When the test focus is on preformance RF testing in line with the specification rather than 3GPP validation testing, the right choice is the R&S®CMW500 RF tester, remotely controlled via R&S®CMWrun. RF preformance testing in line with 3GPP is available for LTE, WCDMA-HSPA, GSM, CDMA2000, 1xRTT/1xEV-DO, NB-IoT and eMTC.

Using a standalone R&S®CMW500 and with just a few configuration clicks for bands, channels and bandwidth, the tool provides a comprehensive result report, giving the user a first impression of in-band compliance. This provides benefits in the very early stage of verification, before doing more complex system tests or validation.





The preformance testing solution is available in the following standard-specific R&S®CMWrun options:

- ▶ R&S®CMW-KT053 WCDMA/HSPA and GSM (planned)
- ▶ R&S®CMW-KT054 for TDSCDMA
- ▶ R&S®CMW-KT055 for LTE/FDD and TDD
- ▶ R&S®CMW-KT058 for CDMA2000® 1xRTT/1xEV-DO
- ▶ R&S®CMW-KT057 for WLAN/BT Option
- ▶ R&S®CMW-KT052 for NB-IoT/eMTC (Cellular IoT)

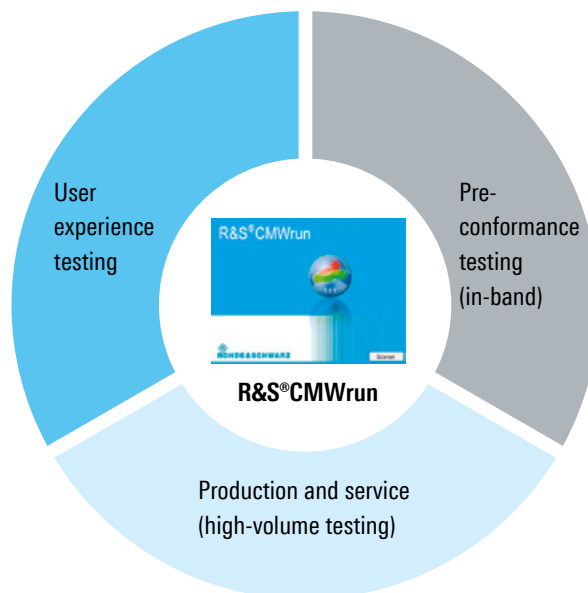
R&S®CMWrun use cases

-  **Throughput testing**
-  **Audio performance**
-  **Video analysis**
-  **Battery life testing**
- MIMO** **MIMO performance testing**
-  **Coexistence testing**
-  **IP connection security testing**



- 3GPP** 3GPP TS testing (all technologies)
- 3GPP2** CDMA2000® 1xRTT/1xEV-DO
-  **Bluetooth®**
-  **eCall/ ERA-GLONASS**
-  **Basic signaling with different technologies**
-  **Find attenuation routines**
-  **Chipset support in non-signaling mode**



R&S® CMW500 PROTOCOL TESTER



One tester for all phases of development

The R&S®CMW500 is the ideal multitechnology protocol tester, as it provides developers of wireless devices with a radio access network simulation. Equipped with powerful hardware and various interfaces to wireless devices, the R&S®CMW500 can be used throughout all phases of LTE device development – from the initial software module test to the integration of software and chipset in R&D, as well as GCF and PTCRB certification testing of conformance and performance tests of the protocol stack of 3GPP-compliant wireless devices. The R&S®CMW500 provides developers of LTE protocols with a specification-conforming reference implementation of the air interface. The comprehensive functions of the programming interfaces and the highly detailed representation in the analysis tools can be used to quickly detect discrepancies in the DUT protocol stack.

Hardware platform

- ▶ LTE and NB-IoT protocol tester with a layer 1 to layer 3 protocol stack implementation in accordance with 3GPP Rel. 8 to Rel. 14, incl. LTE-A features such as eCA
- ▶ Future-ready, powerful RF hardware that supports the 3GPP-defined LTE bandwidths from 1.4 MHz to 20 MHz and all 3GPP frequency bands up to 6 GHz
- ▶ For LTE-A, any combination of bands and bandwidth can be tested up to 8 carriers, incl. MIMO (R&S®CMWflexx)
- ▶ Data rates up to 2 Gbps downlink and 450 Mbps uplink
- ▶ Digital baseband fading with internal fading simulators
- ▶ 2x2, 4x2, 8x2, 4x4, 8x4 MIMO
- ▶ Multicell and multi-RAT capability for LTE and LTE-A intracell, intercell and inter-RAT handover tests (GSM, WCDMA, CDMA2000®, 1xEV-DO, WLAN incl. IEEE 802.11ac/ax)

Software components

- ▶ Development environment for layer 1 to layer 3 signaling scenarios with automatic configuration of the layers below (MLAPI) for LTE, NB-IoT and WCDMA
- ▶ TTCN-2, TTCN-3 libraries and software tools for developing LTE signaling conformance test cases
- ▶ Extensive library with preconfigured messages and signaling scenarios for speeding up test development
- ▶ Practice-proven R&S®CMWmars software tool for carrying out, working on, automating and analyzing signaling scenarios
- ▶ Graphical test script tool R&S®CMWcards for simplified creation of wireless signaling tests

Protocol stack test solutions for R&D and protocol conformance

R&D/carrier acceptance tests

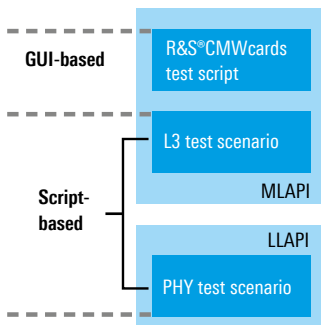

R&S®CMW500 protocol stacks

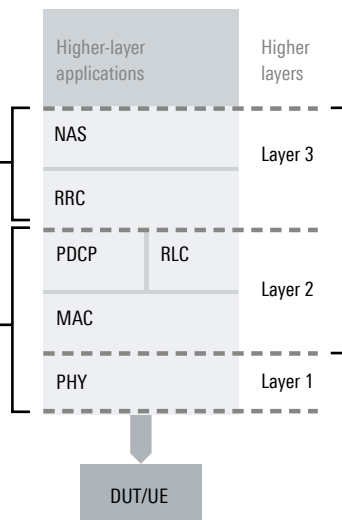

Protocol conformance tests

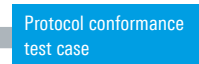

Rohde & Schwarz solution



R&S® CMWcards SIGNALING AND APPLICATION TESTER

Smart network emulation for all wireless device tests

The R&S®CMWcards graphical test script definition tool lets users set up the tests they always wanted, but never had time to implement. Wireless signaling and application tests can be created on the R&S®CMW by simply setting up a hand of cards – no programming required. Revolutionary card wizards and unique game rules guide users through setting up test sequences that fully comply with test specifications. They can rapidly reproduce signaling scenarios for various wireless communications standards.

Key facts

- ▶ Just GUI, no programming, no code compilation
- ▶ Test creation, parameterization, execution and analysis in a single tool
- ▶ Multicell support (up to six independent cells)
- ▶ Remote test execution and campaign management with DUT automation
- ▶ More than 400 sample test cases included
- ▶ Ready to use test script packages
- ▶ Fine control over content of peer messages
- ▶ Import real network configurations using Field-to-Lab wizard

Applications

- ▶ Protocol stack feature verification
- ▶ Regression testing
- ▶ Replication of field issues
- ▶ Roaming use cases
- ▶ Simulation of network failures and reject causes
- ▶ Data throughput and performance measurements
- ▶ Application tests (data, voice and video)
- ▶ Key performance indicator (KPI) testing

Testing scope

- ▶ Layer 3 signaling tests for 3GPP LTE (Rel. 8 to Rel. 14), WCDMA, GSM and inter-RAT
- ▶ C-IoT tests for Cat. 1, eMTC (Cat. M1) and NB-IoT (Cat. NB1/NB2, Rel. 14)
- ▶ Up to 8CC with MIMO 4x4 and DL 256QAM
- ▶ LBS testing with AGNSS and OTDOA
- ▶ LTE-U and LTE-LAA
- ▶ Cell selection, redirections and handovers
- ▶ IMS and VoLTE including call flow fallback (CSFB) and SRVCC
- ▶ LTE-WLAN offload
- ▶ Evolved multimedia broadcast multicast service (eMBMS)
- ▶ Failure scenarios
- ▶ CMAS (WEA) and ETWS public warning system

R&S®CMWcards sample scenario for LTE inter-RAT and multicell tests

Test case simulation

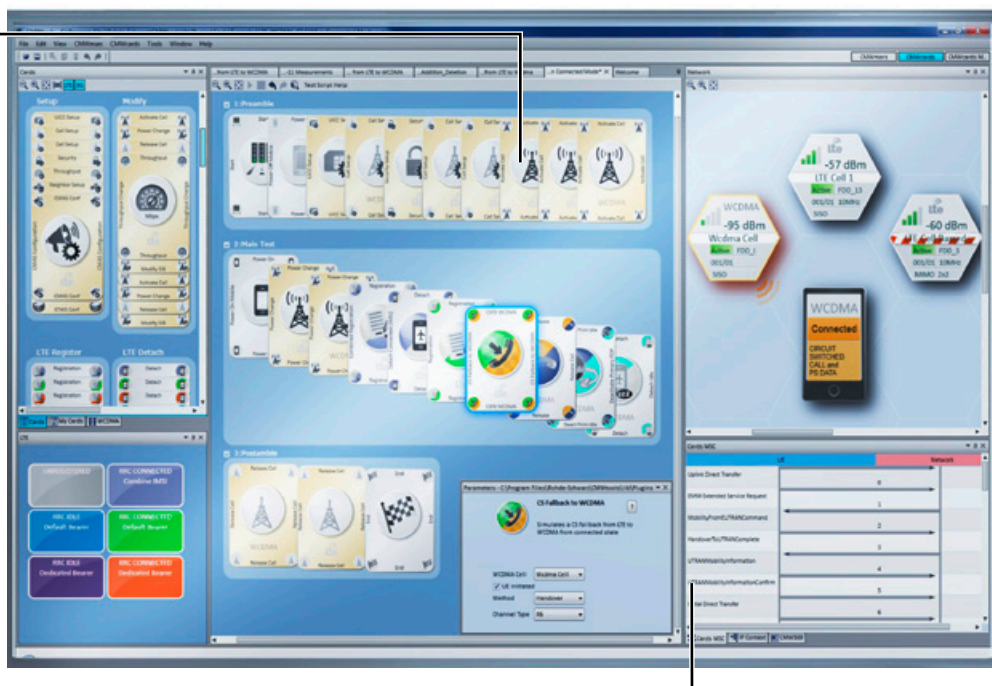

Different views for parameterization and monitoring



Videos



Product site

R&S® CMWmars MULTIFUNCTIONAL LOGFILE ANALYZER

Powerful message analyzer for all R&S®CMW applications and use cases

R&S®CMWmars is the message analyzer for all R&S®CMW signaling applications. Users can efficiently analyze recorded message logfiles and trace information on the fly in realtime while a test is running. The convenient, intuitive R&S®CMWmars user interface combined with various tools and views helps users quickly narrow down the root cause of signaling protocol and lower layer problems.

The multifunctional logfile analyzer provides access to all information elements of all protocol layers for LTE, WCDMA, GSM, TD-SCDMA, CDMA2000®, WLAN, Bluetooth®, eMTC and NB-IoT, including the IP layer. It is well-established as the standard analysis tool for customers such as chipset manufacturers, handset manufacturers and network operators as well as for device certification in test houses.

Key facts

- ▶ Access to all protocol stack layers of all wireless technologies, including the IP data layer
- ▶ Easiest filtering thanks to optimized GUI usability
- ▶ Inline message and message content comparison
- ▶ Pass/fail view at a glance
- ▶ Smart UE capability view for DUT features at a glance
- ▶ Unique graphical timeline view for chronological analysis
- ▶ Easy navigation in logfiles with powerful full-text search features and bookmarks
- ▶ Realtime display of message flow (online tracing) during test case execution
- ▶ Effective graphical protocol measurement charts for throughput and BLER measurements on all layers
- ▶ Postprocessing (offline analysis) of recorded message logs
- ▶ Powerful scripting interface for automatic logfile analysis using predefined macros

R&S®CMWmars message logfile for a WLAN offload measurement

The screenshot displays the R&S CMWmars interface with several key components highlighted:

- High-level message flow:** A top-level overview of the message sequence, showing a flow from the UE through various protocol layers (RRC, NAS, IP, etc.) to the network.
- Detailed message flow:** A more granular view of the message exchange, showing individual messages and their contents across different protocol layers.
- Decoded information elements:** A detailed view of a specific message, showing its structure and the decoded information elements within it.
- Throughput measurements on all protocol layers:** A graph showing throughput over time for various layers, with a table below it providing summary statistics.

Layer	Throughput	Current	Min	Max	Avg	Unit
IP Throughput	4.44					Mbit/s
IPsec	4.39					Mbit/s
IPsec ESP	4.39	22.00	222.20	0.00	266.70	Mbit/s
IPsec ESP Encrypted	4.39	0.00	266.68	0.00	266.68	Mbit/s
IPsec ESP Decrypted	4.39	199.00	0.00	266.67	266.67	Mbit/s
IPsec ESP Authenticated	4.39	896.70	0.00	266.67	266.67	Mbit/s
- Bit analysis of information elements:** A table showing the bit analysis of information elements, including their names, lengths, and whether they are supported or not.
- Relationship of messages within protocol stack:** A diagram showing the relationship between messages within the protocol stack, highlighting the flow of information between different layers.



R&S® CMW-ATE TERMINAL TESTING SOLUTION FOR IMS, VoLTE AND RCS

1



Powerful test solution for network operator specific IMS services such as voice over LTE (VoLTE), video over LTE (IR94) and rich communication services (RCS)

- ▶ Network operator-specific (NetOp) test case packages for operator acceptance and certification testing
- ▶ GSMA IR.92 and IR.94 compliant
- ▶ IMS, VoLTE, SMS over IMS, IMS E911 emergency calls and RCS (rich communication services) protocol testing of wireless devices and chipsets using different RATs up to 5G
- ▶ Support of various network operator-specific IMS and VoLTE test plans (NetOp) such as Verizon Wireless, AT&T, T-Mobile US, Docomo and CMCC, Deutsche Telekom and America Movil
- ▶ Wireless device testing for all current and future IP multimedia subsystem (IMS) functionalities
- ▶ P-CSCF discovery (PCO/DHCP/DNS)
 - IMS registration and re-registration
 - IMS authentication and re-authentication
 - MO/MT calls (MTSI speech and text calls)
 - Session handling
 - Supplementary services
 - MO/MT SMS over IMS
 - Emergency calls over IMS (with and without positioning)
 - RCS (rich communication services): one to one chat, group chat, file transfer and more
- ▶ Intuitive GUI
 - Easy and fast configuration of test cases with R&S®CONTEST sequencer software
 - Fast and flexible test plan creation
 - Fast and easy changing of parameters
- ▶ Powerful reporting
 - Fast and thorough problem analysis through visualization of message flow
 - Automatic pcap file generation for typical IP-based analysis
 - IMS-centric verdict presentation in XML log files
 - Report with pass/fail verdict for seeing results at a glance
- ▶ Flexible and scalable solution
 - Upgradeable for LTE and NR protocol testing
 - Upgradeable for R&S®CMW-PQA VoLTE performance testing under realistic network conditions
 - Upgradeable for audio quality tests with the R&S®UPV audio analyzer, supporting audio analysis with established mechanisms
 - Upgradeable for location based services (LBS) and SUPL 2.0 testing
- ▶ Fully automated test system



R&S® CMW-PQA TEST SYSTEM FOR PERFORMANCE QUALITY ANALYSIS



Automated performance quality analysis (PQA) test solution

The R&S®CMW-PQA is the test solution for benchmarking and optimizing the performance of chipsets and wireless devices.

The R&S®CMW-PQA makes it possible to measure end-to-end data throughput, call and mobility performance and the quality of services, such as video performance, on chipsets and wireless devices under realistic network conditions. It supports various network operator specific throughput and performance test plans and customized test plans can be created quickly and easily. As a result, the performance of chipsets and wireless devices can be tested under realistic conditions throughout the development process up to approval and bottlenecks during implementation can be identified.

The R&S®CMW-PQA is a test solution for measuring the performance of chipsets and wireless devices under realistic conditions. It simulates the complex network conditions, such as noise, fading and IP impairments, that wireless devices are exposed to in the real world. This is the basis for a variety of throughput and performance measurements.

Wireless device users are promised ever higher data rates. However, users are not just interested in the data rate. What they care about most is the quality of the service they are using on their wireless devices. This is why the R&S®CMW-PQA offers a variety of end-to-end data throughput measurements and above all, can reliably measure the quality of services such as webpage loading and video performance.

Network operators place strong emphasis both on ensuring customer satisfaction and on simplifying network planning. Self-organizing networks (SON) and one of their features (ANR, automatic neighbor relation) represent a first step toward simplifying network optimization. As a result, wireless devices are faced with new requirements, whose fulfillment must be checked. The R&S®CMW-PQA is a platform for call and mobility performance measurements on wireless devices.

- ▶ Explore the performance of chipsets and wireless devices from an end-user perspective for numerous technologies (WCDMA, HSPA+, LTE, LTA-A)
- ▶ Identify bottlenecks in the wireless device's/chipset's implementation from application down to physical layer
- ▶ Evaluate call and mobility performance of chipsets and wireless devices
- ▶ Measure the quality of services such as webpage loading and video performance
- ▶ Supports throughput and performance test plans of major network operators

Specifications in brief

Supported technologies		LTE-A, LTE, WCDMA/HSPA+
Overview of test methods		
Throughput measurements	direction	uplink, downlink, bidirectional, alternating
	data sources	iPerf UDP, iPerf TCP, ftp, http
Call and mobility performance measurements		call retainability, call accessibility, UE measurement reporting, ANR measurement reporting, reject cause handling
Quality of service measurements		video quality, webpage loading



R&S® TS8980 RF/RRM TEST SYSTEM FOR 5G NR, LTE, WCDMA AND GSM

1



Leading platform for 2G, 3G, 4G and 5G testing

The R&S®TS8980 is the most compact full range conformance testing solution on the market for testing in line with requirements from GCF (global certification forum), PTCRB and regulatory bodies (ETSI). It supports the entire device certification process for RF and RRM, covering the widest range of technologies including 5G NR, LTE-Advanced, WCDMA and GSM.

It is modular and fully automated for RF transmitter, receiver and performance measurements. The scalable hardware and software allows cost-efficient testing solutions and can be configured for design verification, precompliance or final type approval testing.

The R&S®TS8980 integrates seamlessly R&S®CMX mmWave transceivers, IF units and over-the-air test chambers like the R&S®ATS1800C to support 5G FR2 (mmWave)

test cases on the same platform. Either in combination with legacy technologies or stand-alone.

Scalable R&S®TS8980 setups for different requirements

- ▶ Full conformance/precompliance tests in line with
 - 3GPP TS 38.521-1/2/3/4 (5G NR with NSA&SA)
 - 3GPP TS 36.521-1 (LTE-A Pro, NB-IoT, M1)
 - 3GPP TS 34.121-1 (WCDMA)
 - 3GPP TS 51.010-1 (GSM)
- ▶ Conducted regulatory tests in line with
 - ETSI EN 301 908 25 for 5G NR
 - ETSI EN 301 908 13 for LTE
 - ETSI EN 301 908 2 for 3G
 - ETSI EN 301 511 for 2G
- ▶ Supplementary network operator tests (AT&T, Verizon Wireless, etc.)

Future-proof architecture – tailored to suit customer needs

- ▶ 5G certification in FR1 (sub-6GHz) and FR2 (mmWave)
- ▶ TX, RX, demodulation & radio resource management
- ▶ EN-DC, CA, margin search and parallel testing

R&S®CONTEST software platform

- ▶ Advanced sequencer tool for all technologies
- ▶ Fully automated runtime optimization
- ▶ Debugging with breakpoints, step-by-step execution
- ▶ Easy-to-use graphical parameterization of test cases
- ▶ Online report with status of progress and pie chart
- ▶ Test results in HTML, XML or CSV format
- ▶ Internal and external database access

Consistent RF tests from R&D to conformance

The R&S®TS8980 test system family covers the widest range of applications on the market. Customers can rely on consistent test results from R&D stages all the way to final conformance tests.

Precise and reproducible measurement results

The fully automated path calibration used in the R&S®TS8980 test system and high-speed self-test mechanisms deliver maximum accuracy and reproducibility of measurement results.

Low cost of ownership and quick results

Scalable configurations ensure an optimum match of budget and functionality, starting with the R&S®TS8980S. Selected instruments can be configured to require external calibration only every 2 years. The system is designed for 24/7 operation to maximize return on investment. Short test case run times help to minimize time to market.



Videos



Product site

R&S®TS-RRM LTE, WCDMA AND 5G RRM TEST SYSTEM

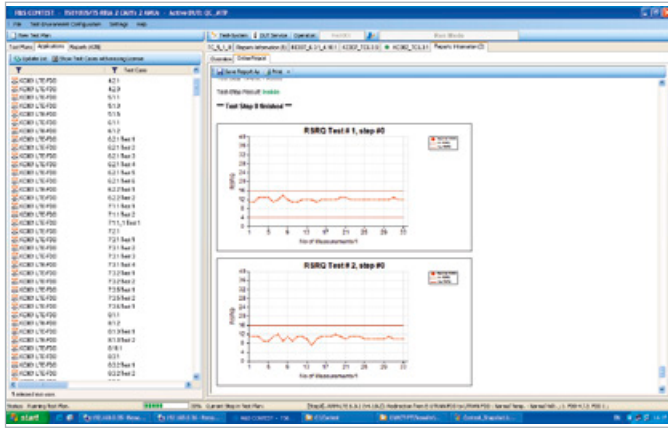

- ▶ Scalable platform for different technologies, covering the various test needs that arise in R&D, conformance and network operator acceptance testing
- ▶ Automated for faster test runs and reduction of test time
- ▶ Runs on R&S®CONTEST platforms such as the R&S®TS8980

Supported technologies

- ▶ WCDMA single mode
- ▶ WCDMA inter-RAT to GSM
- ▶ LTE single mode
- ▶ LTE inter-RAT to WCDMA, GSM, CDMA2000® and TD-SCDMA
- ▶ 5G EN-DC (NSA) FR1 (sub-6GHz) and FR2 (mmWave)
- ▶ 5G NR (SA) FR1 (sub-6GHz) and FR2 (mmWave)
- ▶ 5G and FR2 (mmWave) 1xAoA and 2xAoA
- ▶ Network operator specific tests for AT&T and Verizon

Different setups

- ▶ R&S®TS-RRM standard setup: supports single-mode test cases for GCF and PTCRB with almost 100% of GCF priority 1 release 8 test cases and about 70% of all GCF test cases as well as RX diversity and MIMO
- ▶ R&S®TS-RRM advanced setup: supports 100% of all GCF and PTCRB test cases as well as RX diversity and MIMO
- ▶ R&S®TS8980FTA in combination with R&S®TS-RRM: for multibox test cases supporting 100% of all GCF and PTCRB test cases as well as RX diversity and MIMO

Standalone platform for radio resource management (RRM) testing of wireless devices in line with 3GPP LTE, 3GPP WCDMA, 3GPP 5G and operator test plans

The R&S®TS-RRM LTE and WCDMA RRM test system is a test solution for running WCDMA, LTE, inter-RAT RRM and 5G test cases on wireless devices. It is the perfect solution for the entire mobile station development lifecycle. The R&S®TS-RRM is a fully automated conformance test system prepared for running validated RRM conformance test cases in the design, precertification and type approval of wireless devices. In addition to the RRM test cases required by GCF/PTCRB, the R&S®TS-RRM also supports network operator specific RRM tests.

Key facts

- ▶ R&S®TS-RRM testing of radio resource management technologies in 3GPP TS 36.521-3 (LTE), 3GPP TS 34.121-1 (WCDMA) and 3GPP TS 38.533 (5G) devices and chipsets
- ▶ Coverage of RRM conformance and network operator specific test plans
- ▶ Reusable for LBS OTDOA/eCID

Configuration examples



R&S®TS-RRM advanced setup



R&S®TS8980FTA and R&S®TS-RRM



R&S®TS-LBS TEST SYSTEM FOR LOCATION BASED SERVICES

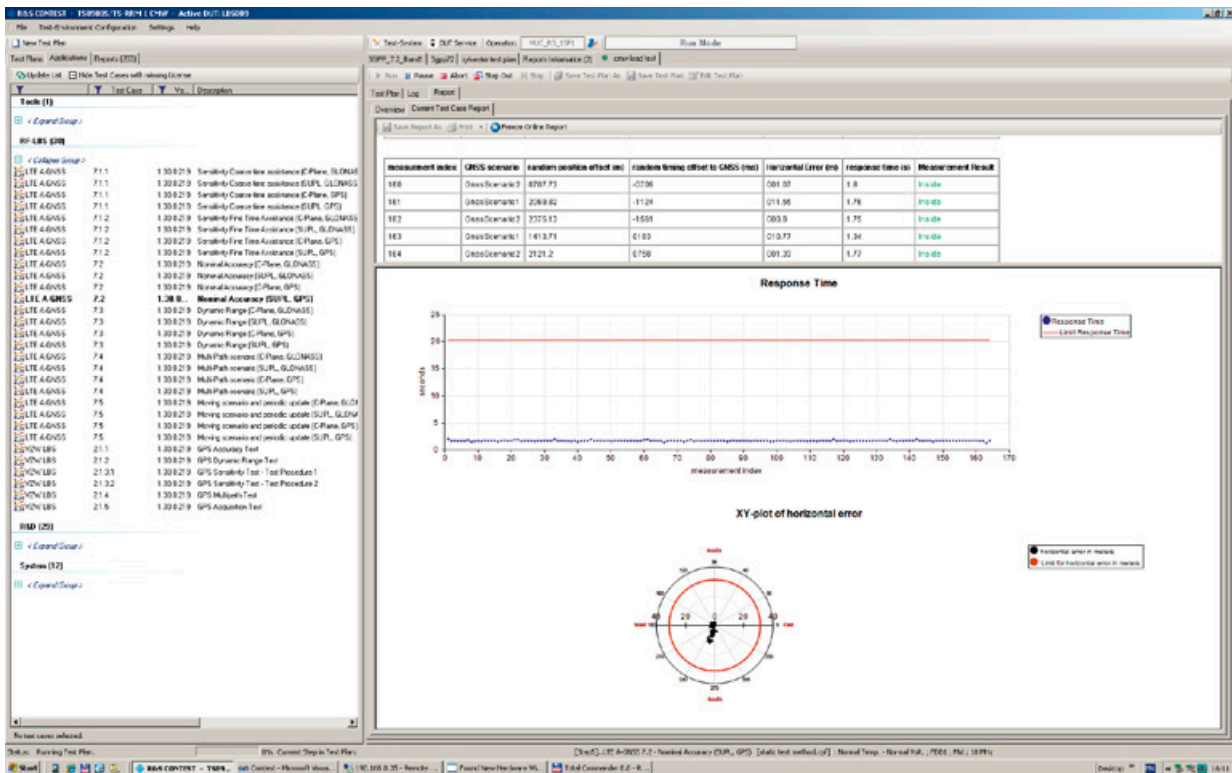

Comprehensive test solution for network and satellite-based location technology testing of wireless devices and chipsets

The R&S®TS-LBS test system family is highly configurable for testing different location technologies of user equipment (UE) and chipsets.

The R&S®TS-LBS represents the second generation of Rohde&Schwarz LBS test systems. It fulfills the requirements for LBS conformance testing and operator acceptance testing on GSM, WCDMA, LTE and 5G devices and chipsets.

The R&S®TS-LBS provides complete LBS test coverage through all phases

A-GNSS minimum performance	LBS protocol conformance	Network-based positioning OTDOA/eCID	Operator acceptance field-to-lab	LBS hybrid	5G NR	Indoor positioning	LBS development features	A-GNSS OTA	RED EN 303 413 L1+L2/L5
LTE A-GNSS	OMA SUPL2.0 TTCN3	LTE FDD OTDOA eCID	Verizon AT&T	LTE A-GNSS OTDOA	5G NR FR1 NSA	WLAN Bluetooth®	Margin search User def. scenarios OTDOA/eCID R&D	Verizon LTE GPS	Adjacent frequency band
WCDMA A-GNSS	LTE LPP FDD/TDD C-plane	Interband OTDOA	T-Mobile DoCoMo	LTE A-GNSS hybrid	5G NR FR1 SA	Barometric LPPe	LBS receiver testing GPS GLONASS BeiDou GALILEO	CTIA 3.4 LTE A-GNSS	Receiver spurious emissions
GSM A-GPS	WCDMA RRC C-plane	CA OTDOA	Softbank CMCC	Position calculation	5G NR FR2 NSA	LPP R13 MBS			
3 const. GNSS	GSM RRLP C-plane	NB-IoT eMTC	Sprint		5G NR FR2 SA	ToF/TOA			



Wireless communications testers and systems

Location based services (LBS) testing of satellite, cellular and hybrid-based location technologies

- ▶ Coverage of 3GPP minimum performance, signaling conformance (C-plane, U-plane) and network operator specific test plans
- ▶ Scalable platform for different technologies, covering various test needs that arise in R&D, conformance and network operator acceptance testing
- ▶ Automated for faster test execution and reduction of test time
 - Automation of DUT for minimum manual intervention during test runs
 - Fully automatic path calibration routines that run with minimum manual intervention

Supported technologies

Support of satellite, cellular and hybrid-based location technologies in UE and chipsets

- ▶ Support of GNSS-based LBS
 - 3GPP minimum performance
 - Protocol conformance
 - Operator test plans
 - OTA LBS
 - 5G EN-DC (NSA) A-GNSS
 - 5G NR (SA) A-GNSS
- ▶ Support of cellular network-based LBS (requires the R&S®TS-LBS advanced hardware platform)
 - LTE OTDOA/eCID for LTE
 - Operator test plans
- ▶ Support of hybrid location technologies
 - GNSS and OTDOA/eCID

- ▶ Support of indoor positioning
 - WLAN, Bluetooth®, Barometric, terrestrial beacon
 - LPPe, LPP R13
 - ToF/TOA

Different setups

Scalable and flexible test system family suitable for applications ranging from R&D to conformance testing of GSM, WCDMA, LTE and 5G user equipment (UE) and chipsets

- ▶ Modular hardware and software depending on individual test requirements
- ▶ Scalable hardware and software allowing cost-efficient R&D solutions
- ▶ Availability of upgrade paths for preformance and full conformance testing
- ▶ Upgradeability to R&S®CMW-PQA test system for performance quality analysis
- ▶ Upgradeability to R&S®TS-RRM test system for radio resource management

R&S®CONTEST software platform

Intuitive GUI and powerful reporting capabilities

- ▶ Debugging capabilities: breakpoints, step-by-step execution
- ▶ Easy-to-use graphical parameterization of test cases
- ▶ DUT services including graphical antenna configurations
- ▶ Online report with status of progress and pie chart for overview
- ▶ Summary report with filter for report explorer
- ▶ Test results in HTML, XML or CSV format and internal and external database access

R&S®TS-LBS on different platforms

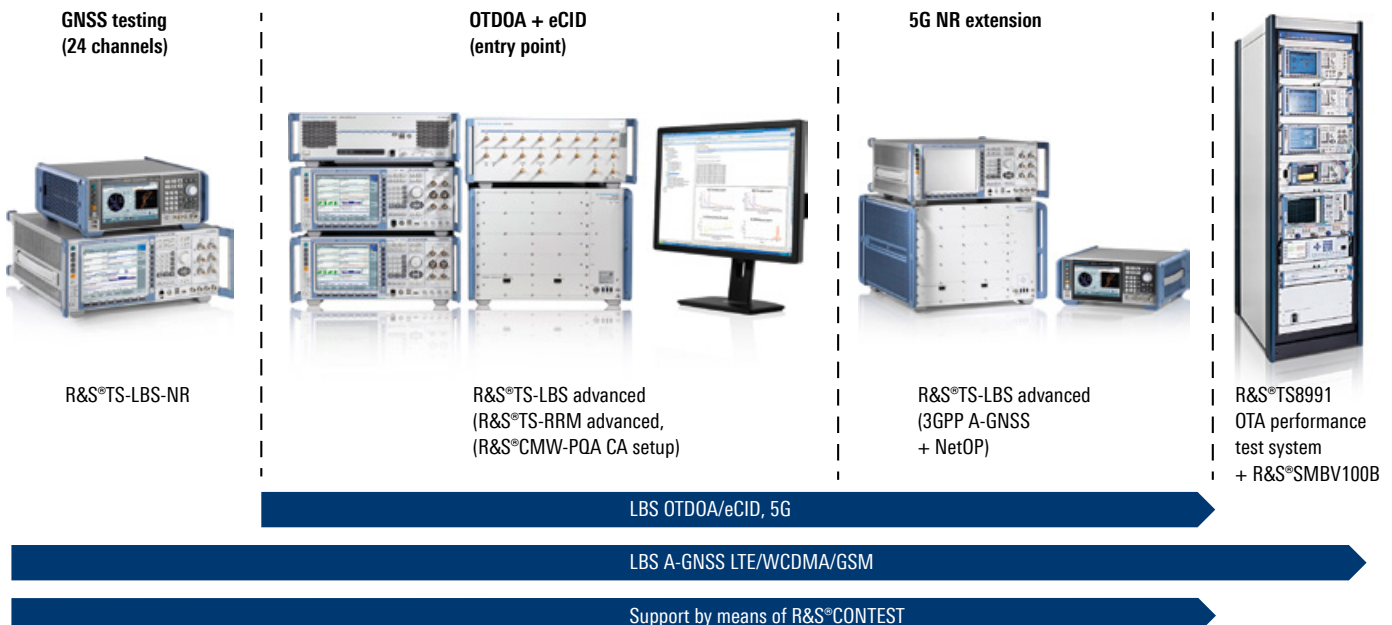

R&S® TS8991 OTA PERFORMANCE TEST SYSTEM

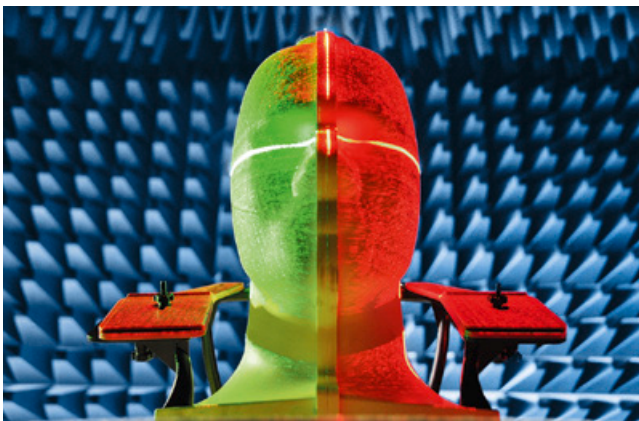

CTIA-compliant OTA measurements

Over-the-air (OTA) measurements are an essential part of the certification testing of wireless devices that require an omnidirectional antenna radiation pattern. The R&S®TS8991 OTA performance test system measures the spatial radiation and sensitivity characteristic as specified by CTIA and 3GPP.

The R&S®AMS32 system software provides ready-to-use test templates for OTA measurements and supports all common wireless standards. The integrated report function collects all measured test data such as graphics or numeric results, test environments, EUT information and hardware setup in one document.

In cooperation with Albatross Projects, a world-leading provider of solutions for RF chambers, various models of wireless performance test chambers (WPTC) were created.

Key facts

- ▶ Measurement of OTA performance in line with CTIA, Wi-Fi Alliance, CWG, PTCRB standards and test cases
- ▶ For all major cellular and non-cellular technologies, including A-GPS
- ▶ Time-optimized, configurable test sequences for qualification and development, based on R&S®AMS32 system software
- ▶ Can be combined with radiated spurious emission and EMC test systems
- ▶ Turnkey solution with test instruments, system software, WPTC anechoic test chamber, OTA chamber and EUT positioner
- ▶ Passive antenna measurements with near field to far field transformation
- ▶ Specific system configurations for 5G OTA measurements

 AlbatrossProjects

WPTC model overview

Model	WPTC-XS	WPTC-S	WPTC-M	WPTC-L	WPTC-XL
Outer dimensions of shielding panels (W x H x D)	2.43 m x 2.40 m x 2.43 m (7.97 ft x 7.87 ft x 7.97 ft)	3.70 m x 3.00 m x 3.10 m (12.14 ft x 9.84 ft x 10.17 ft)	4.60 m x 3.45 m x 3.70 m (15.09 ft x 11.32 ft x 12.12 ft)	5.20 m x 4.05 m x 4.30 m (17.06 ft x 13.29 ft x 14.12 ft)	5.80 m x 5.10 m x 5.20 m (9.03 ft x 16.73 ft x 17.06 ft)
Frequency range of test chamber	0.6 GHz to 87 GHz	0.6 GHz to 87 GHz	0.6 GHz to 67 GHz	0.4 GHz to 50 GHz	0.4 GHz to 50 GHz
Typical range length	> 0.65 m (2.2 ft)	> 1.02 m (3.3 ft)	> 1.30 m (4.3 ft)	> 1.38 m (4.5 ft)	> 1.83 m (6.0 ft)
CTIA-compliant	– (R&D)	– (R&D)	•	•	•



Product site

R&S® TS8996 RSE TEST SYSTEM

Fully automatic emission measurements on wireless communications equipment required for R&D and quality assurance

The R&S®TS8996 RSE test system is used for EMI and spurious emission measurements on wireless communications equipment during EMC and type approval testing. Typical DUTs are mobile phones, base stations, radio sets and short-range devices.

The relevant standards stipulate a wide variety of measurements in a very wide frequency range, all of which can be covered with the R&S®TS8996. For some radiocommunications systems (i.e. short-range devices), higher frequency limits (i.e. 40 GHz) are stipulated for spurious emission measurements. The R&S®TS8996 can be easily adapted to customer requirements.

The modular design of the R&S®OSP-F7x filter unit for carrier frequency suppression allows flexible configuration and easy expansion for various frequency bands. For measuring radiated spurious emissions from radiocommunications equipment, filter configurations for the following technologies have been prepared: GSM, Bluetooth®, WLAN, WCDMA (UMTS).

LTE is supported with the R&S®OSP-B155 plug-in module in combination with the R&S®EMC32-K26 software option. It enables radiated spurious emission measurements of all LTE bands and bandwidths with one compact unit.

In the vicinity of the carrier the signal is shifted in the ideal dynamic range of the test receiver for measurement of spurious in the presence of the carrier.

Key facts

- ▶ Frequency range from 30 MHz to 18 (40) GHz
- ▶ Radiated measurements in line with ETSI EN301489, FCC part 15 and 3GPP TS51.010 standards
- ▶ Conducted spurious emission measurements from 100 kHz to 12.75 GHz on antenna connector of DUT
- ▶ Measurement of spurious emissions from radiocommunications equipment

System software

The R&S®EMC32 software enables fully automatic simple testing. The R&S®EMC32-K2 option offers special features:

- ▶ Automatic setup and control of wireless link
- ▶ Control of different 3D DUT manipulators
- ▶ ERP/EIRP measurement
- ▶ Automatic suppression of carrier signal

The predefined test sequences allow a high degree of automation. Users are freed from tedious extra work and incorrect settings or signal connections can be avoided right from the start. Our product managers assist customers with option selection and system configuration.

Typical test system R&S®TS8996 for radiated spurious emissions

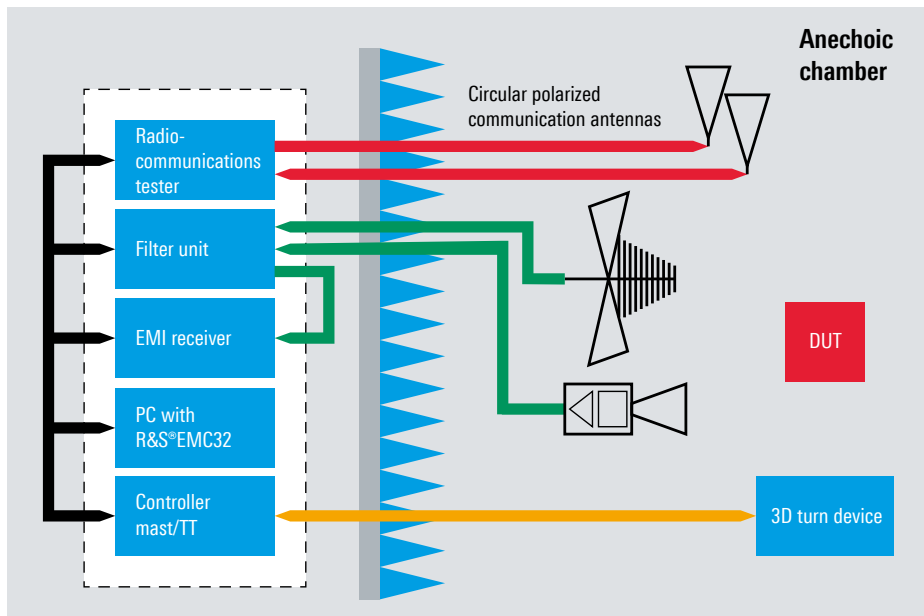

Filter unit



R&S®TS8997 REGULATORY TEST SYSTEM FOR WIRELESS DEVICES

1

For compliance with ETSI EN 300328 in 2.4 GHz band, ETSI EN 301893 in 5 GHz band and FCC §15.247, FCC §15.407

All wideband transmission systems in the 2.4 GHz and 5 GHz bands must be tested to verify compliance with ETSI EN 300328 (2.4 GHz band), ETSI EN 301893 (5 GHz band) and FCC §15.247, FCC §15.407. The latest versions of these standards require the use of special automated test procedures and test equipment. The R&S®TS8997 fully meets these requirements. Measurements are performed using the R&S®EMC32 software platform, which is the standard solution in EMC test labs. The key components in the test system are the R&S®WMS32-Kxx options and the R&S®TS8997 specific R&S®OSP modules, which provide power measurement and path switching. A menu-driven navigation system guides users through the multistage measurements as required for the technology used and the characteristics of the device under test (DUT). The test system supports all measurements required by the standards, even for complex DUTs such as those featuring up to eight antenna ports or adaptive hopping.

The R&S®TS8997 measures the technologies typically used in wideband wireless devices, i.e. devices with a radio interface, in the 2.4 GHz and 5 GHz bands:

- ▶ WLAN IEEE 802.11a/b/g/n/ac
- ▶ Bluetooth®
- ▶ Wireless video transmission
- ▶ Radio remote control

Key facts

- ▶ Fast wideband power measurement that exceeds ETSI requirements
- ▶ Support for DUTs with up to eight antenna ports
- ▶ Menu-driven, automatic measurements based on radio technology selected by the user
- ▶ Measurements via RF connection or antenna coupler
- ▶ Tested R&S®WMS32 GUI and software structure
- ▶ Automatic switching of test paths up to 40 GHz with R&S®OSP-B157WX

Block diagram of the R&S®TS8997 8-port test system

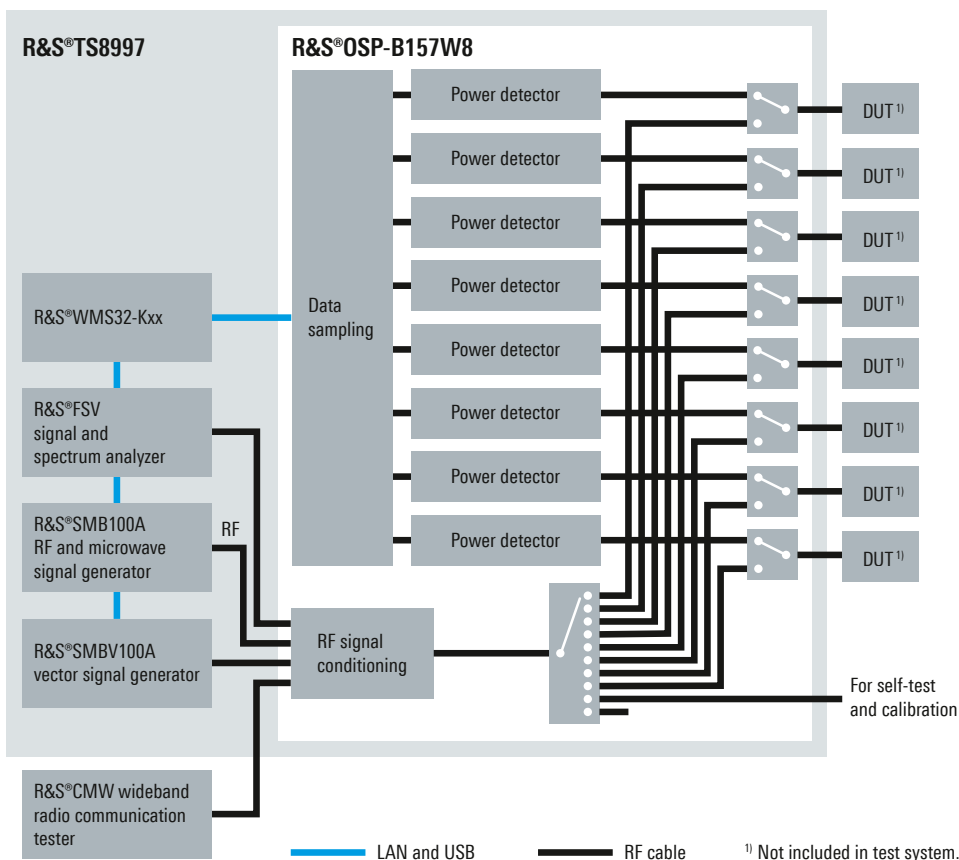

R&S®TS8997 test system with eight ports for up to eight DUTs

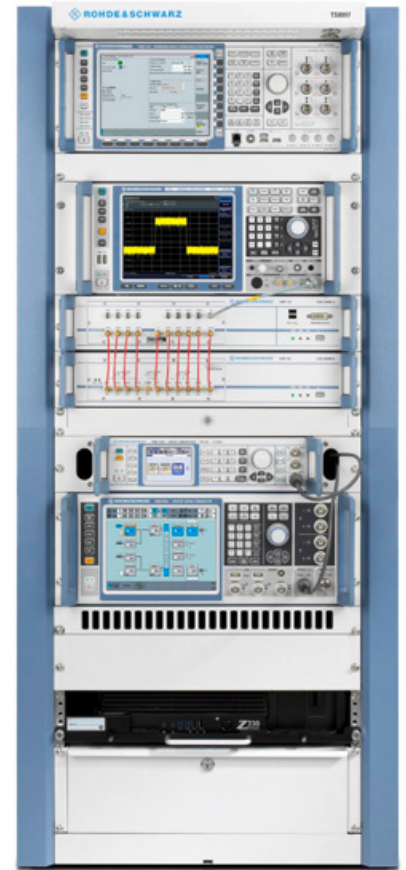

Product site

R&S® CMA180 RADIO TEST SET



The reference in radio testing

The R&S®CMA180 is a radiocommunications tester for radio systems that operate in the 100 kHz to 3 GHz range. Its technology is based fully on digital signal processing and advanced computing. Intuitive operation and efficient measurement capabilities make the R&S®CMA180 an indispensable tool for performing radio measurements.

The R&S®CMA180 demodulates and modulates all common analog RF signals, making it ideal for testing transmitters and receivers. For receiver tests, audio signals from the internal generators or from external sources can be modulated onto the RF carrier. The audio signals demodulated by the device under test (DUT) are fed into the R&S®CMA180 via analog or digital inputs and then analyzed. For transmitter tests, the R&S®CMA180 demodulates the received signal and measures the demodulated audio signal and the RF signal. The test set now also incorporates a digital signal generator and analyzer that can be used to carry out digital receiver and transmitter measurements.

Using the ARB generator, users can play back nearly any type of signal. These signals can be generated with MATLAB® or R&S®WinIQSIM2™, including proprietary

waveforms from software defined radios (SDR), and then loaded into the R&S®CMA180 and replayed. The advanced and efficient user interface makes it easy to learn to use the R&S®CMA180. Users can quickly reach all settings and easily perform measurements. Measurement results are clearly and conveniently displayed.

The optional ILS, VOR and marker beacon generator as well as VoIP support in line with EUROCAE ED-137B make the R&S®CMA180 invaluable for air traffic control (ATC) and radio navigation. The R&S®CMA180 can be powered by batteries, making it independent and portable. Results are displayed in a straightforward manner, and the graphical user interface is easy to operate.

Key facts

- ▶ Frequency range from 100 kHz to 3 GHz
- ▶ Analog modulation and demodulation (CW, AM, FM)
- ▶ Up to 150 W peak input power and up to 100 W continuous input power
- ▶ Signal level for receiver measurements can be lowered to -140 dBm
- ▶ Integrated audio generators
- ▶ Audio quality tests (SINAD, THD, SNR)
- ▶ Integrated sweeping spectrum analyzer, tracking generator and scope
- ▶ Use of R&S®NRP and R&S®NRT power sensors, no configuration required
- ▶ I/Q recorder and ARB generator
- ▶ Digital signal analysis
- ▶ ILS, VOR and marker beacon generator
- ▶ VoIP in line with EUROCAE ED-137B for ATC radios
- ▶ Digital receiver and transmitter measurements

Applications in the R&S®CMA180 frequency range

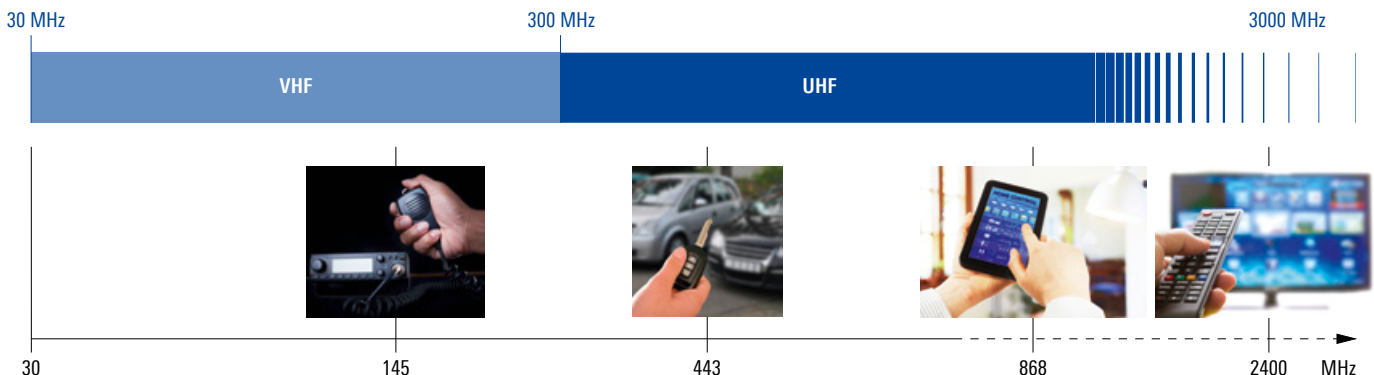

R&S® CTH PORTABLE RADIO TEST SET



Always on duty

The R&S®CTH allows dependable testing of analog FM radio systems even under challenging environmental conditions. The radio test set was designed especially for outdoor use. Ensuring the smooth functioning of transceivers is the key to successful communications. The R&S®CTH performs this type of work without requiring expert knowledge. The user can simply connect the device under test (DUT) to the R&S®CTH and immediately begin transmitter and receiver measurements.

The R&S®CTH includes all the measurement functions needed for reliable testing of transceivers. The measurement results are clearly presented on a display that is optimized for outdoor use so the measured values are easily readable even under difficult lighting conditions.

With its high measurement accuracy and straightforward operation, the R&S®CTH delivers unrivaled performance and functionality for its class.

Key facts

- ▶ Frequency measurement
- ▶ Power measurement
- ▶ Over-the-air measurement (R&S®CTH200A)
- ▶ Distance-to-fault measurement (R&S®CTH200A)
- ▶ Voice reporting (R&S®CTH200A)
- ▶ Handy and ergonomic
- ▶ Rugged and all-weatherproof

Robust and shockproof

The compact aluminum enclosure is rugged and very solid. The corners are rubber-reinforced, making the test set ideal for outdoor use.

Splashproof

Enclosure, battery compartment, keypad and display are absolutely splashproof. As a result, the R&S®CTH is ideal even for operation under poor weather conditions.

Wide temperature range

All of the components are designed so that the R&S®CTH can be used over a wide temperature range. This means that the R&S®CTH is the ideal companion for all seasons and climate zones.

Ergonomic operation

All of the buttons are easy to operate. Plus, the test set is designed for operation with a single hand, providing equal convenience to both right-handed and left-handed users.

Model overview		
	R&S®CTH100A	R&S®CTH200A
Transmitter measurements		
Forward power	•	•
Reflected power	•	•
VSWR		•
Frequency counter	•	•
FM receiver measurements		
Squelch	•	•
Demodulation	•	•
Additional measurements		
Over the air	–	•
Distance to fault	–	•
Voice reporting	–	•

R&S®CTH100/R&S®CTH200A – the handy analog radio test set



R&S® AMS32 OTA PERFORMANCE MEASUREMENT SOFTWARE

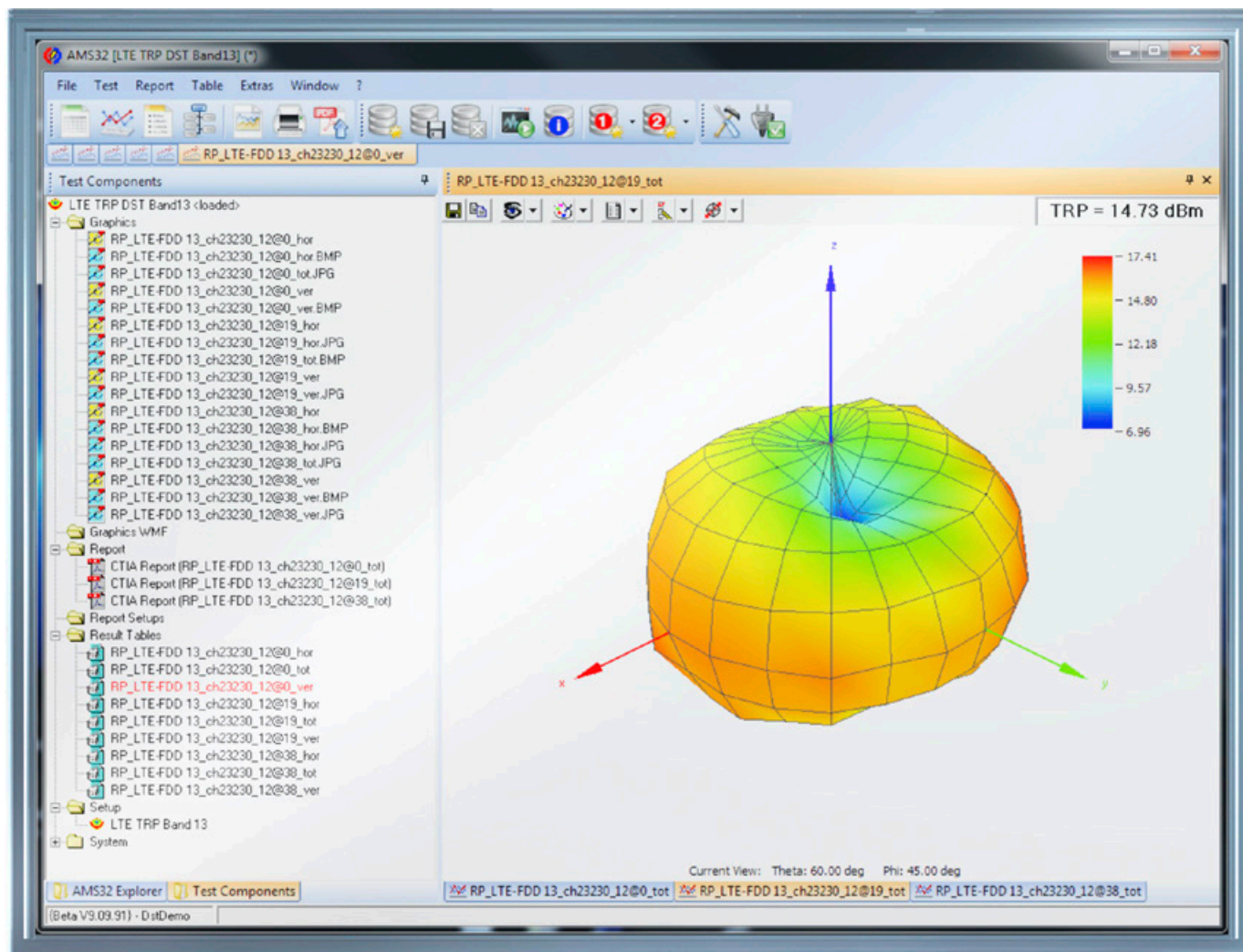

Key features

- ▶ Over-the-air (OTA) measurements on mobile phones
- ▶ Intermediate sensitivity tests on mobile phones
- ▶ Desense tests on mobile phones
- ▶ Passive antenna measurements
- ▶ Conducted and radiated tests
- ▶ MIMO OTA measurements, Rohde & Schwarz decomposition method (options required)
- ▶ Path loss and range calibration
- ▶ Ripple test in line with CTIA
- ▶ Anechoic chamber validation in line with 3GPP and WMF
- ▶ R&D and viewer modes
- ▶ Sequencer (ability to run multiple tests in sequential order with little or no user interaction)
- ▶ Configuration through intuitive GUI

Standards

- ▶ CTIA 3.5.2 or higher
- ▶ 3GPP TS 34.114
- ▶ Verizon Wireless proprietary standards

Measured parameters

- ▶ Total radiated power (TRP)
- ▶ Near-horizon partial radiated power (NHPRP) (at different angles, upper and lower hemisphere)
- ▶ Total isotropic sensitivity (TIS)
- ▶ Near-horizon partial isotropic sensitivity (NHPIS) (at different angles, upper and lower hemisphere)
- ▶ Antenna gain, efficiency, directivity

Reporting

- ▶ HTML, RTF, PDF
- ▶ 3D graphics

R&S®ATS800B/R CATR BENCHTOP/RACK ANTENNA TEST SYSTEMS

New

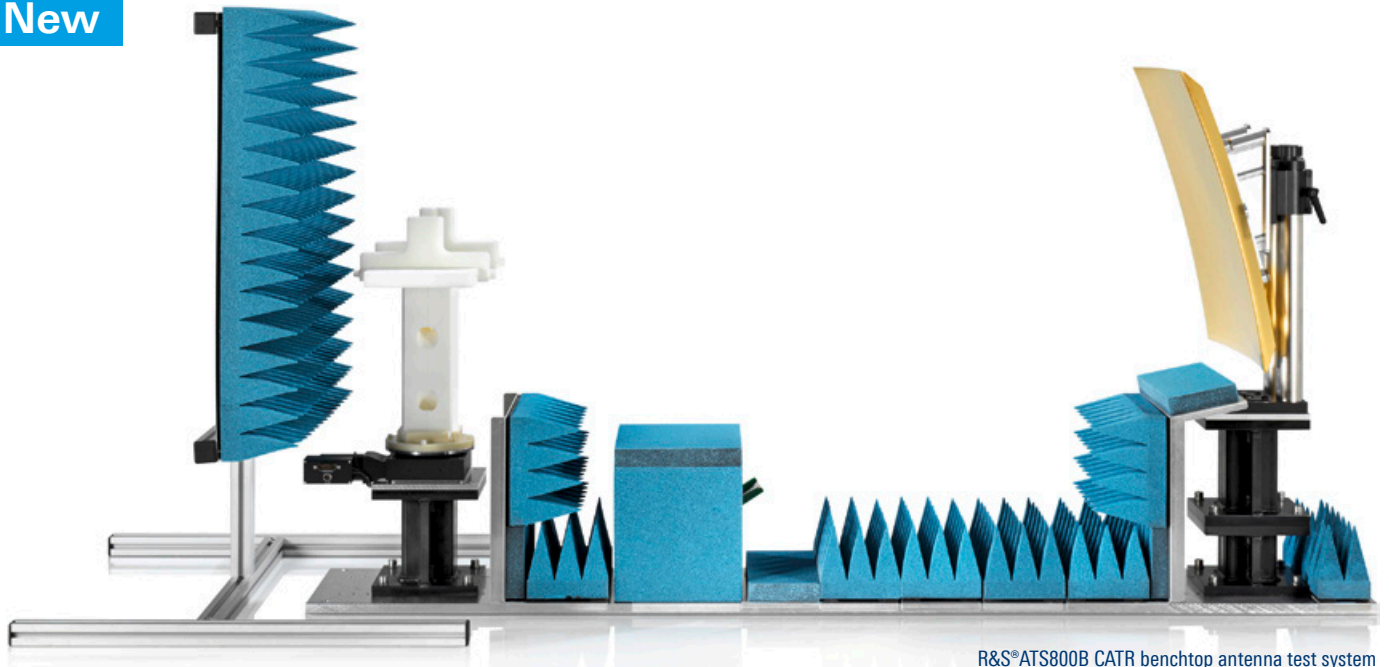

R&S®ATS800B CATR benchtop antenna test system

5G antenna characterization in a small footprint

The R&S®ATS800B/R antenna test systems are the ideal environment for 5G antenna, module and device characterization throughout the entire process from R&D to design verification – for both active and passive devices.

Thanks to their compact design, the R&S®ATS800B/R support far-field over-the-air RF measurements in labs of any size. They help optimize the overall RF performance of RF modules in the early phases of development. This prevents costly and time-consuming modifications for a large number of prototypes at a later stage. Over-the-air RF testing during development reduces costs and keeps the product launch on schedule with a faster time to market.

One-stop-shop solutions combining the R&S®ATS800B/R with a Rohde&Schwarz test system ensure fast and smooth measurements in the lab and provide optimized capabilities for determining a 5G device's antenna performance and characteristics in the millimeterwave range.

In summary, the R&S®ATS800B/R antenna test systems are convenient and accurate solutions for testing 5G modules in the new 5G millimeterwave frequency bands in a compact benchtop or rack setup.

Key facts

- ▶ Very compact far-field over-the-air (OTA) test systems based on compact antenna test range (CATR) technology
- ▶ Unrivalled measurement frequency range within 0.8 m²

- ▶ State-of-the-art reflector surface precision for high quiet zone accuracy
- ▶ Unique benchtop or rack CATR system supporting over 50 GHz
- ▶ Automated high-precision 2D positioner (optional)
- ▶ Indirect far-field method – approved by 3GPP for 5G OTA testing

R&S®ATS800R CATR rack antenna test system



Product site

R&S®ATS1000 ANTENNA TEST SYSTEM



- ▶ Passive (magnitude and phase) and active (TRP, EIRP, TIS, EIS, EVM) antenna measurements
- ▶ Near-field to far-field transformation with the R&S®AMS32 test measurement and control software
- ▶ Device characterization under extreme temperature conditions from -40°C to $+85^{\circ}\text{C}$
- ▶ One-stop-shop for 5G devices measurements: R&S®ATS1000 chamber, R&S®AMS32 software, test instruments
- ▶ NF to FF transformation with the R&S®AMS32 test measurement and control software
- ▶ Extremely fast measurements with spiral scan (dual axis rotation)

5G antenna characterization with small footprint

The R&S®ATS1000 antenna test chamber is the ideal environment for 5G antenna characterization throughout the entire process from R&D to production for both active and passive devices. Due to its compact design, the R&S®ATS1000 supports far-field and near-field antenna measurements inside any R&D lab space. The mobile chamber helps to optimize the overall RF performance of antenna modules already in the initial phases of development. This avoids costly and time-consuming modifications for a large number of prototypes at a later stage. Antenna testing during development reduces costs and keeps the product launch on schedule with a faster time to market.

Thermal effects diagnostics on DUTs is becoming a requirement for 5G since device heating can affect the RF components and consequently the radiation pattern of the antennas. Engineers no longer need to depend on separate testing in an RF OTA chamber and a climatic chamber because the R&S®ATS1000 thermal solution combines both into a single chamber.

Key facts

- ▶ Extremely fast and accurate 3D antenna characterization
- ▶ Designed for maximum compactness and mobility: includes wheels and easily fits next to a 19" rack
- ▶ Frequency range from 18 GHz to 87 GHz
- ▶ Greater than 50 dB shielding effectiveness up to 87 GHz
- ▶ Broadband measurement antenna from 4 GHz to 87 GHz with very low radar cross section

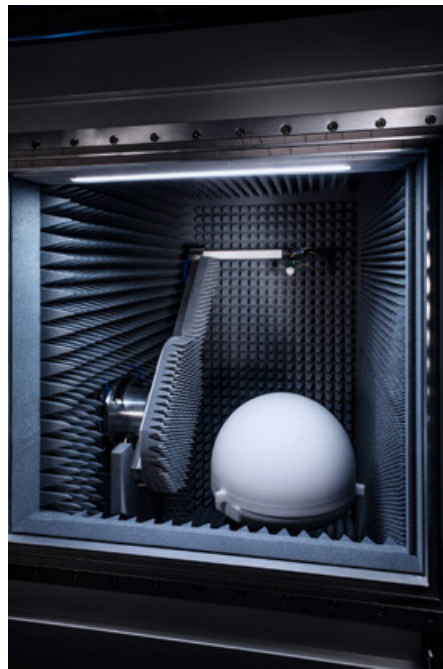

Extremely fast and accurate 3D antenna characterization

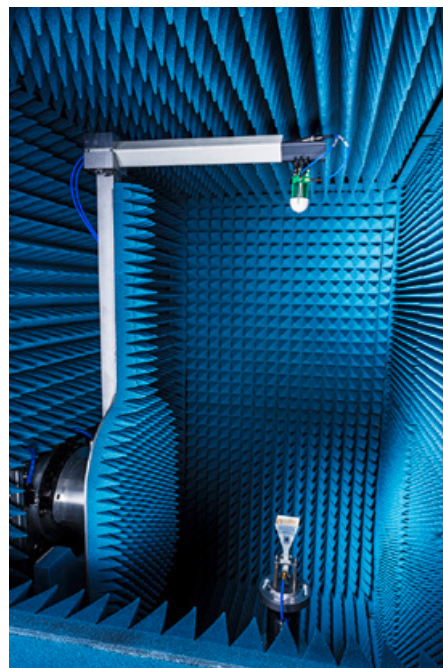

R&S®ATS1000 with an integrated high-precision positioner



R&S® ATS1800C CATR BASED COMPACT 5G NR mmWave TEST CHAMBER

New



5G NR compliant device test and antenna characterization in a small footprint

The R&S®ATS1800C CATR based compact 5G NR mmWave test chamber is fully shielded from the outside world to provide the ideal environment for uninterrupted measurements of 5G antenna, module and device characterization throughout the entire lifecycle from R&D to conformance for both active and passive measurements.

Inside the fully shielded chamber is the compact antenna test range (CATR) consisting of a feed antenna, a bidirectional parabolic reflector and a 3D positioner. The parabolic reflector is specially designed and manufactured by Rohde & Schwarz with optimized rolled edges that promise a well distributed power of the collimated beams after reflection. Moreover, the reflector has an extremely high-precision surface roughness, which minimizes the errors introduced by the reflection. This allows the reflector to be used in a very wide frequency range for accurate measurement results.

Due to the CATR technology, the generated quiet zone is 30 cm to accommodate both a black box measurement approach and large DUTs. Heavy DUTs can be placed on the highly accurate and stable 3D positioner so that parameters such as TRP, EIRP and EIS can be automated and measured. The stability and device weight specifications of the positioner also allow for CTIA frequency range 2 (FR2) antenna performance tests where phantom heads and hands are to be used.

The compact setup of the R&S®ATS1800C can act as your best assistant from R&D to product validation. At early stages, it can help improve the overall performance of RF modules, greatly reducing the risk of costly and time-consuming modifications of prototypes at later stages. During design optimization, specific beam characterization can be measured to verify the beamforming capabilities of modules and devices.

Key facts

- ▶ Very compact and mobile far-field over-the-air (OTA) test system based on compact antenna test range (CATR) technology
- ▶ State-of-the-art CATR reflector with optimized edges for uniform power distribution and high-precision surface finishing for minimal deviations in quiet zone
- ▶ Very high frequency range, including 5G frequency range 2 (dependent on CATR feed antenna)
- ▶ High shielding effectiveness of 100 dB
- ▶ Large, 3GPP compliant quiet zone
- ▶ Highly accurate spherical 3D positioner with built-in hardware triggering functionality for significantly shorter test times
- ▶ Suitable for conformance testing as specified by 3GPP as well as CTIA antenna performance testing and device beam characterization

R&S®ATS1800C interior view



R&S® DST200 RF DIAGNOSTIC CHAMBER

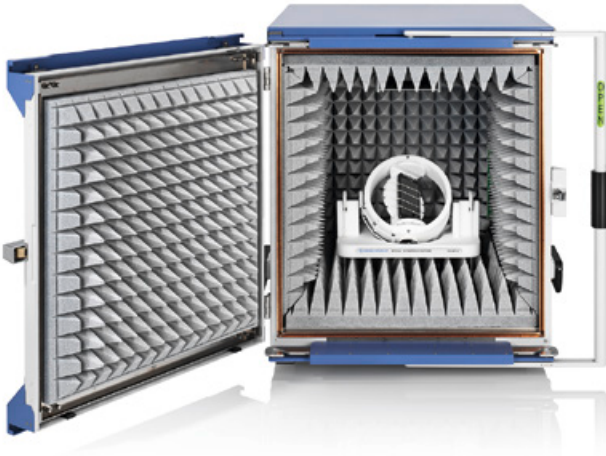

Accurate radiated testing of wireless devices from 400 MHz to 18 GHz

The R&S® DST200 RF diagnostic chamber is the ideal environment for RF analysis during development. It supports a wide range of radiated test applications for wireless devices and fits on any R&D lab bench, where it can be used at all times during the product design and optimization phase. The R&S® DST200 effectively assists in achieving high first-time pass rates during final type approval, which saves time and money.

High-quality wireless devices have to pass special radiated tests such as desense and coexistence tests to ensure operation without self-interference. The R&S® DST200 provides support for the radiated tests that are required in R&D, quality assurance, production and service.

Compared to applications using large EMC anechoic chambers, test setups with the R&S® DST200 are compact and easy to use and generate consistent, comparable results.

- ▶ Anechoic RF chamber with highly effective shielding > 110 dB for interference-free testing in unshielded environments
- ▶ Wide frequency range from 400 MHz to 18 GHz covering all important wireless standards
- ▶ High reproducibility of measurements due to excellent field uniformity at location of equipment under test (EUT)
- ▶ Compact dimensions suitable for any lab environment
- ▶ Unique mechanical design provides long-term stability and maintains high shielding effectiveness
- ▶ Simple and effective front door locking mechanism without pneumatic components
- ▶ Automated 3D positioner for OTA precompliance measurements
- ▶ Main test applications
 - Desense (self-interference) and coexistence testing
 - Verification of over-the-air (OTA) performance



R&S® DST-B165 option

Specifications in brief

Frequency range		400 MHz to 18 GHz (extended range on request)
Antenna polarization	R&S® DST-B215 option	cross-polarized
	R&S® DST-B220 option	right-hand circular-polarized
	R&S® DST-B270 option	linear-polarized
Shielding effectiveness	700 MHz to 3 GHz, base unit with R&S® DST-B102 option	> 110 dB
	3 GHz to 6 GHz, base unit with R&S® DST-B102 option	> 100 dB
Quiet zone	above EUT table, Ø × L (cylindrical)	200 mm × 30 mm (7.9 in × 1.2 in)
Field uniformity	max. field variation in quiet zone with R&S® DST-B220 option	< 3.2 dB (meas.)
Field perturbation	with R&S® DST-B150 option, 300 MHz to 2.7 GHz	-0.6 dB to +0.6 dB (meas.)
	with R&S® DST-B150 option, 2.7 GHz to 6 GHz	-1.5 dB to 1.5 dB (meas.)
	with R&S® DST-B160 option, 700 MHz to 2.7 GHz	-1 dB to +1 dB (meas.)
	with R&S® DST-B160 option, 2.7 GHz to 6 GHz	-2.3 dB to +2.3 dB (meas.)
Max. EUT dimensions (W × H × D)	R&S® DST200 without positioning options	400 mm × 330 mm × 400 mm (15.7 in × 13.0 in × 15.7 in)
	with R&S® DST-B150 option	150 mm × 100 mm × 20 mm (5.9 in × 3.9 in × 0.8 in)
	with R&S® DST-B160 option	149 mm × 100 mm × 20 mm (5.9 in × 3.9 in × 0.8 in)
	with R&S® DST-B165 option	257 mm × 190 mm × 20 mm (10.1 in × 7.5 in × 0.8 in)



System accessories

R&S®CMW-Z10/Z11 RF Shielding Box and Antenna Coupler



Product site

Available options include a D-Sub feedthrough (R&S®CMW-Z12), a USB 2.0 feedthrough (R&S®CMW-Z13), a RF feedthrough (R&S®CMW-Z14), a 100 Mbps LAN feedthrough (R&S®CMW-Z18) and a tool for audio measurements (R&S®CMW-Z15). All modules are optimized so that their effect on shielding characteristics is kept to a minimum. The module slots are identical, allowing each module to be inserted into any slot. The optional connectors can be flexibly assigned. It is also possible to insert customer-specific modules. The R&S®CMW-Z16 second antenna element enables diversity/MIMO measurements (requires R&S®CMW-Z14).

- ▶ Excellent shielding characteristics
- ▶ Ultralow reflections
- ▶ Broadband spiral antenna allowing a wide variety of applications

Specifications in brief

- ▶ Shielding effectiveness
 - 0.4 GHz to 4 GHz: > 80 dB
 - 4 GHz to 6 GHz: > 60 dB
- ▶ Outer dimensions (W × H × D): 320.9 mm × 267.5 mm × 527.7 mm (12.6 in × 10.5 in × 20.8 in)
- ▶ Weight: 9 kg (19.8 lb)

R&S®TS7121 Shielded RF Test Chambers



Product site

Reliable RF tests on devices with radio interface

The R&S®TS7121 RF test chamber has been designed to meet the requirements of automatic production lines. These include long life, rugged design and automatic opening and closing of the RF chamber. Featuring high shielding effectiveness over a wide frequency range, the RF test chambers perform tests on modules and devices with a radio interface in accordance with a wide variety of standards such as ISM, GSM/CDMA2000®/WCDMA, WLAN, Bluetooth®, ZigBee, WiMAX™ and LTE.

Specifications in brief

- ▶ Wide frequency range: 300 MHz to 14 GHz
- ▶ Shielding effectiveness:
 - 500 MHz < f < 3 GHz: typ. 70 dB
 - 300 MHz < f < 14 GHz: typ. 35 dB
- ▶ Standard feedthroughs: RF 4 × N, 1 × 25 and 1 × 9 D-Sub digital I/O filters
- ▶ Optional feedthroughs: USB 2.0
- ▶ Outer dimensions (W × H × D) automatic version: 155 mm × 305 mm × 428 mm (6.10 in × 12.00 in × 16.85 in)
- ▶ Weight: 25 kg (55.12 lb)

R&S®TS7124AS/R&S®TS7124M Shielded RF Test Chambers

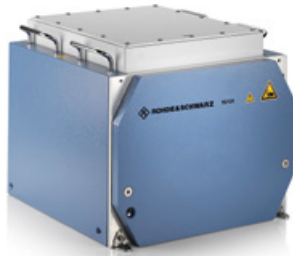

Product site

The R&S®TS7124AS/M features a large interior working space for measurements on larger DUTs. It offers the possibility to integrate an antenna ring where numerous antennas can be placed to create an own radiation pattern. This makes radiated power measurements possible at selected orientations. The R&S®TS7124 offers higher shielding effectiveness and a rugged mechanical design for reproducible results and a long service life. The soft close option allows operation of the automatic version without additional security equipment.

Specifications in brief

- ▶ Frequency range: 300 MHz to 6 GHz
- ▶ Shielding effectiveness: > 80 dB at 6 GHz
- ▶ Antenna couplers: wideband antenna or standard specific antennas
- ▶ Standard feedthroughs: RF 4 × N (outside) to SMA (inside)
- ▶ Optional feedthroughs: digital I/O filters, USB 2.0 filter, Ethernet filter, fiber optic, pneumatic
- ▶ Outer dimensions (W × H × D) of automatic version: 450 mm × 400 mm × 480 mm (17.72 in × 15.75 in × 18.90 in)
- ▶ Weight: approx. 35 kg (77.2 lb)

R&S®RT-ZVC02A/R&S®RT-ZVC04A Multi-Channel Power Probe



Product site

The R&S®CMW combined with the R&S®CMWrun sequencer gives users a powerful setup to optimize the power consumption of their devices.

Predefined setting and the controlled environment of the R&S®CMW500 allow users to determine the exact power consumption behavior of their devices. They can simultaneously observe up to four different measurement points to determine which IP or signaling events are increasing/decreasing power consumption. Everything is consolidated into one report.

- ▶ 2-port model and 4-port model
- ▶ 5 Msample/s sampling rate for voltage and current
- ▶ 18-bit resolution for voltage and current, 32-bit for power
- ▶ Internal multiplier for power with full sampling rate of 5Msample/s
- ▶ Capable of running a measurement and logging the data for days
- ▶ Autoranging



CHAPTER 2

OSCILLOSCOPES

Oscilloscopes that fit your requirements and your budget, from top value to top performance.

Oscilloscope innovation that delivers measurement confidence. Excellent signal fidelity, high acquisition rate, an innovative trigger system and a clever user interface – that's what you get with Rohde & Schwarz, a leading manufacturer of oscilloscopes. Match your needs with the right oscilloscope platform, probing options and software applications. From general purpose test to solutions for specific industry standards, we have you covered.

Type	Designation	Bandwidth	Channels	Description	Page
Oscilloscopes					
R&S®RTP	High-performance oscilloscope	4/6/8/13/16 GHz	4	Signal integrity in realtime	44
R&S®RTO2000	Oscilloscope	600 MHz, 1/2/3 GHz, 4 GHz, 6 GHz	2 or 4 4	Excellent signal fidelity and up to 16-bit vertical resolution	46
R&S®RTE1000	Oscilloscope	200/350/500 MHz, 1/1.5/2 GHz	2 or 4	Easy to use, powerful	47
R&S®RTA4000	Oscilloscope	200/350/500 MHz, 1 GHz	4	Class-leading signal integrity and responsive ultra-deep memory	48
R&S®RTM3000	Oscilloscope	100/200/350/500 MHz, 1 GHz	2 or 4	Daily problem-solving tool, with a Rohde & Schwarz probe interface	49
R&S®RTB2000	Oscilloscope	70/100/200/300 MHz	2 or 4	Largest display with highest resolution in its class	50
R&S®RTC1000	Oscilloscope	50/70/100/200/300 MHz	2	High sensitivity, multifunctionality and a great price	51
R&S®ScopeRider RTH	Handheld oscilloscope	60/100/200/350/500 MHz	2 or 4	Lab performance in a rugged and portable design	52
Oscilloscope probes					
Oscilloscope probes compatibility chart					55
R&S®RT-ZM modular probe system					56
Passive probes					57
Passive broadband probes					57
Active broadband probes					58
Modular broadband probes					59
Power rail probes					59
Multi-channel power probes					60
High-voltage probes					60
Current probes					61
EMC near-field probes					61
Logic probes (see MSO option of the oscilloscopes)					

► [See the oscilloscope portfolio table on the next page.](#)

OSCILLOSCOPE PORTFOLIO



R&S®	RTH1000	RTC1000	RTB2000	RTM3000
Vertical				
Bandwidth	60/100/200/350/500 MHz ¹⁾	50/70/100/200/300 MHz ¹⁾	70/100/200/300 MHz ¹⁾	100/200/350/500 MHz/1 GHz ¹⁾
Number of channels	2 plus DMM/4	2	2/4	2/4
Resolution	10 bit	8 bit	10 bit	10 bit
V/div 1 MΩ	2 mV to 100 V	1 mV to 10 V	1 mV to 5 V	500 μV to 10 V
V/div 50 Ω	–			500 μV to 1 V
Horizontal				
Sampling rate per channel (in Gsample/s)	1.25 (4-channel model); 2.5 (2-channel model); 5 (all channels interleaved)	1; 2 (2 channels interleaved)	1.25; 2.5 (2 channels interleaved)	2.5; 5 (2 channels interleaved)
Max. memory (per channel/1 channel active)	125 ksample (4-channel model); 250 ksample (2-channel model); 500 ksample (50 Msample in segmented memory mode ²⁾)	1 Msample; 2 Msample	10 Msample; 20 Msample (160 Msample in segmented memory mode ²⁾)	40 Msample; 80 Msample (400 Msample in segmented memory mode ²⁾)
Segmented memory	option	–	option	option
Acquisition rate (in waveforms/s)	50 000	10 000	50 000 (300 000 in fast segmented memory mode ²⁾)	64 000 (2 000 000 in fast segmented memory mode ²⁾)
Trigger				
Options	advanced, digital trigger (14 trigger types) ²⁾	elementary (5 trigger types)	basic (7 trigger types)	basic (10 trigger types)
Mixed signal option				
No. of digital channels ¹⁾	8	8	16	16
Sampling rate of digital channels (in Gsample/s)	1.25	1	1.25	two logic probes: 2.5 on each channel; one logic probe: 5 on each channel
Memory of digital channels	125 ksample	1 Msample	10 Msample	two logic probes: 40 Msample per channel; one logic probe: 80 Msample per channel
Analysis				
Cursor meas. types	4	13	4	4
Stand. meas. functions	37	31	32	32
Mask test	elementary (tolerance mask around the signal)	elementary (tolerance mask around the signal)	elementary (tolerance mask around the signal)	elementary (tolerance mask around the signal)
Mathematics	elementary	elementary	basic (math on math)	basic (math on math)
Serial protocols triggering and decoding ¹⁾	I ² C, SPI, UART/RS-232/RS-422/RS-485, CAN, LIN, CAN-FD, SENT	I ² C, SPI, UART/RS-232/RS-422/RS-485, CAN, LIN	I ² C, SPI, UART/RS-232/RS-422/RS-485, CAN, LIN	I ² C, SPI, UART/RS-232/RS-422/RS-485, CAN, LIN, I ² S, MIL-STD-1553, ARINC 429
Display functions	data logger	–	–	–
Applications ^{1), 2)}	high-resolution frequency counter, advanced spectrum analysis, harmonics analysis, user scripting	digital voltmeter (DVM), component tester, fast Fourier transform (FFT)	digital voltmeter (DVM), fast Fourier transform (FFT), frequency response analysis	power, digital voltmeter (DVM), spectrum analysis and spectrogram, frequency response analysis
Compliance testing ^{1), 2)}	–	–	–	–
Display and operation				
Size and resolution	7", color, 800 × 480 pixel	6.5", color, 640 × 480 pixel	10.1", color, 1280 × 800 pixel	10.1", color, 1280 × 800 pixel
Operation	optimized for touchscreen operation, parallel button operation	optimized for fast button operation	optimized for touchscreen operation, parallel button operation	
General data				
Dimensions in mm (W × H × D)	201 × 293 × 74	285 × 175 × 140	390 × 220 × 152	390 × 220 × 152
Weight in kg	2.4	1.7	2.5	3.3
Battery	lithium-ion, > 4 h	–	–	–

¹⁾ Upgradeable.

²⁾ Requires an option.



RTA4000	RTE1000	RTO2000	RTP
200/350/500 MHz/1 GHz ¹⁾	200/350/500 MHz/1/1.5/2 GHz ¹⁾	600 MHz/1/2/3/4/6 GHz ¹⁾	4/6/8/13/16 GHz ¹⁾
4	2/4	2/4 (only 4 channels in 4 GHz and 6 GHz models)	4
10 bit	8 bit (up to 16 bit with HD mode)	8 bit (up to 16 bit with HD mode) ²⁾	8 bit (up to 16 bit with HD mode) ²⁾
500 μ V to 10 V	500 μ V to 10 V	1 mV to 10 V (500 μ V to 10 V) ²⁾	8 bit (up to 16 bit with HD mode) ²⁾
500 μ V to 1 V	500 μ V to 1 V	1 mV to 1 V (500 μ V to 1 V) ²⁾	1 mV to 1 V
2.5; 5 (2 channels interleaved)	5	10; 20 (2 channels interleaved in 4 GHz and 6 GHz model)	20; 40 (2 channels interleaved)
100 Msample; 200 Msample (1 Gsample in segmented memory mode)	50 Msample/200 Msample	standard: 50 Msample/200 Msample; max. upgrade: 1 Gsample/2 Gsample	standard: 50 Msample/200 Msample; max. upgrade: 1 Gsample/2 Gsample
standard	standard	standard	standard
64 000 (2 000 000 in fast segmented memory mode)	1 000 000 (1 600 000 in ultra-segmented memory mode)	1 000 000 (2 500 000 in ultra-segmented memory mode)	750 000 (3 200 000 in ultra-segmented memory mode)
basic (10 trigger types)	advanced, digital trigger (13 trigger types)	advanced (includes zone trigger), digital trigger (14 trigger types) ²⁾	advanced, digital trigger (14 trigger types) with realtime deembedding ²⁾ , high-speed serial pattern trigger incl. 8/16 Gbps CDR ²⁾ , zone trigger ²⁾
16	16	16	16
two logic probes: 2.5 on each channel; one logic probe: 5 on each channel	5	5	5
two logic probes: 100 Msample per channel; one logic probe: 200 Msample per channel	100 Msample	200 Msample	200 Msample
4	3	3	3
32	47	47	47
elementary (tolerance mask around the signal)	advanced (user-configurable, hardware based)	advanced (user-configurable, hardware based)	advanced (user-configurable, hardware based)
basic (math on math)	advanced (formula editor)	advanced (formula editor)	advanced (formula editor)
I ² C, SPI, UART/RS-232/RS-422/RS-485, CAN, LIN, I ² S, MIL-STD-1553, ARINC429	I ² C, SPI, UART/RS-232/RS-422/RS-485, CAN, LIN, I ² S, MIL-STD-1553, ARINC429, FlexRay™, CAN-FD, USB 2.0/HSC, Ethernet, Manchester, NRZ, SENT, SpaceWire, CXPI, USB Power Delivery, automotive Ethernet 100BASE-T1	I ² C, SPI, UART/RS-232/RS-422/RS-485, CAN, LIN, I ² S, MIL-STD-1553, ARINC429, FlexRay™, CAN-FD, MIPI RFFE, USB 2.0/HSC, MDIO, 8b10b, Ethernet, Manchester, NRZ, SENT, MIPI D-PHY, SpaceWire, MIPI M-PHY/UniPro, CXPI, USB 3.1 Gen1, USB-SSIC, PCIe 1.1/2.0, USB Power Delivery, automotive Ethernet 100BASE-T1	I ² C, SPI, UART/RS-232/RS-422/RS-485, CAN, LIN, MIL-STD-1553, ARINC429, CAN-FD, MIPI RFFE, USB 2.0/HSC, MDIO, 8b10b, Ethernet, Manchester, NRZ, MIPI D-PHY, SpaceWire, MIPI M-PHY/UniPro, USB 3.1 Gen1/Gen2, USB-SSIC, PCIe 1.1/2.0, USB Power Delivery, automotive Ethernet 100BASE-T1
–	histogram, trend, track ²⁾	histogram, trend, track ²⁾	histogram, trend, track
power, digital voltmeter (DVM), spectrum analysis and spectrogram, frequency response analysis	power, 16-bit high definition mode (standard), advanced spectrum analysis and spectrogram	power, 16-bit high definition mode, advanced spectrum analysis and spectrogram, jitter/jitter decomposition, clock data recovery, I/Q data, RF analysis, deembedding	16-bit high definition mode, advanced spectrum analysis and spectrogram, jitter/jitter decomposition, I/Q data, RF analysis, realtime deembedding, TDR/TDT analysis
–	–	various options available (see PD 3607.2684.22)	various options available (see PD 5215.4152.22)
10.1", color, 1280 × 800 pixel	10.4", color, 1024 × 768 pixel	12.1", color, 1280 × 800 pixel	12.1", color, 1280 × 800 pixel
optimized for touchscreen operation, parallel button operation			
390 × 220 × 152	427 × 249 × 204	427 × 249 × 204	441 × 285 × 316
3.3	8.6	9.6	18
–	–	–	–

R&S® RTP HIGH-PERFORMANCE OSCILLOSCOPE



Signal integrity in realtime

Benefit from the advanced technology in the R&S®RTP oscilloscope. Customized frontend ASICs and realtime processing hardware enable highly accurate measurements with unprecedented speed in a compact form factor.

The R&S®RTP high-performance oscilloscope combines high-class signal integrity with a fast acquisition rate. The Rohde & Schwarz designed frontend components enable an expandable oscilloscope platform from 4 GHz to 16 GHz. Dedicated acquisition and processing ASICs and a high-precision digital trigger deliver an industry-leading acquisition rate of approx. 1 million waveforms/s.

The R&S®RTP compensates the impairment of the signal contacting in realtime while maintaining the high acquisition rate. Hardware-based compensation filters are configured using user-applied S-parameters. With the R&S®RTP, it is even possible to trigger on deembedded signals.



The R&S®RTP oscilloscope:
multiple test instruments in one

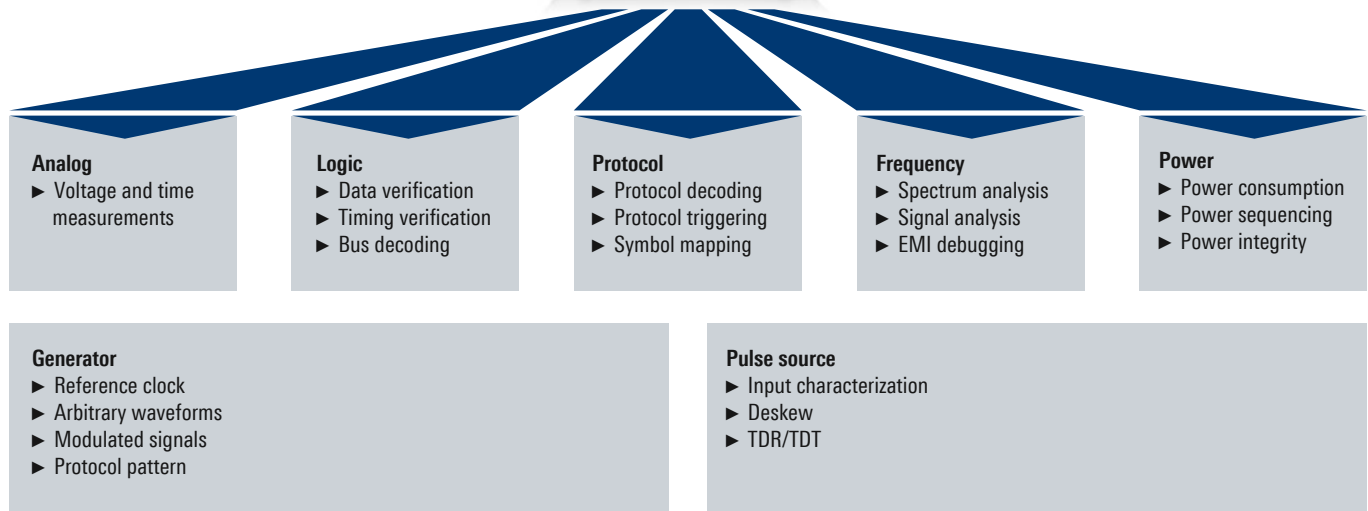

Models						
Base unit	Bandwidth	Channels	Sampling rate	Acquisition memory	Acquisition rate	Mixed signal analysis (MSO)
R&S®RTP164	16 GHz 8 GHz	2 4	40 Gsample (2 channels), 20 Gsample/s per channel	50 Msample per channel, max. 2 Gsample	> 750 000 waveforms/s	16 digital channels; 400 MHz bandwidth, 5 Gsample/s sampling rate, 200 Msample memory depth
R&S®RTP134	13 GHz 8 GHz	2 4				
R&S®RTP084	8 GHz	4				
R&S®RTP064	6 GHz	4				
R&S®RTP044	4 GHz	4				



The R&S®RTP oscilloscope combines multiple instrument capabilities for time-correlated debugging in one box. Additional integrated test resources such as MSO or multiple 18-bit high-precision voltage and current channels for power measurements make the R&S®RTP the most powerful debugging tool. With all this in a compact instrument format plus silent operation, the R&S®RTP oscilloscope is the best fit for any lab.

Key features

- ▶ High-performance analog ASICs
- ▶ 16 Gbps HW-CDR and serial pattern trigger
- ▶ Fastest throughput processing – ASIC
- ▶ Realtime deembedding and advanced triggering
- ▶ General purpose MSO
 - Upgrade any R&S®RTP with the mixed signal option
 - Analysis of low-speed serial protocols with digital channels
- ▶ High-precision voltage and current channels
 - Optional 8 voltage and 8 current channels
 - Very high dynamic range with 18-bit resolution
 - Full GUI integration
- ▶ Integrated arbitrary waveform generator
 - Device stimulus with a two-channel 100 MHz arbitrary waveform generator
 - Protocol based programming with the eight channel pattern generator
- ▶ 16 GHz differential pulse source
 - Differential pulse signal with configurable parameters
 - Application as DUT stimulus or for deskewing
 - Reference outputs for TDT/TDR analysis
- ▶ Quiet, compact and configurable
- ▶ Premium front panel design

Features and benefits

- ▶ High-performance frontend
 - Flat frequency response and high SFDR for precise and fast measurements
 - High input sensitivity of 2 mV/div for small signals
 - High temperature stability for consistent results
 - Low intrinsic jitter
- ▶ Realtime deembedding
 - Deembedding in realtime for fast results
 - Correction of cascaded signal paths
 - Triggering on corrected signals
 - Full bandwidth for all trigger types
- ▶ Hardware accelerated processing for fast results
 - Quickly find signal faults with > 750 000 waveforms/s
 - Fast eye mask test and histogram
 - Increase realtime resolution with 16-bit HD mode
- ▶ Versatile connectivity
 - 18 GHz BNC-compatible Rohde&Schwarz probe interface for measurement channels and external trigger

Comprehensive tools

- ▶ Wideband RF signal analysis
 - Precise wideband RF signal analysis up to 16 GHz on up to four channels simultaneously
 - Advanced RF signal analysis with R&S®VSE vector signal explorer application software
- ▶ Powerful jitter analysis
 - Cycle-to-cycle jitter
 - Time interval error (TIE)
 - Long-term trend
 - Track
 - Histogram
 - FFT on track
 - Eye diagram
- ▶ Frequency domain analysis
 - Multichannel frequency analysis
 - Zone trigger in frequency display
 - Spectrogram: display changes in power and frequency over time
 - Logarithmic display
 - Automatic peak list measurement
- ▶ Automatic compliance tests
 - Easy configuration and automatic control with R&S®ScopeSuite
 - Flexible test execution
 - Configurable reports for result documentation
- ▶ Serial protocol analysis
 - Isolate protocol events with protocol-specific trigger
 - Clear display of decoded data
- ▶ Works with external analysis tools like MATLAB® also

Quickly operate the instrument via touchscreen

- ▶ Easily customizable waveform display with R&S®SmartGrid technology
- ▶ Fast access to important tools via the toolbar
- ▶ Fast configuration on the sidebar
- ▶ Touchscreen gesture support
- ▶ Unique color coding

Use the app cockpit to quickly access applications

- ▶ Directly access all analysis functions
- ▶ Easily add user applications
- ▶ Decode protocols in seconds

Interfaces

- ▶ Four USB 3.0 and two USB 2.0 ports
- ▶ USB device port
- ▶ Removable SSD
- ▶ DVI-D and display port
- ▶ LAN connector with 1 Gbps support
- ▶ GPIB IEEE-4811 interface

R&S® RTO2000 OSCILLOSCOPE



Turn your signals into success

R&S®RTO oscilloscopes combine excellent signal fidelity, up to 16-bit vertical resolution and high acquisition rate in a compact device format in the 600 MHz to 6 GHz class. They offer a fully integrated multi-domain test solution with frequency, protocol and logic analysis functions. The brilliant touchscreen makes the oscilloscopes very comfortable to use.

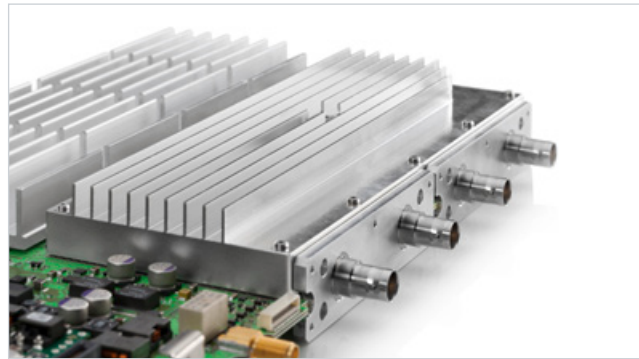

Excellent shielding to ensure low crosstalk even with high frequencies

Best oscilloscope performance

- ▶ Precise measurements due to very low noise level
- ▶ Up to 16-bit vertical resolution
- ▶ Trigger on any signal detail you can see
- ▶ Quickly find signal faults with 1 million waveforms/s
- ▶ Integrated spectrum analysis

Widest range of capabilities

- ▶ Industry-leading 2 Gsample deep memory
- ▶ First zone trigger in time and frequency domain
- ▶ Analyze previous acquisitions (history buffer)
- ▶ Deep toolset for signal analysis

Powerful user interface

- ▶ 12.1" capacitive touchscreen with gesture support
- ▶ Easily customizable waveform display with R&S®SmartGrid technology
- ▶ Clear orientation thanks to color coding

Engineered for multi-domain challenges

- ▶ Logic analysis: unrivaled in its power class
- ▶ Serial protocols: easy triggering and decoding
- ▶ Spectrum, signal and power analysis
- ▶ Advanced jitter analysis
- ▶ Automatic compliance tests, EMI debugging

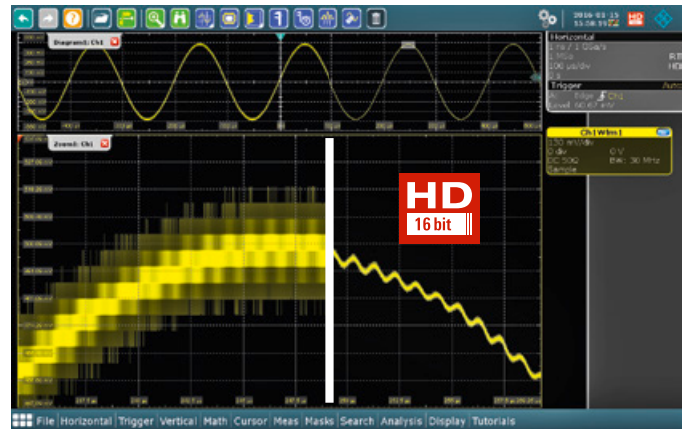

The high definition mode increases the vertical resolution up to 16 bit

Models							
Base unit	Bandwidth	Channels	Sampling rate	Acquisition memory	Acquisition rate	Mixed signal analysis (MSO)	
R&S®RTO2064	6 GHz ¹⁾	4	20 Gsample/s	50 Msample per channel, max. 2 Gsample	1 million waveforms/s	16 channels; 400 MHz bandwidth, 5 Gsample/s sampling rate, 200 Msample memory depth	
R&S®RTO2044	4 GHz	4	20 Gsample/s				
R&S®RTO2034	3 GHz	4	10 Gsample/s				
R&S®RTO2032	3 GHz	2					
R&S®RTO2024	2 GHz	4					
R&S®RTO2022	2 GHz	2					
R&S®RTO2014	1 GHz	4					
R&S®RTO2012	1 GHz	2					
R&S®RTO2004	600 MHz	4					
R&S®RTO2002	600 MHz	2					

¹⁾ 6 GHz on 2 channels, 4 GHz on 4 channels



R&S® RTE1000 OSCILLOSCOPE



Truly uncompromised in performance and impressively user-friendly

Tools such as QuickMeas, fast mask tests, powerful spectrum analysis, history function and 77 automatic measurement functions are supplied as standard. Results are available fast thanks to hardware-assisted implementation of the measurement tools in the Rohde & Schwarz ASIC. The results are based on a large number of waveforms to

R&S® RTE oscilloscopes offer a complete multi-domain test solution

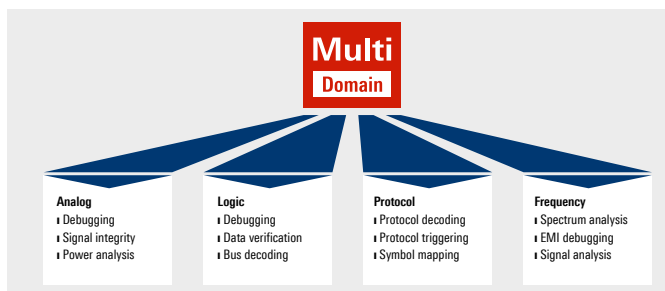

provide statistically conclusive information. R&S® RTE oscilloscopes support dedicated application solutions for complex analyses, including trigger and decoding options for serial protocols and a power analysis option.

More confidence in measurement results

- ▶ Very low inherent noise of 100 μV at 1 mV/div and 1 GHz
- ▶ Full measurement bandwidth up to 2 GHz, even at 500 $\mu\text{V}/\text{div}$
- ▶ Single-core A/D converter and up to 16-bit vertical resolution
- ▶ Memory up to 200 Msample
- ▶ Minimal trigger jitter < 1 ps
- ▶ Finding rare signal faults quickly thanks to 1 million waveforms/s
- ▶ Accurate triggering with a digital trigger system

More fun to use

- ▶ High-resolution 10.4" XGA touchscreen
- ▶ Fully customizable display
- ▶ Fast access to important tools
- ▶ Signal details at your fingertip
- ▶ Fast access to instrument setups
- ▶ Documentation at the push of a button

Engineered for multi-domain challenges

- ▶ Logic analysis: 16 digital channels for analyzing logical components in embedded designs.
- ▶ Serial protocols: easy triggering and decoding
- ▶ Power analysis
- ▶ Spectrum analysis
- ▶ EMI debugging: testing during development
- ▶ Integrated arbitrary waveform generator
- ▶ High definition: see more with 16-bit vertical resolution

Models	Base unit	Bandwidth	Channels	Sampling rate	Acquisition memory	Acquisition rate	Mixed signal analysis (MSO)
R&S® RTE1022		200 MHz	2	5 Gsample/s	50 Msample per channel, max. 200 Msample	1 million waveforms/s	16 channels; 400 MHz, 5 Gsample/s, 100 Msample, > 200 000 waveforms/s
R&S® RTE1024		200 MHz	4				
R&S® RTE1032		350 MHz	2				
R&S® RTE1034		350 MHz	4				
R&S® RTE1052		500 MHz	2				
R&S® RTE1054		500 MHz	4				
R&S® RTE1102		1 GHz	2				
R&S® RTE1104		1 GHz	4				
R&S® RTE1152		1.5 GHz	2				
R&S® RTE1154		1.5 GHz	4				
R&S® RTE1202		2 GHz	2				
R&S® RTE1204		2 GHz	4				



Configurator



Videos



Product site

R&S® RTA4000 OSCILLOSCOPE



Brings the power of 10 to a new level

A Rohde & Schwarz designed 10-bit ADC combined with class-leading low noise, memory depth and timebase accuracy gives you sharp waveforms, more accurate measurements and confidence when facing unexpected measurement challenges.

The R&S®RTA4000 is more than just an oscilloscope. It includes a logic analyzer, protocol analyzer, spectrum analyzer, waveform and pattern generator and digital voltmeter.

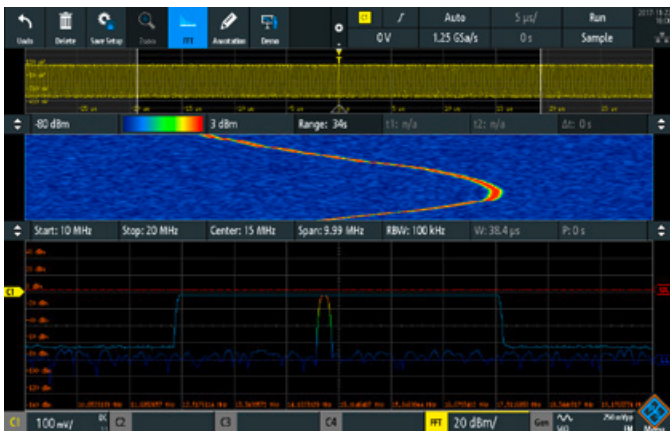

Test signal from three different perspectives: time domain (top), spectrogram (center) and frequency domain (bottom)

A large, high-resolution capacitive touchscreen with a widely acclaimed user interface makes it easy to take advantage of all these tools.

Unrivaled signal integrity

- ▶ 10-bit ADC with up to 16-bit resolution
- ▶ 500 $\mu\text{V}/\text{div}$: full measurement bandwidth
- ▶ Class-leading low noise

Capture more time at full bandwidth

- ▶ Deep memory: standard 100 Msample per channel and 200 Msample interleaved
- ▶ Class-leading timebase accuracy of ± 0.5 ppm
- ▶ Standard segmented memory: 1 Gsample

Large high-resolution display in a compact housing

- ▶ 10.1" high-resolution capacitive touchscreen
- ▶ Gesture support for scaling and zooming

Protocol analysis: efficiently debug serial buses

- ▶ Protocol aware triggering and decoding for serial buses
- ▶ Segmented memory for long time captures
- ▶ Table view of packets/frames

Capture the longest time periods with class-leading 1000 Msample memory

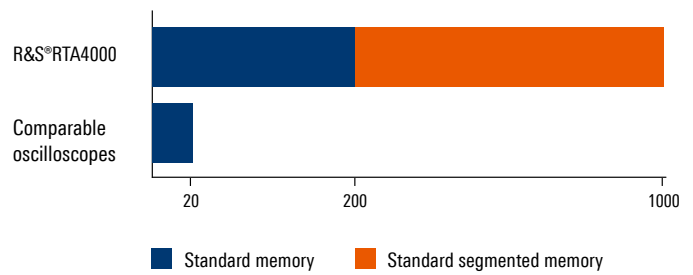

10 to 50 times more memory depth than traditional oscilloscopes in the same instrument class: Capture the longest time periods with class-leading total 1000 Msample memory.

Models						
Base unit	Bandwidth	Channels	Sampling rate	Acquisition memory	Acquisition rate	Mixed signal analysis (MSO)
R&S®RTA4004	200 MHz	4	2.5 Gsample/s per channel, 5 Gsample/s interleaved	100 Msample per channel, max. 200 Msample	64 000 waveforms/s	16 channels; 2.5 Gsample/s; 5 Gsample/s, interleaved; two logic probes: 100 Msample for every channel, one logic probe: 200 Msample for every channel
R&S®RTA4004 + R&S®RTA-B243	350 MHz	4				
R&S®RTA4004 + R&S®RTA-B245	500 MHz	4				
R&S®RTA4004 + R&S®RTA-B2410	1 GHz	4				



R&S®RTM3000 OSCILLOSCOPE



Scope of the art: compact, precise, versatile

Ease of use combined with fast and reliable results is precisely what users get with the R&S®RTM bench oscilloscope. While other oscilloscopes are still booting up, the R&S®RTM is already displaying signals that would otherwise be lost in the noise, and evaluating results. All on one screen with two displays, with lightning fast functions. The R&S®RTM3000 is more than just an oscilloscope. It includes a logic analyzer, protocol analyzer, waveform and



The Bode application allows to characterize the frequency response of a variety of today's electronic designs like passive filters, amplifier circuits or negative feedback networks of switch mode power supplies.

pattern generator, digital voltmeter and dedicated operating modes for frequency analysis, mask tests and long data acquisitions. You can quickly and efficiently debug all kinds of electronic systems – and the R&S®RTM3000 satisfies the all-important rule of investment protection at a very attractive price.

See small signal details in the presence of large signals

- ▶ 10-bit vertical resolution
- ▶ 500 $\mu\text{V}/\text{div}$: full measurement bandwidth and low noise

Capture more time at full bandwidth

- ▶ 40 Msample standard and 80 Msample interleaved
- ▶ Segmented memory: 400 Msample with history function

10.1" high-resolution capacitive touchscreen

- ▶ Touchscreen with gesture support and on-screen annotation
- ▶ Fast access to important tools

Protocol analysis: efficiently debug serial buses

- ▶ Supported busses: I²C, UART/RS-232/RS-422/RS-485, SPI, MIL-STD-1553, ARINC 429, CAN, LIN, I²S/LJ/RJ/TDM
- ▶ Table view of packets/frames

The best choice for power

- ▶ Analyze the transfer function of switched-mode power supplies
- ▶ Measurement wizard for fast results

The right probe for the best measurement

- ▶ More than 30 available Rohde & Schwarz probes
- ▶ Automatic probe detecting via probe interface

Spectrum analysis: identify interactions between time and frequency

- ▶ Spectrogram: display of frequency over time
- ▶ Markers: find peaks automatically

Models

Base unit	Bandwidth	Channels	Sampling rate	Acquisition memory	Acquisition rate	Mixed signal analysis (MSO)
R&S®RTM3002	100 MHz	2	2.5 Gsample/s per channel, 5 Gsample/s interleaved	40 Msample per channel, max. 80 Msample one channel	64 000 waveforms/s	16 channels; 2.5 Gsample/s; 5 Gsample/s, interleaved; two logic probes: 40 Msample for every channel, one logic probe: 80 Msample for every channel
R&S®RTM3004	100 MHz	4				
R&S®RTM3002 + R&S®RTM-B222	200 MHz	2				
R&S®RTM3004 + R&S®RTM-B224	200 MHz	4				
R&S®RTM3002 + R&S®RTM-B223	350 MHz	2				
R&S®RTM3004 + R&S®RTM-B243	350 MHz	4				
R&S®RTM3002 + R&S®RTM-B225	500 MHz	2				
R&S®RTM3004 + R&S®RTM-B245	500 MHz	4				
R&S®RTM3002 + R&S®RTM-B2210	1 GHz	2				
R&S®RTM3004 + R&S®RTM-B2410	1 GHz	4				



Configurator



Videos



Product site

R&S® RTB2000 OSCILLOSCOPE



More signal details with the power of ten

Power of ten (10-bit ADC, 10 Msample memory and 10.1" touchscreen) combined with smart operating concepts make the R&S®RTB2000 digital oscilloscope the perfect tool for troubleshooting embedded designs, for university laboratories as well as for production and service departments.

The R&S®RTB2000 provides users with more than just an oscilloscope. It includes a logic analyzer, protocol analyzer, waveform and pattern generator and digital voltmeter.

Logic analyzer option (MSO)



Dedicated operating modes for frequency analysis, mask tests and long data acquisitions are integrated. Debugging all kinds of electronic systems is easy and efficient – and satisfies the all-important rule of investment protection at a very attractive price.

See small signal details in the presence of large signals

- ▶ 10-bit vertical resolution
- ▶ 1 mV/div: full measurement bandwidth and low noise

Capture more time at full bandwidth

- ▶ 10 Msample standard and 20 Msample interleaved
- ▶ Segmented memory: 160 Msample with history function
- ▶ Maintain fast sampling rates at all times

10.1" high-resolution capacitive touchscreen

- ▶ Touchscreen with gesture support and on-screen annotation
- ▶ Gesture support as on your smartphone
- ▶ Fast access to important tools

The best choice for education

- ▶ Ready for the teaching lab
- ▶ X-in-1 integration saves space and costs

R&S®RTB-B1 option: integrated logic analyzer (MSO) with 16 additional digital channels. Ideal for synchronous and time-correlated analysis of analog and digital components of embedded designs.



Models						
Base unit	Bandwidth	Channels	Sampling rate	Acquisition memory	Acquisition rate	Mixed signal analysis (MSO)
R&S®RTB2002	70 MHz	2	1.25 Gsample/s per channel, 2.5 Gsample/s interleaved	10 Msample per channel, max. 20 Msample one channel	50000 waveforms/s	16 channels; 1.25 Gsample/s; 10 Msample
R&S®RTB2004	70 MHz	4				
R&S®RTB2002 + R&S®RTB-B221	100 MHz	2				
R&S®RTB2004 + R&S®RTB-B241	100 MHz	4				
R&S®RTB2002 + R&S®RTB-B222	200 MHz	2				
R&S®RTB2004 + R&S®RTB-B242	200 MHz	4				
R&S®RTB2002 + R&S®RTB-B223	300 MHz	2				
R&S®RTB2004 + R&S®RTB-B243	300 MHz	4				



R&S® RTC1000 OSCILLOSCOPE



Top-class oscilloscope at a great price

High sensitivity, multifunctionality and a great price – that is what makes the R&S® RTC1000 oscilloscope so special. From embedded developers to service technicians to educators – the wide range of functions address a broad group of users. State-of-the-art, high-performance technology in a fanless design meets the high requirements of today's customers. These oscilloscopes include a wide range of upgrade options, providing true investment protection for the future.

Waveform and pattern generator

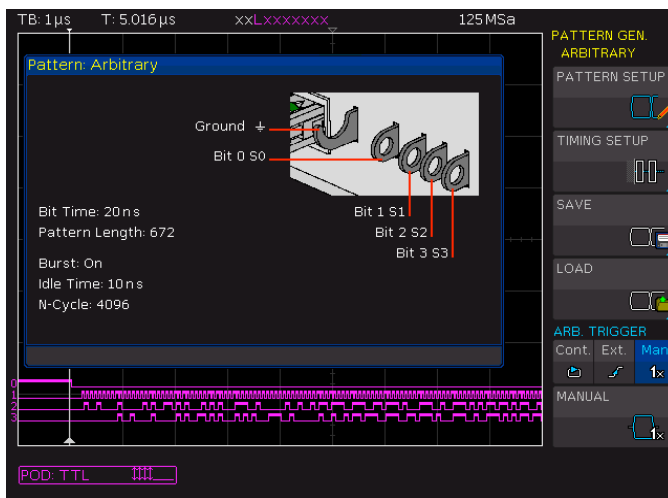

Oscilloscope for precise measurement results

- ▶ Bandwidth: 50 MHz to 300 MHz
- ▶ 8-bit vertical resolution
- ▶ Max. sample rate: 2 Gsample/s
- ▶ Max. memory depth: 2 Msample

Versatile measurement functions and fast results

- ▶ Wide selection of automatic measurement functions
- ▶ QuickView: key results at the press of a button
- ▶ Mask test: easy creation of a new mask with just a few keystrokes
- ▶ FFT: the easy way to analyze the signal spectrum

X-in-1 oscilloscope

- ▶ Oscilloscope
- ▶ Logic analyzer
- ▶ Protocol analyzer
- ▶ Waveform and pattern generator
- ▶ Digital voltmeter
- ▶ Component tester
- ▶ Frequency analysis mode
- ▶ Mask test mode

Future-ready investment and scalability

- ▶ Free firmware updates
- ▶ Bandwidth upgrades as required
- ▶ Serial bus analysis options via software licenses

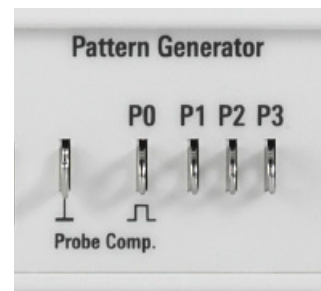

The integrated R&S® RTC-B6 waveform and pattern generator up to 50 Mbit/s is useful for educational purposes and for implementing prototype hardware. In addition to common sine, square/pulse, ramp and noise waveforms, it outputs 4-bit patterns. Waveforms and patterns can be imported as CSV files or copied from oscilloscope waveforms. Predefined patterns for e.g. I²C, SPI, UART and CAN/LIN are provided.

Models							
Base unit	Bandwidth	Channels	Sampling rate	Acquisition memory	Acquisition rate	Mixed signal analysis (MSO)	
R&S® RTC1002	50 MHz	2	1 Gsample/s per channel, 2 Gsample/s interleaved	1 Msample per channel, 2 Msample interleaved	10000 waveforms/s	8 channels; 1 Gsample/s; 2 Msample	
R&S® RTC1002 + RTC-B220	70 MHz	2					
R&S® RTC1002 + RTC-B221	100 MHz	2					
R&S® RTC1002 + RTC-B222	200 MHz	2					
R&S® RTC1002 + RTC-B223	300 MHz	2					



Configurator



Videos



Product site

R&S® Scope Rider RTH HANDHELD OSCILLOSCOPE



- ▶ 500 ksample memory depth
- ▶ 50 000 waveforms per second
- ▶ 8 in 1: lab oscilloscope, logic analyzer (MSO), protocol analyzer, data logger, digital multimeter (DMM), spectrum analyzer, harmonic analyzer and frequency counter
- ▶ User scripting option for “made to measure” automated scripts
- ▶ 7" capacitive touch display
- ▶ Wireless LAN remote control
- ▶ IP51: rugged, dust and water resistant housing

Lab performance in a rugged and portable design

When debugging embedded devices in the lab or analyzing complex problems in the field, the R&S®Scope Rider RTH offers the performance and capabilities of a lab oscilloscope combined with the form factor and ruggedness of a battery-operated handheld device.

Key facts

- ▶ 60 MHz to 500 MHz, with 5 Gsample/s sampling rate
- ▶ Isolated channels: CAT IV 600 V/CAT III 1000 V
- ▶ 10-bit A/D converter

Designation	Type
R&S®Scope Rider RTH model	
60 MHz, 2 channels, DMM	R&S®RTH1002
100 MHz, 2 channels, DMM	R&S®RTH1012
200 MHz, 2 channels, DMM	R&S®RTH1022
350 MHz, 2 channels, DMM	R&S®RTH1032
500 MHz, 2 channels, DMM	R&S®RTH1052
60 MHz, 4 channels	R&S®RTH1004
100 MHz, 4 channels	R&S®RTH1014
200 MHz, 4 channels	R&S®RTH1024
350 MHz, 4 channels	R&S®RTH1034
500 MHz, 4 channels	R&S®RTH1054
60 MHz, 2 channels, MSO, DMM	R&S®RTH1002MSO
100 MHz, 2 channels, MSO, DMM	R&S®RTH1012MSO
200 MHz, 2 channels, MSO, DMM	R&S®RTH1022MSO
350 MHz, 2 channels, MSO, DMM	R&S®RTH1032MSO
500 MHz, 2 channels, MSO, DMM	R&S®RTH1052MSO
60 MHz, 4 channels, MSO	R&S®RTH1004MSO
100 MHz, 4 channels, MSO	R&S®RTH1014MSO
200 MHz, 4 channels, MSO	R&S®RTH1024MSO
350 MHz, 4 channels, MSO	R&S®RTH1034MSO
500 MHz, 4 channels, MSO	R&S®RTH1054MSO
Application bundles	
Power electronics: contains history and segmented memory, advanced triggering and harmonics analysis	R&S®RTH-PPKWR
Industrial: contains hard shell protective carrying case, battery charger for lithium-ion battery and replacement lithium-ion battery pack	R&S®RTH-ZELEC
Automotive: contains trigger and decoding for serial busses: CAN/LIN, CAN-FD and SENT	R&S®RTH-PPKAUTO

Application areas

Electric and industrial installation and maintenance	Electronic field service and maintenance	Research and product development
Field use		Lab use
<ul style="list-style-type: none"> ▶ Electric installations ▶ Motors, fans and pumps ▶ Electric drives ▶ Sensors and transducers ▶ Industrial machinery 	<ul style="list-style-type: none"> ▶ Robotic systems ▶ Solar inverters ▶ Backup power supplies ▶ Avionic and military systems ▶ Medical equipment ▶ Rail vehicle systems 	<ul style="list-style-type: none"> ▶ Embedded systems ▶ Industrial controllers ▶ Power electronics ▶ General electronics ▶ Environmental testing
Unmatched performance, versatility and user experience for all kinds of electric troubleshooting.	Laboratory oscilloscope performance and capabilities for advanced troubleshooting applications in the field.	Portable laboratory oscilloscope for all kinds of debugging tasks with the advantage of isolated channels for power electronics applications.



ONLINE PRODUCT CONFIGURATOR FOR OPTIONS AND ACCESSORIES

For each of the R&S®RTx series an online product configurator is provided. It is a convenient way to configure your oscilloscope according to your individual needs. Choose the base unit first and proceed with selecting software and hardware options, further extras like probes and finally the available service and calibration options. If you have selected an option which requires another option as a condition the item is marked by a red cross and a message will be displayed.

2

The generated listings include the type of the article with a short description, the part number and the quantity.

Check out the product configurator for the R&S®RTP series by clicking or scanning the QR code below:

Type	Order No.	Designation
Hardware		
<input checked="" type="checkbox"/>	R&S® RTP-B1	1333 2424 02 Mixed signal 400MHz, 5Gsa/s, 16 channels, 200MSa/chan. (SL)
<input checked="" type="checkbox"/>	R&S® RTP-B1E	1337 9581 02 Digital Extension Port for R&S®RTP
<input checked="" type="checkbox"/>	R&S® RTP-B19	1337 9498 02 Replacement SSD incl. firmware for R&S®RTP
<input checked="" type="checkbox"/>	R&S® RTP-B101	1337 9500 02 Memory upgrade 100 Msamples per channel
<input checked="" type="checkbox"/>	R&S® RTP-B102	1337 9517 02 Memory upgrade 200 Msamples per channel (SL)
<input checked="" type="checkbox"/>	R&S® RTP-B105	1337 9523 02 Memory upgrade 500 Msamples per channel (SL)
<input checked="" type="checkbox"/>	R&S® RTP-B110	1337 9530 02 Memory upgrade 1 Gsamples per channel (SL)
Software		
<input checked="" type="checkbox"/>	R&S® RTP-K1	1337 8604 02 I2C/SPI serial triggering and decoding (SL)
<input checked="" type="checkbox"/>	R&S® RTP-K2	1337 8610 02 RS-232/UART serial triggering and decoding (SL)
<input checked="" type="checkbox"/>	R&S® RTP-K3	1337 8627 02 CAN/LIN serial triggering and decoding (SL)
<input checked="" type="checkbox"/>	R&S® RTP-K9	1337 8640 02 CAN-FD serial triggering and decoding (SL)
<input checked="" type="checkbox"/>	R&S® RTP-K12	1337 8656 02 Jitter analysis (SL)
<input checked="" type="checkbox"/>	R&S® RTP-K17	1337 8856 02 High definition mode, up to 16 bit vertical resolution (SL)
<input checked="" type="checkbox"/>	R&S® RTP-K19	1337 8879 02 Zone trigger for time and frequency domain (SL)
<input checked="" type="checkbox"/>	R&S® RTP-K21	1337 8685 02 USB2.0 compliance test software (SL)
<input checked="" type="checkbox"/>	R&S® RTP-K22	1337 8691 02 10M/100M/1G-Base-T Ethernet compliance test software (SL)
<input checked="" type="checkbox"/>	R&S® RTP-K23	1337 8704 02 Ethernet compliance test SW for 10G-Base-T Ethernet (SL)
<input checked="" type="checkbox"/>	R&S® RTP-K25	1337 8710 03 2.5G/5GBASE-T compliance test software (UN)
<input checked="" type="checkbox"/>	R&S® RTP-K26	1337 8727 02 MIPI D-PHY compliance test software (SL)
<input checked="" type="checkbox"/>	R&S® RTP-K37	1338 1110 02 Spectrogram (SL)
<input checked="" type="checkbox"/>	R&S® RTP-K40	1337 8733 02 MIPI RFFE serial triggering and decoding (SL)
<input checked="" type="checkbox"/>	R&S® RTP-K42	1337 8740 02 D-PHY serial triggering and decoding for DSI and CSI-2 (SL)
<input checked="" type="checkbox"/>	R&S® RTP-K44	1337 8756 02 MIPI M-PHY/ UniPro serial triggering and decoding (SL)
<input checked="" type="checkbox"/>	R&S® RTP-K50	1337 8762 02 Manchester and NRZ triggering & decoding (SL)
<input checked="" type="checkbox"/>	R&S® RTP-K52	1337 8779 02 8b10b serial decoding (SL)
<input checked="" type="checkbox"/>	R&S® RTP-K55	1337 8785 02 MDIO serial triggering and decoding (SL)
<input checked="" type="checkbox"/>	R&S® RTP-K61	1337 8804 02 USB 3.1 Gen 1 serial triggering and decoding (SL)
<input checked="" type="checkbox"/>	R&S® RTP-K63	1337 8810 02 USB-PD serial triggering and decoding (SL)
<input checked="" type="checkbox"/>	R&S® RTP-K64	1337 9117 02 USB SSIC serial triggering and decoding (SL)
<input checked="" type="checkbox"/>	R&S® RTP-K86	1337 8833 02 EEE compliance test software for 10M/100M/1G-Base-T (SL)
<input checked="" type="checkbox"/>	R&S® RTP-K91	1337 8840 02 DDR3 Signal Integrity and compliance test software (SL)
<input checked="" type="checkbox"/>	R&S® RTP-K99	1326 4425 02 ScopeSuite Automation for Compliance Tests (SL)
<input type="checkbox"/>	R&S® RTP-K121	1326 3064 02 Deembedding base option for R&S®RTP (SL)
<input type="checkbox"/>	R&S® RTP-K122	1326 3070 02 Realtime Deembedding extension of RTP-K121 (SL)

Base Unit Options Extras Service & Calibration

R&S®RTP Digital Oscilloscope

Type	Designation
RTP	



R&S®RTP044 Digital Oscilloscope
4 GHz BW, 4 Ch
Order No. 1320 5007 04

R&S®RTP064 Digital Oscilloscope
6 GHz BW, 4 Ch
Order No. 1320 5007 06

R&S®RTP084 Digital Oscilloscope
8 GHz BW, 4 Ch
Order No. 1320 5007 08

When the selection is finished choose one of the following buttons:

- [Preview](#)
- [Export PDF](#)
- [Export CSV](#)
- [Request a Quote](#)

- ▶ **Preview:** displays a listing with the selected articles
- ▶ **Export PDF:** download a PDF file with the selected articles
- ▶ **Export CSV:** generates a CSV file with the selected articles
- ▶ **Request a Quote:** fill in the online form to get an individual quote from our sales department



Example configurator for R&S®RTP series

OSCILLOSCOPE PROBES



Passive probes



Passive broadband probes



Active broadband probes



Modular broadband probes



Power rail probe



Multi-channel power probes



High-voltage probes



Current probes



EMC near-field probes



Logic probes (see MSO option of the oscilloscopes)

OSCILLOSCOPE PROBES COMPATIBILITY CHART

	Interface	Oscilloscope family (R&S®)					
		RTH1000	RTC1000/ RTB2000	RTM3000/ RTA4000	RTE	RTO	RTP
Passive probes							
R&S®RT-ZP1X	BNC						2)
R&S®RT-ZI10/10C/11	BNC						
R&S®RT-ZP03/05S	BNC						
R&S®RTM-ZP10	BNC						
R&S®RT-ZP10	BNC						2)
Passive broadband probes							
R&S®RT-ZZ80	SMA/BNC						
Active broadband probes (single-ended and differential models)							
R&S®RT-ZS10L ¹⁾	BNC						
R&S®RT-ZS10E/10/20/30/60	Rohde & Schwarz probe interface						
R&S®RT-ZD02/08 ¹⁾	BNC						
R&S®RT-ZD10/20/30/40	Rohde & Schwarz probe interface						
Modular broadband probes							
R&S®RT-ZM15/30/60/90	Rohde & Schwarz probe interface						
Power rail probe							
R&S®RT-ZPR20/40	Rohde & Schwarz probe interface						
Multi-channel power probes							
R&S®RT-ZVC02/04	R&S®RTE/R&S®RTO MSO interface						
High voltage probes							
R&S®RT-ZH03/10/11	BNC						2)
R&S®RT-ZD002/003/01	BNC						
R&S®RT-ZHD07/15/16/60	Rohde & Schwarz probe interface						2)
Current probes							
R&S®RT-ZC02/03	BNC						2)
R&S®RT-ZC10/20/30	BNC						2)
R&S®RT-ZC05B/10B/15B/20B	Rohde & Schwarz probe interface						2)
EMC near-field probes							
R&S®HZ-14/15/17	BNC						

¹⁾ Probe requires 50 Ω input coupling. For oscilloscopes with 1 MΩ input a BNC feedthrough termination adapter is required.

²⁾ Requires R&S®RT-Z1M 1 MΩ adapter.

 Recommended  Usable

For more information of the complete probe portfolio and for downloading the product brochure: [Probes and accessories for Rohde & Schwarz oscilloscopes \(PD 3606.8866.12\)](#).



R&S®RT-ZF20 power deskew and calibration test fixture:
easy deskewing for measurements on power electronics



Product site

R&S®RT-ZM MODULAR PROBE SYSTEM

Addressing high-speed probing challenges

The R&S®RT-ZM modular probe system delivers high performance in combination with flexible and configurable connectivity. The R&S®RT-ZM probe system includes probe tip modules for various measurement tasks and conditions. The probe tip modules can be connected to amplifier modules with bandwidths ranging from 1.5 GHz to 9 GHz. The modular probe system also offers multimode functionality, enabling users to switch between different measurement modes.

The integrated R&S®ProbeMeter functionality makes it possible to perform high-precision DC voltage measurements at the same time.

Multiple measurement modes with a single connection

The multimode functionality allows users to switch between single-ended, differential and common mode measurements without reconnecting or resoldering the probe tip. The multimode functionality is implemented on the company-designed high-speed R&S®RT-ZM amplifier ASIC.

Block diagram of the R&S®RT-ZM modular probe system

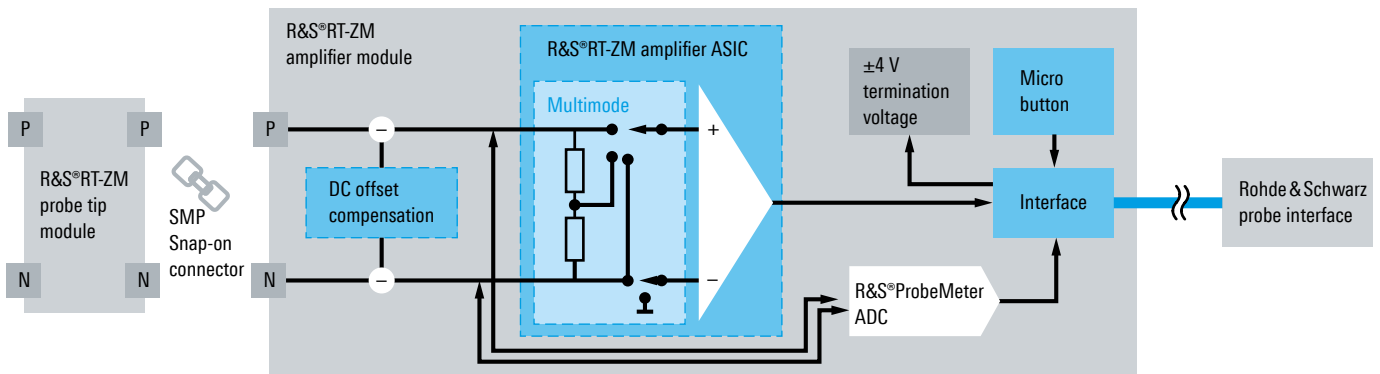

Block diagram of the R&S®RT-ZM modular probe system with exchangeable R&S®RT-ZM probe tip module, connected via a high-performance double-socket SMP snap-on interface to an R&S®RT-ZM probe amplifier module with Rohde & Schwarz probe interface.

Multimode measurement

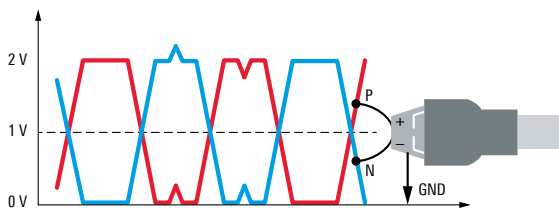

Measurement mode	Description
Differential mode (DM) 	Voltage between positive and negative input pin: $V_{DM} = V_P - V_N$

Common mode (CM) 	Mean voltage between positive and negative input pin versus ground: $V_{CM} = \frac{V_P + V_N}{2}$
-----------------------------	---

Single-ended modes	P mode	N mode	Description
		Voltage between positive or negative input pin and ground:	



R&S®RT-ZM modular probe with R&S®RT-ZMA40

OSCILLOSCOPE PROBES IN OVERVIEW

High-quality active and passive probes complete the Rohde&Schwarz oscilloscopes. Besides excellent specifications, they feature reliability and ease of use.



2

Passive probes

Model	Bandwidth	Attenuation factor	Input impedance	Dynamic range	Comment	Order No.
Probes						
R&S®RT-ZP1X	38 MHz	1:1	1 MΩ 39 pF	55 V (RMS) CAT II	2.5 mm probe tip, spring-loaded	1333.1370.02
R&S®RT-ZP03	300 MHz	10:1 1:1	10 MΩ 12 pF 1 MΩ 82 pF	400 V (RMS)/55 V (RMS)	robust 5 mm probe tip, no readout	3622.2817.02
R&S®RT-ZP05S	500 MHz	10:1	10 MΩ 10 pF	300 V (RMS)	5 mm probe tip, spring-loaded	1333.2401.02
R&S®RTM-ZP10	500 MHz	10:1	10 MΩ 9.5 pF	400 V (RMS), 300 V (RMS) CAT II	2.5 mm probe tip, spring-loaded	1409.7550.00
R&S®RT-ZP10	500 MHz	10:1	10 MΩ 9.5 pF	400 V (RMS), 300 V (RMS) CAT II	2.5 mm probe tip, spring-loaded, preadjusted for R&S®RTO/RTE/RTM/RTA	1409.7708.02
R&S®RT-ZI10	500 MHz	10:1	10 MΩ 12 pF	600 V (RMS) CAT IV, 1000 V (RMS) CAT III	for R&S®ScopeRider RTH	1326.1761.02
R&S®RT-ZI10C	500 MHz	10:1	10 MΩ 11 pF	300 V (RMS) CAT III	compact laboratory probe, for R&S®ScopeRider RTH	1326.3106.02
R&S®RT-ZI10C-2	500 MHz	10:1	10 MΩ 11 pF	300 V (RMS) CAT III	dual-pack of R&S®RT-ZI10C	1333.1811.02
R&S®RT-ZI10C-4	500 MHz	10:1	10 MΩ 11 pF	300 V (RMS) CAT III	quad-pack of R&S®RT-ZI10C	1333.1328.02
Accessories						
R&S®RT-ZA1					accessory set for R&S®RTM-ZP10/R&S®RT-ZP10	1409.7566.02
R&S®RT-ZA4					mini clips	1416.0428.02
R&S®RT-ZA5					micro clips	1416.0434.02
R&S®RT-ZA6					lead set	1416.0440.02
R&S®RT-ZA21					extension set for R&S®RT-ZI10/R&S®RT-ZI11	1326.1984.02
R&S®RT-ZA40					probe tip accessory set for R&S®RT-ZP03/-ZP05S/-ZH03, includes rigid and flexible probe tips	1338.0742.02
R&S®RT-ZA27					PCB adapter 2.5 mm	1801.4784.02
R&S®RT-ZA28					PCB adapter 2.5 mm, angled	1801.4790.02
R&S®RT-ZA29					probe positioner, 2 legs	1801.4803.02



Passive broadband probe

Model	Bandwidth	Attenuation factor	Input impedance	Dynamic range	Comment	Order No.
Probes						
R&S®RT-ZZ80	8 GHz	10:1	500 Ω 0.3 pF	20 V (RMS) max. input voltage	SMA-BNC adapter included	1409.7608.02



Active broadband probes

Model	Bandwidth	Attenuation factor	Input impedance	Dynamic range	Comment	Order No.
Active broadband probes (single-ended)						
R&S®RT-ZS10L	1 GHz	10:1	1 MΩ 0.9 pF	±8 V	BNC interface , 50 Ω output ¹⁾	1333.0815.02
R&S®RT-ZS10E	1.0 GHz	10:1	1 MΩ 0.8 pF	±8 V	Rohde&Schwarz probe interface	1418.7007.02
R&S®RT-ZS10	1.0 GHz	10:1	1 MΩ 0.8 pF	±8 V (±12 V offset compensation)	R&S®ProbeMeter and micro button for instrument control, Rohde&Schwarz probe interface	1410.4080.02
R&S®RT-ZS20	1.5 GHz	10:1	1 MΩ 0.8 pF			1410.3502.02
R&S®RT-ZS30	3.0 GHz	10:1	1 MΩ 0.8 pF	±8 V (±10 V offset compensation)		1410.4309.02
R&S®RT-ZS60	6.0 GHz	10:1	1 MΩ 0.3 pF			1418.7307.02
Active broadband probes (differential)						
R&S®RT-ZD02	200 MHz	10:1	1 MΩ 3.5 pF	±20 V	BNC interface , 50 Ω output	1333.0821.02
R&S®RT-ZD08	800 MHz	10:1	200 kΩ 1 pF	±15 V	BNC interface , 50 Ω output	1333.0838.02
R&S®RT-ZD10	1 GHz	10:1	1 MΩ 0.6 pF	±5 V, with R&S®RT-ZA15: ±70 V DC/ ±46 V AC (peak)	R&S®ProbeMeter and micro button for instrument control; R&S®RT-ZA15 included with the R&S®RT-ZD10; Rohde&Schwarz probe interface	1410.4715.02
R&S®RT-ZD20	1.5 GHz	10:1	1 MΩ 0.6 pF			1410.4409.02
R&S®RT-ZD30	3.0 GHz	10:1	1 MΩ 0.6 pF			1410.4609.02
R&S®RT-ZD40	4.5 GHz		1 MΩ 0.4 pF	±5 V		1410.5205.02
Accessories						
R&S®RT-ZA2					accessory set for R&S®RT-ZS10/20E/20/30	1416.0405.02
R&S®RT-ZA3					pin set for R&S®RT-ZS10/10E/20/30	1416.0411.02
R&S®RT-ZA4					mini clips	1416.0428.02
R&S®RT-ZA5					micro clips	1416.0434.02
R&S®RT-ZA6					lead set	1416.0440.02
R&S®RT-ZA7					pin set for R&S®RT-ZD10/20/30	1417.0609.02
R&S®RT-ZA8					pin set for R&S®RT-ZD40	1417.0867.02
R&S®RT-ZA9					N(m) adapter for R&S®RT-Zxx oscilloscope probes	1417.0909.02
R&S®RT-ZA15	2 GHz	10:1	1 MΩ 1.3 pF	±60 V DC/ ±42.4 V AC (peak)	external attenuator for R&S®RT-ZD20/30, included with R&S®RT-ZD10	1410.4744.02

¹⁾ Requires 5:1 attenuation factor setting on oscilloscopes with 1 MΩ input.



Modular broadband probes

Model	System bandwidth	Rise time (10% to 90%)	Multimode	Comment	Order No.
Probe amplifier modules					
R&S®RT-ZM15	> 1.5 GHz	< 230 ps			1800.4700.02
R&S®RT-ZM30	> 3 GHz	< 100 ps			1419.3005.02
R&S®RT-ZM60	> 6 GHz	< 75 ps			1419.3105.02
R&S®RT-ZM90	> 9 GHz	< 50 ps			1419.3205.02
R&S®RT-ZM130	> 13 GHz	< 35 ps			1800.4500.02
R&S®RT-ZM160	16 GHz	< 28 ps			1800.4600.02
Probe tip modules					
R&S®RT-ZMA10	16 GHz (meas.)	28 ps	P/N/DM/CM	length: 15 cm (5.9 in)	1419.4301.02
R&S®RT-ZMA11	16 GHz (meas.)	28 ps	P/N/DM/CM	length: 15 cm (5.9 in)	1419.4318.02
R&S®RT-ZMA12	6 GHz (meas.)	75 ps	P/N/DM/CM	length: 15 cm (5.9 in)	1419.4324.02
R&S®RT-ZMA14	16 GHz (meas.)	28 ps	P/N/DM/CM	length: 15 cm (5.9 in), incl. 10 solder-in flex tips	1338.1010.02
R&S®RT-ZMA15	12 GHz (meas.)	37 ps	P/N/DM/CM	length: 15 cm (5.9 in)	1419.4224.02
R&S®RT-ZMA30	16 GHz (meas.)	28 ps	DM		1419.4353.02
R&S®RT-ZMA40	16 GHz (meas.)	28 ps	P/N/DM/CM	50 Ω/100 Ω, suitable for SMA, 3.5 mm and 2.92 mm systems, termination voltage ±4 V, supplied from R&S®RT-ZM probe amplifier module	1419.4201.02
R&S®RT-ZMA50	max. 9 GHz ¹⁾	28 ps	P/N/DM/CM	cable length: 1 m (39.37 in); consists of R&S®RT-ZMA11 and a pair of matched extension cables, temperature range: -55°C to +125°C	1419.4218.02
Probe tip module case					
R&S®RT-ZMA1				for up to 6 R&S®RT-ZMAxx probe tip modules	1419.3928.02
R&S®RT-ZAP				3D probe positioner	1326.3641.02

¹⁾ Firmware 4.15 or higher.



Power rail probes

Model	Bandwidth	Attenuation factor	Input impedance	Dynamic range	Comment	Order No.
R&S®RT-ZPR20	2.0 GHz	1:1	50 kΩ	±0.85 V	R&S®ProbeMeter	1800.5006.02
R&S®RT-ZPR40	4.0 GHz			(±60 V offset compensation), optional AC coupling		1800.5406.02
R&S®RT-ZA25	–	–	–	–	power rail browser kit, included with R&S®RT-ZPR20/40	1800.5329.00
R&S®RT-ZA26	–	–	–	–	pigtail cable, 15 cm, solder-in, SMA for R&S®RT-ZPR20/40 power rail probe, included with R&S®RT-ZPR20/40	1800.5258.00



Multi-channel power probes

Model	Input channels	Bandwidth/ sampling rate	Resolution	Input impedance	Full-scale input range	Common mode input voltage range	Order No.
Probes							
R&S®RT-ZVC02	2 current, 2 voltage	1 MHz/ 5 Msample/s	18 bit	10 MΩ 48 pF 1 MΩ shunt	±1.8 V to ±15 V, ±4.5 μA to ±10 A	±15 V	1326.0259.02
R&S®RT-ZVC04	4 current, 4 voltage	1 MHz/ 5 Msample/s	18 bit	10 MΩ 48 pF 1 MΩ shunt	±1.8 V to ±15 V, ±4.5 μA to ±10 A	±15 V	1326.0259.04
Accessories							
R&S®RT-ZA30	Extended cable set for R&S®RT-ZVC, PCB probing, 1 current and 1 voltage lead, length: 32 cm						1333.1686.02
R&S®RT-ZA31	Extended cable set for R&S®RT-ZVC, 4 mm probing, 1 current and 1 voltage lead, length: 32 cm						1333.1692.02
R&S®RT-ZA33	Oscilloscope interface cable for R&S®RT-ZVC (included with R&S®RT-ZVC02/-ZVC04, 1326.0259.02/.04)						1333.1770.02
R&S®RT-ZA34	Extended cable set for R&S®RT-ZVC, 4 mm probing, 1 current and 1 voltage lead, length: 1 m						1333.1892.02
R&S®RT-ZA35	Extended cable set for R&S®RT-ZVC, PCB probing, 1 current and 1 voltage lead, length: 1 m						1333.1905.02
R&S®RT-ZA36	Solder-in cable set for R&S®RT-ZVC, 4 current and voltage solder-in cables, solder-in pins						1333.1911.02
R&S®RT-ZA37	Extended cable set for R&S®RT-ZVC, BNC connector, 1 current and 1 voltage lead, length: 16 cm						1337.9130.02
R&S®RTE-B1E	Digital extension port for R&S®RT-ZVC usage with the R&S®RTE oscilloscope (included with R&S®RTE-B1)						1333.0750.02
R&S®RTO-B1E	Digital extension port for R&S®RT-ZVC usage with the R&S®RTO oscilloscope (included in R&S®RTO-B1)						1333.0738.02



High-voltage probes

Model	Bandwidth	Attenuation factor	Input impedance	Dynamic range	Comment	Order No.
Passive						
R&S®RT-ZH03	250 MHz	100:1	100 MΩ 6.5 pF	850 V (RMS)	robust 5 mm probe tip	1333.0873.02
R&S®RT-ZH10	400 MHz	100:1	50 MΩ 7.5 pF	1000 V (RMS), 6000 V (peak)	1000 V (RMS) CAT II, 5 mm probe tip, spring-loaded	1409.7720.02
R&S®RT-ZH11	400 MHz	1000:1	50 MΩ 7.5 pF	1000 V (RMS), 6000 V (peak)	1000 V (RMS) CAT II, 5 mm probe tip, spring-loaded	1409.7737.02
R&S®RT-ZI11	500 MHz	100:1	100 MΩ 4.6 pF	1000 V (RMS)	600 V (RMS) CAT IV, 1000 V (RMS) CAT III, 3540 V (RMS) CAT 0, for R&S®ScopeRider RTH only	1326.1810.02
Active, differential						
R&S®RT-ZD002	25 MHz	10:1/100:1	8 MΩ 2.75 pF	±700 V	1000 V (RMS) CAT III	1337.9700.02
R&S®RT-ZD003	25 MHz	20:1/200:1	8 MΩ 2.75 pF	±1400 V	1000 V (RMS) CAT III	1337.9800.02
R&S®RT-ZD01	100 MHz	100:1/1000:1	8 MΩ 3.5 pF	±1400 V	1000 V (RMS) CAT III	1422.0703.02
R&S®RT-ZHD07	200 MHz	25:1/250:1	5 MΩ 2.5 pF	±750 V	300 V (RMS) CAT III	1800.2307.02
R&S®RT-ZHD15	100 MHz	50:1/500:1	10 MΩ 2 pF	±1500 V	1000 V (RMS) CAT III	1800.2107.02
R&S®RT-ZHD16	200 MHz	50:1/500:1	10 MΩ 2 pF	±1500 V	1000 V (RMS) CAT III	1800.2207.02
R&S®RT-ZHD60	100 MHz	100:1/1000:1	40 MΩ 2 pF	±6000 V	1000 V (RMS) CAT III	1800.2007.02

Model	Bandwidth	Attenuation factor	Input impedance	Dynamic range	Comment	Order No.
-------	-----------	--------------------	-----------------	---------------	---------	-----------

Accessory

R&S®RT-ZA24	replacement kit for R&S®RT-ZHD probes					1800.2707.00
-------------	---------------------------------------	--	--	--	--	--------------

**Current probes**

Model	Bandwidth	Sensitivity	Dynamic range	Rise time	Comment	Order No.
-------	-----------	-------------	---------------	-----------	---------	-----------

Probes

R&S®RT-ZC02	20 kHz	0.01 V/A, 0.001 V/A	±200 A, ±2000 A	5 µs	battery powered	1333.0850.02
R&S®RT-ZC03	100 kHz	0.1 V/A	20 A (RMS), ±30 A (peak)	1 µs	battery powered	1333.0844.02
R&S®RT-ZC05B	2 MHz	0.01 V/A	500 A (RMS), 700 A (peak)	175 ns	power supply via Rohde&Schwarz probe interface	1409.8204.02
R&S®RT-ZC10	10 MHz	0.01 V/A	150 A (RMS)	35 ns	power supply via R&S®RT-ZA13	1409.7750K02
R&S®RT-ZC10B	10 MHz	0.01 V/A	±300 A (peak), ±500 A (peak) (single pulse)	35 ns	power supply via Rohde&Schwarz probe interface	1409.8210.02
R&S®RT-ZC15B	50 MHz	0.1 V/A	30 A (RMS) ±50 A (peak)	7 ns	power supply via Rohde&Schwarz probe interface	1409.8227.02
R&S®RT-ZC20	100 MHz	0.1 V/A		3.5 ns	power supply via R&S®RT-ZA13	1409.7766K02
R&S®RT-ZC20B	100 MHz	0.1 V/A		3.5 ns	power supply via Rohde&Schwarz probe interface	1409.8233.02
R&S®RT-ZC30	120 MHz	1 V/A	5 A (RMS) 7.5 A (peak)	2.9 ns	power supply via R&S®RT-ZA13	1409.7772K02

Accessories

R&S®RT-ZF20	power deskew and calibration test fixture					1800.0004.02
R&S®RT-ZA13	external power supply for up to four Rohde&Schwarz current probes					1409.7789.02

**EMC near-field probes**

Model	Frequency range	Comment	Order No.
-------	-----------------	---------	-----------

R&S®HZ-14	9 kHz to 1 GHz	active E and H near-field probe set, requires R&S®HZ-9 external power supply	1026.7744.03
R&S®HZ-15	30 MHz to 3 GHz	compact E and H near-field probe set	1147.2736.02
R&S®HZ-17	30 MHz to 3 GHz	compact H near-field probe set	1339.4141.02

Accessories

R&S®HZ-16	100 kHz to 3 GHz	preamplifier 3 GHz, 20 dB, power adapter 100 V to 230 V	1147.2720.02
R&S®HZ-9		external power supply for R&S®HZ-14	0816.1015.03

CHAPTER 3

SIGNAL AND SPECTRUM ANALYZERS

All Rohde & Schwarz signal and spectrum analyzers, from basic value and handheld models to benchtop instruments up to 85 GHz, set standards in accuracy, RF performance and usability.

We support performance-oriented, cost-conscious users during the development, production, installation and servicing of RF systems. For production and monitoring systems, we also offer specially designed remote controlled ultra compact spectrum analyzers that require minimal rack space.



Type	Designation	Frequency range	Description	Page	
Top class					
R&S®FSW	Signal and spectrum analyzer	2 Hz to 8/13.6/26.5/43/50/67/85 GHz	Setting standards in RF performance and usability	64	
R&S®FSWP	Phase noise analyzer and VCO tester	1 MHz to 8/26.5/50 GHz	High-end analysis of signal sources and components	65	
R&S®FSMR	Measuring receiver	20 Hz to 3.6/26.5/43/50 GHz	Combines the functions of multiple instruments	66	
General purpose					
New	R&S®FSV3000	Signal and spectrum analyzer	10 Hz to 4/7.5/13.6/30/44 GHz	Fast setup and fast measurements	67
New	R&S®FSVA3000	Signal and spectrum analyzer	10 Hz to 4/7.5/13.6/30/44 GHz	Ahead with demanding applications	68
New	R&S®FS-SNS	Smart noise sources	10 MHz to 26.5/40/55 GHz	For easy and accurate noise figure measurements	69
	R&S®FSV/FSVA	Signal and spectrum analyzers	10 Hz to 4/7/13.6/30/40 GHz	The right choice of general purpose analyzers	70
	R&S®FSVR	Realtime spectrum analyzer	10 Hz to 7/13.6/30/40 GHz	Discover the unseen	71
	R&S®FPS	Signal and spectrum analyzer	10 Hz to 4/7/13.6/30/40 GHz	Compact and fast for automated tests	72
	R&S®FPL1000	Signal and spectrum analyzer	5 kHz to 3 GHz	Experience high performance wherever you take it	73
	R&S®FSL	Spectrum analyzer	9 kHz to 3/6/18 GHz	Best performance in its class	74
	R&S®FSC	Spectrum analyzer	9 kHz to 3/6 GHz	Compact, cost-efficient solution	75
	R&S®FPC	Spectrum analyzer	5 kHz to 1/2/3 GHz	Unexpected performance in entry class	76
Handheld					
	R&S®Spectrum Rider FPH	Handheld spectrum analyzer	5 kHz to 2/6/13.6/26.5 GHz	Small form factor to handle big tasks	77
	R&S®FSH	Handheld spectrum analyzer	9 kHz to 3.6/8/13.6/20 GHz	The all-in-one handheld platform	78
Accessories for R&S®FSx analyzers					
	R&S®FS-Zxx	Harmonic mixers	40 GHz to 500 GHz	Spectrum analysis in the waveguide bands above 40 GHz	79
Application-specific solutions					
	Application firmware/software packages for R&S®Fxx analyzers		Overview	80	
Signal analysis software					
	R&S®VSE	Vector signal explorer software	Desktop signal analysis	91	
Modulation analyzers for avionics					
	R&S®EVSF1000	VHF/UHF nav/flight analyzer	Efficient flight inspection of terrestrial navigation and communications systems	92	
	R&S®EVSG1000	VHF/UHF airnav/com analyzer	Efficient servicing of air navigation and communications systems	93	
	R&S®EDS300	DME/pulse analyzer	Precise distance and pulse analysis for ground and air measurements	94	
	R&S®EDST300	TACAN/DME station tester	Maintenance checks and signal-in-space analysis on TACAN and DME stations	95	

R&S®FSW SIGNAL AND SPECTRUM ANALYZER



Setting standards in RF performance and usability

The high-performance R&S®FSW signal and spectrum analyzer helps engineers accomplish the most demanding tasks. Its wide internal analysis bandwidth allows the characterization of wideband components and communications systems. Its unparalleled phase noise facilitates the development of high-performance oscillators such as those used in radars. A state-of-the-art multitouch display with gesture support ensures straightforward and intuitive operation. An embedded SCPI recorder enables easy creation of executable scripts.

The R&S®FSW offers up to 8.3 GHz analysis bandwidth for measuring wideband-modulated or frequency agile signals like those used in the new 5G New Radio standard or in automotive and pulsed radars. The 800 MHz realtime

analysis bandwidth allows users to monitor wide portions of the spectrum and trigger on short duration signals.

The R&S®FSW can measure multiple standards simultaneously. Users can quickly and easily detect and eliminate errors caused by interaction between signals. Featuring a multitouch display and intuitive menu structure, the R&S®FSW offers exceptional ease of operation. Various measurements can be displayed simultaneously in separate windows on the large 12.1" screen, which greatly facilitates result interpretation.

Key facts

- ▶ Frequency range from 2 Hz to 90 GHz (up to 500 GHz with external harmonic mixers from Rohde&Schwarz)
- ▶ Low phase noise of -140 dBc (1 Hz) at 10 kHz offset, -143 dBc at 100 kHz offset (1 GHz carrier)
- ▶ 60 dBc spurious-free dynamic range for 2 GHz internal analysis bandwidth
- ▶ Up to 8.3 GHz analysis bandwidth
- ▶ 800 MHz real-time analysis bandwidth with 2.4 million FFT/s, 0.46 μs POI and 500 MHz I/Q data streaming interface.
- ▶ SCPI recorder simplifies code generation
- ▶ New flat Windows 10 design and multitouch gesture support
- ▶ Multiple measurement applications can be run and displayed in parallel

Recommended signal analysis bandwidth extensions for the different signal analysis applications										
R&S®FSW8/13/26/43/50/67/85 with bandwidth extension R&S®... (see data sheet (PD 5214.5984.22) for compatibility)	Standard 10 MHz	FSW-B28 28 MHz	FSW-B40 40 MHz	FSW-B80 80 MHz	FSW-B160 160 MHz	FSW-B320 320 MHz	FSW-B512 512 MHz	FSW-B1200 1.2 GHz	FSW-B2001 2 GHz	FSW-B4001/-B6001/-B8001 4/6.4/8.3 GHz
Standard applications and measurements on single carriers, e.g. WCDMA, CDMA2000®, TD-SCDMA, TETRA, NB-IoT	•									
LTE, WLAN IEEE802.11a/b/g/p signals		•								
5G NR					•			•		
WLAN IEEE802.11n signals			•							
WLAN IEEE802.11ac and WLAN IEEE802.11ax signals				•	•					
WLAN IEEE802.11ad signals									•	
WLAN IEEE802.11ay signals										•
Component characterization and linearization (amplifiers, frequency converters, etc.)			•	•	•	•	•	•	•	•
Pulsed radar				•	•	•	•	•	•	•
Wideband measurements on CW and frequency hopping radar systems					•	•	•	•	•	•
Automotive radar							•	•	•	•
Satellite RF measurements					•	•	•	•	•	



R&S® FSWP PHASE NOISE ANALYZER AND VCO TESTER



High-end analysis of signal sources and components

The R&S®FSWP phase noise analyzer and VCO tester combines extremely low-noise internal sources and cross-correlation technology, delivering extremely high sensitivity for phase noise measurements. As a result, it takes just seconds to measure even highly stable sources such as those found in radar applications. Additional options such as pulsed signal measurements, additive phase noise (including pulsed) characterization and integrated high-end signal and spectrum analysis make the analyzer a unique test instrument.

High measurement speed

- ▶ Perfect for production applications
- ▶ Faster development

Measuring phase and amplitude noise with high sensitivity

- ▶ Extremely low phase noise from internal sources
- ▶ Cross-correlation to improve phase noise sensitivity
- ▶ Accuracy of amplitude noise measurements significantly higher than with diode detectors
- ▶ Display of improvement in sensitivity through cross-correlation
- ▶ Frequency offset up to maximum input frequency
- ▶ Measurement of Allan variance

Phase noise measurements on pulsed sources at the push of a button

- ▶ Simple test setup
- ▶ High sensitivity despite desensitization
- ▶ Automatic pulse parameter measurement

Internal source for measuring residual phase noise, also on pulsed signals

- ▶ Simple and fast measurement
- ▶ Higher sensitivity through cross-correlation
- ▶ Residual phase noise on pulsed signals
- ▶ Additional inputs for an external source
- ▶ Measuring the phase and amplitude stability of pulsed signals

Signal and spectrum analyzer and phase noise analyzer up to 50 GHz in a single box

- ▶ Simple, cost-optimized test setup
- ▶ A worthwhile investment
- ▶ High-end signal and spectrum analyzer

Low-noise internal DC sources for VCO characterization

- ▶ Complete VCO characterization
- ▶ Measuring higher harmonics
- ▶ Phase noise relative to the tuning voltage

Measuring transients or frequency hops (transient analysis)

- ▶ Up to 8 GHz bandwidth for frequency and phase analysis
- ▶ Triggering on phase or frequency deviation
- ▶ Analysis linearity of FMCW chirps
- ▶ Automatic measurement of settling time

Typical phase noise sensitivity with R&S®FSWP-B61 option (correlations = 1, start offset = 1 Hz)¹⁾

	Offset from carrier								
	1 Hz	10 Hz	100 Hz	1 kHz	10 kHz	100 kHz	1 MHz	10 MHz	30 MHz
RF input frequency: 1 GHz	-81	-103	-126	-156	-172	-179	-179	-179	-179

¹⁾ Typical values in dBc (1 Hz).

Models

R&S®FSWP8	1 MHz to 8 GHz
R&S®FSWP26	1 MHz to 26.5 GHz
R&S®FSWP50	1 MHz to 50 GHz



Configurator Videos Product site



Rear view of the R&S®FSWP with interfaces and extension slots

R&S®FSMR MEASURING RECEIVER



- ▶ Audio analysis with automatic measurement of modulation frequency, THD and SINAD
- ▶ Display of audio signals and demodulated signals in frequency and time domain
- ▶ Audio input for calibration of modulation generators

The R&S®FSMR not only displays the demodulated signal or the audio signal in the time domain, the signal is also displayed selectively as an RF spectrum, generated by means of an FFT, with harmonics and any spurious modulation, such as hum.

Combines the functions of multiple instruments

The R&S®FSMR combines the functionality of several instruments in one and is capable of calibrating all vital parameters of signal generators and fixed or adjustable attenuators. The R&S®FSMR offers full spectrum analyzer functionality, e.g. for measuring harmonics or phase noise. The base unit does not provide for image frequency rejection in the range above 3.6 GHz since the YIG filters normally used for this would impair level linearity. The optional YIG preselection filter makes the R&S®FSMR a full-featured spectrum analyzer, also in the microwave range. The tracking YIG filter can be switched off for accurate level calibration.

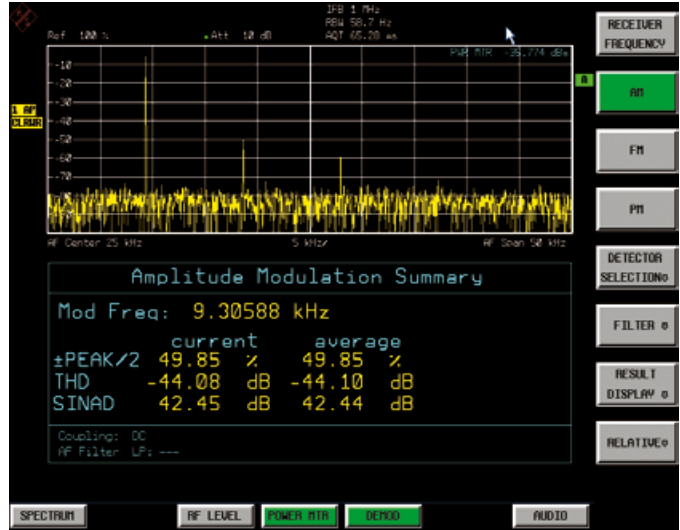

Versatile, high-performance spectrum analysis

- ▶ Full-featured spectrum analyzer
- ▶ Full choice of detectors
- ▶ Versatile resolution filter characteristics and large bandwidth
- ▶ Full range of analysis functions

Direct connection of power sensors for accurate power measurements

- ▶ Power sensor module with integrated power splitter
- ▶ Control of all functions incl. power meter from front panel or via IEC/IEEE bus or LAN
- ▶ Many supported power meters
- ▶ Automatic VSWR correction

Level calibration – precise, repeatable and easy

- ▶ Exceptionally high linearity and level stability across an extended time and temperature range enable high-precision measurements across a longer period of time
- ▶ Automatic VSWR correction when a power sensor with a power splitter is used
- ▶ Traceability to national standards, R&S®FSMR-Z2 PTB-calibrated attenuation calibration kit for verifying the linearity of the R&S®FSMR

Example: the R&S®FSMR controls the R&S®NRP-Z27 power meter



Modulation and audio analysis made easy

- ▶ Measurement of modulation depth, frequency deviation and phase deviation with < 1% measurement uncertainty

Models	
R&S®FSMR3	20 Hz to 3.6 GHz
R&S®FSMR26	20 Hz to 26.5 GHz
R&S®FSMR43	20 Hz to 43 GHz
R&S®FSMR50	20 Hz to 50 GHz



R&S® FSV3000 SIGNAL AND SPECTRUM ANALYZER

New



Fast setup and fast measurements

Measurements at the push of a button, capturing rare events with event based actions and simple script programming with the SCPI recorder – setting up complex measurements in no time is the strength of the R&S®FSV3000 signal and spectrum analyzer. Its other major advantage is its fast measurement speed, for high throughput in production applications.

The R&S®FSV3000 features functions that make complex measurements fast and easy. Setting up RF parameters with touchscreen gestures is as easy as using your smartphone. The auto set feature automatically sets the most important parameters such as frequency, level and gating. The SCPI recorder, which translates manual operation into remote control command scripts, is the dream of any test system software engineer. And event based actions support you when debugging your DUT by capturing and documenting rare events.

The R&S®FSV3000 has been designed for high-speed measurements. Production lines benefit from fast measurement times for spectral measurements, high-speed signal demodulation and rapid switching between different measurement modes.

The R&S®FSV3000 provides digital modulation analysis up to 200 MHz analysis bandwidth for cellular and wireless standards, including 5G NR.

Key facts

- ▶ Frequency range of 10 Hz to 4 GHz, 7.5 GHz, 13.6 GHz, 30 GHz or 44 GHz (up to 500 GHz with external harmonic mixers from Rohde&Schwarz)
- ▶ Analysis bandwidth up to 200 MHz (option)
- ▶ SSB phase noise at 10 kHz offset (1 GHz): -107 dBc (1 Hz)
- ▶ Third-order intercept (TOI) at 1 GHz: +18 dBm (typ.)
- ▶ DANL at 1 GHz: -151 dBm
- ▶ DANL at 1 GHz with optional preamp: -165 dBm
- ▶ Ready for cloud based testing
- ▶ 10 Gbit/s LAN interface (option)
- ▶ User interface with multitouch, SCPI recorder and event based actions
- ▶ Measurement applications for analog and digital signal analysis, including 5G NR

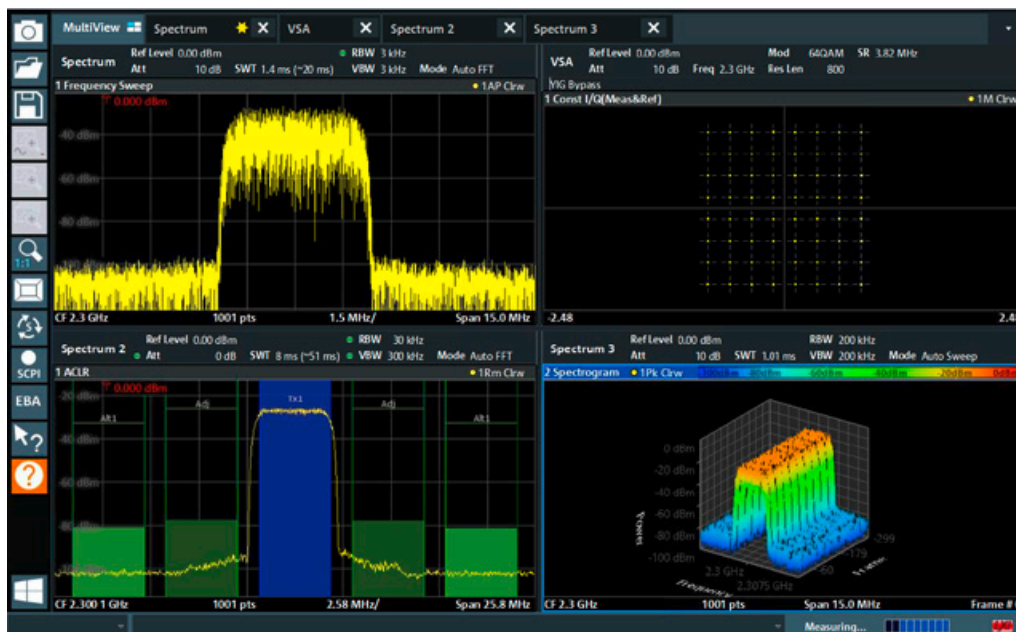

FFT based ACLR measurements provide significant speed improvements versus swept measurements. The R&S®FSV3000 still has an excellent dynamic range.



Configurator



Videos



Product site

R&S®FSVA3000 SIGNAL AND SPECTRUM ANALYZER

New



Ahead with demanding applications

An analysis bandwidth of 400 MHz, an outstanding phase noise of -120 dBc (1 Hz) at 10 kHz offset and a high dynamic range: the R&S®FSVA3000 signal and spectrum analyzer has everything needed to keep up with demanding measurement applications such as 5G NR measurements. With its high measurement speed and easy usability, it is the right instrument for demanding signal analysis tasks both in the lab and on a production line.

The R&S®FSVA3000 delivers a performance level that until recently was reserved for high-end instruments. It is equally suitable for analyzing frequency agile signals and wide-band signals as for linearizing power amplifiers. It supports all modern cellular and wireless standards; its frequency ranges and bandwidth options are a perfect match for 5G NR.

The R&S®FSVA3000 excels with high-speed measurements coupled with no compromise in RF performance.

It provides high throughput and yield in the production of cellular base stations and components and is equally suitable for development and verification labs.

The R&S®FSVA3000 features functions and wizards, which makes complex user measurement scenarios fast and easy. Setting up RF parameters with touchscreen gestures is as easy as using your smartphone. The auto set feature automatically sets the most important parameters such as frequency, level and gating. The SCPI recorder, which translates manual operation into remote control command scripts, is the dream of any test system software engineer. And event based actions support you when debugging your DUT by capturing and documenting rare events.

Key facts

- ▶ Frequency range of 10 Hz to 4 GHz, 7.5 GHz, 13.6 GHz, 30 GHz or 44 GHz (up to 500 GHz with external harmonic mixers from Rohde&Schwarz)
- ▶ Analysis bandwidth up to 400 MHz
- ▶ SSB phase noise at 10 kHz offset (1 GHz): -120 dBc (1 Hz)
- ▶ Third-order intercept (TOI) at 1 GHz: $+20$ dBm (typ.)
- ▶ DANL at 1 GHz: -153 dBm
- ▶ DANL at 1 GHz with optional preamp: -167 dBm
- ▶ Ready for cloud based testing
- ▶ 10 Gbit/s LAN interface (option)
- ▶ User interface with multitouch, SCPI recorder and event based actions
- ▶ Measurement applications for analog and digital signal analysis, including 5G NR

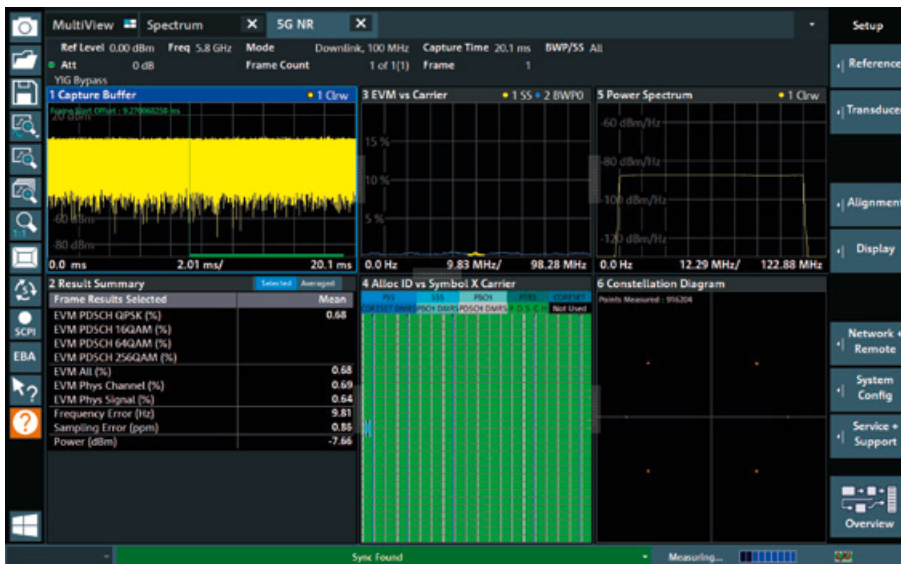

Analysis of a 5G NR signal with the R&S®FSVA3-K144 (downlink) and R&S®FSVA3-K145 (uplink) options



R&S®FS-SNS SMART NOISE SOURCES

New



For easy and accurate noise figure measurements

The R&S®FS-SNS smart noise sources enable simple and accurate noise figure and gain measurements by automatically loading all necessary setup parameters and taking the environmental temperature into account. Measurement uncertainty is calculated automatically and can even be displayed on the result screen.

Key facts

- ▶ Frequency range up to 26 GHz, 40 GHz or 55 GHz
- ▶ Supported by the R&S®FSW, R&S®FSV3000, R&S®FSVA3000 signal and spectrum analyzers and the R&S®FSWP phase noise analyzer and VCO tester
- ▶ Automatic loading of ENR table
- ▶ ENR uncertainty and reflection coefficients table for automatic uncertainty calculation
- ▶ Automatic temperature readout for improved accuracy

Fig. 1: Noise figure and gain measurement with R&S®FSx-K30 application firmware. In addition to the result table and the noise figure traces, the calculated gain and Y factor uncertainty can also be displayed.



Noise figure and gain measurement

To perform noise figure and gain measurements with a spectrum analyzer, an excess noise ratio (ENR) source is needed that adds a well-defined (and ideally “white”) noise to the input of the DUT. The Y factor is the ratio of the noise power at the output of the DUT with and without this added noise. It forms the basis for calculating the amount of noise contributed by the DUT and its resulting noise figure and gain.

Although the characteristics of the output signal of a noise source in the specified frequency range comes close to white noise, it still has a slight frequency response and temperature dependency. To eliminate this deviation from ideal behavior, noise sources come with written tables that indicate the ENR behavior of the noise source with respect to frequency and temperature. These correction values must be manually transferred to the noise figure measurement software.

The R&S®FS-SNS smart noise sources eliminate this time consuming and error prone activity by providing the ENR tables and environmental temperature to the spectrum analyzer in electronic format.

The R&S®FS-SNS smart noise sources are connected to the analyzer via a 7-pin cable for power supply and control interface. An adapter cable is supplied for instruments not equipped with the necessary connector. When connected to a spectrum analyzer (Fig. 2) equipped with the application firmware R&S®FSx-K30 noise figure measurements (Fig. 1), the instrument handles all needed parameters automatically.

Fig. 2: When the R&S®FS-SNS smart noise source is connected, ENR, uncertainty and reflection coefficient tables are automatically loaded and the temperature is set.

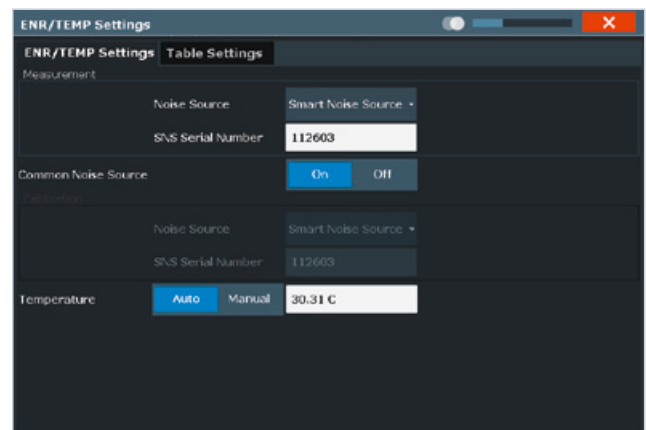

R&S® FSV/FSVA SIGNAL AND SPECTRUM ANALYZERS



The right choice of general purpose analyzers

The R&S®FSV and R&S®FSVA signal and spectrum analyzer family always provides the right model with the optimum combination of price and performance.

The R&S®FSV is the ideal instrument for all general-purpose measurement tasks – on the bench, in production, and in the field. It provides digital modulation analysis for the latest cellular and wireless standards with up to 160 MHz analysis bandwidth for measurements on components, chipsets and base stations.

The YIG preselector bypass is a hardware option for the R&S®FSVA13/30/40. It allows signal analysis with up to 160 MHz analysis bandwidth over the instrument's full frequency range.

Models		
R&S®FSV4	10 Hz to 4 GHz	
R&S®FSV7	10 Hz to 7 GHz	
R&S®FSV13	10 Hz to 13.6 GHz	
R&S®FSV30	10 Hz to 30 GHz	
R&S®FSV40	10 Hz to 40 GHz	
R&S®FSVA4	10 Hz to 4 GHz	
R&S®FSVA7	10 Hz to 7 GHz	
R&S®FSVA13	10 Hz to 13.6 GHz	YIG preselector bypass opt.
R&S®FSVA30	10 Hz to 30 GHz	YIG preselector bypass opt.
R&S®FSVA40	10 Hz to 40 GHz	YIG preselector bypass opt.

Typical measurement tasks

- ▶ Standard-compliant spectrum emission measurements
- ▶ Spurious emission and adjacent channel leakage ratio (ACLR) measurements
- ▶ EMI diagnostics: finding, classifying and eliminating electromagnetic interference
- ▶ Noise factor and gain measurement
- ▶ AM/FM/φM demodulation and vector signal analysis

Wideband digital modulation analysis

- ▶ Frequency range up to 4/7/13.6/30/40 GHz
- ▶ 28 MHz signal analysis bandwidth with base unit; 40 MHz and 160 MHz optional
- ▶ 200 Msample signal memory for capturing long signal sequences
- ▶ Analyzing cellular and wireless standards, including IEEE 802.11ac, for frequencies up to 7 GHz

Digital signal modulation analysis at microwave frequencies

- ▶ Modulation quality measurements over the full K band
- ▶ Demodulation of digitally modulated signals with up to 160 MHz analysis bandwidth for carrier frequencies up to 40 GHz.
- ▶ High dynamic range and low phase noise
- ▶ Perfect for demanding spectral measurements such as ACLR measurements on narrowband signals and phase noise measurements with the R&S®FSV-K40 option

Rich set of analysis software

- ▶ In-depth pulse analysis with R&S®VSE-K6
- ▶ OFDM vector signal analysis with R&S®VSE-K96
- ▶ EUTRA/LTE NB-IoT (narrowband internet of things) UL and DL with R&S®VSE-K106



Using an R&S®FSV or R&S®FSVA in combination with the R&S®VSE vector signal explorer makes it possible to run additional measurement applications such as the R&S®VSE-K6 pulse measurements option on an external PC.



R&S®FSVR REALTIME SPECTRUM ANALYZER



Discover the unseen

The R&S®FSVR combines a full-featured signal and spectrum analyzer with a realtime spectrum analyzer with analysis software for GSM/EDGE, WCDMA/HSPA+, LTE, WiMAX™, WLAN, analog and digital modulation methods, noise figure and phase noise measurements. In realtime operation, the R&S®FSVR seamlessly measures and displays the spectrum in the time domain with a span of up to 40 MHz. As a result, it captures every event for analysis, no matter how brief that event might be.

Realtime spectrum analysis up to 40 GHz

- ▶ Spectrogram function for gapless spectrum display in the time domain
- ▶ Frequency mask trigger (FMT) for triggering the measurement on individual, sporadic events in the spectrum
- ▶ Persistence mode for visualizing how frequently signals occur
- ▶ Power versus time for analyzing the length/time variance of signals

Frequency mask trigger

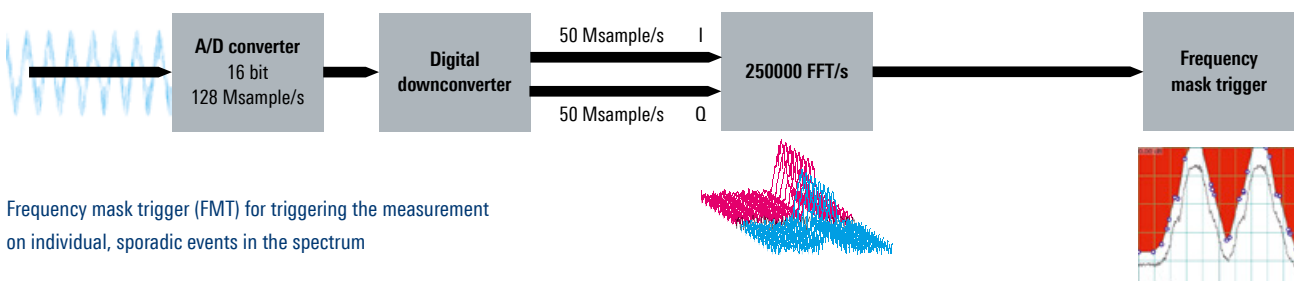

Frequency mask trigger (FMT) for triggering the measurement on individual, sporadic events in the spectrum

Models

R&S®FSVR7	10 Hz to 7 GHz
R&S®FSVR13	10 Hz to 13.6 GHz
R&S®FSVR30	10 Hz to 30 GHz
R&S®FSVR40	10 Hz to 40 GHz



Configurator



Videos



Product site

- ▶ Realtime streaming of I/Q data for recording long RF sequences

Full-featured signal and spectrum analyzer

- ▶ Frequency sweep across the entire frequency range from 10 Hz to 40 GHz in just a few milliseconds
- ▶ Expansion of the maximum input frequency to 110 GHz using external mixers e.g. from Rohde & Schwarz
- ▶ Outstanding level measurement accuracy up to 7 GHz
- ▶ Excellent dynamic range and low phase noise
- ▶ High measurement speed
- ▶ Power measurement functions and statistical evaluations for analyzing digitally modulated signals
- ▶ Versatile marker and trace evaluation functions
- ▶ Measurement software for determining noise figure or phase noise
- ▶ General vector signal analysis (VSA) and special analysis options for GSM/EDGE, WCDMA/HSPA+, LTE, WiMAX™, WLAN as well as analog modulation methods
- ▶ Large I/Q memory depth

Simple and intuitive touchscreen operation

- ▶ Touchscreen operation using a finger as a mouse cursor
- ▶ Fast access to all important functions
- ▶ Built-in help function
- ▶ Undo/redo function

Low total cost of ownership

- ▶ Convenient on-site retrofitting of options
- ▶ Easy scalability to handle specific requirements
- ▶ Always up-to-date with firmware updates



Users can retrofit hardware options simply by using the plug & play interfaces on the rear of the instrument

R&S®FPS SIGNAL AND SPECTRUM ANALYZER



Compact and fast for automated tests

The R&S®FPS excels with its high measurement speed, 160 MHz signal analysis bandwidth and wide range of analysis packages for analog modulation methods and wireless/wideband communications standards. It is up to five times faster than comparable signal and spectrum analyzers and provides measurement routines optimized for speed and high data throughput, which is a crucial advantage in production applications.

Key facts

- ▶ Only 2 HU of rack space required – a reduction of 50% compared with traditional instruments
- ▶ Frequency range up to 4/7/13.6/30/40 GHz
- ▶ Up to 160 MHz signal analysis bandwidth
- ▶ 0.4 dB level measurement uncertainty up to 7 GHz
- ▶ –110 dBc (1 Hz) phase noise at 10 kHz frequency offset
- ▶ +15 dBm third-order intercept (TOI)
- ▶ –155 dBm displayed average noise level (DANL) at 1 GHz in 1 Hz bandwidth
- ▶ Measurement applications for GSM/EDGE (including EDGE Evolution), WCDMA/HSPA+, LTE, WLAN, vector signal analysis
- ▶ Removable hard disk for applications where security is a concern

High throughput for efficient production

- ▶ Up to five times faster than other signal and spectrum analyzers
- ▶ Fast switchover between instrument setups
- ▶ Fast and accurate measurement results
- ▶ Reduced volume in test racks
- ▶ Customized test routines for production applications
- ▶ Efficient operation via remote control

Ready for tomorrow's standards

- ▶ Fully digital backend ensures high measurement accuracy and excellent repeatability
- ▶ 160 MHz signal analysis bandwidth, suitable for WLAN IEEE 802.11ac
- ▶ Easy transition to the next generation in signal analysis
- ▶ Always up-to-date – the firmware can be updated using an USB storage device or the LAN port

Connectivity

- ▶ Supports all standard interfaces
- ▶ Communication with other measuring instruments and the controller PC via GPIB, LAN (Gigabit Ethernet) or USB
- ▶ SCPI commands can be issued directly without going through a script interpreter. This triples the speed of measurement tasks compared with communicating via SCPI

Signal analysis bandwidth			
Standard	28 MHz bandwidth (standard)	40 MHz bandwidth (optional)	160 MHz bandwidth (optional)
LTE	exceeds the 20 MHz max. channel width of LTE signals	with LTE carrier aggregation, up to two neighboring 20 MHz LTE channels can be analyzed	wireless communications bands can be fully analyzed
WLAN	exceeds the 20 MHz channel width of WLAN IEEE802.11a/b/g signals	covers WLAN IEEE802.11n wideband technology	covers WLAN IEEE802.11ac wideband technology
WCDMA	exceeds the 20 MHz bandwidth required for CCDF measurements on four-carrier WCDMA signals	–	–

Models	
R&S®FPS4	10 Hz to 4 GHz
R&S®FPS7	10 Hz to 7 GHz
R&S®FPS13	10 Hz to 13.6 GHz
R&S®FPS30	10 Hz to 30 GHz
R&S®FPS40	10 Hz to 40 GHz



All interfaces are located on the rear panel, making it ideal for integration into rack systems.



R&S®FPL1000 SIGNAL AND SPECTRUM ANALYZER



Experience high performance wherever you take it

The R&S®FPL1000 signal and spectrum analyzer makes measuring fast and simple. The intuitive touch-screen is straightforward and easy to use. With its solid RF performance, light weight and small footprint, the R&S®FPL1000 combines the functionality of a benchtop instrument with the portability of a handheld instrument.

Using the R&S®FPL1000 is as intuitive as using a smart-phone. Simple swiping gestures adjust the center frequency or the reference level. Two-finger gestures change the span or the displayed power level, while the 10.1" screen with 1280 x 800 pixel resolution provides a clear display of the signal. Furthermore, the user can freely arrange the layout of the measurement results on the display. Using the MultiView display mode, even different measurement modes can be combined and all the results can be displayed on one screen.

Key facts

- ▶ Frequency range 5 kHz to 7.5 GHz
- ▶ SSB phase noise: -108 dBc (1 Hz) at 10 kHz offset (1 GHz carrier)

Screenshot of the R&S®FPL1000 with MultiView. The sequencer consecutively performs a spectrum measurement, an adjacent channel power measurement, an I/Q analysis and a spectrogram measurement

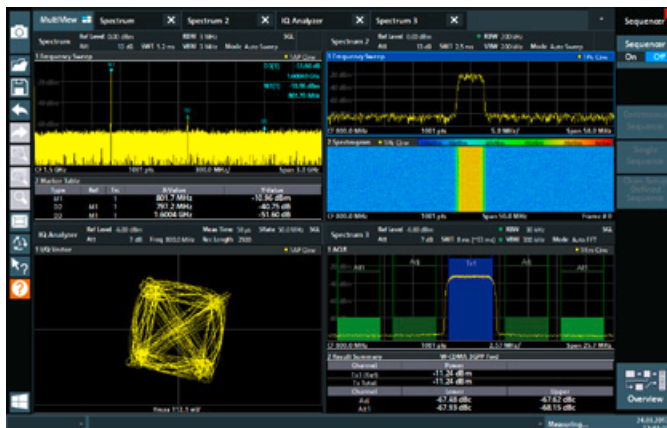

- ▶ DANL with preamplifier: -166 dBm from 10 MHz to 2 GHz
- ▶ Lightweight with small footprint
- ▶ Battery or 12 V/24 V DC operation (option)
- ▶ Use with power sensors (option)
- ▶ 40 MHz analysis bandwidth (option)
- ▶ Analog and digital signal analysis (option)
- ▶ Gated sweep, narrowband resolution filters and spectrogram measurements as standard

One instrument for multiple applications

- ▶ Spectrum analysis
- ▶ Signal analysis of analog and digitally modulated signals
- ▶ Power measurements with power sensors
- ▶ Noise figure and gain measurements

Solid RF performance

- ▶ Low spurious response
- ▶ Low displayed average noise level (DANL)
- ▶ 40 MHz signal analysis bandwidth
- ▶ Low level measurement uncertainty
- ▶ Precise spectral measurements due to low phase noise

Intuitive user interface

- ▶ High-resolution display
- ▶ Multipoint touchscreen
- ▶ Flexible arrangement of results and MultiView
- ▶ Toolbar
- ▶ Quiet operation

Fully portable

- ▶ Battery pack and 12 V/24 V power supply
- ▶ Carrying bag and shoulder harness
- ▶ Low power consumption

Fully portable configuration with optional transport bag and shoulder harness as well as optional R&S®HE400LP antenna module



Product site

R&S® FSL SPECTRUM ANALYZER

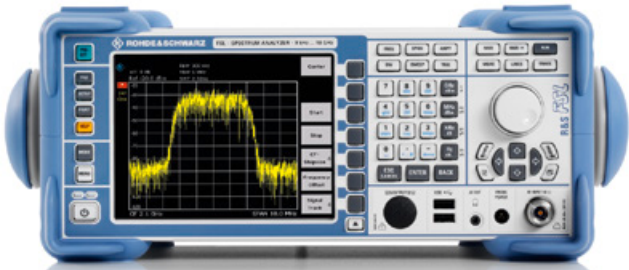

Best performance in its class

The high-end approach is also evident in the operating features. When equipped with a tracking generator up to 18 GHz, the R&S®FSL18 is an easily portable, microwave scalar network analyzer. As with the higher-class analyzers from Rohde&Schwarz, the main functions of the R&S®FSL are directly accessible by fixed-assignment function keys, with additional functions accessed using softkeys and tables. This shortens the learning curve for new users.

Key facts

- ▶ Frequency range from 9 kHz to 3 GHz/6 GHz/18 GHz
- ▶ 3 GHz, 6 GHz and 18 GHz models with and without tracking generator
- ▶ Best RF characteristics in its class
- ▶ Largest signal analysis bandwidth in its class (28 MHz)
- ▶ Low measurement uncertainty, even in microwave range
- ▶ High resolution filter accuracy owing to all-digital implementation
- ▶ Robust and compact
- ▶ Carrying handle and low weight 8 kg
- ▶ Optional battery operation
- ▶ Wide range of functions, simple operation
- ▶ Easy on-site upgrading with options

Exceptional performance for its class

- ▶ Continuous RF frequency range from 9 kHz to 18 GHz and 28 MHz demodulation bandwidth
- ▶ Low measurement uncertainty even in microwave range

Fast and versatile in production

- ▶ High measurement speed and time-saving routines improve throughput
- ▶ Remote control via LAN or IEC/IEEE bus in line with SCPI

At home in every development lab

- ▶ Excellent price/performance ratio
- ▶ General-purpose signal analysis
- ▶ Wide range of personalities for various wireless/cellular digital standards

Lightweight and compact for on-site installation, maintenance and service

- ▶ Easy portability due to small size and low weight
- ▶ Optional internal battery pack for cordless use
- ▶ Power measurements with R&S®NRP-xx power sensors
- ▶ Ideal for service

Easy upgrades and a wide range of interfaces

- ▶ On-site plug&play installation of options without opening the instrument
- ▶ Additional interfaces expand the application range of the R&S®FSL

Wide range of functions – simple operation

- ▶ Comprehensive set of measurement functions and features more typical of high-end analyzers
- ▶ Built-in measurement routines and versatile selection of firmware options

Models	
R&S®FSL3	9 kHz to 3 GHz
R&S®FSL3	9 kHz to 3 GHz, with tracking generator
R&S®FSL6	9 kHz to 6 GHz
R&S®FSL6	9 kHz to 6 GHz, with tracking generator
R&S®FSL18	9 kHz to 18 GHz (overrange 20 GHz)
R&S®FSL18	9 kHz to 18 GHz, with tracking generator



Its compact size and low weight, plus its optional battery pack and soft carrying bag make the R&S®FSL ideal for mobile use.



R&S® FSC SPECTRUM ANALYZER

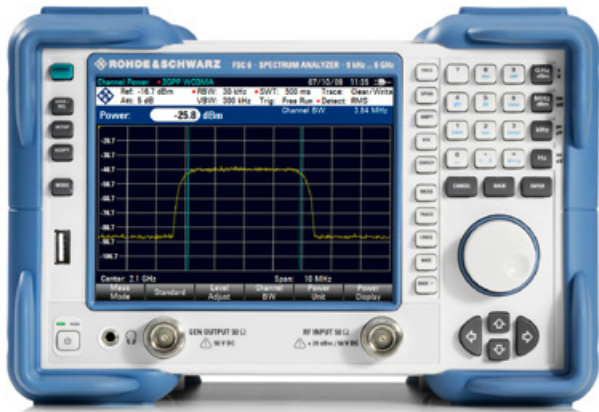

Compact, cost-efficient solution

The R&S®FSC is a compact, cost-efficient solution that offers all essential features of a professional spectrum analyzer with Rohde&Schwarz quality. It covers a wide range of applications from simple development tasks to production, or can be used for training RF professionals. Four different R&S®FSC models are available in the frequency range from 9 kHz to 3 GHz or 6 GHz. Separate models with tracking generator are available for each frequency range. An optional preamplifier that is available for all models increases sensitivity for measuring weak signals. When installed in a rack, two R&S®FSC or one R&S®FSC and one R&S®SMC signal generator situated next to each other fit into the 19" space.

Key facts

- ▶ Frequency range 9 kHz to 3 GHz or 6 GHz
- ▶ Resolution bandwidths 10 Hz to 3 MHz
- ▶ High sensitivity (< -141 dBm (1 Hz), with optional preamplifier < -161 dBm (1 Hz))
- ▶ High third order intercept (> 10 dBm, typ. 15 dBm)
- ▶ Low measurement uncertainty (< 1 dB)
- ▶ Internal tracking generator (models .13/.16)
- ▶ LAN and USB interface for remote control and transfer of measurement data
- ▶ R&S®InstrumentView software for simple documentation of measurement results
- ▶ Easy operation and user interface in different languages
- ▶ Compact dimensions, optional 19" rack adapter
- ▶ Low power consumption (12 W)

Models

R&S®FSC3	9 kHz to 3 GHz
R&S®FSC3	9 kHz to 3 GHz, with tracking generator
R&S®FSC6	9 kHz to 6 GHz
R&S®FSC6	9 kHz to 6 GHz, with tracking generator



Configurator



Product site

Measurement functions

- ▶ Noise marker for determining the noise power referenced to 1 Hz measurement bandwidth
- ▶ Frequency counter with 0.1 Hz resolution
- ▶ Limit line monitoring (pass/fail function) for indicating whether the DUT complies with defined limits
- ▶ Modulation depth measurement of AM signals
- ▶ Measurement of harmonics and total harmonic distortion
- ▶ AM/FM audio demodulator (monitoring via audio output)
- ▶ Scalar transmission measurement for fast and simple determination of the transmission characteristics of DUTs such as cables, filters or amplifiers (models .13/16)
- ▶ Location of EMC problems on printed boards using the R&S®HZ-15 near-field probe set for emission measurements from 30 MHz to 3 GHz
- ▶ Field-strength measurements taking into account the specific antenna factors of the connected antenna, the field strength being displayed directly in dBμV/m
- ▶ Power measurement on pulsed signals in the time domain with predefined settings for GSM and EDGE
- ▶ Channel power measurement in a definable transmission channel with predefined settings for 3GPP WCDMA, cdmaOne, CDMA2000® and LTE standards
- ▶ Measurement of occupied bandwidth (OBW)
- ▶ Adjacent channel power, absolute or referenced to the TX carrier for up to 12 channels and 12 adjacent channels
- ▶ Gated sweep for displaying the modulation spectrum of burst signals such as GSM or WLAN
- ▶ Measurement of spurious emissions

Flexible remote-control anywhere, anytime

- ▶ Remote-control via SCPI-compatible commands
- ▶ Drivers for LabWindows/CVI, LabView, VXI-Plug & Play and Linux
- ▶ Wireless remote-control with R&S®MobileView app¹⁾
- ▶ Wired or wireless¹⁾ remote-control with R&S®InstrumentView PC software

Wireless remote control with R&S®MobileView app



Wired/wireless remote control with R&S®InstrumentView PC software



¹⁾ Via a wireless router connected to the instrument's LAN port.

R&S®FPC SPECTRUM ANALYZER



Unexpected performance in entry class

Outstanding quality and innovation does not have to come with a high price tag. The R&S®FPC spectrum analyzer provides unexpected performance at a budget-friendly price. It is engineered in Germany and designed to the same quality standards as high-end instruments.

Investment protection, high resolution and easy control – these traits make the R&S®FPC spectrum analyzer a perfect tool for university laboratories, research institutions as well as production and service facilities.

Key facts

- ▶ RF performance engineered in Germany
- ▶ 10.1" WXGA (1366 x 768 pixel) display – largest and highest resolution in its class
- ▶ Frequency range from 5 kHz to 1 GHz, keycode upgradeable to 2 GHz/3 GHz
- ▶ Resolution bandwidth settings down to 1 Hz
- ▶ Wi-Fi-enabled, supported by included remote control software
- ▶ 3 year standard warranty
- ▶ R&S®FPC1500 only:
 - Tracking generator and independent CW signal generator
 - Built-in VSWR bridge
 - One-port vector network analyzer with Smith chart display

Model selection guide		
Feature	R&S®FPC1000	R&S®FPC1500
Spectrum analyzer	•	•
One-port vector network analyzer	–	•
Signal generator	–	•
Internal VSWR bridge	–	•
Independent signal source	–	•
Silent operation	•	•
Small footprint	•	•
Low power consumption	•	•
Remote control software (free of charge)	•	•

Value of Three

More than a spectrum analyzer

The R&S®FPC has the Value of Three: it is the only spectrum analyzer on the market that provides the value of three instruments. Incidentally, these are the three most commonly used instruments on an RF engineer's workbench, for instance in IoT device development.

Spectrum analyzer		
Investment protection	High resolution	Easy virtual control
Vector network analyzer		
Internal VSWR bridge	One-port vector network analyzer	Smith chart
Signal generator		
Tracking generator	Independent signal source	Coupled CW mode

Wireless remote control ¹⁾



Wireless remote control with R&S®InstrumentView PC software or R&S®MobileView apps (available on Android and iOS)

¹⁾ Wi-Fi feature not available in some countries due to local certification requirements.

Frequency extension using keycodes: Buy what you need when you need it

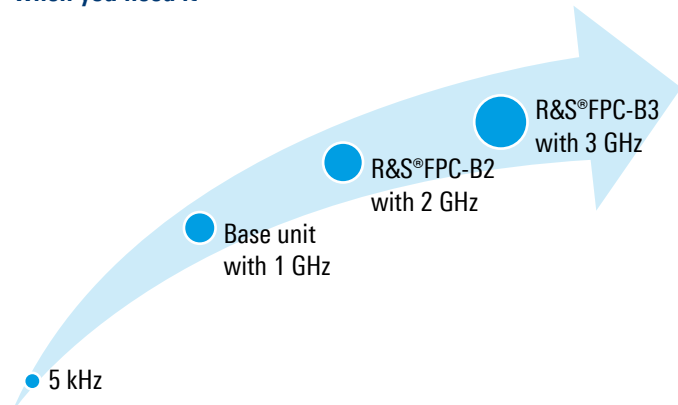

R&S® Spectrum Rider FPH HANDHELD SPECTRUM ANALYZER



The quality you expect at an unexpected price

The R&S® Spectrum Rider FPH is a versatile, user-friendly instrument in a rugged and appealing design. The frequency range of the basic analyzer is 5 kHz to 2 GHz/6 GHz/13.6 GHz/26.5 GHz. The upper frequency limit can easily be extended via keycode; for example from 26.5 GHz to 31 GHz. It suits both field and lab applications in indoor and outdoor measurement environments.

Key facts

- ▶ Frequency ranges from 5 kHz up to 31 GHz
- ▶ Frequency extension via keycode
- ▶ Solid RF performance
 - DANL: typ. -163 dBm (10 MHz to 3 GHz, preamp. on)
 - TOI measurement: $+10$ dBm ($f = 2.4$ GHz)
- ▶ Ideal for field use: > 6 hour battery life, 2.5 kg weight
- ▶ Large color display with touch and gesture operation
- ▶ Three-year warranty as standard (battery one year)

Excellent in the field

- ▶ Lightweight, small form factor and long battery life
- ▶ Wide range of accessories

- ▶ Nonreflective display and backlit keypad designed for outdoor use
- ▶ Ruggedized in line with MIL-PRF-28800F class 2

Excellent for lab diagnostics

- ▶ Solid RF performance for diagnostics in the lab
- ▶ EMI debugging with optional near-field probes

User-friendly

- ▶ Easy to use with smartphone-like gestures on the touchscreen
- ▶ Increasing productivity through measurement wizard
- ▶ Configuration overview menu
- ▶ Setting frequencies with channel tables

Future-ready

- ▶ Software-upgradeable frequency ranges
- ▶ Multipurpose use in various industries, R&D and education
- ▶ Easy upgrade of all options via software keycode
- ▶ Optional software applications
 - Power measurements with power sensors
 - Internal channel power meter
 - Pulse measurements with power sensors
 - Interference analysis and signal strength mapping
 - AM/FM/ASK/FSK analysis
 - Receiver mode

Postprocessing and remote control

- ▶ R&S® InstrumentView software for measurement postprocessing and documentation
- ▶ Remote control via LAN or USB
- ▶ R&S® MobileView app for remote control and file transfer



Models

R&S®FPH, model .02	base unit, 5 kHz to 2 GHz	upgradeable to 3 GHz (with R&S®FPH-B3 option), upgradeable to 4 GHz (with R&S®FPH-B4 option)
R&S®FPH, model .06	base unit, 5 kHz to 6 GHz	upgradeable to 8 GHz (with R&S®FPH-B8 option)
R&S®FPH, model .13	base unit, 5 kHz to 13.6 GHz	upgradeable to 20 GHz (with R&S®FPH-B20 option)
R&S®FPH, model .26	base unit, 5 kHz to 26.5 GHz	upgradeable to 31 GHz (with R&S®FPH-B31 option)



Configurator



Product site

R&S®FSH HANDHELD SPECTRUM ANALYZER



The all-in-one handheld platform

The R&S®FSH is a handheld spectrum analyzer – and depending on the model and the options installed – a power meter, a cable and antenna tester and a two-port vector network analyzer in a single device. Its ruggedized housing, low weight and easy operation make it an indispensable tool for anyone who needs an efficient measuring instrument for outdoor work.

Models	
R&S®FSH4, model .04	9 kHz to 3.6 GHz, with preamplifier
R&S®FSH4, model .14	9 kHz to 3.6 GHz, with preamplifier and tracking generator
R&S®FSH4, model .24	100 kHz to 3.6 GHz, with preamplifier, tracking generator and internal VSWR bridge
R&S®FSH8, model .08	9 kHz to 8 GHz, with preamplifier
R&S®FSH8, model .18	9 kHz to 8 GHz, with preamplifier and tracking generator
R&S®FSH8, model .28	100 kHz to 8 GHz, with preamplifier, tracking generator and internal VSWR bridge
R&S®FSH13, model .13	9 kHz to 13.6 GHz, with preamplifier
R&S®FSH13, model .23	9 kHz to 13.6 GHz, with preamplifier, tracking generator ¹⁾ and internal VSWR bridge
R&S®FSH20, model .20	9 kHz to 20 GHz, with preamplifier
R&S®FSH20, model .30	9 kHz to 20 GHz, with preamplifier, tracking generator ¹⁾ and internal VSWR bridge

¹⁾ Tracking generator 300 kHz to 8 GHz.

Key facts

- ▶ Frequency range from 9 kHz to 3.6/8/13.6/20 GHz
- ▶ High sensitivity < -141 dBm (1 Hz), with preamplifier < -161 dBm (1 Hz)
- ▶ 20 MHz demodulation bandwidth for analyzing LTE signals
- ▶ Low measurement uncertainty (< 1 dB)
- ▶ Two-port network analyzer
- ▶ Rugged, splash-proof housing for rough work in the field
- ▶ Easy handling due to low weight (3 kg with battery) and easy-to-reach function keys
- ▶ Easy operation thanks to user configurable, automatic test sequences (wizard)

Installation and maintenance of transmitter stations

- ▶ Checking of signal quality in the spectral and time domain using channel power measurements and measurements on pulsed signals
- ▶ Analysis of transmit signals for numerous transmission standards, also over the air (OTA)
- ▶ Spectrogram analysis of intermittent faults
- ▶ Distance-to-fault measurements on cables and one-port cable loss measurements
- ▶ Measuring of antenna match and testing of power amplifiers using vector network analysis
- ▶ Determination of transmission power with power sensors

Measurements of electromagnetic fields

- ▶ Field strength measurements with directional antennas
- ▶ Field strength measurements with isotropic antennas

Diagnostic applications in the lab or in service

- ▶ General spectrum analysis
- ▶ EMC precompliance measurements and channel scan
- ▶ AM modulation depth measurements
- ▶ Measurement of signal distortions caused by harmonics

Interference analysis, geotagging and indoor mapping

- ▶ Spectrogram measurements with R&S®FSH-K14/-K15
- ▶ Geotagging and indoor mapping (R&S®FSH-K16/-K17)



Interference analysis with R&S®FSH-K15 option and directional antennas



R&S® FS-Zxxx HARMONIC MIXERS



Spectrum analysis in the waveguide bands above 40 GHz

Frequencies in the high GHz range still require the use of external harmonic mixers. Such mixers can be connected to numerous Rohde&Schwarz analyzers that are equipped with the R&S®FSx-B21 LO/IF ports option for external mixers. Rohde&Schwarz mixers cover the frequency range up to 500 GHz. If other mixers are used, up to 1.1 THz is possible.

Models	Covered waveguide bands
R&S®FS-Z60	40 GHz to 60 GHz (U band)
R&S®FS-Z75	50 GHz to 75 GHz (wideband signal analysis)
R&S®FS-Z90	60 GHz to 90 GHz (wideband signal analysis)
R&S®FS-Z110	75 GHz to 110 GHz (wideband signal analysis)
R&S®FS-Z140	90 GHz to 140 GHz
R&S®FS-Z170	110 GHz to 170 GHz
R&S®FS-Z220	140 GHz to 220 GHz
R&S®FS-Z325	220 GHz to 325 GHz
R&S®FS-Z500	325 GHz to 500 GHz
Required option: LO/IF ports for external mixers	
R&S®FSV-B21	for R&S®FSV30/40
R&S®FSV-B21	for R&S®FSVR30/40
R&S®FSW-B21	for R&S®FSW26

The mixers additionally feature the following

- ▶ Low conversion loss
- ▶ High 1 dB compression point
- ▶ High LO frequency range
- ▶ No biasing required
- ▶ Conversion loss data provided in file format

Due to their double-diode design, the mixers are operated without any additional biasing. No frequency-dependent adjustment of bias current is needed – an invaluable feature for automated measurements.

The frequency-dependent conversion loss is calibrated over the entire frequency range. The large number of frequency points included in the resulting conversion loss table provides high level accuracy during measurements. The conversion loss table comes in file format with each mixer and can be loaded directly into the analyzer, which makes mixer configuration very easy.

The following instrument models support the harmonic mixers (R&S®FSx-B21 option required):

- ▶ R&S®FSV30/40
- ▶ R&S®FSVA30/40
- ▶ R&S®FSVR30/40
- ▶ R&S®FSW26/43/50/67/85
- ▶ R&S®FSWP26/50

High sensitivity

The low conversion loss yields high sensitivity, which is the basis for measuring signals even at very low levels.

High large-signal immunity

With a high 1 dB compression point and low conversion loss, the mixers feature a very wide dynamic range. Therefore, measurements of low-level signals can easily be performed even in the presence of high-level signals.

Straightforward spectrum display

The high LO frequency range and the low order of harmonics used significantly reduce the number of unwanted mixing products. In addition, the analyzer firmware provides algorithms to identify and suppress remaining unwanted mixing products.

Wideband signal analysis

The models R&S®FS-Z75, R&S®FS-Z90 and R&S®FS-Z110 have a higher IF OUT frequency range (IF OUT) of 5 MHz to 6 GHz that enables an analysis bandwidth of more than 5 GHz.



APPLICATION-SPECIFIC SOLUTIONS AT A GLANCE

General measurement applications															
Firmware or PC software R&S®FSx/FPS/RTO		R&S®FSV	R&S®FSVA	R&S®FSV/A 3000	R&S®FPS	R&S®FSVR	R&S®FSW	R&S®FPL	R&S®FSL	R&S®FSMR	R&S®FSWP	R&S®FSH	R&S®FPH	R&S®RTO	Page
-K6/-K6S	Pulse measurements	-	-	•	•	-	•	-	-	-	•	-	-	-	82
-K6P	Pulse stability measurements	-	-	-	-	-	-	-	-	-	•	-	-	-	82
-K7	Analog modulation analysis	•	•	•	•	•	•	•	•	•	-	-	•	-	82
-K7S	FM stereo modulation analysis	•	-	-	-	•	-	-	-	-	-	-	-	-	82
-K9	Measurement with power sensors	•	•	•	-	•	• ¹⁾	•	•	•	• ¹⁾	• ¹⁾	•	-	-
-K14	Spectrogram measurements	•	•	-	-	•	• ¹⁾	•	•	-	• ¹⁾	-	• ²⁾	-	83
-K15	VOR/ILS measurements	-	-	-	-	-	•	-	-	•	-	-	-	-	83
-K17	Multicarrier group delay measurements	-	-	-	-	-	•	-	-	-	-	-	-	-	-
-K18	Amplifier measurements	-	-	•	•	-	•	-	-	-	-	-	-	-	84
-K18D	Direct DPD measurements	-	-	•	• ³⁾	-	• ⁴⁾	-	-	-	-	-	-	-	-
-K18F	Frequency response measurement	-	-	•	-	-	•	-	-	-	-	-	-	-	-
-K19	Noise power ratio measurements	-	-	-	-	-	•	-	-	-	-	-	-	-	-
-K20	Cable TV measurements, analog/digital	-	-	-	-	-	-	-	•	-	-	-	-	-	-
-K29	Pulse measurements with power sensor	-	-	-	-	-	-	-	-	-	-	•	•	-	-
-K30	Noise figure and gain measurements	•	•	•	•	•	•	•	•	•	•	-	-	-	84
-K40	Phase noise measurements	•	•	•	•	•	•	-	-	•	-	-	-	-	84
-K50	Spurious measurements	-	-	-	-	-	•	-	-	-	•	-	-	-	85
-K54	EMI measurement application	•	•	-	-	•	•	•	-	-	-	-	• ²⁾	-	85
-K60	Transient measurement application	-	-	-	-	-	•	-	-	-	•	-	-	-	85
-K60C	Transient chirp measurement	-	-	-	-	-	• ⁵⁾	-	-	-	• ⁶⁾	-	-	-	85
-K60H	Transient hop measurement	-	-	-	-	-	• ⁵⁾	-	-	-	• ⁶⁾	-	-	-	85
-K70	Vector signal analysis	•	•	•	•	•	•	•	-	•	•	-	-	-	86
-K70M	Multi modulation analysis	-	-	•	-	-	• ⁷⁾	•	-	-	-	-	-	-	86
-K70P	PBRs bit error rate measurements	-	-	•	-	-	• ⁷⁾	•	-	-	-	-	-	-	86
-K161R/ -K512RE/ -K800RE	Realtime spectrum analysis	-	-	-	-	-	•	-	-	-	-	-	-	-	90

Measurements in line with mobile communications standards														
Firmware R&S®FSx/FPS/RTO		R&S®FSV	R&S®FSVA	R&S®FSV/A 3000	R&S®FPS	R&S®FSVR	R&S®FSW	R&S®FSL	R&S®FSMR	R&S®FSWP	R&S®FSH	R&S®FPH	R&S®RTO	Page
-K5	GSM/EDGE	-	-	-	-	-	-	-	•	-	• ^{8) 9)}	-	-	-
-K10	GSM/EDGE/EDGE Evolution/VAMOS	•	•	•	•	•	•	-	-	-	-	-	-	83
-K48/-K48A	3GPP TD-SCDMA	-	-	-	-	-	-	-	-	-	•	-	-	-
-K56	EUTRA/LTE NB-IoT downlink measurements	-	-	-	-	-	-	-	-	-	•	-	-	-
-K72/-K73	3GPP WCDMA DL/UL	•	•	•	•	•	•	• ⁸⁾	•	-	• ^{8) 9)}	-	-	86
-K74	3GPP WCDMA HSDPA	- ¹⁰⁾	- ¹⁰⁾	-	•	- ¹⁰⁾	- ¹⁰⁾	- ¹¹⁾	•	-	• ^{8) 9)}	-	-	86
-K73+/-K74+	3GPP WCDMA HSPA+	- ^{10) 12)}	- ^{10) 12)}	-	•	- ^{10) 12)}	- ^{10) 12)}	-	-	-	• ^{8) 9)}	-	-	86
-K82/-K83	CDMA2000®	•	•	-	•	•	•	• ⁸⁾	•	-	• ^{8) 9)}	-	-	87
-K84/-K85	1xEV-DO	•	•	-	•	-	•	-	•	-	• ^{8) 9)}	-	-	87
-K76/-K77	3GPP TD-SCDMA	•	•	-	•	•	•	-	•	-	-	-	-	86
-K100/-K101	3GPP LTE FDD	•	•	•	•	•	•	-	-	-	• ^{8) 9)}	-	-	89
-K102	3GPP LTE MIMO	•	•	•	•	•	•	-	-	-	-	-	-	89
-K103	3GPP LTE-Advanced uplink	-	-	•	-	-	•	-	-	-	-	-	-	89
-K104/-K105	3GPP LTE TDD	•	•	•	•	•	•	-	-	-	• ^{8) 9)}	-	-	89
-K106	EUTRA/LTE NB-IoT downlink measurements	•	-	•	•	-	•	-	-	-	-	-	-	89
-K118	V5GTF downlink measurements	-	-	-	•	-	•	-	-	-	-	-	-	-
-K119	V5GTF uplink measurements	-	-	-	-	-	•	-	-	-	-	-	-	-
-K144/-K145	3GPP 5G NR downlink/uplink measurements	-	-	•	-	-	•	-	-	-	-	-	-	90

Other wireless applications													
Firmware or PC software R&S®FSx		R&S®FSV/A	R&S®FSV/A 3000	R&S®FPS	R&S®FSVR	R&S®FSW	R&S®FSL	R&S®FSMR	R&S®FSWP	R&S®FSH	R&S®RTO		Page
-K91	IEEE802.11 a/b/g/j WLAN	•	•	•	•	•	•	-	-	-	-		87
-K91N	IEEE802.11 n WLAN	•	•	•	•	•	•	-	-	-	-		87
-K91AC	IEEE802.11 ac WLAN	•	•	-	-	•	-	-	-	-	-		87
-K91AX	IEEE802.11 ax WLAN	-	•	-	-	•	-	-	-	-	-		87
-K91P	IEEE802.11p WLAN	•	•	•	-	•	-	-	-	-	-		87
-K93	IEEE802.16 e-2005 WiMAX™	•	-	-	•	-	•	-	-	-	-		87
-K95	IEEE 802.11ad WLAN	-	-	-	-	•	-	-	-	-	-		88
-K97	IEEE 802.11aa WLAN	-	-	-	-	•	-	-	-	-	-		88

Measurement application for wire-connected communications systems													
Firmware R&S®FSW		R&S®FSV/A	R&S®FSV/A 3000	R&S®FPS	R&S®FSVR	R&S®FSW	R&S®FSL	R&S®FSMR	R&S®FSWP	R&S®FSH	R&S®RTO		Page
-K192	DOCSIS3.1 downstream	-	-	-	-	•	-	-	-	-	-		90
-K193	DOCSIS3.1 upstream	-	-	-	-	•	-	-	-	-	-		90

Vector signal explorer base software														
PC software R&S®VSE		R&S®FSV	R&S®FSVA	R&S®FSV/A 3000	R&S®FPS	R&S®FPL	R&S®FSL	R&S®FSW	R&S®FSWP	R&S®FPL1000	R&S®RTO	R&S®ZNL	R&S®FSVR/FSMR/FSH	Page
-K6	Pulse measurements	•	•	•	•	-	-	•	•	•	•	•	-	82
-K7	Analog demodulation analysis	•	•	•	•	-	•	•	•	•	•	•	-	82
-K10	GSM measurements	•	•	•	•	-	•	•	-	•	•	•	-	83
-K60	Transient analysis	•	•	-	•	-	•	•	•	•	•	•	-	85
-K60C	Transient chirp analysis	-	-	-	-	-	-	• ¹³⁾	• ¹³⁾	-	• ¹³⁾	-	-	85
-K60H	Transient hop analysis	-	-	-	-	-	-	• ¹³⁾	• ¹³⁾	-	• ¹³⁾	-	-	85
-K70	Vector signal analysis	•	•	•	•	•	•	•	•	•	•	•	-	86
-K72	3GPP FDD measurements	•	•	•	•	-	•	•	-	•	•	•	-	86
-K91	IEEE 802.11a/b/g measurements	•	•	•	•	-	•	•	-	•	•	•	-	87
-K91N/AC/P	IEEE 802.11n/ac/p measurements	•	•	•	•	-	•	•	-	•	•	•	-	87
-K96	OFDM analysis	•	•	•	•	-	•	•	-	•	•	•	-	88
-K100	EUTRA/LTE FDD	•	•	•	•	-	•	•	-	•	•	•	-	89
-K102	EUTRA/LTE-Advanced and MIMO	•	•	•	•	-	•	•	-	•	•	•	-	89
-K104	EUTRA/LTE TDD	•	•	•	•	-	•	•	-	•	•	•	-	89
-K106	LTE narrowband IoT analysis	•	•	•	•	•	•	•	-	•	•	•	-	89
-K144	3GPP 5G NR downlink and uplink measurements	•	•	•	•	-	-	•	-	-	•	-	-	90

¹⁾ Standard.

²⁾ See R&S®Spectrum Rider FPH data sheet (PD 3607.2149.22); option number may differ.

³⁾ Requires R&S®FPS-K18.

⁴⁾ Requires R&S®FSW-K18.

⁵⁾ Requires R&S®FSW-K60.

⁶⁾ Requires R&S®FSWP-K60.

⁷⁾ Requires R&S®FSW-K70.

⁸⁾ Base station only.

⁹⁾ See R&S®FSH (PD 5214.0482.32) data sheet; option number may differ.

¹⁰⁾ The functionality of R&S®FS-K74 and R&S®FS-K74+ is included in R&S®FSV-K72.

¹¹⁾ Included in R&S®FSL-K72.

¹²⁾ The functionality of R&S®FS-K73+ is included in R&S®FSV-K73.

¹³⁾ Requires R&S®VSE-K60.

APPLICATION-SPECIFIC SOLUTIONS

General measurement applications

R&S®FSxx-K6 Pulse Measurements

R&S®FSW/FSWP-K6S Time Sidelobe Measurements

R&S®FSWP-K6P Pulse Stability Measurements

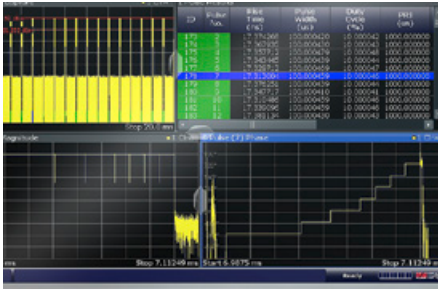

Measuring pulse parameters at the touch of a key

The R&S®FSW-K6 option measures – at the touch of a key – all relevant parameters such as pulse duration, pulse period, pulse rise and fall times, power drop across a pulse, and intrapulse phase modulation, and produces a trend analysis over many pulses. The user selects the results to be displayed simultaneously on the screen. The R&S®FSW delivers a full picture of a radar system within seconds.

The R&S®FSW-K6 option can be upgraded with the R&S®FSW-K6S option to automatically measure the compression parameters of modulated pulses. Results such as the mainlobe vs. sidelobe level and the time differences between the mainlobe and the sidelobes are displayed in the results summary table.

The user can upload reference pulse waveforms in I/Q format and compare phase and frequency within a pulse with the measured values.

R&S®FSWP-K6P option is an additional extension for R&S®FSWP to measure the phase and amplitude stability of pulses for amplifier characterization, either absolutely or additive.

Key facts

- ▶ Point-in-pulse measurements: frequency, amplitude, phase versus pulse, trends and histograms for all parameters
- ▶ Pulse statistics: standard deviation, average, maximum, minimum
- ▶ Pulse tables
- ▶ User-defined measurement parameters
- ▶ Segmented data capturing
- ▶ Time sidelobe analysis (R&S®FSW-K6S option required)
- ▶ Pulse stability measurements (R&S®FSW-K6P option required)

R&S®FSxx/FPL/FPSK7 AM/FM/φM Measurement Demodulator

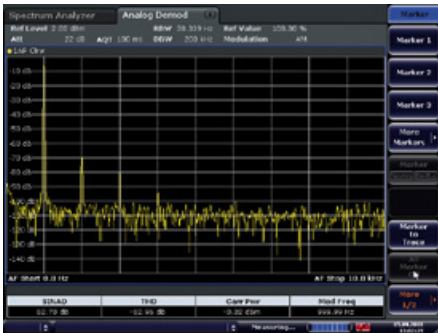

Analog signal measurement

The R&S®FSxx/FPL/FPS/FSL-K7 AM/FM/φM measurement demodulator application converts the R&S®FSV(A)3000/FSV(A)/FPL/FPS/FSL/FSW/FSWP into an analog modulation analyzer for amplitude, frequency or phase-modulated signals. The following display and analysis alternatives are available:

Key facts

- ▶ Modulation signal versus time
- ▶ Spectrum of modulation signal (FFT)
- ▶ RF signal power versus time
- ▶ Spectrum of RF signal
- ▶ Table with numeric display of
- ▶ Deviation or modulation factor, RMS weighted, +peak, -peak, ±peak/2
- ▶ Modulation frequency
- ▶ Carrier frequency offset
- ▶ Carrier power
- ▶ Total harmonic distortion (THD) and SINAD

R&S®FSV-K7S FM Stereo Measurements

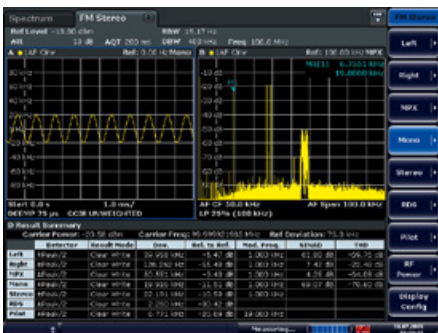

Comprehensive measurement functions for complete FM stereo analysis

The R&S®FSV-K7S application firmware expands the functionality of the R&S®FSV-K7 application firmware with measurements on FM stereo transmitters.

Wide variety of audio filters and detectors for standard-compliant measurements

- ▶ CCIR filter, weighted and unweighted
- ▶ 20 Hz, 50 Hz, 300 Hz highpass filters and 3 kHz, 15 kHz, 23 kHz, 150 kHz lowpass filters
- ▶ Selectable deemphasis of 50 μs, 75 μs, 750 μs
- ▶ Detectors: ±peak/2, +peak, -peak, RMS, RMSxSQR2, quasi-peak (in line with CCIR468) and quasi-peakxSQR2

Key facts

- ▶ Frequency deviation measurement in channels MPX, L, R, M, S and frequency deviation measurement of pilot and RDS carrier
- ▶ Carrier power and carrier frequency measurement
- ▶ Audio frequency measurement
- ▶ Absolute and relative deviation measurement for easy-to-perform S/N ratio and crosstalk attenuation measurement
- ▶ AF spectrum display and display per channel
- ▶ Up to 4 measurement windows

General measurement applications

R&S®FSxx/FPS-K10 GSM/EDGE/EDGE Evolution Analysis



Evolution analysis

The R&S®FSxx/FPS-K10 measurement application firmware enables transmitter tests on mobile stations and base stations. It provides all the functionality needed for GSM/EDGE, EDGE Evolution and VAMOS.

Key facts

- ▶ Power measurement in time domain including carrier power
- ▶ Modulation quality
- ▶ EVM
- ▶ Phase/frequency error
- ▶ Origin offset suppression
- ▶ Spectrum measurements
- ▶ Modulation spectrum
- ▶ Transient spectrum
- ▶ Spurious emissions

R&S®FSV/FSL-K14 Spectrogram Measurements

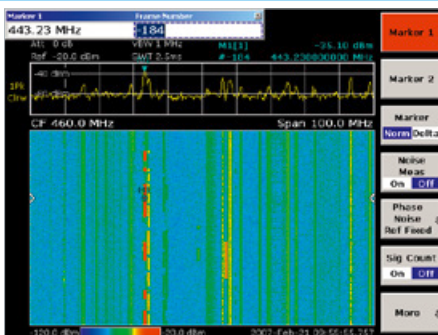

Spectrogram measurements

The R&S®FSV/FSL-K14 application firmware adds a spectrogram display and trace recording to the R&S®FSV/FSL. The spectrogram view shows a history of the spectrum and helps analyze intermittent problems or variations in frequency and level versus time. It also adds a new trigger, i.e. a time trigger that makes it possible to record a trace at a regular time interval.

Key facts

- ▶ Recording of up to 20000 traces: approx. 5.5 h continuous monitoring with repetition interval set to 1 s
- ▶ Time trigger, 100 ms to 5000 s repetition interval: allows unattended continuous monitoring
- ▶ Scrolling through recorded traces with markers: replay and repeated analysis of recorded data

R&S®FSW-K15 VOR/ILS Measurements



Precise VOR and ILS modulation analysis for calibration, development, production and service

The option R&S®FSW-K15 brings VOR/ILS analysis into the R&S®FSW. In the R&S®FSW analyzer, the option extends the calibration possibilities to include VOR/ILS signal generators (for example R&S®SMBV100A with R&S®SMBV-K151/-K152) and navigation/ramp testers (for example R&S®CMA).

Key facts

- ▶ Low measurement uncertainty for
- ▶ ILS DDM (difference in depth of modulation)
- ▶ VOR phase
- ▶ Modulation parameters of single signal components such as 90/150 Hz tones, 30 Hz/9.96 kHz subcarrier
- ▶ All measurement parameters and spectrum overview at a glance
- ▶ Selective distortion measurements for all AM and FM components of VOR and ILS signals
- ▶ Identifier measurement and Morse code indication (1020 Hz)
- ▶ Easy to operate: user simply has to select between VOR and ILS

With the R&S®FSW and the R&S®FSW-K15 option, such instruments can be calibrated by a single box without the need for an additional VOR/ILS tester.

The R&S®FSW-K15 is designed to replace the R&S®FS-K15 option for the R&S®FSMR, R&S®FSU and R&S®FSQ. It offers the same function set for VOR/ILS analysis, adds some features and has the same uncertainty specification as the R&S®FS-K15.

General measurement applications

R&S®FSW-K18/FPS-K18 Amplifier Measurement Application

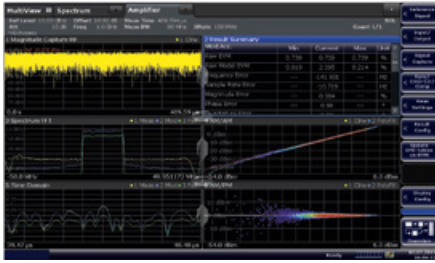

Characterization and optimization of power amplifiers, including envelope tracking measurements

The R&S®FSW-K18/FPS-K18 amplifier measurement application enables users to characterize and optimize power amplifiers. The R&S®FSW-K18/FPS-K18 supports the following measurements:

- ▶ Conventional power amplifier measurements
 - Fast and easy characterization of amplifiers, including AM/AM and AM/φM traces. Measures and models the linear and nonlinear distortions of amplifiers
- ▶ Envelope tracking measurements
 - Full characterization of envelope tracking power amplifiers
 - Measures the impact of envelope tracking on power efficiency and signal quality, including instantaneous power-added efficiency (PAE) (R&S®FSW only)
- ▶ Digital predistortion

Modeling of the amplifier and computation of a polynomial model of the power amplifier. The coefficients can be used by the R&S®SMW-K541 real-time predistortion option

The R&S®FSW-K18/FPS-K18 controls a Rohde&Schwarz vector signal generator, including downloading the currently used waveform and setting the frequency and power. The R&S®FSW-K18/FPS-K18 synchronizes the measured data with an ideal I/Q file (reference signal). In addition, the R&S®FSW-K18/R&S®FPS-K18 is also capable of generating and uploading its own waveforms with user-configurable parameters.

R&S®FSV/FPL1/FSL/FSW/FSWP-K30 Noise Figure and Gain Measurements

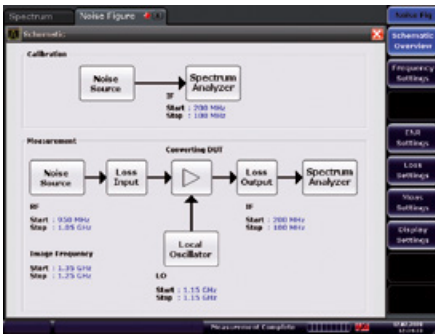

Wide variety of RF measurements

The R&S®FSV/FPL1/FSL/FSW/FSWP-K30 application firmware expands the R&S®FSV/FSVR/FPL/FSL/FSW/FSWP signal and spectrum analyzers by adding measurement functionality otherwise only provided by special noise measurement analyzers. The following parameters can be measured at a specified frequency or in a selectable frequency range:

- ▶ Noise figure in dB
- ▶ Noise temperature in °K
- ▶ Gain in dB

Noise measurements

- ▶ Measurement range from 0 dB to 35 dB
- ▶ Resolution of 0.01 dB
- ▶ Device measurement uncertainty of 0.05 dB

Gain measurements

- ▶ Measurement range from -20 dB to +60 dB
- ▶ Resolution of 0.01 dB
- ▶ Measurement accuracy of ±0.2 dB

R&S®FS/FSV/FSW-K40 Phase Noise Measurements



Fast and easy phase noise measurements

The R&S®FS/FSV/FSW-K40 application firmware enables the R&S®FSMR/FSV/FSVR/FSW signal and spectrum analyzers to perform fast and easy phase noise measurements in development and production.

Key facts

- ▶ Carrier offset frequency range selectable from 1 Hz to 1 GHz in 1/3/10 sequence (1 Hz, 3 Hz, 10 Hz, 30 Hz, etc.)
- ▶ Number of averages, sweep mode and filter bandwidth for every measurement subrange can be individually selected to optimize the measurement speed

- ▶ Fast results for the subranges are obtained by starting the measurement at the maximum carrier offset
- ▶ Verification of carrier frequency and power prior to each measurement prevents incorrect measurements
- ▶ Improved dynamic range by measuring the thermal inherent noise in a reference trace and performing noise correction
- ▶ Tabular display of residual FM, residual φM and RMS jitter in addition to measurement trace
- ▶ Limit lines with PASS/FAIL indication

General measurement applications

R&S®FSW/FSWP-K50 Spurious Measurements



Advanced techniques for spurious search

The R&S®FSW/FSWP signal and spectrum analyzers equipped with the R&S®FSW/FSWP-K50 application firmware speeds up low-level spur search in the design, verification and production of RF and microwave devices.

Key facts

- ▶ Automatically sets RBW based on measured analyzer noise floor, spur detection threshold and required signal to noise ratio
- ▶ Automatically calculates the optimum RBW for each frequency range

- ▶ Performs a high-speed search around each detected spur frequency
- ▶ Identifies and removes analyzer residual spurs
- ▶ Spur search table can be updated manually, imported from a previous search or from a .CSV file
- ▶ It is possible to set two limit lines: one for pass/fail, another for the spur detection threshold
- ▶ Search regions are highlighted in different colors for easy recognition; single spurs are identified

3

R&S®FSV/FSVR/FSW-K54 EMI Measurement Application



Finding, classifying and eliminating electromagnetic interference

The R&S®FSV/FSW-K54 EMI measurement application adds EMI diagnostic functionality to the R&S®FSV/FSW signal and spectrum analyzers and the R&S®FSVR real-time spectrum analyzer. R&S®FSV/FSW-K54 offers EMI bandwidths for commercial and military applications, detectors such as quasi-peak, CISPR-average and RMS-average, limit lines and correction factors. It allows users to analyze the effectiveness of shielding measures and the effects of changes in the circuit or design prior to testing in the EMC lab.

Key facts

- ▶ EMI bandwidths for commercial and military standards
- ▶ Standard EMI detectors: quasi-peak, CISPR-average, RMS-average
- ▶ Linking of measurement markers to various EMI detectors
- ▶ Limit lines and transducers for typical measurement tasks
- ▶ Choice of linear or logarithmic scale on frequency axis
- ▶ Seamless analysis of frequency spectrum up to 40 MHz using the R&S®FSVR

R&S®FSW/FSWP-K60/-K60C/-K60H Transient Analysis



Analyzing transient signals, for example signals from frequency hopping radios or radar chirps

The R&S®FSW/FSWP-K60 transient analysis option and its extensions R&S®FSW/FSWP-K60H and R&S®FSW/FSWP-K60C are designed to analyze transient signals, for example signals from frequency hopping radios or radar chirps. Detailed numerical results such as switching times, dwell times or rate of frequency changes as well as corresponding frequency/amplitude/phase vs. time displays are provided.

The R&S®FSW/FSWP-K60H adds hop analysis. It detects frequency hops automatically or measures according to a predefinable hop table. Results include dwell time/hop, switching time, frequency, deviation and many more.

The R&S®FSW/FSWP-K60C adds chirp analysis. It detects FMCW chirps automatically or from a predefinable chirp table. It measures parameters such as the chirp rate, chirp length and linearity of FMCW chirps.

General measurement applications

R&S®FSV/FPS/FSW/FSWP-K70 Vector Signal Analysis

**Flexible modulation analysis from MSK to 16384QAM**

The R&S®FSV/FPS/FSW/FSWP-K70 option enables users to flexibly analyze digitally modulated single carriers down to the bit level. The clearly structured operating concept simplifies measurements, despite the wide range of analysis tools.

Modulation formats:

- ▶ 2FSK, 4FSK, 16FSK, 32FSK
- ▶ MSK, GMSK, DMSK
- ▶ BPSK, QPSK, Offset-QPSK, DQPSK, 8PSK, D8PSK, $\pi/4$ -DQPSK, $3\pi/8$ -8PSK, $\pi/8$ -D8PSK
- ▶ 16QAM, 32QAM, 64QAM, 128QAM, 256QAM, 512QAM, 1024QAM, 2048QAM, 4096QAM, 8192QAM, 16384QAM
- ▶ 16APSK (DVB-S2), 32APSK (DVB-S2), 2ASK, 4ASK, $\pi/4$ -16QAM (EDGE), $-\pi/4$ -16QAM (EDGE), SOQPSK

Key facts

- ▶ Analysis length up to 64 000 symbols
- ▶ Analysis bandwidth depends on base unit: 10 MHz standard (optionally 40/80/160/320/512/1200/2000/4000/6400/8312 MHz)
- ▶ User definable and standard-specific settings: GSM, WCDMA, LTE, etc.
- ▶ Display choices for amplitude, frequency, phase, I/Q, eye diagram, amplitude, phase or frequency error, constellation or vector diagram
- ▶ Fast and easy-to-operate equalizer
- ▶ Measurement of raw bit error rate (BER) on PRBS data up to PRBS23 (with R&S®FSW-K70P extension).
- ▶ Multicarrier modulation analysis supported (with R&S®FSW-K70M extension)

R&S®FS-K72/-K73/-K73+/-K74/-K74+, R&S®FSV/FPS/FSW-K72/-K73 WCDMA 3GPP Measurements

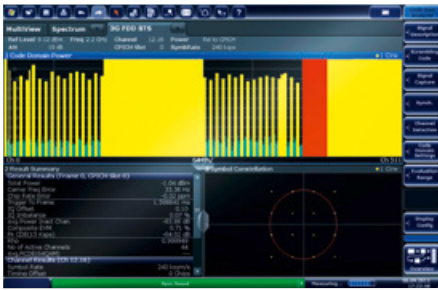
**Code domain power measurements (3GPP FDD)**

The application firmware adds measurement functions in line with the 3GPP specifications for the FDD mode to Rohde & Schwarz signal and spectrum analyzers.

- ▶ Measurement of modulation quality: EVM, peak code domain error and relative code domain error
- ▶ Automatic detection of active channels and their data rate
- ▶ Scrambling code search
- ▶ Automatic detection of modulation formats in HSDPA and HSPA+
- ▶ Provides the functionality needed for base station testing

R&S®FS-K72/-K73

Provides all the functionality for testing base stations (R&S®FS-K72) or user equipment (R&S®FS-K73) in line with WCDMA Release 99

R&S®FS-K74

Extends the capabilities of R&S®FS-K72 to encompass HSPA (high speed packet access) for base station testing (R&S®FS-K74)

R&S®FS-K73+

Adds HSPA+ capabilities to R&S®FS-K73

R&S®FS-K74+

Provides additional functionality for HSPA+ testing in line with 3GPP Release 7

R&S®FSV/FPS-K72

3GPP BS (DL) analysis, incl. HSDPA

R&S®FSV/FPS-K73

3GPP UE (UL) analysis, incl. HSUPA

R&S®FSW-K72

3GPP FDD (WCDMA) BS measurements, incl. HSDPA and HSDPA+

R&S®FSW-K73

3GPP FDD (WCDMA) MS measurements, incl. HSDPA and HSDPA+

R&S®FS/FPS/FSW-K76/-K77 TD-SCDMA Test

**Base station and mobile station tests on TD-SCDMA with the R&S®FSMR/FSV/FSW analyzers**

The R&S®FS/FPS/FSW-K76/-K77 application firmware adds measurement functions in line with 3GPP as well as China Wireless Telecommunication Standard Group (CWTS) specifications to the R&S®FSMR/FSV/FSW signal and spectrum analyzers. It enhances the range of applications to include code domain power and modulation measurements on TD-SCDMA base stations.

Key facts

- ▶ Code domain power measurement
- ▶ Easy measurement of modulation quality
- ▶ Automatic detection of active channels
- ▶ Spectrum emission mask
- ▶ Remote control

R&S®FS/FPS/FSW-K76

Provides the functionality needed for base station testing.

R&S®FS/FPS/FSW-K77

Provides user equipment (UE) functionality.

General measurement applications

R&S®FS/FSV/FPS/FSW-K82/-K84 Base Station Test



CDMA2000®/IS-95 base station testing

The R&S®FS/FSV/FPS/FSW-K82 application firmware enhances the range of applications to include code domain power and modulation measurements on CDMA2000® signals for radio configurations 1 to 5 and radio configuration 10. cdmaOne base station signals can be analyzed by using radio configuration 1 or 2.

1xEV-DO base station testing

The R&S®FS/FSV/FPS/FSW-K84 application firmware adds the capability to measure code domain power modulation accuracy on all four channel types (pilot, preamble, MAC and DATA) of a 1xEV-DO base station signal.

Measurement parameters

- ▶ Code domain power (code domain analyzer)
- ▶ Code domain power versus time (R&S®FS/FSV/FPS/FSW-K82)
- ▶ Rho
- ▶ Error vector magnitude (EVM)
- ▶ Peak code domain error
- ▶ Power versus symbol
- ▶ Symbol constellation
- ▶ Channel table
- ▶ Code domain error power

R&S®FS/FSV/FPS/FSW-K83/-K85 Mobile Station Test



Transmitter measurements on 3GPP2 signals with the R&S®FSMR/FSV/FSW analyzers

The R&S®FS/FSV/FPS/FSW-K83 application firmware enhances the range of applications to include code domain power and modulation measurements on CDMA2000® signals for radio configurations 3 and 4. 1xEV-DV reverse link channels of release C are also supported. The R&S®FS/FSV/FPS/FSW-K85 application firmware adds the capability to measure code domain power modulation accuracy on all five channel types (PICH, RRI, DATA, ACK and DRC) as well as TRAFFIC and ACCESS operating modes of an access terminal.

Measurement parameters

- ▶ Code domain power
- ▶ Code domain power versus time
- ▶ Rho
- ▶ Error vector magnitude (EVM)
- ▶ Peak code domain error
- ▶ Power versus symbol
- ▶ Symbol constellation
- ▶ Channel table
- ▶ Code domain error power
- ▶ Power versus chip (R&S®FS/FSV/FPS/FSW-K85)

R&S®FSx-K91/-K91n/-K91ac/-K91p/-K91ax WLAN TX Measurements



WLAN TX measurements with Rohde & Schwarz analyzers

The R&S®FSx-K91/-K91n/-K91ac/-K91ax application firmware enables the R&S®FSW/FSV/FPS/FSVR/FSL signal and spectrum analyzers to perform spectrum and modulation measurements on signals in line with the WLAN IEEE 802.11a/b/g/j/n/ac standard.

Key facts

- ▶ Analysis at the RF or in the analog/digital baseband
- ▶ Demodulation bandwidth of 28 MHz/40 MHz/120 MHz

- ▶ Modulation formats for IEEE 802.11a/g/j/n/p/ac: BPSK, QPSK, 16QAM, 64QAM, 256QAM
- ▶ Modulation formats for IEEE 802.11b: DBPSK, DQPSK, CCK, short PLCP, long PLCP
- ▶ Very low residual EVM of -44 dB/-46 dB (0.7% at 2.4 GHz)
- ▶ Legacy/mixed/Greenfield mode of IEEE 802.11n signals
- ▶ Support of up to four MIMO streams
- ▶ Provides complex WLAN measurements at a keystroke (automatic setting of modulation format)
- ▶ Allows remote control of all functions via IEC/IEEE bus or LAN

R&S®FSV-K93 WiMAX™/MIMO TX Measurements

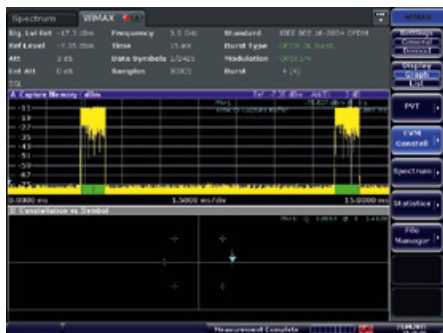

TX measurements on OFDM and OFDMA signals

The R&S®FSV-K93 application firmware allows TX measurements on OFDM and OFDMA signals in line with the WiMAX™ IEEE 802.16-2004 and IEEE 802.16e-2005 standards.

Key facts

- ▶ Enhances the R&S®FSL/FSV analyzers by adding the capability to perform spectrum and modulation measurements on signals in line with the IEEE 802.16-2004 and IEEE 802.16e-2005 standards
- ▶ Supports OFDM and OFDMA
- ▶ Complex WiMAX™ measurements at a keystroke
- ▶ Measurements in RF/IF range and baseband
- ▶ Remote control of all functions via IEC/IEEE bus or LAN

General measurement applications

R&S®FSW-K95 IEEE 802.11ad Measurements

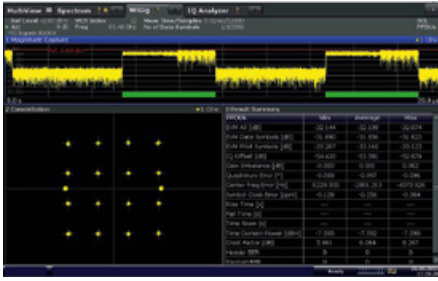
**Transmitter measurements on WLAN 802.11ad signals**

R&S®FSW-K95 analyzes uplink and downlink signals in line with WLAN standard 802.11ad in the 60 GHz range. Beside spectral measurements, the R&S®FSW-K95 can analyze modulation accuracy as well. The R&S®FSW-B2000 option and an additional R&S®RTO are needed to obtain a 2 GHz wide analysis bandwidth for the 1.8 GHz wide signal.

Modulation quality

- ▶ EVM (pilot, data)
- ▶ Constellation diagram
- ▶ I/Q offset
- ▶ I/Q imbalance
- ▶ Gain imbalance
- ▶ Symbol clock error
- ▶ Center frequency error
- ▶ Time skew
- ▶ Phase error versus symbol
- ▶ Phase tracking versus symbol

Spectrum measurements

- ▶ Spectrum mask
- ▶ Power spectrum
- ▶ Channel frequency response

R&S®VSE-K96 OFDM Signal Analysis

**OFDM signal analysis**

The R&S®VSE-K96 OFDM signal analysis software analyzes OFDM signals that are either user-defined or compliant with standards such as IEEE802.11a/g/n/ac (WLAN) and DVB-T. Moreover, it supports development engineers in the analysis of proprietary signals in the initial phases of forthcoming OFDM standards. This includes the following:

- ▶ Wizard with a step-by-step guide for easy setup of the configuration file from a captured signal
- ▶ Support of OFDM and OFDMA
- ▶ Support of any PSK or QAM modulation format (up to 4096QAM)

User-configurable and standard-independent

- ▶ General OFDM parameters such as signal bandwidth, sample rate, FFT length, cyclic prefix length
- ▶ Preamble structure
- ▶ Position of the pilots and data carriers
- ▶ Modulation format of the data carriers
- ▶ Flexible assignment of cyclic prefix length

Configuration file wizard to quickly extract all necessary parameters from a signal

The integrated wizard guides users through the process of creating a configuration file that describes the OFDM system. It allows users to extract the necessary parameters directly from a signal recorded by the R&S®VSE-K96 software and creates a matching configuration file. At the same time, it visualizes the structure of the signal.

R&S®FSW-K97 IEEE 802.11ay Measurements

**Transmitter measurements on WLAN 802.11ay signals**

R&S®FSW-K97 analyzes uplink and downlink signals in line with WLAN standard 802.11ay up to 71 GHz directly with R&S®FSW85. Beside spectral measurements, the R&S®FSW-K97 can analyze modulation accuracy as well. The R&S®FSW-B2001 option allows to measure one channel. However, with the options R&S®FSW-B4001/-B6001 and -B8001, signals with channel bonding Ncb = 2, 3, 4 can be measured as well.

Modulation quality

- ▶ EVM (pilot, data)
- ▶ Constellation diagram
- ▶ I/Q offset
- ▶ I/Q imbalance
- ▶ Gain imbalance
- ▶ Symbol clock error
- ▶ Center frequency error
- ▶ Time skew
- ▶ Phase error versus symbol
- ▶ Phase tracking versus symbol

Signal measurements

- ▶ Channel bonding 1-4
- ▶ Automatic detection of guard interval
- ▶ Automatic detection of PPDU length

Spectrum measurements

- ▶ Spectrum mask
- ▶ Power spectrum
- ▶ Channel frequency response

Bit error measurement

- ▶ Bit error rate payload and header

General measurement applications

R&S®FSV/FPS/FSW-K100/K101/K102/K104/K105 EUTRA/LTE Signal Analysis

**Transmitter measurements on LTE signals**

The software analyzes the modulation quality, e.g. EVM or I/Q imbalance, of 3GPP EUTRA FDD and TDD signals in both uplink and downlink. When combining two or up to four signal analyzers, these tasks can even be performed on MIMO transmitters.

The most important measurement results are listed in a table to provide a quick overview of the performance of the transmitter.

- ▶ Error vector magnitude (EVM) of all carriers
- ▶ EVM physical channel
- ▶ EVM physical signal
- ▶ Frequency error
- ▶ Sampling error
- ▶ Modulation parameters: I/Q error, gain imbalance, quadrature error
- ▶ Power
- ▶ Crest factor

For advanced analysis, a number of graphical displays is available.

R&S®FSx-K100

EUTRA/LTE FDD downlink measurement application

R&S®FSx-K101

EUTRA/LTE FDD uplink measurement application

R&S®FSx-K102

EUTRA/LTE downlink MIMO measurement application (requires R&S®FSx-K100 or R&S®FSx-K104)

R&S®FSW-K103

EUTRA/LTE-Advanced uplink measurement application

R&S®FSx-K104

EUTRA/LTE TDD downlink measurement application

R&S®FSx-K105

EUTRA/LTE TDD uplink measurement application

R&S®VSE-K100/K102/K104 LTE Signal Analysis

**3GPP LTE and LTE-Advanced in-band measurements**

The R&S®VSE-K10x options cover 3GPP LTE and LTE-Advanced in-band measurements. The options provide convenient analysis due to automatic detection of modulation formats. Each signal subframe is analyzed and the QPSK, 16QAM and 64QAM modulation formats plus the length of the cyclic prefix are automatically detected and used in the analysis. The cell identity can also be automatically detected. This minimizes the number of settings users have to make.

Supported LTE capabilities

- ▶ **R&S®VSE-K100:** Uplink and downlink capabilities for LTE FDD
- ▶ **R&S®VSE-K104:** Uplink and downlink capabilities for LTE TDD
- ▶ **R&S®VSE-K102:** MIMO and LTE-Advanced capabilities added to the R&S®VSE-K100/K104 options

Extensive TDD support

R&S®VSE-K104 provides many TDD-specific features such as power versus time measurement, special subframe configurations and measurements on downlink dual layer beamforming signals using UE-specific reference signals. Users can verify all important aspects of a TDD transmitter.

Supported LTE measurements

- ▶ EVM
- ▶ Constellation diagram
- ▶ I/Q offset
- ▶ Gain imbalance
- ▶ Quadrature error
- ▶ Center frequency error (symbol clock error)
- ▶ Bitstream
- ▶ Allocation summary list
- ▶ Averaging over multiple measurements

With R&S®VSE-K102 option, additionally

- ▶ MIMO demodulation
- ▶ MIMO time alignment for R&S®FSW-K100/K104
- ▶ Interband carrier aggregation time alignment

R&S®FPS/FSV/FSW-K106 EUTRA/LTE NB-IoT Measurement Application

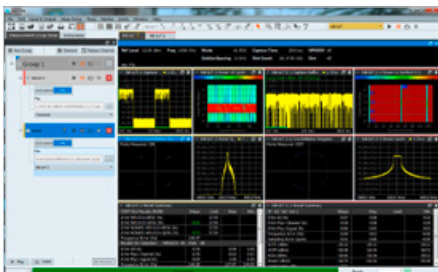
**LTE narrowband IoT analysis**

The R&S®VSE-K106 option covers the modulation measurements for narrowband IoT (NB-IoT) specified by 3GPP for base stations and user equipment.

NB-IoT focuses specifically on indoor coverage, low cost and long-life battery devices. The NB-IoT technology can be deployed "in-band" in a spectrum allocated to LTE within a normal LTE carrier or standalone for deployments in a dedicated spectrum specifically targeting GSM refarming.

Supported LTE measurements

- ▶ EVM
- ▶ Constellation diagram
- ▶ I/Q offset
- ▶ Gain imbalance
- ▶ Quadrature error
- ▶ Center frequency error (symbol clock error)
- ▶ Bitstream
- ▶ Allocation summary list

General measurement applications

R&S®FSW-K144/-K145 3GPP 5G-NR DL/UL measurements

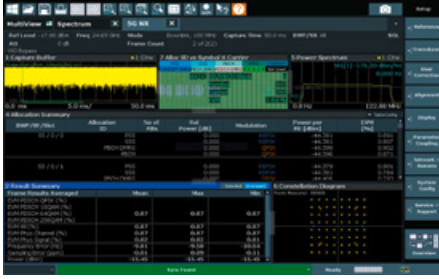

In-band measurements of 3GPP 5G NR in the downlink and uplink

Each signal subframe is analyzed and a wide range of measurement results are provided, including EVM, frequency and power of different channels and signals.

With its wide internal analysis bandwidth of optionally up to 2 GHz, the R&S®FSW-K144 can capture the entire bandwidth of the downlink signal and allows you to evaluate the complete system. Its high-performance digitizer yields a low inherent error vector magnitude (EVM), providing new insight into designs.

The R&S®FSW-K144 and R&S®FSW-K145 support all specified 5G signal bandwidths from 5 MHz to 400 MHz, with multiple numerologies, multiple bandwidth parts and modulation formats from QPSK to 256QAM. The R&S®FSW-K145 supports both the OFDMA and the transform precoded modes in the uplink.

- ▶ Power versus time
- ▶ EVM
- ▶ EVM xPDSCCH
- ▶ Constellation diagram
- ▶ I/Q offset
- ▶ I/Q imbalance
- ▶ Gain imbalance
- ▶ Center frequency error

R&S®FSW-K161R/-K512RE/-K800RE/-B512R/-B800R Realtime Extension

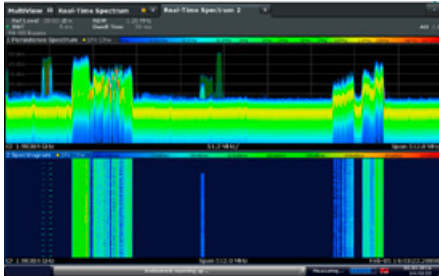

Seamless display of RF spectra

Equipped with the R&S®FSW-K161R/-B512R/-B800R real-time spectrum analyzer options, the R&S®FSW seamlessly displays 160/512/800 MHz wide RF spectra. It offers a real-time spectrogram in addition to the instantaneous spectrum and a persistence mode with the signal amplitudes shown in different colors according to their frequency of occurrence.

While R&S®FSW-B512R and R&S®FSW-B800R are special hardware options the R&S®FSW-K161R/-K512RE/-K800RE options can be installed alongside R&S®FSW-B160/-B512/-B1200/-B2001.

Frequency-dependent masks help the user reliably detect sporadic signals in the spectrum.

While realtime analysis functionality previously required an extra device, it can be provided by simply configuring or retrofitting the R&S®FSW signal and spectrum analyzer now.

R&S®FSW-K161R

Real-Time Spectrum Analyzer 160 MHz bandwidth, POI = 1.87 μ s

R&S®FSW-B512R/-K512RE

Real-Time Spectrum Analyzer 512 MHz bandwidth, POI = 0.91 μ s (> 15 μ s for R&S®FSW-K512RE)

R&S®FSW-B800R/-K800RE

Real-Time Spectrum Analyzer 800 MHz bandwidth, POI = 0.46 μ s (> 15 μ s for R&S®FSW-K800RE)

R&S®FSW-K192 DOCSIS3.1 OFDM Downstream



Analysis of DOCSIS3.1 downstream signals

Cable network providers can use the existing cable TV network to maximize both the downstream (DS) and upstream (US) data throughput by employing the data over cable service interface specification DOCSIS3.1.

The R&S®FSW-K192 analyzes DOCSIS3.1 downstream signals. This software application offers a wide range of graphical displays with detailed results as well as tables listing the key measurement parameters. In addition to manual input of signal configurations, the R&S®FSW-K192 also offers automatic detection of a variety of signal parameters.

Modulation quality

- ▶ MER approx. 57 dB
- ▶ MER versus carrier
- ▶ MER versus symbol
- ▶ MER versus symbol x carrier
- ▶ MER (pilot, data)
- ▶ Constellation diagram
- ▶ Center frequency error
- ▶ Symbol clock error
- ▶ Group delay

Decoding

- ▶ LDPC BER
- ▶ LDPC CWER
- ▶ Trigger to frame

R&S®FSW-K193 DOCSIS3.1 OFDM Upstream



Analysis of DOCSIS3.1 upstream signals

Cable network providers can use the existing cable TV network to maximize both the downstream (DS) and upstream (US) data throughput by employing the data over cable service interface specification DOCSIS3.1.

The R&S®FSW-K193 analyzes DOCSIS3.1 upstream signals. The graphical results and tables are similar to R&S®FSW-K192, even if this signal has a burst structure and covers a maximum bandwidth of only 96 MHz.

Modulation quality

- ▶ MER ~57 dB
- ▶ MER versus carrier
- ▶ MER versus symbol
- ▶ MER versus symbol x carrier
- ▶ MER (pilot, data)
- ▶ Constellation diagram
- ▶ Center frequency error
- ▶ Symbol clock error
- ▶ Group delay

Spectrum measurements

- ▶ Power spectrum
- ▶ Power versus carrier (synchronous ACP)
- ▶ Spectrum flatness

General measurement applications

R&S®VSE Vector Signal Explorer Software

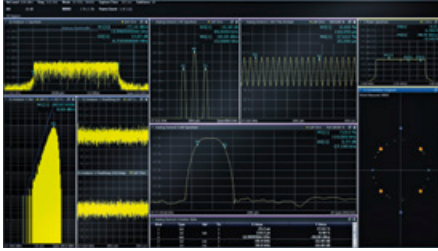

Desktop signal analysis

The R&S®VSE vector signal explorer software brings the experience and power of Rohde&Schwarz signal analysis to the desktop, offering a wide range of analysis tools for troubleshooting and optimizing designs on your PC. With this software, users analyze and solve problems in analog and digitally modulated signals for a wide range of standards using Rohde&Schwarz signal and spectrum analyzers and oscilloscopes.

Key facts

- ▶ Supports R&S®FSL/FPS/FSV/FSVA/FSW/FSWP/RTO/FPL1000/ZNL
- ▶ Control multiple instruments from one PC
- ▶ Remote controllable and compatible with R&S®FSW
- ▶ Advanced pulse analysis with R&S®RTO oscilloscopes
- ▶ Supports all relevant mobile and wireless communications standards

Software options

- ▶ R&S®VSE-K6 Pulse measurements application
- ▶ R&S®VSE-K7 Modulation analysis for AM/FM/φM modulated single carriers
- ▶ R&S®VSE-K10 GSM measurements
- ▶ R&S®VSE-K60 Transient measurements
- ▶ R&S®VSE-K60C Transient chirp measurements (requires R&S®VSE-K60)
- ▶ R&S®VSE-K60H Transient hop measurements (requires R&S®VSE-K60)
- ▶ R&S®VSE-K70 Vector signal analysis
- ▶ R&S®VSE-K70M Multi-modulation analysis
- ▶ R&S®VSE-K70P PRBS bit error rate measurements
- ▶ R&S®VSE-K72 3GPP FDD measurements
- ▶ R&S®VSE-K91 IEEE802.11a/b/g measurements
- ▶ R&S®VSE-K91P IEEE802.11p measurements
- ▶ R&S®VSE-K91N IEEE802.11n measurements
- ▶ R&S®VSE-K91AC IEEE802.11ac measurements
- ▶ R&S®VSE-K96 OFDM signal analysis
- ▶ R&S®VSE-K100 EUTRA/LTE FDD uplink and downlink measurement application
- ▶ R&S®VSE-K102 EUTRA/LTE Advanced and MIMO (downlink)
- ▶ R&S®VSE-K104 EUTRA/LTE TDD uplink and downlink measurement application
- ▶ R&S®VSE-K106 EUTRA/LTE narrowband IoT analysis
- ▶ R&S®VSE-K144 5G uplink and downlink measurement application
- ▶ R&S®VSE-K544 User-defined frequency correction by SnP file

R&S® EVSF1000

VHF/UHF NAV/FLIGHT ANALYZER



Efficient flight inspection of terrestrial navigation and communications systems

The R&S®EVSF1000 is a signal level and modulation analyzer for installation in flight inspection aircraft. It performs measurements on ILS, GBAS, VOR and marker beacon ground stations during startup, maintenance and servicing and analyzes air traffic control communications (ATC COM) signals. The instrument's mechanical and electrical design and high sensitivity make it ideal for state-of-the-art flight inspection. In addition, the R&S®EVSF1000 performs specialized, drone-based measurements on terrestrial navigation systems. As an integral component of a modern flight inspection system on board an aircraft, the R&S®EVSF1000 delivers precise, high-sensitivity analyses in the frequency range from 70 MHz to 410 MHz.

Key facts

- ▶ Precise, reproducible analyses on ILS, GBAS, VOR and marker beacon ground systems (in line with ICAO Doc. 8071 and ICAO Annex 10)
- ▶ High measurement rate, at 100 data records/s
- ▶ Analysis of ATC COM signals
- ▶ High sensitivity for coverage measurements
- ▶ Compact, robust design (ARINC 600)
- ▶ Two identical signal processing units for simultaneous localizer and glidepath measurements

Excellent performance for state-of-the-art flight inspection systems

- ▶ Level measurements with utmost accuracy
- ▶ Outstanding input sensitivity, efficient preselector
- ▶ Precision modulation analysis in realtime
- ▶ Reliable measurement of identifier parameters

Highly customizable for specific tasks

- ▶ Simultaneous analysis of course and clearance signals (R&S®EVSG-K1)
- ▶ Detailed analysis of VOR and marker beacon signals (R&S®EVSG-K2, R&S®EVSG-K3)
- ▶ Testing of ground-based augmentation systems (GBAS/SCAT-I) for satellite navigation (R&S®EVSG-K4, R&S®EVSG-K5)
- ▶ Integrated data recording
- ▶ High measurement rate
- ▶ RF spectrum analysis (R&S®EVSG-K10)
- ▶ AF spectrum analysis (R&S®EVSG-K11)

Tailored to flight inspection applications

- ▶ Integration into flight inspection aircraft
- ▶ Reliable bridging of short-term interruptions in the on-board power supply
- ▶ Detailed analyses in line with ICAO requirements
- ▶ Compact, robust, lightweight

Virtual screen of the R&S®EVSF1000

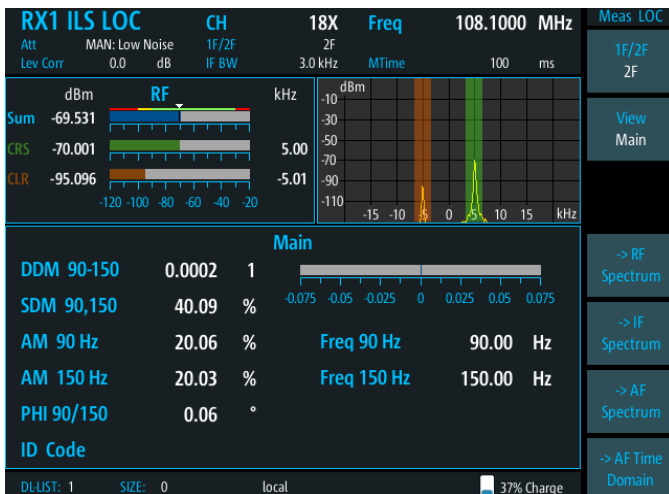

Integrated flight inspection system



R&S® EVSG1000 VHF/UHF AIRNAV/COM ANALYZER



Efficient servicing of air navigation and communications systems

The R&S®EVSG1000 is a portable signal level and modulation analyzer specifically designed for commissioning and servicing ILS, GBAS, VOR and marker beacon ground stations and for analyzing air traffic control communications (ATC COM) signals. The instrument's high accuracy and measurement speed, robust mechanical design and integrated battery make it ideal for high-precision measurements in the field.

Key facts

- ▶ High-precision analysis of ILS, GBAS, VOR and marker beacon ground systems (in line with ICAO Doc. 8071 and ICAO Annex 10)
- ▶ Analysis of ATC COM signals
- ▶ High dynamic range of >130 dB, precise level and modulation depth measurements
- ▶ Spectrum preview and detailed analysis options in the frequency and time domain
- ▶ Extremely compact, with integratable battery
- ▶ Dynamic measurements at up to 100 data records/s in high measurement rate mode
- ▶ Simultaneous analysis of course and clearance signals on dual-frequency (2F) ILS systems

Unique measurement functions for high-precision, efficient ground inspection

- ▶ Level measurements with utmost accuracy
- ▶ Outstanding input sensitivity, efficient preselector
- ▶ Precision modulation analysis in realtime
- ▶ Reliable measurement of identifier parameters
- ▶ AF signal analysis via the LF input

User-friendly design and application-specific extras

- ▶ Intuitive operation via straightforward GUI
- ▶ Detailed analyses in line with ICAO requirements
- ▶ Simple remote operation via standard interfaces
- ▶ Trigger and synchronization functions
- ▶ Easy maintenance, repair and service

Software options for customized analysis

- ▶ Simultaneous analysis of course and clearance signals (R&S®EVSG-K1)
- ▶ Detailed analysis of VOR and marker beacon signals (R&S®EVSG-K2, R&S®EVSG-K3)
- ▶ Testing of ground-based augmentation systems (GBAS/SCAT) for satellite navigation (R&S®EVSG-K4, -K5)
- ▶ ATC communications signal analysis (R&S®EVSG-K6)
- ▶ Integrated data recording (R&S®EVSG-K21)
- ▶ High measurement rate (R&S®EVSG-K22)
- ▶ RF spectrum analysis (R&S®EVSG-K10)
- ▶ AF spectrum analysis (R&S®EVSG-K11)
- ▶ AF time domain analysis (R&S®EVSG-K12)

Hardware options and accessories

- ▶ Compact, robust, lightweight
- ▶ Battery-powered field measurements (R&S®EVSG-B3)
- ▶ Weather and transit protection for mobile use (R&S®EVSG-Z1)
- ▶ Safe transport in a hard-shell case (R&S®EVSG-Z2)
- ▶ ILS/VOR test antenna (R&S®EVS-Z3) with carrying bag

VOR measurement (R&S®EVSG-K2 option)

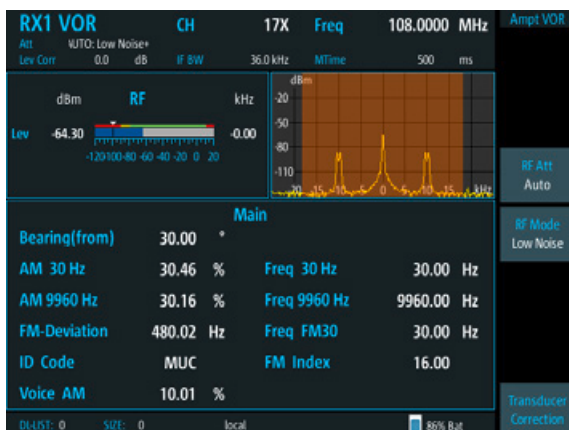

ILS measurements with R&S®EVS-Z3 ILS/VOR test antenna



Product site

R&S® EDS300 DME/PULSE ANALYZER



Precise distance and pulse analysis for ground and air measurements

The R&S®EDS300 is a level and modulation analyzer designed for installing and maintaining pulsed, terrestrial navigation services. Its high sensitivity and compact design make the R&S®EDS300 ideal for conducting field measurements on the ground and in the air. The DME/pulse analyzer also features trigger and synchronization capabilities for easy integration into test vehicles and flight inspection systems.

Key facts

- ▶ High-precision measurement of DME and TACAN systems on the ground and in the air (in line with ICAO Doc. 8071, ICAO Annex 10, STANAG 5034 and MIL-STD-291C)
- ▶ Total peak level deviation < 1 dB
- ▶ Receiver acquisition sensitivity -97 dBm
- ▶ 0.01 NM distance measurement uncertainty down to -80 dBm
- ▶ 0.2° TACAN bearing deviation for input levels ≥ -80 dBm
- ▶ Detailed automated pulse shape analysis
- ▶ Multi-DME mode for measuring up to ten DME stations quasi-simultaneously, i.e. within 50 ms (R&S®EDS-K5)
- ▶ Synchronization via GPS, trigger and remote interfaces

GPS-based measurements using R&S®EDS-K3

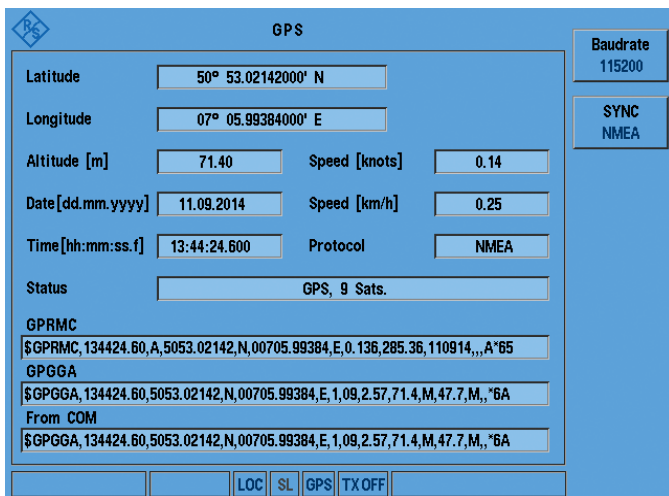

Measurement functions for regular verification of pulsed navigation signals

- ▶ High-precision distance and level measurements on DME ground stations
- ▶ Accurate analysis of military TACAN stations
- ▶ High dynamic range of 105 dB
- ▶ Detailed analysis in line with ICAO requirements, STANAG and MIL-STD

Expanded functionality and adaptation using hardware and software options

- ▶ Precise distance measurements on the ground and in the air
- ▶ High-performance multi-DME mode for measuring up to ten DME stations
- ▶ Simultaneous measurement of two different signals using an additional RX unit
- ▶ Low-power interrogator for ground measurements with variable output power
- ▶ Flight inspection with integrated high-power interrogator
- ▶ Modulation and signal analysis of TACAN ground stations
- ▶ Detailed pulse shape analysis on DME systems
- ▶ GPS-based measurements

User-friendly design and application-specific extras

- ▶ Compact, robust design for stationary and mobile applications
- ▶ Remote control via LAN interface
- ▶ Easy measurement data transfer via USB data logger
- ▶ Various synchronization capabilities for integration into existing flight inspection systems
- ▶ Maintenance, repair and service



R&S®EDS-Z2 rugged wheeled transport case



R&S® EDST300 TACAN/DME STATION TESTER

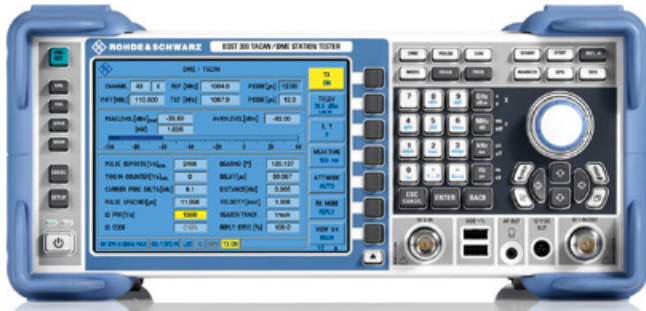

Maintenance checks and signal-in-space analysis on TACAN and DME stations

The R&S®EDST300 TACAN/DME station tester is an analyzer designed for commissioning, testing and servicing pulsed terrestrial navigation systems. Its wide dynamic range and compact design make the R&S®EDST300 ideal especially for wired and field measurements on TACAN and DME ground stations.

Key facts

- ▶ High-precision TX/RX measurements on TACAN and DME systems (in line with ICAO Annex 10, ICAO Doc. 8071, MIL-STD-291C and STANAG 5034)
- ▶ All required measurements with a single instrument
- ▶ High dynamic range (110 dB) and precise peak power measurements
- ▶ Precise, efficient measurement of characteristic TACAN/DME parameters (main delay < 50 ns, bearing < 0.2°)
- ▶ Detailed, automated time domain analysis
- ▶ Extremely compact with internal battery

Commissioning and regular maintenance checking of TACAN and DME ground stations

- ▶ Precise on-channel peak power and frequency measurements
- ▶ Analysis of TACAN/DME spectrum

The R&S®EDST300 TACAN/DME station tester with R&S®EDST-Z1 test antenna (960 MHz to 1215 MHz)



- ▶ Detailed analysis of TACAN bursts
- ▶ Automated pulse shape analysis
- ▶ Detailed analysis of station identifier
- ▶ Efficient on-channel sensitivity measurement
- ▶ Interrogation loading test
- ▶ Adjacent-channel measurement and decoder rejection
- ▶ High-precision measurement of reply delay and reply delay variation

Signal-in-space analysis on TACAN and DME stations

- ▶ Efficient analysis in the field
- ▶ High dynamic range
- ▶ Modulation and signal analysis on TACAN ground stations
- ▶ Site environment analysis
- ▶ Battery-operated field measurements

User-friendly design and application-specific extras

- ▶ Detailed analysis in line with relevant standards
- ▶ Compact, robust design for stationary and mobile applications
- ▶ Remote control via LAN interface
- ▶ Exporting measurement data via USB data logger
- ▶ Power measurements using an external power sensor
- ▶ Maintenance, repair and service

Peak power measurements with level correction

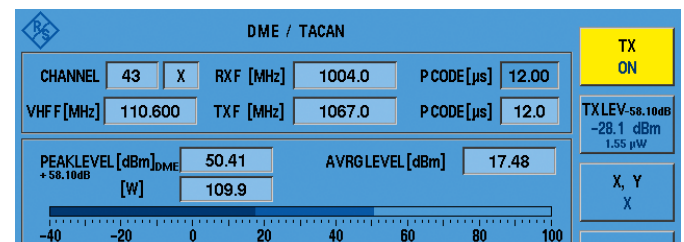

Analysis of main and auxiliary reference bursts (MRB, ARB)

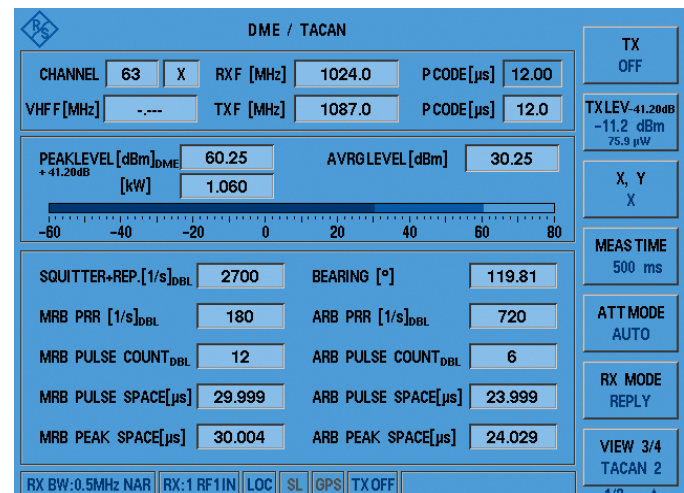

Product site

CHAPTER 4

SIGNAL GENERATORS

Baseband, RF and microwave signal generators from Rohde & Schwarz excel in signal quality, flexibility and usability. Rohde & Schwarz signal generators offer wide frequency ranges up to 67 GHz (up to 170 GHz with frequency multipliers), feature modulation bandwidths up to 2 GHz and support all major mobile communications and wireless digital standards.

The portfolio ranges from ultracompact and unexcelled fast analog and digital signal sources, optimized for use in production and automated solutions, to premium class vector signal generators with multichannel and fading simulation capabilities for the most demanding applications.



Type	Designation	Frequency range	Description	Page
RF vector signal generators				
R&S®SMW200A	Vector signal generator	100 kHz to 3/6/7.5/12.75/20/31.8/40/44 GHz	The fine art of signal generation	98
R&S®SMBV100B	Vector signal generator	8 kHz to 3 GHz/6 GHz	Perfect combination of performance and usability	100
R&S®SGS100A	SGMA RF source	1 MHz to 6/12.75 GHz (CW) 80 MHz to 6/12.75 GHz (I/Q)	Compact – fast – reliable	101
R&S®SGU100A	SGMA upconverter	12 GHz to 20/40 GHz (CW) 12 GHz to 20/40 GHz (I/Q)	High performance up to microwave frequencies	101
R&S®SGT100A	SGMA vector RF source	1 MHz to 3 GHz or 6 GHz	Fast and compact production solution	102
R&S®SZU100A	I/Q upconverter	58.32 GHz to 64.80 GHz	Wideband mmWave vector signal generation	103
New R&S®SZV100A	Q/V band RF upconverter	36 GHz to 56 GHz	Vector signal generation for component and satellite payload testing	104
RF analog signal generators				
R&S®SMA100B	RF and microwave signal generator	8 kHz to 3/6/12.75/20/31.8/40/50/67 GHz	Performance leadership without compromise	105
R&S®SMB100A	Microwave signal generator	100 kHz to 12.75/20/31.8/40 GHz	Versatile, compact solution for signal generation up to 40 GHz	106
R&S®SMB100B	RF signal generator	8 kHz to 1 GHz, 3 GHz or 6 GHz	Perfect combination of performance and usability in a compact size	107
R&S®SMC100A	Signal generator	9 kHz to 1.1 GHz/3.2 GHz	Flexible and universal all-purpose signal generator	108
R&S®SGS100A	SGMA RF source	1 MHz to 6/12.75 GHz (CW) 80 MHz to 12.75 GHz (I/Q)	Compact – fast – reliable	101
R&S®SGU100A	SGMA upconverter	12 GHz to 20 GHz (CW) 12 GHz to 20 GHz (I/Q)	High performance up to microwave frequencies	101
R&S®SMZ	Frequency multiplier	50/60/75/110 GHz to 75/90/110/170 GHz	Precise and adjustable output levels (for R&S®SMZ75, R&S®SMZ90 and R&S®SMZ110)	109
Baseband signal generators				
R&S®AFQ100A	I/Q modulation generator		High-performance baseband signals	110
R&S®AFQ100B	UWB signal and I/Q modulation generator			
R&S®HMF2525	Arbitrary function generators	10 µHz to 25 MHz/50 MHz	Accurate, versatile and price convenient	111
R&S®HMF2550				
R&S®HM8150	Arbitrary function generator	10 mHz to 12.5 MHz	Easy to use, multifunctional and a great price	112
Application-specific solutions				
Application firmware packages for Rohde & Schwarz signal generators			Overview	113
Software solutions				
R&S®WinIQSIM2™	Simulation software		Ideal for the generation of digitally modulated signals	122
R&S®Sxx-Kxxx	Pulse sequencing, direction finding, pulse on pulse simulation, DFS signal generation		Generation of pulsed signals (for R&S®SMW200A, R&S®SMBV100B, R&S®SMBV100B and R&S®SGT100A)	122

R&S® SMW200A VECTOR SIGNAL GENERATOR



The fine art of signal generation

The R&S®SMW200A is the ideal generator for the digitally modulated signals required to develop the new wideband communications systems, to verify 4G and 5G base stations or in the aerospace and defense sector.

Key facts

- ▶ Frequency range from 100 kHz to 3/6/7.5/12.75/20/31.8/40/44 GHz
- ▶ Optional second RF path with 100 kHz up to 3/6/7.5/20 GHz
- ▶ Up to 2 GHz I/Q modulation bandwidth (in RF) with internal baseband
- ▶ Options for all important digital communications standards
- ▶ Optional integrated fading simulator with up to 200 MHz bandwidth
- ▶ Support of all key MIMO modes including 3x3, 4x4, 8x4, 4x8 and 4x2x2
- ▶ Intuitive operation via touchscreen with block diagram as key element

Simplify your setup

- ▶ Wideband baseband and vector signal generator in one box
- ▶ Easy generation of complex signals
- ▶ Max. eight baseband generators on two internal baseband modules with realtime coder and ARB

Models	
R&S®SMW200A + R&S®SMW-B1003	100 kHz to 3 GHz
R&S®SMW200A + R&S®SMW-B1006	100 kHz to 6 GHz
R&S®SMW200A + R&S®SMW-B1012	100 kHz to 12.75 GHz
R&S®SMW200A + R&S®SMW-B1020	100 kHz to 20 GHz
R&S®SMW200A + R&S®SMW-B1031	100 kHz to 31.8 GHz
R&S®SMW200A + R&S®SMW-B1040	100 kHz to 40 GHz
R&S®SMW200A + R&S®SMW-B1040N	100 kHz to 40 GHz, I/Q modulation bandwidth and minimum pulse width limited
R&S®SMW200A + R&S®SMW-B1044	100 kHz to 44 GHz
R&S®SMW200A + R&S®SMW-B1044N	100 kHz to 44 GHz, I/Q modulation bandwidth and minimum pulse width limited

- ▶ Internal digital adding of baseband signals, even with frequency and level offset
- ▶ Support of all important digital standards such as 5G NR, LTE (up to Release 15), NB-IoT, eMTC, 3GPP FDD/HSPA/HSPA+, GSM/EDGE/EDGE Evolution, CDMA2000®/1xEV-DO, WLAN IEEE 802.11a/b/g/n/j/p/ac/ax/ad
- ▶ No separate PC software required for digital standards
- ▶ Generation of radar signal scenarios for module, receiver and DFS tests
- ▶ LTE and 3GPP test case wizards for easy base station conformance testing in line with 3GPP TS 25.141 or 3GPP TS 36.141
- ▶ Envelope tracking and AM/AM, AM/φM predistortion options for full testing and verification of ET modulator chipsets

Bring reality to your lab

- ▶ Optional integrated fading section for channel emulation with up to 200 MHz bandwidth
- ▶ All important fading scenarios available as presets
- ▶ Installation of up to four fading modules, providing as many as 32 “logical” faders
- ▶ Implementation of all key MIMO fading scenarios such as 2x2, 3x3, 4x4, 8x4 and 4x8 using a single instrument
- ▶ Support of complex applications such as dual-carrier HSPA, LTE carrier aggregation with MIMO and multi-user LTE
- ▶ Connection of R&S®SGT100A signal generator modules to provide up to eight RF paths

Make your device even better

- ▶ Excellent signal quality for high accuracy in spectral and modulation measurements
- ▶ Up to 2 GHz I/Q modulation bandwidth (in RF) with internal baseband
- ▶ Exceptional modulation frequency response of < 0.4 dB (meas.) over 2 GHz bandwidth
- ▶ High-end pulse modulation with on/off ratio > 80 dB and rise/fall time < 10 ns
- ▶ Excellent spectral purity (SSB phase noise –150 dBc (typ.) at 1 GHz, 10 kHz offset)
- ▶ Phase coherence option, e.g. for beamforming applications
- ▶ 3/6/7.5/12.75 GHz RF paths with electronic attenuator

Grows with your needs

- ▶ Advanced plug-in system for retrofitting baseband modules without instrument recalibration
- ▶ Software upgrades possible at any time, simple and quick activation via key codes



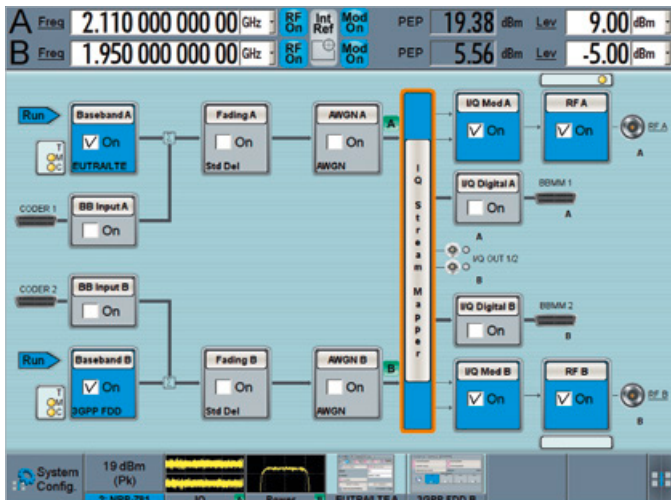

Speed up your development

- ▶ Intuitive operating concept and clever help functions for quick success
- ▶ Block diagram as key operating element to visualize signal flow
- ▶ Adaptive GUI for overview of both simple and complex scenarios
- ▶ Graphical signal monitoring at practically every point in the signal flow
- ▶ Context-sensitive online help system with complete user documentation
- ▶ SCPI macro recorder and code generator for generating executable remote control code from manual operating steps (for MATLAB®, LabWindows/CVI, etc.)

4

The R&S®SMW200A can be used together with many other Rohde & Schwarz instruments

R&S®SMW200A function/connection	Related option(s)	Rohde & Schwarz partner instrument	Application example
Digital baseband input	R&S®SMW-B9/-B10	e.g. R&S®CMW500 wideband radio communication tester	R&S®CMW500 as external I/Q source, e.g. for signaling
Digital baseband output	R&S®SMW-K18/-K19	e.g. R&S®SGT100A signal generator module	provides additional RF paths
Analog I/Q output	R&S®SMW-K16/-K17	e.g. R&S®SGS100A signal generator module	provides additional RF paths
R&S®NRP sensor connector	–	R&S®NRPxxS power sensors, R&S®NRP-Z28/-Z98 level control sensors	high-accuracy power measurement, result display on the R&S®SMW200A

Setup for antenna testing

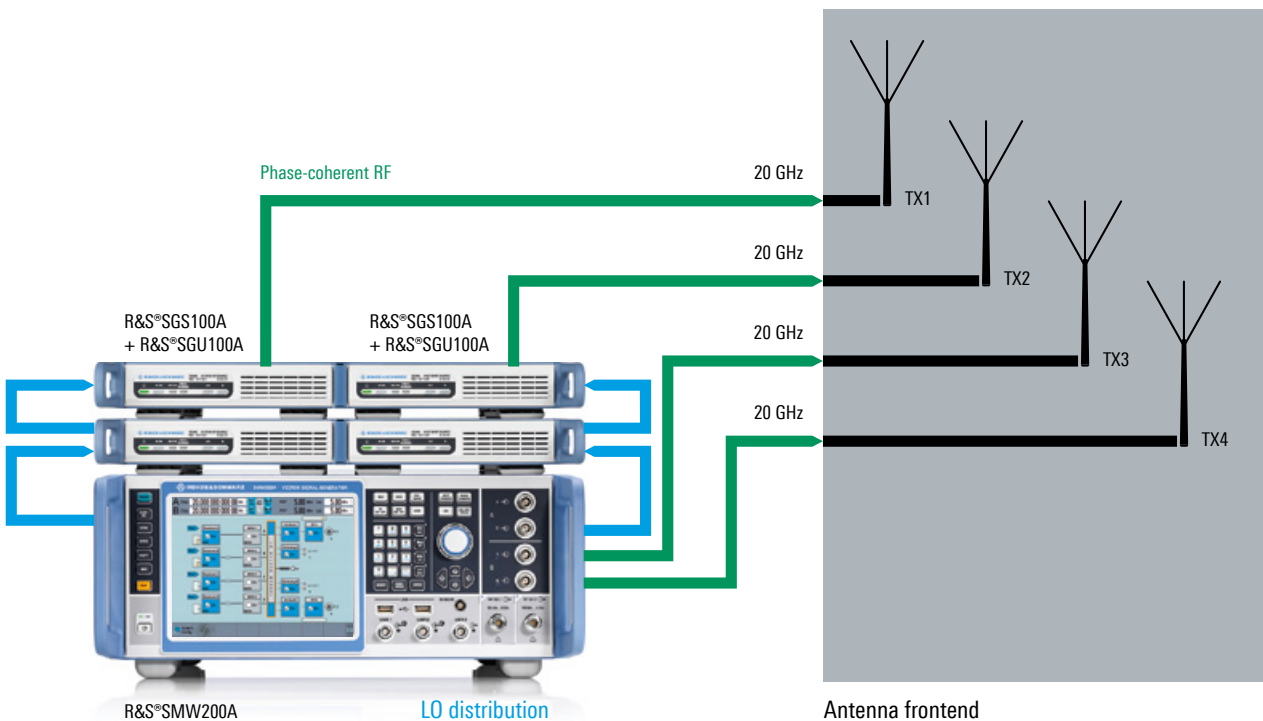

Setup with a two-path R&S®SMW200A, two R&S®SGS100A and two R&S®SGU100A to generate four phase-coherent CW or modulated signals, for example for antenna testing up to 20 GHz. The setup can be scaled to 40 GHz and duplicated if more RF paths are required.

R&S® SMBV100B VECTOR SIGNAL GENERATOR

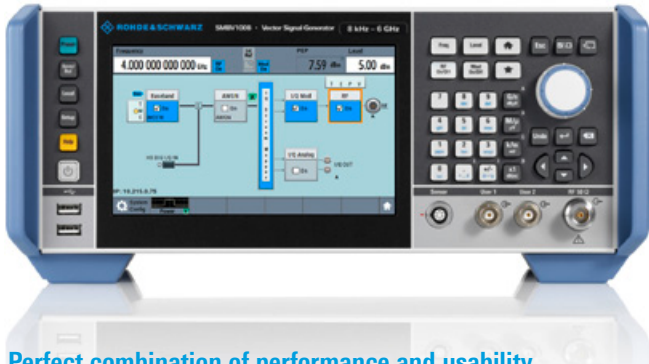

Perfect combination of performance and usability

The state-of-the-art R&S®SMBV100B vector signal generator sets new standards in its class. Ultra high output power, fully calibrated wideband signal generation and intuitive touchscreen operation make the R&S®SMBV100B ideal for all kinds of applications.

Key facts

- ▶ Frequency range from 8 kHz to 3 GHz or 6 GHz
- ▶ Internal signal generation for all major digital communication standards
- ▶ Easy upgrading of instrument at customer premises via software keycodes

Perfect for signal quality

- ▶ New realtime, user-defined frequency response correction to compensate for the effect of test fixtures
- ▶ Very low single-sideband (SSB) phase noise: <math>< -134\text{ dBc}</math> (meas.) at 1 GHz and 20 kHz offset
- ▶ Wide modulation bandwidth with perfect accuracy: modulation frequency response of <math>< 0.3\text{ dB}</math> (meas.) across 500 MHz bandwidth
- ▶ Excellent EVM and ACPR up to high power levels

Perfect for output power

- ▶ Ultra high output power: up to +34 dBm at 1 GHz
- ▶ Excellent level accuracy for CW and modulated signals: level linearity of <math>< 0.2\text{ dB}</math> (meas.)

Perfect for use

- ▶ Convenient operation via 7" touchscreen
- ▶ Automation made easy with context-sensitive help system and SCPI recording
- ▶ Internal realtime signal generation
- ▶ Protecting user data

Perfect for GNSS testing

- ▶ Take control over your GNSS scenarios
- ▶ Signals, systems and scenario configuration

Overview of important software and hardware options

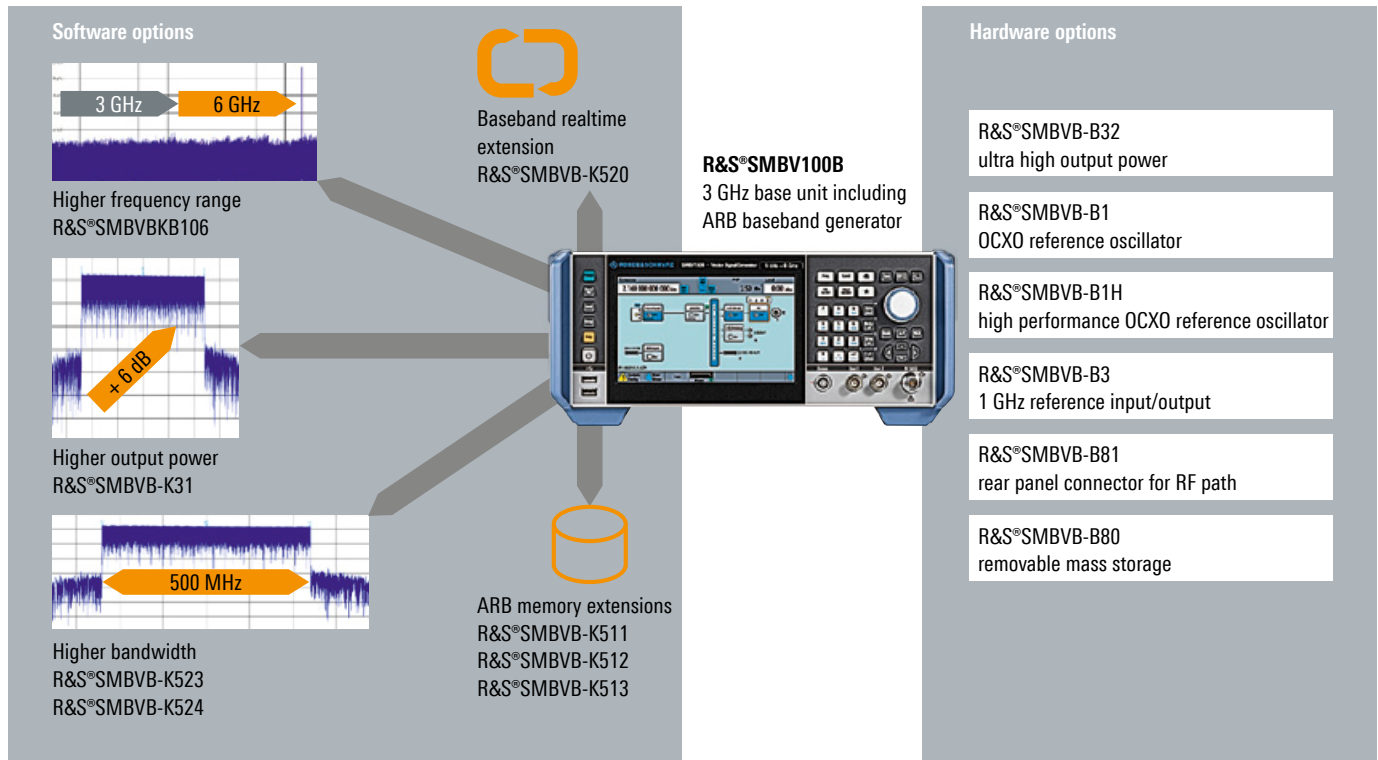

R&S®SGS100A SGMA RF SOURCE, R&S®SGU100A SGMA UPCONVERTER



Compact – fast – reliable

The R&S®SGS100A is an RF source designed to meet the requirements of automated test systems. It is available as a CW source or as a vector signal generator with an integrated I/Q modulator. With its frequency range of up to 12.75 GHz, the vector signal generator version covers the essential digital signals. The CW version can be used as a flexible local oscillator as well as for interference testing against mobile radio standards.

The R&S®SGU100A SGMA upconverter offers a frequency extension to 20 GHz or 40 GHz. When the R&S®SGS100A and the R&S®SGU100A are connected, they act as a single instrument for both remote control and manual operation via the R&S®SGMA-GUI PC software.

Key facts R&S®SGS100A

- ▶ Smallest fully integrated vector signal generator on the market, space-saving design for system integration
- ▶ High throughput due to very short frequency and level setting times of typ. 280 μ s via PCIe interface
- ▶ Excellent RF performance in a compact format
- ▶ Maximum output level of typ. +22 dBm for compensating losses in the setup
- ▶ Closed ALC loop for CW and I/Q modes for highest level repeatability
- ▶ Wear-free electronic attenuator for high reliability up to 12.75 GHz
- ▶ Low initial costs and low cost of ownership

Connections between the R&S®SGS100A and the R&S®SGU100A

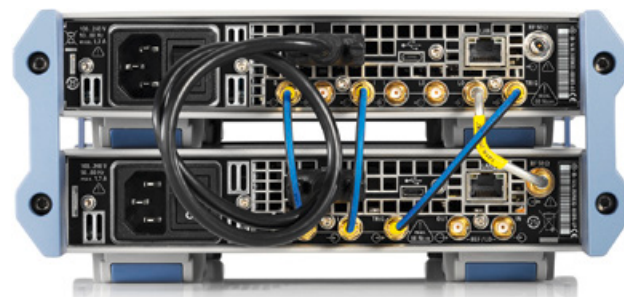

R&S®SGMA-GUI PC software with the R&S®SGS100A connected to the R&S®SGU100A upconverter

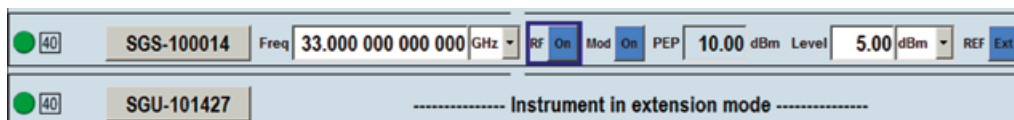

R&S®SGS100A and R&S®SGU100A model overview

R&S®SGS100A alone			
CW source as local oscillator		Vector signal generator for generating digital signals with an external baseband signal	
1 MHz to 6 GHz	1 MHz to 12.75 GHz	80 MHz to 6 GHz	80 MHz to 12.75 GHz
with R&S®SGS-B106	with R&S®SGS-B106 and R&S®SGS-B112	with R&S®SGS-B106V	with R&S®SGS-B106V and R&S®SGS-B112V
R&S®SGS100A together with R&S®SGU100A			
CW source as local oscillator		Vector signal generator for generating digital signals with an external baseband signal	
10 MHz to 20 GHz	10 MHz to 40 GHz	80 MHz to 20 GHz	80 MHz to 40 GHz
with R&S®SGS-B106, R&S®SGS-B112 and R&S®SGU-B120	with R&S®SGS-B106, R&S®SGS-B112, R&S®SGU-B120 and R&S®SGU-B140	with R&S®SGS-B106V, R&S®SGS-B112V and R&S®SGU-B120V	with R&S®SGS-B106V, R&S®SGS-B112V, R&S®SGU-B120V and R&S®SGU-B140V

SGS100A:



Configurator



Product site

SGU100A:



Configurator



Product site

R&S®SGT100A SGMA VECTOR RF SOURCE



Fast and compact production solution

The R&S®SGT100A is an RF vector signal generator with an integrated baseband generator. It has been optimized for use in production and automated applications. Designed as a fast and compact, space-saving solution, it provides top speed to ensure optimized throughput and fits into any test system.

Key facts

- ▶ Fastest vector signal generator with frequency and level switchover times of typ. 240 µs for optimized throughput in production
- ▶ Smallest standalone vector signal generator up to 6 GHz with integrated baseband generator (1 HU ½ 19")
- ▶ Integrated baseband generator with I/Q modulation bandwidth of up to 240 MHz (in RF) supporting all advanced digital standards, including 5G NR
- ▶ Excellent RF performance for EVM and ACLR
- ▶ Easy signal generation for digital standards such as 5G and WLAN using the R&S®WinIQSIM2™ simulation software
- ▶ Ideal enhancement for the R&S®SMW200A in MIMO applications with more than two receiving antennas

Optimized for use in production

- ▶ Smallest standalone vector signal generator with integrated baseband generator
- ▶ Fast frequency and level switchover to optimize production throughput
- ▶ High output level to compensate for losses in the test system
- ▶ Low power consumption for reduced heat dissipation and simplified thermal management within the system

The right signal performance in the right package

- ▶ Excellent modulation accuracy for large test margins
- ▶ Outstanding frequency response due to integrated baseband generator
- ▶ Low phase noise of typ. -133 dBc at 1 GHz and 20 kHz offset (1 Hz measurement bandwidth)
- ▶ Excellent level repeatability and level linearity for outstanding reproducibility of measurements
- ▶ Optional high-performance oven-controlled crystal oscillator for easy integration into test system
- ▶ Optional analog I/Q outputs enabling full-featured envelope tracking testing capabilities

Low cost of ownership

- ▶ Low acquisition costs
- ▶ Simple modular design for easy servicing
- ▶ Easily upgradeable at customer premises
- ▶ Waveform package as ideal production solution
- ▶ Many remote control interfaces for easy integration into the test setup
- ▶ R&S®SGMA-GUI PC software

Models

R&S®SGT100A	1 MHz to 3 GHz
R&S®SGT100A + R&S®SGT-KB106	1 MHz to 6 GHz

Concept of realtime envelope tracking tests with R&S®SGT-K540

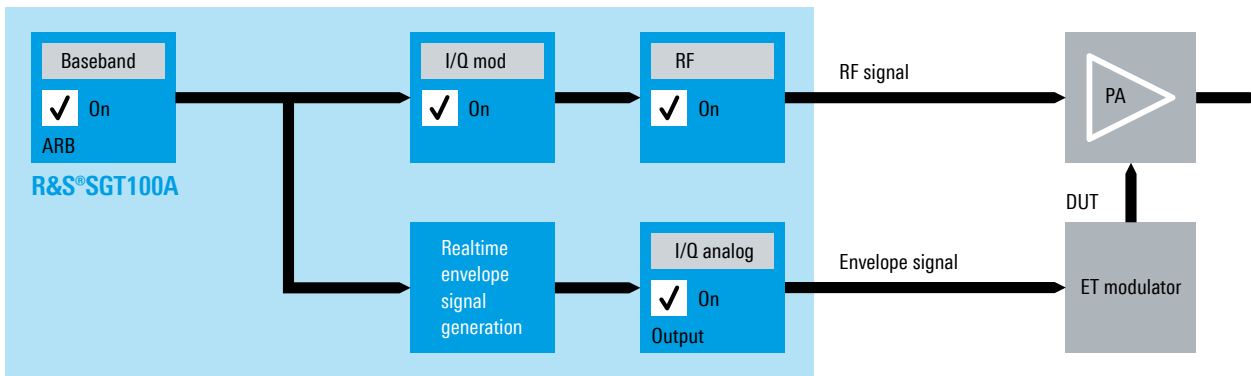

Equipped with the R&S®SGT-K540 option, the R&S®SGT100A calculates the envelope signal in realtime. This unique feature offers the advantage of test time reduction since no manual calculation of the envelope waveform is required.



R&S®SZU100A I/Q UPCONVERTER

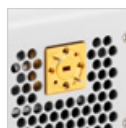

Standard WR15



Opt. 1.85 mm (f)



Opt. (HP/A)

- ▶ Flat frequency response independent of set level and frequency
- ▶ Fully characterized in factory; no need for external frequency response correction prior to measurements
- ▶ High spectral purity paired with high dynamic range
- ▶ Seamless integration into the R&S®SMW200A operating concept for maximum usability

High performance for challenging applications

- ▶ Field-proven design as a flexible RF head
 - Waveguide connector WR15
 - Highest output power available close to the DUT
- ▶ High frequency and large bandwidth
 - Center frequency from 58.32 GHz to 64.80 GHz
 - RF modulation bandwidth ± 1 GHz around center frequency
- ▶ High output power and wide dynamic range from -80 dBm to $+5$ dBm (PEP)
- ▶ Easy upgrading of the R&S®SMW200A
- ▶ Multichannel operation

Reliable results due to outstanding signal quality

- ▶ Automatic frequency response compensation
 - Flat frequency response of < 2.0 dB
 - Fully characterized in factory
 - No need for external frequency response correction
- ▶ Harmonics, nonharmonics and subharmonics better than -50 dBc (level > -40 dBm)
- ▶ Wideband noise -146 dBm (1 Hz) or better
- ▶ Excellent modulation quality: EVM for WLAN IEEE802.11ad at 60.48 GHz better than -32 dB (meas.)

Wideband mmWave vector signal generation

The R&S®SZU100A I/Q upconverter extends the R&S®SMW200A vector signal generator into the mmWave range. Its 2 GHz bandwidth, flat frequency response and dynamic range of over 80 dB allows the R&S®SZU100A to generate high-quality test signals in the frequency range from 57.32 GHz to 65.80 GHz for WLAN IEEE802.11ad, 5G or microwave links as well as to test satellite and radar systems. Components, chips, transceivers, mobile devices and the communications infrastructure for these fields of application are conveniently tested using the R&S®SZU100A I/Q upconverter.

Key facts

- ▶ Upconversion of R&S®SMW200A generated signals to mmWave frequencies

R&S®SZU100A I/Q upconverter test setup

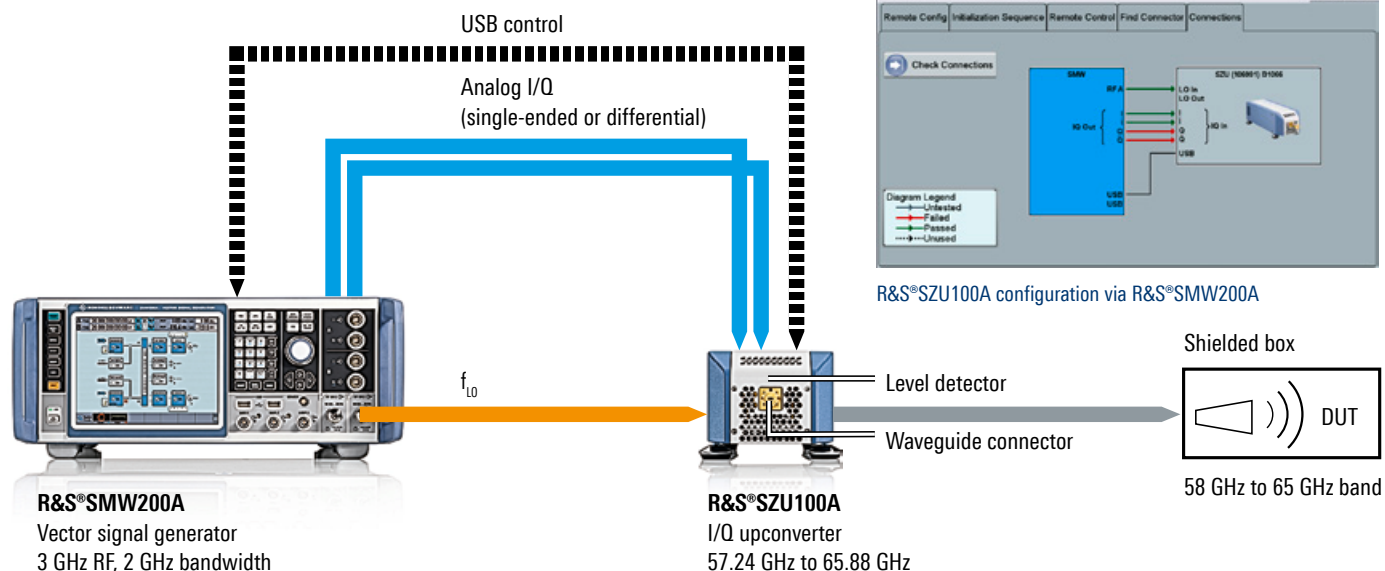

Product site

R&S®SZV100A Q/V BAND RF UPCONVERTER

New



Vector signal generation for component and satellite payload testing

With its instantaneous 2 GHz modulation bandwidth, the R&S®SZV100A covers the entire frequency range from 36 GHz to 56 GHz and enables testing far beyond the bandwidth limits of typical satellite and IMT/5G NR applications.

The R&S®SMW200A vector signal generator and R&S®SZV100A Q/V band RF upconverter work together to provide continuous coverage of all satellite bands from VHF to V as well as the frequencies used in mobile communications.

The Q/V band upconverter setup consists of the R&S®SMW200A vector signal generator, R&S®SMA100B RF and microwave signal generator and R&S®SZV100A Q/V band RF upconverter. With its outstanding RF performance, the R&S®SMW200A provides the modulated, broadband wanted signal with bandwidths of up to 2 GHz.

The R&S®SMA100A is responsible for the setup's highly precise, pure LO frequency.

The upconverter setup is controlled using PC control software via IP protocol in the LAN. This makes it easy to configure all devices.

The R&S®SZV100A can be reliably remotely operated at distances up to 10 m thanks to the PC control software and feeding of the LO and wanted signals.

The R&S®SZV100A's compact housing design, low weight and mounting points allow it to be mounted as close as possible to the DUT, for instance on the outside of the TVAC or on the DUT itself. This makes it possible to optimally supply the DUT with the high output power of +15 dBm.

Key facts

- ▶ Continuous frequency range from 36 GHz to 56 GHz across the Q/V band
- ▶ Instantaneous modulation bandwidth up to 2 GHz
- ▶ High output power up to +15 dBm (specified)
- ▶ Setup with 20 GHz R&S®SMW200A (modulated signal) and 20 GHz R&S®SMA100B (local oscillator)
- ▶ Best EVM performance using R&S®SMA100B as the local oscillator (LO) signal source
- ▶ Switchable gain modes for optimized broadband noise
- ▶ Small form factor, low weight, mounting points for outdoor TVAC mounting closest to the DUT
- ▶ Remote operation with cable length up to 10 m between signal sources and R&S®SZV100A
- ▶ PC software with graphical user interface via LAN (IP) for comfortable instrument remote control
- ▶ Classified as a dual use product under 3A992 and not export control restricted

Satellite band	Frequency range	Spectrum	Satellite service	Satellite link type
Q band	37.5 GHz to 39.5 GHz	shared	fixed satellite, earth exploration satellite	space-to-earth
Q band	40.5 GHz to 42.5 GHz	shared	fixed satellite, mobile satellite, broadcasting (40.5 GHz to 41 GHz)	space-to-earth
V band	42.5 GHz to 43.5 GHz	shared	fixed satellite, radio astronomy	earth-to-space
V band	47.2 GHz to 48.9 GHz	shared	fixed satellite	earth-to-space
V band	48.9 GHz to 50.2 GHz	shared	fixed satellite, earth exploration satellite (50.2 GHz to 50.4 GHz)	earth-to-space
V band	50.4 GHz to 51.4 GHz	shared	fixed satellite	earth-to-space



R&S® SMA100B RF AND MICROWAVE SIGNAL GENERATOR



Performance leadership without compromise

The R&S®SMA100B RF and microwave signal generator delivers maximum performance without compromise. It provides purest output signals while maintaining the highest output power level, far outpacing the competition. As the world's leading signal generator, it can handle the most demanding component, module and system T&M tasks in the RF semiconductor, wireless communications and aerospace and defense industries.

The R&S®SMA100B is the first choice for all applications requiring extremely clean analog signals. For LO substitution in radar applications, the R&S®SMA100B can generate microwave signals with extremely low close-in SSB phase noise, enabling radar systems to detect even very slow objects. For testing analog-to-digital converters (ADC), the R&S®SMA100B produces signals with extremely low jitter and highest spurious-free dynamic range (SFDR).

Via a second, independent output, the R&S®SMA100B can at the same time provide extremely pure clock signals for ADC testing with lowest wideband phase noise.

In automated production environments, the R&S®SMA100B generator's ultra high output power eliminates the need for additional amplifiers while keeping harmonics extremely low.

With the R&S®SMA100B, it is no longer necessary to choose between signal purity and high output power. It is the only signal generator that can supply signals with ultra high output power in combination with extremely low harmonic signal components, setting new standards for high-end analog signal generators.

The R&S®SMA100B covers all fields of application, from research and development to production, service and maintenance.

To meet the specific needs of any given application, the base unit's already excellent performance can be improved with options. Different levels to improve the SSB phase noise and diverse stages to maximize the output power can be selected.

Key facts

- ▶ Frequency range from 8 kHz to 3 GHz, 6 GHz, 12.75 GHz, 20 GHz, 31.8 GHz, 40 GHz, 50 GHz and 67 GHz (overrange up to 72 GHz)
- ▶ Excellent SSB phase noise of -152 dBc (typ.) at 1 GHz and -132 dBc (typ.) at 10 GHz, each at 10 kHz offset
- ▶ Virtually no wideband noise (-162 dBc (meas.) at 10 GHz and 30 MHz offset)
- ▶ Maximum output power exceeds 30 dBm across wide frequency ranges
- ▶ Exceptionally low harmonics
- ▶ State-of-the-art GUI with touch display

Very high output power without compromise

- ▶ Exceptionally high output level
 - Ultra high output power up to 38 dBm with the 6 GHz instrument
 - Over 30 dBm at 18 GHz and 28 dBm at 20 GHz with the 20 GHz instrument
 - Over 25 dBm between 20 GHz and 35 GHz with the 40 GHz instrument
 - Over 19 dBm between 40 GHz and 65 GHz with the 67 GHz instrument
- ▶ Excellent level accuracy and repeatability for CW signals, narrow pulses and modulated signals

User friendly in every detail

- ▶ Flexible 2 HU or 3 HU housing
- ▶ 3 HU with larger 7" display and multiple front panel connectors
- ▶ Ergonomic operation thanks to state-of-the-art GUI with touch display

Models R&S®SMA100B and frequency option

R&S®SMAB-B103	8 kHz to 3 GHz
R&S®SMAB-B106	8 kHz to 6 GHz
R&S®SMAB-B112	8 kHz to 12.75 GHz
R&S®SMAB-B120	8 kHz to 20 GHz
R&S®SMAB-B131	8 kHz to 31.8 GHz
R&S®SMAB-B140	8 kHz to 40 GHz
R&S®SMAB-B140N	8 kHz to 40 GHz, limited minimum pulse width
R&S®SMAB-B150	8 kHz to 50 GHz
R&S®SMAB-B150N	8 kHz to 50 GHz, limited minimum pulse width
R&S®SMAB-B167	8 kHz to 67 GHz
R&S®SMAB-B167N	8 kHz to 67 GHz, limited minimum pulse width



Configurator



Videos



Product site

R&S® SMB100A MICROWAVE SIGNAL GENERATOR

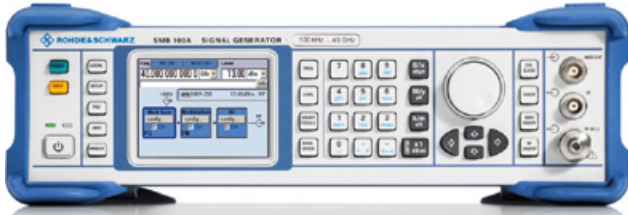

Versatile, compact solution for signal generation up to 40 GHz; 170 GHz with upconverter

The compact, versatile R&S®SMB100A microwave signal generator with a frequency range up to 40 GHz provides outstanding spectral purity and high output power. In addition, it features easy operation, comprehensive functionality and low cost of ownership.

For even higher frequencies, the frequency range of the R&S®SMB100A can be easily extended with the R&S®SMZ frequency multiplier. The R&S®SMB100A plus R&S®SMZ solution combines easy handling with precise, adjustable output levels in the frequency range from 50 GHz to 110 GHz (adjustable output levels are not possible with R&S®SMZ170).

Key facts

- ▶ Wide frequency range from 100 kHz up to 40 GHz
- ▶ Excellent signal characteristics with low SSB phase noise of typ. -128 dBc (at 1 GHz, 20 kHz offset)
- ▶ High output power of up to $+27$ dBm (meas.)
- ▶ All important analog modulations with AM, FM/φM and pulse modulation supported
- ▶ Optional internal low harmonic filters for the 20 GHz and 40 GHz model to lower the harmonics to less than -50 dBc for frequencies above 150 MHz

Benefits

- ▶ All-purpose signal source
- ▶ Best signal quality in the mid-range
- ▶ High output power and wide level range
- ▶ Ideal for production
- ▶ Ready for aerospace and defense applications
- ▶ Flexible service concept

Models R&S®SMB100A and RF path/frequency option

R&S®SMB-B112	100 kHz to 12.75 GHz, with electronic step attenuator
R&S®SMB-B112L	100 kHz to 12.75 GHz, without step attenuator
R&S®SMB-B120	100 kHz to 20 GHz, with mechanical step attenuator
R&S®SMB-B120L	100 kHz to 20 GHz, without step attenuator
R&S®SMB-B131	100 kHz to 31.8 GHz, with mechanical step attenuator
R&S®SMB-B140	100 kHz to 40 GHz, with mechanical step attenuator
R&S®SMB-B140N	100 kHz to 40 GHz, with mechanical step attenuator, minimum pulse width limited
R&S®SMB-B140L	100 kHz to 40 GHz, without step attenuator



Test setup containing the R&S®SMB100A microwave signal generator (20 GHz or 40 GHz model) and the R&S®SMZ110 frequency multiplier with built-in electronically controlled attenuator.



R&S® SMB100B RF SIGNAL GENERATOR



Perfect combination of performance and usability in a compact size

The new R&S®SMB100B RF signal generator is all about performance and versatility in a small footprint. Outstanding spectral purity and very high output power combined with comprehensive functionality and very simple operation are some of the impressive features of the R&S®SMB100B.

Key facts

- ▶ Frequency range from 8 kHz to 1 GHz, 3 GHz or 6 GHz
- ▶ Outstanding single sideband (SSB) phase noise of -134 dBc (meas.) at 1 GHz and an offset of 20 kHz
- ▶ Very low wideband noise of typ. -153 dBc at $15 \text{ MHz} < f \leq 6 \text{ GHz}$ and an offset of 30 MHz
- ▶ Ultra high output power of 34 dBm (meas.) at 1 GHz
- ▶ Compact form factor with 2 HU and $\frac{3}{4}$ 19" width
- ▶ Large, state-of-the-art 5" GUI with touchscreen

Perfect for signal quality

- ▶ Very low SSB phase noise of -134 dBc (meas.) at 1 GHz and an offset of 20 kHz
- ▶ Very low close-in SSB phase noise of -94 dBc (meas.) at 1 GHz and offset of 10 Hz

- ▶ Very low wideband noise of typ. -153 dBc at $15 \text{ MHz} < f \leq 6 \text{ GHz}$ and an offset of 30 MHz
- ▶ Very low nonharmonic signal components of < -76 dBc (spec.) at 1 GHz

Perfect for output power

- ▶ The R&S®SMBB-K31 high output power option provides 28 dBm at 1 GHz and 24 dBm at 6 GHz (measured values) – easy keycode activation
- ▶ Ultra high output power of 34 dBm at 1 GHz and 31 dBm at 6 GHz with additional R&S®SMBB-B32 ultra high output power option (measured values)

Perfect for use

- ▶ Ergonomic operation thanks to state-of-the-art GUI with touchscreen
- ▶ Support of R&S®NRP power sensors and display of measured power on the generator display
- ▶ Easy integration into existing test environments using versatile reference frequency inputs and outputs
- ▶ Sanitizing of user data for secured areas

R&S®LegacyPro: refresh your T&M equipment

- ▶ R&S®Legacy Pro program: replacement and emulation of obsolete signal generators using the R&S®SMB100B in an automated test environment without modifying the control software

Models

R&S®SMB100B + R&S®SMBB-B101	8 kHz to 1 GHz
R&S®SMB100B + R&S®SMBB-B103	8 kHz to 3 GHz
R&S®SMB100B + R&S®SMBB-B106	8 kHz to 6 GHz

The main screen with all important parameters and information

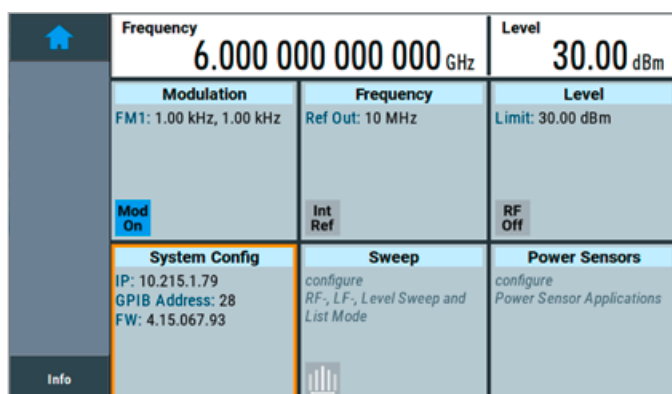

Individual menu items can be added to the user menu. Added items are marked with a blue star.

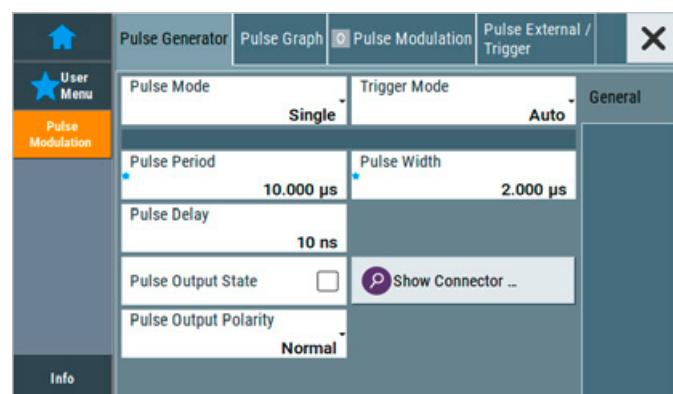

Configurator



Videos



Product site

R&S® SMC100A SIGNAL GENERATOR



Flexible and universal all-purpose signal generator

The R&S®SMC100A offers outstanding signal quality at an attractive price. It covers the frequency range from 9 kHz to 1.1 GHz or 3.2 GHz. Output power is typ. > +17 dBm. All important functions (AM, FM, φM, PM) are already integrated in the instrument. This makes the R&S®SMC100A signal generator a flexible and versatile instrument.

Key facts

- ▶ Smallest size and best price/performance ratio in its class
- ▶ Frequency range from 9 kHz to 1.1 GHz/3.2 GHz
- ▶ Maximum output level of typ. > +17 dBm
- ▶ AM/FM/φM/PM provided as standard
- ▶ Integrated overvoltage protection
- ▶ Wear-free electronic attenuator
- ▶ Minimized total cost of ownership

Ideal tool for many application fields

- ▶ Service and maintenance
- ▶ Research and education
- ▶ Field use
- ▶ Secure areas
- ▶ Simple production applications

High performance at an attractive price

- ▶ Low SSB phase noise of typ. -111 dBc (f = 1 GHz, 20 kHz carrier offset, 1 Hz measurement bandwidth)
- ▶ Wideband noise of typ. < -146 dBc (f > 1 MHz, carrier offset > 10 MHz, 1 Hz measurement bandwidth)
- ▶ Nonharmonics of typ. < -72 dBc (f ≤ 1600 MHz, carrier offset > 10 kHz)
- ▶ Level error < 0.9 dB
- ▶ Frequency and level setting times < 5 ms
- ▶ Optional high-stability reference oscillator

Flexible and universal all-purpose signal generator

- ▶ Frequency range 9 kHz to 1.1 GHz or 3.2 GHz
- ▶ Typical maximum level of > +17 dBm
- ▶ Analog modulation modes (AM/FM/φM/pulse modulation) integrated as standard
- ▶ Remote control compatibility with other signal generators
- ▶ Multiple language support (nine selectable GUI languages)
- ▶ Integrated overvoltage protection
- ▶ Wear-free electronic attenuator

Space-saving operation due to small dimensions

- ▶ Smallest signal generator in the economy class: ½ 19", 2 HU
- ▶ Lightweight

Minimized total cost of ownership

- ▶ Attractive initial cost
- ▶ Long calibration interval
- ▶ Simplified error diagnostics through built-in selftests
- ▶ Repair by users by means of precalibrated replacement modules
- ▶ Optimization of level accuracy through level correction with R&S®NRP power sensors

R&S®SMC100A graphical user interface

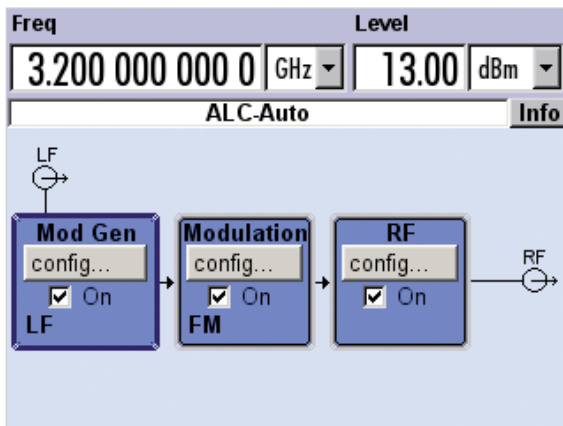

Models

R&S®SMC100A + R&S®SMC-B101	9 kHz to 1.1 GHz
R&S®SMC100A + R&S®SMC-B101	9 kHz to 3.2 GHz

R&S®SMC100A rear view with optional R&S®SMC-K4 GPIB interface and R&S®SMC-B1 OCXO option



R&S® SMZ FREQUENCY MULTIPLIER



Precise output levels from 50 GHz to 170 GHz

The R&S®SMZ family of frequency multipliers combines easy handling and precise output levels in the frequency range from 50 GHz to 170 GHz. It can be used in diverse applications, e.g. in the automotive sector with distance radars, in astronomy with sophisticated telescopes and in radar interferometry for analyzing the earth's surface.

The family of frequency multipliers consists of four models R&S®SMZ75/90/110/170 as well as optional attenuators (the attenuator is not available for R&S®SMZ170). The attenuator is integrated into the same housing as the frequency multiplier, which simplifies handling. The R&S®SMZ can be controlled via USB in different ways. The most convenient way is to use the R&S®SMZ together with the R&S®SMF100A or R&S®SMB100A microwave signal generator.

Key facts

- ▶ Wide frequency range
- ▶ Wide dynamic range
- ▶ Convenient easy handling
- ▶ High signal quality

Wide frequency range

- ▶ Frequency ranges from 50 GHz to 75 GHz, 60 GHz to 90 GHz, 75 GHz to 110 GHz and 110 GHz to 170 GHz

Models	
R&S®SMZ75	frequency multiplier, 50 GHz to 75 GHz
R&S®SMZ-B75M	mechanically controlled attenuator
R&S®SMZ-B75E	electronically controlled attenuator (via USB)
R&S®SMZ90	frequency multiplier, 60 GHz to 90 GHz
R&S®SMZ-B90M	mechanically controlled attenuator
R&S®SMZ-B90E	electronically controlled attenuator (via USB)
R&S®SMZ110	frequency multiplier, 75 GHz to 110 GHz
R&S®SMZ-B110M	mechanically controlled attenuator
R&S®SMZ-B110E	electronically controlled attenuator (via USB)
R&S®SMZ170	frequency multiplier, 110 GHz to 170 GHz



Videos



Product site

- ▶ Two models (R&S®SMZ75 and R&S®SMZ110) cover the wide frequency range from 50 GHz to 110 GHz

Wide dynamic range

- ▶ Mechanically controlled attenuator with a dynamic range of 25 dB
- ▶ Electronically controlled attenuator with a dynamic range of 15 dB

Easy handling

- ▶ Automatic detection and control of the R&S®SMZ by means of the R&S®SMF100A or R&S®SMB100A microwave signal generator via USB
- ▶ Easy setups with the one-box solution consisting of the R&S®SMF100A or R&S®SMB100A, the R&S®SMZ plus an optional mechanically or electronically controlled attenuator (the attenuators are not available for the R&S®SMZ170)
- ▶ Frequency setting on the R&S®SMF100A or R&S®SMB100A taking the connected R&S®SMZ into consideration
- ▶ Level setting on the R&S®SMF100A or R&S®SMB100A taking the connected R&S®SMZ into consideration (only for built-in attenuator)¹⁾
- ▶ Automatic frequency response correction of the precalibrated R&S®SMZ including attenuator by means of the R&S®SMF100A or R&S®SMB100A¹⁾
- ▶ Use of the R&S®SMZ also possible with any microwave signal generator that meets the level and frequency requirements; for the convenient operation of this setup the external PC software (R&S®SMZ-K1) can be used
- ▶ For frequency-, phase- and pulse-modulated signals

High signal quality

- ▶ Very low single sideband phase noise when the R&S®SMF100A is used as a source
- ▶ High accuracy of the set output level
- ▶ Excellent matching

¹⁾ With the mechanical attenuator, users must set the setting screw to the value displayed on the R&S®SMF100A or R&S®SMB100A



The R&S®SMZ110 with the mechanically controlled attenuator (R&S®SMZ-B110M option)

R&S® AFQ100A I/Q MODULATION GENERATOR, R&S® AFQ100B UWB SIGNAL AND I/Q MODULATION GENERATOR



High-performance baseband signals

Whether in the commercial or aerospace and defense field, customers require excellent signal quality, speed and high flexibility when selecting a signal source. Besides, there is a growing need for development and testing in the digital baseband domain. The signals to be created are increasingly complex and dynamic. They use complex modulation schemes and demand more and more bandwidth.

R&S® AFQ100A – fit for digital communications systems

- ▶ Variable memory clock rate (1 kHz to 300 MHz) can optimally be adjusted to the useful signal
- ▶ RF bandwidth of 200 MHz, e.g. for compensating higher-order non-linearities of multicarrier power amplifiers
- ▶ Long signal duration of up to 1 Gsample (R&S® AFQ-B11 option). Long signals are needed e.g. for bit error ratio (BER) measurements
- ▶ R&S® WinIQSIM2™ options for communications standards such as WiMAX, LTE, HSPA

R&S® AFQ100B – tailored to UWB applications

- ▶ Memory clock rate:
 - Standard mode (mode 1): variable clock rate (1 kHz to 300 MHz) can optimally be adjusted to the useful signal
 - Broadband mode (mode 2): very high clock rate of 600 MHz
- ▶ RF bandwidth:
 - Standard mode (mode 1): 200 MHz
 - Broadband mode (mode 2): 528 MHz (especially suited for UWB applications)

- ▶ Long signal duration of up to 1 Gsample (R&S® AFQ-B11 option). Long signals are needed, for example, when using multisegment waveforms to reduce switching times between different test signals
- ▶ R&S® WinIQSIM2™ option for flexible UWB (ECMA-368) signal generation (R&S® AFQ-K264)

R&S® AFQ100A and R&S® AFQ100B shared features

Aerospace and defense applications

- ▶ High bandwidth for generating very short pulses with short rise and fall times
- ▶ Accuracy < 20 ps when starting several instruments simultaneously for phased-array antenna development and testing
- ▶ Removable hard disk to meet high security requirements

Outstanding signal quality

- ▶ Excellent spurious-free dynamic range (SFDR) of up to typ. 83 dBc
- ▶ Frequency response of typ. 0.1 dB across 100 MHz I/Q bandwidth
- ▶ Frequency response compensation
- ▶ Very pure sine-wave source

Broad scope of applications

- ▶ Analog I/Q outputs (balanced and unbalanced), e.g. for D/A and A/D converter tests
- ▶ Multisegment waveform for reducing switching time between different test signals
- ▶ Numerous trigger and marker capabilities
- ▶ Optional BER measurements for characterizing receivers

Easy creation of test signals

- ▶ Digital standards using R&S® WinIQSIM2™
- ▶ MATLAB Transfer Toolbox for easy interoperability with MATLAB®
- ▶ ARB Toolbox for converting numeric I/Q data into R&S® AFQ waveform files

Models	
R&S® AFQ100A	I/Q modulation generator
+ R&S® AFQ-B10	waveform memory 256 Msample
+ R&S® AFQ-B11	wWaveform memory 1 Gsample
R&S® AFQ100B	UWB signal and I/Q modulation generator
+ R&S® AFQ-B11	waveform memory 1 Gsample
+ R&S® AFQ-B12	waveform memory 512 Msample

R&S® AFQ100A and R&S® AFQ100B can be remote-controlled via GPIB (IEC/IEEE bus), USB and LAN (Gigabit Ethernet)



R&S® HMF2525/HMF2550 ARBITRARY FUNCTION GENERATORS



Accurate, versatile and affordable

- ▶ Two models: R&S®HMF2525 with 25 MHz and R&S®HMF2550 with 50 MHz maximum frequency
- ▶ 14-bit resolution and 8 ns rise time
- ▶ Besides standard waveforms such as sine, rectangle and triangle, the instruments provide powerful arbitrary signal functionality. In addition to predefined signal shapes such as $\sin(x)/x$, white or pink noise, they can also output customer-specific, arbitrary curve shapes with a signal length of up to 256 ksample
- ▶ The burst, sweep, gating, internal and external triggering operating modes and the AM, FM, PM, PWM and FSK modulation functions (in each case internal and external) can be applied on all signals

Key facts

- ▶ Frequency range: 10 μ Hz to 25/50 MHz
- ▶ Triangle waveforms up to 10 MHz

- ▶ Output voltage: 5 mV to 10 V (V_{pp}) (into 50 Ω)
- ▶ Total harmonic distortion of 0.04 % ($f < 100$ kHz)
- ▶ Waveforms: sine, square, triangle/ramp, pulse, arbitrary (incl. predefined waveforms such as white/pink noise, cardinal sine, exponential rise/fall)
- ▶ Modulation modes: AM, FM, PWM, FSK (internal and external)
- ▶ External connectors: TRIGGER (I/O), SWEEP (O), MODULATION (I)
- ▶ External reference input/output (10 MHz) via BNC connector
- ▶ Arbitrary waveform generator: 250 Msample/s, 14 bit, 256 kpoints
- ▶ Oscillographic signal display in realtime
- ▶ Front USB connector to easily save and recall waveforms and settings
- ▶ USB/RS-232 dual interface for remote control
- ▶ Fanless design

Rear view with R&S®H0720 dual-interface, alternatively with optional R&S®H0740 IEEE-488 (GPIB) interface



Model overview						
Model	Frequency range	Output voltage	Total harmonic distortion	Arbitrary waveform vertical resolution	Arbitrary waveform signal memory length	Interface
R&S®HMF2525	10 μ Hz to 25 MHz	5 mV to 10 V (V_{pp}) (into 50 Ω) 10 mV to 20 V (V_{pp}) (open circuit)	typ. 0.04 % ($f \leq 100$ kHz)	14 bit	up to 256k points	dual-interface USB/RS-232, opt. LAN/USB or GPIB
R&S®HMF2550	10 μ Hz to 50 MHz	5 mV to 10 V (V_{pp}) (into 50 Ω) 10 mV to 20 V (V_{pp}) (open circuit)	typ. 0.04 % ($f \leq 100$ kHz)	14 bit	up to 256k points	dual-interface USB/RS-232, opt. LAN/USB or GPIB

Signal examples

Frequency shift keying (FSK)

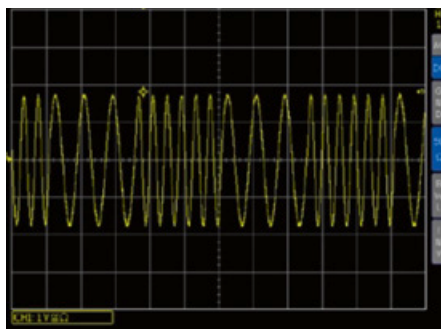

Amplitude modulation (AM)

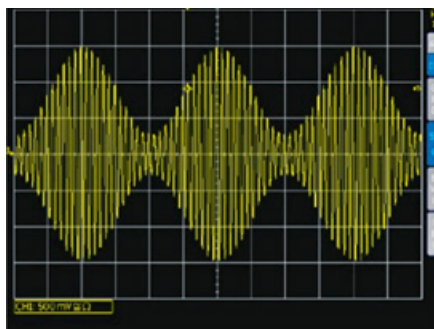

Pulse width modulation (PWM)

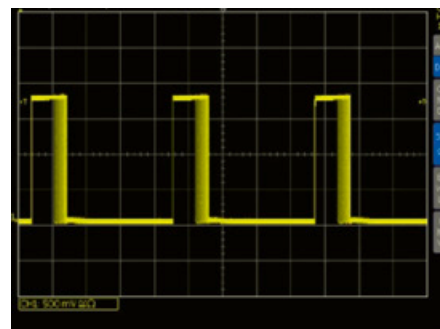

Product site

R&S® HM8150 ARBITRARY FUNCTION GENERATOR



Versatile and price convenient

- ▶ Waveforms: sine wave, square wave, triangle, pulse, sawtooth, arbitrary
- ▶ Rise and fall time: < 10 ns
- ▶ Pulse width adjustment: 100 ns to 80 s
- ▶ Arbitrary waveform generator: 40 Msample/s
- ▶ Burst, gating, external triggering, sweep
- ▶ Free of charge software to program arbitrary waveforms
- ▶ External amplitude modulation (bandwidth 20 kHz)
- ▶ Intuitive operation with one touch of a button – quick change of signals

Options

R&S®HO880	IEEE-488 (GPIB) interface
R&S®HZ42	19" rack adapter, 2 HU

Key facts

- ▶ Frequency range: 10 mHz to 12.5 MHz
- ▶ Output voltage: 10 mV to 10 V (V_{pp}) (into 50 Ω)
- ▶ Waveforms: sine wave, square wave, triangle, pulse, sawtooth, arbitrary
- ▶ Rise and fall time: < 10 ns
- ▶ Pulse width adjustment: 100 ns to 80 s
- ▶ Arbitrary waveform generator: 40 Msample/s
- ▶ Burst, gating, external triggering, sweep
- ▶ External amplitude modulation (bandwidth 20 kHz)
- ▶ Intuitive operation with one touch of a button – quick change of signals
- ▶ USB/RS-232 dual-interface, optional IEEE-488 (GPIB) interface

Rear view with R&S®H0720 Dual-Interface, alternatively with optional R&S®H0880 IEEE-488 (GPIB) interface



Models overview

Model	Frequency range	Voltage output	Total harmonic distortion	DC offset	Arbitrary waveform resolution
R&S®HM8150	10 mHz to 12.5 MHz	<ul style="list-style-type: none"> ▶ 10 mV to 10 V (V_{pp}) (into 50 Ω) ▶ 20 mV to 20 V (V_{pp}) (open circuit) 	typ. 0.05% ($f < 100$ kHz)	± 75 mV to $+7.5$ V	12 bit



APPLICATION FIRMWARE PACKAGES FOR ROHDE & SCHWARZ SIGNAL GENERATORS

The tables provide an overview of the digital modulation systems supported by Rohde & Schwarz signal generators and show the wide range of applications covered.

Digital standards and options for Rohde & Schwarz signal generators (internal signal generation)				
Option R&S®SMW R&S®SMBVB		R&S®SMW200A	R&S®SMBV100B	Page
-K40	GSM/EDGE	•	•	117
-K41	EDGE Evolution (incl. VAMOS)	•	•	117
-K42	3GPP FDD ¹⁾	•	•	117
-K44	GPS	•	•	123
-K46	CDMA2000®	•	•	119
-K47	1xEV-DO Rev. A	•	•	119
-K50	TD-SCDMA ¹⁾	•	•	117
-K51	TD-SCDMA enhanced BS/MS tests ¹⁾	•	•	117
-K52	DVB-H/DVB-T	•	–	–
-K54	IEEE802.11 (a/b/g/n/j/p)	•	•	120
-K55	LTE Release 8	•	•	117
-K60	Bluetooth® 4.2 (incl. EDR, low energy)	•	•	121
-K61	Multicarrier CW signal generation	•	•	–
-K62	Additive white Gaussian noise (AWGN)	•	•	123
-K66	Galileo	•	•	123
-K68	TETRA Release 2	•	–	123
-K69	LTE closed-loop BS test	•	–	117
-K71	Dynamic fading and enhanced resolution	•	–	117
-K72	Extended statistics functions	•	–	117
-K73	OTA-MIMO fading enhancements	•	–	117
-K74	MIMO fading	•	–	117
-K75	Higher order MIMO	•	–	117
-K76	Multiple entities	•	–	117
-K78	Radar echo generation	•	–	123
-K80	Bit error rate tester	•	–	–
-K81	LTE log file generation	•	–	117
-K83	3GPP FDD HSPA/HSDPA+, enhanced BS/MS tests	•	•	117
-K84	LTE Release 9 and enhanced features	•	•	117
-K85	LTE Release 10 (LTE-Advanced)	•	•	117
-K86	IEEE802.11ac	•	•	120
-K87	1xEV-DO Rev. B	•	•	119
-K89	NFC A/B/F	•	•	121
-K94	GLONASS	•	•	123
-K98	Modernized GPS	•	•	123
-K106	SBAS/QZSS	•	•	123
-K107	BeiDou	•	•	123
-K108	Real world scenarios	•	•	–
-K109	GNSS realtime interfaces (RT remote control)	•	•	–
-K111	GBAS	–	•	–
-K112	LTE Release 11 and enhanced features	•	•	117
-K113	LTE Release 12	•	•	117
-K114	OFDM signal generation	•	•	122

Signal generators

Digital standards and options for Rohde & Schwarz signal generators (internal signal generation)				
Option R&S®SMW R&S®SMBVB		R&S®SMW200A	R&S®SMBV100B	Page
-K115	Cellular IoT	•	•	118
-K116	DVB-S2/DVB-S2X	•	–	125
-K117	Bluetooth® 5.x	•	•	121
-K118	Verizon 5GTF signals	•	–	–
-K119	LTE Release 13/14/15	•	•	118
-K120	Advanced GNSS applications	•	–	–
-K130	OneWeb user-defined signal generation	•	–	125
-K131	LoRa®	•	•	121
-K133	Single-satellite GNSS	–	•	–
-K134	Upgrade to dual-frequency GNSS	–	•	–
-K135	Upgrade to triple-frequency GNSS	–	•	–
-K136	Add 6 GNSS channels	–	•	–
-K137	Add 12 GNSS channels	–	•	–
-K141	IEEE 802.11ad	•	–	117
-K142	IEEE 802.11ax	•	•	120
-K143	Cellular IoT Release 14	•	–	118
-K144	5G New Radio	•	•	117
-K146	Cellular IoT Release 15	•	•	118
-K151	ILS	–	•	–
-K152	VOR	–	•	–
-K153	DME	–	•	–
-K355	OneWeb reference signals	•	–	–
-K360	ERA-GLONASS test suite	•	•	–
-K361	eCall test suite	•	•	–
-K542	Baseband power sweep	•	–	–
-K550	Stream extender	•	–	–
-K820	Customized dynamic fading	•	–	117
-K821	MIMO subsets for higher-order MIMO	•	–	117

¹⁾ Functionality is instrument-specific.

• Available – Not usable

Digital standards and options for Rohde & Schwarz signal generators (R&S®WinIQSIM2™ – see page 122)							
Option R&S®SMW R&S®SMBVB R&S®SGT R&S®AFQ		R&S®SMW200A	R&S®SMBV100B	R&S®SGT100A	R&S®AFQ100A	R&S®AFQ100B	Page
-K240	GSM/EDGE	•	•	•	•	•	119
-K241	EDGE Evolution (incl. VAMOS)	•	•	•	•	•	119
-K242	3GPP FDD	•	•	•	•	•	118
-K243	3GPP enhanced BS/MS tests incl. HSDPA	–	–	–	•	•	118
-K244	GPS ²⁾	•	•	•	•	•	123
-K245	3GPP FDD HSUPA	–	–	–	•	•	118
-K246	CDMA2000®	•	•	•	•	•	119
-K247	1xEV-DO Rev. A	•	•	•	•	•	119
-K248	IEEE 802.11 (a/b/g)	•	•	•	•	•	120
-K249	IEEE 802.16	•	–	•	•	•	–
-K250	TD-SCDMA	•	•	•	•	•	119
-K251	TD-SCDMA enhanced BS/MS test	•	•	•	•	•	119
-K252	DVB-H/DVB-T	•	•	•	•	•	–
-K253	DAB/T-DMB	•	•	•	•	•	–
-K254	IEEE 802.11 (a/b/g/n/j/p)	•	•	•	•	•	120
-K255	LTE	•	•	•	•	•	117
-K259	HSPA+	–	–	–	•	•	117
-K260	Bluetooth® (incl. EDR, low energy)	•	•	•	•	•	121
-K261	Multicarrier CW	•	•	•	•	•	–
-K262	Additive white Gaussian noise (AWGN)	•	•	•	•	•	123
-K264	ECMA-368 IEEE 802.15.3a (UWB)	–	–	–	–	•	–
-K266	Galileo ²⁾	•	•	•	•	•	123
-K268	TETRA Release 2	•	–	•	•	•	120
-K283	3GPP FDD HSPA/HSDPA+, enhanced BS/MS tests	•	•	•	–	–	117
-K284	LTE Release 9 and enhanced features	•	•	•	•	•	117
-K285	LTE Release 10/LTE-Advanced	•	•	•	•	•	117
-K286	IEEE 802.11ac	•	•	•	•	•	117
-K287	1xEV-DO Rev. B	•	•	•	•	•	119
-K289	NFC A/B/F	•	•	•	•	•	121
-K294	GLONASS ²⁾	•	•	•	•	•	123
-K298	Modernized GPS ²⁾	•	•	•	–	–	123
-K407	BeiDou ²⁾	•	•	•	–	–	123
-K412	LTE Release 11 and enhanced features	•	•	•	•	•	117
-K413	LTE Release 12	•	•	•	•	•	117
-K414	OFDM signal generation	•	•	•	–	–	122
-K415	Cellular IoT	•	•	•	•	•	118
-K416	DVB-S2/DVB-S2X	•	•	•	–	–	125
-K417	Bluetooth® 5.x	•	•	•	–	–	121
-K418	Verizon 5GTF	•	•	•	•	•	–
-K419	LTE Release 13/14/15	•	•	•	•	•	118
-K430	OneWeb user-defined signal generation	•	–	–	–	–	125
-K441	IEEE 802.11ad	•	–	–	–	–	117
-K442	IEEE 802.11ax	•	•	•	•	•	120
-K443	Cellular IoT Release 14	•	•	•	–	–	118
-K444	5G New Radio	•	•	•	–	–	117
-K446	Cellular IoT Release 15	•	•	•	–	–	118

Signal generators

Digital standards and options for Rohde & Schwarz signal generators (external PC software or waveforms)							
Option R&S®SMW R&S®SMBVB R&S®SGT R&S®AFQ		R&S®SMW200A	R&S®SMBV100B	R&S®SGT100A	R&S®AFQ100A	R&S®AFQ100B	Page
-K256	Playback of XM radio waveforms	-	-	-	•	•	-
-K300	Pulse sequencer	•	•	•	-	-	126
-K301	Enhanced pulse sequencer	•	•	•	-	-	126
-K304	Moving emitters and receivers	•	-	-	-	-	126
-K306	Multiple emitters	•	-	-	-	-	126
-K308	Direction finding	•	•	•	-	-	124
-K315	Pulse on pulse simulation	•	-	-	-	-	127
-K350	DFS signal generation	•	•	•	-	-	127
-K352	Playback of HD Radio™ waveforms	-	-	-	•	•	-
-K353	DAB+ streams	-	-	-	-	-	-
-K354	T-DMB/DAB streams	-	-	-	-	-	-
-K355	OneWeb reference signals	•	-	-	-	-	-
-K501	Extended sequencing	•	-	-	-	-	124
-K502	Wideband extended sequencing	•	-	-	-	-	124
-K503	Realtime control interface	•	-	-	-	-	124
-K504	Extended pulse rate	•	-	-	-	-	124

²⁾ One satellite only.

• Available - Not usable

APPLICATION-SPECIFIC SOLUTIONS

General measurement applications

xxx-K144 5G New Radio (internal)

xxx-K444 5G New Radio (R&S®WinIQSIM2™)

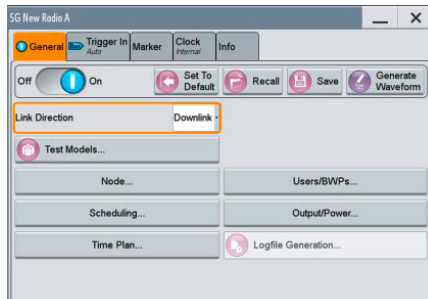

5G New Radio

The 5G NR software option (xxx-K144, xxx-K444) simplifies uplink and downlink 5G NR signal configuration. It supports all waveforms, channel bandwidths, modulation schemes and numerology options specified in the standards. The intuitive GUI allows configuring these and many other parameters, such as bandwidth parts, directly on the instrument.

Predefined settings are also available to configure specific test signals quickly.

Key facts

- ▶ All supported features are in line with 3GPP Release 15
- ▶ Downlink and uplink (CP-OFDM and DFT-S-OFDM)
- ▶ All numerologies
- ▶ All channel bandwidths
- ▶ Sync (SS/PBCH)
- ▶ Support of multi-bandwidth part (BWP)
- ▶ Channel coding and PDSCH/PUSCH spatial multiplexing
- ▶ Presets for test models and FRCs
- ▶ CORESETs with DMRS
- ▶ Time plan
- ▶ Filtering per carrier or per BWP

xxx-K55/-K69/-K81/-K84/-K85/-K112/-K113 LTE Release 9/10/11/12 (internal)

xxx-K255/-K284/-K285/-K412/-K413 LTE Release 9/10/11/12 (R&S®WinIQSIM2™)

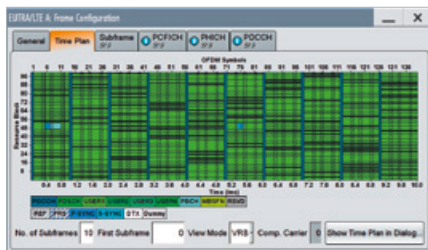

xxx-K55 LTE uplink functionality

- ▶ PUSCH incl. channel coding, scrambling and multiplexing
- ▶ PUCCH, PRACH
- ▶ Demodulation and sounding reference signals
- ▶ PUSCH frequency hopping type 1 and type 2
- ▶ Group and sequence hopping

R&S®SMW-K69

(together with R&S®SMW-K55)

- ▶ Support of uplink closed-loop base station tests in line with 3GPP TS36.141
- ▶ Realtime processing of feedback commands for HARQ feedback, timing adjustment and timing advance

R&S®SMW-K81

(together with R&S®SMW-K55)

- ▶ Output of log files with intermediate results (bits/symbols) from the signal generation chain
- ▶ Generation of summary log files with LTE signal description

xxx-K84 (together with xxx-K55)

- ▶ In line with 3GPP LTE Release 9
- ▶ MBMS/MBSFN subframes including PMCH
- ▶ Downlink positioning reference signals (PRS)
- ▶ Dual-layer beamforming (TX mode 8)
- ▶ Mapping of logical antenna ports to physical TX antennas

xxx-K85 (together with xxx-K55)

- ▶ In line with 3GPP LTE Release 10/ LTE-Advanced
- ▶ Carrier aggregation
- ▶ Enhanced SC-FDMA
- ▶ PUSCH/PUCCH synchronous transmission
- ▶ Clustered PUSCH
- ▶ PUCCH format 3
- ▶ Generation of CSI reference signals
- ▶ Eight-layer transmission (TX mode 9)
- ▶ UL-MIMO

xxx-K112 (together with xxx-K55)

- ▶ In line with 3GPP LTE Release 11
- ▶ TDD special subframe configurations
- ▶ DL auto sequence (enhanced Auto DCI)

xxx-K113 (together with xxx-K55)

- ▶ In line with 3GPP LTE Release 12
- ▶ LTE FDD and TD-LTE support
- ▶ Uplink and downlink signal generation
- ▶ 256QAM in downlink

LTE receiver and performance testing

The LTE signal generation options allow comprehensive LTE testing of base stations, mobile devices, modules and components.

xxx-K55, general features

- ▶ In line with 3GPP LTE Release 8
- ▶ FDD and TDD
- ▶ Downlink (OFDMA) and uplink (SC-FDMA)

xxx-K55 LTE downlink functionality

- ▶ PBCH, PDSCH, PDCCH, PCFICH, PHICH
- ▶ Full MIMO and TX diversity support
- ▶ P-SYNC, S-SYNC and DL reference signals
- ▶ Channel coding and scrambling for PDSCH/PBCH
- ▶ Predefined test models
- ▶ LTE test case wizard

General measurement applications

xxx-K119 LTE Release 13/14/15 (internal)
xxx-K419 LTE Release 13/14/15 (R&S®WinIQSIM2™)

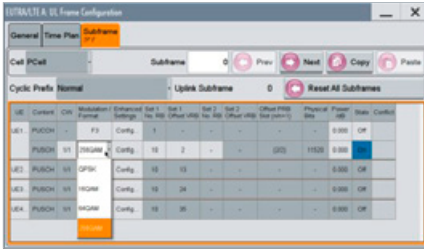

The releases incorporate important technological steps on the evolution path from LTE to 5G, such as further carrier aggregation enhancements, licensed assisted access (LAA) or 256QAM in uplink direction.

By means of the xxx-K119 option vector signal generators from Rohde&Schwarz generate physical layer signals in line with 3GPP LTE Releases 13 and 14.

The xxx-K119 option requires the xxx-K55 LTE option. Downlink SCell LAA functionality additionally requires xxx-K85 option.

Key facts

- ▶ In line with 3GPP LTE Release 13, 14 and 15
- ▶ LTE FDD and TD-LTE support
- ▶ Uplink and downlink signal generation
- ▶ 256QAM in uplink for PUSCH
- ▶ 1024QAM in downlink for PDSCH
- ▶ Frame structure type 3 for downlink licensed assisted access (LAA)
- ▶ Discovery reference signal (DRS) for downlink licensed assisted access (LAA)
- ▶ DCI format 1C support for downlink licensed assisted access (LAA)
- ▶ Cellular V2X

LTE Release 13/14/15

The additions in 3GPP LTE Releases 13, 14 and 15 – also referred to as “LTE-Advanced Pro” – further enhance the LTE standard to improve its overall efficiency.

xxx-K115/-K143/-K146 Cellular IoT (internal)
xxx-K415/-K443/-K446 Cellular IoT (R&S®WinIQSIM2™)

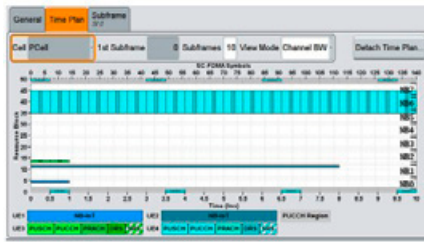

xxx-K115 Cellular IoT

- ▶ Generation of eMTC and NB-IoT uplink and downlink signals in line with LTE Release 13
- ▶ eMTC mode: in-band
- ▶ SCFDMA 15 kHz tone spacing
- ▶ NB-IoT mode
 - In-band; guard band; standalone
 - Single tone, 15 kHz/3.75 kHz
 - SCFDMA 15 kHz tone spacing
- ▶ Frequency hopping

xxx-K146 Cellular IoT Release 15 (together with xxx-K115)

- ▶ Generation of eMTC and NB-IoT uplink and downlink signals in line with LTE Release 15 for eMTC and NB-IoT
- ▶ TDD for all NB-IoT operational modes
- ▶ NPRACH Format 2
- ▶ Early data transmission
- ▶ Wake up signals

xxx-K143 Cellular IoT Release 14 (together with xxx-K115)

- ▶ Generation of eMTC and NB-IoT uplink and downlink signals in line with LTE Release 14
- ▶ New PUSCH TBS sizes
- ▶ Wider bandwidth in CE mode

xxx-K42/-K83 3GPP FDD/HSPA/HSPA+ (internal)
xxx-K242/-K243/-K245/-K259/-K283 3GPP FDD/HSPA/HSPA+ (R&S®WinIQSIM2™)

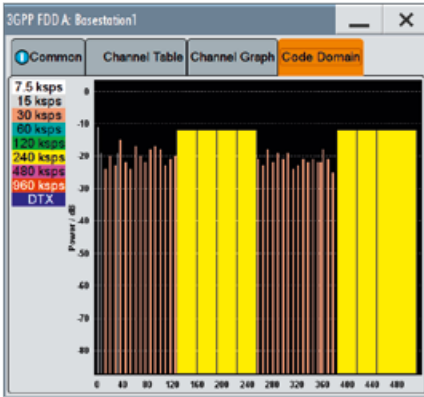

3GPP signal generation

These options provide signal generation capabilities in line with 3GPP FDD Release 11, including HSDPA, HSUPA and HSPA+.

The options combine realtime operation and arbitrary waveform mode for realtime generation of the P-CCPCH and up to three DPCHs in the downlink, for example. In the uplink, one UE can be simulated in realtime; up to 128 UEs can be simulated via the ARB and added to the realtime signal.

The xxx-K83 HSPA+ option supports higher-order modulation (64QAM) for higher data rates, multiple input multiple output (MIMO) for higher data throughput in the downlink and continuous packet connectivity (CPC) for reduction of latency and control information overhead.

The R&S®SMW-K83 combines the functionality of the R&S®SMBVB-K43/-K45 and R&S®SMBVB-K59 in one option for the R&S®SMW200A

General measurement applications

xxx-K40/-K41 GSM/EDGE/EDGE Evolution (internal)

xxx-K240/-K241 GSM/EDGE/EDGE Evolution (R&S®WinIQSIM2™)

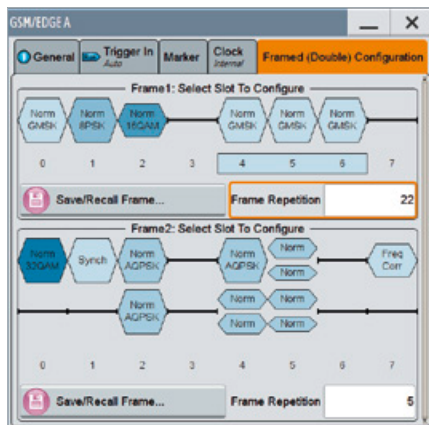

GSM/EDGE signal generation

With the xxx-K40 option, GSM/EDGE signals can be generated in realtime, whereas the type of modulation can be changed from slot to slot. In addition, eight different power levels can be defined for the timeslots. All necessary burst types (e.g. normal (full and half rate), EDGE, synchronization, access) are supported.

The xxx-K41 option adds EDGE Evolution and VAMOS features such as:

- ▶ Higher symbol rate (325 kHz)
- ▶ Higher-order modulation types: 16QAM, 32QAM
- ▶ Mixed frames with GSM, EDGE and EGPRS2 slots in one frame (with same symbol rate per frame)
- ▶ "Framed double" sequence mode for generation of realistic test scenarios with changing frame content
- ▶ Adaptive QPSK (AQPSK) modulation scheme

xxx-K50/-K51 TD-SCDMA (internal)

xxx-K250/-K251 TD-SCDMA (R&S®WinIQSIM2™)

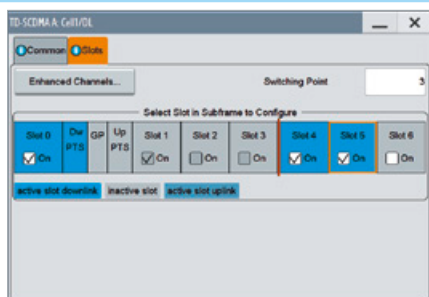

TD-SCDMA signal generation

The combination of the xxx-K50 and -K51 options offers easy, flexible configuration of realtime, fully coded (transport and physical layer) TD-SCDMA (3GPP TDD LCR) test signals for evaluating components, power amplifiers, digital baseband receiver chips and RF receivers in user equipment and base stations. The TD-SCDMA signal generation is in accordance with 3GPP TDD LCR with a chip rate of 1.28 Mcps (low chip rate mode) and contains the HSDPA and HSUPA functionality for TD-SCDMA.

xxx-K51 TD-SCDMA enhanced functionality

xxx-K50 TD-SCDMA functionality

- ▶ Simulation of up to four TD-SCDMA cells with variable switching point of uplink and downlink
- ▶ User-configurable channel table for each slot and simulation of downlink and uplink pilot timeslot
- ▶ PRACH can be generated in the uplink

- ▶ Enhancing R&S®SMW/R&S®SMBVB-K50 to support full channel coding in fixed coding schemes and user-defined coding schemes, HSDPA and HSUPA
- ▶ Simulation of up to four TD-SCDMA cells with generation of the coded P-CCPCH (BCH with running SFN) in the downlink
- ▶ Fixed reference measurement channels RMC 12.2 kbps to RMC 384 kbps in both uplink and downlink; user configuration supported
- ▶ Simulation of HSDPA channels HS-SCCH, HS-PDSCH, HS-SICH and H-RMC 0.5 Mbps, 1.1 Mbps, 1.6 Mbps, 2.2 Mbps, 2.8 Mbps (QPSK and 16QAM), H-RMC 64QAM; user configuration supported
- ▶ Simulation of HSUPA channels E-DCH FRC from 1 to 4 (QPSK and 16QAM); user configuration supported

xxx-K46/-K47/-K87 CDMA2000® incl. 1xEV-DV and 1xEV-DO (internal)

xxx-K246/-K247/-K287 CDMA2000® incl. 1xEV-DV and 1xEV-DO (R&S®WinIQSIM2™)

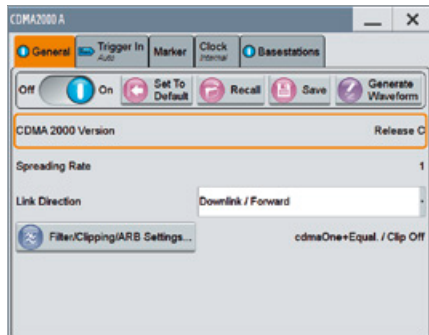

xxx-K46 option for generating CDMA2000® signals

- ▶ Configuration of up to four base stations or four mobile stations
- ▶ All special channels and up to 78 channels in the downlink (depending on radio configuration)
- ▶ Packet channel in line with 1xEV-DV in the downlink
- ▶ Operating modes in the uplink: traffic, access, enhanced access and common control
- ▶ Simulation of up to 64 additional mobile stations
- ▶ All channel coding modes included in IS-2000 (frame quality indicator, convolutional encoder, turbo encoder, symbol puncture, interleaver, etc.)

- ▶ Downlink data rate selectable through rate index and packet size
- ▶ Matrix for reverse power control (RPC) allowing flexible testing of power control
- ▶ Traffic and access mode in the uplink; automatic setting of different data rates and modulations by selected payload size

CDMA2000®, 1xEV-DV and 1xEV-DO signal generation

The xxx-K46 option generates signals for CDMA2000®, the North American standard for the third mobile radio generation including IS-95 as a subset.

xxx-K47 option for generating signals for 1xEV-DO (Rev. A)

- ▶ Simulation of up to four users in the downlink and up to four terminals in the uplink
- ▶ Physical layer subtypes 0 and 1 or 2 selectable

xxx-K87 option for generating signals for 1xEV-DO (Rev. B)

- ▶ Independent configuration of up to four traffic channels in the downlink or four access terminals in the uplink
- ▶ Support of physical layer subtypes 0, 1, 2 and 3
- ▶ Support of multicarrier operation with up to 16 simultaneous carriers
- ▶ Operating modes in the uplink: traffic and access
- ▶ Simulation of up to 360 additional MAC users
- ▶ Supports configuration of public data as defined in the standard, such as long code masks for I and Q channel, preamble length, DRC length

General measurement applications

xxx-K68 TETRA Release 2 (internal)

xxx-K268 TETRA Release 2 (R&S®WinIQSIM2™)

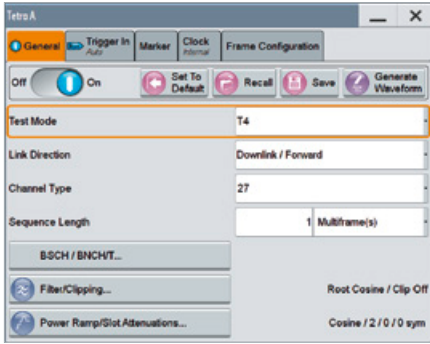

TETRA Release 2 digital standard

- ▶ In line with ETSI EN300392-2 digital standard (V3.2.1) and TETRA conformance testing specification ETSI EN300394-1 (V3.1.1)
- ▶ Link direction: downlink and uplink (not for T3)
- ▶ T1 downlink channels 0, 1, 2, 3, 4, 21, 22, 24
- ▶ T1 uplink channels 7, 8, 9, 10, 11, 21, 23, 24
- ▶ T2 TETRA interferer phase modulation, QAM
- ▶ T3 CW interferer
- ▶ T4 downlink channel 27
- ▶ T4 uplink channels 25, 26

xxx-K54/-K86/-K142 IEEE 802.11a/b/g/n/j/p/ac/ax (internal)

xxx-K248/-K254/-K286/-K442 IEEE 802.11a/b/g/n/j/p/ac/ax (R&S®WinIQSIM2™)

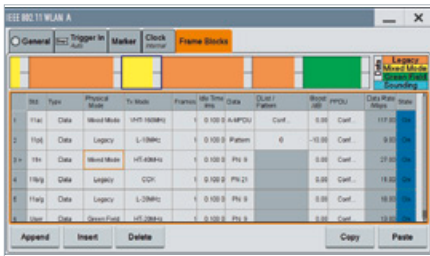

Simple diversity and static MIMO tests are possible without additional channel simulator. Simulation of realtime MIMO channel condition is possible for instruments equipped with the R&S®SMW-B14 (2x or 4x)/R&S®SMW-K74 fading options. The number of spatial streams, space time streams and additional spatial streams is configurable as well as the modulation type per spatial stream.

xxxx-K86 for IEEE 802.11ac

- ▶ Support of all mandatory physical layer modes: VHT-20 MHz, VHT-40 MHz, VHT-80 MHz, VHT-80+80 MHz and VHT-160 MHz
- ▶ BPSK, QPSK, 16QAM, 64QAM and 256QAM modulation

xxx-K142 for IEEE 802.11ax

- ▶ Support of all mandatory physical layer modes: HE-20 MHz, HE-40 MHz, HE-80 MHz, HE-80+80 MHz and HE-160 MHz
- ▶ BPSK, QPSK, 16QAM, 64QAM, 256QAM and 1024QAM modulation

WLAN signal generation

The xxx-K54 option allows the generation of signals in line with the IEEE802.11a/b/g/n/j/p WLAN standards.

The options xxx-K86 and xxx-K142 enable the signal generation for IEEE 802.11ac and 802.11ax (both options require xxx-K54). The integrated frame block sequencer allows to generate a sequence of cascaded frame blocks with different WLAN modes, configurations and data rates for realistic WLAN scenario simulation.

xx-K54 for IEEE 802.11a/b/g/j/p

- ▶ Physical layer modes: OFDM (IEEE 802.11a/g/j/p) and CCK/PBCC (IEEE.802.11b/g)
- ▶ Data scrambling can be activated or deactivated (CCK/PBCC), and initial scrambler state can be set randomly or to a user-defined value (OFDM)

xxx-K54 for IEEE 802.11n

- ▶ Support of all mandatory physical layer modes: HT-20 MHz, HT-40 MHz, HT-Duplicate, HT-Upper, HT-Lower
- ▶ BPSK, QPSK, 16QAM and 64QAM modulation
- ▶ Additional support of the CCK and PBCC frames in accordance with IEEE 802.11a/b/g standard

R&S®SMW-K141 IEEE 802.11ad (internal)

R&S®SMW-K441 IEEE 802.11ad (R&S®WinIQSIM2™)



The R&S®SMW200A excels with extraordinary flat frequency response over 2 GHz bandwidth – and that without the need for a special external calibration procedure. Baseband signals or IF signals at frequencies up to 40 GHz (depending on the R&S®SMW frequency option) are directly available at high quality out of a single instrument.

As a result, the R&S®SMW200A instantly delivers outstanding EVM performance for IEEE802.11ad signals. The user has full control over the IEEE802.11ad signal configuration and does not need to run any tedious calibration of the test setup – not when setting up the signal scenario the first time nor when changing signal parameters, signal content, level or frequency while working.

Key facts

- ▶ PHY modes: single carrier and control
- ▶ Modulation and coding schemes (MCS) 0 to 12
- ▶ DBPSK, $\pi/2$ -BPSK, $\pi/2$ -QPSK, $\pi/2$ -16QAM
- ▶ LDPC channel coding and scrambling
- ▶ MAC header and FCS support
- ▶ Data source: All1, All0, pattern, PN sequences, data list
- ▶ A-MPDU support (up to 64 MDPUs)
- ▶ Settable last RSSI value (for single carrier signal)
- ▶ Support for training sequences TRN-T and TRN-R with settable length

Physical layer signals in line with IEEE 802.11ad

The R&S®SMW-K141 option enables the R&S®SMW200A with R&S®SMW-B9 wideband baseband option to generate physical layer signals in line with the IEEE802.11ad standard.

General measurement applications

xxx-K60/-K117 Bluetooth® V 4.2 incl. EDR and LE / V 5.x (internal)
xxx-K260/-K417 Bluetooth® V 4.2 incl. EDR and LE / V 5.x (R&S®WinIQSIM2™)



Bluetooth® 4.2 including EDR and LE and Bluetooth® 5.x

The xxx-K60 option enables the signal generator to generate Bluetooth® signals in accordance with Bluetooth® specification 4.2 including enhanced data rate (EDR) and low energy (LE).

The option xxx-K117 (requires option xxx-K60), covers all improvements compared to Bluetooth® 4.2.

xxx-K60 for Bluetooth® 4.2

- ▶ In line with Bluetooth® specification 4.2, including enhanced data rate (EDR) and low energy (LE) mode
- ▶ Support of all three transport modes, in particular ACL+EDR, SCO and eSCO+EDR
- ▶ Support of all packet types for basic rate and enhanced data rate (EDR) modes
- ▶ Automatic selection of modulation type according to chosen packet type

xxx-K117 for Bluetooth® 5.x

- ▶ Further improvements of several low energy characteristics for IoT applications
- ▶ Quadruple the range (LE long range)
- ▶ Double the speed (2 Msps)
- ▶ Increase data broadcasting capacity by 800% (LE advertising extensions)

xxx-K89 NFC A/B/F (internal)
xxx-K289 NFC A/B/F (R&S®WinIQSIM2™)

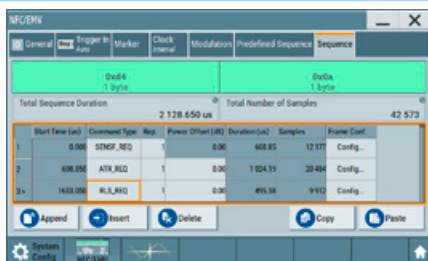

NFC A/B/F signal generation

NFC is based on RFID technology and makes mobile phones suitable for numerous applications including, for example, contactless payment of tickets, downloading of information from a passive RFID tag, use as security ID, etc. Other than with RFID, some devices can also act as a reader (poller) and as a listener. There are three types of NFC, all working on the same frequency of 13.56 MHz but with different data rates and modulation characteristics: NFC-A, NFC-B and NFC-F. The xxx-K89 support all three.

Key facts

- ▶ Standard-conforming signals for NFC A/B/F
- ▶ Sequence generator with all signals from standard
- ▶ Predefined sequences for polling applications
- ▶ Flexible definition for pulse forms
- ▶ Support for EMV type A and EMV type B

xxx-K131 LoRa® (internal)
xxx-K431 LoRa® (R&S®WinIQSIM2™)

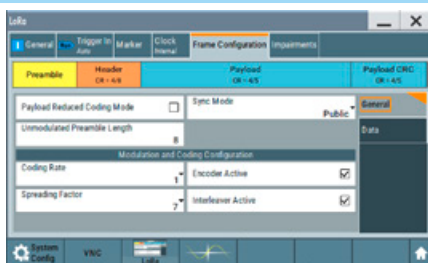

LoRa® (long range) is a digital wireless communication technology owned by Semtech that enables very-long-range transmission (> 10 km in rural areas) with low power consumption. This fits perfectly to internet of things (IoT) applications in rural areas.

With the xxx-K131 option it is possible to generate LoRa® physical layer signals with the Rohde&Schwarz signal generators according to the specification.

Key facts

- ▶ Chirped spread spectrum (125/250/500 kHz)
- ▶ Individual idle time
- ▶ Supporting all specified coding rates and spreading factors
- ▶ Configurable payload data
- ▶ Impairments: symbol timing error, frequency offset, frequency drift

General measurement applications

xxx-K114 OFDM Signal Generation (internal)

xxx-K414 OFDM Signal Generation (R&S®WinIQSIM2™)

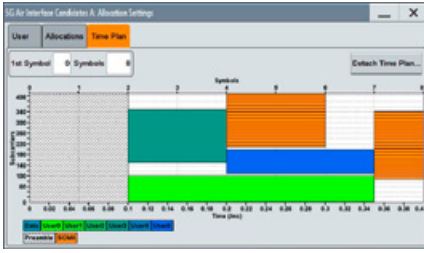

OFDM signal generation

The vector signal generators from Rohde&Schwarz are ideal tools for early 5G physical layer testing. Using the xxx-K114 option, the vector signal generators flexibly generate customized 5G air interface candidate signals.

The user can choose from various waveform types such as GFDM, FBMC, UFMC or f-OFDM and parameterize the signals as desired. Pulse shaping filters, subcarrier spacing and the number of carriers as well as the modulation and data content can be set. Preamble generation, a configurable cyclic prefix length and support for sparse code multiple access (SCMA) allow the testing of components or receivers with realistic pre-5G physical layer signals. Direct internal signal generation – without the need for any external PC software – helps to speed up the signal creation process.

Optionally, the vector signal generators from Rohde&Schwarz can also be equipped with a second signal generation path. This allows simultaneous generation of a 5G candidate signal and a legacy LTE signal from a single signal generator without complicated synchronization of multiple separate signal sources.

Interdependencies between LTE and 5G are hence quickly simulated. And interference that occurs in the device under test (DUT) due to the simultaneous presence of 5G and LTE are easily discovered.

Key facts

- ▶ Create customized 5G signals
- ▶ GFDM, UFMC, FBMC, f-OFDM
- ▶ Sparse code multiple access (SCMA)
- ▶ Easy waveform parameterization
- ▶ Allocation time plan for visualization
- ▶ PN sequences, data patterns or user data lists
- ▶ BPSK, QPSK, 16QAM, 64QAM, 256QAM

R&S®WinIQSIM2™ Simulation Software

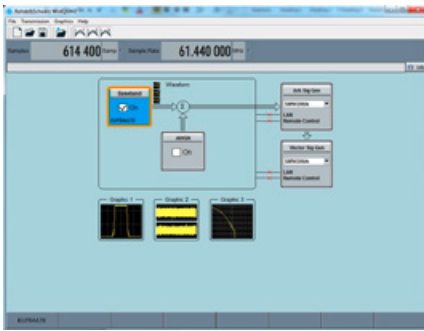

By offering a convenient way to create any standard-conforming waveform with all the included standards and to generate multicarrier signals as well as multisegment waveforms, R&S®WinIQSIM2™ is suitable for a wide range of applications.

Signals generated with the aid of the R&S®WinIQSIM2™ software can be output by the R&S®AFQ100A and R&S®AFQ100B arbitrary waveform generators as well as by the R&S®SMW200A (R&S®SMW-B9/-B10 options), R&S®SMBV100A (R&S®SMBVB-B10/-B50/-B51 options), R&S®SMBV100B and R&S®SGT100A (R&S®SGT-K510 option) vector signal generators.

Some standards also work for the R&S®CMW500/CMW100/CMW290 wideband radio communication tester, the R&S®CMW270 wireless connectivity tester, the R&S®CMA180 radio test set and the R&S®EX-IQ-Box digital signal interface module. R&S®WinIQSIM2™ is delivered with these arbitrary waveform generators free of charge; it is also available on the Rohde&Schwarz website.

Large variety of digital standards

- ▶ 5G New Radio
- ▶ Verizon 5GTF signals
- ▶ OFDM signal generation
- ▶ LTE Release 9/10/11/12/13/14/15
- ▶ Cellular IoT (eMTC and NB-IoT)
- ▶ GSM/EDGE
- ▶ EDGE Evolution, VAMOS
- ▶ 3GPP FDD with HSDPA, HSUPA and HSPA+ (HSPA Evolution)
- ▶ CDMA2000® with 1xEV-DV
- ▶ 1xEV-DO Rev. A, Rev. B
- ▶ TD-SCDMA
- ▶ WLAN IEEE 802.11a/b/g/n/j/p/ac/ax/ad
- ▶ IEEE 802.16 WiMAX™ supporting OFDM and OFDMA
- ▶ DVB-T/DVB-H
- ▶ DAB/T-DMB
- ▶ UWB (ECMA-368)
- ▶ GPS, GLONASS, Galileo, BeiDou (Compass)
- ▶ OneWeb
- ▶ Bluetooth®, up to Release 5.0
- ▶ TETRA Release 2
- ▶ NFC A/B/F including EMV Type A/B 1
- ▶ LoRa®

Ideal for the generation of digitally modulated signals

R&S®WinIQSIM2™ has been especially developed for easily generating digitally modulated signals. The graphical user interface allows intuitive operation, supported by context-sensitive help.

General measurement applications

R&S®SMW-B14/B15/K62/K71/K72/K73/K74/K75/K76/K820/K821 Multipath and Channel Simulation

xxx-K62 Additive white Gaussian noise (AWGN) (internal)

xxx-K262 Additive white Gaussian noise (AWGN) (R&S®WinIQSIM™)



Multichannel, fading and interference simulation with the R&S®SMW200A

The multipath R&S®SMW200A can simulate up to 8 SISO channels as well as sophisticated MIMO channels. It is a cost-effective and powerful solution for testing the behavior of products under realistic transmission conditions. The R&S®SMW200A fading simulator allows emulation of both static and dynamically changing fading conditions. Complex correlation between the fading paths, geometric antenna setup definition (via AoA/AoD) as well as channel matrix inversion and user defined antenna patterns for OTA-MIMO are supported. Together with the AWGN simulation capability, the signal generator is ideal for performance tests in line with all important digital communications standards as well as multistandard radio (MSR) test scenarios.

Channel simulation options

- ▶ R&S®SMW-B14: Fading simulator
- ▶ R&S®SMW-B15: Wideband fading simulator
- ▶ xxx-K62: AWGN
- ▶ R&S®SMW-K71: Dynamic fading and enhanced resolution
- ▶ R&S®SMW-K72: Extended statistics functions
- ▶ R&S®SMW-K73: OTA-MIMO enhancements
- ▶ R&S®SMW-K74: MIMO fading
- ▶ R&S®SMW-K75: Higher order MIMO
- ▶ R&S®SMW-K76: Multiple entities
- ▶ R&S®SMW-K820: Customized dynamic fading
- ▶ R&S®SMW-K821: MIMO subsets for higher order MIMO

xxx-K44/K66/K94/K98/K106/K107

GNSS Simulation with GPS, Galileo, GLONASS, BeiDou including Augmentation Systems (QZSS, SBAS, GBAS)

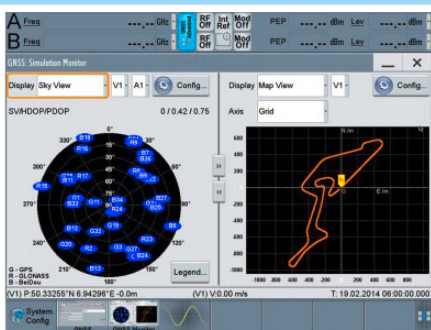

GNSS simulation

Both the R&S®SMBV100B and the R&S®SMW200A can be turned into a powerful and feature-rich GNSS simulator. With capabilities to simulate multi-constellation and multi-frequency as well as multi-antenna and multi-vehicle scenarios, GNSS test solutions from Rohde & Schwarz are able to cover a variety of test applications.

R&S®SMx-K44 for GPS

The R&S®SMW-K44 allows to simulate GPS satellites in the frequency bands L1, L2 and L5.

R&S®SMx-K66 for Galileo

The R&S®SMW-K66 allows to simulate Galileo satellites in the frequency bands E1 and E5.

R&S®SMx-K94 for GLONASS

The R&S®SMW-K94 allows to simulate Glonass satellites in the frequency bands L1 and L2.

R&S®SMx-K98 for Modernized GPS

The R&S®SMW-K98 allows to simulate satellites transmitting modernized GPS signals in the frequency bands L2 and L5.

R&S®SMx-K106 for SBAS/QZSS

The R&S®SMW-K106 allows to simulate SBAS and QZSS satellites in the L1 frequency band.

R&S®SMx-K107 for BeiDou

The R&S®SMW-K107 allows to simulate BeiDou satellites in the frequency bands B1 and B2.

Key facts

- ▶ Support of GPS, GLONASS, Galileo, BeiDou and QZSS/SBAS, including hybrid constellations
- ▶ Realtime simulation of realistic constellations with unlimited simulation time

- ▶ Flexible scenario generation including moving scenarios, dynamic power control and atmospheric modeling
- ▶ Configuration of realistic user environments, including obscuration and multipath, antenna characteristics and vehicle attitude
- ▶ Static mode for basic receiver testing using signals with zero or constant Doppler shift
- ▶ Support of Assisted GNSS (A-GNSS) test scenarios, including generation of assistance data for GPS, GLONASS, Galileo, BeiDou and QZSS/SBAS
- ▶ Realtime external trajectory feed for hardware in the loop (HIL) applications
- ▶ Logging of simulation data
- ▶ High signal dynamics, simulation of spinning vehicles and precision code (P code) simulations to support aerospace and defense applications
- ▶ Enhanced simulation capabilities for aerospace applications by supporting ground-based augmentation systems (GBAS)
- ▶ Support of other digital communications and radio standards in the same instrument

R&S®SMW-K78 Radar Echo Generation

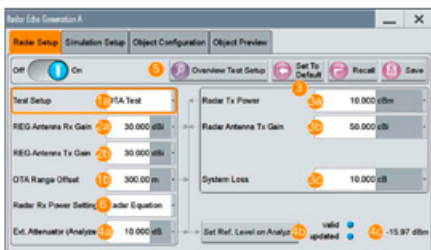

Radar echo generation

The R&S®SMW-K78 radar echo generation option, in conjunction with the R&S®SMW200A vector signal generator and the R&S®FSW spectrum and signal analyzer, makes it possible to artificially generate radar signal echoes. These tests can be performed via a wired connection (conducted test) or via the air interface (over the air test), eliminating much of the need for time-consuming and costly field tests.

Key facts

- ▶ Realtime capability for echo generation
- ▶ Simulation of up to 24 independent virtual static or moving objects
- ▶ 160 MHz RF bandwidth throughout the entire frequency range up to 40 GHz
- ▶ Possibility to add interferers and noise
- ▶ Internal generator solution, no need for external PC
- ▶ Intuitive and easy-to-use graphical user interface

General measurement applications

xxx-K308 Direction Finding



Configure test scenarios for multichannel receivers in direction finding applications

The R&S®Pulse Sequencer software together with xxx-K308 option enhances the capabilities of xxx-K300 and xxx-K301 options.

The xxx-K308 option allows the user to configure test scenarios for multichannel receivers in direction finding applications. This option provides a receiver as a new simulation component. The receiver can store individual antenna patterns for each channel. Each antenna can be assigned a position, an antenna pattern and a pointing direction. The ensemble of all individual antennas is an antenna system.

On the 2D map, the antenna system itself can be assigned attitude and height information. In combination with an emitter placed on the 2D map, the R&S®Pulse Sequencer software automatically calculates the individual power levels at the output of each individual receiver antenna taking into consideration free space propagation and the attitude information.

Key facts

- ▶ Direction finding with a single emitter
- ▶ Up to 20 individual antenna elements
- ▶ Predefined antenna patterns or user-defined antenna patterns
- ▶ Consideration of attitude information of receiver and emitter
- ▶ Consideration of co- and cross-polarization

R&S®SMW-K501 Extended Sequencing

R&S®SMW-K502 Wideband Extended Sequencing



Reduces memory requirements to a minimum and increases playtime enormously

The R&S®SMW-K501/-K502 extended sequencing option can be used manually via sequencing lists and waveform segments or via the R&S®Pulse Sequencer software and its options. In both cases, memory requirements are reduced to a minimum and playtime is increased enormously.

In manual user mode, the R&S®SMW-K501/-K502 option allows sequencing of waveforms. It supports loops, nested loops and repetitions, enabling ultralong playtimes.

If used with the R&S®Pulse Sequencer software and its options, the software calculates all required signals and required sequencing lists and transfers them to the signal generator. Continuous wave signals, unmodulated rectangular CW pulses and pulses with linear frequency modulation or Barker codes are calculated in real-time inside the R&S®SMW200A.

Changes in amplitude, offset frequency, offset phase and off time are always applied in realtime as defined by the sequencing list.

Key facts

- ▶ Sequencing of arbitrary waveform files
- ▶ Support of loops, nested loops and repetitions
- ▶ Realtime change of amplitude, offset frequencies, relative phase and off times for waveform files instead of many individual segments
- ▶ Realtime signal generation of CW, unmodulated rectangular CW pulses and pulses with linear frequency modulation or Barker codes with the R&S®Pulse Sequencer software together with the R&S®SMW-K3xx options
- ▶ Ultralong playtimes
- ▶ Can be used manually via sequencing lists and waveform segments or via the R&S®Pulse Sequencer software and R&S®SMW-K3xx options

R&S®SMW-K503 Realtime Control Interface

R&S®SMW-K504 Extended Pulse Rate

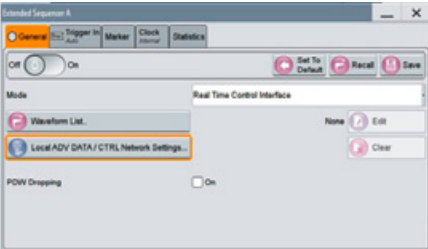

Realtime control interface for PDW streaming

With the option R&S®SMW-K503 the vector signal generator R&S®SMW200A gets ready to directly receive streamed PDWs via Ethernet and TCP/IP from a customer simulator. Customers can generate highly dense radar scenarios.

Key facts

- ▶ Streaming of PDWs via LAN to R&S®SMW200A
- ▶ R&S®SMW-K503 generates realtime pulses with a maximum rate of up to 1 Mpulse/s per installed option on one baseband
- ▶ R&S®SMW-K504 allows you to upgrade to up to 2 Mpulses/s per installed option on one baseband
- ▶ One-box solution for PDW streaming including I/Q waveform segments
- ▶ Integrate the vector signal generator R&S®SMW200A into the most modern and flexible radar simulators

General measurement applications

R&S®SMW-K116 DVB-S2/DVB-S2X

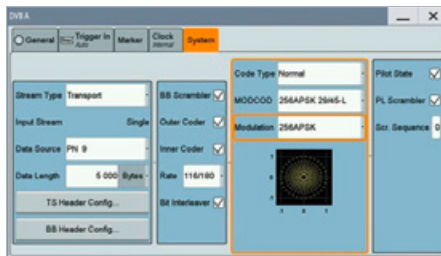

DVB-S2/DVB-S2X physical layer testing

The R&S®SMW200A vector signal generator is the ideal tool for DVB-S2/DVB-S2X physical layer testing. By means of the R&S®SMW-K116 option, the R&S®SMW200A flexibly generates customized DVB-S2/DVB-S2X signals. DVB-S2 is the common standard for providing TV program from satellites to millions of homes.

The physical parameters of the signals are defined to ideally fit the satellite to ground links. Thus the DVB-S2 modulation scheme is not only used for TV broadcast but also for many other professional satellite data services for enterprises, in-flight entertainment, maritime, military and government applications. With DVB-S2X as the newest version higher order modulation schemes are added to increase the data rate in a given frequency band. The standard TV transmission is in the Ku band and other satellite links using the same physical layer are typically in the Ka band. Both are directly addressed with the microwave frequency options of the R&S®SMW200A up to 44 GHz.

Key facts

- ▶ Fully encoded DVB-S2 and DVB-S2X signal generation
- ▶ Support of transport stream (TS), generic packetized (GP), generic continuous (GC), generic stream encapsulated high efficiency mode
- ▶ Signal generation from arbitrary data sources and TS or GSE files
- ▶ Maximum symbol rate of up to 600 MHz
- ▶ Channel coding according to the standard, incl. scrambling, interleaving, outer code (BCH), inner code (LDPC) with varying code rates from 1/4 to 31/45
- ▶ Support of all specified Walsh-Hadamard sequences for VL-SNR (very low signal-to-noise ratio) mode
- ▶ Configurable header information, incl. baseband (BB) header, VL-SNR header, TS header, GSE header
- ▶ Supported modulation schemes:
 - For DVB-S2: QPSK, 8PSK, 16APSK, 32APSK
 - For DVB-S2X: QPSK, 8APSK, 8PSK, 16APSK, 32APSK, 64APSK, 128APSK, 256APSK
 - For VL-SNR: QPSK, $\pi/2$ BPSK
- ▶ Pilot insertion and configuration
- ▶ Signals suitable for testing of satellite transponders, components and ground modems

R&S®SMW-K130 OneWeb User-Defined Signal Generation

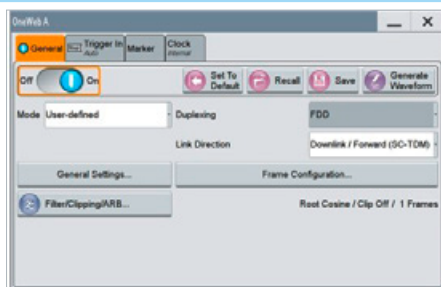

OneWeb user-defined signal generation

The R&S®SMW-K130 option allows users to easily generate standard-compliant OneWeb signals. This option support both forward link and reverse link. Users have access to all relevant setting parameters for these transmission links. It supports a single-carrier scenario for the forward link with an occupied bandwidth of 250 MHz. For the reverse link, users can configure single-carrier scenarios with a 20 MHz carrier. Multi-carrier scenarios for the reverse link can be generated by using carrier aggregation.

Key facts

- ▶ Fully standard-compliant OneWeb signal generation
- ▶ Highest flexibility for customized signal design
- ▶ Signal generation for forward link (SC-TDM) and reverse link (SC-FDMA)
- ▶ Support of forward link and reverse link parameter settings
- ▶ Define multicarrier scenarios for reverse link
- ▶ Single carrier scenarios for forward link
- ▶ Test of receivers in user terminal, ground station and satellite payload
- ▶ Test of RF components, ground stations, satellite payloads and user terminals

General measurement applications

**xxx-K300 Pulse Sequencing
xxx-K301 Enhanced Pulse Sequencing**



R&S®Pulse Sequencer software

The R&S®Pulse Sequencer software together with the xxx-K300 option makes it possible to generate pulsed signals with basic modulation schemes. Signals with simple pulses, pulse trains and repetition of pulses can be generated. In addition, pulse trains with different pulses and pulse breaks can be generated sequentially. All major modulation formats for modulation on pulse are available with internal and external data sources.

Typical pulse parameters such as rise and fall time, ripple, droop and overshoot, etc. can be defined. Only deterministic interpulse modulation with frequency hops, staggered pulse repetition intervals and user-defined lists can be used. Instead of pulses, waveform files can be used in the sequencer with a repetition count.

Enhanced pulse sequencing

The R&S®Pulse Sequencer software together with the xxx-K301 option enhances the capabilities of the xxx-K300 option. The xxx-K301 option allows users to utilize various control elements like loops, nested loops, overlays, fillers and subsequences for sequencing applications. The xxx-K301 option can only be used together with the xxx-K300 option.

Key facts

- ▶ ARB-based signal generation and multisegment waveform sequencing
- ▶ Single pulse and pulse train generation with repetition count per pulse

- ▶ Powerful sequencing tool with loops, nested loops, subsequences and overlays
- ▶ Antenna diagram definition and antenna scan definition
- ▶ Antenna diagrams such as pencil beams, cosecant beams, Gaussian diagrams, user-defined antenna diagrams, phased array antenna diagrams
- ▶ Antenna scan types such as helical scans, circular scans, conical scans
- ▶ Emitter definition based on waveforms, antenna diagram, antenna scan, attitude information, EIRP and carrier frequency
- ▶ Receiver definition based on antenna diagram, antenna scan and attitude information
- ▶ Calculation of signal taking into account one-way free space propagation according to emitter and receiver location on the 2D map
- ▶ Import of R&S®WinIQSIM2™ or customer waveforms for interference generation

R&S®SMW-K304 Moving Emitters and Receiver

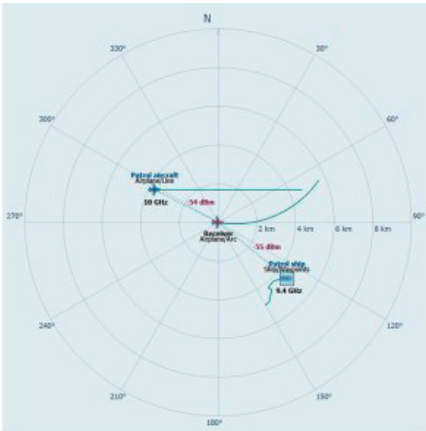

Generate scenarios including moving emitters and receiver

The R&S®SMW-K304 moving emitters option adds the capability to simulate emitters and receiver moving along trajectories. Complex radar scenarios consisting of many moving emitters are processed in Pulse Sequencer Software and generated on the R&S®SMW200A vector signal generator.

Key facts

- ▶ Simulate movements of emitters and receiver along trajectories
- ▶ Waypoint file import interface for complex movements
- ▶ Automatically calculated Doppler shift and acceleration
- ▶ Import waypoint files with standardized or Rohde & Schwarz proprietary formats
- ▶ Graphical preview of movements and calculated signals

R&S®SMW-K306 Multiple Emitters

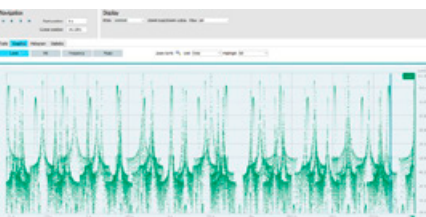

Generate scenarios including many emitters with pulse dropping algorithm

R&S®SMW-K306, the Pulse Sequencer Software can calculate multi emitter scenarios that contain many emitters. Real stress test cases for radar warning receivers can be generated.

Key facts

- ▶ Simulate wanted emitter with background emitters
- ▶ Simulate several wanted emitters
- ▶ Simulate high pulse density to test the limits of radar warning receivers

General measurement applications

R&S®SMW-K315 Pulse on Pulse Simulation

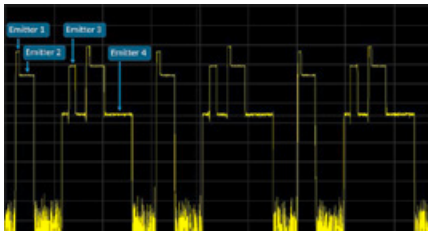

Generate demanding radar signals without pulse dropping

The R&S®SMW-K315 option is a key enabler to simulate highly realistic radar signals with pulse on pulse in combination with Pulse Sequencer software or with PDW streaming. Thanks to option R&S®SMW-K502 wideband extended sequencing and Pulse Sequencer software, features like ultralong playtimes and sequencing of arbitrary waveform segments are supported.

Key facts

- ▶ Generate pulse-on-pulse signals using the vector signal generator R&S®SMW200A
- ▶ Simulate up to six simultaneous emitters with R&S®Pulse Sequencer software and generate pulse-on-pulse signals with one R&S®SMW200A
- ▶ Achieve up to 12 MPDW/s with PDW streaming Combine up to six independent simultaneous signals with PDW streaming and generate one RF signal within the baseband bandwidth
- ▶ Manual turning on/off of emitters during simulation

xxx-K350 DFS Signal Generation

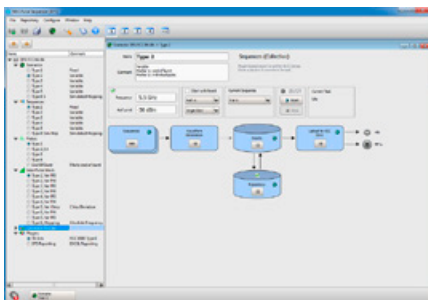

Generation of radar signals

The R&S®Pulse Sequencer (DFS) software and its respective software option for the Rohde & Schwarz signal generators have been especially developed for generation of radar signals as specified by various DFS standards.

Supported standards

- ▶ United States: FCC 06-96, FCC 13-22A1), FCC KDB 905462 D02
- ▶ Europe: ETSI EN301893 V2.1.1 (2018-05), ETSI EN302502 V2.0.8 (2017 06)
- ▶ Japan: MIC-W53, -W56 (2019 10)
- ▶ Australia/New Zealand: AS/NZS 4268:2008
- ▶ Korea (06-2016)
- ▶ China: YD/T 2950-2015 (11-2017)

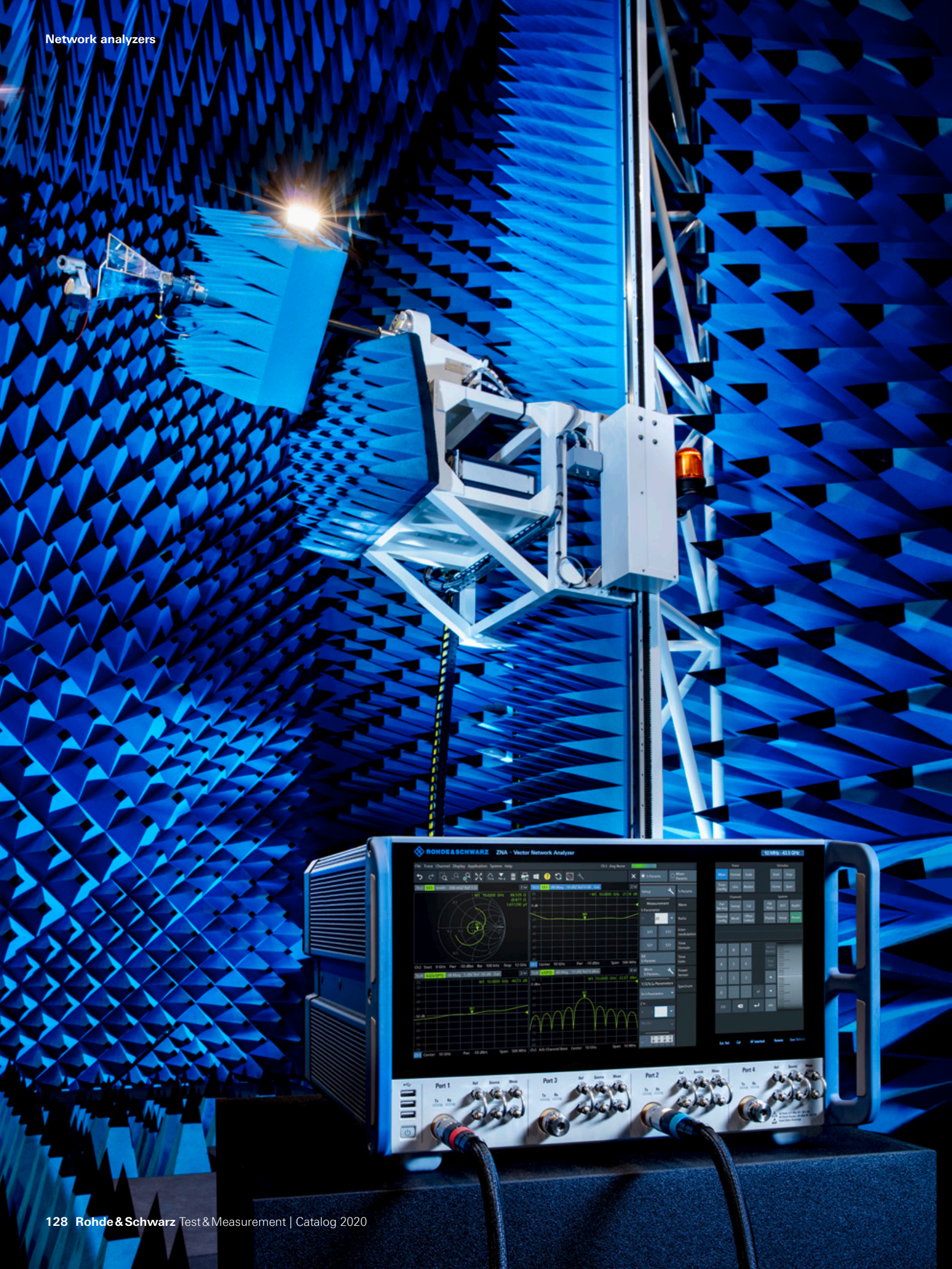

CHAPTER 5

NETWORK ANALYZERS

Vector network analysis (VNA) is one of the most essential RF and microwave measurement approaches. Rohde & Schwarz offers a wide range of versatile, high-performance network analyzers up to 750 GHz and multiport solutions up to 48 ports. Rohde & Schwarz vector network analyzers are ideal for analyzing passive and active components such as filters, amplifiers, mixers and multiport modules. The network analyzers feature excellent RF characteristics and a wide variety of analysis functions that help the user evaluate important parameters at a glance.

Type	Designation	Frequency range	Description	Page	
Vector network analyzers					
New	R&S®ZNA	Vector network analyzer	100 kHz to 43.5 GHz	Masters the most challenging measurement tasks	130
	R&S®ZVA	Vector network analyzer	300 kHz to 8 GHz; 10 MHz to 24/40/50/67/110 GHz	High-end VNA with up to 4 sources for sophisticated measurements up to 110 GHz	134
	R&S®ZVT	Multiport vector network analyzer	300 kHz to 8 GHz 10 MHz to 20 GHz	Network analysis with up to 8 ports	136
	R&S®ZNB4/8 R&S®ZNB20 R&S®ZNB40	Vector network analyzer	9 kHz to 4.5/8.5 GHz 100 kHz to 20 GHz 10 MHz to 40 GHz	Leading in speed, dynamic range and ease of operation	137
	R&S®ZNB8 R&S®ZNB20/26/40	Vector network analyzer	9 kHz to 8.5 GHz 100 kHz to 20/26/40 GHz	Network analysis with up to 24 ports	138
	R&S®ZNL	Vector network analyzer	5 kHz to 3 GHz/6 GHz	The 3-in-1 allrounder	139
	R&S®ZNLE	Vector network analyzer	1 MHz to 3 GHz/6 GHz	Measurements as easy as ABC	140
	R&S®ZND	Vector network analyzer	100 kHz to 4.5/8.5 GHz	Basic, solid-performance network analysis	141
	R&S®ZVL	Vector network analyzer	9 kHz to 3/6/13.6 GHz	Cost-efficient compact class	142
	R&S®ZVH	Cable and antenna analyzer	100 kHz to 3.6/8 GHz	The benchmark for efficiency in the field	143
	R&S®CableRider ZPH	Cable and antenna analyzer	2 MHz to 3 GHz/4 GHz	Expect fast, expect efficient	144
Converters					
	R&S®ZCxxx	Millimeterwave converters	75 GHz to 750 GHz	Millimeterwave measurements – network analysis from 75 GHz to 750 GHz, depending on converter model	146
	R&S®ZVA-Zxxx	Millimeterwave converters	50 GHz to 500 GHz	Millimeterwave measurements in the V, E, W, J and Y bands – network analysis from 50 GHz to 500 GHz, depending on converter model	147
	RPG ZRX	High dynamic receivers for vector network analyzers	75 GHz to 750 GHz	High-performance VNA frequency extension up to 750 GHz, depending on receiver model	148
Accessories for network analysis					
	R&S®ZNrun	Automated test software		PC based server platform for automated VNA tests	145
	R&S®ZVAX-TRM	Extension unit	10 MHz to 67 GHz	Advanced measurements on active devices	150
	R&S®ZN-Z32/-Z33	Inline calibration units	10 MHz to 40 GHz	Automatic calibration, delivering high accuracy with thermal vacuum testing and multiport measurements	149
	R&S®ZN-Z84/-Z85	Switch matrix	10 MHz to 8.5/20 GHz	2 or 4 VNA ports, up to 48/12 test ports	150
	R&S®ZCAN	Calibration kit	0 Hz to 3 GHz	Manual calibration (coaxial)	150
	R&S®ZV-Z2xx	Calibration kits	0 Hz to 67 GHz	Manual calibration of VNAs (precision)	150
	R&S®ZV-Z170/ -Z135/-Z129	Calibration kits	0 Hz to 9 GHz/15 GHz/40 GHz	Manual calibration of VNAs (economy)	150
	R&S®ZN-Z15x/ ZN-Z5x/ZV-Z5x	Calibration units	100 kHz to 50 GHz	Automatic calibration of VNAs (2 to 24 ports)	151
	R&S®ZV-WRxx R&S®ZCWM-xxx	Waveguide calibration kits	50 GHz to 500 GHz	Manual calibration (waveguide)	151
	R&S®ZV-Z3xx/-Z4xx	Verification kits	45 MHz to 50 GHz	Verification of VNA specifications after system error correction	151

R&S® ZNA VECTOR NETWORK ANALYZER

New



Masters the most challenging measurement tasks

Offering outstanding RF characteristics and a unique hardware architecture, the R&S®ZNA high-end vector network analyzer makes demanding measurements easier than ever. Another exceptional feature is the analyzer's DUT-centric operating concept, which guides users quickly and conveniently to the desired measurement setup. Two independent touchscreens provide utmost flexibility for smooth, efficient operation.

The R&S®ZNA features exceptional stability, low trace noise and excellent raw data, making it a perfect choice for development and production applications that require high accuracy, e.g. for developing and producing components and modules for A&D and satellite applications.

The R&S®ZNA offers four internal, phase-coherent sources, allowing independent control of the signal's frequency at each port as well as phase measurements on mixers. It provides two internal LO sources, a true multichannel receiver architecture, pulse generators and modulators, an internal combiner, and comprehensive trigger and synchronization capabilities. These hardware features make the R&S®ZNA a universal, compact test system for active and passive device characterization. Even intermodulation measurements on mixers and receivers can be performed without external sources, minimizing test time and simplifying test configuration.

Thanks to the phase-coherent digital sources and receivers, no reference mixers are needed for mixer phase measurements, and test setups are configured just as easily as for non-frequency-converting S-parameter measurements.

The R&S®ZNA characterizes low-noise amplifiers (LNA), receivers, frequency-converting DUTs and T/R modules precisely and efficiently; the DUT needs to be connected only once.

Key facts and benefits

- ▶ Four internal phase-coherent sources
 - Compact multiple source setups
 - Convenient phase measurements on mixers
- ▶ Two internal LO sources
 - Fast mixer measurements
 - More accurate phase results due to parallel signal sampling
 - Rear panel LO output for mmWave systems and general-purpose applications
- ▶ Eight truly parallel measurement receivers
 - Measurements on multipath DUTs and antenna arrays, use of analyzer as a powerful core in antenna test systems
- ▶ Flexible signal routing and path access
 - Internal combiner for intermodulation and embedded LO converter group delay measurements
 - Reference signal access before or after source step attenuator for low trace noise even with very low stimulus signals (e.g. for high-gain DUTs)
 - Direct IF access for antenna test systems with external up/downconversion
 - Rear panel LO output and direct IF input for compact mmWave test setups: 2/4-port mmWave converter setups with 2/4-port R&S®ZNA, without additional external source
- ▶ Four internal pulse modulators
 - Two-tone and bidirectional pulsed signal measurements
- ▶ Phase measurements on mixers without reference mixers
 - Simple mixer tests in a compact setup
- ▶ Spectrum analysis option
 - DUT characterization and spurious search without reconnecting the DUT to a spectrum analyzer
- ▶ Group delay measurements on frequency converters with embedded LOs
 - Reliable, straightforward satellite receiver measurements
- ▶ High dynamic range: 139 dB (typ.), up to 170 dB (typ.) with options
 - Characterization of high-rejection filters
 - Short test times and low trace noise
- ▶ Wide power sweep range of 100 dB (typ.)
 - Versatile compression measurements
- ▶ Low trace noise of < 0.001 dB (at 1 kHz IF bandwidth)
 - Accurate, highly reproducible measurements
- ▶ DUT-centric operating concept
 - Easy startup, short configuration times



Hardware options

Description	Applications and benefits	Hardware option
Direct source and receiver access ¹⁾ <ul style="list-style-type: none"> ▶ With start frequency down to 100 kHz ▶ Supports reversed coupler configuration 	<ul style="list-style-type: none"> ▶ Facilitates external test setups for power measurements across a wide frequency range ▶ Reversed coupler configuration increases dynamic range and reduces system noise figure 	R&S®ZNAxx-B16 ²⁾
R&S®ZNA 4-port model with up to four internal sources	<ul style="list-style-type: none"> ▶ Short measurement times ▶ Flexible-to-configure, compact test setups, e.g. for DUTs with two converter stages 	R&S®ZNAxx-B3 ²⁾³⁾
2nd internal LO source <ul style="list-style-type: none"> ▶ For simultaneous measurement of two different frequencies (e.g. RF and IF signal on mixers) ▶ Additional RF source (in combination with R&S®ZNA-B8 mmWave converter LO output) 	<ul style="list-style-type: none"> ▶ Fast mixer and converter measurements ▶ Very low trace noise with frequency-converting measurements ▶ General-purpose RF source up to 26.5 GHz (e.g. to provide LO signal for external mixers) 	R&S®ZNA-B5
Four/eight true receivers (no multiplexing)	<ul style="list-style-type: none"> ▶ Reliable multichannel phase and antenna measurements 	Provided as standard in base unit
Direct IF access, switchable to input or output, with 2 GHz analog IF bandwidth (output) and 1 GHz analog IF bandwidth (input)	Enhanced flexibility and sensitivity, e.g. when used in antenna test systems <ul style="list-style-type: none"> ▶ Provides direct access to up to eight phase-coherent receivers 	R&S®ZNA-B26
Four internal pulse generators and four internal pulse modulators	<ul style="list-style-type: none"> ▶ For measurements on pulsed signals and for flexible system integration 	R&S®ZNA-K7 R&S®ZNAxx-B4n ²⁾⁴⁾
Enhanced trigger and control functions (three additional trigger inputs, four trigger outputs, four pulse control I/O ports, ready for trigger, busy, RF interlock control) ⁵⁾	<ul style="list-style-type: none"> ▶ Universal system adaptation and easy system integration ▶ High reference frequency for low phase noise 	R&S®ZNA-B91
Source step attenuators, 0 dB to 70 dB in 10 dB steps	<ul style="list-style-type: none"> ▶ Generation of low-power stimulus signals down to -110 dBm 	R&S®ZNAxx-B2n ²⁾⁴⁾
Receiver step attenuators, 0 dB to 35 dB in 5 dB steps	<ul style="list-style-type: none"> ▶ Compression-free measurements with input power up to destruction limit of +27 dBm 	R&S®ZNAxx-B3n ²⁾⁴⁾
Rear panel output for internal LO signal (when 2nd internal LO source (R&S®ZNA-B5) is installed, the 2nd LO source is made available)	<ul style="list-style-type: none"> ▶ Support of compact mmWave converter setups (2/4-port mmWave converter setups with 2/4-port R&S®ZNA) without additional external source ▶ General-purpose RF source up to 26.5 GHz 	R&S®R&S ZNA-B8
Switchable internal combiner Provides a two-tone signal at port 1 ⁶⁾	<ul style="list-style-type: none"> ▶ Intermodulation measurements ▶ Embedded LO converter group delay measurements (R&S®ZNA-K9 option) 	R&S®ZNAxx-B213 ²⁾
Direct source monitor (reference signal) access When reconnecting the R&S®ZNAxx-B16 ²⁾ reference signal front panel jumper to the direct source monitor output (R&S®ZNAxx-B161/-B163) ²⁾ , the signal to the reference receiver can be picked up before the source step attenuator	<ul style="list-style-type: none"> ▶ Low trace noise even with low output power levels as typically encountered with high-gain DUTs ▶ Monitoring of source output power simultaneously at source monitor output and test port 	R&S®ZNAxx-B161/-B163 ²⁾

¹⁾ Between 100 kHz and 10 MHz, the internal coupler can only be used to a limited extent. Here, external directional components and recalibration are required.

²⁾ xx designates the R&S®ZNA model (R&S®ZNA26/R&S®ZNA43).

³⁾ The 2-port R&S®ZNA models come with one RF source as standard, the 4-port R&S®ZNA models with two RF sources.

⁴⁾ n designates the port number (1/2/3/4).

⁵⁾ 1 GHz reference frequency input provided as standard.

⁶⁾ 4-port R&S®ZNA only.

Principle of operation of 4-port R&S®ZNA vector network analyzer

xx designates the R&S®ZNA model (R&S®ZNA26/R&S®ZNA43).
 n designates the port number (1/2/3/4).

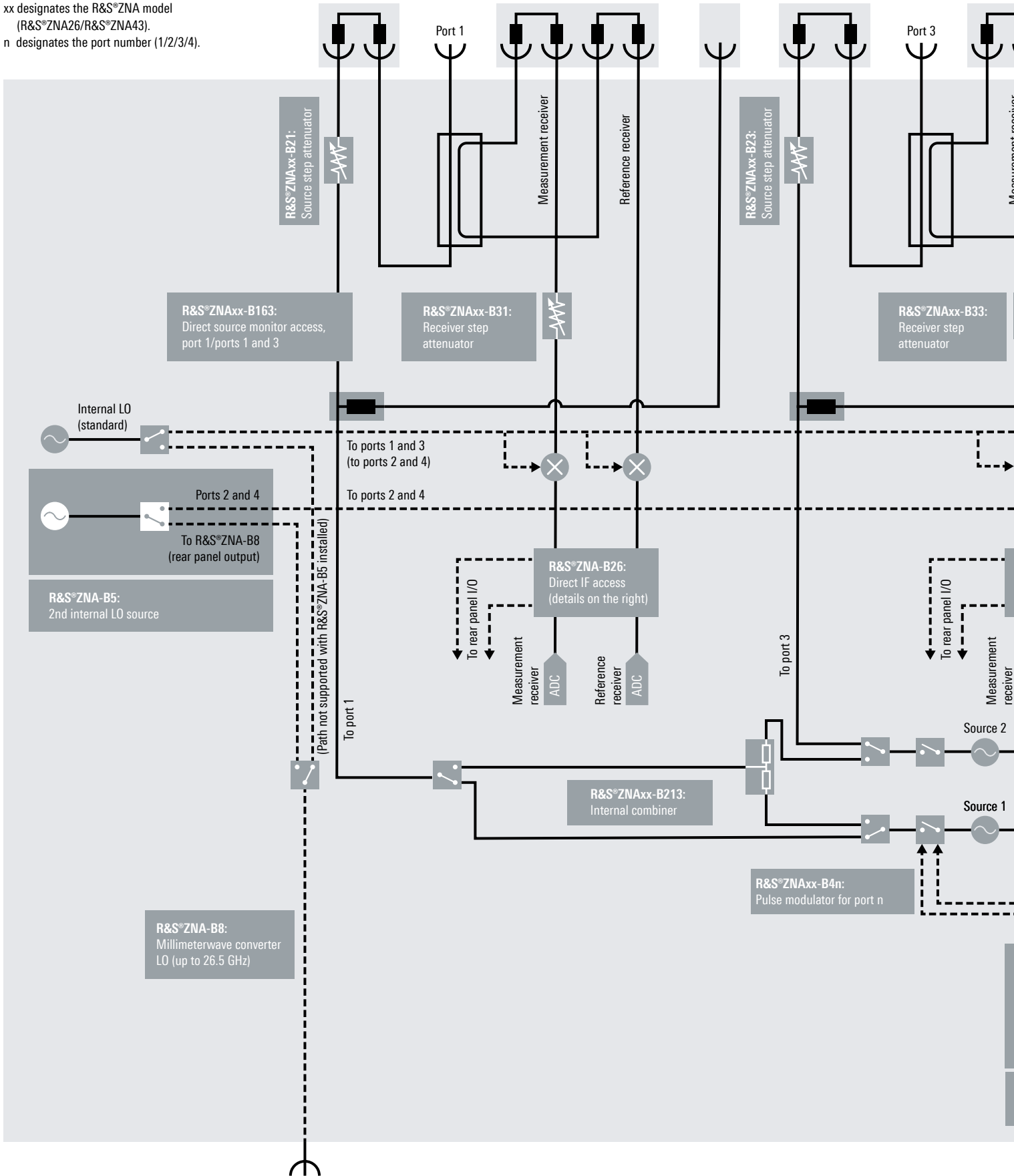

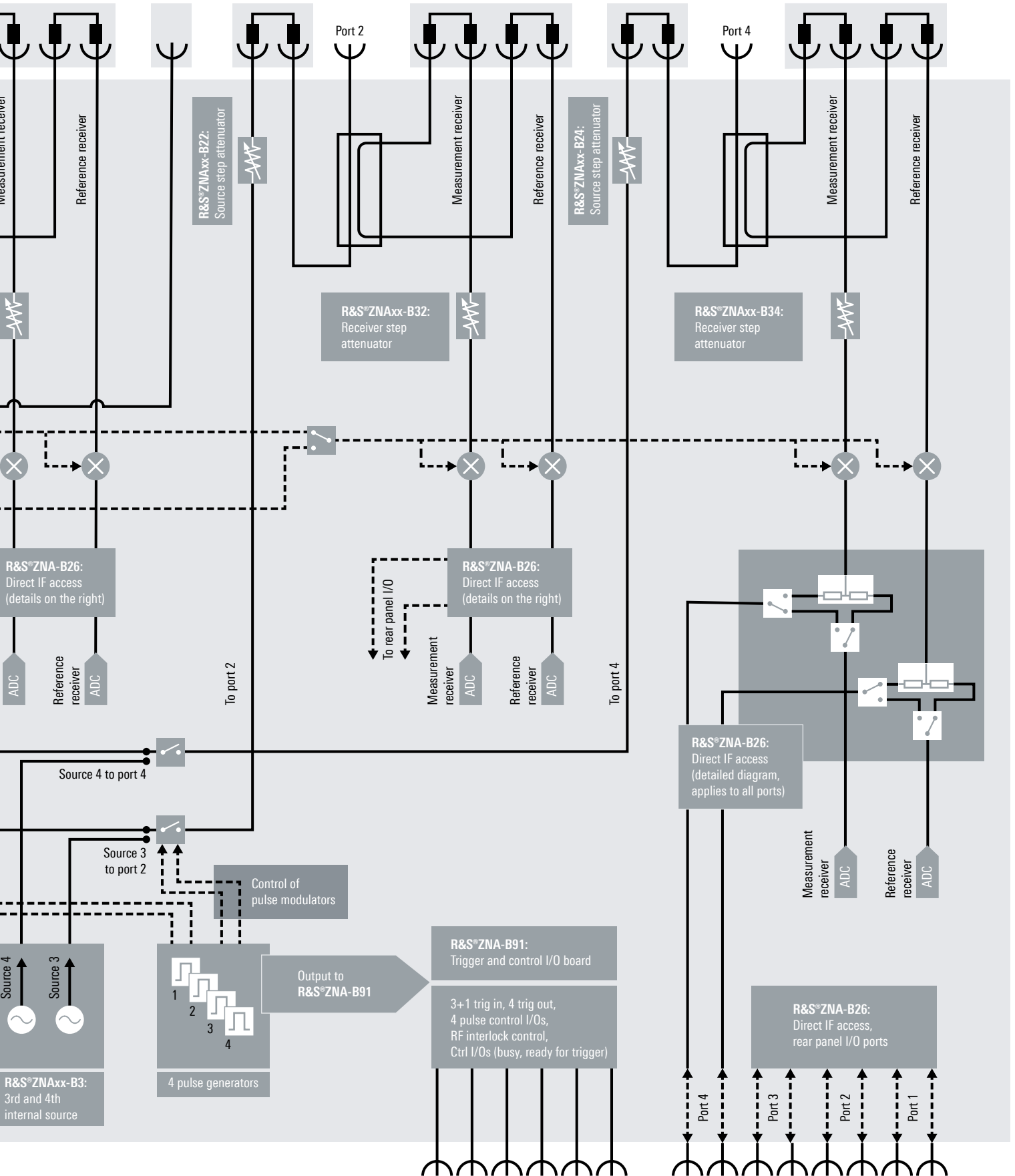

R&S® ZVA VECTOR NETWORK ANALYZER

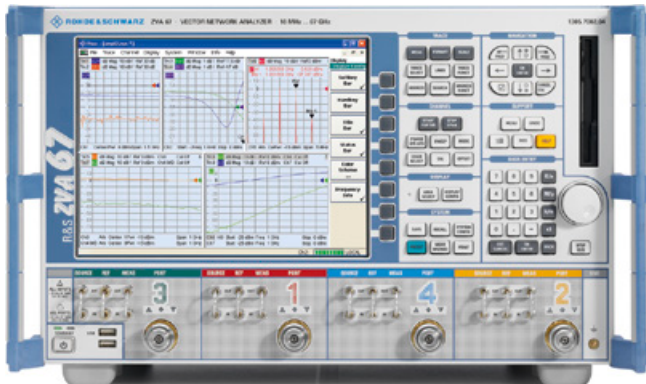

High performance up to 110 GHz with up to four test ports

The R&S®ZVA series is the high-end class of the Rohde&Schwarz network analyzers. It combines operating ease and high measurement speed, uniformly implemented in the R&S®ZVA and R&S®ZVT, with exceptional RF characteristics, a wide scope of functions and high flexibility.

The R&S®ZVA series is an ideal choice for demanding measurements in the lab and in production – from filter measurements requiring maximum dynamic range to linear and nonlinear measurements on amplifiers and mixers as well as on receivers and transceivers.

The R&S®ZVA has set milestones for the most challenging applications:

- ▶ First VNA with four internal sources up to 67 GHz for fast two-tone measurements on amplifiers and mixers
- ▶ First VNA up to 67 GHz that generates phase-coherent signals
- ▶ First VNA with IF bandwidths up to 30 MHz for pulsed measurements on amplifiers and mixers up to 110 GHz

Key facts

- ▶ Linear and nonlinear amplifier and mixer measurements
- ▶ Noise figure measurements
- ▶ Pulse profile measurements with 12.5 ns resolution

- ▶ True differential measurements for reliable characterization of active devices with balanced ports
- ▶ High output power typ. up to 18 dBm
- ▶ Wide dynamic range typ. > 140 dB
- ▶ High measurement speed < 3.5 μs per test point
- ▶ Wide IF bandwidth: 1/5/30 MHz
- ▶ Versatile calibration techniques: TOSM, TRL/LRL, TOM, TRM, TNA, UOSM
- ▶ Automatic calibration units
- ▶ Phase and group delay measurements on mixers with and without LO access
- ▶ Frequency range: 300 kHz to 8 GHz (R&S®ZVA8), 10 MHz to 24/40/50/67/110 GHz (R&S®ZVA24/40/50/67/110)

Design and operating principle of the R&S®ZVA110

The R&S®ZVA110 consists of an R&S®ZVA67 four-port base unit that is enhanced by two R&S®ZVA-Z110E W-band converters with electronic attenuator and diplexer. The overall system has two test ports with 1 mm connectors located on the diplexer outputs.

In the frequency range from 10 MHz to 67 GHz, the test signal will be generated in the R&S®ZVA67 four-port network analyzer and routed to the 1 mm test ports via diplexers. From 67 GHz to 110 GHz, the diplexers switch over and the test signal is routed to the test port via the converters and diplexers.

The R&S®ZVA hardware platform with up to four independent signal sources and two independent receivers per test port is the right base for future measurement requirements and secure investments.

Test set design for enhanced performance and flexibility

The test set includes a number of special design features. There is one measurement channel and one reference channel for each test port, an RF switch in each generator path and a generator for each pair of test ports. The R&S®ZVA24/40 four-source models and the R&S®ZVA67

Number of sources of the R&S®ZVA				
	Two-port	Four-port	Four-port with four sources	Upgrade options
R&S®ZVA8	1 (model .08)	2 (model .10)	–	
R&S®ZVA24	1 (model .24)	2 (model .26)	4 (model .28)	R&S®ZVA24-U5: upgrade from R&S®ZVA24 model .26 to four sources
R&S®ZVA40	1 (models .40/.43)	2 (models .42/.45)	4 (model .48)	R&S®ZVA40-U5: upgrade from R&S®ZVA40 model .26 to four sources
R&S®ZVA50	1 (model .50)	2 (model .52)	–	
R&S®ZVA67	2 (model .02)	–	4 (model .04)	
R&S®ZNA26/43	1	2	4 (option R&S®ZNA26/43-B3)	



four-port model even have a generator for each test port. This makes the R&S®ZVA an analyzer of unprecedented performance and functionality, which is especially true for the four-port model:

- ▶ True differential measurements on balanced DUTs
- ▶ Two or four independent sources, e.g. for LO and RF signals for fast mixer or intermodulation measurements
- ▶ Parallel signal output and measurement at the test ports for measuring two or more DUTs simultaneously

- ▶ Direct generator/receiver access option to connect external test setups, e.g. power amplifiers, or use as a multichannel receiver, e.g. for antenna measurements
- ▶ Generation of up to four coherent signals for A&D applications such as measurement of antenna arrays
- ▶ Extendable to active harmonic load pull solutions (four-source models)

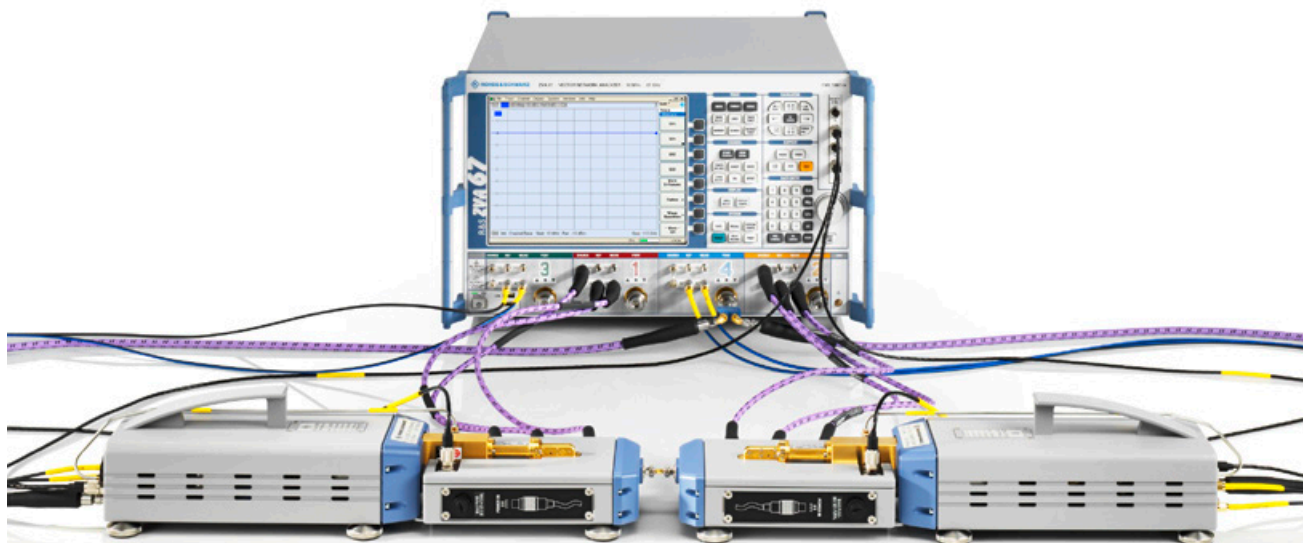

R&S®ZVA110 with continuous sweep from 10 MHz to 110 GHz

Block diagram of the R&S®ZVA8/24/40/50 four-port models

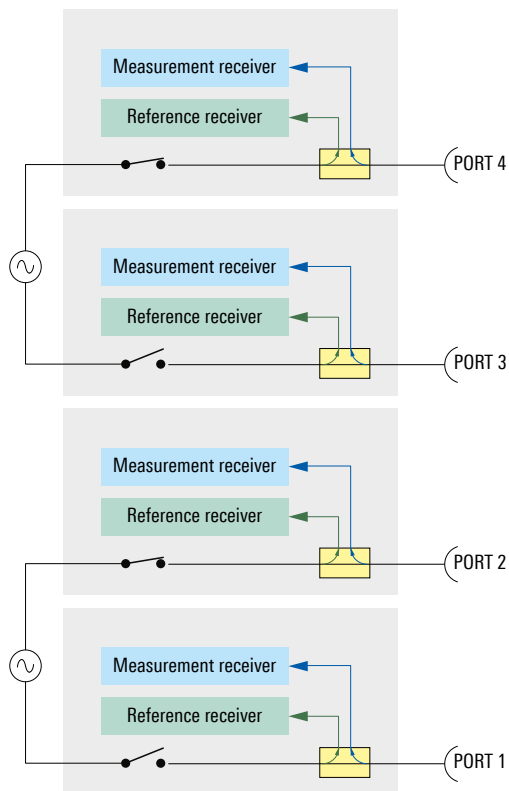

Block diagram of the R&S®ZVA24/40 four-source models and the R&S®ZVA67 four-port model

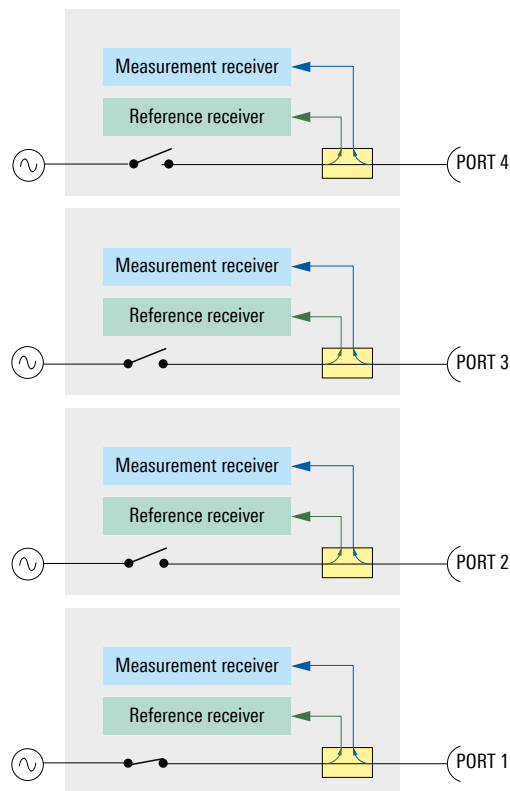

R&S® ZVT MULTIPOINT VECTOR NETWORK ANALYZER



Network analysis with up to eight test ports from 300 kHz to 20 GHz

The R&S®ZVT8 contains up to four internal generators and up to 8 ports with 16 receivers. The R&S®ZVT20 includes up to three internal generators and up to 6 ports with 12 receivers. This unique concept with one generator per two test ports makes the R&S®ZVT ideal for intermodulation measurements, even on mixers, (true) differential balanced measurements, multireceiver measurements with antennas or high throughput and efficiency in production. Hardware options such as direct generator/receiver access

for the individual ports enable versatile test set configuration. Based on this concept, the R&S®ZVT multiport vector network analyzers provide solutions for even the most demanding measurement tasks.

The R&S®ZVT provides all functions of the R&S®ZVA, plus features based on multichannel and multireceiver capability

- ▶ Arbitrary frequency conversion measurements
- ▶ Multiport measurements, avoiding any time loss due to matrix control
- ▶ Flexible configuration of test ports for balanced and single-ended measurements
- ▶ True differential measurements, coherence mode
- ▶ Multiple-signal measurements, e.g. intermodulation measurements on mixers or double-converting DUTs
- ▶ Enhanced performance by parallel measurements on several DUTs
- ▶ Multichannel receiver with simultaneous sampling of channels, e.g. for phase measurements on antenna arrays
- ▶ Automatic calibration units
- ▶ Point-in-pulse and pulse profile measurements with up to 16 receivers
- ▶ Embedding/deembedding

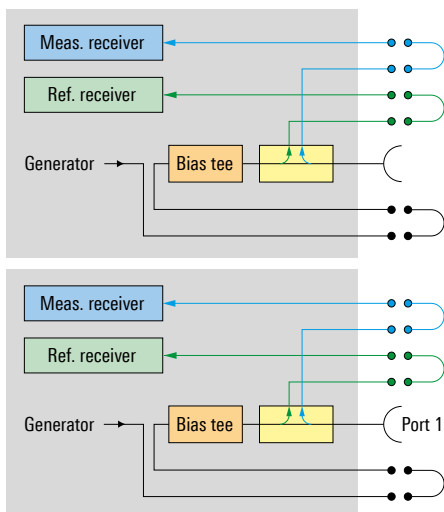
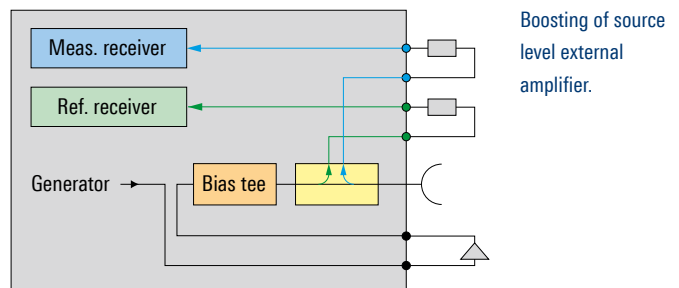
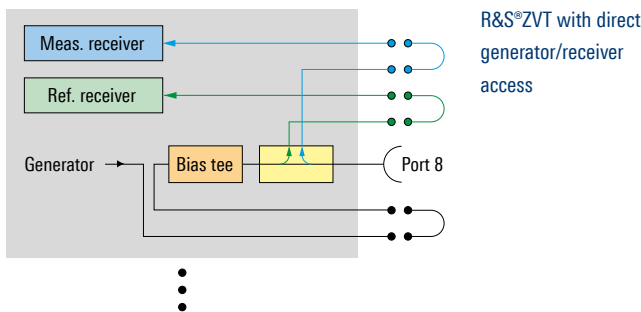

Internal combiner and generator step attenuators

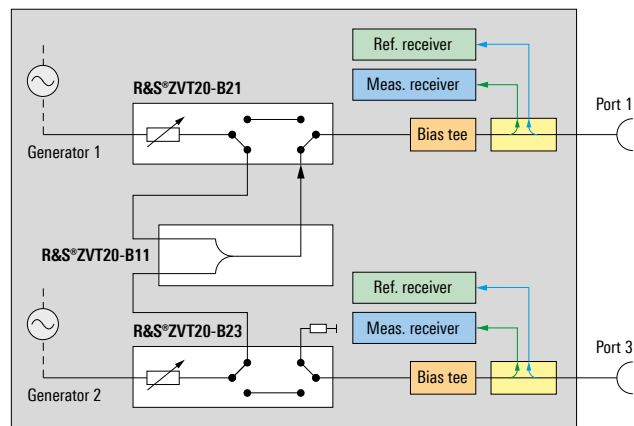

R&S®ZNB VECTOR NETWORK ANALYZER



Leading in speed, dynamic range and ease of operation

More than 60 years of experience in the field of vector network analysis pay off: Rohde&Schwarz sets new benchmarks with its R&S®ZNB family of vector network analyzers. These analyzers feature high measurement speed, outstanding precision and exceptional ease of operation.

With frequency ranges of 9 kHz to 4.5 GHz, 9 kHz to 8.5 GHz, 100 kHz to 20 GHz and 100 kHz to 40 GHz, the network analyzers are targeted at applications in the mobile radio, electronic goods and aerospace and defense sectors, plus they can be used in high-speed printed board design. The R&S®ZNB is the right choice when it comes to developing, producing and servicing RF components such as amplifiers, mixers, filters, connectors and cables. The R&S®ZNB vector network analyzers feature a wide dynamic range of up to 140 dB (at 10 Hz IF bandwidth), low trace noise of less than 0.004 dB RMS (at 10 kHz IF bandwidth) and high output power of up to +13 dBm, which can be adjusted electronically in a range of more than 95 dB.

The R&S®ZNB analyzers combine high measurement accuracy with exceptional speed – better than 5 μ s per point. They feature excellent temperature and long-term stability, which ensures reliable measurements over several days without having to recalibrate the units.

The short-depth, compact two-port and four-port analyzers leave plenty of space on the workbench for the measurement application. They feature low operating noise thanks to low power consumption and a sophisticated cooling concept. The low power consumption also reduces operating costs and protects the environment.

Key facts

- ▶ Frequency range from 9 kHz up to 40 GHz
- ▶ Wide dynamic range of up to 140 dB
- ▶ Short sweep times, e.g. 4 ms for 401 points
- ▶ High temperature stability of typ. 0.01 dB/°C
- ▶ Wide power sweep range of 98 dB
- ▶ Wide range of IF bandwidths from 1 Hz to 10 MHz
- ▶ Manual and automatic calibration
- ▶ Large, high-resolution 12.1" screen
- ▶ Touchscreen user interface
- ▶ Two or four ports
- ▶ Four-port model with two independent generators
- ▶ Expansion to up to 48 ports using switch matrices

R&S®ZNB models

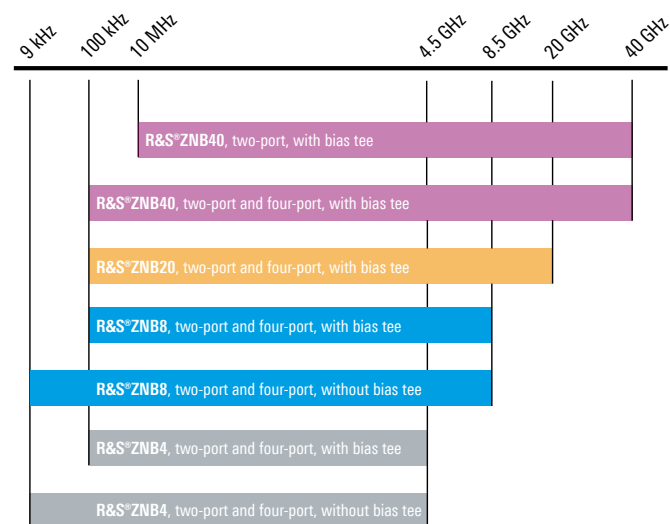

Functional elements of the two-port R&S®ZNB

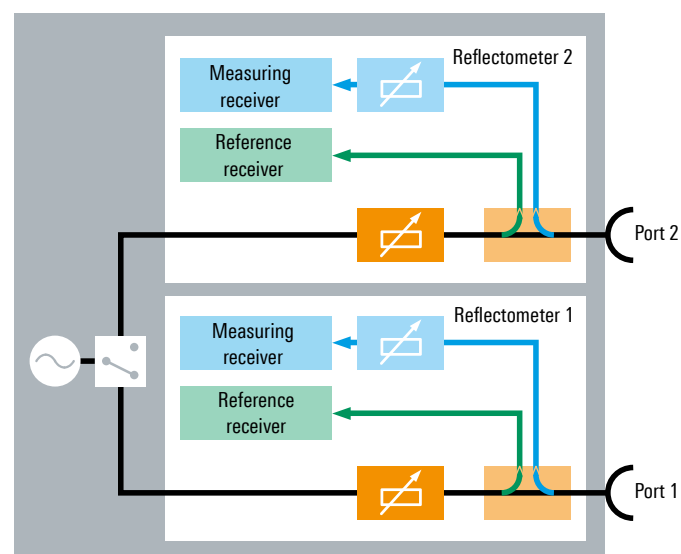

Configurator



Product site

R&S® ZNBT VECTOR NETWORK ANALYZER



Network analysis with up to 24 test ports

The R&S®ZNBT8/20 can simultaneously test multiple DUTs or measure one DUT with up to 24 ports. The instrument offers short measurement times even in scenarios with a large number of ports. Other highlights include a wide dynamic range, high output power levels and inputs featuring high power-handling capacity.

These features make the R&S®ZNBT ideal for applications in the mobile radio, wireless communications and electronic goods industries. The instrument is successfully used in the development and production of active and passive multiport components and frontend modules for mobile communication devices such as smart phones. Its outstanding performance also allows efficient analysis of base station filters and other highly selective components. Thanks to its high frequency range and number of ports, the R&S®ZNBT provides easy and high speed measurements for signal integrity as well as multi-array antenna measurement applications such as 5G antenna systems. The R&S®ZNBT outperforms switch matrix based multiport systems. Its high integration density makes it a very compact solution for analyzing components with up to 24 ports while requiring no more rack space than an R&S®ZNB.

The convenient user interface makes it easy to handle even very complex multiport measurements. The R&S®ZNBT supports various remote control options and is easy to integrate into automated test systems, for example for carrying out phased-array antenna measurements.

Key facts

- ▶ Four-port R&S®ZNBT8 base unit, upgradeable to 8, 12, 16, 20 or 24 ports
- ▶ Eight-port R&S®ZNBT20, R&S®ZNBT26 or R&S®ZNBT40 base unit, upgradeable to 12, 16, 20 or 24 ports
- ▶ Frequency range from 9 kHz to 8.5 GHz (R&S®ZNBT8), from 100 kHz to 20 GHz (R&S®ZNBT20), to 26.5 GHz (R&S®ZNBT26) and to 40 GHz (R&S®ZNBT40)

- ▶ Up to 24 fully phase-coherent receivers
- ▶ Wide dynamic range of up to 140 dB
- ▶ Short sweep times, e.g. 1.7 ms (R&S®ZNBT8) and 2.7 ms (R&S®ZNBT20, R&S®ZNBT26, R&S®ZNBT40) for a sweep across 201 points
- ▶ Wide power sweep range of up to 100 dB
- ▶ High power-handling capacity
- ▶ IF bandwidths from 1 Hz to 10 MHz
- ▶ High temperature stability of 0.01 dB/°K
- ▶ More than 100 traces and channels
- ▶ Simple configuration of multiport measurements
- ▶ Manual and automatic calibration methods optimized for multiport applications
- ▶ Status information
- ▶ Compatible with all vector network analyzers from the R&S®ZVA/R&S®ZVT and R&S®ZNx families

Functional elements of an R&S®ZNBT8

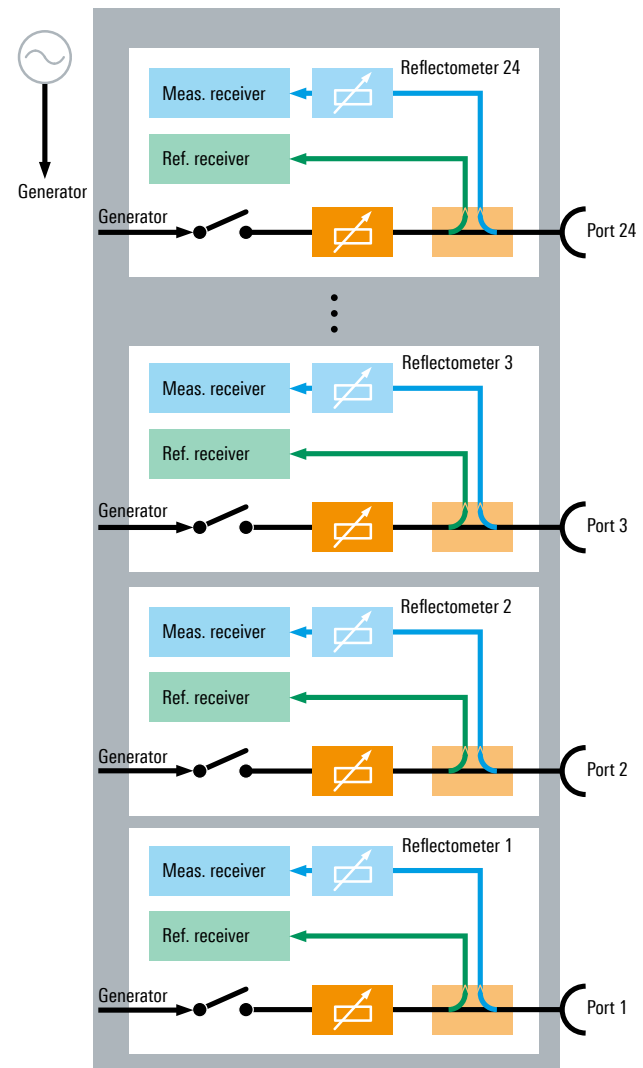

R&S®ZNL VECTOR NETWORK ANALYZER



The three-in-one allrounder

Measurement equipment for RF applications must fulfill high quality standards. Instruments should be easy to use and offer a high versatility. Fast measurements and reliable performance are crucial. With the R&S®ZNL, Rohde&Schwarz exceeds these expectations and offers even more: vector network analysis, spectrum analysis and power meter measurements are unified in one single, compact instrument making the R&S®ZNL a universal all-rounder.

Offering frequency ranges from 5 kHz to 3 GHz or 6 GHz the R&S®ZNL is well suited for various RF component measurement applications in industrial electronics and wireless communications. Ever changing measurement tasks in research laboratories can be demanding. The R&S®ZNL helps to reduce investment costs due to its unique concept. The base unit can be extended with a fully integrated spectrum analyzer option. Optionally, the R&S®ZNL can be used as a RF power meter.

Instead of investing in different instruments, research labs, service centers, universities and production facilities can use one single instrument that offers even higher measurement speeds and RF performance than other instruments in comparable classes. Vector network analysis and spectrum analysis measurements can be displayed on the 10.1" multitouch screen in parallel. Clear menu structures and numerous wizards help the user to configure each measurement conveniently.

Although the R&S®ZNL unifies a variety of different functionalities, it is a very compact instrument with an attractive form factor. Weighing only 6 to 8 kg, offering a carrying handle and a battery option, the R&S®ZNL is fully portable and can be operated, wherever needed.

Key facts

- ▶ Frequency range from 5 kHz to 3 GHz (R&S®ZNL3) or 5 kHz to 6 GHz (R&S®ZNL6)
- ▶ Two-port vector network analyzer for bidirectional measurements
- ▶ Universal instrument concept
 - Vector network analyzer
 - Fully integrated spectrum analyzer option
 - Power sensor measurement with R&S®NRP power sensors
- ▶ Wide dynamic range up to 130 dB
- ▶ Output power range from -40 dBm to typ. + 3 dBm
- ▶ Measurement bandwidths from 1 Hz to 500 kHz
- ▶ Fast measurements, i.e. 16.7 ms for 401 points (100 kHz IFBW, 200 MHz span, two-port TOSM (SOLT))
- ▶ Compact size and low weight (6 kg to 8 kg)
- ▶ Optional battery pack available

Comparison of the needed work bench space of different VNAs

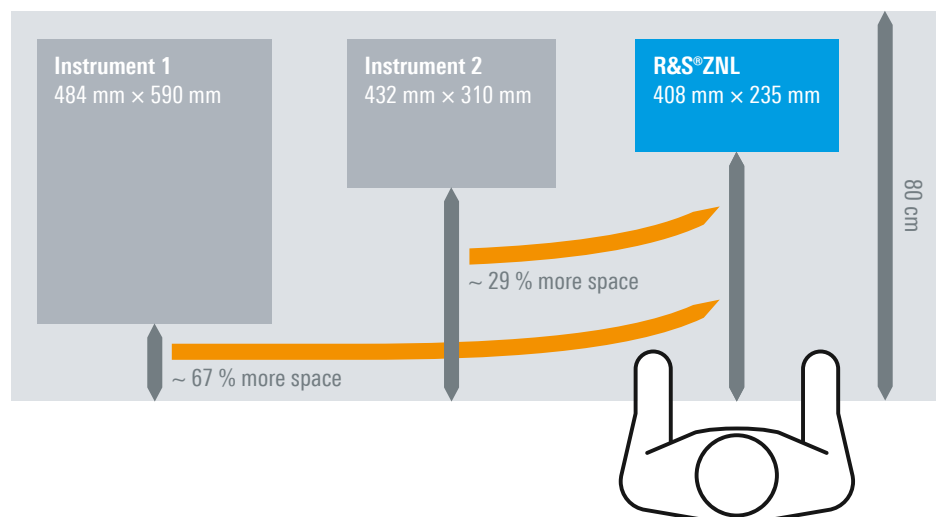

Configurator



Product site

R&S® ZNLE VECTOR NETWORK ANALYZER



Measurements as easy as ABC

The R&S® ZNLE makes vector network analyzer measurements as easy as ABC: easy to configure, easy to calibrate, easy to measure. The renowned high-quality design, an innovative user interface and its compact size make the R&S® ZNLE ideal for basic VNA applications.

The R&S® ZNLE is a two-port vector network analyzer that can be used for bidirectional measurements of S-parameters on passive components. Ordering the R&S® ZNLE requires only two decisions: the frequency range, whether or not you need a GPIB interface and whether you need to perform time domain analysis or distance-to-fault measurements.

The analyzer is available with a frequency range of 100 kHz to 3 GHz (R&S® ZNLE3 with R&S® ZNLE-B100 option) or 100 kHz to 6 GHz (R&S® ZNLE6 with R&S® ZNLE-B100 option). The optional GPIB interface lets you remotely control the R&S® ZNLE. As a standalone instrument, the R&S® ZNLE does not require an external PC to configure

the setup. You can start measuring immediately after you switch on the instrument.

Key facts

- ▶ Frequency range from 100 kHz to 3 GHz or to 6 GHz
- ▶ Two-port vector network analyzer with a full S-parameter test set for bidirectional measurements on passive components
- ▶ Wide dynamic range of up to typ. 120 dB
- ▶ Measurement bandwidths from 1 Hz to 500 kHz
- ▶ Fast measurements, i.e. 8.7 ms for 401 points (100 kHz IFBW, 200 MHz span, correction off)
- ▶ Compact size (depth 23.5 cm) and low weight (6 kg)
- ▶ Standalone instrument with 10.1" WXGA touchscreen
- ▶ Windows 10 operating system

An economical instrument with solid performance

- ▶ Compact vector network analyzer
- ▶ Low trace noise for high accuracy
- ▶ High measurement speed

User interface with multi-touchscreen

- ▶ Wide 10.1" WXGA touchscreen
- ▶ Clearly structured user interface
- ▶ Undo/redo softkey for user-friendly operation
- ▶ Fully integrated context-sensitive help menu

Standard instrument for use in a lab

- ▶ Calibration units for quick calibration
- ▶ De/embedding functionality and fixture compensation
- ▶ Remote controllable with LAN and GPIB option

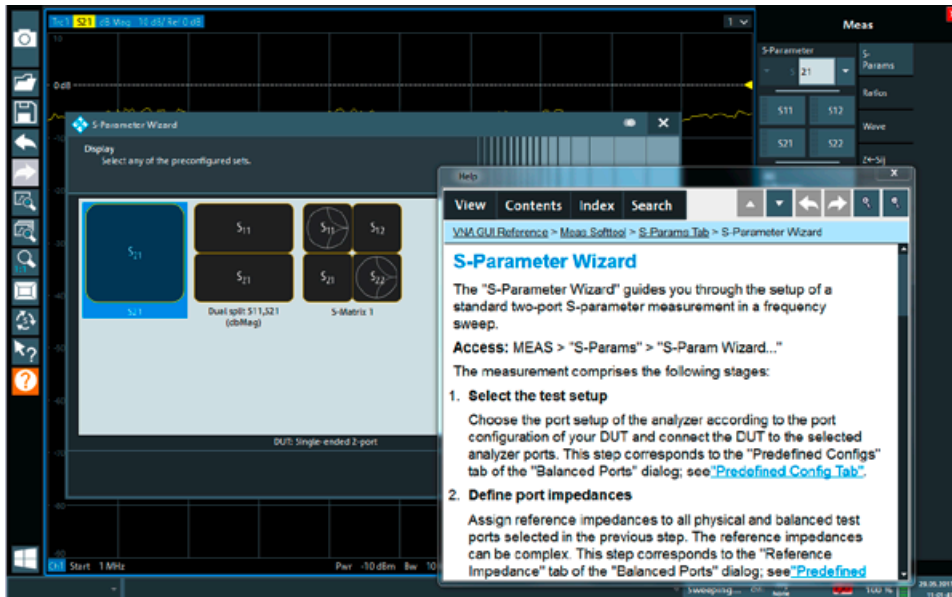

Overview of the R&S® ZNLE user interface. Here the wizard for easy configuration of S-parameters is opened as well as the context-sensitive help menu.



R&S®ZND VECTOR NETWORK ANALYZER



Basic, solid-performance network analysis

The R&S®ZND is a basic network analyzer that provides unidirectional measurements up to 4.5 GHz. Options are available to perform bidirectional measurements and to extend the frequency range to 8.5 GHz. The R&S®ZND supplements the R&S®ZNB family of network analyzers. The unidirectional R&S®ZND base model can be used to measure the S-parameters S_{11} and S_{21} . The R&S®ZND can easily be upgraded to provide bidirectional measurements and to extend the frequency range up to 8.5 GHz. Users can tailor the instrument to their specific needs in RF component production and development. The easy-to-operate R&S®ZND is also ideal for training purposes. The analyzer's large touchscreen makes it possible to display multiple results simultaneously. The R&S®ZND has the same remote control command set as the analyzers from the R&S®ZNB family. Users can switch between instruments without having to modify control programs.

Key facts

- ▶ Two-port network analyzer for unidirectional measurements from 100 kHz to 4.5 GHz
- ▶ Frequency range can be extended to 8.5 GHz

Unidirectional/bidirectional test set

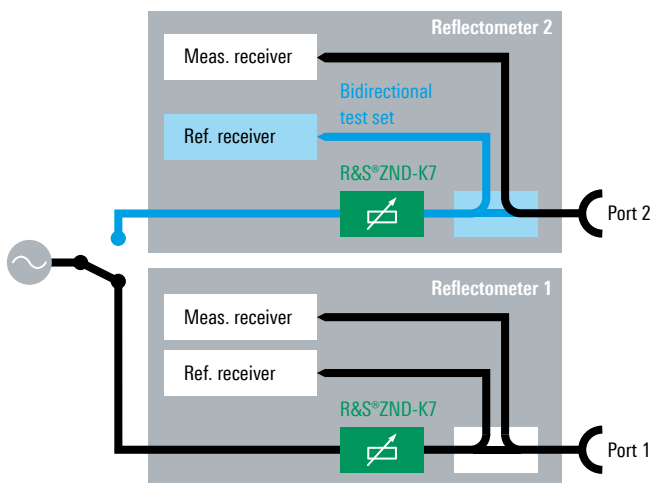

- ▶ Test set can be enhanced for bidirectional measurements
- ▶ Touchscreen operation
- ▶ Dynamic range up to 120 dB
- ▶ Power sweep range up to 55 dB
- ▶ Bandwidths from 1 Hz to 300 kHz
- ▶ More than 100 traces and channels
- ▶ Compatible with all Rohde & Schwarz network analyzers
- ▶ Embedding/deembedding
- ▶ Output power up to +10 dBm

The analyzer that grows with your requirements

- ▶ Vector network analysis
- ▶ Unidirectional test set
- ▶ Bidirectional test set
- ▶ Easy to upgrade
- ▶ Time domain analysis for cable and filter measurements
- ▶ Easy transition to analyzers from the R&S®ZNB family
- ▶ Interfaces for test sequence control in production environments

Easy to operate

- ▶ Flat menu structures for efficient operation
- ▶ Optimal display configuration for each measurement task

Convenient calibration

- ▶ The right calibration method for every application
- ▶ Flexibility and accuracy with Rohde & Schwarz calibration kits
- ▶ Automatic calibration within 30 seconds

Upgrade options for R&S®ZND base unit

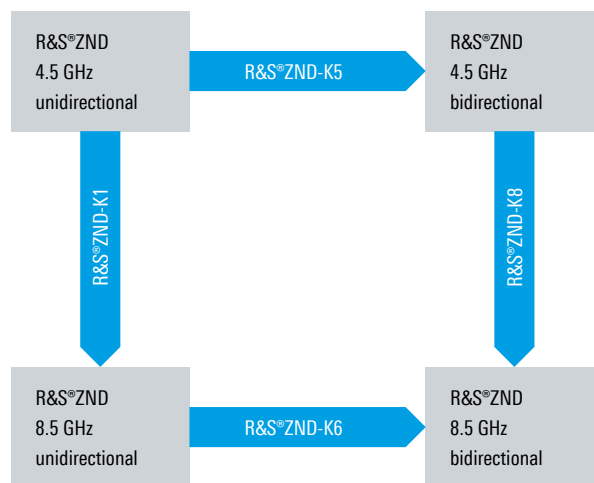

R&S® ZVL VECTOR NETWORK ANALYZER



The cost-efficient compact class in network analysis

The R&S®ZVL is a compact, powerful, and future-proof network analyzer, and therefore ideal for use in development, production, and service. It is the only instrument to combine the functions of a network analyzer, spectrum analyzer, and power meter in a single box, and will thus tremendously increase your work efficiency.

The R&S®ZVL is ideal for lab applications where the measurement tasks vary frequently; it can be used to measure S-parameters as well as the output spectrum, ACP, and TOI without having to reconnect the device under test (DUT). With the R&S®ZVL, production lines can now be run even more flexibly, as the switchover from network analyzer to spectrum analyzer can easily be effected via remote control. Moreover, an R&S®NRP-Z power sensor, which can be directly connected to the R&S®ZVL, ensures precise power measurements.

Key facts

- ▶ Wide frequency range: 9 kHz to 13.6 GHz (overrange 5 kHz to 15 GHz)
- ▶ Bidirectional test set: display of all four S-parameters

Offering excellent specifications and a wide range of functions at a favorable price, the R&S®ZVL is every development engineer's ideal network analyzer.

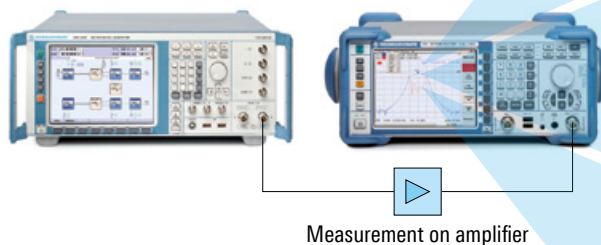

- ▶ Complete spectrum analyzer as an option
- ▶ Accurate power measurement (USB connector for R&S®NRP-Z power sensor series)
- ▶ Compact size and low weight (< 7 kg)
- ▶ 12 V DC operation and internal battery

Versatile solution

- ▶ Favorable price and high performance reduce costs
- ▶ Compact dimensions and low weight save space and facilitate mobile operation
- ▶ Upgradeability and compatibility within the instrument family protect your investment
- ▶ TV and CATV applications

All-in-one solution

- ▶ Wide scope of functions
- ▶ Universal tool for installation and service

High throughput in production

- ▶ Dynamic range and speed for complex DUTs
- ▶ Sweep modes adapted to the task reduce measurement time
- ▶ Multitrace display for faster DUT characterization

Easy and intuitive operation

- ▶ User-friendly and error-tolerant even for complex measurement tasks
- ▶ Trace evaluation and marker functions facilitate manual filter tuning
- ▶ Easy export and import of measurement results for quick documentation or comparison with a golden device

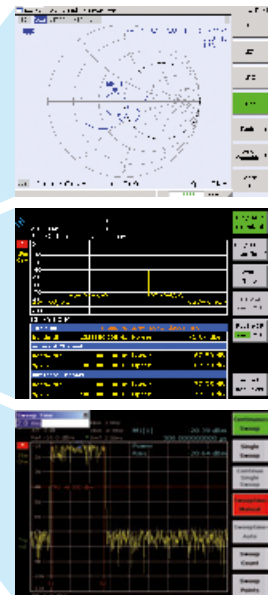

Configurator



Product site

R&S® ZVH CABLE AND ANTENNA ANALYZER



For more efficiency in the field

The R&S®ZVH cable and antenna analyzer is rugged, handy and designed for use in the field. Its low weight and simple operation make it indispensable for anyone who needs an efficient measuring instrument outdoors for the installation and maintenance of antenna systems.

When it comes to the installation or maintenance of antenna systems for mobile radio, broadcasting or radiocommunications, the R&S®ZVH cable and antenna analyzer performs fast, reliable and highly accurate measurements. Even in its basic configuration, the R&S®ZVH detects cable faults, measures the matching of filters and amplifiers and checks the loss of cable connections – the three most important tasks involved in setting up transmitter systems and putting them into operation. For further measurements such as the isolation between transmit and receive antennas or the output power of output amplifiers, suitable options are available to the RF service engineer or maintenance team.

Weighing only 3 kg, the R&S®ZVH is a handy instrument. Frequently used functions have their own function keys and are within fingertip reach. The built-in wizard lets users perform even extended test sequences fast and flawlessly. Using the R&S®InstrumentView software, test reports can be generated in just a few simple operating steps.

The brilliant color display is easy to read even under poor lighting conditions, and it has a monochrome mode for extreme conditions. The capacity of the R&S®ZVH battery enables uninterrupted operation for up to 4.5 hours. The battery is changed within seconds. And if it rains? No problem – all connectors are splash-proof.

Key facts

- ▶ Frequency range from 100 kHz to 3.6 GHz or 8 GHz
- ▶ Typ. 100 dB dynamic range for filter and antenna isolation measurements
- ▶ Factory calibration over entire frequency range
- ▶ Built-in DC voltage supply (bias) for active components such as amplifiers
- ▶ Power meter option
- ▶ Saving of measurement results on SD memory card or USB memory stick
- ▶ Easy operation with user-configurable test sequences (wizard)
- ▶ Easy-to-replace lithium-ion battery for up to 4.5 h of operation
- ▶ Rugged, splash-proof housing for rough work in the field
- ▶ Easy handling due to low weight (3 kg with battery) and easy-to-reach function keys



Configurator



Product site

R&S® Cable Rider ZPH CABLE AND ANTENNA ANALYZER



Expect fast, expect efficient

The R&S®CableRider ZPH has all the essential basic measurement capabilities required for installing and maintaining antenna systems in the field. Its unique features ensure fast and efficient cable and antenna measurements. The easy-to-use analyzer features a touchscreen and large keypad designed for field use.

With its short boot and warm-up times and fast measurement speed, the R&S®CableRider ZPH gets down to analyzing extremely fast. Measurement setups can be pre-drawn and settings preconfigured. Thanks to the wizard function, fast and accurate measurements are performed in a single step. Generating measurement reports is easy with the R&S®InstrumentView software.

There is no need to calibrate the analyzer before use. It is reliably and accurately calibrated before leaving the factory. Should calibration be needed to eliminate the effects of additional cables or adapters used to connect the analyzer to the device under test (DUT), the R&S®ZN-Z103 automatic calibration unit performs the calibration in just one step.

The battery lasts up to an entire work day on just one charge. The keypad is illuminated to facilitate working in dim environments. The leading-edge capacitive touchscreen of the R&S®CableRider ZPH is changing the way

users interact with an analyzer – simply touch the screen to add markers and change settings. These features and the ergonomic design make the R&S®Cable Rider ZPH ideal for fast and efficient on-site measurements.

Two different R&S®ZPH models are available to suit different needs; a pure one port cable and antenna analyzer as well as a two-port model with additional spectrum analysis and tracking generator features.

Key facts

- ▶ Frequency range in cable and antenna analyzer mode from 2 MHz to 3 GHz or 4 GHz, upgrade via keycode
- ▶ Frequency range in spectrum analyzer mode from 5 kHz to 3 GHz or 4 GHz, upgrade via keycode
- ▶ One-port model features: DTF, return loss, VSWR and cable loss measurements
- ▶ Two-port model additionally features S_{21} measurements, spectrum and interference analysis, AM/FM/ASK/FSK demodulation
- ▶ Ideal for field use: up to 9-hour battery life, 2.5 kg (5.5 lb), backlit keypad, fast boot time, non-reflective display, small form factor, ruggedized housing (IP51)
- ▶ Large color touchscreen
- ▶ Measurement wizard to speed up measurements and eliminate human error
- ▶ Easy and cost-efficient upgrades of all options via software keycode

Model selection guide

Feature	model .02	model .12
Frequency upgrade to 4 GHz	•	•
Measurement wizard	•	•
R&S®InstrumentView support	•	•
R&S®MobileView support	•	•
DTF	•	•
Return loss and VSWR	•	•
Cable loss	•	•
Transmission (S_{21})	–	•
Spectrum analysis, 5 kHz to 3 GHz or 4 GHz	–	•
Tracking generator capability	–	•
Signal generator capability	–	•
Bias tee	–	•
Ideal for cable and antenna measurement and troubleshooting	•	•
Ideal for verifying signal transmission	–	•
Ideal for interference hunting	–	•



R&S®ZRun AUTOMATED TEST SOFTWARE



PC-based server platform for automated VNA tests

In production environments, measurements need to be performed on devices under test (DUT) with an ever-increasing number of ports. Vector network analyzers (VNA) are often used in combination with other test equipment in order to perform these tests as quickly and efficiently as possible. With the R&S®ZRun automated test software, Rohde&Schwarz offers a powerful control software application for automated measurements. Characterization of a complex DUT, such as a frontend module, requires detailed configuration of the test setup and precise definition of the test sequence.

The R&S®ZRun automated test software simplifies these tasks. In a first step, the user sets the test equipment to be used, the number of ports on the DUT and the measurements to be performed.

R&S®ZRun-K2 option for controlling multiple test systems

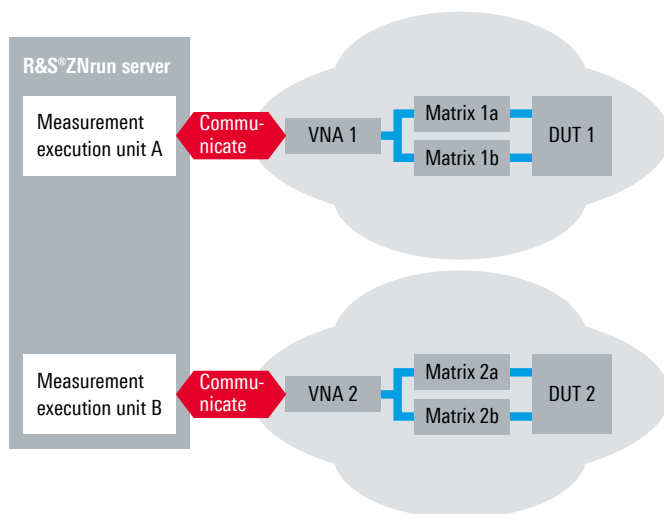

The multiclient version of the automated test software can be used to control multiple test systems in parallel, including differently configured systems.

The R&S®ZRun automated test software then takes over communications with the test equipment and configures it in accordance with the user's specifications. The software helps users boost measurement speed. The software executes the preconfigured measurements in an optimized sequence that requires the fewest possible changes to the system between one measurement and the next. If a switch matrix is used, the software keeps the number of switching operations and switching levels to a minimum.

To configure the test, the user can utilize the graphical user interface (GUI) as well as plug-ins. It is up to the user to decide whether to use one or the other, or a combination of the two. For example, a test can be configured in the GUI and plug-ins can be used to add further test equipment to the VNA. This ability to mix and match gives users a powerful tool for obtaining the best possible performance from the equipment on hand.

Key facts

- ▶ Configuration of tests with vector network analyzers in production systems
- ▶ One software package to manage and control multiple test setups
- ▶ Optimization of production system speed
- ▶ Integration of external components (power supplies, multimeters, etc.) in test sequences by using plug-ins
- ▶ Control of DUT, e.g. via RFFE GPIO interface
- ▶ Efficient system error correction on test system
- ▶ Test setups centered around the DUT
- ▶ Graphical visualization and analyzing of the measured data

Functional model of R&S®ZRun software

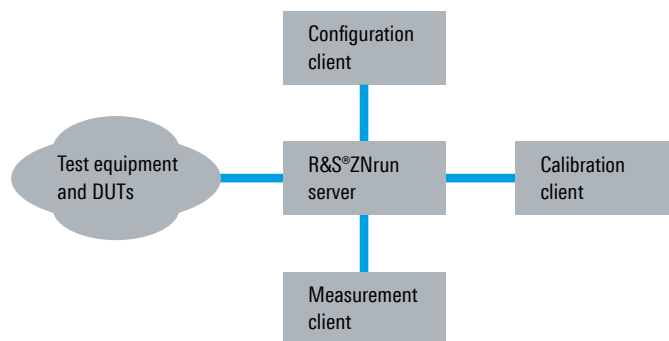

The R&S®ZRun server controls communications between the test equipment, the DUT and the various clients of the software.



R&S® ZCxxx MILLIMETERWAVE CONVERTERS

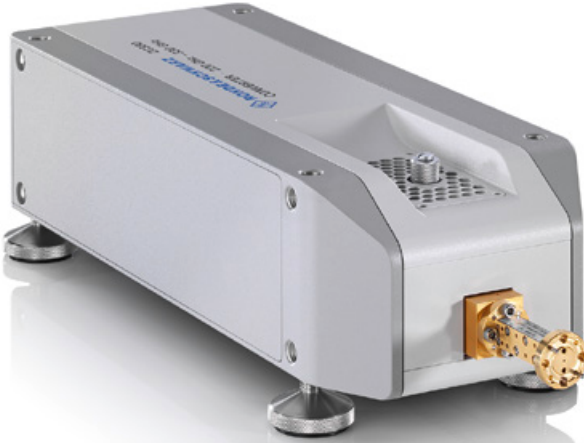

Network analysis up to 750 GHz

The R&S® ZCxxx millimeter-wave converters allow millimeter-wave measurements in the frequency range from 60 GHz to 750 GHz (WM-2540/-2032/-1651/-1295/-864/-570 and -380). They feature a wide dynamic range and high output power. Plus, they offer high operating convenience and allow highly stable measurements.

The converters' wide dynamic range is particularly beneficial for measurements on high-blocking filters, for antenna measurements and on-wafer amplifier measurements. It also speeds up measurements in general, as it enables the use of wider bandwidths while maintaining the same excellent performance.

Key facts

- ▶ Wide frequency range
60 GHz to 90/110/140/170/220/330/500/750 GHz
- ▶ For use with an R&S® ZNA26, R&S® ZNA43, R&S® ZVA24, R&S® ZVA40, R&S® ZVA50, R&S® ZVA67 or R&S® ZVT20 (R&S® ZVT20 not suitable for R&S® ZC140, R&S® ZC500 and R&S® ZC750)
- ▶ R&S® ZC750 only with R&S® ZNA26, R&S® ZNA43, R&S® ZVA24, R&S® ZVA40 and R&S® ZVA67
- ▶ R&S® ZC90E not with R&S® ZNA26 and R&S® ZNA43
- ▶ High output power
- ▶ Wide dynamic range
- ▶ Variable output power (not with R&S® ZC90 and R&S® ZC110)
- ▶ Automatic parameter setting
- ▶ Easy handling
- ▶ Highly stable measurements

Specifications in brief

	R&S® ZC90	R&S® ZC90E	R&S® ZC110
Waveguide designator	WR-12	WR-12	WM-2540
Frequency range	60 GHz to 90 GHz	60 GHz to 90 GHz	75 GHz to 110 GHz
Output power at +7 dBm input power from the R&S® ZNA/ZVA/ZVT	> +7 dBm (n. trc.), typ. +10 dBm	> +2 dBm (n. trc.), typ. +6 dBm	> +12 dBm (n. trc.), typ. +15 dBm
Output power attenuation	–	electronically adjustable 0 dB to 25 dB	–
Dynamic range	> 110 dB, typ. 120 dB	> 105 dB, typ. 118 dB	> 110 dB, typ. 120 dB
	R&S® ZC140	R&S® ZC170	R&S® ZC220
Waveguide designation	WM-2032	WM-1651	WM-1295
Frequency range	90 GHz to 140 GHz	110 GHz to 170 GHz	140 GHz to 220 GHz
Output power at +7 dBm input power from the R&S® ZNA/ZVA/ZVT	> +5 dBm to +7 dBm (n. trc.), typ. +7 dBm to +9 dBm	> +5 dBm (n. trc.), typ. +9 dBm	> –2 dBm (n. trc.), typ. +1 dBm
Output power attenuation	manually adjustable: 0 dB to 40 dB	manually adjustable: 0 dB to 40 dB	manually adjustable: 0 dB to 40 dB
Dynamic range	> 105 dB, typ. 120 dB	> 90 dB, typ. 105 dB	> 100 dB, typ. 115 dB
	R&S® ZC330	R&S® ZC500	R&S® ZC750
Waveguide designation	WM-864	WM-570	WM-380
Frequency range	220 GHz to 330 GHz	330 GHz to 500 GHz	500 GHz to 750 GHz
Output power at +7 dBm input power from the R&S® ZNA/ZVA/ZVT	> –10 dBm (n. trc.), typ. –7 dBm	> –15 dBm (n. trc.), typ. –11 dBm	> –30 dBm (n. trc.), typ. –18 dBm
Output power attenuation	manually adjustable: 0 dB to 40 dB	manually adjustable: 0 dB to 40 dB	manually adjustable: 0 dB to 40 dB
Dynamic range	> 100 dB, typ. 115 dB	> 85 dB, typ. 100 dB	> 80 dB, typ. 90 dB



R&S® ZVA-ZXX MILLIMETERWAVE CONVERTERS



Network analysis up to 500 GHz

Featuring a wide dynamic range, these Rohde & Schwarz converters offer high operating convenience and allow fast measurements. Two-port measurements can be performed using a four-port network analyzer and two converters; no external generator is required.

When using a two-port network analyzer, an external generator is needed to supply the LO signals. The wide dynamic range is particularly important for high-blocking filters, for example, but it also speeds up measurements in general, as it enables the use of wider bandwidths while maintaining the same excellent performance.

Key facts

- ▶ Network analysis from 50 GHz to 500 GHz depending on converter model
- ▶ Variable output power
- ▶ Electronic power control (R&S®ZVA-Z110E)
- ▶ Automatic parameter setting
- ▶ Multiport and true differential measurements
- ▶ Pulsed measurements
- ▶ Calibration
- ▶ Applications
 - On-wafer measurements
 - True differential measurements

Specifications in brief			
	R&S®ZVA-Z75	R&S®ZVA-Z90	R&S®ZVA-Z110
Waveguide designation			
Electronic Industries Alliance (EIA)	WR15	WR12	WR10
Connector type			
Anti-cocking flange	precision waveguide flange compatible with UG387/U-M		
Frequency range	50 GHz to 75 GHz	60 GHz to 90 GHz	75 GHz to 110 GHz
Output power			
	at +7 dBm input power from the R&S®ZVA/R&S®ZVT		
	typ. +4 dBm	typ. +10 dBm	typ. +10 dBm
Output power attenuation			
	manually variable attenuator	adjustable by RF input power reduction	(manually 0 dB to 40 dB) reduction of RF input power
Range	0 dB to 40 dB	0 dB to 70 dB	0 dB to 70 dB
Dynamic range	> 90 dB, typ. 110 dB	> 100 dB, typ. 115 dB	> 100 dB, typ. 110 dB
	R&S®ZVA-Z110E (model .40)	R&S®ZVA-Z110E (model .50)	
Waveguide designation			
Electronic Industries Alliance (EIA)	WR10	WR10	
Connector type			
Anti-cocking flange	precision waveguide flange compatible with UG387/U-M		
Frequency range	75 GHz to 110 GHz	75 GHz to 110 GHz	
Output power			
	at +7 dBm input power from the R&S®ZVA/R&S®ZVT		
	typ. -5 dBm	typ. 0 dBm	
Output power attenuation			
	electronic power control	electronic power control	
Range	0 dB to 25 dB	0 dB to 25 dB	
Dynamic range	> 90 dB, typ. 105 dB	> 95 dB, typ. 110 dB	



Videos



Product site

RPG ZRX HIGH DYNAMIC RECEIVERS FOR VECTOR NETWORK ANALYZERS



High-performance VNA frequency extension

The RPG¹⁾ vector network analyzer extenders (VNA extenders) extend the frequency of vector network analyzers up to 750 GHz. The RPG ZRXxxx high dynamic receivers offer superior broadband conversion performance. Antenna measurements are a typical application.

A typical setup includes an RPG ZRXxxx on the receiving side and an R&S®ZCxxx millimeterwave converter on the transmitting side. The available models cover a frequency range up to 750 GHz. Passive cooling is a standard feature with all these modules. They are compatible with the R&S®ZCxxx millimeterwave converters. The R&S®ZCPS power supply is also available for the RPG ZRX receivers.

Key facts

- ▶ Fullband operation
- ▶ Compatible with R&S®ZCxxx converters
- ▶ Applications
 - Vector network analysis
 - Signal and spectrum analysis
- ▶ LO input power +7 dBm
- ▶ IF frequency range 1 MHz to 2.9 GHz

¹⁾ RPG – A Rohde & Schwarz company.

Overview of high dynamic receivers			
	RPG ZRX90	RPG ZRX110	RPG ZRX140
Frequency range	60 GHz to 90 GHz	75 GHz to 110 GHz	90 GHz to 140 GHz
RF port	WR12	WM-2540	WM-2032
Intrinsic mixer CL (SSB, without IF amplification)	typ. 12 dB	typ. 10 dB	typ. 12 dB
Dynamic range (with R&S®ZCxxx)	typ. 120 dB	typ. 150 dB	typ. 145 dB
LO frequency range	15 GHz to 22.5 GHz	9.37 GHz to 13.75 GHz	11.25 GHz to 17.5 GHz
Multiplication factor	4	8	8
Internal IF amplifier (gain)	13 dB	13 dB	13 dB
	RPG ZRX170	RPG ZRX220	RPG ZRX260
Frequency range	110 GHz to 170 GHz	140 GHz to 220 GHz	170 GHz to 260 GHz
RF port	WM-1651	WM-1295	WM-1092
Intrinsic mixer CL (SSB, without IF amplification)	typ. 22 dB	typ. 11 dB	typ. 12 dB
Dynamic range (with R&S®ZCxxx)	typ. 135 dB	typ. 140 dB	typ. 130 dB
LO frequency range	11 GHz to 17 GHz	11.66 GHz to 18.33 GHz	14.16 GHz to 21.6 GHz
Multiplication factor	10	12	12
Internal IF amplifier (gain)	28 dB	20 dB	13 dB
	RPG ZRX330	RPG ZRX500	RPG ZRX750
Frequency range	220 GHz to 330 GHz	325 GHz to 500 GHz	500 GHz to 750 GHz
RF port	WM-864	WM-570	WM-380
Intrinsic mixer CL (SSB, without IF amplification)	typ. 15 dB	typ. 22 dB	typ. 35 dB
Dynamic range (with R&S®ZCxxx)	typ. 128 dB	typ. 115 dB	typ. 105 dB
LO frequency range	9.16 GHz to 13.75 GHz	13.5 GHz to 20.8 GHz	13.888 GHz to 20.833 GHz
Multiplication factor	24	24	36
Internal IF amplifier (gain)	18 dB	26 dB	28 dB

R&S®ZN-Z32/-Z33 INLINE CALIBRATION UNITS



R&S®ZN-Z32, 10 MHz to 8.5 GHz (for ambient conditions)



R&S®ZN-Z33, 10 MHz to 40 GHz (for ambient conditions)



R&S®ZN-Z33, 10 MHz to 40 GHz (for ambient conditions – TVAC qualified model (without display and control button))

Automatic calibration, delivering high accuracy with thermal vacuum testing and multipoint measurements

The R&S®ZN-Z3x inline calibration units (ICU) provide an automatic system error correction with Rohde & Schwarz network analyzers. In contrast to common calibration units, the R&S®ZN-Z3x remain permanently connected to the test cable, facilitating a recalibration without the need for reconnection of calibration devices by the operator. Controlled via CAN bus, recalibration is possible at any time using a single keystroke in the control software tool.

Calibration solution for demanding setups: TVAC (satellite) testing

When testing in a thermal vacuum chamber (TVAC), thermal drift effects of the test system components, e.g. RF cables, adapters, switches, or preamplifiers, cause the original calibration to become invalid. With the R&S®ZN-Z33 TVAC in-line calibration units permanently connected to the ends of the test cables, a fast calibration update can be applied after each change of the environmental parameters. The factory-based temperature characterization of the units, provides accurate and reliable results in a range as wide as –30°C to +80°C.



R&S®ZN-Z30 CAN bus control unit (front view)

R&S®ZN-Z33 TVAC system (R&S®ZN-Z3ASW application software installed on PC or VNA)

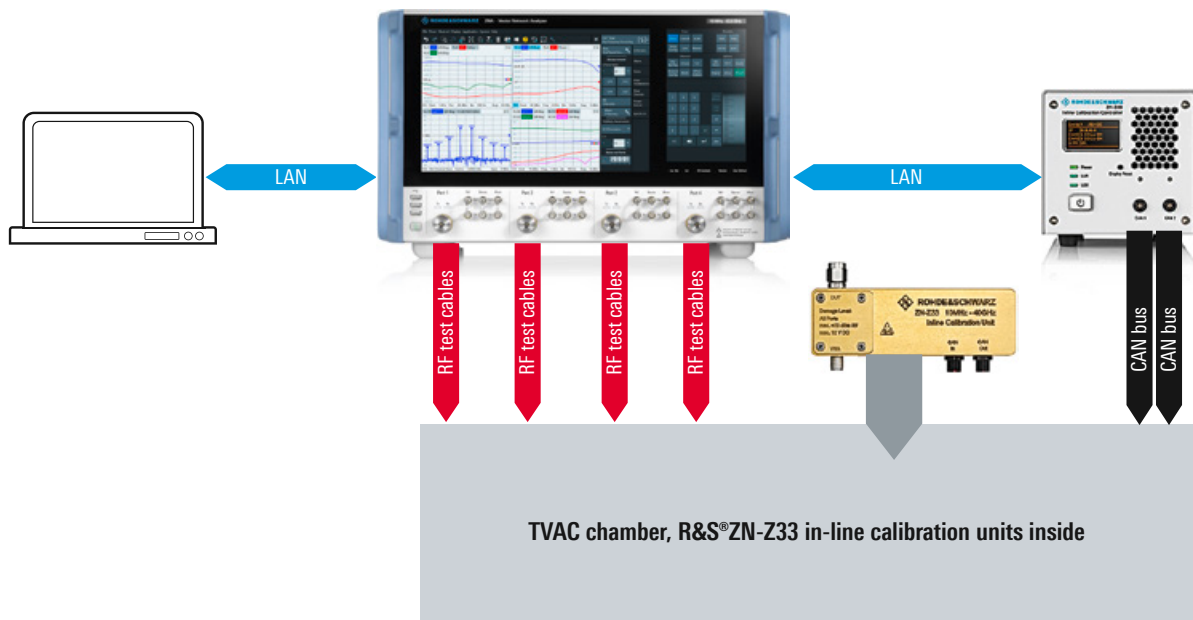

Accessories for network analysis

R&S®ZVAX-TRM Extension Unit



Measurements on active devices made easy

The R&S®ZVAX-TRMxx (xx = 24, 40, 50, 67 GHz) extension unit for the R&S®ZVA(T) simplifies intermodulation, high-power, noise figure, embedded LO group delay and pulsed measurements on active devices, mainly transmit/receive modules or amplifiers. Besides the standard high-power test set, components for signal conditioning, such as combiners, pulse modulators and preamplifier can be fitted as options.

The R&S®ZVAX-TRMxx is directly controlled by the R&S®ZVA via a graphical user interface. The combination of an R&S®ZVA and the R&S®ZVAX-TRMxx behaves like a fully integrated single box. However, if multiple R&S®ZVA analyzers are being used in a lab, they can share one extension unit. This helps ensure optimum investment utilization.

R&S®ZN-Z84 Switch Matrix



Two or four VNA ports, up to 48 test ports

- ▶ Frequency range: 10 MHz to 8.5 GHz
- ▶ Test ports: 6, 12, 18 or 24 ports, SMA(f)
- ▶ Up to 48 ports by combining two R&S®ZN-Z84 matrices
- ▶ Port connector: SMA(f)
- ▶ Damage level: +23 dBm

- ▶ Damage DC voltage: 12 V
- ▶ Impedance: 50 Ω
- ▶ Switching time:
 - USB: nom. < 1 ms
 - LAN: nom. < 2 ms
 - Direct connect: nom. < 100 μs
 - Remote control: USB, LAN, direct connect
- ▶ Directly controlled by R&S®ZNB

R&S®ZN-Z85 Switch Matrix



Two VNA ports with 6 test ports or four VNA ports with 12 test ports

- ▶ Frequency range: 10 MHz to 20 GHz
- ▶ Test ports: 6 or 12 ports, SMA(f)
- ▶ Port connector: SMA(f)
- ▶ Damage level: +23 dBm

- ▶ Damage DC voltage: 12 V
- ▶ Impedance: 50 Ω
- ▶ Switching time:
 - USB: nom. < 1 ms (nom.)
 - LAN: < 2 ms (nom.)
 - Direct connect: < 100 μs (nom.)
- ▶ Remote control: USB, LAN, direct connect
- ▶ Directly controlled by R&S®ZNB

R&S®ZCAN/ZV-Z2xx/ZV-Z170/-Z135/-Z129 Manual Calibration Kits (coaxial)



Type, connectors

- ▶ R&S®ZCAN, N (m) and N (f), 75 Ω
- ▶ R&S®ZCAN, N (m) and N (f), 50 Ω
- ▶ R&S®ZV-Z270, N (m) or N (f)
- ▶ R&S®ZV-Z235, 3.5 mm (m) or 3.5 mm (f)
- ▶ R&S®ZV-Z235E, 3.5 mm (m) or 3.5 mm (f)
- ▶ R&S®ZV-Z229, 2.92 mm (m) or 2.92 mm (f)
- ▶ R&S®ZV-Z224, 2.4 mm (m) or 2.4 mm (f)
- ▶ R&S®ZV-Z218, 1.85 mm (m) or 1.85 mm (f)
- ▶ R&S®ZV-Z210, 1.0 mm (m) or 1.0 mm (f)

Frequency range

- ▶ 0 Hz to 3 GHz
- ▶ 0 Hz to 3 GHz
- ▶ 0 Hz to 18 GHz
- ▶ 0 Hz to 24 GHz
- ▶ 0 Hz to 33 GHz
- ▶ 0 Hz to 40 GHz
- ▶ 0 Hz to 50 GHz
- ▶ 0 Hz to 67 GHz
- ▶ 0 Hz to 110 GHz

4-in-1 calibration kits

- ▶ R&S®ZV-Z170, N (m) or N (f)
- ▶ R&S®ZV-Z135, 3.5 mm (m) or 3.5 mm (f)
- ▶ R&S®ZV-Z129, 2.92 mm (m) or 2.92 mm (f)

Frequency range

- ▶ 0 Hz to 9 GHz
- ▶ 0 Hz to 15 GHz
- ▶ 0 Hz to 40 GHz



Accessories for network analysis

R&S®ZN-Z15x/ZN-Z51/ZV-Z5x Calibration Units

**Type, connector**

- ▶ R&S®ZN-Z150, N (f)
- ▶ R&S®ZN-Z151, N (f)
- ▶ R&S®ZN-Z151, SMA (f)
- ▶ R&S®ZN-Z152, SMA (f)
- ▶ R&S®ZN-Z153, SMA (f)
- ▶ R&S®ZN-Z154, SMA (f)
- ▶ R&S®ZN-Z156, 1.85 mm (f)

- ▶ R&S ZN-Z50, 3.5 mm (f)
- ▶ R&S ZN-Z50, 3.5 mm (f)
- ▶ R&S®ZN-Z51, N (f) or 3.5 mm (f), individual configuration of each port possible

- ▶ R&S®ZV-Z52, 3.5 mm (f)
- ▶ R&S®ZV-Z53, 3.5 mm (f)
- ▶ R&S®ZV-Z53, N (f)
- ▶ R&S®ZV-Z54, 2.92 mm (f)
- ▶ R&S®ZV-Z55, 2.4 mm (f)
- ▶ R&S®ZV-Z58, N (f), for R&S®ZVT8 with up to 8 test ports
- ▶ R&S®ZV-Z58, 3.5 mm (f)
- ▶ R&S®ZV-Z59, 3.5 mm (f)

Frequency range, ports

- ▶ 5 kHz to 9 GHz, 2 ports
- ▶ 100 kHz to 8.5 GHz, 2 ports
- ▶ 100 kHz to 8.5 GHz, 2 ports
- ▶ 100 kHz to 8.5 GHz, 6 ports
- ▶ 100 kHz to 8.5 GHz, 4 ports
- ▶ 100 kHz to 8.5 GHz, 6, 12, 18 or 24 ports ¹⁾
- ▶ 5 GHz to 67 GHz, 2 ports

- ▶ 9 kHz to 9 GHz, 2 ports
- ▶ 9 kHz to 26.5 GHz, 2 ports
- ▶ 100 kHz to 8.5 GHz, 2 or 4 ports

- ▶ 100 kHz to 26.5 GHz, 4 ports
- ▶ 100 kHz to 26.5 GHz, 2 ports
- ▶ 100 kHz to 18 GHz, 2 ports
- ▶ 9 kHz to 40 GHz, 2 ports
- ▶ 9 kHz to 50 GHz, 2 ports
- ▶ 300 kHz to 8 GHz, 8 ports

- ▶ 300 kHz to 8 GHz, 8 ports
- ▶ 10 MHz to 20 GHz, 6 ports

¹⁾ Six-port base model with options for R&S®ZNZ154-B22, R&S®ZNZ154-B32 and R&S®ZNZ154-B42 port extensions.

R&S®ZV-WRxx/ZCWM-570 Waveguide Calibration Kits

Designation

- ▶ Calibration kit WR15
- ▶ Calibration kit WR12
- ▶ Calibration kit WR10
- ▶ Calibration kit WR08
- ▶ Calibration kit WR06
- ▶ Calibration kit WR05
- ▶ Calibration kit WR03
- ▶ Calibration kit WR02
- ▶ Calibration kit WM-570

Type (models with/without sliding match)

- ▶ R&S®ZV-WR15
- ▶ R&S®ZV-WR12
- ▶ R&S®ZV-WR10
- ▶ R&S®ZV-WR08
- ▶ R&S®ZV-WR06
- ▶ R&S®ZV-WR05
- ▶ R&S®ZV-WR03
- ▶ R&S®ZV-WR02
- ▶ R&S®ZCWM-570

Frequency range

- ▶ 50 GHz to 75 GHz
- ▶ 60 GHz to 90 GHz
- ▶ 75 GHz to 110 GHz
- ▶ 90 GHz to 140 GHz
- ▶ 110 GHz to 170 GHz
- ▶ 140 GHz to 220 GHz
- ▶ 220 GHz to 325 GHz
- ▶ 325 GHz to 500 GHz
- ▶ 330 GHz to 500 GHz

R&S®ZV-Z3xx/ZV-Z4xx Verification Kits

Type

- R&S®ZV-Z370
- R&S®ZV-Z335
- R&S®ZV-Z329
- R&S®ZV-Z324
- R&S®ZV-Z470
- R&S®ZV-Z435
- R&S®ZV-Z429
- R&S®ZV-Z424

Frequency range

- ▶ 45 MHz to 18 GHz
- ▶ 45 MHz to 26.5 GHz
- ▶ 45 MHz to 40 GHz
- ▶ 45 MHz to 50 GHz
- ▶ 45 MHz to 18 GHz
- ▶ 45 MHz to 26.5 GHz
- ▶ 45 MHz to 40 GHz
- ▶ 45 MHz to 50 GHz

Description

- ▶ T-check verification device, type N (f to m)
- ▶ T-check verification device, 3.5 mm (f to m)
- ▶ T-check verification device, 2.92 mm (f to m)
- ▶ T-check verification device, 2.4 mm (f to m)
- ▶ Verification kit, type N
- ▶ Verification kit, 3.5 mm
- ▶ Verification kit, 2.92 mm
- ▶ Verification kit, 2.4 mm

R&S®ZN-ZTW Torque Wrench

**Type**

- ▶ R&S®ZN-ZTW (model .71)
- ▶ R&S®ZN-ZTW (model .19)

- ▶ R&S®ZN-ZTW (model .35)
- ▶ R&S®ZN-ZTW (model .10)
- ▶ R&S®ZN-ZTW (model .12)

Description

- ▶ For type N connectors, 1.5 Nm, 20 mm width
- ▶ For 3.5/2.92/2.4/1.85 mm connectors, 0.9 Nm, 19 mm width
- ▶ For 3.5/2.92/2.4/1.85 mm connectors, 0.9 Nm, 8 mm width
- ▶ For 1.0 mm connectors, 0.45 Nm, 6 mm width
- ▶ For 1.0 mm connectors, 0.34 Nm, 6 mm width



CHAPTER 6

MOBILE NETWORK TESTING

Tailored solutions for all test use cases along the entire mobile network lifecycle.

Rohde & Schwarz offers an extensive portfolio of standalone products and integrated solutions for testing the entire mobile network lifecycle from the lab to the field. This allows addressing every test scenario for all technologies – from base station installation to network acceptance and network benchmarking; from optimization and troubleshooting to interference hunting and spectrum analysis; from IP application awareness to QoS and QoE of voice, data, video and app-based services. Since the launch of cellular technology, Rohde & Schwarz has been an innovator and industry reference with unique test solutions covering the whole range of measurements in mobile networks from RF to end-user quality of experience (QoE). Therefore, Rohde & Schwarz is a preferred and trusted supplier of global top-tier mobile network operators, infrastructure vendors, testing service providers and regulators.

Type	Designation	Description	Page	
Drive and walk test scanner				
	R&S®TSMAG	Autonomous mobile network scanner	Walk and drive testing with maximum flexibility	154
	R&S®TSMEM6	Ultracompact drive test scanner	All bands, all technologies, simultaneously, future-proof upgradeability	155
	R&S®TSMEM30DC	Downconverter 24 GHz to 30 GHz	Upgrade R&S®TSMx6 for 5G NR millimeterwave measurements	156
Portfolio for testing the entire network lifecycle				
For spectrum and signal analysis, and cable and antenna measurements, please refer to chapter 3, signal and spectrum analyzers				
	QualiPoc Android	The premium handheld troubleshooter	Ad-hoc voice and data service quality testing and verification	157
	QualiPoc Android Probe	Non-stop service quality monitoring and optimization	Targeted, 24/7, and unattended service quality monitoring and service level agreement verification in hotspots	158
	SmartBenchmarker	Benchmarking tests made easier	Flexible and customizable web interface that facilitates configuration, execution and monitoring of benchmarking test campaigns	159
	Benchmarker II	The reference benchmarker	Modular and scalable solution for large scale and fully fledged drive-test-based quality of experience benchmarking campaigns	160
	TCM	Test device containment module	Provides a robust, thermo-insulated casing to run devices in a temperature controlled environment	161
New	R&S®FR4 Freerider 4	Walk testing with maximum flexibility	Compact, lightweight backpack system solution for walk test and drive test campaigns	162
	Benchmarker II Go	The flexible benchmarker	Highly scalable and flexible benchmarking solution	163
	R&S®MNT100	RF interference locator	Spectrum clearance in mobile networks from the experts	164
	R&S®PR200	Portable Monitoring Receiver	Detect, analyze and locate any emission	165
	PiMPro Tower	Passive intermodulation analyzer	The challenge of keeping base stations PIM-free	166
Software				
	R&S®ROMES4	Drive test software	Mobile coverage and QoS measurements in mobile networks	167
	R&S®MobileLocator	System software	Advanced interference hunting and emitter location	168
	NQDI	The source of insights for business decisions	Flexible data selection and filtering can be performed for detailed troubleshooting and long-term trend analysis	169
	R&S®NESTOR	Cellular network analysis software	Accurate multitechnology RF measurements for full network insights	170
	SmartMonitor	Realtime service quality monitoring	Informative dashboards, providing the latest results and status of the probes in realtime	171
	SmartAnalytics	Powerful QoE-centric insights into your mobile network performance	For automation of data management, alarming, and report generation	172
	Automation Agent	Automation tool for data management	For automation of data management, alarming, and report generation	173
	SmartLicenser	Floating license server	Floating license server for QualiPoc Android and QualiPoc Android Probe	174

R&S® TSMA6 AUTONOMOUS MOBILE NETWORK SCANNER



Walk and drive testing with maximum flexibility

The compact R&S®TSMA6 autonomous network scanner is an integrated solution for efficient walk and drive testing. It offers maximum performance, autonomy and connectivity with an integrated high-performance PC and a mobile network scanner to comply with the latest requirements for state-of-the-art mobile network testing.

In-building and urban hot spot traffic is growing tremendously, and with it mobile network testing requirements. A typical measurement setup no longer consists of a network scanner and a mobile phone. Now it has to operate a high-performance setup of scanners and smartphones/devices processing a huge amount of measurement data in order to obtain deep realtime network insights and analyze user experience. Accurate scanner based RF measurements and device based user experience analysis complement each other, creating a perfectly aligned ecosystem.

The R&S®TSMA6 combines the technology of the R&S®TSME6 multitechnology network scanner with a high-performance Intel CPU based PC. The system can run Windows PC based drive test software, which supports multiple external devices, such as smartphones, connected via USB. With its ultrabroadband frontend, the integrated scanner measures all supported technologies from 350 MHz to 6 GHz simultaneously. The future-proof architecture and in-field upgradeability for both hardware and software allows up to MIMO 4x4 measurements and paves the way for the upcoming 5G technology.

With its sophisticated and lightweight design of only 1360 g and optional hot-swappable batteries, the measurement equipment can be stowed in a carrying bag, making it the ideal companion for remote or unattended operation on efficient walk and drive test campaigns.

Technologies supported	SIB decoding
GSM	•
WCDMA	•
CDMA2000®	•
1xEV-DO (Rel. 0/Rev. A/Rev. B)	•
WiMAX™ IEEE 802.16e	•
TD-LTE	•
LTE-FDD, LTE-M	•
NB-IoT/Cat NB1	•
TETRA, TETRA DMO	•
TD-SCDMA	•
RF power scan	–
CW channel power RSSI scan	–
5G NR (FR1, FR2)	MIB

Key facts

- ▶ No limitation in 3GPP (e.g. LTE, WCDMA, GSM, NB-IoT) frequency bands up to 6 GHz, including a multi-GNSS receiver for uninterrupted location tracking
- ▶ More than ten technologies simultaneously in one scanner
- ▶ Supports R&S®TSME30DC downconverter for millimeterwave measurements
- ▶ Compact and lightweight design with customized mechanical concept for cascading multiple scanners
- ▶ Maximum connectivity supporting additional scanner hardware, Windows based PC, Android based UEs and tablets using wireless and wired connections
- ▶ Integrated high-performance Intel i7 CPU based PC



R&S® TSME6 ULTRACOMPACT DRIVE TEST SCANNER



6

All bands, all technologies, simultaneously, future-proof upgradeability

The R&S®TSME6 is designed for efficient drive and walk tests with a maximum degree of freedom and upgradeability. With its ultracompact design and multiband and multi-technology support for simultaneous measurements, the scanner fulfills all requirements for a state-of-the-art measurement tool.

With its ultrabroadband frontend, the scanner measures all supported technologies from 350 MHz to 6 GHz simultaneously. The future-proof architecture and the in-field

upgradeability for both hardware and software allow up to MIMO 4x4 measurements and pave the way for 5G. A compact, lightweight and sophisticated design with low power consumption of max. 13 W rounds out the features of this flexible and high-performance measurement tool that can be used for both drive and walk tests.

Key facts

- ▶ No limitation in 3GPP frequency bands up to 6 GHz
- ▶ More than ten technologies simultaneously in one scanner
- ▶ Supports R&S®TSME30DC downconverter for millimeterwave measurements
- ▶ Compact and lightweight design with customized mechanical concept for cascading
- ▶ Low power consumption

Technologies supported	SIB decoding
GSM	•
WCDMA	•
CDMA2000®	•
1xEV-DO (Rel. 0/Rev. A/Rev. B)	•
WiMAX™ IEEE802.16e	•
TD-LTE	•
LTE-FDD, LTE-M	•
NB-IoT/Cat NB1	•
TETRA, TETRA DMO	•
TD-SCDMA	•
RF power scan	–
CW channel power RSSI scan	–
5G NR (FR1, FR2)	MIB



Product site

R&S® TSME30DC DOWNCONVERTER



24 GHz to 30 GHz: upgrade R&S® TSMx6 for 5G NR millimeterwave measurements

The R&S® TSME30DC is designed to easily upgrade the R&S® TSMx6 scanners to measure 5G NR signals in the millimeterwave frequency range. It perfectly extends the latest generation mobile network scanner family and provides all features for easy drive and walk testing. It is fully controlled by the R&S® TSMx6 and the corresponding software layers, which allows seamless, unattended operation.

With its broadband downconversion frequency range, the downconverter covers a huge part of the new mmWave frequency bands allocated for 5G NR networks. These new frequency bands show completely different behavior in terms of propagation and phase noise, which puts demanding requirements on measurement tools' hardware. Using millimeterwave frequencies necessitates beamforming for sufficient propagation.

To provide best sensitivity, image frequency rejection and lowest phase noise, the R&S® TSME30DC adjusts internal parameters such as the intermediate frequency (IF) and the local oscillator (LO) to the measurement task. This takes place in the background and is unnoticeable by the user. It ensures that every single parameter is optimized for best system performance. The R&S® TSME30DC is also future-proof. It supports up to five scanners for future 5G NR measurements tasks and ultra high performance measurement modes.

Key facts

- ▶ Ultra broadband RF frequency range for downconversion (24 GHz to 30 GHz)
- ▶ Fully controlled by R&S® TSMx6 scanners to simplify operation and maximize performance
- ▶ Simultaneous millimeterwave and sub 6 GHz measurements with a single scanner
- ▶ Customized mechanical concept, fully compatible with the latest R&S® TSMx6 network scanner generation
- ▶ Future-proof concept (supports up to five scanners)
- ▶ Low power consumption

Multiple measurements with up to five network scanners for increased dynamic range

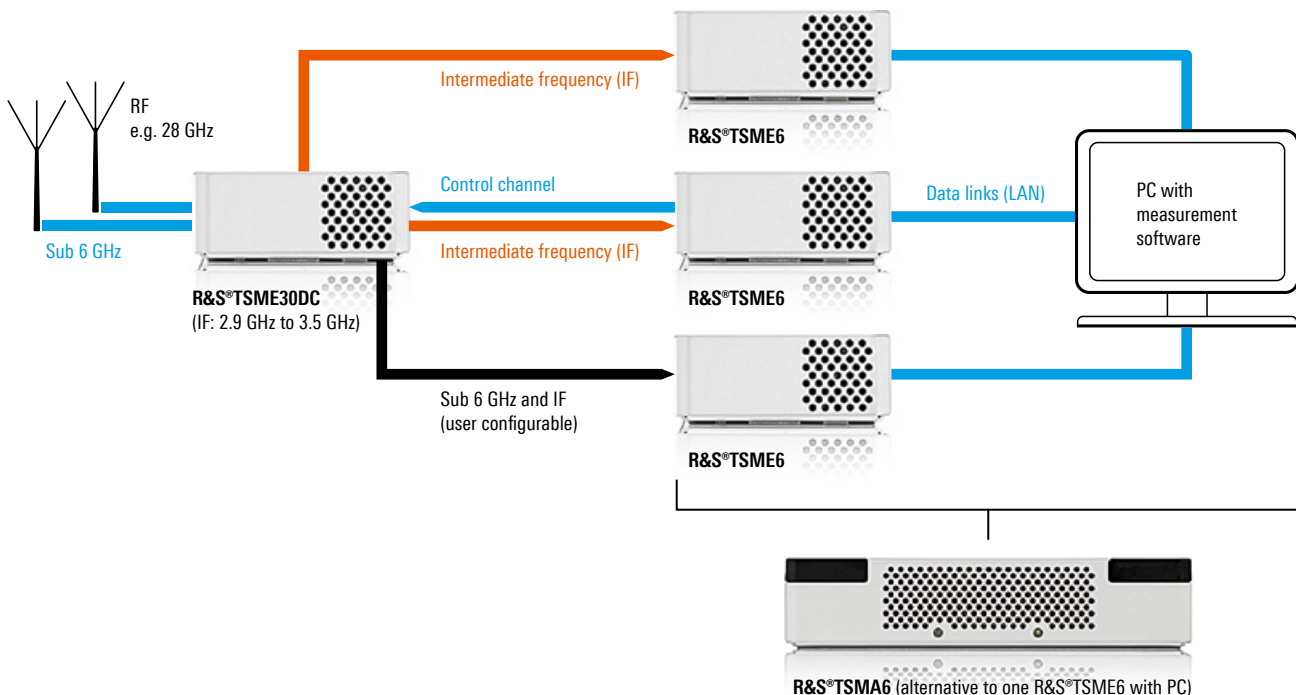

QualiPoc Android

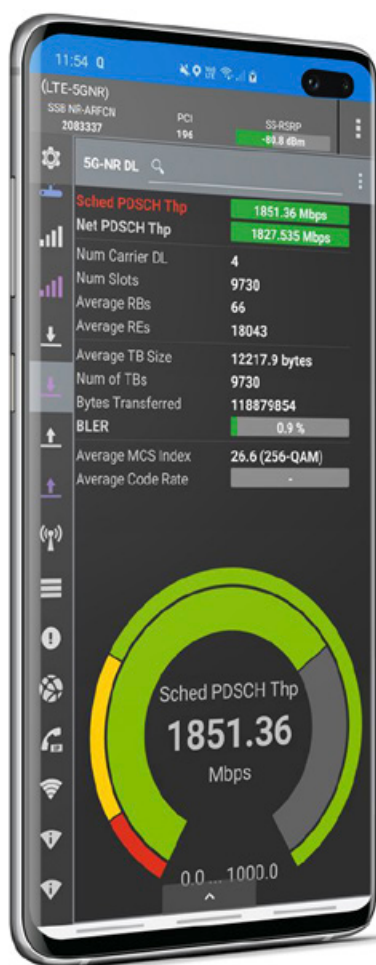

The premier handheld troubleshooter

QualiPoc Android is a multifunctional smartphone-based tool for voice and data service quality troubleshooting and RF optimization. As the premier handheld troubleshooter, QualiPoc Android sets a new industry standard for smartphone-based mobile network testing.

QualiPoc is based on the latest commercial Android smartphones. It supports all mobile network technologies used worldwide and covers multiple protocol layers as well as the IP stack in realtime. QualiPoc Android provides extensive test functions for voice, including MOS, data, video streaming incl. VMOS and OTT app service tests to assess and reflect the real end-user experience (QoS/QoE) within a mobile network.

The multifunctional QualiPoc Android is a cost-efficient and powerful pocket solution for every RF engineer who performs daily tasks such as site verification and commissioning, troubleshooting and RF optimization.



Product site

Key facts

- ▶ Smartphone-based RF optimization and service quality assessment application, supported on a wide range of the latest Android smartphones and tablets
- ▶ Comprehensive range of service test functions for voice, data, video and app service tests, as well as channel and cell locking features for dedicated RF optimization
- ▶ Intuitive user interface, including customizable monitors and workspaces

Extensive set of service tests

QualiPoc Android provides an extensive set of service tests. These include call tests, voice quality (including POLQA, PESQ, and SQuad08) as well as data tests, video streaming, and video quality. QualiPoc covers all test functions and latest technologies such as:

- ▶ 5G NR, LTE-FDD, TDD-LTE, HSDPA(DC), HSUPA, WCDMA, EDGE, GPRS, GSM, CDMA2000®, EV-DO Rev.0/A
- ▶ Direct decoding of L3 text messages and TCP/IP, RTP packets on smartphones

Video quality measurements

QualiPoc supports video quality measurements including video MOS for live streaming content using the non-reference video quality algorithm J.343.1. This unique feature allows to measure quality of many popular streaming services as well as live TV apps.

Advanced RF optimization feature

QualiPoc Android offers advanced channel and cell locking, a crucial RF optimization feature to control the quality and coverage of wireless networks.

OTA (over-the-air) application update

With an OTA update function, users can conveniently keep their QualiPoc applications up to date. Furthermore, user can also update all the supported OTT applications directly via QualiPoc Android.

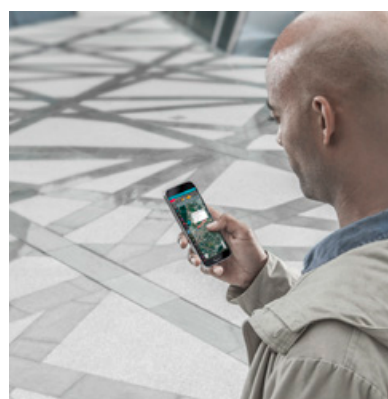

QualiPoc Android Probe



Non-stop service quality monitoring and optimization

QualiPoc Android Probe is a versatile, smartphone-based mobile network probe for unattended network-wide, non-stop service quality monitoring and optimization. It is remotely controlled via SmartMonitor and in realtime delivers a continuous stream of KPIs and insight into network quality just as the customer perceives it. This enables multiple applications in fixed or moving locations. These include targeted, 24/7 service quality monitoring in realtime, or large-scale data collection on one or more mobile networks for the purpose of optimization.

QualiPoc Android Probe evolved from the proven hand-held troubleshooting solution QualiPoc Android from Rohde&Schwarz mobile network testing (MNT) offers extensive active testing functionalities for automated service quality measurements of voice, data, video, messaging, and app services. The multi-functional back-end system SmartMonitor offers tailored functionalities to control and monitor the network probes, including active alarm functions for seamless service quality monitoring.

Key facts

- ▶ Smartphone-based (QualiPoc Android platform), remotely controlled network measurement probe for unattended network-wide, non-stop service quality monitoring and optimization
- ▶ No specific license required to operate QualiPoc Android in "SmartMonitor Probe" mode
- ▶ Multi-application ready for desktop, wall, or in-car installation
- ▶ Ruggedized and future-proof hardware design with extra safety features for reliable and trouble-free 24/7 operation

Key use case

QualiPoc Android Probes are controlled and monitored by SmartMonitor, a web-based module that can be installed on any application server or in the cloud. SmartMonitor is accessible for everyone from everywhere when access to the Internet is available. Connected to SmartMonitor, QualiPoc Android Probes are placed in critical and strategic locations or deployed in cars, taxis or buses delivering a constant flow of information about the mobile network's quality of service.

Targeted, 24/7, and unattended service quality monitoring and service level agreement verification in hotspots

Thanks to its smart design and self-healing functions, QualiPoc Android Probe continuously reports the perceived end-user service quality in real-time. Installed in stationary and moving hotspots, such as shopping malls, airports, business districts, trains, metros etc., QualiPoc Android Probe enables mobile operators to ensure a stable quality of service where it matters most. Network and service instabilities, or errors that have an adverse effect on end-user experience, are immediately detected; network and service operation centres are instantly alarmed, so that they can take prompt action.

24/7 and unattended large-scale data collection for network optimization (drive test)

QualiPoc Android Probe deployed in fleets, for example taxis, buses, couriers, etc., offers a cost-efficient way to collect measurements for optimization, and enables mobile operators, infrastructure vendors, and testing service providers to continuously collect data from a real end-user perspective. The fleets are controlled and monitored via the web-based application SmartMonitor that displays the status of the probes in dashboards and on maps. Tests are remotely configured and scheduled; the performance of each service is visible in a dedicated dashboard displaying test results and alarms in realtime.

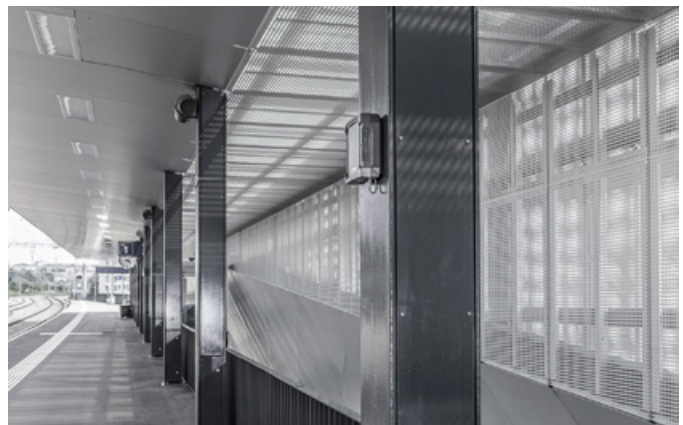

SmartBenchmarker



Benchmarking tests made easier

SmartBenchmarker is a software platform from Rohde&Schwarz mobile network testing (MNT) for benchmarking tests. It is the technological evolution of the Diversity and NQView platforms and allows the seamless configuration, execution and monitoring of benchmarking test campaigns. SmartBenchmarker is built on state-of-the-art technology: users can control benchmarking tests either locally or remotely from the office.

SmartBenchmarker and its supported hardware components are delivering an extreme reliable platform for collecting data even under tough conditions. It has the lowest re-drive rate in the industry. Turn-by-turn navigation instructions are helping to guide the user accurately through the planned drive test route. With all these features, SmartBenchmarker helps to do data collection in a very efficient way and reduces the risk for expensive re-drives.

Remote controlled benchmarking drive test

With SmartBenchmarker, mobile network operators and service providers can perform accurate and advanced benchmarking tests that not only are in line with the latest standards and methodologies, but also reduce CAPEX and OPEX. SmartBenchmarker connected to a SmartMonitor server allows users to remotely control one or more benchmarking systems. For example, a system could comprise the Benchmarker II chassis installed in a vehicle and a number of TCMs hosted inside the VRB on top of the car. Via a secure and encrypted connection, a test supervisor can log in to the system and simultaneously manage the vehicle and monitor multiple devices (smartphones and scanners)

Key facts

- ▶ Flexible and customizable web interface that facilitates configuration, execution and monitoring of benchmarking test campaigns
- ▶ Supports the existing Benchmarker II hardware chassis and all its modules, including the vehicle roof box (VRB), the test device containment module (TCM) and the phone mounting wall (PMW)
- ▶ Supports Benchmarker II Go
- ▶ Offers capabilities to control the system locally or remotely via SmartMonitor from the office via a secure and reliable connection without affecting ongoing test results
- ▶ Remote fleet management supported with SmartMonitor, providing advanced remote system control capabilities, smart alarming and notification tailored to specific test scenarios



Product site

Benchmarker II



The reference benchmarker

Benchmarker II is a fully fledged solution for large-scale drive-test-based quality of experience benchmarking campaigns. It allows mobile operators and testing service providers to assess and compare service quality (QoS and QoE) based on the most comprehensive set of key performance indicators (KPI) and accurate test scenarios.

Benchmarker II is based on a highly reliable, modular and scalable hardware platform which guarantees unmatched system stability, outstanding testing flexibility, high operational efficiency and maximum future readiness. Combined with its versatile and productive data management, analysis and reporting suite, Rohde&Schwarz mobile network testing (MNT) offers the most powerful solution for network service benchmarking.

Large-scale benchmarking campaigns

Benchmarker II is the ideal solution for large-scale drive test campaigns in all environments (highways, urban areas, the country side, etc.). The multi-channel solution can measure multiple operators and their services in parallel (up to 48 channels), collecting voice, messaging, video, and data KPIs. In addition, an optional RF scanner, such as the R&S®TSMA6 or R&S®TSME6, can be supported to provide a full representation of the physical RF environment.

Key facts

- ▶ Modular and scalable solution for large scale and fully fledged drive-test-based quality of experience benchmarking campaigns
- ▶ Laptop-controlled system with SmartBenchmarker
- ▶ Highly reliable hardware platform designed for drive testing – shock and vibration proof according to automotive standards – and equipped with self-healing features, auto shutdown, and smart power concepts as well as active cooling features to ensure uninterrupted and accurate data collection
- ▶ Fully modular and scalable system architecture supporting up to 48 devices located in hot swappable slide-in modules
- ▶ Support of a wide range of devices such as commercial smartphones (end-user devices), IoT modules, and optional RF scanners (R&S®TSMA6 or R&S®TSME6)



TEST DEVICE CONTAINMENT MODULE (TCM)



The test device container for reliable and stable mobile network testing

The TCM test device containment module sets optimal conditions for uninterrupted data collection in a stable environment. It ensures maximum data quality for large-scale benchmarking campaigns with Benchmarker II and offers the following key product benefits:

- ▶ Enables the use of unmodified test devices (smartphones) and their built-in RF antennas
- ▶ Ensures stable thermal environments and uniform conditions for all test devices to guarantee comparable results
- ▶ Allows simulation of multiple end-user scenarios (handheld, beside head) in different environments (pedestrian, in-car, in-house), using configurable RF attenuation per device
- ▶ Supports a unique device self-healing feature to minimize failures or lost data to prevent repeat drives
- ▶ Offers convenient test device access and simplifies future product updates

The TCM is fully compatible with Benchmarker II and it enables multiple use cases for large-scale and fully fledged drive-test-based quality of experience benchmarking campaigns.

Vehicle roof box setup

TCMs can be installed in the specially designed VRB vehicle roof box and connected to Benchmarker II. The VRB can contain up to 16 TCMs (measurement channels) and ensures uniform RF and temperature conditions. The roof box and the IP65 rated cable duct for the cable entry into the vehicle are ready for any weather condition.

Customized installation

TCMs can also be installed in a customized setup, based on the drive test vehicle's configuration (e.g. in-car) or user-specific requirements.

Key facts

- ▶ TCM provides a robust, thermo-insulated casing to run devices in a temperature controlled environment
- ▶ Simulation of multiple end-user scenarios (handheld, beside head) in various environments (pedestrian, in-car, in-house) by applying an exchangeable, intended RF attenuation (absorbing foam) onto single test devices
- ▶ A hinged top with a single latch to release offers easy access to test device
- ▶ Vehicle roof box (VRB) or customized installation (e.g. in-car) available

6



Product site

R&S®FR4 Freerider 4

New



Walk testing with maximum flexibility

The R&S®FR4 Freerider 4 backpack system is a compact, lightweight solution for walk test and drive test campaigns. Supporting up to 12 test mobile phones and high-performance scanner measurements (including 5G millimeterwave and LTE 4x4 MIMO), it is ideal for network optimization, benchmarking and cellular network analysis. To ensure maximum autonomy, the R&S®FR4 Freerider 4 backpack system is equipped with an intelligent voltage supply with one to eight batteries that can be hot swapped. The integrated Ethernet switch and optional USB hub allow R&S®TSMx6 scanners and QualiPoc mobile phones to be connected and charged. A light, yet water-resistant coating with air passages and silent fans allows the backpack to be used in a wide range of climates. The carrying straps can be individually adjusted to offer the best wearing comfort. An external tablet or laptop can be used to wirelessly control the measurement application running on an R&S®TSMx6 autonomous mobile network scanner or R&S®NCM2 compact integrated PC.

Key facts

- ▶ Modular and future-proof for network optimization, benchmarking and cellular network analysis
- ▶ Supports up to 12 test mobile phones
- ▶ Supports 5G NR, including millimeterwave
- ▶ Compact and lightweight
- ▶ Designed for all environmental conditions

Flexible solution

- ▶ Ideal backpack solution for your application
- ▶ Supports all Rohde&Schwarz drive test applications

Wide range of supported measurements

- ▶ Extensive test mobile phone support
- ▶ Unrivalled scanner support

Professional platform for everyday use

- ▶ Designed for usability and reliability
- ▶ Designed for the toughest environmental conditions



View of inside with QualiPoc, R&S®NCM2 compact integrated PC and R&S®TSMx6 ultracompact drive test scanner



Benchmarker II Go



The flexible benchmarker

The Benchmarker II Go is designed for ad-hoc drive test campaigns. The highly scalable and flexible benchmarking solution uses the same base components as the industry's leading mobile network testing system, the Benchmarker II.

The system comes precabled with up to eight commercially available smartphones and is ready to start measurements immediately. It can be installed in virtually every standard vehicle (e.g. rental car) and is powered via standard car cigarette lighter sockets. The robust transport case contains the complete test equipment, including the power supply. The in-car installation is simple and plug-and-play-like.

Thanks to its transportability and easy installation, the Benchmarker II Go is the most suitable and reliable product for benchmarking drive test campaigns abroad – saving costs in logistics, installation and transport. Weight and dimensions are within the standard limits and regulations for international flight transport and therefore Benchmarker II Go can be shipped as luggage on any flight.

This facilitates moving the complete system to a remote location. At the destination, the system can be installed in a rental car and the drive test campaign can be started immediately.

Key facts

- ▶ Flexible benchmarking solution, ideal for ad hoc drive test campaigns
- ▶ Modular and scalable system architecture, supporting up to 16 smartphones and one R&S®TSME6 scanner
- ▶ Easy to install in any vehicle as it is powered via standard car cigarette lighter sockets
- ▶ Simple and hassle-free transport to remote locations: the size and weight are optimized to comply with free check-in and carry-on luggage requirements
- ▶ Controlled via laptop using SmartBenchmarker

6

Compact and transportable, the Benchmarker II Go drive test system is the ideal equipment for ad hoc benchmarking campaigns, especially at remote locations.



Product site

R&S® MNT100 RF INTERFERENCE LOCATOR



Key facts

- ▶ Detect, analyze and locate sources of interference from 600 MHz to 6 GHz
- ▶ Easy-to-use solution that automatically locates interferers strikingly faster than other solutions on the market
- ▶ Designed for use with antennas in dense spectrum environments thanks to extensive preselection
- ▶ Exceptionally high spurious-free dynamic range and fastest realtime signal processing in its class
- ▶ Innovative handheld dual-mode antenna for accurate manual direction finding as option
- ▶ Fast automatic direction finding with magnet-mounted DF antenna and interference locator software as upgrade

Spectrum clearance in mobile networks from the experts

The increasing number of wireless products that can be bought globally over the internet contribute to the growing number of RF interferers experienced by mobile network operators. The R&S®MNT100 RF interference locator detects, analyzes and locates even complex pulsed interference signals. With the direction finding (DF) and PC-based radiolocation software upgrade, sources of interference can be located automatically and strikingly faster than with other solutions on the market.

Rohde&Schwarz has earned a high reputation among spectrum monitoring authorities worldwide for providing reliable high-performance equipment. This know-how and experience that has been built up over decades has now been used to make radiolocation of interferers in mobile networks much faster and more accurate. The R&S®MNT100 guides the operator to the interferer location based on 600 bearings per minute in combination with sophisticated statistical analysis.

Sophisticated preselection

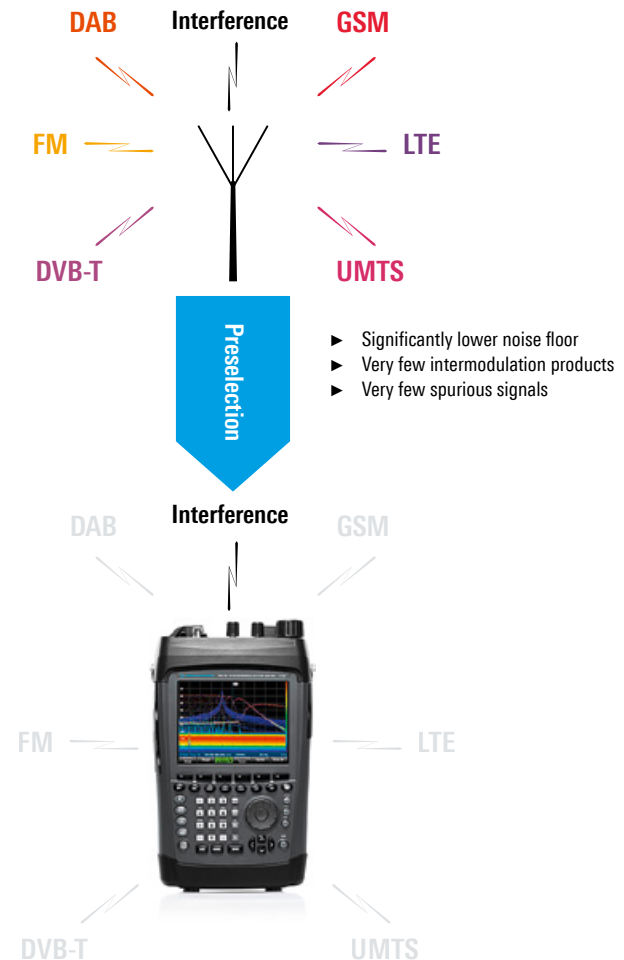

R&S® PR200 PORTABLE MONITORING RECEIVER



Detect, analyze and locate any emission

The R&S®PR200 portable monitoring receiver is engineered to effectively support you in your spectrum monitoring and interference hunting tasks. Optimized and designed for field operations, it combines excellent RF performance with an intuitive user interface and offers an expanded range of functions.

Key facts

- ▶ Detect, analyze and locate RF signals from 8 kHz to 8 GHz; extendable to 18 GHz with R&S®HF907DC SHF directional antenna with downconverter
- ▶ Comprehensive tools for frequency and time domain analysis with up to 40 MHz real-time bandwidth
- ▶ High RF performance optimized for use in dense spectrum environments thanks to sub-octave preselection and automatic overload protection
- ▶ Optimized for demanding field operation with minimal size, weight and power
- ▶ Convenient, simple and intuitive operation with application-oriented user interface



Mobile direction finding that can be set up in minutes (R&S®ADD107 antenna and R&S®ADD17XZ3 vehicle adapter with magnet mount).

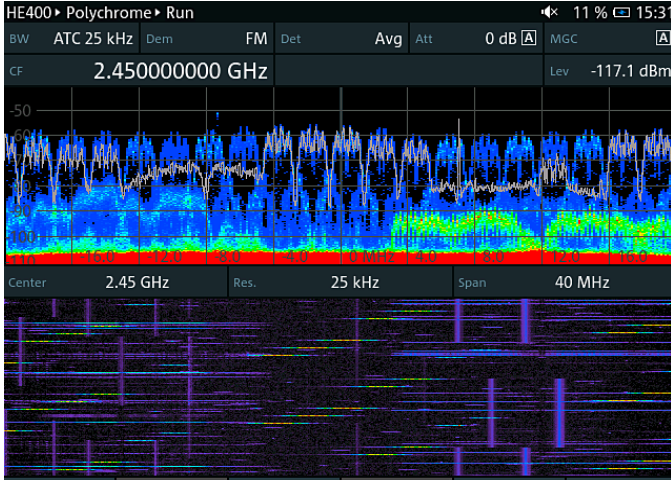

Fast spectral scan (panorama scan, up to 40 GHz/s) across entire frequency range and polychrome display to reveal hidden signals

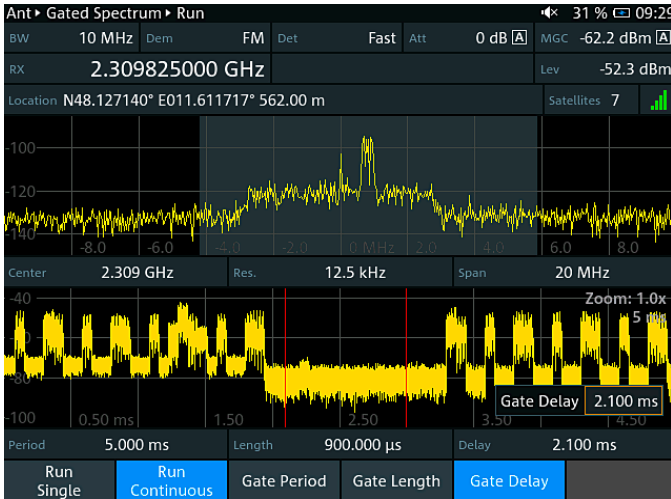

Parallel time and frequency domain analysis with gated measurements for easy analysis and hunting of interference in TDD networks



Realtime spectral analysis using smartphone app (Android and iOS) via an external Wi-Fi hotspot; supports gesture operation and is suitable for homing.



Product site

PiMPro TOWER PASSIVE INTERMODULATION ANALYZER



The challenge of keeping base stations PIM-free

In response to the increasing demand for higher data rates, network operators have to push their networks' spectral efficiency to the theoretical limit. Passive intermodulation (PIM) is one source of interference that affects spectral efficiency: it may cause a reduction in the data rate, dropped calls or even non-accessibility of the network.

Key facts

- ▶ One-port measurement of PIM, RL, PiMPont (DTP), DTF
- ▶ Real-world 40 W × 2 PIM testing capability
- ▶ Dual-band models for 1800/2100 and 1900/2100 bands
- ▶ Easy to operate with look and feel of a smart phone
- ▶ Lightest unit in the market (8.5 kg – PIM2600 model)

Site installation and maintenance

Thanks to a collaboration with Communication Components Inc. (CCI), Rohde&Schwarz adds the PiMPro Tower PIM analyzer to its portfolio to provide network operators and test

service companies with a comprehensive solution for base station installation and maintenance. It ideally complements the fast VSWR, cable loss, DTF and power measurements of the R&S®CableRider ZPH and R&S®ZVH cable and antenna analyzers and R&S®FSH handheld spectrum analyzer.

Performance ready to go

Each lightweight, compact unit is protected by a reinforced backpack case. Even in battery mode, the PiMPro Tower can deliver two 40 W output signals. Its excellent measurement sensitivity of -135 dBm and its ability to reduce two-tone transmit signals to 24 dBm (100 mW) make the PIM analyzer the ideal instrument for measurements on base stations and DAS.

PIM measurements

Instantaneous PIM and RL, dynamic PIM vs time and frequency sweep measurements enable users to ensure a PIM-free site and do not require any previous instrument calibration. Fail limits, output power, frequency and IM settings are easily configured. The PiMPro Tower's unique return loss diagnostic feature at high transmit (TX) power quickly points out open cables.

One-port measurements

Users are able to perform PIM, return loss, PiMPont (distance-to-PIM) and distance-to-fault measurements on a single port and without requiring additional hardware.

DTF and PiMPont (DTP) measurements

Distance-to-fault and PiMPont (distance-to-PIM) are simultaneously measured and displayed on the same graph. The DTF and PiMPont results guide users to the fault location.

Report generator

Report data for all measurements can be stored in either HTML or PDF file format. Users can combine a limitless series of measurements with different sectors, feeders and color codes in one single PDF file. Reports can be saved in the internal memory of the PiMPro Tower PIM or to an external USB memory from the front panel of the unit.



R&S®Cable Rider ZPH
cable and antenna analyzer

▶ See page 144



R&S®ZVH cable and antenna analyzer

▶ See page 143



R&S®FSH handheld spectrum analyzer

▶ See page 78



R&S®ROMES4 DRIVE TEST SOFTWARE

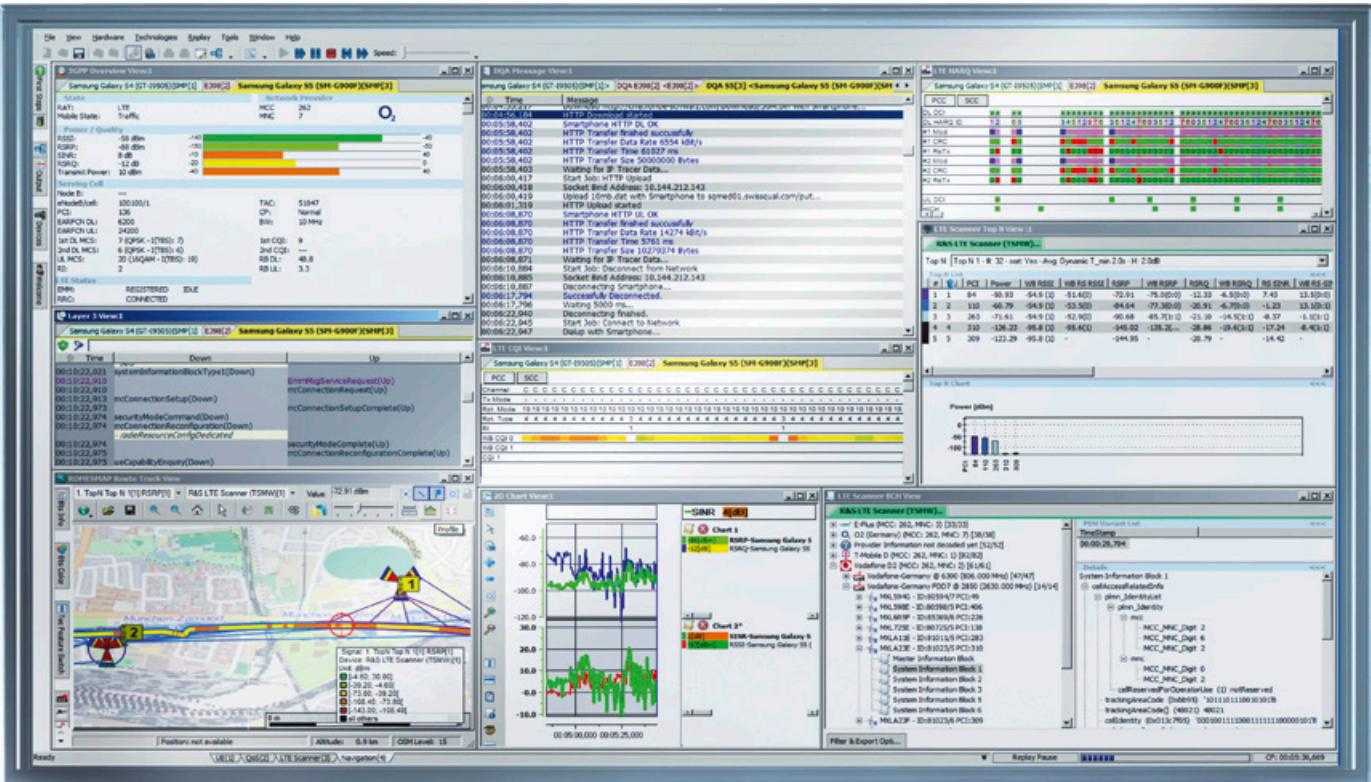

6

Straightforward R&S®ROMES4 drive test software user interface

Mobile coverage and QoS measurements

The R&S®ROMES4 drive test software, the unique scanners and network problem analyzer (NPA) tool from Rohde&Schwarz provides an all-in-one solution for network analysis and optimization.

R&S®ROMES4 is the universal software platform for network engineering and network optimization systems from Rohde&Schwarz. In combination with other test and measurement equipment such as wireless communications scanners and test mobile phones, it provides solutions for all essential tasks involved in coverage measurements, interference identification, performance measurements and quality analysis in mobile networks. In addition to measuring and displaying test parameters, data is processed instantly and statistics are calculated in realtime.

Combination with R&S®TSMx scanners

When R&S®ROMES4 is combined with the R&S®TSMx band-unlimited scanners, the measurements help typical users (such as network operators, regulatory authorities, service providers, chipset manufacturers and government authorities) complete their work quickly and easily.

Key facts

- ▶ One software for all technologies from a single source
- ▶ Flexible software licenses that meet user requirements reduce startup costs
- ▶ Analysis of R&S®TSME6 and R&S®TSM6 5G NR scanner measurements and 5G Qualcomm and Samsung (Exynos) based UE measurements
- ▶ Parallel measurements with up to eight mobile devices per license save time, allowing more effective utilization of existing resources and saving operating expenses (OPEX)
- ▶ High-precision, fast RF test and measurement equipment (Rohde&Schwarz devices) delivers a large quantity of reliable measurements and results
- ▶ Automated analysis at the end of the measurement using the integrated replay function or the network problem analyzer (NPA) considerably reduces OPEX
- ▶ Automatic identification of GSM interference considerably reduces OPEX (up to 80% potential savings compared to standard analysis)
- ▶ Unique scanner for 5G NR, GSM, WCDMA, CDMA2000® 1xEV-DO, WiMAX™, LTE, NB-IoT/Cat NB1 and TETRA in all bands and decoding of broadcast information



Product site

R&S® MobileLocator

 After 30 s¹⁾



 After 3 min¹⁾



 After 6 min¹⁾



Result after 30 s into the mission.¹⁾

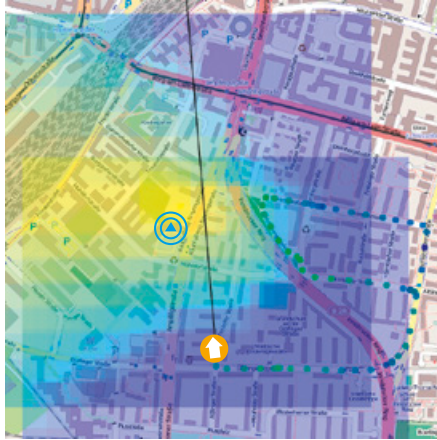

Approaching the source of interference.

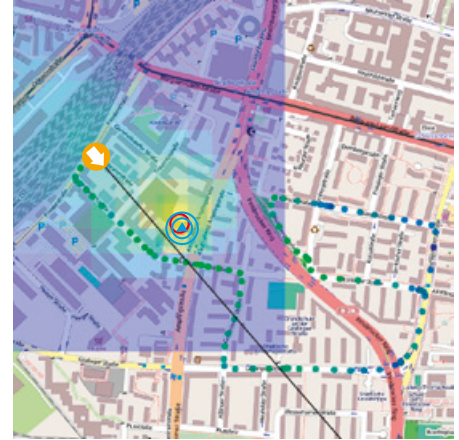

Position fix with 10 m accuracy after 6 min.¹⁾

 Position of interferer

 Mobile direction finder (DF)

Advanced interference hunting and emitter location

R&S® MobileLocator makes it possible for the first time to detect and automatically locate a transmitter from a moving DF vehicle. Within minutes, the compact DF system based on the R&S® DDF007 portable direction finder can turn a commercial vehicle into a DF platform for the frequency range from 20 MHz to 6 GHz. In combination with other Rohde & Schwarz direction finders, R&S® MobileLocator can also be used in dedicated DF vehicles and helicopters.

Faulty, poorly shielded or incorrectly configured electronic devices can unintentionally emit electromagnetic waves and interfere with or even disrupt existing radio services. Sources of such interference are frequently located in urban areas. This makes precise direction finding extremely difficult due to multipath propagation that results from radio waves being reflected and diffracted by surrounding buildings and other objects. Unless the operator has many years of experience in finding radio interference sources, having capabilities that quickly and automatically lead to the target is highly desirable.

Broad scope of application

R&S® MobileLocator was developed for automatic location of fixed frequency signals in urban areas. The signal does not have to be continuously active as long as a sufficient number of signal bearings are taken. R&S® MobileLocator is not designed to locate push-to-talk (PTT) networks or frequency agile signals.

Key facts

- ▶ Fast, easy installation in commercial vehicles
- ▶ Optimized for interference hunting in urban areas (multipath propagation)
- ▶ Automatic location of the transmitter's position
- ▶ Generation of an interference search report with all relevant information
- ▶ Straightforward and easy-to-use user interface
- ▶ Easy to transport, easy to set up
 - Simple system configuration
 - Support for laptops and tablets
 - Fast setup in commercial vehicles
- ▶ Comprehensive, optimized system software
 - Complete system software package
 - Optimized web-based user interface for touchscreen operations
 - Wide variety of expansion options
- ▶ Straightforward interference search and signal monitoring
 - Panorama scan for quick overview of all signal activity
 - Signal demodulation and audio recording
 - Spectrum display in realtime bandwidth for detailed signal monitoring



NQDI

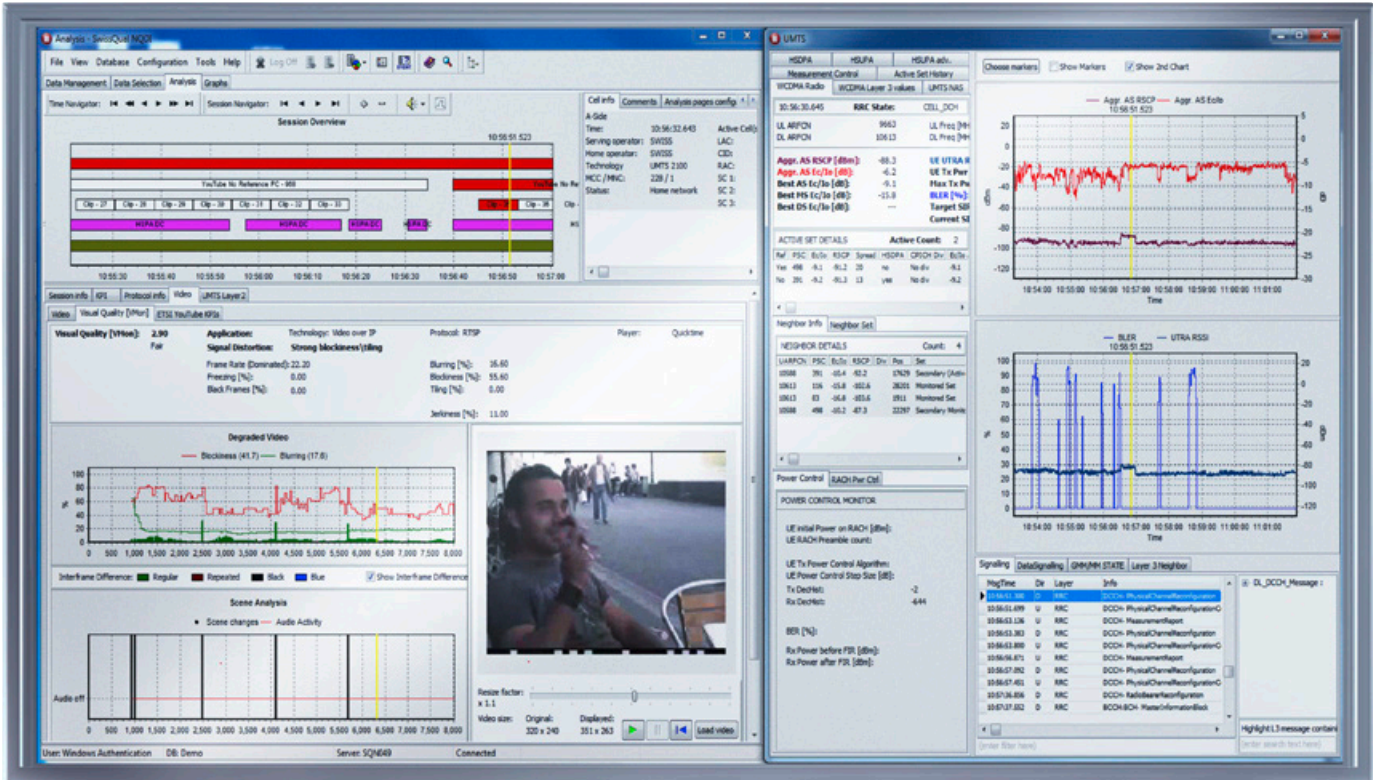

6

Transform data into insights to support business decisions

The network quality data investigator NQDI from Rohde & Schwarz mobile network testing (MNT) is a post-processing system that maximizes the potential of the data collected with QualiPoc and Smart products for network optimization, benchmarking and monitoring. Based on data from all radio technologies, NQDI Classic provides automated data validation, detailed quality analysis, troubleshooting and long-term reporting for voice and data services.

NQDI combines the benefits of insight generated by high-level key performance indicator (KPI) summaries with the investigative power of detailed drilldowns. This allows for the generation of comprehensive reports and maps to benchmark networks and easily identify critical areas with underperformance. In addition to traditional network related analysis – from layer 1 and layer 3 – and service related analysis based on IP and application layers, NQDI provides KPIs representing user perception for voice and video services, e.g. mean opinion score (MOS). In case of low MOS values, industry unique quality codes can directly point to the underlying causes in the network.

Key facts

- ▶ NQDI stores all gathered information in a scalable database. Flexible data selection and filtering can be performed for detailed troubleshooting and long-term trend analysis
- ▶ A smart adapting GUI, which is sensitive to contextual information, enables users to focus on relevant information; time synchronization and correlation of numerous data layers help automate fault categorization. The quality of voice, video, messaging, and data services can be investigated using primary RF measurements, network trace events, call control parameters, IP and application level events, and voice and video quality indicators
- ▶ NQDI presents such information in time-synchronized views using maps, message monitors, grids, line graphs, bar graphs, pie charts, tables, or hierarchical lists. Thanks to its powerful report generator, NQDI features multiple options for reporting from predefined packages to guided KPI-based creation of Excel reports



Product site

R&S® NESTOR CELLULAR NETWORK ANALYSIS SOFTWARE

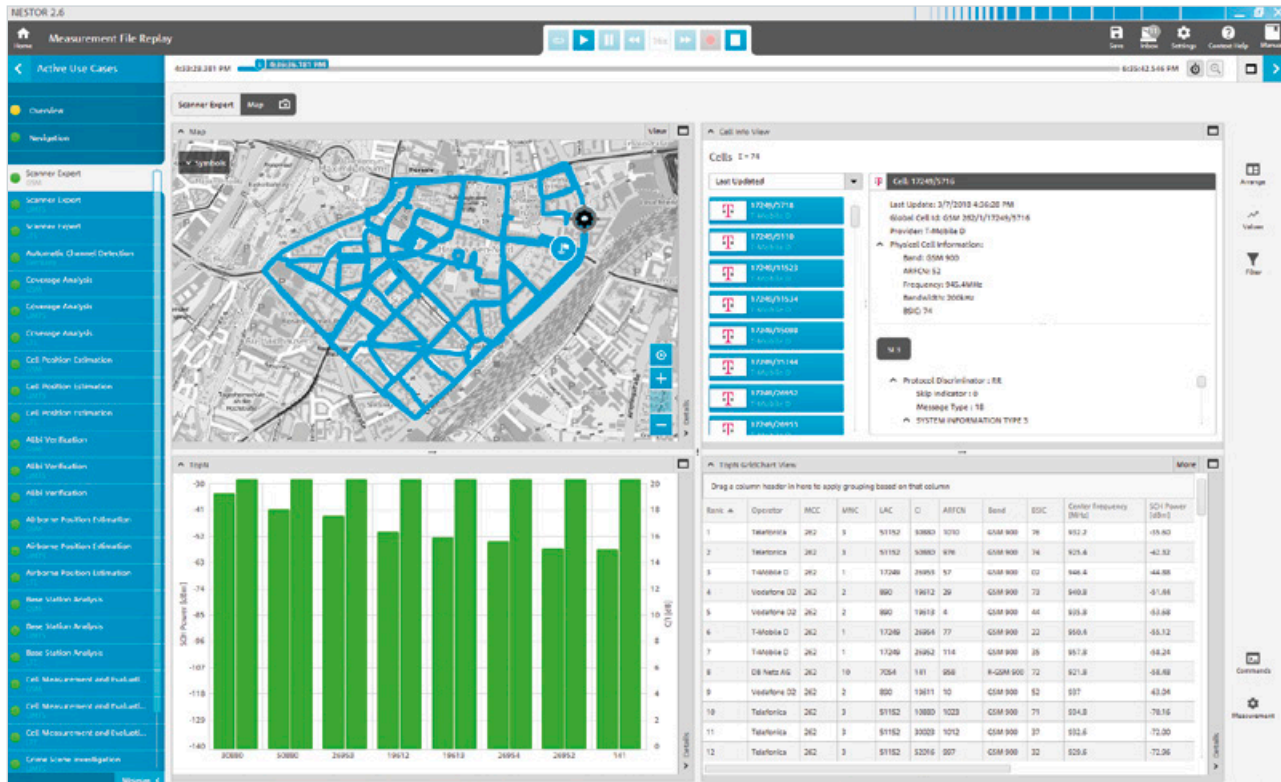

Accurate multitechnology RF measurements for full network insights

R&S®NESTOR is a Windows based software for analyzing cellular networks over the air interface. It is widely deployed by law enforcement agencies, intelligence services, armed forces and regulatory authorities. R&S®NESTOR is used together with Rohde&Schwarz mobile network scanners, which offer the most advanced technology worldwide. It supports all relevant applications that public authorities and security organizations need to gather necessary information about cellular networks. R&S®NESTOR is used in vehicles, trains, aircraft, drones, on ships or on foot.

R&S®NESTOR combines a cutting-edge touchscreen software architecture with top-of-the-line mobile radio acquisition equipment from Rohde&Schwarz. In addition to direct acquisition, visualization and realtime analysis of all measurement data (online), the software enables users to carry out in-depth postprocessing and long-term analysis (offline).

The R&S®TSME6 and R&S®TSMA6 mobile network scanners deliver parallel measurements of 2G, 3G, 4G, 5G, CDMA2000®, EV-DO and WLAN downlink signals in all frequency bands. The R&S®NESTOR architecture supports direct (live), autonomous (offline) and networked operations as well as client/server operation over IP-based links.

R&S®NESTOR supports the following applications:

- ▶ Automatic detection of all GSM, UMTS, LTE (TDD and FDD), 5G NR, CDMA2000® and EV-DO networks, bands and channels
- ▶ Autonomous acquisition of cell information, signal power and signal quality
- ▶ Mobile radio coverage measurements and determination of cell boundaries
- ▶ Creation and management of cell lists including geographic positions
- ▶ Retrieval of coverage data for forensic investigations
- ▶ Detection and analysis of misconfigured cells (mobile and stationary applications)
- ▶ Spectrum analysis in uplink and downlink bands

Key facts

- ▶ Cellular network analysis to measure parameters and read out data from these networks
- ▶ Parallel measurements of all supported technologies and bands for comprehensive, reliable measurement data
- ▶ Realtime analyses during data acquisition
- ▶ Data postprocessing for in-depth analysis
- ▶ Intuitive operation for complex tasks
- ▶ Free map data (OpenStreetMap)
- ▶ User interface supporting multiple languages



SmartMonitor



Realtime service quality monitoring

When monitoring network performance and quality of service from a real end-user perspective, it is crucial to recognize network failures or quality drops and get immediately notified, so that appropriate actions can be taken.

Precisely for that purpose, Rohde&Schwarz mobile network testing (MNT) has implemented SmartMonitor, a web-based application that provides a realtime overview of the current network situation based on QualiPoc Android Probes and offers to control complete SmartBenchmarker systems or R&S®TSMA6 scanners remotely from the office.

SmartMonitor offers an easy and straightforward fleet management, drag&drop job configuration, and realtime map-based information as well as test results, statistics and analysis, all in one tool. The reported data by the fleet of QualiPoc Android Probes is immediately displayed on SmartMonitor dashboards and provides an instant overview of the service quality and network performance from a real end-user perspective."

SmartMonitor, with its communications concept towards the probes, is an essential component to cost-effectively monitor service quality status in realtime from a real end-user perspective and helps to reduce operational costs in the field. Ultimately, SmartMonitor ensures seamless quality of service.

As a central, web-based module for controlling and monitoring a fleet of QualiPoc Android Probes, SmartMonitor can be installed on any application server at the customer IT infrastructure or in the cloud. It is accessible from anywhere with Internet access.

SmartMonitor, connected to QualiPoc Android Probes that are placed in critical and strategic locations or deployed in cars, taxis or buses, delivers a constant flow of information about a mobile network's quality of service.

Key facts

- ▶ Web-based SmartMonitor application for Windows, Linux or OS X application server
- ▶ Informative dashboards, providing the latest results and status of the probes in real-time
- ▶ Intuitive campaign configuration and fleet operation
- ▶ Fast and easy registering of new QualiPoc Android Probes
- ▶ Remotely control QualiPoc Android Probes, SmartBenchmarker systems or R&S®TSMA6 scanners conveniently from the office or anywhere else where internet is available
- ▶ Tailored user roles offer an efficient and secure system and fleet management



Product site

SmartAnalytics

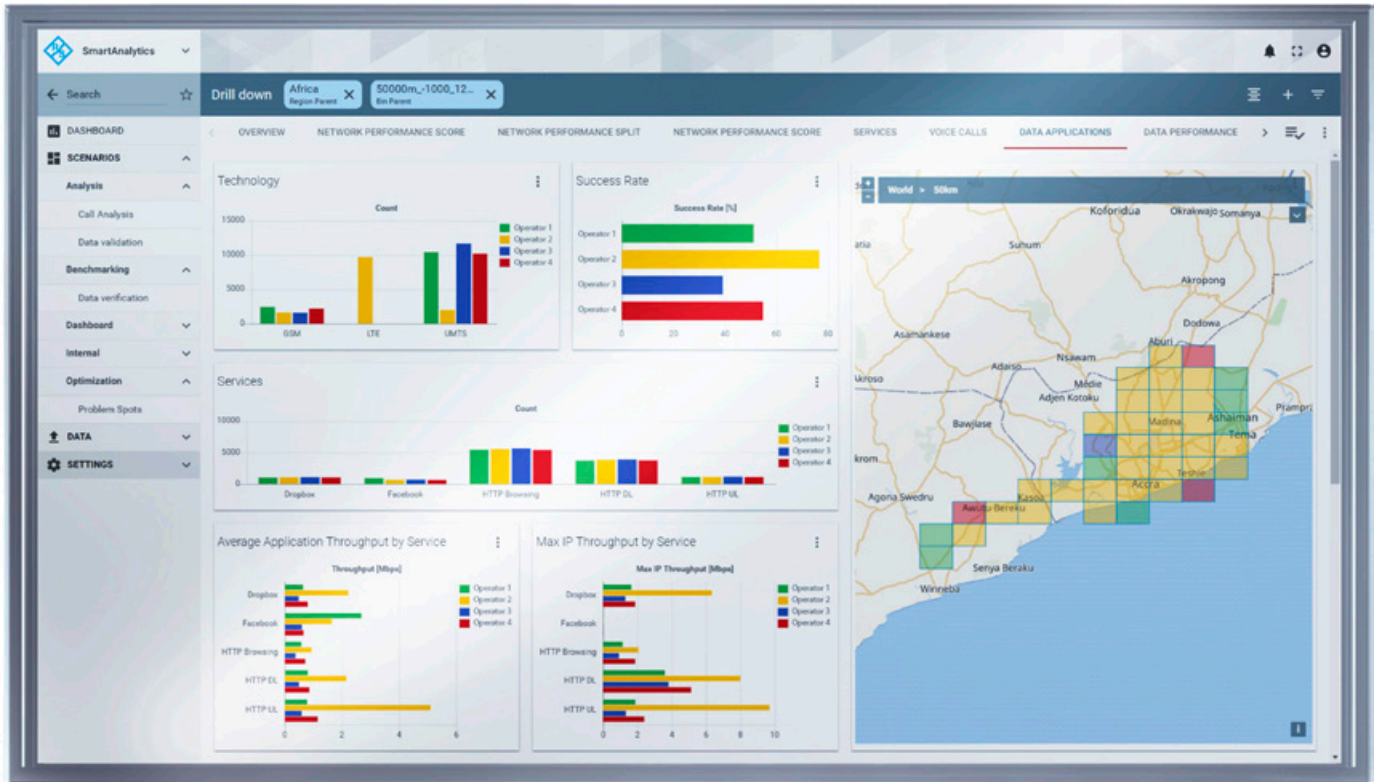

Powerful QoE-centric insights into your mobile network performance

For accurate network engineering, benchmarking, monitoring and optimization, it is necessary to process complex data and produce clear and easy-to-understand intelligence on a network to make better decisions. Correct decisions can only be made based on reliable and accurate data that is processed quickly and accurately. SmartAnalytics provides a precise and clear assessment of the operator's own network quality (QoE from end-user perspective) and competitive position in the market. SmartAnalytics provides visibility of the principle factors influencing network performance and quality of experience (QoE), including the context, development trends, problems and possible degradation causes. In addition, SmartAnalytics offers machine-learning features which allow to reveal previously hidden insights and enable guided optimization.

Network performance score (NPS)

The Network Performance Score integrates all relevant RAN factors that influence the end-user QoE to provide a unified metric that quantifies the network quality in a single number. It uses objective methodology to deliver a network-wide, vendor-independent assessment that enables comparison with other networks in the same market and globally.

SmartAnalytics calculates the NPS for the whole network and can drill it down by use case, technology and other variables.

5G NR optimization and roll out

5G NR comes with a previously unseen level of configuration, this also creates a lot of challenges in the optimization and roll out of this new technology and also to coexist with older technologies. SmartAnalytics can process and aggregate the measurement data in order to simplify the process and go down to the bold facts and recommendations in order to deploy a successful 5G NR network.

Benchmarking, insights on competition

SmartAnalytics provides an evaluation of the network QoE and a comparison with competitor networks. Its powerful architecture enables users to easily browse huge benchmarking data files in real time. It is also possible to easily adapt the interface to compare different networks and generate data insights on the fly.

Optimization and lab testing – go down to the bit level to understand network behavior

SmartAnalytics offers drilldown, root-cause analysis in order to identify specific areas for network optimization. It goes to a level of detail that explains every parameter affecting the quality of experience perceived by end users.



Automation Agent

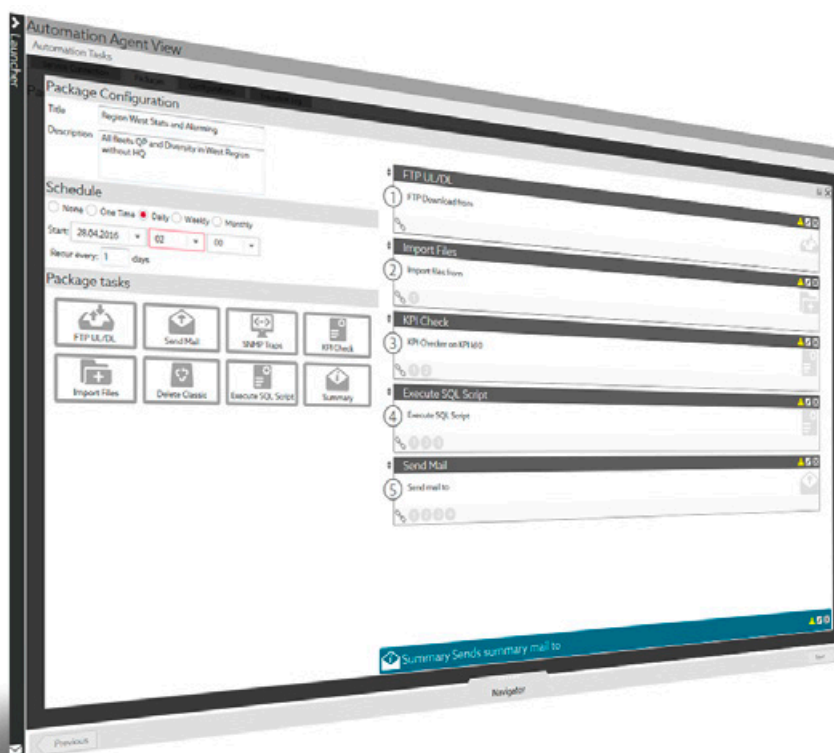

For automation of data management, alarming, and report generation

The complexity of today's networks and the variety of services offered by mobile operators lead to an increased demand for testing and verification of quality of service. At the same time, pressure to reduce OPEX requires that the end-to-end effort and time for measurement campaigns are minimized, without compromising the quality of the results. This requires a tool, such as the Automation Agent, that combines the faultless and automated information management as well as the transfer and processing with automated alarms and report generation.

The Automation Agent is aimed at helping users to unlock the value of customer-perception oriented tests, performed by Rohde&Schwarz mobile network testing (MNT) measurement collection tools such as QualiPoc. The Automation Agent offers a full range of automated actions for managing the retrieval, storage, organization, and reporting of data collected during drive and walk tests. The reliable server service supports engineers in making changes to the network and helps managers make strategic decisions.

Key facts

- ▶ Automated data management: copies/moves/downloads/uploads measurement files for import and backup
- ▶ Automated import: imports measurement files into databases
- ▶ Automated report processing: creates reports and content for e-mail or web distribution
- ▶ Automated 5G NR rollout reports
- ▶ Automated data warehouse statistics processing: automatically updates the data warehouse to enable interactive data analysis without the need to generate reports for each question
- ▶ Automated alarming: sends alarms based on KPIs or events, according to simple or complex rules, via e-mail and/or an SNMP alarm system interface
- ▶ Automated calculation of key performance indicators (KPIs), failure causes, and statistics



SmartLicenser

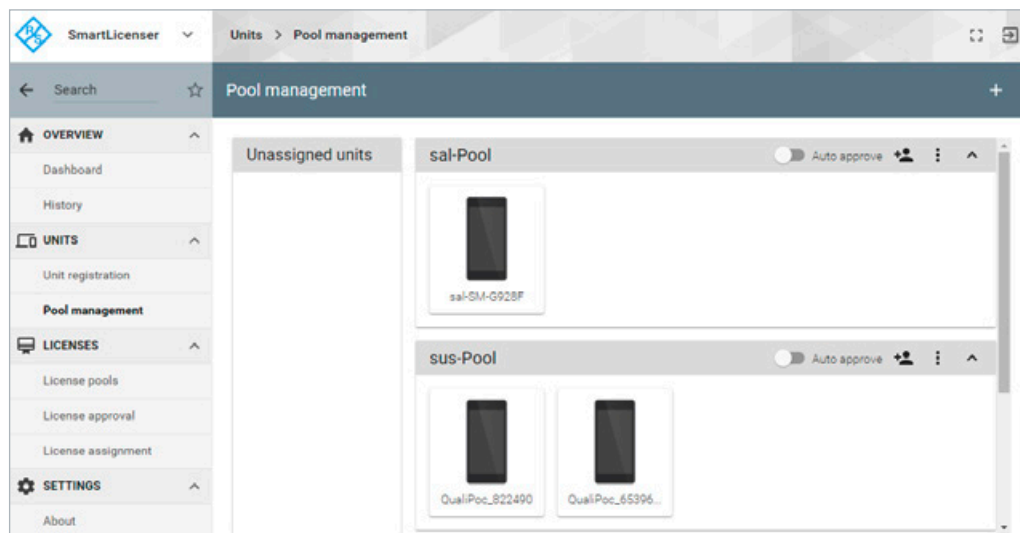

Floating license server for QualiPoc Android and QualiPoc Android Probe

SmartLicenser is a web-based floating license server. It lets you more efficiently organize and operate QualiPoc Android or QualiPoc Android Probe fleets. The option to create different license pools offers a well-structured and organized way to operate your fleet of QualiPoc Android devices. SmartLicenser can be installed at customer premises or hosted by Rohde&Schwarz.

The user interface is very intuitive and clean. Users feel comfortable from the start. SmartLicenser is web-based and can be accessed from anywhere the Internet is available.

Dashboard

The dashboard shows an overview of the current license situation, including the total license count and the number of available and used licenses. The history menu shows how every installed license was used over a specified period. This helps users monitor license usage and assess the required number of a certain license type.

Unit management

Administrators can register new units (QualiPoc devices) on the SmartLicenser server. Under pool management, the administrator creates new license pools. These pools are very convenient if you want to split licenses by project, region or team and assign them to a license pool.

Licenses

This section contains all tasks relevant to assigning licenses. Administrators or pool administrators can assign licenses to pools. They can view all pending requests and approve license requests, either manually or automatically.

All borrowed licenses are listed per user in a clear overview. Administrators have a complete overview of when, for how long and to whom licenses have been lent.

User management

SmartLicenser offers powerful user management, where users can be defined with different access and privilege levels:

- ▶ The SmartLicenser administrator has full access to the license server and creates new users
- ▶ The SmartLicenser pool administrator can only manage the license pool for which he is responsible

Floating licenses

All QualiPoc test options and the basic QualiPoc software are available as floating licenses. Floating licenses are installed on SmartLicenser. Via license pools, administrators can assign licenses to regions or project teams, providing a clear overview of all borrowed licenses.

Issue license request directly from QualiPoc smartphone

QualiPoc devices registered to SmartLicenser recognize available licenses on the server. It is easy for a QualiPoc user to request licenses for a specific period and receive them on the device within seconds.

Manual or auto license check-in

Borrowed licenses are automatically checked back into the SmartLicenser server after the validity period has expired. If licenses are not used for the entire period, the QualiPoc user can manually check the license back into SmartLicenser. By doing so, other SmartLicenser users can use this license earlier than planned and thereby increase efficiency.

PORTFOLIO FOR TESTING THE ENTIRE NETWORK LIFECYCLE

Network engineering

Verify new technologies and services in the lab

The capabilities of new technologies, such as 5G NR, NB-IoT or LTE-M, new features and services must be first verified in a lab environment under special network conditions. The testing is done in an isolated network environment using user equipment (UE) simulators or pre-commercial devices connected to the complete radio access and the core network. Although such lab setups do not accurately reflect real network environments, they do allow the verification of fundamental functions and objectives, including:

- ▶ Radio connection setup and release procedures
- ▶ User authentication and subscriber profile management
- ▶ Provision of end-to-end user services
- ▶ Radio link allocation and utilization
- ▶ Data bearer performance

Installation and maintenance

Install and maintain your BTS with ease of use and high efficiency

Network operators are investing heavily in expanding network capacity and introducing new technologies. The number of newly deployed BTS installations is increasing. The situation becomes even more complex when a site consists of more than one technology from more than one infrastructure supplier.

Before going live with these installations, it is crucial to check if the components work as expected as a system and that the technicians did not make any mistakes. However, it is not enough to perform these measurements only when the BTS is deployed.

Interference hunting

Locate and eliminate all kinds of interference

Unwanted transmitters are pervasive in today's mobile networks, degrading network capacity and reducing subscriber QoE. With the densification of cells and the deployment of emerging standards with higher-order modulation over legacy technologies, the RF environment is becoming ever-more complex making networks increasingly susceptible to interference and therefore interference hunting is a key issue for mobile network operators and regulators.

External interference can originate from a licensed or non-licensed radio transmitter. A few dBs of reduction in signal to noise ratio at the receiver dramatically impacts network capacity with subsequent loss of revenue and subscriber QoE, requiring operators to hunt down interference quickly.

Network optimization

Meet coverage, quality and service performance objectives

The rollout of 5G NR and other new technologies, including NB-IoT and LTE-M, has initiated a surge in network optimization and troubleshooting. To ensure end-user quality of experience (QoE) and network performance, use case-targeted testing solutions need to offer reliable data collection and extensive drill-down functions in data analytics.

Data and intelligence enable operators to assess and identify network QoE and performance-critical factors effectively and systematically. Intelligent insights, generated from reliable and accurate data, help operators take well-informed and fact-based decisions for strategic investments.

Quality benchmarking

Compare your network with your competitors

For mobile operators, quality of experience (QoE) is one of the key factors that drives differentiation, increases revenue and reduces churn. Nowadays, subscriber growth can only come from competing operators. How good should a mobile network or service be?

Benchmarking tests against the competition are an effective way of measuring the marginal improvements that are necessary to trigger focused investments. It is also an effective way of getting to know the competition and to gather valuable information as a source for focused promotional campaigns. In a mature mobile network, it is fundamental to ensure that the subscriber perceived quality is under control. This means ensuring that QoE keeps improving or is not getting worse, especially when compared to the competition or whenever a new technology is introduced, such as 5G, NB-IoT and LTE-M.

Network monitoring

Detect network and service instabilities instantly

Monitoring user experience and sending alerts immediately upon detecting network and service instabilities can drastically reduce the negative effect that network problems have on end-user applications.

When voice, data, video and messaging services fail to deliver the expected quality levels, network and service operations centers need to be notified instantly to take prompt action. This is particularly important in critical hotspots such as shopping malls, airports, commercial centers, train stations, highly populated areas, key commuting routes and public transport.



CHAPTER 7

EMC AND FIELD STRENGTH TEST SOLUTIONS

Rohde & Schwarz offers an exceptional range of EMC and field strength test equipment, from standalone instruments to customized turnkey test chambers. EMI and EMS test instruments and systems from Rohde & Schwarz determine the causes and effects of electromagnetic interference and ensure compliance with the relevant EMC standards.

The EMC test solutions support all relevant commercial, automotive, military and aerospace standards as well as ETSI and FCC standards for radiated spurious emissions and audio breakthrough measurements. Decades of experience in the field of EMC measurements has made us the world market leader.



Type	Designation	Description	Page
EMI precompliance/compliance			
R&S®ESW	EMI test receiver, 2 Hz to 8/26.5/44 GHz	Unrivalled dynamic range, extremely fast standard-compliant EMI measurements, 80 MHz realtime spectrum analysis	182
R&S®ESR	EMI test receiver, 9 kHz to 3/7/26 GHz	More speed – more insight – more intelligence	183
R&S®ESRP	EMI test receiver, 9 kHz to 3/7 GHz	Precompliance measurements – fast and straightforward	184
R&S®ESL	EMI test receiver, 9 kHz to 3/6 GHz	The EMC expert for every lab bench	185
R&S®TS9975	EMI test system	Tests in accordance with commercial, A&D and automotive standards	186
EMS measurements			
R&S®CEMS100	Compact EMS/EMI test platform	Standard-compliant all-in-one solution for EMS measurements	188
R&S®TS9982	EMS test system	Radiated and conducted EMS measurements in line with commercial, wireless, automotive and A&D standards	189
EMF measurements			
R&S®TS-EMF	Portable EMF measurement system	Simple, frequency-selective measurement of EMF emissions	193
TEMPEST measurements			
R&S®FSWT	Test receiver	TEMPEST measuring receiver with digital signal evaluation	194
EMC software			
R&S®ELEKTRA	EMC test software	Swift and reliable measurements of electromagnetic disturbances	195
R&S®EMC32	EMC measurement software platform	For use in development, for compliance and batch testing	196
R&S®AdVISE	Visual inspection software	A new way to eliminate human inattention	198
Broadband amplifiers			
R&S®BBA130	Broadband amplifier	The amplifier you can tune	199
R&S®BBA150	Broadband amplifier	Excellent microwave amplifiers with high power density	200
R&S®BBL200	Broadband amplifier	Liquid-cooled power amplifiers for high field strengths	201
RF test chambers			
Albatross Projects	Test chambers	Compact diagnostic chambers, fully anechoic rooms for EMC and field strength test solutions up to test sites for automotive test solutions	202
EMC accessories			
Disturbance voltage measurements			
R&S®ENV216/ENV432/ENV4200, R&S®ESH3-Z6		V-networks for EMC measurements on power supply networks	205
R&S®ENY21/ENY41/ENY81, R&S®ENY81-CA6		Coupling networks for EMC measurements on telecommunications ports	206
R&S®EZ-12, R&S®EZ-25		Antenna impedance converter, 150 kHz highpass filter	207
R&S®ESH2-Z3, R&S®ESH3-Z2		Voltage probe, pulse limiter	207
Disturbance current measurements			
R&S®EZ-17, R&S®ESV-Z1		Current probes for disturbance current measurements on cables	208
Disturbance power measurements			
R&S®MDS-21		Absorbing clamp for EMC measurements on cables	208
Field strength measurements			
R&S®HZ-14/HZ-15/HZ-16/HZ-17		E and H near-field probe sets	209
R&S®HFH2-Z2E/HFH2-Z6E		Loop/rod antennas	210
R&S®HZ-9		Power supply	210
R&S®AM524		Active antenna system	211
R&S®HL033/HL040E		Log-periodic antennas	211
R&S®HL046E/HL050(E)/HL223		Log-periodic antennas	212
R&S®HM020E		Triple-loop antenna	213
R&S®HK116E, R&S®HF907, R&S®HL562E		Biconical antenna, double-ridged waveguide horn antenna, ULTRALOG antenna	213

INTRODUCTION

EMC = EMI + EMS

Electromagnetic compatibility (EMC) is the capability of an electrical device or system to operate in its electromagnetic environment without disturbing it or being disturbed by it. EMC is an important criterion of product quality. To ensure EMC of a product in the most economical way, appropriate measures should be taken early in the design phase.

In line with the definition, EMC is subdivided into electromagnetic interference (EMI) and electromagnetic susceptibility (EMS). Legislation prescribes compliance with maximum values for EMI and minimum values for EMS. The applicable limits, the measurement methods and instruments to be employed are specified in the relevant standards.

Conformity mark

To show their conformity to the EMC requirements prescribed by law, all electrical devices have to be marked accordingly, e.g. by the CE conformity mark required in the entire European Economic Area.

EMI measurements

For measuring electromagnetic disturbance, the disturbance sink is replaced by the measuring instrument. As a result, all test receivers for commercial EMI measurements should have human-like response built in: they must have a quasi-peak-weighting detector to show the human perception of disturbance as a measured value. Disturbance measurements higher than 1 GHz use peak, CISPR-average and RMS-average weighting.

In the military sector, the disturbance sink is assumed to be a technical device that responds to the maximum disturbance level. Therefore, the peak level of disturbance is measured.

Disturbance is emitted by the equipment under test in various ways of coupling. Therefore, the EMC standards contain procedures for coupling the test receiver to the equipment under test (EUT).

EMS measurements

For measuring electromagnetic susceptibility, the different disturbance sources occurring in practice are replaced by appropriate generators, the interfering signals of which are applied to the EUT via suitable coupling/decoupling networks and antennas.

For monitoring the proper functioning of the EUT, suitable monitoring equipment can be provided, which so far has not been defined in the relevant EMC standards. In many cases, highly shielded video cameras with monitors or automatic visual inspection software are used for this purpose.

EMC measurement software

Reproducible EMC measurements are only possible if a number of rules and standards for the measuring instruments and the measurement methods used are complied with.

For computer-controlled EMC measurements, two different software tools are available. The R&S®ELEKTRA and R&S®EMC32 system control software include various modules for electromagnetic interference (EMI) and electromagnetic susceptibility (EMS) measurements. Due to its flexible structure the software can be optimally adapted to the requirements of almost any commercial, automotive or military EMC application.

These tools relieve the user of routine settings and offer convenience – from automatic consideration of frequency-dependent transducer factors of the coupling/decoupling networks, automatic selection of the applicable limit lines, display of the results in graphical or tabular form to the generation of test reports. Similar convenience is provided by the automatic EMI test routines implemented in the R&S®ESW, R&S®ESR, R&S®ESRP and R&S®ESL test receivers. They allow fully automatic time-saving measurements without an external controller, so that very compact test setups can be implemented.

EMC test systems

Planning and implementation of practice-oriented EMC test systems requires a great deal of specialized knowledge. Rohde&Schwarz has been building EMC test systems for decades and has gained immense experience.

These systems are always tailored to the specific needs of the user to provide the optimum solution to the tasks at hand. We offer everything from small systems to complete test houses including shielded anechoic chamber and the required infrastructure, covering all major standards in the commercial, automotive, wireless and military range.

EMC standards in the European Economic Area

The number of standards published in the Official Journal is steadily increasing. The different types of standards include basic standards, which define the measurement method and environment. Generic standards, which can be applied in all cases not covered by specific product or product family standards and the product (family) standards, which define limits or setups for defined products.

Generic standards – emission

- ▶ **EN 61000-6-3:** Residential, commercial and light-industrial environments
- ▶ **EN 61000-6-4:** Industrial environments

Generic standards – immunity

- ▶ **EN 61000-6-1:** Residential, commercial and light-industry environments
- ▶ **EN 61000-6-2:** Industrial environments

Basic standards – immunity

- ▶ **EN 61000-4-3:**
Radiated electromagnetic field immunity test
- ▶ **EN 61000-4-6:**
Immunity to conducted disturbances by RF fields

Product family standards for high-frequency emission

- ▶ **EN 55011:** ISM equipment
- ▶ **EN 55012:** Automotive equipment – protection of off-board receivers
- ▶ **EN 55014-1:** Household appliances, electric tools and similar apparatus
- ▶ **EN 55015:** Lighting equipment
- ▶ **EN 55025:** Automotive equipment – protection of on-board receivers
- ▶ **EN 55032:** Multimedia equipment
- ▶ **EN 55103-1:** Audio/video equipment for professional use

Product standards for immunity

- ▶ **EN 55014-2:** Household appliances, electric tools and similar apparatus
- ▶ **EN 61547:** Lighting equipment
- ▶ **EN 55020:** Sound and TV broadcast receivers
- ▶ **EN 55024:** Information technology equipment
- ▶ **EN 55035:** Multimedia equipment
- ▶ **EN 55103-2:** Audio/video equipment for professional use

Special standards for signal transmission in low-voltage installations

- ▶ **EN 50065-1:** Signaling on low-voltage electrical installations, Part 1: General requirements, frequency bands and electromagnetic disturbances
- ▶ **EN 50065-2-x:** Immunity

Product standards containing EMC requirements

- ▶ **EN 50083-2:** Cable networks for TV and sound signals
- ▶ **EN 50090-2-2:** Electronic systems for homes and buildings
- ▶ **EN 62040-2:** Uninterruptible power systems
- ▶ **EN 50130-4:** Alarm systems
- ▶ **EN 50148:** Electronic taximeters
- ▶ **EN 60974-10:** Arc welding equipment
- ▶ **EN 50263:** Measuring relays and protection equipment
- ▶ **EN 50270:** Gas sensors
- ▶ **EN 50293:** Road traffic signal systems
- ▶ **EN 50295, EN 60439-1, EN 60947-x-x:** Low-voltage switchgear and control gear
- ▶ **EN 50370-1, -2:** Machine tools
- ▶ **EN 60034-1:** Rotating electrical machines
- ▶ **EN 60204-31:** Sewing machines
- ▶ **EN 62052-x, EN 62053-x, EN 62054-x:** Several AC watt-hour meters, tariff and load control equipment
- ▶ **EN 60601-1-2:** Medical electrical equipment
- ▶ **EN 50428, EN 60669-2-x:** Switches for household and similar fixed electrical installations
- ▶ **EN 60730-x-x:** Automatic electric controls for household and similar use
- ▶ **EN 60870-2-1:** Telecontrol equipment and systems
- ▶ **EN 60945:** Maritime navigational equipment
- ▶ **EN 61008-1, EN 61009-1, EN 61543:** Residual current circuit breakers
- ▶ **EN 61037:** Electronic ripple control receivers for tariff and load control
- ▶ **EN 61204-3:** Low-voltage power supplies
- ▶ **EN 61131-2:** Programmable controllers
- ▶ **EN 61326-x:** Electrical equipment for measurement, control and laboratory use
- ▶ **EN 61800-3:** Adjustable speed electrical power drive systems
- ▶ **EN 61812-1:** Time relays for industrial and residential use
- ▶ **EN 617, EN 618, EN 619, EN 620:** Continuous handling equipment
- ▶ **EN 12015, EN 12016:** Elevators and escalators
- ▶ **EN 12895:** Industrial trucks
- ▶ **EN 13241:** Doors and gates
- ▶ **EN 13309:** Construction machinery with internal power supply
- ▶ **EN 14010:** Power driven parking equipment for vehicles
- ▶ **EN ISO 14982:** Agricultural and forestry machinery
- ▶ **ETSI EN 301489:** Radio equipment and services

HIGH-QUALITY EQUIPMENT FOR EVERY EMI STANDARD

Group of equipment	International Europe Japan USA	Industrial, scientific and medical equipment	Vehicles, boats and internal combustion engines	Electrical devices, household appliances and tools	Electrical lighting and similar equipment	Multimedia equipment	Military equipment and systems	Airborne equipment	Generic emission standards	Combined equipment	Mains signaling equipment	Cabled distribution systems TV/sound	Uninterruptible power systems (UPS)	Electric railways	Medical electrical apparatus	Maritime navigation equipment	Low-voltage switchgear and control gear
Standards	CISPR 11 EN 55011 J55011 FCC Part 18, Subpart C	CISPR 12/CISPR 25; ECE 10 EN 55012 JASO D001-82 SAE J951, J1113	CISPR 14-1 EN 55014-1 J55014-1	CISPR 15 EN 55015 J55015	CISPR 32 EN 55032 J55032 FCC Part 15	DEF-STAN 59-411 (UK); VG 95370/95373 MIL-STD-461	RTCA/DO-160	EN 61000-6-3/4	EN 303446-1, EN 303446-2	EN 50065-1	EN 50089-2	EN 50091-2	EN 50121-x	EN 60601-1-2	EN 60945	EN 60947-x-x	

Frequency range	Accessories and extras																	
	R&S®ELEKTRA EMC test software	○	○	○	○	○	○	○	○	○	○	○	○	○	○	○	○	○
From 9 kHz ¹⁾	R&S®EZ-17 current probe	○	○	○	○	○	●	●	○	○	○	○	○	○	○	○	○	○
	R&S®EZ-25 150 kHz highpass	○	○	○	○	○	○	○	○	○	●	○	○	○	○	○	○	○
	R&S®HFH2-Z2E active loop antenna	●					● ²⁾			●				●		●		
	R&S®HFH2-Z8 tripod	●					● ²⁾			●				●		●		
	R&S®HFH2-Z6E rod antenna		●				● ³⁾			●								
	R&S®HZ-1 tripod						●			●								
	R&S®ENV432 V-network	●		●	●	●	● ³⁾		●	●	● ⁵⁾	●	●	●	●	●	●	●
	R&S®ESH3-Z6 V-network		●				●	● ⁶⁾		●								
	R&S®ENV216 V-network	●		●	●	●	● ³⁾		●	●	● ⁵⁾	●	●	●	●	●	●	●
	R&S®ENV4200 V-network	●		●	●	●	●		●	●	● ⁵⁾	●	●	●	●	●	●	●
	R&S®ENY81/ENY81-CA6 coupling network						●			●								
	R&S®ESH2-Z3 voltage probe	●		●	●	●	●			●	●	●	●	●	●	●	●	●
	R&S®EZ-12 antenna impedance converter		●							●								
	R&S®HZ-14 probe set	○	○	○	○	○	○	○	○	○	○	○	○	○	○	○	○	○
	R&S®HM020E triple-loop antenna	○			●					●							●	
	R&S®HZ-9 power supply	○	●	○	○	○	○	○	○	○	○	○	○	○	○	○	○	○
	From 30 MHz	R&S®EZ-17 current probe	○	○		○	○	●		●	●	○		○				
R&S®ESV-Z1 current probe		○	○		○	○	●		○	○	○							
R&S®MDS-21 absorbing clamp		●	●	●		●			●	●	●	●						
R&S®HZ-15/HZ-17 probe set		○	○	○	○	○	○	○	○	○	○	○	○	○	○	○	○	○
R&S®HK116E biconical antenna		●	●		●	●	●	●	●	●	●	●	●	●	●	●	●	●
R&S®HL223 log-periodic antenna		●	●		●	●	●	● ⁴⁾	●	●	●	●		●	●	●	●	●
R&S®HL562E ULTRALOG antenna		●	●			●				●	●			●	●	●	●	●
R&S®HZ-1 tripod						●	●		●									
From 1 GHz	R&S®HL050, R&S®HF907 antennas	●					●	●	●		●							
	Other antennas on request						●	●										

R&S® ESW EMI TEST RECEIVER



Excellent RF characteristics and high measurement speed

The R&S®ESW is an EMI test receiver with outstanding RF characteristics, including high dynamic range and measurement accuracy. It meets the most stringent requirements for certification measurements in line with CISPR, EN, MIL-STD-461, DO-160 and FCC. With its FFT-based time domain scan, the R&S®ESW captures and weights disturbance spectra in virtually no time. The instrument's realtime spectrum analysis capability with spectrogram function permits a detailed analysis of disturbance signals and their history. MultiView mode delivers a straightforward display of results, even for multiple operating modes.

The R&S®ESW EMI test receiver is ideal for demanding EMI certification measurements as required in the automotive and A&D sectors. It features the widest dynamic range with a high 1 dB compression point and high sensitivity due to its low inherent noise. The preselection in the R&S®ESW offers additional highpass filters at 150 kHz and 2 MHz as well as notch filters specifically for the license-free ISM bands at 2.4 GHz and 5.8 GHz. It is thus ensured that high carrier signals in these bands – which are used by Bluetooth® and WLAN, for example – do not affect the instrument's dynamic range, and that even small disturbance signals outside these bands are detected.

The R&S®ESW comes with an FFT-based time domain scan as standard. Measurements that previously took minutes or hours are completed in just seconds. Even measurements that use two CISPR detectors (quasi-peak, CISPR-average, RMS-average) are possible, cutting overall measurement time in half. The R&S®ESW combines the functions of an EMI test receiver with those of a full-featured spectrum analyzer in a single instrument. Realtime spectrum analysis (R&S®ESW-K55 option) with a bandwidth of 80 MHz allows users to detect hidden or superimposed disturbances and analyze their causes using persistence mode and a frequency mask trigger. The spectrogram function provides seamless spectrum display in the time domain, making even rapidly changing disturbance signals visible. This saves considerable time and cost during product development and certification.

With the MultiView function, users can display different measurements and traces – including in different operating modes – simultaneously and in a straightforward manner. Clearly structured, flat menus and the touchscreen simplify operation.

Key facts

- ▶ Frequency ranges 2 Hz to 8 GHz/26.5 GHz/44 GHz
- ▶ Compliant with CISPR 16-1-1, ANSIC63.2, MIL-STD-461 and FCC
- ▶ Highest dynamic range and highest accuracy for demanding certification measurement
- ▶ Ultrafast measurements with FFT-based time domain scan
- ▶ Preselection with selectable highpass filters and notch filters for the ISM bands
- ▶ EMI test receiver and signal and spectrum analyzer in a single box
- ▶ Realtime spectrum analysis (R&S®ESW-K55 option) with 80 MHz bandwidth and spectrogram function
- ▶ MultiView function for straightforward display of multiple operating modes on a single screen

FFT-based time domain scan for ultrafast measurements

Time domain scan table with total measurement times for different CISPR bands					
Band	Frequency	Resolution bandwidth	Measurement time	CISPR detectors	Total measurement time
CISPR band B	150 kHz to 30 MHz	9 kHz	100 ms	peak	110 ms
CISPR band B	150 kHz to 30 MHz	9 kHz	1 s	quasi-peak and CISPR-average	2 s
CISPR band C/D	30 MHz to 1000 MHz	120 kHz	10 ms	peak	620 ms
CISPR band C/D	30 MHz to 1000 MHz	9 kHz	10 ms	peak	840 ms
CISPR band C/D	30 MHz to 1000 MHz	120 kHz	1 s	quasi-peak	80 s
CISPR band C/D	30 MHz to 1000 MHz	9 kHz	1 s	quasi-peak and CISPR-average	67 s



R&S® ESR EMI TEST RECEIVER



More speed – more insight – more intelligence

The R&S®ESR is an EMI test receiver for the frequency range from 10 Hz to 26.5 GHz and complies with the CISPR 16-1-1 standard. It measures electromagnetic disturbances with the conventional stepped frequency scan or – at an extremely high speed – with an FFT-based time domain scan. At the same time, the R&S®ESR functions as a full-featured, powerful signal and spectrum analyzer for lab applications. Featuring realtime spectrum analysis capability with a wide range of diagnostic tools, the test receiver also enables detailed analysis of disturbance signals and their history. The R&S®ESR comes with clearly structured menus and an intuitive touchscreen, making it very easy to operate in any mode.

The R&S®ESR measures up to 6000 times faster than conventional EMI test receivers. Disturbance measurements that took hours in the past can now be completed in just seconds. This also applies to measurements across wide frequency ranges or with small step sizes as well as to

disturbance voltage measurements using quasi-peak and average weighting. This saves considerable time and cost during product development and certification.

Besides offering functionality for EMC conformance testing, the R&S®ESR features realtime spectrum analysis capability, providing new diagnostic tools such as a spectrogram, persistence mode and frequency mask trigger. With these tools, users can detect hidden or sporadic emissions and analyze their causes.

The clearly structured menus combined with the intuitive touchscreen make the test receiver very easy to operate in any mode. It displays up to six different traces on the large, 21 cm (8.4") touchscreen for fast, effective result analysis. Compact dimensions, low weight, optional ruggedized housing and optional DC power supply make the R&S®ESR an ideal choice also for mobile applications.

Key facts

- ▶ EMI test receiver and signal/spectrum analyzer combined in a single instrument
- ▶ Compliant with CISPR 16-1-1 Ed. 3.1
- ▶ Preselection with integrated 20 dB preamplifier
- ▶ Resolution bandwidths in line with CISPR and optionally in decade steps from 10 Hz to 1 MHz (MIL-STD-461, DO-160)
- ▶ Ultrafast time domain scan (option) or conventional stepped frequency scan
- ▶ Realtime spectrum analysis with up to 40 MHz span for detailed investigation of disturbances (option)
- ▶ Time domain display with high resolution (50 μ s)
- ▶ Automatic test routines
- ▶ IF analysis (option)

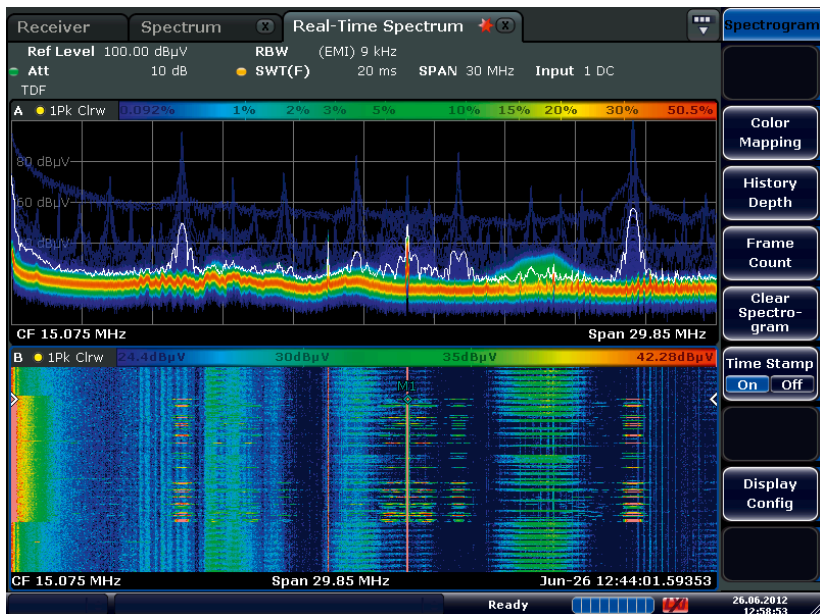

Simultaneous display of disturbance spectrum in persistence mode (top) and as a spectrogram (bottom). The spectrogram provides seamless information about the behavior over time of disturbances emitted by a DUT. In persistence mode, users can clearly distinguish between narrowband and broadband disturbances. The position in time of a user-selected, individual spectrum (shown as a white trace in persistence mode) is indicated in the spectrogram by marker M1, which can be positioned as required.



R&S® ESRP EMI TEST RECEIVER



Precompliance measurements – fast and straightforward

The R&S®ESRP EMI test receiver has been designed for diagnostic measurements during development and for pre-compliance measurements in order to prepare products for final certification testing. It measures electromagnetic disturbances in the frequency range from 10 Hz to 7 GHz, using either conventional stepped frequency scan or an FFT-based time domain scan, a method that significantly speeds up measurements. At the same time, the R&S®ESRP is a full-featured, powerful signal and spectrum analyzer for lab applications. The R&S®ESRP comes with a straightforward menu structure that together with the intuitive touchscreen makes the test receiver very easy to operate in any mode.

The R&S®ESRP EMI test receiver uses an FFT-based time domain scan to carry out EMI measurements that took hours in the past in just a fraction of this time. This considerably cuts time and cost in product development and in preparing the product for final certification. An optional

preselection module prevents overloading of the frontend and ensures reproducible results. The R&S®ESRP comes with tried-and-tested functions such as IF analysis for displaying the spectrum around disturbance signals, or spectrogram display in the analyzer mode, to help users analyze disturbance signals. The neatly organized menu structure makes it easy to navigate to a desired function or setting.

The instrument can simultaneously display up to six different traces on its 21 cm (8.4") touchscreen for fast, effective result analysis. Featuring compact dimensions, low weight, an optional ruggedized housing and optional DC power supply, the R&S®ESRP is perfectly suited also for mobile applications.

Key facts

- ▶ EMI test receiver and signal/spectrum analyzer combined in one box
- ▶ Optional preselection and preamplifier (R&S®ESRP-B2)
- ▶ Resolution bandwidths in line with CISPR, optionally in decade steps from 10 Hz to 1 MHz (R&S®ESRP-B29)
- ▶ Weighting detectors: max. peak, min. peak, average, RMS, quasi-peak, average with meter time constant, and RMS in line with current CISPR 16-1-1 version
- ▶ Standard-compliant disturbance measurements for pulsed disturbances with repetition frequencies ≥ 10 Hz (with R&S®ESRP-B2 preselection/preamplifier option)
- ▶ Very fast FFT-based time domain scan as an option (R&S®ESRP-K53)
- ▶ Automatic test routines
- ▶ IF analysis as an option (R&S®ESRP-K56)



The R&S®ESRP performs disturbance voltage measurements with quasi-peak and average weighting in a matter of seconds



R&S® ESL EMI TEST RECEIVER



Compact, cost-effective measuring receiver

The R&S®ESL EMI test receiver combines two instruments in one, measuring EMC disturbances in accordance with the latest standards and also serving as a full-featured spectrum analyzer for diverse lab applications. The R&S®ESL is the ideal instrument for small budgets.

The R&S®ESL is a compact, cost-effective measuring receiver. It includes all of the functions, bandwidths and weighting detectors that are needed to make EMC measurements in accordance with commercial standards. The receiver provides useful support to manufacturers of components, modules and devices who need to detect disturbances at the early stages of product development. They can thus take any required actions and avoid the expense of having to redevelop completed products. This also saves time and money during the certification process.

Menu for selecting the main receiver settings (receiver mode). In the upper window, the SPLIT SCREEN display shows continuously updated level values for the selected detectors (max. 4) and the selected measurement frequency. In the lower window, the emission spectrum measured using the SCAN table settings is displayed. Up to six traces can be simultaneously activated.

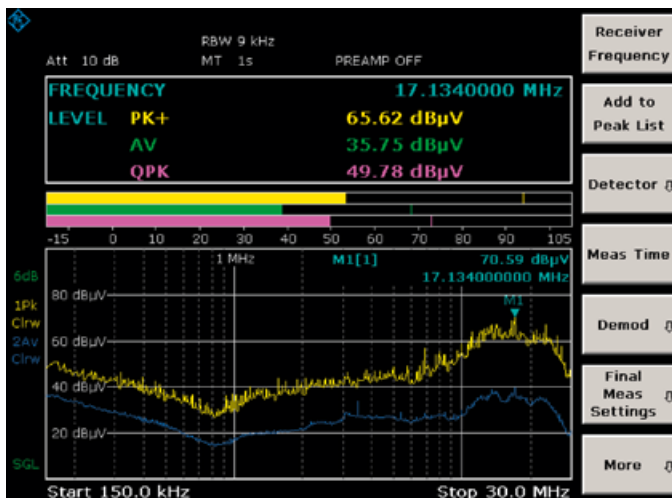

The combination of very good RF characteristics and all of the important functions needed for fast, precise measurement and evaluation of the EMC of a device under test in accordance with commercial standards is unmatched in this class of instrument. The diverse analysis capabilities, high measurement speed and time-saving automated test routines make the R&S®ESL the obvious choice for any development lab that needs to prepare for EMC certification tests.

Key facts

- ▶ Frequency range from 9 kHz to 3 GHz or 9 kHz to 6 GHz covering almost all commercial EMC standards
- ▶ First-ever combination of an EMI test receiver and spectrum analyzer in the entry-level class
- ▶ All major functions of an advanced EMI test receiver, including fully automated test sequences
- ▶ Weighting detectors: max./min. peak, average, RMS, quasi-peak as well as average with meter time constant and RMS-average in accordance with the latest version of CISPR 16-1-1
- ▶ Compact, lightweight instrument, can be battery-powered for mobile applications

Menu for selection of weighting detectors. Values produced by a maximum of four different detectors are simultaneously displayed numerically and as an analog bargraph.

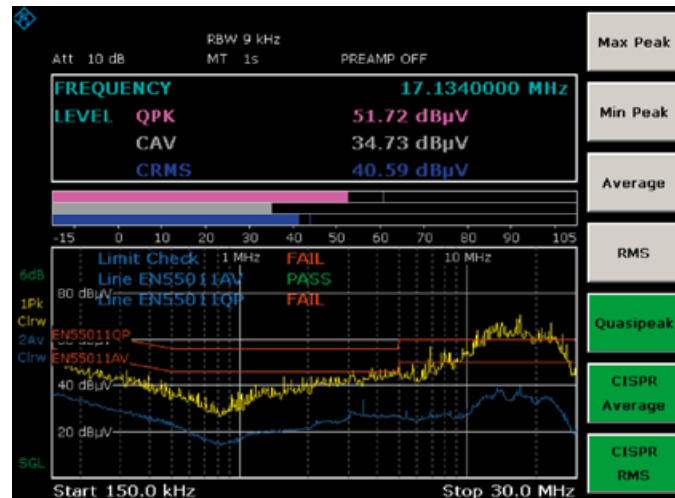

Configurator



Product site

R&S® TS9975 EMI TEST SYSTEM

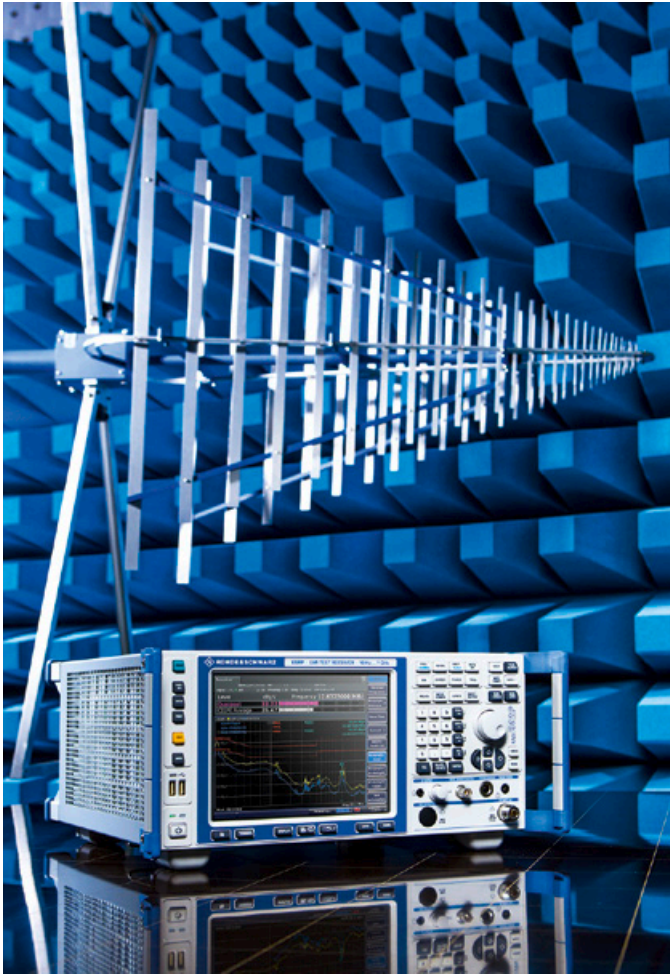

Commercial application in anechoic test chamber with R&S® ESRP EMI test receiver

Tests in line with commercial, A&D and automotive standards

The R&S® TS9975 is the base system for conducted and radiated EMI measurements. Due to its modular design, it covers a wide range of applications and can be very easily adapted to the measurement task at hand. Any configuration is possible – from conducted measurements and a small precompliance system with compact test cell to an accredited test system for complete vehicles. Combinations of different applications or incremental expansion can also be implemented without any problem.

From system design and implementation to installation and training, these turnkey systems and our EMC experts provide everything from a single source, enabling the user to concentrate on testing.

Commercial standards (examples)

- ▶ CISPR 11 to 32
- ▶ IEC/EN 55011 to IEC/EN 55032
- ▶ ANSI-C63.4
- ▶ FCC Part 15, Part 18
- ▶ 2014/30/EU
- ▶ User-specific requirements
- ▶ IEC 60601-1-2 Edition 4.0

A&D standards (examples)

- ▶ MIL-STD-461
- ▶ RTCA DO160
- ▶ Country-specific requirements
- ▶ User-specific requirements

Automotive standards (examples)

- ▶ CISPR 12
- ▶ CISPR 25
- ▶ UN/ECE R10
- ▶ User-specific requirements

For tests in line with wireless EMC standards, e.g. ETSI EN 301489, see our R&S® TS8996 RSE test system for radiated spurious emissions measurements.

For a combined EMS/EMI solution in line with commercial standards, see our R&S® CEMS100 EMC test system.

Main features

- ▶ Conducted EMI measurements from 0.15 MHz to 30 MHz
- ▶ Radiated EMI measurements from 30 MHz to 40 GHz (200 GHz)
- ▶ System automation via automatic path switching
- ▶ Equipment for system calibration

System configuration

The system features a highly modular hardware and software concept. Customized systems can be configured from a variety of instruments. The system is a complete package of hardware, user-friendly software, system services and installation. Users can very quickly learn to use the system.

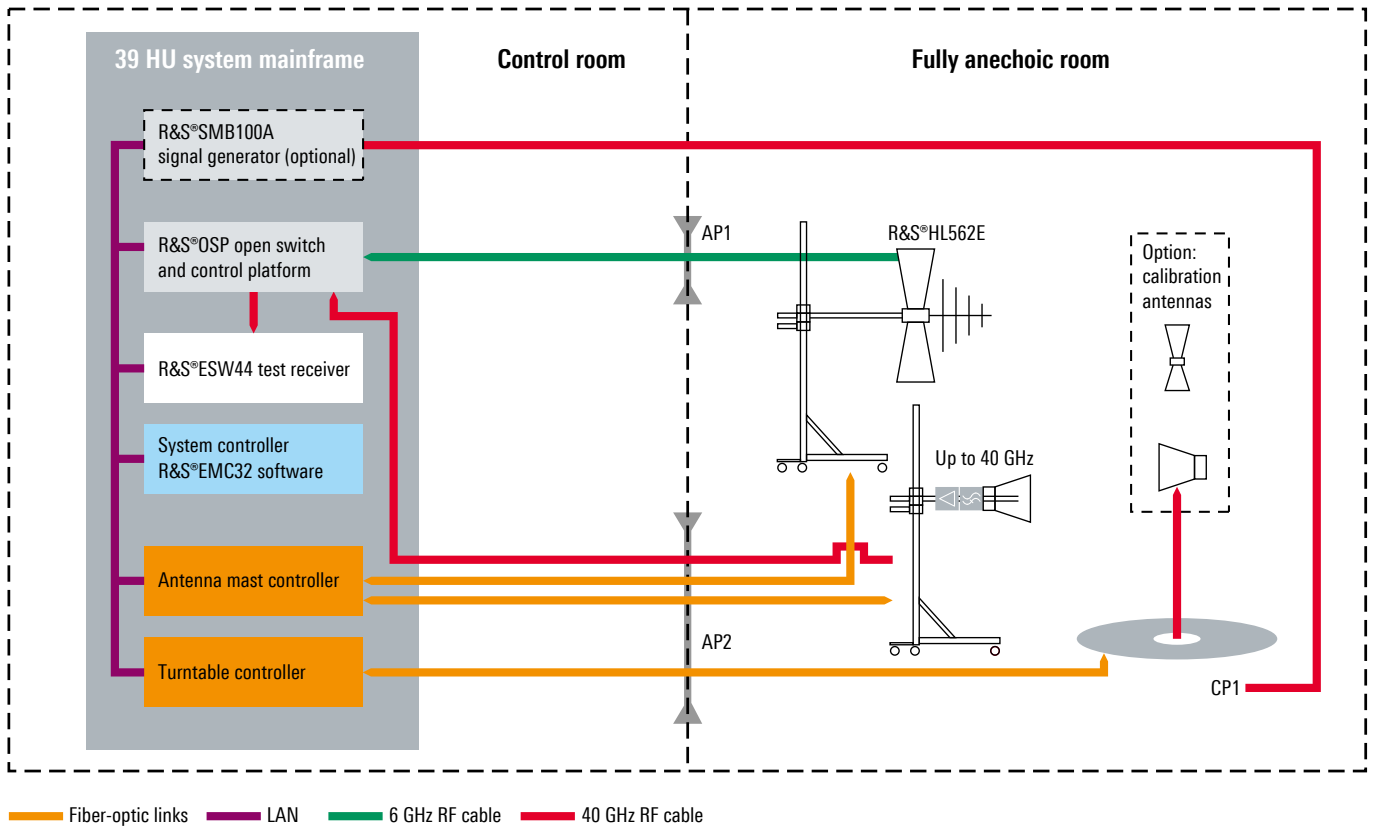

R&S®TS9975 block diagram

**Anechoic chamber**

Radiated emissions are measured mostly in an anechoic chamber as an alternative to an open area test site (OATS). This requires a remote controlled turntable and an automatic antenna mast with a control unit. These optional components can be supplied with the system and controlled by the system software. For development and quality assurance purposes, smaller test cells that easily fit into the lab are available. The upper frequency limit of the test system is 40 GHz (200 GHz using mixers) and depends on the type of DUT and the applied standard.

Test receiver

The test receiver (R&S®ESW, R&S®ESR or R&S®ESRP) forms the core of the system. It evaluates and displays emissions in line with the relevant standards. If precompliance measurements are sufficient for EMC testing, a spectrum analyzer can be used instead of the test receiver.

Test antennas and LISN

Suitable test antennas such as the R&S®HL562E and R&S®HF907 as well as artificial mains networks (LISN) are used for measuring emissions.

Switching unit

The R&S®OSP switching unit configured with appropriate plug-in modules for switching antennas and transducers is integrated into the system.

Test software

The R&S®TS9975 EMI test system comes with the R&S®EMC32 test software. The software makes it possible to carry out automatic and manual EMI measurements in line with all relevant standards. The R&S®EMC32 test software is a convenient, cost-effective and reliable tool, enabling fast and easy system operation and high throughput. The extended test and configuration capabilities ensure high reproducibility of results.

R&S® CEMS100 COMPACT EMS/EMI TEST PLATFORM



Components of the R&S® CEMS100

Standard-compliant all-in-one solution for EMS measurements

Setting up an EMS/EMI test system is a very complex process requiring significant investment. The steps involved include custom planning, design, installation and configuration of various components and stand-alone instruments as well as the RF-shielded anechoic chamber. Rohde & Schwarz is offering the standardized R&S® CEMS100 test platform that is a flexible, reliable and cost-effective off-the-shelf solution for radiated EMS measurements in line with IEC/EN 61000-4-3. It covers the most common frequency ranges and field strengths needed for precompliance tests and certification.

The R&S® CEMS100 control software is the tried and tested R&S® EMC32, which is used on a daily basis in many test laboratories worldwide. User experience is tapped continuously to aid in further development of the software. Users and test houses that already rely on the R&S® EMC32 software have confirmed that it is very easy to integrate the R&S® CEMS100 into existing test environments.

Key facts

- ▶ Certifiable base system for commercial standards
- ▶ EMS measurements from 80 MHz to 3 GHz, 10 V/m
- ▶ EMS and EMI measurements without changing antennas
- ▶ Scalable and expandable for further EMC applications
- ▶ Various proven EUT monitoring capabilities
- ▶ Immediate deployment with preconfigured hardware and software

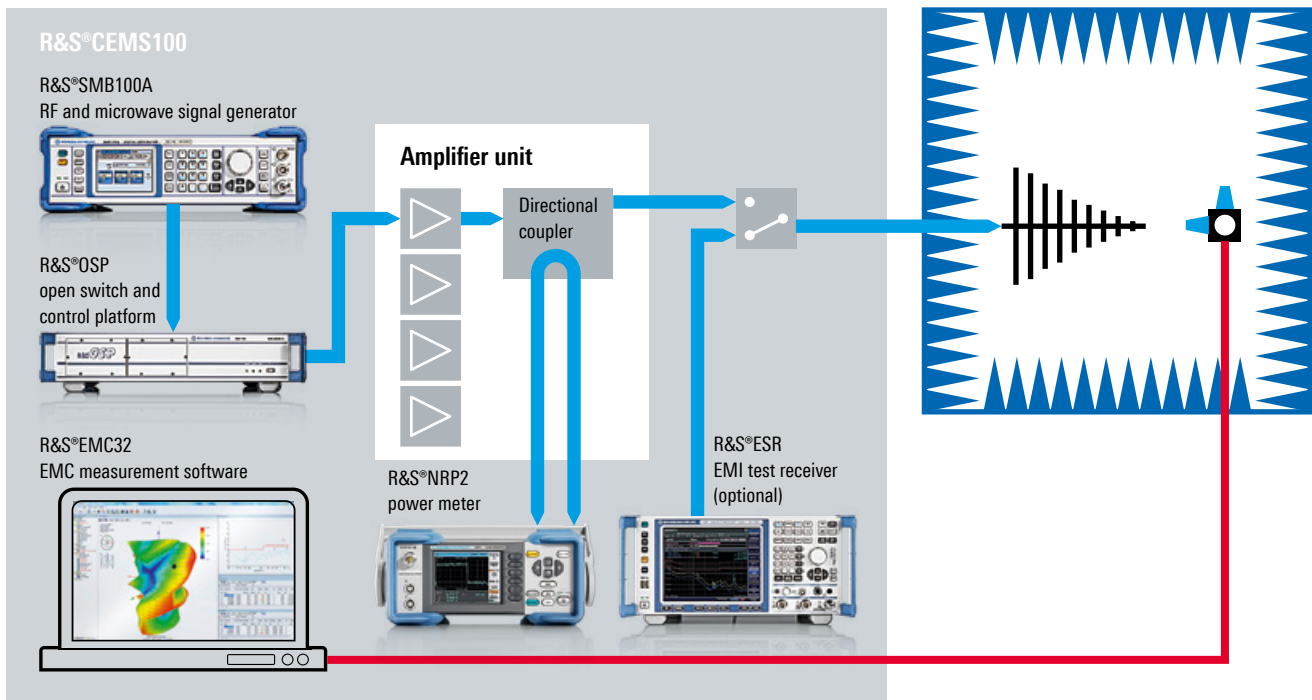

R&S®TS9982 EMS TEST SYSTEM

Radiated and conducted EMS measurements in line with commercial, wireless, automotive and A&D standards

The R&S®TS9982 EMS test system is the base system for conducted and radiated EMS measurements. Due to its modular design, it covers a wide range of applications and can be very easily adapted to the measurement task at hand. Any configuration is possible – from conducted measurements and a small precompliance system with compact test cell to an accredited test system for complete vehicles with a field strength level of 200 V/m or greater. Combinations of different applications or incremental expansion can also be implemented without any problem. All test systems are controlled by the R&S®EMC32 test software with its various capabilities, including extensive DUT and system monitoring. From system design and implementation to installation and training, these turnkey systems and our EMC experts provide everything from a single source, enabling the customer to concentrate on testing.

System configuration

The R&S®TS9982 consists of an EMS control unit, one or more amplifiers, transducers for conducted measurements (CDNs, injection clamps, etc.), antennas for radiated measurements and a field probe. The system is software controlled, which allows reproducible and fully automatic test sequences. You can also activate the interactive test mode for running further tests or making modifications. The EMS control unit contains a signal generator, a power meter and the R&S®OSP switching unit, which is configured with appropriate plug-in modules. This includes the control of an interlock circuit and the possibility to drive external power relays up to 10 kW. Based on experience gained from the large number of systems implemented worldwide, all system components have been ideally matched to one another, yielding efficient field generation on the DUT.

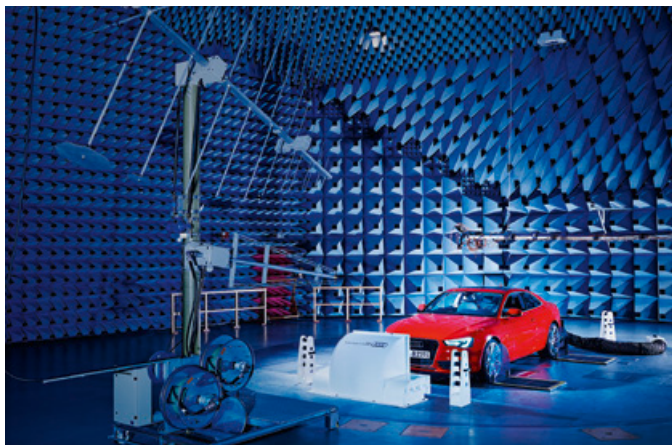

In the 1 GHz to 40 GHz frequency range, a mobile microwave test system is used directly adjacent to the DUT, thus preventing high RF cable loss above 3 GHz. Provisions for safety are included in the system, for example, we integrate an interlock circuit that switches off the RF power when the door of the chamber is opened.

Test software

The R&S®TS9982 EMS test system comes with R&S®EMC32 EMC test software. The software makes it possible to carry out automatic and manual EMS measurements to all relevant standards. R&S®EMC32 is a convenient, cost-effective and reliable tool, enabling fast and easy system operation and high throughput. The extended test and configuration capabilities ensure high reproducibility of results.

Commercial tests

Covered standards (examples)

This test system covers all relevant standards for radiated and conducted commercial measurements for the different ranges of applications.

- ▶ IEC/EN 61000-4-3, -6, -20 and -21
- ▶ EN 61000-6-1 and -2
- ▶ CISPR 24/EN 55024
- ▶ CISPR 35/EN 55035
- ▶ EN 60601-1-2 Edition 4.0

Features

A typical test level is 10 V (+80% AM 1 kHz modulation) in the 150 kHz to 80 MHz frequency range for conducted measurements and a field strength of 10 V/m (+80% AM 1 kHz modulation) from 80 MHz to 6 GHz in a uniform field area of 1.5 m × 1.5 m.



System design

Transducers (conducted): The system can include a coupling/decoupling network (CDN), EM clamp and a bulk current injection (BCI) clamp as transducers.

Antenna: The EMS antenna is optimally designed for efficient field generation in line with EN61000-4-3. Due to its compact design, it is also suitable for small anechoic chambers.

Amplifiers: The amplifier power is optimally adapted to the transducers or the antenna as well as to the required test level, yielding an excellent price/performance ratio. The R&S®BBA and R&S®BBL series amplifiers are designed in such a way that with the required upward modulation of 80%, the amplifier's 1 dB compression point is not exceeded and spurious emissions do not exceed a value of -15 dBc. In line with EN61000-4-3, the amplifier saturation check after completion of the field uniformity calibration is mandatory. Monitoring of the amplifier's forward and reflected power and of the injected current in the case of BCI, is integrated in the system.

Accessories

The system comes with all accessories (such as a field probe, including tripod and load resistor) necessary for operation and calibration. Also all test routines for multimedia tests in line with the new EN55035 are available.

Wireless tests

Standards

Measurements of this type are based on the standards and technical regulations published by the European Telecommunications Standards Institute (ETSI). EMC is defined in ETSI EN301489 with its subparts for the different wireless services.

- ▶ CDMA2000®, 1xEV-DO
- ▶ GSM, GPRS, EDGE
- ▶ UMTS, HSPA, HSPA+
- ▶ LTE
- ▶ Bluetooth®
- ▶ WLAN IEEE802.11

Coverage of other standards is available on request. In addition, measurements in line with the commercial standards for ITE and telecommunications equipment conforming to IEC/EN61000-4-3, -6 (EMS) are available. The system can be used both in design and type approval testing.

Main features

The standards specify a wide variety of measurements in a very wide frequency range.

- ▶ Conducted and radiated EMS measurements
- ▶ Audio breakthrough measurement to monitor audio quality in uplink and downlink
- ▶ Multiple monitoring capabilities

Audio breakthrough measurement

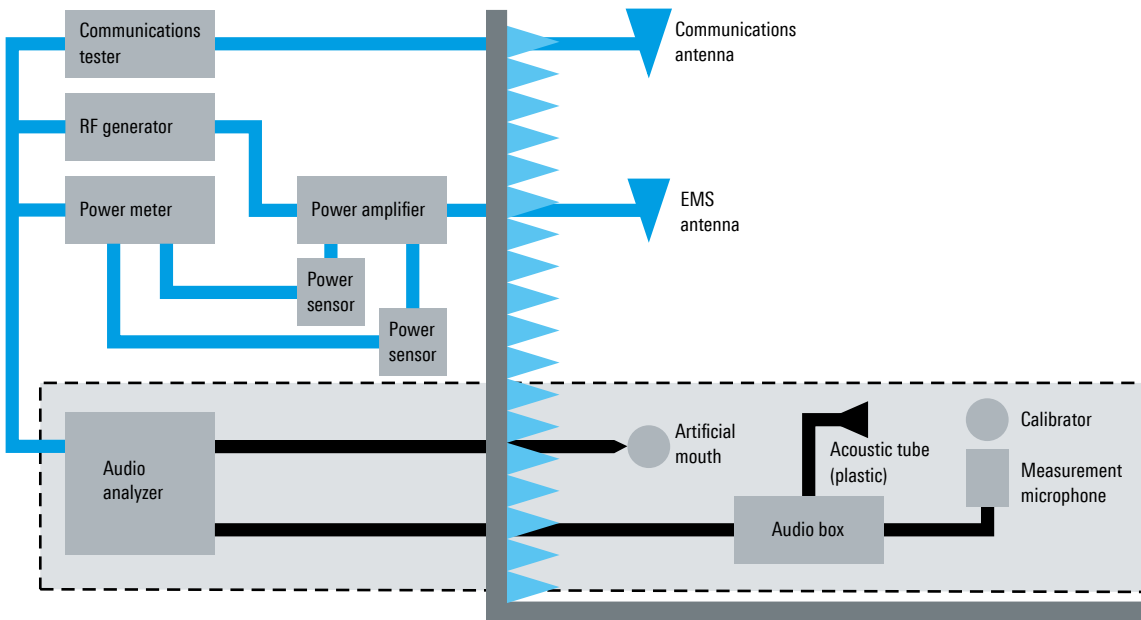

- ▶ Automatic stimulation and monitoring of the air link to the wireless device
- ▶ Automatic handover between different services or frequency bands
- ▶ System automation through automatic path switching
- ▶ Equipment for calibration of the audio path and system check

Test software

The R&S®EMC32 control software features all necessary measurement routines for testing wireless devices. It supports fully automatic measurements for certification as well as interactive measurements during development and device modification.

System design

The R&S®TS9982 EMS test system is based on a standard commercial EMS test system as defined by IEC/EN61000-4-3 and -6 for radiated and conducted measurements. In addition, it is equipped with all necessary components to establish and maintain the radio link and to monitor DUT performance. This includes the monitoring of audio quality, bit error rate measurements and interfaces to equipment for end-to-end data testing.

Communications tester

An R&S®CMW500 wideband radio communication tester is integrated into the test system to set up, switch and control the link to the DUT in a defined operating state. It combines all common wireless standards in one unit. The R&S®CMW500 is also used for analysis of the wireless link quality to the DUT and as an interface for audio and data throughput monitoring.

Audio equipment

The audio measurement is carried out by the R&S®UPP audio analyzer. All accessories for measurement and calibration such as microphone and artificial mouth are included.



The audio test system must be very sensitive and it must not interact with the electric field applied at the DUT. Therefore, the audio signal is transferred from the DUT to the reception unit via a plastic tube. The reception unit itself is shielded against electromagnetic fields and placed at an appropriate distance from the DUT.

Automotive tests

Standards

- ▶ ISO 11451 and ISO 11452
- ▶ UNECE Regulation 10
- ▶ Customer-specific requirements

Features

The system allows tests to be performed in line with the above standards. It can also take additional requirements into account, such as those of different vehicle manufacturers – in particular special test levels and frequency ranges as well as pulse modulations as they are used to test electromagnetic susceptibility to radar applications. Precompliance test systems based on test cells (e.g. GTEM cells) are also available. The scope of systems ranges from compact car component test systems to test sites for vehicles, including electric powered and hybrid cars.

System design

These systems are designed on the basis of customer requirements. Due to the high field strengths and the associated amplifier power (R&S®BBA and R&S®BBL series amplifiers), stringent demands are placed on the infrastructure, while the large DUTs require special concepts for efficient field generation. In addition to pure field generation, features such as efficient system utilization, high degree of system automation, complex interfaces to the DUT and service concepts are important factors for these projects.



Software

The R&S®EMC32 software includes the specific functionality necessary for automotive applications. Versatile monitoring possibilities – from TTL levels to TCP/IP, GPIB and RS-232 communications to CAN, LIN, MOST and FlexRay™ bus monitoring – are also important for these measurements.

A&D tests

Standards

- ▶ MIL-STD-461
- ▶ MIL-STD-464
- ▶ RTCA DO-160
- ▶ Customer-specific requirements
- ▶ Country-specific requirements

Features

The detailed configuration of the test system depends on the required measurements, test levels and the DUT characteristics. It may range from a test system for a single test to the coverage of all EMC tests in line with MIL-STD-461 and RTCA DO-160. The system design is based on experience gained from the large number of A&D test systems implemented worldwide.

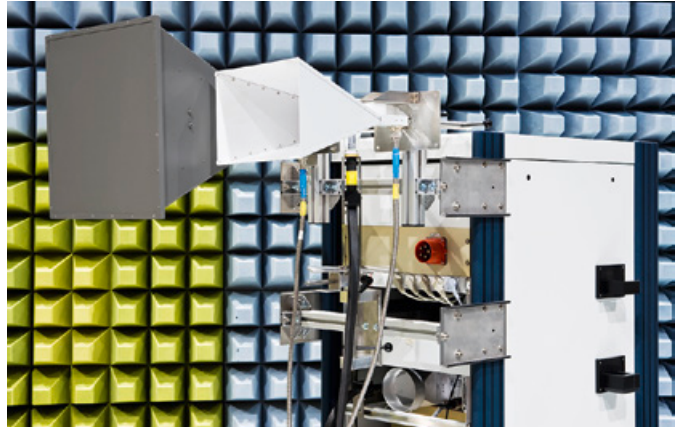

EMS microwave test

Microwave tests up to 40 GHz

The test system for 1 GHz to 18 GHz or 40 GHz is a mobile rack that includes all necessary equipment such as signal generator, power amplifier and power meter. This prevents cable losses, allowing more amplifier power to be used for field generation. The system can be configured for different test levels up to 200 V/m CW and 3000 V/m pulsed at a test distance of 1 m. It is controlled by the EMC software from outside the chamber via fiber-optic link.

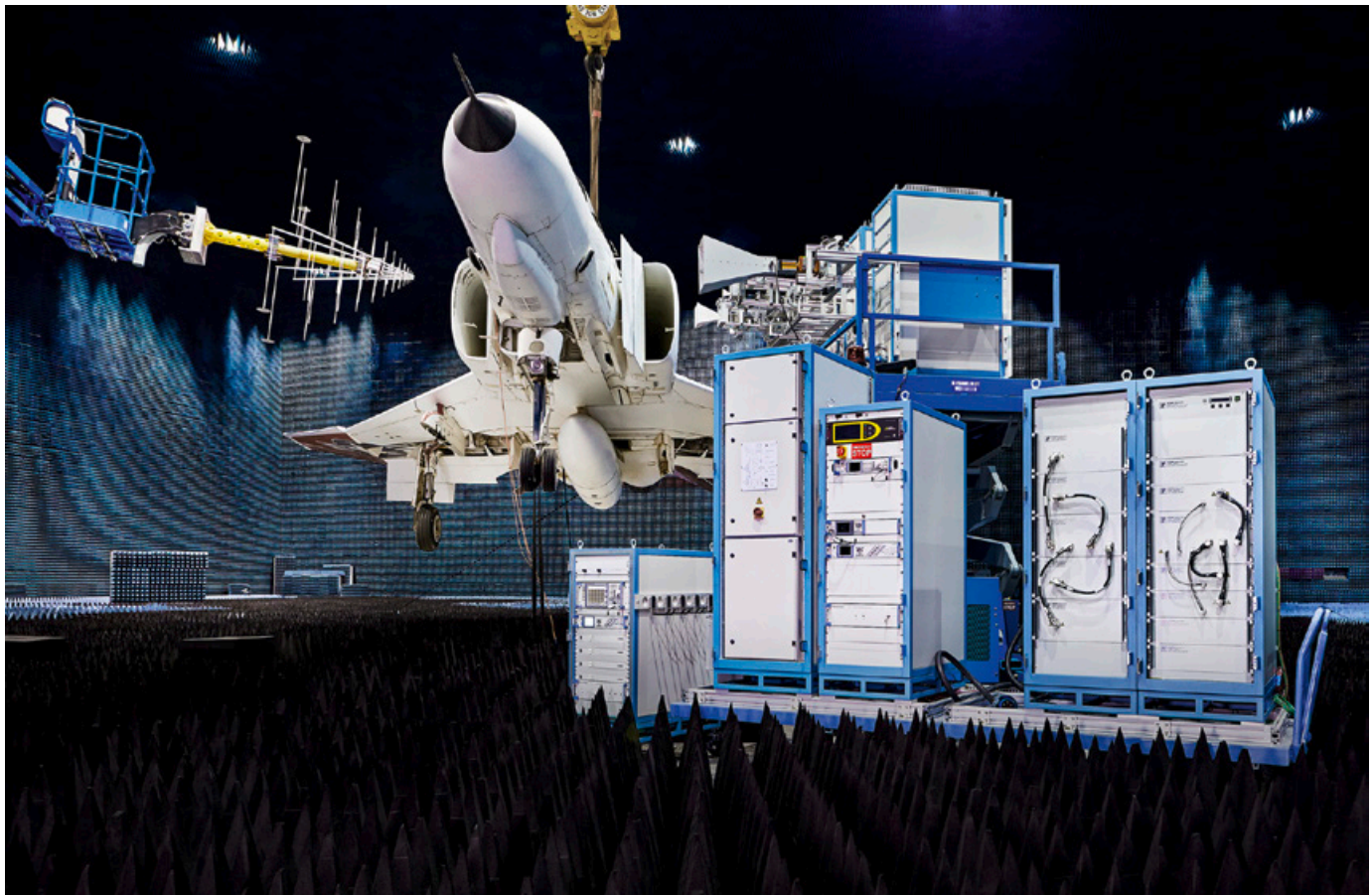

R&S® TS-EMF PORTABLE EMF MEASUREMENT SYSTEM



Simple, frequency-selective measurement of EMF emissions

In combination with Rohde&Schwarz spectrum analyzers, the R&S®TS-EMF measurement system detects high-frequency electromagnetic fields (EMF). The isotropic antenna, together with the software, which has been specifically designed for EMF measurements, allows simple and precise on-site evaluation of total and individual emissions.

Key facts

- ▶ Automated EMF measurements
- ▶ Precise measurements of even complex scenarios and RF signals
- ▶ Wide frequency range from 9 kHz to 6 GHz using isotropic antennas
- ▶ Isotropic antenna for detecting fields independent of direction and polarization
- ▶ Combined use possible with various Rohde&Schwarz spectrum analyzers and test receivers

Safety based on exact measurements for reproducible and reliable results

- ▶ Evaluation of total emissions, individual radio services or individual frequencies
- ▶ Measurements in line with all common EMF standards and measurement methods
- ▶ Correct evaluation of even complex scenarios or RF signals
- ▶ Excellent reproducibility using automated measurements

Efficient on-site measurements

- ▶ Fast, simple measurements owing to predefined test routines
- ▶ On-site interpretation of results using integrated report generation
- ▶ Easy adaptation to local conditions
- ▶ Versatile use due to the compact one-box solution with the R&S®FSL spectrum analyzer

Suitable for a wide range of applications

- ▶ Investigation of specific problems or radio signals by directly setting individual measurement parameters
- ▶ Additional manual measurements using a full-featured spectrum analyzer
- ▶ Optional storage of raw measurement data for further in-depth result evaluation
- ▶ Precise extrapolation for WCDMA using CPICH demodulation
- ▶ Support for LTE measurements through decoding and frequency-selective procedure

Future-oriented

- ▶ Coverage of the complete frequency range from 9 kHz to 6 GHz, extendable up to 40 GHz using additional antennas
- ▶ Measurements of advanced radio services with wide bandwidths and high crest factors



Product site

R&S®FSWT TEST RECEIVER



TEMPEST measuring receiver with digital signal evaluation

Thanks to its digitally implemented measurement bandwidth of up to 500 MHz and its very high sensitivity, the R&S®FSWT fulfills the requirements for a TEMPEST measuring receiver. The intuitive, straightforward operating concept permits users to accomplish measurement tasks quickly and easily.

The R&S®FSWT is the right T&M instrument for applications that require checking the information content of even the smallest signals. With two equivalent, switchable RF inputs, up to 500 MHz measurement and analysis bandwidth and two independently settable analog outputs for video voltage and demodulators, it fits perfectly into typical test setups and easily replaces older instruments. The R&S®FSWT can optionally be equipped with preselection and preamplifier in the base unit (5 HU). Twenty-one switchable filters with very low insertion loss suppress even strong out-of-band signals. With preamplifier, the noise figure at 100 MHz is only 1.5 dB. The test receiver measures and demodulates even weak signals reliably.

Thanks to its selection of measurement bandwidth and detectors, the R&S®FSWT is also used for EMI measurements in line with commercial and military standards.

All measurement bandwidths from 1 Hz to 500 MHz are digitally implemented with extremely high accuracy. Video voltage, IF, AM, FM and other signals are exactly reconstructed by two digital/analog converters and fed to two analog outputs. The outputs are configured independently of the other instrument settings; the user observes the signals in parallel on an oscilloscope. Alternatively, the test receiver can save the I/Q data for offline analysis, in which case it transmits the data via the remote control interface to a PC for further processing.

Its large 12.1" touchscreen, clear diagrams and flat menus make the R&S®FSWT easy to operate; different measurements can be displayed simultaneously in separate

windows. At a weight of up to 28 kg, the R&S®FSWT is easy to transport. This considerably facilitates on-site measurements, e.g. on ships.

Key facts

- ▶ Frequency range from 10 Hz to 26.5 GHz
- ▶ Low phase noise of -137 dBc (1 Hz) at 10 kHz from 1 GHz carrier
- ▶ Digital IF with signal analysis and measurement bandwidth of up to 500 MHz
- ▶ Two equivalent RF inputs
- ▶ Two settable analog outputs with 250 MHz bandwidth for video, demodulation, IF and I/Q
- ▶ Optional preselection and preamplifier in base unit
- ▶ Measuring receiver and spectrum analyzer in one instrument
- ▶ Vector signal analyzer function with external R&S®VSE software
- ▶ < 0.4 dB total measurement uncertainty up to 8 GHz
- ▶ 12.1" (31 cm) touchscreen for convenient operation
- ▶ Simultaneous use and display of multiple measurement applications

Powerful analysis functions

- ▶ The IF analysis function simplifies the manual adjustment of the receiver. The user always sees the position of the signal of interest
- ▶ Simultaneous display of up to four bargraph detectors and up to six traces in the scan window
- ▶ Test setup consisting of a combination of antenna factors (transducers) in defined frequency ranges. Antenna gain and cable loss, for example, are automatically included in the measurement result
- ▶ The user saves limit lines in a separate library on the instrument. The R&S®FSWT automatically compares the frequency scan to the assigned limit line and generates a list of the frequencies of interest
- ▶ The R&S®EMC32 measurement software can be used to remotely control the R&S®FSWT. The software measures spectra, offers extensive analysis functions and generates informative test reports
- ▶ PC monitors and video screens emit electromagnetic radiation, which may reveal the displayed content. The R&S®FSWT-K57 video raster option reconstructs this content on the screen of the R&S®FSWT. The software application runs on the R&S®FSWT and is activated by keycode. There is no need for additional external devices
- ▶ By adding the optional external generator control, the R&S®FSWT can be combined with a signal generator to form a simple scalar network analyzer, e.g. for checking cables and filters



R&S® ELEKTRA EMC TEST SOFTWARE



Swift and reliable measurements of electromagnetic disturbances

The R&S®ELEKTRA EMC test software controls complete EMC systems and automates measurements on equipment under test (EUT) that is being tested for emissions (EMI) and immunity (EMS) compliance. New, reliable and highly efficient automatic and interactive measuring procedures create accurate results and allow in-depth analysis of EMI and EMS measurements during development and certification. This reduces the time needed to develop and certify products.

R&S®ELEKTRA features a predefined software library in accordance with the common standards – including relevant limit lines, test setups and transducer factors – to simplify configuration and enable users to start testing faster.

The ability to create EUT test plans allows users to build and define EUT-applicable tests and prepare comprehensive reports in advance. The dashboard with favorites (frequently used items), tagging and search functions and the all-in-one page interface enhances usability and allows users to easily navigate through the huge amount of data created during EMC testing.

Planning, execution and reporting of test campaigns based on the EUT enables users to maintain an overview. Test setups, measurement procedures and reports can be tailored to user requirements for tests that differ from the standards. R&S®ELEKTRA has an open interface that supports a huge variety of instruments and system components.

Key facts

- ▶ Creates test plans with multiple tests for easy management of EUTs
- ▶ Intuitive, interactive and automatic EMC measurements
- ▶ Covers most common EMC standards with predefined settings/templates
- ▶ Efficient result analysis and reporting
- ▶ Scalable and flexible platform – from small systems for R&D debugging to multi-site EMC certification labs with multi-user and multi-project management

Service options	EMI	EMS
CISPR 11	supported	not applicable
CISPR 14	supported	supported
CISPR 15	supported	not applicable
CISPR 32	supported	not applicable
CISPR 35	not applicable	supported
IEC 61000-4-3	not applicable	supported
IEC 61000-4-6	not applicable	supported
CISPR 12	supported	not applicable
CISPR 25	supported	not applicable
ISO 11451	not applicable	–
ISO 11452	not applicable	–
MIL-STD-461	supported	–
ETSI/Wireless	–	–



Product site

R&S® EMC32 EMC MEASUREMENT SOFTWARE PLATFORM

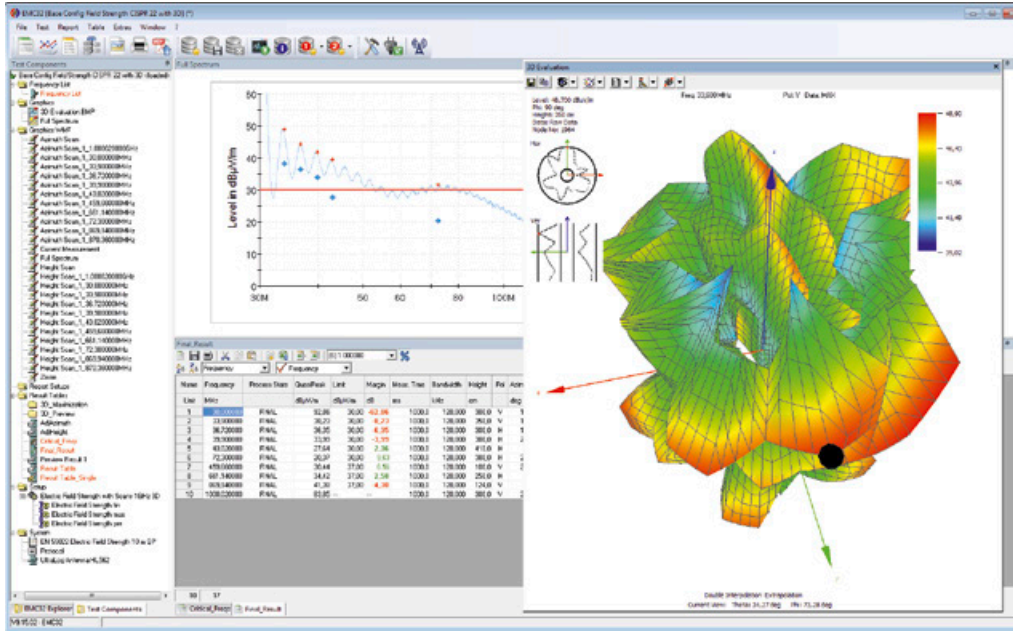

R&S®EMC32 as virtual instrument, e.g. user interface for 3D result evaluation

For use in development, for compliance and batch testing

The R&S®EMC32 EMC measurement software can be used for all electromagnetic interference (EMI) and electromagnetic susceptibility (EMS) measurements. The software is a modern and powerful tool for controlling and monitoring Rohde&Schwarz devices as well as third-party equipment. Its comprehensive and modular configuration capabilities and its open software structure ensure reliable collection, evaluation and documentation of measurement results.

Key facts

- ▶ Cost-efficient
- ▶ Flexible and scalable
- ▶ Future-ready
- ▶ Modular concept allowing flexible adaptation to customer needs
- ▶ Predefined hardware setups to support easy generation of test setups
- ▶ Support of measurements in line with all major standards in the commercial, wireless, automotive and military range
- ▶ Manual and automatic EMI and EMS measurements
- ▶ Fully automatic and interactive sequences
- ▶ Customer or EUT-specific data handling
- ▶ Extensive EUT monitoring capabilities and user-specific actions
- ▶ Interface to lab management system
- ▶ User administration for managing different user profiles

EMS qualification test with several EUT monitoring channels

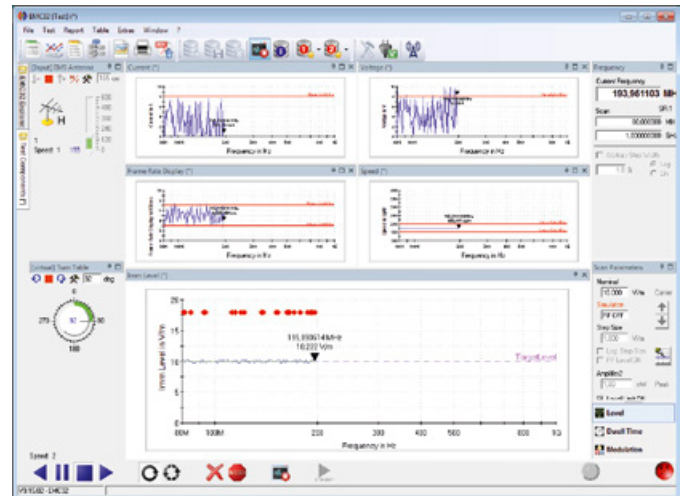

Basic packages and expansion modules for the R&S®EMC32 EMC measurement software

Module	Application
R&S®EMC32-S	Basic package for EMS measurements
R&S®EMC32-EB	Basic package for EMI measurements
R&S®EMC32-K1	Enhanced EMS functionality for automotive/A&D measurements
R&S®EMC32-K2	Measurement of audio breakthrough and spurious emissions in wireless communications
R&S®EMC32-K3	Susceptibility measurements in reverberation chambers in line with EN61000-4-21 (R&S®EMC32-K4 also required)
R&S®EMC32-K4	EMS auto test functionality
R&S®EMC32-K6	Measurements in line with MIL-STD-461E/F CS103/4/5
R&S®EMC32-K7	Generic drivers for RF generators, power meters and oscilloscopes
R&S®EMC32-K8	Database interface to laboratory management systems
R&S®EMC32-K10	EMI auto test functionality
R&S®EMC32-K10A	EMI auto test extension for spurious measurements in line with ETSI EN300328, 301893
R&S®EMC32-K11	Test plan generation and automatic control with test sequencer
R&S®EMC32-K21	Automation of additional measurement tasks using macro language
R&S®EMC32-K22	Measurement of RF radiation patterns of antennas and EUTs
R&S®EMC32-K23	3D evaluation for R&S®EMC32-K10 EMI auto test
R&S®EMC32-K24	Interactive measurement for R&S®EMC32-K10 EMI auto test
R&S®EMC32-K251	TD-SCDMA option for R&S®EMC32-K2
R&S®EMC32-K26	LTE option for R&S®EMC32-K2
R&S®EMC32-K27	Dual receiver measurement
R&S®EMC32-K33	EMI measurements in reverberation chambers in line with EN61000-4-21 (R&S®EMC32-K10 also required)
R&S®EMC32-K35	Measurements in line with CISPR35 and CISPR33; EMS measurements on multimedia receivers in line with CISPR35/EN55035
R&S®EMC32-K48	Shielding effectiveness measurement

Basic packages and expansion modules for the R&S®EMC32 EMC measurement software

R&S®EMC32-K51	EMI evaluation with flexible scan sequences (e.g. in line with GMW3091/3097)
R&S®EMC32-K56	EMI measurement in line with MIL-STD: transmitter in transmit mode
R&S®EMC32-K84	Report interface to word processing apps
R&S®EMC32-U9E	Update to version 9 for R&S®EMC32-EB, -E and -E+ basic package
R&S®EMC32-U9S	Update to version 9 for R&S®EMC32-S basic package

Application overview (examples)

Application	Standards EMS	Standards EMI
Industrial and household products (commercial)	IEC/EN61000-4-3, -6	CISPR 11/EN55011, CISPR 14-1/EN55014-1, ANSI-C63.4 FCC 15, 18
Information technology/multi-media devices (commercial)	CISPR 24/EN55024, CISPR 35/EN55035, IEC/EN61000-4-3, -6	CISPR 22/EN55022, CISPR 32/EN55032, ANSI-C63.4 FCC 15, 18
Medical devices (commercial)	EN 60601-1-2, EN 60601-2-x	EN 60601-1-2, CISPR 11/EN55011
Wireless devices (commercial)	ETSI EN301498-x, ETSI EN300826	ETSI EN301498-x, 3GPP TS51.010, ETSI EN301908-1, ETSI EN300328-1, FCC part 15
Automotive	ISO 11451, ISO 11452, SAE J1113, SAE J551, UNECE Regulation 10, reverberation chamber (mode-tuned)	2004/104/EC CISPR 12, SAE J551/2 CISPR 25, SAE J1113/41 reverberation chamber (mode-tuned)
Military/avionics	MIL-STD-461, CS103, CS104, CS105, RTCA/DO-160, MIL-STD-464	MIL-STD-461, CE 101, CE 102, CE 106, RE 101, RE 102, RE 103, RTCA/DO-160, VG95370-95377, DEF-STAN 49-41, GAM-EG 13
Consumer products, radio/TV (commercial)		CISPR 13/EN55013, CISPR 32/EN55032

7

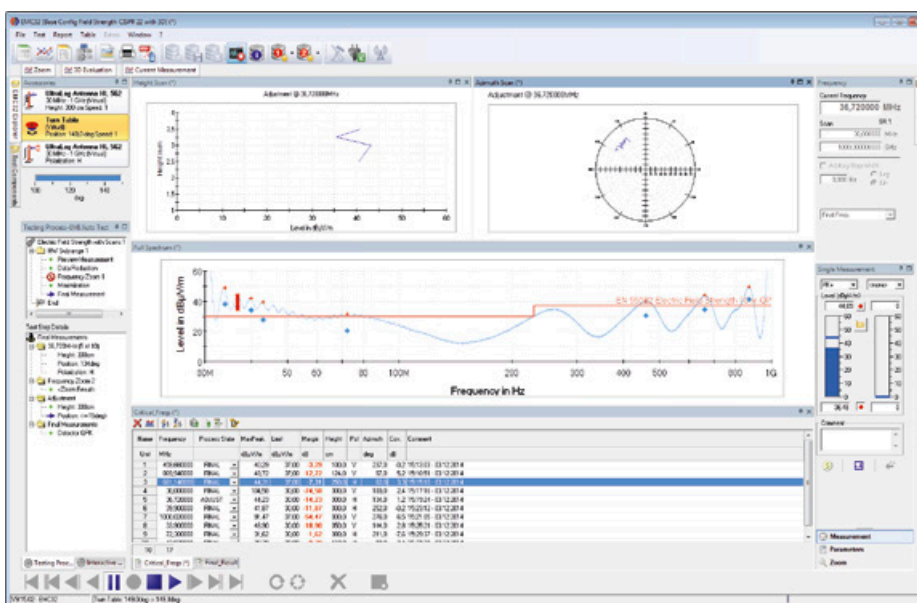

Interactive measurement mode in EMI measurements

R&S® AdVISE VISUAL INSPECTION SOFTWARE

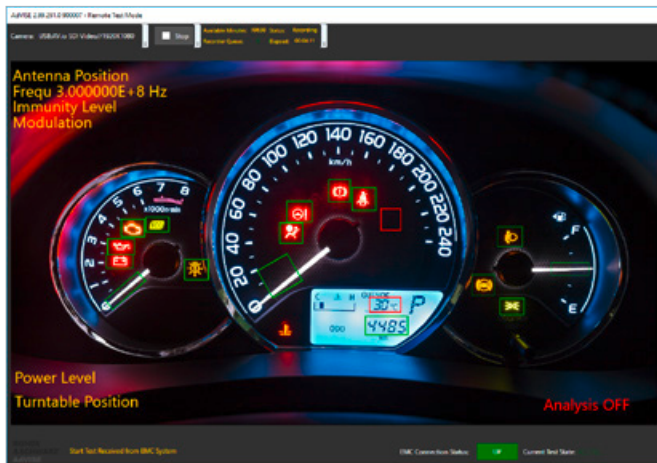

A new way to eliminate human inattention

R&S® AdVISE visual inspection software automates the process of visually monitoring an equipment under test (EUT) during a test sequence. This eliminates human inattention, ensures reproducible results and simplifies the test documentation. A typical application is EMS testing with R&S® EMC32 test software.

Visually monitoring an EUT during a complex test sequence is time-consuming and requires utmost concentration. Errors can be overlooked in a momentary lapse of attention. Furthermore, many events cannot be reliably monitored with the naked eye, such as slight changes in color or brightness or deviation from a predefined flashing frequency.

R&S® AdVISE uses object based algorithms to analyze the incoming video signal of an HDTV camera attached to a PC. With the aid of parameters defined by the user, the software detects any deviations from the target status of the EUT and documents these deviations in a video protocol and status report. R&S® AdVISE can be connected to system software such as R&S® EMC32 via a remote control interface. The system software controls the test sequence and creates its own report containing the results.

Analysis focuses on the regions of interest (ROI), with which the user marks which areas of the picture are to be analyzed and which methods are to be used. The R&S® AdVISE system analyzes data at rates of up to 30 frames per second and can see transitory events that a human may miss.

The intuitive and clearly structured user interface makes it possible to configure measurements in only a few minutes. The operator can intervene at any point during the test sequence to deactivate or adjust individual regions.

Key facts

- ▶ Automatic error recognition for EUTs based on camera signal evaluation
- ▶ Continuous monitoring of up to 32 regions of interest at 30 frames per second
- ▶ High-performance image processing thanks to object based evaluation with optimized test methods
- ▶ Generation of event-controlled video protocols and test reports
- ▶ Runs independently and under the control of a system software

R&S® AdVISE in a networked system with the R&S® EMC32 EMC control software

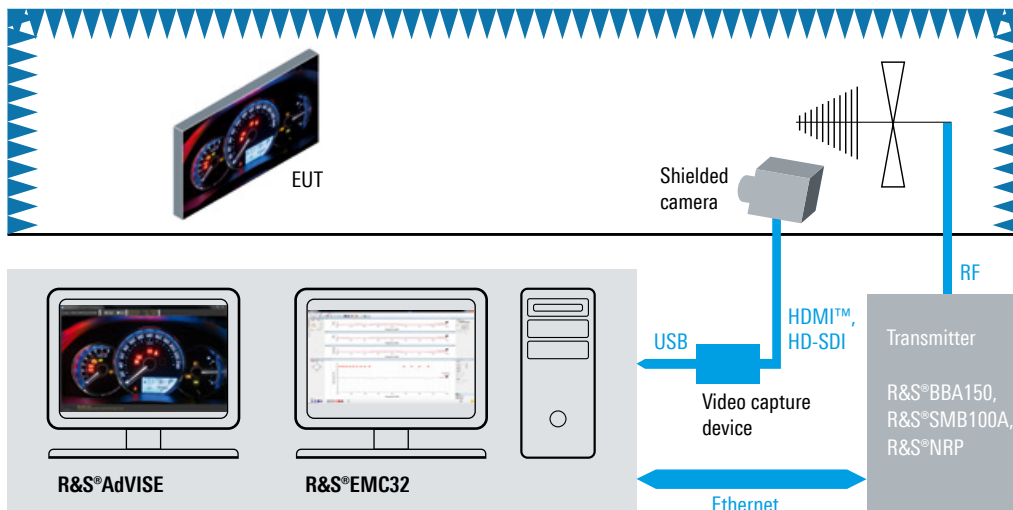

R&S® BBA130 BROADBAND AMPLIFIER

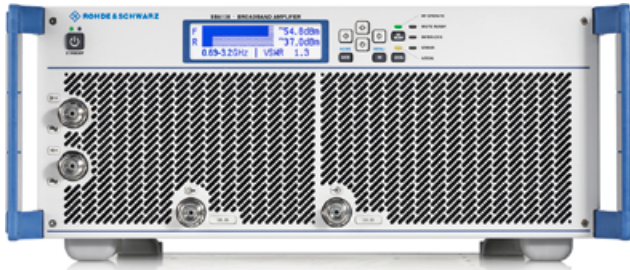

The amplifier you can tune

The R&S®BBA130 broadband amplifiers offer a variety of setting options so you can optimally tune the output signal to your specific application. During operation, you can adjust the operating class for transistors between Class A and Class AB as well as choose between maximum output power or higher mismatch tolerance at the output.

The primary area of application for R&S®BBA130 broadband amplifiers is design and product validation testing during RF component development, production and quality assurance.

The R&S®BBA130 broadband amplifiers feature a lightweight, modular design that is optimized for the specific frequency range. The amplifiers are available as a desktop and a rack model. The low-power amplifiers are 4 HU, 19" desktop models that can also be installed in a rack. Devices with higher power are rack models. The amplifiers can be operated via the display and buttons, via a remote

control interface (automated operation) or via a web browser. The modular design allows you to later upgrade the power and frequency range. The comprehensive service concept and global availability of spare parts promote the trust and confidence of customers around the world.

An amplifier for every application

- ▶ User-optimized tuning
- ▶ Adjustable bias point
- ▶ Choice between maximum output power or higher mismatch tolerance

Flexible control and operation

- ▶ Manual operation
- ▶ Local and remote operation via web browser and PC
- ▶ Remote control via Ethernet
- ▶ Safety thanks to two different interlocks

Key facts

- ▶ Three frequency ranges:
 - 80 MHz to 1.0 GHz
 - 0.69 GHz to 3.2 GHz
 - 2.5 GHz to 6.0 GHz
- ▶ Output power from 22 W to 4200 W
- ▶ Operating class for transistors adjustable between Class A and Class AB
- ▶ Suitable for amplitude, frequency, phase and pulse modulation
- ▶ Warranty and flexible service level agreements

Model overview

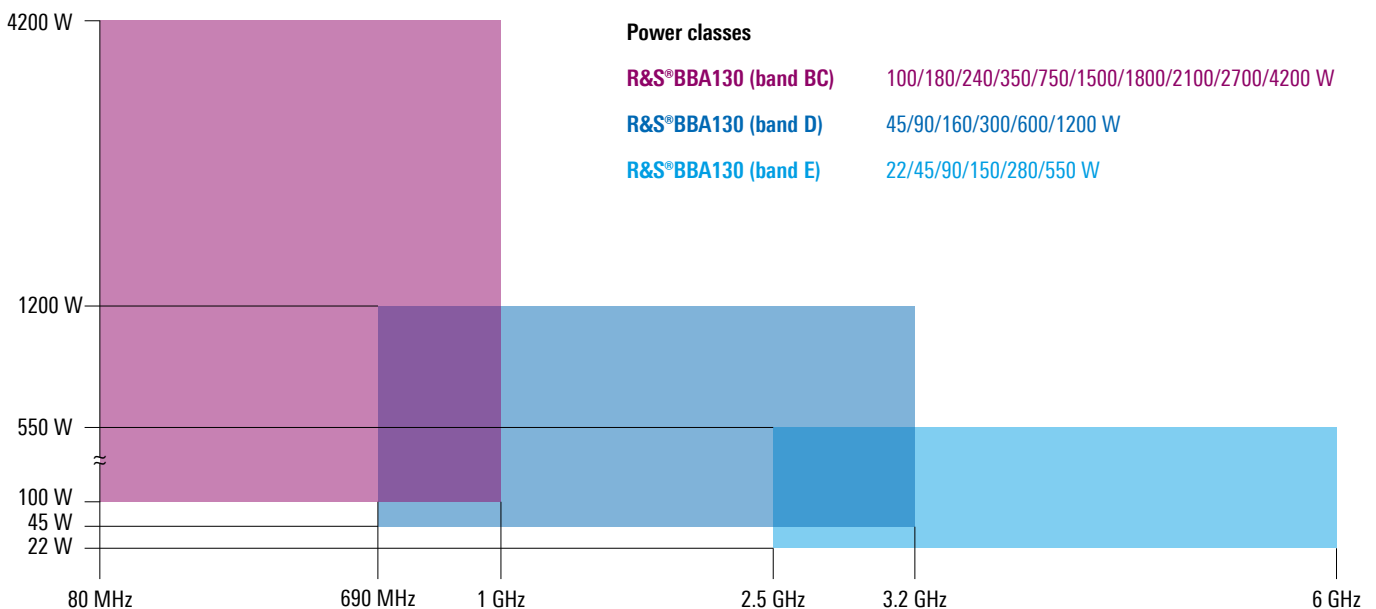

Product site

R&S® BBA150 BROADBAND AMPLIFIER



Excellent amplifiers with high power density

The R&S®BBA150 broadband amplifier family generates power in the frequency range from 4 kHz to 6 GHz. The compact amplifiers are rugged and feature high availability. They are ideal for amplitude, frequency, phase and pulse modulation. Extensive switching options for input, output and sample ports are available for different applications.

The broadband amplifiers cover a total of four frequency bands: 9 kHz to 250 MHz, 4 kHz to 400 MHz, 80 MHz to 1 GHz, 0.69 GHz to 3.2 GHz and 2.5 GHz to 6 GHz. They can be used to address a variety of applications, including the various standards for EMS measurements. In the industry environment, the R&S®BBA150 broadband amplifiers are suitable for development and product validation tests in quality assurance and in the development and production of components. Other fields of use include research, physical engineering and communications.

The R&S®BBA150 broadband amplifiers are based on a modular, lightweight design that is optimized for the required frequency band. The low-power amplifier comes as a 4 HU 19" rackmount that can be used as a desktop model or installed in a rack. Devices with higher power must be installed in racks. The amplifiers are operated either using display and buttons, or via remote control interface (automated operation) or via a web browser. The modular concept is a prerequisite for upgrading power and frequency range later on.

Flexible control and operation

- ▶ Manual operation
- ▶ Local and remote operation via web browser and PC
- ▶ Safety thanks to two different interlocks

All in one device

- ▶ Compact design and modular structure
- ▶ Twin-band and dual-band amplifiers in four height units
- ▶ Extensive switching options for inputs, outputs and sample ports

Key facts

- ▶ Frequency bands: 9 kHz to 250 MHz, 4 kHz to 400 MHz, 80 MHz to 1.0 GHz, 0.69 GHz to 3.2 GHz, 2.5 GHz to 6.0 GHz
- ▶ Output power from 15 W to 3000 W
- ▶ 100% mismatch tolerance
- ▶ Suitable for amplitude, frequency, phase and pulse modulation
- ▶ Warranty and flexible service level agreements

Model overview

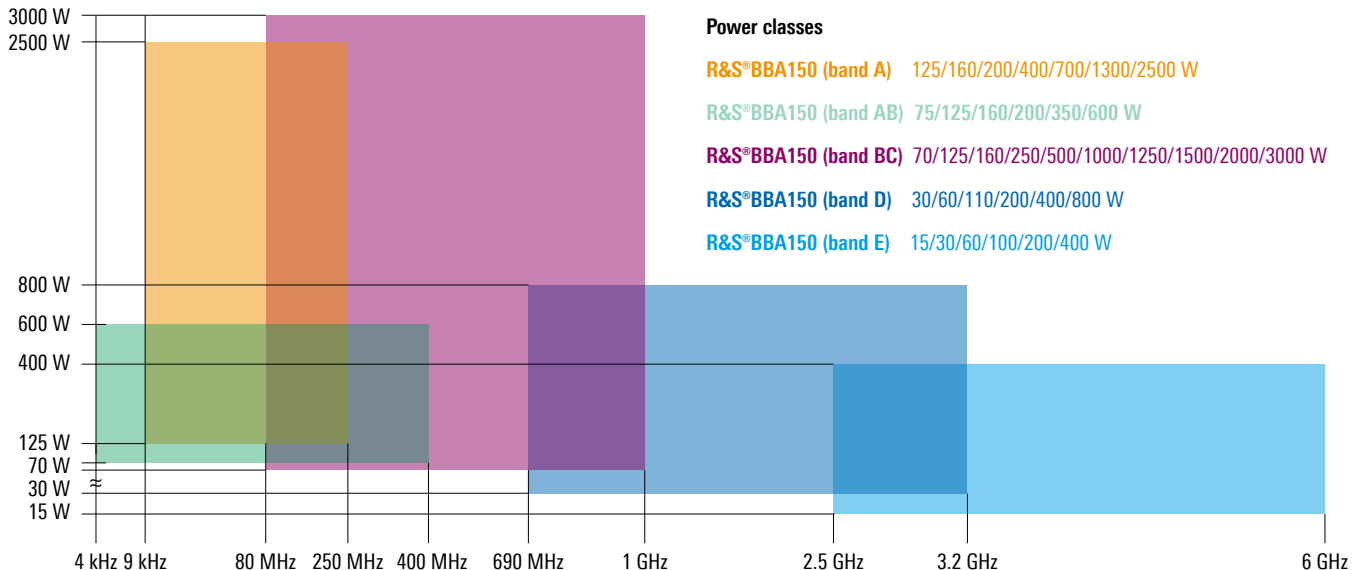

Power classes

R&S®BBA150 (band A) 125/160/200/400/700/1300/2500 W

R&S®BBA150 (band AB) 75/125/160/200/350/600 W

R&S®BBA150 (band BC) 70/125/160/250/500/1000/1250/1500/2000/3000 W

R&S®BBA150 (band D) 30/60/110/200/400/800 W

R&S®BBA150 (band E) 15/30/60/100/200/400 W



R&S® BBL200 BROADBAND AMPLIFIER

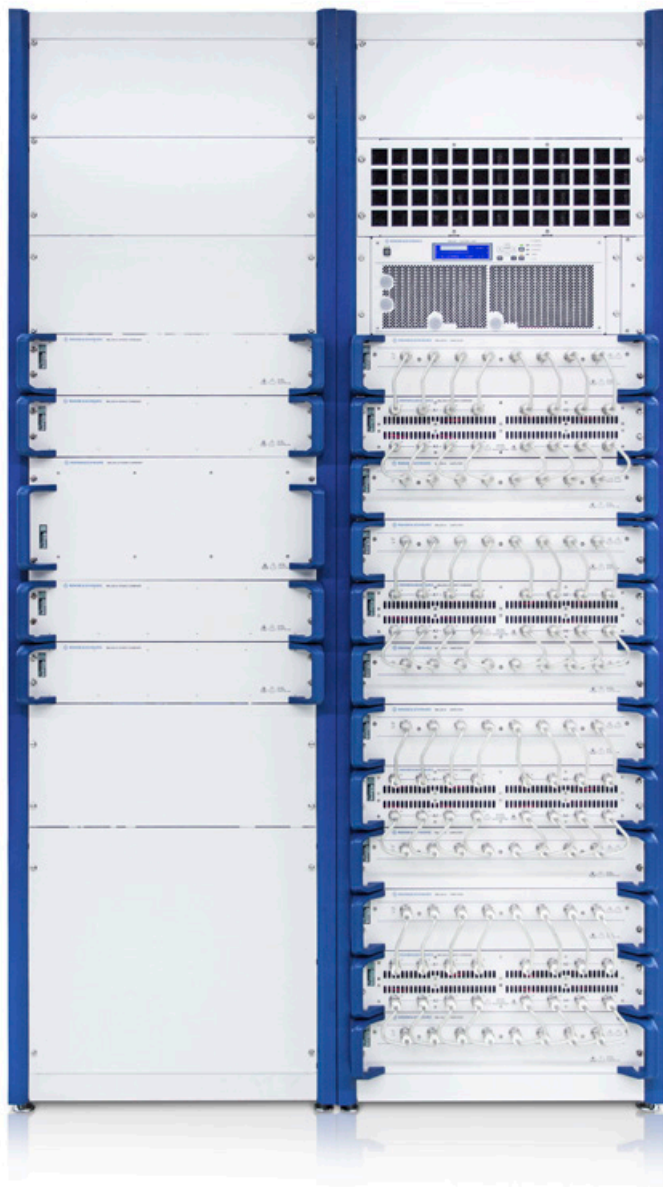

Liquid-cooled power amplifiers for high field strengths

The R&S® BBL200 broadband amplifiers from 9 kHz to 225 MHz open up applications requiring high field strengths and high amplifier power. Especially in EMC environments, they easily fulfill typical requirements as specified by relevant standards as well as those resulting from the physical characteristics of the antennas being used. This includes outstanding performance at 1 dB compression and high mismatch tolerance. The amplifiers are designed for continuous operation and deliver constant power even under mismatch conditions.

Reliable with high availability

- ▶ Outstanding expertise in amplifier development
- ▶ Cost benefit due to low downtime
- ▶ Rugged even under mismatch conditions

Flexible control and operation

- ▶ Manual operation
- ▶ Local and remote operation via web browser and PC
- ▶ Ethernet or GPIB remote control
- ▶ Integration into the R&S® EMC32 measurement software
- ▶ Safety thanks to two different interlocks

Excellent service and quick maintenance

- ▶ Outstanding service concept
- ▶ Maximum investment protection through service level agreements
- ▶ From pre-sale to service – at your doorstep

Key facts

- ▶ Frequency range from 9 kHz to 225 MHz
- ▶ 3000 W, 5000 W and 10000 W output power
- ▶ 100% mismatch tolerance
- ▶ Designed for continuous operation even under mismatch conditions
- ▶ Liquid-cooled, compact and quiet
- ▶ For amplitude, frequency, phase and pulse modulation
- ▶ Three year warranty and flexible service level agreements

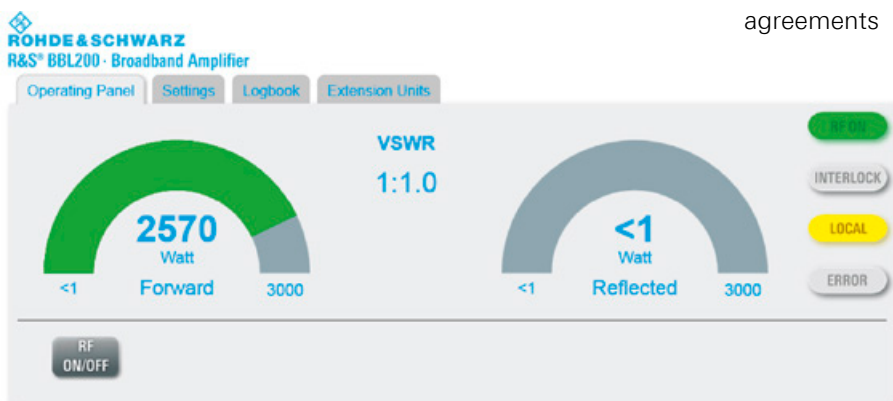

Operating panel on the R&S® BBL200 web GUI



COMPACT DIAGNOSTIC CHAMBERS

Precompliant test sites provide consistent and reproducible measurements of an EUT's EMI performance. They allow fully compliant EMS tests for certification. Recognized as a working tool to assist R&D engineers during development, the family of precompliant EMC test sites includes semi-anechoic chambers (SAC) as well as fully anechoic rooms (FAR) for 3 m test distance.

The end user has a choice between the two types of test sites. In connection with chamber validation, correlation factors from the 3 m FAR performance to a 10 m OATS

can be worked out and provided. Compact in size with a total height between 2.6 m (8.4 ft) and 3.6 m (11.8 ft), the precompliant test site (CDC) is ideal for office and laboratory areas.

The completely modular configuration of the CDC and the durable pan shielding system allows time- and cost-efficient upgrading to a compliant 3 m test site at a later stage. All precompliant test sites provide shielding in line with EN50147-1. Conducted EMC measurements in accordance with all relevant standards can be performed in all chambers, provided that the geometry of the test site allows it.



Room dimensions without white caps FAR/SAC			
Room type (L x W x H)	Total required space	Shielding external	Clear internal
E-CDC, QZ Ø 1 m	6.1 m x 3.1 m x 2.71 m (20 ft x 10.1 ft x 8.9 ft)	6.1 m x 3.1 m x 2.55 m (20 ft x 10.1 ft x 8.4 ft)	5.52 m x 2.2 m x 1.66 m/1.97 m (18.1 ft x 7.2 ft x 5.44 ft/6.5 ft)
M-CDC, QZ Ø 1 m	7.3 m x 3.1 m x 3.16 m (24 ft x 10.1 ft x 10.4 ft)	7.3 m x 3.1 m x 3.0 m (24 ft x 10.1 ft x 9.8 ft)	6.59 m x 1.93 m x 1.86 m/2.30 m (21.6 ft x 6.3 ft x 6.1 ft/7.55 ft)
C-CDC, QZ Ø 1.2 m	7.5 m x 3.3 m x 3.46 m (24.6 ft x 10.8 ft x 11.4 ft)	7.3 m x 3.4 m x 3.3 m (24 ft x 11.2 ft x 10.8 ft)	6.59 m x 2.23 m x 2.15 m/2.59 m (21.6 ft x 7.3 ft x 7.05 ft/8.5 ft)
XL-CDC, QZ Ø 1.5 m	7.8 m x 4.2 m x 3.76 m (25.6 ft x 13.8 ft x 12.3 ft)	7.6 m x 4.0 m x 3.6 m (24.9 ft x 13.1 ft x 11.8 ft)	6.89 m x 2.83 m x 2.15 m/2.89 m (22.6 ft x 9.3 ft x 7.05 ft/9.4 ft)

Performance					
Example of C-CDC	NSA FS			Site VSWR	Field uniformity
Standard	ANSI C63.4, CISPR 16-1-4, EN 55016-1-4			CISPR 16-1-4, EN 55016-1-4	IEC 61000-4-3, EN 61000-4-3
Frequency range	30 MHz to 1 GHz			1 GHz to 18 GHz	80 MHz to 18 GHz
Test distance	3 m			3 m	3 m
Test volume	1.2 m	1.2 m	1.2 m	1.2 m	1.5 m x 1.5 m vertical plane
Test frequency	30 MHz to 100 MHz	101 MHz to 200 MHz	201 MHz to 1 GHz		80 MHz to 18 GHz
Test axis	off axis	off axis	off axis	off axis	in axis
Deviation	±6 dB	±5 dB	±4 dB	≤ 6 dB	0 dB to +6 dB/75% rule

FULLY COMPLIANT ANECHOIC TEST CHAMBERS

Fully compliant test sites and their components are designed to have the lowest possible contribution to the total measurement uncertainty of the test facility, (i.e. to allow reproducible, accurate and fast measurements). Our family of fully compliant EMC test sites includes all semi-anechoic chambers (SAC) for 3 m, 5 m and 10 m test distance and fully anechoic rooms (FAR) for 3 m and 5 m test distance.

The chamber validation of these solutions is described in CISPR 16-1-4. The final dimensions of the 10 m semi-anechoic chambers depend a lot on the dimensions of the EUT, whereas the dimensions of the fully-anechoic 3 m and 5 m chambers easily can be standardized. All fully compliant test sites provide shielding compliant to EN 50147-1 and IEEE 299. Conducted EMC measurements, in accordance with all relevant standards can be performed in all chambers, provided that the geometry of the test site allows it.

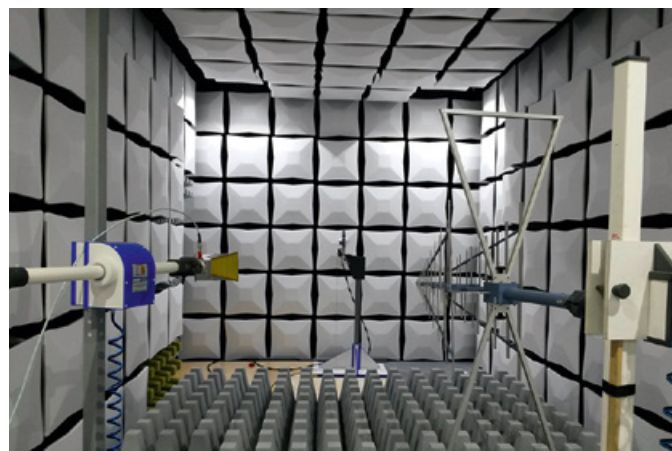
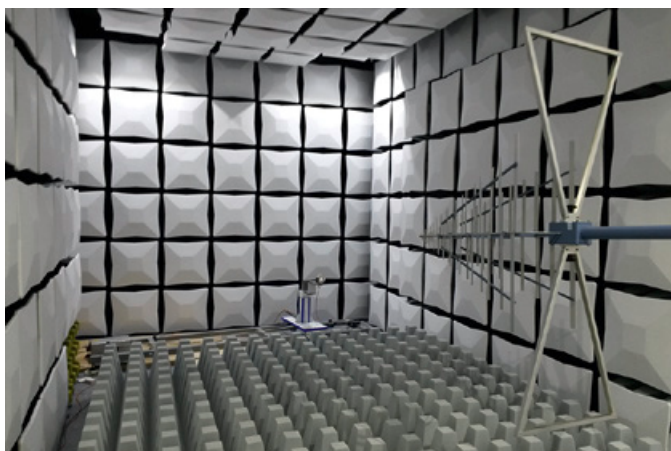

 AlbatrossProjects

Room dimensions without white caps

Room type (L x W x H)	Total required space	Shielding external	Clear internal
FAR 3 m, QZ Ø 1.5 m	9.0 m x 4.8 m x 4.4 m (29.5 ft x 15.7 ft x 14.4 ft)	8.8 m x 4.6 m x 4.2 m (28.9 ft x 15.1 ft x 13.8 ft)	7.7 m x 3.4 m x 2.8 m (25.3 ft x 10.9 ft x 10.7 ft)
SAC 3 m, QZ Ø 2 m	10 m x 6.1 m x 6.05 m (32.8 ft x 20.0 ft x 19.8 ft)	9.4 m x 5.5 m x 5.55 m (30.8 ft x 18.0 ft x 18.2 ft)	8.36 m x 4.33 m x 4.8 m (27.4 ft x 14.2 ft x 15.7 ft)
SAC 5 m, QZ Ø 3 m	13.1 m x 8.3 m x 6.5 m (42.9 ft x 27.2 ft x 21.3 ft)	12.1 m x 7.3 m x 6.0 m (39.7 ft x 24.0 ft x 19.7 ft)	11.06 m x 5.5 m x 5.25 m (36.3 ft x 18.0 ft x 17.2 ft)
SAC 10 m, QZ Ø 3 m	20.2 m x 13.0 m x 9.25 m (66.3 ft x 42.7 ft x 30.35 ft)	19 m x 11.8 m x 8.55 m (62.3 ft x 38.7 ft x 28.05 ft)	17.5 m x 10.0 m x 7.15 m (57.4 ft x 32.8 ft x 23.5 ft)
SAC 10 m, QZ Ø 4 m	21.2 m x 13.4 m x 9.25 m (69.6 ft x 43.9 ft x 30.35 ft)	20.2 m x 12.4 m x 8.55 m (66.3 ft x 40.7 ft x 28.05 ft)	18.7 m x 10.6 m x 7.15 m (61.3 ft x 34.7 ft x 23.5 ft)

Performance

Example for 3 m FAR	NSA	Site VSWR	Field uniformity
Standard	CISPR 16-1-4, ANSIC63.4, EN 55016-1-4	CISPR 16-1-4, EN 55016-1-4	IEC 61000-4-3, EN 61000-4-3
Frequency range	30 MHz to 1 GHz	1 GHz to 18 GHz	80 MHz to 18 GHz
Test distance	3 m	3 m	3 m
Test volume	1.5 m	1.5 m	1.5 m x 1.5 m (vertical plane)
Test axis	off axis	off axis	in axis
Deviation	±4 dB	≤ 6 dB	0 dB to +6 dB/75% rule

EMC TEST SITES FOR THE AUTOMOTIVE INDUSTRY

The family of EMC test sites for the automotive industry and their suppliers of electric and electronic subassemblies (ESA) include semi-anechoic chambers (SAC) for 1 m, 3 m, 5 m and 10 m test distance. For 20 years, the automotive industry has considered the semi-anechoic chamber as “state-of-the-art” for vehicle testing and the same has held true for component testing for the last decade. The CISPR25 and automotive chamber differ in terms of size, cost and the variety of measurements to be performed.

CISPR25 or ESA test chambers are used for emission and immunity testing on electronic subassemblies. A higher integration along with much higher ESA clock frequencies in vehicles makes the “inner EMC” of vehicles the challenge of today. The vehicle is driven by the chassis dynamometer to simulate various traffic situations and cover all functional stresses. All CISPR25 and automotive test sites provide a shielding compliant to EN50147-1 and IEEE 299. Conducted EMC measurements in accordance with all relevant standards can be performed in all chambers, provided that the geometry of the test site and its configuration allows it.

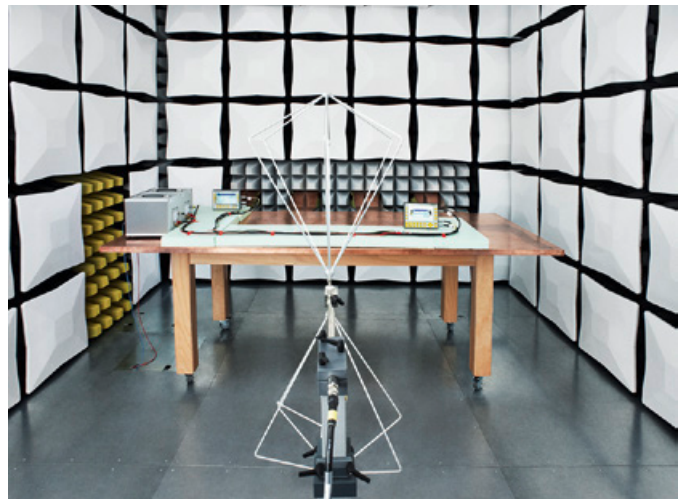

 AlbatrossProjects

Room dimensions without white caps			
Room type (L x W x H)	Total required space	Shielding external	Clear internal
CISPR25	5.5 m x 4.3 m x 3.5 m (18.04 ft x 14.11 ft x 11.48 ft)	5.5 m x 4.3 m x 3.3 m (18.04 ft x 14.11 ft x 10.83 ft)	4.62 m x 3.42 m x 2.86 m (15.16 ft x 11.22 ft x 9.38 ft)
SAC 5 m, Automotive QZ Ø 4 m	16.1 m x 10.6 m x 6.6 m (52.8 ft x 33.1 ft x 21.65 ft)	15.1 m x 9.1 m x 6.0 m (49.5 ft x 29.9 ft x 19.69 ft)	14.06 m x 7.3 m x 5.2 m (46.1 ft x 24.0 ft x 17.1 ft)
SAC 10 m, Automotive QZ Ø 5.5 m	25.1 m x 16.4 m x 9.8 m (82.3 ft x 53.8 ft x 32.15 ft)	24.1 m x 15.4 m x 9.0 m (79 ft x 50.5 ft x 29.52 ft)	22.64 m x 13.6 m x 7.6 m (74.27 ft x 44.62 ft x 24.9 ft)

Performance			
Site attenuation, example of CISPR25 (ALSE validation)			
Standard	CISPR25	CISPR25	CISPR25
Frequency range	150 kHz to 30 MHz	30 MHz to 1 GHz	1 GHz to 2.5 GHz
Test distance	1 m	1 m	1 m
Test bench size	2.5 m x 1.0 m	2.5 m x 1.0 m	2.5 m x 1.0 m
Test axis	in axis	in axis	in axis
Deviation	±6 dB	±6 dB	±6 dB

EMC ACCESSORIES FOR DISTURBANCE VOLTAGE/CURRENT/POWER AND FIELD STRENGTH MEASUREMENTS

Disturbance voltage measurements

R&S®ENV216 Two-Line V-Network



Product site

Disturbance voltage measurements on single-phase EUTs

- ▶ Several models for Germany, United Kingdom, France, China/Australia, USA
- ▶ Air-core design and artificial hand
- ▶ Switch-selectable highpass filter of 150 kHz
- ▶ Built-in 10 dB attenuator pad
- ▶ Built-in pulse limiter (can be switched off)
- ▶ Remote control with TTL levels (compatible with Rohde & Schwarz EMI test receivers)
- ▶ Compact, lightweight

Specifications in brief

- ▶ Frequency range: 9 kHz to 30 MHz
- ▶ Power-handling capacity up to 16 A constant current (country-specific)
- ▶ Simulated impedance ($50 \mu\text{H} + 5 \Omega$) || 50Ω in line with CISPR 16-1-2 Amd. 2:2006
- ▶ V-network in line with CISPR, EN, VDE, ANSI, FCC Part 15 and MIL-STD-461D, E and F
- ▶ Calibrated in line with CISPR 16-1-2

R&S®ENV432 Four-Line V-Network



Product site

Disturbance voltage measurements on three-phase EUTs

- ▶ Meets the requirements of CISPR 16-1-2, EN55016-1-2 and ANSI C63.4
- ▶ Air-core design and artificial hand
- ▶ Built-in 10 dB attenuator pad
- ▶ Built-in pulse limiter (can be switched off)
- ▶ Automatic temperature monitoring
- ▶ Remote control with TTL levels (compatible with Rohde & Schwarz measuring receivers)

Specifications in brief

- ▶ Frequency range from 9 kHz to 30 MHz
- ▶ Power-handling capacity up to 32 A, constant current
- ▶ Simulated impedance ($50 \mu\text{H} + 5 \Omega$) || 50Ω in line with CISPR 16-1-2
- ▶ V-network in line with CISPR, EN, VDE, ANSI, FCC Part 15 and MIL-STD-461D, E and F
- ▶ Calibrated in line with CISPR 16-1-2

R&S®ENV4200 200 A Four-Line V-Network



Product site

Disturbance voltage measurements at high currents

The R&S®ENV4200 V-network meets the requirements of CISPR 16-1-2, EN55016-1-2 and ANSI C63.4 for V-networks with impedance in the frequency range from 150 kHz to 30 MHz. The maximum attainable current of the V-network is limited by the voltage drop at the standardized inductances (CISPR 16-1-2 limits the voltage drop to 5% of the AC supply voltage) and by unavoidable heat losses.

Key facts

- ▶ Air-core design and artificial hand
- ▶ Built-in 10 dB attenuator pad
- ▶ Built-in pulse limiter (can be switched off)
- ▶ Automatic temperature monitoring
- ▶ Remote control with TTL levels (compatible with Rohde & Schwarz measuring receivers)

Specifications in brief

- ▶ Frequency range from 150 kHz to 30 MHz
- ▶ Power-handling capacity up to 200 A constant current
- ▶ Simulated impedance $50 \mu\text{H}$ || 50Ω in line with CISPR 16-1-2
- ▶ V-network for RFI voltage measurements in line with CISPR, EN, VDE, ANSI and FCC Part 15
- ▶ Calibrated in line with CISPR 16-1-2

R&S®ESH3-Z6 150 A Single-Line V-Network



Product site

Measurements of disturbance voltage and susceptibility in low-impedance power supply networks

The R&S®ESH3-Z6 is a single-phase V-network with an simulated impedance of $5 \mu\text{H}$ || 50Ω for the frequency range from 100 kHz to 200 MHz. The R&S®ESH3-Z6 is rated for a continuous current up to 115 A and can handle surges of up to 500 A for a maximum time of 30 s. Its screw terminals ensure a low-impedance connection of test device and power supply.

Specifications in brief

- ▶ Frequency range: 0.1 MHz to 200 MHz
- ▶ Continuous current up to 115 A
- ▶ Simulated impedance: $5 \mu\text{H}$ || 50Ω in line with
 - CISPR 25 (on-board power supply systems)
 - MIL-STD-461, DEF-STAN 59-411 and DO-160
- ▶ Calibrated in line with CISPR 16-1-2

Disturbance voltage measurements

R&S®ENY21 Two-Wire Coupling Network



Product site

Radio disturbance and immunity measurements on unshielded, symmetrical telecommunications ports

- ▶ Radio disturbance measurements in line with
 - CISPR 22:2005 and EN 55022:2010 figure D.1 (150 kHz to 30 MHz)
 - CISPR 32 and EN 55032 figure G.1
- ▶ Immunity measurements in line with CISPR 24 and EN 55024 (150 kHz to 80 MHz)
- ▶ CISPR 16-1-2 compliant
- ▶ Adapter sets to meet standardized LCL requirements (55 dB and 65 dB) and to accommodate various telecommunications interfaces
- ▶ High transmission bandwidth for wanted signal (100 MHz)

Specifications in brief

- ▶ Frequency range
 - Radio disturbance: 150 kHz to 30 MHz
 - Immunity: 150 kHz to 80 MHz
- ▶ Asymmetrical impedance
 - Imp. (0.15 MHz to 30 MHz): $150 \Omega \pm 20 \Omega$
 - Phase angle (0.15 MHz to 30 MHz): $0^\circ \pm 20^\circ$
 - Imped. (> 30 MHz to 80 MHz): $150 \Omega \pm 40 \Omega$
- ▶ Voltage division factor in asymmetrical circuit
 - 150 kHz to 30 MHz: typ. 10 dB \pm 2 dB
- ▶ Maximum permissible values
 - Max. RF input voltage: < 15 V
 - Max. DC voltage between line/ground: 100 V
 - Max. AC voltage between line/ground: 63 V
 - Max. DC current: 600 mA (current on each individual wire of one or different pairs)

R&S®ENY41 Four-Wire Coupling Network



Product site

Radio disturbance and immunity measurements on unshielded, symmetrical telecommunications ports

- ▶ Radio disturbance measurements in line with
 - CISPR 22:2005 and EN 55022:2010 fig D.2 (150 kHz to 30 MHz)
 - CISPR 32 and EN 55032 figure G.2
- ▶ Immunity measurements in line with CISPR 24 and EN 55024 (150 kHz to 80 MHz)
- ▶ CISPR 16-1-2 compliant
- ▶ Adapter sets to meet standardized LCL requirements (55 dB and 65 dB) and to accommodate various telecommunications interfaces
- ▶ High transmission bandwidth for wanted signal (100 MHz)

Specifications in brief

- ▶ Frequency range
 - Radio disturbance: 150 kHz to 30 MHz
 - Immunity: 150 kHz to 80 MHz
- ▶ Asymmetrical impedance
 - Imp. (0.15 MHz to 30 MHz): $150 \Omega \pm 20 \Omega$
 - Phase angle (0.15 MHz to 30 MHz): $0^\circ \pm 20^\circ$
 - Imp. (> 30 MHz to 80 MHz): $150 \Omega \pm 40 \Omega$
- ▶ Voltage division factor in asymmetrical circuit
 - 150 kHz to 30 MHz: typ. 10 dB \pm 2 dB
- ▶ Maximum permissible values
 - Max. RF input voltage: < 15 V
 - Max. DC voltage between line/ground: 100 V
 - Max. AC voltage between line/ground: 63 V
 - Max. DC current: 600 mA (current on each individual wire of one or different pairs)

R&S®ENY81 Eight-Wire Coupling Network



Product site

Radio disturbance measurements on unshielded, symmetrical telecommunications ports

- ▶ Radio disturbance measurements in line with
 - CISPR 22:2005 and EN 55022:2010 figure D.3 (150 kHz to 30 MHz)
 - CISPR 32 and EN 55032 figure G.3
- ▶ CISPR 16-1-2 compliant
- ▶ Adapter sets to meet standardized LCL requirements (55 dB and 65 dB) and to accommodate various telecommunications interfaces
- ▶ High transmission bandwidth for wanted signal (100 MHz)

Specifications in brief

- ▶ Frequency range: 150 kHz to 30 MHz
- ▶ Asymmetrical impedance
 - Imp. (0.15 MHz to 30 MHz): $150 \Omega \pm 20 \Omega$
 - Phase angle (0.15 MHz to 30 MHz): $0^\circ \pm 20^\circ$
- ▶ Voltage division factor in asymmetrical circuit
 - 150 kHz to 30 MHz: typ. 10 dB \pm 2 dB
- ▶ Maximum permissible values
 - Max. RF input voltage: < 15 V
 - Max. DC voltage between line/ground: 100 V
 - Max. AC voltage between line/ground: 63 V
 - Max. DC current: 600 mA (current on each individual wire of one or different pairs)

R&S®ENY81-CA6 Eight-Wire Coupling Network for cable category CAT 6



Product site

Radio disturbance measurements on unshielded, symmetrical telecommunications ports

- ▶ Radio disturbance measurements in line with
 - CISPR 22:2005 and EN 55022:2010 fig. D.3
 - CISPR 32 and EN 55032 figure G.3
- ▶ Immunity measurements in line with CISPR 24 and EN 55024 (150 kHz to 80 MHz)
- ▶ CISPR 16-1-2 compliant
- ▶ 75 dB longitudinal conversion loss (LCL)
- ▶ High transmission bandwidth for wanted signal (250 MHz)

Specifications in brief

- ▶ Frequency range
 - Radio disturbance: 150 kHz to 30 MHz
 - Immunity: 150 kHz to 80 MHz
- ▶ Asymmetrical impedance
 - Imped. (0.15 MHz to 30 MHz): $150 \Omega \pm 20 \Omega$
 - Phase angle (0.15 MHz to 30 MHz): $0^\circ \pm 20^\circ$
 - Imped. (> 30 MHz to 80 MHz): $150 \Omega \pm 40 \Omega$
- ▶ Voltage division factor in asymmetrical circuit
 - 150 kHz to 30 MHz: typ. 9.5 dB \pm 1 dB
 - > 30 MHz to 80 MHz: typ. 9.5 dB \pm 2 dB
- ▶ Maximum permissible values
 - Max. RF input voltage: < 15 V
 - Max. DC voltage between line/ground: 100 V
 - Max. AC voltage between line/ground: 63 V
 - Max. DC current: 600 mA (current on each individual wire of one or different pairs)

Disturbance voltage measurements

R&S®EZ-12 Antenna Impedance Converter



Product site

Broadband matching unit for test receivers and spectrum analyzers with low-impedance inputs

The R&S®EZ-12 is used for high-impedance measurements of disturbance voltage at the feed-point of a vehicle-mounted antenna in the long-, medium-, shortwave and FM bands in line with VDE 0879 Part 2 and CISPR 25. For measurements in the VHF FM range, the antenna signal can be switched to a separate 50 Ω input.

- ▶ Flat frequency response
- ▶ High sensitivity and overload capacity
- ▶ Calibration in line with CISPR 25:2008
- ▶ Remotely controlled FM range switch

Specifications in brief

- ▶ Frequency range: 150 kHz to 30 MHz (120 MHz)
- ▶ RF input: SO 10599-1
- ▶ Input impedance: > 100 kΩ, < 10 pF (at 1 MHz)
- ▶ Gain factor for direct input to antenna connector: +11.2 dB ± 1 dB
- ▶ Correction factor (nom. gain in line with CISPR 25 is 10 dB): 10 dB
- ▶ VSWR: ≤ 1.4
- ▶ Noise voltage at output (input terminated with antenna simulator; AVG, bandwidth = 10 kHz)
 - f > 150 kHz: < -5 dBμV
 - f > 500 kHz: < -7 dBμV
- ▶ 1 dB compression point: > 107 dBμV

R&S®EZ-25 150 kHz Highpass Filter



Product site

Conducted emission measurements in the presence of longwave mains disturbance signals

For the measurement of equipment that requires higher selectivity at the transition between 130 kHz and 150 kHz as shown in Fig. 2 of CISPR 16-1-1 (e.g. signaling equipment as defined in EN 50065-1), a highpass filter may be added in front of the measuring receiver to improve the selectivity and achieve the values stipulated in EN 50065 Part 1 without impairing the passband of the measuring receiver.

- ▶ Conducted emission measurements in line with EN 50065 Part 1
- ▶ Very steep slope in line with CISPR 16-1-1
- ▶ Suitable for any CISPR measuring receiver
- ▶ Relative attenuation > 50 dB below 130 kHz
- ▶ Built-in 10 dB attenuation pad for exact 50 Ω termination of LISN
- ▶ High pulse energy capability (50 mWVs)
- ▶ Calibrated response

Specifications in brief

- ▶ Passband: 150 kHz to 30 MHz
- ▶ Insertion loss in passband: 9.5 dB to 11.5 dB
- ▶ VSWR in passband: < 1.2
- ▶ Stopband: below 130 kHz
- ▶ Minimum attenuation in stopband: 60 dB
- ▶ Attenuation in transition region
 - 146 kHz: < 12 dB
 - 145 kHz: > 12 dB
 - 140 kHz: > 24 dB
 - 130 kHz: > 60 dB
- ▶ Max. input voltage (continuous): 137 dBμV
- ▶ Max. impulse energy (50 μs): 50 mWVs
- ▶ RF connectors: N (female)

R&S®ESH2-Z3 Voltage Probe, R&S®ESH2-Z31 Attenuator

R&S®ESH2-Z3 passive voltage probe

The passive voltage probe is suitable for measuring disturbance voltages on AC supply lines. The R&S®ESH2-Z3 meets the requirements of CISPR 16-1-2 and EN 55016-1-2.

R&S®ESH2-Z31 attenuator

For checking the disturbance source impedance in line with EN 55016-2-1 and CISPR 16-2-1.

Specifications in brief (R&S®ESH2-Z3)

- ▶ Frequency range: 9 kHz to 30 MHz
- ▶ Measurement range (AVG, 200 Hz IF bandwidth with Rohde & Schwarz test receivers):
 - typ. 10 dBμV to 150 dBμV
- ▶ Attenuation, uncertainty of calibration: 30 dB, 0.5 dB
- ▶ Input impedance: 1.5 kΩ ± 5% || 8 pF
- ▶ Max. input voltage
 - f < 63 Hz: 250 V
 - f > 63 Hz to 30 MHz: 30 V

R&S®ESH3-Z2 Pulse Limiter



High RF input levels and high-energy disturbance pulses generated on artificial mains networks when the DUT is switched on and off can damage the RF input circuits of test receivers. The R&S®ESH3-Z2 pulse limiter limits and reduces the disturbance level.

Specifications in brief

- ▶ Frequency range: 0 Hz to 30 MHz
- ▶ Insertion loss: 10 dB ± 0.3 dB
- ▶ Frequency response: ≤ ± 0.3 dB
- ▶ SWR with 50 Ω termination, input/output: ≤ 1.06/≤ 1.25
- ▶ Power handling capacity in continuous mode: 1 W
- ▶ Pulse power handling capacity:
 - E = 0.1 Ws (6 ms)
- ▶ RF connectors (input/output): N (female/male)

Disturbance current measurements

R&S®EZ-17 Current Probe



Emission and susceptibility measurements

The R&S®EZ-17 model .02 with its extremely flat frequency response is optimal for current measurements and for measuring screening effectiveness.

Due to its high load capacity, model .03 is recommended for EMS measurements (bulk current injection).

- ▶ Model .02 for emission measurements
- ▶ Model .03 for emission and susceptibility measurements
- ▶ High sensitivity and overload capability
- ▶ Wide frequency range
- ▶ High load capacity for DC and AC current
- ▶ Small dimensions despite large inner diameter (30 mm)
- ▶ Simple clamping thanks to spring-loaded mechanism



Product site

Specifications in brief (model .02/model .03)

- ▶ Frequency range: 20 Hz to 100 (200) MHz
- ▶ Range with constant transducer factor (-3 dB): 1 MHz/2 MHz to 100 MHz
- ▶ Transducer factor reduced by 20 dB/decade in range from 20 Hz to 1 MHz/2 MHz
- ▶ Source impedance: $\leq 0.8 \Omega / \leq 1 \Omega$
- ▶ Transfer impedance Z_t in range with constant transducer factor: $3.16 \Omega / 7.1 \Omega$
- ▶ Transducer factor k in range with flat frequency response: -10 dB/-17 dB
- ▶ Load capacity (RF current measurement)
 - Max. DC current or peak, AC current: 300 A ($f < 1$ kHz)
 - Max. RF current (RMS): 2 A ($f > 1$ MHz)/1 A ($f > 1$ MHz)
- ▶ Load capacity of model .03 (EMS measurement)
 - Max. power at RF connector: 10 W ($f > 1$ MHz)
- ▶ RF connector: N (female)

R&S®ESV-Z1 VHF Current Probe



The R&S®ESV-Z1 current probe is used for selective or broadband measurements of very small or very large RF currents in electric lines. It is shielded against electrostatic effects and complies with CISPR 16-1-2 and VDE 0876.

Specifications in brief

- ▶ Frequency range: 9 kHz to 600 MHz
- ▶ Measurement range (AVG, 7.5 kHz IF bandwidth): -33 dB μ A to +117 dB μ A
- ▶ Transfer admittance ($Y_t = \text{lin}/V_{\text{out}}$): 0.1 S (20 MHz to 600 MHz)
- ▶ Transducer factor ($k = 20 \log(Y_t/s)$): -20 dB (20 MHz to 600 MHz)
- ▶ Max. current (superimposed on RF current or peak AC current): 50 A
- ▶ Max. diameter of conductor: 13.5 mm (0.53 in)

Disturbance power measurements

R&S®MDS-21 Absorbing Clamp

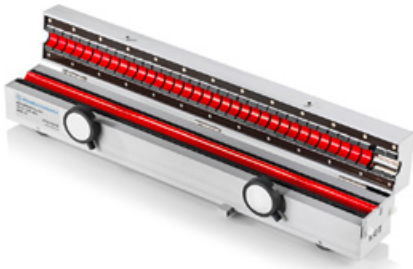

Measurement of disturbance power and screening effectiveness on cables

The R&S®MDS-21 absorbing clamp meets the requirements of CISPR 16-1-3/EN 55016-1-3 for disturbance power measurements in the frequency range of 30 MHz to 1000 MHz and is applicable for screening effectiveness measurements.

The disturbance emitted by electrical appliances, machines and systems must comply with the limits specified in national and international standards. Meyer de Stadelhofen (MDS) absorbing clamps in conjunction with EMI measuring receivers are used to measure the disturbance power on cables in line with CISPR 13/EN 55013, CISPR 14-1/EN 55014-1 and EN 50083-2.



Product site

They can also be used in conjunction with two-port measuring devices to measure the screening effectiveness of cables in line with IEC 62153-4 and EN 50083-2.

MDS absorbing clamps are also used to test the efficiency of disturbance suppression devices for high-voltage ignition systems in line with CISPR 12/EN 55012.

Specifications in brief

- ▶ Frequency range from 30 MHz to 1000 MHz
- ▶ Maximum cable diameter: 20 mm
- ▶ Clamp opens for easy insertion of the test cable
- ▶ Ball bearing rollers for continuous use in automatic measurements
- ▶ Requirements and calibration in line with CISPR 16-1-3

Field strength measurements

R&S®HZ-14 Probe Set for E and H Near-Field Measurements



Diagnostic tools for detecting EMC trouble spots

The R&S®HZ-14 near-field probe set can be used together with test receivers, spectrum analyzers or oscilloscopes to determine electromagnetic emissions of any type. The main application is the diagnosis of emissions from printed boards, cables and leakage spots in shielded enclosures. The two passive H-field probes can be used for a local susceptibility test. The R&S®HZ-14 probe set allows quantitative analysis. It comes in a handy transit case.

Equipment supplied

- ▶ Two passive H-field probes (9 kHz to 30 MHz and 30 MHz to 1 GHz)
- ▶ One active E-field probe (9 kHz to 1 GHz)
- ▶ One 30 dB preamplifier for the H-field probe (can be powered from all Rohde&Schwarz test receivers and spectrum analyzers)
- ▶ Test jig for functional testing of H-field probes and simplified normalization of H-field measurements with the aid of a tracking generator and normalization functions provided in spectrum analyzers



Product site

Specifications in brief

- ▶ H-field probes
 - Max. input power: ≤ 30 MHz: 0.5 W; > 30 MHz: 0.25 W
 - Max. permissible voltage of uninsulated conductor (0 Hz to 120 Hz): 500 V (V_p)
- ▶ E-field probe
 - Frequency response: ± 3 dB
 - Sensitivity: 13 mV/V
 - Max. permissible voltage at probe tip: 20 V
- ▶ RF connector: SMA (female)
- ▶ Preamplifier
 - Frequency range: 9 kHz to 1 GHz
 - Gain: 30 dB ± 2 dB, typ. ± 1 dB
 - Noise figure: < 4 dB (at $+25$ °C, 100 MHz), typ. < 3 dB
 - Max. output level (1 dB compression): 8 dBm
 - Input/output: BNC female/N male
 - Impedance: 50 Ω
 - VSWR: < 1.5
 - DC powering: 10/15 V ± 0.1 V, < 100 mA
 - DC connector: LEMO

R&S®HZ-15 Probe Set for E and H Near-Field Emission Measurements



The R&S®HZ-15 probe set contains special probes from 30 MHz to 3 GHz for near-field emission measurements on electronic modules and can be used together with test receivers, spectrum analyzers and oscilloscopes. Inserting the optional R&S®HZ-16 preamplifier between the near-field probe and the spectrum analyzer makes it easier to measure very weak high-frequency fields of up to 3 GHz.

- ▶ Five probes for easy diagnostic measurements
- ▶ Special, electrically shielded magnetic field probes
- ▶ Probe tips adapted to near-field measurement
- ▶ High-resolution measurements
- ▶ Easy-to-determine magnetic field orientation
- ▶ Easy operation and handling



Product site

Specifications in brief

- ▶ Frequency range: 30 MHz to 3 (1.5) GHz
- ▶ One E-field probe with large surface of approx. 2 cm \times 5 cm up to 1.5 GHz
- ▶ One E-field probe with sharp tip of 0.2 mm in width
- ▶ Two H-field probes with loop diameter of approx. 10 mm and 25 mm
- ▶ One H-field probe with active groove of 0.5 mm
- ▶ RF connector: SMB (female)
- ▶ Isolation voltage: 60 V DC/42.4 V AC (peak)

R&S®HZ-16 Preamplifier for E and H Near-Field Emission Measurements



Inserting the R&S®HZ-16 preamplifier between the near-field probe and the measuring instrument makes it easier to measure very weak high-frequency fields of up to 3 GHz. The input and output are provided as 50 Ω BNC connectors.



Product site

Specifications in brief

- ▶ Frequency range: 100 kHz to 3 GHz
- ▶ Gain: typ. 20 dB
- ▶ Noise figure: nom. 4.5 dB
- ▶ Max. input power: +13 dBm
- ▶ Operating voltage: 12 V
- ▶ Plug-in power supply: 100 V to 240 V, 50 Hz/60 Hz, Euro connector (2 mm \times 4 mm), adapter for USA and Japan

R&S®HZ-17 Probe Set for H Near-Field Emission Measurements



The R&S®HZ-17 probe set contains two passive H near-field probes from 30 MHz to 3 GHz. Inserting the optional R&S®HZ-16 preamplifier between the near-field probe and the spectrum analyzer makes it easier to measure very weak high-frequency fields of up to 3 GHz.

- ▶ Special, electrically shielded magnetic field probes
- ▶ High-resolution measurements
- ▶ Easy-to-determine magnetic field orientation
- ▶ Easy operation and handling



Product site

Specifications in brief

- ▶ Frequency range: 30 MHz to 3 GHz
- ▶ Two H-field probes with loop diameter of approx. 25 mm
- ▶ One H-field probe with active groove of 0.5 mm
- ▶ RF connector: SMB (female)
- ▶ Isolation voltage: 60 V DC/42.4 V AC (peak)

Field strength measurements

R&S®HFH2-Z2E Active Loop Antenna



Product site

Broadband active loop antenna for measuring the magnetic field strength components

The R&S®HFH2-Z2E active loop antenna measures the magnetic field strength in the LF, MF and HF frequency range. It can be used for EMI measurements in line with various standards (i.e. CISPR, MIL, FCC, ANSI, ETSI).

- ▶ Each antenna is individually calibrated
- ▶ It is characterized by an almost frequency-independent antenna factor and very high sensitivity
- ▶ In strong field environments, an attenuator can be activated to reduce distortion. An integrated RF detector with a threshold circuit reports overload of the antenna
- ▶ The antenna is supplied via a coaxial cable using the optional R&S®IN600 bias unit

Specifications in brief

- ▶ Frequency range: 8.3 kHz to 30 MHz
- ▶ Polarization: linear/vertical
- ▶ Nominal impedance: 50 Ω
- ▶ VSWR:
 - 8.3 kHz to 20 kHz: < 1.8
 - > 20 kHz to 30 MHz: < 1.6
- ▶ Antenna factor in normal mode:
 - 8.3 kHz to 20 kHz: 20 dB/m ± 2 dB
 - > 20 kHz to 30 MHz: 20 dB/m ± 1.5 dB
- ▶ Antenna factor in attenuation mode:
 - 8.3 kHz to 20 kHz: 30 dB/m ± 2 dB
 - > 20 kHz to 30 MHz: 30 dB/m ± 1.5 dB
- ▶ Antenna connector: BNC female
- ▶ Power supply (via coaxial cable): +24 V DC -3 V/+1 V (max. 150 mA)
- ▶ Loop diameter: 600 mm (24 in)

R&S®HFH2-Z6E Active Rod Antenna



Product site

Broadband active rod antenna for measuring the electrical component of radiated EMI in test setups in line with CISPR 25

The R&S®HFH2-Z6E active rod antenna is used to measure the electrical field strength in the LF, MF and HF frequency range. It can be used for EMI measurements in line with various standards (i.e. CISPR, MIL, FCC, ANSI, ETSI).

- ▶ Each antenna is individually calibrated
- ▶ It is characterized by an almost frequency-independent antenna factor and very high sensitivity
- ▶ In strong field environments, an attenuator can be activated to reduce distortion. An integrated RF detector with a threshold circuit reports overload of the antenna
- ▶ The antenna is supplied via a coaxial cable using the optional R&S®IN600 bias unit

Specifications in brief

- ▶ Frequency range: 8.3 kHz to 30 MHz
- ▶ Polarization: linear/vertical
- ▶ Nominal impedance: 50 Ω
- ▶ VSWR: < 1.6
- ▶ Antenna factor in normal mode:
 - 8.3 kHz to 20 kHz 10 dB(1/m) ± 2 dB
 - > 20 kHz to 30 MHz 10 dB(1/m) ± 1.5 dB
- ▶ Antenna factor in attenuation mode:
 - 8.3 kHz to 20 kHz: 20 dB(1/m) ± 2 dB
 - > 20 kHz to 30 MHz: 20 dB(1/m) ± 1.5 dB
- ▶ Antenna connector: N female
- ▶ Power supply (via coaxial cable): +24 V DC -3 V/+1 V (max. 150 mA)
- ▶ Rod height: approx. 1040 mm (41 in)

R&S®HZ-9 External Power Supply



Product site

Low-noise linear regulator

Power supply for the R&S®EZ-12 antenna impedance converter and the R&S®HZ-14 probe set for E and H near-field measurements in situations where these instruments cannot be supplied directly from a measuring receiver or when it is not possible to connect the instrument to the measuring receiver (standalone operation)

Specifications in brief

- ▶ Output voltages: ±10 V ± 0.1 V
- ▶ Max. current load: 100 mA
- ▶ DC connector: 12-contact Tuchel female
- ▶ AC supply: 100 V to 120 V/220 V to 240 V, ±10%
- ▶ Dimensions (W × H × D): 129 mm × 67 mm × 205 mm (5.08 in × 2.64 in × 8.07 in)
- ▶ Weight: 1.7 kg (3.75 lb)

Field strength measurements

R&S®AM524 Active Antenna System

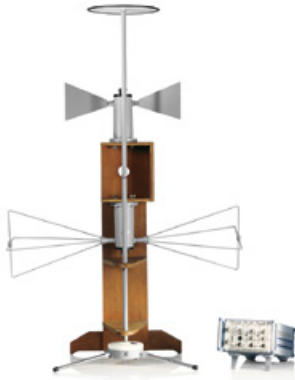

Product site

For measuring low-level signals in anechoic chambers

The R&S®AM524 active antenna system has been designed for measuring low-level signals in anechoic chambers. Criteria for dimensioning such antennas are different from those of active antennas used outside shielded rooms.

Essential parameters for antennas used in anechoic chambers are for instance low dimensions, high large-signal immunity and maximum sensitivity.

- ▶ Extremely high sensitivity
- ▶ Excellent large-signal characteristics
- ▶ Wide frequency range
- ▶ Especially suitable for TEMPEST measurements
- ▶ Individual calibration in line with ANSI C63.5

Specifications in brief

- ▶ Frequency range (in three subranges)
 - 100 Hz to 1 GHz
- ▶ Input impedance 50 Ω
- ▶ Antenna factor (without attenuator or amplifier)
 - 100 Hz to 30 MHz: 0 dB
 - 100 MHz: -10 dB
 - 1 GHz: typ. 19 dB
- ▶ Field sensitivity ($\Delta f = 1$ Hz, $S/N = 0$ dB)
 - 100 Hz: typ. 0 dB(μ V/m)
 - 100 kHz: typ. -43 dB(μ V/m)
 - 30 MHz: typ. -51 dB(μ V/m)
 - 100 MHz: typ. -54 dB(μ V/m)
 - 1 GHz: typ. -37 dB(μ V/m)

R&S®HL033 Log-Periodic Broadband Antenna

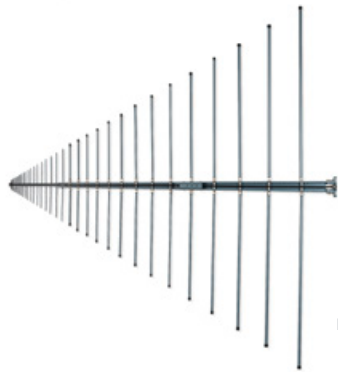

Product site

Detection and measurement of RF signals

- ▶ Extremely broadband
- ▶ Only one antenna required to cover a wide frequency range
- ▶ Low frequency dependence of radiation patterns and input impedance
- ▶ Can be used as transmit antenna
- ▶ Metal parts electrically connected to mast flange for protection against electric charges and lightning
- ▶ Highly weatherproof
- ▶ Stable installation due to optional center bracket
- ▶ Individual calibration in line with ANSI C63.5

Specifications in brief

- ▶ Frequency range: 80 MHz to 2 GHz
- ▶ Polarization: linear
- ▶ Input impedance: 50 Ω
- ▶ VSWR: ≤ 2
- ▶ Max. input power ($T_{amb} = +30^\circ\text{C}$)
 - 80 MHz: 460 W + 100% AM
 - 2 GHz: 120 W + 100% AM
- ▶ Gain: typ. 6.5 dBi
- ▶ Max. wind speed (without ice deposit): 150 km/h
- ▶ Dimensions (L x W): approx. 1800 mm x 1960 mm (70.87 in x 77.17 in)
- ▶ Weight: approx. 6 kg (13 lb)

R&S®HL040E Log-Periodic Broadband Antenna



Product site

For broadband transmission and reception under open-field and laboratory conditions

Precise construction and optionally available individual calibration make the antenna suitable for field strength and EMI measurements.

Power rating and matching (VSWR) allow its use in EMS measurements where field strengths of 10 V/m or higher are required.

- ▶ Wide frequency range
- ▶ Suitable for susceptibility and emission measurements
- ▶ Stable radiation patterns over frequency range ensure optimum illumination of EUT
- ▶ Low cross-polarization
- ▶ Compact size, low weight
- ▶ Ease of handling
- ▶ Sturdy design

Specifications in brief

- ▶ Frequency range: 400 MHz to 6 GHz
- ▶ Polarization: linear
- ▶ Input impedance: 50 Ω
- ▶ VSWR: < 2.0
- ▶ Max. input power:
 - 400 MHz: 100 W CW
 - 1 GHz: 90 W CW
 - 3 GHz: 50 W CW
 - 6 GHz: 35 W CW
- ▶ Gain: typ. 5.5 dBi
- ▶ Front-to-back ratio
 - 400 MHz to 4.5 GHz: > 20 dB
 - 4.5 GHz to 6 GHz: > 15 dB
- ▶ Cross-polarization: typ. -25 dB
- ▶ Max. wind speed (without ice deposit): 275 km/h
- ▶ Dimensions (H x W x L): approx. 130 mm x 430 mm x 550 mm (5.1 in x 16.9 in x 21.6 in)
- ▶ Weight: approx. 2.5 kg (5.5 lb)

Field strength measurements

R&S®HL046E High Gain Log-Periodic Antenna



Product site

Antenna for EMS measurements

- ▶ High antenna gain, i.e. low amplifier power required
- ▶ No change of antennas needed over wide frequency range
- ▶ Uniform object irradiation due to optimized radiation patterns
- ▶ Small size, suitable for use in test chambers
- ▶ Reduced influence of test chamber
- ▶ Antenna gain approximately constant over entire frequency range
- ▶ Wall mounting possible

Specifications in brief

- ▶ Frequency range: 80 MHz to 3 GHz
- ▶ Polarization: linear
- ▶ Input impedance: 50 Ω
- ▶ VSWR: < 2 (< 2.5 GHz); < 2.5 (≥ 2.5 GHz)
- ▶ Practical gain: typ. > 8 dBi
- ▶ Max. input power
 - 80 MHz: 1400 W + 100% AM
 - 3 GHz: 250 W + 100% AM
- ▶ Optional trolley
 - Height continuously adjustable between approx. 1 m and 1.75 m above ground
 - Optional pneumatic actuators

R&S®HL050 Log-Periodic Antenna



Product site

Log-periodic directional antenna for linear polarization

- ▶ Extremely wide frequency range
- ▶ Rotation-symmetrical radiation patterns
- ▶ High gain due to V-shaped configuration of antenna elements
- ▶ Can be used in the lab and for open-area applications
- ▶ Can be used as a separate antenna or as a feed for microwave directional antennas

Specifications in brief

- ▶ Frequency range: 850 MHz to 26.5 GHz
- ▶ Polarization: linear
- ▶ Input impedance: 50 Ω
- ▶ VSWR: ≤ 2.5
- ▶ Max. input power: 10 W to 2 W
- ▶ Gain: typ. 8.5 dBi
- ▶ Max. wind speed (without ice deposit): 180 km/h
- ▶ Dimensions (∅ × H, with radome): approx. 210 mm × 300 mm (8.27 in × 11.81 in)
- ▶ Weight: approx. 0.7 kg (1.54 lb)

R&S®HL050E Log-Periodic Antenna

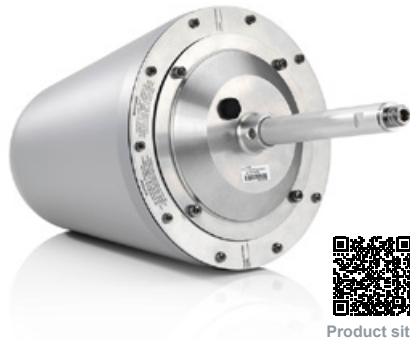

Product site

For EMI and EMS measurements

Outstanding power rating and matching (VSWR) allow its use in EMS applications where field strengths of 10 V/m or higher are required.

- ▶ Wide frequency range
- ▶ Suitable for susceptibility and emission measurements
- ▶ Stable radiation patterns over frequency range ensure optimum illumination of EUT
- ▶ Very low cross-polarization
- ▶ Compact size, low weight
- ▶ Ease of handling
- ▶ Outstanding power rating up to 6 GHz

Specifications in brief

- ▶ Frequency range: 750 MHz to 6 GHz
- ▶ Polarization: linear
- ▶ Input impedance: 50 Ω
- ▶ VSWR: typ. ≤ 2.5; < 2
- ▶ Max. input power: 100 W CW
- ▶ Gain: typ. 8.5 dBi
- ▶ Dimensions (∅ × H, with radome): approx. 210 mm × 450 mm (8.3 in × 17.7 in)
- ▶ Weight: approx. 1.4 kg (3.1 lb)

R&S®HL223 Log-Periodic Antenna

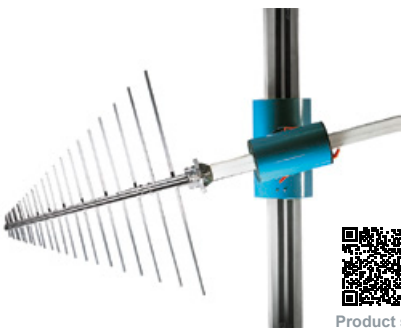

Product site

For measurement, monitoring and transmission

Owing to its broadband characteristics and the virtually frequency-independent radiation patterns, the R&S®HL223 covers a very wide frequency range. The sturdy construction makes the antenna suitable for stationary and mobile applications. Each antenna is supplied with an individual calibration certificate so that measurements can be performed in addition to monitoring and transmitting.

Specifications in brief

- ▶ Frequency range: 200 MHz to 1.3 GHz
- ▶ Polarization: linear
- ▶ Input impedance: 50 Ω
- ▶ VSWR: typ. ≤ 2, 1.6
- ▶ Max. input power: 1500 W to 600 W CW
- ▶ Gain: typ. > 6 dBi
- ▶ Max. wind speed (without ice deposit): 200 km/h
- ▶ Dimensions (L × W): approx. 710 mm × 765 mm (27.95 in × 30.12 in)
- ▶ Weight: approx. 2 kg (4.41 lb)

Field strength measurements

R&S®HM020E Triple-Loop Antenna



Product site

Fully automatic measurement of magnetic field strength

The R&S®HM020E triple-loop antenna allows fully automatic measurement of the magnetic field strength in the X, Y and Z plane as prescribed in CISPR15 and CISPR16-1-4.

- ▶ Fully automatic measurements of the magnetic field strength in the X, Y and Z planes of a DUT placed at the antenna center
- ▶ Remote control via a Rohde&Schwarz EMI receiver
- ▶ Loop system suitable for mobile use and foldable into one plane
- ▶ Wooden pedestal for 100 kg load available permitting the loops to be moved freely
- ▶ Measuring method in line with CISPR15 (refers to CISPR16-1-4)

Specifications in brief

- ▶ Frequency range: 9 kHz to 30 MHz
- ▶ Loop planes: switchable between X, Y and Z plane
- ▶ Nominal impedance: 50 Ω
- ▶ RF connector: N female
- ▶ Dimensions (W × H × D); weight
 - Loops set up: approx. 2.49 m × 2.07 m × 2.57 m (98 in × 82 in × 101 in)
 - Loops in transport crate: approx. 2.50 m × 0.43 m × 2.13 m (98 in × 17 in × 84 in)
 - Basic pedestal: approx. 0.9 m × 0.9 m × 1.0 m (35 in × 35 in × 39 in)
 - Adapter pedestal: approx. 0.9 m × 0.9 m × 0.5 m (max.) (35 in × 35 in × 20 in (max.))
 - Load capacity of pedestal: 100 kg (221 lb)

R&S®HK116E Biconical Antenna



Product site

For radiated emission measurements

- ▶ Wide frequency range
- ▶ Radiation patterns virtually independent of frequency
- ▶ Individual calibration in line with ANSI C63.5 (free-space calibration) and ARP958
- ▶ Low weight

Specifications in brief

- ▶ Frequency range: 20 MHz to 300 MHz
- ▶ Polarization: linear
- ▶ Input impedance: 50 Ω
- ▶ VSWR: typ. 2.5
- ▶ Max. input power: 75 W CW
- ▶ Dimensions (L × W × H): approx. 1380 mm × 530 mm × 780 mm (54.3 in × 20.9 in × 30.7 in)
- ▶ Weight: approx. 3 kg (6.6 lb)

R&S®HF907 Double-Ridged Waveguide Horn Antenna



Product site

Broadband directional antenna, ideal for EMC measurements

- ▶ Wide frequency range
- ▶ High gain and low VSWR for measurement of weak signals and generation of high field strengths without any significant return loss
- ▶ Radiation pattern contains only one main lobe over the entire frequency range
- ▶ Ideal for use in EMC laboratories
- ▶ Compact size, low weight
- ▶ Each antenna is calibrated individually in line with ANSI C63.5 and SAE ARP958

Specifications in brief

- ▶ Frequency range: 800 MHz to 18 GHz
- ▶ Polarization: linear
- ▶ Polarization decoupling: > 25 dB, typ. > 30 dB
- ▶ Input impedance: 50 Ω
- ▶ VSWR: ≤ 3.0 (f < 1.5 GHz); < 2.0 (f ≥ 1.5 GHz)
- ▶ Max. input power: 300 W CW/500 W PEP
- ▶ Gain: typ. 5 dBi to 14 dBi
- ▶ Dimensions (L × W × H): approx. 280 mm × 305 mm × 226 mm (11.0 in × 12.0 in × 9 in)
- ▶ Weight: approx. 1.9 kg (4.2 lb)

R&S®HL562E ULTRALOG Antenna

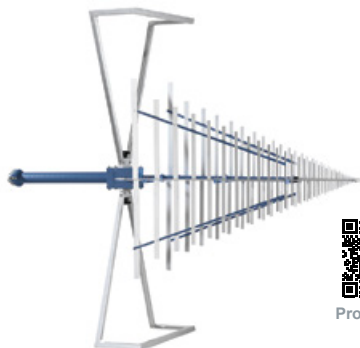

Product site

EMI and EMS measurements in an extremely wide frequency range

- ▶ Suitable for immunity tests and emission measurements
- ▶ No change of antennas needed throughout the whole frequency range
- ▶ Radiation patterns in E and H plane practically rotationally symmetrical (from 200 MHz to 6 GHz)
- ▶ Compact size, low weight
- ▶ High gain, low antenna factor
- ▶ Movable tripod optionally available
- ▶ Individual calibration in line with ANSI C63.5

Specifications in brief

- ▶ Frequency range: 30 MHz to 6 GHz
- ▶ Polarization: linear
- ▶ Cross-polarization: < -20 dB
- ▶ Nominal impedance: 50 Ω
- ▶ VSWR: typ. < 2
- ▶ Max. input power (T_{amb} = +40 °C)
 - 30 MHz: 225 W CW
 - 80 MHz: 900 W CW
 - 250 MHz: 750 W CW
 - 1 GHz: 420 W CW
 - 3 GHz: 270 W CW
 - 6 GHz: 150 W CW
- ▶ Gain: typ. 8 dBi from 200 MHz

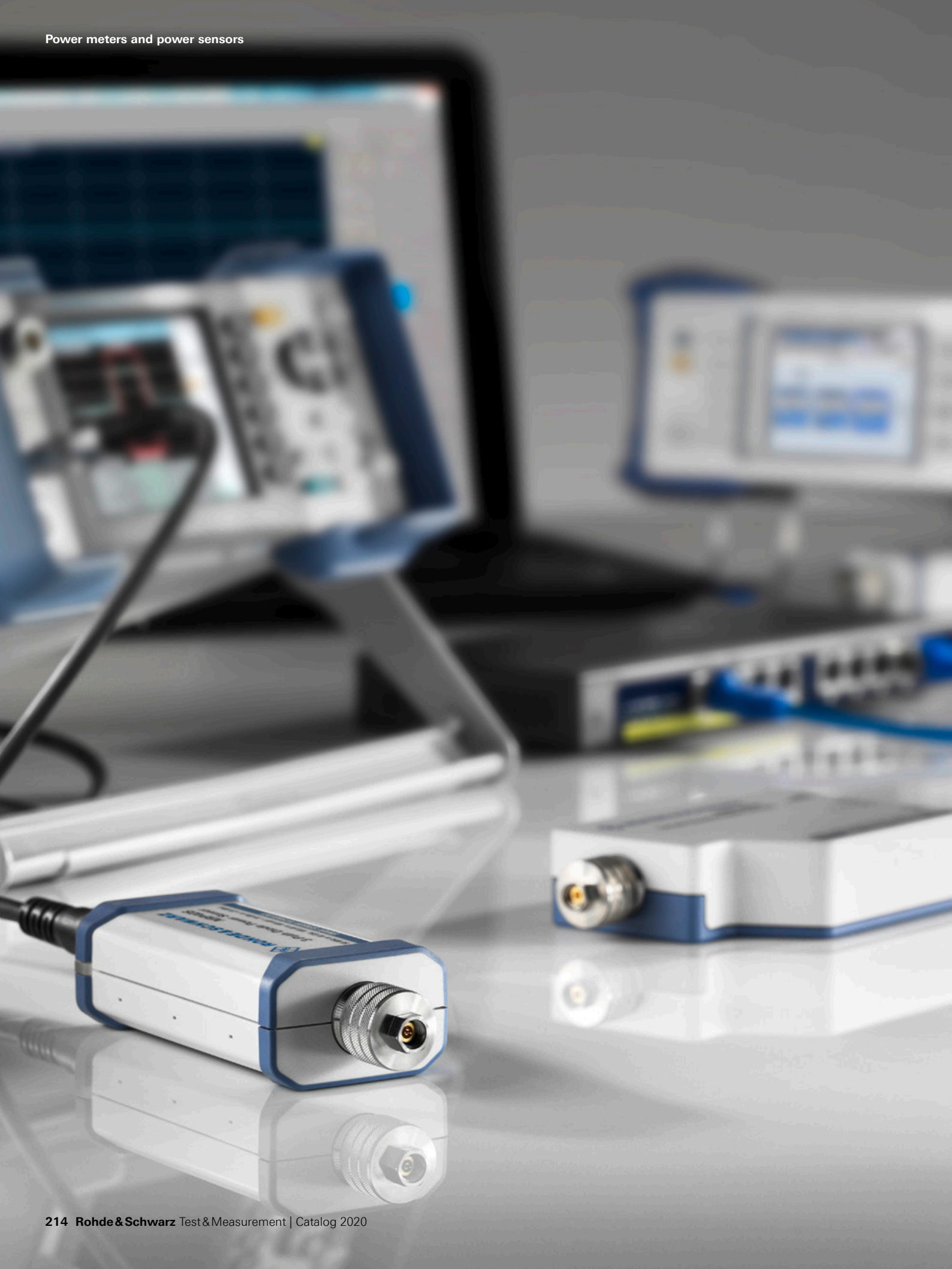

CHAPTER 8

POWER METERS AND POWER SENSORS

Power meters and power sensors from Rohde & Schwarz stand for highest measurement accuracy and reliability – and have done so for decades. Rohde & Schwarz power sensors are intelligent standalone instruments with a flexible connection concept.

The comprehensive USB-capable sensor portfolio is designed to operate with the power meter base unit or a PC/laptop. The latest power sensor family can also be controlled via LAN. This makes power meters from Rohde & Schwarz unique on the market.

Type	Designation	Description	Page
R&S®NRX	Power meter	Versatile, user-friendly base unit	216
R&S®NRP	Power sensors	USB and LAN power sensors	217
R&S®NRPxxS/SN	Three-path diode power sensors	Fast and accurate power measurements for CW and modulated signals	217
R&S®NRP18S-xx	High-power three-path diode power sensors	Fast and accurate power measurements for CW and modulated signals	217
R&S®NRPxxT/TN/TWG	Thermal power sensors	Highest measurement accuracy	217
R&S®NRPxxA/AN	Average power sensors	Designed for EMC applications	217
R&S®NRP-Zxx	Power sensors	USB power sensors for power measurements with a base unit or standalone on a PC	218
R&S®NRQ6	Frequency selective power sensor	A milestone in power measurements	219
R&S®NRPV	Virtual power meter	RF power measurements with R&S®NRP and R&S®NRP-Zxx power sensors on a PC	220
R&S®NRP-Z5	Sensor hub	Connecting up to four R&S®NRPxxS/SN and R&S®NRP-Zxx power sensors	220
R&S®NRPC	Calibration kits	Calibration of power sensors	221
R&S®NRT2	Power reflection meter	Directional power meter measures forward and reflection power between source and load	222
R&S®NRT-Zxx	Power sensors	Intelligent sensors: simply plug in and measure	222
R&S®NRPM	Over-the-air (OTA) power measurement solution	For 5G, WLAN IEEE 802.11ad and IEEE 802.11ay and automotive radar	223

► [Power sensor overview on page 224](#)

R&S®NRX POWER METER



Versatile, user-friendly base unit

The R&S®NRX simultaneously supports up to four power sensors of the R&S®NRP and R&S®NRQ family. Function keys on the front panel provide quick access to the most important functions. Users can open the frequency setting menu or zero the connected sensors at the push of a button. Presets for all major mobile radio standards, such as 3GPP LTE, 3GPP WCDMA, GSM/EDGE, WLAN and Bluetooth®, ensure correct measurement.

The 5" TFT color display supports the intuitive, window-based operating concept. Key parameters and functions are color-coded and can be seen at a glance. Results are presented in numerical and graphical display windows that can be easily configured.

Trace measurements and statistical measurements are presented in graphical windows. The trace mode allows simultaneous display of two traces in one measurement window. Level differences and time offset can be seen at a glance and accurately measured using horizontal and ver-

tical markers. It is also possible to display the ratio of two traces. The statistical amplitude distribution of the envelope power is shown as CCDF, CDF or PDF in a statistics window.

Hardware interfaces for remote control and triggering

The R&S®NRX provides three different remote interfaces for integration in automated test setups as standard: Ethernet, USB and optionally GPIB (R&S®NRX-B8). A trigger input on the rear panel permits external triggering for synchronized power measurements.

Expandable to up to four measurement channels

The R&S®NRX standard configuration includes one measurement channel. The base unit can be optionally expanded to two (R&S®NRX-K2) or four (R&S®NRX-K2 and R&S®NRX-K4) measurement channels.

Power reflection measurements

The R&S®NRX optionally provides the R&S®NRX-B9 interface for the R&S®NRT2 directional power sensors.

Code emulation of the R&S®NRP2

The R&S®NRX can interpret the command set of the predecessor, the R&S®NRP2.

Sensor check source

An optional high-precision 50 MHz/1 GHz reference source module can be used in CW mode to check the function of all R&S®NRP power sensors and in pulse mode the pulse measurement performance of the R&S®NRP-Z8x and R&S®NRQ power sensors.

Multiple ways to operate the R&S®NRP power sensors

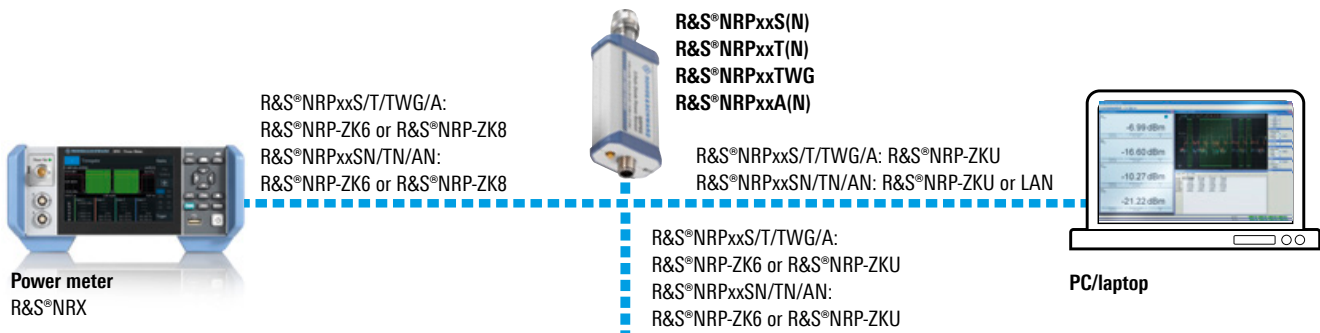

Supported Rohde & Schwarz instruments



Signal generators
e.g. R&S®SMW200A



Signal and spectrum analyzers
e.g. R&S®FSW



Network analyzers
e.g. R&S®ZVA



R&S®NRP USB AND LAN POWER SENSORS



Taking power measurements to the next level

The R&S®NRPxxS(N) three-path diode power sensors, R&S®NRPxxT(N) thermal power sensors and R&S®NRPxxA(N) average power sensors are self-contained, fully characterized instruments. They can be operated with the R&S®NRP2 base unit, with a laptop/PC via USB, and with many Rohde&Schwarz instruments (e.g. signal generators, signal and spectrum analyzers, network analyzers). The R&S®NRPxxSN, R&S®NRPxxTN and R&S®NRPxxAN power sensors additionally offer LAN capability, allowing remote control over large distances.

Key facts

- ▶ Maximum dynamic range: -70 dBm to $+45$ dBm
- ▶ Frequency range: DC to 110 GHz
- ▶ More than 50 000 readings/s
- ▶ Flexible operation with R&S®NRP2 base unit, laptop/PC and many Rohde&Schwarz instruments

Remote monitoring of power sensors

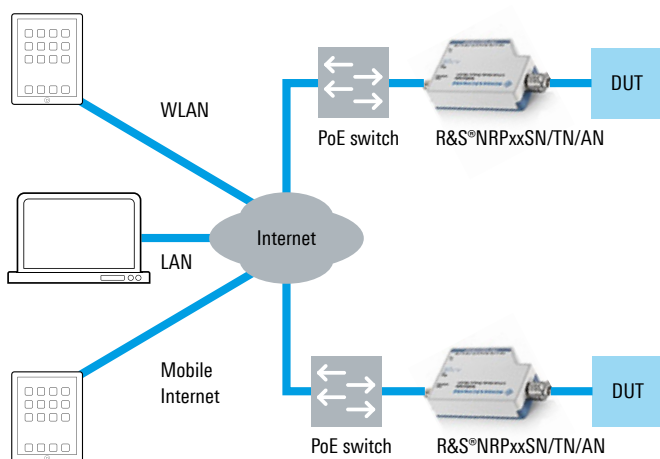

Simultaneous, location-independent remote monitoring of multiple R&S®NRPxxSN/TN/AN power sensors using a web browser

- ▶ Control and monitoring via LAN and USB
- ▶ Easy LAN operation from a web browser
- ▶ R&S®NRPxxS(N) for widest dynamic range
- ▶ R&S®NRPxxT(N) for highest accuracy
- ▶ R&S®NRPxxA(N) for EMC applications

The R&S®NRP power sensors have long been recognized for delivering supreme precision and speed. The R&S®NRPxxS(N), R&S®NRPxxT(N) and R&S®NRPxxA(N) power sensors take power measurements to the next level. They offer USB capability and can be additionally controlled via LAN. This makes the R&S®NRP power meter portfolio unique in the industry.

Intelligent, LAN enabled power measurements

- ▶ Almost every sensor available as LAN model
- ▶ Remote monitoring via LAN over any distance
- ▶ Power supply via Power over Ethernet (PoE)
- ▶ Built-in web GUI with full power measurement support

Sensor types

Three-path diode power sensors

R&S®NRP8S(N) ¹⁾	8 GHz, -70 dBm to $+23$ dBm, N (m)
R&S®NRP18S(N) ¹⁾	18 GHz, -70 dBm to $+23$ dBm, N (m)
R&S®NRP33S(N) ¹⁾	33 GHz, -70 dBm to $+23$ dBm, 3.5 mm (m)
R&S®NRP40S(N) ¹⁾	40 GHz, -70 dBm to $+20$ dBm, 2.92 mm (m)
R&S®NRP50S(N) ¹⁾	50 GHz, -70 dBm to $+20$ dBm, 2.4 mm (m)

High power three-path diode power sensors (up to 30 W)

R&S®NRP18S-10	18 GHz, -60 dBm to $+33$ dBm, N (m)
R&S®NRP18S-20	18 GHz, -50 dBm to $+42$ dBm, N (m)
R&S®NRP18S-25	18 GHz, -45 dBm to $+45$ dBm, N (m)

TVAC-compliant three-path diode power sensor

R&S®NRP33SN-V	33 GHz, -70 dBm to $+23$ dBm, 3.5 mm (m), LAN
---------------	---

Thermal power sensors

R&S®NRP18T(N) ¹⁾	18 GHz, -35 dBm to $+20$ dBm, N (m)
R&S®NRP33T(N) ¹⁾	33 GHz, -35 dBm to $+20$ dBm, 3.5 mm (m)
R&S®NRP40T(N) ¹⁾	40 GHz, -35 dBm to $+20$ dBm, 2.92 mm (m)
R&S®NRP50T(N) ¹⁾	50 GHz, -35 dBm to $+20$ dBm, 2.4 mm (m)
R&S®NRP67T(N) ¹⁾	67 GHz, -35 dBm to $+20$ dBm, 1.85 mm (m)
R&S®NRP110T	110 GHz, -35 dBm to $+20$ dBm, 1 mm (m)

Thermal waveguide power sensors

R&S®NRP75TWG	75 GHz, -35 dBm to $+20$ dBm, WR-15
R&S®NRP90TWG	90 GHz, -35 dBm to $+20$ dBm, WR-12
R&S®NRP110TWG	110 GHz, -35 dBm to $+20$ dBm, WR-10

Average power sensors

R&S®NRP6A(N) ¹⁾	6 GHz, -70 dBm to $+23$ dBm, N (m)
R&S®NRP18A(N) ¹⁾	18 GHz, -70 dBm to $+23$ dBm, N (m)

¹⁾ The R&S®NRPxxN models additionally offer LAN capability, allowing remote control over large distances.



Product site
R&S®NRPxxS(N)



Product site
R&S®NRPxxT(N)/TWG



Product site
R&S®NRPxxA(N)



Product site
R&S®NRP18S-xx

R&S®NRP-Zxx POWER SENSORS

The right sensor for all applications

The R&S®NRP-Zxx power sensors function as independent measuring instruments and are completely characterized over frequency, level and temperature. The sensors can be operated either on an R&S®NRX base unit or directly on a laptop/PC. They are also supported by numerous signal generators, signal analyzers, spectrum analyzers and network analyzers from Rohde&Schwarz.

Solution for accurate level calibration

The R&S®NRP-Z27/-Z37 power sensor modules turn the R&S®FSMR measuring receivers into precision power meters with a wide dynamic range from -115 dBm to +30 dBm. The R&S®NRP-Z27 and -Z37 power sensor modules were developed especially for level calibration using the R&S®FSMR measuring receiver. These sensors act as highly accurate references for determining the absolute power level.

R&S®FSMR measuring receiver with R&S®NRP-Z27/-Z37 power sensor module

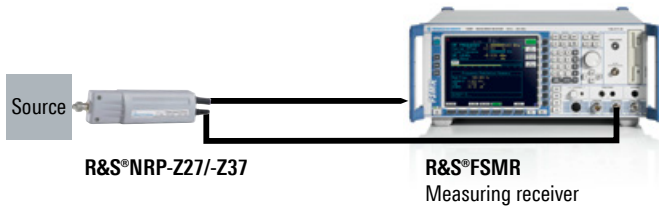

Constant monitoring of signal generator output power and automated level correction using the R&S®NRP-Z28/-Z98 level control sensor

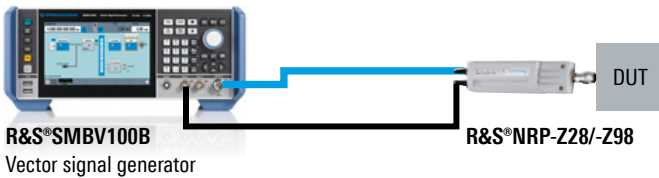

R&S®NRP-Z81/-Z85/-Z86 wideband power sensors



Feeding accurate power level to a device under test

The R&S®NRP-Z28/-Z98 level control sensors provide an integrated power splitter. One part is measured by the integrated power sensor and displayed on a Rohde&Schwarz signal generator, on the R&S®NRX base unit or on a laptop/PC. The other part, which is identical to the measured part, is output at the sensor's RF output and can be directly fed to the DUT.

Up to 44 GHz

The R&S®NRP-Z8x wideband power sensors are ideal for power measurements on microwave link modules. Especially the R&S®NRP-Z86 model .44 (upper frequency limit of 44 GHz) can be used for the development, production, installation and maintenance of the latest generation of microwave link modules. The user benefits from the sensor's high measurement speed and large dynamic range.

Cost-effective solution for production applications

The R&S®NRP-Z211/-Z221 two-path diode power sensors combine all key characteristics relevant for their use in production. They are cost-effective, fast, precise and USB-capable. The sensors support the same measurement functions as the R&S®NRPxxS three-path diode power sensors and offer the best price/performance ratio in their class.

▶ See also the chapter probes in overview on page 224.

R&S®NRP-Z211/-Z221 two-path diode power sensors



R&S®NRQ6 FREQUENCY SELECTIVE POWER SENSOR



A milestone in power measurements

The R&S®NRQ6 combines the accuracy of a power meter with excellent dynamic range. It is based on receiver technology and can perform band-limited power measurements – i.e. power measurements on a selected transmission channel – down to -130 dBm. The R&S®NRQ6 delivers high-precision, high-speed measurements beyond the limits of currently available power meters.

In addition to conventional continuous average measurements, the R&S®NRQ6 has a trace display function and also performs ACLR measurements – a common mobile communications application. Using the optional R&S®NRQ6-K1 I/Q data interface, I/Q data can be downloaded from the power sensor to a PC for further analysis.

The R&S®NRQ6-K2 power servoing option enables a dedicated high-speed remote control channel for fast power servoing between an R&S®NRQ6 and an R&S®SGT100A RF vector RF source. This significantly improves the typical setting time via SCPI.

Using additionally the R&S®NRQ6-K3 phase coherent measurements option, complex phase coherent measurements can be carried out by configuring one master R&S®NRQ6 and one or multiple slave R&S®NRQ6.

The R&S®NRQ6 is controlled via LAN, requiring power over Ethernet (PoE+). The sensor's integrated web server makes it possible to operate the GUI without any extra software – all that is needed is a PC with a web browser. The intuitive GUI is well structured and easy to operate thanks to diverse autoset functions.

Key facts

- ▶ Frequency selective power measurements
- ▶ Frequency range: 50 MHz to 6 GHz
- ▶ Power measurement range: -130 dBm to $+20$ dBm
- ▶ 100 MHz measurement bandwidth
- ▶ I/Q data capturing for RF vector signal analysis
- ▶ Phase coherent measurements for low-power modulated signals

Diverse measurement functions

- ▶ Continuous average power measurements down to -130 dBm – precise and fast
- ▶ I/Q data capturing for RF vector signal analysis
- ▶ Phase coherent measurements
- ▶ Trace measurements
- ▶ ACLR measurements
- ▶ Ultrafast triggered pulse measurements
- ▶ RF power, EVM and phase measurements with one single instrument

Easy operation

- ▶ Intuitive web GUI
- ▶ Diverse autoset functions
- ▶ Automatic frequency tracking
- ▶ Spectrum display for signal check
- ▶ Hardware interfaces for user convenience

Applications

- ▶ TX power calibration
- ▶ Band-limited power measurements on multistandard radios (MSR)
- ▶ Fast power servoing with R&S®NRQ6 and R&S®SGT100A
- ▶ Calibration of multiple active antenna modules for beamforming



Using the optional R&S®NRQ6-K1 I/Q data interface, I/Q data can be downloaded from the power sensor to a PC for further analysis



R&S®NRPV VIRTUAL POWER METER



Convenient power measurements via PC

Sophisticated PC application

In combination with the R&S®NRPV virtual power meter software, the USB capability of the R&S®NRP power sensors can be ideally utilized. The software covers all sensor functions and supports up to four sensors connected to a laptop/PC via the R&S®NRP-Z3/-Z4 USB adapter cables or the R&S®NRP-Z5 sensor hub. The sensors are automatically detected when plugged in and added to all open measurement windows (hot plugging).

This cost-effective measurement solution supports all available measurement modes. Mathematical calculations during measurements to determine the SWR, difference or ratio are possible in the ContAv, gated average and burst average numerical modes and in the graphical trace mode.

Multifunctional trace mode window

The trace mode is supported by all three-path diode power sensors, two-path diode power sensors and wideband power sensors. Up to four trace measurements and four mathematical traces can be simultaneously displayed in one window.

Intelligent licensing: dongle-free on multiple PCs

The R&S®NRPV virtual power meter software can be installed on an unlimited number of laptops/PCs. For use with the R&S®NRPV software, each R&S®NRP-Zxx power sensor has to be activated individually using the sensor-related R&S®NRPZ-K1 keycode option. Once activated, the sensor can be operated on any laptop/PC. This licensing concept eliminates the need for USB dongles and does not tie a license to a specific laptop/PC.

Key facts

- ▶ Support of all sensor dependent measurement modes
- ▶ Support of all R&S®NRPxxS(N), R&S®NRPxxT(N), R&S®NRPxxA(N) series power sensors (free of charge)
- ▶ R&S®NRP-Zxx operational with a sensor based keycode option R&S®NRPZ-K1
- ▶ Multiple traces in one measurement window
- ▶ Automatic pulse analysis
- ▶ Flexible marker functionality
- ▶ Dongle free on multiple PCs



Product site

R&S®NRP-Z5 SENSOR HUB



Connecting up to four R&S®NRP and R&S®NRP-Zxx power sensors

The R&S®NRP-Z5 can host up to four R&S®NRP power sensors. A professional trigger solution allows simultaneous internal and external triggering of all connected sensors.

Key facts

- ▶ Connection of up to four R&S®NRPxxS(N), R&S®NRPxxT(N), R&S®NRPxxA(N) (with R&S®NRP-ZK6) or R&S®NRP-Zxx power sensors
- ▶ Internal triggering, individual for each sensor
- ▶ Bidirectional trigger bus for external and synchronous triggering
- ▶ Trigger master mode (with R&S®NRP-Z8x)



Product site

R&S®NRPC CALIBRATION KITS



Optional verification sensor
R&S®NRPCxx-B1

Calibration of power sensors

The five modular R&S®NRPC calibration kits are used to calibrate R&S®NRP power sensors, as well as other power sensors from Rohde & Schwarz make, to a very high level of accuracy. Following calibration, the sensors are within the specified calibration uncertainties and usually remain below these uncertainties. Each calibration kit includes a highly accurate power standard that is traceable to primary power standards of the Physikalisch-Technische Bundesanstalt (PTB, Germany's national metrology institute) by means of a calibration accredited by the Deutsche Akkreditierungsstelle (DAkkS, Germany's national accreditation body).

Calibration kits with optional verification sensors

R&S®NRPC18	DC to 18 GHz, 10 μ W to 100 mW, N
R&S®NRPC18-B1	Verification sensor for R&S®NRPC18
R&S®NRPC33	DC to 33 GHz, 10 μ W to 100 mW, 3.5 mm
R&S®NRPC33-B1	Verification sensor for R&S®NRPC18
R&S®NRPC40	DC to 40 GHz, 10 μ W to 100 mW, 2.92 mm
R&S®NRPC40-B1	Verification sensor for R&S®NRPC18
R&S®NRPC50	DC to 50 GHz, 10 μ W to 100 mW, 2.4 mm
R&S®NRPC50-B1	Verification sensor for R&S®NRPC18
R&S®NRPC67	DC to 67 GHz, 10 μ W to 100 mW, 1.85 mm
R&S®NRPC67-B1	Verification sensor for R&S®NRPC18



Product site

High quality and reliability

- ▶ More than 30 years of experience in manufacturing power meters
- ▶ Superior to thermistor-based power standards
- ▶ Verification sensor for daily checking
- ▶ Exchangeable test port

Precise and accurate

- ▶ Direct link to Germany's national metrology institute
- ▶ Gamma correction as an important prerequisite
- ▶ Dependable specifications

Cost-efficient

- ▶ Flexible, modular concept
- ▶ High throughput

Remote-control calibration

- ▶ R&S®Recal+ user interface
- ▶ ZVX_Recal plug-in for integrating Rohde & Schwarz vector network analyzers
- ▶ No miscalibrations
- ▶ Integration into application programs

Verification sensor

The R&S®NRPCxx-B1 option is used for regular verification of each R&S®NRPC model. It consists of a thermal power sensor calibrated to the associated power standard and aligned such that it displays, for each frequency point, the same value as the power standard.

Key facts

- ▶ Program-controlled calibration of the power sensors of the R&S®NRP and R&S®FSH families
- ▶ Short measurement times for high throughput
- ▶ Modular concept for cost-effective, flexible operation
- ▶ DAkkS-accredited, PTB-traceable

Application example: power meter R&S®NRX with R&S®NRP08S and R&S®NRP50S 3-path diode power sensors



R&S®NRT2 POWER REFLECTION METER, R&S®NRT-Zxx DIRECTIONAL POWER SENSORS



Power measurement on transmitters, amplifiers, industrial RF and microwave generators

Directional power sensors measure forward and reverse power under operating conditions. These measurements are required when installing, servicing and monitoring transmitters, antennas and RF generators. The R&S®NRT family consists of the R&S®NRT2 power reflection meter and various R&S®NRT-Zxx directional power sensors. Thanks to their wide range of measurement functions and high accuracy, they are suitable for use in research, development and production.

The R&S®NRT-Zxx directional power sensors are self-contained measuring instruments. They can be connected directly to the R&S®NRT2 or, via the R&S®NRT-Z5 USB interface adapter, to the PC (communications via USB).

The compact R&S®NRT2 power reflection meter supports all the measurement functions of the R&S®NRT-Zxx directional power sensors. The large, user-friendly touchscreen simultaneously displays the forward and reverse power. The base unit is exceptionally easy and intuitive to use and can be remotely controlled via LAN, GPIB (R&S®NRT2-B8 option) or USB.

Key facts

- ▶ Simultaneous display of forward and reverse power
- ▶ Measurement of average power, average burst power, peak power, crest factor, CCDF and mismatch
- ▶ 5" color touchscreen

Power reflection meter with optional power sensors	
R&S®NRT2	Power reflection meter (base unit)
Directional power sensors (optional)	
R&S®NRT-Z14	120 (300) W, 25 MHz to 1 GHz
R&S®NRT-Z43	30 (75) W, 0.4 GHz to 4 GHz
R&S®NRT-Z44	120 (300) W, 0.2 GHz to 4 GHz

- ▶ Direct operation of the R&S®NRT-Zxx directional power sensors from a PC
- ▶ Frequency range from 25 MHz to 4 GHz (sensor-dependent)

Versatile applications

- ▶ Continuous monitoring of transmitter systems
- ▶ Power measurements with digital modulation

R&S®NRT2 power reflection meter

- ▶ Simple touchscreen operation
- ▶ Simultaneous display of forward and reverse power
- ▶ Analog bargraph and autoscale
- ▶ Visual limit monitoring
- ▶ 100% code compatibility with predecessor model

R&S®NRT-Zxx directional power sensors

The R&S®NRT-Zxx directional power sensors are fully calibrated, independent measuring instruments that can also be used without the base unit.

The R&S®NRT-Z14, R&S®NRT-Z43 and R&S®NRT-Z44 power sensors make high-precision power and reflection measurements extremely cost-effective. Direct monitoring on a PC is very useful in applications where data needs to be collected (e.g. in development labs and for maintenance of base stations) as well as for purely remote controlled applications such as power monitoring in transmitter stations and EMC test systems. The R&S®V-NRT Windows user interface (supplied with the sensors) allows users to define measurement functions and also display and store individual results and series of measurements.



The optional R&S®NRT-Z5 USB interface adapter enables direct connection of an R&S®NRT-Zxx directional power sensors to a laptop/PC



R&S® NRPM OVER-THE-AIR (OTA) POWER MEASUREMENT SOLUTION

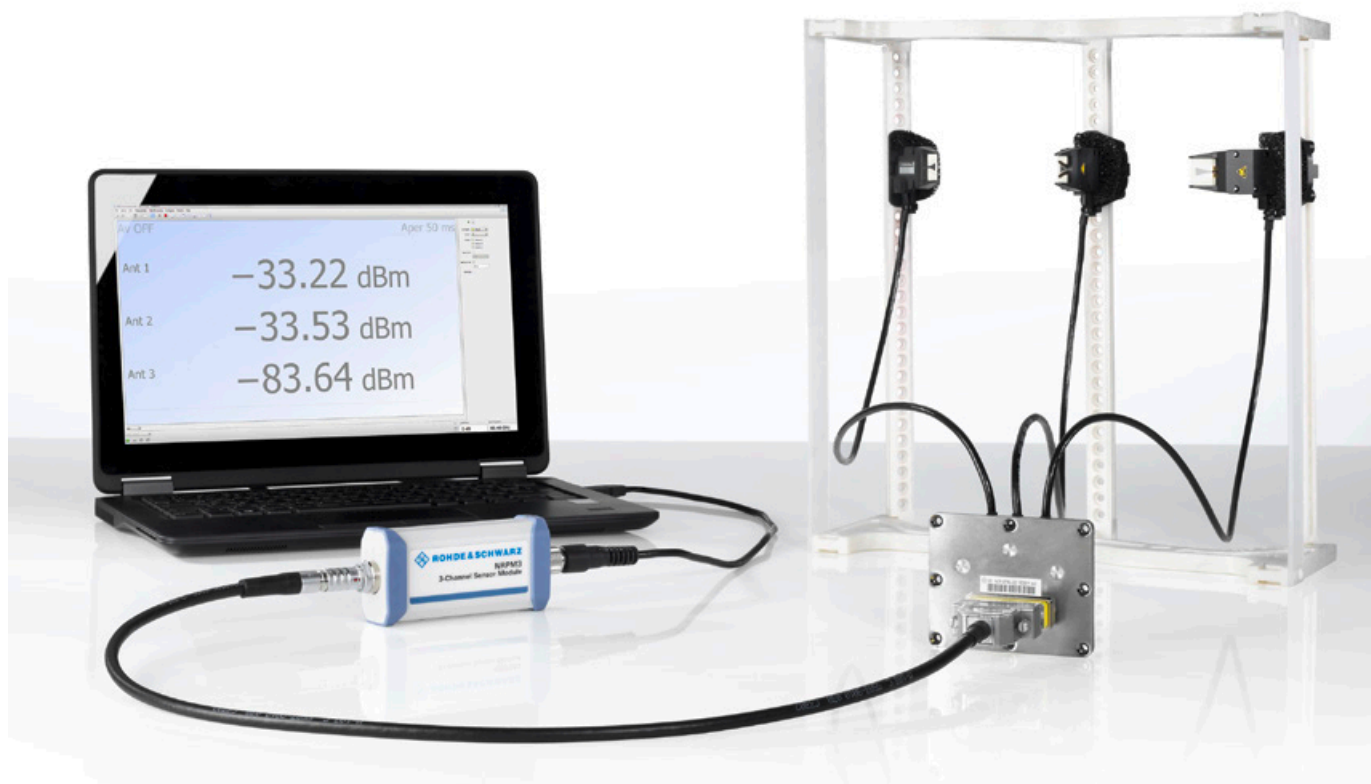

For 5G, WLAN IEEE 802.11ad and IEEE 802.11ay and automotive radar

The R&S®NRPM OTA power measurement solution is designed to calibrate the transmit antenna output power and test the beamforming function over the air.

The R&S®NRPM OTA power measurement solution is ideal for these measurements. The fully calibrated R&S®NRPM antenna modules, a Vivaldi antenna with an integrated diode detector, measure the power directly at the receive antenna. The number of antenna modules can be selected to scale the system to meet different test requirements. The economical base configuration with one antenna module measures the power of the incident wave from the DUT to the antenna module. More antenna modules can be added to test the beamforming function.

Components of the R&S®NRPM OTA power measurement solution

R&S®NRPM3	Three-channel sensor module
R&S®NRPM-A90	R&S®NRPM-A90 single-polarized antenna module
R&S®NRPM-A90D	R&S®NRPM-A90D dual-polarized antenna module
R&S®NRPM-ZD3	R&S®NRPM-ZD3 filtered cable feedthrough for shielded RF test box
R&S®NRPM-Z3	R&S®NRPM-Z3 interface module for benchtop application

Monitoring and operation can be performed by connecting the R&S®NRPM3 sensor module to a laptop/PC via R&S®NRP-ZKU USB interface cable (available as accessories).

Key facts

- ▶ For 5G, WLAN IEEE 802.11ad and IEEE 802.11ay and automotive radar
- ▶ Frequency range from 18 GHz to 90 GHz
- ▶ Ideal for beamforming tests
- ▶ Fully calibrated antenna module with integrated diode detector
- ▶ Highest sensitivity
- ▶ Low reflection antenna module
- ▶ Scalable to customer requirements
- ▶ Fits perfectly into Rohde&Schwarz shielded RF test box

Solution components

- ▶ Single-polarized antenna module
- ▶ Dual-polarized antenna module
- ▶ Filtered cable feedthrough
- ▶ Three-channel sensor module
- ▶ Interface module for benchtop application
- ▶ Measuring and monitoring with R&S®Power Viewer Plus software
- ▶ Compact test setup with R&S®TS7124 shielded RF test box

Test applications

- ▶ General OTA power calibration
- ▶ System calibration for OTA receiver tests
- ▶ TX antenna gain calibration
- ▶ TX beamforming verification



Videos



Product site

POWER SENSOR OVERVIEW

Level range

-70 dBm -60 -50 -40 -30 -20 -10 0 +10 +20 +30 +40 dBm

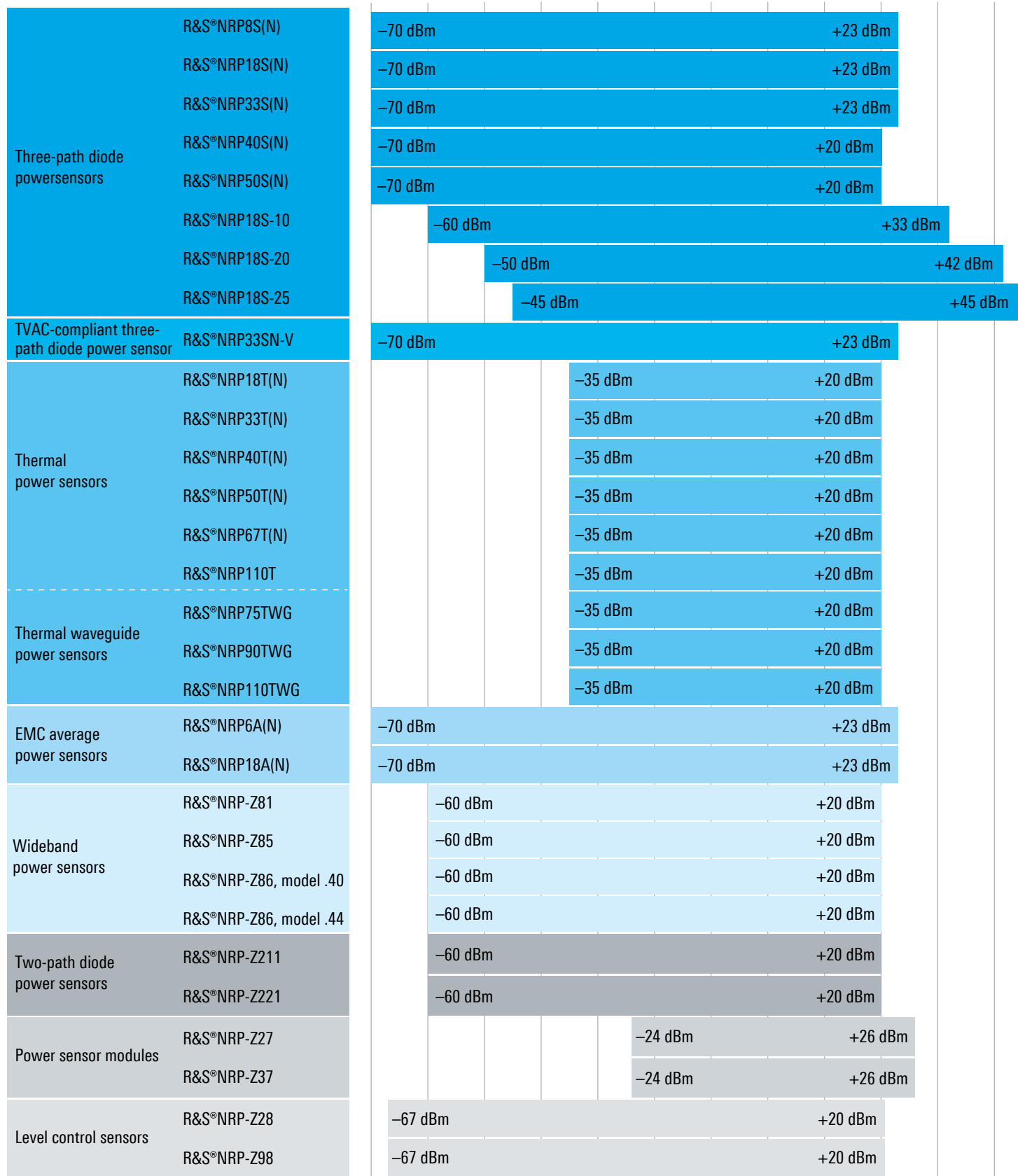

Frequency range

Connector type

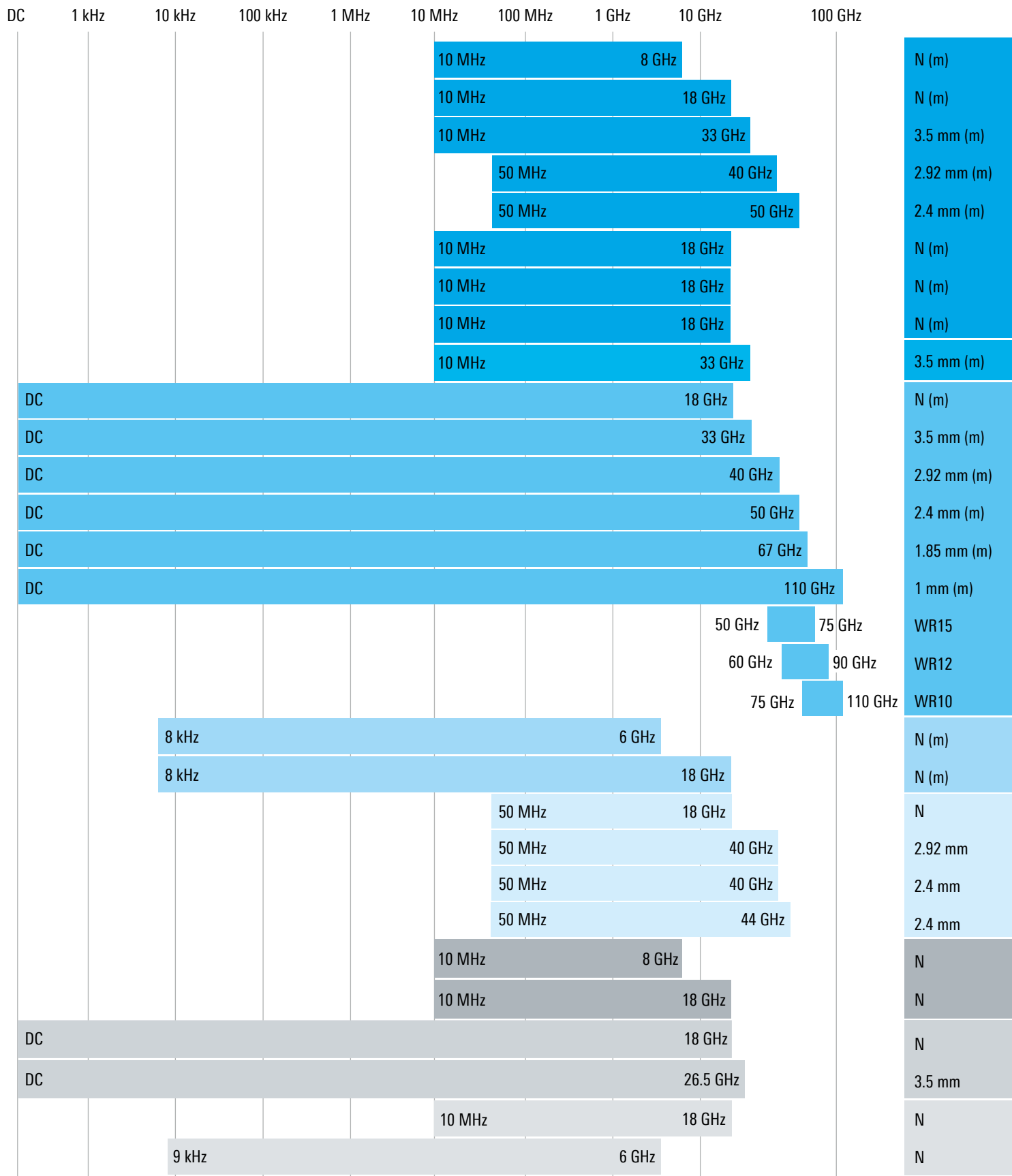

8

CHAPTER 9

AUDIO ANALYZERS

Measurement accuracy and dynamic range at the limits of what is possible combined with unique measurement capabilities make audio analyzers from Rohde & Schwarz ideal for research, development and quality assurance tasks.

Rohde & Schwarz audio analyzers enable users to perform virtually all measurements required in the audio world. For analog and digital interfaces, audio analyzers specially designed for use in production deliver the high measurement speed, parallel signal processing in multichannel applications and stable continuous operation that are vital in this environment.

Type	Designation	Description	Page
R&S®UPV	Audio analyzer	Compact instrument for all audio measurements	227
R&S®UPP	Audio analyzer	Audio analyzer for use in the lab and in production	228
R&S®UPZ	Audio switcher	Multichannel switcher for audio channel inputs and outputs	229



R&S® UPV AUDIO ANALYZER

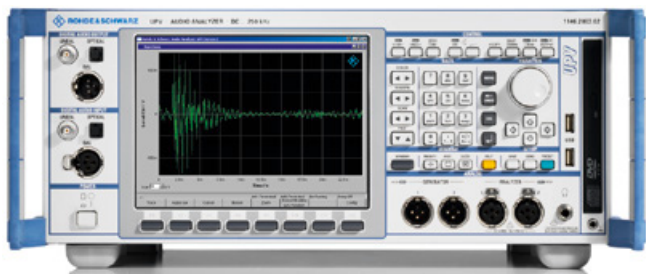

Compact instrument for all audio measurements

The R&S®UPV enables users to perform virtually all measurements that are necessary in the audio world: frequency response measurement, total harmonic distortion (THD) displays, spectral displays, analysis of digital interfaces and much more. The generator is just as versatile. It can be used to create any conceivable signal from sine-wave and noise signals up to multisine-wave signals.

Key facts

- ▶ Suitable for all interfaces: analog, digital and combined
- ▶ Simultaneous display of multiple measurement functions
- ▶ Sampling rate up to 400 kHz
- ▶ User-programmable filters for analyzer and generator
- ▶ Compact all-in-one instrument with integrated PC
- ▶ Slots for optional interfaces

¹⁾ PESQ®, PEAQ® and POLQA® are registered trademarks of OPTICOM Dipl.-Ing. M. Keyhl GmbH, Germany.

All test signals/measurement functions in a single box

- ▶ Wide variety of analog and digital (optional) test signals
- ▶ Extensive measurement capabilities, on analog and digital (optional) interfaces
- ▶ Efficient as well as multichannel FFT analysis with a resolution down to the mHz range
- ▶ User-programmable filters can be adapted to the measurement task at hand in only a few seconds
- ▶ Everything included; no peripherals required

Largest variety of interfaces in a single instrument

- ▶ Analog generator outputs as standard
- ▶ Dual-channel analyzer with analog inputs as standard
- ▶ Expansion to 8 or 16 measurement channels
- ▶ Digital audio interfaces (optional)
- ▶ Digital protocol analysis and generation (optional)
- ▶ Jitter and interface test (optional)
- ▶ Test of audio ICs with I²S interfaces (optional)
- ▶ Virtually any audio circuit adaptable using the universal serial interface (optional)
- ▶ PDM bitstream analysis (optional)

Options for other applications

- ▶ The PESQ®¹⁾ measurement option analyzes speech signals in line with psycho-acoustic methods
- ▶ The PEAQ® measurement option analyzes broadband audio signals in line with psycho-acoustic methods
- ▶ The POLQA® measurement option analyzes broadband speech quality in line with psycho-acoustic methods
- ▶ Standard-compliant measurements on hearing aids
- ▶ Acoustic measurements on mobile phones

R&S®UPV-B41 option: I²S interface; R&S®UPV-B42 option: universal serial interface

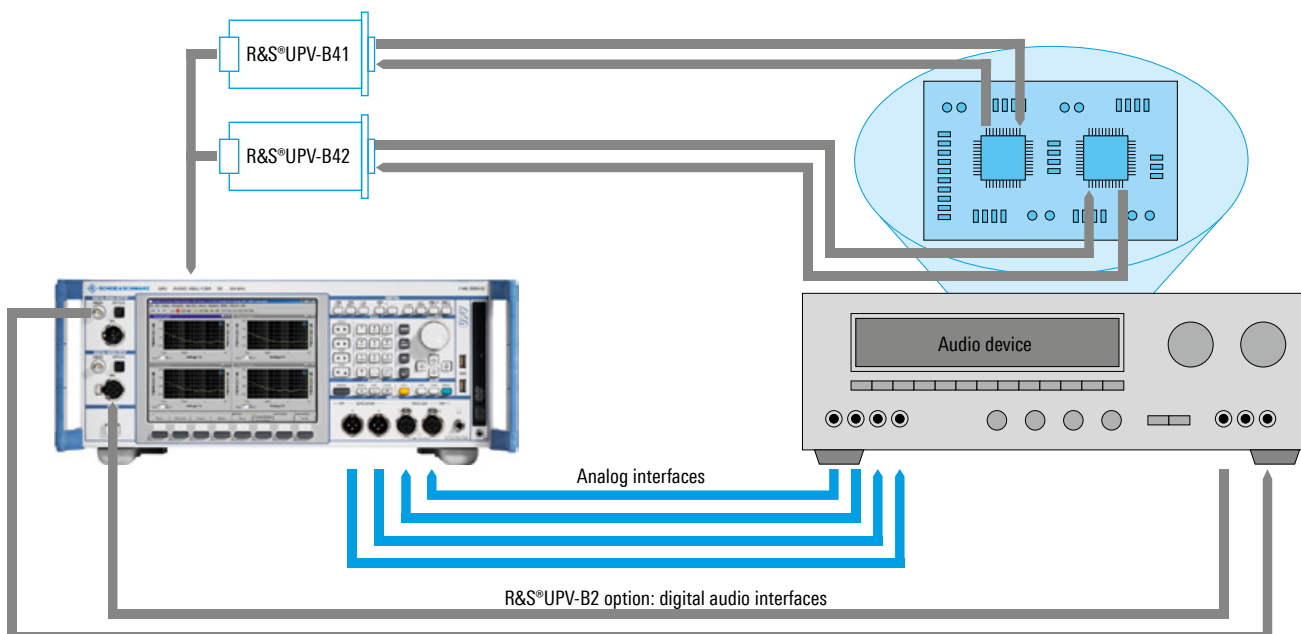

Configurator



Product site

R&S® UPP AUDIO ANALYZER



Audio analyzer for use in the lab and in production

High measurement speed, parallel signal processing in multichannel applications and high reliability in continuous operation are vital requirements to be met by audio analyzers used in production. If, on top of that, a cost-efficient instrument is what you need, the solution is the R&S®UPP audio analyzer.

Key facts

- ▶ Suitable for all interfaces: analog, digital and combined
- ▶ Parallel measurements on up to eight channels
- ▶ Up to 80 kHz bandwidth and 200 kHz sampling rate
- ▶ User-programmable filters for analyzer and generator
- ▶ Compact instrument with integrated PC and low height

Powerful and fast

- ▶ Parallel measurements for high throughput
- ▶ High measurement speed throughout the system
- ▶ Ideal for use in production
- ▶ Multichannel measurements by means of cascading

Cascading several R&S®UPP audio analyzers

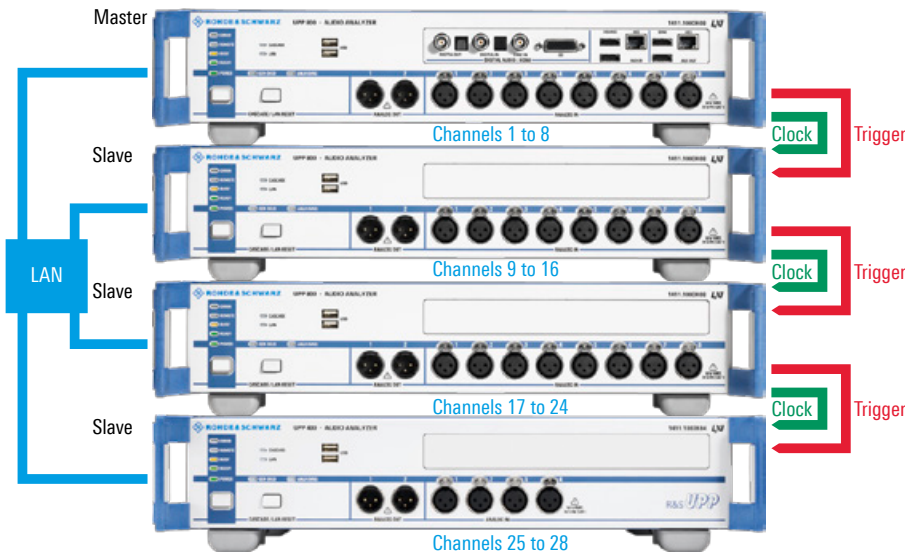

If more than eight channels have to be measured in parallel, several R&S®UPP audio analyzers can be cascaded. The master, an R&S®UPP800, controls the other audio analyzers, so the entire cascade acts as a single measuring instrument.

All test signals and measurement functions in a single box

- ▶ Generation of a wide variety of analog and – optional – also digital test signals
- ▶ Broad scope of measurements on both analog and – optional – digital interfaces
- ▶ Powerful and even multichannel FFT analysis with resolution down to below 1 Hz
- ▶ User-programmable filters that can be adapted in seconds to the individual measurement task
- ▶ Integrated control PC; manual operation requires only an external monitor and a mouse and keyboard

Large variety of interfaces in a single instrument

- ▶ Two-, four- or eight-channel analyzer with analog inputs
- ▶ Analog generator outputs (two-channel)
- ▶ Eight-channel generator (optional)
- ▶ AES/EBU and S/PDIF interfaces for measuring digital audio components (optional)
- ▶ I²S interfaces for testing audio ICs (optional)
- ▶ HDMI™ device testing (optional)
- ▶ Interfaces for the generator and analyzer can be set independently of one another and used together in any combination

Convenient operation throughout

- ▶ State-of-the-art and intuitive user interface
- ▶ All measurement results at a glance
- ▶ Effective online help functions



R&S®UPZ AUDIO SWITCHER



Multichannel switcher for audio channel inputs and outputs

As an add-on unit to the Rohde&Schwarz audio analyzers, the R&S®UPZ audio switcher can be used whenever input or output signals have to be switched over to multiple channels or DUTs. Users can directly operate the switcher from the graphical user interface of the R&S®UPV and R&S®UPP audio analyzers or from a PC via its RS-232-C or USB 2.0 interfaces.

Key facts

- ▶ Available as input and output switcher
- ▶ Cascading of up to 128 channels
- ▶ Operation directly from the R&S®UPV or R&S®UPP audio analyzers
- ▶ Control via RS-232 or USB 2.0

Wide variety of applications for all kinds of audio measurements

Surround applications in homes, multichannel mixing consoles in sound studio environments, multichannel amplifiers as well as the adaptation of several DUTs in production are just some examples of the wide variety of applications that are possible using the R&S®UPZ audio switcher. As an add-on unit to the R&S®UPV and R&S®UPP audio analyzers, the R&S®UPZ is directly operated from the graphical user interface. Remote control, e.g. in production environments, also runs via the audio analyzer.

Up to 16 input switchers plus 16 output switchers can be cascaded, allowing up to 128 input or output channels to be switched



Available as input and output switcher

The R&S®UPZ audio switcher – like the R&S®UPV and R&S®UPP audio analyzers – comes with XLR connectors. Since there is a difference between male and female connectors in the XLR system, the R&S®UPZ is available both as an input and as an output model. Both models feature two switching channels, enabling users to simultaneously operate the two generator or measurement channels of the audio analyzer.

Applications for testing multichannel amplifiers

The standard application is paired or individual switching of the DUTs or measurement channels to be tested. In each case, one signal path is connected to an assigned channel. A special feature is measuring the crosstalk of the individual channels of multichannel amplifiers, which requires a particularly critical measurement. For this application, the signal coupled into a channel will be measured while all other amplifier channels are driven at the same time. The output switcher enables users to switch signal path B through to all channels in parallel, while signal path A can be switched to any selectable channel.

Switch paths with the R&S®UPZ switcher

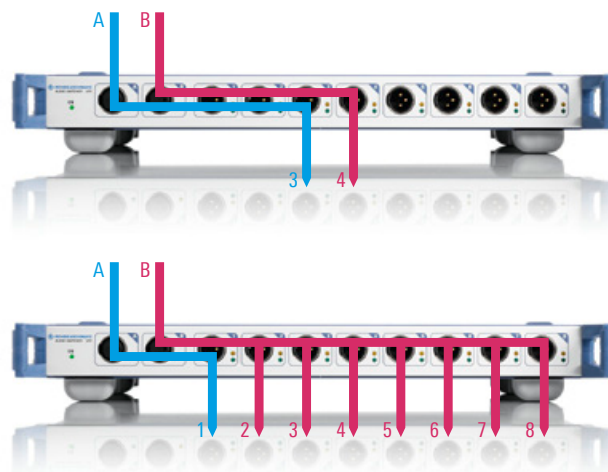

The R&S®UPZ together with the R&S®UPV



CHAPTER 10

AUTOMOTIVE TEST, MODULAR INSTRUMENTS

Production testing is performed in various industries, from automotive to communications to infotainment. Testing departments need to flexibly configure required functions in compact units to cover present and future requirements without large additional investments.



Type	Designation	Description	Page	
Automotive test solutions				
	R&S®AREG100A	Automotive radar echo generator	Reliable and simple production testing of automotive radar sensors	232
	R&S®TS6710	TRM radar test solution	All-in-one solution for efficient RF characterization	233
New	R&S®TS6	TRM test library	Test automation software for TRM characterization in R&D and production	234
New	R&S®QAR	Quality automotive radome tester	A new era in material characterization	235
R&S®CompactTSVP test system versatile platform at a glance			236	
Modular instrument chassis				
	R&S®TS-PCA3	R&S®CompactTSVP industrial test and measurement chassis	Open test platform based on CompactPCI and PXI	238
	R&S®TS-PWA3	R&S®PowerTSVP industrial switching application chassis	Open test platform based on CAN bus	238
System controllers				
	R&S®TS-PSC6x	System controller	CompactPCI embedded system controller (Intel® Core™ i7)	239
	R&S®TS-PSC57	System controller	CompactPCI embedded system controller (Intel® Core™ 2 Duo)	239
	R&S®TS-PSCX	Interface panel	Front interface panel for R&S®TS-PSC5 system controller	239
	R&S®TS-PSC0	System controller	CompactPCI – PCI remote system controller	239
	R&S®TS-PSC07	System controller	CompactPCI – PCIe remote system controller	239
Digital multimeter and in-circuit test				
	R&S®TS-PSAM	Analog source and measurement module	Scanning multimeter and data acquisition unit	240
	R&S®TS-PICT	In-circuit test extension	Analog ICT in conjunction with the R&S®TS-PSAM	240
Signal routing and switching				
	R&S®TS-PMB	Switch matrix module	High-density, 90-channel, full matrix relay-multiplexer module	240
	R&S®TS-PSM1	Power switching module	High-power multiplexer and multiple DUT power switching module	240
	R&S®TS-PSM2	Multiplex and switch module	Medium-power multiplexer and switching module	241
	R&S®TS-PSM3	High-power switching module	Automotive DUT supply and load switching up to 30 A	241
	R&S®TS-PSM4	Multiplex and switch module	Power multiplexer and DUT power switching module	241
	R&S®TS-PSM5	High-power switching module	Automotive DUT supply and load switching up to 50 A	241
Communications, digital I/O and mixed signal acquisition				
	R&S®TS-PDFT	Digital functional test module	Programmable 32-bit digital pattern I/O and serial communications interfaces	243
	R&S®TS-PXM1	Switching extension module	Switching extension module with a total of 32 switches	243
	R&S®TS-PXB2	Backplane extension module	Fast, comprehensive tests in automobile production	243
	R&S®TS-PIO2	Analog and digital I/O module	Analog and digital 16-channel stimulus and measurement unit for mixed signal DUT testing	244
	R&S®TS-PIO3B and R&S®TS-PTRF	Digital I/O module and signal port and transmission module	Digital control and coil driver with power outputs	244
	R&S®TS-PIO4	32-channel programmable digital I/O module	Flexibly programmable 32-bit digital inputs and 32-bit digital outputs that are able to acquire and generate static or dynamic digital patterns	244
	R&S®TS-PIO5	LVDS digital functional test module	Very flexibly programmable bidirectional LVDS channels to acquire and generate static or dynamic digital patterns	245
Arbitrary waveform generator and signal analyzer				
	R&S®TS-PFG	Function generator module	Dual-channel arbitrary waveform generator with isolated outputs	245
	R&S®TS-PAM	Signal analyzer module	Eight-channel digitizer and waveform analyzer	245
Power supplies				
	R&S®TS-PSU	Power supply and load module	Four-quadrant source with integrated measurement unit	246
	R&S®TS-PSU12	Power supply and load module	Four-quadrant source with integrated measurement unit	246
In-system calibration				
	R&S®TS-ISC	In-system calibration kit	On-site calibration solution for the R&S®CompactTSVP	247
	R&S®TS-PCAL2	Calibration module	On-site calibration module for chassis rear I/O	247

R&S® AREG100A AUTOMOTIVE RADAR ECHO GENERATOR



Reliable and simple production testing of automotive radar sensors

The R&S®AREG100A automotive radar echo generator is a smart and robust solution for testing automotive radar sensors in production. The R&S®AREG100A gives engineers the advantage of test case flexibility combined with simple and robust operation.

Key facts

- ▶ Supports 24 GHz, 77 GHz and 79 GHz automotive radar sensors
- ▶ Future-proof frontend with instantaneous bandwidth up to 4 GHz
- ▶ 4 m minimum object distance short-range radar testing
- ▶ Individually controllable radial velocity for each object¹⁾

Reliable and flexible echo generation

- ▶ Simulate up to four artificial objects at fixed distances at the same time

- ▶ Simulate echoes with minimum delay for SRR sensor tests and for LRR sensor tests
- ▶ Select additional Doppler offsets to simulate radial velocity¹⁾

Test today's and tomorrow's radar sensors

- ▶ Choose a 24 GHz ISM band frontend or an E-band frontend from 76 GHz to 77 GHz or 81 GHz
- ▶ Wideband E-band frontend with 4 GHz instantaneous bandwidth for short range radar sensor tests with any FMCW or I/Q modulated radar signal

Ready for RED²⁾

- ▶ Measure the sensor's equivalent radiated isotropic power (EIRP) in line with the applicable standards – with a connected R&S®NRP8S(N) power sensor
- ▶ Verify robustness of radar sensors to in-band interferers – with a connected analog or vector signal generator
- ▶ Measure occupied bandwidth and unwanted emissions – with a connected signal and spectrum analyzer

Simple and stable operation

- ▶ Linux-based operating system for maximum software stability
- ▶ Optimized for minimal footprint of just 3 HU
- ▶ SCPI macro recorder with automatic code generator
- ▶ Intuitive GUI for user-friendly operation

¹⁾ Under development.

²⁾ Radio Equipment Directive (RED).

Rohde & Schwarz reference solution for reliably testing the robustness of automotive radar sensors to in-band interferers as defined by RED²⁾

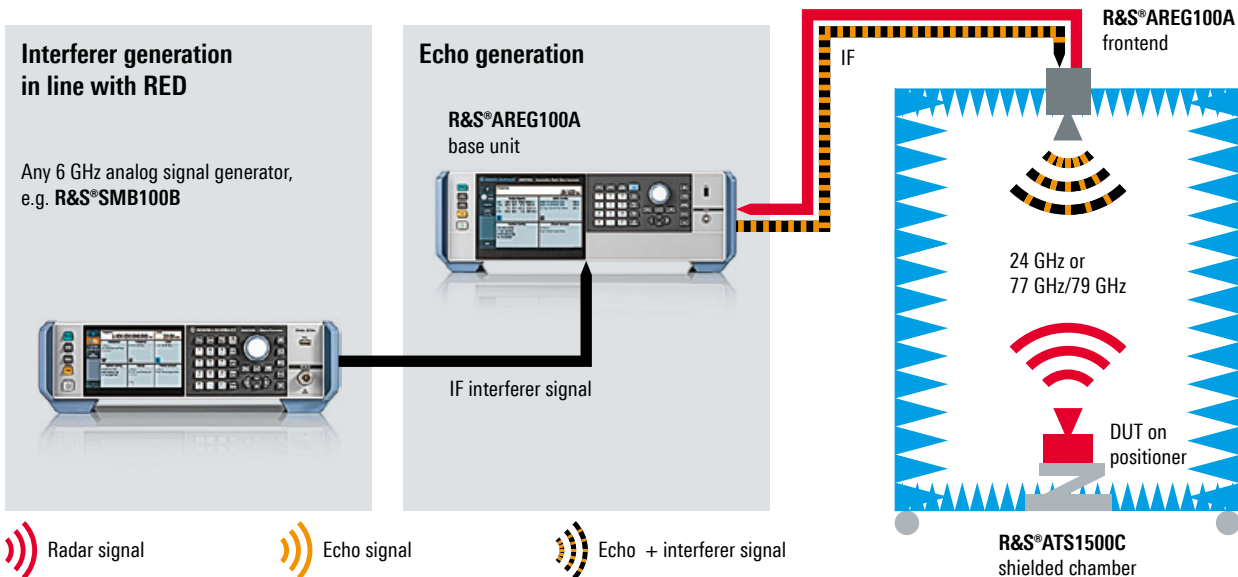

R&S® TS6710 TRM RADAR TEST SOLUTION

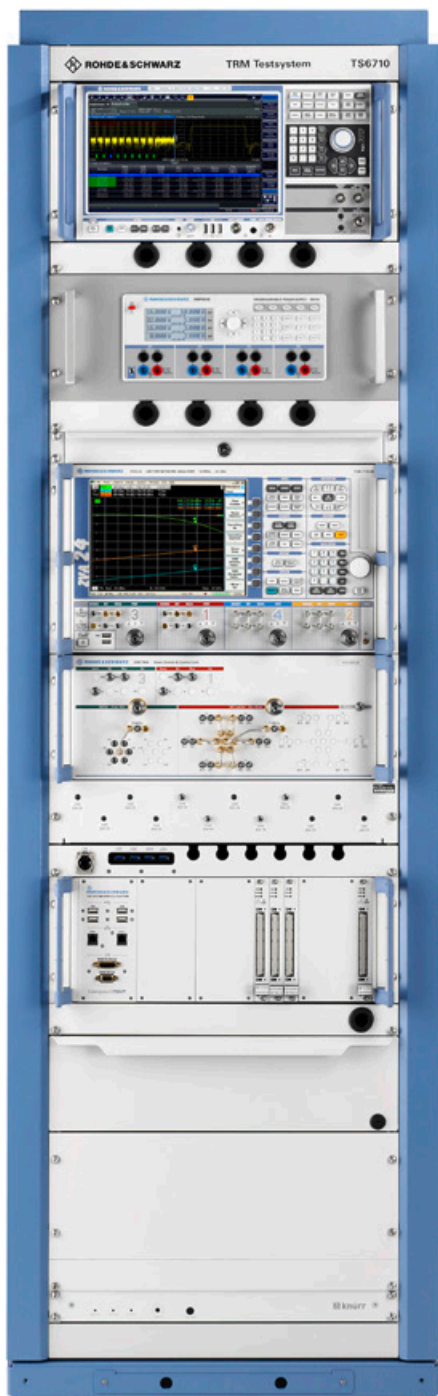

All-in-one solution for efficient RF characterization

The R&S®TS6710 TRM radar test system allows manufacturers of state-of-the-art AESA radar equipment to perform fast, automatic RF measurements on transmit-receive modules (TRM) in development and production. The R&S®TRM-LIB test case library covers all common tests for a TR module and its components. The module control can be implemented locally by an open C# interface.



Product site

State-of-the-art AESA radars contain several thousand TRMs each and each TRM must be tested separately during development and production. To handle the large number of different measurements and measurement values involved, testing requires a high degree of automation.

This test automation is carried out by the R&S®TRM-LIB test software together with the R&S®ZVA network analyzer and the R&S®ZVAX-TRM signal conditioning units or R&S®OSP-TRM. Because the R&S®ZVA can cover all test cases, the use of the R&S®FSW spectrum analyzer within the setup is optional for enhanced performance.

Combined with device specific components for DUT power supply and control the all-in-one solution R&S®TS6710 offers extremely short test times for ensuring the high throughput required in production. In addition, it allows measurements to be flexibly configured for development. These capabilities help the manufacturer develop modules, reduce production cycles and make production more efficient.

Since the test details can be adapted to the customer requirements and because of the wide parameter ranges, the R&S®TS6710 supports the measurement of TRMs for diverse applications, e.g. due to its wide frequency range for future broadband radar equipment.

Key facts

- ▶ Very short test times
- ▶ Optional multiplexing of 12 DUTs per test system
- ▶ Test sequencer for user-configurable test runs
- ▶ Open C# interface for control of customer DUT
- ▶ Turnkey solution from a single source
- ▶ Based on Rohde & Schwarz standard components
 - R&S®ZVA vector network analyzer for RF measurements
 - R&S®ZVAX-TRM or R&S®OSP-TRM for RF signal conditioning and DUT multiplexing
 - R&S®CompactTSVP for fast communications with the TRM

Typical system configuration

R&S®TRM-LIB	Automation software with open interface to DUT
R&S®ZVA	Network analyzer
R&S®ZVAX-TRM or R&S®OSP-TRM	Signal conditioning unit
R&S®FSW (optional)	Spectrum analyzer
R&S®TSVP (optional)	DUT control interface and system controller
Power supplies and accessories (optional)	

R&S®TS6 TRM TEST LIBRARY

New



TRM test solution using a single R&S®ZVA vector network analyzer (with or without R&S®ZVAX-TRM extension unit) controlled by the R&S®TS6 TRM test library software

Test automation software for TRM characterization in R&D and production

The RF characterization of a transmit-receive module (TRM), the core component of state-of-the-art AESA radars, requires extensive testing with several thousand results in many different test scenarios. The R&S®TS6 TRM test library software automates this measurement including system calibration, test execution, result evaluation and documentation. TRM-specific control implementation is possible locally via an open C# plug-in.

State-of-the-art AESA radars contain several thousand TRMs each, and each TRM must be tested separately during the development and production stage. To handle the large number of different measurements and result values, these tests require a high degree of automation.

The R&S®TS6 TRM test library software automates all tests typical for a TRM characterization. It utilizes an R&S®ZVA vector network analyzer and additional equipment such as R&S®ZVAX-TRM or R&S®OSP-TRM signal conditioning units, different power supplies, switch matrices and an R&S®FSW signal and spectrum analyzer.

The test software comprises the R&S®TSrun test sequencer and TRM-specific test cases for all common types of TRM tests. Configuration by test parameters for each test case ensures the flexibility to adopt DUT-specific requirements. DUT control and triggering are always device-specific and locally programmable via an open C# software plug-in.

The R&S®TS6 TRM test library combines the advantages of standard software as a proven solution based on decades of experience in TRM testing and regular updates with the flexibility of an open device control and a wide range of parametrization of test parameters.

Key facts

- ▶ All typical tests for a TRM covered by standard software
- ▶ DUT-specific test case adaptation by parametrization
- ▶ Open C# DUT control interface
- ▶ Automation reduces calibration and testing effort
- ▶ Modular and scalable: support for Rohde&Schwarz equipment typical for TRM tests, from a single vector network analyzer to a fully loaded TRM test solution
- ▶ Suitable for development and production
- ▶ High throughput thanks to optimized test cases

R&S®TS6 TRM test library test cases and typical hardware configurations

		R&S®ZVA	R&S®ZVA, R&S®ZVAX-TRM	R&S®ZVA, R&S®OSP-TRM, R&S®TSVP	Additional R&S®FSW
Test case	Test mode	Supported modulation			
		CW	CW, pulsed	CW, pulsed	CW, pulsed
S-parameter over DUT states	RX, TX	•	•	•	
Compression point	RX, TX	•	•	•	
Spurious emissions	RX, TX	•	•	•	•
Pulse profile (rise time, fall time, power droop)	TX		•	•	•
Noise figure	RX	•	• ¹⁾	• ¹⁾	•
Out-of-band rejection	RX, TX	•	•	•	•
Harmonics	RX, TX	•	•	•	
Power added efficiency	TX	• ²⁾	• ²⁾	• ²⁾	
Intermodulation	RX		• ³⁾	• ³⁾	

¹⁾ CW only.

²⁾ Requires a supported power supply.

³⁾ Requires a power combiner.



R&S®QAR QUALITY AUTOMOTIVE RADOME TESTER

New

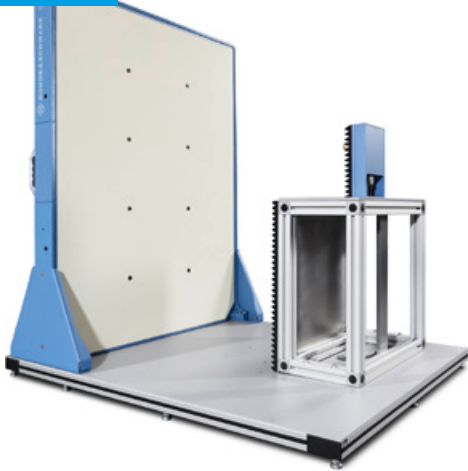

A new era in material characterization

The R&S®QAR is a millimeterwave imaging system for the most demanding radome material and fascia measurements and validations. Thanks to its outstanding performance, speed, quality and intuitive operation, it is the perfect tool for applications ranging from development and

production to verification of radome material and integration of 76 GHz to 81 GHz radars. Operating in the 72 GHz to 82 GHz frequency range, the R&S®QAR is ideal for verifying materials that will cover a radar sensor. With its support of spatially resolved reflection and transmission loss measurements, the R&S®QAR provides an intuitive and powerful way to evaluate the radar performance of a radome. The high resolution of the resulting images allows you to identify even the smallest disturbances in the radome design. Since the frequency range of the R&S®QAR matches that of automotive radar sensors (76 GHz to 81 GHz), any faults visible in the millimeterwave image directly correlate to the performance of the radome/radar sensor combination.

Key facts

- ▶ Combines two measurements
 - Spatially resolved reflectivity measurement
 - Material transmission frequency response (attenuation)
- ▶ Frequency range: 72 GHz to 82 GHz
- ▶ Spatial resolution: approx. 2 mm
- ▶ Maximum DUT size: 0.3 m × 0.5 m
- ▶ Measurement cycle: approx. 6 s
- ▶ Easy normalization, data storage and export
- ▶ Supports barcode readers and scan protocols

Measurement result of a plastic Rohde & Schwarz part with 500 μm thickness mismatch

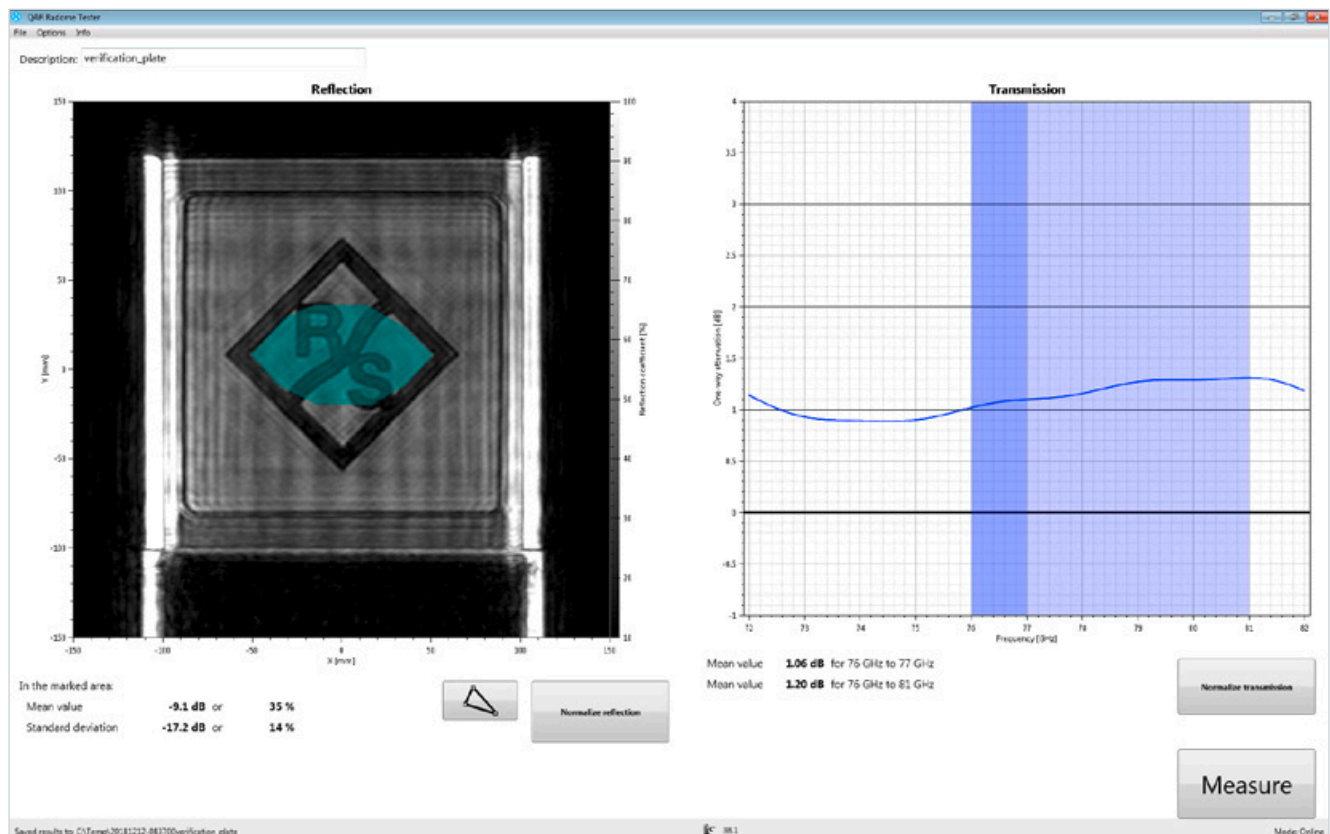

10



Product site

R&S® CompactTSVP TEST SYSTEM VERSATILE PLATFORM AT A GLANCE



Open test platform based on CompactPCI and PXI

The R&S® CompactTSVP family of products is an open test platform based on CompactPCI and PXI and has been developed for high-performance ATE applications. The chassis contains a mechanical frame, digital backplane, analog backplane, mains switching and filtering, power supply and diagnostic extensions. The R&S® CompactTSVP is offered as a test and measurement platform (R&S®TS-PCA3) and as a switching application platform (R&S®TS-PWA3).

Key facts

- ▶ Comprehensive system approach:
 - System oriented, compact basic unit and modular instruments for DC and LF signals from own production

- Floating stimulus and measurement technology
- Optimized signal concept (analog measurement bus, Rear I/O concept)
- Conceptual solutions to handle high voltages and currents
- Integration of DUT supply modules and loads
- High reliable mass interconnect solution for quick change of application specific fixtures and adapters
- System technology allows combination of functional and in-circuit test
- Wide range of functionality in a compact system design, ideal for in-line applications
- ▶ High test speed (by “intelligent” modules)
- ▶ Standardized and powerful software modules (GTSL, EGTSL) with simulation and tracing possibilities
- ▶ Integration of cPCI/PXI-Modules from the market without modification
- ▶ Integrated selftest secures readiness of system use and allows detailed diagnostics in case of system fault
- ▶ Option for in-system calibration permits high system availability in mass production lines

Interoperable with commercially available CompactPCI or PXI modules

For various application requirements, such as special interface functionality or additional test and measurement modules, the R&S® CompactTSVP is interoperable with commercially available 3 HU CompactPCI and PXI products.

R&S® CompactTSVP front view

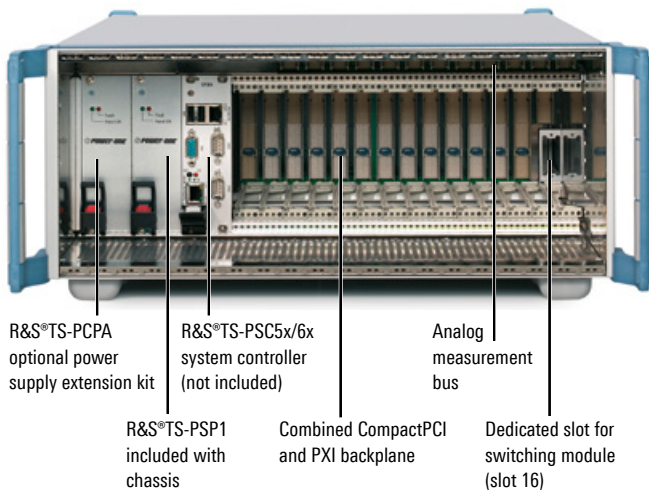

R&S® CompactTSVP rear view

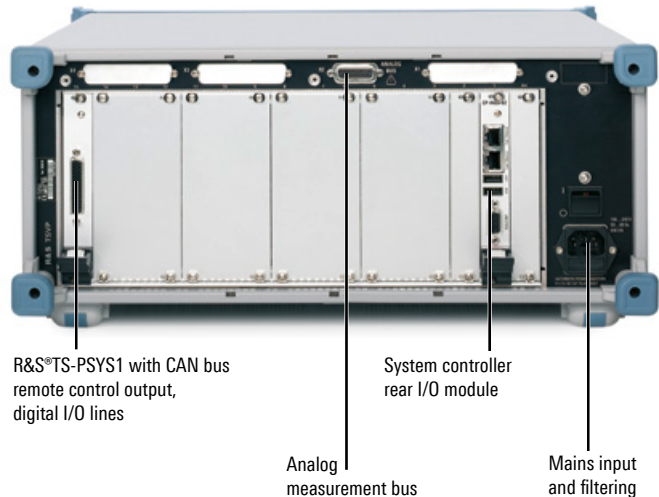

General concept of the R&S® PowerTSVP module format

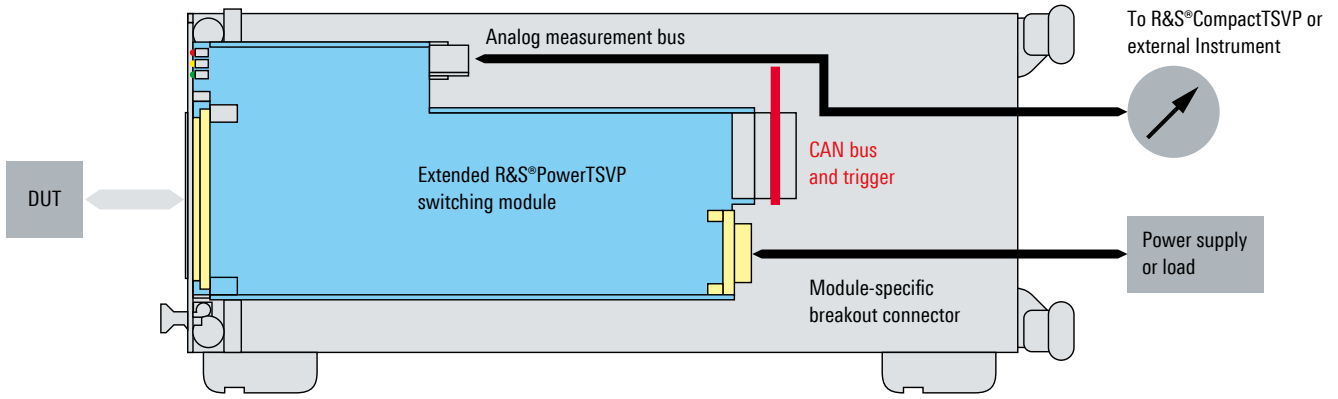

Analog measurement bus

The analog measurement bus offers short routing of signals to the measurement modules and electrical immunity to the digital PCI backplane. The highly sophisticated handling of analog signals led to the interconnection solution for the R&S CompactTSVP analog bus. The analog bus is located directly above the front connector area where space is provided for on-board signal conditioning and signal routing using coupling relays for the analog bus. The eight lines of the system-wide analog measurement bus are available at all peripheral slots. They are used to temporarily interconnect DUT signals routed via switching modules and various measurement or stimulus modules that have access to the analog measurement bus. The implementation is a physically dedicated backplane located 160 mm from the digital CompactPCI/PXI backplane.

System layout

R&S®TS-PCA3 CompactTSVP | R&S®TS-PCA3 CompactTSVP with external PC

R&S®TS-PCA3 CompactTSVP



R&S®TS-PCA3 CompactTSVP with external PC



R&S®TS-PCA3 CompactTSVP

The R&S®TS-PCA3 CompactTSVP chassis with an embedded computer as a system controller for modular instrumentation. With its 14 peripheral slots, medium-pincount ATE systems can be built as a one-box approach.

Medium-pincount ATE with external general-purpose PC using transparent PCI link via standardized StarFabric interface. Standard PC equipment and exotic extensions may be present, though the user may want to keep the external PC. The StarFabric interface does not require special software drivers and does not slow down the system.

10

R&S®TS-PCA3 CompactTSVP and R&S®TS-PWA3 PowerTSVP | R&S®TS-PWA3 PowerTSVP

R&S®TS-PCA3 CompactTSVP



R&S®TS-PWA3 PowerTSVP

CAN



R&S®TS-PWA3 PowerTSVP

The combination of the R&S®TS-PCA3 CompactTSVP and the R&S®TS-PWA3 PowerTSVP stands for high performance and high pin-count ATE systems. For high-power applications, the parts of a system that handle signals with high currents or high voltages can be separated at a safe distance from the R&S®TS-PCA3 as a dedicated measurement unit.

Medium-pincount ATE with an external standard PC using a third-party CAN bus interface to control the R&S®TS-PWA3 PowerTSVP chassis. The CAN interface can be based on various standard interfaces such as USB to CAN or a PCI standard PC board. With this application scenario, right-sized switching applications can be used for various requirements ranging from general-purpose signals, high power load and power supply switching up to RF switching.

R&S®TS-PCA3 R&S®CompactTSVP INDUSTRIAL TEST AND MEASUREMENT CHASSIS



Open test platform based on CompactPCI and PXI

The R&S®CompactTSVP concept represents true innovation in state-of-the-art PC-based instrumentation while offering traditional capabilities found in high-performance ATE systems. The versatile platform accelerates the adoption of CompactPCI and PXI in all major fields of industrial test and measurement applications.

Key facts

- ▶ Modular instrument chassis for CompactPCI and PXI modules
- ▶ Standard 19" 4 HU rackmount enclosure for 3 HU CompactPCI
- ▶ CompactPCI backplane conforming to PICMG 2.0 Rev. 3.0 specification
- ▶ Rear I/O support for easy system cabling (IEEE 1101.11-1998)
- ▶ Sophisticated analog measurement bus subsystem
- ▶ Support of PXI trigger concept
- ▶ 14 peripheral slots for versatile instrumentation
- ▶ Seamless test adaptation by using standardized adapter components
- ▶ Simple and efficient module connection concept
- ▶ Easily expandable ATE switching
- ▶ High-pincount switching expansion by cascading an R&S®PowerTSVP chassis
- ▶ Cost-effective peripheral control via CAN
- ▶ Rohde&Schwarz commitment to industrial standards

R&S®TS-PWA3 R&S®PowerTSVP INDUSTRIAL SWITCHING APPLICATION CHASSIS



Open test platform based on CAN bus

The R&S®TS-PWA3 R&S®PowerTSVP chassis was created as a cost-efficient subsystem for switching applications. It can be used to build systems ranging from dedicated switching instruments to complex switching applications in test and measurement systems.

The chassis contains a mechanical frame, digital backplane, analog backplane, mains switching and filtering, power supply and diagnostic extensions. For cost-effective peripheral control via CAN bus, the R&S®TS-PSYS2 slave interface is included as a rear I/O module.

Key facts

- ▶ Modular switching instrument chassis
- ▶ Standard 19" rackmount 4 HU enclosure
- ▶ 6 peripheral slots for switching instrumentation
- ▶ Rear I/O support for easy system cabling (IEEE 1101.11-1998)
- ▶ Sophisticated analog measurement bus subsystem
- ▶ Support of system-wide trigger concept
- ▶ Seamless test adaptation by using standardized adapter components
- ▶ Simple and efficient module connection concept
- ▶ Easily expandable ATE switching
- ▶ High-pincount switching applications, e.g. for in-circuit test (ICT)
- ▶ High-power switching
- ▶ Cost-effective peripheral control via controller area network (CAN)
- ▶ Switching extension for R&S®CompactTSVP



Modules of the R&S®CompactTSVP family: system controllers

R&S®TS-PSC6x System Controller (Intel® Core™ i7)



CompactPCI embedded system controller

Test and measurement computing platform for R&S®CompactTSVP instruments.

Users can configure the system by choosing the hardware, operating system and software that meets their specific requirements. The configuration can be extended at any time.

Key facts

- ▶ Intel® Core™ i7-5700EQ processor
- ▶ Includes rear I/O module
- ▶ 256 Gbyte SSD (R&S®TS-PSC6S)
- ▶ Windows 10 operating system (R&S®TS-PSC6W)

Specifications in brief

- ▶ Packaging: 3 HU dual-slot CompactPCI CPU board
- ▶ Processor: Intel® Core™ i7-5700EQ 2.6 GHz
- ▶ RAM: 16 Gbyte DDR4 SDRAM
- ▶ SDD: 2.5", 256 Gbyte, SATA
- ▶ Computer interfaces
 - 2 × USB 2.0
 - 1 × USB 3.0
 - 3 × 1 Gbit Ethernet
 - 1 × RS-232
 - 1 × DisplayPort
 - 1 × VGA
- ▶ Operating system: Windows 10

R&S®TS-PSC57 System Controller (Intel® Core™2 Duo)



CompactPCI embedded system controller

Test and measurement computing platform for R&S®CompactTSVP instruments.

The CompactPCI system controller board combines the performance of Intel's Core™2 Duo 2.26 GHz CPU with the high integration of the GS45 Express chipset. Legacy interfaces can be accessed on the R&S®CompactTSVP instrument rear panel via the additional rear I/O module, which is included.

Specifications in brief

- ▶ Packaging: 3 HU dual-slot CompactPCI CPU board
- ▶ Processor: Intel® Core™2 Duo 2.26 GHz
- ▶ RAM: 4 Gbyte DDR3 SO-DIMM
- ▶ HDD: 250 Gbyte, enhanced availability type
- ▶ Computer interfaces
 - 5 × USB 2.0
 - 3 × 1 Gbit Ethernet
 - 1 × PS/2
 - 1 × RS-232
 - 1 × DVI-I
- ▶ Operating system: Windows 7 Ultimate

R&S®TS-PSCX Interface Panel



Front interface panel for system controller R&S®TS-PSC5x and R&S®TS-PSC6x

Accessory product to expand the legacy ports of the R&S®TS-PSC5 industrial embedded computer.

The R&S®CompactTSVP chassis can be equipped to be deployed as a benchtop instrument.

Specifications in brief

- ▶ Legacy expansion panel for R&S®TS-PSC5x and R&S®TS-PSC6x system controller
- ▶ 4 × USB 2.0
- ▶ 2 × Ethernet, RJ-45
- ▶ Monitor interfaces

R&S®TS-PSC0 System Controller



Product site



CompactPCI – PCI remote system controller

- ▶ An external PC – can be used as R&S®CompactTSVP system controller for the R&S®CompactTSVP chassis (R&S®TS-PCA3)
- ▶ Ideal for solutions where the system design requires the PCI-bus-based hardware to be integrated into the system

The transparent, serial StarFabric interface is ready to run without any software installation and has nearly no influence on the system performance compared to the embedded controller solution.

Specifications in brief

- ▶ Remote interface: StarFabric
- ▶ External host PC: PCI bus
- ▶ Implementation: transparent PCI bridge, serial PCI to CompactPCI link
- ▶ Interface location: rear panel of R&S®CompactTSVP chassis, controller slot 1

R&S®TS-PSC07 System Controller

CompactPCI – PCIe remote system controller

Modern desktop and industrial PCs that are equipped with PCIe extension slots can also be used as a system controller for the R&S®CompactTSVP chassis (R&S®TS-PCA3).

The transparent downstream PCIe X1 cable interface is ready to run without software driver installation and provides sophisticated system performance.

Specifications in brief

- ▶ Remote interface: PCIe express
- ▶ External host PC: PCIe express bus
- ▶ Implementation: transparent PCIe bridge
- ▶ Interface location: rear panel of R&S®CompactTSVP chassis, controller slot 1

Modules of the R&S®CompactTSVP family: digital multimeter and in-circuit test

R&S®TS-PSAM Analog Source and Measurement Module



Product site

Scanning multimeter and data acquisition unit

- ▶ Floating measurement of voltage, current (AC/DC) and resistance in 2 and 4-wire mode
- ▶ Analog in-circuit test with short, contact and continuity test
- ▶ Test of resistors, diodes, bipolar transistors, jumpers/switches and discharge of capacitors
- ▶ Measurement synchronization via PXI clock and trigger

Specifications in brief

- ▶ Voltage ranges
 - DC: ±10 mV to ±125 V
 - AC: ±20 mV to ±90 V (RMS)
- ▶ Current ranges
 - DC: ±1 µA to ±1 A
 - AC: ±100 µA to ±1 A
- ▶ Resistance ranges: 1 Ω to 10 MΩ
- ▶ Sample rate: 0.01 sample/s to 200 ksample/s
- ▶ DC source: ±5 V, 100 mA, 4-quadrant
- ▶ Discharge unit: max. 125 V DC, 400 mA
- ▶ Bus interface: CompactPCI/PXI

R&S®TS-PICT In-Circuit Test Extension

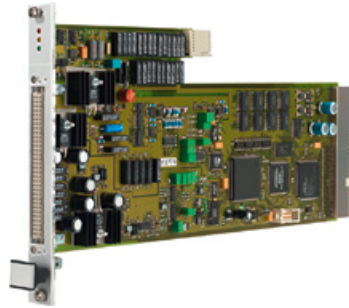

Product site

Analog ICT in conjunction with the R&S®TS-PSAM

- ▶ Test of R, L, C, diodes, transistors, parallel R-C
- ▶ For guarded measurements in 3, 4, 6-wire technology
- ▶ Measurement of inductors, capacitors and impedances

Specifications in brief

- ▶ AC source: referenced to GND
- ▶ Voltage: 0.1 V, 0.2 V, 1.0 V
- ▶ Voltage offset: off, pos., neg.
- ▶ Impedance: 1 Ω, 10 Ω, 1 kΩ, 10 kΩ
- ▶ Frequency: DC, 100 Hz, 1 kHz, 10 kHz
- ▶ Measurement unit: referenced to GND
- ▶ Current ranges: 1 µA to 200 mA
- ▶ Sample rate: max. 200 ksample/s
- ▶ Working voltage: max. 60 V DC
- ▶ Bus interface: CompactPCI/PXI

R&S®TS-PMB Switch Matrix Module

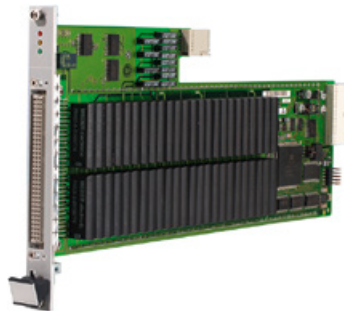

Product site

High-density, 90-channel, full matrix relay-multiplexer module

The R&S®TS-PMB establishes test channels for functional and in-circuit tests. It provides all routing of signals between DUT and measurement modules via the R&S®CompactTSVP analog bus.

The general-purpose switch matrix module can handle input signals up to 125 V and up to 1 A. It provides self-test capability and fast switching of signal paths.

Specifications in brief

- ▶ Switching: relay, full matrix
- ▶ Configuration: 90 channels to 2 × 4 buses
- ▶ Deployed as
 - Single matrix: 90 pins to 4 bus lines
 - Single matrix: 45 pins to 8 bus lines
 - Dual matrix: 45 pins to 4 bus lines
- ▶ Analog measurement bus access to 8 bus lines
- ▶ Voltage: max. 125 V DC
- ▶ Current: max. 1 A
- ▶ Power: max. 10 W
- ▶ Switch time: 0.5 ms (incl. bouncing)
- ▶ Bus interface: CAN

R&S®TS-PSM1 Power Switching Module



Product site

High-power multiplexer and multiple DUT power switching module

- ▶ Power switching module for supplies and loads
- ▶ Can handle voltages up to 70 V with
 - 8 high-power channels with max. 16 A
 - 10 power channels with max. 2 A
 - 4 high-power 4-to-1 multiplexer channels with max. 16 A
- ▶ Indirect high-current measurements on high-power channels via shunt resistors; routing of corresponding voltage via analog measurement bus
- ▶ Self-test of all relays via analog measurement bus and R&S®TS-PSAM

Specifications in brief

- ▶ Switching: high and medium-power relays
- ▶ Configuration MP: 10 × SPST front – front/rear
- ▶ Configuration HP
 - 8 × SPST rear – front, shunt
 - 2 × SP 4:1 MUX front – front
 - 2 × SP 4:1 MUX rear – rear
- ▶ Voltage: max. 60 V DC
- ▶ Current MP/HP: max. 2 A/16 A
- ▶ Power MP/HP: max. 150 W/480 W
- ▶ Switch time MP: 5 ms (incl. bouncing)
- ▶ Switch time HP: 10 ms (incl. bouncing)
- ▶ Bus interface: CAN

Modules of the R&S®CompactTSVP family: signal routing and switching

R&S®TS-PSM2 Multiplex and Switch Module

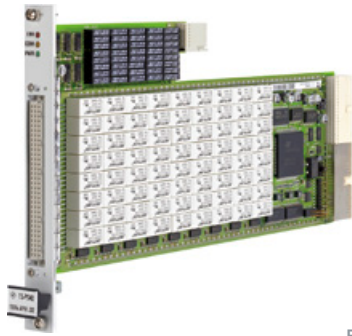

Product site

Medium-power multiplexer and switching module

- ▶ Medium-power switching module for voltages up to 125 V and 2 A
- ▶ Eight independent groups of 3 SPST/1 SPDT relay channels or 4-to-1 DPST relay multiplexers
- ▶ Relay multiplexers can be cascaded via local power buses
- ▶ Indirect current measurements on each SPxT channel via shunt resistors
- ▶ Direct current measurements up to 1 A on all channels via R&S®CompactTSVP analog measurement bus and R&S®TS-PSAM

Specifications in brief

Switching: 8 independent relay groups

- ▶ Configuration
 - 3 × SPST + SPDT, shunt or
 - DP 4:1 MUX
- ▶ Voltage: max. 125 V DC
- ▶ Current: max. 2 A
- ▶ Power: max. 60 W
- ▶ Switch time: 5 ms (incl. bouncing)
- ▶ Bus interface: CAN

R&S®TS-PSM3 High-Power Switching Module

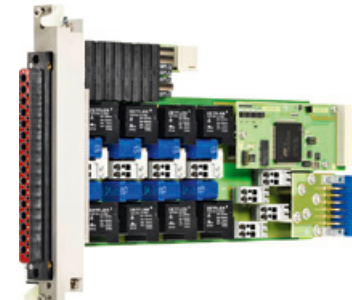

Product site

Automotive DUT supply and load switching up to 30 A

- ▶ 8 high-power channels for currents up to 30 A
- ▶ 8 medium-power channels for currents up to 2 A
- ▶ Switching voltage up to 30 V
- ▶ Integrated current measurement via current sensors and analog bus coupling
- ▶ Rear I/O access to the power signals for unique flexibility during system integration and seamless adaptation to power supplies and loads within a system paradigm based on R&S®PowerTSVP
- ▶ Unique comprehensive selftest and measurement of relay contact resistance

Specifications in brief

- ▶ High-power channels
 - Switching voltage: max. DC 30 V
 - Switching current: max. 30 A
 - Switching power: max. DC 900 W
 - Operate/release time: typ. < 8 ms
- ▶ Medium-power channels
 - Switching voltage: max. DC 30 V
 - Switching current: max. 2 A
 - Switching power: max. DC 60 W
 - Operate/release time: typ. < 6 ms
- ▶ Adaptation to R&S®TS-PRIO3 rear I/O module
 - All high-power and medium-power channels

R&S®TS-PSM4 Multiplex and Switch Module



Product site

Power multiplexer and DUT power switching module

- ▶ 12 high-power channels for currents up to 16 A
- ▶ 8 medium-power channels for currents up to 2 A
- ▶ Switching voltage up to 30 V
- ▶ Integrated current measurement via shunt resistors and analog bus coupling
- ▶ Rear I/O access to the power signals for unique flexibility during system integration and seamless adaptation to power supplies and loads within a system paradigm based on R&S®PowerTSVP
- ▶ Unique comprehensive selftest and measurement of relay contact resistance

Specifications in brief

- ▶ High-power channels
 - Switching voltage: max. DC 30 V
 - Switching current: max. 16 A
 - Switching power: max. DC 480 W
 - Operate/release time: typ. < 4 ms
- ▶ Medium-power channels
 - Switching voltage: max. DC 30 V
 - Switching current: max. 2 A
 - Switching power: max. DC 60 W
 - Operate/release time: typ. < 6 ms
- ▶ Adaptation to R&S®TS-PRIO2 rear I/O module
 - All high-power and medium-power channels

R&S®TS-PSM5 High-Power Switching Module



Product site

Automotive DUT supply and load switching up to 50 A

- ▶ 4 high-power channels for currents up to 50 A
- ▶ 4 medium-power channels for currents up to 2 A
- ▶ Switching voltage up to 24 V
- ▶ Integrated current measurement via current sensors and analog bus coupling
- ▶ Rear I/O access to the power signals for unique flexibility during system integration and seamless adaptation to power supplies and loads within a system paradigm based on R&S®PowerTSVP
- ▶ Unique comprehensive selftest and measurement of relay contact resistance

Specifications in brief

- ▶ High-power channels
 - Switching voltage: max. DC 24 V
 - Switching current: max. 50 A
 - Switching power: max. DC 1120 W
 - Operate/release time: typ. < 14 ms
- ▶ Medium-power channels
 - Switching voltage: max. DC 30 V
 - Switching current: max. 2 A
 - Switching power: max. DC 60 W
 - Operate/release time: typ. < 6 ms
- ▶ Adaptation to R&S®TS-PRIO5 rear I/O module
 - All high-power and medium-power channels

Modules of the R&S® CompactTSVP family: rear I/O instrument extensions

Support slide – rear I/O module application

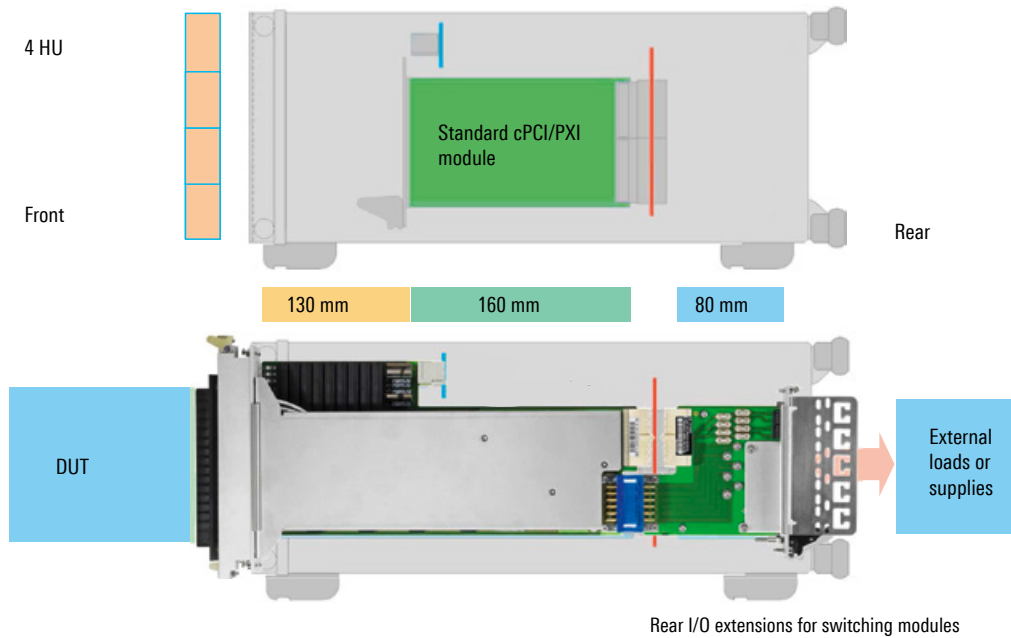

R&S®TS-PRIOx rear I/O instrument extensions

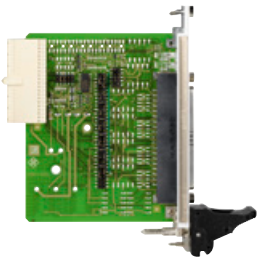

R&S®TS-PRIO4, rear I/O transmission module for R&S®TS-PI03B, R&S®TS-PTR

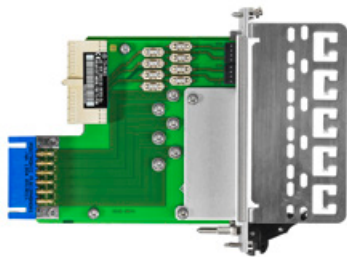

R&S®TS-PRIO3, rear I/O module for R&S®TS-PSM3

The R&S®TS-PRIOx modules are a ruggedized implementation of modular rear I/O switching module extensions to make high current switching an intrinsic part of the test system.

- ▶ Distribution of a power supply to multiple DUTs
- ▶ Flexible distribution of power supplies to DUTs including sense lines via medium-power relays
- ▶ Connection of test loads, original loads or simulated and electronic actuators in automotive test scenarios
- ▶ Multiplexing of power supplies and electronic loads

Switching module

R&S®TS-PI03B, R&S®TS-PTR
 R&S®TS-PMB, R&S®TS-PSM2
 R&S®TS-PSM3
 R&S®TS-PSM4
 R&S®TS-PSM5

Suitable rear I/O

R&S®TS-PRIO4
 R&S®TS-PRIO
 R&S®TS-PRIO3
 R&S®TS-PRIO2
 R&S®TS-PRIO5

Specifications in brief

- ▶ Feedthrough from rear panel to switching module
- ▶ All switching lines typically supported
- ▶ In conjunction with power switch modules, both force and sense lines are supported
- ▶ High-power rear I/O provides mounting brackets for ground terminals

Modules of the R&S®CompactTSVP family: communications, digital I/O and mixed signal acquisition

R&S®TS-PDFT Digital Functional Test Module

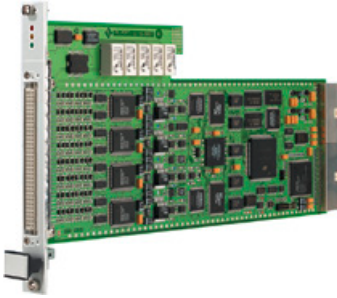

Programmable 32-bit digital pattern I/O and serial communications interfaces

- ▶ 32 digital output channels with pattern acquisition rate up to 20 MHz
- ▶ One programmable output level per group
- ▶ High output current and short-circuit protection
- ▶ Four high-power open drain channels, fully protected and capable of pulse width modulation
- ▶ Five SPST relay channels
- ▶ 32 digital input channels with two programmable input threshold levels per group for hysteresis or level monitoring

Specifications in brief

- ▶ Output channels: 32, in 4 groups
- ▶ Voltage/group: -3 V to +10 V, tristate
- ▶ Current/channel: 80 mA
- ▶ Sample rate: 0.01 sample/s to 20 Msample/s
- ▶ Input channels: 32, in 4 groups
- ▶ Threshold/group: 0 V to 9.5 V
- ▶ Data buffer: 128/64/32 kbyte at 8/16/32 bit
- ▶ DUT interfaces: CAN, K-line, RS-232, SPI, I²C
- ▶ Bus interface: CompactPCI/PXI

R&S®TS-PXM1 Switching Extension Module



Product site

General-purpose switching extension of the R&S®TS-PIO3B digital I/O module

- ▶ Breakout and routing of internal signals from adjacent PXI modules, e.g. boundary scan lines
- ▶ Discrete wiring of DUTs with auxiliary voltages in the functional test
- ▶ Connection of load resistances to DUT outputs
- ▶ Simple control via one R&S®TS-PIO3B control port each for up to eight R&S®TS-PXM1 switching extension modules
- ▶ Can be used on slots A1 to A4, which in the past were ordinarily not used for DUT connections and in front of controller slots 1 and 2; if needed, PXI slots can be kept free for additional measurement modules

Specifications in brief

- ▶ Relay organization: 8 × 4PDT
- ▶ Switching voltage: 30 V DC (max.)
- ▶ Switching current: 2 A (max.)
- ▶ Switching power: 60 W (max.)
- ▶ Relay control: 8 bit, low active

R&S®TS-PXB2 Backplane Extension Module

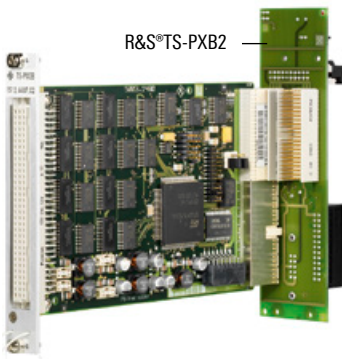

Product site

Flexible expansion of the R&S®CompactTSVP and R&S®PowerTSVP with two additional CAN bus slots

The R&S®TS-PXB2 is a backplane extension module for slots A1 and A2.

As a result, PXI slots can be kept free to preferably equip them with measurement modules. The cabling kit for the backplane option likewise includes a breakout of the system CAN bus on the rear I/O slot 4 for controlling remote modules directly in the test fixture.

Furthermore, the R&S®TS-PXB2 option makes it possible to route 24 signals to the instrument's backplane, e.g. to the R&S®TS-PIO3B option's digital I/O ports 5, 6 and 7.

Specifications in brief

- ▶ Expansion by two CAN bus slots at slots A1, A2 without linkup to the analog bus
- ▶ Breakout of the CAN bus to the rear panel
- ▶ Breakout of each of the 24 digital I/O channels of slots A1 and A2 on the rear panel
- ▶ Use in the R&S®CompactTSVP and R&S®PowerTSVP
- ▶ Bus interface: CAN

Modules of the R&S®CompactTSVP family: communications, digital I/O and mixed signal acquisition

R&S®TS-PIO2 Analog and Digital I/O Module



Product site

Analog and digital 16-channel stimulus and measurement unit for mixed signal DUT testing

- ▶ Analog and digital signal acquisition with high measurement resolution of 24 bit for level ranges up to ± 27 V
- ▶ Sampling rate of up to 5 ksample/s for inputs and outputs
- ▶ Autocorrection feature for all input and output channels
- ▶ Analog and digital stimulus outputs, offering static and dynamic signal outputs
- ▶ 16-bit resolution, high output level up to ± 27 V
- ▶ Versatile signal switching and DUT interconnection
- ▶ Stimulus and acquisition channels providing floating operation

Specifications in brief

- ▶ Output channels: 16, in 4 groups, floating high/low voltage: ± 27 V/ ± 27 V (L per group)
- ▶ Current/channel: 12×15 mA, 4×100 mA
- ▶ Modes: analog, digital, frequency
- ▶ Input channels: 16, in 4 groups, floating
- ▶ High/low threshold: ± 27 V/ ± 27 V (both per group)
- ▶ Data buffer: 4×5 ksample ($A_{out}/D_{out}/A_{in}/D_{in}$)
- ▶ Sample rate: 0.01 sample/s to 5 ksample/s
- ▶ Bus interface: CAN

R&S®TS-PIO3B Digital I/O Module and R&S®TS-PTRF Signal Port and Transmission Module

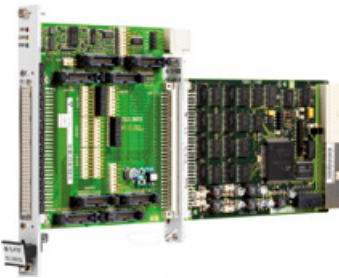

Product site

Digital control and coil driver with power outputs

The R&S®TS-PIO3B is a versatile digital I/O module with 64 (model .02) or 40 (model .04) channels. It offers eight ports with eight digital I/O lines each that have MOSFET output drivers. The circuitry is designed to drive RF relays with all common control voltages. The high current-carrying capacity makes the module a universal coil driver. An SPI interface offers the capability to control external SPI modules.

The transmission to front module R&S®TS-PTRF is designed to either route the digital signals to the front connector or distribute digital ports to control auxiliary modules, e.g. R&S®TS-PXM1.

Specifications in brief

- ▶ Digital I/O channels
 - 64, in 8 groups (model .02)
 - 40, in 5 groups (model .04)
- ▶ Voltage: 0 V to 35 V
- ▶ Current output: max. 200 mA per bit, 1 A per port
- ▶ Analog inputs: 8
- ▶ Level range : 0 V to 5 V
- ▶ Resolution: 10 bit
- ▶ Accuracy: $\pm(100$ mV + 5%)
- ▶ SPI interface: SPI SCLK
MOSI 5 V TTL output with 300 Ω series
MISO 5 V TTL input
- ▶ Bus interface: CAN

Easy deployment by sophisticated software

- ▶ Selftest software
- ▶ Soft front panels for immediate use
- ▶ LabWindows/CVI device driver support
- ▶ Test software library R&S®GTSL in DLL format

R&S®TS-PIO4 32-Channel Programmable Digital I/O Module

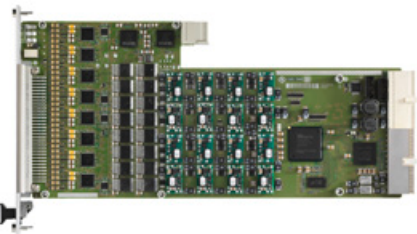

Product site

Flexibly programmable 32-bit digital inputs and 32-bit digital outputs that are able to acquire and generate static or dynamic digital patterns

- ▶ 32 digital input and 32 digital output channels
- ▶ 40 MHz sample rate, depending on levels and number of channels
- ▶ FPGA-based flexibility and realtime task execution independent of operating system
- ▶ 8 groups of 4 channels each: -6 V to $+10$ V
- ▶ Tristate control for every output channel in dynamic mode
- ▶ Programmable DIO level (high and low) per group with 14 bit resolution
- ▶ Two programmable input threshold levels per group for hysteresis or level monitoring
- ▶ High output current with 150 mA per channel
- ▶ Synchronization/trigging (bidirectional) via PXI trigger bus or XTI (TTL)
- ▶ External clock input via EXT_CLK input pin (TTL)

Specifications in brief

- ▶ Output channels: 32, in 8 groups of 4 bit
- ▶ Voltage/group: -6 V to $+10$ V, tristate
- ▶ High output current with 150 mA per channel
- ▶ Input channels: 32, in 8 groups of 4 bit
- ▶ Threshold/group: -6.0 V to 7.1 V
- ▶ Sample rate: 0.01 sample/s to 40 Msample/s
- ▶ Resolution: 12.5 ns
- ▶ Data buffer: 2 Msample at 32 bit
- ▶ Bus interface: CompactPCI/PXI

Easy deployment by sophisticated software

- ▶ Selftest software
- ▶ Soft front panels for immediate use
- ▶ LabWindows/CVI device driver support
- ▶ Test software library R&S®GTSL in DLL format

Modules of the R&S®CompactTSVP family: in-system calibration

R&S®TS-PIO5 LVDS Digital Functional Test Module



Product site

Very flexibly programmable bidirectional LVDS channels to acquire and generate static or dynamic digital patterns

- ▶ Two MDR connectors with 10 LVDS channels each (8 × data, 1 × general purpose, 1 × clock); bidirectional LVDM with fixed termination (100 Ω) onboard
- ▶ Two single-ended control lines per connector
- ▶ 10 RS-485 (RS-422) compatible I/O channels with interface connector onboard
- ▶ Stimulation with digital realtime data streams with 2 Mpattern (32-bit) memory onboard
- ▶ Acquisition of digital realtime data streams
- ▶ LVDS transceivers with internal ESD protection
- ▶ FPGA based flexibility and simultaneous task operation independent of the operating system
- ▶ Self-test software
- ▶ Software front panels for immediate use
- ▶ LabWindows/CVI device driver support
- ▶ Test software library GTSL in DLL format

Specifications in brief

- ▶ 5 V/max. 0.30 A power supply available at each digital connector, protected by diode and fuse
- ▶ Pattern rate up to 200 Mbit, 5 ns resolution
- ▶ Triggering (bidirectional) via PXI trigger bus; resolution based on PXI or external clock, ≥ 10 ns
- ▶ Synchronization via
 - TTL external clock input (SMB plug)
 - LVDS clock lines (MDR connector)
 - PXI clock 10 MHz
- ▶ Jitter and signal delay compensation in steps of typically 2.5 ns, 180° phase shift or delay of numerous clock cycles (combination possible)

Modules of the R&S®CompactTSVP family: arbitrary waveform generator and signal analyzer

R&S®TS-PFG Function Generator Module



Product site

Dual-channel arbitrary waveform generator with isolated outputs

- ▶ Arbitrary waveform generator module featuring two floating signal outputs with independent channel isolation
- ▶ High output level range up to 40 V (V_{pp})
- ▶ High sampling rate of 25 Msample/s per channel
- ▶ Output of standard waveforms up to 1 MHz sine, square, triangle, arbitrary waveform
- ▶ Sequencing of multiple memory sections and multiple repetitions

Specifications in brief

- ▶ Channels: 2, fully independent, floating, cascadable
- ▶ Voltage ranges: ±1 V, ±5 V, ±10 V, ±20 V
- ▶ Voltage resolution: 16 bit
- ▶ Output current: max. 250 mA
- ▶ Data buffer: 1 Msample per channel
- ▶ Sample rate: 0.01 sample/s to 25 Msample/s
- ▶ Standard waveforms: sine wave, triangle, square wave (1 Hz to 1 MHz), DC static
- ▶ Pulse: min. 500 ns (1% to 99%)
- ▶ Output ranges: ±1 V to ±20 V, max. 40 V (V_{pp})
- ▶ Output current: max. ±250 mA
- ▶ Bus interface: CompactPCI/PXI

R&S®TS-PAM Signal Analyzer Module



Product site

Eight-channel digitizer and waveform analyzer

- ▶ Digitizer module featuring two fully independent, floating acquisition units
- ▶ Acquisition modes with up to eight single-ended or four differential channels
- ▶ High sampling rate of 20 Msample/s for each acquisition unit
- ▶ Multichannel signal recording for up to eight channels at 5 Msample/s
- ▶ Synchronous acquisition of eight programmable comparator signals and PXI trigger
- ▶ Wide dynamic range with 14-bit resolution

Specifications in brief

- ▶ Acquisition units: 2, fully independent and floating
- ▶ Data buffer: 1 Msample per acquisition unit
- ▶ Channels per unit: 4
- ▶ Voltage ranges: ±0.2 V to 100 V (per channel)
- ▶ Resolution: 14 bit
- ▶ Sample rate: 0.02 sample/s to 20 Msample/s
- ▶ Relay multiplexer: 3:1 per channel
- ▶ Bus interface: CompactPCI/PXI

Modules of the R&S®CompactTSVP family: power supplies

R&S®TS-PSU Power Supply and Load Module



Product site

Four-quadrant source with integrated measurement unit

- ▶ Two independent, floating channels of four-quadrant sources with separate sensing per channel
- ▶ Programmable current and voltage limiting
- ▶ Integrated voltage and current measurement unit per channel
- ▶ Electronic load simulation of 20 W per channel
- ▶ Output and recording of voltage and current profiles
- ▶ Protection against overvoltage, overcurrent, overtemperature and short circuits
- ▶ 4-to-1 relay multiplexer for force and sense lines of each channel

Specifications in brief

- ▶ Output channels: 2, floating, fully independent, 4 quadrants, cascadable
- ▶ Voltage ranges: ± 15 V, ± 50 V (16 bit)
- ▶ Current ranges: 10 mA, 100 mA, 3 A (16 bit)
- ▶ Data buffer: 2×10 ksample (V_{out}/I_{out})
- ▶ Measurement unit: voltage or current
- ▶ Data buffer: 10 ksample
- ▶ Sample rate: 0.01 sample/s to 10 ksample/s
- ▶ Bus interface: CAN

R&S®TS-PSU12 Power Supply and Load Module



Product site

Four-quadrant source with integrated measurement unit

- ▶ Two independent, floating channels of four-quadrant sources with separate sensing per channel
- ▶ Programmable current and voltage limiting
- ▶ Same feature set as the R&S®TS-PSU but with R&S®TS-PDC internal primary power supply

Specifications in brief

- ▶ Output channels: 2, floating, fully independent, 4 quadrants, cascadable
- ▶ Voltage ranges: ± 12 V (16 bit)
- ▶ Current ranges: 10/100/500 mA (16 bit)
- ▶ Data buffer: 2×10 ksample (V_{out}/I_{out})
- ▶ Measurement unit: voltage or current
- ▶ Data buffer: 10 ksample
- ▶ Sample rate: 0.01 sample/s to 10 ksample/s
- ▶ Bus interface: CAN

Modules of the R&S®CompactTSVP family: in-system calibration

R&S®TS-ISC In-System Calibration Kit



Product site

On-site calibration solution for the R&S®CompactTSVP

The R&S®TS-ISC in-system calibration kit contains the fundamental tools for calibrating all modular instruments available for the R&S®CompactTSVP product family.

The most important benefit for systems deployed on the factory floor is that all modules that must be calibrated may remain in the instrument chassis slots. Additionally, a dedicated type of highly accurate multimeter is required to achieve a corresponding measuring accuracy during calibration.

Specifications in brief

The R&S®TS-ISC in-system calibration kit consists of the following components:

- ▶ R&S®TS-PCAL2 calibration module
- ▶ Calibration adapters
 - R&S®TS-PCALA
 - R&S®TS-PCALB
 - R&S®TS-PCALC
- ▶ R&S®TS-PKL cable for connecting the adapters to the external multimeter

R&S®TS-PCAL2 Calibration Module



On-site calibration module for chassis rear I/O

The R&S®TS-PCAL2 calibration module is used to provide traceable calibration signals. It can be integrated into multiple chassis on the factory floor to prepare each R&S®CompactTSVP instrument for on-site calibration without changing the module configuration.

An on-board relay multiplexer connects the components to the analog bus lines on an R&S®TS-PMB module which has to be installed in front of the R&S®TS-PCAL2 module.

Specifications in brief

The R&S®TS-PCAL2 provides the following functionalities:

- ▶ Floating 5 V reference source
- ▶ Three reference resistors for resistance measurements
- ▶ Ground-referenced current source, adjustable up to 1 A current measurements
- ▶ Floating signal generator for dynamic measurements of
 - DC: -40 V to +40 V
 - AC, sinusoidal:
 - 2 V to 80 V (V_{pp}) in frequency range from 20 Hz to 50 kHz
 - 0.2 V to 2 V (V_{pp}) in frequency range from 50 kHz to 1 MHz



CHAPTER 11

BROADCASTING AND MULTIMEDIA TEST AND MEASUREMENT SOLUTIONS

Rohde & Schwarz supplies producers of consumer electronics with all the T&M equipment needed to develop and produce satellite receivers, TVs and other consumer electronics equipment, including high-resolution formats such as UltraHD. For broadcasters as well as cable network operators, we offer high-performance instruments for digital and analog baseband generation, modulation, demodulation and analysis, including baseband analysis. Our multistandard platforms cover the wide variety of broadcast and video technologies, providing great flexibility at all stages of the value chain.

Type	Designation	Description	Page
RF signal generation			
R&S®BTC	Broadcast test center	Reference signal generator with audio/video analysis functions	250
R&S®TA-TRS	Sequencer	RF performance testing for TV, radio and satellite receivers	251
R&S®SFE100	Test transmitter	Powerful broadcast signal generator for production test systems	252
R&S®SFC	Compact modulator	Test signals for TV and audio broadcasting – compact and cost-effective	253
R&S®SFC-U	USB compact modulator	Test signals for TV and audio broadcasting – compact and cost-effective	253
R&S®SFD	DOCSIS signal generator	Signal generator for DOCSIS3.1 downstream and upstream	254
R&S®CLGD	DOCSIS cable load generator	Multichannel signal generator for DOCSIS4.0	255
R&S®SLG	Satellite load generator	Multichannel digital satellite TV modulator	256
RF signal analysis			
R&S®ETL	TV analyzer	Universal reference for analyzing TV, mobile TV and sound broadcasting signals	257
R&S®ETC	Compact TV analyzer	Economical TV transmitter testing	258
R&S®DSA	DOCSIS signal analyzer	Best signal quality for maximum data throughput	259
R&S®DVMS	Digital TV monitoring system family	Ensuring high quality of digital TV network operation	260
R&S®BCDRIVE	Broadcast drive test software	Efficient coverage analysis for terrestrial broadcast signals	262
Audio/video generation			
R&S®VTC/VTE	Video test center/video tester	A/V interface testing of consumer electronics devices	263
R&S®VTS	Compact video tester		
Stream Libraries		Test signal libraries for development, production and testing of TV components	265
Audio/video analysis			
R&S®DVMS	Digital TV monitoring system family	Ensuring high quality of digital TV network operation	260
R&S®VTC/VTE	Video test center/video tester	A/V interface testing of consumer electronics devices	263
R&S®VTS	Compact video tester		

R&S®BTC BROADCAST TEST CENTER



Reference signal generator with audio/video analysis functions

The R&S®BTC broadcast test center is a reference signal generator featuring analysis functions and automated tests for audio, video and multimedia applications. It is a unique combination of outstanding technical features and a modular, flexible design to meet the highest demands.

The multistandard R&S®BTC offers a complete DUT environment in a single instrument. As a high-end signal generator, it generates RF signals for all global broadcasting standards, simulates transmission channels and simultaneously carries out audio and video tests on DUTs. All this is made possible by using diverse interface, generator and analysis modules.

Due to its extremely fine scalability, the R&S®BTC can be tailored to meet different customer and test requirements while simultaneously optimizing costs. This eliminates the need for expensive and time-consuming test setups with many separate T&M instruments. Integrated and automated test sequence control as well as test suites ensure that test results are reproducible while reducing test times.

Key facts

- ▶ Signal generation and DUT analysis
- ▶ Modular design
- ▶ Automated test sequences in line with recognized test specifications
- ▶ Realtime video/audio transport stream generation
- ▶ Realtime signal generation for all global broadcasting standards



Due to its modular design, the R&S®BTC hardware can be ideally adapted to different measurement tasks.

Realtime support for all global TV and audio broadcasting standards

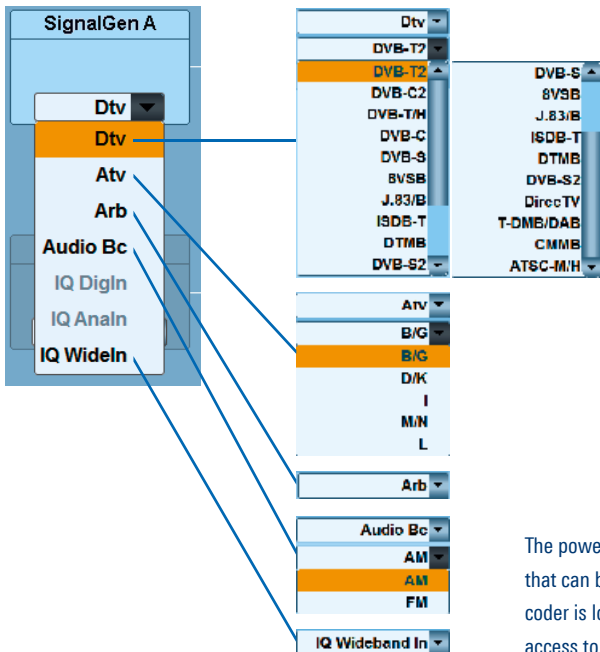

The powerful R&S®BTC platform offers all global TV and audio broadcasting standards that can be implemented by means of FPGA software coders. The required realtime coder is loaded into the FPGA by tapping the touchscreen. The user will then have access to all required parameters.



R&S®TA-TRS SEQUENCER TEST SOFTWARE



RF performance testing for TV, radio and satellite receivers

R&S®TA-TRS is a sequencer test software that further enhances seamless RF test experience for broadcast receivers. It features a user-friendly interface and unique test configurations such as loss compensation, multiple interfering signals, and smart learning of DUT control by infrared remote control.

Incorporated with the R&S®BTC broadcast test center, R&S®VTx platforms and other Rohde&Schwarz broadcast signal generators, R&S®TA-TRS offers users easy execution and management of test cases for product validation and production testing.

R&S®TA-TRS sequencer is based on the ETSI RED requirements for TV, radio and satellite receivers as specified in ETSI EN 303340, EN 303345 and EN 303372-2.

R&S®TA-TRS sequencer supports composite, HDMI™ and camera inputs for a comprehensive solution for video and audio quality analysis. With R&S®TA-TRS reducing the required testing and development time, thus effectively lowers investment, maintenance costs and increases manpower efficiency.

Automated testing in line with EN 303340, EN 303345, EN 303372-2

- ▶ Automated image comparisons with reference image and perceptual evaluation of video quality
- ▶ Optional camera solution for automated error detections
- ▶ Modern intuitive GUI with signal path compensation
- ▶ Ease of report generation

All-in-one broadcast solution

- ▶ Support RF signals generations of all global broadcasting standards and real-time interference signal generations
 - Support DUT audio and video analysis
 - Spectrum, measurement results and video at a glance
- ▶ User-friendly selection for test execution with path compensation
- ▶ Perceptual evaluation of video and audio quality using R&S®VTx
- ▶ Ensure reproducibility and consistency in test results
- ▶ Efficient utilization of resources
- ▶ Reduces time and cost of testing
- ▶ Ability to re-test failed test case
- ▶ Ability to resume test



Product site

R&S®SFE100 TEST TRANSMITTER



Powerful broadcast signal generator for production test systems

The R&S®SFE100 is a multistandard test transmitter providing realtime coding for broadcast signals. It supports all common digital and analog TV standards and a number of audio broadcasting standards. Its flexible customization options make the R&S®SFE100 suitable for a wide variety of applications – from production and quality assurance to simple development applications. The R&S®SFE100 is available with or without front panel controls.

The R&S®SFE100 is a compact and reliable instrument that can be equipped with a power amplifier that is unique in this class and makes the R&S®SFE100 particularly valuable in production test systems. Plus, it can be used as a simple and economical signal generator and as a second RF channel for special applications available with the R&S®SFU.

The R&S®SFE100 can be equipped with the appropriate digital or analog baseband signal sources. This makes it possible to replay test signals from Rohde&Schwarz libraries as well as proprietary test signals. The R&S®SFE100 thus combines two functions in one box, which significantly simplifies even complex production test systems. An optional arbitrary waveform generator allows the user to generate any type of modulation signal and to replay proprietary waveform files regardless of the available realtime coders.

Occupying only one height unit, the R&S®SFE100 is extremely compact. Nevertheless, all functions can be selected locally on the instrument.

Alternatively, the R&S®SFE100 can be remotely controlled from a PC. In this case, the test transmitter is operated via the same convenient graphical user interface as is used for the R&S®SFE and the R&S®SFU. For applications that do not require local control, an R&S®SFE100 model without display and keys is available.

- ▶ Versatile multistandard test transmitter with realtime coding
- ▶ High-precision signal generation over wide frequency and level range
- ▶ Integrated power amplifier for high output levels (optional)
- ▶ Integrated baseband signal sources
- ▶ User-friendly control elements and convenient remote operation
- ▶ Economical models without display and keys
- ▶ Optimized for use in production test systems
- ▶ Low power consumption



In production test systems, the signals from multiple R&S®SFE100 test transmitters are combined via a coupling network and then distributed over large distances.

Overview of R&S®SFE100 models

Model	.12	.13	.02	.03
Front-panel control	–	–	●	●
Remote control via LAN	●	●	●	●
USB and monitor ports	●	●	●	●
Digital standards	●	–	●	●
Analog standards	–	●	–	●
Transport stream generator	–	–	●	●
Transport stream player	●	–	●	●
Audio/video generator	–	●	–	●
Noise generator	●	●	●	●
ARB generator	–	–	●	●
Power amplifier	–	–	●	●



R&S®SFC COMPACT MODULATOR, R&S®SFC-U USB COMPACT MODULATOR



Test signals for TV and audio broadcasting – handy and economical

The R&S®SFC compact modulator and the R&S®SFC-U USB compact modulator are economical multistandard signal sources. They support realtime coding for all conventional digital and analog TV and audio broadcasting standards. The R&S®SFC is equipped with a built-in computer, making it ideal for standalone operation. The R&S®SFC-U is a USB device designed for use with a PC.

The R&S®SFC and R&S®SFC-U have an extremely compact design. Though small in size, they are full-featured TV and audio broadcasting signal generators with integrated transport stream player, audio/video generator and optional noise source. Even when it comes to signal quality, Rohde&Schwarz makes no compromises in this price class.

The R&S®SFC compact modulator is particularly well-suited for rack installation in production test systems. It is controlled using remote desktop via LAN or remotely with SCPI commands. The instrument can also be operated directly with a mouse, keyboard and monitor – with the same tried-and-tested graphical user interface (GUI) as the R&S®SFU and R&S®SFE.

The R&S®SFC-U USB compact modulator offers the same signal generator functions as the R&S®SFC in an even smaller housing, making room on the lab bench for the DUT and other equipment. The R&S®SFC-U is connected to the USB port of a host PC and controlled from the PC. The wide range of functions make the R&S®SFC-U ideal for developing software and hardware for TVs and set-top boxes. In addition, both instruments support the other tried-and-tested functions included in the Rohde&Schwarz professional broadcast signal generators, such as external reference, digital I/Q input, 1PPS input and ASI transport stream input.

Key facts

- ▶ High precision modulator with MER > 40 dB
- ▶ Level range from 0 dBm to -31.5 dBm, optionally to -110 dBm
- ▶ Transport stream player and audio/video generator
- ▶ AWGN generator
- ▶ Digital and analog standards for cable, satellite and terrestrial TV
 - Terrestrial: DVB-T2, DVB-T, DVB-H, DTMB, CMMB, T-DMB, ISDB-T, ISDB-TB, ATSC/8VSB, ATSC-M/H, MediaFLO™
 - Cable: DVB-C2, DVB-C, J.83/B, ISDB-C
 - Satellite: DVB-S2, DVB-S, DIRECTV
 - Analog TV: B/G, D/K, I, M/N, L
- ▶ Digital and analog audio broadcasting standards
 - DAB, DAB+, ISDB-TSB, FM/RDS
- ▶ Realtime signal generation and coding
- ▶ Additional standards available as software options

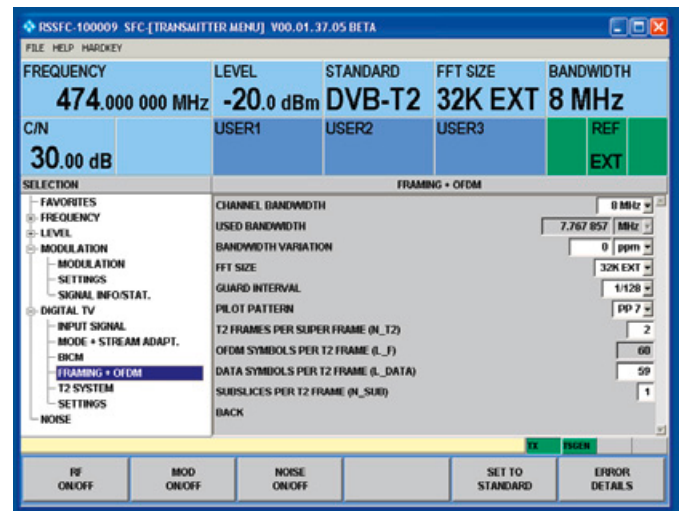

User-friendly, simple GUI of the R&S®SFC-U software on PC

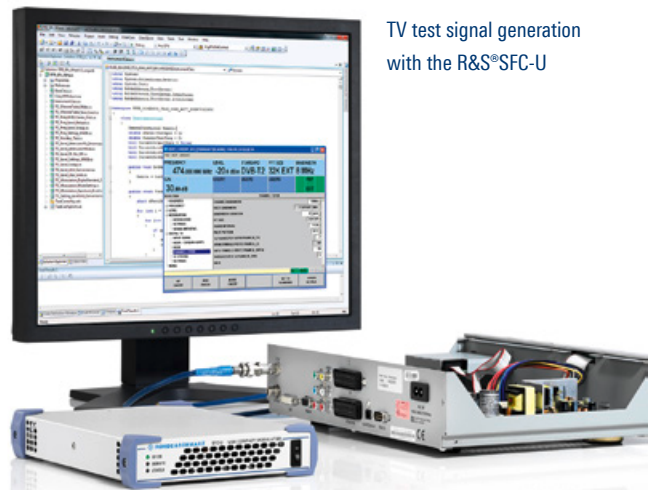

TV test signal generation with the R&S®SFC-U

R&S®SFC:			R&S®SFC-U:		
	Configurator	Product site		Configurator	Product site

R&S®SFD DOCSIS SIGNAL GENERATOR



Signal generator for DOCSIS 3.1 downstream and upstream

The R&S®SFD produces signals for DOCSIS 3.1, DOCSIS 3.0, digital cable TV in line with J.83/A/B/C and analog cable TV. Its downstream frequency range is 47 MHz to 1794 MHz for DOCSIS 3.1 and 47 MHz to 1218 MHz for DOCSIS 3.0 and TV. Within this range, the R&S®SFD generates a DOCSIS 3.1 channel with up to 192 MHz bandwidth.

The level, frequency, forward error correction (FEC) and constellation of this channel can be set. The R&S®SFD can alternatively produce a digital, QAM-modulated or analog TV signal. The DOCSIS 3.1 channel or digital TV channel is modulated in realtime. The data to be transmitted can be fed in via IP or internally generated by the R&S®SFD.

The upstream frequency range is 5 MHz to 204 MHz. Within this range, a DOCSIS 3.1 orthogonal frequency division multiple access (OFDMA) signal can be generated in realtime. A DOCSIS 3.0 TDMA or CDMA signal can be produced in realtime in the 5 MHz to 85 MHz range.

Thanks to its digital signal generation capabilities, the R&S®SFD is ideal for testing tuners, cable modems and upstream CMTS receivers in R&D and production and also for simulating DOCSIS 3.1 signals in real cable segments. For realistic signal generation, the R&S®SFD can add interference such as noise, phase noise, hum, tilt and even a defined bit error rate.

The generator is accommodated in ½ 19" housing that takes up a mere two height units. The complex signal generation process can be conveniently configured from a PC or via a web interface. Remote control through SCPI commands enables the generator to be used in automatic test systems. The R&S®SFD can be adapted to different application requirements thanks to its software option concept.

Key facts

- ▶ Frequency range in downstream: 47 MHz to 1218 MHz (extendable to 1794 MHz)
- ▶ Frequency range in upstream: 5 MHz to 204 MHz
- ▶ DOCSIS 3.1, DOCSIS 3.0, J.83/A/B/C and analog TV
- ▶ Up to 192 MHz signal bandwidth for DOCSIS 3.1
- ▶ ARB generator bandwidth up to 200 MHz
- ▶ Signal interference and distortion simulation

Overview of the R&S®SFD interfaces and function blocks

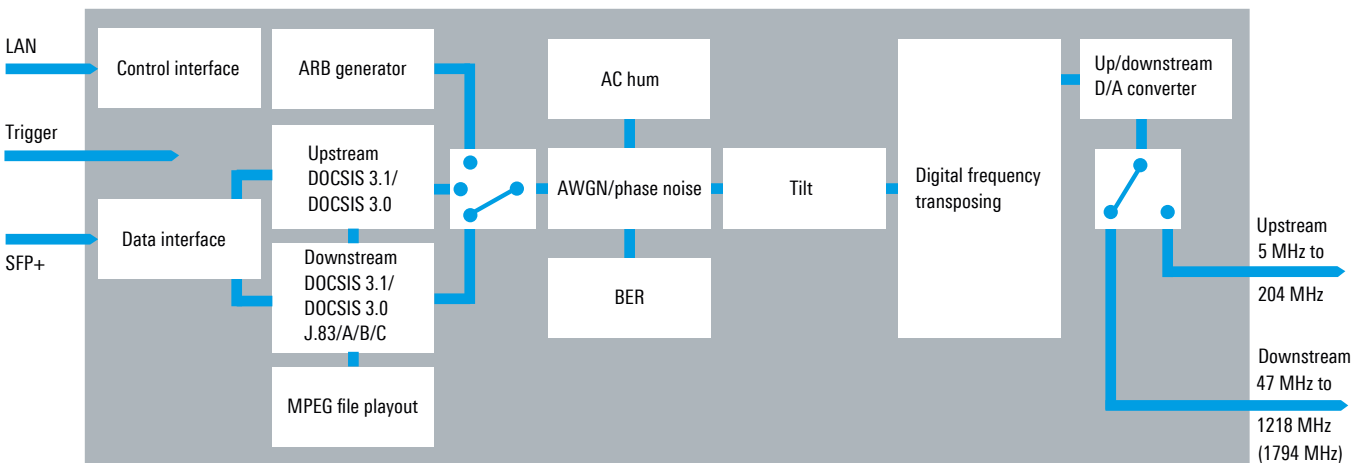

R&S® CLGD DOCSIS CABLE LOAD GENERATOR



Multichannel signal generator for DOCSIS 4.0

The R&S®CLGD is a multichannel signal generator for simulating a cable TV network with full channel loading. It generates broadband data signals for DOCSIS 4.0 (FDX), DOCSIS 3.1 as well as digital and analog TV channels. In the downstream or upstream, signals can be freely combined, allowing users to simulate any conceivable channel loading scenario in the lab.

The R&S®CLGD is the first generator that simultaneously produces signals for DOCSIS 4.0, DOCSIS 3.1, DOCSIS 3.0, digital cable TV in line with J.83/A/B/C and analog cable TV. Its downstream frequency range is 47 MHz to 1002 MHz for TV and 47 MHz to 1794 MHz for DOCSIS 3.1. Within this range, the R&S®CLGD generates multiple DOCSIS 3.1 channels with up to 192 MHz bandwidth each.

The R&S®CLGD FDX mode extends R&S®CLGD functionality with DOCSIS 4.0 test feature set. It includes the flexible configurable generation of FDX downstream and upstream channels. In addition the CLGD generates the FDX sounding (OUDP). The level, frequency, forward error correction (FEC) and constellation of these channels can be set independently. At the same time, the R&S®CLGD produces

a large number of digital and analog TV signals that can be placed anywhere below or between the DOCSIS 3.1 signals.

The DOCSIS 3.1 channels and digital TV channels are implemented in realtime. The data to be transmitted can be fed in via IP or internally generated by the R&S®CLGD. The upstream frequency range is from 5 MHz to 204 MHz. Within this range, DOCSIS 3.1 orthogonal frequency division multiple access (OFDMA) signals can be freely combined with DOCSIS 3.0 TDMA or CDMA signals.

The flexible multichannel signal generation capabilities of the R&S®CLGD enable it to simulate network loading in a reproducible manner, making it ideal for testing tuners, cable modems and upstream CMTS receivers. The influence of QAM and TDMA/CDMA signals in adjacent channels on DOCSIS 3.1 signal reception is a research topic of great interest. The R&S®CLGD makes such simulations realistic by adding different types of interference, such as noise, reflections and narrowband interference.

Key facts

- ▶ Frequency range in downstream: 47 MHz to 1218 MHz (extendable to 1794 MHz)
- ▶ Frequency range in upstream: 5 MHz to 204 MHz
- ▶ DOCSIS 4.0 (FDX), DOCSIS 3.1, DOCSIS 3.0, J.83/A/B/C and analog TV
- ▶ Up to eight times 192 MHz signal bandwidth for DOCSIS 3.1
- ▶ ARB generator bandwidth up to 200 MHz

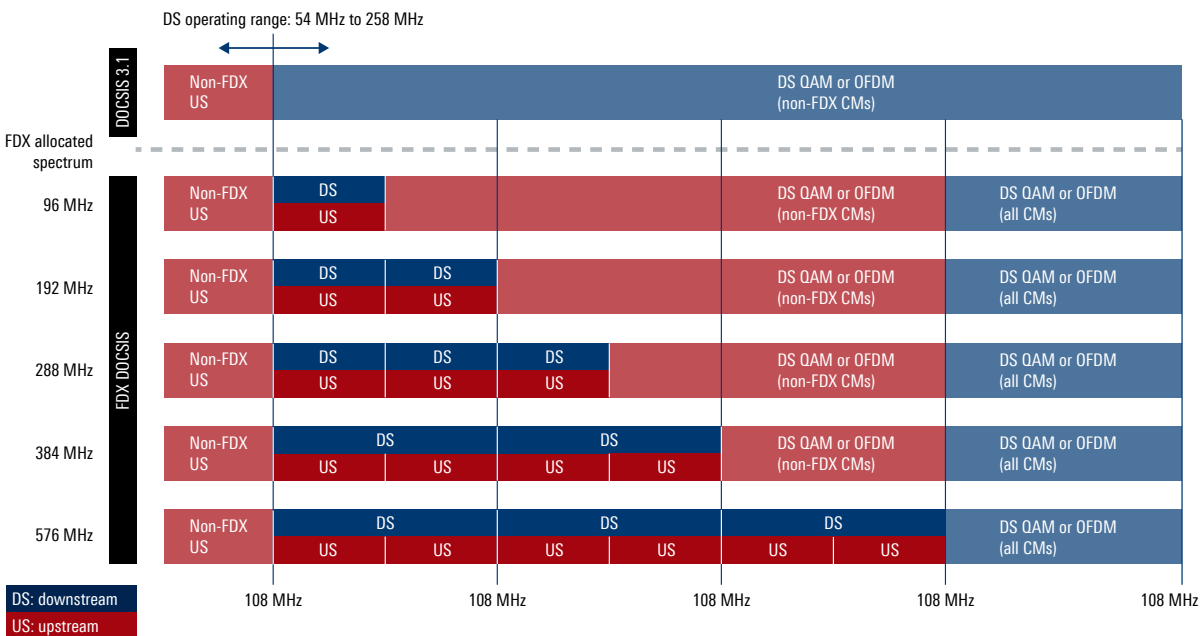

R&S® SLG SATELLITE LOAD GENERATOR

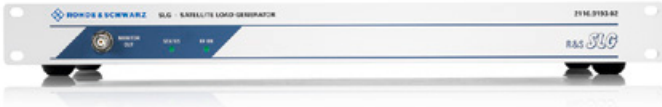

Multichannel digital satellite TV modulator

The R&S®SLG satellite load generator is a multichannel signal generator for digital satellite TV. It is the world's first integrated instrument to simulate TV satellite bands with full channel load. The R&S®SLG generates satellite TV signals using different standards and parameters and combines them in any desired manner. Users can simulate any conceivable uplink and downlink configurations in the lab. The R&S®SLG covers all satellite IF frequency bands used worldwide. Up to 16 transponders can transmit MPEG transport streams; the other transponders carry PRBS data. The transport streams are fed into the instrument via IP or ASI inputs. The R&S®SLG uses its integrated transport stream generator to play short transport stream files. Each channel can contain an ARB waveform or a CW carrier instead of a TV signal.

The R&S®SLG is primarily suited for performing RF tests on satellite TV components. Its interfaces, which are commonly used in consumer electronics and professional

satellite electronics, make the generator ideal for testing tuners and set-top boxes as well as upconverters, amplifiers and satellite payloads. Because it can simultaneously generate multiple channels with high symbol rates, the R&S®SLG is also well suited for performing stress tests on systems that process large data quantities, such as transcoders, conditional access middleware and military surveillance data processing systems. The R&S®SLG can be fully remote controlled, making it ideal for integration into automatic test systems. All this functionality has been packed into a compact 19" 1 HU housing. Previously a rack full of modulators was needed to generate as many satellite TV signals as the R&S®SLG does.

Key facts

- ▶ Satellite IF range from 250 MHz to 3225 MHz
- ▶ Up to 32 simultaneous transponder signals
- ▶ Independent setting of symbol rate, FEC, level and frequency
- ▶ DVB-S/S2, DVB-S2 wideband, DVB-S2X, DVB-S2X channel bonding and ISDB-S/S2 and ISDB-S3 standards
- ▶ Echostar turbo coding
- ▶ Signal quality of typ. 40 dB MER

Signal flow

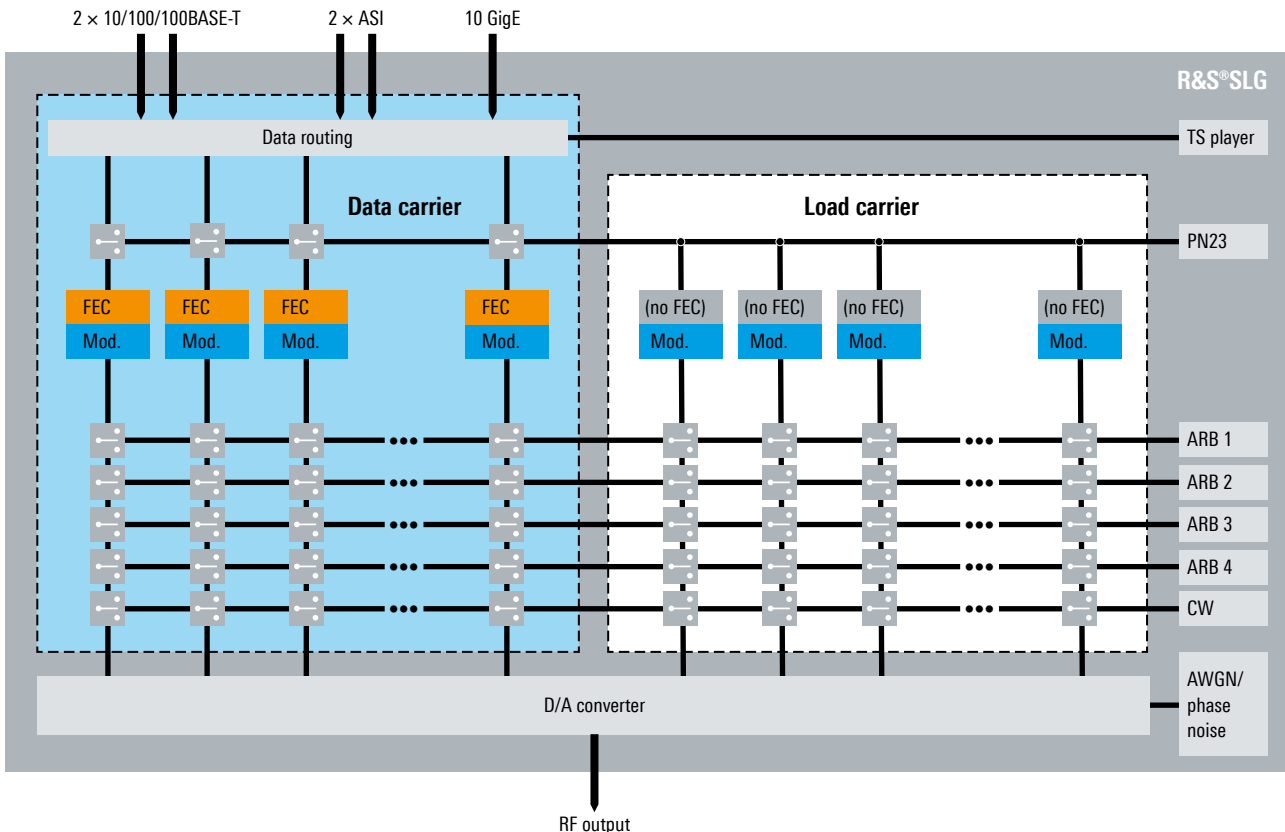

R&S® ETL TV ANALYZER



Universal reference for analyzing TV, mobile TV and sound broadcasting signals

The R&S®ETL TV analyzer has been successful on the market for years. For many network operators and manufacturers, it is the ultimate reference measurement tool. The R&S®ETL combines the functionality of a TV (analog and digital) and FM (radio) signal analyzer, a video and MPEG TS analyzer and a spectrum analyzer in a single instrument. The R&S®ETL also contains generators to create analog video signals, audio signals and MPEG-2 transport streams.

Key facts

- ▶ Frequency range from 500 kHz to 3 GHz
- ▶ Preselection with additional 75 Ω RF input
- ▶ Realtime demodulation for analog TV, DVB-T, DVB-T2, DVB-H, ATSC/8VSB, ATSC Mobile DTV, ISDB-T(B), DTMB, T-DMB/DAB, FM (radio), CDR ¹⁾, J.83/A/C, DVB-C, J.83/B
- ▶ Advanced frontend and FPGA-based demodulation
- ▶ Fast and accurate measurements of transmission impairments (e.g. level, MER(f), BER, echo pattern, amplitude and phase response)

Hardware-based video decoding (MPEG-2/H.264 (MPEG-4)/HEVC/AVS(+)) with video output on integrated screen and CCVS/HDMI™ output

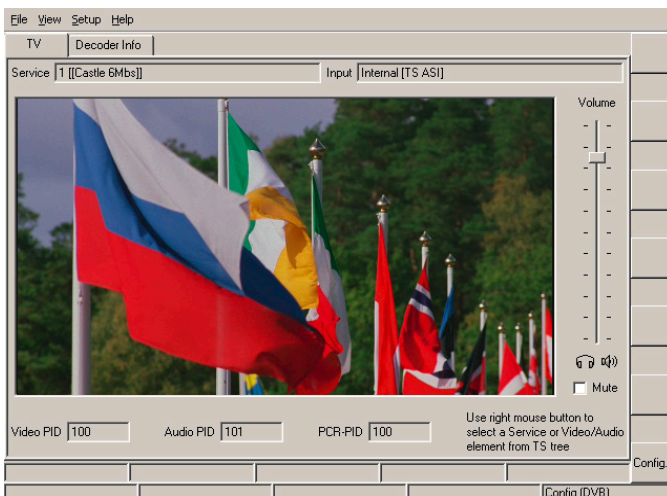

- ▶ Video display and output for MPEG-2, H.264 (MPEG-4), HEVC and AVS/AVS+ coded video signals
- ▶ Decoding and display of HEVC and AVS/AVS+ coded video signals
- ▶ Support of UHD video resolution (optional)
- ▶ TS over IP interface (decode, analyze, generate and stream received TS, optional)
- ▶ SSD with 256 Gbyte

Acceptance testing, maintenance and servicing of TV, mobile TV, DAB and FM transmitters

- ▶ Precise analysis of signal quality at transmitter output
- ▶ Measurements to optimize transmitter operating parameters
- ▶ Measurement of spurious emissions
- ▶ Detection of faults
- ▶ Documentation of signal parameters
- ▶ Remote maintenance via IP networks with remote desktop function

Quality assurance during the production of modulators and TV, DAB and FM transmitters

- ▶ Reproducible analysis of signal quality of modulators and transmitters

Optimization of TV, mobile TV, DAB and FM transmitter networks

- ▶ Measurement of receive levels and signal quality at reception site
- ▶ Checking and optimization of digital single-frequency networks (SFN)
- ▶ Systematic determination of receive quality in transmission area (coverage measurement)

¹⁾ CDR analysis requires a PC with dedicated software and Ethernet connection to the R&S®ETL.

Echo pattern with SFN frequency offset measurement (red lines)

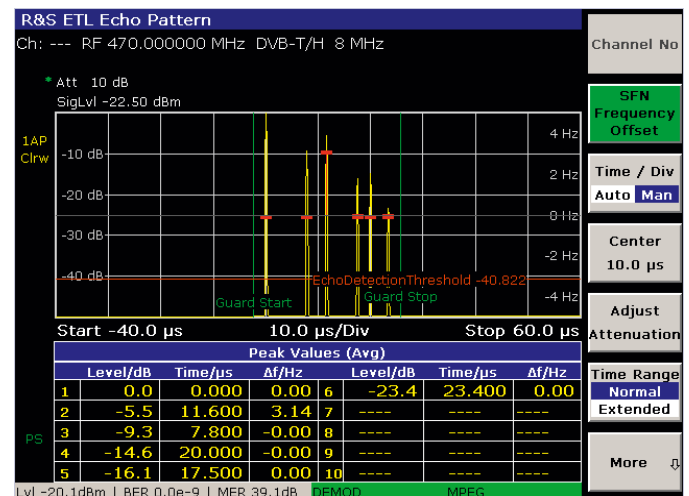

R&S®ETC COMPACT TV ANALYZER



Economical TV transmitter testing

The R&S®ETC compact TV analyzer offers a comprehensive set of measurement functions for DVB-T2, DVB-T/ DVB-H and ISDB-T digital TV transmitter testing. It is also useful for service and maintenance of TV transmitters as well as for testing modulators in R&D or quality assurance environments. The design of the analyzer is ideal for coverage measurements in broadcast network planning. The R&S®ETC is specialized in TV analysis and also performs

The channel impulse response measurement is essential for analyzing receive signal problems



The R&S®ETC internal power meter allows users to measure power levels with a power sensor



spectrum and scalar network analysis as well as power measurements. For tests that require higher sensitivity and selectivity, users can activate an integrated preselector followed by a preamplifier.

The core component of the R&S®ETC is an FPGA-based realtime digital TV demodulator that optimizes realtime BER measurements and provides a demodulated MPEG-2 transport stream at the ASI output. The instrument also offers a comprehensive set of transmitter measurement functions including amplitude, phase and group delay measurements for DVB-T2, DVB-T and ISDB-T. Further advantages of the compact TV analyzer are its high measurement speed and fast booting and mode switching times, which significantly reduces the time needed for test procedures.

To facilitate data exchange and monitoring, the R&S®ETCView Windows-based PC software, which comes with the instrument, allows users to document measurement results. The data can be transferred via a USB or LAN interface.

Key facts

- ▶ Support of DVB-T2, DVB-T/DVB-H and ISDB-T digital TV standards
- ▶ Wide frequency range up to 3.6 GHz or 8 GHz
- ▶ Precision MER measurement in realtime (typ. 44 dB at 500 MHz)
- ▶ Wide input level range from -76 dBm to +10 dBm for quasi-error-free transport stream decoding
- ▶ Spectrum analyzer DANL of typ. -165 dBm (1 Hz)
- ▶ Comprehensive analysis of digital signal transmission
- ▶ Support of MPEG decoding and analysis
- ▶ Easy operation, network coverage analysis and automatic test measurement

R&S®ETC is used for DUT analysis and result data is transferred using R&S®ETCView



R&S® DSA DOCSIS SIGNAL ANALYZER



Best signal quality for maximum data throughput

Only the highest signal quality ensures maximum throughput. The R&S® DSA DOCSIS signal analyzer has been designed for supporting users by ensuring the highest signal quality. DOCSIS is the standard for transmitting IP data within hybrid fiber coaxial (HFC) cable TV networks. The new DOCSIS 3.1 standard supports unprecedented data rates, meeting the demand for increased data throughput.

The R&S® DSA allows precise, gapless signal analysis of DOCSIS 3.0, EuroDOCSIS 3.0 and DOCSIS 3.1 signals on the physical layer in realtime. A user can detect effects that degrade signal quality, e.g. ingress, reflections and laser clipping. With its dual receivers, the R&S® DSA analyzes downstream and upstream signals. The frequency spectrum and key signal characteristics are displayed in compact overviews and diagrams, providing conclusive information about the signal quality.

In addition to DOCSIS signals, the R&S® DSA can analyze digital TV signals such as J.83 A/B/C and DVB-C. Although IP data transfer is consuming more and more transmission capacity, digital TV transmission continues to play an important role in cable TV networks. The R&S® DSA can analyze digital TV, helping users to ensure interference-free coexistence of DOCSIS and digital TV channels.

Convenient operation via the 10.1" touchscreen, intuitive pictograms and logically structured menus allow even less-experienced users to operate the instrument after a quick introduction.

Key facts

- ▶ Demodulation and analysis of DOCSIS 3.0/3.1 and EuroDOCSIS 3.0 downstream and upstream signals in realtime
- ▶ Demodulation and analysis of digital TV signals (J.83/A/B/C, DVB-C) in realtime
- ▶ Residual MER ≥ 50 dB with DOCSIS 3.1
- ▶ Residual MER ≥ 56 dB with SC-QAM
- ▶ Dual receivers for
 - Downstream (47 MHz to 1794 MHz)
 - Upstream (5 MHz to 204 MHz)
- ▶ Integrated spectrum analyzer
- ▶ 10.1" (25.6 cm) touchscreen
- ▶ Remote desktop function
- ▶ SCPI/ SNMP remote control

Assessing the quality of an HFC network with the R&S® DSA and a field strength meter

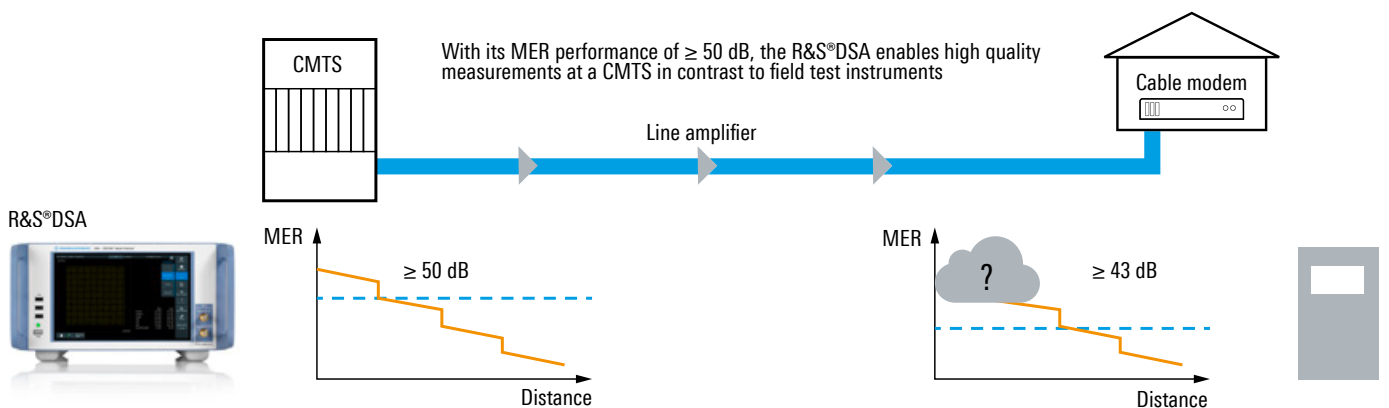

R&S® DVMS DIGITAL TV MONITORING SYSTEM FAMILY



Ensuring high quality of digital TV network operation

The R&S®DVMS family is a professional, attractively priced and compact solution for monitoring digital TV networks. It includes the R&S®DVMS1 and the R&S®DVMS4. Typical fields of applications for the R&S®DVMS family are signal monitoring at transmitter site, satellite uplink or headend.

The R&S®DVMS1 (1 HU, ½ rack width) makes it possible to simultaneously monitor an RF signal and an ASI signal or as an alternative up to four IP flows. The R&S®DVMS4 (1 HU) allows simultaneous monitoring of up to four RF/IP/ASI signals. Interface modules for DVB-T/DVB-T2, DVB-S/DVB-S2 as well as for IP (optical/electrical) are available.

All relevant errors at the RF, IP, TS and T2-MI level are recognized and reported immediately. Thumbnail display and electronic program guide (EPG) simplify visual monitoring of the transmitted contents. Remote access is supported via an integrated web server allowing independent, simultaneous access from different locations. SNMP and SNMP traps are supported for integration into central network management systems.

High-quality analysis functions and easy-to-understand displays complement the system's extensive array of monitoring functions. The analysis functions include program clock reference (PCR) analysis and buffer analysis as well as analysis of data and object carousels as used for system software update (SSU) and HbbTV®, for example. As a result, the R&S®DVMS is also ideal for troubleshooting, for example at a multiplex center or headend. Due to its small size, the R&S®DVMS1 in particular is a versatile and valuable tool for development.

Key facts

- ▶ Simultaneous monitoring of up to four signals
- ▶ RF modules for DVB-T/DVB-T2 and DVB-S/DVB-S2
- ▶ IP module for electrical and optical (SFP) connections
- ▶ Support for DVB, ATSC and ISDB-T/ISDB-T_B transport streams
- ▶ T2-MI and BTS support
- ▶ Optional functions for detailed analysis
- ▶ Modular and extremely compact design (1 HU)

Comparison of models		
	R&S®DVMS1	R&S®DVMS4
Number of module slots	1	4
Maximum number of simultaneously monitored inputs	4 (1 x TS and/or 1 x RF or 4 x TS IP)	4 (TS, RF and TS IP in any combination)
TS interfaces integrated in base unit	–	4 x TS
Total maximum bit rates of all inputs used	360 Mbit/s (IP), 86 Mbit/s (ASI/RF)	360 Mbit/s (IP + ASI + RF)
Integrated display (configure IP address, check firmware version or input status)	–	yes
Width	½ rack	full rack



Immediate detection of all relevant errors at the RF, IP, TS, T2-MI and BTS level

- ▶ Extensive RF measurements for DVB-T/DVB-T2 and DVB-S/DVB-S2 signals
- ▶ Extensive IP measurements
- ▶ Template function for transmission parameters
- ▶ Monitoring of DVB, ATSC and ISDB-specific TS
- ▶ T2-MI monitoring
- ▶ Template function for transport stream characteristics
- ▶ Detection of transport stream changes
- ▶ Data rate monitoring
- ▶ EPG/EIT monitoring
- ▶ MIP monitoring in SFN networks
- ▶ Encryption monitoring

Extensive analysis and visualization functions

- ▶ Constellation display
- ▶ Spectrum display (DVB-T and DVB-T2)
- ▶ Echo pattern display (DVB-T and DVB-T2)
- ▶ MDI display (IP flows)
- ▶ Thumbnail display
- ▶ EPG display
- ▶ Graphic display of data rates and table repetition rates
- ▶ Table interpreter
- ▶ PCR analysis
- ▶ PTS analysis
- ▶ Elementary stream analysis for video and audio according to buffer model
- ▶ Analysis of DVB object and data carousels
- ▶ Analysis of video encoding quality (qPSNR analysis)

Simple operation and configuration

- ▶ Clearly structured dialogs for all settings (monitoring characteristics, signal input and instrument)
- ▶ Detailed configuration capabilities for all monitoring functions and limits
- ▶ Convenient callup of measurement functions via view selector window
- ▶ Protection against unauthorized use by defining user-specific operation rights

Extensive range of monitoring features

- ▶ Monitoring of multiple DVB-T/DVB-H and DVB-S/ DVB-S2 signals through a single input with scheduler suite
- ▶ Triggered recording and archiving of transport stream segments
- ▶ Detailed monitoring and error logging
- ▶ Different profiles for bit rate measurements for long-term and peak evaluation
- ▶ Permanent or temporary suppression of error messages with hiding of events function

Powerful network functions

- ▶ Multiple user access via standard web browser (Java-based) or VNC viewer
- ▶ Integration in network management systems via built-in SNMP interface
- ▶ Simple data exchange using FTP
- ▶ Firewall-protected access
- ▶ Streaming of selected program or PID to any point in network

Use of multiple R&S®DVMS in one system

The instruments of the R&S®DVMS family have a powerful SNMP interface. As a result, they can easily be integrated into SNMP-based network management software.

Connection to a central monitoring station via SNMP

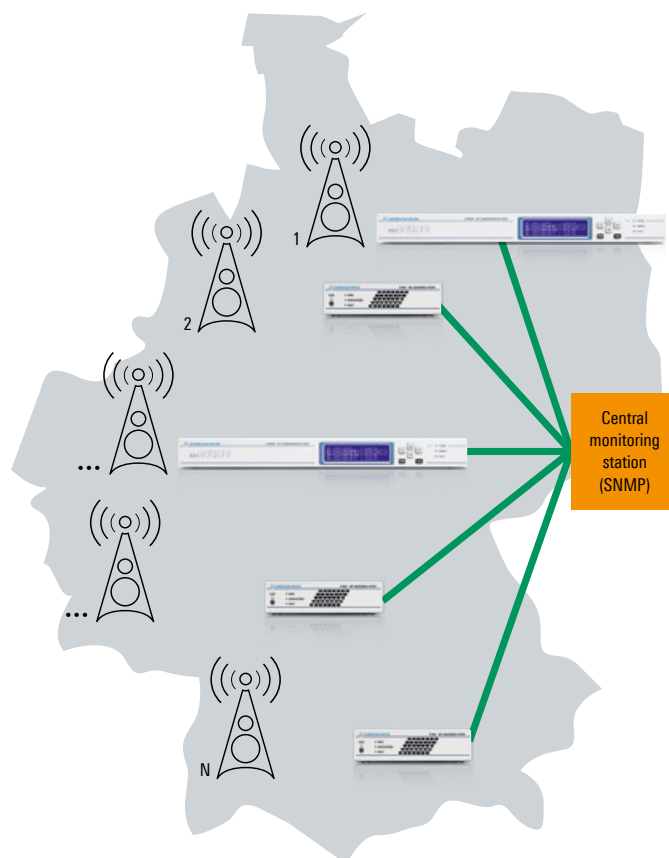

R&S®BCDRIVE BROADCAST DRIVE TEST SOFTWARE



Reliable coverage of specific regions is of central importance for terrestrial broadcast network operators. They use complex simulation programs during the planning phase to predict the coverage that will be provided by planned transmitter sites. However, because it is impossible to make a detailed determination of a region's complex propagation characteristics in advance, a series of real field measurements are needed after commissioning to verify that the planned network coverage was achieved..

Key facts

- ▶ Support of all relevant measurements in line with a variety of terrestrial broadcast standards
- ▶ Highly informative output through precise signal quality recording every second using the R&S®ETL or R&S®ETC TV analyzer
- ▶ Efficient drive tests through intuitive program operation and measurement of multiple frequencies in parallel
- ▶ Effective conversion of test results for Google Earth, or alternatively in CSV format for maximum flexibility

Efficient coverage analysis for terrestrial broadcast signals

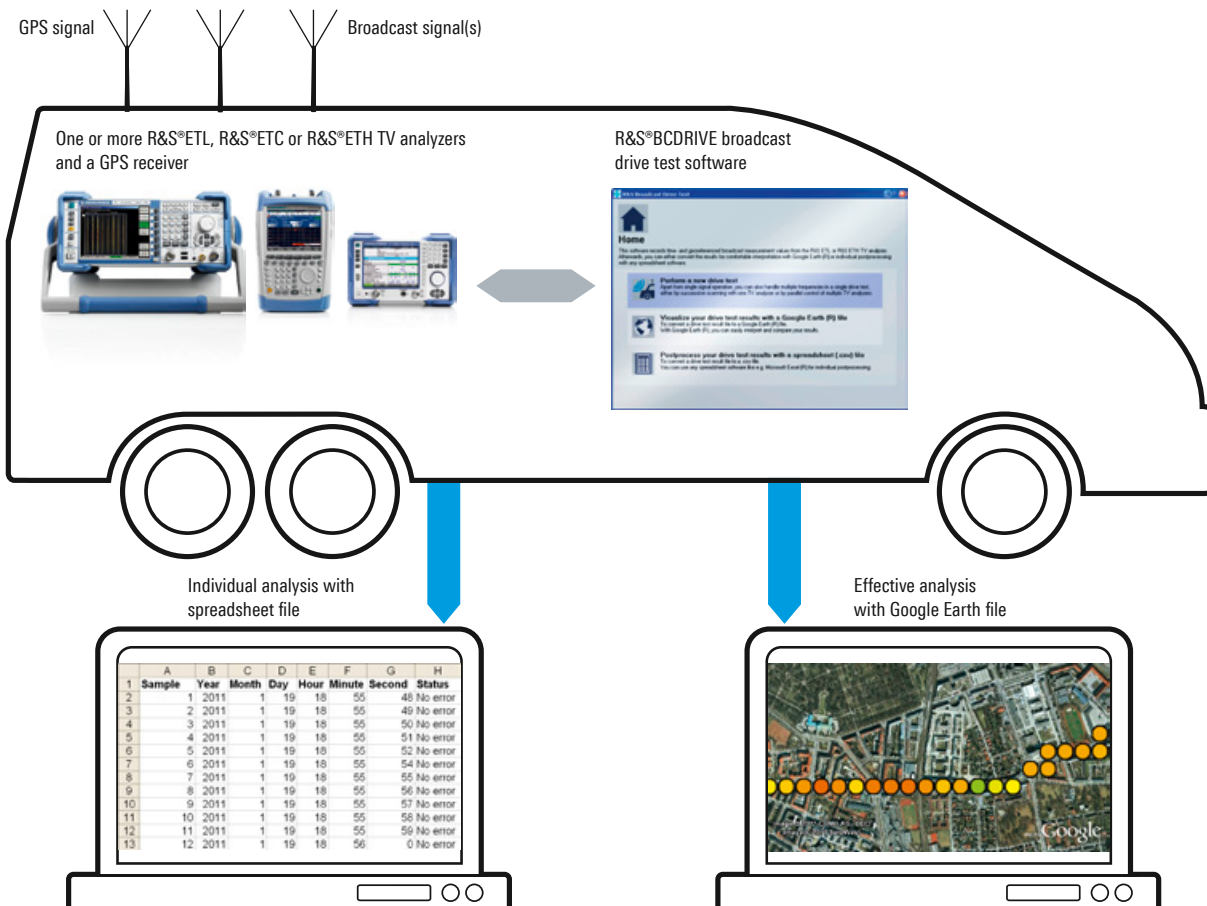

The R&S®BCDRIVE broadcast drive test software controls one or more R&S®ETL or R&S®ETC TV analyzers, including one GPS receiver, in order to efficiently analyze coverage for a large number of terrestrial broadcast standards.

System overview



R&S®VTC VIDEO TEST CENTER, R&S®VTE VIDEO TESTER, R&S®VTS COMPACT VIDEO TESTER

Model overview

	<p>R&S®VTC video test center High-end platform for A/V interface testing of consumer electronics devices</p>	<p>Accommodates up to eight different test modules</p> <ul style="list-style-type: none"> ▶ Large 11.6" touchscreen ▶ 4 HU, 19" ▶ Extensive protocol testing and audio/video analysis capabilities ▶ Powerful built-in PC with up to two hard drives
	<p>R&S®VTE video tester Compact all-purpose tester for A/V interface testing in quality assurance and for test system integration</p>	<p>Accommodates up to three different test modules</p> <ul style="list-style-type: none"> ▶ 7" touchscreen ▶ 3 HU, 1/2 19" ▶ Extensive protocol testing and audio/video analysis capabilities ▶ Powerful built-in PC with up to two hard drives
	<p>R&S®VTS compact video tester A/V interface testing in device manufacturing</p>	<p>Cost-effective A/V interface testing with one test module</p> <ul style="list-style-type: none"> ▶ Extremely compact with only 1 HU, 1/2 19" ▶ Operation via remote control/operation or external I/O ▶ Protocol testing and basic audio/video analysis capabilities ▶ Power-saving built-in PC

A/V interface testing of consumer electronics devices

Rohde&Schwarz offers audio/video T&M instruments covering the entire value chain in the consumer electronics sector – the R&S®VTC video test center for development applications, the R&S®VTE video tester for automated applications in test setups and the R&S®VTS compact video tester for manufacturing applications.

The R&S®VTC/VTE/VTS video testers are used for testing video and audio interfaces on consumer electronics equipment. With test modules for HDMI™ and analog A/V interfaces and comprehensive analysis capabilities, these instruments support a spectrum of applications.

The future-oriented, modular platforms accommodate up to eight (R&S®VTC), three (R&S®VTE) or one (R&S®VTS) test module(s) and can be equipped with additional software to optimally suit the requirements of specific applications.

The test instruments perform standard interface protocol tests and also analyze media content in realtime during application tests on consumer electronics equipment. This makes it easy to verify whether mobile devices provide the required video quality when video content is transmitted over a Long Term Evolution (LTE) link. It is also possible to measure the picture failure point (PFP) on broadcast and cellular terminal devices.



Configurator



Product site

Key facts

- ▶ Universal platform for HDMI 2.0, MHL 1.4/2.2 and analog A/V interfaces
- ▶ Protocol compliance testing
- ▶ Enhanced video and audio analysis
- ▶ Touchscreen user interface with multilingual support
- ▶ Integrated test automation and report generation

Mobile high-definition link (MHL) interface testing

- ▶ Realtime protocol analysis
- ▶ Control bus (CBUS) testing
- ▶ Generation of user-defined patterns and patterns in line with MHL, CEA-861-E
- ▶ Compliance testing of sources, sinks and dongles for MHL interfaces

High-definition multimedia interface (HDMI™) testing

- ▶ HDMI™ signal analysis up to 18 Gbit/s
- ▶ HDMI™ signal generation up to 18 Gbit/s (6G mode)
- ▶ HDMI 1.4 and 2.0a testing in line with the HDMI™ compliance test specification (CTS)

Time domain analysis solution with full 6 Gbps support for TMDS sources

- ▶ Powerful eye diagram analysis using subsampling
- ▶ Precompliance measurement solution for HDMI™ sources

Analog audio/video interface testing

- ▶ Composite (CCVS, CVBS) signal analysis
- ▶ YCbCr/RGB/RGBHV component signal analysis
- ▶ Powerful two-channel audio analysis

RF test signal generation for TV and audio broadcast standards

- ▶ Realtime coding of all relevant analog and digital standards
- ▶ Integrated transport stream player and analog audio/video generator
- ▶ Extensive test signal libraries of transport streams and analog test patterns

Complementary functions for media content analysis

- ▶ Video analysis of composite or digital component signals in the time domain
- ▶ Double-ended video and audio quality analysis
- ▶ Audio analysis
- ▶ Psycho-acoustic measurements

Easy operation

- ▶ Local operation via touchscreen
- ▶ Remote control and remote operation over a network from a tablet or PC
- ▶ Remote control for integration in automated test systems
- ▶ Integrated R&S® AVBrun test sequencer

The difference picture analysis function detects video degradations and analyzes them using suitable metrics



The R&S®VT-K2150 audio analysis option supports essential audio measurements on the available interfaces



STREAM LIBRARIES

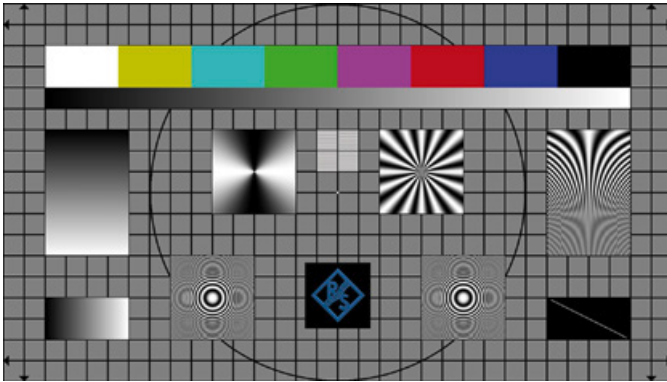

Test signal libraries for development, production and testing of TV components

Whenever the development, production and testing of TV components or devices is involved, suitable test signals are needed. To meet this need, Rohde&Schwarz offers not only the generators and modulators that are required but also an extensive collection of stream libraries. The R&S®DV-ASC advanced stream combiner software complements the stream library collection. This software provides an easy way to generate customized MPEG-2 transport streams for DVB, ATSC and ISDB-T. Alternatively, Rohde&Schwarz offers the generation of customized test signals as a service.

Key facts

- ▶ Support of numerous transmission standards
- ▶ High-quality video and audio contents
- ▶ Efficient use

Extensive collection of libraries

- ▶ HEVC stream library
- ▶ Basic stream library
- ▶ Extended SDTV library
- ▶ Extended HDTV library
- ▶ 3D TV library
- ▶ ISDB-T transport streams
- ▶ CMMB transport streams
- ▶ ATSC and ATSC Mobile DTV streams
- ▶ DVB-T2-MI streams
- ▶ T-DMB/DAB streams
- ▶ DAB+ streams
- ▶ French DMB streams
- ▶ MDI streams
- ▶ Transport streams for EMC tests
- ▶ Analog TV test pattern

Baseband streams for special customer requirements

- ▶ Generation of customer-specific transport streams with the R&S®DV-ASC advanced stream combiner software
- ▶ Generation of customer-specific transport streams or analog CCVS signals as a service

Large variety of applications

- ▶ Testing of TVs, set-top boxes and mobile TV handsets
- ▶ EMC testing of TVs in line with CISPR
- ▶ Testing of decoders and encoders
- ▶ Testing of analog/digital TV networks and transmitters
- ▶ Testing of radio receivers

Support of numerous transmission standards

- ▶ Digital TV
- ▶ Mobile TV
- ▶ Audio broadcasting
- ▶ Analog TV

High-quality video contents

- ▶ High-quality video sequences also for 4k
- ▶ Precise test patterns
- ▶ Numerous resolutions, including full HD
- ▶ MPEG-2, H.264 coding and HEVC coding

High-quality audio contents

- ▶ Detailed audio signals
- ▶ Precise test tones
- ▶ Surround/multichannel sound
- ▶ Various coding methods, including MPEG-4 HE-AAC v2

Efficient use

- ▶ Standard-compliant, reliable operation worldwide
- ▶ Available at the push of a button
- ▶ Clear and simple property rights
- ▶ Comprehensive documentation

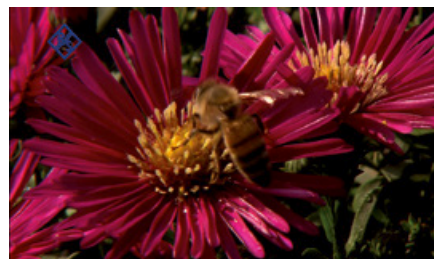

CHAPTER 12

POWER SUPPLIES

Having the right power supply for the right application is crucial. Rohde & Schwarz provides a wide range of laboratory power supplies that are tailored to a variety of uses with the features required for a specific application.

Type	Designation	Description	Page
Basic power supplies			
R&S®HMC8041 R&S®HMC8042 R&S®HMC8043	Power supply series	100 W, up to 32 V and up to 10 A/5 A/3 A	267
R&S®HM7042-5	Triple power supply	155.5 W, up to 32 V and up to 5 A	268
R&S®NGE102B R&S®NGE103B	Power supply series	66 W/100 W, up to 32 V and up to 3 A	269
Performance power supplies			
R&S®HMP2020 R&S®HMP2030 R&S®HMP4030 R&S®HMP4040	Power supply series	188 W, up to 32 V and up to 5 A/10 A per channel 384 W, up to 32 V and up to 10 A per channel	270
Specialty power supplies			
R&S®HM8143	Three-channel arbitrary power supply	130 W, up to 30 V and up to 2 A	271
New R&S®NGL200/NGM200	Power supply series	60 W/120 W, up to 20 V and up to 6 A	272
Modular power supply and load module			
R&S®TS-PSU	Power supply/load module for R&S®CompactTSVP family	20 W per channel, up to ±50 V and up to 3 A	244



R&S® HMC8041/HMC8042/HMC8043 POWER SUPPLY SERIES



Compact and easy to use

One, two or three channels – the R&S®HMC804x power supplies with their specifications and wide range of functions are ideal for use in development labs and industrial environments. Thanks to their high energy efficiency, the power supplies remain cool and quiet, even at maximum load. Practical interfaces and connectors allow users to work quickly and conveniently with the R&S®HMC804x, even in 19" racks. Convenient functions enable the instruments to be used in special applications.

EasyArb

EasyArb is the time/current flow or time/voltage curve that is individually programmable in each channel, with up to 512 points. Programming is possible via remote software or directly on the instrument.

EasyRamp function

Sometimes test sequences should avoid the abrupt rise of the supply voltage. The EasyRamp function allows users to simulate a startup curve. After the channels are switched on, the increase in output voltage will be practically linear to the set voltage value within a defined time span.

Sequencing function

The R&S®HMC804x power supply includes a sequencing function that can be adjusted via a menu. Sequencing enables you to automatically and consecutively connect available channels to the device under test, with adjustable time offsets when the MASTER on/off key is activated.

Key facts

- ▶ 0 V to 32 V per channel, max. 10 A/5 A/3 A per channel (model dependent)
- ▶ High efficiency, low heat dissipation and quiet fans
- ▶ Low residual ripple due to linear postregulation
- ▶ Convenient parallel and serial operation
- ▶ Overvoltage protection (OVP) for all outputs
- ▶ Overpower protection (OPP) for all outputs
- ▶ FuseLink (freely combinable electronic fuses)
- ▶ EasyArb function for user-definable V/I curves
- ▶ EasyRamp for simulating a start-up curve (directly programmable on device)
- ▶ Sequencing (sequenced start of channels)
- ▶ Analog input for external control via voltage (0 V to 10 V) and current (4 mA to 20 mA)
- ▶ Trigger input for starting/controlling EasyArb
- ▶ Data logging to USB flash drive in CSV format

Ideal for industrial environment: power supply units in industrial production are often found in 19" racks. All R&S®HMC804x models can be integrated into 19" racks with the R&S®HMC95 rackmounting kit.



Model overview

Model	Number of channels	Output voltage per channel	Maximum output current per channel	Total output power	Overvoltage protection	GPIB interface
R&S®HMC8041	1	32 V	max. 10 A	max. 100 W	adjustable for each channel	–
R&S®HMC8041G	1	32 V	max. 10 A	max. 100 W	adjustable for each channel	•
R&S®HMC8042	2	32 V	max. 5 A	max. 100 W	adjustable for each channel	–
R&S®HMC8042G	2	32 V	max. 5 A	max. 100 W	adjustable for each channel	•
R&S®HMC8043	3	32 V	max. 3 A	max. 100 W	adjustable for each channel	–
R&S®HMC8043G	3	32 V	max. 3 A	max. 100 W	adjustable for each channel	•



Configurator Product site

R&S® HM7042-5 TRIPLE POWER SUPPLY



Lab performance in a rugged and portable design

- ▶ 2 x 0 V to 32 V/max. 2 A; 1 x 0 V to 5.5 V/max. 5 A
- ▶ High-performance, inexpensive laboratory power supply
- ▶ Floating, overload and short-circuit proof outputs
- ▶ Separate voltage and current displays for each output
- ▶ Display resolution: 10 mV/1 mA at channel 1 + 3; 10 mV/10 mA at channel 2
- ▶ Protection of sensitive loads by current limit and electronic fuse
- ▶ Low residual ripple, high output power, excellent regulation
- ▶ Temperature-controlled fan

Parallel and serial operating mode

Because all channels are galvanically separated, they can be combined:

- ▶ In the parallel operating mode, channels can be bundled to achieve higher currents
- ▶ In the serial operating mode, channels can be combined for higher output voltages

Benefits	Features
Straightforward operation	All functions can be operated from the front panel; separate rotary knobs for each channel to adjust voltage and current
The separate output channels can work like individual power supplies	All channels are galvanically separated and can be combined for higher voltage or current
Small, compact and quiet	Combination of primary transformer, secondary switching regulator and additional linear control reduces weight and size

Rear view of the R&S®HM7042-5



Model overview					
Model	Number of channels	Output voltage per channel	Maximum output current per channel	Total output power	Resolution
R&S®HM7042-5	3	channel 1: 0 V to 32 V channel 3: 0 V to 32 V channel 2: 0 V to 5.5 V	channel 1: 2 A channel 3: 2 A channel 2: 5 A	max. 155.5 W	channel 1: 10 mV/ 1 mA channel 3: 10 mV/ 1 mA channel 2: 10 mV/ 10 mA



R&S® NGE100B POWER SUPPLY SERIES



Reduced to the max

The R&S® NGE100B power supply series consists of robust, high-performance, affordable instruments. They offer high efficiency combined with low ripple plus a variety of comfort functions that are not usually found in this class of power supplies.

Meets your daily needs

- ▶ All channels galvanically isolated and earth-free
- ▶ All channels electrically equivalent with the same voltage, current and power
- ▶ Parallel and serial operation
- ▶ Short-circuit-proof outputs
- ▶ Protection functions to safeguard instrument and DUT
- ▶ Modern architecture; small, compact and quiet
- ▶ Tailored to be used in education, labs and system racks

Easy operation

- ▶ Straightforward operation
- ▶ Color-coding of operating conditions

Operation modes

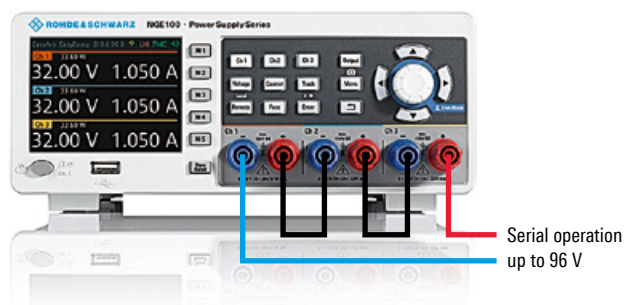
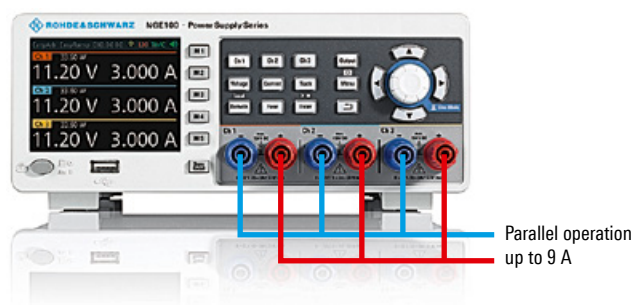

- ▶ Comfort features for special applications
- ▶ Tracking and link functions
- ▶ Five memory keys to save/recall instrument settings

Connectivity – everything you need

- ▶ Front connectors with 4 mm safety binding posts
- ▶ USB interface (virtual COM port and TMC class)
- ▶ LAN interface (LXI) with integrated web server (R&S® NGE-K101 option)
- ▶ Wireless LAN, unique in this class (R&S® NGE-K102 option)
- ▶ Digital trigger in/out (4 bit) on the rear (R&S® NGE-K103 option)

Key facts

- ▶ R&S® NGE102B with two or R&S® NGE103B with three channels
- ▶ Max. output power of 66 W with R&S® NGE102B, 100 W with R&S® NGE103B (33.6 W per channel)
- ▶ Max. output voltage of 32 V per channel (up to 64 V/96 V in serial operation)
- ▶ Max. output current of 3 A per channel (up to 6 A/9 A in parallel operation)
- ▶ Electronic fuse (OCP), overvoltage protection (OVP), overpower protection (OPP), overtemperature protection (OTP)
- ▶ USB interface (CDC/TMC), optional LAN (LXI), optional wireless LAN
- ▶ Optional digital I/O (4 bit)

Model overview

Model	Number of channels	Output voltage per channel	Max. output current per channel	Total output power	Protection functions	Interfaces
R&S® NGE102B	2	0 V to 32 V	3 A	max. 66 W	Electronic fuse (OCP), overvoltage protection (OVP), overpower protection (OPP), overtemperature protection (OTP)	Standard: USB, optional: LAN, WLAN, digital trigger I/O (4 bit)
R&S® NGE103B	3	0 V to 32 V	3 A	max. 100 W	Electronic fuse (OCP), overvoltage protection (OVP), overpower protection (OPP), overtemperature protection (OTP)	Standard: USB, optional: LAN, WLAN, digital trigger I/O (4 bit)



Configurator Product site

R&S®HMP2020/HMP2030 R&S®HMP4030/HMP4040 POWER SUPPLY SERIES



Up to four channels in a single instrument

The R&S®HMP power supplies are primarily designed for industrial use – for production environments as well as for development labs. These rugged instruments offer high efficiency with low residual ripple and many protection functions.

- ▶ Four models: 2 or 3 channels with 188 W total output power, 3 or 4 channels with 384 W total output power
- ▶ Galvanically isolated, floating outputs with overload and short-circuit protection
- ▶ Remote sensing eliminates voltage drops on the load leads
- ▶ Comfortable programming features and 19" rack adapters ensure perfect integration into production environments

Options and accessories

R&S®HO740	IEEE-488 (GPIB) interface
R&S®HO720	Dual interface RS-232/USB
R&S®HZ42	19" rack adapter, 2 HU, for R&S®HMP2020/HMP2030
R&S®HZP91	19" rack adapter, 4 HU, for R&S®HMP4030/HMP4040

Key facts

- ▶ R&S®HMP2020: 1 × 0 V to 32 V/max. 10 A;
1 × 0 V to 32 V/max. 5 A (188 W)
- ▶ R&S®HMP2030: 3 × 0 V to 32 V/max. 5 A (188 W)
- ▶ R&S®HMP4030: 3 × 0 V to 32 V/max. 10 A (384 W)
- ▶ R&S®HMP4040: 4 × 0 V to 32 V/max. 10 A (384 W)
- ▶ Low residual ripple due to linear postregulators
- ▶ Realtime voltage, current and power values
- ▶ High programming and readback resolution: 1 mV and 0.1/0.2/1.0 mA (depending on current and model)
- ▶ FuseLink (electronic fuse) freely combinable for all channels
- ▶ FuseDelay tunable up to 250 ms
- ▶ Independently adjustable overvoltage protection (OVP) for each channel
- ▶ EasyArb function directly programmable on device
- ▶ Advanced parallel and serial operation
- ▶ Front connectors: 4 mm safety sockets
- ▶ Rear connectors for all channels, including SENSE
- ▶ LAN/USB dual interface, remote control via SCPI-based commands

Benefits	Features
Up to 4 channels in a single compact box	Flexible configuration for any specific application, including sense lines for each channel to compensate voltage drops over the supply leads
Channels galvanically isolated and floating	Serial operation with up to 128 V or parallel operation with up to 40 A
Overcurrent protection (electronic fuse) and overvoltage protection	To safeguard the instrument and the DUT. The fuse link technology switches off all selected channels when one of them reaches its current limit
Easily programmable time/voltage or time/current curves	To vary voltage or current during a test sequence; can be programmed manually via the user interface or via the external interfaces



Connections for all channels – including sense lines – are also provided on the rear panel (shown here: R&S®HMP4040 with opt. R&S®HO740 IEEE-488 interface)

Model overview

Model	Number of channels	Output voltage per channel	Maximum output current per channel	Total output power	Max. output power per channel	Max. voltage in serial operation	Max. current in parallel operation
R&S®HMP2020	2	0 V to 32 V	channel 1: 10 A channel 2: 5 A	max. 188 W	channel 1: 160 W channel 2: 80 W	64 V	15 A
R&S®HMP2030	3	0 V to 32 V	5 A	max. 188 W	80 W	96 V	15 A
R&S®HMP4030	3	0 V to 32 V	10 A	max. 384 W	160 W	96 V	30 A
R&S®HMP4040	4	0 V to 32 V	10 A	max. 384 W	160 W	128 V	40 A



Configurator

R&S®HMP2000:



Product site

R&S®HMP4000:



Product site

R&S®HM8143 ARBITRARY POWER SUPPLY



Flexible solution for special applications

The R&S®HM8143 power supply is the perfect choice whenever two-quadrant operation is needed. Besides the source functionality, it also provides electronic loads to accurately sink current and dissipate power in a controlled manner, for example to emulate the characteristics of a battery being charged or unloaded.

The R&S®HM8143 offers two channels with up to 30 V source and sink functionality plus one source channel with 5 V. Electronic fuse and modulation inputs are additional features.

Parallel and serial operating mode

In the parallel operating mode, channels can be bundled to achieve higher currents. In the serial operating mode, channels can be combined for higher output voltages.

Modulation inputs

The R&S®HM8143 provides two modulation inputs on the rear, so it can be used as a power amplifier with a frequency range from DC to 20 kHz. Applications include testing of AC motors, relays, etc.

Electronic fuse

In order to provide even better protection than current limiting, the R&S®HM8143 offers the feature of an electronic fuse. As soon as the current limit is reached, all outputs are simultaneously disabled.

Arbitrary function

The arbitrary mode can be used to generate a time/voltage flow. A table comprising up to 1024 voltage and time values can be defined using external software tools.

Key facts

- ▶ 2 × 0 V to 30 V/max. 2 A, 1 × 5 V/max. 2 A (130 W)
- ▶ Realtime voltage and current values
- ▶ Linear regulated, two-quadrant power supply (current source and sink)
- ▶ Setting and readback resolution: 10 mV, 1 mA
- ▶ Electronic fuse and tracking mode
- ▶ Advanced parallel (up to 6 A) and serial (up to 65 V) operation
- ▶ Front connectors: 4 mm safety sockets
- ▶ Sense connectors for line loss compensation (30 V channels)
- ▶ External modulation of output voltages up to 20 kHz
- ▶ Arbitrary module: 4096 points, 12 bit
- ▶ RS-232/USB dual interface, optionally IEEE-488 (GPIB)

Benefits	Features
Two channels with source/sink functionality	Two-quadrant functionality can be used to source or sink current, e.g. to emulate any charging/unloading application
Additional 5 V source channel	Can be used to supply often used 5 V circuitries without needing another instrument
Electronic fuse	Overcurrent protection can be set to switch off all channels in case the configured current limit is overdriven
Modulation inputs	Via external modulation signals, the R&S®HM8143 can be used as a power amplifier, for example to supply AC motors

Model and options

R&S®HM8143	Arbitrary power supply
R&S®H0880	IEEE-488 (GPIB) interface
R&S®HZ42	19" rackmount kit, 2 HU

Rear view with R&S®H0720 dual-Interface, alternatively with optional R&S®H0880 IEEE-488 (GPIB) interface



Product site

R&S® NGL200/NGM200 POWER SUPPLY FAMILY

New



High precision source and sink

Thanks to their high accuracy and fast load recovery time, the R&S®NGL200 and R&S®NGM200 power supplies are perfect for challenging applications. Their two-quadrant architecture allows them to function both as a source and a sink to simulate batteries and loads. Their short recovery times enable them to handle fast load changes that occur for example when mobile communications devices switch from sleep mode to transmit mode.

The single-channel R&S®NGL201/NGM201 and the two-channel R&S®NGL202/NGM202 deliver up to 60 W of output power per channel. The output channels are floating, galvanically isolated and protected against overload and short circuits.

Thanks to their fast recovery time of $< 30 \mu\text{s}$ and minimum overshoot even during a demanding load change, the R&S®NGL200 and R&S®NGM200 power supplies are ideal for powering IoT devices and other battery-operated devices.

With a resolution of up to $6\frac{1}{2}$ digits when measuring voltage, current and power, the R&S®NGL200 and R&S®NGM200 power supplies are perfect for characterizing devices that have low power consumption in standby mode and high current in full load operation. In many cases, an additional digital multimeter is no longer necessary.

The linear two-quadrant design of the output stages allows the R&S®NGL200/NGM200 power supply series to operate as a source and sink with minimum residual ripple and noise, ideally supporting the development of power amplifiers and MMICs.

Power supplies usually respond to abrupt load changes with overshoot and slow recovery times. Thanks to specially optimized control circuits, the R&S®NGL200/NGM200 series achieves recovery times of $< 30 \mu\text{s}$.

Key facts	R&S®NGL201/ R&S®NGM201	R&S®NGL202/ R&S®NGM202
Number of output channels	1	2
Total output power	60 W	120 W
Max. output power per channel	60 W	
Output voltage per channel	0 V to 20 V	
Max. output current per channel	$\leq 6 \text{ V}: 6 \text{ A}, > 6 \text{ V}: 3 \text{ A}$	
Load recovery time	$< 30 \mu\text{s}$	
Max. power and current per channel when used as a load	60 W, 3 A	

Technology for challenging tasks

- ▶ Fast load regulation
- ▶ Minimum residual ripple and low noise
- ▶ Readings with up to $6\frac{1}{2}$ digit resolution
- ▶ Galvanically isolated, floating channels
- ▶ Output stage isolated with relays
- ▶ Two quadrants: operates as source and sink
- ▶ Constant voltage, constant current and constant resistance modes
- ▶ Variable internal impedance
- ▶ Protection functions to safeguard instrument and DUT
- ▶ Safety limits to safeguard the DUT

Easy operation

- ▶ High-resolution touchscreen
- ▶ Color coding of operating modes
- ▶ QuickArb function
- ▶ EasyRamp function
- ▶ Save and recall instrument settings

Ideal for use in labs and test systems

- ▶ Tailored for use in labs and system racks
- ▶ Remote sensing for lead resistance compensation
- ▶ Front and rear connectors
- ▶ Full remote capabilities
- ▶ Fast on the bus and on the bench
- ▶ Compact form factor, quiet operation

Fast load regulation

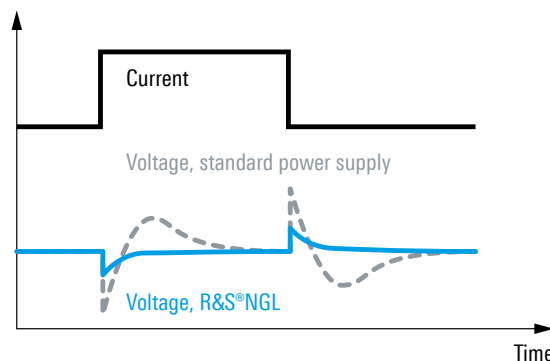

R&S®NGL200:



Configurator



Product site

R&S®NGM200 exclusive features

Multiple measurement ranges

Two voltage measurement ranges and four ranges to measure current provide a high accuracy and resolution down to 1 μ V/10 nA.

High-speed acquisition

The R&S®NGM200 power supplies offer the high-speed FASTLog functionality to capture voltage and current measurement results. With an acquisition rate of up to 500 ksample/s, voltage and current results are available every 2 μ s. With this high-speed acquisition, even spikes in the microsecond range are captured.

Battery simulation

Real batteries show different characteristics depending on the type of battery and its charging condition. Capacity, open circuit voltage (VOC) and equivalent series resistance (ESR) are important battery characteristics that depend on its state of charge. The optional R&S®NGM-K106 functionality allows users to simulate the behavior of batteries under different charging conditions, e.g. when powering a DUT.

Battery simulation: the main parameters to characterize a battery's condition are summarized in one display

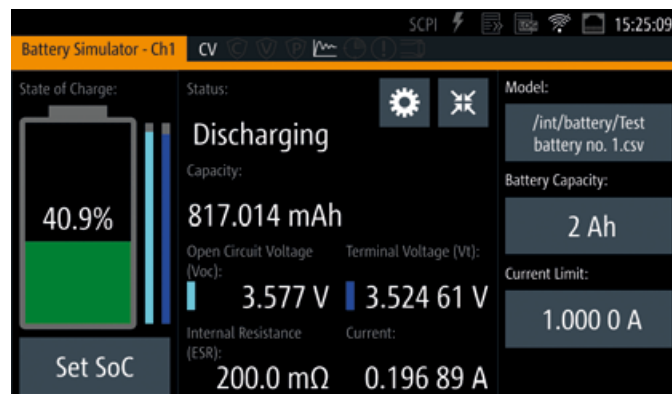

Digital voltmeter functionality

Like other power supplies, the R&S®NGM200 instruments measure the voltage supplied to the DUT. In addition, the R&S®NGM-K104 option activates a port that allows the internal digital voltmeter to be connected to any point in the customer's circuitry.

FastLog functionality

Min: 2.036 12 V
Avg: 2.313 08 V
Max: 2.682 64 V



Min: 1.813 26 V
Avg: 2.454 01 V
Max: 4.786 46 V



The FastLog functionality follows voltage/current variations with a resolution of up to 2 μ s. It detects spikes that would be overseen by slower instruments.

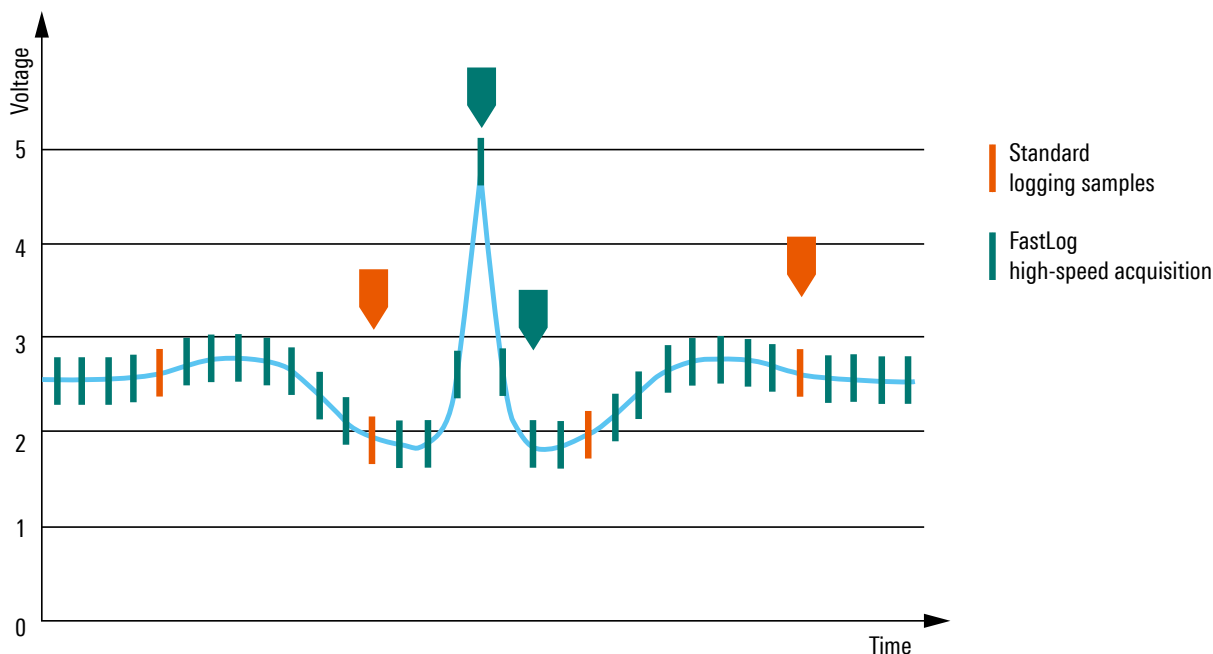

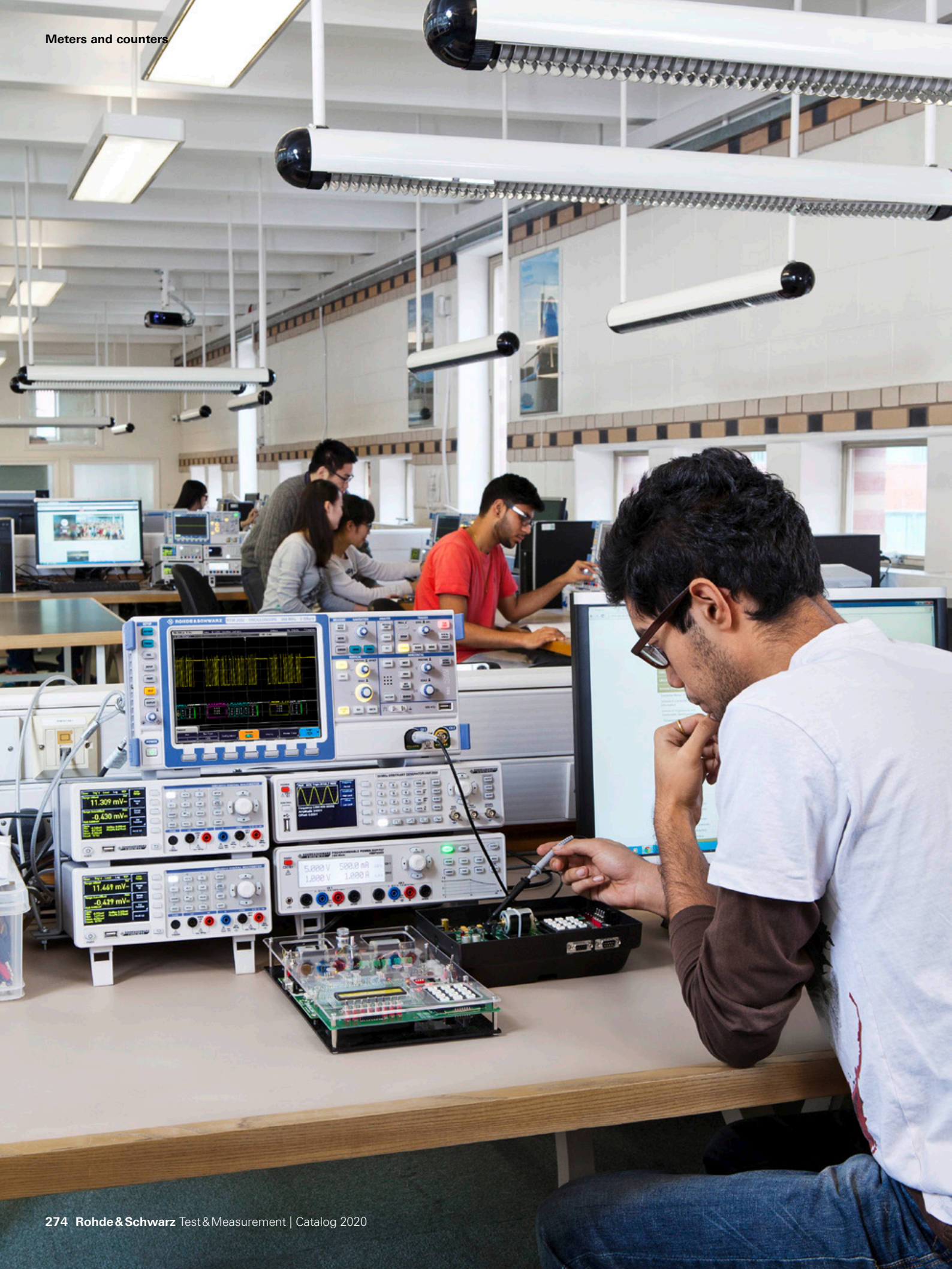

CHAPTER 13

METERS AND COUNTERS

Get accurate and reliable voltage, current, power, frequency, impedance and temperature measurements with Rohde & Schwarz meters.

Type	Designation	Description	Page
Digital multimeter			
R&S®HMC8012	Digital multimeter	5¾-digit digital multimeter (480 000 points)	276
LCR meter			
R&S®HM8118	LCR bridge/meter	Universal, flexible and easy to use	277
Frequency counter			
R&S®HM8123	Universal counter	10-digit resolution for precise measurement results	278
Power analyzer			
R&S®HMC8015	Power analyzer	All in one: the compact class that has it all	279

R&S®HMC8012 DIGITAL MULTIMETER



See more – up to three results in parallel

- ▶ Measurement range: DC to 100 kHz
- ▶ Resolution: 1 μ V, 100 nA, 1 m Ω , 1 pF, 1 Hz, 0.1 $^{\circ}$ C/F
- ▶ Basic accuracy: 0.015% (DC)
- ▶ True RMS measurement, AC and AC + DC
- ▶ 5 $\frac{3}{4}$ -digit display (480 000 counts)
- ▶ Simultaneous display of three measurement functions, e.g. DC+AC+statistics
- ▶ Measurement rate: up to 200 values/s
- ▶ Measurement functions: V (DC), I (DC), V (AC), I (AC), frequency, resistance (two- and four-wire), temperature, capacitance, diode and continuity test
- ▶ Mathematic functions: limit testing, min./max., average, offset, DC power, calculation of dB and dBm
- ▶ Data logging to internal memory or USB flash drive in CSV format
- ▶ Interfaces: USB-TMC/-VCP, Ethernet (LXI)
- ▶ IEEE-488 (GPIB) port (R&S®HMC8012-G)
- ▶ SCPI commands largely compatible with Keysight 34410A

Benefits	Features
See more at a glance with three values displayed on one screen	Measured voltage, measured current, calculated power
Limit testing on color display for easy minimum/maximum analysis	Programmable test functions such as limit and min./max.
10 A range as standard	One current input with up to 10 A and no need to change connectors for different ranges
Saves up to 4 GB of data directly onto storage devices	Writes directly to USB thumb drive

Rear panel interfaces (shown here: R&S®HMC8012-G with IEEE-488 interface)



Models and options	
R&S®HMC8012	Digital multimeter, 5 $\frac{3}{4}$ -digit
R&S®HMC8012-G	Digital multimeter, 5 $\frac{3}{4}$ -digit, incl. IEEE-488 (GPIB) interface
R&S®HMC95	19" rack adapter, 2 HU for R&S®HMC series



R&S® HM8118 LCR BRIDGE/METER



Universal, flexible and easy to use

- ▶ Basic accuracy: 0.05%
- ▶ Up to 12 measurements per second
- ▶ Parallel and serial mode
- ▶ Internal programmable voltage and current bias
- ▶ Kelvin cable and four-terminal SMD test adapter included
- ▶ R&S®HO118 binning interface (optional) for automatic sorting of components

R&S®HO118 binning interface: The R&S®HO118 binning interface enables use with external hardware that sorts components by physical type after measurement. Data lines for eight sorting containers and control lines (ALARM, INDEX, EOM, TRIG).

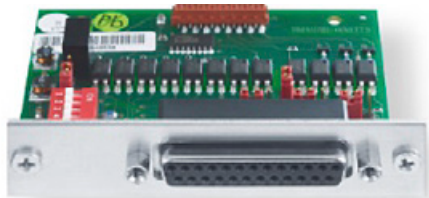

Benefits	Features
Versatile functionality, all usually needed measurements included	The R&S®HM8118 provides the full range of measurements to characterize resistors, capacitors and inductors; results are displayed in absolute, relative or average values
Easy to use	Frequently used functions are directly accessible via front panel keys
Easy to interface for remote control	RS-232/USB interface; optional GPIB
Quiet on the bench	Fanless design

R&S®HZ181 4-terminal test fixture including shorting plate



R&S®HZ186 4-terminal transformer test cable



Models and options

R&S®HM8118	200 kHz LCR bridge/meter
R&S®HO880	Interface IEEE-488 (GPIB)
R&S®HO118	Binning interface (service center installation only)
R&S®HZ181	Four-terminal test fixture including shorting plate
R&S®HZ186	Four-terminal transformer test cable
R&S®HZ42	19" rack adapter, 2 HU



Product site

R&S® HM8123 UNIVERSAL COUNTER



Wide frequency range and accurate results

- ▶ Measurement range: DC to 3 GHz
- ▶ Input A/B (BNC): DC to 200 MHz
- ▶ Input C (SMA): 100 MHz to 3 GHz
- ▶ Input impedance A/B: 50 Ω or 1 MΩ (switchable), sensitivity 25 mV
- ▶ Input impedance C: 50 Ω, sensitivity 30 mV
- ▶ 10-digit resolution (at 10 s gate time)
- ▶ Nine measurement functions, external GATE and ARMING connectors (BNC)
- ▶ External reference input (10 MHz) via BNC connector
- ▶ R&S®HM8123: TCXO (temperature stability: $\pm 0.5 \times 10^{-6}$), R&S®HM8123-X: OCXO (temperature stability: $\pm 1.0 \times 10^{-8}$)
- ▶ RS-232/USB dual interface, optionally IEEE-488 (GPIB)
- ▶ Fanless design

Models and options

R&S®HM8123	Universal counter with TCXO (temperature stability: $\pm 0.5 \times 10^{-6}$)
R&S®HM8123-X	Universal counter with OCXO (temperature stability: $\pm 1.0 \times 10^{-8}$)
R&S®HO880	Interface IEEE-488 (GPIB)
R&S®HZ42	19" rack adapter, 2 HU

Benefits	Features
High accuracy	<ul style="list-style-type: none"> ▶ High sensitivity and switchable attenuators to adapt to a wide range of input levels ▶ 10-digit resolution for precise measurements ▶ Optional OCXO for even higher accuracy
Two identical inputs A and B	Can be used for interchannel measurements such as frequency ratio A/B, time interval A:B, phase A to B
Additional input for higher frequencies	Widens the frequency range up to 3 GHz
Easy to use	Frequently used functions are directly accessible via front-panel keys

Rear panel interfaces with USB/RS-232 interface as standard



External arming

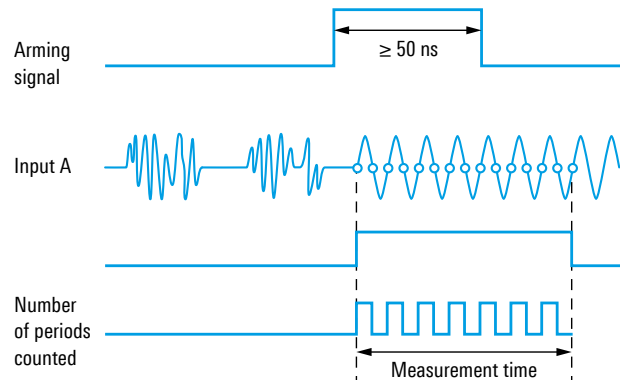

External arming prevents undesired signals from triggering of a measurement



R&S®HMC8015 POWER ANALYZER



All in one: the new compact class that has it all

The R&S®HMC8015 power analyzer is the first compact tester for AC/DC load and standby current characterization that enables measurements without additional tools such as a computer or remote infrastructure. In addition to a numerical and graphical display with 26 key parameters, the instrument delivers performance and compliance protocols in line with IEC 62301, EN 50564 and EN 61000-3-2.

Key facts

- ▶ Power measurement range: 50 μ W to 12 kW
- ▶ Analog bandwidth: DC to 100 kHz
- ▶ Sampling rate: 500 ksample/s
- ▶ 16-bit resolution for current and voltage
- ▶ Basic accuracy: 0.05%
- ▶ 26 different measurement and mathematical functions

Enhanced functions

- ▶ Graphical display modes¹⁾ for inrush, harmonic analysis, waveform and trend chart
- ▶ Advanced I/O option²⁾ provides a current-proportional voltage input and PASS/FAIL function
- ▶ Compliance test option³⁾ includes wizards for the IEC 62301, EN 50564 and EN 61000-3-2 standards

Ports and extensibility

- ▶ Front panel: 4 mm safety connectors
- ▶ Rear panel: 4 BNC ports²⁾ for analog and digital inputs and outputs
- ▶ Additional sensor input²⁾ for current probe or shunt

R&S®HMC8015 power analyzer with the R&S®HMC815 adapter



Rear panel interfaces (shown here: R&S®HMC8015-G with GPIB interface)



Benefits	Features
Clear display of all measured parameters	<ul style="list-style-type: none"> ▶ Simultaneous display of up to 10 numerical measurement functions ▶ User-configurable measurement display ▶ Graphical display modes¹⁾ for inrush, harmonic analysis, waveform and trend chart
High measurement accuracy	<ul style="list-style-type: none"> ▶ Basic accuracy: 0.05% ▶ Signal acquisition from DC to 100 kHz at a sampling rate of 500 ksample/s ▶ Simultaneous display of current and voltage, each with 16-bit resolution
Everyday measurement functions	<ul style="list-style-type: none"> ▶ 26 different measurement and mathematical functions ▶ Limit testing with pass/fail indication for up to six selectable limits

- ▶ USB port (virtual COM port, TMC)
- ▶ Ethernet port (LXI)
- ▶ IEEE-488 (GPIB) port (R&S®HMC8015-G)
- ▶ Compliance test³⁾ for key standby and harmonic standards
- ▶ Remote control via SCPI-based commands
- ▶ Driver packages for LabVIEW, LabWindows/CVI, VXI, IVI.net

¹⁾ With HVC151 advanced analysis option.

²⁾ With HVC152 advanced I/O option.

³⁾ With HVC153 compliance test option.

Models and options

R&S®HMC8015	Power analyzer
R&S®HMC8015-G	Power analyzer, incl. IEEE-488 (GPIB) interface
R&S®HMC50	AC/DC current probe, 30 A, 4 mm connectors
R&S®HMC51	AC/DC current probe, 1000 A, 4 mm connectors
R&S®HMC815-US	Line adapter, US version
R&S®HMC815-EU	Line adapter, EU version
R&S®HMC815-GB	Line adapter, GB version
R&S®HMC815-CHN	Line adapter, CHN/AUS version
R&S®HOC/HVC151	Advanced analysis, voucher upgrade
R&S®HOC/HVC152	Advanced I/O, voucher upgrade
R&S®HOC/HVC153	Compliance test, voucher upgrade
R&S®HMC95	19" rack adapter, 2 HU



Product site

CHAPTER 14

SYSTEM COMPONENTS

For demanding computational tasks, Rohde & Schwarz offers the versatile, flexible equipment you need for everyday use – from the system controller and switch unit to the test chamber. All feature excellent EMC shielding, reliable test results and modular solutions.

Type	Designation	Description	Page
R&S®OSP	Open switch and control platform	Modular solution for RF switch and control tasks	281
R&S®IQW	I/Q wideband data recorder	Bring real RF scenarios to your lab	285
R&S®RSC	Step attenuator	Precise signal levels and high repeatability	286
R&S®QuickStep	Test executive software	Flexibility and excellent performance	287



R&S® OSP OPEN SWITCH AND CONTROL PLATFORM



R&S®OSP220 with 3 slots each on the front and rear panel.



R&S®OSP230 with built-in touchscreen, 2 slots on the front panel and 3 slots on the rear panel.

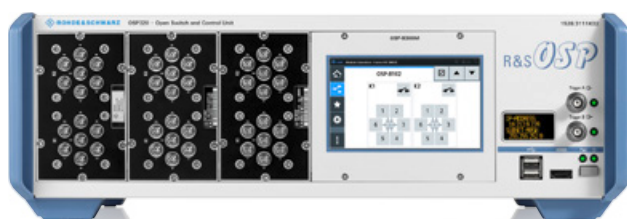

R&S®OSP320 with 5 slots each on the front and rear panel. The front panel can optionally be configured with 3 slots and a touchscreen.

Modular solution for RF switch and control tasks

The product family is available in three models (R&S®OSP220, R&S®OSP230 and R&S®OSP320) plus a satellite box (R&S®OSP-B200S2) to meet the requirements of diverse test scenarios – ranging from desktop configurations for laboratory measurements to complex, rack-integrated test systems.

The R&S®OSP switch and control units can be controlled via Ethernet. Manual control via a touchscreen or an external monitor and a keyboard and mouse is also possible. Multiple units can be combined into a system via LAN.

The units have module slots on their front and rear panels, allowing users to implement application-specific configurations, from simple RF switch functions to automatic path switchover in complex RF test systems.

Typical applications include mobile and wireless communications as well as broadcast and EMC applications.

The R&S®OSP-B200S2 satellite box, in combination with up to two R&S®OSP modules, enables remotely controlled RF switch and control tasks close to the DUT or the antennas.



Product site

Modular, reliable, cost-efficient

Thanks to the modular design of the R&S®OSP family, users can quickly and easily set up test and measurement configurations for applications in production, test labs and development. The ability to implement complex wiring configurations with a single switch and control platform is an essential prerequisite for reliable and reproducible measurements that can be automated to enable cost-efficient test sequences.

Compact and flexible

The R&S®OSP units come with a powerful CPU that provides maximum flexibility in controlling switch and control modules, enables the use of internal and external interfaces and supports a convenient web interface. The web GUI delivers a compact menu display on a built-in touchscreen (R&S®OSP230 and optionally R&S®OSP320) and an extended view on a connected monitor or PC.

The R&S®OSP units come in a compact 2 HU 19" cabinet (R&S®OSP220 and R&S®OSP230) with up to six module slots and a 3 HU version (R&S®OSP320) with up to ten module slots.

The module slots on the front and rear panels can be combined into wider slots to accept larger modules that provide an extended range of functions.

Powerful control and RF relay modules

Switch and control modules can be inserted into the front and rear module slots. Different types of modules can be combined in an R&S®OSP unit – from simple RF switch modules to more complex, application-specific modules – allowing users to tailor their R&S®OSP platform cost-efficiently as required for the application at hand.

The following module types are available:

- ▶ Universal electromechanical RF relay modules up to 67 GHz in different versions, i.e. with terminated and non-terminated, failsafe and latching relays
- ▶ Solid-state relay (SSR) modules (up to 10 GHz)
- ▶ Digital I/O modules and multiplexer module

Special modules such as the R&S®OSP-B104, R&S®OSP-B114 and R&S®OSP-PM-I simplify the implementation of EMS test systems.

System components

Front view of the 2 HU R&S®OSP220 switch and control unit



Front view of the 2 HU R&S®OSP230 switch and control unit



Rear view of the 2 HU R&S®OSP220 and R&S®OSP230 switch and control units

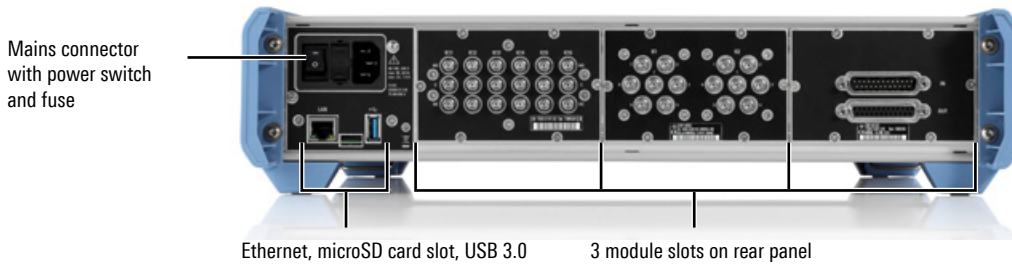

Front view of the 3 HU R&S®OSP320 switch and control unit

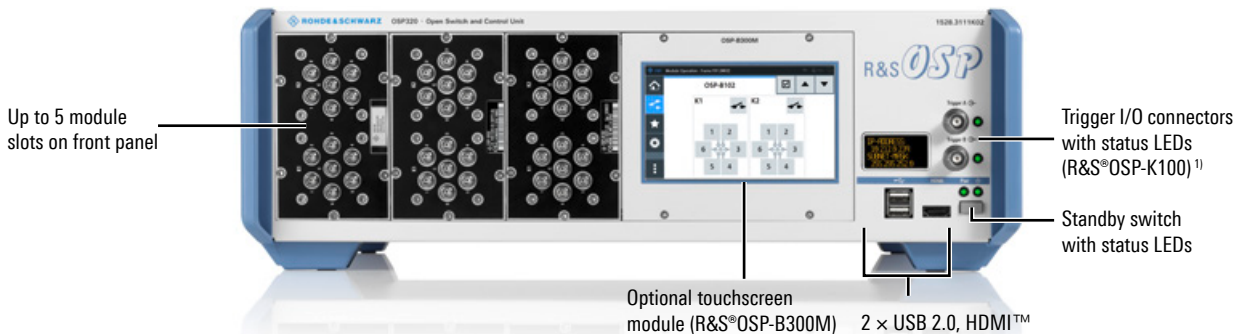

Rear view of the 3 HU R&S®OSP320 switch and control unit

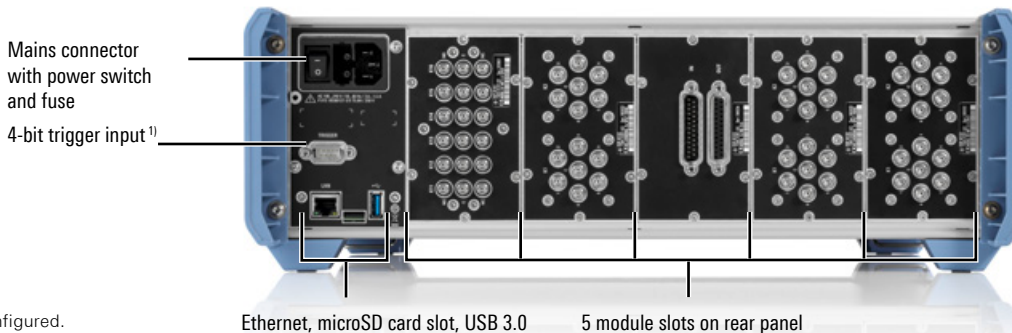

¹¹ Preconfigured.

Easy system integration

All R&S®OSP units can be controlled via Ethernet. This makes it possible to connect R&S®OSP units to a PC or laptop in the lab, integrate them into a test system or remotely operate them from a workstation over a corporate network or the internet.

The units can be controlled with SCPI commands either via PTY or from application programs such as LabVIEW, LabWindows/CVI, Keysight VEE, C++, C#, Visual Basic and Visual Basic .NET.

Virtually unlimited expandability

All R&S®OSP models can be combined via Ethernet into a local network or a corporate or global network in a master/

slave configuration. This makes it possible to substantially enhance the R&S®OSP units' functionality, including trigger function and path control, plus it provides an economical way to expand existing R&S®OSP systems to meet future requirements.

As an alternative to networking multiple R&S®OSP units, the compact R&S®OSP-B200S2 satellite box can be used for remote operation. The satellite box shifts RF switch and control tasks close to the DUT or the antennas. This reduces the number of long RF cables required, improving RF performance of the setup and saving cost. The satellite box is controlled via a serial electrical bus cable (wired link) or a fiber-optic link (FOL), as required in a given application.

Possible combinations of R&S®OSP base units and satellite boxes

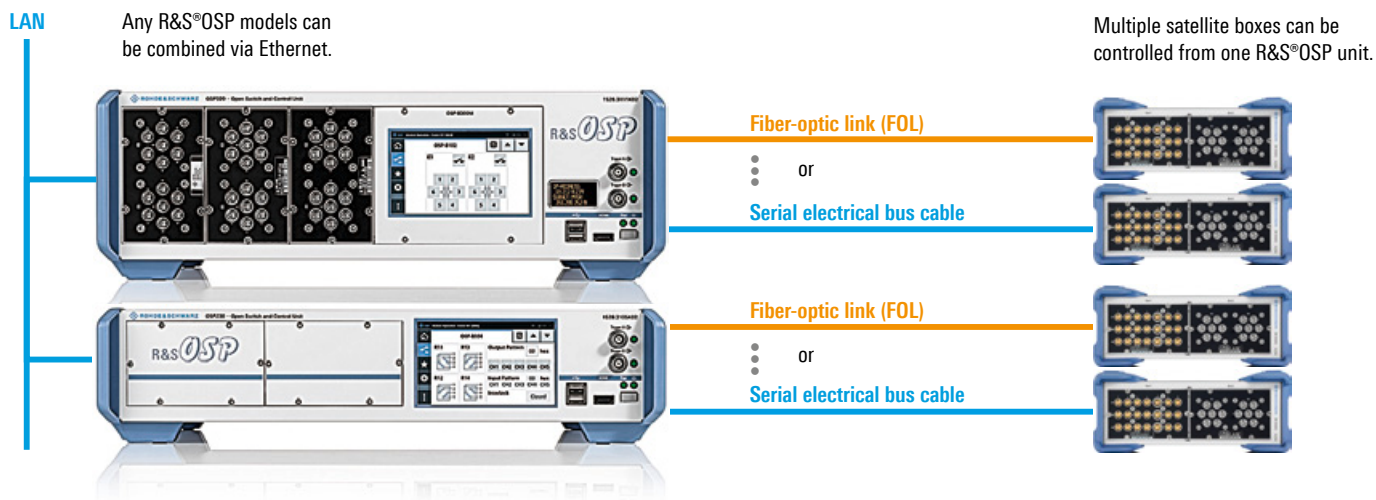

Example modules



System components

Designation	Type	Order No.
Switch and control units and satellite boxes¹⁾		
Switch and control unit (2 HU) with 3+3 module slots and monitor interface	R&S°OSP220	1528.3105K02
Switch and control unit (2 HU) with 3+2 module slots, touchscreen and monitor interface	R&S°OSP230	1528.3105K03
Switch and control unit (3 HU) with 5+5 module slots and monitor interface	R&S°OSP320	1528.3111K02
Satellite box, with electrical interface (wired link)	R&S°OSP-B200S2	1528.3134.02
Satellite box, with fiber-optic link (FOL) interface and electrical interface (wired link)	R&S°OSP-B200S2	1528.3134.04
R&S°OSP switching modules²⁾		
RF switch modules with electromechanical RF relays		
RF switch modules with non-terminated relays up to 67 GHz		
6 × changeover relays SPDT (SMA), 0 Hz to 18 GHz	R&S°OSP-B101	1505.5101.02
6 × SPDT (SMA), 0 Hz to 18 GHz, latching	R&S°OSP-B101L	1505.5101.52
2 × multiposition relays SP6T (SMA), 0 Hz to 18 GHz	R&S°OSP-B102	1505.5201.02
2 × SP6T (SMA), 0 Hz to 18 GHz, latching	R&S°OSP-B102L	1505.5201.52
6 × SPDT (SMA), 0 Hz to 26.5 GHz	R&S°OSP-B111E	1505.4605.26
6 × SPDT (SMA 2.92 mm, K), 0 Hz to 40 GHz	R&S°OSP-B111	1505.4605.02
n × SPDT (2.4 mm), 0 Hz to 50 GHz, n = 3 or 6	R&S°OSP-B111U	1505.4605.5n
n × SPDT (2.4 mm), 0 Hz to 50 GHz, latching, n = 3 or 6	R&S°OSP-B111UL	1528.1531.1n
n × SPDT (1.85 mm), 0 Hz to 67 GHz, latching, n = 3 or 6	R&S°OSP-B111VL	1515.5991.1n
n × SP6T (SMA), 0 Hz to 26.5 GHz, n = 1 or 2	R&S°OSP-B112E	1528.1560.1n
2 × SP6T (SMA 2.92 mm, K), 0 Hz to 40 GHz	R&S°OSP-B112	1505.4611.02
n × SP6T (2.4 mm), 0 Hz to 50 GHz, n = 1 or 2	R&S°OSP-B112U	1528.1560.5n
1 × SP6T (2.4 mm), 0 Hz to 50 GHz, latching	R&S°OSP-B112UL	1528.1548.11
2 × transfer relays DPDT (SMA), 0 Hz to 18 GHz	R&S°OSP-B116	1515.5827.02
2 × DPDT (SMA), 0 Hz to 26.5 GHz	R&S°OSP-B116E	1515.5827.26
2 × DPDT (2.92 mm, K), 0 Hz to 40 GHz	R&S°OSP-B116H	1515.5827.40
n × DPDT (2.4 mm), 0 Hz to 50 GHz, n = 1 or 2	R&S°OSP-B116U	1515.5827.5n
1 × SP8T (SMA) and 2 × SPDT (SMA), 0 Hz to 18 GHz	R&S°OSP-B119	1515.5856.02
1 × SP8T (SMA), 2 × SPDT (SMA), 0 Hz to 26.5 GHz	R&S°OSP-B119E	1515.5856.26
RF switch modules with terminated relays up to 40 GHz		
3 × SPDT (SMA), 0 Hz to 18 GHz, terminated	R&S°OSP-B121	1515.5504.02
3 × SPDT (SMA), 0 Hz to 26.5 GHz, terminated	R&S°OSP-B121E	1515.5504.26
3 × SPDT (SMA 2.92 mm, K), 0 Hz to 40 GHz, terminated	R&S°OSP-B121H	1515.5504.40
1 × SP6T (SMA), 0 Hz to 18 GHz, terminated	R&S°OSP-B122	1515.5510.02
1 × SP6T (SMA), 0 Hz to 26.5 GHz, terminated	R&S°OSP-B122E	1528.1525.26
1 × SP6T (2.92 mm), 0 Hz to 40 GHz, terminated	R&S°OSP-B122H	1528.1525.02
6 × SPDT (SMA) and 1 × SP6T (SMA), 0 Hz to 18 GHz, terminated	R&S°OSP-B123	1515.5527.02
3 × SPDT (SMA) and 2 × SP6T (SMA), 0 Hz to 18 GHz, terminated	R&S°OSP-B124	1515.5533.02
6 × SPDT (SMA) and 3 × SP6T (SMA), 0 Hz to 18 GHz, terminated	R&S°OSP-B125	1515.5540.02
6 × SPDT (SMA) and 3 × SP6T (SMA), 0 Hz to 26.5 GHz, terminated	R&S°OSP-B125E	1515.5540.26
6 × SPDT (2.92 mm) and 3 × SP6T (2.92 mm), 0 Hz to 40 GHz, terminated	R&S°OSP-B125H	1515.5540.40
3 × SP6T (SMA), 0 Hz to 18 GHz, terminated	R&S°OSP-B126	1515.5556.02
1 × SP8T (SMA), terminated and 2 × SPDT (SMA), non-terminated, 0 Hz to 18 GHz	R&S°OSP-B129	1517.7004.02
1 × SP8T (SMA), terminated and 2 × SPDT (SMA), non-terminated, 0 Hz to 26.5 GHz	R&S°OSP-B129E	1517.7004.26
RF switch modules with relays up to 12.4 GHz with N (f) connectors		
3 × SPDT (N), 0 Hz to 12.4 GHz, and 3 × SPDT (BNC), 0 Hz to 900 MHz	R&S°OSP-B106	1505.5601.02
2 × SPDT (N), 0 Hz to 12.4 GHz	R&S°OSP-B131	1505.4740.02
6 × SPDT (N), 0 Hz to 12.4 GHz	R&S°OSP-B132	1505.4757.02
1 × SP6T (N), 0 Hz to 12.4 GHz	R&S°OSP-B133	1528.3157.02
2 × DPDT (N), 0 Hz to 12.4 GHz	R&S°OSP-B136	1522.4500.02
RF switch modules with RF solid-state relays (SSR)		
6 × SPDT (SMA), SSR, 9 kHz to 6 GHz	R&S°OSP-B107	1505.5901.02
6 × SPDT (SMA), SSR, 9 kHz to 10 GHz, terminated	R&S°OSP-B127	1505.4728.02
n × SP6T (SMA), SSR, 9 kHz to 10 GHz, terminated, n = 1 to 3	R&S°OSP-B128	1505.4734.1n
3 × DP3T (SMA), power SSR 10 W, 9 kHz to 8 GHz, external termination optional	R&S°OSP-B142	1505.4792.03
Other modules		
Passive module, for integration of one R&S°NRP-Zxx power sensor (with USB interface)	R&S°OSP-PM-I	1515.5985.02
EMS module, with drivers for four external power relays, additional digital inputs/outputs, interlock	R&S°OSP-B104	1505.5401.02
EMS module, for small systems with 1 × DPDT (N), digital inputs/outputs, interlock with SPDT	R&S°OSP-B114	1505.4711.02
Digital I/O module, 16 × digital inputs, 16 × digital outputs	R&S°OSP-B103	1505.5301.02
Multiplexer module, 6-channel, 4-wire multiplexer	R&S°OSP-B108	1505.5718.02
Remote control module for one R&S°OSP satellite box	R&S°OSP-B200R	1528.3140.02/04

¹⁾ For options and accessories, see data sheet PD 5216.1340.22.

²⁾ Relays are failsafe, non-terminated unless otherwise specified.

R&S® IQW WIDEBAND I/Q DATA RECORDER



Bring real RF scenarios to the lab

The R&S®IQW wideband I/Q data recorder is a versatile instrument for fast and reliable realtime recording, storage and playback of wideband I/Q data streams. In contrast to field tests, recording of live RF scenarios allows users to perform tests in the lab under real-world conditions reproducibly and at lower cost.

The wide recording bandwidth and high sampling rate and bit depth of the R&S®IQW are ideally suited for deployment in areas such as aerospace and defense, and for R&D of wideband communications systems.

In combination with Rohde & Schwarz signal and spectrum analyzers and signal generators, the R&S®IQW can be used in a wide variety of situations for recording, archiving and playback of GNSS, communications and radar signals, as well as complex signal scenarios.

Recording, storage and playback of RF live signals

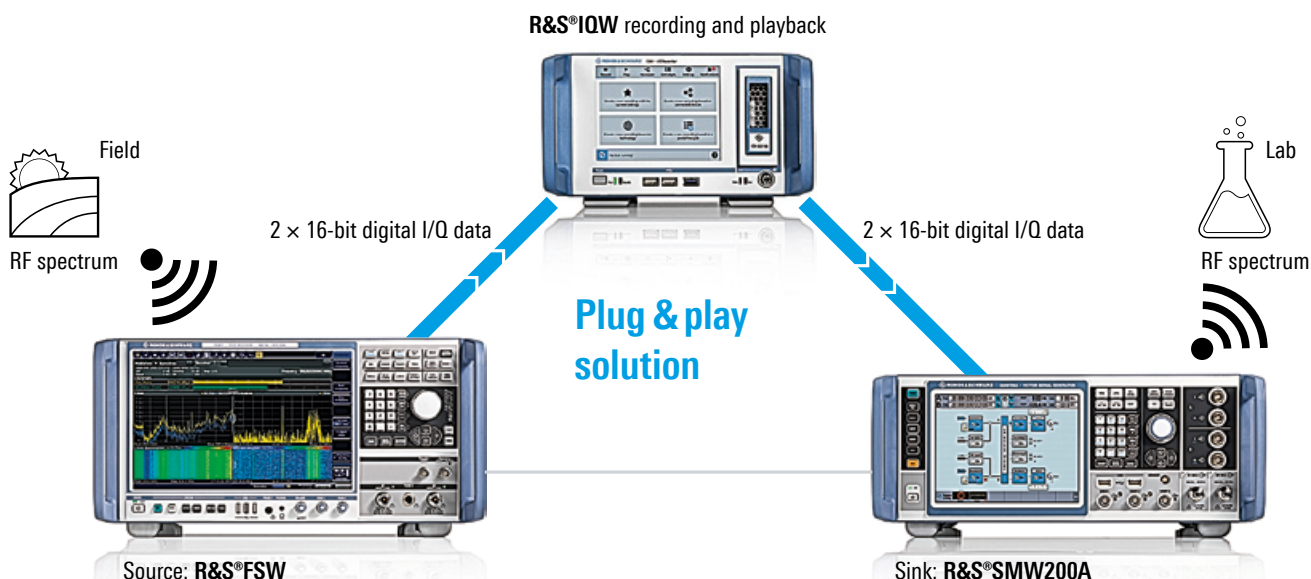

The smart GUI concept makes working with I/Q data quick and easy. Easily removable and lockable SSD memory packs provide the necessary flexibility and security. With its very short boot time, the Linux-based operating system ensures fast availability while reducing vulnerability to external malware attacks.

Along with wide bandwidth and high speed, the R&S®IQW features easy operation and a high level of security.

Key facts

- ▶ Realtime recording, storage and playback of digital I/Q data with bandwidths up to 100/200/512 MHz
- ▶ Accurate data acquisition with a sampling rate up to 640 Msample/s and 16-bit digital I/Q data (complex)
- ▶ Fast data provision and memory expansion with easily removable memory packs (SSD) up to 15 Tbyte
- ▶ Easy operation with the 5.7" TFT touchscreen user interface or by remote control with the SCPI command set and web-based responsive GUI
- ▶ Linux operating system for fast, stable operation and protection against malware
- ▶ Import and export of I/Q data via USB 3.0 and 40 Gbit LAN interface
- ▶ Recording of GPS coordinates



Configurator



Product site

R&S®RSC STEP ATTENUATOR



Precise signal levels and high repeatability

The R&S®RSC is a switchable, mechanical step attenuator. It is available in various models with different upper frequency limits (6 GHz or 18 GHz), maximum attenuation ranges and minimum settable step sizes. The R&S®RSC can also control external step attenuators with frequency ranges from DC to 40 GHz or 67 GHz.

The R&S®RSC step attenuator is an ideal choice in all applications that call for precise signal levels. Operation is intuitive and all settings are visible at a glance. Featuring high attenuation accuracy and high linearity, the R&S®RSC delivers reliable results and ensures stable conditions for the test setup. This simplifies work for developers of RF components.

In automated test systems, the R&S®RSC stands out for its high repeatability of 0.02 dB, long life and high reliability with specified 10 million switching cycles.

Various frequency ranges from DC to 6 GHz, 18 GHz, 40 GHz and 67 GHz are available to meet the requirements

of wireless communications, electronic products and aerospace and defense. The R&S®RSC is available with one internal step attenuator and allows up to four additional external step attenuators to be controlled.

The R&S®RSC offers a wide scope of functions, including frequency response correction and display of attenuation deviation relative to a nominal value. Moreover, it can display an overall attenuation value, taking into account additional test setup components such as high-power attenuators. The R&S®RSC covers a broad range of applications from power measurements to high-precision calibration.

Its low weight and compact dimensions make the R&S®RSC ideal for flexible applications in the lab. The step attenuator can be manually operated via its front panel keypad. The built-in screen shows current device settings at a glance. The R&S®RSC takes up just half a rack width (½ 19"). It can be delivered with RF connectors optionally on the front or rear panel. Various interfaces (IEC/IEEE, LAN and USB) are available for remote control. These features make the device ideal for system applications as well.

Key facts

- ▶ Step attenuators with frequency ranges up to 6 GHz, 18 GHz, 40 GHz and 67 GHz
- ▶ Maximum attenuation ranges up to 139.9 dB, 115 dB and 75 dB
- ▶ Minimum step sizes of 0.1 dB, 1 dB and 5 dB
- ▶ Control of one internal plus up to four external step attenuators by a single R&S®RSC
- ▶ Outstanding accuracy due to frequency response correction and user calibration

Specifications in brief		R&S®RSC models .03/.13 ¹⁾	R&S®RSC models .04/.14 ¹⁾	R&S®RSC models .05/.15 ¹⁾	R&S®RSC-Z405 external step attenuator	R&S®RSC-Z675 external step attenuator
Frequency range		DC to 6 GHz	DC to 6 GHz	DC to 18 GHz	DC to 40 GHz	DC to 67 GHz
Attenuation range		0 dB to 139 dB	0 dB to 139.9 dB	0 dB to 115 dB	0 dB to 75 dB	0 dB to 75 dB
Connectors		type N (f)	type N (f)	type N (f)	2.92 mm (f)	1.85 mm (f)
Minimum attenuation step size		1 dB	0.1 dB	5 dB	5 dB	5 dB
Matching	up to	> 20 dB	> 20 dB	> 20 dB	> 20 dB	> 20 dB
Attenuation uncertainty (relative to attenuation at 0 dB)	up to	< 0.2 dB + 1% of attenuation value	< 0.07 dB + 0.5% of attenuation value (corrected)	< 0.6 dB + 1% of attenuation value	< 0.5 dB	< 0.5 dB
Repeatability		typ. 0.02 dB				
Maximum power handling capability	CW					1 W
	pulse < 10 μs					200 W
Maximum voltage	pulse < 10 μs					150 V
Operating life		> 10 × 10 ⁶ switching cycles			> 1 × 10 ⁶ switching cycles	
Switching speed		< 25 ms			< 30 ms	

¹⁾ Model .0x: RF connectors on front panel; model .1x: RF connectors on rear panel.



R&S® QUICKSTEP TEST EXECUTIVE SOFTWARE

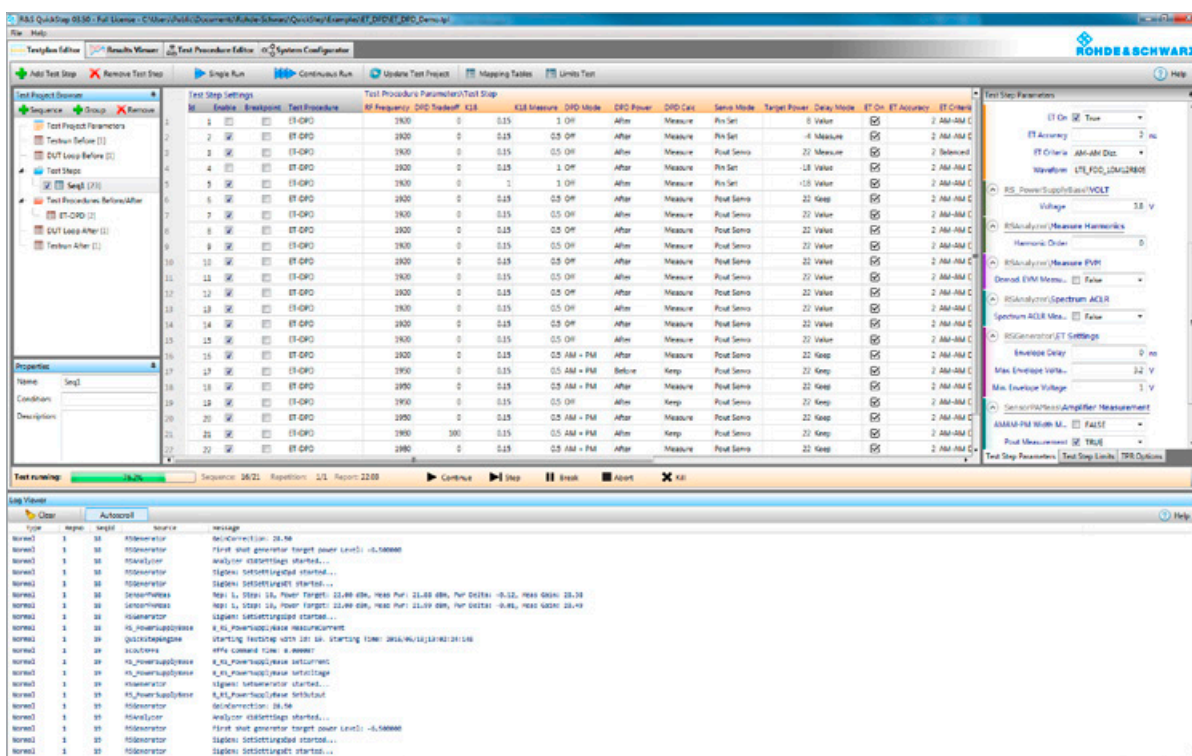

Test execution with R&S®QuickStep

Flexibility and excellent performance

The powerful R&S®QuickStep test executive software fulfills the demanding performance requirements of production tests and provides the flexibility for test automation in R&D and verification. The use of R&S®QuickStep in combination with Rohde&Schwarz instruments significantly increases test development efficiency and minimizes the effort for transfer and correlation of tests between different test systems in R&D, verification and production.

R&S®QuickStep provides a high-speed test sequencer in combination with a powerful graphical user interface for the parameterization and control of test execution. Test procedures are designed in a graphical editor as flowcharts, based on the provided or additionally developed test functions. New test functions can be developed with Visual Studio® in C++ or C# based on automatically generated source code templates or in Python with R&S®Forum.

Users with different needs and profiles – including R&D engineers, application experts, test engineers, test technicians right up to the operator on the production floor – are involved in the development and execution of tests. R&S®QuickStep takes this into account by providing role-specific graphical user interfaces and intrinsic workflows.

Special software development skills and intensive education are not necessary, not even for the development of new test functionalities.

The use of one common test executive in all domains increases the efficiency of test development and shortens the time to market due to significantly reduced effort for test transfer and correlation.

Key facts

- ▶ Performance-optimized design for low overhead test execution
- ▶ Intrinsic parallelism for efficient use of test system resources
- ▶ Role-specific graphical user interfaces with excellent usability
- ▶ Graphical editor for simple development of new test procedures
- ▶ Efficient and simple extension of available test functions
- ▶ Development of new functions in C++ or C# with Microsoft Visual Studio® based on source code templates
- ▶ Development of new functions in Python in combination with R&S®Forum
- ▶ Graphical test procedure editor



Product site

APPENDIX

SERVICE AND SUPPORT



Description	Page
Rohde & Schwarz contact information	289
Service that adds value	290
Training and application support	293
Global sales and service locations, trademarks	294
Index by type	296

ROHDE & SCHWARZ

CONTACT INFORMATION

Rohde & Schwarz GmbH & Co. KG

www.rohde-schwarz.com

Corporate communications

Rohde & Schwarz GmbH & Co. KG
Corporate Communications
Mühlendorfstraße 15
81671 Munich, Germany
Phone +49 89 4129 139 58
Fax +49 89 4129 135 63
press@rohde-schwarz.com

Sales

The addresses of the local sales companies can be found at: www.sales.rohde-schwarz.com

Rohde & Schwarz training

www.training.rohde-schwarz.com

Rohde & Schwarz customer support

Our customer support center will be happy to answer any questions regarding our products and service:

www.rohde-schwarz.com/support



Rohde & Schwarz Cybersecurity GmbH

Mühlendorfstraße 15 | 81671 München
Info: +49 89 4129-206 000
E-mail: cybersecurity@rohde-schwarz.com
www.cybersecurity.rohde-schwarz.com

Plants

Memmingen plant

info.memmingen@rohde-schwarz.com

Teisnach plant

info.teisnach@rohde-schwarz.com

Vimperk plant

info.vimperk@rohde-schwarz.com

Singapore and Malaysia plants

Phone +65 6307 0000

SERVICE THAT ADDS VALUE

Dear Customers,
we are often asked what has made Rohde & Schwarz so successful over so many decades and enabled the company to drive technological progress in its fields of business. One aspect is the passion with which we work every day in our development labs to push the limits of what is physically feasible. Another is our desire to create only products that meet customer expectations in terms of technology, functionality and quality.

Our service philosophy is another key factor to our success. For us it goes without saying that we offer our customers the best possible support in all phases of the product lifecycle. We therefore provide a wide variety of customized service offerings, which we plan in dialog with our customers and our specialists as early as the product development phase. This lets us identify and cater to individual needs early on, in order to minimize costs while maximizing availability and autonomy. Our comprehensive and continually growing range of services is designed to ensure that you are satisfied with every aspect of our products. We are convinced that this commitment, implemented by our worldwide network of dedicated, expert service personnel, is one of the major factors behind the success of our company.

Investment protection, tailor-made

Rohde & Schwarz offers full-range service at your command. You can mix and match our services according to your technical and budgetary requirements.

R&S®Extended Warranty

The R&S®Extended Warranty offers cost control while giving you full service from the start. If there is a problem, you are insured against extra service costs. For a fraction of the purchase price, you can rest easy for years with the security afforded by manufacturer service.

- ▶ Low, predictable costs
- ▶ Safe and dependable
- ▶ Transparent and flexible

To make sure you get the full benefit of the functionality and precision of your instruments for the longest possible time, we offer a range of services that are tailored to your specific needs. Choose extended warranty for complete protection in case of repair, or the attractive extended warranty with calibration coverage package for additional regular calibration of your instrument. Both are available with terms of one to four years.

Extended warranty:

- ▶ Repair in case of malfunction
- ▶ R&S®Manufacturer Calibration if necessary during repair
- ▶ Firmware updates
- ▶ Preventive maintenance and reliability modifications

Extended warranty with calibration coverage additionally covers:

- ▶ Planned calibrations in line with Rohde & Schwarz guidelines and ISO/IEC 17025
- ▶ Calibration as needed during technical upgrades

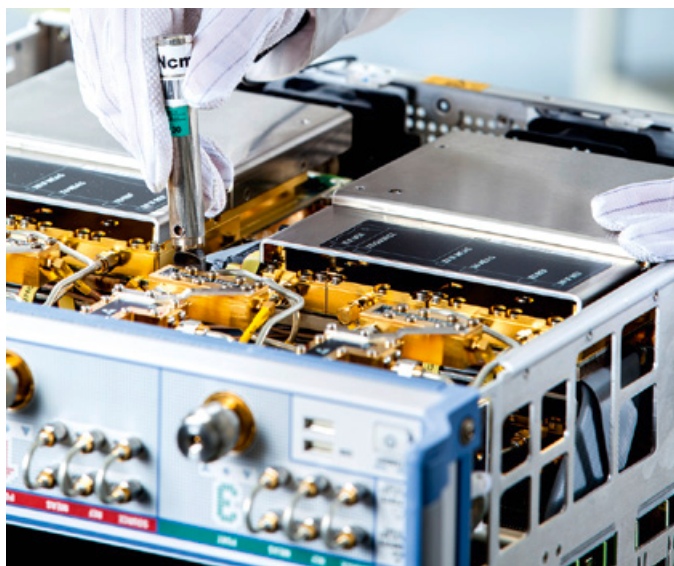

Rohde & Schwarz calibration services

Our various calibration products enable us to tailor our services to your individual needs. Whether you choose our Rohde & Schwarz manufacturer calibration or a Rohde & Schwarz accredited calibration – you will always receive a service package that is more complete and comprehensive than what a pure service provider can provide. We offer attractive contract solutions for all our products. Our sales and service representatives will be happy to help you determine the right solution for your requirements.

R&S® Accredited Calibration

R&S® Accredited Calibration ensures compliance with international standards and calibration data traceability. Many standards require R&S® Accredited Calibration as proof of competence. Our accredited service centers not only measure accredited parameters, they also verify all product characteristics. R&S® Accredited Calibration is as comprehensive and in-depth as R&S® Manufacturer Calibration and provides additional accreditation documentation.

R&S® Manufacturer Calibration

R&S® Manufacturer Calibration ensures you a comprehensive range of services. As the manufacturer, we take care of all required adjustments, software updates and hardware modifications. We document each calibration with a certificate that contains both the incoming and outgoing status of your instrument. This enables you to evaluate your instrument's past performance and draw conclusions

about future performance. Like all Rohde & Schwarz calibrations, R&S® Manufacturer Calibration is based on national and international standards.

Multivendor Performance Calibration

We also service other manufacturers' instruments. As an equipment manufacturer, we know the relevant parameters for a definitive calibration. That is what makes us a competent partner for calibrating other manufacturers' instruments. During multivendor performance calibration, all required manufacturer-specified instrument parameters are measured. You receive a calibration certificate and documentation of measurement results. These services are also available as accredited services.

Depot calibration

Take advantage of all the benefits of our fast and efficient depot service. With Rohde & Schwarz depot calibration, your instrument is returned after just a few days. Express depot calibration takes just one day plus shipping time. We will be happy to take care of the logistics for you – just ask.

On-site calibration

Would you like to reduce your downtime even more? We can come to you with our mobile calibration system – no need for time-consuming packing and shipping. Our sales and service representatives will be happy to sit down with you and tailor a calibration concept to your needs.

	R&S® Accredited Calibration	R&S® Manufacturer Calibration	Multivendor Performance Calibration
ISO 17025 accredited	•	–	optionally accredited
ISO 9001 certified	•	•	•
Calibrated in line with ISO 17025	•	•	•
Traceability to national/international standards	•	•	•
Virus and malware scan for Rohde & Schwarz products	•	•	•
Incoming results	•	•	•
Comprehensive measurement in line with manufacturer specifications	•	•	•
Firmware update	•	•	–
Required adjustments	•	•	–
Preventive maintenance/performance modifications	•	•	–
Outgoing results (after repair or adjustment)	•	•	–
Calibration certificate	•	•	•
R&S® Online Service Management	•	•	•
Service report	•	•	•
Cleaning	•	•	•
Electrical safety test	•	•	•

Rohde & Schwarz standard price repair

If a Rohde & Schwarz product ever does need to be repaired, smooth handling is required: without hassle, without losing time and without any unpleasant surprises regarding costs. That's why Rohde & Schwarz offers its customers a standard price repair option: an intelligent comprehensive solution featuring guaranteed all-inclusive fixed prices, little handling effort and efficient procedures.

Scope of the Rohde & Schwarz standard price repair:

- ▶ Repair of the equipment
- ▶ Full calibration in line with ISO 17025, including documentation of the test results¹⁾
- ▶ 12-month service warranty on the entire equipment²⁾
- ▶ Latest firmware and hardware updates³⁾

With the standard price repair, you are always on the safe side:

- ▶ Defined fixed price
- ▶ Smooth handling
- ▶ Minimum effort
- ▶ Reliable repair by the manufacturer
- ▶ Updates and calibration included
- ▶ Extensive service warranty

R&S® Online Service Management

R&S® Online Service Management provides you with a clear overview and helps you save time by simplifying the management of instrument data, service cases and test equipment. You also benefit from numerous service management functions. A clear user interface makes operation intuitive.

Advantages

- ▶ **Secure:** R&S® Online Service Management gives you secure access to all service-related data, 24/7. Just log on to the password-protected area at my.rohde-schwarz.com/service to conveniently manage your service requests and calibration schedule, wherever you are
- ▶ **Comprehensive:** To make sure that you have more time for your core business, we put all your instrument data together in one place for an easy overview. It shows you all the documentation and configuration data for your instruments, as well as the status of repairs and calibrations. At a glance, you can track service cases, make new requests and see active and inactive warranties

¹⁾ For equipment requiring calibration.

²⁾ Applies to the repaired component if the system consists of several components, e.g. amplifier modules. Please see our General Conditions of Delivery and Service for more warranty information.

³⁾ Such modifications, e.g. precautionary component replacement, are performed as part of the continuous product improvement process and do not change the specifications or other product characteristics.

- ▶ **Efficient:** A good management system should make even complex things easier. The R&S® Online Service Management helps you organize your service cases, making previous, current and scheduled calibrations easy to enter and manage. The easy operation and clear navigation save you time as well as unnecessary paperwork

Functions and operation

- ▶ **Equipment:** Manage your equipment – see at a glance whether an instrument was recently calibrated or needs to be in the near future
- ▶ **Service requests:** Place service requests, track the status of orders or review past services. You can also download calibration and service reports
- ▶ **Contracts and more:** Keep your contracts in view and store your personal data – user, division, contact information and much more



TRAINING AND APPLICATION SUPPORT

The product portfolio of Rohde & Schwarz is accompanied by a comprehensive choice of training seminars and detailed application notes. By offering comprehensive application notes and practice-oriented training, we want to show you how to use our products most effectively. This ranges from first-time users who can choose from detailed introductory courses and practical T&M examples up to seasoned users who can gain deep insight into the numerous – and very special – ways to use the high-performance solutions from Rohde & Schwarz.

Training

The extensive choice of seminars includes everything from standard training classes on numerous topics in radio engineering and test and measurement to practice-oriented product training for Rohde & Schwarz solutions. If needed, customer-specific training programs specially designed to meet your wishes and requirements are held in order to achieve optimum benefit for the participants. Skilled trainers convey concise, practice-oriented knowledge at our state-of-the-art, fully equipped training center in Munich. Alternatively, training can also be held on the customer's premises or at any other location of choice. Limiting the number of participants helps ensure better communications between participant and trainer. Knowledge is conveyed more intensely and extra time is available for questions so that the participants can put their newly gained knowledge and skills into practice immediately after the seminar.



Comprehensive choice of training seminars

Standard seminars

Detailed seminars are offered on numerous topics in radio engineering and T&M such as RF and EMC testing, as well as classes covering the fields of wireless communications, television and antennas from the basics up to workshop level.

Small groups

The number of participants is intentionally kept small so that everyone has sufficient time for questions as well as the opportunity to try out the class content in a hands-on environment.

Timetable

Standard training classes are scheduled twice a year. For dates, see the Rohde & Schwarz homepage. The schedule for customized seminars is drawn up together with the individual customer.

Customized seminars

These seminars aim at providing optimum benefit for customers and their participants. The training content is tailored specifically to the customer's wishes and requirements.

Trainers/training staff

The trainers continuously keep their technical knowledge up to date. They not only possess technical expertise, they are also able to convey it in an understandable and lasting manner.

Languages

The seminars are conducted either in German or English. If needed, special training classes can be held in other languages.

Hands-on experience

Practical exercises are an essential part of all seminars to help ensure that the material just learned can be tried out immediately using state-of-the-art test setups. This is crucial for understanding and clarifying the training content in detail.

Location

Classes may be held at the state-of-the-art training center at company headquarters in Munich. Optionally, seminars can take place on the customer's premises or at any other suitable location.

Registration and organization

All detailed information regarding the seminars – including class descriptions, registration, cost, procedure and content – is provided on the Rohde & Schwarz homepage.

Skill and up-to-date knowledge are top priorities in all our seminars. The company's intensive participation in relevant bodies – such as for the standardization of state-of-the-art wireless communications – is reflected in training classes, which are always cutting-edge both in theory and T&M expertise. Our customers also benefit from this.

Application support

Rohde&Schwarz has created a series of application notes, application cards and application videos to share our knowledge of instruments, principles and methods and to assist you in getting the best performance from your Rohde&Schwarz instruments. Comprehensive white papers inform about changes in standardization, latest trends in our fields of business, or the state of the art in emerging technologies.

- ▶ Local application engineers help you successfully implement your specific application on site using Rohde&Schwarz T&M solutions and provide advice on all T&M matters
- ▶ Application-relevant questions will be answered at tm-applications@rohde-schwarz.com
- ▶ A large number of application notes, often combined with helpful application programs or T&M examples, can be downloaded from www.rohde-schwarz.com/appnote
- ▶ Use apps from Rohde&Schwarz on your smart phone or tablet on Google Play, Apple App Store or Windows Phone Store



Abstracts of some popular application notes

Download application notes from www.rohde-schwarz.com/appnote

Narrowband Internet of Things (3GPP NB-IoT) White Paper (1MA266)

As part of Release 13, 3GPP has specified a new radio interface. NB-IoT is optimized for machine-type traffic. It is kept as simple as possible in order to reduce device costs and to minimize battery consumption. In addition, it is also adapted to work in difficult radio conditions. In this white paper we introduce the NB-IoT technology and its close connection to LTE.

Doherty, Balanced, Push-Pull & Spatial Amplifier Optimization Application Note (1MA279)

The advent of 5G, with its inevitable microwave and millimeterwave air interfaces, increase the design challenges associated with its construction; not least of all because of the potential for increased dispersion in the constituent amplifiers and combiners. This application note describes a measurement-based development methodology by which the Doherty amplifier may be enhanced, increasing performance and/or performance bandwidth. The methodology may also be extended to balanced, spatially combined and anti-phase ("push-pull") amplifiers.

R&S®Commander – Versatile Software Tool for use with Rohde & Schwarz Instruments (1MA74)

R&S®Commander is a popular software tool that makes your daily business easier when operating Rohde & Schwarz T&M instruments and especially when using them via remote control. In addition to many other useful functions, screenshots from T&M instruments can be generated and trace data can be output in order to process it on your computer. The tool also provides convenient access to the T&M equipment's file management system.

Radar Echo Generator – Application Note (1MA283)

In-the-field RADAR tests are expensive to carry out and have a complicated setup and operation. One of the main advantages of the radar echo generator is its ability to generate arbitrary virtual radar echo signals in realtime in the laboratory using only commercial measurement equipment. This not only allows to reproduce the results and automate the tests, but also significantly reduces measurement efforts and costs while providing greater utility for the existing common test equipment. This application note presents a solution for testing the complete radar system by generating any kind of radar echo signals with arbitrary range, doppler frequency and radar cross section.

ROHDE & SCHWARZ WORLDWIDE

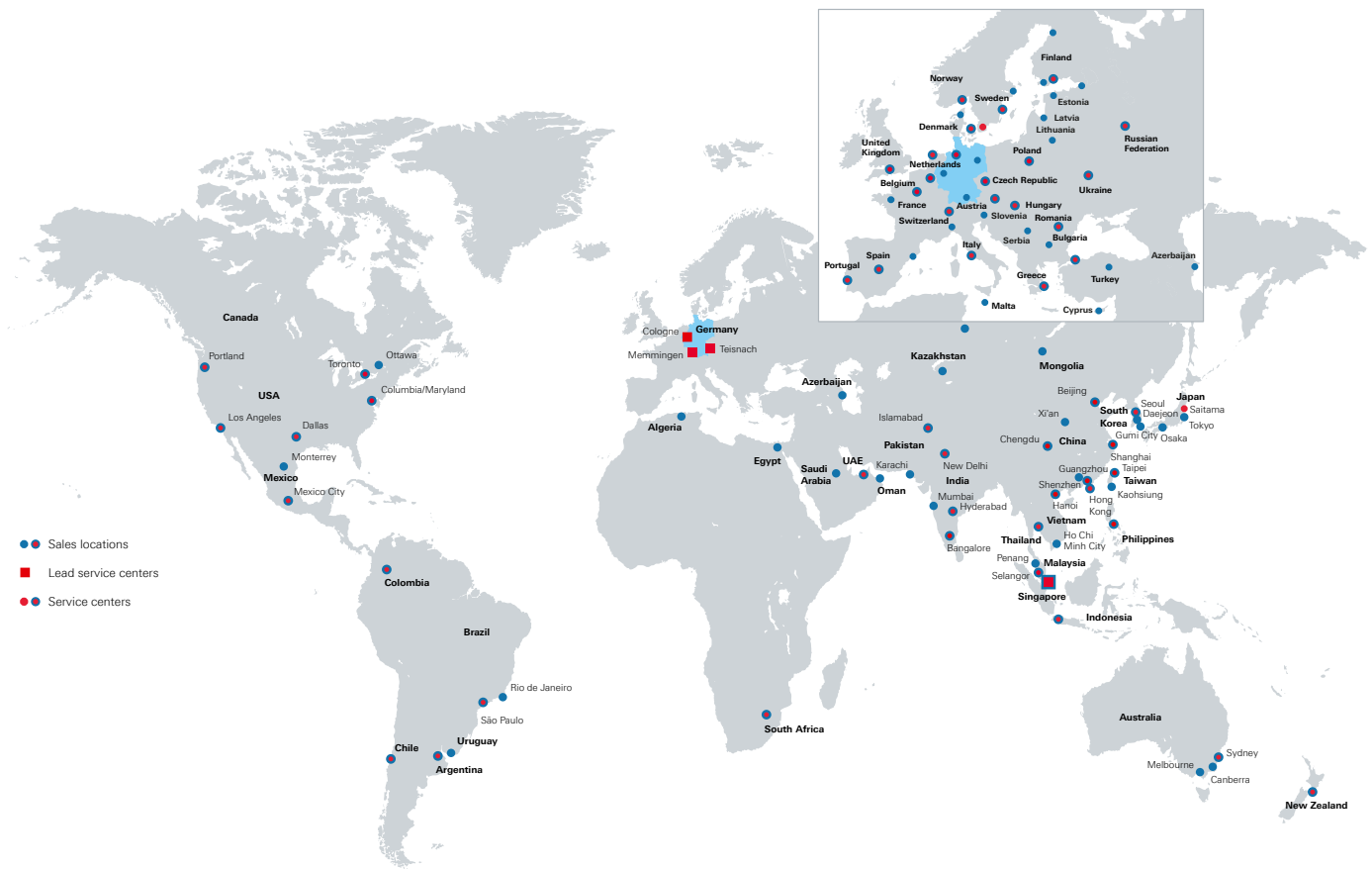

TRADEMARKS

Trade names are trademarks of the owners

- ▶ R&S® is a registered trademark of Rohde&Schwarz GmbH&Co. KG. Example: R&S®FSC spectrum analyzer
- ▶ Windows® is a registered trademark of Microsoft Corp., USA
- ▶ WiMAX™ Forum is a registered trademark of the WiMAX Forum. WiMAX, the WiMAX Forum logo, WiMAX Forum Certified and the WiMAX Forum Certified logo are trademarks of the WiMAX Forum
- ▶ The Bluetooth® word mark and logos are registered trademarks owned by Bluetooth SIG, Inc. and any use of such marks by Rohde&Schwarz is under license
- ▶ CDMA2000® is a registered trademark of the Telecommunications Industry Association (TIA-USA)
- ▶ Dolby® is a registered trademark of Dolby Laboratories.
- ▶ The terms HDMI™ and HDMI High-Definition Multimedia Interface and the HDMI logo are trademarks or registered trademarks of HDMI Licensing LLC in the United States and other countries.
- ▶ MHL™, Mobile High-Definition Link and the MHL Logo are trademarks or registered trademarks of the MHL, LLC.

Published by

Rohde&Schwarz GmbH&Co. KG

Arrangement, layout: Gerhard Krätschmer, Josef Reicherzer – department GF-BS1

INDEX BY TYPE

Type	Designation	Page
A		
R&S® AdVISE	Visual inspection software	198
R&S® AFQ100A	I/Q modulation generator	110
R&S® AFQ100B	UWB signal and I/Q modulation generator	110
R&S® AFQ-Kxxx	Application-specific solutions (firmware or software – overview)	113
R&S® AM524	Active antenna system	211
R&S® AMS32	OTA performance measurement software	34
R&S® AREG100A	Automotive radar echo generator	230
R&S® ATS800B/R	CATR benchtop/rack antenna test system	35
R&S® ATS1000	Antenna test system	36
R&S® ATS1800C	New CATR based 5G NR mmWave test chamber	37
Automation Agent	The automation tool for data management	173
B		
R&S® BBA130	Broadband amplifier	199
R&S® BBA150	Broadband amplifier	200
R&S® BBL200	Broadband amplifier	201
R&S® BCDRIVE	Broadcast drive test software	262
R&S® BTC	Broadcast test center	250
Benchmarker II	The reference benchmarker	160
Benchmarker II Go	The flexible benchmarker	163
C		
R&S® Cable Rider ZPH	Cable and antenna analyzer	144
R&S® CEMS100	Compact EMS/EMI test platform	188
R&S® CLGD	DOCSIS cable load generator	255
R&S® CMPQ	New Compact solution for 5G mmWave RF testing	11
R&S® CMP200	New Radio communication tester	12
R&S® CMPHEAD30	New Remote radio head	12
R&S® CMQ200	New Shielding cube	12
R&S® CMW-ATE	Terminal testing solution for IMS, VoLTE and RCS	23
R&S® CMW-PQA	Test system for performance quality analysis	24
R&S® CMW-Z10/-Z11	RF shielding box and antenna coupler	39
R&S® CMA180	Radio test set	32
R&S® CMW100	Communication manufacturing test set	13
R&S® CMW270	Wireless connectivity tester	17
R&S® CMW290	Functional radio communication tester	16
R&S® CMW500	Wideband radio communication tester	14
R&S® CMW500	Protocol tester	20
R&S® CMW Callbox	Signaling tester	18
R&S® CMWcards	Signaling and application tester	21
R&S® CMWmars	Multifunctional logfile analyzer	22
R&S® CMWrun	Sequencer software tool	19
R&S® CMX500	New Radio communication tester	10
R&S® CTH	Portable radio test set	33
D		
R&S® DSA	DOCSIS signal analyzer	259
R&S® DST200	RF diagnostic chamber	38
R&S® DVMS	Digital TV monitoring family	260
E		
R&S® EDS300	DME/pulse analyzer	94
R&S® EDST300	Maintenance checks and signal-in-space analysis on TACAN and DME stations	95

Type	Designation	Page
R&S®ELEKTRA	EMC test software	195
R&S®EMC32	EMC measurement software platform	196
R&S®ENV216	Two-line V-network	205
R&S®ENV432	Four-line V-network	205
R&S®ENV4200	200 A four-line V-network	205
R&S®ENY21/41/81	Two/four/eight-wire coupling network	206
R&S®ENY81-CA6	Eight-wire coupling network for cable category CAT6	206
R&S®ESH2-Z3	Voltage probe	207
R&S®ESH3-Z2	Pulse limiter	207
R&S®ESL	EMI test receiver	185
R&S®ESR	EMI test receiver	183
R&S®ESRP	EMI test receiver	184
R&S®ESV-Z1	VHF current probe	208
R&S®ESW	EMI test receiver	182
R&S®ETC	Compact TV analyzer	258
R&S®ETL	TV analyzer	257
R&S®EVSF1000	VHF/UHF Nav/Flight analyzer	92
R&S®EVSG1000	VHF/UHF Airnav/Com analyzer	93
R&S®EZ-12	Antenna impedance converter	207
R&S®EZ-17	Current probe	208
R&S®EZ-25	150 kHz highpass filter	207
F		
R&S®FPC	Spectrum analyzer	76
R&S®Spectrum Rider FPH	Handheld spectrum analyzer	77
R&S®FPL1000	Signal and Spectrum analyzer	73
R&S®FPS	Signal and spectrum analyzer	72
R&S®FPS-Kxxx	Application-specific solutions (firmware or software – overview)	80
R&S®FR4 Freerider 4	New Walk testing with maximum flexibility	162
R&S®FS-SNS	New Smart noise sources	69
R&S®FS-Zxx	External mixers	79
R&S®FSC	Spectrum analyzer	75
R&S®FSH	Handheld spectrum analyzer	78
R&S®FSL	Spectrum analyzer	74
R&S®FSMR	Measuring receiver	66
R&S®FSx-Kxxx	Application-specific solutions (firmware or software – overview)	80
R&S®FSV3000	New Signal and spectrum analyzer	67
R&S®FSVA3000	New Signal and spectrum analyzer	68
R&S®FSV/FSVA	Signal and spectrum analyzer	70
R&S®FSVR	Realtime spectrum analyzer	71
R&S®FSW	Signal and spectrum analyzer	64
R&S®FSWP	Phase noise analyzer and VCO tester	65
R&S®FSWT	Test receiver	194
H		
R&S®HF907	Double-ridged waveguide horn antenna	213
R&S®HFH2-Z2/-Z6	Loop antenna, rod antenna	210
R&S®HK116E	Biconical antenna	213
R&S®HL033/HL040E	Log-periodic broadband antennas	211
R&S®HL046E	High gain log-periodic antenna	212
R&S®HL050/HL050E/HL223	Log-periodic antennas	212
R&S®HL562E	ULTRALOG	213
R&S®HM020	Triple-loop antenna	213
R&S®HM8118	LCR bridge/meter	277
R&S®HM8123	Universal counter	278
R&S®HM8143	Three-channel arbitrary power supply	271

Appendix

Type	Designation	Page
R&S®HMC8012	Digital multimeter	276
R&S®HMC8015	Power analyzer	279
R&S®HMC804x	Power supplies	267
R&S®HMF25xx	Arbitrary function generators	111
R&S®HMP20x0	Programmable two/three-channel power supply	270
R&S®HMP40x0	Programmable three/four-channel power supply	270
R&S®HZ-9	Power supply	210
R&S®HZ-14, R&S®HZ-15	H near-field probe set, probe set for E and H near-field emission measurements	209
R&S®HZ-16	Preamplifier	209
I		
R&S®IQW	I/Q wideband data recorder	285
M		
R&S®MDS-21	Absorbing clamp	208
R&S®MNT	RF interference locator	164
R&S®MobileLocator	System software	168
N		
R&S®NESTOR	Cellular network analysis software	170
R&S®NGE100B	Power supply series	269
R&S®NGL200	New Power supply series	272
R&S®NGM200	New Power supply series	272
R&S®NRP	USB and LAN power sensors	217
R&S®NRP-Zxx	Power sensors	218
R&S®NRP-Z5	Sensor hub	220
R&S®NRPC	Calibration kits	221
R&S®NRPM	Over-the-air (OTA) power measurement solution	223
R&S®NRPV	Virtual power meter	220
R&S®NRQ6	Frequency selective power sensor	219
R&S®NRT/NRT-Zxx	Power reflection meter/power sensors	222
R&S®NRX	Power meter	216
NQDI	The source of insights for business decisions	169
O		
R&S®OSP	Open switch and control platform	281
P		
PiMPro Tower	Passive intermodulation analyzer	166
Q		
R&S®QAR	Quality automotive radome tester	233
R&S®QuickStep	Test executive software	287
QualiPoc Android	The premier handheld troubleshooter	157
QualiPoc Android Probe	Non-stop service quality monitoring and optimization	158
R		
R&S®ROMES4	Drive test software	167
R&S®RSC	Step attenuator	286
R&S®RTA4000	Oscilloscopes	48
R&S®RTB2000	Oscilloscopes	50
R&S®RTC1000	Oscilloscopes	51
R&S®RTE1000	Oscilloscopes	47
R&S®ScopeRider RTH	Handheld oscilloscopes	52
R&S®RTM3000	Oscilloscopes	49
R&S®RTO2000	Oscilloscopes	46
R&S®RTO-Kxxx	Application-specific solutions (firmware or software – overview)	80
R&S®RTP	High-performance oscilloscope	44
R&S®RT-Zxx	Oscilloscope probes	57
S		
R&S®ScopeRider RTH	Handheld oscilloscopes	52

Type	Designation	Page
R&S® SFC	Compact modulator	253
R&S® SFC-U	USB compact modulator	253
R&S® SFD	DOCSIS® signal generator	254
R&S® SFE100	Test transmitter	252
R&S® SGS100A	SGMA RF source	101
R&S® SGT100A	SGMA vector RF source	102
R&S® SGT-Kxxx	Application-specific solutions (firmware or software – overview)	113
R&S® SGU100A	SGMA upconverter	101
R&S® SLG	Satellite load generator	256
R&S® SMA100B	RF and microwave signal generator	105
R&S® SMB100A	Microwave signal generator	106
R&S® SMB100B	RF and microwave signal generator	107
R&S® SMBV100B	Vector signal generator	100
R&S® SMC100A	Signal generator	108
R&S® SMW200A	Vector signal generator	98
R&S® SMx-Kxxx	Application-specific solutions (firmware or software – overview)	113
R&S® SMZ	Frequency multiplier	109
R&S® Spectrum Rider FPH	Handheld spectrum analyzer	77
R&S® Stream Libraries	Test signal libraries	265
R&S® SZU100A	I/Q upconverter	103
R&S® SZV100A	RF upconverter	104
SmartAnalytics	Automation tool for data management	172
SmartBenchmarker	Benchmarking tests made easier	159
SmartLicensor	Floating license server	174
SmartMonitor	Realtime service quality monitoring	171
T		
R&S® TA-TRS	Sequencer	251
R&S® TS-EMF	Portable EMF measurement system	193
R&S® TS-ISC	In-system calibration kit	245
R&S® TS-LBS	Test system for location based services	27
R&S® TS-PAM	Signal analyzer module	243
R&S® TS-PCA3	R&S® CompactTSVP test and measurement chassis	236
R&S® TS-PCAL2	Calibration module	245
R&S® TS-PDFT	Digital functional test module	241
R&S® TS-PFG	Function generator module	243
R&S® TS-PICT	In-circuit test extension	238
R&S® TS-PIO2	Analog and digital I/O module	242
R&S® TS-PIO3B	Digital I/O module	242
R&S® TS-PIO4	32-channel programmable digital I/O module	242
R&S® TS-PIO5	LVDS digital functional test module	243
R&S® TS-PMB	Switch matrix module	238
R&S® TS-PRIOx	Rear I/O transmission module	240
R&S® TS-PSAM	Analog source and measurement module	238
R&S® TS-PSC0	System controller	237
R&S® TS-PSC07	System controller	237
R&S® TS-PSC57	System controller	237
R&S® TS-PSC6x	System controller	237
R&S® TS-PSCX	Interface panel	237
R&S® TS-PSM1	Power switching module	238
R&S® TS-PSM2	Multiplex and switch module	239
R&S® TS-PSM3	High-power switching module	239
R&S® TS-PSM4	Multiplex and switch module	239
R&S® TS-PSM5	High-power switching module	239
R&S® TS-PSU	Power supply and load module	244

Appendix

Type	Designation	Page
R&S®TS-PSU12	Power supply and load module	244
R&S®TS-PWA3	R&S®PowerTSVP switching application chassis	236
R&S®TS-PXM1	Switching extension module	241
R&S®TS-PXB2	Backplane extension module	241
R&S®TS-RRM	LTE and WCDMA RRM test system	26
R&S®TS6	TRM test library	232
R&S®TS6710	TRM radar test solution	231
R&S®TS712x	Shielded RF test chambers	39
R&S®TS8980	RF/RRM test system for LTE, WCDMA and GSM	25
R&S®TS8991	OTA performance test system	29
R&S®TS8996	RSE test system	30
R&S®TS8997	Regulatory test system for wireless devices	31
R&S®TS9975	EMI test system	186
R&S®TS9982	EMS test system	189
R&S®TSMA6	Autonomous mobile network scanner	154
R&S®TSME6	Ultracompact drive test scanner	155
R&S®TSME30DC	New Downconverter	156
TCM	Test device containment module	161
U		
R&S®UPP	Audio analyzer	228
R&S®UPV	Audio analyzer	227
R&S®UPZ	Audio switcher	229
V		
R&S®VTC/VTE/VTS	Video test center/video tester/compact video tester	263
W		
R&S®WinIQSIM2™	Simulation software	122
Z		
R&S®ZCAN	Manual calibration kits	150
R&S®ZCxxx	Millimeterwave converters	146
R&S®ZCWM-570	Waveguide calibration kits	151
R&S®ZN-Z15x/-Z5x	Calibration units	151
R&S®ZN-Z32/-Z33	Inline calibration units	149
R&S®ZN-Z84	Switch matrix	150
R&S®ZN-Z85	Switch matrix	150
R&S®ZN-ZTW	Torque wrench	151
R&S®ZNA	New Vector network analyzer	130
R&S®ZNB	Vector network analyzer	137
R&S®ZNBt	Vector network analyzer	138
R&S®ZND	Vector network analyzer	141
R&S®ZNL	Vector network analyzer	139
R&S®ZNLE	Vector network analyzer	140
R&S®ZRun	Automated test software	145
R&S®Cable Rider ZPH	Cable and antenna analyzer	144
RPG ZRXxxx	High dynamic receivers for VNAs	148
R&S®ZV-WRxx	Waveguide calibration kits	151
R&S®ZV-Z170/-Z135/-Z129/-Z2xx	Calibration kits	151
R&S®ZV-Z3xx/-Z4xx/-Z5x	Verification kits	151
R&S®ZVA-Zxxx	Millimeterwave converters	147
R&S®ZVA	Vector network analyzer	134
R&S®ZVAX-TRM	Extension unit	150
R&S®ZVH	Cable and antenna analyzer	143
R&S®ZVL	Vector network analyzer	142
R&S®ZVT	Multiport vector network analyzer	136

R&S® is a registered trademark of
Rohde&Schwarz GmbH&Co. KG
Trade names are trademarks of the owners
Printed in Germany (gk/jr)
PD 5213.7590.42 | Version 09.00 | February 2020
Subject to change

© 2020
Rohde&Schwarz GmbH&Co. KG
81671 Munich, Germany

5213759042



PD 5213.7590.42 | Version 09.00 | PDF 1 en