



**CONNECT AND PROTECT**

# Varistar – The Versatile Electronic Cabinet Platform

  
nvent

**SCHROFF**

# We Protect

## YOUR ELECTRONICS: IN 19" AND BEYOND

### ABOUT NVENT

Today, nVent is the global equipment protection partner with industry leading products and solutions. Around the globe, over 9,000 nVent employees work in collaboration to provide fresh insights and drive innovation which promotes a healthier and safer environment for all.

### ABOUT NVENT SCHROFF

The nVent SCHROFF brand contains a broad product portfolio from printed circuit board (PCB) accessories, such as card retainers and extractors, front panels and handles to subracks, cases, backplanes, power supplies, cabinets and pre-assembled chassis for embedded computing systems. The brand SCHROFF, which belongs to nVent has been a world leader in electronics packaging for over five decades.

### MULTI-PURPOSE ELECTRONICS CABINETS

When it comes to protecting your ruggedized electronic devices or mission-critical IT infrastructure, get the performance you want and the specifications you need with nVent SCHROFF cabinets. We offer steel and aluminum frame cabinet platforms with a wide range of dimensions and cover parts. Choose from different IP / NEMA protection levels, as well as options such as perforated doors, fan units and air-to-water heat exchangers. A RFI shielding option for up to 60 dB at 1 GHz / 40 dB at 3 GHz or earthquake resistance up to Bellcore Zone 4 is also available to withstand extreme environments while meeting the strictest safety requirements. To complete your project, we can assemble, integrate and test your mechanical and electrical accessories.

Features	Standards	Results
Static load	Internal load testing and measurement of deformation	1.600 kg (3,500 lbs) (tested with 2000 kg (4400 lbs), safety 25 %)
Dynamic load	IEC 61587-1 and internal testing	Slim-Line 400 kg (880 lbs), Heavy-Duty 800 kg (1700 lbs), with reinforcement up to 1000 kg (2200 lbs)
Shock test	IEC 61587-1	Maximum acceleration: 5 g duration: 11 ms
Vibration test	IEC 61587-1	Frequency: 5 Hz - 100 Hz acceleration: 1 g
Earthquake test	IEC 61587-2 GR-63-CORE	Heavy-Duty standard up to Bellcore Zone 3 (acceleration 3 g, frequency 1 Hz ... 5 Hz) with strengthening up to Bellcore Zone 4 (acceleration 5 g, frequency 2 Hz ... 5 Hz)
Electromagnetic compatibility (EMC)	IEC 61587-3	60 dB at 1 GHz, 40 dB at 3 GHz
Type of protection	DIN VDE 0470 EN 60529	IP 20 and IP 55
Installation options	IEC 60297-3-100 ETS 3000-119-3	Slim-Line 19" or ETS Heavy-Duty 19"

## Contents

Maximum Reliability	4
Rugged And Secure	5
Service Plus	6
Modular Cooling Solutions	7

# One Versatile Platform

## FOR VARIOUS MARKETS

### PERFORMANCE & DEPENDABILITY FOR CRITICAL SYSTEMS

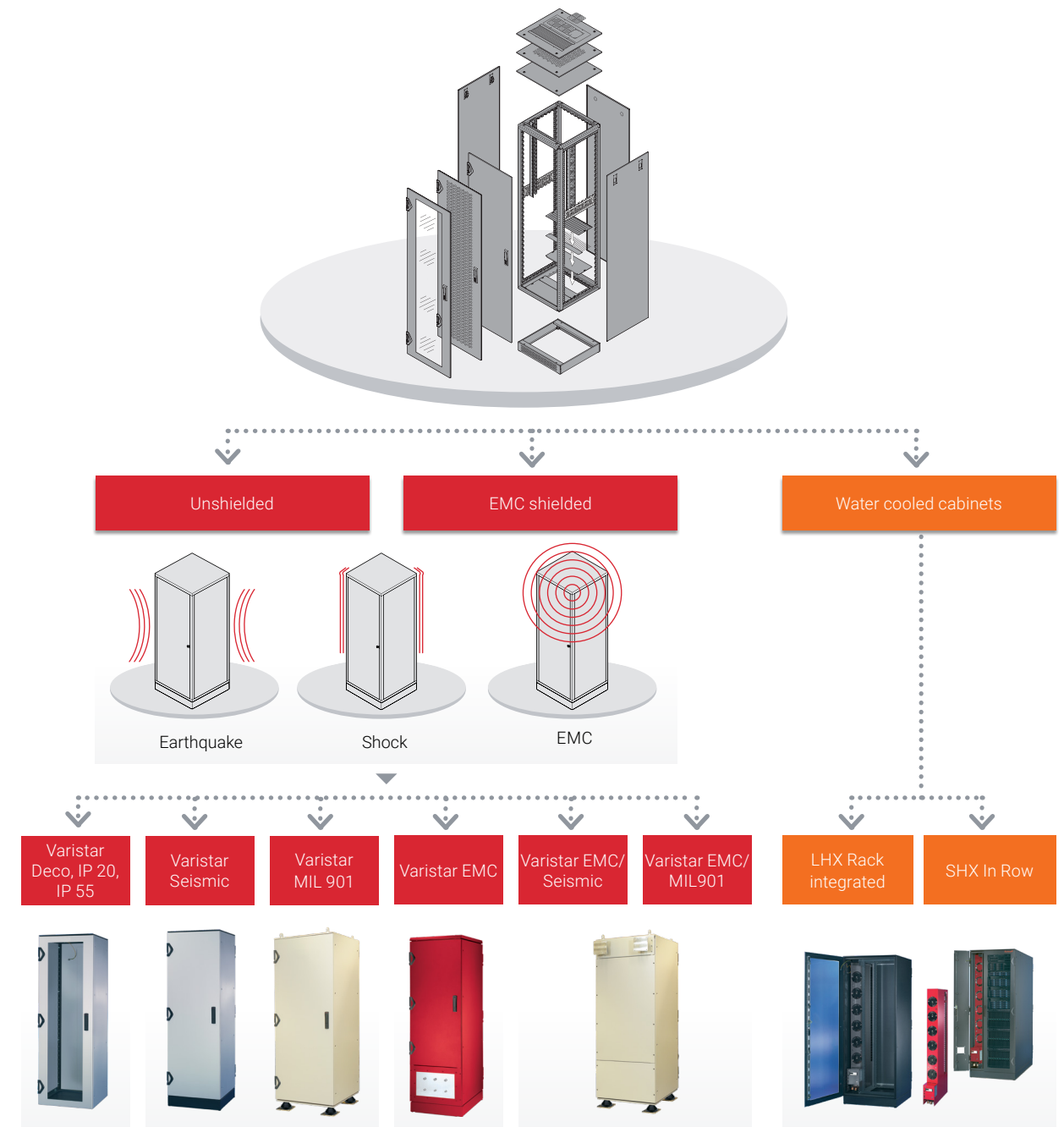

### APPLICATIONS

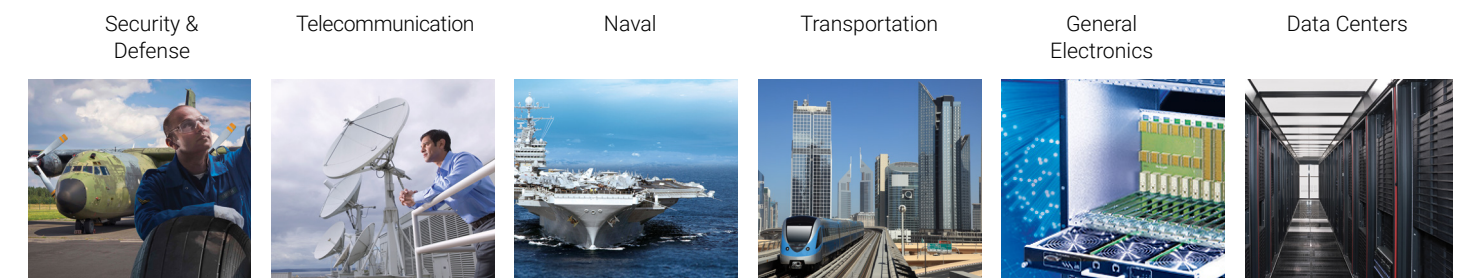

# Maximum Reliability

## IN THE MOST DEMANDING ENVIRONMENTS

The design of Varistar is based on a welded frame construction. Its modular conception, ensures the highest flexibility on a single platform. At its core, it features robust steel profiles, allowing the greatest range of applications. The frame meets the requirement classes up to DL6 in accordance with IEC 61587-1 and support static loads up to 1,600 kg (3500 lbs). Two profiles with different cross-sections cater for two principal sets of requirements – Slim-Line and Heavy-Duty

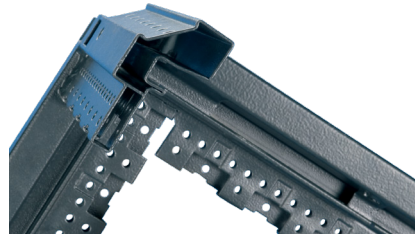

### HEAVY-DUTY

The robust Heavy-Duty frame was especially designed for high dynamic load requirements or regions susceptible to earthquakes. Dynamic tests verify earthquake protection to Zone 4.

#### BENEFITS AT A GLANCE:

- Maximum stability
- Fulfills IEC 60297-3-100 (19")
- Excellent earthquake resistance (Bellcore Zone 3 without reinforcement, Zone 4 with reinforcing brackets)

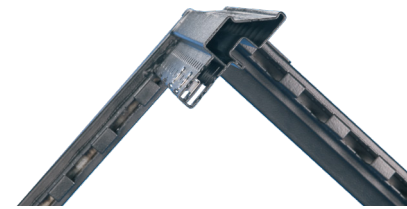

### SLIM-LINE

The Slim-Line profile with minimum material outlay supports high static load requirements while obtaining the greatest opening width between the uprights.

#### BENEFITS AT A GLANCE:

- Maximum width for installations
- Fulfills IEC 60297-3-100 (19")
- Fulfills IEC 60917-2-2 (hard metric)
- Internal and external dimensions to ETS 300 119-3

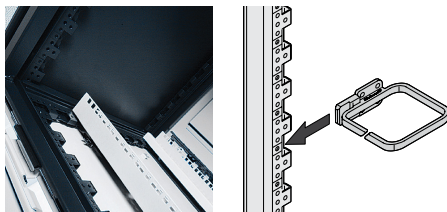

### PEERLESS AND EFFICIENT PROFILE

The Varistar profile has mounting holes in all three axes (height, width, depth), following a 25 mm (1") grid. The intricately shaped form of the profile offers further new assembly possibilities. Cable eyes for instance, can be tool less plugged directly into the frame.

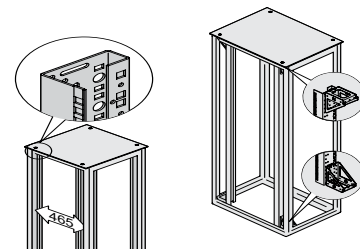

### INSTALLATION OF 19" RACK ANGLES

Can be mounted directly on the frame in 600 mm (24") wide cabinets. In 800 mm (31") wide cabinets you can choose the following options according to your requirements for static load:

**Reduction Bracket:** This covers most electronic applications.

**Crossbar:** This design supports applications with extremely high static load requirements of up to 1600 kg (3500 lbs).



### MECHATRONIC ACCESS CONTROLS

Depending on the access control requirements, various mechanic and electronic handles can be combined like: integrated card reader units that allow decentralized access control solution; or all locks can be networked together, creating a centralized control and monitoring system by using appropriate software.

# Rugged And Secure

## FOR DEFENSE & TRANSPORTATION

From traffic and transport planning, to guidance systems and traffic management systems to highly ruggedized military applications, one thing is of highest priority: uncompromising security.

Varistar is designed to provide outstanding shock and vibration stability, offers shielding against high frequency interference and is built to provide long-term durability you can rely on.

With attention to every detail, the proven design, quality materials and craftsmanship ensure that Varistar cabinets will meet your most demanding security tasks in an economically way.

### HF SHIELDING: TWICE AS GOOD

The Varistar shielding principle protects security relevant data from interference radiation. Tested to IEC 61587-3.

The frame profiles are surrounded by a surface set at 45°, fitted with conductive textile gaskets. All cladding parts are electrically connected and induced interference currents flow automatically away via the surfaces. This design principle pays off in two ways: you profit from more effective shielding, yet doesn't

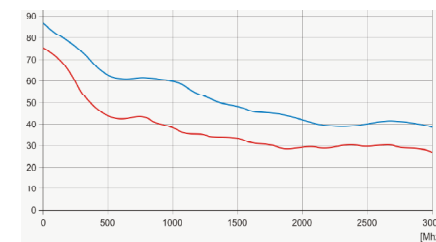

1. Cabinet with solid door
2. Cabinet with perforated door

require any costly surface treatments of the frame.

Varistar offers outstanding shielding protection: 60dB for 1 GHz, 40 dB for 3 GHz.

Effectiveness even in most diverse configurations (like special equipped fan top cover, perforated doors, base plate with cable entries).

Refer to the configurator for more choices.

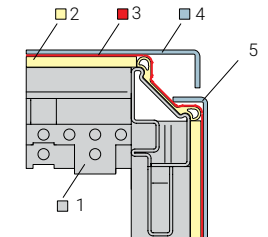

1. Frame
2. Conductive EMC textile gasket
3. Contact/shielding
4. Rear panel
5. Side panel

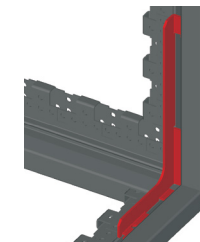

### SEISMIC PROTECTION

By reinforcing the corners of the cabinet frame, Varistar offers certified earthquake-protection to earthquake Zone 4, providing reliable protection anywhere in the world.

High mechanical stability to Bellcore Zone 4 in accordance with IEC 61587-2.



### SHOCK ABSORBERS

For even higher levels of shock and vibration resistance, Varistar can be equipped with shock absorbers.

Shock and vibration resistant to DL6 in accordance with IEC 61587-1 and IEC 60068-2-6.

Tested to MIL-STD-910D.

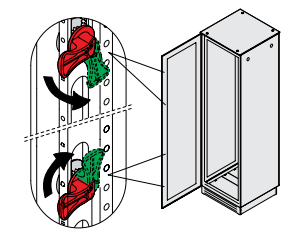

### THE VARISTAR LOCK SYSTEM

The latching system also contributes to protection class and shielding.

Activating the locking bar causes the latches to move in the opposite direction. The frictional forces of the bolts are balanced out and a resulting uneven vertical force on the door is avoided. The doors close easily and are completely sealed. EMC doors are fitted with 4-point locking, IP and server doors with 3-point locking.



# Service Plus

SIMPLY UNBEATABLE!

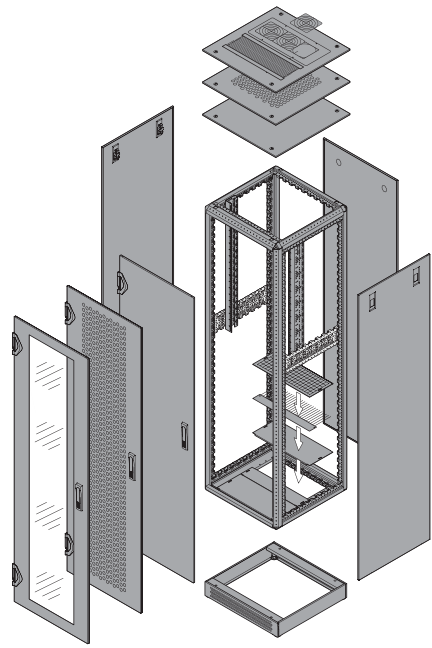

## CONFIGURATION

### SIMPLE. FAST. CONVENIENT.

ServicePLUS allows you to easily configure your specific Varistar system based on standard components - for cost effective custom solutions with short lead times.

- Interactive configurator online
- Configuration tables in the catalog
- Telephone configuration hotline
- Power search: quick selection of standard dimensions

### CABINET CONFIGURATION:

- Height: 24 U to 47 U
- Width: 600 mm (24") and 800 mm (31")
- Depth: 300 mm (12") to 1200 mm (47")
- Cabinets are available in 21 standard RAL colors

## ASSEMBLY

### ASSEMBLED BY PROFESSIONALS. TWICE THE BENEFIT!

Let our specialists install all mechanical, electrical and electronic components for you.

For turnkey products, ServicePLUS assemblies allow you to focus on your core activity without interruption, while we carry out the complete assembly of all your system components, on time and with technical competence.

## EXPRESS

### WHEN FAST HAS TO BE FASTER.

In many projects speed is of the essence, and flexibility a decisive criterion. With its comprehensive express options, ServicePLUS express gives you maximum flexibility in regards to lead time.

- Plan economically
- Control manufacturing time
- Receive your items superfast

## MODIFICATION

### SMALL CHANGES. BIG EFFECTS!

Custom cut-outs and special colors for Varistar cabinets, fast and easy:

- Holes, cut-outs and special colors at set prices
- 3D PDF preview available by order number
- CAD download by order number

Ready for delivery in 15 working days. You can find our current range of special colors and drawings online.



HIGH-QUALITY.  
COMPREHENSIVE.  
CLEAR.

[HTTPS://SCHROFF.NVENT.COM/EN-US/CONFIGURATORS/3D/VARISTAR/NEW](https://schroff.nvent.com/en-us/configurators/3d/varistar/new)

# Modular

## COOLING SOLUTIONS

### MODULAR AND EFFICIENT

Depending on the amount of heat generated and the internal and external temperatures, various cooling options are available for Varistar cabinets to ensure effective cooling of the installed electronics. Cooling concepts include air-filtered fans, fan trays or controlled airflow systems through to air/air or air/water heat exchangers and compressor-driven air conditioners.

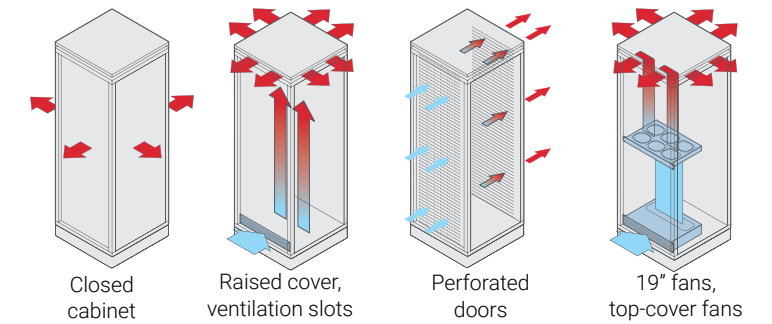

Description	Natural convection via thermal radiation	Free convection through top-cover opening	Free convection through openings in the doors/rear panels	Forced cooling with air
Type of protection	≤ IP 55	≤ IP 20	≤ IP 20	≤ IP 20
Noise level approx.	0	0	55 ... 65 dB (A)	34 ... 67 dB (A)
Ambient conditions	$T_i > T_u$	$T_i > T_u$	$T_i > T_u$	$T_i > T_u$
Cooling capacity approx. <sup>1)</sup>	< 500 W	< 500 W ... 800 W	< 500 W ... 6000 W <sup>2)</sup>	< 2000 W

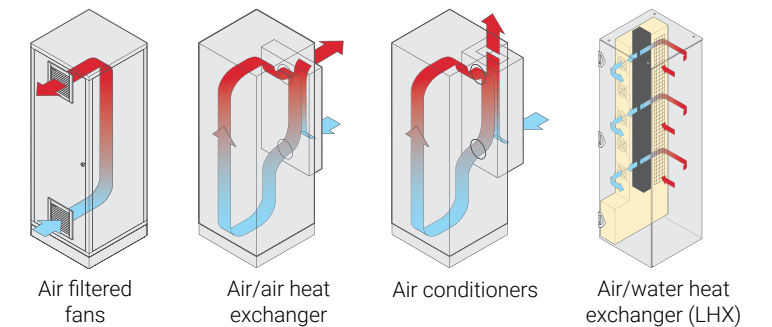

Description	Forced cooling with air	Forced cooling with air	Cooling with coolant	Cooling with water
Type of protection	≤ IP 54	≤ IP 54	≤ IP 54	≤ IP 55
Noise level approx.	39 ... 71 dB (A)	55 ... 75 dB (A)	50 ... 81 dB (A)	50 ... 60 dB (A)
Ambient conditions	$T_i > T_u$	$T_i > T_u$	$T_u \leq 55^\circ\text{C}$	$T_u \leq 70^\circ\text{C}$
Cooling capacity approx. <sup>1)</sup>	< 1500 W	< 2000 W	< 2600 W	< 40000 W

1) should be depending on cabinet size, electronic components, location and room cooling concept.  
2) >800 W are only possible with own, active cooling through components like servers, etc.



## Europe

<b>Straubenhardt, Germany</b>	Tel: +49.7082.794.0
<b>Betschdorf, France</b>	Tel: +33.3.88.90.64.90
<b>Warsaw, Poland</b>	Tel: +48.22.209.98.35
<b>Hemel Hempstead, Great Britain</b>	Tel: +44.1442.24.04.71

## North America

<b>All locations</b>	Tel: +1.800.525.4682
----------------------	----------------------

## Middle East & India

<b>Dubai, United Arab Emirates</b>	Tel: +971.4.37.81.700
<b>Bangalore, India</b>	Tel: +91.80.67152000
<b>Istanbul, Turkey</b>	Tel: +90.216.250.7374

## Asia

<b>Shanghai, China</b>	Tel: +86.21.2412.6943
<b>Qingdao, China</b>	Tel: +86.523.8771.6101
<b>Singapore</b>	Tel: +65.6768.5800
<b>Shin-Yokohama, Japan</b>	Tel: +81.45.476.0271

Our powerful portfolio of brands:

**CADDY ERICO HOFFMAN RAYCHEM SCHROFF TRACER**



[nVent.com/SCHROFF](https://www.nVent.com/SCHROFF)