

cryptogamie

Bryologie

2023 • 44 • 3

Bryoflora and landscapes of the eastern Andes of central Peru: II. Understory epiphyllous bryophyte assemblages of the Cordillera El Sira

James G. GRAHAM, János PODANI,
Armin NIESSNER, Margaux FISCHER &
Tamás PÓCS

art. 44 (3) — Published on 14 March 2023
www.cryptogamie.com/bryologie

PUBLICATIONS
SCIENTIFIQUES



DIRECTEUR DE LA PUBLICATION / *PUBLICATION DIRECTOR*: Bruno DAVID
Président du Muséum national d'Histoire naturelle

RÉDACTEUR EN CHEF / *EDITOR-IN-CHIEF*: Denis LAMY

ASSISTANT DE RÉDACTION / *ASSISTANT EDITOR*: Chris LE COQUET-LE ROUX (bryo@cryptogamie.com)

MISE EN PAGE / *PAGE LAYOUT*: Chris LE COQUET-LE ROUX

RÉDACTEURS ASSOCIÉS / *ASSOCIATE EDITORS*

Biologie moléculaire et phylogénie / *Molecular biology and phylogeny*

Bernard GOFFINET

Department of Ecology and Evolutionary Biology, University of Connecticut (United States)

Mousses d'Europe / *European mosses*

Isabel DRAPER

Centro de Investigación en Biodiversidad y Cambio Global (CIBC-UAM), Universidad Autónoma de Madrid (Spain)

Francisco LARA GARCÍA

Centro de Investigación en Biodiversidad y Cambio Global (CIBC-UAM), Universidad Autónoma de Madrid (Spain)

Mousses d'Afrique et d'Antarctique / *African and Antarctic mosses*

Rysiek OCHYRA

Laboratory of Bryology, Institute of Botany, Polish Academy of Sciences, Krakow (Pologne)

Bryophytes d'Asie / *Asian bryophytes*

Rui-Liang ZHU

School of Life Science, East China Normal University, Shanghai (China)

Bioindication / *Biomonitoring*

Franck-Olivier DENAYER

Faculté des Sciences Pharmaceutiques et Biologiques de Lille, Laboratoire de Botanique et de Cryptogamie, Lille (France)

Écologie des bryophytes / *Ecology of bryophyte*

Nagore GARCÍA MEDINA

Department of Biology (Botany), and Centro de Investigación en Biodiversidad y Cambio Global (CIBC-UAM), Universidad Autónoma de Madrid (Spain)

COUVERTURE / *COVER*:

Landscape view of the study area from the upper reaches of our elevational transect at 2000 meters, looking northeast across the Ucayali River Basin. Photograph taken by Armin Niessner in March 2022.

Cryptogamie, Bryologie est indexé dans / *Cryptogamie, Bryologie is indexed in*:

- Biological Abstracts
- Current Contents
- Science Citation Index
- Publications bibliographiques du CNRS (Pascal)

Cryptogamie, Bryologie est distribué en version électronique par / *Cryptogamie, Bryologie is distributed electronically by*:

- BioOne® (<http://www.bioone.org/loi/cryb>)

Cryptogamie, Bryologie est une revue en flux continu publiée par les Publications scientifiques du Muséum, Paris
Cryptogamie, Bryologie is a fast track journal published by the Museum Science Press, Paris

Les Publications scientifiques du Muséum publient aussi / *The Museum Science Press also publish: Adansonia, Geodiversitas, Zoosystema, Anthropolozologica, European Journal of Taxonomy, Naturae, Comptes Rendus Palevol, Cryptogamie sous-sections Algologie, Mycologie.*

Diffusion – Publications scientifiques Muséum national d'Histoire naturelle

CP 41 – 57 rue Cuvier F-75231 Paris cedex 05 (France)

Tél. : 33 (0)1 40 79 48 05 / Fax : 33 (0)1 40 79 38 40

diff.pub@mnhn.fr / <http://sciencepress.mnhn.fr>

© Publications scientifiques du Muséum national d'Histoire naturelle, Paris, 2023

ISSN (imprimé / *print*) : 1290-0796 / ISSN (électronique / *electronic*) : 1776-0992

Bryoflora and landscapes of the eastern Andes of central Peru: II. Understory epiphyllous bryophyte assemblages of the Cordillera El Sira

James G. GRAHAM

Botany Department, Field Museum, Chicago (United States)
and Herbario Forestal, Universidad Nacional Agraria La Molina, Lima (Perú)
jgraham@fieldmuseum.org (corresponding author)

János PODANI

Department of Plant Systematics, Ecology and Theoretical Biology,
Eötvös University, Budapest (Hungary)

Armin NIESSNER

Department of Molecular Botany, University of Hohenheim, Stuttgart (Germany)

Margaux FISCHER

Botany Department, Field Museum, Chicago (United States)

Tamás PÓCS

Botany Department, Institute of Biology, Eszterházy Károly Catholic University, Eger (Hungary)

Submitted on 15 February 2022 | Accepted on 26 October 2022 | Published on 14 March 2023

Graham J. G., Podani J., Niessner A., Fischer M. & Pócs T. 2023. — Bryoflora and landscapes of the eastern Andes of central Peru: II. Understory epiphyllous bryophyte assemblages of the Cordillera El Sira. *Cryptogamie, Bryologie* 44 (3): 89–105. <https://doi.org/10.5252/cryptogamie-bryologie2023v44a3>. <http://cryptogamie.com/bryologie/44/3>

KEY WORDS

Peru,
neotropical cloud forests,
epiphyllous bryophytes,
beta diversity,
microhabitat diversity,
orographic gradients,
elevation,
new records.

ABSTRACT

We document the makeup of four understory epiphyllous (leaf-inhabiting) bryophyte assemblages along an elevational gradient on the eastern slopes of the Cordillera El Sira in Ucayali, Peru. Epiphyllous from two lowland rainforest (250 and 350 m) and two upland cloud forest (1550 and 1800 m) sites were sampled along a transect spanning 6.8 km horizontal and 1.6 km vertical distance, with 74 epiphyllous taxa (69 liverworts and 5 mosses) identified. Change in community composition along the elevational gradient and factors affecting the diversity and distribution of understory epiphyllous bryophytes are explored using various approaches to diversity measurement and multivariate analysis.

RÉSUMÉ

Bryoflore et paysages des Andes orientales au Pérou central: II. Assemblages de bryophytes épiphyllous de sous-bois de la Cordillère El Sira.

Nous documentons la composition de quatre assemblages de bryophytes épiphyllous (vivant sur les feuilles) de sous-bois le long d'un gradient d'altitude sur les pentes orientales de la Cordillère El Sira au Pérou. Les épiphyllous de deux sites de forêt pluviale de basse altitude (250 et 350 m) et de deux sites de forêt nuageuse de haute altitude (1550 et 1800 m) ont été échantillonnées le long d'un transect couvrant une distance horizontale de 6,8 km et une distance verticale de 1,6 km. 74 taxons épiphyllous (69 hépatiques et 5 mousses) ont été identifiés. Nous avons exploré, en utilisant diverses approches de mesure de la diversité et d'analyse multivariée, le changement de composition de la communauté le long du gradient d'altitude ainsi que les facteurs affectant la diversité et la distribution des bryophytes épiphyllous de sous-bois.

MOTS CLÉS

Pérou,
forêts nuageuses
néotropicales,
bryophytes épiphyllous,
diversité bêta,
diversité des microhabitats,
gradients orographiques,
élévation,
signalements nouveaux.

INTRODUCTION

The forests of the Selva Central (Fig. 1) harbor some of the greatest concentrations of biological diversity on earth. This rugged and geologically complex region, comprising the eastern foothills and outlying ranges of the Andes mountains as they transition to the Amazonian lowlands, has until relatively recently remained isolated and difficult to access. The first published accounts of bryophyte diversity in the Selva Central were from inventories made in the environs of Yanachaga-Chemillén National Park (Romanski 2007; Opissa & Churchill 2008; Romanski *et al.* 2011), although herbarium records attest to earlier collections made in the region; at least as early as 1929 at Oxapampa (Tropicos 2022).

In 2009 we initiated bryophyte collections in the El Sira Communal Reserve, along the windward slopes of the cordillera El Sira in Ucayali Department, and in 2016 we continued bryological exploration further to the west, with expeditions made to the Oxapampa-Ashaninka-Yanesha and the Bosques de Neblina-Selva Central Biosphere Reserves in Pasco and Junín Departments, respectively. Collections were made in Yanachaga-Chemillén National Park and adjacent Bosque Sho'llet municipal conservation area, as well as in the Pampa Hermosa National Sanctuary and nearby Puyu Sacha conservation concession. These collections from Junín and Pasco have yielded 195 liverwort species to date (unpublished data), although this figure remains far from complete.

As part of an ongoing multi-taxa inventory in the El Sira mountains of Ucayali and Pasco we have previously catalogued, 171 liverwort species, 38 of which represented new distribution records for Peru (Graham *et al.* 2016), and 54 moss species (unpublished data). Additional bryophyte collections from Junín, Pasco and Ucayali have added 28 new liverwort distribution records for Peru (Pócs *et al.* 2022) as well as four species new to science (Pócs 2019a, b).

All the collections documented in our 2016 paper (Graham *et al.* 2016) were of liverworts, primarily epiphytes – organisms growing not on mineral soils, but attached to the surface of plants. Epiphytes are non-parasitic organisms that derive their nutrients and moisture from the air and rain as well as from “aerial soil” – accumulated debris made up primarily of decomposed plant material. The present study focuses on epiphylls – a form of epiphyte that specializes in colonizing the surface of leaves – and explores the makeup of a series of understory epiphyll assemblages sampled along an environmental gradient on the steep slopes of the eastern flank of the El Sira mountains.

Some of the earliest historical records of tropical bryophytes were of epiphylls (Glime & Pócs 2018), these entering herbarium collections in the late 18th century on the leaves of vascular plant specimens. Interest in (and collection of) tropical epiphylls increased slowly throughout the 19th and the first half of the 20th century, expanding progressively thereafter (Pócs 2009). Current research efforts continue to augment our knowledge of this enigmatic life form in the new- and old-world tropics, Oceania, as well as in specialized temperate locations (Schiffner 1929; Pócs 1976; Lücking 1997; Kraichak 2013; Mežaka *et al.* 2020).

Epiphylls are of mixed lifeforms, including algae, cyanobacteria, lichens, liverworts and mosses, but in our area tend to be dominated by liverworts in the family Lejeuneaceae. Follicolous lichens as well as a few mosses were sampled in our epiphyll collections; both were found only at lower-elevation sites. Epiphyllic lichens may also be detected at upper elevations, but only in light-exposed sites, such as in elfin forest canopy layers. The extent to which this distributional pattern can be attributed to specific physiological constraints is not yet fully established (Coley *et al.* 1993).

Our study site, located along the steep eastern slopes of the Cordillera El Sira, presents an ideal combination of topographic relief and climatic conditions to explore the makeup of adjacent lowland and upland epiphyll assemblages from sites only a short distance (< 5 km) apart. The uplands of the cordillera above about 1200 m maintain the montane forests so prevalent throughout the region, while above 2000 m distinctive elfin forest formations are found. Along the base of its eastern flank below about 400 m are found extensive tracts of lowland (Amazonian) rainforest stretching to the east. The presence of lowland Amazonian forest surrounding the El Sira mountains contrasts with Andean outlying ranges found further to the west, which ascend from increasingly higher base-elevations as they approach the main Andean chain along the Cordillera Occidental.

In El Sira, the eastern flank of this easternmost outlying Andean range of the Selva Central receives moisture-laden trade winds arriving from the northeast, passing thousands of kilometers across lowland Brazil from the Atlantic. Orographic uplifting along the steep eastern flank of the range results in heavy rains upslope, marked by episodes of intense precipitation. Ten years of rainfall data along the elevational transect document mean annual rainfalls well-above 6000 mm all along the slope, including the lowland forests found in a narrow band along the eastern base of the uplift. Environmental data collected over the past decade at our research site provide some insight into key abiotic elements influencing local structure of forest communities (Graham *et al.* 2016; Niessner *et al.* 2020).

Rainfall and humidity, understory light intensity and ambient temperature have all been suggested as factors that control the distribution of epiphylls (Frahm 1987). Elevational zonation is recognized as a key factor in structuring patterns of bryophyte species richness and diversity, and canonical community epiphyte structure in montane cloud forest is typically contrasted with that found in lowland rainforest sites (Van Reenen & Gradstein 1983; Gradstein & Frahm 1987). Below elevations of about 500 m, bryophyte cover is generally characterized as poor, and primarily restricted to the canopy, while in the cooler, wetter conditions found in upland cloud forests, the growth of epiphytic bryophytes is denser and more luxuriant, in the canopy as well as the understory (Gradstein *et al.* 2001).

A notable exception to the convention of lowland bryophyte communities with low density was observed in certain forest habitats in French Guyana (Gradstein 2006; Gradstein *et al.* 2011). There, sites were observed that had noticeably higher

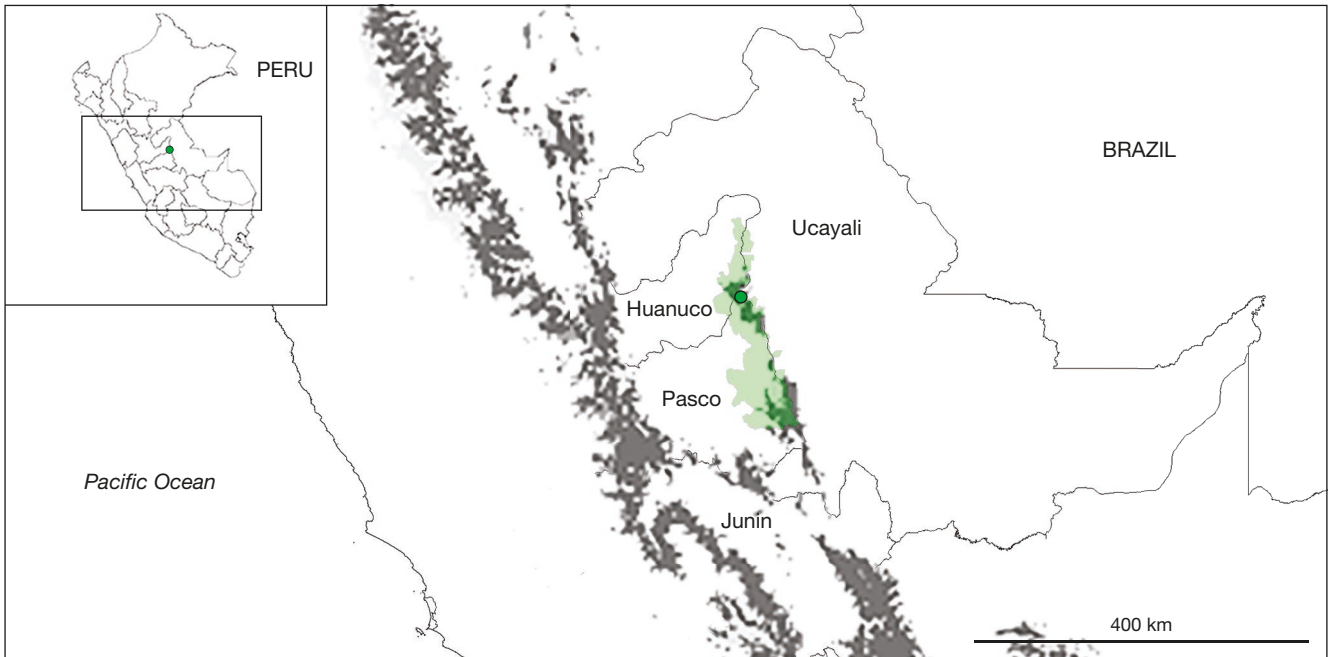

FIG. 1. — Map of central Peru, with the El Sira Communal Reserve marked with **light green shading**, and our study site represented by **darker green color within a black circle**. Ucayali Department and adjacent sections of Pasco, Huánuco and Junín Departments (comprising the selva central region) are represented on the map. Tropical Montane Cloud Forest habitats found along the eastern Andes are indicated with **dark gray shading** (derived from Helmer *et al.* 2019 map).

species richness and epiphytic biomass – particularly bryophytes – than found in surrounding rainforest areas. These observations resulted in the postulation of a new forest-type: tropical lowland cloud forest (TLCF) – specialized habitats found in isolated patches where lowland river valleys pass through hilly areas, and local conditions promote comparatively higher atmospheric humidity and the frequent formation of low-level night fogs. These habitats record noteworthy shifts in the vertical distribution of epiphyll species; an understory-restricted taxa in lowland rainforest habitat, for example, can shift to dominate in canopy or subcanopy zones in TLCF (Gehrig-Downie *et al.* 2012, 2013).

Zonal stratification of organisms within forest layers (emergent, canopy, subcanopy, understory, etc.) is a widespread phenomenon in both plant and animal communities, particularly in tropical forests (Thiel *et al.* 2021). For understory epiphylls, colonization and maintenance of populations on leaf surfaces is attuned to more limited available light energy and less microclimatic fluctuation (temperature and humidity) than typically found in adjacent canopy layers or at nearby sites open to full sun.

Abiotic effects on bryophyte community structure in tropical Andean cloud forests was quantified, based on correlation of local microclimatic data with epiphytic bryophyte diversity patterns observed at a cloud-forest study site in the Cordillera Yanachaga (Romanski 2007; Romanski *et al.* 2011). In this study diurnal fluctuations in both ambient temperature and humidity were identified as critical influences on distribution of bryophytes in distinct zones on a single large tree. The effect of annual cloud cover and orography were also emphasized as influencing wider distributional patterns of bryophytes across

tropical montane cloud-forest landscapes. Another study in Central America showed that minimal diurnal humidity fluctuation correlated with increases in understory epiphyll diversity at lowland rainforest sites in Costa Rica (Sonnleitner *et al.* 2009). Kraichak (2014) monitored epiphyll assemblages at 18 sites in contiguous lowland (c. 120–240 m) secondary forest in the Opunohu Valley on Moorea Island, French Polynesia, in a study that revealed microclimate fluctuation correlated with lower diversities among adjacent local epiphyll communities.

Light appears to play a critical role in structuring epiphyll populations within tropical evergreen forest landscapes (Glime & Pócs 2018). One study measured the interplay of light and humidity, comparing conditions in montane cloud forest and lowland rainforest sites in Brazil (Bittencourt *et al.* 2019). Their study revealed higher rates of evapotranspiration (resulting in lower available moisture) at lowland tropical forest sites, while upland cloud forests experienced attenuation of light energy due to cloud immersion effects, resulting in as much as a 20% reduction in total incident solar radiation reaching the canopy. Reduction in solar energy by cloud cover resulted in lower rates of evapotranspiration (and higher available moisture) at upland sites, along with the additional contribution of precipitated fog-water to the hydrological cycle.

Comparative analysis of turnover rates between epiphyll assemblages was explored through inventories conducted in southern Thailand (Pócs & Podani 2015) and in Sabah, Malaysian Borneo (Pócs *et al.* 2020) explored patterns of species turnover in tropical bryophyte epiphyll assemblages scattered across much wider landscape scales. The Thailand collections were made at nine different lowland forest sites distributed along

TABLE 1. — Epiphyllous liverworts and mosses identified in this study. Mosses are (five taxa) indicated with an **asterisk**. Species in **boldface** represent new distribution records for Peru.

Species	1800 m	1550 m	350 m	250 m
<i>Anoplolejeunea conferta</i> (C.F.W.Meissn. ex Spreng.) A.Evans	0	3	0	0
* <i>Brachytheciaceae</i> sp.	0	0	1	0
* <i>Callicostella pallida</i> (Hornsch.) Ångstr.	0	0	0	2
<i>Calypogeia grandistipula</i> (Steph.) Steph.	1	0	0	0
<i>Ceratolejeunea cubensis</i> (Mont.) Schiffn.	0	1	0	0
<i>Ceratolejeunea cornuta</i> (Lindenb.) Steph.	1	6	2	0
<i>Cheilelejeunea filiformis</i> (Sw.) W.Ye, R.L.Zhu & Gradst.	0	1	0	0
<i>Cololejeunea bekkeræ</i> Tixier	0	0	0	2
<i>Cololejeunea camillii</i> (Lehm.) A.Evans	0	4	1	0
<i>Cololejeunea gracilis</i> (Jovet-Ast) Pócs	0	0	5	7
<i>Cololejeunea linopteroides</i> H.Rob.	0	0	3	1
<i>Cololejeunea microscopica</i> (Taylor) Schiffn. var. <i>exigua</i> (A.Evans) Pócs	13	0	0	4
<i>Cololejeunea obliqua</i> (Nees & Mont.) Schiffn.	0	0	4	20
<i>Cololejeunea papilliloba</i> (Steph.) Steph.	0	1	0	0
<i>Cololejeunea papillosa</i> (K.I.Goebel) Mizut.	30	13	2	12
<i>Cololejeunea platyneura</i> (Spruce) A.Evans	0	0	5	18
<i>Cololejeunea winkleri</i> (M.I.Morales & A.Lücking) Pócs	0	0	0	6
<i>Colura tenuicornis</i> (A.Evans) Steph.	2	1	0	0
<i>Colura tortifolia</i> (Nees et Mont.) Trevis.	0	0	1	0
<i>Colura ulei</i> Jovet-Ast.	0	0	0	1
* <i>Crossomitrium patrisiae</i> (Brid.) Müll.Hal.	0	0	3	22
* <i>Crossomitrium sintenisii</i> Müll.Hal.	0	0	1	6
<i>Cyclolejeunea accedens</i> (Gottsche) A.Evans	16	0	0	0
<i>Cyclolejeunea chitonia</i> (Taylor) A.Evans	4	0	0	0
<i>Cyclolejeunea convexistipa</i> (Lehm. & Lindenb.) A.Evans	7	0	0	0
<i>Cyclolejeunea foliorum</i> (Nees) Grolle	0	3	0	0
<i>Cyclolejeunea luteola</i> (Spruce) Grolle	0	0	0	2
<i>Cyclolejeunea peruviana</i> (Lehm. & Lindenb.) A.Evans	44	6	2	14
<i>Cyclolejeunea</i> sp.	0	1	0	0
<i>Diplasiolejeunea brunnea</i> Steph.	25	14	8	5
<i>Diplasiolejeunea cavifolia</i> Steph.	0	2	0	0
<i>Diplasiolejeunea evansii</i> Tixier	1	0	0	0
<i>Diplasiolejeunea johnsonii</i> A.Evans var. <i>mexicana</i> Jovet-Ast	0	1	0	0
<i>Diplasiolejeunea pellucida</i> (C.F.W.Meissn. ex Spreng.) Schiffn.	24	22	0	0
<i>Diplasiolejeunea unidentata</i> (Lehm. & Lindenb.) Schiffn.	0	1	0	0
<i>Drepanolejeunea aculeata</i> Bischl.	0	1	0	0
<i>Drepanolejeunea biocellata</i> A.Evans	8	13	0	0
<i>Drepanolejeunea crucianella</i> (Taylor) A.Evans	0	0	1	0
<i>Drepanolejeunea inchoata</i> (C.F.W.Meissn.) Steph.	50	9	0	0
<i>Drepanolejeunea lichenicola</i> (Spruce) Steph.	4	0	0	0
<i>Drepanolejeunea mosenii</i> (Steph.) Bischl.	14	10	0	0
<i>Drepanolejeunea orthophylla</i> (Nees & Mont.) Bischl.	38	7	0	0
<i>Drepanolejeunea ramentiflora</i> Steph.	0	7	0	0
<i>Drepanolejeunea spinosa</i> Herzog	3	0	0	0
* <i>Erpodiaceae</i> sp.	0	0	1	0
<i>Frullania brasiliensis</i> Raddi	0	2	0	0
<i>Harpalejeunea stricta</i> (Lindenb. & Gottsche) Steph.	0	2	0	0
<i>Lejeunea adpressa</i> Nees.	2	0	9	18
<i>Lejeunea aphanes</i> Spruce	7	1	1	0
<i>Lejeunea flava</i> (Sw.) Nees	0	1	0	3
<i>Lejeunea phyllobola</i> Nees & Mont.	0	1	0	0
<i>Lejeunea reflexistipula</i> (Lehm. & Lindenb.) Lehm. & Lindenb.	2	5	0	0
<i>Lejeunea</i> sp.	0	2	0	0
<i>Lejeunea</i> sp.	7	0	0	0
<i>Leptolejeunea elliptica</i> (Lehm. & Lindenb.) Besch.	0	0	5	11
<i>Leptolejeunea jamaicensis</i> R.M.Schust.	26	0	0	0
<i>Leptolejeunea maculata</i> (Mitt.) Schiffn.	0	7	0	0
<i>Leptoscyphus</i> sp.	0	0	0	1
<i>Lophocolea bidentata</i> (L.) Dumort.	0	0	0	1
<i>Lophocolea muricata</i> (Lehm.) Nees.	0	1	0	0
<i>Metzgeria albinea</i> Spruce	3	0	0	0
<i>Metzgeria ciliata</i> Raddi.	8	0	0	0
<i>Metzgeria consanguinea</i> Schiffn.	1	0	0	0
<i>Metzgeria furcata</i> (L.) Corda	0	2	0	3
<i>Odontolejeunea lunulata</i> (F.Weber) Schiffn.	5	13	0	2
<i>Plagiochila gymnocalycina</i> (Lehm. & Lindenb.) Mont. & Nees	0	0	1	1
<i>Plagiochila</i> sp.	0	2	0	0
<i>Prionolejeunea</i> sp.	0	0	0	1
<i>Prionolejeunea trachyodes</i> (Spruce) Steph.	9	1	0	0

TABLE 1. — Continuation.

Species	1800 m	1550 m	350 m	250 m
<i>Radula mammosa</i> Spruce	1	0	0	2
<i>Radula stenocalyx</i> Mont.	0	0	1	12
<i>Rectolejeunea flagelliformis</i> A.Evans	0	4	0	0
<i>Symbiezidium barbiflorum</i> (Lindenb. & Gottsche) A.Evans	0	0	0	1
<i>Symbiezidium transversale</i> (Sw.) Trevis.	0	0	0	2
Sum of number of species, per leaf, per assemblage	356	171	57	180
Species diversity per assemblage (alpha diversity)	29	36	20	28
Ratio of epiphyll density to species diversity	12	4	3	6

the west coast of the Malay Peninsula across an approximately 100 km (N-S) distance. In the Borneo study, three sites were sampled – two middle elevation (525-570 and 600-740 m) and one upland (1900-1940 m) site, with approximately 50 and 200 km distance between sites. Comparative analysis of epiphyll community structure in both the Thailand and Borneo collections was conducted using a statistical method that partitions various components of diversity, identifying the relative contribution of species turnover, nestedness and species-richness agreement in driving community composition and turnover between each site (Podani & Schmera 2011). The data we present here for El Sira epiphyll communities diverge in some fundamental respects from the Polynesian and Thailand data, which were both limited to lowland forests, whereas we introduce a significant elevational gradient into our community sampling. It differs also from the Thailand and Borneo studies in that we explore microclimate effects across a significantly reduced landscape scale.

Epiphyllous bryophyte assemblages provide an excellent system for monitoring change in community composition along habitat gradients that are often overlooked in ecological studies. Characteristically, a limited number of environmental factors, such as those outlined above, are considered, while a combination of factors including multiple biotic and abiotic processes are rarely examined experimentally. It may be useful to consider that relationships between each input (individual environmental factor) to a system (local microhabitat) may not result in a proportionate output (composition of epiphyll assemblage), and that correlation of cumulative environmental effects and self-organization of local epiphyll populations may represent complex, nonlinear systems, in which case linear cause-and-effect pathways may be confounded.

MATERIAL AND METHODS

Epiphyllous bryophyte assemblages were sampled in primary forest in the reserved zone of the El Sira Communal Reserve under authorization of the Service for Natural Protected Areas (SERNANP) of the Peruvian Ministry of Environment. Collections of a series of epiphyll-bearing leaves from host plants (phorophytes) were pressed and dried in the field by J. Graham. Taxonomic identification of bryophytic epiphylls on each leaf was performed by T. Pócs (EGR) and M. Fischer (F). Duplicates of epiphyll collections are deposited at Herbario Forestal (MOL) of the Universidad Nacional Agraria

La Molina, Lima, Peru and at Field Museum (F) in Chicago, United States, as well as at Herbarium of Eger (EGR), Eszterházy Károly University, Eger, Hungary.

Epiphyll-bearing leaves were sampled from the understory of primary closed-canopy forest along an elevational transect between 250 and 1800 m. Epiphyll-bearing leaf pairs from host phorophytes were collected in quadrats of 120 × 2.5 × 1 m, with an assessment of all potential host-plants – consisting of all vascular plants bearing leaves – inside each sampling unit. Bryophytic epiphylls were identified from leaf pairs collected at four sites: 87 epiphyll-bearing leaf pairs were collected in upper cloud forest habitat at 1800 m elevation, 23 leaf pairs were collected at 1550 m in middle cloud forest, 35 leaf pairs were collected at 350 m in lowland rain forest, and 35 leaf pairs were collected at 250 m elevation (see Fig. 2 for landscape view of collection sites).

Additionally, understory vegetation-densities adjacent to each quadrat were estimated from two 5-meter-wide × 2.5-meter-high parcels, parallel to the 120-meter axis of each epiphyll quadrat. Each parcel was subdivided into two horizontal layers, with partitioning of vegetation densities into two units: the herbaceous layer, from ground level to one meter in height, and the shrub layer, from 1-2.5 m. Vegetation density estimates were made for each of ten 12-meter segments (Fig. 3) to account for natural variation in understory vegetation density along the plot axis.

Temperature data were collected using ThermoChron DS1922L iButton data logging devices and rainfall data were collected using Stratus RG202 Long-Term Professional Rain Gauges. Percent Incident understory light at each quadrat was calculated using the Gap Light Analyzer (GLA) imaging software from Cary Institute of Ecosystem studies with pooled data generated from images of four hemispherical canopy photographs taken at each site with a Nikon Coolpix 4500 camera equipped with a 180° fisheye lens. Slope of terrain was measured using a Nikon Laser Forestry Pro Rangefinder. Wind speed and direction, barometric pressure, relative humidity and dewpoint were logged on a Kestrel 5000 environmental meter. Fog-catchers consisted of a one-meter square area of double-layer Raschel mesh of 35% shade coefficient, installed perpendicular to prevailing wind direction and suspended at two meters height. These were installed under a waterproof canopy in order to restrict the contribution of direct vertical rainfall.

Species diversities in the four epiphyll assemblages were estimated using the Shannon diversity function based on the



FIG. 2. — Landscape view (derived from Google Earth online platform) showing general features of the study site, with location of four epiphyll assemblages (at 250, 350, 1550 and 1800 m) indicated.

relative frequency distribution of species, and evenness, which is Shannon diversity standardized by the possible maximum ($\log[\text{number of species}]$) (Magurran 2021). To reveal internal structure of presence-absence data in terms of beta diversity and related ecological phenomena, each matrix was analyzed by the SDR simplex procedure (Podani & Schmera 2011). This method calculates the Jaccard dissimilarity between every pair of objects j and k , given by $DIS_{jk} = (b + c) / (a + b + c)$ in which a is the number of species appearing in both objects, b is the number of species found only in object j and c is the number of species occurring only in object k . The value of DIS_{jk} is decomposed into two additive components as follows: $DIS_{jk} = D + R = |b - c| / (a + b + c) + 2 \min\{b, c\} / (a + b + c)$ where D is the relative richness difference between the two objects and R corresponds to their relative species replacement – i.e., twice the number of species at site j are replaced by other species at site k – and divided by the total. These two fractions, together with Jaccard similarity ($S = a / (a + b + c)$) always sum to one, giving the possibility to represent this pair as a point in an equilateral triangle diagram, the so-called SDR simplex plot (Fig. 4). Its vertices correspond to the three factions: S , D and R .

In general, the larger the value of a given fraction, the closer the point to the respective vertex. For example, if the two objects are completely identical in species composition ($S = 1, D = R = 0$) then the point will fall onto the bottom right (S , similarity) vertex of the triangle. In addition to the vertices, the three sides also have ecological interpretation.

For example, the sum $D + R$ corresponds to beta diversity whereas $S + D$ (provided that $a > 0$) is nestedness. The shape of the point cloud obtained for all possible pairs of objects is informative on data pattern and, in turn, on potential ecological drivers influencing community development. In addition to the graphical output, the averages of S , D and R values are also useful – these three values determine the centroid of the point cloud in the diagram. Calculations were done by program SDRSimplex available at <http://podani.web.elte.hu/SYN2000.html>.

Presence-absence data at leaf level were subjected to hierarchical clustering (group average method) based on Jaccard dissimilarity. For comparison, the same dissimilarity matrix was also analyzed by metric multidimensional scaling (Principal Coordinates Analysis, PCoA). For methodology, see standard textbooks such as Legendre & Legendre (2012). Computations were performed by the SYN-TAX 2000 package (Podani 2001).

RESULTS

BRYOPHYTE ASSEMBLAGES

Factors shaping community assemblages

The geographic scale at which we document understory microclimate ranges from about one ha for each local assemblage to about seven km² – the maximum extended area from which all these data were derived (*c.* 10 km walking distance along

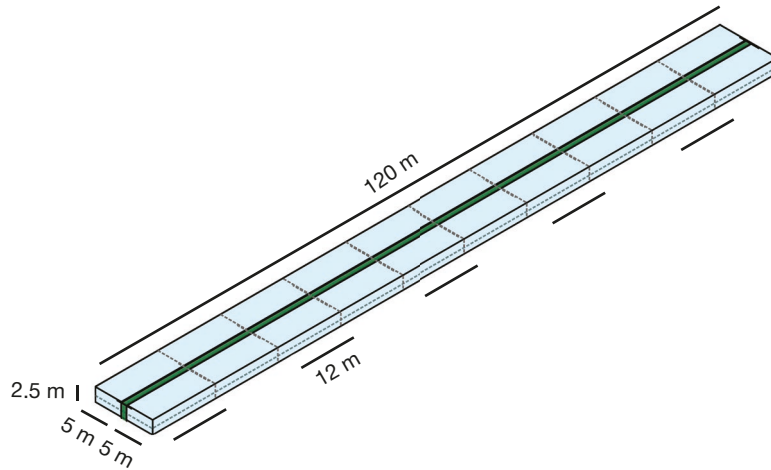

FIG. 3. — Schema of epiphyll quadrat (green color) and adjacent vegetation density plots (blue color).

the transect). Microclimatic conditions, including abiotic (elevation, temperature, moisture, solar energy) as well as mixed biotic/abiotic (canopy cover effect on understory light) elements are documented, including emergent local effects particular to individual sampling sites along the environmental gradient. These climatic data permit exploration of the adaptation of epiphyll assemblages to prevailing microclimatic conditions along the gradient in space, but not in time, as epiphyll population structures at each site represent single time-point samples, albeit embedded in an environmental matrix observed and sampled over multiple years.

THE ABIOTIC BACKGROUND

Rainfall

In general, we can describe seasonal effects on rainfall accumulation at our research site as being divided between rainy and dry seasons of the year. Minimum monthly rainfall totals of 700 mm define a rainy season typically falling between October and March, with heaviest rains generally falling from November through February. Monthly rainfall totals below 500 mm define dry season months generally falling between May and August. Referring to Figure 5, one can follow the generalities of this annual cycle at the study site, where only slight differences in annual rainfall across all elevations can be observed along the elevational gradient. Mean annual rainfall accumulation (ten years of data) is 7050 mm. Maximum and minimum annual accumulations are 8300 and 5280 mm, respectively.

Trade winds carrying moisture across the lowlands of Brazil from the northeast dominate weather patterns at our study site, where they encounter the steep windward (eastern) flank of the Cordillera El Sira, here rising 1.8 km over a run of less than 7 km (>25% slope). Precipitation patterns along the eastern escarpment of the cordillera would be expected to vary, depending on the height and steepness of its uplifts, while rainfall accumulation on its leeward slopes is expected to be significantly lower where intervening elevations are highest. Only 10–15 km to the east of the uplift annual rainfalls

average less than 2000 mm/year (USAID 2012). Relative humidity (RH) in the forest understory, like rainfall, remains fairly stable along our transect, consistently measuring above 90%. Even in full sun we have not recorded RH less than 70%, although humidity measurements are not sampled as regularly as those of rainfall.

Starting at about 1000 m elevation, fog immersion effects begin to influence the upland environment. Data from fog-catchers that were installed at 1050, 1550 and 1750 m elevation reveal that seasonal accumulation of fog moisture is variable across the landscape. Precipitated fog collected at 1550 m had roughly four times the volume than was captured simultaneously at the 1050-meter site, while no measurable accumulation of fog water was recorded at 1750 m elevation.

Temperature

Mean annual temperatures along the elevational gradient vary at a rate of about one degree centigrade per 200 m of elevation (Fig. 6), with mean maximum and minimum temperature differences varying evenly (by about 15°C) along the gradient, independent of elevation. If we compare hourly patterns of temperature change between sites (Fig. 7), a different pattern emerges, one which reflects diurnal and seasonal fluctuations in temperature. Note that the overall pattern, particularly of temporal maxima and minima, appear to fluctuate fairly consistently across all elevations. This reflects the local nature of the study site, each elevation being embedded in a contiguous landscape. The relative proximity of temperature sampling locations results in each site experiencing near-simultaneous effects from the same local weather fronts as its neighbors.

Light

Light environments are caused by, and can be predicted from, the geometry of light paths, local weather conditions, and time of day (Endler 1993). Epiphyllous understory bryophyte species, requiring both sufficient shade and humidity, are primarily confined to lower forest strata (Gradstein 1992), where the spatio-temporal availability of light is due

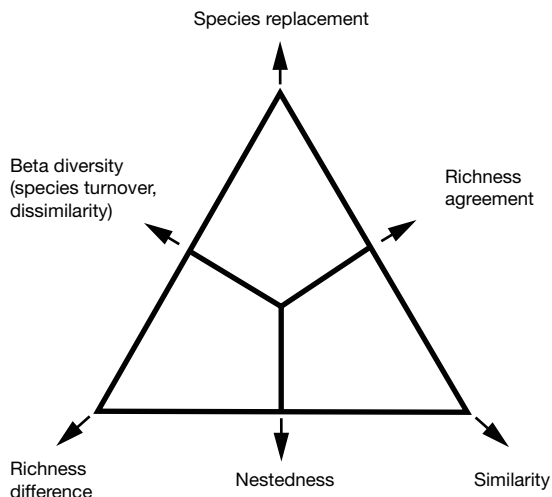

FIG. 4. — Summary of theory of SDR simplex analysis (after Podani & Schmera 2011) of presence-absence data structure.

to both abiotic (surface topography and weather patterns) as well as biotic (forest structure) factors. At upland sites the most important factors influencing light attenuation in the understory are aspect and steepness of slopes and the relative persistence of daytime cloud and fog cover, as well as local density of the forest canopy. At lowland sites important elements driving microclimate include their relative position along stream channels passing through valleys and as well as local density of forest canopy cover. Annual light regimes across the gradient are clearly divergent between upland and lowland sites, due to a characteristic zone of fog immersion cloaking the upper slopes of the cordillera. With a lower limit between about 1000-1200 m elevation, depending on atmospheric conditions, this dense cover extends upslope to the uppermost elevations (1900-2400 m) of the cordillera in our area, typically dissipating at sunset.

We employed hemispherical photographic methods to estimate canopy cover and corresponding understory light availability at all epiphyll quadrats, in order to compare incident understory light availability between them. Figure 8 shows a comparison of understory light regime, along with other key environmental factors (temperature and rainfall), documented along the environmental gradient at these sites.

BIOTIC RESPONSES

Light effects

Although unquantified, daytime fog immersion patterns clearly drive differences in light attenuation between upland and lowland epiphyll assemblages across the gradient as a whole, while locally emergent effects on understory light correlate with divergence in epiphyll assemblages at much finer scales. Note that % transmitted understory light at the uppermost (1800 m) epiphyll assemblage is roughly two times higher than found at all other epiphyll sampling sites. This is associated with a large tree-fall gap located approximately 25 m to the west of the understory vegetation plot which admits increased (afternoon) light energy into the understory, relative

to all other quadrats sampled. Although this large treefall gap (> 0.3 ha) is more than ten years old, its effective admission of afternoon light into the understory remains pronounced. Corresponding understory shrub densities, ratio of epiphyll-bearing shrubs (Table 3), and density of epiphylls are also higher at this location, relative to other sampled assemblages.

In the primary tropical forests along our transect, independent of slope, treefalls represent a latent phenomenon causing abrupt changes in local light regimes, at meter to hectare scale, with potential influence on epiphyll population structure in the understory. Direct and diffuse solar radiation transmitted through forest gaps can admit light energy into forest layers in a heterogenous manner in a process that is entirely dependent on the stratigraphy of each individual treefall (or branch fall) event. Depending on canopy and vertical forest structure, a large to medium-sized branch, or small to medium tree fall may not affect understory light regime in an appreciable way, depending on their relative position in the canopy structure. Conversely, these events may create a light gap admitting increased solar radiation to the forest floor, but with temporal limits depending on the area of the canopy gap, local terrain effects (slope and aspect) as well as degree of latitude. Larger trees, particularly canopy emergents, can fall and carry with them a series of neighbors, both large and small, opening significantly larger light gaps. Large trees falling often bring down a series of its neighbors in a domino-like effect, or sometimes through a network of shared canopy lianas, resulting in exposure of areas of understory up to one-quarter hectare or more to direct sun. In large treefalls, significant direct light energy enters the understory vertically, but can also enter the understory horizontally, particularly to the east (morning sun) and west (afternoon sun) of large treefalls.

Much larger light gaps can be formed along the extremely steep slopes along our transect through landslides. This is an entirely geophysical process, primarily due to a combination of local orogeny and geological activity, or in some cases by high rainfall and subsurface water flow. These landslides result in exposure of bare mineral soils, with subsequent early successional stages in our area initially dominated by lichens, mosses and ferns. Contrast this with treefall events caused primarily by mixed biotic and abiotic effects, where trees of mixed life stages are typically brought down during strong storms with intense wind gusts and bouts of heavy precipitation, which are particularly frequent following prolonged period of abnormally low rainfall. Such events expose surviving understory vegetation- shade-tolerant seedlings, saplings and surviving smaller trees- to direct solar energy, which then undergo rapid growth until the largest competitors establish dominance in a nascent canopy structure, and understory light energies begin to reach appropriate levels to support epiphyll recolonization.

Light gap disturbances are strongly implicated in sustaining biodiversity in closed-canopy tropical forests (Hubbell *et al.* 1999), and our exploration of canopy treefalls began in 2018, with quantitation of annual treefalls along a 10 km section of our transect. Data reveal that around one in six treefall events (14/84 distinct treefall locations

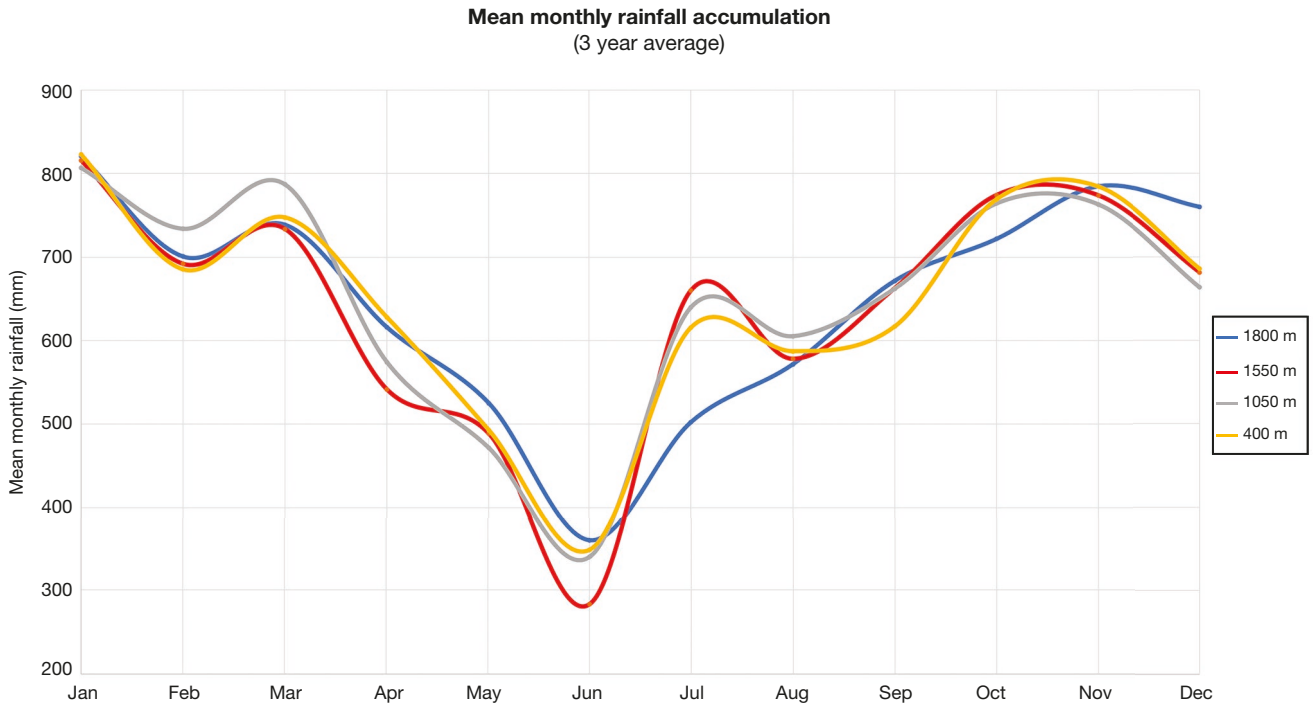

FIG. 5. — Mean annual precipitation pattern, per month, recorded over three years (2015–2018) along the elevational gradient at our study site.

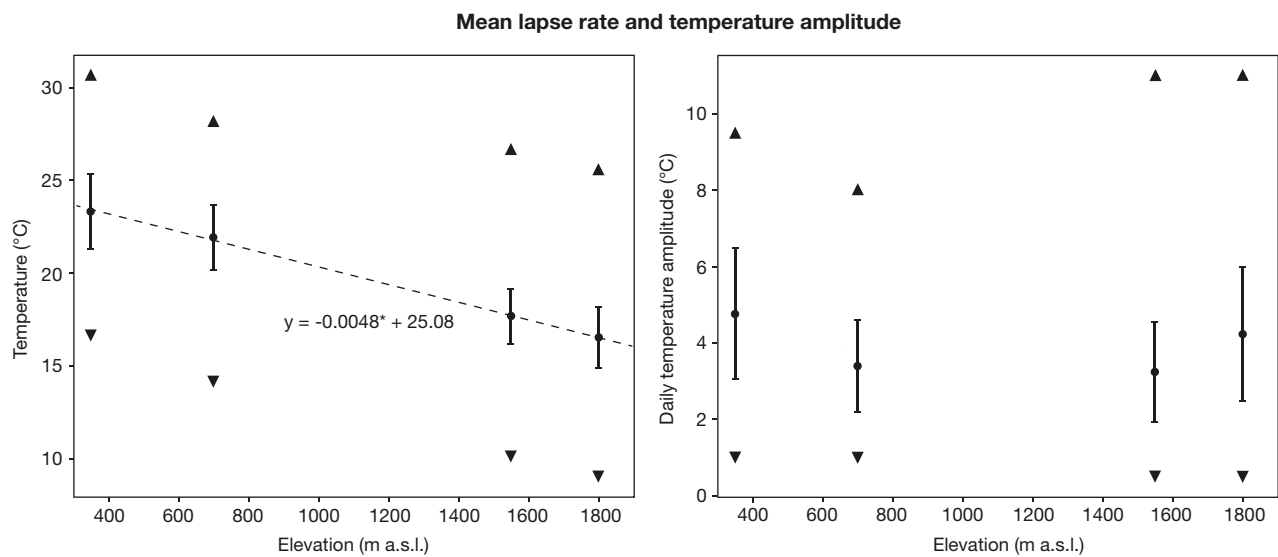

FIG. 6. — Mean lapse rate and temperature amplitude recorded across the elevational gradient at the study site.

recorded over four years) produced significant canopy gaps of between 300 m² and 2800 m², the majority of which (12/14) occurred in years (2019–2021) which logged the lowest mean annual rainfall accumulations recorded along the transect (ten years' rainfall data). Although our treefall dataset of only four years is limited, the data in presented in Table 2 suggest that there may be an inverse relationship between annual rainfall and annual treefalls, both in total annual basal diameter of fallen trees as well as overall number of fallen or killed individuals.

Moisture effects

Bimonthly rainfall measurements are the sole source of quantitative hydrological data that serve as proxy for annual moisture across elevations presented in Figure 8. The lack of variation between annual mean rainfall volumes along the transect belies the actual divergence in moisture regimes at each site due to relative contribution of fog precipitate or potential differences in understory humidity. While comparison of relative humidity (RH) at a site over time, or between sites, is a critical component of many ecological studies of bryophytes,

TABLE 2. — Annual treefall data collected along a 10 km section of the elevational transect at our study site.

Mean annual treefall data	2018-2019	2019-2020	2020-2021	2021-2022
Number of treefall gaps >0.1 hectare	1	10	7	3
Number of individual trees killed in treefalls	11	193	252	173
Total basal diameter of dead trees (cm ²)	488	4915	5465	3275
Mean annual rainfall (mm)	7709	5568	5277	6053

TABLE 3. — Comparison of understory vegetation structure and relative density of epiphyll-bearing hosts, including vegetation densities estimated for epiphyll quadrats at various elevations along our transect.

Understory vegetation characteristics	1800 m	1550 m	1050 m	700 m	400 m	350 m
Number of potential host plants	191	121	69	90	78	77
Epiphyll-bearing/Host plant ratio	46%	19%	38%	38%	24%	26%
Mean estimated vegetation density 0-1 m (herbaceous layer)	79%	48%	59%	33%	22%	42%
Mean estimated vegetation density 1-2.5 m (shrub layer)	62%	34%	49%	32%	23%	34%
Epiphyll hosts bearing lichens	0	0	0	18	12	11

we recognize that the accuracy and reproducibility of even well-calibrated hygrometers is much reduced at RH greater than 90%, particularly at higher temperatures. Despite these limitations, we can say that understory humidity at multiple elevations along the gradient consistently measure above 90% in the understory, and in full sun not lower than 70%, and that more sensitive systems are required to accurately identify subtle shifts in RH at these locations.

Under the right atmospheric conditions fog-water precipitation can generate additional condensed atmospheric water vapor to the hydrological cycle along the transect at elevations between about 1000 and 1600 m, when atmospheric conditions permit. This provides an important, if anecdotal, clue to considering potential environmental conditions driving diversity within and between epiphyll assemblages. The graph in Figure 8 illustrates that the highest species diversity of all epiphyll assemblages in this study occurs at 1550 m, notably higher than that found at its upland neighboring site at 1800 m, or at either of the two lowland sites. In addition to presenting the highest alpha and beta diversity of epiphylls in the study, the 1550-meter site has the lowest ratio of epiphyll-bearing understory host plants (Table 3).

Without appropriate controls we cannot say unequivocally whether the contribution of precipitated fog-water at 1550 m supports the site's higher epiphyll diversity, or if the higher light energy (and/or other co-limiting factors, including absence of fog-water input) at the upper cloud forest site acts to suppress epiphyll diversity in some way. Other potential factors influencing the structure of these upland epiphyll assemblages, including the relationship between host plants and epiphylls, cannot be ruled out, as data on phorophyte taxonomy and leaf-surface texture were not collected.

Regarding the moisture regime at the two lowland epiphyll assemblages, it is important to note that both sites are situated in the bottom of stream valleys, the 350 m site being surrounded closely on both sides by very steep slopes while the 250-meter site is located at the base of a sloping ridge on one side only. These lowland riparian sites may represent Peruvian examples of tropical lowland cloud forest, *sensu* Grad-

stein (2006; Gradstein *et al.* 2011), first identified in French Guiana. Riparian forests are known to exert strong control on local microclimates and have been shown to significantly modulate air temperatures at distances of up to 60 m from an active stream channel, as well as influencing soil temperatures and relative humidity (Naiman *et al.* 2010). We found that these riparian valley sites supported a more stable microclimate than adjacent terraces and ridges upslope (at <50 m vertical distance), with higher relative humidity measured at riparian sites, particularly on sunny days, while upslope sites registered higher daytime temperatures.

The epiphyll taxa documented at these two lowland sites reflect a very different suite of species than identified at other lowland (<300 m) sites in Ucayali department (collections by James Graham, unpublished data). Collection of epiphyll-bearing leaves were made at non-riparian locations under significantly lower rainfalls (*c.* 2000-3000 mm annually), and include a total of 20 species, half of them in the Genus *Cololejeunea* (Spruce) Steph. Interestingly, these scattered non-riparian lowland epiphyll taxa share more convergence with the El Sira upland epiphyll assemblages than with lowland (riparian) ones.

Elevation, temperature, slope effects

Mean temperature differences of *c.* 6°C are found between the closest lowland and upland epiphyll assemblages, across an 1100 m elevational divide. Unlike the more variable light and moisture (precipitated fog-water) effects noted for certain elevations, both elevation and temperature vary steadily up the gradient in an inverse manner: as elevations rise, temperature falls. The 1550-meter site does experience slightly reduced annual temperatures than predicted by linear regression models. This is likely due to cooling associated with increased local cloud immersion effects observed at that specific location.

Terrain differences clearly distinguish upland from lowland sites: while the landscape everywhere along the transect is dissected, rough and rocky, the gentler slopes measured at the lowland sites are unambiguously divergent from the extremely precipitous slopes found at the upland sampling sites. These

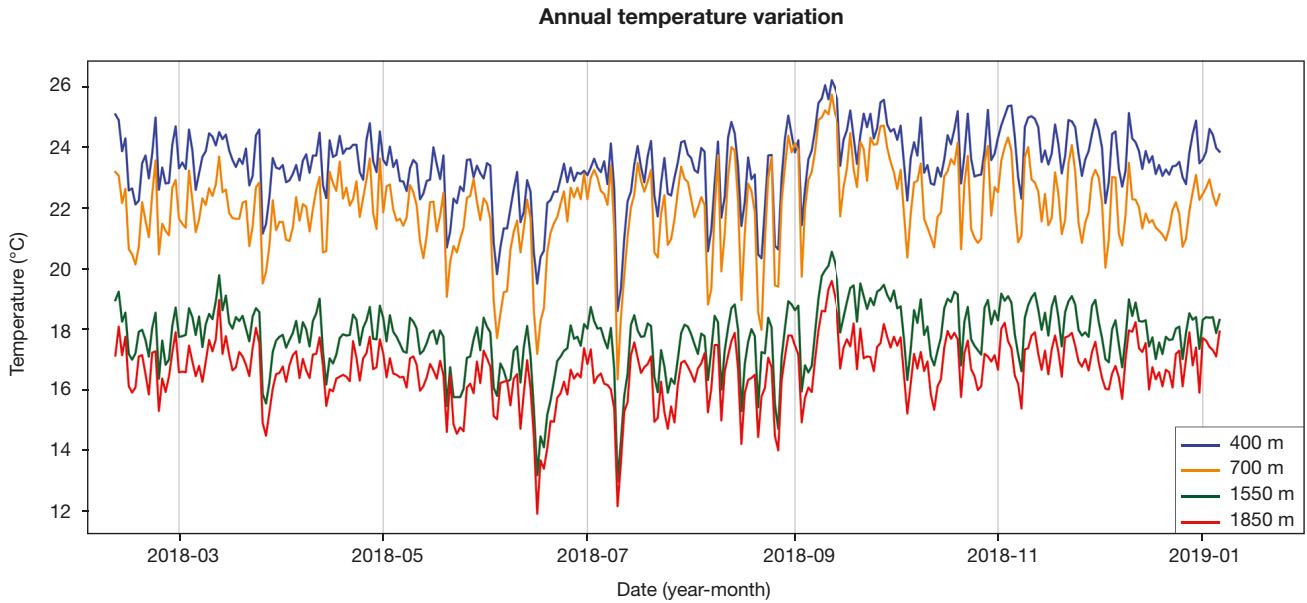

FIG. 7. — Annual temperature variation across an elevational gradient at our study site. Image shows the pattern of hourly temperatures at four sites along our elevational transect. The characteristic large descending spikes reflect the periodic weather phenomenon ‘friaie’ (periodic cold fronts), caused by the arrival of cold air masses from Antarctica, expected every year to pass through the southeastern Amazon region of Peru.

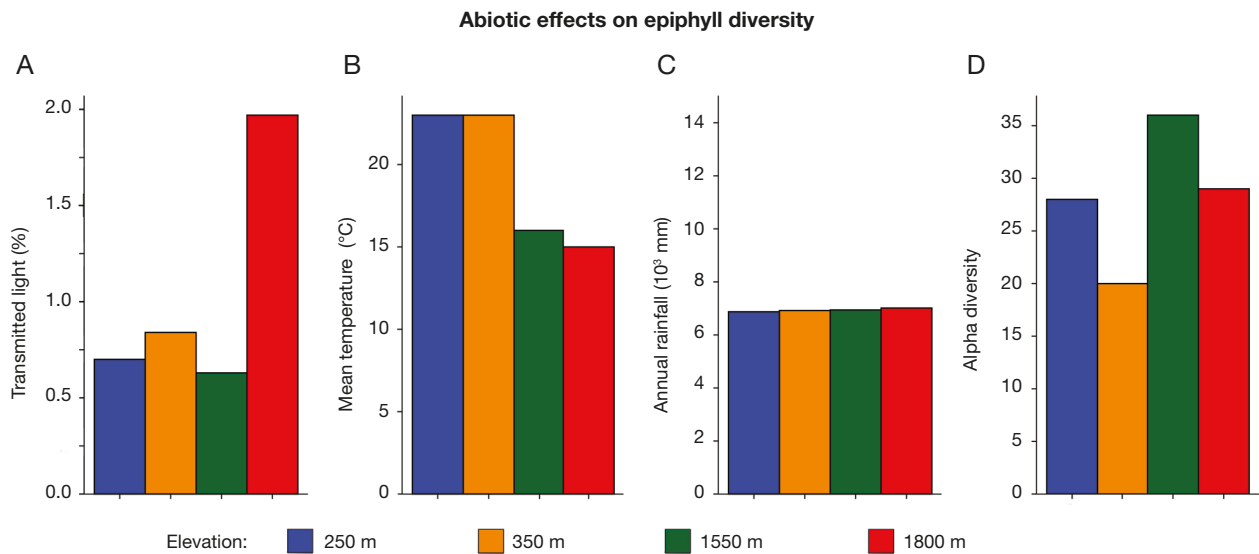

FIG. 8. — Abiotic conditions: understory light, annual temperature, annual rainfall (A–C), compared with the alpha diversity (D) of epiphyllic bryophytes at four sites along an elevational gradient. Light (% incident light measured at one meter above ground-level in the understory), temperature (mean annual temperature, seven years pooled data), rainfall (mean annual rainfall in mm, scale in 1000 mm units), and alpha diversity (number of epiphyllic bryophyte species identified at each elevation).

steep slopes experience more intense diurnal temperature changes, caused by nighttime radiative cooling at higher elevations upslope, producing downslope (katabatic) winds caused by colder (denser) air sinking, with steep slopes accelerating a layer of colder surface air downslope. Anabatic (upslope) winds, in contrast, carry warmer air (and moisture) to higher elevations during the day (Markowski & Richardson 2011) resulting in a characteristic movement of warm, moist air from the lowlands followed by induction of low-level cloud immersion upslope. The graph in Figure 6 illustrates a slight

elevation-dependent temperature differential, with slightly greater daily temperature amplitudes found along the steep slopes at upper elevations of the transect.

Response of understory vascular vegetation

Both leafy tracheophyte hosts and associated leaf-colonizing bryophytes participate in formation of the understory epiphyll assemblages sampled along the elevational transect. Table 3 presents quantitative estimates of understory shrub densities estimated at various locations along the elevational gradient,

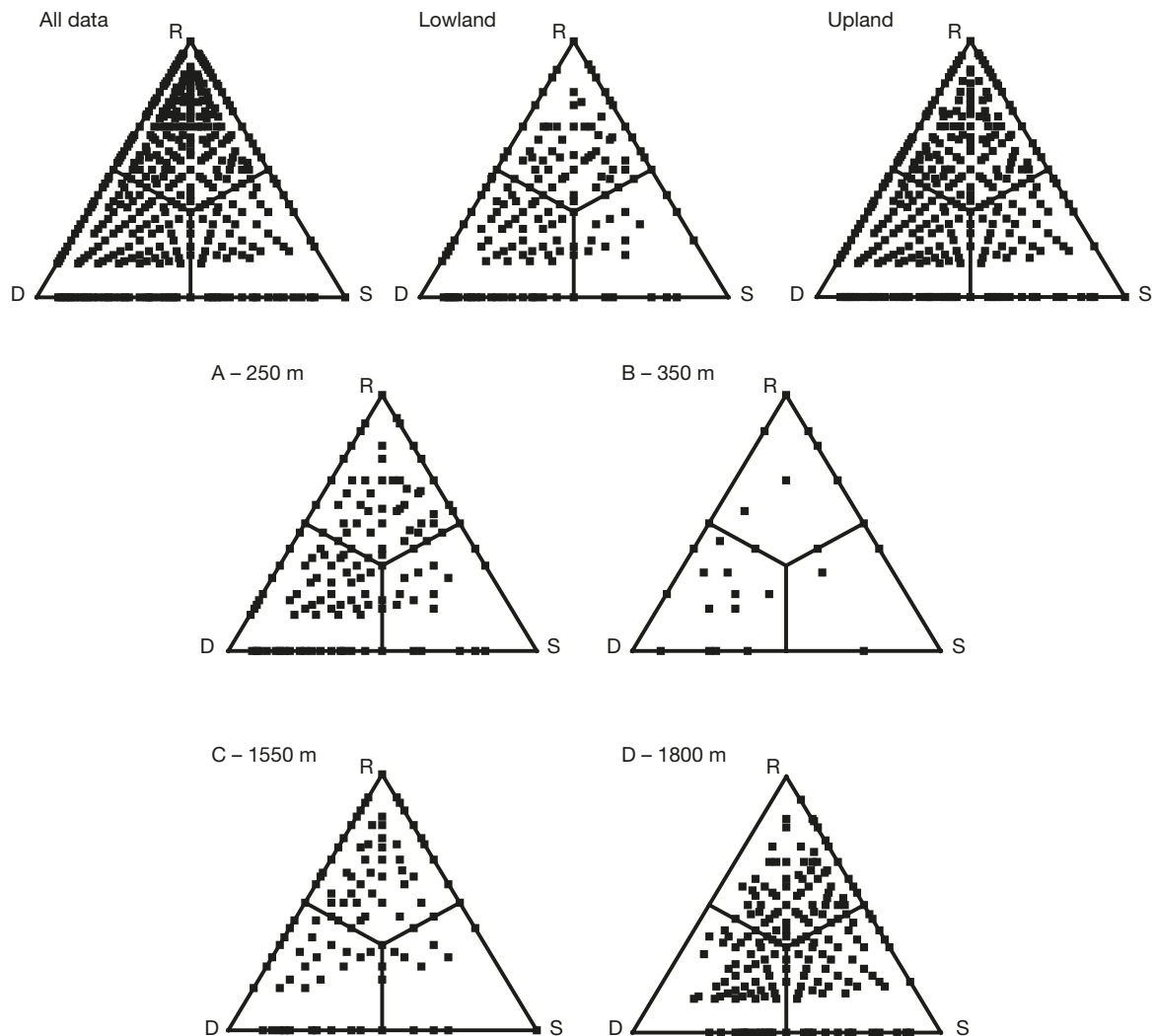

FIG. 9. — SDR Simplex plots of partitioned dissimilarity-similarity components of epiphyll assemblages and their combinations: all data (lowland + upland assemblages combined); lowland assemblages combined; upland assemblages combined; **A-D**, assemblages at elevations as indicated. For the meaning of S, D and R, see Material and methods.

along with the general pattern of epiphyll colonization of understory plants at each site (ratio of epiphyll-bearing host plants per quadrat). Variation in number of phorophyte hosts, ratio of epiphyll bearing host plants and understory vegetation densities all diverge along the gradient, with upper elevations supporting higher densities of phorophyte hosts, with the notable exception of the 1550 m site having an anomalously low ratio of epiphyll-bearing hosts overall. Epiphyllous lichens are absent at cooler upland sites, but emerge in premontane forests and into lowland sites, while topographic shading (reduced hours of direct light due to steep cliffs located immediately to the east and west) at the 350 m site shows an increase in understory shrub densities, compared with adjacent sites upslope.

DESCRIPTIVE STATISTICS

A total of 74 taxa of epiphyll bryophytes (identified at the species or higher taxonomic level) were distributed across a total of 134 host plants (leaf-pair sample units) in this study.

Species frequency (number of occurrences of individual epiphyte species, recorded from across all 134 leaf-pair units) ranges from one to 66, with 20 species being found only on a single leaf unit, and the number of species appearing on at least 10 leaf units is 20. The most common species, *Cyclolejeunea peruviana* (Lehm. & Lindenb.) A. Evans, was found on 49% (66/134) of all leaves sampled.

Of the 74 epiphyll taxa identified in this study, only eight species are shared between lowland and upland assemblages. Nine species occur only in lowland assemblages, and 12 species are restricted to upland assemblages. Forty-five species (c. 60% of taxa recorded in the study) are recorded at a single elevation – ten species at 250 m, four species at 350 m, 19 species at 1550 m and 12 species at 1800 m. These absolute values are less informative and less comparable in statistical analyses since sampling intensity was not the same in the four assemblages. For this reason, relativized data are used in characterizations of diversity and evenness, simplex analyses of beta diversity, and in multivariate analyses.

Diversity and evenness

Overall, species diversity is very high in the data set (Table 4), regardless of whether individual elevations, lowland or upland stands, or the full data matrix are considered. Absolute Shannon diversity values have a relatively narrow range, between 1.17 and 1.54. The highest value is for the entire dataset, as expected. Also, the diversity in the combined assemblages (both lowland and both upland) was slightly higher than when each elevational assemblage was examined separately. There is no clear altitudinal trend in diversity change, the minimum is at 350 m, the maximum at 1550 m. Evenness values are more readily comparable due to the implied standardization and – as a consequence – their use modifies the picture. Evenness reaches its maximum at 350 m and the minimum at 1800 m. Lowland and upland evenness is lower than the evenness of the respective elevations, and their average gives the evenness for the entire sample.

SDR simplex analysis

The SDR scores are calculated at three levels:

- 1) Lowland (L) + Upland (U) (all data pooled);
- 2) L and U separately (lowland vs upland);
- 3) A, (250 m); B, (350 m); C, (1550 m); D, (1800 m) separately (quadrat or stand level).

Numerical results are summarized in Table 4, whereas the simplex diagrams are presented in Figure 9. High beta diversity was found all along the transect, and, correspondingly, low overall similarity, which is closely related to the relatively low matrix fill percentages. Interestingly, the highest and the lowest beta diversity were both obtained for the upland cases, for 1550 m (85.2%) and 1800 m (62%) respectively. The largest component of beta diversity is species replacement (R), which is sometimes twice as high as the other component, richness difference.

It is remarkable that from low elevation to 1550 m the structure of the assemblage does not change much – all assemblages are characterized by high beta diversity. This agrees well with previous results from lowland forests in Thailand (Pócs & Podani 2015), where beta diversity was even higher (87) but the El Sira collections are a bit more unbalanced in species richness because the 1800 m assemblage from the study contained a larger number of leaf pairs than at other assemblages sampled. Agreement with results from epiphyllous assemblages in Malaysian Borneo (Pócs *et al.* 2020) is also considerable; beta diversity there was around 80 across lowland, montane and cloud forests as well.

The plot at 1800 m in Peru, however, is unusual in comparison with previously published results. Beta diversity is lower than in any other place, the number of species is relatively high, suggesting that this assemblage is much more homogeneous than elsewhere. This trend is clear from the ternary plots as well (Fig. 9) because no point coincides with the left edge of the triangle (which corresponds to extreme beta diversity with zero similarity). Low beta is associated with high similarity, and the nestedness and richness patterns in the ternary plot at 1800 m support this effect.

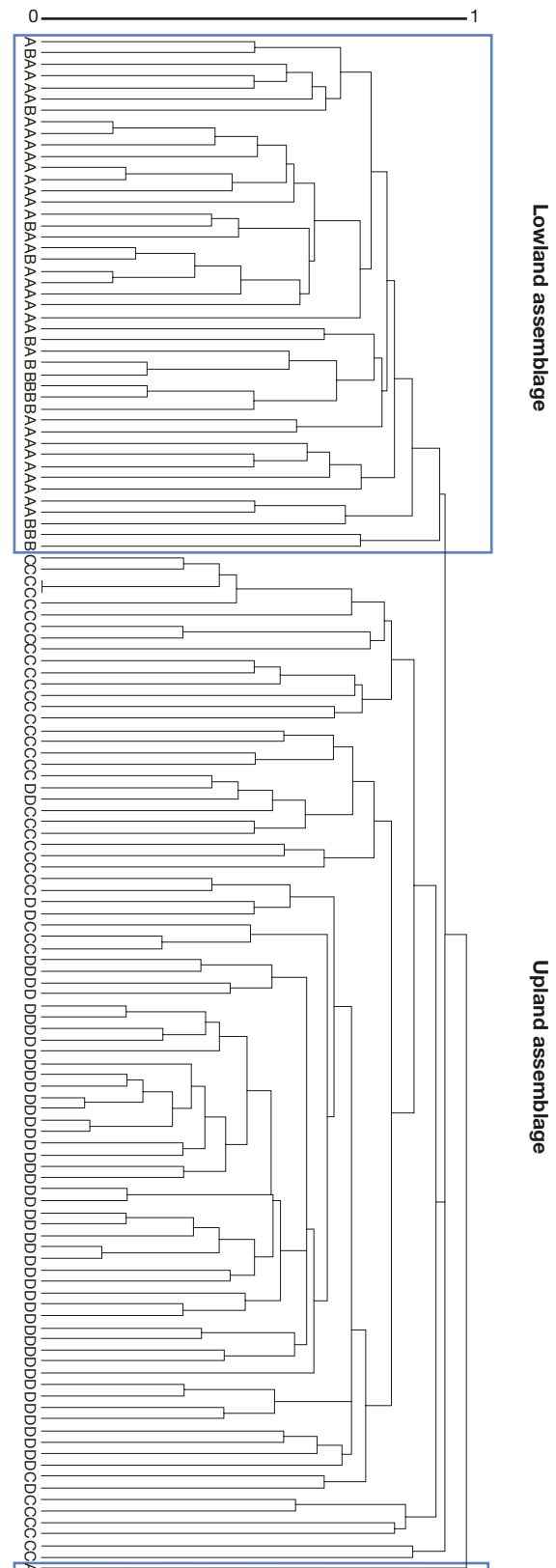

FIG. 10. – Group average clustering of epiphyll sample units (leaf pairs) using the Jaccard dissimilarity index. Note the dissimilarity of the lowland (blue rectangles) and upland assemblages in two separate groups, with a single notable exception (*Radula mammosa* Spruce), which clusters with the upland assemblages (on the extreme right of the dendrogram). A, 250 m assemblage; B, 350 m assemblage; C, 1550 m assemblage; D, 1800 m assemblage.

TABLE 4. — Descriptive statistics and numerical results of the SDR calculations for epiphyll assemblages at different elevations individually or combined.

	250 m	350 m	Lowland	1550 m	1800 m	Upland	All sites
Number of species	28	20	35	36	29	51	74
Number of host plants	33	13	46	38	50	88	134
Total epiphyll presence	180	57	237	171	356	527	764
Matrix fill (%)	19.5	21.9	14.7	12.5	24.5	11.7	7.7
Shannon index	1.24	1.17	1.28	1.36	1.23	1.38	1.54
Evenness	0.86	0.9	0.83	0.87	0.84	0.81	0.82
S (similarity)	23.3	20	20.3	14.8	38	21.9	13.8
D (richness difference)	34.5	28.6	33.2	27.3	23.6	28.1	28.7
R (species replacement)	42.2	51.4	46.5	57.9	38.4	50	57.5
Beta diversity	76.7	80	79.7	85.2	62	78.1	86.2
Nestedness – Anti-nestedness	51.4	41.5	45.9	34	61	45.1	31.6
Richness Agreement	65.5	71.4	66.8	72.7	76.4	71.9	71.3

Classification and principal coordinates ordination of leaf pair sample units

Most leaf pairs classify into two major groups, containing lowland units on the left and upland units on the right side of the dendrogram in Figure 10. The leaves from lowland are mixed considerably, whereas the 1550 and 1800 m assemblages are much better separated. There are some outliers that do separate earlier, one leaf pair from 250 m in which a single species (*Radula mammosa* Spruce) appears only, and then six leaf pairs from 1550 m. These findings are largely confirmed by the principal coordinates ordination of leaves, even though the first two axes represent only 12% and 6% of variation (Fig. 11). The convex hulls drawn around points representing the same altitude clearly indicate the separation of lowland and upland bryoflora along axis 1, and the high overlap between the lowland assemblages, as well as a less conspicuous overlap between upland assemblages. The entire scatterplot is a typical manifestation of the so-called horseshoe effect, with a continuous change from A to D through B and C, arranged as a horseshoe (or arched) pattern – which also indicates high species turnover along the elevational gradient, confirming the simplex results.

DISCUSSION

The diversity analyses presented above clearly identify a higher overlap between epiphyll assemblages among adjacent lowland riparian sites than found between the two upland sites. The pattern of similarity found in lowland epiphyll assemblages is associated with reduction of local microclimatic instability, while divergence between the upland assemblages is linked with higher microclimatic variation. The pattern of overlap between lowland epiphyll assemblages and greater divergence in upland assemblages coincides with distance between sites, temperature and elevation, but not rainfall, which is remarkably constant across the transect (Fig. 8). Lowland and upland sites are, at their closest, separated by *c.* 4 km distance and 1100 m elevation, while lowland assemblages are separated by 1.4 km (horizontal) distance and 100 m elevation, while upland sites by 1.9 km distance and 200 m elevation. Lowland sites have mean, maximum and minimum (0.3°, 0.5°, 0.0°C)

temperature differences, respectively, with upland sites registering about three orders of magnitude greater temperature divergence (1.1°, 2.5°, 0.5°C) between them.

Correlating species responses along environmental gradients in multiple dimensions is complicated, even for environmental factors operating along smooth gradients, and even clear discontinuities (such as divergence in daytime cloud immersion between lowland and upland sites) may not have much effect on overall beta diversity change along the transect. We have identified several locally-driven microclimatic effects – emergent elements relating to treefall gaps, locally-persistent cloud immersion, proximity to permanent streams and generalized orographic contributions to local microclimate (slope and aspect) – that appear to contribute to divergence in epiphyll assemblages between sites.

How the observed occurrences of a species relate to environmental gradients is a fundamental question in community ecology, and the relative contribution of various abiotic and biotic factors on cryptogam community structure have been extensively explored in the ecological literature, from across a wide range of landscapes, habitat types and microclimatic conditions, utilizing a variety of methodological approaches. We have cited here only a few important papers from among these, favoring those with particular focus on tropical epiphyll assemblages. In comparison, we are cognizant of limitations of our own investigational methods, with key data points lacking in the study including (but not limited to): taxonomic identification of phorophyte host plants; exploration of leaf-surface physical and chemical conditions (variation in surface topology, cuticle chemistry and lifespan of leaves between phorophyte hosts); potential intra-specific interactions; more quantitative measures of solar input and annual cloud and fog cover; quantitative measures of wind speed and direction; monitoring of temporal changes in epiphyll assemblages. Despite these limitations, we have explored a suite of microclimatic factors implicated in divergence of epiphyll community structure across the environmental gradients observed along our transect, identifying a number of important locally emergent effects among them: light-gap dependent incident understory light regime, orographically-driven fog immersion and condensation effects, as well as orographically-driven microclimate stabilization effects in riparian habitats.

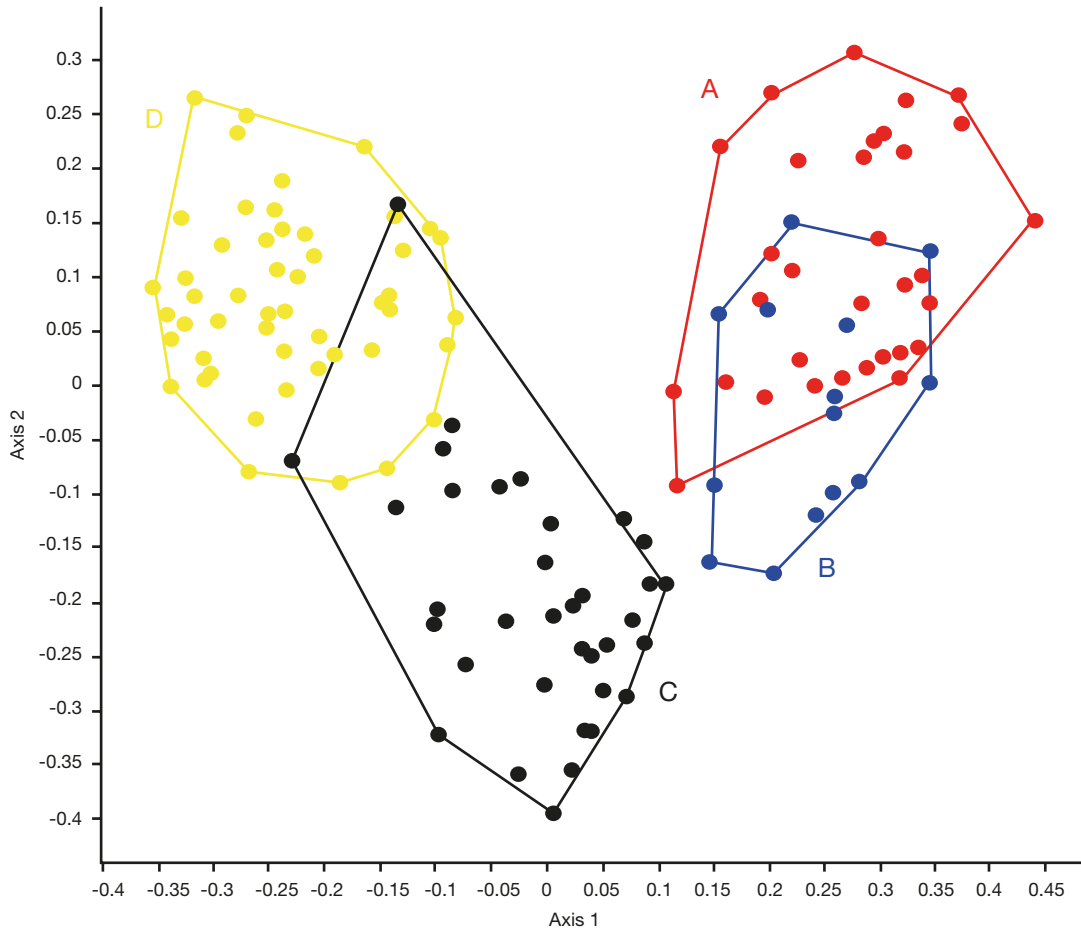

FIG. 11. — Principal coordinates ordination of leaves with epiphyllous liverworts, with convex hulls drawn around units from the same altitude: **A**, 250 m assemblage (red); **B**, 350 m assemblage (blue); **C**, 1550 m assemblage (black); **D**, 1800 m assemblage (yellow).

Incident understory light, a combination of abiotic (solar insolation) and biotic (forest canopy structure) elements, is subject to modulation through both anthropogenic and natural processes. Our remote research site is, happily, still entirely covered by primary forest, where a large treefall gap to the west of an upper cloud forest site provided insight into the important, eminently local and ephemeral contribution of gap-phase light energy inputs to divergence in epiphyll assemblages. The additional energy from afternoon light entering the understory at this site was associated with higher phorophyte host density and higher epiphyll densities in the understory, corresponding to higher epiphyll assemblage similarity and lower beta diversity.

Daytime fog cover is dependent on a series of abiotic conditions: elevation and temperature, available atmospheric moisture, anabatic wind, and vapor pressure. Fog immersion both attenuates light energy and can increase available moisture to the hydrological cycle under the right conditions. One assemblage site, situated atop a narrow ridge in lower cloud forest at 1550 m, experiences significantly greater daytime cloud immersion than all other epiphyll sampling sites, and supported the highest diversity (both alpha and beta) of epiphyll assemblages in the study. This site presents an inter-

esting combination of more persistent daytime fog cover, yet having an unexpectedly low density of potential epiphyll hosts in shrub and herbaceous layers of the understory (Table 3). The comparatively low ratio of epiphyll hosts at this site is associated with a local population of dominant subcanopy clustering palms (*Wettinia augusta* Poepp. & Endl.) unique to this location. Reaching from 3–7 m in height, these palms contribute to an understory light regime that, despite the more open understory below them, maintain incident understory light levels roughly equivalent to other epiphyll assemblages (unaffected by adjacent large treefall gaps). Persistent local fog immersion effects at this elevation contribute greater moisture inputs to the hydrological cycle as well as attenuate solar energy, promoting the higher alpha and beta diversity of epiphylls noted at this site.

Reduction of diurnal variation in temperature and humidity – particularly at the higher temperatures found at lower elevations along the base of the uplift – is highly dependent on local topography. Lowland riparian epiphyll assemblages in stream valleys at 350 and 250 m harbor rich bryophytic communities, in contrast to adjacent upslope terrace and ridge habitats which support much reduced bryophytic biomass and diversity. A combination of local topographic effect and

proximity to permanent streams appear to drive the climatic stability fostering the epiphyll diversity of these lowland riparian forest habitats.

With this publication, representing the second in a series exploring the bryoflora and landscapes of the eastern Andes of central Peru, we now catalog the bryoflora of the Cordillera El Sira at 282 species (207 liverworts, 55 mosses), recording 43 new liverwort distribution records and one new species to the Flora of Peru (Pócs 2019b; Pócs *et al.* 2022). Having documented how the unique climatic conditions and orographic diversity found along an altitudinal transect along the eastern escarpment of the Cordillera El Sira sustains a diverse bryoflora (Graham *et al.* 2016), we have further identified how a complex of abiotic and biotic elements drive epiphyll community structure along the same elevational gradient.

We look forward to exploring how the El Sira bryoflora articulates into the megadiverse complex of landscapes and habitats found in the selva central region, encompassing the series of eastern Andean outlying ranges and valleys found to the west of the research site. With less than 15% of our more than 5600 bryophyte collections made during expeditions to Pasco and Junín departments determined to species, (unpublished data), much work remains. Regional bryophyte diversity is expected to grow substantially as taxonomic identification of these collections advances; in addition to understanding longer-range patterns of bryophyte distribution and diversity across the region, species-level data from inventories provides critical evidence in support of efforts to safeguard the essential life-sustaining ecological processes and vulnerable landscapes of the region.

Acknowledgements

We wish to thank the Jefatura of the El Sira Communal Reserve for their support of our research program over the years. Our sincere gratitude is extended to Carlos Reynel, Aniceto Daza Yomona and Sonia Palacios Ramos at Herbario Forestal, La Molina, Lima, Peru (MOL), as well as Rodolfo Vasquez and Rocio Rojas at Herbario Selva Central at Oxapampa, Peru for their enthusiastic support of our Peruvian fieldwork over the years. Thanks to our colleagues Yarency Rodriguez and Anna Balla at the Field Museum (F), and to the herbarium staff at Eszterhazy Karoly University (EGR). Reagan Dunn provided critical advice on hemispherical photography equipment and light analysis software, and Jonathan Bisson prepared the schematic image illustrated in Figure 3. Manuscript reviews were kindly provided by Janice M. Glime, Matt von Konrat and S. Robbert Gradstein. All collections were made under authorization (*Resolución del Jefe del ANP-Reserva Comunal El Sira*) (no. 002-2009-SERNANP-DGANP-JEF; no. 005-2011-SERNANP-DGANP-JEF; no. 007-2014-SERNANP-RCS-JEF; no. 002-2017-SERNANP-RCS-JEF; no. 014-2019-SERNANP-RCS) of the El Sira Communal Reserve, administered by the Service for Natural Protected Areas (SERNANP) of the Peruvian Ministry of Environment.

REFERENCES

- BITTENCOURT P., BARROS F., ELLER C. B., MÜLLER C. & OLIVEIRA R. 2019. — The fog regime in a tropical montane cloud forest in Brazil and its effects on water, light and microclimate. *Agricultural and Forest Meteorology* 265: 359-369. <https://doi.org/10.1016/j.agrformet.2018.11.030>
- COLEY P. D., KURSAR T. A. & MACHADO J. L. 1993. — Colonization of tropical rain forest leaves by epiphylls: effects of site and host plant leaf lifetime. *Ecology* 74 (2): 619-623. <https://doi.org/10.2307/1939322>
- ENDLER J. A. 1993. — The color of light in forests and its implications. *Ecological Monographs* 63 (1): 1-27. <https://doi.org/10.2307/2937121>
- FRAHM J.-P. 1987. — Which factors control the growth of epiphytic bryophytes in tropical rainforests? *Symposia Biologica Hungarica* 35: 639-648.
- FRAHM J.-P. 1990. — Bryophyte phytomass in tropical ecosystems. *Botanical Journal of the Linnean Society* 104 (1-3): 23-33. <https://doi.org/10.1111/j.1095-8339.1990.tb02209.x>
- GEHRIG-DOWNIE C., MARQUARDT J., OBREGÓN A., BENDIX J. & GRADSTEIN S. R. 2012. — Diversity and vertical distribution of filmy ferns as a tool for identifying the novel forest type “tropical lowland cloud forest”. *Ecotropica* 18: 35-44.
- GEHRIG-DOWNIE C., OBREGÓN A., BENDIX J. & GRADSTEIN S. R. 2013. — Diversity and vertical distribution of epiphytic liverworts in lowland rain forest and lowland cloud forest of French Guiana. *Journal of bryology* 35 (4): 243-254. <https://doi.org/10.1179/1743282013Y.0000000070>
- GLIME J. M. & PÓCS T. 2018. — Tropics: Epiphylls, in GLIME J. M. (ed.), *Bryophyte Ecology*. Vol. 4. Michigan Technological University and the International Association of Bryologists, Houghton: 2-47.
- GRADSTEIN S. R. 1992. — The vanishing tropical rain forest as an environment for bryophytes and lichens, in BATES J. W. & FARMER A. M. (eds), *Bryophytes and Lichens in a Changing Environment*. Clarendon Press, Oxford: 234-258.
- GRADSTEIN S. R. 2006. — The lowland cloud forest of French Guiana – a liverwort hotspot. *Cryptogamie, Bryologie* 27 (1): 141-152.
- GRADSTEIN S. R. & FRAHM J.-P. 1987. — Die floristische Höhengliederung der Moose entlang des BRYOTROP-Transsektes in NO-Peru. *Beiheft zur Nova Hedwigia* 88: 105-113.
- GRADSTEIN S. R., GRIFFIN D., MORALES M. I. & NADKARNI N. M. 2001. — Diversity and habitat differentiation of mosses and liverworts in the cloud forest of Monteverde, Costa Rica. *Caldasia* 23 (1): 203-212.
- GRADSTEIN S. R., OBREGÓN A. M., GEHRIG-DOWNIE C. & BENDIX J. 2011. — Tropical lowland cloud forest: a neglected forest type, in BRUIJNZEEL L. A., SCATENA F. N. & HAMILTON L. S. (eds), *Tropical Montane Cloud Forests: Science for Conservation and Management*. Cambridge University Press, New York: 130-133.
- GRAHAM J. G., FISCHER M. & PÓCS T. 2016. — Bryoflora and landscapes of the Eastern Andes of Central Peru: I. Liverworts of the El Sira Communal Reserve. *Acta Biologica Plantarum Agriensis* 4: 3-60. <https://doi.org/10.21406/abpa.2016.4.3>
- HELMER E. H., GERSON E. A., BAGGETT L. S., BIRD B. J., RUZYCKI T. S. & VOGGESSER S. M. 2019. — Neotropical cloud forests and páramo to contract and dry from declines in cloud immersion and frost. *PLoS ONE* 14 (4): e0213155. <https://doi.org/10.1371/journal.pone.0213155>
- HUBBELL S. P., FOSTER R. B., O'BRIEN S. T., HARMS K. E., CONDIT R., WECHSLER B., WRIGHT S. J. & DE LAO S. L. 1999. — Light-Gap Disturbances, Recruitment Limitation, and Tree Diversity in a Neotropical Forest. *Science* 283 (5401): 554-557. <https://doi.org/10.1126/science.283.5401.554>
- KRAICHAK E. 2013. — *Adaptive traits and community assembly of epiphyllous bryophytes*. Ph.D. thesis, University of California, Berkeley, 63 p.

- KRAICHAK E. 2014. — Microclimate fluctuation correlated with beta diversity of epiphyllous bryophyte communities. *Biotropica* 46 (5): 575-582. <https://doi.org/10.1111/btp.12140>
- LEGENDRE P. & LEGENDRE L. 2012. — *Numerical Ecology*. Elsevier, Oxford, 989 p.
- LÜCKING A. 1997. — Diversity and distribution of epiphyllous bryophytes in a tropical rainforest in Costa Rica. *Abstracta Botanica* 21 (1): 79-87.
- MAGURRAN A. E. 2021. — Measuring biological diversity. *Current Biology* 31 (19): R1174-R1177.
- MALOMBE I., MATHEKA K. W., PÓCS T. & PATIÑO J. 2016. — Edge effect on epiphyllous bryophytes in Taita Hills fragmented afro montane forests. *Journal of Bryology* 38 (1): 33-46. <https://doi.org/10.1179/1743282015Y.0000000015>
- MARKOWSKI P. & RICHARDSON Y. 2011. — Orographic mesoscale phenomena, in MARKOWSKI P. & RICHARDSON Y. (eds), *Mesoscale meteorology in midlatitudes*. Vol. 2. Wiley & Sons, Hoboken: 316-325.
- MEŽAKA A., BADER M. Y., SALAZAR ALLEN N. & MENDIETA-LEIVA G. 2020. — Epiphyll specialization for leaf and forest successional stages in a tropical lowland rainforest. *Journal of Vegetation Science* 31 (1): 118-128. <https://doi.org/10.1111/jvs.12830>
- MEŽAKA A., SALAZAR ALLEN N., MENDIETA-LEIVA G. & BADER M. Y. 2022. — Life on a leaf. The development of spatial structure in epiphyll communities. *Journal of Ecology* 110 (3): 619-630. <https://doi.org/10.1111/1365-2745.13824>
- NAIMAN R. J., DECAMPS H. & MCCLAIN M. 2010. — Biotic Functions of Riparia, in NAIMAN J. R., DECAMPS H. & MCCLAIN M. (eds), *Riparia: ecology, conservation, and management of streamside communities*. Elsevier, Amsterdam: 1521-1538.
- NISSNER A., KÜPPERS M., GRAHAM J., VALENZUELA L., GÜNEY A., REMMELE S. & ZIMMERMANN R. 2020. — Climate and seasonal rainfall anomalies along an elevational gradient in the El Sira Mountains, Peru, and their impacts on tree radial growth. *Journal of Forestry Research* 31: 1521-1538. <https://doi.org/10.1007/s11676-019-00985-y>
- OPISSA J. M. & CHURCHILL S. P. 2008. — Bryophytes from the Environs of Yanachaga-Chemillén National Park, Department of Pasco, Peru. *The Bryologist* 111 (2): 310-317. [https://doi.org/10.1639/0007-2745\(2008\)111\[310:BFTEOY\]2.0.CO;2](https://doi.org/10.1639/0007-2745(2008)111[310:BFTEOY]2.0.CO;2)
- PÓCS T. 1976. — Bioclimatic studies in the Uluguru Mountains (Tanzania, East Africa) II. Correlations between orography, climate and vegetation. *Acta Botanica Hungarica* 22: 163-183.
- PÓCS T. 1982. — Tropical forest bryophytes, in SMITH A. J. E. (ed.), *Bryophyte Ecology*. Springer, London: 59-104.
- PÓCS T. 2009. — Epiphyllous liverwort diversity at worldwide level and its threat and conservation. *Anales del Instituto de Biología serie Botánica* 67 (1): 109-127.
- PÓCS T. 2019a. — New liverworts from the Peruvian Andes. I. *Colura ochyrana* and *Drepanolejeunea halinae* (Lejeuneaceae, Marchantiophyta). *Acta Musei Silesiae, Scientiae Naturales* 68 (1-2): 37-44. <http://dx.doi.org/10.2478/cszma-2019-0005>
- PÓCS T. 2019b. — New liverworts from the Peruvian Andes. II. *Zoopsideella grahamii* and *Riccardia gradsteinii* (Marchantiophyta). *Acta Botanica Hungarica* 61 (3-4): 387-395. <https://doi.org/10.1556/034.61.2019.3-4.8>
- PÓCS T. & PODANI J. 2015. — Southern Thailand bryophytes II Epiphylls from the Phang-Nga area. *Acta Botanica Hungarica* 57 (1-2): 183-198. <https://doi.org/10.1556/abot.57.2015.1-2.14>
- PÓCS T., LEE G. E., PODANI J., PESIU E., HAVASI J., TANG H. Y., MUSTAPENG A. M. A. & SULEIMAN M. 2020. — A study of community structure and beta diversity of epiphyllous liverwort assemblages in Sabah, Malaysian Borneo. *PhytoKeys* 153: 63-83. <https://doi.org/10.3897/phytokeys.153.53637>
- PÓCS T., GRAHAM J. G., VON KONRAT M. & LARRAIN J. 2022. — New liverwort records from the Peruvian Andes. *Acta Botanica Hungarica* 64 (1-2): 187-200. <https://doi.org/10.1556/034.64.2022.1-2.10>
- PODANI J. 2001. — *Computer Programs for Data Analysis in Ecology and Systematics. SYN-TAX 2000 User's Manual*. Scientia, Budapest, 53 p.
- PODANI J. & SCHMERA D. 2011. — A new conceptual and methodological framework for exploring and explaining pattern in presence – absence data. *Oikos* 120 (11): 1625-1638. <https://doi.org/10.1111/j.1600-0706.2011.19451.x>
- ROMANSKI J. 2007. — *Epiphytic bryophytes and habitat microclimate variation in lower montane rainforest, Peru*. Honours thesis, University of Tasmania (School of Geography and Environmental Studies), Sandy Bay, 146 p.
- ROMANSKI J., PHARO E. J. & KIRKPATRICK J. B. 2011. — Epiphytic bryophytes and habitat variation in montane rainforest, Peru. *The Bryologist* 114 (4): 720-731. <https://doi.org/10.1639/0007-2745-114.4.720>
- SCHIFFNER V. 1929. — Über epiphyll Lebermoose aus Japan nebst einigen Beobachtungen über Rhizoiden, Elateren und Brutkörper. *Annales Bryologici* 2: 87-106.
- SONNLEITNER M., DULLINGER S., WANEK W. & ZECHMEISTER H. 2009. — Microclimatic patterns correlate with the distribution of epiphyllous bryophytes in a tropical lowland rain forest in Costa Rica. *Journal of Tropical Ecology* 25 (3): 321-330. <https://doi.org/10.1017/S0266467409006002>
- THIEL S., TSCHAPKA M., HEYMAN E. W. & HEER K. 2021. — Vertical stratification of seed-dispersing vertebrate communities and their interactions with plants in tropical forests. *Biological Reviews* 96 (2): 454-469. <https://doi.org/10.1111/brv.12664>
- TROPICOS. 2022. — Tropicos Specimen Search. Available from <http://legacy.tropicos.org/SpecimenSearch.aspx> (accessed 22 January 2022).
- USAID. 2012. — *Vulnerabilidad y riesgo de la Región Ucayali*. United States Agency for International Development-Peru, Lima, 175 p.
- VAN REENEN G. B. A. & GRADSTEIN S. R. 1983. — Studies on Colombian cryptogams XX: A transect analysis of the bryophyte vegetation along an altitudinal gradient on the Sierra Nevada de Santa Marta, Colombia. *Acta Botanica Neerlandica* 32 (3): 163-175. <https://doi.org/10.1111/j.1438-8677.1983.tb01698.x>

Submitted on 15 February 2022;
accepted on 26 October 2022;
published on 14 March 2023.