

POSSIBLE NEGATIVE EFFECT OF STOMATOPOD (MANTIS SHRIMP) DISCARDS FROM SHRIMP TRAWLERS IN INDIA



Antony P. J., S. Ajmal Khan, B. Madhusoodana Kurup*

**School of Industrial Fisheries,
Cochin University of Science and Technology,
Lake Side Campus, Fine Arts Avenue,
Kochi-682016, Kerala, India
*kurup424@gmail.com***



Introduction

- Major concern on bycatch and discards from trawlers in global fisheries
- Non-target (40%) fishery groups play crucial roles in ecosystems
- Stomatopods -mantis shrimps, squilla-major discards-carnivorous and predators
- Works regarding their ecological niche is nil
- Ecosystems are balanced by nature-each component role in the sustenance of others



Shrimp trawler



Antony P.J., S. Ajmal Khan and B. Madhusoodana Kurup
ECOSYSTEMS 2010, Anchorage, Alaska, USA
8-11 November 2010

C. smithii formed major discards in post monsoon



Fate of discards



Original catch



Antony P.J., S. Ajmal Khan and B. Madhusoodana Kurup
ECOSYSTEMS 2010, Anchorage, Alaska, USA
8-11 November 2010



Bycatch after target groups sorted out



Antony P.J., S. Ajmal Khan and B. Madhusoodana Kurup
ECOSYSTEMS 2010, Anchorage, Alaska, USA
8-11 November 2010



Onboard discarding
of non-edible biota and
low value ground fishes &
juveniles of commercially
important fishes after
segregating the Target catch





Fate of discards other than stomatopods



Antony P.J., S. Ajmal Khan and B. Madhusoodana Kurup
ECOSYSTEMS 2010, Anchorage, Alaska, USA
8-11 November 2010



Discarded stomatopods impact



Antony P.J., S. Ajmal Khan and B. Madhusoodana Kurup
ECOSYSTEMS 2010, Anchorage, Alaska, USA
8-11 November 2010



Objectives

- Model a marine trophic ecosystem
- Evaluate the trophic niche overlaps
- To assess trophic impacts & trophic interactions in the ecosystem
- Simulate the impacts of stomatopods discard by increasing their biomass in the ecosystem and fisheries



Study area



Antony P.J., S. Ajmal Khan and B. Madhusoodana Kurup
ECOSYSTEMS 2010, Anchorage, Alaska, USA
8-11 November 2010



Bycatch from trawlers

Stomatopod – *Miyakea nepa*



Antony P.J., S. Ajmal Khan and B. Madhusoodana Kurup
ECOSYSTEMS 2010, Anchorage, Alaska, USA
8-11 November 2010



Materials and methods

➤ Ecopath with Ecosim version 5 software

Polovina(1984)

$$B_i (P/B)_i EE_i = Y_i \sum B_j (Q/B)_j DC_{ij} + Ex_i$$

➤ B_i = the biomass of prey group i ; P/B_i = production/biomass ratio of group i ; EE_i = ecotrophic efficiency; Y_i = its yield (=fishery catch); B_j = the biomass of predator group j ; Q/B_j = the food consumption per unit biomass of j , DC_{ij} = the fraction of i in the diet of j and Ex_i = the export of group i

➤ **Mass balancing: Production of any given prey=Bimass consumed by predators +fisheries+any exports from the system**

➤ **Entered basic inputs**

➤ **Ecopath parametrisation**

➤ **Ecosim simulation**

EwE - data requirements

1. Biomass (B): For fishery groups $B=Y/F$ (Catch/Fishing mortality) expressed in tonnes/km²
2. Production per biomass (P/B) ratio: $P/B = Z$ (Total mortality)= fishery yield + predation + net migration + biomass change + other mortality
3. Consumption per biomass (Q/B) ratio
$$\log Q/B = 7.964 - 0.204 \log W_{\infty} - 1.965 T + 0.083 A + 0.532 h + 0.398 d$$
 (Pauly et al. 1998)
where W_{∞} = asymptotic weight, T = temperature, A = Aspect ratio, h and d are binary variables (0 for carnivores and 1 for herbivores and detritivores)
4. Ecotrophic efficiency (EE) – proportion of production that is utilized in the ecosystem (predation or harvest)



➤ Catch data

Multi-stage stratified random sampling

3 landing centres covered (Nov. 2004 – Oct. 2005)

17 functional groups defined

➤ F, Z, Q/B and diet composition data

secondary data available from the study area

➤ Stomatopod - single functional group

Parameters were directly estimated

length frequency data - FiSAT software

diet composition - gut content analysis)



Functional groups

- Marine mammals
- Elasmobranchs
- Large pelagic
- Tunas
- Benthopelagic fishes
- Cephalopods
- Benthic carnivore fishes
- Mackerel
- Clupeids
- Stomatopods
- Crabs and Lobsters
- Shrimps
- Macrobenthos
- Meiobenthos
- Zooplankton
- Phytoplankton
- Detritus



- Basic input entered
- Mass balancing by automatic parameterization
- Evaluated the various outputs
- Ecosim simulation run
- Fishing mortality increased from the present level of 2.5 year^{-1} to 5.0 year^{-1} in the initial two years, and decreased gradually to 0.25 year^{-1} in 10 years



Results

Group name	TL	B (t km ⁻²)	P/ B (/ year)	Q/ B (/ year)	EE	OI
Marine mammals	4.49	0.007	0.250	11.230	0.000	0.343
Elasmobranchs	4.47	0.024	2.600	8.900	0.980	0.375
Large pelagic	3.91	0.015	4.200	6.820	0.974	0.584
Tunas	4.29	0.024	5.020	11.860	0.980	0.332
Benthopelagic fishes	3.92	0.104	4.350	14.300	0.979	0.624
Cephalopods	4.04	0.292	4.500	28.000	0.953	0.159
Benthic carnivore fishes	4.06	0.359	4.523	21.200	0.969	0.312
Mackerel	2.07	0.409	6.240	31.560	0.906	0.088
Clupeids	2.69	1.049	8.200	55.120	0.966	0.623
Stomatopods	3.49	0.284	4.600	15.000	0.980	0.794
Crabs and Lobsters	3.35	0.343	5.700	21.000	0.976	0.771
Shrimps	3.06	0.774	7.621	13.600	0.879	0.666
Macrobenthos	3.17	16.192	4.500	11.140	0.489	0.492
Meiobenthos	2.45	11.546	14.600	34.600	0.646	0.375
Zooplankton	2.28	17.844	78.000	300.000	0.972	0.281
Phytoplankton	1.00	71.000	82.000	-	0.735	0.000
Detritus	1.00	9.200	-	-	0.087	0.484

Mass balancing results

- Trophic level of the groups ranged from 1 (phytoplankton) to 4.49 (marine mammals)
- EE values for all the groups were less than 1
- Stomatopods occupied trophic level 3.49, indicates the carnivorous habit
- The exceptionally high value of omnivory index in stomatopods indicated their large feeding spectrum, carnivorous behaviour and wide distribution in the system



Diet matrix



Prey \ Predator	1	2	3	4	5	6	7	8	9	10	11	12	13	14	15
1 Marine mammals															
2 Elasmobranchs															
3 Large pelagic	0.005	0.062													
4 Tunas															
5 Benthopelagic s	0.115	0.101	0.061	0.073						0.022	0.015				
6 Cephalopods	0.193	0.207	0.070	0.162	0.164		0.088								
7 Benthic carnivore	0.215	0.182	0.135	0.108	0.103	0.075	0.048			0.016	0.021				
8 Mackerel			0.296		0.302		0.129								
9 Clupeids	0.254	0.279	0.213	0.266	0.104	0.305	0.073		0.048	0.083	0.119				
10 Stomatopods			0.004	0.018	0.010	0.028	0.030		0.001	0.002	0.006				
11 Crabs & Lobsters			0.007	0.034	0.027	0.066	0.051			0.013	0.018	0.000			
12 Shrimps	0.099	0.057	0.032	0.084	0.061	0.137	0.142		0.015	0.049	0.074	0.008			
13 Macrobenthos	0.119	0.087	0.107	0.191	0.102	0.312	0.360		0.076	0.355	0.191	0.189	0.114		
14 Meiobenthos		0.025	0.071	0.064	0.024	0.077	0.079		0.035	0.183	0.165	0.221	0.561		
15 Zooplankton					0.103			0.057	0.281	0.045	0.135	0.244	0.082	0.354	0.220
16 Phytoplankton								0.881	0.458					0.153	0.780
17 Detritus			0.003					0.062	0.085	0.230	0.255	0.338	0.243	0.493	
18 Import															
Sum	1.000	1.000	1.000	1.000	1.000	1.000	1.000	1.000	1.000	1.000	1.000	1.000	1.000	1.000	1.000



Estimated group-wise split mortality rates

Group name	Production/Biomass (=Z)	Fishing mortality	Predation mortality	Other mortality
Marine mammals	0.250	0.000	0.000	0.250
Elasmobranchs	2.600	2.548	0.000	0.052
Large pelagic	4.200	3.186	0.907	0.108
Tunas	5.020	4.920	0.000	0.100
Benthopelagic fishes	4.350	1.740	2.519	0.091
Cephalopods	4.500	0.774	3.515	0.210
Benthic carnivore fishes	4.523	0.324	4.060	0.139
Mackerel	6.240	2.091	3.564	0.585
Clupeids	8.200	0.884	7.034	0.282
Stomatopods	4.600	2.459	2.048	0.094
Crabs and Lobsters	5.700	2.171	3.393	0.136
Macrobenthos	4.500	0.021	2.180	2.299
Meiobenthos	14.600	0.000	9.427	5.173
Zooplankton	78.000	0.000	75.797	2.203
Phytoplankton	82.000	0.000	60.240	21.760

Antony P.J., S. Ajmal Khan and B. Madhusoodana Kurup
 ECOSYSTEMS 2010, Anchorage, Alaska, USA
 8-11 November 2010



Estimated predation mortality rates of different groups



	Prey \ Predator	1	2	3	4	5	6	7	8	9	10	11	12	13	14	15
1	Marine mammals	-	-	-	-	-	-	-	-	-	-	-	-	-	-	-
2	Elasmobranchs	-	-	-	-	-	-	-	-	-	-	-	-	-	-	-
3	Large pelagic	0.026	0.881	-	-	-	-	-	-	-	-	-	-	-	-	-
4	Tunas	-	-	-	-	-	-	-	-	-	-	-	-	-	-	-
5	Benthopelagic s	0.084	0.204	0.059	0.200	-	-	-	-	-	0.917	1.055	-	-	-	-
6	Cephalopods	0.050	0.148	0.024	0.158	0.835	-	2.301	-	-	-	-	-	-	-	-
7	Benthic carnivore	0.045	0.106	0.038	0.085	0.428	1.717	1.027	-	-	0.196	0.418	-	-	-	-
8	Mackerel	-	-	0.073	-	1.097	-	2.394	-	-	-	-	-	-	-	-
9	Clupeids	0.018	0.056	0.020	0.072	0.147	2.377	0.527	-	2.663	0.338	0.815	-	-	-	-
10	Stomatopods	-	-	0.001	0.018	0.055	0.792	0.793	-	0.203	0.026	0.159	-	-	-	-
11	Crabs and Lobsters	-	-	0.002	0.028	0.116	1.576	1.128	-	-	0.167	0.370	0.004	-	-	-
12	Shrimps	0.010	0.015	0.004	0.031	0.118	1.449	1.394	-	1.092	0.272	0.688	0.112	-	-	-
13	Macrobenthos	0.001	0.001	0.001	0.003	0.009	0.157	0.169	-	0.271	0.093	0.085	0.123	1.266	-	-
14	Meiobenthos	-	0.000	0.001	0.002	0.003	0.054	0.052	-	0.177	0.068	0.103	0.201	8.766	-	-
15	Zooplankton	-	-	-	-	0.009	-	-	0.041	0.912	0.011	0.055	0.144	0.833	7.926	65.87
16	Phytoplankton	-	-	-	-	-	-	-	0.160	0.373	-	-	-	-	0.862	58.84

Niche overlap

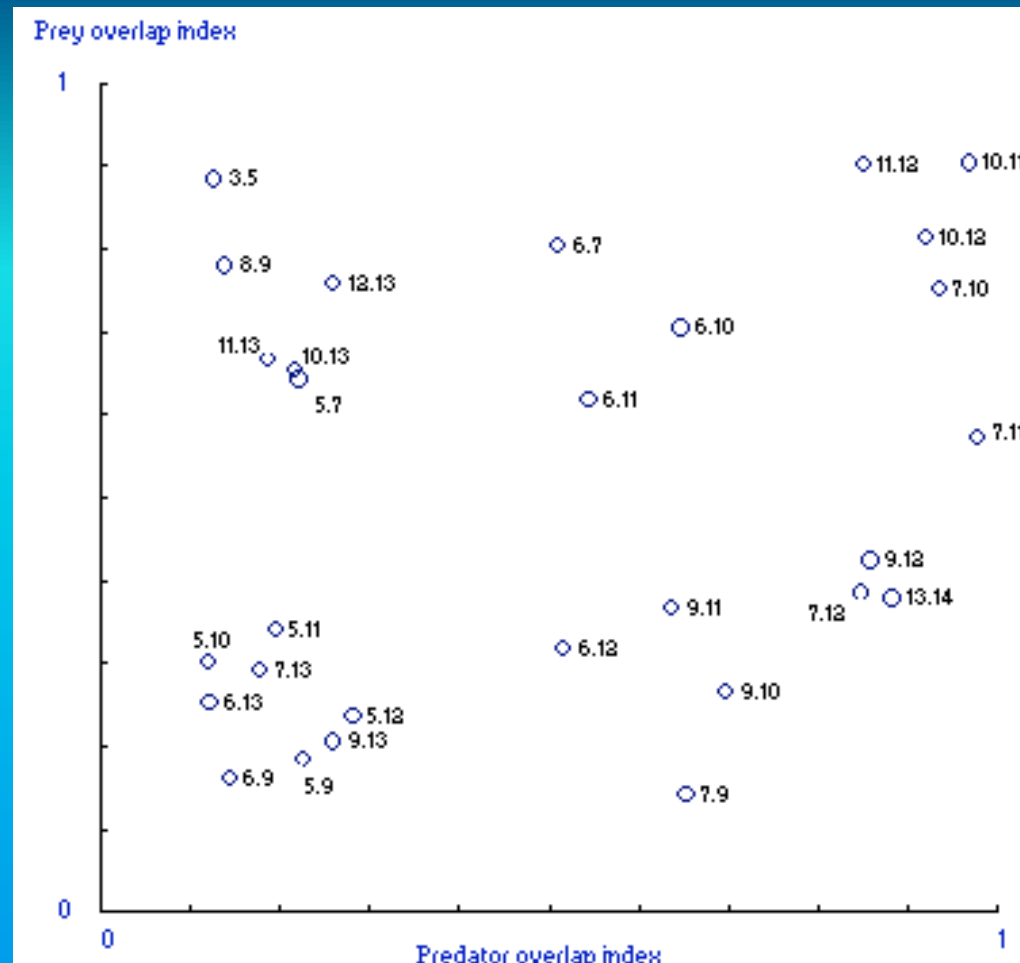

Prey and predators of group 10 (stomatopods) have very good overlap with the prey and predators of groups 11 (crabs and lobsters), 12 (shrimps) and 7 (benthic carnivores)

Mixed trophic impact

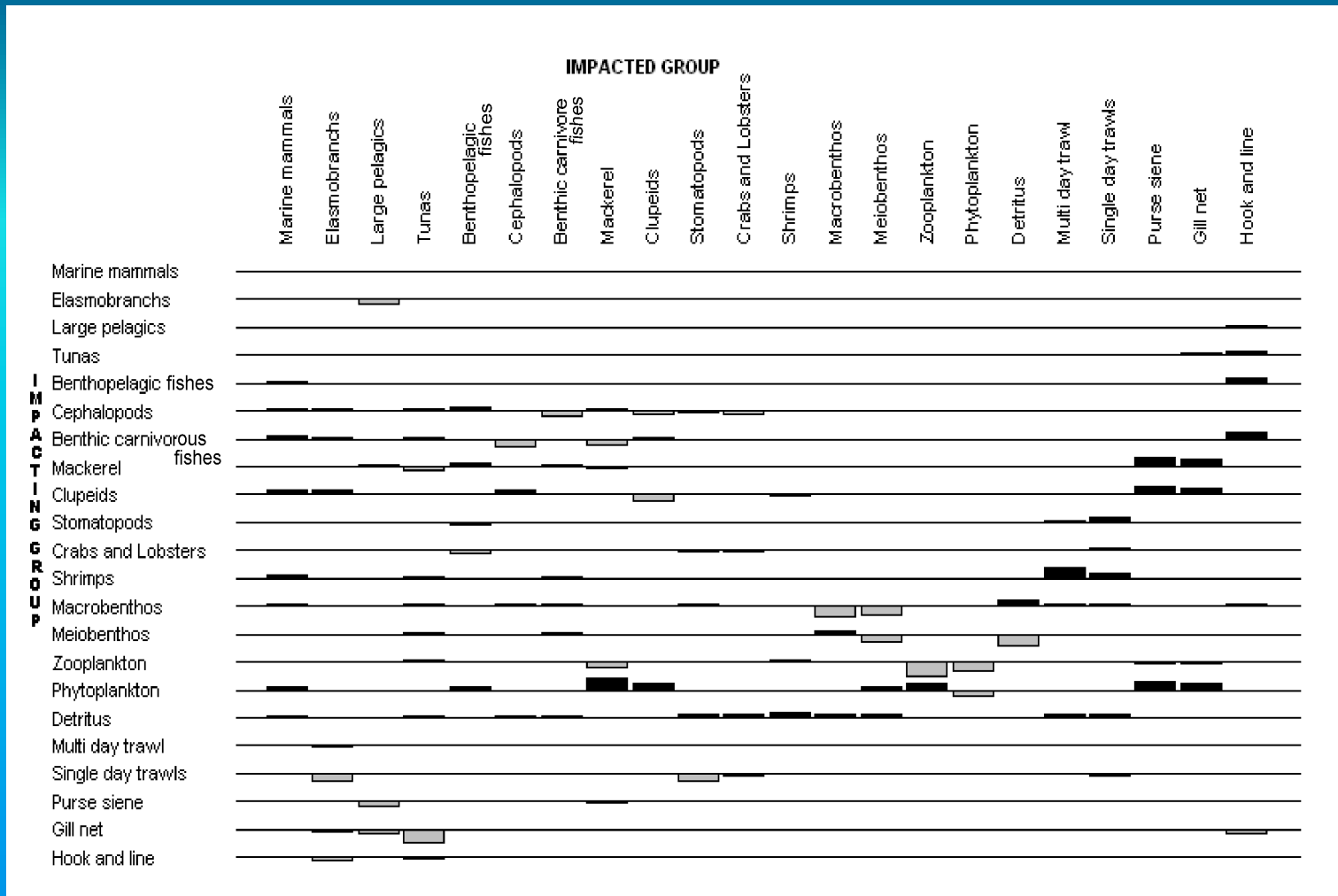

Stomatopods showed negative impact on benthopelagic fishes



Trophic level connectance plot

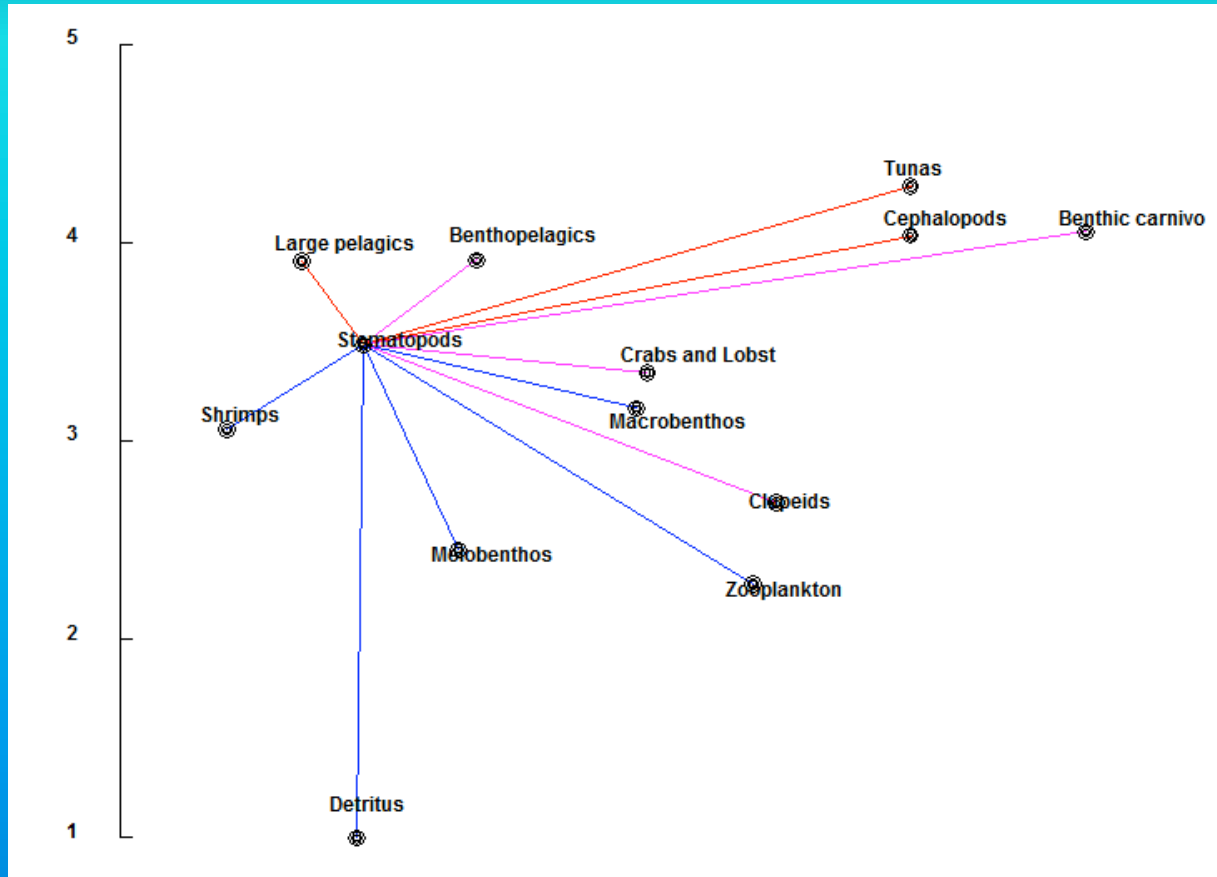

— Preys
— Predators
— Related both ways

Trophic flows from stomatopods

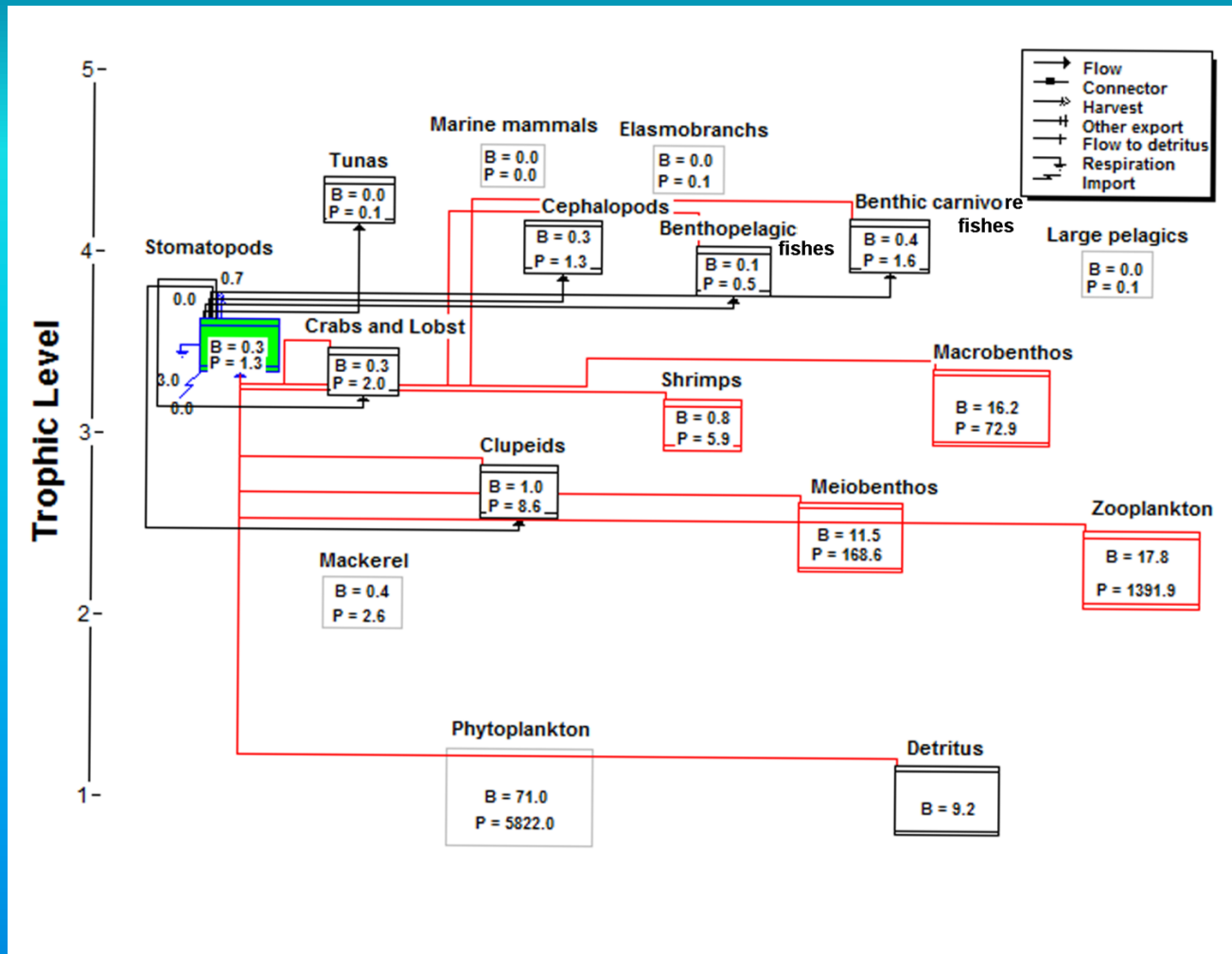

Inflows in red lines and outflows in black lines



Simulated change in biomass

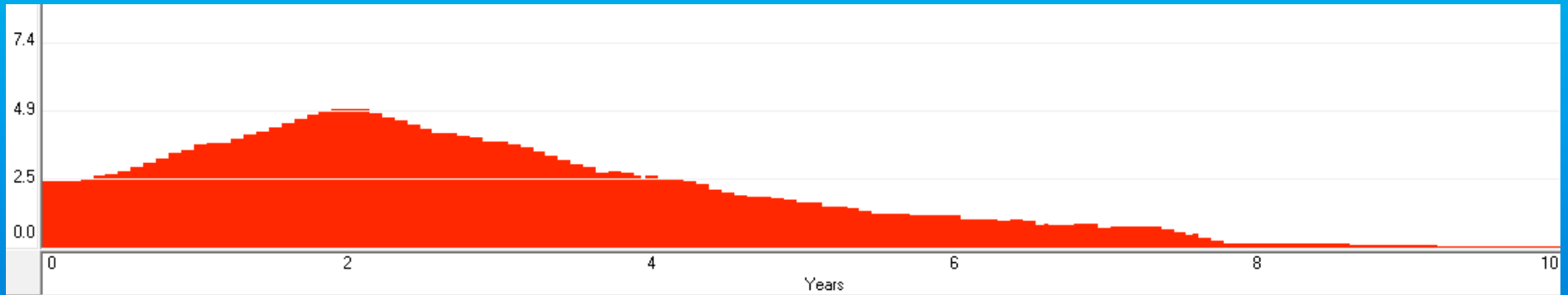
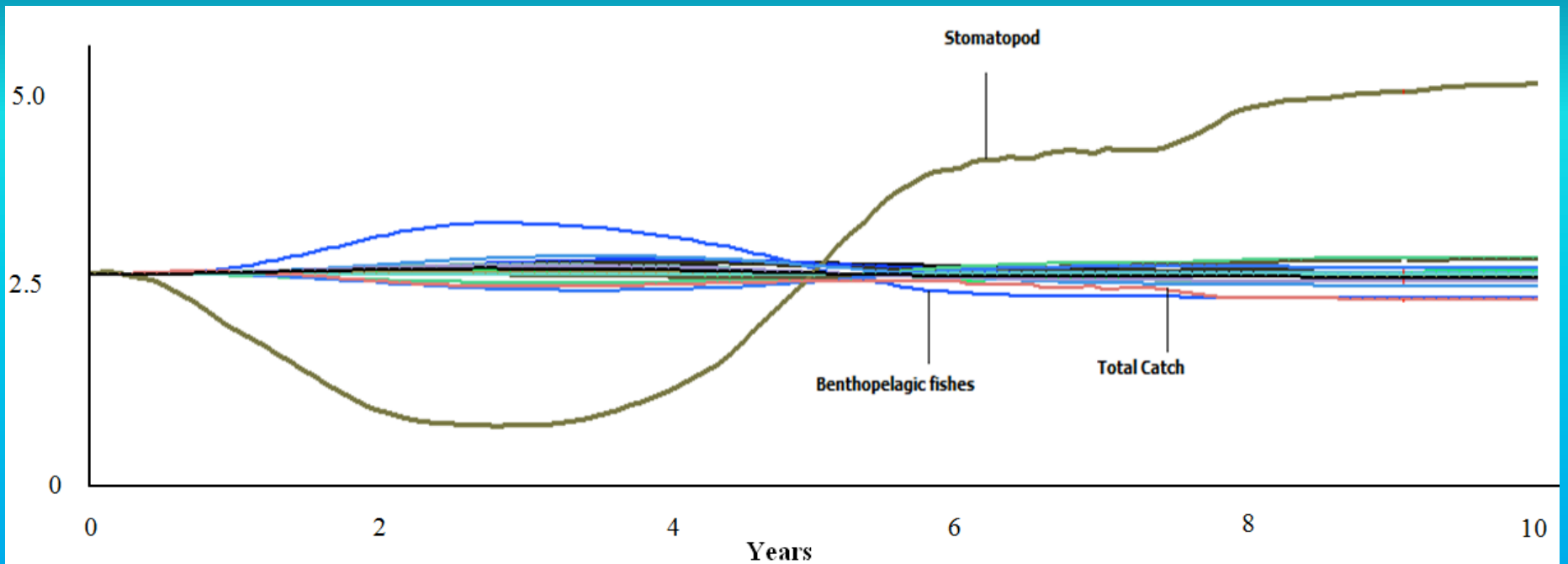

Antony P.J., S. Ajmal Khan and B. Madhusoodana Kurup
ECOSYSTEMS 2010, Anchorage, Alaska, USA
8-11 November 2010



Ecosim results



Group name	SB	EB	EB/SB
Marine mammals	0.007	0.007	1.00
Elasmobranchs	0.024	0.023	0.99
Large pelagic	0.015	0.015	1.01
Tunas	0.024	0.025	1.03
Benthopelagic fishes	0.104	0.090	0.87
Cephalopods	0.292	0.317	1.09
Benthic carnivore fishes	0.359	0.385	1.07
Mackerel	0.409	0.424	1.04
Clupeids	1.049	1.007	0.96
Stomatopods	0.284	0.570	2.00
Crabs and Lobsters	0.343	0.320	0.93
Shrimps	0.774	0.742	0.96
Macrobenthos	16.192	16.063	0.99
Meiobenthos	11.546	11.59	1.00
Zooplankton	17.843	17.848	1.00
Phytoplankton	70.994	70.999	1.00
Detritus	60.127	60.112	1.00
Total	180.384	180.536	1.00



Simulated changes in yield

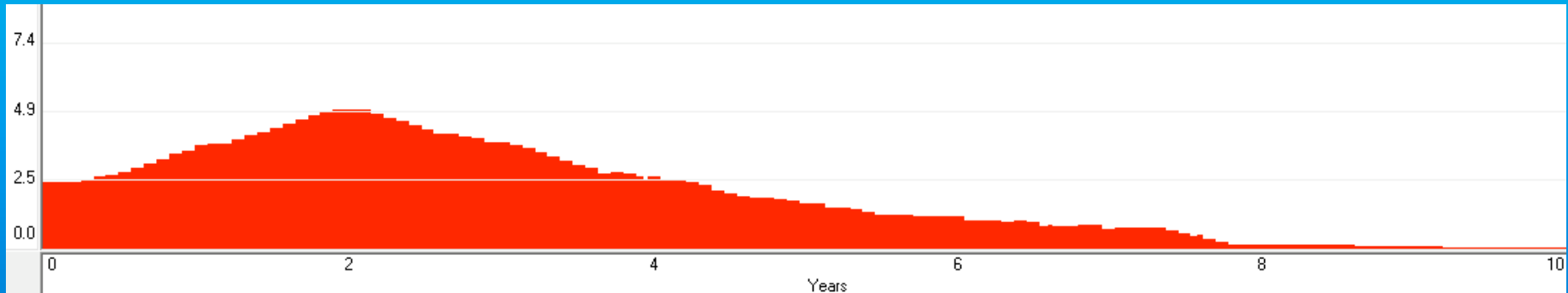
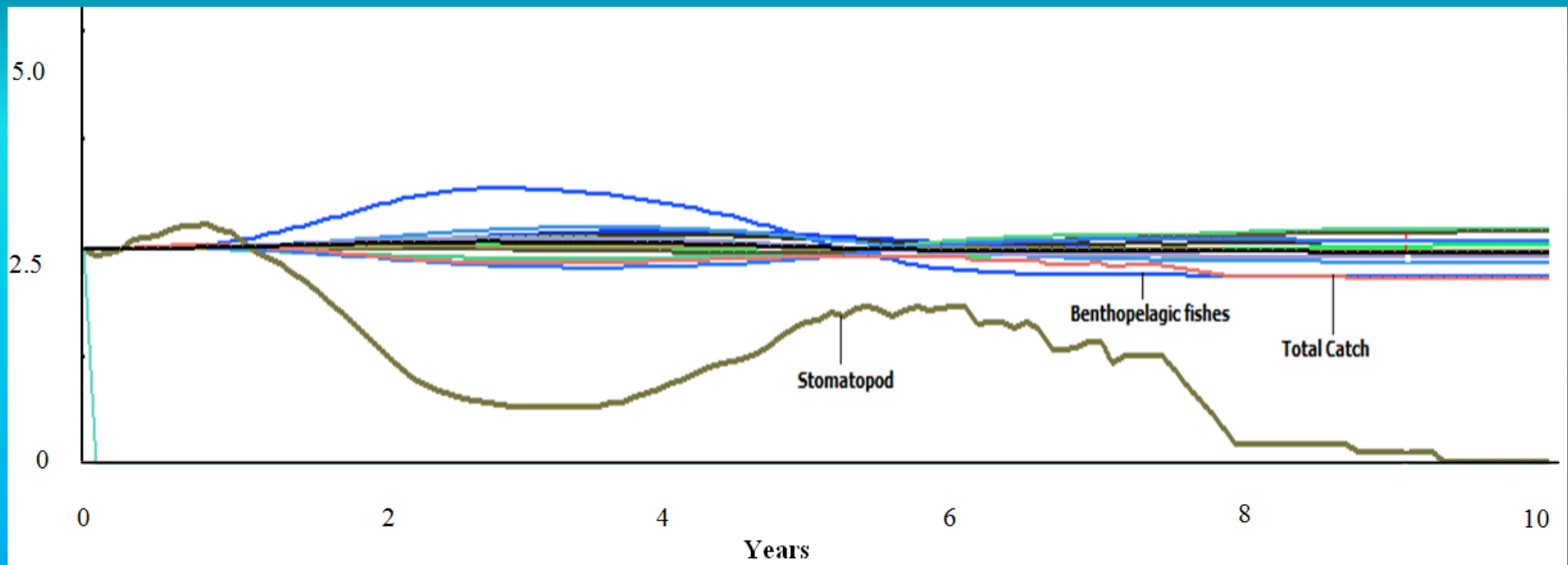

Antony P.J., S. Ajmal Khan and B. Madhusoodana Kurup
ECOSYSTEMS 2010, Anchorage, Alaska, USA
8-11 November 2010



Conclusion

- Discard of juveniles fishes in live condition is found very essential in trawl fishery
- Increase of the biomass of Stomatopods is having negative impact on ecosystem and fisheries
- Ecosystem overfishing (Pauly, 1994) due to live discards of stomatopods in live condition
- Impact is mostly on commercial groups including benthopelagic fishes, shrimps, crabs and lobsters and macrobenthos
- Competition for food, increased predation

Antony P.J., S. Ajmal Khan and B. Madhusoodana Kurup
ECOSYSTEMS 2010, Anchorage, Alaska, USA

8-11 November 2010



Ecosystem based fisheries management is advocated for better management of fish stocks

- **Better understand the ecosystem, their components, interlinks and niche are essential for sustenance of the stock**
- **Increase awareness for an optimum exploitation and utilization of stomatopods**
- **Utilisation of squilla as fishery products and biproducts needs to be investigated**



We are very much grateful to the FAO and Steering Committee of this meeting for providing travel support to make this presentation possible

**Thank you
for your kind attention.....**