

audison

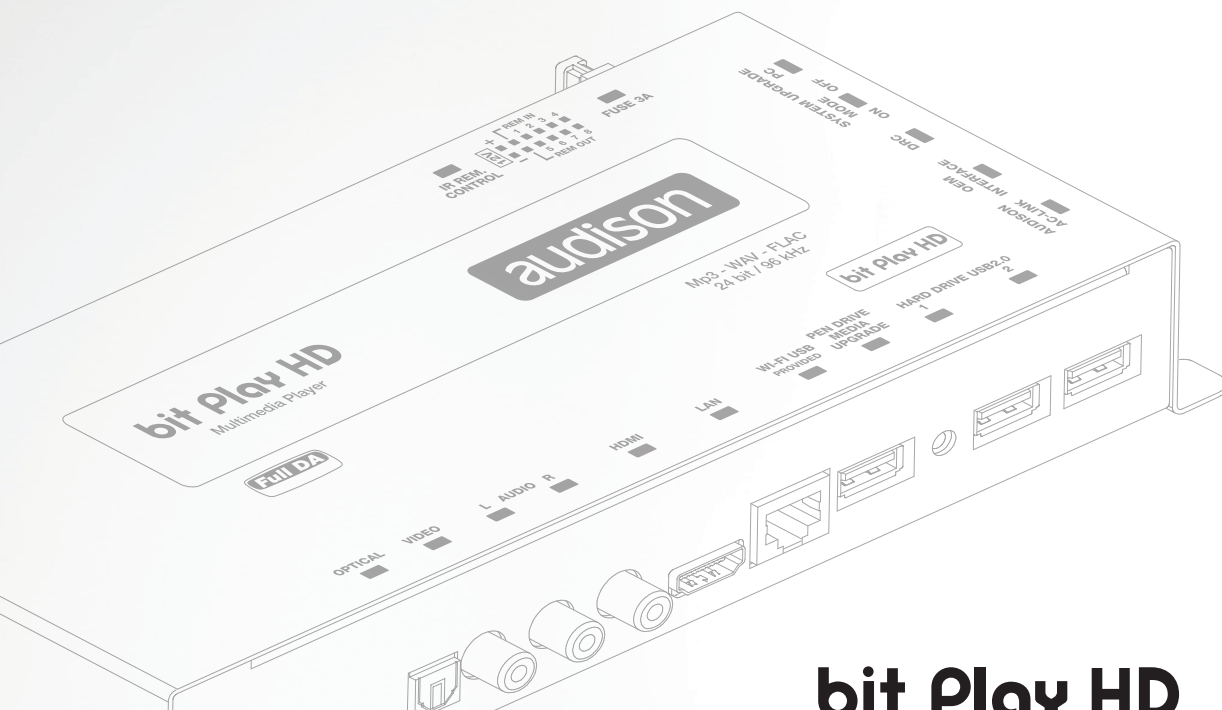

bit

bit Play HD bit Play HD SSD

USER'S MANUAL

rel. 1.0



ideato,
progettato,
costruito
in Italia

Index

1. bit Play HD - bit Play HD SSD DESCRIPTION	3
1.1 SAFETY CONSIDERATIONS	3
1.2 CONTENT OF THE PACKAGING	4
1.3 DIMENSIONIS AND FASTENING	5
2. DESCRIPTION OF THE CONNECTION PANELS	6
3. REMOTE DESCRIPTION	9
3.1 ARC (Advance Remote Control) REMOTE	9
3.2 USR (User Remote Control) REMOTE	10
4. CONNECTIONS	11
4.1 POWER SUPPLY AND REMOTE CONTROL	11
4.2 AUDIO OUTPUT SIGNALS	12
4.2.1 ANALOG OUTPUT SIGNALS	12
4.2.2 S/PDIF DIGITAL OUTPUT SIGNALS	12
4.2.3 S/PDIF DIGITAL OUTPUT SIGNALS WITH HI-DEFINITION VOLUME CONTROL	13
4.3 VIDEO OUTPUT SIGNALS	14
4.3.1 COMPOSITE VIDEO SIGNAL	14
4.3.2 HDMI VIDEO SIGNAL	14
4.4 AUX/OPTICAL INPUT AUTO SWITCH	15
4.5 STORAGE DEVICES/EXTERNAL FILE READING	16
4.6 INFRARED RECEIVER	17
4.7 WI-FI AND MOBILE DEVICES	17
5. HOW TO USE THE bit Play HD WITH AN EXTERNAL MONITOR	18
6. HOW TO USE THE bit Play HD ON MOBILE DEVICES	21
6.1 DOWNLOAD THE AUDISON Bit Play HD APP	20
6.2 DEVICE SETUP	20
6.3 AUDISON APP FOR ANDROID	21
7. MAIN SYSTEM SETTINGS	24
7.1 INTERNAL HDD INSTALLATION	24
7.1.1 INTERNAL HDD FORMAT	25
7.2 EXTERNAL MONITOR GRAPHIC RESOLUTION	26
7.3 SELECT SYSTEM LANGUAGE	27
7.4 SELECT AUDIO/VIDEO LANGUAGE	27
7.5 RESTORING FACTORY SETTINGS	28
8. TROUBLESHOOTING	29
8.1 MEDIA FIRMWARE UPGRADE	29
8.2 SYSTEM FIRMWARE UPGRADE	29
8.3 FAQ	30
9. TECHNICAL SPECIFICATIONS	34

1. BIT PLAY HD - BIT PLAY HD SSD DESCRIPTION







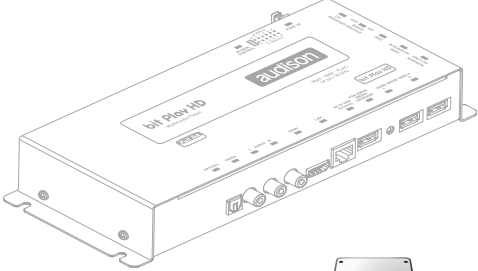

1.1 SAFETY CONSIDERATIONS

1. For the safety of the driver and third parties, the driver should not watch any video and/or operate the controls of the device while driving. While driving, we also recommend to adjust the volume to a level that allows you to hear sounds from outside the vehicle. The law prohibits the display and use of video while driving. For this reason, the unit is equipped with a function that inhibits the viewing of such content, unless the car is parked and the parking brake is engaged ([see sections 2.1 and 4.3](#)). We accept no responsibility if you choose to ignore this warning and do not install the product correctly to inhibit video content while in motion.
2. Operate the bit Play HD only when the internal temperature is between 0°C (32°F) and 55°C (131°F). The bit Play HD must be a minimum of 3 cm (1.5") from other structures and there must be good air circulation around the chassis.
3. Make sure your car has a 12VDC negative ground.
4. Make sure the location you choose for the product and its accessories does not affect the vehicle's other mechanical and electrical devices.
5. Make sure the power cable does not short circuit during installation and connection.
6. Use extreme caution when cutting or drilling the car chassis, checking that there is no electrical wiring or structural elements underneath.
7. Use rubber grommets to protect wires running through holes in metal and use proper materials if close to heat-generating devices.
8. Make sure all the cables are properly secured along their entire length. Also, make sure their outer protective jacket is flame resistant and self-extinguishing. Secure the wiring near the terminals.

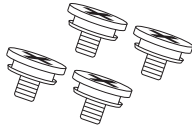
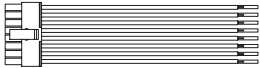
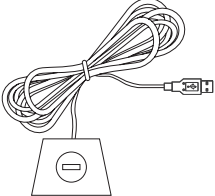
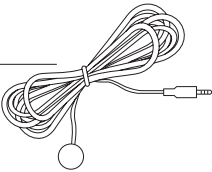
SAFE SOUND

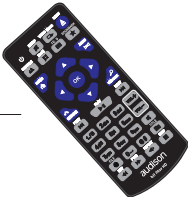
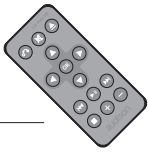
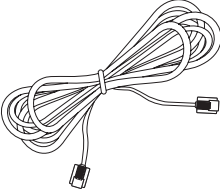
Use common sense while listening; long exposure to excessive sound levels may damage your hearing. Safety while driving must always come first.

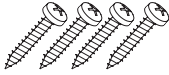
1.2 CONTENT OF THE PACKAGING

- bit Play HD: _____ 
- 2,5" SATA 250GB SSD HARD DISK (only for the bit Play HD SSD): _____ 
- N°4 Hard Disk assembling/fastening screws (only for the bit Play HD): _____ 
- Input/Rem cable with multi-pin connector: _____ 
- USB extension cable 2 m. (79 in.): _____ 
- Infrared receiver cable 5 m. (196 in.): _____ 
- WI-FI USB dongle: _____ 
- ARC remote (Advanced Remote Control): _____ 
- USR remote (User Remote Control): _____ 
- 1m (40 in.) AC-LINK (RJ12) cable _____ 
- N° 1 (3A) replacement fuse: _____ 
- N° 4 crosshead 4.2 x 50 mm self-tapping fastening screws: _____ 
- QSG _____ 
- Warranty: _____ 

1.3 DIMENSIONS AND FASTENING

Dimensions:

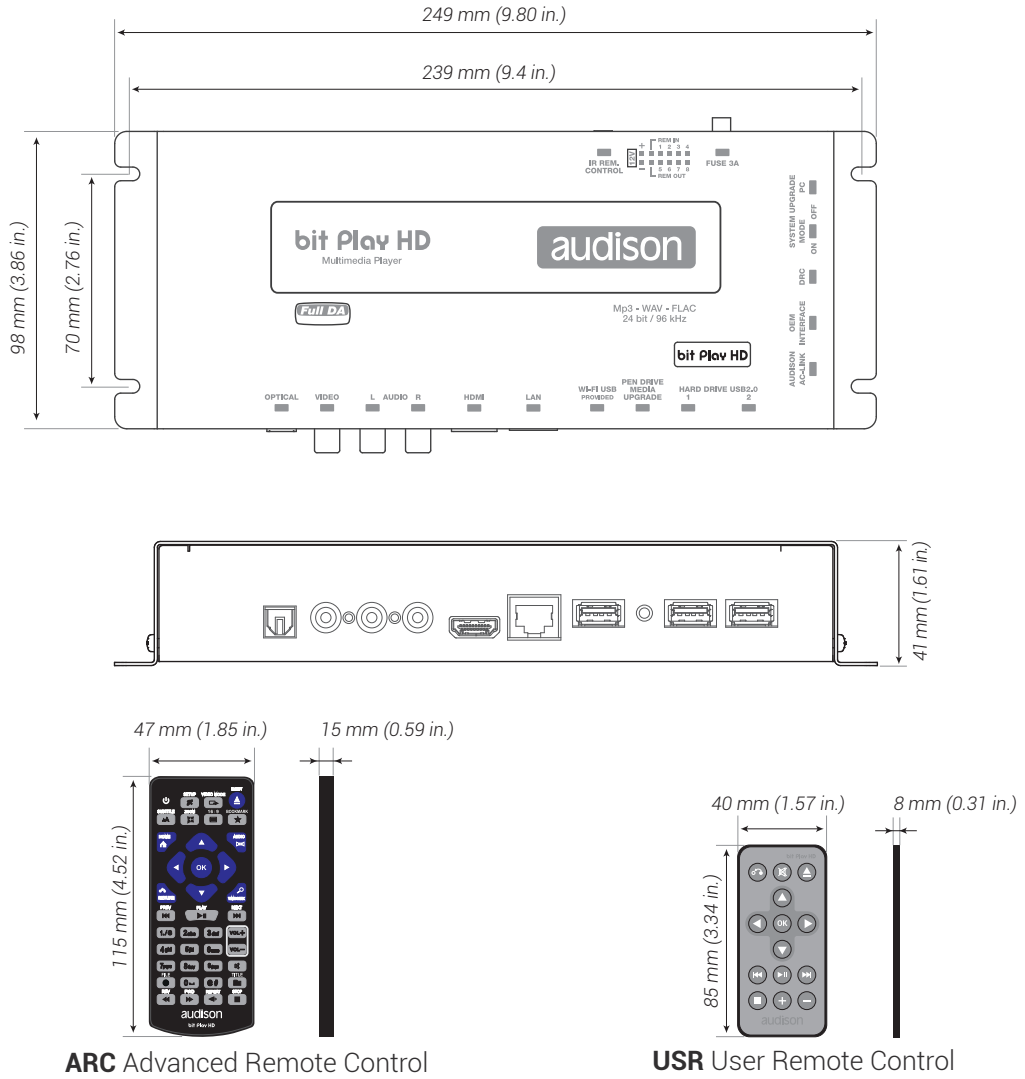

Fastening:

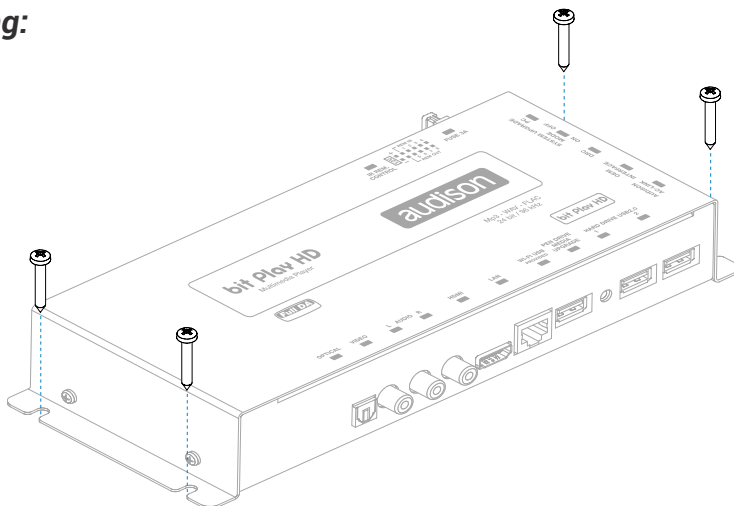

2. DESCRIPTION OF THE CONNECTION PANELS

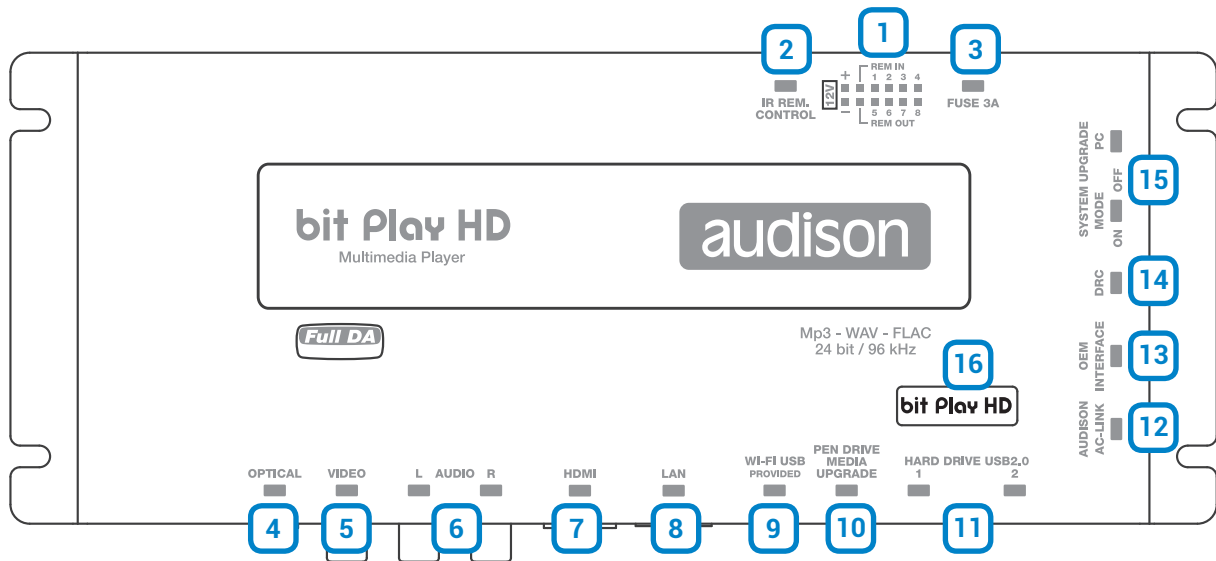

1 The bit Play HD comes with a 12-pin multi-pin connector through which you can manage the power and different control connections.

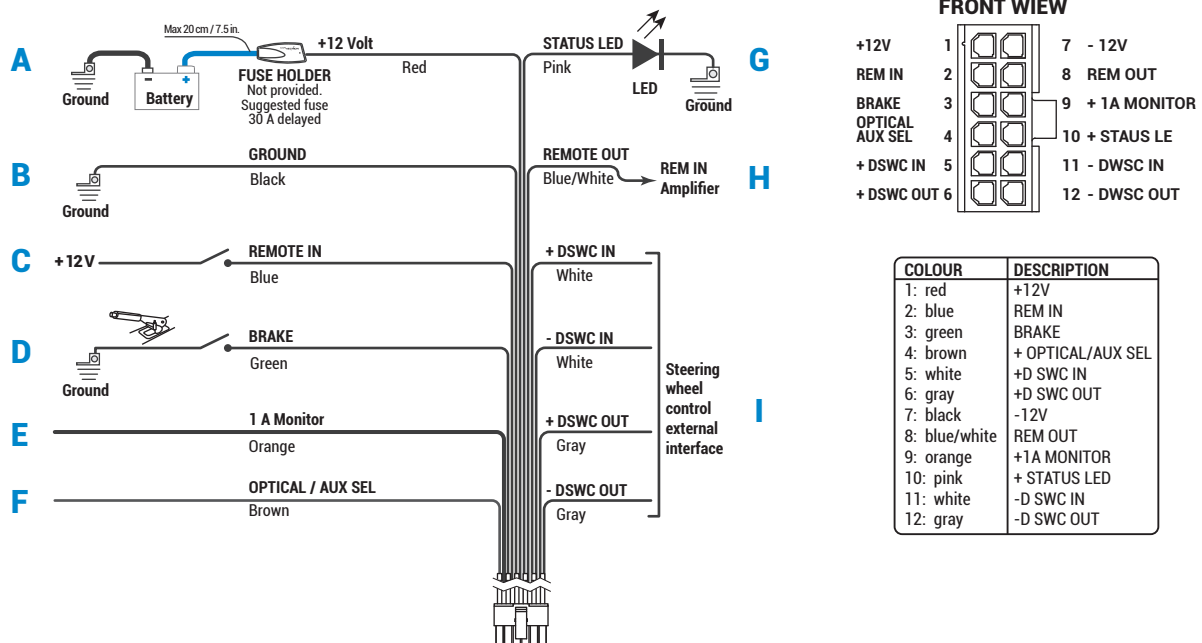

- A +12 VOLT - RED:** 12V positive connection terminal from the car power supply.
- B -12 VOLT GROUND - BLACK:** Negative power connection terminal (GND).
- C REMOTE IN - BLUE:** Remote start input for via the Remote Out output of the audio signal source.
- D BRAKE - GREEN:** This terminal prevents viewing video contents while driving. Connect this terminal to the parking brake on the power supply side, and the "1A MONITOR" terminal to the power or consent terminal to enable the monitor used.
- E 1A MONITOR - ORANGE:** Consent terminal to enable the external monitor. This terminal reaches +12V when the vehicle parking brake is engaged. The 1A MONITOR terminal can be connected to the power consent terminal of the external monitor or directly to the power supply (MAX. 1 A).

- F OPTICAL/AUX SEL BROWN:** This terminal can be used for AUX and OPTICAL IN on the products with OPTICAL/SEL AUX SEL activation input.
- G STATUS LED PINK:** Connect a LED (*not supplied*) as shown in the figure (*optional*). This LED duplicates the one in the infrared receiver sensor (*see section 2*). If the LED flashes, the product is processing information and is not ready, while if it starts normally the bit Play HD is ready for use.
- H REMOTE OUT - BLUE/WHITE:** Output to remotely control other devices/amplifiers connected to the bit Play HD. After turning on, the device takes 2 seconds to output the REM OUT signal. This output has a current capacity of 130 mA, and can drive an automotive relay (*verify it will not exceed 130 mA*).
- I STEERING WHEEL CONTROL:** Terminals used for future use.

- 2 IR REM CONTROL:** Connector for the infrared receiver of the bit Play HD remote control. Point the remote at the sensor from within 2 meters. Use only the remotes supplied in the package (*see sections 3.1 and 3.2*). The sensor incorporates a green status LED. If the LED flashes, the product is processing information and is not ready. If it starts normally, the bit Play HD is ready for use.

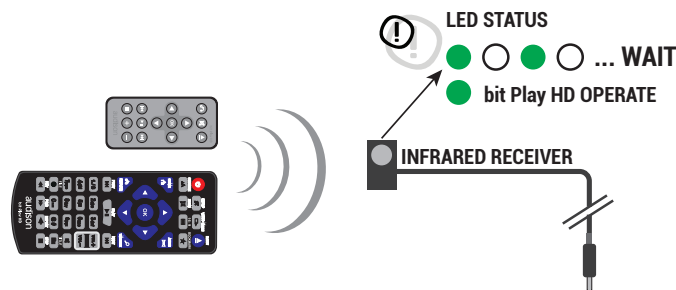

- 3 FUSE:** Blade 3A protection fuse. If you need to replace the fuse, use only the same type and value of the original.

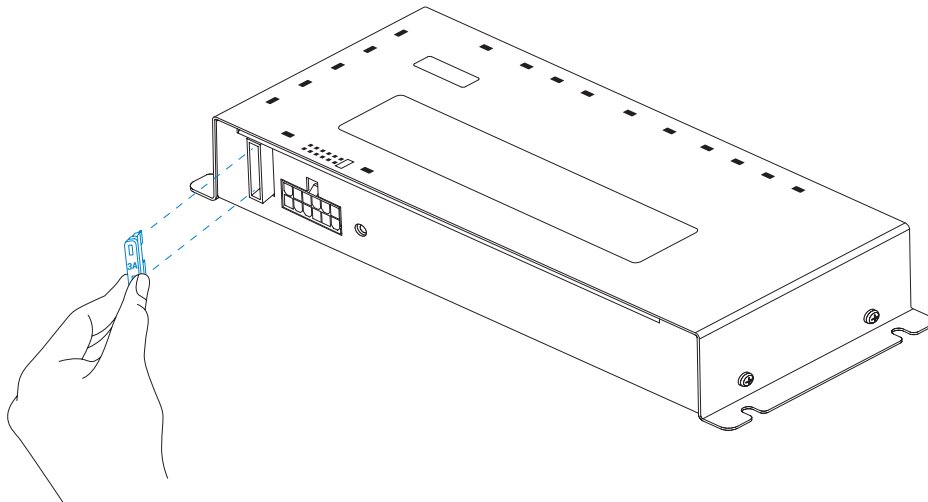

- 4 OPTICAL:** Connect a fibre optic cable with a TOSLINK connector to a processor or Audison amplifier with S/PDIF optical input. This way, you create a Full DA system capable of achieving a new quality benchmark that goes well beyond the CD standard, since you can play FLAC encoded audio files up to 24 bit/96 kHz. This output is subject to volume control via the remote or ANDROID APP for mobile devices (*see section 6.3.4*).
- 5 VIDEO:** Composite video output for an external monitor, 75-Ohm impedance. Connect a RCA male cable with 75-Ohm impedance to an external monitor. The external display is enabled by connecting the consent terminal (active at +12V) to the power supply of the monitor (Max. Consumption 1A) or to the appropriate monitor terminal. Default resolution set to 480P; to set the video resolution *see section 7.2*.

- 6 AUDIO L-R:** Stereo output. Analog connection for a processor or amplifier. The output volume is controlled via the remote ([see sections 3.1 and 3.2](#)) or Android App for mobile devices
- 7 HDMI:** HDMI video output for high definition external monitors. External display is enabled by connecting the consent terminal (active at +12V) to the power supply of the monitor (Max. Consumption 1A) or to the appropriate monitor terminal. To set the video resolution [see section 7.2](#)
- 8 LAN:** plug not enabled, used for future applications.
- 9 WI FI USB:** USB plug to connect the WI-FI DONGLE and interface with external mobile devices ([see section 6.2](#)).
- 10 PEN DRIVE MEDIA UPGRADE:** Button to enable bit Play HD firmware updates ([see section 8.1](#)).
- 11 HARD DRIVE USB 2.0:** USB plugs to connect an external data storage device (Hard Disk, Pen Drive, DVD ROM ...). Compatible storage device formats: FAT 32, NTFS, HFS+, EXT 3.

WARNING: Audison assumes no responsibility for the loss of data from USB storage devices connected to the bit Play HD.



- To prevent malfunction or damage, please observe the following:
- Do not disconnect USB devices while copying or executing a file.
 - Carefully read the manual of the USB mass storage device used.
 - Do not touch the USB terminals with your hands or metal objects.
 - Do not strike the USB mass storage device.
 - Do not modify or disassemble the USB mass storage device.
 - Use only certified USB mass storage devices.

Avoid using and storing USB mass memories in the following places:

- In a car exposed to direct sunlight or high temperatures.
- In damp areas or near corrosive substances.

- 12 AUDISON AC-LINK:** Connection plug to control the volume of Audison processors with an AC LINK connection. By connecting the AC LINK cable and the DRC to the bit Play HD, it is possible to build a system with High Definition volume control ([see section 4.2.3](#)).
- 13 OEM INTERFACE:** Plug not enabled, used for future applications.
- 14 DRC:** Connection to remotely control the DRC volume (OPTIONAL) of the bit Play HD ([see section 12](#)).
- 15 SYSTEM UPGRADE:** Button to enable bit Play HD firmware updates ([see section 8.2](#)).
- 16 LOGO:** The bit Play HD incorporates an internal control that manages the state of the product;

The BLUE logo indicates:

The bit Play HD is on.

The flashing RED logo indicates:

The "UPGRADE MODE" switch is "ON"; the product is ready for firmware updates.

The flashing BLUE logo indicates:

The "UPGRADE MODE" switch is "ON"; the product is updating.

3 REMOTE DESCRIPTION

3.1 ARC (Advance Remote Control) REMOTE

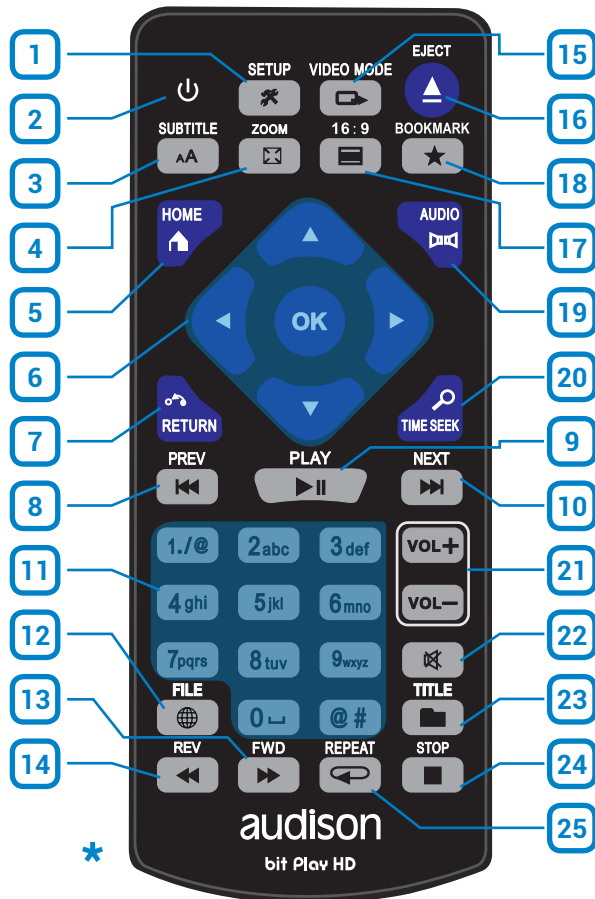

1. SETUP: Open the Settings Menu.	13. FWD: Fast-forward Audio/Video tracks.
2. POWER: bit Play HD power on/off.	14. REV: Rewind Audio/Video tracks.
3. SUBTITLE: Select Video subtitle language.	15. VIDEO MODE: Change the video resolution.
4. ZOOM: Zoom in Video mode.	16. EJECT: Extract DVD from the external player if installed.
5. HOME: Go to the main menu.	17. 16:9: Select 16:9 video format.
6. CURSOR: Navigate the bit Play HD internal menus.	18. BOOKMARK: Bookmark function.
7. RETURN: Return to the previous menu.	19. AUDIO: Select Video audio language.
8. PREV: Select previous Audio/Video tracks.	20. TIME SEEK: Seek rendering time.
9. PLAY/PAUSE: Audio/Video track Play/Pause.	21. VOLUME: VOL+ -> increase volume. VOL- -> decrease volume.
10. NEXT: Select next Audio/Video track.	22. MUTE: Audio muting.
11. TASTIERA ALFA NUMERICA: Alpha numeric interface keyboard.	23. TITLE: Show the title of the current file.
12. FILE: Transfer file key.	24. STOP: Stop Audio/Video tracks.
	25. REPEAT: Repeat Audio/Video tracks.

***WARNING:** Batteries not included in the package.



NOTES ON USING THE REMOTE.

1. Point the remote at the bit Play HD control infrared sensor which can receive input at 30° in all directions.
2. Remove the batteries if you will not be using the remote for more than a month.
3. Do not store the remote in a place subject to direct sunlight or near heat sources.
4. The remote batteries last 6 months under normal use. If the remote does not work, replace the batteries.
5. Use only AAA 1.5 V batteries.
6. Do not recharge, disassemble, heat or expose the batteries to heat.
7. Insert the batteries in the remote with the correct polarity (+) and (-).
8. Keep the batteries and the remote control out of the reach of children.

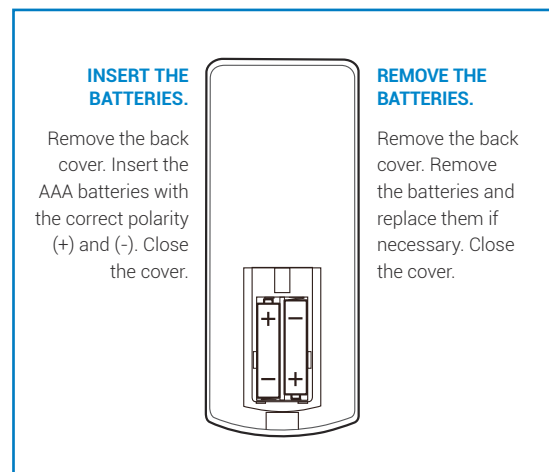

3.2 USR (User Remote Control) REMOTE

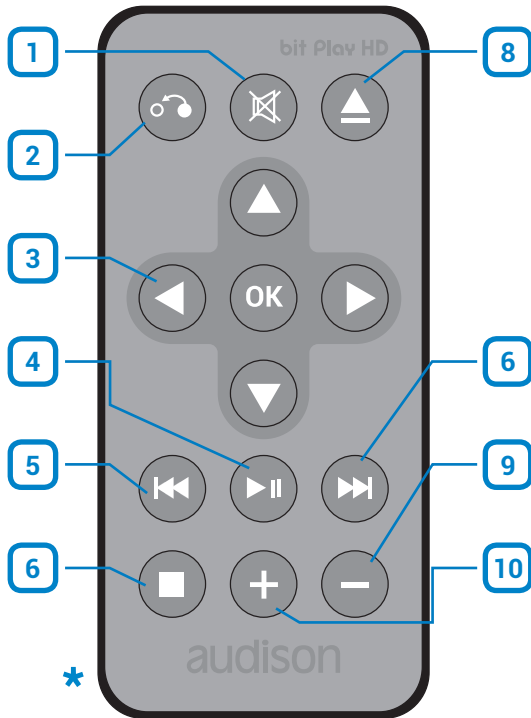

1. MUTE: Audio muting.
2. RETURN: Return to the previous menu.
3. CURSORI: Cursors to navigate the menu.
4. PLAY/PAUSE: Audio/Video track Play/Pause.
5. PREV: Select previous track.
6. NEXT: Select next track.
7. STOP: Stop Audio/Video tracks.
8. EJECT: Extract DVD from the external player if installed.
9. VOLUME -: Decrease audio volume.
10. VOLUME +: Increase audio volume.

***WARNING:** Batteries not included in the package.



NOTES ON USING THE REMOTE.

1. Point the remote at the bit Play HD control infrared sensor which can receive input at 30° in all directions.
2. Remove the battery if you will not be using the remote for more than a month.
3. Do not store the remote in a place subject to direct sunlight or near heat sources.
4. The remote battery last 6 months under normal use. If the remote does not work, replace the battery.
5. Use only coin CR 2025 3 V batteries.
6. Do not recharge, disassemble, heat or expose the battery to heat.
7. Insert the battery in the remote with the correct polarity (+) and (-).
8. Keep the battery and the remote control out of the reach of children.

INSERT THE BATTERY.

Slide the back cover downwards. Insert the CR2025 3 V battery with the correct polarity (+) and (-). Close the cover

REMOVE THE BATTERY.

Slide the back cover downwards. Remove the battery and replace it if necessary. Close the cover.

4. CONNECTIONS

4.1 POWER SUPPLY AND REMOTE CONTROL

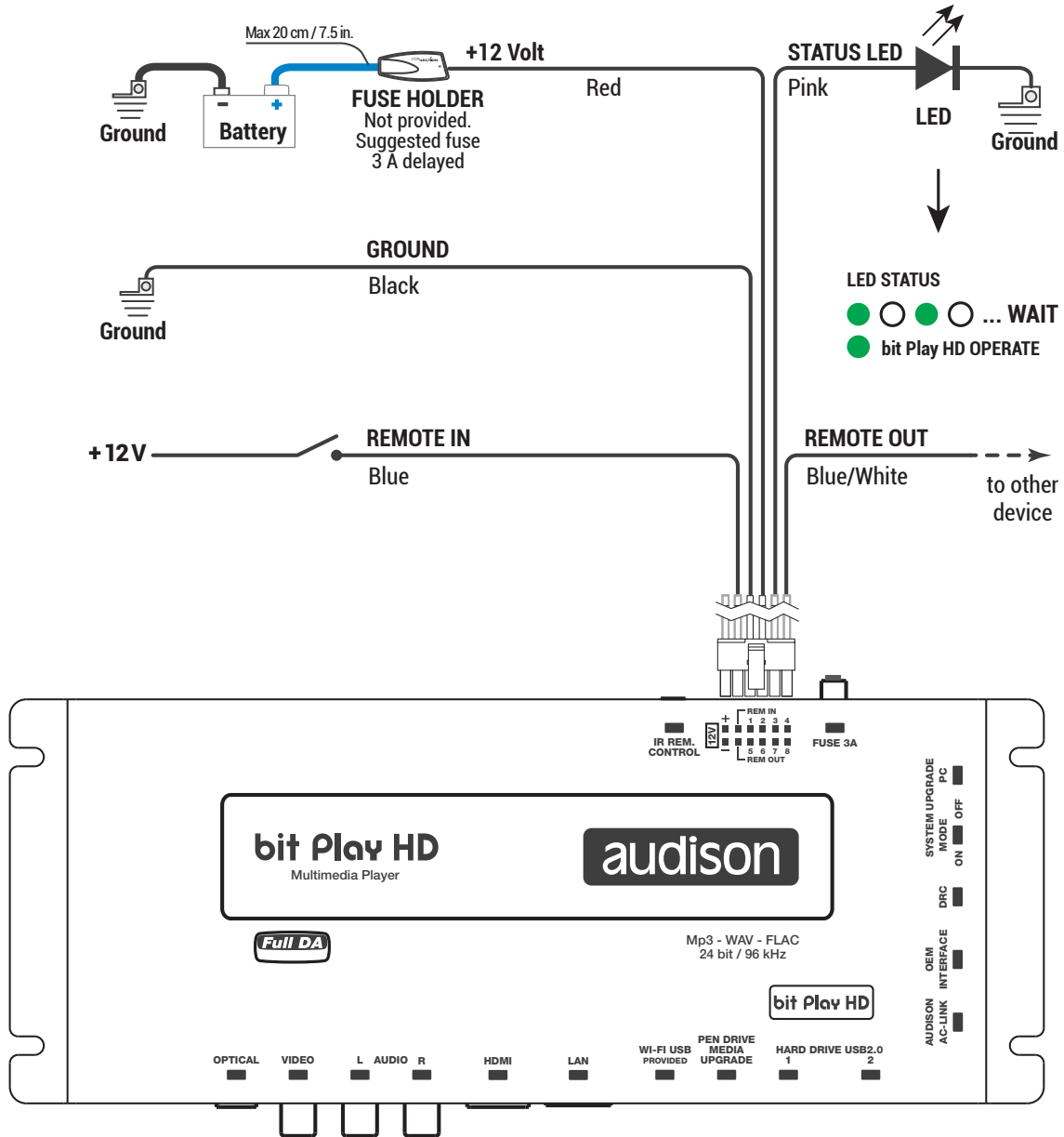

TURN THE bit Play HD ON AND OFF

The bit Play HD is on when the upper logo turns blue. You can turn it on/off by connect the Remote In terminal to an external source or the car subkey terminal.

4.2 AUDIO OUTPUT SIGNALS

4.2.1 ANALOG OUTPUT SIGNALS

ANALOG OUTPUT TO bit One AUX INPUTS

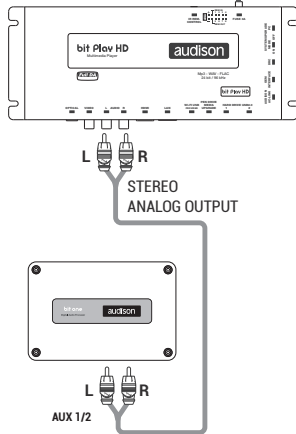

ANALOG OUTPUT TO bit Ten AUX INPUTS

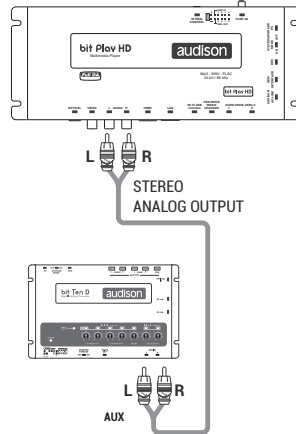

ANALOG OUTPUT TO PRE-AMPLIFIER INPUTS

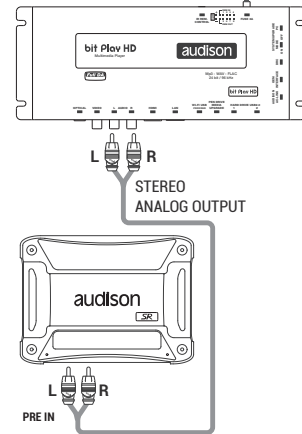

4.2.2 S/PDIF DIGITAL OUTPUT SIGNALS

OPTICAL OUT: bit One OPTICAL INPUT, MAX 48kHz / 24 bit

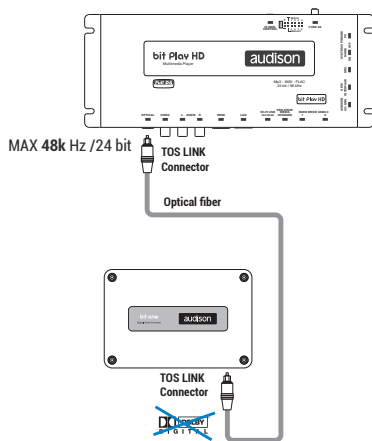

OPTICAL OUT: bit One + SFC OPTICAL INPUT, MAX 96kHz / 24 bit

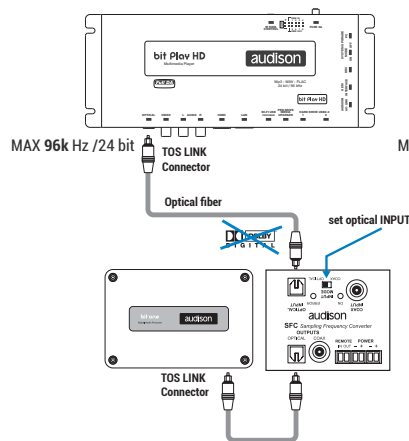

OPTICAL OUT: bit Ten D OPTICAL INPUT, MAX 96kHz / 24 bit

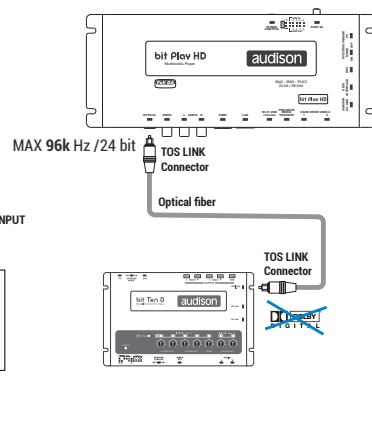

OPTICAL OUT: AP bit Prima OPTICAL INPUT, MAX 96kHz / 24 bit

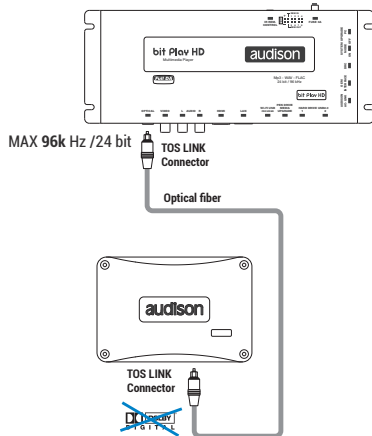

OPTICAL OUT: TH AMPLIFIERS OPTICAL INPUT, MAX 96kHz / 24 bit

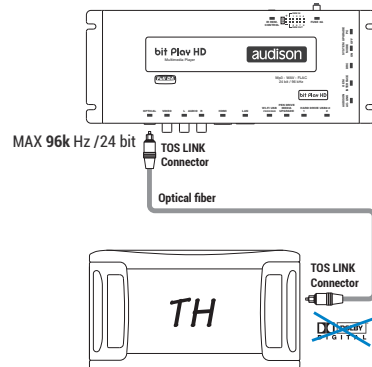

4.2.3 S/PDIF DIGITAL OUTPUT SIGNALS WITH HI-DEFINITION VOLUME CONTROL

OPTICAL OUT: bit One OPTICAL INPUT, MAX 48kHz / 24 bit

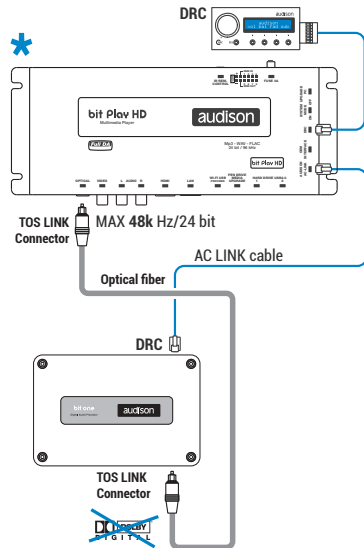

OPTICAL OUT: bit One +SFC OPTICAL INPUT, MAX 96kHz / 24 bit

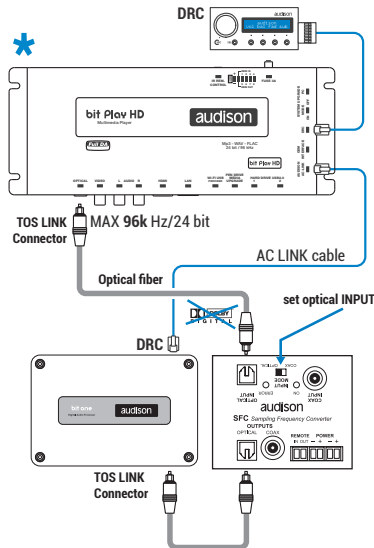

OPTICAL OUT: bit Ten D OPTICAL INPUT, MAX 96kHz / 24 bit

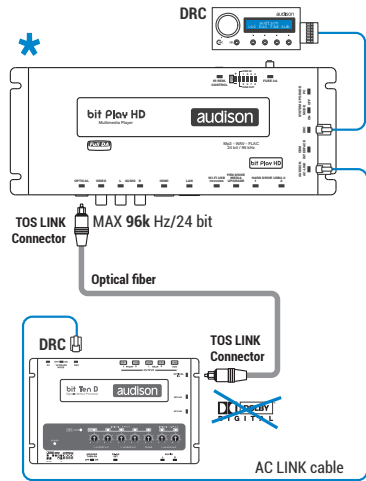

OPTICAL OUT: AP bit Prima OPTICAL INPUT, MAX 96kHz / 24 bit

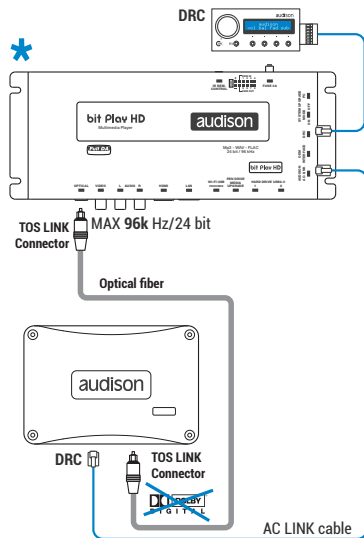

OPTICAL OUT: TH AMPLIFIERS OPTICAL INPUT, MAX 96kHz / 24 bit

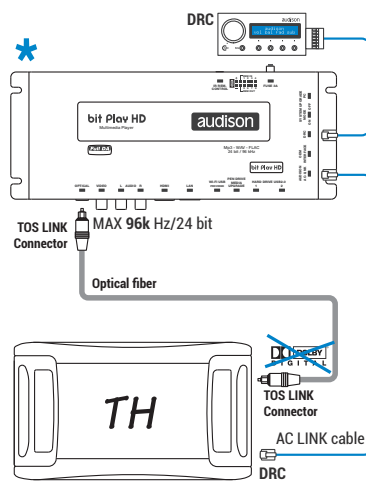

* Set to MAX the bit play HD Volume

4.3 VIDEO OUTPUT SIGNALS

4.3.1 COMPOSITE VIDEO SIGNAL

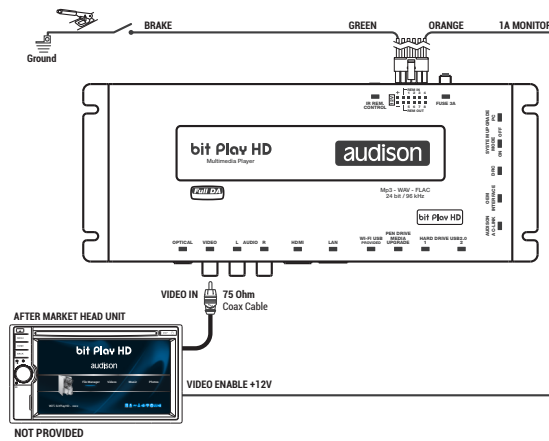
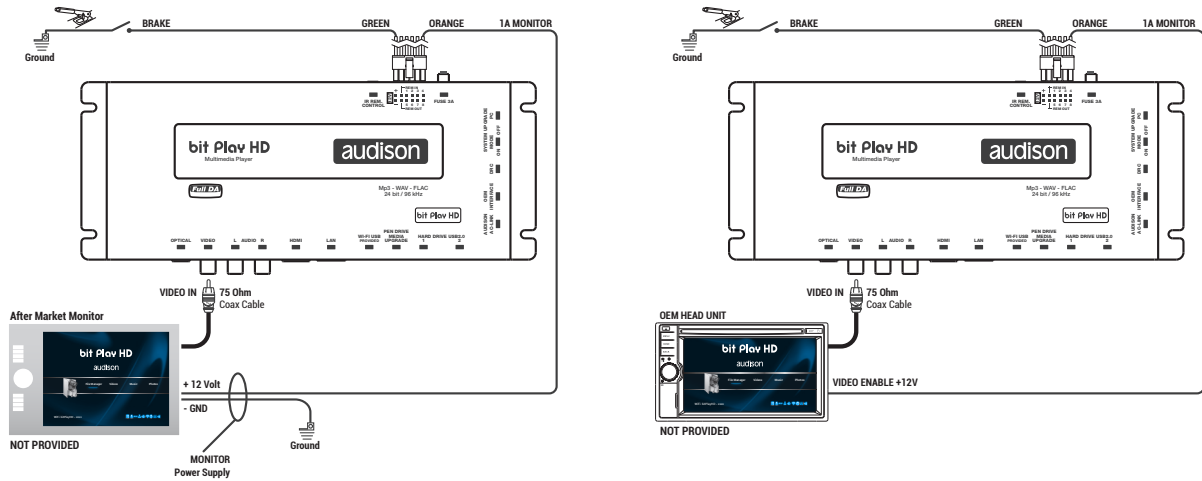

4.3.2 HDMI VIDEO SIGNAL

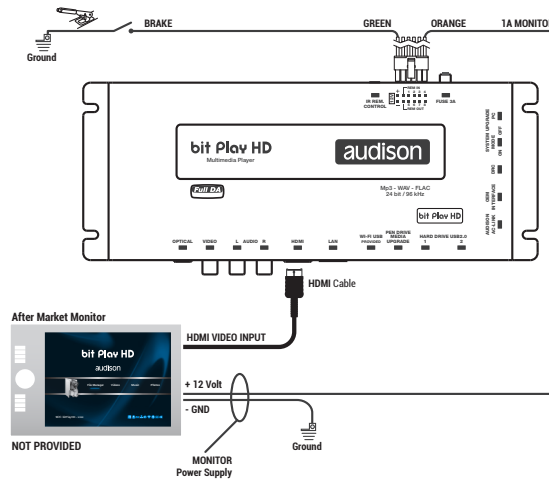

4.4 AUX/OPTICAL INPUT AUTO SWITCH

AUX SELECT with bit Ten D

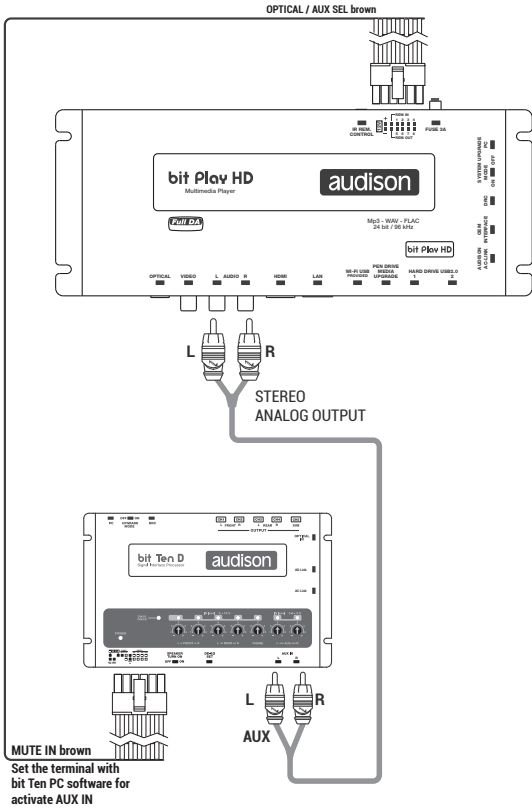

AUX SELECT with AP bit

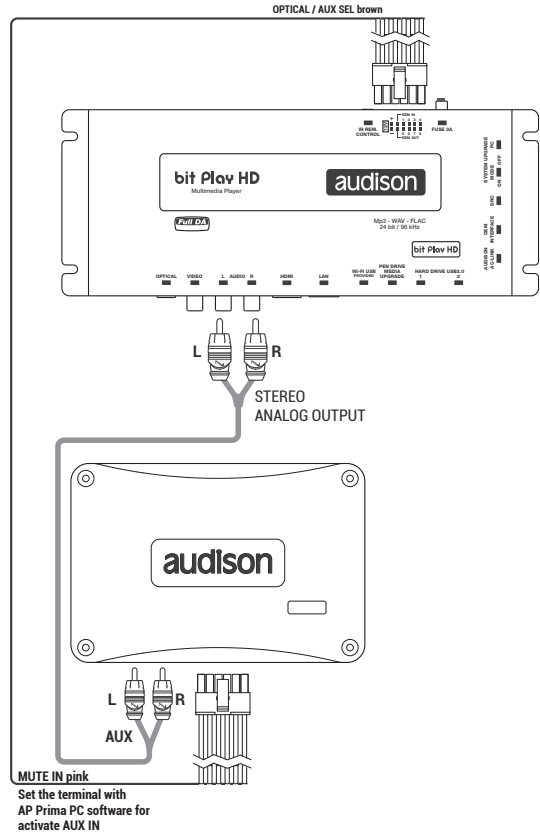

OPTICAL SELECT with bit Ten d

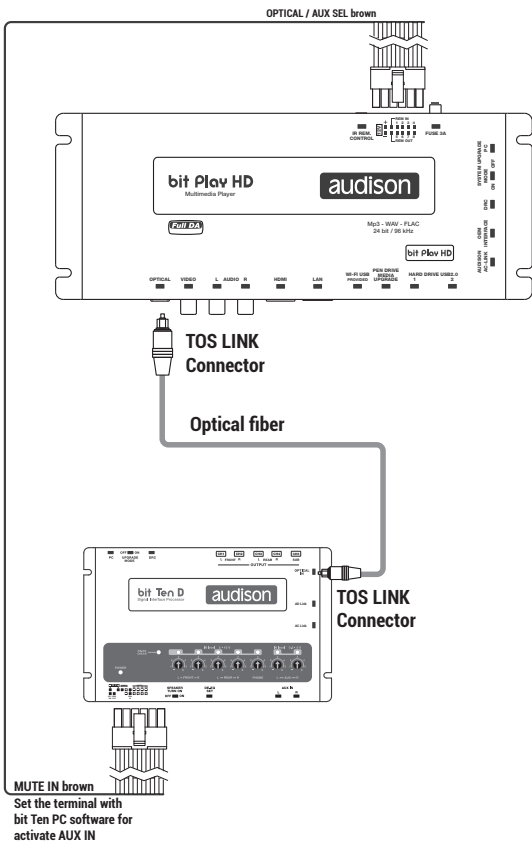

OPTICAL SELECT with AP bit

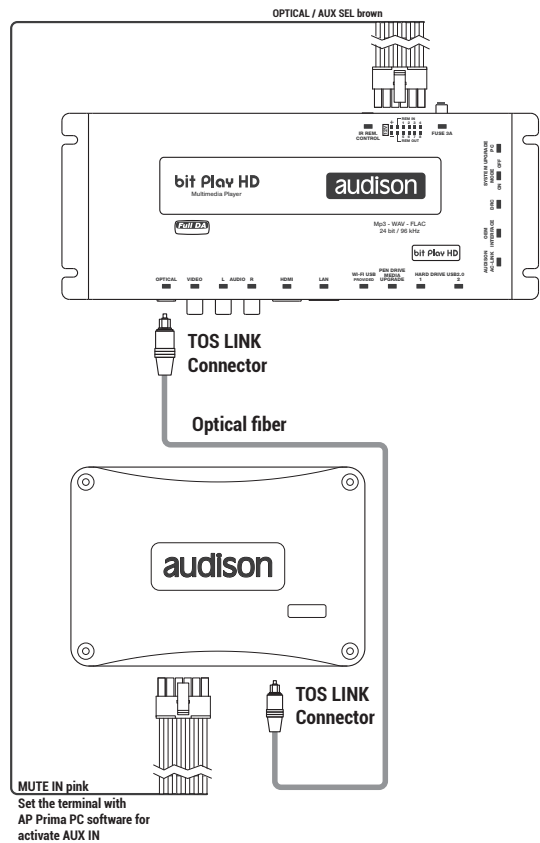

4.5 STORAGE DEVICES/EXTERNAL FILE READING

External USB PEN DRIVE

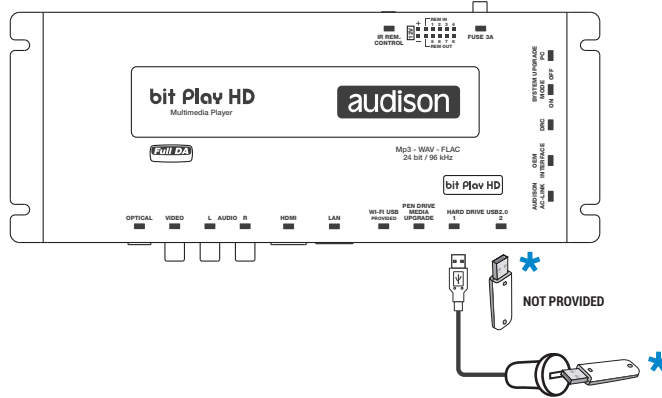

External HARD DISK

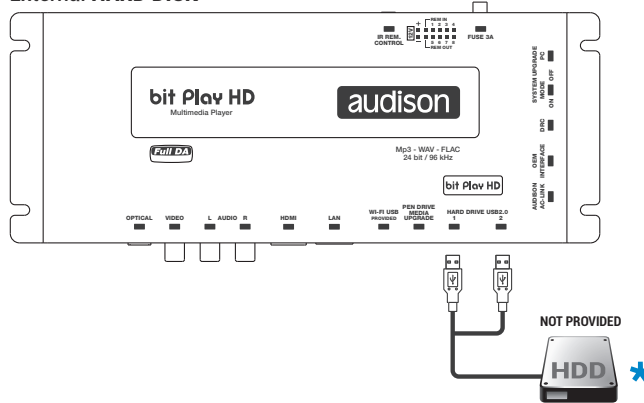

External DVD ROM

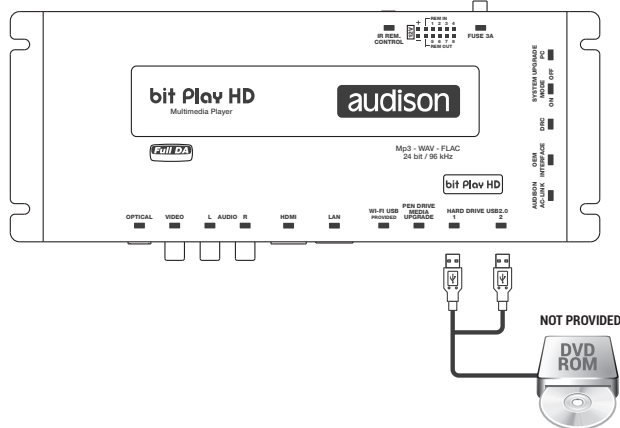

External SD CARD READER

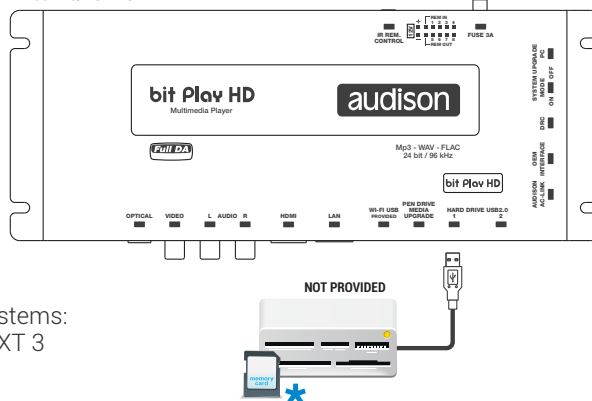

* **WARNING:** Compatible File Systems: FAT32; NTFS; HFS+; EXT 3



4.6 INFRARED RECEIVER

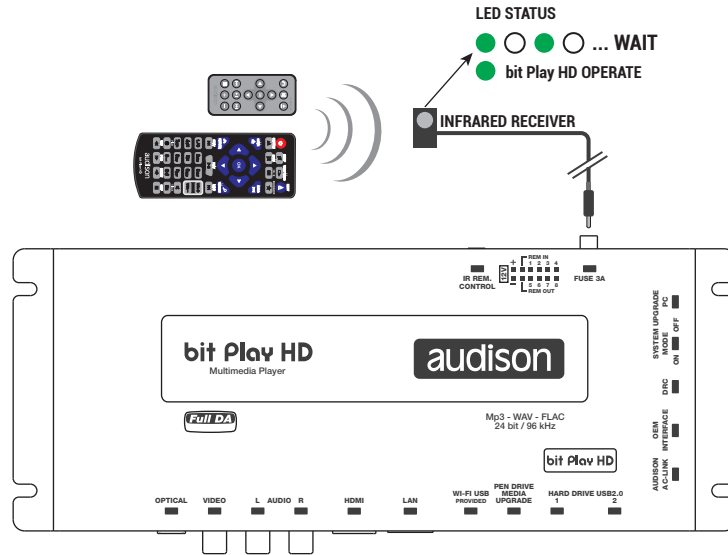

4.7 WI-FI AND MOBILE DEVICES

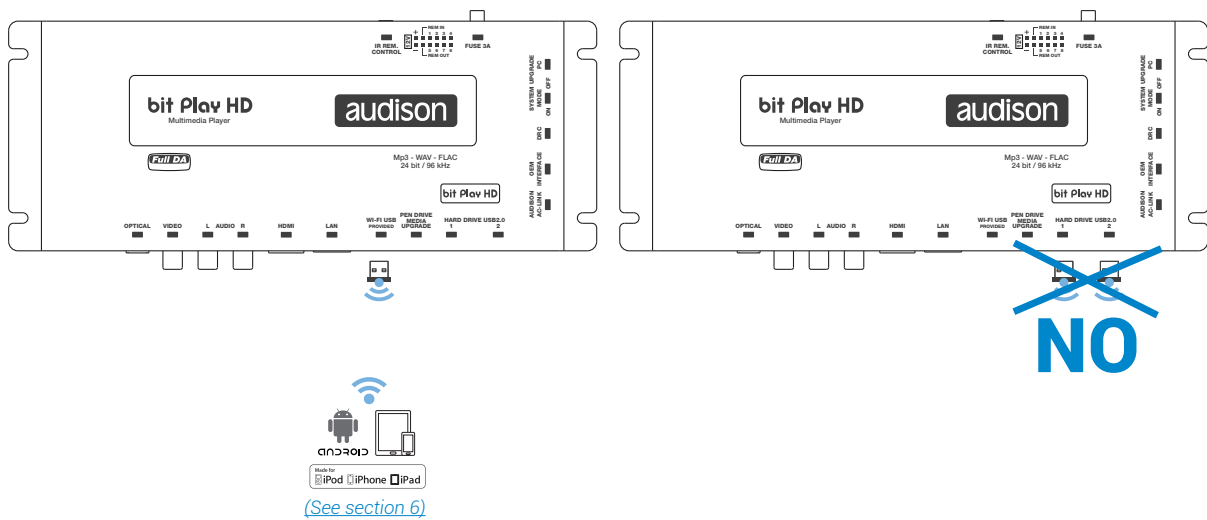

5. HOW TO USE THE BIT PLAY HD WITH AN EXTERNAL MONITOR



1 DEVICE INFO: This window indicates whether the WI-FI interface is working properly and is initialized. This window also shows the device firmware version (FW Media).

- 2** This window shows the active peripherals connected to the device
- A.** When this logo is on, an internal HDD is present.
 - B.** When this logo is on, USB storage devices are connected to the bit Play HD.
 - C.** When this logo is on, the external **WI-FI USB** is turned on.
 - D.** When this logo is on, the **HDMI** port is connected to an external monitor.
 - E.** When this logo is on, audio output is active.



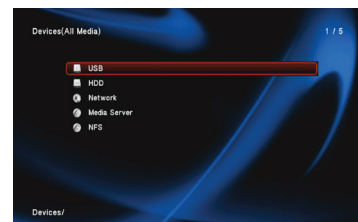

3 FILE MANAGER: The File Manager menu allows you to navigate the storage directory of the device and open, copy, delete, move, or rename multimedia files.

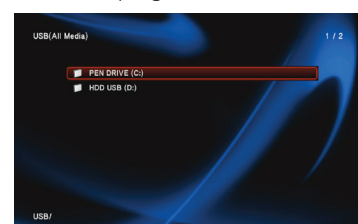

How to copy your multimedia files in the bit Play HD.

- A.** Transfer the multimedia (audio/video/photo) files to a USB storage device.
- B.** Connect the bit Play HD to the USB storage device using the HARD DRIVE USB 2.0 plugs.
- C.** Select "File Manager" from the main menu of the bit Play HD then select the USB device containing the multimedia data to transfer.



D. Press the  button on the ASR remote control and select **"COPY"** to copy individual files or folders, or **"MULTIPLE SELECT"** to select multiple files or folders.

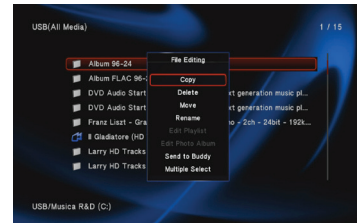

E. Select the destination folder for the files to be copied on the Hard Disk Drive (HDD) and press the PLAY key on the USR remote.

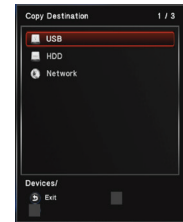

F. Wait until the selected files are copied to the destination folder, and then press OK.



To perform other operations such as deleting, moving and renaming files, select the desired entry from section D.

WARNING: Do not turn off or disconnect the device while transferring files in order to avoid possibly damaging them and making them inaccessible.

4 FILM: By clicking on the **Film** menu you can navigate the device storage directory only displaying video files. It is possible to open, copy, delete, move or rename them [\(see point 3\)](#).

5 MUSICA: By clicking on the **Music** menu you can navigate the device storage directory only displaying music files. It is possible to open, copy, delete, move or rename them [\(see point 3\)](#).

6 PHOTO: By clicking on the **Photo** menu you can navigate the device storage directory only displaying photo files. It is possible to open, copy, delete, move or rename them [\(see point 3\)](#).

7 SETTINGS: By clicking on the **Settings** menu, you can select the bit Play HD system settings. The navigation buttons on the remote allow you to navigate the submenus: Audio; Video; Network; Advanced; System. In the default configuration, system settings are optimized for an ideal installation of the product, but you can customize settings according to your needs.

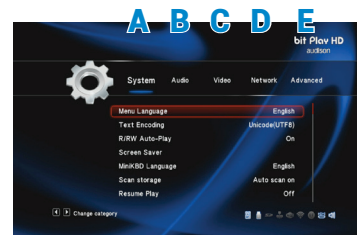

6. HOW TO USE THE BIT PLAY HD ON MOBILE DEVICES

The **Audison bit Play HD** App is an application providing the ability to control the **Audison bit Play HD multimedia player** through the WI-FI network of your smartphone or tablet.

Once you install the **bit Play HD** player in your car, this App will let you listen to the music stored in your smartphone or tablet directly through your car audio system. You can also control the bit Play HD player to listen to music stored inside on its internal SSD or USB mass storage devices connected to the USB plugs.

Through the **Audison bit Play HD** App as well as the Apps using the DLNA protocol you can select and start playing a music track, adjust volume and manage playback controls. Only with the **Audison bit Play HD** App you can transfer files between the USB mass storage devices or within the internal SSD.

Compatibility: The App has been tested with:

- Android: version 2.2 or higher
- Smartphones: Samsung Galaxy S4, S3, S3/S4 mini, Note 1/2, Nexus; Huawei Y330, Y530
- Tablets: Samsung Galaxy Tab 3 10.1; Galaxy Tab 3 7.0

Note: The bit Play HD player, with some limitations, is compatible with Apps using the DLNA protocol ([see sez 8.3](#)).



Only the Audison bit Play HD App provides the ability to transfer files between the USB mass storage devices or the internal SSD.

6.1 DOWNLOAD THE AUDISON BIT PLAY HD APP

The App is available for download as freeware, however if you turn on a mobile data connection, costs might be charged by the mobile network operator. The App supports all Android cell phones and tablets provided that an Android 4.2 or higher operating system is installed. A list of compatible devices is available in the Play Store. To install the App, proceed as follows:

- 1 Launch the Play Store App .
2. Search for the **Audison bit Play HD** App.
3. Select **Install** to download and install the App

Otherwise, if the **Play Store App** is not available for your device, go to the Google Play website with your device, search for the **Audison bit Play HD** App and download the App from there.

6.2 DEVICE SETUP

How to connect your Android mobile device to the **bit Play HD**.

1. Before turning the bit Play HD on, check and make sure that the WI-FI USB dongle is inserted into the device "WI-FI USB" plug ([see section 4.7.5.1](#)).
2. Connect the power and turn the bit Play HD on; check and make sure that, once started, a WI-FI connection is available ([see section 5.1](#)). If not, restart the device and check if the WI-FI USB dongle is correctly inserted.
3. From the Home window of your Android device, select **Menu-> Settings-> Wireless and networks**.
4. Select **WI-FI Settings -> WI-FI** to enable the wireless antenna. Wait until your device automatically detects the available **WI-FI** networks and select the bit Play HD XXX network ([see section 5.1](#)).
5. The Android mobile device is now correctly set up and ready for use.

6.3 AUDISON APP FOR ANDROID

From the **Home** screen of your mobile device select the previously installed **"Audison bit HD Play"** application.



Navigation within the App can be made by:

- The App main function keys.
- The  system key of the Android device, allowing you to navigate system folders or exit the App.
- Swiping left or right to switch from one window to the other.



Description of the control panel.

1. Connection status:

- **Green LED:** connection was successful.
- **Red LED:** connection is not available. Check that the bit Play is turned on and properly connected to the mobile device ([see section 6.2](#)).



2. PHONE menu

This "File Manager" allows you to browse the storage directory of the mobile device and select the files to play.

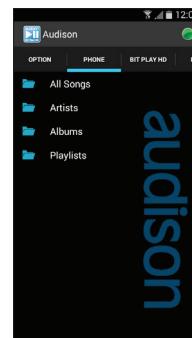

3. bit Play HD menu

This "File Manager" allows you to browse the storage directory of the bit Play HD and select the files to play.

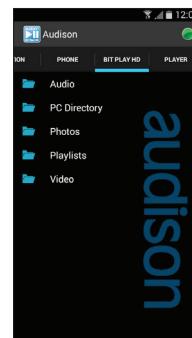

4. PLAYER menu

This window allows you to access not only the information about the track playing but also other playback functions:

- A.** Information about the playing track.
- B.** Cover of the song or folder for the selected track.
- C.** Management of the output volume of the bit Play HD.
- D.** Press to select the previous track, or return to the beginning of the song.
- E.** Press to start the song.
- F.** Press to pause the song.
- G.** Press to stop the song.
- H.** Press to select the next track.

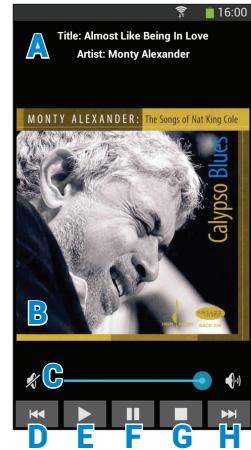

5. Menù OPTIONS

This "File Manager" allows you to navigate the memory devices of the bit Play HD and connected devices.

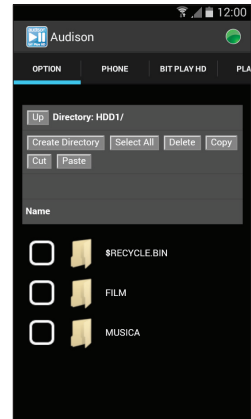

How to copy multimedia files on the bit Play HD.

- A.** Transfer the multimedia (audio/video/photo) files to a USB storage device.
- B.** Connect the bit Play HD to the USB storage device using the HARD DRIVE USB 2.0 plugs.
- C.** From the OPTIONS menu of the App, select the USB storage device where the files to be transferred are stored

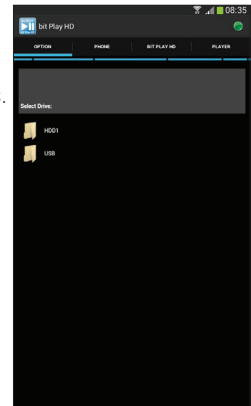

- D.** Select the files or folders you mean to copy onto the internal bit Play HD HDD. Then select **"COPY"**. Wait a few seconds.

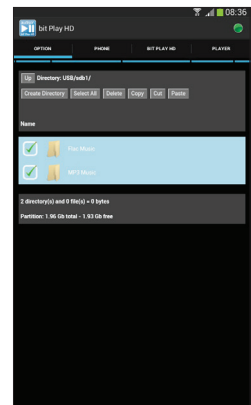

- E. Select the HDD destination directory for the files/folders previously selected and then select **"PASTE"**.

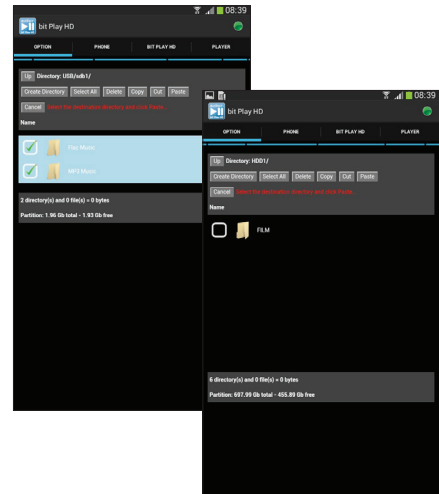

- F. Select **"OK"** if you want to keep copying the files, or **"CANCEL"** if you want to stop the operation.

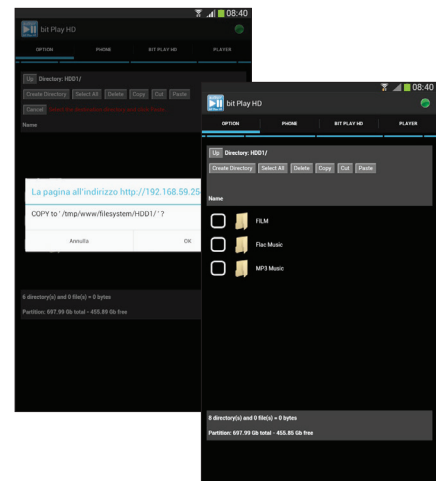

- G. If the operation is successful, the copied files will be displayed in the HDD directory.

WARNING: Do not turn off or disconnect the device while transferring files in order to avoid possibly damaging them and making them inaccessible.



7. MAIN SYSTEM SETTINGS

7.1 INTERNAL HDD INSTALLATION

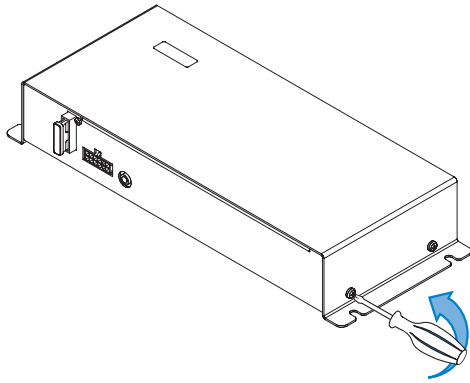

STEP 1

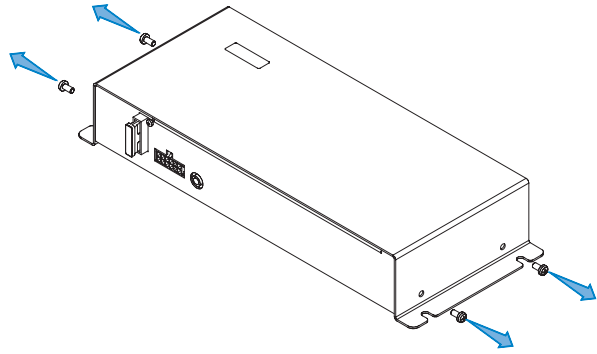

STEP 2

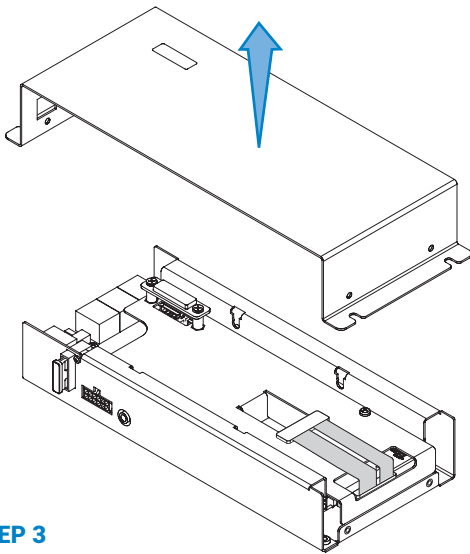

STEP 3

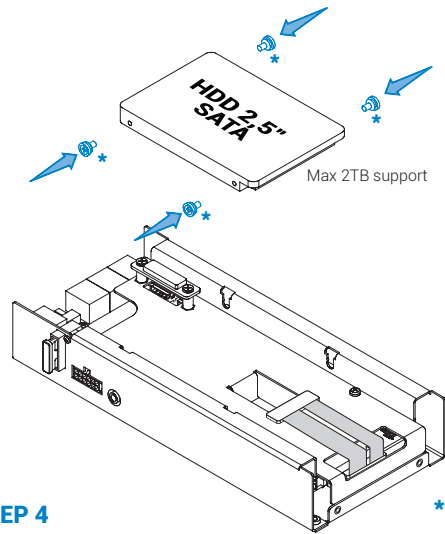

STEP 4

* Included in the package

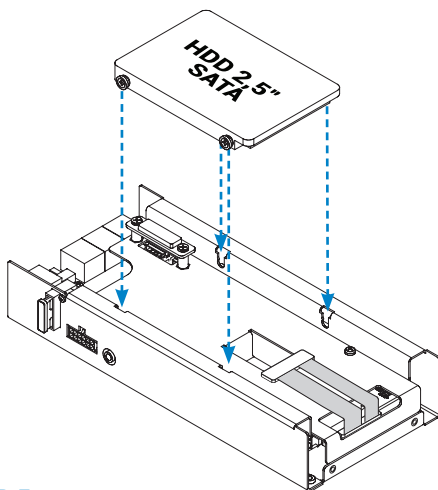

STEP 5

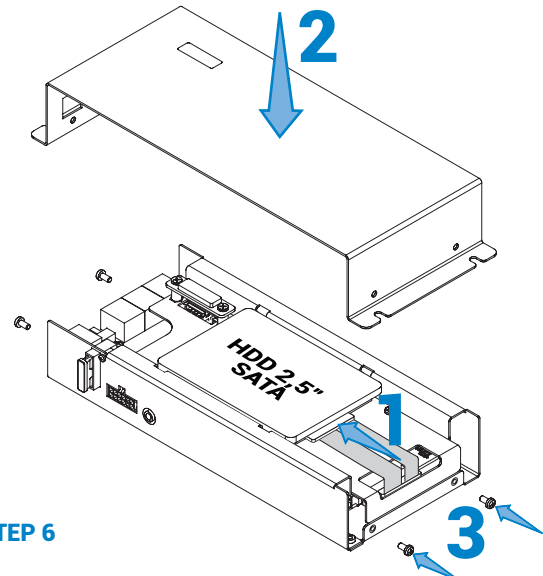

STEP 6

7.1.1 INTERNAL HDD FORMAT

After installing the hard drive in the bit Play HD ([see section 7.1](#)) proceed as follows:

1. Turn on the bit Play HD SSD.
2. Use the remote control to select:

SETUP

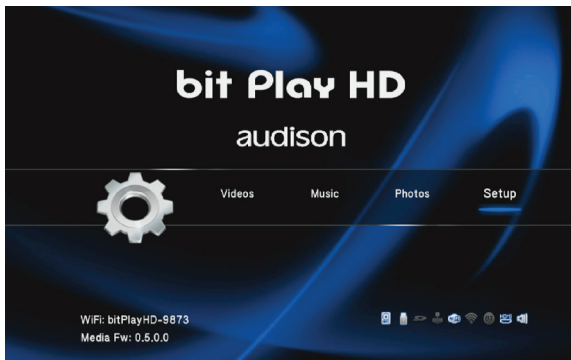

FORMAT

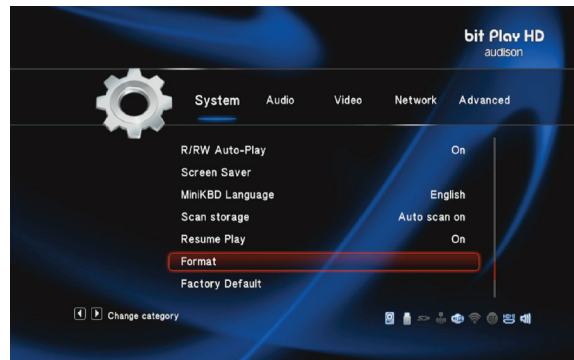

INTERNAL HD

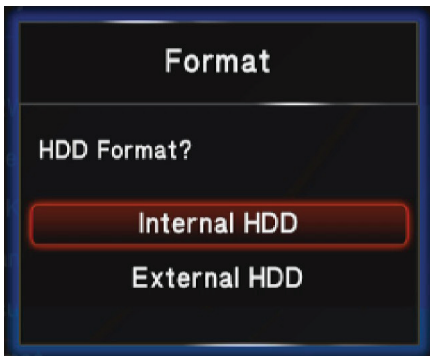

OK

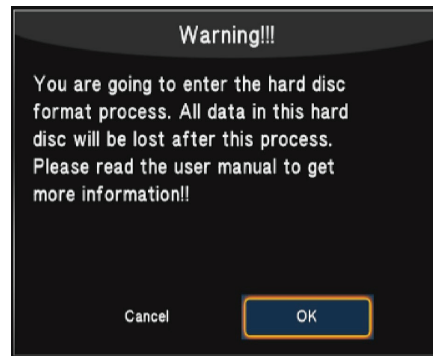

NEXT

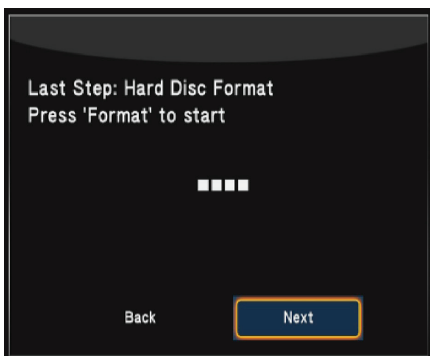

OK

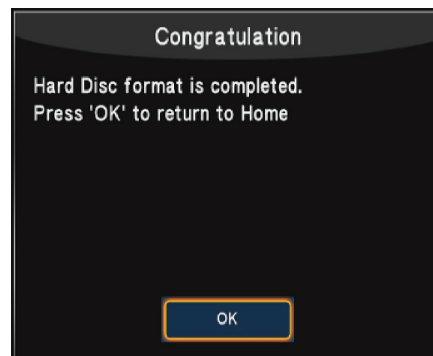

3. Return to the main screen using the RETURN button on the remote control and then turn off the product.

7.2 EXTERNAL MONITOR GRAPHIC RESOLUTION

Procedure by remote control

To change the VIDEO resolution, press the button **VIDEO MODE** on the ARC remote, until a suitable resolution for your monitor is displayed.

It is also possible to select the size of the VIDEO depending on the monitor you are using, via the remote control button 16:9. Press the button **16:9** until you get the best possible picture quality.

Procedure using the Settings Menu.

Use the remote control to select:

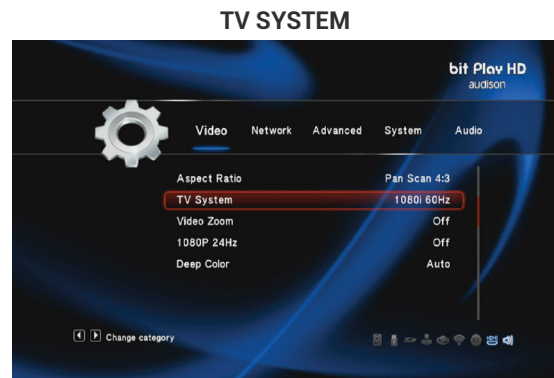
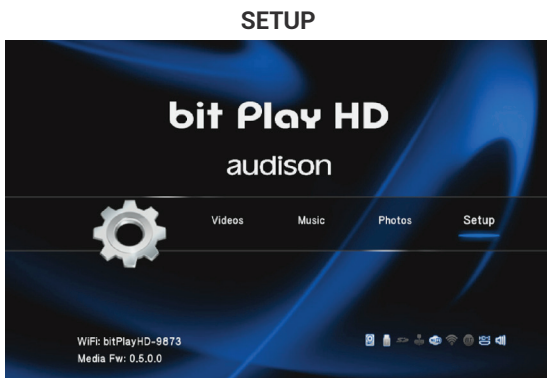

Select the desired resolution

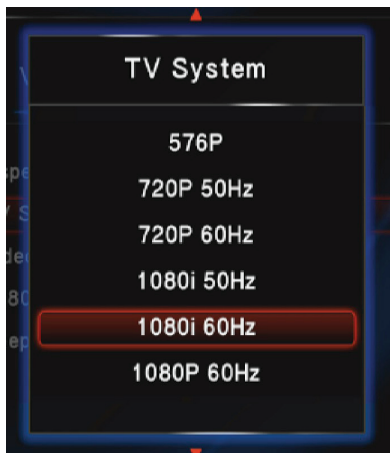

Confirm the selected resolution

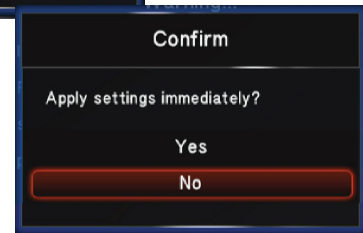

Select Aspect Ratio



Select the desired ratio

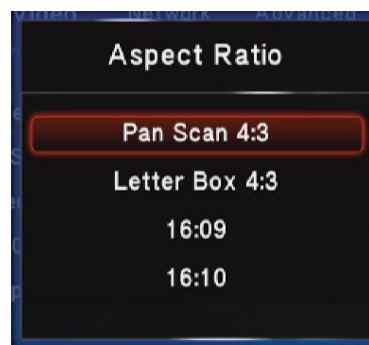

7.3 SELECT SYSTEM LANGUAGE

Use the remote control to select:



7.4 SELECT AUDIO/VIDEO LANGUAGE

Use the remote control to select:



7.5 RESTORING FACTORY SETTINGS

Use the remote control to select:



8. TROUBLESHOOTING

8.1 MEDIA FIRMWARE UPGRADE

All FIRMWARE updates must be performed in strict accordance with the following procedures. The FIRMWARE update must be performed with the utmost care, following the precautions displayed on the monitor, to prevent damage to the product.

1. Turn off the bit Play HD.
2. Go to www.audison.eu/bitplayhd to download the latest firmware version, if available.
3. Download the "install.img" file and copy it to the main directory of a USB flash drive.
4. Connect the USB flash drive to the "WI-FI USB" connector.
5. Press the "PEN DRIVE UPGRADE MEDIA" button releasing it about 30 seconds after turning the bit Play HD on.
6. Release the "PEN DRIVE MEDIA UPGRADE" button when the window shown below is displayed. Wait about 2 minutes for the firmware update.

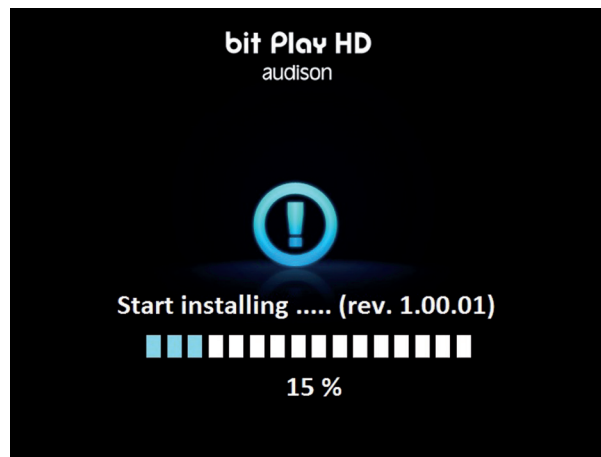

Do not turn off the bit Play HD or disconnect the USB Flash drive while updating.

7. After the upgrade the product will reboot. Wait for the restart, then shut it down and pull out the USB flash drive used to update the device.









8.2 SYSTEM FIRMWARE UPGRADE

All FIRMWARE system updates must be performed in strict accordance with the following procedures. The FIRMWARE update must be performed with the utmost care, following the precautions displayed on the monitor, to prevent damage to the product.

1. Turn off the bit Play HD.
2. Go to www.audison.eu/bitplayhd to download the latest firmware version, if available.
3. Download the "system_firmware_upgrade_ver xxx. exe " file and copy it to the PC Desktop.
4. Set the switch "UPGRADE MODE" to "ON" ([see sez 2.15](#)).
5. Connect the PC to bit Play HD "PC" plug, with USB cable.
6. Power and turn On the bit Play HD
7. Launch the "system_firmware_upgrade_ver xxx. exe" loaded file, and follow the guided update procedure.
8. Once the update is complete, turn Off the product, set the switch "UPGRADE MODE" to "OFF" and remove the USB cable.
9. The Updated product is ready to use.

8.3 FAQ

FREQUENTLY ASKED QUESTIONS	
BIT PLAY INTERNAL MEMORY	
<i>How do I install the solid state drive (SSD) in the bit Play HD?</i>	<p>To install an SSD unit in the bit Play proceed as follows:</p> <ol style="list-style-type: none"> 1. Acquire a 2.5-inch SATA SDD unit; 2. Turn off the power to the bit Play HD; 3. Remove the 4 screws on the lid of the product; 4. Apply the 4 anti-vibration fasteners to the SSD unit (supplied in the box); 5. Fasten the SSD unit inside the bit Play HD, using the anti-vibration fasteners previously attached; 6. Attach the SATA connector inside the bit Play HD to the SSD unit. 7. Put back the bit Play HD lid and screws. 8. Power the bit Play HD and turn it on. 9. Format the SDD from the product menu: SETUP -> SYSTEM -> FORMAT -> INTERNAL HDD 10. Wait until formatting has completed successfully.
<i>Which solid state drives (SSD) are compatible with the bit Play HD?</i>	2.5-inch SATA interface SSDs.
<i>Can I install a 3.5-inch SSD unit?</i>	The SSD HDD to be installed inside the bit Play HD must be 2.5 inches. Bigger HDD cases are not compatible.
<i>Can I install a 2.5-inch SATA HDD hard disk instead of a 2.5-inch SATA SSD?</i>	Both kinds of memory are compatible, but we recommend using solid state memory (SSD) to prevent damage caused by vibration while driving the vehicle.
USB EXTERNAL MEMORY	
<i>What kind of USB ports are on the bit Play?</i>	USB 2.0 plugs are available with type A connectors. Compatibility is also guaranteed for USB 3.0 devices with type A connectors.
<i>How many external USB devices can I connect to the bit Play HD?</i>	The bit Play HD has 2 USB ports. An external USB HUB can increase the number of ports but may occasionally result in errors.
<i>Can I connect an external USB HDD to the bit Play USB plug?</i>	It is possible, but it is not recommended while driving the vehicle to avoid prolonged vibrations that could damage the HDD.
<i>What is the maximum size of the USB device that can be installed in the bit Play HD?</i>	Up to 2 TB.
EXTERNAL OPTICAL DRIVES	
<i>Can the bit Play read FLAC/MP3 formats from a portable DVD-ROM drive connected externally via USB?</i>	Yes, but the DVD must use the ISO file.
<i>Can I install an external DVD-ROM drive and an internal SSD at the same time?</i>	Yes. You can use an external DVD ROM by connecting it to one of the two USB ports on the bit Play HD.
DRC	
<i>Where should the DRC must be connected in a system with an Audison bit processor?</i>	<p>The DRC can be connected to the processor, but if you connect it to the bit Play you lose some automation. In any case, the DRC operates on the signal inside the processor and does not degrade the quality.</p> <p>By adjusting the App or remote volume on the bit Play HD; to obtain the highest quality these controls should always be set high and only operate on the DRC volume.</p>

FILE MANAGER	
<p><i>How do I transfer files within the bit Play HD SSD?</i></p>	<p>You can transfer files or folders:</p> <ul style="list-style-type: none"> • Through the ARC remote, using a monitor as a video interface: <ul style="list-style-type: none"> • Connect the USB device (USB pen drive, USB external HDD, etc.) containing the files/folders you want to copy to the bit Play HD; • From the main menu of the bit Play HD, select the menu "File Manager"; • Select the USB device; • Using the "FILE" button on the ARC remote, you can manage the files/folders (Copy, Delete, Move, Rename, Multi-Select). (see section 5 of the bit Play HD user's manual). • Through the official Audison bit Play HD Android App, without the need to connect an external monitor as a video interface: <ul style="list-style-type: none"> • Connect the USB device (USB pen drive, USB external HDD, etc.) containing the files/folders you want to copy to the bit Play HD; • Select the "Option" menu in the Audison bit Play HD App; • Use the controls for managing files/folders (Copy, Delete, Move, Rename, Multi-Select). (see section 6.1.3 of the bit Play HD user's manual).
APP	
<p><i>Is it possible to use the remote control and the App simultaneously?</i></p>	<p>Not if there is a file running.</p>
<p><i>Il bit Play HD funziona solo con le App ufficiali o è possibile utilizzare una App compatibile?</i></p>	<p>The bit Play HD can work with all Apps that implement the DLNA communication protocol between devices, barring some limitations on the functionality and usability of the product.</p> <p>For Apple systems, we recommend using the following Apps, downloadable from the App Store:</p> <ol style="list-style-type: none"> 1.  Kinsky. Manages only bit Play HD contents. 2.  Sitecom Media Controller. Manages only bit Play HD contents. 3.  iMediaShare. Manages only bit Play HD and IOS device contents. 4.  Unplay. Manages only bit Play HD contents. <p>For Android systems, we recommend using the following Apps, downloadable from the Play Store:</p> <ol style="list-style-type: none"> 1.  Kinsky. Manages only bit Play HD contents. 2.  Bubble UPnP. Manages only bit Play HD and Android device contents. 3.  Unplay. Manages only bit Play HD contents. 4.  iMediaShare. Manages only bit Play HD and Android device contents.

MALFUNCTION

POWER

<i>The bit Play HD does not turn on.</i>	<ol style="list-style-type: none"> 1. Check the charge level of your car battery. If the power is low, it is necessary to recharge the battery. 2. Check the integrity of the 3 Amp fuse in the product side panel. 3. Make sure the "+" (red wire) and "-" (black wire) terminals are connected properly and that there is a 12V nominal voltage when the car is off. 4. Make sure that the "REM IN" terminal (blue wire) is properly connected to a power consent terminal of the audio system.
<i>The bit Play HD logo flashes red.</i>	Verify that the "SYSTEM UPGRADE MODE" switch on the product side panel is in the "OFF" position.

DISPLAY

<i>The monitor connected to the bit Play HD doesn't display anything.</i>	<ul style="list-style-type: none"> • Make sure the monitor is turned on. • Check that the video cable is properly connected. • Set a suitable video resolution for the monitor used.
General issues: <ul style="list-style-type: none"> - The monitor flashes; - The image is blurred; - The image is not scaled to fit the screen; - The image is not displayed on the monitor. 	<ul style="list-style-type: none"> • Check that the video cable is working and is properly connected. • Set a suitable video resolution for the monitor used.

AUDIO

<i>You cannot hear the audio signal.</i>	<ul style="list-style-type: none"> • Verify that the volume of the sound system is set correctly. • If you use the TOSLINK optical connection, the S/SPDIF LPCM setting from the main menu: SETTING -> AUDIO -> SPDIF OUTPUT must be active.
<i>Noise is heard while playing songs using the bit One with TOSLINK input.</i>	<ul style="list-style-type: none"> • Check the integrity of the optical cable and connections; • If you are using the bit Play with bit One, make sure that you are playing files with 48KHz 24-bit resolution MAX. In case you want to play files with higher resolution, place an SRC (SAMPLE RATE CONVERTER) between the bit Play HD and the bit One. <i>(see section 13.1 of the bit One user's manual v.1.5d)</i>

USB DEVICE

<i>The bit Play HD does not recognize any USB storage device.</i>	Verify that the system file of your USB device is NTFS, FAT/ FAT32 or HFS+.
---	---

REMOTE CONTROL

<i>The multimedia player remote control does not work.</i>	<ul style="list-style-type: none"> • Make sure the batteries are properly installed. • The batteries may be depleted. Replace them with new batteries. • Press only one button at a time. • Verify that the line of sight between the remote and the IR receiver is not obstructed. • Make sure that the IR receiver is properly connected to the bit Play HD.
--	---

REPRODUCTION OF CONTENTS	
<i>The file does not play.</i>	<ul style="list-style-type: none"> • Check the list of supported multimedia file formats (refer to section 8). • Use a multimedia program to convert the file to a suitable format.
<i>The selected folder does not contain any supported multimedia files.</i>	<ul style="list-style-type: none"> • Select another folder that contains multimedia files in the correct format. • Disconnect and reconnect the USB device from the bit Play HD. • Connect the USB device to the computer and verify that the stored files are supported and not corrupt.
CONNECTIVITY	
<i>You cannot establish a connection between Apps and the bit Play HD.</i>	<ul style="list-style-type: none"> • Check that the WI-FI USB key (WI-FI Dongle) is inserted correctly. • Using the external monitor (if installed), verify that the bit Play HD has generated the WI-FI network, then verify that "bit Play-HD_xxxx" is displayed on the main screen, on the lower left; • Ensure that the WI-FI setting on your mobile device is enabled and detects the "bit Play-HD_xxxx Play" network; • Verify that the mobile device is connected to the "bit Play-HD_xxxx" WI-FI network; • Shut down and restart the application.
<i>The connection between the bit Play HD and the mobile device is not stable.</i>	<ul style="list-style-type: none"> • Check that the WI-FI USB key (WI-FI Dongle) is placed in an open area of the passenger compartment and as close as possible to the point of use of the mobile device. Avoid installing the bit Play HD and the WI-FI USB key in close proximity to metal surfaces, vehicle control units or possible electromagnetic shields; • Use the USB extension cable (included) or a compatible type A USB extension cable to reposition the WI-FI USB key (WI-FI Dongle).
<i>You cannot access the bit Play HD internal SSD contents through your App.</i>	<ul style="list-style-type: none"> • Verify that the LED status light is not flashing; wait until it stays on. • Close the App and restart the bit Play HD. • Check that the internal SSD unit is correctly installed.
<i>You cannot play the files stored on the mobile device.</i>	<ul style="list-style-type: none"> • Check that the file format is supported by the bit Play HD; • Use an App able to play the content stored on the mobile device.

9 TECHNICAL SPECIFICATIONS

Power Supply		Signal Connection	
Voltage	8.5 ÷ 14 VDC	Digital Video Output	1 x HDMI v1.3 (type A receptacle) Resolution: 480p, 576p, 720p@50Hz/60Hz, 1080i@50Hz/60Hz, 1080p@50Hz/60Hz
Idling current	1.0 A with internal SSD A	Analog Video Output	1 x RCA - Composite video Resolution: 576i (PAL), 480i (NTSC)
Fuse	3 A	Toslink Optical Output	1 x S/P-DIF - PCM 96 kHz/24 bit
Remote IN	7 ÷ 15 VDC (1 mA)	Analog Pre Out	2 x RCA, Left / Right
Remote OUT	12 VDC (130 mA)		
General Features		Data Connection	
User Interface	Dual mode: 1) Advanced control on Video out via Remote control 2) Basic control via iOS/Android App	USB Hard Drive / Pen Drive	2 x USB/A (1.1/2.0), USB extension supplied
Smartphone Control	Dedicated Audison App for Android and iOS smartphone, to allow: 1) Wi-Fi Streaming of smartphone multimedia contents to bit Play HD output (Android only). Alternatively standard DLNA Apps (iOS/Android). 2) Play the bit PlayHD storage multimedia contents. 3) File management of bit Play HD storage contents, with copy, delete and move functions	LAN	1 x 10/100M Ethernet / RJ45 port for future upgrade (Car NAS; 3G/LTE router, etc.)
Media Storage	1) 240GB SSD 2.5" (Included in bit Play HD SSD, internal, up to 2TB support) 2) External USB HDD/Pendrive/DVD drive	SATA	1 x internal mini SATA 2.0 port for 2.5" SSD Drive (Available version with SSD 240GB built-in)
File System - Media Storage	FAT32, NTFS, EXT3, HFS+ (Mac OS X)	Firmware Media Upgrade	USB Pen Drive 1.1/2.0 (not supplied)
Wi-Fi	802.11n - Internal Hotspot with external USB Wi-Fi Dongle (supplied)		
Multimedia Format		Control Connection	
Audio Formats	Hi-Res Uncompressed: WAV, FLAC (Up to 96kHz/24bit) Compressed: OGG, AAC, MPEG Audio (MP1, MP2, MP3, MPA)	Audison AC Link	1 x RJ12 - To Audison AC link provided devices
Video Formats	WMV, DivX, Xvid, MPEG, H264	Audison DRC	1 x RJ12
Subtitle Formats	MicroDVD [.sub], SubRip [.srt], Sub Station Alpha [.ssa], Sami [.smi], Idx+Sub, PGS	OEM Interface	1 x RJ12 - Ready for external interface
Image Formats	JPG, BMP, PNG, GIF	Steering Wheel Control	Wires - Ready for In / Out control signal BUS for external interface
		IR remote control	1x 3.5mm 4 way mini-jack for IR receiver with status LED (supplied)
		Parking Brake Video Inhibition	Wires - GND control to the parking brake; monitor power supply
		Optical Receiver Enable	Wire - Control to enable optical In for external devices
		Status Led	Wire - To external status LED (not supplied)
Analog Signal stage		Infrared Remote Controls (Supplied)	
Distortion - THD @ 1 kHz, 1 VRMS	0.003%	USR	User Remote Control - Ultra-Compact 14 keys for audio control
Bandwidth	20 ÷ 20k Hz	ARC	Advanced Remote Control - Compact 40 keys for audio/video control
S/N RATIO (A weighted)	100 dBA		
Output Level	1 VRMS		
Size / Weight & Temperature			
W x H x D (mm / in.)	249 x 98 x 41 / 9.80 x 3.85 x 1.61 in.		
Weight (kg / lb.)	0,9 Kg / 1.98 lb.		
Ambient Operating Temperature	0°C to 50°C (32°F to 122°F)		



www.audison.eu

audison
ISTINTO
INNOVATIVO

PART OF ELETTROMEDIA
62018 Potenza Picena (MC) Italy
T +39 0733 870 870 - F +39 0733 870 880
www.elettromedia.it