



# Sontec Instruments®

A TRADITION OF FINE SURGICAL INSTRUMENTS

EQUINE CATALOG

Dear Customer,

Sontec Instruments, Inc. is a family owned & operated medical company, providing personalized service featuring the finest in surgical instrumentation for over half a century.

Our surgical instruments encompass the entire human anatomy including specialty products specific to small and large animal surgery.

Owner of Sontec Instruments, Dennis Russell Scanlan III and his sons, Johann, Stefan and Angus Scanlan bring with them a lifetime of experience creating the highest quality products made by the world's leading manufacturing facilities featuring, cutting edge robotic technology, handmade workmanship combined with an understanding how to make exactly what our valued customers have come to expect.

Dennis R. Scanlan, III President & CEO and his wife Caron C. Scanlan thank you, for the opportunity to present our specialty Equine catalog.

Sincerely,



Dennis Russell Scanlan III

---

**Table of Contents**

---

Important Information . . . . . 4

Rongeurs . . . . . 33

Equine Specialty . . . . . 55

Forceps . . . . . 121

Retractors . . . . . 149

Scissors . . . . . 159

Needle Holders . . . . . 209

Index . . . . . 228

## IMPORTANT INFORMATION

### Guarantee & Repairs Policy

Sontec® surgical instruments are guaranteed to be free of defects in materials and workmanship. Any Sontec® instrument that is defective will be repaired or replaced at our discretion. Instruments not properly cared for, used for unintended purposes, or beyond their designed capacity will not be covered under this guarantee. Our liability under this guarantee is limited to the repair or replacement of the defective merchandise.

Sontec® has its own repair department where most mechanically functional instruments can be returned to like-new condition.

Sontec® performs a variety of repairs, such as replacing worn TC jaws or sharpening scissors. In addition, we complete a comprehensive evaluation of your instruments to determine if further service is required.

For repair service, please send the following directly to the address below:

- Instruments clean, sterilized, securely wrapped and carefully packaged.
- Purchase and/or repair order
- A note with contact and shipping information
- Sending multiple items eliminates \$50 minimum charge

### Return Policy

The return of new, unused instruments in their original packaging is accepted within 30 days of purchase with an authorized "Return Merchandise Authorization". Please contact Sontec directly by phone or email with your invoice or proof of purchase in order to obtain your RMA slip and instructions. Restocking fee applies and credit will not be issued for shipping charges or handling fees. Proper credit is not guaranteed without an RMA. Custom, Special Order or Modified items are non-returnable.

Sontec Instruments, Inc.  
Toll free: 800.821.7496  
Local: 303.790.9411  
returns@sontecinstruments.com

### Remember

Sontec® offers other catalogs for a variety of surgical instrumentation, including:

- Alligator, Grasping, & Biopsy Forceps
- Avian & Exotic
- Bandage Scissors
- Cardiovascular & Thoracoscopic
- Caspar & Cloward Retractor Systems
- Colon & Rectal
- Cranial Cruciate Ligament Lateral Suture

- System
- Equine (Arthroscopic)
  - Eye
  - Neurology & Orthopedic
  - Orthopedic & Arthroscopic
  - Urology
  - Veterinary Dental
  - Veterinary Eye
  - General Veterinary Instrumentation

Also, if you do not find what you are looking for, please contact us.

### Instrument Care

Designed and crafted to exacting specifications, surgical instruments will perform for a number of years, provided they are maintained correctly and used for their intended purpose. A strict maintenance schedule will help reduce the need for premature replacements, thus cutting costs. For proper safeguarding of surgical instruments, please read and share the following information.

- Never substitute sterilization for cleanliness
- Wash brand new instruments prior to the first sterilization
- Remove saline solution, bleach, blood and tissue from instruments quickly and thoroughly
- Always use distilled water for cleaning instruments
- Never use saline solution for cleaning instruments
- Prevent cross-corrosion by separating corroded instruments from other instruments
- Never autoclave econo-grade stainless with superior-grade stainless.
- Always autoclave instruments with box lock open to alleviate pressure at the joint and to prevent fracture
- Lubricate joint and box lock after cleaning with an anti-microbial, water soluble lubricant
- Protect the tips of delicate instruments with protective covers (see page a.)
- Never use an instrument for anything other than its intended use

### Additional Safeguarding Guidelines

#### Scissors and Other Blades

- Perform routine inspections for sharpness, as a blade becomes duller with each stroke (all operating and Mayo scissors should be able to cut through four layers of gauze)
- When blades no longer cut without an excessive amount of force, please return them to Sontec® for sharpening
- The more often a blade is sharpened, the longer it tends to last

#### Needle Holders

- Repair is necessary when needle holder no longer securely holds needle when locked on the second ratchet tooth, and needle turns easily by hand

### Please Note

- We are not responsible for typographical errors in this catalog
- Instruments pictured in this catalog may or may not be to size
- Variations and changes in instrument design are possible
- Pricing is subject to change without notice
- Delivery schedules may vary from original estimates
- Some items are for veterinary use

### Contact Info

Sontec Instruments, Inc.  
7248 South Tucson Way  
Centennial, Colorado 80112, USA  
Toll free: 800.821.7496  
Local: 303.790.9411  
service@sontecinstruments.com  
www.sontecinstruments.com

## Troubleshooting Guide

Problem	Cause	Solution
Rust	Worn chrome plating on brass instruments	Be aware of plating condition and remove from service when wear is visible.
	Cross-corrosion from carbon instruments to stainless steel	Keep carbon steel and stainless steel instruments separated during cleaning and sterilization.
	Low grade instruments may not have been passivated	Remove from service.
	Autoclave not operating properly	Clean and thoroughly flush water lines in sterilizer according to manufacturer's instructions. Only use distilled water, never tap water, to generate steam.
	Organic matter left on instrument after surgery	Remove all blood and tissue before drying. Use distilled water and a nylon brush to clean hard to reach areas.
Pitting	Prolonged exposure to corrosive chemicals and/or organic substances	Only use approved cleaning and sterilization solutions. Thoroughly rinse and dry instruments.
Orange / Brown Stains	Contaminated sterilizer, high alkaline detergent, cold disinfectants	Clean sterilizer. Use neutral pH solutions. Thoroughly clean, rinse, and dry instruments.
Bluish Black Stains	Mixing dissimilar metals during cleaning and sterilization	Separate carbon steel, aluminum, and stainless steel instruments.
Rainbow - olored Stains	Chromium oxide stain-result of excessive heat	Send in for polishing and hardness check.
Cracked Box Lock	Excessive force, sterilized in the closed position	Replace the instrument.
Cracked Jaw on Pin Cutter	Cutting pin at tip of jaws	Replace the instrument. Cut pin in center of jaws.



Conversion Table

Multiply	By	To Obtain
Millimeters	0.1	Centimeters
Millimeters	0.03937	Inches
Centimeters	0.3937	Inches
Centimeters	0.01	Meters
Centimeters	10	Millimeters
Inches	2.540	Centimeters
1/8" = 3.175 millimeters		
1/4" = 6.350 millimeters		
3/8" = 9.525 millimeters		
1/2" = 12.70 millimeters		
1" = 25.40 millimeters		

- 1 mm
- 2 mm
- 3 mm
- 4 mm
- 5 mm
- 6 mm
- 7 mm
- 8 mm
- 9 mm
- 10 mm
- 2 french
- 4 french
- 6 french
- 8 french
- 10 french
- 12 french
- 14 french
- 16 french
- 18 french
- 20 french
- 22 french

Conversion Table

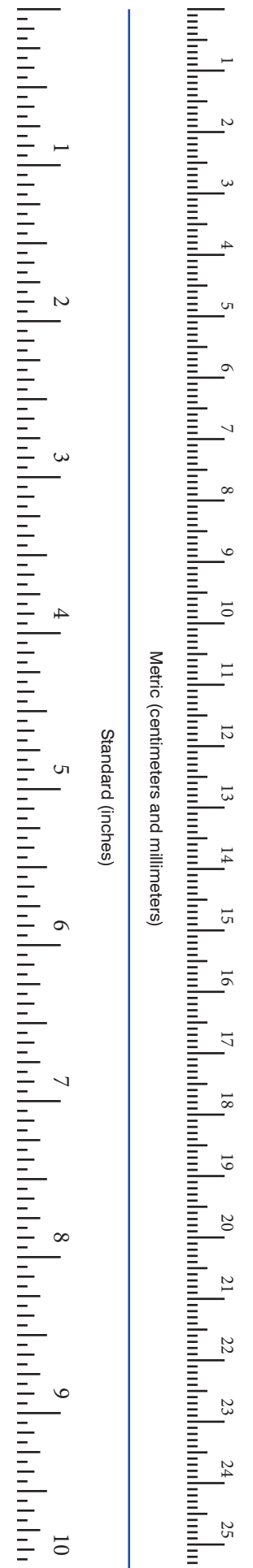

**Metal Micro Instrument Tray**

Single level / includes pin mat and retainers

- 18-3519 10" x 10" x 1.5" (25.5 cm x 25.5 cm x 4 cm)
- 18-3510 10" x 15" x 1.5" (25.5 cm x 38 cm x 4 cm)

\* Instruments not included



18-3519



18-3510

**Metal Micro Instrument Tray**

Double level / includes pin mat and retainers / instruments not included

- 18-3505 10" x 10" x 3" (25.5 cm x 25.5 cm x 8 cm)
- 18-3515 10" x 15" x 3" (25.5 cm x 38 cm x 8 cm) short tray / full height

\* Instruments not included



18-3505



18-3515

**Metal Micro Instrument Tray**

Double level / includes pin mat and retainers

- 18-3520 10.5" x 15" x 2.5" (26.5 cm x 38 cm x 6.5 cm) long tray / half height
- 18-3525 10" x 19.5" x 2.5" (25.5 cm x 49.5 cm x 6.5 cm) short tray / full height
- 18-3530 10.5" x 19.5" x 2.5" (26.5 cm x 49.5 cm x 6.5 cm) long tray / half height

\* Instruments not included



18-3520



18-3525

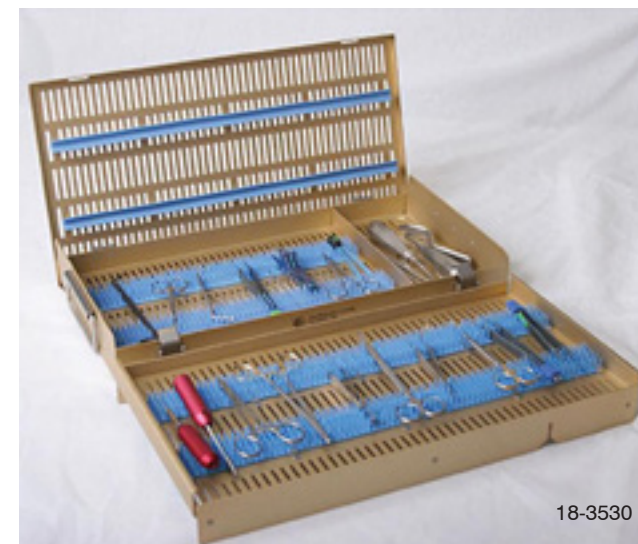

18-3530



**Thermoplastic Instrument Tray**

With silicone mat / autoclavable

1103-702	single	6" x 2 1/2" x 3/4"
1103-703	single	1.5" x 2.7" x .75" mini tray
1103-705	single	6" x 4" x 3/4"
1103-723	single	7 1/2" x 4" x 3/4"
1103-710	single	10" x 6" x 3/4"
1103-702D	single	6" x 2 1/2" x 1 1/4" deep
1103-724	single	7 1/2" x 4" x 1 1/2" deep
1103-716	single	10" x 6" x 1 1/2" deep
1103-715	double decker	10" x 6" x 1 1/2"

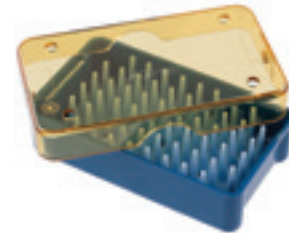

1103-703

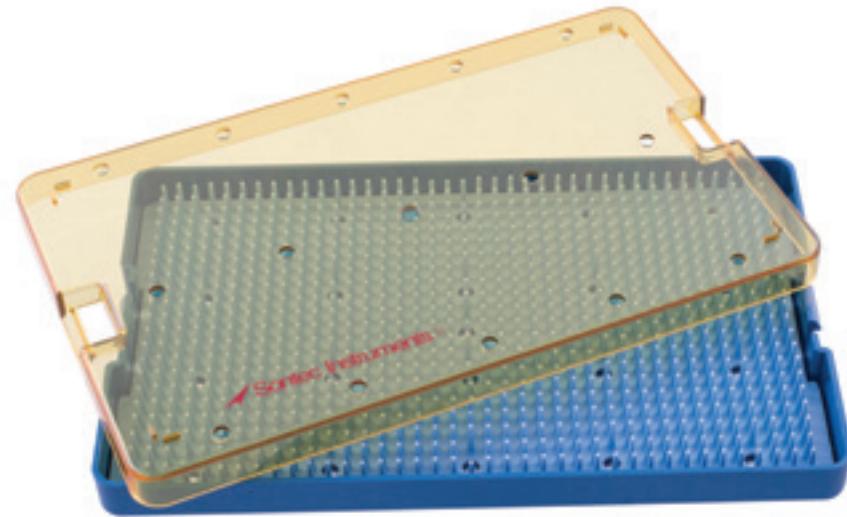

1103-710

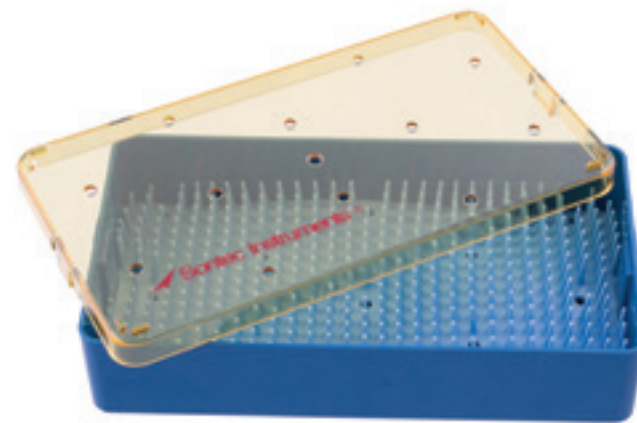

1103-724

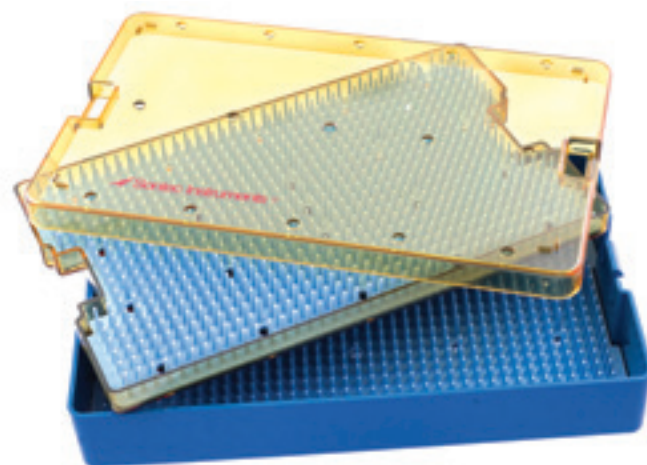

1103-715

**Thermoplastic Instrument Tray**

With silicone mat / autoclavable

18-3214	single	10" x 15" x 3/4"
18-3215	single	10" x 15" x 1 1/2" deep
18-3213	double decker	10" x 15" x 1 1/2"

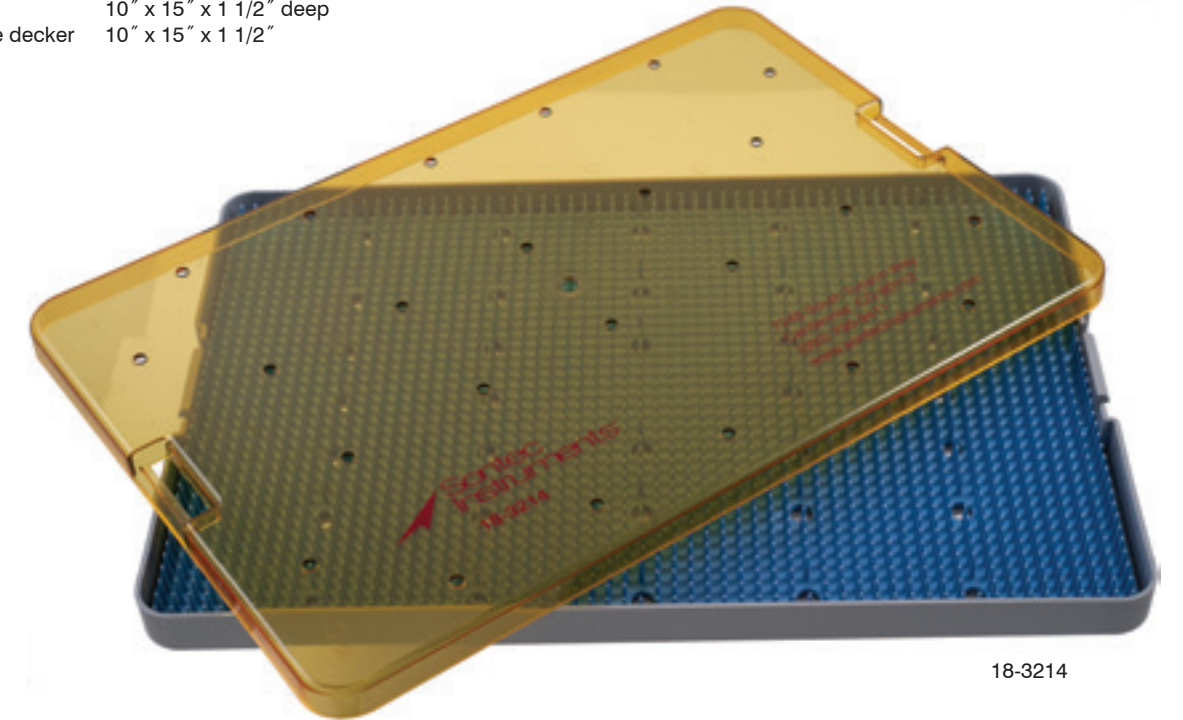

18-3214

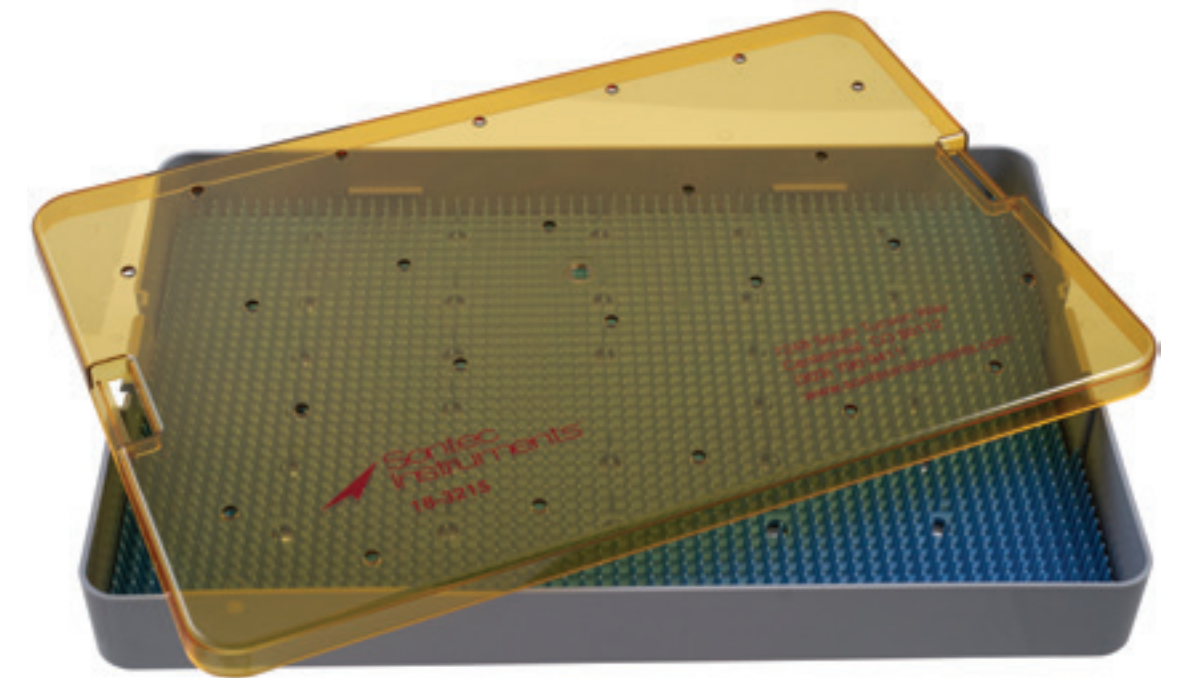

18-3215



**Thermoplastic Instrument Trays**

With silicone mat and metal clasps / autoclavable

- 1103-717 double decker 11" x 7" x 1 1/2"
- 1103-717D single deep 11" x 7" x 1 1/2"
- 1103-712 single shallow 11" x 7" x 3/4"

\* Other sizes available upon request, requires special order. Check your measurements.

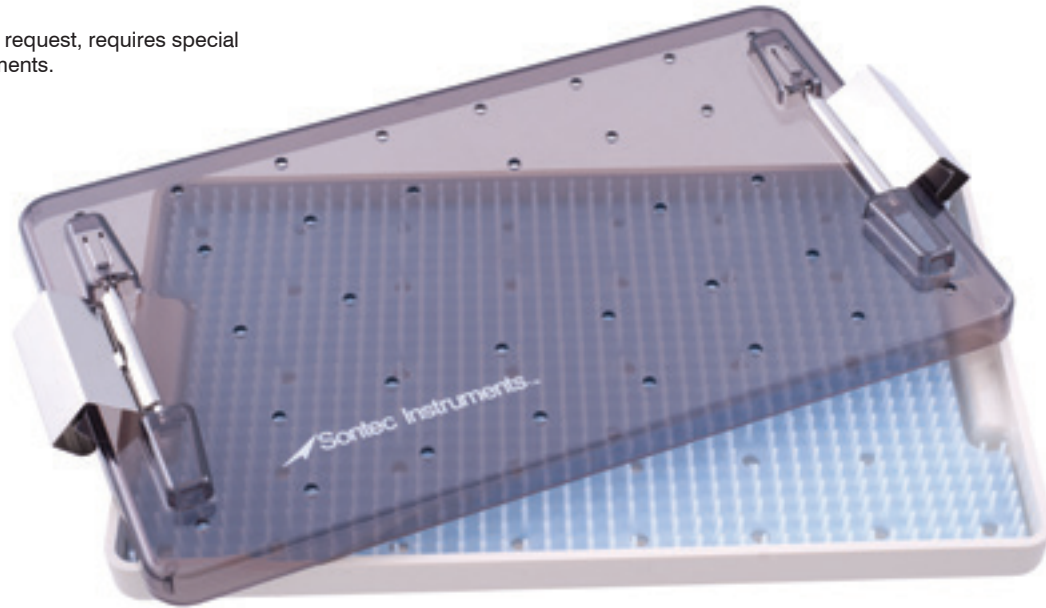

1103-712

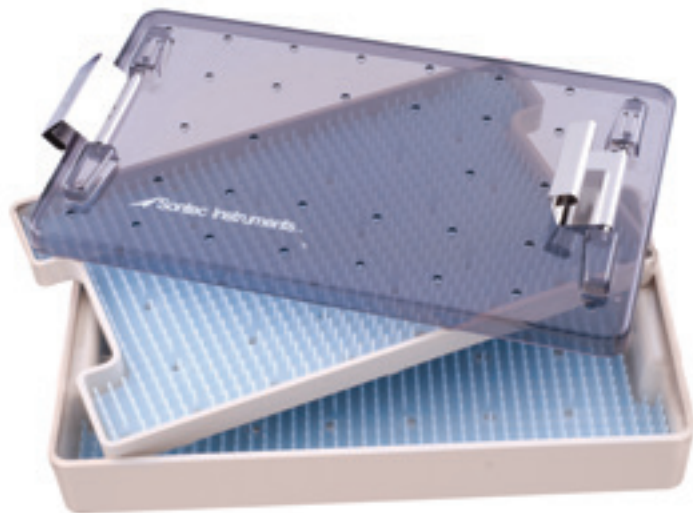

1103-717

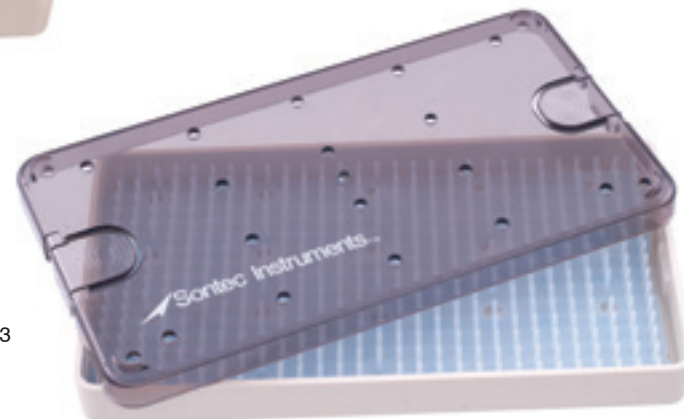

1103-723

**Alligator Sterilizing Rack**

3.5" x 3" x 7.5"

325-130

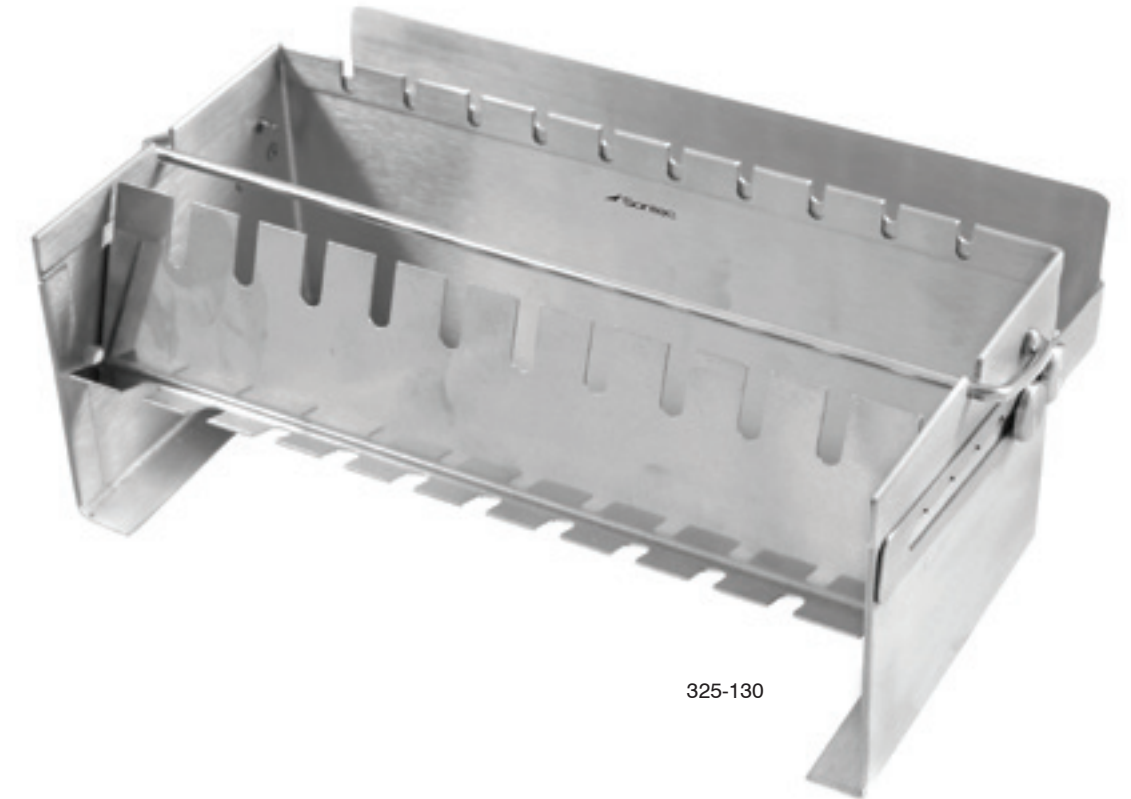

325-130

**Silicone Mat**

For instrument trays / cut to size / autoclavable

- 18-3120 18" x 13" (46 cm x 33 cm) with holes
- 18-3121 10" x 6" (25.5 cm x 15 cm)
- 18-3122 10" x 15" (25.5 cm x 38 cm)
- 18-3123 14" x 19" (35.5 cm x 48.5 cm)

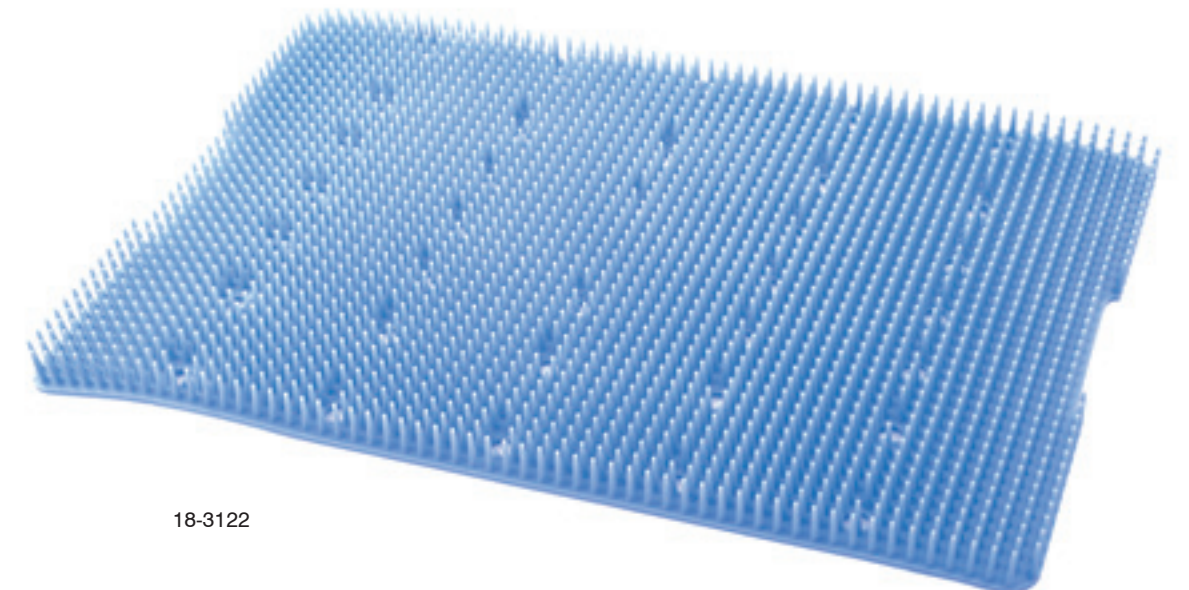

18-3122

**Sontec Slim Thermo Plastic Instrument Tray**

18-3232 shallow with mat 11" x 14 1/2" x 3/4" (28 cm x 35 cm x 2 cm)

\* "Check Your Measurements", These items are FINAL SALE

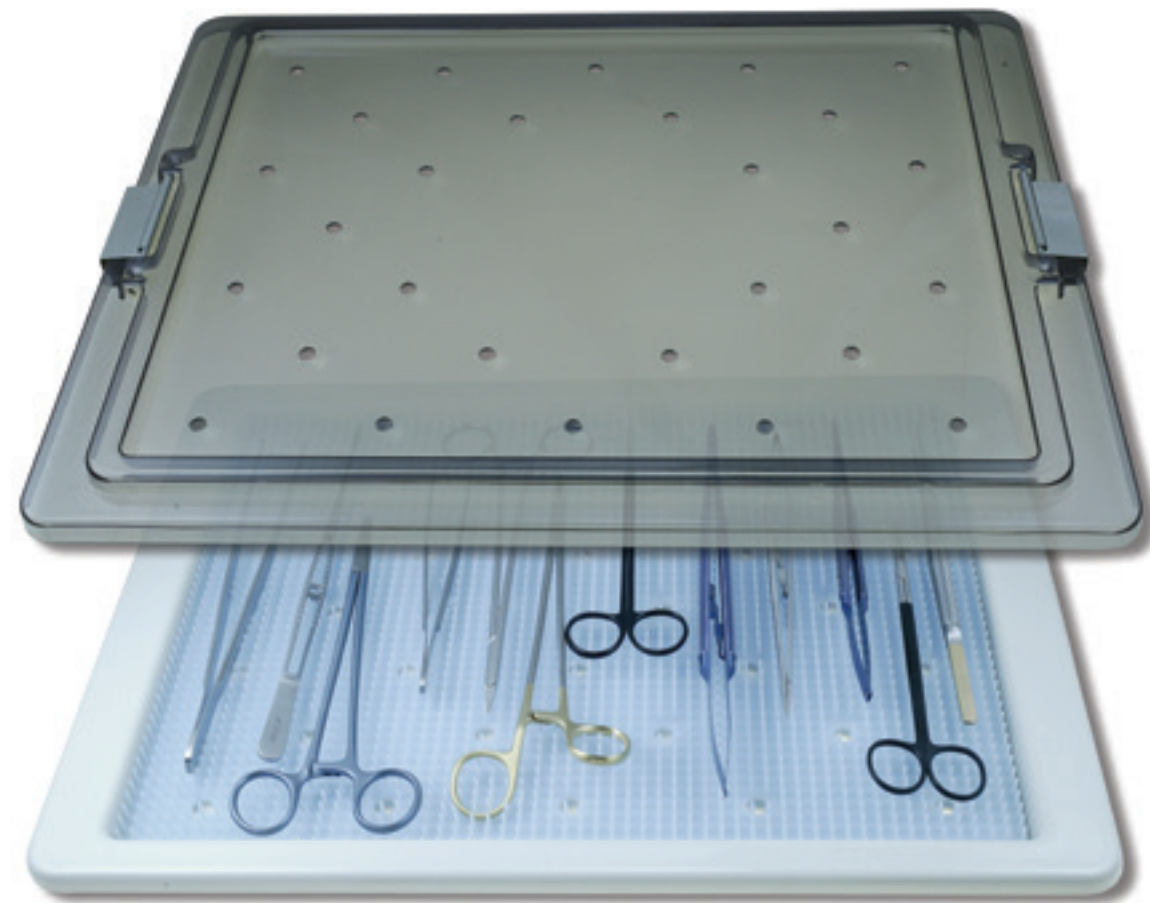

18-3232

**Sontec Slim Thermo Plastic Instrument Tray**

18-3123	silicone mat	14" x 19"
18-3209	tray	10.3" x 18.3" x 2.33
18-3226	tray	8 1/4" x 17.3" x .62
18-3235	tray	13 1/4" x 8" x 2"
18-3240	tray	12 1/4" x 7 1/4" x 4"
18-3245	tray	17.3" x 7 1/2" x 4"
18-3270	tray	18.3" x 8.35" x 2"

\* "Check Your Measurements", These items are FINAL SALE



18-3209



18-3240



18-3226



18-3245



18-3235



18-3270



**Catheter Tray**

Heavy duty / seamless

**Dome Cover**

For catheter trays / strap handles / easy to handle

ST83 8 3/4" x 3 1/4" x 1 1/2"  
ST83-2 cover: fits tray ST83

ST17-0-0 17 1/4" x 4 1/2" x 2"  
ST17-0-2 cover: fits tray ST170

ST95-2 8 7/8" x 5" x 2"  
ST95-3 8 7/8" x 5" x 3"  
ST95-2D-2 cover: fits trays ST952, ST953



\* "Check Your Measurements", These items are FINAL SALE

**Sterilization Tray / Bath Set**

Used for hot or cold sterilization

**Solid Flat Cover**

For Sterilization Trays / recessed strap handles / easy to handle / easy to store / safe to transport

STE2-0124 solid 20 3/4" x 12 3/4" x 4"  
STP2-0122 perforated 20 3/4" x 12 3/4" x 2 1/2"  
STE2-0126 solid 20 3/4" x 12 3/4" x 6"  
STP2-0124 perforated 20 3/4" x 12 3/4" x 4"  
ST20-00-2 cover: fits trays STE20124, STP20122, STE20126, STP20124

STE1-2104 solid 12 3/4" x 10 3/8" x 4"  
STP1-2102 perforated 12 3/4" x 10 3/8" x 2 1/2"  
STP1-2104 perforated 12 3/4" x 10 3/8" x 4"  
ST13-11-2 cover: fits trays STE1-2104, STP1-2102, STP1-2104



**Metal Instrument Tray**

Heavy duty / seamless / covered corners / easy to sterilize

**Solid Flat Cover**

For instrument trays / recessed strap handles / easy to handle / easy to store

ST43 5 3/8" x 4" x 2 5/8"  
ST43-2 cover: fits tray ST43

ST63 6 1/8" x 6 1/8" x 2 7/8"  
ST63-2 cover: fits tray ST63

ST95-3 8 7/8" x 5" x 3"  
ST95-2 8 7/8" x 5" x 2"  
ST95-2-2 cover: fits trays ST952 & ST953

ST10-02 10" x 6 1/2" x 2"  
ST10-02-2 cover: fits tray ST1002

ST12-02 12 1/4" x 7 3/4" x 2 1/4"  
ST12-02-2 cover: fits tray ST1202

STE1-082 10" x 8 1/4" x 2 1/2"  
STE10-82-2 cover: fits trays STE1082

STE1-654 16 1/2" x 10" x 4"  
STE1-650 16 1/2" x 10" x 2 1/2"  
ST16-50-2 cover: fits trays STE1650, STE1654

STE9-02 6 7/8" x 4 1/4" x 2"

STE2-304 13 7/8" x 12 7/8" x 4"  
STE2-302 13 7/8" x 12 7/8" x 2 1/2"

STE0-6066 6 7/8" x 6 3/8" x 6"  
STE0-6064 6 7/8" x 6 3/8" x 4"  
STE0-6062 6 7/8" x 6 3/8" x 2 1/2"  
ST60-2-2 cover: fits trays STE06062, STE06064, STE06066

STE1-0066 10 3/8" x 6 3/8" x 6"  
STE1-0064 10 3/8" x 6 3/8" x 4"  
STE1-0062 10 3/8" x 6 3/8" x 2 1/2"  
ST40-2-2 cover: fits trays STE10062, STE10064, STE10066

\* "Check Your Measurements", These items are FINAL SALE

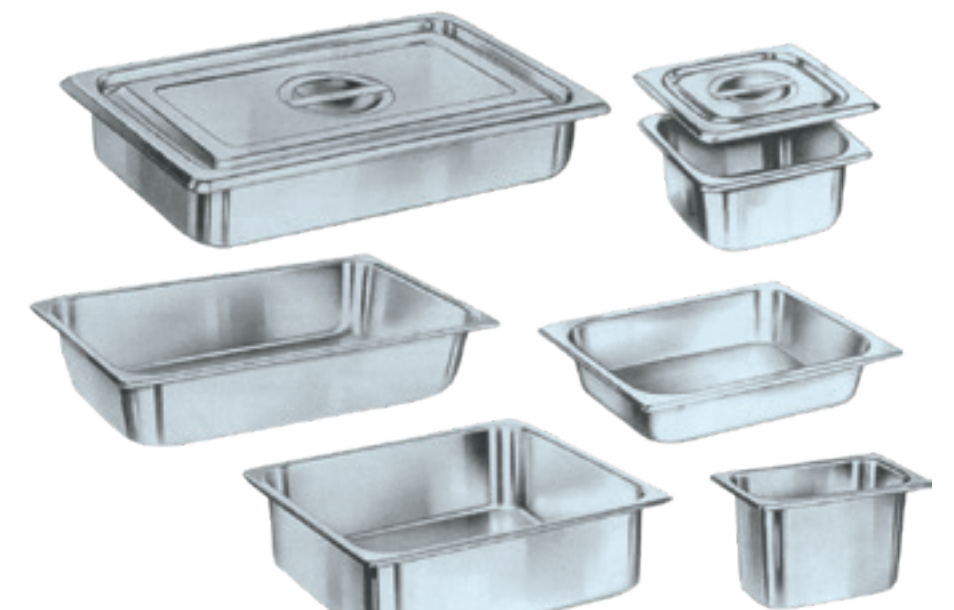

**Solid Flat Cover**

**For instrument trays / standard weight / 22 gauge**

STE1-2066 12 3/4" x 6 7/8" x 6"  
 STE1-2064 12 3/4" x 6 7/8" x 4"  
 STE1-2062 12 3/4" x 6 7/8" x 2 1/2"

**Heavy weight / 20 gauge**

STS1-2066 12 3/4" x 6 7/8" x 6"  
 STS1-2064 12 3/4" x 6 7/8" x 4"  
 STS1-2062 12 3/4" x 6 7/8" x 2 1/2"  
 ST30-2-2 cover: fits trays STE1-2062,  
 STE1-2064, STE1-2066,  
 STS1-2062, STS1-2064,  
 STS1-2066

**Standard weight / 22 gauge**

STE1-2106 12 3/4" x 10 3/8" x 6"  
 STE1-2104 12 3/4" x 10 3/8" x 4"  
 STE1-2102 12 3/4" x 10 3/8" x 2 1/2"

**Heavy weight / 20 gauge**

STS1-2106 12 3/4" x 10 3/8" x 6"  
 STS1-2104 12 3/4" x 10 3/8" x 4"  
 STS1-2102 12 3/4" x 10 3/8" x 2 1/2"  
 ST13-11-2 cover: fits trays STE1-2102,  
 STE1-2104, STE1-2106,  
 STS1-2102, STS1-2104,  
 STS1-2106

**Standard weight / 22 gauge**

STE2-0126 20 3/4" x 12 3/4" x 6"  
 STE2-0124 20 3/4" x 12 3/4" x 4"  
 STE2-0122 20 3/4" x 12 3/4" x 2 1/2"

**Heavy weight / 20 gauge**

STS2-0126 20 3/4" x 12 3/4" x 6"  
 STS2-0124 20 3/4" x 12 3/4" x 4"  
 STS2-0122 20 3/4" x 12 3/4" x 2 1/2"  
 ST20-00-2 cover: fits trays STE2-0122,  
 STE2-0124, STE2-0126,  
 STE2-0122, STE2-0124,  
 STE2-0126

\* "Check Your Measurements", These items are FINAL SALE

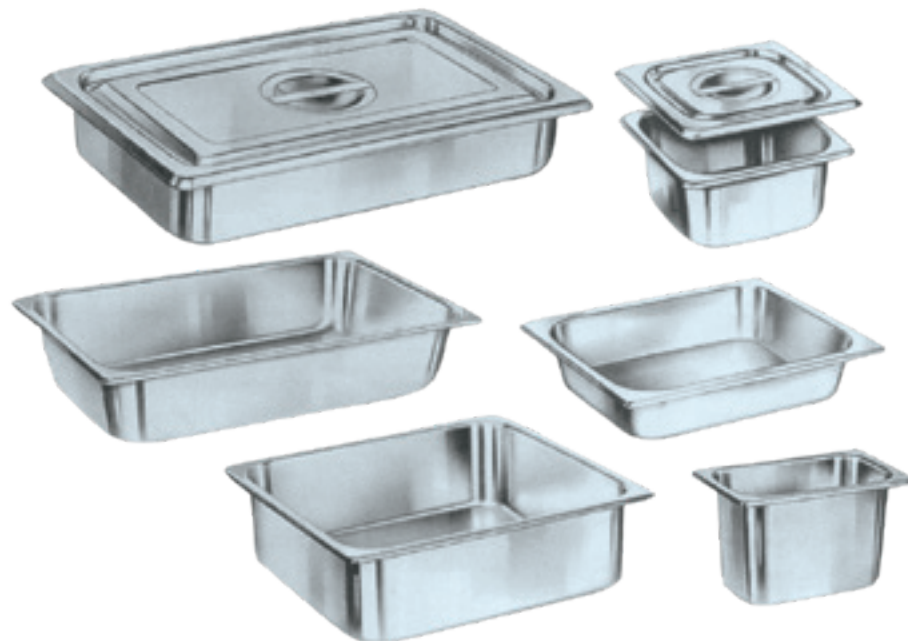

**Emesis Basin**

ST6 10 oz.  
 ST8 12 oz.  
 ST10 26 oz.  
 ST12 50 oz.



**Instrument Tray**

**Rolled edge**

ST10-F 10" x 6 1/2" x 3/4"  
 ST13-F 13 1/2" x 9 3/4" x 3/4"  
 ST15-20 21 1/4" x 16 1/4" x 7/8"  
 ST15-F 15 1/8" x 10 5/8" x 3/4"  
 ST17-F 17" x 11 5/8" x 3/4"  
 ST19-F 19 1/8" x 12 5/8" x 3/4"



**Perforated Mayo Tray**

ST10-F-PMT	10" x 6 1/2" x 3/4"
ST15-20-PM	21 1/4" x 16 1/4" x 7/8"
ST15-F-PMT	15 1/8" x 10 5/8" x 3/4"
ST17-F-PMT	17" x 11 5/8" x 3/4"
ST19-F-PMT	19 1/8" x 12 5/8" x 3/4"



**Non-Perforated Mayo Tray**

ST3-926	10" x 6 1/2" x 3/4"
ST3-927	14" x 10" x 5/8"
ST3-929	17" x 11 5/8" x 3/4"
ST3-930	19 1/8" x 12 5/8" x 3/4"



**Iodine Cup**

ST6G	6 oz.	3 7/16" x 2"
ST14-G	14 oz.	4 3/8" x 2 5/8"

\* "Check Your Measurements",  
These items are FINAL SALE



**Medicine Cup**

ST2	2 oz.
-----	-------





**Sponge Bowl**

Flat bottom / straight sides /  
extra stable

- ST10-7 64 oz. 7 9/16" x 3"
- ST14-8 48 oz. 7 1/8" x 2 3/4"
- ST10-6 36 oz. 6 1/4" x 2 3/4"
- ST10-0 30 oz. 5 9/16" x 2 9/16"
- ST75 20 oz. 5" x 2 3/8"
- ST52 14 oz. 4 1/4" x 2"

\* "Check Your Measurements",  
These items are FINAL SALE



**Dressing Jar**

With cover / cover  
included with jar

- ST2J 2 quart
- ST3J 3 quart
- ST4J 4 3/4 quart
- ST6J 6 quart
- ST8J 8 quart



**Forceps Jar**

- ST14-K 1 x 4"
- ST32-K 2 1/4 x 4 1/2"
- ST72-K 2 1/4 x 7"



**Tip Cover**

For surgical instrument tip protection / economical & long-lasting / prevents damaging tips and edges / steam-permeable / autoclavable / conveniently color coded / soft vinyl construction, no latex / for a wide variety of instruments, including: scissors, forceps, curettes, drills, and retractors

\* See colors online  
 \* Larger sizes available. Please call for details.  
 \* Individual styles, packaged 100 per bag

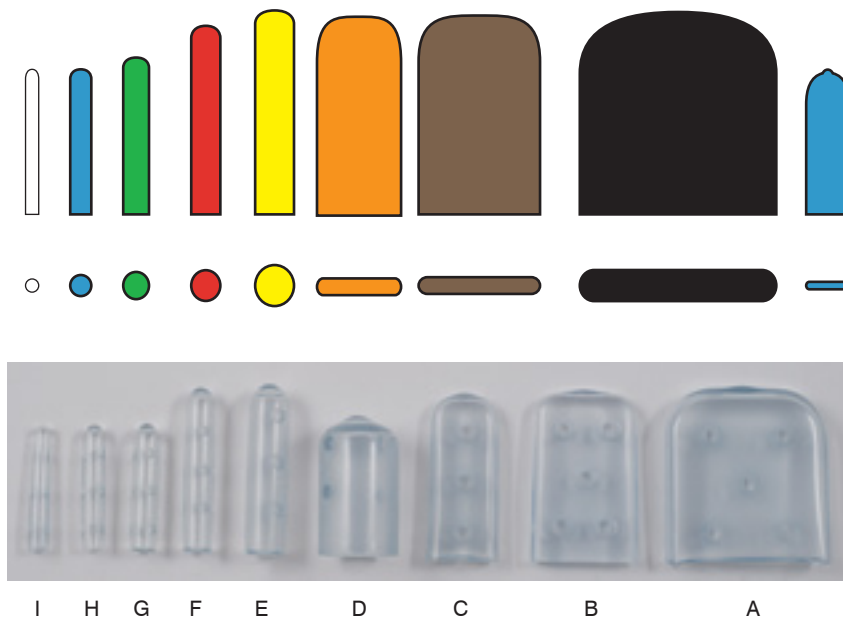

**Individual styles, packaged 100 per bag**

	Color	Solid #	Tinted #
A	White	105-730	105-782
B	Blue	105-732	105-783
C	Green	105-734	105-784
D	Red	105-736	105-785
E	Yellow	105-738	105-786
G	Orange	105-742	105-787
H	Brown	105-744	105-789
I	Black	105-746	105-790
J	Blue	105-764	N/A

**Individual styles, packaged 100 per bag**

	Size	Item #
A	1.6 mm x 19 mm	105-791
B	2 mm x 19 mm	105-792
C	2.8 mm x 19 mm	105-793
D	3 mm x 25 mm x 25 mm	105-794
E	3.2 mm x 25.4 mm	105-7951
F	5 mm x 25 mm	105-796
G	10 mm x 19 mm	105-797
H	2 mm x 9 mm x 25 mm	105-798
I	2 mm x 16 mm x 25 mm	105-799
	Assorted Sizes	105-791A

**Available Assortments**

	Solid #	Tinted #	Description
Large Assorted	105-748	105-780	Bag of 100, Equal parts A -J
Small Assorted	105-750	105-781	Bag of 100, Equal parts A - E, G, J

**Sontec® Sheet Tape**

For surgical instrument identification / color-codes instruments with pre-cut strips / each 8 1/2" x 11" sheet contains: 44 strips, 2" long x 1/4" wide / 220 strips, 1" long x 1/4" wide (total: 264 strips, 374" of tape)

\* See colors online  
 \* PLEASE NOTE: Sontec® Sheet Tape is not recommended for use with cold sterilization fluids.  
 \* Size and color of tapes may vary slightly from actual products



	105-610 White		105-581 Plum		105-640 Fuchsia
	105-612 Kelly Green		105-540 Blue/Green		105-642 Medical Blue
	105-614 Red		105-541 Blue/Red		105-644 Emerald Green
	105-616 Yellow		105-542 Yellow/Blue		105-646 Violet
	105-618 Orange		105-543 Yellow/Green		105-660 Fuchsia
	105-620 Gray		105-544 Yellow/Red		105-662 Medical Blue
	105-622 Lavender		105-686 Purple/Black		105-664 Emerald Green
	105-624 Beige		105-688 Orange/Black		105-666 Violet
	105-626 Light Blue		105-690 Blue/Black		105-590 Smiley Face, Yellow/Black
	105-628 Lime Green		105-692 Rubine/Black		105-600 Red Hearts on White
	105-630 Pink		105-694 Yellow/Black		105-602 White Hearts on Red
	105-632 Plum		105-696 Green/Black		105-670 Fuchsia*
	105-570 Royal Blue		105-720 Lime Green		105-672 Medical Blue*
	105-571 Kelly Green		105-722 Gray		105-674 Emerald Green*
	105-572 Red		105-723 Beige		105-676 Violet*
	105-573 Yellow		105-724 Light Blue	* Each color sheet contains numbers 0 - 8	
	105-574 Orange		105-725 Pink		105-550 Red/White/Blue
	105-575 Brown		105-726 Plum		105-551 Red/White/Black
	105-576 Black		105-727 Lavender		105-552 Red/Yellow/Black
	105-577 Lavender		105-650 Fuchsia		105-553 Red/Black/Green
	105-578 Light Blue		105-652 Medical Blue	Above Styles: 3/8" wide, 245" total tape	
	105-579 Lime Green		105-654 Emerald Green		
	105-580 Pink		105-656 Violet		









**Medi-Mark™ Tape**

Surgical instrument color coding system / fast and efficient identification system / available in 9 solid colors / one spool codes an average of 230 instruments / clinically proven safe in conventional, flash and gas sterilization / bonds to itself / lasts many months

\* PLEASE NOTE: Medi-Mark™ Tape is not recommended for use with cold sterilization fluids.  
\* See colors online

**Application of Medi-Mark™ Tape**

1. Instrument and hands must be clean and dry.
2. Cut Medi-Mark™ Tape with scissors. DO NOT STRETCH!
3. Overlap Medi-Mark™ Tape once.
4. Replace Medi-Mark™ Tape when color changes, before it becomes brittle.
5. Avoid placing Medi-Mark™ Tape on the shank of scissors.

	105-700 Green
	105-702 Yellow
	105-704 Blue
	105-706 Red
	105-708 Brown
	105-710 White
	105-712 Orange
	105-714 Black
	105-716 Purple

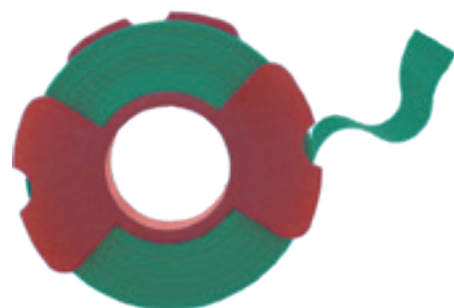

**Whisk 'R Brush™**

For general purpose cleaning / two bristle lengths & a sure-grip handle / available sterile & non-sterile / convenient & economical / simple to use on various shapes and surfaces / for a wide variety of instruments, including: burs, drill points, rasps, and rongeurs / easily removes bone fragments and soft tissue

- 9B-010 12 sterile brushes
- 9B-025 25 non-sterile brushes
- 9B-020 100 non-sterile brushes



### Endozime AW Triple Plus®

- Multi-tiered enzymatic cleaner
- specifically designed for all washers, washer sterilizers, ultrasonics and manual cleaning
- proprietary synergistic mixture of enzymes and non-ionic detergents
- Protease, Amylase, Lipase, Carbohydrase and other proprietary enzymes
- dissolves all blood, fat, protein, carbohydrates and starches
- built in detergent eliminating the need for all other cleaners and detergents
- compatible with all washers, washer sterilizers and ultrasonics
- strong enough for the most difficult instruments but safe on the most delicate

345A-P16 16 oz  
345A-PAG1 1 gal



### Surgistain®

- Rust and stain remover
- removes rust, pitting, stains and corrosion from stainless steel instruments
- restores instrument's original finish
- restores articulation to box-locks and joints
- prevents destructive pitting on ridges of micro instruments
- non-corrosive; will not harm quality stainless steel

345B-16 16 oz  
345B-G1 1 gal



### Premixslip®

- instrument lubricant and rust inhibitor
- the only bacteriostatic pre-mixed instrument lubricant and rust inhibitor
- clinically tested to be thoroughly steam penetrable, steam sterilizable and ETO sterilizable
- prevents rust, spots, stains and corrosion
- non-oily, non-sticky, non-toxic and silicone free
- bacteriostatic high-grade mineral oil lubricant

345P-MX16 16 oz  
345P-MXG1 1 gal



### Prepzyme®

- multi-tiered enzymatic foam spray
- prevents bio-film from adhering to surface prior to decontamination
- foaming spray covers soiled instruments, scopes and biopsy forceps
- breaks down blood, fat, carbohydrates and starches immediately
- perfect for use in departments where instruments & scope cleaning is not readily available
- safe for all instruments and scopes (flexible or rigid), extends usable lifetime
- neutral PH, non-abrasive, free-rinsing and 100% biodegradable
- will not harm any metals, plastic, rubber, glass or corrugated tubing

345P-RP08 8 oz (with sprayer)  
345P-RP22 22 oz (with sprayer)



### F\*A\*C\*T\*S®

- foaming autoclave cleaning treatment system
- removes all rust, pitting, stains and corrosion from walls of autoclaves and from stainless steel carts and trays
- removes scale, alkaline and mineral deposits
- foaming spray remains on walls longer for better penetration
- eliminates all noxious odors
- restores original finish to all autoclaves, carts and trays
- non-corrosive; will not harm quality stainless steel

345F-CT22 22oz (with sprayer)  
345F-CT1G 1 gal



### INSTRU-BIN

- for large instruments
- for soaking and safely transporting soiled instruments without messy spills
- durable snap-down lid and transparent walls
- light-weight and sturdy with integrated handles for easy lifting and carrying
- multi-purpose, reusable, high quality
- includes mesh blanket

3451-B





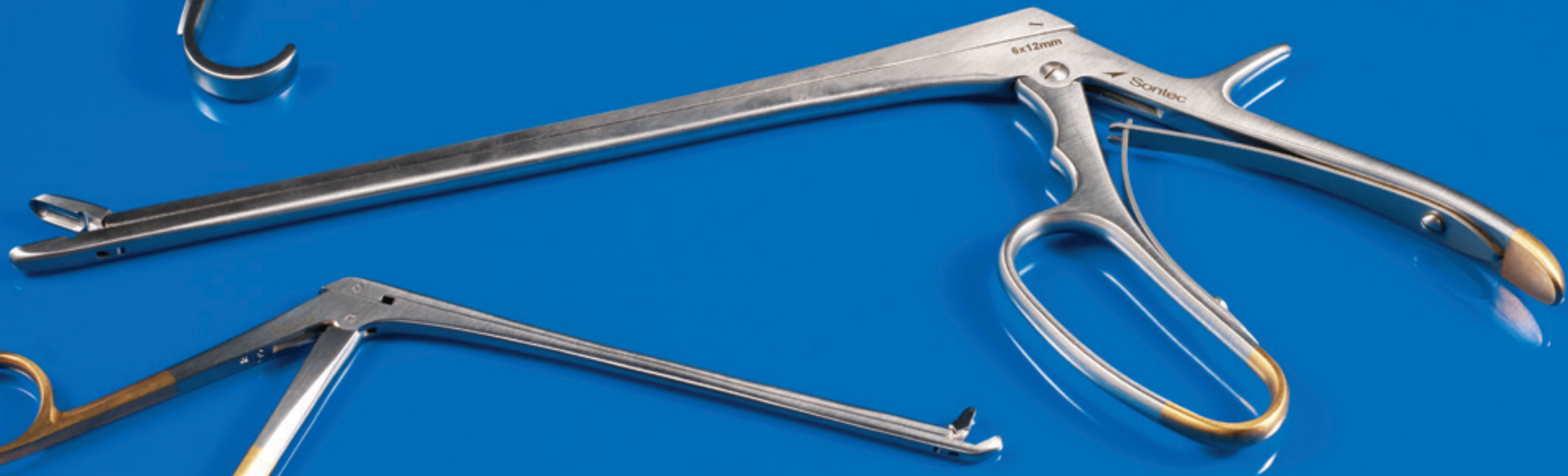

 Sontec Instruments®

Rongeurs

**Ferris-Smith Arthroscopic Rongeur**

4 mm x 6 mm square jaw / 7" (18 cm) shaft

404-814



404-814

**Ferris-Smith Arthroscopic Rongeur**

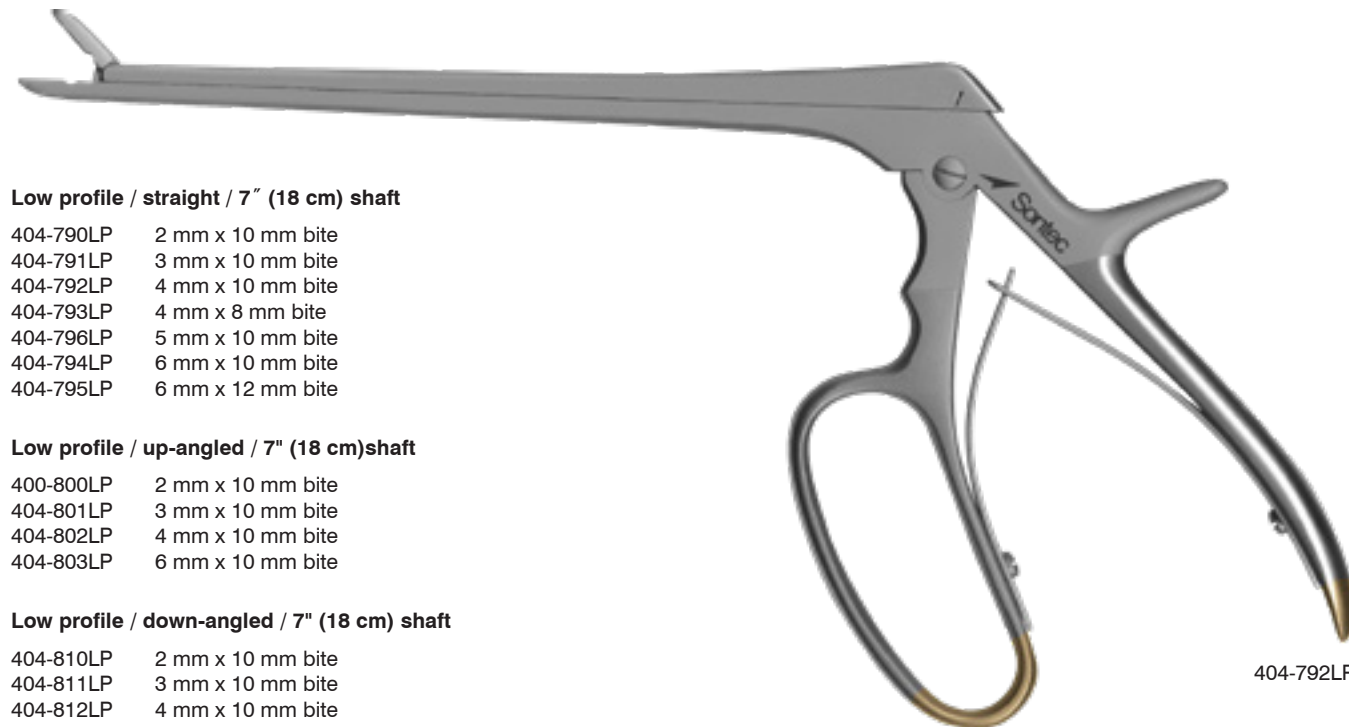

404-792LP

**Low profile / straight / 7" (18 cm) shaft**

- 404-790LP 2 mm x 10 mm bite
- 404-791LP 3 mm x 10 mm bite
- 404-792LP 4 mm x 10 mm bite
- 404-793LP 4 mm x 8 mm bite
- 404-796LP 5 mm x 10 mm bite
- 404-794LP 6 mm x 10 mm bite
- 404-795LP 6 mm x 12 mm bite

**Low profile / up-angled / 7" (18 cm) shaft**

- 400-800LP 2 mm x 10 mm bite
- 404-801LP 3 mm x 10 mm bite
- 404-802LP 4 mm x 10 mm bite
- 404-803LP 6 mm x 10 mm bite

**Low profile / down-angled / 7" (18 cm) shaft**

- 404-810LP 2 mm x 10 mm bite
- 404-811LP 3 mm x 10 mm bite
- 404-812LP 4 mm x 10 mm bite

**Ferris-Smith Arthroscopic Rongeur**

**Straight / 7" (18 cm) shaft**

- 404-790 2 mm x 10 mm bite
- 404-791 3 mm x 10 mm bite
- 404-792 4 mm x 10 mm bite
- 404-792B 4 mm x 10 mm bite Ceramitec
- 404-793 4 mm x 8 mm bite
- 404-792S 4 mm x 10 mm bite serrated
- 404-796 5 mm x 10 mm bite
- 404-794 6 mm x 10 mm bite
- 404-795 6 mm x 12 mm bite

**Straight/ 8" (20.5 cm) shaft / special order**

- 404-825 2 mm x 10 mm bite
- 404-826 3 mm x 10 mm bite
- 404-827 4 mm x 10 mm bite
- 404-828 5 mm x 10 mm bite
- 404-829 6 mm x 10 mm bite

**Straight/ 9" (23 cm) shaft**

- 404-7929 4 mm x 10 mm bite
- 404-7959 6 mm x 12 mm bite

**Up-angled / 7" (18 cm) shaft**

- 404-800 2 mm x 10 mm bite
- 404-801 3 mm x 10 mm bite
- 404-802 4 mm x 10 mm bite
- 404-802S 4 mm x 10 mm bite serrated
- 404-803 6 mm x 10 mm bite

**Up-angled/ 8" (20.5) shaft / special order**

- 404-830 2 mm x 10 mm bite
- 404-831 3 mm x 10 mm bite
- 404-832 4 mm x 10 mm bite
- 404-833 5 mm x 10 mm bite
- 404-834 6 mm x 10 mm bite

\*special order

**Down-angled / 7" (18 cm) shaft**

- 404-810 2 mm x 10 mm bite
- 404-811 3 mm x 10 mm bite
- 404-812 4 mm x 10 mm bite

**Down-angled / 8" (20.5 cm) shaft / special order**

- 404-835 2 mm x 10 mm bite
- 404-836 3 mm x 10 mm bite
- 404-837 4 mm x 10 mm bite
- 404-838 5 mm x 10 mm bite
- 404-839 6 mm x 10 mm bite

\*special order

- 2 mm x 10 mm
- 3 mm x 10 mm
- 4 mm x 8 mm
- 4 mm x 10 mm
- 6 mm x 10 mm
- 6 mm x 12 mm



404-792



404-792B



404-792

404-802S

404-792S



**Cushing Pituitary Rongeur**

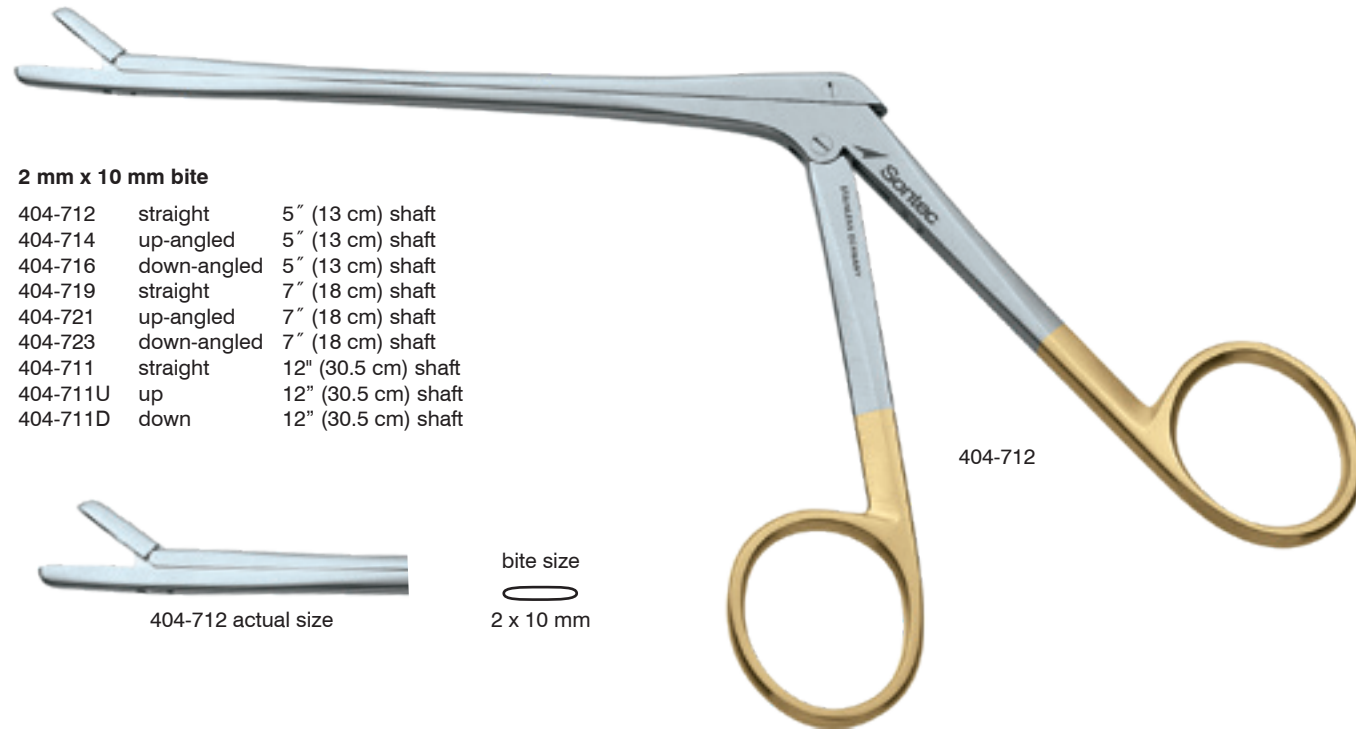

**Love-Gruenwald Pituitary Rongeur**

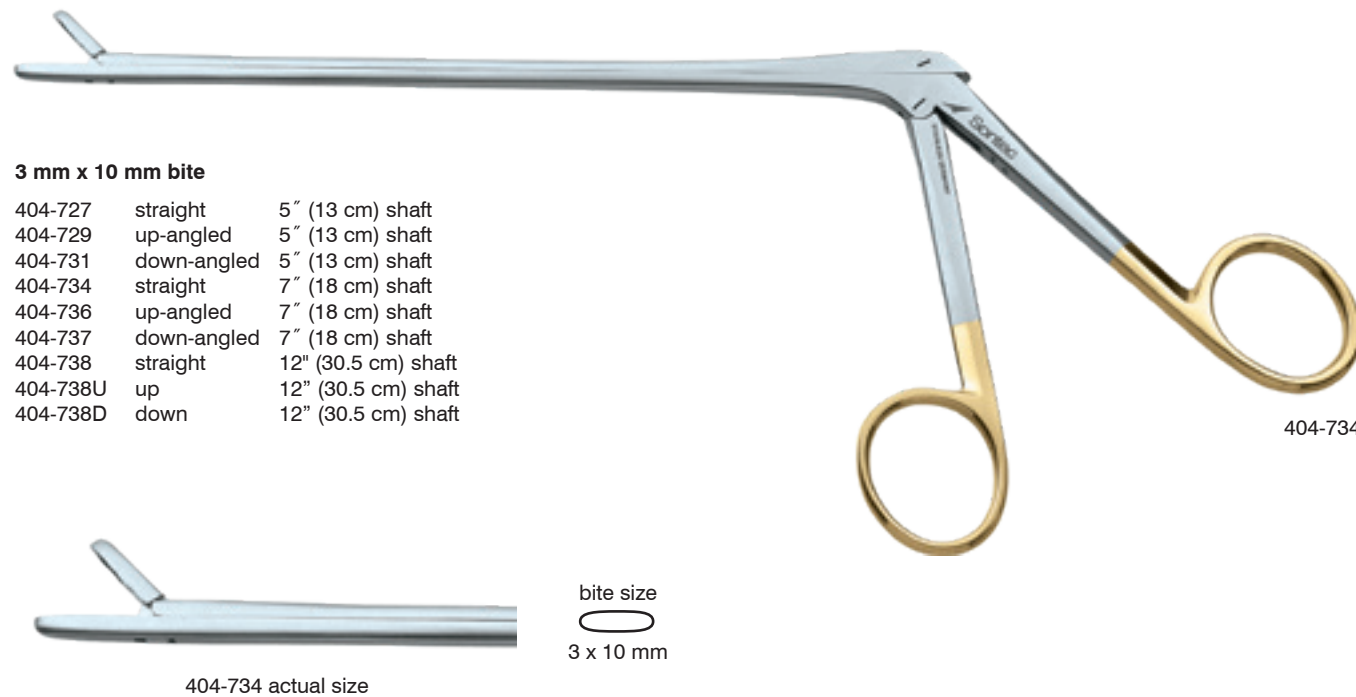

**Schlesinger (Cloward) Rongeur**

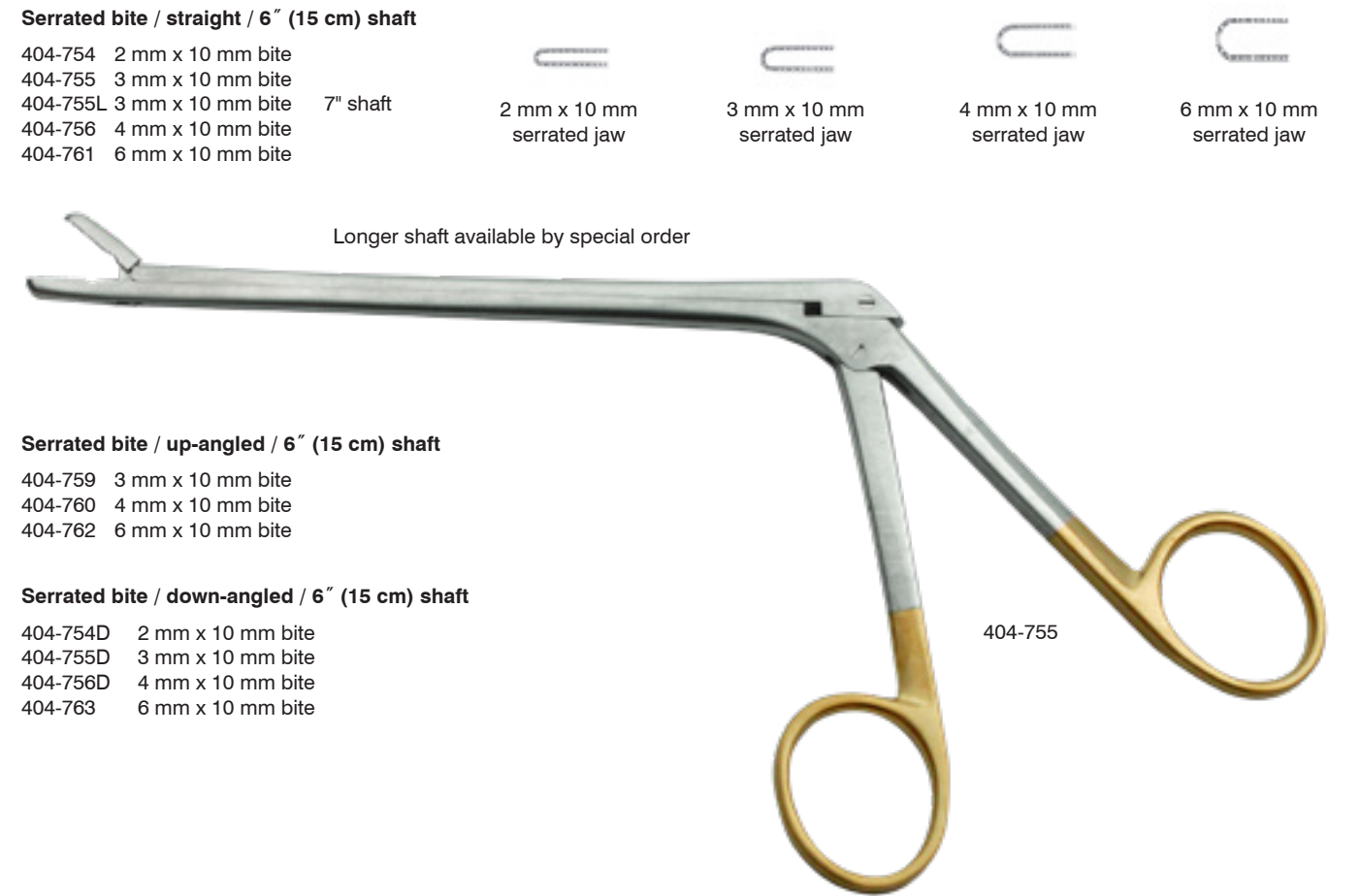

**Spurling Pituitary Rongeur**



**Wilde-Blakesley Rongeur**

Pointed elliptical fenestrated jaw / 4 1/2" (11.5 cm) shaft

- 404-767 3 x 8 mm jaw
- 404-768 4 x 12 mm jaw
- 404-769 5 x 12.5 mm jaw
- 404-770 6 x 13 mm jaw

Pointed elliptical fenestrated jaw / 45° / 4 1/2" (11.5 cm) shaft

- 404-766 3 x 8 mm jaw
- 404-771 4 x 12 mm jaw
- 404-772 5 x 12.5 mm jaw

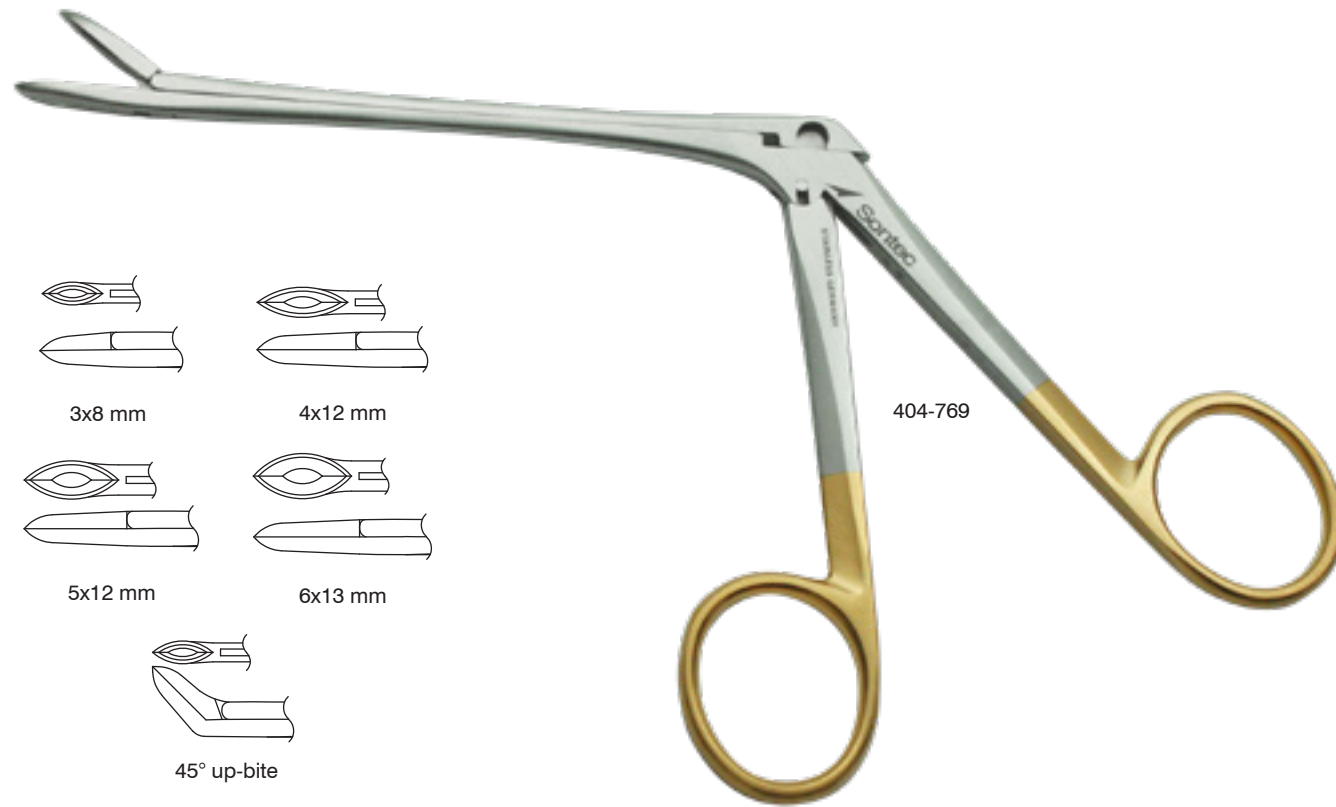

**Wilde Ethmoid Arthroscopic Rongeur**

Fenestrated jaw / 7" (17.8 cm) shaft / 2.5 mm

- 404-774 straight
- 404-775 up-bite
- 404-776 down-bite



**McIlwraith Arthroscopic Scissors Rongeur**

Scissor action / serrated / 1 mm x 14 mm cup / 5" (12.5 cm) shaft

1404-855





**Silverstone Peapod Rongeur**

Straight / 2 mm x 5 mm jaw / 6" (15.5 cm) shaft  
404-789



404-789



1271-041

**Arthroscopic, Forceps, Biopsy & Grasping Rongeur Forceps**

**Biopsy grasper forceps / tubular shaft / serrated bite**

- 1271-020 2.0 mm cup 4" (10 cm) shaft
- 1271-016 2.7 mm cup 4" (10 cm) shaft
- 1271-018 3.4 mm cup 4" (10 cm) shaft
- 1271-021 2.0 mm cup 6" (15.5 cm) shaft
- 1271-021A 2.0 mm cup 6" (15.5 cm) shaft rear actuator hand

\* Available in 4.5 mm, please ask for details

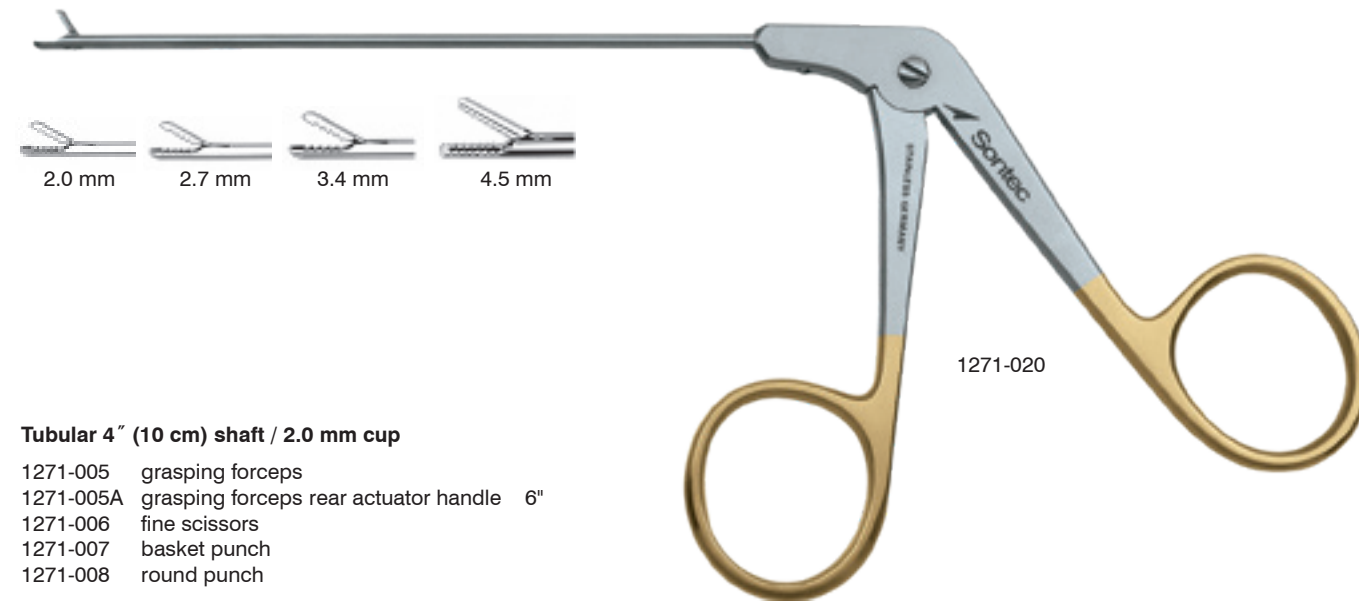

**Tubular 4" (10 cm) shaft / 2.0 mm cup**

- 1271-005 grasping forceps
- 1271-005A grasping forceps rear actuator handle 6"
- 1271-006 fine scissors
- 1271-007 basket punch
- 1271-008 round punch

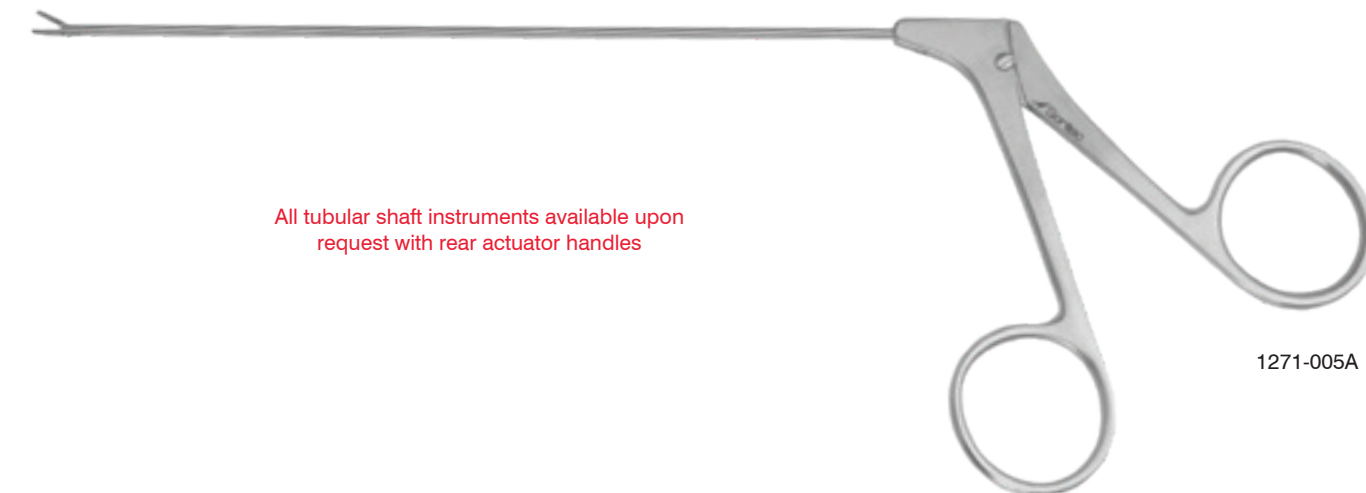
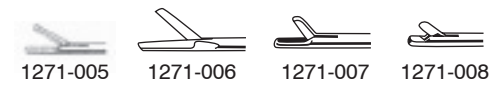

**Mini Arthro Small Joints Rongeur Set**

**Tubular 4" (15 cm) shaft / 2.0 mm jaws**

- 1271-005 grasping forceps
- 1271-005A grasping forceps rear actuator handle 6"
- 1271-006 fine scissors
- 1271-007 basket punch
- 1271-008 round cup biopsy

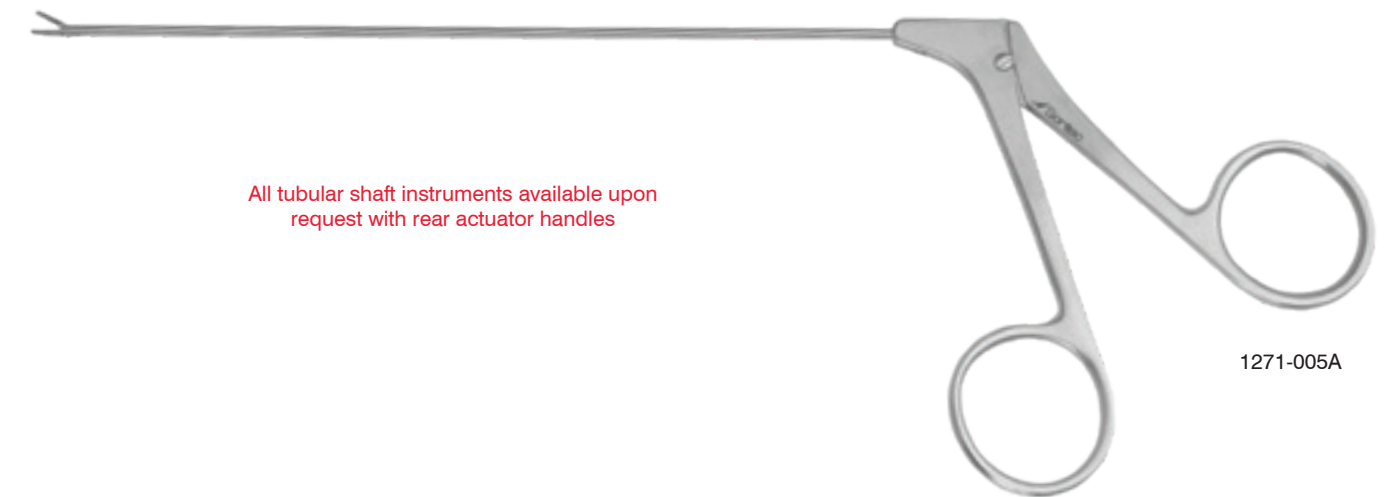
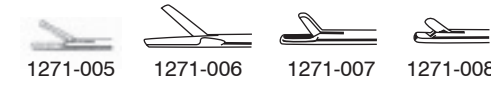

**Arthroscopic Grasping Forceps**

Overload cone / available with or without ratchet /  
5 3/4" (14.5 cm) shaft

<b>Grasping Forcep</b>								
	2.7 mm		1271-060	1271-061	1271-062	1271-063	1271-064	1271-085
	3.4 mm		1271-065	1271-066	1271-067	1271-068	1271-069	1271-086
	4.5 mm		1271-070	1271-071	1271-072	1271-073	1271-074	1271-087
	3.4 mm / 1x2 tth		1271-610	1271-611	1271-612	1271-613	1271-614	1271-615
	4.5 mm / 1x2 tth		1271-620	1271-621	1271-622	1271-623	1271-624	1271-625
<b>Grasping Forcep with ratchet</b>								
	2.7 mm		1271-060R	1271-061R	1271-062R	1271-063R	1271-064R	1271-085R
	3.4 mm		1271-065R	1271-066R	1271-067R	1271-068R	1271-069R	1271-086R
	4.5 mm		1271-070R	1271-071R	1271-072R	1271-073R	1271-074R	1271-087R
	3.4 mm / 1x2 tth		1271-640	1271-641	1271-642	1271-643	1271-644	1271-645
	4.5 mm / 1x2 tth		1271-650	1271-651	1271-652	1271-653	1271-654	1271-655
<b>Biopsy &amp; Grasping Forceps</b>								
	2.7 mm		1271-090	1271-091	1271-092	1271-093	1271-094	1271-095
	3.4 mm		1271-101	1271-102	1271-103	1271-104	1271-105	1271-106
	4.5 mm		1271-107	1271-108	1271-109	1271-110	1271-111	1271-112

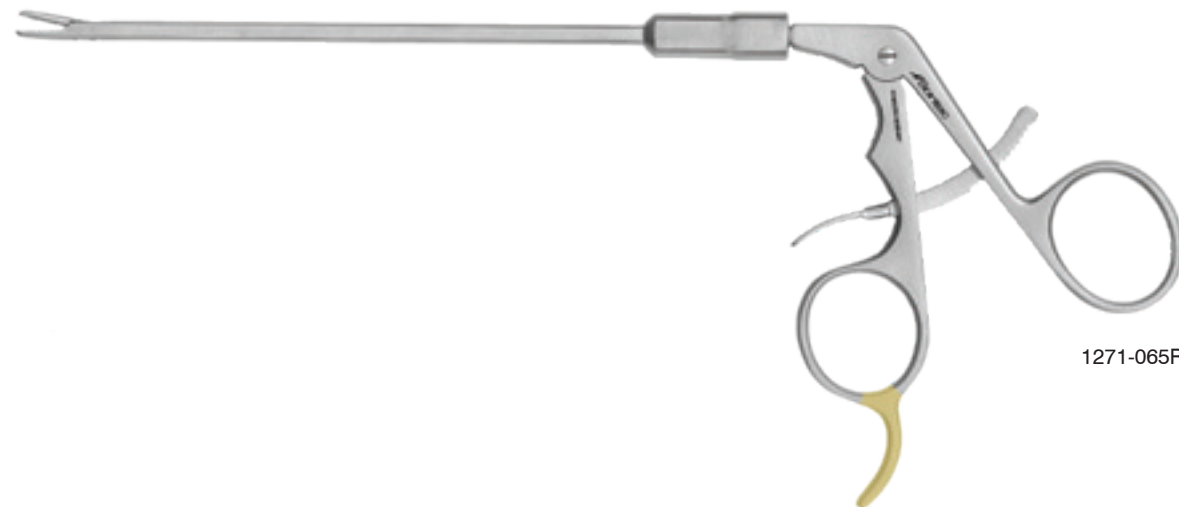

1271-065R

**Takahashi Rongeur**

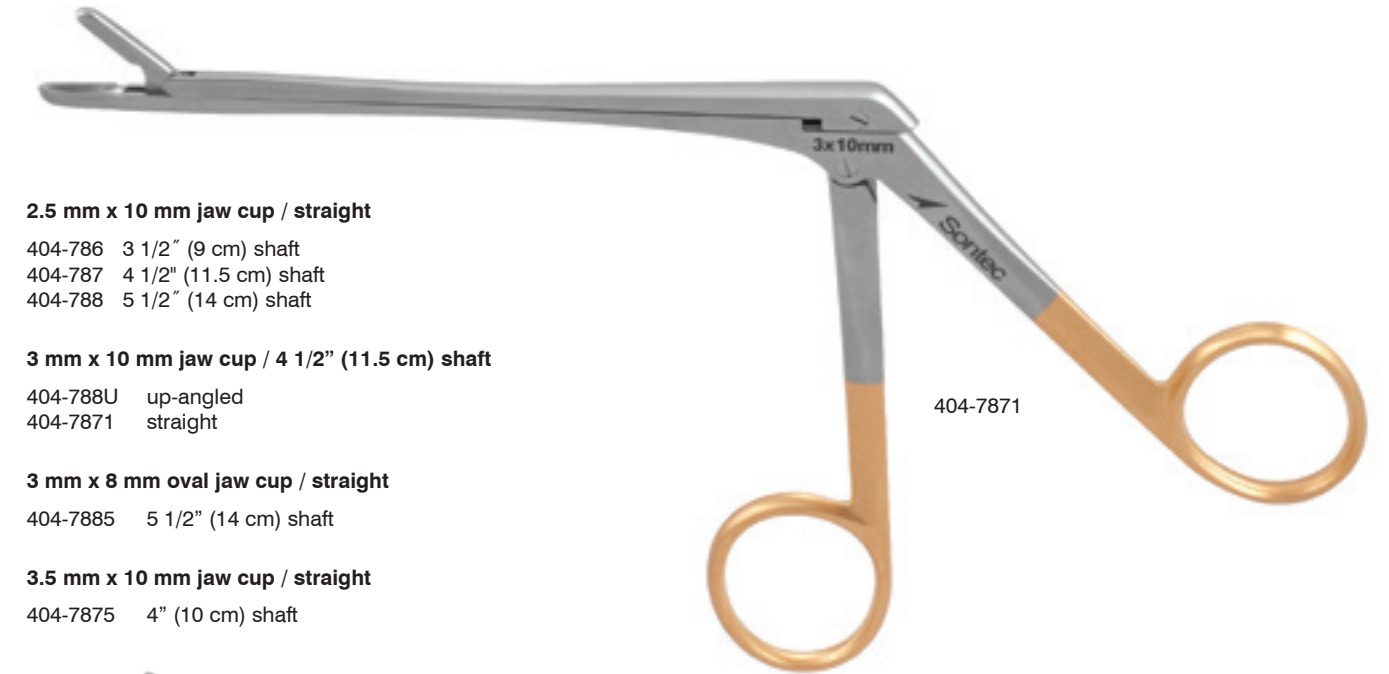

**2.5 mm x 10 mm jaw cup / straight**

- 404-786 3 1/2" (9 cm) shaft
- 404-787 4 1/2" (11.5 cm) shaft
- 404-788 5 1/2" (14 cm) shaft

**3 mm x 10 mm jaw cup / 4 1/2" (11.5 cm) shaft**

- 404-788U up-angled
- 404-7871 straight

**3 mm x 8 mm oval jaw cup / straight**

- 404-7885 5 1/2" (14 cm) shaft

**3.5 mm x 10 mm jaw cup / straight**

- 404-7875 4" (10 cm) shaft



404-788U



404-7875

**McIlwraith-Peapod Rongeur**

Longer shaft available by special order

**Straight / 5 1/2" (14 cm) shaft**

404-782 2.2 mm x 6 mm jaw cup

**Up-angled / 5 1/2" (14 cm) shaft**

404-783 2.2 mm x 6 mm jaw cup small  
 404-784 3 mm x 6 mm jaw cup medium  
 404-785 4 mm x 6 mm jaw cup large



404-783

**Williams-Sontec Rongeur**

For arthroscopy & dissection / very sharp / 2 mm x 5 mm jaw / 1 x 2 teeth / 5 1/2" (14 cm) shaft

404-824



actual size



404-824

**McIlwraith Cup Rongeur**

**Round cup / straight / 7" (18 cm) shaft**

1404-845A 2 mm cup  
 1404-845B 4 mm cup  
 1404-845D 6 mm cup

**Round cup / up-angled / 7" (18 cm) shaft**

1404-846A 2 mm cup  
 1404-846B 4 mm cup  
 1404-846D 6 mm cup



1404-846D



1404-845A

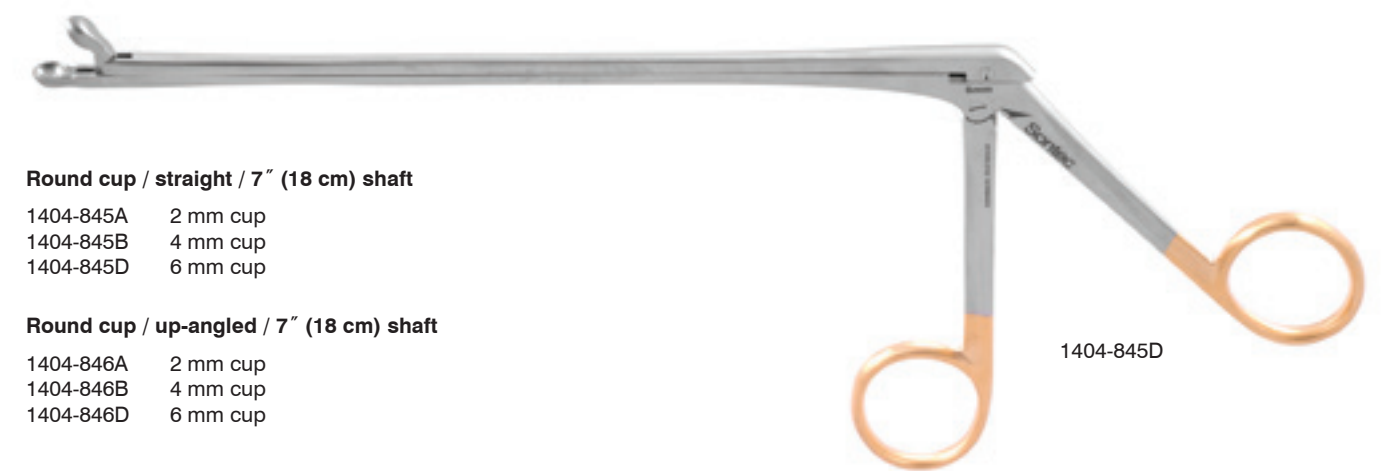

1404-845D

**McIlwraith Basket Cutter Rongeur**

5" (12.5 cm)

1404-857 2.5 mm x 8 mm jaw  
 1404-858 3.5 mm x 8 mm jaw



actual size



1404-857

**McIlwraith Arthroscopic Grasping Rongeur**

Heavy duty / 1 x 2 teeth / 6 1/2" (16.5 cm) shaft

- 1404-860 4 mm x 10 mm jaw
- 1404-865 3.4 mm x 10 mm standard
- 1404-861 3 mm x 10 mm jaw delicate

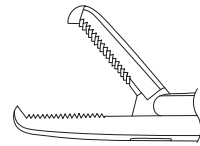

1404-860



1404-861

1404-860

**Caspar Grasping Rongeur**

Straight / 5 1/2" (14 cm) shaft

- 53-0510 2 mm x 12 mm jaw
- 53-0512 3 mm x 12 mm jaw
- 53-0514 4 mm x 14 mm jaw
- 53-0516 5 mm x 14 mm jaw
- 53-0518 6 mm x 16 mm jaw

Straight / 6 1/4" (16 cm) shaft

- 53-0520 2 mm x 12 mm jaw
- 53-0522 3 mm x 12 mm jaw
- 53-0524 4 mm x 14 mm jaw
- 53-0526 5 mm x 14 mm jaw
- 53-0528 6 mm x 16 mm jaw

Straight / 7 1/4" (18.5 cm)

- 53-0530 2 mm x 12 mm jaw
- 53-0532 3 mm x 12 mm jaw
- 53-0534 4 mm x 14 mm jaw
- 53-0536 5 mm x 14 mm jaw
- 53-0538 6 mm x 16 mm jaw

Straight / custom instrument / fenestrated / 6 mm x 16 mm jaw / 9" (23 cm) shaft

53-0539

Up-angled / 5 1/2" (14 cm) shaft

- 53-0542 3 mm x 12 mm jaw
- 53-0544 4 mm x 14 mm jaw
- 53-0546 5 mm x 14 mm jaw

Up-angled / 6 1/4" (16 cm) shaft

- 53-0552 3 mm x 12 mm jaw
- 53-0554 4 mm x 14 mm jaw
- 53-0556 5 mm x 14 mm jaw

Up-angled / 7 1/4" (18.5 cm) shaft

- 53-0560 2 mm x 12 mm jaw
- 53-0562 3 mm x 12 mm jaw
- 53-0564 4 mm x 14 mm jaw
- 53-0566 5 mm x 14 mm jaw

Down-angled / 5 1/2" (14 cm) shaft

- 53-0572 3 mm x 12 mm jaw
- 53-0574 4 mm x 14 mm jaw

Down-angled / 6 1/4" (16 cm) shaft

- 53-0582 3 mm x 12 mm jaw
- 53-0584 4 mm x 14 mm jaw

Down-angled / 7 1/4" (18.5 cm) shaft

- 53-0590 2 mm x 12 mm jaw
- 53-0592 3 mm x 12 mm jaw
- 53-0594 4 mm x 14 mm jaw

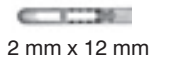

2 mm x 12 mm



3 mm x 12 mm



4 mm x 14 mm



5 mm x 14 mm



6 mm x 16 mm

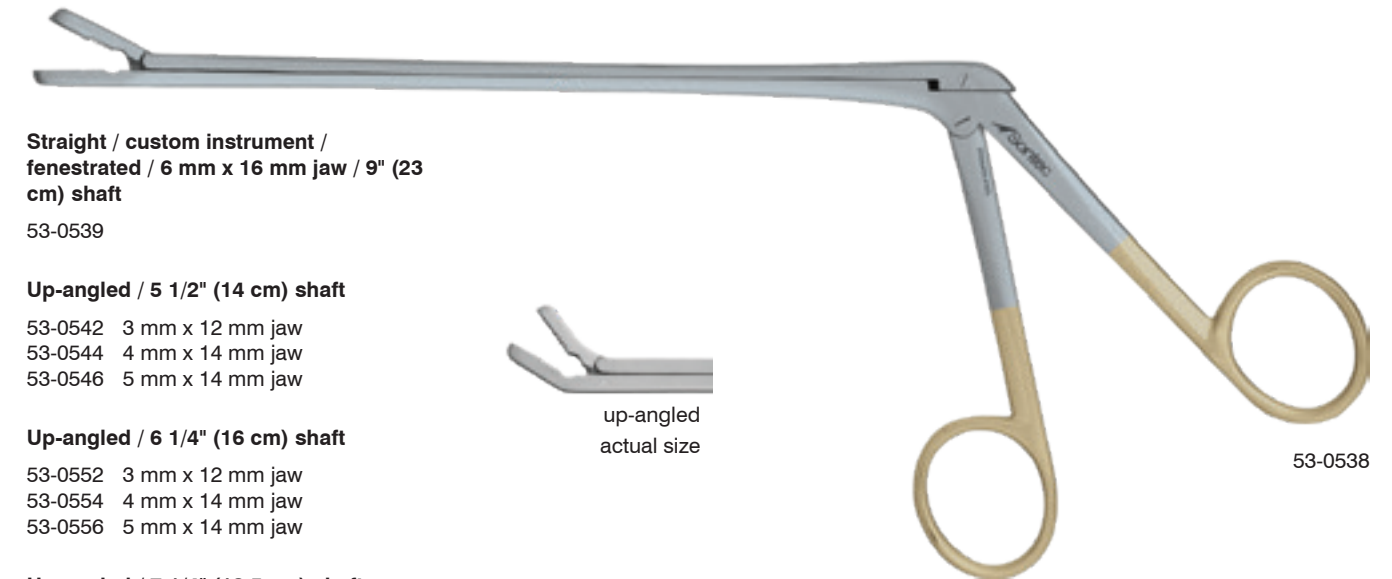

53-0538



up-angled  
actual size



down-angled  
actual size



**Arthroscopic Maxi Grasper**

Large serrated teeth / crab claw jaws / open center jaw 18 mm elliptical gap when jaws are fully closed / 7" (18 cm)

404-765



404-765

**Arthroscopic Mini Grasper**

Serrated upper jaw with smooth lower jaw / crab claw jaw / 18 mm jaw / 6" (15.2 cm)

404-764



404-764

**Hoehn Grasping Forceps**

1 x 2 teeth / 5 1/2" (14 cm) shaft

1404-862



1404-862



1404-862

**Meniscus Grasping Forceps**

Axial, ring handled grip / serrated jaw / 1 x 2 teeth / 7" (18 cm)

- 1404-852 straight
- 1404-854 curved left
- 1404-853 curved right



1404-852



1404-853

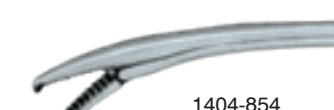

1404-854

**Rotary Arthroscopic Scissors**

1273-100	hook left	20°
1273-101	hook right	20°
1273-103	hook right	60°
1273-105	hook left	60°



1273-100



1273-103

**McIlwraith Tendon Grasper / Retriever**

Tip 1.3 cm / malleable / 8 1/4" (21 cm)

1404-850

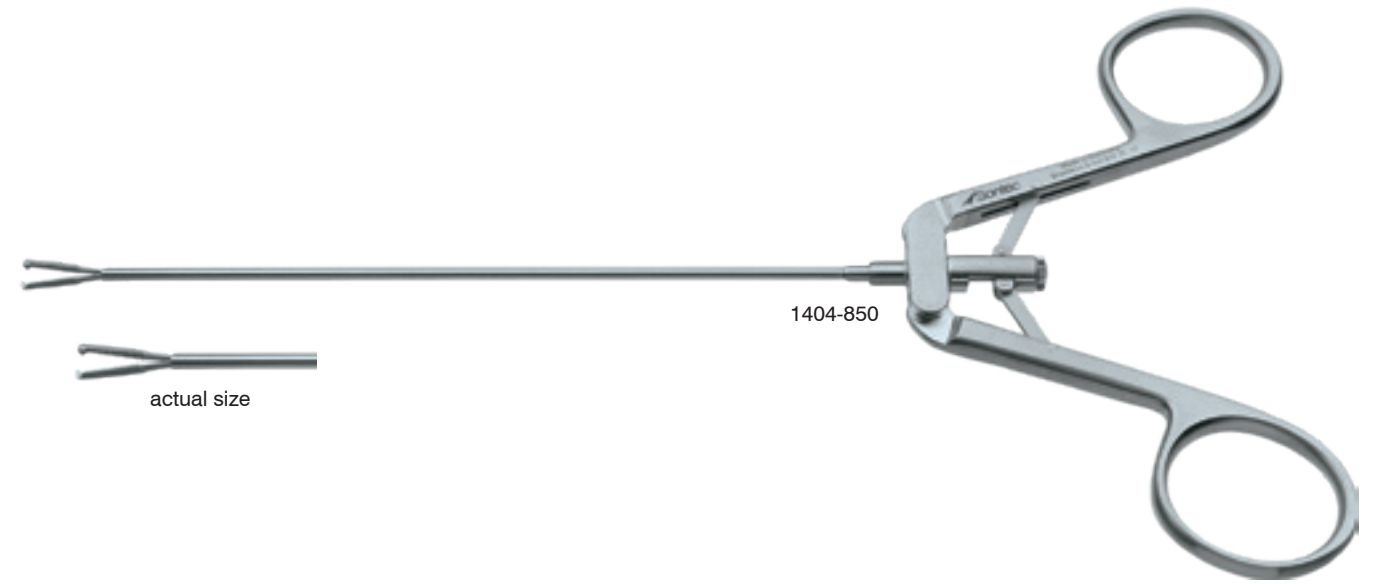

actual size

1404-850





**Arthroscopic Punch & Scissors**

Overload cone for added strength / 5 3/4" (14.5 cm) shaft measurement is from jaw to overload cone

		Straight	Left 30°	Right 30°	Left 45°	Right 45°	wCurved Up 15°
Square Punch	2.7 mm	1271-350	1271-351	1271-352	1271-353	1271-354	1271-355
	3.4 mm	1271-360	1271-361	1271-362	1271-362	1271-364	1271-365
Hook Punch with Sccep	2.7 mm	1271-370	1271-371	1271-372	1271-373	1271-374	1271-375
	3.4 mm	1271-380	1271-381	1271-382	1271-383	1271-384	1271-385
	4.5 mm	1271-390	1271-391	1271-392	1271-393	1271-394	1271-395
Basket Punch	3.4 mm	1271-400	1271-401	1271-402	1271-403	1271-404	
	4.5 mm	1271-410	1271-411	1271-412	1271-413	1271-414	
	4.5 mm	1271-420	1271-421	1271-422	1271-423	1271-424	1271-425
Hook Punch	2.7 mm	1271-430	1271-431	1271-432	1271-433	1271-434	1271-435
	3.4 mm	1271-440	1271-441	1271-442	1271-443	1271-444	1271-445
	4.5 mm	1271-450	1271-451	1271-452	1271-453	1271-454	
Hook Scissors	2.7 mm	1271-460	1271-461	1271-462	1271-463	1271-464	
	3.4 mm	1271-470	1271-471	1271-472	1271-473	1271-474	
	4.5 mm						

continues on next page

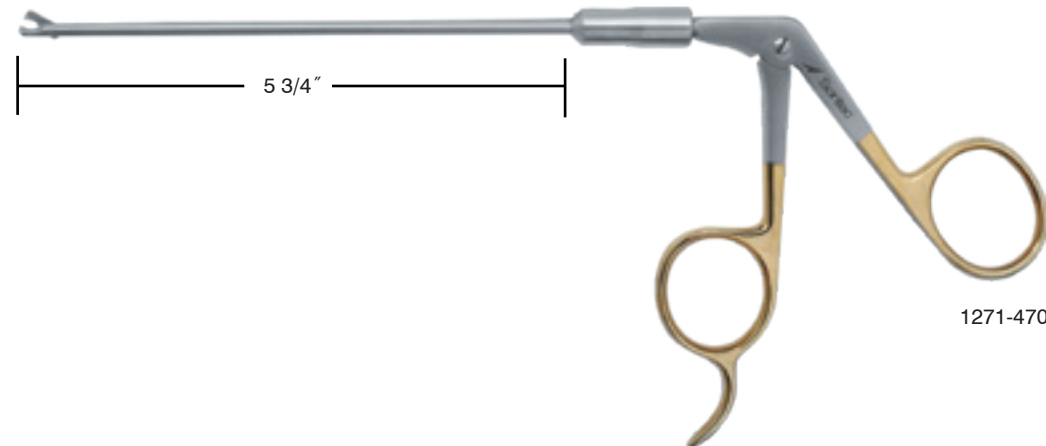

**Arthroscopic Grasping Forceps**

Overload cone / available with or without ratchet / 5 3/4" (14.5 cm) shaft

<b>Grasping Forcep</b>								
	2.7 mm		1271-060	1271-061	1271-062	1271-063	1271-064	1271-085
	3.4 mm		1271-065	1271-066	1271-067	1271-068	1271-069	1271-086
	4.5 mm		1271-070	1271-071	1271-072	1271-073	1271-074	1271-087
	3.4 mm / 1x2 tth		1271-610	1271-611	1271-612	1271-613	1271-614	1271-615
	4.5 mm / 1x2 tth		1271-620	1271-621	1271-622	1271-623	1271-624	1271-625
<b>Grasping Forcep with ratchet</b>								
	2.7 mm		1271-060R	1271-061R	1271-062R	1271-063R	1271-064R	1271-085R
	3.4 mm		1271-065R	1271-066R	1271-067R	1271-068R	1271-069R	1271-086R
	4.5 mm		1271-070R	1271-071R	1271-072R	1271-073R	1271-074R	1271-087R
	3.4 mm / 1x2 tth		1271-640	1271-641	1271-642	1271-643	1271-644	1271-645
	4.5 mm / 1x2 tth		1271-650	1271-651	1271-652	1271-653	1271-654	1271-655
<b>Biopsy &amp; Grasping Forceps</b>								
	2.7 mm		1271-090	1271-091	1271-092	1271-093	1271-094	1271-095
	3.4 mm		1271-101	1271-102	1271-103	1271-104	1271-105	1271-106
	4.5 mm		1271-107	1271-108	1271-109	1271-110	1271-111	1271-112

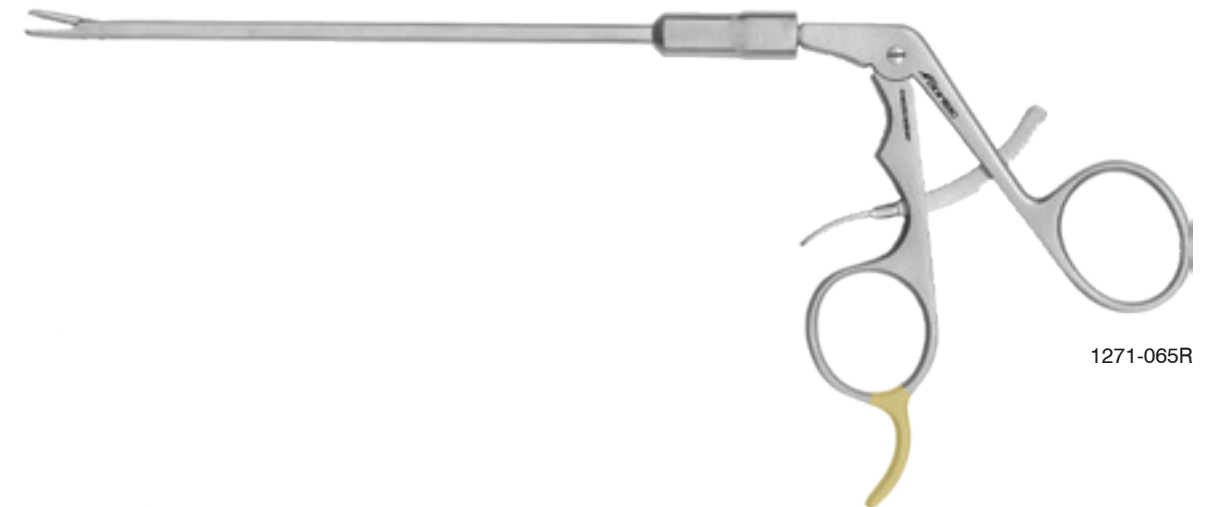

### Small Joint Arthroscopic Cannula Switch Stick Set

Complete with 4 cannulas, 4 switch sticks, dilation needle (set of five) cannulated obturator, and lightweight anodized case

SC95-0425

\*Instruments are also available separately

### Small Joint Arthroscopic Cannula

SC95-0421	2.9 mm	2 1/2" (6.5cm)
SC95-0422	3.7 mm	2 1/2" (6.5cm)
SC95-0423	4.3 mm	3 1/4" (8.3cm)
Sc95-0424	5.1 mm	3 1/4" (8.3cm)

### Arthroscopic Switch Stick

8 3/4"

1271-117-1	1.1mm
1271-117-5	2.4mm
1271-117-2	2.9mm
1271-117	3.2mm
1271-117-3	3.7mm

Set of 5 / 8 3/4"

1271-117-4	1.1mm
1271-117-4	2.4mm
1271-117-4	2.9mm
1271-117-4	3.2mm
1271-117-4	3.7mm

### Arthroscopic Cannulated Obturator

Small joint / 1.3 mm / 4 1/2" (11.5cm)

SC95-0420

### Arthroscopic Dilation Needle

Set of 5 / 8" (20.3cm)

1271-117-4

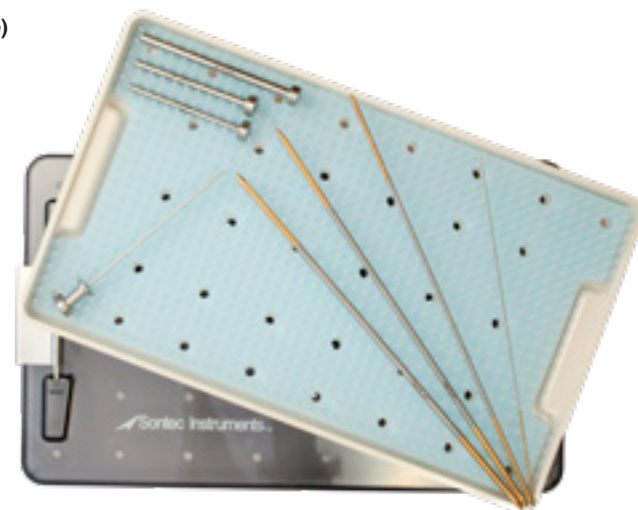

### Small Joint Complete Arthroscopic Set

Includes the following instruments

Sc95-0427 complete set

\* instruments are also available separately

Item Number	Description				
1271-020	grasping biopsy forcep	2 mm	serrated	4" (10 cm)	
1271-090	grasping biopsy forcep	2.7 mm	straight	7" (18 cm)	overload cone
1271-060R	grasping forcep with ratchet	2.7 mm	straight	7" (18 cm)	overload cone
1271-480	hook punch with mini jaws	2.7 mm	straight	7" (18 cm)	overload cone
1271-143	universal anthro handle	125 mm			
1271-127U	universal hook probe	3 mm	90°		
1271-139U	universal banana knife				
1271-122U	universal hook probe	2.5 mm	graduated		
1271-121U	universal hook probe	3.5 mm	graduated		
1271-142U	universal toothed knife		straight		
1271-140U	universal ring curette	3 mm	angled		
SC95-0315	irrigation cannula	3.2 mm			with stop cock
1271-117-1	arthroscopic switch stick	1.1 mm		8" (20.3 cm)	
1271-117-2	arthroscopic switch stick	2.9 mm		8" (20.3 cm)	
1271-117-3	arthroscopic switch stick	3.7 mm		8" (20.3 cm)	
SC95-0420	cannulated obturator	1.3 mm		4" (10 cm)	small joint
SC95-0421	arthroscopic cannula	2.9 mm		2 1/4" (6 cm)	small joint
SC95-0422	arthroscopic cannula	3.7 mm		2 1/4" (6 cm)	small joint
SC95-0423	arthroscopic cannula	4.3 mm		3 1/4" (8 cm)	small joint

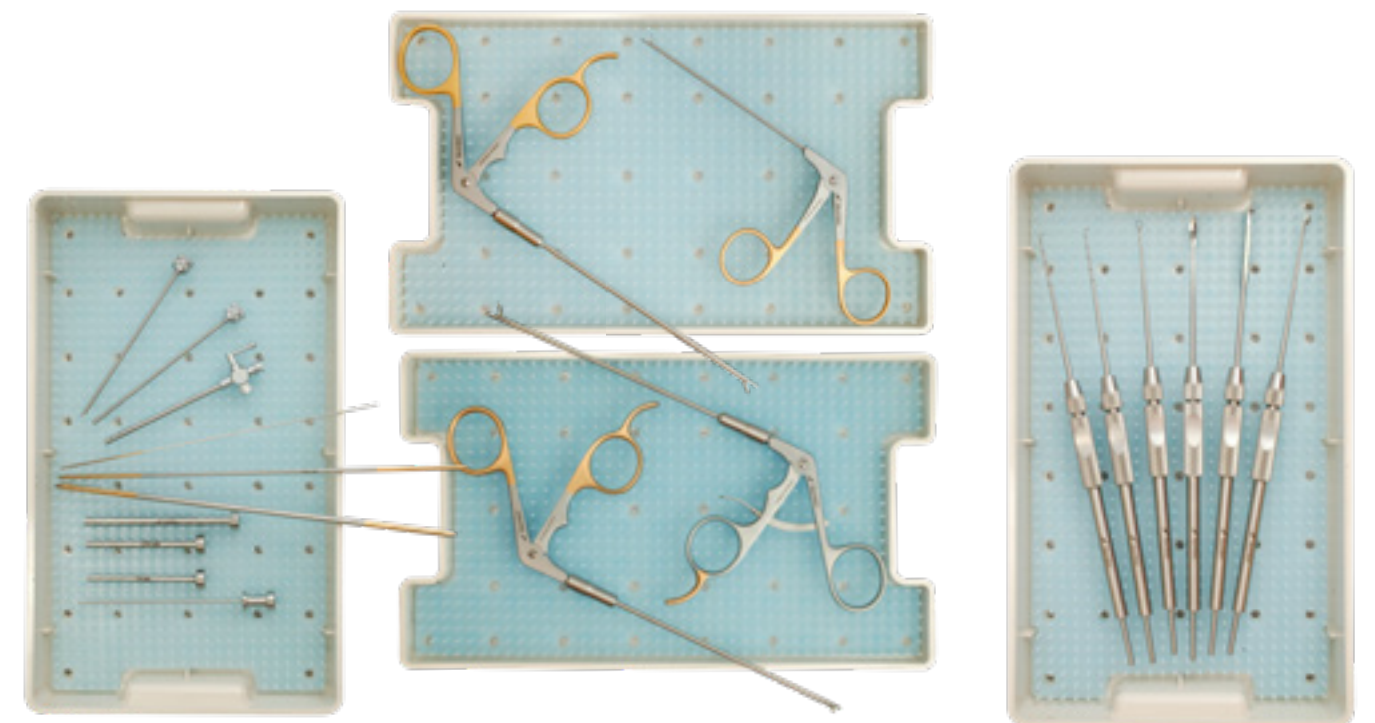

**Egress Cannula Set**

Cutting obturator / lateral irrigation holes / 2 3/4" (7 cm) working length / set includes a sharp and blunt cannula

SC95-0310	3.2 mm diameter	without stop cock	special order
SC95-0315	3.2 mm diameter	with stop cock	
SC95-0415	4.5 mm diameter	with stop cock	

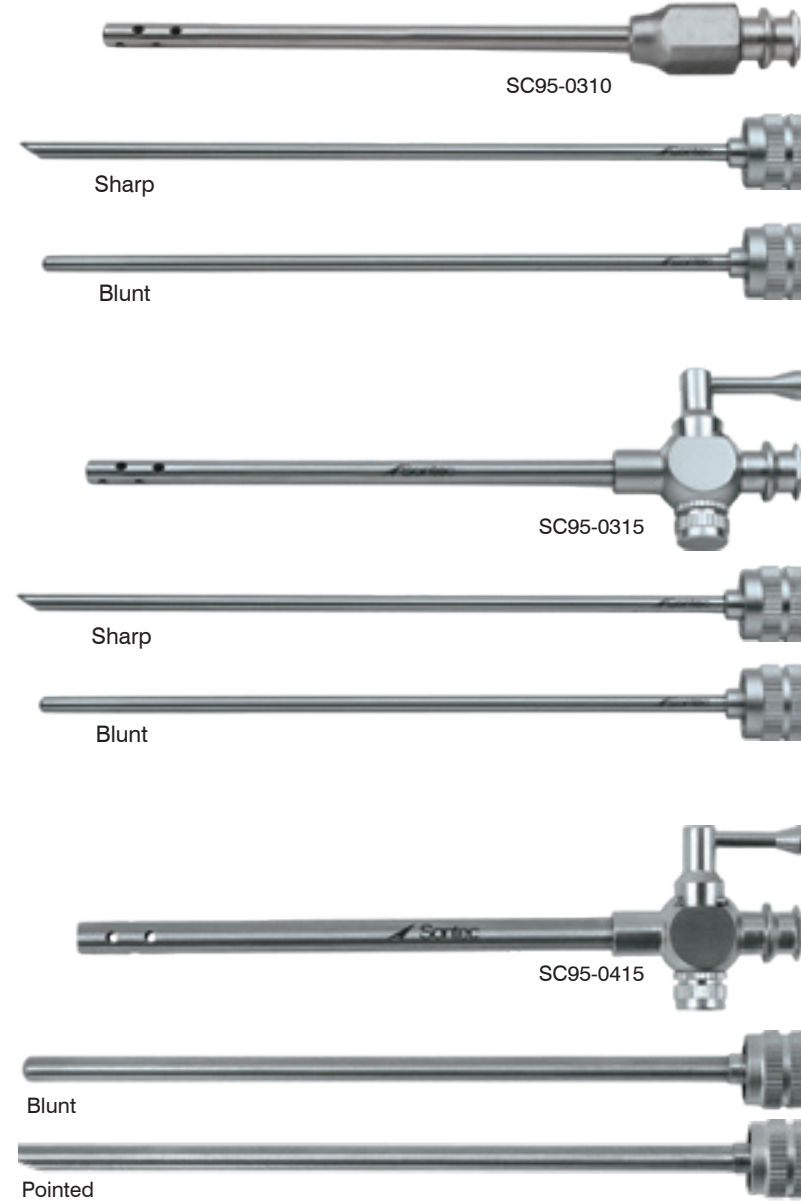

**Egress Cannula Set**

With conical obturator / 6" (15.2 cm) working length

SC94-0312	3.1 mm ID
SC94-0313	4.1 mm ID
SC94-0314	5.1 mm ID
SC94-0315	6.1 mm ID
SC94-03157	7.1 mm ID
SC94-03158	8.1 mm ID
SC94-03159	9.1 mm ID

With Conical obturator / 12" (30.5 cm) working length

SC94-0316	3.1 mm ID
SC94-0317	4.1 mm ID
SC94-0318	5.1 mm ID
SC94-0319	6.1 mm ID
SC94-0320	7.1 mm ID
SC94-0321	8.1 mm ID
SC94-0322	9.1 mm ID

\* CUSTOM - specify size (diameter & length) when ordering

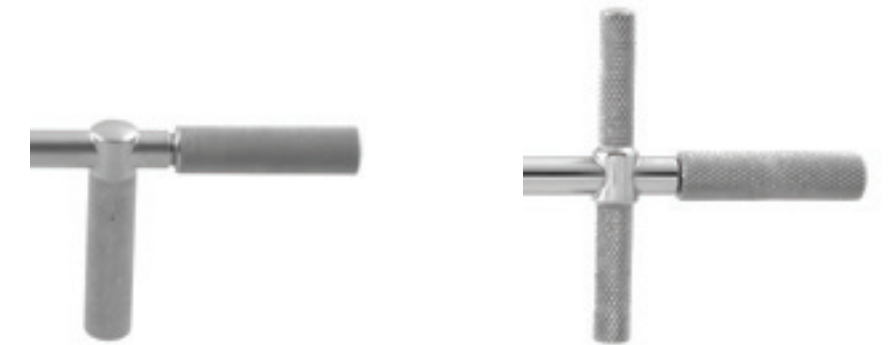

available with T-handle or L-handle shown above



SC94-0312

**Inflow Cannula Set**

Set includes a sharp and blunt cannula

SC95-0300	4.5 mm	includes infusion adapter	complete set
SC95-0305	4.5 mm	infusion adapter only	
SC95-0302	5.5 mm	includes infusion adapter	complete set
SC95-0306	5.5 mm	infusion adapter only	

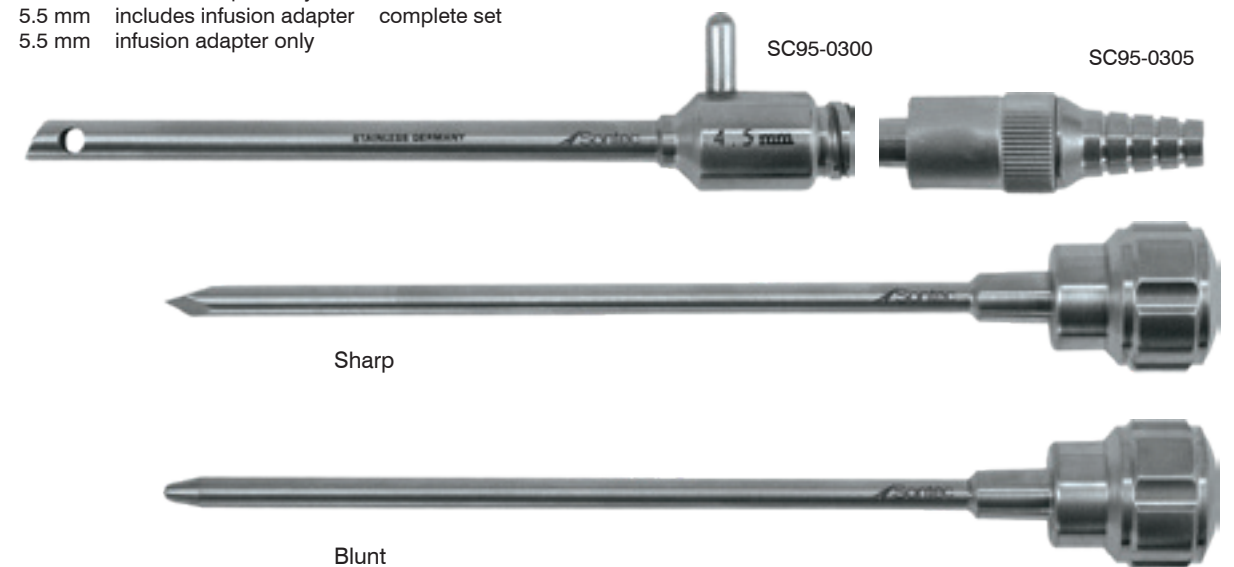

**Nasal/Tendon Knife**

5 1/2" (14 cm)

1271-165 single edge 30 mm blade str

6 1/2" (16.5 cm)

1271-175 single classic edge 23 mm blade str  
 1271-180 single lance edge 23 mm blade str  
 1271-152 double lance edge 24 mm blade str  
 1271-181 single retrograde edge 36 mm blade cvd



**McIlwraith Tendon Knife**

6 1/2" (16.5 cm)

1271-160 single edge 40 mm blade  
 1271-153 double edge 45 mm blade



**Tendon Knife**

Single side / 30 mm blade / sharp point / 6" (15.2 cm)

1271-163



**Joseph Nasal/Tendon Knife**

6" (17 cm)

1271-152C curved  
 1271-152B blunt  
 1271-152D round tip





**McIlwraith Bistouri Knife**

**Button end blade**

1271-156	straight	35 mm	6" (15 cm)
1271-155	curved	55 mm	7" (18 cm)
1271-154	straight	55 mm	7" (18 cm)



1271-156



1271-155



1271-154

**Nixon XXL Banana Knife**

**Double sided / wide blade / serrated / 9" (23 cm)**

1271-139C	curved
1271-139D	straight



1271-139C

**Winberg Equine Tendon Knife**

**7" (18 cm)**

1271-157



1271-157

**Arthroscopic Meniscotomes Hook, Probe & Knife**

9" (23 cm) / item numbers followed by "U" fit universal handle. Handle is sold separately / choose either knurled handle or universal handle-shaft combination

1271-143	universal handle	sold separately	4 3/4"
1271-143L	universal handle	extra long 8"	special order



1271-139S

1271-143

1271-143L



Toothed / 1271-142

Tendon / 1271-131

Toothed 1271-142U

Banana, double-sided, serrated / 1271-139S

Button-end / 1271-132

Banana, serrated 1271-139SU

Banana, double-sided / 1271-139

Banana 1271-139U

Sickle / 1271-118

Sickle 1271-118U

Hook / 1271-127

Hook 1271-127U

Scalpel / 1271-128

Scalpel 1271-128U

45° Hook / 1271-126

45° 1271-126U

Meniscotome / 1271-136

Meniscotome 1271-125U

Meniscotome 1271-136U

Meniscotome / 1271-138

Bayonet 1271-119U

Meniscotome 1271-138U

**Triangle Handle Arthroscopic Meniscotome, Hook, Probe & Knife**

9 1/4" (23.5 cm) / triangle handle

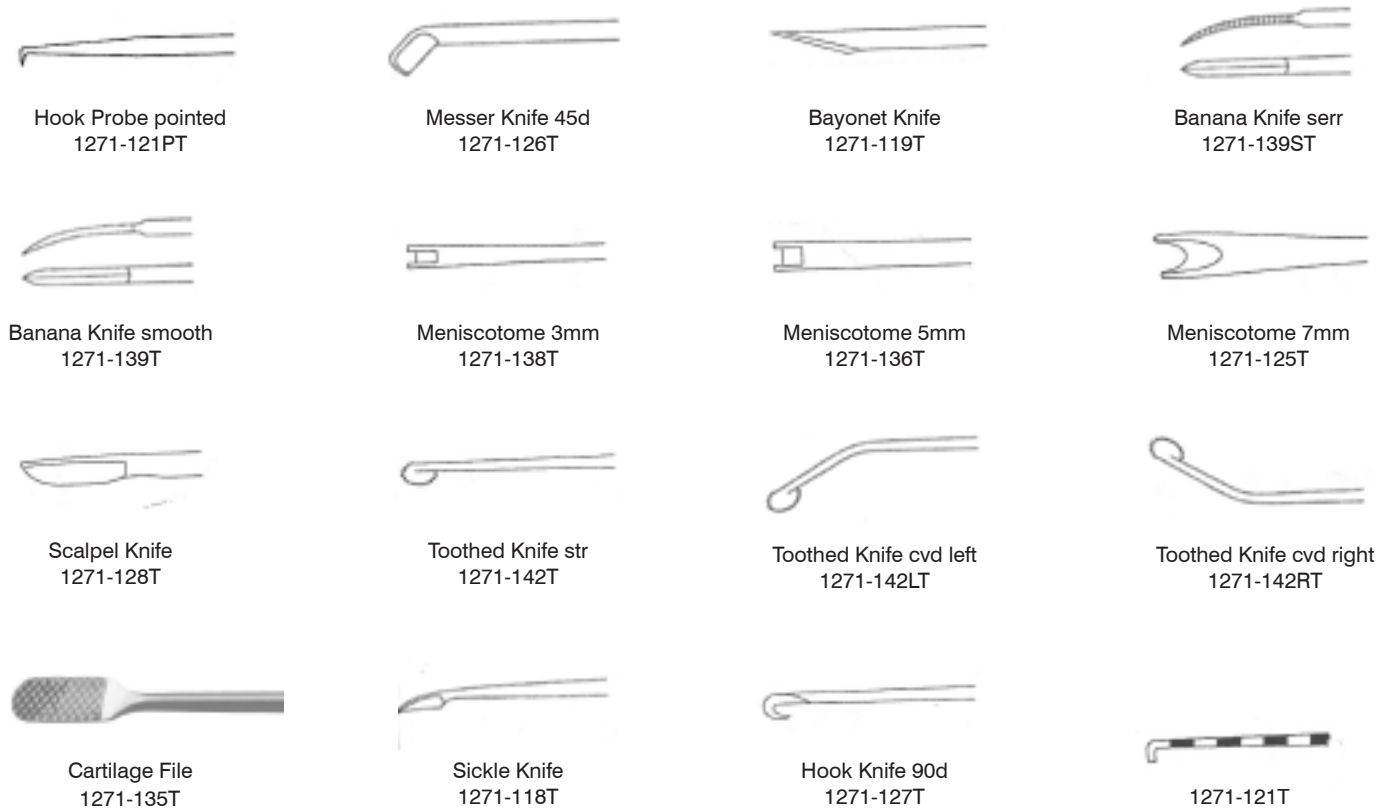

**Arthroscopic Rasp**

Item numbers followed by "U" fit universal handle / 9" (23 cm)

1271-134  
1271-143 universal handle sold separately

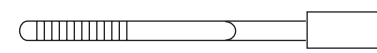

1271-134



1271-143

**Arthroscopic Rasp**

Item numbers followed by "U" fit universal handle / 4x6 mm / 9" (23 cm)

1271-133U straight  
1271-133AU-ang 15° angle  
1271-143 universal handle sold separately



1271-133U



1271-143

**Arthroscopic Curette & Ring Curette**

9 1/4" (23.5 cm) / triangle handle

1271-116T 30 degrees  
1271-148S 3 mm ring tip  
1271-148T 7 mm ring tip 30°

9 1/4" (23.5 cm) / triangle handle / 30°

1271-149 5 mm ring tip

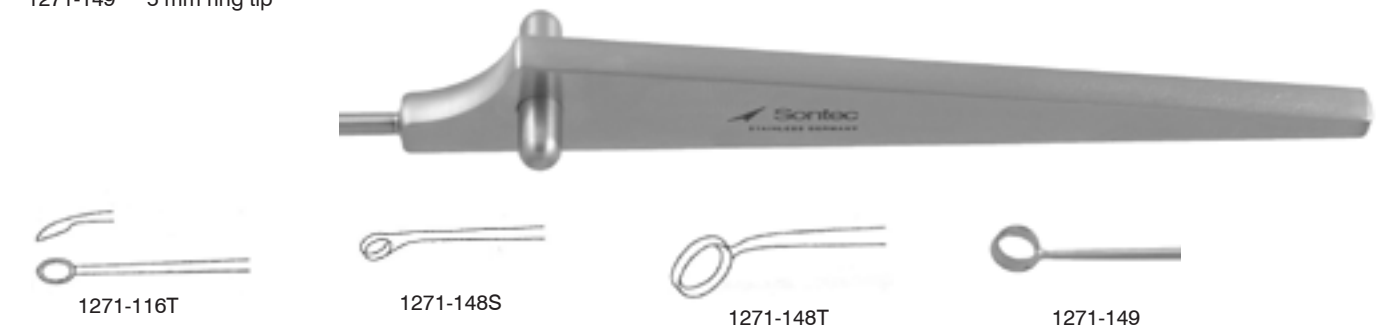

**Knurled handle / 3 mm / 9" (23 cm)**

1271-115 30° curved curette  
1271-140 right angled sharp ring tip

**"U" Fit universal handle / 3 mm / 9" (23 cm)**

1271-116U 30° curved curette  
1271-140U right angled sharp ring tip

**Universal handle sold separately**

1271-143 universal handle sold separately



1271-115



1271-115



1271-140



1271-143



1271-116U



1271-140U

**Arthroscopic Hook Probe**

9" (23 cm)

1271-121	3.5 mm	knurled handle
1271-122	2.5 mm	knurled handle
1271-122U	2.5 mm	for universal handle
1271-121U	3.5 mm	for universal handle
1271-1204U	4 mm	for universal handle
1271-120U	5 mm	for universal handle



Universal Handle sold separately

**McIlwraith Arthroscopic Hook Probe**

Graduated / light / 9 1/2" (24 cm)

1271-129



Graduated / heavy / 10 1/2" (26 cm)

1271-130



Phenolic handle / 10 1/4" (26 cm)

1271-130PH



**Taylor Micro Arthroscopic Hook Probe & Pick**

1.2mm / 8" (20 cm)

1271-120	straight
1271-123	curved

3 mm hook / 1 mm ball tip / lightweight type handle / 8 1/2" (21.5 cm)

1271-123LW



**Bone Pick Micro Fracture**

Phenolic handle / 30° tip

1271-320	6 7/8" (17.5 cm)	mini
1271-330	7 1/2" (19 cm)	peterson
1271-325	10 3/4" (27.5cm)	equine

Phenolic handle / 60° tip

1271-321	6 7/8" (17.1 cm)
1271-322	7 1/2" (19.1 cm)
1271-326	10 3/4" (27.3 cm)

Phenolic handle / 90° tip

1271-323	6 7/8" (17.1 cm)
1271-324	7 1/2" (19.1 cm)
1271-327	10 3/4" (27.3 cm)



**Telescoping Metal Fragment Retriever**

Magnetic / 5" (12.5 cm) closed / chrome / 25" extended  
1404-840

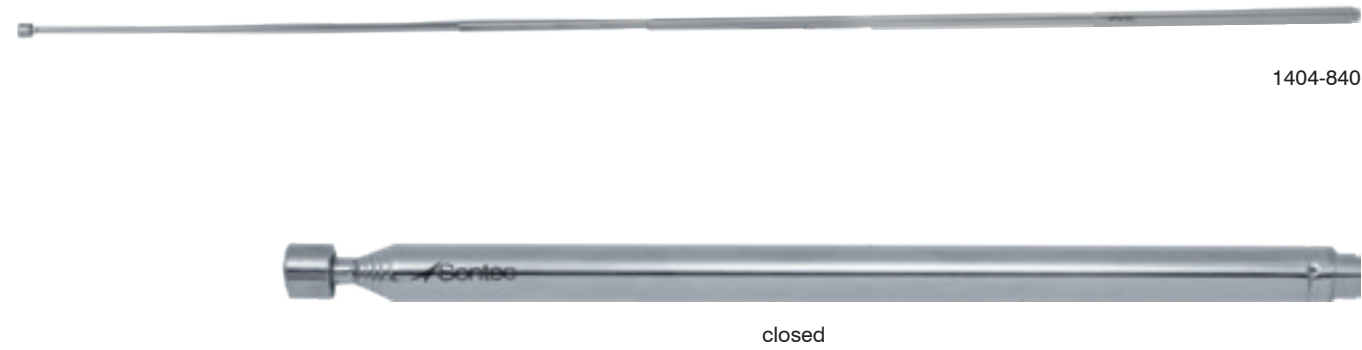

1404-840

**Universal Magnet for Retrieval/Demagnetizing**

1404-841P phenolic handle 7" (18 cm)  
1404-841 tubular handle 8" (20.5 cm)



1404-841P

**Bruns Oval Cup Curette**

Oval cup / straight / 6 3/4" (17 cm)

- 320-808 size 00000
- 320-809 size 0000
- 320-810 size 000
- 320-811 size 00
- 320-812 size 0
- 320-813 size 1
- 320-814 size 2
- 320-815 size 3
- 320-816 size 4
- 320-817 size 5
- 320-818 size 6

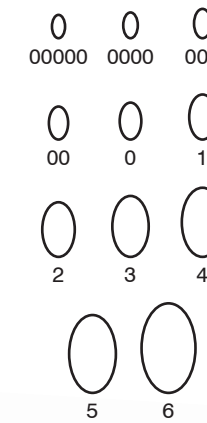

320-811

Oval cup / straight / 9" (23 cm)

- 320-827 size 00000
- 320-829 size 0000
- 320-830 size 000
- 320-831 size 00
- 320-832 size 0
- 320-833 size 1
- 320-834 size 2
- 320-835 size 3
- 320-836 size 4
- 320-837 size 5
- 320-838 size 6



320-834

Oval cup / angled / 9" (23 cm)

- 320-848 size 00000
- 320-849 size 0000
- 320-850 size 000
- 320-851 size 00
- 320-852 size 0
- 320-853 size 1
- 320-854 size 2
- 320-855 size 3
- 320-856 size 4
- 320-857 size 5
- 320-858 size 6



**Spinal Curette**

**Phenolic handle / straight / 11" (28 cm)**

- 320-866 size 000
- 320-859 size 00
- 320-860 size 0
- 320-861 size 1
- 320-862 size 2
- 320-863 size 3
- 320-864 size 4
- 320-865 size 5



**Phenolic handle / angled / 11" (28 cm)**

- 320-866A size 000
- 320-859A size 00
- 320-860A size 0
- 320-861A size 1
- 320-862A size 2
- 320-863A size 3
- 320-864A size 4
- 320-865A size 5

**Extra Long Spinal Curette**

**Phenolic handle / extra long / angled / 13" (33 cm)**

- 320-920 size 0



 Straight

 Angled

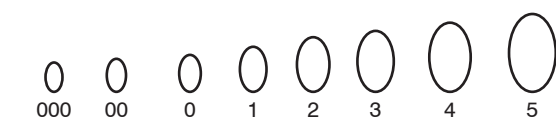

**Lampert Curette**

**Thin neck / oval cup / straight / 8" (20.5 cm)**

- 320-826T size 000000
- 320-827T size 000000
- 320-829T size 0000
- 320-830T size 000
- 320-831T size 00
- 320-832T size 0
- 320-833T size 1
- 320-834T size 2



**Thin neck / oval cup / angled / 8" (20.5 cm)**

- 320-847T size 000000
- 320-848T size 000000
- 320-849T size 0000
- 320-850T size 000
- 320-851T size 00
- 320-852T size 0
- 320-853T size 1
- 320-854T size 2



**Hatt Spoon Curette**

Solid hexagonal handle / 9" (23 cm)

- 320-778 10 mm
- 320-779 15 mm
- 320-780 20 mm



320-780

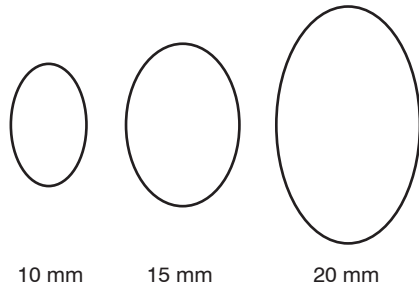

**Bruns Hexagonal Handle Curette**

Solid hexagonal handle / 9" (23 cm)

- 320-870 size 000
- 320-871 size 00
- 320-872 size 0
- 320-873 size 1
- 320-874 size 2
- 320-875 size 3
- 320-876 size 4
- 320-877 size 5
- 320-878 size 6

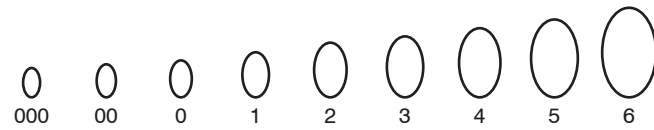

320-876

**Two Handed Curette**

Phenolic handle / serrated cup / 6mm x 9mm / 14 1/2" (37 cm)

- 320-621 straight
- 320-622 30d up
- 320-623 45d cvd left
- 320-624 45d cvd right
- 320-625 90d



320-621

Black handle / serrated cup / 6 mm x 9 mm / 14 1/2" (37 cm)

- 320-621B straight
- 320-622B 30d up
- 320-623B 45d cvd left
- 320-624B 45d cvd right
- 320-625B 90d



\* Available in a green handle



320-621B

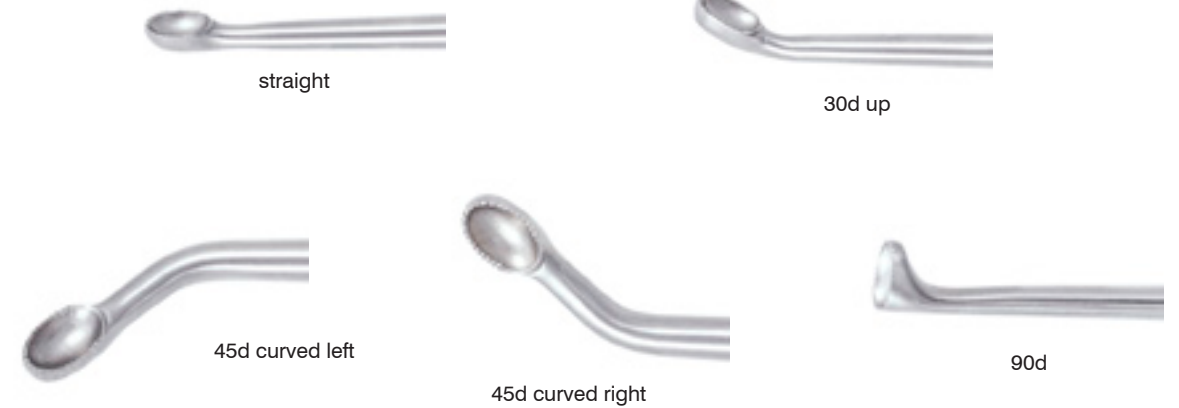

straight

30d up

45d curved left

45d curved right

90d

**Long Handle Curette**

**Sharp / black handle / 16 1/2" (41.9 cm)**

- 320-626B teardrop
- 320-629B #3 angled
- 320-630B #6 angled

**Sharp / green handle / 16 1/2" (41.9 cm)**

- 320-626G teardrop
- 320-629G #3 angled
- 320-630G #6 angled



320-626G



320-626B



320-629G



320-630G



320-626G



320-626B

**Cone Ring Two Handed Curette**

**Phenolic handle / straight / 15" (38 cm) / 380 mm**

- 320-881A size 1
- 320-881B size 2
- 320-881C size 3
- 320-881D size 4



**Phenolic handle / angled / 15" (38 cm) / 380 mm**

- 320-882A size 1
- 320-882B size 2
- 320-882C size 3
- 320-882D size 4

320-881C

**Phenolic handle / lateral angled / 15" (38 cm) / 380 mm**

- 320-883A size 1
- 320-883B size 2
- 320-883C size 3
- 320-883D size 4



320-883C

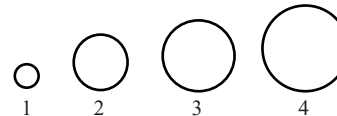



**Down Pushing Curette**

Phenolic handle / 10 mm x 5 mm /  
9" handle / 15" (38 cm) / 380 mm

320-879



320-879

**O'Brien Curette**

Phenolic handle / 9"  
handle / 15" (38 cm)

320-924A 8mm  
320-924B 11 mm



320-924A

**Charnley Curette**

Phenolic handle / 9" handle /  
15" (38 cm) / 380 mm

320-869L large  
320-869S small



320-869L

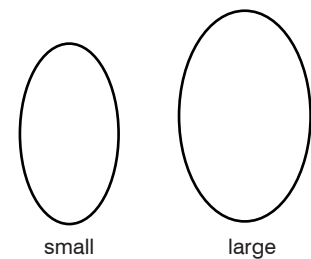

**Tear Drop Spinal Curette**

Phenolic handle / 52 mm x 12 mm /  
11" (27.9 cm)

320-958 straight  
320-959 angled 15°

Phenolic handle / 52 mm x 12 mm /  
17" (43.2 cm)

320-960 straight  
320-962 angled 15°



320-958



320-960



320-962

**Cone Ring Two Handed Curette**

Phenolic handle / straight / 15" (38 cm) / 380 mm

- 320-881A size 1
- 320-881B size 2
- 320-881C size 3
- 320-881D size 4



Phenolic handle / angled / 15" (38 cm) / 380 mm

- 320-882A size 1
- 320-882B size 2
- 320-882C size 3
- 320-882D size 4

Phenolic handle / lateral angled / 15" (38 cm) / 380 mm

- 320-883A size 1
- 320-883B size 2
- 320-883C size 3
- 320-883D size 4

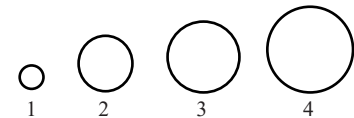

320-881C

320-883C

**Cone Ring Two Handed Curette**

Phenolic handle / 9mm / 14 1/2" (37 cm) / 370 mm

- 320-615 straight
- 320-617 40° lateral



320-615



320-617

Black handle / 9mm / 14 1/2" (37 cm) / 370 mm

- 320-615B straight
- 320-617B 40° lateral



**Bruns Ring Curette**

9" (23 cm)

- 1271-145 5 mm inside ring diameter
- 1271-147 8 mm inside ring diameter
- 1271-146 10 mm inside ring diameter



1271-145

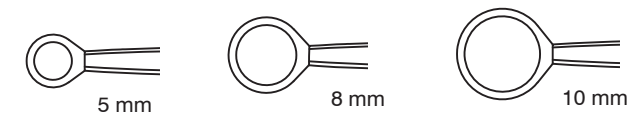

**Freer Periosteal Elevator**

Double-ended / square handle / straight  
/4.5 mm tip / sharp/blunt / 7 3/4"

1100-798S

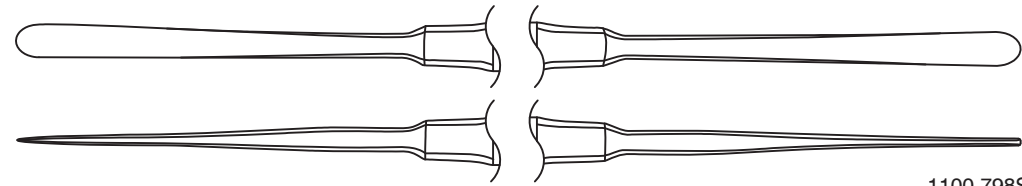

1100-798S

Double-ended / square handle / curved /  
4.5 mm tip / sharp/blunt

1100-798 7 3/4"

1100-798F 8 3/4"



1100-798

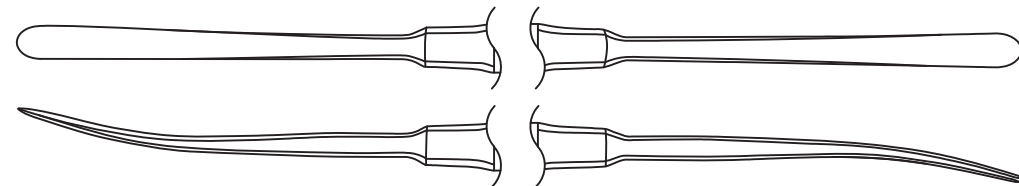

Double-ended / square handle / curved /  
6.5 mm tip / sharp/blunt

1100-798A 7 3/4"

1100-798E 8 3/4"



1100-798A

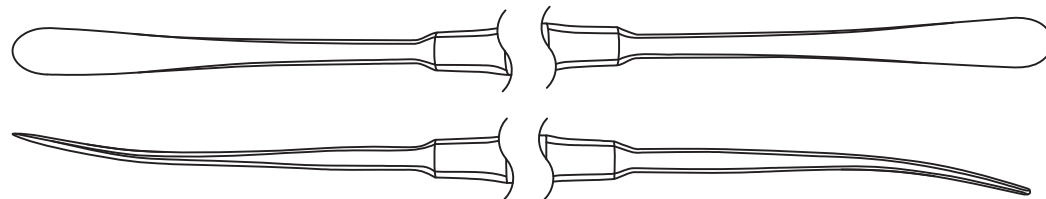

**Freer Periosteal Elevator**

Double-ended / round handle / curved /  
sharp/blunt / 7 1/2"

1100-798B 5 mm tip

1100-798C 6.7 mm tip



1100-798B

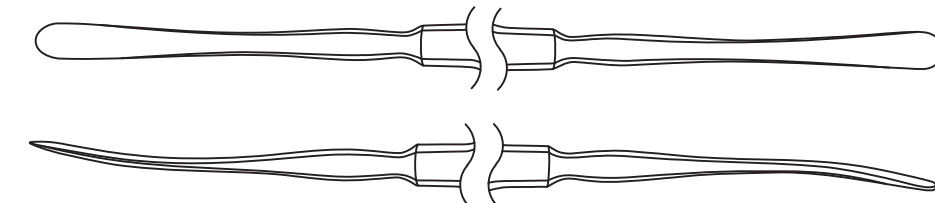

1100-798C

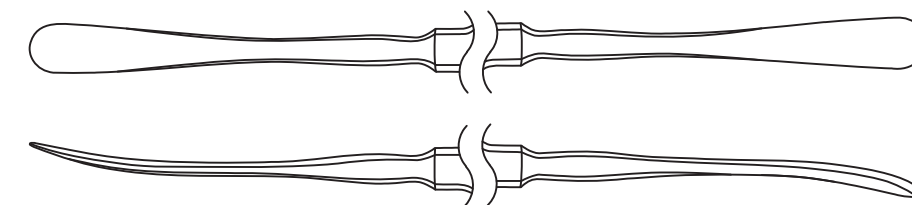

Double-ended / knurled round handle /  
curved / 4.5 mm tip / sharp/blunt / 6 3/4"

1100-798D



1100-798D

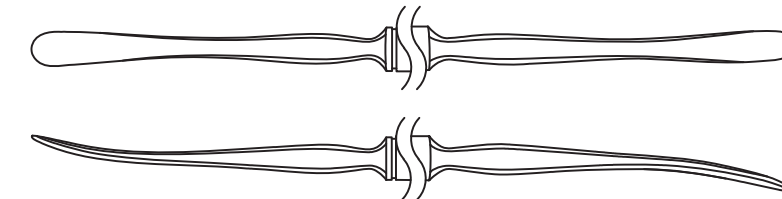



**Freer Periosteal Elevator**

Double-ended / round handle / curved / 3.5 mm tip / sharp / 7 1/4"

1100-798H



1100-798H

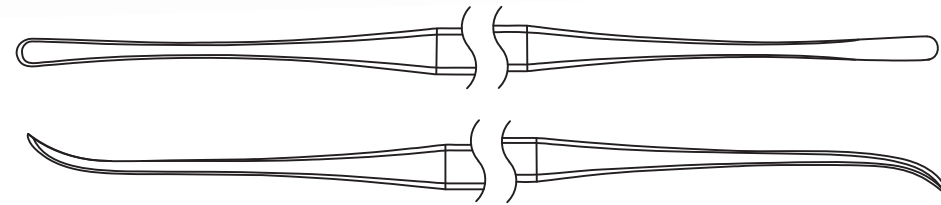

**Sontec A O Type Elevator / Raspatory**

Phenolic handles / 7 /12" (19 cm)

335-250	6 mm tip	str	flat edge
335-254	3 mm tip	slight curve	round edge
335-255	3 mm tip	slight curve	flat edge
335-260	6 mm tip	slight curve	flat edge
335-265	6 mm tip	slight curve	round edge



335-250



335-255



335-260

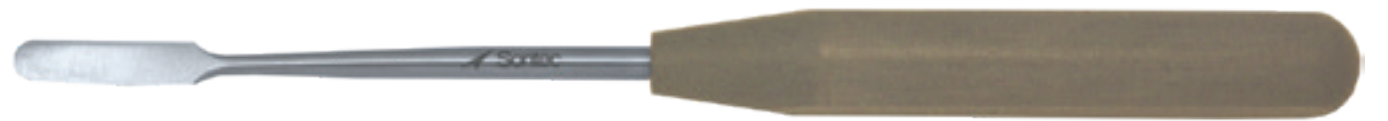

335-265



335-250



335-255



335-260



335-265

**Sontec A O Type Elevator / Raspatory**

Phenolic handles / 8" (20 cm)

335-270	13 mm tip	angled	flat edge
335-275	14 mm tip	str	round edge
335-280	14 mm tip	cvd	round edge
335-285	20 mm tip	str	round edge



335-270



335-275



335-280



335-285

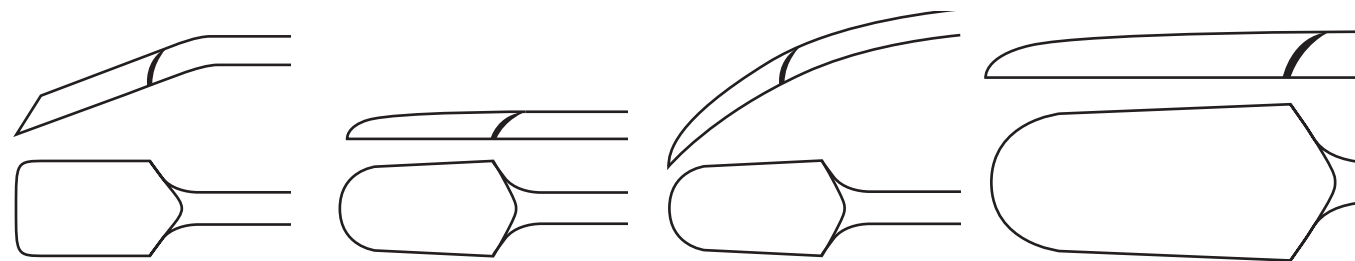

335-270

335-275

335-280

335-285

**Joker Periosteal Elevator**

Blunt / curved / 6" (15.5 cm)

412-518



412-518

**Joseph Periosteal Elevator**

Curved / 6 3/4" (17 cm)

16-2207	3 mm
16-2208	3.5 mm
16-2209	4 mm
16-2210	5 mm
16-2200	6.5 mm



16-2209



16-2210

**McIlwraith Periosteal Elevator**

Single-ended / 7 1/2" (19 cm)

1404-870	sharp
1404-871	sharp phenolic handle



1404-870



1404-871

**Lane Periosteal Elevator**

Single-ended / 7 1/2" (19 cm)

- 335-210 narrow semi-sharp tip 6 mm
- 335-212 wide semi-sharp tip 10 mm



**McKenty Elevator**

Semi-sharp / curved / 5 1/2" (14 cm)

- 412-5563 3 mm tip
- 412-556 4 mm tip
- 412-557 5 mm tip

Double-ended / curved / 8 1/2" (21.75 cm)

412-555



**Masing Elevator / Dissector**

Double-ended / curved / octagonal handle / 7 7/8" (19.75 cm)

412-575



**Joseph Massing Elevator**

Bayonet shaft / 8" (20 cm)

335-105

Straight / 6 mm / 8" (20.3 cm)

335-106



**Mini Lexer Gouge**

7" (18 cm)

- 330-020 4 mm tip
- 330-021 6 mm tip
- 330-022 8 mm tip
- 330-023 10 mm tip
- 330-024 12 mm tip





**Killian Elevator**

Double-ended / 7 1/4"  
(18.4 cm)

412-536



412-536

**Roger Elevator**

Double-ended / full curve / 7  
1/4" (18.5 cm)

412-558



412-558

**Pennington Elevator**

Double-ended / 8 1/4" (21 cm)

412-580



412-580

**Sontec® Cottle Elevator**

Double-ended / sharp & blunt /  
graduated / 8 1/4" (21 cm)

1271-302



1271-302

**CSU Cottle Elevator**

Double-ended / graduated /  
9" (23 cm)

1271-300 blunt  
1271-301 sharp



1271-300



**CSU Cottle Elevator**

Double-ended / graduated /  
9" (23 cm)

1271-300



1271-300

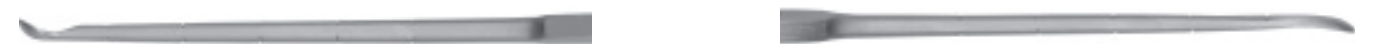

**Foerner Sesmoid Knife Elevator**

Curved / 5 mm tip / 6 1/4" (16 cm)

1404-875



1404-875



**Key Periosteal Elevator**

**6 3/4" (17 cm)**

- 335-135 1/8" tip
- 335-136 1/4" tip
- 335-137 3/8" tip



**7 1/2" (19 cm)**

- 335-138 1/2" tip
- 335-139 5/8" tip



**8" (20.5 cm)**

- 335-140 3/4" tip

**8 3/8" (21.5 cm)**

- 335-141 1" tip

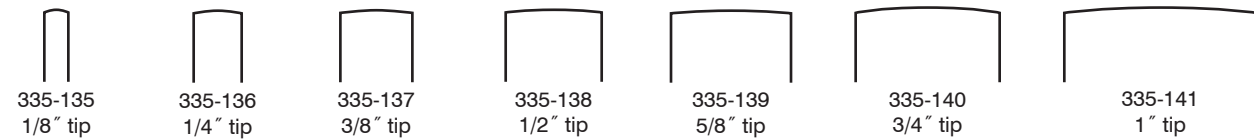

**Sayre Elevator**

**Double-ended / 6 1/2" (16.5 cm)**

- 1100-512 sharp/blunt
- 1100-512B blunt/blunt



1100-512

**Adson Periosteal Elevator**

**Single-ended / 6 1/2" (16.5 cm)**

- 412-520 str chisel edge
- 412-522 cvd blunt
- 412-524 cvd semi-sharp
- 412-526 str semi-sharp



412-522



412-524



412-526

**Love Adson Periosteal Elevator**

**Single-ended / 6 3/4" (16.5 cm)**

- 412-528 cvd semi-sharp



412-528

**Lempert Elevator**

**7 1/2" (19 cm)**

- 412-519



412-519

**Smith Peterson Osteotome**

**Straight / 8" (20.5 cm)**

330-610	1/4"
330-611	3/8"
330-612	1/2"
330-613	5/8"
330-614	3/4"
330-615	1"
330-616	1 1/4"



330-610



330-611



330-613



330-614



330-615



330-616

**Curved / 8" (20.5 cm)**

330-620	1/4"
330-621	3/8"
330-622	1/2"
330-623	5/8"
330-624	3/4"
330-625	1"
330-626	1 1/4"

**Hoke Osteotome**

**Hex handle / straight / 5" (12.5 cm)**

330-690	1/8" (3 mm)
330-691	3/16" (4 mm)
330-692	1/4" (6 mm)
330-693	5/16" (8 mm)
330-694	3/8" (10 mm)
330-695	1/2" (13 mm)
330-696	5/8" (16 mm)

**Curved / 5" (12.5 cm)**

330-700	1/8" (3 mm)
330-701	3/16" (4 mm)
330-702	1/4" (6 mm)
330-703	5/16" (8 mm)
330-704	3/8" (10 mm)
330-705	1/2" (13 mm)
330-706	5/8" (16 mm)



330-705

**Cottle Plastic Osteotome**

**Specially designed edge / heavy type / with end stop platform / with no corners on blade / 7" (18 cm)**

330-849A	3/32" (2 mm)
330-849B	5/32" (4 mm)
330-849C	9/32" (7 mm)
330-849D	11/32" (9 mm)
330-849E	15/32" (12 mm)



330-849C

**Lambotte Osteotome**

**Straight / 9" (23 cm)**

- 330-660 1/4" (6 mm)
- 330-661 1/2" (13 mm)
- 330-662 3/4" (19 mm)
- 330-663 1" (25 mm)
- 330-664 1 1/4" (32 mm)
- 330-665 1 1/2" (38 mm)

**Curved / 9" (23 cm)**

- 330-670 1/4" (6 mm)
- 330-671 1/2" (13 mm)
- 330-672 3/4" (19 mm)
- 330-673 1" (25 mm)
- 330-674 1 1/4" (32 mm)
- 330-675 1 1/2" (38 mm)



330-675

**Sontec-Cottle Osteotome Set**

**Graduated markings / 7" (18 cm)**

- 1100-479K 2 mm
- 1100-479M 3mm
- 1100-479L 4 mm
- 1100-479A 6 mm
- 1100-479B 8 mm
- 1100-479C 10 mm
- 1100-479D 12 mm
- 1100-479E 14 mm
- 1100-479F 16 mm
- 1100-479G 18 mm
- 1100-479N 19mm
- 1100-479J 20 mm
- 1100-479H 22 mm



Set of 7  
1100-479  
(choose your sizes)  
with a canvas bag



1100-479



1100-479A



1100-479B



1100-479C



1100-479D

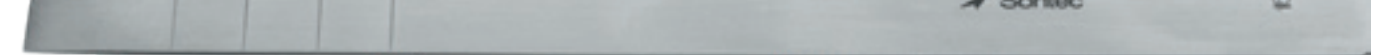

1100-479E



1100-479F

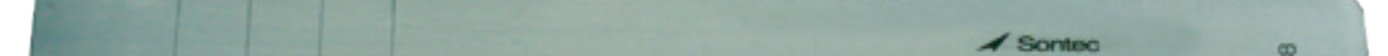

1100-479G

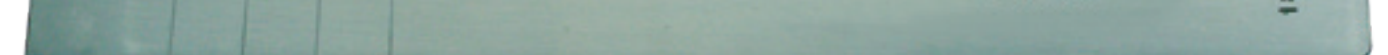

1100-479H

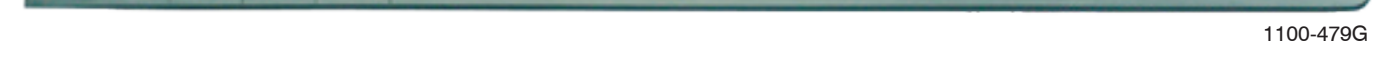

1100-479I



1100-479J



1100-479K



1100-479L



**Sontec Large Handle Mallet**

**Ribbed phenolic handle**

330-840 10 1/4" (26 cm) 1 3/4" head dia. 3 lbs  
 330-842 10 1/4" (26 cm) 1 1/4" head dia.



330-842

**Sontec Combo Nylon Mallet**

**1" head diameter / removable heads / 7 3/8" (18.75 cm)**

1100-462S removable nylon head  
 1100-463 nylon head for mallet 1"  
 1100-463S nylon head for new style mallet

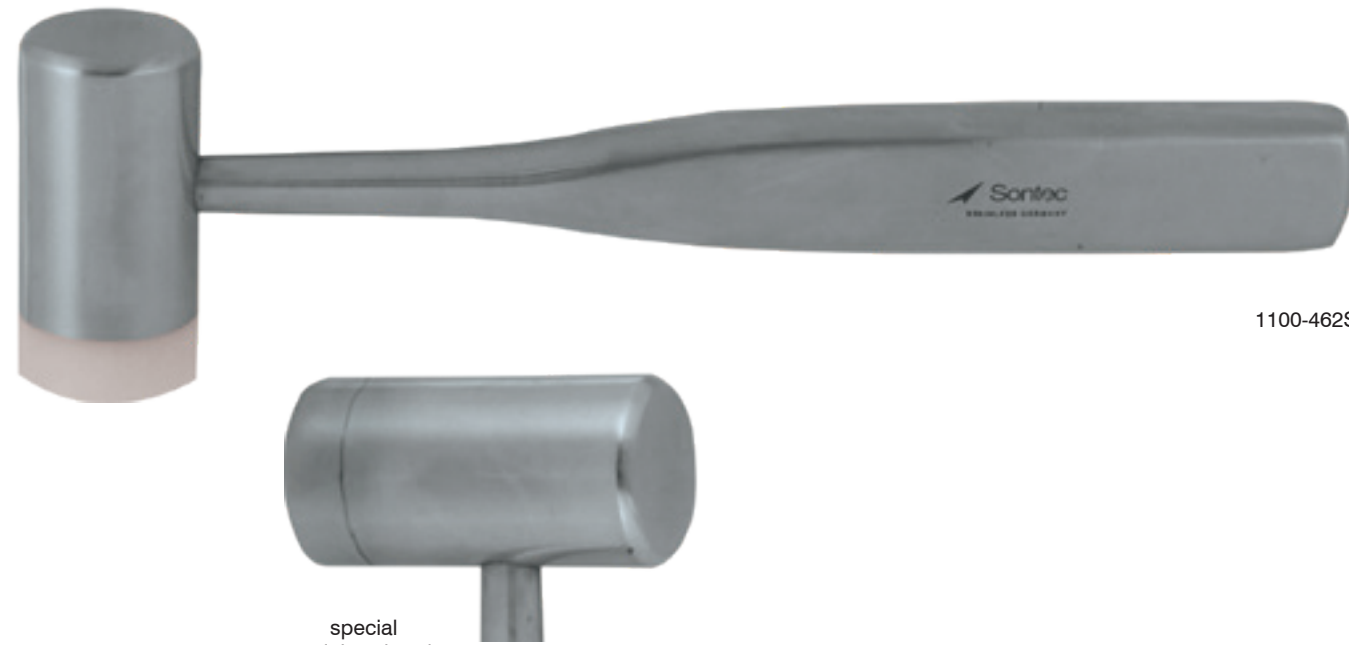

1100-462S

special  
 stainless head  
 \*available upon  
 request

**Large Sontec Combo Mallet**

**1 1/2" head / replaceable heads / 8" (20.5 cm)**

330-824  
 330-824S stainless & nylon head

**Replaceable heads / 1 1/2" (3.8 cm)**

330-824NH nylon  
 330-824SH stainless steel



330-824NH



330-824SH



330-824

**Heavyweight Mallet**

**1 1/2" head diameter / 7 1/4" (18.5 cm)**

330-832 1.72 lbs



330-832

**Sontec Spinal File/Rasp**

Phenolic handle / TC / 10" (25.4 cm)  
/ curved

345-270



Phenolic handle / cross-serrated /  
straight / 6.5 mm / 15" (38 cm)

345-216



Black plastic handle / 6 mm

345-216B straight 15" (38.1 cm)

345-215B angled 14 1/2" (36.8 cm)



**Knife Handle #3**

Fits surgical blades 10-15 /  
with calibrated scale

\* surgical blade not included

1100-740 5" (12.5 cm)



Round handle

1100-741 6" (15 cm)

1100-740



Round knurl handle /  
double / 1 mm / 6 1/4"

1100-7411



**Knife Handle #3L**

Fits surgical blades 10-15

- 1100-866 8 1/2" (21.5 cm)
- 1100-868 12" (30 cm)
- 117-582 8 3/8" (20 cm) angled



1100-866

117-582

**Knife Handle #4**

fits surgical blades 20-25  
/ with calibrated scale

- 1100-742 5" (12.5 cm)



1100-742

**Joseph Tendon Knife**

6 1/2" (16.5 cm)

- 345-400 single edge 60° angled



345-400

**Piermattei Smillie Meniscotome**

6 3/4" (17 cm)

- 1103-205



1103-205

**Smillie Meniscotome**

Straight blade / 6 3/4" (17 cm)

- 1103-208



1103-208

**Braake Tendon Knife**

Angled down / carbon coated shaft / 7" (18 cm)

1271-183



1271-183

**Freer Mucosa Knife**

6 1/4" (16 cm)

345-405



345-405

**Femoral Head Disarticulator Knife**

Curved

1103-211 Small 5 1/2" (14 cm)

1103-213 Large 7 1/2" (19 cm)



1103-213



1103-211

**V Blade Meniscotome**

Flat handle / 6 3/4" (17 cm)

1103-206

Curved / 8" (20.5 cm)

1103-209



1103-206

**Mini V-Blade Meniscotome**

Flat handle / 6 3/4" (17 cm)

1103-2063 3mm



1103-2063



**Esophageal Grasping Forceps Vertical Jaw**

30" / without ratchet / 4.5 mm jaw width

1404-881  
1404-881T 1 x 2T

30" / without ratchet / malleable / 4.5 mm jaw width

1404-881M  
1404-881MT 1 x 2T

30" / with ratchet / 4.5 mm jaw width

1404-881R  
1404-881TR 1 x 2T

30" / without ratchet / malleable / 4.5 mm jaw width

1404-881RM  
1404-881RMT 1 x 2T



1x2 teeth



vertical jaw

1404-881

**Esophageal Grasping Forceps Horizontal Jaw**

30" / without ratchet / 4.5 mm jaw width

1404-881H  
1404-881HT 1 x 2T

30" / without ratchet / malleable / 4.5 mm jaw width

1404-881HM  
1404-881HMT 1 x 2T

30" / with ratchet / 4.5 mm jaw width

1404-881HR  
1404-881HTR 1 x 2T

30" / without ratchet / malleable / 4.5 mm jaw width

1404-881HRM  
1404-881HRMT 1 x 2T  
1404-881HRMTL left



1x2 teeth



horizontal jaw



1404-881HRM

**Embertson Esophageal Epiglottis Scissors**

30" (75 cm) long / Metzenbaum tip / curved shaft

1404-883  
1404-883B black coated



1404-883B

**Equine Epiglottis Entrapment Knife**

29" (74 cm) handle / includes one blade

1404-885  
1404-890 single blade only  
1404-8902 double blade only

\* Extra long instrument. Many Extra long instruments are also available, including:

- Extra long scissors
  - Extra long needle holders
  - Extra long forceps
  - Extra long knife handles
- Please call Sontec® for details



1404-8902



1404-890

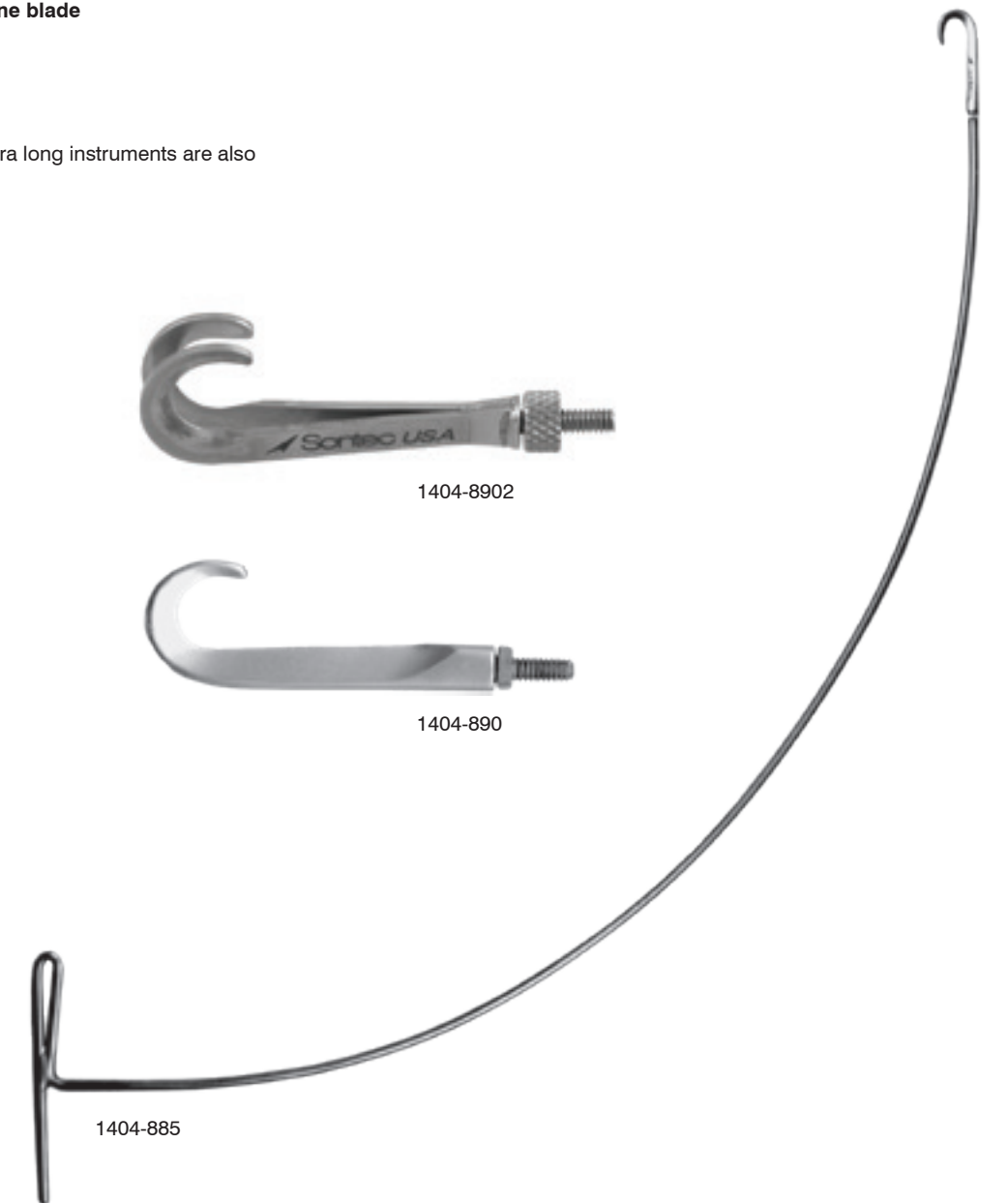

1404-885

**Willis Ovariotome**

19" (48.5 cm)  
 1103-901 small  
 1103-902 large

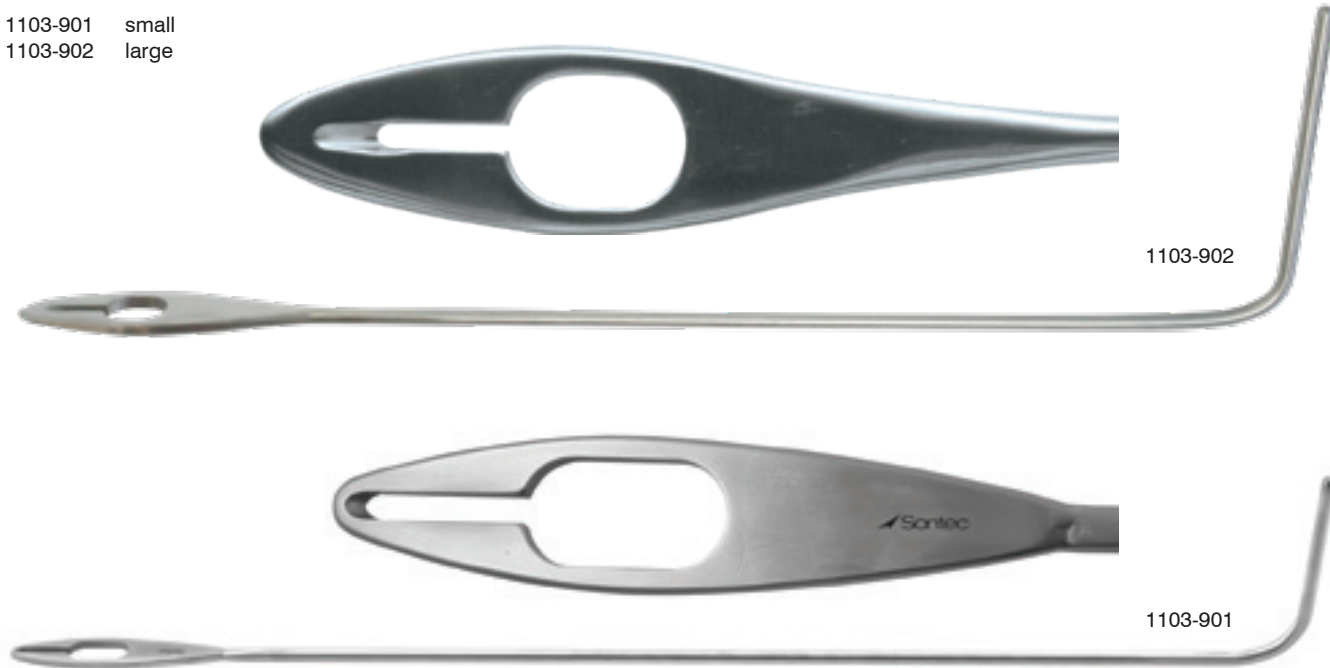

**Ecrasseur Chain**

With Ratchet / for spaying  
 / approx. 19" (47.5 cm) in  
 length  
 1100-907



**Courtney Large Animal  
 Liver Biopsy**

With screws / 13" (33 cm)  
 1103-904

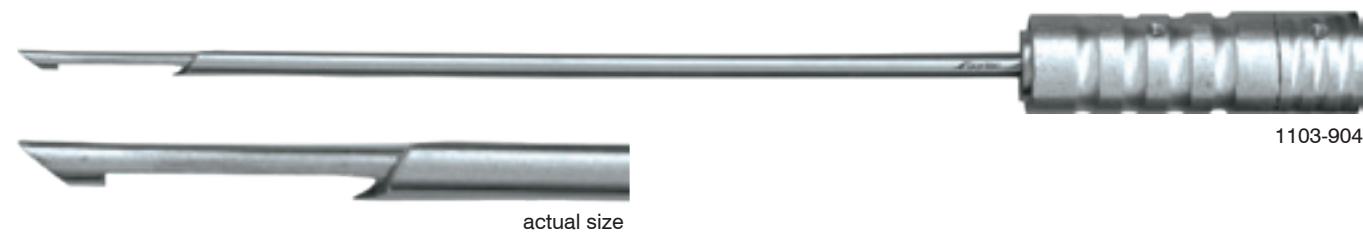

actual size

**Scudder Intestinal Clamp**

Heavy / 20.5" (52 cm)  
 1404-895



Double screw end / 20.5" (52 cm)  
 1404-897



**Uterine Equine Tenaculum Forceps**

2 x 2 tenaculum teeth / 19" (48 cm)  
 1404-945



1404-945

**Serra Emasculator**

With ratchet / 15" (38 cm)  
1100-902



1100-902

**Reimer Emasculator**

With ratchet / 12 1/2" (32 cm)  
1100-904



1100-904

**Serra Modified Emasculator**

Curved / 14" (35.5 cm)  
1100-903  
1100-905 w/ ratchet



1100-903



1100-905

**University of Pennsylvania Equine Biopsy**

5 mm x 20 mm jaw / 26" (66 cm) shaft

1100-728  
1100-728S detachable handle 360° rotating shaft



1100-728

actual size



1100-728S

**Uterine Equine Forceps**

Serrated jaw / 19 1/2" (49 cm)

1404-940



1404-940

**Knowles Equine Uterine Grasper**

Serrated / 1 x 2 teeth / 19 1/2" (49 cm)

1404-942

\* 3 staggered meshing teeth for maximum grasping power.



1404-942

**Virginia Roaring Burr Short**

9" (23 cm)

1271-281D right clockwise is for the left ventricle  
1271-282 left counter clockwise is for the right ventricle

1271-281D



**Virginia Roaring Burr Long**

41 1/2" (104 cm)

1271-283 right long-clockwise is for the left ventricle  
1271-284 left long-counter clockwise is for the right ventricle

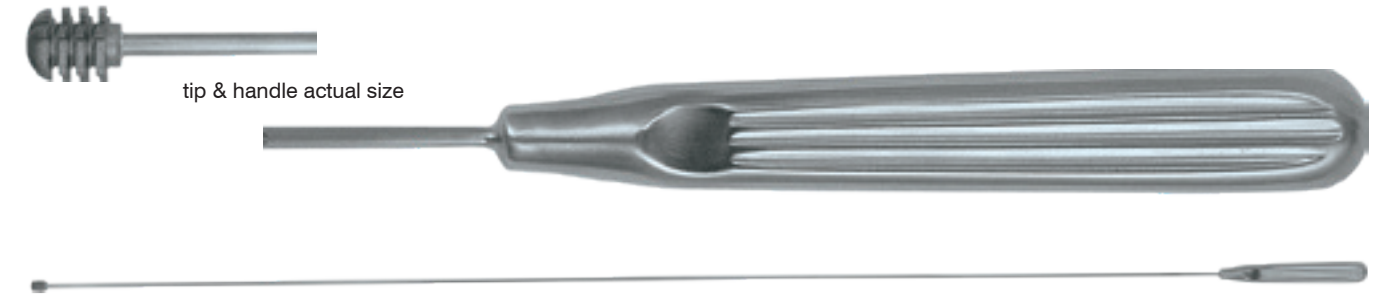

tip & handle actual size

**Galt Trepine**

419-378 1/2" / 13 mm  
419-380 5/8" / 16 mm  
419-382 3/4" / 19 mm  
419-384 7/8" / 22 mm  
419-386 1" / 25 mm

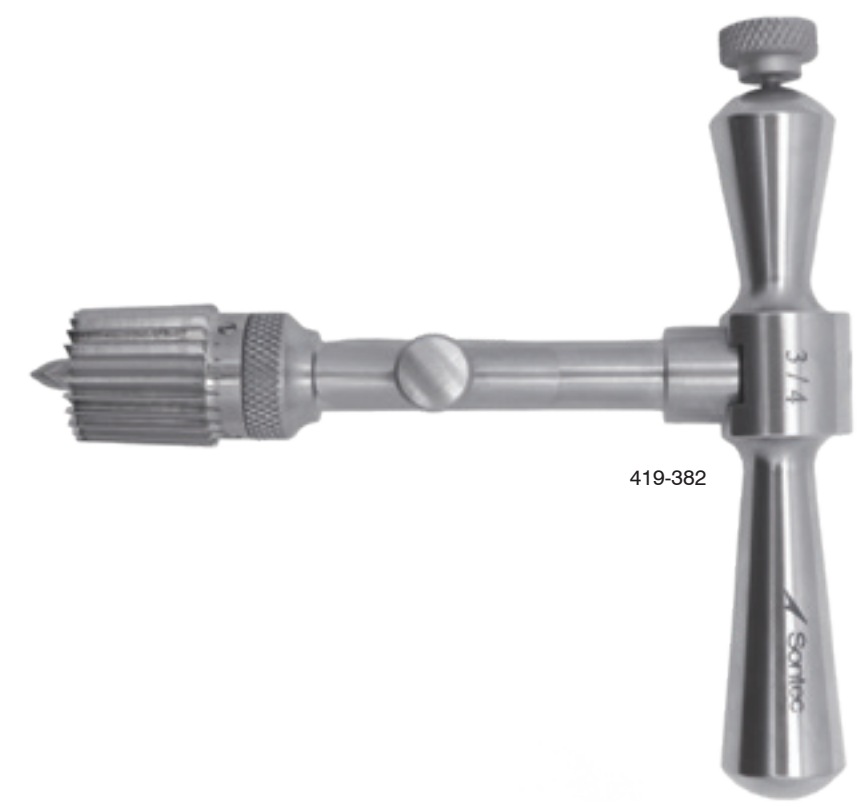

419-382



**Tap Sleeve & Insert Drill Sleeve Set**

- 1103-162S set
- 1103-161 Taylor Universal drill guide handle
- 1103-162A tap sleeve 4.5 mm
- 1103-162B insert drill sleeve for 3.2 mm

\* The toothed tip prevents slipping on the bone



1103-162S



drill sleeve spacer

1103-162B

1103-162A

1103-161

**Baby Poole Suction**

Curved / 17 french / 8" (20.3 cm)

180-420



180-420

**Michele Trephine**

- 1100-460T 1/8" / 3 mm special diameter
- 1100-460S 3/16" / 5 mm
- 1100-460M 7/32" / 6 mm
- 1100-460L 5/16" / 8 mm
- 1100-460E 13/32" / 10 mm
- 1100-460X 15/32" / 12 mm

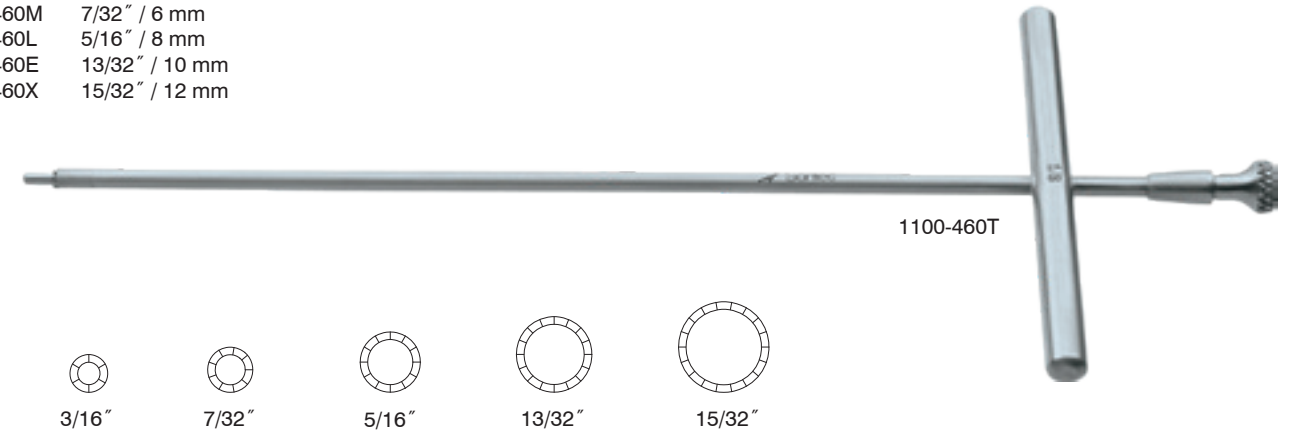

1100-460T

**Nested Trocar Set**

6 1/2" (16.5 cm)

- 190-246 set includes:
- 6 french
- 9 french
- 13 french
- 17 french
- handle & cover

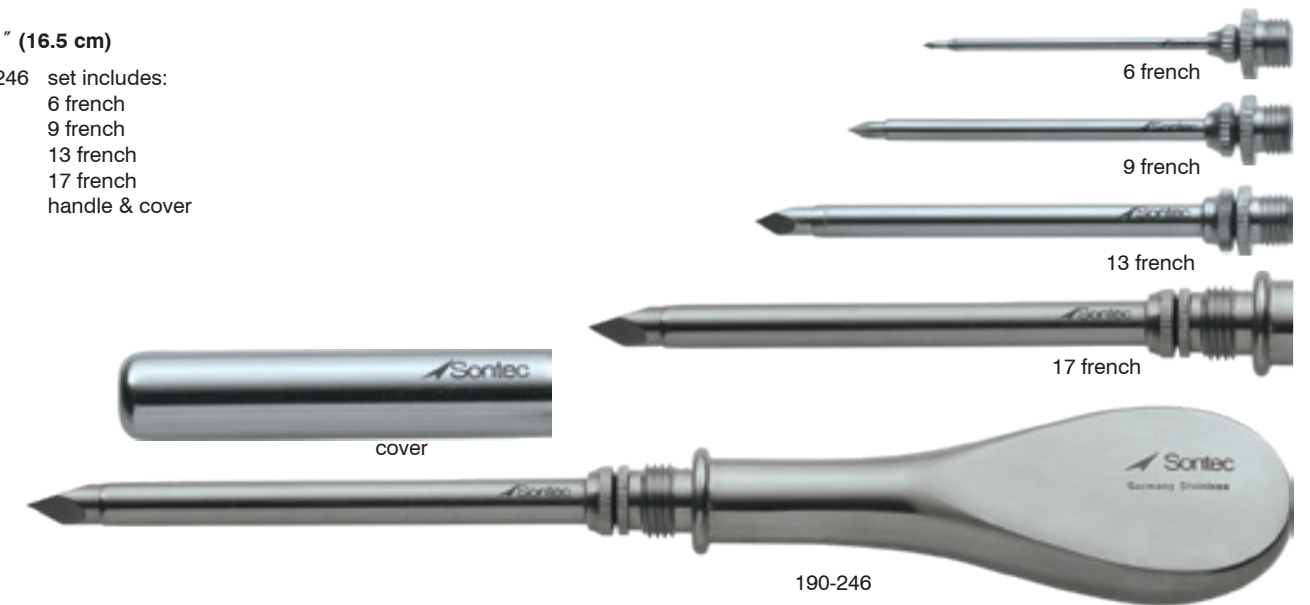

6 french

9 french

13 french

17 french

cover

190-246

**Duke Trocar & Drainage Set**

Set includes-trocar, 15 french, 4 1/2" (11.5 cm) / cannula, 17 french, 5 1/2" (14 cm)

190-260



trocar

cannula

**Castroviejo Equine Eye Speculum**

1" / 25 mm blades / 4 3/4" ( cm)  
10-1704

10-1704

**Hoffman Utrata Capsulorhexis Forceps**

Stainless / flat handle

14-5383  
14-5389 17 mm long jaw

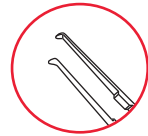

14-5389

Titanium / flat handle

T14-5383  
T14-5383R round knurled handle  
T14-5389 17 mm long jaw



T14-5383



T14-5383R

**Wells Enucleation Spoon**

Angled head

12-4750



12-4750

**Enucleation Scissors**

PC Gold / 5 1/4" (13 cm)

13-9805 light curve  
13-9810 medium curve  
13-9820 full curve  
13-9822 full curve PC Black



13-9820



13-9822

**Castaneda Enucleation Clamp Forceps**

Autramatic curved jaw / curved shank / 4 3/4" (12 cm)

23-1818

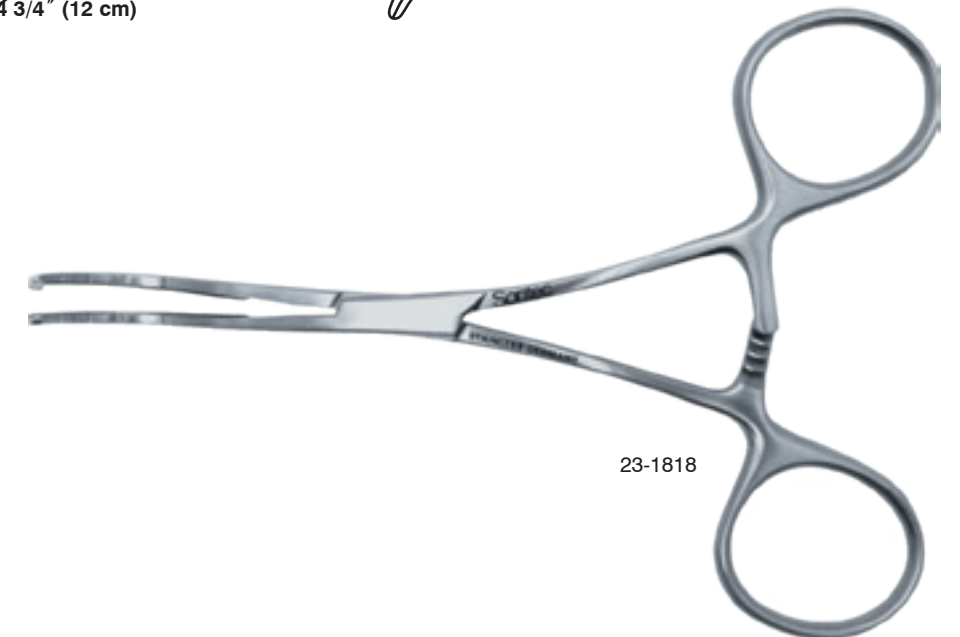

23-1818

**Bone Reduction Clamp Extra Large**

Oversized / extra long ratchet / 12" (30 cm)

- 1103-049 extra-long prongs
- 1103-049L extra-long shanks



**TC Pin Cutter**

Cuts pins up to 6.4 mm / replaceable jaws

- 1103-140 19" (48 cm) special order
- 1103-140A 19" (48 cm) handles are removable for smaller autoclaves

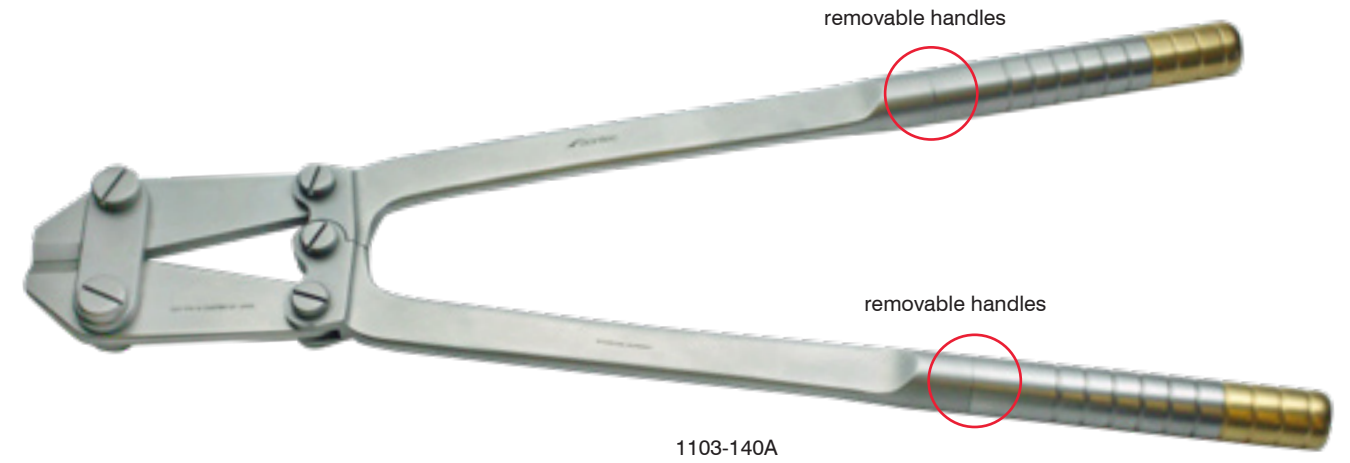

**Pin Cutter Specialty Harden Jaws**

Cuts pins up to 4 mm

- 1103-140J 15" (38 cm)

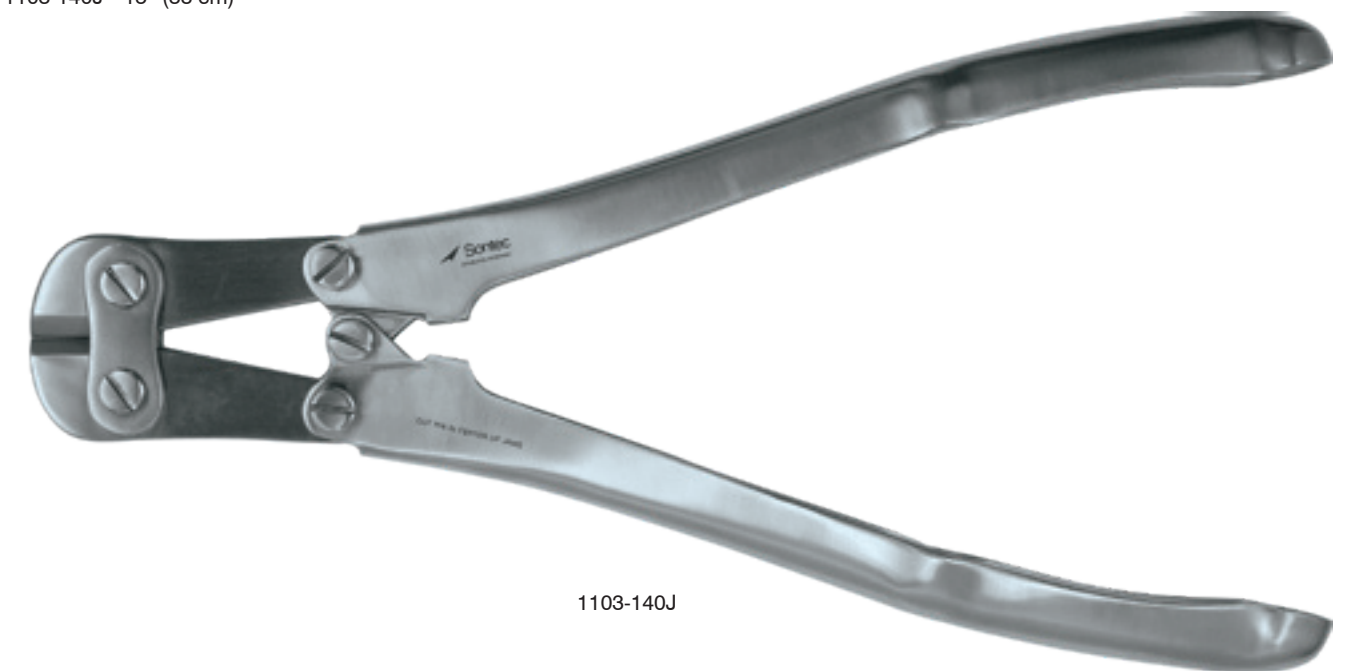



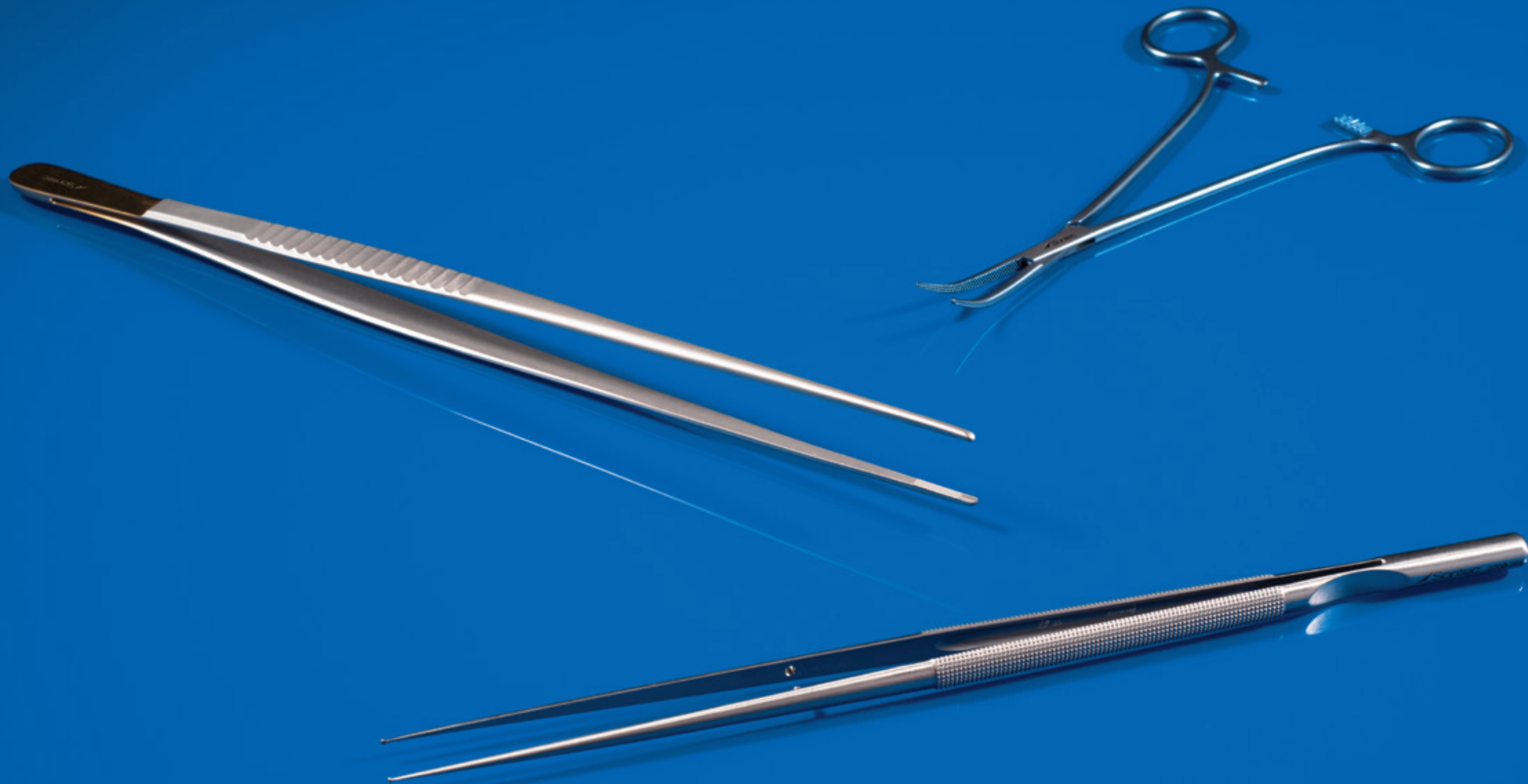

 Sontec Instruments®

Forceps



**Foerster Sponge Forceps**

**Serrated / straight**

- 123-618 13" (33 cm)
- 123-617 14" (35.5 cm)
- 123-619 16" (40.5 cm)



**Allis Tissue Forceps**

**4 x 5 teeth**

- 140-315 5 1/2" (14 cm) delicate
- 140-320 6" (15 cm)

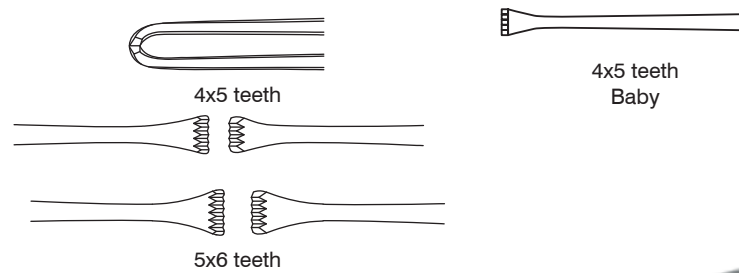

**Baby / 4 x 5 teeth**

- 140-313 5" (12.5 cm)

**5 x 6 teeth**

- 140-322 6" (15 cm)
- 140-330A 7" (18 cm)
- 140-329 7 1/2" (19 cm)
- 140-331 7 1/2" (19 cm) delicate
- 140-334 10" (25 cm)

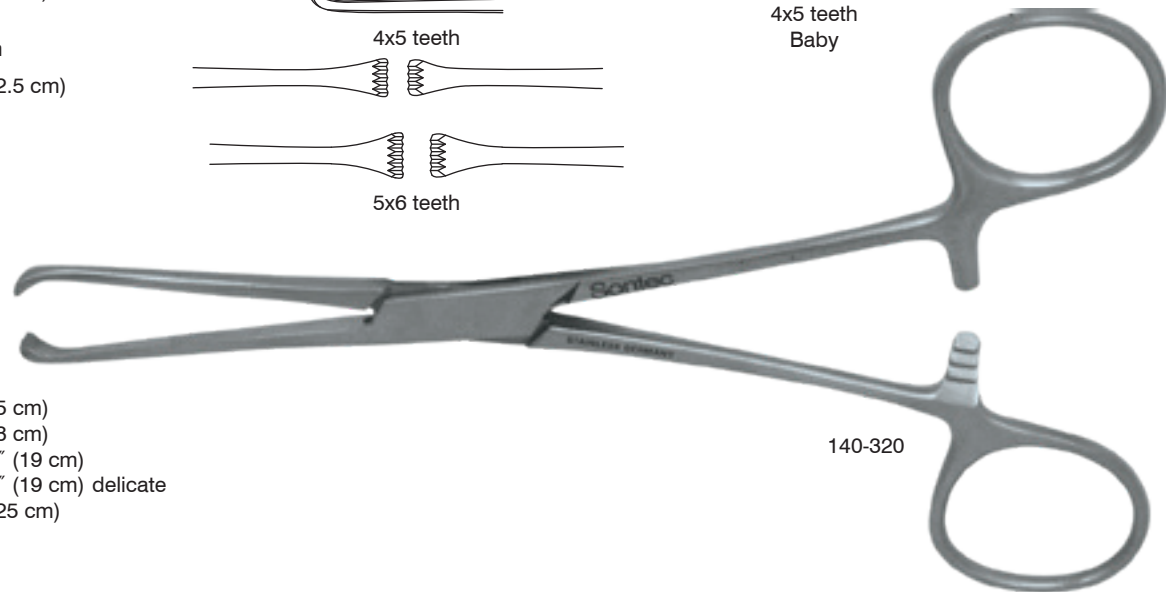

**Allis-Willauer Tissue Forceps**

**5 x 6 teeth**

- 438-408 7 3/4" (19.5 cm)
- 438-410 10" (25 cm)
- 438-412 12" (30 cm)



**Crile Forceps**

**5 1/2" (14 cm)**

- 115-432 straight
- 115-434 curved

**6 1/4" (16 cm)**

- 115-450 straight
- 115-452 curved

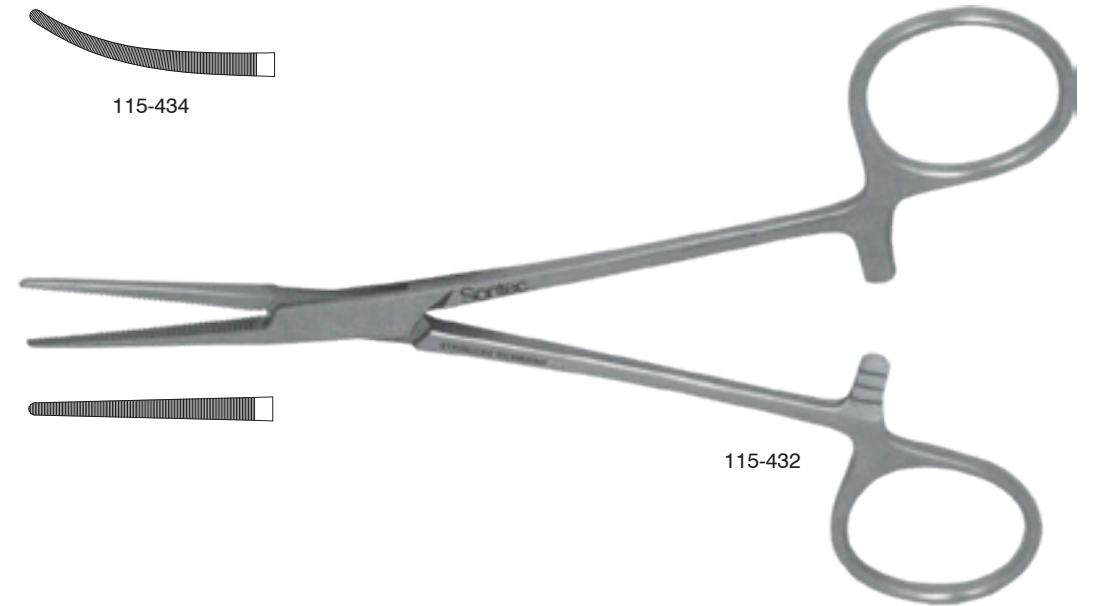

**Titanium / 6 1/4" (16 cm)**

- T115-452 curved
- T115-450 straight

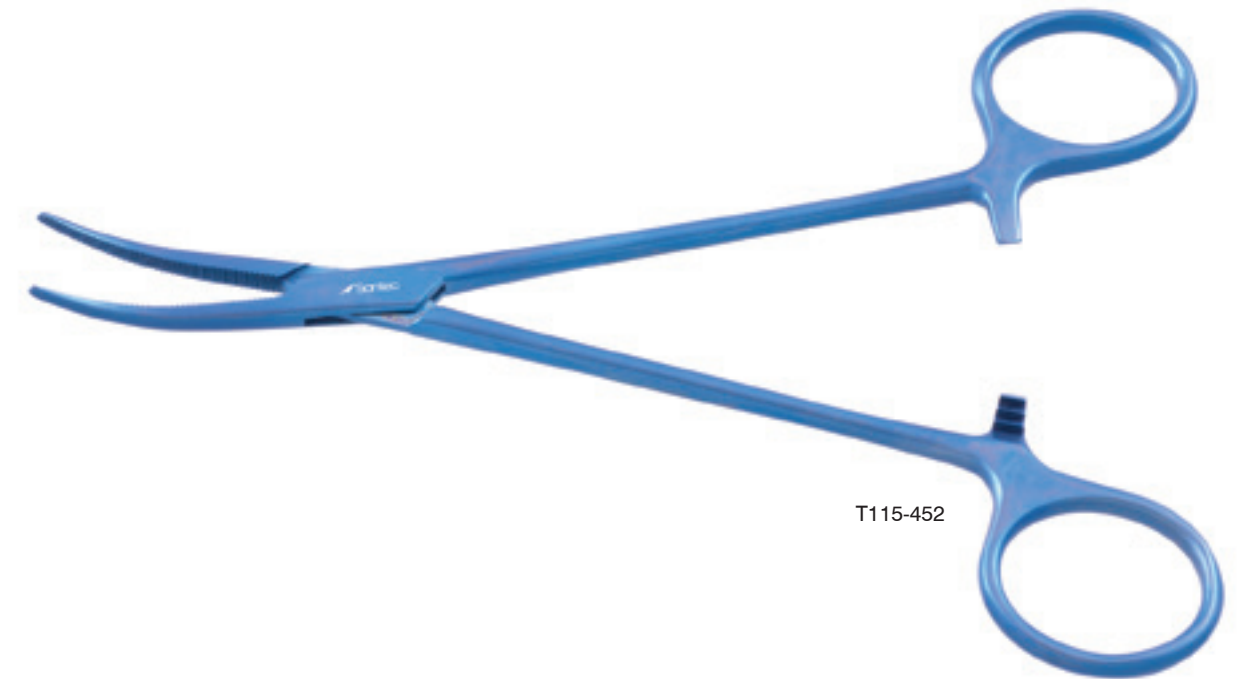

**Bainbridge Forceps**

Delicate / Longitudinal serrations with cross-serrated tip / 6" (15 cm)

- 115-600 straight
- 115-602 curved

Delicate / Longitudinal serrations with cross-serrated tip / 7 1/4" (18.5 cm)

- 115-604 straight
- 115-606 curved



**Coller-Crile Forceps**

Delicate jaw / 5 1/2" (14 cm)

- 115-454 straight
- 115-458 curved

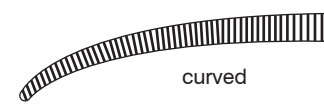
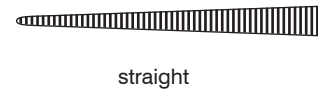

Delicate jaw / 6 1/4" (16 cm)

- 115-456 straight
- 115-460 curved

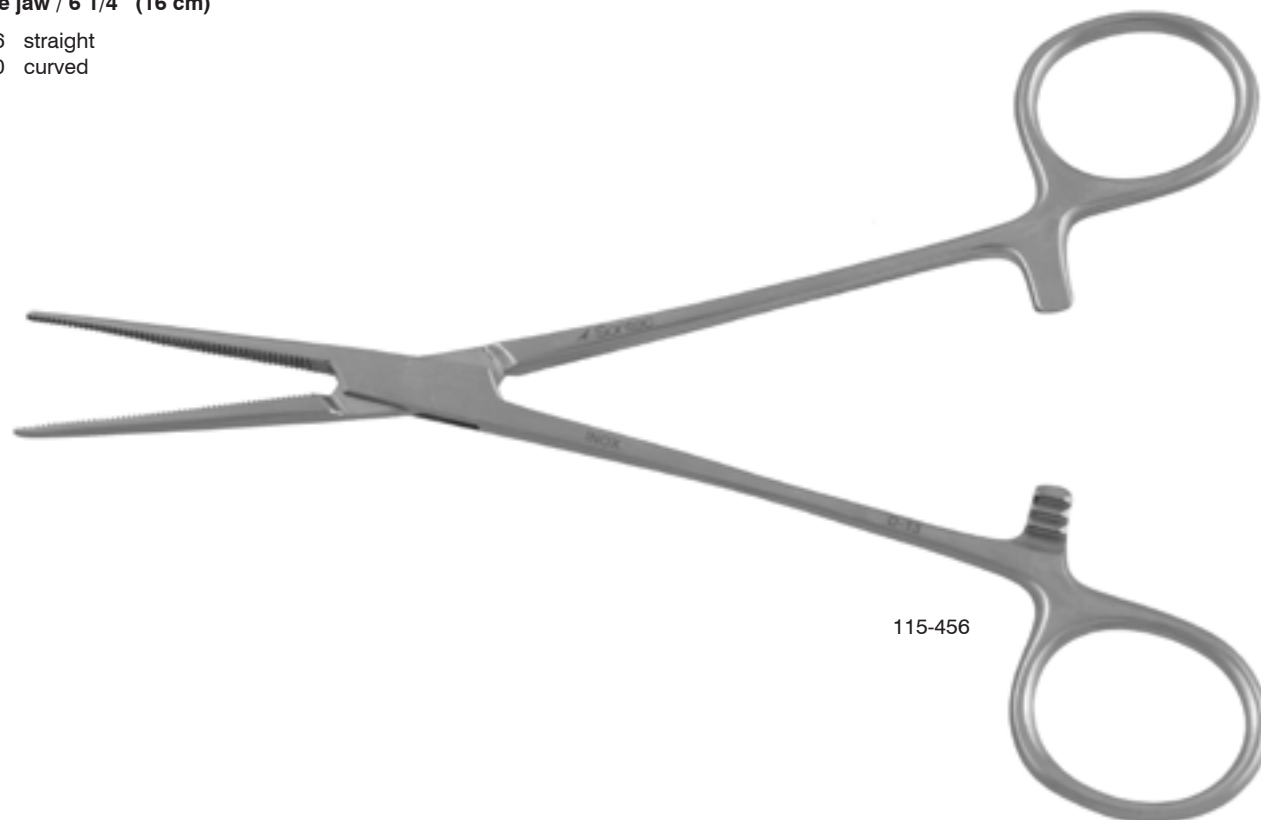

**Kelly Forceps**

5 1/2" (14 cm)

- 115-446 straight
- 115-448 curved
- 115-448L curved left handed



115-446



115-448

Blue electro coated / 5 1/2" (14 cm)

- 115-4461 straight
- 115-4481 curved

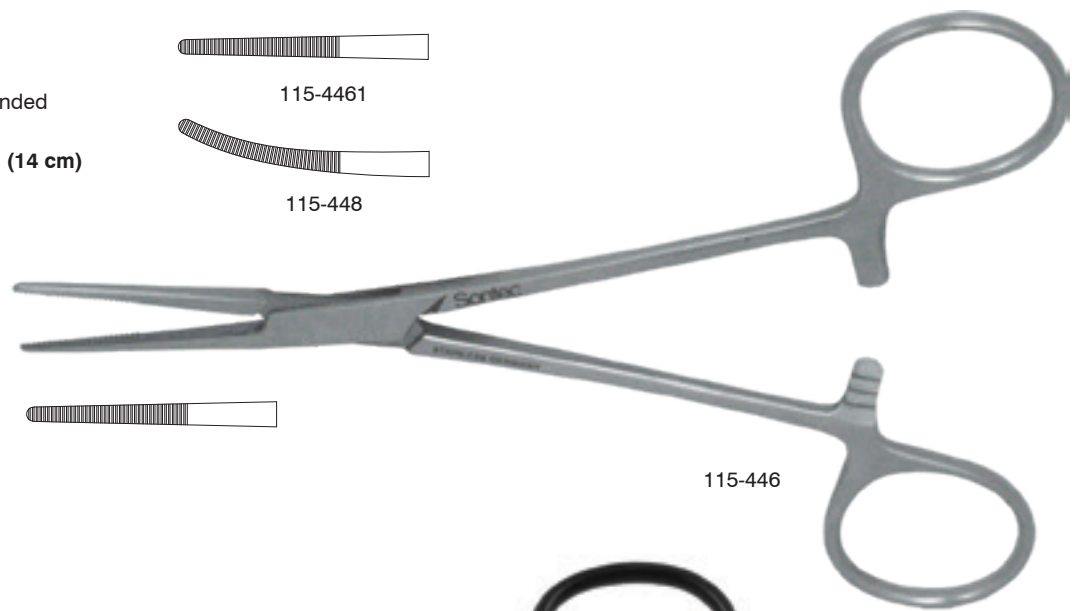

**Hartman Mosquito Forceps**

**Delicate / 3 1/2" (9 cm)**

- 115-426D straight
- 115-428D curved

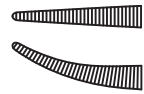

**Standard / 3 1/2" (9 cm)**

- 115-426 straight
- 115-428 curved

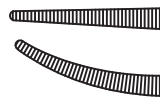

**Delicate / 4" (10 cm)**

- 115-425D straight
- 115-427D curved

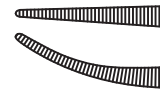

**Shank angled on flat / straight/ 3 1/2" (9cm)**

- 115-429



straight

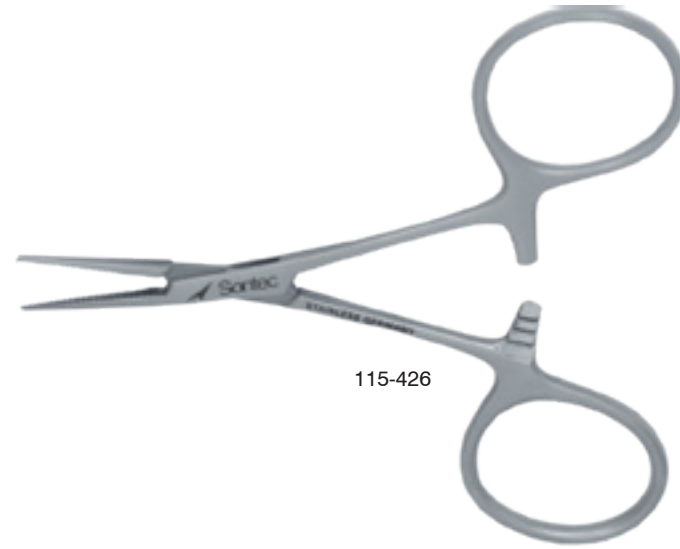

115-426

**Halstead Mosquito Forceps Titanium**

**5" (12.5 CM)**

- 2600-409 straight
- 2600-411 curved

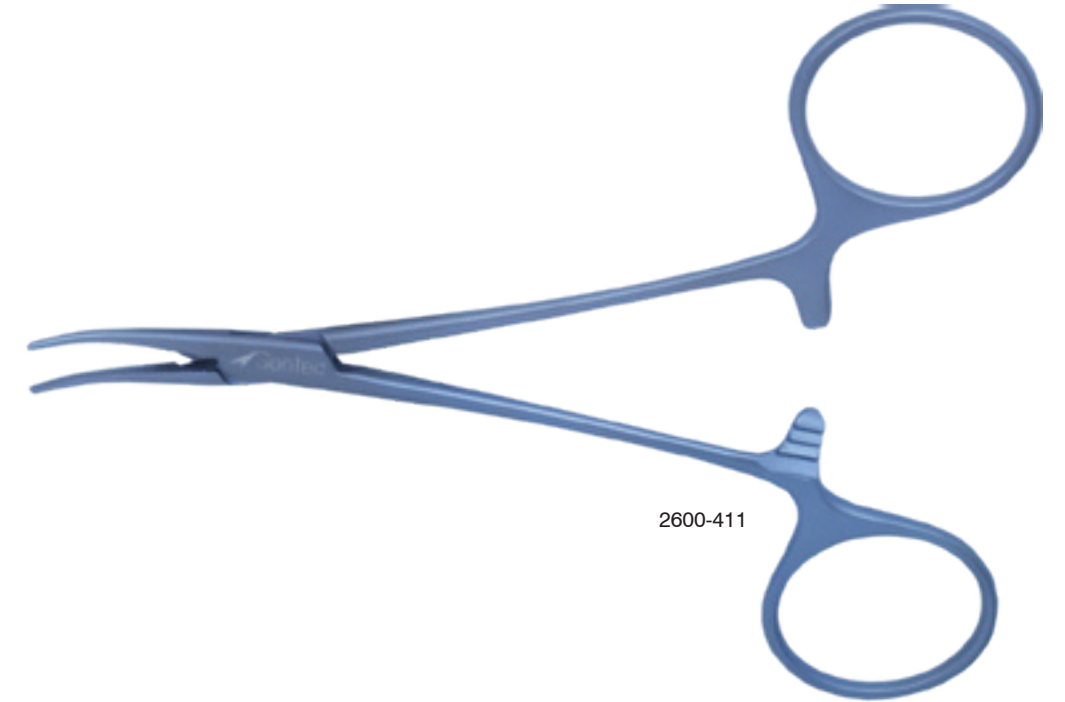

2600-411

**Halstead Mosquito Forceps**

**Standard / non-magnetic / 5" (13 cm)**

- 115-413 straight
- 115-414 curved

**Standard / 1 x 2 teeth / 5" (13 cm)**

- 115-422 straight
- 115-424 curved

**Specially tapered jaws / straight / 1 x 2 micro teeth / 5" (13 cm)**

- 115-422M



**Halstead Mosquito Forceps**

**Standard / 5" (13 cm)**

- 115-410 straight
- 115-412 curved
- 1100-140L curved left

**Blue coated / standard / 5" (13 cm)**

- 115-4121 curved

**Curved/ streamlined/ 5" (13 cm)**

- 115-412S

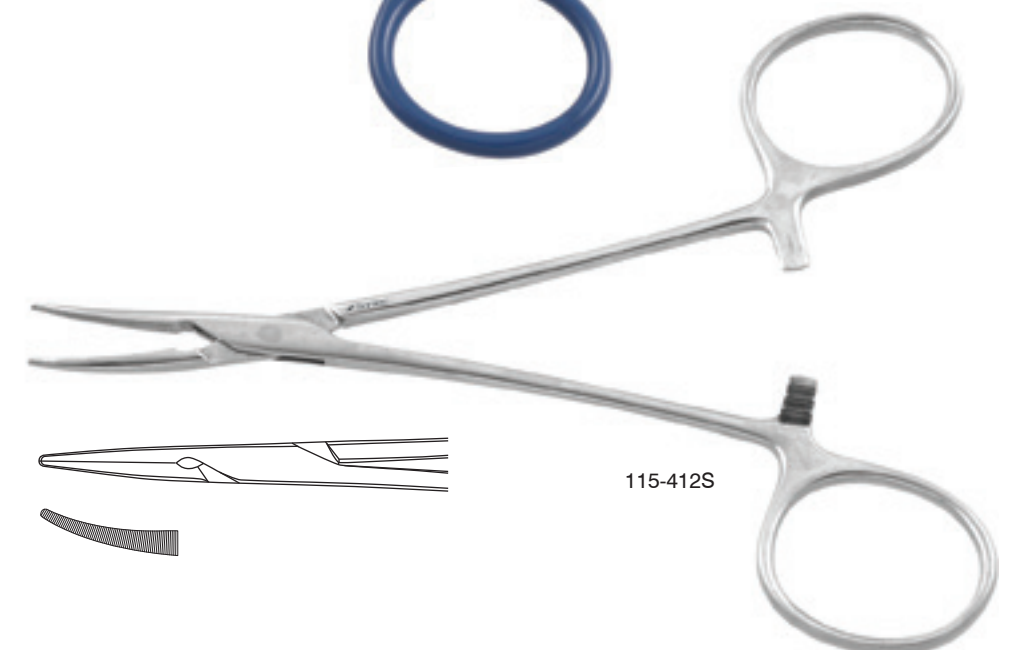
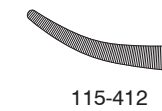



**Mosquito Forceps**

Standard / 6 1/4" (15.5 cm)

115-408 curved

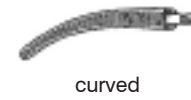

115-408

Standard / 8 1/4" (21 cm)

115-400 straight  
115-402 curved  
115-404 right angled

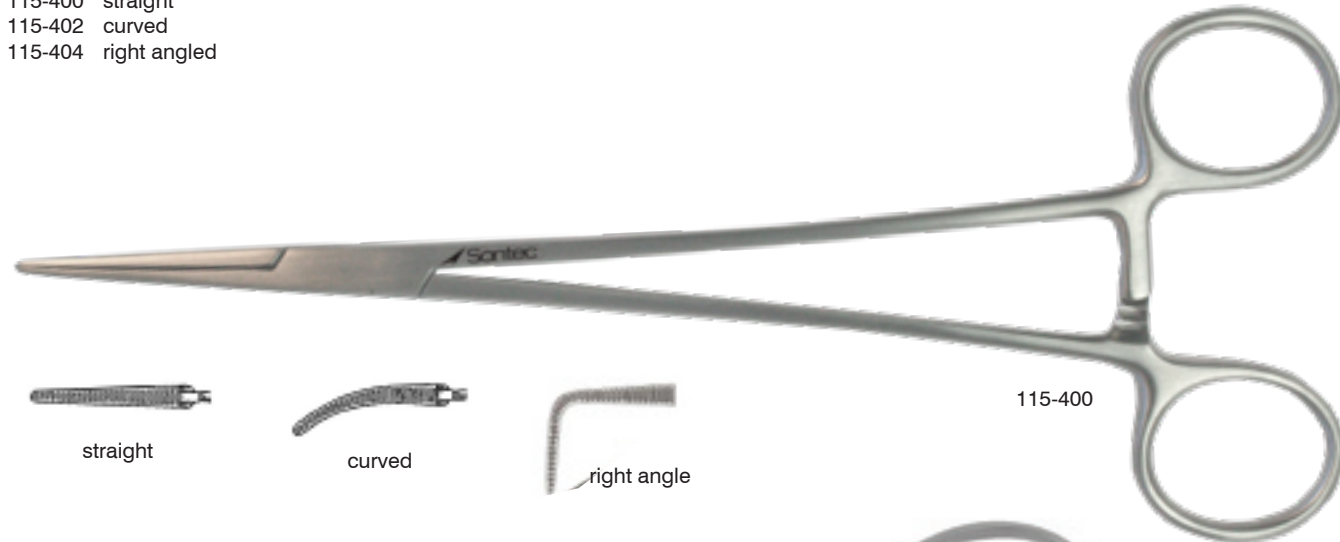

115-400

Delicate / 5" (13 cm)

115-410D straight  
115-412D curved

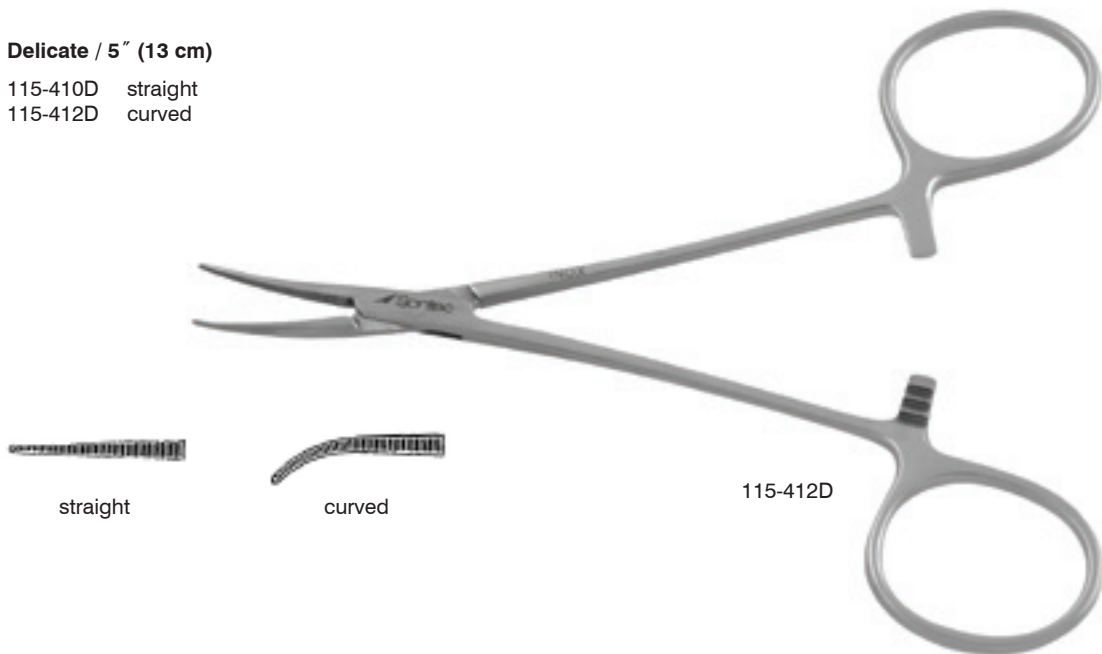

115-412D

**Halstead Mosquito Forceps**

Petit Point / curved

115-407 6" (14 cm)  
2200-461 7" (17.8 cm)



115-407

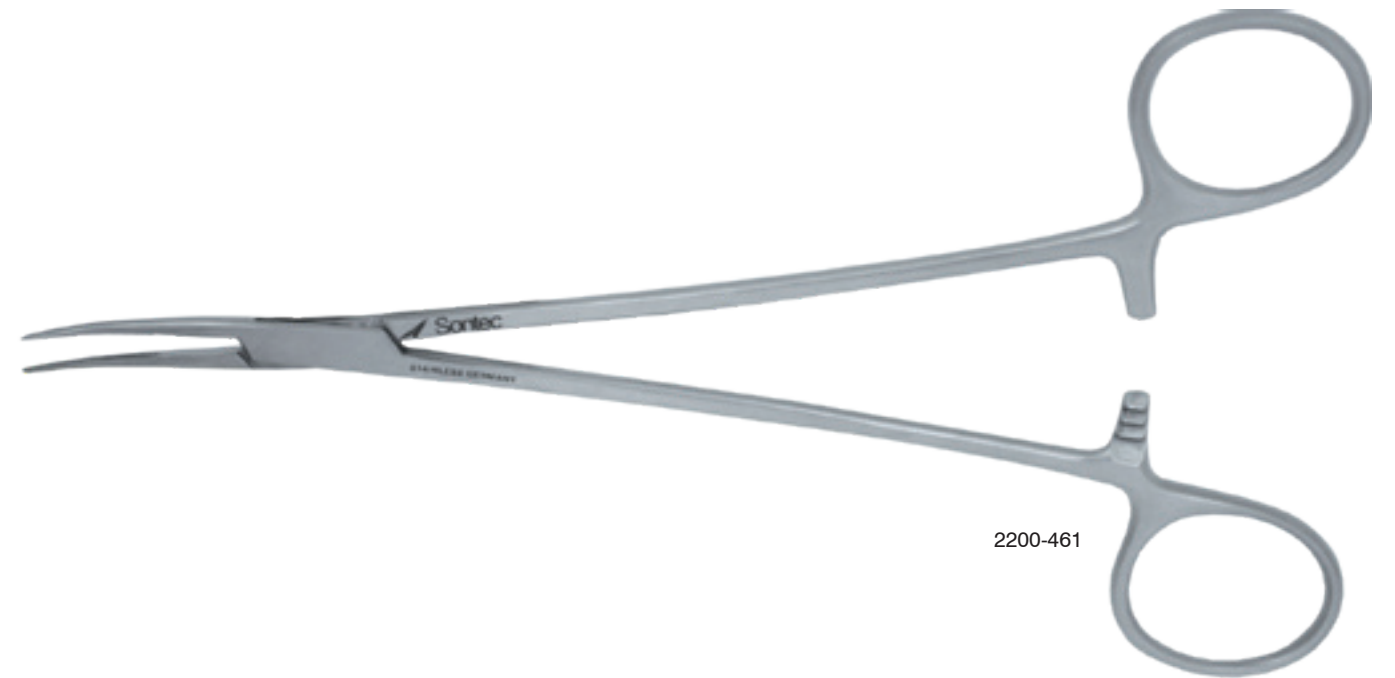

2200-461

**Rochester-Pean Forceps**

**Serrated / 5 1/2" (14 cm)**

- 115-480 straight
- 115-482 curved

**Serrated / 6 1/4" (16 cm)**

- 115-484 straight
- 115-486 curved

**Serrated / 7 1/4" (18.5 cm)**

- 115-490 straight
- 115-492 curved

**Serrated / 8" (20 cm)**

- 115-500 straight
- 115-502 curved

**Serrated / 9" (23 cm)**

- 115-506 straight
- 115-508 curved

**Serrated / 10 1/4" (25.5 cm)**

- 115-514 straight
- 115-515 curved

**Serrated / 12" (30 cm)**

- 115-510 straight
- 115-512 curved



115-484



115-508

**Rochester-Carmalt Forceps**

**Serrated / cross-serrated tip / 6 1/4" (16 cm)**

- 1100-150 straight
- 1100-152 curved
- 1100-152L curved left

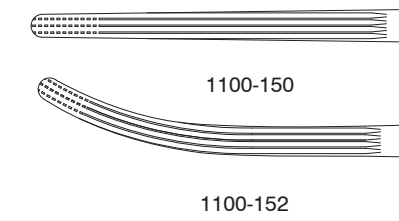

**Serrated / cross-serrated tip / 8" (20 cm)**

- 1100-151 straight
- 1100-153 curved

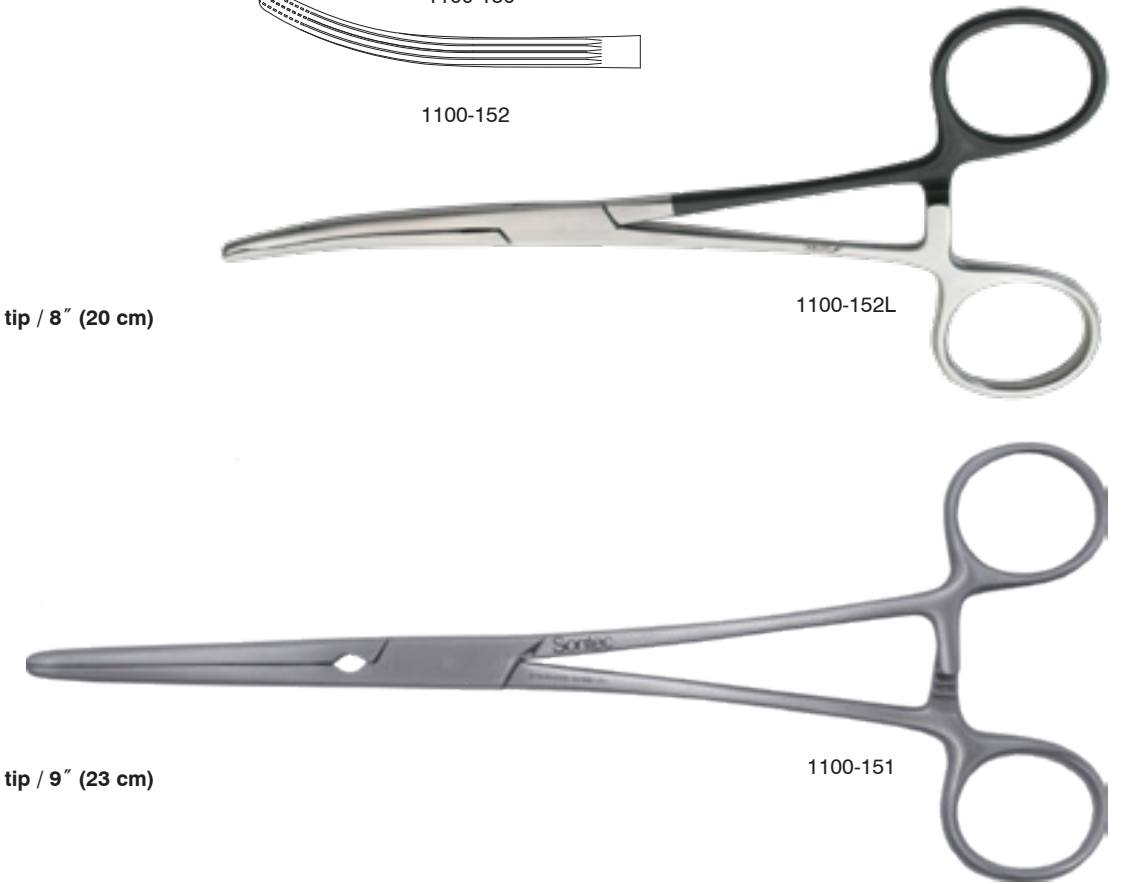

1100-152L



1100-151

**Serrated / cross-serrated tip / 9" (23 cm)**

- 438-614 straight
- 438-615 curved

**Serrated / cross-serrated tip / 10" (25 cm)**

- 438-610 straight
- 438-611 curved



438-610

**Serrated / cross-serrated tip / 12" (31 cm)**

- 438-612 straight
- 438-613 curved

**Kocher Forceps**

1 x 2 teeth / 5 1/2" (14 cm)

- 115-550 straight
- 115-552 curved

**Baby / 1 x 2 teeth / 5" (12.7cm)**

- 115-422K straight
- 115-424K curved

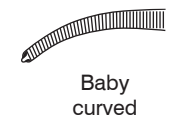
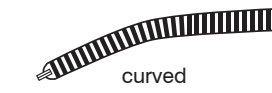

**Jacobson-Gemini Mixer Right Angle Forceps**

Full curve

- 150-348 5" (12.7 cm)
- 150-349 5 1/2" (14 cm)
- 150-350 6 1/4" (16 cm)
- 150-351 7 1/8" (18.25 cm)
- 150-353 8" (20 cm)
- 150-355 9" (23 cm)

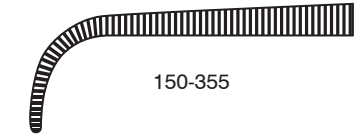
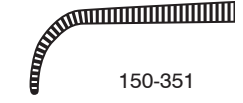
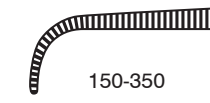
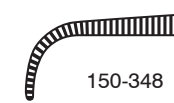

**Jacobson-Gemini Mixer Right Angle Forceps**

**Full curve**

- 150-348 5" (12.7 cm)
- 150-349 5 1/2" (14 cm)
- 150-350 6 1/4" (16 cm)
- 150-351 7 1/8" (18.25 cm)
- 150-353 8" (20 cm)
- 150-355 9" (23 cm)
- 150-356 10" (25.5 cm)
- 150-357 11" (28 cm)
- 150-361 12" (30.5 cm)
- 150-358 14" (35.5 cm)
- 150-359 16" (40.5 cm)



150-348

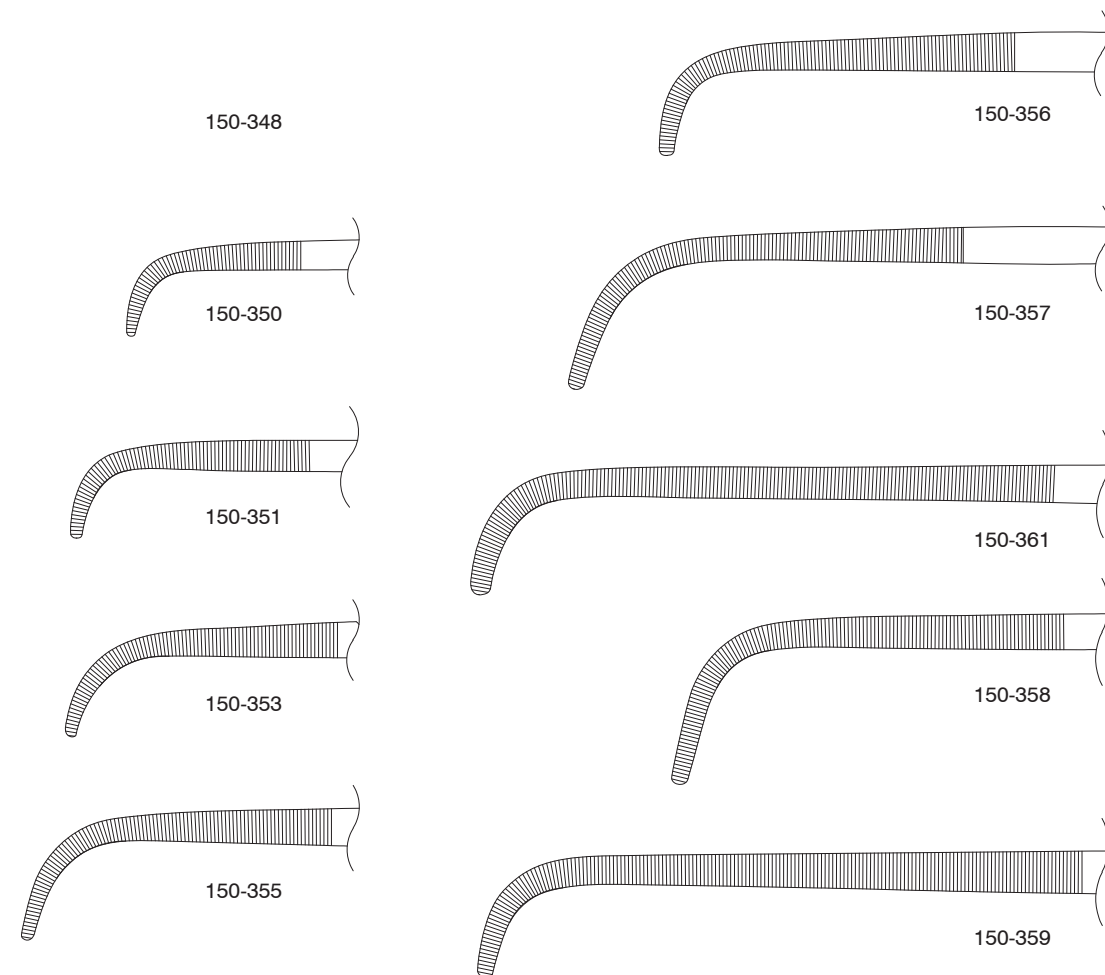

**Olsen-Lahey Right Angle Forceps**

For PDA procedures / longitudinal serrations / cross-serrated tip

- 150-307 5 3/4" (14.5 cm)
- 150-315 7" (18 cm)

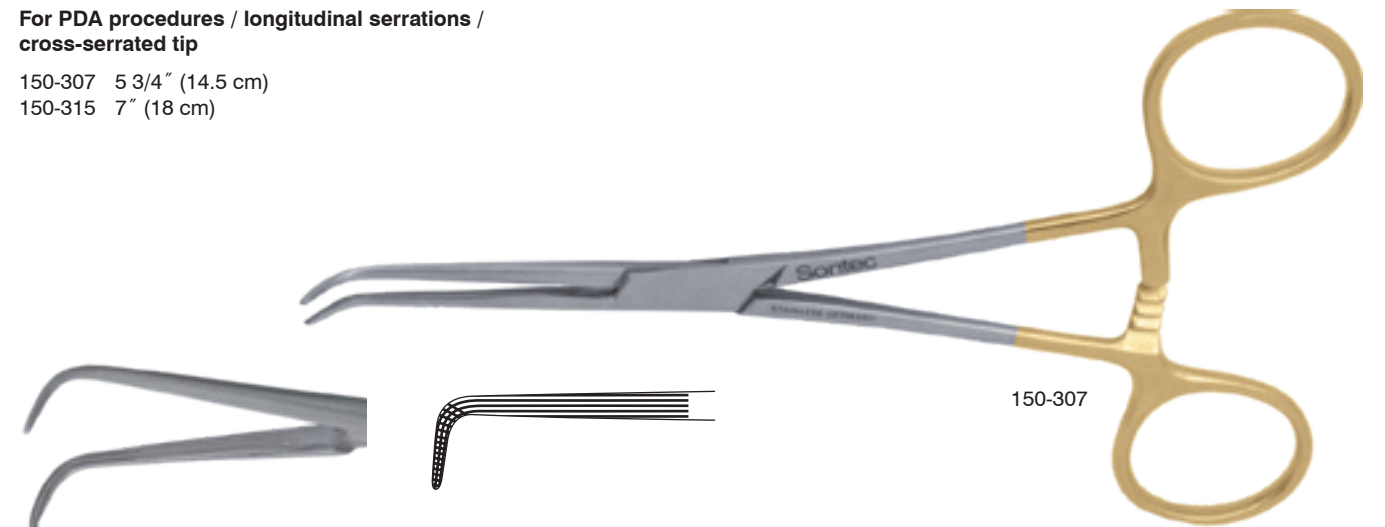

150-307

**Micro Tip Mixer Right Angle Forceps**

Partial serrated / 90° angle / 5 1/4" (13 cm)

2200-521

Serrated / 90° angle / 7 1/4" (18.5 cm)

2200-523A

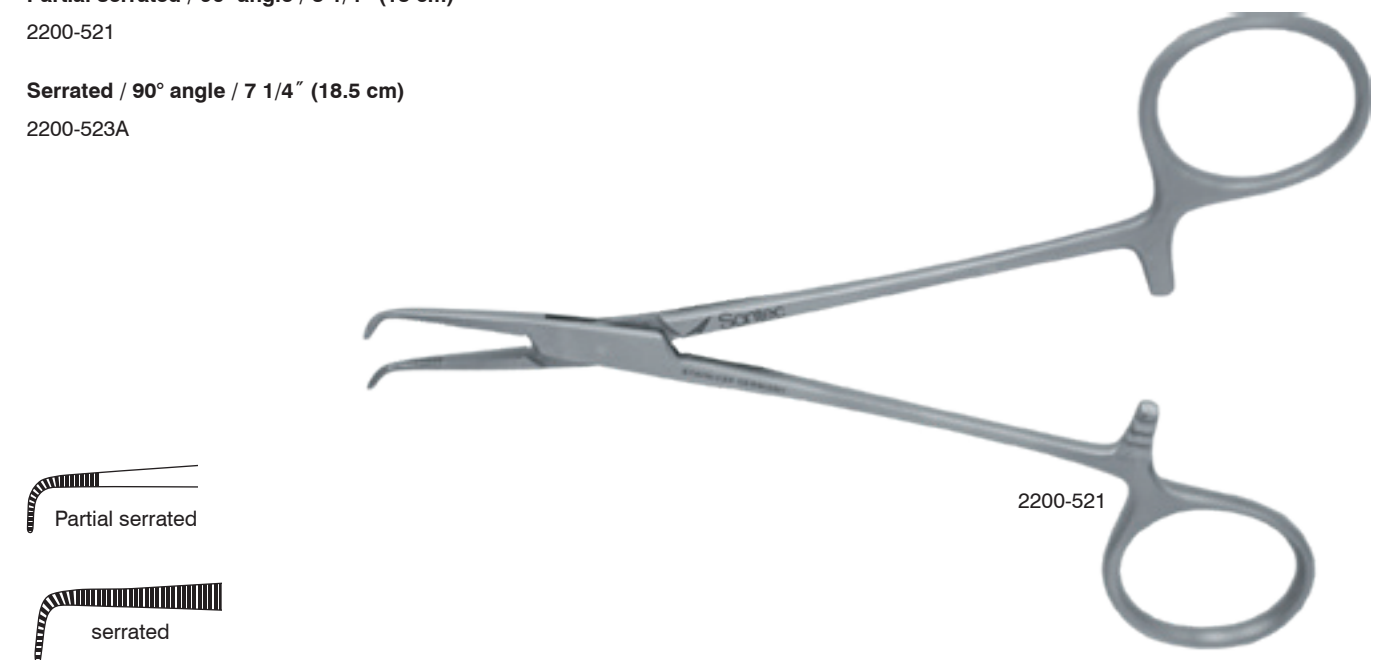

2200-521



**Long Tissue Forceps**

**12" (30 cm)**

- 1100-859 1 x 2 teeth
- 1100-858 2 x 3 teeth

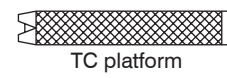

1100-859

**TC platform / 12" (30 cm)**

- 1100-863 1 x 2 teeth
- 1100-862 2 x 3 teeth

**14" (35.5 cm)**

- 1100-874 1 x 2 teeth
- 1100-878 2 x 3 teeth

**TC platform / 14" (35.5 cm)**

- 1100-875 1 x 2 teeth
- 1100-879 2 x 3 teeth

**16" (40.5 cm)**

- 1100-876 1 x 2 teeth
- 1100-880 2 x 3 teeth



1100-880

**TC platform / 16" (40.5 cm)**

- 1100-877 1 x 2 teeth
- 1100-881 2 x 3 teeth



1100-861

**18" (45.5 cm)**

- 1100-861 1 x 2 teeth
- 1100-860 2 x 3 teeth



1100-881

**TC platform / 18" (45.5 cm)**

- 1100-865 1 x 2 teeth
- 1100-864 2 x 3 teeth

**Thumb Dressing Forceps**

**Serrated**

- 136-600 4" (10 cm)
- 136-602 4 1/2" (11.5 cm)
- 136-605 5" (13 cm)
- 136-607 5 1/2" (14 cm)
- 136-610 6" (15.5 cm)
- 136-613 7" (18 cm)
- 136-615 8" (20.5 cm)
- 136-617 10" (25.5 cm)
- 136-619 12" (30.5 cm)

**TC serrated**

- 1100-739B 6" (15.5 cm)
- 1100-739A 7" (18 cm)



136-607

**Tissue Forceps with Teeth**

**1 x 2 teeth**

136-621	4 1/2" (11.5 cm)	
136-624	5" (12.7 cm)	
136-626	5 1/2" (14 cm)	
136-629	6" (15.5 cm)	
136-632	7" (18 cm)	
136-632B	7" (18 cm)	electro blue coated
136-634	8" (20.5 cm)	
136-636	10" (25.5 cm)	



136-632B

**2 x 3 teeth**

136-639	5" (12.7 cm)	
136-633	5" (12.7 cm)	TC serrated
136-640	5 1/2" (14 cm)	
136-637	5 1/2" (14 cm)	TC serrated
136-642	6" (15.5 cm)	
1100-179	6 1/4" (16 cm)	
136-641	6 1/4" (16 cm)	TC serrated
1100-165	7" (18 cm)	
136-643	7" (18 cm)	TC serrated
1100-167	8" (20 cm)	
136-645	8" (20 cm)	TC serrated
1100-187	9 3/4" (25 cm)	
136-649	9 3/4" (25 cm)	TC serrated
1100-169	10" (25 cm)	
136-651	10" (25 cm)	TC serrated



136-640

**3 x 4 teeth**

136-644	5 1/2" (14 cm)	
136-652	5 1/2" (14 cm)	TC serrated
136-646	6" (15 cm)	

**4 x 5 teeth**

136-648	5 1/2" (14 cm)	
136-653	5 1/2" (14 cm)	TC serrated
136-650	6" (15.5 cm)	
136-6508	8" (20.3 cm)	

**DeBakey Thoracic Forceps**

**Flat handle / 2.5 mm tip**

442-210	6" (15 cm)
442-212	7 3/4" (20 cm)
442-214	9 1/2" (24 cm)
442-216	12" (30.5 cm)

**Flat handle / 2.8 mm tip / 12" (30.5 cm)**

442-219

**Flat handle / 3.5 mm tip / 14" (35.5 cm)**

442-215

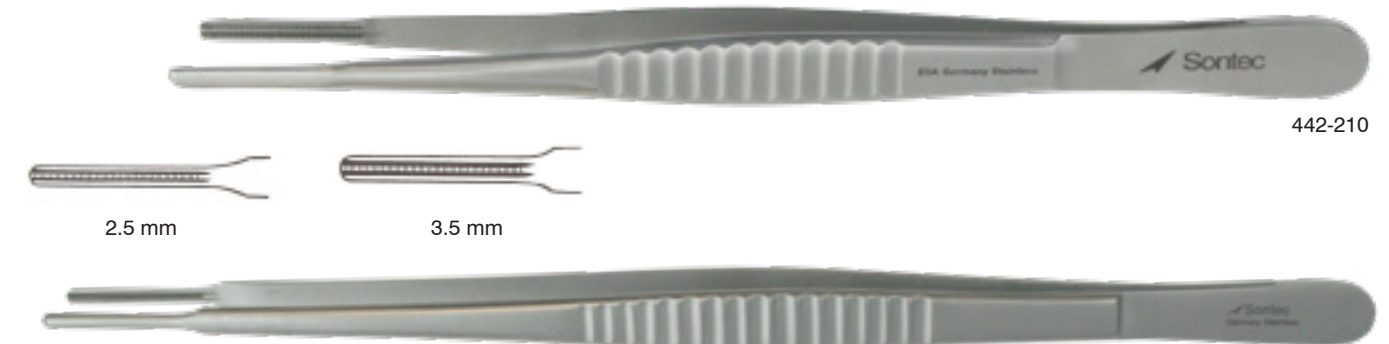

442-210

442-214

**Skinner Tissue Forceps**

**1 x 2 teeth / TC platform / 8" (20.5 cm)**

- 140-517M micro
- 140-517 delicate
- 140-517G standard

**1 x 2 teeth / TC platform / 9" (23 cm)**

- 140-379 micro
- 140-378 delicate
- 140-376 standard

**1 x 2 teeth / TC platform / 10" (25.5 cm)**

- 140-519M micro
- 140-519 delicate
- 140-519G standard



standard tip    delicate tip    micro tip



140-376

**Semken Forceps**

**Dressing / serrated**

- 136-702 4 3/4" (12 cm)
- 136-704 6" (15.5 cm)

**Tissue / 1 x 2 teeth / delicate / 0.7mm tip / 4 3/4" (12 cm)**

136-701

**Tissue / 1 x 2 teeth**

- 136-706 5" (13 cm)
- 136-708 6" (15.5 cm)

**Tissue / TC platform / 1 x 2 teeth**

- 140-350 5 3/4" (15 cm)
- 140-358 6 1/4" (16 cm)
- 140-364 7" (18 cm)

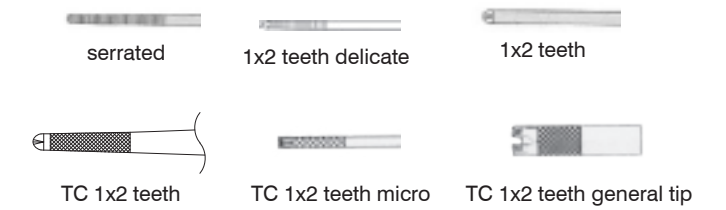

140-350



140-364

**Tissue / TC platform / 1 x 2 teeth / micro**

- 140-352 5 3/4" (15 cm)
- 140-360 6 1/4" (16 cm)
- 140-366 7" (18 cm)

**Tissue / TC platform 1 x 2 teeth / general**

- 140-354 5 3/4" (15 cm)
- 140-362 6 1/4" (16 cm)
- 140-368 7" (18 cm)
- 140-369 8" (20.5 cm)

**DeBakey Vascular Forceps**

6" (15 cm)

1100-183 1.5 mm tip fenestrated handle



1.5 mm DeBakey tip



1100-183

**McGravey Tissue Forceps**

5 x 6 delicate teeth

136-766 7" (18 cm)

136-767 9" (22.9 cm)



136-766

**Brown Tissue Forceps**

9 x 9 teeth

136-690 6" (15.5 cm)

136-692 8" (20.5 cm)

136-694 10" (25.5 cm)

9 x 9 teeth / TC

136-691 6" (15.5 cm)

136-695 10" (25.4 cm)



136-690

**Russian Tissue Forceps**

136-771 6" (15.5 cm)

136-773 8" (20.5 cm)

136-775 10" (25.5 cm)

136-776 12" (30.5 cm)

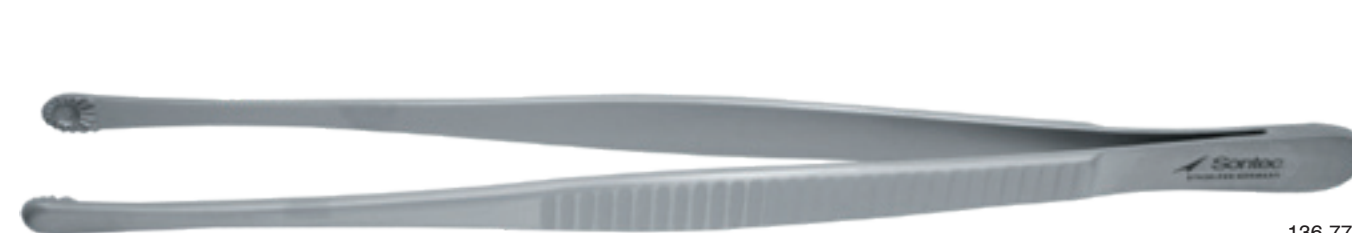

136-773





**Singley Tuttle Forceps**

**Serrated**

142-108	7" (18 cm)	
142-110	9" (23 cm)	
2200-0175	9" (23 cm)	large ring
142-107	10" (25 cm)	
142-111	12" (30 cm)	
142-104	14" (35.5 cm)	
142-106	16" (40.5 cm)	



142-108



**DeBakey-Adson Tissue Forceps**

1.5 mm / atraumatic DeBakey jaws / 4 3/4" (12 cm)

1100-185



1100-185

**Brown-Adson Tissue Forceps**

Serrated handle / 7 x 7 teeth / 4 3/4" (12 cm)

136-688 fenestrated handle  
136-688S



136-688

3 x 4 teeth / TC platform / 4 3/4" (12 cm)

136-689 serrated handle  
1100-735F fenestrated handle

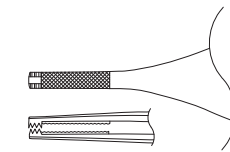

TC platform  
3 X 4 teeth



136-6891

3 x 4 teeth / TC platform / electro black coated / 4 3/4" (12 cm)

136-6891 serrated handle



136-700

Russian fenestrated handle / 8 x 8 teeth / 4 3/4" (12 cm)

136-700



136-686

Serrated handle / 9 x 9 teeth / 4 3/4" (12 cm)

136-686  
136-686D delicate  
136-698 angled

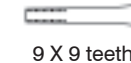

9 X 9 teeth



Serrated handle / 9 x 9 teeth / 6" (15.5 cm)

136-687  
136-697 TC platform



136-697

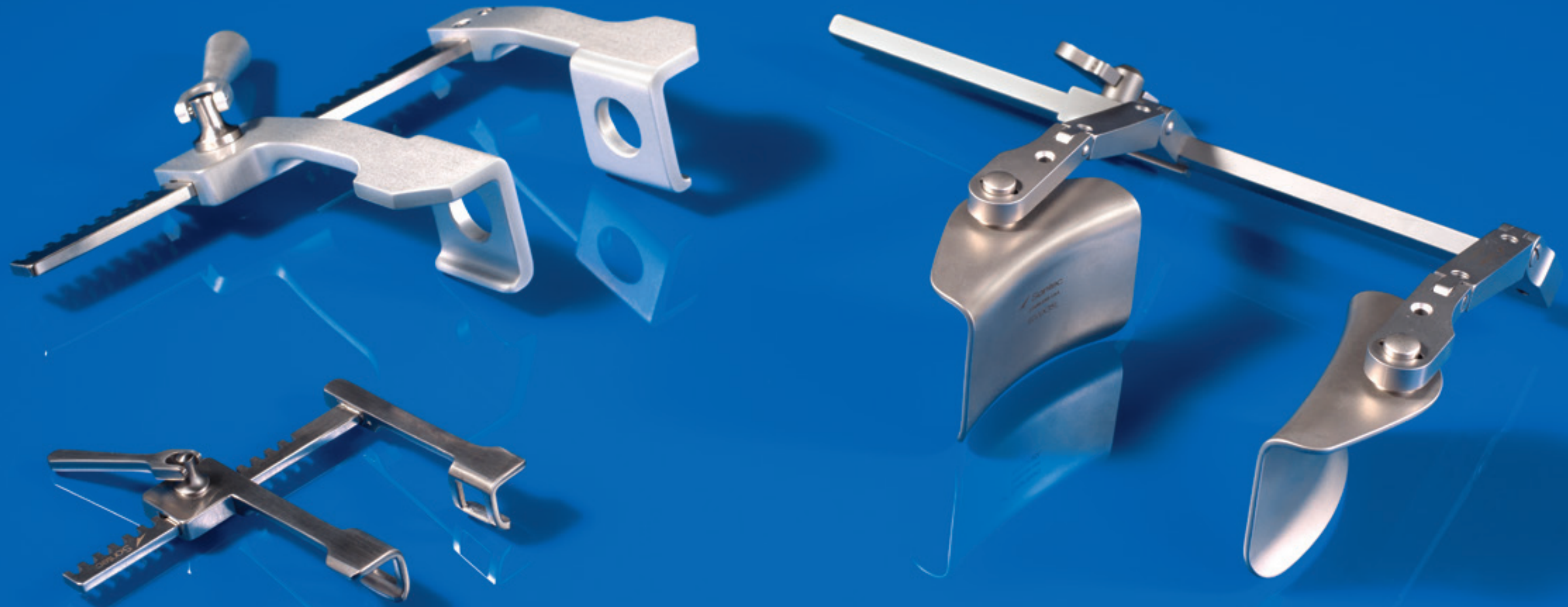

 Sontec Instruments®

Retractors

**Gelpi Classic Retractor**

**Standard**

1100-629	3 1/2" (9 cm)	micro
1100-628	3 3/4" (9.5 cm)	heavy
1100-629B	4 1/2" (11.5 cm)	
1100-6280	4 1/2" (11.5 cm)	heavy
1100-628B	5 1/2" (14 cm)	
1100-632	6 1/2" (16.5 cm)	
1100-630	7 1/2" (19 cm)	
1100-630A	8" (20 cm)	



1100-629B

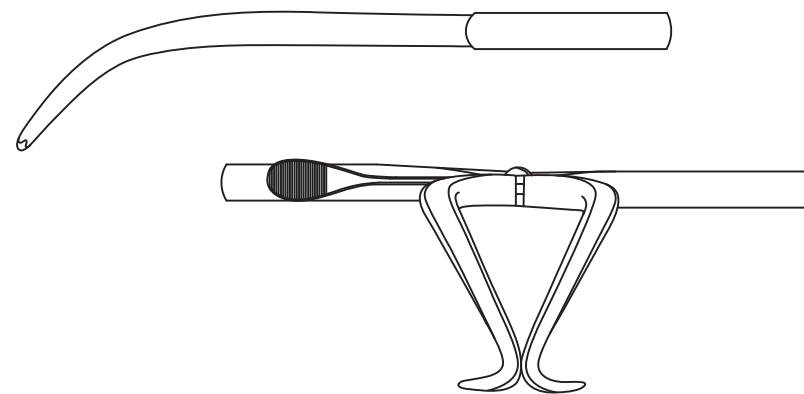

**Gelpi Deep Angle Neroma (Crossover) Retractor**

**Deep angle**

1100-633H	3 1/2" (9 cm)
1100-633G	4 1/2" (11.5 cm)
1100-633F	5 1/2" (14 cm)
1100-633I	6 1/2" (16.5 cm)
1100-632R	6 3/4" (17.5 cm)
1100-630N	7 1/2" (19 cm)
1100-631N	8" (20 cm)

**Enclosed ratchet / deep angle**

1100-633HR	3 1/2" (9 cm)
1100-633GR	4 1/2" (11.5 cm)
1100-633FR	5 1/2" (14 cm)



1100-633G



enclosed ratched

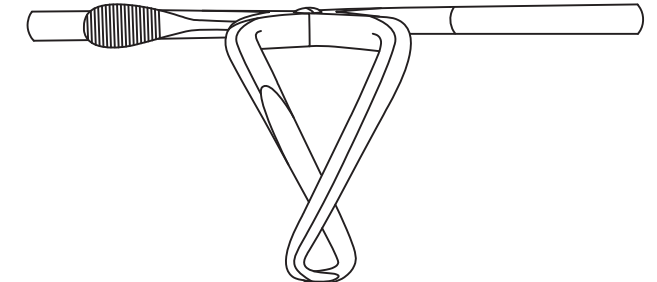
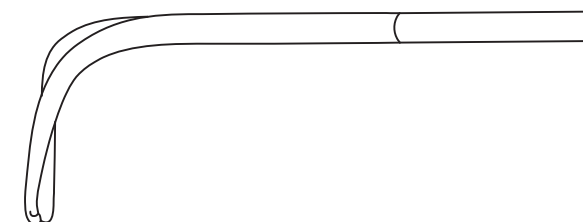



**Weitlaner Retractor**

**Hinged arms / 3 x 4 prongs**

- 1100-636 sharp 5 1/2" (14 cm)
- 1100-638 blunt 5 1/2" (14 cm)
- 1100-640 sharp 6 1/4" (16 cm)
- 1100-642 blunt 6 1/4" (16 cm)
- 1100-644 sharp 8" (20.5 cm)
- 1100-644B blunt 8" (20.5 cm)

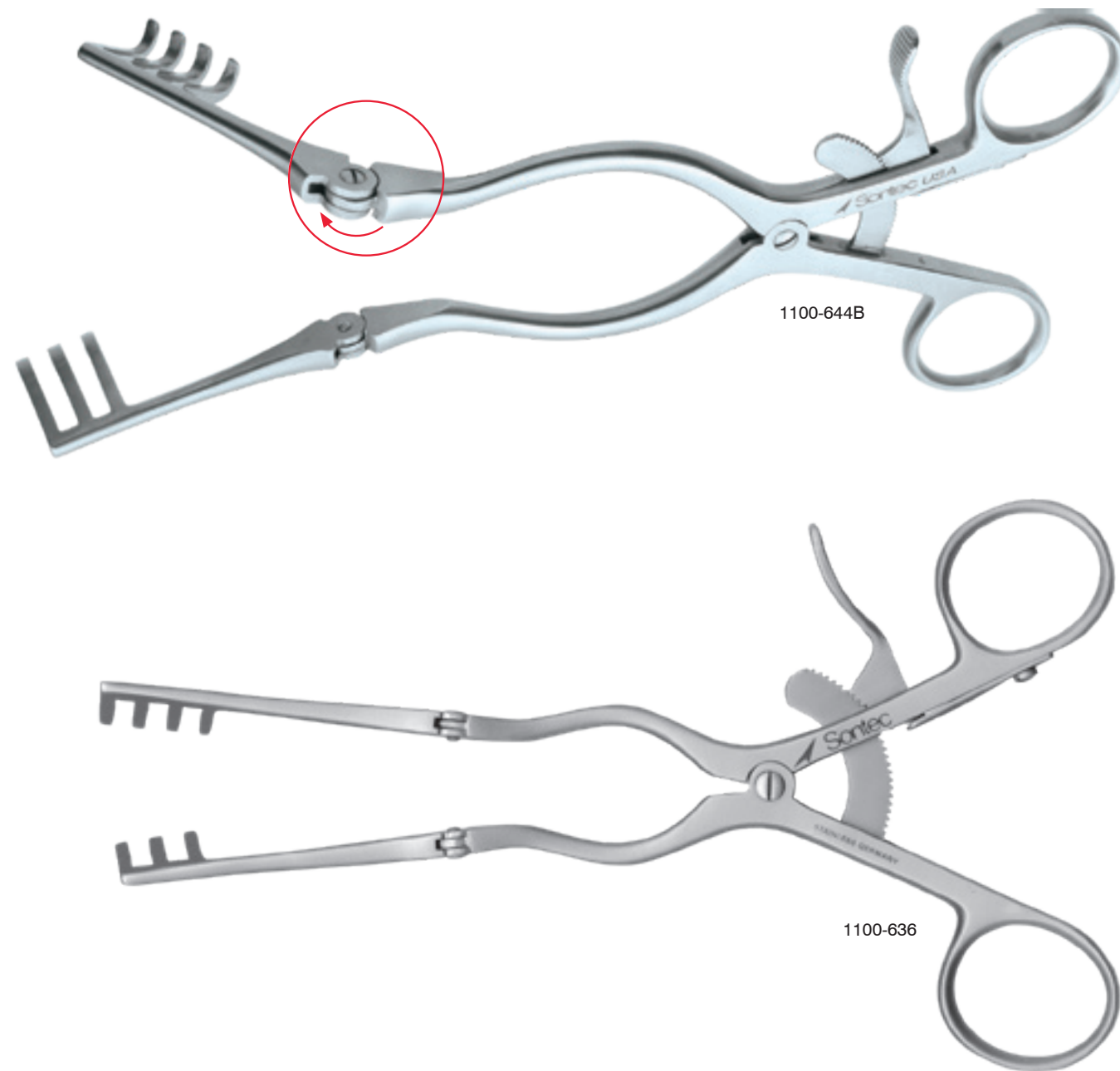

**Weitlaner Retractor**

**2 x 3 prongs**

- 1100-616 sharp 4" (10 cm)
- 1100-617 blunt 4" (10 cm)

**3 x 4 prongs**

- 1100-618 sharp 5 1/2" (14 cm)
- 1100-619 blunt 5 1/2" (14 cm)
- 1100-620 sharp 6 1/4" (16 cm)
- 1100-621 blunt 6 1/4" (16 cm)
- 1100-622 sharp 8" (20.5 cm)
- 1100-623 blunt 8" (20.5 cm)
- 1100-624 sharp 9 1/2" (24 cm)
- 1100-625 blunt 9 1/2" (24 cm)



sharp



blunt

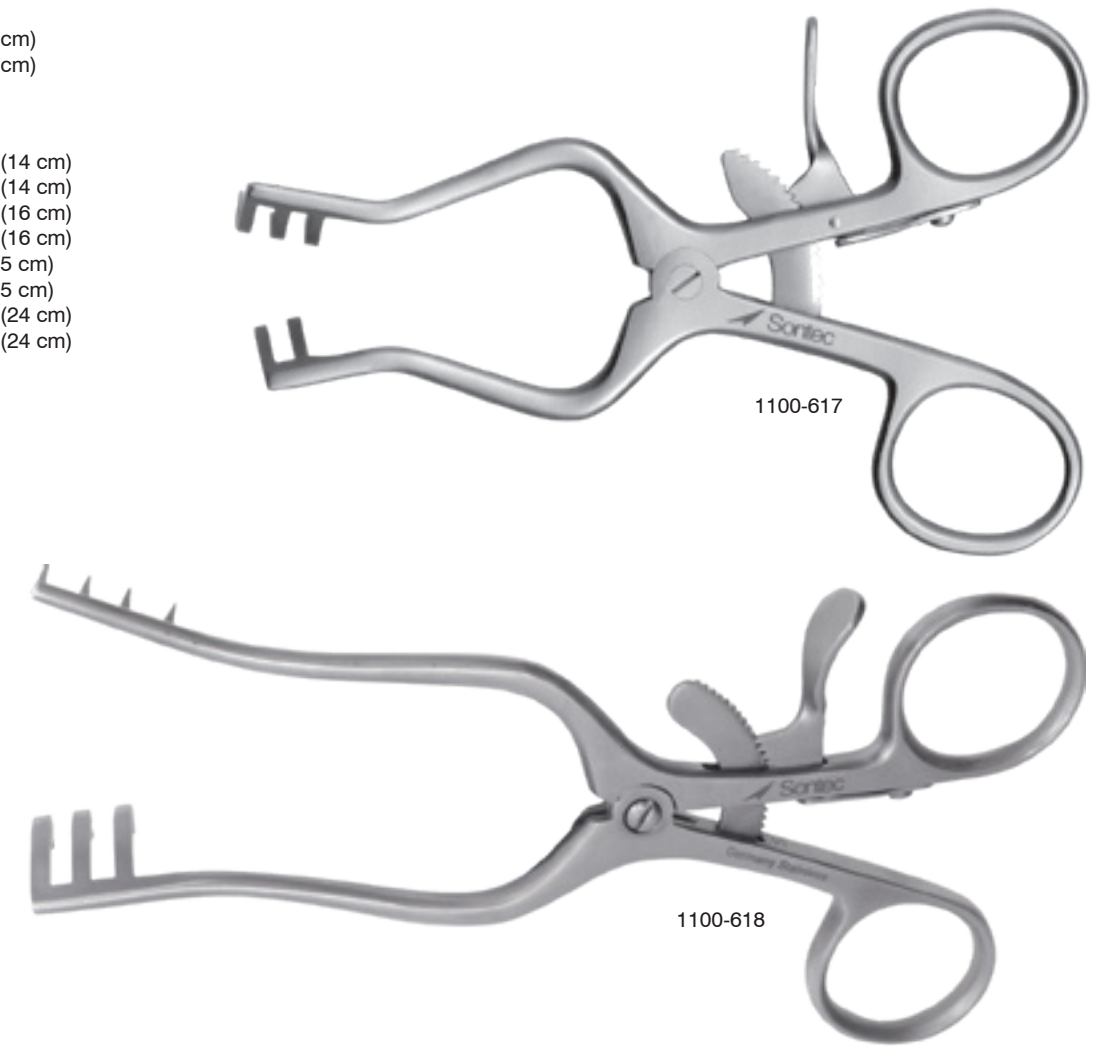

**Weitlaner Extended Blades Retractor**

With 4 prongs / prong depth 3.5 cm / straight arms / blunt tips / 4 1/2" (11.4 cm)

230-445

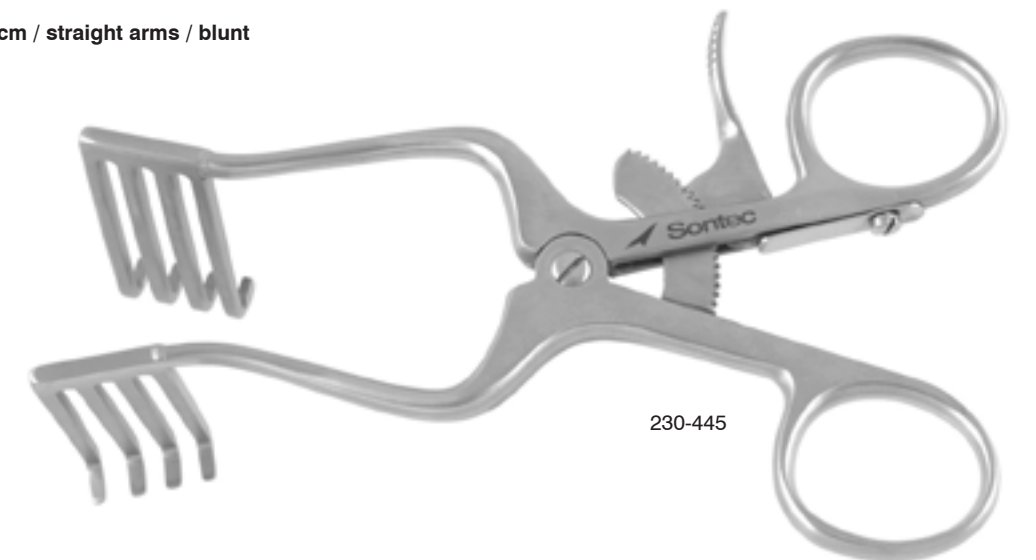



**Adson Cerebella Retractor**

4 x 4 sharp prongs / 7 1/2" (19 cm)

- 230-480 straight arms
- 230-486 angled arms

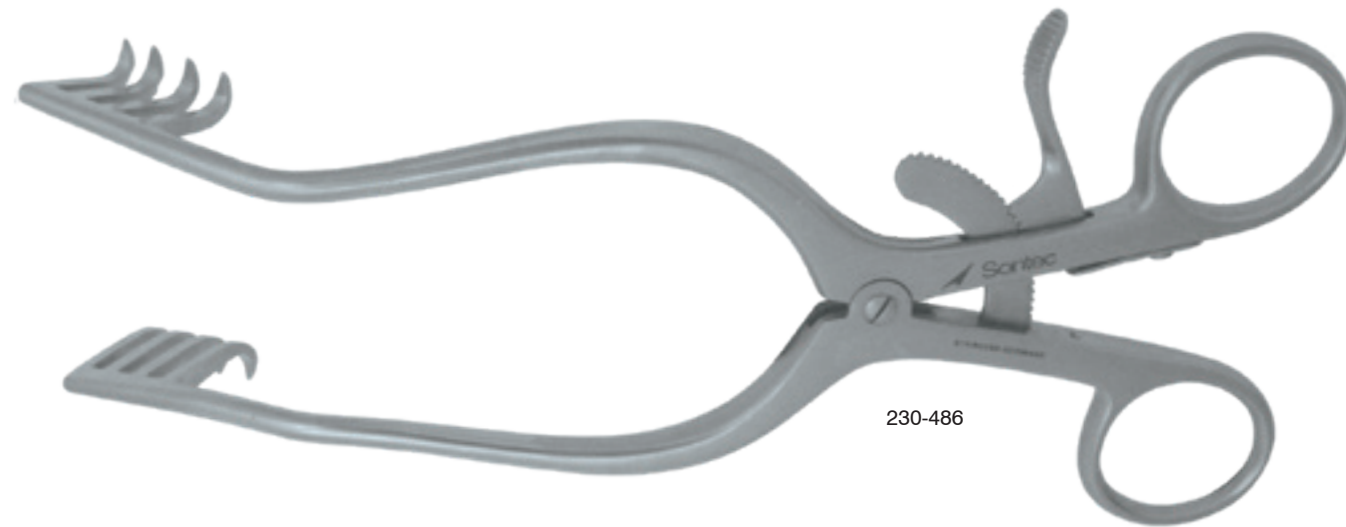

230-486

**Richardson-Eastman Retractor**

- 207-319-SET set of two, one large and one small
- 207-321 small 10" (25 cm)
- 207-323 large 11" (28 cm)

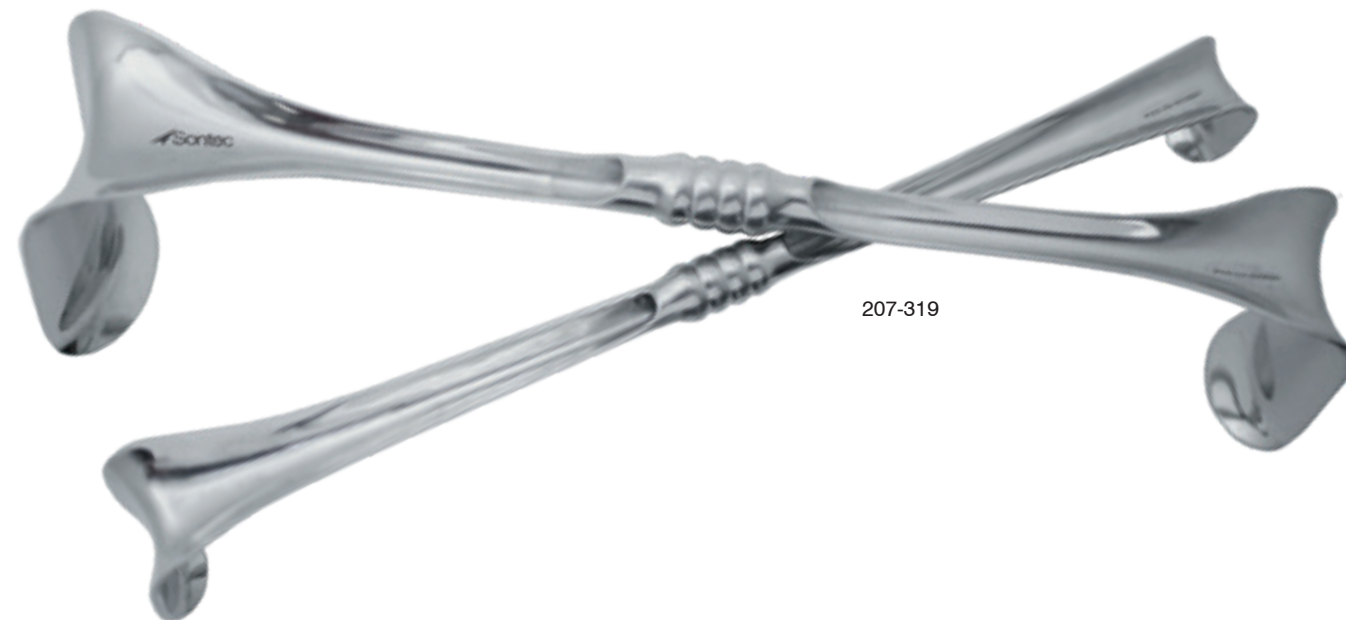

207-319

**Richardson Retractor**

9 1/2" overall length / loop grip handle

- 207-338 1" x 3/4"
- 207-340 1" x 1 1/4"
- 207-342 1 1/2" x 1 1/2"
- 207-345 2" x 3/4"

9 1/4" overall length / hollow grip handle

- 207-333 2" x 3/4"

11" overall length / lamb grip handle

- 207-326 1" x 3/4"
- 207-328 1 1/4" x 1"
- 207-330 1 1/2" x 1 1/2"



207-326

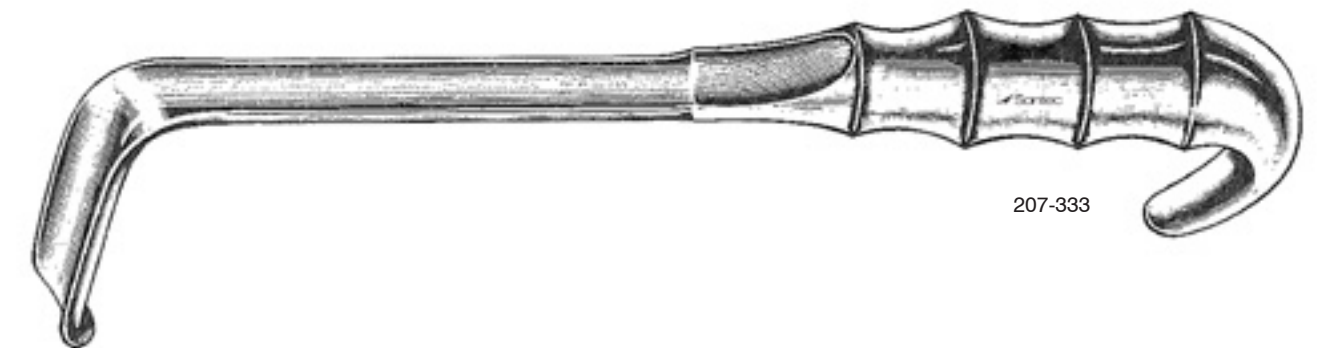

207-333

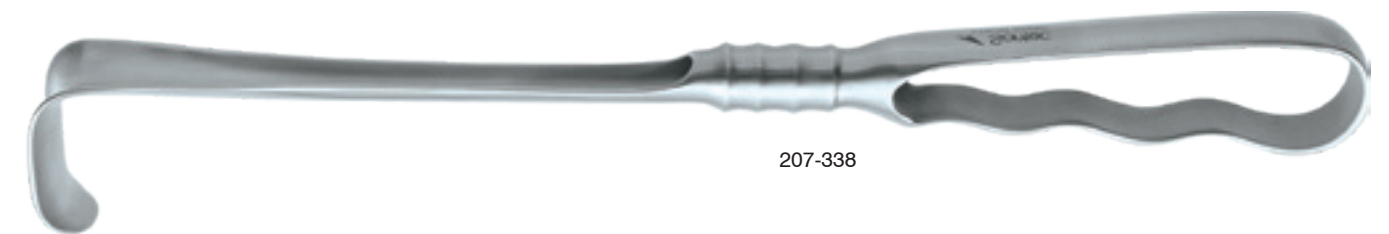

207-338

**Retractor**

207-415	large blade	3 1/2" x 2" x 9 1/2"
207-413	medium blade	3" x 1" x 9 1/2"
207-411	small blade	2" x 5/8" x 9 1/2"



207-411

**Aanes Retractor/Speculum**

For equine reproductive surgery / includes one pair of blades / 7" spread (18 cm) / comes with one set of blades, choose from sizes below

1101-538

**Blades for Aanes Retractor/Speculum**

1101-540	5"
1101-542	6"
1101-544	7"
1101-546	8"
1101-548	9"
1101-550	10"
1101-552	11"
1101-553	12"

\* Please specify blade size when ordering

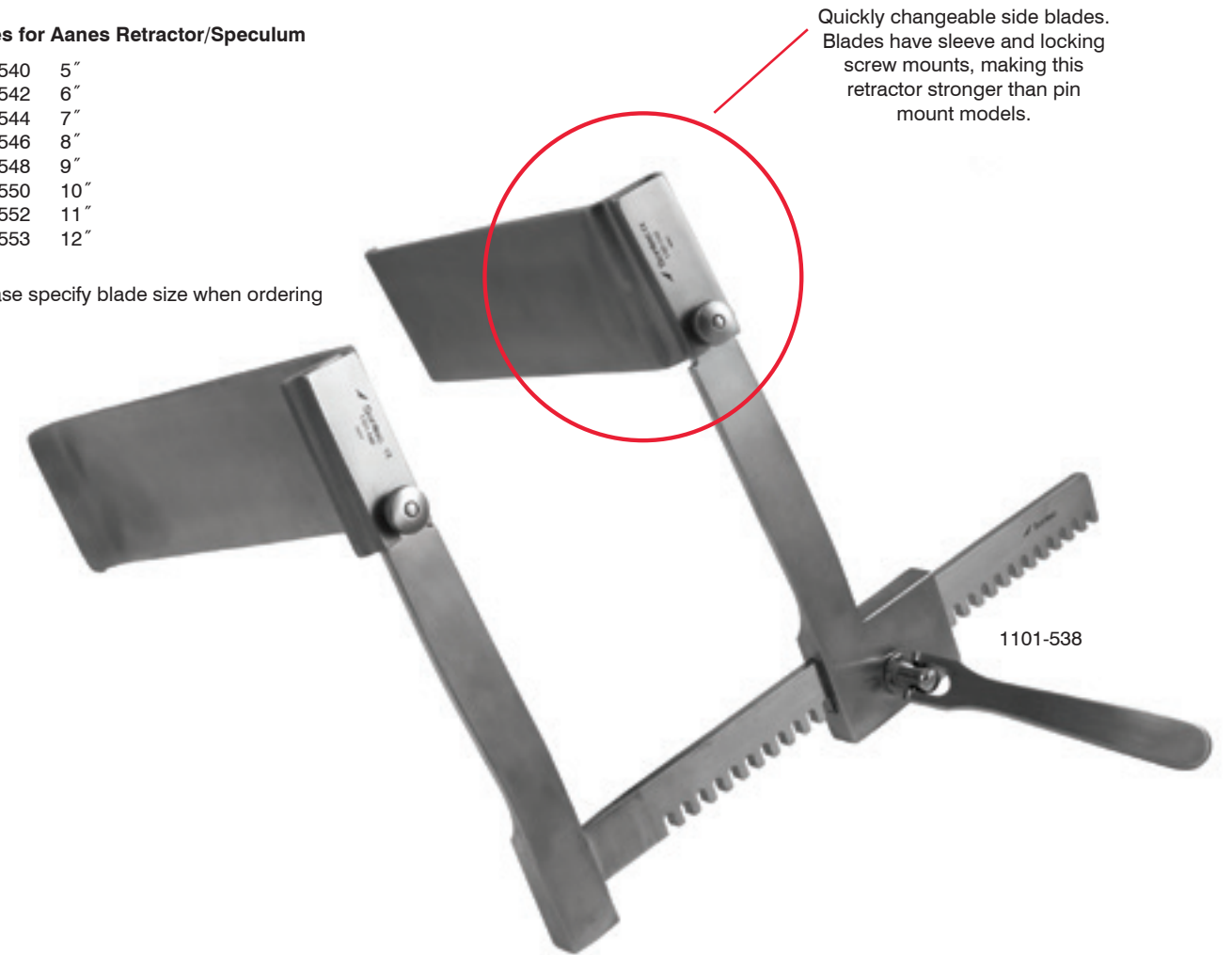

1101-538

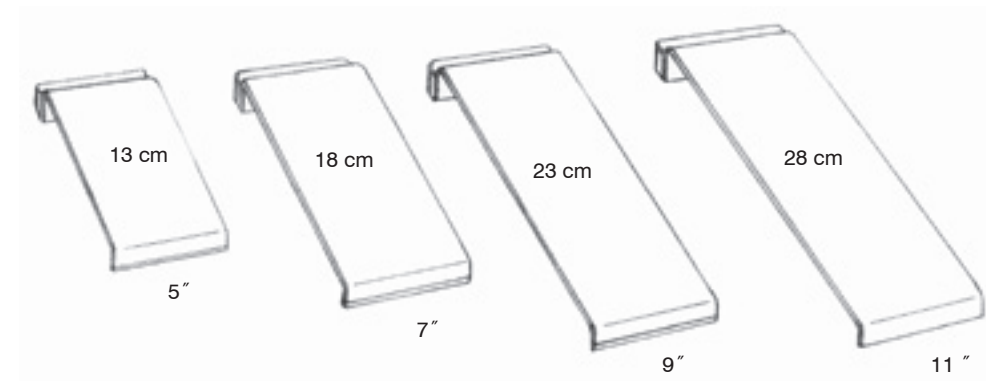



 Sontec Instruments®

Scissors



**Metzenbaum Classic Model Scissors**

**Classic model / 4 1/2" (11.5 cm)**

- 1100-233 straight
- 1100-241 curved



straight



curved

**Classic model / 5 3/4" (14.5 cm)**

- 1100-236 straight
- 1100-236L straight left handed
- 1100-242 curved
- 2400-346 curved extra-light
- 2400-347 curved extra-light tenotomy tip

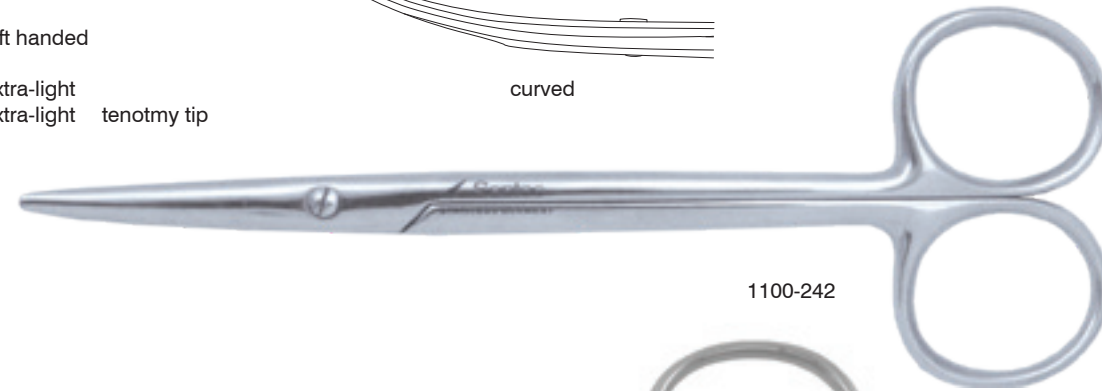

1100-242

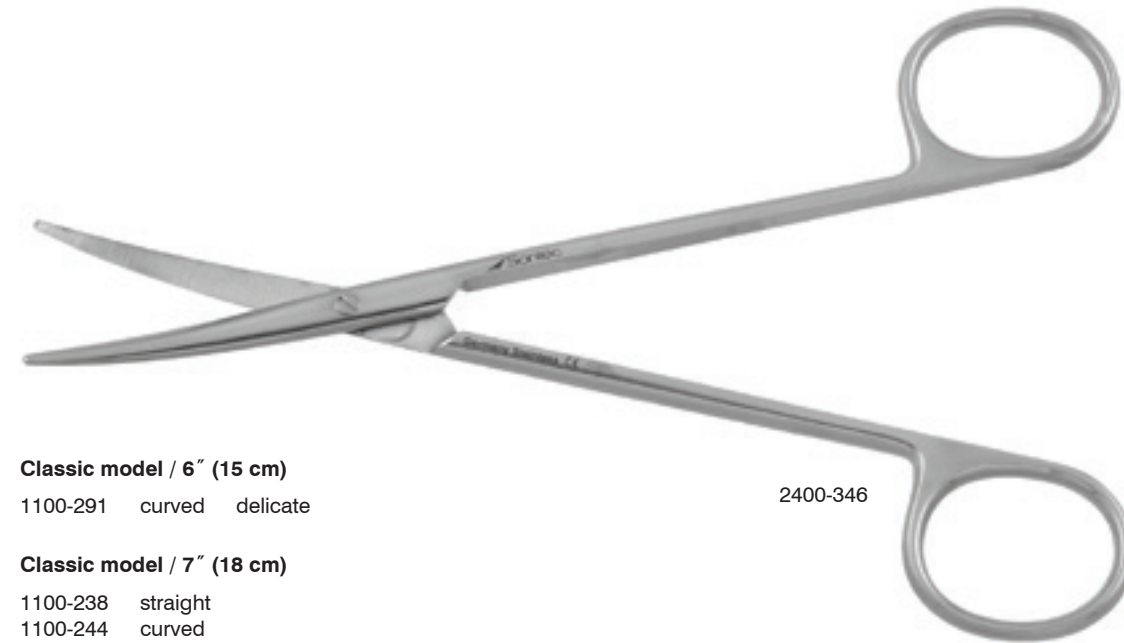

2400-346

**Classic model / 6" (15 cm)**

- 1100-291 curved delicate

**Classic model / 7" (18 cm)**

- 1100-238 straight
- 1100-244 curved
- 2400-349 curved extra-light



1100-244



2400-349

**Metzenbaum Classic Model Scissors**

**Classic model / 8" (20.5 cm)**

- 1100-240 straight
- 1100-246 curved
- 2400-320 straight fino



1100-240

**Classic model / 9" (23 cm)**

- 110-301 straight
- 110-302 curved
- 2400-352 curved extra-light

**Classic model / 10" (25.4 cm)**

- 1100-243 straight
- 1100-245 curved



1100-245

**Metzenbaum Scissors**

**Curved / power cut silver / 5 3/4" (14.6 cm)**

- 1200-333



1200-333



**Metzenbaum Tungsten Carbide Scissors**

**Tungsten Carbide (TC) / 5 3/4" (15 cm)**

- 2400-265 straight
- 2400-267 curved
- 2400-250 straight delicate
- 2400-252 curved delicate

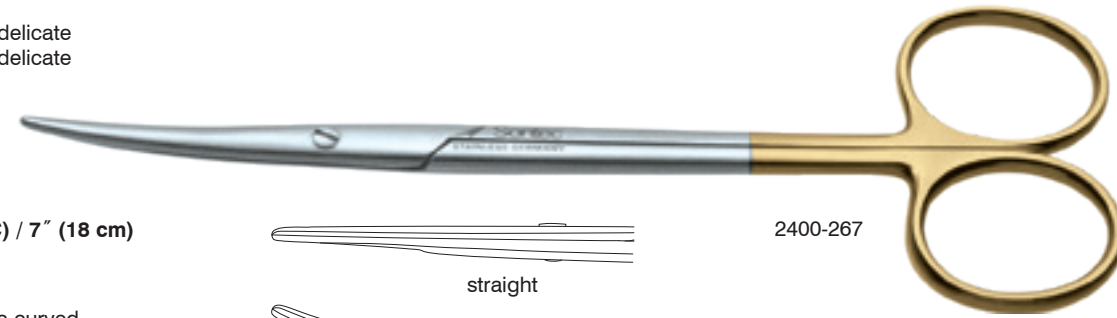

2400-267

**Tungsten Carbide (TC) / 7" (18 cm)**

- 2400-269 straight
- 2400-270 curved
- 2400-253 curved s-curved
- 2400-254 straight delicate
- 2400-256 curved delicate

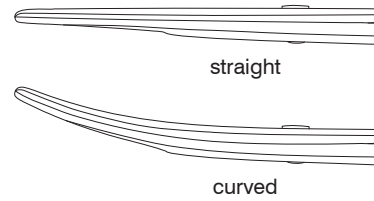

straight

curved

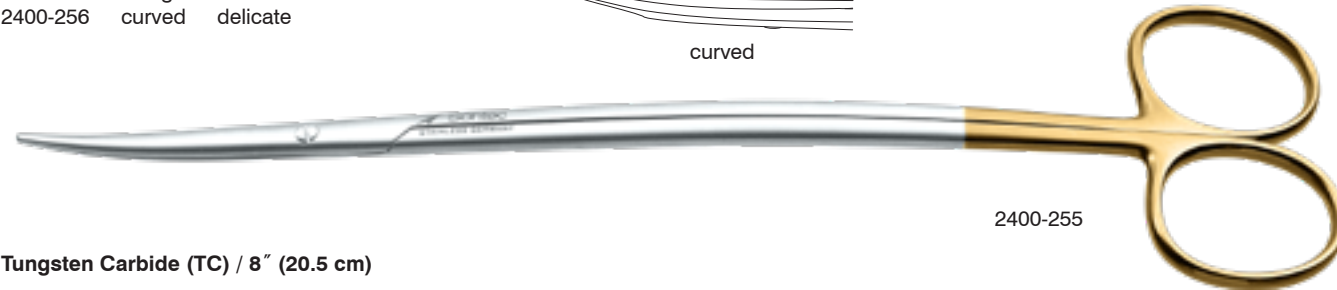

2400-255

**Tungsten Carbide (TC) / 8" (20.5 cm)**

- 2400-271 straight
- 2400-272 curved
- 2400-255 curved s-curved
- 2400-257 straight delicate
- 2400-258 curved delicate



2400-272



2400-253

**Metzenbaum Tungsten Carbide Long Model Scissors**

**Tungsten Carbide (TC) / 9" (23 cm)**

- 2400-273 straight
- 2400-275 curved
- 2400-260 straight delicate
- 2400-262 curved delicate

**Tungsten Carbide (TC) / 10" (25.5 cm)**

- 2400-279 straight
- 2400-280 curved

**Tungsten Carbide (TC) / 11" (28 cm)**

- 2400-277 straight
- 2400-278 curved
- 2400-264 curved delicate

**Tungsten Carbide (TC) / 12" (30.5 cm)**

- 2400-341 straight
- 2400-345 curved

**Tungsten Carbide (TC) / curved / extra long**

- 1100-847 14" (35.5 cm)
- 1100-849 16" (40.5 cm)
- 1100-850 18" (45.5 cm)



2400-264

**Metzenbaum Power Cut® Gold Scissors**

**Power Cut Gold (PC Gold) / 4 3/4" (12 cm)**

- 1200-326 straight
- 1200-328 curved

**Power Cut Gold (PC Gold) / 5" (12.5 cm)**

- 2400-286 straight
- 2400-287 curved

**Power Cut Gold (PC Gold) / straight / 5 3/4" (15 cm)**

- 1200-330
- 1200-334 delicate

**Power Cut Gold (PC Gold) / curved / 5 3/4" (15 cm)**

- 1200-332
- 1200-335 delicate
- 1200-347 ergonomic spread handle

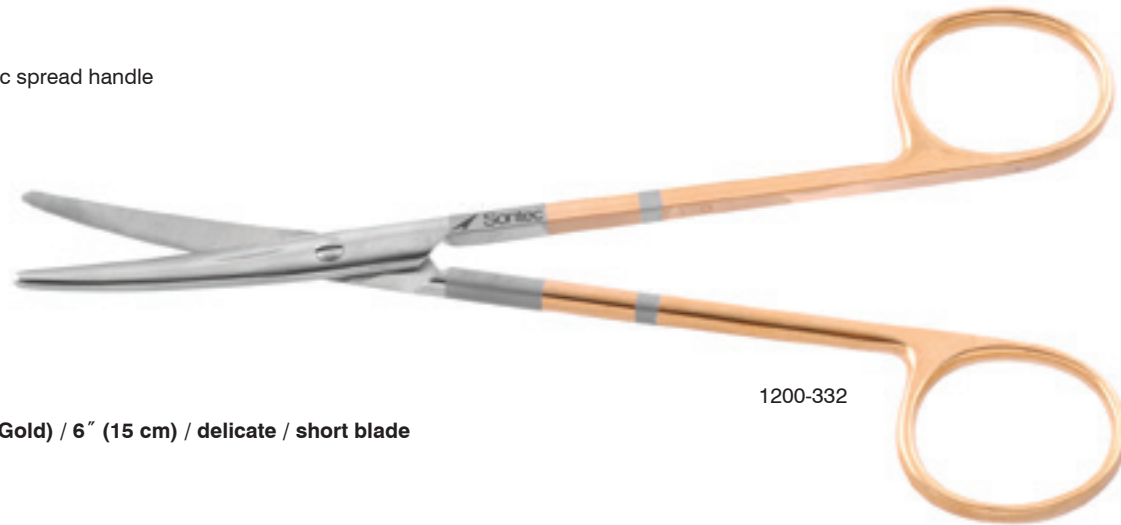

1200-332

**Power Cut Gold (PC Gold) / 6" (15 cm) / delicate / short blade**

- 2400-314 straight
- 2400-315 curved

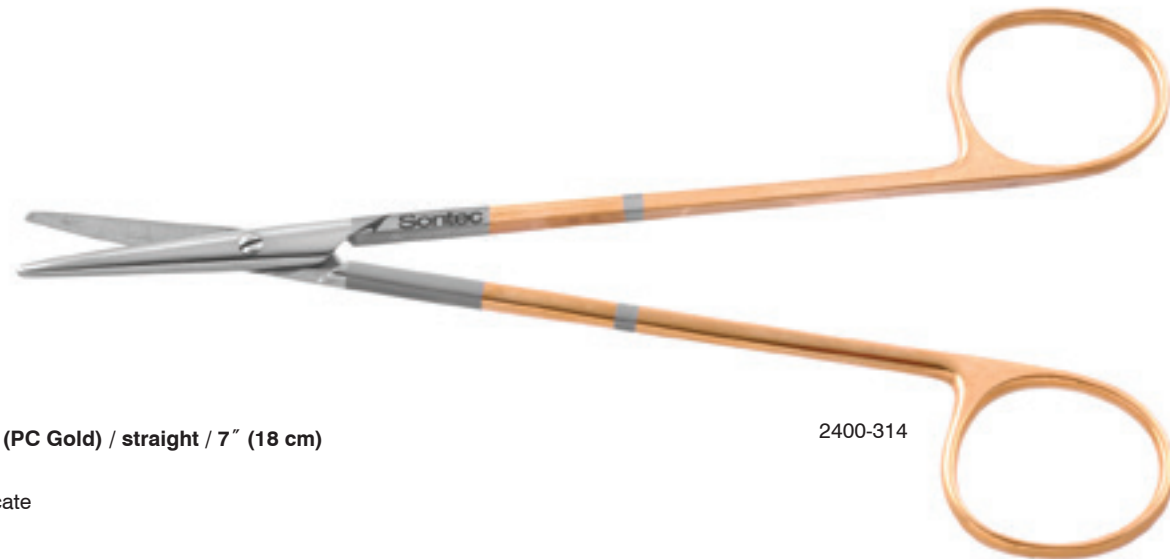

2400-314

**Power Cut Gold (PC Gold) / straight / 7" (18 cm)**

- 1200-340
- 2400-316 delicate

**Metzenbaum Power Cut® Gold Scissors**

**Power Cut Gold (PC Gold) / curved / 7" (18 cm)**

- 1200-342
- 1200-342H heavy
- 1200-342L left handed
- 1200-344 ergonomic spread handle
- 2400-317 delicate
- 2400-330 2.5 mm tip

**Power Cut Gold (PC Gold) / 8" (20.5 cm)**

- 1200-360 straight
- 1200-362 curved
- 2400-318 straight delicate
- 2400-319 curved delicate



1200-344

1200-342

**Metzenbaum S-Curved Power Cut® Gold Scissors**

Power Cut Gold (PC Gold) / s-curved / curved shank & blade

- 1200-525 7" (17.8 cm)
- 1200-523 8" (20.5 cm)



**Metzenbaum Bayonet Power Cut® Gold Scissors**

Power Cut Gold (PC Gold) / bayonet / curved / 7" (18 cm)

- 1200-370
- 1200-372 tenotomy tip

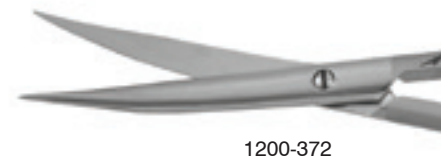
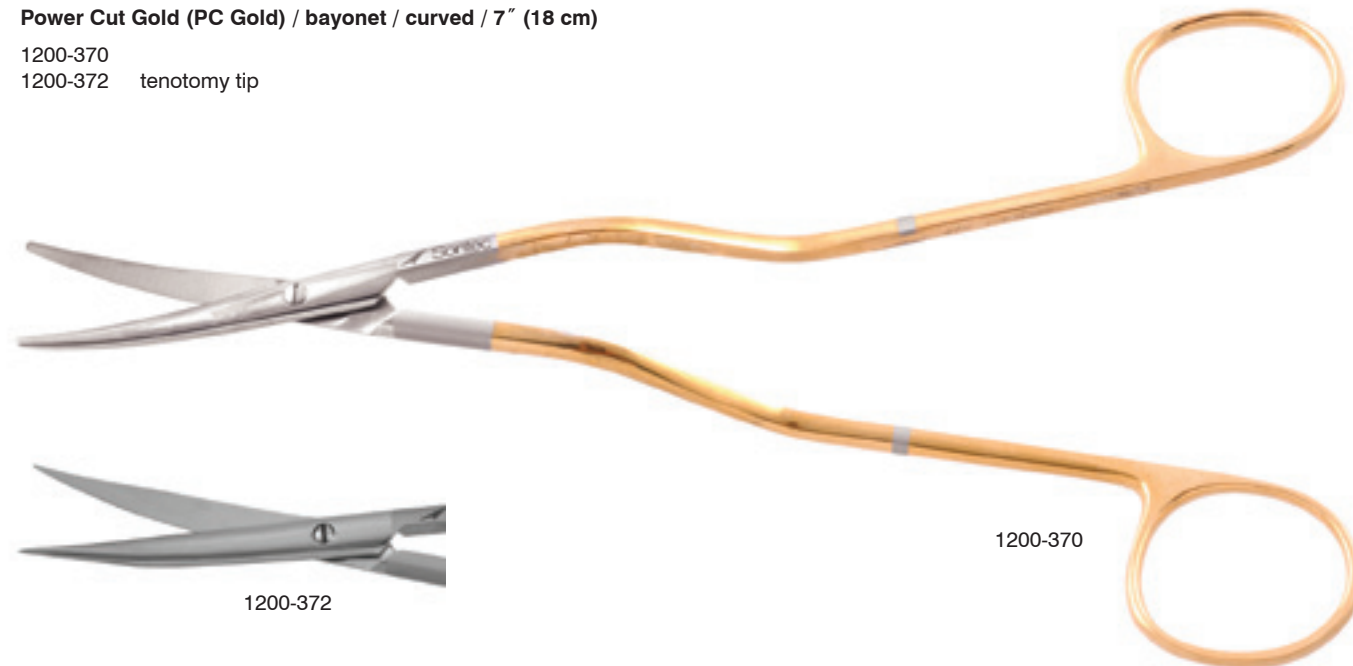

**Metzenbaum Power Cut® Gold Long Model Scissors**

Power Cut Gold (PC Gold) / 9" (23 cm)

- 2400-302 straight
- 2400-304 curved
- 2400-322 straight delicate
- 2400-321 curved delicate



Power Cut Gold (PC Gold) / 10 1/4" (26 cm)

- 2400-306 straight
- 2400-308 curved
- 2400-309 straight delicate
- 2400-323 curved delicate



Power Cut Gold (PC Gold) / curved /

- 2400-310 11" (28 cm)
- 2400-311 12" (30.5 cm)
- 1200-268 14" (35.5 cm)
- 1200-269 16" (40.5 cm)
- 1200-270 18" (45.5 cm)



**Metzenbaum Power Cut® Black Scissors**

**Power Cut Black (PC Black) / 4 1/2" (11.5 cm)**

- 1200-775M straight baby
- 1200-776M curved baby

**Power Cut Black (PC Black) / 5" (13 cm)**

- 1200-780 straight
- 1200-782 curved
- 1200-750 straight tenotomy tip
- 1200-752 curved tenotomy tip

**Power Cut Black (PC Black) / extra delicate / 5 1/4" (13.5 cm)**

- 2400-812A straight
- 2400-813A curved

**Power Cut Black (PC Black) / extra delicate / 5 5/8" (14 cm)**

- 2400-814A straight
- 2400-815A curved

**Power Cut Black (PC Black) / tenotomy tip / 5 3/4" (14.6 cm)**

- 1200-760 straight
- 1200-762 curved

**Power Cut Black (PC Black) / 5 3/4" (14.5 cm)**

- 1200-784 straight
- 1200-786 curved
- 1200-783 straight delicate
- 1200-787 curved delicate



1200-775M



1200-752



2400-815A



1200-760



delicate blade

**Metzenbaum Power Cut® Black Scissors**

**Power Cut Black (PC Black) / 6" (15 cm)**

- 2400-790 straight unique short blades
- 2400-792 curved unique short blades
- 2400-816 straight delicate
- 1200-770 curved tenotomy tip ergonomic spread handle



delicate blade



2400-792

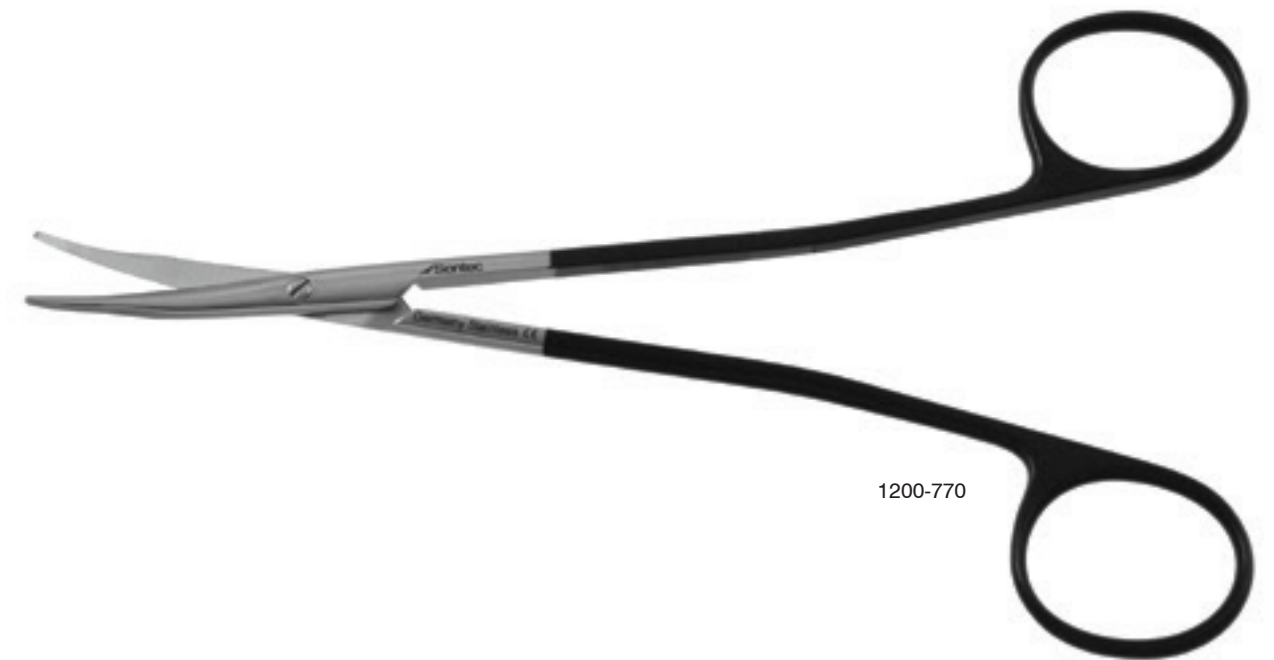

1200-770



**Metzenbaum Power Cut® Black Scissors**

**Power Cut Black (PC Black) / 7" (18 cm)**

- 1200-788 straight
- 1200-790 curved
- 2400-797 curved 2.5mm tip

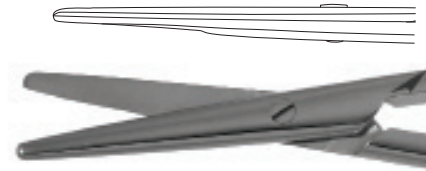

1200-788

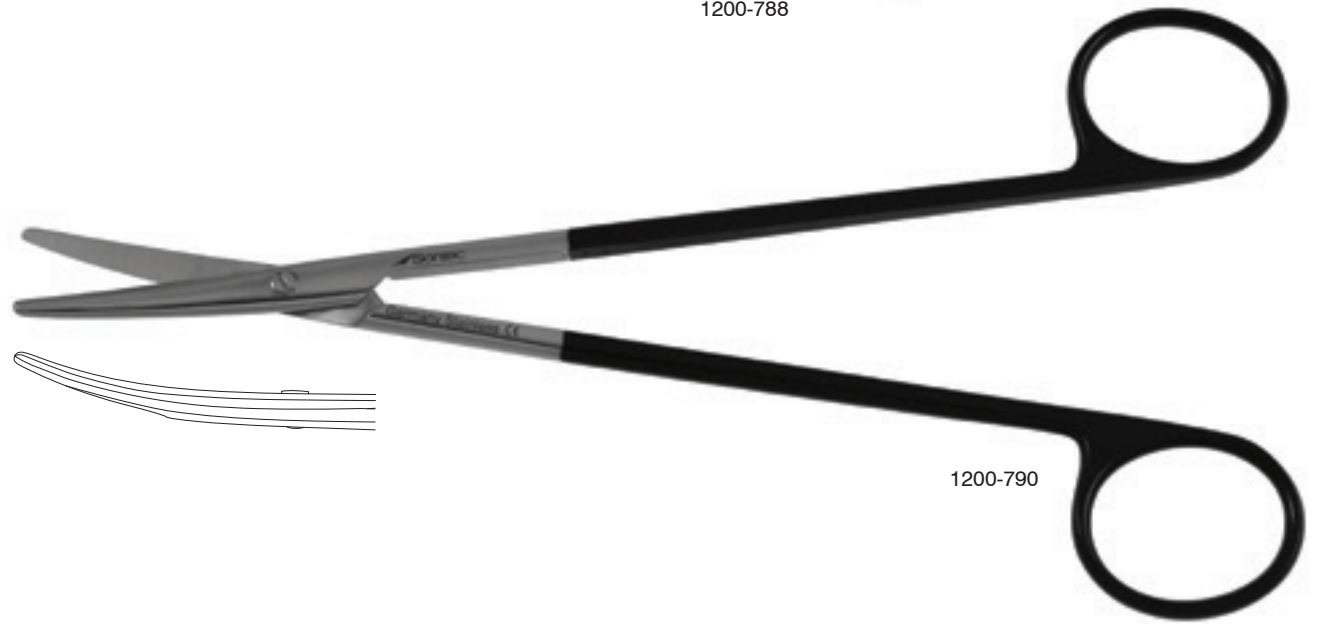

1200-790

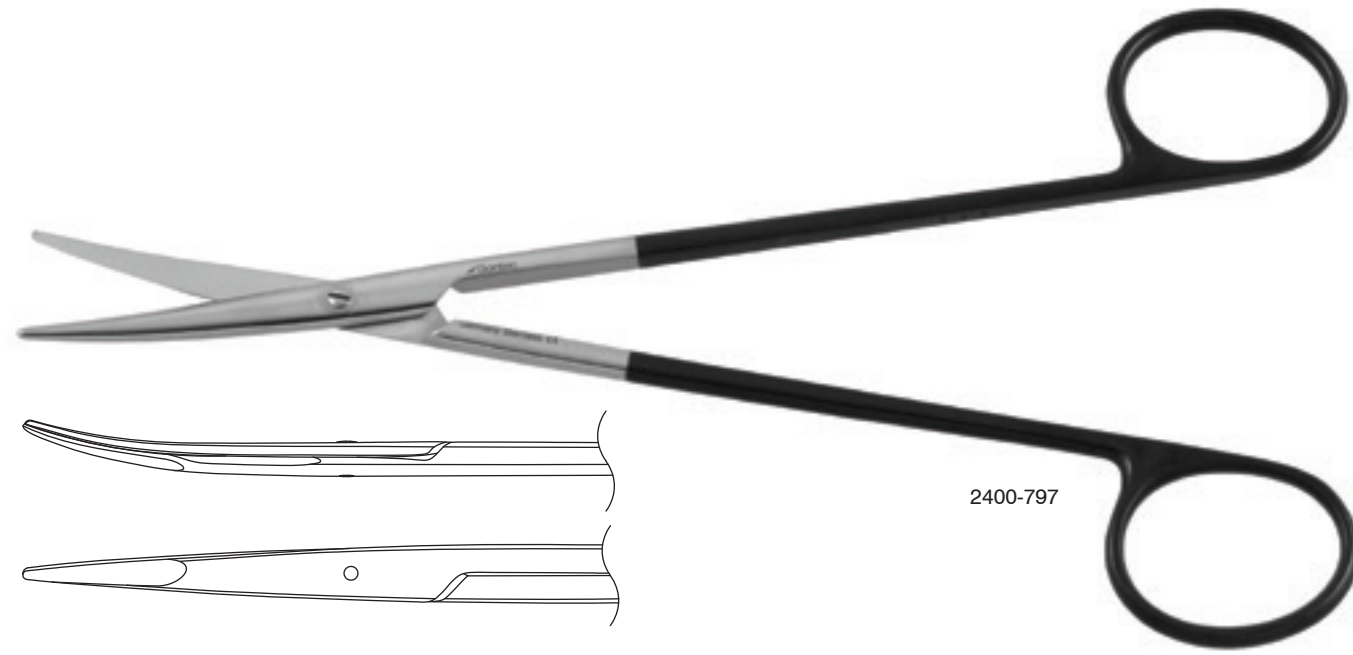

2400-797

**Metzenbaum Power Cut® Black Scissors**

**Power Cut Black (PC Black) / 8" (20.5 cm)**

- 2400-798 straight
- 2400-800 curved
- 2400-801 curved tenotomy tip
- 2400-820 straight delicate
- 2400-819 curved delicate

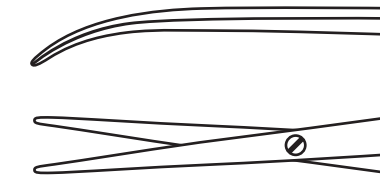

curved  
extra delicate

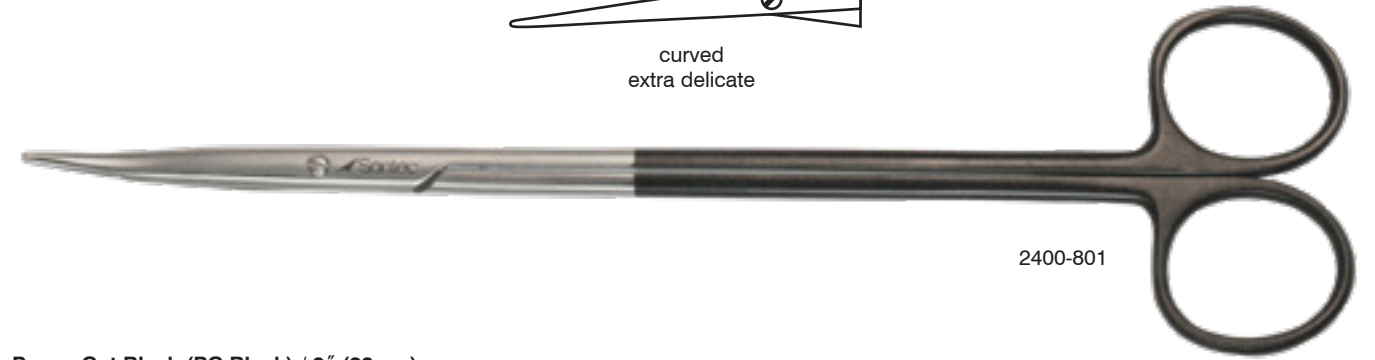

2400-801

**Power Cut Black (PC Black) / 9" (23 cm)**

- 2400-802 straight
- 2400-804 curved
- 2400-822 straight delicate
- 2400-821 curved delicate



2400-821

**Power Cut Black (PC Black) / 10 1/4" (26 cm)**

- 2400-806 straight
- 2400-808 curved
- 2400-807 straight delicate
- 2400-809 curved delicate

**Power Cut Black (PC Black) / 11" (28 cm)**

- 2400-803 straight
- 2400-805 curved

**Power Cut Black (PC Black) / curved / 12" (30.5 cm)**

- 2400-811



2400-808

**Baby Metzenbaum Power Cut Black® Scissors**

PC Black / 4 3/4" (12.1 cm)

- 2400-785 straight
- 2400-787 curved



2400-787

**Metzenbaum Ceramic Coated Power Cut® Scissors**

Special / ceramic coated scissors / with Power Cut blades / delicate / 5" (13 cm)

- 1200-900 straight
- 1200-905 curved

Special / ceramic coated scissors / with Power Cut blades / 5 3/4" (15 cm)

- 1200-909 straight
- 1200-908 curved

Special / ceramic coated scissors / with TC/PC blades / curved / delicate

- 1200-910 5 3/4" (15 cm)
- 1200-904 7" (18 cm)

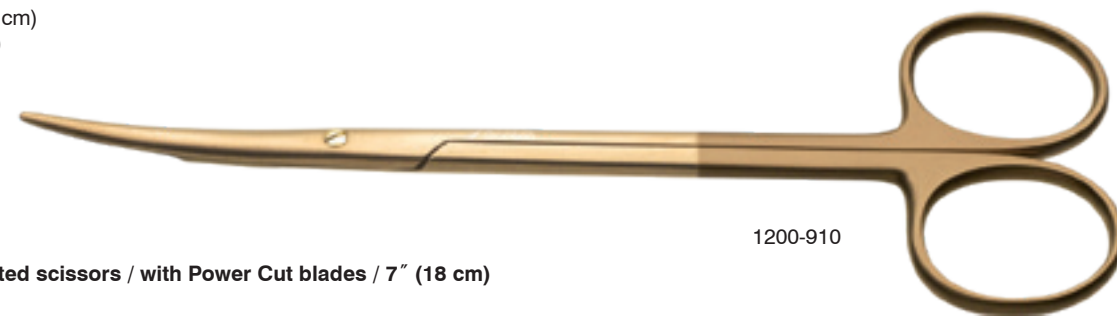

1200-910

Special / ceramic coated scissors / with Power Cut blades / 7" (18 cm)

- 1200-907 straight
- 1200-906 curved
- 1200-902 straight delicate



1200-904

\* Titanium Nitrate Coating is a very hard coating that keeps scissors sharper longer, reduces friction and adds a layer of corrosion protection

**Metzenbaum Tungsten Carbide Power Cut® Gold/Black Scissors**

Strabismus / tungsten Carbide /Power Cut (TC/PC) / 4 1/2" (11.5 cm)

- 1200-500 straight
- 1200-501 curved

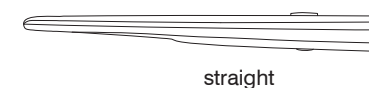

straight

Tungsten Carbide /Power Cut (TC/PC) / Serrated / 5 3/4" (14.5 cm)

- 1200-505 straight
- 1200-510 curved
- 1200-507 straight delicate
- 1200-512 curved delicate
- 1200-514 curved ergonomic spread handle



curved



1200-505



1200-514

Tungsten Carbide /Power Cut (TC/PC) / 7" (18 cm)

- 1200-515 straight
- 1200-520 curved
- 1200-526 curved ergonomic spread handle
- 1200-526S curved ergonomic spread handle sharp tips
- 2400-247 curved delicate

Tungsten Carbide /Power Cut (TC/PC) / 8" (20.5 cm)

- 1200-530 straight
- 1200-529 curved
- 1200-531 curved ergonomic spread handle
- 2400-248 curved delicate



1200-529

Tungsten Carbide /Power Cut (TC/PC) / 9" (23 cm)

- 1200-535 straight
- 1200-536 curved
- 2400-259 curved delicate

Tungsten Carbide /Power Cut (TC/PC) / 10" (25.5 cm)

- 1200-537 straight
- 1200-538 curved
- 2400-281 curved delicate

**Metzenbaum Ceramitec Power Cut® Scissors**

Special / ceramic coated scissors / with Power Cut blades / black with gold screw / curved

1200-911		5 3/4" (15 cm)
1200-912		5 3/4" (15 cm)
1200-915		7" (18 cm)
1200-916	delicate	7" (18 cm)

\* Titanium Nitrate Coating is a very hard coating that keeps scissors sharper longer, reduces friction and adds a layer of corrosion protection



1200-911



1200-915

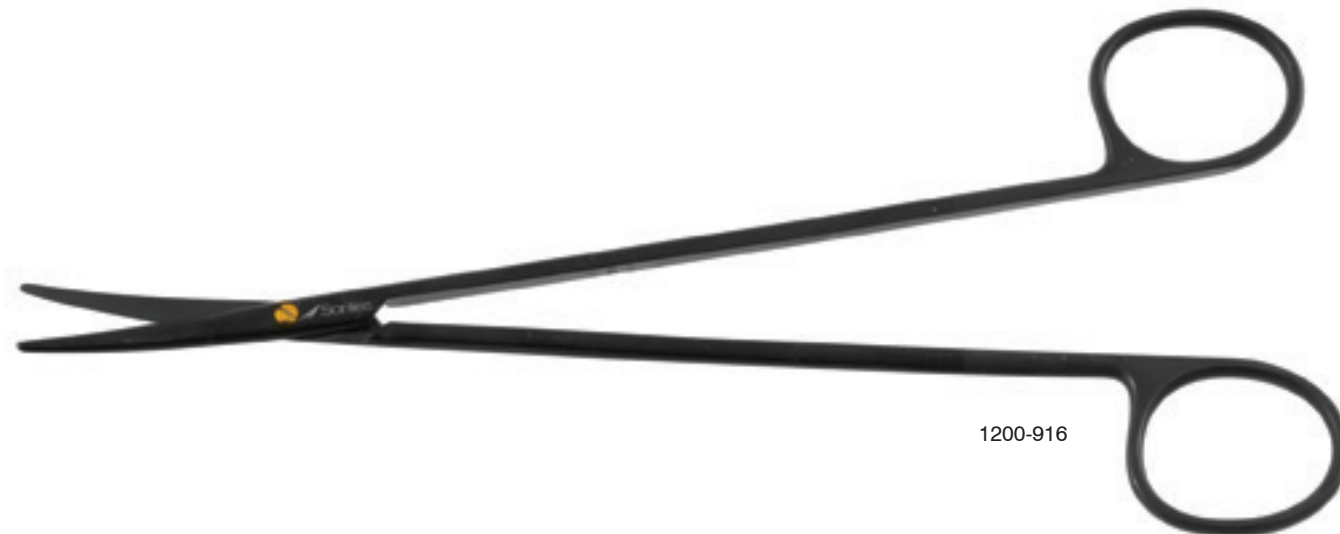

1200-916

**Metzenbaum Ceramitec Power Cut® Scissors**

Special / ceramic coated scissors / with Power Cut blades / black with gold screw / curved / spread handle / 4 3/4" (12.1 cm)

1200-899

\* Titanium Nitrate Coating is a very hard coating that keeps scissors sharper longer, reduces friction and adds a layer of corrosion protection



1200-899

**Stussak Metzenbaum Power Cut® Gold Scissors**

Strong curve / blunt / 7" (17.8 cm)

1100-235	classic
508-617	PC



508-617

strong curve

**Metzenbaum-Toennis Power Cut® Black Scissors**

PC black / extra delicate / 7" (18 cm)

2400-841 curved



2400-841



**Metzenbaum Brophy Sharp/Sharp Tip Scissors**

**Sharp/sharp tips / power cut / 5 3/4" (14.5 cm)**

- 475-158 straight
- 475-160 curved



475-158

**Sharp/sharp tips / tungsten carbide / delicate / 5 3/4" (14.5 cm)**

- 2400-235 straight
- 2400-237 curved



2400-235

**Sharp/ tungsten carbide / power cut / 5 3/4" (14.5 cm)**

- 2400-236 straight
- 2400-238 curved



2400-238

**Sharp/sharp tips / tungsten carbide / 7" (18 cm)**

- 112-506 curved
- 112-418 straight

**Sharp/sharp tips / tungsten carbide / delicate / 7" (18 cm)**

- 2400-239 straight
- 2400-240 curved



2400-239

**Metzenbaum Brophy Sharp/Sharp Scissors**

**Sharp/sharp tips / tungsten carbide / delicate / 8" (20 cm)**

- 2400-241 straight
- 2400-242 curved



2400-242

**Sharp/sharp tips / tungsten carbide/power cut / curved**

- 2400-242T 8" (20 cm)
- 2400-240T 7" (17.8 cm)
- 2400-245T 9" (22.9 cm)

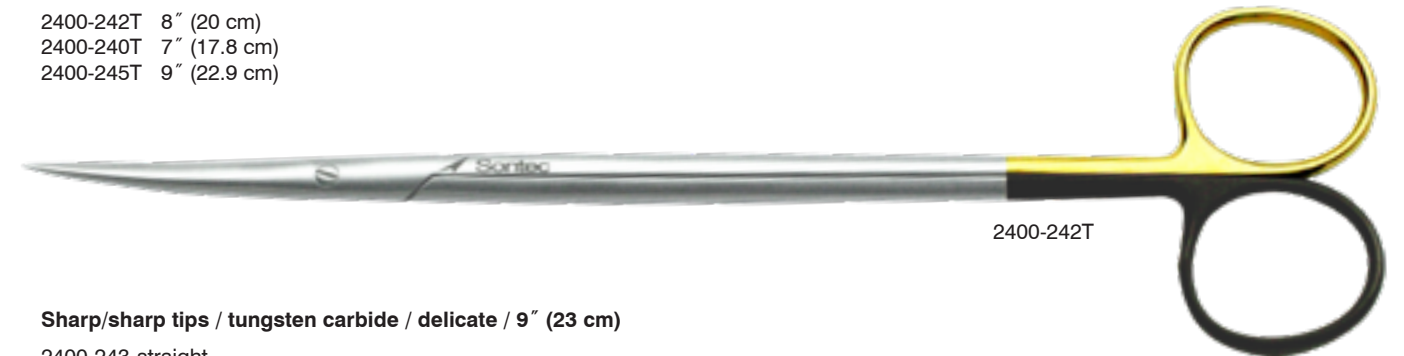

2400-242T

**Sharp/sharp tips / tungsten carbide / delicate / 9" (23 cm)**

- 2400-243 straight
- 2400-245 curved



2400-243



**Mayo Classic, Tungsten Carbide, Power Cut Gold, Power Cut Black®, TC/PC Power Cut®, Ceramitec Coated Scissors**

**Classic beveled blades / straight / 5 1/2" (14 cm)**

- 1100-248 classic
- 1100-272 TC
- 1200-248 PC gold
- 1200-726 PC black
- 1200-539 TC/PC



1100-278

**Classic beveled blades / curved / 5 1/2" (14 cm)**

- 1100-254 classic
- 1100-278 TC
- 1200-254 PC gold
- 1200-728 PC black
- 1200-544 TC/PC

**Ceramitec coated / beveled blades / black with gold screw / PC / curved / 5 1/2" (14 cm)**

- 1200-960



1200-960

**Ceramitec coated / beveled blades / TC/PC curved blades / black with gold screw and gold shiny rings**

- 1200-962 5 1/2"
- 1200-966 6 3/4"



1200-966

**Mayo Classic, Tungsten Carbide, Power Cut Gold, Power Cut Black®, TC/PC Power Cut®, Ceramitec Coated Scissors**

**Classic beveled blades / straight / 6 3/4" (17 cm)**

- 1100-250 classic
- 1100-274 TC
- 1200-250 PC gold
- 1200-727 PC black
- 1200-540 TC/PC



straight

**Classic beveled blades / curved / 6 3/4" (17 cm)**

- 1100-256 classic
- 1100-280 TC
- 1200-256 PC gold
- 1200-730 PC black
- 1200-545 TC/PC

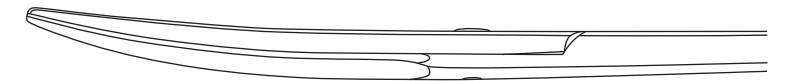

curved

**Classic beveled blades / PC / 7 1/2" (23 cm)**

- 2400-206 straight
- 2400-207 curved

**Classic beveled blades / TC / 8" (20 cm)**

- 2400-187 straight
- 2400-188 curved

**Classic beveled blades / PC / round handle / 8 1/4" (21 cm)**

- 2400-231 straight
- 2400-232 curved

**Classic beveled blades / TC / 9" (23 cm)**

- 2400-189 straight
- 2400-190 curved



1200-250

**Mayo-Stille Classic, Tungsten Carbide, Power Cut Gold, Power Cut Black®, TC/PC Power Cut®, Ceramic Coated Scissors**

**Round blades / straight / 5 1/2" (14 cm)**

- 110-268 classic
- 1100-272R TC
- 2400-191 PC gold

**Round blades / curved / 5 1/2" (14 cm)**

- 110-269 classic
- 1100-278R TC
- 2400-192 PC gold

**Round blades / TC/PC / 5 3/4" (14.25 cm)**

- 1200-542 straight
- 1200-547 curved



1200-542

**Round blades / PC gold / 6" (15 cm)**

- 2400-193 straight
- 2400-194 curved

**Round blades / PC black / 6" (15 cm)**

- 2400-706 straight
- 2400-708 curved

**Round blades / straight / 6 3/4" (17 cm)**

- 110-271 classic
- 1100-274R TC
- 2400-195 PC gold
- 1200-729 PC black
- 1200-550 TC/PC

**Round blades / curved / 6 3/4" (17 cm)**

- 110-272 classic
- 1100-280R TC
- 2400-197 PC gold
- 1200-731 PC black
- 1200-551 TC/PC

**Round blades / PC Gold / 7 1/2" (23 cm)**

- 2400-198 straight
- 2400-199 curved

**Round blades / PC Black / 7 1/2" (23 cm)**

- 2400-701 curved
- 2400-703 straight

**Round blades / straight / 8 1/4" (21 cm)**

- 2400-229 TC
- 2400-231 PC gold

**Round blades / curved / 8 1/4" (21 cm)**

- 2400-230 TC
- 2400-232 PC gold

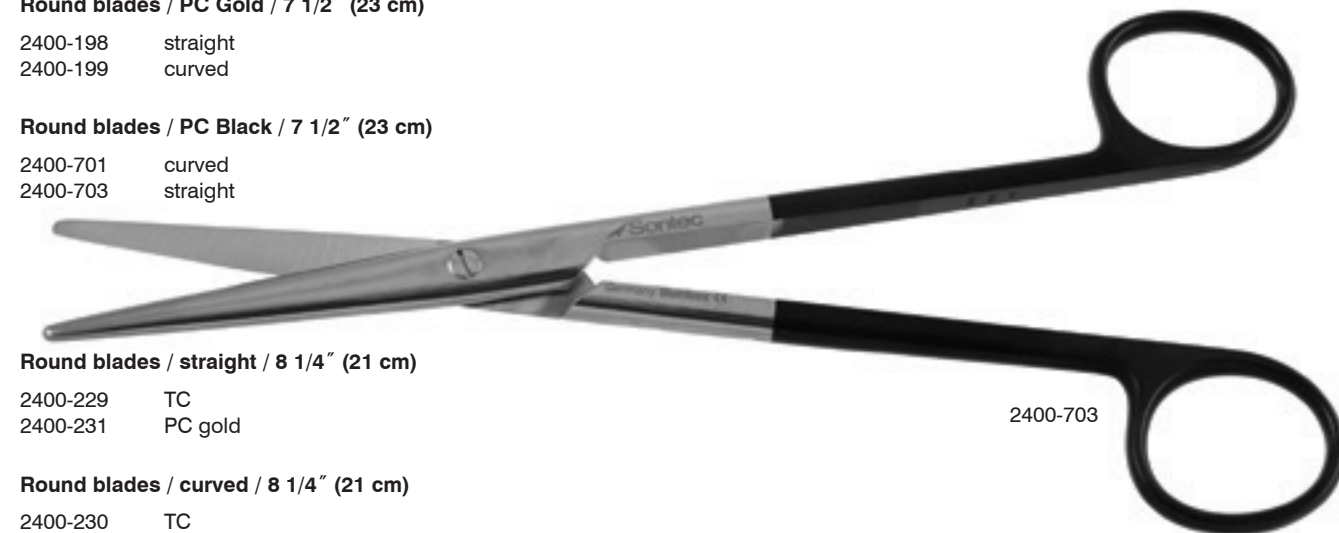

2400-703

**Mayo-Stille Classic, Tungsten Carbide, Power Cut Gold, Power Cut Black®, TC/PC Power Cut®, Ceramic Coated Scissors**

**Round blades / PC black / 8 1/4" (21 cm)**

- 2400-916 straight
- 2400-918 curved



2400-918

**Round blades / PC Gold / 9" (23 cm)**

- 2400-233 straight
- 2400-234 curved



2400-234

**Mayo-Lexer, Classic, Power Cut Gold, Power Cut Black®, TC/PC Power Cut®, Scissors**

Round more delicate finer shaped blades / straight / 6 1/2" (16.5 cm)

- 110-280 classic
- 1200-543 TC/PC
- 1200-733 PC black
- 2400-227 PC gold

Round more delicate finer shaped blades / curved / 6 1/2" (16.5 cm)

- 110-281 classic
- 1200-548 TC/PC
- 1200-735 PC black
- 2400-226 PC gold

TC / curved / 8 1/4" (21 cm)

- 2400-225



**Mayo-Lexer Fino Classic Tungsten Carbide Power Cut® Gold Scissors**

Very delicate / round blades / TC / 6 1/2" (16.5 cm)

- 2400-222 straight
- 2400-223 curved

Very delicate / round blades / PC gold / 6 1/2" (16.5 cm)

- 2400-226 straight
- 2400-227 curved



**Mayo-Carroll Scissors**

Extra heavy design / TC / 9" (23 cm)

- 1100-276 straight
- 1100-282 curved



**Mayo-Harrington Scissors**

Classic beveled blades / straight / 8" (20 cm)

- 2400-214 TC
- 2400-208 PC gold
- 2400-920 PC black

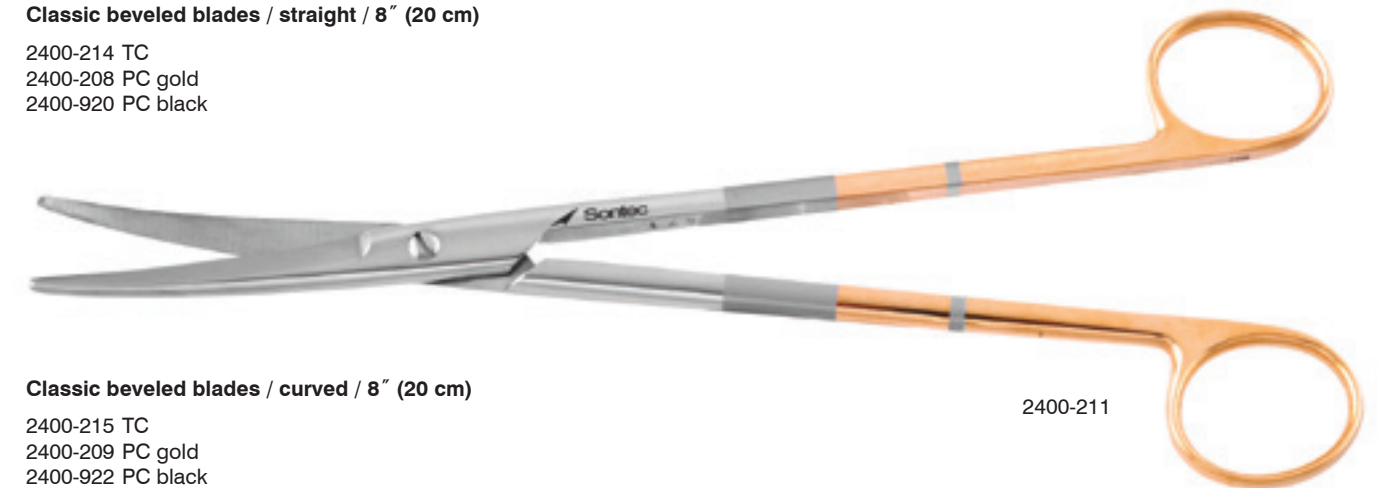

Classic beveled blades / curved / 8" (20 cm)

- 2400-215 TC
- 2400-209 PC gold
- 2400-922 PC black

Classic beveled blades / straight / 9" (23 cm)

- 2400-216 TC
- 2400-210 PC gold
- 2400-924 PC black

Classic beveled blades / curved / 9" (23 cm)

- 2400-217 TC
- 2400-211 PC gold
- 2400-926 PC black



Classic beveled blades / curved / 11" (30 cm)

- 2400-218 TC
- 2400-213 PC gold
- 2400-928 PC black

Classic beveled blades / curved / TC / 16" (40.5 cm)

- 2400-212



**Gum Scissors**

**Sharp tips / 4 1/2" (11.5 cm)**

- 475-151 straight
- 475-153 curved



**Sharp tips / PC / 4 1/2" (11.5 cm)**

- 1200-406 straight
- 1200-408 curved



**Sharp tips / PC black / curved / 4 1/2" (11.5 cm)**

- 1200-409



**Dean Tonsil & Nasal Scissors**

**PC gold / serrated / s-curve / 6 3/4" (17 cm)**

- 1200-691



**Davis Cartilage Scissors**

**Classic / 6 3/4" (17 cm)**

- 350-857 straight
- 350-858 curved

**PC gold / 6 3/4" (17 cm)**

- 350-859 straight
- 350-860 curved



**Martin Cartilage Tenotomy Classic Power Cut Gold® Scissors**

**Classic / 8" (20.5 cm)**

- 350-861 straight
- 350-862 curved



**PC gold / 8" (20.5 cm)**

- 350-863 straight
- 350-864 curved

**PC black / 8" (20.5 cm)**

- 350-861B straight
- 350-862B curved





**Freeman-Kaye Ergonomic Spread Handle Saberback Power Cut Gold®, Power Cut Black®, TC/PC Power Cut Scissors**

Ergonomic / spread handle / double beveled blades / flat tip / curved / PC black / delicate

475-178 7 1/2" (19 cm)

Ergonomic / spread handle / double beveled blades / flat tip / straight / PC black / 7 1/2" (19 cm)

475-179

Ergonomic / spread handle / double beveled blades / flat tip / curved / PC gold / 8" (20 cm)

475-181

Ergonomic / spread handle / double beveled blades / flat tip / curved / TC/PC / black ceramic coating / 7 1/2" (20 cm)

1200-970



**Freeman-Kaye Ergonomic Spread Handle Saberback Scissors**

Ergonomic / spread handle / double beveled blades / flat tip / curved / PC black / delicate

475-182 7 3/4" (20 cm) fino

475-184 9" (23 cm)

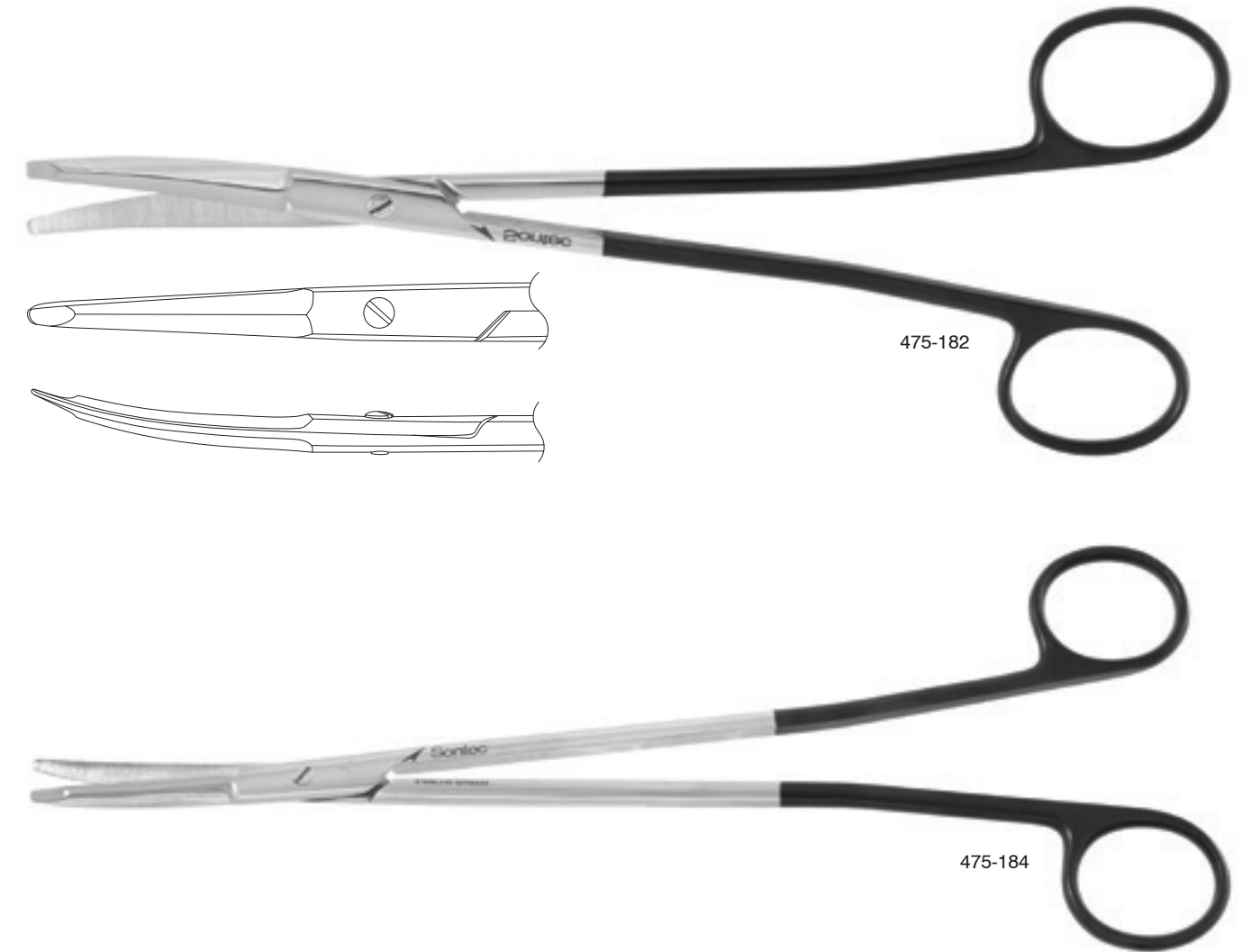

**Freeman-Kaye Ergonomic Spread Handle Saberback Scissors**

Ergonomic / spread handle / double beveled blades / spatulated tip / curved / TC/PC

- 475-188 7 1/4" (18.5 cm)
- 475-187 9" (23 cm)

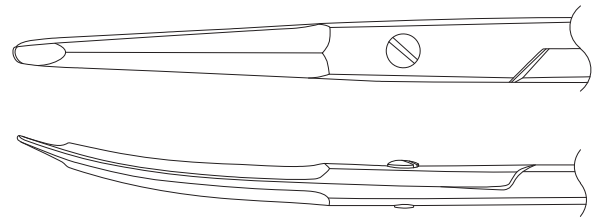

475-188

Ergonomic / spread handle / double beveled blades / flat tip / straight / TC/PC

- 475-185 7 1/4" (18.5 cm)
- 475-186 9" (23 cm)



475-185



**Delicate Freeman-Kaye Ergonomic Spread Handle Saberback Scissors**

Ergonomic / spread handle / double beveled blades / flat tip / delicate / curved / TC / 7" (18 cm)

- 475-183 c-shaped special order
- 475-183D



475-183D

**Delicate Freeman-Kaye Ergonomic Spread Handle Saberback Scissors**

Ergonomic / spread handle / double beveled blades / spatulated tip / delicate / curved / TC/PC / one serrated blade / 7" (17.8 cm)

- 475-188D



475-188D

**Kahn-Fomon Scissors**

Saberback / PC gold / spread handle / curved / 5 1/2" (14 cm)

1200-392



1200-392

**Gorney Power Cut Gold® Power Cut Black® Scissors**

Double beveled blade / PC gold / 7 1/2" (19 cm)

1200-414 straight  
1200-415 curved

Double beveled blade / PC gold / 10" (25.5 cm)

1200-416 straight  
1200-418 curved

Double beveled blade / PC black / 5 3/4" (15 cm)

1200-814 straight  
1200-815 curved



1200-815

Double beveled blade / PC black / 7 3/4" (20 cm)

1200-816 straight  
1200-818 curved

Double beveled blade / TC/PC / 6 3/4" (17 cm)

1200-494 straight  
1200-495 curved

Double beveled blade / PC gold / 6 3/4" (17 cm)

1200-412 straight  
1200-413 curved

**Aufricht Saberback Power Cut Black® Scissors**

PC black / 5 3/4" (14.6 cm)

1200-848 straight  
1200-849 curved

PC gold / 6 3/4" (17 cm)

475-220 straight  
475-225 curved



1200-848

**Jameson Tenotomy Classic, Tungsten Carbide, Power Cut Gold, Power Cut Black®, TC/PC Power Cut® Scissors**

**Classic / straight**

- 2405-325 7" (18 cm)
- 2405-330 8" (20 cm)
- 2405-332 9" (23 cm)
- 2405-334 10 1/4" (25.5 cm)



**Classic / curved**

- 2405-329 7" (18 cm)
- 2405-331 8" (20 cm)
- 2405-333 9" (23 cm)
- 2405-335 10 1/4" (25.5 cm)

**PC gold / straight**

- 2400-325 7" (18 cm)
- 2400-331S 8" (20 cm)
- 2400-332 9" (23 cm)
- 2400-334 10 1/4" (25.5 cm)

**PC gold / curved**

- 2400-329 7" (18 cm)
- 2400-331 8" (20 cm)
- 2400-333 9" (23 cm)
- 2400-335 10 1/4" (25.5 cm)



**PC black / straight**

- 2400-825 7" (18 cm)
- 2400-830 8" (20 cm)
- 2400-832 9" (23 cm)
- 2400-834 10 1/4" (25.5 cm)

**PC black / curved**

- 2400-829 7" (18 cm)
- 2400-829H 7" (18 cm) heavy
- 2400-831 8" (20 cm)
- 2400-833 9" (23 cm)
- 2400-835 10 1/4" (25.5 cm)

**Jameson Tenotomy Classic, Tungsten Carbide, Power Cut Gold, Power Cut Black®, TC/PC Power Cut® Scissors**

**TC/PC / straight**

- 2405-825 7" (18 cm)
- 2405-825E 7" (18 cm) spread ergonomic handle
- 2405-830 8" (20 cm)
- 2405-830E 8" (20 cm) spread ergonomic handle
- 2405-832 9" (23 cm)
- 2405-834 10 1/4" (25.5 cm)

**TC/PC / curved**

- 2405-829 7" (18 cm)
- 2405-829E 7" (18 cm) spread ergonomic handle
- 2405-831 8" (20 cm)
- 2405-831E 8" (20 cm) spread ergonomic handle
- 2405-833 9" (23 cm)
- 2405-835 10 1/4" (25.5 cm)





**Reynolds Tenotomy Classic, Power Cut Gold®, Power Cut Black®, TC/PC Power Cut Scissors**

**Delicate / classic / 7" (18 cm)**

- 2405-325D straight
- 2405-329D curved

**Delicate / PC gold / 7" (18 cm)**

- 2400-325D straight
- 2400-329D curved

**Delicate / PC black / 7" (18 cm)**

- 2400-825D straight
- 2400-829D curved

**Delicate / TC/PC / 7" (18 cm)**

- 2405-825D straight
- 2405-829D curved
- 2405-828D straight spread handle
- 2405-832D curved spread handle

**Delicate / classic / 8" (20.5 cm)**

- 2400-826D straight
- 2400-828D curved

**Delicate / PC gold / 8" (20.5 cm)**

- 2400-832D straight
- 2400-833D curved

**Delicate / PC black / 8" (20.5 cm)**

- 2400-830D straight
- 2400-831D curved

**Delicate / TC/PC / 8" (20.5 cm)**

- 2405-830D straight
- 2405-831D curved

**Delicate / TC/PC / curved / 9" (23 cm)**

- 2405-8259

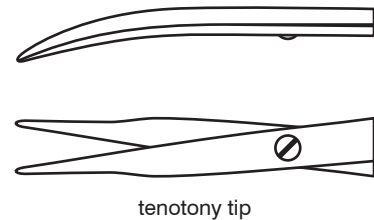

2400-329D

2405-832D

2400-831D

**Reynolds Tenotomy Classic, Power Cut Gold®, Power Cut Black®, TC/PC Power Cut® Scissors**

**Classic / 5 3/4" (14.5 cm)**

- 2405-324S straight
- 2405-324 curved

**PC gold / 5 3/4" (14.5 cm)**

- 2400-324S straight
- 2400-324 curved

**PC black / 5 1/4" (13.3 cm)**

- 2400-823S straight
- 2400-823 curved

**PC black / 5 3/4" (14.5 cm)**

- 2400-824S straight
- 2400-824 curved

**TC/PC / 5 3/4" (14.5 cm)**

- 2405-824S straight
- 2405-824 curved

**Classic / 6 1/4" (16 cm)**

- 2405-326 straight
- 2405-327 curved

**PC gold / 6 1/4" (16 cm)**

- 2400-326 straight
- 2400-327 curved
- 1200-348 curved spread handle

**PC black / 6 1/4" (16 cm)**

- 2400-826 straight
- 2400-827 curved
- 2400-827S curved spread handle

**TC/PC / spread handle / 6 1/4" (16 cm)**

- 2405-826 straight
- 2405-827 curved



2405-324S



2400-327



2400-827S

**Ragnell Undermining Power Cut Gold® Scissors**

PC gold / spatulated tips / curved

- 2400-374 4 1/2" (11.5 cm)
- 2400-375 5" (12.5 cm)
- 2400-376 5 1/2" (14 cm)
- 2400-377 6" (15 cm)
- 2400-379 7" (18 cm)
- 2400-381 8" (20 cm)
- 2400-383 9" (23 cm)
- 2400-383S 9" (23 cm) strong curved
- 2400-385 10 3/4" (26.5 cm)



strong curved  
2400-383S



2400-374



2400-375



2400-377

**Ragnell Tungsten Carbide Power Cut Gold® Scissors**

TC PC gold / spatulated tips / curved / delicate / spread handles

- 2400-380D 7" (17.8 cm)

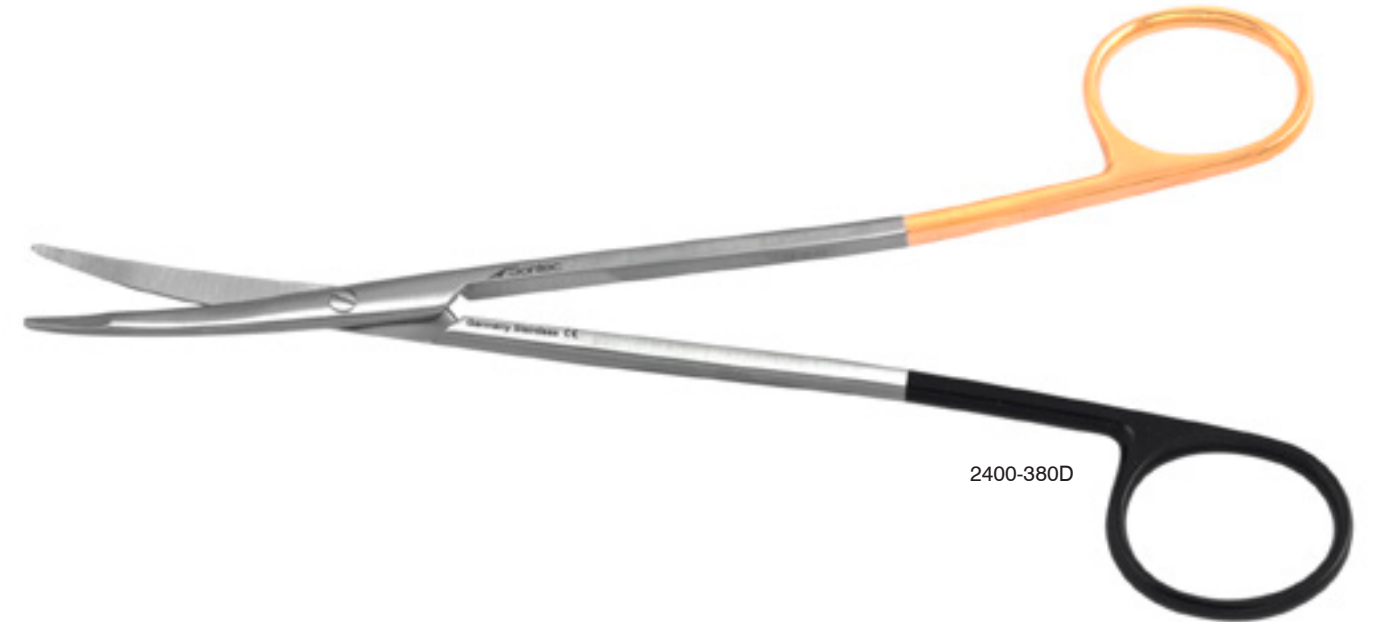

2400-380D

**Iris Scissors**

**Classic / 4 1/2" (11.5 cm)**

- 13-7700 straight
- 13-7710 curved
- 13-7620 curved sideways
- 13-7715 angled sideways

**PC gold / 4 1/2" (11.5 cm)**

- 1200-025 angled sideways
- 1200-026 straight
- 1200-028 curved

**PC black / sharp tips / 4 1/2" (11.4 cm)**

- 2400-711 straight
- 2400-713 curved

**PC black / blunt / 4" (10 cm)**

- 2400-715 straight
- 2400-717 curved

**TC / 4 1/2" (11.5 cm)**

- 112-480 straight
- 112-478 curved

**TC/PC / 4 1/2" (11.5 cm)**

- 1200-502 straight
- 1200-503 curved



13-7700



1200-025



1200-503

**Doyen Classic Model Power Cut Gold® Scissors**

**Serrated / classic / 6 1/2" (16.5 cm)**

- 1100-196 straight
- 1100-198 curved

**Serrated / PC gold / 6 1/2" (16.5 cm)**

- 1200-601 straight
- 1200-603 curved

**Serrated / classic / 7 1/4" (18.5 cm)**

- 1100-197 straight
- 1100-199 curved

**Serrated / PC gold / 7 1/4" (18.5 cm)**

- 1200-600 straight
- 1200-602 curved



1200-602

**Operating Classic, Tungsten Carbide, Power Cut Gold, Power Cut Black®, TC/PC Power Cut® Scissors**

**Blunt-blunt / straight / 5 1/2" (14 cm)**

- 1100-212 classic
- 1100-260 TC
- 1200-212 PC gold
- 1200-712 PC black



blunt-blunt



sharp-blunt

**Blunt-blunt / curved / 5 1/2" (14 cm)**

- 1100-224 classic
- 1100-262 TC
- 1200-224 PC gold
- 1200-713 PC black



1200-229

**Sharp-blunt / straight / 5 1/2" (14 cm)**

- 1100-214 classic
- 1100-214L classic left
- 1100-265 TC
- 1200-214 PC gold
- 1200-229 TC/PC
- 1200-714 PC black



1100-214L

**Sharp-blunt / curved / 5 1/2" (14 cm)**

- 1100-226 classic
- 1100-264 TC
- 1200-226 PC gold
- 1200-715 PC black



1200-714

**Operating Classic, Tungsten Carbide, Power Cut Gold, Power Cut Black®, TC/PC Power Cut® Scissors**

**Sharp-sharp / straight / 5 1/2" (14 cm)**

- 1100-216 classic
- 1100-268 TC
- 1200-216 PC gold
- 1200-231 TC/PC
- 1200-716 PC black



blunt-blunt



sharp-blunt

**Sharp-sharp / curved / 5 1/2" (14 cm)**

- 1100-228 classic
- 1100-270 TC
- 1200-228 PC gold
- 1200-717 PC black



1100-268



1200-716



**Operating Classic, Tungsten Carbide, Power Cut Gold, Power Cut Black®, TC/PC Power Cut® Scissors**

**Blunt-blunt / straight / 6 1/2" (16.5 cm)**

- 1100-218 classic
- 1200-218 PC gold



sharp-blunt



sharp-sharp

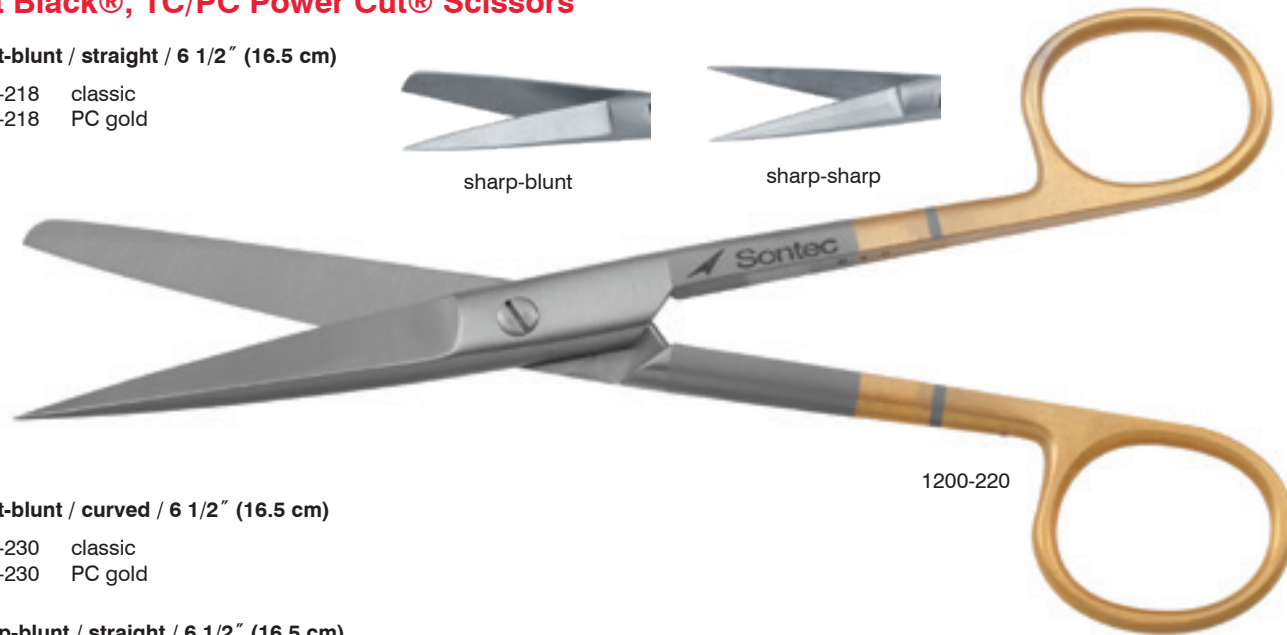

1200-220

**Blunt-blunt / curved / 6 1/2" (16.5 cm)**

- 1100-230 classic
- 1200-230 PC gold

**Sharp-blunt / straight / 6 1/2" (16.5 cm)**

- 1100-220 classic
- 1200-220 PC gold



1100-218

**Sharp-blunt / curved / 6 1/2" (16.5 cm)**

- 1100-232 classic
- 1200-232 PC gold



1100-230

**Operating Classic, Tungsten Carbide, Power Cut Gold, Power Cut Black®, TC/PC Power Cut® Scissors**

**Sharp-sharp / straight / 6 1/2" (16.5 cm)**

- 1100-222 classic
- 1200-222 PC gold



sharp-blunt



sharp-sharp

**Sharp-sharp / curved / 6 1/2" (16.5 cm)**

- 1100-234 classic
- 1200-234 PC gold



1100-222

**Utility Scissors**

**Ribbon handled / delicate flat blade / slight curve / 4" (10 cm)**

- 13-9340 PC Gold
- 13-9341 PC Black

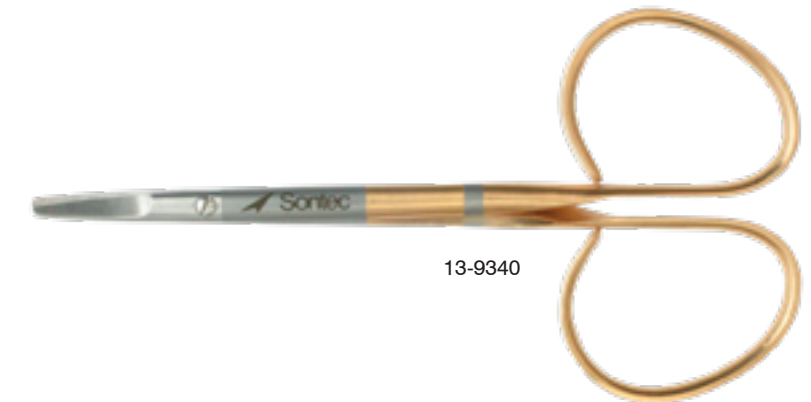

13-9340



13-9341

**Knowles Bandage Scissors**

Superior cutting ability / straight / 5 1/2" (14 cm)

- 1100-207 classic
- 1200-192 PC gold

Superior cutting ability / angled / 5 1/2" (14 cm)

- 1100-208 serrated
- 1200-190 PC gold
- 1200-690 PC black
- 1200-480 TC/PC



1200-690

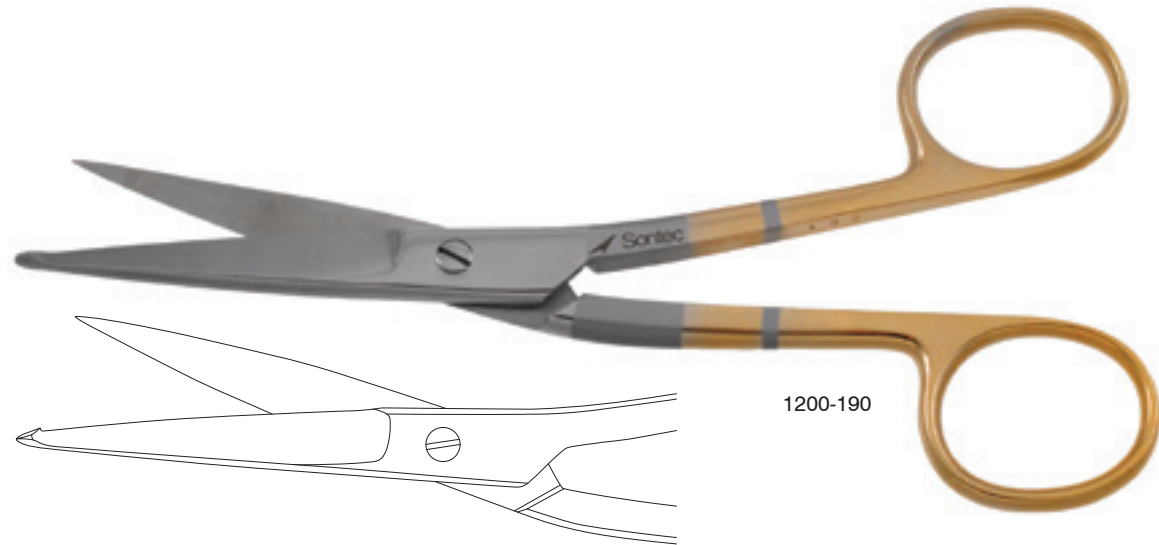

1200-190

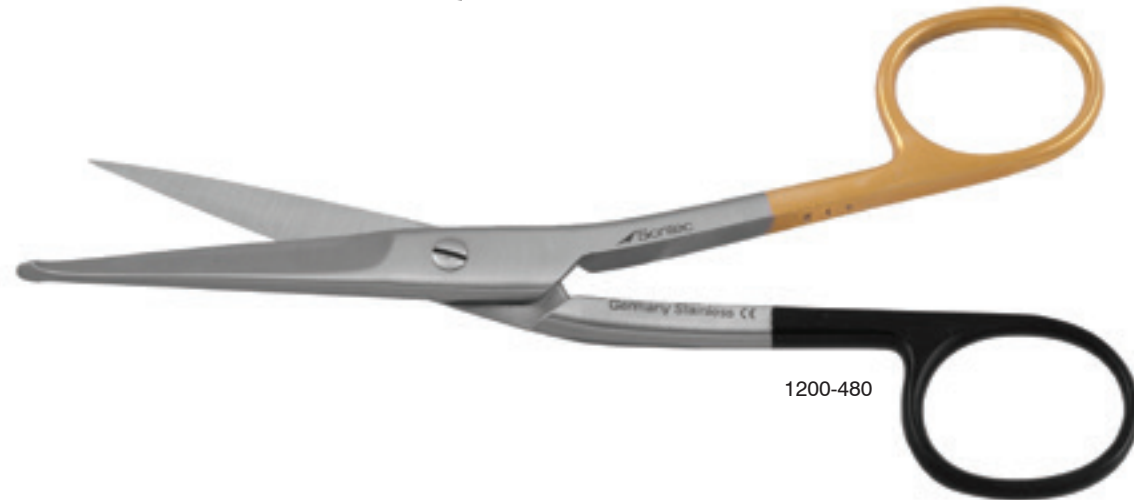

1200-480

**Knowles Bandage Scissors**

Superior cutting ability / angled / serrated / rainbow / 5 1/2" (14 cm)

- 1100-208R

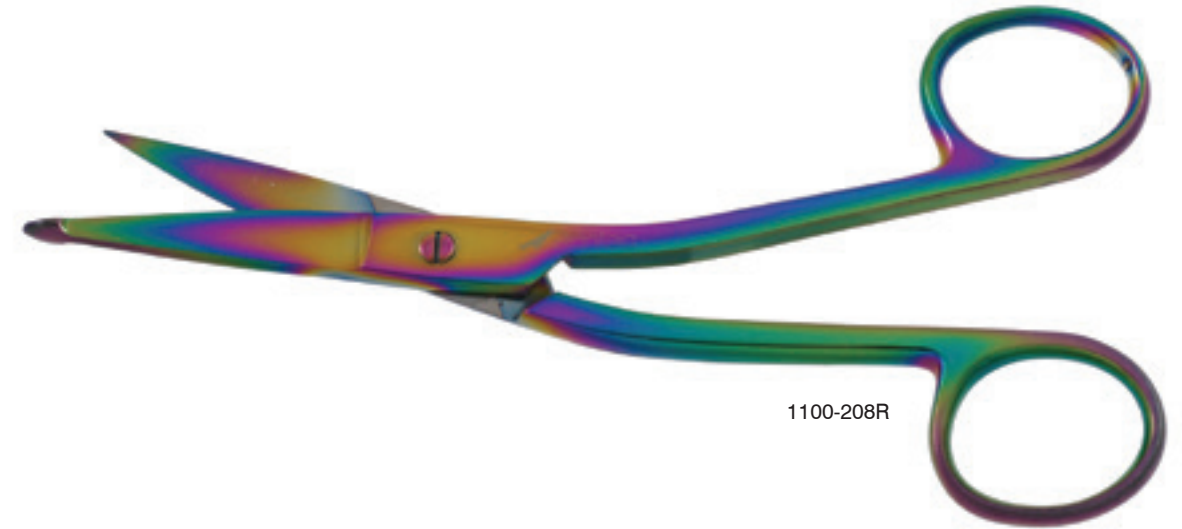

1100-208R

**Ceramitec Knowles Bandage Scissors**

Superior cutting ability / angled / PC / 5 1/2" (14 cm)

- 1200-980



1200-980

**Taylor Bandage Scissors**

Double-curved / PC gold / 5 1/2" (14 cm)  
1200-195



1200-195

**Commander Utility Shears**

One serrated blade / with wire cutter / 8" (19.5 cm)  
240-625



**Esmarch Heavy Bandage Scissors**

8" (20.5 cm)  
240-610 classic  
1200-188 PC



1200-188

**Utility Scissors**

Autoclavable - serrated / plastic black handle

1100-211 5 1/2" (14 cm)  
1100-210 7 1/2" (19 cm)



1100-211

Autoclavable - serrated / plastic red handle

1100-211R 5 1/2" (14 cm)  
1100-210R 7 1/2" (19 cm)



1100-211R







**Mayo-Hegar Needle Holder**

**Serrated jaws without TC**

130-527	6 1/4" (15 cm)
130-529	7 1/4" (18 cm)
130-531	8" (20 cm)



130-527



130-529



130-531

**Tungsten carbide serrated jaws**

2300-328	5 3/4" (14.6 cm)
132-115	6 1/4" (15 cm)
132-118	7 1/4" (18 cm)
132-120	8" (20 cm)
132-122	9" (23 cm)
132-123	10" (25 cm)
132-125	12" (30 cm)
1100-853	14" (35 cm)
1100-851	16" (40 cm)
1100-854	18" (45 cm)



132-115



132-118

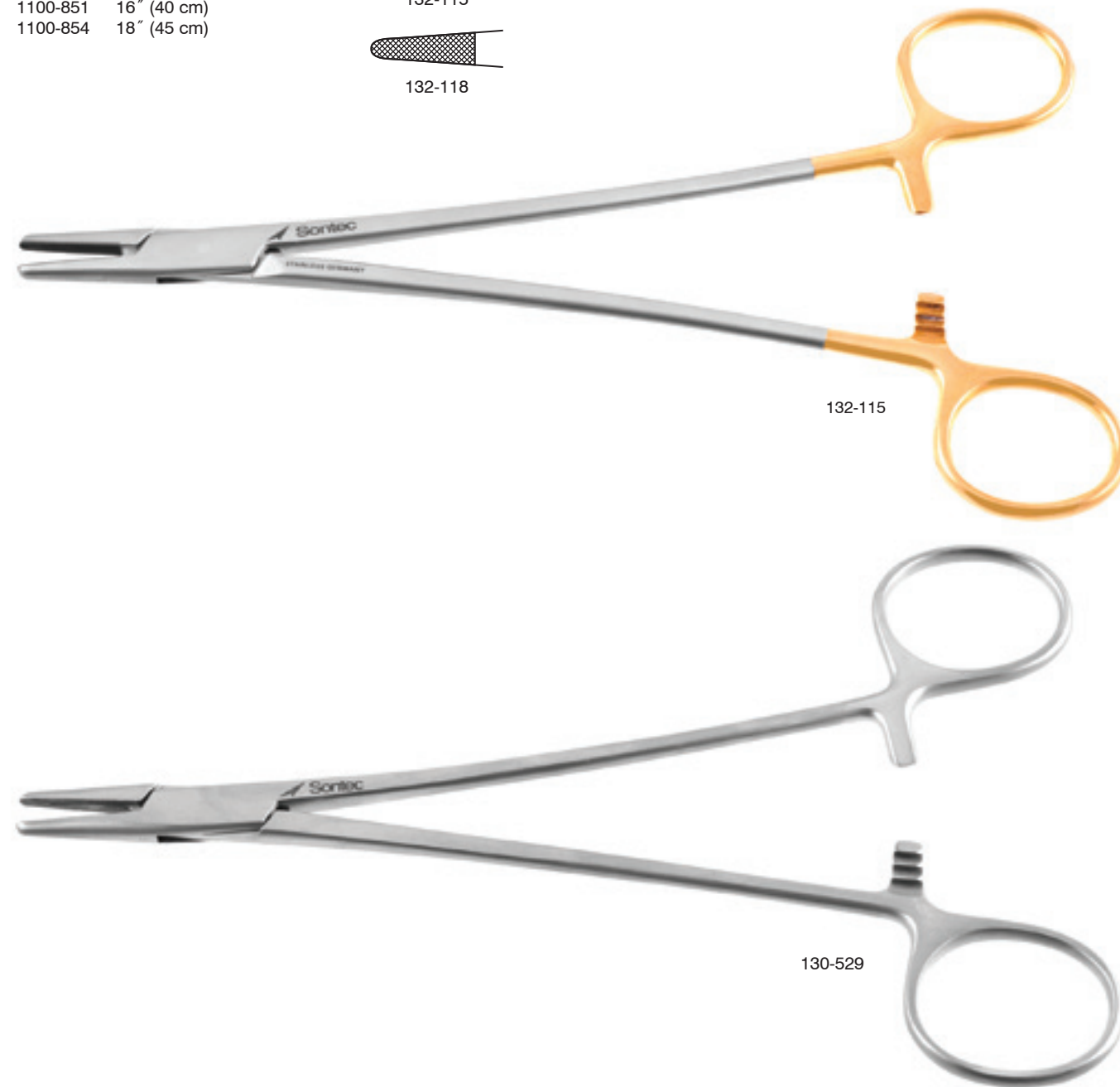

132-115

130-529

**Sontec Mayo-Hegar Needle Holder**

Unique design / TC serrated / 6 1/4" (14 cm)

1100-113



1100-113

**Sontec Olsen-Hegar Deluxe Needle Holder**

Unique jaw design standard / serrated

1100-124D 5 3/4" (14.6 cm) deluxe

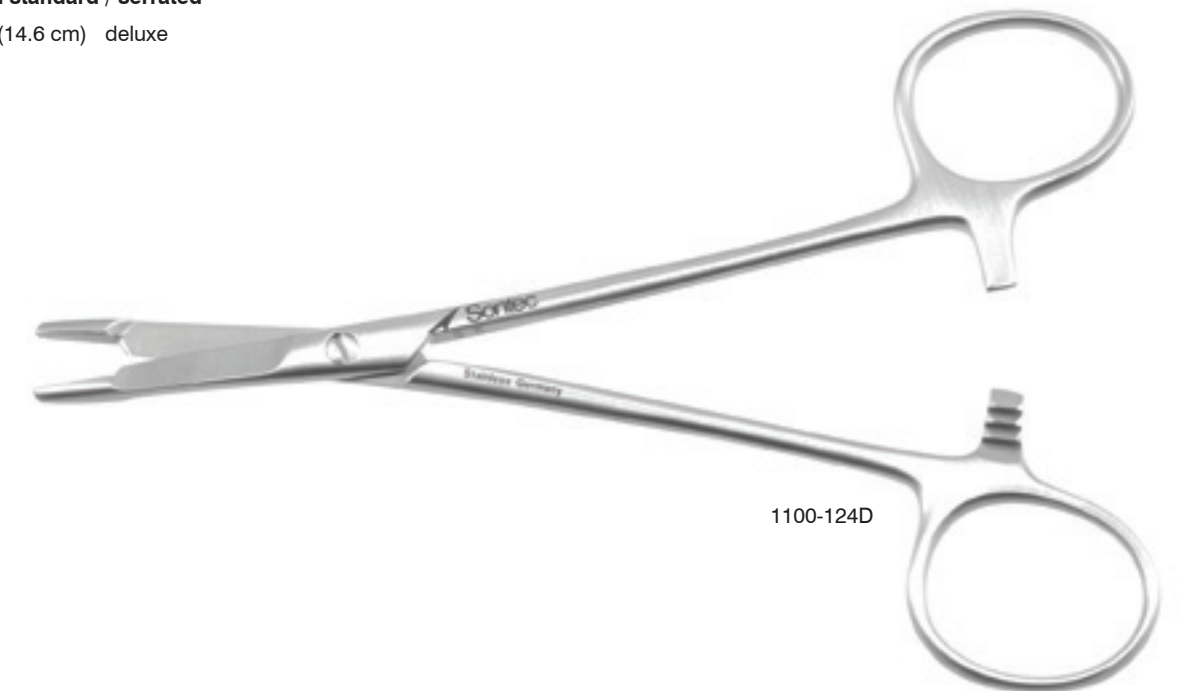

1100-124D

**Olsen-Hegar Needle Holder**

Serrated without TC/standard / suggested suture size 5-0 and smaller

1100-124A 5 1/2" (14 cm)

Tungsten carbide / suggested suture size 5-0 and smaller

1100-111A 5 1/2" (14 cm) round jaw  
1100-111 5 1/2" (14 cm) custom delicate

Tungsten carbide / suggested suture size 5-0 and smaller

1100-110 7 1/2" (19 cm)  
1100-110H 7 1/2" (19 cm) heavy

Cutting edge

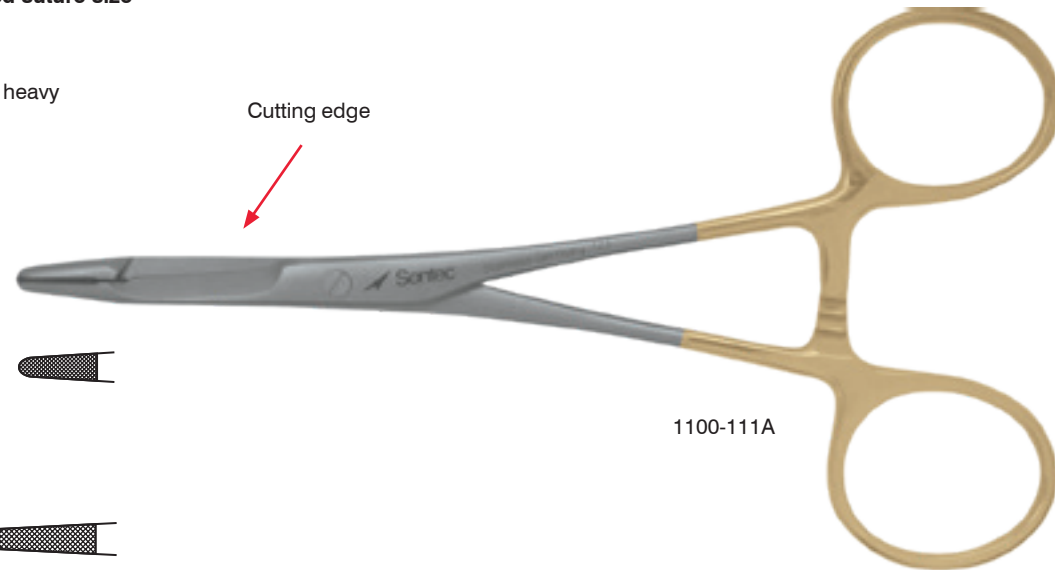

1100-111A

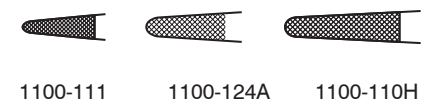

1100-111 1100-124A 1100-110H

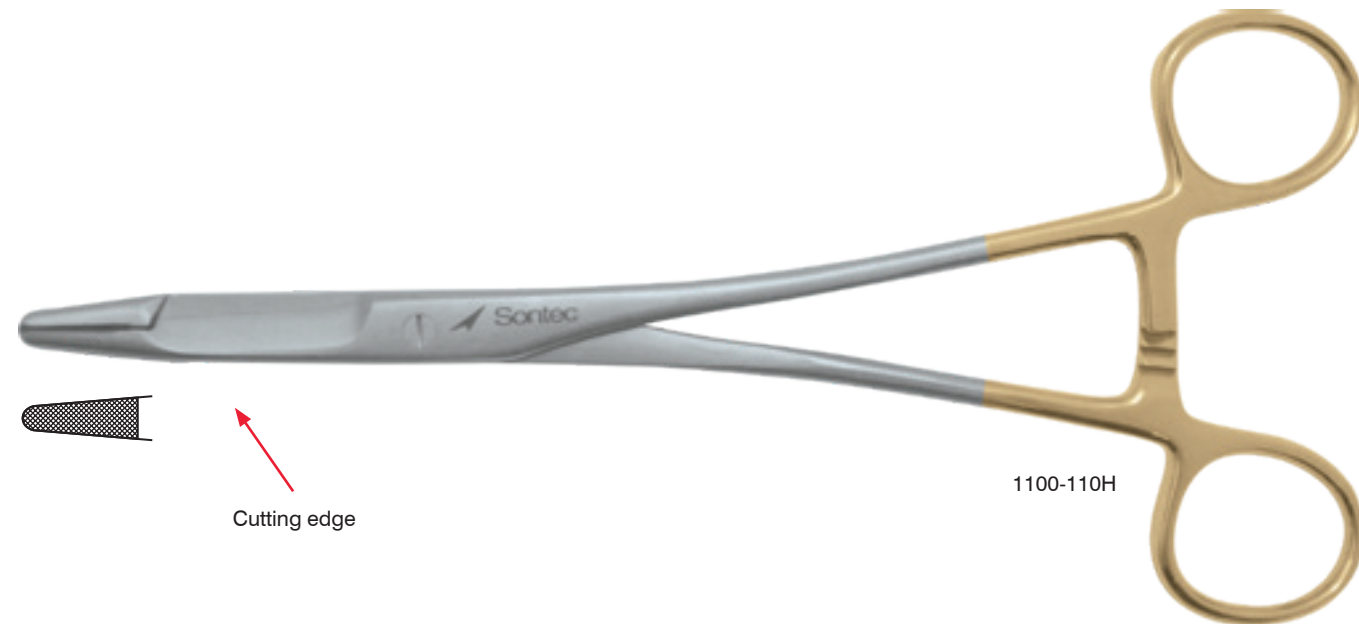

1100-110H

Cutting edge

**Olsen-Hegar Deluxe Needle Holder**

Tungsten carbide

1100-105A 5" (12.5 cm)  
1100-106D 5 3/4" (14.5 cm)

TC Dust jaws

1100-105D 5 3/4" (14.5 cm)

Serrated without TC/standard

1100-124D 5 3/4" (14.5 cm)  
1100-126D 6 3/4" (17 cm)  
1100-128D 7 3/4" (19.5 cm)

Cutting edge

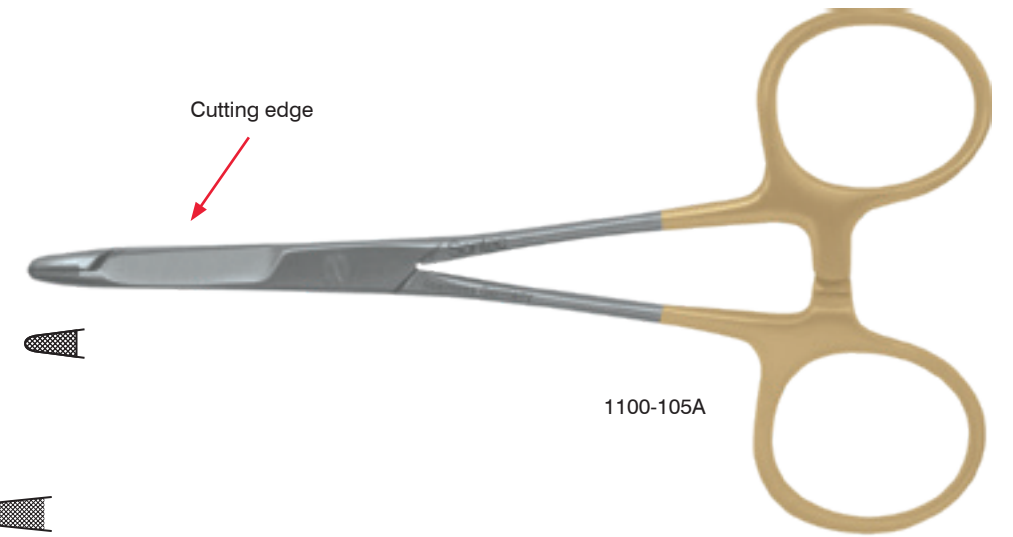

1100-105A



1100-124D 1100-126D 1100-128D

Cutting edge

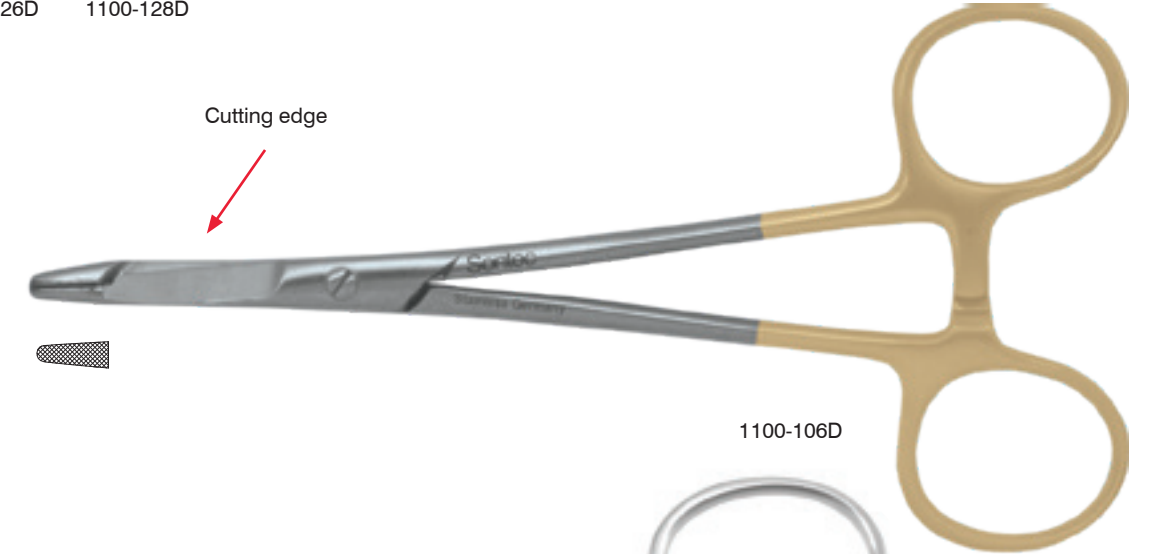

1100-106D



1100-124D

**Sontec-Olsen-Hegar Deluxe Needle Holder**

Tungsten carbide jaws / unique jaw design

- 1100-108D 6 3/4" (17 cm)
- 1100-110D 7 3/4" (19.5 cm)



**Sontec Olsen-Hegar Needle Holder**

Unique jaw design / tungsten carbide

- 1100-106 5 1/2" (14 cm)
- 1100-106A 5 1/2" (14 cm) delicate
- 1100-108 6 1/2" (16.5 cm)

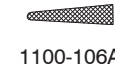

**Sontec Olsen-Hegar Needle Holder**

Unique jaw design / serrated without TC-standard

- 1100-124 5 1/2" (14 cm)
- 1100-126 6 1/2" (16.5 cm)



**Webster Needle Holder**

4 3/4" (12 cm)

- 1100-392 serrated w/out TC
- 2300-516 TC serrated
- 2300-518 TC smooth
- 2300-520 TC dust
- 2300-521 6" TC dust



2300-520  
TC Dust



2300-518  
TC Smooth



2300-516  
TC Serrated

**Olsen-Webster Needle Holder Titanium**

Fine jaw / 5" (12.7 cm) / TC dust

- 1100-105T

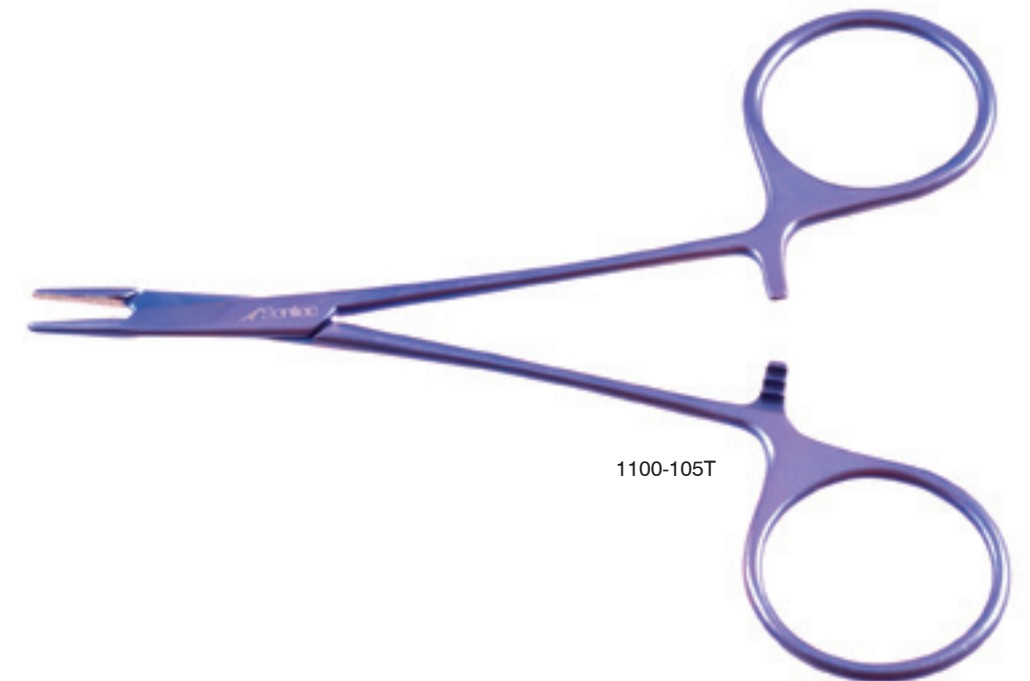



**Olsen-Webster Needle Holder**

4 3/4" (12 cm)

- 1103-601 serrated w/out TC/standard
- 132-362 TC serrated
- 132-359 TC serrated delicate
- 132-360 TC smooth
- 1103-604 TC dust delicate
- 132-361 TC dust
- 132-362D TC serrated \*
- 132-362S TC offset ring

\* Double offset ring

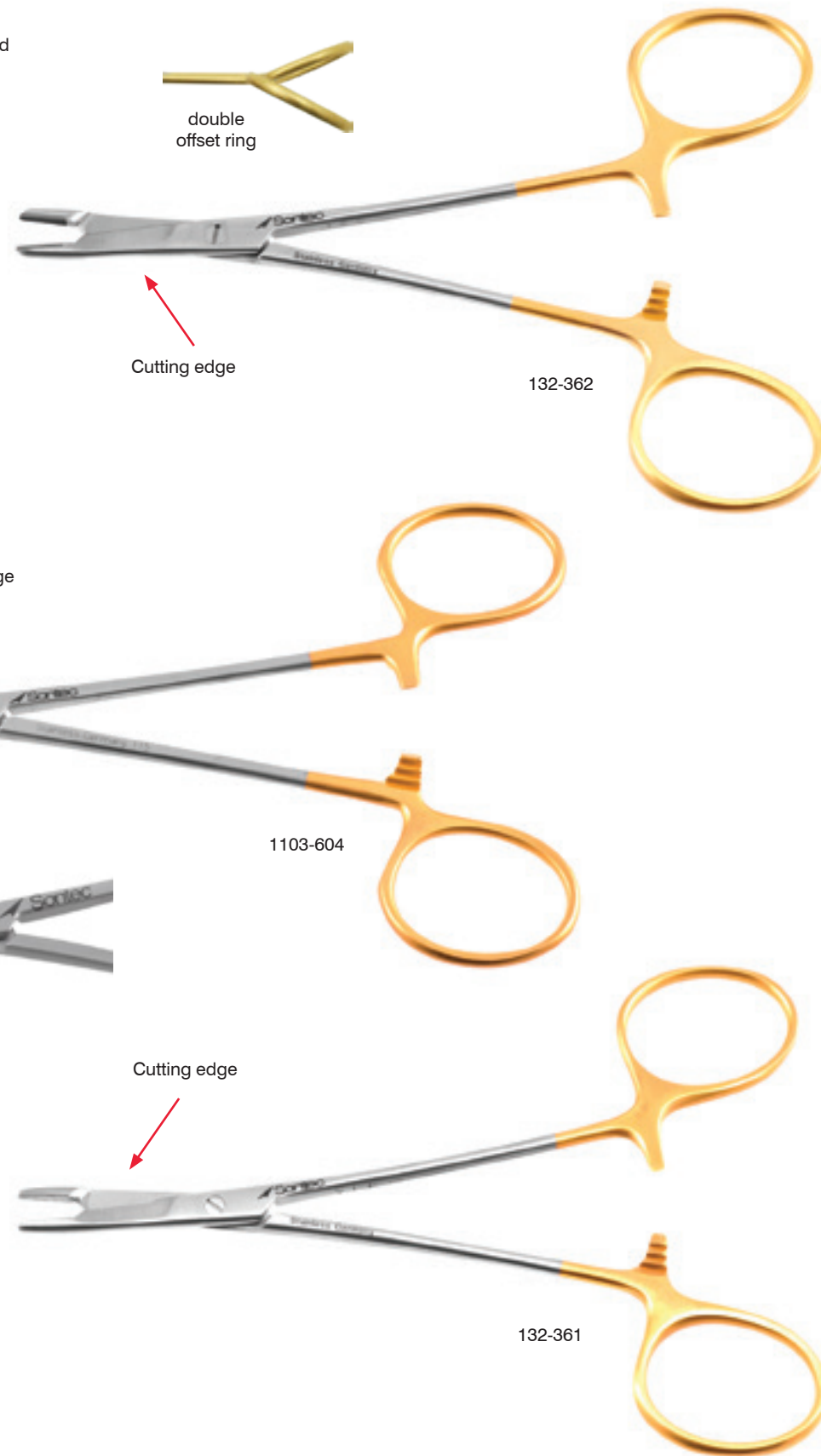
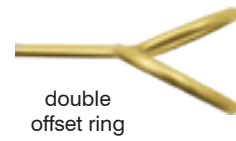

**Kaye Needle Holder**

Tungsten carbide

- 132-348 4 3/4" (12.1 cm)
- 132-350 7" (18 cm)

TC Dust

- 132-352 4 3/4" (12.1 cm)
- 132-354 7" (18 cm)

Cutting edge



**Ryder Needle Holder Titanium**

Standard box lock / TC dust / suggested suture size 5-0 and smaller

- 2600-791 6" (15 cm)
- 2600-792 6 3/4" (17 cm)
- 2600-793 7 1/2" (19 cm)

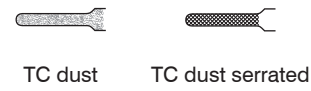

Microvascular / standard box lock / TC Dust

- 2600-790 6" (15 cm)

TC serrated

- 2600-794 6" (15 cm)
- 2600-795 6 3/4" (17 cm)
- 2600-796 7 1/2" (19 cm)

TC dust / straight / 7" (18 cm)

- 2600-797

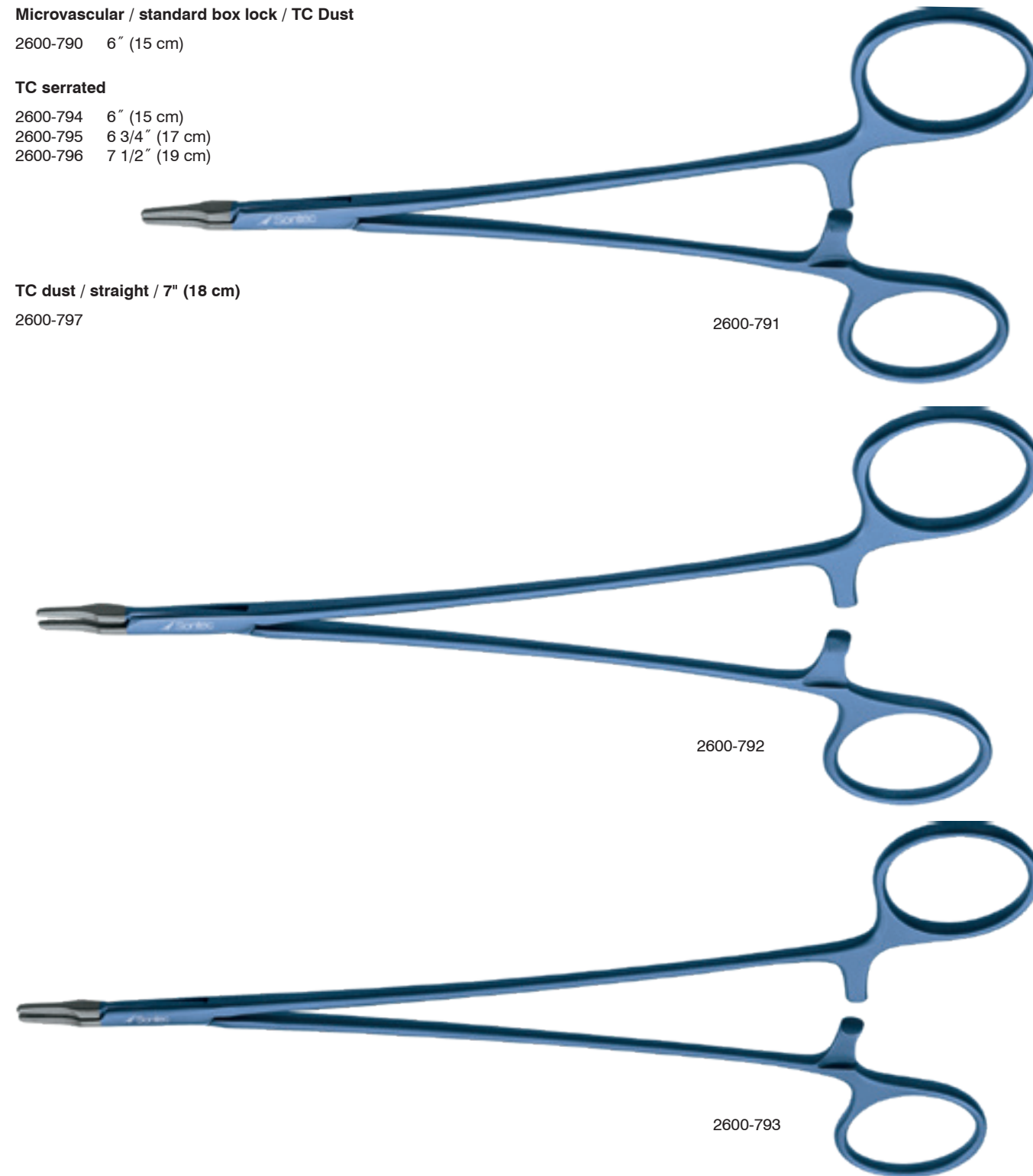

**Ryder Standard Size Needle Holder**

1.5 mm jaw / streamlined box lock / TC

- 2300-307 5" (13 cm)
- 2300-309 6" (15 cm)
- 2300-310 6 1/2" (15.5 cm)
- 2300-311 7" (18 cm)
- 2300-313 8" (20 cm)
- 2300-315 9" (23 cm)

2 mm jaw / streamlined box lock / TC

- 2300-3132 8" (20 cm)

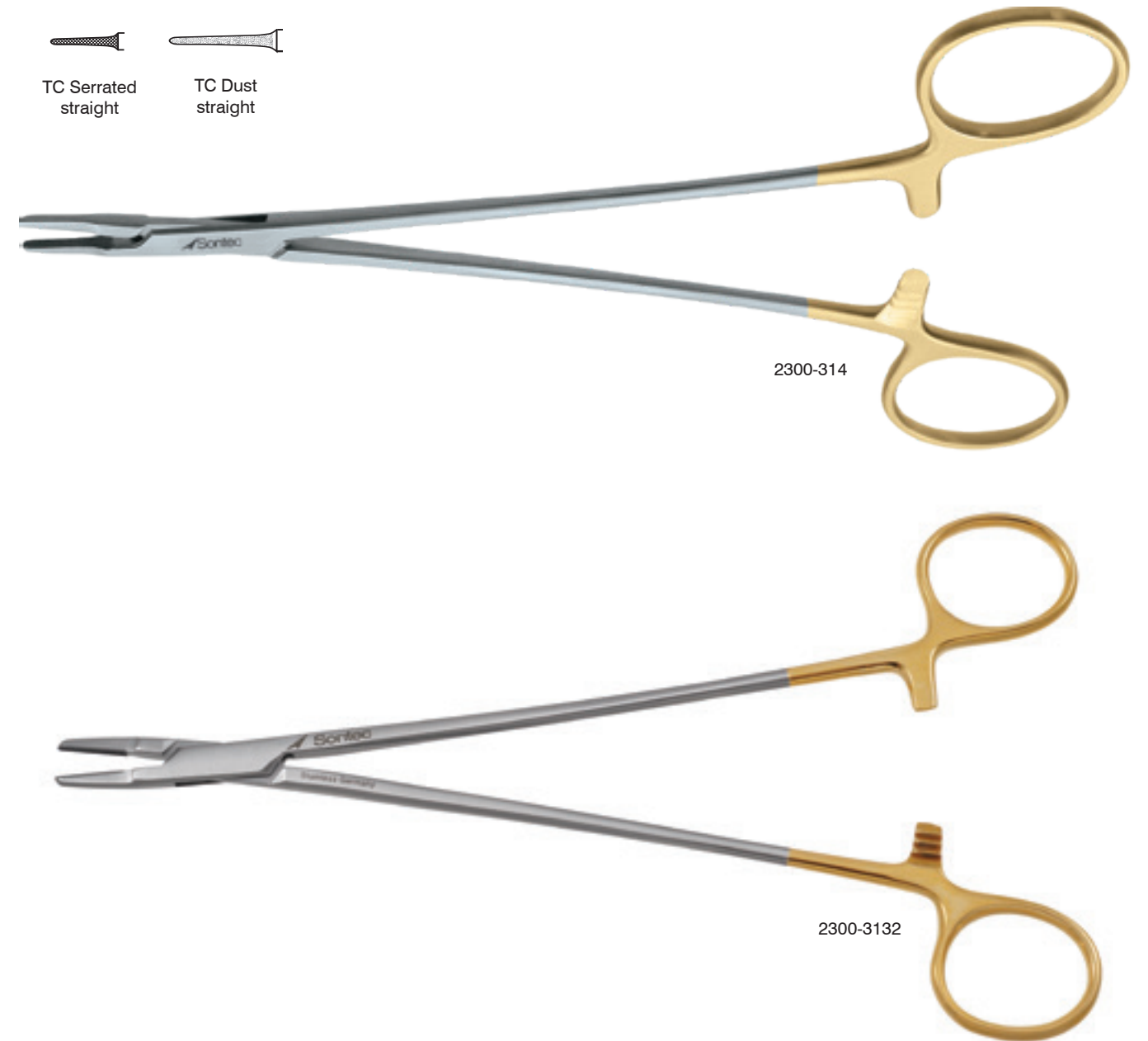
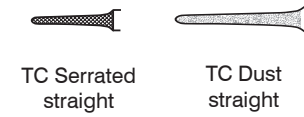

**Ryder Standard Size Needle Holder**

1.5 mm jaw / streamlined box lock / TC / serrated

- 2300-307 5" (13 cm)
- 2300-309 6" (15 cm)
- 2300-310L 6" (15 cm) left
- 2300-310 6 1/2" (15.5 cm)
- 2300-311 7" (18 cm)
- 2300-313 8" (20 cm)
- 2300-315 9" (23 cm)

2 mm jaw / streamlined box lock / TC

- 2300-3132 8" (20 cm)

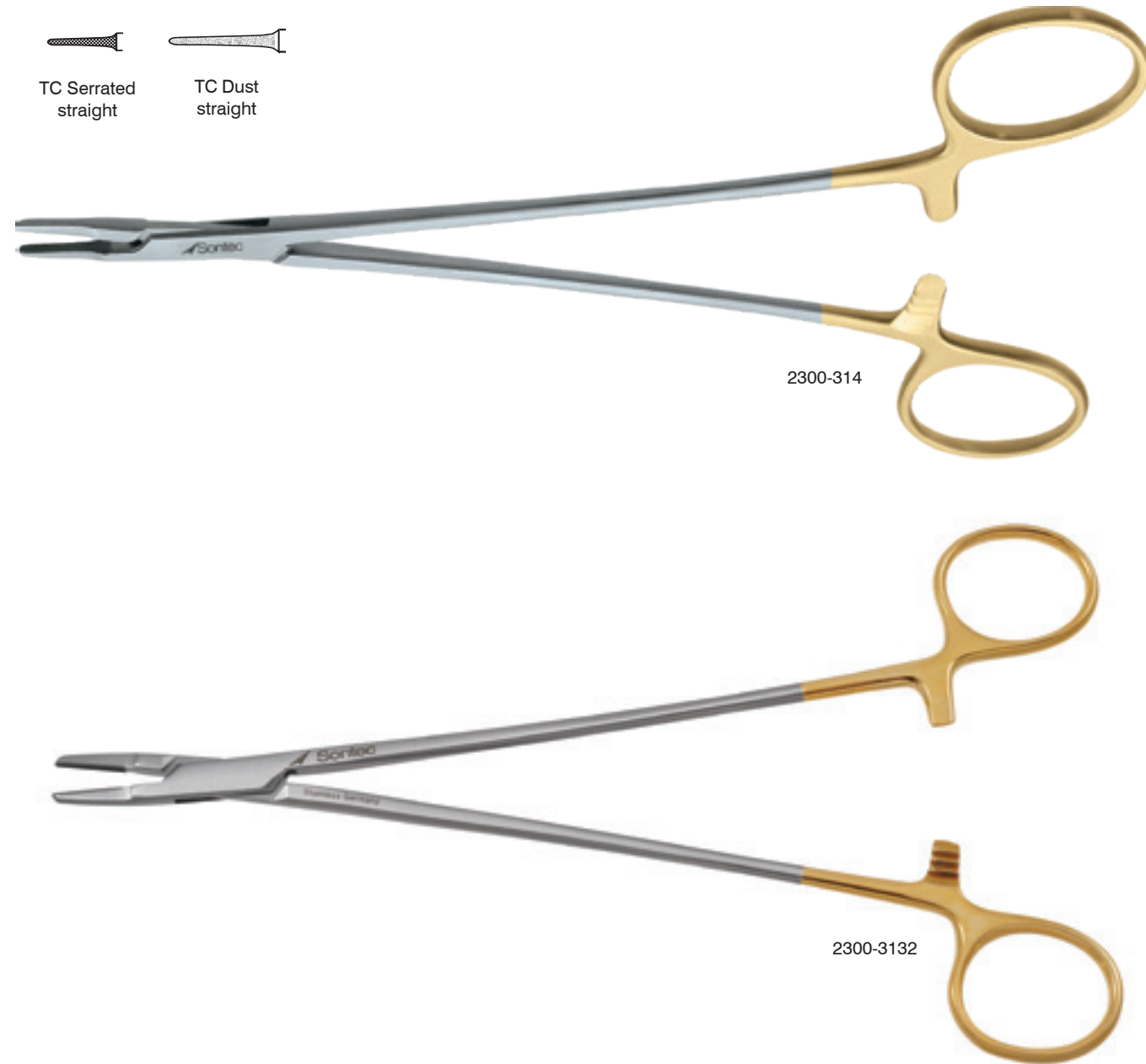
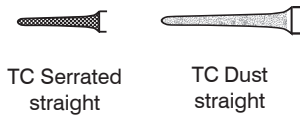

**Sontec Ryder Needle Holder**

TC serrated / 5 1/2" (14 cm)

- 132-298



**Ryder Delicate Needle Holder**

1 mm jaw / TC serrated

- 2300-298 4 3/4" (12 cm)
- 2300-300 5" (12.5 cm)
- 1100-122 5" (12.5 cm) 2 mm jaw
- 2300-302 6" (15 cm)
- 2300-304 7" (18 cm)
- 2300-306 8" (20 cm)
- 2300-308 9" (23 cm)

1 mm jaw / TC smooth

- 2300-298S 4 3/4" (12 cm)
- 2300-300S 5" (12.5 cm)
- 2300-302S 6" (15 cm)
- 2300-304S 7" (18 cm)
- 2300-306S 8" (20 cm)
- 2300-308S 9" (23 cm)

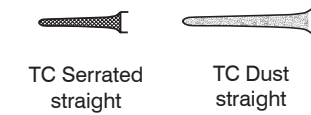
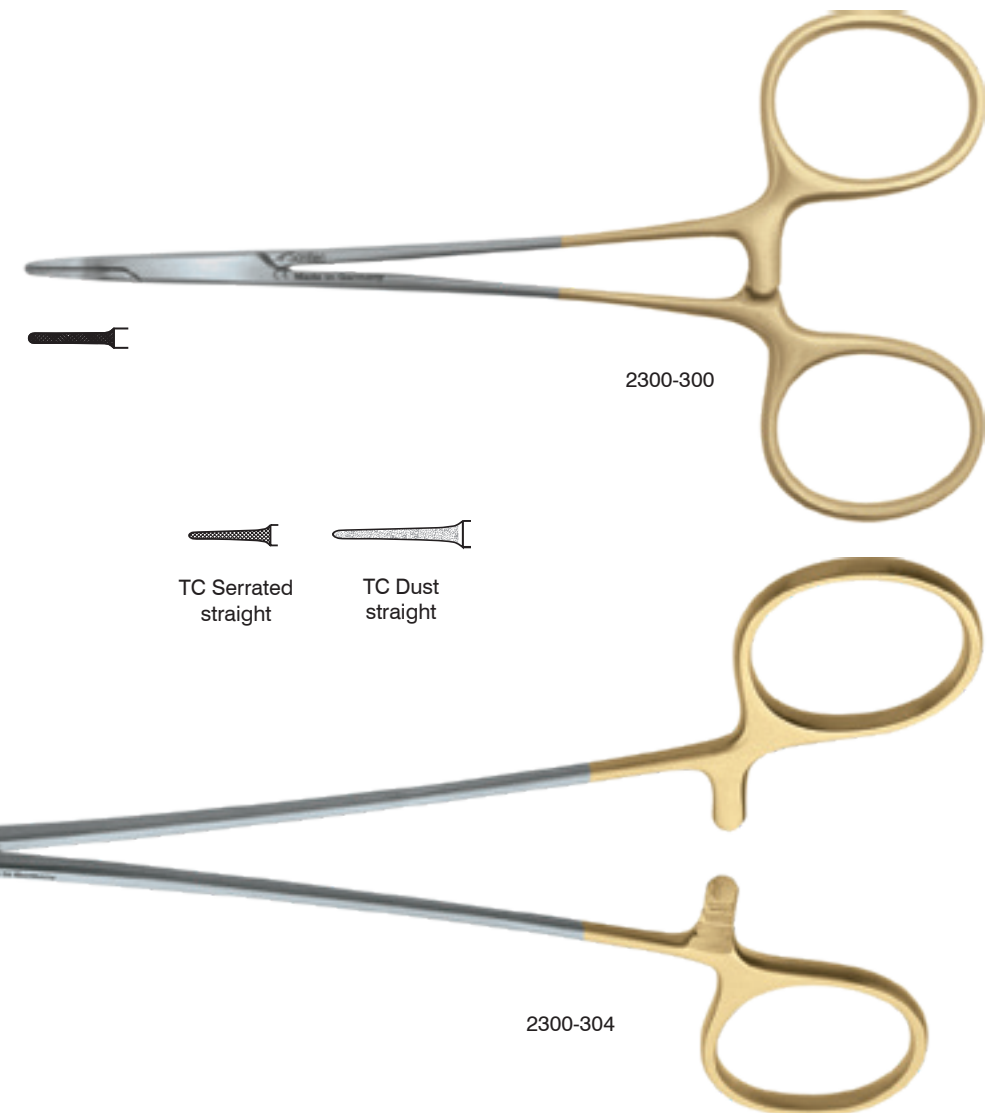

**Derf Needle Holder**

**Mini / 3 1/2" (9 cm)**

- 132-375 TC dust
- 132-376 TC serrated
- 132-376S TC smooth

**Mini / 4 1/4" (11 cm)**

- 132-632 TC serrated
- 132-634 smooth

**4 3/4" (12 cm)**

- 130-508
- 132-364 TC serrated
- 132-365 TC Dust

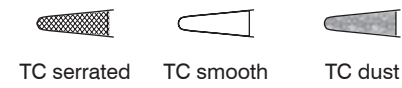

**Par Needle Holder**

**TC serrated**

- 132-367A 4 1/2" (11.5 cm)
- 132-367 5 1/4" (13 cm)





**Crile-Wood Needle Holder**

**Serrated without TC**

- 130-521 6" (15 cm)
- 130-523 7" (18 cm)
- 130-525 8" (20 cm)
- 130-526 9" (23 cm)



130-521



132-210



132-214



132-218

**TC Serrated**

- 132-388 str 6" (15 cm)
- 132-210 str 7" (18 cm)
- 132-223 cvd 7" (18 cm)
- 132-212 str 8" (20 cm)
- 132-225 cvd 8" (20 cm)
- 132-214 str 9" (23 cm)
- 132-224 cvd 9" (23 cm)
- 132-216 str 10" (25 cm)
- 132-218 str 12" (30 cm)



132-388

**Streamlined box lock / TC serrated**

- 2300-378 6" (15 cm)
- 2300-384S 7" (18 cm)
- 2300-388S 8" (20 cm)
- 2300-390S 9" (23 cm)
- 2300-394S 10" (25 cm)
- 2300-396S 12" (30 cm)

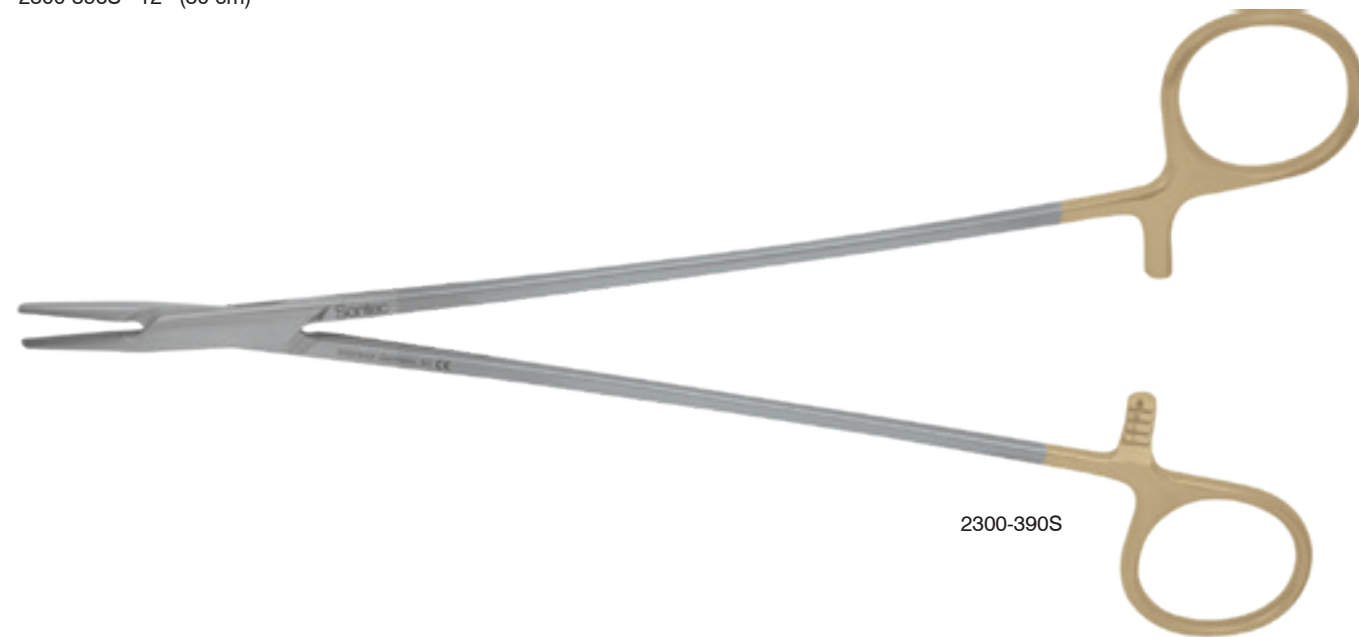

2300-390S

**Mathieu Heavy Needle Holder**

**Standard**

- 130-564 6 3/4" (17 cm) \*
- 130-565 8" (20 cm) \*

**Tungsten carbide serrated**

- 1100-094 6 3/4" (17 cm) \*
- 1100-098 8" (20 cm) \*
- 1100-096G 6 3/4" (17 cm) heavy w/guard

\* Also suitable as a wire twister

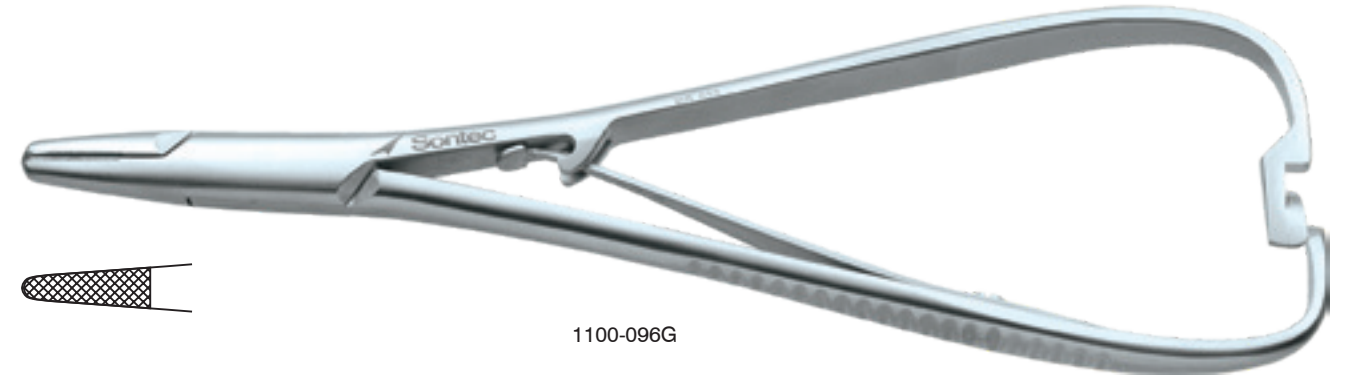

1100-096G

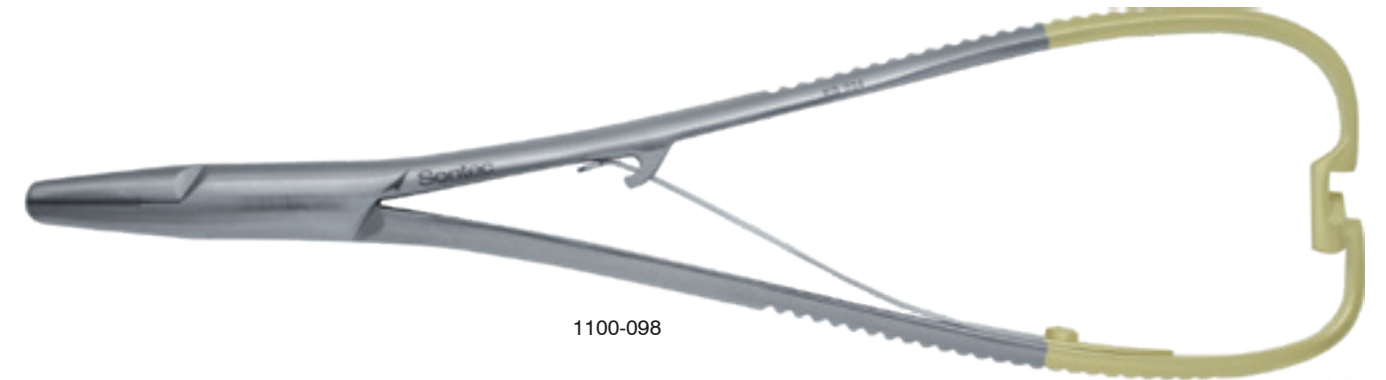

1100-098

## Index

T115-452	123	53-0554	49	105-688	27
10-1704	116	53-0556	49	105-690	27
12-4750	116	53-0560	49	105-692	27
13-7620	198	53-0562	49	105-694	27
13-7700	198	53-0564	49	105-696	27
13-7710	198	53-0566	49	105-700	28
13-7715	198	53-0574	49	105-702	28
13-9340	203	53-0582	49	105-704	28
13-9341	203	53-0584	49	105-706	28
13-9805	117	53-0590	49	105-708	28
13-9810	117	53-0592	49	105-710	28
13-9820	117	53-0594	49	105-712	28
13-9822	117	105-540	27	105-714	28
14-5383	116	105-541	27	105-716	28
T14-5383	116	105-542	27	105-720	27
T14-5383R	116	105-543	27	105-722	27
14-5389	116	105-544	27	105-723	27
T14-5391	116	105-550	27	105-724	27
16-2207	87	105-551	27	105-725	27
16-2208	87	105-552	27	105-726	27
16-2209	87	105-553	27	105-727	27
16-2210	87	105-570	27	105-730	26
18-3120	13	105-571	27	105-732	26
18-3121	13	105-572	27	105-734	26
18-3122	13	105-573	27	105-736	26
18-3123	13, 17	105-574	27	105-738	26
18-3209	17	105-575	27	105-742	26
18-3213	11	105-576	27	105-744	26
18-3214	11	105-577	27	105-746	26
18-3215	11	105-578	27	105-748	26
18-3226	17	105-579	27	105-750	26
18-3232	16	105-580	27	105-780	26
18-3235	17	105-581	27	105-781	26
18-3240	14, 17	105-590	27	105-782	26
18-3241	14	105-600	27	105-783	26
18-3242	14	105-602	27	105-784	26
18-3245	17	105-610	27	105-785	26
18-3270	17	105-612	27	105-786	26
18-3505	8	105-614	27	105-787	26
18-3510	8	105-616	27	105-789	26
18-3515	8	105-618	27	105-790	26
18-3519	8	105-620	27	105-791	26
18-3520	9	105-622	27	105-791A	26
18-3525	9	105-624	27	105-792	26
18-3530	9	105-626	27	105-793	26
23-1818	117	105-628	27	105-794	26
53-0510	49	105-630	27	105-796	26
53-0512	49	105-632	27	105-797	26
53-0514	49	105-640	27	105-798	26
53-0516	49	105-642	27	105-799	26
53-0518	49	105-644	27	105-7951	26
53-0520	49	105-646	27	110-268	180
53-0522	49	105-650	27	110-269	180
53-0524	49	105-652	27	110-271	180
53-0526	49	105-654	27	110-272	180
53-0528	49	105-656	27	110-280	182
53-0530	49	105-660	27	110-281	182
53-0532	49	105-662	27	110-301	161
53-0534	49	105-664	27	110-302	161
53-0536	49	105-666	27	112-418	176
53-0538	49	105-670	27	112-478	198
53-0542	49	105-672	27	112-480	198
53-0544	49	105-674	27	112-506	176
53-0546	49	105-676	27	115-400	130
53-0552	49	105-686	27	115-402	130

115-404	130	132-115	210	136-687	147
115-407	131	132-118	210	136-688	147
115-408	130	132-120	210	136-688S	147
115-410	129	132-122	210	136-689	147
115-410D	130	132-123	210	136-690	145
115-412	129	132-125	210	136-691	145
115-412D	130	132-210	226	136-692	145
115-412S	129	132-212	226	136-694	145
115-413	128	132-214	226	136-695	145
115-414	128	132-216	226	136-697	147
115-422	128	132-218	226	136-698	147
115-422K	134	132-223	226	136-700	147
115-422M	128	132-224	226	136-701	143
115-424	128	132-225	226	136-702	143
115-424K	134	132-298	223	136-704	143
115-425D	126	132-348	219	136-706	143
115-426	126	132-350	219	136-708	143
115-426D	126	132-352	219	136-766	144
115-427D	126	132-354	219	136-767	144
115-428	126	132-359	218	136-771	145
115-428D	126	132-360	218	136-773	145
115-429	126	132-361	218	136-775	145
115-432	123	132-362	218	136-776	145
115-434	123	132-362D	218	136-6508	140
115-446	125	132-362S	218	136-6891	147
115-448L	125	132-364	224	140-313	122
115-450	123	132-365	224	140-315	122
115-452	123	132-367	225	140-320	122
115-454	124	132-367A	225	140-322	122
115-456	124	132-375	224	140-329	122
115-458	124	132-376	224	140-330A	122
115-460	124	132-376S	224	140-331	122
115-480	132	132-388	226	140-334	122
115-482	132	132-632	224	140-350	143
115-484	132	132-634	224	140-352	143
115-486	132	136-600	139	140-354	143
115-490	132	136-602	139	140-358	143
115-492	132	136-605	139	140-360	143
115-500	132	136-607	139	140-362	143
115-502	132	136-610	139	140-364	143
115-506	132	136-613	139	140-366	143
115-508	132	136-615	139	140-368	143
115-510	132	136-617	139	140-369	143
115-512	132	136-619	139	140-376	142
115-514	132	136-621	140	140-378	142
115-515	132	136-624	140	140-379	142
115-550	134	136-626	140	140-517	142
115-552	134	136-629	140	140-517G	142
115-600	124	136-632	140	140-517M	142
115-602	124	136-632B	140	140-519	142
115-604	124	136-633	140	140-519G	142
115-606	124	136-634	140	140-519M	142
115-4121	129	136-636	140	142-104	146
115-4461	125	136-637	140	142-106	146
115-4481	125	136-639	140	142-107	146
117-582	102	136-640	140	142-108	146
123-617	122	136-641	140	142-110	146
123-618	122	136-642	140	142-111	146
123-619	122	136-643	140	150-307	137
130-508	224	136-644	140	150-315	137
130-521	226	136-645	140	150-348	135, 136
130-523	226	136-646	140	150-349	135, 136
130-525	226	136-648	140	150-350	135, 136
130-526	226	136-649	140	150-351	135, 136
130-527	210	136-650	140	150-353	135, 136
130-529	210	136-652	140	150-355	135, 136
130-531	210	136-653	140	150-356	136
130-564	227	136-686	147	150-357	136
130-565	227	136-686D	147	150-358	136

150-359	136	320-837	71	330-020	89
150-361	136	320-838	71	330-021	89
180-420	114	320-847	73	330-022	89
190-246	115	320-848	71	330-023	89
190-260	115	320-848T	73	330-024	89
207-319-SET	154	320-849	71	330-610	94
207-321	154	320-849T	73	330-611	94
207-323	154	320-850	71	330-612	94
207-326	155	320-850T	73	330-613	94
207-328	155	320-851	71	330-614	94
207-330	155	320-851T	73	330-615	94
207-333	155	320-852	71	330-616	94
207-338	155	320-852T	73	330-620	94
207-340	155	320-853	71	330-621	94
207-342	155	320-853T	73	330-622	94
207-345	155	320-854	71	330-623	94
207-411	156	320-854T	73	330-624	94
207-413	156	320-855	71	330-625	94
207-415	156	320-855T	74	330-626	94
230-445	153	320-856	71	330-660	96
230-480	154	320-857	71	330-661	96
230-486	154	320-858	71	330-662	96
240-610	206	320-859	72	330-663	96
240-625	206	320-859A	72	330-664	96
320-615	81	320-860	72	330-665	96
320-617	81	320-861	72	330-670	96
320-621	75	320-861A	72	330-671	96
320-622	75	320-862	72	330-672	96
320-623	75	320-862A	72	330-673	96
320-624	75	320-863	72	330-674	96
320-625	75	320-863A	72	330-675	96
320-626B	76	320-864	72	330-690	95
320-626G	76	320-864A	72	330-691	95
320-629B	76	320-865	72	330-692	95
320-629G	76	320-865A	72	330-693	95
320-630B	76	320-866	72	330-694	95
320-630G	76	320-866A	72	330-695	95
320-778	74	320-869L	78	330-696	95
320-779	74	320-869S	78	330-700	95
320-780	74	320-870	74	330-701	95
320-808	71	320-871	74	330-702	95
320-809	71	320-872	74	330-703	95
320-810	71	320-873	74	330-704	95
320-811	71	320-874	74	330-705	95
320-812	71	320-875	74	330-706	95
320-813	71	320-876	74	330-824	99
320-814	71	320-877	74	330-824NH	99
320-815	71	320-878	74	330-824S	99
320-816	71	320-879	78	330-824SH	99
320-817	71	320-881A	77, 80	330-832	99
320-818	71	320-881B	77, 80	330-840	98
320-826T	73	320-881C	77, 80	330-842	98
320-827	71	320-881D	77, 80	330-849A	95
320-827T	73	320-882A	77, 80	330-849B	95
320-829	71	320-882B	77, 80	330-849C	95
320-829T	73	320-882C	77, 80	330-849D	95
320-830	71	320-882D	77, 80	330-849E	95
320-830T	73	320-883A	77, 80	335-105	89
320-831	71	320-883B	77, 80	335-106	89
320-831T	73	320-883C	77, 80	335-135	92
320-832	71	320-883D	77, 80	335-136	92
320-832T	73	320-920	72	335-137	92
320-833	71	320-924A	78	335-138	92
320-833T	73	320-924B	78	335-139	92
320-834	71	320-958	79	335-140	92
320-834T	73	320-959	79	335-141	92
320-835	71	320-960	79	335-210	88
320-835T	73, 74	320-962	79	335-212	88
320-836	71	325-130	13	335-250	85

335-254	85	404-760	37	412-524	93
335-255	85	404-761	37	412-526	93
335-260	85	404-762	37	412-528	93
335-265	85	404-763	37	412-555	88
335-270	86	404-764	50	412-556	88
335-275	86	404-765	50	412-557	88
335-280	86	404-766	38	412-558	90
335-285	86	404-767	38	412-575	89
345-215B	100	404-768	38	412-580	90
345-216	100	404-769	38	412-5863	88
345-216B	100	404-770	38	419-378	113
345-270	100	404-771	38	419-380	113
345-400	102	404-772	38	419-382	113
345-405	104	404-774	39	419-384	113
345A-P16	30	404-775	39	419-386	113
345A-PAG1	30	404-776	39	438-408	122
345B-16	30	404-782	46	438-410	122
345B-G1	30	404-783	46	438-412	122
345F-CT1G	31	404-784	46	438-610	133
345F-CT22	31	404-785	46	438-611	133
345P-MX16	30	404-786	45	438-612	133
345P-MXG1	30	404-787	45	438-613	133
345P-RP08	31	404-788	45	438-614	133
345P-RP22	31	404-788U	45	438-615	133
350-857	185	404-789	40	442-210	141
350-858	185	404-790	35	442-212	141
350-859	185	404-791	35	442-214	141
350-860	185	404-792	35	442-215	141
350-861	185	404-792B	35	442-216	141
350-861B	185	404-792S	35	442-219	141
350-862	185	404-793	35	475-151	184
350-862B	185	404-794	35	475-153	184
350-863	185	404-795	35	475-158	176
350-864	185	404-796	35	475-160	176
404-711	36	404-800	35	475-178	186
404-711D	36	404-801	35	475-179	186
404-711U	36	404-802	35	475-181	186
404-712	36	404-802S	35	475-183	189
404-714	36	404-803	35	475-183D	189
404-716	36	404-810	35	475-184	187
404-719	36	404-811	35	475-185	188
404-721	36	404-812	35	475-186	188
404-723	36	404-814	34	475-187	188
404-727	36	404-824	46	475-188	188
404-729	36	404-825	35	475-188D	189
404-731	36	404-826	35	475-220	191
404-734	36	404-827	35	475-225	191
404-736	36	404-828	35	508-617	175
404-737	36	404-829	35	1100-094	227
404-738	36	404-830	35	1100-096G	227
404-738D	36	404-831	35	1100-098	227
404-738U	36	404-832	35	1100-104	162
404-739	37	404-833	35	1100-105A	213, 214
404-739D	37	404-834	35	1100-105D	213
404-739U	37	404-835	35	1100-105T	217
404-740	37	404-836	35	1100-106	215
404-742	37	404-837	35	1100-106A	215
404-744	37	404-838	35	1100-106D	213
404-747	37	404-839	35	1100-108	215
404-749	37	404-881HT	106	1100-108D	214
404-751	37	404-7871	45	1100-110	212
404-754	37	404-7875	45	1100-110D	214
404-754D	37	404-7885	45	1100-110H	212
404-755	37	404-7929	35	1100-111	212
404-755D	37	404-7959	35	1100-111A	212
404-755L	37	412-518	87	1100-113	211
404-756	37	412-519	93	1100-122	223
404-756D	37	412-520	93	1100-124	216
404-759	37	412-522	93	1100-124A	212

1100-124D	211, 213	1100-278R	180	1100-742	102
1100-126	216	1100-280	179	1100-798	82
1100-126D	213	1100-280R	180	1100-798A	82
1100-128D	213	1100-282	183	1100-798B	83
1100-140L	129	1100-290	162	1100-798C	83
1100-150	133	1100-291	160	1100-798D	83
1100-151	133	1100-392	217	1100-798E	82
1100-152	133	1100-460E	115	1100-798F	82
1100-152L	133	1100-460L	115	1100-798H	84
1100-153	133	1100-460M	115	1100-798S	82
1100-165	140	1100-460S	115	1100-847	163
1100-167	140	1100-460T	115	1100-849	163
1100-168	125	1100-460X	115	1100-850	163
1100-169	140	1100-462S	98	1100-851	210
1100-179	140	1100-463	98	1100-853	210
1100-183	144	1100-463S	98	1100-854	210
1100-185	146	1100-479	97	1100-858	138
1100-187	140	1100-479A	97	1100-859	138
1100-196	199	1100-479B	97	1100-860	138
1100-197	199	1100-479C	97	1100-861	138
1100-198	199	1100-479D	97	1100-862	138
1100-199	199	1100-479E	97	1100-863	138
1100-207	204	1100-479F	97	1100-864	138
1100-208	204	1100-479G	97	1100-865	138
1100-208R	205	1100-479H	97	1100-866	102
1100-210	207	1100-479J	97	1100-868	102
1100-210R	207	1100-479K	97	1100-874	138
1100-211	207	1100-479L	97	1100-875	138
1100-211R	207	1100-479M	97	1100-876	138
1100-212	200	1100-479N	97	1100-877	138
1100-214	200	1100-512	92	1100-878	138
1100-214L	200	1100-616	153	1100-879	138
1100-216	201	1100-617	153	1100-880	138
1100-218	202	1100-618	153	1100-881	138
1100-222	203	1100-619	153	1100-902	110
1100-224	200	1100-620	153	1100-903	111
1100-226	200	1100-621	153	1100-904	110
1100-228	201	1100-622	153	1100-905	111
1100-230	202	1100-623	153	1100-907	108
1100-232	202	1100-624	153	1100-6280	150
1100-233	160	1100-625	153	1100-7411	101
1100-234	203	1100-628	150	1101-538	157
1100-235	175	1100-628B	150	1101-540	157
1100-236	160	1100-629	150	1101-542	157
1100-236L	160	1100-629B	150	1101-544	157
1100-238	160	1100-630	150	1101-546	157
1100-240	161	1100-630A	150	1101-548	157
1100-241	160	1100-630N	151	1101-550	157
1100-242	160	1100-631N	151	1101-552	157
1100-243	161	1100-632	150	1101-553	157
1100-244	160	1100-632R	151	1103-049	118
1100-245	161	1100-633F	151	1103-049L	118
1100-246	161	1100-633G	151	1103-140	119
1100-248	178	1100-633H	151	1103-140A	119
1100-250	179	1100-633HR	151	1103-140J	119
1100-254	178	1100-633I	151	1103-161	114
1100-256	179	1100-636	152	1103-162A	114
1100-260	200	1100-638	152	1103-162B	114
1100-262	200	1100-640	152	1103-162S	114
1100-264	200	1100-642	152	1103-205	103
1100-265	200	1100-644	152	1103-206	105
1100-268	201	1100-644B	152	1103-208	103
1100-270	201	1100-728	112	1103-209	105
1100-272	178	1100-728S	112	1103-211	105
1100-272R	180	1100-735F	147	1103-213	105
1100-274	179	1100-739A	139	1103-601	218
1100-274R	180	1100-739B	139	1103-604	218
1100-276	183	1100-740	101	1103-702	10
1100-278	178	1100-741	101	1103-702D	10

1103-703	10	1200-416	190	1200-788	170
1103-705	10	1200-418	190	1200-790	170
1103-710	10	1200-480	204	1200-814	190
1103-712	12	1200-494	190	1200-815	190
1103-715	10	1200-495	190	1200-816	190
1103-716	10	1200-500	173	1200-818	190
1103-717	12	1200-501	173	1200-848	191
1103-717D	12	1200-502	198	1200-849	191
1103-723	10	1200-503	198	1200-899	175
1103-724	10	1200-505	173	1200-900	172
1103-901	108	1200-507	173	1200-902	172
1103-902	108	1200-510	173	1200-904	172
1103-904	108	1200-512	173	1200-905	172
1103-2063	105	1200-514	173	1200-906	172
1200-025	198	1200-515	173	1200-907	172
1200-026	198	1200-520	173	1200-908	172
1200-028	198	1200-525	166	1200-909	172
1200-76M	168	1200-526	173	1200-910	172
1200-188	206	1200-526S	173	1200-911	174
1200-190	204	1200-529	173	1200-912	174
1200-192	204	1200-530	173	1200-915	174
1200-195	206	1200-531	173	1200-916	174
1200-212	200	1200-535	173	1200-962	178
1200-214	200	1200-536	173	1200-966	178
1200-216	201	1200-537	173	1200-970	186
1200-218	202	1200-538	173	1200-980	205
1200-220	202	1200-539	178	1271-005	42, 43
1200-222	203	1200-540	179	1271-005A	42, 43
1200-224	200	1200-542	180	1271-006	42, 43
1200-226	200	1200-543	182	1271-007	42, 43
1200-228	201	1200-544	178	1271-008	42, 43
1200-229	200	1200-545	179	1271-016	42
1200-230	202	1200-547	180	1271-018	42
1200-231	201, 203	1200-548	182	1271-020	42, 59
1200-232	202	1200-550	180	1271-021	42
1200-234	203	1200-551	180	1271-021A	42
1200-248	178	1200-600	199	1271-060	44, 57
1200-250	179	1200-601	199	1271-060R	44, 57, 59
1200-254	178	1200-602	199	1271-061	44, 57
1200-256	179	1200-603	199	1271-061R	44, 57
1200-268	167	1200-690	204	1271-062	44, 57
1200-269	167	1200-691	184	1271-062R	44, 57
1200-270	167	1200-712	200	1271-063	44, 57
1200-326	164	1200-713	200	1271-063R	44, 57
1200-328	164	1200-714	200	1271-064	44, 57
1200-330	164	1200-715	200	1271-064R	44, 57
1200-332	164	1200-716	201	1271-065	44, 57
1200-333	161	1200-717	201	1271-065R	44, 57
1200-334	164	1200-726	178	1271-066	44, 57
1200-335	164	1200-727	179	1271-066R	44, 57
1200-340	164	1200-728	178	1271-067	44, 57
1200-342	165	1200-729	180	1271-067R	44, 57
1200-342H	165	1200-730	179	1271-068	44, 57
1200-342L	165	1200-731	180	1271-068R	44, 57
1200-344	165	1200-733	182	1271-069	44, 57
1200-347	164	1200-735	182	1271-069R	44, 57
1200-348	195	1200-750	168	1271-070	44, 57
1200-360	165	1200-752	168	1271-070R	44, 57
1200-362	165	1200-760	168	1271-071	44, 57
1200-370	166	1200-762	168	1271-071R	44, 57
1200-372	166	1200-770	169	1271-072	44, 57
1200-392	190	1200-775M	168	1271-072R	44, 57
1200-406	184	1200-776M	168	1271-073	44, 57
1200-408	184	1200-780	168	1271-073R	44, 57
1200-409	184	1200-782	168	1271-074	44, 57
1200-412	190	1200-783	168	1271-074R	44, 57
1200-413	190	1200-784	168	1271-085	44, 57
1200-414	190	1200-786	168	1271-085R	44, 57
1200-415	190	1200-787	168	1271-086	44, 57



1271-086R	44, 57	1271-138T	66	1271-372	56
1271-087	44, 57	1271-138U	65	1271-373	56
1271-087R	44, 57	1271-139	65	1271-374	56
1271-090	44, 57, 59	1271-139C	64	1271-375	56
1271-091	44, 57	1271-139D	64	1271-380	56
1271-092	44, 57	1271-139S	65	1271-381	56
1271-093	44, 57	1271-139ST	66	1271-382	56
1271-094	44, 57	1271-139SU	65	1271-383	56
1271-095	44, 57	1271-139T	66	1271-384	56
1271-101	44, 57	1271-139U	59, 65	1271-385	56
1271-102	44, 57	1271-140	67	1271-390	56
1271-103	44, 57	1271-140U	59, 67	1271-391	56
1271-104	44, 57	1271-142	65	1271-392	56
1271-105	44, 57	1271-142LT	66	1271-393	56
1271-106	44, 57	1271-142RT	66	1271-394	56
1271-107	44, 57	1271-142T	66	1271-395	56
1271-108	44, 57	1271-142U	59, 65	1271-400	56
1271-109	44, 57	1271-143	59, 66, 67	1271-401	56
1271-110	44, 57	1271-145	81	1271-402	56
1271-111	44, 57	1271-146	81	1271-403	56
1271-112	44, 57	1271-147	81	1271-404	56
1271-115	67	1271-148S	67	1271-410	56
1271-116T	67	1271-148T	67	1271-411	56
1271-116U	67	1271-149	67	1271-412	56
1271-117	58	1271-152	62	1271-413	56
1271-117-1	58, 59	1271-152B	63	1271-414	56
1271-117-2	58, 59	1271-152C	63	1271-420	56
1271-117-3	58, 59	1271-152D	63	1271-421	56
1271-117-4	58	1271-153	63	1271-422	56
1271-117-5	58	1271-154	64	1271-423	56
1271-118	65	1271-155	64	1271-424	56
1271-118T	66	1271-156	64	1271-425	56
1271-118U	65	1271-157	64	1271-430	56
1271-119T	66	1271-160	63	1271-431	56
1271-119U	65	1271-163	63	1271-432	56
1271-120	69	1271-165	62	1271-433	56
1271-120U	68	1271-175	62	1271-434	56
1271-121	68	1271-180	62	1271-435	56
1271-121PT	66	1271-181	62	1271-440	56
1271-121T	66	1271-183	104	1271-441	56
1271-121U	59, 68	1271-281D	113	1271-442	56
1271-122	68	1271-282	113	1271-443	56
1271-122U	59, 68	1271-283	113	1271-444	56
1271-123	69	1271-284	113	1271-445	56
1271-123LW	69	1271-300	91	1271-450	56
1271-125T	66	1271-301	91	1271-451	56
1271-125U	65	1271-302	90	1271-452	56
1271-126	65	1271-320	69	1271-453	56
1271-126T	66	1271-321	69	1271-454	56
1271-126U	65	1271-322	69	1271-460	56
1271-127	65	1271-323	69	1271-461	56
1271-127T	66	1271-324	69	1271-462	56
1271-127U	59, 65	1271-325	69	1271-463	56
1271-128	65	1271-326	69	1271-464	56
1271-128T	66	1271-327	69	1271-470	56
1271-128U	65	1271-330	69	1271-471	56
1271-129	68	1271-350	56	1271-472	56
1271-130	68	1271-351	56	1271-473	56
1271-130PH	68	1271-352	56	1271-474	56
1271-131	65	1271-353	56	1271-480	59
1271-132	65	1271-354	56	1271-610	44, 57
1271-133AU-ang	66	1271-355	56	1271-611	44, 57
1271-133U	66	1271-360	56	1271-612	44, 57
1271-134	66	1271-361	56	1271-613	44, 57
1271-135T	66	1271-362	56	1271-614	44, 57
1271-136	65	1271-364	56	1271-615	44, 57
1271-136T	66	1271-365	56	1271-620	44, 57
1271-136U	65	1271-370	56	1271-621	44, 57
1271-138	65	1271-371	56	1271-622	44, 57

1271-623	44, 57	2200-523A	137	2400-230	180
1271-624	44, 57	2300-298	223	2400-231	179, 180
1271-625	44, 57	2300-298S	223	2400-232	179, 180
1271-640	44, 57	2300-300	223	2400-235	176
1271-641	44, 57	2300-300S	223	2400-236	176
1271-642	44, 57	2300-302	223	2400-237	176
1271-643	44, 57	2300-302S	223	2400-238	176
1271-644	44, 57	2300-304	223	2400-239	176
1271-645	44, 57	2300-304S	223	2400-240	176
1271-650	44, 57	2300-306	223	2400-240T	177
1271-651	44, 57	2300-306S	223	2400-241	177
1271-652	44, 57	2300-307	221, 222	2400-242	177
1271-653	44, 57	2300-308	223	2400-242T	177
1271-654	44, 57	2300-308S	223	2400-243	177
1271-655	44, 57	2300-309	221, 222	2400-245	177
1271-1204U	68	2300-310	221, 222	2400-245T	177
1273-100	52	2300-310L	222	2400-247	173
1273-101	52	2300-311	221, 222	2400-248	173
1273-103	52	2300-313	221, 222	2400-250	162
1273-105	52	2300-315	221, 222	2400-252	162
1404-840	70	2300-328	210	2400-253	162
1404-841	70	2300-378	226	2400-254	162
1404-841P	70	2300-384S	226	2400-255	162
1404-845A	47	2300-388S	226	2400-256	162
1404-845B	47	2300-390S	226	2400-257	162
1404-845D	47	2300-394S	226	2400-258	162
1404-846A	47	2300-396S	226	2400-259	173
1404-846B	47	2300-516	217	2400-260	163
1404-846D	47	2300-518	217	2400-262	163
1404-850	53	2300-520	217	2400-264	163
1404-852	51	2300-521	217	2400-265	162
1404-853	51	2300-3132	221, 222	2400-267	162
1404-854	51	2400-181	178	2400-269	162
1404-855	39	2400-185	179	2400-270	162
1404-857	47	2400-187	179	2400-271	162
1404-858	47	2400-188	179	2400-272	162
1404-860	48	2400-189	179	2400-273	163
1404-861	48	2400-190	179	2400-275	163
1404-862	50, 51	2400-191	180	2400-277	163
1404-865	48	2400-192	180	2400-278	163
1404-870	87	2400-193	180	2400-279	163
1404-871	87	2400-194	180	2400-280	163
1404-875	91	2400-195	180	2400-281	173
1404-881	106	2400-197	180	2400-286	164
1404-881H	106	2400-198	180	2400-287	164
1404-881HM	106	2400-199	180	2400-302	167
1404-881HMT	106	2400-200	178	2400-304	167
1404-881HR	106	2400-201	178	2400-306	167
1404-881HRM	106	2400-206	179	2400-308	167
1404-881HRMT	106	2400-207	179	2400-309	167
1404-881HRMTL	106	2400-208	183	2400-310	167
1404-881HTR	106	2400-209	183	2400-311	167
1404-881M	106	2400-210	183	2400-314	164
1404-881MT	106	2400-210B	183	2400-315	164
1404-881R	106	2400-211	183	2400-316	164
1404-881RM	106	2400-211B	183	2400-317	165
1404-881T	106	2400-212	183	2400-318	165
1404-881TR	106	2400-213	183	2400-319	165
1404-883	107	2400-214	183	2400-320	161
1404-883B	107	2400-215	183	2400-321	167
1404-885	107	2400-216	183	2400-322	167
1404-890	107	2400-217	183	2400-323	167, 195
1404-895	109	2400-218	183	2400-324	195
1404-897	109	2400-222	182	2400-324S	195
1404-940	112	2400-223	182	2400-325	192
1404-945	109	2400-225	182	2400-325D	194
1404-8902	107	2400-226	180, 182	2400-326	195
2200-0175	146	2400-227	182	2400-327	195
2200-521	137	2400-229	180	2400-329	192

2400-329D	194	2400-829D	194	SC94-0315	61
2400-330	165	2400-830	192	SC94-0316	61
2400-331	192	2400-830D	194	SC94-0317	61
2400-331S	192	2400-831	192	SC94-0318	61
2400-332	192	2400-831D	194	SC94-0319	61
2400-333	192	2400-832	192	SC94-0320	61
2400-334	192	2400-832D	194	SC94-0321	61
2400-335	192	2400-833	192	SC94-0322	61
2400-341	163	2400-833D	194	SC94-03157	61
2400-345	163	2400-834	192	SC94-03158	61
2400-346	160	2400-835	192	SC94-03159	61
2400-349	160	2400-841	175	SC95-0300	61
2400-352	161	2400-916	181	SC95-0302	61
2400-374	196	2400-918	181	SC95-0305	61
2400-375	196	2400-920	183	SC95-0306	61
2400-376	196	2400-922	183	SC95-0310	60
2400-377	196	2400-924	183	SC95-0315	59, 60
2400-379	196	2400-926	183	SC95-0415	60
2400-380D	197	2400-928	183	SC95-0420	58, 59
2400-381	196	2405-324	195	SC95-0421	58, 59
2400-383	196	2405-324S	195	SC95-0422	58, 59
2400-383S	196	2405-325	192	SC95-0423	58, 59
2400-385	196	2405-325D	194	SC95-0424	58
2400-701	180	2405-326	195	SC95-0425	58
2400-703	180	2405-327	195	ST2	23
2400-706	180	2405-329	192	ST3-926	22
2400-708	180	2405-329D	194	ST3-927	22
2400-711	198	2405-330	192	ST3-929	22
2400-713	198	2405-331	192	ST3-930	22
2400-715	198	2405-332	192	ST6	21
2400-717	198	2405-333	192	ST6G	23
2400-719	178	2405-334	192	ST8	21
2400-785	172	2405-335	192	ST10	21
2400-787	172	2405-824	195	ST10-F	21
2400-790	169	2405-824S	195	ST10-F-PMT	22
2400-792	169	2405-825	193	ST12	21
2400-797	170	2405-825D	194	ST13-F	21
2400-798	171	2405-826	195	ST14G	23
2400-800	171	2405-827	195	ST14-K	25
2400-801	171	2405-828D	194	ST15-20	21
2400-802	171	2405-829	193	ST15-20-PM	22
2400-803	171	2405-829D	194	ST15-F	21
2400-804	171	2405-830	193	ST15-F-PMT	22
2400-805	171	2405-830D	194	ST17-F	21
2400-806	171	2405-831	193	ST17-F-PMT	22
2400-807	171	2405-831D	194	ST19-F	21
2400-808	171	2405-832	193	ST19-F-PMT	22
2400-809	171	2405-832D	194	ST32-K	25
2400-811	171	2405-833	193	ST43	19
2400-812A	168	2405-834	193	ST43-2	19
2400-813A	168	2405-835	193	ST52	24
2400-814A	168	2405-8259	194	ST63	19
2400-815A	168	2600-409	127	ST63-2	19
2400-816	169	2600-411	127	ST72-K	25
2400-819	171	2600-790	220	ST75	24
2400-820	171	2600-791	220	ST83	18
2400-821	171	2600-792	220	ST83-2	18
2400-822	171	2600-793	220	ST100	24
2400-823S	195	2600-794	220	ST106	24
2400-824	195	2600-795	220	ST107	24
2400-824S	195	2600-796	220	ST148	24
2400-825	192	2600-797	220	ST170-0	18
2400-825D	194	3451-B	31	ST170-2	18
2400-826	195	9B-010	29	ST302-2	20
2400-826D	194	9B-020	29	ST402-2	19
2400-827	195	9B-025	29	ST602-2	19
2400-827S	195	SC94-0312	61	ST952	18, 19
2400-828D	194	SC94-0313	61	ST952-2	19
2400-829	192	SC94-0314	61	ST952D-2	18

ST953	18, 19	sors	172	Medicine Cup	23
ST1002	19	Baby Poole Suction	114	Curette	
ST1002-2	19	Bainbridge Forceps	124	Arthroscopic Curette & Ring Curette	67
ST1082-2	19	Basin		Bruns Hexagonal Handle Curette	74
ST1202	19	Emesis Basin	21	Bruns Oval Cup Curette	71
ST1202-2	19	Bin		Bruns Ring Curette	81
ST1311-2	18, 20	INSTRU-BIN	31	Charnley Curette	78
ST1650-2	19	Biopsy		Cone Ring Two Handed Curette	77, 80, 81
ST2000-2	18, 20	Courtney Large Animal Liver Biopsy		Down Pushing Curette	78
STE902	19	108		Extra Long Spinal Curette	72
STE1082	19	Biopsy & Grasping Rongeur Forceps	42	Hatt Spoon Curette	74
STE1650	19	Bone Pick Micro Fracture	69	Lampert Curette	73
STE1654	19	Bone Reduction Clamp Extra Large	118	Long Handle Curette	76
STE2302	19	Bowl		O'Brien Curette	78
STE2304	19	Sponge Bowl	24	Spinal Curette	72
STE06062	19	Braake Tendon Knife	104	Tear Drop Spinal Curette	79
STE06064	19	Brown-Adson Tissue Forceps	147	Two Handed Curette	75
STE06066	19	Brown Tissue Forceps	145	Cushing Pituitary Rongeur	36
STE10062	19	Bruns Hexagonal Handle Curette	74		
STE10064	19	Bruns Oval Cup Curette	71		
STE10066	19	Bruns Ring Curette	81		
STE12062	20	Brush			
STE12064	20	Whisk 'R Brush	29		
STE12066	20	Burr			
STE12102	20	Virginia Roaring Burr Long			
STE12104	18, 20	113			
STE12106	20	Virginia Roaring Burr Short			
STE20122	20	113			
STE20124	18, 20				
STE20126	18, 20				
STP12102	18				
STP12104	18				
STP20122	18				
STP20124	18				
STS12062	20				
STS12064	20				
STS12066	20				
STS12102	20				
STS12104	20				
STS12106	20				
STS20122	20				
STS20124	20				
STS20126	20				
		<b>C</b>			
		Cannula			
		Egress Cannula Set	60, 61		
		Inflow Cannula Set	61		
		Small Joint Arthroscopic Cannula	58		
		Caspar Grasping Rongeur	49		
		Castaneda Enucleation Clamp Forceps	117		
		Castroviejo Equine Eye Speculum	116		
		Catheter Tray	18		
		Ceramitec Coated Scissors	178, 179		
		Ceramitec Knowles Bandage Scissors	205		
		Charnley Curette	78		
		Clamp	118		
		Castaneda Enucleation Clamp Forceps	117		
		Scudder Intestinal Clamp	109		
		<b>Cleaner</b>			
		Endozyme AW Triple Plus	30		
		F*A*C*T*S	31		
		Premixslip	30		
		Prepzyme	31		
		Surgistain	30		
		Coller-Crile Forceps	124		
		Commander Utility Shears	206		
		Cone Ring Two Handed Curette	77, 80, 81		
		Cottle Plastic Osteotome	95		
		Courtney Large Animal Liver Biopsy	108		
		<b>Cover</b>			
		Dome Cover	18		
		Solid Flat Cover	18, 19, 20		
		Tip Cover	26		
		Crile Forceps	123		
		Crile-Wood Needle Holder	226		
		CSU Cottle Elevator	91		
		Cup			
		Iodine Cup	23		
		<b>A</b>			
		Aanes Retractor/Speculum	157		
		Adson Cerebella Retractor	154		
		Adson Periosteal Elevator	93		
		Alligator Sterilizing Rack	13		
		Allis Tissue Forceps	122		
		Allis-Willauer Tissue Forceps	122		
		Arthroscopic	42		
		Arthroscopic Curette & Ring Curette	67		
		Arthroscopic Dilation Needle	58		
		Arthroscopic Grasping Forceps	44, 57		
		Arthroscopic Hook Probe	68		
		Arthroscopic Maxi Grasper	50		
		Arthroscopic Meniscotomes Hook	65		
		Arthroscopic Mini Grasper	50		
		Arthroscopic Punch & Scissors	56		
		Arthroscopic Rasp	66		
		Arthroscopic Switch Stick	58		
		Aufricht Saberback Power Cut Black® Scissors	191		
		<b>B</b>			
		Baby Metzenbaum Power Cut Black® Scissors			
		<b>D</b>			
		Davis Cartilage Scissors	185		
		Dean Tonsil & Nasal Scissors	184		
		DeBakey-Adson Tissue Forceps	146		
		DeBakey Thoracic Forceps	141		
		DeBakey Vascular Forceps	144		
		Delicate Freeman-Kaye Ergonomic Spread Handle Saberback Scissors	189		
		Derf Needle Holder	224		
		Dilation Needle	58		
		<b>Dissector</b>			
		Masing Elevator / Dissector	89		
		Dome Cover	18		
		Down Pushing Curette	78		
		Doyen Classic Model Power Cut Gold® Scissors	199		
		Dressing Jar	25		
		<b>Drill</b>			
		Tap Sleeve & Insert Drill Sleeve Set	114		
		Duke Trocar & Drainage Set	115		
		<b>E</b>			
		Ecrasseur Chain	108		
		Egress Cannula Set	60, 61		
		<b>Elevator</b>			
		Adson Periosteal Elevator	93		
		CSU Cottle Elevator	91		
		Foerner Sigmoid Knife Elevator	91		
		Freer Periosteal Elevator	82, 83, 84		
		Joker Periosteal Elevator	87		
		Joseph Masing Elevator	89		
		Joseph Periosteal Elevator	87		
		Key Periosteal Elevator	92		
		Killian Elevator	90		
		Lane Periosteal Elevator	88		
		Lempert Raspatory Elevator	93		
		Love Adson Periosteal Elevator	93		
		Masing Elevator / Dissector	89		
		McIlwraith Periosteal Elevator	87		
		McKenty Elevator	88		
		Pennington Elevator	90		
		Roger Elevator	90		
		Sayre Elevator	92		
		Sontec A O Type Elevator / Raspatory	85, 86		

Sontec Cottle Elevator . . . . .	90
Emasculator	
Reimer Emasculator . . . . .	110
Serra Emasculator . . . . .	110
Serra Modified Emasculator . . . . .	111
Embertson Esophageal Epiglottis Scissors . . . . .	107
Emesis Basin . . . . .	21
Endozime AW Triple Plus® . . . . .	30
Enucleation Scissors . . . . .	117
Equine Epiglottis Entrapment Knife . . . . .	107
Esmarch Heavy Bandage Scissors . . . . .	206
Esophageal Grasping Forceps Horizontal Jaw . . . . .	106
Esophageal Grasping Forceps Vertical Jaw . . . . .	106
Extra . . . . .	72
<b>F</b>	
F*A*C*T*S® . . . . .	31
Femoral Head Disarticulator Knife . . . . .	105
Ferris-Smith Arthroscopic Rongeur . . . . .	34, 35
File	
Sontec Spinal File/Rasp . . . . .	100
Foerner Sesmoid Knife Elevator . . . . .	91
Foerster Sponge Forceps . . . . .	122
Forceps . . . . .	42
Allis Tissue Forceps . . . . .	122
Allis-Willauer Tissue Forceps . . . . .	122
Arthroscopic, Forceps, Biopsy & Grasping Rongeur Forceps . . . . .	42
Arthroscopic Grasping Forceps . . . . .	44, 57
Bainbridge Forceps . . . . .	124
Brown-Adson Tissue Forceps . . . . .	147
Brown Tissue Forceps . . . . .	145
Castaneda Enucleation Clamp Forceps . . . . .	117
Crile Forceps . . . . .	123
DeBakey-Adson Tissue Forceps . . . . .	146
DeBakey Thoracic Forceps . . . . .	141
DeBakey Vascular Forceps . . . . .	144
Esophageal Grasping Forceps Horizontal Jaw . . . . .	106
Esophageal Grasping Forceps Vertical Jaw . . . . .	106
Foerster Sponge Forceps . . . . .	122
Halstead Mosquito Forceps . . . . .	128, 129, 130, 131
Halstead Mosquito Forceps Titanium . . . . .	127
Hartman Mosquito Forceps . . . . .	126
Hartman Mosquito Forceps Titanium . . . . .	127
Hatt Spoon Curette . . . . .	74

**G**

Galt Trepine . . . . .	113
Gelpi Classic Retractor . . . . .	150
Gelpi Deep Angle Neroma (Crossover) Retractor . . . . .	151
Gorney Power Cut Gold Power Cut Black Scissors . . . . .	190
Gouge	
Mini Lexer Gouge . . . . .	89
Grasper	
Arthroscopic Mini Grasper . . . . .	50
Gum Scissors . . . . .	184

**H**

Halstead Mosquito Forceps . . . . .	128, 129, 130, 131
Halstead Mosquito Forceps Titanium . . . . .	127
Hartman Mosquito Forceps . . . . .	126
Hatt Spoon Curette . . . . .	74

Heavyweight Mallet . . . . .	99
Hoehn Grasping Forceps . . . . .	51
Hoffman Utrata Capsulorhexis Forceps . . . . .	116
Hoke Osteotome . . . . .	95
Hook . . . . .	66
Arthroscopic Hook Probe . . . . .	68
Mcllwraith Arthroscopic Hook Probe . . . . .	68
Taylor Micro Arthroscopic Hook Probe & Pick . . . . .	69
Triangle Handle Arthroscopic Meniscotome, Hook, Probe & Knife . . . . .	66
Hooks . . . . .	66
Taylor Micro Arthroscopic Hook Probe . . . . .	69

**I**

Inflow Cannula Set . . . . .	61
INSTRU-BIN . . . . .	31
Instrument Tray . . . . .	21
Iodine Cup . . . . .	23

**J**

Jacobson-Gemini Mixer Right Angle Forceps . . . . .	135, 136
Jar	
Dressing Jar . . . . .	25
Joker Periosteal Elevator . . . . .	87
Joseph Massing Elevator . . . . .	89
Joseph Nasal/Tendon Knife . . . . .	63
Joseph Periosteal Elevator . . . . .	87
Joseph Tendon Knife . . . . .	102

**K**

Kahn-Fomon Scissors . . . . .	190
Kaye Needle Holder . . . . .	219
Kelly Forceps . . . . .	125
Key Periosteal Elevator . . . . .	92
Killian Elevator . . . . .	90
Knife	
Arthroscopic Meniscotomes Hook, Probe & Knife . . . . .	65
Braake Tendon Knife . . . . .	104
Equine Epiglottis Entrapment Knife . . . . .	107
Femoral Head Disarticulator Knife . . . . .	105
Joseph Nasal/Tendon Knife . . . . .	63
Mcllwraith Tendon Knife . . . . .	63
Nasal/Tendon Knife . . . . .	62
Nixon XXL Banana Knife . . . . .	64
Smillie Meniscus . . . . .	103
Tendon Knife . . . . .	63
Triangle Handle Arthroscopic Meniscotome, Hook, Probe & Knife . . . . .	66
Winberg Equine Tendon Knife . . . . .	64
Knife Handle	
Knife Handle #3 . . . . .	101
Knife Handle #3L . . . . .	102
Knife Handle #4 . . . . .	102
Knife Handle #3 . . . . .	101
Knife Handle #3L . . . . .	102
Knife Handle #4 . . . . .	102

Knowles Bandage Scissors . . . . .	204, 205
Knowles Equine Uterine Grasper . . . . .	112
Kocher Forceps . . . . .	134

**L**

Lambotte Osteotome . . . . .	96
Lampert Curette . . . . .	73
Lane Periosteal Elevator . . . . .	88
Large Sontec Combo Mallet . . . . .	99
Lempert Raspatory Elevator . . . . .	93
Long Handle Curette . . . . .	76
Long Handle Curette & Elevator . . . . .	76
Long Tissue Forceps . . . . .	138
Love Adson Periosteal Elevator . . . . .	93
Love-Gruenwald Pituitary Rongeur . . . . .	36

**M**

Magnet	
Universal Magnet for Retrieval/Demagnetizing . . . . .	70
Mallet	
Heavyweight Mallet . . . . .	99
Large Sontec Combo Mallet . . . . .	99
Sontec Combo Nylon Mallet . . . . .	98
Sontec Large Handle Mallet . . . . .	98
Martin Cartilage Tenotomy Classic Power Cut Gold Scissors . . . . .	185
Masing Elevator / Dissector . . . . .	89
Mat	
Silicone Mat . . . . .	13
Mathieu Heavy Needle Holder . . . . .	227
Mayo-Carroll Scissors . . . . .	183
Mayo Classic . . . . .	178, 179
Mayo-Harrington Scissors . . . . .	183
Mayo-Hegar Needle Holder . . . . .	210
Mayo-Lexer Classic Power Cut Gold Power Cut Black TC/PC Power Cut Scissors . . . . .	182
Mayo-Lexer Fino Classic Tungsten Carbide Power Cut Gold Scissors . . . . .	182
Mayo-Stille Classic, Tungsten Carbide, Power Cut Gold, Power Cut Black, TC/PC Power Cut, Ceramic Coated Scissors . . . . .	180, 181
McGravey Tissue Forceps . . . . .	144
Mcllwraith . . . . .	68
Mcllwraith Arthroscopic Grasping Rongeur . . . . .	48
Mcllwraith Arthroscopic Hook Probe . . . . .	68
Mcllwraith Arthroscopic Scissors Rongeur . . . . .	39
Mcllwraith Basket Cutter Rongeur . . . . .	47
Mcllwraith Cup Rongeur . . . . .	47
Mcllwraith-Peapod Rongeur . . . . .	46
Mcllwraith Periosteal Elevator . . . . .	87
Mcllwraith Tendon Grasper / Retriever . . . . .	53
Mcllwraith Tendon Knife . . . . .	63
McKenty Elevator . . . . .	88
Medicine Cup . . . . .	23
Medi-Mark™ Tape . . . . .	28
Meniscotome	
Arthroscopic Meniscotomes Hook, Probe & Knife . . . . .	65
Mini V-Blade Meniscotome . . . . .	105
Piermattei Smillie Meniscotome . . . . .	103

Triangle Handle Arthroscopic Meniscotome, Hook, Probe & Knife . . . . .	66
V Blade Meniscotome . . . . .	105

Meniscus Grasping Forceps . . . . .	51
Metal Instrument Tray . . . . .	19
Metal Micro Instrument Tray . . . . .	8, 9
Metzenbaum Bayonet Power Cut Gold Scissors . . . . .	166
Metzenbaum Brophy Sharp/Sharp Scissors . . . . .	177
Metzenbaum Brophy Sharp/Sharp Tip Scissors . . . . .	176
Metzenbaum Ceramic Coated Power Cut Scissors . . . . .	172
Metzenbaum Ceramitec Power Cut® Scissors . . . . .	174, 175
Metzenbaum Classic Model Scissors . . . . .	160, 161
Metzenbaum Power Cut Black Scissors . . . . .	168, 169, 170, 171
Metzenbaum Power Cut Gold Long Model Scissors . . . . .	167
Metzenbaum Power Cut Gold Scissors . . . . .	164, 165
Metzenbaum Power Cut® Gold Scissors . . . . .	164
Metzenbaum Scissors . . . . .	161
Metzenbaum S-Curved Power Cut Gold Scissors . . . . .	166
Metzenbaum-Toennis Power Cut Black Scissors . . . . .	175
Metzenbaum Tungsten Carbide Long Model Scissors . . . . .	163
Metzenbaum Tungsten Carbide Power Cut® Gold/Black Scissors . . . . .	173
Metzenbaum Tungsten Carbide Scissors . . . . .	162
Meyerding Retractor . . . . .	156
Michele Trepine . . . . .	115
Micro Tip Mixer Right Angle Forceps . . . . .	137
Mini Arthro Small Joints Rongeur Set . . . . .	43
Mini Lexer Gouge . . . . .	89
Mini V-Blade Meniscotome . . . . .	105

**N**

Nasal/Tendon Knife . . . . .	62
Needle Holder	
Crile-Wood Needle Holder . . . . .	226
Derf Needle Holder . . . . .	224
Kaye Needle Holder . . . . .	219
Mathieu Heavy Needle Holder . . . . .	227
Mayo-Hegar Needle Holder . . . . .	210
Olsen-Hegar Deluxe Needle Holder . . . . .	213
Olsen-Hegar Needle Holder . . . . .	212
Olsen-Webster Needle Holder . . . . .	218
Olsen-Webster Needle Holder Titanium . . . . .	217
Par Needle Holder . . . . .	225

Ryder Delicate Needle Holder . . . . .	223
Ryder Needle Holder Titanium . . . . .	220
Ryder Standard Size Needle Holder . . . . .	221, 222
Sontec Mayo-Hegar Needle Holder . . . . .	211
Sontec Olsen-Hegar Deluxe Needle Holder . . . . .	211
Sontec-Olsen-Hegar Deluxe Needle Holder . . . . .	214
Sontec Olsen-Hegar Needle Holder . . . . .	215, 216
Sontec Ryder Needle Holder . . . . .	223
Webster Needle Holder . . . . .	217
Nested Trocar Set . . . . .	115
Nixon XXL Banana Knife . . . . .	64
Non-Perforated Mayo Tray . . . . .	22

**O**

O'Brien Curette . . . . .	78
Olsen-Hegar Deluxe Needle Holder . . . . .	213
Olsen-Hegar Needle Holder . . . . .	212
Olsen-Lahey Right Angle Forceps . . . . .	137
Olsen-Webster Needle Holder . . . . .	218
Olsen-Webster Needle Holder Titanium . . . . .	217
Operating Classic, Tungsten Carbide, Power Cut Gold, Power Cut Black, TC/PC Power Cut Scissors . . . . .	200, 201
Operating Scissors . . . . .	202
Osteotome	
Cottle Plastic Osteotome . . . . .	95
Hoke Osteotome . . . . .	95
Lambotte Osteotome . . . . .	96
Smith Peterson Osteotome . . . . .	94

**P**

Par Needle Holder . . . . .	225
Pennington Elevator . . . . .	90
Perforated Mayo Tray . . . . .	22
Pick	
Bone Pick Micro Fracture . . . . .	69
Taylor Micro Arthroscopic Hook Probe & Pick . . . . .	69
Piermattei Smillie Meniscotome . . . . .	103
Pin Cutter	
Pin Cutter Specialty Harden Jaws . . . . .	119
TC Pin Cutter . . . . .	119
Pin Cutter Specialty Harden Jaws . . . . .	119
Plastic Instrument Tray . . . . .	14
Power Cut Black® . . . . .	178, 179
Power Cut Gold . . . . .	178, 179
Premixlip® . . . . .	30
Prepzyme® . . . . .	31
Probe	
Arthroscopic Hook Probe . . . . .	68
Arthroscopic Meniscotomes Hook, Probe & Knife . . . . .	65
Mcllwraith Arthroscopic Hook Probe . . . . .	68
Taylor Micro Arthroscopic Hook Probe &	



Pick . . . . . 69  
 Triangle Handle Arthroscopic Menis-  
 cotome, Hook, Probe & Knife . . . . . 66  
 Probe & Knife . . . . . 65, 66  
 Probes & Knives . . . . . 66  
 Punch  
 Arthroscopic Punch & Scissors . . . . . 56

**R**

Ragnell Undermining Power Cut Gold Scis-  
 sors . . . . . 196

Rasp  
 Arthroscopic Rasp . . . . . 66  
 Sontec Spinal File/Rasp . . . . .  
 100

Raspatory  
 Lempert Raspatory Elevator . . . . . 93  
 Sontec A O Type Elevator / Raspatory . 85,  
 86  
 Reimer Emasculator . . . . . 110

Retractor  
 Aanes Retractor/Speculum . . . . .  
 157  
 Adson Cerebella Retractor . . . . .  
 154  
 Gelpi Classic Retractor . . . . .  
 150  
 Gelpi Deep Angle Neroma (Crossover)  
 Retractor . . . . . 151  
 Meyerding Retractor . . . . .  
 156  
 Richardson-Eastman Retractor . . . . .  
 154  
 Richardson Retractor . . . . .  
 155  
 Weitlaner Extended Blades Retractor . .  
 153  
 Weitlaner Retractor . . . . .  
 152, 153

Reynolds Tenotomy Classic, Power Cut  
 Gold, Power Cut Black, TC/PC  
 Power Cut Scissors . . . . . 195

Reynolds Tenotomy Scissors . . . . . 194

Richardson-Eastman Retractor . . . . . 154

Richardson Retractor . . . . . 155

Weitlaner Extended Blades Retractor . .  
 153

Weitlaner Retractor . . . . .  
 152, 153

Rongeur  
 Arthroscopic Maxi Grasper . . . . . 50  
 Caspar Grasping Rongeur . . . . . 49  
 Cushing Pituitary Rongeur . . . . . 36  
 Ferris-Smith Arthroscopic Rongeur . . . 34,  
 35  
 Hoen Grasping Forceps . . . . . 51  
 Love-Gruenwald Pituitary Rongeur . . . 36  
 Mcllwraith Arthroscopic Grasping Rongeur  
 . 48  
 Mcllwraith Arthroscopic Scissors Rongeur  
 . 39  
 Mcllwraith Basket Cutter Rongeur . . . . 47  
 Mcllwraith Cup Rongeur . . . . . 47  
 Mcllwraith-Peapod Rongeur . . . . . 46  
 Schlesinger (Cloward) Rongeur . . . . . 37  
 Selverstone Peapod Rongeur . . . . . 40  
 Spurling Pituitary Rongeur . . . . . 37  
 Takahashi Rongeur . . . . . 45

University of Pennsylvania Equine Bi-  
 opsy Rongeur . . . . .  
 112

Wilde-Blakesley Rongeur . . . . . 38

Wilde Ethmoid Arthroscopic Rongeur . . 39

Williams-Sontec Rongeur . . . . . 46

Rotary Arthroscopic Scissors . . . . . 52

Russian Tissue Forceps . . . . . 145

Ryder Delicate Needle Holder . . . . . 223

Ryder Needle Holder Titanium . . . . . 220

Ryder Standard Size Needle Holder . . 221,  
 222

**S**

Sayre Elevator . . . . . 92

Schlesinger (Cloward) Rongeur . . . . . 37

Operating Scissors . . . . . 202

Scissors  
 Arthroscopic Punch & Scissors . . . . . 56  
 Aufricht Saberback Power Cut Black®  
 Scissors . . . . .  
 191  
 Baby Metzenbaum Power Cut Black®  
 Scissors . . . . .  
 172  
 Ceramitec Knowles Bandage Scissors .  
 205  
 Commander Utility Shears . . . . .  
 206  
 Davis Cartilage Scissors . . . . .  
 185  
 Dean Tonsil & Nasal Scissors . . . . .  
 184  
 Delicate Freeman-Kaye Ergonomic Spread  
 Handle Saberback Scissors . . . . .  
 189  
 Doyen Classic Model Power Cut Gold®  
 Scissors . . . . .  
 199  
 Embertson Esophageal Epiglottis Scissors  
 . 107  
 Enucleation Scissors . . . . .  
 117  
 Esmarch Heavy Bandage Scissors . . . .  
 206  
 Freeman-Kaye Ergonomic Spread Handle  
 Saberback Power Cut Gold, Power  
 Cut Black, TC/PC Power Cut Scis-  
 sors . . . . .  
 186  
 Freeman-Kaye Ergonomic Spread  
 Handle Saberback Scissors . . . . .  
 187, 188  
 Gorney Power Cut Gold Power Cut Black  
 Scissors . . . . .  
 190  
 Gum Scissors . . . . .  
 184  
 Jameson Tenotomy Classic, Tungsten  
 Carbide, Power Cut Gold, Power Cut  
 Black, TC/PC Power Cut Scissors  
 . 192, 193  
 Kahn-Fomon Scissors . . . . .  
 190  
 Knowles Bandage Scissors . . . . .  
 204, 205  
 Martin Cartilage Tenotomy Classic  
 Power Cut Gold Scissors . . . . .

185

Mayo-Carroll Scissors . . . . .  
 183

Mayo Classic, Tungsten Carbide, Power  
 Cut Gold, Power Cut Black®, TC/  
 PC Power Cut®, Ceramitec Coated  
 Scissors . . . . .  
 178, 179

Mayo-Harrington Scissors . . . . .  
 183

Mayo-Lexer Classic Power Cut Gold Power  
 Cut Black TC/PC Power Cut Scissors  
 . 182

Mayo-Lexer Fino Classic Tungsten Carbide  
 Power Cut Gold Scissors . . . . .  
 182

Mayo-Stille Classic, Tungsten Car-  
 bide, Power Cut Gold, Power Cut  
 Black, TC/PC Power Cut, Ceramic  
 Coated Scissors . . . . .  
 180, 181

Metzenbaum Bayonet Power Cut Gold  
 Scissors . . . . .  
 166

Metzenbaum Brophy Sharp/Sharp Scis-  
 sors . . . . .  
 177

Metzenbaum Brophy Sharp/Sharp Tip  
 Scissors . . . . .  
 176

Metzenbaum Ceramic Coated Power Cut  
 Scissors . . . . .  
 172

Metzenbaum Ceramitec Power Cut® Scis-  
 sors . . . . .  
 174, 175

Metzenbaum Classic Model Scissors . .  
 160, 161

Metzenbaum Power Cut Black Scissors  
 . 168, 169, 170, 171

Metzenbaum Power Cut Gold Long  
 Model Scissors . . . . .  
 167

Metzenbaum Power Cut Gold Scissors  
 . 164, 165

Metzenbaum Scissors . . . . .  
 161

Metzenbaum S-Curved Power Cut Gold  
 Scissors . . . . .  
 166

Metzenbaum-Toennis Power Cut Black  
 Scissors . . . . .  
 175

Metzenbaum Tungsten Carbide Long  
 Model Scissors . . . . .  
 163

Metzenbaum Tungsten Carbide Power  
 Cut® Gold/Black Scissors . . . . .  
 173

Metzenbaum Tungsten Carbide Scissors  
 . 162

Operating Classic, Tungsten Carbide,  
 Power Cut Gold, Power Cut Black,  
 TC/PC Power Cut Scissors . . . . .  
 200, 201, 202, 203

Ragnell Undermining Power Cut Gold  
 Scissors . . . . .  
 196

Reynolds Tenotomy Classic, Power Cut

Gold, Power Cut Black, TC/PC  
 Power Cut Scissors . . . . .  
 195

Reynolds Tenotomy Scissors . . . . .  
 194

Rotary Arthroscopic Scissors . . . . . 52

Stussak Metzenbaum Power Cut Gold  
 Scissors . . . . .  
 175

Taylor Bandage Scissors . . . . .  
 206

Utility Scissors . . . . .  
 207

Scudder Intestinal Clamp . . . . . 109

Selverstone Peapod Rongeur . . . . . 40

Semken Forceps . . . . . 143

Serra Emasculator . . . . . 110

Serra Modified Emasculator . . . . . 111

Set  
 Mini Arthro Small Joints Rongeur Set . 43  
 Small Joint Arthroscopic Cannula Switch  
 Stick Set . . . . . 58  
 Sontec-Cottle Osteotome Set . . . . . 97  
 Silicone Mat . . . . . 13  
 Singley Tuttle Forceps . . . . . 146  
 Skinner Tissue Forceps . . . . . 142  
 Small Joint Arthroscopic Cannula . . . . . 58  
 Small Joint Arthroscopic Cannula Switch  
 Stick Set . . . . . 58  
 Small Joint Complete Arthroscopic Set . 59  
 Smillie Meniscus . . . . . 103  
 Smith Peterson Osteotome . . . . . 94  
 Solid Flat Cover . . . . . 18, 19, 20  
 Sontec A O Type Elevator / Raspatory . 85,  
 86  
 Sontec Combo Nylon Mallet . . . . . 98  
 Sontec Cottle Elevator . . . . . 90  
 Sontec-Cottle Osteotome Set . . . . . 97  
 Sontec Large Handle Mallet . . . . . 98  
 Sontec Mayo-Hegar Needle Holder . 211  
 Sontec Olsen-Hegar Deluxe Needle Holder .  
 211  
 Sontec-Olsen-Hegar Deluxe Needle Holder .  
 214  
 Sontec Olsen-Hegar Needle Holder . 215,  
 216  
 Sontec Ryder Needle Holder . . . . . 223  
 Sontec Sheet Tape . . . . . 27  
 Sontec Slim Thermo Plastic Instrument Tray.  
 16, 17  
 Sontec Spinal File/Rasp . . . . . 100

Speculum  
 Aanes Retractor/Speculum . . . . .  
 157  
 Castroviejo Equine Eye Speculum . . . .  
 116

Spinal Curette . . . . . 72

Sponge Bowl . . . . . 24

Spoon  
 Wells Enucleation Spoon . . . . .  
 116

Spurling Pituitary Rongeur . . . . . 37

Sterilization Tray / Bath Set . . . . . 18

Sterilizing Rack  
 Alligator Sterilizing Rack . . . . . 13

Stussak Metzenbaum Power Cut Gold Scis-  
 sors . . . . . 175

Suction  
 Baby Poole Suction . . . . .

114

Surgistain® . . . . . 30

Switch Stick . . . . . 58

**T**

T115-450 . . . . . 123

Takahashi Rongeur . . . . . 45

Tape  
 Medi-Mark™ Tape . . . . . 28  
 Sontec Sheet Tape . . . . . 27

Tap Sleeve & Insert Drill Sleeve Set . . 114

Taylor Bandage Scissors . . . . . 206

Taylor Micro Arthroscopic Hook Probe . . 69

Taylor Micro Arthroscopic Hook Probe &  
 Pick . . . . . 69

TC/PC Power Cut® . . . . . 178, 179

TC Pin Cutter . . . . . 119

Tear Drop Spinal Curette . . . . . 79

Telescoping Metal Fragment Retriever . . 70

Tendon Knife . . . . . 63

Thermoplastic Instrument Tray . . . . . 10, 11

Thermoplastic Instrument Trays . . . . . 12

Thumb Dressing Forceps . . . . . 139

Tip Cover . . . . . 26

Tissue Forceps with Teeth . . . . . 140

Tray  
 Catheter Tray . . . . . 18  
 Instrument Tray . . . . . 21  
 Metal Instrument Tray . . . . . 19  
 Metal Micro Instrument Tray . . . . . 8,  
 9  
 Non-Perforated Mayo Tray . . . . . 22  
 Perforated Mayo Tray . . . . . 22  
 Plastic Instrument Tray . . . . . 14  
 Sontec Slim Thermo Plastic Instrument  
 Tray . . . . . 16,  
 17  
 Sterilization Tray / Bath Set . . . . . 18  
 Thermoplastic Instrument Tray . . . . . 10,  
 11  
 Thermoplastic Instrument Trays . . . . . 12

Trephine  
 Galt Trephine . . . . .  
 113  
 Michele Trephine . . . . .  
 115

Triangle Handle Arthroscopic Meniscotome .  
 66

Trocar  
 Duke Trocar & Drainage Set . . . . .  
 115  
 Nested Trocar Set . . . . .  
 115

Tungsten Carbide . . . . . 178, 179

Two Handed Curette . . . . . 75

**U**

Universal Magnet for Retrieval/Demagnetiz-  
 ing . . . . . 70

University of Pennsylvania Equine Biopsy  
 Rongeur . . . . . 112

Uterine Equine Forceps . . . . . 112

Uterine Equine Tenaculum Forceps . . 109

Utility Scissors . . . . . 203, 207

V Blade Meniscotome . . . . . 105

Virginia Roaring Burr Long . . . . . 113

Virginia Roaring Burr Short . . . . . 113

**W**

Webster Needle Holder . . . . . 217

Weitlaner Extended Blades Retractor . . 153

Weitlaner Retractor . . . . . 152, 153

Wells Enucleation Spoon . . . . . 116

Whisk 'R Brush™ . . . . . 29

Wilde-Blakesley Rongeur . . . . . 38

Wilde Ethmoid Arthroscopic Rongeur . . 39

Williams-Sontec Rongeur . . . . . 46

Willis Ovariometer . . . . . 108

Winberg Equine Tendon Knife . . . . . 64







## Sonlec Instruments®

A TRADITION OF FINE SURGICAL INSTRUMENTS

Sonlec Instruments, Inc.  
7219 South Tucson Way  
Centennial, Colorado 80112 USA  
Tel-Free : 800.821.7193  
Local : 303.793.9411  
Fax : 303.792.2606

[SonlecInstruments.com](http://SonlecInstruments.com)