

UNIT -1 MOTHERBOARD COMPONENTS

Learning Objectives:

Learner should be able to

- Acquire the skills of motherboard and its components
- Explain the basic concepts of processor.
- Differentiate the types of processor technology
- Describe the concepts of chipsets
- Differentiate the features of PCI,AGP, USB and processor bus

Introduction:

To troubleshoot the PC effectively, a student must be familiar about the components and its features. This chapter focuses the motherboard and its components. Motherboard is an important component of the PC. The architecture and the construction of the motherboard are described. This chapter deals the various types of processors and its features. The architecture of chip sets is described. The various bus standards of PC are also covered. Students must be able to disassemble and reassemble the unit quickly.

Motherboard Components:

The motherboard is a printed circuit board located on the back side or at the bottom of the computer case. It allocates power and allows communication to the CPU, RAM, and all other hardware components. The base of a motherboard consists of a very firm sheet of non-conductive material. Thin layers of copper or aluminum foil, called as traces, are printed onto this sheet. These traces form the circuits between the various components. In addition to circuits, a motherboard contains a number of sockets and slots to connect the other components. Figure 1.1 shows the motherboard with parts labeled.

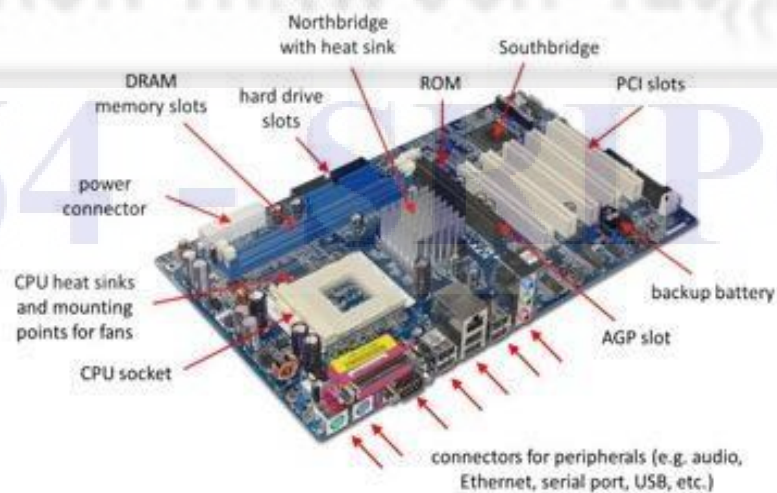
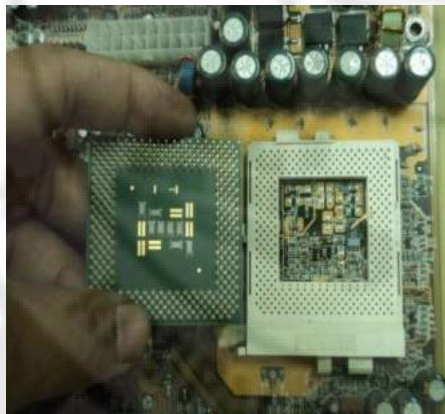

Figure 1.1 Motherboard.

Processor Sockets/slots

A processor or CPU socket or CPU slot comprises one or more mechanical components and electrical connections between a microprocessor and a printed circuit board (PCB). This allows for placing and replacing the CPU without soldering. Every motherboard contains at least one processor socket and the location varies from motherboard to motherboard. There are two types of Sockets. They are Pin grid array (PGA) and Land Grid array (LGA). A pin grid array (PGA) where pins on the underside of the processor connect to holes in the processor socket. Figure 1.2 shows the pictures of PGA and LGA slots. The land grid array (LGA) contains pins on the socket (when a socket is used) rather than the integrated circuit.



PGA



LGA

Figure 1.2 PGA and LGA Sockets

The table below lists some of the latest sockets.

	Pins	Processor	Computer Type
Socket T	775 LGA	Core 2 Duo	Desktop
Socket GT	988 rPGA	Core i3,i5,i7	Notebook
Socket H	1156 LGA	Core i3,i5,i7	Desktop
Socket AM4	1131 PGA	AMD Zen Processor	Desktop
Socket R	2011 LGA	Xeon Processor	Server

Table1.1 Latest sockets

Memory Sockets

Memory slot, memory socket, or RAM slot allows computer memory (RAM) to be inserted into the computer. Depending on the motherboard, there may be 2 to 4 memory slots and it also determines the type of RAM used with the computer. The most common types of RAM are Synchronous Dynamic RAM (SDRAM) and Double Data Rate (DDR) for desktop computers and Small Outline Dual Inline Memory Module (SODIMM) for laptop computers, each having various types and speeds. The different types of memory sockets are available. Single inline memory module sockets (SIMM) are used to hold DRAM. Double inline memory sockets (DIMM) are use to hold SDRAM, DDR, etc. Rambus Inline Memory Module (RIMM) sockets are used to hold RDRAM. Figure 1.3 shows the different types of memory sockets.

SIMM Socket

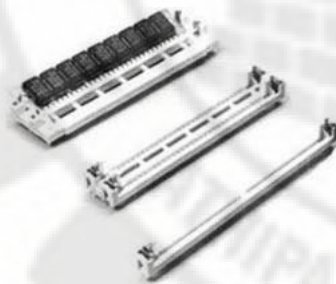

DIMM Socket

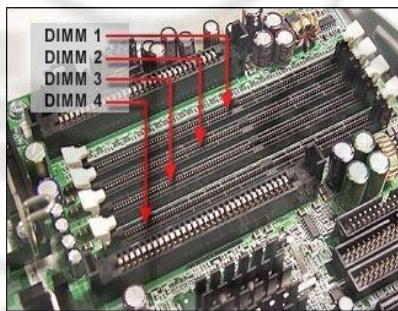

RIMM Socket



Figure 1.3 Different types of Memory Sockets

Chipsets

A chipset is a set of electronic components in an integrated circuit that manages the data flow between the processor, memory and peripherals. It is usually found on the motherboard. Chipsets are unique for specific family of microprocessors because it controls communications between the processor and external devices. It determines the nature of the motherboard components such as type, speed of CPU, memory type, speed and Size, hard disk, number and speed of USB ports, number of PCI slot. The Figure 1.4 shows the chipset.



Figure 1.4 Chip set

Cache

Cache memory is small fast memory in between CPU and main memory. It is otherwise called static RAM (SRAM). Cache memory increases the execution speed of the computer. During execution, the needed data blocks are loaded from main memory to cache. It is transferred to CPU. There are three levels of cache. They are

- (i) Level 1 cache (Primary cache)
- (ii) Level 2 cache
- (iii) Level 3 Cache

- (i) Level 1 cache

This cache is within the CPU. This is used as a temporary storage of instructions and data. These are organized in blocks of 32 bytes. CPU gets the information and data from this cache memory without any delay. The size of this cache varies from 8kb to 64kb.

- (ii) Level 2 cache

This cache is present outside the CPU. This is used to bridge CPU and memory but in some versions like Pentium pro, multi core systems, this cache is present inside the CPU. The size of the cache is 256KB or 512 KB.

- (iii) Level 3 Cache

A Level 3 (L3) cache is built on the motherboard and, in certain special processors, built within the CPU module itself. It works together with the L1 and L2 cache to improve computer performance. The L3 cache feeds information to the L2 cache, which then forwards information to the L1 cache.

BIOS

The BIOS is an acronym for Basic Input / Output System and also known as the System BIOS, ROM BIOS or PC BIOS, is a type of firmware used to perform hardware initialization during the booting process (power-on startup) on computers. It provides runtime services for operating systems and programs. The BIOS is the first software run on the computer when powered on. The fundamental purposes of the BIOSs are to initialize and test the system hardware components, and to load a boot loader or an operating system from a mass memory device. The BIOS additionally provides an abstraction layer for the hardware, i.e., a consistent way for application programs and operating systems to interact with the keyboard, display, and other input/output (I/O) devices. The different functions of BIOS are

- (i) Start up routines
- (ii) Service handling routines
- (iii) Hardware interrupt handling routines

(i) **Start up routines**

This routine starts functioning as soon as the machine is switched on. It inspects all the hardware components and conducts some simple test to check whether everything is functioning normally. If any component is faulty, it gives an error message. This process is called power-on-self test (POST). If any plug and play devices are present, it assigns their resources. After all the tests are over, BIOS tries to find the drive to boot the machine. For this it first checks drive A for boot record. If it is not present, it checks the hard disk. If it is present, the boot program begins the process of loading the operating systems. If no bootable disk is present the following message is displayed.

“System requires a system disk”

The searching sequence of drive for boot record can be changed with the help of CMOS setup.

(ii) **Service handling routines**

This routine is to perform the requests from the programs. The important requests are:

- (i) To clear the display screen
- (ii) To switch screen from text mode to graphic mode
- (iii) To write information on the printer

To perform these requests, BIOS interacts directly with the computer's I/O devices.

(iii) **Hardware interrupt handling routines**

This routine is to perform work for the hardware part of the computer and is working with the help of service handling programs. For example when a key is pressed on the keyboard, the keyboard generates an interrupt. The „hardware interrupts routine“ services the interrupt and displays the character.

Clock generator

Clock generator is an electric circuit which generates a continuous sequence of clock pulses. These pulses are used to synchronize a circuit operation. The clock generator in a motherboard is often changed by computer enthusiasts to control the speed of their CPU, FSB, GPU and RAM. Typically the programmable clock generator is set by the BIOS at boot time to the selected value; although some systems have dynamic frequency scaling, which frequently re-programs the clock generator.

RTC

A real-time clock (RTC) is a computer clock that keeps track of the current time. RTCs often have an alternate source of power, so they can continue to keep time while the primary source of power is off or unavailable. This alternate source of power is normally a lithium battery in older systems, but some newer systems use a super capacitor because they are rechargeable and can be soldered.

Super I/O Controller

Super I/O controller is an integrated circuit that began to be used on personal computer motherboards. The functions of the super I/O controller are as follows:

- (i) A floppy-disk controller
- (ii) An IEEE 1284-compatible parallel port (commonly used for printers)
- (iii) One or more 16C550-compatible serial port UARTs
- (iv) An embedded controller and/or keyboard controller that is sometimes connected to a PS/2 keyboard and/or mouse interface.
- (v) An Intel 8254-compatible programmable interval timer
- (vi) A battery-backed real-time clock and nonvolatile BIOS memory

Power Connector

Power connectors are cables with sockets used to give power supply to the motherboard components. The size shape and number of pins vary with the type of the connector. The following are some important type of power connectors

- (i) 24 pin ATX power connector
- (ii) 16 pin SAT power connector
- (iii) 6 pin PCI Express power connector
- (iv) 4 pin FDD power connector

Battery

All motherboards contain a CR2032 coin battery. This battery is used to power the ROM which contains BIOS. Normally batteries last up to 10 years. Incorrect or slow system date and time or loss of BIOS settings are the signs of a dead battery.

Keyboard / Mouse Connectors

The keyboard connector is the device at the end of the cable that is used to attach the keyboard to the system. There are two standard types of connectors. The older style is the larger of the two, called the 5-pin DIN keyboard connector. The smaller is the 6-pin, so-called "mini-DIN" keyboard connector. (DIN stands for Deutsches Institut Norm, a German standards-setting organization.) The smaller connector was introduced on the IBM model PS/2 and is therefore sometimes called a "PS/2 connector". It has replaced the larger connector as the standard for modern PCs. Figure 1.5 shows the DIN connectors.



Figure 1.5 A 5-pin DIN and a 6-pin mini-DIN keyboard connector

The signal assignments for each connector are found in the table below.

Table 1.2 Signal assignments of the connectors.

Pin #	5-pin DIN Connector	6-pin "mini-DIN" Connector
1	Keyboard Clock	Keyboard Data
2	Keyboard Data	(not connected)
3	(not connected)	Ground
4	Ground	Power (+5V)
5	Power (+5V)	Keyboard Clock
6	--	(not connected)

Mouse Connector

A mouse connector is a dedicated socket or interface in the computer for connecting a mouse. There are three types of mouse. 9 pin DIN connector, 6 pin PS/2 connector, USB connector. Figure 1.6 shows the types of mouse connectors.

9 pin DIN connector



PS/2



USB Port



Figure 1.6 Different types of mouse connectors

Jumpers

Jumpers allow the computer to close an electrical circuit, allowing the electricity to flow through certain sections of the circuit board. Jumpers consist of a set of small pins that can be covered with a small plastic box (jumper block) as shown in the Figure 1.7. Jumpers are used to configure the settings for computer peripherals such as the motherboard, hard drives, modems, sound cards, and other components. For example, in motherboard supported intrusion detection, a jumper can be set to enable or disable this feature.

Back of IDE hard disk drive



IDE interface cable

Jumpers

Power connection

<http://www.computerhope.com>

Figure 1.7 Jumpers

Ports and Headers

Ports are connectors used to connect external cables and devices to the motherboard. Some types of motherboard have integrated serial and parallel ports. Motherboards that don't use integrated ports use headers on the motherboard instead. Headers are groups of pins used to connect devices or ports to the motherboard. A cable runs from the port and is plugged into the header on the board. The following are some commonly used ports.

- Serial Port header : There are usually two serial port headers. Each has 9 or 10 pins
- Parallel Port header: This header is used for the external parallel port and has 26 pins (25 are actually used).

Unit-1 Motherboard Components

PS/2 Mouse Port: The PS/2 mouse header has 5 pins.

USB (Universal Serial Bus): A new technology, USB is proposed to be the new standard for connecting devices such as keyboards, mice and external modems to the PC. This header has 10 pins.

IR (Infrared) Port: Some motherboards have a header to allow you to run a connection for an infrared communications port, typically used for wireless communication to printers and similar devices. Infrared ports are far more common on laptop computers than desktop machines. These headers have 4 or 5 pins.

Primary and Secondary IDE/ATA Hard Disk Interface: Most new motherboards have integrated headers for two IDE Channels. Each has 40 pins.

Floppy Disk Interface: Most newer motherboards provide a 34-pin header for the floppy disk cable.

SCSI: Some motherboards have integrated SCSI ports or headers; they are either 50 or 68 pins in size, depending on the flavor of SCSI implemented.

Pin Connectors

The motherboard provides several connectors that are attached to the case LEDs, indicators, and switches. The physical layout of these connectors can vary a lot as well; some motherboards physically separate these connectors on the board while others group many together into a large "multifunction connector".

Motherboard Form factor

The form factor describes the general layout of the case, the positioning of the slots in the back of the case, and the way that the case matches to the major components that fit into it. The three main components that must be matched in terms of their form factor are the case, the power supply, and the motherboard. Table 1.3 shows the form factors for the different motherboard.

Table 1.3 Forms Factors of the different motherboards.

Style	Width	Depth	Where Found	Match to Case and Power Supply
Full AT	12"	11-13"	Very Old PCs	Full AT, Full Tower
Baby AT	8.5"	10-13"	Older PCs	All but Slimline, ATX

Unit-1 Motherboard Components

ATX	12"	9.6"	Newer PCs	ATX
Mini ATX	11.2"	8.2"	Newer PCs	ATX
LPX	9"	11-13"	Older Retail PCs	Slimline
Mini LPX	8-9"	10-11"	Older Retail PCs	Slimline
NLX	8-9"	10-13.6"	Newer Retail PCs	Slimline

Hardware, Software and Firmware

Hardware

Hardware is the physical parts or components of a computer, such as the monitor, keyboard, computer data storage, hard disk drive (HDD), graphic cards, sound cards, memory (RAM), motherboard, and so on, all of which are tangible physical objects.

Software

Software is a collection of instructions that enable the user to interact with a computer, its hardware, or perform tasks. There are two types of software. Application software solves the particular problem and system software controls the operation of the computer.

Firmware

Firmware is a type of software that provides control, monitoring and data manipulation of engineered products and systems. Typical examples of devices containing firmware are embedded systems (such as traffic lights, consumer appliances, remote controls and digital watches), computers, computer peripherals, mobile phones, and digital cameras. Firmware is held in non-volatile memory devices such as ROM, EPROM, or flash memory. Changing the firmware of a device may rarely or never be done during its lifetime; some firmware memory devices are permanently installed and cannot be changed after manufacture.

764 - SRIPC

Mother Board

2.1 Architecture and Block diagram of motherboard

Motherboard includes peripherals, interface cards, and daughter cards: sound cards, video cards, network cards, hard drives, or other forms of persistent storage; TV tuner cards, cards providing extra USB or FireWire slots and a variety of other custom components. It has no additional expansions or capability, such as controlling boards in laser printers, televisions, washing machines and other embedded systems with limited expansion abilities.

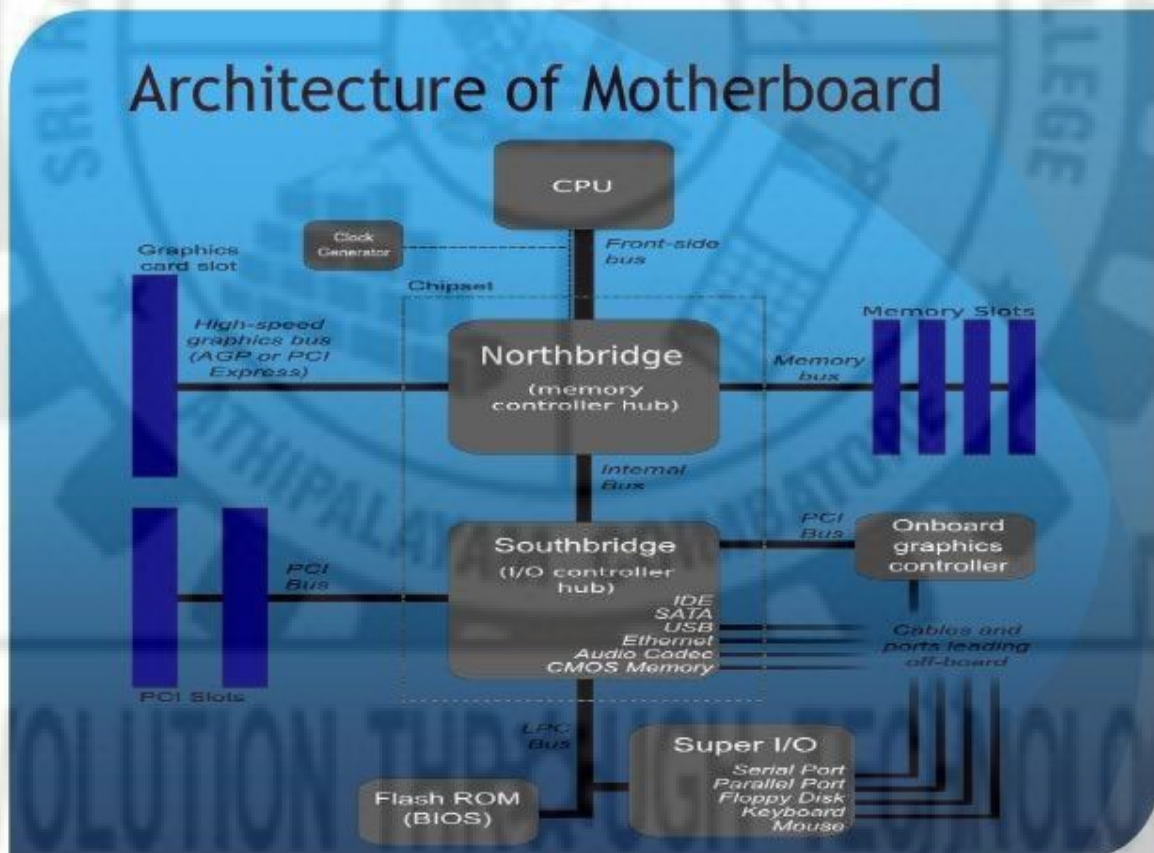

Figure 1.8 Architecture of motherboard.

The Figure 1.8 shows the architecture of motherboard.

Processor Socket

The processor socket is the central piece of a motherboard that holds the processor (brain of the computer) and it is located near the center of the motherboard.

Power Connectors

The power connector, commonly a 20 or 24-pin connector, can be situated either near the right edge of the motherboard, or somewhere close to the processor socket on older motherboards. Newer motherboards have an additional 4-pin or 8-pin connector near the processor for additional power.

Memory Slots

Located in the upper-right part of the motherboard, the memory slots are used to hold the memory modules. The low-end motherboards have two memory slots. High end memory and gaming slots have 8 memory slots. It is important to pay attention on types of memory a motherboard supports. Newer motherboards support DDR3 memory. The older motherboard model supports different types of memory with two DDR1 memory slots and 2 DDR2 memory slots, or two DDR2 slots and two DDR3 slots. The number of memory slots determines the maximum amount of memory.

Video Card Slot

It is available as PCI-Express slot on newer motherboards or AGP on older ones, the video card slot is situated right below the processor. High-end gaming motherboards come with multiple video card slots, allowing the installation of multiple video cards in a SLI or Crossfire configuration.

Expansion Slots

Expansion slots allow installing additional components and to enhance or expand the functionality of the PC. For example TV tuner, a video capture card, a better soundcard, etc may be installed. These ports are located under the video card slot, and come in the form of PCI slots (on older motherboards) or a scaled-down version of PCI-Express slots (on newer motherboards). Some motherboards come with both types of expansion slots. The number of slots is usually dependent on the format of the motherboard – larger motherboards (full ATX) have more, while smaller formats (micro-ATX) have fewer, if any.

IDE and SATA Ports

IDE and SATA ports are used to provide connectivity for the storage devices and optical drives. The current version of SATA interface achieves maximum speeds of up to 600 MB/s, as opposed to the IDE interface, which can reach a maximum of 133 MB/s.

BIOS Chip and Battery

The BIOS chip contains the basic code that boots the computer up to the point where the operating system takes over. Since the BIOS code is stored on a memory chip that needs constant power to function, a battery is also present to keep the chip powered when the computer is unplugged.

Northbridge and Southbridge

A square metal component located somewhere in the lower-right part of the board. This metal component is actually a heat sink, and its role is to provide thermal protection for the Northbridge – one of the most important components of a motherboard. The northbridge is responsible for coordinating the data flow between the memory, the video card and the processor. A secondary chip, known as Southbridge, has a similar function, coordinating the data flow between the processor and peripherals such as sound cards or network cards.

Front Panel Connectors, USB Headers and Audio Header

The front panel connector is where all the elements present on the front of the case. Power button, reset button, power LED, audio connectors and USB connectors are all connected to the front panel or the corresponding headers.

Rear Connectors

These connectors are the bridge between the outside of the computer and the inside. The connectors are actually located on the left edge of the motherboard; however, since these connectors are accessible from the outside, the name simply implies where they are accessible from – the rear of the PC case. External peripherals such as keyboard, mouse, monitor, speakers and so on are all connected via these connectors.

Processors

Introduction

A processor is the logic circuit that processes the basic instructions which drives the computer. It is called as Central Processing Unit (CPU). The four primary functions of a processor are fetch, decode, execute and write back.

The basic elements of a processor are:

- i. The arithmetic logic unit (ALU), carries out arithmetic and logic instructions.
- ii. The floating point unit (FPU), also called as math coprocessor or numeric processor that manipulate numbers.
- iii. Registers, which hold instructions and other data. Registers supply operands to the ALU and store the results of operations.
- iv. L1 and L2cache memory. It saves the CPU time compared to having to get data from random access memory (RAM).
- v. Multi-core processor contains two or more processors that enhances the performance, reduces power consumption and performs multiple tasks.

Properties of the Processor are as follows

- i. All the signals are in the form of binary 0"s and 1"s
- ii. It determines binary 1 by 3.3V and binary 0 by 0V
- iii. Processors are based on instruction set and are able to take a decision according to the input data. The decisions are carried out using logic gates.
- iv. The number of binary bits that can be handled at a time is different for different processors.
- v. The number of instructions carried out per second is called the speed of the CPU. This is different for different processors.

Core2 Duo processor

Core 2 is basically a brand name which refers to the wide range of Intel’s processors. These models are embedded on single die or integrated circuit which is embedded on the two ICs. This technique enables the user to perform multiple tasks simultaneously using software and processor at the same time. The ranges of products associated with the core 2 Duo technology are listed in table 1.4. Intel core 2 duo processors come in both 45nm and 65nm having virtualization, trusted execution technology and clock speed of about 2 GHz.

TABLE 1.4 Range of Products associated with the Core 2 Duo Technology

Processor type	Year of release	Features
E4300	2007	L2 cache of 2 MB
E4400	April 2007	
E4500 and E4600	October 2007	
E4700	March 2008	Frequency rate of 2600 MHz

Features

- i. It has sustained backward compatibility with the software and existing hardware.
- ii. It is efficient enough to run two operating systems at a time by help from working virtual machines. (The virtual machines are smart enough to share physical hardware, having separate operating system and busy running their own applications.)
- iii. It has advanced security features and enables to set the trusted Platform Module.
- iv. It has L2 cache. Its size varies from 1 MB to 6 MB.
- v. Its operating speed varies from 1.8 GHz to 3.3 GHz. The speed of front side bus is 533 or 800 MHz or 1066 MHz or 1333 MHz or 1600 MHz.

Figure 1.9 shows the memory structure of core duo processor.

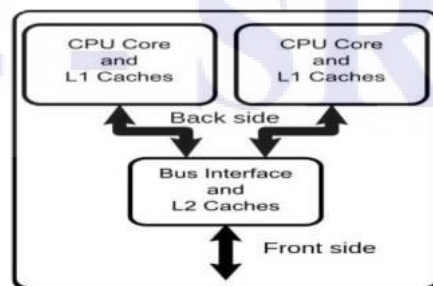

Figure 1.9 Memory Structure

Quad Core processor

A quad-core processor is a chip with four independent units called cores that read and execute central processing unit (CPU) instructions such as add, move data, and branch. Each core operates in conjunction with other circuits such as cache, memory management, and input/output (I/O) ports. The individual cores can run multiple instructions at the same time, increases the overall speed for programs and compatible with parallel processing. Quad-core and higher multi-core processor configurations are used in general-purpose computing, PC, mobile devices such as smart phones and tablets. The quad-core CPU has the ability to do complicated work more quickly than dual-core or single-core processors. It performs more tasks at the same time. Virus scans, modern 3-D video games, video editing and graphics programs can run together smoothly. The three key architectural differences between the current dual core and phase 2 quad core processors are shown in Figure 1.10.

1. Each of the cores in the quad core processor has a slower clock speed compared to the dual core processor.
2. There is a different cache hierarchy, with smaller L2 caches and a new shared L3 cache.
3. Memory is increased from 6GB to 8GB per processor with an increased transaction frequency.

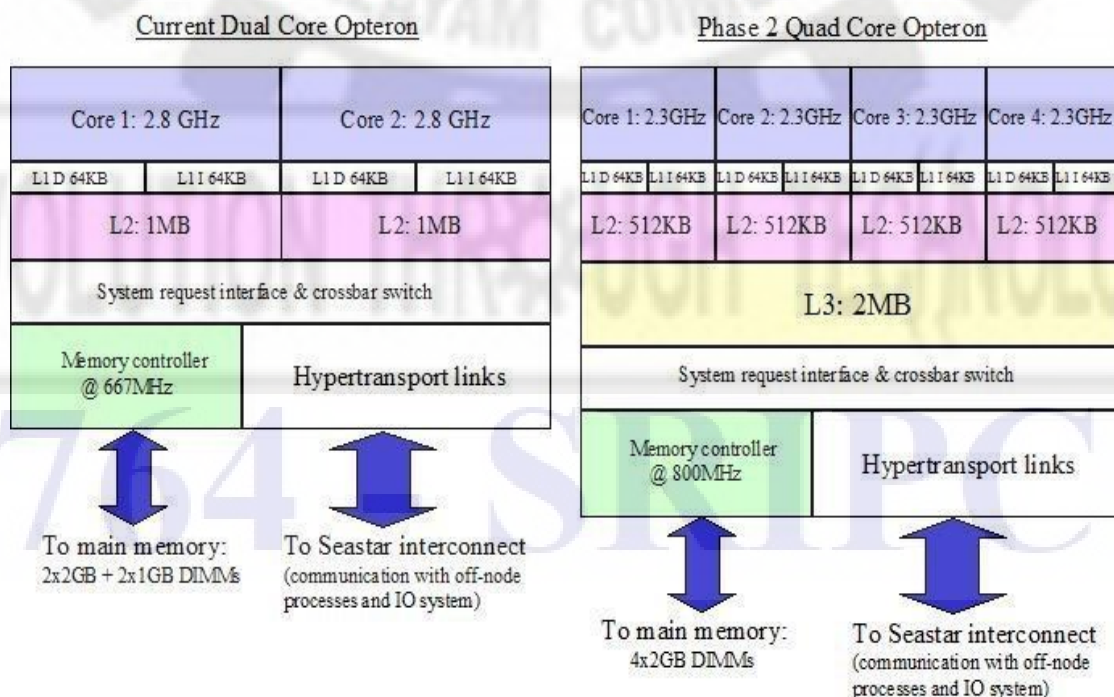

Figure 1.10: The architectural differences between the current dual core and Phase 2 quad core processors.

Core i3, i5, i7 series

With the release of the Nehalem micro architecture in November 2008, Intel introduced a new naming scheme for its Core processors. There are three variants, Core i3(low level), Core i5(mid range) and Core i7. Common features of all Nehalem based processors include an integrated DDR3 memory controller, Quick Path Interconnect or PCI Express and Direct Media Interface. All these processors have 256 KB L2 cache per core, plus up to 12 MB shared L3 cache.

Core i3

Intel intended the Core i3 as the new low end of the performance processor line from Intel. The first Core i3 processors were launched on January 7, 2010. The first Nehalem based Core i3 was Clarkdale-based, with an integrated GPU and two cores. The Core i3-3xxM processors are based on Arrandale, the mobile version of the Clarkdale desktop processor. They are similar to the Core i5-4xx series but running at lower clock speeds and without Turbo Boost. Intel 5 series chipset supports non-ECC memory only with the Core i5 or i3 processors, using those processors on a motherboard with 3400 series chipsets, it supports the ECC function of ECC memory. Feature of core i3 series is shown in Table 1.5.

Table 1.5 Features of Core i3 series

Codename	Brand name	Cores	L3 Cache	Socket	TDP	I/O Bus
Clarkdale	Core i3	2	4 MB	LGA 1156	73 W	Direct Media Interface, Integrated GPU
Arrandale	Core i3-3xxM		3 MB	rPGA-988A	35 W	
	Core i3-3xxUM		3 MB	BGA-1288	18 W	

Core i5

The first Core i5 using the Nehalem micro architecture was introduced on 2009, as a mainstream variant of the earlier Core i3, the Lynnfield core. Lynnfield Core i5 processors have an 8 MB L3 cache, a DMI bus running at 2.5 GT/s and support for dual-channel DDR3-800/1066/1333 memory and have Hyper-threading disabled. A new feature called Turbo Boost Technology was introduced which maximizes speed for demanding applications, dynamically accelerating performance to match the workload.

Unit-1 Motherboard Components

The Core i5-5xx mobile processors are named Arrandale and based on the 32 nm Westmere shrink of the Nehalem micro architecture. Arrandale processors have integrated graphics capability but only two processor cores. They were released in January 2010, together with Core i7-6xx and Core i3-3xx processors based on the same chip. The L3 cache in Core i5-5xx processors is reduced to 3 MB, while the Core i5-6xx uses the full cache and the Core i3-3xx does not support for Turbo Boost. Clarkdale, the desktop version of Arrandale, is sold as Core i5-6xx, along with related Core i3 and Pentium brands. It has Hyper-Threading enabled and the full 4 MB L3 cache. Table 1.6 shows the features of i5 series.

Table 1.6 Features of Core i5 series

Codename	Brand name	Cores	L3 Cache	Socket	TDP	I/O Bus
Lynnfield	Core i5-7xx	4	8 MB	LGA 1156	95 W	Direct Media Interface
	Core i5-7xxS				82 W	
Clarkdale	Core i5-6xx	2	4 MB	rPGA-988A	73-87 W	Direct Media Interface, Integrated GPU
Arrandale	Core i5-5xxM		3 MB		35 W	
	Core i5-4xxM					
	Core i5-5xxUM			BGA-1288	18 W	
	Core i5-4xxUM					

Core i7

Intel Core i7 as an Intel brand name applies to several families of desktop and laptop 64-bit x86-64 processors using the Nehalem, Westmere, Sandy Bridge, Ivy Bridge, Haswell, Broadwell and Skylake microarchitectures. The first six-core processor in the Core lineup is the Nehalem-based Gulftown, which was launched on March 16, 2010. Core i7 has family members using two distinct system-level architectures, and therefore two distinct sockets (for example, LGA 1156 and LGA 1366 with Nehalem). In each generation, the highest-performing Core i7 processors use the same socket and QPI-based architecture as the medium-end Xeon processors of that generation, while lower-performing Core i7 processors use the same socket and PCIe/DMI/FDI architecture as the Core i5. Table 1.7 shows the features of core i7 series.

Table 1.7 Features of Core i7 series

Code name	Brand name	Cores	L3 Cache	Socket	TDP	Process	Buses	Release Date
Gulftown	Core i7-9xxX Extreme Edition	6	12 MB	LGA 1366	130 W	32 nm	QPI, 3 × DDR3	Mar 2010
	Core i7-970							Jul 2010
Bloomfield	Core i7-9xx Extreme Edition	4	8 MB	LGA 1156	95 W	45 nm	DMI, PCI-e, 2 × DDR3	Nov 2008
	Core i7-9xx (except Core i7-970/980)							Sep 2009
Lynnfield	Core i7-8xx	4	8 MB	LGA 1156	82 W	45 nm	DMI, PCI-e, 2 × DDR3	Jan 2010
	Core i7-8xxS				55 W			Sep 2009
Clarksfield	Core i7-9xxXM Extreme Edition	4	6 MB	rPGA-988A	45 W	45 nm	DMI, PCI-e, 2 × DDR3	Sep 2009
	Core i7-8xxQM				35 W			Jan 2010
	Core i7-7xxQM				25 W			
Arrandale	Core i7-6xxM	2	4 MB	BGA-1288	18 W	32 nm	DMI, PCI-e, FDI, 2 × DDR3	Jan 2010
	Core i7-6xxLM				35 W			
	Core i7-6xxUM				25 W			

AMD Series

Advanced Micro Devices, Inc. (AMD) is an American multinational semiconductor company. AMD's main products include microprocessors, motherboard chipsets, embedded processors and graphics processors for servers, workstations and personal computers and embedded systems applications. AMD was founded in 1969 in Sunnyvale USA. It was considered to be the second largest supplier of X86 architecture and third largest supplier of graphic processors. AMD is a manufacturer of many leading processor technologies like AM2900, AMD 29K, AMD7910 and AMD7911. The various generations of microprocessors include AM2900 series, X86 Architecture processors, K5 series, K6 series, K7 series, K8 series, K9 series and K10 series. The features of AMD are as follows

- i. It has advance clock calibration, which alters the internal settings of the computer by allowing individual settings of the core and the CPU.

Unit-1 Motherboard Components

- ii. AMD supports virtualization, which is known as the virtual extension of AMD 86 processors.
- iii. It allows for low voltage and power utilization and hence low temperature of the PC.
- iv. Enhanced virus protection prevents the buffer overloading and attack of malicious viruses. Presidio is a viable feature of AMD processors because it makes use of particular commands for trusted computations.
- v. Hyper transport is a major replacement for front buses and can also be used for direct connect architecture.
- vi. Thermal design power helps the processors to determine the maximum heat.

AMD K10 family is the latest generation of AMD x86 microprocessors. K10 families cover three main market segments - desktop, mobile and server, and are divided into three main groups in accordance with processors' price and performance:

- i. Budget processors - Sempron, Athlon II, and Sempron Mobile.
- ii. Mid-class microprocessors - Athlon X2, Athlon II X2 / X3 / X4, and Athlon II Dual-Core Mobile.
- iii. High-performance families - Phenom X3 / X4, Phenom II X2 / X3 / X4 / X6, Turion II Dual-Core Mobile, and Turion II Ultra Dual-Core Mobile.
- iv. Server families: Third-Generation Opteron, Six-Core Opteron and Opteron 6100 series.

K10 microprocessors include many performance improvements. The most important ones are listed below:

- i. Contain up to 6 cores per die, or up to 12 cores per CPU.
- ii. Integrate large level 3 cache shared between all cores.
- iii. Faster HyperTransport link.
- iv. Improved integrated memory controller which may be configured as dual-channel controller, or as two single channel controllers. Memory controller supports DDR3 memory.
- v. Recent generations of K10 families are built on more modern 0.045 process, which allows better CPU frequency scaling.
- vi. The width of AMD Floating Point unit was increased to 128 bits.
- vii. Enhanced branch prediction and out-of order execution.
- viii. It has enhanced power management features.

Unit-1 Motherboard Components

The CPUs can dynamically adjust frequency of individual cores depending on their load, change voltage of integrated memory independently from core voltage of CPU cores, and include other power-saving features

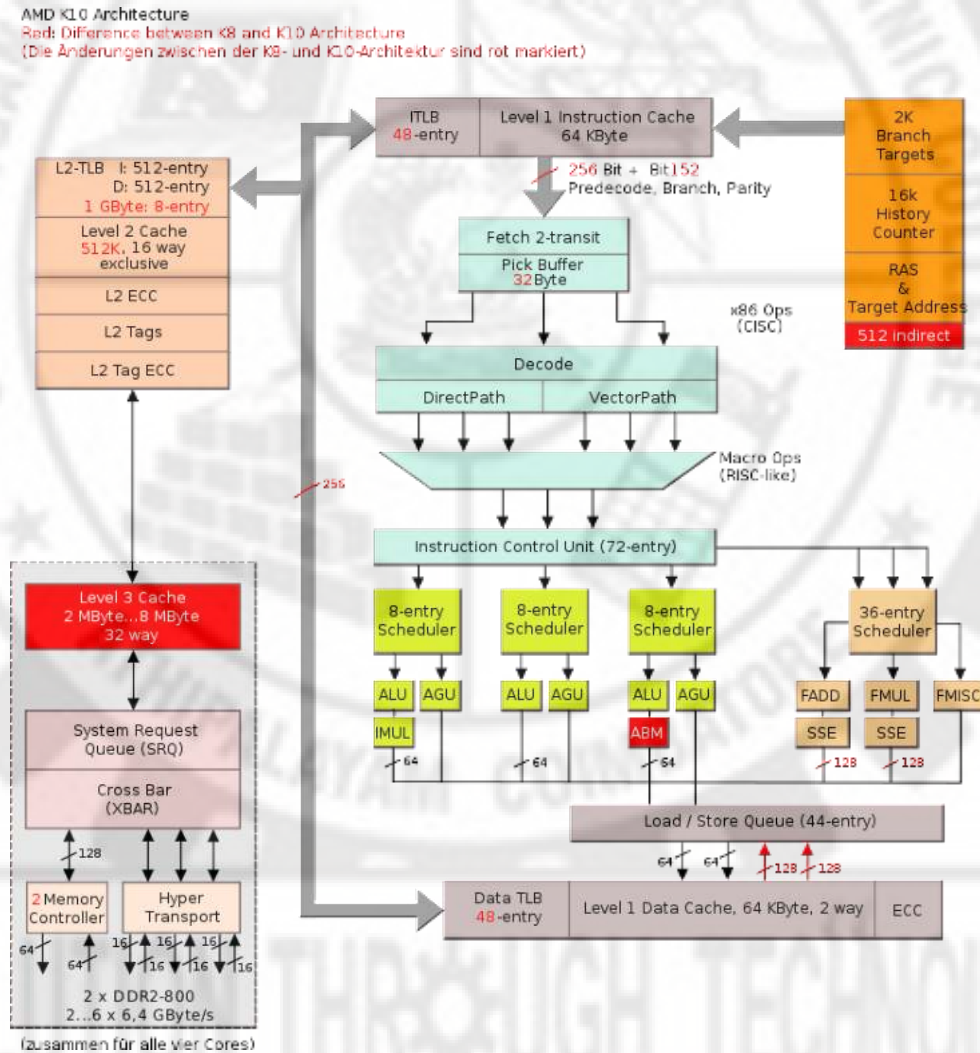

Figure 1.11 shows the architecture of AMD K10.

Phenom II is a family of AMD's multi-core 45 nm processors using the AMD K10 micro architecture. The Phenom II X4 operates as the processor component of AMD's Dragon Platform. It has 790 series chipset and Radeon HD 4800 series graphics.

Features

The Phenom II triples the shared L3 cache size from 2MB (in the original Phenom line) to 6MB. it reduces the effectiveness of over clocking the CPU and RAM, but also decreases power consumption and heat output. Socket AM3 versions of the Phenom II are backwards-compatible with Socket AM2+, The AM3 memory controller supports both DDR2 and DDR3 memory (up to DDR2-1066 and DDR3-1333), "Thuban" and "Zosma" Phenom II

Unit-1 Motherboard Components

processors support AMD's Turbo Core over clocking performance-boost technology. Some top-level AM3 processors (x945 125W, x955 and x965) require a special power-supply feature, often called "dual power-plane". It's supported by default in all native AM3 main boards, however not in most AM2+ main boards, even those advertised as "AM3 optimized" or "AM3 ready".

Table 1.7 List of AMD Phenom microprocessors

AMD Phenom II-based processor family					
AMD K10	Desktop				
	Hex-core	Quad-core	Quad-core	Triple-core	Dual-core
Code-named	Thuban	Zosma	Deneb	Heka	Callisto
Process	45 nm	45 nm	45 nm	45 nm	45 nm
Date released	Apr 2010	Jun 2010	Jan 2009	Feb 2009	Jun 2009

Phenom II CPUs are based on two dies: the original Deneb die with four cores and the new Thuban die with six. These are divided into five series for marketing. The first two series are flagships based on full dies. The other three series are formed from Deneb dies by die harvesting, that is, chips that were produced with some amount of defects. The affected portions of these chips are disabled and the chips themselves marked as a lower-grade product. Figure 1.12 shows the die of four-core Phenom II processor

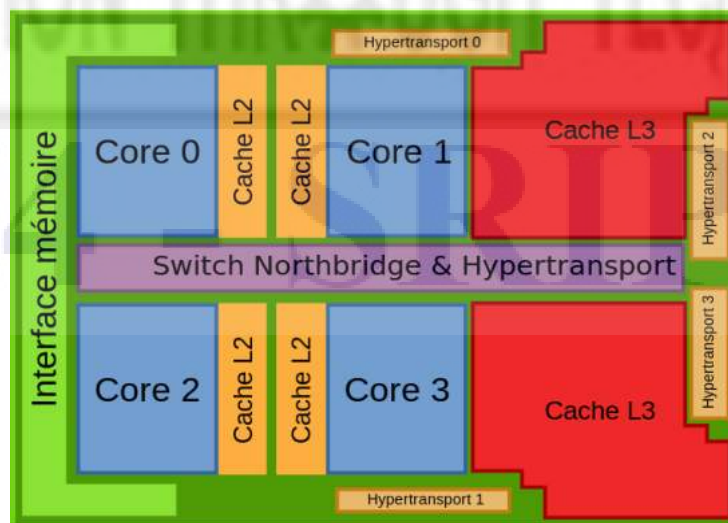

Figure 1.12 Die of a four-core Phenom II processor.

Xeon processor

The Xeon is a brand of x86 microprocessors designed, manufactured, and marketed by Intel Corporation. It has multi-socket, higher core counts, and support for ECC memory. A Xeon Phi co-processor can be used with existing Xeon processor to provide increased computing power, requiring an available PCI Express 3.0 x16 slot in x16, or x8 mode. Intel Xeon CPUs support the following chipsets: Z87, X99, and for dual CPUs the C600 series of chipsets. Disadvantages of Xeon processors are unsuitable for most consumer-grade desktop PCs, lower clock rates, absence of an integrated GPU, and non-existent support for overclocking. Despite such disadvantages, Xeon processors preferred by desktop users, (primarily gamers, and extreme users) mainly due to higher core count potential, and higher price to performance ratio vs. the Core i7. Because Intel Xeon CPUs lack an integrated GPU, they require graphics installed in an available PCI Express x16 slot. Figure 1.16 shows the picture of Xeon processor. The architecture of Xeon Processor is shown in Figure 1.13.



Figure 1.13 Picture of Xeon Processor

Xeon features:

- i. It has faster L1 and L2 cache, either 512 Kbytes or 1 Mbytes, which runs at the same 400 MHz clock speed of the processor.
- ii. A faster bus to carry data between the processor, RAM, and I/O devices. The 450NX PClset is a chipset that works at a 100 Mhz clock speed and supports up to 8 GB of extended data output RAM memory.
- iii. A larger Accelerated Graphics Port (AGP) chip set called the 440GX AGP set that also runs at 100 Mhz. It supports 2 GB of 100 Mhz SDRAM .
- iv. An extended server memory architecture that provide for 36-bit addresses, allowing up to 64 GB of physical memory to be addressed.
- v. It has 32 or 64 bit instruction set. Figure shows the block diagram of Xeon wood crest processor having two cores.

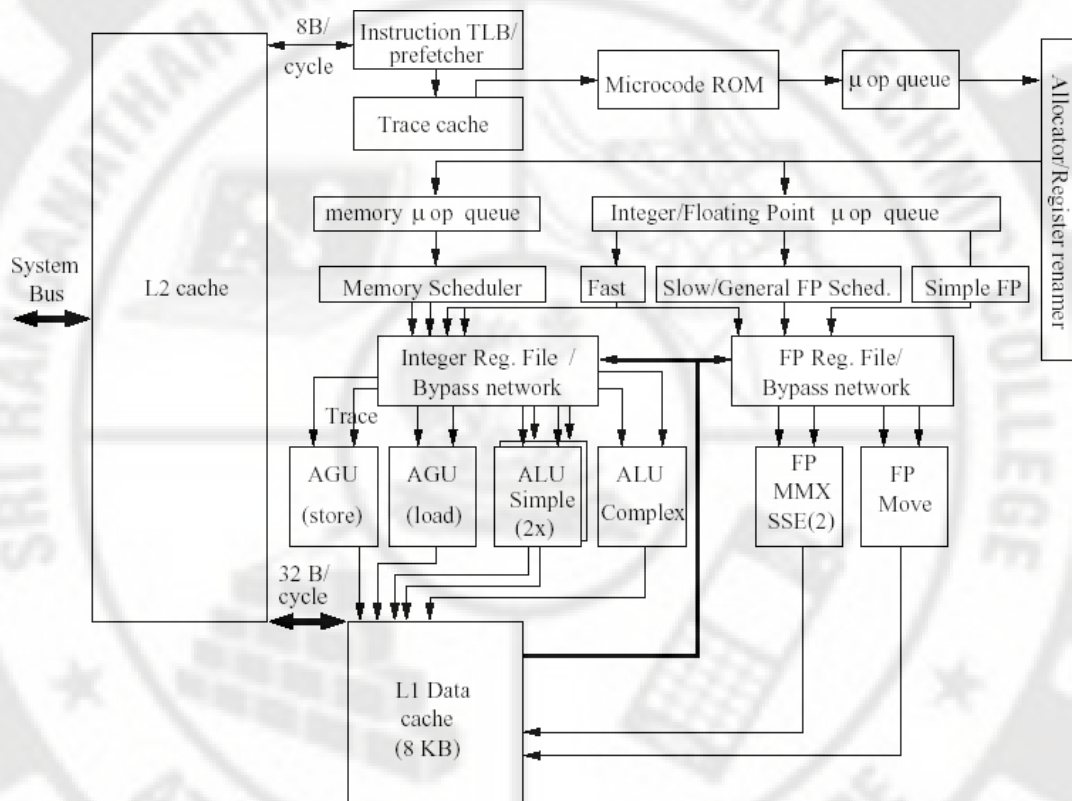

Figure 1.14 Architecture of Xeon Processor

Chipsets

Chipset basics

The term chipset often refers to a specific pair of chips on the motherboard: the north bridge and the south bridge. The north bridge links the CPU to very high-speed devices, especially RAM and graphics controllers, and the south bridge connects to lower-speed peripheral buses (such as PCI or ISA). In many modern chipsets, the south bridge contains some on-chip integrated peripherals, such as Ethernet, USB, and audio devices. Manufacturers of chipsets for x86 motherboards include AMD, Broadcom, Intel, NVIDIA, SiS and VIA Technologies.

North/South Bridge architecture

North bridge is connected directly to the CPU via the front side bus (FSB) and is responsible for tasks that require the highest performance. The north bridge is usually paired with a south bridge, also known as I/O controller hub. These two chips manage communications between the CPU and other parts of the motherboard, and constitute the core logic chipset of the PC motherboard. Integrating more functions onto fewer

Unit-1 Motherboard Components

components, decreases overall motherboard cost and improves performance. The advantage of integrating the memory controller on the CPU reduces the latency from the CPU to memory.

The functionality of the Southbridge is as follows:

- i. PCI bus. The PCI bus supports the traditional PCI specification, but may also include support for PCI-X and PCI Express (PCIe).
- ii. ISA bus or LPC bridge. ISA support remains an integrated part of the modern south bridge, though ISA slots are no longer provided on more recent motherboards. The LPC bridge provides a data and control path to the super I/O (the normal attachment for the keyboard, mouse, parallel port, serial port, IR port, and floppy controller) and FWH (firmware hub which provides access to BIOS flash storage).
- iii. SPI bus. The SPI bus is a simple serial bus mostly used for firmware (e.g., BIOS) flash storage access.
- iv. SM Bus. The SM Bus is used to communicate with other devices on the motherboard (e.g., system temperature sensors, fan controllers, SPDs).
- v. DMA controller. The DMA controller allows ISA or LPC devices direct access to main memory without needing help from the CPU.
- vi. Interrupt controllers such as 8259A and/or I/O APIC. The interrupt controller provides a mechanism for attached devices to get attention from the CPU.
- vii. Mass storage controllers such as PATA and/or SATA. This typically allows direct attachment of system hard drives.
- viii. Real-time clock. The real time clock provides a persistent time account.
- ix. Power management (APM and ACPI). The APM or ACPI functions provide methods and signaling to allow the computer to sleep or shut down to save power.
- x. Nonvolatile BIOS memory. The system CMOS (BIOS configuration memory), assisted by battery supplemental power, creates a limited non-volatile storage area for system configuration data
- xi. Intel High Definition Audio sound interface.
- xii. Out-of-band management controller such as a BMC or HECI.

Optionally, a south bridge also includes support for Ethernet, RAID, USB, audio codec, and FireWire. Where support is provided for non-USB keyboard, mouse, and serial

ports, a machine normally does so through a device referred to as a Super I/O; still more rarely, a south bridge may directly support the keyboard, mouse, and serial ports. The architecture of North bridge and South bridge is shown in Figure 1.15.

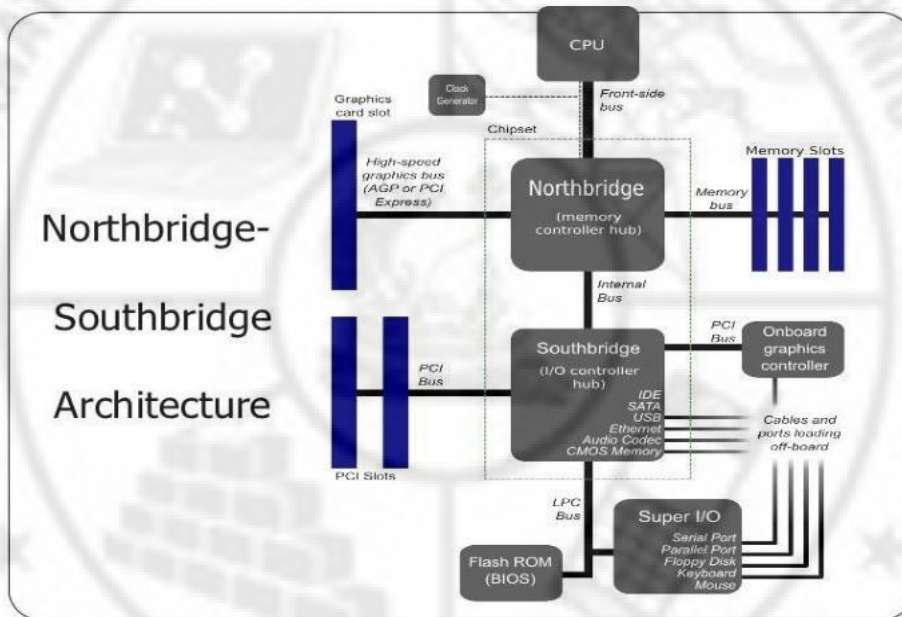

Figure 1.15 North bridge and South bridge Architecture

Hub architecture

Intel's architecture for the 8xx family of chipsets uses a memory controller hub (MCH) that is connected to an I/O controller hub (ICH) via a 266 MB/sec bus. The MCH chip supports memory and AGP, while the ICH chip provides connectivity for PCI, USB, sound, IDE hard disks and LAN. The IHA optimizes data transfer based on data type. The architecture of Intel hub is shown in Figure 1.16.

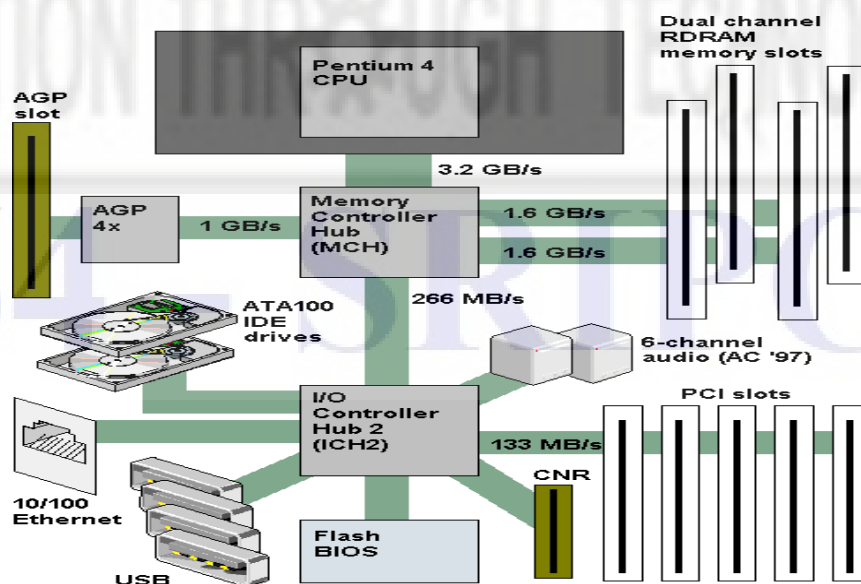

Figure 1.16 Architecture of Intel Hub

Unit-1 Motherboard Components

Intel hub architecture starting with the 820 chipset, divides control between a memory controller chip (MCH) and an I/O controller chip (ICH). An illustration of the 850 is shown in figure. The memory controller is a digital circuit that manages the flow of data going to and from the computer's main memory. A memory controller can be a separate chip or integrated into another chip, or as an integral part of a microprocessor called an integrated memory controller (IMC). A memory controller is also called a memory chip controller (MCC) or a memory controller unit (MCU). Memory controllers contain the logic necessary to read and write to DRAM, and to "refresh" the DRAM. Reading and writing to DRAM is performed by selecting the row and column data addresses of the DRAM as the inputs to the multiplexer circuit, where the demultiplexer on the DRAM uses the converted inputs to select the correct memory location and return the data, which is then passed back through a multiplexer to consolidate the data in order to reduce the required bus width for the operation. Bus width is the number of parallel lines with range between 8-bit to 512-bit. Memory controllers, such as the one integrated into Power QUICC II processors, can be connected to different kinds of devices at the same time, including SDRAM, SRAM, ROM, and memory-mapped I/O. It has error detection and correction hardware facility.

Bus Standards

A bus is a communication system that transfers data between components inside a computer, or between computers. Buses are parallel electrical wires with multiple connections. Modern computer buses use both parallel and bit serial connections.

PCI

The PCI stands for Peripheral Component Interconnect. It is high performance Bus that is used to integrate chips, processor, memory subsystems and expansion boards. This bus was designed by Intel in 1992 for integrating chips on a board. Initially it supported 32 bit but now it also supports 64 bit transmission.

The features of PCI bus are:

- i. Synchronous Bus Architecture: PCI is a synchronous Bus. Data transfers in PCI bus takes place according to a system clock. The maximum clock frequency is 66 MHz.
- ii. 64 Bit Addressing: PCI bus supports 64 bit addressing. With PCI Bus, 64 Bit addressing can be implemented with the same 32 Bit connector.
- iii. Linear Burst Mode Data Transfer: PCI supports the feature of 'Burst Data Transfer'. With Burst Data Transfer, the data can be transferred at very high speeds. Data transfer speeds is 266 MB/sec for 32 bit data.
- iv. Large Bandwidth: It can handle both 32 bit as well as 64 bit data. For 32 bit data, the maximum bandwidth will be 132 MB/sec which becomes more when Burst Data

Transfer mode is used. It comes out to 364 MB/sec when Burst Data Transfer is used.

The conceptual diagram of PCI is shown in Figure 1.17.

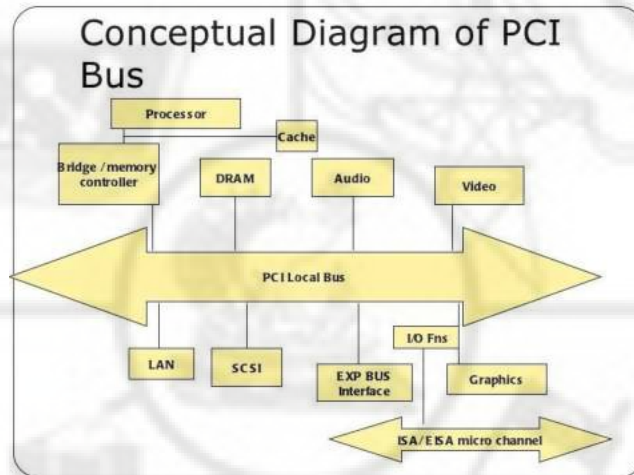

Figure 1.17 Conceptual Diagram of PCI

AGP

Accelerated Graphics Port (AGP) is an interface specification developed by Intel Corporation. It enables 3-D graphics (for example, from Web sites or CD-ROMs to display quickly on ordinary personal computers. It is useful in programs such as gaming, three-dimensional (3D) video, and sophisticated scientific/engineering graphics. AGP has dedicated point-to-point channel that connects the graphics controller and main memory for direct access. The AGP channel is 32 bits wide and runs at 66 MHz. This translates into a total bandwidth of 266 MBps, as opposed to the PCI bandwidth of 133 MBps. AGP also supports two optional faster modes, with throughputs of 533 MBps and 1.07 GBps. In addition, AGP allows 3-D textures to be stored in main memory rather than video memory. The system requirements for AGP are Chipset, motherboard with AGP slot and the operating system must be the OSR 2.1 version of Windows 95, Windows 98 or Windows NT and macintoshes. The following features are considered optional:

- i. Texturing: Also called Direct Memory Execute mode, allows textures to be stored in main memory.
- ii. Throughput: Various levels of throughput are offered: 1X is 266 MBps, 2X is 533 MBps; and 4X provides 1.07 GBps.
- iii. Sideband Addressing: Speeds up data transfers by sending command instructions in a separate, parallel channel.

- iv. Pipelining: Enables the graphics card to send several instructions together instead of sending one at a time.

The Block diagram of AGP is shown in Figure 1.18

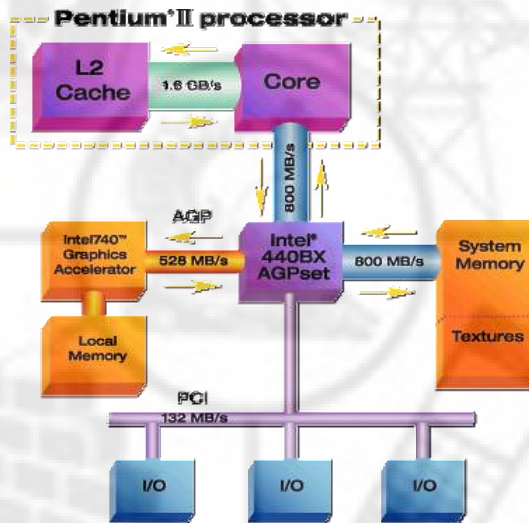

Figure 1.18 Block diagram of AGP.

USB

Figure shows the picture of USB.



Figure 1.19 USB

It is designed to allow many peripherals to be connected using a single standardized interface. It provides an expandable, fast, bi-directional, low-cost, hot-pluggable Plug and Play serial hardware interface that allows the users to plug different peripheral devices into a USB port and have them automatically configured and ready to use. USB allows the user to connect a wide range of peripheral devices, such as keyboards, mice, printers, scanners, mass storage devices, telephones, modems, digital still-image cameras, video cameras, audio devices to a computer. The USB has the following key features:

- i. Single connector type: It eliminates the need for different cables and connectors and thus simplifying the design of the USB devices. USB devices can be connected directly to a standard USB port on a computer.

Unit-1 Motherboard Components

- ii. Hot-swappable: USB devices can be safely plugged and unplugged
- iii. Plug and Play: Operating system software automatically identifies, configures, and loads the appropriate device driver when a user connects a USB device.
- iv. High performance: USB offers low speed (1.5 Mbit/s), full speed (12 Mbit/s) and high speed (up to 480 Mbit/s) transfer rates that can support a variety of USB peripherals. USB 3.0 (Super Speed USB) achieves the throughput up to 5.0 Gbit/s.
- v. Expandability: Up to 127 different peripheral devices may be connected to a single bus at one time.
- vi. Power supplied from the bus: USB distributes the power to all connected devices eliminating the need for external power source for low-power devices. High-power devices can still require their own local power supply. USB also supports power saving suspend/resume modes.
- vii. Easy to use for end user: A single standard connector type for all USB devices simplifies the end user's task at figuring out which plugs go into which sockets. The operating system automatically recognizes the USB device attachment and loads appropriate device drivers.
- viii. Low-cost implementation: low-cost connection for peripherals makes the design simple and low cost.

USB Specification

The specification describes the bus attributes, the protocol definition, types of transactions, bus management, and the programming interface required to design USB compatible peripherals and software. The comparison of different versions is shown in table below.

USB Revision	USB1.0	USB2.0	USB3.0
Media (Data Size)	Transfer Time		
Song / Pic (4 MB)	5.3 sec	0.1 sec	0.01 sec
256 Flash (256 MB)	5.7 min	8.5 sec	0.8 sec
USB Flash (1 GB)	22 min	33 sec	3.3 sec
SD-Movie (6 GB)	2.2 hr	3.3 min	20 sec
USB Flash (16 GB)	5.9 hr	8.9 min	53.3 sec
HD-Movie (25GB)	9.3 hr	13.9 min	70 sec

Unit-1 Motherboard Components

The actual maximum throughput may vary depending on the transfer type, maximum packet size, time reserved for control transfers, the overhead due to signaling imposed bit stuffing etc.

Processor bus

Processor bus is defined as the bus that provides the path for communication between the main buses and the central processing unit. It also serves as the communication medium between the central processing units and other chipboard devices in the CPU. Size of the processor bus varies with the type of the processor and CPU brand. But it depends on the length of the data word. The block diagram of the bus is shown below

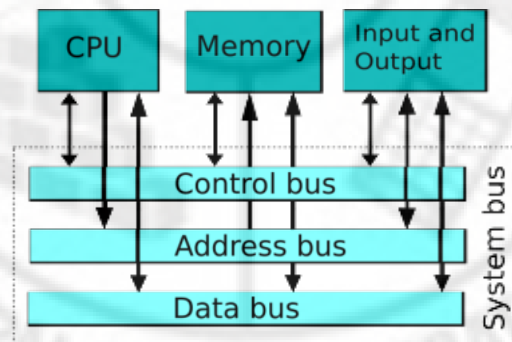

Figure 1.20 Block diagram of the System bus.

A system bus is a single computer bus that connects the major components of a computer system, combining the functions of a data bus to carry information, an address bus to determine where it should be sent, and a control bus to determine its operation.

Review Questions

PART -A

1. What is the function of motherboard?
2. List the components of the motherboard.
3. List the latest sockets with computer type.
4. What is a chip set?
5. What are the levels of cache memory? Write short notes on it.
6. What are the functions of BIOS?
7. How a real time Clock keeps track of the current time even when the power is off?
8. Define the term power connector. List its types.

Unit-1 Motherboard Components

9. Draw the different types of keyboard and mouse connector.
10. What is the purpose of jumper?
11. What are port and headers?
12. Tabulate the different types of motherboard form factor and match with its case and power supply.
13. Draw the architecture of the motherboard.
14. Differentiate north bridge and south bridge
15. How many processors can be installed in a motherboard?
16. What are the different form factors of motherboard?
17. Name any two motherboard manufactures.
18. What is a chipset?
19. Define jumpers.
20. Define Ports and Headers.
21. What is pin connector?
22. Tabulate the different form factors of motherboard.
23. Define Hardware, software and firmware.
24. List the properties of processor.
25. Range the products associated with core 2 duo technology.
26. State the three architectural differences between the dual core and 2 quad core processor.
27. What are the features of core i3,i5,and i7 series?
28. What are the key features of AMD opteron?
29. What are the disadvantages of Xeon processor?
30. What is northbridge and southbridge?
31. What are the various bus standards?
32. List the specifications of USB.
33. Define processor bus.

PART-B

1. Explain the structure of the generic motherboard.
2. Explain the block diagram of the motherboard.
3. Explain the functional block diagram of the motherboard.
4. Explain the core2 Duo processor in detail.
5. Explain the quad core processor.
6. Explain features of Core i3,i5,i7.
7. Draw the architecture of AMD K10 processor.
8. Draw the architecture of Phenom II processor.
9. Draw the architecture of opteron processor.

Unit-1 Motherboard Components

10. Explain the north/south bridge architecture.
11. Explain the hub architecture.
12. Discuss the features of different bus standards.

REVOLUTION THROUGH TECHNOLOGY

764 - SRIPC

UNIT -2 MEMORY AND I/O DEVICES

Learning Objectives:

Learner should be able to

- Define the terminologies such as memory, memory speed, access time and wait states.
- Classify the memory types.
- Understand the working of hard disk, formatting and to diagnose the problems.
- Know the Importance and applications of removal storages and its drives.
- Types of keys, Construction and working principle of keyboard.
- Understand and repair computer keyboards.
- Know the operation of mouse and how to troubleshoot the mouse.
- Understand the types, working, maintenance and troubleshooting concepts of printers and scanners.

Introduction

In this chapter few basic terminologies such as memory speed, access time and wait states are outlined. It also shows the working principles of hard disk, removal storage devices such as DVD- ROM, DVD, Blu ray, USB Flash drives, Keyboard, optical mouse, printers and scanners. This chapter also provides troubleshooting tips for memory and I/O devices.

Primary and Secondary Memory

Primary memory is computer memory that a processor or computer accesses first or directly. It allows a processor to access running execution applications and services that are temporarily stored in a specific memory location. Primary memory is also known as primary storage or main memory. Primary memory holds only those data and instructions on which computer is currently working. It has limited capacity and data is lost when power is switched off. It is generally made up of semiconductor device. These memories are not as fast as registers. It is divided into two subcategories RAM and ROM. Characteristics of main memory are as follows

- (i) Usually volatile memory.
- (ii) It is working memory of the computer.
- (iii) Faster than secondary memories.
- (iv) A computer cannot run without primary memory



1. Memory Speed

This is simply the speed at which the memory is rated to run. If the memory is rated at DDR3-1600 (PC3-12800), it's rated to run on a 800MHz Front Side Bus. Since it processes data on both the rising and falling edges of the clock pulse, it acts as 1600MHz RAM. The PC3-12800 indicates that the data throughput is 12.8Tb per second. The DDR part of the name means that it can read/write data at twice the memory bus speed. For example, this memory is rated at 333MHz. This means that the bus speed is 166MHz. It can pass data at twice the bus clock speed because it processes data on both the rising AND falling portions of the clock pulse. DDR-333 RAM labeled as PC2700 RAM. The 2700 in PC2700 means that it can process 2.7GB (2.7 billion bytes) of data per second.

2. Access time

Access time is the time from the start of one storage device access to the time when the next access can be started. Access time consists of latency (the overhead of getting to the right place on the device and preparing to access it) and transfer time. Access time to RAM is usually measured in nanoseconds. Access time to a hard disk or CD-ROM is usually measured in milliseconds.

3. Wait states

A pause in the processor's clock cycles while it waits for data, wait states frequently occur when the computer's processor has a higher clock speed than other components, such as memory.

4. Main memory

A program is first loaded in the computer memory before it is executed. The instructions of the loaded program are executed one by one by the CPU. The data and results of calculations are also stored in the main memory. The main memory is also known as working area of the computer. A computer cannot work without having main memory. A computer system consists of two types of memories.

i) RAM

ii) ROM

Structure of Main Memory

The main memory used in modern computer is built in the form of a chip. The chip is made of a semi-conductor material. The main memory of a computer consists of thousands 0s or 1s. These cells are logically organized into group of 8 bits called a byte. Figure 2.1 shows memory cells organized as a byte.



Figure 2.1 Memory cells organized as byte.

01010100	11100001	10000011	01010100

Figure 2.2 Scheme of arranging cells in to bytes

Each byte in the memory has a unique number assigned to it. This number is called the address of that byte. This scheme of arranging cells into bytes is shown in Figure 2.2.

5. Memory types

Primary Memory / Volatile Memory: Primary Memory is internal memory of the computer. RAM AND ROM both form part of primary memory. The primary memory provides main working space to the computer.

Random Access Memory (RAM): The primary storage is referred to as random access memory (RAM) because it is possible to randomly select and use any location of the memory directly to store and retrieve data. It takes same time to any address of the memory as the first address. It is also called read/write memory. The storage of data and instructions inside the primary storage is temporary. It disappears from RAM as soon as the power to the computer is switched off. The memories, which lose their content on failure of power supply, are known as volatile memories.

Read Only Memory (ROM): There is another memory in computer, which is called Read Only Memory (ROM). Again it is the ICs inside the PC that form the ROM. The storage of program and data in the ROM is permanent. The ROM stores some standard processing programs supplied by the manufacturers to operate the personal computer. The ROM can only be read by the CPU but it cannot be changed. The basic input/output program is stored in the ROM that examines and initializes various equipments attached to the PC when the power switch is ON. The memories, which do not lose their content on failure of power supply, are known as non-volatile memories. ROM is non-volatile memory.

PROM: There is another type of primary memory in computer, which is called Programmable Read Only Memory (PROM). You know that it is not possible to modify or erase programs stored in ROM, but it is possible for you to store your program in PROM chip. Once the programmers' are written it cannot be changed and remain intact even if power is switched off. Therefore programs or instructions written in PROM or ROM cannot be erased or changed.

EPROM: This stands for Erasable Programmable Read Only Memory, which overcome the problem of PROM & ROM. EPROM chip can be programmed time and again by erasing the information stored earlier in it. Information is stored in EPROM. Exposing the

chip for some time to ultraviolet light erases the data. Chip is reprogrammed using a special programming facility. When the EPROM is in use, information can only be read.

Cache Memory: The speed of CPU is extremely high compared to the access time of main memory. Therefore the performance of CPU decreases due to the slow speed of main memory. To decrease the mismatch in operating speed, a small memory chip is attached between CPU and Main memory whose access time is very close to the processing speed of CPU. It is called CACHE memory. CACHE memories are accessed much faster than conventional RAM. It is used to store programs or data currently being executed or temporary data frequently used by the CPU. So cache memory makes main memory to be faster and larger than it really is. It is also very expensive to have bigger size of cache memory and its size is normally kept small.

Registers: The CPU processes data and instructions with high speed; there is also movement of data between various units of computer. It is necessary to transfer the processed data with high speed. So the computer uses a number of special memory units called registers. They are not part of the main memory but they store data or information temporarily and pass it on as directed by the control unit.

Secondary Memory / Non-Volatile Memory: Secondary memory is external and permanent in nature. The secondary memory is concerned with magnetic memory. Secondary memory can be stored on storage media like floppy disks, magnetic disks, and magnetic tapes. This memory can also be stored optically on Optical disks - CD-ROM.

Magnetic Tape: Magnetic tapes are used for large computers like mainframe computers where large volume of data is stored for a longer time. In PC also you can use tapes in the form of cassettes. The cost of storing data in tapes is inexpensive. Tapes consist of magnetic materials that store data permanently. It can be 12.5 mm to 25 mm wide plastic film-type and 500 meter to 1200 meter long which is coated with magnetic material. The deck is connected to the central processor and information is fed into or read from the tape through the processor. It's similar to cassette tape recorder.

Magnetic Disk: You might have seen the gramophone record, which is circular like a disk and coated with magnetic material. Magnetic disks used in computer are made on the same principle. It rotates with very high speed inside the computer drive. Data is stored on both the surfaces of the disk. Magnetic disks are most popular for direct access storage device. Each disk consists of a number of invisible concentric circles called tracks. Information is recorded on tracks of a disk surface in the form of tiny magnetic spots. The presence of a magnetic spot represents one bit and its absence represents zero bit. The information stored in a disk can be read many times without affecting the stored data. So the reading operation is non-destructive. New data is overwritten i.e, the existing data is erased from the disk and new data is recorded. For Example- Floppy Disk.

Optical Disk: With every new application and software, there is greater demand for memory capacity. It is the necessity to store large volume of data that has led to the development of optical disk storage medium. The categories of Optical disks are Compact Disk/ Read Only Memory (CD-ROM), Write Once Read Many (WORM) and Erasable Optical Disk.

6. Memory errors

The following are some important memory errors

- (i) Contact Corrosion: Corrosion occurs on memory module when the contact metal is not the same as the sockets contact material.
- (ii) Parity errors: These errors occur because of the following problems:
 - a) Poor connection between the memory module and its sockets
 - b) An intermittent failure or other fault in the power supply.
 - c) A Bug, Computer Virus etc.
 - d) A fault in the memory controller chip parity checking circuit present in the motherboard.
- (iii) Incorrect memory size message.

This error occurs if the CMOS setup is not updated to reflect the memory addition. If the error exists after saving CMOS, then the problem is with the RAM.

- (iv) The number 164 error.

This is memory size error. This occurs if the POST does not match with the amount of memory listed in the systems CMOS setup.

- (v) New memory is installed but the system refuses to recognize it.

This error occurs because of wrong setting of jumpers or DIP switches.

7. Hard disk

A hard disk drive (sometimes abbreviated as Hard drive, HD, or HDD) is a non-volatile memory hardware device that permanently stores and retrieves information. There are many variations, but their physical sizes are 3.5" and 2.5" for desktop and laptop computers respectively. A hard drive consists of one or more platters to which data is written using a magnetic head, all inside of an air-sealed casing. Internal hard disks reside in a drive bay, connect to the motherboard using an ATA, SCSI, or SATA cable, and are powered by a connection to the PSU (power supply unit).

Construction

Hard disk drives are otherwise called Winchester disk. A hard disk consists of number of disks called platters coated with magnetic material on both sides put together on a common shaft or spindle. These disks are not removable. It is shown in Figure 2.3

Spindle & Motor

A hard drive's motor rotates the platter (or platters) counter-clockwise at speeds measured in revolutions per minute (RPM). The speed varies depending on the individual hard drive and

manufacturer. Spindles spin continuously unless the hard drive is set up to go into a sleep mode when it is inactive or idle (not being used).

Actuator

The actuator is the device used to position the head arms to different tracks on the surface of the platter (actually, to different cylinders, since all head arms are moved as a synchronous unit, so each arm moves to the same track number of its respective surface). The actuator is a very important part of the hard disk, because changing from track to track is the only operation on the hard disk that requires active movement: changing heads is an electronic function, and changing sectors involves waiting for the right sector number to spin around and come under the head (passive movement). Changing tracks means the heads must be shifted. So making sure this movement can be done quickly and accurately is of paramount importance.

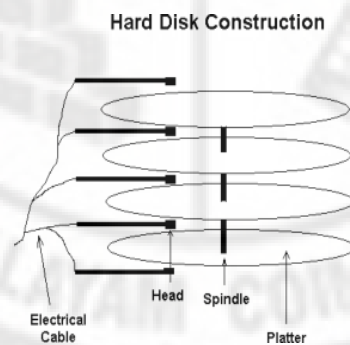

Tracks, Cylinders, and Sectors

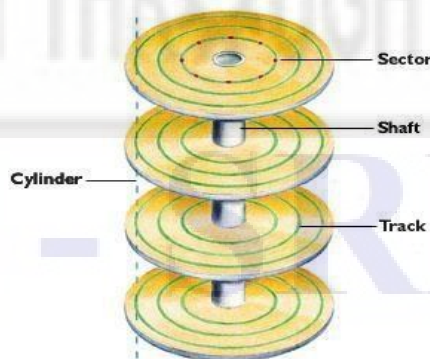

Figure 2.3 Organization of the Hard disk.

Figure 2.3 shows the organization of hard disk. The surface of the drive platter is organized with coordinates, much like a map. Data is stored in concentric tracks on the surfaces of each platter. (A platter has two sides, and thus, two data recording surfaces.) A typical disk drive can have more than 2,000 tracks per inch (TPI) on its recording surface. A cylinder describes the group of all tracks located at a given head position across all platters. To allow for easier access to data, each track is divided into individually addressable sectors. The process of organizing the disk surface into tracks and sectors is called formatting, and almost all hard disk drives today come preformatted by the manufacturer. The process of formatting a hard drive applies addressing data to the platter's surface. In almost all systems, including PCs and Macintoshes, sectors typically contain 512 bytes of user data plus addressing information used by the drive electronics (although some proprietary systems use other sector lengths). The disk drive controller, which resides on the drive's PCB, uses the formatting information and addresses - much like a tourist uses a city map - to guide data into and out of a specific location on the hard drive. Without formatting instructions, neither the controller nor the operating system would know where to store data or how to retrieve it. In earlier hard drive designs, the number of sectors per track was fixed and, because the outer tracks on a platter have a larger circumference than the inner tracks, space on the outer tracks was wasted.

The number of sectors that would fit on the innermost track constrained the number of sectors per track for the entire platter. However, many of today's advanced drives use a formatting technique called Multiple Zone Recording to pack more data onto the surface of the disk. Multiple Zone Recording allows the number of sectors per track to be adjusted so more sectors are stored on the larger, outer tracks. By dividing the outer tracks into more sectors, data can be packed uniformly throughout the surface of a platter, disk surface is used more efficiently, and higher capacities can be achieved with fewer platters. The number of sectors per track on a typical 3.5-inch disk ranges from 60 to 120 under a Multiple Zone Recording scheme. Not only is effective storage capacity increased by as much as 25 percent with Multiple Zone Recording, but the disk-to-buffer transfer rate is also boosted. With more bytes per track, data in the outer zones is read at a faster rate. Quantum Corporation is a pioneer in Multiple Zone Recording, and was the first manufacturer to implement Multiple Zone Recording on 2.5-inch disk drive products.

Working Principle

Reading

When the computer wants to read data, the operating system works out where the data is on the disk. To do this, it first reads the FAT (File Allocation Table) at the beginning of the partition. This tells the operating system in which sector on which track to find the data. With this information, the head can then read the requested data. The disk controller controls the drive's servo-motors and translates the fluctuating voltages from the head into digital data for the CPU.

More often than not, the next set of data to be read is sequentially located on the disk. For this reason, hard drives contain between 256KB and 8MB of cache buffer in which to store all the information in a sector or cylinder in case it's needed. This is very effective in speeding up both throughput and access times. A hard drive also requires servo information, which provides a continuous update on the location of the heads. This can be stored on a separate platter, or it can be intermingled with the actual data on all the platters. A separate servo platter is more expensive, but it speeds up access times, since the data heads won't need to waste any time sending servo information.

However, the servo and data platters can get out of alignment due to changes in temperature. To prevent this, the drive constantly rechecks itself in a process called thermal recalibration. During multimedia playback this can cause sudden pauses in data transfer, resulting in stuttered audio and dropped video frames. Where the servo information is stored on the data platters, thermal recalibration isn't required. For this reason the majority of drives embed the servo information with the data.

Writing:

The computer follows the following steps to write a data onto the hard disk

- (i) When a write request is given from the CPU, The O/S reads the FAT from hard disk and searches for free area.
- (ii) If it is present, it informs the disk controller.
- (iii) The disk controller drives the spindle and head actuator and locates the selected free sectors (area) under the read/write heads.
- (iv) Then the O/S sends write signal to the disk controller.
- (v) The disk controller receives the digital data from CPU and converts it into analog signals.
- (vi) According to the analog signals, the heads magnetise the sectors.

To improve the operation, a cache buffer is added to the hard disk drive. The size of the cache buffer is between 256 KB and 8 MB.

8. File Systems

A file system consists of two or three layers. Sometimes the layers are explicitly separated, and sometimes the functions are combined.

The logical file system is responsible for interaction with the user application. It provides the application program interface (API) for file operations — OPEN, CLOSE, READ, etc., and passes the requested operation to the layer below it for processing. The logical file system "manage[s] open file table entries and pre-process file descriptors." This layer provides "file access, directory operations, [and] security and protection."

The second optional layer is the virtual file system. "This interface allows support for multiple concurrent instances of physical file systems, each of which is called a file system implementation". The third layer is the physical file system. This layer is concerned with the physical operation of the storage device (e.g. disk). It processes physical blocks being read or written. It handles buffering and memory management and is responsible for the physical placement of blocks in specific locations on the storage medium. The physical file system interacts with the device drivers or with the channel to drive the storage device.

File Name:

A filename (or file name) is used to identify a storage location in the file system. Most file systems have restrictions on the length of filenames. In some file systems, filenames are not case sensitive (i.e., filenames such as FOO and foo refer to the same file); in others, filenames are case sensitive (i.e., the names FOO, Foo and foo refer to three separate files)

Directory:

File systems typically have directories (also called folders) which allow the user to group files into separate collections. This may be implemented by associating the file name with an index in a table of contents or an inode in a Unix-like file system. Directory structures may be flat (i.e. linear), or allow hierarchies where directories may contain subdirectories.

Meta data:

The length of the data contained in a file may be stored as the number of blocks allocated for the file or as a byte count. The time that the file was last modified may be stored as the file's timestamp. File systems might store the file creation time, the time it was last accessed, the time the file's metadata was changed, or the time the file was last backed up. Other information can include the file's device type (e.g. block, character, socket, subdirectory, etc.), its owner user ID and group ID, its access permissions and other file attributes (e.g. whether the file is read-only, executable, etc.).

Utilities:

File systems include utilities to initialize, alter parameters of and remove an instance of the file system. File utilities create, list, copy, move and delete files, and alter metadata. They may be able to truncate data, truncate or extend space allocation, append to, move, and modify files in-place. Depending on the underlying structure of the file system, they may provide a mechanism to prepend to, or truncate from, the beginning of a file, insert entries into the middle of a file or delete entries from a file. Utilities to free space for deleted files, if the file system provides an undelete function, also belong to this category.

File System for Windows Operating System

Windows makes use of the FAT, NTFS, exFAT, Live File System and ReFS file systems (the last of these is only supported and usable in Windows Server 2012; Windows cannot boot from it).

Windows uses a drive letter abstraction at the user level to distinguish one disk or partition from another. For example, the path C:\WINDOWS represents a directory WINDOWS on the partition represented by the letter C. Drive C: is most commonly used for the primary hard disk drive partition, on which Windows is usually installed and from which it boots. This "tradition" has become so firmly ingrained that bugs exist in many applications which make assumptions that the drive that the operating system is installed on is C. The use of drive letters, and the tradition of using "C" as the drive letter for the primary hard disk drive partition, can be traced to MS-DOS, where the letters A and B were reserved for up to two floppy disk drives. This in turn derived from CP/M in the 1970s, and ultimately from IBM's CP/CMS of 1967.

FAT:

The family of FAT file systems is supported by almost all operating systems for personal computers, including all versions of Windows and MS-DOS/PC DOS and DR-DOS. (PC DOS is an OEM version of MS-DOS, MS-DOS was originally based on SCP's 86-DOS. DR-DOS was based on Digital Research's Concurrent DOS, a successor of CP/M-86.) The FAT file systems are therefore well-suited as a universal exchange format between computers and devices of almost any type and age.

The FAT file system traces its roots back to an (incompatible) 8-bit FAT precursor in Standalone Disk BASIC and the short-lived MDOS/MIDAS project. Various features have been added to the file system including subdirectories, codepage support, extended attributes, and long filenames. Third parties such as Digital Research have incorporated optional support for deletion tracking, and volume/directory/file-based multi-user security schemes to support file and directory passwords and permissions such as read/write/execute/delete access rights. Most of these extensions are not supported by Windows.

The FAT12 and FAT16 file systems had a limit on the number of entries in the root directory of the file system and had restrictions on the maximum size of FAT-formatted disks or partitions. FAT32 addresses the limitations in FAT12 and FAT16, except for the file size limit of close to 4 GB, but it remains limited compared to NTFS. FAT12, FAT16 and FAT32 also have a limit of eight characters for the file name, and three characters for the extension (such as .exe). This is commonly referred to as the 8.3 filename limit. VFAT, an optional extension to FAT12, FAT16 and FAT32, introduced in Windows 95 and Windows NT 3.5, allowed long file names (LFN) to be stored in the FAT file system in a backward compatible fashion.

NTFS:

NTFS, introduced with the **Windows NT** operating system in 1993, allowed **ACL**-based permission control. Other features also supported by **NTFS** include hard links, multiple file streams, attribute indexing, quota tracking, sparse files, encryption, compression, and re-parse points (directories working as mount-points for other file systems, symlinks, junctions, remote storage links).

exFAT:

exFAT is a proprietary and patent-protected file system with certain advantages over NTFS with regard to file system overhead. exFAT is not backward compatible with FAT file systems such as FAT12, FAT16 or FAT32. The file system is supported with newer Windows systems, such as Windows Server 2003, Windows Vista, Windows 2008, Windows 7, Windows 8, and more recently, support has been added for Windows XP. exFAT is supported in OS X starting with version 10.6.5 (Snow Leopard). Support in other operating systems is sparse since Microsoft has not published the specifications of the file system and implementing support for exFAT requires a license. exFAT is the only file system that is fully supported on both OS X and Windows that can hold files bigger than 4 GB.

9. Formatting and Troubleshooting

Formatting

Formatting a disk for use by an operating system and its applications typically involves three different processes.

1. Low-level formatting (i.e., closest to the hardware) marks the surfaces of the disks with markers indicating the start of a recording block (typically today called sector markers) and other information like block CRC to be used later, in normal operations, by the disk controller to read or write data. This is intended to be the permanent foundation of the disk, and is often completed at the factory.
2. Partitioning divides a disk into one or more regions, writing data structures to the disk to indicate the beginning and end of the regions. This level of formatting often includes checking for defective tracks or defective sectors.

3. High-level formatting creates the file system format within a disk partition or a logical volume. This formatting includes the data structures used by the OS to identify the logical drive or partition's contents. This may occur during operating system installation, or when adding a new disk. Disk and distributed file system may specify an optional boot block, and/or various volume and directory information for the operating system.

Troubleshooting hard disk drives

Problem: System is not booting from hard disk drive.

Solution: In CMOS setting drive type may be incorrect or lost. Therefore run SETUP and auto detect the hard disk type. Boot track maybe corrupted. So reinstall boot tracks using sys.

Problem: No fixed disk present message on the monitor.

Solution: Enter into CMOS setup and see whether all drive parameters are entered correctly. If not, enter the parameters and save it. Make sure that there is no IRQ conflicts between resources.

Problem: Performance of the disk is slow.

Solution: Check the BUFFER setting. If it is too low, increase the values in CONFIG.SYS. Arrange the data in the hard disk in an order by running SCAN Disk. Interleave may be incorrect. Therefore do low level formatting.

Problem: Drive may produce high noise during operation.

Solution: Disconnect the drive signal cable and switch on the system. If the noise stops, there may be a problem with cable or controller. Else back up the data and replace the drive as early as possible.

Problem: Drive spins, but the system fails to recognize the drive.

Solution: Check whether the interface signal cable is inserted properly and completely at the drive and the controller. If cable is properly fixed, try with a new cable. Enter the CMOS setup and check whether all the parameters are entered correctly. Try with auto detect option. Check the partition on the hard disk by running FDISK from CD drive. There must be at least one DOS partition. If there is no DOS partition, repartition it and reformat the drive. Try with a new working hard drive. If it fails, replace the drive controller. If the new drive works, replace the existing hard drive.

Removable Storage and Special Devices

1. DVD-ROM

DVD, in full digital video disc or digital versatile disc, is a type of optical disc used for data storage and as a platform for multimedia. Its most prominent commercial application is for playing back recorded motion pictures and television programs (hence the designation 'digital video disc'), though read-only, recordable, and even erasable and rewritable versions can be used on personal computers to store large quantities of almost any kind of data (hence 'digital versatile disc').

The DVD represents the second generation of compact disc (CD) technology, and, in fact, soon after the release of the first audio CDs by the Sony Corporation and Philips Electronics NV in 1982, research was under way on storing high-quality video on the same 120-mm (4.75-inch) disc. In 1994-95 two competing formats were introduced, the Multimedia CD (MMCD) of Sony and Philips and the Super Density (SD) disc of a group led by the Toshiba Corporation and Time Warner Inc. By the end of 1995 the competing groups had agreed on a common format, to be known as DVD, that combined elements of both proposals, and in 1996 the first DVD players went on sale in Japan.

Like a CD drive, a DVD drive uses a laser to read digitized (binary) data that have been encoded onto the disc in the form of tiny pits tracing a spiral track between the centre of the disk and its outer edge. However, because the DVD laser emits red light at shorter wavelengths than the red light of the CD laser (635 or 650 nanometers for the DVD as opposed to 780 nanometers for the CD), it is able to resolve shorter pits on more narrowly spaced tracks, thereby allowing for greater storage density. In addition, DVDs are available in single- and double-sided versions, with one or two layers of information per side. A double-sided, dual-layer DVD can hold more than 16 gigabytes of data, more than 10 times the capacity of a CD-ROM, but even a single-sided, single-layer DVD can hold more than four gigabytes—more than enough capacity for a two-hour movie that has been digitized in the highly efficient MPEG-2 compression format. Indeed, soon after the first DVD players were introduced, single-sided DVDs became the standard media for watching movies at home, almost completely replacing videotape. Consumers quickly appreciated the convenience of the discs as well as the higher quality of the video images, the interactivity of the digital controls, and the presence of numerous extra features packed into the discs' capacious storage. Figure 2.4 shows the DVD technology.

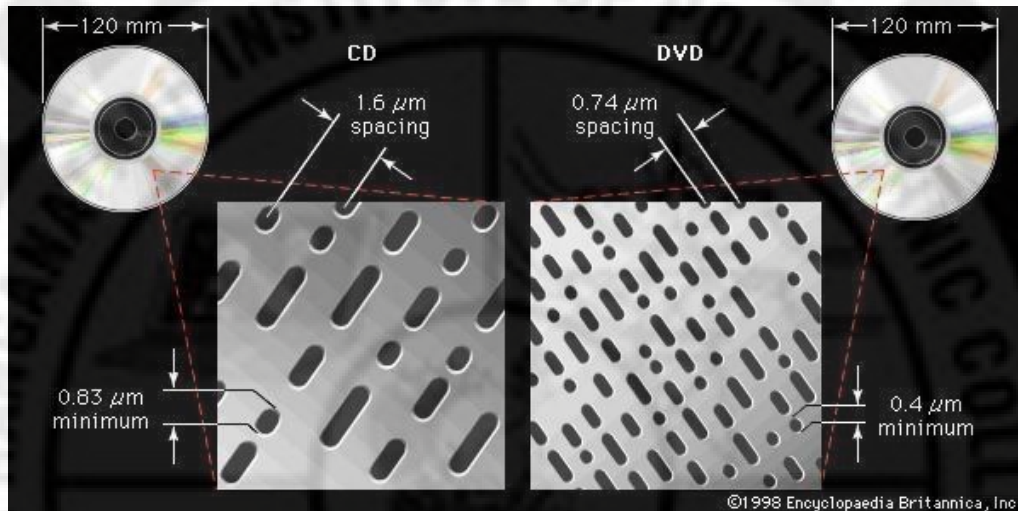

Figure 2.4 The DVD technology.

DVD ROM

This is used to store large amount of data. The important features are

- (i) DVD data recording layer is in the middle of the disk . So DVD-ROM drive construction is more complex.
- (ii) Speed of rotation of DVD drive is slow. But because of the high density data, the reading is fast.
- (iii) The data transfer rate is 8100 KB/sec and above.

DVD-Video

The main features of DVD include:

- (i) Over 2 hours of high-quality digital video (over 8 on a double-sided, dual-layer disc).
- (ii) Support for widescreen movies on standard or widescreen TVs (4:3 and 16:9 aspect ratios).
- (iii) Up to 8 tracks of digital audio (for multiple languages), each with as many as 8 channels.
- (iv) Up to 32 subtitle/karaoke tracks.
- (v) Automatic *seamless* branching of video (for multiple story lines or ratings on one disc).
- (vi) Up to 9 camera angles (different viewpoints can be selected during playback).
- (vii) Menus and simple interactive features (for games, quizzes, etc.).
- (viii) Multilingual identifying text for title name, album name, song name, cast, crew, etc.
- (ix) *Instant* rewind and fast forward, including search to title, chapter, track, and time code.
- (x) Durability (no wear from playing, only from physical damage).
- (xi) Not susceptible to magnetic fields. Resistant to heat.
- (xii) Compact size (easy to handle and store, players can be portable, replication is cheaper)

2. Recordable DVD

Recordable DVD is a device used to write data once and it can be read many times. This was introduced in 1997. This was introduced in the autumn of 1997. The important features are

- (i) The storage capacity is 4.7 GB for single sided and 9.4 GB for double sided.
- (ii) These disks can be used in DVD-ROM drives of DVD video players
- (iii) For reading, it uses a red laser of wave length 635 to 650 μ m
- (iv) The size of pit formed during writing is 0.40 μ m
- (v) The different types of DVD-R are

DVD-R(A) - This refers to DVD-R authoring. This is used by professional DVD users.

In this format writing is done by using 635 μ m laser beam. DVD-R(G)- This refers to DVD-R general. In this format writing is done by using 650 μ m laser

Recording (writing)

cross-sectional view of a double-sided DVD-R disc

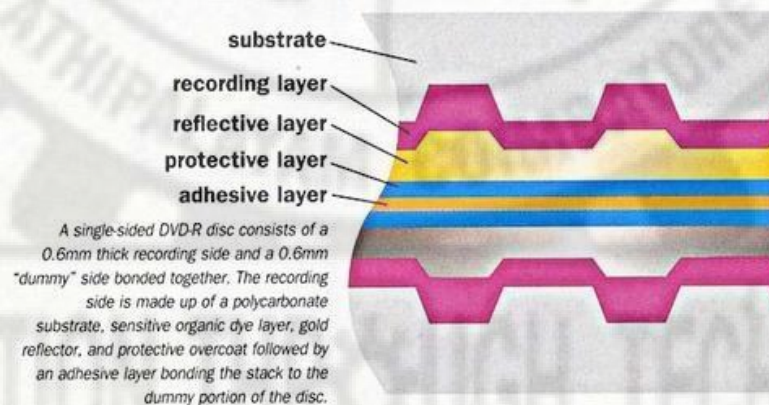

Figure 2.5 Cross Sectional View of Double Sided DVD

Figure 2.5 shows the cross sectional view of double sided DVD. This is made up of a pregrooved polycarbonate disk . Pregroove is use to guide the laser beam while writing. The pregroove contains

- a) A synchronized signal to control the movement of DVD drive's spindle motor during writing. This signal is also called wobble signal.
- b) Land pre-pits in the land area between the grooves. This is used for addressing purposes.

Over the polycarbonate disk, a thin layer of recording dye is sprayed and is used for recording. Then a thin reflective layer is coated over this for reflecting the laser beam during reading operation. Over this a protective layer is coated and is used to protect the disk from scratch and dust.

There are two types of recording. They are

- (i) Disk at Once

In this type of recording, the 4.7 GB of data is written over the disk at a time with the help of a 635-650 μm laser beam

- (ii) Increment

In this type of recording, the 4.7 GB of data are split into number of packets. Then it is written over the disk packet by packet with the help of a laser beam.

3. Rewritable DVD

Rewritable DVD is a device that be erased and written again and again. The Figure 2.6 shows the cross sectional view of a single sided 4 layer DVD

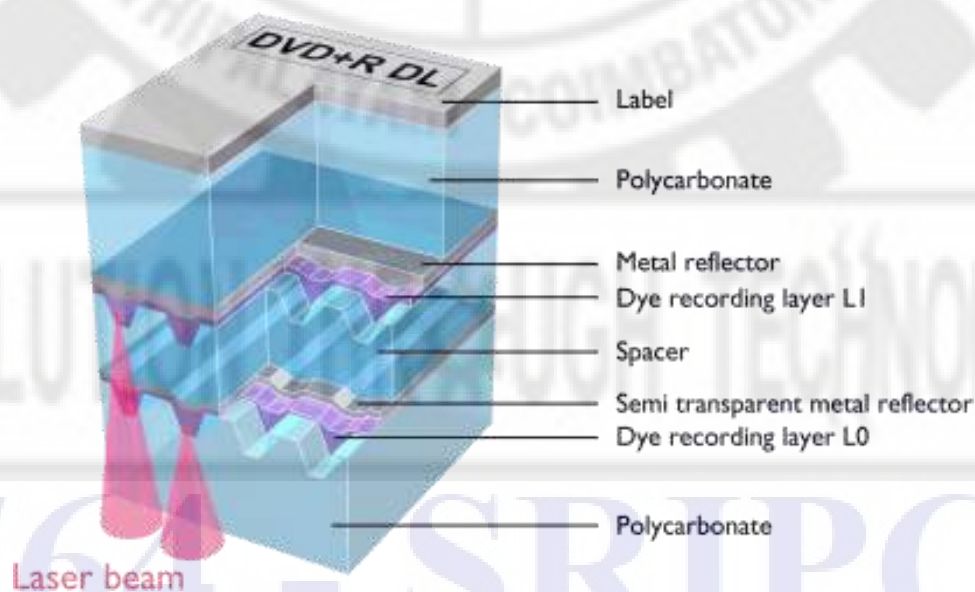

Figure 2.6 Cross Sectional view of Single Sided 4 layer DVD.

Rewritable DVD uses phase-change technology for reading, writing and erasing. The phase change medium consists of a grooved polycarbonate substrate. This has four layers. The phase change (recording) layer namely silver, indium antimony-tellurium is sandwiched between dielectric layers. This layer changes from crystalline state to amorphous state.

Writing

During writing, laser beam of wave length $650\mu\text{m}$ is used to heat selected spots above 500° - 700° C. So the spots change to liquid state. Then the spots are allowed to cool. After cooling the spots becomes amorphous state.

Reading

To read the data in the DVD, a lower power(read power) laser is made to fall on the surface of the DVD. The amorphous area(pits)reflects less light and crystalline area reflects more light(land). With the help of the difference in reflectivity, we can read the data.

Erasing

To erase the data on the DVD, a medium power (Erase power) laser of temperature 200° C is made to fall on the recording layer. This melts the amorphous area (pits) and reverts back to crystalline state.

The important features are

- (i) IT uses a $650\mu\text{m}$ laser for writing.
- (ii) This uses land pre-pits between the grooves for addressing.
- (iii) The pregroove has a synchronized signal to control the DVD drive's spindle motor during writing. This signal is also called Wobble signal.
- (iv) The storage capacity is 4.5 GB.
- (v) It is mainly used for data storage and storing movies.

4. Blu-ray

A Blu-ray Disc is a high density optical disc storage medium, which is used for the storage of all high-definition digital formats like audio, video, and play-station games and so on. They have the same physical appearance as a DVD. The name 'BLU-RAY' is actually a combination of the colour 'blue' and 'ray'. Here blue refers to the blue colour of the laser that is used for its reading and ray refers to the optical ray. BD is present in both single layer and double layer. The single layer Blu-Ray Disc has a capacity of up to 25 GB and double layer has a capacity of 50 GB. Though this is a practical storage capacity meant for the present Blu-Ray players, there are BD's that have capacities up to 200 GB. The features of Blu-ray are as follows.

- (i) Blu-Ray Disc needs a wavelength of 400 nanometer violet-blue laser for its reading at different speeds like 4.5 MBPS, 9 MBPS, 18 MBPS, 27 MBPS, 36 MBPS and 54 MBPS.
- (ii) Blu-Ray disc can run formats that are encoded in MPEG-4 and MPEG-2.

BD is used for data storage, playing 1080p HD video and audio, 3-D Stereophonic and so on

5. Blu-ray Disc Parameters

Blu-ray disc parameters are measurable factors that define the disc. The important parameters are Optical, Disk structure and Data Management. Optical parameters include

laser wavelength, objective lens numerical aperture, protective layer thickness and free working distance. Data management parameters include data rate, video format, and HDTV play time and bit-rate scheme. Disk structure parameters are user data capacity, minimum channel bit length and track-to-track spacing.

(i) Optical Parameters

Digital information is stored on optical disks in the form of arrangements of data marks in spiral tracks. The process for exposing data marks on a recordable optical disk is shown in Figure 2.7, where an input stream of digital information is converted with an encoder and modulator into a drive signal for a laser source. The laser source emits an intense light beam that is directed and focused onto the surface by the objective lens. As the surface moves under the scanning spot, energy from the intense scan spot is absorbed, and a small, localized region heats up. The surface, under the influence of heat

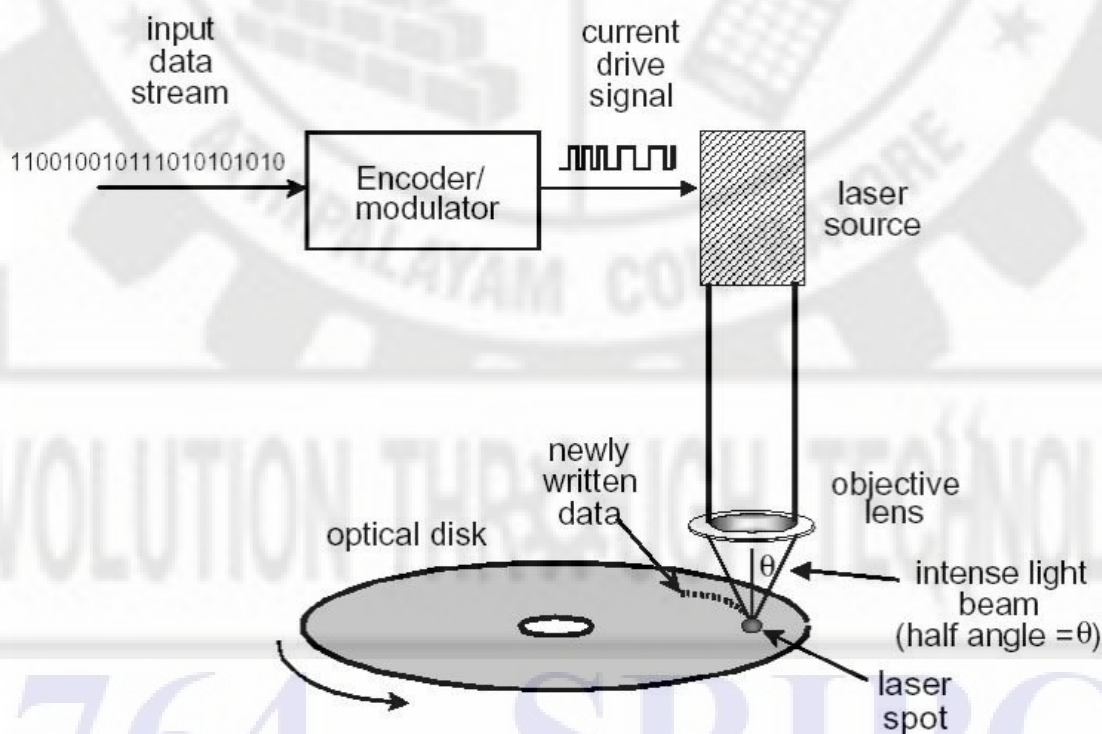

Figure 2.7 Recordable Optical Disk

beyond a critical writing threshold, changes its reflective properties. Modulation of the intense light beam is synchronous with the drive signal, so a circular track of data marks is formed as the surface rotates. Data marks on prerecorded disks are fabricated by first making a master disk with the appropriate data-mark pattern. Readout of data marks on the

disk is illustrated in Figure 2.8, where the laser is used at a constant output power level that does not heat the data surface beyond its thermal writing threshold. The laser beam is directed through a beam splitter into the objective lens, where the beam is focused onto the surface. As the data marks to be read, pass under the scan spot, the reflected light is modulated. Modulated light is collected by illumination optics and directed by the beam splitter to servo and data optics, which converge the light onto detectors. The detectors change light modulation into current modulation that is amplified and decoded to

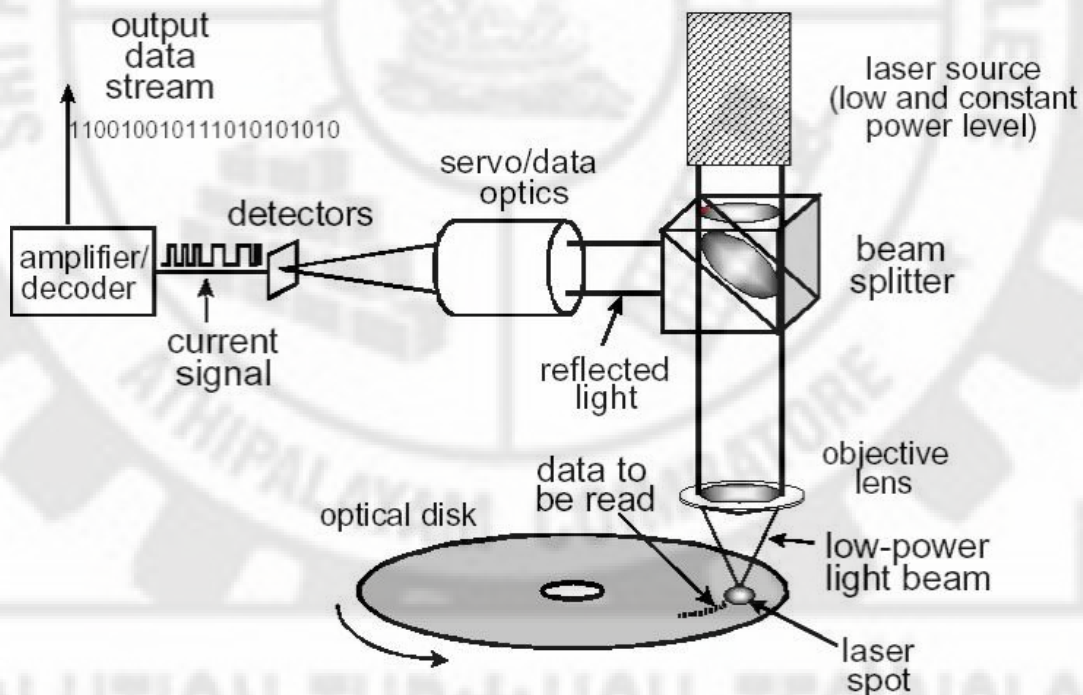

Figure 2.8 Readout of the Data Mask

produce the output data stream. A fundamental limitation to the number of data marks per unit area is due to the size of the focused laser beam that illuminates the surface. Small laser spots are required to record and read out small data marks. More data marks per unit area translate into higher capacity disks, so evolution of optical data storage is toward smaller spot sizes. Figure 2.9 shows a detailed picture of the laser irradiance approaching the surface, where irradiance is defined as the laser power per unit area. Ideally, maximum irradiance is located at the recording material, along with the smallest spot size s . As the distance increases away from the ideal focus, the spot size increases and the peak irradiance decreases. A defocus distance δz of only a few micrometers dramatically reduces peak irradiance and increases spot size. An approximate formula used to estimate the ideal spot size at best focus is $s = \lambda / (\sin \theta)$, where θ is the marginal ray angle of the illumination

optics, as shown in Fig. 1. Spot size s is the full width of the irradiance distribution at the $1/e^2$ (13.5%) irradiance level relative to the peak. The value of $\sin \theta$ is often called the numerical aperture or NA of the optical system.

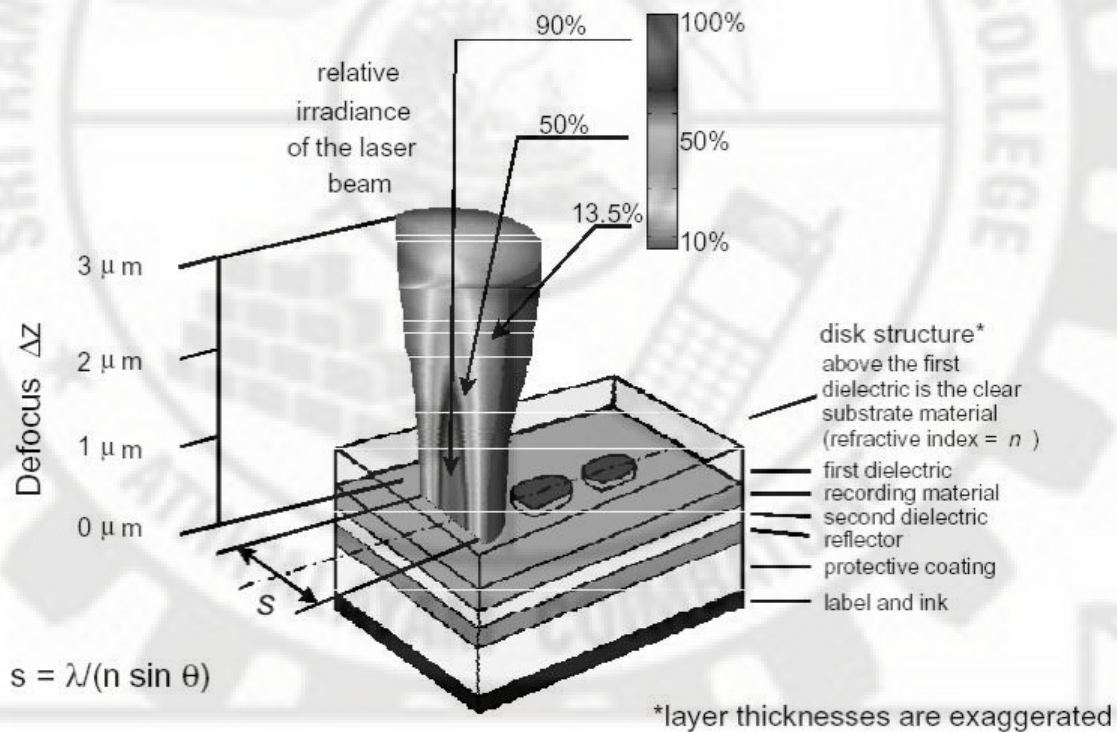

Figure 2.9 Laser irradiance

Instead of focusing directly on the recording surface, optical disks focus through a protective layer, as shown in Figure 2.10 for a simple CD-ROM. The protective layer prevents dust and other contamination from directly obstructing the laser spot at the data marks. Instead, the out-of-focus contamination only partially obscures the laser focus cone, and data can usually be recovered reliably. If the protective layer is scratched or damaged, it can be cleaned or buffed. As the protective layer gets thinner, the error rate increases to an unacceptable threshold due to obscuration of the laser beam. This sensitivity decreases as NA increases, due to the smaller defocus range associated with these systems. In addition, the free working distance separates the objective lens from the spinning disk. This separation protects the disk against accidental contact between the objective lens and the disk. In order to maximize disk capacity, the optical system uses high NA and short

wavelength. For maximum contamination protection, the protective layer should be as thick as possible. However, the combination of thick protective layer and high NA is not easily accomplished. High NA systems are sensitive to changes in substrate thickness and disk tilt. Manufacturing variations create thickness non-uniformities, which are usually a small percentage of the total disk thickness.

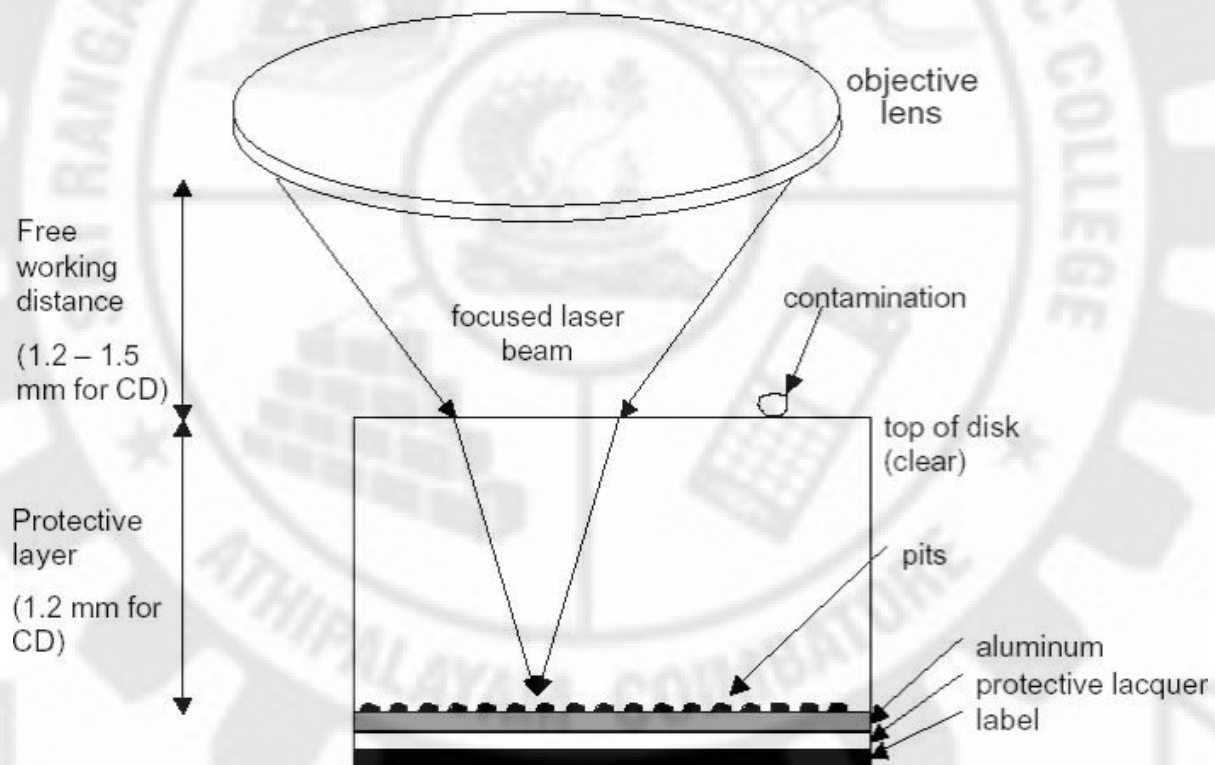

Figure 2.10 Optical disk focus through a protective layer.

Motor instabilities induce tilt as the disk spins. Energy from the central portion of the spot is redistributed to concentric rings, which degrade the quality of the read out signal. This degrades the read out signal. Tilt causes coma, which is another form of aberration effect, is called spherical aberration. Sensitivity of the spot to degradation from thickness variations and disk tilt is plotted in Figure 2.11 as a function of total protective layer thickness for two values of NA. In order to limit these effects, the substrate is made as thin as possible without sacrificing contamination protection. The most conservative technology is the Video CD. Its thick protective layer, relatively low NA and long laser wavelength produce a stable system that is not very sensitive to environmental factors like dust and scratches. The ideal spot size is about $0.78/0.5 = 1.6$ micrometers. Although the cover layer is thick at 1.2 mm, the sensitivity to thickness variations and disk tilt is low because of the low NA.

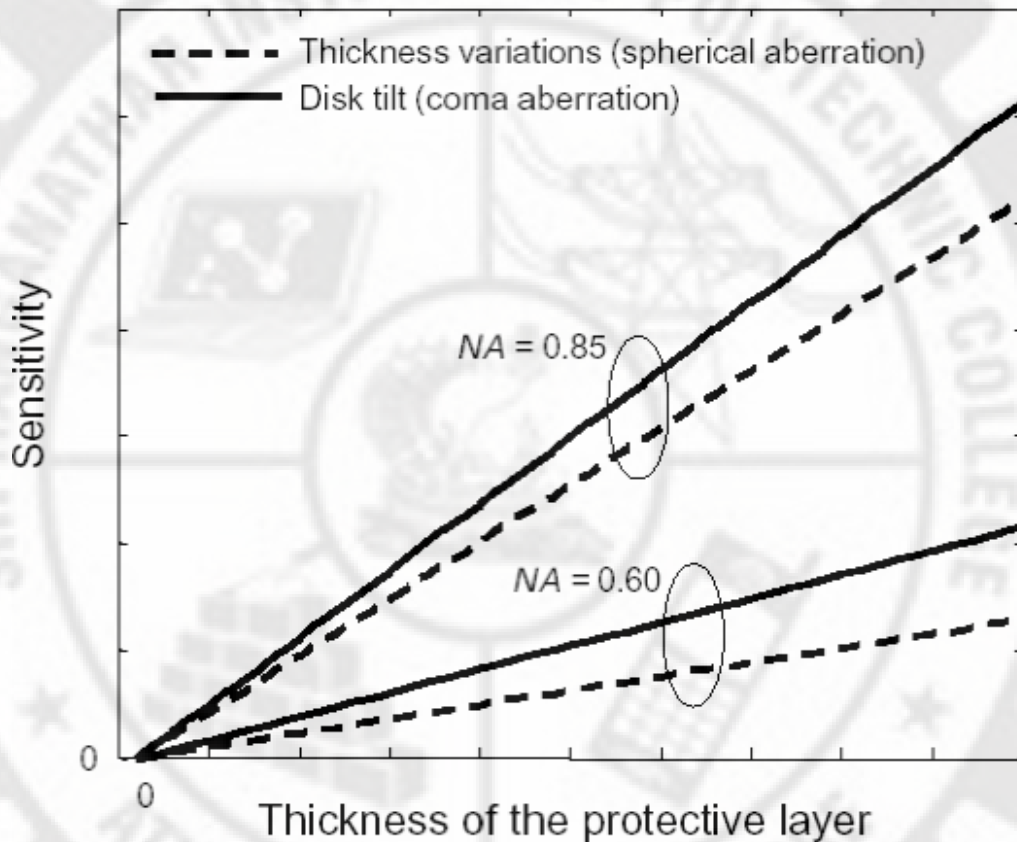

Figure 2.11 Sensitivity of the Spot

DVD technology uses a shorter wavelength laser, higher NA optics and a thinner protective layer. The combination of short wavelength and higher NA produce a spot size of about 1.1 micrometers. The protective layer had to be made thinner, because the sensitivity to thickness variations and disk tilt is too high otherwise. DVDs are slightly more sensitive to dust and scratches than CDs. The net effect is not great, because higher NA reduces the focal depth and DVDs have a more robust error management strategy. The Advanced Optical Disk and Blu-Ray systems both use a new blue laser source that emits 0.405 micrometer light. The Advanced Optical Disk system uses the same protective layer thickness as a DVD, and it uses the same NA objective lens. Due to the short wavelength, the spot size for the Advanced Optical Disk is about 0.62 micrometers. Sensitivity to dust and scratches is about the same as a DVD, as well as the sensitivity to thickness variations and disk tilt. The Blu-Ray system uses both higher NA and thinner cover layer. The spot size is $0.405/0.85 = 0.48$ micrometers, which is the smallest spot size of all the technologies. However, because of the high NA, the protective layer had to be made thin to limit sensitivity to thickness variations and disk tilt. Therefore, Blu-Ray disks are sensitive to dust and

scratches. The free working distance is nearly the same for all technologies except Blu-Ray.

Blu-Ray systems utilize more complicated lens systems due to the high NA, so working distance had to be reduced. The integrity of this reduced working distance is not clear at this time.

(ii) Disk Structure Parameters

The spot size created from the NA and wavelength parameters is the most important factor to determine the track-to-track spacing and the minimum channel bit length along the track. Several channel bits are encoded into each data mark. The number of channel bits per data mark depends on the modulation scheme. The relatively large spot produces relatively large data marks and correspondingly wide tracks and large channel-bit lengths. Progressively smaller spot sizes enable smaller track spacing and shorter channel bit lengths.

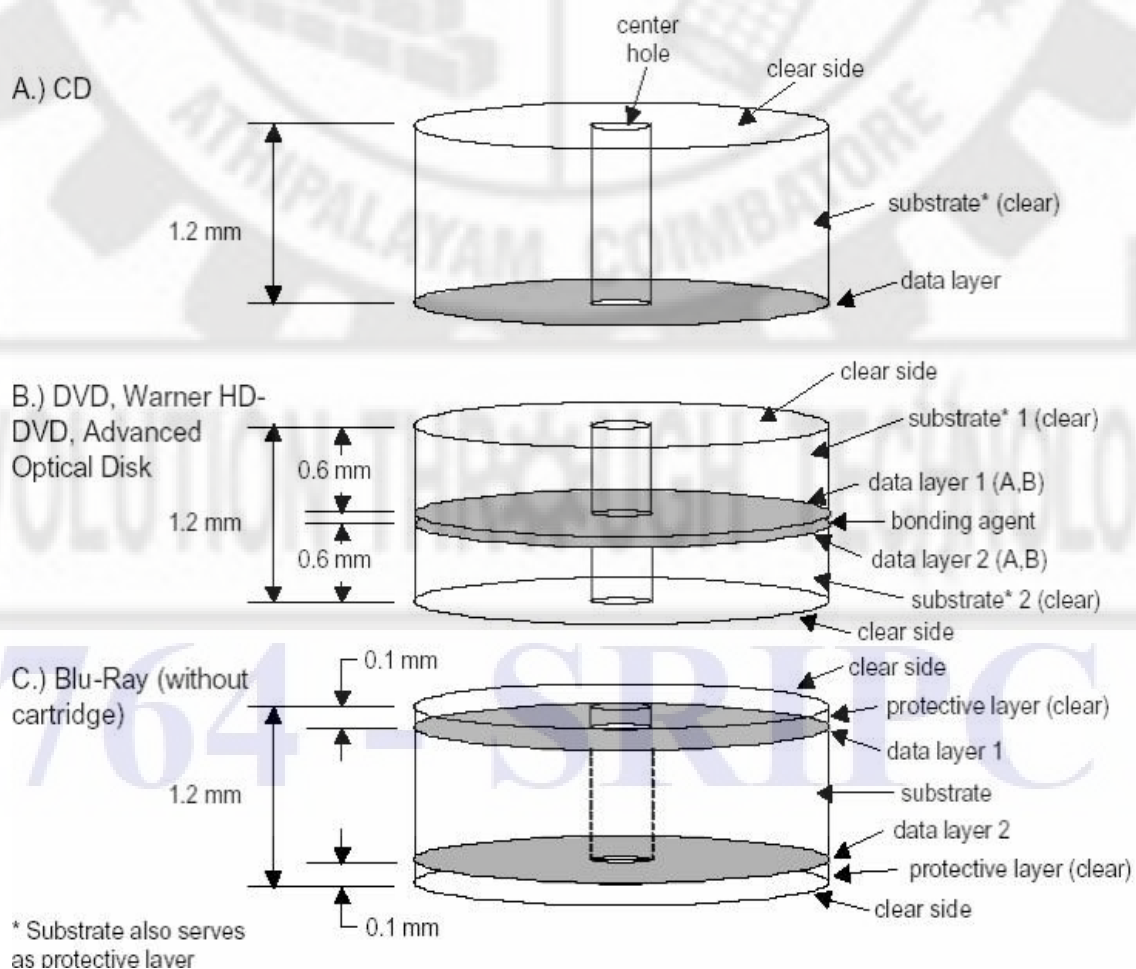

Figure 2.12 Disk Structure parameters.

To the user, all generations of optical disks look very similar. They all are round disks that are approximately 120 mm in diameter, have a central mounting hole and are approximately 1.2 mm thick. The CD uses a simple 1.2 mm thick substrate, as shown in Figure 2.12A. Data are recorded on only one side of the disk, through the clear 1.2 mm substrate, which also serves as the protective layer. DVDs, Warner HD-DVDs and Advanced Optical Disks use the format shown in Figure 2.12B, where two 0.6 mm substrates are bonded together and the data are recorded on the bond side of each substrate. DVDs also allow two layers. One layer per side (A, B in Figure 2.12B), where the layers are separated by a thin adhesive spacer. The two layers are fabricated before bonding at the same time as the individual 0.6 mm substrates. Like the CD, data are recorded and read through the clear substrates. It is likely that the Warner HDDVD and Advanced Optical Disk will also take advantage of this multiple-layer concept. A potential implementation of the Blu-Ray disk is shown in Figure 2.12C, where the protective layers on each side are very thin at 0.1 mm. In this case, data are recorded on the substrate, which does not serve as the protective layer. Instead, a protective layer resin is spun on and hardened or a thin protective sheet is bonded on each side of the substrate. Because of the thin protective layer, the Blu-Ray disk must also be used with a cartridge. The only optical disk technology that plans to use a Cartridge is the Blu-Ray system. The Blu-Ray cartridge is necessary for contamination protection, but the working distance of around 0.1 mm and protective layer thickness of 0.1 mm are large compared to the contact recording. Higher-resolution mastering machines and finer control over the injection molding process should produce the required changes without substantially retooling the industry.

(iii) Data Management Parameters

The logical organization of data on the disk and how those data are used are considerations for data management. The random-access nature of DVDs allows very efficient methods for data compression. For example, MPEG-2 with variable bit rate allows data to be read out from the disk as they are required, rather than supplying data at a constant rate. The random-access architecture of optical disks is a much more efficient way to use the available storage area. That is, optical disks do not require as many gigabytes of user data capacity for an equivalent length and quality HDTV presentation. It is not practical to store HDTV on CDs and DVDs with MPEG-2. For CDs, special multiple-beam readout or high velocity disk drives could produce the data rate, which is an advantage of the fixed-bit-rate scheme. DVDs are not capable of the 13 Mbps random data rate to support

MPEG-2. The Advanced Optical Disk exhibits acceptable data rate and reasonable user data capacity for up to two hours of HDTV per side, compressed with variable bitrate MPEG-2. Blu-ray has slightly higher capacity and data rate. The two-hour play time for HDTV with Blu-Ray is really a specification for realtime recording, which is not easily compressed into an efficient variable-rate scheme. Blu-Ray should easily provide two hours or longer of prerecorded HDTV per side compressed with MPEG-2. MPEG-2 is a technique for compressing video data and replaying the data associated with certain rules that are defined in the MPEG-2 specifications. The action of the optical disk system is not to compress data or interpret the video information rules. Instead, the optical disk system only stores and retrieves data on command from the video operating system. Therefore, as video operating systems and associated compression technology become more advanced, no fundamental changes are required to the optical disk system. MPEG-4 technology is an advanced video compression scheme that utilizes advanced pre-filtering and post-filtering, in addition to a rule-based algorithm. Estimated improvement in compression is around a factor of three beyond MPEG-2.

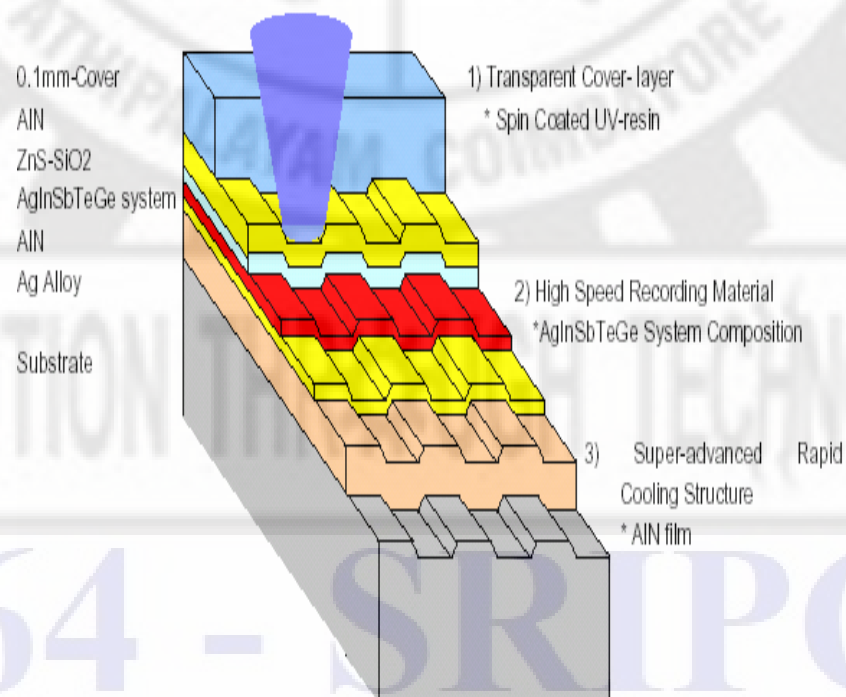

Figure 2.13 Structure.

The structure of the BD is as shown in Figure 2.13. The 0.1mm transparent cover layer is made of a spin-coated UV resin. It is formed by sandwiching a transparent layer between a protective coating and a bonding layer. This layer offers excellent birefringence. Beneath,

there is a layer of Antis. The layer acts as a heat sink, dissipating the excess heat during the write process. A spacer layer made of ZnS-SiO₂ comes next. Then, the recording layer made of Ag, In, Sb, Te, Ge comes. Grooves are formed on this layer for recording. Reflective layer of Ag alloy falls beneath and finally a plastic substrate comes.

6. Recording and Playback Principles

Writing(Recording)

During writing, a high power blu laser of temperature 500-700°C is made to fall on the recording surface. This melts the crystalline recording surface according to the data to be written. Then it is cooled quickly. So the liquid state becomes frozen and changes to amorphous state. This shrinks and creates pits(data) of size 0.15 micron. This technique is called writing.

Reading(Play Back)

To read the data in the blu ray, a lower power (read power) laser is made to fall on the surface of the blu-ray. The amorphous area (pits) reflects less light and crystalline area reflects more light(land). With the help of the difference in reflectivity we can read the data.

Erasing

To erase the data on the blu-ray. A medium power (erase power) laser of temperature 200°C is made to fall on the recording layer. This melts the amorphous area (pits) and reverts back to crystalline state.

7. Special Drives:

External Drives

External drives are drives which are not mounted on the computer system. But these are outside the system. These can be connected to the system with the help of USB or firewire interfaces. These drives can be carried from one place to another and can be used with any computer instantly.

Memory Stick

Developed by Sony, the Memory Stick is a digital data storage technology with up to 10 times the storage capacity of a 3.5 diskette. Sony is promoting the Memory Stick as a new way to share and transfer pictures, sound, and other data between different compact electronic devices such as digital cameras and camcorder. About the size of a flat AA battery, Memory Sticks are available in 4mb, 8mb, 16mb, 32mb and 64mb sizes. They are smaller in size than comparable data storage devices, including smart media and compact flash memory. Figure 2.14 shows the memory stick.



Figure 2.14 Memory Stick

This 128 MB Memory Stick Duo Media card is the ideal storage solution. Save the files in eight seconds or less with the super-fast 16 MB/s write speed, then slip it easily into your pocket or carrying case thanks to the compact, ultra-lightweight design.

USB Flash Drive

A small, portable flash memory card that plugs into a computer via USB port and it functions as a hard drive. USB flash drives have less storage capacity than an external hard drive, but they are smaller and more durable because they do not contain any internal moving parts. USB flash drives also are called thumb drives, jump drives, pen drives, key drives, tokens, or simply USB drives.

USB flash drives represent a large part of the storage device market, which is also, occupied by hard-disk drives and SD memory cards. Because USB drives contain no moving parts, they are more durable than hard drives, and it is this durability, combined with their very small size that makes them easy to carry around. USB drives also provide transfer speeds and memory capacity that equal or surpass those of other storage devices. This enables users to move data around more quickly and to store a large number of media files, computer files, and even programs on USB drives. USB flash drives do this all while consuming less power than standard hard-disk drives. Plus, USB drives can be connected to essentially any type of computer.

Floppy Disk Drives offer capacities of typically 1.44MB while USB Flash Drives are offered in the GB capacity range. The read and write speed on a Floppy Disk Drive is approx. 60kB/s whereas Full-Speed USB Flash Drives transfer data at maximum speed of approx. 4.8GB/s.

Features of Flash Drive are as follows

- (i) **Durability:** This means that they are much less vulnerable to damage from shocks or drops.
- (ii) **Portability:** Average USB drives are typically no longer than two or three inches, with a width of about one inch.
- (iii) **Memory Capacity:** Most USB flash drives offer memory capacities ranging from 1 to 128 gigabytes.
- (iv) The USB drive could be used as a backup, or to store large media files like photographs, movies, and music.
- (v) **Transfer Speeds:** USB 3.0 devices provide a transfer rate of up to 4.8 gigabytes per second. Even the highest-performing SD memory cards cannot match this speed, trailing behind with a maximum rate of 312 megabytes per second. For average hard-disk drives, the maximum transfer rates range from roughly 50 to 110 megabytes per second.
- (vi) **Applications and Programs Made Specifically for USB Flash Drives:** USB flash drives offer the option of adding a variety of applications that can be run directly from the device. There are already a wide range of USB-drive applications, including portable office software, image editors, web browsers, games, and even whole operating systems that can be quickly booted from the portable drive.
- (vii) **Compatibility:** The USB interface has become one of the most common ways to connect an electronic device to virtually any type of computer. Netbooks, laptops, and desktop computers all feature multiple USB ports.
- (viii) **Low Power Consumption.**



Figure 2.15 USB Drive

Solid State Drive

An SSD (solid-state drive or solid-state disk) is a nonvolatile storage device that stores persistent data on solid-state flash memory. SSD devices embed silicon-based memory chips as the storage media for the writing and reading of persistent data. SSDs,

also known as flash drives or flash cards, are inserted into slots in computer servers referred to as server-side flash storage or as part of an enterprise flash storage array system. Sometimes the flash devices are called solid-state hard drives, although that term is misleading. Unlike a spindled hard disk drive (HDD), an SSD contains no mechanical parts. A traditional HDD consists of a spinning disk with a read/write head on a mechanical arm, known as an actuator. An SSD, on the other hand, has an array of semiconductor memory organized as a disk drive, using integrated circuits rather than magnetic or optical storage media. The Solid State Storage Initiative has identified three major SSD form factors for the enterprise:

- (i) SSDs that come in traditional HDD form factors and fit into the same slots.
- (ii) Solid-state cards that use standard card form factors, such as Peripheral Component Interconnect Express (PCIe), and reside on a printed circuit board.
- (iii) Solid-state modules that reside in a Dual In-line Memory Module (DIMM) or small outline dual in-line memory module (SO-DIMM), and may use a standard HDD interface such as Serial Advanced Technology Attachment (SATA).

Keyboard and Mouse

Keyboard:

1. Interfacing and Signals

A keyboard is defined as the set of typewriter-like keys that enables you to enter data into a computer or other devices. Computer keyboards are similar to electric typewriters but contain additional typing keys. Interfacing is defined as a process connecting the keyboard with communication I/O port. The USB and Wireless Connectors are discussed below.

USB is a serial bus. It uses 4 shielded wires: two for power (+5v & GND) and two for differential data signals (labelled as D+ and D- in pinout). In a USB data cable Data+ and Data- signals are transmitted on a twisted pair with no termination needed. Half-duplex differential signalling is used to reduce the effects of electromagnetic noise on longer lines. D+ and D- operate together; they are not separate simplex connections. Features of USB connectors are as follows:

- (i) USB supports four data rates:
- (ii) Low Speed (1.5 Mbits per second) that is mostly used for Human Input Devices (HID) such as keyboards, mice, joysticks and often the buttons on higher speed devices such as printers or scanners;

- (iii) Full Speed (12 Mbits per second) which is widely supported by USB hubs.
- (iv) Hi-Speed (480 Mbits per second) was added in USB 2.0 specification. Not all USB 2.0 devices are Hi-Speed.
- (v) Super Speed (USB 3.0) rate of 4800 Mbits/s (~572 MB/s).

A USB device must indicate its speed by pulling either the D+ or D- line high to 3.3 volts. These pull up resistors at the device end will also be used by the host or hub to detect the presence of a device connected to its port. Without a pull up resistor, USB assumes there is nothing connected to the bus. Pinout for the various connectors are shown Figure 2.16

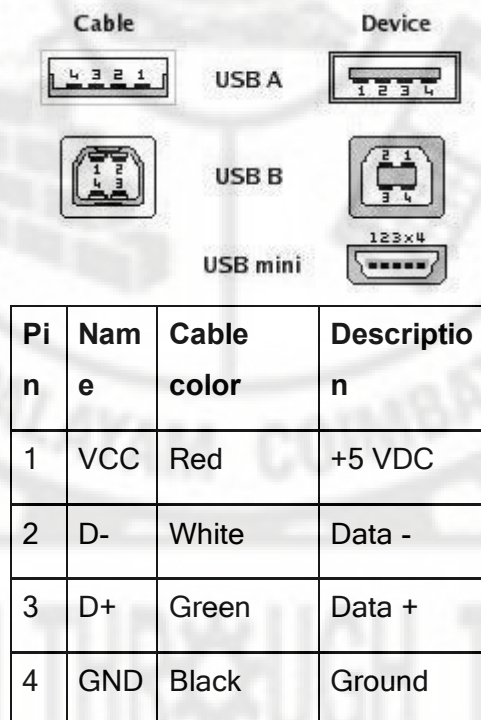
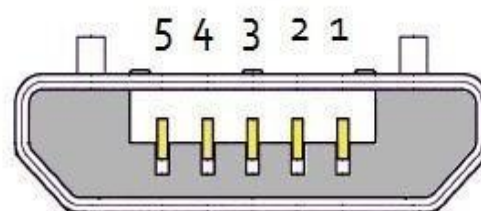

Figure 2.16 USB Connector and its Pin details

USB Micro-B Connector

Figure 2.17 shows the Micro-B connector. It is becoming more and more popular on small devices. Here is the pin out shown in Table 2.1 from the end of the plug



USB Micro-B

Figure 2.17 USB Micro- B

Table 2.1 Pin Details

Pin	Name	Cable color	Description
1	VCC	Red	+5 VDC
2	D-	White	Data -
3	D+	Green	Data +
4	ID	n/a	USB OTG ID
5	GND	Black	Ground

Wireless Connector

Wireless connector is used to connect the keyboard with the computer without wires, but is connected to the computer through infrared (IR) or Bluetooth or radio frequency connection. The signals sent from the keyboard are received by the receiver. The receiver is either inbuilt or plugged into the USB port. Since the keyboard has no connection with the computer it must be powered by either battery or AC power. The Signals in the wireless keyboard are

- (i) Radio frequency or infrared or Bluetooth signal sent from the keyboard to the receiver.
- (ii) The receiver in the USB port receives the signal and sends it to the CPU. The CPU converts the scan code into ASCII form.

2. Types of Keys

The following are the types of the keys in the keyboard.

Alphanumeric keys - All of the letters and numbers on the keyboard. A-Z and 0-9.

Punctuation keys - All of the keys associated with punctuation such as the comma, period, semicolon, brackets, parenthesis and so on. Also, all of the mathematical operators such as the plus sign, minus sign and equal sign.

Special keys- All of the other keys on the computer keyboard such as the function keys, control keys, arrow keys, caps lock key, delete key, etc

Function keys - F1-F12 for doing special operations on the programs.

Modifier key - Temporarily modifies the normal action of another key when pressed together.

By themselves, modifier keys usually do nothing; that is, pressing any of the \uparrow Shift, Alt, or Ctrl keys alone does not (generally) trigger any action from the computer.

System Command key – To carry out special actions. The keys are Esc, print screen, pause.

3. Keyboard Matrix

Keyboard is a lot like a miniature computer. It has its own processor and circuitry that carries information to and from that processor. A large part of this circuitry makes up the key matrix. The key matrix is shown in Figure 2.18.

The key matrix is a grid of circuits underneath the keys. In all keyboards, each circuit is broken at a point below each key. When key is pressed, it presses a switch, completing the circuit and allowing a tiny amount of current to flow through. The mechanical action of the switch causes some vibration, called bounce, which the processor filters out. If a key is pressed and hold, the processor recognizes it as the equivalent of pressing a key repeatedly.

When the processor finds a circuit that is closed, it compares the location of that circuit on the key matrix to the character map in its read-only memory . A character map is basically a comparison chart or lookup table. It tells the processor the position of each key in the matrix and what each keystroke or combination of keystrokes represents. For example, the character map lets the processor know that pressing the a key by itself corresponds to a small letter "a," but the Shift and a keys pressed together correspond to a capital "A."



Figure 2.18 The key matrix

A computer can also use separate character maps, overriding the one found in the keyboard. This can be useful if a person is typing in a language that uses letters that don't have English equivalents on a keyboard with English letters. People can also set their computers to interpret their keystrokes as though they were typing on a Dvorak keyboard even though their actual keys are arranged in a QWERTY layout. In addition, operating systems and applications have keyboard accessibility settings that let people change their keyboard's behaviour to adapt to disabilities.

4. Key bouncing

Mechanical switches are used as keys in most of the keyboards. When a key is pressed the contact bounce back and forth and settle down only after a small time delay (about 20ms). Even though a key is actuated once, it will appear to have been actuated

several times. This problem is called Key Bouncing. This problem is eliminated by using digital filter software.

5. Types of keyboard

There are two types of keyboards depending on the type of the key switches. They are Simple or membrane keyboard and Mechanical Keyboard.

Simple or membrane keyboard

A membrane keyboard is a computer keyboard whose "keys" are not separate, moving parts, as with the majority of other keyboards, but rather are pressure pads that have only outlines and symbols printed on a flat, flexible surface. Very little, if any, tactile feedback is felt when using such a keyboard and error-free blind typing is difficult.

Membrane keyboards work by electrical contact between the keyboard surface and the underlying circuits when keytop areas are pressed. The keyboards are quite inexpensive to mass-produce, and are more resistant against dirt and liquids than most other keyboards. However, due to a low or non-existent tactile feedback, most people have difficulty typing with them, especially when larger numbers of characters are being typed. Chiclet keyboards were a slight improvement, at least allowing individual keys to be felt to some extent.

Aside from early hobbyist/kit/home computers and some video game consoles, membrane-based QWERTY keyboards are used in some industrial computer systems, and are also found as portable, even "rollable-collapsible" designs for PDAs and other pocket computing devices. Smaller, specialised membrane keyboards, typically numeric-and-a-few-control-keys only, have been used in access control systems (for buildings and restricted areas), simple handheld calculators, domestic remote control keypads, microwave ovens, and other similar devices where the amount of typing is relatively small or infrequent, such as cell phones. Modern PC keyboards are essentially a membrane keyboard mechanism covered with an array of dome switches which give positive tactile feedback.

In the Figure 2.19, the membrane keyboard basically consists of three layers; two of these are membrane layers containing conductive traces. The center layer is a "spacer" containing holes wherever a "key" exists. It keeps the other two layers apart.

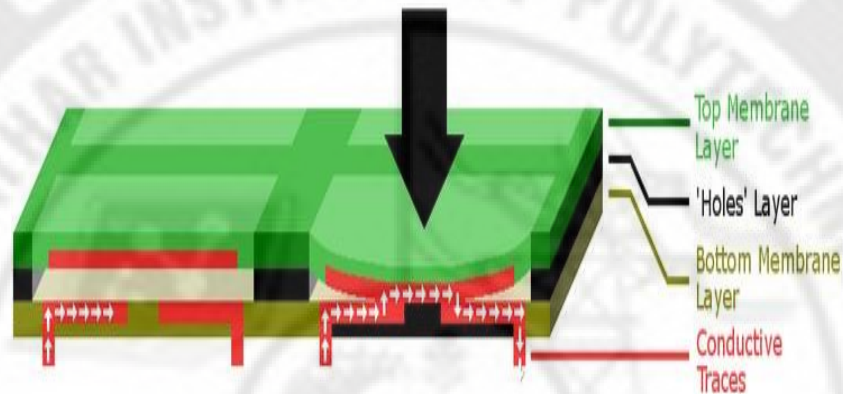

Figure 2.19 Cross-section diagram of a typical membrane keyboard.

The thickness of the bottom three layers has been exaggerated for clarity; in reality, they are not much thicker than pieces of paper or thin cardstock.

Under normal conditions, the switch (key) is open, because current cannot cross the non-conductive gap between the traces on the bottom layer. However, when the top layer is pressed down (with a finger), it makes contact with the bottom layer. The conductive traces on the underside of the top layer can then bridge the gap, allowing current to flow. The switch is now "closed", and the parent device registers a keypress. Typical applications include; Industrial controls, Access control systems, Medical equipment, Telecommunications apparatus, Telephone systems, Household appliances and Security systems.

Mechanical Keyboard

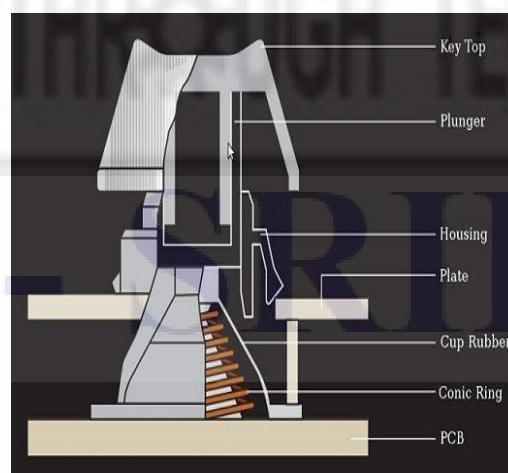

Figure 2.20 Tactile Capacitive Switch

A mechanical keyboard uses an actual physical switch underneath each key to determine when a key has been pressed. Press the key, and press the switch down. Press the switch down, and the keyboard sends a signal to the PC telling it that key is pressed.

The vast majority of keyboards used with PCs these days consist of three layers of plastic membranes lying underneath the set of keys. When the top and bottom layers connect, they close an electrical circuit that causes the keyboard to send information to the PC. The middle membrane keeps the two layers separate, but it has holes where the various keys are positioned. When key is pressed all the way down, that pushes a dome-shaped piece of rubber or silicone through the holes in the middle membrane to connect the top and bottom membranes, creating the circuit that causes the keyboard to send the corresponding input. Technically, the keyboard operates very similarly to the keypad on the microwave oven or the remote control for your TV. Those devices don't use rubber domes, however, which is why they don't provide much tactile feedback. Most console gaming system gamepads use a rubber-dome system, as well.

Rubber-dome keyboards are cheaper to manufacture than mechanical keyboards and they resist liquid spills better, but they don't provide as much tactile feedback for each button press. As a result, it's hard to know exactly how much pressure is applied to the N button before an N will appear on your screen. Mechanical keyboards tend to offer much better feedback. One of the key features of a good mechanical keyboard is called N-Key Rollover. Keyboards with this feature detect each key press independently. Keyboards without N-Key Rollover will simply ignore certain key presses once you have too many keys held down at once.

If the keyboard is connected to PC through a USB port, the most keys you can press at once and still have the keyboard recognize them is six. Almost all mechanical keyboards come with PS/2 connectors that don't have this limitation. Figure 2.20 shows the tactile capacitive switch.

Mouse:

A mouse is a pointing device (hand control) that detects two-dimensional motion relative to a surface. This motion is typically translated into the motion of a pointer on a display, which allows a smooth control of the graphical user interface. Physically, a mouse consists of an object held in one's hand, with one or more buttons. Mice often also feature other elements, such as touch surfaces and "wheels", which enable additional control and dimensional input.

Optical mouse operation

An optical mouse is an advanced computer pointing device that uses a light-emitting diode (LED), an optical sensor, and digital signal processing (DSP) in place of the traditional mouse ball and electromechanical transducer. Movement is detected by sensing changes in reflected light, rather than by interpreting the motion of a rolling sphere.

The optical mouse takes microscopic snapshots of the working surface at a rate of more than 1,000 images per second. If the mouse is moved, the image changes. The tiniest irregularities in the surface can produce images good enough for the sensor and DSP to generate usable movement data. The best surfaces reflect but scatter light; an example is a blank sheet of white drawing paper. Some surfaces do not allow the sensor and DSP to function properly because the irregularities are too small to be detected. An example of a poor optical-mousing surface is unfrosted glass.

In practice, an optical mouse does not need cleaning, because it has no moving parts. This all-electronic feature also eliminates mechanical fatigue and failure. If the device is used with the proper surface, sensing is more precise than is possible with any pointing device using the old electromechanical design. This is an asset in graphics applications, and it makes computer operation easier in general.

Optical mouse cleaning

The following steps are used to clean the mouse.

- (i) Grab the items such as tooth pick, cotton, non-oily liquid.
- (ii) Take the mouse off the mouse pad (if present) and unplug it from the computer.
- (iii) Turn the mouse over, so the bottom is facing up.
- (iv) Dip a cotton swab/Q-tip into rubbing alcohol, to clean each of the mouse's little "feet".
- (v) Use a toothpick to clean the area around these rubber feet.
- (vi) Clean the center "eye" of the mouse with another cotton-swab/Q-tip.
- (vii) Use a cotton-like (like Kimberly-Clark's Viva) paper towel, soaked in water to clean the rest of the bottom of the mouse.
- (viii) Use a hair dryer to dry the bottom of the mouse.
- (ix) Take another toothpick and clean the groove in between the two/three mouse buttons. Do not press too hard, as pieces of the wooden toothpick will shatter, and cause the mouse to falter to an early death.
- (x) Clean the mouse-wheel using toothpicks around the edges, along with the exterior of the mouse-wheel itself. Wipe from left to right.
- (xi) Place the mouse to the side.
- (xii) Clean the mouse pad with another paper towel and water (if a mouse pad is currently present).

- (xiii) Return the mouse to it's normal position on the mouse pad.
- (xiv) Take a wet cloth with a little bit of rubbing alcohol and cleanse the cord (if a cord is present).

Troubleshooting flowchart for a mouse

The mouse is not working. The flow chart for troubleshooting the mouse is shown in Figure 2.21.

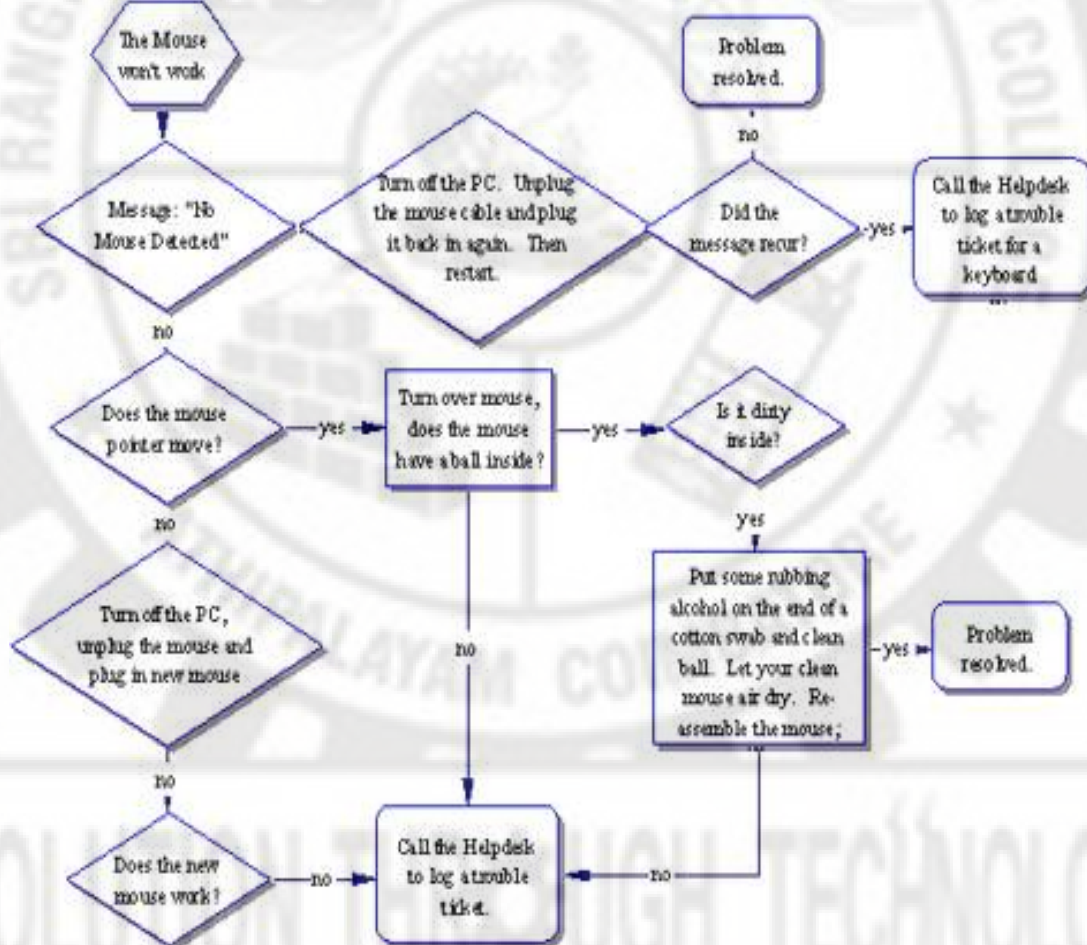

Figure 2.21 Flowchart for troubleshooting the mouse

Symptom : The mouse is acting erratic

Diagnosis: Reboot the computer and see if that corrects the problem. If not check to see if there is insufficient memory.

Symptom: The mouse will only move one way, either vertically or horizontally

Diagnosis: Clean the mouse. Shut down the machine and unplug your mouse from the computer. Open the underside of the mouse and remove the ball. If the ball is a rubber ball, do not clean it with alcohol. Clean it with a soft cloth. There should be no lubricant placed on a mouse ball. Clean the roller in the body of the mouse with a cotton swab that is slightly damp with alcohol. Replace the ball when the rollers are dry and replace the bottom portion.

Printers and Scanners

Printer:

A printer is an external output device that takes data from a computer and generates output in the form of graphics / text on a paper.

1. Types of Printers

There are two types of printers. They are Impact printer and non impact printer.

Impact printer makes contact with the paper. It usually forms the print image by pressing an inked ribbon against the paper using a hammer or pins. Examples are dot matrix, daisywheel, line , drum, chain and drum printers.

Non-impact printer Non-impact printers do not use a striking device to produce characters on the paper; and because these printers do not hammer against the paper they are much quieter. Inkjet and laser jet printer are the examples.

Impact Printers:

1. Dot Matrix

They create an image on paper by striking pins against an inked ribbon. The ink is transferred to the paper as closely shaped dots that form each character. Dot matrix printers are having two important characteristics that include speed which is given in characters per second (cps). The speed might get varied from about 50 to over 500 cps. Depending on the quality of print desire, most of the dot matrix printers offer different speeds. Another characteristic is the quality of print. The quality is determined by the number of pins. It might get varied from 9 to 24.

Operation of 7 pin printer

The print head of the dot matrix printer consists of a column of 7 small needles. It is shown in Figure 2.22. Each needle can move freely. Each needle can be made to print a dot by means of a hammer action that forced the needle to come out and press the ribbon against the paper. Standard characters are produced in a 5 x 7 dot matrix. (7 dots high and 5 dots wide).

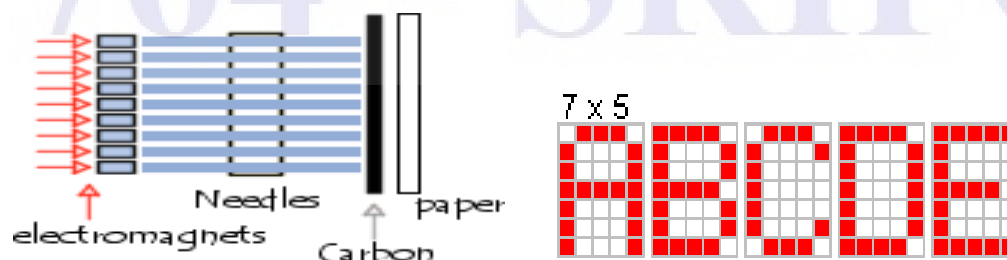

Figure 2.22 Operation of dot matrix printer.

Thus first column of the characters is got. Then the print head is moved towards right and once again the pin 1 is made to contact the ribbon. Thus second column of the character is got. Then the print head is moved to get the third column and so on.

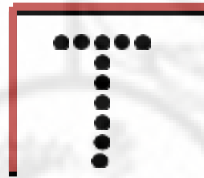

Figure 2.23 Sample Output.

In serial dot matrix printers the characters are formed by the print head (or print head). Such a print head has a number of print wires (pins) arranged in vertical columns and electro-magnetic mechanism able to shoot these wires. There are two main print head technologies - in the first one electromagnetic field shoots the print head's wire. In the second one, the so called permanent magnet printheads, a spring shoots the print head wire and the magnetic field just holds the spring in stressed and ready to shoot position. When the electromagnetic field equalizes the magnetic field, the spring is released to shoot the wire. Both print head mechanisms are shown in action at the picture bellow.

Dot matrix printer head mechanisms in action:

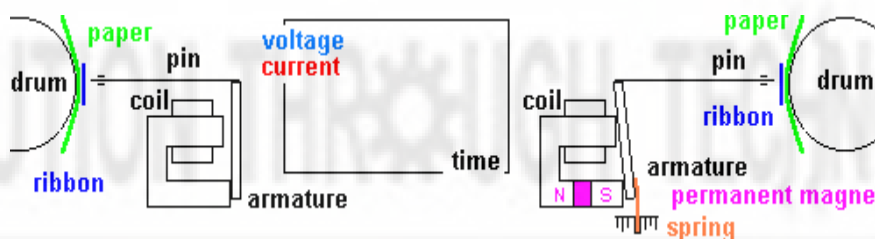

Figure 2.24 Mechanism.

Classical print head mechanism is showed from the left side and it is shown in figure 2.24. The permanent magnet printer head mechanism. In general the permanent magnet print heads are faster and are used in heavy-duty printers. Some of the most popular print heads of this type are: Epson DFX, IBM 4226, Fujitsu 5600 and 6400, and all Oki print heads.

The distance between wires in column may give us the vertical printing resolution. For example: 9 wire print head with distance 0.35 mm between adjacent wires will result in $25.4/0.35=72.5$ dots/inch (dots per inch DPI) vertical printing resolution for one pass printed line of characters. 24 wire print heads has 2 columns - 12 wires in each, with a vertical displacement of $\frac{1}{2}$ step. So if the distance between adjacent wires is 0.21 mm, then one column will print with $25.4/0.21=120.9$ dots/inch (DPI) vertical resolution, but since the second column print between the dots printed from the first one, the overall vertical resolution will be 240 DPI. The feature and specifications are shown in Table 2.2

Table 2.2 Features and specifications

Serial dot matrix printer Features:	Specifications
Print Technology:	Serial impact dot matrix
Print Speed CPS (characters per second)	200 - 1120 CPS (draft)
Graphics Resolution	72 - 360 DPI
Copies (Original +)	4 - 9
Printhead life	200 - 400 million characters
Workload (Duty cycle) PPM (Pages per month)	6,000 - 60,000 PPM

Features of dot matrix printer

- (i) Both text and graphics can be printed.
- (ii) Printing cost is very low.
- (iii) Multiple copies can be taken with the help of carbon papers.
- (iv) By increasing the number of pins from 7 to 9 or 24 the quality of printing can be increased.
- (v) Its operating speed is slow.

2. Inkjet Printer

Inkjet printing has two benefits over laser printers: lower printer cost and color-printing capabilities. But while inkjet printers are priced much less than laser printers, they are actually more expensive to use and maintain. Cartridges need to be changed more frequently and the special coated paper required to produce high-quality output is very expensive. At a cost per page level, inkjet printing costs about 10 times more than laser printing.

Operation

Inkjet printing is a liquid deposition technique, by which the droplets of the ink were ejected with the same volume and printed on the substrate. It is a low cost, material-conserving, non-contact, additive patterning, and maskless approach with the scalability to large area manufacturing. According to the formation of the uniform drops, printers are classified into two categories: continuous inkjet printer and drop-on-demand (DOD) inkjet printer.

For continuous inkjet printer, the ink ejected by the high pressure is broken into uniform droplets by electromechanical devices, at the same time the droplets are charged and directed to the desired place in the presence of the deflecting electrode. Figure 2.25 shows the schematic of the continuous inkjet printer. This type of inkjet printer possesses high-frequency drop generation; however, the cost is also high as its great space requirement and the complicated ink system. It is best suited for graphic arts and industrial applications.

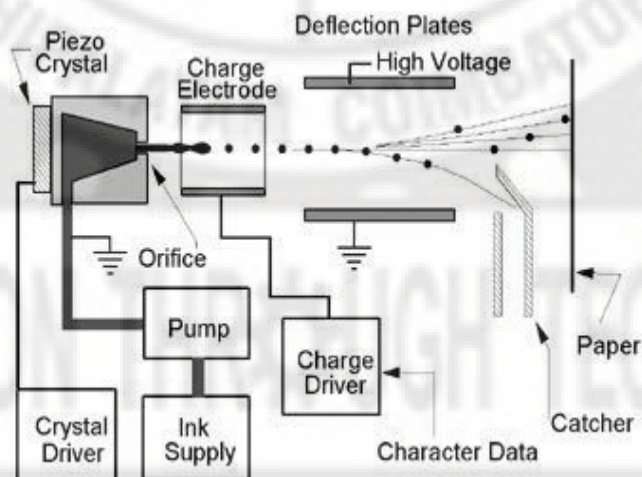

Figure 2.25 The schematic of continuous inkjet printer

For DOD inkjet printers, the drops were generated by the volume changes of the channel caused by the applied voltage on the piezoelectric materials of the channel wall. Figure 2.26 shows the actuator principle of ejecting uniform drops from the ink. At the beginning the voltage is applied on one channel and with the piezoelectric effect, the channel is enlarged and filled with the ink; then the voltage will be applied to the neighbour channel, which is enlarged and at the same time the first channel will shrink and release a drop of ink. Thus by

applying voltage on channels, the ink can be ejected as a form of drop and printed on substrate as the pattern desired.

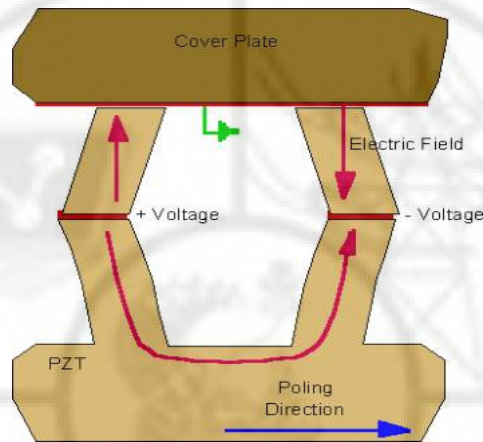

Figure 2.26. Actuator operation principle of the print head

There is another type of DOD printer, bubble jet, which is thermal driven. The stream pocket is produced in the channel by the heating element, as shown in Figure 2.27. As the applied voltage, the resistor heat up and produces bubble which forces the ink to jet out to form drop. The schematic of DOD inkjet printer is shown in Figure 2.28, in which the droplets are produced by applying voltage according to the print desired.

From Computer Desktop Encyclopedia
© 1998 The Computer Language Co. Inc.

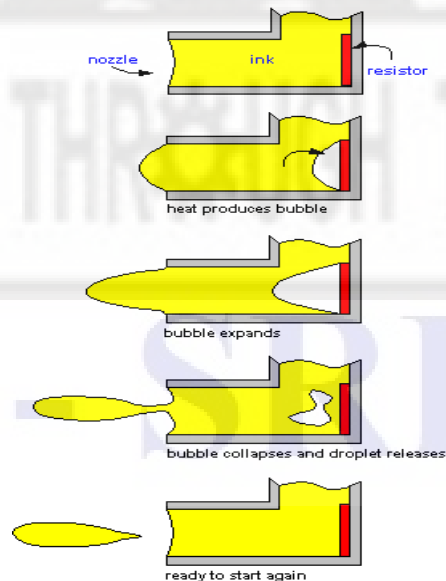

Figure 2.27 Thermal driven Principle

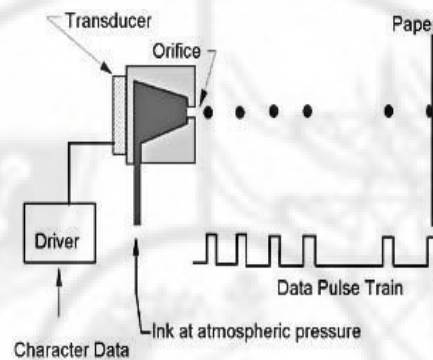

Figure 2.28 DOD inkjet printing system.

The DOD printer system is less complex than the continuous printers, and thus the cost will be lower. It is the commercially available inkjet printer today.

3. Laser Printer

A laser printer is a popular type of personal computer printer that uses a non-impact (keys don't strike the paper), photocopier technology. When a document is sent to the printer, a laser beam "draws" the document on a selenium-coated drum using electrical charges. After the drum is charged, it is rolled in toner, a dry powder type of ink. The toner adheres to the charged image on the drum. The toner is transferred onto a piece of paper and fused to the paper with heat and pressure. After the document is printed, the electrical charge is removed from the drum and the excess toner is collected. Most laser printers print only in monochrome. A color laser printer is up to 10 times more expensive than a monochrome laser printer.

When print something, the computer sends a vast stream of electronic data (typically a few megabytes or million characters) to the laser printer. An electronic circuit in the printer figures out what all this data means and what it needs to look like on the page. It makes a laser beam scan back and forth across a drum inside the printer, building up a pattern of static electricity. The static electricity attracts onto the page a kind of powdered ink called toner. Finally, as in a photocopier, a fuser unit bonds the toner to the paper.

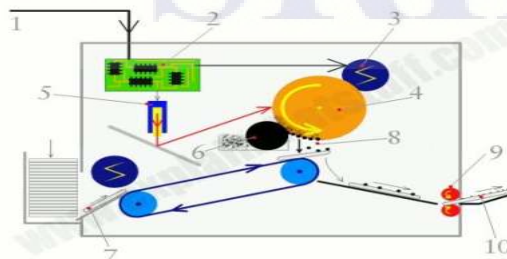

Figure 2.29 operation of Laser printer.

- (i) Millions of bytes (characters) of data stream into the printer from the computer.
- (ii) An electronic circuit in the printer (effectively, a small computer in its own right) figures out how to print this data so it looks correct on the page.
- (iii) The electronic circuit activates the corona wire. This is a high-voltage wire that gives a static electric charge to anything nearby.
- (iv) The corona wire charges up the photoreceptor drum so the drum gains a positive charge spread uniformly across its surface.
- (v) At the same time, the circuit activates the laser to make it draw the image of the page onto the drum. The laser beam doesn't actually move: it bounces off a moving mirror that scans it over the drum. Where the laser beam hits the drum, it erases the positive charge that was there and creates an area of negative charge instead. Gradually, an image of the entire page builds up on the drum: where the page should be white, there are areas with a positive charge; where the page should be black, there are areas of negative charge.
- (vi) An ink roller touching the photoreceptor drum coats it with tiny particles of powdered ink (toner). The toner has been given a positive electrical charge, so it sticks to the parts of the photoreceptor drum that have a negative charge (remember that opposite electrical charges attract in the same way that opposite poles of a magnet attract). No ink is attracted to the parts of the drum that have a positive charge. An inked image of the page builds up on the drum.
- (vii) A sheet of paper from a hopper on the other side of the printer feeds up toward the drum. As it moves along, the paper is given a strong positive electrical charge by another corona wire.
- (viii) When the paper moves near the drum, its positive charge attracts the negatively charged toner particles away from the drum. The image is transferred from the drum onto the paper but, for the moment, the toner particles are just resting lightly on the paper's surface.
- (ix) The inked paper passes through two hot rollers (the fuser unit). The heat and pressure from the rollers fuse the toner particles permanently into the fibers of the paper.
- (x) The printout emerges from the side of the copier. Thanks to the fuser unit, the paper is still warm.

Features

- (i) Quality of printing is high.
- (ii) Low printing cost.
- (iii) Colour printing is possible.
- (iv) It is very easy to print on envelopes, cards and other non-regular media.
- (v) Speed of operation is high.

4. Thermal Printers

Most inkjets use thermal technology, whereby heat is used to fire ink onto the paper. Thermal technology is shown in Figure 2.30. There are three main stages in this process. The squirt is initiated by heating the ink to create a bubble until the pressure forces it to burst and hit the paper. The bubble then collapses as the element cools, and the resulting vacuum draws ink from the reservoir to replace the ink that was ejected. Canon and Hewlett-Packard favour this method.

Tiny heating elements are used to eject ink droplets from the print head's nozzles. Most thermal inkjets have print heads containing a total of between 300 and 600 nozzles, each about the diameter of a human hair (approx. 70 microns). These deliver drop volumes of around 8 to 10 picolitres (a picolitre is a million millionth of a litre), and dot sizes of between 50 and 60 microns in diameter. By comparison, the smallest dot size visible to the naked eye is around 30 microns. Dye-based cyan, magenta and yellow inks are normally delivered via a combined three-color (cyan, magenta and yellow) print head. Several small color ink drops - typically between four and eight - are typically combined to deliver a variable dot size. Black ink, which is generally based on bigger pigment molecules, is delivered from a separate print head in larger drop volumes of around 35pl.

Nozzle density, corresponding to the printer's native resolution, varies between 300 and 600 dpi, while enhanced resolutions of 1200 dpi are increasingly becoming available. Print speed is chiefly a function of the frequency with which the nozzles can be made to fire ink drops and the width of the swath printed by the print head. This is usually around 12MHz and half an inch respectively, giving print speeds of between 4 to 8 ppm for monochrome text and 2 to 4 ppm for color text and graphics.

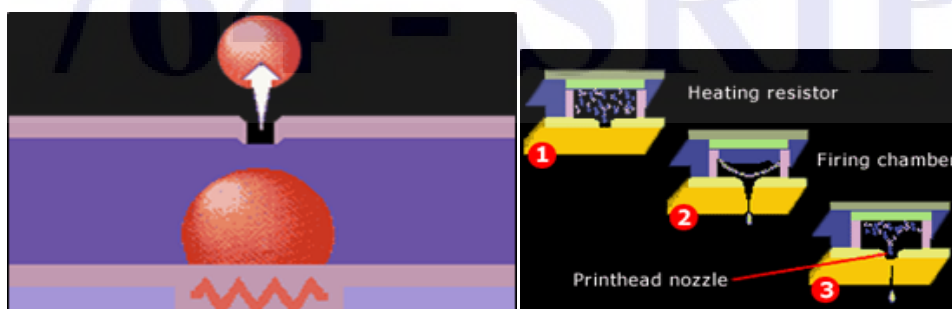

Figure 2.30 Thermal Technology

Thermal technology, meanwhile, imposes the limitation that whatever type of ink is used; it must be heat-resistant because the firing process is heat-based. Using heat in thermal printers conversely also creates a need for cooling, which adds to the overall length of printing time.

5. MFP printer

MFPs are also known as multifunction printers. Multifunction peripheral, a single device that serves several functions, including printing. Typically, multifunction printers can act as a printer, a scanner, a fax machine and a photocopier. These devices are becoming a popular option for Small Office/ Home office users because they're less expensive than buying three or four separate devices. The downsides to combining all these functions in one device are:

- (i) If the device breaks, all of its functions could be lost at the same time.
- (ii) It performs one operation at a time. For example, either it will print a document or receive a fax at a time.

Benefits

- (i) Convenient: The ability to scan and print a document in one device is also very convenient.
- (ii) Cost Savings: More functionalities with less investment.
- (iii) Reduce waste: Reduces carbon foot print.
- (iv) Space saving: It saves space , energy and time.

8. Troubleshooting

- (i) Printer won't print.

If there are no error messages pointing to the problem, check to be sure that the printer is still connected, via USB or Ethernet cable or—if a wireless model—that the Wi-Fi is enabled and that printer is connected to the right network. The printer driver and software needs to be installed on the computer.

- (ii) Running out of ink, but printer still can print.

Replace cartridges if the error message is "low-ink warning". Nearly all recent printers have some sort of ink tank level indicator, and will issue warnings when the ink is low. The accuracy of these warnings varies widely among manufacturers and models. Sometimes low-ink warnings indicate that the ink level is critically low.

- (iii) Cannot print from mobile device to printer.

Even if printer is old or a non-Wi-Fi model, probably we can print from a phone or tablet to it. Most new Wi-Fi printers support AirPrint, which lets users of iOS devices print to them (provided that both the iPhone, iPad, or iPod touch and printer are on the same Wi-Fi network). Nearly all major printer makers have released apps so that

iPhone, iPad, Android, and in some cases Windows Phone and BlackBerry users can print from their devices to that manufacturer's recent models. Printopia requires a Mac, while Presto! (formerly Fingerprint 2) works either with Macs or Windows machines. Cloud printing services such as Cortado, ThinPrint Cloud Printer and Google CloudPrinter work across platforms and device types and with non-WiFi printers as well. These solutions tend to be limited to printing from a select set of apps. Some new wireless printers support printing via Wi-Fi Direct, a protocol that lets two compatible devices make a direct wireless connection without needing a wireless access point. Although many recent Android devices support Wi-Fi Direct, iPhones do not. Some HP and Kodak printers support printing via email. In either case, printer gets assigned an email address, and use an email to attach documents and the printer will automatically print them out.

(iv) Wi-Fi printing takes too long.

Placing the printer very close to the router should increase throughput and reduce printing time, but there are other ways to improve Wi-Fi performance while retaining the flexibility of printer placement that wireless printing promises. Be sure the router is adequate—it should support 802.11n and offer the 5GHz band as well as 2.4 GHz—and that its firmware is up to date.

(v) Printer too slow.

Some printers are cheetahs and some are sloths, but you may be able to get even a slow printer to speed up a bit. Unless you need high-quality output for a formal report or the like, print in draft mode (or whatever the lowest-quality setting is). Avoid duplex (two-sided) printing, as the printer has to flip the document over to print on both sides, which can significantly slow it down. Choose printer drivers, print from a host-based or PCL driver; although PostScript drivers can print photos at higher quality, it may come at the expense of speed.

(vi) It costs too much to print.

Believe it or not, cost per printed page (based on ink and toner cartridge costs and yields) has declined in recent years, but that's small comfort to someone having to pony up for yet another set of cartridges.

(vii) Print those pages that are really needed. Print in draft mode for presentation, which uses less ink. If the printer supports duplex (two-sided) printing, using it will save a lot of paper. Just remember to switch back to simplex printing and quality mode when it requires. The higher capacity cartridges cost more up front but they have higher yields (can print more pages), and lower cost per printed page.

(viii) The printed text looks lousy.

Printers vary widely in text quality; inkjets generally offer text suitable for home, school, or casual business use, while most lasers are capable of printing crisp text for more professional-looking document. Whether inkjet or laser, make sure the print settings are correct. If it is in draft mode, switch to higher quality mode (though it will slow down the printing). Be sure that the paper type listed on screen matches the paper to be printed on. With laser printers, it may mean that the toner has settled; remove the cartridge(s) and shake several times from side to side. Often, a cartridge will respond to this, though eventually it will run out of toner and have to be replaced. For inkjets, try a nozzle cleaning and print head alignment. Try to replace the cartridges. Inkjet's photos look lousy.

(ix) Lot of paper jams.

The most common cause of paper jams is paper misalignment. Be sure to square off the stack of paper before inserting it in the tray, be sure that the guides are flush with the paper, and avoid over-filling the tray.

(x) MFP won't scan anymore.

If multifunction printer's (MFP) scanner stops working, it may be that the scanner software has become corrupted; try reinstalling the printer's software package. It's not too unusual for the scanner in a lower-end MFP to fail, and the whole unit may have to be replaced.

Scanner:

A scanner is an input device that captures images from photographic prints, posters, magazine pages, and similar sources for computer editing and display. Scanners usually attach to the personal computer with a Small Computer System Interface (SCSI). Some major manufacturers of scanners include: Epson, Hewlett-Packard, Microtek, and Relisys. At the simplest level, a scanner is a device which converts light into 0s and 1s (a computer-readable format). In other words, scanners convert analog data into digital data.

Scanner mechanism

The important components of the Scanner are :

- (i) Charge-coupled device (CCD) array
- (ii) Scan head
- (iii) Stepper motor
- (iv) Lens
- (v) Power supply
- (vi) Control circuitry
- (vii) Interface ports

- (viii) Mirrors
- (ix) Glass plate
- (x) Lamp
- (xi) Filters
- (xii) Stabilizer bar
- (xiii) Belt
- (xiv) Cover

Though the configuration of the above components differs according to the manufacturers design, the basic working is almost the same.

A scanner consists of a flat transparent glass bed under which the CCD sensors, lamp, lenses, filters and also mirrors are fixed. The document has to be placed on the glass bed. There will also be a cover to close the scanner. This cover may either be white or black in colour. This colour helps in providing uniformity in the background. This uniformity will help the scanner software to determine the size of the document to be scanned. If a page from a book is to be scanned, you may not be able to use the cover.

The lamp brightens up the text to be scanned. Most scanners use a cold cathode fluorescent lamp (CCFL).

A stepper motor under the scanner moves the scanner head from one end to the other. The movement will be slow and is controlled by a belt. The scanner head consists of the mirrors, lens, CCD sensors and also the filter. The scan head moves parallel to the glass bed and that too in a constant path. As deviation may occur in its motion, a stabilizer bar will be provided to compromise it. The scan head moves from one end of the machine to the other. When it has reached the other end the scanning of the document has been completed. For some scanners, a two way scan is used in which the scan head has to reach its original position to ensure a complete scan.

As the scan head moves under the glass bed, the light from the lamp hits the document and is reflected back with the help of mirrors angled to one another. According to the design of the device there may be either 2-way mirrors or 3-way mirrors. The mirrors will be angled in such a way that the reflected image will be hitting a smaller surface. In the end, the image will reach a lens which passes it through a filter and causes the image to be focused on CCD sensors. The CCD sensors convert the light to electrical signals according to its intensity. Take a look at the Figure 2.31

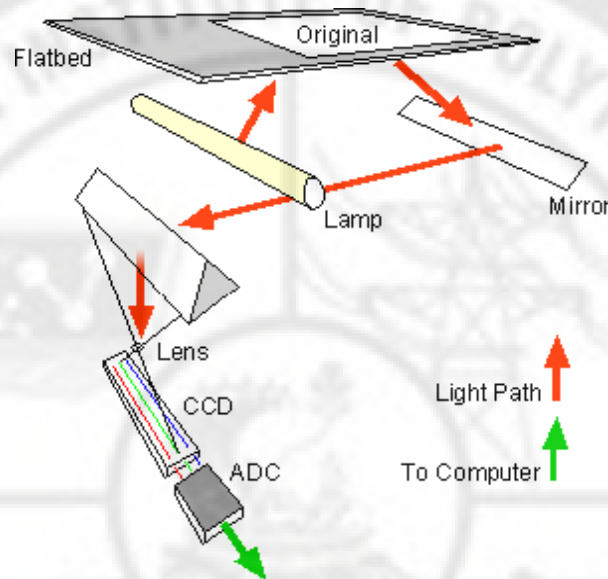

Figure 2.31 Principle of Operation

The electrical signals will be converted into image format inside a computer. This reception may also differ according to the variation in the lens and filter design. A method called three pass scanning is commonly used in which each movement of the scan head from one end to another uses each composite colour to be passed between the lens and the CCD sensors. After the three composite colours are scanned, the scanner software assembles the three filtered images into one single -colour image.

There is also a single pass scanning method in which the image captured by the lens will be split into three pieces. These pieces will pass through any of the colour composite filters. The output will then be given to the CCD sensors. Thus the single-colour image will be combined by the scanner.

In some recent scanners, a contact image sensor [CIS], has replaced the CCD sensor. Though this method is not as expensive as the CCD scanner, the quality of the image produced and the resolution is much lower.

Working principle

All scanners work on the same principle of reflectance or transmission. The image is placed before the carriage, consisting of a light source and sensor; in the case of a digital camera, the light source could be the sun or artificial lights. When desktop scanners were first introduced, many manufacturers used fluorescent bulbs as light sources. While good enough for many purposes, fluorescent bulbs have two distinct weaknesses: they rarely emit consistent white light for long, and while they're on they emit heat which can distort the other optical components. For these reasons, most manufacturers have moved to cold-cathode bulbs. These differ from standard fluorescent bulbs in that they have no filament. They therefore operate at much lower temperatures and, as a consequence, are more reliable.

Standard fluorescent bulbs are now found primarily on low-cost units and older models. Xenon bulbs had emerged as an alternative light source. Xenon produces a very stable, full-spectrum light source that's both long lasting and quick to initiate. However, xenon light sources do consume power at a higher rate than cold cathode tubes.

To direct light from the bulb to the sensors that read light values, CCD scanners use prisms, lenses, and other optical components. Like eyeglasses and magnifying glasses, these items can vary quite a bit in quality. A high-quality scanner will use high-quality glass optics that are colour-corrected and coated for minimum diffusion. Lower-end models will typically skimp in this area, using plastic components to reduce costs.

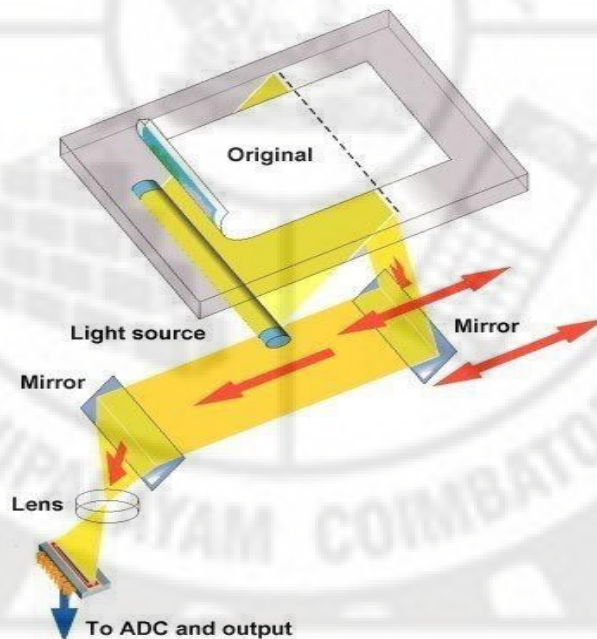

Figure 2.32 Working principle

The amount of light reflected by or transmitted through the image and picked up by the sensor, is then converted to a voltage proportional to the light intensity – the brighter the part of the image, the more light is reflected or transmitted, resulting in a higher voltage. This analogue-to-digital conversion (ADC) is a sensitive process, and one that is susceptible to electrical interference and noise in the system. In order to protect against image degradation, the best scanners on the market today use an electrically isolated analogue-to-digital converter that processes data away from the main circuitry of the scanner. However, this introduces additional costs to the manufacturing process, so many low-end models include integrated analogue-to-digital converters that are built into the scanner's primary circuit board. Figure 2.32 shows the working principle.

The sensor component itself is implemented using one of three different types of technology:

- (i) PMT (photomultiplier tube), a technology inherited from the drum scanners of yesteryear.

- (ii) CCD (charge-coupled device), the type of sensor used in desktop scanners.
- (iii) CIS (contact image sensor), a newer technology which integrates scanning functions into fewer components, allowing scanners to be more compact in size.

Types of Scanners

There are three types of Scanners. They are Barcode, Handheld and Flatbed Scanner

Barcode Scanner

Barcode scanners have become such a ubiquitous technology that it is easy to take the complexity of their underlying designs for granted. Barcode scanners require multiple discrete integrated circuits and an array of passive and active circuitry to provide the functionality and reliability that end users have come to expect. Many barcode scanners generally use an optical sensor, such as a charge-coupled device (CCD), which outputs an analog representation of what is visible to the sensor to an analog-to-digital converter (ADC) controlled by a microcontroller (MCU). The MCU interprets the ADC’s output as a sequence of thick and thin black and white bars and processes this sequence further to derive a string of characters from the pattern. The character sequence may be encoded in any one of a number of well-defined barcode protocols, such as Code 39.

Additional features found in barcode scanners include USB connectivity, regulators, audio output (usually driven by a discrete digital-to-analog converter (DAC) or simple pulse-width modulation (PWM)), and other glue logic for level-shifting between components running from 3 volts, such as the MCU, and components running from 5 volts, such as the CCD. Figure 2.33 shows the Barcode Scanner.

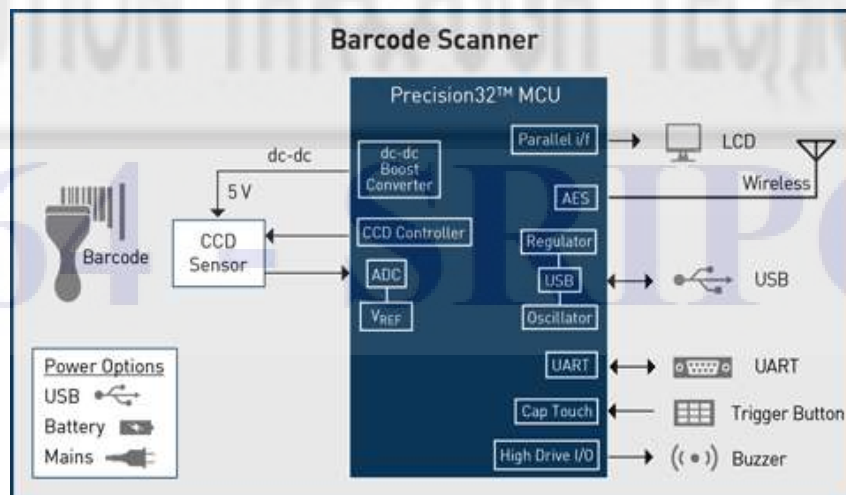

Figure 2.33 Barcode Scanner based on highly integrated 32-bit controller.

Handheld Scanners

Hand-held scanners are used to scan documents by dragging the scanner across the surface of the document. They are available as document scanners as well as 3-D scanners. This scanning will be effective only if with a steady hand technique, or else the image may seem distorted. They have sensors to detect the distortion rate and an indicator will be provided to alert if the motion of the scanner is too fast.

They also have a START button, which has to be on during the scan duration. They are synchronized with the computer and also have an automatic optical resolution. The scanner also has LEDs which light up the image to be scanned. As the image can be distorted, most of the time there are special reference markers available in the device which helps in compensating the distortion. Though poor image quality is obtained, fast scanning of texts can be done with this device.

Hand 3D scanner

Handheld 3D scanners are used in industrial design, reverse engineering, inspection and analysis, digital manufacturing and medical applications. "To compensate for the uneven motion of the human hand, most 3D scanning systems rely on the placement of reference markers, typically adhesive reflective tabs that the scanner uses to align elements and mark. Handheld scanner is show in Figure 2.34.



Figure 2.34 handheld Scanner.

Flat bed scanner

The main difference in the old scanners and modern scanners is the type of image sensor used. In old scanners, a photomultiplier tube [PMT] was used. For modern scanners, a Charge-coupled device [CCD] is used. A CCD sensor is used to capture the light from the scanner and then convert it into the proportional electrons. The charge developed will be more if the intensity of light that hits on the sensor is more. This type of scanner is sometimes called reflective scanner because it works by shining white light onto the object to be scanned and reading the intensity and color of light that is reflected from it, usually a line at a time. They are designed for scanning prints or other flat, opaque materials but some

have available transparency adapters, which for a number of reasons, in most cases, are not very well suited to scanning film. Refer scanner working principle for operation.

CCD Scanner

"A flatbed scanner is usually composed of a glass pane (or platen), under which there is a bright light (often xenon, LED or cold cathode fluorescent) which illuminates the pane, and a moving optical array in CCD scanning. CCD-type scanners typically contain three rows (arrays) of sensors with red, green, and blue filters." Figure 2.35 shows the operation of CCD Scanner.

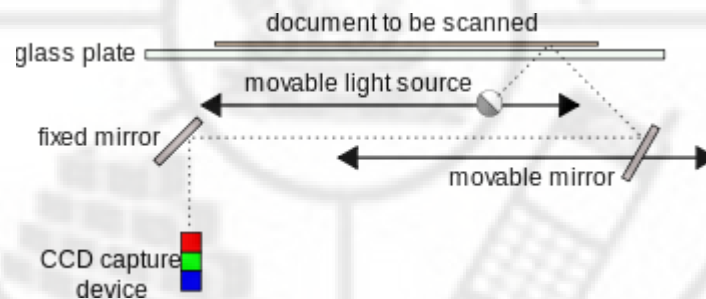

Figure 2.35 Operation of CCD scanner.

Preventive Maintenance

Good indications that scanner requires maintenance are:

- (i) Sensor alarms/errors (normally the result of dust build-up preventing sensors from operating).
- (ii) Persistent paper jams despite cleaning and consumable change (normally caused by residue build-up on rollers or dust inside sensors).
- (iii) Degraded image quality such as lines down image or other artefacts (normally caused by dust and/or residues on the glass guides or inside the optical units).
- (iv) Unusual 'grinding' or 'knocking' noises (normally caused by advanced build-up of residues, dust/toner on rollers and moving parts, or sometimes staples preventing normal operation).
- (v) The frequency of preventative maintenance is governed by how many documents are scanned within a given period of time. As paper is scanned, dust and chemicals are transferred to the moving parts and interior of the product. This process is accelerated on production scanners due to their high speed and high daily duty cycles.

Troubleshooting

The common problems and solutions of the scanner are shown in Table 2.3.

Table 2.3 Scanner Problems and Solutions

Scanners Problems and Solutions	
Problem	Solution
The computer does not recognize a scanner has been connected to it, and therefore is unresponsive.	<ul style="list-style-type: none"> • Verify the cables are connected properly to the back of the scanner. • If the scanner is a parallel port scanner, it likely has two available connections on the back of the scanner. Verify that the cable coming from the computer is connected to the "Computer In" port. • Make sure the scanner is receiving power. Push the power button, which can be located on the top or on the side. • Check to see if the scanner appears in My Computer. If it does not appear, it is possible the scanner, scanner software, or scanner driver (TWAIN) was not installed properly.
Error message similar to "Scanner Initialization failed", "Scanner not found" or the TWAIN_32 error , when trying to use the scanner.	<ul style="list-style-type: none"> • Reset the scanner. • Close any Scanner software. • Disconnect the cable that connects the scanner to the computer. • Turn the power switch on the back of the scanner to OFF. • Turn the computer off, wait 60 seconds, and then turn the computer on again. • Turn the power switch on the back of the scanner to ON. • Reconnect the cable that connects the computer and the scanner. • The scanner should be working again. If not, you may need to contact your technology coordinator.

<p>Scanner has stopped working properly. (If the scanner stops scanning, complete the following steps, in the presented order. After each step, start a scan to see if the scanner is working again. If the problem persists, proceed with the next step.)</p>	<ul style="list-style-type: none"> • A cable might be loose. Ensure that both the USB cable and power cable are securely connected. • Unplug the power cable from the power source, wait 60 seconds, and then plug it back in. • Reboot the computer. • A software conflict might exist on the computer. need to uninstall and then reinstall the scanner software via Control Panel's Add/Remove Programs. • Reinstall the software. If the problem persists, you may need to contact your technology coordinator.
<p>The scanned documents, both written text and images have smudges.</p>	<ul style="list-style-type: none"> • Check to see if the glass has smudges on them from repeated and prolonged use. • Check the original document. It is possible this is the way the original appeared. • Try scanning again and see if the cleaning fixed the issue. If necessary repeat the cleaning process.
<p>The Light Bar Flashes or Blinks on the Scanner.</p>	<ul style="list-style-type: none"> • When the light bar flashes or blinks, the built-in diagnostics are reporting the hardware is not functioning as expected. • Turn off the computer that is connected to the scanner • Disconnect power cord and USB cable from the back of the scanner. • Unlock the Transport Lock several times, if necessary. Make sure it is opened. • Wait 60 seconds before reconnecting the USB Cable and the power cord to the scanner. • Turn on the computer and rescan to test.

Review Questions

PART-A

1. What is primary memory? What are its Characteristics?

Indicate the Speed of the following memories.

- (i) DDR 3 -1600
 - (ii) PC3-12800
 - (iii) Memory is rated as 333 MHz
 - (iv) PC2700
2. Define Access time. How it is measured for RAM and CD-ROM?
 3. Define the term latency related to access time.
 4. Define wait states.
 5. How primary memory is classified?
 6. How secondary memory is classified?
 7. Mention the important memory errors.
 8. How reading is done in hard disk?
 9. What is FAT?
 10. How many layers does the file system contain?
 11. What is File name?
 12. Define the term directory and meta data.
 13. Expand NTFS.
 14. What are the three different processes of formatting?
 15. State the features of DVD-ROM.
 16. List the features of DVD-video.
 17. What are the two types of DVD technology?
 18. What is Blu-ray?
 19. What are the parameters of Blu ray?
 20. List the latest memory sticks with its specifications.
 21. What is SSD? What are its three major form factors?
 22. Give the pin details of USB connector.
 23. State the functions of different keys of the keyboard.
 24. Draw the flow chart for troubleshooting the mouse.
 25. List the specifications of dotmatrix printer.
 26. What are the functions of Multifunction printer.
 27. List the different types of scanner.

PART-B

1. Explain the types of memory in detail.
2. Explain the memory errors.
3. Explain the construction of Hard disk.
4. Explain the working principle of hard disk.
5. Explain the file systems.
6. How to format the hard disk?
7. What are the common problems that occur in Hard disk? What are its solutions?
8. Explain the DVD-ROM in detail.
9. Explain the Recordable DVD.
10. Discuss the Blu ray and its parameters.
11. How recording and playback is done in Blu ray.
12. Write short notes on memory stick, USB Flash drive, Solid State Drive.
13. Write short notes on USB and Wireless.
14. Explain the keyboard matrix.
15. Explain the key bouncing.
16. Explain the mechanism of membrane key switches.
17. Explain the operation of optical mouse.
18. How will you clean the optical mouse?
19. Draw the flowchart to troubleshoot the mouse.
20. Explain the Dot Matrix printer in detail.
21. Explain the operation Inkjet printer.
22. Explain the working of Laser printer.
23. Explain the common problems encountered in printer and provide its solutions.
24. Explain the scanner mechanism.
25. Explain any type of scanner.
26. Explain the preventive maintenance of scanner.
27. How will you troubleshoot the scanner?

764 - SRIPC

UNIT III DISPLAY, POWER SUPPLY AND BIOS

Learning Objectives

Learners should be able to

- Know the Working principles of display and graphic cards
- Be aware of Switched Mode Power Supply
- Identify Connectors
- Know the features of Basic Input Output System.
- Be aware of Power on self Test (POST).

Introduction

The output of the computer is shown in display. There are a wide variety of displays with its own merits and demerits. It's concepts are presented in this chapter. Technicians must be aware of the details of power supply in order to troubleshoot the computer. The concept of switched mode power supply and connector details are briefed. Technician has to be configuring the computer with the help of BIOS. Certain faults may be identified while running self testing program. BIOS and POST concepts are explained in this chapter.

Display and Graphic Cards

1. Displays:

A display device is an output device for presentation of information in visual or tactile form. When the input information is supplied as an electrical signal; the display is called an electronic display. The different types of displays are

- (i) Cathode ray tube display (CRT)
- (ii) Light-emitting diode display (LED)
- (iii) Electroluminescent display (ELD)
- (iv) Electronic paper, E Ink.
- (v) Plasma display panel (PDP)
- (vi) Liquid crystal display (LCD) ...
- (vii) Organic light-emitting diode display (OLED)

2. LCD Principles

Introduction:

A liquid crystal display or LCD is combination of two states of matter, the solid and the liquid. LCD uses a liquid crystal to produce a visible image. Liquid crystal displays are super-thin technology display screens that are generally used in laptop computer screen, TVs, cell phones and portable video games. LCD technologies allow displays to be much thinner when compared to cathode ray tube (CRT) technology.

LCD - Liquid crystal display screen works on the principle of blocking light rather than emitting light. LCDs require backlight as they do not emit light by themselves. Cathode ray tube draw more power compared to LCDs and are also heavier and bigger.

Twisted nematic (TN):

Molecular structure of nematic was naturally twisted. The orientation of the molecules in the nematic phase is based on the 'director'; this can be anything from a magnetic field, resulting from the application of an electric current due to an applied voltage across the glass plates holding the liquid crystal solution, to a surface that has microscopic grooves in it. In the latter, the molecules at the various layers of the liquid crystal will gradually align themselves till the molecules at the layer adjacent to the surface will be exactly in line with the direction of the microscopic grooves on the surface.

Microscopic grooves:

Microscopic grooves in LCD display panels are applied on the surface of the glass plate that does not have the polarizing film on it to help align the molecular structure of the liquid crystals as these approaches the glass surface in line with the polarization filters on either side of the LCD panel.

The Figure 3.1 shows the structure of first principle

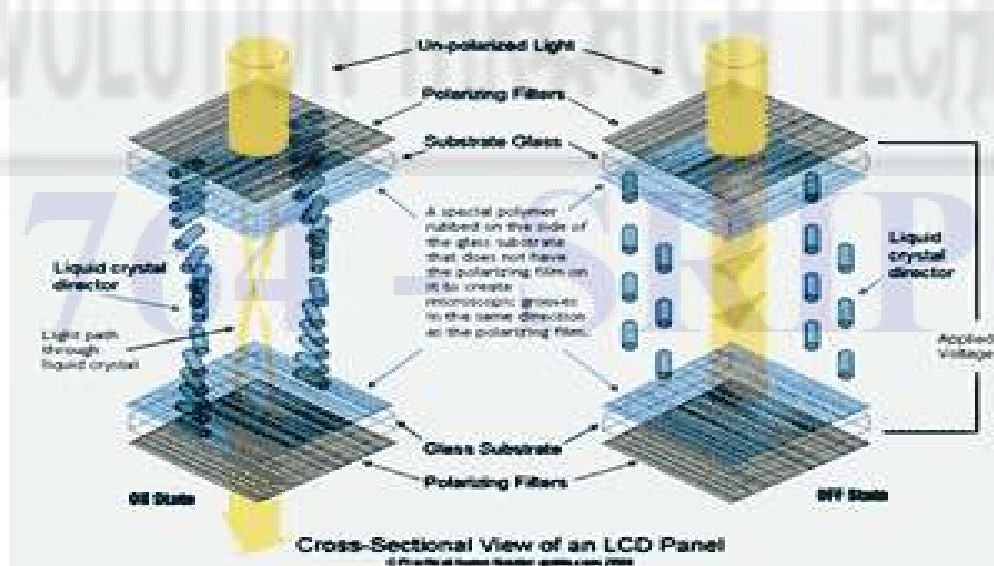

Figure 3.1 Cross-Sectional View of an LCD Panel

Polarization filters:

The polarization filters on either side of an LCD display are set at 90 degrees to each other (ref. to above diagram). This means that the crystal lineup will go through a 90 degrees twist from one panel surface to the other. When a light shines on the glass surface of the first polarization filter, the molecules in each layer of the liquid crystal solution will guide the light they receive to the next layer. In the process, they will also change the light's plane of vibration to match their own angle. When the light reaches the far side of the liquid crystal substance, it vibrates at the same angle as the final layer of molecules. If the final layer is matched up with the second polarized glass filter, then the light will pass through.

Operation:

When an electric current is passed through these liquid crystals, they will untwist to varying degrees, depending on the current's voltage. This untwisting effect will change the polarization of the light passing through the LCD panel. As the polarization changes in response to the applied voltage across the glass plates, more or less light is able to pass through the polarized filter on the face of the LCD display.

Color Liquid Crystal Display:

- (i) Colour LCDs are those that can display pictures in colors. Three sub-pixels with red, green and blue colour filters to create each colour pixel.
- (ii) For combining these sub-pixels these LCDs should be connected to a large number of transistors. If any problem occurs to these transistors, it will cause a bad pixel.
- (iii) One of the main disadvantages of these types of LCDs is the size. Most manufacturers try to reduce the height because more transistors and greater pixels will be needed to increase the length.
- (iv) This will increase the probability of bad pixels. It is very difficult or also impossible to repair an LCD with bad pixels.

Advantages of LCDs:

- (i) LCDs consume less amount of power compared to CRT and LED.
- (ii) LCDs consume some microwatts for display in comparison to some milli watts for LEDs.
- (iii) LCDs are of low cost.
- (iv) Provides excellent contrast.
- (v) LCDs are thinner and lighter when compared to cathode ray tube and LED.

Disadvantages of LCDs:

- (i) Require additional light sources.
- (ii) Range of temperature is limited for operation.
- (iii) Low reliability.

- (iv) Speed is very low.
- (v) LCDs need an AC drive.

Applications of Liquid Crystal Display

Liquid crystal technology has major applications in the field of science and engineering as well on electronic devices.

- (i) Liquid crystal thermometer.
- (ii) Optical imaging.
- (iii) The liquid crystal display technique is also applicable in visualization of the radio frequency waves in the waveguide.
- (iv) Used in medical applications.

3. Plasma displays

Introduction:

Research on plasma displays began in the United States over four decades ago, in 1960. The technology was developed by four researchers: Bitzer, Slottow, Willson, and Arora. The first prototype came out very quickly, in 1964. The matrix, which was revolutionary for its time, consisted of 4 x 4 pixels emitting monochrome blue light. Then, in 1967, the size of plasma matrices increased to 16 x 16 pixels, this time emitting a pale red light, still monochrome, using neon.

Working:

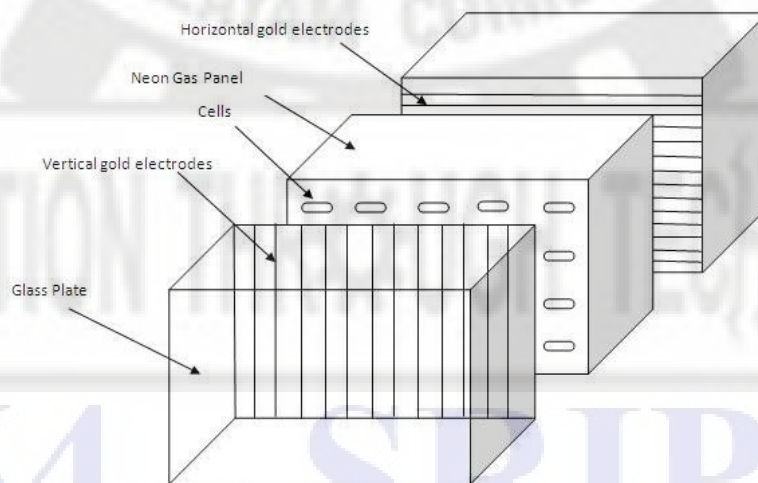

Figure 3.2 Structure of the Plasma

Plasma is referred to be the main element of a fluorescent light. It is actually a gas including ions and electrons. Two plates of glass are taken between which millions of tiny cells containing gases like xenon and neon are filled. It is shown in Figure 3.2.

In a plasma panel display, two glass plates having horizontal and vertical gold electrodes are kept. These gold electrodes are covered with dielectric material. In between these two glass plates there is another glass plate filled with neon gas.

When voltage is applied through the gold electrodes the neon gas is split into independent cells and they start to glow. By applying voltages through the gold electrodes this glow can be controlled, thus, creating a display. No refresh is required in a Plasma panel display. This also includes the collision between the ions and electrons resulting in the emission of photon light.

Plasma TV Resolutions

The resolution of a plasma display varies from the early enhanced definition [ED], to the modern high-definition displays. The most common ED resolutions were 840*480 and 853*480. With the emergence of HDTV's the resolution also became higher. The modern plasma TV's have a resolution of 1024*1024, 1024*768, 1280*768, 1366*768, 1280*1080, and also 1920*1080.

Advantages of Plasma Display

- (i) Very high contrast ratios [1:2,000,000].
- (ii) Weighs less and is less bulky than CRTs.
- (iii) Higher viewing angles compared to other displays [178 degrees].
- (iv) Can be placed even on walls.
- (v) High clarity and hence better colour reproduction.
- (vi) Has a life span of about 100,000 hours.

Disadvantages of Plasma Display

- (i) Cost is much higher compared to other displays.
- (ii) Energy consumption is more.
- (iii) Produces glares due to reflection.
- (iv) These displays are not available in smaller sizes than 32 inches.
- (v) Glass screen, which is needed to protect the display, is included, weighs more.
- (vi) Cannot be used in high altitudes. Area flickering is possible.

4. TFT Displays

A display screen made with TFT (thin-film transistor) technology is a liquid crystal display (LCD), common in notebook and laptop computers, that has a transistor for each pixel. Having a transistor at each pixel means that the current that triggers pixel illumination can be smaller and therefore can be switched on and off more quickly.

TFT is also known as active matrix display technology. A TFT or active matrix display is more responsive to change.

A more recent development is organic thin-film transistor technology, which makes it possible to have flexible display surfaces.

Construction:

The only difference is that, the TFT LCD has a sandwich-like structure with liquid crystal filled between two glass plates. From the figure, TFT Glass has as many TFTs as the number of pixels displayed. The Color Filter Glass has color filter which generates color. Figure 3.3 Shows the TFT Display.

Figure 3.3 TFT Display

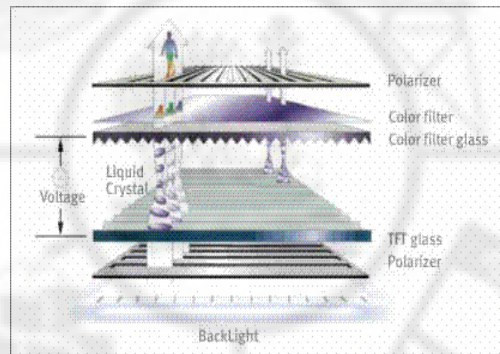

The Liquid Crystal Displays (LCDs) have the tendency to change the properties of light passing through the crystals, when they are stimulated by some external electrical charge. With this property, the Liquid crystals move according to the difference in voltage between the Color Filter Glass and the TFT Glass. The amount of light supplied by Back Light is determined by the amount of movement of the liquid crystals in such a way as to generate color.

Working:

All that is required for LCD pixels to create color is to place a color filter in front of each pixel. By using red, green, and blue color filters, the required primary colors are generated to produce the millions of color variations needed for graphics and video display. Modern LCD technology uses what is known as Thin-Film Transistor (TFT) technology. Each pixel has its own transistor and capacitor, which increase the contrast rating of the LCD due to the increased retention of charge. It is shown in Figure 3.5 .

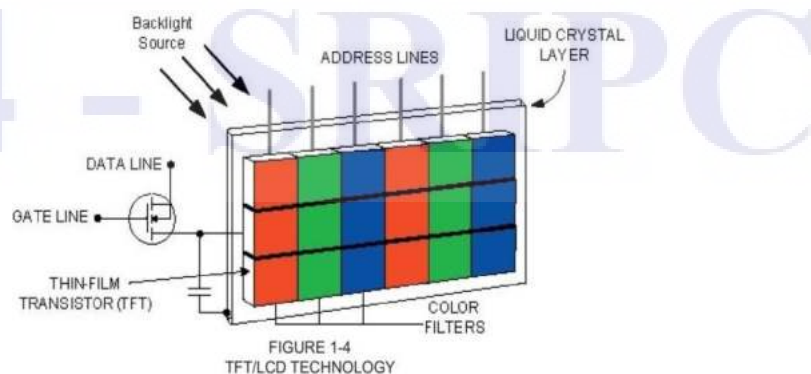

Figure 3.5 TFT Glass

This helps to dramatically increase the response time for each pixel as they are scanned. Control of each pixel is simply a matter of addressing a particular column and individually activating each pixel in that row with a properly timed address pulse on the horizontal plane. The higher the pulse level, the more the crystals align, producing a lower light output. TFT-LCD screens consume a significantly higher amount of energy than other display technologies and are normally found in LCD computer monitors or lower-end and older cell phones.

5. LED Displays

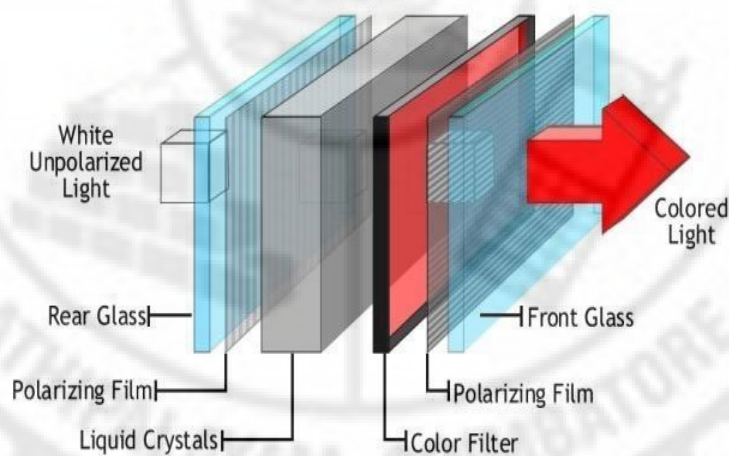

Figure 3.6 LED Display

Figure 3.6 shows the structure of the LED display. An LED display, or light emitting diode display, is a flat panel display that uses light emitting diodes as the video display. An LED display panel can be either a small display or part of a larger display. LED diodes are used in order to make up an LED display. LED displays are also used in billboards and store signs. An LED panel consists of several LEDs, whereas an LED display consists of several LED panels. LEDs used in order to make up LED displays offer several advantages in comparison to other light emitting sources. A light emitting diode is made up of a semiconductor chip which is surrounded by a transparent plastic case. The plastic case allows the light to pass through it. The emission of different colors including ultraviolet and infrared light depends on the semiconductor material which is used in the diode.

The most common types for display type are light bar, seven segment and dot matrix. Digit/Alpha/Matrix Size can range from 0.03" to 0.40", with the most common sizes being 0.2" , 0.3" and 0.4".

LED display chip can be used for devices such as an LED display screen, LED display sign, LED display panel, LED backlit display, LED display lighting, outdoor LED display, LED digital display, LED display board or any other LED display chip for lighting or programming.

Types of LED TV

Full- or Direct-Lit LED TV

Full - LED televisions, sometimes referred to as full-array or direct-lit LED, have the LED lights arranged behind the entire LCD panel. They are thicker than edge-lit LCD TVs and have a picture quality similar to that of CCFL-backlit LCD televisions

Edge-Lit LED TV

Edge - lit LED televisions have a series of LED backlights that run along the outside edges of the screen, which are dispersed across the entire screen by light guides. By placing the LEDs along the edges only, manufacturers are able to make screens very thin and further reduce costs.

Applications for LED Displays:

- (i) LED displays are often found outdoors in billboards and store signs. They can also be found in destination signs on public transportation vehicles or as part of transparent glass area.
- (ii) LED panels can either be used for lighting or for general illumination, task lighting or stage lighting.

LED displays can be found in sports stadiums, public squares, train stations, airports, highways, commercial plazas, subways, parks, shopping centers, on tall buildings and for corporate image promotion and advertising.

6. Graphics Cards:

A graphics card is a type of display adapter or video card installed within most computing devices to display graphical data with high clarity, color, definition and overall appearance. A graphics card provides high-quality visual display by processing and executing graphical data using advanced graphical techniques, features and functions.

A graphics card is also known as a graphics adapter, graphics controller, and graphics accelerator card or graphics board. A graphics card enables the display of 3-D images, image pasteurization, higher pixel ratio, a broader range of colors and more. Moreover, a graphics card includes various expansion ports such as AGP, HDMI, TV and multiple monitor connectivity. A graphics card can be integrated within the motherboard or be added on as an extension card.

Video capture Card:

Video capture is the process of converting an analog video signal—such as that produced by a video camera or DVD player—to digital video. The resulting digital data are computer files referred to as a digital video stream, or more often, simply video stream. This is in contrast with screen casting, in which previously digitized video is captured while displayed on a digital monitor. TV tuner cards have a television tuner with the capabilities to capture broadcast television.

SMPS

Switched Mode Power Supply uses a switching regulator to convert electric power efficiently. SMPS transfers electric power from a source (AC mains) to the load by converting the characteristics of current and voltage. SMPS always provides a well regulated power to the load irrespective of the input variations. SMPS incorporates a Pass transistor that switches very fast typically at 50Hz and 1 MHz between the on and off states to minimize the energy waste. SMPS regulates the output power by varying the on to off time using minimum voltage so that efficiency is very high compared to the linear power supply.

1. Block diagram

Figure 3.7 Shows the block diagram of SMPS.

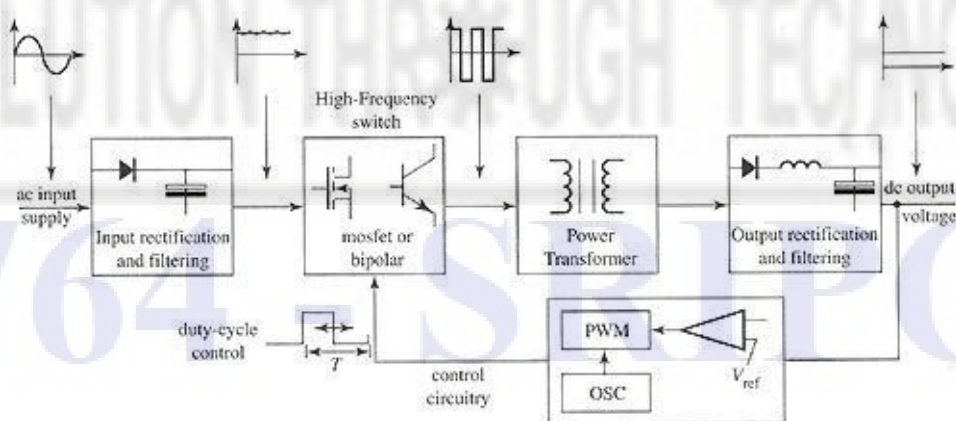

Figure 3.7 Block diagram of SMPS

2. Basic Principles and Operations

Basic principle:

Switched-mode power supplies are classified according to the type of input and output voltages. The four major categories are:

- (i) AC to DC
- (ii) DC to DC
- (iii) DC to AC
- (iv) AC to AC

A basic isolated AC to DC switched-mode power supply consists of:

- (i) Input rectifier and filter
- (ii) Inverter consisting of switching devices such as MOSFETs
- (iii) Transformer
- (iv) Output rectifier and filter
- (v) Feedback and control circuit

The input DC supply from a rectifier or battery is fed to the inverter where it is turned on and off at high frequencies between 20 KHz and 200 KHz by the switching MOSFET or power transistors. The high-frequency voltage pulses from the inverter are fed to the transformer primary winding, and the secondary AC output is rectified and smoothed to produce the required DC voltages. A feedback circuit monitors the output voltage and instructs the control circuit to adjust the duty cycle to maintain the output at the desired level.

There are different circuit configurations known as topologies, each having unique characteristics, advantages and modes of operation, which determines how the input power is transferred to the output. Most of the commonly used topologies such as flyback, push-pull, half bridge and full bridge, consist of a transformer to provide isolation, voltage scaling, and multiple output voltages. The non-isolated configurations do not have a transformer and the power conversion is provided by the inductive energy transfer.

3. O/P voltage

In a computer mainly three types of DC voltage are required to run. 12 Volts is necessary to feed the main board itself as well as any new age graphic cards, 5 Volts is required for the chassis and CPU fan or USB ports, and 3.3 Volts is used for the CPU itself. 12 Volts is also applicable for specific “smart” chassis fans. Thus in broader sense, a computer power supply can convert 110 Volt electrical current (or 220 Volt for the European scheme) to +12V, -12V, +5V, -5V, and +3.3Volt.

4. Cable color code

Inside power supplies, you see bunch of colored cable sets coming out with different sockets or connectors and different numbers of wires each. Color codes of power supply cables are as follows:

- (i) **Black Wires:** Those are used to provide a ground for the current. Every other color should be paired with a black wire.
- (ii) **Yellow Wires:** This color denotes +12Volt
- (iii) **Red Wires:** This color denotes +5Volt
- (iv) **Blue Wires:** -12Volt
- (v) **White Wires** -5Volt
- (vi) **Orange Wires:** 3.3Volt
- (vii) **Green Wires:** Control wire to check DC voltage
- (viii) **Purple Wires:** +5V on standby mode

A computer power supply's output voltages can be measured with a proper multimeter. Using multimeter's nodes, specific voltages can be checked. But due to the higher risk of any short circuit, user must always connect black cables with black one on the multimeter and other colored wire with the other note making a pair. Black cable must always be used in the pair.

5. Connectors and Power Good

There are three types of SMPSs. They are AT, ATX, BTX. These three types of SMPSs have different connectors and each wire has different voltages.

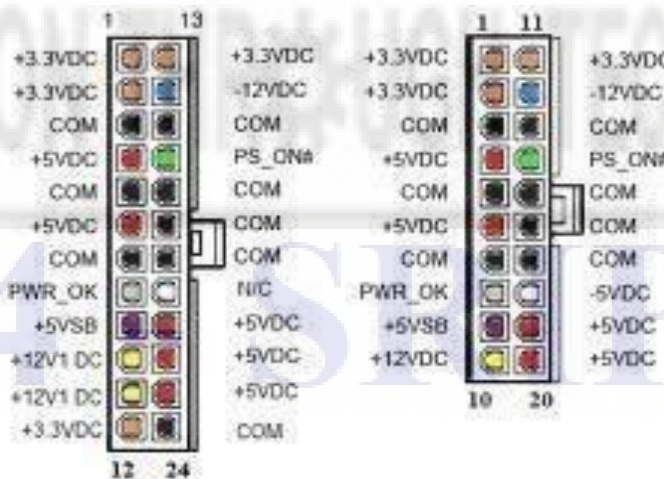

Figure 3.8 Connectors

AT SMPSs have 12 pin power connector, ATX SMPSs have 20 pin power connector and BTX SMPSs have 24 and 28 pin power connectors. AT power supplies were used in

80's and from 1996 we use ATX power supplies. Here are the AT, ATX and BTX SMPSs voltages and users. Figure 3.8 and Figure 3.9 shows the details of AT and ATX connectors.

SMPS	AT	ATX	BTX
Red	+5v	+5v	+5v
Yellow	+12v	+12v	+12v
Blue	-12v	-12v	-12v
White	-5v	-5v	-5v
Black	0v	0v	0v
Orange	+5v	+3.3v	+3.3v
Green	----	+5v	+5v
Gray or Brown	----	+5v	+5v
Purple	----	+5v	+5v

Red : it is used for signal sending

Yellow : It is used for motor running

White & Blue: It is used for backward compatibility

Black : It is used for grounding purpose

Orange : It is used for power good signal

Green : It is used for power supply on in ATX

Gray & Brown: It is used for power good signal in ATX

Purple : It is used for auto shutdown in ATX

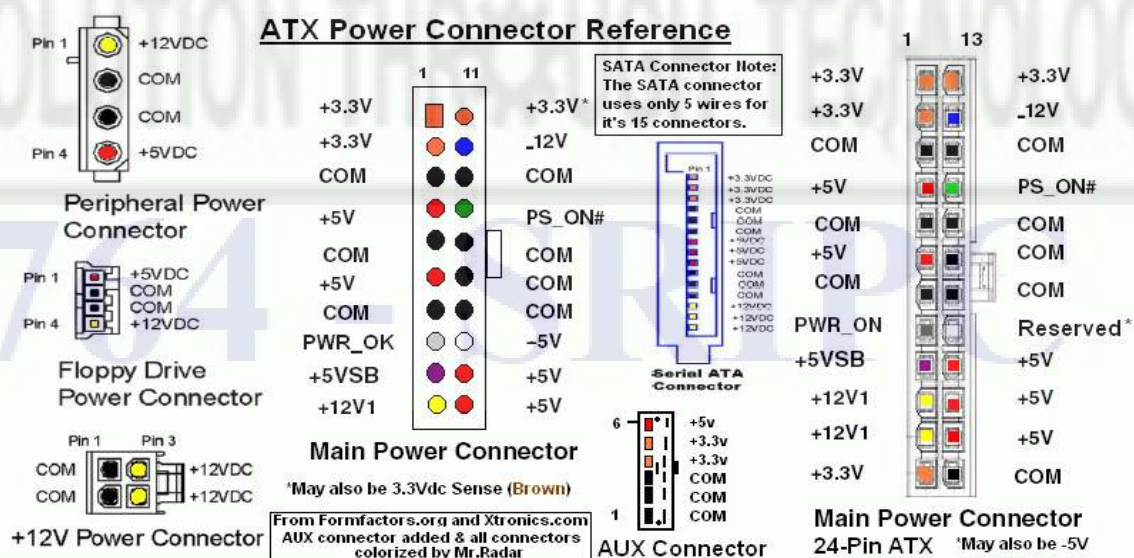

Figure 3.9 ATX Power Connector Reference

6. Power Good

The ATX specification defines the Power-Good signal as a +5 volt (V) signal generated in the power supply when it has passed its internal self-tests and the outputs have stabilized. This normally takes between 0.1 and 0.5 seconds after the power supply is switched on. The signal is then sent to the motherboard, where it is received by the processor timer chip that controls the reset line to the processor. Cheaper and/or lower quality power supplies do not follow the ATX specification of a separate monitoring circuit; they instead wire the power good output to one of the 5 V lines. This means the processor will never reset given bad power unless the 5 V line drops low enough to turn off the trigger, which could be too low for proper operation.

1. Common Failures

The following probably account for 95% or more of the common SMPS ailments:

- (i) Supply dead, fuse blown - shorted switch mode power transistor and other semiconductors, open fusible resistors, other bad parts. Supply dead, fuse not blown - bad startup circuit (open startup resistors), open fusible resistors (due to shorted semiconductors), bad controller components.
- (ii) Supply mostly dead or takes a long time to come alive. There may be an LED flashing but the equipment doesn't respond to power button (or takes awhile) - bad electrolytic capacitors.
- (iii) One or more outputs out of tolerance or with excessive ripple at the line frequency (50/60 Hz) or twice the line frequency (100/120 Hz) - dried up main filter capacitor(s) on rectified AC input.
- (iv) One or more outputs out of tolerance or with excessive ripple at the switching frequency (10s of kHz typical) - dried up or leaky filter capacitors on affected outputs.
- (v) Audible whine with low voltage on one or more outputs - shorted semiconductors, faulty regulator circuitry resulting in overvoltage crowbar kicking in, faulty overvoltage sensing circuit or SCR, faulty controller.
- (vi) Periodic power cycling, tweet-tweet, flub-flub, blinking power light - shorted semiconductors, faulty over voltage or over current sensing components, bad controller.

BIOS

A basic input/output system (BIOS) is a preinstalled program used during startup on Windows-based computers. The CPU initially accesses the BIOS, after which the operating system is loaded. A basic input/output system is also known as system BIOS or ROM BIOS.

1. BIOS functions

The BIOS includes instructions on how to load basic computer hardware and includes a test referred to as a POST (Power On Self Test) that helps verify the computer meets requirements to boot up properly. If the computer does not pass the POST, you will receive a combination of beeps indicating what is malfunctioning within the computer.

The four main functions of a PC BIOS

- (i) POST - Test the computer hardware and make sure no errors exist before loading the operating system. Additional information on the POST can be found on our POST and Beep Codes page.
- (ii) Bootstrap Loader - Locate the operating system. If a capable operating system is located, the BIOS will pass control to it.
- (iii) BIOS drivers - Low level drivers that give the computer basic operational control over computer's hardware.
- (iv) BIOS or CMOS Setup - Configuration program that allows you to configure hardware settings including system settings such as computer passwords, time, and date.

2. Cold and Warm booting

Cold booting: Alternatively referred to as a hard boot, cold boot is a term used to describe the process of turning on the computer after it has been powered off. For example, when you first turn your computer on after being off for the night you are cold booting the computer.

Warm Booting: Alternatively referred to as a soft boot, a warm boot is one method of resetting a computer system that is already powered on, commonly used to recover from errors that cannot be recovered, or when a computer locks. A warm boot can be accomplished by pressing the CTRL - ALT - DEL keys simultaneously, or by selecting the restart command from an operating system menu. Warm boots run faster than turning a computer off and on again.

In other words, warm booting is Reloading the operating system by performing a Restart operation from the computer's main menu while it is still turned on. The warm boot does not turn the power off and back on, and it does not clear memory. Contrast with cold boot.

3. BIOS error codes

A beep code is the audio signal given out by a computer to announce the result of a short diagnostic testing sequence the computer performs when first powering up (called the Power-On-Self-Test or POST).

The POST is a small program contained in the computer's Basic Input/output Operating System (BIOS) that checks to make sure necessary hardware is present and required memory is accessible. If everything tests out correctly, the computer will typically emit a single beep and continue the starting-up process. If something is wrong, the computer will display an error message on the monitor screen and announce the errors audibly with a series of beeps that vary in pitch, number and duration. The beeping sequence is really a coded message (beep code) designed to tell the user what is wrong with the computer. Some number of short beeps that are sounded by the BIOS upon startup when a memory, cache or processor error is encountered. There are numerous beep code patterns, and Phoenix BIOS codes are long and short beeps delivered in groups.

Table 3.1

Beep state	Meaning
1 long beep followed by 2 short beeps	Video configuration failure (a faulty video card or no card installed), or an external ROM module does not properly checksum to zero.
1	Refresh failure
2	Parity can't be reset
3	First 64K memory failure
4	Timer not operational
5	Processor failure (reserved; not used)
6	8042 GateA20 can't be toggled (memory failure or not present)
7	Exception interrupt error
8	Display memory R/W error
9	(Reserved; not used)
10	CMOS Shutdown register test error
11	Invalid BIOS (such as, POST module not found)

4. BIOS interrupts

Interrupts are used to demand attention from the CPU. There are processor's hardware and software driven interrupts. The PC was designed as an interrupt driven system. Communications between the CPU, hardware and software occurs by means of flags or interrupts which signal when a device or piece of software needs attention from the CPU. The PC is limited to 256 interrupts each of which receives a number. The Programmable Interrupt Controller (PIC) controls which interrupt gets the attention of the CPU and when. Basically, the lower numbered interrupts receive attention from the CPU before the higher numbered interrupts. The PC interrupts can be divided into six categories:

- (i) Processor Interrupts - Interrupts 00h to 07h are called by the processor directly, but can also be called from software using the INT instruction.
- (ii) Hardware Interrupts - The hardware interrupts differ from all the software interrupts in that they have a direct channel to the processor through an Interrupt Request Line or IRQ.
- (iii) Software Interrupts - These interrupts are generated by the ROM BIOS during the start up of the computer. These interrupts are used for general low-level services.
- (iv) DOS Interrupts - These interrupts are available when DOS is running and provide additional routines for enhanced access to devices and other resources.
- (v) ROM Basic Interrupts - These interrupts are available when BIOS is running.
- (vi) General use Interrupts - These interrupts are available for use by other programs.

Table 3.2 Interrupt and its functions

Interrupt	Address	Type	Function
00h	0000:0000h	Processor	Divide By Zero
09h	0000:0024h	Hardware	Keyboard - IRQ 1
0Eh		Software	Page Fault (80386 Only)

5. BIOS advanced setup

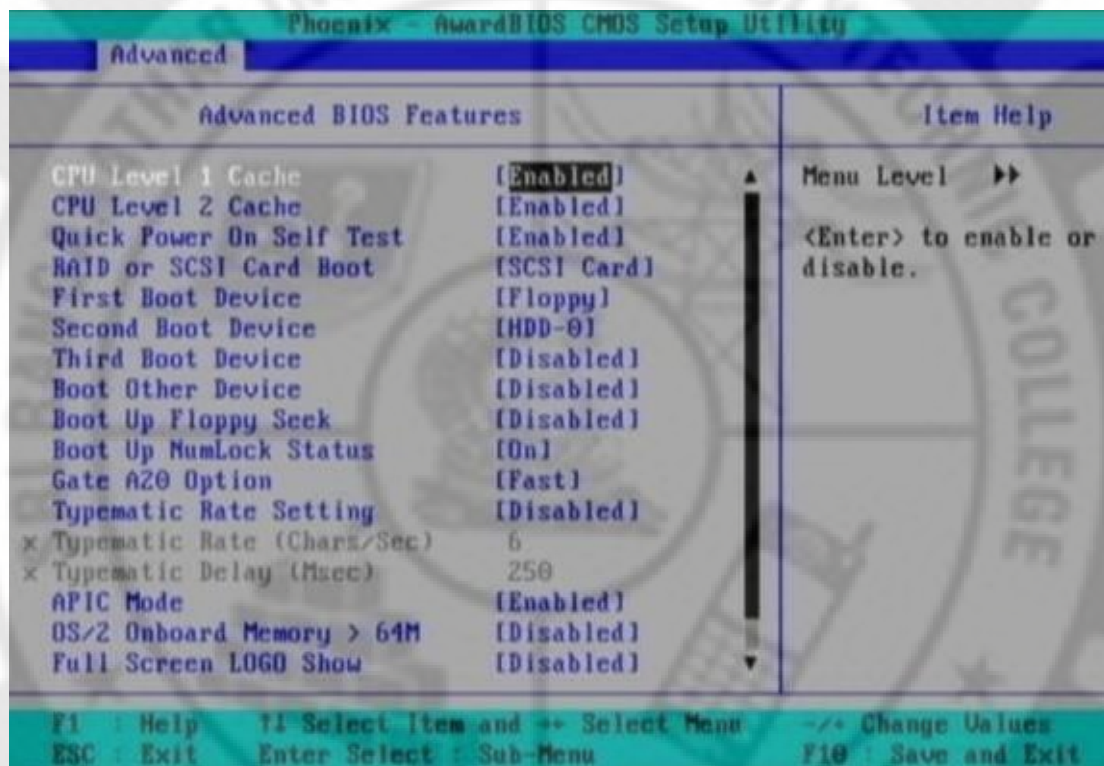

Figure 3.10 Advanced Setup

Figure 3.10 shows the advanced setup.

Virus Detection: Enabled. Sometimes this is located under the Standard or Main section of some BIOS. While boot sector viruses are no longer the major threat they once were, enabling this feature will protect your data should you boot from an infected floppy disk or CD-ROM.

CPU Level 1 Cache: Enabled.

CPU Level 2 Cache: Enabled.

Quick Power On Self Test: Enabled. This will skip the repetitive memory count that occurs when we turn on PC; chances are there for bad memory, this basic test won't catch it anyway.

First, Second, or Third Boot Device: Set boot order, and disable any boot device here that you do not want to boot from.

Boot Other Device : Disabled, unless you are booting from a network or SCSI card.

Boot Up Floppy Seek : Disabled. It's a waste of time and a noise maker.

Boot Up Num Lock Status : Some folks like the Num Lock on their keyboard activated when Windows starts, while others want it disabled.

Gate A20 Option: FAST. This feature is made more or less obsolete by Windows XP.
Typematic Rate Setting: Disabled. This feature determines how long the keyboard waits when holding down a key until it starts repeating it, and how fast that happens.

APIC Mode: Enabled. This is the Advanced Programmable Interrupt Controller, which is responsible for multi-processor support, more IRQs, and faster interrupt handling.

OS/2 Onboard Memory > 64M: Disabled. This setting only applies to users running the now defunct OS/2 operating system from IBM.

Full Screen LOGO Show: When enabled, the memory count and Power-On Self-Test (POST) are hidden behind a "curtain" - a graphic logo. For example, when you first turn on a Gateway computer, you might see GATEWAY in big letters across the screen. When disabled, the "normal" initiation sequence is displayed on the screen - the way most computers look when you first turn them on before the operating system begins to load.

POST Complete Report: Your choice. This setting, when enabled, will display the results of the POST.

Speech POST Reporter: This setting, when enabled on a PC with speakers, will "talk" over your speakers at boot time to tell you the status of the POST. The voice quality is a far cry from that of the computers on Star Trek, but some people think it's cool.

6. Upgrading BIOS

Its quality and modernness determine the features and capabilities of machine to a large degree. The most famous example of this is support for IDE/ATA hard disks over 504 MB; the only change necessary to support these larger drives in most cases is a BIOS capable of doing the geometry translation. There are other examples as well; many motherboard manufacturers are able to expand the capabilities of their boards, or fix problems with them, by making changes to the BIOS and either giving free downloads or selling upgrades, just as software application houses like Microsoft, Lotus, etc. do. The BIOS program in PC is programmed into a read-only memory (ROM). ROMs are, of course, not rewriteable the way RAM is; that is why they are called "read-only". Fortunately, technology came to the rescue through the invention of the flash BIOS. Some machines still require the physical upgrade but by using the flash BIOS, most newer machines can upgrade using special software without having to open the case at all.

7. Flash BIOS-Setup

Machines with flash BIOS capability use a special type of BIOS ROM called an *EEPROM*; this stands for "Electrically Erasable Programmable Read-Only Memory". This is a ROM that can be erased and re-written using a special program. This procedure is called *flashing* the BIOS and BIOS that can do this is called flash *BIOS*. The advantages of this capability are obvious; no need to open the case to pull the chip, and much lower cost.

Many motherboards have a special "safety feature" to prevent accidental (or malicious) changes to the flash BIOS--a jumper that must be changed before performing a flash BIOS upgrade. With the increasing commonality of viruses that can change flash BIOS code, this may soon be a feature on every motherboard. There is one big disadvantage to using the flash process to upgrade the BIOS. While the BIOS is actually being flashed, it is in a very vulnerable state. You can also end up with a corrupted system if you boot the wrong flash BIOS image into the chip--motherboard manufacturers usually use an unintelligent, universal flash program that will happily program the entirely wrong BIOS image into your system if you tell it to! Fortunately, some manufacturers are now making these programs smarter.

If your system becomes corrupted to the point where it will not boot, you are in a catch-22. Your BIOS is corrupted, so you can't boot the PC, and since you can't boot the PC there's no conventional way to re-flash the BIOS. Fortunately, BIOS chip corruption is quite rare; the BIOS is a small program and flashing it usually takes only a few seconds. Still, it's not something to try in the middle of a thunderstorm, and using a UPS when doing this type of work, is good. And it should be ensured that the right BIOS image is being used.

8. Identification of different BIOS(AMI,AWARD BIOS)

The AMI or Award BIOS id appears at the bottom of the screen after power on, during memory count up. The PAUSE key should work at that point, allowing one to write down the BIOS number, the BIOS date, and the version. Another (easier) way to get the Award/AMI BIOS ID is by downloading the BIOS Agent Plus software (spyware/adware free) which will scan the PC and return the BIOS ID among other hardware information. Optionally it'll also find the correct BIOS Update (if available) and offer a paid subscription option to the BIOS Agent Plus service where one will get access to BIOS Updates and Driver Updates on PCs (between 1 to 10 PCs for 1 year). (One can perform the scan without buying anything.)

In this example of an Award BIOS id: **2A59/Z1DC-00**. The first 5 characters identify the chipset. **2A59I** stands for the Intel Triton TX chipset. The sixth & seventh character identifies the manufacturer: in this case it's **Z1**. The 8th character identifies the model.

The AMI BIOS id appears at the bottom of your screen after power on, during memory count up. The PAUSE key should work at that point, allowing you to write down the BIOS number, the BIOS date, and the version. In this example of an AMI BIOS id: **51-0102-1101-00111111-101094-AMIS123-P**. To find motherboard manufacturer, please look at the third (3) set of numbers in BIOS string. In this case its 1101 indicates the manufacturer is SUNLOGIX INC.

POST

POST is a series of program routing in the motherboard ROM firmware and is used to check the system components. This was introduced by IBM in 1981. When we switch on the computer, POST is executed first and automatically performs a series of tests that check the various components in the system. The components tested by POST are CPU, ROM, motherboard support circuitry memory and major peripherals.

Whenever a faulty component is found, it gives an error or warning message. There are two types of error message. They are Audio error codes and display error codes. The POST programs are stored in the final 8 KB area of the 1 MB BIOS ROM. Once the computer is switched on or reset, the microprocessor starts processing POST from memory address FFFF0.

1. Error

Error is a warning given by the system during POST for a faulty hardware component.

2. Beep Codes

Some number of short beeps that are sounded by the BIOS upon startup when a memory, cache or processor error is encountered. There are numerous beep code patterns, and Phoenix BIOS codes are long and short beeps delivered in groups. The following beep codes are for AMI BIOSs.

1 Beep - Refresh Failure-Reseat/replace memory, troubleshoot motherboard.

2 Beeps - Parity Error-Reseat/replace memory, troubleshoot motherboard.

3 Beeps - Memory Error (first 64KB)-Reseat/replace memory.

4 Beeps - Timer Failure-Troubleshoot motherboard.

5 Beeps - Processor Failure-Troubleshoot CPU, motherboard.

6 Beeps - Keyboard Controller Failure-Troubleshoot keyboard, motherboard.

7 Beeps - Virtual Mode Exception Error-Troubleshoot CPU, motherboard.

8 Beeps - Display Memory Failure-Troubleshoot graphics card, motherboard.

9 Beeps - ROM BIOS Checksum Failure-Replace ROM BIOS, troubleshoot motherboard.

10 Beeps - CMOS Shutdown Register Failure-Troubleshoot motherboard.

11 Beeps - L2 Cache Failure-Troubleshoot L2 cache, motherboard.

Continuous Beeps - Memory or Video Failure-Troubleshoot memory, graphics card, motherboard.

3. Error Messages

A POST error message is an error message displayed on the monitor during the Power On Self Test (POST), if the BIOS encounters some kind of problem while starting the PC. A POST error message will only display on screen if the computer is capable of booting this far. If the POST detects an error before this point, a beep code or POST code will be

generated instead. POST error messages are usually fairly descriptive and should give you enough information to begin troubleshooting whatever problem the POST found. A POST error message is sometimes called a BIOS error message, POST message, or POST screen message.

Examples:"The POST error message that was on my screen said that the CMOS battery had failed on my motherboard."

4. Post-Fault related to Hardware

The computer POST (power-on self-test) checks a computer's internal hardware for compatibility and connection before starting the remainder of the boot process. If the computer passes the POST, the computer may give a single beep (some computers may beep twice) as it starts and continue to boot. However, if the computer fails the POST, the computer will either not beep or generate a beep code that tells the user the source of the problem. If computer has an irregular POST or a beep code not mentioned below, follow the POST troubleshooting steps to determine the failing hardware component.

Beep Code	Descriptions
1 short	DRAM refresh failure
2 short	Parity circuit failure
3 short	Base 64K RAM failure
4 short	System timer failure
5 short	Process failure
6 short	Keyboard Controller Failure
7 short	Virtual mode exception error
8 short	Display memory Read/Write test failure
9 short	ROM BIOS checksum failure
10 short	CMOS shutdown Read/Write error
11 short	Display/retrace text failed
Continuous	No power, Memory

- 1 long and 1 short Motherboard failure
- 1 long and 2 short Video adapter card failure
- 1 short and no display Video cable and /or display
- 1 short and no boot Disk cable, adapter failure.

REVOLUTION THROUGH TECHNOLOGY

764 - SRIPC

Review Questions:

PART – A

1. What are the merits and demerits of LCD Display?
2. Mention the applications of LCD Display.
3. What are the advantages and disadvantages of plasma display?
4. What are the different types of LED display?
5. What are the applications of LED Display?
6. State the common failures of SMPS.
7. What are the four main functions of BIOS?
8. How will you identify the different types of BIOS?
9. Give examples of error messages.
10. List the faults related to hardware.

PART – B

1. Explain the principle of LCD in detail.
2. Explain the operation of LCD with its advantages and disadvantages.
3. Explain the working of Plasma display with its advantages and disadvantages.
4. Explain the construction and working of TFT Display.
5. Explain the working of LED Display.
6. Explain Graphics card and Video capture card.
7. Explain the basic principles and Operations of SMPS.
8. Explain the BIOS functions in detail.
9. Write Short notes on Cold and warm booting, BIOS error codes, BIOS interrupts, BIOS advanced setup & Upgrading BIOS

UNIT IV MAINTENANCE AND TROUBLESHOOTING OF DESKTOP AND LAPTOP

Learning Objectives

Learners should be able to

- Know the working principles of Laptop
- Aware of configuring the laptops
- Identify the laptop components and its specifications
- Know the installation and troubleshoot the laptop
- Aware of preventive maintenance of laptop and to upgrade the same.

Introduction

A laptop computer, sometimes called a notebook computer by manufacturers, is a battery- or AC-powered personal computer generally smaller than a briefcase that can easily be transported and conveniently used in temporary spaces such as on airplanes, in libraries, temporary offices, and at meetings. Laptop systems are especially prone to problems because they are portable and therefore exposed to potentially harsh environments, rougher handling, and more problems than desktop systems that remain in a single location. This chapter presents the types of laptop, working principles, components, Installation, troubleshooting, preventive maintenance and upgrading.

Laptop

A laptop is an all-in-one machine, with the screen, keyboard and mouse built into the device. A laptop is a versatile, small and portable computer that gives people access to internet browsing and files from any location.

Difference between Laptop and Desktop

S.No	Desktop	Laptop
1	Desktop has more hard drive space, a faster central processor and better graphics performance	Sacrifices the performance for portability
2	Screen size is 27 inches	screen size that exceeds 15 to 17

		inches
3	desktop is typically set up on a desk, table or counter	laptops are designed for portability.
4	desktop computer has its central processing unit detached from the visual display and other peripheral devices	laptop computers are small, self-contained machines, all of the hardware that is needed to use the computer is bundled into one unit, including the display and keyboard
5	The separate CPU allows users space to install more advanced components and adequate cooling to achieve high-performance hardware configurations, desirable for applications such as 3D modeling and gaming.	the size limits the space available inside for hardware and internal cooling, which has been a limiting factor in terms of overall performance
6	Individuals who run their business, academic or personal affairs from a fixed home or office location are able to opt for desktop	Students and traveling professionals prefer laptop

Types of laptop

Types of laptop computers differ according to functionality, weight and price. The following are the most common types of laptop computers.

(i) Tablet Laptops

These types of laptops have a joint between the keyboard and the display permitting the display panel to lie flat on the housing of the keyboard. Typically, the base of this type of laptop is attached to the display by a swivel or rotating hinge. You can fold the screen up to one hundred and eighty degrees so that it lies flat on the keyboard. Some tablet laptops have a sliding format where the screen cover slides from its position and locks into the normal position hence providing the laptop mode. Hybrid tablet laptops have a removable keyboard that allows the user to choose whether to attach the keyboard or utilize the touch screen alone. Tablet laptops are touch screen.

(ii) Rugged Laptops

A rugged laptop is one that is designed to operate in harsh conditions such as extreme conditions, dusty environments, dusty or wet environments and in areas with strong vibrations. They are usually created from scratch and are heavier, bulkier and more expensive than the regular laptops. These rugged laptops have rubber sheeting below the keyboard keys, passive cooling, sealed connector covers and are made from strong magnesium alloy. They are commonly used by public safety services such as the police, military, medical emergency and fire fighting departments. They are usually manufactured and sold to organizations.

(iii) Subnotebooks

This is an ultraportable laptop that is marketed based on its portability since it has low weight, smallness in size and has a battery with a longer life. It resembles the notebook. As compared to standard laptops, a subnotebook is smaller and lighter. It weights between two and five pounds, and its battery life exceeds ten hours. Most subnotebooks do not have the removable media drive so as to lower the weight. In such cases the laptop is paired with a docking station. These computers run general-purpose operating systems as opposed to the specialized software.

(iv) Desktop Replacement Laptops

A desktop replacement computer refers to a laptop that can provide all the capabilities that a desktop does, with a similar performance level. These types of laptops are usually heavier and larger than standard laptops. Their components are more powerful and are much bulkier than other laptops. The operation time of their batteries is shorter. They are used as alternatives to desk top computers. Some of them use some desktop components for improved performance.

(v) Netbooks

Netbooks are economical, light-weight, energy efficient and inexpensive laptops suited for internet access and wireless communication. They excel in web-based performance. Netbooks focus majorly on e-mailing and web browsing. Most netbooks do not have an optical disk, and range from between five and twelve inches and between two and three pounds. Netbooks usually have light-weight operating systems such as Windows XP and Linux installed in them. Most netbooks have one memory slot which does not recognize any memory card beyond 2GB. This limits how the netbook functions beyond the basic functions i.e. emailing and internet.

Block Diagram

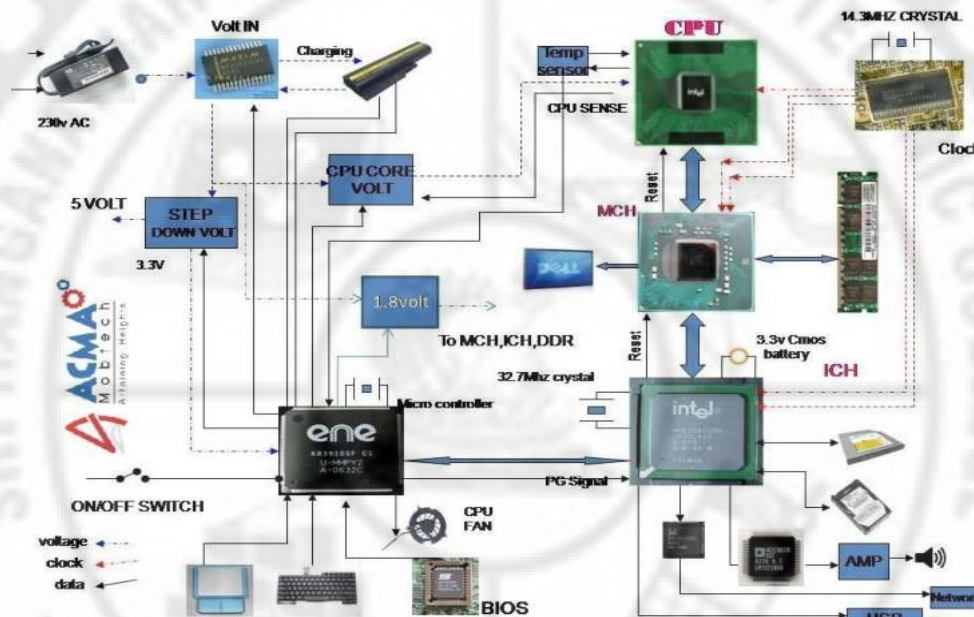

Figure 4.1 Block diagram of the Laptop

Working Principles

The figure 4.1 shows the block diagram of laptop. The microprocessor, or CPU, works with the operating system to control the computer. It essentially acts as the computer's brain. The CPU produces a lot of heat, so a desktop computer uses circulating air, a fan and a heat sink -- a system of plates, channels and radiator fins used to draw heat off of the processor -- to cool off. Since a laptop has far less room for each of these cooling methods, its CPU usually:

- (i) Runs at a lower voltage and clock speed -- This reduces heat output and power consumption but slows the processor down. Most laptops also run at a higher voltage and clock speed when plugged in, and at lower settings when using the battery.
- (ii) Mounts to the motherboard without using pins -- Pins and sockets take up a lot of room in desktop PCs. Some motherboard processors mount directly to the motherboard without the use of a socket. Others use a Micro-FCBGA (Flip Chip Ball Grid Array), which uses balls instead of pins. These designs save space, but in some cases mean that the processor cannot be removed from the motherboard for replacement or upgrading.
- (iii) Has a sleep or slow-down mode -- The computer and the operating system work together to reduce the CPU speed when the computer is not in use or when the processor does not need to run as quickly. The Apple G4 processor also prioritizes data to minimize battery drain.

Unit -IV Maintenance and Troubleshooting of Desktop and Laptop

- (iv) Some laptops use desktop CPUs that are set to run at lower clock speeds. Although this can improve performance, these laptops typically run much hotter and have a significantly reduced battery life.

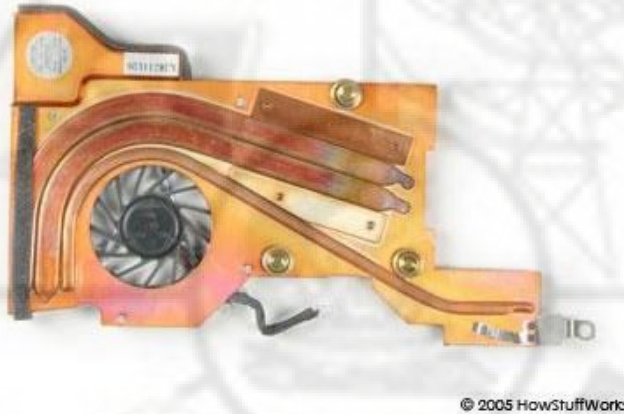

- (v) A laptop heat sink and fan
- (vi) Laptops usually have small fans, heat sinks, heat spreaders or heat pipes to help dissipate the heat from the CPU. Some higher end laptop models reduce heat even further with liquid coolant kept in channels alongside the heat pipe. Also, most laptop CPUs are near the edge of the unit. This allows the fan to move the heat directly to the outside instead of across other components.

Like a desktop, a laptop has an internal hard disk drive, which stores the operating system, applications and data files. However, laptops generally have less disk space than desktops. A laptop hard drive is also physically smaller than that of a desktop. In addition, most laptop hard drives spin more slowly than desktop hard drives, reducing both heat and power consumption.

Desktop computers have multiple bays for installing additional drives, such as CD and DVD ROM drives. However, space in a laptop is in much shorter supply. Many laptops use a modular design, allowing a variety of drives to fit in the same bay. These drives come in three different designations:

- (i) Hot swappable - The computer can stay on while changing the drive.
- (ii) Warm swappable - The computer can stay on while changing the drive, but the corresponding bus (the path the drive uses to send data to the CPU) must be inactive.
- (iii) Cold swappable - The computer must be off during the swap.
- (iv) Laptop Screen, Graphics and Sound
- (v) A laptop GPU
- (vi) A graphics processing unit (GPU) is a microprocessor that handles the calculations necessary for 3-D graphics rendering. Like a CPU, a GPU produces a lot of heat.

Unit -IV Maintenance and Troubleshooting of Desktop and Laptop

Most laptops have graphics capability built into the motherboard or have smaller graphics cards with a GPU designed specifically for laptop use. GPU manufacturers ATI and nVidia both make GPUs specifically for laptops. Laptops frequently share memory between the CPU and the GPU, saving space and reducing power consumption.

(vii) Many people don't notice a laptop's reduced graphics performance. Laptops have plenty of processing power for Web surfing and productivity applications. However, they may struggle with the latest 3-D games. A few specialty laptops, designed for gaming enthusiasts, include more powerful GPUs and additional video memory.

A laptop displays its graphics on a liquid crystal display (LCD) screen. Most screens measure between 12 and 17 inches, and the size of the screen affects the overall size of the laptop. In addition, laptop screens can be:

- (i) Black-and-white (16 grayscale) or color (65,536 colors)
- (ii) Active or passive matrix
- (iii) Reflective or backlit

Active matrix displays have sharper images and are easier to read, and backlit screens are better for low-level lighting conditions.

Most laptops also have sound cards or integrated sound processing on the motherboard as well as small, built-in speakers. However, there is generally not enough space inside a laptop for a top-of-the-line sound card or a high-quality speaker. Gaming enthusiasts and audiophiles can supplement their laptops' sound capabilities with external sound controllers, which use USB or FireWire ports to connect to the laptop.

Configuring laptops and power settings

A laptop is purchased with the ability to be configured with many different settings for security, memory, speed or other options. Follow these steps to configure the laptop for a variety of settings.

Step 1

Configure the laptop for security by making a startup password. Press the power button on laptop, press the "F2" key and hold down "Alt" while pressing "P" to scroll through the pages. Find the page titled "System Security." Use the left and right arrow keys to modify values. Change the primary password to "Enabled," enter a password and push "Esc" to exit and confirm your password.

Step 2

Set and configure the laptop speed. Speed up your laptop by upgrading the RAM. Opt for 1GB RAM, this boost 13 percent of speed and 8 minutes of battery power only may lose.

Step 3

Boost your laptop's speed even more by installing a high-end hard drive. If laptop is upgrade from a 4,200 rpm drive to a 5,400 rpm drive, 18 percent increase in speed can acquire and only a 7 minute decrease in the life of the battery.

Step 4

Opt for a 2.13G Hz Pentium M CPU if laptop is used for multimedia applications. The hard drive should be 60GB and 5,400 rpm. At least 1G of RAM is required.

Step 5

Perform a DHCP configuration on Windows XP. Click "Start," "Control Panel," "Network and Internet Connections" and "Network Connections." Select "Local Area Connection," "Change Settings of This Connection," "Internet Protocol," "Properties," and then check the boxes for "Obtain an IP Address Automatically" and "Obtain DSN Server Address Automatically." Click "OK" twice.

Configuring Laptop Power Settings:

To access power plan options, type power settings into the search bar in the Start Menu and hit Enter. The Figure 4.2 shows the power settings.



Figure 4.2 Power settings

The Power Options screen opens and select from three predefined plans-Balanced, Power saver, or High performance. It is shown in Figure 4.3

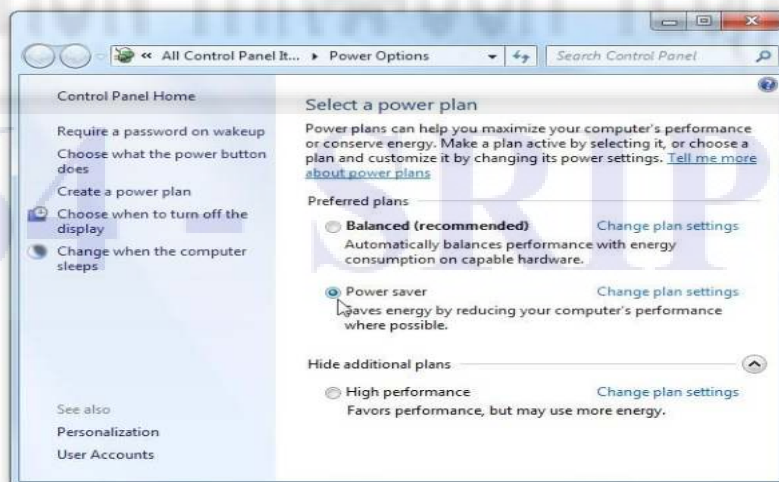

Figure 4.3 Power Option

Click on Choose what the power button does and you can tweak several options such as Requiring a password on wakeup and what the power button on the computer does. I set “When I press the power button” to Do nothing, you won’t have a problem with the PC shutting down when you accidentally hit the power button. It is shown in Figure 4.4.

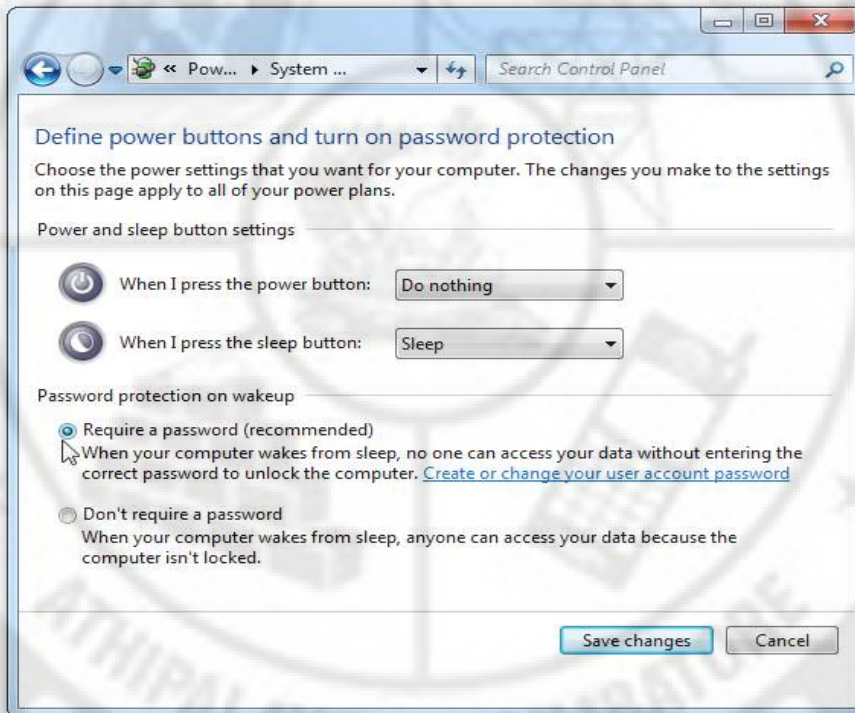

Figure 4.4 Options in Power button

To change any one of the predefined power plans click on Change plan settings. It is shown in Figure 4.5

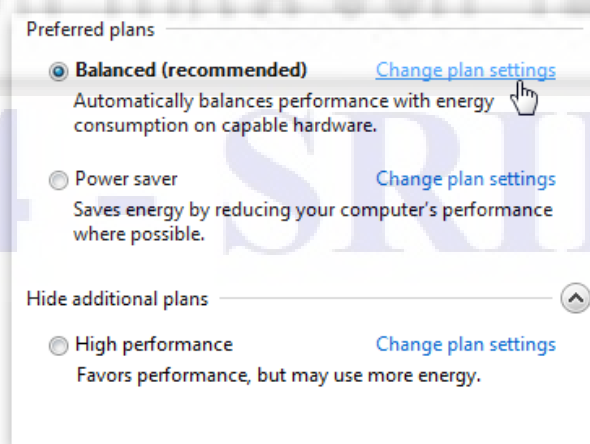

Figure 4.5 Power Plans

Then change the amount of inactive time before the monitor is turned off or the computer goes into Sleep mode. It is shown in Figure 4.7.

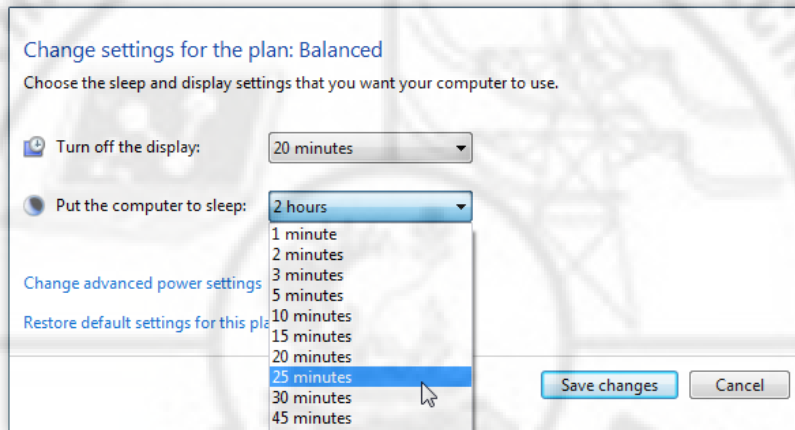

Figure 4.6

To revert back to the default settings, simply click on Restore default settings for this plan. It is shown in Figure 4.7

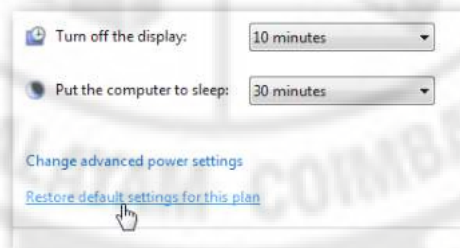

Figure 4.7

Custom Power Plan

To create a custom plan, click on Create a power plan from the Power Options section. It is shown in Figure 4.8

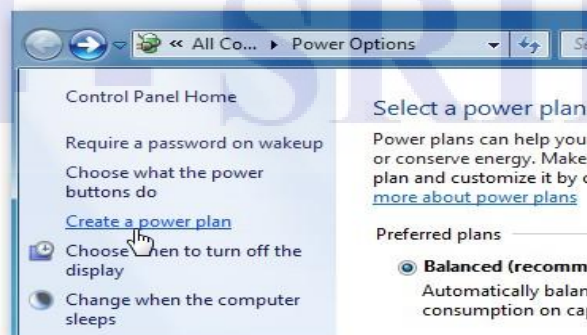

Figure 4.8

In the Create a power plan window a predetermined plan that is closest to what you want, and give the plan a name. It is shown in Figure 4.9

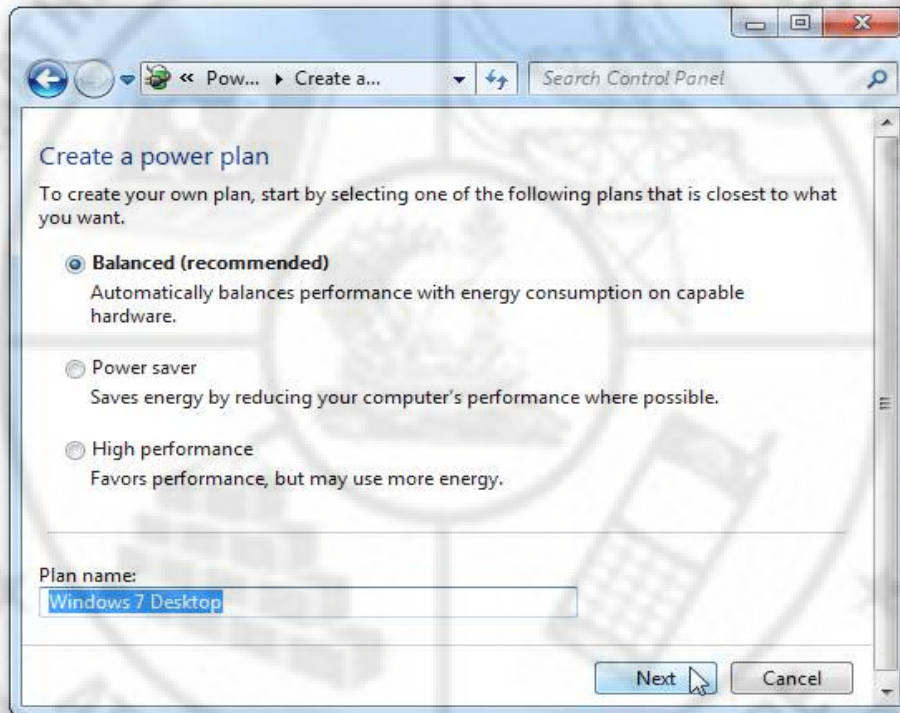

Figure 4.9

In the next screen as shown in Figure 4.10 select the sleep and display settings you want to use and click the Create button.



Figure 4.10

After your plan is created you'll see it under the preferred plans list. It is shown in Figure 4.11

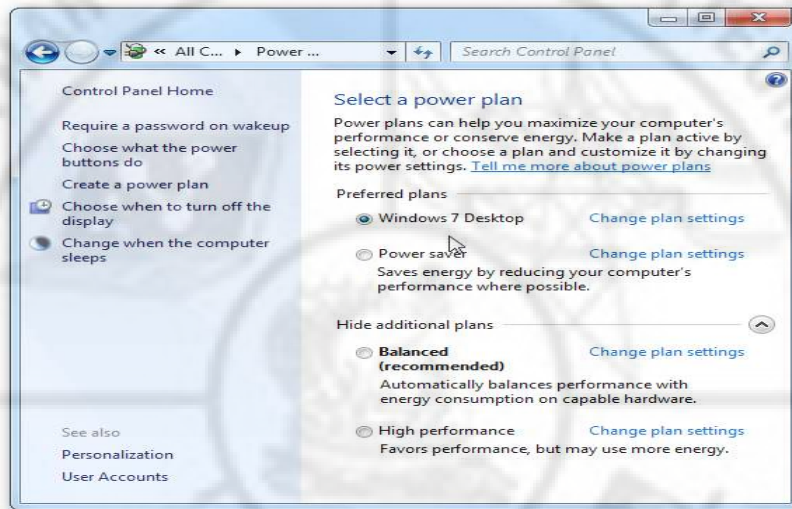

Figure 4.11

Change advanced power settings; it should only be used by advanced users, as if you turn off the wrong thing, your computer may not function correctly. Choosing between the predetermined settings should be adequate for most users. It is shown in Figure 4.12

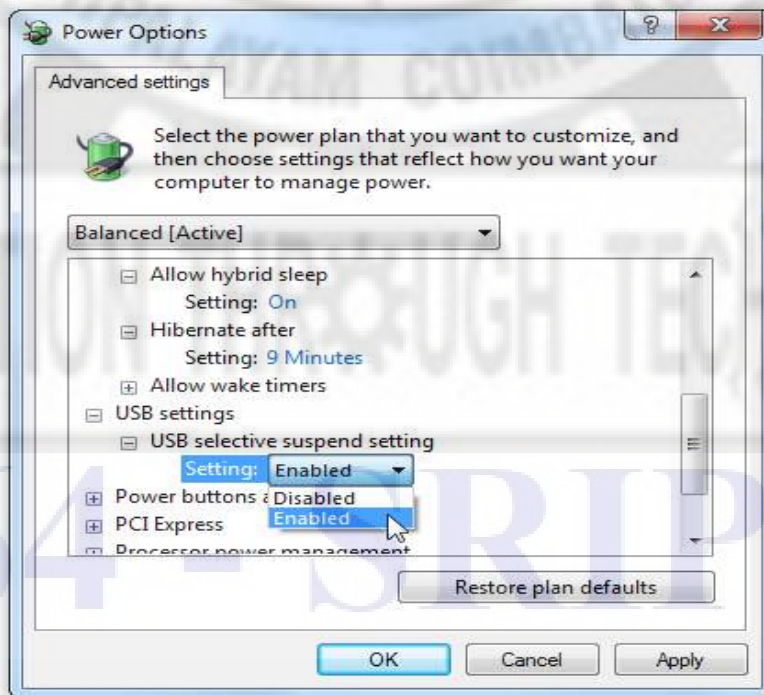

Figure 4.12

If you are having issues where your laptop is draining too much battery power, or you want to check the overall efficiency of power usage on your computer, Use PowerCfg in Windows 7 to Evaluate Power Efficiency. It is shown in Figure 4.13

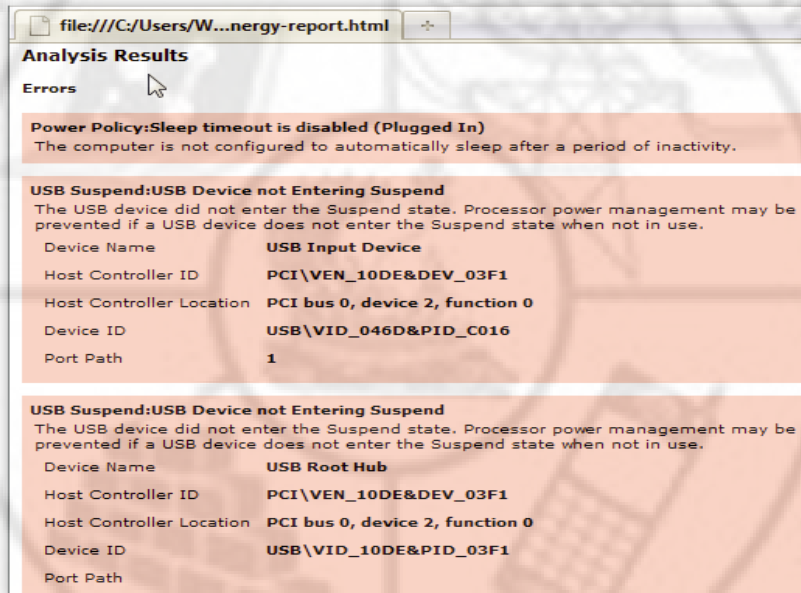

Figure 4.13

SMD components

Surface-mount technology (SMT) is a method for producing electronic circuits in which the components are mounted or placed directly onto the surface of printed circuit boards (PCBs). An electronic device so made is called a surface-mount device (SMD). An SMT component is usually smaller than its through-hole counterpart because it has either smaller leads or no leads at all. It may have short pins or leads of various styles, flat contacts, a matrix of solder balls (BGAs), or terminations on the body of the component. Surface mounting was originally called "planar mounting.

The main advantages of SMT over the older through-hole technique are:

- (i) Smaller components. As of 2012 smallest was 0.4×0.2 mm (0.016×0.008 in: 01005). Expected to sample in 2013 are 0.25×0.125 mm (0.010×0.005 in, size not yet standardized)
- (ii) Much higher component density (components per unit area) and many more connections per component.
- (iii) Higher density of connections because holes do not block routing space on inner or back-side layers.
- (iv) Components can be placed on both sides of the circuit board.

- (v) Small errors in component placement are corrected automatically as the surface tension of molten solder pulls components into alignment with solder pads.
- (vi) Better mechanical performance under shake and vibration conditions.
- (vii) Lower resistance and inductance at the connection; consequently, fewer unwanted RF signal effects and better and more predictable high-frequency performance.
- (viii) Fewer holes need to be drilled.
- (ix) Lower initial cost and time of setting up for production.
- (x) Simpler and faster automated assembly. Some placement machines are capable of placing more than 136,000 components per hour.
- (xi) Many SMT parts cost less than equivalent through-hole parts.
- (xii) Better EMC performance (lower radiated emissions) due to the smaller radiation loop area (because of the smaller package) and the smaller lead inductance.

Disadvantages

- (i) Manual prototype assembly or component-level repair is more difficult and requires skilled operators and more expensive tools, due to the small sizes and lead spacings of many SMDs.
- (ii) SMDs cannot be used directly with plug-in breadboards (a quick snap-and-play prototyping tool), requiring either a custom PCB for every prototype or the mounting of the SMD upon a pin-leaded carrier. For prototyping around a specific SMD component, a less-expensive breakout board may be used. Additionally, stripboard style protoboards can be used, some of which include pads for standard sized SMD components. For prototyping, "dead bug" breadboarding can be used.
- (iii) SMDs' solder connections may be damaged by potting compounds going through thermal cycling.
- (iv) Solder joint dimensions in SMT quickly become much smaller as advances are made toward ultra-fine pitch technology. The reliability of solder joints becomes more of a concern, as less and less solder is allowed for each joint. Voiding is a fault commonly associated with solder joints, especially when reflowing a solder paste in the SMT application. The presence of voids can deteriorate the joint strength and eventually lead to joint failure.
- (v) SMT is unsuitable for large, high-power, or high-voltage parts, for example in power circuitry. It is common to combine SMT and through-hole construction, with transformers, heat-sinked power.

SMT is unsuitable as the sole attachment method for components that are subject to frequent mechanical stress, such as connectors that are used to interface with external devices that are frequently attached and detached.

ESD and Precautions

Electrostatic discharge (ESD) is the sudden flow of electricity between two electrically charged objects caused by contact, an electrical short, or dielectric breakdown. A buildup of static electricity can be caused by tribocharging or by electrostatic induction.

How does ESD occur?

ESD can occur in a variety of forms. One of the most common is through human contact with sensitive devices. Human touch is only sensitive on ESD levels that exceed 4,000V. A recent investigation found the human body and its clothing capable of storing between 500V and 2,500V electrostatic during the normal workday. This is far above the level that damages circuits yet below the human perception threshold. Other sources of ESD damage to equipment include:

- (i) Troubleshooting electronic equipment or handling of printed circuit boards without using an electrostatic wrist strap;
- (ii) Placement of synthetic materials (i.e. plastic, Styrofoam, etc.) on or near electronic equipment; and
- (iii) Rapid movement of air near electronic equipment (including using compressed air to blow dirt off printed circuit boards, circulating fans blowing on electronic equipment, or using an electronic device close to an air handling system).

Precautions :

The following guidelines will be helpful to avoid ESD.

- (i) Keep all synthetic materials at least 4 in. away from electronic equipment.
- (ii) When cleaning printed circuit boards, use a spray labeled as non-static forming.
- (iii) When troubleshooting electronic equipment, always wear a static wrist strap that's grounded to the frame of the device. Also, wear the wrist strap when handling printed circuit boards.
- (iv) Treat carpets and floors with compounds that reduce the buildup of static charges.
- (v) Use static floor mats where necessary.
- (vi) Make sure the grounding system for equipment has a low impedance for ESD currents to dissipate to an earthing reference.

. Laptop Components

Adapter –types

The charging units for laptops are known as 'adapters' because they must adapt AC power to DC power or one type of DC power to another type in order to provide energy to the laptop unit. There are two types of adaptor. AC power adaptor and DC power adaptor.

AC Power Adapter

A laptop power adapter consists first of a wire which plugs into the wall socket and accepts AC power. This wire generally travels to a black box, called a transformer, which converts the AC power provided by wall the outlet to the DC power needed by the electronic device, the same type of power which is provided by its battery. This electric current it then carried by a second wire which connects to the device itself.

DC Power Adapters

There are many common types of DC power units, including car power plugs, those offered on aeroplane flights, and batteries designed to recharge other batteries. Because laptops run on DC power, it is easy to assume that plugs which provide DC power can be connected to the outlet directly. However, this is not always a safe or helpful to the laptop since it is common for DC plugs to provide less voltage than is needed to power the unit. Therefore, DC power adapters need to store up the power that the plug provides in order to convert it to a voltage high enough to power the laptop itself.

Universal Power Adapters

The purpose of a universal power adapter is to accommodate all types of laptops and charging situations through the use of interchangeable tips. There are also various voltages and sizes offered to make sure that buyers can function in virtually any environment including AC and DC charging conditions, as well as across multiple brands and types of laptops.

Battery-types and Basic Problems

Laptop battery provides power to the computer when the user does not have access to a power outlet. Laptop batteries, like most batteries used in portable devices, are rechargeable. Most modern laptop batteries hold a charge for between two and five hours of light-duty use, though that number can drop to less than an hour for power-intensive tasks.

The three main types of batteries used in modern laptops are nickel-metal hydride (NiMH), lithium ion (Li-ion), and lithium polymer (LiPo) batteries. NiMH batteries are the oldest technology currently in use, while LiPo batteries represent the cutting edge of portable power supply technology.

Nickel-Metal Hydride Batteries

Commercial-size NiMH batteries first appeared on the market in the late 1980s, replacing the less-efficient and potentially toxic nickel-cadmium batteries. NiMH batteries provide an inexpensive and efficient alternative to standard alkaline batteries. In addition, NiMH batteries offer smoother discharge rates and more efficient power transfer during high current drain applications, such as portable computing. However, NiMH batteries do have a high rate of self-discharge, sometimes as much as 3 percent per day.

Lithium Ion Batteries

Li-ion batteries began to see widespread use in the mid-1990s, as they provide a significant increase in total charge capacity over NiMH batteries. Li-ion batteries also proved to be lighter than comparable NiMH batteries, in addition to suffering significantly less self-discharge. Where a NiMH might automatically discharge up to 30 percent of its power in a month of non-use, a similar Li-ion would only lose between 10 and 15 percent of its total power.

However, Li-ion batteries do have a few serious flaws. Li-ions are prone to steep drops in total charge capacity over time, as deposits build up within the electrolyte, which inhibits ion transfer. In addition, high charge levels and elevated temperature result in a permanent loss of charge capacity, with up to 20 percent of the battery's capacity lost if consistently kept at full charge and 77 degrees Fahrenheit. Lastly, some Li-ion batteries, especially those based on lithium cobalt oxide, can suffer thermal runaway and cell rupture if overheated or overcharged. In the most severe cases, this can lead to catastrophic failure, including the ignition of the chemicals inside the battery.

Lithium Polymer Batteries

LiPo batteries are an outgrowth of Li-ion technology. Instead of holding the lithium-salt electrolyte in an organic solvent, LiPo batteries use a solid polymer composite. This allows for a lower cost of manufacture, wider adaptability, and increased reliability and ruggedness. Their adaptability in particular has led to their adoption in small-scale consumer electronics, including products by Apple and Sony. However, LiPo batteries also run the risk of explosion if they are not charged properly or if the battery short-circuits. In addition, delamination can occur at high states of charge, which necessitates a strong casing to ensure the polymer retains its shape.

The common battery problems and its solutions are listed in Table 4.2.

Table 4.2 Common battery problems and solutions

Problems	Solutions
Laptop shuts off when AC adapter	1. The battery not seated correctly. Try reconnecting it. 2. The battery contacts got dirty or oxidized and it's not making good

unplugged.	<p>connection with the motherboard. Apply some electronic contact cleaner on the contacts.</p> <p>3. If reconnecting the battery doesn't help, most likely it's bad and has to be replaced</p> <p>4. If you replaced the battery but the problem still exists, this is motherboard related failure. Apparently the charging circuit on the motherboard failed. In this case the whole motherboard has to be replaced (or repaired on the component level).</p>
The battery not detected by the laptop.	<p>1. Most likely the battery is bad. You have a very good chance to fix this problem by replacing it with a new one.</p> <p>2. If replacing the battery doesn't help, this is motherboard related failure. The motherboard has to be replaced (or repaired on component level).</p>
The battery discharges very quickly after it reaches some critical point.	This is battery failed. It has to be replaced with a new one.
The battery charges only if the power plug positioned correctly.	<p>1. AC adapter failure. The AC adapter power cable is damaged.</p> <p>2. If the AC adapter works fine, most likely this is power jack (connector where you plug power adapter) failure. In this case the power jack has to be replaced.</p>

RAM –types

Laptop memory comes in several shapes and sizes. Laptops rarely use the standard SIMM and DIMM memory modules used by non-portable machines. The different types of Memory with its features are listed in Table 4.3

Table 4.3 MEMORY TYPES

Module	Configuration	Definition	Size
SODIMM	72 PIN 32-bit transfer 2.35" wide 3.3V	Small Outline Dual Inline Memory Module	128-512 Meg
SODIMM	144 PIN 32-bit transfer 2.66" wide 3.3V 144-pin SO-DIMMs have a single notch near (but not at) the center.	Small Outline Dual Inline Memory Module	128-512 Meg

Unit -IV Maintenance and Troubleshooting of Desktop and Laptop

SDRAM	PC100 100MHz, XFER 800MB/s 168-pin SDRAM modules operate at 3.3V or 5V.	Synchronous Dynamic RAM	128-512 Meg
SDRAM	PC133 133MHz, XFER 1.1 GB/s 168-pin SDRAM modules operate at 3.3V or 5V.	Synchronous Dynamic RAM	128-512 Meg
DDR1 SDRAM	PC2100 DDR 266 Mhz 2.5V	Dual Data Rate Synchronous RAM	256 Meg - 1GB
DDR1 SDRAM	PC2700 DDR 333 Mhz 2.5V	Dual Data Rate Synchronous RAM	256-512 Meg
DDR1 SDRAM	PC3200 DDR1 400 Mhz 2.5V The rejection slot on the ram changes because the voltage differences between DDR1 and DDR2 prevents interchangeability.	Dual Data Rate Synchronous RAM	512 Meg - 1 GB
DDR2 SDRAM	PC3200* DDR2-400. Memory Clock: 100 MHz. Bus Clock: 200 MHz. Data Transfers/Sec.: 400,000,000. 200p SODIMM, 1.8v 200-pin SO-DIMMs have a single notch nearer to one side.	Dual Data Rate Synchronous RAM	512 Meg - 1 GB
DDR2 SDRAM	PC4200* DDR2-533. Memory Clock: 133 MHz. Bus Clock: 266 MHz. Data Transfers/Sec.: 533,000,000. 200p SODIMM, 1.8v	Dual Data Rate Synchronous RAM	512 Meg - 2 GB
DDR2 SDRAM	PC5300* DDR2-667. Memory Clock: 166 MHz. Bus Clock: 333 MHz. Data Transfers/Sec.: 667,000,000. 200p SODIMM, 1.8v	Dual Data Rate Synchronous RAM	512 Meg - 4 GB
DDR2 SDRAM	PC6400* DDR2-800. Memory Clock: 200 MHz. Bus Clock: 400 MHz. Data Transfers/Sec.: 800,000,000. 200p SODIMM, 1.8v	Dual Data Rate Synchronous RAM	1GB - 4 GB
DDR3 SDRAM	PC8500* DDR3-1066 204p SODIMM, 1.8v	Dual Data Rate Synchronous RAM	1GB - 4 GB

CPU-types

There are different types of laptop processors. The Table 4.4 shows the features of different processors.

Table 4.4 Features of different processors.

Features	Explanation	Processors Using Feature
Intel Features		
Hyper-Threading (HT)	Improves the performance by allowing the operating system to improve its ability to 'multitask' processes more intelligently. One physically present core is treated as two logical cores which share workloads between each other. Hence, a dual-core with HT has 4 logical cores and a quad-core has 8 logical cores.	Core i7, Core i5, Core i3, Atom
Turbo Boost	Allows the processor to intelligently and dynamically overclock a core(s) such that thermal/power constraints are not violated. For example, a dual core processor with Turbo Boost can overclock one core to much higher frequencies while decreasing speed of the other core; in some situations this can improve performance.	Core i7, Core i5 (Mobile Dual-Cores only)
QuickPath Interconnect (QPI)	An Intel technology which replaced Front Side Bus (FSB) -- similar in purpose to AMD's competing Hyper Transport technology.	Implemented in some fashion across all Intel core iX series
Tri-Gate (3D) Transistor	A new fabrication technology implemented for mass production for the first time in 2012 with Ivy Bridge. Essentially, increases the surface area of each transistor on the chip while also reducing power leakage which on the whole significantly decreases power consumption and improves performance.	Ivy Bridge (2012) iX series
vPro	Synchronizes remote desktop, security, and other multi-station support features. Decreases desk-side maintenance visits.	Current Intel processors

Unit -IV Maintenance and Troubleshooting of Desktop and Laptop

Execute Disable Bit	Prevents certain viruses from infecting the system by labeling some data "executable."	Current Intel processors
AMD Features		
HyperTransport	A feature that helps minimize the number of buses in a system. This can reduce system 'bottlenecks' and allow microprocessors to use system memory more efficiently.	All current AMD processors
Cool'n'Quiet	Reduces heat and noise of processors allowing for increased energy efficiency.	Phenom I & II, Athlon, Sempron (with exceptions)
Turbo Core	Turbo Core allows for contextual overclocking of the processor to optimize performance subject to electrical and thermal requirements/specifications.	Phenom II X6, Trinity APUs
Cool Core	Limits unused elements of the processor such that power is conserved -- allows for increased notebook battery life on a single charge.	Phenom I & II, Turion

Laptop Mother Board

The motherboard is the largest card in the computer and it is the one to which all other cards and the CPU are attached. Both laptops and desktops contain motherboards, but those in laptops are much more difficult to repair since the components are all packed in so tightly. The motherboard's primary purpose is to manage all the computer's subsystems. A chipset manages communications among systems. The motherboard also distributes power to the systems with low power needs.

Functions

A motherboard contains a socket into which one or more processors can be attached. It has slots for peripheral cards such as video cards, sound cards or networking cards. It includes a chipset that acts as an interface between all of a computer's subsystems. It holds the ROM or permanent memory used by the BIOS (Basic Input/Output System) -- a bit of memory that doesn't get erased when the computer is turned off because it contains the instructions that remind the computer what to do when it gets turned back on. In addition, a motherboard includes a clock generator that is a sort of electronic metronome that the computer uses to synchronize various operations. It also holds the more active memory RAM that the machine uses when it runs software. Finally, the motherboard has

slots for expansion cards and power connectors which provide power to various components (high speed graphics cards and disk drives get their power directly from the power supply).

Compatibility

Different motherboards support different types of CPUs, memory, disks drives, video cards and other peripherals. If you are attempting to replace a motherboard, make sure that all the components are compatible with the slot and connector types available on the motherboard. For instance, the CPU socket on a motherboard will vary depending on whether it supports Intel or AMD and also varies among CPUs by the same maker. Disk drives have different connectors and standards as well. Most commonly, a motherboard can support IDE, SATA or both. The slots for expansion cards will vary as well with later versions of PCI Express being the fastest.

Block Diagram

Block diagram of the motherboard is shown in Figure 4.14

- The main components of the motherboard

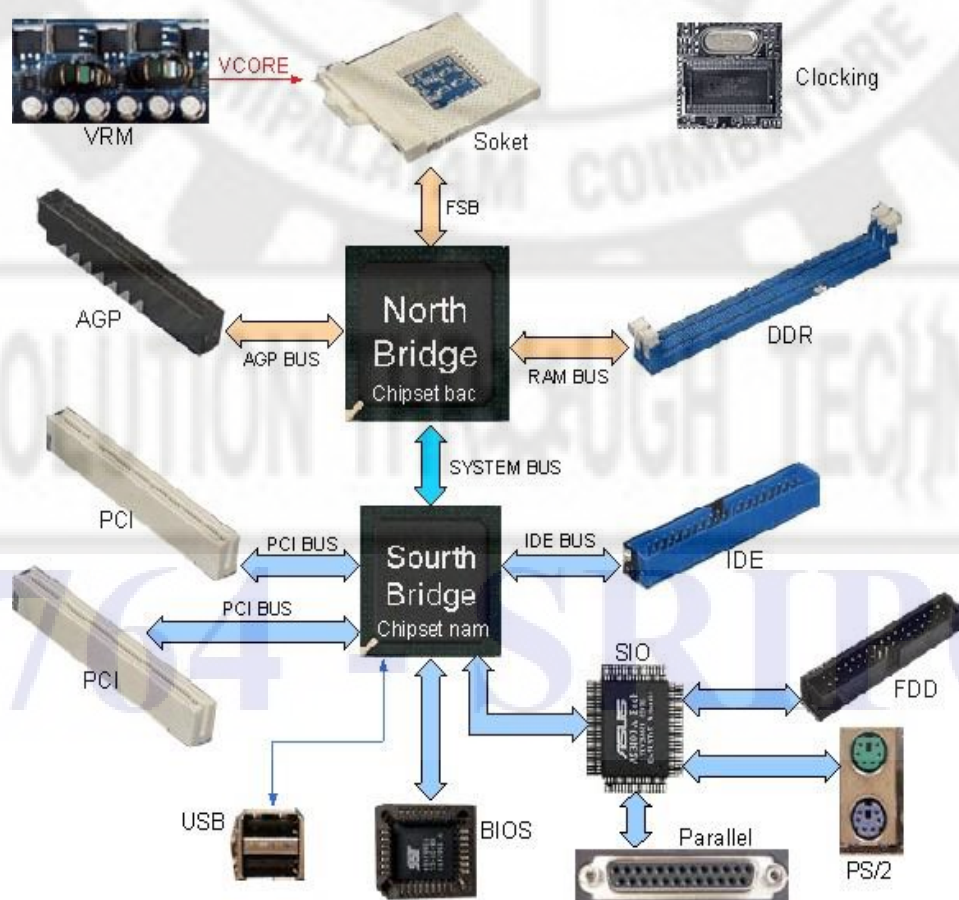

Figure 4.14 Block diagram of the motherboard.

Socket (CPU sockets)

There are different types depending on the CPU socket type motherboard

- On the Main board Socket 370 Pentium 3
- Socket 478 Pentium 4 motherboard on the
- Socket 478 Pentium 4 motherboard on the
Socket pins controlled by the chipset north.

North Bridge (north Chipset)

- Chipset North is responsible for control of high speed components like CPU, RAM and Video Card
- Chipset BUS speed control and switch control data, ensuring data back and forth between the components is a smooth and continuous, fully exploit the speed of the CPU and RAM
- It can be a chipset like the traffic in an intersection, as drivers switch traffic lights to allow each data stream passes through a period of time, while speed control is a BUS different directions of the intersection, the vehicle must run on a specified speed.

South Bridge (south Chipset)

- The function is similar as chipset north, but the south bridge driver chipset components slower as: Sound Card, Net Card, hard disk, CD ROM drive, USB port, SIO and BIOS IC etc..

ROM BIOS (Read Only Memory - Basic In Out System)

ROM is read-only memory IC, BIOS is a program loaded in ROM by the manufacturer loaded Main board, BIOS program has the following functions:

- Start the computer, maintaining the operation of the CPU
- Error checking the RAM and Video Card
- Manage the chipset drivers for north, south chipset, IC-SIO and onboard video card
- Supply of CMOS SETUP default settings for our machine can not operate CMOS settings

IC SIO (Super In Out) - IC controller ports to the data

- SIO control Parallel port devices such as printers, scanners, floppy controller, serial ports as COM ports, PS / 2
- The SIO also supervise other departments on Main activities to provide signal incident
- Integrated power control circuit switches, making the system reset signal.

Clock gen (clocking) - Clock pulse generator circuit

Clock pulse generator circuit has an important role on the Mainboard , The generated clock provided on Main components operate simultaneously synchronize the operation of the entire computer system, if broken, the clock circuit components on Main unable to work, clocking circuit after the first operation Main sources of supply.

VRM (Vol Regu Module) - voltage regulator module.

This is the power control circuit for CPU VCore, the circuit is responsible for hanging the voltage 12V/2A to 1.5 V and current up to 10A to the CPU level, the circuit includes components such as Mosfet , IC oscillator, the filter circuit LC

AGP or PCI Express slot

AGP and PCI Express slots to add video card, AGP or PCI Express slot north controlled by the chipset.

Slot RAM

Memory RAM controlled by the chipset north to add RAM memory, this memory is indispensable intermediary in a computer system.

PCI slot

PCI slot controlled by the chipset south to add the extension Card as Sound Card, net work card etc.

IDE port

Gateway Chipset IDE by male drivers, the port used to attach IDE drives such as HDD, CDROM, DVD.

See the flash file attached)

The components on the motherboard and the block diagram of the motherboard

Laptop Keyboard



Figure 4.15 Keyboard

A typical laptop keyboard layout has typewriter keys, shift keys, function keys, and cursor control keys. The Figure 4.15 illustrates a typical laptop keyboard layout, where all the common keys found on the whopping desktop keyboard have been miniaturized to laptop size.

- (i) **Alphanumeric, or “typewriter,” keys:** These are the basic typing keys, each of which is labeled with a character (a letter, number, or punctuation symbol). Pressing a key produces its character on the screen.
- (ii) **Shift keys:** The keyboard sports various shift keys used either alone or in combination with other keys. These include Shift, Alt, Ctrl, and the special Windows keys Win and Context. The Win key appears in the bottom row between the Fn and Alt keys; the Context key appears between Alt and Ctrl. Also note the Esc (or Escape) key, found at the beginning of the top row of keys.
- (iii) **Function keys:** These keys are labeled F1 through F12 and are found on the top row of the keyboard, right above the number keys.
- (iv) **Cursor-control keys:** These keys can be anywhere around the keyboard, although in this example, they’re on the top and bottom right. They include the four directional arrow keys, usually found in an inverted T pattern, as well as the Insert (or Ins), Delete (or Del), Home, End, PgUp (or Page Up), and PgDn (or Page Down) keys.

. Installing and Troubleshooting

Formatting

The following steps to be followed to format the Laptop.

- (i) Step 1 - Make sure all essential files of laptop hard drive are backed up on the back up storage medium. These can be external hard drives, DVDs or Flash drives.
- (ii) Step 2 - Check device drivers before starting installation. If laptop came with an original operating system installation, either you must have the installation CD or you have to burn it before hand from an existing partition on your laptop.
- (iii) Step 3 - You should have a utility or CD burning software on your laptop, which will allow you to burn the operating system installation files from your hidden hard drive partition on to a CD. You can confirm the existence of the files by either pressing F8 or F10 when starting up your computer.
- (iv) Step 4 - Check if all essential software installation files are saved on an alternate storage medium. When downloading any software from the internet ensure that you have backed up the installation files on an outside medium.

- (v) Step 5 - Insert the operating system installation CD in the DVD or CD drive on your laptop. Now boot up the computer. If you are directly formatting from the hidden partition available on your laptop, start up your system, and then press the shortcut keys F8 or F10. Now follow the instructions that come up on the screen.
- (vi) Step 6 - You should do a full system recovery and install the Windows operating system to complete re-formatting your laptop.
- (vii) Step 7 - Install an antivirus program on the laptop. You should also check and adjust firewall settings to reinforce your computer's security system.
- (viii) Step 8- Connect the backup storage media to the laptop and transfer all essential files back on to the system. You should re-install functional software that is most essential for your work. This conclusively completes full formatting of your windows laptop

Partitioning and Installation of Operating System

A partition is an area of a hard disk that can be formatted and assigned a drive letter. On a hard disk, a volume is a formatted primary partition or logical drive. The terms partition and volume are often used interchangeably. HP and Compaq computers with Windows 7 have hard disk drives that contain at least two partitions: the main partition for Windows and your work, and a recovery partition to restore the computer back the way it came from the factory. Here is a list of some of the partitions you may find on your hard drive:

- (i) The main partition, usually labeled with the letter C, contains the system files, program files, and usable file storage space.
- (ii) A recovery partition, usually drive letter D and labeled RECOVERY, contains system recovery information in case the files on the C partition are damaged or unusable.
- (iii) A hidden partition may exist called SYSTEM. A SYSTEM partition is used by Windows to store protected files for troubleshooting and should not be altered.
- (iv) computer may also have a partition called "HP_TOOLS". If so, this partition contains HP tools for UEFI that you can use to help troubleshoot boot problems or test for hardware failures.

The following steps to be followed to create a new partition in windows 7

1. To open the Disk Management tool, click Start . In the Search field, type Partition. Then click Create and format hard disk partitions. The Disk Management tool opens and displays information about the data storage devices on the computer.
2. To create unallocated space on the drive, right-click the drive you want to partition. For most applications, select the C: drive.

Then click Shrink Volume..It is shown in Figure 4.16

Do not use the Recovery or FACTORY_IMAGE partition to create a new partition. Doing so might prevent the HP Recovery Manager from recovering the computer when the information on the C: partition is damaged.

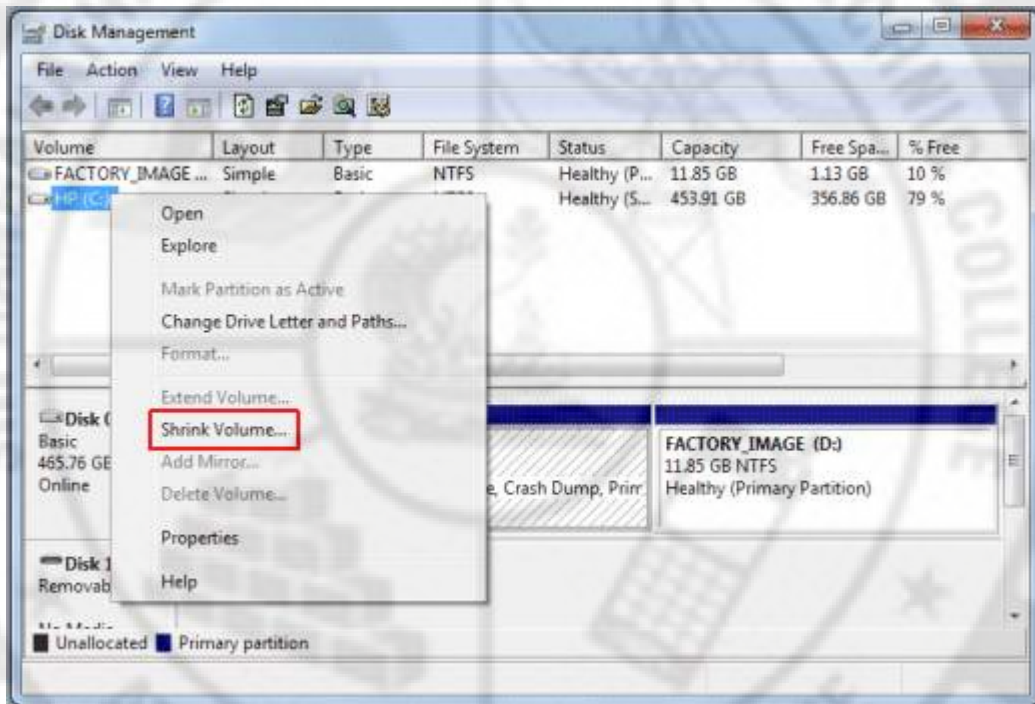

Figure 4.16 : Shrink Volume

3. Do not make any adjustments to the settings In the Shrink window. Click Shrink.

Figure : Shrink C: window as shown in Figure 4.17

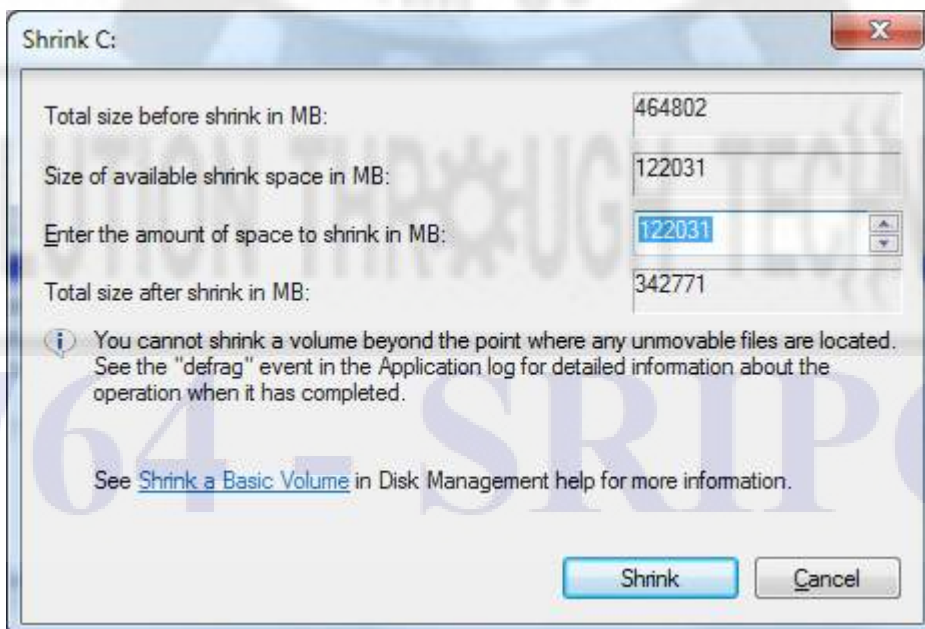

Figure 4.17 Shrink C:Window

When the Shrink is complete, the new partition displays in the Disk Management utility as Unallocated space.

Figure 4.18 : Disk Management window with unallocated space encircled in red

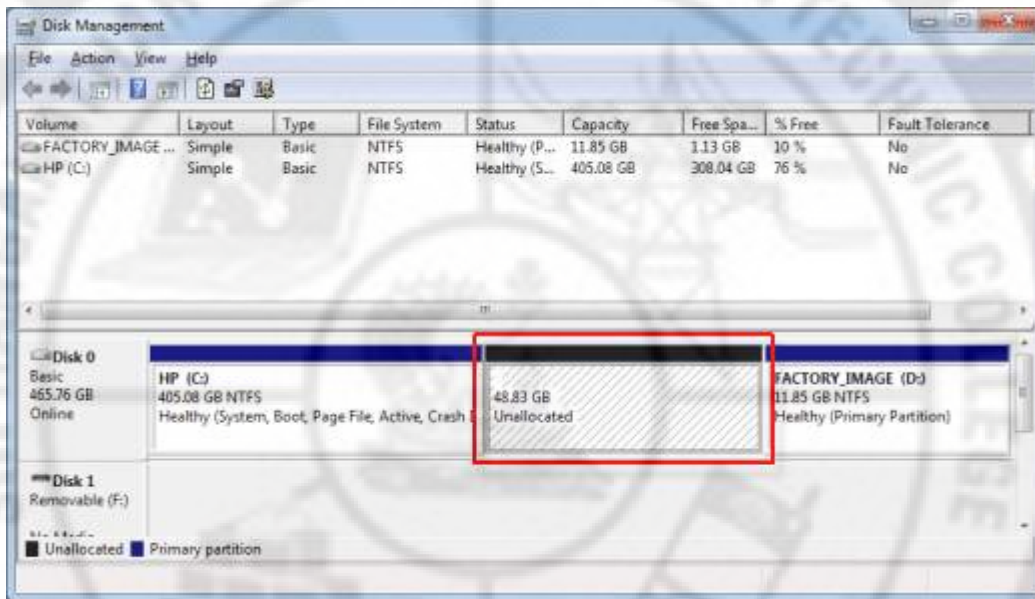

Figure 4.18 Disk Management window

4. Right-click the new partition. In the menu that displays, click New Simple Volume...

Figure 4.19 : New Simple Volume...

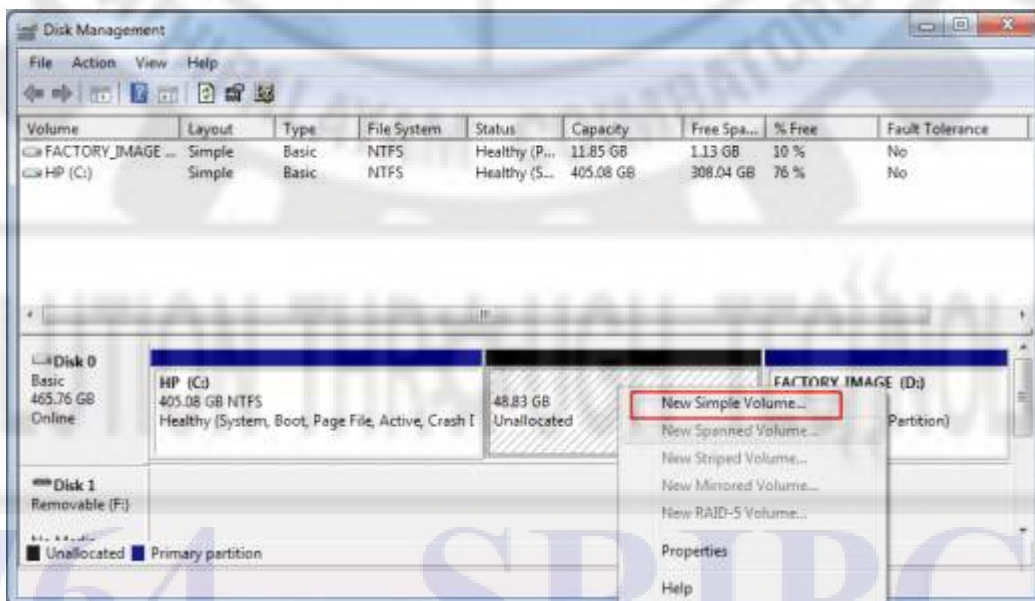

Figure 4.19 New Simple Volume

5. The New Simple Volume Wizard displays. To continue, click Next.
6. The Specify Volume Size window displays. Type in the volume size, or click Next to accept the default setting.

Figure 4.20 : Specify Volume Size window

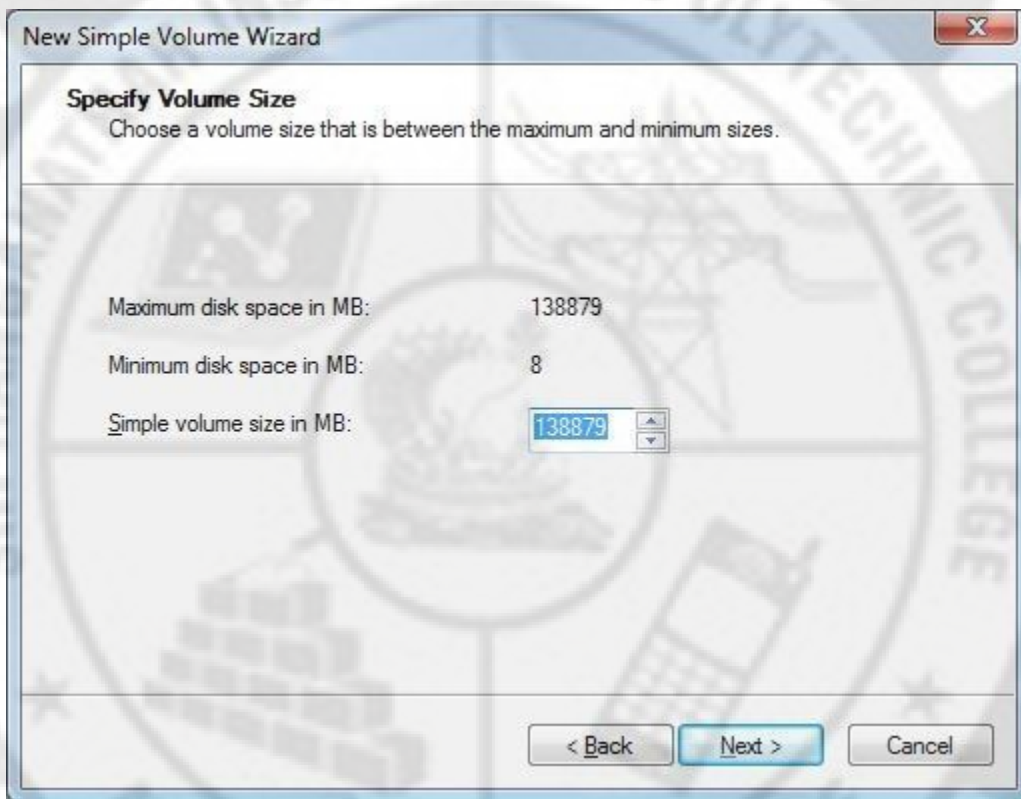

Figure 4.20 Specify Volume size window

7. The Assign Drive Letter or Path window displays. Select a drive letter and click Next.

Figure 4.21 : Assign Drive Letter or Path window

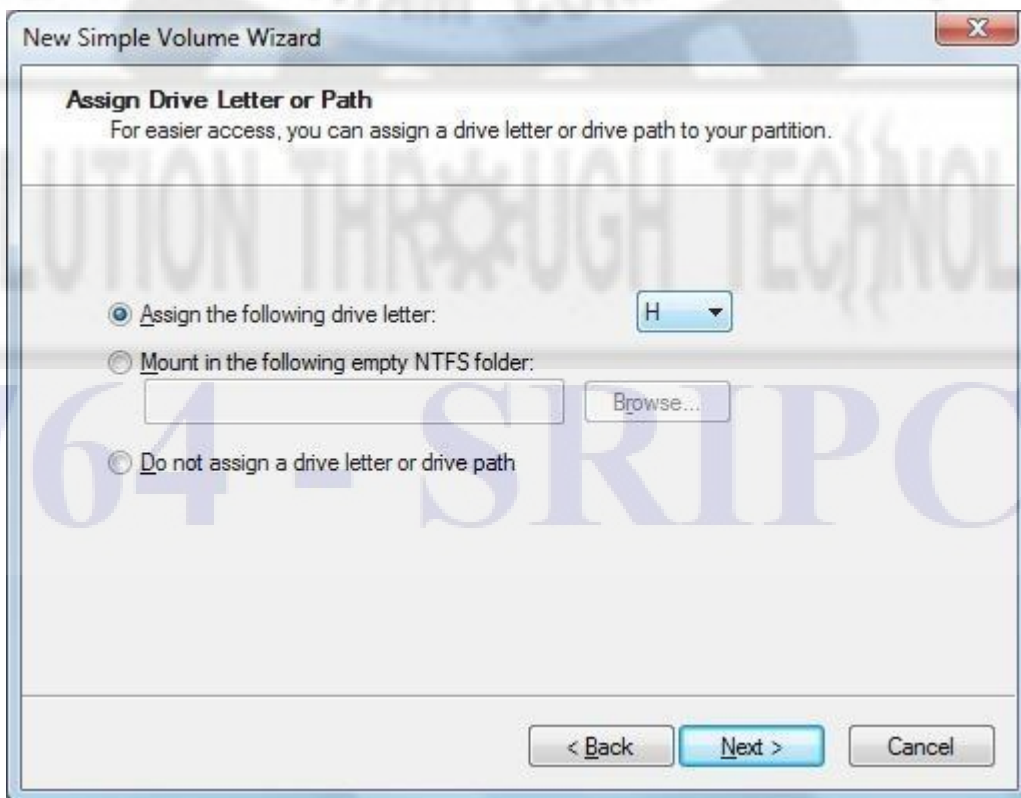

Figure 4.21 Assign Drive letter or path window

- The Format Partition window displays. To name the drive, type a name in the Volume label box. Then click Next.

Do **not** select Perform a quick format or Enable file and folder compression.

Figure 4.22 : Format Partition window

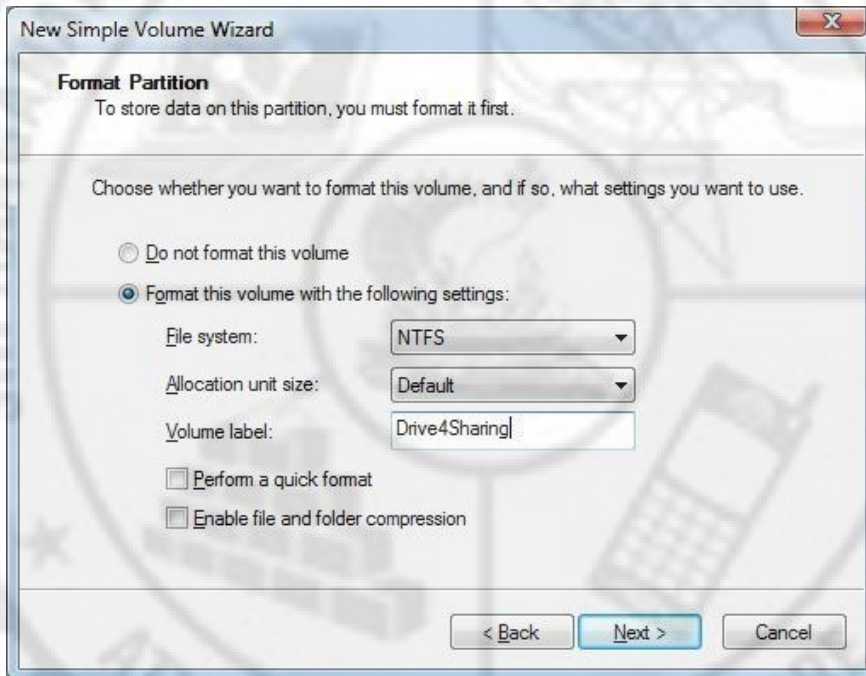

Figure 4.22 Format Partition window

- The settings window displays. Click Finish.

Figure 23: Completing the New Simple Volume Wizard

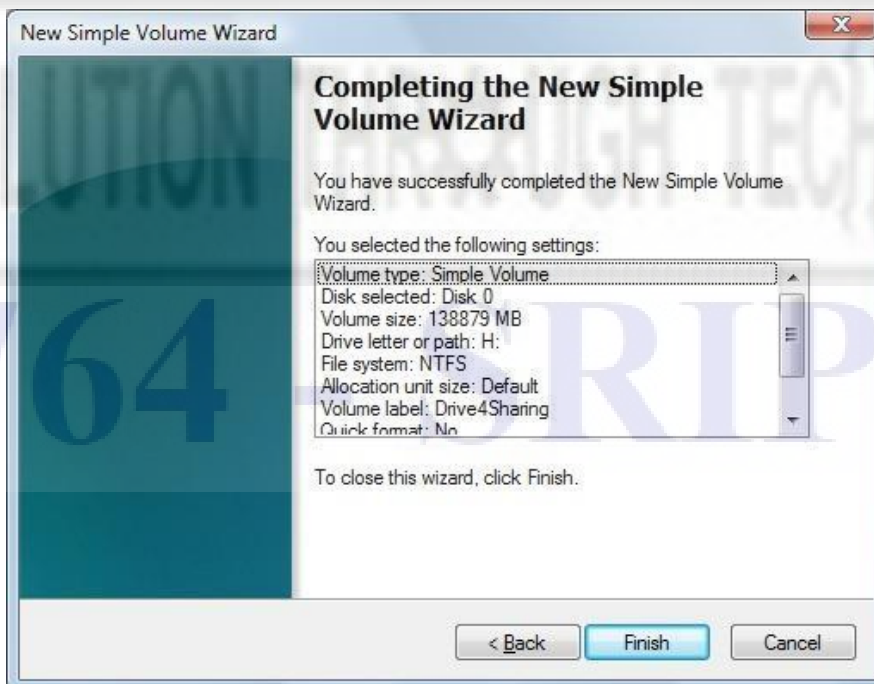

Figure 4.23 Completing the new simple Wizard.

10. The Disk Management utility displays, showing the formatting progress.

Figure 4.24 : Formatting

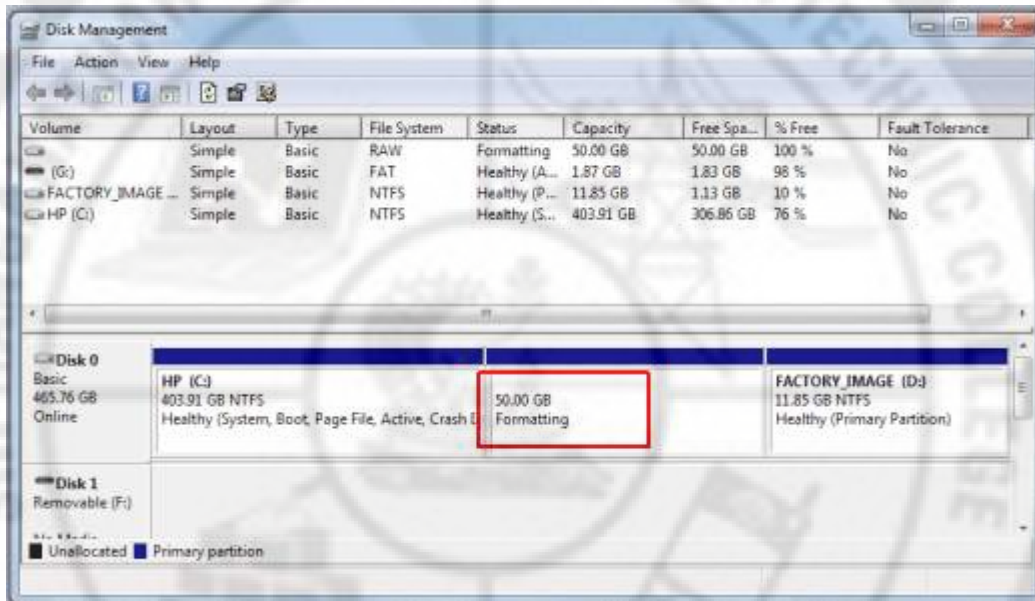

Figure 4.24 Formatting

When the format is complete, the new drive shows in the Disk Management utility. If the AutoPlay window displays, click the X in the upper-right corner to close it.

Figure 4.25 : New volume

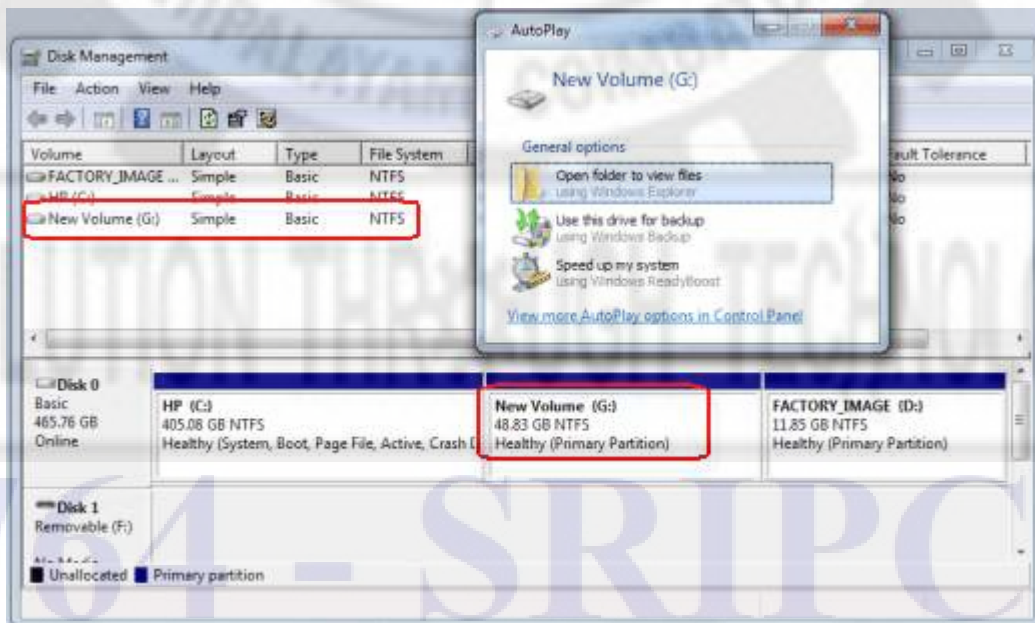



Figure 4.25 New Volume

Changing a drive letter in Windows 7

The letters C through Z can be assigned to each drive on your computer. The system partition is usually labeled with the letter C, while the letters A and B are reserved for floppy disk drives or removable drives. If the computer does not have floppy disk drives, you can assign A and B to volumes. Some MS-DOS and Windows programs make references to

specific drive letters. If you change a drive letter, some programs that you have installed on your hard disk might not work correctly. You cannot change a drive letter if the drive is either a system partition or a boot partition. If you get an error, the partition or drive you are trying to change might be in use. Close any program or window that is using the partition or drive and try again.

Complete the following steps to change a drive letter.

1. To open the Disk Management tool, click Start . In the Search field, type partition. Then click Create and format hard disk partitions. The Disk Management tool opens and displays information about the data storage devices on the computer.
2. Right-click the partition or drive to rename and then click Change Drive Letter and Paths... as shown in Figure 4.26

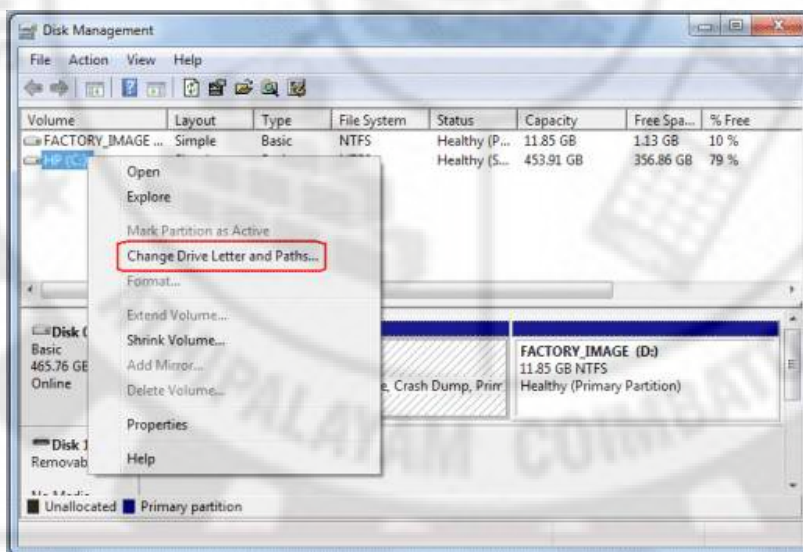

Figure 4.26

3. In the Change Drive Letter window, click Change.

Figure 4.27 : Change Drive Letter window with Change highlighted

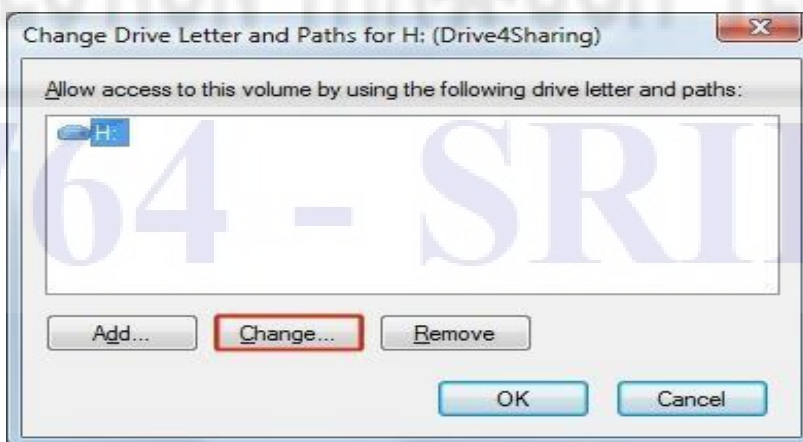

Figure 4.27 Change drive letter window

4. In the menu, select the new drive letter. Then click OK.

Figure 4.28 : Change Drive Letter window

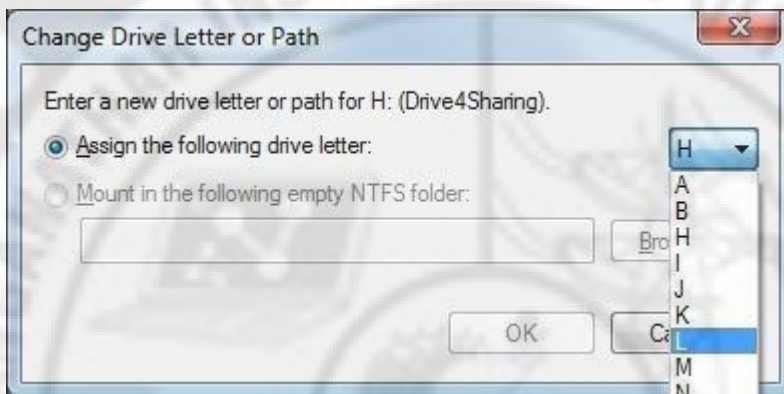

Figure 4.28 Change Drive letter window

5. The Disk Management caution message is displayed. Click Yes to continue.

Figure 4.29: Disk Management caution message



Figure 4.29 Disk Management Caution message

Removing a drive letter in Windows 7

Storage space can be cleared and accessed on your computer by removing drive letters. A drive letter can be deleted by using the Disk Management tool.

caution:

Deleting a volume erases all the data on it. Back up any data you want to keep before deleting.

1. Back up any data you want to keep from the drive you want to delete.
2. To open the Disk Management tool, click Start . In the Search field, type Partition. Then click Create and format hard disk partitions. The Disk Management tool opens and displays information about the data storage devices on the computer.
3. Right-click the drive letter you want to remove. Then click Change Drive Letter and Paths...
4. In the Change Drive Letter window, click Remove.

Figure 4.30: Change Drive Letter window with Remove highlighted

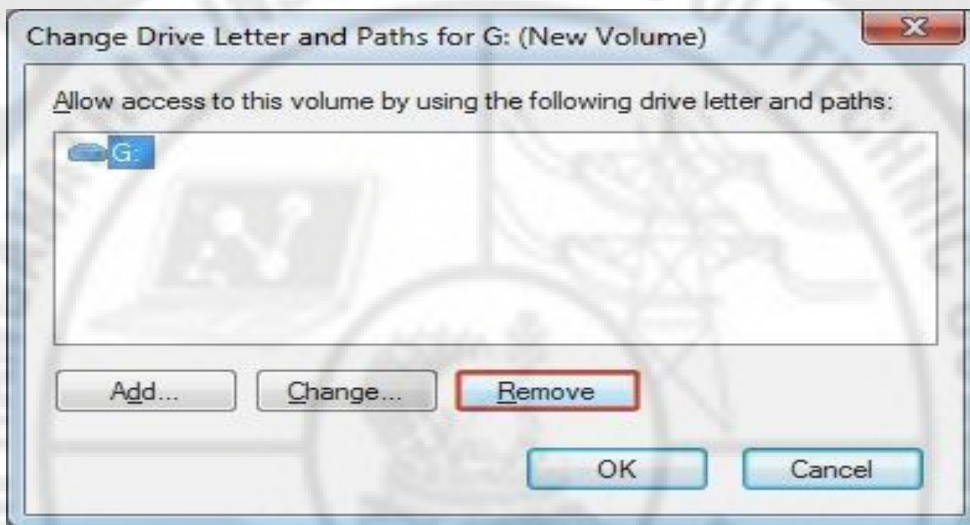

Figure 4.30 Remove the drive letter

5. The Disk Management caution message displays. Click Yes to continue.

Figure 4.31: Disk Management caution message

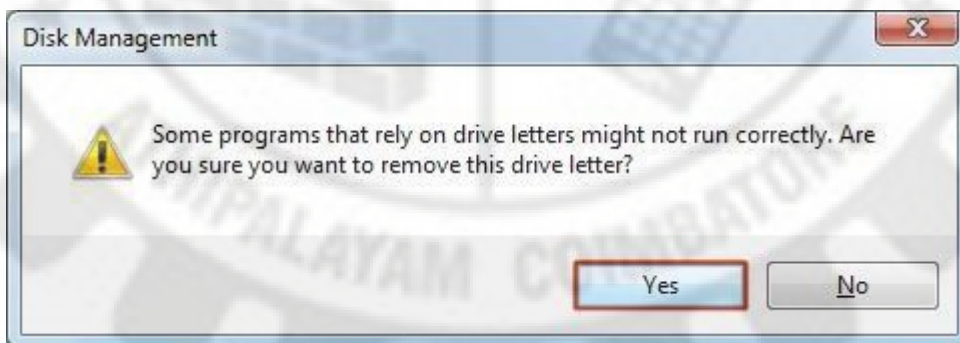

Figure 4.31 Disk Management

The drive letter disappears. To use this hard drive space again, continue to the next section to remove the partition.

Removing a partition in Windows 7

Storage space can be cleared and accessed on your computer by removing partitions. A partition can be deleted from the Disk Management portion of the Computer Management window when you select Delete Volume, click Delete Partition, and then add the unallocated space to another disk.

Caution:

Deleting a volume erases all the data on it. Back up any data you want to keep before deleting.

1. To open the Disk Management tool, click Start . In the Search field, type Computer Management. Then click the Computer Management option from the search results.

Figure 4.32 : Search results for Computer Management

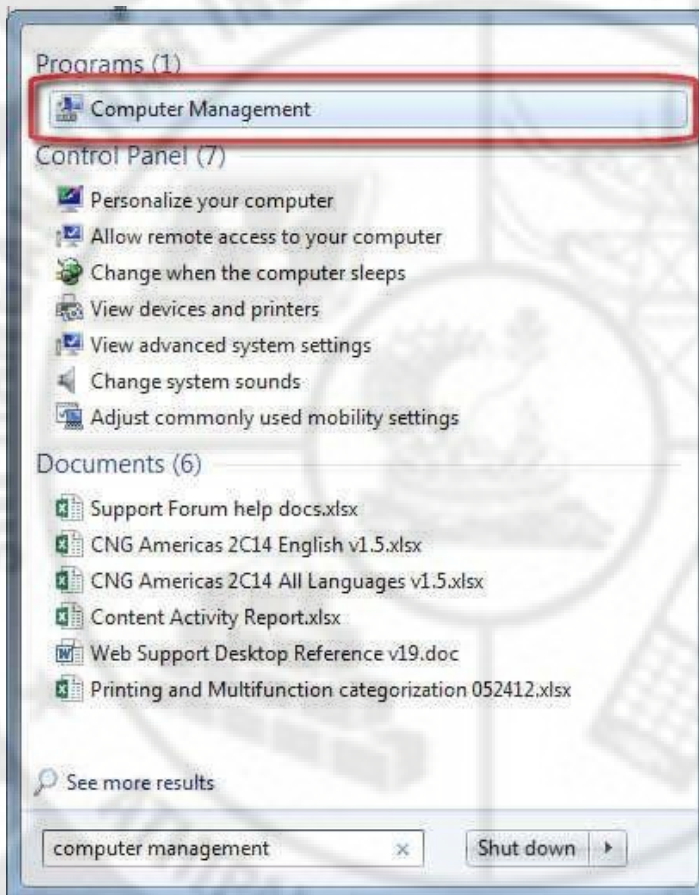

Figure 4.33 Computer Management

The Computer Management window opens .

2. In the menu bar on the left of the Computer Management window, select Disk Management.

Figure 4.34: Disk Management



Figure 4.34 Disk Management

The partitions of your computer are displayed.

Unit -IV Maintenance and Troubleshooting of Desktop and Laptop

3. Right-click the volume or partition you want to delete, and then click Delete Volume...

Figure : Delete Volume...

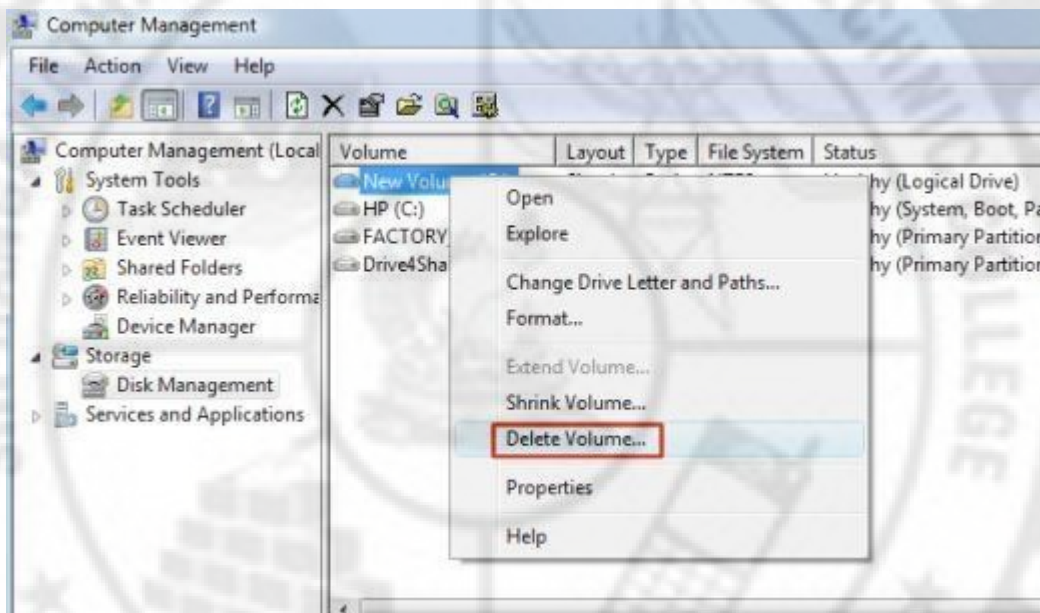

Figure 4.35 Delete Volume

4. If you have backed up the data you want to keep, click Yes.
The drive letter disappears and the partition is labeled as Free space.

Figure 4.36 : Free space in the partition



Figure 4.36

- Right-click the free space. In the menu that displays, click Delete Partition...

Figure 4.37 : Delete Partition...

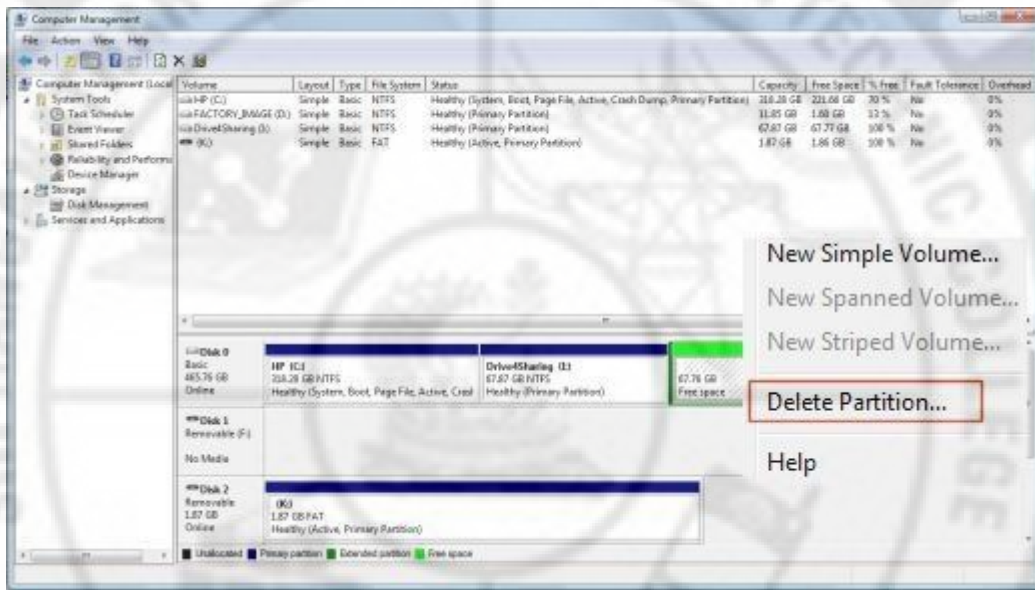

Figure 4.37

Now the space is shown as **Unallocated**.

- Right-click the drive to which you want to add the unallocated space. In the menu that displays, click Extend Volume...

Figure 4.38 : Extend Volume...

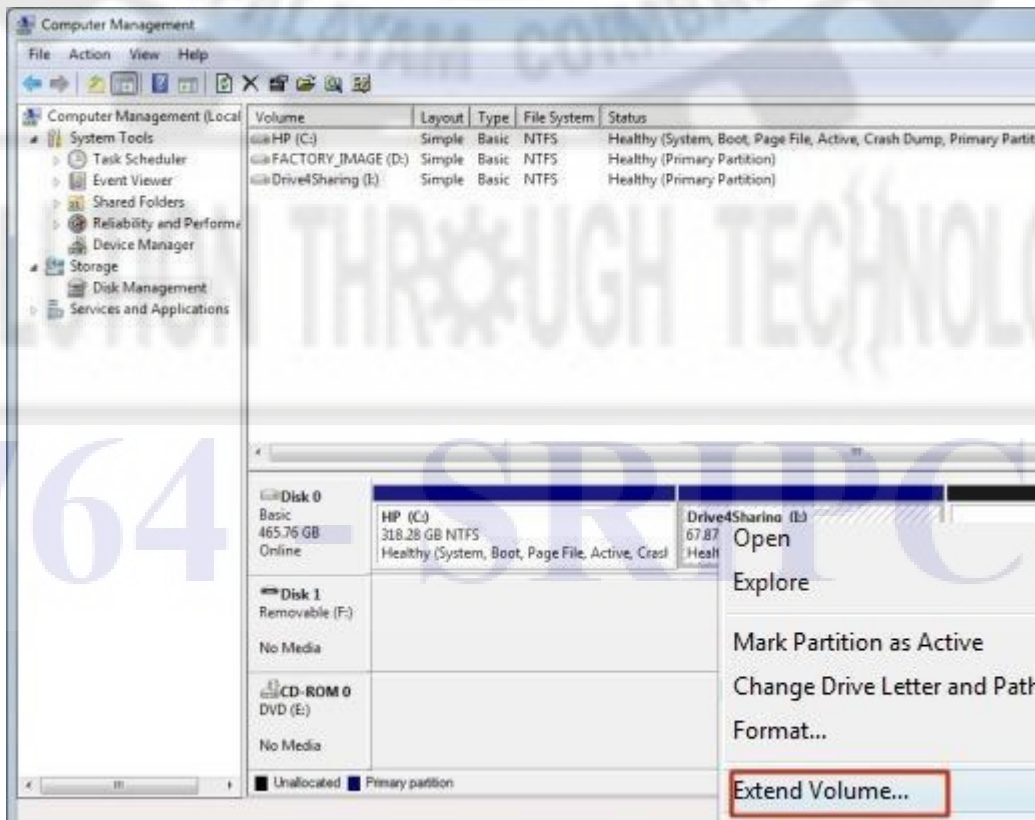

Figure 4.38

7. The Extend Volume Wizard displays. Click Next.

Figure 4.39 : Extend Volume Wizard



Figure 4.39

8. The Select Disks window displays. Do not change any settings. Click Next.

Figure : Select Disks window

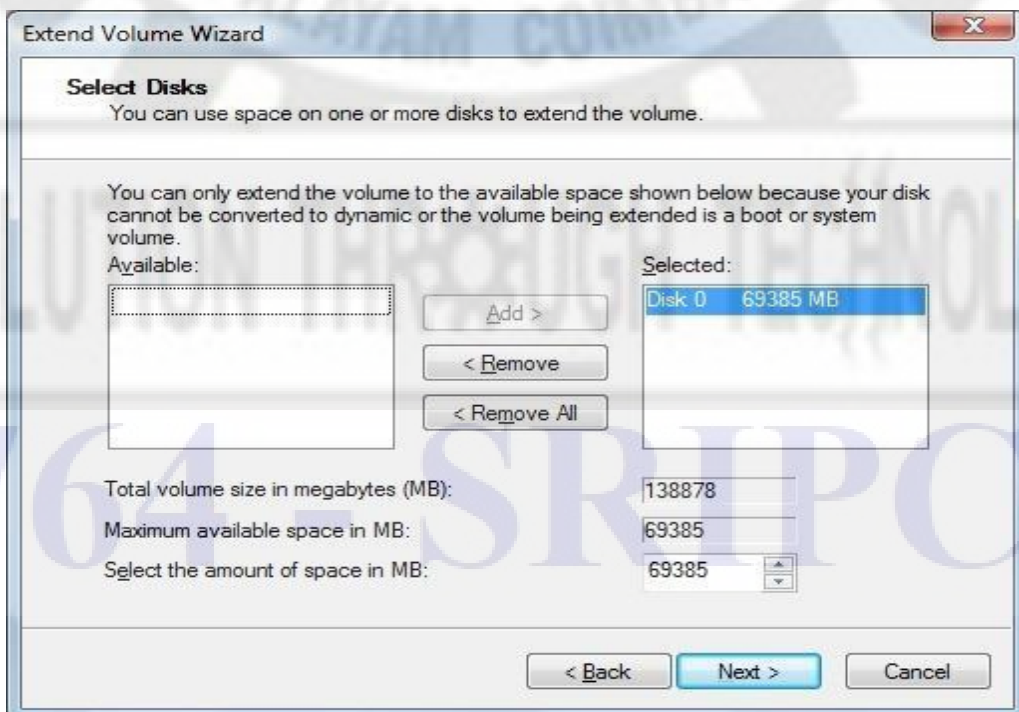

Figure 4.40

9. Click Finish.

The unallocated space can now be used.

Performing a New Installation of Windows 7

The three basic types of clean installation procedures are as follows:

- (i) Install on a brand new disk or computer system
- (ii) Erase the disk, format it, and install
- (iii) Install into a new directory for dual-booting If you intend to use either of the first two methods, be sure your computer can boot from a DVD (most newer computers support booting from a DVD drive). Doing so might require changing the drive boot order in the BIOS or CMOS, but try it first as-is. With no floppy disk inserted and a clean hard disk, try the DVD drive next. The Windows 7 DVD is bootable and should run the Setup program automatically.

Installation takes 15 to 30 minutes, depending on the speed of your machine. Note: Windows 7 automatically applies the NTFS format to any disk partition upon which it is installed during a clean installation.

Typical Clean Setup Procedure

If you're installing into an empty partition and you can boot an operating system that is supported for the purpose of Setup (Windows Vista or XP), just boot up, insert the DVD and choose Install Now from the resulting dialog box. Then follow the installation step-by-step procedure.

If Windows doesn't detect the DVD automatically upon insertion, you must run the Setup program, setup.exe, from the Start, Run dialog box (after opening the Run dialog box, type D:/setup.exe; on Vista use the Start menu Search box instead [using the correct letter for your DVD drive if it isn't D]). The setup.exe application is located in the Sources directory on the DVD. After the Setup routine starts, you can follow the installation procedure step by step.

If your computer has a blank hard disk or your current OS isn't supported, this process changes. You must launch the installation process from the Windows 7 DVD (this works only if you can boot from the DVD drive). Setup automatically runs if you boot from the DVD.

Yet another setup method involves the network. To initiate a network installation, you must create a network share of the distribution DVD or a copy of the DVD on a hard drive. The destination system must have network access, and the user account must have at least read access to the installation files. Initiate Setup by executing setup.exe from the network share. For example, from the Start, Run command, or the Vista Start menu Search box, type this path: \\ \sources\Setup. Setup recognizes an over-the-network installation and automatically copies all files from the network share to the local system before the first reboot.

Tip: All versions of Windows 7, 32- or 64-bit, are included on the same DVD. The product key that you enter during setup determines which actual version of Windows 7 you end up with after the installation completes. Keep your Windows 7 DVD and product key in a safe location after you've performed your installation. It's useful for repairs of all kinds.

Figure 4.40 Installing Windows 7 from an existing Windows installation.

Clean Install from DVD, Step by Step

A typical clean installation (on a blank hard disk) step-by-step procedure is as follows:

Here's how to step out of the server closet and into a more robust (and possibly more rewarding) tech

1. Insert the Windows 7 DVD into your computer's DVD-ROM drive, and restart the computer. Windows 7 Setup should start automatically. If Setup does not start automatically, ensure that your computer is configured to boot from the DVD drive.
2. You are asked to select regional options for the Windows 7 installation. Make your selections and click Next to continue.
3. In the next dialog box, you are prompted to start the installation. Click Install Now to begin the installation. This produces a screen that tells you that Setup is starting.
4. In the Software License Terms dialog box, ensure that you read and understand the End User Licensing Agreement (EULA). When you're ready, select the I Accept the License Terms option and click Next to continue.
5. In the Which Type of Installation Do You Want? dialog box, shown in Figure 2.10, you can select only the Custom (Advanced) option because you're performing a new installation on a blank hard disk. Click Custom (Advanced) to continue.
6. In the Where Do You Want to Install Windows? dialog box, select the partition onto which you'll install Windows 7. When you're ready to proceed, click Next. If you need to provide a RAID or SCSI driver, now is the time to do it.
7. The Installing Windows dialog box appears and gives you an updated status of the upgrade process.
8. After some time, your computer restarts and the newly installed Windows 7 loads. Windows 7 resumes the installation process. Before the restart, a warning appears.
9. After the restart, you'll see a notification telling you that Windows 7 is preparing the new installation. Windows 7 moves back into a graphical display after a few minutes and tells you it's updating Registry settings and starting services, after which it lets you know it's completing the installation.

10. After completing the installation, Windows 7 asks you to provide a username and a computer name. After providing this information, click Next to continue.

11. In the next dialog box, you are asked to supply a password for your user account (which you must reenter as a double-check) and a password hint to help you remember that string. After making your selections, click Next to continue. Here's how to step out of the server closet and into a more robust (and possibly more rewarding) tech.

12. In the Type Your Windows Product Key dialog box, enter the product key that came with your Windows 7 DVD. I recommend that you leave the Automatically Activate Windows When I'm Online option checked to take care of Windows Product Activation within the three days after the Windows 7 installation. After entering this information, click Next to continue.

You can also leave the Product Key box blank. If you do this, you'll be asked which version of Windows 7 you want to install, and you can select any version from Starter to Ultimate. You'll have to provide a valid product key, however, within 30 days for whatever version you install or else Windows 7 will nag you regularly and often about registration. (If you install a slip-streamed copy of Windows 7 Service Pack 1, or use the Windows Update service to upgrade to SP-1, you'll be reminded to register rather than receiving constant nags.)

You can use the no-key method to play around with different versions of Windows 7, but be careful if you select a version for which you don't have a key; you must perform a clean install every time you reinstall Windows 7, and you must eventually install a version for which you have a license, or erase it. You'll lose your applications and data every time you reinstall.

Caution: You should definitely not play with alternate versions if you are upgrading from an older version of Windows. After the first such install, there's no way to go back and repeat the upgrade with your licensed version of Windows 7.

13. In the Help Protect Your Computer and Improve Windows Automatically dialog box, you configure the base security for Windows 7. In most cases, you should select Use Recommended Settings. To make your selection, click it.

14. In the Review Your Time and Date Settings dialog box, select your time zone, daylight savings option, and current date options. Click Finish to complete the upgrade process.

15. In the Select Your Computer's Current Location dialog box, shown in Figure 2.17, tell Windows where you'll be using your computer. As with Windows Vista, Windows 7 configures your network adapters for DHCP and does not ask you what to do.

16. Windows prompts you one last time-after you click Start, you're finished with the installation.

17. After a few more minutes, you are finally presented with your brand new Windows 7 login screen, as shown in Figure 2.18. Congratulations, you've completed the installation of Windows 7!

Tip: If you plan to perform a clean installation on your computer that is currently running some earlier Windows version, be sure to get your data and other files off the computer beforehand. You can perform this process manually, or you can opt to use Windows Easy Transfer to automatically copy all your files and settings to an external hard drive or network location. After the clean installation of Windows 7 has completed, you can run Windows Easy Transfer again to reload your files and settings on the new installation of Windows 7.



Figure 4.41: The different location choices correspond to different levels of security on your Windows 7 computer.



Figure 2.42: The Windows 7 login screen is much different than previous versions.



Figure 4.43: For new installations, only the Custom (Advanced) option is available.

Clean Install from Inside Windows, Step by Step

If you initiate the Setup routine from within Windows XP or Windows Vista, the step-by-step procedure is as follows:

Here's how to step out of the server closet and into a more robust (and possibly more rewarding) tech

1. Insert the Windows 7 DVD into your computer's DVD-ROM drive. It should AutoPlay and present the Install Windows dialog box. If not, locate and double-click the setup.exe program in the Sources folder on the DVD.
2. To download, install, and use the Windows 7 Upgrade Advisor, click the Check Compatibility Online link. Otherwise, to begin the in-place upgrade to Windows 7, click the Install Now link.
3. In the Get Important Updates for Installation dialog box, you are asked whether you want to download updates to the Windows 7 install files. Typically, for computers that have an active Internet connection, you're better off getting the updates. Make your selection by clicking it.
4. In the Please Read the License Terms dialog box, ensure that you read and understand the End User Licensing Agreement (EULA). When you're ready, select the I Accept the License Terms option and click Next to continue.
5. In the Type Your Product Key for Activation dialog box, you are asked to enter your Windows 7 product key. Enter the key and ensure that the Automatically Activate Windows

When I'm Online option is checked, to enable Windows Product Activation. After entering the product key, click Next to continue.

6. In the Which Type of Installation Do You Want? dialog box, shown previously in Figure 2.10, select Custom (Advanced) because you're performing a clean installation here on top of an existing Windows XP installation.

7. In the Where Do You Want to Install Windows? dialog box, shown in Figure 2.20, select the partition onto which you'll install Windows 7. When you're ready to proceed, click Next.

8. The Setup application warns you that the selected partition contains files from another Windows installation, as shown in Figure 2.21. After you read this information, click OK to continue.

9. The Installing Windows dialog box appears and updates the status for the upgrade process.

10. From here, the rest of the process is just like that for a clean installation (on a blank hard disk) above, starting with step 9. After some time, your computer restarts and the newly installed Windows 7 loads.

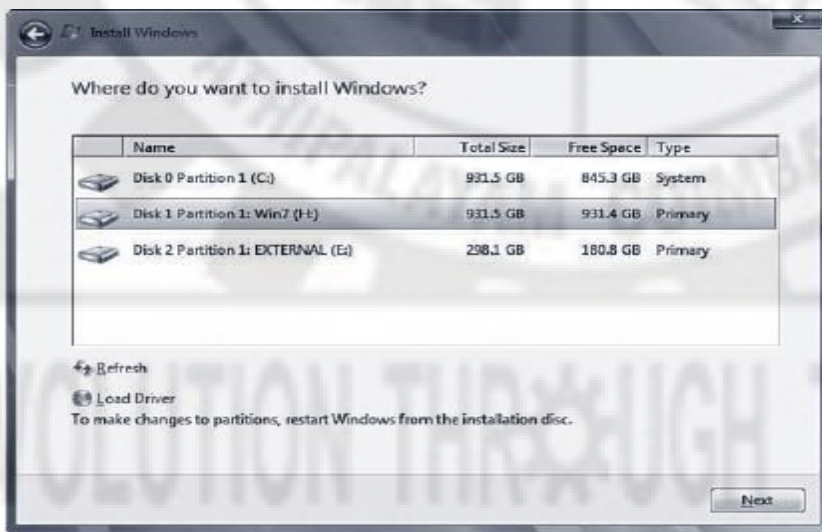

Figure 4.44.: You need to select an existing partition for the installation of Windows 7.



Figure 4.45: Windows 7 Setup moves all your old Windows files to a new directory - you must delete that directory later to reclaim that disk space.

Here's how to step out of the server closet and into a more robust (and possibly more rewarding) tech

- Many users use two or more OSs because of application-compatibility issues. Hardware support issues occur, too: Windows 2000 and Windows XP might have drivers for older hardware that Windows 7 doesn't support.
- Some users want to run specific applications or games in an optimal environment for their use.
- A developer might swap among Windows XP Professional, Windows Vista, and maybe even several different versions of Windows 7, to test application compatibility.
- Website developers need to use different OS versions to see how pages look and behave with corresponding web browser versions.

Other than buying multiple computers, there are two ways to accommodate such needs. You can multiboot (that is, select the desired OS at bootup) or you can run one OS in a virtual computer inside another OS (that is, in a special application program that lets the alternate OS think it's running on a PC of its own). A virtual approach can be quite useful.

Windows 7 uses a boot scheme introduced with Windows Vista based on so-called Boot Configuration Data, usually abbreviated as BCD. BCD is more complex than and incompatible with the boot scheme used in previous versions of Windows. While Windows 2000 and XP let you set up a boot menu from which you could select any version of Windows, as well as other OSs, Windows 7's boot menu only lets you select Windows Vista or 7 versions, or something else, and all something else selections must be managed separately.

As a result of the boot manager changes, if you want to set up a computer that can boot several different versions of Windows and/or other OSs, you need to follow these guidelines:

- (i) You must install each OS into a separate disk volume (drive letter). To get these separate volumes, you can create multiple partitions on one disk drive, or use multiple disk drives, or a combination of these two organizing principles.
- (ii) If you install multiple versions of Windows 7 on the same computer, the same rule applies: You must install each version in a separate disk volume.
- (iii) Install versions of Windows starting with the oldest and working toward the newest. For example, to set up a computer that can boot into Windows Me, Windows XP, and Windows 7, install Me first, then XP, then Windows 7. You must install Windows 7 last!
- (iv) To install OSs other than Windows, such as Linux, you might need a boot manager that can recognize all the different OSs in use. Linux offers a choice of several

different boot managers. Their use is beyond the scope of this book, but you should be able to find instructions on the Web for multibooting Linux and Windows 7.

Here's a rough sketch of what's changed: In the boot scheme used by the Intel x86 versions of Windows 2000 and XP, the boot partition's boot sector program loaded ntldr, which read the menu file boot.ini, and then loaded Windows. Aside from the boot sector, all of the stuff was in super hidden files (files marked with the system and hidden attributes), stored in the root directory.

The Windows Vista and Windows 7 boot sectors load a file called bootmgr from the root directory, which loads a set of programs and DLLs in the \boot folder, which then reads the BCD file (actually a Registry hive), and then loads Windows. The BCD hive is also loaded into and visible in the Windows Registry after bootup.

In a Windows 7 multiboot configuration, the root directory file bootsect.bak is a copy of the preWindows 7 boot sector (XP's version of the boot sector). Choosing Legacy from the Windows 7 boot menu loads and runs the original boot sector program, which carries on as before.

The reason for making this change was to create a common boot system that would work on both BIOS-based computers and computers using the newer EFI configuration system (built around Intel's Extensible Firmware Interface). The impact of this new scheme is that the Windows 7 boot menu can offer only Windows 7, Windows Vista, and Windows Server 2008 versions, where anything using the older boot loader gets lumped under the Legacy entry. The boot.ini file is used only to list and load non-BCD operating systems.

To create a multiboot installation on a computer that already has Windows Vista installed, follow this procedure. These steps are quite similar to the clean install procedure described earlier.

1. Insert the Windows 7 DVD into your computer's DVD-ROM drive. It should AutoPlay and present the Install Windows dialog box. If not, locate the setup.exe program in the Sources folder on the DVD, and double-click it.
2. To download, install, and use the Windows 7 Upgrade Advisor, as detailed previously, click the Check Compatibility Online link. Otherwise, to begin the in-place upgrade to Windows 7, click the Install Now link.
3. In the Get Important Updates for Installation dialog box, you are asked whether you want to download updates to the Windows 7 install files. Typically, for computers that have an active Internet connection, you are better off getting the updates. Make your selection by clicking it.

4. In the Please Read the License Terms dialog box, ensure that you read and understand the End User Licensing Agreement (EULA). When you're ready, select the I Accept the License Terms option, and click Next to continue.
5. In the Type Your Product Key for Activation dialog box, you are asked to enter your Windows 7 product key. Enter the key and ensure that the Automatically Activate Windows When I'm Online option is checked, to enable Windows Product Activation. After entering the product key, click Next to continue.
6. In the Which Type of Installation Do You Want? dialog box, select Custom (Advanced) because here you're performing a clean, multiboot installation of Windows 7, not an upgrade.
7. In the Where Do You Want to Install Windows? dialog box, select the partition into which you'll install Windows 7. This must be a partition that does not already have a version of Windows installed on it. When you're ready to proceed, click Next.
8. Follow the rest of the procedure described previously under Typical Clean Setup Procedure, from step 6 on through the end.
9. If you plan on installing another version of Windows 7 on this same computer, you'll want to rename the current version's title in the boot menu.
10. You can check out the new Windows 7 boot menu, on the next restart of your computer.

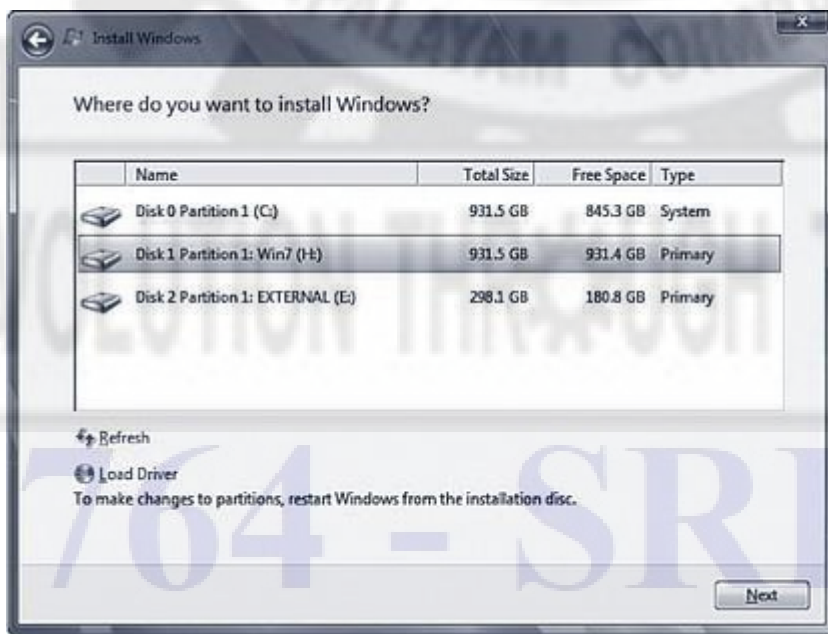

Figure 4.46: You must select an empty partition for multiboot installation of Windows 7.



Troubleshooting Laptop and Desktop Computer Problems

The following are the some common problems and the troubleshooting of Laptop

Table 4.5 Common Problems and its troubleshooting tips

Problems	Troubleshooting tips to repair
Computer doesn't turn on at all	<ul style="list-style-type: none"> – The AC adapter failed and the battery has no charge left. In this case test the AC adapter with a voltmeter. If it's dead, replace it with a new one. – DC jack failed and the motherboard doesn't receive any power from the adapter. In this case the DC jack has to be replaced. – Motherboard failed. The motherboard has to be replaced, if it's not too expensive. Otherwise get ready to buy a new computer.
Screen is blank	<p>This can be memory failure. It's possible one of the memory modules failed. In this case you can try reseating memory modules to make sure they are making good contact with the slot. You can try removing memory modules one by one and test the laptop with only one module installed. You can try replacing memory modules.</p> <p>- If reseating/replacing memory doesn't help, try removing the hard drive, DVD drive, modem, wireless card, keyboard, etc... In other words, disassemble the laptop to bare minimum and test again. If the laptop still doesn't turn on, most likely you have failed motherboard or processor</p>
Laptop turns on and off repeatedly.	<p>Most likely this is motherboard failure. You can try reseating/replacing memory as I described in the Problem 2. If it doesn't help, probably the motherboard failed</p>
Laptop makes noise while running	<p>In most cases this noise is coming from the cooling fan or hard drive. Take a closer look at the cooling fan.</p> <p>If the fan doesn't spin but the the laptop makes noise, probably it's coming from the hard drive. Back up all personal data as soon as possible and replace the hard drive.</p>

Unit -IV Maintenance and Troubleshooting of Desktop and Laptop

	Also, you can remove the hard drive and stat the laptop. If the laptop still makes noise, most likely it's bad fan
Laptop shuts down or freezes	Most likely this is heat related issue. It happens because the fan heat sink is clogged with dust and the processor not cooling down properly. Cleaning the fan and heat sink from dust should fix it
Battery not charging properly.	Failed battery. If it doesn't charge completely try reconnecting the battery first. Also, try running the laptop just from AC adapter with battery removed. If it runs fine from AC adapter, most likely it's either bad battery or failed motherboard. Try replacing the battery first. - Failed DC power connector. If the battery charges only after you adjust the position of AC adapter tip inside the connector, most likely this the DC jack failed
Screen light fails	Most likely it's either failed screen inverter or backlight lamp (CCFL) failure. When either one fail, the backlight stops working. In order to troubleshoot this, you'll need some spare parts: either new working inverter or known good backlight lamp
Strange or garbled image on the screen.	The graphics card failed. First of all, test your laptop with an external monitor or TV. If you see the same garbled image on the external screen, most likely the graphics card failed. - If the problem appears only on the laptop screen, this can be related to one of the following: poor connection between the video cable and motherboard or screen. Also can be failed video cable or screen.
Some keyboard keys stopped working	Most likely the keyboard failed and they are not repairable
Keyboard has missing or broken keys.	If a key separated from the keyboard, it's still possible to fix it. If you have many keys missing, probably it makes sense to replace the whole keyboard.
Repetitive beep sound on startup	Most likely you have stuck keys. In this case you'll have to replace the keyboard
Liquid spill.	Liquid spills are very dangerous and unpredictable. If it happened, turn off the laptop ASAP, remove the battery and do not use it until all internal parts are inspected for liquid damage. It's still possible to make it work again.

The following are the some common problems and the troubleshooting of Desktop

Table 4.6 Problems and solutions of Desktop PC

Problems	Troubleshooting tips to repair
My computer is slow	Fragmented data, a corrupted registry, spyware and dozens of unnecessary programs running at the same time, easily eat at the speed and performance of your PC. Remove the unwanted programs, clean the registry, run disk drefragmenter
My computer freezes	Run antivirus software
I forgot to backup my data	Make a backup in external hard drive, server and cloud
My computer turns off by itself	this is due to dying power supply, bad cable connections, defective battery or overheating when the computer shuts down by itself to cool down.
My smartphone will not synch with my PC	when synchronisation does not work as expected may be due to various factors, depending on the type of smartphone and PC. Sometimes it is required that all programs are closed, during synching or backup.
My wireless network is unstable	It can be caused by everything from radio waves that interfere with the signal to the router's location in the home or outdated network drivers.
I cannot print from the web	If your computer's pop-up blocker is turned on, this can cause you to not be able to print. There are also PDF documents that are rights protected by passwords and therefore not printable.

Preventive Maintenance and Upgrading

Preventive maintenance is defined as the proactive maintenance of equipment before a fault or failure occurs. Preventive maintenance involves routine tasks to ensure that your system is running optimally and to avoid problems before they arise. This is similar to routine maintenance performed on a car: In the same way you need to periodically check the oil, lights, engine, and other parts of the car in order for it to run smoothly, the same principle applies to preventive maintenance for a computer. There are several preventative measures you can take, including installing Windows updates, scanning for viruses and malware, and running cleaning programs. Anti-virus and anti-malware scans should be run at least once a week. Be sure to run updates for these programs whenever they're released, as new viruses and malware spring up constantly. Keeping your network secure, installing a firewall, and using safe downloading practices can protect your computer and any information on it from being compromised. Power surges and overheating can destroy electronic equipment, so protect your hardware by investing in a surge protector and cleaning your equipment periodically to remove dust. Should any preventative measures fail, it is always a good idea to have a backup for important files: Invest in an external hard drive to save any important files should your computer need replacing.

Preventive Maintenance: Tools required

Hardware tools	- Star Screw driver, two size flat head screw driver, a set of torx screw driver, flash light, tweezers
Software tools	- An emergency boot disk, antivirus software, error checking tools, disk cleanup
Measurement tools	- Multimeter, logic probs and logic pulsers, IR thermometer
Cleaning tools	- Cotton swap, lint free cloth, vaccum cleaner soft brush, cleaning solution.

Active and passive maintenance

An active preventive maintenance program includes performing procedures that promote a longer, trouble-free life for your laptop. This type of preventive maintenance primarily involves the periodic cleaning of the system and its components, as well as performing backups, antivirus and antispyware scans, and other software-related procedures.

- (i) Back up any data or important files.
- (ii) Run a full system antivirus and antispyware scan. Before starting the scans, be sure to check for and install antivirus and antispyware software updates. Note that most of these programs have integrated update routines that automatically check for updates on a weekly or monthly basis, or at some other interval you may choose.
- (iii) Run the Windows Disk Cleanup tool, which searches the system for files you can safely delete, such as
 - a. Files in the Recycle Bin.
 - b. Temporary Internet files.
 - c. Windows temporary files.
 - d. Install programs for previously downloaded and installed programs.
 - e. System restore points except the most recent restore point.
 - f. Optional Windows components that you are not using.
 - g. Installed programs that you no longer use.
- (iv) Finally, run a disk-defragmenting program.

Passive preventive maintenance includes precautionary steps to protect a system from the environment, such as using power-protection devices; ensuring a clean, temperature-controlled environment; and preventing excessive vibration. General

- (i) General system Care and Handling
- (ii) Operating Environment
- (iii) Temperature, Humidity, altitude
- (iv) Static electricity
- (v) Radio frequency Interference
- (vi) Dusts and Pollutants

Types of diagnostic software

Desktop computer comes with several sophisticated diagnostic programs. Technicians use these tools to find the causes of erratic behavior in the computer, slow operation and other problems. These programs consist of software that is built into hardware drivers and components of the Windows operating system.

(i) POST

POST performs basic diagnostics on computer's memory and hard drives, checks for the presence of a keyboard and mouse, and tests the clock and other system settings. POST resides in a small, permanent memory area called BIOS, which stands for Basic Input Output System; this contains compact, simple programs the computer uses when you first turn it on. If a problem exists with the computer's hardware, POST signals this through coded audio beeps. Though hardware makers have produced different versions of POST over the years, they all ensure that the computer works correctly before it starts the operating system.

(ii) Check Disk

The program "CHKDSK," or Check Disk, is part of Microsoft's Windows software. It tests and repairs the file system information on hard drives. For example, if you work on your computer during a storm, a sudden power failure may shut your computer down immediately. Electrical noise from the power line may write random data into hard drive files that were open as you worked. This random data can corrupt the Windows file system, making files unreadable. If Windows senses a problem with the file system, it runs Check Disk automatically when you restart your computer; you can run it manually from Windows Explorer or a command prompt. Check Disk scans the file structure, looking for and reporting on problems. If you run it in "fix" mode -- "chkdsk /f" -- the program attempts to repair any damage it finds. Check Disk is sophisticated and fixes file system problems for the vast majority of cases.

(iii) Task Manager

The Windows operating system runs dozens of programs on your computer and you will seldom notice them unless problems arise. These programs monitor the state of your printer, network, mobile devices and other hardware. If your computer becomes unusually sluggish, the cause may be one of these programs running excessively. The Windows Task Manager displays a list of all the programs running on your computer, along with the amount of memory they consume and how active they are. To see the Task Manager, press "Ctrl-Shift-Esc." If a program in the Task Manager

window uses more than 20 percent of the computer's CPU time for a prolonged period, the program may be caught in an error state. To solve this problem, try restarting the computer.

(iv) Windows Defender

If your PC has a malware infection, your computer's performance suffers. Malware may cause your Web browser to display unwanted pop-up ads and you may experience other annoyances. The Windows operating system includes a program called Windows Defender, which scans your hard drives for viruses, spyware and other malicious programs. Windows Defender reports on the problems it finds, isolates the malware and removes it. Windows Defender uses a database of known malware, and the database is continually updated by Microsoft so that the program catches even the newest viruses.

(v) Drivers

PC uses a variety of devices for data storage, communications, input and display. Each of these has a program called a driver that carries data between the hardware and Windows. Frequently, drivers have a diagnostic capability that checks the device's operation and troubleshoots problems. Windows organizes these drivers in its Device Manager, which you can see by clicking the Windows "Start" button, right-clicking "Computer," selecting "Properties" and clicking the "Device Manager.

Preventive Maintenance Schedule

This is simply a chart that shows various maintenance activities, and how often they should be done, to allow you to setup a calendar. Table shows the Preventive Maintenance Schedule

Table 4.7 Preventive Maintenance Schedule

Preventive Maintenance Activity	Recommended Frequency	Auto?
Scan hard disk file systems for errors	Daily	Yes
Scan for viruses	Daily	Yes
Back up data	Daily	No
Clean CRT screen	Weekly	No
Defragment hard disks	Weekly	Yes
Scan for hard disk read errors	Weekly	Yes
Clean mouse	Monthly	No
Check for full hard disk volumes and remove unnecessary files	Monthly	No

Update virus definition files	Monthly	Sometimes
Check power protection devices to ensure they are still protecting the system	Quarterly	No
Check power supply fan for ventilation and dirt buildup and clean if necessary	Quarterly	No
Back up CMOS information	Quarterly	No
Update emergency boot floppies	Quarterly	No
Clean floppy disk drive internals and read/write heads	Quarterly (depending on use)	No
Check processor temperature, inspect heat sink and fan to ensure they are working	Annually (or whenever case is opened)	No
Check hard disk for temperature and vibration	Annually (or whenever case is opened)	No
Clean exterior of case	Annually	No
Clean exterior of monitor	Annually	No
Check and clean interior, motherboard and expansion cards if necessary	Annually	No
Check internal connections and cables	Annually	No
Clean keyboard	Annually	No

Upgrading of Systems:

Upgrading of system is defined as a process of replacing software or hardware present in the computer with the latest one.

Motherboard, CPU, Graphics Card, BIOS up gradation

Upgrading system motherboard

The following steps to be carried out to upgrade the motherboard

- (i) Set up a workspace, and with adequate lighting. Also, be sure to give enough room to lay out tools and parts. Good lighting is especially critical if the case has an all-black interior.
- (ii) Prior to disassembling the system, back up the contents of hard drive.

Unit -IV Maintenance and Troubleshooting of Desktop and Laptop

- (iii) Collect all CD keys. Deactivate or deauthorize any applications that has activated previously. This includes iTunes and Adobe professional apps (such as Photoshop and Premiere CS5). In addition, be sure to uninstall or deactivate any games that required activation.
- (iv) Determine which parts need to be removed. Take out the power supply unit (PSU) or hard drives to make motherboard removal easier. While removing the PSU, take care to disconnect all power cables first. The ATX12V (a small four- or eight-pin connector) is easy to overlook.
- (v) Take out all cards, the CPU fan, and all memory.
- (vi) Prior to removing the old board, disconnect all wiring, including the Serial ATA connector.
- (vii) Disconnect all wiring.
- (viii) Remove all the screws holding the motherboard in place. Usually, a number 2 Phillips screwdrivers will fit the screws. Place the old board in an antistatic bag.
- (ix) Check to confirm that all of the mounting nuts are firmly screwed into the case. Sometimes, these nuts will come out or become loose when you remove the motherboard screws.
- (x) Remove the ATX I/O shield, and store it with the old motherboard. It is shown in Figure 4.47



Figure 4.47

- (xi) Don't forget to remove the old ATX I/O shield, and install the new one in its place.10. Install the ATX I/O shield for the new board. This step is crucial: It's frustrating to

Unit -IV Maintenance and Troubleshooting of Desktop and Laptop

have screwed in the new motherboard and only then realize that you forgot about the I/O shield.

- (xii) if exotic cooler is used, it may require that a special support plate be attached to the underside of the motherboard.
- (xiii) Line up the I/O ports with the holes in the ATX I/O shield. Then align the screw holes with the motherboard mounting nuts on the interior of the case.
- (xiv) Carefully screw in the mounting screws. Do not overtighten them. For an electric screwdriver equipped with an adjustable clutch, set the clutch to the minimum setting. If the electric screwdriver doesn't have a clutch, use a hand screwdriver instead. It is shown in Figure 4.48



Figure 4.48

- (xv) Before reattaching the wiring and cables, reinstall any storage devices (like this hard drive) that has been removed earlier.
- (xvi) Reinstall the power supply unit, (if removed it earlier). Also reinstall any storage devices that has been removed.
- (xvii) Reattach all of the wiring and cables that you disconnected earlier: front panel connectors, USB wiring for the USB case connectors, power cables, wires for the case fan, and so on. If case allows us to route wiring behind the motherboard, do so now.
- (xviii) Attach the power cables, taking care to connect both the main and the ATX12V cables.



Figure 4.49

- (xix) After installing the new motherboard and memory and reattaching the power cables, add back the CPU cooler and lock it in place with the fan clips.
- (xx) Install the CPU and the memory. Don't install the CPU cooler until the memory and the power connectors are installed.
- (xxi) Plug in the data cables and the power connectors to the storage devices.
- (xxii) Reinstall cards that have been removed. For installing a high-performance graphics card, PCI Express power connectors are supposed to be attached.
- (xxiii) Connect wall power, the video cable, the mouse, and the keyboard, and give the system a test boot. If nothing happens, make sure that the PSU switch is on.
- (xxiv) When booting the system, we have to wait until Windows accounts for all of the new motherboard devices. Keyboard and mouse may be unusable during this time.
- (xxv) Once Windows has logged all of the devices, reboot.
- (xxvi) Take the motherboard CD and install the new motherboard drivers, network drivers, video drivers, USB 3.0 drivers, and so on. Rebooting may be required several times.
- (xxvii) check to see whether Windows needs to be reactivated. If so, first try activating over the Internet. If this fails, in the Activation Window. call the toll-free number listed to activate over the phone, be sure you tell Microsoft that installing this copy of Windows on one system. This is just an upgrade after all.
- (xxviii) Reinstall and reactivate any needed applications.

Upgrading the Memory

Follow the steps to upgrade the computer memory

- (i) Open the case
- (ii) Open the latches on either side of the RAM bay. True, some of Asus's new motherboards have openable latches only on *one* side of the RAM bay, but the principle is the same.
- (iii) Push the memory down firmly but carefully until it clicks into place, and the latches on both sides of the RAM bay secure the stick in place.
- (iv) Close up the case
- (v) Boot up the PC. If the PC does not boot up, turn it off and repeat steps 1-6.
- (vi) Right-click on the "My Computer" icon and select Properties from the pop-up menu to verify that the computer recognizes the RAM you've just installed

Upgrading the CPU

Follow the instructions before upgrading the CPU.

- (i) Disconnect all cabling and wiring
- (ii) Carefully remove the CPU cooler
- (iii) Be prepared to pull out your motherboard

To upgrade Intel CPU, follow the steps given below.

- (i) Rotate all four mounting pushpin caps to the left.
- (ii) Gently pull one of the pushpins straight up until you feel it release. Use minimal force to accomplish this. Repeat the operation for all four pushpin latches.
- (iii) The CPU is often stuck to the heat sink with thermal compound, which helps transmit accumulated heat from the CPU heat spreader surface to the heat sink. Gently rotate the processor back and forth (you're rocking it around the vertical axis). As you do this, the CPU will gradually loosen. Eventually the heat sink will come free, and you can lift it up.

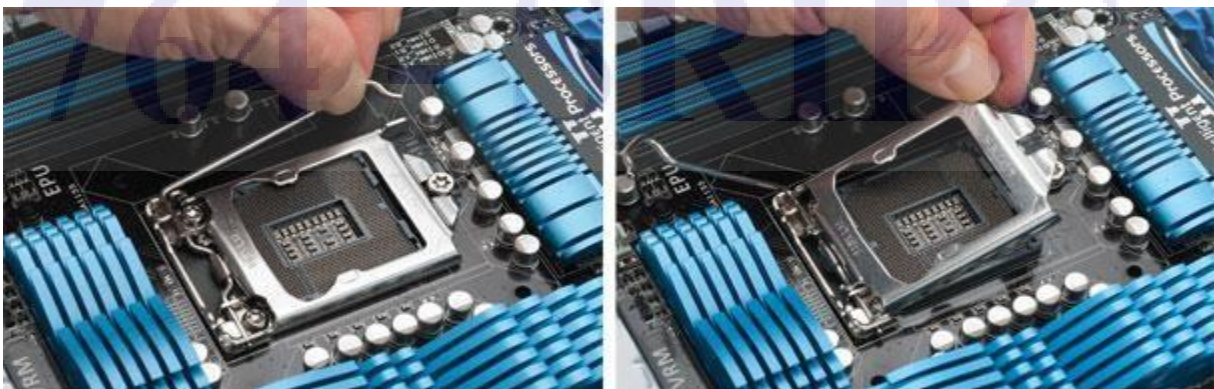

Figure 4.50

Unit -IV Maintenance and Troubleshooting of Desktop and Laptop

- (iv) Steps 4 and 5: Push down on the latching lever, pull it slightly to the outside, and release it upward. Lift the socket cover up on its hinge and out of the way. You'll see a latching lever on the side of the CPU. Push down on the lever, pull it slightly to the outside, and release it upward.
- (v) The socket cover will now lift up. Note that the socket cover for LGA775 swings in a different direction than it does for other Intel CPU sockets.
- (vi) Once the latch cover is open, gently grasp the CPU by the edges. Lift it straight up. Do not slide it to one side. You may have to angle it a bit to get it out from under the latch cover, but try not to do this until the CPU is clear of all the pins in the socket.
- (vii) Place the CPU in an antistatic container for storage.

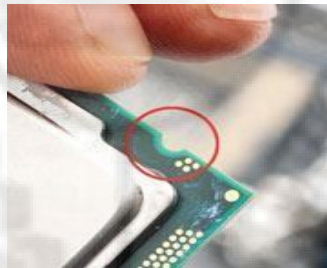

Figure 4.51

- (viii) Step 8: Align the notches on the opposing edges of the CPU with the tabs on the socket, and gently lower the CPU into the socket. Handling the new CPU only by the edges, align the notches on the two opposing edges of the CPU with the tabs on the socket. Gently lower the processor straight down into the socket. Do not press it.
- (ix) With the CPU in place, relatch the CPU socket cover.
- (x) If the heat sink has old thermal compound on it, remove the compound with isopropyl alcohol (rubbing alcohol) and let it dry.



Figure 4.52

- (xi) Step 11: Apply a tiny bead of thermal compound to the CPU surface.11. Put a tiny bead of thermal compound on the surface of the CPU. Spread it evenly over the surface with a knife or screwdriver blade.



Figure 4.53

- (xii) Rotate and pull up the heat-sink latch covers.12. Rotate the heat-sink latch covers to the right and pull them up. Check to confirm that none of the actual split pushpins are bent.
- (xiii) Align the four plastic pushpins with the mounting holes in the motherboard. You should be able to feel the four pins settling into the mounting holes properly.
- (xiv) Steady the heat sink with one hand to keep it level. Push each of the four pushpins in diagonal order until each is latched in place.
- (xv) Attach the heat-sink fan connector to the assembly.
- (xvi) Reattach any wires or cables that you may have removed, or reinstall the motherboard if you removed it at the beginning of the process.

Upgrade an AMD CPU

- (i) The steps for installing an AMD CPU are fairly similar to those for installing an Intel CPU. On AMD processors, however, the contact pins are located on the CPU rather than in the socket.
- (ii) The factory AMD heat sink has a hinged lever latch that locks the heat sink in place. Lift this latch up.
- (iii) The heat sink is held in place by one or more tabs on the CPU socket. You may need to use a thin-bladed screwdriver to release the heat-sink bracket.
- (iv) The CPU is often stuck to the heat sink with thermal compound, which helps transmit accumulated heat from the CPU heat spreader surface to the heat sink. Gently rotate the CPU back and forth (you're rocking it around the vertical axis). It will gradually loosen. Eventually the heat sink will come free, and you can lift it up.

- (v) The ZIF (zero-insertion force) lever locks the CPU in place. Lift it up and swing the lever as far as it will go. You may see the CPU shift slightly to one side.
 - (i) Gently lift the CPU straight up to remove it.
 - (ii) Store the processor in an antistatic bag. Since the CPU has pins that can bend, press it into antistatic foam, if you have any, for storage.
 - (iii) Grasping the new CPU only by the edges, look for a small gold or silver triangle silk-screened onto one corner of the processor. Match this with a triangle of similar size that is engraved in the processor's socket corner.
 - (iv) Line up the triangles, and gently lower the CPU in place. You should feel the CPU nestle into position. If it doesn't settle fully, do not force it. Instead, lift the processor up and try again.
 - (v) Once the CPU is in place, relatch the ZIF lever.
 - (vi) If the heat sink has old thermal compound on it, remove the compound with isopropyl alcohol (rubbing alcohol) and let it dry.
 - (vii) Put a tiny bead of thermal compound on the surface of the CPU. Spread it evenly over the surface with a knife or screwdriver blade.
 - (viii) Reattach the heat sink by latching it to one set of tabs on one side, and then carefully pushing the other side down while pressing the metal holes into position on the other set of tabs.
 - (ix) Swing the heat-sink lock lever into place.
 - (x) Attach the heat-sink fan connector.
 - (xi) Reattach any wires or cables that you may have removed, or reinstall the motherboard if you removed it at the beginning of the process.

Upgrading Graphics Card

- (i) Ensure that the machine's power supply is up to the task. My example PC has a robust 750W Corsair power supply, which should be sufficient. Check the manufacturer's specs for minimum power requirements before you take the plunge.
- (i) Ensure that the case has enough room for the new card. Graphics boards have become longer over the years, and the space in older cases may be a little tight. In my example PC, the GTX 560 Ti just barely fits inside the older Antec Sonata Designer 500 case.
- (ii) Download the latest driver for the new graphics card. Don't install it yet.
- (iii) Uninstall the older graphics drivers. Even if you're installing a GPU of the same brand as before, removing the older drivers prior to installing the new card is a good idea.

- (iv) Power down the system.
- (v) Carefully disconnect the power cables from the old card and remove the screws holding it in place.



Figure 4.54

- (vi) Remove any power connectors from the old graphics card. Also remove the screws that attach the connector bracket to the case.
- (vii) Ensure that no clutter--cables or wiring--surrounds the card. In addition, large CPU heat sinks can interfere with physical card removal or installation, so you may need to remove the heat sink. Be sure to detach the monitor cable from the old graphics card's outside connector, too.
- (viii) Hold a latch down with one hand while removing the old graphics card with the other.



Figure 4.55

- (ix) Most motherboards have a little latch that locks the graphics card securely into its slot. hold this latch down (or aside) while removing the card with your other hand.
- (x) If the amount of room inside the case is too constricted, you might have to preattach the PCI Express power connectors to the new card.

- (xi) Install the new graphics board, first making sure that no small wires are overhanging the PCI Express slot. If the card seems difficult to push down, check to see whether the connector bracket is sliding in properly.
- (xii) Once the card is firmly in place, replace the connector-bracket screws.
- (xiii) Attach the monitor cable. If you've been using a VGA cable, and your monitor has a digital input (DVI, HDMI, or DisplayPort), now is a good opportunity to switch to digital inputs with the right cable. All done! Organizing cables makes it easier to access the PC's insides later.



Figure 4.56

- (xiv) Double-check to confirm that the graphics card's power connectors are in place. Additionally, verify that no small wires or cables will interfere with any of the fans.
- (xv) Power up the PC. power down and check to make sure that no fans have become blocked.
- (xvi) Once the system is powered up and running normally, install the latest drivers for the graphics card. Reboot the system.

BIOS upgradation

- (i) Check the current BIOS version
- (ii) Determine the system's origins.
- (iii) Backup the existing BIOS first! If using BIOS update software executed from Windows or another operating system, backup the existing BIOS image first. Most BIOS updaters have this functionality built-in (e.g., "Save" or "Backup"), and will advise you to perform a backup first.
- (iv) Prepare your system.
- (v) Perform the update. Run the downloaded installer or .exe file for the BIOS updating software.

- (vi) Restart the computer. After the update is completed, many update programs will automatically restart the computer. Some updaters will request your permission to do so while others will warn about this before starting the update
- (vii) Clear existing BIOS settings if recommended. This is not always necessary, depending on what features have changed between the existing version and the updated version.
- (viii) Configure the BIOS with the default settings.

Updating of System and Application Software

System software are programs which makes the computer usage easy. Examples are compilers, loaders, etc. The important requirements for system software updation are

- (i) To make the computer system to run better
- (ii) To enforce additional security
- (iii) To fix bugs easy

The following steps to be used to update the windows operating system software using internet.

- (i) Connect the system to the internet
- (ii) Click on to the start button
- (iii) A pull down menu appears. Select windows update option
- (iv) Update window opens, Click check for updates on the window
- (v) The system check for updates. After checking updates click install button
- (vi) When the updates finshed installing, restart the computer.

Updating application software

Application software are programs designed to perform specific tasks or users. The following steps to be used to update application software (2007 to 2010) using internet.

- (i) Download the office 2010 software
- (ii) Run the downloaded file and enter the product key in the text box and click the continue button
- (iii) In the next window , accept the license agreement and click the continue button
- (iv) In the next window click the upgrade button to upgrade office 2007 to office 2010
- (v) In the next window click yes to reboot the system for completing the rebooting process.

Review Questions:

PART –A

1. Define the term Laptop
2. Distinguish desktop and laptop
3. List the different types of laptop
4. Write down the steps to configure laptop
5. What is SMD?
6. What are the advantages of SMD?
7. Mention the drawbacks of SMD?
8. Expand ESD
9. How does ESD Occur?
10. What are the precautions and measure to prevent ESD?
11. List the types of adapter, battery, CPU
12. Draw the block diagram of Motherboard
13. Format the laptop
14. How will you partition the laptop or desktop?
15. List the common problems occur in Laptop
16. Define active and passive maintenance
17. Mention the types of diagnostic software
18. How will you upgrade the BIOS?
19. Write down the steps to upgrade the graphics card
20. How will you update the system software?

PART-B

1. Explain the types of laptop in detail
2. Draw the block diagram and explain the working principle of laptop
3. Explain the SMD components and ESD
4. Explain the types of Adapter
5. Explain the types of Battery
6. What are the basic problems associated with RAM?
7. Explain the types of CPU
8. Explain the motherboard of laptop
9. How Formatting and Partitioning is done ?
10. How will you install the operating system?
11. Explain the common problems and its solutions for Laptop and Desktop
12. Explain the tools required
13. Explain the active and passive maintenance
14. Explain the types of diagnostics software
15. Explain the preventive maintenance schedule
16. How will you upgrade the systems
17. Discuss about the application software.

UNIT V MOBILE PHONE SERVICING

Learning Objectives

Learner should be able to do

- Know the terminologies of mobile communication and its generations
- Identify the electronic components of the mobile phone instrument
- Aware of the functions of IC's used in circuit board
- Identify the tools and it functions of mobile servicing kit
- Solder and desolder the components.
- Use the multimeter
- Assemble and disassemble the different types of mobile phones
- Install the operating system
- Troubleshoot the phone
- Aware of software functions such as flashing, formatting, unlocking, secret codes, downloading and routing
- Diagnostic software and Viruses.

Introduction

A mobile phone is a portable telephone that can make and receive calls over a radio frequency carrier while the user is moving within a telephone service area. Mobile phones are used for a variety of purposes, such as keeping in touch with family members, for conducting business, and in order to have access to a telephone in the event of an emergency. This chapter gives the idea of mobile communication and the instrument. To service the phone one must aware of the tools used to service the instrument and its usage. The tools and instruments used in mobile servicing are explained in detail manner. Assembling and disassembling of mobile phones are also explained. This chapter also discusses the troubleshooting of the mobile phone and software functions such as flashing, formatting, unlocking, secret codes, downloading and routing. The diagnostic software and viruses are also briefed.

Mobile Phone Components

Basics of Mobile Communication

In the first half of the 20th century radio broadcast was used. There is one transmitter, the so-called radio station. Information, such as news, music, etc. is transmitted from the radio station to the receiver equipment, the radio device. This type of one-way transmission is called simplex transmission. The transmission takes place only in one direction, from the transmitter to

the receiver. The transmission in which information flow can take place in two directions is called duplex transmission. In Walky-talky transmission of user data take place in two directions, but there was a limitation: The users were not allowed to transmit at the same time. In other words, either receive or transmit takes place. This type of transmission is therefore often called semi-duplex transmission. For telephony services, a technical solutions is required, where subscribers have the impression, that they can speak (transmit) and hear (receive) simultaneously. This type of transmission solution is regarded as full duplex transmission. Figure 5.1 shows the transmission of simplex and duplex.

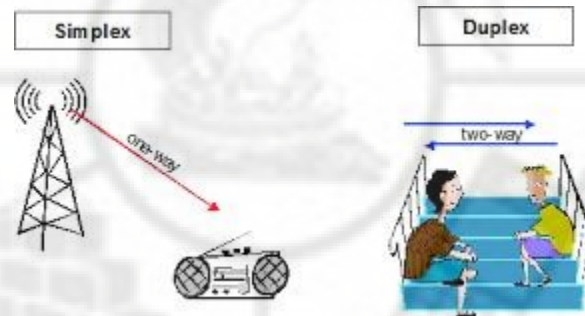

Figure 5.1 Transmission

In the 50ies, several vehicle radio systems were installed in Europe. These systems are nowadays called single cell systems. The user data transmission takes place between the mobile phone and the base station (BS). A base station transmits and receives user data. While a mobile phone is only responsible for its user's data transmission and reception, a base station is capable to handle the calls of several subscribers simultaneously. The transmission of user data from the base station to the mobile phone is called downlink (DL), the transmission from the mobile phone to the base station uplink (UL) direction. The area, where the wireless transmission between mobile phones and the base station can take place, is the base stations supply area, called cell. It is shown in Figure 5.2

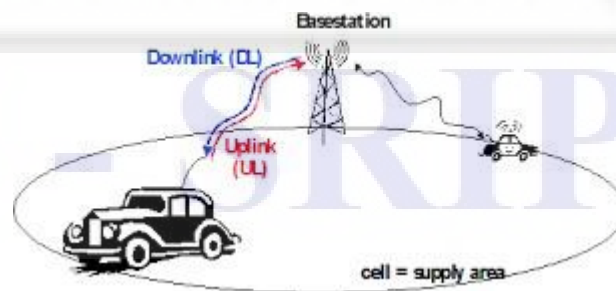

Figure 2. Single Cell System

Single cell systems are quite limited. The mobile communication service was only available within the cell. In order to overcome this limitation, cellular systems were introduced. A cellular mobile communication system consists of several cells, which can overlap. By doing so, a whole geographical area can be supported with the mobile communication service. Figure 5.3 shows the cellular system.

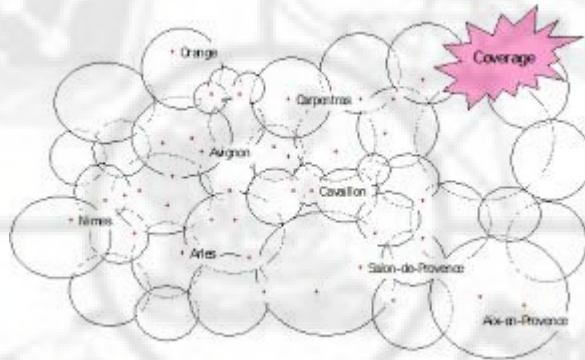

Figure 5.3 Cellular System

But what happens, when a subscriber moves during a call from one cell to another cell? It would be very annoying, if the call is dropped. If the subscriber is leaving a cell, and in parallel is entering a new cell, then the system makes new radio resources available in the neighbouring cell, and then the call is handed over from one cell to the next one. By doing so, service continuation is guaranteed, even when the subscriber is moving. The process is called handover (HO). It is shown in Figure 5.4.

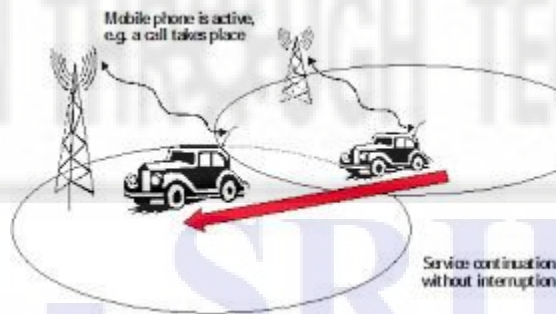

Figure 5.4. Handover

In mobile terminated call, The mobile phone is paged in the cell. This means that the phone receives information that there is a mobile terminated call. A cellular system may consist of hundreds of cells. If the mobile network does not know, in which cell the mobile phone is

located, it must be paged in all of them. To reduce load on networks, paging is done in small parts of a mobile an operators network. Mobile network operators group cells in administrative units called location areas (LA). A mobile phone is paged in only one location area. In every cell, system information is continuously transmitted. The system information includes the location area information. In the idle mode, the mobile phone is listening to this system information. If the subscriber moves hereby from one cell to the next cell, and the new cell belongs to the same location area, the mobile stays idle. If the new cell belongs to a new location area, then the mobile phone has to become active. It starts a communication with the network, informing it about it new location. This is stored in databases within the mobile network, and if there is a mobile terminated call, the network knows where to page the subscriber. The process, where the mobile phone informs the network about its new location is called Location Update Procedure (LUP).It is shown in Figure 5.5

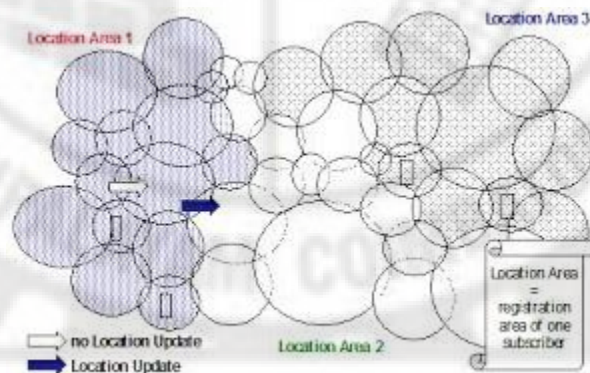

Figure 5.5 Location Update and Paging

First generation mobile communication systems are TACS (Total Access Communications System), NMT (Nordic Mobile Telephony), AMPS (Advanced Mobile Phone Service) and C450 etc. But there were limitations. Most of them did not support roaming. Roaming is the ability to use another operator's network infrastructure. International roaming is the ability to go even to another country and use the local operator's infrastructure.

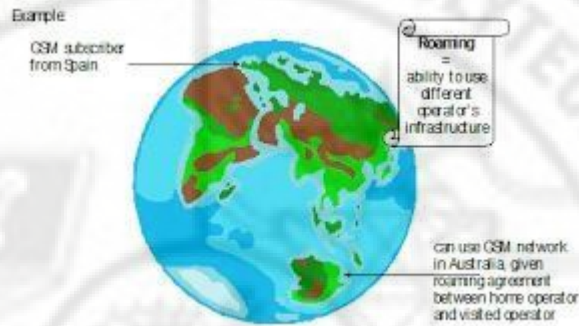

Figure 5.6 Roaming

1st generation mobile communication systems only support speech transmission, but not data transmission, such as fax. Supplementary services, well known from ISDN, were not available, such as number indication and call forwarding, when busy. The transmission takes place unprotected via the radio interface – as a consequence, eavesdropping is possible. Finally, mobile communication started to become a mass market. And the radio interface is the main bottleneck in terms of capacity. The limitations are overcome in 2nd generation mobile communication systems, one of which is GSM. The other generations and its features are shown in Table 5.1.

Table 5.1 Generations of mobile Communication Systems

Generation	Technologies	Drawbacks	Benefits/Applications
First	Analog FDMA(Frequency Division Multiple Acces) NMT(Nordic Mobile Telephone) AMPS (Advanced Mobile Phone System)	No security Prone to distortions	
Second	Digital with 10kbits/sec GSM CDMA TDMA	GSM is a circuit switched, connection oriented technology, where the end systems are dedicated for the entire call session. This causes inefficiency in usage of bandwidth and resources. They are unable to handle complex data such as video	Consume less battery power Improves the voice clarity Reduce noise in the line Secrecy and safety to the data and voice calls

Third	Ability to transfer voice data and non voice data Speed is 144kbts/sec	High bandwidth requirement High Spectrum Licensing fees Huge Capital.	Internet,email,fax,ecommerce,music,video clips and video conferencing
Fourth (MAGIC) Mobile multimedia, Any-where, Global Mobility solutions over, Integrated wireless and Customized Services	1 Mbps in out door 1 GbPS in indoor.		Games Electronic Agent Broad band Access in Remote Locations
Fifth (research papers)			New revolutions in Mobile Market with extra ordinary data capabilities and has ability to tie together unrestricted cell volumes and infinite data broadcast with latest mobile operating system.

Components:

The components of the cell phone are battery, Antenna, ear piece, Microphone, Speaker, buzzer, Keyboard, LCD Screen.

Battery and Antenna

The battery and the antenna are the two parts of the cell phone. It is shown in Figure 5.7 That are most likely to encounter (and damage) While opening the cell phone. The battery supplies the electricity that makes the phone work. Without the battery, nothing happens. The battery is protected as long as it is installed in the phone. It is surprisingly fragile and easy to drop while taking out. The antenna is the portal through which the phone is linked to other phones. In most phones it is a coil of wire attached to a removable cover that is easy to break.



Figure 5.7 Battery and Antenna

Microphone and Speaker

The microphone and speaker are the channels through which the telephone communicates messages between the users. It is shown in Figure 5.8 The microphone converts sound to electricity. The speaker converts electricity into sound. Microphone converts voice into

electrical signals which get digitized and then transmitted out through the antenna. When the signal from another phone strikes the antenna, it first gets un-digitized, and then sent to the speaker where it converts to sound.



Figure 5.8 Microphones and Speaker

Keyboard and LCD Screen

The keyboard and LCD form another pair of channels through which communication happens with the phone nonverbally. By pressing buttons on the keyboard, it issues data and commands to the phone--turn on, turn off, look up a number or call a number, among other things. The LCD screen is the way the phone communicates nonvocal data, including number dialed, last number called, who is currently calling you, etc. The keyboard and LCD screen not only handle nonverbal communications, but they also handle commands, errors and status reports.

Basic Circuit Board Components

The circuit board is the component of the phone that controls the operation of the phone. It transforms digital signals to analog and vice versa. It also contains buzzer and vibrator that alerts the user for incoming calls, a SIM card that shows the phone tower is in the long-distance carrier or not, and a monitor to check the energy level of the battery so the phone can alert when the battery needs charging. Figure 5.9 shows the Circuit board of the phone.

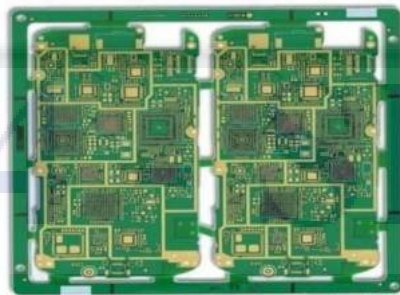

Figure 5.9 Circuit Board

Non- Electrolytic Capacitor: It is found in any section of a mobile phone. Its height is little more than chip resistance. It can be of gray, yellow or brown in color. It has no Positive (+) or Negative (-) side. It filters DC current

Electrolytic Capacitor: It is found in any section of a mobile phone. Its size is larger than non-electrolytic capacitor. It is found in 2 colors – (i) Orange with brown strip: and (ii) Black with white strip. The side with the strip is Positive (+) and the other side is Negative (-). It filters and stores current.

Network Capacitor: It is found in any section of a mobile phone. It is made from 2 or more Non-Electrolytic Capacitors

Coupler: This electronic component is found in the Network Section of a mobile phone. It is of either black or white and has 6 pins bent inside.

Function: It filters network

Faults: If the coupler is faulty then there will be no network in the mobile phone

Diode: Diodes are of 4 types

Rectifier Diode: It is found in black color and converts AC Current to DC Current. It passes current in one direction. It does not pass current in reverse direction

LED: It is found in white or light yellow color and emits light

Zener Diode: It is found in charging section. It filters and minimize current and passes forward. It acts as voltage regulator. Zener diode has fixed capacity like 4V, 6V, 8V etc.

Photo Diode: It is used for Infrared. It captures Infrared Rays

Regulator: This electronic component is found in any section of a mobile phone. It is of black color and has 5 or 6 legs. It filters current and regulates voltage

Resistance or Resistor: There are 2 types of resistance on the PCB of a mobile phone.

Chip Resistance: It can be found in any section of a mobile phone. It is of black color. In some sets it is also found in blue and green colour. It is the smallest electronic components on the PCB of a mobile phone. It Decreases current and passes forward

Network Resistance: It can be found in any section of a mobile phone. It is made from 2 or more Chip Resistance

Transistor: This electronic component is found in any section of a mobile phone. It is of black color and it has 3 legs. It does the work of switching.

Names and functions of different ICs used in mobile Phones

There are all kinds of parts and electronic components in a mobile cell phone. These parts and components can be divided into Big Parts and Small Parts. The PCB of a mobile phone is divided into 2 sections namely: Network Section; and Power Section. Figure 5.10 PCB of a mobile cell phone.

Mobile Phone PCB Diagram

Antenna Switch: It is found in the Network Section of a mobile phone Cell Phone Antenna

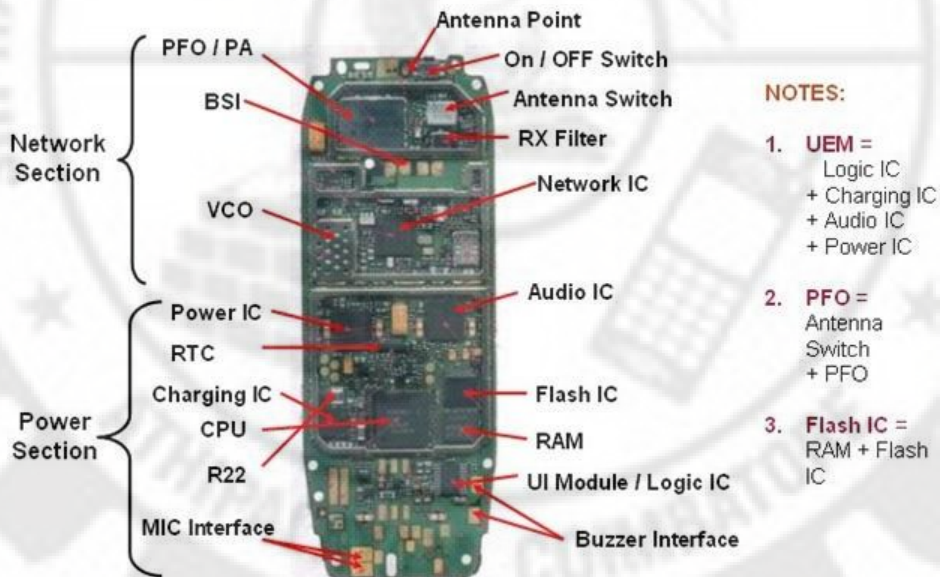

Figure 5.10 PCB of the Mobile Phone.

Switch and is made up of metal and non-metal. In GSM sets it is found in white color and in CDMA sets it is found in golden metal. Figure 5.11 shows the Antenna Switch.



Figure 5.11 Antenna Switch

Work: It searches network and passes forward after tuning.

Faults: If the Antenna Switch is faulty then there will be no network in the mobile phone.

P.F.O: It is found near the Antenna Switch in the Network Section of the Cell Phone P.F.O. PCB of Mobile Phone. It is also called P.A (Power Amplifier) and Band Pass Filter



Figure 5.12 P.F.O

Work: It filters and amplifies network frequency and selects the home network.

Faults: If the PFO is faulty then there will be no network in the mobile phone. If it gets short then the mobile phone will get dead.

RF IC / Hagar / Network IC: This electronic component found near Cell Phone Network IC / RF IC the PFO in the Network Section of a Mobile Phone. It is also called RF signal processor.



Figure 5.13 Network IC

Work: It works as transmitter and receiver of audio and radio waves according to the instruction from the CPU.

Faults: If the RF IC is faulty then there will be problem with network in the mobile phone. Sometimes the mobile phone can even get dead.

26 MHz Crystal Oscillator: It is found near the PFO in the Network Mobile Phone 26 MHz Crystal Oscillator Section of a Mobile Phone and it is shown in Figure 5.14. It is also called Network Crystal. It is made up of metal.



Figure 5.14 Crystal Oscillator

Work: It creates frequency during outgoing calls.

Faults: If this crystal is faulty then there will be no outgoing call and no network in the mobile phone.

VCO: It is found near the Network IC in the Network Section of a Mobile Phone. It is shown in Figure 5.15



Figure 5.15 VCO

Work: It sends time, date and voltage to the RF IC / Hager and the CPU. It also creates frequency after taking command from the CPU.

Faults: If it is faulty then there will be no network in the mobile phone and it will display “Call End” or “Call Failed”.

RX Filter: It is found in the Network Section of a Mobile Phone. Figure 5.16 shows the RX filter IC.



Figure 5.16 RX Filter

Work: It filters frequency during incoming calls.

Faults: If it is faulty then there will network problem during incoming calls.

TX Filter: It is found in the Network Section of a Mobile Phone. It is shown in figure 5.17.



Figure 5.17 TX Filter

Work: It filters frequency during outgoing calls.

Faults: If it is faulty then there will network problem during outgoing calls.

ROM: It is found in the Power Section of a Mobile Phone. It is shown in Figure 5.18



Figure 5.18 ROM

Work: It loads current operating program in a Mobile Phone.

Faults: If ROM is faulty then there will software problem in the mobile phone and the set will get dead.

RAM: It is found in the Power Section of a Mobile Phone. It is shown in Figure 5.19.

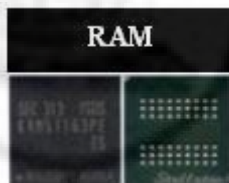

Figure 5.19 RAM

Work: It sends and receives commands of the operating program in a mobile phone.

Faults: If RAM is faulty then there will be software problem in the mobile phone and it will get frequently get hanged and the set can even get dead.

Flash IC: It is found in the Power Section of a Mobile Phone. It is also called EEPROM IC, Memory IC, RAM IC and ROM IC. It is shown in Figure 5.20



Figure 5.20 Flash IC

Work: Software of the mobile phone is installed in the Flash IC.

Faults: If Flash IC is faulty then the mobile phone will not work properly and it can even get dead.

Power IC: It is found in the Power Section of a Mobile Phone. It is shown in Figure 5.21. There are Cell Phone Power IC many small components mainly capacitor around this IC. RTC is near the Power IC.



Figure 5.21 Power IC

Work: It takes power from the battery and supplies to all other parts of a mobile phone.

Faults: If Power IC is faulty then the set will get dead.

Charging IC: It is found in the Power Section near R22. It is shown in Figure 5.22



Figure 5.22 Charging IC

Work: It takes current from the charger and charges the battery.

Faults: If Charging IC is faulty then the set will not get charged. If the Charging IC is short then the set will get dead.

RTC (Simple Silicon Crystal): It is Real Time Clock and is found in Mobile Phone RTC (Real Time Clock) the Power Section near Power IC. It is made up of either metal or non-metal. It is of long shape. It is shown in Figure 5.23.

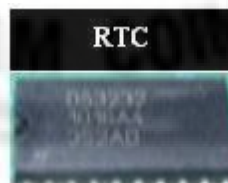

Figure 5.23 RTC

Work: It helps to run the date and time in a mobile phone.

Faults: If RTC is faulty then there will be no date or time in the mobile phone and the set can even get dead.

CPU: It is found in the Power Section. It is also called MAD IC, RAP IC and UPP. It is the largest IC on the PCB of a Mobile Phone and it looks different from all other ICs. It is shown in Figure 5.24.



Figure 5.24 CPU

Work: It controls all sections of a mobile phone.

Faults: If CPU is faulty then the mobile phone will get dead.

Logic IC / UI IC: It is found in any section of a mobile phone. It is shown in Figure 5.25 It has 20 pins or legs. It is also called UI IC and Interface IC.

Logic IC



Figure 5.25 Logic IC

Work: It controls Ringer, Vibrator and LED of a mobile phone.

Faults: If Logic IC / UI IC is faulty then Ringer, Vibrator and LED of mobile phone will not work properly.

Audio IC: It is found in Power Section of a mobile phone. It is shown in Figure 5.26. It is also called Cobba IC and Melody IC.

Audio IC



Figure 5.26 Audio IC

Work: It controls Speaker and Microphone of a mobile phone.

Faults: If Audio IC is faulty then Speaker and Microphone of a mobile phone will not work and the set can even get dead.

764 - SRIPC

Tools & Instruments used in Mobile Servicing

Mobile Servicing kit

Below are the tools and equipment needed for mobile phone servicing

(i) Soldering Iron

Used to solder small components like capacitor, resistor, diode, transistor, regulator, speaker, microphone, display etc. A 50 watt soldering iron is good enough for most mobile phones repairing job. Figure 5.27 shows the soldering iron.



Figure 5.27 Soldering Iron



Figure 5.28 PCB Holder

(ii) PCB Holder / PCB Stand (Printed Circuit Board):

PCB is used to hold the PCB of a mobile phone while soldering or repairing. It holds the PCB very strongly and doesn't allow it to move thus helping in repairing. Figure 5.28 shows the PCB Holder.

(iii) Solder Wire

Used to solder electronic components, ICs or jumpers. The composition of most solder wire is Tin / Lead in the ratio 60:40 or 63:37.

764 - SRIPC



Figure 5.28 Solder wire



Figure 5.29 PCB Cleaner

(iv) Thinner or PCB Cleaner

Thinner or PCB cleaner is used to clean the PCB of a mobile phone. The most common PCB cleaner used in mobile phone repairing is IPA or Isopropyl Alcohol. It is important to buy only good quality PCB cleaner as poor quality PCB cleaners can damage the system board.

(v) Jumper Wire:

This is a thin laminated or coated copper wire used to jumper from one point to another on the track of a mobile phone during repair.



Figure 5.30 Jumper wire, Cutter and Blade Cutter

(vi) Point Cutter

It is used for cutting

(vii) Blade Cutter

This is used to remove lamination from jumper wire. It can also be used for several other purposes.

(viii) Nose Cutter

This is used for cutting.



Figure 5.31 Nose Cutter, Precision Screw Driver and Tweezers.

(ix) Precision Screwdriver

It is used to remove and tighten screws while assembling and disassembling a mobile phone. Precision screwdrivers of sizes T4, T5, T6 and forehead are good for Most mobile repairing job.

(x) Tweezers

These are needed to hold electronic components, ICs, jumper wire etc. while soldering and Desoldering.

(xi) Brush

These are used for cleaning the PCB of a mobile phone when it is being repaired. It is important to buy only ESD Safe cleaning brushes. It is shown in Figure 5.32



Figure 5.30 Brushes.

(xii) Multimeter

An electronic measuring device that has the ability to measure voltage, current and resistance. It is used to test and check the readings of various parts and components of a mobile phone. It is shown in Figure 5.31

764 - SRIPC



Figure 5.31 Digital Multimeter.

(xiii) **Hot Air Blower**

It is also called SMD (Surface Mount Device) rework system and SMD repair system. It has control to regulate or manage temperature and flow or hot air. Always buy a good quality ESD Safe hot air blower. It is shown in Figure 5.32.



Figure 5.32 Hot air blower

(xiv) **Battery Booster:**

It is used to boost the power of battery of a mobile phone. It is shown in Figure 5.33



Figure 5.33 Battery booster

(xv) Screwdriver Kit

It has several screwdrivers of different shapes and sizes to disassemble and assemble a mobile phone. It is shown in Figure 5.34



Figure 5.34 Assorted Screwdrivers.

(xvi) Microscope

It is used to see a magnified view of PCB or electronic components. These are available in different zoom options. Many microscopes can also be connected to a computer or a monitor. It is shown in Figure 5.35.



Figure 5.35 Microscope

(xvii) Test JIG Box

This device is used to diagnose and find fault or problem in a mobile phone. It helps the mobile phone to work and function normally outside its case. This helps to test and check voltage and other test points on the PCB. In simple words it helps the mobile phone to work without battery. It is shown in Figure 5.34.

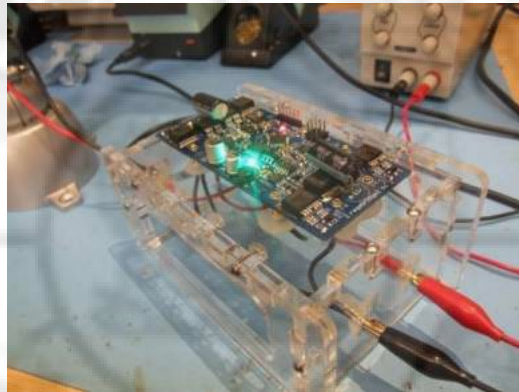

Figure 5.34 Test JIG box

(xviii) Battery Tester:

This device is used to test and analyze the status or condition of the battery of a mobile cell phone. It is shown in Figure 5.35



Figure 5.35 Battery tester

Cleaning Sponge.

This is used to clean the tip of soldering iron while soldering. It is shown in Figure 5.36.



Figure 5.36 Cleaning sponge

(xix) Solder Paste:

The solder paste is a low melting metal allow used to join together metal work pieces. It has a lower melting point than the metal work pieces. It is shown in Figure 5.37.



Figure 5.37 Solder Paste

(xx) LCD Tester

Used to check whether the LCD screen of a mobile phone is faulty or not. It is shown in Figure 5.38.



Figure 5.38 LCD tester

Soldering and De-soldering Components using different soldering tools

Soldering Iron.

A soldering iron is composed of a heated metal tip and an insulated handle. Heating is often achieved electrically, by passing an electrical current (supplied through an electrical cord or battery cables) through the resistive material of a heating element. Another heating method includes combustion of a suitable gas, which can either be delivered through a tank mounted on the iron (flameless), or through an external flame. Some soldering irons heat up and cool down

in a few seconds, while others may take several minutes.

Soldering LEAD

Soldering lead is used to bond or connect electronic components.

Solder is a fusible metal alloy with a melting point or melting range of 90 to 450 degree Celsius (190 to 840 °F), used in a process called soldering where it is melted to join metallic surfaces. It is especially useful in electronics. Alloys that melt between 180 and 190 °C (360 and 370 °F) are the most commonly used. By definition, using alloys with melting point above 450 °C (840 °F) is called brazing. Solder can contain lead and/or flux but in many applications solder is now lead free. While it is possible to do some wiring without soldering connections, soldering is the preferred approach.

Soldering Paste

Solder paste (or solder cream) is used for connecting the terminations of integrated chip packages with land patterns on the printed circuit board. The paste is applied to the lands by printing the solder using a stencil, while other methods like screening and dispensing are also used.

Soldering flux Soldering flux is just a safe, convenient acid for dissolving the oxide skin off the metal you want your solder to wet well. Also dissolves oxide off the liquid solder, making it less crusty and therefore more shiny.

The flux built into most solder wire is called rosin flux. That is the clear yellow-brownish plaque that sits on the solder's surface. It is only strong enough to reduce weakly oxidizable metals like copper, tin, lead, silver. So it is just strong enough for electronics use, but not for soldering to stainless steel or iron or anything with chrome or aluminum. "Flux remover" is sold in spray-cans for this. Rubbing alcohol with a dash of dish-soap sort of works for me.

- (i) **Pick your iron.** Most electronic component soldering is done to fasten components to a PCB (printed circuit board). Therefore, an iron with a smaller tip is recommended.
- (ii) **Pick your solder.** Both solid wire and Rosin-cored solders are available at stores and online. Be sure the solder you choose will bond to the materials you are trying to solder.
- (iii) **Prepare the iron.** Plug in the iron and let it warm up its stand for a few minutes. Be sure to gently wipe it across a sponge if it's been used previously, as described above. Tin it (as described above) once it's clean. When you're ready, set out your components, clips, and solder.
- (iv) **Set a piece in place.** Put a component in the spot you want to solder it. If soldering to a PCB, be sure the wires of the component are appropriately placed through its pinholes.

- (v) **Pick up the solder wire.** Hold a length of solder with your non-dominant hand. Use a long length to ensure that you'll be able to keep your hand well away from the tip of the iron.
- (vi) **Heat the component.** Touch the tip of the iron to the component you want to solder. Only touch it for about one second. This warms the metal so that it can handle the solder more flexibly.
- (vii) **Finish the solder.** Pull the solder wire away first, wait one second, and then pull the iron away from the soldering point to let the molten solder cool. Again, this should only take 5 or 10 seconds at most
- (viii) **Repeat until finished.** Repeat the above steps for each point you wish to solder

Soldering Wick

A solder wick (also desoldering wick or desoldering braid) is a tool for removing solder from any solder joint. Usually, it is a roll of fine, braided 18 to 42 AWG wire, typically oxygen free copper, which has been treated with a rosin solder flux.

To remove solder with it, one presses the wick onto the solder joint to be removed and then heats the wick portion that is on the connection with the tip of a soldering iron. As the rosin melts onto the wick and the connection and the solder reaches its melting point the solder rushes via capillary action onto the clean copper braid. Once everything has melted and the solder fuses with the braided copper, the wick is lifted along with the solder and is then cut off and disposed of. A Photograph of desoldering is shown in Figure 5.39.

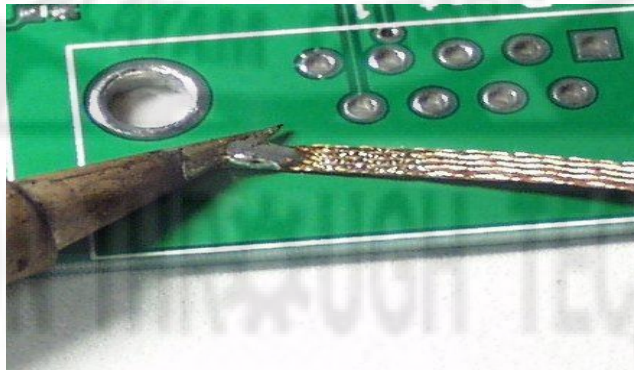

Figure 5.39 De-Soldering

Use of multimeter and battery booster

The following steps show how to use the multimeter and it is shown in Figure 5.40

1. **Function and Range Switch:** This switch is used to select the function and desired range as well as to turn the instrument. In order to extend the life of the battery of the

Multimeter, this switch must be kept in the “OFF” position when the instrument is not in use.

2. **Display or LCD:** To display all the readings.
3. **Common Jack:** Plug in connector for black (negative) test lead or probe.
4. **V ? mA Jack:** Plug in connector for red (positive) test lead or probe for all voltage, resistance and current (except 10A) measurements.
5. **10A Jack:** Plug in connector for red (positive) test lead or probe for 10A measurement.

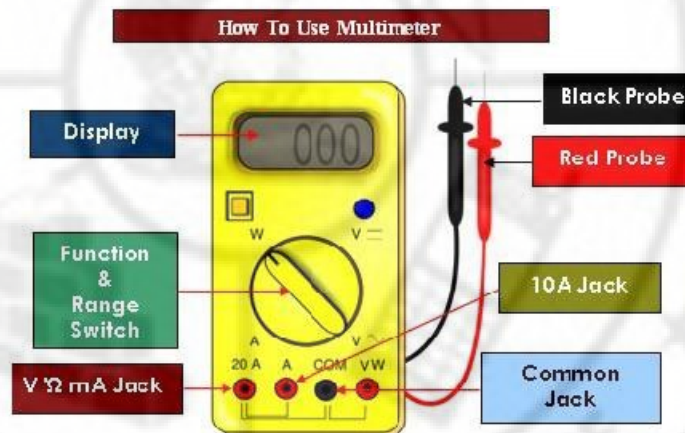

Figure 5.40 Use of Multimeter

Battery Booster

Battery Booster is an all-in-one **battery** boosting and power management tool for both Android smartphone and tablet. The following ways boosts the battery power of the mobile phone.

- (i) **Discipline Your Display:** It consume more energy to power the backlight. By limiting screen’s maximum brightness, saves cell phone battery life.
Keep A Lid On Bluetooth & Wifi: Some phones will automatically connect to any public network they encounter, battery power is consumed without the knowledge of the user.
- (ii) **Beware GPS & Location Requests :** Check the FourSquare or adding the location to a tweet but constant use otherwise this will affect the battery life time. Best to avoid GPS intensive applications like mapping tools (save then for the car).
- (iii) **Disable 3G network.**
- (iv) **Manage Power and Avoid Power-Hungry Apps:** Multitasking on Anroid and iOS is handled slightly differently by each operating system. iOS freezes the application in its current state. Though apps like iTunes and media players will continue downloading or playing in the

background. Android operated similarly but with greater scope for true multitasking with apps able to stay awake in the background, sucking up power more than iPhone.

- (v) Ditch Vibrate & Pointless Notifications: Vibrate setting consumes more than simple audible alert. Similarly notifications also consume power.

Installation and Troubleshooting

Assembling and disassembling of different types of mobile phones

Each and every cellular phone has a different method to assemble and disassemble, especially when it comes to smart phones.

Disassembling

Now let's begin with disassembling procedure of :

- (i) Switch off the phone (If it's already not switched off).
- (ii) Remove battery cover.
- (iii) Now remove battery, SIM Card, Memory Card (If any) as per shown in figure.
- (iv) Remove all the screws from the phone with the help of screwdriver.
- (v) lift back cover with the help of a flat screw driver.
- (vi) After removing back cover, now remove the buzzer strip using plastic separation tool and then gently remove the assembly in order to proceed further.
- (vii) Now remove the strips such as Front Camera, Display, Volume and Speaker button assembly, camera, Motherboard, Vibrator, Second Camera (after removing screw) and st Volume & Speaker.
- (viii) Remove Ant wire from outside, and it is considered to be important because there is a slight chance that might damage the wire or connector (or both).

The disassemble parts of the Phone is shown in Figure 5.41.

764 - SRIPC



Figure 5.41 Parts of the Phone

Assembling:

Following Steps to be carried out to assemble the mobile phone with photographs.

- (i) Fix Vibrator, Strips of Speaker & Volume button assembly.
- (ii) Now on Motherboard:
Fix main Camera.
Place Motherboard on LCD and connect its Strip.
SIM and Memory Card strip on board
- (iii) Connect following wires:
 - a) Antenna with wire
 - b) Wire of Speaker - Volume Strip
- (iv) Place front camera and connect it
- (v) Now go with HD Phone Jack assembly and Buzzer.
- (vi) Put Camera cover.
- (vii) Now before you place the screw in your make sure that its LCD is working by switching it on, after that, fix it with the help of screws.
- (viii) Finally put battery and battery cover.

Installation of OS

The operating system determines which functions, software and applications are applicable for the device. Examples of mobile operating systems available include Palm OS, Symbian OS, MXI, Mobile Lynux and Windows Mobile.

Step 1

Connect the phone to the computer. Establish a connection (through phone management software) between the mobile phone and the computer. Make sure that the connection is active. install Windows Mobile operating system, and download a “bootloader” first. Extract the "bootloader" executable file and run the file to start installation. Follow the instructions as the bootloader performs a number of checks on the mobile phone. Restart the phone or wait for it to automatically reboot.

Step 2

Pair the mobile phone to the computer. Insert the mobile OS CD/DVD into the optical drive of the computer. Extract the operating system file from its location (in this case the CD/DVD-ROM) onto another location in your mobile phone. In Windows Mobile, extract the “bootloader” to the same location where you extracted the operating system.

Step 3

Wait for the operating system installation to finish. When the process completes, the phone will automatically reboot.

Fault Finding and Troubleshooting

Basically there are 3 types of faults in cell phones:

1. Settings Faults
2. Software Faults
3. Hardware Faults

Common faults occur in mobile phone

- (i) Dead: When a phone doesn't switch-on, it is called a dead phone.
- (ii) Insert SIM: In this fault, the SIM card does not get detected.
- (iii) Hanging Problem: In this fault, the handset gets stuck and freezes frequently.

- (iv) Network Problem: No network signal or low network or even fluctuating network.
- (v) Microphone Problem: No out-going sound.
- (vi) Ringer Problem: No ring tone, music and loud speaker sound.
- (vii) Speaker Problem: No incoming sound.
- (viii) Vibrator Problem: No vibration.
- (ix) Display Problem: No graphics on LCD or a broken LCD.
- (x) Auto Switch Off: Phone switches off automatically even when its not prompted.
- (xi) Restart Problem: Phone restarts automatically.
- (xii) Call Cuts Off: Call gets disconnected or cuts off. It may also be due to poor service from network provider.
- (xiii) Charging Problem: No charging or very slow charging.
- (xiv) Keypad Problem: Keypad doesn't work or some keys do not function. Home button or volume buttons do not work.
- (xv) Touch Problem: Touch doesn't work or slow touch.
- (xvi) Battery Discharge Problem: Battery gets drained very fast even when fully charged.
- (xvii) Bluetooth Problem: Bluetooth does not work.
- (xviii) Camera Problem: Camera does not work.
- (xix) FM Radio: Radio does not work or no tuning.
- (xx) LED Problem: Not back-light on LCD.
- (xxi) Memory Card Problem: MMC does not get detected.
- (xxii) No Internet
- (xxiii) WiFi Problem: WiFi does not function

Following are different electronic parts and components in different sections inside a mobile cell phone:

- a) **Network Fault:** Antenna Switch, PFO, FEM, RF IC, VCO, RX-Filter, TX-Filter, RF Antenna, RF Crystal, External Antenna Socket, Network Signal and Supply Control and Interface Section. If we know about the parts and components present in the Network section and their function then we can easily repair the fault by looking at the code number of the faulty component in the Circuit Diagram and the PCB Layout Diagram. In this way we can easily make good use of circuit diagram for mobile cell phone repairing.
- b) **Power ON Fault:** Battery (3.7V), Battery Connector Jack, Power IC, CPU, Flash IC, S-RAM IC, RF Crystal, RF Clock Section Component, RF IC, Power ON / OFF Trigger Components.

- c) **Charging Fault:** Charger (5-6V), Battery (3.7V), Charger Connector, Charger Volt Fuse, Coil, Charger Over Volt Protector, Charging IC, Power IC, Charging Regulator, Charging Volt Output Components, Charger and Charger Volt Detector Components.
- d) **SIM Fault:** SIM Card, SIM Socket, SIM Signal and Supply Interface Components, Resistance, Coil, Power IC, CPU etc.
- e) **Ringer Fault:** Ringer, Ringer Signal Input and Output Components, Audio Amplifier IC, Power IC, CPU etc.
- f) **Ear Speaker Fault:** Ear Speaker, Ear Speaker Signal Components, Audio Amplifier IC, CPU, Power IC etc.
- g) **Micro SD Card Fault / MMC Fault:** Micro SD Card, Micro Card Connector, Micro Card Detector Switch, Micro Card Detector Signal Components, CPU etc.
- h) **USB and Bottom Connector fault:** USB and Bottom Connector, USB and Signal Interface Connector Components, USB Signal Interface IC, USB Driver IC, CPU etc.
- i) **Keypad Fault:** Key Tip, Key Pad Dot Sheet, Key Signal Filters, Key Signal Varactors, Key Board to Key Connector, CPU etc.
- j) **Display Fault:** LCD, LCD Connector, LCD Supply Components, LCD Signal Interface Filter IC, CPU, LCD Signal Interface Resistance etc.
- k) **MIC Sound Fault:** MIC, MIC Interface Connection, MIC Signal and Supply Components, Power IC, CPU etc.
- l) **Backlight (LED) Fault:** LED, Backlight Driver IC, Backlight Driver Section Components, Power IC, CPU etc.
- m) **Bluetooth Fault:** Bluetooth Antenna, Bluetooth Driver IC, Bluetooth Section Crystal, CPU etc.
- n) **FM Radio Fault:** Fands Free Lead, Hands Free Connector, FM and Bluetooth IC, FM Driver IC, CPU etc.
- o) **Vibrator Fault:** Vibrator Motor, Vibration Supply Components, Power IC, Vibrator Driver IC etc.
- p) **Touch Panel (PDA) Fault:** Touch Panel / PDA Panel, Touch Panel Control IC, CPU, Signal Interface Parts etc.

Troubleshooting

The Most Common problem in the Cell Phone:

- (i) **Handset is dead:** If the handset is not switching on, it is considered as a dead phone.
- (ii) **Freezing:** In this type of problem, the handset freezes, hangs or gets stuck frequently. It is most probably because of virus or corrupt software.
- (iii) **Booting related errors:** When switching on the phone gets stuck on the logo of the manufacturer or starts blinking on the logo screen. Or sometimes, the handset displays a blank screen without any graphics.
- (iv) **No outgoing sound:** This is because of a faulty microphone (also called mic and mouth piece) or its connections
- (v) **No incoming sound:** This is because of a faulty speaker (also called ear piece) or its connections.
- (vi) **No ringtone or music:** This is because of a faulty ringer or its connections.
- (vii) **No vibration:** This is because of a faulty vibrator or its connections.
- (viii) **No signal:** The handset doesn't catch the signals from network.
- (ix) **Call gets cut off:** The calls get cut off in middle. This may be because of poor network coverage or a faulty handset.
- (x) **SIM card detection failure:** The handset doesn't detect SIM card and shows the message „insert SIM“ or a related error.
- (xi) **No graphics/ broken LCD:** The LCD either doesn't show any graphics or it is broken.
- (xii) **Touch function is not working:** This is because of a faulty touch or its connections.
- (xiii) **Switches off automatically:** The cell phone switches off automatically or restarts frequently without pressing the power button.
- (xiv) **Keypad doesn't work:** This issue was in older keypad phones. All or some of the keys do not work.
- (xv) **Fast draining battery:** This may be because of a faulty battery or problems in the circuit. It also may also occur due to excessive use of online applications installed.
- (xvi) **MMC Card detection failure:** Can be either a faulty memory card or the connector and its tracks.

Table 5.2 Common Problems and Solutions

Problems	Solutions
Battery Overheating	<ol style="list-style-type: none"> 1. Use the phone less. The longer you use it continuously and the more intensive the task, the hotter it will get. There is no way around this. 2. Turn the phone off and remove the battery so it can cool faster. 3. Press and hold the power key up top until the BB Q10 restarts
Battery life is poor	<ol style="list-style-type: none"> 1. Turn off any features you aren't using - GPS, NFC, data, Wi-Fi, Bluetooth, etc. 2. Sync your email and accounts less frequently. 3. Reduce screen brightness and use a black background. 4. Reduce volume, turn off vibrate on notifications
Contacts just display number or don't appear	<ol style="list-style-type: none"> 1. Turn off contacts syncing from accounts you don't want to draw contacts from, like Facebook. Go into the Contacts app on your Q10 and tap Settings and you can set which accounts you want to pull in contacts from. 2. If you have contacts on your SIM card and you then sync them from BlackBerry Protect or a carrier backup app then you'll end up with duplicates. If you're certain they're all backed up then it might be quickest to just delete one of the sources. 3. You can link contacts manually by tapping on a contact, selecting the <i>Links</i> icon and then tapping the <i>Add link</i> icon then choose the contact you want to merge and tap <i>Save</i>
Problem: Emails and notifications stop	<ol style="list-style-type: none"> 1. Restart your Q10 by holding down the power key and selecting restart
Freezing	<ol style="list-style-type: none"> 1. Make sure you have latest updates via <i>Settings>Security Update</i>. 2. Hold down the power key for several seconds to turn the device off. Remove the battery for 30 seconds and then put it back in and restart the Q10. 3. There might be a problem with one of your apps, but it could be tough to find the culprit. Make sure that all of your apps are up to date. If you notice an issue with a specific app, then try uninstalling it. 4. Try a master reset. Make sure that everything on your internal storage is backed up and remove your media card to avoid any problems, then go to <i>Settings > Security and Privacy > Security Wipe</i>. Type "blackberry" in the box then tap <i>Delete Data</i>. 5. If none of these solutions helps, contact BlackBerry, your carrier, or your retailer and see if you can get a replacement handset.
Mobile Cell Phone Charging Problem and Solution	<ol style="list-style-type: none"> 1. Change the charger and check. Voltage must be 5 to 7 Volts.

	<ol style="list-style-type: none"> 2. Clean, Resold or Change the Charger Connector. 3. If the problem is not solved then change the Battery and Check. 4. Check Voltage of the Battery Connector using a Multimeter. Voltage must be 1.5 to 3.7 DC Volts. 5. If there is no voltage in the connector then check track of the charging section. Refer to the diagram of the particular model of the mobile phone. Books with track diagrams are easily available in the market. The same can also be searched on the internet. 6. If the problem still persists then check Fuse, Coil and Regulator one by one. Change if required. 7. If the problem is still not solved then Heat or Change the Charging IC. 8. Finally Heat, Reball or Change the Power IC.
<p>Display Not Working</p>	<ol style="list-style-type: none"> 1. Clean Display Tips and Display Connector. 2. Resold the Display Connector. 3. Change the Display. 4. Check Display Track. 5. Resold or Change the Display IC. 6. Heat, Reball or Change the CPU.
<p>SIM Not Working</p>	<ol style="list-style-type: none"> 1. Check settings and see if the mobile phone is in Flight Mode or Not. If it is in "Flight Mode" then change the Mode to Normal. 2. Clean SIM Card Tips and SIM Connector. 3. If the problem is not solved then change the SIM Card and Check. 4. If the problem still persists then Change the SIM Connector. 5. If you still do not find solution to the problem then Check Track of the SIM Section. Refer to the Diagram of the Particular Model of the Mobile Phone. Books with Diagrams of Tracks are available in the Market and on the Internet. 6. If the problem is still not solved then Heat or Change the SIM IC. 7. Finally, Heat, Reball or Change the Power IC
<p>Mobile Phone Ringer</p>	<ol style="list-style-type: none"> 1. Check ringer settings in mobile phone. Check Ringer Volume and Silent Mode. Adjust or change volume and / or mode if required. 2. If the problem is not solved then open the mobile phone and clean ringer point and ringer connector.

	<ol style="list-style-type: none"> 3. If the problem is not solved then check ringer by keeping the multimeter in buzzer mode. Value must be 8 ~ 10 Ohm. If the Value is not between 8~10 Ohm then change the Ringer. 4. If the problem is not solved then check track of ringer section. Do jumper wherever required. 5. If the problem is not solved then check Ringer IC. Heat or change the IC if required. 6. If the problem is not solved then heat, reball or change UEM / Logic IC. 7. If the problem is still not solved then heat, reball or change the CPU.
<p>Microphone</p>	<ol style="list-style-type: none"> 1. Check Microphone settings. <div data-bbox="932 751 1224 970" style="text-align: center;"> </div> <p style="text-align: center;">Mobile Phone Microphone IC Jumper</p> <ol style="list-style-type: none"> 2. If all settings are OK then, Check and clean Microphone Tips and Connector. 3. If the problem is not solved then Check Microphone by Keeping the Multimeter in Buzzer Mode. Value must be 600~1800 Ohm. If the Value is not between 600~1800 Ohm then change the Microphone. NOTE: Only one side will give value. The other side will not give any value. 4. If the problem is not solved then Check Track of Microphone Section. Do Jumper Wherever required. 5. If the problem is not solved then Heat or Change Microphone IC. 6. If the problem is not solved then Heat Reball or Change the UEM / Audio IC / Power IC. 7. If the problem is still not solved then Heat, Reball or Change CPU.
<p>Problems with Keypad</p>	<ol style="list-style-type: none"> 1. Check Facial of the Keypad.

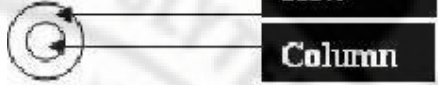
	
	<p>Mobile Phone Keypad Track Row Column</p> <ol style="list-style-type: none"> 2. Clean Key pad Tikli and Keypad Points. 3. Keep Multimeter in Buzzer Mode and Check Row and Column of the Keypad. If there is Beep Sound then Pad is OK. 4. Heat or Change Keypad IC / Interface IC. 5. Heat, Reball or Change the CPU.

Jumper techniques and Solutions

Most mobile phone repairing is done by doing jumper. Different parts of a mobile cell phone like display, keypad, speaker, microphone, LED lights, different ICs, different small parts and electronic components, all have different jumper settings. It is important to first track the fault or missing track and then do the jumper.

- (i) Mobile phone jumper wire.
- (ii) Soldering iron.
- (iii) Solder wire.
- (iv) Blade cutter.
- (v) Multimeter.
- (vi) Soldering flux.
- (vii) PCB holder.
- (viii) Tweezers.

How to use Jumper?

- (i) Disassemble mobile phone and place it on a PCB holder.
- (ii) Using a multimeter, check track and find the fault or the missing track that need jumper.
- (iii) Apply liquid soldering flux to the points where you need to solder jumper wire.
- (iv) Cut jumper wire to desired length and remove its lamination using blade cutter.
- (v) Hold one end of the jumper wire and solder it to one point of the faulty circuit track. Use a good quality tweezers to hold the wire and good quality of soldering iron and solder wire to solder.
- (vi) Now hold the other end of the jumper wire and solder to the other point of the track

- (vii) Using a multimeter check the jumper.

Software Flashing

- (i) For instance, we are able to manually uninstall applications that come pre-installed with the phone, use a tool like like Nandroid Backup to perform a full backup, and many others.
- (ii) Installing a custom operating system (such as Cyanogen instead of Stock Android) in order to obtain a customized experience; get rid of bloatware or any other reason. Usually done after installing a custom recovery
- (iii) Restoring phone to the stock firmware, in other words, make it as it was originally.

The steps to do flashing depend on operating systems. The most widely used on is android mobile. The following steps to be followed to perform flashing.

- (i) download ROM, move to SD card, Reboot device Custom recovery and then flash the new ROM and reboot.
- (ii) To install custom ROMs all you need a rooted device with custom Recovery installed. Once both the requirement are completed on your device you can find lots of Free custom ROM from the internet or you can use GoogManager app to search best ROMs for your android. The following are some useful android application which helps you to install custom ROMs on the phone



Figure 5.41 ROM Manger

ROM Manager

One of the most download applications from the Google play store to Flash ROMs and its snapshot is shown in Figure 5.41. Reboot in recovery mode and Install ROMs from the SD card. The user interface of the application is neat and clean and easy to use, select the option from application settings page. To use this application need a rooted device with ClockworkMod Recovery.

ROM Toolbox Pro

Works only with rooted phone and tablets. you can easily install, manage, backup, and restore multiple ROMs from the SD card. The extra features such as Batch backup & restore apps and their data, Restore apps from android backups, Backup your apps to drop box and more.

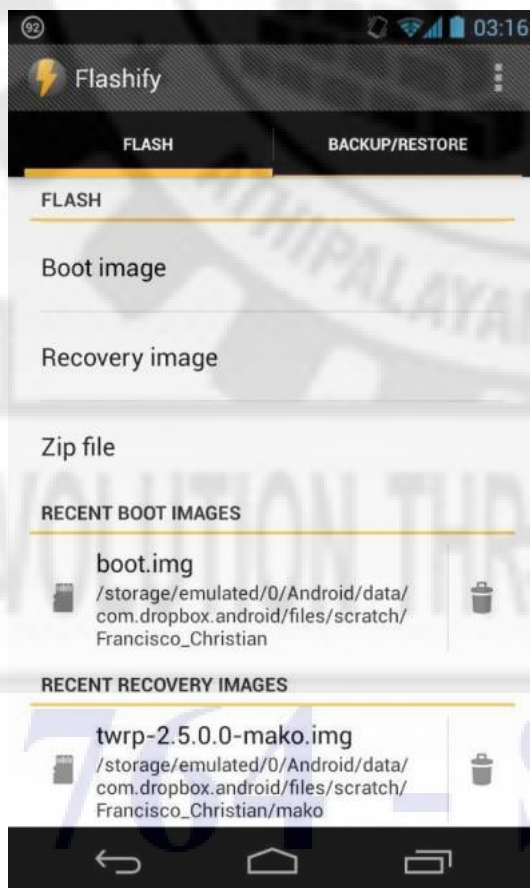

Figure 5.42 Flashify

Flashify

A new Application in Google play store, tested and fully working on the Galaxy Nexus, Nexus 7, Nexus 4 and Nexus 10. The snapshot of flashify is shown in figure 5.42. Another simple way to install custom ROMs, recovery images and zip files right away from the android home screen. Again to use this application root access on the device and custom recovery are required. This app is free but has a limit of 3 flashes per day.

The term means overwriting phone's partitions with an image that may have downloaded elsewhere, but it usually extends to installing many other things, such as root or another OS in the phone. Specifically, and in layman's terms, flashing the phone usually means we are doing one of the following:

- (i) Installing a custom recovery (such as TeamWin - TWRP or ClockworkMod), which allows us to do things like make a backup of any part of your phone, root your phone, install or flash zips containing a custom operating system and many others.
- (ii) Usually done after installing a custom recovery (and depending on the phone), the recovery allows us to "flash" arbitrary files. One of these may be a file which "roots" your phone, allowing you to do many things which are usually blocked because they require "Super user" permission.

Formatting

Formatting

Some cell phones come with expansion slots for memory cards while others have PDA functions. Due to large data storage options, the performance of a cell phone sometimes decreases due to cookies and other temporary files that occupy the memory. In such a case, the best solution is to format the cell phone to keep it in order.

Things required.

- Connector cable
- Memory card
- Stylus or pin

Step 1

Backup all the data and files of the cell phone. Attach a connector cable to one end of the cell phone and plug the other end into a computer. If the phone has a memory card slot, backup the data on the memory card.

Step 2

Download back-up software online for a small fee if cell phone did not come with the software. Some Pocket PC phones have a backup/restore utility built in to the phone and do not need any additional software.

Step 3

Format the phone by holding down the power button and using a pin or a stylus to press the restore button. This step will erase all data on the phone and will take approximately five to seven minutes. Once the phone has been formatted it will shut down and restart.

Step 4

Turn on the cell phone and follow the on-screen prompts to install the factory settings on the phone. This will free up storage and ensure optimal performance. Install new programs on your formatted cell phone or restore original data

Unlocking

It is easy to identify whether the phone is locked or not . Simply insert a SIM card from another carrier and see if the name of the network appears on the handset. If it does and you're able to use your phone, it's unlocked. Unlocking can be done by getting hold of a code or using a special data cable and software.

Need for Unlocking

- (i) to take advantage of well priced SIM only deals.
- (ii) not limited to tariffs offered by the network you bought your phone from
- (iii) Many people unlock their phone when they want to sell it. Generally unlocked phones command higher prices and sell faster than those that are still tied to a network.
- (iv) frequent traveller and want to save money on roaming charges by using SIMs from overseas networks

An unlockable bootloader is important to those of us who want to modify the software that came installed on our phone. A bootloader is a program that loads an operating system when a computer is powered on. Usually, it does its thing in the background and loads things to the normal user state, but a bootloader can also bring up other interfaces, like recovery or fastboot. It's what runs first every time you turn your phone on, and is usually set up so that only "official" software can be installed and will run. The bootloader on the phone came locked from the factory. This is a good thing, because having a bootloader that's not locked will allow

modification to the software, and is not secure at all. But the ability to modify the software on our phones is precisely why many of us want an unlocked bootloader.

To Unlock Pattern Lock From Android Mobile Phone Without Any Software Or Internet.

Unlock/Disable Pattern Lock From Android Mobile Steps are in below:

1. Turn off/ Shutdown you android mobile phone or Smartphone by pressing turn off button.
2. Turn on your android mobile phone
3. Entering wrong pattern fast one by one .
4. At last your number of wrong attempt, Pattern not working and give message.
5. Then you will find two button “Emergency call” and “Unlock”.
6. Press Unlock then you will find below two options to unlock android pattern lock.
 1. “Answer Question”
 2. “Enter Google account Details”
7. Select preferred option as of your choice.
8. In first option “Answer question” you have to give security answer which is submitted by you at pattern lock created time.
9. In second option “Enter Google account Details” you have to submit your Gmail user name (Email) or Password.
10. After selecting one of two options, you have to draw new pattern as your new pattern lock.

Use of Secret Codes

Know all the most important new secret codes of cell phones. Secret codes are some strange number combinations in cellular phones which do certain tasks or display information which may or may not be possible from inside the mobile phone’s menu. They can be called as tricks to display some secret information or to tweak your gadget. Some of the important changes or important information which may not be available through any settings in the menu options can be done through them. These codes are many times necessary to insert in the handset to repair certain software related faults. These number combinations are not known to all mobile phone device users, so it is an added advantage and many a times very helpful to reset or format or repair your device without opening it

Codes to launch various Factory Tests:

- ***#0*** – LCD test
- ***#3264*** – RAM version
- ***#0673*** OR ***#0289*** - Melody test
- ***#0842*** – Device test (Vibration test and BackLight test)
- ***#2663*** – Touch screen version
- ***#2664*** – Touch screen test

0588 – Proximity sensor test
0283 – Packet Loopback

WLAN, GPS and Bluetooth Test Codes:

232338 – Shows WiFi MAC address
1472365 – GPS test
1575 – Another GPS test
232331 – Bluetooth test
232337 – Shows Bluetooth device address

8255 – This code can be used to launch GTalk Service Monitor.
232339 OR ***526*** OR ***528*** – WLAN test (Use “Menu” button to start various tests)

Codes to get Firmware version information:

4986*2650468 – PDA, Phone, H/W, RFCallDate
1234 – PDA and Phone
1111 – FTA SW Version
2222 – FTA HW Version
44336 – PDA, Phone, CSC, Build Time, Changelist number

All Android Smartphone for Hidden Codes: Android Secret Codes

#0# – Enter the service menu on newer phones like Galaxy S 3
4636 – Phone information, usage statistics and battery
34971539 – Detailed Camera information
273282*255*663282 – Immediate backup of all media files
197328640 – Enable test mode for service
232339 – Wireless LAN tests
0842 – Backlight / vibration test
2664 – Test the touch screen
1111 – FTA software version (1234 in the same code will give PDA and firmware version)
*#12580*369# – Software and Hardware info
*#9090# – Diagnostic configuration
*#872564# – USB logging control
*#9900# – System dump mode
*#301279# – HSDPA/HSUPA control menu
*#7465625# – View phone lock status
7780 – Reset the data partition in factory state
*2767*3855# – Format device to factory state (will delete everything on phone)
##7764726 – Hidden service menu for Motorola Droid

This code can be used to enter into Service mode. You can run various tests and change settings in the service mode

*#06#	To check IMEI of your device, enter this code.
#0#	To enter service menu on the very new Android phones.
*#0228#	To check battery status.
*#9090# / *#1111#	To make device in Service mode.
4636	To get information about battery, usage statistics and device.
34971539	To get all information about camera.
*#12580*369#	To get software and hardware info.
*#228#	For ADC Reading.

#7353#	To hide test menu 2/Self Test Mode.
##7764726	To hide service menu for Motorola Droid.
###273283*255*663282###	For backup of our all media files.
###232338###	It display the Wi-Fi mac address.
*#7465625#	To view status of lock-phone.
###3264###	To show RAM version.
###44336###	To display build time and change list number.
###232337###	To see or display device's Bluetooth address.
###197328640###	It enables test mode for service.
###8351###	To enable voice dial mode.
###8350###	To disable the voice dial mode.
###0842###	To test Back-light/vibration.
###2664###	To test the touch-screen.
###0289###	For Audio test.
###0###	For LCD display test.
###232331###	To test Bluetooth of any Android device.
###0283###	To perform a packet loop-back test.
###1575###	For advanced GPS test.
###1472365###	To Perform a quick GPS test.
###0588###	To perform a proximity sensor test.
###7262626###	To perform field test.
###232339###	Testing Wireless LAN.
*#9090#	To Diagnose configuration of device.
*#872564#	To control U-S-B logging.
*#9900#	System dump mode.
###7780###	Reset to factory state.
*2767*3855#	To format Android device.
###4986*2650468###	To get pda, phone, H/W and RF Call Date.
###1234###	To know about pda and firmware version.
###1111###	For FTA Software version.
###2222###	For FTA Hardware version.
###7594###	To change power button behaviour once code enabled.
###8255###	To launch Google Talk service monitor.

Downloading

Downloading means transmission of files from system to another system. Downloading may be done in various methods

Android OS

Visit the Google Play Store There are many free applications, games, songs, and videos available for download.

Download apps from other sources. In order to install apps from sources other than the Google Play Store, set the phone to allow non-market apps.

- (i) Press the Menu button on the phone and tap Settings. Scroll down to Security and tap it to open the Security menu. Scroll down and check the “Unknown Sources” box. This will install apps directly from the APK file.
- (ii) An APK file is the file that Android uses to install a program. File must be APK format.
- (iii) Make sure that you download apps from trusted sources. There are a variety of communities that offer applications that aren’t available on the Store, often for free. These can include beta versions of apps that are in progress, or apps that are purchased outside of the store.
- (iv) download an APK file, using the Downloads app on the phone.

Transfer music, videos, and pictures from your computer. Transfer the files from computer to phone using the USB cable.

- (i) For Windows, use Windows Media Player 10 or higher installed to transfer files directly to phone when plug it in.
- (ii) For Mac, install the Android File Transfer before phone can be recognized.
- (iii) Copy music to the Music folder, videos to the Videos folder, and images to the Pictures folder.

Download files from the web. When browsing the web on your phone, you can download files directly to your phone’s storage.

- (i) To download an image, tap and hold the image in your phone’s browser for a second, and then release. A menu will open and you will have the option to save the image to your phone.
- (ii) Downloaded files will be stored in your Downloads folder on your phone. You can move these around by either attaching your phone to your computer and moving the files using Windows, or by installing a File Manager app.

Method 2 : iOS

- (i) **Download new applications.** Use the App Store button on the Home screen to browse the apps available to download. There are many free options available.
- (ii) **Download new music and videos.** Use the iTunes button on home screen to browse available music and videos.
- (iii) **Transfer Music and videos from Computer:** Use iTunes to transfer the files
- (iv) **Install apps not found in the App Store:** jailbreak the iPhone to install apps from other sources.

Diagnostic Software and Viruses

Mobile Viruses

Mobile Viruses is malicious software that targets mobile phones or wireless-enabled Personal digital assistants (PDA), by causing the collapse of the system and loss or leakage of confidential information. As wireless phones and PDA networks have become more and more common and have grown in complexity, it has become increasingly difficult to ensure their safety and security against electronic attacks in the form of viruses or other malware. Cell phone malware were initially demonstrated by Brazilian software engineer Marcos Velasco. He created a virus that could be used by anyone in order to educate the public of the threat.

The first known mobile virus, "Timofonica", originated in Spain and was identified by antivirus labs in Russia and Finland in June 2000. "Timofonica" sent SMS messages to GSM mobile phones that read (in Spanish) "Information for you: Telefónica is fooling you." These messages were sent through the Internet SMS gate of the Movistar mobile operator. In June 2004, it was discovered that a company called Ojam had engineered an anti-piracy Trojan virus in older versions of its mobile phone game, Mosquito. This virus sent SMS text messages to the company without the user's knowledge. Although this malware was removed from the game's more recent versions, it still exists in older, unlicensed versions, and these may still be distributed on file-sharing networks and free software download web sites. In July 2004, computer hobbyists released a proof-of-concept mobile virus Cabir, that replicates and spreads itself on Bluetooth wireless networks and infects mobile phones running the Symbian OS.

In March 2005, it was reported that a computer worm called Commwarrior-A had been infecting Symbian series 60 mobile phones. This specific worm replicated itself through the phone's Multimedia Messaging Service (MMS), sending copies of itself to other phone owners listed in the phone user's address book. Although the worm is not considered harmful, experts agree that it heralded a new age of electronic attacks on mobile phones. In August 2010, Kaspersky Lab reported a trojan designated Trojan-SMS.Android OS.FakePlayer.a. This was the first malicious program classified as a Trojan SMS that affects smartphones running on Google's Android operating system, and which had already infected a number of mobile devices, sending SMS messages to premium rate numbers without the owner's knowledge or consent, and accumulating huge bills. Currently, various antivirus software companies like

Trend Micro, AVG, avast!, Comodo, Kaspersky Lab, PSafe, and Softwin are working to adapt their programs to the mobile operating systems that are most at risk. Meanwhile, operating system developers try to curb the spread of infections with quality control checks on software and content offered through their digital application distribution platforms, such as Google Play or Apple's App Store.

Precautions

Virus is a terrific word that fills terror in us to mind when it comes in front of us. Further, when we hear that mobiles contain virus then this is the worst thing that can happen to it. Because the mobile containing virus is at a great risk. Moreover files, documents etc fed inside the mobile can be destroyed or deleted permanently due to the virus.

- (i) Type URL in to the address bar
- (ii) Avoid clicking on unknown attachments
- (iii) Never click on any untrusted link
- (iv) Beware before sharing your memory card.
- (v) Be careful about connecting your mobile with an unknown computer
- (vi) Be careful about downloading files and documents from the unknown source
- (vii) Be careful about opening SMS or MMS from the unknown source
- (viii) Keep updating your antivirus and spyware software periodically
- (ix) Scan your mobile regularly
- (x) Before downloading any app from Internet, check its review
- (xi) Diagnosis the type of virus present in the mobile

Antivirus Software

Antivirus software is a free protection for the Phone Against Virus Attacks, Theft, and Unwanted Numbers.

- (i) Protect your device from unauthorized users.
- (ii) Review apps that might affect your privacy.
- (iii) Easily share Quick Heal Mobile Security app with other Android devices.
- (iv) Protect your lost device with remote lock and data wipe feature.

Scan Device

This flexible feature offers the following functionalities:

- (i) **Quick Scan:**Runs a quick scan on the device based on request.
- (ii) **Custom Scan:** Offers multiple scanning options such as Full Scan, Scan All Apps, Scan Selected Apps, Scan Memory Card and Scan Selected Folders.
- (iii) **Schedule Scan:** This feature allows to schedule a virus scan at a time
- (iv) **Security Advisor:** The Security Advisor guides about settings that can enhance the overall security of your Smartphone. For example, if the 'Screen Lock' setting is enabled on the phone, then the Security Advisor will instruct to enable it.
- (v) **Privacy Advisor:** Privacy Advisor notifies and allows us to do a quick inspection of apps that might affect our privacy. It helps to review the permissions used by such apps, and you can decide whether to keep them or not.
- (vi) **Set Privacy** The Set Privacy feature allows to protect the privacy with the following functionalities:
 - a) **Call & Message Filter:** It easily block incoming calls and SMSs from unknown or unwanted numbers.
 - b) **International Call Block:** This feature allows to block unknown International calls.
 - c) **Message Exception List:** This list displays non-numeric senders that are excluded from SMS blocking.
 - d) **Register With TRAI:** This feature block all types of telemarketing calls by registering the number in the DND (Do Not Disturb) list. It can also raise a complaint with TRAI (Telecom Regulatory Authority of India) against unwanted telemarketing calls and SMSs.
- (i) **Message Center** Displays important notifications that require your attention. Latest IT security news and alerts are also displayed in the Message Center.
- (ii) **Activity** Receive extensive reports on the activities performed by Quick Heal Mobile Security on your device.
- (iii) **Call Forwarding Helps** us to set a number to which all your incoming calls will get forwarded. Set this number by sending an SMS or via the Remote Device Management portal.
- (iv) **Background Scan** Assured protection from all kinds of virus and malware threats. Automatically detects virus and spyware in real-time. The Background Scan runs silently without interfering with the normal functionality of your phone.

- (v) **Regular Automated Virus Updates** Takes automatic virus definition updates, so that your device is secured from new and emerging threats.
- (vi) **Share App** shares Quick Heal Mobile Security application with other Android devices using Bluetooth, Wi-Fi Direct, or NFC.
- (vii) **Anti-Theft** Quick Heal's anti-theft technology prevents the device from being misused. It allows to remotely lock the device, erase its data, and track its location if it gets lost or stolen.
- (viii) **Quick Settings Notification** Enable this feature to get quick access to device setting options such as Wi-Fi, Bluetooth, Mobile Data, Brightness, and Torch.
- (ix) **Remote Device Management** This is a portal provided by Quick Heal, where you can easily manage your device if it gets lost or stolen. Through this portal, remotely lock, unlock, and delete the data on phone is possible. The Remote Device Management portal also helps to track the location of the device.
- (x) **Security Shield** The Security Shield displays the security level of the device and data through a graphical representation. By tapping this shield, It can configure the security settings of your device.
- (xi) **Personal Security This** new mobile security feature has been introduced keeping safety in mind. In case of emergency, press device's power button 3-5 times. This will activate this feature, and an SOS message with the current location will be sent to the alternate contact numbers set during the time of registration.
- (xii) **Intruder detection** If someone enters a wrong password 2 times consecutively (to unlock device's lock screen), this feature will take snapshots using the front and rear camera of the device.
- (xiii) **Trusted SIMs List** Add multiple SIM numbers to Trusted SIMs List. This feature is beneficial for users using multiple SIMs. When the SIM is changed, the device is not blocked if its entry is present in the Trusted SIM list. Fifty (50) SIM numbers can be added to this List.
- (xiv) **News** Get latest news on mobile protection, security alerts, and other important information related to IT security.

764 - SRIPC

Review Questions

Part-A

1. Define simplex, duplex and semi duplex transmission
2. What is base station?
3. What is uplink and downlink?
4. Define the term handover, location area location update procedure
5. Tabulate the generation of mobile communication system with its benefits and drawbacks
6. Mention the tools used for mobile servicing
7. List the steps to be followed while soldering the component
8. How to use the Multimeter?
9. How battery power may be boosted?
10. List the different types of Mobile Operating System
11. What is fault? How it is classified?
12. What is jumper? What are its solutions
13. What is virus?
14. How can we prevent the virus?
15. How antivirus software is used?

PART-B

1. Explain the basics of Communication
2. Explain the Components of the Mobile Phone
3. How circuit board of mobile phone is designed? Explain
4. Name and explain the functions of different ICs used in mobile phones
5. Explain the tools use to service the mobile phone
6. How soldering and de-soldering is done ?
7. What is the use of Multimeter?
8. What is battery booster?
9. Explain the assembling and disassembling of mobile phone
10. What are the common fault occur in mobile phone?
11. What are the different types of fault related to electronic components of the mobile phone
12. Explain the jumper techniques and solutions
13. Explain flashing and its steps to be do in android phone
14. How formatting is done? Explain
15. What is unlocking? why it is required ?how pattern is unlocked?
16. What is secret codes? explain it with examples?

17. How downloading is done?
18. Explain routing in detail
19. Explain the mobile virus and its evolution
20. Explain the precautionary measures to prevent the phone from virus
21. Explain the features of antivirus.

REVOLUTION THROUGH TECHNOLOGY

764 - SRIPC