





The Digital Photography SourceBook

Section 3

DIGITAL ACCESSORIES

Cleaning Products	250-255
LCD Protective Covers	256-258
White Balance Calibration	259
Digital Angle Finders	260-261
Camera Armor	262
Instructional Media	263
Kaidan VR Photography	264-269
Memory Cards & Reader	270-281
Portable Storage & Viewers ..	282-287
Digital Picture Frames	288-293

Obtaining information and ordering from B&H is quick and easy. When you call us, just punch in the corresponding Quick Dial number anytime during our welcome message. The Quick Dial code then directs you to the specific professional sales associates in our order department.

 For Section 3, Digital Accessories
use Quick Dial #: 73

SENSORSCOPE SYSTEM

The safest and most effective system for cleaning your digital SLR image sensor

What you can't see can affect your pictures. Dirt comes from many sources and it must be removed in a safe and effective way, or your images will show this debris. Four common types of contaminants can get on your image sensor: Metallic, Fiber, Organic and Silica/Quartz particles. Only the SensorScope system addresses all four types of material and the proper way to remove them safely.

The SensorScope looks like a camera lens; however, it allows you to look back into your camera to inspect your sensor to see if it needs cleaning—remember, there is nothing safer than not cleaning your sensor. The SensorScope is easily portable and provides a 5x magnification lens and 4 ultra bright LED lights, which are focused to completely illuminate the field of inspection. Although specifically designed for Canon and Nikon DSLRs, the SensorScope may be used on any manufacturer's DSLR.



FEATURES

How it Works: Anyone can clean an image sensor in just a few minutes. Clean all digital SLR cameras in four easy steps:

Step One: Set up your camera to be cleaned.

Step Two: Use the SensorScope to inspect your sensor. If it isn't dirty, don't clean it!

Step Three: Clean your sensor with SensorVac and wet/dry SensorWands

Step Four: Inspect your sensor with SensorScope again. That's it!



Digital Duster Cleaning Kit

Delkin Digital Duster Cleaning Kit (DEDDK): Kit includes a SensorVac with 4 AA batteries, 12x SensorWands, 0.5 oz. SensorSolution, cleaning guide, and a carrying case.....**79.95**

SensorScope System Includes:

SensorScope: Enables you to see and inspect your camera's sensor magnified, with focused ultra bright light. This patent-pending Delkin exclusive fits all digital SLR cameras with no adapter. The safest thing you can do is



NOT clean your sensor if it doesn't need it. Find out with SensorScope. Includes 1 SensorScope and 2 CR2025 batteries.

SensorVac: An ultra small custom mini vacuum designed with a unique static free brush tip to dislodge debris and suction it away. Other brushes shed and scratch. The custom brush and high power, moisture free suction of the SensorVac are the best way to remove abrasive debris. Includes one SensorVac and 4 AA batteries.



SensorWands: This unique wet/dry double sided wand eliminates all small dust particles and chemically bonded debris. You must remove all contaminants, or your sensor is not clean. The SensorWand does the job. 24 wands are included.

SensorSolution: SensorSolution is specially formulated to leave no residue yet break the chemical bond that causes dirt, dust, oils and debris to adhere to the sensor. SensorSolution when used as directed easily wipes away. This quick drying formula is alcohol free and safe for all air travel. One 0.5 oz. bottle included.



SensorScope (DESSK)
Kit includes a SensorScope with 2 CR2025 batteries, SensorVac with 4 AA batteries, 24x SensorWands, 0.5 oz. SensorSolution, carrying case, and a cleaning guide**169.95**

Delkin Digital Duster Refill Kit (DEDDRK)
A refill kit for the Digital Duster. Kit includes 15x SensorWands, SensorSolution, and a cleaning guide**49.95**

DSLR DRY SENSOR CLEANING

Arctic Butterfly® Sensor Brush

The Arctic Butterfly® is the most technologically advanced, economical, travel-friendly DSLR sensor cleaning tool to remove dust, fibers and dry contaminants. There are two models of Arctic Butterfly®, the SL 700 and the 724. The SL 700 is an entry-level DSLR sensor cleaning tool for more budget orientated consumers. It is compact and easily fits into a photographer's pocket. The Arctic Butterfly® 724 features a spinning action that simultaneously charges the brush. It has a durable plastic body with a contoured grip and a snap-on battery cover that makes changing batteries easy.



Arctic Butterfly® SL 700 (VIABBSL700)

An entry-level DSLR sensor cleaning tool, the SL 700 requires one AAA battery and has a lower spinning speed than the Arctic Butterfly® 724. It can remove dust and fibers in all DSLR sensors. Includes a carry case.....**59.95**

Arctic Butterfly® 724 (VIABB)

Ideal for travel, this Butterfly® requires two AAA batteries, has a durable plastic body with a contoured grip, a snap-on battery cover and an On/Off switch design. An elegant carrying case is included for added protection and class**92.00**

HDF Sensor Brush (VIHDFSB)

An optional replacement head for the Arctic Butterfly® 724. It is suited for larger sensor size cameras such as the Canon 1DS, 1Ds MKII, and 5D (full frame sensors). Includes a carry case.....**39.95**

DSLR WET SENSOR CLEANING

Generally, if your sensor is dirty, it is because there is a build up of dust on the low pass filter. On rare occasions, the problem can be caused by moisture build up or a smear from the chamber lubricants. To heighten this problem, sometimes dust gets in the mix and binds to the filter in a very stubborn fashion. This is when it is necessary to do a wet cleaning. As a rule of thumb: if you have a distinct smear, you should do a wet cleaning, followed by a dry cleaning. In all other cases, it is preferable to do a dry cleaning only (for safety precautions).

Liquid Cleansers

Sensor Clean (VISCL): Clean stubborn dirt, organic dust and water stains from delicate image sensors. It's anti-static properties prevent dust accumulation and leave no organic residue. Non-flammable, non-toxic, non-corrosive, streak-free and travel-safe. Good for 150 swabs.....**27.95**

VDust Formula (VIVF): Cleans DSLR image sensors from all kinds of contamination. It is excellent for light oil removal, and prevents sensor surface friction and static build up, resulting in crystal clear images. Good for 72 swabs.....**19.95**

Smear Away (VISAW): Provides a barrier on the sensor while removing smears from sensors that are not easily removable. It protects the sensor from minor scratches, and has excellent dust repellent properties. Good for 72 swabs.....**18.95**

Lens Clean Solution (VILCTM): Specifically formulated to safely remove finger prints and water/oil based contamination from optical surfaces without streaking. 30ml bottle....**12.95**



Sensor Swabs

Clean your delicate sensor without leaving streaks, pooling or scratches. **Green Series (MXD) Sensor Cleaning Swabs** are compatible with ALL VisibleDust liquid cleansers. **Orange Series (DHAP) Sensor Cleaning Swabs** are compatible with VDust Formula and Smear Away.

1.5-1.6x Swabs: For DSLR cameras with a 1.5 - 1.6x sensor size. Includes 12 swabs. Available in Green Series (VIS1516G) and Orange Series (VIS1516O)**32.95**

1.3x Swabs: For DSLR cameras with the 1.3x sensor size range. Includes 12 swabs. Available in Green Series (VIS13G) and Orange Series (VIS13O).....**32.95**

1.0x Swabs: For DSLR cameras with a 1.0x full-frame sensor size. Includes 12 swabs. Available in Green Series (VIS10G) and Orange Series (VIS10O).....**32.95**

Corner Swabs: Removes dust build up in hard to reach areas. Includes 16 swabs. Available in Green Series (VIGCS) and Orange Series (VIOCS).....**26.95**

LENS CLEANING KITS



Dot Line Digital
Cleaning Kit
(DODCK)



Giottos
Modular Lens
Cleaning Kit
(GILCMK)



Kintronics
Digital Camera
Cleaning Kit
12 pack
(KIDCCK12P)



Giottos
Lens Cleaning Kit
(GILCS)



Hakuba Lens Cleaning
Set (HALCS)



Kintronics
Optics
First Aid Kit
(KIOFAK)



Giottos
Lens Cleaning Kit
with Small Rocket
Blaster (GILCK)



Hakuba Lens Cleaning
Kit (HALCK)



Zhumell
Cleaning Kit
(ZHCK)

Dot Line Digital Cleaning Kit (DODCK)
The Digital Cleaning Kit contains everything you need to keep the LCD screen on your digital camera clean. It includes a bottle of anti-static LCD cleaner, a micro-fiber cleaning cloth, a jumbo hurricane blower, and a retractable cleaning brush.....**14.95**

Hakuba Lens Cleaning Kit (HALCK)
Easily remove dust and fingerprints from your lens. The Lens Cleaning Kit comes complete with 30 sheets of lint-free lens cleaning paper, along with 30cc of optical-safe lens cleaning liquid.....**3.95**

Hakuba Lens Cleaning Set (HALCS)
Keep your lens dust free with the Hakuba Lens Cleaning Set. It comes complete with 30 sheets of lint-free lens cleaning paper, 30cc of optical safe lens cleaning liquid, a bulb-type blower brush, and a soft cleaning cloth**4.50**

Giottos Lens Cleaning Kit (GILCS)
One of the best ways to care for your lenses and equipment, this kit includes a retractable soft brush, a pack of 10 pointed-tip cotton swaps, a micro-fiber cleaning cloth and a bottle of environmentally-friendly, anti-static, anti-fog Multi Optical Cleaning Solution ..**8.95**

Giottos Lens Cleaning Kit with Small Rocket Blaster (GILCK)
One of the best ways to care for your lenses and equipment, this kit includes Giottos' small Rocket Air Blaster, a retractable soft brush, a pack of 10 pointed tip cotton swaps, a micro-fiber cleaning cloth and a bottle of lens cleaner.....**16.95**

Giottos Modular Lens Cleaning Kit (GILCMK)
A deluxe set of tools that helps you maintain all of your optical surfaces, including sensitive multi-coated lenses. It consists of a retracting, two-position goat's-hair brush in a metal case. The case has plastic, slide-on storage areas on either side that hold a soft large micro-fiber cloth. On the opposite side, a slide-on case holds a chamois stick cleaner pen with a lens fluid dispenser inside the stick.....**11.95**

Kintronics Digital Camera Cleaning Kit (KIDCCK)
A kit that provides the professional tools to clean lenses on digital cameras, camcorders, binoculars, etc. The kit contains a StaticWisk 7/8" Brush and an MFC microfiber optical cleaning cloth for removing dust and debris from critical surfaces.....**10.95**

Kintronics Digital Camera Cleaning Kit 12 pack (KIDCCK12P)
Contains 12 StaticWisk 7/8" Brushes and 12 MFC microfiber optical cleaning cloths...**99.95**

Kintronics Optics First Aid Kit (KIOFAK)
When you're on safari, on tour, or in the field, the Optics First Aid Kit will help you make sure that those irreplaceable photos are clear and sharp. It's like an insurance policy for quality images. The kit includes Precision Cleaning Solution, anti-static Tiger Cloth, StaticWisk 7/8" Brush and SpeckGrabber for removing specks from lenses**19.95**

Targus LCD Lens Cleaning Kit (TALCDK)
Easy-to-use cleaning set with fluid, and a microfiber cleaning cloth that easily removes grime, dust, and fingerprints. Excellent choice for LCD screens and other photographic items such as filters.....**7.95**

Zhumell Cleaning Kit (ZHCK)
Banish fingerprints and grime with this complete care kit. The compact unit includes a microfiber optical cleaning cloth, lens-cleaning fluid, a super-flexible lens brush with bellows, cleaning tissues, cotton swabs, and a water-resistant Vue-Thru plastic case.....**14.95**

GENERAL ACCESSORIES

BLOWER BRUSHES

Rubber Blower Brushes

Rubber bulb type with protective sleeve. Helps clean lint and dirt from negatives and camera parts without scratching or smudging.

- Small Blower Brush (GBBBS)**3.59
- Medium Blower Brush (GBBMM)**3.99
- Large Blower Brush (GBBBL)**4.95

Medium Rubber Blower Brush with Sliding Tube and Cap (GBBB)

With a sliding tube and protective cap to cover the brush when not in use.....5.95

Giottos Rocket Air Blowers

Made from silical gel, these powerful, tear-proof blowers are resistant to both high and low temperatures. The unique rocket-shaped design allows it to stand upright, and its removable nozzle can be removed and stowed. An air valve prevents back-flow and blows dust away with a powerful stream of air. Includes a neck strap.

- Rocket Air Blower (GIBAM):** 6.6" long9.95
- Rocket Air Blower (GIBAL):** 7.5" long11.95
- Rocket Air Blower (GIBAS):** 5.3" long.....9.95

Giottos Q-Ball Air Blower (GIBAQB)
The Q-Ball features a super air stream with an adjustable angle air nozzle, and a unique tripod base design that allows it to stand by itself. It handily and safely blows off dust particles, even those attracted by static electricity. The inlet valve prevents back-flow from the air tube.....14.95



Hakuba Blowers and Blower Brushes

Made from natural rubber for easy handling and pinpoint accuracy, these blowers and blow brushes remove lint and dust from hard to reach places. Essential for cameras and optics, they are also ideal for maintaining computer, audio and other electronic equipment.

- Hurricane Blower (HABHQ):** 5.25" x 2"5.95
- Super Blower Medium (HABSM):** 5.5" x 2"6.95
- Super Blower Large (HABSL):** 6" x 2.5"8.95
- Blower Brush Deluxe Small (HABBS):** 3.75" x 1.75" x 1.25"4.95
- Blower Brush Deluxe Medium (HABBM):** 4.75" x 2.25" x 1.5"5.95
- Blower Brush Deluxe Large (HABBL):** 5.75" x 2.5" x 1.75"6.95

Kaiser Blower Brushes

Blower brushes take up little space, and are the all-purpose and gentle method for removing loosely deposited dust and fluff. The large rubber blower bulb is available with a flat brush (KABBF) or a round brush (KABBR).....9.95

Kaiser Lens Brush (KABLS)

A lipstick-style brush in a plastic tube that features a twist mechanism9.95

VisibleDust Hurricane Blower (VIHB)

A top-quality, heavy-duty blower bulb that produces an optimum blowing effect through its double valve system. It effectively "brushes" away unwanted dust from your sensors, lenses, or other sensitive equipment with a gentle blast of clean air.....11.95

HAKUBA LENS PEN

Perfect for cleaning lenses, binoculars, scopes and other optical equipment. The LensPen has a handy retractable dust removal brush and a special non-liquid cleaning element, that is designed to never dry out. Safe and very easy to use, it's unique cleaning technology outperforms the most advanced microfiber cloths by getting into nooks and crannies, leaving a sparkling shine over 100% of the lens surface.



LensPen MiniPRO

LensPen (HAPLC)
5.75" x 2.5" x 1.75". Recommended for lenses 13mm in diameter and higher9.95

LensPen MiniPRO (HAPLCMPQ)
Designed for smaller optical lenses, the MiniPRO's tip can reach very small areas around the lens surface. Recommended for lenses between 7mm - 13mm in diameter.....9.95



LensPen

BRUSHES AND CLEANING CLOTHS

Cleaning Solutions

ROR Residual Oil Remover (RORR20)

Residual Oil Remover is a lens cleaner that aims specifically to remove microcarbon residue which is present on the surface of a lens. Although invisible to the naked eye, when removed from the lens it provides a remarkable change and a significant light entry increase (up to 3/4 of an f-stop, in most cases). 2 oz spray bottle**6.95**

Zeiss Liquid Cleaner (ZELC)

A 3 oz. pump spray bottle of high-tech, ammonia-free formula cleaner, that safely and quickly cleans all multi-coated lenses and optics, especially those with Zeiss multi reflective coatings**4.95**



Cleaning Cloths

Clearsight Lens Cleaning Cloth (CLLC88)

Made of 20% polyamide and 80% polyester, this washable, 100% lint-free 8" x 8" thin micro-fiber cleaning cloth has the look and soft feel of suede to assure a firm grip and good cleaning control.....**4.95**

Falcon Dust-Off**Luminex Cleaning Cloth (FALC)**

The high-tech way to clean multi-coated lenses. Its 220,000 microfibers per square inch easily lift away dirt, grease and dust. This washable and reusable 7.5" x 7.5" cloth is 100% lint-free**5.95**

Hakuba SuperKnit

SuperKnit is a microfiber cloth designed to remove not only dust and lint but also difficult to clean smudges and oil based spots. Uses no chemicals and will not scratch or mark polished surfaces. Washable and reusable, it offers superior cleaning power for the care of digital, and traditional cameras and lenses.

Small SuperKnit (HACCSS)

6.3" x 7.8"**4.95**

Medium SuperKnit (HACCMS)

9.5" x 11.8"**7.95**

Hakuba UltraKnit Polishing/Cleaning Cloth

Superior cleaning power for the care of digital, and traditional cameras and lenses. It is also perfect for cleaning CDs, monitors, jewelry, crystal and most other polished surfaces. Washable and reusable.

Small Cloth (HACCUS)

7.5" x 7.5"**9.50**

Medium Cloth (HACCUM)

11.8" x 11.8"**13.95**

Hoodman Hoodwipes (HOHW1)

A pack of 12 specially-treated wipes for safely cleaning digital LCD screens. These super safe non-static moist screen wipes will wipe away smears and finger prints and keep the display dust-free.**10.99**

Kodak Lens Cleaning Paper (KOLT)

A clean camera is critical for sharp, clear pictures. This soft, absorbent 3" x 5" paper is safe for use on the finest lenses, It is lint-free and chemically pure. Contains 50 sheets.....**1.99**



Leland
PowerClean MiniCloth

Clearsight Lens
Cleaning Cloth

Leland PowerClean MiniCloth (LEMC)

A super-soft synthetic 6.5" x 6.5" micro-fiber cloth. Safely and effectively wipes, contamination, dirt, and even finger oil from a variety of coated and non-coated optical surfaces, including CD's, lasers, lenses, and even eyeglasses**4.95**

Photographic Solutions E-Wipe Professional Cleaning System (PHEW)

These soft, pre-moistened cleaning pads are safe for all kinds of optical glass - lenses, filters, - even imaging sensors. E-Wipes combine an ultra-pure lint-free wipe and a precise pre-measured amount of an ultra-pure, highly refined alcohol mixture. Recommended by manufacturers of digital cameras, scanners and other devices with critical cleaning requirements. (25 packets)**23.95**

Spudz Micro Fiber Cleaning Cloth

A small micro fiber cleaning cloth that is perfect for photographers, birders, and any one who needs to clean their optics in the field, it has a convenient pouch and hook design that allows you to attach, and keep the cloth where you want. Available in Black (SPSPB) and Blue (SPSPBL) colors**4.95**

VisibleDust Magic Cleaner**Microfiber Cloth (VIMC)**

Magic Cleaner microfiber cloth is produced from ultra-fine 0.1 denier microfibers for optimum softness and density. It absorbs dirt, grease and moisture more effectively than natural chamois leather, leaving a spot-free finish without scratching.....**9.95**

Zeiss Pre Moistened Lens Cloths (ZECT)

Pre-moistened, non-abrasive lens cloths safely and quickly clean any lens. The high-tech ammonia-free formula cleans effectively without leaving streaks or residue. Clean smudged and dirty lenses at your convenience with this handy package of 21 individual packets**6.95**

GENERAL ACCESSORIES

CLEANING SOLUTIONS AND SWABS

Brushes

Photographic Solutions BRUSHOFF

Sensor Cleaning Brush (PHBHTSCB)

A high-tech sensor brush with a unique blend of fibers that neutralizes charged dust particles AND the sensor surface to prevent further dust attraction. Although the brush head is remarkably soft, the brush core is entirely electronically conductive, through an ingeniously designed grounding plug**49.95**

Delta 1" Camel Hair Brush (DEBCH1)

The photo standard for 50 years, this brush will clean your optics, lenses and other photographic equipment. It's safe, ultra soft, and will last for years.....**13.99**

Delta 2" Camel Hair Brush (DEBCH2)**17.49**

Kinetronics StaticWisk Lens Brushes

StaticWisk hand-held anti-static brushes are used for cleaning lenses, films, cameras, glass, monitors and technical equipment. The unique blend of soft natural hairs and conductive synthetic fibers plus the conductive nature of the construction result in effective static dissipation. Dust and lint are whisked away. Brushes are available in 1/4" to 4" widths.

StaticWisk 1/4" Brush (KIB14)

Includes vinyl pouch with lanyard**24.95**

StaticWisk 7/8" Brush (KIB34): With carrying case....**6.95**

StaticWisk 1.25" Brush (KIB1.25)**12.99**

StaticWisk 2.5" Brush (KIB2.5).....**19.95**

StaticWisk 4" Brush (KIB4)**24.95**



Swabs

Photographic Solutions

Sensor Swabs (Type 1) (PHSS12)

Designed for cleaning the imaging sensor (CMOS or CCD) on Kodak DCS; Fuji S1, S2, S3; Canon 1D, 1D Mark II; and Sigma SD-10 SLR digital cameras. Pack of 12 swabs.....**45.95**

Photographic Solutions

Sensor Swabs (Type 2) (PHSS12ND1)

Designed for cleaning the imaging sensor on Nikon D1, D1H, D1X, D100, D70, D2H/s, D2X; Canon D30, D60, 10D, 20D, Digital Rebel, Digital Rebel XT; Pentax *ist D, *ist DS; Olympus E-1; and Konica Minolta 7D digital cameras. Pack of 12 swabs.....**45.95**

Photographic Solutions

Sensor Swabs (Type 3) (PHSS312)

Designed for cleaning the imaging sensor on Kodak 14n, SLR/n, SLR/c; Canon 1DS; and Leica Digital Modul-R digital SLR cameras. Pack of 12 swabs**45.95**

Giottos Cotton Swabs (GICS25)

Made from 100% cotton with a blunt end and a pointed end for cleaning corners. Any dirt or dust remaining in the corners is easily removed. Pack of 25 swabs**0.95**

Giottos Cotton Swabs (GICS50)

Same as above in a pack of 50**1.50**

KINETRONICS SPECKGRABBER

SpeckGrabber Pro (KISGP2P): Facilitates the removal of dust "specks" from film and transparencies, lenses, CCDs, SLR mirrors, imaging devices, and other delicate surfaces. A small, soft washable pad on the end provides a high adhesion surface that, when put in contact with the particle, adheres to the particle, leaving no residue on the contacted surface. Comes with a SpeckGrabber Pro handle and two cleaning pads. 5 3/4" length**8.95**

SpeckGrabber Pro Kit (KISGPK): Includes a SpeckGrabber Pro handle with three SpeckGrabber tips, Precision Cleaning Solution and an anti-static Tiger Cloth.....**17.50**

SpeckGrabber Pro with Light Kit (KISGPLK): See and capture small specks of dust more easily. The handle of this SpeckGrabber contains a small flashlight with a receptacle for inserting the SpeckGrabber tip. The kit includes a AAA battery, three tips, a 1 oz. spray bottle of Precision Cleaning Solution, a 10" x 18" anti-static Panther cloth, and a sturdy storage box.....**19.95**

SpeckGrabber XL (KISGXL): Similar to the SpeckGrabber Pro, but 11 1/4" length.....**9.95**

SpeckGrabber XL Dust Remover Tool Kit (KISGXLK): Includes a SpeckGrabber XL handle with three SpeckGrabber tips, Precision Cleaning Solution and an anti-static Tiger Cloth**19.95**



POP-UP SHADES

LCD Screen Protective Covers/Glare Guards

Pop-Up Shades are LCD screen protective covers, which also double as glare guards. These sturdy and lightweight covers are easily installed (and removed), but most importantly help to protect a digital camera's expensive LCD screen. Flipped up with the flick of a finger, the shade provides easier viewing of the display in bright sunlight. The cover pops up to form a three sided canopy over the LCD to diminish glare and folds right back down when you're finished. Even with the shade flipped up an optically clear plastic guards the LCD preventing damage to the screen. Pop-Up Shades are available in both snap-on and stick-on design. Snap-on shades hook onto the grooves of your camera while stick-on shades attach to the camera with a non-residue adhesive that keeps the camera finish smooth and clean.

Unlike other "one size fits all" LCD hoods out on the market, Delkin's Pop-Up Shades are designed for specific digital SLR camera models. In addition, the Universal Pop-Up Shades fit hundreds of point-and shoot camera models, giving you the best option for finding a shade that works perfectly for your camera.



Snap-On Pro Pop Up Shades -

The DSLR Professional attach to your camera using the existing eye piece and slots around the display. It easily snaps on and off, and features an optically clear plastic to protect your camera's screen. The simple pop-up design allows for easy opening to block the glare. Buttons on the Professional shades are aligned with your camera to reduce the wear and tear on delicate parts and components.



Snap-On Pro Pop Up Shades for...

Canon EOS 1D Mark II (DC1DM2P)	39.95
Canon EOS 1Ds Mark II (DEDC1DSM2P)	39.95
Canon EOS 1D Mark II N (DEDC1DM2NP)	39.99
Canon EOS 5D (DEDC5DP)	39.95
Canon EOS 10D (DEDC10DP)	39.95
Canon EOS 20D (DEDC20DP)	39.95
Canon EOS 30D (DEDC30DP)	28.95
Canon EOS Digital Rebel (DEDC300DP)	39.95
Canon EOS Digital Rebel XT (DEDC350DP)	39.95
Canon EOS Digital Rebel XTi (DEDC400DP)	39.95
Fuji Finepix S3 (DEDFS3P)	39.95
Minolta Maxxum 5D (DEDKM5DP)	39.95
Minolta Maxxum 7D (DEDKM7DP)	39.95
Nikon D2X (DEDND2XP)	39.95
Nikon D50 (DEDND50P)	39.95
Nikon D70 (DEDND70P)	39.95
Nikon D70s (DEDND70SP)	39.95
Nikon D80 (DEDND80P)	34.95
Nikon D100 (DEDND100P)	39.95
Nikon D200 (DEDND200P)	39.95
Olympus E300 (DEDOE300P)	39.95
Olympus E500 (DEDOE500P)	31.95
Pentax *ist DL (DEDPISTDLP)	31.95
Pentax *ist DS (DEDPISTDSP)	39.95
Sony Alpha 100 (DSA100P)	CALL



Standard Snap-On Pop Up Shades -

The Digital SLR Standard simply snaps on the back of most popular digital SLR cameras. An optically clear plastic protects your camera's screen, and the hard impact plastic leaves less chance of scratching or breaking your display. The simple design of the shade allows for easy opening to block the glare.

DSLR Stick-On Pop-Up Shades -

The DSLR Mini Pop-Up Shade is distinct from the other SLR Pop-Up Shades as it attaches to your camera with a non-residue adhesive. The adhesive does not damage the camera when the shade is removed, nor does it leave behind any film. An optically clear plastic protects your camera's screen, and the simple pop-up design allows for easy opening to block the glare. The unique two-part design enables easy removal of the shade while keeping the clear plastic in place for protection.



Universal & Point-&-Shoot Pop-Up Shades -

The Universal Pop-Up Shade is designed to fit hundreds of cameras, both new and old. Like the DSLR Mini, the Universal shade attaches to your camera by a non-residue adhesive. The adhesive does not damage the camera when the shade is removed, nor does it leave behind any film. An optically clear plastic protects your camera's screen, and the simple pop-up design allows for easy opening to block the glare.

The two-part design enables easy removal of the shade while keeping the clear plastic in place for protection. This shade is perfect for those with a Point-and-Shoot camera.

Standard Snap-On Pop Up Shades for...

- Canon EOS 1D Mark II (DEDC1DM2S).....**29.95**
- Canon EOS 1Ds Mark II (DEDC1DSM2S).....**29.95**
- Canon EOS 1D Mark II N (DEDC1DM2NS)**23.95**
- Canon EOS 5D (DC5DS), EOS 10D (DC10DS), EOS 20D (DC20DS), EOS 30D (DC30DS)**29.95**
- Canon EOS Digital Rebel (DEDC300DS)**29.95**
- Canon EOS Digital Rebel XT (DEDC350DS)**29.95**
- Canon EOS Digital Rebel XTi (DEDC400DS) ...**29.95**
- Fuji Finepix S3 (DEDFS3S)**29.95**
- Maxxum 5D (DEDKM5DS).....**29.95**
- Minolta Maxxum 7D (DEDKM7DS)**29.95**
- Nikon D1X (DND1XS), D1H (DND1HS)**29.95**
- Nikon D2HS (DND2HSS), D2X (DND2XS).....**29.95**
- Nikon D50 (DND50S), D70 (DND70S).....**29.95**
- Nikon D70s (DND70SS), D80 (DND80S).....**29.95**
- Nikon D100 (DND100S), D200 (DND200S).....**29.95**
- Olympus E300 (DOE300S), E500 (DOE500S)**29.95**
- Sony Alpha 100 (DSA100S).....**CALL**

Stick-On Pop-Up Shades for...

- Canon EOS 5D (DEDC5DP)**39.95**
- Canon EOS 20D (DEDC20DD).....**24.95**
- Canon EOS Digital Rebel (DEDC300DD).....**24.95**
- Canon EOS Digital Rebel XT (DEDC350DD) ...**24.95**
- Minolta Maxxum 5D (DEDKM5DD)**24.95**
- Nikon D2X (DEDND2XD)**24.95**
- Nikon D50 (DEDND50D), D70 (DEDND70D)**24.95**
- Nikon D70s (DEDND70SD)**24.95**
- Nikon D100 (DEDND100D) **24.95**
- Nikon D200 (DEDND200D).....**24.99**

Pop-Up Shades for...

- For 1.8" LCDs - Silver (DEDU18M)**19.95**
- For 2.0" LCDs - Silver (DEDU20M)**19.95**
- For 2.5" LCDs - Silver (DEDU25M)**19.95**
- For 3.0" LCDs - Silver (DEDU30M)**19.99**
- For 1.8" LCDs - Black (DEDU18MBLK)**19.99**
- For 2.0" LCDs - Black (DEDU20MBLK)**19.99**
- For 2.5" LCDs - Black (DEDU25MBLK)**19.99**
- For 3.0" LCDs - Black (DEDU30MBLK)**19.99**

INVISIBLESHIELD

Scratch-Proof Protective Film



Protect your digital camera's LCD screen from scratches and dings forever with the ultimate in scratch protection. invisibleSHIELD comes with a lifetime guarantee, which means that if your invisibleSHIELD ever gets scratched up, they'll replace it. For FREE. For LIFE. Now that's protection! Pay once, protect forever.

The invisibleSHIELD is the toughest, most durable gadget scratch protection film available on planet Earth. The film has its origins in the U.S. military, where it was used to protect the leading edges of helicopter blades from wear and tear while traveling hundreds of miles per hour. The proprietary film is a clear, urethane plastic (invisible, invincible) with unique properties that allow it to provide self-healing qualities and unparalleled abrasion resistance. The film's flexibility allows Shield Zone to custom design the invisibleSHIELD to "wrap" around an entire device, including the screen, front, back, edges, corners and sides.

Other clear "screen protectors" are often disposable, hard, plastic pieces that scratch very easily and have problems adhering. Others may claim to have a similar product, but it is NOT the same thing.

Nothing compares to the quality of the invisibleSHIELD combined with their Lifetime Replacement Guarantee!

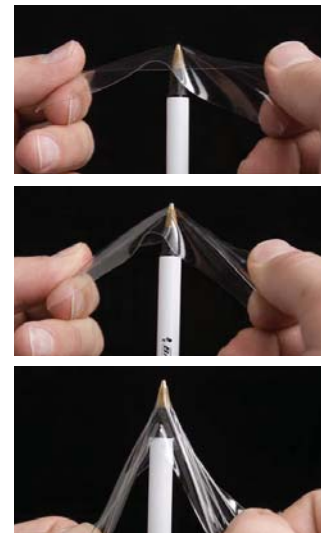

For Canon

- EOS 10D (SHLSSCE10D), EOS 1D IIN (SHLSSCE1DIIN), EOS 1D Mark II (SHLSSC1DMII), EOS 20D (SHLSSCE20D), EOS 300D Digital Rebel (SHLSS300DDR), EOS 30D (SHLSSCE30D), EOS 5D (SHLSSCE5D), EOS Digital Rebel (SHLSSCEDR), EOS Digital Rebel XT (SHLSSCEDRXT), Powershot G6 (SHLSSCPG6), Powershot SD30, SD40/SD45 (SHLSSD30404), SD400 (SHLSSCPD400), SD450 (SHLSSCPD450), SD500 (SHLSSCPD500), SD550 (SHLSSCPD550), SD600 (SHLSSCPD600), SD630 (SHLSSCPD630), SD700IS (SHLSSPD700I).....**9.95**

For Casio

- Exilim EX-Z500 (SHLSSCEXZ500), EX-Z55 (SHLSSCEZ55), EX-Z750 (SHLSSCEXZ750)**9.95**

For Fuji

- Finepix E550 (SHLSSFFE550), F10 (SHLSSFFF10), S3100 (SHLSSFSS3100), S9500 (SHLSSFFS9500)**9.95**

For Panasonic

- Lumix DMC-LC80 (SHLSSPLDMCLC), Lumix DMC-FZ7 (SHLSSPDMCFZ7)**9.95**

For Nikon

- D200 (SHLSSND200), D2H & D2HS (SHLSSND2HS), D2x (SHLSSND2X), D50 (SHLSSND50), D70 (SHLSSND70DSL), D70S (SHLSSND70S)**9.95**

For Sony

- Cybershot DSC-N1 (SHLSSDSCP200), DSC-S60 (SHLSSCDSCS60), DSC-T70 (SHLSSSDSCT7), DSC-W100 (SHLSSDSCW100), DSC-W50 (SHLSSSDSCW50), HDR HC1 (SHLSSHDRHC1).....**9.95**

For Digital Cameras with...

- 1.8" display (SHLSSDC1.8), 2" display (SHLSSDC2) 2.5" display (SHLSSDC2.5), 3" display (SHLSSDC3), 3.5" display (SHLSSDC3.5).....**9.95**

FLIPUP LCD CAPS

Protective Caps which flip up into 3-Sided LCD Hoods

The FlipUp LCD Cap clips into place by slipping the manufacturer's original eye piece up and off the camera. Next slide the FlipUp cap over the eyepiece mounting flanges to cover the entire LCD screen. (On Nikon and Fuji cameras, clips into place just like the OEM cap that came with the camera). The cap provides protection for the delicate LCD screen when in closed position. The cap flips up into a three sided hood for improved outdoor viewing. A great investment in LCD screen protection and performance.



FlipUp LCD cap shown on Nikon D2HX

For Canon EOS Digital Rebel (HOHREBEL)	29.95	For Nikon D40/40x (HOHD40)	29.95
For Canon EOS Digital Rebel XT (HOHRXT)	29.95	For Nikon D50 (HOHD50)	28.95
For Canon EOS Digital Rebel XTi (HOHRXTi)	29.95	For Nikon D70 and D70s (HOHD70S)	28.95
For Canon EOS Digital 10D and 20D (HOH20D)	29.95	For Nikon D80 (HOHD80)	29.95
For Canon EOS Digital 5D (HOHC5D)	29.95	For Nikon D100 (HOHD100)	29.95
For Canon EOS Digital 30D (HOH30D)	34.95	For Nikon D200 (HOHD200)	29.95
For Fuji S3 (HOS3)	28.95	For Nikon D2xs and D2Hs (HOHD2HX)	29.95
For Minolta 5D (HOHM5D)	29.95	For Sony DSRL-A100 (HOHA100)	29.95

H-DCR

Rubber Hood with Magnifier

The H-DCR rubber hood turns your digital camera's LCD screen into a viewfinder. The rubber hood universally mounts to all digital cameras with LCD screens of 1.5 to 1.8" in size. Simply strap the H-DCR hood in place over your LCD screen for optimum outdoor glare free viewing. Utilizes a 2X magnifier to allow close focus on the LCD screen. The hood collapses into itself for compact storage.

H-DCR Rubber Hood (HOHDCR).....17.95

HCD-1 LCD Cover

The Hoodman Clear Protective LCD Cover is designed for Nikon D1, D1x and with an optically clear Hoodcap in place, your LCD screen is always protected from scratches, dirt and skin oil.



HCD-1 LCD Cover (HOHCND1)

H-RAV Universal Right Angle Finder

The H-RAV fits all Canon, Nikon, and Fuji and Olympus digital SLR cameras. No need to crawl on your belly to line up an off the deck shot. H-RAV features include a built in diopter with a 1x and a 2.5x capability, full 360° rotation and 4 mounting attachments to provide universal mounting. Compact, protective storage case included.

H-RAV Professional Right Angle Viewfinder (HOHRAV)119.95



HoodLoupe Professional LCD Screen Loupe

Professional is worn around your neck just like a normal loupe. When it is time to review your shot; bring HoodLoupe up to your image and place your eye up to the eye cup for complete glare free viewing. HoodLoupe isolates the camera's LCD display from ambient light so you won't be distracted by glare or shadows, and the 2x magnification makes it easy to view image details quickly to confirm focus and other image details to ensure that you have the best image possible.

HoodLoupe has a ±3 diopter to accommodate those with less than perfect vision. It adjusts focus just like a binocular eye piece... you turn the eye piece in or out to set for your vision. Minimal magnification is used to eliminate visual pixilation of your image. Each HoodLoupe is encased in a user friendly rubber for comfort and protection from bumps that will occur throughout your shoot. Includes comfortable lanyard and compact protective storage case.



H-LPP Professional LCD Screen Loupe (HOHLPP).....64.95

WhiBal/PhotoVision/ExpoImaging

WHITE BALANCE CALIBRATION

WhiBal

G6 Reference Cards

The WhiBal Generation 6 (G6) RAW Reference Card is a simple-to-use standard for setting white balance in all RAW converters, as well as image editors such as Adobe Photoshop. The light & easy to handle single-card format eliminates a need to fan out reference cards, thereby speeding reference capture



G6 Reference Cards & Accessories

G6 Pocket White Balance Card (3.5 x 2") (WHWBCKP)	29.95
G6 Studio White Balance Card (6 x 3.5") (WHWBCKS)	36.95
G6 Reference White Balance Card (11 x 8.5") (WHSLRBC)	49.95
G6 Combo Pocket / Studio White Balance Card Kit (WHWBCKK)	59.95
G6 Trio Pocket/Studio/Reference White Balance Card Kit (WHWBCTK)	99.95
SLR (Spring Loaded Retractor) with Spring Clip Mount (WHSLRSC)	19.95
SLR (Spring Loaded Retractor) with Belt Clip Mount (WHSLRBC)	21.95

PhotoVision

One Shot Digital Calibration Target



Neutral 3-Tone Panels allow for custom white balancing, accurate metering and exposure monitoring through the camera's histogram function all with a single shot. Vastly improves setup time over the original design, minimizing the need for post correction to your image files.



By using the Digital Calibration Target, you can achieve perfect exposures and white balance every time. Collapsible reflector style frames fold to one third of their open size & fits into camera bags.

14" Pocket One Shot Digital Target (PHDT14)	49.95
24" One Shot Digital Target (PHDT24)	77.95
34" One Shot Digital Target (PHDT34)	99.95
Digital Calibration Utility Kit (Includes CD) (PHDTB)	174.95

ExpoImaging ExpoDisc Digital White Balance Filters

Spend more time shooting and less on workflow

- Convenient, Fast and Easy-to-Use
- Works in Mixed & Difficult Lighting
- Reclaim Time Spent Correcting Color
- Replaces Gray and White Cards

The ExpoDisc Neutral Filter

A custom white balance filter that allows digital photographers to quickly and easily set an accurate custom white balance.

Consistently producing excellent results in natural, artificial, and studio lighting, the versatile ExpoDisc even excels in difficult mixed lighting environments.

Neutral or Portrait White Balance Filter

58mm White Balance Filter (EXWB58)	79.95
62mm White Balance Filter (EXWB62)	84.95
67mm White Balance Filter (EXWB67)	89.95
72mm White Balance Filter (EXWB72)	94.95
77mm White Balance Filter (EXWB77)	99.95
82mm White Balance Filter (EXWB82)	104.95
4x4" White Balance Filter (EXWB44)	159.95

The ExpoDisc Portrait (Warm) Filter

Designed specifically for portrait photographers, it enhances and accentuates healthy skin tones. Rather than producing an image file with neutral whites, the filter first neutralizes, then enhances the image with a subtle warming effect. Effectively add pleasing red tones to the entire image, producing an image with subtle red highlights in the hair and skin.

Neutral or Portrait (Warm) Balance Filter

58mm Warm Balance Filter (EXWB58Q)	79.95
62mm Warm Balance Filter (EXWB62Q)	84.95
67mm Warm Balance Filter (EXWB67Q)	89.95
72mm Warm Balance Filter (EXWB72Q)	94.95
77mm Warm Balance Filter (EXWB77Q)	99.95
82mm Warm Balance Filter (EXWB82Q)	104.95
4x4" Warm Balance Filter (EXWB44Q)	159.95



ExpoCap White Balance Filter

Each ExpoCap is constructed of a durable black aluminum ring mount securing an assembly of carefully selected photographic materials. It is designed to fit over the end of the lens during the custom white balance procedure. If you desire consistently better color, but don't need the precision of the hand calibrated ExpoDisc, then the ExpoCap is an affordable alternative that's just as easy to use

52mm ExpoCap Filter (EXECWB52)	44.95
58mm ExpoCap Filter (EXECWB58)	49.95
67mm ExpoCap Filter (EXECWB67)	54.95
77mm ExpoCap Filter (EXECWB77)	59.95

ZIGVIEW

ZIGVIEW-B



Digital Angle Finder for Digital SLR Cameras

The Zigview-B Digital Angle Finder makes low and high level photography easy with its unique rotating LCD monitor. It simply attaches to the eyepiece of your SLR camera where the viewfinder image is captured by a CMOS sensor built into the Zigview and relayed in real time to a 1.9" TFT color display for easy viewing at any angle. The Zigview-B is particularly useful for low angle photography where you would struggle to see through the viewfinder like

with macro photography or high angle situations where it is impossible to see the subject when taking pictures over crowds.

- ◆ Rotate the LCD of the Zigview-B a full 360° so you can use it for low-level shots without bending over or lying on the ground; macro shooting at any angle; high-angle shots over crowds; or use it as a waist level viewfinder to take more intimate portraits.

- ◆ The Zigview-B includes eyepiece adapters to fit almost almost any Canon, Nikon and Fuji digital cameras. Additional adapters are available for Pentax and Sony/Minolta as well.

Zigview-B Digital Angle Finder (ZISCV100B)229.95

Zigview R2 Twin1 Transmitter/Receiver Sets

Provides both wired and wireless (infrared) remote trigger capabilities to most Canon and Nikon digital SLR cameras. They are simple to install, and the compact size of the receiver will not interfere with other camera functions.

- ◆ Compact receiver with dual side sensor (front and back)
- ◆ LED operation indicator on receiver
- ◆ Supports instant shutter and delay shutter
- ◆ Supports half shutter for AE/AF in both wired and wireless mode

R2-SRN Twin1 Transmitter/Receiver Remote Release Set: For Nikon SLR (ZIR2SRN) and Canon SLR (ZIR2SRC) Digital Cameras.....79.95

ZIGVIEW-R

Digital Angle Finder with TLL Motion Sensor Shutter Release and Interval & Exposure Timer for Digital SLR Cameras

The Zigview-R incorporates all of the features of the Zigview-B with its unique rotating angled TFT color display, showing the viewfinder image on the screen for low and high angle photography and other situations where you normally wouldn't be able to see through the viewfinder or simply where it is more convenient providing a "Waist Level Finder" style of approach.

However, the Zigview -R also offers electronic shutter release capability. The features built into the Zigview-R can be used in a variety of situations to control the shutter; when motion is detected with its 9-area motion sensor, using the sophisticated interval timing facility, using the Bulb exposure timer or simply as a remote cable release. With timer and motion detection release features, you'll be able to set up your SLR for all kinds of specialty applications including time-lapse photography, surveillance, wildlife and game tracking, timer delayed photography, and much more.



Step-up Features from the Zigview-B

Motion Sensing Trigger: The Zigview-R can be programmed to initiate a shutter release when small variations in the brightness level in 9 areas of the LCD screen indicate that there is movement in the image. Variable sensitivity allows for each of these 9 areas to have independent sensitivities set by the user or some areas can have their sensing turned off to allow movement in these areas of the image, or you can select to use the whole image as one sensor area instead of the 9 separate areas. Motion sensing capability isn't restricted by distance or angle of view since it is sensing movement from the image projected through the lens of your camera. Therefore you can use the most extreme wide angle or telephoto lenses - whether you are trying to capture an image of a train 5 miles away, a bee on a flower 6" from your camera, or a deer crossing a clearing, the Zigview-R will still look for movement over the whole viewable area.

ZIGVIEW

ZIGVIEW-R

Camera Wake Up Time & AF Time Compensation:

Since all SLR cameras are different the Zigview-R can be programmed to allow a user set period of time for the camera to "Wake up" if it has gone into sleep mode, and to focus if in AF mode BEFORE the shutter is triggered. This delays the shutter release time for a small period to allow your camera to wake and focus, rather than firing a signal to the shutter at the instant the motion is detected which could then be missed as the camera cannot start quickly enough.

Works with most SLR Cameras:

Includes eyepiece adapters that fit most Nikon, Fuji and Canon cameras, and additional adapters are available for other camera systems including Sony/Minolta and Pentax. The included RC01 Shutter Release Cable works with select Canon and Pentax digital cameras, and additional shutter releases cable are available for other camera systems including Nikon and Fuji.

Timer Release Features:

A number of timer features are available in the Zigview-R for specialty applications including:

- ◆ Countdown so users can choose to start the motion sensor feature after a pre defined period of up to 24 hours.
- ◆ Alarm where a start time and date can be programmed to any year, month & day & time.
- ◆ Motion Detection Interval where the interval between motion detections can be varied to longer periods in order to detect the motion of slow moving subjects, or shorter periods to detect fast moving subjects.
- ◆ Multiple exposures per motion detection to capture several exposures per motion trigger at minimum intervals of 0.5s apart.
- ◆ Interval Timing where the camera continues to shoot at a specified interval (with simple settings using number of shots required and the interval between shots, or more detailed settings can be specified).

Zigview-R Digital Angle Finder for SLR Cameras (Film and Digital) (ZISCV100R)279.95

ZIGVIEW S2

Digital Angle Finder for Digital SLR Cameras

The Zigview S2 is a unique Live preview monitor which relays a real time image from the viewfinder to the 2.5" TFT LCD display with a high 25fps frame rate giving a quality video image, with a screen which can be rotated and swivelled into any position for convenient viewing. The screen can also be detached from the camera module using the RV01 and RV02 extension cables allowing remote viewing from up to 10 meters away from the camera with a convenient shutter release button for triggering the shutter while also retaining the Motion Sensing and Interval Timing facilities.



Zigview S2
Item # ZIS2

- ◆ The 2.5" TFT screen of the Zigview S2 can also be used away from the camera using the Remote Video cables and extensions, allowing the photographer to view the field of view from the camera at a distance of up to 10 meters away.
- ◆ The detachable screen has a shutter release button for firing the camera shutter, and can be used in conjunction with Interval Timing and Motion sensing making it the perfect accessory for wildlife applications, surveillance as well as extreme high level photography with the camera located on a pole. When detached the screen also incorporates the TV output function so an additional monitor can be used for viewing a larger image or a video/DVD player can be connected to record the subject in real time, while the camera captures high resolution stills.
- ◆ The unit incorporates a sophisticated Motion Sensor which will trigger the shutter automatically where motion is detected in any of 9 areas of the viewfinder image, regardless of distance or angle of view, with threshold settings for sensitivity based on brightness/contrast changes in the subject area.
- ◆ Interval timing can be performed with simple settings using number of shots required and the interval between shots, or more detailed settings can be specified to take shots over a particular duration with a specified number of shots, a duration and specific interval time or interval time and number of shots. The unit can also be programmed to take into account the AF time of your camera, wake the camera up from sleep mode and start after a particular duration. You can even take multiple exposures per duration and use bulb exposures.

CAMERA ARMOR

The Toughest Protection for Your Camera

Your camera is most likely to be damaged when it is being used. Camera Armor is not only the toughest protection for your camera, it is the only choice for full-time protection. Rubberized comfort for ergonomic shooting, each case is designed to fit your camera like a glove. So you are shielded while you shoot. The rugged Camera Armor is always on your camera protecting it from scratches, dirt and drops, while leaving you in full control of the creative process. All controls and access points are accessible and you can use your camera at a moments notice. No more missed photographs trying to get your camera out of its case. Corners and lenses protected by impact resistant material, every Camera Armor package includes a custom designed and crystal clear polycarbonate LCD cover; this is the same material that is used in bullet proof glass. It also includes a Lens Guard to it most lenses up to 85mm, and a lens cap leash.



Each Camera Armor package includes:

- ◆ **Body Armor** – the main shock and scratch protection for your camera body
- ◆ **Lens Armor** – the lens hood and impact bumper for your lenses. The elastomeric reversible hood stretches over most lenses with 52mm-82mm front filter size.
- ◆ **The LCD Shield** – crystal clear polycarbonate shield covers the camera's LCD, and ensures that the most fragile area of your digital SLR can take some serious abuse. Camera armor will works with existing LCD protection if you have it on your camera.
- ◆ **Lens Cap Leash** – handy elastic leash attaches directly to your lens cap with a self -adhesive patch and to a convenient loop on the Lens Armor, so you don't lose any more lens caps.



ToughStrap Shoulder Strap

The Camera Armor ToughStrap Shoulder Strap is designed to protect your investment wherever you go. It is a slash-proof strap, thanks to embedded stainless steel wire, with a breaking strength of over 3000 lbs, so you don't need to worry about your camera getting away from you. The ToughStrap allows you to suspend the camera on the ergonomic neoprene shoulder strap that adjusts from 30" to 50" to fit any body shape or position.

SafeGrip Hand Strap

The Camera Armor SafeGrip Hand Strap locks the camera securely in your hand as you work and is easy to adjust while improving your ability to hold your camera - such that the camera will almost feel like an extension of your arm. The SafeGrip strap may be used with a shoulder strap, or attached directly to the camera with the hardware included. The mesh-backed strap helps keep your hand cool, and the reflective trim adds a splash of color even in the dark.



PRICING

For Canon EOS 30D: In Black (CACAC30DB) or Smoke (CACAC30DS) ..	49.95
For Nikon D8: In Black (CACAND80B) or Smoke (CACAND80S).....	49.95
For Canon EOS Digital Rebel XTi: In Black (CACERXTIB).....	49.95
For Canon EOS Digital Rebel XTi: In Smoke (CACERTIS).....	49.95
For Nikon D70/D70S: In Black (CACAND7070SB)	49.95
For Nikon D70/D70S: In Smoke (CACAND7070SS)	49.95
For Sony DSLR-A100: In Black (CACASA100B).....	49.95
For Sony DSLR-A100: In Smoke (CACASA100S)	49.95
For Nikon D40: In Black (CACAND40B)	49.95
For Nikon D40: In Smoke (CACAND40S)	49.95
For Canon EOS 20D: In Black (CACAC20DB).....	49.95
For Canon EOS 5D: In Black (CACAC5DB) or Smoke (CACAC5DS)	59.95
For Canon EOS 5D: In Camouflage (CACAC5DC).....	59.95
For Nikon D200: In Black (CACAND200B) or Smoke (CACAND200S)	59.95
For Nikon D200: In Camouflage (CACAND200C)	59.95
For Canon EOS 1DS: In Black (CACAC1DSM2B)	79.95
For Canon EOS 1DS: In Smoke (CACAC1DSM2S)	79.95
For Nikon D2X: In Black (CACAND2XB)	79.95

BLUE CRANE DIGITAL

GUIDE BOOKS & TRAINING DVDs

Visual Tools for a Digital Age

Digital cameras have been available to the general public for about a decade. In the last ten years, both the cameras and the supporting software tools have become more sophisticated while the price has continued to drop. Digital SLR cameras on the market today can overwhelm a new user with all the buttons and controls marked with cryptic symbols and abbreviations. If you've ever tried to learn how to shoot better photos by reading the supplied user manual, you understand why Blue Crane Digital exists.

They write, produce, and manufacture training DVDs and field reference cards for photographers buying their first Digital SLR, or for film users making the switch to digital technology. Use the DVDs to get up to speed quickly with your new camera. Then use the inBrief reference card to answer technical questions when you are out shooting. Blue Crane has one goal: to remove confusion and reduce frustration so you can use and enjoy your new purchase in the shortest time possible.

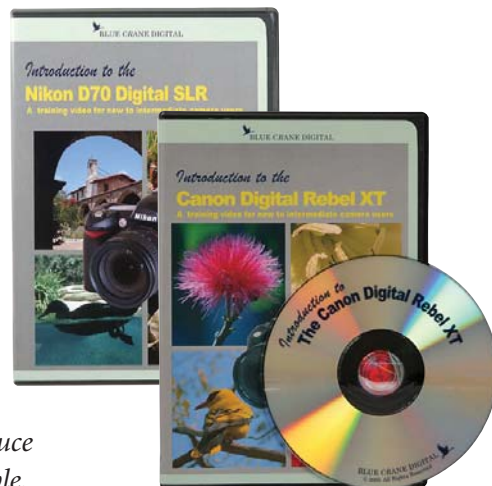

FEATURES

Your camera manual covers all the functions on your new digital camera. It's also over one hundred pages long.

When you are in the field, you need quick and accurate answers to achieve the best shot. With the inBrief line of camera guides you can get the answers, and more importantly, the shot you want.

Each card is divided into eight color-coded panels. If you have a question about metering or bracketing, simply look at the yellow panel. Questions about custom functions are answered on the green panel. The layout and description for the control panel and view finder can be found on the blue panel. And a color-coded index on the front page immediately points you toward the answer you need.

The inBrief guide is laminated for long life and protection from the elements. As importantly, the panels are separated by thin strips of clear lamination, allowing the card to be folded easily and stored in your camera bag.

The inBrief guide is not a replacement for your manual, but it will remind you of what functions are available, and how you can get them to work for you.

Every inBrief includes a line drawing of your camera with the controls for shooting, displaying images, and general operation clearly labeled. It also has a panel that shows you, at a glance, the camera functions available for each mode dial setting, as well as a cross reference to flash sync modes.

So quit fumbling with the controls and take control of your camera and the images you want to capture. Blue Crane gives you the answers inBrief.

Training DVDs

For Canon

- Digital Rebel XT (BLDVDCRXT)...19.95
- Digital Rebel XTi (BLDVDCRXTI)...19.95
- EOS 20D (BLDVDC20D).....19.95
- EOS 30D (BLDVDC30D).....19.95
- 5D (BLDVDC5D).....19.95
- Speedlite 580EX/430EX (BLDVDC430).....19.95

For Nikon

- D50 (BLDVDND50).....19.95
- D70/D70s (BLDVDND70).....19.95
- D200 (BLDVDND200).....19.95

For Olympus

- E300 (BLDVDOE300).....19.95

For Sony

- DSLR A100 (BLDVDSA100).....19.95



Quick Reference Field Guides

For Canon

- Digital Rebel (BLDVDCDR).....19.95
- Digital Rebel XT (BLQFRCRXT).....9.95
- Digital Rebel XTi (BLQFRCRXTI).....9.95
- EOS 30D (BLQFRC30D).....9.95
- EOS 5D (BLQFRC5D).....12.95

For Nikon

- D50 (BLQFRND50).....9.95
- D70/70S (BLQFRND70).....9.95
- D80 (BLQFRND80).....9.95
- D200 (BLQFRND200).....12.95

DVD and Guide Book Combo Pack

For Canon

- EOS Rebel XT (BLCCRXT).....29.95
- EOS Rebel XTi (BLCCRXTI).....29.95
- EOS 30D (BLCC30D).....29.95
- EOS 5D (BLCC5D).....29.95

For Nikon









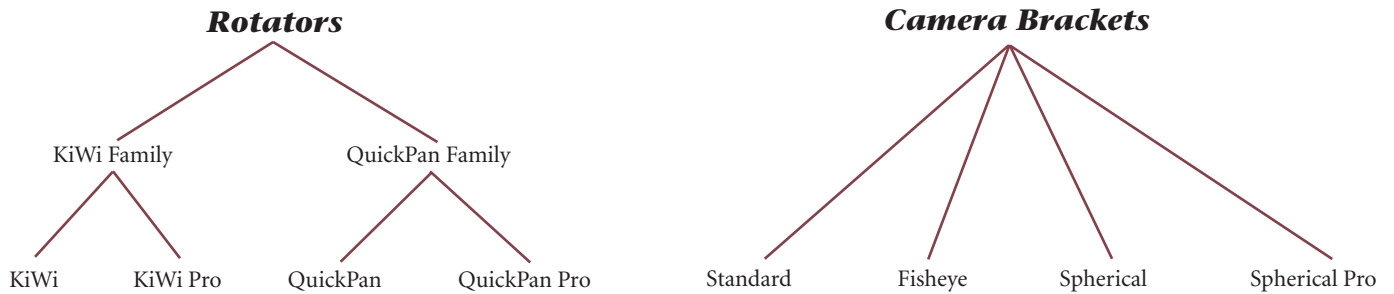

- D50 (BLCND50).....29.95
- D70/70S (BLCND70).....29.95
- D80 (BLCND80).....29.95
- D200 (BLCND200).....29.95

PANORAMIC TRIPOD HEADS

The Kaidan family of Panoramic Tripod Heads consist of a modular family of Rotators and Camera Brackets. There are two families of Rotators, Kiwi and Quick Pan and four Camera Brackets. In general the KiWi is entry level and the QuickPan is for the professional.

2007 Panoramic Tripod Head Family

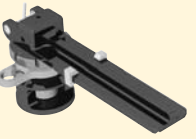

Pan Head Family - Modular Usage					
 Camera Brackets → Rotators ↓	 Standard	 Twin Axis	 Fisheye/Landscape	 Spherical	 Spherical Pro
 KiWi Standard	 KiWi (used only with Standard)	Not Recommended	Not Recommended	Not Recommended	Not Recommended
 KiWi Pro	OK	← Option	OK	Not Recommended	Not Recommended
 QuickPan Standard	OK	← Option	OK	OK	OK
 QuickPan Pro	OK	OK	OK	OK	Default Combination

CAMERA BRACKETS

Standard Bracket

Used to mount cameras in portrait orientation, the standard bracket has 3 mounting slots to handle most cameras. The mounting surface is made of hard rubber to grip your camera's base. It includes positioning lugs which retain the camera and act as placeholders, a captive camera knob, and two 1/4-20 threaded accessory mounts for flash brackets or other attachments. Used for single-row (cylindrical) panos. It weighs 14 oz. (KABS) ...**104.95**

Standard Bracket and Twin-Axis

Designed to support most digital and film cameras with a variety of lens combinations, including a circular fisheye, or for those users who need or appreciate two independent sliding and locking axes of adjustment. The Twin Axis Adapter enables two independent axes of adjustment and positions the lens in such a manner so as not to capture any more of the Rotator Base than necessary. When a camera equipped with a 8mm circular fisheye lens is installed properly on the bracket, only a small segment of the Rotator Base will appear in the image. This feature makes the Twin-Axis Adapter option ideal for those using Panoweaver (www.easypano.com) and other software applications that use fisheye images. It weighs 6.7 oz.

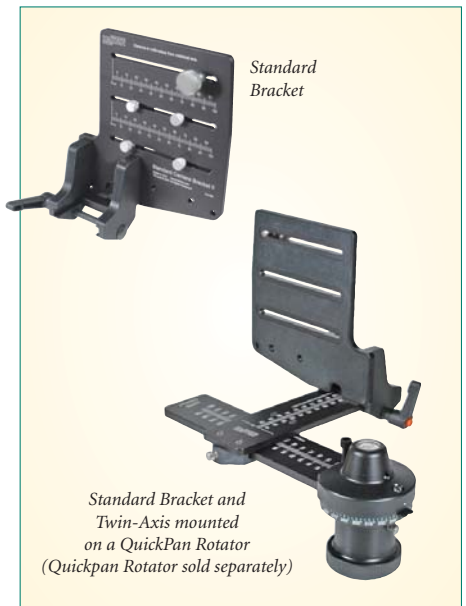

Fisheye/Landscape Bracket mounted on a QuickPan Rotator (QuickPan Rotator sold separately)

**Fisheye/Landscape Bracket**

The Fisheye/Landscape Bracket mounts your camera in the landscape orientation. It is ideal for circular fisheye lenses, and provides a wide, sturdy platform that supports heavy lenses. The diamond grip mounting surface also has a rubber strip to better grip your camera's base. Includes positioning lugs (which retain the camera and act as placeholders) and a captive camera knob. It weighs 15 oz.

Spherical Bracket with Universal Camera Mount

Designed to support most digital and film cameras, the Spherical Bracket with Universal Camera Mount permits the angular up/down elevation for the capture of multirow 360° spherical and cubic panoramas. High strength aluminum and composite construction. Has detent clicks every 15 degrees to assist with positioning. It weighs 2 lbs.

Spherical Bracket with Quick Release

Designed to meet the requirements of the professional panoramic photographer and discerning novices, the Quick Release Camera Bracket for the QuickPan Spherical uses an Arca Swiss style mount to hold your camera securely. The Arca style mounting system is recognized and recommended by professional photographers worldwide as being the best and most compact quick release mount system on the market today. Arca style camera specific mounting plates will be necessary in order to attach your camera to our Arca Swiss Quick Release mount. They use a precision dovetail clamping system to mate your camera to the bracket. Attaching and removing your camera is as simple as loosening and tightening a single clamp knob. It weighs 2 lbs.

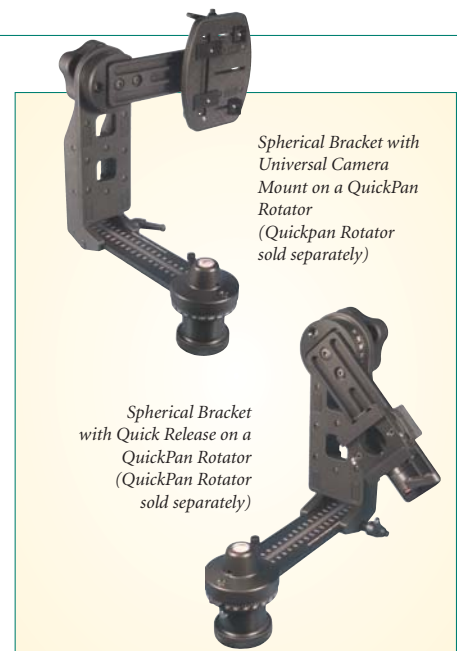

ROTATORS



KiWi Standard

Sturdy, entry level rotator. Recommended for use with the Kaidan Standard Camera Bracket only. Uses polymer bearing surfaces. Includes detent plunger, ClickDiscs (comes with 6), tool and ClickDisc storage pouch, built-in bubble level, engraved axis indicia, 1/4-20 and 3/8-16 tripod threads. Ideal for schools, hobbyists, real estate virtual tours. Can be upgraded with purchase of KiWi Pro Indexing Hub and ClickDiscs. It weighs 10 oz.

KiWi Pro

A solid, compact rotator with a quality roller bearing movement. High-strength aluminum arm, interchangeable ClickDiscs (comes with 9), tool and disc storage pouch, built-in bubble level, engraved axis indicator, 1/4-20 and 3/8-16 tripod threads. An ideal rotator for those professionals who use smaller cameras, and also desire a lightweight, portable panoramic tripod head. A good choice for nature photographers who want to travel as light as possible. It weighs 13 oz.

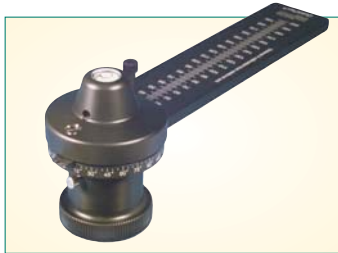
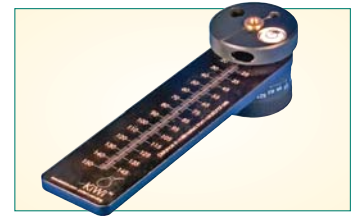

QuickPan Standard

Designed to index larger and heavy cameras (i.e. large digital SLRs). High-strength aluminum and composite construction. Comes with heavy-duty sealed lifetime ball bearing axle, interchangeable ClickDiscs that support any number of click-stop positions from 2 though 22, tool and disc storage pouch, built-in bubble level, engraved axis/angle indicator, 1/4-20 and 3/8-16 tripod threads. The QuickPan rotator will work with all of our camera brackets, so it's an excellent choice if you wish to change or upgrade cameras in the future. It weighs 1 lb. -8 oz.

QuickPan Professional

The QuickPan Pro addresses the requirement for unparalleled adjustability and extreme levels of accuracy and precision. Kaidan developed a new indexing mechanism, named WedgeLock, that eschews conventional spring plunger designs. Spring plungers, even those used on other "precision" tripod heads, require certain levels of clearance in order to work. With careful design and expensive machining, it is possible to minimize this clearance and attain acceptable levels of rigidity. The QuickPan Professional offers a level of precision and performance that no other panoramic tripod head can match, at any price. It incorporates all the benefits of a quick release plate directly on the swing arm of the tripod head. Each QuickPan Pro comes with adjustable sliding PlaceHolders that slide and securely lock along the length of the swing arm, conforming to your camera's unique base profile. Once you've mounted and adjusted your camera, the PlaceHolders maintain the location of the camera at all times. You can remove and reattach your camera at will, always being sure that it will be in the same exact position every time.

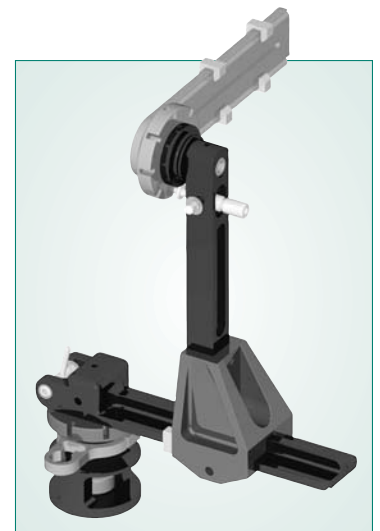

When you slam the door of a well-crafted automobile, you hear a wonderful and satisfying "thunk". It's the same with any well engineered product. The tactile feedback when you activate the controls are an integral part of the operation and affect how you relate to a product. Of course, photographers know and appreciate this element of design. They know when something feels right. Throughout the development of the QuickPan Pro, Kaidan strived for excellence in physical ergonomics. When you index the QuickPan Pro, in either axis, not only will you feel the positive indexing with no wobble or play, but you'll also hear and feel that indescribable and satisfying thunk when the mechanism engages.

KAIDAN

ROTATORS

QuickPan Professional con't

- ◆ Two (2) through 20 position WedgeLock Indexers are available for both azimuth and elevation motions. (Two Indexers are included with each unit).
- ◆ Supports cameras weighing up to 20 lbs., (assuming you have a sturdy tripod).
- ◆ Precise laser-engraved adjusting scales and dials.
- ◆ Fully sealed high-precision bearings — no need to mess with grease or oil upon disassembly.
- ◆ 1/4-20 and 3/8-16 tripod screw mount.
- ◆ Optional offset bracket for cameras with asymmetrical camera thread mount locations.
- ◆ Two optional bubble level mounts. One mounts on the QuickPan Pro base and the other mounts on your tripod center post.
- ◆ QuickPan Professional Rotator and camera bracket can be purchased separately. Certain prior Kaidan camera brackets will fit on the QuickPan Professional.

QuickPan Professional.....849.95

QuickTilt II Leveler



The latest version of Kaidan's popular QuickTilt design, the QuickTilt II Leveler (QPXL-II) has been completely redesigned with the professional photographer in mind.

It mounts on both 1/4-20 and 3/8-16 threaded tripods using the interchangeable mounting knobs that come standard with every leveler. You can easily

change the knobs from a 1/4-20 to a 3/8-16 configuration, or you can even have a 1/4-20 on the top and a 3/8-16 on the bottom. On most leveler heads you must physically spin the entire camera/panohead combo onto your tripod and leveler. The QuickTilt II solves this problem by utilizing threaded knobs that are tightened with your fingertips. These knobs securely mount the leveler to the tripod and your camera or panohead to the leveler.

Weights: 11.5 oz.

Maximum Height: 2.5"

Minimum Height: 2"

Max. Angle of Adjustment: 10°

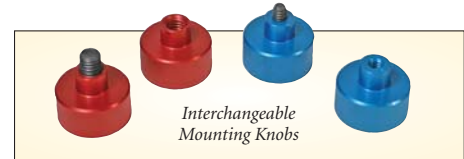

QuickTilt II Leveler (KAQPXL2)144.95

PiXi Manual Turntable

The Kaidan PiXi Manual Turntable is the ideal way for you to photographically capture collectibles, products, toys, sculptures and other objects in a 3-D form.

With this object turntable, consumers can quickly and easily create stunning VR objects for inclusion in documents, e-mail messages or web pages.

With Kaidan's PiXi solution, anyone can easily and affordably create 3-D object movies. They can post this 3-D image to their web site or use it to showcase and sell on e-commerce or auction web sites, such as eBay or Amazon.com. The PiXi Manual Turntable is 15" in diameter and can support objects weighing up to 50 pounds. The turntable has click-stops every 10° and has index markings for manual positioning in 5° increments.



PiXi Manual Turntable (KAPIXI)94.95

QuickTime VR (QTVR) and other forms of photographic VR Rotational Object Photography are innovative ways to capture and present 3-D objects. Using Kaidan Object Rigs, you'll be able to create interactive 3-D movies of your products, collectibles, artwork, and devices for inclusion on web-pages, CD-ROM titles or multimedia applications. With QTVR, for example, you can rotate, pan, zoom, and create linked hotspots on your objects, making them ideal for interactive training manuals, advertising, archiving, and entertaining.

OBJECT RIGS

Magellan Desktop Turntable

The Magellan is a motorized turntable used to index objects, under computer control for immersive imaging object photography. The device has a diameter of 19" and can support objects up to 75 lbs. The turntable is coated in a durable matte black finish that also can be topped with optional blue, green or red-screen elastic caps. Typically, objects are placed on the turntable to capture the sequence of images. Optional telescoping and fixed pedestals that support and elevate the object are also available.



- ◆ Indexing control is accomplished with Kaidan's eMCee controller and software. The controller connects to the serial port of your computer, while the eMCee software (Mac/Win) controls the turntable. You can also use VR ObjectWorx (Mac/Win) software from VR Toolbox to completely manage the process of object movie creation and turntable control.

- ◆ VR ObjectWorx is used to set the number of shots, speed and other control aspects of the turntable and then is used to provide bluescreen masking, movie creation, hotspots, sounds, and to select file compression options. The Magellan Desktop Turntable is the perfect, affordable solution for single-row object movies for e-commerce applications on the internet.

- ◆ Capacity 19" diameter, 75 lbs. maximum weight.
- ◆ Modular construction for easy assembly and transport.
- ◆ Scriptable eMCee Motion Control Software.

Magellan Desktop Turntable: For Windows (KAMDT19PC) and Mac (KAMDT19MAC) ..1249.95



PiXi -M

The Kaidan Motorized PiXi-M Turntable is 10" in diameter and supports up to 20 pounds. It is extremely easy to use and set up. Three voltages are available, be sure to select the correct one: 100-110v AC, 110-120v AC, and 220-240v AC. The PiXi Motorized turntable is also bundled in a Kit. (NOTE: If ordering the PiXi Motorized you must have software that will capture live feed with a 4 RPM turntable. You can try SpinImage DV or DV Pro. Macintosh users may also like to review Kaidan's PiXiMation, an innovative software for 3D Object creation.)

- PiXi-M Motorized Turntable 110v AC; 60Hz - U.S.A. Power (KAPIXIM110).....104.95
- PiXi-M Motorized Turntable 220-240v AC; 50Hz (KAPIXIM220)99.95
- PiXi-M Motorized Turntable 110v AC; 50Hz (KAPIXIM100).....99.95

Pedestal Kits

In situations where in creating 3-D photographic VR you need to elevate the object to eliminate the turntable from the final movie the Pedestal Kits below will raise the object the needed amount.

- M1001P Large Fixed Pedestal Set (KAM1000AP)**
Includes a pedestal base and cap with two pedestal tubes, 8" and 12" long97.95
- M1001AP Adjustable Pedestal Set (KAM1000AP)**
Includes a pedestal base with an adjustable arm and top.....119.95



KAIDAN

360 ONE VR

Single Shot Panoramic System

With single-shot technology that requires no stitching, photographing action scenes like busy city streets or sporting events is a breeze. A single click effortlessly captures a complete panoramic view.

In fact, it's so easy you can publish hundreds of panoramas in an afternoon. Whether it's photojournalism, industrial documentation or real estate virtual tours, 360 One VR offers a simple and elegant solution for panoramic photography.



How it works...

The 360 One VR consists of a rugged optical reflector assembly that attaches to most digital cameras and a companion software application for Windows and Macintosh called PhotoWarp.

Here's how it works...Your camera points up through the center of the optic and photographs the entire scene as reflected on the patented OptiFOV mirror. Once the round-shaped images are transferred to your computer, PhotoWarp quickly unwraps them into panoramas.

The 360 One VR optic has an integrated sliding protective cover which quickly retracts or extends for use or transport. The telescope-grade mirror and glass center stage are cushion mounted and the entire unit is protected with an impact-resistant foam outer covering. The lightweight sunshield above the mirror incorporates a target ring allowing PhotoWarp to automatically center the 'donut' images, a crucial feature for batch processing. A circular bubble level for easy leveling is located on top of the sunshield. The optic has a standard 67mm thread at its mounting base which fits a variety of cameras and lenses. Standard photographic step ring adapters or extension tubes, can be used to connect the optic to many cameras. Camera attachment brackets and quick-release camera mounts are also available.

Traditional single-shot unwarping software requires you to go through several tedious steps to process just one panorama. With PhotoWarp, just drag a collection of image files onto the application and click "Unwrap." PhotoWarp processes all the images as a batch, in just seconds apiece!

PhotoWarp supports a broad range of panoramic viewers, giving you the choice to deliver your images the way you want. QuickTime VR, Java, flat images for printing, and even Flash panoramas can be produced. PhotoWarp will generate a web page that will automatically choose the right format for any user, computer or browser.

Already using a BeHere, Egg Solution, Remote Reality or 0-360 optic? Upgrade to the 360 One VR and PhotoWarp can even process your old donut images, often with less distortion than your old software. And unlike some other solutions, you never have to pay per-image 'click' fees or yearly license fees to use the software.

360 One VR (KASSPS360M3): Includes PhotoWarp 2.5 software.....749.95



SLR Bracket 2

The SLR Bracket 2 securely mounts the 360 One VR optic to a wide variety of SLR cameras facilitating single-shot panoramic photography. The bracket can also be used to attach any camera that has a longer focal length where step rings or conventional adapters would position the camera too close to the optic.

The adjustable camera mount slides and locks into position to accommodate a variety of focal length lenses. Since the camera does not attach directly to the 360 One VR optic, no step rings or other adapters are required.

An optional Arca-Swiss quick-release mount makes it easy to attach and remove the camera in a matter of seconds, making it ideal for those who need to mix conventional and panoramic photography. (Requires Arca Swiss camera plate).

SLR Bracket (KAB360SLR): For 360 One VR.....279.95