

**Forklift**

Vehicle Management Codes: E814 – E816, E819, E820, E822 – E826, E828 – E842, E844 – E847, E849 – E851, E853 – E859, E860, E886, E895, E948, E949, E952, E954, E956 – E959, E977, E979 – E981, F816, F822, F842



**QUALIFICATION TRAINING PACKAGE**

**CONTENTS**

<b>SECTION 1—OVERVIEW</b> .....	<b>3</b>
1.1. Overview.....	3
<b>SECTION 2—RESPONSIBILITIES</b> .....	<b>3</b>
2.1. Responsibilities. ....	3
<b>SECTION 3—INTRODUCTION</b> .....	<b>4</b>
3.1. Objectives:.....	4
3.2. Desired Learning Outcomes:.....	5
3.3. Lesson Duration.....	5
3.4. Instructional References. ....	5
3.5. Instructional Training Aids and Equipment.....	6
3.6. Suggested Sources for Obtaining Supplemental Training Material. ....	6
<b>SECTION 4—TRAINEE PREPARATION</b> .....	<b>7</b>
4.1. Licensing Requirements.....	7
4.2. Required Reading.....	7
<b>SECTION 5—KNOWLEDGE LECTURE</b> .....	<b>7</b>
5.1. Knowledge Overview (Lecture).....	7
5.2. Overview of Training and Requirements.....	8
5.3. Vehicle Inspection.....	13
5.4. Vehicle Safety and Equipment. ....	18
5.5. Driving Safety and Precautions.....	19
5.6. Forklift Load Composition and Stability. ....	21
5.7. Forklift Loading and Unloading. ....	25
5.8. Forklift Operation. ....	32
<b>SECTION 6—EXPLANATION AND DEMONSTRATION</b> .....	<b>35</b>
6.1. Instructor’s Preparation. ....	35
6.2. Safety Procedures and Equipment.....	35
6.3. Operator Maintenance Demonstration.....	37
6.4. Operation Demonstration. ....	37
<b>SECTION 7—TRAINEE PERFORMANCE AND EVALUATION</b> .....	<b>41</b>
7.1. Trainee Performance.....	41
7.2. Performance Evaluation. ....	44
<b>Attachment 1—GLOSSARY OF REFERENCES AND SUPPORTING INFORMATION</b>	<b>46</b>
<b>Attachment 2—VEHICLE INSPECTION GUIDE</b>	<b>47</b>
<b>Attachment 3—PERFORMANCE TEST</b>	<b>57</b>
<b>Attachment 4—SEVEN-STEP INSPECTION PROCESS</b>	<b>61</b>
<b>Attachment 5—FORKLIFT OPERATION REVIEW QUESTIONS</b>	<b>70</b>

## **Section 1—OVERVIEW**

### **1.1. Overview.**

1.1.1. Send comments and suggested improvements on AF Form 847, *Recommendation for Change of Publication* through Air Force Installation and Mission Support Center (AFIMSC) functional managers via e-mail at AFIMSC.IZSL.VehicleOps@us.af.mil.

1.1.2. How to use this plan:

1.1.2.1. Trainer:

1.1.2.1.1. Provide overview of training, **Section 2** and **Section 3**.

1.1.2.1.2. Trainer's lesson plan for trainee preparation, give classroom lecture, **Section 4**.

1.1.2.1.3. Trainer's lesson plan for knowledge lecture, **Section 5**.

1.1.2.1.4. Trainer's lesson plan for demonstration, **Section 6**.

1.1.2.1.5. Trainer's lesson plan for performance and evaluation, **Section 7**.

1.1.2.2. Trainee:

1.1.2.2.1. Reads entire lesson plan prior to classroom lecture.

1.1.2.2.2. Follows along with lecture using this lesson plan and its attachments.

1.1.2.2.3. Accomplishes forklift operation review questions (**Attachment 5**) with trainer.

1.1.2.2.4. Uses **Attachments 2 and 4** as guides for vehicle inspection.

1.1.2.2.5. Takes performance test.

## **Section 2—RESPONSIBILITIES**

### **2.1. Responsibilities.**

2.1.1. The trainee shall:

2.1.1.1. Ensure the trainer explains the Air Force Qualification Training Package (AFQTP) process and the responsibilities.

2.1.1.2. Review the AFQTP/Module/Unit with the trainer.

2.1.1.3. The trainee should ask questions if he/she does not understand the objectives for each unit.

2.1.1.4. Review missed questions with the trainer.

2.1.2. Instructor shall:

2.1.2.1. Review the AFQTP with the trainee.

2.1.2.2. Conduct knowledge training with the trainee using the AFQTP.

2.1.2.3. Grade the review questions using the answer key.

2.1.2.4. Review missed questions with the trainee to ensure the required task knowledge has been gained to complete the task.

2.1.2.5. Sign-off the task(s).

2.1.3. The Certifier shall:

2.1.3.1. Evaluate the Airman's task performance without assistance.

2.1.3.1.1. The Performance Test will be successfully accomplished prior to initial certification on the forklift.

2.1.3.1.2. The Performance Test will be successfully accomplished, every three years, in order to be recertified on the forklift.

2.1.3.2. Sign-off the task(s).

## **Section 3—INTRODUCTION**

### **3.1. Objectives:**

3.1.1. Given lectures, demonstrations, review questions, hands-on driving session, and a performance and written test, trainees will be able to perform operator's inspection and complete the performance test (go/no-go checklist) with zero instructor assists.

3.1.1.1. Train and qualify each trainee in safe operation and preventive maintenance of various forklifts.

3.1.1.2. This training will ensure the trainee becomes a qualified forklift operator; an operator who has the knowledge and skills to operate a forklift in a safe and professional manner.

### 3.2. Desired Learning Outcomes:

- 3.2.1. Understand the safety precautions to be followed before-, during-, and after-operation of the forklift.
- 3.2.2. Understand the purpose of the forklift and its role in the mission.
- 3.2.3. Understand Occupational Safety & Health Administration (OSHA) and Air Force Occupational Safety and Health (AFOSH) compliance requirements.
- 3.2.4. Know the proper operator maintenance procedures of the forklift, in accordance with (IAW) applicable technical orders and use of Air Force (AF) Form 1800.
- 3.2.5. Safely and proficiently operate the forklift.

### 3.3. Lesson Duration.

- 3.3.1. Recommended instructional and hands on training time is 40 hours:

**Figure 3.1. Recommended Training Time for Training Activities.**

<b>Training Activity</b>	<b>Training Time</b>
Trainee's Preparation	2 Hours
Instructor's Lecture	2 Hours
Trainee's Written Evaluation	1 Hour
Instructor's Demonstration	4 Hours
Trainee's Personal Experience (to build confidence and proficiency) <ul style="list-style-type: none"><li>▪ Perform Operator Maintenance</li><li>▪ Operate the Vehicle</li></ul>	30 Hours
Trainee's Performance Evaluation	1 Hour

**Note:** This is a recommended time; training time may be more or less depending how quickly a trainee learns new tasks.

### 3.4. Instructional References.

- 3.4.1. Risk Management (RM) and Safety Principles.
- 3.4.2. Applicable Technical Orders (TOs) or Manufacturer's Operator's Manual (see vehicle maintenance for TO number for vehicle being used in training).
- 3.4.3. Air Force Manual (AFMAN) 24-306, *Operation of Air Force Government Motor Vehicles*.
- 3.4.4. AFMAN 91-201, *Explosive Safety Standards*.

3.4.5. Hazardous Materials Lesson Plan.

3.4.6. Regulations (Standards - 29 Code of Federal Regulations (CFR)), Part 1910 - Occupational Safety and Health Standards, Subpart N – *Material Handling and Storage*.

3.4.7. OSHA Directive, Enforcement and Compliance (CPL) 02-01-028 - CPL 2-1.28A - *Compliance Assistance for the Powered Industrial Truck Operator Training Standards*

3.4.8. AF Form 1800, *Operator's Inspection Guide and Trouble Report* (General Purpose Vehicles).

### **3.5. Instructional Training Aids and Equipment.**

3.5.1. Forklift Lesson Plan.

3.5.2. Forklift.

3.5.3. Applicable TO or Manufacturer's Operator's Manual.

3.5.4. AF Form 1800.

3.5.5. Videos (if locally produced).

3.5.6. Suitable training area.

3.5.7. Traffic cones or suitable markers.

3.5.8. Palletized loads or skids.

3.5.9. Tractor/Trailer combination and/or loading dock.

3.5.10. K-Loader, rollerized trailer, or aircraft (for aircraft loading).

### **3.6. Suggested Sources for Obtaining Supplemental Training Material.**

3.6.1. J.J. Keller & Associates - [www.jjkeller.com](http://www.jjkeller.com).

3.6.2. OSHA Training Online – [www.free-training.com/osha/forklift/forkmenu.htm](http://www.free-training.com/osha/forklift/forkmenu.htm).

3.6.3. The Training Network - [www.safetytrainingnetwork.com/products/forklift.shtml](http://www.safetytrainingnetwork.com/products/forklift.shtml).

## **Section 4—TRAINEE PREPARATION**

### **4.1. Licensing Requirements.**

- 4.1.1. Trainee must have in his/her possession a valid state driver's license.
- 4.1.2. AF Form 171, *Request for Driver's Training and Addition to U.S. Government Driver's License IAW Air Force Instruction (AFI) 24-301, Ground Transportation.*
- 4.1.3. Applicable local licensing jurisdiction requirements.

### **4.2. Required Reading.**

- 4.2.1. Read Forklift Lesson Plan.
- 4.2.2. Read AFMAN 24-306.
- 4.2.3. Read Manufacturer's Operator's Manual for the vehicle being trained on.
- 4.2.4. Complete forklift operation review questions, **Attachment 5**.

## **Section 5—KNOWLEDGE LECTURE**

### **5.1. Knowledge Overview (Lecture).**

5.1.1. The AF uses a variety of different forklifts (also referred to as “powered industrial trucks”) to accomplish its mission, they range from small to large, from simple hand lifts to complex powered forklifts. Like any other vehicle, training and licensing is a requirement to ensure an operator can operate a forklift safely and proficiently. Forklift training, as required by OSHA, includes:

- 5.1.1.1. A combination of formal instruction and practical demonstrations and exercises.
- 5.1.1.2. A wide range of subjects and skills specified in the regulation.
- 5.1.1.3. Refresher training must be given under a variety of specific circumstances.
- 5.1.1.4. Operators shall be evaluated at least once every 3 years.
- 5.1.1.5. Required training shall be certified in writing.

## 5.2. Overview of Training and Requirements.

### 5.2.1. Training objectives:

5.2.1.1. Given lectures, demonstrations, review questions, hands-on driving session, and a performance and written test, trainees will be able to perform operator's inspection and complete the performance test (go/no-go checklist) with zero instructor assists.

5.2.1.2. Train and qualify each trainee in safe operation and preventive maintenance of the various forklifts.

5.2.1.3. This training will ensure the trainee becomes a qualified forklift operator—an operator who has the knowledge and skills to operate a forklift in a safe and professional manner.

### 5.2.2. Desired learning outcomes:

5.2.2.1. Understand the safety precautions to be followed before-, during-, and after-operation of the forklift.

5.2.2.2. Understand the purpose of the forklift and its role in the mission.

5.2.2.2.1. Purpose is for cargo movement.

5.2.2.2.2. Role in the mission (Unit/Base/Community (during natural disasters)/Air Force).

5.2.2.2.3. Know the proper operator maintenance procedures of the forklift, IAW applicable technical orders and use of AF Form 1800.

5.2.2.2.4. Be able to safely and proficiently operate the forklift.

5.2.2.2.4.1. Meet mission requirements.

5.2.2.2.4.2. Demonstrates a qualified trained professional operator.

5.2.3. Forklift Design. Forklifts vary in size, shape and specifications, determined by make and model; it is imperative to know the specifications and rated loads of the forklift that will be operated before use. Specifications and rated load information should be used together to determine the proper use and area in which the forklift will be used. This information is best found in the appropriate TO or for quick reference, the information may be found on the vehicle data plate located on the forklift, see **Figure 5.1** for an example of a forklift data plate.

5.2.4. While the discussion following will explain the general design of a forklift, it is recommended that the operator studies the manufacturer's operator manual for the specifics of the forklift.



**Figure 5.1. Forklift Data Plate Example.**



5.2.5. Specifications. Specifications generally described are equipment dimensions/weight; engine/drive train information; turning radius; and engine/drive train fluid types. Forklift specifications can be found on the vehicle’s data plate, and the Manufacturer’s Operator’s Manual or appropriate TO for the vehicle.

5.2.6. Rated Load/Capabilities. Rated loads and capabilities generally described are lifting capacity; load center; maximum reach; and maximum stacking height.

**Note:** Specifications given are for a centered and balanced load. Lifting the maximum amount of the forklift capacity when the load is not properly balanced could cause tipping of the forklift.

5.2.7. Forklift Parts. The make-up of a forklift differs by make and model, however all forklifts will have a counterweight, lifting mast, or device and overhead guard.

5.2.7.1. Counterweights. The counterweight on a forklift does exactly what its name implies; it counters, or opposes the forces of the load put on the forklift.

5.2.7.1.1. Counterweights come in many shapes and sizes. Some are removable or can be stacked/un-stacked to eliminate weight when small loads are being handled over soft terrain or for shipping purposes.

5.2.7.1.2. Most counterweights are rested into place and require little hardware to keep them in place. Therefore, it is in the best interest to ensure the counterweight is securely fastened to the forklift before operation. **Figure 5.2.** illustrates different styles of counterweights.

**Figure 5.2. Forklift Counterweight Styles.**

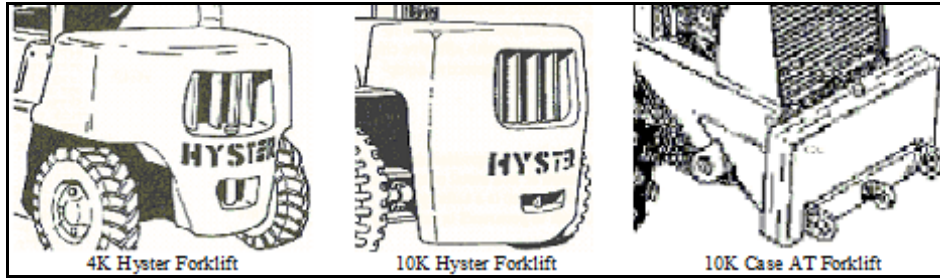

5.2.7.2. Lifting mast or device. Lifting devices on forklifts can be complicated or extremely simple. Lifting devices differ by make, model and function for which they are used.

5.2.7.2.1. Some forklifts in the AF inventory are equipped to rotate loads; some masts swing in and out, while other masts are boom style. There are many different models; therefore it is imperative the trainee becomes fully trained on the model that the trainee is about to operate. One of the big differences in lifting devices is “reach”.

5.2.7.2.2. Standard forklifts lift loads straight up and down, while all terrain (AT) and other models of forklifts lift their masts at an angle and “reach” when raised. **Figure 5.3.** shows the difference in lifting device reach.

**Figure 5.3. Lifting Device Reach.**

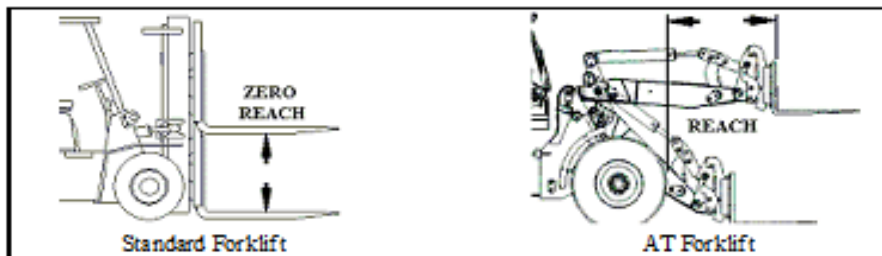

5.2.7.3. Overhead guards. Overhead guards are put in place to protect the operator in case of falling objects and should the forklift tip over.

5.2.7.3.1. In the case of forklifts with cabs, the overhead guard is built into the cab itself. These also provide protection from the outside elements of the environment.

5.2.7.3.2. Some of these cabs are removable for shipping purposes, after shipment, these cabs should be put back in place before operation continues. **Figure 5.4.** illustrates different styles of overhead guards.

**Figure 5.4. Overhead Guards.**

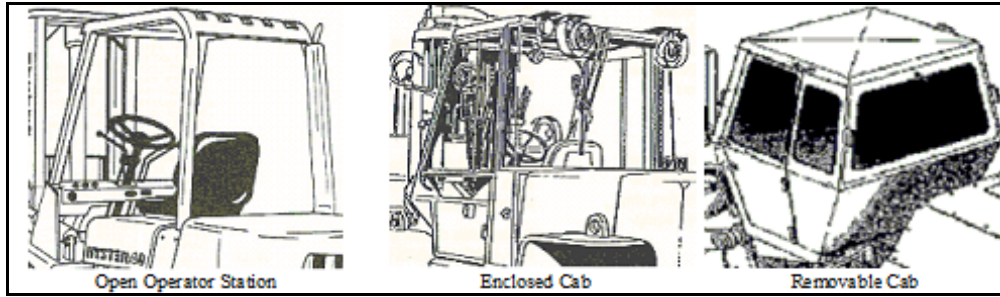

### 5.2.8. Forklift Steering and Speed Control.

5.2.8.1. Steering. The majority of forklifts utilize rear wheel steering or articulated steering. The ability of using rear wheel steering gives the operator more maneuverability for placing loads in the correct position and moving through tight warehouse locations.

5.2.8.1.1. Articulated steering is used mainly on all terrain forklifts, this function is best for all wheel drive equipment, as it requires less differential slipping. Of course these steering systems can take some time to get used to.

5.2.8.1.2. Having the rear wheel steering adds more areas that the operator needs to have good visibility. While turning the forklift, not only does the front of the equipment move, but the rear as well, adding to more possibilities of striking something.

5.2.8.1.3. Articulated steering gives the view of all moving parts in the same direction, as long as the equipment's operator station is high enough with unrestricted visibility this is a benefit to the operator. **Figure 5.5.** illustrates different steering systems used on most forklifts, and the difference of front wheel steering.

**Figure 5.5. Forklift Steering Systems.**

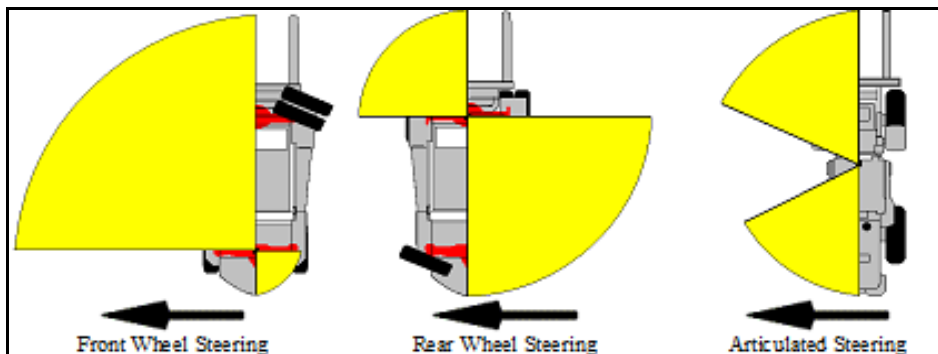

5.2.8.2. Speed Control. Speed not only makes accidents more likely, but also makes death in accidents more likely. Never operate a vehicle at a speed greater than is reasonable and prudent under the existing conditions.

5.2.8.2.1. Speed affects the ability to turn, pass, slow down and stop. The most important safety factor in any vehicle is the control the driver has over the machine.

5.2.8.2.2. The faster the vehicle goes and the more of that control the driver gives up, the less chance the driver has of avoiding an accident and the more deadly the accident will be.

5.2.8.2.3. Accelerating. Gradually accelerate a forklift to minimize jerking. Rapid acceleration can cause mechanical failure and is considered vehicle misuse. Jerking and rapid acceleration also contributes to loads falling off the forks and adding unnecessary hazards to pedestrians around the vehicle.

5.2.8.2.4. Steering.

5.2.8.2.4.1. Normally, both hands are kept on the steering wheel while operating the forklift. During loading and unloading the left hand is used to steer while the right hand operates the hydraulic controls.

5.2.8.2.4.2. Remember to turn slowly; a forklift is unstable when the forks are elevated, with or without a load. Tip-over can occur when the forklift is empty. Avoid turning on an incline. Watch tail swing when making turns observing rear clearances.

5.2.8.2.5. Stopping. Stop the forklift as gradually as possible. Hard braking and wheel sliding are unnecessary and may cause the load to fall off the forks, possibly damaging the load and/or hurting someone. The following factors affect the ability to bring the forklift to a stop:

5.2.8.2.5.1. Type and condition of road surface, such as concrete, asphalt, or gravel.

5.2.8.2.5.2. Foreign material on the road, such as ice, snow, leaves, water, or mud.

5.2.8.2.5.3. Road configuration, such as inclines, curves, high crowns.

5.2.8.2.5.4. Tire conditions, such as type, tire inflation, and condition of tread.

5.2.8.2.5.5. Brakes, such as type and state of repair and adjustment.

5.2.8.2.5.6. Load on forklift, an unloaded forklift will stop sooner and smoother than a loaded one.

5.2.8.2.6. Stopping Distance. For any speed, the distance required to stop a forklift in an emergency depends on three things; driver perception time, driver reaction time, and forklift stopping time. During driver perception time and driver reaction time, the forklift slows down very little because the brakes have not yet been applied. Forklifts equipped with air brakes take additional time because it takes the air time to travel through the system to engage the brakes. This is called brake lag.

### 5.3. Vehicle Inspection.

5.3.1. Types of Vehicle Inspection. **Note:** If discrepancies are found the operator must report them to Vehicle Control Officer/Vehicle Control Non Commissioned Officer (VCO/VCNCO), the supervisor, and/or vehicle maintenance:

5.3.1.1. Pre-trip inspection – find items/problems that could cause accident or breakdown.

5.3.1.1.1. Vehicle maintenance to authorize continued use for all other maintenance discrepancies.

5.3.1.1.2. Cleanliness/damage/missing items.

5.3.1.1.3. Leaks (fuel/oil/coolant/hydraulic/air).

5.3.1.1.4. Fluid levels; ensure level is within limits:

5.3.1.1.4.1. Engine oil.

5.3.1.1.4.2. Brake fluid.

5.3.1.1.4.3. Transmission fluid.

5.3.1.1.4.4. Antifreeze.

5.3.1.1.4.5. Hydraulic fluid.

5.3.1.1.5. Battery; security, fluid, damage, and corrosion.

5.3.1.1.6. All wheel rims (cracks, splits, etc.); check for loose or missing lug nuts.

5.3.1.1.7. All tires.

5.3.1.1.7.1. Proper inflation. **Note:** Notify VCO/VCNCO, the supervisor, and/or vehicle maintenance if split rim is completely flat.

5.3.1.1.7.2. Tread to include depth.

5.3.1.1.7.3. Cuts and abrasions.

- 5.3.1.1.8. Drive belts; tension, and fraying.
  - 5.3.1.1.9. Air restriction gauge.
  - 5.3.1.1.10. Carriage.
  - 5.3.1.1.11. Hydraulic hoses/cylinders (damage/leaks).
  - 5.3.1.1.12. Wiring/lights/reflectors/mirrors.
  - 5.3.1.1.13. Safety devices.
  - 5.3.1.1.14. Mast tines/roller tines.
  - 5.3.1.1.15. Towing connection.
  - 5.3.1.1.16. Markings – check visibility.
  - 5.3.1.1.17. Horn operation.
  - 5.3.1.1.18. Windshield wipers/washers.
  - 5.3.1.1.19. Heater/defroster.
  - 5.3.1.1.20. Exhaust system.
  - 5.3.1.1.21. Brake and accelerator covers.
  - 5.3.1.1.22. Air tanks.
  - 5.3.1.1.23. Cold weather aids.
  - 5.3.1.1.24. Emergency stand-by system.
  - 5.3.1.1.25. Refill alcohol injector reservoir (in season).
  - 5.3.1.1.26. Fire extinguisher(s).
- 5.3.1.2. During-operation:
- 5.3.1.2.1. All gauges and warning lights for proper operations.
    - 5.3.1.2.1.1. Warning lights.
    - 5.3.1.2.1.2. Gauges.

5.3.1.2.1.3. Indicators.

5.3.1.2.2. Forklift controls for proper operations.

5.3.1.2.2.1. Steering wheel.

5.3.1.2.2.2. Steering wheel tilt control.

5.3.1.2.2.3. Direction control lever.

5.3.1.2.2.4. Gear selector lever.

5.3.1.2.2.5. Parking brake control.

5.3.1.2.2.6. Hydraulic control levers, normal controls are lift/lower and tilt.

5.3.1.2.2.6.1. Lift/lower control lever.

5.3.1.2.2.6.2. Tilt control lever.

5.3.1.2.2.6.3. Side shift,

5.3.1.2.2.6.4. Fork positioning lever.

5.3.1.2.2.6.5. Other controls (rotate, swing, extend, etc.).

5.3.1.2.2.7. Off/on/enrich knob.

5.3.1.2.2.8. Battery disconnect switch.

5.3.1.2.2.9. Accelerator control pedal.

5.3.1.2.2.10. Ignition switch (glow plugs).

5.3.1.2.2.11. Service brakes/inching pedal.

5.3.1.2.2.12. Selector switch.

5.3.1.2.2.13. Selector gas or liquefied petroleum gas (LPG) for bi-fuel engines.

5.3.1.2.3. Unusual noises.

5.3.1.2.4. Listen for exhaust and air leaks.

5.3.1.2.5. All gauges and warning lights for proper operations.

- 5.3.1.2.5.1. Warning lights.
- 5.3.1.2.5.2. Gauges.
- 5.3.1.2.5.3. Indicators.
- 5.3.1.2.6. Forklift controls for proper operations.
  - 5.3.1.2.6.1. Steering wheel.
  - 5.3.1.2.6.2. Steering wheel tilt control.
  - 5.3.1.2.6.3. Direction control lever.
  - 5.3.1.2.6.4. Parking brake control.
  - 5.3.1.2.6.5. Hydraulic control levers.
    - 5.3.1.2.6.5.1. Lift/lower control lever.
    - 5.3.1.2.6.5.2. Tilt control lever.
    - 5.3.1.2.6.5.3. Side shift (if equipped).
    - 5.3.1.2.6.5.4. Fork positioning lever (if equipped).
    - 5.3.1.2.6.5.5. Other controls (rotate, swing, extend, etc.).
  - 5.3.1.2.6.6. Off/on/enrich knob.
  - 5.3.1.2.6.7. Battery disconnect switch.
  - 5.3.1.2.6.8. Accelerator control pedal.
  - 5.3.1.2.6.9. Ignition switch.
  - 5.3.1.2.6.10. Service brakes/inching pedal.
  - 5.3.1.2.6.11. Selector switch.
  - 5.3.1.2.6.12. Selector gas or LPG for bi-fuel engines.
- 5.3.1.2.7. Unusual noises. Listen for exhaust and air leaks.



### 5.3.1.3. After-Operation Inspection.

5.3.1.3.1. Ensure the forklift is cleaned (free of dirt, excess oil, and grease).

#### 5.3.1.3.2. Refuel.

5.3.1.3.2.1. For all types of fuel and charging: Use refueling area or charging area, turn-off engine and use parking brake, and do not smoke or use electronic devices.

5.3.1.3.2.2. Diesel or gasoline.

5.3.1.3.2.3. Compressed natural gas.

5.3.1.3.2.3.1. Ensure refueling hose is properly connected.

5.3.1.3.2.4. Propane.

5.3.1.3.2.4.1. Turn-off fuel valve at cylinder.

5.3.1.3.2.4.2. Let engine die to purge all liquid phase propane (LPP) from lines.

5.3.1.3.2.4.3. Disconnect cylinder and remove.

#### 5.3.1.3.3. Battery charging.

5.3.1.3.3.1. Use eye protection when making connections.

5.3.1.3.3.2. Use manufacturer's approved charger.

5.3.1.3.3.3. Have eye wash facilities available.

5.3.1.3.3.4. Have an acid neutralizing agent available.

5.3.1.3.3.5. Don't over fill the batteries with water.

5.3.1.4. Pre-trip vehicle inspection test. Use **Attachment 2** as a walk-around guide along with AF Form 1800.

5.3.2. A Seven-Step Inspection Method will help ensure the inspection is the same each time it is conducted, and that nothing is left out. See **Attachment 4** for the Seven-Step Inspection Method.

## **5.4. Vehicle Safety and Equipment.**

### 5.4.1. Hazards and Human Factors.

#### 5.4.1.1. Common mishap types.

5.4.1.1.1. Dropped property.

5.4.1.1.2. Bruises, head injuries, cuts and lacerations to personnel.

5.4.1.1.3. Fatalities due to roll-overs.

#### 5.4.1.2. Common operator mishap causes:

5.4.1.2.1. Jerky starts and stops.

5.4.1.2.2. Failure to give proper signals when turning.

5.4.1.2.3. Traveling too fast and turning too sharply.

5.4.1.2.4. Failure to sound horn at intersections or when entering or exiting a building.

5.4.1.2.5. Turning too wide on corners; cutting corners too sharply.

5.4.1.2.6. Forklift carrying loads too high when traveling (tines should not be higher than 6 inches above the working surface).

5.4.1.2.7. Lowering loads too fast; failure to ensure that a pallet load is properly balanced and stacked.

5.4.1.2.8. Failure to ensure that forks (tines) are fully under the load before lifting.

5.4.1.2.9. Striking the pallet or the floor with the forks.

5.4.1.2.10. Driving across bridge plates too fast and failure to observe load carrying capacity on bridge plates.

5.4.1.2.11. Positioning empty forks too high when traveling (no higher than 6 inches above the working surface).

5.4.1.2.12. Failure to release parking brake before traveling.

5.4.1.2.13. Driving forward when the load restricts vision.

5.4.1.2.14. Descending an incline with the load in front.

5.4.1.2.15. Pinch points on articulated steering systems.

5.4.1.2.16. Failure to secure load to the forklift over long distances.

5.4.1.2.17. Failure to use a spotter in difficult areas/situations.

#### 5.4.2. Safety Clothing and Equipment:

5.4.2.1. Safety steel-toed boots must be worn.

5.4.2.2. Gloves will be worn during cargo loading and unloading (take off rings/jewelry first).

5.4.2.3. Reflective belts/vests during operation of low visibility and on the flightline.

5.4.2.4. Raingear, cold weather gear, etc. **Note:** Avoid operating an open operation forklift during the rain.

5.4.2.5. Hearing protection when utilizing a gas or diesel driven forklift without a properly installed cab with the door and windows closed.

5.4.2.6. AF Form 1800.

### 5.5. Driving Safety and Precautions.

5.5.1. Forklift Safety and Operator Maintenance. Ensure trainee understands the importance of these safety items and procedures. The following safety operations are directly from OSHA regulations, by abiding in these regulations and following RM processes operating a forklift can be accomplished without mishaps.

5.5.1.1. Do NOT drive a forklift up to anyone standing in front of a bench or other fixed object.

5.5.1.2. Do NOT stand, work, or pass under the elevated portion of any forklift, whether loaded or empty.

5.5.1.3. Personnel shall NOT be permitted to ride on powered forklifts.

5.5.1.4. Never place arms or legs between the uprights of the mast or outside the running lines of the forklift.

5.5.1.5. When a forklift is left unattended: fully lower forks, neutralize controls, shut-off power, and set brakes. Block wheels if the forklift is parked on an incline.

- 5.5.1.6. A forklift is unattended when the operator is 25 feet or more away from the vehicle which remains in his view or whenever the operator leaves the vehicle and it is not in his view.
- 5.5.1.7. When the operator of a forklift is dismounted and within 25 feet of the truck still in view: lower the load engaging means, neutralize controls, and set the brakes to prevent movement.
- 5.5.1.8. Maintain a safe distance from the edge of ramps or platforms while on any elevated dock, or platform or freight car.
- 5.5.1.9. Do NOT use forklifts for opening or closing freight doors.
- 5.5.1.10. Ensure sufficient headroom under overhead installations, lights, pipes, sprinkler system, etc.
- 5.5.1.11. Ensure an overhead guard is in place as protection against falling objects. An overhead guard is intended to offer protection from the impact of small packages, boxes, bagged material, etc., representative of the job application, but not to withstand the impact of a falling capacity load.
- 5.5.1.12. Use a load backrest extension whenever necessary to minimize the possibility of the load or part of it from falling rearward.
- 5.5.1.13. Only approved forklifts shall be used in hazardous locations.
- 5.5.1.14. Keep fire aisles, access to stairways, and fire equipment clear.
- 5.5.1.15. Observe all traffic regulations. Maintain a safe distance of approximately three forklift lengths from the vehicle ahead, and keep the forklift under control at all times.
- 5.5.1.16. Yield the right of way to ambulances, fire trucks, or other vehicles in emergency situations.
- 5.5.1.17. Do NOT pass other forklifts traveling in the same direction at intersections, blind spots, or other dangerous locations.
- 5.5.1.18. The driver shall be required to slow down and sound the horn at cross aisles and other locations where vision is obstructed. If the load being carried obstructs forward view, the driver shall be required to travel with the load trailing.
- 5.5.1.19. Cross railroad tracks diagonally wherever possible. Do NOT park closer than 8 feet from the center of railroad tracks.
- 5.5.1.20. Look in the direction of, and keep a clear view of the path of travel.

- 5.5.1.21. Ascend/descend grades slowly.
- 5.5.1.22. When ascending or descending grades in excess of 10%, drive loaded trucks with the load upgrade.
- 5.5.1.23. On all grades, tilt back the load and load engaging means, if applicable, and raise the load only as far as necessary to clear the road surface. Drive forward up a ramp and back down a ramp.
- 5.5.1.24. Operate the forklift under all travel conditions at a speed that will permit it to be brought to a stop in a safe manner.
- 5.5.1.25. Stunt driving and horseplay will NOT be permitted.
- 5.5.1.26. Slow down for wet and slippery floors.
- 5.5.1.27. Properly secure board or bridge plates before they are slowly and carefully driven over. Ensure their rated capacity never exceeded. Remove snow or ice.
- 5.5.1.28. Approach elevators slowly, and then enter squarely after the elevator car is properly leveled. Once on the elevator, neutralize controls, shut-off power and set brakes.
- 5.5.1.29. Motorized hand trucks must enter elevator or other confined areas with load end forward.
- 5.5.1.30. Avoid running over loose objects on the roadway surface.
- 5.5.1.31. While negotiating turns, reduce speed (braking) and steer in a smooth, sweeping motion. Except when maneuvering at a very low speed, turn the hand steering wheel at a moderate, even rate.

**Note:** Secure loads to the forklift when carrying bulky loads or traveling long distances.

## **5.6. Forklift Load Composition and Stability.**

5.6.1. Definitions. The following definitions help to explain the principle of stability.

5.6.1.1. Center of gravity. The point on an object at which all of the object's weight is concentrated. For symmetrical loads, the center of gravity is at the middle of the load.

5.6.1.2. Counterweight. The weight that is built into the forklift's basic structure and is used to offset the load's weight and to maximize the vehicle's resistance to tipping over.

5.6.1.3. Fulcrum Point. The point on the truck between which balances the weight of the truck and the weight of the load being carried. The forklift's axis of rotation when it tips over is called the fulcrum.

5.6.1.4. Grade. The slope of a surface, which is usually measured as the number of feet of rise or fall over a hundred foot horizontal distance (the slope is expressed as a percent).

5.6.1.5. Lateral stability. A forklift's resistance to overturning sideways.

5.6.1.6. Line of action. An imaginary vertical line through an object's center of gravity.

5.6.1.7. Load center. The horizontal distance from the load's edge (or the fork's or other attachment's vertical face) to the line of action through the load's center of gravity.

5.6.1.8. Longitudinal stability. The forklift's resistance to overturning forward or rearward.

5.6.1.9. Moment. The product of the object's weight times the distance from a fixed point (usually the fulcrum point). In the case of a powered forklift, the distance is measured from the point at which the forklift will tip over to the object's line of action. The distance is always measured perpendicular to the line of action.

5.6.1.10. Track. The distance between the wheels on the same axle of the forklift.

5.6.1.11. Wheelbase. The distance between the centerline of the vehicle's front and rear wheels.

5.6.2. General. Determining the stability of a forklift is simple once a few basic principles are understood. There are many factors that contribute to a vehicle's stability: the vehicle's wheelbase, track, and height; the load's weight distribution; and the vehicle's counterweight location (if the vehicle is so equipped). The "stability triangle," used in most stability discussions, demonstrates stability simply.

5.6.2.1. Basic Principles. Whether an object is stable depends on the object's moment at one end of a system being greater than, equal to, or smaller than the object's moment at the system's other end.

5.6.2.1.1. This principle can be seen in the way a see-saw or teeter-totter works: that is, if the product of the load and distance from the fulcrum point (moment) is equal to the moment at the device's other end, the device is balanced and it will not move. However, if there is a greater moment at one end of the device, the device will try to move downward at the end with the greater moment.

5.6.2.1.2. The longitudinal stability of a counterbalanced powered industrial truck depends on the vehicle's moment and the load's moment. In other words, if the mathematic product of the load moment (the distance from the front wheels, the approximate point at which the vehicle would tip forward) to the load's center of gravity times the load's weight is less than the vehicle's moment, the system is balanced and will not tip forward. However, if the load's moment is greater than the vehicle's moment, the greater load-moment will force the truck to tip forward.

5.6.3. Physics/Stability. In order to safely operate a forklift one must understand the physical aspects of carrying a load.

5.6.3.1. If a load is not properly balanced on the forks, tipping of the forklift or dropping of the cargo can result. Loads will be of different shapes, weights and balance, it is imperative that correct load balancing is learned and practiced.

5.6.3.2. To better the understanding of how a load will carry it is also important to know where the Center of Gravity of the forklift is and the parts of the forklift that add to this.

5.6.4. Stability. Stability is the resistance to sudden change, dislodgement or overthrow. As one can guess the stability of the forklift is extremely important during operation.

5.6.4.1. The center of gravity, dictated by the forklift, load size and weight on the forklift are all contributing factors. Forklift stability is a function of three-point suspension (stability triangle), as indicated by **Figure 5.6.**

**Figure 5.6. Center of Gravity.**

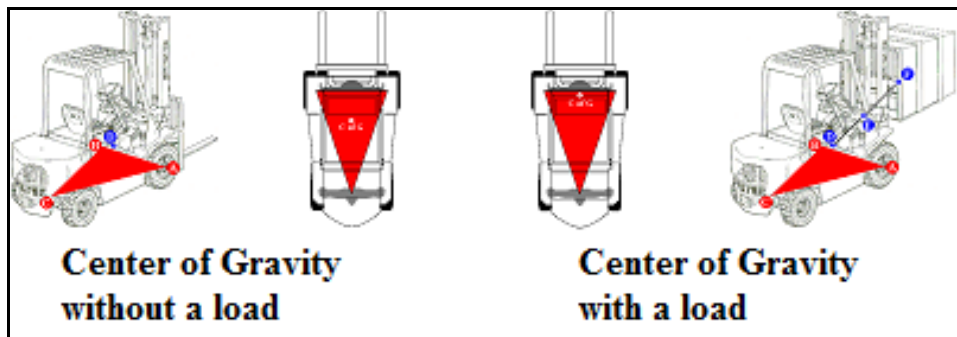

5.6.4.2. This stability triangle is formed by the drive axle tread of the forklift and the center point mount on the steering axle. Each vehicle has an imaginary stability triangle, an area of the vehicle in which the center of gravity must remain.

5.6.4.3. If the center of gravity shifts out of this triangle, handling characteristics diminish and tipping can follow. Refer to **Figure 5.6.** for the remainder of this paragraph.

5.6.4.4. Point D is the center of gravity of an empty forklift at rest on level ground. Point F is the center of gravity of the load, and point E is the combined center of gravity of the forklift and load. The combined center of gravity (point E) is within the triangle formed by points A, B, and C when the mast is vertical. Stability depends upon how close point E comes to the edge of the triangle. As this point approaches, or exceeds, the triangle's boundary, the truck will tip.

5.6.4.5. Remember that stability is not only a forward and backward concern. As the center of gravity of the load is moved from left and right, the stability of the forklift is also.

5.6.4.5.1. The concern here is that forklifts are longer than they are wide; the same goes for the stability triangle. Tipping to the front is not as common as tipping to the side.

5.6.4.5.2. This can happen due to poor handling practices (turning too hard and fast) and poor load planning (placing heavier object to the right or left). At all times the center of gravity of the load and forklift must remain in the stability triangle.

5.6.5. Load Handling. The capacity of a forklift is given by weight and distance to the load center. This information is listed on the forklift data plate.

5.6.5.1. Before attempting to lift a load, make sure the weight is within the capacity of the forklift at the load center involved. Also, the rated capacity presumes that the center of the load is no further from the top of the forks than it is from the face of the carriage.

5.6.5.2. If these conditions do not exist, the operator may have to reduce the load weight since the center of gravity may be out of the stability triangle. See **Figure 5.7.** for illustration of load center and example.

**Note:** Forward tipping can be caused by, loads that exceed the rated capacity, excessive forward tilt with the load elevated, or by abrupt stopping while the load is elevated.



**Figure 5.7. Forklift Load Center.**

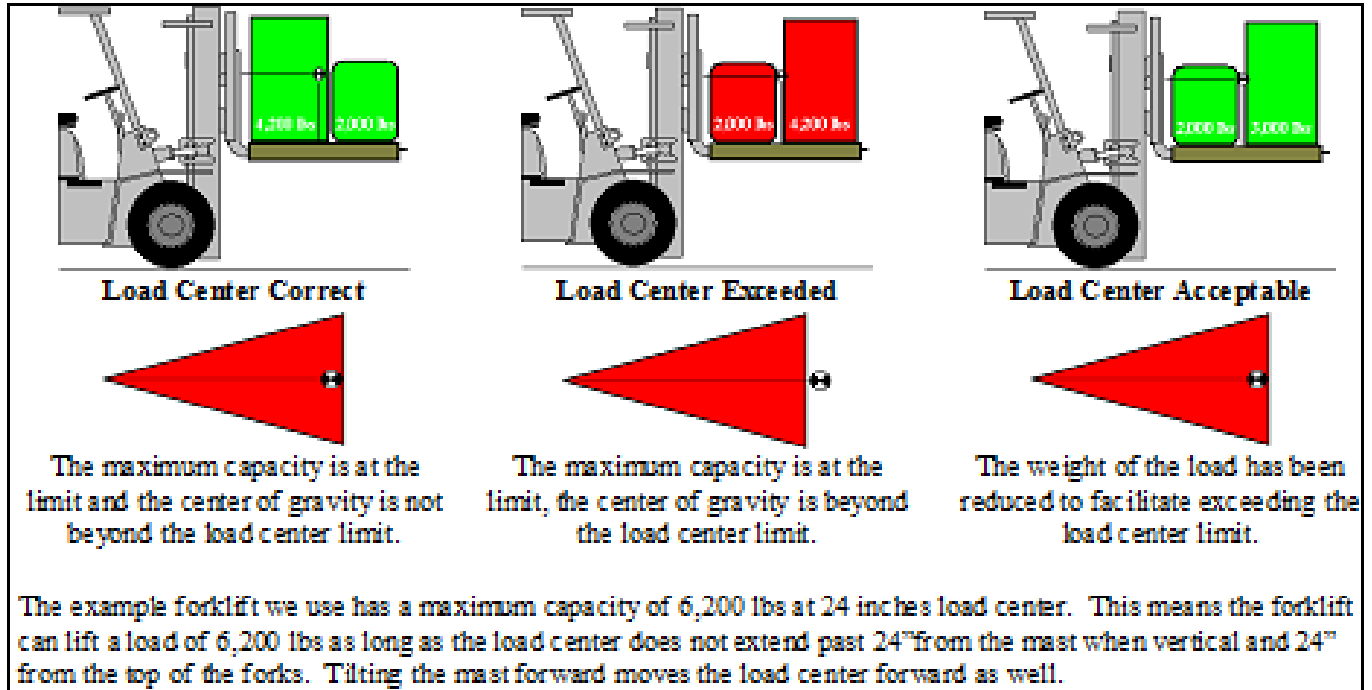

## **5.7. Forklift Loading and Unloading.**

5.7.1. Loading and Unloading Safety. The following are safe practices to be observed when loading and unloading include:

5.7.1.1. Only handle stable and safely arranged loads. Exercise caution when handling off-center loads which cannot be centered.

5.7.1.2. Only handle loads within the rated capacity of the forklift.

5.7.1.3. Adjust the long or high (including multiple-tiered) loads which may affect capacity.

5.7.1.4. Operate forklifts equipped with attachments as partially loaded forklifts when not handling a load. Use only attachments issued with the forklift or approved by the forklift manufacturer.

5.7.1.5. Place the forks a load engaging means under the load as far as possible so that the load is up against the mast; the mast shall be carefully tilted backward to stabilize the load.

5.7.1.6. Use extreme care when tilting the load forward or backward, particularly when high tiering. Tilting forward with load engaging means elevation is prohibited except to pick up a load. An elevated load will not be tilted forward except when the load is in a deposit position over a rack or stack. When stacking or tiering, only use enough backward tilt to stabilize the load.

5.7.2. Preparing Loads. The operator may be tasked to prepare the load or transport it. Either way as an operator moving the load, once the operator receives the load, the load becomes their responsibility. It is therefore imperative to know if the load is ready for transport or not.

5.7.2.1. Cargo comes in all shapes and sizes, however there are requirements for all. Whenever possible, place cargo on pallets for stability.

5.7.2.2. There are hundreds, if not thousands, of different types of pallets and containers, however, in the AF most cargo will be packaged on skids, 463L pallets or self-contained (KITS pallet). These self-contained loads will vary as per the packaging requirements. Self-contained loads require less prepping as long as they have been properly assembled and loaded. See **Figure 5.8.** for different styles of loads.

**Figure 5.8. Forklift Load Styles.**

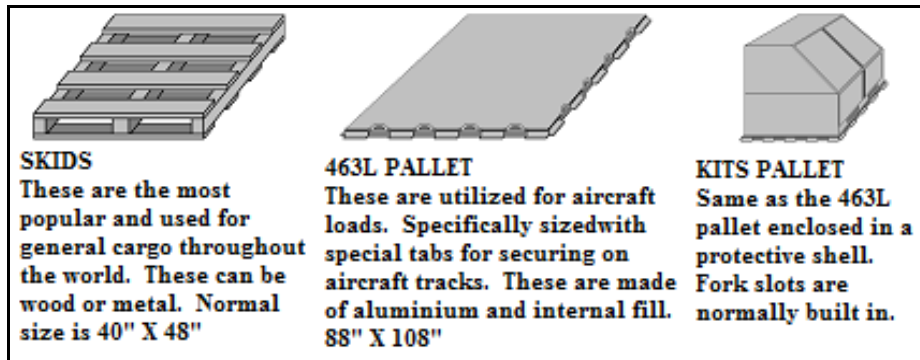

5.7.2.3. Loads will always be tightly packed to reduce shifting and secured to the pallet before transport. Utilize cargo nets, cargo straps, chains, or multiple layers of plastic wrap/straps for lighter loads to secure the load to the pallet.

5.7.2.3.1. When the load must be placed outside during inclement weather, loads should be covered with tarpaulin for protection

5.7.2.3.2. Loads traveling over-the-road require different load preparation than loads traveling on military airlift. Contact Traffic Management Office (TMO) for further details and instructions.

**Figure 5.9. Properly/Improperly Loaded Pallet.**

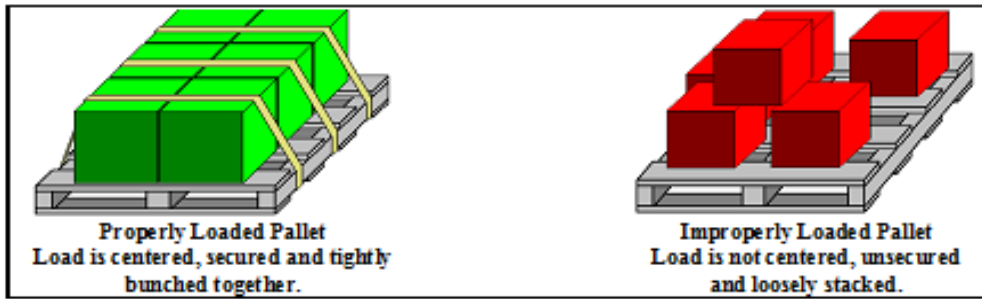

5.7.2.4. Spotter. Generally, standard forklifts have a diminished view of the working area in front of the operator. Utilization of a spotter during loading and unloading of cargo is necessary to ensure the ability to see where the vehicle is going.

5.7.2.4.1. If visual contact with the spotter is lost, the spotter is dangerously positioned, or the operator is in doubt, the operator must immediately stop the vehicle.

5.7.2.4.2. Hand signals are often used to communicate between the spotter and the operator, if ever in doubt on what the spotter is trying to communicate, the operator should stop immediately and clarify with the spotter the meaning of the hand signal(s). Standard AF forklift-specific hand signals are pictured below. See **Figures 5.10. – 5.19.** Refer to AFMAN 24-306 for additional standard AF spotter hand signals.

**Figure 5.10. Forklift Hand Signals – Close/Open Fork Tines.**



**Figure 5.11. Forklift Hand Signals – Side Shift Right/Left.**



**Figure 5.12. Forklift Hand Signals – Raise/Lower Carriage.**



**Figure 5.13. Forklift Hand Signals – Tilt Mast Forward/Back.**



**Figure 5.14. Standard Spotting Hand and Arm Signals – Come Towards the Spotter.**



**Figure 5.15. Standard Spotting Hand and Arm Signals – Move Away from the Spotter.**



**Figure 5.16. Standard Spotting Hand and Arm Signals – Right/Left Turn.**

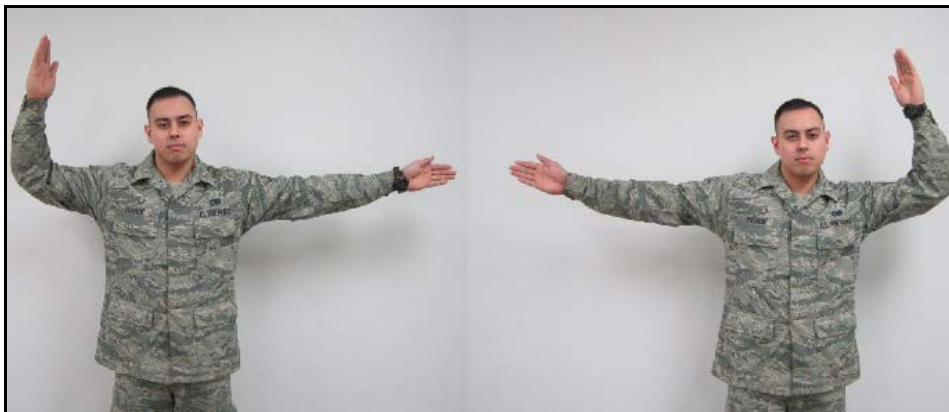

**Figure 5.17. Standard Spotting Hand and Arm Signals – Slow Down.**



**Figure 5.18. Standard Spotting Hand and Arm Signals – Stop.**



**Figure 5.19. Standard Spotting Hand and Arm Signals – Shut Down.**





5.7.2.5. Picking Up Loads. When approaching a load to pick it up; move in slowly, ensure the forklift is square and centered with the load and the forks are at the proper height for engaging the load. Move slowly until the forks are entirely under the load.

5.7.2.5.1. Forks should be spread according to the load width for the maximum stability on the forks. Ensure to not over extend the forks and damage a load behind the one being approached. Forks should be longer than the load, after picking up the load, inch back, lower the load and fully rest the load against the carriage. Raise the load from the surface and tilt back just enough to safely carry it.

5.7.2.5.2. If the load is stacked, slowly back the forklift clear of the stack and lower the forks to a safe traveling height. During loading of cargo it is the best practice to utilize a spotter in tight or low visibility areas. The forklift mast blocking the operator's view of the forks and load can cause low visibility.

5.7.2.6. Transporting Loads.

5.7.2.6.1. To transport a load, tilt the mast back just enough to travel safely. Do not raise the load higher than what is necessary for adequate floor clearance.

5.7.2.6.2. Travel in reverse in standard forklifts at all times with or without a load.

5.7.2.6.3. Travel forward in all terrain forklifts, unless visibility is impaired. If visibility is impaired, travel in reverse.

5.7.2.6.4. Avoid any sudden starts, stops and turns.

5.7.2.6.5. Ensure the load does not exceed the limitation of the forklift, and when starting to transport the load keep in mind the load may exceed the height and width of the forklift.

5.7.2.6.6. Forklifts should not be used to transport cargo over long distances or through heavy traffic areas. It is better to load the cargo on a tractor/trailer, pickup, stake & platform truck, etc. for transport and then use a forklift at the distant end to download the cargo. Pallets should be secured to the forklift when this is not possible.

5.7.2.7. Unloading. To unload on the floor, level the load with the floor and lower into place. It may be necessary to tilt the forks forward to remove the load smoothly.

5.7.2.7.1. Back out of the load. When backing out of the load, ensure the back portion of the forks are not in contact with the floor; this can damage the carriage keepers, eventually causing them to break.

5.7.2.7.2. To place the load on a stack, raise the load as the vehicle is inching into position. Be careful not to collide with adjacent loads. Once the load is square with the stack, level the load and lower the forks just enough to free them from the pallet, be careful not to drag the forks. Back away from the load and lower the forks as soon as the vehicle has cleared the stack.

5.7.2.7.3. When unloading 463L or KITS type pallets place load on shoring (dunnage). Shoring (dunnage) provides a space for the forks to easily move in and out from underneath the load and keeps the pallets clean and dry. Utilize at least three pieces of shoring (dunnage) for each pallet to prevent warping of the pallet.

## **5.8. Forklift Operation.**

5.8.1. Operating Inside and Outside of Warehouses. Observe the following items when operating in and out of warehouses:

5.8.1.1. Speed limit inside a warehouse is 5 miles per hour (mph).

5.8.1.2. Stop between 5 and 10 ft., sound horn prior to entering all warehouse openings/adjacent rooms

5.8.1.3. Warehouse ramps/Loading docks: Ensure gear selection is correct for safe operation in and out of buildings and prior to exiting ramps. Forklifts will be downshifted to “L” or low prior to descending or ascending ramps.

5.8.1.4. Only approved forklifts may be operated in warehouses with hazardous material.

5.8.1.5. Operate fuel (gas, diesel, propane, compressed natural gas) powered forklifts in approved ventilated warehouses

5.8.2. Forklift Attachments Use.

5.8.2.1. Two of the most common attachments that can be encountered on a forklift are rollerized tines and a personnel lift platform.

5.8.2.2. Rollerized Tines. Rollerized tines are used to unload rollerized trailers, rollerized docks, and aircraft during contingency operations. This accessory simplifies some tasks but at the same time adds to hazards.

5.8.2.2.1. When rollerized tines are issued with the forklift, these will be added to pre-inspections and preventive maintenance procedures. Rollerized tines will be turned in to transportation with the forklift for scheduled maintenance.

5.8.2.2.2. Rollerized tines will only be utilized on forks of the same size and capability as the forklift they are issued with. Rollerized tines will not be utilized as fork extensions at any time.



- 5.8.2.2.3. Do not utilize rollerized tines for SKID type pallets.
  - 5.8.2.2.4. Lay the tines on a level floor and slowly drive into them. Do not lift the tines onto the forks.
  - 5.8.2.2.5. Ensure rollerized tines are mechanically secured to the forks.
  - 5.8.2.2.6. Whenever a load is placed on the rollerized tines, the load must be secured to the forklift.
  - 5.8.2.2.7. Use rollerized tines only when necessary and for the shortest distance needed.
  - 5.8.2.2.8. When stored, rollerized tines will be kept in the work area and not present a tripping hazard.
- 5.8.2.3. Personnel Lift Platform. Whenever a forklift is equipped with vertical controls only, or vertical or horizontal, the following additional precautions shall be taken for the protection of personnel being elevated:
- 5.8.2.3.1. Use of safety platform firmly secured to the lifting carriage and/or forks.
  - 5.8.2.3.2. Means shall be provided whereby personnel on the platform can shut off power to the forklift.
  - 5.8.2.3.3. Protection from falling objects as indicated necessary by the operating conditions shall be provided.
- 5.8.2.4. Parking. Parking of a forklift has a few more added requirements than parking a vehicle. Never leave the forklift in a condition that can cause damage and injury. Do not park a forklift so that it limits access to fire aisles, stairways and fire equipment. To park a forklift:
- 5.8.2.4.1. Find a level area to park the forklift.
  - 5.8.2.4.2. Stop the forklift, place transmission control in neutral and apply the parking brake.
  - 5.8.2.4.3. Lower the carriage completely; tilt the mast forward until the fork tips touch the ground.
  - 5.8.2.4.4. On a forklift with a turbo-charged engine, let the engine idle for 5 minutes.
  - 5.8.2.4.5. On a forklift without a turbo, let the engine idle according to manufacturer's recommendation.

- 5.8.2.4.6. Turn-off all lights and accessories.
  - 5.8.2.4.7. Turn ignition switch to the OFF position.
  - 5.8.2.4.8. If applicable turn the master switch to the OFF position.
  - 5.8.2.4.9. If the forklift must be parked on an incline or flightline, chock the drive wheels.
  - 5.8.2.4.10. Drain air tanks if applicable.
  - 5.8.2.4.11. Perform a walk around inspection of the forklift.
- 5.8.2.5. Flightline Rules and Regulations. Refer to AFI 13-213, *Airfield Driving* and AFMAN 24-306.
- 5.8.2.5.1. Flightline training will be conducted separately.
  - 5.8.2.5.2. General rules while operating on the flightline:
    - 5.8.2.5.2.1. Do not exceed 5 mph around aircraft.
    - 5.8.2.5.2.2. Do not load/unload while aircraft is being serviced with fuel or oxygen, unless concurrent servicing is authorized.
    - 5.8.2.5.2.3. Utilize spotter when approaching or moving away from aircraft.
    - 5.8.2.5.2.4. Place pre-positioned wheel chocks between aircraft and forklift.
    - 5.8.2.5.2.5. Parking on flightline:
      - 5.8.2.5.2.5.1. Place transmission control in neutral.
      - 5.8.2.5.2.5.2. Apply the parking brake.
      - 5.8.2.5.2.5.3. Lower the carriage completely (tilt the mast forward until fork tips touch ground).
      - 5.8.2.5.2.5.4. Turn ignition switch to the OFF position.
      - 5.8.2.5.2.5.5. Chock the drive wheels.
      - 5.8.2.5.2.5.6. Leave key in ignition.
    - 5.8.2.5.2.6. Forklift has proper lighting to include beacon light and/or flashers.

5.8.2.6. Fire Extinguisher Training. Most forklifts are equipped with fire extinguishers, which mean training is required. The supervisor or Squadron VCO will schedule training with the local Fire Department. Fire extinguisher training is an annual requirement after initial forklift training.

5.8.2.6.1. The fire extinguisher itself must be inspected to ensure current inspection date, ensure needle is positioned in the green and ensure it is securely mounted.

5.8.2.6.2. Ensure forklift is equipped with appropriate number of rated fire extinguishers (see AFMAN 91-201 for specific requirements concerning transport of explosive on a forklift).

5.8.2.7. Hazardous Materials. Personnel who transport explosives and hazardous material will receive separate training. The trainee must receive this training prior to transporting any hazardous materials.

5.8.2.8. Workplace Policies and Procedures. Ensure the trainee understands local policies and procedures in regards to forklift operations. If the trainee is at a temporary duty location, take the time to learn the policies and procedures for the location the vehicle is at.

## **Section 6—EXPLANATION AND DEMONSTRATION**

### **6.1. Instructor's Preparation.**

6.1.1. Establish a training location.

6.1.2. Obtain appropriate Manufacturer's Operator's Manual.

6.1.3. Schedule/reserve a vehicle.

6.1.4. Ensure trainee completes AF Form 171.

### **6.2. Safety Procedures and Equipment.**

6.2.1. The following safety items should be followed by both the instructor and trainee.

6.2.1.1. Chock wheel (if required) when forklift is parked.

6.2.1.2. Remove all jewelry and identification tags.

6.2.1.3. Personal protective equipment and equipment items.

6.2.1.3.1. Safety steel-toed boots must be worn.

- 6.2.1.3.2. Gloves will be worn during cargo loading and unloading.
- 6.2.1.4. Walk-around vehicle to familiarize the trainer and the trainee with all warning labels and signs.
- 6.2.1.5. Ensure trainee wears seat belts.
- 6.2.1.6. Properly adjust driver's seat and all mirrors, if available.
- 6.2.1.7. Throughout demonstration, practice forklift safety:
  - 6.2.1.7.1. Always observe speed and safety precautions while carrying loads.
  - 6.2.1.7.2. Keep loads within the rated capacity of the forklift.
  - 6.2.1.7.3. Travel with the forks raised no more than 6 inches from floor or ground.
  - 6.2.1.7.4. When moving loads that obstructs view, travel in reverse.
  - 6.2.1.7.5. Do not extend hands and arms through mast of forklift.
  - 6.2.1.7.6. Only the operator is allowed to ride on the forklift.
  - 6.2.1.7.7. Following other vehicles, allow at least three vehicle lengths.
  - 6.2.1.7.8. Proper overhead clearance for any overhead objects.
  - 6.2.1.7.9. If load is bulky or wide, check for side clearance.
  - 6.2.1.7.10. Avoid driving close to the edge of any elevated areas of operation.
  - 6.2.1.7.11. Avoid sudden stops.
  - 6.2.1.7.12. Never descend ramps with a load in front.
  - 6.2.1.7.13. Lift with the mast vertical or tilted slightly back.
  - 6.2.1.7.14. Park forklift, hand brake set, engine off, forks flat on the floor/ground.
- 6.2.2. Practice basic AF RM process during demonstration:
  - 6.2.2.1. Identify hazards.
  - 6.2.2.2. Assess hazards.
  - 6.2.2.3. Develop controls and make decisions.

6.2.2.4. Implement controls.

6.2.2.5. Supervise and evaluate.

### **6.3. Operator Maintenance Demonstration.**

6.3.1. With trainee, accomplish vehicle inspection using AF Form 1800. The vehicle inspection will follow the seven-step method as described in **Attachment 3**. An inspection guide (**Attachment 2**) can be used to ensure all areas of the forklift are covered in addition to the “Operation Demonstration” guidelines provided below.

### **6.4. Operation Demonstration.**

6.4.1. Throughout demonstration.

6.4.1.1. Allow for questions.

6.4.1.2. Repeat demonstrations as needed.

6.4.1.3. For more information refer to the vehicle data plate and the Operator’s Manufacturer’s Manual.

6.4.2. For all forklifts, within the training area, demonstrate and explain the following. **Note:** Use information contained on the data plate and/or the operator’s manual:

6.4.2.1. Forklift stability.

6.4.2.1.1. Go over the capabilities of the forklift.

6.4.2.1.2. Center of gravity.

6.4.2.1.3. Stability triangle, the area of the vehicle in which the center of gravity must remain.

6.4.2.2. Explain parking brake as they apply to forklift being used.

6.4.2.2.1. Air brakes.

6.4.2.2.2. Manual (how to adjust).

6.4.2.3. Brake pedal.

6.4.2.4. The proper use of inching pedal (if equipped).

6.4.2.5. Transmission gearshift levers.

- 6.4.2.5.1. Speed selection lever.
- 6.4.2.5.2. Directional control lever (forward and reverse).
- 6.4.2.6. Show the operations of hydraulic control levers.
  - 6.4.2.6.1. Lift/lower control lever.
    - 6.4.2.6.1.1. Standard forklift reach.
    - 6.4.2.6.1.2. Articulating forklift reach.
  - 6.4.2.6.2. Tilt control lever.
  - 6.4.2.6.3. Side shift (if equipped).
  - 6.4.2.6.4. Fork positioning lever (if equipped).
  - 6.4.2.6.5. Other controls as equipped (rotate, swing, extend, etc.).
- 6.4.2.7. Explain the pivot lock (if equipped) (10-13K AT F/L).
- 6.4.2.8. Steering (show how the forklift maneuvers forward and backward). **Note:** Steering systems will vary for different forklift types/models. The operator must be trained on the steering system specific to the vehicle being operated prior to operating the vehicle. (e.g. if the operator is trained/licensed on a 10K F/L with rear wheel steering, he/she will be familiarized with front wheel/articulated steering prior to operating a F/L with either steering system).
  - 6.4.2.8.1. Front wheel steering.
  - 6.4.2.8.2. Rear wheel steering (most standard 4-10K F/L).
  - 6.4.2.8.3. Articulated steering (10-13K AT F/L).
- 6.4.2.9. Demonstrate the maneuverability of the forklift (forward and backward).
  - 6.4.2.9.1. Forks no more than 6 inches off the ground.
  - 6.4.2.9.2. Point how the steering moves the forklift (standard or articulating).
  - 6.4.2.9.3. Following example is a suggested course.

**Figure 6.1. Forklift Maneuverability Course Example.**

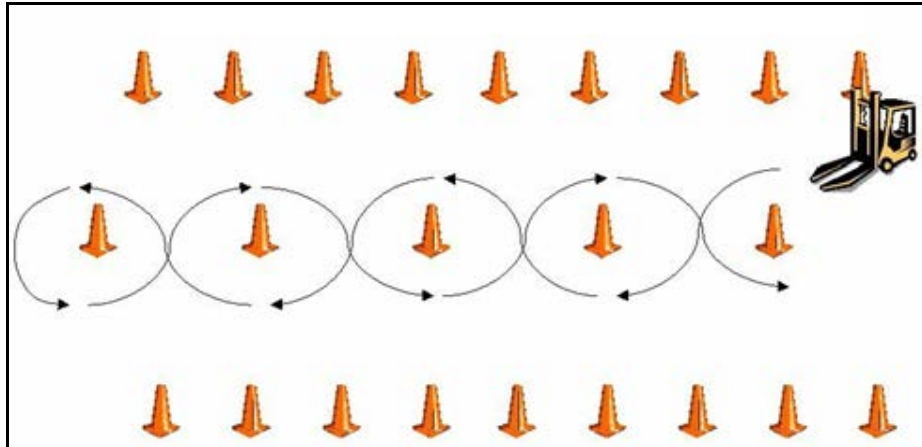

6.4.2.10. Demonstrate loading and unloading the forklift.

6.4.2.10.1. Go over hand signals, have trainee serve as the spotter. Keep spotter in sight at all times. When picking up loads, observe the following:

6.4.2.10.1.1. Approach slowly.

6.4.2.10.1.2. Ensure forklift is square and centered with load.

6.4.2.10.1.3. Spread the forks according to the load width.

6.4.2.10.1.4. Forks at proper height of engaging load.

6.4.2.10.1.5. Move slowly until forks are entirely under load.

6.4.2.10.1.6. Raise load for resting spot and tilt back.

6.4.2.10.1.7. Slowly back away from stacked cargo, when clear lower mast to safe traveling distance.

6.4.2.10.2. Unloading loads.

6.4.2.10.2.1. On floor/ground.

6.4.2.10.2.1.1. Ensure load level with floor.

6.4.2.10.2.1.2. Lower load, tilt forward slightly to clear load.

6.4.2.10.2.1.3. Back out slowly.

6.4.2.10.2.2. On stacked cargo.

6.4.2.10.2.2.1. Raise mast.

6.4.2.10.2.2.2. Slowly position loads over stacked cargo.

6.4.2.10.2.2.3. Lower load, tilt forward slightly to clear load.

6.4.2.10.2.2.4. Back out slowly.

6.4.2.10.2.3. Use shoring (dunnage) for 463L pallets (gloves).

6.4.3. Show trainee the after operation inspection and report.

6.4.3.1. Ensure vehicle cleaned.

6.4.3.2. Refueled.

6.4.3.3. Following manufacturer's shut-down procedures.

6.4.3.4. Park.

6.4.3.4.1. Level area.

6.4.3.4.2. Place transmission control in neutral.

6.4.3.4.3. Apply the parking brake (adjust if necessary).

6.4.3.4.4. Lower the carriage completely (tilt the mast forward until fork tips touch ground).

6.4.3.4.5. Turbo-charged engine, let the engine slow idle for 5 minutes.

6.4.3.4.6. Without a turbo, let the engine idle according to manufacturer's recommendation.

6.4.3.4.7. Turn-off all lights and accessories.

6.4.3.4.8. Turn ignition switch to the OFF position.

6.4.3.4.9. Turn the master switch to the OFF position.

6.4.3.4.10. If the forklift must be parked on an incline or flightline, chock the drive wheels.

6.4.3.4.11. Drain air tanks if applicable.



6.4.3.5. Perform a walk around inspection.

6.4.3.6. Annotate any discrepancies found on AF Form 1800.

6.4.4. Conclude by allowing time for questions and any requested re-demonstrations.

## **Section 7—TRAINEE PERFORMANCE AND EVALUATION**

### **7.1. Trainee Performance.**

7.1.1. Instructor will:

7.1.1.1. Ensure safety at all times. **Note:** Stop training when safety items are violated. Proceed only when the trainee fully understands how to avoid repeating the safety infraction(s).

7.1.1.1.1. Chock wheel (if required) when forklift is parked.

7.1.1.1.2. Remove all jewelry and identification tags.

**Note:** If available, mark vehicle with magnetic sign indicating “Driver-in-Training” or “Trainee Operator”.

7.1.1.2. Personal protective equipment and other items.

7.1.1.2.1. Safety steel-toed boots must be worn.

7.1.1.2.2. Gloves will be worn during cargo loading and unloading.

7.1.1.2.3. Hearing protection.

7.1.1.2.4. Reflective belt/vest during low visibility times.

7.1.1.3. Pay particular attention to the cautions and warnings listed in the operator's manual.

7.1.1.4. Ensure trainee wears seat belts.

7.1.1.5. Properly adjust driver's seat and all mirror.

7.1.1.6. Forklift safety items/procedures.

7.1.1.7. Ensure the driver is aware of driving situations he/she is to perform.

7.1.1.8. Conduct during/after-action reviews with the trainee (demonstration may need to be re-accomplished).

#### 7.1.2. Trainee Performance:

7.1.2.1. Conduct operator maintenance (have trainee explain items being inspected).  
**Note:** Allow trainee to use **Attachment 2** as a guide while performing inspection.

7.1.2.1.1. Pre-inspection.

7.1.2.1.2. During inspection.

7.1.2.2. Ensure AF Form 1800 is properly documented.

7.1.2.2.1. Establish a road course with turns and stops signs.

7.1.2.2.2. Backing. Serve as the trainee's spotter, or if available, have another trainee be the spotter.

7.1.2.2.3. Continue until trainee can show proficiency in operating.

7.1.2.3. Have trainee practice the following forklift operations (use spotter when backing) until they can safely and efficiently perform:

7.1.2.3.1. Operate forklift forward and backward. Continue until trainee can show proficiency in operating.

7.1.2.3.2. See **Figure 7.1.** for a recommended course.

**Figure 7.1. Forklift Maneuverability Course Example.**

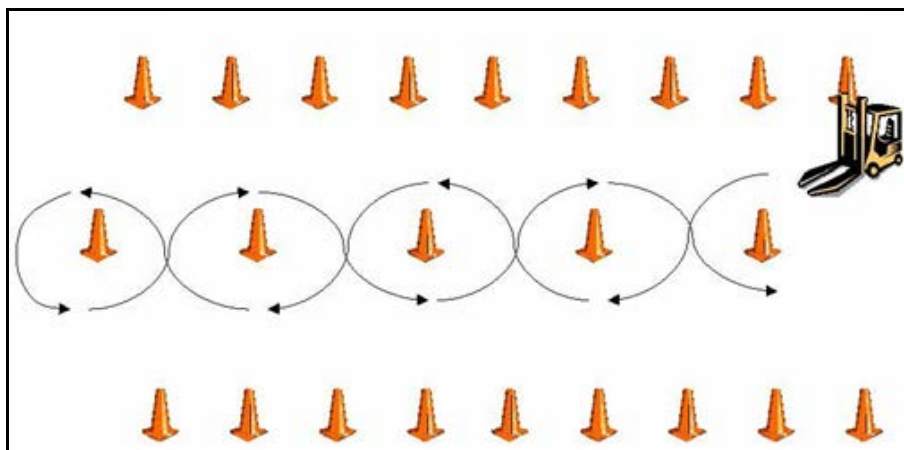

7.1.2.3.3. Using 4 to 6 stacked wooden pallets:

7.1.2.3.3.1. Wooden pallets for 4-6K F/L and 463L pallets for 10K 463L F/L.

7.1.2.3.3.2. Load one pallet at a time and maneuver through course.

7.1.2.3.3.3. Unload pallets (stacking on top of each other).

7.1.2.3.3.4. Repeat until all pallets are moved.

7.1.2.3.3.5. Repeat process until trainee shows proficiency in operating.

7.1.2.3.3.5.1. Rearrange course.

7.1.2.3.3.5.2. Accomplish operating forward and backward.

**Note:** For simplicity, empty pallets will provide the greatest visibility in allowing the trainee to learn how to properly approach and pick-up the load.

7.1.2.3.4. Using Training Cargo:

7.1.2.3.4.1. Load cargo.

7.1.2.3.4.2. Unload cargo on trailer or dock if available.

7.1.2.3.4.3. Repeat process until trainee show proficiency in operating.

7.1.2.3.4.3.1. Rearrange course or create scenarios related to mission requirements.

7.1.2.3.4.3.2. Accomplish operating forward and backward.

7.1.2.3.4.4. Create scenarios as appropriate and have trainee perform tasks.

7.1.2.3.4.5. Have trainee perform after operation inspection.

7.1.2.3.4.6. Have trainee properly show how to park the forklift.

## **7.2. Performance Evaluation.**

7.2.1. Trainee will perform performance evaluation found in **Attachment 3**.

7.2.1.1. Instructor and trainee will review **Attachment 3**.

7.2.1.2. Instructor will answer trainee's questions.

**Note:** If available, mark vehicle with magnetic sign indicating "Driver-in-Training" or "Trainee Operator".

7.2.2. Instructor will:

7.2.2.1. Ensure safety at all times.

7.2.2.1.1. Place wheel chocks (if required) when forklift is parked.

7.2.2.1.2. Remove all jewelry and identification tags.

7.2.2.2. Personal protective equipment and other items.

7.2.2.2.1. Safety steel-toed boots must be worn.

7.2.2.2.2. Gloves will be worn during cargo loading and unloading.

7.2.2.2.3. Hearing protection.

7.2.2.3. Pay particular attention to the cautions and warnings listed in the operator's manual.

7.2.2.4. Ensure trainee wears seat belts, if equipped.

7.2.2.5. Properly adjust driver's seat and all mirrors (if available).

7.2.2.6. Forklift safety items/procedures.

7.2.3. Explain driving techniques.

7.2.4. Ensure the driver is aware of driving situations.

7.2.5. Conduct after-action reviews with the trainee.

7.2.6. Trainee is not allowed any instructor assists to pass performance evaluation.

7.2.7. Evaluation checklist provided in **Attachment 3**.

7.2.8. Retraining; retrain No-Go's.

7.2.8.1. Re-demonstrate No-Go items.

7.2.8.2. Have trainee re-perform until they show proficiency in operating, critique weaknesses as observed.

7.2.8.3. Re-evaluate.

## Attachment 1

### GLOSSARY OF REFERENCES AND SUPPORTING INFORMATION

#### *References*

**AFI 24-301**, *Ground Transportation*, 23 April 2019

**AFI 13-213**, *Airfield Driving*, 1 June 2011

**AFMAN 24-306**, *Operation of Air Force Government Motor Vehicles*, 9 December 2016

**AFMAN 91-201**, *Explosive Safety Standards*, 12 January 2011

**OSHA Directive, Enforcement and Compliance (CPL) 2-1.28A**, *Compliance Assistance for the Powered Industrial Truck Operator Training Standards*

**Regulations (Standards - 29 Code of Federal Regulations (CFR)), Part 1910** - Occupational Safety and Health Standards, Subpart N – *Material Handling and Storage*

**Title 29 CFR Part 1910**, *Occupational Safety and Health Standards, Subpart N – Material Handling and Storage*

#### *Adopted Forms*

**AF Form 171**, *Request for Driver's Training and Addition to U.S. Government Drivers*, 1 November 2018

**AF Form 847**, *Recommendation for Change of Publication*

**AF Form 1800**, *Operator's Inspection Guide and Trouble Report*

#### *Abbreviations and Acronyms*

**AF**—Air Force

**AFI**—Air Force Instruction

**AFIMSC**—Air Force Installation Mission Support Center

**AFMAN**—Air Force Manual

**AFOSH**—Air Force Occupational Safety and Health

**AFQTP**—Air Force Qualification Training Plan

**AT**—All Terrain

**CFR**—Code of Federal Regulations

**IAW**—In Accordance With

**LPG**—Liquefied Petroleum Gas

**LPP**—Liquid Phase Propane

**MPH**—Miles per Hour

**OSHA**—Occupational Safety & Health Administration

**RM**—Risk Management

**TMO**—Traffic Management Office

**TO**—Technical Order

**VCNCO**—Vehicle Control Non Commissioned Officer

**VCO**—Vehicle Control Officer

## Attachment 2

### VEHICLE INSPECTION GUIDE

#### **A2.1. Desired Learning Outcome.**

A2.1.1. Understand the safety precautions to be followed before, during, and after operation of the forklift.

A2.1.2. Understand the purpose of the forklift and their role in the mission.













#### **A2.2. Inspection During-Operations.** The operator must ensure the following items are checked after starting the forklift and during operations.

A2.2.1. Gauges and Warning Lights. Most warning lights will show when the ignition is in the start position to show proper operation of the bulb. Some gauges will “peg” to one side showing operation.



A2.2.2. Once the engine has started these warning lights should go out and gauges will go to appropriate readings. It is important the operator becomes familiar with the proper operating readings of gauges; specific meaning of warning and indicator lights and what to do if indications are warning of a malfunction on the forklift the operator will be operating.

A2.2.3. Some forklifts will have all these items and some will be limited. Along with indicators and gauges; warning lights may service the same function, however placed on the forklift as an added precaution from operator error. Some generic forklift warning lights, indicators and gauges are shown as follows:







**Figure A2.1. Forklift Warning Lights.**

<b>Display:</b>	<b>Indicates:</b>	<b>Response:</b>
	Indicates low brake pressure.	Wait for pressure to build up before moving forklift.
	Indicates low engine oil pressure	Check engine oil level, fill to required level.
	Indicates machine requires servicing soon.	Discontinue use and contact VCO/VCNCO for support.
	Indicates parking brake is engaged.	Will remain on until parking brake is released.
	Indicates an electrical malfunction.	Discontinue use and contact VCO/VCNCO for support.
	Indicates the transmission filter restriction.	Discontinue use and contact VCO/VCNCO for support.
	Indicates the hydraulic oil filter restriction.	Discontinue use and contact VCO/VCNCO for support.
	Indicates the air filter is restricted.	Remove and shake out air filter if dry type.
	Indicates intake air restricted.	Remove and shake out air filter if dry type.
	Indicates transmission overheating.	Stop use of forklift and let transmission cool down.
	Indicates alternator malfunction.	Check drive belt tension.
	Indicates coolant level is low.	Check coolant level and fill.
	Indicates seatbelt not in use.	Fasten seat belt.

**Figure A2.2. Forklift System Gauges.**

<b>Display:</b>	<b>Gauge:</b>	<b>Description:</b>	<b>Reading Evaluation:</b>
	Hour Meter	Operates when the key switch is ON and the engine is running.	Periodic maintenance and vehicle rotations are based on these hours.
	Ammeter	Actuates once the ignition switch is ON, shows the amount of AMPS the alternator is putting out.	Normal ammeters indicate red or green. If the gauge shows red check for alternator belt tension first.



	<p>Transmission Oil Temperature</p>	<p>Actuates once the ignition switch is ON, shows reading of transmission fluid temperature.</p>	<p>During heavy movement or driving on inclines the transmission temperature will increase. If it shows over heating discontinue use and let the vehicle cool. Check fluid level.</p>
	<p>Coolant System Temperature</p>	<p>Actuates once the ignition switch is ON, shows reading of engine coolant temperature.</p>	<p>During heavy movement or driving on inclines the coolant temperature will increase. If it shows over heating discontinue use and let the vehicle cool. Check coolant level.</p>
	<p>Engine Oil Pressure</p>	<p>Actuates once the ignition switch is ON and the engine is running, shows reading of engine oil pressure</p>	<p>When the engine is cold and oil viscosity is less, the gauge should read a high oil pressure. 40 to 60 psi is a normal operating range. If oil pressure drops below required level, discontinue use; check engine oil level.</p>
	<p>System Air Pressure</p>	<p>Actuates once the ignition switch is ON, shows reading of system air pressure.</p>	<p>To release the parking brake, system air pressure normally requires 60 psi. Some systems are split and the gauge will have two indicators. If air pressure drops below required level the parking brakes will apply.</p>
	<p>Hydraulic Filter Restriction</p>	<p>Actuates once hydraulic fluid flow has started, normally once the engine is running.</p>	<p>Sometimes placed in the cab and other times on the hydraulic system by the hydraulic filter. If the gauge shows in the red, discontinue use and contact the VCO/VCNCO.</p>
	<p>Air Filter Restriction</p>	<p>This indicator holds the highest restriction reading until manually reset.</p>	<p>Placed in the cab or on the engine air intake system. If the gauge shows red, remove and shake out air filter if dry type. Reset the indicator by pushing the button on the top.</p>

**Figure A2.3. Forklift System Indicators.**

<b>Display:</b>	<b>Gauge:</b>	<b>Description:</b>	<b>Reading Evaluation:</b>
	Glow Plug Light	Actuates when the glow plug system is in use.	Depending on the system, glow plugs actuate automatically or when manually applied. On diesel engines, for initial start utilize the glow plugs.

**A2.3. Pre-Inspection.** The following are items to be inspected for proper operation before operating a forklift. Numbers correlate with **Figure A2.4.**, which can be used as a forklift inspection guide for the trainee.

A2.3.1. Cleanliness/Damage/Missing Items.

A2.3.2. Leaks (fuel/oil/coolant/hydraulic/air).

A2.3.3. Fluid Levels; ensure level is within limits:

A2.3.3.1. Engine oil. **(1)**

A2.3.3.2. Brake fluid. **(3)**

A2.3.3.3. Transmission fluid. **(4)**

A2.3.3.4. Hydraulic fluid. **(8)**

A2.3.4. Battery; security, fluid damage and corrosion. **(2)**

A2.3.5. All wheel rims (bents/dents/cracks, etc.); check for loose lug nuts. **(6)**

A2.3.6. Drive belts; tension and fraying. **(7)**

A2.3.7. Air restriction gauge. **(9)**

A2.3.8. All tires; check for proper inflation and tread. **(11)**

A2.3.9. Carriage. **(12)**

A2.3.10. Hydraulic hoses/cylinder (damage).

A2.3.11. Wiring/lights/reflectors/mirrors.

A2.3.12. Safety devices.

- A2.3.13. Mast tines/roller tines.
- A2.3.14. Towing connection.
- A2.3.15. Markings – check visibility.
- A2.3.16. Horn operation.
- A2.3.17. Windshield wipers/washers.
- A2.3.18. Heater/defroster.
- A2.3.19. Exhaust system.
- A2.3.20. Brake and accelerator covers.
- A2.3.21. Air tanks.
- A2.3.22. Cold weather aids.
- A2.3.23. Emergency stand-by system.
- A2.3.24. Refill alcohol injector (in season).
- A2.3.25. Fire extinguisher(s).

Figure A2.4. Forklift Inspection Guide (1/2).

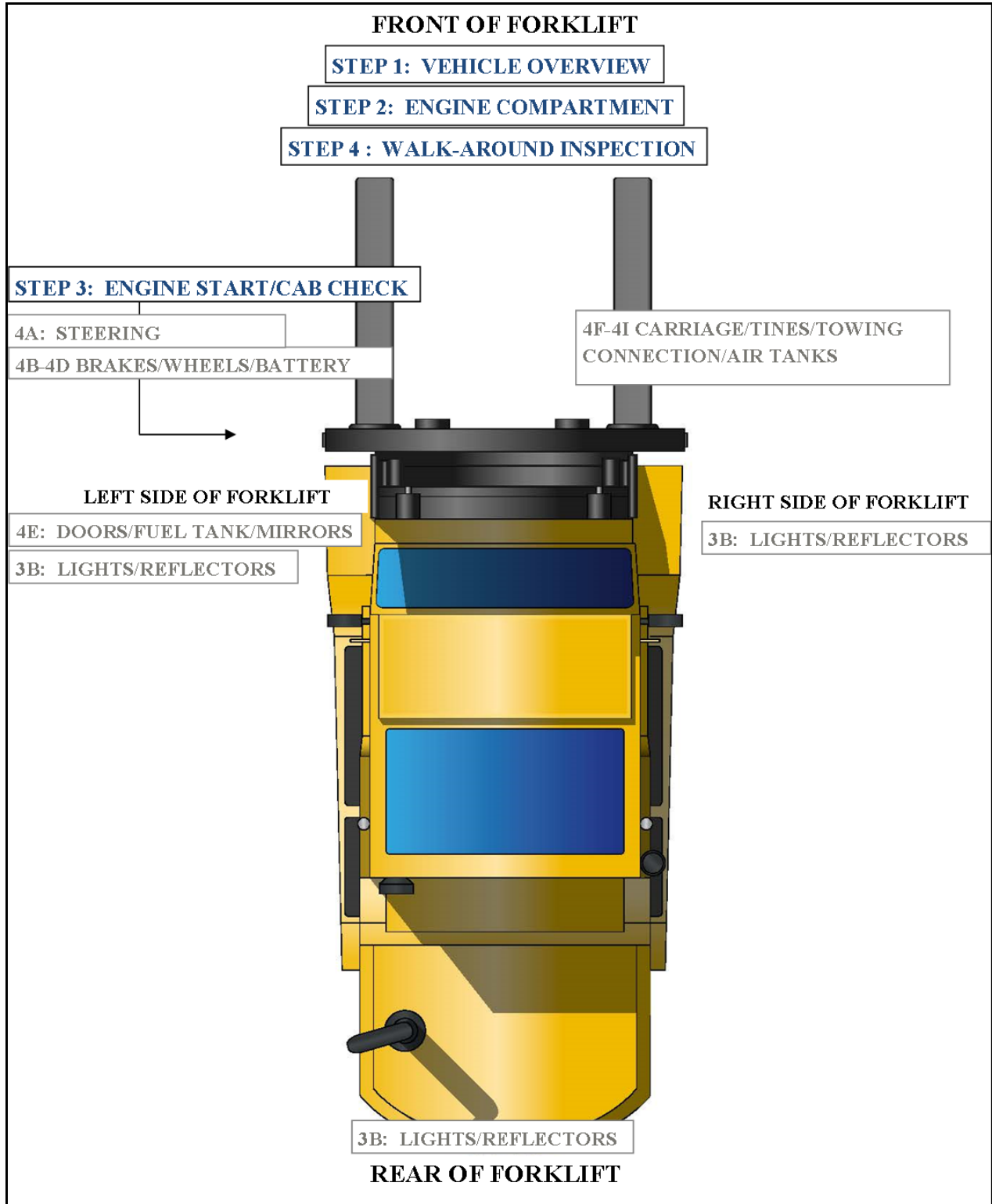



**A2.4. Forklift Controls.** (See) **Figure A2.6.** illustrates the controls the operator might find on a forklift, the numbers in the figure correspond with the discussion that follows. Numbers align with the diagram.

**Figure A2.6. Forklift Controls.**

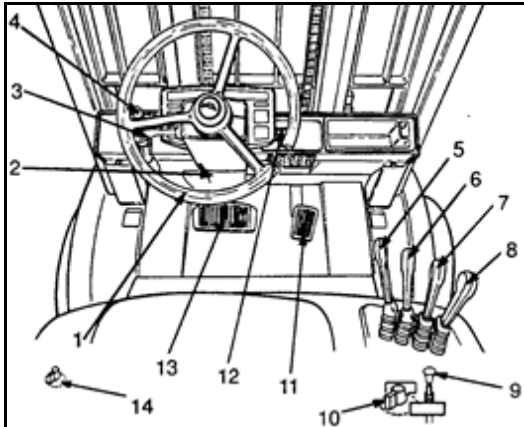

A2.4.1. Steering Wheel, controls position of steering wheels. **(1)**

A2.4.2. Steering Wheel Tilt Control, allows operator to adjust tilt of steering wheel. **(2)**

A2.4.3. Direction Control Lever. Forklifts can have from one gear in forward and reverse to four gears in each direction. It is always best to start off in the lowest gear selection and work the gears as needed. Always bring the forklift to a complete stop with the brakes before shifting transmission direction. Utilize lower gears to drive down an incline, this slows the forklift down using the engine and transmission and takes less effort when braking. **(3)**

A2.4.4. Parking Brake Control, engage the parking brake any time the forklift is parked or waiting. If the park brake does not hold when parking, adjustment is necessary. Parking brakes should hold when the forklift is sitting level and the transmission is in reverse with engine at idle speed. Most hand lever park brakes can be adjusted by turning the end cap handle clockwise to tighten and counterclockwise to loosen. For proper adjustment, apply the service brake and place the forklift in reverse, adjust the park brake until forklift is held in place solely by the parking brake. Do not over tighten the parking brake adjustment. When adjustment is at the maximum capacity and the forklift still does not move, contact the VCO/VCNCO, the supervisor, and/or vehicle maintenance for repairs. **(4)**

**Figure A2.7. Parking Brake Control.**

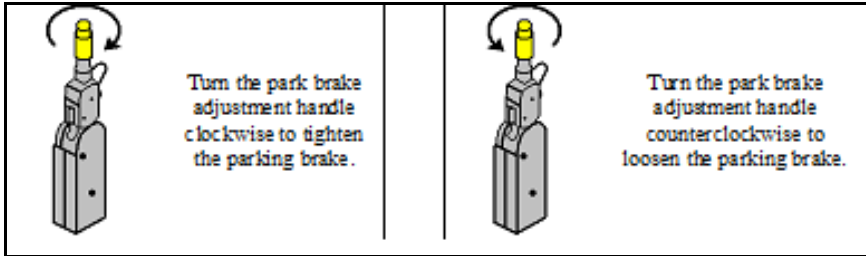

A2.4.5. Hydraulic Control Levers. These controls can be either lever type or joystick actuated. By manipulating these controls the hydraulics will move the load-carrying device. Normal functions are lift, lower, and tilt. Additional functions can be fork spread, side shift, rotate, swing, and extend. Standard forklifts normally utilize single acting hydraulic cylinders with the lift function; meaning gravity lowers the forks. Dual acting cylinders are used on all-terrain forklifts, these cylinders use hydraulic pressure to lower the forks, be careful not to dig into the driving surface by lowering too far. The following are the most common hydraulic controls on a forklift (it is recommended the operator refers to the operator’s manual for proper operation of the controls). (5-8)

A2.4.5.1. Lift/Lower Control Lever (5):

	Push the lever forward in order to lower the forks.
<b>HOLD</b>	The lever will return to the HOLD position when released.
	Pull the lever backward in order to raise the forks.



A2.4.5.2. Tilt Control Lever (6):

	Move the lever forward in order to tilt the forks down.
<b>HOLD</b>	The lever will return to the HOLD position when released.
	Move the lever backward in order to tilt the forks back.

A2.4.5.3. Side Shift (7):

	Move the lever forward to shift the carriage to the left.
<b>HOLD</b>	The lever will return to the HOLD position when released.
	Move the lever backwards to shift the carriage to the right.

A2.4.5.4. Fork Positioning Lever (8):

	Move the lever to the right and forward to spread the forks.
<b>HOLD</b>	The lever will return to the HOLD position when released.
	Move the lever to the right and backward to close the forks.

A2.4.5.5. Off/On/Enrich Knob. (9)

A2.4.5.6. Battery Disconnect Switch, for routine and emergency use. Disconnects the battery and removes power from all electrical circuits for non-use times and emergency electrical situations. (10)

A2.4.5.7. Accelerator Control Pedal, controls engine rpm. (11)

A2.4.5.8. Ignition Switch. Controls electrical current to forklift functions and starter motor. (12)

A2.4.5.9. Service Brakes/Inching Pedal, many forklifts utilize a clutch/inching pedal. During operation this foot control disengages the transmission from the engine for the first few inches of depression of the pedal and applies the brake thereafter. This function allows the operator to maintain high engine rpm for fast operation of the load mechanism while traveling at slow speed. This function saves wear and tear on the transmission during load movement. Some forklifts have three pedals; the pedal to the far left is the inching pedal, the center pedal is the standard brake and the right pedal is the accelerator. Other forklifts have just one inching/brake pedal combined. (13)

A2.4.5.10. Selector Switch. Selects Gas or LPG for Bi-Fuel engines. (14)

A2.4.5.11. Unusual noises. Listen for any unusual sounds, noises, erratic motions, or vibrations. Use the five senses to check for problems (look, listen, smell, feel). If encountered, the operator should stop the forklift and investigate the cause, if cause cannot be determined, then report to the Squadron VCO/VCNCO and/or the supervisor.

A2.4.5.12. Listen for exhaust and air leaks. Exhaust leaks are often confused with other sounds. Exhaust systems can leak from anywhere, though the mating flanges at the cylinders; silencer and tailpipe extensions are the usual spots. Another typical exhaust sound is a whistle as the engine is accelerated. For air leaks, the operator may hear the escaping of air, a continuous hissing noise. Also, low air pressure may be an indicator there may be an air leak.



## **Attachment 3**

### **PERFORMANCE TEST**

#### **A3.1. Desired Learning Outcome.**

A3.1.1. Understand the safety precautions to be followed before-, during-, and after-operation of the forklift. Understand the purpose of the forklift and their role in the mission.

A3.1.2. Understand Occupational Safety & Health Administration (OSHA) and Air Force Occupational Safety and Health (AFOSH) compliance requirements.

A3.1.3. Know the proper operator maintenance procedures of the forklift, IAW applicable technical orders and use of AF Form 1800.

A3.1.4. Safely and proficiently operate the forklift.

#### **A3.2. Certification/Recertification Requirements.**

A3.2.1. The Performance Test will be successfully accomplished prior to initial certification on the forklift.

A3.2.2. The Performance Test will be successfully accomplished, every three years, in order to be recertified on the forklift.

**A3.3. Instructions.** Before beginning the performance test, the trainer will brief the trainee on the scenario that will need to be accomplished. The trainee will be given additional directions and instructions as needed as the trainee proceed through the scenario.

#### **A3.4. Scoring.**

A3.4.1. The trainer examiner will be scoring the trainee on forklift operations and also the general safe driving practices. The examiner will give directions and instructions to the trainee in sufficient time for the trainee to execute a driving maneuver. The trainee will not be asked to drive in an unsafe manner.

A3.4.2. The examiner will be making various marks on the performance test checklist. This does not necessarily mean the trainee has done anything wrong. It is in the best interest to concentrate on the operation of the forklift. The trainer will explain the test results to the trainee at the conclusion of the performance test.

A3.4.3. Tasks being graded are listed on the following page; the trainee will be required to successfully pass all items.

A3.4.4. The instructor will stop the test at any time safe forklift operations are not being followed or as deemed necessary for safety concerns.

**Figure A3.1. Performance Test Checklist.**

<b>PERFORMANCE TEST</b>			
<b>Trainees Name:</b>		<b>Date:</b>	
<b>Event</b>	<b>Go</b>	<b>No Go</b>	<b>Notes</b>
<b>1. PRE, DURING, AND POST- OPERATION INSPECTION</b>			
1.1. Operator has required Personal Protective Equipment.			
1.2. Follows general condition while approaching vehicle.			
1.3. Checks all items listed on AF Form 1800.			
1.4. Signs AF Form 1800 to signify accomplishment of complete inspection.			
1.5. Checks for proper operation of controls/instruments during operations.			
<b>Event</b>	<b>Go</b>	<b>No Go</b>	<b>Notes</b>
<b>2. USE OF VEHICLE CONTROLS</b>			
2.1. Understands all gauges, switches, levers and buttons.			
2.2. Does not raise or lower forks while vehicle is in motion.			
2.3. Failure to release parking brake before traveling.			
<b>Event</b>	<b>Go</b>	<b>No Go</b>	<b>Notes</b>
<b>3. BASIC CONTROL AND OPERATION</b>			
3.1. Avoids jerky starts and stops (Proper use of inching pedal).			
3.2. Understands basic forklift stability of load and while operation (i.e. load is within capability of forklift).			
3.3. Maintains proper speed to ensure safety.			
3.4. Forklift carrying loads or empty too high when traveling (tines should not be higher than 6 inches above the surface).			

3.5. Ensure proper forklift safety practices (instructor will stop testing at any time to prevent any safety occurrence from happening). List safety violations.			
3.6. Properly parks forklift, parking brake set, ignition off, fork tines flat on ground or floor.			
<b>Event</b>	<b>Go</b>	<b>No Go</b>	<b>Notes</b>
<b>3. KNOWLEDGE OF VEHICLE AND USE OF CONTROLS</b>			
3.1. Engine:			
Uses proper starting procedures			
Allows proper warm-up.			
Understands all gauges.			
Uses proper shutdown procedures.			
Basic knowledge of engines.			
3.2. Clutch and Transmission.			
Understands proper clutching techniques.			
Uses clutch properly through all gears.			
Shifts smoothly.			
Time shifts properly.			
Avoids riding the clutch.			
Proper use of tachometer and shifting range.			
3.3. Brakes and Braking Techniques			
Understands the principles of an air brake system.			
Knows proper use of the hand valve.			
Understands the low air warning.			
Uses proper techniques on downgrades.			
Understands the principle of front wheel limiting switch.			
Proper use of parking brake.			
Ensures air tank is at full tank pressure prior to moving the vehicle.			

<b>Event:</b>	<b>Go</b>	<b>No Go</b>	<b>Notes</b>	
<b>4. CARGO LOADING/UNLOADING</b>				
4.1. Request Spotter				
4.2. Understands and follows spotter's directions.				
4.3. Lowering loads too fast, failure to ensure load is properly balanced and stacked.				
4.4. Failure to ensure that forks (tines) are fully under the load before lifting.				
4.5. Striking the pallet or the floor with the forks.				
4.6. Uses tie-down straps accordingly.				
4.7. Driving forward when the load restricts vision.				
4.8. Safely loads/unloads cargo.				
<b>Event:</b>	<b>Go</b>	<b>No Go</b>		<b>Notes</b>
<b>5. GENERAL DRIVING HABITS</b>				
5.1. Consistently alert and attentive.				
5.2. Aware of changing traffic conditions.				
5.3. Adjusts to changing conditions.				
5.4. Nervous/apprehensive.				
5.5. Easily angered.				
5.6. Courteous to other vehicles.				
5.7. Avoids excessive conversation.				
Checks to ensure forklift is not overloaded and within legal limits.				
Cargo is not top heavy and load is distributed evenly.				
Cargo is securely fastened (blocking/bracing and cargo tie-downs).				
Double checks securement of cargo prior to operating.				
<b>CERTIFIER COMMENTS:</b>				

## Attachment 4

### SEVEN-STEP INSPECTION PROCESS

**Figure A4.1. Seven-Step Inspection Process.**

<b>Seven-Step Inspection Process</b>	
<b>Step</b>	<b>Procedure</b>
1. Vehicle Overview	<ul style="list-style-type: none"> <li>● Review the AF Form 1800.</li> <li>○ Ensure any discrepancy has been corrected.</li> <li>○ Vehicle Management annotated the discrepancy was completed.</li> <li>○ Approaching the vehicle.               <ul style="list-style-type: none"> <li>▪ Damage or vehicle leaning to one side.</li> <li>▪ Fresh leakage of fluids.</li> <li>▪ Hazards around vehicle.</li> </ul> </li> </ul>
2. Check Engine Compartment	<ul style="list-style-type: none"> <li>● <b>Note:</b> Check that the parking brakes are on and/or wheels chocked. The operator may have to raise the hood, tilt the cab (secure loose things so they don't fall and break something), or open the engine compartment door.</li> <li>● Check the following:               <ul style="list-style-type: none"> <li>○ Engine oil level.</li> <li>○ Coolant level in radiator; condition of hoses.</li> <li>○ Power steering fluid level; hose condition (if so equipped).</li> <li>○ Windshield washer fluid level.</li> <li>○ Battery fluid level, connections and tie-downs (battery may be located elsewhere).</li> <li>○ Automatic transmission fluid level (may require engine to be running).</li> <li>○ Check belts for tightness and excessive wear (alternator, water pump, air compressor)--learn how much "give" the belts should have when adjusted right.</li> </ul> </li> </ul>

	<ul style="list-style-type: none"> <li>○ Leaks in the engine compartment (fuel, coolant, oil, power steering fluid, hydraulic fluid, battery fluid). Cracked, worn electrical wiring insulation.</li> </ul>
<p>3. Start Engine and Inspect Inside the Cab (Get in and Start Engine)</p>	<ul style="list-style-type: none"> <li>● Make sure parking brake is on.</li> <li>● Put gearshift in neutral (or park if automatic). Start engine; listen for unusual noises.</li> <li>● If equipped, check the Anti-lock Braking System (ABS) indicator lights. Light on dash should come on and then turn-off. If it stays on the ABS is not working properly.</li> <li>● <b>Note:</b> For trailers only, if the yellow light on the left rear of the trailer stays on, the ABS is not working properly.</li> <li>● Look at the gauges. <ul style="list-style-type: none"> <li>○ <u>Oil pressure</u>. Should come up to normal within seconds after engine is started.</li> <li>○ <u>Air pressure</u>. Pressure should build from 50 to 90 psi within 3 minutes. Build air pressure to governor cut-out (usually around 120 – 140 psi. Know the vehicle’s requirements.</li> <li>○ <u>Ammeter and/or voltmeter</u>. Should be in normal range(s).</li> <li>○ <u>Coolant temperature</u>. Should begin gradual rise to normal operating range.</li> <li>○ <u>Engine oil temperature</u>. Should begin gradual rise to normal operating range.</li> <li>○ <u>Warning lights and buzzers</u>. Oil, coolant, charging circuit warning, and antilock brake system lights should go out right away.</li> <li>○ Check Condition of Controls. Check all of the following for looseness, sticking, damage, or improper setting: <ul style="list-style-type: none"> <li>▪ Steering wheel.</li> <li>▪ Clutch.</li> <li>▪ Accelerator (gas pedal).</li> </ul> </li> </ul> </li> </ul>

	<ul style="list-style-type: none"> <li>▪ Brake controls.</li> <li>▪ Foot brake.</li> <li>▪ Trailer brake (if vehicle has one).</li> <li>▪ Parking brake.</li> <li>▪ Retarder controls (if vehicle has them).</li> <li>▪ Transmission controls.</li> <li>▪ Inter-axle differential lock (if vehicle has one).</li> <li>▪ Horn(s).</li> <li>▪ Windshield wiper/washer.</li> <li>▪ Lights.</li> <li>▪ Headlights.</li> <li>▪ Dimmer switch.</li> <li>▪ Turn signal.</li> <li>▪ Four-way flashers.</li> <li>▪ Parking – clearance – identification – marker switch (switches).</li> <li>● Check mirrors and windshield.</li> <li>○ Inspect mirrors and windshield for cracks, dirt, illegal stickers, or other obstructions to seeing clearly. Clean and adjust as necessary.</li> <li>● Check emergency equipment.</li> <li>○ Check for safety equipment: <ul style="list-style-type: none"> <li>▪ Spare electrical fuses (unless vehicle has circuit breakers).</li> <li>▪ Three red reflective triangles, 6 fuses or 3 liquid burning flares.</li> <li>▪ Properly charged and rated fire extinguisher. Check for optional items such as: <ul style="list-style-type: none"> <li>▪ Chains (where winter conditions require).</li> <li>▪ Tire changing equipment.</li> <li>▪ List of emergency phone numbers</li> <li>▪ Accident reporting kit (packet).</li> </ul> </li> </ul> </li> <li>○ Check safety belt. Check that the safety belt is securely mounted, adjusts; latches properly and is not ripped or frayed.</li> </ul>
4. Turn-off Engine	<ul style="list-style-type: none"> <li>● Make sure the parking brake is set, turn-off the engine, and take the key with.</li> </ul>

	<ul style="list-style-type: none"> <li>• Turn-on headlights (low beams) and four-way emergency flashers, and get out of the vehicle.</li> </ul>
<p>5. Do Walk-Around Inspection</p>	<ul style="list-style-type: none"> <li>• General. <ul style="list-style-type: none"> <li>○ Go to front of vehicle and check that low beams are on and both of the four-way flashers are working.</li> <li>○ Push dimmer switch and check that high beams work.</li> <li>○ Turn-off headlights and four-way emergency flashers.</li> <li>○ Turn-on parking, clearance, side-marker, and identification lights.</li> <li>○ Turn-on right turn signal, and start walk-around inspection.</li> <li>○ Walk around and inspect. <ul style="list-style-type: none"> <li>▪ Clean all lights, reflectors, and glass as while doing the walk-around inspection.</li> </ul> </li> </ul> </li> <li>• Left front side. <ul style="list-style-type: none"> <li>○ Driver's door glass should be clean.</li> <li>○ Door latches or locks should work properly.</li> </ul> </li> <li>• Left front wheel. <ul style="list-style-type: none"> <li>○ Condition of wheel and rim--missing, bent, broken studs, clamps, lugs, or any signs of misalignment.</li> <li>○ Condition of tires--properly inflated, valve stem and cap OK, no serious cuts, bulges, or tread wear.</li> <li>○ Use wrench to test rust-streaked lug nuts, indicating looseness.</li> <li>○ Hub oil level OK, no leaks. Left front suspension.</li> <li>○ Condition of spring, spring hangers, shackles,</li> <li>○ U-bolts.</li> <li>○ Shock absorber condition.</li> </ul> </li> <li>• Left front brake. <ul style="list-style-type: none"> <li>○ Condition of brake drum or disc.</li> <li>○ Condition of hoses.</li> </ul> </li> <li>• Front. <ul style="list-style-type: none"> <li>○ Condition of front axle. Condition of steering system.</li> <li>○ No loose, worn, bent, damaged or missing parts.</li> </ul> </li> </ul>



	<ul style="list-style-type: none"> <li>○ Mustgrabsteering mechanism to test for looseness.</li> <li>○ Condition of windshield.</li> <li>○ Check for damage and clean if dirty.</li> <li>○ Check windshield wiper arms for proper spring tension.</li> <li>○ Check wiper blades for damage, "stiff" rubber, and securement.</li> <li>○ Lights and reflectors.</li> <li>○ Parking, clearance, and identification lights clean, operating, and proper color (amber at front).</li> <li>○ Reflectors clean and proper color (amber at front).</li> <li>○ Right front turn signal light clean, operating, and proper color (amber or white on signals facing forward).</li> <li>● Right side <ul style="list-style-type: none"> <li>○ Right front: check all items as done on left front.</li> <li>○ Primary and secondary safety cab locks engaged (if cab-over-engine design).</li> <li>○ Right fuel tank(s).</li> <li>○ Securely mounted, not damaged, or leaking. Fuel crossover line secure.</li> <li>○ Tank(s) contain enough fuel. Cap(s) on and secure.</li> <li>○ Condition of visible parts. Rear of engine--not leaking. Transmission--not leaking.</li> <li>○ Exhaust system--secure, not leaking, not touching wires, fuel, or air-lines.</li> <li>○ Frame and cross members--no bends or cracks.</li> <li>○ Air-lines and electrical wiring--secured against snagging, rubbing, wearing.</li> <li>○ Spare tire carrier or rack not damaged (if so equipped).</li> <li>○ Spare tire and/or wheel securely mounted in rack.</li> <li>○ Spare tire and wheel adequate (proper size, properly inflated).</li> <li>○ Cargo securement (trucks).</li> </ul> </li> </ul>
--	--

	<ul style="list-style-type: none"> <li>○ Cargo properly blocked, braced, tied, chained, etc. Header board adequate, secure (if required).</li> <li>○ Side boards, stakes strong enough, free of damage, properly set in place (if so equipped).</li> <li>○ Canvas or tarp (if required) properly secured to prevent tearing, billowing, or blocking of mirrors.</li> <li>○ If oversize, all required signs (flags, lamps, and reflectors) safely and properly mounted and all required permits in driver's possession.</li> <li>○ Curbside cargo compartment doors in good condition, securely closed, latched/locked and required security seals in place.</li> <li>● Right rear. <ul style="list-style-type: none"> <li>○ Condition of wheels and rims--no missing, bent, or broken spacers, studs, clamps, or lugs.</li> <li>○ Condition of tires--properly inflated, valve stems and caps OK, no serious cuts, bulges, tread wear, tires not rubbing each other, and nothing stuck between them.</li> <li>○ Tires same type, e.g., not mixed radial and bias types.</li> <li>○ Tires evenly matched (same sizes). Wheel bearing/seals not leaking.</li> <li>○ Suspension. <ul style="list-style-type: none"> <li>○ Condition of spring(s), spring hangers, shackles, and U-bolts.</li> <li>○ Axle secure.</li> <li>○ Powered axle(s) not leaking lube (gear oil). Condition of torque rod arms, bushings.</li> <li>○ Condition of shock absorber(s).</li> <li>○ If retractable axle equipped, check condition of lift mechanism. If air powered, check for leaks.</li> <li>○ Condition of air ride components.</li> <li>○ Brakes. <ul style="list-style-type: none"> <li>○ Brake adjustment.</li> <li>○ Condition of brake drum(s) or discs.</li> </ul> </li> </ul> </li> </ul> </li> </ul>
--	---

	<ul style="list-style-type: none"> <li>○ Condition of hoses--look for any wear due to rubbing.</li> <li>○ Lights and reflectors.</li> <li>○ Side-marker lights clean, operating, and proper color (red at rear, others amber).</li> <li>○ Side-marker reflectors clean and proper color (red at rear, others amber).</li> <li>● Rear. <ul style="list-style-type: none"> <li>○ Lights and reflectors.</li> <li>○ Rear clearance and identification lights clean, operating, and proper color (red at rear).</li> <li>○ Reflectors clean and proper color (red at rear).</li> <li>○ Taillights clean, operating, and proper color (red at rear).</li> <li>○ Right rear turn signal operating, and proper color (red, yellow, or amber at rear).</li> <li>○ License plate(s) present, clean, and secured.</li> <li>○ Splash guards present, not damaged, properly fastened, not dragging on ground, or rubbing tires.</li> <li>○ Cargo secure (trucks).</li> <li>○ Cargo properly blocked, braced, tied, chained, etc. Tailboards up and properly secured.</li> <li>○ End gates free of damage, properly secured in stake sockets.</li> <li>○ Canvas or tarp (if required) properly secured to prevent tearing, billowing, or blocking of either the rearview mirrors or rear lights.</li> <li>○ If over-length, or over-width, make sure all signs and/or additional lights/flags are safely and properly mounted and all required permits are in driver's possession.</li> <li>○ Rear doors securely closed, latched/locked.</li> </ul> </li> <li>● Left side. <ul style="list-style-type: none"> <li>○ Check all items as done on right side, plus:</li> </ul> </li> </ul>
--	---

	<ul style="list-style-type: none"> <li>○ Battery (batteries) (if not mounted in engine compartment).</li> <li>○ Battery box (boxes) securely mounted to vehicle. Box has secure cover.</li> <li>○ Battery (batteries) secured against movement. Battery (batteries) not broken or leaking.</li> <li>○ Fluid in battery (batteries) at proper level (except maintenance-free type).</li> <li>○ Cell caps present and securely tightened (except maintenance-free type).</li> <li>○ Vents in cell caps free of foreign material (except maintenance-free type).</li> </ul>
<p>6. Check Signal Lights</p>	<ul style="list-style-type: none"> <li>● Get in and turn-off all lights.</li> <li>● Turn-on stop lights (apply trailer hand brake or have a helper put on the brake pedal).</li> <li>● Turn-on left turn signal lights.</li> <li>● Get out and check lights.</li> <li>● Left front turn signal light clean, operating and proper color (amber or white on signals facing the front).</li> <li>● Left rear turn signal light and both stop lights clean operating, and proper color (red, yellow, or amber).</li> <li>● Get in vehicle.</li> <li>○ Turn-off lights not needed for driving.</li> <li>○ Check for all required papers, trip manifests, permits, etc.</li> <li>○ Secure all loose articles in cab (they might interfere with operation of the controls or hit the operator in a crash).</li> <li>○ Start the engine.</li> </ul>
<p>7. Start the Engine and Check Test for Hydraulic Leaks</p>	<ul style="list-style-type: none"> <li>● Test for hydraulic leaks.</li> <li>○ If the vehicle has hydraulic brakes, pump the brake pedal three times.</li> <li>○ Then apply firm pressure to the pedal and hold for five seconds.</li> <li>○ The pedal should not move. If it does, there may be a leak or other problem.</li> </ul>

	<ul style="list-style-type: none"> <li>● Brake system.</li> <li>● Test parking brake.</li> <li>○ Fasten safety belt.</li> <li>○ Set parking brake (power unit only). Release trailer parking brake (if applicable). Place vehicle into a low gear.</li> <li>○ Gently pull forward against parking brake to make sure the parking brake holds.</li> <li>○ Repeat the same steps for the trailer with trailer parking brake set and power unit parking brakes released (if applicable).</li> <li>○ If it doesn't hold vehicle, it is faulty; get it fixed.</li> <li>● Test service brake stopping action.</li> <li>○ Go about 5 miles per hour.</li> <li>○ Push brake pedal firmly.</li> <li>○ "Pulling" to one side or the other can mean brake trouble.</li> <li>○ Any unusual brake pedal "feel" or delayed stopping action can mean trouble.</li> <li>○ If the trainee finds anything unsafe during the Vehicle inspection, get it fixed. Federal and state laws forbid operating an unsafe vehicle.</li> <li>● Check vehicle operation regularly:</li> <li>○ Instruments.</li> <li>○ Air pressure gauge (if the vehicle has air brakes). Temperature gauges.</li> <li>○ Pressure gauges.</li> <li>○ Ammeter/voltmeter.</li> <li>○ Mirrors.</li> <li>○ Tires.</li> <li>○ Cargo, cargo covers. Lights, etc.</li> <li>○ If the trainee sees, hears, smells, or feels anything that might mean trouble, he/she should check it out.</li> <li>● Safety inspection.</li> <li>● Document any discrepancy on AF Form 1800. Sign-off AF Form 1800 to signify accomplishment of inspection.</li> </ul>
--	---

## Attachment 5

### FORKLIFT OPERATION REVIEW QUESTIONS

**A5.1. Knowledge Exam Overview.** This test is designed to test each student's knowledge of the forklift. Content was obtained from the Occupational Safety and Health Administration (OSHA) Forklift Operation and Safety Course Test. In order to pass the test, students must achieve at least 70% accuracy.

A5.1.1. Date Updated: April 2017.

#### A5.2. Forklift.

A5.2.1. When parking or leaving your truck, you should:

- A. Park or leave your truck in a safe area away from traffic.
- B. Lower the forks until they are flat on the floor.
- C. Turn-off the engine.
- D. Set the parking brake and set the directional control to neutral.
- E. All of the above.

A5.2.2. All industrial trucks (lift trucks) are equipped with controls which allow you to raise/lower and tilt the forks.

- A. True
- B. False

A5.2.3. Of the three load positions illustrated below, which is the most stable?

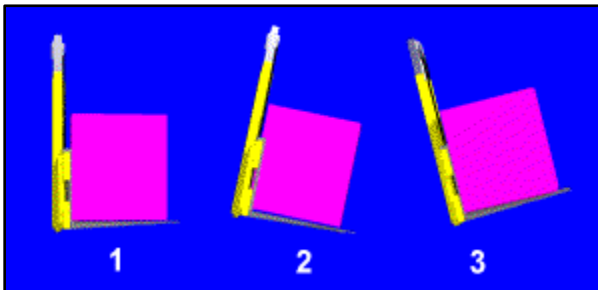

- A. 1
- B. 2
- C. 3

A5.2.4. Rear wheel steering is used on lift trucks because it gives the operator greater control when using the forks.

- A. True
- B. False

A5.2.5. Always check the air pressure in tires from the side, not by facing the tread.

- A. True
- B. False

A5.2.6. All industrial trucks (lift trucks) are equipped with a clutch.

- A. True
- B. False

A5.2.7. Which of the following is NOT a type of lift truck?

- A. Gasoline Powered
- B. Diesel Powered
- C. Electric Powered
- D. Air-cooled Powered

A5.2.8. Wide and long loads are more unstable than other types of loads.

- A. True
- B. False

A5.2.9. If the lift mechanism on your lift fails, you should try to repair the chains or hydraulic system yourself.

- A. True
- B. False

A5.2.10. The load capacity of a truck can be found on its data plate.

- A. True
- B. False

A5.2.11. It is part of your job to complete a Daily Operator's Report after you have thoroughly inspected your lift truck.

- A. True
- B. False

A5.2.12. If your truck starts to tip over:

- A. Do not jump.
- B. Stay in your seat.
- C. Grip the wheel securely.
- D. Brace yourself with your feet.

E. All of the above.

A5.2.13. You can stand under the forks if the engine of the lift truck is turned-off.

- A. True
- B. False

A5.2.14. A brake pedal that sinks to the floor under continued pressure is in good operating condition.

- A. True
- B. False

A5.2.15. You can drive a lift truck over any type of surface.

- A. True
- B. False

A5.2.16. The most important safety device on your lift truck is \_\_\_\_\_.

- A. Horn
- B. Seat Belt
- C. Warning Light
- D. Backup Alarm
- E. You

A5.2.17. Anyone who has a valid driver's license can operate a lift truck.

- A. True
- B. False

A5.2.18. The gauge below is a/an:

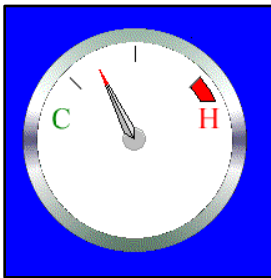

- A. Gas Gauge
- B. Amperes Gauge
- C. Oil Gauge
- D. Total Hour Meter
- E. None of the above



A5.2.19. The three major parts of a lift truck are the body (truck), overhead guard, and hydraulic lift.

- A. True
- B. False

A5.2.20. What is wrong in the illustration below?

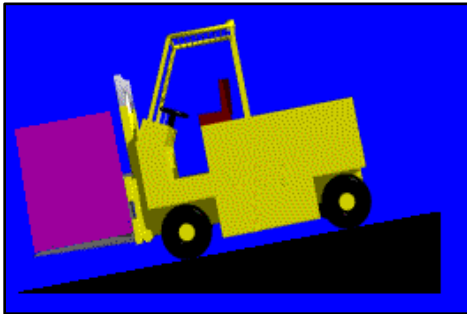

- A. Driving in the wrong direction
- B. Load is too high
- C. Nothing is wrong

A5.2.21. In order to solve an “Inch Pound Equation”, you must use information provided on a truck’s data plate.

- A. True
- B. False

A5.2.22. The front wheels of a lift truck serve as the \_\_\_\_\_ between the weight of the truck and the weight of the load being carried.

- A. Balance Point
- B. Fulcrum Point
- C. Center of Gravity
- D. Seesaw Center

A5.2.23. Which of the following should NOT be allowed during the refueling or recharging process?

- A. Park your lift truck in a designated refueling/recharging area.
- B. Do not block doorways or access to production or emergency equipment.
- C. Keep a flame burning nearby to burn off unwanted vapors or gases.
- D. Check to see that there is a fire extinguisher nearby.

A5.2.24. It is safe to give someone a ride on your lift truck.

- A. True
- B. False

A5.2.25. Before loading or unloading a trailer at a loading dock, you should:

- A. Inspect the floor of the trailer to ensure that it will support the lift truck and the load.
- B. Chock the wheels of the trailer.
- C. Make sure that dock plates, boards, and ramps are in place and secure.
- D. All of the above.

A5.2.26. When transporting a load, you should not raise your load more than 6" from the ground.

- A. True
- B. False

A5.2.27. You can place your hands and feet outside of the operator's compartment, as long as your head and body are protected.

- A. True
- B. False

A5.2.28. Lift trucks use a hydraulic cylinder attached to chains to raise and lower the forks.

- A. True
- B. False

### A5.3. Answer Key.

- 5.2.1. E. All of the above
- 5.2.2. A. True
- 5.2.3. C. 3
- 5.2.4. A. True
- 5.2.5. B. False
- 5.2.6. B. False
- 5.2.7. D. Air-cooled powered
- 5.2.8. A. True
- 5.2.9. B. False
- 5.2.10. A. True
- 5.2.11. A. True
- 5.2.12. E. All of the above
- 5.2.13. B. False
- 5.2.14. B. False
- 5.2.15. B. False
- 5.2.16. E. You
- 5.2.17. B. False
- 5.2.18. E. None of the above
- 5.2.19. A. True
- 5.2.20. A. Driving in the wrong direction
- 5.2.21. A. True
- 5.2.22. B. Fulcrum point
- 5.2.23. C. Keep a flame burning nearby to burn off unwanted vapors or gases
- 5.2.24. B. False
- 5.2.25. D. All of the above
- 5.2.26. A. True
- 5.2.27. B. False
- 5.2.28. A. True