

Industrial
& Urban
Lighting

INDUSTRIAL

INDUSTRIAL, STREET & URBAN PROFESSIONAL LIGHTING

linealightgroup

industrial & extended area lighting range index

Projectors & suspension

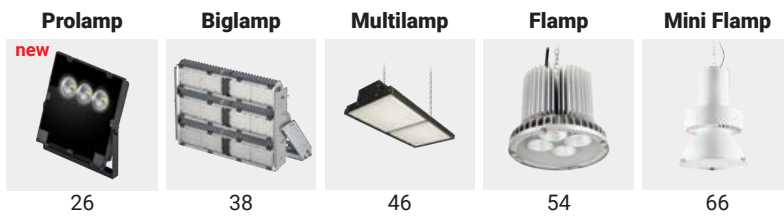

Ceiling light

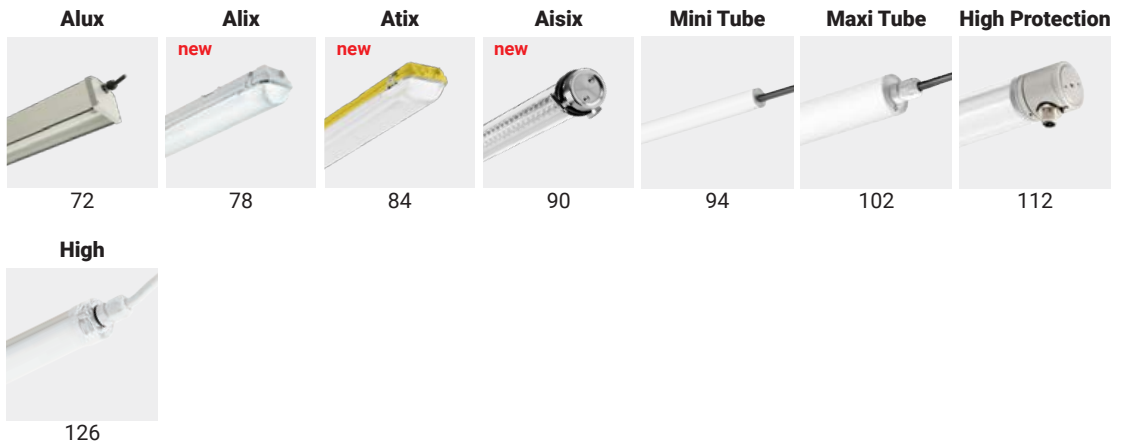

General lighting

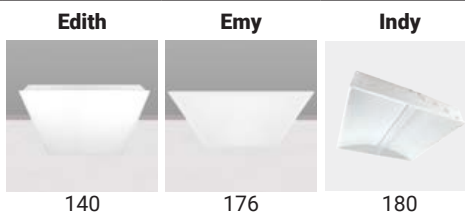

street & urban lighting range index

Pole light

Mini Parker



196

Parker



204

Mini Ledweg



208

Drop



214

Fosten



220

Fabula



new

224

Voyager



228

Enterprise



232

Tunnel lighting

Driled



234

ECO line light

ECO Mini Parker



238

Posts



242





HIGH RESISTANCE

DESIGNED FOR A LONG LIFESPAN

IN ORDER TO GUARANTEE INCREASINGLY HIGHER CORROSION RESISTANCE LEVELS, THE ALUMINIUM BODY OF THE OUTDOOR FIXTURES IS COATED WITH A SURFACE PRETREATMENT THAT USES NANOTECHNOLOGY POLYMERS. THE BODY IS SUBSEQUENTLY POWDER COATED WITH POLYESTER, TGIC FREE POWDER COATING, SPECIFICALLY RESEARCHED FOR USE IN HIGHLY CORROSIVE OUTDOOR ENVIRONMENTS.

THE VARIOUS TREATMENTS WE APPLY ON OUR FIXTURES GUARANTEE:



- HIGH TRANSPARATION AND IMPERMEABILITY TO HUMIDITY;



- EXCELLENT CHEMICAL RESISTANCE;



- HIGH ELECTRICAL RESISTANCE;



- HIGH RESISTANCE TO TEMPERATURE CHANGES -20°C +50°C.



ELECTRONIC HEART

BETTER LONGEVITY GUARANTEED

ELECTRONICS, THE BEATING HEART OF ANY MODERN PIECE OF TECHNOLOGY, IS CENTRAL TO THE FIELD OF LED AND, CONSEQUENTLY, TO THE DEVELOPMENT OF LINEA LIGHT'S PROJECTS. THIS IS BECAUSE, ALTHOUGH THIS TECHNOLOGY IS EXTREMELY ADAPTABLE, A BESPOKE CIRCUIT CREATED FOR A SPECIFIC PURPOSE IS BETTER ABLE TO FULLY EMPHASISE THE LIGHTING QUALITY OF THE SELECTED DIODES AND HOW THEY FULFIL THE PURPOSE FOR WHICH THE LED FIXTURES WERE DESIGNED AND CREATED. COMPATIBILITY, SAFETY, PERFORMANCE: A TRIO OF EXCELLENCE ENABLING US TO GUARANTEE SAFE AND EFFICIENT PRODUCTS.

THE POWER SUPPLIES USED IN LINEA LIGHT ITEMS FEATURE VARIOUS PROTECTION TECHNOLOGIES:



- SURGE PROTECTION UP TO 6KV BETWEEN PHASE/NEUTRAL AND UP TO 10KV BETWEEN PHASE/NEUTRAL AND EARTH



- PROTECTION AGAINST ELECTROSTATIC DISCHARGE UP TO $\pm 30KV$



- THERMAL PROTECTION TO PREVENT ABNORMAL OVERHEATING



RELIABILITY AND PERFORMANCE

**EVERY FIXTURE IS RESEARCHED AND DESIGNED TO EXPRESS
THE MAXIMUM POTENTIAL OF THE SOURCE**

IN THE DESIGN PHASE OF A LAMP, MORE THAN JUST THE AESTHETIC ASPECT
COUNTS:

THE MAIN ROLE OF THE BODY IS TO GUARANTEE EFFICIENT HEAT DISSIPATION
IN ORDER NOT TO ALTER THE PERFORMANCE OF THE LED AND THE LIFE CYCLE
OF THE LAMP.

TO ENSURE THE CORRECT THERMAL DISSIPATION, THE JOINT TEMPERATURE
IS USED AS A REFERENCE POINT. THIS IS MEASURED WHERE THE DIODE
SUBSTRATE AND THE PRINTED CIRCUIT MEET.

THIS ALLOWS US TO BE CERTAIN THAT NO LIGHT SOURCE USED WILL UNDERGO
FLUCTUATIONS THAT COULD COMPROMISE THE QUALITY AND PERFORMANCE
OF THE LAMP.

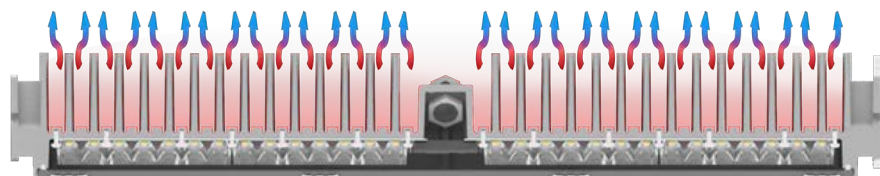



THE "L" AND "B" VALUES INDICATE RESPECTIVELY THE PERCENTAGE OF RESIDUAL FLOW AND THE PERCENTAGE OF LEDs THAT DO NOT RESPECT THE SPECIFICATION IN THE TIME PERIOD INDICATED BY THE MANUFACTURER, CONSIDERING A CONSTANT AMBIENT TEMPERATURE (AT) OF 25°C AND A CONTACT TEMPERATURE (CT) OF 60°C. A LED DECLARED L70B10=223'824 HOURS INDICATES THAT UPON REACHING 223'824 HOURS, 90% (B10) OF THE DIODES HAVE A RESIDUAL LUMINOUS FLOW EQUAL TO OR GREATER THAN 70% OF THE INITIAL FLOW (L70).

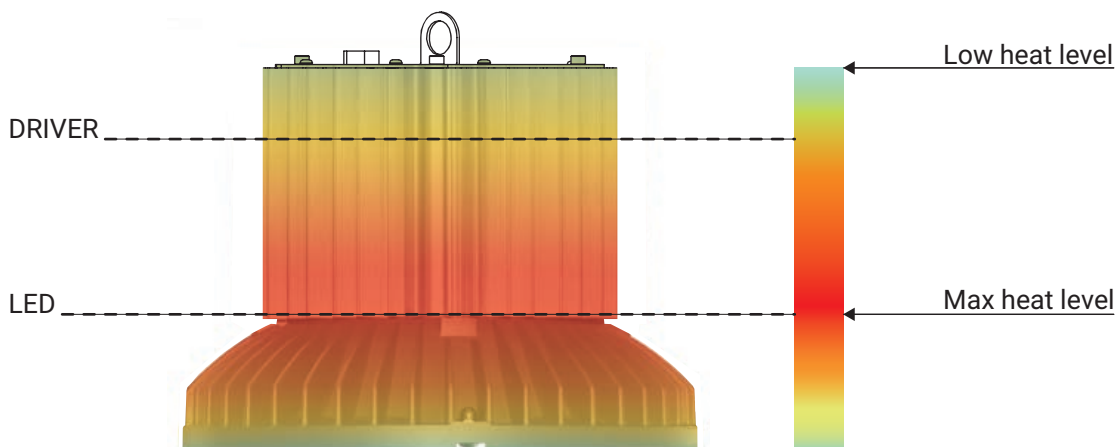

OPTICS SYSTEM

IN THE HEART OF THE LIGHT

A VAST RANGE OF OPTICS ARE THE KEY TO THE PERFORMANCE OF OUR PRODUCTS. AN UNPARALLELED OFFER, THE RESULT OF YEARS OF EXPERIENCE. A POWERFUL TOOL IN YOUR HANDS.

THE LINEA LIGHT OPTICS SYSTEMS ARE THE RESULT OF INTENSE RESEARCH AND DEVELOPMENT ACTIVITY. THE REFLECTION TECHNIQUE USED IN THE DEVELOPMENT OF REFLECTORS AND LENSES ALLOWS US TO ACHIEVE BETTER PERFORMANCE, REDUCTION OF GLARE AND HIGH VISUAL COMFORT. THE HIGH TRANSPARENCY AND HIGH RESISTANCE PROTECTIVE GLASS HAS BY NOW BECOME A CONSOLIDATED CHOICE. THIS GUARANTEES ADEQUATE PROTECTION OF THE OPTICS ASSEMBLY AND EASY CLEANING OF THE PRODUCT, MAINTAINING EFFICIENCY OVER TIME.

LINEA LIGHT'S HIGH LIGHTING PERFORMANCE OPTICS SYSTEM IS UNDOUBTEDLY AN AMBITIOUS CHALLENGE, IN TERMS OF BOTH DESIGN AND PRODUCTION. HIGHLY ADVANCED SOFTWARE SYSTEMS AND MODERN PHOTOMETRIC LABORATORIES HAVE ALLOWED THE OPTIMISATION OF MULTIPLE OPTICS TECHNOLOGIES SUITABLE FOR THE WIDEST VARIETY OF LIGHTING APPLICATIONS.



PROJECTS MADE TO MEASURE

FROM DESIGN TO REALITY

LINEALIGHT SUPPORTS LIGHTING DESIGNERS, PROVIDING ONE OF THE MOST ARTICULATED AND UNIQUE PHOTOMETRIC PORTFOLIOS ON THE MARKET THAT LET THEM SIMULATE THE ACHIEVABLE PERFORMANCE WITH OUR PRODUCTS IN INDUSTRIAL, STREET AND COMMERCIAL APPLICATIONS. PROJECTS DESIGNED IN OBSERVANCE OF THE PREVAILING LOCAL REGULATIONS AND MAXIMISING ENERGY SAVINGS: EVEN A SLIGHT REDUCTION IN POWER FOR EACH LAMP INSTALLED MAKES A BIG DIFFERENCE OVER TIME. ON REQUEST, A COMPLETE ASSESSMENT IS MADE OF ALL THE LIGHTING PARAMETERS, ALSO INCLUDING A THREE-DIMENSIONAL MODEL.

ECONOMIC ASSESSMENT OF THE PROJECT, WITH ANALYSIS OF THE INITIAL COST, ENERGY SAVINGS, RETURN ON INVESTMENT (PAYBACK) AND WHITE CERTIFICATES, INCLUDING COST OF INSTALLATION AND FUTURE MAINTENANCE.



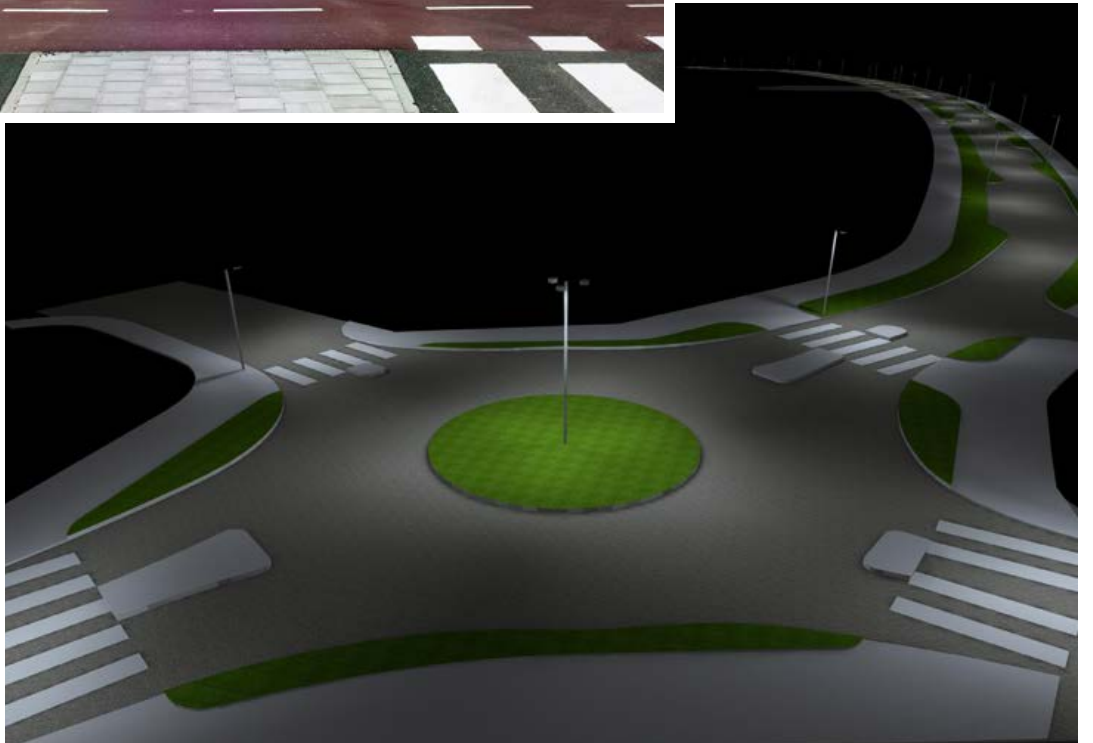

CLF

CLF TECHNOLOGY - RECOVERY OF THE LED LUMINOUS FLOW (ON REQUEST)

THE LIGHT EMITTED FROM A LED LIGHT FIXTURE DIMINISHES OVER THE COURSE OF ITS LIFE DUE TO THE DETERIORATION OF THE DIODE'S LUMINOUS FLOW. THIS IRREVERSIBLE PROCESS CANNOT BE ELIMINATED. ALTHOUGH PROGRESS IN LED TECHNOLOGY HAS MADE THIS FLOW DETERIORATION PROCESS VERY SLOW, THE LUMINOUS FLOW OF A NEW LAMP WILL BE GREATER THAN THAT OF A LAMP AT THE END OF ITS LIFE. CLF (CONSTANT LIGHT FLUX) TECHNOLOGY IS AVAILABLE ON REQUEST FOR ALL LIGHT FIXTURES WITH POWER GREATER THAN OR EQUAL TO 70W AND IT ALLOWS THE ENTIRELY AUTONOMOUS COMPENSATION OF LUMINOUS FLOW DETERIORATION THROUGH THE INCREASE OF THE POWER SUPPLY CURRENT BASED ON PREDEFINED TIME STEPS. THIS TECHNOLOGY GUARANTEES A PRACTICALLY CONSTANT LEVEL OF THE LUMINOUS FLOW EMITTED, CONSEQUENTLY ALSO INCREASING THE USEFUL LIFE OF THE SYSTEM.

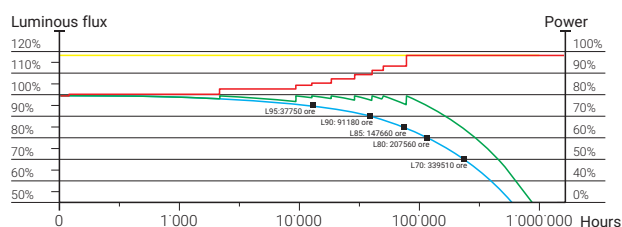

- Potenza apparecchio con tecnologia CLF
- Potenza apparecchio standard on/off senza CLF
- Flusso luminoso di apparecchio standard on/off senza CLF
- Flusso luminoso di apparecchio con CLF

Tempo (ore)	Potenza apparecchio con tecnologia CLF	Flusso luminoso apparecchio senza CLF	Flusso luminoso apparecchio con CLF
0	80%	100%	
1'000	81,3%	98,75%	
10'000	83,2%	97,5%	
30'000	84,8%	96,25%	
37'750	86%	95%	
50'000	88%	93,75%	
70'000	90%	92,5%	
90'000	92%	90%	
110'000	94%	88,5%	
147'000	99%	85%	

~100%
Il flusso luminoso si mantiene ad un livello costante (variazioni non percepibili dall'occhio umano)



EXAMPLE OF POWER AND SYSTEM SIZING

THE SIZING OF THE ELECTRICAL SYSTEM SHOULD BE MADE CONSIDERING THE FINAL POWER OF THE LED FIXTURES. THEREFORE, THERE WILL BE NO DIFFERENCE BETWEEN A SYSTEM WITH STANDARD LAMPS (ON/OFF WITHOUT CLF) AND ONE WITH LAMPS FEATURING CLF TECHNOLOGY. THE CLF SYSTEM CAN BE DISABLED AT ANY TIME USING SOFTWARE, IMMEDIATELY RESTORING THE FULL POWER OF THE LAMP. IT FOLLOWS THAT, WITH CLF INSTALLED, THE FINAL POWER NEVER EXCEEDS THE NOMINAL POWER OF THE LAMP. IN FACT, THE LED LIGHT FIXTURE IS NEVER OVER-POWERED, GUARANTEEING A LONG LIFE.

TECHNICAL CHARACTERISTICS	STANDARD FIXTURE ON/OFF FLAMP WITHOUT CLF	FIXTURE FLAMP WITH CLF
INITIAL POWER	200W AC	180W AC
FINAL POWER	200W AC	200W AC
LUMINOUS FLOW INITIAL NOMINAL (natural white LED)	29205 LM	~26451 LM
LUMINOUS FLOW NOMINAL AFTER 90,000 HOURS	26285 LM	~26451 LM



COMPATIBLE FIXTURES IN DIRECT CURRENT

ALL OUR LIGHT FIXTURES WITH POWER EQUAL TO OR GREATER THAN 100W AC WORK BOTH IN ALTERNATING CURRENT (190/305VAC 50/60HZ) AND DIRECT CURRENT (186/275VDC), THEREFORE, THEY LEND THEMSELVES WELL FOR USE AS EMERGENCY LIGHTING IN COMPLIANCE WITH THE PREVAILING STANDARDS.



INPUT:
190/305VAc 50/60Hz
186/275Vdc

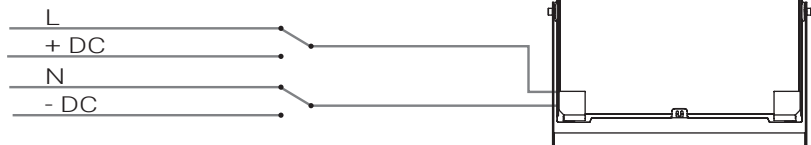

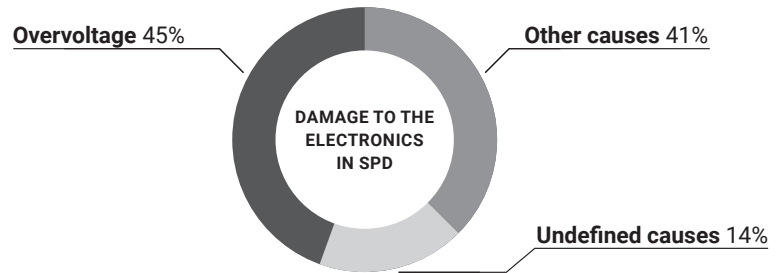

SPD



SYSTEMS (OVERVOLTAGE LIMITERS)

THESE DAYS, WITH THE EVER-INCREASING USE OF ELECTRICAL EQUIPMENT AND WITH THE EXPONENTIAL INCREASE OF THE LEVEL OF SEMICONDUCTOR INTEGRATION, MORE AND MORE ATTENTION IS GIVEN TO THE PHENOMENA RELATED TO TRANSITORY SURGE VOLTAGE OF ATMOSPHERIC ORIGINS AND SURGE VOLTAGE DUE TO ELECTRICAL SWITCHING ON DISTRIBUTION SYSTEMS BECAUSE OF THE SUBSTANTIAL ECONOMIC DAMAGE THAT THEY CAN CAUSE. THERE IS CONSEQUENTLY A NEED TO ADOPT INCREASINGLY GREATER SAFETY MEASURES INSIDE BUILDING AND SYSTEM INFRASTRUCTURES IN ORDER TO ENSURE THAT THE ELECTRICAL AND ELECTRONIC EQUIPMENT IS NOT DAMAGED AND CAN PROVIDE ITS PERFORMANCE, EVEN IN THE PRESENCE OF INTERFERENCES. THE SPDS, DEPENDING ON THE PARAMETERS OF THE LIGHTNING CURRENT PULSE THEY ARE CALLED UPON TO DISCHARGE TO EARTH, ARE TESTED AND THEN CLASSIFIED IN DIFFERENT WAYS. THE IEC 61643-11 ED.1 (2011-03) STANDARD AND THE CORRESPONDING CEI EN 61643-11/A11 STANDARD, ALTHOUGH USING DIFFERENT, BUT SUBSTANTIALLY IDENTICAL DEFINITIONS, DIVIDE THEM UP AS FOLLOWS:

IEC 61643-11 (2011-03)	CEI EN 61643-11/A11	SPD		WAVE FORM	DISCHARGE CURRENT	COMBINED PULSE	
Class 1 SPD	Type 1 SPD T	SPD for lightning current		Tested with limp pulse current (10/350 μ s) and with the nominal I_n discharge current (8/20 μ s)	10/350 μ s	limp 25 kA	-
Class 2 SPD	Type 2 SPD T	Overvoltage limiter		Tested with nominal I_n discharge current (8/20 μ s) and with maximum I_{max} discharge current (8/20 μ s). The I_{max} , nevertheless, is neither useful nor usable to choose the SPD	8/20 μ s	limp 20 kA	-
Class 3 SPD	Type 3 SPD T	Overvoltage limiter		Tested with the combined generator that applies U_{oc} no-load voltage (1,2/50 μ s) and in short circuit a presumed I_n current (8/20 μ s)	1,2/50 μ s	-	10 kV

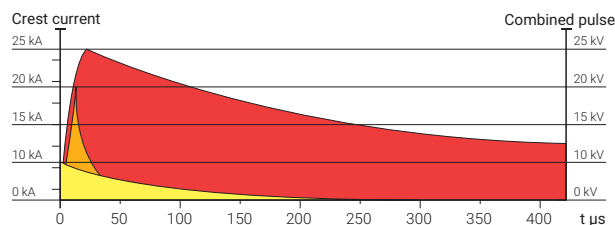

OPTIMAL ELECTRICAL SYSTEM

THE PROPOSED EXAMPLE SHOWS A TYPICAL, MEDIUM-SIZED INDUSTRIAL SYSTEM WITH AVANQUADRO.

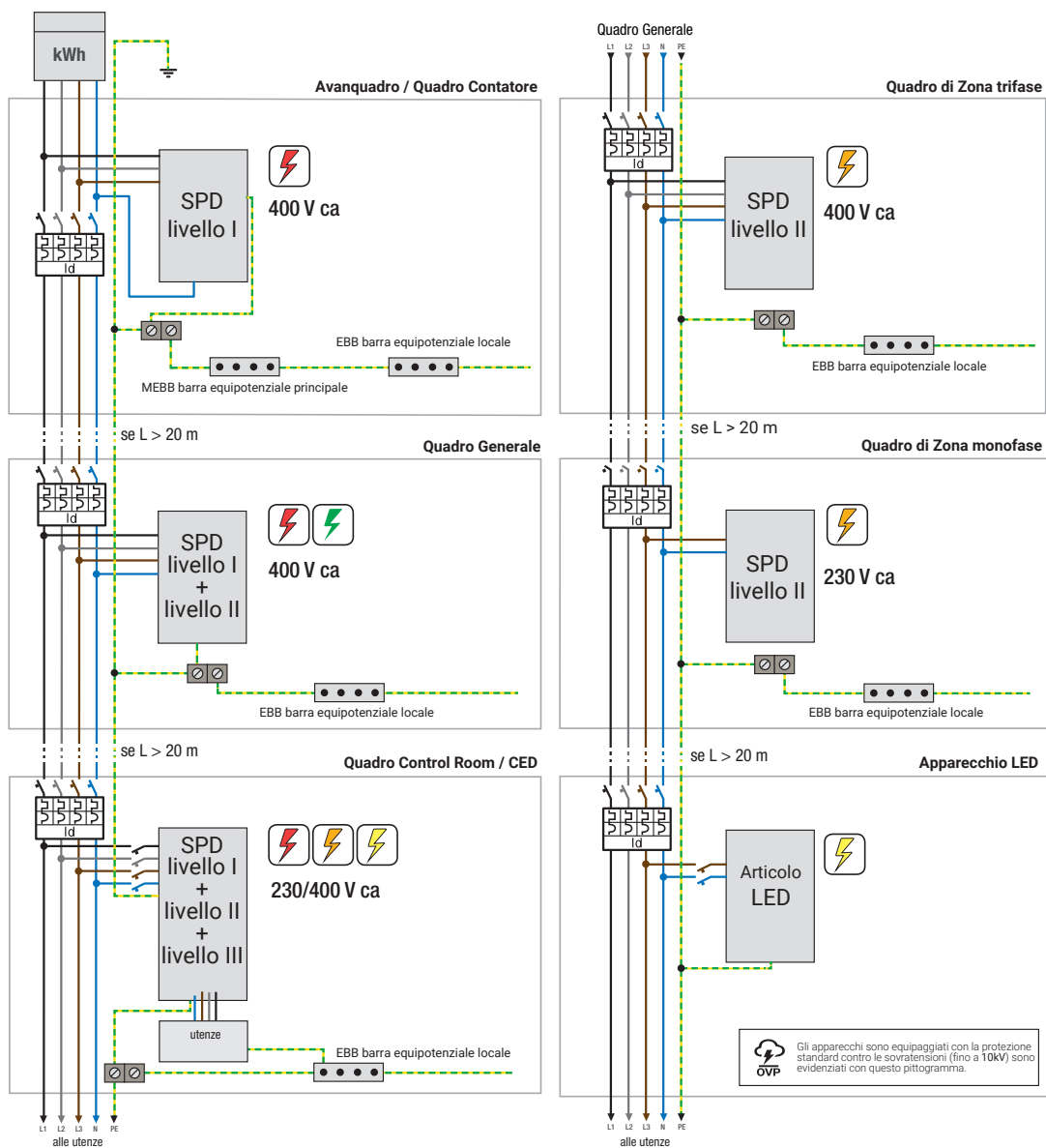

RESEARCH, DEVELOPMENT AND SUSTAINABILITY

RENEWABLE ENERGY

LINEA LIGHT GROUP INVESTS IN AND CONTINUES TO PURSUE A GREEN-ORIENTED PHILOSOPHY FOR ALL COMPANY DEPARTMENTS, FROM OFFICES TO PRODUCTION TO THE WAREHOUSE. THE COMPANY HAS DEDICATED RESOURCES TO CONTAINING THE ENVIRONMENTAL IMPACT OF THE VARIOUS OPERATIONS FOR MANY YEARS, THANKS TO MEASURES IN FAVOUR OF SUSTAINABLE DEVELOPMENT SUCH AS THE USE OF ALMOST ENTIRELY SELF-PRODUCED RENEWABLE ENERGIES, THE REDUCTION OF REDUCING CONSUMPTION AND CO₂ EMISSIONS, AS WELL AS THE RECOVERY AND RECYCLING OF PRODUCTION SCRAP AND RAW MATERIALS. THESE ARE JUST A FEW OF THE ECO-COMPATIBLE OPERATIONS UNDERTAKEN TO GROW A VIRTUOUS ECONOMIC MODEL. WASTE DISPOSAL AND RECYCLING ARE TWO IMPORTANT ISSUES FOR THE GROUP: ALL COMPANY WASTE IS DISPOSED OF FOLLOWING REGULATIONS AND STRICT PROTOCOLS IN ORDER TO PREVENT ANY DISPERSAL INTO THE SOIL OR WATERWAYS. THIS IS WHY, AS A GROUP, OUR EFFORTS ARE CONSTANTLY FOCUSED ON THE RESEARCH AND DEVELOPMENT OF SOLUTIONS INTENDED TO REDUCE ENVIRONMENTAL IMPACT TO A MINIMUM. ONE EXAMPLE IS THE USE OF NEW ORGANIC OILS AS LUBRICANTS FOR OUR PRODUCTION MACHINERY SUCH AS C.N.C. MACHINES AND CUTTING LINES. FOR THIS INSTRUMENTATION, WE USE PLANT-ORIGIN LUBRICATING COOLANTS (SYNTHETIC ESTERS-BASED) AND FREE OF MINERAL OIL, CHLORINE, SECONDARY AMINES, FORMALDEHYDE-RELEASING PRESERVATIVES, BORON AND DERIVATIVES THEREOF.

RECYCLING

AT THE END OF THE PRODUCTION CYCLE, THE DEPLETED OILS ARE RECOVERED AND RECYCLED BY SPECIALISED AND CERTIFIED COMPANIES. IN ADDITION TO THIS, WE ALSO MANAGE OTHER ASPECTS THAT HAVE LED US TO AN INCREASINGLY LOWER ENVIRONMENTAL IMPACT. IN THE FIRST PLACE, THE REPLACEMENT OF OBSOLETE AND ENERGY-INTENSIVE MACHINERY WITH NEW, MORE EFFICIENT AND THEREFORE MORE EFFECTIVE EQUIPMENT. SECONDLY, THE USE OF SPECIAL AIR FILTERS WHICH SIGNIFICANTLY REDUCE THE EMISSIONS OF THE LASER-CUTTING MACHINERY. THE WORK STATIONS IN THE INDIVIDUAL DEPARTMENTS HAVE ALSO BEEN DESIGNED TO REDUCE AND OPTIMISE ENERGY CONSUMPTION.



projectors & suspensions range index

Prolamp



Prolamp Suspension

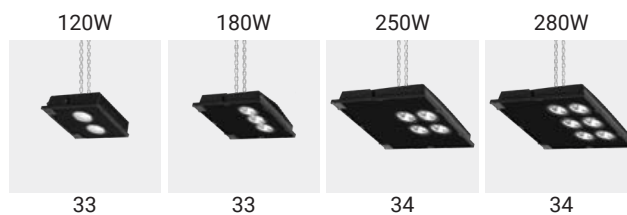

Biglamp

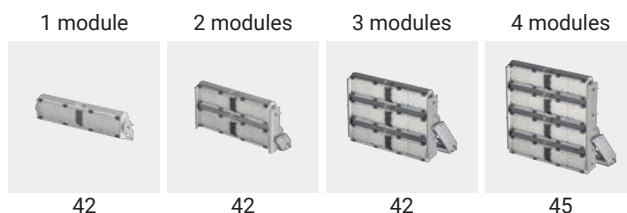

Biglamp Suspension



Multilamp



Flamp



Flamp HP

200W



65

Mini Flamp

50W



67





Prolamp

A complete range of highly efficient and sturdy adjustable projectors. Different variations of Prolamp are available: versions with adjustable bracket for wall installation and versions for hanging installation.

The vast selection of power, sizes and LED colour temperatures correlated with the wide range of optics that can be used make the Prolamp family extremely versatile. Prolamp guarantees maximum mechanical and electrical safety thanks to built in protection against surges and electrostatic discharge. The electrical compartment of each fixture is accessible for easy maintenance. The fixtures can also be fitted with protective cages to increase impact resistance.

Materials

Body in die-cast aluminium.
Tempered glass.
Bracket in iron.





Prolamp range

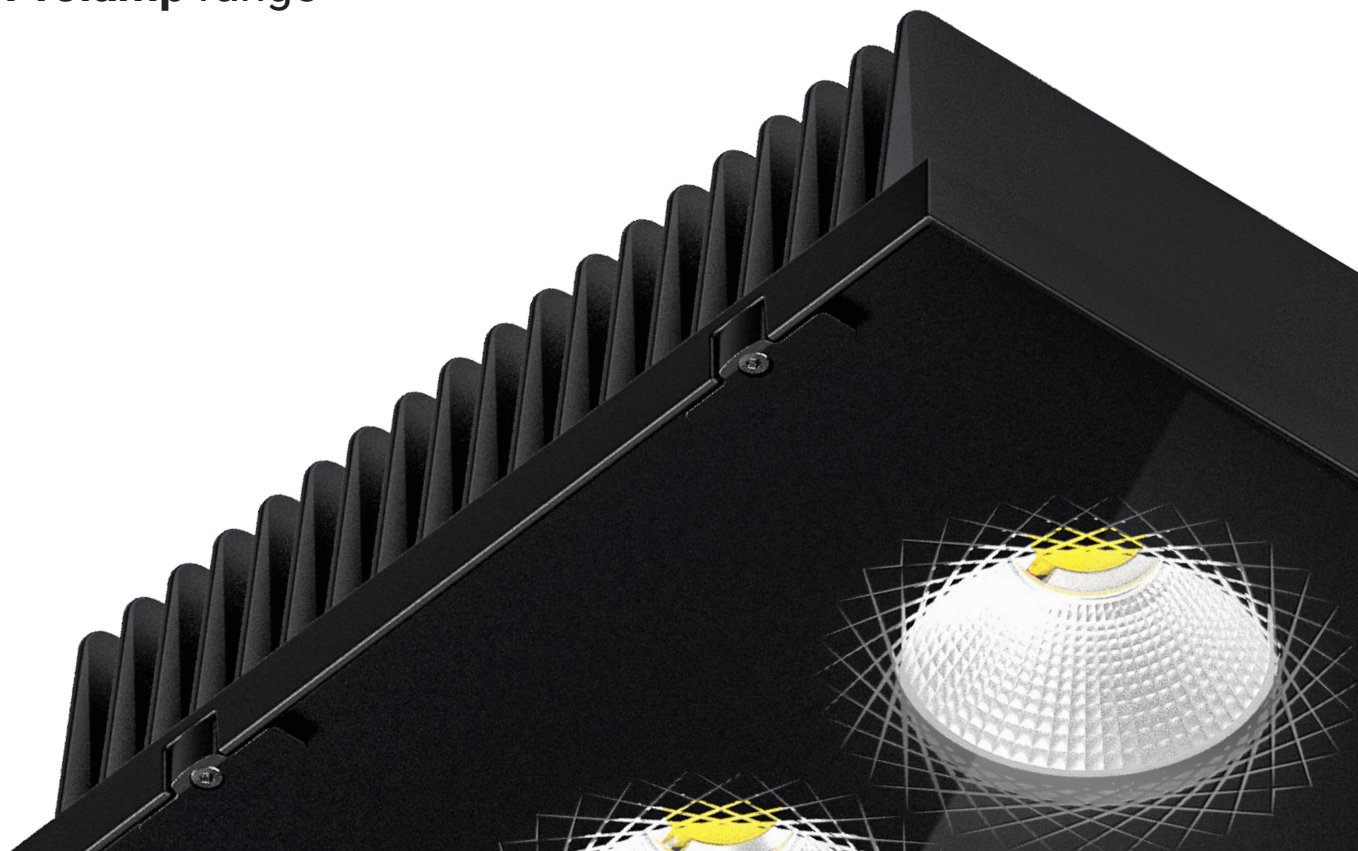

40 W



80 W



120 W



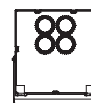

180 W

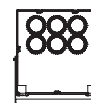

250 W



280 W

	40 W	80 W	120 W	180 W	250 W	280 W
Bracket version 	192 x 240 mm	292 x 300 mm	324 x 301 mm	391 x 439 mm	502 x 548 mm	502 x 548 mm
Suspension version 	-	-	324 x 301 mm	391 x 439 mm	502 x 548 mm	502 x 548 mm
Accessories	Protective cage	Protective cage	Protective cage	Protective cage	Protective cage	Protective cage
Finish	RAL9005	RAL9005	RAL9005	RAL9005	RAL9005	RAL9005
n. LED	1	1	2	3	4	6
Efficiency CRI 80	3000K 4000K 5000K	3000K 4000K 5000K	3000K 4000K 5000K	3000K 4000K 5000K	3000K 4000K 5000K	3000K 4000K 5000K
Optics	Medium Flood Flood Wide Flood Asymmetrical	Medium Flood Flood Wide Flood Asymmetrical	Medium Flood Flood Wide Flood Asymmetrical	Medium Flood Flood Wide Flood Asymmetrical	Medium Flood Flood Wide Flood Asymmetrical	Medium Flood Flood Wide Flood Asymmetrical
Driver	On/Off 1-10 V DALI	On/Off 1-10 V DALI	On/Off 1-10 V DALI	On/Off 1-10 V DALI	On/Off 1-10 V DALI	On/Off 1-10 V DALI

Construction details

Light fixture made entirely in ENAB-44300 die-cast Aluminium, textured RAL9005 powder coating, UV ray stabilised. On request, an electrochemical open-pore anodising pretreatment is carried out on the base alloy which guarantees outstanding corrosion resistance. Adjustable bracket and tightening screws are in AISI 304 stainless steel. The electronic compartment is accessible for easy maintenance.

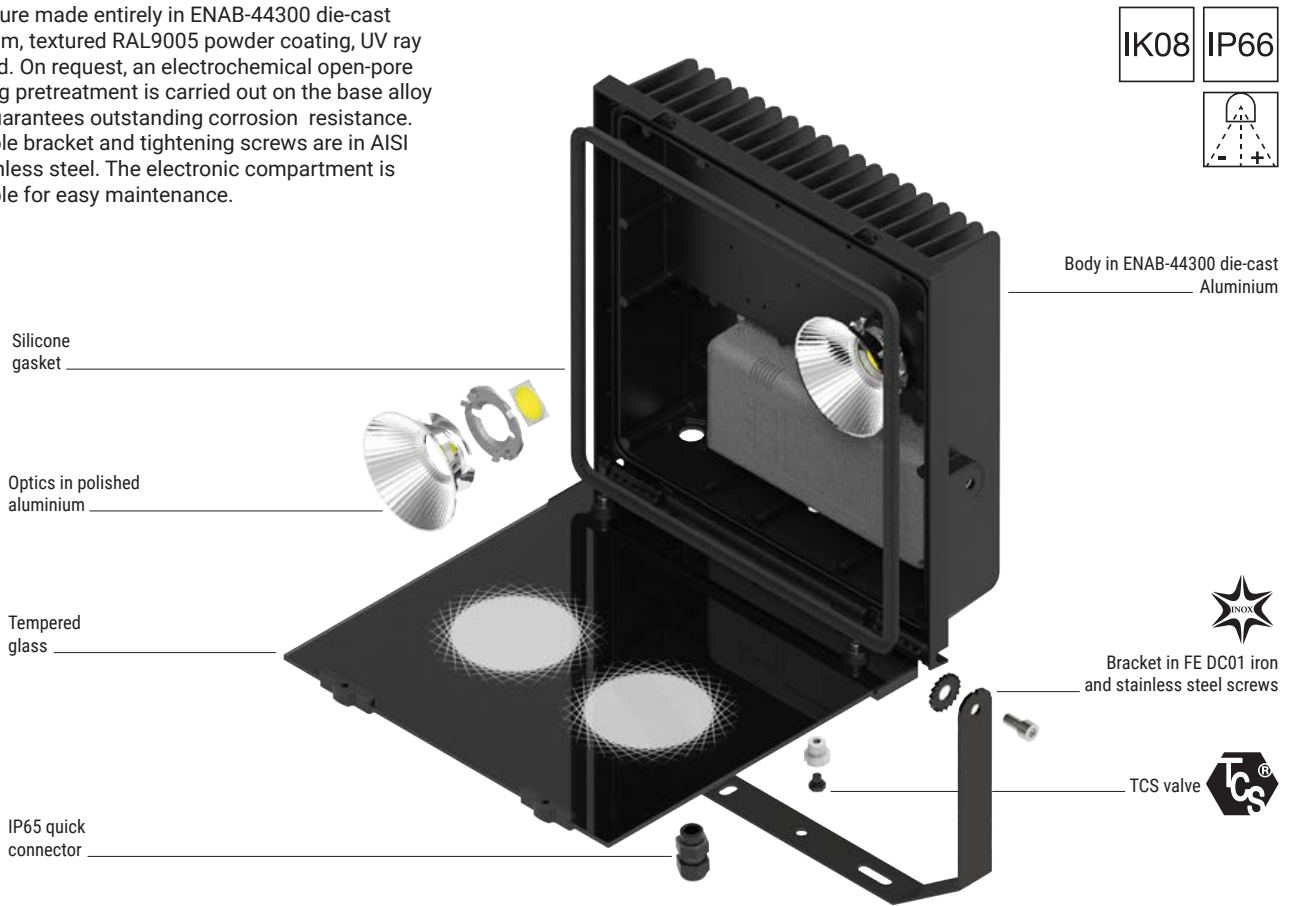

Technical lighting characteristics

Direct light lighting system fitted with high efficiency COB LED channelled through optics in iridescence-free, polished aluminium. Light fixture characterised by quality light and outstanding chromatic yield, combined with a vast range of optics with narrow or wide beam to adapt to a wide variety of situations. The available optics are: Medium Flood 30°, Flood 60°, Wide Flood 90° or 120° and Asymmetrical.

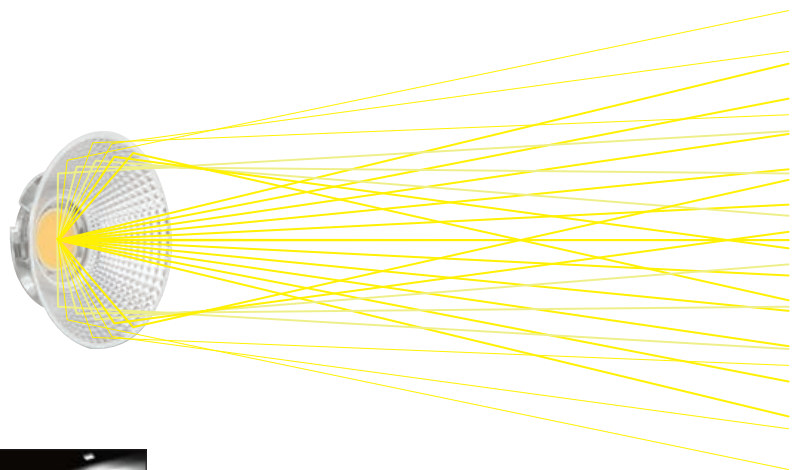

Using Medium Flood 30° optics, UGR_{≤22} values are guaranteed in compliance with the regulations for the workplace.

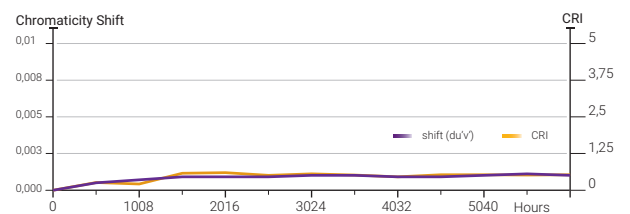
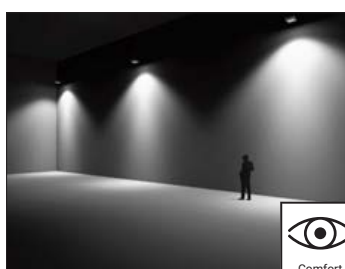

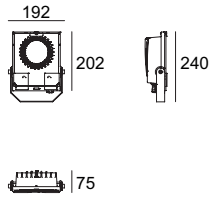
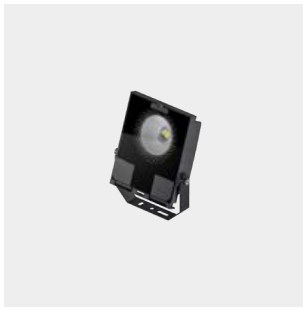

1,7 Kg
 4,9 dm³
 Comfort
UGR_s22*

1 LED - CRI 80

82270	RAL9005	W 3000 K	4870 lm	30 Medium Flood*
		N 4000 K	5140 lm	60 Flood
		C 5000 K	5199 lm	90 Wide Flood
				12 Wide Flood
				07 Asymmetrical

1 LED - CRI 80

DALI	82271	RAL9005	W 3000 K	4870 lm	30 Medium Flood*
			N 4000 K	5140 lm	60 Flood
			C 5000 K	5199 lm	90 Wide Flood
					12 Wide Flood
					07 Asymmetrical

Accessories



99391
Protective cage

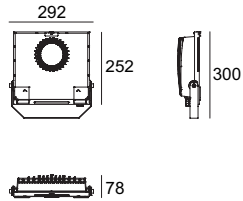
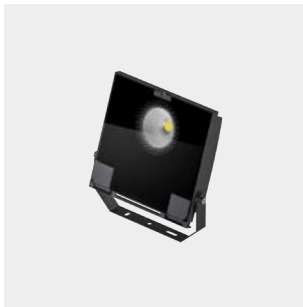

3,8 Kg
 9 dm³
 Comfort
UGR_s22*

1 LED - CRI 80

82272	RAL9005	W 3000 K	9336 lm	30 Medium Flood*
		N 4000 K	9856 lm	60 Flood
		C 5000 K	9969 lm	90 Wide Flood
				12 Wide Flood
				07 Asymmetrical

1 LED - CRI 80

DALI	82273	RAL9005	W 3000 K	9336 lm	30 Medium Flood*
			N 4000 K	9856 lm	60 Flood
			C 5000 K	9969 lm	90 Wide Flood
					12 Wide Flood
					07 Asymmetrical

Accessories



99392
Protective cage

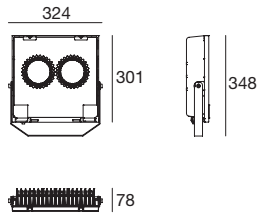
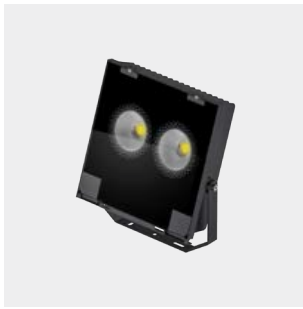

4,5 Kg



21,4 dm³



UGR_s22*

2 LEDs - CRI 80

82274 RAL9005	W 3000 K	16911 lm	30 Medium Flood*
	N 4000 K	17852 lm	60 Flood
	C 5000 K	18057 lm	90 Wide Flood
			12 Wide Flood
			07 Asymmetrical

2 LEDs - CRI 80

82275 RAL9005	W 3000 K	16911 lm	30 Medium Flood*
	N 4000 K	17852 lm	60 Flood
	C 5000 K	18057 lm	90 Wide Flood
			12 Wide Flood
			07 Asymmetrical

Accessories



99574
Protective cage

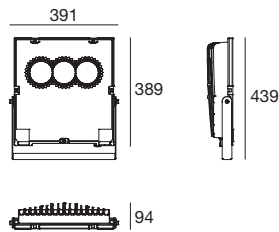

7,8 Kg



21,4 dm³



UGR_s22*

3 LEDs - CRI 80

82286 RAL9005	W 3000 K	23815 lm	30 Medium Flood*
	N 4000 K	25141 lm	60 Flood
	C 5000 K	25428 lm	90 Wide Flood
			12 Wide Flood
			07 Asymmetrical

3 LEDs - CRI 80

82287 RAL9005	W 3000 K	23815 lm	30 Medium Flood*
	N 4000 K	25141 lm	60 Flood
	C 5000 K	25428 lm	90 Wide Flood
			12 Wide Flood
			07 Asymmetrical

Accessories



83035
Protective cage

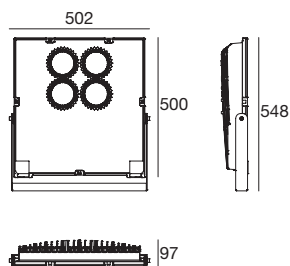
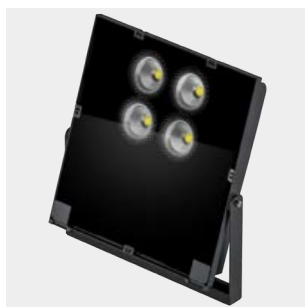
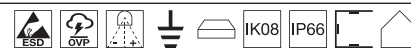

14,8 Kg
 35,7 dm³
 Comfort
UGR≤22*

4 LEDs - CRI 80

82276 RAL9005	W 3000 K	33823 lm	30 Medium Flood*
Available from October 2020	N 4000 K	35704 lm	60 Flood
	C 5000 K	36114 lm	90 Wide Flood
			12 Wide Flood
			07 Asymmetrical

4 LEDs - CRI 80

DALI 82277 RAL9005	W 3000 K	33823 lm	30 Medium Flood*
Available from October 2020	N 4000 K	35704 lm	60 Flood
	C 5000 K	36114 lm	90 Wide Flood
			12 Wide Flood
			07 Asymmetrical

Accessories



99393
Protective cage

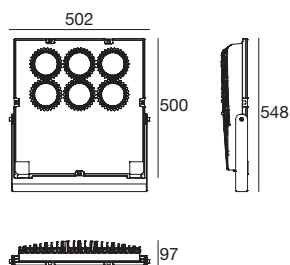

14,8 Kg
 35,7 dm³
 Comfort
UGR≤22*

6 LEDs - CRI 80

82278 RAL9005	W 3000 K	39321 lm	30 Medium Flood*
Available from October 2020	N 4000 K	41510 lm	60 Flood
	C 5000 K	41985 lm	90 Wide Flood
			12 Wide Flood
			07 Asymmetrical

6 LEDs - CRI 80

DALI 82279 RAL9005	W 3000 K	39321 lm	30 Medium Flood*
Available from October 2020	N 4000 K	41510 lm	60 Flood
	C 5000 K	41985 lm	90 Wide Flood
			12 Wide Flood
			07 Asymmetrical

Accessories



99393
Protective cage

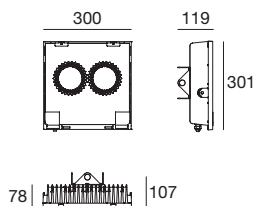

4,4 Kg 21,4 dm³



2 LEDs - CRI 80

82280 RAL9005	W 3000 K	16911 lm	30 Medium Flood*
	N 4000 K	17852 lm	60 Flood
	C 5000 K	18057 lm	90 Wide Flood
			12 Wide Flood
			07 Asymmetrical

2 LEDs - CRI 80

DALI 82281 RAL9005	W 3000 K	16911 lm	30 Medium Flood*
	N 4000 K	17852 lm	60 Flood
	C 5000 K	18057 lm	90 Wide Flood
			12 Wide Flood
			07 Asymmetrical

Accessories



99574
Protective cage

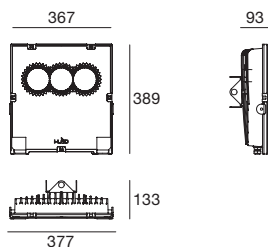

7,2 Kg 21,4 dm³



3 LEDs - CRI 80

82288 RAL9005	W 3000 K	23815 lm	30 Medium Flood*
	N 4000 K	25141 lm	60 Flood
	C 5000 K	25428 lm	90 Wide Flood
			12 Wide Flood
			07 Asymmetrical

3 LEDs - CRI 80

DALI 82289 RAL9005	W 3000 K	23815 lm	30 Medium Flood*
	N 4000 K	25141 lm	60 Flood
	C 5000 K	25428 lm	90 Wide Flood
			12 Wide Flood
			07 Asymmetrical

Accessories



83035
Protective cage

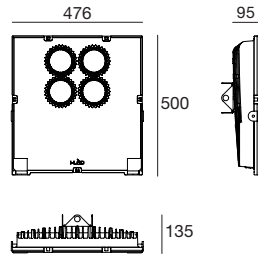

4 LEDs - CRI 80

82282 RAL9005

Available from October 2020

W	3000 K	33823 lm	30 Medium Flood*
N	4000 K	35704 lm	60 Flood
C	5000 K	36114 lm	90 Wide Flood
			12 Wide Flood
			07 Asymmetrical

4 LEDs - CRI 80

DALI

82283 RAL9005

Available from October 2020

W	3000 K	33823 lm	30 Medium Flood*
N	4000 K	35704 lm	60 Flood
C	5000 K	36114 lm	90 Wide Flood
			12 Wide Flood
			07 Asymmetrical

Kg
13,7 Kg

Vol
35,7 dm³

Comfort
UGR≤22*

Accessories



99393
Protective cage

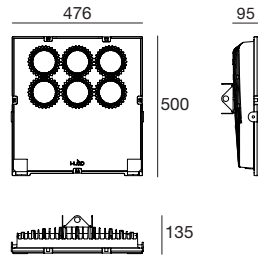

6 LEDs - CRI 80

82284 RAL9005

Available from October 2020

W	3000 K	39321 lm	30 Medium Flood*
N	4000 K	41510 lm	60 Flood
C	5000 K	41985 lm	90 Wide Flood
			12 Wide Flood
			07 Asymmetrical

6 LEDs - CRI 80

DALI

82285 RAL9005

Available from October 2020

W	3000 K	39321 lm	30 Medium Flood*
N	4000 K	41510 lm	60 Flood
C	5000 K	41985 lm	90 Wide Flood
			12 Wide Flood
			07 Asymmetrical

Kg
13,7 Kg

Vol
35,7 dm³

Comfort
UGR≤22*

Accessories



99393
Protective cage



The photometric curves are available at www.linealight.com. On request, we carry out technical lighting calculations to determine the number of items that will be satisfactory in order to guarantee the required lighting needs.

Bracket accessory for hanging dual projector



description
Bracket accessory made in galvanised iron, ideal for hanging installation of the dual projector.

code	siutable for
on request	Prolamp 250W
	Prolamp 280W

Protective cage accessory



description
Protective cage in steel wire, ideal for increasing the impact resistance of the fixture.

code	siutable for
99391	Prolamp 40W
99392	Prolamp 80W
99574	Prolamp 120W
83035	Prolamp 180W
99393	Prolamp 250W / 280W



With protection, compliant with standards EN13964 (annex D) and DIN 57710-13.







Biglamp

Extremely high performance modular projectors available in 3 power sizes for the versions with built-in driver, 4 power sizes for the versions with driver not included. The projectors are fitted with independent swivelling modules. The entire lamp body and each individual module are independently adjustable with maximum precision. Biglamp is ideal for lighting large areas such as sports facilities, arenas, multi-purpose fitness centres and other large environments. Also available in hanging version with single module.

Materials

Body in die-cast aluminium.

Tempered glass.

Iron bracket with cataphoresis treatment and polyester powder coating.



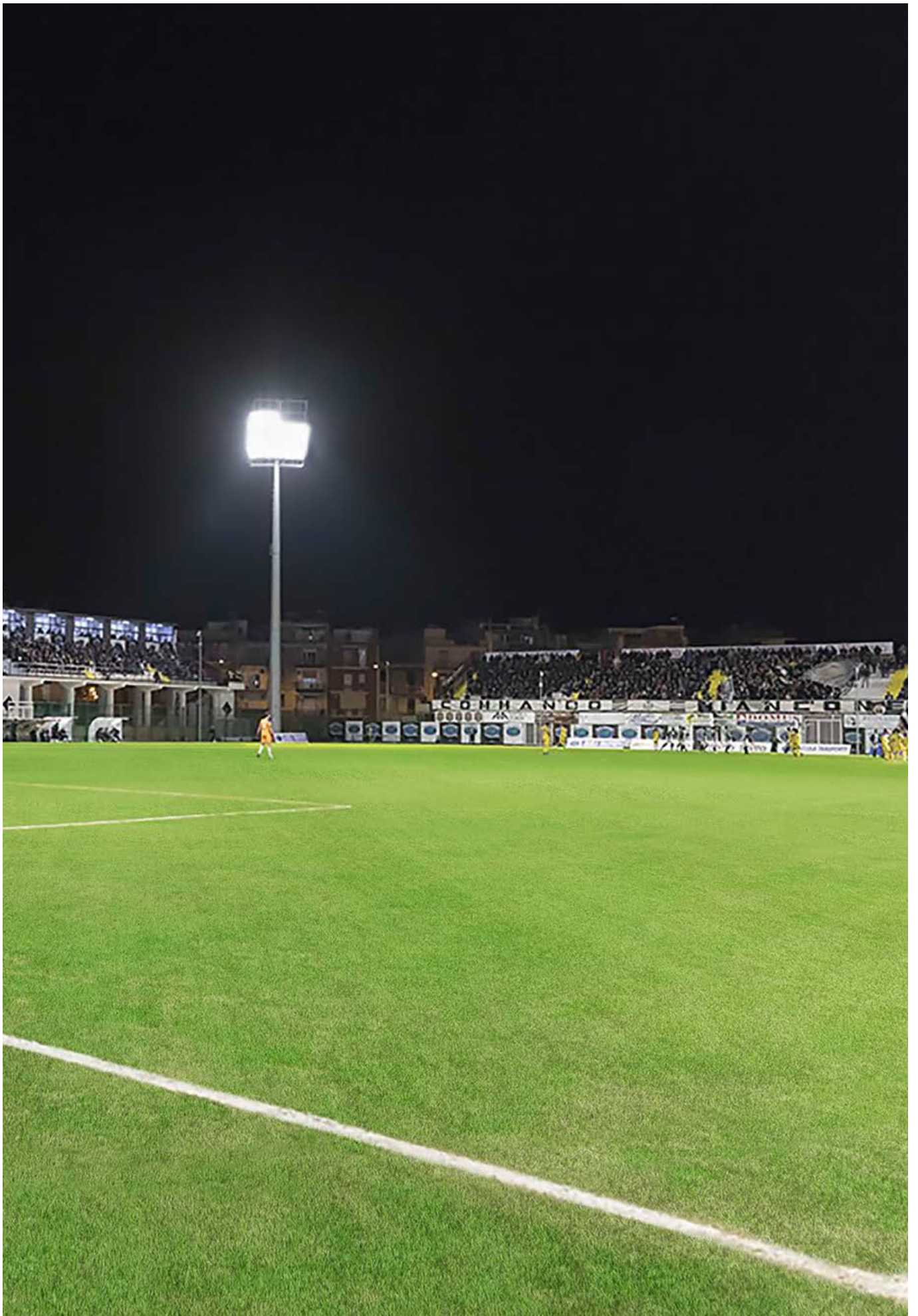

Biglamp range

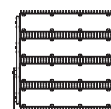
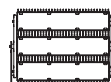

 On board

300 W

600 W

900 W

-

 Remote

348 W

696 W

1044 W

1392 W

Size	712 x 188 mm	759 x 421 mm	759 x 539 mm	759 x 716 mm
Finish	Natural Al.	Natural Al.	Natural Al.	Natural Al.
Suspension	✓	-	-	-
Module n.	1	2	3	4
Led n.	112	224	336	448
Efficiency CRI 80	3000K 4000K 5700K	3000K 4000K 5700K	3000K 4000K 5700K	3000K 4000K 5700K
Optics	Spot Medium Flood Flood Asymmetrical	Spot Medium Flood Flood Asymmetrical	Spot Medium Flood Flood Asymmetrical	Spot Medium Flood Flood Asymmetrical
Driver	On/Off 1-10 V DALI	On/Off 1-10 V DALI	On/Off 1-10 V DALI	On/Off 1-10 V DALI

Construction details

The LED module body is made in EN AB 46100 die-cast, mill-finish aluminium, whereas the fastening bracket is in FE00 painted grey RAL9006. All the light fixture's screws are in AISI 316 stainless steel. The optics are in high yield transparent polycarbonate with anti UV ray protection in three different versions: 15° Spot, 30° Medium Flood and 60° Flood. The fixture's IP66 protection grade and the IK08 seal are ensured by an anti-UV silicone gasket and retaining springs in black galvanised stainless steel designed to compensate for the item's thermal expansion and to guarantee the integrity of the glass over time. The front protective glass is 4 mm thick.

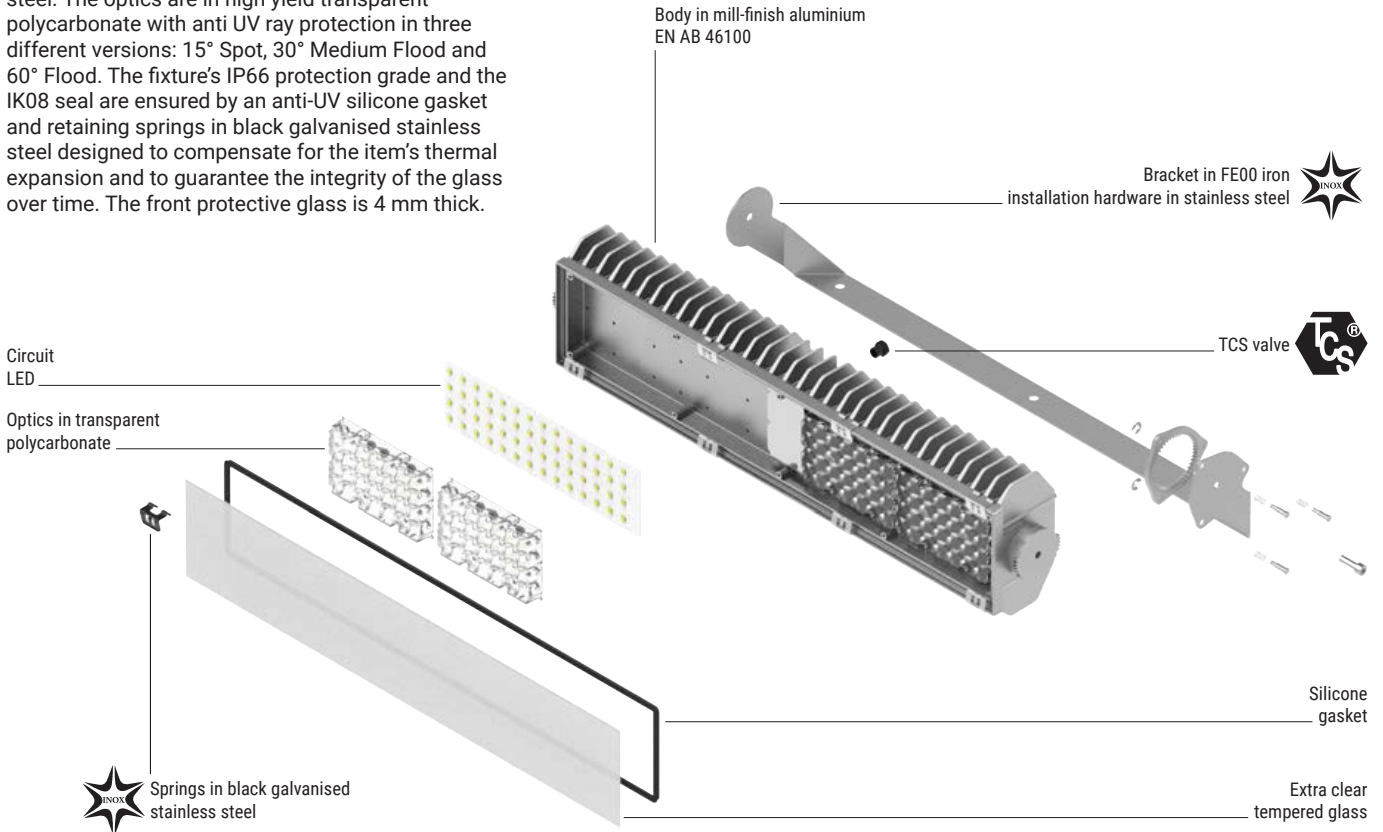

Heat dissipation

Heat dissipation is optimised thanks to the radiator with fins designed to achieve maximum dissipation through natural convection in order to ensure a long life for the LED light source.

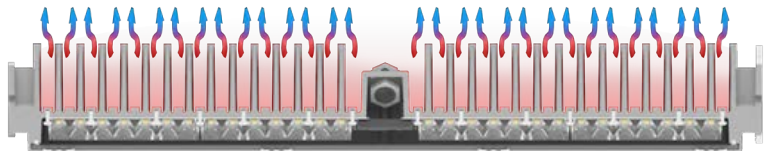

On request, the fixtures are available with a colour rendering index of ≥ 90 and colour temperature of 5700K. With these characteristics, the light fixtures are in compliance with TV broadcasting requirements with filming in HDTV and super slow motion quality.

Swivelling

Independent swivelling of each individual module by manually pressing the three-spring mechanism with practical hook and release system. Adjustment of $\pm 20^\circ$ with a step every 5° . The entire luminaire can be adjusted on the horizontal axis by $\pm 90^\circ$ with a step every 5° .

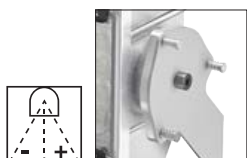
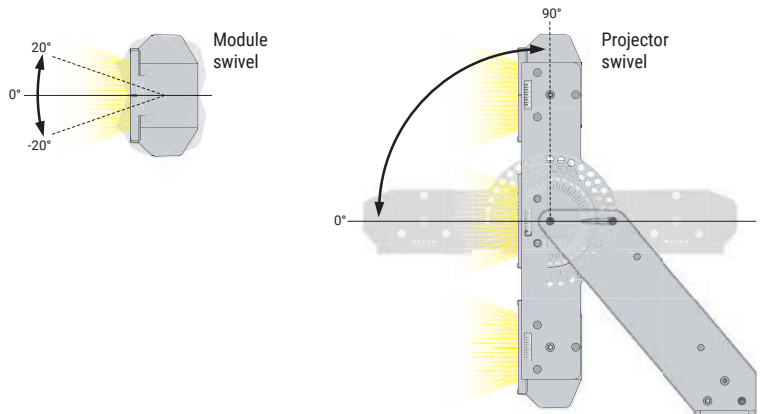

Three-spring hook/release mechanism.

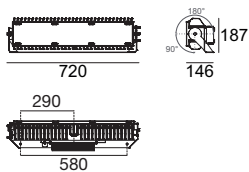
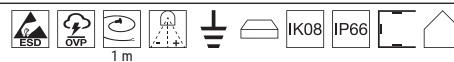

112 LEDs - CRI 80

82424 Natural AL	W 3000 K	42795 lm	15 Spot
	N 4000 K	46155 lm	30 Medium Flood
	C 5700 K	46155 lm	60 Flood
			07 Asymmetrical*

*Available from July

Kg 12,2 **Vol** 19,5 dm³

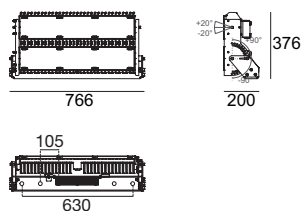
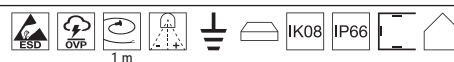

224 LEDs - CRI 80

82425 Natural AL	W 3000 K	85590 lm	15 Spot
	N 4000 K	92310 lm	30 Medium Flood
	C 5700 K	92310 lm	60 Flood
			07 Asymmetrical*

*Available from July

Kg 31,6 **Vol** 56,5 dm³

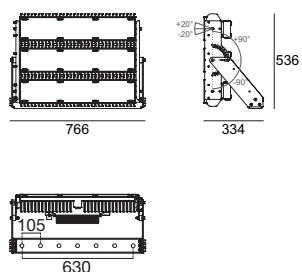
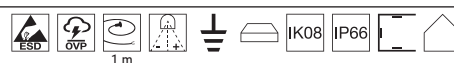

336 LEDs - CRI 80

82426 Natural AL	W 3000 K	128385 lm	15 Spot
	N 4000 K	138465 lm	30 Medium Flood
	C 5700 K	138465 lm	60 Flood
			07 Asymmetrical*

*Available from July

Kg 45,9 **Vol** 74 dm³

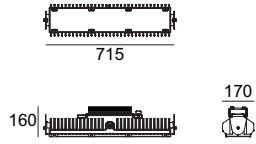
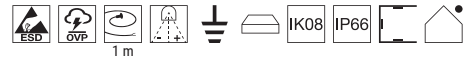

112 LEDs - CRI 80

82428 Natural Al.	W 3000 K	42795 lm	15 Spot
	N 4000 K	46155 lm	30 Medium Flood
	C 5700 K	46155 lm	60 Flood
			07 Asymmetrical*

*Available from July

11,3 Kg 19,5 dm³

Installation on light tower

The Biglamp protector design was conceived to make installation and directing of the light beam as easy as possible. Considering the possibility of swivelling the projector and the individual modules, Biglamp is ideal for applications on any type of light tower.

Aiming

Projector aiming service is available on request.

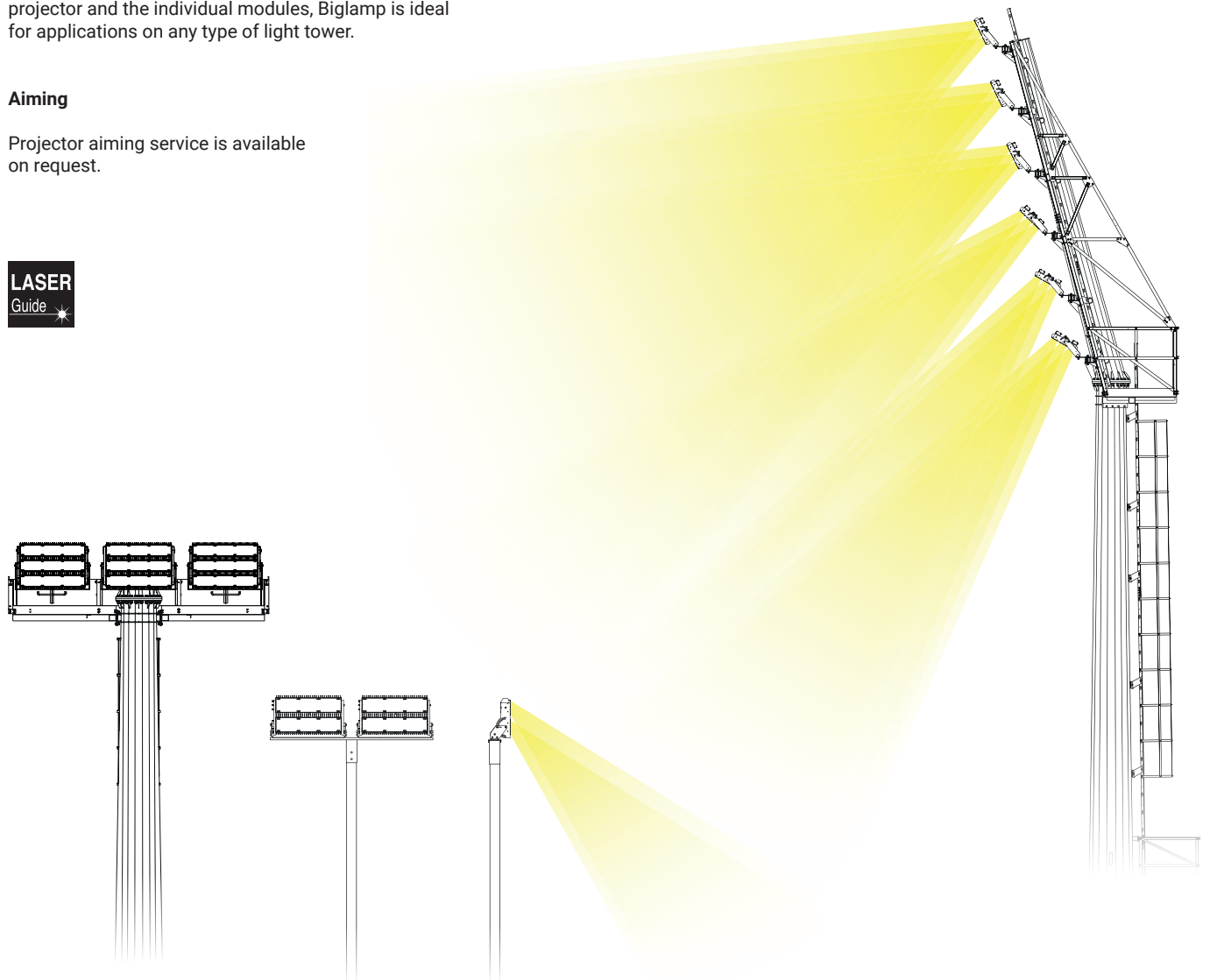

Biglamp | Projector | 348 W DC powerLED

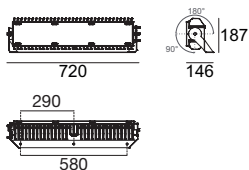

Kg
9,2 Kg

Vol
19,5 dm³

112 LEDs - CRI 80

82429 <small>Natural AL</small>	W 3000 K	47600 lm	15 Spot
	N 4000 K	51341 lm	30 Medium Flood
	C 5700 K	51341 lm	60 Flood
			07 Asymmetrical*

*Available from July

Driver

Control



83027
Driver ON-OFF/1-10
370W input 380V

83028
Driver ON-OFF
370W input 220V

83030
DALI
controller

83031
DMX
controller

Biglamp | Projector | 2 x 348 W DC powerLED

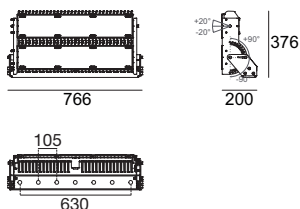

Kg
25,5 Kg

Vol
56,5 dm³

224 LEDs - CRI 80

82430 <small>Natural AL</small>	W 3000 K	95200 lm	15 Spot
	N 4000 K	102682 lm	30 Medium Flood
	C 5700 K	102682 lm	60 Flood
			07 Asymmetrical*

*Available from July

Driver

Control



83027
Driver ON-OFF/1-10
370W input 380V

83028
Driver ON-OFF
370W input 220V

83030
DALI
controller

83031
DMX
controller

The Driver and Control equipment is to be considered for each individual module (2x)

Biglamp | Projector | 3 x 348 W DC powerLED

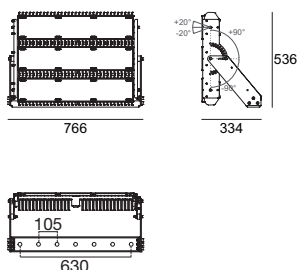

Kg
36,8 Kg

Vol
74 dm³

336 LEDs - CRI 80

82431 <small>Natural AL</small>	W 3000 K	142800 lm	15 Spot
	N 4000 K	154023 lm	30 Medium Flood
	C 5700 K	154023 lm	60 Flood
			07 Asymmetrical*

*Available from July

Driver

Control



83027
Driver ON-OFF/1-10
370W input 380V

83028
Driver ON-OFF
370W input 220V

83030
DALI
controller

83031
DMX
controller

The Driver and Control equipment is to be considered for each individual module (3x)

Biglamp | Projector | 4 x 348 W DC powerLED

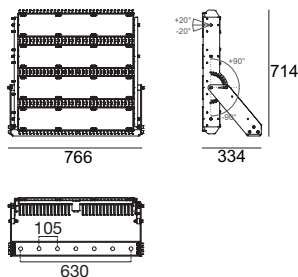

Kg 46 Kg **Vol** 92,5 dm³

448 LEDs - CRI 80

82432 Natural AL	W 3000 K	190400 lm	15 Spot
	N 4000 K	205364 lm	30 Medium Flood
	C 5700 K	205364 lm	60 Flood
			07 Asymmetrical*

*Available from July

Driver

Control

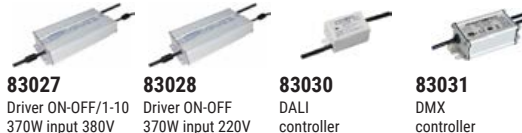

The Driver and Control equipment is to be considered for each individual module (4x)

Biglamp Suspension | Projector | 348 W DC powerLED

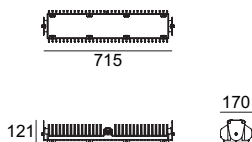
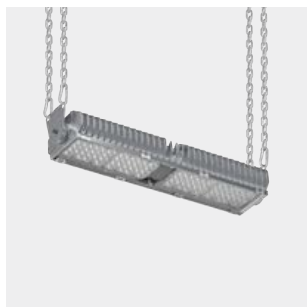

Kg 8,3 Kg **Vol** 19,5 dm³

112 LEDs - CRI 80

82433 Natural AL	W 3000 K	42795 lm	15 Spot
	N 4000 K	46155 lm	30 Medium Flood
	C 5700 K	46155 lm	60 Flood
			07 Asymmetrical*

*Available from July

Driver

Control



Remote connection

In certain situations where the distances between the power substation and the light fixtures may be extensive, correct installation of the lighting system prevents any electrical voltage drops. To prevent this from occurring, in the cases where Biglamp is used in the versions without driver included, using a 2 x 2.5mm² gauge cable can cover up to 200 m of distance between Driver and light source, without suffering any voltage drop in the system. The remote power supplies have output voltage of 120 Vdc with both AC and DC input voltage.

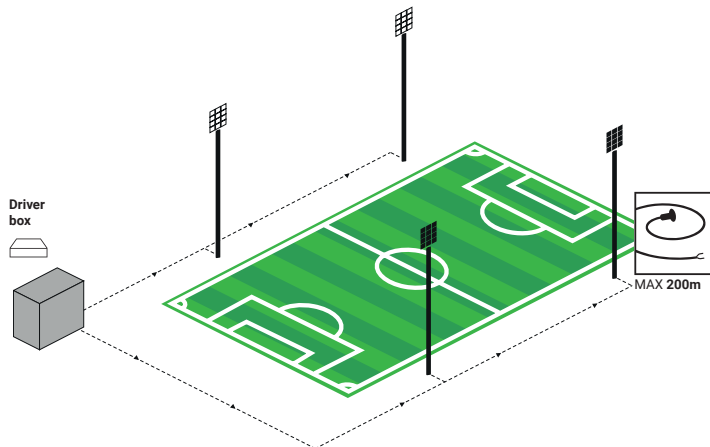

The photometric curves are available at www.linealight.com. On request, we carry out technical lighting calculations to determine the number of items that will be satisfactory in order to guarantee the required lighting needs.

Multilamp

Rectangular-shaped projector, modular from 1 to 4 modules that can be combined with 3 different types of optics. Item suitable for different technical lighting solutions thanks to multiple accessories designed for the different types of installation: surface ceiling or wall mounting, hanging, on busbar or with springs for recessed installation. The fixtures can also be fitted with protective cages to increase impact resistance.

Materials

Body in extruded aluminium.

Side plugs in iron with galvanising treatment and polyester powder coating.

Optics screen in polycarbonate with UV protection.



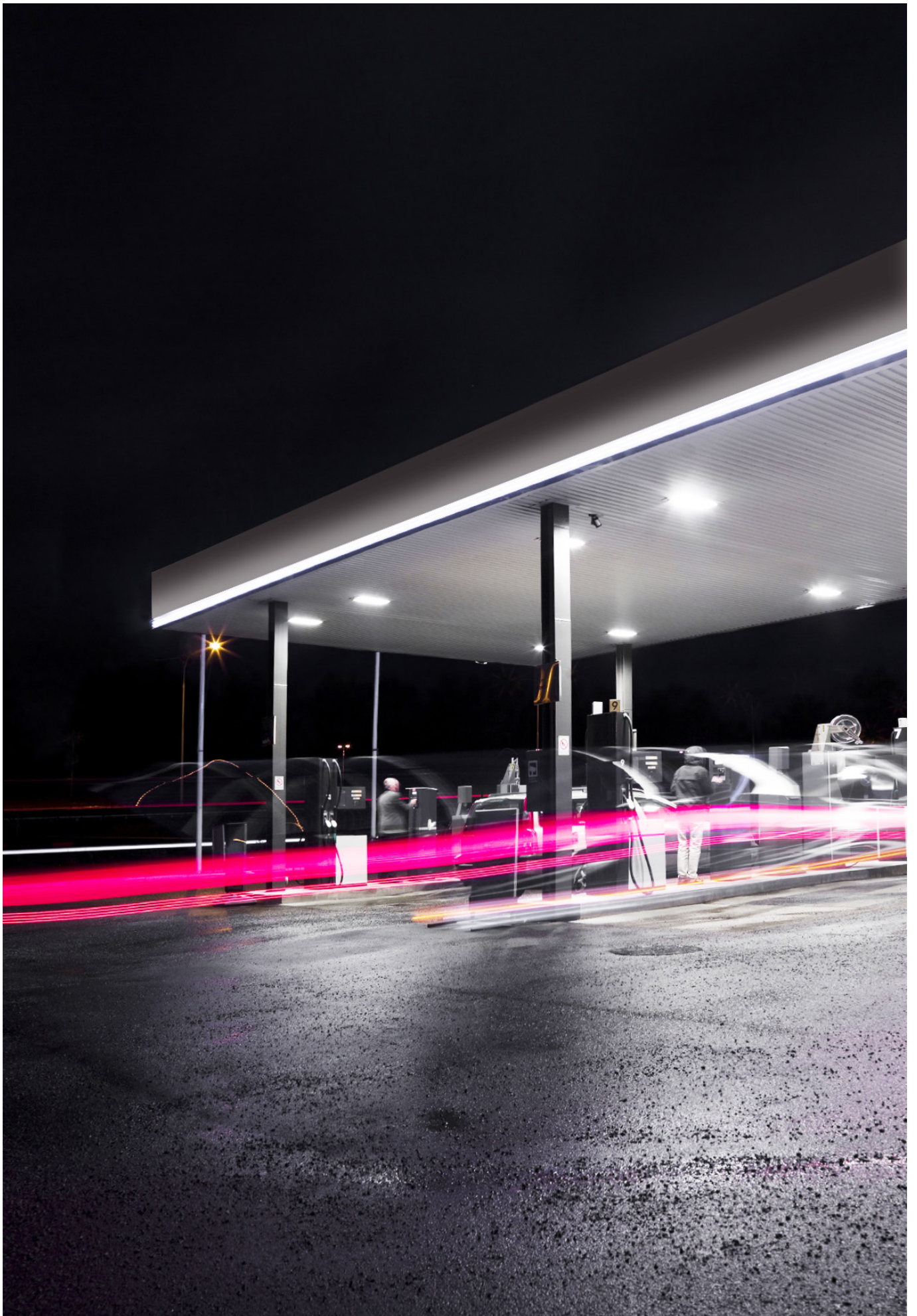

Multilamp range



70 W

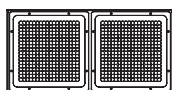

130 W

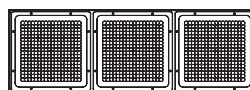

200 W

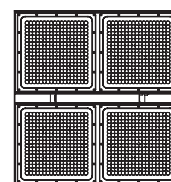

260 W

	70 W	130 W	200 W	260 W
Size	245 x 240 mm	482 x 240 mm	719 x 240 mm	481 x 505 mm
Module n.	1	2	3	4
Finish	RAL9005 RAL9003	RAL9005 RAL9003	RAL9005 RAL9003	RAL9005 RAL9003
n. LED	324	648	972	1296
Efficiency CRI 80	3000K 4000K 6500K	3000K 4000K 6500K	3000K 4000K 6500K	3000K 4000K 6500K
Optics	Medium Flood Wide Flood	Medium Flood Wide Flood	Medium Flood Wide Flood	Medium Flood Wide Flood
Driver	On/Off DALI	On/Off DALI	On/Off DALI	On/Off DALI

Construction details

Light fixture with rectangular shape made in 6060 anodised black or RAL9003 White painted extruded aluminium. Side plugs in painted steel (black or white to match the projector body). Optics assembly in transparent, UV ray stabilised polycarbonate that also acts as a protective screen. Tightening screws and brackets in AISI 316 steel.

IK08 IP65

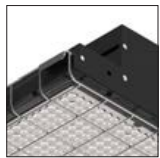
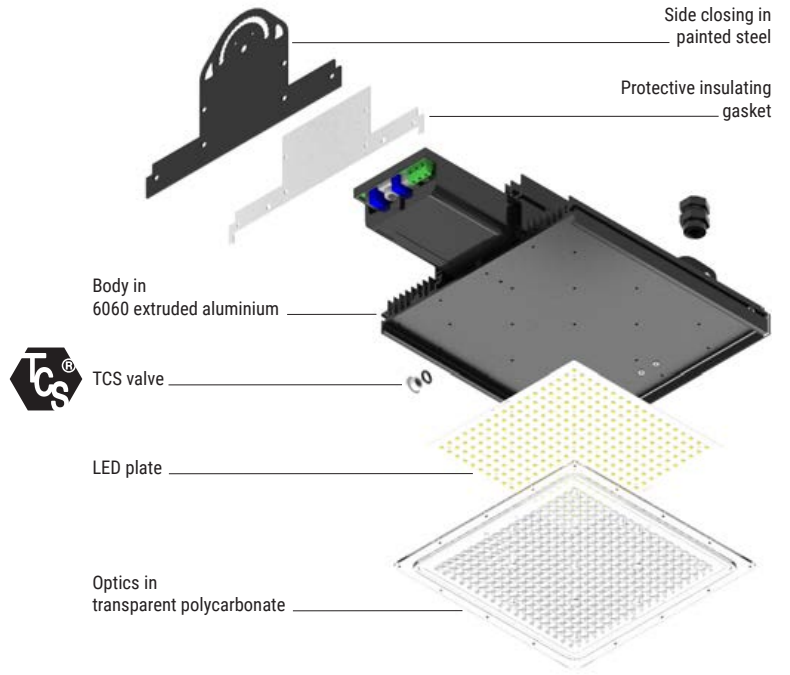

Metallic cage available on request to protect against impact.



With protection, compliant with standards EN13964 (annex D) and DIN 57710-13.

IK08 → IK10

Installation options

Numerous installation solutions: surface, ceiling or wall, on busbar, hanging and recessed, thanks to the numerous accessories.

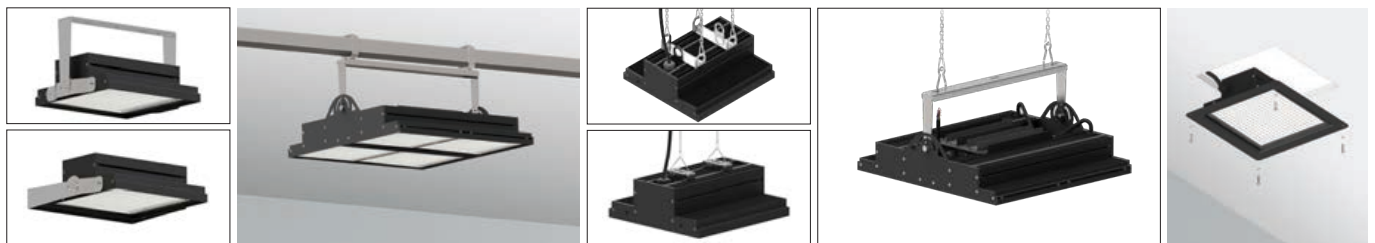

Technical lighting characteristics

Thanks to its modular nature, Multilamp is easy to expand. Each module contains 324 highly efficient power diodes.

It can be assembled with 1, 2, 3 or 4 modules that can be combined with three different types of optics to make the projector as versatile as possible.

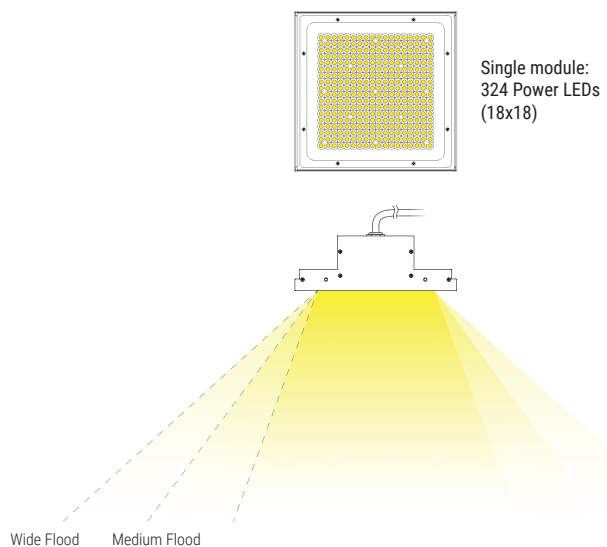

Multilamp One | Projector | 190-250 V | 63 W DC - 70 W AC topLED

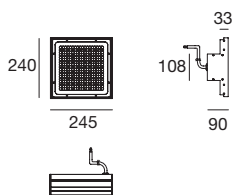
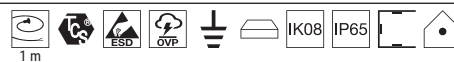

Kg 2,9 Kg
Vol 8,4 dm³

324 LEDs - CRI 80

90442 Black	W 3000 K	10180 lm	30 Medium Flood
90443 White	N 4000 K	10638 lm	90 Wide Flood
	C 6500 K	11201 lm	12 Wide Flood

324 LEDs - CRI 80

DALI 90444 Black	W 3000 K	10180 lm	30 Medium Flood
90445 White	N 4000 K	10638 lm	90 Wide Flood
	C 6500 K	11201 lm	12 Wide Flood

Multilamp Duo | Projector | 190-250 V | 120 W DC - 130 W AC topLED

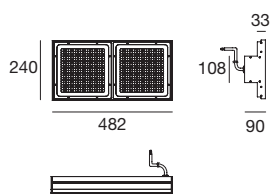
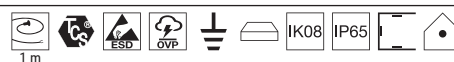

Kg 4,8 Kg
Vol 16,1 dm³

648 LEDs - CRI 80

90446 Black	W 3000 K	16459 lm	30 Medium Flood
90447 White	N 4000 K	17237 lm	90 Wide Flood
	C 6500 K	18144 lm	12 Wide Flood

648 LEDs - CRI 80

DALI 90448 Black	W 3000 K	16459 lm	30 Medium Flood
90449 White	N 4000 K	17237 lm	90 Wide Flood
	C 6500 K	18144 lm	12 Wide Flood

Multilamp Trio | Projector | 190-250 V | 190 W DC - 200 W AC topLED

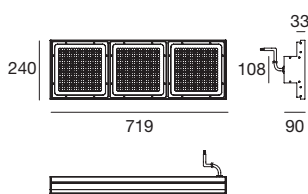
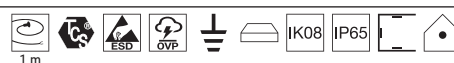

Kg 6,7 Kg
Vol 44,9 dm³

972 LEDs - CRI 80

90450 Black	W 3000 K	28480 lm	30 Medium Flood
90451 White	N 4000 K	29743 lm	90 Wide Flood
	C 6500 K	31396 lm	12 Wide Flood

972 LEDs - CRI 80

DALI 90452 Black	W 3000 K	28480 lm	30 Medium Flood
90453 White	N 4000 K	29743 lm	90 Wide Flood
	C 6500 K	31396 lm	12 Wide Flood

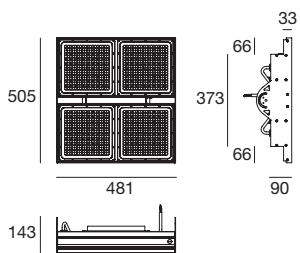
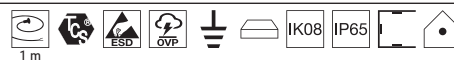

1296 LEDs - CRI 80

90454	Black	W 3000 K	32918 lm	30 Medium Flood
90455	White	N 4000 K	34474 lm	90 Wide Flood
		C 6500 K	36288 lm	12 Wide Flood

1296 LEDs - CRI 80

90456	Black	W 3000 K	32918 lm	30 Medium Flood
90457	White	N 4000 K	34474 lm	90 Wide Flood
		C 6500 K	36288 lm	12 Wide Flood



11,3 Kg



30,6 dm³

Protective cage accessory



description

Protective metallic cage, ideal for increasing the impact resistance of the fixture.

code	n.	siutable for
98758	1x	Multilamp One
	2x	Multilamp Duo
	3x	Multilamp Trio



Multilamp One



code	n.	siutable for
98760	1x	Multilamp Four

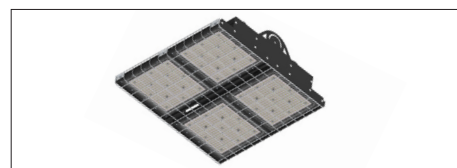

The fixture with protection is in compliance with standards EN13964 (annex D) and DIN 57710-13.



The photometric curves are available at www.linealight.com. On request, we carry out technical lighting calculations to determine the number of items that will be satisfactory in order to guarantee the required lighting needs.

Adjustable bracket accessory

description	code	siutable for
Adjustable bracket in steel with screws and safety pins for wall or ceiling installation.	98755	Multilamp One
	98756	Multilamp Duo
	98757	Multilamp Trio



Multilamp One

description	code	siutable for
Adjustable bracket in steel with screws and safety pins for wall or ceiling installation.	99581	Multilamp Four



description	code	siutable for
Adjustable bracket in steel with screws and safety pins. Ideal for installation on busbar, surface installation or hanging.	99582	Multilamp Four



Hanging bracket accessory

description	code	n.	siutable for
Steel bracket for ceiling installation (chains not included).	98754	2x	Multilamp One
		2x	Multilamp Duo
		3x	Multilamp Trio

Chains not included in the kit



Multilamp One

description	code	n.	siutable for
Steel clip bracket for dual installation, hanging or surface mounted (chains not included).	98748	2x	Multilamp One
		2x	Multilamp Duo
		3x	Multilamp Trio

Chains not included in the kit



Multilamp One

Recess frame accessory

description	code	type	siutable for
Frame in aluminium painted for recessed installation with adjustable springs.	98764	RAL9005	Multilamp One
	98761	RAL9003	
	98765	RAL9005	Multilamp Duo
	98762	RAL9003	
	98766	RAL9005	Multilamp Trio
	98763	RAL9003	

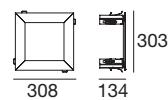

Multilamp One

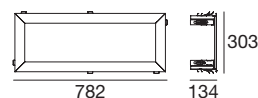
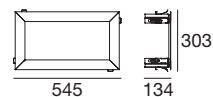

description	code	type	siutable for
Frame in painted aluminium for direct recessed installation with screws.	99484	RAL9005	Multilamp One
	99585	RAL9003	

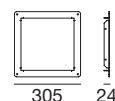



Flamp

LED suspensions for industrial lighting designed to ensure maximum visual comfort and safety in work environments. Lamps fitted with powerful, new generation diodes with bright and uniform light. Thanks to an excellent heat dissipation system and built-in overheating protection, Flamp guarantees long life, high efficiency and high performance. The vast range of available power and optics variations lets you meet a multitude of technical lighting needs. The fixtures can also be fitted with protective cages to increase impact resistance.

Materials

Structure in die-cast aluminium.

Radiator in extruded aluminium.

Tempered glass.





Flamp range

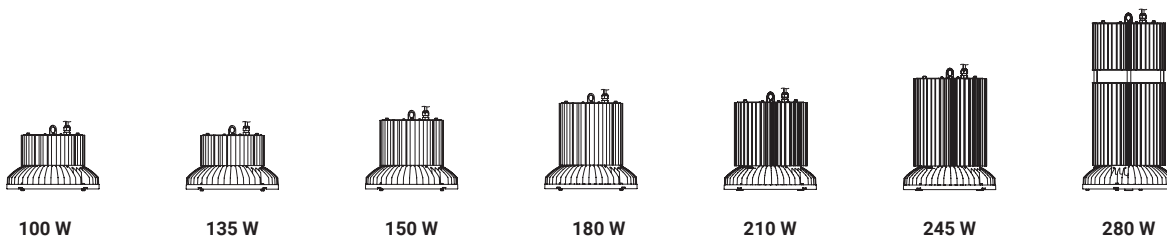

	100 W	135 W	150 W	180 W	210 W	245 W	280 W
Size	Ø 300 x 180 mm	Ø 300 x 180 mm	Ø 300 x 230 mm	Ø 300 x 280 mm	Ø 300 x 280 mm	Ø 300 x 330 mm	Ø 300 x 577 mm
Finish	RAL9006	RAL9006	RAL9006	RAL9006	RAL9006	RAL9006	RAL9006
Led n.	3	3	3	3	4	4	4
Efficiency CRI 80	3000K 4000K 5000K	3000K 4000K 5000K	3000K 4000K 5000K	3000K 4000K 5000K	3000K 4000K 5000K	3000K 4000K 5000K	3000K 4000K 5000K
Optics	Medium Flood Flood Wide Flood Oval	Medium Flood Flood Wide Flood Oval	Medium Flood Flood Wide Flood Oval	Medium Flood Flood Wide Flood Oval	Medium Flood Flood Wide Flood Oval	Medium Flood Flood Wide Flood Oval	Medium Flood Flood Wide Flood Oval
Driver	On/Off DALI	On/Off DALI	On/Off DALI	On/Off DALI	On/Off DALI	On/Off DALI	On/Off DALI

Construction details

Structure made of epoxy powder coated die-cast aluminium (EN AB 46100). An electrochemical open-pore anodising pretreatment is carried out on the base alloy which guarantees outstanding corrosion resistance. Front cover in extra clear tempered glass (4 mm thick) that ensures high impact resistance. The grade of protection and the seal are guaranteed by a silicone gasket. High mechanical resistance (IK08) LED suspension. Hook system to allow installation with suspension cables/chains (not included). All of the light fixture's screws and brackets are in stainless steel.

IK08 IP65



Metallic cage available on request to protect against impact.



With protection, compliant with standards EN13964 (annex D) and DIN 57710-13.

IK08 → IK10

Heat sink in AL6060 extruded aluminium

Front in EN AB 46100 aluminium

COB LED

Optics in chromium-plated aluminium

Silicone gasket

Extra clear, 4 mm thick tempered glass



High performance and efficiency

Lamp body integrated with electronic system and hardware control which allows the power supply and operation to be managed with optimum efficiency. The excellent heat dissipation of the dissipating body, designed specifically in the fins form, guarantees further efficiency and a long life for Flamp projectors.



Control-Unit chips

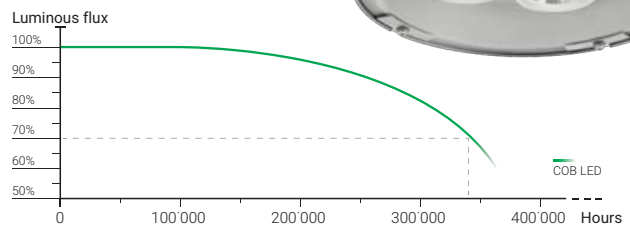
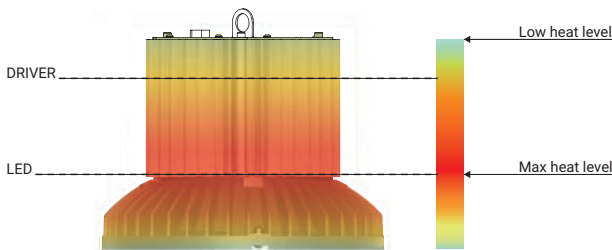

Visual comfort

For safety reasons, in certain work environments, lighting with controlled and specific glare values is required. In these environments, the reference UGR values must be equal to or lower than 22. We recommend the use of 30° (Flood) and 60° (Medium flood) optics designed specifically to guarantee UGR values in compliance with the standards for work environments.



For all the Flamp versions, a micro-prismatic diffuser accessory in UV polycarbonate is available, ideal for reducing direct glare.



UGR ≤ 22



Flamp | Suspension | 190-250 V | 91 W DC - 100 W AC arrayLED

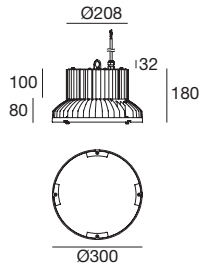

6,5 Kg



21,6 dm³



UGR_s22*

3 LEDs - CRI 80

80761	RAL9006	W 3000 K	12984 lm	30 Medium Flood*
80762	RAL9006	N 4000 K	13703 lm	60 Flood*
		C 5000 K	13861 lm	90 Wide Flood
				11 Wide Flood
				88 Oval

Flamp | Suspension | 190-250 V | 125 W DC - 135 W AC arrayLED

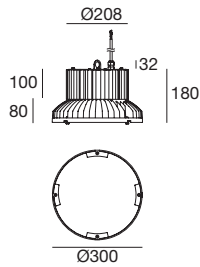

6,5 Kg



21,6 dm³



UGR_s22*

3 LEDs - CRI 80

80536	RAL9006	W 3000 K	16445 lm	30 Medium Flood*
80537	RAL9006	N 4000 K	17358 lm	60 Flood*
		C 5000 K	17558 lm	90 Wide Flood
				11 Wide Flood
				88 Oval

Flamp | Suspension | 190-250 V | 140 W DC - 150 W AC arrayLED

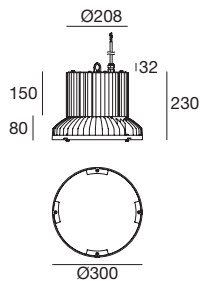

6,7 Kg



21,6 dm³



UGR_s22*

3 LEDs - CRI 80

80538	RAL9006	W 3000 K	20287 lm	30 Medium Flood*
80539	RAL9006	N 4000 K	21416 lm	60 Flood*
		C 5000 K	21661 lm	90 Wide Flood
				11 Wide Flood
				88 Oval

Flamp | Suspension | 190-250 V | 170 W DC - 180 W AC arrayLED

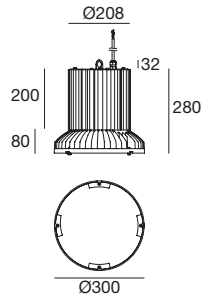

3 LEDs - CRI 80

80540	RAL9006	W 3000 K	25367 lm	30 Medium Flood*
80541	RAL9006	N 4000 K	26778 lm	60 Flood*
		C 5000 K	27086 lm	90 Wide Flood
				11 Wide Flood
				88 Oval

Kg
6,75 Kg

Vol
21,6 dm³



Flamp | Suspension | 190-250 V | 190 W DC - 210 W AC arrayLED

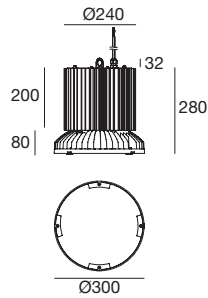

4 LEDs - CRI 80

80542	RAL9006	W 3000 K	27049 lm	30 Medium Flood*
80543	RAL9006	N 4000 K	28554 lm	60 Flood*
		C 5000 K	28881 lm	90 Wide Flood
				11 Wide Flood
				88 Oval

Kg
9,7 Kg

Vol
34,6 dm³



Flamp | Suspension | 190-250 V | 220 W DC - 245 W AC arrayLED

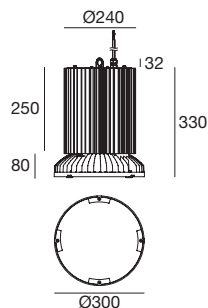

4 LEDs - CRI 80

80544	RAL9006	W 3000 K	32920 lm	30 Medium Flood*
80545	RAL9006	N 4000 K	34751 lm	60 Flood*
		C 5000 K	35150 lm	90 Wide Flood
				11 Wide Flood
				88 Oval

Kg
11,3 Kg

Vol
34,6 dm³



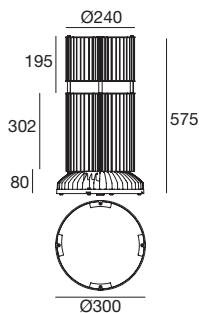

4 LEDs - CRI 80

80766	RAL9006	W 3000 K	39055 lm	60 Flood*
80767	RAL9006	N 4000 K	40330 lm	90 Wide Flood
		C 5000 K	40793 lm	11 Wide Flood
				88 Oval

17 Kg 51 dm³ UGR_{s22}*

Micro-prismatic diffuser accessory



description
Diffuser accessory in UV polycarbonate is available, ideal for reducing direct glare.

code	n.	siutable for
98727	1x	All Flamp version

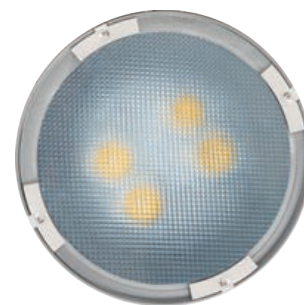

Wide Flood 110° optic

The fixtures with Wide Flood 110° optic have an internal surface adjacent to the LED source painted reflective white.



Oval 50°x85° optic

The fixtures with Oval 50°x85° optic have a fastening system with double connection. This way, the fixtures can be hung with the chains, keeping the light beam direction fixed. The transparent glass diffuser is tempered with a grooved pattern.



The photometric curves are available at www.linealight.com. On request, we carry out technical lighting calculations to determine the number of items that will be satisfactory in order to guarantee the required lighting needs.

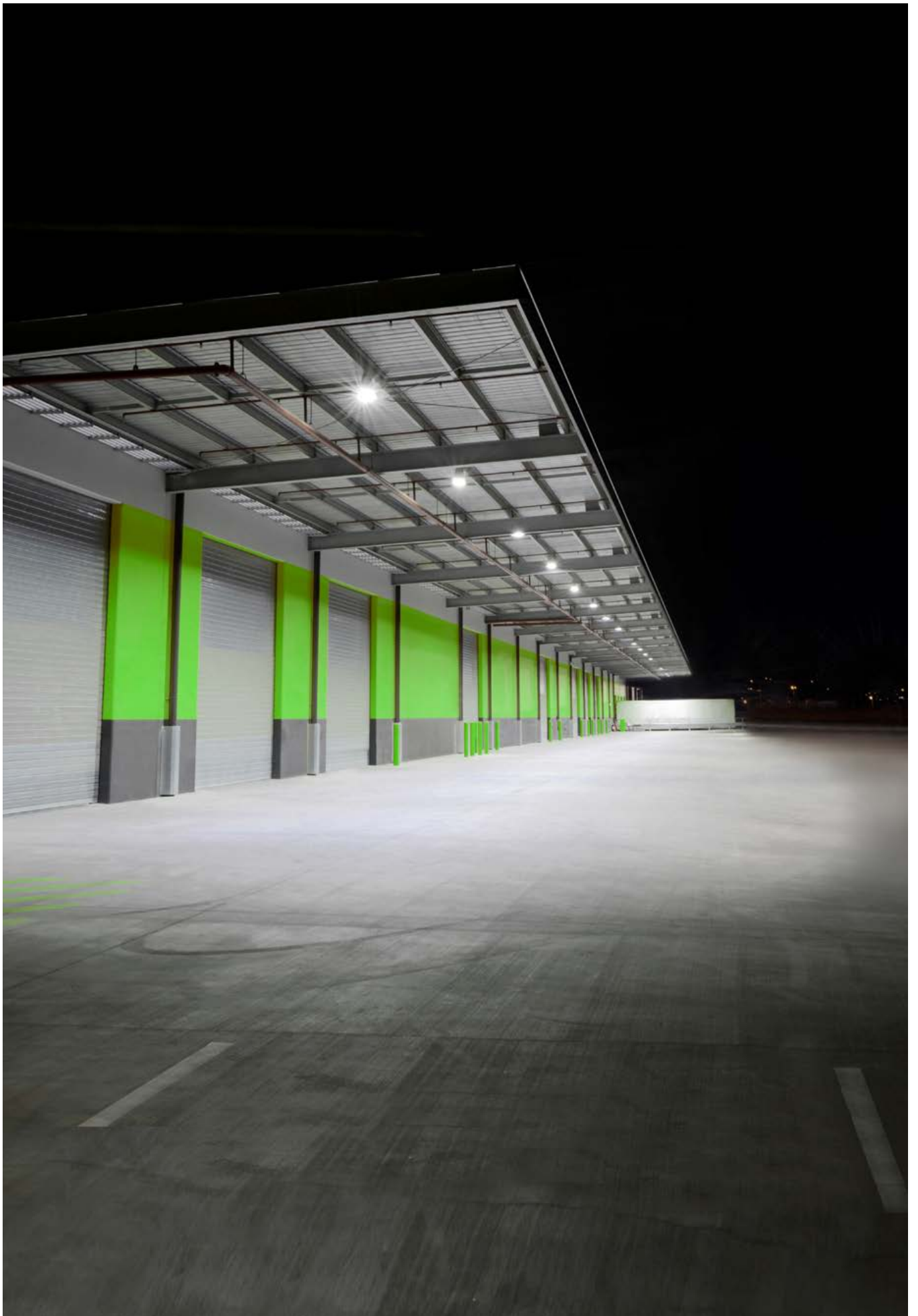

Flamp HP

Flamp HP (heat proof), version designed for industrial applications in harsh environments. Conceived to withstand operation in critical industrial environments, where there may be an abundance of sprayed oils in the atmosphere and the temperature can reach 70°C. The fixtures can also be fitted with protective cages to increase impact resistance.

Materials

Structure in die-cast aluminium.

Radiator in extruded aluminium.

Tempered glass.

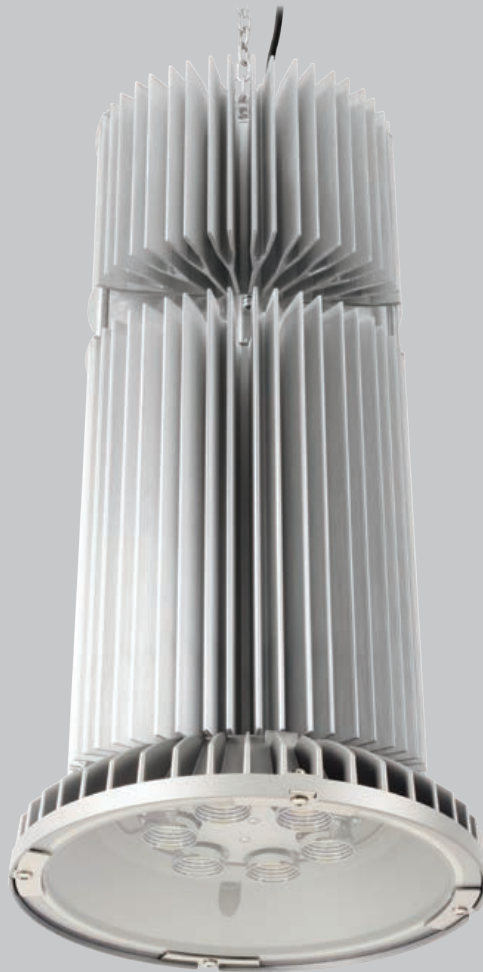



Harsh environments

In industrial locations with the presence of large machinery, furnaces, lathes or casting machinery, a lot of heat is usually generated. In these environments, the air can be harsh due to the presence of sprayed oils, fumes or scrap particles. Flamp HP is ideal for this type of environment that can be found in foundries, steel plants, turning shops or steelworks where temperature levels are rather high, even up to 70°C.



Heat dissipation

The excellent heat dissipation provided by the shape of the dissipating body ensures efficiency and long life for the projector.



The driver compartment is spaced interspersed by an empty space with respect to the main heat sink where the diodes are housed. This space allows greater ventilation that increases the dissipating capacity, keeping the driver at adequate operating temperature.

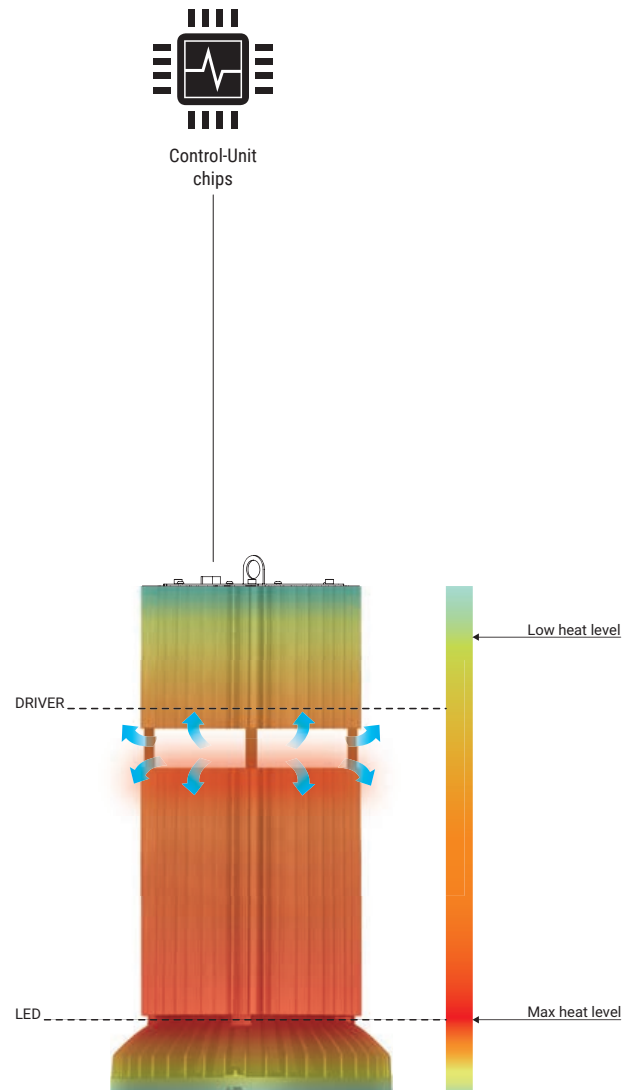

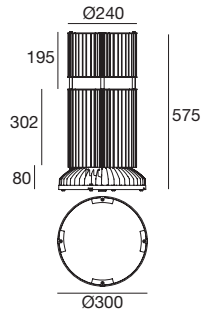

6 LEDs - CRI 80

92793	RAL9006	W 3000 K	29905 lm	60 Flood*
		N 4000 K	31570 lm	90 Wide Flood
		C 5000 K	31931 lm	11 Wide Flood
				88 Oval

Different projector models for environments with high temperatures are available on request

17 Kg 51 dm³ UGR_s22*

Operation of the fixture in relation to the temperature of the surrounding environment

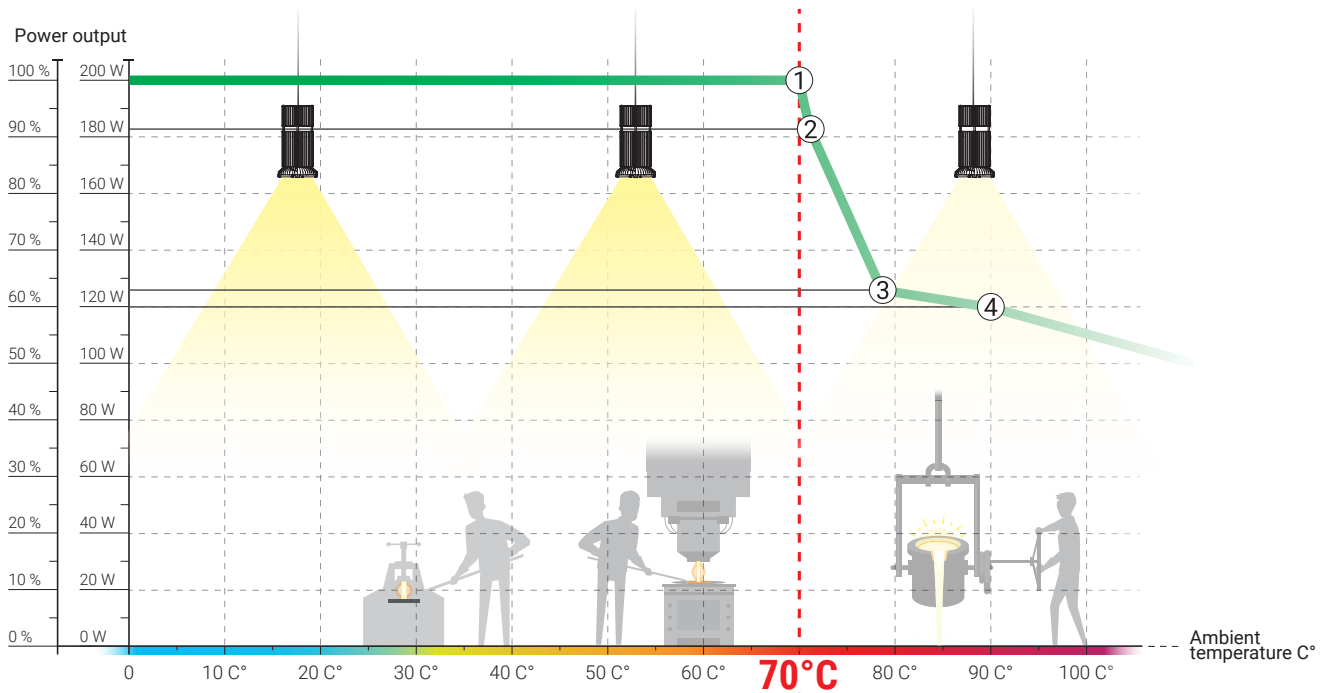

	Operation percentage	Power output	Ambient temperature
①	100 %	200 W	70 C°
②	90 %	184 W	73 C°
③	65 %	125 W	79 C°
④	60 %	100 W	90 C°

The photometric curves are available at www.linealight.com. On request, we carry out technical lighting calculations to determine the number of items that will be satisfactory in order to guarantee the required lighting needs.

Mini Flamp

Compact and high performance commercial hanging lamp fitted with bright and highly efficient diodes. The fixture features a dissipating system designed specifically to guarantee optimal dissipation of the heat generated and long life for the fixture. Thanks to this peculiarity, Mini Flamp finds its ideal habitat in a wide variety of applications. In fact, it can be installed in industrial environments, in commercial areas and in large areas.

Materials

Steel.

Die-cast aluminium.

Optics diffuser in PMMA with UV protection.



Mini Flamp | Suspension | 190-250 V | 46 W DC - 50 W AC arrayLED

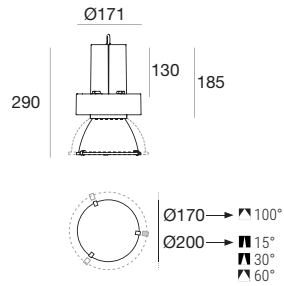

1 LED - CRI 80

96759 White	W 3000 K	6002 lm	15 Spot
96760 Black	N 4000 K	6452 lm	30 Medium Flood
	C 5000 K	6903 lm	60 Flood
			99 Wide Flood

2,8 Kg 12 dm³

Mini Flamp | Suspension | 190-250 V | 71 W DC - 80 W AC arrayLED

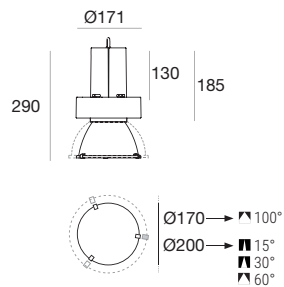

1 LED - CRI 80

92800 White	W 3000 K	9305 lm	15 Spot
92801 Black	N 4000 K	10339 lm	30 Medium Flood
	C 5000 K	10339 lm	60 Flood
			99 Wide Flood

2,8 Kg 12 dm³

Visual comfort

The 15° Spot, 30° Medium Flood and 60° Flood are designed specifically to guarantee visual comfort and UGR values in compliance with the standards for certain environments.

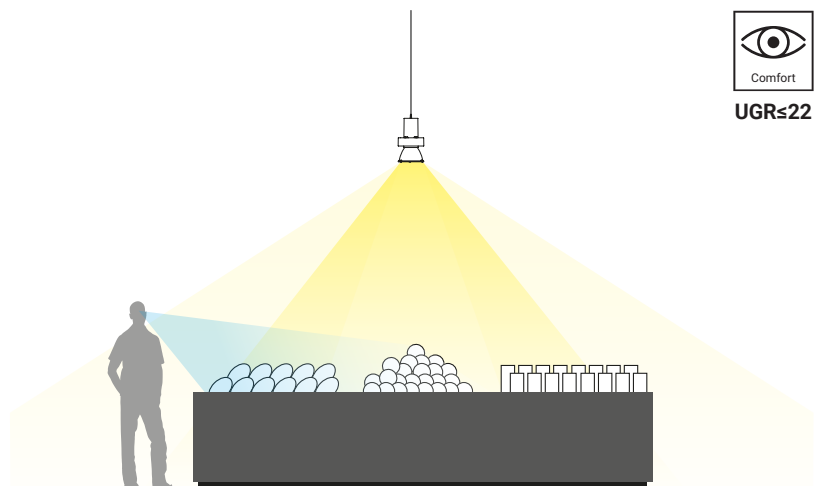

The photometric curves are available at www.linealight.com. On request, we carry out technical lighting calculations to determine the number of items that will be satisfactory in order to guarantee the required lighting needs.

industrial ceiling range index

Alux



Alix



Atix

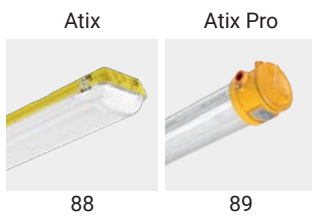

Aisix

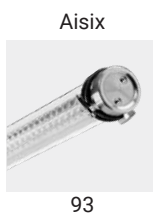

Mini Tube

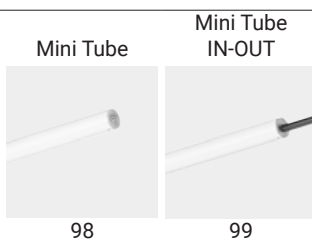

Maxi Tube

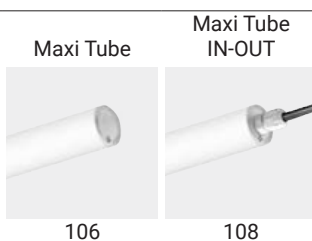

High Protection

High Protection



116

High Protection Wired



120

High

High Wired IP40



130

High Wired IP40



132

High Wired Suspension



134

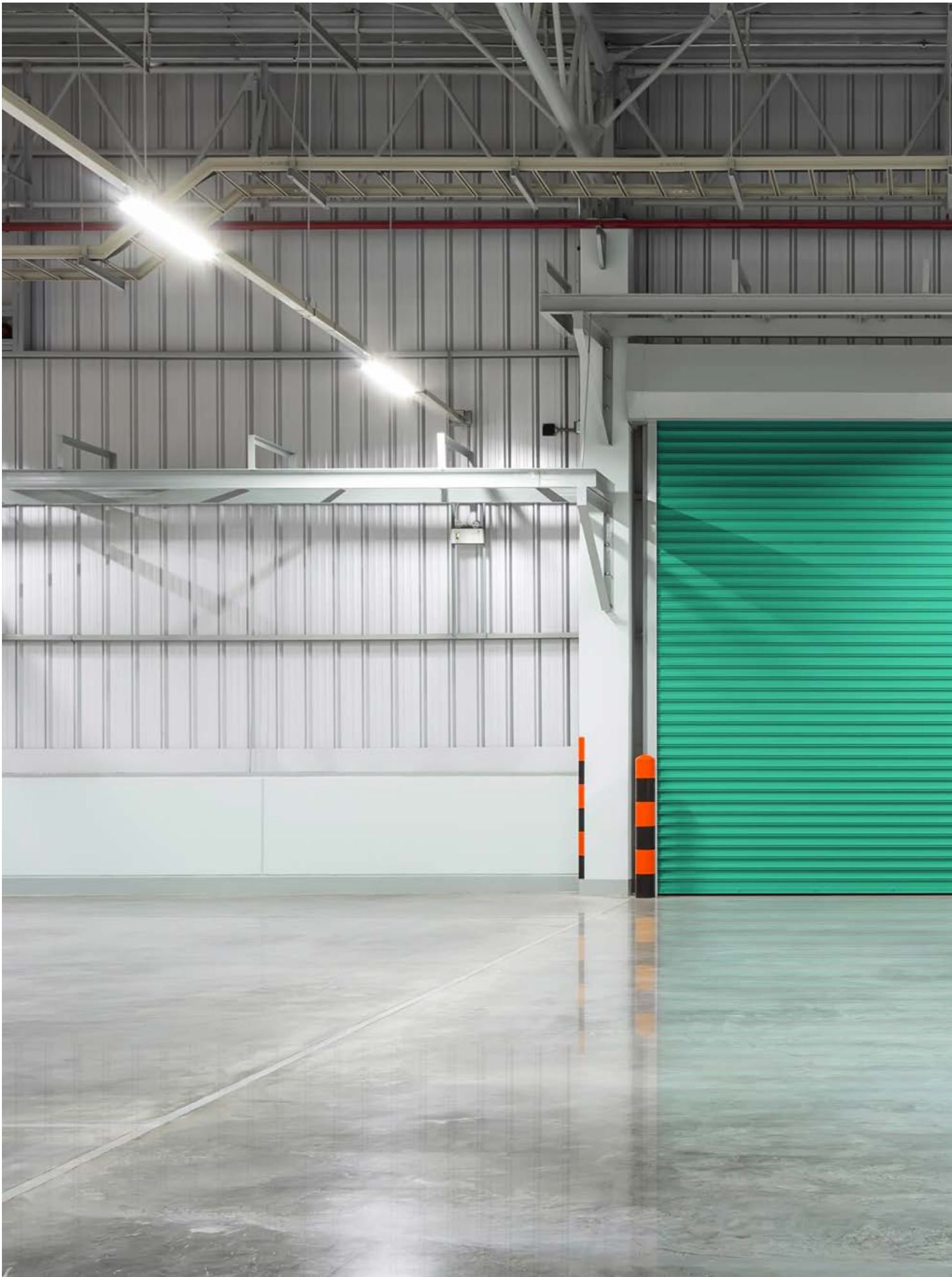



Alux

Waterproof light fixture with a high impact resistance index, totally protected against dust and water jets. The sturdy body is made in anodised extruded aluminium, the plugs in powder coated die-cast aluminium and the diffuser in tempered glass. The fixture can be surface mounted, hung or installed on busbar thanks to the specific accessories included. Alux meets multiple technical lighting needs in different settings and is therefore the ideal solution for lighting industrial warehouses, storerooms or commercial areas.

Materials

Plugs in painted die-cast aluminium.
Body in anodised extruded aluminium.
Tempered glass.





Ceiling light

Alux range



	40 W	70 W	100 W	130 W	170 W
Size	454 mm	844 mm	1234 mm	1624 mm	2014 mm
Finish	RAL9006	RAL9006	RAL9006	RAL9006	RAL9006
Efficiency CRI 80	3000K 4000K 6500K	3000K 4000K 6500K	3000K 4000K 6500K	3000K 4000K 6500K	3000K 4000K 6500K
Optics	Medium Flood Flood Wide Flood Diffused	Medium Flood Flood Wide Flood Diffused	Medium Flood Flood Wide Flood Diffused	Medium Flood Flood Wide Flood Diffused	Medium Flood Flood Wide Flood Diffused
Driver	On/Off DALI	On/Off DALI	On/Off DALI	On/Off DALI	On/Off DALI

Construction details

Waterproof structure made in anodised extruded aluminium, cover in impact resistant tempered glass. Driver built into the lamp body with direct connection to the mains power via neoprene cable.

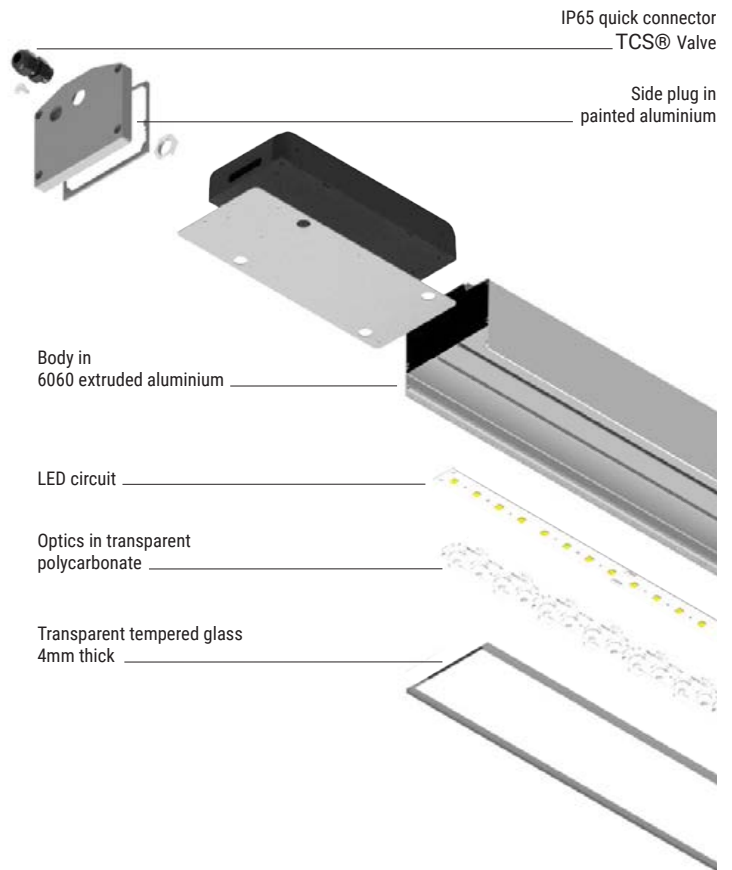

Resistance to corrosion

An electrochemical open-pore anodising pretreatment is carried out on the base allow to guarantee resistance to the corrosion typical in environments where aggressive substances are in the air. The TCS® valve is built into the closing plug of the profile for transpiration.



Controlled UGR

The high precision optics used channel emission of the primary light cone perfectly, significantly decreasing the light of the secondary cone. This aspect is also ensured with the use of narrow optics, notoriously more problematic in situations of undesired glare. The result is a particularly intense and uniform light, without reflections and with controlled UGR.

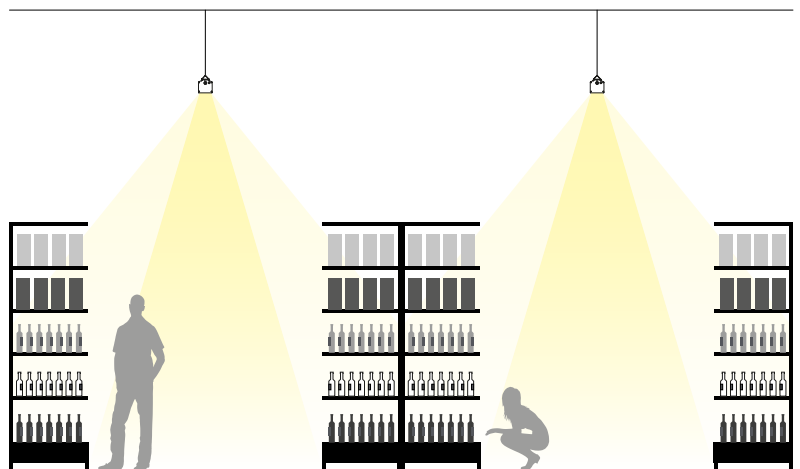

UGR≤22

Installation

Easy hanging or surface installation. Application using double clip bracket and double support hook included with the item (cables for hanging not included).



Hanging installation

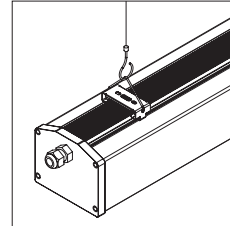

Surface installation

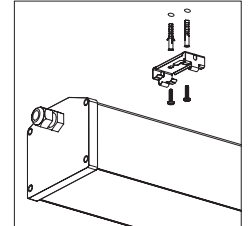

To create continuous lines, use the accessories neoprene "extension cable" and "quick connector" IP68 socket/plug.

Extension cable



Not included

IP68 connector



Not included

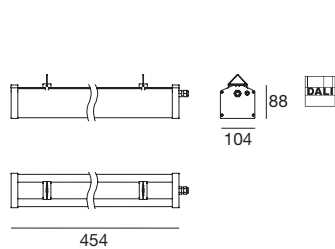

454 mm - CRI 80 - 35 W DC - 40 W AC

81774 Grey	W 3000 K	5390 lm	30 Medium Flood*
81775 Grey	N 4000 K	5635 lm	60 Flood*
	C 5700 K	5635 lm	12 Wide Flood
			00 Diffused

Kg 2 Kg **Vol** 8,6 dm³

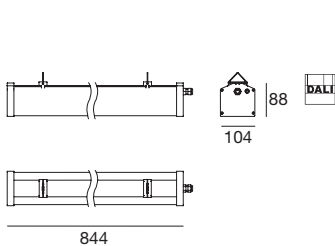

844 mm - CRI 80 - 65 W DC - 70 W AC

81776 Grey	W 3000 K	10055 lm	30 Medium Flood*
81777 Grey	N 4000 K	10538 lm	60 Flood*
	C 5700 K	10538 lm	12 Wide Flood
			00 Diffused

Kg 3,2 Kg **Vol** 16 dm³

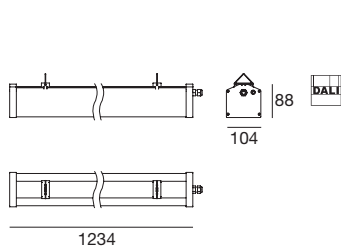

1234 mm - CRI 80 - 90 W DC - 100 W AC

81778 Grey	W 3000 K	13891 lm	30 Medium Flood*
81779 Grey	N 4000 K	14558 lm	60 Flood*
	C 5700 K	14558 lm	12 Wide Flood
			00 Diffused

Kg 4,4 Kg **Vol** 21 dm³

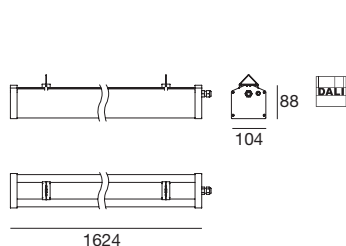

1624 mm - CRI 80 - 121 W DC - 130 W AC

81780 Grey	W 3000 K	17711 lm	30 Medium Flood*
81781 Grey	N 4000 K	18563 lm	60 Flood*
	C 5700 K	18563 lm	12 Wide Flood
			00 Diffused

Kg 5,8 Kg **Vol** 27 dm³

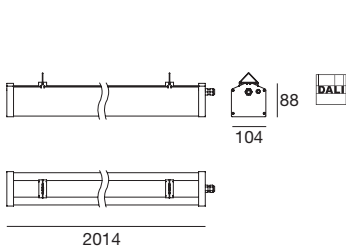

2014 mm - CRI 80 - 157 W DC - 170 W AC

81782 Grey	W 3000 K	24021 lm	30 Medium Flood*
81783 Grey	N 4000 K	25120 lm	60 Flood*
	C 5700 K	25120 lm	12 Wide Flood
			00 Diffused

Kg 8,8 Kg **Vol** 33 dm³



Ceiling light

Alix

Waterproof light fixture suitable for ceiling or hanging installation, characterised by a high impact resistance index and totally protected against dust and water jets. Body and diffuser made in impact resistant, heat resistant and anti UV polycarbonate.

The fixture's closing clips are in stainless steel. Alix is extremely functional, with high quality light and a sturdy body for a smarter, simpler and faster installation.

Alix guarantees energy savings and longer life to reduce operating costs.

Materials

Body in polycarbonate with UV protection.

Diffuser in polycarbonate with UV protection.

Closing clip in stainless steel.

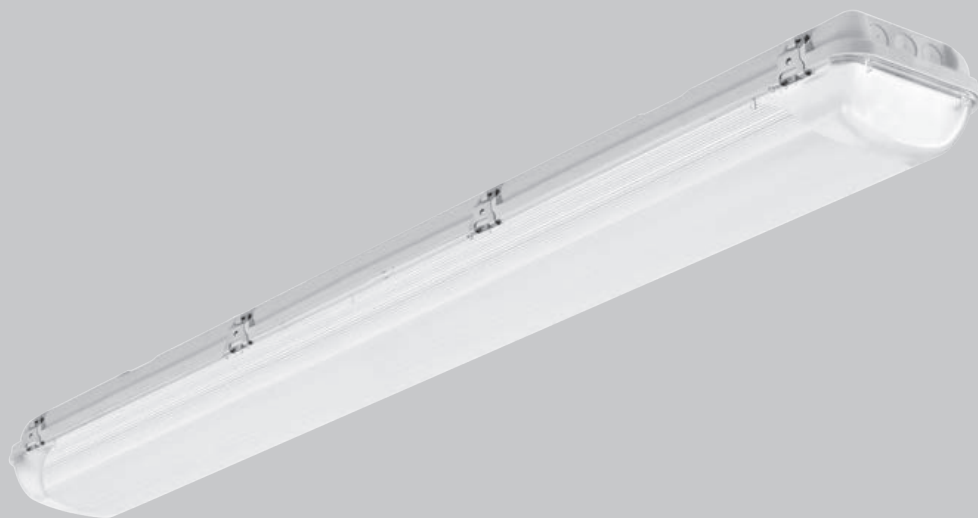

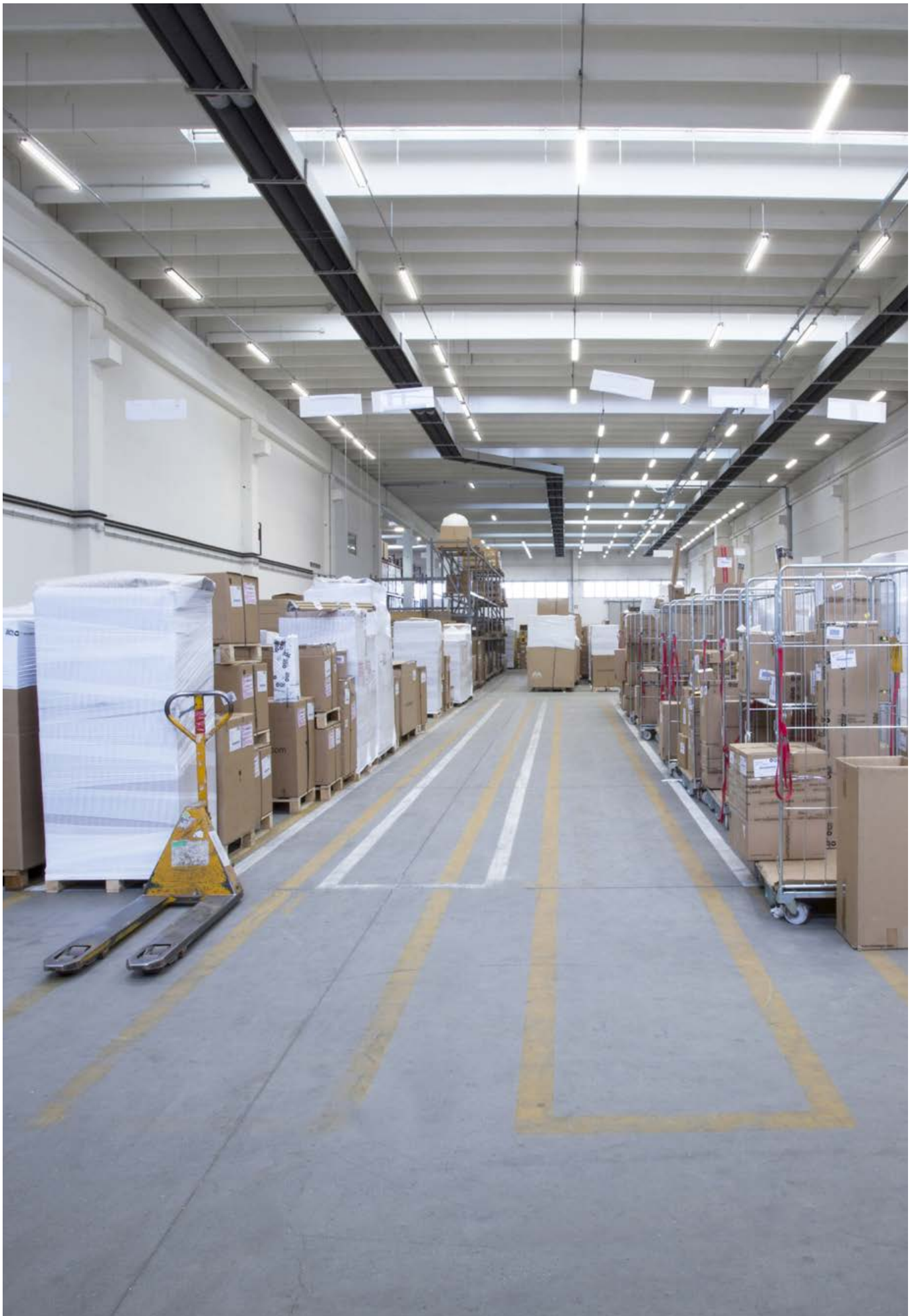

Alix range



Alix Single		6,5 W	15 W	24 W
Alix Double		13 W	30 W	48 W
Size		<u>660</u> mm	<u>1277</u> mm	<u>1573</u> mm
Finish		Grey	Grey	Grey
Efficiency CRI 80		4000K	4000K	4000K
Optics		Wide Flood	Wide Flood	Wide Flood
Driver		On/Off	On/Off	On/Off
Alix Single EM		6,5 W	15 W	24 W
Alix Double EM		13 W	30 W	48 W
Size		<u>660</u> mm	<u>1277</u> mm	<u>1573</u> mm
Finish		Grey	Grey	Grey
Efficiency CRI 80		4000K	4000K	4000K
Optics		Wide Flood	Wide Flood	Wide Flood
Driver		On/Off + EM	On/Off + EM	On/Off + EM

Versatility

The family of Alix fixtures features a light source made up of a single central LED tube in the narrow body for the Single version, and a double LED tube in the wide body for the Double version. Both versions are subdivided into three different lengths corresponding to three different operating powers. Moreover, all the Alix versions have the corresponding EM emergency version.

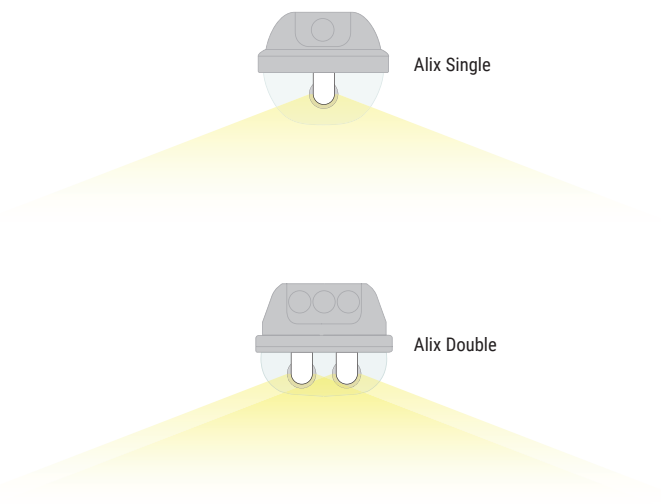

Alix EM versions available to generate emergency light.

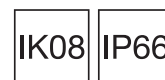

Knurled prismatic cover

The prismatic diffuser ensures optimum light distribution, overcoming the direct glare effect. The ends of the cover have a different pattern to hide the LED tube connections.

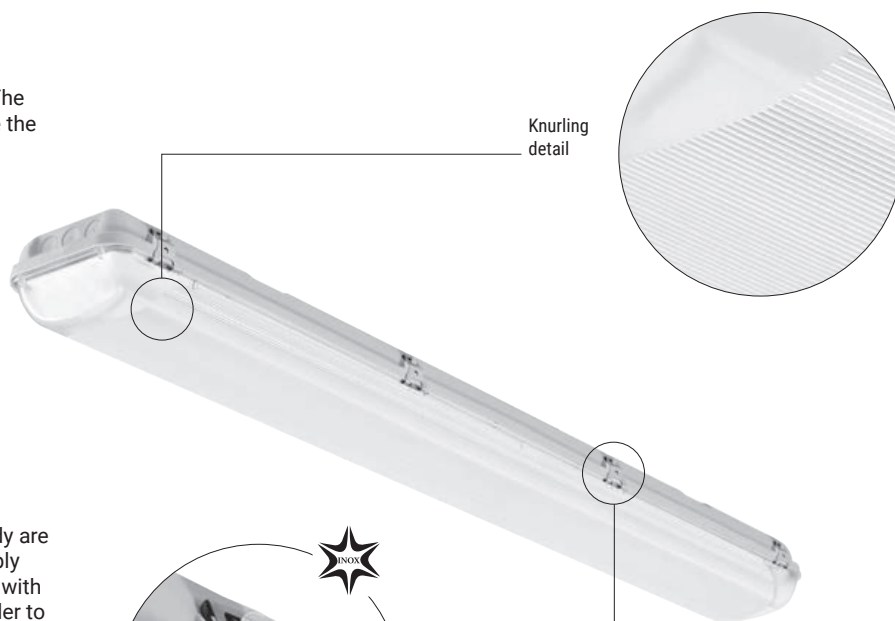

Closing clip in stainless steel

The clips that fasten the diffuser to the lamp body are in stainless steel and they allow for easy assembly and disassembly of the diffuser. Lock the fixture with a single safe click, audible in a unique way, in order to ensure that the IP66 Protection is guaranteed.

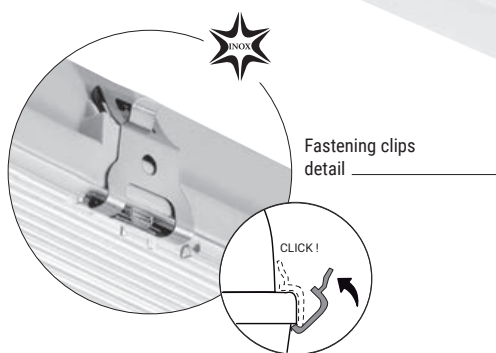

Installation

Easy hanging or surface installation. Application using double clip bracket and double support hook included with the item. The cables for hanging are not included.

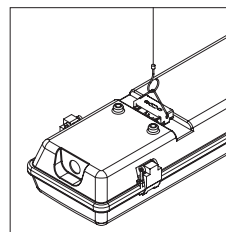

Hanging installation

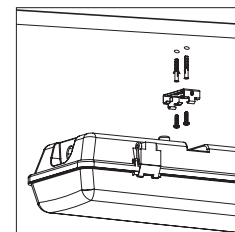

Surface installation

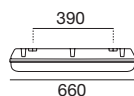

660 mm - CRI 80 - 5,5 W DC - 6,5 W AC

82347 Grey **N** 4000 K 950 lm **12** Wide Flood

 0,9 Kg  7,1 dm³

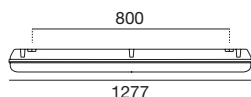

1277 mm - CRI 80 - 13,5 W DC - 15 W AC

82348 Grey **N** 4000 K 2375 lm **12** Wide Flood

 1,6 Kg  13,6 dm³

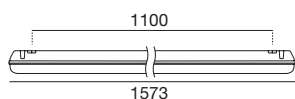

1573 mm - CRI 80 - 22 W DC - 24 W AC

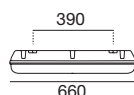

82349 Grey **N** 4000 K 3850 lm **12** Wide Flood

 1,9 Kg  16,7 dm³



660 mm - CRI 80 - 5,5 W DC - 6,5 W AC

EM 82858 Grey **N** 4000 K 950 lm **12** Wide Flood

 0,9 Kg  7,1 dm³

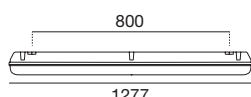

1277 mm - CRI 80 - 13,5 W DC - 15 W AC

EM 82859 Grey **N** 4000 K 2375 lm **12** Wide Flood

 1,6 Kg  13,6 dm³

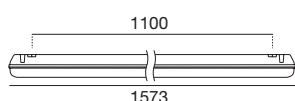

1573 mm - CRI 80 - 22 W DC - 24 W AC

EM 82860 Grey **N** 4000 K 3850 lm **12** Wide Flood

 1,9 Kg  16,7 dm³

Alix Double | Ceiling lamp - Suspension | 190-250 V | topLED

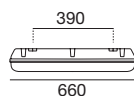

660 mm - CRI 80 - 12 W DC - 13 W AC

82350 Grey **N** 4000 K 1950 lm **12** Wide Flood

Kg **Vol**
1,1 Kg 10,3 dm³

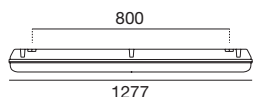

1277 mm - CRI 80 - 28 W DC - 30 W AC

82351 Grey **N** 4000 K 4650 lm **12** Wide Flood

Kg **Vol**
2 Kg 19,7 dm³

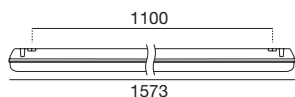

1573 mm - CRI 80 - 44 W DC - 48 W AC

82352 Grey **N** 4000 K 7300 lm **12** Wide Flood

Kg **Vol**
2,4 Kg 24,2 dm³

Alix Double EM | Ceiling lamp - Suspension | 190-250 V | topLED

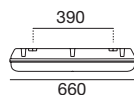

660 mm - CRI 80 - 12 W DC - 13 W AC

EM **82861** Grey **N** 4000 K 1950 lm **12** Wide Flood

Kg **Vol**
1,1 Kg 10,3 dm³

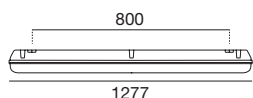

1277 mm - CRI 80 - 28 W DC - 30 W AC

EM **82862** Grey **N** 4000 K 4650 lm **12** Wide Flood

Kg **Vol**
2 Kg 19,7 dm³

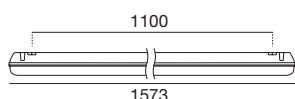

1573 mm - CRI 80 - 44 W DC - 48 W AC

EM **82863** Grey **N** 4000 K 7300 lm **12** Wide Flood

Kg **Vol**
2,4 Kg 24,2 dm³

Atix

ATEX IP66 waterproof, explosion proof fixtures for use in locations where there is an atmosphere with risk of explosion. Fixtures available in two versions that differ in shape and impact resistance index:

Atix is the rectangular-shaped version with IK08 impact protection index. Atix Pro is the tubular-shaped version with maximum IK10 impact protection index. Atix and Atix Pro are the ideal fixtures for lighting highly harsh environments thanks to the use of the most modern and technological explosion proof materials, therefore, personnel safety is guaranteed.

Atix materials

Body in fibreglass.

Diffuser in polycarbonate with UV protection.

Clip in stainless steel.

Atix Pro materials

Plugs in aluminium alloy with polyurethane finish.

Body in transparent polycarbonate with UV protection.

Gaskets in NBR nitrile rubber.



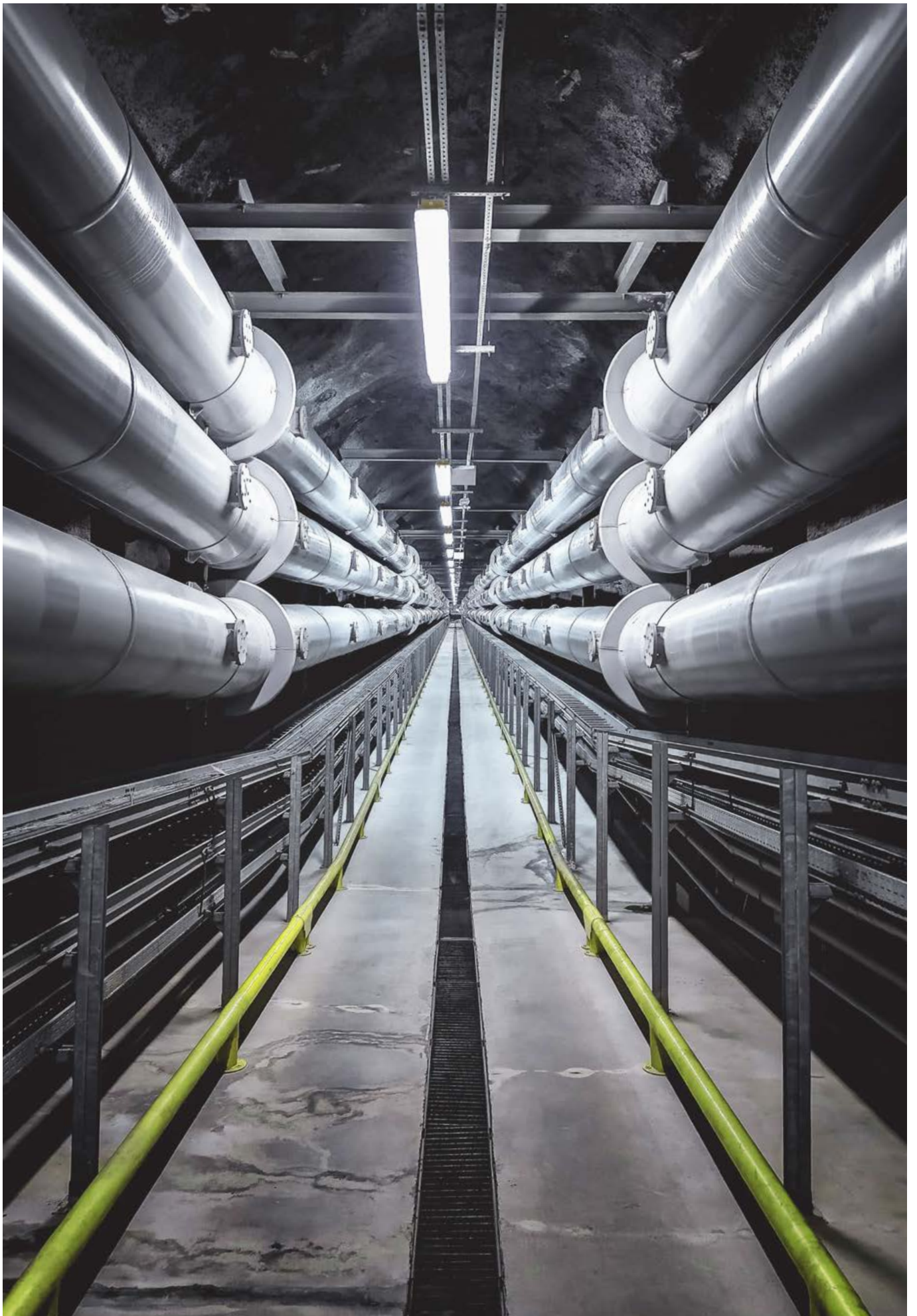



Ceiling light

Atix range



Atix		22 W	40 W	45 W
Size		665 mm	1282 mm	1578 mm
Finish		RAL1003	RAL1003	RAL1003
Efficiency CRI 80		4000K	4000K	4000K
Optics		Wide Flood	Wide Flood	Wide Flood
Driver		On/Off	On/Off	On/Off

Atix Pro		40 W
Size		1360 mm
Finish		RAL1003
Efficiency CRI 80		4000K
Optics		Wide Flood
Driver		On/Off

ATEX explosion proof

The Atix articles are designed with extremely high quality tested materials to guarantee adequate resistance and function. They are, therefore, perfectly suited for use in EX areas in accordance with directive ATEX 2014/34 / EU.

Some of the major industrial sectors where explosions can occur and where ATEX directives may be required include: the pharmaceutical sector, the chemical sector, gas or oil extraction refinement sites and the food and agricultural industry.



Chemical



Pharmaceutical



Oil & Gas sites



Food & Agricultural industry

Atix

II 3 G Ex nA IIC T6 Gc
II 3 D Ex t IIIC T85 °C Dc IP66

Suitable version for EX zone: 2 and 22

Body in compressed fibreglass, reinforced with yellow polyester (RAL 1003)

Closing clip in stainless steel



Transparent diffuser in polycarbonate with UV protection



IK08 IP66

Atix Pro

II 2 G Ex db IIC T6 Gb
II 2 D Ex tb IIIC T85 Db

Suitable version for EX zone: 1 and 21

Outer cover in polycarbonate

Terminal plugs in aluminium alloy with RAL 1003 yellow polyurethane finish

Gasket in nitrile rubber (NBR)



IK10 IP66



Suitable version
for EX zone: **2** and **22**

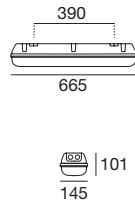

665 mm - CRI 80 - 18 W DC - 22 W AC

93280	RAL1003	N 4000 K	2200 lm*	12 Wide Flood
--------------	----------------	-----------------	----------	----------------------

Kg 2 Kg **Vol** 10,7 dm³

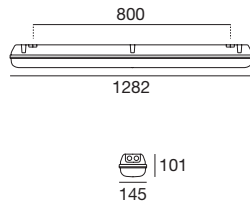

1282 mm - CRI 80 - 36 W DC - 40 W AC

93281	RAL1003	N 4000 K	4400 lm*	12 Wide Flood
--------------	----------------	-----------------	----------	----------------------

Kg 3,25 Kg **Vol** 20,43 dm³

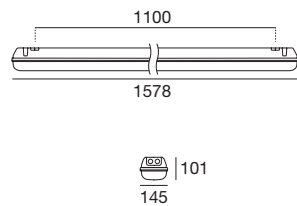

1578 mm - CRI 80 - 40 W DC - 45 W AC

93282	RAL1003	N 4000 K	5200 lm*	12 Wide Flood
--------------	----------------	-----------------	----------	----------------------

Kg 3,6 Kg **Vol** 25,19 dm³

Accessories



Included
Hanging
fixing kit

Installation

Easy hanging or surface installation. Application using double clip bracket and double support hook included with the item (cables for hanging not included).



Hanging installation

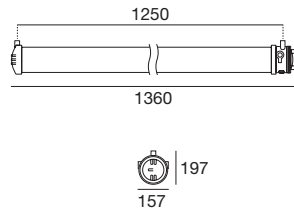

1360 mm - CRI 80 - 36 W DC - 40 W AC

82636 RAL1003 **N** 4000 K 5000 lm **12** Wide Flood

 9,9 Kg
  60 dm³

Suitable version
for EX zone: **1** and **21**

Accessories



83024
Hanging
fixing kit



83025
Surface-mount
fixing kit



83026
Double cable
quick connector

Installation

Hanging or surface installation. Application using double ring bracket for hanging hook or bracket for surface-mount fixing (cables for hanging not included).



Hanging installation

Aisix

Aisix is the tubular lighting fixture for the most demanding conditions and it is the ideal solution for lighting in industrial sectors where the cleaning processes of the spaces imply very strict requirements. Aisix is designed to withstand specific environments where the lamps may be touched by powerful jets of high pressure (100 bar) and high temperature (up to 80°C) water. Aisix is also designed to operate in atmospheres with gas or sulphuric vapours. The fixture's IP69K grade of protection is the highest level on the "Ingress Protection" scale. It indicates a very high capacity of protection against parts of liquids and solids.

Materials

Plugs in stainless steel.

Body in polycarbonate with UV protection.

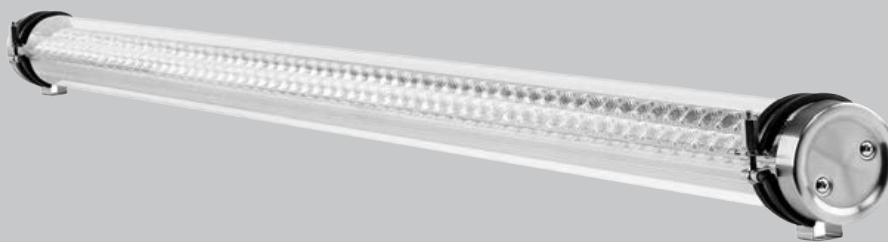



Ceiling light

Aisix range



Aisix	20 W	40 W	60 W
Size	Ø 75 x <u>552</u> mm	Ø 75 x <u>1152</u> mm	Ø 75 x <u>1452</u> mm
Finish	Opaline Embossed	Opaline Embossed	Opaline Embossed
Efficiency CRI 80	4000K	4000K	4000K
Optics	Medium Flood	Medium Flood	Medium Flood
Driver	On/Off DALI (on request)	On/Off DALI (on request)	On/Off DALI (on request)

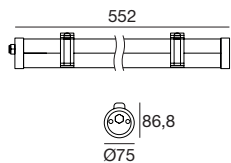

552 mm - CRI 80 - 18 W DC - 20 W AC

82633 Opaline **N** 4000 K 2850 lm **40** Medium Flood

Kg **Vol**
1,3 Kg 3,6 dm³

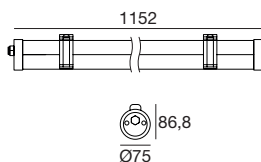

1152 mm - CRI 80 - 37 W DC - 40 W AC

82634 Opaline **N** 4000 K 6100 lm **40** Medium Flood

Kg **Vol**
2,4 Kg 7,5 dm³

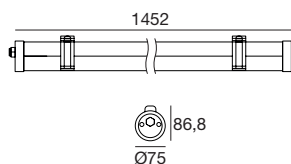

1452 mm - CRI 80 - 56 W DC - 60 W AC

82635 Opaline **N** 4000 K 8400 lm **40** Medium Flood

Kg **Vol**
3,3 Kg 9,4 dm³



DALI versions available on request.



UGR≤22

IP69K protection

IP69K is a classification that extends the classification system of protection against the access of solid and liquid bodies. IP69K was developed for the sectors where supplementary protection against high pressures and high temperatures is needed.



The typical applications that require this classification are relative to mobile environments or machinery such as those in the food industry, where the equipment is cleaned daily in an intensive way with high pressure water, steam and aggressive detergents. Aisix is also gas proof, resistant to ammonia and sulphuric vapours.



The photometric curves are available at www.linealight.com. On request, we carry out technical lighting calculations to determine the number of items that will be satisfactory in order to guarantee the required lighting needs.

Mini Tube

Very small sized tubular profile.

Able to be connected directly to the electrical mains, it is available in version with single output cable or IN&OUT version with double input and output cable. The version with double cable allows a continuous line of light to be created, connecting multiple fixtures in series. Installation is made easy thanks to the use of clip springs. Mini Tube is the ideal fixture for lighting refrigerated shelves, such as supermarket refrigerated showcases, thanks to the high grade of protection that protects the profile from humidity and condensation.

Materials

Polycarbonate with UV protection.

Neoprene cables.





Mini Tube range



	5,2 W	8,5 W	10,5 W	13,5 W	15,5 W	18 W
Size	Ø 18 x <u>331</u> mm	Ø 18 x <u>621</u> mm	Ø 18 x <u>911</u> mm	Ø 18 x <u>1201</u> mm	Ø 18 x <u>1491</u> mm	Ø 18 x <u>1781</u> mm
IP range	IP65	IP65	IP65	IP65	IP65	IP65
Finish	Opaline	Opaline	Opaline	Opaline	Opaline	Opaline
Efficiency CRI 80	3000K 4000K 6500K	3000K 4000K 6500K	3000K 4000K 6500K	3000K 4000K 6500K	3000K 4000K 6500K	3000K 4000K 6500K
Optics	Diffused	Diffused	Diffused	Diffused	Diffused	Diffused
Driver	On/Off	On/Off	On/Off	On/Off	On/Off	On/Off

Minimum dimensions

LED tube with minimum dimensions, with a profile just 18 mm in diameter. The reduced dimensions allow easy and functional installations. Applied on the edges, corners or niches of shelving, Mini Tube is perfectly integrated into the setting. The IP65 grade of protection allows sheltered outdoor installation.

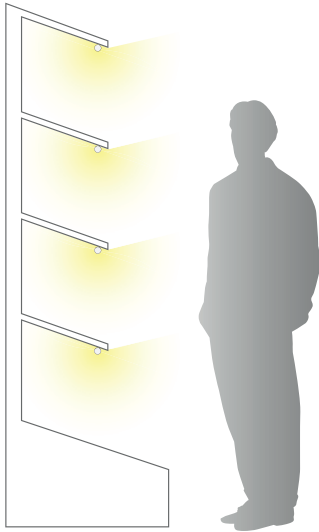

Multiple connection

Fixture available in two variations: version **Mini Tube** with single input cable for installation of a single article, version **Mini Tube IN & OUT** with input and output cable to be able to create continuous lines of light, connecting multiple fixtures in series.

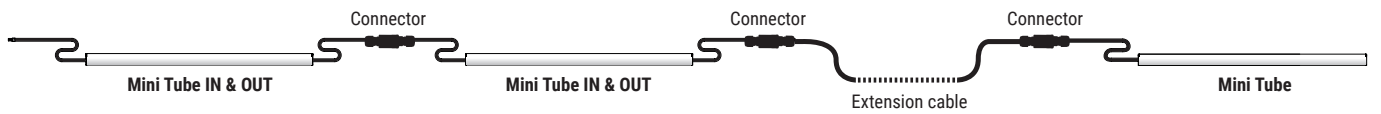
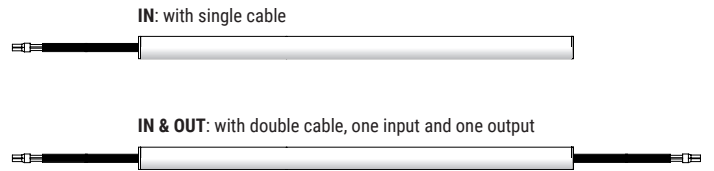

To create continuous lines, use the accessories neoprene "extension cable" and "quick connector" IP68 socket/plug.



Installation

We recommend the installation of each individual tube with at least two fixing accessories. Clip springs in transparent polycarbonate and self-tapping screws included with the article. The kit with steel clip springs can be ordered separately as an accessory.

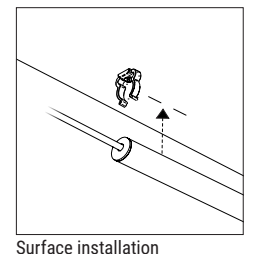

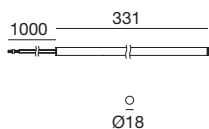
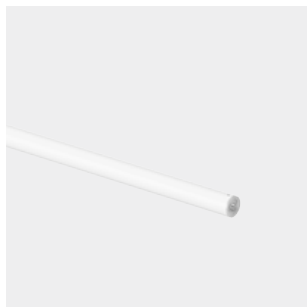

331 mm - CRI 80 - 4,5 W DC - 5,2 W AC

92392 Opaline	W 3000 K	586 lm	00 Diffused
	N 4000 K	612 lm	
	C 6500 K	646 lm	
	P 445 nm	320 lm	

Kg 0,09 Kg **Vol** 0,44 dm³

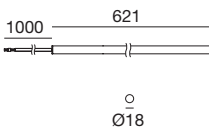

621 mm - CRI 80 - 7,5 W DC - 8,5 W AC

92393 Opaline	W 3000 K	1172 lm	00 Diffused
	N 4000 K	1224 lm	
	C 6500 K	1292 lm	
	P 445 nm	640 lm	

Kg 0,13 Kg **Vol** 0,77 dm³

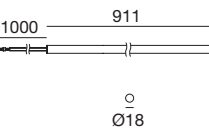

911 mm - CRI 80 - 9 W DC - 10,5 W AC

92421 Opaline	W 3000 K	1354 lm	00 Diffused
	N 4000 K	1414 lm	
	C 6500 K	1492 lm	
	P 445 nm	740 lm	

Kg 0,16 Kg **Vol** 1,11 dm³

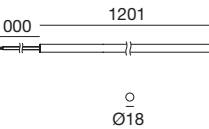

1201 mm - CRI 80 - 12 W DC - 13,5 W AC

92422 Opaline	W 3000 K	2039 lm	00 Diffused
	N 4000 K	2129 lm	
	C 6500 K	2248 lm	
	P 445 nm	1136 lm	

Kg 0,2 Kg **Vol** 1,45 dm³

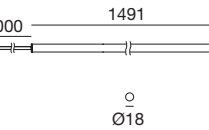

1491 mm - CRI 80 - 14 W DC - 15,5 W AC

92423 Opaline	W 3000 K	2461 lm	00 Diffused
	N 4000 K	2570 lm	
	C 6500 K	2713 lm	
	P 445 nm	1344 lm	

Kg 0,24 Kg **Vol** 1,78 dm³

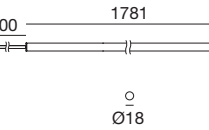

1781 mm - CRI 80 - 16,5 W DC - 18 W AC

92424 Opaline	W 3000 K	2883 lm	00 Diffused
	N 4000 K	3011 lm	
	C 6500 K	3178 lm	
	P 445 nm	1575 lm	

Kg 0,28 Kg **Vol** 2,12 dm³

Accessories

2x	2x		
Included Polycarbonate clip springs kit	98710 Steel clip springs kit	99229 Extension cables 2x1mm ²	98729 Quick connector IP68 socket/plug

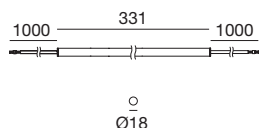

331 mm - CRI 80 - 4,5 W DC - 5,2 W AC

92384 Opaline	W 3000 K	586 lm	00 Diffused
	N 4000 K	612 lm	
	C 6500 K	646 lm	
	P 445 nm	320 lm	
0,16 Kg	0,44 dm ³		

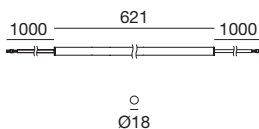

621 mm - CRI 80 - 7,5 W DC - 8,5 W AC

92385 Opaline	W 3000 K	1172 lm	00 Diffused
	N 4000 K	1224 lm	
	C 6500 K	1292 lm	
	P 445 nm	640 lm	
0,2 Kg	0,77 dm ³		

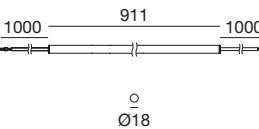

911 mm - CRI 80 - 9 W DC - 10,5 W AC

92386 Opaline	W 3000 K	1354 lm	00 Diffused
	N 4000 K	1414 lm	
	C 6500 K	1492 lm	
	P 445 nm	740 lm	
0,23 Kg	1,11 dm ³		

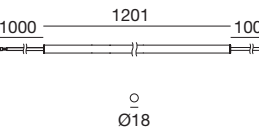

1201 mm - CRI 80 - 12 W DC - 13,5 W AC

92387 Opaline	W 3000 K	2039 lm	00 Diffused
	N 4000 K	2129 lm	
	C 6500 K	2248 lm	
	P 445 nm	1136 lm	
0,27 Kg	1,45 dm ³		

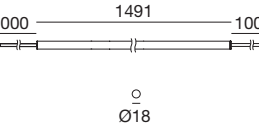

1491 mm - CRI 80 - 14 W DC - 15,5 W AC

92390 Opaline	W 3000 K	2461 lm	00 Diffused
	N 4000 K	2570 lm	
	C 6500 K	2713 lm	
	P 445 nm	1344 lm	
0,31 Kg	1,78 dm ³		

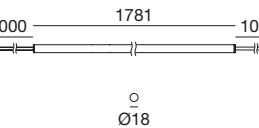

1781 mm - CRI 80 - 16,5 W DC - 18 W AC

92391 Opaline	W 3000 K	2883 lm	00 Diffused
	N 4000 K	3011 lm	
	C 6500 K	3178 lm	
	P 445 nm	1575 lm	
0,35 Kg	2,12 dm ³		

Accessories

2x	2x		
Included Polycarbonate clip springs kit	98710 Steel clip springs kit	99229 Extension cables 2x1mm ²	98729 Quick connector IP68 socket/plug





Maxi Tube

Tubular profile made of opal or embossed polycarbonate with protection against UV rays.

Maxi Tube is available in the version with single output cable or IN&OUT version with double input and output cable. The IN&OUT version allows a continuous line of light to be created, connecting multiple fixtures in series. Maxi Tube is the ideal solution for lighting industrial areas and commercial areas, but it can also be used to enhance the architectural lines of buildings. The vast selection of available lengths, LED colour temperatures and the range of optics that can be used make the Maxi Tube extremely versatile.

Materials

Polycarbonate with UV protection

Neoprene cables

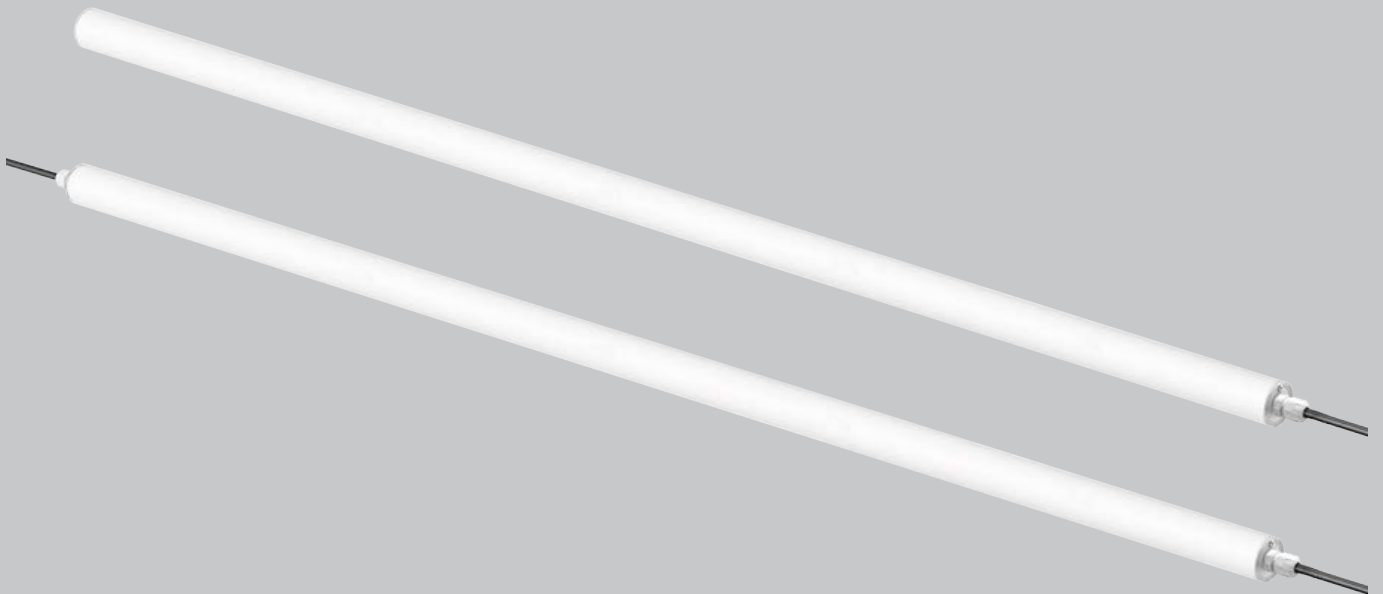

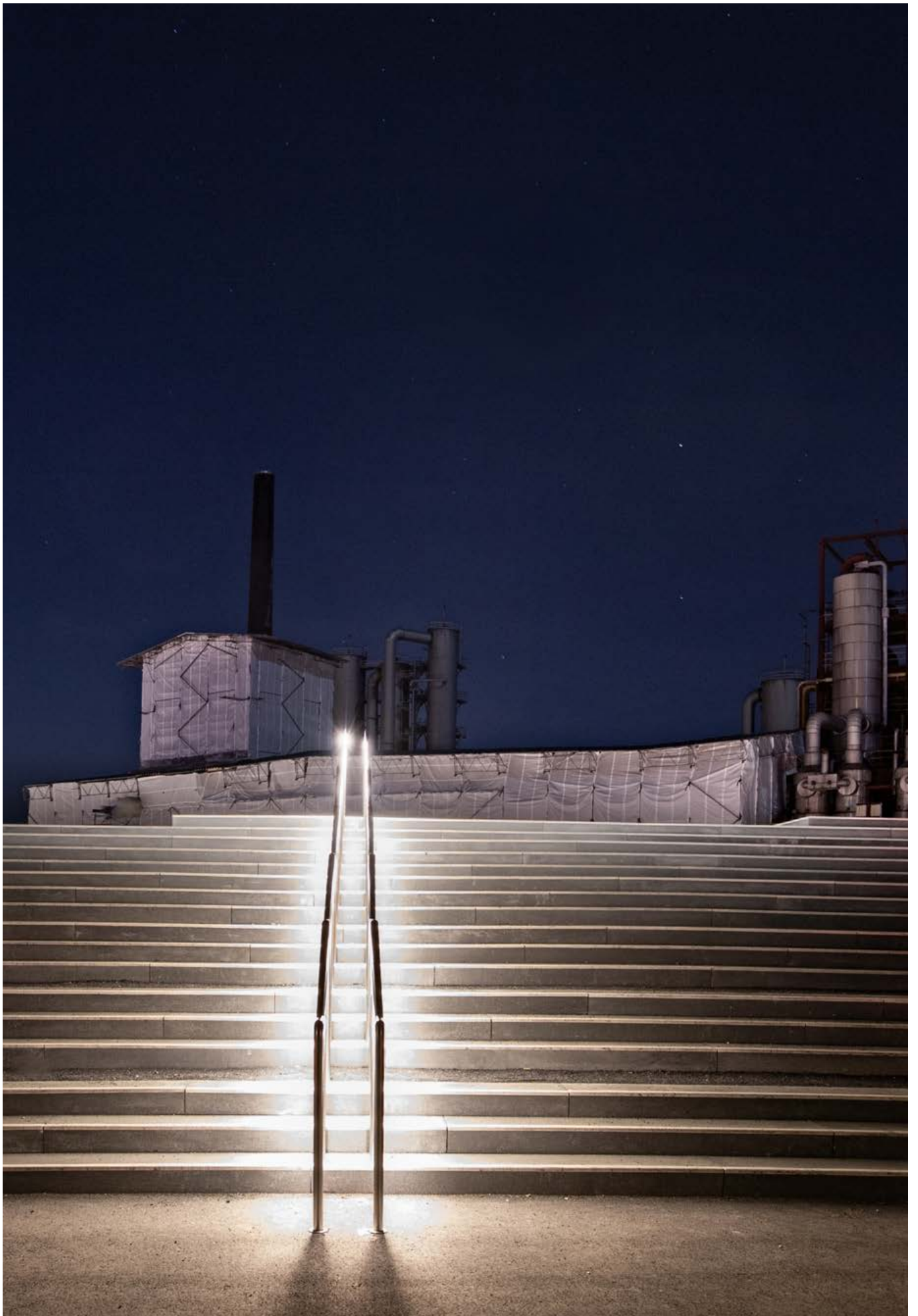

Ceiling light

Maxi Tube range



	14,5 W	22 W	40,5 W
Size	Ø 33 x <u>596</u> mm	Ø 33 x <u>1176</u> mm	Ø 33 x <u>1476</u> mm
Finish	Opaline <input type="checkbox"/> Embossed <input type="checkbox"/>	Opaline <input type="checkbox"/> Embossed <input type="checkbox"/>	Opaline <input type="checkbox"/> Embossed <input type="checkbox"/>
Efficiency CRI 80	3000K 4000K 6500K	3000K 4000K 6500K	3000K 4000K 6500K
Efficiency CRI 92	3000K 4000K	3000K 4000K	3000K 4000K
Optics	Flood Medium Flood Wide Flood	Flood Medium Flood Wide Flood	Flood Medium Flood Wide Flood
Driver	On/Off	On/Off	On/Off

Technical details

Opal or embossed polycarbonate tube with waterproof closing system using side plugs in transparent polycarbonate. The diameter of the tube is 33 mm.

IK08 IP67



Scale 1:1



DALI version available on request.

Multiple connection

Fixture available in two variations: version **Maxi Tube** with single input cable for installation of a single article or as end-of-line, version **Maxi Tube IN & OUT** with double cable input and output cable to be able to create continuous lines of light with the use of specific accessories.

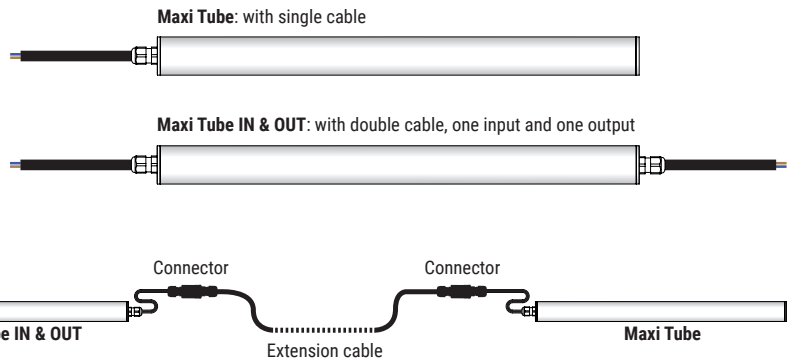

To create continuous lines, use the accessories neoprene "extension cable" and "quick connector" IP68 socket/plug.

Extension cable



IP68 connector



Installation

We recommend the installation of each individual tube with at least two fixing accessories. Fixing kit available for ordered separately as an accessory.

Clip fixing kit



Clip + fitting fixing kit



Connection with safety tightening



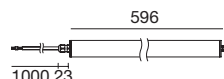
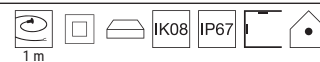

Ø33

0,5 Kg 2,7 dm³

596 mm - CRI 80 - 13 W DC - 14,5 W AC

92438 Embossed	W 3000 K	1688 lm	30 Medium Flood
	N 4000 K	1793 lm	60 Flood
	C 6500 K	1864 lm	12 Wide Flood

596 mm - CRI 92 - 13 W DC - 14,5 W AC

92442 Embossed	W 3000 K	1440 lm	30 Medium Flood
	N 4000 K	1501 lm	60 Flood
			12 Wide Flood

596 mm - CRI 80 - 13 W DC - 14,5 W AC

92242 Opaline	W 3000 K	1688 lm	30 Medium Flood
	N 4000 K	1793 lm	60 Flood
	C 6500 K	1864 lm	12 Wide Flood

596 mm - CRI 92 - 13 W DC - 14,5 W AC

92245 Opaline	W 3000 K	1440 lm	30 Medium Flood
	N 4000 K	1501 lm	60 Flood
			12 Wide Flood

Accessories for installation

Cables and accessories

1x	1x	1x		
99226 Clip fixing kit	99227 Clip + fitting fixing kit	98695 Connection with safety tightening	99229 Extension cables 2x1 mm ²	98729 Quick connector IP68 socket/plug

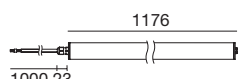

Ø33

0,8 Kg 4,9 dm³

1176 mm - CRI 80 - 20 W DC - 22 W AC

92439 Embossed	W 3000 K	2780 lm	30 Medium Flood
	N 4000 K	2923 lm	60 Flood
	C 6500 K	3032 lm	12 Wide Flood

1176 mm - CRI 92 - 20 W DC - 22 W AC

92443 Embossed	W 3000 K	2318 lm	30 Medium Flood
	N 4000 K	2478 lm	60 Flood
			12 Wide Flood

1176 mm - CRI 80 - 20 W DC - 22 W AC

92243 Opaline	W 3000 K	2780 lm	30 Medium Flood
	N 4000 K	2923 lm	60 Flood
	C 6500 K	3032 lm	12 Wide Flood

1176 mm - CRI 92 - 20 W DC - 22 W AC

92246 Opaline	W 3000 K	2318 lm	30 Medium Flood
	N 4000 K	2478 lm	60 Flood
			12 Wide Flood

Accessories for installation

Cables and accessories

1x	1x	1x		
99226 Clip fixing kit	99227 Clip + fitting fixing kit	98695 Connection with safety tightening	99229 Extension cables 2x1 mm ²	98729 Quick connector IP68 socket/plug

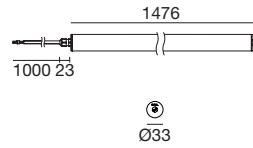

Kg
1,1 Kg

Vol
5,9 dm³

1476 mm - CRI 80 - 37 W DC - 40,5 W AC

92440 Embossed	W 3000 K	4766 lm	30 Medium Flood
	N 4000 K	5011 lm	60 Flood
	C 6500 K	5198 lm	12 Wide Flood

1476 mm - CRI 92 - 37 W DC - 40,5 W AC

92444 Embossed	W 3000 K	3974 lm	30 Medium Flood
	N 4000 K	4248 lm	60 Flood
			12 Wide Flood

1476 mm - CRI 80 - 37 W DC - 40,5 W AC

92244 Opaline	W 3000 K	4766 lm	30 Medium Flood
	N 4000 K	5011 lm	60 Flood
	C 6500 K	5198 lm	12 Wide Flood

1476 mm - CRI 92 - 37 W DC - 40,5 W AC

92247 Opaline	W 3000 K	3974 lm	30 Medium Flood
	N 4000 K	4248 lm	60 Flood
			12 Wide Flood

Accessories for installation

1x **99226**
Clip fixing kit

1x **99227**
Clip + fitting fixing kit

1x **98695**
Connection with safety tightening

Cables and accessories

99229
Extension cables 2x1 mm²

98729
Quick connector IP68 socket/plug

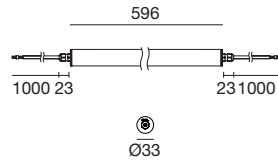

0,6 Kg 2,7 dm³

596 mm - CRI 80 - 13 W DC - 14,5 W AC

92445 Embossed	W 3000 K	1688 lm	30 Medium Flood
	N 4000 K	1793 lm	60 Flood
	C 6500 K	1864 lm	12 Wide Flood

596 mm - CRI 92 - 13 W DC - 14,5 W AC

92448 Embossed	W 3000 K	1440 lm	30 Medium Flood
	N 4000 K	1501 lm	60 Flood
			12 Wide Flood

596 mm - CRI 80 - 13 W DC - 14,5 W AC

92248 Opaline	W 3000 K	1688 lm	30 Medium Flood
	N 4000 K	1793 lm	60 Flood
	C 6500 K	1864 lm	12 Wide Flood

596 mm - CRI 92 - 13 W DC - 14,5 W AC

92353 Opaline	W 3000 K	1440 lm	30 Medium Flood
	N 4000 K	1501 lm	60 Flood
			12 Wide Flood

Accessories for installation

1x 
99226
Clip fixing kit

1x 
99227
Clip + fitting fixing kit

1x 
98695
Connection with safety tightening

Cables and accessories

99229
Extension cables 2x1 mm²

98729
Quick connector IP68 socket/plug

1176 mm - CRI 80 - 20 W DC - 22 W AC

92446 Embossed	W 3000 K	2780 lm	30 Medium Flood
	N 4000 K	2923 lm	60 Flood
	C 6500 K	3032 lm	12 Wide Flood

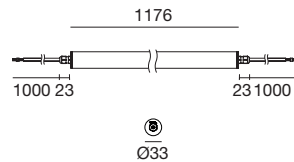

0,9 Kg 4,9 dm³

1176 mm - CRI 92 - 20 W DC - 22 W AC

92449 Embossed	W 3000 K	2318 lm	30 Medium Flood
	N 4000 K	2478 lm	60 Flood
			12 Wide Flood

1176 mm - CRI 80 - 20 W DC - 22 W AC

92249 Opaline	W 3000 K	2780 lm	30 Medium Flood
	N 4000 K	2923 lm	60 Flood
	C 6500 K	3032 lm	12 Wide Flood

1176 mm - CRI 92 - 20 W DC - 22 W AC

92356 Opaline	W 3000 K	2318 lm	30 Medium Flood
	N 4000 K	2478 lm	60 Flood
			12 Wide Flood

Accessories for installation

1x 
99226
Clip fixing kit

1x 
99227
Clip + fitting fixing kit

1x 
98695
Connection with safety tightening

Cables and accessories

99229
Extension cables 2x1 mm²

98729
Quick connector IP68 socket/plug

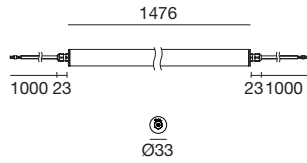
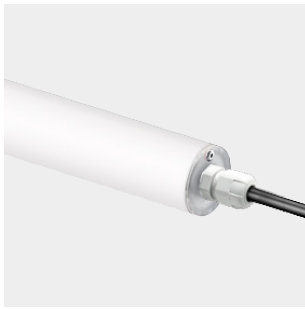

Kg
1,2 Kg

Vol
5,9 dm³

1476 mm - CRI 80 - 37 W DC - 40,5 W AC

92447 Embossed	W 3000 K	4766 lm	30 Medium Flood
	N 4000 K	5011 lm	60 Flood
	C 6500 K	5198 lm	12 Wide Flood

1476 mm - CRI 92 - 37 W DC - 40,5 W AC

92450 Embossed	W 3000 K	3974 lm	30 Medium Flood
	N 4000 K	4248 lm	60 Flood
			12 Wide Flood

1476 mm - CRI 80 - 37 W DC - 40,5 W AC

92352 Opaline	W 3000 K	4766 lm	30 Medium Flood
	N 4000 K	5011 lm	60 Flood
	C 6500 K	5198 lm	12 Wide Flood

1476 mm - CRI 92 - 37 W DC - 40,5 W AC

92357 Opaline	W 3000 K	3974 lm	30 Medium Flood
	N 4000 K	4248 lm	60 Flood
			12 Wide Flood

Accessories for installation

1x **99226**
Clip fixing kit

1x **99227**
Clip + fitting fixing kit

1x **98695**
Connection with safety tightening

Cables and accessories

99229
Extension cables 2x1 mm²

98729
Quick connector IP68 socket/plug

Parking | Rome, Italy







High Protection

The High Protection tube boasts a high grade of protection against atmospheric agents. Protection is guaranteed by the tubular profile in transparent polycarbonate and the waterproof closing system using rotating side plugs in anodised aluminium. The TCS valve is inserted in the plugs for transpiration between the inside and outside of the lamp. The item features a quick connector system with a range of accessory cables to create continuous lines directly connected to the electrical mains. The driver is included in the profile. There are multiple installation solutions, hanging or surface, thanks to the numerous accessories available.

Materials

Body in polycarbonate with UV protection
Plugs in anodised 6026 aluminium
Neoprene cables



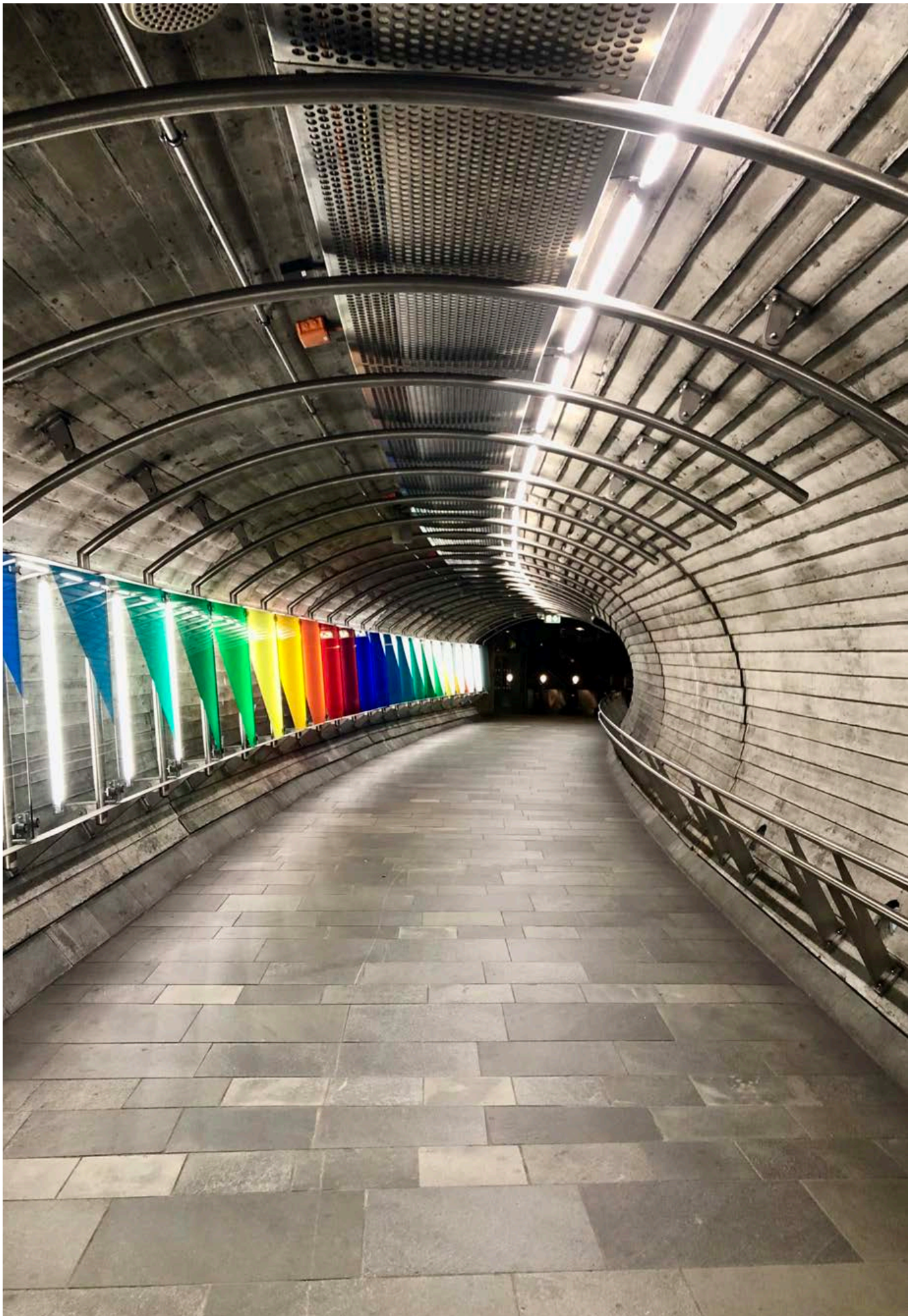

Ceiling light

High Protection range



High Protection	14,5 W	22 W	40,5 W
Size	Ø 38 x <u>666</u> mm	Ø 38 x <u>1276</u> mm	Ø 38 x <u>1576</u> mm
<hr/>			
High Protection Wired	14,5 W	22 W	40,5 W
Size	Ø 38 x <u>694</u> mm	Ø 38 x <u>1303</u> mm	Ø 38 x <u>1605</u> mm
<hr/>			
Finish	<input type="checkbox"/> Opaline <input type="checkbox"/> Embossed	<input type="checkbox"/> Opaline <input type="checkbox"/> Embossed	<input type="checkbox"/> Opaline <input type="checkbox"/> Embossed
<hr/>			
Efficiency CRI 80	3000K 4000K 6500K	3000K 4000K 6500K	3000K 4000K 6500K
<hr/>			
Efficiency CRI 92	3000K 4000K	3000K 4000K	3000K 4000K
<hr/>			
Optics	Flood Medium Flood Wide Flood Diffused	Flood Medium Flood Wide Flood Diffused	Flood Medium Flood Wide Flood Diffused
<hr/>			
Driver	On/Off	On/Off	On/Off
<hr/>			

Construction details

Polycarbonate tube in the two different varieties, embossed and opal, with waterproof closing system using rotating side plugs in 6026 anodised aluminium. Special TCS® valve as protective air vent to prevent the formation of condensation inside the tube, thereby ensuring long life for the lamp. Quick connector system with a range of accessory cables to create continuous lines directly connected to the electrical mains, thanks to the driver included in each bar. LED tube featuring light source made up of latest generation high density SMD Top LEDs mounted on PCB. In the case of embossed internal diffuser with the use of optics in the Flood and Medium Flood versions, or without using optics in the Wide Flood version, perfect cleaning of the cone of light is ensured thanks to the special embossing. In the version with opal internal diffuser, the difference between the two Flood and Diffused optics is substantially aesthetic, connected to the size of the light emission area from the tube. Item also available with CRI92 high chromatic yield SMD Top LEDs.

IK08 IP66

CRI 92

DALI DALI version available on request.

High Protection

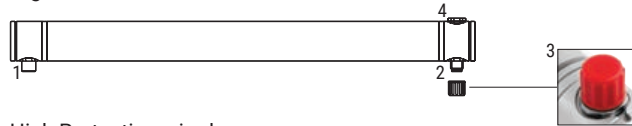

High Protection wired

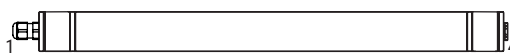

- 1 INPUT: Male quick connector
- 2 OUTPUT: Female quick connector
- 3 Insulating terminal plug
- 4 TCS® Valve for transpiration

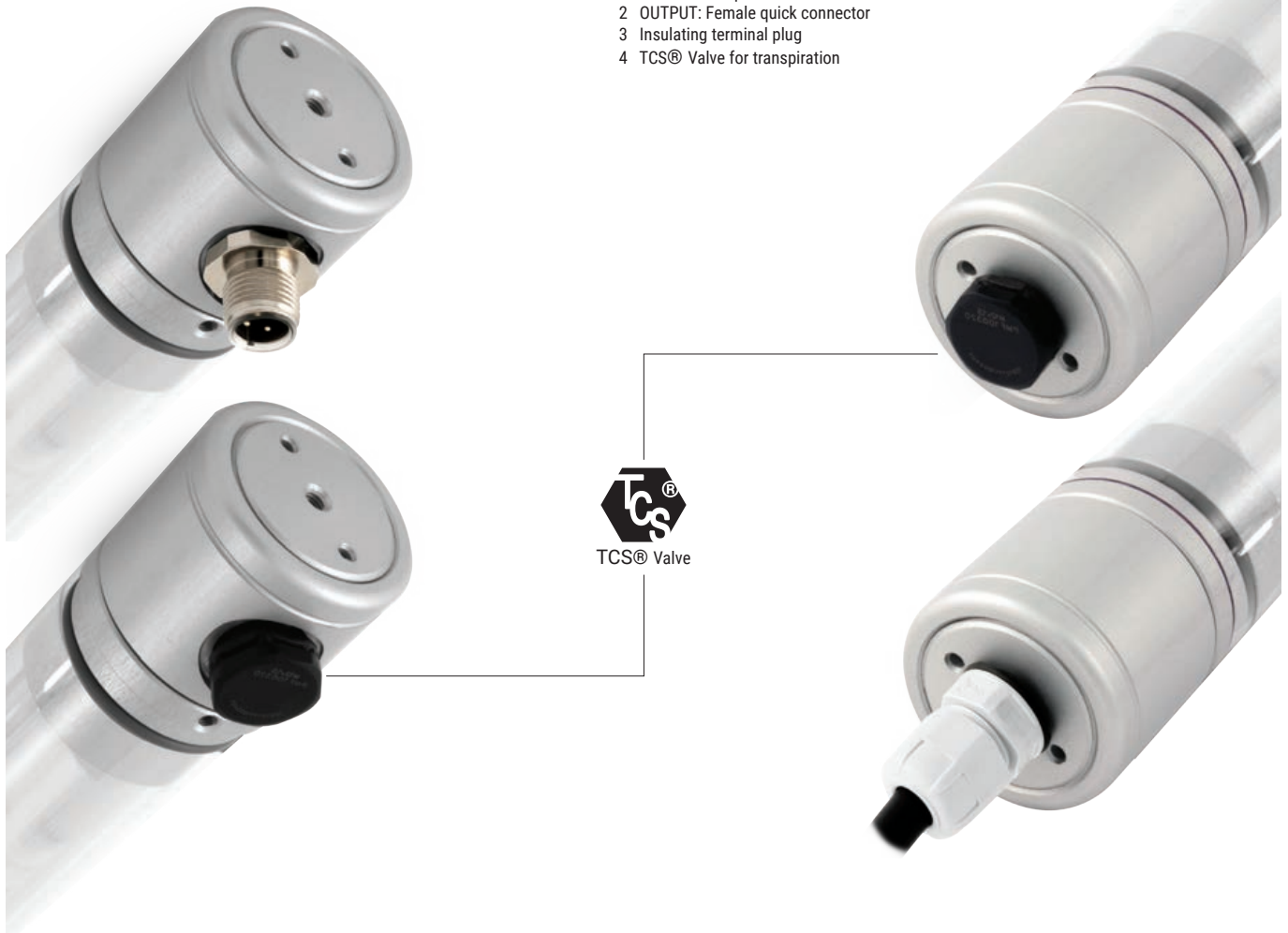

Cable exit positions

The orthogonal cable exit from the High Protection tube allows the space between two continuous tubes to be minimised, thereby optimising the continuous line of light effect. The High Protection wired version has a linear cable exit position along the axis of the tube, through the closing plug.

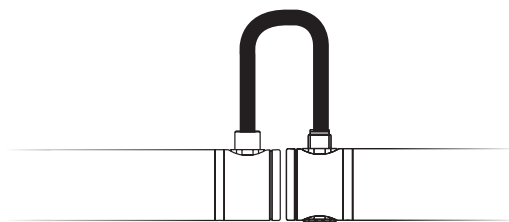

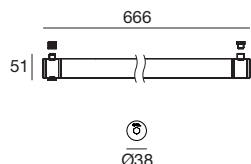

Kg 0,74 Kg **Vol** 2,72 dm³

666 mm - CRI 80 - 13 W DC - 14,5 W AC

95257 Opaline	W 3000 K	1688 lm	30 Medium Flood
	N 4000 K	1793 lm	00 Diffused
	C 6500 K	1864 lm	

666 mm - CRI 80 - 13 W DC - 14,5 W AC

95254 Embossed	W 3000 K	1688 lm	30 Medium Flood
	N 4000 K	1793 lm	60 Flood
	C 6500 K	1864 lm	12 Wide Flood

666 mm - CRI 92 - 13 W DC - 14,5 W AC

94679 Embossed	W 3000 K	1440 lm	30 Medium Flood
	N 4000 K	1501 lm	60 Flood
			12 Wide Flood

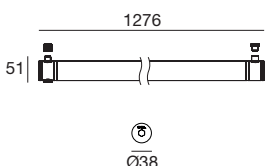

Kg 1,13 Kg **Vol** 4,9 dm³

1276 mm - CRI 80 - 20 W DC - 22 W AC

95258 Opaline	W 3000 K	2780 lm	30 Medium Flood
	N 4000 K	2923 lm	00 Diffused
	C 6500 K	3032 lm	

1276 mm - CRI 80 - 20 W DC - 22 W AC

95255 Embossed	W 3000 K	2780 lm	30 Medium Flood
	N 4000 K	2923 lm	60 Flood
	C 6500 K	3032 lm	12 Wide Flood

1276 mm - CRI 92 - 20 W DC - 22 W AC

94680 Embossed	W 3000 K	2318 lm	30 Medium Flood
	N 4000 K	2478 lm	60 Flood
			12 Wide Flood

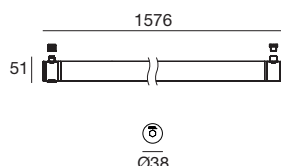

Kg 1,5 Kg **Vol** 6 dm³

1576 mm - CRI 80 - 37 W DC - 40,5 W AC

95259 Opaline	W 3000 K	4766 lm	30 Medium Flood
	N 4000 K	5011 lm	00 Diffused
	C 6500 K	5198 lm	

1576 mm - CRI 80 - 37 W DC - 40,5 W AC

95256 Embossed	W 3000 K	4766 lm	30 Medium Flood
	N 4000 K	5011 lm	60 Flood
	C 6500 K	5198 lm	12 Wide Flood





1576 mm - CRI 92 - 37 W DC - 40,5 W AC

94681 Embossed	W 3000 K	3974 lm	30 Medium Flood
	N 4000 K	4248 lm	60 Flood
			12 Wide Flood

Accessories for installation

- 
99219
 Suspension fixing kit
- 
99221
 Suspension fitting
- 
99222
 Surface fixing kit
- 
99220
 Clip fixing kit
- 
99238
 Clip fixing kit
- 
99224
 Corner fixing kit
- 
98782
 Corner fixing kit

Cables and accessories

- 
99225
 IP66 connection box
- 
99216
 Power supply cable length 1500 mm
- 
99217
 Extension cable length 150 mm
- 
99218
 Extension cable length 1500 mm



Ceiling light

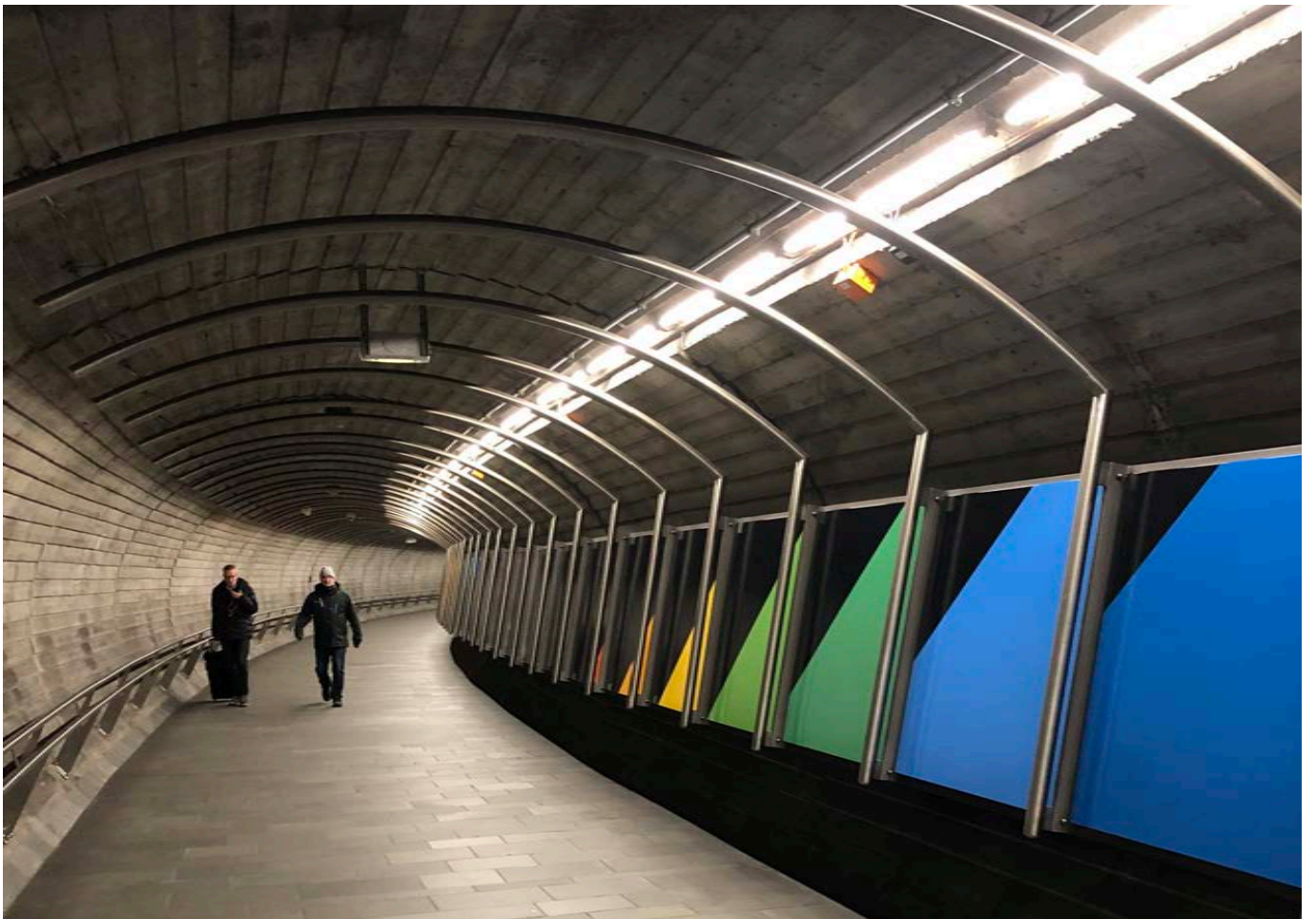

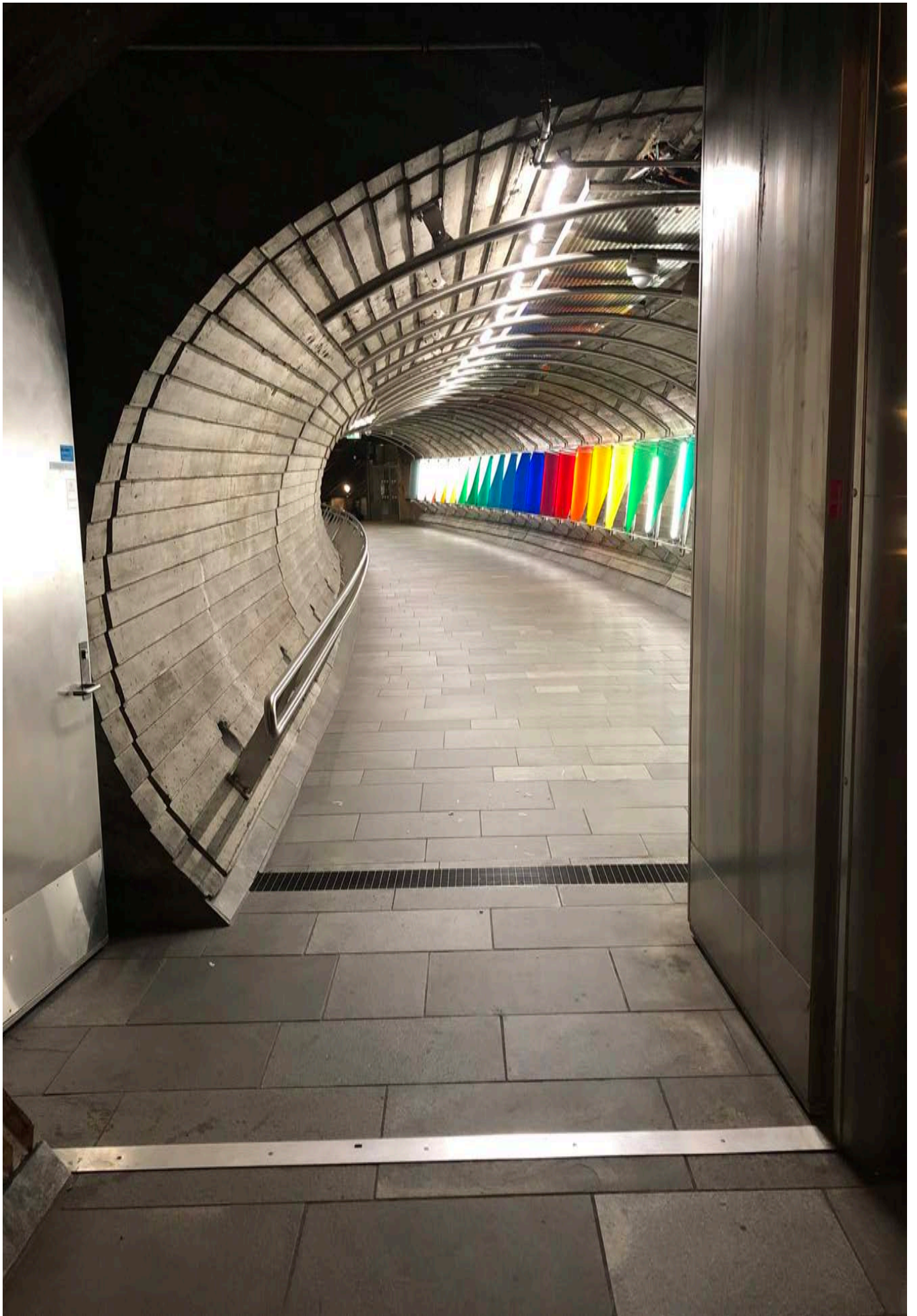

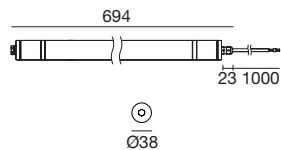
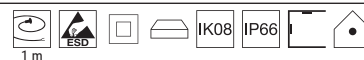

Kg 0,82 Kg
Vol 2,7 dm³

694 mm - CRI 80 - 13 W DC - 14,5 W AC

95281 Opaline	W 3000 K	1688 lm	30 Medium Flood
	N 4000 K	1793 lm	00 Diffused
	C 6500 K	1864 lm	

694 mm - CRI 80 - 13 W DC - 14,5 W AC

95275 Embossed	W 3000 K	1688 lm	30 Medium Flood
	N 4000 K	1793 lm	60 Flood
	C 6500 K	1864 lm	12 Wide Flood

694 mm - CRI 92 - 13 W DC - 14,5 W AC

95465 Embossed	W 3000 K	1440 lm	30 Medium Flood
	N 4000 K	1501 lm	60 Flood
			12 Wide Flood

1303 mm - CRI 80 - 20 W DC - 22 W AC

95282 Opaline	W 3000 K	2780 lm	30 Medium Flood
	N 4000 K	2923 lm	00 Diffused
	C 6500 K	3032 lm	

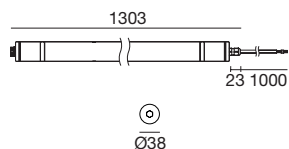

Kg 1,21 Kg
Vol 4,9 dm³

1303 mm - CRI 80 - 20 W DC - 22 W AC

95276 Embossed	W 3000 K	2780 lm	30 Medium Flood
	N 4000 K	2923 lm	60 Flood
	C 6500 K	3032 lm	12 Wide Flood

1303 mm - CRI 92 - 20 W DC - 22 W AC

95466 Embossed	W 3000 K	2318 lm	30 Medium Flood
	N 4000 K	2478 lm	60 Flood
			12 Wide Flood

1605 mm - CRI 80 - 37 W DC - 40,5 W AC

95283 Opaline	W 3000 K	4766 lm	30 Medium Flood
	N 4000 K	5011 lm	00 Diffused
	C 6500 K	5198 lm	

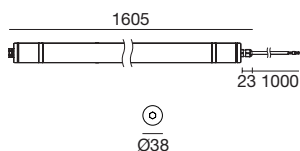

Kg 1,57 Kg
Vol 5,9 dm³

1605 mm - CRI 80 - 37 W DC - 40,5 W AC

95277 Embossed	W 3000 K	4766 lm	30 Medium Flood
	N 4000 K	5011 lm	60 Flood
	C 6500 K	5198 lm	12 Wide Flood

1605 mm - CRI 92 - 37 W DC - 40,5 W AC

95467 Embossed	W 3000 K	3974 lm	30 Medium Flood
	N 4000 K	4248 lm	60 Flood
			12 Wide Flood

Accessories for installation

1x	1x	1x	1x
99219 Suspension fixing kit	99222 Surface fixing kit	99220 Clip fixing kit	99238 Clip fixing kit

Cables and accessories

99225 IP66 connection box	99229 Extension cables 2x1 mm ²	84888 Extension cables 2x1 mm ²	98729 Quick connector IP68 socket/plug



Ceiling light

Installation accessories



description

Suspension fixing system with anodised aluminium ring, tightening safety screws, 1200 mm long steel cable, adjustment system for the cable and fixing with screws and anchors.

code

99219

siutable for

High Protection / High Protection Wired

For suspension installation, 2 kits are required

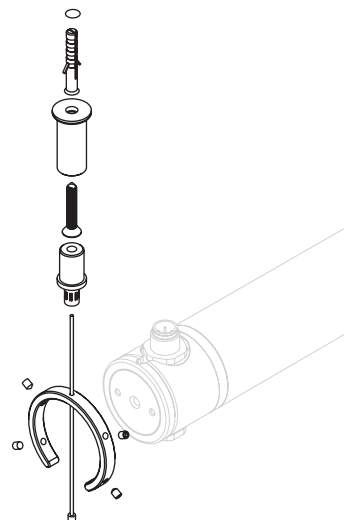

description

Male/female fittings in anodised aluminium to join articles, fixing screws and tightening safety screws. To be used only with the suspension fixing kit (code 99219 - indicated above).

code

99221

siutable for

High Protection

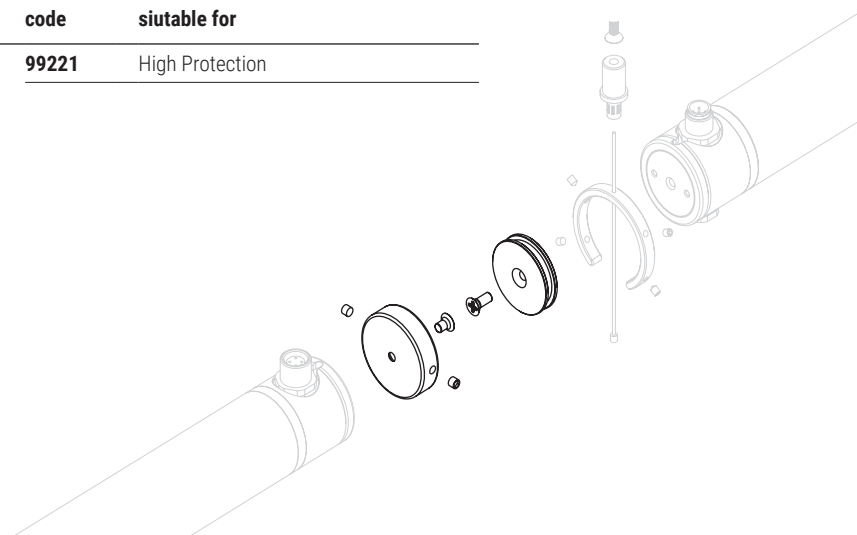

description

Surface installation system with screw locking and fixing using self-tapping screw and anchor. Made in transparent polycarbonate.

code

99222

siutable for

High Protection / High Protection Wired

We recommend using 2 installation accessories.

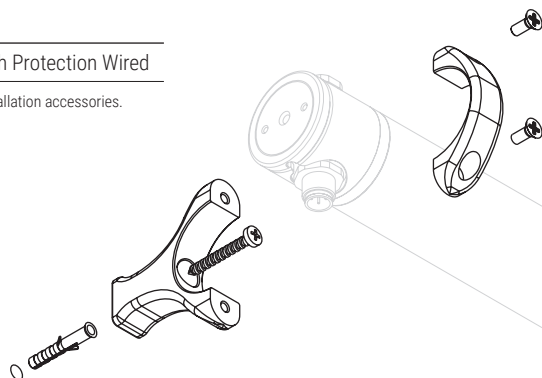



description

Clip fixing spring in nickel plated steel, self-tapping screw, anchor and o-ring for safety closing.

code

99220

siutable for

High Protection / High Protection Wired
For suspension installation, 2 kits are required

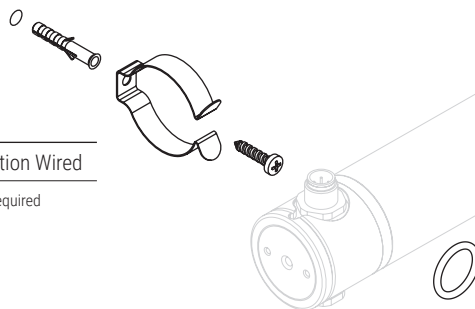

description

Clip fixing spring in transparent polycarbonate, self-tapping screw, anchor and o-ring for safety closing.

code

99238

siutable for

High Protection / High Protection Wired
For suspension installation, 2 kits are required



description

Corner installation system with pair of side brackets with screw locking and fixing using self-tapping screws and anchors.

code

99224

siutable for

High Protection

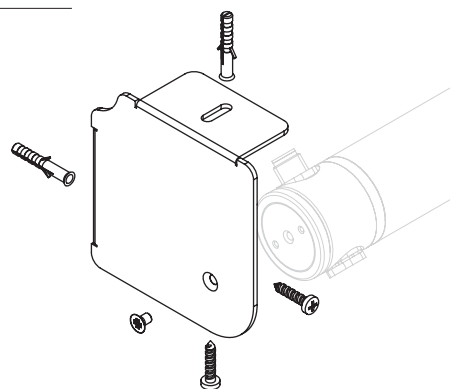

description

Installation system with pair of side brackets with screw locking and fixing using self-tapping screws and anchors.

code

99223

siutable for

High Protection

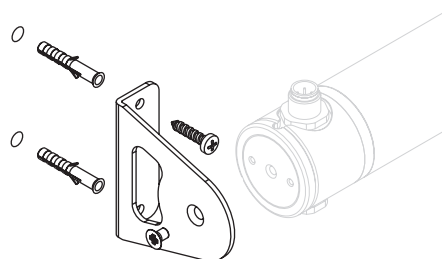



description

IP66 connection box for wall installation, contains cable gland for multiple cables, self-tapping screws, anchors, washers and o-rings.

code

99225

siutable for

High Protection / High Protection Wired

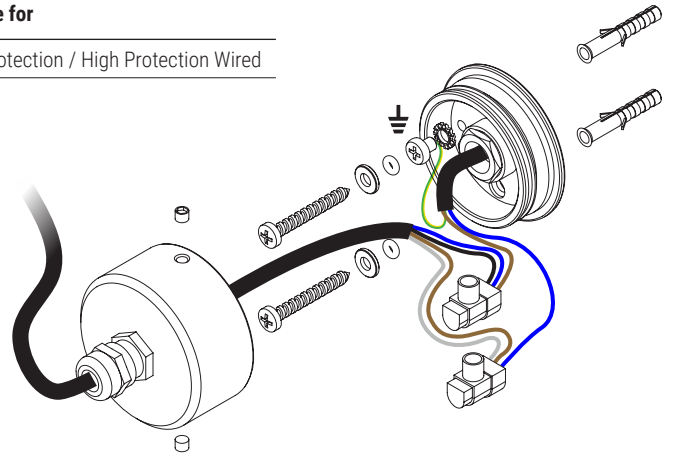

description

1500 mm long power cable with female quick connector in IP66.

code

99216

siutable for

High Protection

L mm

1500

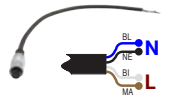

description

Extension cable with male/female quick connector in IP66 for direct connection between tubes.

code

99217

siutable for

High Protection

L mm

150



description

Extension cable with male/female quick connector in IP66 for direct connection between tubes.

code

99218

siutable for

High Protection

L mm

1500

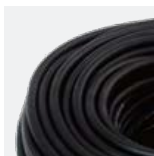

description

Extension cable in neoprene 2x1mm². Two wires: blue/brown for LED tube with built-in driver.

code

99229

siutable for

High Protection Wired

L mm

on demand

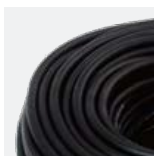

description

Extension cable in neoprene 2x1mm². Two wires: red/black for LED tube without driver.

code

84888

siutable for

High Protection Wired

L mm

on demand



description

Quick connector IP68 socket/plug - Two wires.

code

98729

siutable for

High Protection Wired

L mm

/



Connection examples

Single connection

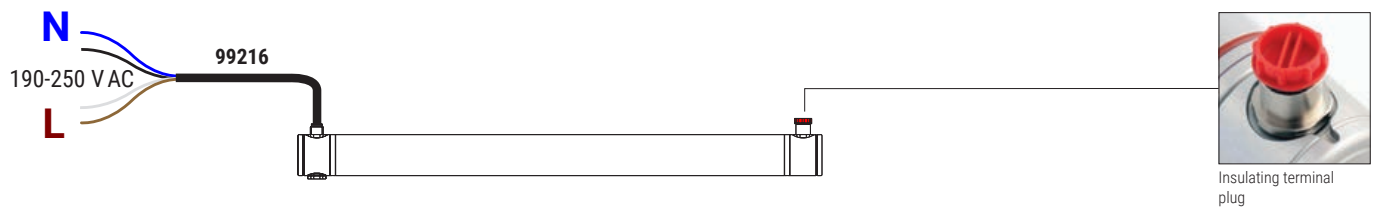

Multiple connection

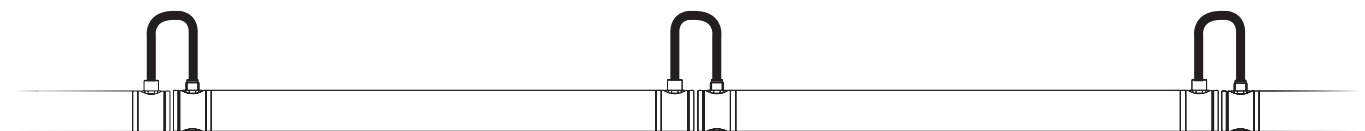
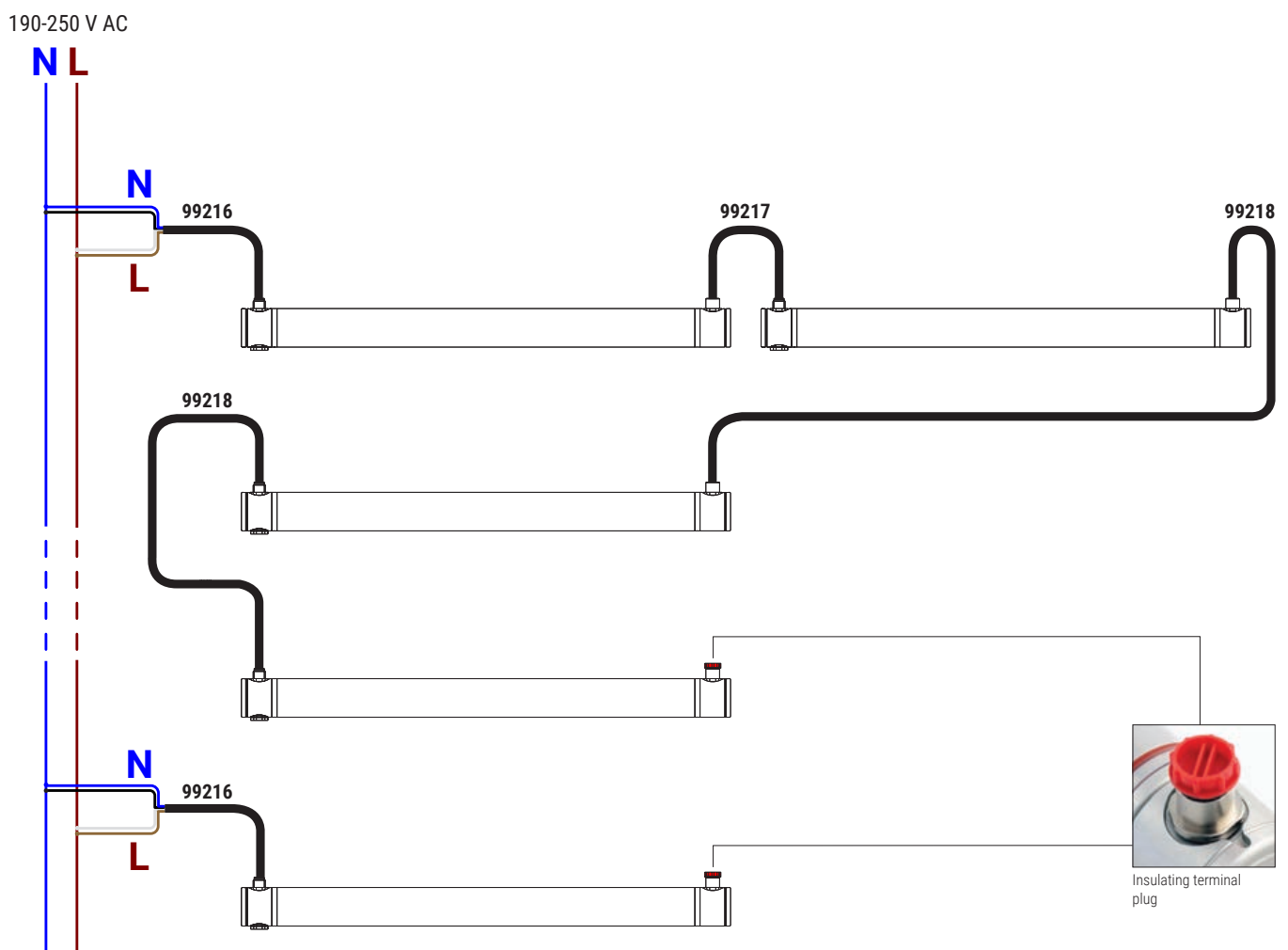

The maximum length of tubes connected in series is **10 m**

High Wired

Tubular profile in anodised aluminium available in the versions with IP40 or IP44 protection grade. The power supply is integrated inside the profile for direct connection to mains power. The cover is in embossed or opal polycarbonate, the light source is made up of SMD Top LEDs featuring optics to channel the light beam. High Wired is available in the CRI92 high chromatic yield index version. Installation is quick and easy using the specific accessories.

Materials

Body in 6060 aluminium.
Polycarbonate cover.

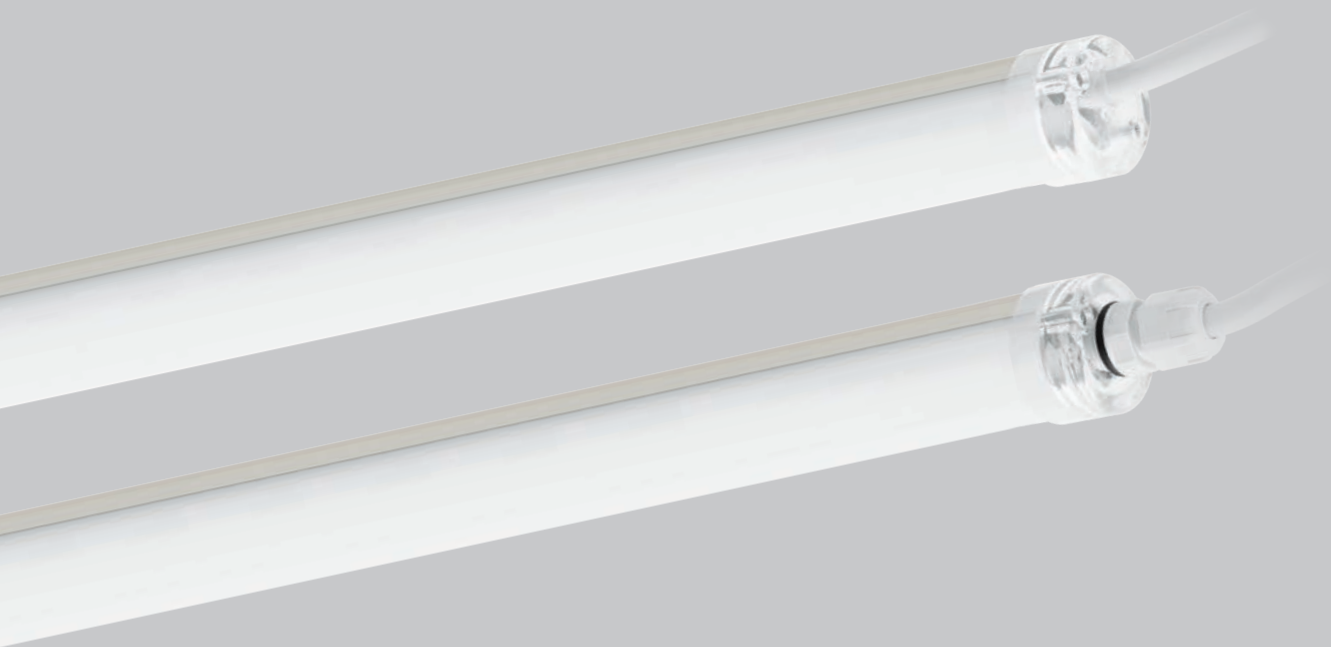



High Wired range



High Wired	14,5 W	22 W	40,5 W
Size	Ø 30 x 585 mm	Ø 30 x 1195 mm	Ø 30 x 1495 mm
Finish	Opaline Embossed	Opaline Embossed	Opaline Embossed
Efficiency CRI 80	3000K 4000K 6500K	3000K 4000K 6500K	3000K 4000K 6500K
Efficiency CRI 92	3000K 4000K	3000K 4000K	3000K 4000K
Optics	Flood Medium Flood Wide Flood Diffused	Flood Medium Flood Wide Flood Diffused	Flood Medium Flood Wide Flood Diffused
Driver	On/Off	On/Off	On/Off

High Wired Suspension	14,5 W	22 W	40,5 W
Size	Ø 30 x 572 mm	Ø 30 x 1182 mm	Ø 30 x 1482 mm
Finish	Opaline Embossed	Opaline Embossed	Opaline Embossed
Efficiency CRI 80	3000K 4000K 6500K	3000K 4000K 6500K	3000K 4000K 6500K
Optics	Wide Flood Diffused	Wide Flood Diffused	Wide Flood Diffused
Driver	On/Off	On/Off	On/Off

Construction details

Profile in 6060 anodised aluminium with cover in embossed or opal polycarbonate. In the version with IP44 protection grade, the insulating cable gland is built in, absent in the IP40 version.



Can be connected directly to the 190~250Vac electrical socket.



DALI version available on request.

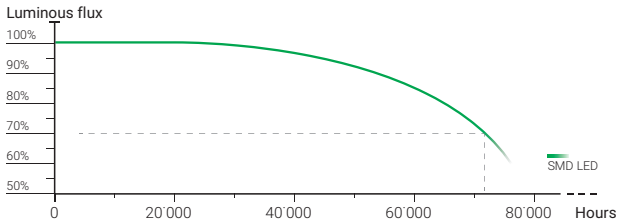

IP40



IP44

Surface installation

High Wired can be surface installed on the desired surface or on busbar, using specific fixing accessories.

Surface installation

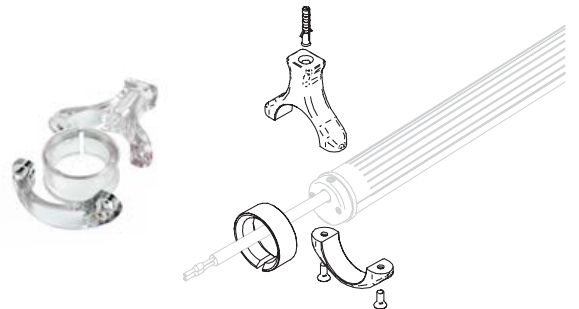

Surface installation on busbar

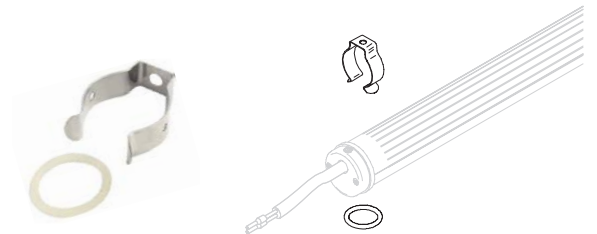

Suspension

The High Wired Suspension version comes with cables and painted metal base with terminal block for connection to the electrical mains. Hanging installation is foreseen using steel cables with a height adjustment system. The maximum cable length is 2.5 m.

MAX
2,5m



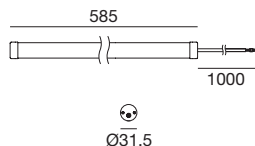
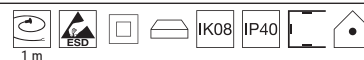

Kg 0,47 Kg **Vol** 0,75 dm³

585 mm - CRI 80 - 13 W DC - 14,5 W AC

95242 Opaline	W 3000 K	1688 lm	30 Medium Flood
	N 4000 K	1793 lm	00 Diffused
	C 6500 K	1864 lm	

585 mm - CRI 80 - 13 W DC - 14,5 W AC

95236 Embossed	W 3000 K	1688 lm	30 Medium Flood
	N 4000 K	1793 lm	60 Flood
	C 6500 K	1864 lm	12 Wide Flood

585 mm - CRI 92 - 13 W DC - 14,5 W AC

94908 Embossed	W 3000 K	1440 lm	30 Medium Flood
	N 4000 K	1501 lm	60 Flood
			12 Wide Flood

1195 mm - CRI 80 - 20 W DC - 22 W AC

95243 Opaline	W 3000 K	2780 lm	30 Medium Flood
	N 4000 K	2923 lm	00 Diffused
	C 6500 K	3032 lm	

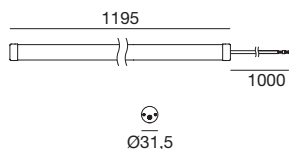

Kg 0,64 Kg **Vol** 1,47 dm³

1195 mm - CRI 80 - 20 W DC - 22 W AC

95237 Embossed	W 3000 K	2780 lm	30 Medium Flood
	N 4000 K	2923 lm	60 Flood
	C 6500 K	3032 lm	12 Wide Flood

1195 mm - CRI 92 - 20 W DC - 22 W AC

94909 Embossed	W 3000 K	2318 lm	30 Medium Flood
	N 4000 K	2478 lm	60 Flood
			12 Wide Flood

1495 mm - CRI 80 - 37 W DC - 40,5 W AC

95244 Opaline	W 3000 K	4766 lm	30 Medium Flood
	N 4000 K	5011 lm	00 Diffused
	C 6500 K	5198 lm	

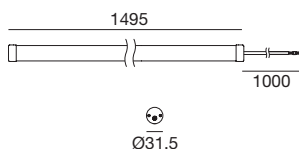

Kg 0,94 Kg **Vol** 1,86 dm³

1495 mm - CRI 80 - 37 W DC - 40,5 W AC

95238 Embossed	W 3000 K	4766 lm	30 Medium Flood
	N 4000 K	5011 lm	60 Flood
	C 6500 K	5198 lm	12 Wide Flood

1495 mm - CRI 92 - 37 W DC - 40,5 W AC

94910 Embossed	W 3000 K	3974 lm	30 Medium Flood
	N 4000 K	4248 lm	60 Flood
			12 Wide Flood

Accessories for installation



99228
Surface fixing kit



99226
Clip fixing kit



99227
Clip + fitting kit

We recommend the installation of each individual tube with at least two fixing accessories.

Cables and accessories



99225
IP66 connection box



99229
Extension cables 2x1 mm²



84888
Extension cables 2x1 mm²



98729
Quick connector IP68 socket/plug

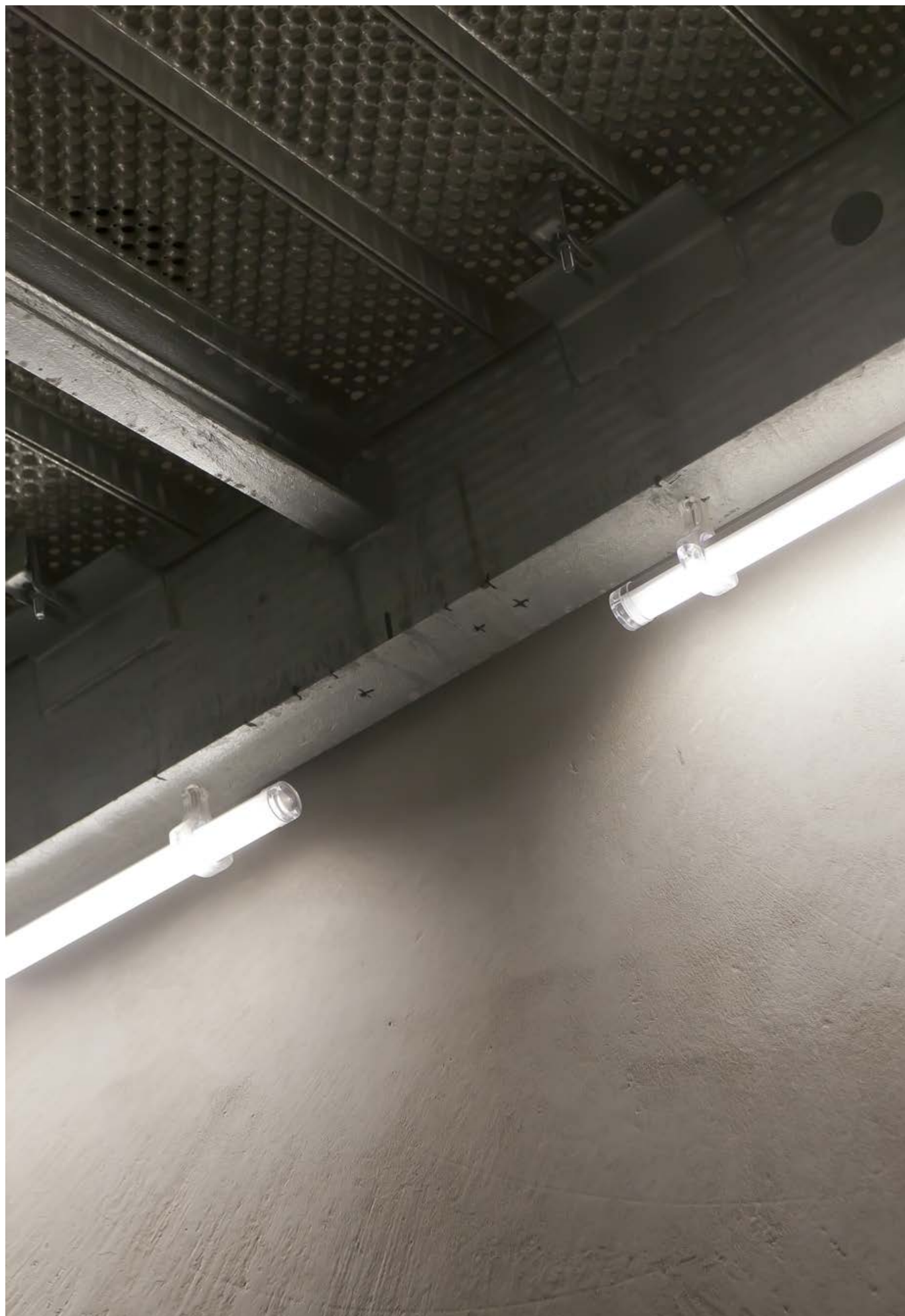

Ceiling light

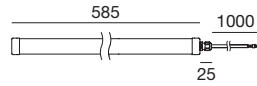
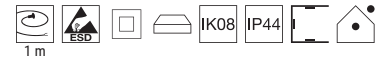

Ø31,5

Kg 0,47 Kg **Vol** 0,75 dm³

585 mm - CRI 80 - 13 W DC - 14,5 W AC

95245 Opaline	W 3000 K	1688 lm	30 Medium Flood
	N 4000 K	1793 lm	00 Diffused
	C 6500 K	1864 lm	

585 mm - CRI 80 - 13 W DC - 14,5 W AC

95239 Embossed	W 3000 K	1688 lm	30 Medium Flood
	N 4000 K	1793 lm	60 Flood
	C 6500 K	1864 lm	12 Wide Flood

585 mm - CRI 92 - 13 W DC - 14,5 W AC

94911 Embossed	W 3000 K	1440 lm	30 Medium Flood
	N 4000 K	1501 lm	60 Flood
			12 Wide Flood

1195 mm - CRI 80 - 20 W DC - 22 W AC

95246 Opaline	W 3000 K	2780 lm	30 Medium Flood
	N 4000 K	2923 lm	00 Diffused
	C 6500 K	3032 lm	

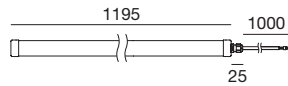

Ø31,5

Kg 0,64 Kg **Vol** 1,47 dm³

1195 mm - CRI 80 - 20 W DC - 22 W AC

95240 Embossed	W 3000 K	2780 lm	30 Medium Flood
	N 4000 K	2923 lm	60 Flood
	C 6500 K	3032 lm	12 Wide Flood

1195 mm - CRI 92 - 20 W DC - 22 W AC

94912 Embossed	W 3000 K	2318 lm	30 Medium Flood
	N 4000 K	2478 lm	60 Flood
			12 Wide Flood

1495 mm - CRI 80 - 37 W DC - 40,5 W AC

95247 Opaline	W 3000 K	4766 lm	30 Medium Flood
	N 4000 K	5011 lm	00 Diffused
	C 6500 K	5198 lm	

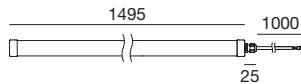

Ø31,5

Kg 0,94 Kg **Vol** 1,86 dm³

1495 mm - CRI 80 - 37 W DC - 40,5 W AC

95241 Embossed	W 3000 K	4766 lm	30 Medium Flood
	N 4000 K	5011 lm	60 Flood
	C 6500 K	5198 lm	12 Wide Flood

1495 mm - CRI 92 - 37 W DC - 40,5 W AC

94913 Embossed	W 3000 K	3974 lm	30 Medium Flood
	N 4000 K	4248 lm	60 Flood
			12 Wide Flood

Accessories for installation



99228
Surface fixing kit



99226
Clip fixing kit



99227
Clip + fitting kit

We recommend the installation of each individual tube with at least two fixing accessories.

Cables and accessories



99225
IP66 connection box



99229
Extension cables 2x1 mm²



84888
Extension cables 2x1 mm²



98729
Quick connector IP68 socket/plug



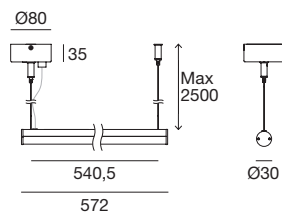
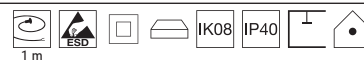

Kg 0,68 Kg **Vol** 7,8 dm³

572 mm - CRI 80 - 13 W DC - 14,5 W AC			
97808 Opaline	W 3000 K	1688 lm	00 Diffused
	N 4000 K	1793 lm	
	C 6500 K	1864 lm	

572 mm - CRI 80 - 13 W DC - 14,5 W AC			
97812 Embossed	W 3000 K	1688 lm	12 Wide Flood
	N 4000 K	1793 lm	
	C 6500 K	1864 lm	

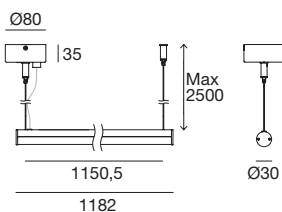

Kg 0,89 Kg **Vol** 15,5 dm³

1182 mm - CRI 80 - 20 W DC - 22 W AC			
97809 Opaline	W 3000 K	2780 lm	00 Diffused
	N 4000 K	2923 lm	
	C 6500 K	3032 lm	

1182 mm - CRI 80 - 20 W DC - 22 W AC			
97813 Embossed	W 3000 K	2780 lm	12 Wide Flood
	N 4000 K	2923 lm	
	C 6500 K	3032 lm	

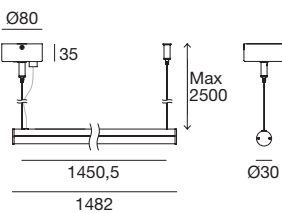

Kg 1,06 Kg **Vol** 19 dm³

1482 mm - CRI 80 - 37 W DC - 40,5 W AC			
97810 Opaline	W 3000 K	4766 lm	00 Diffused
	N 4000 K	5011 lm	
	C 6500 K	5198 lm	

1482 mm - CRI 80 - 37 W DC - 40,5 W AC			
97814 Embossed	W 3000 K	4766 lm	12 Wide Flood
	N 4000 K	5011 lm	
	C 6500 K	5198 lm	

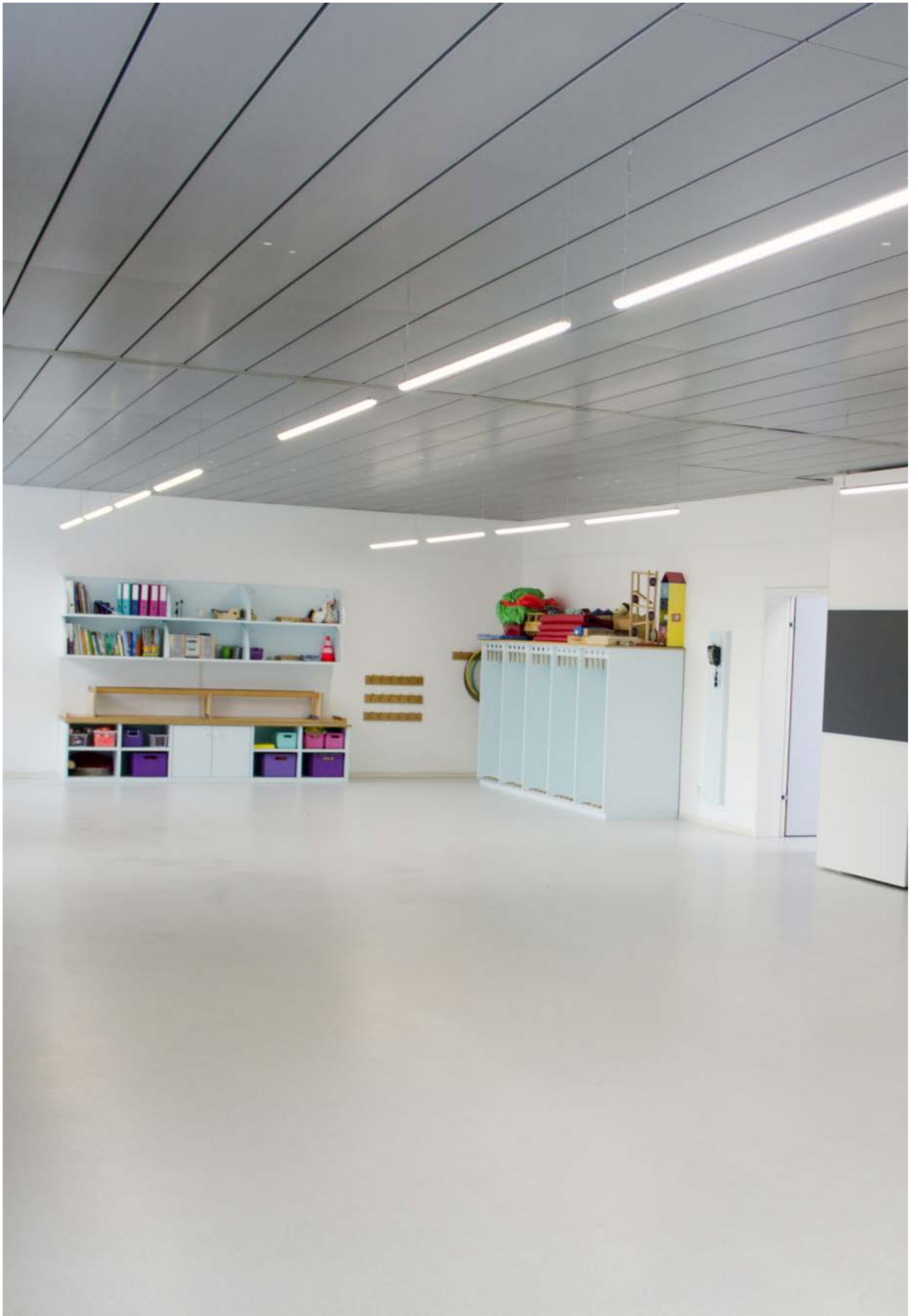

general lighting range index

Edith



Emy

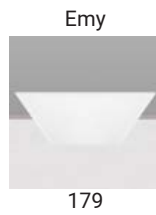

Indy









Edith

Edith is the ideal LED fixture for work spaces where efficient diffused lighting is needed. Edith is available in many options that differ in size, shape and the type of installation required. Edith Surface: surface-mount version for wall installation with bracket. Edith Full-Light and Edith Modular Ceiling: versions for installation on modular false ceilings. Edith Recessed: recessed version with springs. The “comfort” versions of the fixtures are characterised by maximum visual comfort UGR<19 and are ideal for installation in offices, gyms, schools and environments where a low glare index is required. The “protection” versions have a high front protection index, IP65. All the versions feature topLEDs light source with outstanding brightness levels and are available in version with different chromatic yield index, CRI 80 or CRI92. Edith makes lighting design simple and intuitive.

Materials

Body in iron sheet metal painted reflective white.
Diffuser in PMMA.

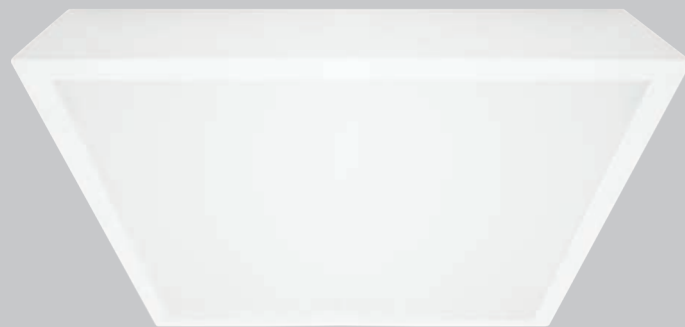

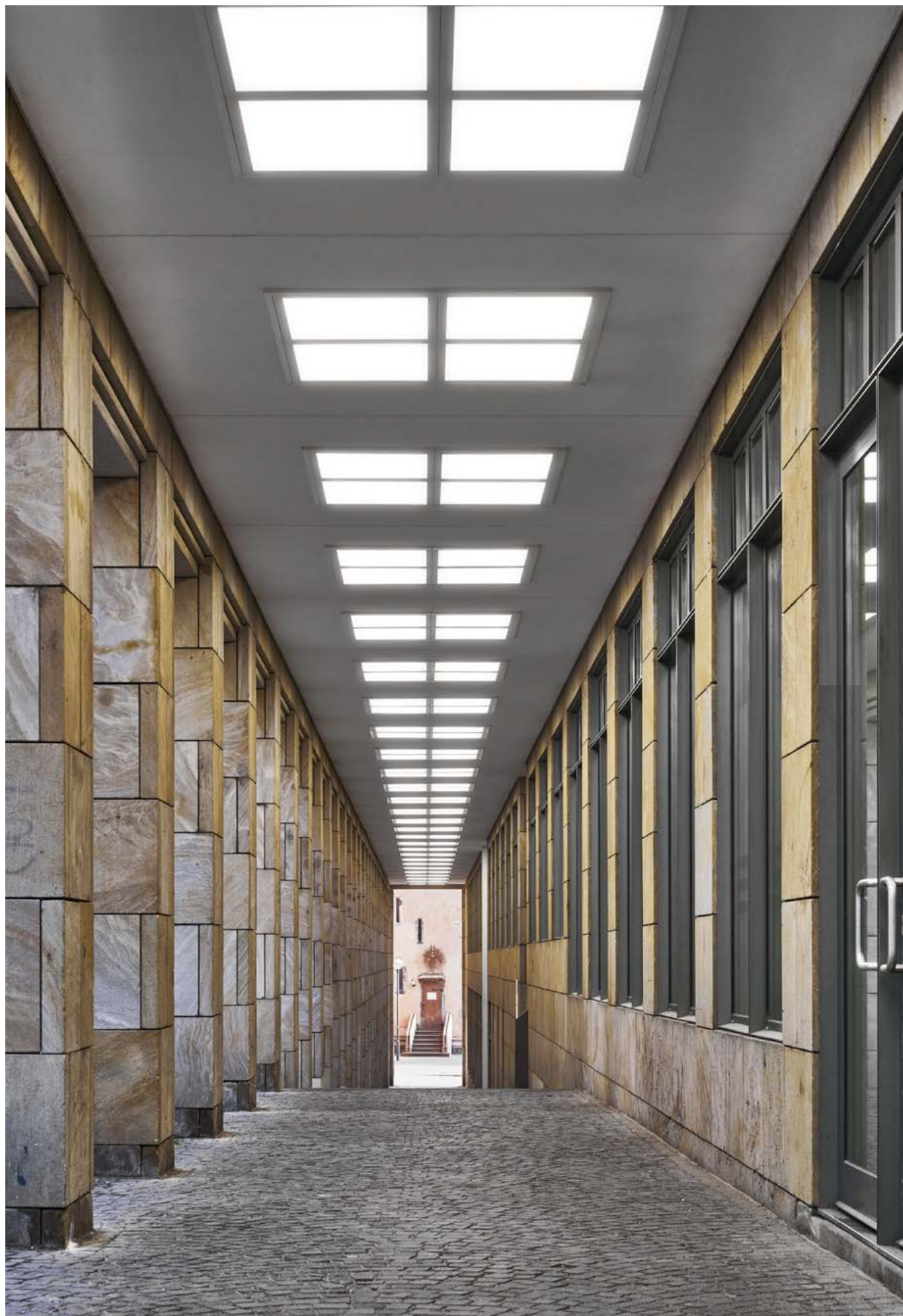



Edith range

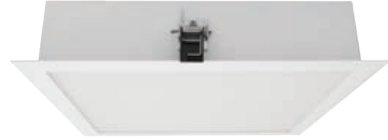
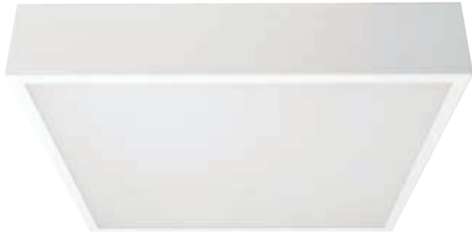

	Edith full-light								Edith modular											
Power	30 W	45 W	11 W	21 W	30 W	50 W	70 W	100 W	30 W	50 W	70 W	100 W	16 W	25 W	30 W	50 W	70 W	100 W	100 W	140 W
Size																				
Standard UGR>19	-	✓	✓	✓	✓	✓	✓	✓	✓	✓	✓	✓	✓	✓	✓	✓	✓	✓	✓	✓
Comfort UGR<19	✓	-	✓	✓	✓	✓	-	-	✓	✓	-	-	✓	✓	✓	✓	-	-	-	-
Protection UGR>19	-	-	-	-	✓	✓	✓	✓	✓	✓	✓	✓	-	-	-	-	-	-	-	-
Emergency	✓	✓	✓	✓	✓	✓	✓	✓	✓	✓	✓	✓	✓	✓	✓	✓	✓	✓	✓	✓
Finish	Opaline								Opaline											
Efficiency CRI 80	3000K 4000K								3000K 4000K											
Efficiency CRI 92	3000K								3000K											
Light emission	Diffused								Diffused											
Driver	On/Off DALI								On/Off DALI											



Edith surface										Edith recessed	
11 W	21 W	30 W	50 W	70 W	16 W	25 W	30 W	50 W	70 W	11 W	21 W
 295x295mm		 595x595mm			 595x295mm		 1195x295mm			 308x308mm	
✓	✓	✓	✓	✓	✓	✓	✓	✓	✓	✓	✓
✓	✓	✓	✓	-	✓	✓	✓	✓	-	✓	✓
-	-	-	-	-	-	-	-	-	-	-	-
✓	✓	✓	✓	✓	✓	✓	✓	✓	✓	✓	✓
Opaline										Opaline	
3000K 4000K										3000K 4000K	
3000K										3000K	
Diffused										Diffused	
On/Off DALI										On/Off DALI	

Dettagli costruttivi

Led SMD disposti in modulo dall'ampia superficie emittente, genera eccellenti livelli di intensità luminosa. Corpo lampada funzionale, la verniciatura bianco riflettente permette di coadiuvare al meglio la trasmissione della luce verso il diffusore. Schermatura in resistente PMMA opalino, rende la diffusione luminosa maggiormente omogenea attenuando la sensazione d'abbagliamento percepita.

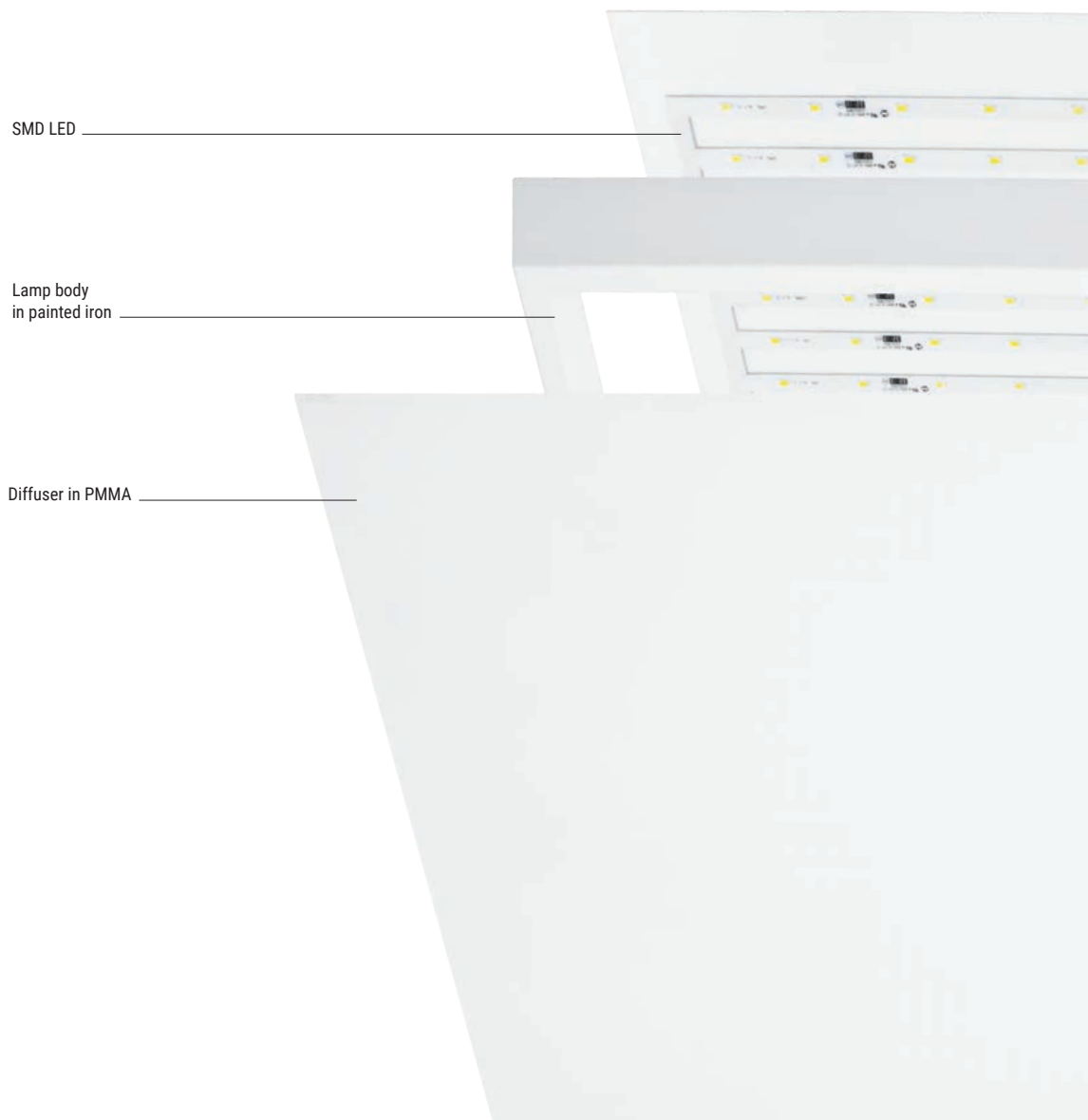

The Edith lamp can be applied in three different installation types, depending on the model used:

- A** Version for modular false ceiling
- B** Surface version
- C** Recessed version

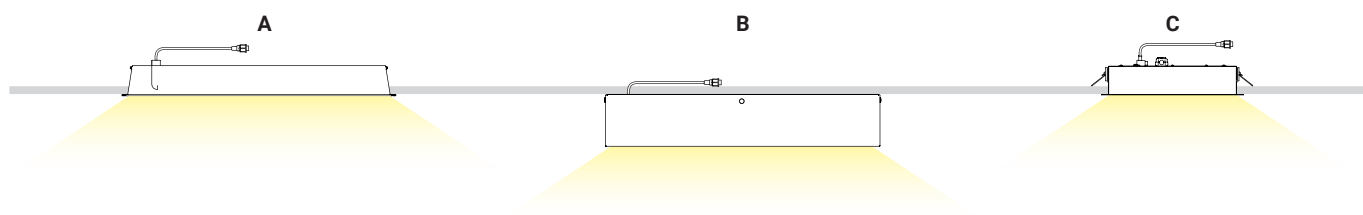

UGR index values suitable for any environment

Edith is the ideal partner for general lighting. Thanks to the wide range of items, it can be used in different environments: offices, schools, hotels, gyms, hospitals, supermarkets, shops, shopping centres and industrial warehouses.



Available in "Comfort" version with UGR<19, ideal for locations that required by regulation a controlled brightness level, such as most offices where computer monitors are used. EN 12464-1 regulation.

Contained UGR values allow rational positioning of the fixtures, both in number and distribution, without straining the vision.

UGR>19

fitness areas, gyms, beauty centres and wellness areas	
common areas, hallways, stair landings, lifts	
large distribution, shopping centres, supermarkets	
public environments, large common areas, waiting rooms	
shops in general, exhibit halls, showcases, shop fronts	

UGR<19

offices with computer monitors, offices in large spaces such as open space, level 2 specific offices, single offices	
hotels, generic environments where high visual comfort is required	
schools, daycare centres, universities, classrooms, laboratories, meeting rooms, press rooms	
environments for TV filming, cinemas	
hospitals, doctors' offices	

Edith Modular Ceiling



Lx	Color
400-500	Yellow
300-400	Orange
200-300	Green



Ceiling height	2,9 m
Spacing	1,5 m

Edith Full-light Standard | General lighting | topLED | 595mm x 595mm

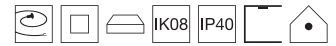

78 | | 66

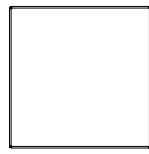

595

3,45 Kg 65,1 dm³

CRI 80 - 45 W AC

	97854 <input type="text" value="White"/>	W 3000 K	5675 lm	00 Diffused
	97855 <input type="text" value="White"/>	N 4000 K	6026 lm	

CRI 92 - 45 W AC

	97856 <input type="text" value="White"/>	W 3000 K	4840 lm	00 Diffused
	97857 <input type="text" value="White"/>			

Driver

Accessories

99355 Kit Emergency 1 art.	98281 Self-supporting suspension kit	98282 Security cable	98313 Visible frame

Edith Full-light Comfort | General lighting | topLED | 595mm x 595mm



78 | | 66

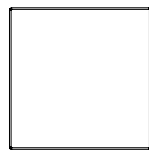

595

3,45 Kg 65,1 dm³



CRI 80 - 30 W AC

	97850 <input type="text" value="White"/>	W 3000 K	3990 lm	00 Diffused
	97851 <input type="text" value="White"/>	N 4000 K	4227 lm	

CRI 92 - 30 W AC

	97852 <input type="text" value="White"/>	W 3000 K	3396 lm	00 Diffused
	97853 <input type="text" value="White"/>			

Driver

Accessories

99355 Kit Emergency 1 art.	98281 Self-supporting suspension kit	98282 Security cable	98313 Visible frame



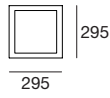
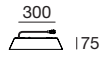

1,05 Kg
 27,5 dm³

CRI 80 - 11 W DC

96475	White	W 3000 K 1422 lm	00 Diffused
		N 4000 K 1490 lm	

CRI 92 - 11 W DC

96476	White	W 3000 K 1193 lm	00 Diffused
--------------	-------	----------------------------	--------------------

Driver

<p>99162 ON/OFF - IP20 1 art.</p>	<p>99163 DALI - IP20 1 art.</p>	<p>99355 Kit Emergency 1 art.</p>
--	--	--

CRI 80 - 21 W DC

97341	White	W 3000 K 2626 lm	00 Diffused
		N 4000 K 2789 lm	

CRI 92 - 21 W DC

97342	White	W 3000 K 2240 lm	00 Diffused
--------------	-------	----------------------------	--------------------

Driver

<p>99162 ON/OFF - IP20 1 art.</p>	<p>99163 DALI - IP20 1 art.</p>	<p>99355 Kit Emergency 1 art.</p>
--	--	--

Accessories

<p>98281 Self-supporting suspension kit</p>	<p>98282 Security cable</p>	<p>98405 Support without exposed frame</p>
--	--	---

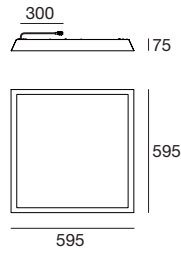

3,4 Kg
 65,1 dm³

CRI 80 - 30 W DC

95049	<input type="text" value="White"/>	W 3000 K 4293 lm	00 Diffused
		N 4000 K 4495 lm	

CRI 92 - 30 W DC

95726	<input type="text" value="White"/>	W 3000 K 3600 lm	00 Diffused
--------------	------------------------------------	----------------------------	--------------------

Driver

99093	99187	99355
ON/OFF - IP20 1 art.	DALI - IP20 1 art.	Kit Emergency 1 art.

CRI 80 - 50 W DC

95049	<input type="text" value="White"/>	W 3000 K 6811 lm	00 Diffused
		N 4000 K 7216 lm	

CRI 92 - 50 W DC

95726	<input type="text" value="White"/>	W 3000 K 5273 lm	00 Diffused
--------------	------------------------------------	----------------------------	--------------------

Driver

99092	99174	99355
ON/OFF - IP20 1 art.	DALI - IP20 1 art.	Kit Emergency 1 art.

CRI 80 - 70 W DC

95724	<input type="text" value="White"/>	W 3000 K 9152 lm	00 Diffused
		N 4000 K 10088 lm	

CRI 92 - 70 W DC

95727	<input type="text" value="White"/>	W 3000 K 8112 lm	00 Diffused
--------------	------------------------------------	----------------------------	--------------------

Driver

99099	99164	99355
ON/OFF - IP20 1 art.	DALI - IP20 1 art.	Kit Emergency 1 art.

CRI 80 - 100 W DC

96547	<input type="text" value="White"/>	W 3000 K 12909 lm	00 Diffused
		N 4000 K 13572 lm	

CRI 92 - 100 W DC

96548	<input type="text" value="White"/>	W 3000 K 8775 lm	00 Diffused
--------------	------------------------------------	----------------------------	--------------------

Driver

99101	99165	99355
ON/OFF - IP20 1 art.	DALI - IP20 1 art.	Kit Emergency 1 art.

Accessories

98281	98282	98311	98313
Self-supporting suspension kit	Security cable	Support without exposed frame	Support with visible frame

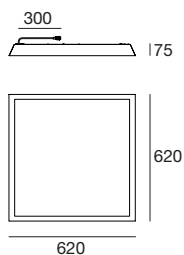

3,5 Kg 65,1 dm³

CRI 80 - 30 W DC

96421	White	W 3000 K 4293 lm	00 Diffused
		N 4000 K 4495 lm	

CRI 92 - 30 W DC

96413	White	W 3000 K 3600 lm	00 Diffused
--------------	-------	----------------------------	--------------------

Driver

99093	99187	99355
ON/OFF - IP20 1 art.	DALI - IP20 1 art.	Kit Emergency 1 art.

CRI 80 - 50 W DC

96421	White	W 3000 K 6811 lm	00 Diffused
		N 4000 K 7216 lm	

CRI 92 - 50 W DC

96413	White	W 3000 K 5273 lm	00 Diffused
--------------	-------	----------------------------	--------------------

Driver

99092	99174	99355
ON/OFF - IP20 1 art.	DALI - IP20 1 art.	Kit Emergency 1 art.

CRI 80 - 70 W DC

96422	White	W 3000 K 9152 lm	00 Diffused
		N 4000 K 10088 lm	

CRI 92 - 70 W DC

96414	White	W 3000 K 8112 lm	00 Diffused
--------------	-------	----------------------------	--------------------

Driver

99099	99164	99355
ON/OFF - IP20 1 art.	DALI - IP20 1 art.	Kit Emergency 1 art.

CRI 80 - 100 W DC

96461	White	W 3000 K 12909 lm	00 Diffused
		N 4000 K 13572 lm	

CRI 92 - 100 W DC

96726	White	W 3000 K 8775 lm	00 Diffused
--------------	-------	----------------------------	--------------------

Driver

99101	99165	99355
ON/OFF - IP20 1 art.	DALI - IP20 1 art.	Kit Emergency 1 art.

Accessories

98281	98282
Self-supporting suspension kit	Security cable

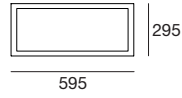
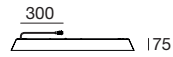

1,9 Kg 28,7 dm³

CRI 80 - 16 W DC

96462	White	W 3000 K	2285 lm	00 Diffused
		N 4000 K	2387 lm	

CRI 92 - 16 W DC

96493	White	W 3000 K	2106 lm	00 Diffused
--------------	-------	-----------------	---------	--------------------

Driver

99113 ON/OFF - IP20 1 art.	99131 DALI - IP20 1 art.	99355 Kit Emergency 1 art.

CRI 80 - 25 W DC

96462	White	W 3000 K	3143 lm	00 Diffused
		N 4000 K	3331 lm	

CRI 92 - 25 W DC

96493	White	W 3000 K	2675 lm	00 Diffused
--------------	-------	-----------------	---------	--------------------

Driver

98166 ON/OFF - IP20 1 art.	98167 DALI - IP20 1 art.	99355 Kit Emergency 1 art.

Accessories

98512 Self-supporting suspension kit	98282 Security cable	98406 Support with visible frame

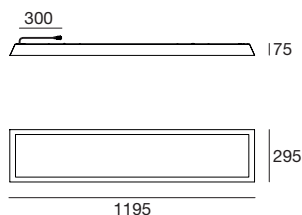

4,5 Kg 61 dm³

CRI 80 - 30 W DC

96593 White	W 3000 K 4623 lm	00 Diffused
	N 4000 K 4841 lm	

CRI 92 - 30 W DC

96595 White	W 3000 K 3887 lm	00 Diffused
---------------------------------	----------------------------	--------------------

Driver

99093 ON/OFF - IP20 1 art.	99187 DALI - IP20 1 art.	99355 Kit Emergency 1 art.
---	---------------------------------------	---

CRI 80 - 50 W DC

96593 White	W 3000 K 6406 lm	00 Diffused
	N 4000 K 7062 lm	

CRI 92 - 50 W DC

96595 White	W 3000 K 5678 lm	00 Diffused
---------------------------------	----------------------------	--------------------

Driver

99092 ON/OFF - IP20 1 art.	99174 DALI - IP20 1 art.	99355 Kit Emergency 1 art.
---	---------------------------------------	---

CRI 80 - 70 W DC

96516 White	W 3000 K 9152 lm	00 Diffused
	N 4000 K 10088 lm	

CRI 92 - 70 W DC

96518 White	W 3000 K 8112 lm	00 Diffused
---------------------------------	----------------------------	--------------------

Driver

99099 ON/OFF - IP20 1 art.	99164 DALI - IP20 1 art.	99355 Kit Emergency 1 art.
---	---------------------------------------	---

CRI 80 - 100 W DC

96517 White	W 3000 K 13621 lm	00 Diffused
	N 4000 K 14433 lm	

CRI 92 - 100 W DC

96563 White	W 3000 K 11593 lm	00 Diffused
---------------------------------	-----------------------------	--------------------



Driver

99101 ON/OFF - IP20 1 art.	99165 DALI - IP20 1 art.	99355 Kit Emergency 1 art.
---	---------------------------------------	---

Accessories

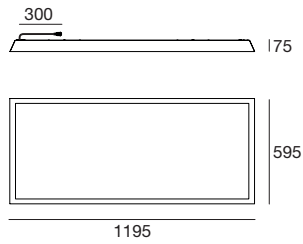
98512 Self-supporting suspension kit	98282 Security cable	98391 Support without exposed frame	98354 Support with visible frame
---	-----------------------------------	--	---



 4,5 Kg
  61 dm³

CRI 80 - 100 W DC

95725	White	W 3000 K	12909 lm	00 Diffused
		N 4000 K	13572 lm	

CRI 92 - 100 W DC

95728	White	W 3000 K	10764 lm	00 Diffused
--------------	-------	-----------------	----------	--------------------

Driver

		
99101	99165	99355
ON/OFF - IP20 1 art.	DALI - IP20 1 art.	Kit Emergency 1 art.

CRI 80 - 140 W DC - 140 W AC

96594	White	W 3000 K	18304 lm	00 Diffused
		N 4000 K	20176 lm	

CRI 92 - 140 W DC - 140 W AC

96611	White	W 3000 K	16224 lm	00 Diffused
--------------	-------	-----------------	----------	--------------------

Driver

		
98172	98173	99355
ON/OFF - IP20 1 art.	DALI - IP20 1 art.	Kit Emergency 1 art.

Accessories

		
98512	98282	98314
Self-supporting suspension kit	Security cable	Support with visible frame



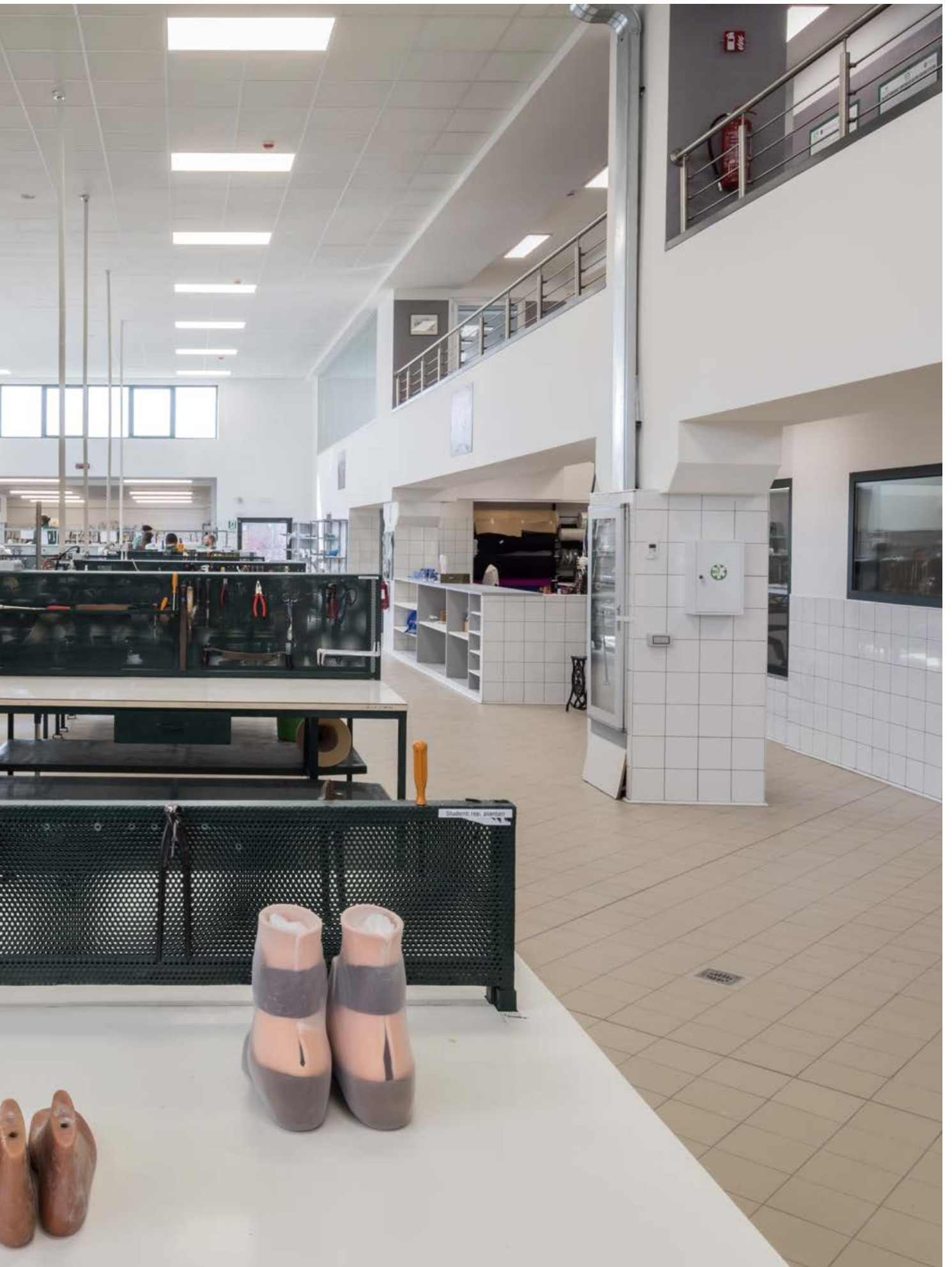

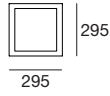
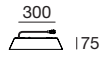

1,05 Kg
 27,5 dm³

CRI 80 - 11 W DC

96477	White	W 3000 K	1422 lm	00 Diffused
		N 4000 K	1490 lm	

CRI 92 - 11 W DC

96478	White	W 3000 K	1193 lm	00 Diffused
--------------	-------	-----------------	---------	--------------------

Driver

<p>99162 ON/OFF - IP20 1 art.</p>	<p>99163 DALI - IP20 1 art.</p>	<p>99355 Kit Emergency 1 art.</p>
--	--	--

CRI 80 - 21 W DC

97343	White	W 3000 K	2626 lm	00 Diffused
		N 4000 K	2789 lm	

CRI 92 - 21 W DC

97344	White	W 3000 K	2240 lm	00 Diffused
--------------	-------	-----------------	---------	--------------------

Driver

<p>99162 ON/OFF - IP20 1 art.</p>	<p>99163 DALI - IP20 1 art.</p>	<p>99355 Kit Emergency 1 art.</p>
--	--	--

Accessories

<p>98512 Self-supporting suspension kit</p>	<p>98282 Security cable</p>	<p>98405 Support without exposed frame</p>
--	--	---

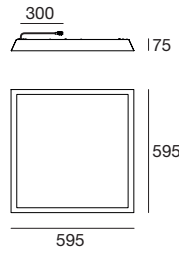

3,4 Kg
 65,1 dm³

CRI 80 - 30 W DC

95729	White	W 3000 K	4293 lm	00 Diffused
		N 4000 K	4495 lm	

CRI 92 - 30 W DC

95736	White	W 3000 K	3600 lm	00 Diffused
--------------	-------	-----------------	---------	--------------------

Driver

99093	99187	99355
ON/OFF - IP20 1 art.	DALI - IP20 1 art.	Kit Emergency 1 art.

CRI 80 - 50 W DC

95729	White	W 3000 K	6811 lm	00 Diffused
		N 4000 K	7216 lm	

CRI 92 - 50 W DC

95736	White	W 3000 K	5273 lm	00 Diffused
--------------	-------	-----------------	---------	--------------------

Driver

99093	99187	99355
ON/OFF - IP20 1 art.	DALI - IP20 1 art.	Kit Emergency 1 art.

Accessories

98512	98282	98311	98313
Self-supporting suspension kit	Security cable	Support without exposed frame	Support with visible frame

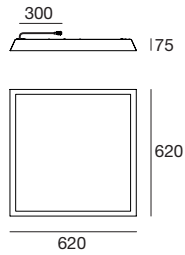

3,5 Kg 65,1 dm³

CRI 80 - 30 W DC

96423	White	W 3000 K	4293 lm	00 Diffused
		N 4000 K	4495 lm	

CRI 92 - 30 W DC

96415	White	W 3000 K	3600 lm	00 Diffused
--------------	-------	-----------------	---------	--------------------

Driver

99093	99187	99355
ON/OFF - IP20 1 art.	DALI - IP20 1 art.	Kit Emergency 1 art.

CRI 80 - 50 W DC

96423	White	W 3000 K	6811 lm	00 Diffused
		N 4000 K	7216 lm	

CRI 92 - 50 W DC

96415	White	W 3000 K	5273 lm	00 Diffused
--------------	-------	-----------------	---------	--------------------

Driver

99092	99174	99355
ON/OFF - IP20 1 art.	DALI - IP20 1 art.	Kit Emergency 1 art.

Accessories

98512	98282
Self-supporting suspension kit	Security cable

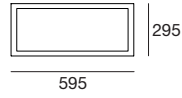
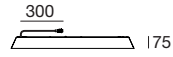

1,9 Kg
 28,7 dm³

CRI 80 - 16 W DC

96494	White	W 3000 K	2285 lm	00 Diffused
		N 4000 K	2387 lm	

CRI 92 - 16 W DC

96495	White	W 3000 K	2106 lm	00 Diffused
--------------	-------	-----------------	---------	--------------------

Driver

<p>99113 ON/OFF - IP20 1 art.</p>	<p>99131 DALI - IP20 1 art.</p>	<p>99355 Kit Emergency 1 art.</p>
--	--	--

CRI 80 - 25 W DC

96494	White	W 3000 K	3143 lm	00 Diffused
		N 4000 K	3331 lm	

CRI 92 - 25 W DC

96495	White	W 3000 K	2675 lm	00 Diffused
--------------	-------	-----------------	---------	--------------------

Driver

<p>98166 ON/OFF - IP20 1 art.</p>	<p>98167 DALI - IP20 1 art.</p>	<p>99355 Kit Emergency 1 art.</p>
--	--	--

Accessories

<p>98512 Self-supporting suspension kit</p>	<p>98282 Security cable</p>	<p>98406 Support with visible frame</p>
--	--	--

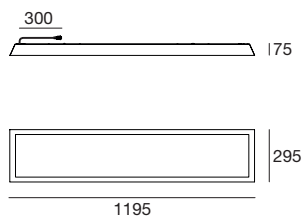

4,5 Kg
 61 dm³

CRI 80 - 30 W DC

96596	White	W 3000 K	4623 lm	00 Diffused
		N 4000 K	4841 lm	

CRI 92 - 30 W DC

96598	White	W 3000 K	3887 lm	00 Diffused
--------------	-------	-----------------	---------	--------------------

Driver

99093	99187	99355
ON/OFF - IP20 1 art.	DALI - IP20 1 art.	Kit Emergency 1 art.

CRI 80 - 50 W DC

96596	White	W 3000 K	6406 lm	00 Diffused
		N 4000 K	7062 lm	

CRI 92 - 50 W DC

96598	White	W 3000 K	5678 lm	00 Diffused
--------------	-------	-----------------	---------	--------------------

Driver

99092	99174	99355
ON/OFF - IP20 1 art.	DALI - IP20 1 art.	Kit Emergency 1 art.

Accessories

98512	98282	98391	98354
Self-supporting suspension kit	Security cable	Support without exposed frame	Support with visible frame



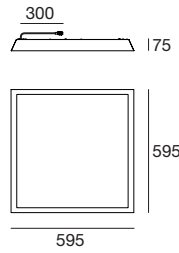

3,4 Kg
 65,1 dm³

CRI 80 - 30 W DC

95739	White	W 3000 K	4293 lm	00 Diffused
		N 4000 K	4495 lm	

CRI 92 - 30 W DC

95741	White	W 3000 K	3600 lm	00 Diffused
--------------	-------	-----------------	---------	--------------------

Driver

99093	99187	99355
ON/OFF - IP20 1 art.	DALI - IP20 1 art.	Kit Emergency 1 art.

CRI 80 - 50 W DC

95739	White	W 3000 K	6811 lm	00 Diffused
		N 4000 K	7216 lm	

CRI 92 - 50 W DC

95741	White	W 3000 K	5273 lm	00 Diffused
--------------	-------	-----------------	---------	--------------------

Driver

99092	99174	99355
ON/OFF - IP20 1 art.	DALI - IP20 1 art.	Kit Emergency 1 art.

CRI 80 - 70 W DC

95740	White	W 3000 K	9152 lm	00 Diffused
		N 4000 K	10088 lm	

CRI 92 - 70 W DC

95742	White	W 3000 K	8112 lm	00 Diffused
--------------	-------	-----------------	---------	--------------------

Driver

99099	99164	99355
ON/OFF - IP20 1 art.	DALI - IP20 1 art.	Kit Emergency 1 art.

CRI 80 - 100 W DC

96512	White	W 3000 K	12909 lm	00 Diffused
		N 4000 K	13572 lm	

CRI 92 - 100 W DC

96513	White	W 3000 K	8775 lm	00 Diffused
--------------	-------	-----------------	---------	--------------------

Driver

99101	99165	99355
ON/OFF - IP20 1 art.	DALI - IP20 1 art.	Kit Emergency 1 art.

Accessories

98512	98282	98311	98313
Self-supporting suspension kit	Security cable	Support without exposed frame	Support with visible frame

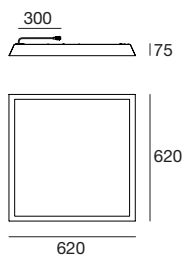

3,5 Kg 65,1 dm³

CRI 80 - 30 W DC

96417	White	W 3000 K 4293 lm	00 Diffused
		N 4000 K 4495 lm	

CRI 92 - 30 W DC

96425	White	W 3000 K 3600 lm	00 Diffused
--------------	-------	----------------------------	--------------------

Driver

99093	99187	99355
ON/OFF - IP20 1 art.	DALI - IP20 1 art.	Kit Emergency 1 art.

CRI 80 - 50 W DC

96417	White	W 3000 K 6811 lm	00 Diffused
		N 4000 K 7216 lm	

CRI 92 - 50 W DC

96425	White	W 3000 K 5273 lm	00 Diffused
--------------	-------	----------------------------	--------------------

Driver

99092	99174	99355
ON/OFF - IP20 1 art.	DALI - IP20 1 art.	Kit Emergency 1 art.

CRI 80 - 70 W DC

96418	White	W 3000 K 9152 lm	00 Diffused
		N 4000 K 10088 lm	

CRI 92 - 70 W DC

96426	White	W 3000 K 8112 lm	00 Diffused
--------------	-------	----------------------------	--------------------

Driver

99099	99164	99355
ON/OFF - IP20 1 art.	DALI - IP20 1 art.	Kit Emergency 1 art.

CRI 80 - 100 W DC

96514	White	W 3000 K 12909 lm	00 Diffused
		N 4000 K 13572 lm	

CRI 92 - 100 W DC

96515	White	W 3000 K 8775 lm	00 Diffused
--------------	-------	----------------------------	--------------------

Driver

99101	99165	99355
ON/OFF - IP20 1 art.	DALI - IP20 1 art.	Kit Emergency 1 art.

Accessories

98512	98282
Self-supporting suspension kit	Security cable

Accessory | Support for installation with exposed frame



Aluminium support frame with embossed white finish, for exposed installation. Accessory suitable for installation of: Edith Modular Ceiling 595x595mm, 595x295mm, 1195x295mm and 1195x595mm.

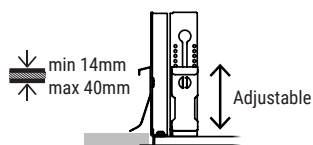

Adjustable based on the thickness of the plasterboard which must be at least 14 mm thick and no thicker than 40 mm.

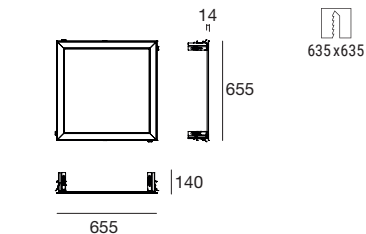

code	size	suitable for
98313	655mm x 655mm	Edith_Modular ceiling 595 x 595mm Edith_Full-Light 595 x 595mm

Kg 1 Kg
Vol 29,3 dm³

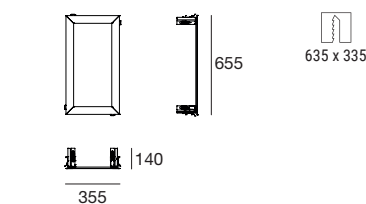

code	size	suitable for
98406	607mm x 302mm	Edith_Modular ceiling 595 x 295mm

Kg 0,9 Kg
Vol 18,8 dm³

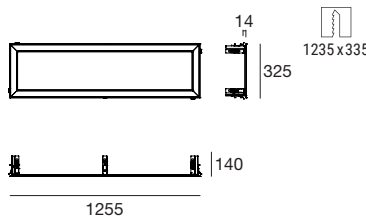

code	size	suitable for
98354	1258mm x 328mm	Edith_Modular ceiling 1195 x 295mm

Kg 1,5 Kg
Vol 29,3 dm³

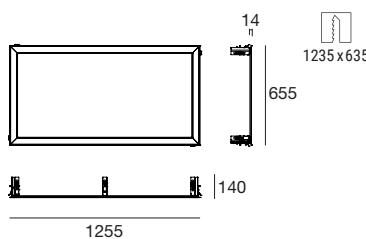

code	size	suitable for
98314	1258mm x 658mm	Edith_Modular ceiling 1195 x 595mm

Kg 1,6 Kg
Vol 58,6 dm³

Accessory | Support for flush installation with exposed frame



Galvanised calendered metal support frame, for flushed installation with a quick-coupling mounting system. Accessory suitable for installation of:
Edith Modular Ceiling 295x295mm, 595x595mm, 595x295mm, 1195x295mm e 1195x595mm and Edith Full-light 595x595mm.

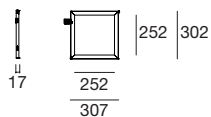

code	size	suitable for
98405	307mm x 302mm	Edith_Modular ceiling 295 x 295mm

Kg 0,22 Kg **Vol** 19,5 dm³

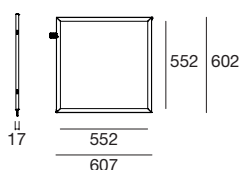

code	size	suitable for
98311	607mm x 602mm	Edith_Modular ceiling 595 x 595mm Edith_Full-Light 595 x 595mm

Kg 0,57 Kg **Vol** 47,2 dm³

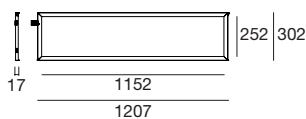

code	size	suitable for
98391	1207mm x 302mm	Edith_Modular ceiling 1195 x 295mm

Kg 0,57 Kg **Vol** 47,2 dm³

Accessory | Double cable self-supporting kit

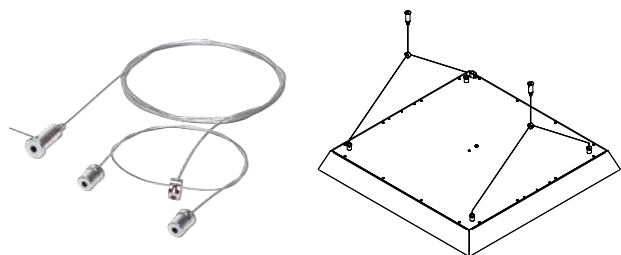

code	size	suitable for
98281	2500 mm	Edith_Modular ceiling

Self-supporting safety kit for suspension in the false ceiling made up of a pair of 2.5 m long steel cords and a ceiling fixing system with cable lock and safety sleeve, for simple and quick installation height adjustment.

Accessory | Single cable self-supporting kit

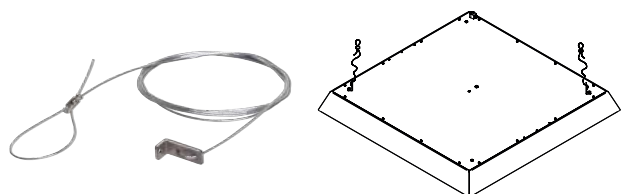

code	size	suitable for
98282	2500 mm	Edith_Modular ceiling Edith_Full-Light

2.5-metre long steel safety cord with fixing bracket. It is recommended to apply at least two cords on the upper part between opposite corners of the ceiling lamp.

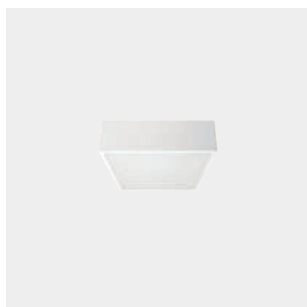

101

295
295

1,9 Kg 27,5 dm³

CRI 80 - 11 W DC

96479 White	W 3000 K 1422 lm	00 Diffused
	N 4000 K 1490 lm	

CRI 92 - 11 W DC

96480 White	W 3000 K 1193 lm	00 Diffused
---------------------------------	-------------------------	--------------------

CRI 80 - 21 W DC

97345 White	W 3000 K 2626 lm	00 Diffused
	N 4000 K 2789 lm	

CRI 92 - 21 W DC

97346 White	W 3000 K 2240 lm	00 Diffused
---------------------------------	-------------------------	--------------------

Driver

 99162 ON/OFF - IP20 1 art.	 99163 DALI - IP20 1 art.	 99355 Kit Emergency 1 art.
--	---	--

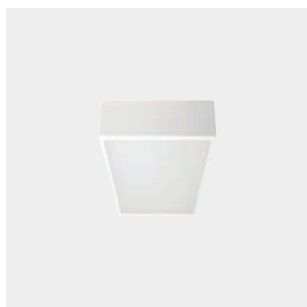

112

295
595

3,2 Kg 28,7 dm³

CRI 80 - 16 W DC

96500 White	W 3000 K 2285 lm	00 Diffused
	N 4000 K 2387 lm	

CRI 92 - 16 W DC

96501 White	W 3000 K 2106 lm	00 Diffused
---------------------------------	-------------------------	--------------------

Driver

 99113 ON/OFF - IP20 1 art.	 99131 DALI - IP20 1 art.	 99355 Kit Emergency 1 art.
--	---	--

CRI 80 - 25 W DC

96500 White	W 3000 K 3143 lm	00 Diffused
	N 4000 K 3331 lm	

CRI 92 - 25 W DC

96501 White	W 3000 K 2675 lm	00 Diffused
---------------------------------	-------------------------	--------------------

Driver

 98166 ON/OFF - IP20 1 art.	 98167 DALI - IP20 1 art.	 99355 Kit Emergency 1 art.
--	---	--

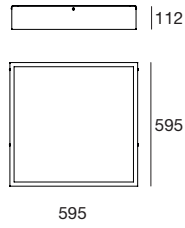

5,5 Kg
 65,1 dm³

CRI 80 - 30 W DC

96471	White	W 3000 K	4293 lm	00 Diffused
		N 4000 K	4495 lm	

CRI 92 - 30 W DC

96472	White	W 3000 K	3600 lm	00 Diffused
--------------	-------	-----------------	---------	--------------------

Driver

99093	99187	99355
ON/OFF - IP20 1 art.	DALI - IP20 1 art.	Kit Emergency 1 art.

CRI 80 - 50 W DC

96471	White	W 3000 K	6811 lm	00 Diffused
		N 4000 K	7216 lm	

CRI 92 - 50 W DC

96472	White	W 3000 K	5273 lm	00 Diffused
--------------	-------	-----------------	---------	--------------------

Driver

99092	99174	99355
ON/OFF - IP20 1 art.	DALI - IP20 1 art.	Kit Emergency 1 art.

CRI 80

96357	White	W 3000 K	9152 lm	00 Diffused
		N 4000 K	10088 lm	

CRI 92

96466	White	W 3000 K	8112 lm	00 Diffused
--------------	-------	-----------------	---------	--------------------

Driver

99099	99164	99355
ON/OFF - IP20 1 art.	DALI - IP20 1 art.	Kit Emergency 1 art.

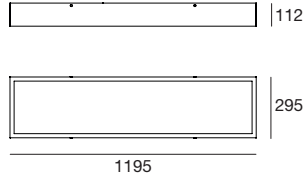

 7 Kg
  65 dm³

CRI 80 - 30 W DC

96568	White	W 3000 K 4623 lm	00 Diffused
		N 4000 K 4841 lm	

CRI 92 - 30 W DC

96570	White	W 3000 K 3887 lm	00 Diffused
--------------	-------	-------------------------	--------------------

Driver

		
99093	99187	99355
ON/OFF - IP20 1 art.	DALI - IP20 1 art.	Kit Emergency 1 art.

CRI 80 - 50 W DC

96568	White	W 3000 K 6406 lm	00 Diffused
		N 4000 K 7062 lm	

CRI 92 - 50 W DC

96570	White	W 3000 K 5678 lm	00 Diffused
--------------	-------	-------------------------	--------------------

Driver

		
99092	99174	99355
ON/OFF - IP20 1 art.	DALI - IP20 1 art.	Kit Emergency 1 art.

CRI 80 - 70 W DC

96569	White	W 3000 K 9152 lm	00 Diffused
		N 4000 K 10088 lm	

CRI 92 - 70 W DC

96571	White	W 3000 K 8112 lm	00 Diffused
--------------	-------	-------------------------	--------------------

Driver

		
99099	99164	99355
ON/OFF - IP20 1 art.	DALI - IP20 1 art.	Kit Emergency 1 art.

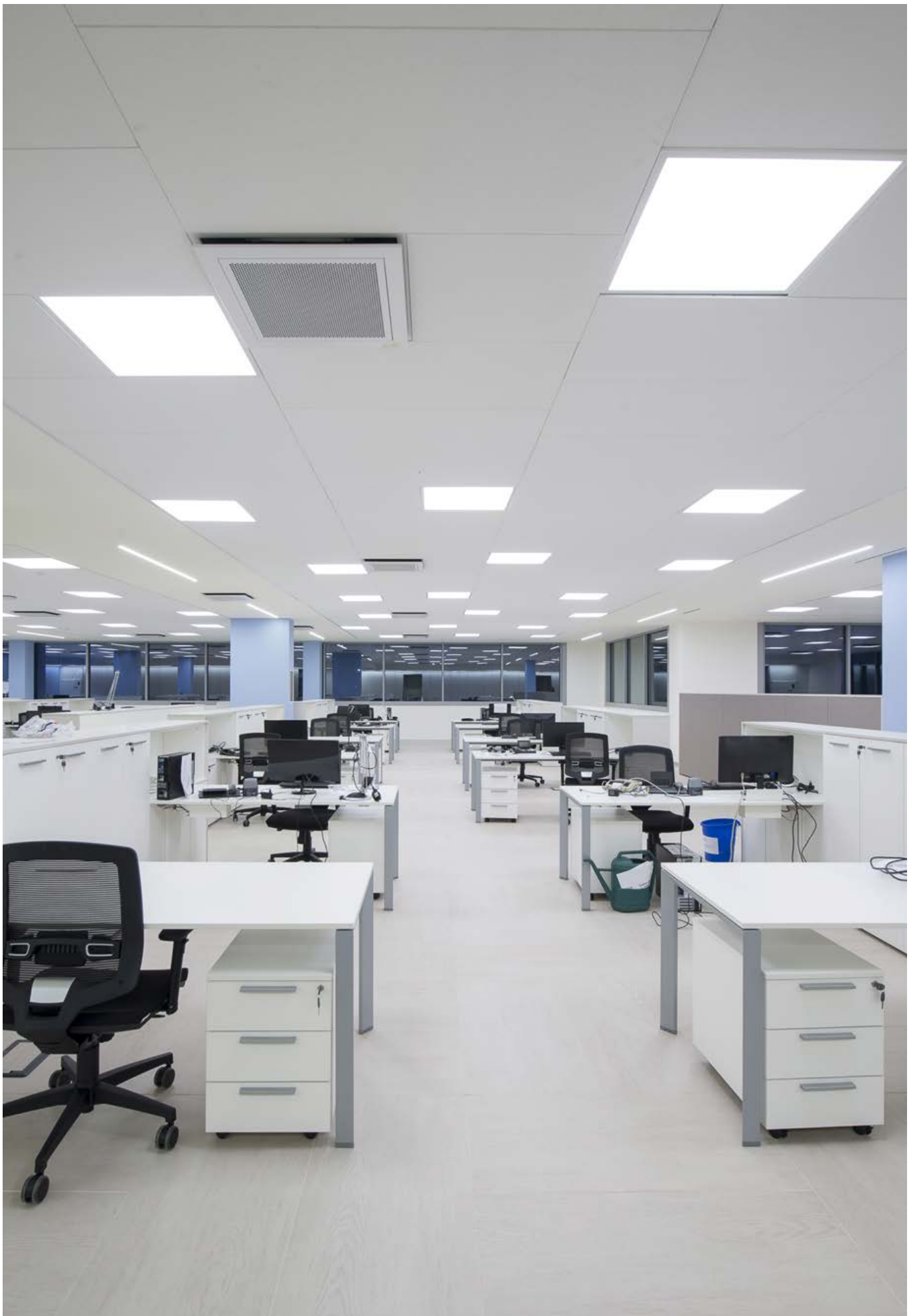

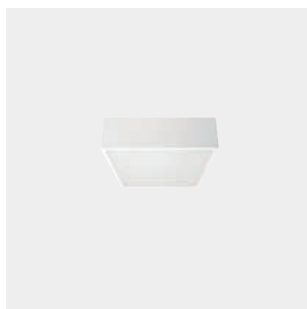

101

295
295



1,9 Kg 27,5 dm³

CRI 80 - 11 W DC

96490 White	W 3000 K 1422 lm	00 Diffused
	N 4000 K 1490 lm	

CRI 92 - 11 W DC

96491 White	W 3000 K 1193 lm	00 Diffused
---------------------------------	-------------------------	--------------------

CRI 80 - 21 W DC

97347 White	W 3000 K 2626 lm	00 Diffused
	N 4000 K 2789 lm	

CRI 92 - 21 W DC

97348 White	W 3000 K 2240 lm	00 Diffused
---------------------------------	-------------------------	--------------------

Driver

 99162 ON/OFF - IP20 1 art.	 99163 DALI - IP20 1 art.	 99355 Kit Emergency 1 art.
--	---	--



112

595
595



5,5 Kg 65,1 dm³

CRI 80 - 30 W DC

96473 White	W 3000 K 4293 lm	00 Diffused
	N 4000 K 4495 lm	

CRI 92 - 30 W DC

96474 White	W 3000 K 3600 lm	00 Diffused
---------------------------------	-------------------------	--------------------

Driver

 99093 ON/OFF - IP20 1 art.	 99187 DALI - IP20 1 art.	 99355 Kit Emergency 1 art.
--	---	--

CRI 80 - 50 W DC

96473 White	W 3000 K 6811 lm	00 Diffused
	N 4000 K 7216 lm	

CRI 92 - 50 W DC

96474 White	W 3000 K 5273 lm	00 Diffused
---------------------------------	-------------------------	--------------------

Driver

 99092 ON/OFF - IP20 1 art.	 99174 DALI - IP20 1 art.	 99355 Kit Emergency 1 art.
--	---	--

Edith Surface Comfort | General lighting | topLED | 595mm x 295mm

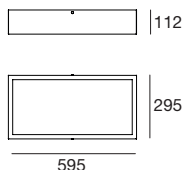
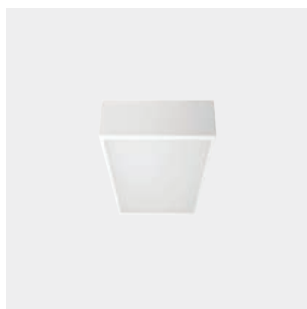

3,2 Kg 28,7 dm³

CRI 80 - 16 W DC

96502 White	W 3000 K 2285 lm	00 Diffused
	N 4000 K 2387 lm	

CRI 92 - 16 W DC

96481 White	W 3000 K 2106 lm	00 Diffused
---------------------------------	-------------------------	--------------------

Driver

99113 ON/OFF - IP20 1 art.	99131 DALI - IP20 1 art.	99355 Kit Emergency 1 art.
---	---------------------------------------	---

CRI 80 - 25 W DC

96502 White	W 3000 K 3143 lm	00 Diffused
	N 4000 K 3331 lm	

CRI 92 - 25 W DC

96481 White	W 3000 K 2675 lm	00 Diffused
---------------------------------	-------------------------	--------------------

Driver

98166 ON/OFF - IP20 1 art.	98167 DALI - IP20 1 art.	99355 Kit Emergency 1 art.
---	---------------------------------------	---

Edith Surface Comfort | General lighting | topLED | 1195mm x 295mm

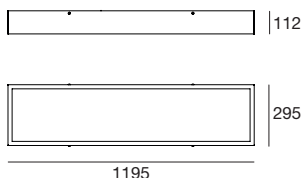

7 Kg 65 dm³

CRI 80 - 30 W DC

96572 White	W 3000 K 4623 lm	00 Diffused
	N 4000 K 4841 lm	

CRI 92 - 30 W DC

96574 White	W 3000 K 3887 lm	00 Diffused
---------------------------------	-------------------------	--------------------

Driver

99093 ON/OFF - IP20 1 art.	99187 DALI - IP20 1 art.	99355 Kit Emergency 1 art.
---	---------------------------------------	---

CRI 80 - 50 W DC

96572 White	W 3000 K 6406 lm	00 Diffused
	N 4000 K 7062 lm	

CRI 92 - 50 W DC

96574 White	W 3000 K 5678 lm	00 Diffused
---------------------------------	-------------------------	--------------------

Driver

99092 ON/OFF - IP20 1 art.	99174 DALI - IP20 1 art.	99355 Kit Emergency 1 art.
---	---------------------------------------	---

Edith Recessed Standard | General lighting | topLED | 308mm x 308mm

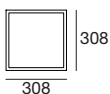

Kg
1,10 Kg

Vol
27,5 dm³

CRI 80 - 11 W DC

96535	White	W 3000 K	1422 lm	00 Diffused
		N 4000 K	1490 lm	

CRI 92 - 11 W DC

96536	White	W 3000 K	1193 lm	00 Diffused
--------------	-------	-----------------	---------	--------------------

CRI 80 - 21 W DC

97349	White	W 3000 K	2626 lm	00 Diffused
		N 4000 K	2789 lm	

CRI 92 - 21 W DC

97350	White	W 3000 K	2240 lm	00 Diffused
--------------	-------	-----------------	---------	--------------------

Driver



99162
ON/OFF - IP20
1 art.



99163
DALI - IP20
1 art.



99355
Kit Emergency
1 art.

Edith Recessed Comfort | General lighting | topLED | 308mm x 308mm

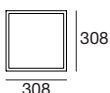
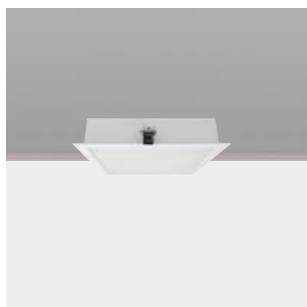

Kg
1,10 Kg

Vol
27,5 dm³

CRI 80 - 11 W DC

96537	White	W 3000 K	1422 lm	00 Diffused
		N 4000 K	1490 lm	

CRI 92 - 11 W DC

96538	White	W 3000 K	1193 lm	00 Diffused
--------------	-------	-----------------	---------	--------------------

CRI 80 - 21 W DC

97351	White	W 3000 K	2626 lm	00 Diffused
		N 4000 K	2789 lm	

CRI 92 - 21 W DC

97352	White	W 3000 K	2240 lm	00 Diffused
--------------	-------	-----------------	---------	--------------------

Driver



99162
ON/OFF - IP20
1 art.



99163
DALI - IP20
1 art.



99355
Kit Emergency
1 art.



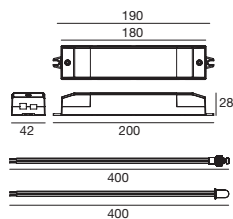

Switchable (on/off) in the presence of mains via switch on SL input (switched line). Automatic reset following battery and/or LED lamp replacement. Electronic multi-level charging system. Supplied with 3,000 mAh battery pack.

range	output	input	eff.	PF	surge
99355 Universal	6-60V 40-400mA	220~240V AC	86%	0.5	4 kV
Frequency	50-60 Hz				
Nominal input current	40 mA (30 A inrush current with cold start)				
Output voltage (without load)	6-60V				
TA Operating temperature	-25 +50 °C				
Max casing temperature TC	70 °C				
Control interface	Switch Line, Rest mode				
Protections	Overtemperature, overload, overvoltage, short-circuit, open circuit				
Charge current	200 mA				
Emergency output current	400-40 mA				
Emergency power	2,4W				
Emergency output current	20 h				
Reference norms	EN 55015 (+A1+A2), EN 61000-3-3 (+A1), EN 61000-3-2 (+A2), EN 61547 (+A1), EN60598-2-22, EN61951-2, CEI EN 61347-1, CEI EN 61347-2-13, CEI EN 50366				

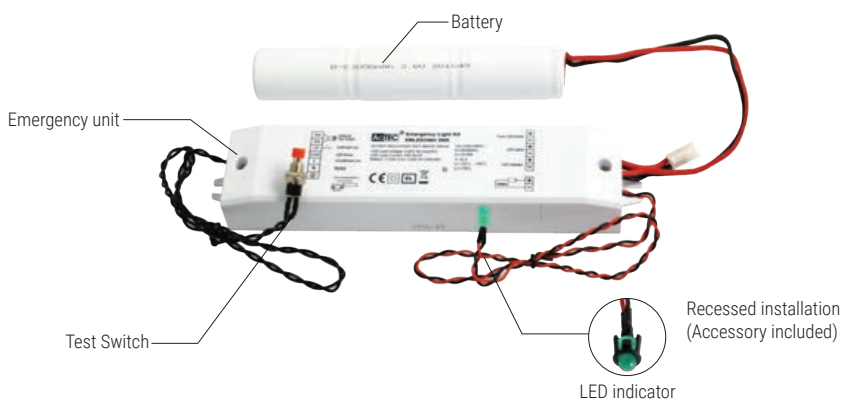

Unswitch Switch

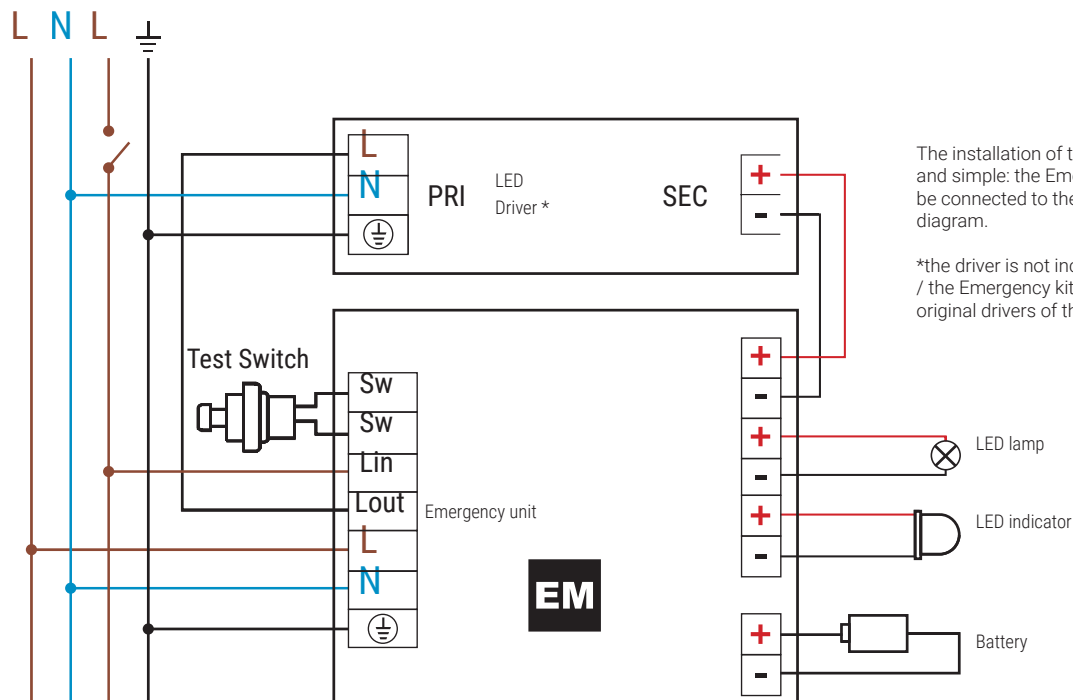

The installation of the emergency kit is quick and simple: the Emergency unit only needs to be connected to the LED driver as shown in the diagram.

*the driver is not included in the Emergency kit / the Emergency kit can be connected to all the original drivers of the LED fixture

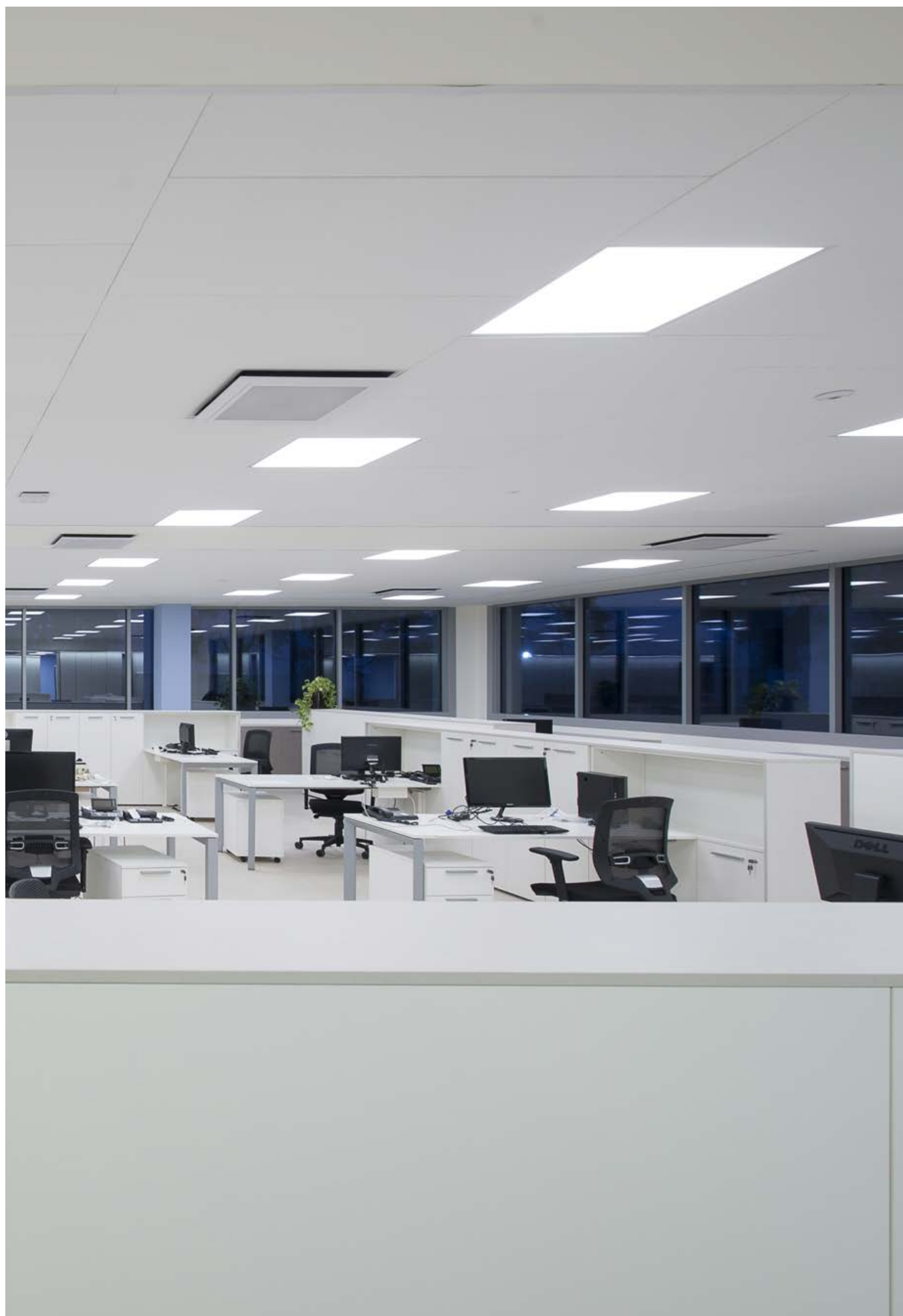

Emy

Light fixture for modular false ceiling with body in white painted aluminium and microprismatic PMMA diffuser that guarantees outstanding visual comfort thanks to the low glare index, $UGR < 19$. Circuits with TOP LEDs arranged in matrix are positioned inside in order to obtain a uniform diffused effect over the entire surface, light characterised by a high chromatic yield index, $CRI > 90$. Surface installation on the modular false ceiling frame, driver included with 300 mm long cable and "Easy-Plug" connector for quick installation.

Materials

Aluminium body

Diffuser in microprismatic PMMA

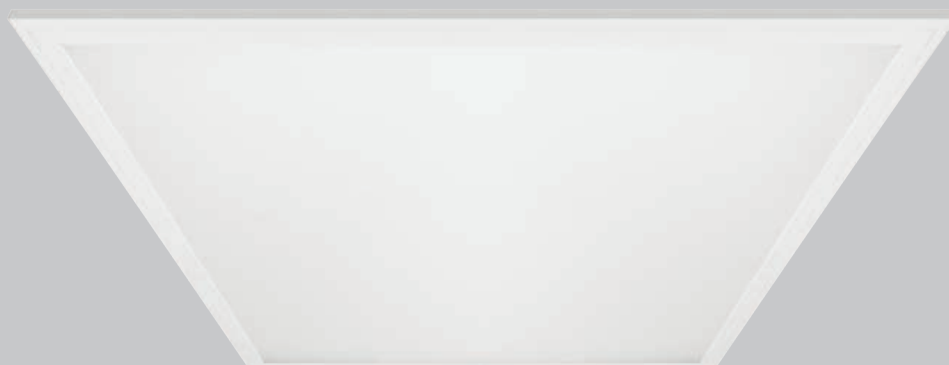



Construction details

Extra thin lamp body, just 9 mm thick. Thanks to the diffuser's particular microprisms, lighting is bright and comfortable with a high chromatic yield index, CRI90. Glare is reduced, UGR<19.



IK08 IP20

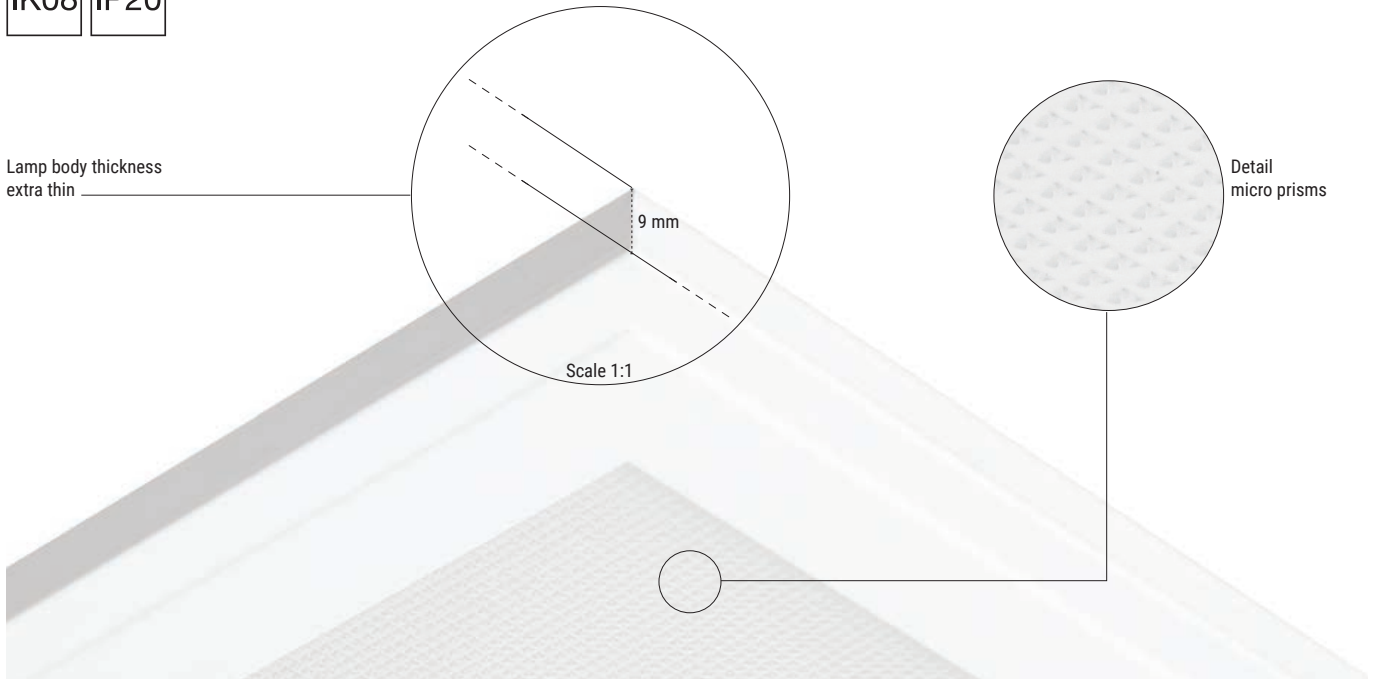

Quick installation

Lamp body in white painted aluminium with minimum bulk and practical installation. The Driver is included in the item with cable and "Easy Plug" quick connector. Simple connection in two quick points.

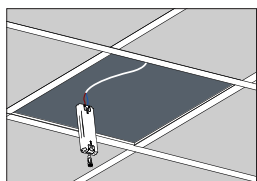

1 Connection of the Driver to the electrical mains.

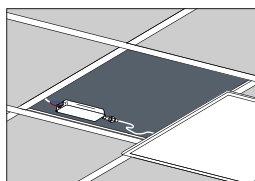

2 Driver-Emy connection using quick connector "Easy Plug".

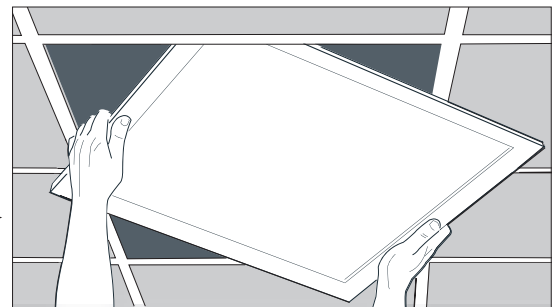

Surface installation on the modular false ceiling frame

Surface or hanging installation

Frame accessory available on request for surface installation, whereas for hanging installation, the specific kit is available with appropriate hooks and cables.

Surface Installation



Hanging installation

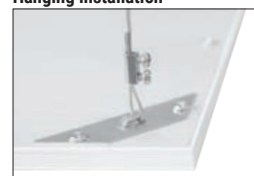

Cables + hooks kit 4x

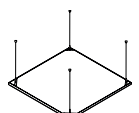

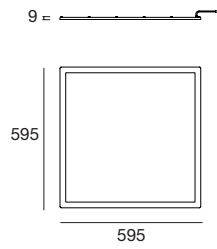

Kg
2,5 Kg

Vol
13 dm³

CRI 90 - 40 W DC - 43 W AC

83525	White	W 3000 K	3700 lm	00 Diffused
		N 4000 K	4000 lm	

CRI 90 - 40 W DC - 43 W AC

83529	White	W 3000 K	3700 lm	00 Diffused
		N 4000 K	4000 lm	

Accessories / Driver

- 
99556
 Frame for surface installation
- 
99584
 Kit for hanging installation
- 
99355
 Emergency Kit
 1 Art.

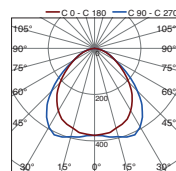

Diffused light emission



The photometric curves are available at www.linealight.com. On request, we carry out technical lighting calculations to determine the number of items that will be satisfactory in order to guarantee the required lighting needs.

Indy

Light fixture for modular false ceiling with body in white painted steel. The LED modules project the light beam toward the acrylic diffuser that features a particular pattern photo-inscribed with laser technology which projects the light onto the highly reflective white metallic surface, completely reducing glare and ensuring high comfort.

Materials

Steel body

Diffuser in PMMA



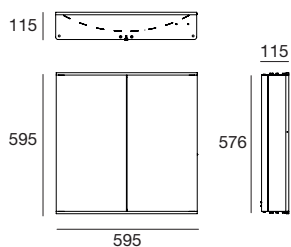

CRI 80

92426	White	W 3000 K	4240 lm	00 Diffused
92427	White	N 4000 K	4392 lm	

3,45 Kg
 65,1 dm³

Circular micro incisions

The circular micro incisions laser cut with absolute perfection make the light shine in the desired points. This new technology lets you always have reduced brightness in order to prevent glare.

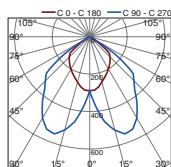
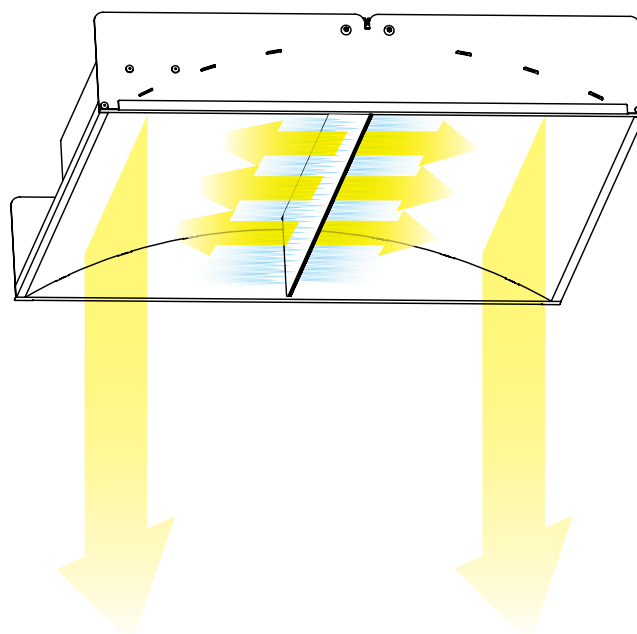
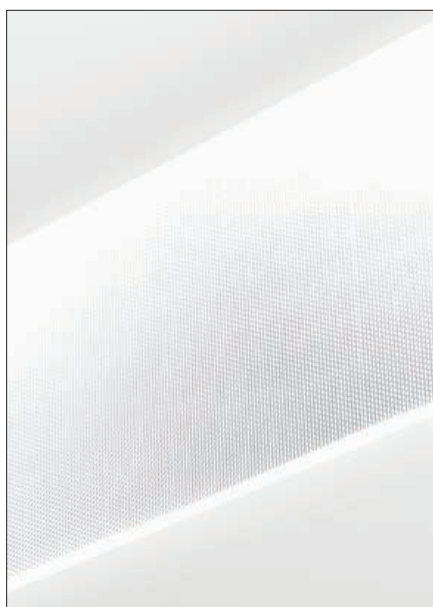

Diffused indirect brightness emission

Street & Urban lighting



Parker

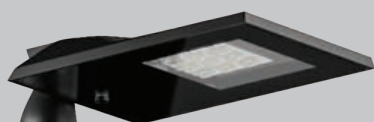

Mini Parker

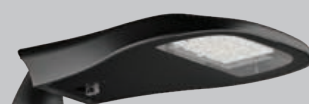

Mini Ledweg



Fabula



Drop



Enterprise



Voyager



Fosten

Street & urban lighting solutions

Street lighting

Street lighting is regulated by standards which define the technical lighting category based on the type of street, vehicle traffic, the presence of pedestrians and dangerous intersections to ensure correct lighting and maximum safety for people.

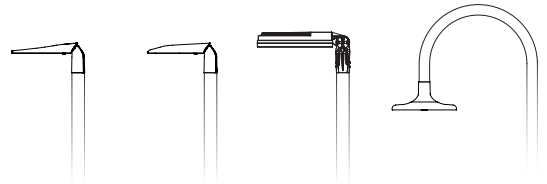

TYPES OF STREETS

- Urban highways
- Urban streets
- Rural streets
- Pedestrian crossings
- Tunnels

Safety and savings

LineaLight lamp post heads have been designed in such a way so as to limit energy waste and undesired phenomena such as debilitating glare and light pollution.

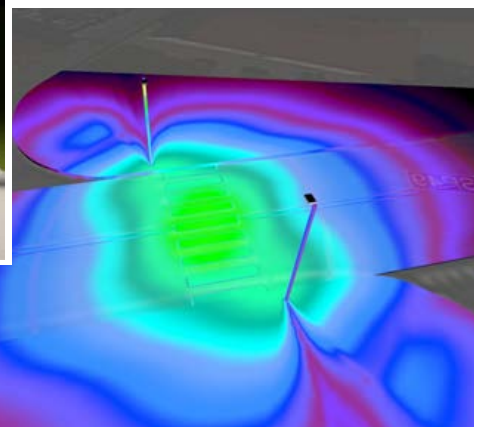
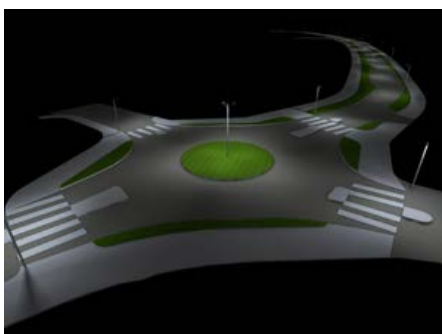

We conduct street simulations where we do precision checks on how to best meet the technical lighting needs.

Urban décor

Urban décor lighting is the result of a careful study that integrates aesthetic and practical aspects with the use of the city for the purpose of increasing the quality of public spaces. Adequate urban lighting plays a fundamental role in the usability of the city and the suburbs.

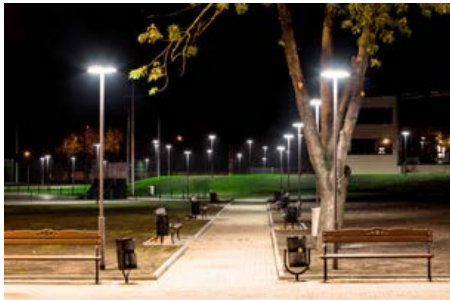
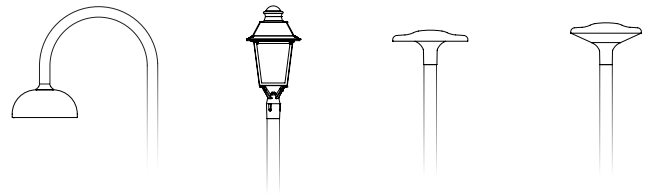

TYPES OF URBAN AREAS

- Public parks
- Historic centres
- Car parks
- Pedestrian walkways
- Squares

Colour temperature

There are 4 different LED colour temperatures available: Warm white 3000K, Natural white 4000K, Cold white 5000K and Ancient white 2200K.

With colour temperature "Ancient White 2200K", the visual perception of the environment is similar to the perception provided by traditional sodium vapour light sources, but with all the advantages and the great potential of the LEDs.

C COLD WHITE 5000K

N NATURAL WHITE 4000K

W WARM WHITE 3000K

A ANCIENT WHITE 2200K

new

Relamping:
 • high chromatic yield >80
 • > light quality

SODIUM VAPOUR 1800K



Lamp post head technologies

Internal components

The Linea Light lamp post heads are conceived to ensure maximum efficiency and lifespan. The internal components and their positioning are the result of painstaking studies and tests of the materials used and their assembly.

RAL7016

RAL7035

Fixtures made entirely in ENAB-46100 aluminium alloy textured RAL7016 / RAL7035 powder coated and UV ray stabilised. On request an electrochemical open-pore anodising pretreatment is carried out on the base alloy which guarantees outstanding corrosion resistance.



ESD



OVP

ESD ELECTROSTATIC DISCHARGE PROTECTIONS:

driver with standard integrated protection against electrostatic discharges (up to $\pm 30\text{kV}$); the CEI EN61547 standard indicates the minimum protection values against electrostatic discharges: $\pm 4\text{kV}$ for contact discharge and $\pm 8\text{kV}$ for discharge into the air.

OVP OVERVOLTAGE PROTECTION:

driver with standard protection against overvoltage (up to 10kV). Integrated protection in all lamp post heads.

Aluminium LED circuit with high heat dissipation capacity.

Optics made in PMMA with high resistance to high temperatures and UV rays.

Resistant protective screen with 4 mm thick tempered and silkscreen glass.

TCS® valve system for transpiration inside the lamp body.



Transpiration Control System TCS®

The technology of the valve with TCS® system permits transpiration from the inside toward the outside of the lamp body. In climate conditions that are favourable to the formation of humidity and condensation on the internal surface of the glass, the TCS® valve prevents formation, ensuring maximum cleanliness of the emitting surface, thereby guaranteeing correct operation even in adverse conditions.



TCS® Valve

Characteristics

- Transpiration by means of membrane
- Unresponsive to chemical agents
- Resistant to UV rays
- There are no dispersions
- Resistant to high temperatures

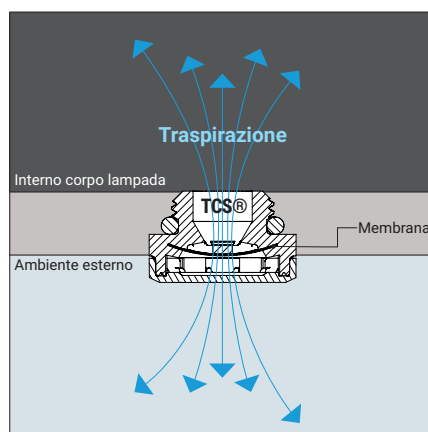

Functional design

Shapes and sizes of the lamp post heads are different depending on the model or the version. Nevertheless, they have smooth surfaces and attractive shapes in common, characteristics that allow the accumulation of dirt or debris to be avoided, reducing any maintenance operations.

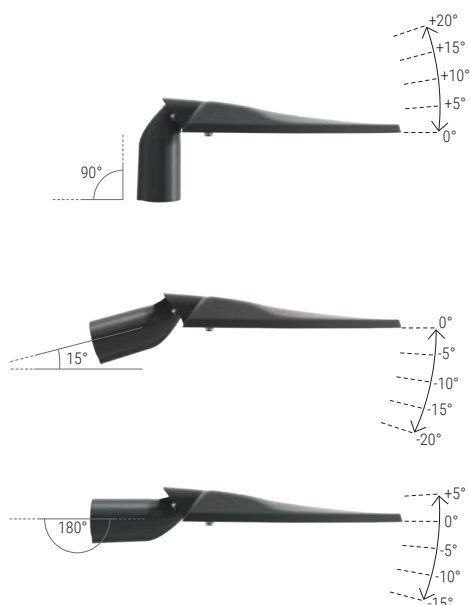

Pedestrian crossing system



Lighting for pedestrian crossings

The EN 13201-2:2003 and the national guidelines recommend additional local and specific lighting of pedestrian crossings to guarantee an effective contrast of the pedestrian on the street surface. As drivers approach the pedestrian crossing, they must be able to distinguish a pedestrian clearly without any glare. The lighting on the vertical plane must be significantly greater than on the horizontal plane. ERAL has designed a compliant, efficient and high performance solution thanks to the use of LED combined with specifically designed asymmetrical optics. The lamp post heads with P.C. (pedestrian crossing) optics system are the perfect solution for lighting pedestrian crossings.



Safety, efficiency, comfort

One out of every four fatal car accidents in which pedestrians are involved takes place on pedestrian crossings. A recent study conducted in Europe showed that one crossing out of five is not safely lit. Obviously, better and compliant lighting could prevent many accidents.

Linea Light, using technical know-how accumulated over many years of experience, presents a range of fixtures designed specifically for correct lighting of pedestrian crossings thanks to the use of highly efficient LEDs combined with special optics. Performance, efficiency and visual comfort are the main characteristics of our light fixtures.

The P.C. optics system directs the light toward the centre of the pedestrian crossing (zone A) and toward the area that surrounds the zebra stripes (zone B), thereby guaranteeing maximum safety and facilitating the view from a distance of the pedestrians on the crossing and curbside.

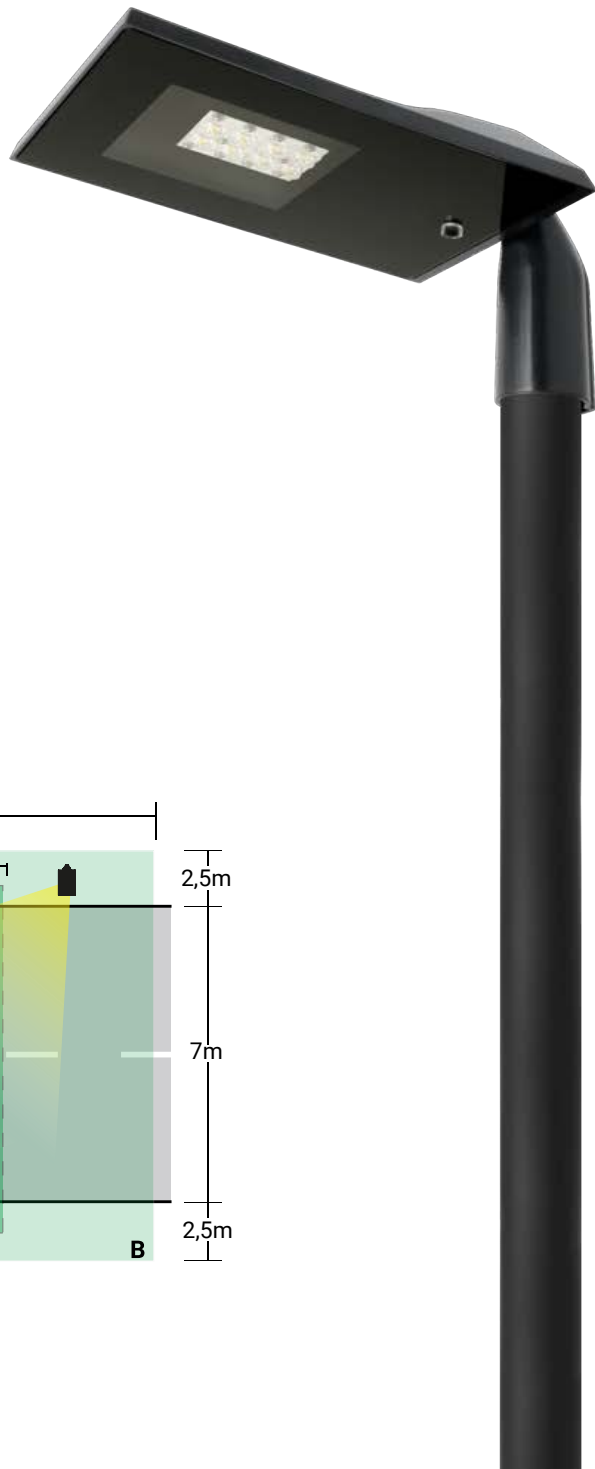
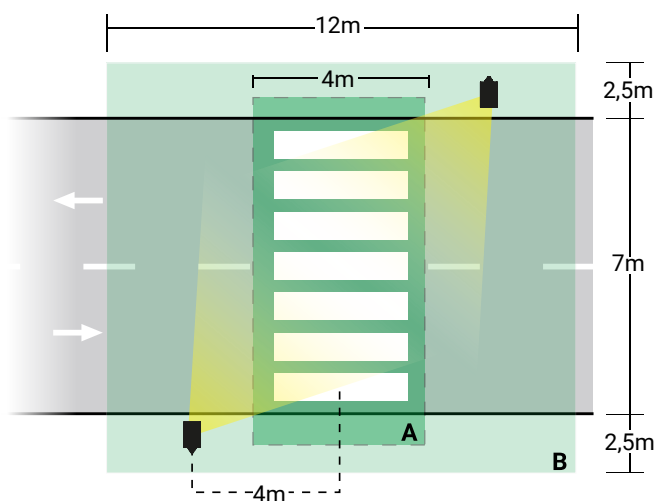

Tunnel lighting system

The main principle of tunnel lighting is to ensure that the driver has the same visual perception inside and outside the tunnel. The difference in brightness between these two zones (during the day) is often too great for the human eye to be able to distinguish any obstacles inside the tunnel and the time when entering the tunnel is too brief to allow the eye to adapt to the different lighting levels.

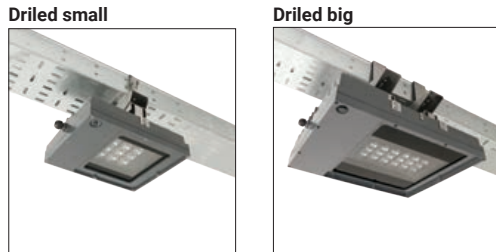

The DriLed article can be used to light the different zones of tunnels. What makes them stand out in light emission and perception is how they are applied in the tunnel, where the required lighting differs from zone to zone.

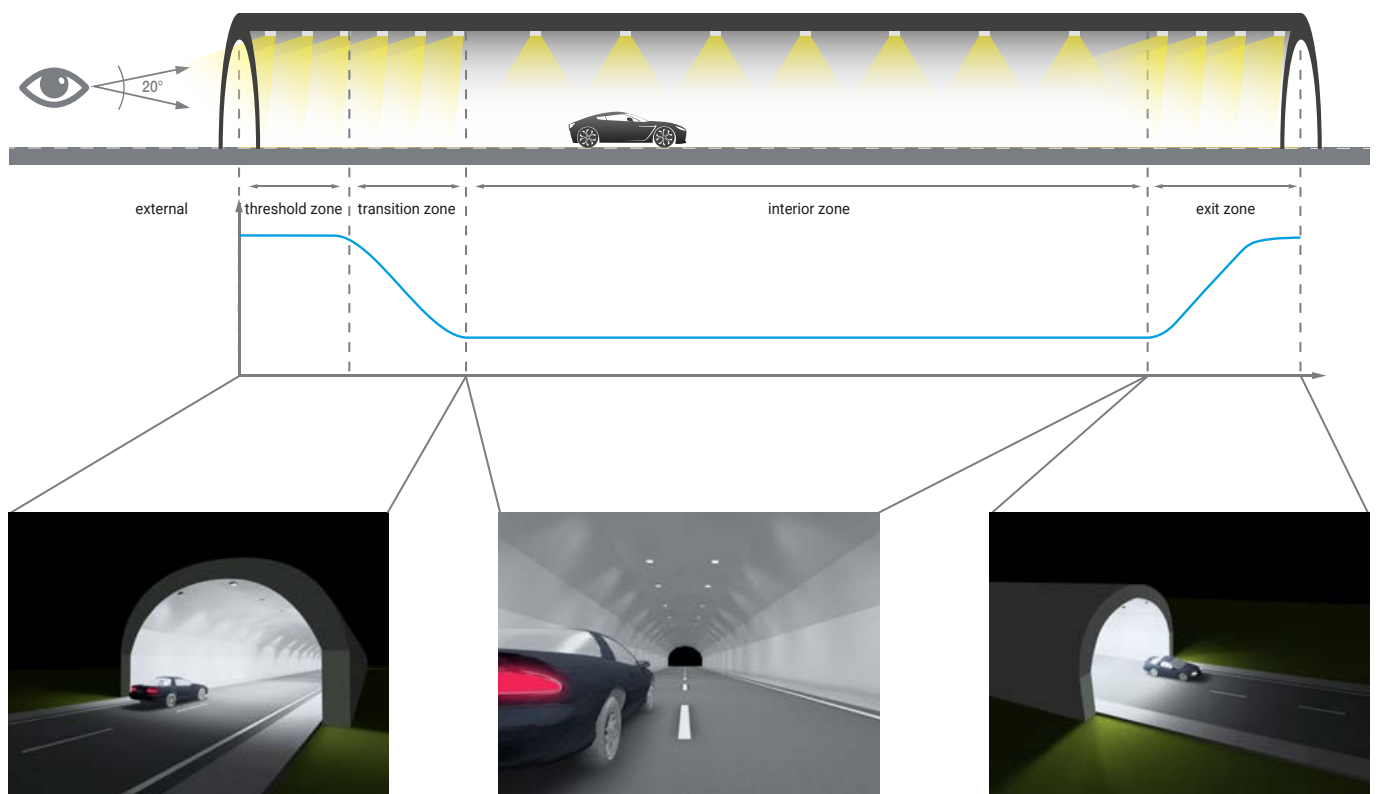

The purpose of the lighting at the initial section of the tunnel is to prevent the 'black hole' effect, in other words, the abrupt change from the outdoor daytime lighting conditions to the darkness of the tunnel. This is called reinforcement lighting. This area of the tunnel is undoubtedly the most critical if not correctly lit and it represents one of the predominant causes in most accidents which occur in it.

The function of the permanent lighting is to light the street for the driver's eye after it has already adjusted to the change of brightness after entering the tunnel. This is present along the entire length of the tunnel and, during the day, in the initial section that corresponds to the entrance and transition zones, it is integrated by the reinforcement lighting to ensure correct perception of the obstacles. The driver arriving at the internal zone has by now become accustomed to the lighting levels similar to night driving and is therefore in a situation where constant, uniform and comfortable lighting is required that does not change until the exit zone.

To ensure reinforcement lighting, proflow or counterflow optics systems are used. Proflow lighting is achieved with a distribution in which glare is reduced to a minimum in that the light beam is aimed in the driving direction. Counterflow, on the other hand, is achieved with distribution in which the maximum peak of brightness intensity is aimed in the opposite direction. In this latter case, the obstacles placed inside the tunnel are highlighted as dark objects on the lit road surface and are therefore highly visible, reaching high negative contrast values.

Autocontrol system



autonomous lamp post head

The Autocontrol system makes it so that autonomous street lights are able to automatically adjust the luminous flow based on the selected programming depending on the technical lighting needs. The system works in combination with a timer or a twilight switch upstream of the system which determines the daily hours of operation.

Generally, the operating time is divided into 5 time slots, proportional in percentage to the "N" duration of the night. This time is stored by the power supply and used to determine the hours of operation in the various time slots of the following day.

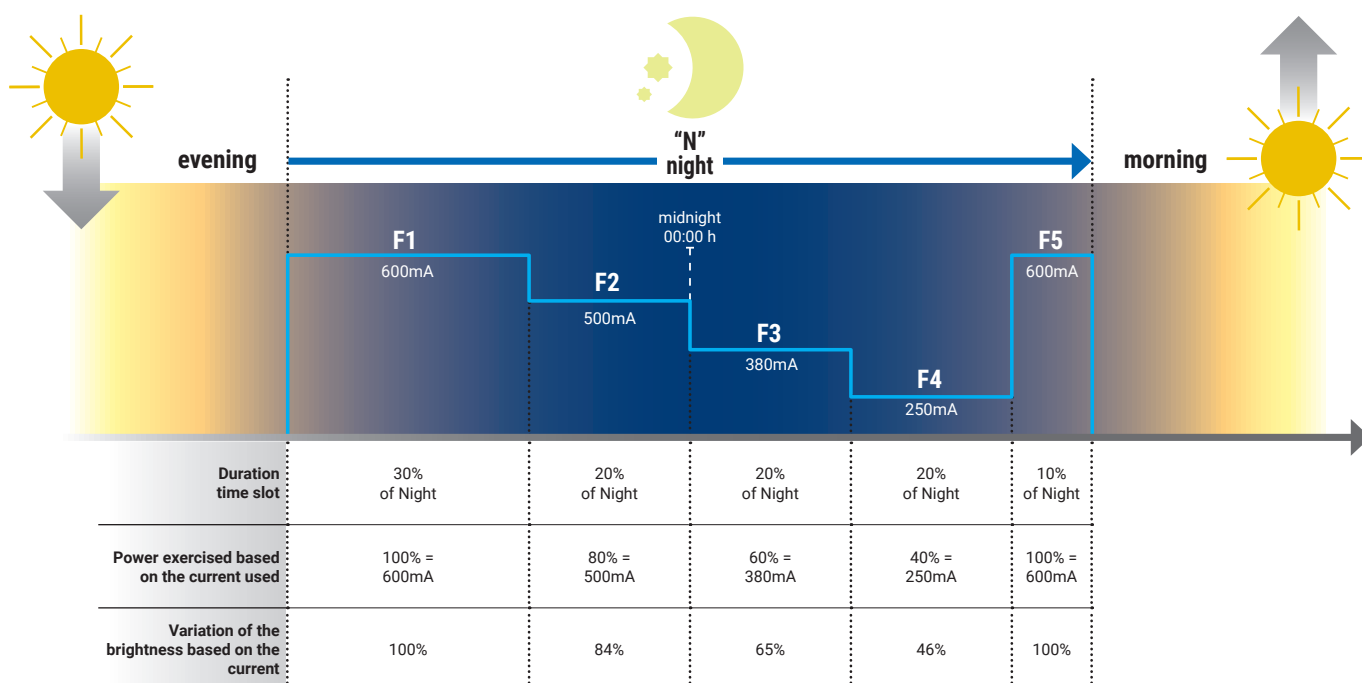

Examples of operation

Dimming varies according to the season of the year and latitude of the location. Below are two examples of operation in periods of the year that differ in number of night hours. With the Autocontrol system, a daily energy savings can be achieved that varies between 20% and 25%.

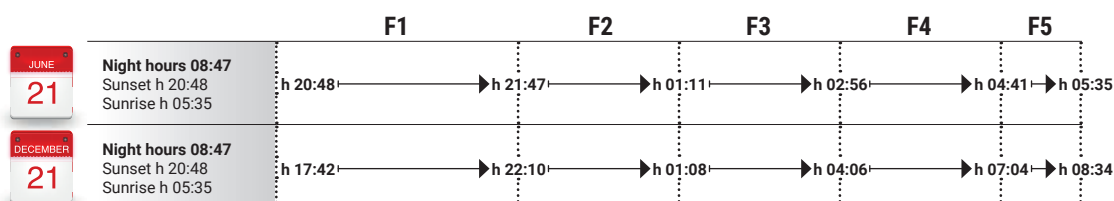

ECO line system

Ecology and savings

The EcoLine lighting systems allow areas without connections to electrical power to be lit. These systems have photovoltaic systems installed on posts associated with batteries that make the system entirely autonomous and therefore ideal for preventing high costs of digging and laying of electrical cables to run electricity to the areas that must be lit. Recommended for towns where streets or dark areas would require high costs to run electrical power. Ideal for private car parks, industrial plants, public gardens, street intersections, areas of environmentally scenic and/or archaeological interest. The lamp post is autonomous, ecological, has no operating costs and is maintenance free. The fact that it is independent from the electrical grid also makes it suitable for safety purposes in places susceptible to electrical blackouts.

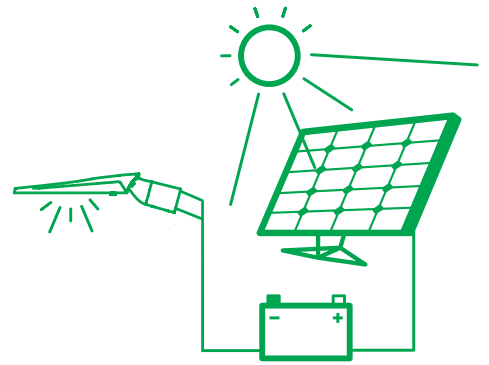

MPPT Controller

Charging regulator with MPPT technology, an acronym which stands for "Maximum Power Point Tracking". These are able to use all the power generated by the panel to charge the battery, unlike traditional PWM regulators that send a lower current to the battery. The battery will be charged with a current of 3.6A instead of just 2.6A which would be used by a traditional PWM regulator. Therefore the battery charge will be carried out with a current greater than 38%.

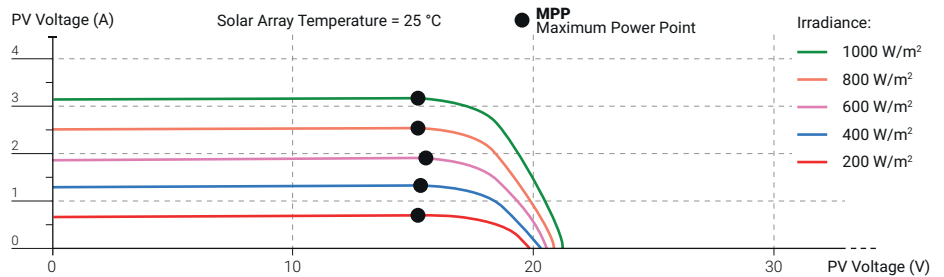

ECO line HYBRID

The EcoLine HYBRID system is made up of a module with photovoltaic cells that convert solar radiation into electrical energy, which is accumulated in a battery during the day and returned by night to power the LEDs. The power is supplied to the lamp by the included battery or the constant voltage driver (built-in or opportunely connected to the 230 Vac electrical mains). The latter can intervene in place of the battery when it is completely flat in order to ensure continuous lighting even with a completely drained battery.

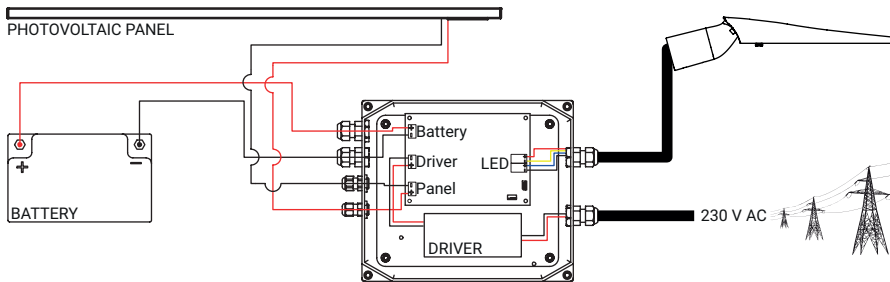

ECO line SOLAR

The EcoLine SOLAR system is made up of a module with photovoltaic cells that convert solar radiation into electrical energy, which is accumulated in a battery during the day and returned by night to power the LEDs. The lamp is therefore powered only by the included battery.

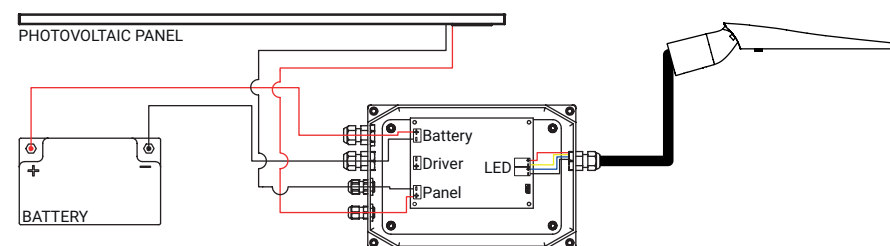

Optics overview

LineaLight fixtures are fitted with highly efficient optics. A wide range of available optics in order to be able to meet all the technical lighting needs depending on the application location. Different types of optics made in PMMA with high resistance to temperature and UV rays. Optics conceived to be combined with latest generation, extremely high efficiency Cree® LEDs characterised by a very long lifespan.

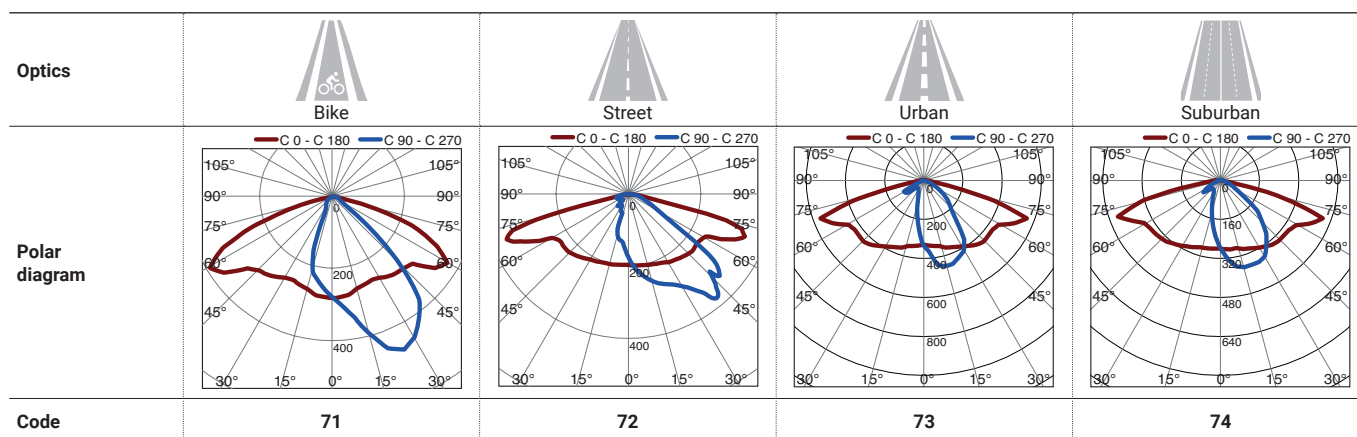



















Case studies

Lighting classes P for areas with primarily pedestrian or cycling uses, residential streets and areas adjacent to carriageways such as hard shoulders, car parks and pedestrian walkways.







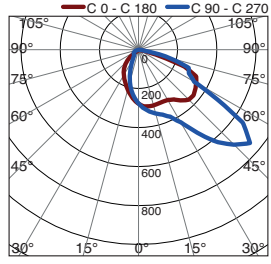
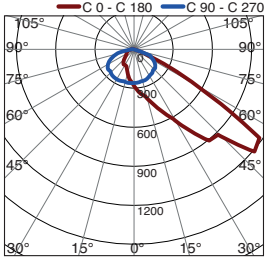
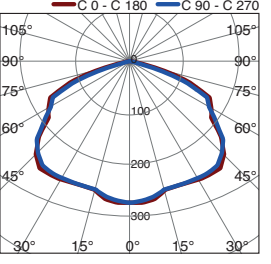
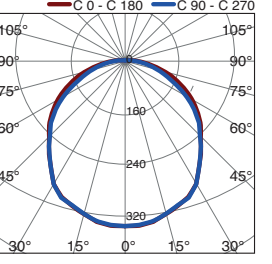







Lighting classes M for urban streets, rural streets and streets with primarily motorised traffic where the luminance values can be calculated.

Lighting classes C for motorised, pedestrian streets, where there are areas of conflict or where the luminance values cannot be calculated: commercial streets, historic centres, rotaries, intersections, streets with pedestrians or cyclists and underpasses.

Lighting technology classification	P3	P3	P2	P2	P1	P1	M6	ME6	M5/C5	M5/C5	M5/C5	M4b/C4	M4b/C4	M4b/C4
Street width (m)	2-3	4-5	2-3	4-5	2-3	4-5	6	6	6	7	5	5	6-7	7
Lamp post height above ground (m)	3-4	3-4	3-4	3-4	3-4	3-4	7-8	5-6	8	7-8	5-6	8	8	7
No. LEDs	2	2	3	3	4	4	3	3	4	5	4	5	6	6
Power	19W	19W	26W	26W	35W	35W	26W	26W	35W	40W	35W	40W	46W	46W
Optics type	 Bike	 Street	 Bike	 Street	 Bike	 Street	 Bike	 Street	 Bike	 Street	 Street	 Urban	 Bike	 Street
Optics code	71	72	71	72	71	72	71	72	71	72	72	73	71	72

Optics	 Pedestrian	 Park	 Diffused	 Diffused
Polar diagram				
Code	78	79	00 (Power Led)	00 (Top Led)



M4a	M4a	M4a	M4a	M3c/C3	M3c/C3	M3c/C3	M3b	M3b	M3b	M3b	M2/C2	M2/C2	M1/C1	M1/C1
7	6	6	7	6	7	8	7	8	7	8	7	8	7	8
7	9	8	8	8	9	8	9	8	9	8	9	8	9	8
9	6	6	9	9	9	9	9	9	9	12	12	12	15	15
60W	46W	46W	60W	71W	79W	79W	79W	79W	79W	95W	95W	95W	126W	126W
														
72	73	73	71	74	74	72	74	72	74	72	73	71	73	71

The cases shown on the table should be considered approximate. Linea Light will not be held liable for inappropriate use of this information

street & urban lighting range index

Mini Parker



Parker



Mini Ledweg



Drop



Drop Air



Fosten



Fabula

Small



226

Big



226

Voyager

Street



230

Urban



231

Enterprise

Urban



233

Driled

Small



236

Big



236

ECO Mini Parker

ECO Mini Parker



240

Posts



242

Mini Parker

Mini Parker is an elegantly shaped and thin fixture, designed for street and urban lighting. Thanks to the wide range of power, LED temperature colour and optics that can be used, Mini Parker meets multiple lighting needs. The Mini Parker Wall version can be installed directly on the wall using the specific bracket. To light pedestrian crossings, the Mini Parker PC version is available which, thanks to the special optics, guarantees maximum visual safety for pedestrians and vehicles in transit in observance of the prevailing regulations.





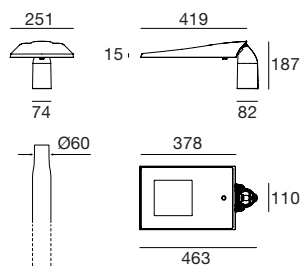

4 Kg
 17,5 dm³
 0,1 m²
 0,03 m²

2 LEDs - 16,5 W DC - 19 W AC

92358	RAL7016	A 2200 K	1559 lm	71 Bike
92359	RAL7035	W 3000 K	2185 lm	72 Street
		N 4000 K	2343 lm	73 Urban
		C 5000 K	2343 lm	79 Park

3 LEDs - 23 W DC - 26 W AC

92360	RAL7016	A 2200 K	2339 lm	71 Bike
92361	RAL7035	W 3000 K	3278 lm	72 Street
		N 4000 K	3515 lm	73 Urban
		C 5000 K	3515 lm	79 Park

4 LEDs - 31 W DC - 35 W AC

92362	RAL7016	A 2200 K	3118 lm	71 Bike
92363	RAL7035	W 3000 K	4371 lm	72 Street
		N 4000 K	4686 lm	73 Urban
		C 5000 K	4686 lm	79 Park

5 LEDs - 35 W DC - 40 W AC

92364	RAL7016	A 2200 K	3534 lm	71 Bike
92365	RAL7035	W 3000 K	4968 lm	72 Street
		N 4000 K	5327 lm	73 Urban
		C 5000 K	5327 lm	79 Park



92550	RAL7016			
92551	RAL7035			

6 LEDs - 42 W DC - 46 W AC

92366	RAL7016	A 2200 K	4241 lm	71 Bike
92367	RAL7035	W 3000 K	5962 lm	72 Street
		N 4000 K	6392 lm	73 Urban
		C 5000 K	6392 lm	79 Park



92552	RAL7016			
92599	RAL7035			

9 LEDs - 54 W DC - 60 W AC

92372	RAL7016	A 2200 K	5228 lm	71 Bike
92373	RAL7035	W 3000 K	7387 lm	72 Street
		N 4000 K	7920 lm	73 Urban
		C 5000 K	7920 lm	74 Suburban



92606	RAL7016			
92607	RAL7035			79 Park

9 LEDs - 64 W DC - 71 W AC

93346	RAL7016	A 2200 K	6361 lm	71 Bike
93347	RAL7035	W 3000 K	8942 lm	72 Street
		N 4000 K	9588 lm	73 Urban
		C 5000 K	9588 lm	74 Suburban



93348	RAL7016			
93349	RAL7035			79 Park

9 LEDs - 71 W DC - 79 W AC

92208	RAL7016	A 2200 K	6799 lm	71 Bike
92209	RAL7035	W 3000 K	9539 lm	72 Street
		N 4000 K	10228 lm	73 Urban
		C 5000 K	10228 lm	74 Suburban



80907	RAL7016			
80908	RAL7035			79 Park

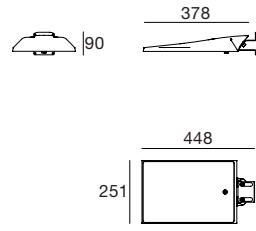

3,6 Kg 17,5 dm³ 0,1 m² 0,03 m²

2 LEDs - 16,5 W DC - 19 W AC

82966 RAL7016	A 2200 K	1559 lm	71 Bike
82967 RAL7035	W 3000 K	2185 lm	72 Street
	N 4000 K	2343 lm	73 Urban
	C 5000 K	2343 lm	79 Park

3 LEDs - 23 W DC - 26 W AC

82968 RAL7016	A 2200 K	2339 lm	71 Bike
82969 RAL7035	W 3000 K	3278 lm	72 Street
	N 4000 K	3515 lm	73 Urban
	C 5000 K	3515 lm	79 Park

4 LEDs - 31 W DC - 35 W AC

82970 RAL7016	A 2200 K	3118 lm	71 Bike
82971 RAL7035	W 3000 K	4371 lm	72 Street
	N 4000 K	4686 lm	73 Urban
	C 5000 K	4686 lm	79 Park

5 LEDs - 35 W DC - 40 W AC

82972 RAL7016	A 2200 K	3534 lm	71 Bike
82973 RAL7035	W 3000 K	4968 lm	72 Street
	N 4000 K	5327 lm	73 Urban
82974 RAL7016	C 5000 K	5327 lm	79 Park
82975 RAL7035			

6 LEDs - 42 W DC - 46 W AC

82976 RAL7016	A 2200 K	4241 lm	71 Bike
82977 RAL7035	W 3000 K	5962 lm	72 Street
	N 4000 K	6392 lm	73 Urban
82978 RAL7016	C 5000 K	6392 lm	79 Park
82979 RAL7035			

9 LEDs - 54 W DC - 60 W AC

82980 RAL7016	A 2200 K	5228 lm	71 Bike
82981 RAL7035	W 3000 K	7387 lm	72 Street
	N 4000 K	7920 lm	73 Urban
82982 RAL7016	C 5000 K	7920 lm	74 Suburban
82983 RAL7035			79 Park

9 LEDs - 64 W DC - 71 W AC

82984 RAL7016	A 2200 K	6361 lm	71 Bike
82985 RAL7035	W 3000 K	8942 lm	72 Street
	N 4000 K	9588 lm	73 Urban
82986 RAL7016	C 5000 K	9588 lm	74 Suburban
82987 RAL7035			79 Park

9 LEDs - 71 W DC - 79 W AC

82988 RAL7016	A 2200 K	6799 lm	71 Bike
82989 RAL7035	W 3000 K	9539 lm	72 Street
	N 4000 K	10228 lm	73 Urban
82990 RAL7016	C 5000 K	10228 lm	74 Suburban
82991 RAL7035			79 Park

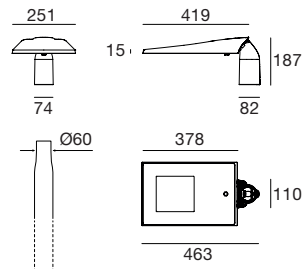

8 LEDs - 53 W DC - 58 W AC

92370	RAL7016	A	2200 K	5655 lm	78 Pedestrian Cros.
92371	RAL7035	W	3000 K	7949 lm	
		N	4000 K	8523 lm	
		C	5000 K	8523 lm	

- 3,5 Kg
- 17,5 dm³
- 0,07 m²
- 0,03 m²

Pedestrian crossing

Pedestrian crossings can be illuminated using a post for each driving direction. Unlike central lighting, the use of posts lateral to the pedestrian crossing allows people to be illuminated vertically and allows better visibility of them. The following examples illustrate the average horizontal lighting, calculated on the pedestrian passage.



One lane and one-way

In the case of crossings on one-way streets, the use of only one fixture is sufficient, which lights the crossing in the driving direction.

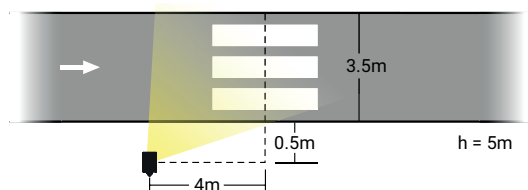

Single post_ Mini Parker P.C.

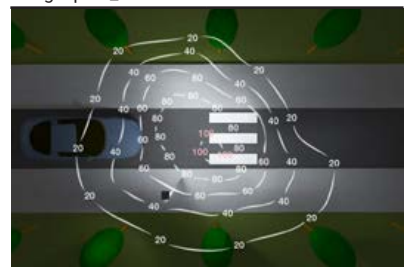

Number of fixtures	1
Number of LEDs	8
Fixture power	58W
Vertical plane min. LUX	30 lux

Two lanes two-way

In the case of two directions of travel, the posts are installed on the two sides of the pedestrian crossing in order to ensure the correct lighting of the pedestrians for both driving directions.

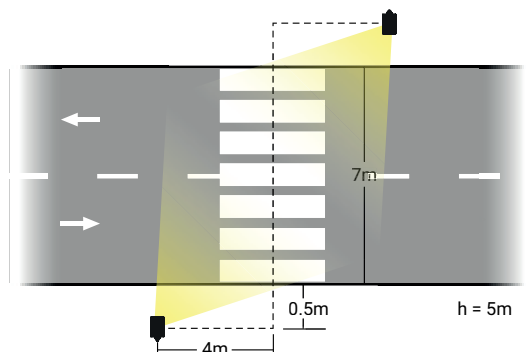

Double post - Mini Parker P.C.

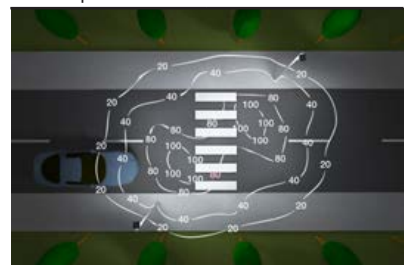

Number of fixtures	2
Number of LEDs	8 + 8
Fixture power	58W + 58W
Vertical plane min. LUX	30 lux



Proposals for installation

Areas of use:

- local streets
- secondary streets
- wide streets
- urban streets
- rural streets

Lighting class	M5/C5	M4b/C4	M4a	M3c	M3b	M3a	P3	P2
Mini Parker version	35W	40W	46W	60W	71W	79W	19W	26W
Lamp post height (H)	7 m	8 m	8 m	9 m	8 m	9 m	3 m	4 m
Lamp post spacing (I)	28 m	30-32 m	30-34 m	34-36 m	30-34 m	34-36 m	20 m	25 m
Carriageway width (L)	5 m	6 m	7.5 m	7.5 m	7.5 m	7.5 m	3 m	4 m

Technical lighting calculations in road surface category C2 and 4000 K LED temperature used

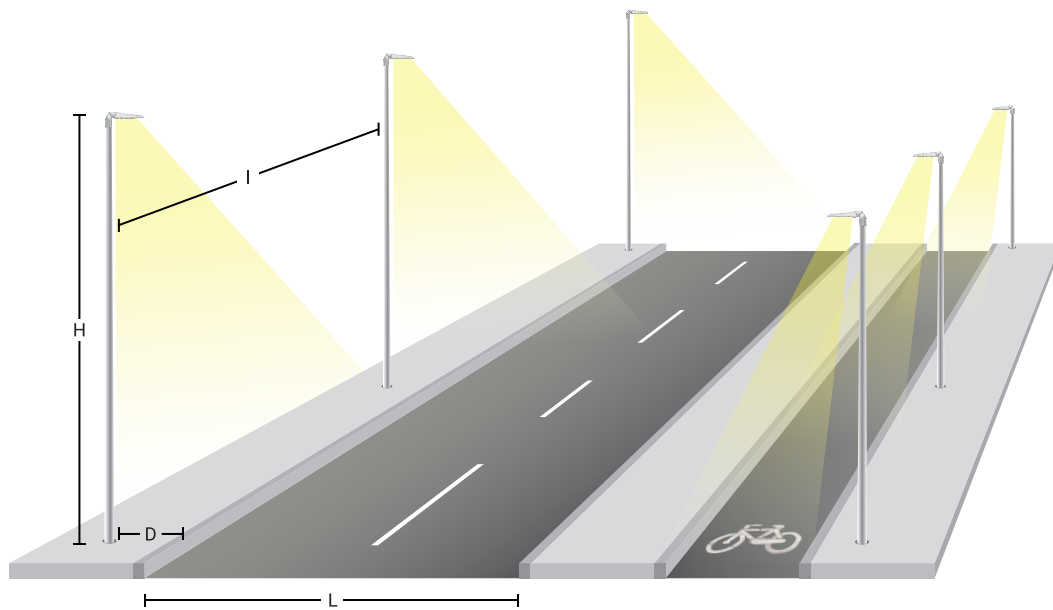



Parker

Powerful and sturdy lamp post head characterised by high performance and featuring the most recent technologies to achieve high level technical lighting performance. Ideal for applications and uses in those street relamping situations where the application posts are considerably tall and/or where the spaces between the posts is high.





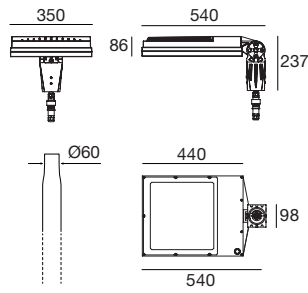

12 LEDs - 88 W DC - 95 W AC

92474	RAL7016	A	2200 K	8482 lm	71	Bike
92475	RAL7035	W	3000 K	11293 lm	72	Street
		N	4000 K	12784 lm	73	Urban
92710	RAL7016	C	5000 K	12784 lm	79	Park
92719	RAL7035					



13,2 Kg 90 dm³ 0,24 m²

15 LEDs - 118 W DC - 126 W AC

92476	RAL7016	A	2200 K	10971 lm	71	Bike
92477	RAL7035	W	3000 K	15407 lm	72	Street
		N	4000 K	16519 lm	73	Urban
92720	RAL7016	C	5000 K	16519 lm	79	Park
92721	RAL7035					



18 LEDs - 134 W DC - 145 W AC

92478	RAL7016	A	2200 K	13165 lm	71	Bike
92479	RAL7035	W	3000 K	18489 lm	72	Street
		N	4000 K	19823 lm	73	Urban
92722	RAL7016	C	5000 K	19823 lm	79	Park
92760	RAL7035					



Proposals for installation

- Areas of use:
- wide streets
 - urban streets
 - rural streets

Lighting class	M2/C2	M1/C1	M1/C1
Parker version	95W	126W	145W
Lamp post height (H)	8 m	9 m	10 m
Lamp post spacing (I)	30 m	34 m	34 m
Carriageway width (L)	7 m	7 m	7.5 m

Technical lighting calculations in road surface category C2, and 4000 K LED temperature used

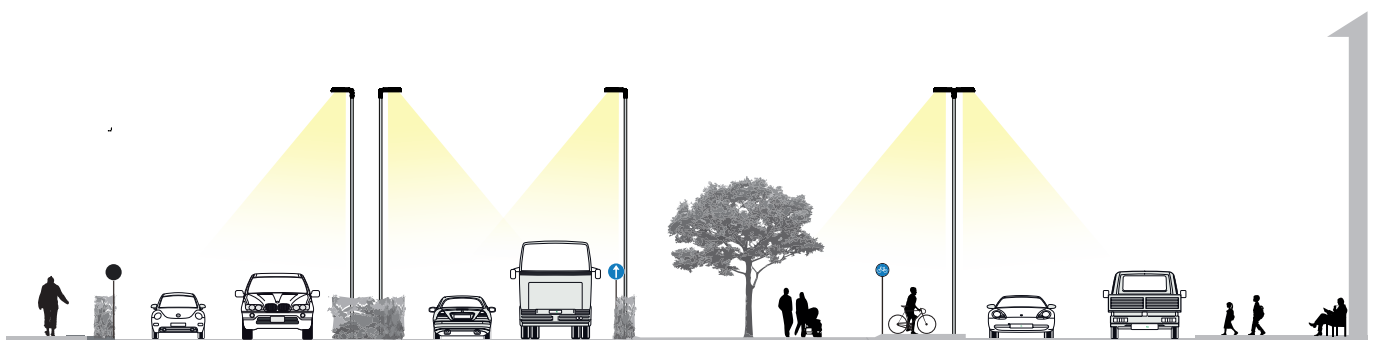
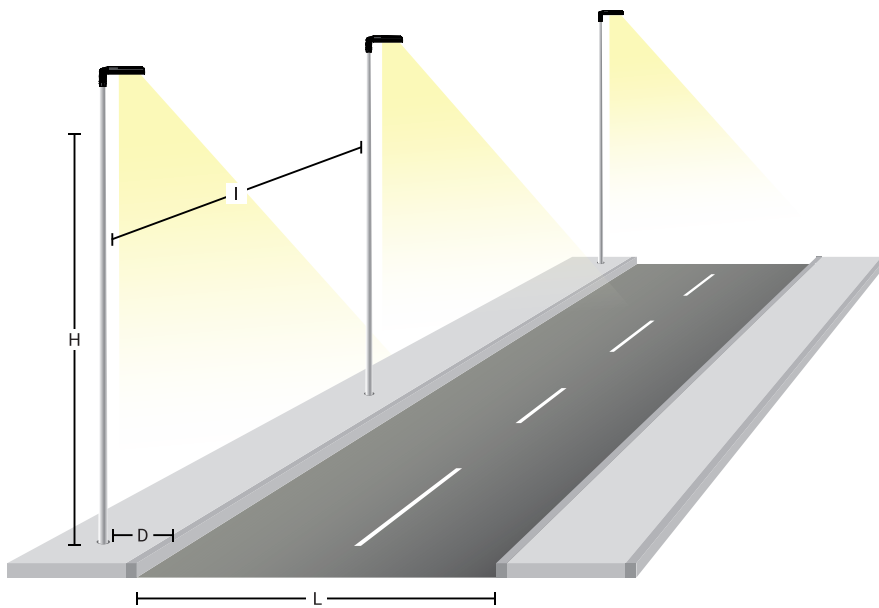

Mini Ledweg

Mini Ledweg stands out for its particular elegant design and its soft and sinuous shapes. Thanks to the wide range of power, LED temperature colour and optics that can be used, Mini Ledweg meets multiple lighting needs and is the ideal fixture for both street and urban lighting. The Mini Ledweg Wall version can be applied directly on the wall using a specific bracket.

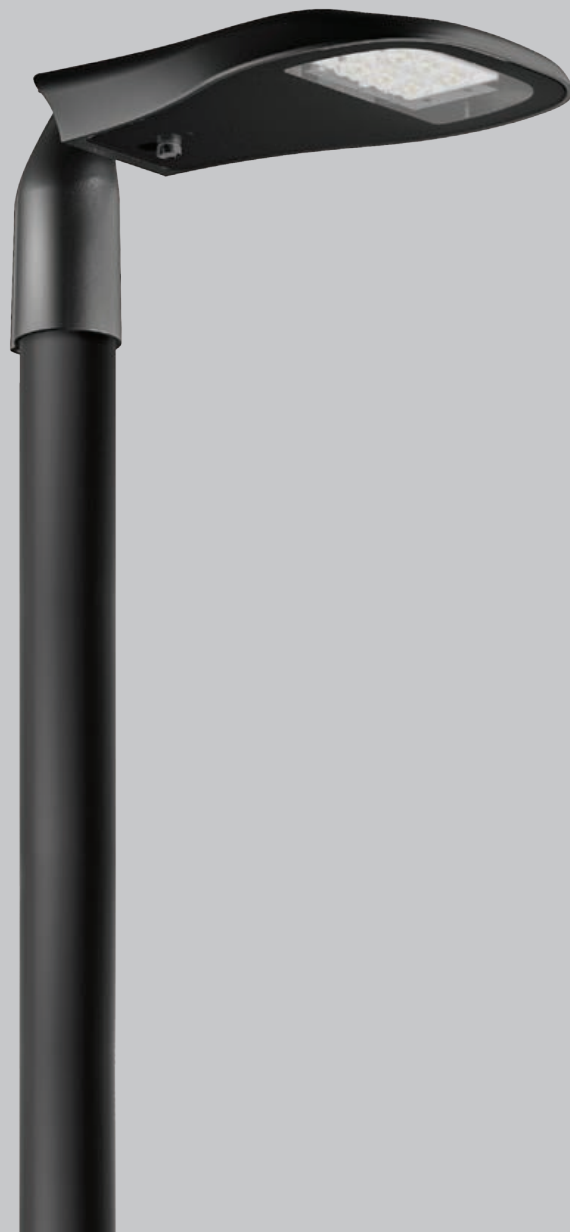



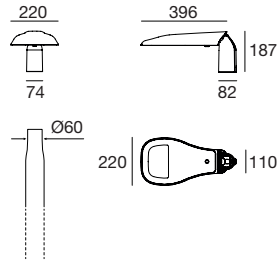

3,5 Kg
 16,2 dm³
 0,06 m²
 0,03 m²

2 LEDs - 16,5 W DC - 19 W AC

92151	RAL7016	A 2200 K	1559 lm	71 Bike
92152	RAL7035	W 3000 K	2185 lm	72 Street 2.0
		N 4000 K	2343 lm	73 Urban 2.0
		C 5000 K	2343 lm	79 Park

3 LEDs - 23 W DC - 26 W AC

92153	RAL7016	A 2200 K	2339 lm	71 Bike
92156	RAL7035	W 3000 K	3278 lm	72 Street 2.0
		N 4000 K	3515 lm	73 Urban 2.0
		C 5000 K	3515 lm	79 Park

4 LEDs - 31 W DC - 35 W AC

92157	RAL7016	A 2200 K	3118 lm	71 Bike
92162	RAL7035	W 3000 K	4371 lm	72 Street 2.0
		N 4000 K	4686 lm	73 Urban 2.0
		C 5000 K	4686 lm	79 Park

5 LEDs - 35 W DC - 40 W AC

92163	RAL7016	A 2200 K	3534 lm	71 Bike
92166	RAL7035	W 3000 K	4968 lm	72 Street 2.0
		N 4000 K	5327 lm	73 Urban 2.0
		C 5000 K	5327 lm	79 Park



92518	RAL7016			
92525	RAL7035			

6 LEDs - 42 W DC - 46 W AC

92167	RAL7016	A 2200 K	4241 lm	71 Bike
92168	RAL7035	W 3000 K	5962 lm	72 Street 2.0
		N 4000 K	6392 lm	73 Urban 2.0
		C 5000 K	6392 lm	79 Park



92526	RAL7016			
92527	RAL7035			

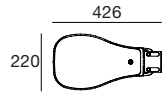
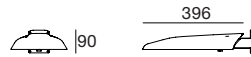

3,1 Kg 16,2 dm³ 0,06 m² 0,03 m²

2 LEDs - 16,5 W DC - 19 W AC

82952 RAL7016	A 2200 K	1559 lm	71 Bike
82953 RAL7035	W 3000 K	2185 lm	72 Street 2.0
	N 4000 K	2343 lm	73 Urban 2.0
	C 5000 K	2343 lm	79 Park

3 LEDs - 23 W DC - 26 W AC

82954 RAL7016	A 2200 K	2339 lm	71 Bike
82955 RAL7035	W 3000 K	3278 lm	72 Street 2.0
	N 4000 K	3515 lm	73 Urban 2.0
	C 5000 K	3515 lm	79 Park

4 LEDs - 31 W DC - 35 W AC

82956 RAL7016	A 2200 K	3118 lm	71 Bike
82957 RAL7035	W 3000 K	4371 lm	72 Street 2.0
	N 4000 K	4686 lm	73 Urban 2.0
	C 5000 K	4686 lm	79 Park

5 LEDs - 35 W DC - 40 W AC

82958 RAL7016	A 2200 K	3534 lm	71 Bike
82959 RAL7035	W 3000 K	4968 lm	72 Street 2.0
	N 4000 K	5327 lm	73 Urban 2.0
	C 5000 K	5327 lm	79 Park



82960 RAL7016			
82961 RAL7035			

6 LEDs - 42 W DC - 46 W AC

82962 RAL7016	A 2200 K	4241 lm	71 Bike
82963 RAL7035	W 3000 K	5962 lm	72 Street 2.0
	N 4000 K	6392 lm	73 Urban 2.0
	C 5000 K	6392 lm	79 Park



82964 RAL7016			
82965 RAL7035			

Proposals for installation

Areas of use:

- local streets
- secondary streets
- wide streets
- urban streets
- rural streets

Lighting class	M5/C5	M4b/C4	M4a	P3	P2
Mini Ledweg version	35W	40W	46W	19W	26W
Lamp post height (H)	7 m	8 m	8 m	3 m	4 m
Lamp post spacing (I)	28 m	32 m	34 m	20 m	25 m
Carriageway width (L)	5 m	6 m	7.5 m	3 m	4 m

Technical lighting calculations in road surface category C2, and 4000 K LED temperature used

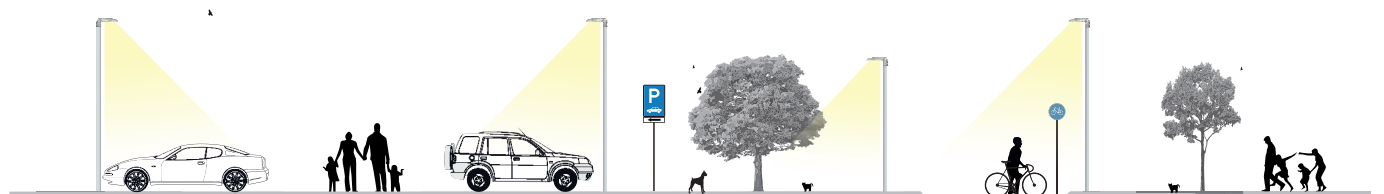
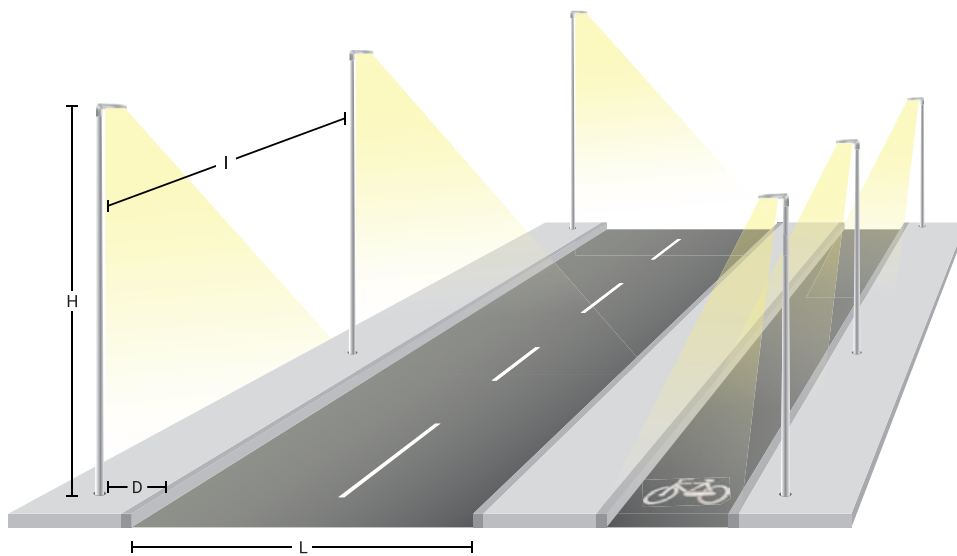



Drop

Drop is a circular lamp post head with rounded edges and it represents a solution for both street and urban lighting. Drop is a very versatile luminaire and it is available in the versions with power LEDs and transparent glass for street applications or with topLED and frosted glass for urban décor applications. The TopLED varieties fitted with circular frosted glass generate a diffused light, ideal for applications in parks or pedestrian walkways. Drop Air is the version for overhead application and it can be used in medium/large traffic areas where the use of posts is impossible.



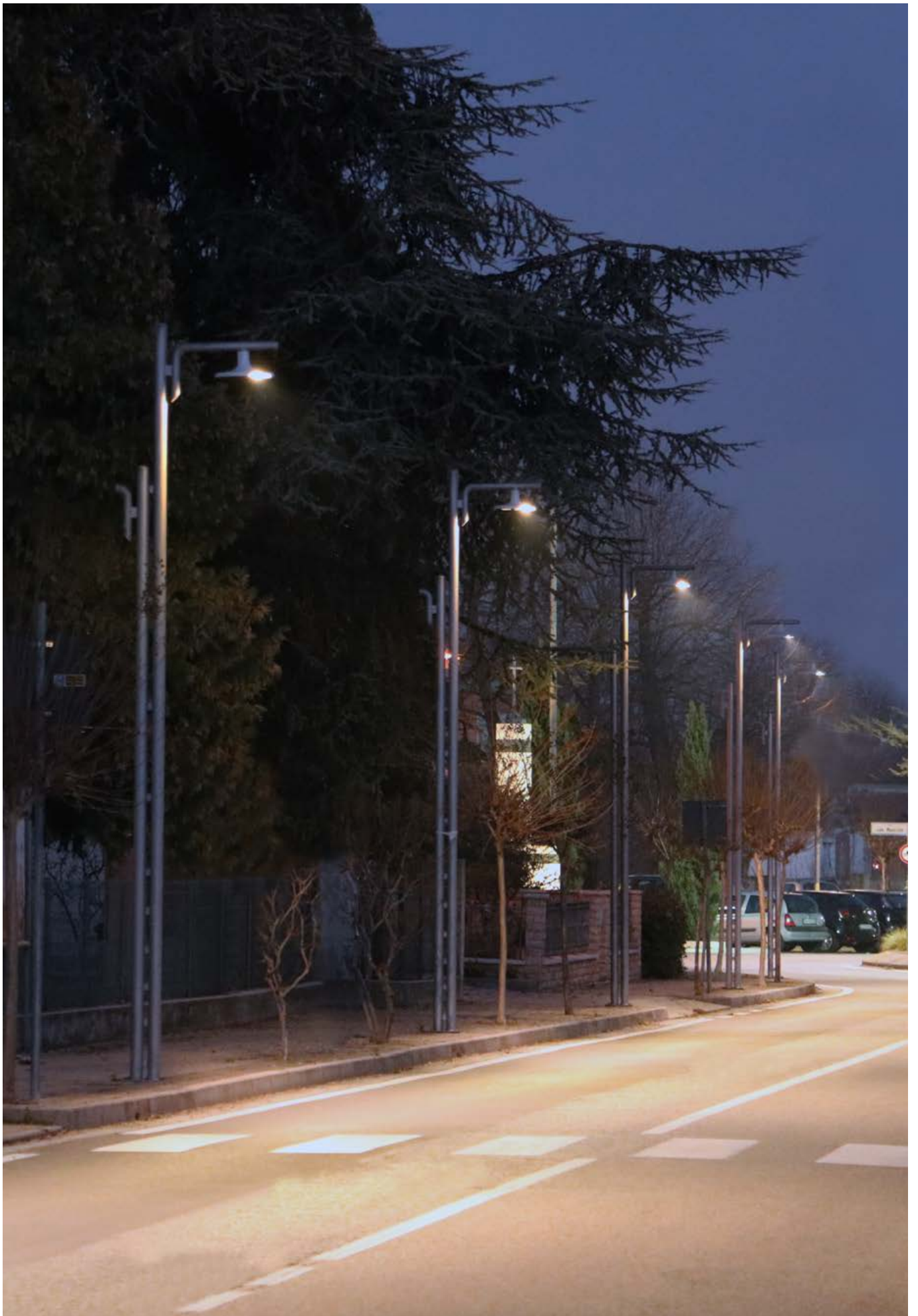

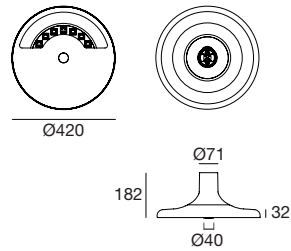

6,3 Kg 36 dm³ 0,14 m² 0,03 m²

3 LEDs - 23 W DC - 26 W AC

93164 RAL7016	A 2200 K	2339 lm	71 Bike
93169 RAL7035	W 3000 K	3278 lm	72 Street 2.0
	N 4000 K	3515 lm	73 Urban 2.0
	C 5000 K	3515 lm	79 Park

4 LEDs - 31 W DC - 35 W AC

93162 RAL7016	A 2200 K	3118 lm	71 Bike
93163 RAL7035	W 3000 K	4371 lm	72 Street 2.0
	N 4000 K	4686 lm	73 Urban 2.0
	C 5000 K	4686 lm	79 Park

5 LEDs - 35 W DC - 40 W AC

93160 RAL7016	A 2200 K	3534 lm	71 Bike
93161 RAL7035	W 3000 K	4968 lm	72 Street 2.0
	N 4000 K	5327 lm	73 Urban 2.0
 93291 RAL7016	C 5000 K	5327 lm	79 Park
93292 RAL7035			

6 LEDs - 42 W DC - 46 W AC

93145 RAL7016	A 2200 K	4241 lm	71 Bike
93159 RAL7035	W 3000 K	5962 lm	72 Street 2.0
	N 4000 K	6392 lm	73 Urban 2.0
 93289 RAL7016	C 5000 K	6392 lm	79 Park
93290 RAL7035			

7 LEDs - 49 W DC - 54 W AC

93143 RAL7016	A 2200 K	4948 lm	71 Bike
93144 RAL7035	W 3000 K	6955 lm	72 Street 2.0
	N 4000 K	7457 lm	73 Urban 2.0
 93287 RAL7016	C 5000 K	7457 lm	79 Park
93288 RAL7035			

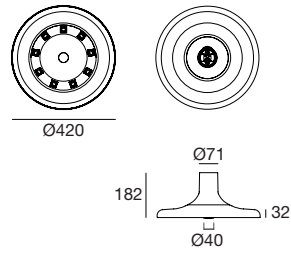

9 LEDs - 64 W DC - 71 W AC

92991	RAL7016	A	2200 K	6361 lm	00 Diffused
92992	RAL7035	W	3000 K	8942 lm	
		N	4000 K	9588 lm	
93283	RAL7016	C	5000 K	9588 lm	
93284	RAL7035				

6,3 Kg 36 dm³ 0,14 m² 0,03 m²

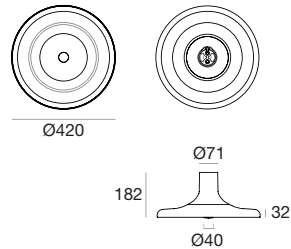

192 LEDs - 47 W DC - 50 W AC

80911	RAL7016	A	2200 K	4992 lm	00 Diffused
80912	RAL7035	W	3000 K	6355 lm	
		N	4000 K	6682 lm	
80915	RAL7016	C	5000 K	6931 lm	
80916	RAL7035				

192 LEDs - 63 W DC - 70 W AC

80945	RAL7016	A	2200 K	6156 lm	00 Diffused
80946	RAL7035	W	3000 K	8352 lm	
		N	4000 K	8832 lm	
80947	RAL7016	C	5000 K	9274 lm	
80948	RAL7035				

6,3 Kg 36 dm³ 0,14 m² 0,03 m²

Drop Air | Urban & Street | 190-250 V | powerLED

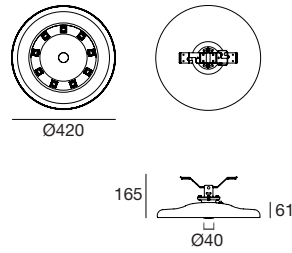

9 LEDs - 64 W DC - 71 W AC

92987	RAL7016	A	2200 K	6361 lm	00 Diffused
92988	RAL7035	W	3000 K	8942 lm	
		N	4000 K	9588 lm	
93350	RAL7016	C	5000 K	9588 lm	
93351	RAL7035				

6,3 Kg
 36 dm³
 0,14 m²
 0,25 m²

Drop Air | Urban | 190-250 V | topLED

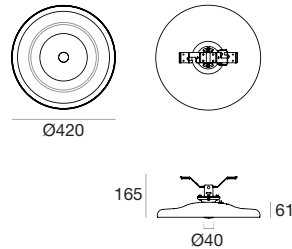

192 LEDs - 47 W DC - 50 W AC

80917	RAL7016	A	2200 K	4992 lm	00 Diffused
80918	RAL7035	W	3000 K	6355 lm	
		N	4000 K	6682 lm	
80919	RAL7016	C	5000 K	6931 lm	
80920	RAL7035				

192 LEDs - 63 W DC - 70 W AC

80937	RAL7016	A	2200 K	6156 lm	00 Diffused
80938	RAL7035	W	3000 K	8352 lm	
		N	4000 K	8832 lm	
80939	RAL7016	C	5000 K	9274 lm	
80940	RAL7035				

6,3 Kg
 36 dm³
 0,14 m²
 0,25 m²

Proposals for installation

Areas of use:

- local streets
- secondary streets
- urban streets
- rural streets

Lighting class	M5/C5	M4b/C4	M4a	P2
Drop version	35W	40W	46W	26W
Lamp post height (H)	7 m	8 m	8 m	4 m
Lamp post spacing (I)	28 m	32 m	34 m	25 m
Carriageway width (L)	5 m	6 m	7.5 m	4 m

Technical lighting calculations in road surface category C2, and 4000 K LED temperature used

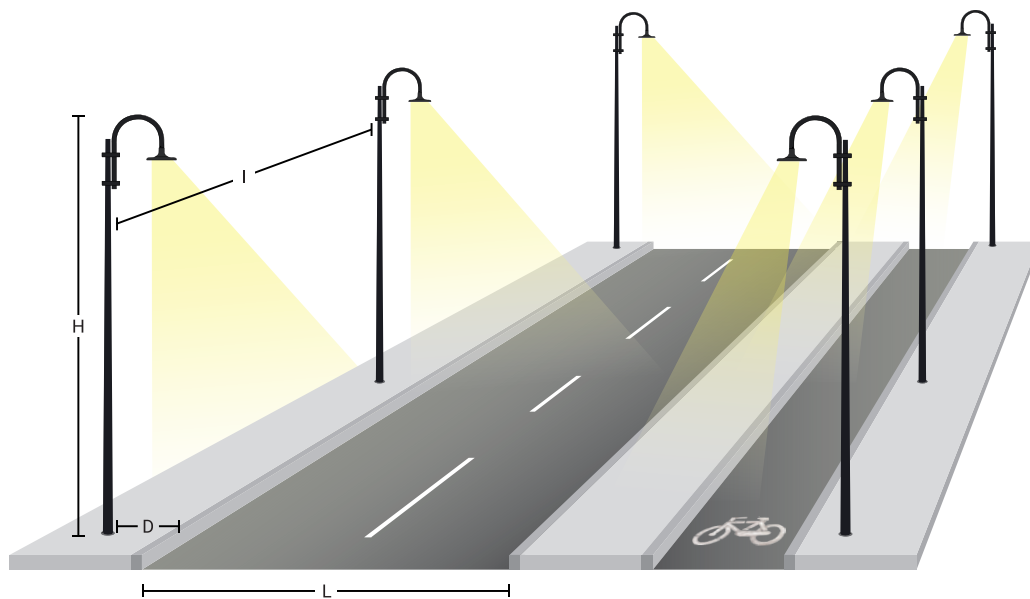

Fosten

Semi spherical lamp post head ideal for street and urban décor installations. The harmonious design of the lamp body fits in ideally in squares, historic centres and pedestrian walkways. Available with transparent or opal circular glass for urban décor applications. For street lighting, the versions mount specific optics and transparent glass arranged on the mid-circumference of the lamp body in order to channel the beam only onto the road surface without dispersion of light and ensuring maximum energy efficiency.





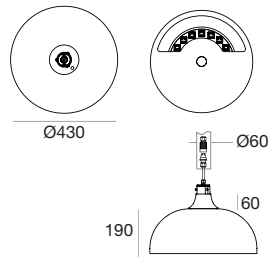

9,3 Kg
 85 dm³
 ? m²
 ? m²

3 LEDs - 23 W DC - 26 W AC

82992 <small>RAL7016</small>	A 2200 K	2339 lm	71 Bike
82993 <small>RAL7035</small>	W 3000 K	3278 lm	72 Street
	N 4000 K	3515 lm	73 Urban
	C 5000 K	3515 lm	79 Park

4 LEDs - 31 W DC - 35 W AC

82994 <small>RAL7016</small>	A 2200 K	3118 lm	71 Bike
82995 <small>RAL7035</small>	W 3000 K	4371 lm	72 Street
	N 4000 K	4686 lm	73 Urban
	C 5000 K	4686 lm	79 Park

5 LEDs - 35 W DC - 40 W AC

82996 <small>RAL7016</small>	A 2200 K	3534 lm	71 Bike
82997 <small>RAL7035</small>	W 3000 K	4968 lm	72 Street
	N 4000 K	5327 lm	73 Urban
82998 <small>RAL7016</small>	C 5000 K	5327 lm	79 Park
82999 <small>RAL7035</small>			

6 LEDs - 42 W DC - 46 W AC

83501 <small>RAL7016</small>	A 2200 K	4241 lm	71 Bike
83502 <small>RAL7035</small>	W 3000 K	5962 lm	72 Street
	N 4000 K	6392 lm	73 Urban
83503 <small>RAL7016</small>	C 5000 K	6392 lm	79 Park
83504 <small>RAL7035</small>			

7 LEDs - 49 W DC - 54 W AC

83505 <small>RAL7016</small>	A 2200 K	4948 lm	71 Bike
83506 <small>RAL7035</small>	W 3000 K	6955 lm	72 Street
	N 4000 K	7457 lm	73 Urban
83507 <small>RAL7016</small>	C 5000 K	7457 lm	79 Park
83508 <small>RAL7035</small>			

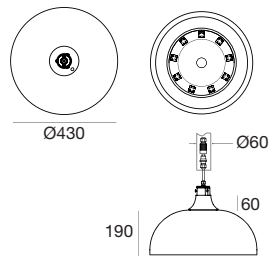

6,3 Kg
 36 dm³
 ? m²
 ? m²

9 LEDs - 64 W DC - 71 W AC

83509 <small>RAL7016</small>	A 2200 K	6361 lm	00 Diffused
83510 <small>RAL7035</small>	W 3000 K	8942 lm	
	N 4000 K	9588 lm	
83511 <small>RAL7016</small>	C 5000 K	9588 lm	
83512 <small>RAL7035</small>			

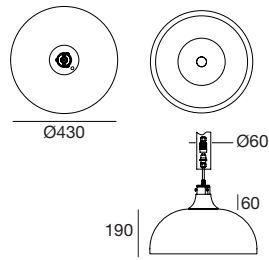

6,3 Kg 36 dm³ ? m² ? m²

192 LEDs - 47 W DC - 50 W AC

83513 RAL7016	A 2200 K	4992 lm	00 Diffused
83514 RAL7035	W 3000 K	6355 lm	
	N 4000 K	6682 lm	
83515 RAL7016	C 5000 K	6931 lm	
83516 RAL7035			

192 LEDs - 63 W DC - 70 W AC

83517 RAL7016	A 2200 K	6156 lm	00 Diffused
83518 RAL7035	W 3000 K	8352 lm	
	N 4000 K	8832 lm	
83519 RAL7016	C 5000 K	9274 lm	
83520 RAL7035			

Proposals for installation

Areas of use:

- local streets
- secondary streets
- urban streets
- rural streets
- urban décor

Lighting class	M4a	M3b	M2/C2
Fosten version	54W	71W	71W
Lamp post height (H)	8 m	8 m	8 m
Lamp post spacing (I)	34 m	34 m	34 m
Carriageway width (L)	7.5 m	7.5 m	7.5 m

Technical lighting calculations in road surface category C2, and 4000 K LED temperature used

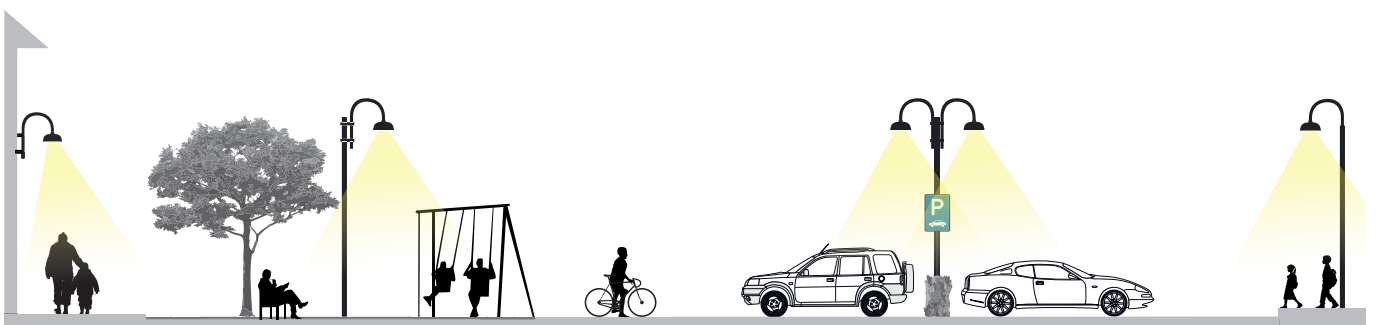
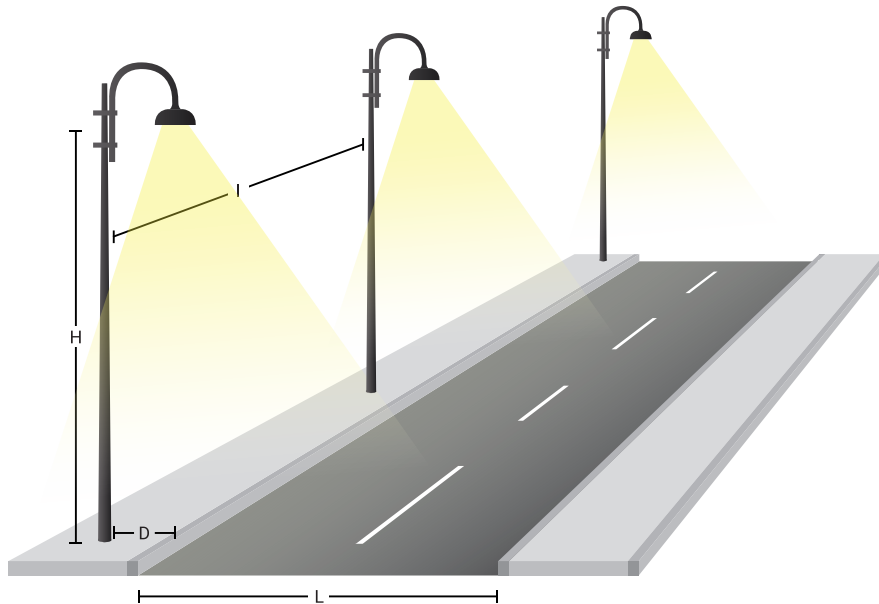

Fabula

Lamp post head with a classic “lantern” shape conceived for urban décor in lighting historic centres. Fabula is available in two different sizes and can be installed on posts or wall mounted using an elegant boom. The fixture can be configured with very warm LEDs, in other words, with a colour temperature of 2200°K, ideal for integrating perfectly in historic centres. With its antique and elegant design, it gives the environment a classic, almost romantic atmosphere and makes a perfect balance possible between modern performance and preservation of tradition.





Fabula Small | Urban & Street | 190-250 V | powerLED



3,5 Kg



41,3 dm³

9 LEDs - CRI80 - 22 W DC - 25 W AC

82401	RAL9005	A 2200 K	1917 lm	00 Diffused
		W 3000 K	2394 lm	07 Asymmetrical
		N 4000 K	2556 lm	

Fabula Big | Urban & Street | 190-250 V | powerLED

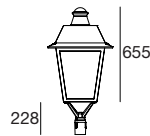

6,5 Kg



135 dm³

18 LEDs - CRI80 - 36 W DC - 40 W AC

82403	RAL9005	A 2200 K	3612 lm	00 Diffused
		W 3000 K	4493 lm	07 Asymmetrical
		N 4000 K	4804 lm	

18 LEDs - CRI80 - 54 W DC - 60 W AC

82402	RAL9005	A 2200 K	6996 lm	00 Diffused
		W 3000 K	8692 lm	07 Asymmetrical
		N 4000 K	9294 lm	





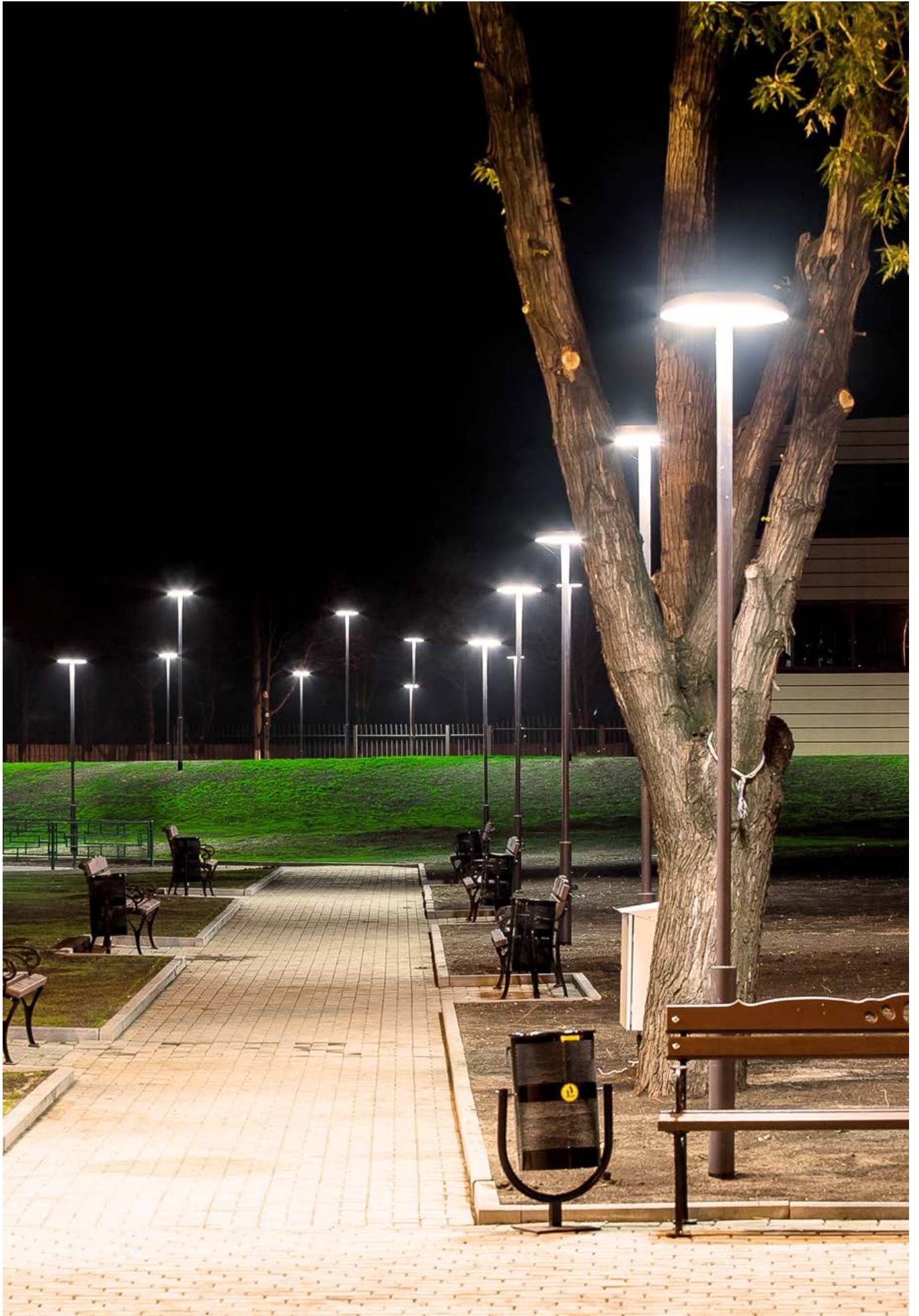

Voyager

Voyager is a disc-shaped lamp post head with rounded edges and it represents a solution for both street and urban lighting. Voyager a very versatile luminaire and it is available in the versions with power LEDs and transparent glass for street applications or with topLED and frosted glass for urban décor applications. The TopLED varieties fitted with circular frosted glass generate a diffused light, ideal for applications in public parks, car parks or squares.

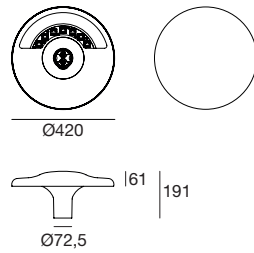









 6,3 Kg  36 dm³  0,14 m²  0,03 m²





3 LEDs - 23 W DC - 26 W AC

93188 	A 2200 K	2339 lm	71 Bike
93189 	W 3000 K	3278 lm	72 Street 2.0
	N 4000 K	3515 lm	73 Urban 2.0
	C 5000 K	3515 lm	79 Park





4 LEDs - 31 W DC - 35 W AC

93186 	A 2200 K	3118 lm	71 Bike
93187 	W 3000 K	4371 lm	72 Street 2.0
	N 4000 K	4686 lm	73 Urban 2.0
	C 5000 K	4686 lm	79 Park





5 LEDs - 35 W DC - 40 W AC

93184 	A 2200 K	3534 lm	71 Bike
93185 	W 3000 K	4968 lm	72 Street 2.0
	N 4000 K	5327 lm	73 Urban 2.0
 93332 	C 5000 K	5327 lm	79 Park
93336 			



6 LEDs - 42 W DC - 46 W AC

93182 	A 2200 K	4241 lm	71 Bike
93183 	W 3000 K	5962 lm	72 Street 2.0
	N 4000 K	6392 lm	73 Urban 2.0
 93324 	C 5000 K	6392 lm	79 Park
93328 			



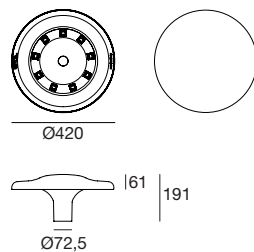
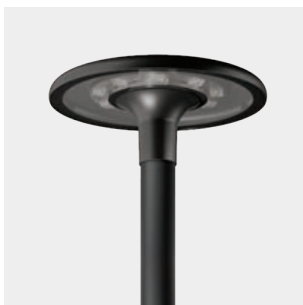

7 LEDs - 49 W DC - 54 W AC

93174 	A 2200 K	4948 lm	71 Bike
93181 	W 3000 K	6955 lm	72 Street 2.0
	N 4000 K	7457 lm	73 Urban 2.0
 93312 	C 5000 K	7457 lm	79 Park
93313 			



 6,3 Kg  36 dm³  0,14 m²  0,03 m²

9 LEDs - 64 W DC - 71 W AC

93170 	A 2200 K	6361 lm	00 Diffused
93171 	W 3000 K	8942 lm	
	N 4000 K	9588 lm	
 93293 	C 5000 K	9588 lm	
93294 			

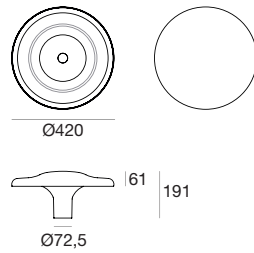

6,3 Kg 36 dm³ 0,14 m² 0,03 m²

192 LEDs - 47 W DC - 50 W AC

80909 RAL7016	A 2200 K	4992 lm	00 Diffused
80910 RAL7035	W 3000 K	6355 lm	
	N 4000 K	6682 lm	
80913 RAL7016	C 5000 K	6931 lm	
80914 RAL7035			

192 LEDs - 63 W DC - 70 W AC

80953 RAL7016	A 2200 K	6156 lm	00 Diffused
80954 RAL7035	W 3000 K	8352 lm	
	N 4000 K	8832 lm	
80955 RAL7016	C 5000 K	9274 lm	
80956 RAL7035			

Proposals for installation

Areas of use:

- local streets
- secondary streets
- urban streets
- rural streets
- urban décor

Lighting class	M5/C5	M4b/C4	M4a	S2
Voyager version	35W	40W	46W	26W
Lamp post height (H)	7 m	8 m	8 m	4 m
Lamp post spacing (I)	28 m	32 m	34 m	25 m
Carriageway width (L)	5 m	6 m	7.5 m	4 m

Technical lighting calculations in road surface category C2, and 4000 K LED temperature used

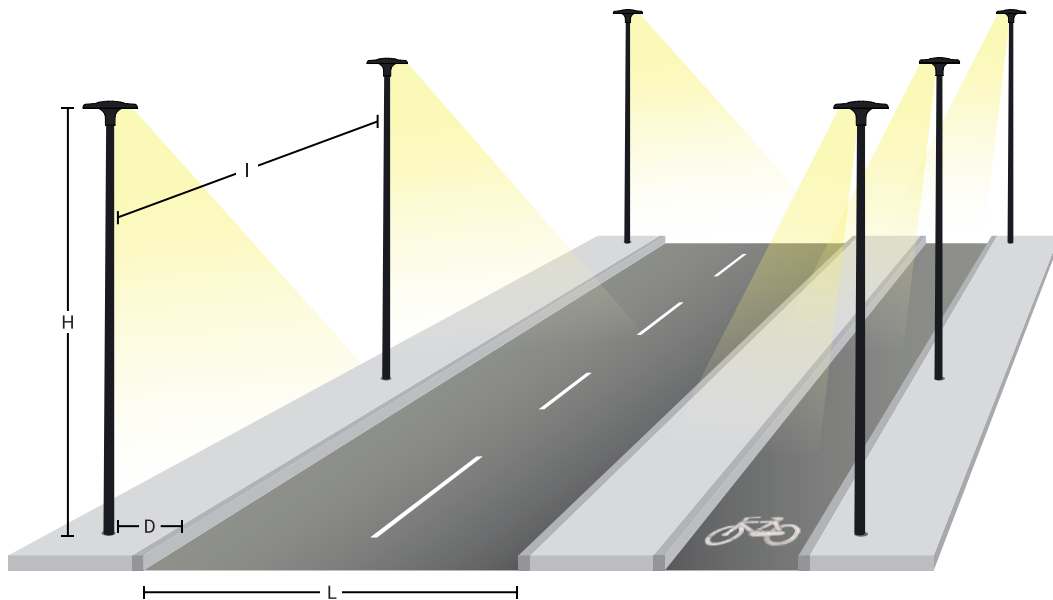

Enterprise

Conical/disc-shaped lamp post head with rounded edges. Enterprise is available in the versions with transparent polycarbonate cover and power LED or in the versions with frosted polycarbonate cover and topLED technology. These fixtures were conceived to be the ideal solution in any urban décor and lighting setting such as squares, pedestrian walkways, cycle paths, public parks or more generally for any urban area where there is a constant flow of pedestrian traffic.



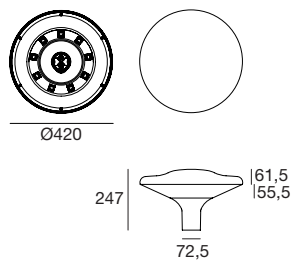

9 LEDs - 64 W DC - 71 W AC

93190	RAL7016	A	2200 K	6361 lm	00 Diffused
93197	RAL7035	W	3000 K	8942 lm	
		N	4000 K	9588 lm	
93340	RAL7016	C	5000 K	9588 lm	
93343	RAL7035				

5,8 Kg 36 dm³ 0,14 m² 0,05 m²

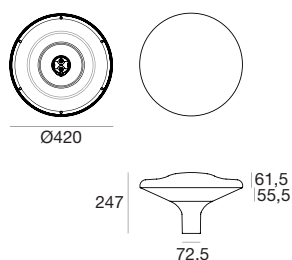

192 LEDs - 47 W DC - 50 W AC

80921	RAL7016	A	2200 K	4992 lm	00 Diffused
80922	RAL7035	W	3000 K	6355 lm	
		N	4000 K	6682 lm	
80923	RAL7016	C	5000 K	6931 lm	
80924	RAL7035				

192 LEDs - 63 W DC - 70 W AC

80961	RAL7016	A	2200 K	6156 lm	00 Diffused
80962	RAL7035	W	3000 K	8352 lm	
		N	4000 K	8832 lm	
80963	RAL7016	C	5000 K	9274 lm	
80964	RAL7035				

5,8 Kg 36 dm³ 0,14 m² 0,05 m²

Proposals for installation

- Areas of use:
- Urban décor
 - Public parks
 - Green areas
 - Pedestrian walkways



Driled

Projectors for application on busbar conceived for tunnel lighting. The Driled lighting system ensures safety for the driver, easy maintenance, reduced operating cost and greater energy efficiency. With cutting-edge LED lighting, the street is perfectly lit in compliance with prevailing regulations. Driled was designed to be used in the various zones of tunnels, thanks to the special optional optics, and it is available in large and small versions.



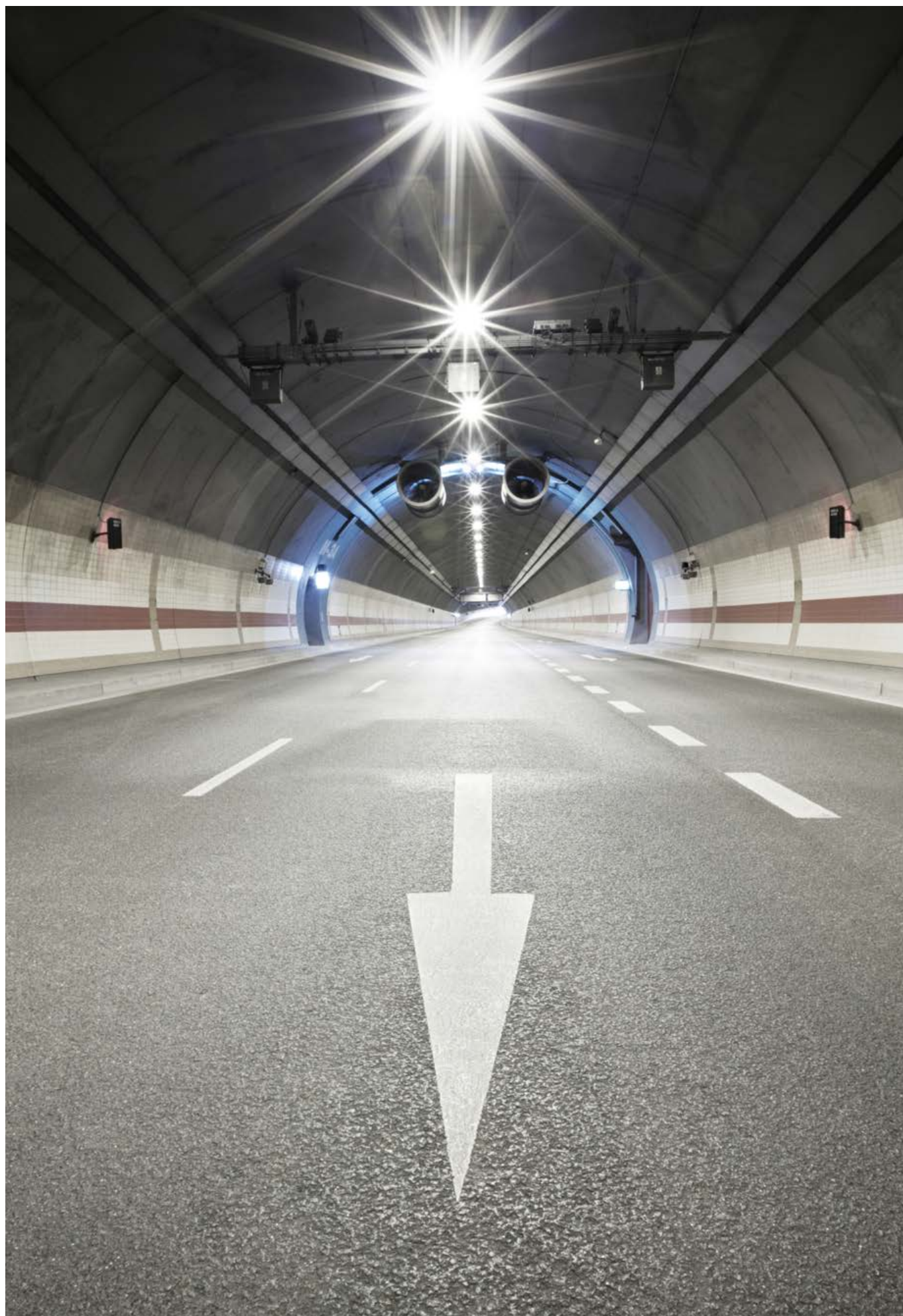

Driled Small | Urban & Street | 190-250 V | powerLED

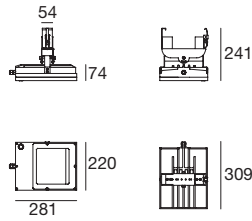

9 LEDs - 64 W DC - 71 W AC

80929	RAL7016	W 3000 K	8942 lm	75 Permanent
80930	RAL7035	N 4000 K	9588 lm	79 Fortifying
		C 5000 K	9588 lm	
80931	RAL7016			
80932	RAL7035			

6 Kg 16 dm³ 0,06 m² 0,03 m²

Driled Big | Urban & Street | 190-250 V | powerLED

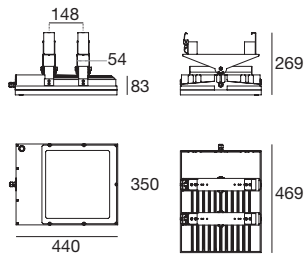

18 LEDs - 134 W DC - 145 W AC

80925	RAL7016	W 3000 K	18423 lm	75 Permanent
80926	RAL7035	N 4000 K	21272 lm	79 Fortifying
		C 5000 K	21272 lm	
80927	RAL7016			
80928	RAL7035			

14 Kg 43 dm³ 0,15 m² 0,05 m²

Lateral swivel

Drilled can be adjusted 30° toward either side for correct and precise directing of the light beam, based on the needs.

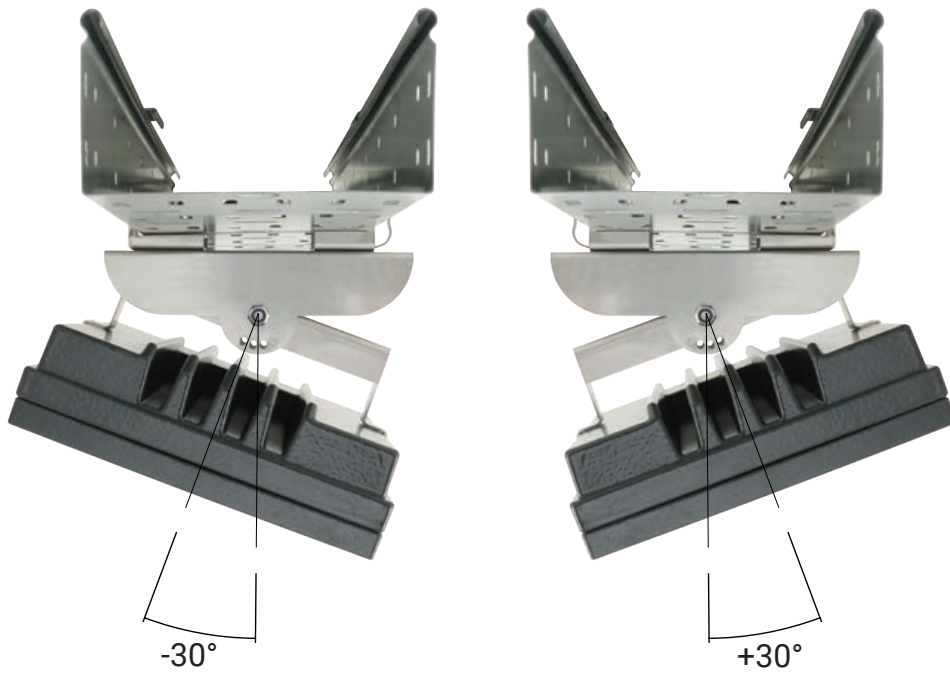
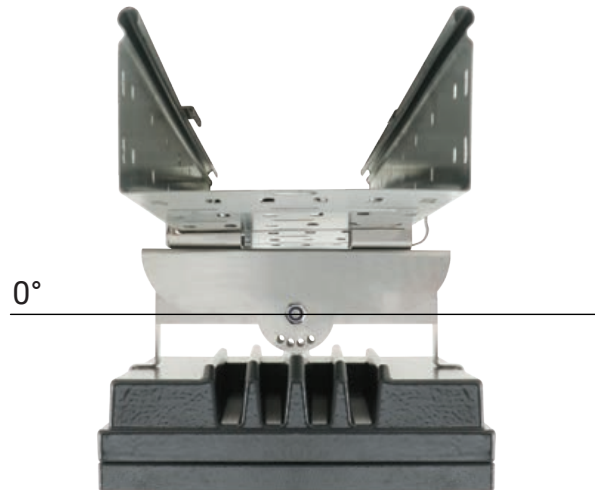

ECO Mini parker

ECO Mini Parker is a photovoltaic solar lighting system and it represents the ideal solution for lighting gardens, parks, car parks, alleys and any other environment that is not reached by the electrical grid. The photovoltaic panel and the box containing the control unit, the driver (only in the Hybrid version) and the battery which make the system completely autonomous are attached to the post head. ECO Mini Parker is the ideal solution for preventing high costs of digging and laying of electrical cables. The installation is autonomous, ecological, has no operating costs and is maintenance free. In addition to the ECO Mini Parker version, on request, the photovoltaic system can also be combined with the other lamp post heads in the i-LèD industrial range.





ECO Mini Parker HYBRID | Projector | 190-250 V | powerLED

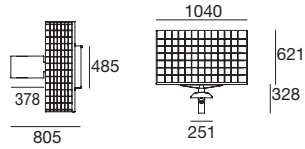

3 LEDs - 20 W DC - 21 W AC

92792 RAL7016

W	3000 K	2462 lm	71 Bike
N	4000 K	2640 lm	72 Street
C	5000 K	2640 lm	73 Urban

1 X 100Wp	1 X 42Ah	16 h	average 1 days

70 Kg 2,2 dm³ 0,67 m² 0,33 m²

ECO Mini Parker HYBRID | Projector | 190-250 V | powerLED

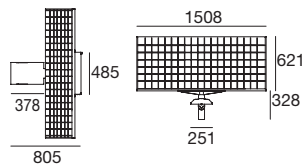

4 LEDs - 30 W DC - 32 W AC

80935 RAL7016

W	3000 K	3975 lm	71 Bike
N	4000 K	4261 lm	72 Street
C	5000 K	4261 lm	73 Urban

1 X 100Wp	1 X 42Ah	16 h	average 1 days

70 Kg 2,2 dm³ 0,95 m² 0,33 m²

ECO Mini Parker SOLAR | Projector | 12 V | powerLED

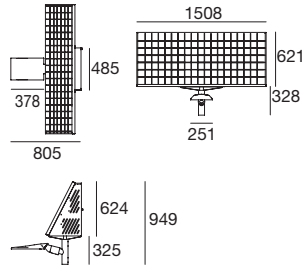

70 Kg 2,2 dm³ 0,95 m² 0,33 m²

3 LEDs - 20 W DC

92790 RAL7016

W 3000 K	2462 lm	71 Bike
N 4000 K	2640 lm	72 Street
C 5000 K	2640 lm	73 Urban

1 X 150Wp
 1 X 100Ah
 24 h
 average 3 days

ECO Mini Parker SOLAR | Projector | 12 V | powerLED

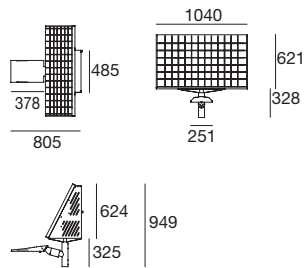

70 Kg 2,2 dm³ 0,67 m² 0,33 m²

3 LEDs - 20 W DC

92805 RAL7016

W 3000 K	2462 lm	71 Bike
N 4000 K	2640 lm	72 Street
C 5000 K	2640 lm	73 Urban

1 X 100Wp
 1 X 100Ah
 16 h
 average 3 days

ECO Mini Parker SOLAR | Projector | 12 V | powerLED

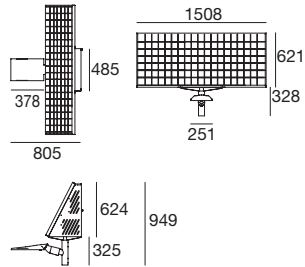

70 Kg 2,2 dm³ 0,95 m² 0,33 m²

4 LEDs - 30 W DC

80936 RAL7016

W 3000 K	3975 lm	71 Bike
N 4000 K	4261 lm	72 Street
C 5000 K	4261 lm	73 Urban

1 X 150Wp
 1 X 100Ah
 16 h
 average 3 days

Posts & fixing accessories

The supports, posts and lamp towers are made with monoblock elements and with modular coupled elements. A finished-elements model is used for their design, comparable to an embedded beam subjected to concentrated and distributed loads, weights and seismic action. The loads consist in the action of the wind and weight, whereas the embedding is achieved with driving a portion of the rod in the foundation base, or with a flange welded to the rod and fixed with a radial series of coach screws to the foundation base.

Materials

Galvanised steel





Posts

Technical characteristics

The calculations with the relative design loads are carried out in accordance with:

- Presidential Decree 07/01/1956 No. 164 "Regulations for the prevention of injuries in the workplace."
- Law No. 1086 of 05/11/71: "Regulations on works by reinforced, normal and prestressed concrete and in metallic structure."
- CNR - UNI 10011/88: "Steel construction: instructions for calculation, execution, commissioning and maintenance."
- CNR10022/84: "Cold formed sections. Instructions for use in building."
- "UNI - ENV " 1993-1-1(2004 - Eurocode 3, Design of concrete structures Part 1- 1: General regulations-General rules and rules for buildings.
- Ministerial Decree 14/01/08 Technical standards for construction.
- Ministerial Circular No. 617 of 02/02/09 "Instructions for the application of the Technical Standards for construction pursuant to Ministerial Decree 14 January 2008.
- "UNI-ENV 1991-2-4 (1997), Eurocode 1, Basis of design and actions on structures" For the entire sector of posts 20 m tall or shorter (straight posts) and equal to or shorter than 18 m (posts with arm), in the European Union, the harmonized UNI-EN standards are applied correlated with the "European Directive Council of 21 December 1988 relative to the reconciliation of the legislative, Regulatory and administrative provisions of the member States concerning construction products EEC 89/106."
- The lamp towers are constructed in observance of DPR 547 "Standards for prevention of accidents" and DPR 459 "Regulation for the implementation of the 89/392/EEC, 91/368/EEC, 93/44/EEC and 93/68/ directives.
- EEC concerning the reconciliation of legislation by the member States relative to machines.

	 MATERIAL	 UNI EN 40/2 DIMENSIONAL TOLERANCES	 PROTECTION
TAPERED AND CYLINDRICAL POSTS	Steel: S235 JRH - UNI EN 10219 (Fe 360B) R: 360 - 490 N/mm ² R and H: 235 N/mm ² A: 20 %	External diameter: ± 1 % Thickness: ± 10 % Straightness: ± 0.3 % of the total length Length: ± 0.5 %	Hot galvanising in accordance with UNI EN ISO 1461
CONICAL POSTS, CURVED BY SHEET METAL	Steel: S235 JRH - UNI EN 10219 (Fe 360B) R: 360 - 490 N/mm ² R and H: 235 N/mm ² A: 20 %	External diameter: ± 1 % Shape: ± 3 % from the diameter Thickness: ± 10 % Straightness: ± 0.3 % of the total length Length: ± 0.5 %	Hot galvanising in accordance with UNI EN ISO 1461
TAPERED AND CONICAL POSTS, HOT ROLLED	Steel: S275 JOH - UNI EN 10219 (Fe 340) - (S235 JOH - UNI EN 10219 on request) R: 410 - 560 N/mm ² (360 - 490 N/mm ² on request) R and H: 275 N/mm ² (360 - 490 N/mm ² on request) A: 20 %	External diameter: ± 3 % Thickness: ± 0.3 % Straightness: ± 0.3 % of the total length Length: ± 50 mm	Hot galvanising in accordance with UNI EN ISO 1461

R = unit tensile strength load
R and H = unit yield load
A = elongation

Processing

- Post top street lamp connecting shaft.
- Slot for terminal block.
- Incoming cables slot.
- Earth connection.

ON REQUEST:

- Base plate with anchoring holes.
- Reinforcing sleeve in welded steel.

Finishes

- Hot galvanising by immersion in melted zinc bath.
- Processing carried out in accordance with UNI EN 40/4 standards.
- Powder coating.
- Hydrocarbonising of the external buried part.
- Anti-corrosion sleeve to the section of coupling in membrane.

ON REQUEST:

- On request, different colouring from the unified RAL range.

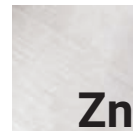

The posts are made entirely in galvanised steel.



The finishes represented here are indicative and may not faithfully reproduce the final appearance of the product.

Conical post

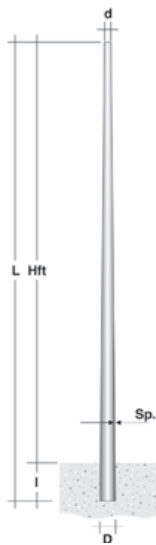

3 mm thick
code

code	L mm	Hft mm	I mm	D mm	d mm	kg	Eyelet mm
98150	3500	3000	500	95	60	21	38x132
98151	4500	4000	500	105	60	28	38x132
98152	5500	5000	500	115	60	37	38x132
98153	6800	6000	800	128	60	48	46x186
98154	7800	7000	800	138	60	58	46x186
98155	8800	8000	800	148	60	81	46x186
98156	9800	9000	800	158	60	81	46x186
98157	10800	10000	800	168	60	93	46x186

4 mm thick
code

code	L mm	Hft mm	I mm	D mm	d mm	kg	Eyelet mm
98158	6800	6000	800	128	60	63	46x186
98159	7800	7000	800	138	60	77	46x186
98160	8800	8000	800	148	60	91	46x186
98161	9800	9000	800	158	60	107	46x186
98162	10800	10000	800	168	60	123	46x186

Cylindrical post

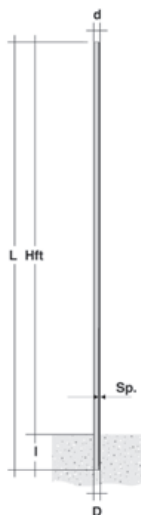

4 mm thick
code

code	L mm	Hft mm	I mm	D mm	d mm	kg	Eyelet mm
98163	5500	5000	500	102	3	44	38x132
98164	7000	6000	1000	102	4	64	46x186

Tapered post

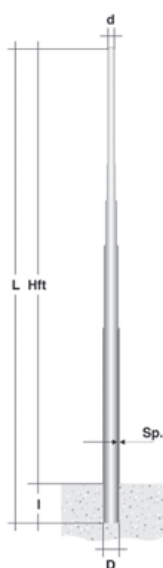

3 mm thick
code

code	L mm	Hft mm	I mm	D mm	d mm	kg	Eyelet mm
99166	5500	5000	500	89	60	31	38x132
99167	6800	6000	800	114	60	53	46x186
99168	6800	6000	800	127	60	58	46x186
99169	7800	7000	800	114	60	61	46x186
99170	7800	7000	800	127	60	66	46x186

4 mm thick
code

code	L mm	Hft mm	I mm	D mm	d mm	kg	Eyelet mm
99171	6800	6000	800	114	60	63	46x186
99172	6800	6000	800	152	60	80	46x186
99173	7800	7000	800	127	60	75	46x186
99174	7800	7000	800	139	60	79	46x186
99175	7800	7000	800	152	60	89	46x186
99176	7800	7000	800	168	60	104	46x186
98165	8000	7000	1000	127	102	103	46x186
98177	8800	8000	800	168	60	104	46x186
98178	8800	8000	800	193	102	131	46x186
98179	9800	9000	800	193	102	143	46x186
98180	10800	10000	800	193	102	155	46x186
98181	12800	12000	800	193	102	182	46x186

Arms & fixing accessories

description	code	type	L mm	T mm	
Round arm Ø 60mm	98182	RAL7016	1000	700	8
	98749	RAL7035			

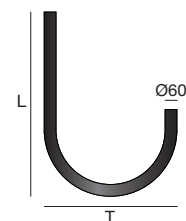

description	code	type	L mm	T mm	
Single head pole coupler	98190	RAL7016	1000	700	8,3
	98753	RAL7035			

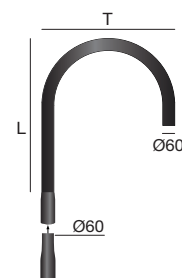

description	code	type	Ø1 mm	Ø2 mm	
Single head pole coupler	98184	RAL7016	102	60	?
	98750	RAL7035			

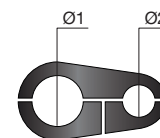

description	code	type	Ø1 mm	Ø2 mm	
Double head pole coupler	98186	RAL7016	102	60	?
	98751	RAL7035			

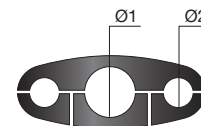

description	code	type	Ø1 mm	Ø2 mm	
Triple head pole coupler	98188	RAL7016	102	60	?
	98752	RAL7035			

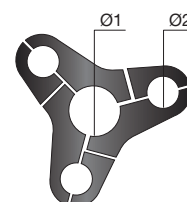

description	code	type	L mm	Ø mm	
Surface mount bracket	98288	Zn	250	70	4,5

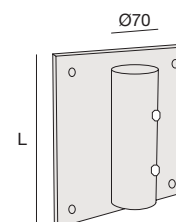

description	code	type	L mm	T mm	
Single arm Ø 60mm	98214	Zn	500	1500	8,5

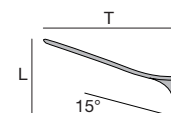

description	code	type	L mm	T mm	
Double arm Ø 60mm	98215	Zn	500	3000	17

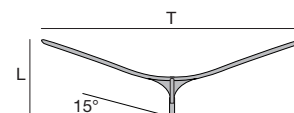

description	code	type	L mm	T mm	
Single bracket arm Ø 60mm	98216	Zn	500	1500	8,5

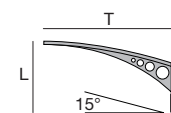

description	code	type	L mm	T mm	
Double bracket arm Ø 60mm	98217	Zn	500	3000	17

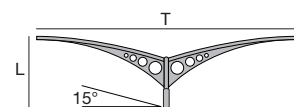

description	code	type	Ø1 mm	Ø2 mm	Kg
Pole adapter Ø 70mm	98742	RAL7016	80	60	0,8
	98743	RAL7035			

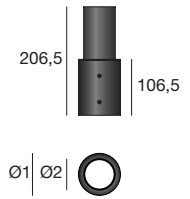

description	code	type	Ø1 mm	Ø2 mm	Kg
Pole adapter Ø 89mm	98744	RAL7016	102	60	1
	98745	RAL7035			

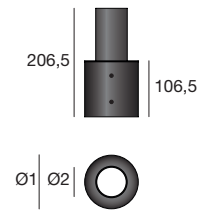

description	code	type	Ø1 mm	Ø2 mm	Kg
Pole adapter Ø 102mm	98746	RAL7016	114	60	1,1
	98747	RAL7035			

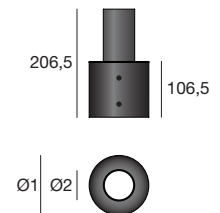

description	code	type	L mm	T mm	Kg
Slot cover	98192	RAL7016	132	38	?
	98194	RAL7016	186	45	?



description	code	L mm	T mm
Terminal for slot	98193	132	38
	98195	186	45



description	code	type	L mm	T mm	
Pole adapter Ø 70mm	98196	Zn	500	70	3
	98197	Zn	1000	70	5

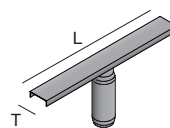

description	code	type	L mm	Ø mm	
Pole adapter Ø 89mm	98198	Zn	250	60	3,5

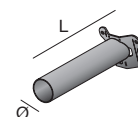

description	code	type	L mm	Ø mm	
Pole adapter Ø 102mm	98199	Zn	500	100	20

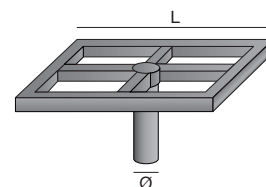

description	code	type	L mm	T mm	
Single arm 15° angled Ø 70mm	98208	Zn	250	250	4,5
	98209	RAL7035	250	250	4,5
	98210	RAL7016	250	250	4,5

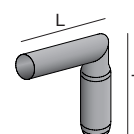



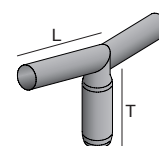

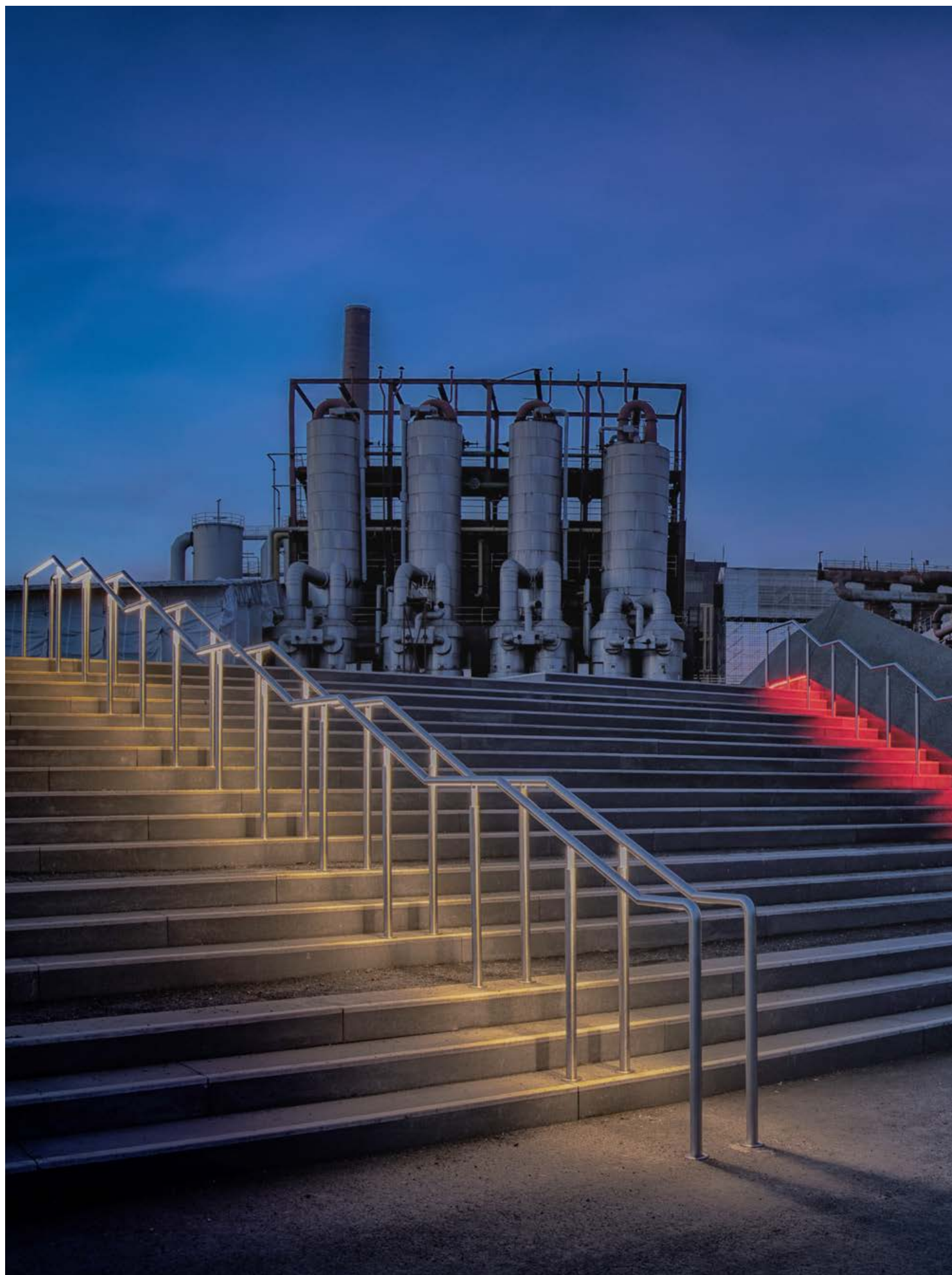

























description	code	type	L mm	T mm	
Single arm 15° angled Ø 60mm	98211	Zn	250	250	5,4
	98212	RAL7035	250	250	5,4
	98213	RAL7016	250	250	5,4







how to read symbols

-  Indoor installation
Installazione in ambiente interno
-  Outdoor installation
Installazione in ambiente esterno
-  Ceiling mounting
Installazione a soffitto
-  Ceiling or wall mounting
Installazione a soffitto o a parete
-  Ceiling, wall or ground mounting
Installazione a soffitto, a parete o a terra
-  Suspension mounting
Installazione a sospensione
-  Protection index (IEC 60529) against foreign bodies and water
Indice di protezione (IEC 60529) da corpi estranei e acqua
-  Protection index (IEC 62262) against external mechanical impacts
Indice di protezione (IEC 62262) contro impatti meccanici esterni
-  Protection against high pressures and high temperatures washes
Protezione contro lavaggi ad alte pressioni e alte temperature
-  Transpiration control system valve
Valvola di controllo della traspirazione
-  Stainless steel
Acciaio inossidabile
-  Tilting light beam
Fascio luminoso basculante
-  Emergency version available
Disponibile in versione emergenza
-  Power supply cable included
Cavo d'alimentazione incluso
-  Device suitable to be mounted on furniture
Apparecchio idoneo al montaggio su mobili
-  Device suitable to be mounted on normally flammable surfaces (EN 60598)
Apparecchio idoneo al montaggio su superfici normalmente infiammabili (EN 60598)
-  Driver included
Driver incluso
-  Driver not included
Driver non incluso
-  Class I - IEC protection class
Classe I - classe di isolamento elettrico (IEC)
-  Class II - IEC protection class
Classe II - classe di isolamento elettrico (IEC)
-  Class III - IEC protection class
Classe III - classe di isolamento elettrico (IEC)
-  Over Voltage Protection
Protezione contro sovratensioni
-  Electrostatic discharge protection
Protezione contro le scariche elettriche
- C.C.** Constant Current
Corrente costante
-  DALI
-  Autocontrol system
-  Comfort light UGR
-  TV broadcasting requirements
Conformità ai requisiti delle trasmissioni TV
-  Protective cage, compliant with standards EN13964 (annex D) and DIN 57710-13
-  Connection directly to the 190~250V AC electrical socket
Collegabile direttamente alla presa elettrica 190~250V AC.
-  Vertical wind exposure index
Indice di esposizione al vento verticale
-  Horizontal wind exposure index
Indice di esposizione al vento orizzontale

Tutti gli articoli sono in classe energetica A++.
I lumen indicati si riferiscono all'emissione della sorgente.
Gli schemi di collegamento per gli articoli dell'elettronica sono disponibili all'interno della documentazione tecnica.

All articles belong to energy class A++. The lumens indicated refer to the light source emission. The connection diagrams for electronics articles are included in the technical documentation.

finishes materials



Signal White | RAL 9003

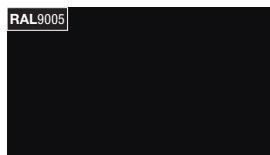

Jet Black | RAL 9005



Light aluminium Grey | RAL 9006

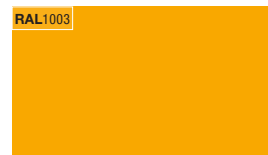

Signal Yellow | RAL 1003

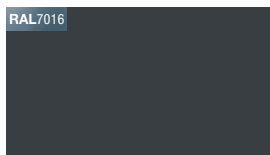

Anthracite grey | RAL 7016

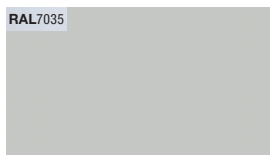

Light grey | RAL 7035



Grey

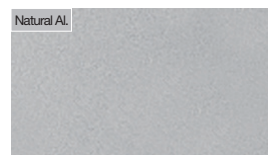

Natural Aluminium

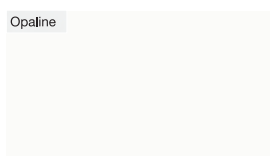

Opaline

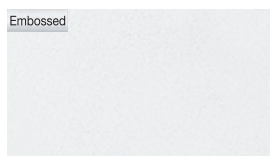

Embossed



Galvanized steel

The drawings, the measurements, the materials and the colours in this catalogue are understood to be indicative. In the interest of the clientele, the company reserves the right to modify the models at any time and without any obligation of advance notice.

"Linea Light Group" reserves the right, without any advance notice, to change the characteristics of their products, as well as the availability of the same at any time. No product, relative technical data, illustrations and information in the catalogue are binding for "Linea Light Group". "Linea Light Group" will not be held liable for any illustration, text and/or translation errors. More product characteristics are contained in the relative technical data sheets and instruction sheets. This catalogue is protected by copyright (law 22/04/1941 No. 633 and law 14/12/1942 No. 1485: this prohibits any reproduction, total or even partial). All values indicated in the catalogue are measured values. There is a +/- 10% tolerance for the flow, CCT and power data.

how to read products

Biglamp | Projector | 348 W DC powerLED

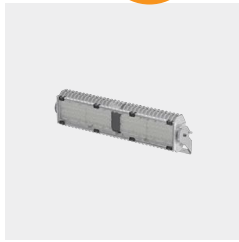

Kg
9,2 Kg

Vol
19,5 dm³

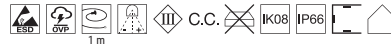
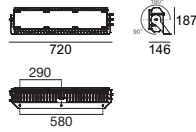

112 LEDs - CRI 80

82429 Natural AL	W 3000 K	47600 lm	15 Spot
	N 4000 K	51341 lm	30 Medium Flood
	C 5700 K	51341 lm	60 Flood
			07 Asymmetrical*

B

*Disponibile da Luglio

Driver

Controllo

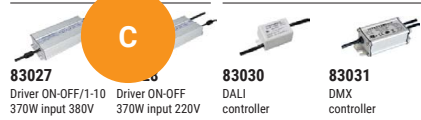

83027
Driver ON-OFF/1-10
370W input 380V

83028
Driver ON-OFF
370W input 220V

83030
DALI
controller

83031
DMX
controller

C

Biglamp | Projector | 2 x 348 W DC powerLED



Kg
25,5 Kg

Vol
56,5 dm³

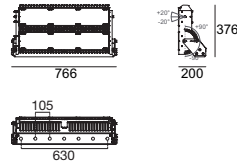

224 LEDs - CRI 80

82430 Natural AL	W 3000 K	95200 lm	15 Spot
	N 4000 K	102682 lm	30 Medium Flood
	C 5700 K	102682 lm	60 Flood
			07 Asymmetrical*

*Disponibile da Luglio

Driver

Controllo

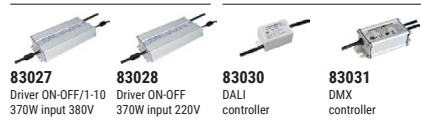

83027
Driver ON-OFF/1-10
370W input 380V

83028
Driver ON-OFF
370W input 220V

83030
DALI
controller

83031
DMX
controller

L'equipaggiamento di Driver e Controllo è da considerare per ogni singolo modulo (2x)

Biglamp | Projector | 3 x 348 W DC powerLED

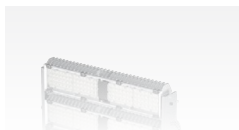

Kg
25,5 Kg

Vol
56,5 dm³

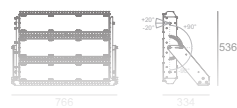

336 LEDs - CRI 80

82431 Natural AL	W 3000 K	142800 lm	15 Spot
	N 4000 K	154023 lm	30 Medium Flood
	C 5700 K	154023 lm	60 Flood
			07 Asymmetrical*

*Disponibile da Luglio

A

Family
Famiglia
appartenenza

Chapter
Capitolo
appartenenza

Power
Potenza

Current
Corrente

L.E.D. Type
Tipologia L.E.D.

Biglamp | Projector | 348 W DC powerLED

112 LEDs - CRI

B

Product measurements
Quote prodotto

Product code
Codice prodotto

Finishing
Finitura

Temperature colour
Temperatura colore

Pictograms
Pittogrammi

Biglamp | Projector | 348 W DC powerLED

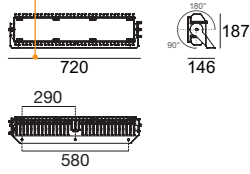
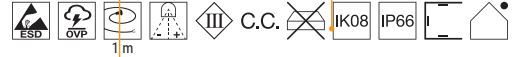

112 LEDs - CRI 80

82429 Natural A.

W	3000 K	47600 lm	15	Spot
N	4000 K	51341 lm	30	Medium Flood
C	5700 K	51341 lm	60	Flood
			07	Asymmetrical*

9,2 Kg 19,5 dm³

Product weight and volume
Peso e volume articolo

Source lumen
Lumen sorgente

Optics
Ottiche

C

Electronics code
Codice elettronica

Electronics information
Informazioni elettronica

Electronics picture
Immagine elettronica

Driver

Control

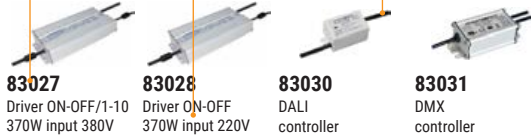

83027

Driver ON-OFF/1-10
370W input 380V

83028

Driver ON-OFF
370W input 220V

83030

DALI controller

83031

DMX controller

D

Optics specify / Definizione ottiche

Degree

Code

Spot

15°

15

Medium Flood

30°>40°

30-40

Flood

60°

60

Wide Flood

90°>120°

90-11-12

Diffused

-

00

Asymmetrical

-

07

Oval "Elliptic"

50°x85°

88

codes index

Code	Page	Code	Page	Code	Page	Code	Page
80536	58	80928	236	82272	30	82433	45
80537	58	80929	236	82273	30	82633	93
80538	58	80930	236	82274	31	82634	93
80539	58	80931	236	82275	31	82635	93
80540	59	80932	236	82276	32	82636	89
80541	59	80935	240	82277	32	82858	82
80542	59	80936	241	82278	32	82859	82
80543	59	80937	218	82279	32	82860	82
80544	59	80938	218	82280	33	82861	83
80545	59	80939	218	82281	33	82862	83
80761	58	80940	218	82282	34	82863	83
80762	58	80945	217	82283	34	82952	211
80766	60	80946	217	82284	34	82953	211
80767	60	80947	217	82285	34	82954	211
80907	198	80948	217	82286	31	82955	211
80908	198	80953	231	82287	31	82956	211
80909	231	80954	231	82288	33	82957	211
80910	231	80955	231	82289	33	82958	211
80911	217	80956	231	82347	82	82959	211
80912	217	80961	233	82348	82	82960	211
80913	231	80962	233	82349	82	82961	211
80914	231	80963	233	82350	83	82962	211
80915	217	80964	233	82351	83	82963	211
80916	217	81774	76	82352	83	82964	211
80917	218	81775	76	82401	226	82965	211
80918	218	81776	76	82402	226	82966	199
80919	218	81777	76	82403	226	82967	199
80920	218	81778	76	82424	42	82968	199
80921	233	81779	76	82425	42	82969	199
80922	233	81780	76	82426	42	82970	199
80923	233	81781	76	82428	43	82971	199
80924	233	81782	76	82429	44	82972	199
80925	236	81783	76	82430	44	82973	199
80926	236	82270	30	82431	44	82974	199
80927	236	82271	30	82432	45	82975	199

Code	Page	Code	Page	Code	Page	Code	Page
82976	199	83035	31	90448	50	92359	198
82977	199	83035	33	90449	50	92360	198
82978	199	83035	35	90450	50	92361	198
82979	199	83501	222	90451	50	92362	198
82980	199	83502	222	90452	50	92363	198
82981	199	83503	222	90453	50	92364	198
82982	199	83504	222	90454	51	92365	198
82983	199	83505	222	90455	51	92366	198
82984	199	83506	222	90456	51	92367	198
82985	199	83507	222	90457	51	92370	200
82986	199	83508	222	92151	210	92371	200
82987	199	83509	222	92152	210	92372	198
82988	199	83510	222	92153	210	92373	198
82989	199	83511	222	92156	210	92384	99
82990	199	83512	222	92157	210	92385	99
82991	199	83513	223	92162	210	92386	99
82992	222	83514	223	92163	210	92387	99
82993	222	83515	223	92166	210	92390	99
82994	222	83516	223	92167	210	92391	99
82995	222	83517	223	92168	210	92392	98
82996	222	83518	223	92208	198	92393	98
82997	222	83519	223	92209	198	92421	98
82998	222	83520	223	92242	106	92422	98
82999	222	83525	179	92243	106	92423	98
83024	89	83529	179	92244	107	92424	98
83025	89	84888	120	92245	106	92426	181
83026	89	84888	124	92246	106	92427	181
83027	44	84888	130	92247	107	92438	106
83027	45	84888	132	92248	108	92439	106
83028	44	90442	50	92249	108	92440	107
83028	45	90443	50	92352	109	92442	106
83030	44	90444	50	92353	108	92443	106
83030	45	90445	50	92356	108	92444	107
83031	44	90446	50	92357	109	92445	108
83031	45	90447	50	92358	198	92446	108

Code	Page	Code	Page	Code	Page	Code	Page
92447	109	92992	217	93292	216	95244	130
92448	108	93143	216	93293	230	95245	132
92449	108	93144	216	93294	230	95246	132
92450	109	93145	216	93312	230	95247	132
92474	206	93159	216	93313	230	95254	116
92475	206	93160	216	93324	230	95255	116
92476	206	93161	216	93328	230	95256	116
92477	206	93162	216	93332	230	95257	116
92478	206	93163	216	93336	230	95258	116
92479	206	93164	216	93340	233	95259	116
92518	210	93169	216	93343	233	95275	120
92525	210	93170	230	93346	198	95276	120
92526	210	93171	230	93347	198	95277	120
92527	210	93174	230	93348	198	95281	120
92550	198	93181	230	93349	198	95282	120
92551	198	93182	230	93350	218	95283	120
92552	198	93183	230	93351	218	95465	120
92599	198	93184	230	94679	116	95466	120
92606	198	93185	230	94680	116	95467	120
92607	198	93186	230	94681	116	95724	149
92710	206	93187	230	94908	130	95725	153
92719	206	93188	230	94909	130	95726	149
92720	206	93189	230	94910	130	95726	149
92721	206	93190	233	94911	132	95727	149
92722	206	93197	233	94912	132	95728	153
92760	206	93280	88	94913	132	95729	157
92790	241	93281	88	95049	149	95736	157
92792	240	93282	88	95236	130	95739	162
92793	65	93283	217	95237	130	95740	162
92800	67	93284	217	95238	130	95741	162
92801	67	93287	216	95239	132	95742	162
92805	241	93288	216	95240	132	96357	167
92987	218	93289	216	95241	132	96413	150
92988	218	93290	216	95242	130	96414	150
92991	217	93291	216	95243	130	96415	158

Code	Page	Code	Page	Code	Page	Code	Page
96417	163	96518	152	97808	134	98167	159
96418	163	96535	172	97809	134	98167	166
96421	150	96536	172	97810	134	98167	171
96422	150	96537	172	97812	134	98172	153
96423	158	96538	172	97813	134	98173	153
96425	163	96547	149	97814	134	98177	245
96426	163	96548	149	97850	146	98178	245
96461	150	96563	152	97851	146	98179	245
96462	151	96568	168	97852	146	98180	245
96466	167	96569	168	97853	146	98181	245
96471	167	96570	168	97854	146	98182	246
96472	167	96571	168	97855	146	98184	246
96473	170	96572	171	97856	146	98186	246
96474	170	96574	171	97857	146	98188	246
96475	148	96593	152	98150	245	98190	246
96476	148	96594	153	98151	245	98192	248
96477	156	96595	152	98152	245	98193	248
96478	156	96596	160	98153	245	98194	248
96479	166	96598	160	98154	245	98195	248
96480	166	96611	153	98155	245	98196	249
96481	171	96726	150	98156	245	98197	249
96490	170	96759	67	98157	245	98198	249
96491	170	96760	67	98158	245	98199	249
96493	151	97341	148	98159	245	98208	249
96494	159	97342	148	98160	245	98209	249
96495	159	97343	156	98161	245	98210	249
96500	166	97344	156	98162	245	98211	249
96501	166	97345	166	98163	245	98212	249
96502	171	97346	166	98164	245	98213	249
96512	162	97347	170	98165	245	98214	247
96513	162	97348	170	98166	151	98215	247
96514	163	97349	172	98166	159	98216	247
96515	163	97350	172	98166	166	98217	247
96516	152	97351	172	98166	171	98281	146
96517	152	97352	172	98167	151	98281	146

Code	Page	Code	Page	Code	Page	Code	Page
98281	148	98391	160	98742	248	99093	149
98281	149	98391	165	98743	248	99093	150
98281	150	98405	148	98744	248	99093	152
98281	165	98405	156	98745	248	99093	157
98282	146	98405	165	98746	248	99093	158
98282	148	98406	151	98747	248	99093	160
98282	149	98406	159	98748	52	99093	162
98282	150	98406	164	98749	246	99093	163
98282	151	98512	151	98750	246	99093	168
98282	152	98512	152	98751	246	99093	170
98282	153	98512	153	98752	246	99093	171
98282	156	98512	156	98753	246	99099	149
98282	157	98512	157	98754	52	99099	150
98282	158	98512	158	98755	52	99099	152
98282	159	98512	159	98756	52	99099	162
98282	160	98512	160	98757	52	99099	163
98282	162	98512	162	98758	51	99099	168
98282	163	98512	163	98760	51	99101	149
98282	165	98695	106	98761	52	99101	150
98288	246	98695	107	98762	52	99101	152
98311	149	98695	108	98763	52	99101	153
98311	157	98695	109	98764	52	99101	162
98311	162	98710	98	98765	52	99101	163
98311	165	98710	99	98766	52	99113	151
98313	146	98727	60	98782	116	99113	159
98313	149	98729	98	99092	149	99113	166
98313	157	98729	99	99092	150	99113	171
98313	162	98729	106	99092	152	99131	151
98313	164	98729	107	99092	158	99131	159
98314	153	98729	108	99092	160	99131	166
98314	164	98729	109	99092	162	99131	171
98354	152	98729	120	99092	163	99162	148
98354	160	98729	124	99092	168	99162	156
98354	164	98729	130	99092	170	99162	170
98391	152	98729	132	99092	171	99162	172

Code	Page	Code	Page	Code	Page	Code	Page
99163	148	99175	245	99225	120	99355	151
99163	156	99176	245	99225	124	99355	152
99163	170	99187	149	99225	130	99355	153
99163	172	99187	150	99225	132	99355	156
99164	149	99187	152	99226	106	99355	157
99164	150	99187	157	99226	107	99355	158
99164	152	99187	158	99226	108	99355	159
99164	162	99187	160	99226	109	99355	160
99164	163	99187	162	99226	130	99355	162
99164	168	99187	163	99226	132	99355	163
99165	149	99187	168	99227	106	99355	166
99165	150	99187	170	99227	107	99355	167
99165	152	99187	171	99227	108	99355	168
99165	153	99216	116	99227	109	99355	170
99165	162	99216	124	99227	130	99355	171
99165	163	99217	116	99227	132	99355	172
99166	245	99217	124	99228	130	99355	174
99167	245	99218	116	99228	132	99355	179
99168	245	99218	124	99229	98	99391	30
99169	245	99218	125	99229	99	99391	35
99170	245	99219	116	99229	106	99392	30
99171	245	99219	120	99229	107	99392	35
99172	245	99219	122	99229	108	99393	32
99173	245	99220	116	99229	109	99393	34
99174	149	99220	120	99229	120	99393	35
99174	150	99220	123	99229	124	99484	52
99174	152	99221	116	99229	130	99556	179
99174	158	99221	122	99229	132	99574	31
99174	160	99222	116	99238	116	99574	33
99174	162	99222	120	99238	120	99574	35
99174	163	99222	122	99238	123	99581	52
99174	168	99223	123	99355	146	99582	52
99174	170	99224	116	99355	148	99584	179
99174	171	99224	123	99355	149	99585	52
99174	245	99225	116	99355	150		

linea light address

Linea Light HQ Italy

via della Fornace, 59 z.i.
31023 Castelfranco di Resana (TV) - Italy
Phone: +39 0423 7868
Fax: +39 0423 786900
info@linealight.com

Linea Light UK

Suite 205 - The Business Design Centre
52 Upper Street - Islington N10QH
London - UK
Phone: +44 0203 6371983
info@linealight-uk.com

Linea Light Polska

ul. Wiosenna, 47
41253 Czeladz - Poland
Phone: +48 32 760 98 71
Fax: +48 32 760 98 76
biuro@linealight.com.pl

Linea Light USA - Inter Lux

3741 Commerce Drive
Suites 306-308
Baltimore, MD 21227 - USA
Phone: +1 410 381 1497
Fax: +1 410 381 1589
answers@inter-lux.com

Linea Light Singapore

21 Kaki Bukit Place, 5th Fl.
Eunos Techpark Singapore
416199 Singapore
Phone: +65-6908 5758
info.sg@linealight.com

Art direction

Linea Light Group
Marketing Dept.

Printed in Italy

May 2020

LightVillage Milano

Exhibition Area Only
via Morimondo, 26 int. 17G
20143 Milano - Italy
Phone: +39 02 36750915
Fax: +39 02 36750915
milano@lightvillage.it

Linea Light France

Z.A. Heiden Est, 12 rue des Pays-Bas
68310 Wittelsheim - France
Phone: +33 389 75 52 23
Fax: +33 389 75 59 07
info@linealight.fr

Linea Light Russia

Design Center ARTPLAY
Nizhnyaya Syromyatnicheskaya 10/2
enter B, 3rd floor, office 14
105120 Moscow - Russian Federation
Phone: +7 495 639 9941
info@linealight.ru

Linea Light GCC

Jumeirah Business Center 2
Unit n. 3504 - 35th Floor - Cluster V
P.O. Box 125902 Dubai - UAE
Phone: +971 4 4218275
Fax: +971 4 4218274
info@linealight.ae

Linea Light Roma

Via Stendhal, 22
00144 Roma - Italy
Phone: +39 06 5935106
info@linealightroma.com

Linea Light Deutschland

Aktienstraße 214
45473 Mülheim Ruhr - Germany
Phone: +49 208 299979-0
Fax: +49 208 299979-10
service@linealight.de

Linea Light Spain

C/ Longares, 48
28022 Madrid - Spain
Phone: +34 912 534 773
info@linealight.es

Linea Light Asia - Pacific

No. 7, Nanyi Huayuan Road, Industry Avenue,
528478 Xiaolan Town, Zhongshan City
Guangdong Province - China
Phone: +86 760 87618355
Fax: +86 760 87553990
info@linealight.cn

I disegni, le quote, i materiali ed i colori del presente catalogo si intendono a titolo indicativo. Nell'interesse della clientela, l'Azienda si riserva il diritto di modificare i modelli in ogni momento senza l'obbligo di preavviso.

The drawings, dimensions, materials and colours contained in this catalogue are merely indicative. In the customers' interest, the Company reserves the right to modify the models at any time without notice.

linealight.com



Your Light | Future Proof