

## Supplier:

## Bendix Formula Blue

<b>Supplier Information</b>	Formula Blue® raises the bar on value and performance with a full line of proven friction material formulations to meet your specific light and medium-duty application needs. Take advantage of our available heavy duty and premium offerings proven equivalent or superior to competitive brands in terms of fade and recovery, rotor and pad wear, and braking effectiveness.
<b>Customer Service &amp; Technical Support</b>	<p>Hino Parts Support Phone: (866) 372-4466</p> <p>Hino Parts Support Email: <a href="mailto:helpdesk@hino.com">helpdesk@hino.com</a></p> <p>Hino Parts Support Fax: (662) 342-3939</p> <p><b>Bendix Main Contacts:</b> <a href="http://www.foundationbrakes.com/en/contacts/contacts_2.jsp">http://www.foundationbrakes.com/en/contacts/contacts_2.jsp</a></p> <p><b>Bendix Has 2 Main US Locations</b></p> <p><b>1. Huntington IN (primary) - Services Eastern US</b>          Phone: (800) AIR-BRAK (follow prompts)          Email: <a href="mailto:BSFBorders@Bendix.com">BSFBorders@Bendix.com</a></p> <p><b>2. Sparks NV - Western US</b>          Phone: (800) AIR-BRAK or (775) 353-4255          Email: <a href="mailto:Gary.Breshears@Bendix.com">Gary.Breshears@Bendix.com</a>; <a href="mailto:Lisa.Mitchell@Bendix.com">Lisa.Mitchell@Bendix.com</a>; <a href="mailto:Caty.Ortega@Bendix.com">Caty.Ortega@Bendix.com</a>; <a href="mailto:Laura.Dziuk@Bendix.com">Laura.Dziuk@Bendix.com</a>          Fax: (775) 353-4270</p>
<b>Order Procedures:</b>	All orders are to be placed through the Hino Dealer Connect System (DCS). For special orders or for customer support contact Vendor directly via phone number.
Stock Orders	Enter orders in DCS DC202 under Sales Type "S". Direct ship (DS) items will be shipped from a local Vendor PDC.
Emergency Orders	Emergency orders (EM) may be entered into DCS screen DC202 as a Sales Type "E" or "V". All emergency orders will be processed with a "rush" order. Freight and Handling fees will be identified on the Hino invoice. **The emergency shipper is not intended as a way to move large volumes of material, but rather small quantities urgently needed to alleviate an immediate problem, i.e., truck down. The freight charges on emergency shipments are always collect and an Emergency Order fee of \$20.00 USD per order will be applied to Priority 1 orders.
Minimum Order Quantity	**A Minimum Order handling fee of \$50.00 USD per order will be applied to all orders less than \$100 USD (excluding cores). The Minimum Order fee will not be applied to orders which include Emergency Order fees.
<b>Freight Policy:</b>	Minimum order quantity of \$1,800.00 (on the invoice / excluding cores) to meet prepaid freight. Smaller orders would ship freight prepaid and added to the invoice. Bendix (BCVS) will have the option to select the carriers for shipments to the distributor when the freight is being prepaid by them. BCVS will pick the routing which is most economical and desirable and will provide a combination of the lowest rate with delivery in the shortest possible time.
<b>Free Freight Policy:</b>	\$1,800.00+ orders (excluding cores) achieves Free Freight to the Dealership.
<b>Order Fulfillment Policy:</b>	The standard order processing time is 8 business days from date of order placement.
<b>Part Number Pricing:</b>	Pricing will be available on-line in the Hino DCS system. In addition, the prices will be forwarded to your service bureaus within two weeks of each pricing update.
<b>Part Number Format:</b>	Standard Part numbers are directly carried over with a prefix of "BX-" with no "-" in the part numbers.
<b>Mega Fleet:</b>	All-Makes parts are not included in the Hino Mega Fleet pricing file but should be sold to Mega Fleet customers and filed as Miscellaneous Items in Corcentric when submitting for reimbursement.
<b>Warranty:</b>	Please view Vendor warranty documents as warranty varies based on item. Contact vendor directly or go to <a href="http://www.bendix.com">www.bendix.com</a> (search in the "document library" under "warranty").
<b>Returns:</b>	Bendix Return Policy: Contact vendor directly to obtain a Return Goods Authorization code by phone number or email address listed above. All returned items MUST have prior approval and the Return Goods Authorization (RGA) marked on the outside of the box. RGAs have an expiration date of thirty (30) days; after thirty (30) days the return will become null and void. The service plants will reply to the distributor's request for return authorization within 30 days of receiving request and a return authorization purchase order will be sent to the distributor at that time. All material will be shipped to and processed at your service plant. Shipments must be prepaid (FOB service plant) and must arrive within two months of authorization date. A copy of the return authorization purchase order must accompany the return material shipment as a packing list. All returns are subject to a 25% or greater restocking fee. Supplier will not authorize any returns that are not properly packaged or in the original packaging. Returns will only be considered for parts that are on the active price list. No credit will be issued for product that has been damaged, altered, or installed on equipment (all product returned must be in good, saleable condition, including complete packets). The customer is responsible for all freight charges on the returned merchandise. Special order items or non stock items are not returnable. *Max \$ amount that can be returned is not to exceed 3% of the prior year's purchases.
<b>Shipping Inspection and Damaged Product:</b>	All merchandise should be inspected upon arrival and carrier damage claims should be filed with the carrier immediately. We are not responsible for, nor are we in a position to make a claim after the freight carrier accepts the shipment from us. For excess stock returns, contact the supplier directly.
<b>Supplier Literature Downloads:</b>	<a href="http://www.foundationbrakes.com/en/products/formulablue/formulablue_1.jsp">http://www.foundationbrakes.com/en/products/formulablue/formulablue_1.jsp</a>
<b>Supplier Cross Ref. Web Site:</b>	<a href="http://www.bendix.com/en/service/support/partscrossreferencetool/partscrossreferencetool_1.jsp">http://www.bendix.com/en/service/support/partscrossreferencetool/partscrossreferencetool_1.jsp</a>
<b>Conclusion:</b>	<b>Formula Blue® Hydraulic Brake Parts</b> It's time to brake out of the ordinary. Heavy duty parts for hard working vehicles from Bendix Spicer Foundation Brake (BSFB).
<b>PA-2014-011</b>	
<b>03-19-14 02.21.PM</b>	

**FORMULABLUE**<sup>®</sup>  
HYDRAULIC BRAKE PARTS

*Import and Domestic*  
**2012 Supplement to  
BW7348 Master Catalog for Light-  
and Medium-Duty Vehicles**



A SUPPLEMENT WITH ILLUSTRATED  
PARTS IDENTIFICATION GUIDE FOR  
FORMULA BLUE<sup>®</sup> HYDRAULIC BRAKE  
PARTS, including brake pads, shoes,  
drums, rotors, wheel cylinders, master  
cylinders and calipers.

**HEAVY DUTY PARTS** FOR HARD WORKING VEHICLES

**Bendix Spicer  
Foundation Brake LLC**  
*A Bendix CVS and Dana Joint Venture*



From the company you trust for your heavy-duty foundation brake needs, comes Formula Blue® brake parts, a complete line of light- and medium-duty hydraulic brake parts for import and domestic vehicles, class 1 – 6.



**Brake Pads and Shoes**

- Proven stopping performance
  - Long service life
  - Superior friction attachment
  - Resistance to noise and kind to rotors
- Formula Blue® medium-duty pads are available in both Heavy Duty grade – where maximum service life is essential – and Premium formulations, where quiet running is a must.



**Calipers**

- Includes remanufactured and service new versions
- Fits the broadest range of medium- and light-duty commercial vehicles
- Available in semi-loaded and loaded applications – to do the complete job right, the first time
- Superior quality control minimizes service related issues



**Rotors & Drums**

- Exact application fit and function
- Superior casting finish
- Smoother stops
- Reduced vibration
- Rust resistant finish



**Brake & Clutch Hydraulics**

- Exact form, fit and function is the key to Formula Blue® brake cylinders, master cylinders, and other key brake components, providing long, reliable service life



**Hardware**

- Formula Blue® brake hardware provides exact form, fit and function, ensuring quiet reliable operation

- **Comprehensive Coverage • Outstanding Value**
- **Prompt Delivery • Proven Sales & Service Support**
  - **Expert Technical Assistance**
  - **Full Electronic Cross Reference**



Find out more. See your Bendix representative, call 1-866-610-9709, or visit [www.foundationbrakes.com](http://www.foundationbrakes.com).

Bendix Spicer  
Foundation Brake LLC



**2012 Edition**

**Supplement for Light-  
and Medium-Duty Vehicles**

Import & Domestic

*Heavy Duty Parts for Hard Working Vehicles*

**Bendix Spicer Foundation Brake LLC**

901 Cleveland Street • Elyria, Ohio 44035

Phone: 440-329-9709

Toll-Free: 1-866-610-9709

Fax: 440-329-9203

Tech Support: 1-866-610-9709, option 2

[www.foundationbrakes.com](http://www.foundationbrakes.com)





## Heavy Duty Parts for Hard Working Vehicles

Select from the full line of long-lasting Formula Blue® Hydraulic Brake Parts for class 1 – 6 commercial vehicles, including:

- Brake Pads and Shoes
- Brake Hardware
- Rotors and Drums
- Brake & Clutch Hydraulics



### **Uncompromising Performance. Outstanding Value.**

If your customers are looking for new ways to better manage margins and overall cost without sacrificing performance and quality, Formula Blue® Hydraulic Brake Parts is the answer. Formula Blue® Hydraulic Brake Parts delivers broad coverage for most light- and medium-duty applications.

**Find out more. See your Bendix representative or visit [www.foundationbrakes.com](http://www.foundationbrakes.com) today.**

# Table of Contents

---

---

Part Numbering System .....	4
Product Groups .....	5
Trademark Notice .....	6
Disclaimer of Liability .....	7
Conversion Table .....	8
Application Guide .....	9
Abbreviations .....	10
Make /Model Index .....	11
Vehicle Make Tables .....	14
Light-Duty Vehicle Application Guide .....	15
Medium-Duty Vehicle Application Guide .....	149
Illustrated Parts Guide .....	221
Brake Pads .....	223
Brake Shoes .....	263
Hardware Kits.....	271
Brake Rotors .....	275
Brake Drums .....	293
Brake Master Cylinders .....	295
Brake Wheel Cylinders .....	309
Clutch Master Cylinders .....	315
Clutch Slave Cylinders .....	317
Brake Calipers .....	319
Brake Caliper Kits.....	335
Caliper Core Identification .....	339
Caliper Type Exploded View .....	345
Buyers' Guide.....	359

# How To Use the Formula Blue<sup>®</sup> Hydraulic Brake Parts Catalog Part Numbering System

The Formula Blue<sup>®</sup> Hydraulic Brake Parts part numbering system is specially designed to easily identify both the type of part, and the type of vehicle the part fits.

## Hard Parts

The digits and letters in this “smart” part number for hard parts represent:

- Prefix: “E”
- Product Group: 3 digits (*see next page for a complete listing of product groups*)
- Vehicle Make: 2 digits (*for all products groups other than friction*)
- Part Number: 3 digits
- Optional Suffix: 1 digit (optional)
  - For Bare Caliper: 1 digit following the decimal (only for product group 146)  
(*this optional digit will be one of the following:*)
    - .1 = denotes a remanufactured bare caliper; or
    - .2 = denotes a “service new” semi-loaded caliper
  - For Loaded Caliper: 1 digit following the decimal (only for product group 147)  
(*this optional digit will be one of the following:*)
    - .1 = denotes medium duty remanufactured calipers loaded with Heavy Duty friction pads. A loaded caliper part number without the .1 represents loaded calipers with Premium grade pads.

For Example: **E146-66-028.1**

**Prefix “E”**

**146** = Semi-loaded remanufactured Caliper with Hardware

**66** = Ford

**028** = Formula Blue<sup>®</sup> hydraulic brake base part number

**.1** = denotes a bare caliper version

## Brake Pads and Shoes

The digits and letters in this “smart” part number for friction parts represent:

- Prefix: “E”
- Product Group: 3 digits (*see next page for a complete listing of product groups*)
- FMSI Part Number: 4 digits
- Variation: 1 digit

For Example: **E109-0786-1**

**Prefix “E”**

**109** = Metallic Brake Pads (Premium) with Shims

**0786** = FMSI D786 brake pad form

**1** = Alternate pad thickness

## When Placing Your Order:

**The decimal points and dashes in our part numbers are in place for your convenience when using this catalog. To ensure accurate and prompt processing of your request, please do not use the decimal points or dashes when placing any orders for Formula Blue<sup>®</sup> Hydraulic Brake Parts with Bendix Spicer Foundation Brake LLC via online ordering, phone or fax.**

## Brake & Clutch Systems Product Groups

### BRAKE PADS AND SHOES†

105	OEM Formula Brake Pads
107	Semi-Metallic Brake Pads
109	Semi-Metallic Brake Pads (Premium)
110	Ceramic Brake Pads with Shims
111	Extended Wear (Heavy Duty) Brake Pads
112	Import Premium Brake Pads
116	New Bonded Brake Shoes
117	Heavy Duty Riveted Brake Shoes
305	Premium Brake Pads with Shims

### BRAKE HARDWARE

121	Brake Pads Sensor Wires
122	Disc Brake Hardware
123	Drum Brake Hardware Kit
124	Self Adjuster Kit

### ROTORS AND DRUMS

125	Premium Brake Rotor
126	Standard Brake Rotor
127	Premium Brake Drum
128	Standard Brake Drum
129	Brake Hub
130	Premium High-Carbon Brake Rotor

### BRAKE & CLUTCH HYDRAULICS\*

135	Premium Brake Master Cylinder
139	Premium Wheel Cylinder
141	Premium Clutch Master Cylinder / Assembly
143	Premium Clutch Slave Cylinder
146	Semi-Loaded & Bare Remanufactured, Service New Calipers*
147	Loaded Remanufactured Calipers*
148	Caliper Kits
149	Wheel Cylinder Kits
155	Brake Hose (some Clutch Hoses)
156	Clutch Hose

#### Important Information About Formula Blue® Calipers, Brake Pads and Friction Material

- \* Caliper part numbers, as listed in the catalog for specific applications, are for both loaded and semi-loaded caliper offerings. The part number is comprised of the letter "E" followed by eight (8) digits.

#### For Product Group 146 (semi-loaded & bare remanufactured, service new calipers):

Select calipers are available as loaded or bare.

- Bare calipers are called out through the addition of a ".1" (dot one) at the end of the part number, resulting in the letter E followed by nine (9) digits.
- Service new semi-loaded calipers are identified through the addition of a ".2" (dot two) at the end of the part number.

#### For Product Group 147 (loaded remanufactured calipers):

Select medium duty calipers are available with Premium or Heavy Duty grade pads.

- Heavy duty grade pads are identified by the addition of a ".1" (dot one) at the end of the part number, resulting in the letter "E" followed by nine (9) digits.

Please refer to the current inventory system at your business to determine availability and price.

- † **Multiple friction offerings are available for Formula Blue® Brake Pads.** Please refer to the three digit product group code to confirm either Premium or Heavy Duty grade friction. Part numbers containing product group code 109 and 112 denote Premium grade, while parts with product group code 111 denote Heavy Duty grade friction material. Please refer to the current inventory system at your business to determine availability and price.



## TRADEMARK NOTICE

FORMULA BLUE® is a trademark of Bendix Commercial Vehicle Systems LLC.

Any references in this catalog to ACURA, AM GENERAL, AMERICAN MOTORS, AUDI, BMW, BUICK, CADILLAC, CHEVROLET, CHRYSLER, DAEWOO, DODGE, FORD, FREIGHTLINER, GMC, HINO, HONDA, HONEYWELL, HUMMER, HYUNDAI, IHC – NAVISTAR, INFINITI, INTERNATIONAL, ISUZU, IVECO, JEEP, KELSEY-HAYES, KIA, LAND ROVER, LEXUS, LINCOLN, MAZDA, MERCEDES-BENZ, MERCURY, MITSUBISHI, NISSAN, OLDSMOBILE, PLYMOUTH, PONTIAC, PORSCHE, ROVER, SAAB, SATURN, SCION, SUBARU, SUZUKI, TOYOTA, UD, VOLKSWAGEN, VOLVO, WINNEBAGO and any other company or trademark are solely for identification and cross reference purposes. The trademarks are the property of their respective companies and are not affiliated with, or endorsing Bendix Spicer Foundation Brake LLC. Bendix Spicer Foundation Brake is a joint venture of Bendix Commercial Vehicle Systems LLC and Dana Commercial Vehicle Products, LLC. Bendix Spicer Foundation Brake LLC does not represent any parts shown as products manufactured or remanufactured by the companies so named herein.





## **NOTICE: DISCLAIMER OF LIABILITY**

Bendix Spicer Foundation Brake LLC obtained the information reflected in this catalog from reliable sources and believes this information to be complete and accurate as of the time of printing. Nevertheless, Bendix Spicer Foundation Brake LLC does not make any warranty, express or implied, as to the correctness, accuracy, or completeness of the information in this catalog, NOR as to MERCHANTABILITY OR FITNESS FOR A PARTICULAR PURPOSE in relation to any of the products described herein. Bendix Spicer Foundation Brake LLC specifically disclaims any responsibility or liability for any errors, omissions, changes, and updates in the information in this catalog and shall not be liable for direct, indirect, incidental, or consequential damages resulting therefrom. Bendix Spicer Foundation Brake LLC's product warranties are limited to those set forth in its warranty policies (visit [www.foundationbrakes.com](http://www.foundationbrakes.com)). While many parts may look alike, the internal components or design may be quite dissimilar, and the parts should not be interchanged. Under no circumstances should replacement parts be used when they do not appear to fit properly, nor should the parts be forced to fit or modified in the field in any way. Confirm that you are using the correct replacement part. Bendix Spicer Foundation Brake LLC specifically disclaims all liability and responsibility for any harm, including any direct, indirect, incidental, or consequential damages resulting from any improper installation, modification, or other misapplication of Bendix Spicer Foundation Brake LLC products. Product applications in this publication are limited to vehicles manufactured for sale in the United States, Canada, or Mexico and distributed through authorized dealer networks. If a vehicle has been manufactured or altered to other than United States, Canadian, or Mexican specifications, the product applications may not apply. Bendix Spicer Foundation Brake LLC does not accept or assume any liability for applications of its products on any vehicle imported into the United States, Canada or Mexico through channels other than the authorized dealer networks or for any vehicle not in compliance with all applicable North American laws and regulations.

# Conversion Table

INCHES TO MILLIMETERS					MILLIMETERS TO INCHES			
Inches - Fraction			Inches- Decimal	Millimeters	Inches	Millimeters	Millimeters	Inches
		1/64	0.156250	0.3969	0.0001	0.00254	0.001	0.000039
	1/32		0.031250	0.7937	0.0002	0.00508	0.002	0.000079
		3/64	0.046875	1.1906	0.0003	0.00762	0.003	0.000118
1/16			0.062500	1.5875	0.0004	0.01016	0.004	0.000157
		5/64	0.078125	1.9844	0.0005	0.12700	0.005	0.000197
	3/32		0.093750	2.3812	0.0006	0.15240	0.006	0.000236
		7/64	0.109375	2.7781	0.0007	0.01778	0.007	0.000276
1/8			0.125000	3.1750	0.0008	0.02032	0.008	0.000315
		9/64	0.140625	3.5719	0.0009	0.02286	0.009	0.000354
	5/32		0.156250	3.9687	0.0010	0.02540	0.010	0.000390
		11/64	0.171875	4.3656	0.0020	0.05080	0.020	0.000790
3/16			0.187500	4.7625	0.0030	0.07620	0.030	0.001180
		13/64	0.201325	5.1594	0.0040	0.10160	0.040	0.001570
	7/32		0.218750	5.5562	0.0050	0.12700	0.050	0.001970
		15/64	0.234375	5.9531	0.0060	0.15240	0.060	0.002360
1/4			0.250000	6.3500	0.0070	0.17780	0.070	0.002760
		17/64	0.265625	6.7469	0.0080	0.20320	0.080	0.003150
	9/32		0.281250	7.1437	0.0090	0.22860	0.090	0.003540
		19/64	0.296875	7.5406	0.0100	0.25400	0.100	0.003940
5/16			0.312500	7.9375	0.0200	0.50800	0.200	0.007870
		21/64	0.328125	8.3344	0.0300	0.76200	0.300	0.011810
	11/32		0.343750	8.7312	0.0400	1.01600	0.400	0.015750
		23/64	0.359375	9.1281	0.0500	1.27000	0.500	0.019690
3/8			0.375000	9.5250	0.0600	1.52400	0.600	0.023620
		25/64	0.390625	9.9219	0.0700	1.77800	0.700	0.027560
	13/32		0.406250	10.3187	0.0800	2.03200	0.800	0.031500
		27/64	0.421875	10.7156	0.0900	2.28600	0.900	0.035430
7/16			0.437500	11.1125	0.1000	2.54000	1.000	0.039370
		29/64	0.453125	11.5094	0.2000	5.08000	2.000	0.078740
	15/32		0.468750	11.9062	0.3000	7.62000	3.000	0.118110
		31/64	0.484375	12.3031	0.4000	10.16000	4.000	0.157480
1/2			0.500000	12.7000	0.5000	12.70000	5.000	0.196850
		33/64	0.515625	13.0969	0.6000	15.24000	6.000	0.236620
	17/32		0.531250	13.4937	0.7000	17.78000	7.000	0.275590
		35/64	0.546875	13.8906	0.8000	20.32000	8.000	0.314960
9/16			0.562500	14.2875	0.9000	22.86000	9.000	0.354330
		37/64	0.578125	14.6844	1.0000	25.40000	10.000	0.393700
	19/32		0.593750	15.0812	2.0000	50.80000	11.000	0.433070
		39/64	0.609375	15.4781	3.0000	76.20000	12.000	0.472440
5/8			0.625000	15.8750	4.0000	101.60000	13.000	0.511810
		41/64	0.640625	16.2719	5.0000	127.00000	14.000	0.551180
	21/32		0.656250	16.6687	6.0000	152.40000	15.000	0.590550
		43/64	0.671875	17.0656	7.0000	177.80000	16.000	0.629920
11/16			0.687500	17.4625	8.0000	203.20000	17.000	0.669290
		45/64	0.703125	17.8594	9.0000	228.60000	18.000	0.708660
	23/32		0.718750	18.2562	10.0000	254.00000	19.000	0.748030
		47/64	0.734375	18.6531	11.0000	279.40000	20.000	0.787400
3/4			0.750000	19.0500	12.0000	304.80000	21.000	0.826770
		49/64	0.765625	19.4469	13.0000	330.20000	22.000	0.866140
	25/32		0.781250	19.8437	14.0000	355.60000	23.000	0.905510
		51/64	0.796875	20.2406	15.0000	381.00000	24.000	0.944880
13/16			0.812500	20.6375	16.0000	406.40000	25.000	0.984250
		53/64	0.828125	21.0344	17.0000	431.80000	26.000	1.023620
	27/32		0.843750	21.4312	18.0000	457.20000	27.000	1.062990
		55/64	0.859375	21.8281	19.0000	482.60000	28.000	1.102360
7/8			0.875000	22.2500	20.0000	508.00000	29.000	1.141730
		57/64	0.890625	22.6219	21.0000	533.40000	30.000	1.181100
	29/32		0.906250	23.0187	22.0000	558.80000	31.000	1.220470
		59/64	0.921875	23.4156	23.0000	584.20000	32.000	1.259840
15/16			0.937500	23.8125	24.0000	609.60000	33.000	1.299210
		61/64	0.953125	24.2094	25.0000	635.00000	34.000	1.338580
	31/32		0.968750	24.6062	26.0000	660.40000	35.000	1.377950
		63/64	0.984375	25.0031	27.0000	690.60000	36.000	1.417320

Any references in this catalog to company names or trademarks are solely for identification and cross reference purposes.  
 Bendix Spicer Foundation Brake LLC does not represent any parts shown as products manufactured or remanufactured by the companies so named herein.  
 © 2012 Bendix Spicer Foundation Brake LLC. All Rights Reserved.



# Application Guide

## Supplement for Light- and Medium-Duty Vehicles

Import & Domestic

*Heavy Duty Parts for Hard Working Vehicles*

**Bendix Spicer Foundation Brake LLC**  
901 Cleveland Street • Elyria, Ohio 44035  
Phone: 440-329-9709  
Toll-Free: 1-866-610-9709  
Fax: 440-329-9203  
Tech Support: 1-866-610-9709, option 2  
[www.foundationbrakes.com](http://www.foundationbrakes.com)

# Abbreviations & Symbols

"	Ditto / Inch	Fr	From	2WS	2 Wheel Steering
#	Number	Frnt	Front	4WD	4 Wheel Drive
+	Plus	FWD	Front Wheel Drive	pkg	package
A/T	Automatic Transmission	GVW	Gross Vehicle Weight	PR	Push Rod
ABS	Anti-lock Brake System	H & R	Hub and Rotor	Pwr	Power
Adj	Adjustable / Adjuster	HD	Heavy Duty	R	Right
Adv	Advance	Hvy	Heavy	RA	Rear Axle
Alum	Aluminum	HW	Hardware	Reg	Regular
Auto	Automatic Transmission	Hyd	Hydraulic	Repl	Replacement
Aux	Auxiliary	IFS	Independent Front Suspension	Req'd	Required
AWD	All Wheel Drive	Incl	Included	Res	Reservoir
Bbl	Bubble	Inv	Inverted	RH	Right Hand Side
BC	Bolt Circle	IRS	Independent Rear Suspension	RHD	Right Hand Drive
Brks	Brakes	IVD	Interactive Vehicle Dynamics	Rr	Rear
Brkt	Bracket	KH	Kelsey-Hayes	RV	Recreational Vehicle
C	Center	L	Liter	RWD	Rear Wheel Drive
Ctr	Center	L	Left	S/Cyl	Slave Cylinder
Cal	Caliper	LH	Left Hand Side	Ser	Serial
cc	Cubic Centimeter	L & R	Left & Right	Sgl	Single
Ch	Chassis	lb	pound	spd	speed
Clu	Clutch	low	lower	SRW	Single Rear Wheel
Cont'd	Continued	LSD	Limited Slip Differential	Std	Standard
Conv	Conventional	M	Thousand	Str	Steering
Ctl	Control	M/Cyl	Master Cylinder	Susp	Suspension
Cyl	Cylinder	M/T	Manual Transmission	Sys	System
Dbt	Double	Man	Manual	T/C	Traction Control
Des	Design	MH	Motor Home	TBA	To Be Announced
Dia	Diameter	MHC	Motor Home Chassis	Thk	Thickness
DOHC	Double Overhead Cam	Min	Minimum	Trans	Transmission
dr	door	mm	millimeter	up	upper
DRW	Dual Rear Wheel	mt	mounting	v	valve
DSC	Dynamic Stability Control	Mtg	Mounting	Vac	Vacuum
Dsl	Diesel	N/A	Not Applicable / Not Available	VDCS	Vehicle Dynamic Control System
Dty	Duty	NPT	National Pipe Thread	Veh	Vehicle
ea	each	OD	Outside Diameter	VSC	Vehicle Stability Control
Elec	Electronic	OE	Original Equipment	w/	with
eng	engine	OEM	Original Equipment	W/Cyl	Wheel Cylinder
ESP	Electronic Stability Program	Opn	Open	w/o	without
exc	except	P/B	Power Brake	WB	Wheel Base
ext	extended	Pass	Passenger	WD	Wheel Drive
FA	Front Axle	PB	Parking Brake	Whl	Wheel
FC	Forward Control	2WD	2 Wheel Drive		

# Make & Model Index

Make & Model	Page	Make & Model	Page
<b>BLUEBIRD BUS</b>	<b>151</b>	<b>FORD</b>	<b>68 / 162</b>
<b>CHEVROLET</b>	<b>16 / 152</b>	B600 Bus	162
AVALANCHE 1500	16	B700 Bus	162
B6P042 School Bus	152	C600 Tilt Cab	162
B7T042 School Bus	152	C700 Tilt Cab	162
CAPRICE	16	C800 Tilt Cab	162
COLORADO	18	CROWN VICTORIA	68
C4500 Kodiak	152	EDGE	68
C5D064	153	ESCAPE	70
C5H042 Kodiak	153	E-SUPER DUTY	78
C5500 Kodiak	153	EXPEDITION	72
C60 C6D042	154	EXPLORER	72
C6500 Kodiak	154	EXPLORER SPORT & SPORT TRAC	72
C70 C7D042, C7D064	155	E150 Van	72
C7500 Kodiak	155	E250 Van	74
EQUINOX	18	E350 Van	76
EXPRESS 1500, 2500, 3500	20	E450, 47 Super Duty	163
HHR	24	E550 Van	164
IMPALA	16	F53, 59 RV Motor Home & Stripped Chassis	164
P4T042	156	F150 Truck	78
P6S	156	F250 Truck	82
P6T042	156	F350 Truck	84
SILVERADO 1500 2WD	26	F450, F47 Super Duty	166
SILVERADO 1500 4WD	30	F550 Super Duty	168
SILVERADO 2500	34	F600 Conventional	169
SILVERADO 3500	36	F650 Conventional	169
SUBURBAN 1500 2WD	40	F700 Conventional	170
SUBURBAN 1500 4WD	42	F750 Conventional	170
SUBURBAN 2500	44	F800 Conventional	171
TAHOE	44	FT800 Conventional	171
TRAILBLAZER	50	L800 Conventional	171
TRAVERSE	50	L900 Conventional	171
UPLANDER	50	LCF Series	171
T5500, T6500, T7500, T8500	157	LN600 Short Conventional	171
W3500	158	LN700 Short Conventional	172
W4500	159	LN800, 900 Short Conventional	172
W5500, W5500HD	160	LNT800 Short Conventional Tandem	172
WT5500	161	LT800 Short Conventional Tandem	172
W6M	161	LTS800 Short Conventional Tandem	172
<b>CHRYSLER</b>	<b>50</b>	RANGER	90
<b>DODGE</b>	<b>52 / 162</b>	SPORT TRAC See EXPLORER SPORT TRAC	72
CALIBER	52	TAURUS, TAURUS SHO, TAURUS X	92
CARAVAN, GRAND CARAVAN	54	TRANSIT CONNECT	92
CHARGER	56	8000 Series (Air over hydraulics)	172
DAKOTA	58	<b>FREIGHTLINER</b>	<b>94 / 173</b>
DURANGO	58	FL50, FL60, FL70	173
RAM 1500 Pickup	58	FRED Chassis	173
RAM 2500 Pickup	60	FS65, FW700	173
RAM 3500 Pickup 2WD	62	M2 100/106	174
RAM 3500 Pickup 4WD	64	MB50, MB60, MB70	174
RAM 4500, 5500	68	MC, MC-L Series Motorhome Chassis	174
SPRINTER	68	SPRINTER	94
		MT10, MT35, MT45, MT55, MT-E	174



# Make & Model Index

Make & Model	Page	Make & Model	Page
<b>GMC TRUCK / VAN</b>	<b>94 / 175</b>	<b>IHC</b>	<b>188</b>
ACADIA	94	CF500, CF600	188
CANYON	94	CO1710A, B Cargostar	192
B6P042 School Bus	175	CO1750A, B Cargostar	192
B7T School Bus	175	CO1810A, B Cargostar	195
C4500 Topkick	175	CO1850A, B Cargostar	195
C5D042, C5D064	176	CO1910A, B Cargostar, Forward Cab	196
C5H042 Topkick	176	F1910A, F1924 Fleetstar except Tandem	197
C5500 Topkick	176	LFE Series	188
C6D042	177	MXT, RXT	188
C6500 Topkick	177	M1400, 1452	188
C7D042, C7D064	178	M1600, 1652 Metro	190
C7500 Topkick	178	S1452, 1452FC	189
DENALI - See YUKON	113	S1624, S1652FC, S1652SC UPS, S1654	191
ENVOY	96	S1723, S1724, S1753, S1754 S Models	193
G4500	179	S1823, S1853 School Bus	195
P4T042	179	S1853FC, S1824, S1854 Conventional	195
P6S	179	S1924, S1954 Conventional	198
P6T042	179	<b>TERRA STAR</b>	<b>188</b>
S7T042 Forward Control	180	140, 1400 Series M Models	188
SAVANA 1500	96	140, 1400 Series S Models	189
SAVANA 2500	96	160, 1600 Series Cargostar	190
SAVANA 3500	98	160, 1600 Series Loadstar	191
SIERRA 1500 2WD	100	160, 1600 Series S Models	191
SIERRA 1500 4WD	104	160, 1600 Series S Models, Binder	192
SIERRA 2500	108	1600, 1624 Loadstar except 4WD	191
SIERRA 3500	108	170, 1700 Series Cargostar	192
TERRAIN	112	170, 1700 Series Loadstar	193
T5500, T6500, T7500, T8500 Tilt Cab	180	170, 1700 Series S Models	193
W3500	180	1700 Loadstar Conventional	193
W4500	181	1723 Bus	194
W5500	183	1724 Loadstar	193
W5500HD	183	180, 1800 Series Cargostar	195
WT5500	183	180, 1800 Series Loadstar	195
YUKON, DENALI	112	180, 1800 Series S Models, School Bus	195
YUKON, DENALI XL	114	1800, 1824 Loadstar	195
W6 M	184	190, 1900 Series Cargostar	196
W7 H	184	1900 Series F Models	197
<b>HINO</b>	<b>185</b>	1900 Series S Models	197
145	185	2000 Series S Models	198
165	185	3000 Series	199
185	185	3000, 3200, 3600, 3700, 3800, 3900FC School Bus	199
238	186	4000 Series	201
258LP	186	4100, 4200, 4300, 4400, 4600 Conventional Cab	201
268	186	4700, 4800, 4900 Conventional Cab	201
<b>HUMMER</b>	<b>116</b>	7000 Series	201
H2	116	7100 Conventional Cab	201
H3	116		
<b>IC BUS</b>	<b>187</b>		
BE, CE, HC, LC (Hydraulic Disc Brakes)	187		

# Make & Model Index

Make & Model	Page	Make & Model	Page
<b>ISUZU</b>	<b>203</b>	<b>MITSUBISHI FUSO</b>	<b>211</b>
EVR	203	FE Series	211
FRR	203	FG, FG	212
FSR	203	FH Series	212
FTR	204	FK Series	212
FVR, FXR	205	<b>NISSAN</b>	<b>132</b>
H Series HTR, HVR	206	ARMADA	132
NPR	206	CUBE	132
NQR	207	FRONTIER	132
NRR	210	NV1500, NV2500 HD, NV3500 HD	136
REACH VAN	210	PATHFINDER	136
		ROGUE	138
<b>IVECO</b>	<b>211</b>	TITAN	138
EURO RANGE 110, 120T	211	XTERRA	140
EURO RANGE 230T	211	<b>PETERBILT</b>	<b>214</b>
EURO TURBO RANGE 10-14, 12-11, 12-12, 12-14, 13-14, 15-14, 18-14, 18-16	211	325, 330, 335 (Hydraulic Disc Brakes)	214
EURO TURBO RANGE 23-16	211	<b>PONTIAC</b>	<b>140</b>
Z100, 110, 120TA, 220, 220T	211	MONTANA, SV6	140
Z230T	211	TORRENT	140
Z340T	211	<b>SATURN</b>	<b>142</b>
<b>JEEP</b>	<b>118</b>	<b>SMITH</b>	<b>214</b>
COMMANDER	118	<b>STERLING</b>	<b>214</b>
COMPASS	118	ACTERRA (Hydraulic Disc Brakes)	214
GRAND CHEROKEE	118	BULLET	215
J8	118	360 Series	215
LIBERTY	120	<b>THOMAS BUILT</b>	<b>215</b>
PATRIOT	120	C2	215
WRANGLER	120	<b>TOYOTA</b>	<b>142</b>
<b>KENWORTH</b>	<b>210</b>	FJ CRUISER	142
T170, T270, T370 (Hydraulic Disc Brakes)	210	HIGHLANDER	142
<b>LINCOLN</b>	<b>122</b>	LAND CRUISER	144
MARK LT	122	SEQUOIA	144
MKT	122	SIENNA	144
MKX	122	TACOMA	146
NAVIGATOR	124	TUNDRA	146
TOWN CAR	124	4 RUNNER	146
<b>MACK</b>	<b>210</b>	<b>UD</b>	<b>216</b>
CS200	210	UD 18CS	216
MS200	210	UD 18HD	216
<b>MAZDA</b>	<b>126</b>	UD 1100	216
B Series PICKUP	126	UD 1200	216
CX-7	126	UD 1300	216
CX-9	126	UD 1400	216
TRIBUTE	126	UD 1800, CS, HD	217
<b>MERCEDES BENZ</b>	<b>128</b>	UD 2300, DH, LP	217
SPRINTER	128	UD 2600, UD 2800, UD 3000	217
<b>MERCURY</b>	<b>130</b>	<b>WORKHORSE Custom Chassis</b>	<b>217</b>
GRAND MARQUIS	130	LF72 Bus 19,000 GVWR	217
MARINER	130	P32, P42	217
MOUNTAINEER	132	P500 (Fedex Delivery Truck)	219
		W Series	219
		UFO	220

## Vehicle Make Code

Vehicle Make	Code	Vehicle Make	Code	Vehicle Make	Code
ACURA	45	GMC LIGHT TRUCK	71	NISSAN	47
AM GENERAL / HUMMER	74	GMC MEDIUM DUTY	85	OLDSMOBILE	67
AMERICAN MOTORS	61	HINO MEDIUM DUTY	80	PLYMOUTH	68
AUDI	38	HONDA	45	PONTIAC	67
BMW	39	HUMMER	74	PORSCHE	42
BUICK	67	HYUNDAI	56	ROVER	33
CADILLAC	67	IHC - NAVISTAR MED DUTY	88	SATURN	67
CHEVROLET	67	INFINITI	47	SUBARU	52
CHEVROLET LIGHT TRUCK	71	INTERNATIONAL	75	SUZUKI	53
CHEVROLET MEDIUM DUTY	85	ISUZU	48	TOYOTA	49
CHRYSLER	68	ISUZU MEDIUM DUTY	81	UD MEDIUM DUTY	82
CHRYSLER LIGHT TRUCK	72	IVECO MEDIUM DUTY	77	VARIOUS EUROPEAN CAR	95
DAIHATSU	46	JEEP	63	VARIOUS JAPANESE CAR	96
DODGE	68	KIA	55	VARIOUS LIGHT TRUCK	73
DODGE LIGHT TRUCK	72	LAND ROVER	27	VARIOUS MEDIUM DUTY	87
DODGE MEDIUM DUTY	86	LEXUS	49	VARIOUS US CAR	69
FORD	66	LINCOLN	66	VOLKSWAGEN	38
FORD LIGHT TRUCK	70	MAZDA	50	VOLVO	44
FORD MEDIUM DUTY	84	MERCEDES-BENZ	40	WINNEBAGO	16
FREIGHTLINER	89	MERCURY	66		
FUSO MEDIUM DUTY	79	MITSUBISHI	51		

## Vehicle Make By Code

Code	Vehicle Make	Code	Vehicle Make	Code	Vehicle Make
16	WINNEBAGO	55	KIA	72	DODGE LIGHT TRUCK
27	LAND ROVER	56	HYUNDAI	73	VARIOUS LIGHT TRUCK
33	ROVER	61	AMERICAN MOTORS	74	AM GENERAL / HUMMER
38	AUDI	63	JEEP	74	HUMMER
38	VOLKSWAGEN	66	FORD	75	INTERNATIONAL
39	BMW	66	LINCOLN	77	IVECO MEDIUM DUTY
40	MERCEDES-BENZ	66	MERCURY	79	FUSO MEDIUM DUTY
42	PORSCHE	67	BUICK	80	HINO MEDIUM DUTY
44	VOLVO	67	CADILLAC	81	ISUZU MEDIUM DUTY
45	ACURA	67	CHEVROLET	82	UD MEDIUM DUTY
45	HONDA	67	OLDSMOBILE	84	FORD MEDIUM DUTY
46	DAIHATSU	67	PONTIAC	85	CHEVROLET MEDIUM DUTY
47	INFINITI	67	SATURN	85	GMC MEDIUM DUTY
47	NISSAN	68	CHRYSLER	86	DODGE MEDIUM DUTY
48	ISUZU	68	DODGE	87	VARIOUS MEDIUM DUTY
49	LEXUS	68	PLYMOUTH	88	IHC - NAVISTAR MED DUTY
49	TOYOTA	69	VARIOUS US CAR	89	FREIGHTLINER
50	MAZDA	70	FORD LIGHT TRUCK	95	VARIOUS EUROPEAN CAR
51	MITSUBISHI	71	CHEVROLET LIGHT TRUCK	96	VARIOUS JAPANESE CAR
52	SUBARU	71	GM TRUCK		
53	SUZUKI	72	CHRYSLER LIGHT TRUCK		



# Light-Duty Vehicle Application Guide

## Hydraulic Brake Parts

Import & Domestic

*Heavy Duty Parts for Hard Working Vehicles*

**Bendix Spicer Foundation Brake LLC**

901 Cleveland Street • Elyria, Ohio 44035

Phone: 440-329-9709

Toll-Free: 1-866-610-9709

Fax: 440-329-9203

Tech Support: 1-866-610-9709, option 2

[www.foundationbrakes.com](http://www.foundationbrakes.com)

# F R O N T

Many products are available in multiple grades or configurations. Refer to page 5 for details.

Make & Model	Year Notes	Pads	Rotor, Drum	DISCARD	Hardware Kits	Calipers, Wheel Cyl	DIAMETER	Kits Calipers, Wheel Cyl	Brake Hoses
		E105 OEM Type E107 Semi-Met E109 Prem Pad E110 Ceramic E111 HD Pad <b>Shoes</b> E116 Std Shoe E117 HD Shoe  E121 Sensor Wire E124 Shoe Adjuster	E125 Prem Rotor E126 Std Rotor E127 Prem Drum E128 Std Drum E129 Hub <b>L = Left</b> <b>R = Right</b> <b>V = Vented</b> <b>S = Solid</b>		E122 Rotor E123 Drum	E139 Prem Cyl E140 Std Cyl E146 Semi-Loaded Cal E147 Loaded Cal		E148 Cal Kit E149 Cyl Kit	E155 Hose

## CHEVROLET

### CAPRICE

2011	PPV	E109-1404-0	V E125-67-113	28.5	E122-67-076	L E146-67-211	60	E148-67-059	L E155-67-183
	Police Patrol Vehicle					R E146-67-210	60		R E155-67-182

### IMPALA

2007 - 2008		E109-1159-0	V E125-67-103	28.6	E122-67-062	L E146-67-165	45	E148-67-051	L E155-67-143
						R E146-67-164	45		R E155-67-142
2009 - 2010		E109-1159-0	V E125-67-103	28.6	E122-67-062	L E146-67-165	45	E148-67-051	L E155-67-143
						R E146-67-164	45		R E155-67-142
2011		E109-1159-0	V E125-67-103	28.6	E122-67-062	L E146-67-165	45	E148-67-051	L E155-67-143
						R E146-67-164	45		R E155-67-142
2012	Except Police & Taxi	E109-1159-0	V E125-67-103	28.6	E122-67-062	L E146-67-165	45	E148-67-051	L E155-67-143
	Police & Taxi	E111-1159-0	V E125-67-104	28.6	E122-67-062	L E146-67-167	45		L E155-67-143
						R E146-67-166	45		R E155-67-142

### AVALANCHE 1500

2005	RWD	E110-0785-0	V E125-71-045	27.2	E122-71-015	L E146-71-013	51	E148-71-018	L E155-71-103
						R E146-71-012	51		R E155-71-102
	4WD	E110-0785-0	V E125-71-045	27.2	E122-71-015	L E146-71-013	51	E148-71-018	L E155-71-103
						R E146-71-012	51		R E155-71-102
2006	RWD	E110-0785-0	V E125-71-045	27.2	E122-71-015	L E146-71-013	51	E148-71-018	L E155-71-129
						R E146-71-012	51		R E155-71-130
	4WD	E110-0785-0	V E125-71-045	27.2	E122-71-015	L E146-71-013	51	E148-71-018	L E155-71-129
						R E146-71-012	51		R E155-71-130



Many products are available in multiple grades or configurations. Refer to page 5 for details.

# R E A R

<b>Pads</b> E105 OEM Type E107 Semi-Met E109 Prem Pad E110 Ceramic E111 HD Pad <b>Shoes</b> E116 Std Shoe E117 HD Shoe  E121 Sensor Wire E124 Shoe Adjuster	<b>Rotor, Drum</b> E125 Prem Rotor E126 Std Rotor E127 Prem Drum E128 Std Drum E129 Hub L = Left R = Right V = Vented S = Solid	DISCARD	<b>Hardware Kits</b> E122 Rotor E123 Drum	<b>Calipers, Wheel Cyl</b> E139 Prem Cyl E140 Std Cyl E146 Semi-Loaded Cal E147 Loaded Cal	DIAMETER	<b>Kits Calipers, Wheel Cyl</b> E148 Cal Kit E149 Cyl Kit	<b>Brake Hoses</b> E155 Hose	<b>Master Cylinders</b> E135 Prem M/C E136 Std M/C	DIAMETER
--	--	---------	---	--	----------	---	---------------------------------	--	----------

## CHEVROLET

### CAPRICE

E110-1352-0 PB Shoe E116-0784-0	V	E125-67-118	20.0	E122-67-073	L E146-67-609 R E146-67-608	45 45	E148-67-057	E155-67-464	E135-67-175	1"
---------------------------------------	---	-------------	------	-------------	--------------------------------	----------	-------------	-------------	-------------	----

### IMPALA

E110-0698-0 PB Shoe E116-0770-0	S	E125-67-102	9.0	E122-67-038 PB Kit E123-67-038	L E146-67-559 R E146-67-558	38 38	E148-52-012	E155-67-437	Except SS E135-67-153 SS E135-67-152	1" 1"
E110-0698-0 PB Shoe E116-0770-0	S	E125-67-102	9.0	E122-67-038 PB Kit E123-67-038	L E146-67-559 R E146-67-558	38 38	E148-52-012	E155-67-437	E135-67-178	1"
E110-0999-0	S	E125-67-134	12.5	E122-67-054	L E146-67-595 R E146-67-594	38 38	E148-67-048	L E155-67-459 R E155-67-458	E135-67-178	1"
E110-0999-0	S	E125-67-134	12.5	E122-67-054	L E146-67-595 R E146-67-594	38 38	E148-67-048	L E155-67-459 R E155-67-458	E135-67-178	1"
E111-0999-0	S	E125-67-134	12.5	E122-67-054	L E146-67-595 R E146-67-594	38 38	E148-67-048	L E155-67-459 R E155-67-458	E135-67-178	1"

### AVALANCHE 1500

E110-0974-1 PB Shoe E116-0781-0	V	E125-71-050	28.5	E122-71-022 PB Kit E123-71-009	L E146-71-525 R E146-71-524	44.5 44.5	E148-71-024	15" up E155-71-363 15 1/2" up E155-71-409 lo L E155-71-337 lo R E155-71-336	E135-71-054	34mm
E110-0834-0 PB Shoe E116-0781-0	V	E125-71-050	28.5	E122-71-018 PB Kit E123-71-009	L E146-71-511 R E146-71-510	45 45	E148-71-019	15" up E155-71-363 15 1/2" up E155-71-409 lo L E155-71-337 lo R E155-71-336	E135-71-054	34mm
E110-0974-1 PB Shoe E116-0781-0	V	E125-71-050	28.5	E122-71-022 PB Kit E123-71-017	L E146-71-525 R E146-71-524	44.5 44.5	E148-71-024	15" up E155-71-363 15 1/2" up E155-71-409 lo L E155-71-337 lo R E155-71-336	E135-71-054	34mm
E110-0834-0 PB Shoe E116-0781-0	V	E125-71-050	28.5	E122-71-018 PB Kit E123-71-017	L E146-71-511 R E146-71-510	45 45	E148-71-019	15" up E155-71-363 15 1/2" up E155-71-409 lo L E155-71-337 lo R E155-71-336	E135-71-054	34mm

# F R O N T

Many products are available in multiple grades or configurations. Refer to page 5 for details.

Make & Model	Year Notes	Pads	Rotor, Drum	Hardware Kits	Calipers, Wheel Cyl	Kits	Brake Hoses		
		E105 OEM Type E107 Semi-Met E109 Prem Pad E110 Ceramic E111 HD Pad <b>Shoes</b> E116 Std Shoe E117 HD Shoe  E121 Sensor Wire E124 Shoe Adjuster	E125 Prem Rotor E126 Std Rotor E127 Prem Drum E128 Std Drum E129 Hub <b>L = Left</b> <b>R = Right</b> <b>V = Vented</b> <b>S = Solid</b>	DISCARD	E122 Rotor E123 Drum	DIAMETER	E139 Prem Cyl E140 Std Cyl E146 Semi-Loaded Cal E147 Loaded Cal	E148 Cal Kit E149 Cyl Kit	E155 Hose

## CHEVROLET (Cont'd)

### AVALANCHE 1500 (Cont'd)

2007	Front Caliper Bracket	E110-1092-0	V	E125-71-062	28.0	35mm Gap	L E146-71-049	51	E148-71-018	L E155-71-137
	Cast # 285C/286C					E122-71-026	R E146-71-048	51		R E155-71-136
2008	Front Caliper Bracket	E110-1363-0	V	E125-71-062	28.0	38mm Gap	L E146-71-057	51	E148-71-018	L E155-71-137
	Cast # 351C/352C					E122-71-030	R E146-71-056	51		R E155-71-142
2009 - 2011		E110-1363-0	V	E125-71-062	28.0	E122-71-030	L E146-71-057	51	E148-71-018	L E155-71-145
							R E146-71-056	51		R E155-71-142

## COLORADO

2007 - 2008		E110-1039-0	V	E125-71-061	25.6	E122-71-025	L E146-71-047	45	E148-71-019	Except RWD Z85
							R E146-71-046	45		L E155-71-127
2009 - 2012	RWD Except V8 Z85	E110-1169-0	V	E125-71-077	27.5	E122-71-028	L E146-71-059	48	E148-63-010	RWD Z85
							R E146-71-058	48		L E155-71-125
	V8 Z85 RWD All 4WD	E110-1169-0	V	E125-71-077	27.5	E122-71-028	L E146-71-059	48	E148-63-010	R E155-71-126
							R E146-71-058	48		L E155-71-127

## EQUINOX

2007 - 2009	Rear Disc	E110-1264-0	V	E125-71-072	27.4	E122-67-065	L E146-67-175	45	E148-67-040	L E155-67-151
							R E146-67-174	45		R E155-67-150
2010 - 2012		E110-1125-0	V	E125-67-125	27.0	E122-67-079	L E146-67-197	60	E148-56-026	L E155-67-175
							R E146-67-196	60		R E155-67-176

Many products are available in multiple grades or configurations. Refer to page 5 for details.

# R E A R

Pads	Rotor, Drum	DISCARD	Hardware Kits	Calipers, Wheel Cyl	DIAMETER	Kits Calipers, Wheel Cyl	Brake Hoses	Master Cylinders	DIAMETER
E105 OEM Type E107 Semi-Met E109 Prem Pad E110 Ceramic E111 HD Pad	E125 Prem Rotor E126 Std Rotor E127 Prem Drum E128 Std Drum E129 Hub	DISCARD	E122 Rotor E123 Drum	E139 Prem Cyl E140 Std Cyl E146 Semi-Loaded Cal E147 Loaded Cal	DIAMETER	E148 Cal Kit E149 Cyl Kit	E155 Hose	E135 Prem M/C E136 Std M/C	DIAMETER
<b>Shoes</b> E116 Std Shoe E117 HD Shoe	L = Left R = Right V = Vented S = Solid								
E121 Sensor Wire E124 Shoe Adjuster									

## CHEVROLET (Cont'd)

### AVALANCHE 1500 (Cont'd)

E110-1194-0 PB Shoe	V E125-71-070 18.5	E122-71-027 PB Kit	L E146-71-535 51 R E146-71-534 51	E148-71-028	up E155-71-377 lo L E155-71-375 lo R E155-71-376	E135-71-061 1 1/4"
E116-0781-0		E123-71-015				
E110-1194-0 PB Shoe	V E125-71-070 18.5	E122-71-027 PB Kit	L E146-71-535 51 R E146-71-534 51	E148-71-028	up E155-71-377 lo L E155-71-375 lo R E155-71-398	E135-71-061 1 1/4"
E116-0781-0		E123-71-015				
E110-1194-0 PB Shoe	V E125-71-070 18.5	E122-71-027 PB Kit	L E146-71-535 51 R E146-71-534 51	E148-71-028	up E155-71-377 lo L E155-71-375 lo R E155-71-398	E135-71-071 1 1/4"
E116-0781-0		E123-71-015				

## COLORADO

E116-0815-1 296 x 47	E127-71-048 296.5	E123-71-014	E139-71-032 15/16"		E155-71-366	E135-71-057 1"
L E124-71-015 R E124-71-014						
E116-0959-0 295 x 45.5	E127-71-048 296.5	E123-71-020	E139-71-035 15/16"		E155-71-401	E135-71-072 1 1/16"
L E124-71-017 R E124-71-016						
E116-0959-0 295 x 45.5	E127-71-048 296.5	E123-71-020	E139-71-035 15/16"		E155-71-401	E135-71-072 1 1/16"
L E124-71-017 R E124-71-016						

## EQUINOX

E110-1275-0 PB Shoe E116-0932-0	V E125-71-073 18.4	E122-71-029 PB Kit E123-67-040	L E146-71-539 40 R E146-71-538 40	E148-44-020	Except Soft Ride & Sport Susp. L E155-67-447 R E155-67-438 Soft Ride & Sport Susp. L E155-67-439 R E155-67-438	E135-67-155 1"
E110-1275-0 PB Shoe E116-0932-0	V E125-71-078 18.4	E122-71-029	L E146-71-539 40 R E146-71-538 40	E148-44-020	L E155-67-447 R E155-67-438	2010 E135-67-087 1" 2011 - 2012 E135-67-180 1"

# F R O N T

Many products are available in multiple grades or configurations. Refer to page 5 for details.

Make & Model	Year Notes	Pads	Rotor, Drum		Hardware Kits	Calipers, Wheel Cyl		Kits Calipers, Wheel Cyl	Brake Hoses
		E105 OEM Type E107 Semi-Met E109 Prem Pad E110 Ceramic E111 HD Pad <b>Shoes</b> E116 Std Shoe E117 HD Shoe  E121 Sensor Wire E124 Shoe Adjuster	E125 Prem Rotor E126 Std Rotor E127 Prem Drum E128 Std Drum E129 Hub <b>L = Left</b> <b>R = Right</b> <b>V = Vented</b> <b>S = Solid</b>	DISCARD	E122 Rotor E123 Drum	E139 Prem Cyl E140 Std Cyl E146 Semi-Loaded Cal E147 Loaded Cal	DIAMETER	E148 Cal Kit E149 Cyl Kit	E155 Hose

## CHEVROLET (Cont'd)

### EXPRESS 1500 1/2 Ton Van

2007	E110-0785-0	V E125-71-045	27.2	E122-71-015	L E146-71-013 51 R E146-71-012 51	E148-71-018	L E155-71-119 R E155-71-118
2008	E110-0785-0	V E125-71-045	27.2	E122-71-015	L E146-71-013 51 R E146-71-012 51	E148-71-018	L E155-71-143 R E155-71-146
2009 - 2010	E110-1363-0	V E125-71-062	28.0	E122-71-030	L E146-71-057 51 R E146-71-056 51	E148-71-018	L E155-71-143 R E155-71-146
2011 - 2012	E110-1363-0	V E125-71-062	28.0	E122-71-030	L E146-71-057 51 R E146-71-056 51	E148-71-018	L E155-71-143 R E155-71-146

### EXPRESS 2500 3/4 Ton Van

2007	E111-0784-0	V E125-71-047	36.5	E122-71-013	L E146-71-009 57 R E146-71-008 57	E148-71-016	L E155-71-121 R E155-71-120
2008	E111-0784-0	V E125-71-047	36.5	E122-71-013	L E146-71-009 57 R E146-71-008 57	E148-71-016	L E155-71-121 R E155-71-120
2009 - 2010	E111-0784-0	V E125-71-047	36.5	E122-71-013	L E146-71-009 57 R E146-71-008 57	E148-71-016	L E155-71-121 R E155-71-120
2011 - 2012	E111-0784-0	V E125-71-047	36.5	E122-71-013	L E146-71-009 57 R E146-71-008 57	E148-71-016	L E155-71-121 R E155-71-120

Many products are available in multiple grades or configurations. Refer to page 5 for details.

# R E A R

Pads	Rotor, Drum	Hardware Kits	Calipers, Wheel Cyl	Kits Calipers, Wheel Cyl	Brake Hoses	Master Cylinders
E105 OEM Type E107 Semi-Met E109 Prem Pad E110 Ceramic E111 HD Pad <b>Shoes</b> E116 Std Shoe E117 HD Shoe  E121 Sensor Wire E124 Shoe Adjuster	E125 Prem Rotor E126 Std Rotor E127 Prem Drum E128 Std Drum E129 Hub L = Left R = Right V = Vented S = Solid	E122 Rotor E123 Drum	E139 Prem Cyl E140 Std Cyl E146 Semi-Loaded Cal E147 Loaded Cal	E148 Cal Kit E149 Cyl Kit	E155 Hose	E135 Prem M/C E136 Std M/C

DISCARD

DIAMETER

DIAMETER

## CHEVROLET (Cont'd)

### EXPRESS 1500 1/2 Ton Van

E110-0974-1 PB Shoe E116-0781-0	V E125-71-050 28.5	E122-71-022 PB Kit E123-71-009	L E146-71-525 44.5 R E146-71-524 44.5	E148-71-024	L E155-71-355 R E155-71-354	E135-71-051 34mm
E110-0974-1 PB Shoe E116-0781-0	V E125-71-050 28.5	E122-71-022 PB Kit E123-71-009	L E146-71-525 44.5 R E146-71-524 44.5	E148-71-024	Except StabiliTrak L E155-71-355 R E155-71-354 StabiliTrak L E155-71-411 R E155-71-354	Except StabiliTrak E135-71-066 34mm StabiliTrak E135-71-068 34mm
E110-0974-1 PB Shoe E116-0781-0	V E125-71-050 28.5	E122-71-022 PB Kit E123-71-009	L E146-71-525 44.5 R E146-71-524 44.5	E148-71-024	Except StabiliTrak L E155-71-355 R E155-71-354 StabiliTrak L E155-71-411 R E155-71-354	Except StabiliTrak E135-71-076 34mm StabiliTrak E135-71-077 34mm
E110-0974-1 PB Shoe E116-0781-0	V E125-71-050 28.5	E122-71-022 PB Kit E123-71-009	L E146-71-525 44.5 R E146-71-524 44.5	E148-71-024		E135-71-077 34mm

### EXPRESS 2500 3/4 Ton Van

E110-0974-0 PB Shoe E116-0771-0	Gas Eng V E125-71-048 26.5 Diesel Eng V E125-71-049 27.0	E122-71-022 PB Kit E123-71-012	L E146-71-521 50.8 R E146-71-520 50.8	E148-71-022	L E155-71-355 R E155-71-354	E135-71-050 1 7/16"
E110-0974-0 PB Shoe E116-0771-0	Gas Eng V E125-71-048 26.5 Diesel Eng V E125-71-049 27.0	E122-71-022 PB Kit E123-71-012	L E146-71-521 50.8 R E146-71-520 50.8	E148-71-022	Except StabiliTrak L E155-71-355 R E155-71-354 StabiliTrak L E155-71-411 R E155-71-354	Except StabiliTrak E135-71-062 37mm StabiliTrak E135-71-067 37mm
E110-0974-0 PB Shoe E116-0962-0	Gas Eng V E125-71-048 26.5 Diesel Eng V E125-71-049 27.0	E122-71-022 PB Kit E123-71-012	L E146-71-521 50.8 R E146-71-520 50.8	E148-71-022	Except StabiliTrak L E155-71-355 R E155-71-354 StabiliTrak L E155-71-411 R E155-71-354	Except StabiliTrak E135-71-073 38mm StabiliTrak E135-71-075 38mm
E110-0974-0 PB Shoe E116-0962-0	Gas Eng V E125-71-048 26.5 Diesel Eng V E125-71-049 27.0	E122-71-022 PB Kit E123-71-012	L E146-71-521 50.8 R E146-71-520 50.8	E148-71-022	Except StabiliTrak L E155-71-355 R E155-71-410 StabiliTrak L E155-71-411 R E155-71-410	Except StabiliTrak E135-71-073 38mm StabiliTrak E135-71-075 38mm



# F R O N T

Many products are available in multiple grades or configurations. Refer to page 5 for details.

Make & Model	Year Notes	Pads	Rotor, Drum	Hardware Kits	Calipers, Wheel Cyl	Kits Calipers, Wheel Cyl	Brake Hoses		
		E105 OEM Type E107 Semi-Met E109 Prem Pad E110 Ceramic E111 HD Pad <b>Shoes</b> E116 Std Shoe E117 HD Shoe  E121 Sensor Wire E124 Shoe Adjuster	E125 Prem Rotor E126 Std Rotor E127 Prem Drum E128 Std Drum E129 Hub <b>L = Left</b> <b>R = Right</b> <b>V = Vented</b> <b>S = Solid</b>	DISCARD	E122 Rotor E123 Drum	DIAMETER	E139 Prem Cyl E140 Std Cyl E146 Semi-Loaded Cal E147 Loaded Cal	E148 Cal Kit E149 Cyl Kit	E155 Hose

## CHEVROLET (Cont'd)

### EXPRESS 3500 1 Ton Van

2007 - 2008	SRW	E111-0784-0	V E125-71-064 36.5	E122-71-013	L E146-71-009 57 R E146-71-008 57	E148-71-016	L E155-71-121 R E155-71-120
	DRW	E111-0784-0	V E125-71-064 36.5	E122-71-013	L E146-71-043 60 R E146-71-042 60	E148-71-020	L E155-71-121 R E155-71-120
2009 - 2010	SRW	E111-0784-0	V E125-71-064 36.5	E122-71-013	L E146-71-009 57 R E146-71-008 57	E148-71-016	L E155-71-121 R E155-71-120
	DRW	E111-0784-0	V E125-71-064 36.5	E122-71-013	L E146-71-043 60 R E146-71-042 60	E148-71-020	L E155-71-121 R E155-71-120
2011 - 2012	SRW	E111-0784-0	V E125-71-064 36.5	E122-71-013	L E146-71-009 57 R E146-71-008 57	E148-71-016	L R E155-71-120
	DRW	E111-0784-0	V E125-71-064 36.5	E122-71-013	L E146-71-043 60 R E146-71-042 60	E148-71-020	L R E155-71-120

Many products are available in multiple grades or configurations. Refer to page 5 for details.

# R E A R

Pads	Rotor, Drum		Hardware Kits	Calipers, Wheel Cyl		Kits Calipers, Wheel Cyl	Brake Hoses	Master Cylinders	
E105 OEM Type E107 Semi-Met E109 Prem Pad E110 Ceramic E111 HD Pad	E125 Prem Rotor E126 Std Rotor E127 Prem Drum E128 Std Drum E129 Hub	DISCARD	E122 Rotor E123 Drum	E139 Prem Cyl E140 Std Cyl E146 Semi-Loaded Cal E147 Loaded Cal	DIAMETER	E148 Cal Kit E149 Cyl Kit	E155 Hose	E135 Prem M/C E136 Std M/C	DIAMETER
<b>Shoes</b> E116 Std Shoe E117 HD Shoe	L = Left R = Right V = Vented S = Solid		E121 Sensor Wire E124 Shoe Adjuster						

## CHEVROLET (Cont'd)

### EXPRESS 3500 1 Ton Van

E110-0974-0 PB Shoe E116-0771-0	86mm High V E125-71-048 26.5 91mm High V E125-71-049 27.0		E122-71-022 PB Kit E123-71-012	L E146-71-521 50.8 R E146-71-520 50.8		E148-71-022	StabiliTrak Passenger L E155-71-371 R E155-71-354 Except StabiliTrak Conversion L E155-71-355 R E155-71-354 Commercial Cutaway L E155-71-357 R E155-71-356	2006 - 2007 Except StabiliTrak E135-71-050 1 7/16" StabiliTrak E135-71-056 1 7/16" 2008 Except StabiliTrak E135-71-062 37mm StabiliTrak E135-71-067 37mm
E111-0989-0 PB Shoe E116-0771-0	V E125-71-055 28.5		E122-71-024 PB Kit E123-71-019	L E146-71-519 54 R E146-71-518 54		E148-71-021	Except Commercial Cutaway L E155-71-407 R E155-71-408 Commercial Cutaway L E155-71-373 R E155-71-374	2006 - 2007 E135-71-050 1 7/16" 2008 E135-71-062 37mm
E110-0974-0 PB Shoe E116-0962-0	86mm High V E125-71-048 26.5 91mm High V E125-71-049 27.0		E122-71-022 PB Kit E123-71-012	L E146-71-521 50.8 R E146-71-520 50.8		E148-71-022	StabiliTrak Passenger L E155-71-411 R E155-71-354 Except StabiliTrak Conversion L E155-71-355 R E155-71-354 Commercial Cutaway L E155-71-357 R E155-71-356	Except StabiliTrak E135-71-073 38mm StabiliTrak E135-71-075 38mm
E110-1411-0 PB Shoe JH6 & JH7 E116-0962-0 JH9 E116-0973-0	V E125-71-076 38.0		E122-70-038 PB Kit JH6 & JH7 E123-71-012	L E146-71-541 54 R E146-71-540 54		E148-71-030	Except Cab & Chassis L E155-71-373 R E155-71-374 Cab & Chassis L E155-71-407 R E155-71-408	Except StabiliTrak E135-71-073 38mm StabiliTrak E135-71-075 38mm
E110-0974-0 PB Shoe E116-0962-0	86mm High V E125-71-048 26.5 91mm High V E125-71-049 27.0		E122-71-022 PB Kit E123-71-012	L E146-71-521 50.8 R E146-71-520 50.8		E148-71-022	StabiliTrak L E155-71-411 R E155-71-410 Except StabiliTrak L E155-71-355 R E155-71-410	Except StabiliTrak E135-71-073 38mm StabiliTrak E135-71-075 38mm
E110-1411-0 PB Shoe JH6 & JH7 E116-0962-0 JH9 E116-0973-0	V E125-71-076 38.0		E122-70-038 PB Kit JH6 & JH7 E123-71-012	L E146-71-541 54 R E146-71-540 54		E148-71-030	L E155-71-407 R	Except StabiliTrak E135-71-073 38mm StabiliTrak E135-71-075 38mm

# F R O N T

Many products are available in multiple grades or configurations. Refer to page 5 for details.

Make & Model	Year Notes	Pads	Rotor, Drum	Hardware Kits	Calipers, Wheel Cyl	Kits Calipers, Wheel Cyl	Brake Hoses
		E105 OEM Type E107 Semi-Met E109 Prem Pad E110 Ceramic E111 HD Pad <b>Shoes</b> E116 Std Shoe E117 HD Shoe  E121 Sensor Wire E124 Shoe Adjuster	E125 Prem Rotor E126 Std Rotor E127 Prem Drum E128 Std Drum E129 Hub <b>L = Left</b> <b>R = Right</b> <b>V = Vented</b> <b>S = Solid</b>	DISCARD	E122 Rotor E123 Drum	E139 Prem Cyl E140 Std Cyl E146 Semi-Loaded Cal E147 Loaded Cal	E148 Cal Kit E149 Cyl Kit  E155 Hose

## CHEVROLET (Cont'd)

### HHR

2006 - 2007		E110-1028-0	V E125-67-100 23.0	E122-67-058	L E146-67-145 60 R E146-67-144 60	E148-51-018	E155-67-116
2008	Rear Drum	E110-1028-0	V E125-67-100 23.0	E122-67-058	L E146-67-145 60 R E146-67-144 60	E148-51-018	E155-67-116
	SS Rear Disc	E110-1028-0	V E125-67-083 23.0	E122-67-058	L E146-67-157 54 R E146-67-156 54	E148-96-021	E155-67-116
2009 - 2010	Rear Drum	E110-1028-0	V E125-67-100 23.0	E122-67-058	L E146-67-145 60 R E146-67-144 60	E148-51-018	E155-67-116
	Rear Disc SS Except Brembo Front Calipers	E110-1028-0	V E125-67-083 23.0	E122-67-058	L E146-67-157 54 R E146-67-156 54	E148-96-021	E155-67-116
	SS & Performance Pkg Brembo Front Calipers	E109-1379-0	V E130-67-121 24.0	E122-67-074	L E146-67-185 38 R E146-67-184 38	E148-42-021	E155-67-162
2011		E110-1028-0	V E125-67-100 23.0	E122-67-058	L E146-67-145 60 R E146-67-144 60	E148-51-018	

Many products are available in multiple grades or configurations. Refer to page 5 for details.

**R E A R**

Pads	Rotor, Drum	Hardware Kits	Calipers, Wheel Cyl	Kits Calipers, Wheel Cyl	Brake Hoses	Master Cylinders
E105 OEM Type E107 Semi-Met E109 Prem Pad E110 Ceramic E111 HD Pad <b>Shoes</b> E116 Std Shoe E117 HD Shoe  E121 Sensor Wire E124 Shoe Adjuster	E125 Prem Rotor E126 Std Rotor E127 Prem Drum E128 Std Drum E129 Hub L = Left R = Right V = Vented S = Solid	E122 Rotor E123 Drum	E139 Prem Cyl E140 Std Cyl E146 Semi-Loaded Cal E147 Loaded Cal	E148 Cal Kit E149 Cyl Kit	E155 Hose	E135 Prem M/C E136 Std M/C

DISCARD

DIAMETER

DIAMETER

**CHEVROLET (Cont'd)**

**HHR**

E116-0795-1 230 x 42	E127-67-041 231.0	E123-67-032	E139-67-073 13/16"		E155-67-409	M/T E135-67-150 15/16" A/T E135-67-149 15/16"
L E124-67-049 R E124-67-048						
E116-0795-1 230 x 42	E127-67-041 231.0	E123-67-032	E139-67-073 13/16"		E155-67-409	M/T Except StabiliTrak E135-67-150 15/16" A/T Except StabiliTrak E135-67-149 15/16" A/T & StabiliTrak E135-67-156 15/16" M/T & StabiliTrak E135-67-157 15/16"
L E124-67-049 R E124-67-048						
E110-1033-0	S E125-67-084 12.0	E122-67-059	L E146-67-585 38 R E146-67-584 38	E148-67-048	up E155-67-409 lo L E155-67-423 lo R E155-67-422	A/T E135-67-156 15/16" M/T E135-67-157 15/16"
E116-0800-1 229 x 44.5	E127-67-044 230.6	E123-68-026	L E139-56-019 3/4" R E139-56-020 3/4"		E155-67-409	A/T E135-67-156 15/16" M/T E135-67-157 15/16"
L E124-68-025 R E124-68-024						
E110-1033-0	S E125-67-084 12.0	E122-67-059	L E146-67-585 38 R E146-67-584 38	E148-67-048	up E155-67-409 lo L E155-67-423 lo R E155-67-422	A/T E135-67-156 15/16" M/T E135-67-157 15/16"
E110-1033-0	S E125-67-084 12.0	E122-67-059	L E146-67-585 38 R E146-67-584 38	E148-67-048	up E155-67-409 lo L E155-67-423 lo R E155-67-422	A/T E135-67-156 15/16" M/T E135-67-157 15/16"
E116-0800-1 229 x 44.5	E127-67-044 230.6	E123-68-026	L E139-56-019 3/4" R E139-56-020 3/4"		E155-67-409	A/T E135-67-156 15/16" M/T E135-67-157 15/16"
L E124-68-025 R E124-68-024						

# F R O N T

Many products are available in multiple grades or configurations. Refer to page 5 for details.

Make & Model	Year Notes	Pads	Rotor, Drum	DISCARD	Hardware Kits	Calipers, Wheel Cyl	DIAMETER	Kits Calipers, Wheel Cyl	Brake Hoses
		E105 OEM Type E107 Semi-Met E109 Prem Pad E110 Ceramic E111 HD Pad <b>Shoes</b> E116 Std Shoe E117 HD Shoe  E121 Sensor Wire E124 Shoe Adjuster	E125 Prem Rotor E126 Std Rotor E127 Prem Drum E128 Std Drum E129 Hub <b>L = Left</b> <b>R = Right</b> <b>V = Vented</b> <b>S = Solid</b>		E122 Rotor E123 Drum	E139 Prem Cyl E140 Std Cyl E146 Semi-Loaded Cal E147 Loaded Cal		E148 Cal Kit E149 Cyl Kit	E155 Hose

## CHEVROLET (Cont'd)

### SILVERADO 1500 1/2 Ton RWD

<b>2007</b>	Classic (GMT 800) Rear Drum  Front Caliper Bracket Cast # 285C/286C	E110-1092-0	V	E125-71-062	28.0	35mm Gap  E122-71-026	L	E146-71-049	51	E148-71-018	Exc Crew Cab	
												R
	Classic (GMT 800) Rear Disc, Except SS	E110-0785-0	V	E125-71-045	27.2	E122-71-015	L	E146-71-013	51	E148-71-018	L	E155-71-129
	SS Classic (GMT 800) Rear Disc	E110-0785-0	V	E125-71-045	27.2	E122-71-015	L	E146-71-013	51	E148-71-018	L	E155-71-129
	1500HD Classic Crew Cab (GMT 800) Rear Disc	E111-0784-0	V	E125-71-047	36.5	E122-71-013	L	E146-71-009	57	E148-71-016	L	E155-71-115
	New Silverado (GMT 900) Rear Drum  Front Caliper Bracket Cast # 351C/352C	E110-1363-0	V	E125-71-062	28.0	38mm Gap  E122-71-030	L	E146-71-057	51	E148-71-018	L	E155-71-137
							R	E146-71-056	51		R	E155-71-142
	New Silverado (GMT 900) Rear Disc  Front Caliper Bracket Cast # 351C/352C	E110-1363-0	V	E125-71-062	28.0	38mm Gap  E122-71-030	L	E146-71-057	51	E148-71-018	L	E155-71-137
							R	E146-71-056	51		R	E155-71-142
<b>2008</b>	Rear Drum	E110-1363-0	V	E125-71-062	28.0	38mm Gap  E122-71-030	L	E146-71-057	51	E148-71-018	L	E155-71-137
							R	E146-71-056	51		R	E155-71-142

Cont'd Next Pg

Many products are available in multiple grades or configurations. Refer to page 5 for details.

# R E A R

Pads	Rotor, Drum	Hardware Kits	Calipers, Wheel Cyl	Kits, Calipers, Wheel Cyl	Brake Hoses	Master Cylinders
E105 OEM Type E107 Semi-Met E109 Prem Pad E110 Ceramic E111 HD Pad	E125 Prem Rotor E126 Std Rotor E127 Prem Drum E128 Std Drum E129 Hub	E122 Rotor E123 Drum	E139 Prem Cyl E140 Std Cyl E146 Semi-Loaded Cal E147 Loaded Cal	E148 Cal Kit E149 Cyl Kit	E155 Hose	E135 Prem M/C E136 Std M/C
<b>Shoes</b> E116 Std Shoe E117 HD Shoe	L = Left R = Right V = Vented S = Solid	DISCARD	DIAMETER	DIAMETER		DIAMETER
E121 Sensor Wire E124 Shoe Adjuster						

## CHEVROLET (Cont'd)

### SILVERADO 1500 1/2 Ton RWD

E116-0855-0 297 x 62	E127-71-049 296.5	E123-71-016	6400Lb GVW E139-71-032 15/16" 7000Lb GVW E139-71-034 1 1/16"		E155-71-341	Rsvr Retained with Roll Pins E135-71-058 1 1/4" Rsvr Retained by Plastic Straps E135-71-080 1 1/4"
E124-71-015						
E110-0792-0 PB Shoe	V E125-71-046 18.5	E122-71-023 PB Kit	L E146-71-527 54 R E146-71-526 54	E148-71-017	up E155-71-341 lo L E155-71-339 lo R E155-71-338	E135-71-053 1 1/4"
E116-0781-0		E123-71-009				
E110-0834-0 PB Shoe	V E125-71-050 28.5	E122-71-018 PB Kit	L E146-71-511 45 R E146-71-510 45	E148-71-019	up E155-71-341 lo R E155-71-338	E135-71-053 1 1/4"
E116-0781-0		E123-71-017				
E110-0785-0 PB Shoe	V E125-71-048 26.5	E122-71-015 PB Kit	L E146-71-012 51 R E146-71-013 51	E148-71-018	up E155-71-341 lo L E155-71-343 lo R E155-71-342	E135-71-050 1 7/16"
E116-0771-0		E123-71-012				
E116-0855-0 297 x 62	E127-71-049 296.5	E123-71-016	6400lb GVW E139-71-032 15/16" 7000lb GVW E139-71-034 1 1/16"		Except StabiliTrak 9.5" Eaton Rear End E155-71-389 8.6" Std Rear End 5'8" or 6'6" Bed E155-71-387 8' Bed E155-71-388 StabiliTrak E155-71-390	Except StabiliTrak E135-71-065 1 1/4" StabiliTrak E135-71-061 1 1/4"
E124-71-015						
E110-1194-0 PB Shoe	V E125-71-070 18.5	E122-71-027 PB Kit	L E146-71-535 51 R E146-71-534 51	E148-71-028	lo L E155-71-395 lo R E155-71-394 9.5" Eaton Rear End up E155-71-397 8.6" Std Rear End up E155-71-390	Except StabiliTrak E135-71-065 1 1/4" StabiliTrak E135-71-061 1 1/4"
E116-0781-0		E123-71-015				
E116-0855-0 297 x 62	E127-71-049 296.5	E123-71-016	6400lb GVW E139-71-032 15/16" 7000lb GVW E139-71-034 1 1/16"		Except StabiliTrak 9.5" Eaton Rear End E155-71-389 8.6" Std Rear End 5'8" or 6'6" Bed E155-71-387 8' Bed E155-71-388 StabiliTrak E155-71-390	Except StabiliTrak E135-71-065 1 1/4" StabiliTrak E135-71-061 1 1/4"
E124-71-015						

# F R O N T

*Many products are available in multiple grades or configurations. Refer to page 5 for details.*

Make & Model	Year Notes	Pads	Rotor, Drum	DISCARD	Hardware Kits	Calipers, Wheel Cyl	DIAMETER	Kits Calipers, Wheel Cyl	Brake Hoses
		E105 OEM Type E107 Semi-Met E109 Prem Pad E110 Ceramic E111 HD Pad <b>Shoes</b> E116 Std Shoe E117 HD Shoe  E121 Sensor Wire E124 Shoe Adjuster	E125 Prem Rotor E126 Std Rotor E127 Prem Drum E128 Std Drum E129 Hub <b>L = Left</b> <b>R = Right</b> <b>V = Vented</b> <b>S = Solid</b>		E122 Rotor E123 Drum	E139 Prem Cyl E140 Std Cyl E146 Semi-Loaded Cal E147 Loaded Cal		E148 Cal Kit E149 Cyl Kit	E155 Hose

## CHEVROLET (Cont'd)

### SILVERADO 1500 1/2 Ton RWD (Cont'd)

<b>2008</b> <i>(Cont'd)</i>	Rear Disc	E110-1363-0	V E125-71-062 28.0	38mm Gap E122-71-030	L E146-71-057 51 R E146-71-056 51	E148-71-018	L E155-71-137 R E155-71-142
<b>2009 - 2010</b>	Rear Drum	E110-1363-0	V E125-71-062 28.0	E122-71-030	L E146-71-057 51 R E146-71-056 51	E148-71-018	L E155-71-145 R E155-71-142
	Rear Disc	E110-1363-0	V E125-71-062 28.0	E122-71-030	L E146-71-057 51 R E146-71-056 51	E148-71-018	L E155-71-145 R E155-71-142
<b>2011 - 2012</b>	Rear Drum	E110-1363-0	V E125-71-062 28.0	E122-71-030	L E146-71-057 51 R E146-71-056 51	E148-71-018	L E155-71-145 R E155-71-142
	Rear Disc	E110-1363-0	V E125-71-062 28.0	E122-71-030	L E146-71-057 51 R E146-71-056 51	E148-71-018	L E155-71-145 R E155-71-142

Many products are available in multiple grades or configurations. Refer to page 5 for details.

# R E A R

<b>Pads</b> E105 OEM Type E107 Semi-Met E109 Prem Pad E110 Ceramic E111 HD Pad <b>Shoes</b> E116 Std Shoe E117 HD Shoe  E121 Sensor Wire E124 Shoe Adjuster	<b>Rotor, Drum</b> E125 Prem Rotor E126 Std Rotor E127 Prem Drum E128 Std Drum E129 Hub L = Left R = Right V = Vented S = Solid	DISCARD	<b>Hardware Kits</b> E122 Rotor E123 Drum	<b>Calipers, Wheel Cyl</b> E139 Prem Cyl E140 Std Cyl E146 Semi-Loaded Cal E147 Loaded Cal	DIAMETER	<b>Kits Calipers, Wheel Cyl</b> E148 Cal Kit E149 Cyl Kit	<b>Brake Hoses</b> E155 Hose	<b>Master Cylinders</b> E135 Prem M/C E136 Std M/C	DIAMETER
--	--	---------	---	--	----------	---	---------------------------------	--	----------

## CHEVROLET (Cont'd)

### SILVERADO 1500 1/2 Ton RWD (Cont'd)

E110-1194-0 PB Shoe E116-0781-0	v E125-71-070 18.5	E122-71-027 PB Kit E123-71-015	L E146-71-535 51 R E146-71-534 51	E148-71-028	lo L E155-71-395 lo R E155-71-394 9.5" Eaton Rear End up E155-71-397 8.6" Std Rear End up E155-71-390	Except StabiliTrak E135-71-065 1 1/4" StabiliTrak E135-71-061 1 1/4"
E116-0960-0 295 x 60.7 E124-71-017	E127-71-050 296.5	E123-71-021	6400lb GVW E139-71-035 15/16" 7000lb GVW E139-71-036 1 1/16"		Except StabiliTrak 5'8" or 6'6" Bed E155-71-387 8" Bed E155-71-388 StabiliTrak & 5'8" or 6'6" Bed E155-71-390 8" Bed E155-71-403	Except StabiliTrak E135-71-078 1 1/4" StabiliTrak E135-71-071 1 1/4"
E110-1194-0 PB Shoe E116-0781-0	v E125-71-070 18.5	E122-71-027 PB Kit E123-71-015	L E146-71-535 51 R E146-71-534 51	E148-71-028	lo L E155-71-395 lo R E155-71-394 8.6" Axle up E155-71-390 9.5" Eaton Axle up E155-71-397	Except Hybrid E135-71-071 1 1/4" Crew Cab Hybrid E135-71-070 13/16"
E116-0960-0 295 x 60.7	E127-71-050 296.5		6400lb GVW E139-71-035 15/16" 7000lb GVW E139-71-036 1 1/16"		Except 8" Bed E155-71-390 8" Bed E155-71-403	Except StabiliTrak E135-71-078 1 1/4" StabiliTrak E135-71-071 1 1/4"
E110-1194-0	v E125-71-070 18.5	E122-71-027	L E146-71-535 51 R E146-71-534 51	E148-71-028	lo L E155-71-395 lo R E155-71-394 8.6" Axle up E155-71-390 9.5" Eaton Axle up E155-71-397	Except Hybrid E135-71-071 1 1/4" Crew Cab Hybrid E135-71-070 13/16"



# FRONT

Many products are available in multiple grades or configurations. Refer to page 5 for details.

Make & Model	Year Notes	Pads	Rotor, Drum	Hardware Kits	Calipers, Wheel Cyl	Kits Calipers, Wheel Cyl	Brake Hoses	
		E105 OEM Type E107 Semi-Met E109 Prem Pad E110 Ceramic E111 HD Pad <b>Shoes</b> E116 Std Shoe E117 HD Shoe  E121 Sensor Wire E124 Shoe Adjuster	E125 Prem Rotor E126 Std Rotor E127 Prem Drum E128 Std Drum E129 Hub <b>L = Left</b> <b>R = Right</b> <b>V = Vented</b> <b>S = Solid</b>	DISCARD	E122 Rotor E123 Drum	E139 Prem Cyl E140 Std Cyl E146 Semi-Loaded Cal E147 Loaded Cal	E148 Cal Kit E149 Cyl Kit	E155 Hose

## CHEVROLET (Cont'd)

### SILVERADO 1500 1/2 Ton 4WD

2007	Classic (GMT 800) Regular & Extended Cab 6400lb GVW & Rear Drums Front Caliper Bracket Cast # 285C/286C	E110-1092-0	v E125-71-062 28.0	35mm Gap E122-71-026	L E146-71-049 51 R E146-71-048 51	E148-71-018	up E155-71-341 lo L E155-71-129 lo R E155-71-130
	Classic (GMT 800) Extended & Crew Cab Except HD Crew Cab 7000lb GVW & Rear Drums Front Caliper Bracket Cast # 285C/286C	E110-1092-0	v E125-71-062 28.0	35mm Gap E122-71-026	L E146-71-049 51 R E146-71-048 51	E148-71-018	up E155-71-341 lo L E155-71-129 lo R E155-71-130
	Classic (GMT 800) Regular & Extended Cab Rear Disc Except Hybrid & SS	E110-0785-0	v E125-71-045 27.2	E122-71-015	L E146-71-013 51 R E146-71-012 51	E148-71-018	L E155-71-129 R E155-71-130
	Classic SS (GMT800)	E110-0785-0	v E125-71-045 27.2	E122-71-015	L E146-71-013 51 R E146-71-012 51	E148-71-018	L E155-71-129 R E155-71-130
	Classic (GMT 800) Crew Cab Heavy Duty Rear Disc	E111-0784-0	v E125-71-047 36.5	E122-71-013	L E146-71-009 57 R E146-71-008 57	E148-71-016	L E155-71-115 R E155-71-114
	New Silverado (GMT 900) Rear Drum Front Caliper Bracket Cast # 351C/352C	E110-1363-0	v E125-71-062 28.0	38mm Gap E122-71-030	L E146-71-057 51 R E146-71-056 51	E148-71-018	L E155-71-137 R E155-71-142
	New Silverado (GMT 900) Rear Disc Front Caliper Bracket Cast # 351C/352C	E110-1363-0	v E125-71-062 28.0	38mm Gap E122-71-030	L E146-71-057 51 R E146-71-056 51	E148-71-018	L E155-71-137 R E155-71-142

Many products are available in multiple grades or configurations. Refer to page 5 for details.

# R E A R

Pads	Rotor, Drum	Hardware Kits	Calipers, Wheel Cyl	Kits Calipers, Wheel Cyl	Brake Hoses	Master Cylinders
E105 OEM Type E107 Semi-Met E109 Prem Pad E110 Ceramic E111 HD Pad	E125 Prem Rotor E126 Std Rotor E127 Prem Drum E128 Std Drum E129 Hub	E122 Rotor E123 Drum	E139 Prem Cyl E140 Std Cyl E146 Semi-Loaded Cal E147 Loaded Cal	E148 Cal Kit E149 Cyl Kit	E155 Hose	E135 Prem M/C E136 Std M/C
<b>Shoes</b> E116 Std Shoe E117 HD Shoe	<b>L = Left</b> <b>R = Right</b> <b>V = Vented</b> <b>S = Solid</b>	DISCARD	DIAMETER	DIAMETER		DIAMETER
E121 Sensor Wire E124 Shoe Adjuster						

## CHEVROLET (Cont'd)

### SILVERADO 1500 1/2 Ton 4WD

E116-0855-0 297 x 62	E127-71-049 296.5	E123-71-016	E139-71-032 15/16"		E155-71-341	Rsvr Retained with Roll Pins E135-71-058 1 1/4" Rsvr Retained by Plastic Straps E135-71-080 1 1/4"
E124-71-015						
E116-0855-0 297 x 62	E127-71-049 296.5	E123-71-016	E139-71-034 1 1/16"		E155-71-341	Rsvr Retained with Roll Pins E135-71-058 1 1/4" Rsvr Retained by Plastic Straps E135-71-080 1 1/4"
E124-71-015						
E110-0792-0 PB Shoe E116-0781-0	V E125-71-046 18.5	E122-71-023 PB Kit E123-71-009	L E146-71-527 54 R E146-71-526 54	E148-71-017	up E155-71-341 lo L E155-71-339 lo R E155-71-338	E135-71-053 1 1/4"
E110-0834-0 PB Shoe E116-0781-0	V E125-71-050 28.5	E122-71-018 PB Kit E123-71-009	L E146-71-511 45 R E146-71-510 45	E148-71-019	up E155-71-341 lo L E155-71-339 lo R E155-71-338	E135-71-053 1 1/4"
E110-0785-0 PB Shoe E116-0771-0	V E125-71-048 26.5	E122-71-015 PB Kit E123-71-012	L E146-71-012 51 R E146-71-013 51	E148-71-018	up E155-71-341 lo L E155-71-343 lo R E155-71-342	E135-71-050 1 7/16"
E116-0855-0 297 x 62	E127-71-049 296.5	E123-71-016	6400 lbs GVWR E139-71-032 15/16" 7000 lbs GVWR E139-71-034 1 1/16"		Except StabiliTrak 9.5" Eaton Rear End E155-71-389 8.6" Std Rear End 5'8" or 6'6" Bed E155-71-387 8' Bed E155-71-388 StabiliTrak E155-71-390	Except StabiliTrak E135-71-065 1 1/4" StabiliTrak E135-71-061 1 1/4"
E124-71-015						
E110-1194-0 PB Shoe E116-0781-0	V E125-71-070 18.5	E122-71-027 PB Kit E123-71-015	L E146-71-535 51 R E146-71-534 51	E148-71-028	lo L E155-71-395 lo R E155-71-394 up E155-71-397 8.6" Axle up E155-71-390	Except StabiliTrak E135-71-065 1 1/4" StabiliTrak E135-71-061 1 1/4"

# F R O N T

*Many products are available in multiple grades or configurations. Refer to page 5 for details.*

Make & Model	Year Notes	Pads	Rotor, Drum	DISCARD	Hardware Kits	Calipers, Wheel Cyl	DIAMETER	Kits Calipers, Wheel Cyl	Brake Hoses
		E105 OEM Type E107 Semi-Met E109 Prem Pad E110 Ceramic E111 HD Pad <b>Shoes</b> E116 Std Shoe E117 HD Shoe  E121 Sensor Wire E124 Shoe Adjuster	E125 Prem Rotor E126 Std Rotor E127 Prem Drum E128 Std Drum E129 Hub <b>L = Left</b> <b>R = Right</b> <b>V = Vented</b> <b>S = Solid</b>		E122 Rotor E123 Drum	E139 Prem Cyl E140 Std Cyl E146 Semi-Loaded Cal E147 Loaded Cal		E148 Cal Kit E149 Cyl Kit	E155 Hose

## CHEVROLET (Cont'd)

### SILVERADO 1500 1/2 Ton 4WD (Cont'd)

<b>2008</b>	Rear Drum	E110-1363-0	V E125-71-062	28.0	38mm Gap E122-71-030	L E146-71-057 51 R E146-71-056 51	E148-71-018	L E155-71-137 R E155-71-142
	Rear Disc	E110-1363-0	V E125-71-062	28.0	38mm Gap E122-71-030	L E146-71-057 51 R E146-71-056 51	E148-71-018	L E155-71-137 R E155-71-142
<b>2009 - 2010</b>	Rear Drum	E110-1363-0	V E125-71-062	28.0	E122-71-030	L E146-71-057 51 R E146-71-056 51	E148-71-018	L E155-71-145 R E155-71-142
	Rear Disc	E110-1363-0	V E125-71-062	28.0	E122-71-030	L E146-71-057 51 R E146-71-056 51	E148-71-018	L E155-71-145 R E155-71-142
<b>2011 - 2012</b>	Rear Drum	E110-1363-0	V E125-71-062	28.0	E122-71-030	L E146-71-057 51 R E146-71-056 51	E148-71-018	L E155-71-145 R E155-71-142
	Rear Disc	E110-1363-0	V E125-71-062	28.0	E122-71-030	L E146-71-057 51 R E146-71-056 51	E148-71-018	L E155-71-145 R E155-71-142

Many products are available in multiple grades or configurations. Refer to page 5 for details.

# R E A R

Pads	Rotor, Drum	Hardware Kits	Calipers, Wheel Cyl	Kits Calipers, Wheel Cyl	Brake Hoses	Master Cylinders
E105 OEM Type E107 Semi-Met E109 Prem Pad E110 Ceramic E111 HD Pad <b>Shoes</b> E116 Std Shoe E117 HD Shoe  E121 Sensor Wire E124 Shoe Adjuster	E125 Prem Rotor E126 Std Rotor E127 Prem Drum E128 Std Drum E129 Hub <b>L = Left</b> <b>R = Right</b> <b>V = Vented</b> <b>S = Solid</b>	E122 Rotor E123 Drum	E139 Prem Cyl E140 Std Cyl E146 Semi-Loaded Cal E147 Loaded Cal	E148 Cal Kit E149 Cyl Kit	E155 Hose	E135 Prem M/C E136 Std M/C
DISCARD		DIAMETER		DIAMETER		DIAMETER

## CHEVROLET (Cont'd)

### SILVERADO 1500 1/2 Ton 4WD (Cont'd)

E116-0855-0 297 x 62	E127-71-049 296.5	E123-71-016	6400 lbs GVWR E139-71-032 15/16" 7000 lbs GVWR E139-71-034 1 1/16"		Except StabiliTrak 9.5" Eaton Rear End E155-71-389 8.6" Std Rear End 5'8" or 6'6" Bed E155-71-387 8' Bed E155-71-388 StabiliTrak E155-71-390	Except StabiliTrak E135-71-065 1 1/4" StabiliTrak E135-71-061 1 1/4"
E124-71-015						
E110-1194-0 PB Shoe E116-0781-0	V E125-71-070 18.5	E122-71-027 PB Kit E123-71-015	L E146-71-535 51 R E146-71-534 51	E148-71-028	lo L E155-71-395 lo R E155-71-394 9.5" Eaton Axle up E155-71-397 8.6" Axle up E155-71-390	Except StabiliTrak E135-71-065 1 1/4" StabiliTrak E135-71-061 1 1/4"
E116-0960-0 295 x 60.7	E127-71-050 296.5	E123-71-021	6400lb GVW E139-71-035 15/16" 7000lb GVW E139-71-036 1 1/16"		Except StabiliTrak & 8' Bed E155-71-387 8' Bed E155-71-388 StabiliTrak Except 8' Bed E155-71-390 8' Bed E155-71-403	Except StabiliTrak E135-71-078 1 1/4" StabiliTrak E135-71-071 1 1/4"
E124-71-017						
E110-1194-0 PB Shoe E116-0781-0	V E125-71-070 18.5	E122-71-027 PB Kit E123-71-015	L E146-71-535 51 R E146-71-534 51	E148-71-028	lo L E155-71-395 lo R E155-71-394 8.6" Axle up E155-71-390 9.5" Eaton Axle up E155-71-397	Except Hybrid E135-71-071 1 1/4" Crew Cab Hybrid E135-71-070 13/16"
E116-0960-0 295 x 60.7	E127-71-050 296.5		6400lb GVW E139-71-035 15/16" 7000lb GVW E139-71-036 1 1/16"		Except 8' Bed E155-71-390 8' Bed E155-71-403	Except StabiliTrak E135-71-078 1 1/4" StabiliTrak E135-71-071 1 1/4"
E110-1194-0 PB Shoe E116-0781-0	V E125-71-070 18.5	E122-71-027 PB Kit E123-71-015	L E146-71-535 51 R E146-71-534 51	E148-71-028	lo L E155-71-395 lo R E155-71-394 8.6" Axle up E155-71-390 9.5" Eaton Axle up E155-71-397	Except Hybrid E135-71-071 1 1/4" Crew Cab Hybrid E135-71-070 13/16"

# F R O N T

*Many products are available in multiple grades or configurations. Refer to page 5 for details.*

Make & Model	Year Notes	Pads	Rotor, Drum	DISCARD	Hardware Kits	Calipers, Wheel Cyl	DIAMETER	Kits Calipers, Wheel Cyl	Brake Hoses
		E105 OEM Type E107 Semi-Met E109 Prem Pad E110 Ceramic E111 HD Pad <b>Shoes</b> E116 Std Shoe E117 HD Shoe  E121 Sensor Wire E124 Shoe Adjuster	E125 Prem Rotor E126 Std Rotor E127 Prem Drum E128 Std Drum E129 Hub <b>L = Left</b> <b>R = Right</b> <b>V = Vented</b> <b>S = Solid</b>		E122 Rotor E123 Drum	E139 Prem Cyl E140 Std Cyl E146 Semi-Loaded Cal E147 Loaded Cal		E148 Cal Kit E149 Cyl Kit	E155 Hose

## CHEVROLET (Cont'd)

### SILVERADO 2500 3/4 Ton RWD

2007 - 2008	E111-0784-0	V E125-71-064	36.5	E122-71-013	L E146-71-009 57 R E146-71-008 57	E148-71-016	L E155-71-383 R E155-71-384
2009 - 2010	E111-0784-0	V E125-71-064	36.5	E122-71-013	L E146-71-009 57 R E146-71-008 57	E148-71-016	L E155-71-383 R E155-71-384
2011 - 2012	E110-1411-0	V E125-71-079	38.5	E122-71-032	L E146-71-061 60 R E146-71-060 60	E148-71-031	L E155-71-147 R E155-71-148

### SILVERADO 2500 3/4 Ton 4WD

2007 - 2008	E111-0784-0	V E125-71-064	36.5	E122-71-013	L E146-71-009 57 R E146-71-008 57	E148-71-016	L E155-71-383 R E155-71-384
2009 - 2010	E111-0784-0	V E125-71-064	36.5	E122-71-013	L E146-71-009 57 R E146-71-008 57	E148-71-016	L E155-71-383 R E155-71-384
2011 - 2012	E110-1411-0	V E125-71-079	38.5	E122-71-032	L E146-71-061 60 R E146-71-060 60	E148-71-031	L E155-71-147 R E155-71-148

Many products are available in multiple grades or configurations. Refer to page 5 for details.

# R E A R

Pads	Rotor, Drum	Hardware Kits	Calipers, Wheel Cyl	Kits Calipers, Wheel Cyl	Brake Hoses	Master Cylinders
E105 OEM Type E107 Semi-Met E109 Prem Pad E110 Ceramic E111 HD Pad <b>Shoes</b> E116 Std Shoe E117 HD Shoe  E121 Sensor Wire E124 Shoe Adjuster	E125 Prem Rotor E126 Std Rotor E127 Prem Drum E128 Std Drum E129 Hub <b>L = Left</b> <b>R = Right</b> <b>V = Vented</b> <b>S = Solid</b>	E122 Rotor E123 Drum	E139 Prem Cyl E140 Std Cyl E146 Semi-Loaded Cal E147 Loaded Cal	E148 Cal Kit E149 Cyl Kit	E155 Hose	E135 Prem M/C E136 Std M/C
DISCARD		DIAMETER		DIAMETER		DIAMETER

## CHEVROLET (Cont'd)

### SILVERADO 2500 3/4 Ton RWD

E110-0785-0 PB Shoe E116-0771-0	V E125-71-049 27.0	E122-71-015 PB Kit E123-71-012	L E146-71-012 51 R E146-71-013 51	E148-71-018	up E155-71-388 lo L E155-71-379 lo R E155-71-380	Except Trailer Brk E135-71-062 37mm Trailer Brake E135-71-063 37mm
E110-0785-0 PB Shoe E116-0771-0	V E125-71-049 27.0	E122-71-015 PB Kit E123-71-012	L E146-71-012 51 R E146-71-013 51	E148-71-018	Except StabiliTrak up E155-71-388 lo L E155-71-379 lo R E155-71-380 StabiliTrak up E155-71-403 lo L E155-71-406 lo R E155-71-380	Except StabiliTrak & Trailer Brake E135-71-073 38mm Trailer Brake Except StabiliTrak E135-71-074 38mm StabiliTrak E135-71-075 38mm
E110-1411-0 PB Shoe E116-0989-0	V E125-71-082 32.5	E122-71-031	L E146-71-542 48 R E146-71-543 48	E148-70-035	up E155-71-420 lo L E155-71-415 lo R E155-71-416	E135-71-075 38mm

### SILVERADO 2500 3/4 Ton 4WD

E110-0785-0 PB Shoe E116-0771-0	V E125-71-049 27.0	E122-71-015 PB Kit E123-71-012	L E146-71-012 51 R E146-71-013 51	E148-71-018	up E155-71-388 lo L E155-71-379 lo R E155-71-380	Except Trailer Brake E135-71-062 37mm Trailer Brake E135-71-063 37mm
E110-0785-0 PB Shoe E116-0771-0	V E125-71-049 27.0	E122-71-015 PB Kit E123-71-012	L E146-71-012 51 R E146-71-013 51	E148-71-018	Except StabiliTrak up E155-71-388 lo L E155-71-379 lo R E155-71-380 StabiliTrak up E155-71-403 lo L E155-71-406 lo R E155-71-380	Except StabiliTrak & Trailer Brake E135-71-073 38mm Trailer Brake Except StabiliTrak E135-71-074 38mm StabiliTrak E135-71-075 38mm
E110-1411-0 PB Shoe E116-0989-0	V E125-71-082 32.5	E122-71-031	L E146-71-542 48 R E146-71-543 48	E148-70-035	up E155-71-420 lo L E155-71-415 lo R E155-71-416	Except StabiliTrak E135-71-073 38mm StabiliTrak E135-71-075 38mm

# F R O N T

Many products are available in multiple grades or configurations. Refer to page 5 for details.

Make & Model	Year Notes	Pads	Rotor, Drum	Hardware Kits	Calipers, Wheel Cyl	Kits Calipers, Wheel Cyl	Brake Hoses	
		E105 OEM Type E107 Semi-Met E109 Prem Pad E110 Ceramic E111 HD Pad <b>Shoes</b> E116 Std Shoe E117 HD Shoe  E121 Sensor Wire E124 Shoe Adjuster	E125 Prem Rotor E126 Std Rotor E127 Prem Drum E128 Std Drum E129 Hub <b>L = Left</b> <b>R = Right</b> <b>V = Vented</b> <b>S = Solid</b>	DISCARD	E122 Rotor E123 Drum	DIAMETER	E139 Prem Cyl E140 Std Cyl E146 Semi-Loaded Cal E147 Loaded Cal	E148 Cal Kit E149 Cyl Kit  E155 Hose

## CHEVROLET (Cont'd)

### SILVERADO 3500 1 Ton RWD

<b>2007</b>	GMT800 Series & SRW	E111-0784-0	V E125-71-064	36.5	E122-71-013	L E146-71-009 R E146-71-008	57 57	E148-71-016	L E155-71-115 R E155-71-114
	GMT800 Series & DRW	E111-0784-0	V E125-71-064	36.5	E122-71-013	L E146-71-043 R E146-71-042	60 60	E148-71-020	L E155-71-115 R E155-71-114
<b>2007 - 2008</b>	GMT900 Series & SRW	E111-0784-0	V E125-71-064	36.5	E122-71-013	L E146-71-009 R E146-71-008	57 57	E148-71-016	L E155-71-383 R E155-71-384
	GMT900 Series & DRW	E111-0784-0	V E125-71-064	36.5	E122-71-013	L E146-71-043 R E146-71-042	60 60	E148-71-020	L E155-71-383 R E155-71-384
<b>2009 - 2010</b>	SRW	E111-0784-0	V E125-71-064	36.5	E122-71-013	L E146-71-009 R E146-71-008	57 57	E148-71-016	L E155-71-383 R E155-71-384
	DRW	E111-0784-0	V E125-71-064	36.5	E122-71-013	L E146-71-043 R E146-71-042	60 60	E148-71-020	L E155-71-383 R E155-71-384
<b>2011 - 2012</b>	SRW	2011 E110-1411-0	V E125-71-079	38.5	E122-71-032	L E146-71-061 R E146-71-060	60 60	E148-71-031	L E155-71-147 R E155-71-148
	DRW	2011 E110-1411-0	V E125-71-079	38.5	E122-71-032	L E146-71-061 R E146-71-060	60 60	E148-71-031	L E155-71-147 R E155-71-148

Many products are available in multiple grades or configurations. Refer to page 5 for details.

# R E A R

Pads	Rotor, Drum	Hardware Kits	Calipers, Wheel Cyl	Kits Calipers, Wheel Cyl	Brake Hoses	Master Cylinders
E105 OEM Type E107 Semi-Met E109 Prem Pad E110 Ceramic E111 HD Pad	E125 Prem Rotor E126 Std Rotor E127 Prem Drum E128 Std Drum E129 Hub	E122 Rotor E123 Drum	E139 Prem Cyl E140 Std Cyl E146 Semi-Loaded Cal E147 Loaded Cal	E148 Cal Kit E149 Cyl Kit	E155 Hose	E135 Prem M/C E136 Std M/C
<b>Shoes</b> E116 Std Shoe E117 HD Shoe	L = Left R = Right V = Vented S = Solid					
E121 Sensor Wire E124 Shoe Adjuster						

DISCARD

DIAMETER

DIAMETER

## CHEVROLET (Cont'd)

### SILVERADO 3500 1 Ton RWD

E110-0785-0 PB Shoe	v E125-71-049 27.0	E122-71-015 PB Kit	L E146-71-012 51 R E146-71-013 51	E148-71-018	up E155-71-341 lo L E155-71-343 lo R E155-71-342	E135-71-050 1 7/16"
E116-0771-0		E123-71-012				
E111-0909-0 PB Shoe	v E125-71-055 28.5	E122-71-021 PB Kit	L E146-71-515 60 R E146-71-514 60	E148-71-020	up E155-71-341 lo L E155-71-345 lo R E155-71-344	E135-71-050 1 7/16"
E116-0771-0		E123-71-013				
E110-0785-0 PB Shoe	v E125-71-049 27.0	E122-71-015 PB Kit	L E146-71-012 51 R E146-71-013 51	E148-71-018	up E155-71-388 lo L E155-71-379 lo R E155-71-380	Except Trailer Brk E135-71-062 37mm Trailer Brake E135-71-063 37mm
E116-0771-0		E123-71-012				
E111-0909-0 PB Shoe	v E125-71-055 28.5	E122-71-021 PB Kit	L E146-71-515 60 R E146-71-514 60	E148-71-020	up E155-71-388 lo L E155-71-385 lo R E155-71-386	Except Trailer Brk E135-71-062 37mm Trailer Brake E135-71-063 37mm
E116-0771-0		E123-71-013				
E110-0785-0 PB Shoe	v E125-71-049 27.0	E122-71-015 PB Kit	L E146-71-012 51 R E146-71-013 51	E148-71-018	up E155-71-388 lo L E155-71-379 lo R E155-71-380	Except Trailer Brk E135-71-073 38mm Trailer Brake E135-71-074 38mm
E116-0771-0		E123-71-012				
E111-0909-0 PB Shoe	v E125-71-055 28.5	E122-71-021 PB Kit	L E146-71-515 60 R E146-71-514 60	E148-71-020	up E155-71-388 lo L E155-71-385 lo R E155-71-386	Except Trailer Brk E135-71-073 38mm Trailer Brake E135-71-074 38mm
E116-0962-0		E123-71-012				
E110-1411-0 PB Shoe	v E125-71-082 32.5	E122-71-031	L E146-71-542 48 R E146-71-543 48	E148-70-035	up E155-71-420 lo L E155-71-415 lo R E155-71-416	E135-71-075 38mm
E116-0989-0						
E110-1411-0 PB Shoe	v E125-71-080 38.0	E122-71-031	L E146-71-545 57 R E146-71-544 57		Pickup up E155-71-422 Cab & Chassis up E155-71-412 Except Wide Track Axle lo L E155-71-413 lo R E155-71-414 Wide Track Axle lo L E155-71-417 lo R E155-71-418	Except Trailer Brk E135-71-073 38mm Trailer Brake E135-71-074 38mm
E116-0989-0						



# F R O N T

Many products are available in multiple grades or configurations. Refer to page 5 for details.

Make & Model	Year Notes	Pads	Rotor, Drum	DISCARD	Hardware Kits	Calipers, Wheel Cyl	DIAMETER	Kits Calipers, Wheel Cyl	Brake Hoses
		E105 OEM Type E107 Semi-Met E109 Prem Pad E110 Ceramic E111 HD Pad <b>Shoes</b> E116 Std Shoe E117 HD Shoe  E121 Sensor Wire E124 Shoe Adjuster	E125 Prem Rotor E126 Std Rotor E127 Prem Drum E128 Std Drum E129 Hub <b>L = Left</b> <b>R = Right</b> <b>V = Vented</b> <b>S = Solid</b>		E122 Rotor E123 Drum	E139 Prem Cyl E140 Std Cyl E146 Semi-Loaded Cal E147 Loaded Cal		E148 Cal Kit E149 Cyl Kit	E155 Hose

## CHEVROLET (Cont'd)

### SILVERADO 3500 1 Ton 4WD

<b>2004 - 2007</b>	GMT800 Series & SRW	E111-0784-0	V E125-71-064	36.5	E122-71-013	L E146-71-009 57 R E146-71-008 57	E148-71-016	L E155-71-115 R E155-71-114
	GMT800 Series & DRW	E111-0784-0	V E125-71-064	36.5	E122-71-013	L E146-71-043 60 R E146-71-042 60	E148-71-020	L E155-71-115 R E155-71-114
<b>2007 - 2008</b>	GMT900 Series & SRW	E111-0784-0	V E125-71-064	36.5	E122-71-013	L E146-71-009 57 R E146-71-008 57	E148-71-016	L E155-71-383 R E155-71-384
	GMT900 Series & DRW	E111-0784-0	V E125-71-064	36.5	E122-71-013	L E146-71-043 60 R E146-71-042 60	E148-71-020	L E155-71-383 R E155-71-384
<b>2009 - 2010</b>	SRW	E111-0784-0	V E125-71-064	36.5	E122-71-013	L E146-71-009 57 R E146-71-008 57	E148-71-016	L E155-71-383 R E155-71-384
	DRW	E111-0784-0	V E125-71-064	36.5	E122-71-013	L E146-71-043 60 R E146-71-042 60	E148-71-020	L E155-71-383 R E155-71-384
<b>2011 - 2012</b>	SRW	2011 E110-1411-0	V E125-71-079	38.5	E122-71-032	L E146-71-061 60 R E146-71-060 60	E148-71-031	L E155-71-147 R E155-71-148
	DRW	2011 E110-1411-0	V E125-71-079	38.5	E122-71-032	L E146-71-061 60 R E146-71-060 60	E148-71-031	L E155-71-147 R E155-71-148

Many products are available in multiple grades or configurations. Refer to page 5 for details.

# R E A R

Pads	Rotor, Drum		Hardware Kits	Calipers, Wheel Cyl		Kits Calipers, Wheel Cyl	Brake Hoses	Master Cylinders	
E105 OEM Type E107 Semi-Met E109 Prem Pad E110 Ceramic E111 HD Pad	E125 Prem Rotor E126 Std Rotor E127 Prem Drum E128 Std Drum E129 Hub	DISCARD	E122 Rotor E123 Drum	E139 Prem Cyl E140 Std Cyl E146 Semi-Loaded Cal E147 Loaded Cal	DIAMETER	E148 Cal Kit E149 Cyl Kit	E155 Hose	E135 Prem M/C E136 Std M/C	DIAMETER
<b>Shoes</b> E116 Std Shoe E117 HD Shoe	<b>L = Left</b> <b>R = Right</b> <b>V = Vented</b> <b>S = Solid</b>		E121 Sensor Wire E124 Shoe Adjuster						

## CHEVROLET (Cont'd)

### SILVERADO 3500 1 Ton 4WD

E110-0785-0 PB Shoe E116-0771-0	V E125-71-049	27.0	E122-71-015 PB Kit E123-71-012	L E146-71-012 51 R E146-71-013 51	E148-71-018	up E155-71-341 lo L E155-71-343 lo R E155-71-342	E135-71-050	1 7/16"
E111-0909-0 PB Shoe E116-0771-0	V E125-71-055	28.5	E122-71-021 PB Kit E123-71-013	L E146-71-515 60 R E146-71-514 60	E148-71-020	up E155-71-341 lo L E155-71-345 lo R E155-71-344	E135-71-050	1 7/16"
E110-0785-0 PB Shoe E116-0771-0	V E125-71-049	27.0	E122-71-015 PB Kit E123-71-012	L E146-71-012 51 R E146-71-013 51	E148-71-018	up E155-71-388 lo L E155-71-379 lo R E155-71-380	Except Trailer Brake E135-71-062 Trailer Brake E135-71-063	37mm 37mm
E111-0909-0 PB Shoe E116-0771-0	V E125-71-055	28.5	E122-71-021 PB Kit E123-71-013	L E146-71-515 60 R E146-71-514 60	E148-71-020	up E155-71-388 lo L E155-71-385 lo R E155-71-386	Except Trailer Brake E135-71-062 Trailer Brake E135-71-063	37mm 37mm 37mm
E110-0785-0 PB Shoe E116-0771-0	V E125-71-049	27.0	E122-71-015 PB Kit E123-71-012	L E146-71-012 51 R E146-71-013 51	E148-71-018	up E155-71-388 lo L E155-71-379 lo R E155-71-380	Except Trailer Brake E135-71-073 Trailer Brake E135-71-074	38mm 38mm
E111-0909-0 PB Shoe E116-0962-0	V E125-71-055	28.5	E122-71-021 PB Kit E123-71-012	L E146-71-515 60 R E146-71-514 60	E148-71-020	up E155-71-388 lo L E155-71-385 lo R E155-71-386	Except Trailer Brake E135-71-073 Trailer Brake E135-71-074	38mm 38mm 38mm
E110-1411-0 PB Shoe E116-0989-0	V E125-71-082	32.5	E122-71-031	L E146-71-542 48 R E146-71-543 48	E148-70-035	up E155-71-420 lo L E155-71-415 lo R E155-71-416	E135-71-075	38mm
E110-1411-0 PB Shoe E116-0989-0	V E125-71-080	38.0	E122-71-031	L E146-71-545 57 R E146-71-544 57		Pickup up E155-71-422 Cab & Chassis up E155-71-412 Except Wide Track Axle lo L E155-71-413 lo R E155-71-414 Cab & Chassis, & Wide Track Axle lo L E155-71-417 lo R E155-71-418	Except Trailer Brake E135-71-073 Trailer Brake E135-71-074	38mm 38mm

# F R O N T

*Many products are available in multiple grades or configurations. Refer to page 5 for details.*

Make & Model	Year Notes	Pads	Rotor, Drum	DISCARD	Hardware Kits	Calipers, Wheel Cyl	DIAMETER	Kits Calipers, Wheel Cyl	Brake Hoses
		E105 OEM Type E107 Semi-Met E109 Prem Pad E110 Ceramic E111 HD Pad <b>Shoes</b> E116 Std Shoe E117 HD Shoe  E121 Sensor Wire E124 Shoe Adjuster	E125 Prem Rotor E126 Std Rotor E127 Prem Drum E128 Std Drum E129 Hub <b>L = Left</b> <b>R = Right</b> <b>V = Vented</b> <b>S = Solid</b>		E122 Rotor E123 Drum	E139 Prem Cyl E140 Std Cyl E146 Semi-Loaded Cal E147 Loaded Cal		E148 Cal Kit E149 Cyl Kit	E155 Hose

## CHEVROLET (Cont'd)

### SUBURBAN 1500 1/2 Ton RWD

2003		E110-0785-0	V E125-71-045 27.2	E122-71-015	L E146-71-013 51 R E146-71-012 51	E148-71-018	L E155-71-103 R E155-71-102
2004		E110-0785-0	V E125-71-045 27.2	E122-71-015	L E146-71-013 51 R E146-71-012 51	E148-71-018	L E155-71-103 R E155-71-102
2005		E110-0785-0	V E125-71-045 27.2	E122-71-015	L E146-71-013 51 R E146-71-012 51	E148-71-018	L E155-71-103 R E155-71-102
2006		E110-0785-0	V E125-71-045 27.2	E122-71-015	L E146-71-013 51 R E146-71-012 51	E148-71-018	L E155-71-129 R E155-71-130
2007	Front Bracket Cast # 285C/286C	E110-1092-0	V E125-71-062 28.0	35mm Gap E122-71-026	L E146-71-049 51 R E146-71-048 51	E148-71-018	L E155-71-137 R E155-71-136
2008	Front Bracket Cast # 351C/352C	E110-1363-0	V E125-71-062 28.0	38mm Gap E122-71-030	L E146-71-057 51 R E146-71-056 51	E148-71-018	L E155-71-137 R E155-71-142
2009 - 2011		E110-1363-0	V E125-71-062 28.0	E122-71-030	L E146-71-057 51 R E146-71-056 51	E148-71-018	L E155-71-145 R E155-71-142

Many products are available in multiple grades or configurations. Refer to page 5 for details.

# R E A R

Pads	Rotor, Drum	Hardware Kits	Calipers, Wheel Cyl	Kits Calipers, Wheel Cyl	Brake Hoses	Master Cylinders
E105 OEM Type E107 Semi-Met E109 Prem Pad E110 Ceramic E111 HD Pad	E125 Prem Rotor E126 Std Rotor E127 Prem Drum E128 Std Drum E129 Hub	E122 Rotor E123 Drum	E139 Prem Cyl E140 Std Cyl E146 Semi-Loaded Cal E147 Loaded Cal	E148 Cal Kit E149 Cyl Kit	E155 Hose	E135 Prem M/C E136 Std M/C
<b>Shoes</b> E116 Std Shoe E117 HD Shoe	<b>L = Left</b> <b>R = Right</b> <b>V = Vented</b> <b>S = Solid</b>	DISCARD	DIAMETER	DIAMETER		DIAMETER
E121 Sensor Wire E124 Shoe Adjuster						

## CHEVROLET (Cont'd)

### SUBURBAN 1500 1/2 Ton RWD

E110-0974-1 PB Shoe E116-0781-0	V E125-71-050 28.5	E122-71-022 PB Kit E123-71-009	L E146-71-525 44.5 R E146-71-524 44.5	E148-71-024	Except StabiliTrak up E155-71-335 StabiliTrak 15" up E155-71-363 15 1/2" up E155-71-409	Except StabiliTrak E135-71-051 34mm StabiliTrak E135-71-052 1 1/4"
E110-0974-1 PB Shoe E116-0781-0	V E125-71-050 28.5	E122-71-022 PB Kit E123-71-009	L E146-71-525 44.5 R E146-71-524 44.5	E148-71-024	Except StabiliTrak up E155-71-362 StabiliTrak 15" up E155-71-363 15 1/2" up E155-71-409	Except StabiliTrak E135-71-051 34mm StabiliTrak E135-71-052 1 1/4"
E110-0974-1 PB Shoe E116-0781-0	V E125-71-050 28.5	E122-71-022 PB Kit E123-71-009	L E146-71-525 44.5 R E146-71-524 44.5	E148-71-024	15" up E155-71-363 15 1/2" up E155-71-409	E135-71-052 1 1/4"
E110-0974-1 PB Shoe E116-0781-0	V E125-71-050 28.5	E122-71-022 PB Kit E123-71-009	L E146-71-525 44.5 R E146-71-524 44.5	E148-71-024	15" up E155-71-363 15 1/2" up E155-71-409	E135-71-054 34mm
E110-1194-0 PB Shoe E116-0781-0	V E125-71-070 18.5	E122-71-027 PB Kit E123-71-015	L E146-71-535 51 R E146-71-534 51	E148-71-028	up E155-71-377 lo L E155-71-375 lo R E155-71-376	E135-71-061 1 1/4"
E110-1194-0 PB Shoe E116-0781-0	V E125-71-070 18.5	E122-71-027 PB Kit E123-71-015	L E146-71-535 51 R E146-71-534 51	E148-71-028	up E155-71-377 lo L E155-71-375 lo R E155-71-398	E135-71-061 1 1/4"
E110-1194-0 PB Shoe E116-0781-0	V E125-71-070 18.5	E122-71-027 PB Kit E123-71-015	L E146-71-535 51 R E146-71-534 51	E148-71-028	up E155-71-377 lo L E155-71-375 lo R E155-71-398	E135-71-071 1 1/4"

# F R O N T

*Many products are available in multiple grades or configurations. Refer to page 5 for details.*

Make & Model	Year Notes	Pads	Rotor, Drum	Hardware Kits	Calipers, Wheel Cyl	Kits Calipers, Wheel Cyl	Brake Hoses	
		E105 OEM Type E107 Semi-Met E109 Prem Pad E110 Ceramic E111 HD Pad <b>Shoes</b> E116 Std Shoe E117 HD Shoe  E121 Sensor Wire E124 Shoe Adjuster	E125 Prem Rotor E126 Std Rotor E127 Prem Drum E128 Std Drum E129 Hub <b>L = Left</b> <b>R = Right</b> <b>V = Vented</b> <b>S = Solid</b>	DISCARD	E122 Rotor E123 Drum	DIAMETER	E139 Prem Cyl E140 Std Cyl E146 Semi-Loaded Cal E147 Loaded Cal	E148 Cal Kit E149 Cyl Kit  E155 Hose

## CHEVROLET (Cont'd)

### SUBURBAN 1500 1/2 Ton 4WD

<b>2003</b>		E110-0785-0	V E125-71-045 27.2	E122-71-015	L E146-71-013 51 R E146-71-012 51	E148-71-018	L E155-71-103 R E155-71-102
<b>2004</b>		E110-0785-0	V E125-71-045 27.2	E122-71-015	L E146-71-013 51 R E146-71-012 51	E148-71-018	L E155-71-103 R E155-71-102
<b>2005</b>		E110-0785-0	V E125-71-045 27.2	E122-71-015	L E146-71-013 51 R E146-71-012 51	E148-71-018	L E155-71-103 R E155-71-102
<b>2006</b>		E110-0785-0	V E125-71-045 27.2	E122-71-015	L E146-71-013 51 R E146-71-012 51	E148-71-018	L E155-71-129 R E155-71-130
<b>2007</b>	Front Bracket Cast # 285C/286C	E110-1092-0	V E125-71-062 28.0	35mm Gap E122-71-026	L E146-71-049 51 R E146-71-048 51	E148-71-018	L E155-71-137 R E155-71-136
<b>2008</b>	Front Bracket Cast # 351C/352C	E110-1363-0	V E125-71-062 28.0	38mm Gap E122-71-030	L E146-71-057 51 R E146-71-056 51	E148-71-018	L E155-71-137 R E155-71-142
<b>2009 - 2011</b>		E110-1363-0	V E125-71-062 28.0	E122-71-030	L E146-71-057 51 R E146-71-056 51	E148-71-018	L E155-71-145 R E155-71-142

Many products are available in multiple grades or configurations. Refer to page 5 for details.

**R E A R**

Pads	Rotor, Drum	Hardware Kits	Calipers, Wheel Cyl	Kits Calipers, Wheel Cyl	Brake Hoses	Master Cylinders
E105 OEM Type E107 Semi-Met E109 Prem Pad E110 Ceramic E111 HD Pad	E125 Prem Rotor E126 Std Rotor E127 Prem Drum E128 Std Drum E129 Hub	E122 Rotor E123 Drum	E139 Prem Cyl E140 Std Cyl E146 Semi-Loaded Cal E147 Loaded Cal	E148 Cal Kit E149 Cyl Kit	E155 Hose	E135 Prem M/C E136 Std M/C
<b>Shoes</b> E116 Std Shoe E117 HD Shoe	L = Left R = Right V = Vented S = Solid	DISCARD	DIAMETER	DIAMETER		DIAMETER
E121 Sensor Wire E124 Shoe Adjuster						

**CHEVROLET (Cont'd)**

**SUBURBAN 1500 1/2 Ton 4WD**

E110-0834-0 PB Shoe E116-0781-0	V E125-71-050 28.5	E122-71-018 PB Kit E123-71-009	L E146-71-511 45 R E146-71-510 45	E148-71-019	Except StabiliTrak up E155-71-335 StabiliTrak 15" up E155-71-363 15 1/2" up E155-71-409 lo L E155-71-337 lo R E155-71-336	Except StabiliTrak E135-71-051 34mm StabiliTrak E135-71-054 34mm
E110-0834-0 PB Shoe E116-0781-0	V E125-71-050 28.5	E122-71-018 PB Kit E123-71-009	L E146-71-511 45 R E146-71-510 45	E148-71-019	Except StabiliTrak up E155-71-362 StabiliTrak 15" up E155-71-363 15 1/2" up E155-71-409 lo L E155-71-337 lo R E155-71-336	Except StabiliTrak E135-71-051 34mm StabiliTrak E135-71-054 34mm
E110-0834-0 PB Shoe E116-0781-0	V E125-71-050 28.5	E122-71-018 PB Kit E123-71-009	L E146-71-511 45 R E146-71-510 45	E148-71-019	15" up E155-71-363 15 1/2" up E155-71-409 lo L E155-71-337 lo R E155-71-336	E135-71-054 34mm
E110-0834-0 PB Shoe E116-0781-0	V E125-71-050 28.5	E122-71-018 PB Kit E123-71-009	L E146-71-511 45 R E146-71-510 45	E148-71-019	15" up E155-71-363 15 1/2" up E155-71-409 lo L E155-71-337 lo R E155-71-336	E135-71-054 34mm
E110-1194-0 PB Shoe E116-0781-0	V E125-71-070 18.5	E122-71-027 PB Kit E123-71-015	L E146-71-535 51 R E146-71-534 51	E148-71-028	up E155-71-377 lo L E155-71-375 lo R E155-71-376	E135-71-061 1 1/4"
E110-1194-0 PB Shoe E116-0781-0	V E125-71-070 18.5	E122-71-027 PB Kit E123-71-015	L E146-71-535 51 R E146-71-534 51	E148-71-028	up E155-71-377 lo L E155-71-375 lo R E155-71-398	E135-71-061 1 1/4"
E110-1194-0 PB Shoe E116-0781-0	V E125-71-070 18.5	E122-71-027 PB Kit E123-71-015	L E146-71-535 51 R E146-71-534 51	E148-71-028	up E155-71-377 lo L E155-71-375 lo R E155-71-398	E135-71-071 1 1/4"

# F R O N T

*Many products are available in multiple grades or configurations. Refer to page 5 for details.*

Make & Model	Year Notes	Pads	Rotor, Drum	DISCARD	Hardware Kits	Calipers, Wheel Cyl	DIAMETER	Kits Calipers, Wheel Cyl	Brake Hoses
		E105 OEM Type E107 Semi-Met E109 Prem Pad E110 Ceramic E111 HD Pad <b>Shoes</b> E116 Std Shoe E117 HD Shoe  E121 Sensor Wire E124 Shoe Adjuster	E125 Prem Rotor E126 Std Rotor E127 Prem Drum E128 Std Drum E129 Hub <b>L = Left</b> <b>R = Right</b> <b>V = Vented</b> <b>S = Solid</b>		E122 Rotor E123 Drum	E139 Prem Cyl E140 Std Cyl E146 Semi-Loaded Cal E147 Loaded Cal		E148 Cal Kit E149 Cyl Kit	E155 Hose

## CHEVROLET (Cont'd)

### SUBURBAN 2500 ¾ Ton RWD

2007	E111-0784-0	v E125-71-047	36.5	E122-71-013	L E146-71-009 57 R E146-71-008 57	E148-71-016	L E155-71-383 R E155-71-384
2008	E111-0784-0	v E125-71-047	36.5	E122-71-013	L E146-71-009 57 R E146-71-008 57	E148-71-016	L E155-71-383 R E155-71-384
2009 - 2010	E111-0784-0	v E125-71-047	36.5	E122-71-013	L E146-71-009 57 R E146-71-008 57	E148-71-016	L E155-71-383 R E155-71-384
2011	E111-0784-0	v E125-71-047	36.5	E122-71-013	L E146-71-009 57 R E146-71-008 57	E148-71-016	L E155-71-383 R E155-71-384

### SUBURBAN 2500 ¾ Ton 4WD

2007	E111-0784-0	v E125-71-047	36.5	E122-71-013	L E146-71-009 57 R E146-71-008 57	E148-71-016	L E155-71-383 R E155-71-384
2008	E111-0784-0	v E125-71-047	36.5	E122-71-013	L E146-71-009 57 R E146-71-008 57	E148-71-016	L E155-71-383 R E155-71-384
2009 - 2010	E111-0784-0	v E125-71-047	36.5	E122-71-013	L E146-71-009 57 R E146-71-008 57	E148-71-016	L E155-71-383 R E155-71-384
2011	E111-0784-0	v E125-71-047	36.5	E122-71-013	L E146-71-009 57 R E146-71-008 57	E148-71-016	L E155-71-383 R E155-71-384

## TAHOE RWD

2002	PBR Rear Calipers	E110-0785-0	v E125-71-045	27.2	E122-71-015	L E146-71-013 51 R E146-71-012 51	E148-71-018	L E155-71-103 R E155-71-102
	Akebono Rear Calipers	E110-0785-0	v E125-71-045	27.2	E122-71-015	L E146-71-013 51 R E146-71-012 51	E148-71-018	L E155-71-103 R E155-71-102
2003		E110-0785-0	v E125-71-045	27.2	E122-71-015	L E146-71-013 51 R E146-71-012 51	E148-71-018	L E155-71-103 R E155-71-102

Many products are available in multiple grades or configurations. Refer to page 5 for details.

# R E A R

Pads	Rotor, Drum	Hardware Kits	Calipers, Wheel Cyl	Kits Calipers, Wheel Cyl	Brake Hoses	Master Cylinders
E105 OEM Type E107 Semi-Met E109 Prem Pad E110 Ceramic E111 HD Pad <b>Shoes</b> E116 Std Shoe E117 HD Shoe  E121 Sensor Wire E124 Shoe Adjuster	E125 Prem Rotor E126 Std Rotor E127 Prem Drum E128 Std Drum E129 Hub L = Left R = Right V = Vented S = Solid	E122 Rotor E123 Drum	E139 Prem Cyl E140 Std Cyl E146 Semi-Loaded Cal E147 Loaded Cal	E148 Cal Kit E149 Cyl Kit	E155 Hose	E135 Prem M/C E136 Std M/C
DISCARD		DIAMETER		DIAMETER		DIAMETER

## CHEVROLET (Cont'd)

### SUBURBAN 2500 ¾ Ton RWD

E110-0785-0 PB Shoe E116-0771-0	V E125-71-048 26.5	E122-71-015 PB Kit E123-71-012	L E146-71-012 51 R E146-71-013 51	E148-71-018	up E155-71-378 lo L E155-71-379 lo R E155-71-380	E135-71-062 37mm
E110-0785-0 PB Shoe E116-0771-0	V E125-71-049 27.0	E122-71-015 PB Kit E123-71-012	L E146-71-012 51 R E146-71-013 51	E148-71-018	up E155-71-404 lo L E155-71-379 lo R E155-71-406	E135-71-067 37mm
E110-0785-0 PB Shoe E116-0771-0	V E125-71-049 27.0	E122-71-015 PB Kit E123-71-012	L E146-71-012 51 R E146-71-013 51	E148-71-018	up E155-71-404 lo L E155-71-379 lo R E155-71-406	12mm Ports E135-71-073 38mm 14mm Ports E135-71-075 38mm
E110-0785-0 PB Shoe E116-0962-0	V E125-71-049 27.0	E122-71-015	L E146-71-012 51 R E146-71-013 51	E148-71-018	up E155-71-404 lo L E155-71-379 lo R E155-71-406	E135-71-075 38mm

### SUBURBAN 2500 ¾ Ton 4WD

E110-0785-0 PB Shoe E116-0771-0	V E125-71-048 26.5	E122-71-015 PB Kit E123-71-012	L E146-71-012 51 R E146-71-013 51	E148-71-018	up E155-71-378 lo L E155-71-379 lo R E155-71-380	E135-71-062 37mm
E110-0785-0 PB Shoe E116-0771-0	V E125-71-049 27.0	E122-71-015 PB Kit E123-71-012	L E146-71-012 51 R E146-71-013 51	E148-71-018	up E155-71-404 lo L E155-71-379 lo R E155-71-406	E135-71-067 37mm
E110-0785-0 PB Shoe E116-0771-0	V E125-71-049 27.0	E122-71-015 PB Kit E123-71-012	L E146-71-012 51 R E146-71-013 51	E148-71-018	up E155-71-404 lo L E155-71-379 lo R E155-71-406	12mm Ports E135-71-073 38mm 14mm Ports E135-71-075 38mm
E110-0785-0 PB Shoe E116-0962-0	V E125-71-049 27.0	E122-71-015	L E146-71-012 51 R E146-71-013 51	E148-71-018	up E155-71-404 lo L E155-71-379 lo R E155-71-406	E135-71-075 38mm

### TAHOE RWD

E110-0834-0 PB Shoe E116-0781-0	V E125-71-050 28.5	E122-71-018 PB Kit E123-71-009	L E146-71-511 45 R E146-71-510 45	E148-71-019	up E155-71-335 lo L E155-71-337 lo R E155-71-336	E135-71-046 34mm
E110-0974-1 PB Shoe E116-0781-0	V E125-71-050 28.5	E122-71-022 PB Kit E123-71-009	L E146-71-525 44.5 R E146-71-524 44.5	E148-71-024	up E155-71-335 lo L E155-71-337 lo R E155-71-336	E135-71-046 34mm
E110-0974-1 PB Shoe E116-0781-0	V E125-71-050 28.5	E122-71-022 PB Kit E123-71-009	L E146-71-525 44.5 R E146-71-524 44.5	E148-71-024	Except StabiliTrak up E155-71-335 lo L E155-71-337 lo R E155-71-336 StabiliTrak 15" up E155-71-363 15 1/2" up E155-71-409 lo L E155-71-337 lo R E155-71-336	Except StabiliTrak E135-71-051 34mm StabiliTrak E135-71-052 1 ¼"



# F R O N T

Many products are available in multiple grades or configurations. Refer to page 5 for details.

Make & Model	Year Notes	Pads	Rotor, Drum	Hardware Kits	Calipers, Wheel Cyl	Kits Calipers, Wheel Cyl	Brake Hoses
		E105 OEM Type E107 Semi-Met E109 Prem Pad E110 Ceramic E111 HD Pad <b>Shoes</b> E116 Std Shoe E117 HD Shoe  E121 Sensor Wire E124 Shoe Adjuster	E125 Prem Rotor E126 Std Rotor E127 Prem Drum E128 Std Drum E129 Hub <b>L = Left</b> <b>R = Right</b> <b>V = Vented</b> <b>S = Solid</b>	E122 Rotor E123 Drum	E139 Prem Cyl E140 Std Cyl E146 Semi-Loaded Cal E147 Loaded Cal	E148 Cal Kit E149 Cyl Kit	E155 Hose

DISCARD

DIAMETER

## CHEVROLET (Cont'd)

### TAHOE RWD (Cont'd)

2004		E110-0785-0	v E125-71-045 27.2	E122-71-015	L E146-71-013 51 R E146-71-012 51	E148-71-018	L E155-71-103 R E155-71-102
2005		E110-0785-0	v E125-71-045 27.2	E122-71-015	L E146-71-013 51 R E146-71-012 51	E148-71-018	L E155-71-103 R E155-71-102
2006		E110-0785-0	v E125-71-045 27.2	E122-71-015	L E146-71-013 51 R E146-71-012 51	E148-71-018	L E155-71-129 R E155-71-130
2007	Front Bracket Cast # 285C/286C	E110-1092-0	v E125-71-062 28.0	35mm Gap E122-71-026	L E146-71-049 51 R E146-71-048 51	E148-71-018	L E155-71-137 R E155-71-136
2008	Front Bracket Cast # 351C/352C	E110-1363-0	v E125-71-062 28.0	38mm Gap E122-71-030	L E146-71-057 51 R E146-71-056 51	E148-71-018	L E155-71-137 R E155-71-142
2009 - 2010		E110-1363-0	v E125-71-062 28.0	E122-71-030	L E146-71-057 51 R E146-71-056 51	E148-71-018	L E155-71-145 R E155-71-142
2011		E110-1363-0	v E125-71-062 28.0	E122-71-030	L E146-71-057 51 R E146-71-056 51	E148-71-018	L E155-71-145 R E155-71-142

Many products are available in multiple grades or configurations. Refer to page 5 for details.

# R E A R

Pads	Rotor, Drum	Hardware Kits	Calipers, Wheel Cyl	Kits Calipers, Wheel Cyl	Brake Hoses	Master Cylinders
E105 OEM Type E107 Semi-Met E109 Prem Pad E110 Ceramic E111 HD Pad <b>Shoes</b> E116 Std Shoe E117 HD Shoe  E121 Sensor Wire E124 Shoe Adjuster	E125 Prem Rotor E126 Std Rotor E127 Prem Drum E128 Std Drum E129 Hub <b>L = Left</b> <b>R = Right</b> <b>V = Vented</b> <b>S = Solid</b>	E122 Rotor E123 Drum	E139 Prem Cyl E140 Std Cyl E146 Semi-Loaded Cal E147 Loaded Cal	E148 Cal Kit E149 Cyl Kit	E155 Hose	E135 Prem M/C E136 Std M/C
DISCARD		DIAMETER		DIAMETER		DIAMETER

## CHEVROLET (Cont'd)

### TAHOE RWD (Cont'd)

E110-0974-1  PB Shoe E116-0781-0	v E125-71-050 28.5	E122-71-022  PB Kit E123-71-009	L E146-71-525 44.5 R E146-71-524 44.5	E148-71-024	Except StabiliTrak up E155-71-362 lo L E155-71-337 lo R E155-71-336 StabiliTrak 15" up E155-71-363 15 1/2" up E155-71-409 lo L E155-71-337 lo R E155-71-336	Except StabiliTrak E135-71-051 34mm StabiliTrak E135-71-052 1 1/4"
E110-0974-1  PB Shoe E116-0781-0	v E125-71-050 28.5	E122-71-022  PB Kit E123-71-009	L E146-71-525 44.5 R E146-71-524 44.5	E148-71-024	15" up E155-71-363 15 1/2" up E155-71-409 lo L E155-71-337 lo R E155-71-336	E135-71-054 34mm
E110-0974-1  PB Shoe E116-0781-0	v E125-71-050 28.5	E122-71-022  PB Kit E123-71-009	L E146-71-525 44.5 R E146-71-524 44.5	E148-71-024	15" up E155-71-363 15 1/2" up E155-71-409 lo L E155-71-337 lo R E155-71-336	E135-71-054 34mm
E110-1194-0  PB Shoe E116-0781-0	v E125-71-070 18.5	E122-71-027  PB Kit E123-71-015	L E146-71-535 51 R E146-71-534 51	E148-71-028	up E155-71-377 lo L E155-71-375 lo R E155-71-376	E135-71-061 1 1/4"
E110-1194-0  PB Shoe E116-0781-0	v E125-71-070 18.5	E122-71-027  PB Kit E123-71-015	L E146-71-535 51 R E146-71-534 51	E148-71-028	up E155-71-377 lo L E155-71-375 lo R E155-71-398	Except Hybrid E135-71-061 1 1/4" Hybrid E135-71-070 13/16"
E110-1194-0  PB Shoe E116-0781-0	v E125-71-070 18.5	E122-71-027  PB Kit E123-71-015	L E146-71-535 51 R E146-71-534 51	E148-71-028	up E155-71-377 lo L E155-71-375 lo R E155-71-398	Except Hybrid E135-71-071 1 1/4" Hybrid E135-71-070 13/16"
E110-1194-0  PB Shoe E116-0781-0	v E125-71-070 18.5	E122-71-027  PB Kit E123-71-015	L E146-71-535 51 R E146-71-534 51	E148-71-028	up lo L E155-71-375 lo R E155-71-398	Except Hybrid E135-71-071 1 1/4" Hybrid E135-71-070 13/16"

# F R O N T

*Many products are available in multiple grades or configurations. Refer to page 5 for details.*

Make & Model	Year Notes	Pads	Rotor, Drum	DISCARD	Hardware Kits	Calipers, Wheel Cyl	DIAMETER	Kits Calipers, Wheel Cyl	Brake Hoses
		E105 OEM Type E107 Semi-Met E109 Prem Pad E110 Ceramic E111 HD Pad <b>Shoes</b> E116 Std Shoe E117 HD Shoe  E121 Sensor Wire E124 Shoe Adjuster	E125 Prem Rotor E126 Std Rotor E127 Prem Drum E128 Std Drum E129 Hub <b>L = Left</b> <b>R = Right</b> <b>V = Vented</b> <b>S = Solid</b>		E122 Rotor E123 Drum	E139 Prem Cyl E140 Std Cyl E146 Semi-Loaded Cal E147 Loaded Cal		E148 Cal Kit E149 Cyl Kit	E155 Hose

## CHEVROLET (Cont'd)

### TAHOE 4WD

<b>2003</b>		E110-0785-0	V E125-71-045 27.2	E122-71-015		L E146-71-013 51 R E146-71-012 51		E148-71-018	L E155-71-103 R E155-71-102
<b>2004</b>		E110-0785-0	V E125-71-045 27.2	E122-71-015		L E146-71-013 51 R E146-71-012 51		E148-71-018	L E155-71-103 R E155-71-102
<b>2005</b>		E110-0785-0	V E125-71-045 27.2	E122-71-015		L E146-71-013 51 R E146-71-012 51		E148-71-018	L E155-71-103 R E155-71-102
<b>2006</b>		E110-0785-0	V E125-71-045 27.2	E122-71-015		L E146-71-013 51 R E146-71-012 51		E148-71-018	L E155-71-129 R E155-71-130
<b>2007</b>	Front Bracket Cast # 285C/286C	E110-1092-0	V E125-71-062 28.0	35mm Gap E122-71-026		L E146-71-049 51 R E146-71-048 51		E148-71-018	L E155-71-137 R E155-71-136
<b>2008</b>	Front Bracket Cast # 351C/352C	E110-1363-0	V E125-71-062 28.0	38mm Gap E122-71-030		L E146-71-057 51 R E146-71-056 51		E148-71-018	L E155-71-137 R E155-71-142
<b>2009 - 2010</b>		E110-1363-0	V E125-71-062 28.0	E122-71-030		L E146-71-057 51 R E146-71-056 51		E148-71-018	L E155-71-145 R E155-71-142
<b>2011</b>		E110-1363-0	V E125-71-062 28.0	E122-71-030		L E146-71-057 51 R E146-71-056 51		E148-71-018	L E155-71-145 R E155-71-142

Many products are available in multiple grades or configurations. Refer to page 5 for details.

# R E A R

Pads	Rotor, Drum	Hardware Kits	Calipers, Wheel Cyl	Kits Calipers, Wheel Cyl	Brake Hoses	Master Cylinders
E105 OEM Type E107 Semi-Met E109 Prem Pad E110 Ceramic E111 HD Pad <b>Shoes</b> E116 Std Shoe E117 HD Shoe  E121 Sensor Wire E124 Shoe Adjuster	E125 Prem Rotor E126 Std Rotor E127 Prem Drum E128 Std Drum E129 Hub L = Left R = Right V = Vented S = Solid	E122 Rotor E123 Drum	E139 Prem Cyl E140 Std Cyl E146 Semi-Loaded Cal E147 Loaded Cal	E148 Cal Kit E149 Cyl Kit	E155 Hose	E135 Prem M/C E136 Std M/C

DISCARD

DIAMETER

DIAMETER

## CHEVROLET (Cont'd)

### TAHOE 4WD

E110-0834-0 PB Shoe E116-0781-0	V E125-71-050 28.5	E122-71-018 PB Kit E123-71-009	L E146-71-511 45 R E146-71-510 45	E148-71-019	Except StabiliTrak up E155-71-335 lo L E155-71-337 lo R E155-71-336 StabiliTrak 15" up E155-71-363 15 1/2" up E155-71-409 lo L E155-71-337 lo R E155-71-336	Except StabiliTrak E135-71-051 34mm StabiliTrak E135-71-054 34mm
E110-0834-0 PB Shoe E116-0781-0	V E125-71-050 28.5	E122-71-018 PB Kit E123-71-009	L E146-71-511 45 R E146-71-510 45	E148-71-019	Except StabiliTrak up E155-71-362 lo L E155-71-337 lo R E155-71-336 StabiliTrak 15" up E155-71-363 15 1/2" up E155-71-409 lo L E155-71-337 lo R E155-71-336	Except StabiliTrak E135-71-051 34mm StabiliTrak E135-71-054 34mm
E110-0834-0 PB Shoe E116-0781-0	V E125-71-050 28.5	E122-71-018 PB Kit E123-71-009	L E146-71-511 45 R E146-71-510 45	E148-71-019	15" up E155-71-363 15 1/2" up E155-71-409 lo L E155-71-337 lo R E155-71-336	E135-71-054 34mm
E110-0834-0 PB Shoe E116-0781-0	V E125-71-050 28.5	E122-71-018 PB Kit E123-71-009	L E146-71-511 45 R E146-71-510 45	E148-71-019	15" up E155-71-363 15 1/2" up E155-71-409 lo L E155-71-337 lo R E155-71-336	E135-71-054 34mm
E110-1194-0 PB Shoe E116-0781-0	V E125-71-070 18.5	E122-71-027 PB Kit E123-71-015	L E146-71-535 51 R E146-71-534 51	E148-71-028	up E155-71-377 lo L E155-71-375 lo R E155-71-376	E135-71-061 1 1/4"
E110-1194-0 PB Shoe E116-0781-0	V E125-71-070 18.5	E122-71-027 PB Kit E123-71-015	L E146-71-535 51 R E146-71-534 51	E148-71-028	up E155-71-377 lo L E155-71-375 lo R E155-71-398	Except Hybrid E135-71-061 1 1/4" Hybrid E135-71-070 13/16"
E110-1194-0 PB Shoe E116-0781-0 E110-1194-0	V E125-71-070 18.5	E122-71-027 PB Kit E123-71-015	L E146-71-535 51 R E146-71-534 51	E148-71-028	up E155-71-377 lo L E155-71-375 lo R E155-71-398	Except Hybrid E135-71-071 1 1/4" Hybrid E135-71-070 13/16"
E110-1194-0 PB Shoe E116-0781-0 E110-1194-0	V E125-71-070 18.5	E122-71-027 PB Kit E123-71-015	L E146-71-535 51 R E146-71-534 51	E148-71-028	up E155-71-377 lo L E155-71-375 lo R E155-71-398	Except Hybrid E135-71-071 1 1/4" Hybrid E135-71-070 13/16"

# F R O N T

Many products are available in multiple grades or configurations. Refer to page 5 for details.

Make & Model	Year Notes	Pads	Rotor, Drum	Hardware Kits	Calipers, Wheel Cyl	Kits Calipers, Wheel Cyl	Brake Hoses		
		E105 OEM Type E107 Semi-Met E109 Prem Pad E110 Ceramic E111 HD Pad <b>Shoes</b> E116 Std Shoe E117 HD Shoe  E121 Sensor Wire E124 Shoe Adjuster	E125 Prem Rotor E126 Std Rotor E127 Prem Drum E128 Std Drum E129 Hub <b>L = Left</b> <b>R = Right</b> <b>V = Vented</b> <b>S = Solid</b>	DISCARD	E122 Rotor E123 Drum	DIAMETER	E139 Prem Cyl E140 Std Cyl E146 Semi-Loaded Cal E147 Loaded Cal	E148 Cal Kit E149 Cyl Kit	E155 Hose

## CHEVROLET (Cont'd)

### TRAILBLAZER

2007 - 2009	4.2L	E109-1169-0	V E125-71-068	27.5	E122-71-028	L E146-71-051 48 R E146-71-050 48	E148-63-010	L E155-71-111 R E155-71-110
	5.3L SS - 6.0L Eng	E109-1169-0	5.3L V E125-71-058 27.5 SS 6.0L V E125-71-069 27.5		E122-71-028	L E146-71-053 48 R E146-71-052 48	E148-63-010	L E155-71-111 R E155-71-110

### TRAVERSE

2007 - 2012		E110-1169-1	V E125-71-074	27.5	E122-71-028	L E146-71-053 48 R E146-71-052 48	E148-63-010	L E155-71-139 R E155-71-138
-------------	--	-------------	---------------	------	-------------	--------------------------------------	-------------	--------------------------------

### UPLANDER

2006	FWD Beam Rear Axle	E109-1075-0	V E125-71-066	30.7	E122-67-053	L E146-67-137 63.5 R E146-67-136 63.5	E148-67-024	L E155-71-131 R E155-71-132
	FWD Independent Rear Susp; AWD	E109-1075-0	V E125-71-066	30.7	E122-67-053	L E146-67-137 63.5 R E146-67-136 63.5	E148-67-024	L E155-71-131 R E155-71-132
2007 - 2009		E109-1075-0	V E125-71-066	30.7	E122-67-053	L E146-67-137 63.5 R E146-67-136 63.5	E148-67-024	L E155-71-131 R E155-71-132

## CHRYSLER

### TOWN & COUNTRY Van

2006 - 2007	FWD Rear Drum	E109-0856-0	V E125-72-054	25.3	E122-73-006	L E146-72-057 66 R E146-72-056 66	E148-63-009	L E155-72-093 R E155-72-094
	FWD Rear Disc	E109-0857-0	V E125-72-054	25.3	E122-72-013	L E146-68-031 66 R E146-68-030 66	E148-68-030	L E155-72-093 R E155-72-094
2008 - 2010		E110-1273-0	V E125-72-074	26.4	E122-66-047	L E146-72-060 66 R E146-72-061 66	E148-72-017	L E155-72-133 R E155-72-134

Many products are available in multiple grades or configurations. Refer to page 5 for details.

# R E A R

Pads	Rotor, Drum	Hardware Kits	Calipers, Wheel Cyl	Kits Calipers, Wheel Cyl	Brake Hoses	Master Cylinders
E105 OEM Type E107 Semi-Met E109 Prem Pad E110 Ceramic E111 HD Pad	E125 Prem Rotor E126 Std Rotor E127 Prem Drum E128 Std Drum E129 Hub	E122 Rotor E123 Drum	E139 Prem Cyl E140 Std Cyl E146 Semi-Loaded Cal E147 Loaded Cal	E148 Cal Kit E149 Cyl Kit	E155 Hose	E135 Prem M/C E136 Std M/C
<b>Shoes</b> E116 Std Shoe E117 HD Shoe	L = Left R = Right V = Vented S = Solid					
E121 Sensor Wire E124 Shoe Adjuster						

## CHEVROLET (Cont'd)

### TRAILBLAZER

E110-0883-0 PB Shoe E116-0781-0	V E125-71-057 18.5	E122-71-019 PB Kit E123-71-010	L E146-71-513 48 R E146-71-512 48	E148-96-020	E155-71-348	E135-71-060 1 1/16"
E110-0883-0 PB Shoe E116-0781-0	V E125-71-057 18.5	E122-71-019 PB Kit E123-71-010	L E146-71-513 48 R E146-71-512 48	E148-96-020	E155-71-348	E135-71-060 1 1/16"

### TRAVERSE

E110-0883-0 PB Shoe 2007 - 2011 E116-0933-0	V E125-71-075 18.4	E122-71-019 PB Kit 2007 - 2011 E123-71-018	L E146-71-537 48 R E146-71-536 48	E148-96-020	L E155-71-381 R E155-71-382	E135-71-064 1 1/16"
--	--------------------	---	--------------------------------------	-------------	--------------------------------	---------------------

### UPLANDER

E110-1093-0	S E125-71-067 10.5	E122-67-061	L E146-71-533 41 R E146-71-532 41	E148-71-027	L E155-71-369 R E155-71-370	E135-71-059 1"
E110-1093-0	S E125-71-071 10.5	E122-67-061	L E146-71-533 41 R E146-71-532 41	E148-71-027	L E155-71-367 R E155-71-368	E135-71-059 1"
E110-1093-0	S E125-71-067 10.5	E122-67-061	L E146-71-533 41 R E146-71-532 41	E148-71-027	L E155-71-369 R E155-71-370	E135-71-059 1"

## CHRYSLER

### TOWN & COUNTRY Van

E116-0714-0 250 x 55	E127-72-034 251.2	E123-68-021	E139-55-007 13/16"	E149-49-006	L E155-72-347 R E155-72-346	Except ABS E135-72-021 15/16" ABS E135-72-040 15/16" E135-72-036 1"
L E124-71-012 R E124-71-013						
E109-0858-0 PB Shoe E116-0761-0	S E125-72-042 11.25	PB Kit E123-68-022	E146-68-514 42	E148-68-025	113" WB up L E155-72-393 up R E155-72-388 lo E155-72-348 119" WB Stow & Go Rr Seats L E155-72-387 R E155-72-386 Std Rear Seats up L E155-72-391 up R E155-72-390 lo E155-72-348	
E110-1021-0	E125-72-076 10.4	E122-72-021	L E146-72-525 43 R E146-72-524 43	E148-72-018	L E155-72-403 R E155-72-404	E135-68-076 1"

# F R O N T

Many products are available in multiple grades or configurations. Refer to page 5 for details.

Make & Model	Year Notes	Pads	Rotor, Drum	DISCARD	Hardware Kits	Calipers, Wheel Cyl	DIAMETER	Kits Calipers, Wheel Cyl	Brake Hoses
		E105 OEM Type E107 Semi-Met E109 Prem Pad E110 Ceramic E111 HD Pad <b>Shoes</b> E116 Std Shoe E117 HD Shoe  E121 Sensor Wire E124 Shoe Adjuster	E125 Prem Rotor E126 Std Rotor E127 Prem Drum E128 Std Drum E129 Hub <b>L = Left</b> <b>R = Right</b> <b>V = Vented</b> <b>S = Solid</b>		E122 Rotor E123 Drum	E139 Prem Cyl E140 Std Cyl E146 Semi-Loaded Cal E147 Loaded Cal		E148 Cal Kit E149 Cyl Kit	E155 Hose

## CHRYSLER (Cont'd)

### TOWN & COUNTRY Van (Cont'd)

2011		E111-1273-0	V E125-72-074	26.4	E122-66-047	L E146-72-060 66 R E146-72-061 66	E148-72-017	L E155-72-133 R E155-72-134
2012	302mm Fr & 305mm Rr Disc	E110-1273-0	V E125-72-074	26.4	E122-66-047	L E146-72-060 66 R E146-72-061 66	E148-72-017	L E155-72-133 R E155-72-134
	330mm Fr & 328mm Rr Disc	E110-1589-0	V E125-72-079	26.4				L E155-72-133 R E155-72-134

## DODGE

### CALIBER

2007 - 2008	Rear Drum	E110-0866-0	V E125-68-073	24.4	E122-51-021	L E146-68-081 57 R E146-68-080 57	E148-68-038	L E155-68-089 R E155-68-088
	R/T 2.4L FWD & AWD Rear Disc	E110-0866-0	V E125-68-072	24.4	E122-51-021	L E146-68-083 57 R E146-68-082 57	E148-68-038	L E155-68-089 R E155-68-088
	SRT-4 2.4L Turbo Rear Disc	E111-1058-0	V E125-68-077	26.5	E122-68-026	L E146-68-050 42 R E146-68-051 42	E148-68-035	L E155-68-089 R E155-68-088
2009	Rear Drum	E110-0866-0	V E125-68-073	24.4	E122-51-021	L E146-68-081 57 R E146-68-080 57	E148-68-038	L E155-68-089 R E155-68-088
	R/T 2.4L Rear Disc	E110-0866-0	V E125-68-072	24.4	E122-51-021	L E146-68-083 57 R E146-68-082 57	E148-68-038	L E155-68-089 R E155-68-088
	SRT-4 2.4L Turbo Rear Disc	E111-1058-0	V E125-68-077	26.5	E122-68-026	L E146-68-050 42 R E146-68-051 42	E148-68-035	L E155-68-089 R E155-68-088
2010 - 2011	Rear Drum	E110-0866-0	V E125-68-073	24.4	E122-51-021	L E146-68-081 57 R E146-68-080 57	E148-68-038	L E155-68-089 R E155-68-088
	Rear Disc 2.0L Eng	E110-0866-0	V E125-68-073	24.4	E122-51-021	L E146-68-081 57 R E146-68-080 57	E148-68-038	L E155-68-089 R E155-68-088
	Rear Disc 2.4L Eng	E110-0866-0	V E125-68-072	24.4	E122-51-021	L E146-68-083 57 R E146-68-082 57	E148-68-038	L E155-68-089 R E155-68-088

Many products are available in multiple grades or configurations. Refer to page 5 for details.

# R E A R

<b>Pads</b> E105 OEM Type E107 Semi-Met E109 Prem Pad E110 Ceramic E111 HD Pad <b>Shoes</b> E116 Std Shoe E117 HD Shoe  E121 Sensor Wire E124 Shoe Adjuster	<b>Rotor, Drum</b> E125 Prem Rotor E126 Std Rotor E127 Prem Drum E128 Std Drum E129 Hub L = Left R = Right V = Vented S = Solid	DISCARD	<b>Hardware Kits</b> E122 Rotor E123 Drum	<b>Calipers, Wheel Cyl</b> E139 Prem Cyl E140 Std Cyl E146 Semi-Loaded Cal E147 Loaded Cal	DIAMETER	<b>Kits Calipers, Wheel Cyl</b> E148 Cal Kit E149 Cyl Kit	<b>Brake Hoses</b> E155 Hose	<b>Master Cylinders</b> E135 Prem M/C E136 Std M/C	DIAMETER
--	--	---------	---	--	----------	---	---------------------------------	--	----------

## CHRYSLER (Cont'd)

### TOWN & COUNTRY Van (Cont'd)

E110-1021-0	S E125-72-076	10.4	E122-72-021	L E146-72-525 R E146-72-524	43 43	E148-72-018	To 12/10 L E155-72-404 R E155-72-403 Fr 1/11 L E155-72-416 R E155-72-417	E135-68-076	1"
E110-1021-0	S E125-72-076	10.4	E122-72-021	L E146-72-525 R E146-72-524	43 43	E148-72-018		E135-68-076	1"
E110-1596-0	S E125-72-080	10.4	E122-72-024	L E146-72-535 R E146-72-534	45 45	E148-66-019			

## DODGE

### CALIBER

E116-0919-0 228.6 x 36.6	E127-68-053	230.6	E123-68-027	E139-68-040	13/16"		L E155-68-389 R E155-68-388	Except ABS E135-68-074 ABS E135-68-073	13/16"
L E124-68-029 R E124-68-028									
E110-1037-0 PB Shoe E116-0886-1	S E125-68-071	8.4	E122-51-020 PB Kit E123-68-028	L E146-68-539 R E146-68-538	35 35	E148-96-008	up L E155-68-389 up R E155-68-388 lb E155-68-390	E135-68-073	13/16"
E110-0868-0 PB Shoe E116-0886-1	S E125-68-074	8.4	E122-51-020 PB Kit E123-68-028	L E146-68-543 R E146-68-542	35 35	E148-96-008	up L E155-68-389 up R E155-68-388 lb E155-68-392	E135-68-083	15/16"
E116-0919-0 228.6 x 36.6	E127-68-053	230.6	E123-68-027	E139-68-040	13/16"		L E155-68-389 R E155-68-388	Except ABS E135-68-074 ABS E135-68-073	13/16"
L E124-68-029 R E124-68-028									
E110-1037-0 PB Shoe E116-0886-1	S E125-68-071	8.4	E122-51-020 PB Kit E123-68-028	L E146-68-539 R E146-68-538	35 35	E148-96-008	up L E155-68-389 up R E155-68-388 lb E155-68-390	E135-68-073	13/16"
E110-0868-0 PB Shoe E116-0886-1	S E125-68-074	8.4	E122-51-020 PB Kit E123-68-028	L E146-68-543 R E146-68-542	35 35	E148-96-008	up L E155-68-389 up R E155-68-388 lb E155-68-392	E135-68-083	15/16"
E116-0919-0 228.6 x 36.6	E127-68-053	230.6	E123-68-027	E139-68-040	13/16"		L E155-68-389 R E155-68-388	E135-68-073	13/16"
L E124-68-029 R E124-68-028									
E110-1037-0 PB Shoe E116-0886-1	S E125-68-071	8.4	E122-51-020 PB Kit E123-68-028	L E146-68-539 R E146-68-538	35 35	E148-96-008	up L E155-68-389 up R E155-68-388 lb E155-68-390	E135-68-073	13/16"
E110-0868-0 PB Shoe E116-0886-1	S E125-68-074	8.4	E122-51-020 PB Kit E123-68-028	L E146-68-543 R E146-68-542	35 35	E148-96-008	up L E155-68-399 up R E155-68-400 lb E155-68-390	E135-68-073	13/16"



# F R O N T

Many products are available in multiple grades or configurations. Refer to page 5 for details.

Make & Model	Year Notes	Pads	Rotor, Drum	Hardware Kits	Calipers, Wheel Cyl	Kits	Brake Hoses
		E105 OEM Type E107 Semi-Met E109 Prem Pad E110 Ceramic E111 HD Pad <b>Shoes</b> E116 Std Shoe E117 HD Shoe  E121 Sensor Wire E124 Shoe Adjuster	E125 Prem Rotor E126 Std Rotor E127 Prem Drum E128 Std Drum E129 Hub <b>L = Left</b> <b>R = Right</b> <b>V = Vented</b> <b>S = Solid</b>	E122 Rotor E123 Drum	E139 Prem Cyl E140 Std Cyl E146 Semi-Loaded Cal E147 Loaded Cal	E148 Cal Kit E149 Cyl Kit	E155 Hose

DISCARD

DIAMETER

## DODGE (Cont'd)

### CALIBER (Cont'd)

2012	Rear Drum	E110-0866-0	V E125-68-073	24.4	E122-51-021	L E146-68-081 57 R E146-68-080 57	E148-68-038	
	Rear Disc	E110-0866-0	V E125-68-073	24.4	E122-51-021	L E146-68-081 57 R E146-68-080 57	E148-68-038	

### CARAVAN, GRAND CARAVAN

2006 - 2007	Rear Drum	E109-0856-0	V E125-72-054	25.3	E122-73-006	L E146-72-057 66 R E146-72-056 66	E148-63-009	L E155-72-093 R E155-72-094
	Rear Disc	E109-0857-0	V E125-72-054	25.3	E122-72-013	L E146-68-031 66 R E146-68-030 66	E148-68-030	L E155-72-093 R E155-72-094
2008 - 2010		E110-1273-0	V E125-72-074	26.4	E122-66-047	L E146-72-060 66 R E146-72-061 66	E148-72-017	L E155-72-133 R E155-72-134
2011		E111-1273-0	V E125-72-074	26.4	E122-66-047	L E146-72-060 66 R E146-72-061 66	E148-72-017	L E155-72-133 R E155-72-134
2012	302mm Fr & 305mm Rr Disc	E110-1273-0	V E125-72-074	26.4	E122-66-047	L E146-72-060 66 R E146-72-061 66	E148-72-017	L E155-72-133 R E155-72-134
	330mm Fr & 328mm Rr Disc	E110-1589-0	V E125-72-079	26.4				L E155-72-133 R E155-72-134

Many products are available in multiple grades or configurations. Refer to page 5 for details.

# R E A R

Pads	Rotor, Drum	Hardware Kits	Calipers, Wheel Cyl	Kits Calipers, Wheel Cyl	Brake Hoses	Master Cylinders
E105 OEM Type E107 Semi-Met E109 Prem Pad E110 Ceramic E111 HD Pad	E125 Prem Rotor E126 Std Rotor E127 Prem Drum E128 Std Drum E129 Hub	E122 Rotor E123 Drum	E139 Prem Cyl E140 Std Cyl E146 Semi-Loaded Cal E147 Loaded Cal	E148 Cal Kit E149 Cyl Kit	E155 Hose	E135 Prem M/C E136 Std M/C
<b>Shoes</b> E116 Std Shoe E117 HD Shoe	L = Left R = Right V = Vented S = Solid					
E121 Sensor Wire E124 Shoe Adjuster						

DISCARD

DIAMETER

DIAMETER

## DODGE (Cont'd)

### CALIBER (Cont'd)

E116-0919-0 228.6 x 36.6		E123-68-027	E139-68-040 13/16"		L E155-68-389 R E155-68-388	E135-68-073 13/16"
L E124-68-029 R E124-68-028						
E110-1037-0 PB Shoe E116-0886-1	S E125-68-071 8.4	E122-51-020 PB Kit E123-68-028	L E146-68-539 35 R E146-68-538 35	E148-96-008	up L E155-68-389 up R E155-68-388 lo E155-68-390	E135-68-073 13/16"

### CARAVAN, GRAND CARAVAN

E116-0714-0 250 x 55	E127-72-034 251.2	E123-68-021	E139-55-007 13/16"	E149-49-006	L E155-72-347 R E155-72-346	Except ABS E135-72-021 15/16" ABS E135-72-040 15/16"
L E124-71-012 R E124-71-013						E135-72-036 1"
E109-0858-0 PB Shoe E116-0761-0	S E125-72-042 11.25	PB Kit E123-68-022	E146-68-514 42	E148-68-025	113" WB up L E155-72-393 up R E155-72-388 lo E155-72-348 119" WB Stow & Go Rr Seats L E155-72-387 R E155-72-386 Std Rear Seats up L E155-72-389 up R E155-72-388 lo E155-72-348	E135-72-036 1"
E110-1021-0	S E125-72-076 10.4	E122-72-021	L E146-72-525 43 R E146-72-524 43	E148-72-018	L E155-72-403 R E155-72-404	E135-68-076 1"
E110-1021-0	S E125-72-076 10.4	E122-72-021	L E146-72-525 43 R E146-72-524 43	E148-72-018	To 12/10 L E155-72-404 R E155-72-403 1/11 - 2011 L E155-72-416 R E155-72-417	E135-68-076 1"
E110-1021-0	S E125-72-076 10.4	E122-72-021	L E146-72-525 43 R E146-72-524 43	E148-72-018		E135-68-076 1"
E110-1596-0	S E125-72-080 10.4	E122-72-024	L E146-72-535 45 R E146-72-534 45	E148-66-019		

# FRONT

Many products are available in multiple grades or configurations. Refer to page 5 for details.

Make & Model	Year Notes	Pads	Rotor, Drum	Hardware Kits	Calipers, Wheel Cyl	Kits Calipers, Wheel Cyl	Brake Hoses	
		E105 OEM Type E107 Semi-Met E109 Prem Pad E110 Ceramic E111 HD Pad <b>Shoes</b> E116 Std Shoe E117 HD Shoe  E121 Sensor Wire E124 Shoe Adjuster	E125 Prem Rotor E126 Std Rotor E127 Prem Drum E128 Std Drum E129 Hub <b>L = Left</b> <b>R = Right</b> <b>V = Vented</b> <b>S = Solid</b>	DISCARD	E122 Rotor E123 Drum	DIAMETER	E139 Prem Cyl E140 Std Cyl E146 Semi-Loaded Cal E147 Loaded Cal	E148 Cal Kit E149 Cyl Kit  E155 Hose

## DODGE (Cont'd)

### CHARGER

<b>2008 - 2010</b>	SE, SXT RWD Solid Rear Disc	E110-1056-0	V E125-68-064	26.5	E122-68-026	E146-68-075	60.5	E148-68-036	L E155-68-079 R E155-68-080
	SXT AWD R/T except Daytona Vented Rear Disc 320x22mm	E111-1058-0	V E125-68-066	26.5	E122-68-026	L E146-68-051 R E146-68-050	42 42	E148-68-035	RWD L E155-68-081 R E155-68-082 AWD E155-68-085
	Daytona R/T Police Package Vented Rear Disc 350x26mm	E111-1058-0	V E125-68-066	26.5	E122-68-026	L E146-68-051 R E146-68-050	42 42	E148-68-035	L E155-68-081 R E155-68-082
<b>2011</b>	SE, RALLYE, RALLYE PLUS RWD Solid Rear Disc	E110-1056-0	V E125-68-064	26.5	E122-68-026	E146-68-075	60.5	E148-68-036	L R E155-68-080
	R/T RWD Except Super Trac Pak Vented Rear Disc 320x22mm	E110-1058-0	V E125-68-066	26.5	E122-68-026	L E146-68-050 R E146-68-051	42 42	E148-68-035	L E155-68-093 R E155-68-094
	Super Track Pak Police Package Vented Rear Disc 350x26mm	E110-1058-0	V E125-68-066	26.5	E122-68-026	L E146-68-050 R E146-68-051	42 42	E148-68-035	L E155-68-093 R E155-68-094
	AWD	E110-1058-0	V E125-68-066	26.5	E122-68-026	L E146-68-050 R E146-68-051	42 42	E148-68-035	E155-68-085
<b>2012</b>	V6 RWD Except Pursuit (Police) Solid Rear Disc	E110-1056-0	V E125-68-064	26.5			60.5	E148-68-036	
	V6 AWD V8 Hemi RWD & AWD Except SRT8 & Pursuit (Police) Vented Rear Disc 320x22mm	E110-1058-0	V E125-68-066	26.5			42	E148-68-035	AWD E155-68-085
	Pursuit (Police) Vented Rear Disc 350x26mm	E110-1058-0	V E125-68-066	26.5			42	E148-68-035	

Many products are available in multiple grades or configurations. Refer to page 5 for details.

**R E A R**

<b>Pads</b>	<b>Rotor, Drum</b>	<b>Hardware Kits</b>	<b>Calipers, Wheel Cyl</b>	<b>Kits Calipers, Wheel Cyl</b>	<b>Brake Hoses</b>	<b>Master Cylinders</b>
E105 OEM Type E107 Semi-Met E109 Prem Pad E110 Ceramic E111 HD Pad <b>Shoes</b> E116 Std Shoe E117 HD Shoe  E121 Sensor Wire E124 Shoe Adjuster	E125 Prem Rotor E126 Std Rotor E127 Prem Drum E128 Std Drum E129 Hub L = Left R = Right V = Vented S = Solid	E122 Rotor E123 Drum	E139 Prem Cyl E140 Std Cyl E146 Semi-Loaded Cal E147 Loaded Cal	E148 Cal Kit E149 Cyl Kit	E155 Hose	E135 Prem M/C E136 Std M/C
<b>DISCARD</b>		<b>DIAMETER</b>		<b>DIAMETER</b>		<b>DIAMETER</b>

**DODGE (Cont'd)**

**CHARGER**

E110-1057-0 PB Shoe E116-0777-0	S E125-68-065 8.5	E122-68-024 PB Kit E123-66-043	E146-68-533 42	E148-68-037	L E155-68-381 R E155-68-380	E135-68-081 1"
E111-1057-0 PB Shoe E116-0777-0	V E125-68-067 20.5	E122-68-025 PB Kit E123-66-043	E146-68-535 42	E148-68-037	RWD L E155-68-393 R E155-68-394 AWD L E155-68-387 R E155-68-386	E135-68-081 1"
E111-1057-1 PB Shoe E116-0777-0	V E125-68-070 24.5	E122-68-029 PB Kit E123-66-043	E146-68-541 42	E148-68-037	L E155-68-393 R E155-68-394	E135-68-082 1 1/16"
E110-1057-0 PB Shoe E116-0777-0	S E125-68-065 8.5	E122-68-024 PB Kit E123-66-043	E146-68-533 42	E148-68-037	L E155-68-381 R E155-68-380	E135-68-082 1 1/16"
E111-1057-0 PB Shoe E116-0777-0	V E125-68-067 20.5	E122-68-025 PB Kit E123-66-043	E146-68-535 42	E148-68-037	L E155-68-381 R E155-68-380	E135-68-082 1 1/16"
E111-1057-1 PB Shoe E116-0777-0	V E125-68-070 24.5	E122-68-029 PB Kit E123-66-043	E146-68-541 42	E148-68-037	L E155-68-393 R E155-68-394	E135-68-082 1 1/16"
E111-1057-0 PB Shoe E116-0777-0	V E125-68-067 20.5	E122-68-025 PB Kit E123-66-043	E146-68-535 42	E148-68-037	L E155-68-387 R E155-68-386	E135-68-082 1 1/16"
E110-1057-0 PB Shoe E116-0777-0	S E125-68-065 8.5	PB Kit E123-66-043	E146-68-533 42	E148-68-037	L E155-68-381 R E155-68-380	E135-68-081 1"
E111-1057-0 PB Shoe E116-0777-0	V E125-68-067 20.5	E122-68-025 PB Kit E123-66-043	E146-68-535 42	E148-68-037	RWD L E155-68-381 R E155-68-380 AWD L E155-68-387 R E155-68-386	E135-68-081 1"
E111-1057-1 PB Shoe E116-0777-0	V E125-68-070 24.5	E122-68-029 PB Kit E123-66-043	E146-68-541 42	E148-68-037	L E155-68-393 R E155-68-394	E135-68-082 1 1/16"

# F R O N T

Many products are available in multiple grades or configurations. Refer to page 5 for details.

Make & Model	Year Notes	Pads	Rotor, Drum	Hardware Kits	Calipers, Wheel Cyl	Kits	Brake Hoses		
		E105 OEM Type E107 Semi-Met E109 Prem Pad E110 Ceramic E111 HD Pad <b>Shoes</b> E116 Std Shoe E117 HD Shoe  E121 Sensor Wire E124 Shoe Adjuster	E125 Prem Rotor E126 Std Rotor E127 Prem Drum E128 Std Drum E129 Hub <b>L = Left</b> <b>R = Right</b> <b>V = Vented</b> <b>S = Solid</b>	DISCARD	E122 Rotor E123 Drum	DIAMETER	E139 Prem Cyl E140 Std Cyl E146 Semi-Loaded Cal E147 Loaded Cal	E148 Cal Kit E149 Cyl Kit	E155 Hose

## DODGE (Cont'd)

### DAKOTA RWD

<b>2005 - 2008</b> Upgraded Steel Piston Front Calipers. Replace Phenolic Piston Calipers in Pairs.	E111-1084-0	V	E125-72-070	26.0	E122-72-018	L E146-72-059 54 R E146-72-058 54	E148-72-014	E155-72-128
<b>2009 - 2011</b> Phenolic Piston Calipers	E111-1084-0	V	E125-72-070	26.0	E122-72-018	L E146-72-049 54 R E146-72-048 54	E148-72-014	E155-72-128

### DAKOTA 4WD

<b>2005 - 2008</b> Upgraded Steel Piston Front Calipers. Replace Phenolic Piston Calipers in Pairs.	E111-1084-0	V	E125-72-070	26.0	E122-72-018	L E146-72-059 54 R E146-72-058 54	E148-72-014	E155-72-128
<b>2009 - 2011</b> Phenolic Piston Calipers	E111-1084-0	V	E125-72-070	26.0	E122-72-018	L E146-72-049 54 R E146-72-048 54	E148-72-014	E155-72-128

### DURANGO

<b>2007 - 2008</b>	E111-1084-0	V	E125-72-058	26.4	E122-72-018	L E146-72-048 54 R E146-72-049 54	E148-72-014	L E155-72-117 R E155-72-116
<b>2009</b>	E111-1084-0	V	E125-72-058	26.4	E122-72-018	L E146-72-048 54 R E146-72-049 54	E148-72-014	L E155-72-117 R E155-72-116
<b>2010</b> <b>Not Produced</b>								
<b>2011 - 2012</b> 330mm Front Disc & Solid Rear Disc	E110-1455-0	V	E125-63-011	30.5	E122-63-012	L E146-63-015 48 R E146-63-014 48	E148-63-006	L E155-63-035 R E155-63-034
350mm Front Disc & Vented Rear Disc	E110-1455-0	V	E125-63-013	30.5	E122-63-012	L E146-63-017 48 R E146-63-016 48	E148-63-006	L E155-63-035 R E155-63-034

### RAM 1500 1/2 Ton RWD Pickup

<b>2007 - 2008</b> Except Mega Cab	E111-1084-0	V	E125-72-058	26.4	E122-72-018	L E146-72-059 54 R E146-72-058 54	E148-72-014	L E155-72-125 R E155-72-124
Mega Cab	E111-0965-0	V	E125-72-066	34.0	E122-72-017	L E146-72-031 56 R E146-72-030 56	E148-70-016	L E155-72-111 R E155-72-112

Many products are available in multiple grades or configurations. Refer to page 5 for details.

# R E A R

Parts	Rotor, Drum	Hardware Kits	Calipers, Wheel Cyl	Kits Calipers, Wheel Cyl	Brake Hoses	Master Cylinders
E105 OEM Type E107 Semi-Met E109 Prem Pad E110 Ceramic E111 HD Pad <b>Shoes</b> E116 Std Shoe E117 HD Shoe  E121 Sensor Wire E124 Shoe Adjuster	E125 Prem Rotor E126 Std Rotor E127 Prem Drum E128 Std Drum E129 Hub L = Left R = Right V = Vented S = Solid	E122 Rotor E123 Drum	E139 Prem Cyl E140 Std Cyl E146 Semi-Loaded Cal E147 Loaded Cal	E148 Cal Kit E149 Cyl Kit	E155 Hose	E135 Prem M/C E136 Std M/C
DISCARD		DIAMETER		DIAMETER		DIAMETER

## DODGE (Cont'd)

### DAKOTA RWD

E116-0922-0 295 x 61.7	2005 E127-72-048 297.5	E123-72-010	E139-72-019 1 1/16"		E155-72-380	Rear Wheel ABS E135-72-041 1 1/4"
L E124-72-009	2006 - 2008					4 Wheel ABS
R E124-72-008	E127-72-049 297.5					E135-72-042 1 1/4"
E116-0922-0 295 x 61.7	E127-72-049 297.5	E123-72-010	E139-72-019 1 1/16"		E155-72-380	Rear Wheel ABS E135-72-041 1 1/4"
L E124-72-009						4 Wheel ABS
R E124-72-008						E135-72-042 1 1/4"

### DAKOTA 4WD

E116-0922-0 295 x 61.7	2005 E127-72-048 297.5	E123-72-010	E139-72-019 1 1/16"		E155-72-380	Rear Wheel ABS E135-72-041 1 1/4"
L E124-72-009	2006 - 2008					4 Wheel ABS
R E124-72-008	E127-72-049 297.5					E135-72-042 1 1/4"
E116-0922-0 295 x 61.7	E127-72-049 297.5	E123-72-010	E139-72-019 1 1/16"		E155-72-380	Rear Wheel ABS E135-72-041 1 1/4"
L E124-72-009						4 Wheel ABS
R E124-72-008						E135-72-042 1 1/4"

### DURANGO

E111-0898-0 PB Shoe 2007 E116-0852-0 2008 E116-0947-0	V E125-72-059 20.4	E122-72-011 PB Kit 2007 - 2008 E123-72-006	L E146-72-507 54 R E146-72-506 54	E148-68-011	E155-72-371	E135-72-046 1 1/4"
E111-0898-0 PB Shoe E116-0947-0	V E125-72-059 20.4	E122-72-011 PB Kit E123-72-006	L E146-72-507 54 R E146-72-506 54	E148-68-011	E155-72-371	Except Hybrid E135-72-046 1 1/4" Hybrid E135-72-052 1 3/16"
E110-1498-0 PB Shoe E116-0986-0	S E125-63-010 12.5	E122-40-039 PB Shoe E123-63-010	L E146-63-515 48 R E146-63-514 48	E148-63-007	L E155-63-323 R E155-63-322	E135-63-014 27mm
E110-1498-0 PB Shoe E116-0986-0	V E125-63-012 20.50	E122-40-039 PB Shoe E123-63-010	L E146-63-517 48 R E146-63-516 48	E148-63-007	L E155-63-323 R E155-63-322	E135-63-014 27mm

### RAM 1500 1/2 Ton RWD Pickup

E111-0898-0 PB Shoe 2007 E116-0852-0 2008 E116-0947-0	V E125-72-059 20.4	E122-72-011 PB Kit E123-72-006	L E146-72-507 54 R E146-72-506 54	E148-68-011	Rear Whl ABS up E155-72-395 lo L E155-72-353 lo R E155-72-407 4 Whl ABS up E155-72-396 lo L E155-72-353 lo R E155-72-383	E135-72-048 1 1/4"
E111-0702-1 PB Shoe E116-0854-0	V E125-72-067 28.4	E122-72-009 PB Kit E123-72-006	L E146-72-517 45 R E146-72-516 45	E148-72-010	up E155-72-364 lo L E155-72-355 lo R E155-72-356	E135-72-033 1 5/16"

# F R O N T

Many products are available in multiple grades or configurations. Refer to page 5 for details.

Make & Model	Year Notes	Pads	Rotor, Drum	DISCARD	Hardware Kits	Calipers, Wheel Cyl	DIAMETER	Kits	Brake Hoses
		E105 OEM Type E107 Semi-Met E109 Prem Pad E110 Ceramic E111 HD Pad <b>Shoes</b> E116 Std Shoe E117 HD Shoe  E121 Sensor Wire E124 Shoe Adjuster	E125 Prem Rotor E126 Std Rotor E127 Prem Drum E128 Std Drum E129 Hub <b>L = Left</b> <b>R = Right</b> <b>V = Vented</b> <b>S = Solid</b>		E122 Rotor E123 Drum	E139 Prem Cyl E140 Std Cyl E146 Semi-Loaded Cal E147 Loaded Cal		E148 Cal Kit E149 Cyl Kit	E155 Hose

## DODGE (Cont'd)

### RAM 1500 1/2 Ton RWD Pickup (Cont'd)

2009 - 2011	E111-1084-0	V E125-72-058	26.4	E122-72-018	L E146-72-049 54 R E146-72-048 54	E148-72-014	L E155-72-125 R E155-72-124
2012	E111-1084-0	V E125-72-058	26.4	E122-72-018	L E146-72-049 54 R E146-72-048 54	E148-72-014	L E155-72-129 R E155-72-130

### RAM 1500 1/2 Ton 4WD Pickup

2007 - 2008	Except Mega Cab	E111-1084-0	V E125-72-058	26.4	E122-72-018	L E146-72-059 54 R E146-72-058 54	E148-72-014	L E155-72-129 R E155-72-130
	Mega Cab	E111-0965-0	V E125-72-066	34.0	E122-72-017	L E146-72-031 56 R E146-72-030 56	E148-70-016	L E155-72-123 R E155-72-114
2009 - 2011		E111-1084-0	V E125-72-058	26.4	E122-72-018	L E146-72-049 54 R E146-72-048 54	E148-72-014	L E155-72-129 R E155-72-130
2012		E111-1084-0	V E125-72-058	26.4	E122-72-018	L E146-72-049 54 R E146-72-048 54	E148-72-014	L E155-72-129 R E155-72-130

### RAM 2500 3/4 Ton RWD Pickup

2006 - 2008	E111-0965-0	V E125-72-066	34.0	E122-72-017	L E146-72-031 56 R E146-72-030 56	E148-70-016	L E155-72-111 R E155-72-112
2009	E111-1399-0	V E125-72-077	37.4	E122-72-022	L E146-72-067 60 R E146-72-066 60	E148-70-024	L E155-72-111 R E155-72-112
2010 - 2011	E111-1399-0	V E125-72-077	37.4	E122-72-022	L E146-72-067 60 R E146-72-066 60	E148-70-024	L E155-72-111 R E155-72-112
2012	E111-1399-0	V E125-72-077	37.4	E122-72-022	L E146-72-067 60 R E146-72-066 60	E148-70-024	L R E155-72-112

Many products are available in multiple grades or configurations. Refer to page 5 for details.

**R E A R**

<b>Pads</b> E105 OEM Type E107 Semi-Met E109 Prem Pad E110 Ceramic E111 HD Pad <b>Shoes</b> E116 Std Shoe E117 HD Shoe  E121 Sensor Wire E124 Shoe Adjuster	<b>Rotor, Drum</b> E125 Prem Rotor E126 Std Rotor E127 Prem Drum E128 Std Drum E129 Hub L = Left R = Right V = Vented S = Solid	<b>Hardware Kits</b> E122 Rotor E123 Drum	<b>Calipers, Wheel Cyl</b> E139 Prem Cyl E140 Std Cyl E146 Semi-Loaded Cal E147 Loaded Cal	<b>Kits Calipers, Wheel Cyl</b> E148 Cal Kit E149 Cyl Kit	<b>Brake Hoses</b> E155 Hose	<b>Master Cylinders</b> E135 Prem M/C E136 Std M/C	<b>DISCARD</b>	<b>DIAMETER</b>
--	--	---	--	---	---------------------------------	--	----------------	-----------------

**DODGE (Cont'd)**

**RAM 1500 1/2 Ton RWD Pickup (Cont'd)**

E111-0898-0 PB Shoe E116-0947-0	v E125-72-059 20.4	E122-72-011 PB Kit E123-72-006	L E146-72-507 54 R E146-72-506 54	E148-68-011	L E155-72-413 R E155-72-412	E135-72-048	1 1/4"
E111-0898-0 PB Shoe E116-0947-0	v E125-72-059 20.4	E122-72-011 PB Kit E123-72-006	L E146-72-507 54 R E146-72-506 54	E148-68-011		E135-72-048	1 1/4"

**RAM 1500 1/2 Ton 4WD Pickup**

E111-0898-0 PB Shoe 2007 E116-0852-0 2008 E116-0947-0	v E125-72-059 20.4	E122-72-011 PB Kit 2007 - 2008 E123-72-006	L E146-72-507 54 R E146-72-506 54	E148-68-011	Rear Whl ABS up E155-72-395 lo L E155-72-353 lo R E155-72-407 4 Whl ABS up E155-72-396 lo L E155-72-353 lo R E155-72-383	E135-72-048	1 1/4"
E111-0702-1 PB Shoe E116-0854-0	v E125-72-067 28.4	E122-72-009 PB Kit E123-72-006	L E146-72-517 45 R E146-72-516 45	E148-72-010	up E155-72-364 lo L E155-72-355 lo R E155-72-356	E135-72-033	1 5/16"
E111-0898-0 PB Shoe E116-0947-0	v E125-72-059 20.4	E122-72-011 PB Kit E123-72-006	L E146-72-507 54 R E146-72-506 54	E148-68-011	L E155-72-413 R E155-72-412	E135-72-048	1 1/4"
E111-0898-0 PB Shoe E116-0947-0	v E125-72-059 20.4	E122-72-011 PB Kit E123-72-006	L E146-72-507 54 R E146-72-506 54	E148-68-011		E135-72-048	1 1/4"

**RAM 2500 3/4 Ton RWD Pickup**

E111-0702-1 PB Shoe E116-0854-0	v E125-72-067 28.4	E122-72-009 PB Kit E123-70-020	L E146-72-517 45 R E146-72-516 45	E148-72-010	up E155-72-364 lo L E155-72-355 lo R E155-72-356	exc. 5.7L E135-72-047 5.7L E135-72-033	1 5/16" 1 5/16"
E111-1400-0 PB Shoe E116-0854-0	v E125-72-078 32.4	E122-72-023 PB Kit E123-70-020	L E146-72-529 45 R E146-72-528 45	E148-72-020	up E155-72-364 lo L E155-72-355 lo R E155-72-356	Hydro Boost E135-72-047 Vac Boost E135-72-033	1 5/16" 1 5/16" 1 5/16"
E111-1400-0 PB Shoe E116-0854-0	v E125-72-078 32.4	E122-72-023 PB Kit E123-70-020	L E146-72-529 45 R E146-72-528 45	E148-72-020	up E155-72-364 lo L E155-72-355 lo R E155-72-356	Hydro Boost E135-72-047 Vac Boost E135-72-033	1 5/16" 1 5/16" 1 5/16"
E111-1400-0 PB Shoe E116-0854-0	v E125-72-078 32.4	E122-72-023 PB Kit E123-70-020	L E146-72-529 45 R E146-72-528 45	E148-72-020			



# F R O N T

Many products are available in multiple grades or configurations. Refer to page 5 for details.

Make & Model	Year Notes	Pads	Rotor, Drum	DISCARD	Hardware Kits	Calipers, Wheel Cyl	DIAMETER	Kits	Brake Hoses
		E105 OEM Type E107 Semi-Met E109 Prem Pad E110 Ceramic E111 HD Pad <b>Shoes</b> E116 Std Shoe E117 HD Shoe  E121 Sensor Wire E124 Shoe Adjuster	E125 Prem Rotor E126 Std Rotor E127 Prem Drum E128 Std Drum E129 Hub <b>L = Left</b> <b>R = Right</b> <b>V = Vented</b> <b>S = Solid</b>		E122 Rotor E123 Drum	E139 Prem Cyl E140 Std Cyl E146 Semi-Loaded Cal E147 Loaded Cal		E148 Cal Kit E149 Cyl Kit	E155 Hose

## DODGE (Cont'd)

### RAM 2500 3/4 Ton 4WD Pickup

2006 - 2008	E111-0965-0	V E125-72-066	34.0	E122-72-017	L E146-72-031 56 R E146-72-030 56	E148-70-016	L E155-72-123 R E155-72-114
2009	E111-1399-0	V E125-72-077	37.4	E122-72-022	L E146-72-067 60 R E146-72-066 60	E148-70-024	L E155-72-123 R E155-72-114
2010 - 2011	E111-1399-0	V E125-72-077	37.4	E122-72-022	L E146-72-067 60 R E146-72-066 60	E148-70-024	L E155-72-123 R E155-72-114
2012	E111-1399-0	V E125-72-077	37.4	E122-72-022	L E146-72-067 60 R E146-72-066 60	E148-70-024	L R E155-72-114

### RAM 3500 1 Ton RWD Pickup, Cab & Chassis

2007 - 2008	SRW	E111-0965-0	V E125-72-066	34.0	E122-72-017	L E146-72-031 56 R E146-72-030 56	E148-70-016	L E155-72-111 R E155-72-112
	Pickup DRW	E111-0965-0	V E125-72-066	34.0	E122-72-017	L E146-72-031 56 R E146-72-030 56	E148-70-016	L E155-72-111 R E155-72-112
	Cab & Chassis DRW	E111-0965-0	V E125-72-066	34.0	E122-72-017	L E146-72-031 56 R E146-72-030 56	E148-70-016	L E155-72-123 R E155-72-114
2009	Pickup SRW	E111-1399-0	V E125-72-077	37.4	E122-72-022	L E146-72-067 60 R E146-72-066 60	E148-70-024	L E155-72-111 R E155-72-112
	Pickup DRW	E111-1399-0	V E125-72-077	37.4	E122-72-022	L E146-72-067 60 R E146-72-066 60	E148-70-024	L E155-72-111 R E155-72-112
	Cab & Chassis SRW	E111-1399-0	V E125-72-077	37.4	E122-72-022	L E146-72-067 60 R E146-72-066 60	E148-70-024	L E155-72-123 R E155-72-114
	Cab & Chassis DRW	E111-1399-0	V E125-72-077	37.4	E122-72-022	L E146-72-067 60 R E146-72-066 60	E148-70-024	L E155-72-123 R E155-72-114

Many products are available in multiple grades or configurations. Refer to page 5 for details.

# R E A R

Pads	Rotor, Drum	Hardware Kits	Calipers, Wheel Cyl	Kits Calipers, Wheel Cyl	Brake Hoses	Master Cylinders
E105 OEM Type E107 Semi-Met E109 Prem Pad E110 Ceramic E111 HD Pad	E125 Prem Rotor E126 Std Rotor E127 Prem Drum E128 Std Drum E129 Hub	E122 Rotor E123 Drum	E139 Prem Cyl E140 Std Cyl E146 Semi-Loaded Cal E147 Loaded Cal	E148 Cal Kit E149 Cyl Kit	E155 Hose	E135 Prem M/C E136 Std M/C
<b>Shoes</b> E116 Std Shoe E117 HD Shoe	<b>L = Left</b> <b>R = Right</b> <b>V = Vented</b> <b>S = Solid</b>	DISCARD		DIAMETER		DIAMETER
E121 Sensor Wire E124 Shoe Adjuster						

## DODGE (Cont'd)

### RAM 2500 3/4 Ton 4WD Pickup

E111-0702-1 PB Shoe E116-0854-0	V E125-72-067 28.4	E122-72-009 PB Kit E123-70-020	L E146-72-517 45 R E146-72-516 45	E148-72-010	up E155-72-364 lo L E155-72-355 lo R E155-72-356	exc. 5.7L E135-72-047 1 5/16" 5.7L E135-72-033 1 5/16"
E111-1400-0 PB Shoe E116-0854-0	V E125-72-078 32.4	E122-72-023 PB Kit E123-70-020	L E146-72-529 45 R E146-72-528 45	E148-72-020	up E155-72-364 lo L E155-72-355 lo R E155-72-356	Hydro Boost E135-72-047 1 5/16" Vac Boost E135-72-033 1 5/16"
E111-1400-0 PB Shoe E116-0854-0	V E125-72-078 32.4	E122-72-023 PB Kit E123-70-020	L E146-72-529 45 R E146-72-528 45	E148-72-020	up E155-72-364 lo L E155-72-355 lo R E155-72-356	Hydro Boost E135-72-047 1 5/16" Vac Boost E135-72-033 1 5/16"
E111-1400-0 PB Shoe E116-0854-0	V E125-72-078 32.4	E122-72-023 PB Kit E123-70-020	L E146-72-529 45 R E146-72-528 45	E148-72-020		

### RAM 3500 1 Ton RWD Pickup, Cab & Chassis

E111-0702-1 PB Shoe E116-0854-0	V E125-72-067 28.4	E122-72-009 PB Kit E123-70-020	L E146-72-517 45 R E146-72-516 45	E148-72-010	up E155-72-364 lo L E155-72-355 lo R E155-72-356	Except 5.7L E135-72-047 1 5/16" 5.7L E135-72-033 1 5/16"
E111-0702-1 PB Shoe E116-0854-0	V E125-72-067 28.4	E122-72-009 PB Kit E123-70-020	L E146-72-519 51 R E146-72-518 51	E148-70-020	up E155-72-364 lo L E155-72-355 lo R E155-72-356	E135-72-047 1 5/16"
E111-0702-1 PB Shoe E116-0854-0	V E125-72-067 28.4	E122-72-009 PB Kit E123-70-020	L E146-72-519 51 R E146-72-518 51	E148-70-020	up E155-72-398 lo L E155-72-397 lo R E155-72-402	E135-72-047 1 5/16"
E111-1400-0 PB Shoe E116-0854-0	V E125-72-078 32.4	E122-72-023 PB Kit E123-70-020	L E146-72-529 45 R E146-72-528 45	E148-72-020	up E155-72-364 lo L E155-72-355 lo R E155-72-356	E135-72-047 1 5/16"
E111-1400-0 PB Shoe E116-0854-0	V E125-72-078 32.4	E122-72-023 PB Kit E123-70-020	L E146-72-531 51 R E146-72-530 51	E148-72-021	up E155-72-364 lo L E155-72-355 lo R E155-72-356	E135-72-047 1 5/16"
E111-1400-0 PB Shoe E116-0854-0	V E125-72-078 32.4	E122-72-023 PB Kit E123-70-020	L E146-72-529 45 R E146-72-528 45	E148-72-020	up E155-72-398 lo L E155-72-397 lo R E155-72-402	E135-72-047 1 5/16"
E111-1400-0 PB Shoe E116-0854-0	V E125-72-078 32.4	E122-72-023 PB Kit E123-70-020	L E146-72-531 51 R E146-72-530 51	E148-72-021	up E155-72-398 lo L E155-72-397 lo R E155-72-402	E135-72-047 1 5/16"

# F R O N T

Many products are available in multiple grades or configurations. Refer to page 5 for details.

Make & Model	Year Notes	Pads	Rotor, Drum	DISCARD	Hardware Kits	Calipers, Wheel Cyl	DIAMETER	Kits Calipers, Wheel Cyl	Brake Hoses
		E105 OEM Type E107 Semi-Met E109 Prem Pad E110 Ceramic E111 HD Pad <b>Shoes</b> E116 Std Shoe E117 HD Shoe  E121 Sensor Wire E124 Shoe Adjuster	E125 Prem Rotor E126 Std Rotor E127 Prem Drum E128 Std Drum E129 Hub <b>L = Left</b> <b>R = Right</b> <b>V = Vented</b> <b>S = Solid</b>	DISCARD	E122 Rotor E123 Drum	E139 Prem Cyl E140 Std Cyl E146 Semi-Loaded Cal E147 Loaded Cal	DIAMETER	E148 Cal Kit E149 Cyl Kit	E155 Hose

## DODGE (Cont'd)

### RAM 3500 1 Ton RWD Pickup, Cab & Chassis (Cont'd)

<b>2010</b>	Pickup SRW	E111-1399-0	V E125-72-077	37.4	E122-72-022	L E146-72-067 R E146-72-066	60 60	E148-70-024	L E155-72-111 R E155-72-112
	Pickup DRW	E111-1399-0	V E125-72-077	37.4	E122-72-022	L E146-72-067 R E146-72-066	60 60	E148-70-024	L E155-72-111 R E155-72-112
	Cab & Chassis SRW	E111-1399-0	V E125-72-077	37.4	E122-72-022	L E146-72-067 R E146-72-066	60 60	E148-70-024	L E155-72-123 R E155-72-114
	Cab & Chassis DRW	E111-1399-0	V E125-72-077	37.4	E122-72-022	L E146-72-067 R E146-72-066	60 60	E148-70-024	L E155-72-123 R E155-72-114
<b>2011</b>	Pickup SRW	E111-1399-0	V E125-72-077	37.4	E122-72-022	L E146-72-067 R E146-72-066	60 60	E148-70-024	L E155-72-111 R E155-72-112
	Pickup DRW	E111-1399-0	V E125-72-077	37.4	E122-72-022	L E146-72-067 R E146-72-066	60 60	E148-70-024	L E155-72-111 R E155-72-112
	Cab & Chassis SRW	E111-1399-0	V E125-72-077	37.4	E122-72-022	L E146-72-067 R E146-72-066	60 60	E148-70-024	L E155-72-123 R E155-72-114
	Cab & Chassis DRW	E111-1399-0	V E125-72-077	37.4	E122-72-022	L E146-72-067 R E146-72-066	60 60	E148-70-024	L E155-72-123 R E155-72-114
<b>2012</b>	Pickup SRW	E111-1399-0	V E125-72-077	37.4	E122-72-022	L E146-72-067 R E146-72-066	60 60	E148-70-024	L E155-72-111 R E155-72-112
	Pickup DRW	E111-1399-0	V E125-72-077	37.4	E122-72-022	L E146-72-067 R E146-72-066	60 60	E148-70-024	L E155-72-111 R E155-72-112
	Cab & Chassis SRW	E111-1399-0	V E125-72-077	37.4	E122-72-022	L E146-72-067 R E146-72-066	60 60	E148-70-024	L E155-72-123 R E155-72-114
	Cab & Chassis DRW	E111-1399-0	V E125-72-077	37.4	E122-72-022	L E146-72-067 R E146-72-066	60 60	E148-70-024	L E155-72-123 R E155-72-114

### RAM 3500 1 Ton 4WD Pickup, Cab & Chassis

<b>2007 - 2008</b>	SRW	E111-0965-0	V E125-72-066	34.0	E122-72-017	L E146-72-031 R E146-72-030	56 56	E148-70-016	L E155-72-123 R E155-72-114
	DRW Except Heavy Duty Cab & Chassis	E111-0965-0	V E125-72-066	34.0	E122-72-017	L E146-72-031 R E146-72-030	56 56	E148-70-016	L E155-72-123 R E155-72-114
	DRW Heavy Duty Cab & Chassis	E111-0965-0	V E125-72-066	34.0	E122-72-017	L E146-72-031 R E146-72-030	56 56	E148-70-016	L E155-72-123 R E155-72-114

Many products are available in multiple grades or configurations. Refer to page 5 for details.

# R E A R

<b>Pads</b> E105 OEM Type E107 Semi-Met E109 Prem Pad E110 Ceramic E111 HD Pad <b>Shoes</b> E116 Std Shoe E117 HD Shoe  E121 Sensor Wire E124 Shoe Adjuster	<b>Rotor, Drum</b> E125 Prem Rotor E126 Std Rotor E127 Prem Drum E128 Std Drum E129 Hub L = Left R = Right V = Vented S = Solid	DISCARD	<b>Hardware Kits</b> E122 Rotor E123 Drum	<b>Calipers, Wheel Cyl</b> E139 Prem Cyl E140 Std Cyl E146 Semi-Loaded Cal E147 Loaded Cal	DIAMETER	<b>Kits Calipers, Wheel Cyl</b> E148 Cal Kit E149 Cyl Kit	<b>Brake Hoses</b> E155 Hose	<b>Master Cylinders</b> E135 Prem M/C E136 Std M/C	DIAMETER

## DODGE (Cont'd)

### RAM 3500 1 Ton RWD Pickup, Cab & Chassis (Cont'd)

E111-1400-0 PB Shoe	V E125-72-078 32.4	E122-72-023 PB Kit	L E146-72-529 45 R E146-72-528 45	E148-72-020	up E155-72-364 lo L E155-72-355 lo R E155-72-356	E135-72-047 1 5/16"
E116-0854-0		E123-70-020				
E111-1400-0 PB Shoe	V E125-72-078 32.4	E122-72-023 PB Kit	L E146-72-531 51 R E146-72-530 51	E148-72-021	up E155-72-364 lo L E155-72-355 lo R E155-72-356	E135-72-047 1 5/16"
E116-0854-0		E123-70-020				
E111-1400-0 PB Shoe	V E125-72-078 32.4	E122-72-023 PB Kit	L E146-72-529 45 R E146-72-528 45	E148-72-020	up E155-72-398 lo L E155-72-397 lo R E155-72-402	E135-72-047 1 5/16"
E116-0854-0		E123-70-020				
E111-1400-0 PB Shoe	V E125-72-078 32.4	E122-72-023 PB Kit	L E146-72-531 51 R E146-72-530 51	E148-72-021	up E155-72-398 lo L E155-72-397 lo R E155-72-402	E135-72-047 1 5/16"
E116-0854-0		E123-70-020				
E111-1400-0 PB Shoe	V E125-72-078 32.4	E122-72-023	L E146-72-529 45 R E146-72-528 45	E148-72-020	up E155-72-364 lo L E155-72-355 lo R E155-72-356	E135-72-047 1 5/16"
E116-0854-0		E123-70-020				
E111-1400-0 PB Shoe	V E125-72-078 32.4	E122-72-023	L E146-72-529 45 R E146-72-528 45	E148-72-020	up E155-72-398 lo L E155-72-397 lo R E155-72-402	E135-72-047 1 5/16"
E116-0854-0		E123-70-020				
E111-1400-0 PB Shoe	V E125-72-078 32.4	E122-72-023	L E146-72-531 51 R E146-72-530 51	E148-72-021	up E155-72-398 lo L E155-72-397 lo R E155-72-402	E135-72-047 1 5/16"
E116-0854-0		E123-70-020				
E111-1400-0 PB Shoe	V E125-72-078 32.4	E122-72-023	L E146-72-529 45 R E146-72-528 45	E148-72-020	up lo L E155-72-355 lo R E155-72-356	
E116-0854-0		E123-70-020				
E111-1400-0 PB Shoe	V E125-72-078 32.4	E122-72-023	L E146-72-531 51 R E146-72-530 51	E148-72-021		
E116-0854-0		E123-70-020				
E111-1400-0 PB Shoe	V E125-72-078 32.4	E122-72-023	L E146-72-529 45 R E146-72-528 45	E148-72-020	up E155-72-398 lo L E155-72-397 lo R E155-72-356	
E116-0854-0		E123-70-020				
E111-1400-0 PB Shoe	V E125-72-078 32.4	E122-72-023	L E146-72-531 51 R E146-72-530 51	E148-72-021	up E155-72-398 lo L E155-72-397 lo R E155-72-402	
E116-0854-0		E123-70-020				

### RAM 3500 1 Ton 4WD Pickup, Cab & Chassis

E111-0702-1 PB Shoe	V E125-72-067 28.4	E122-72-009 PB Kit	L E146-72-517 45 R E146-72-516 45	E148-72-010	up E155-72-364 lo L E155-72-355 lo R E155-72-356	Except 5.7L E135-72-047 1 5/16" 5.7L
E116-0854-0		E123-70-020				E135-72-033 1 5/16"
E111-0702-1 PB Shoe	V E125-72-067 28.4	E122-72-009 PB Kit	L E146-72-519 51 R E146-72-518 51	E148-70-020	up E155-72-364 lo L E155-72-355 lo R E155-72-356	E135-72-047 1 5/16"
E116-0854-0		E123-70-020				
E111-0702-1 PB Shoe	V E125-72-067 28.4	E122-72-009 PB Kit	L E146-72-519 51 R E146-72-518 51	E148-70-020	up E155-72-398 lo L E155-72-397 lo R E155-72-402	E135-72-047 1 5/16"
E116-0854-0		E123-70-020				

# F R O N T

Many products are available in multiple grades or configurations. Refer to page 5 for details.

Make & Model	Year Notes	Pads	Rotor, Drum	DISCARD	Hardware Kits	Calipers, Wheel Cyl	DIAMETER	Kits	Brake Hoses
		E105 OEM Type E107 Semi-Met E109 Prem Pad E110 Ceramic E111 HD Pad <b>Shoes</b> E116 Std Shoe E117 HD Shoe  E121 Sensor Wire E124 Shoe Adjuster	E125 Prem Rotor E126 Std Rotor E127 Prem Drum E128 Std Drum E129 Hub <b>L = Left</b> <b>R = Right</b> <b>V = Vented</b> <b>S = Solid</b>		E122 Rotor E123 Drum	E139 Prem Cyl E140 Std Cyl E146 Semi-Loaded Cal E147 Loaded Cal		E148 Cal Kit E149 Cyl Kit	E155 Hose

## DODGE (Cont'd)

### RAM 3500 1 Ton 4WD Pickup, Cab & Chassis (Cont'd)

<b>2009</b>	Pickup SRW	E111-1399-0	V E125-72-077	37.4	E122-72-022	L E146-72-067 R E146-72-066	60 60	E148-70-024	L E155-72-123 R E155-72-114
	Pickup DRW	E111-1399-0	V E125-72-077	37.4	E122-72-022	L E146-72-067 R E146-72-066	60 60	E148-70-024	L E155-72-123 R E155-72-114
	Cab & Chassis SRW	E111-1399-0	V E125-72-077	37.4	E122-72-022	L E146-72-067 R E146-72-066	60 60	E148-70-024	L E155-72-123 R E155-72-114
	Cab & Chassis DRW	E111-1399-0	V E125-72-077	37.4	E122-72-022	L E146-72-067 R E146-72-066	60 60	E148-70-024	L E155-72-123 R E155-72-114
<b>2010</b>	Pickup SRW	E111-1399-0	V E125-72-077	37.4	E122-72-022	L E146-72-067 R E146-72-066	60 60	E148-70-024	L E155-72-123 R E155-72-114
	Pickup DRW	E111-1399-0	V E125-72-077	37.4	E122-72-022	L E146-72-067 R E146-72-066	60 60	E148-70-024	L E155-72-123 R E155-72-114
	Cab & Chassis SRW	E111-1399-0	V E125-72-077	37.4	E122-72-022	L E146-72-067 R E146-72-066	60 60	E148-70-024	L E155-72-123 R E155-72-114
	Cab & Chassis DRW	E111-1399-0	V E125-72-077	37.4	E122-72-022	L E146-72-067 R E146-72-066	60 60	E148-70-024	L E155-72-123 R E155-72-114
<b>2011</b>	Pickup SRW	E111-1399-0	V E125-72-077	37.4	E122-72-022	L E146-72-067 R E146-72-066	60 60	E148-70-024	L E155-72-123 R E155-72-114
	Pickup DRW	E111-1399-0	V E125-72-077	37.4	E122-72-022	L E146-72-067 R E146-72-066	60 60	E148-70-024	L E155-72-123 R E155-72-114
	Cab & Chassis SRW	E111-1399-0	V E125-72-077	37.4	E122-72-022	L E146-72-067 R E146-72-066	60 60	E148-70-024	L E155-72-123 R E155-72-114
	Cab & Chassis DRW	E111-1399-0	V E125-72-077	37.4	E122-72-022	L E146-72-067 R E146-72-066	60 60	E148-70-024	L E155-72-123 R E155-72-114
<b>2012</b>	Pickup SRW	E111-1399-0	V E125-72-077	37.4	E122-72-022	L E146-72-067 R E146-72-066	60 60	E148-70-024	L E155-72-111 R E155-72-112
	Pickup DRW	E111-1399-0	V E125-72-077	37.4	E122-72-022	L E146-72-067 R E146-72-066	60 60	E148-70-024	L E155-72-111 R E155-72-112
	Cab & Chassis SRW	E111-1399-0	V E125-72-077	37.4	E122-72-022	L E146-72-067 R E146-72-066	60 60	E148-70-024	L E155-72-123 R E155-72-114
	Cab & Chassis DRW	E111-1399-0	V E125-72-077	37.4	E122-72-022	L E146-72-067 R E146-72-066	60 60	E148-70-024	L E155-72-123 R E155-72-114

Many products are available in multiple grades or configurations. Refer to page 5 for details.

# R E A R

Pads	Rotor, Drum	Hardware Kits	Calipers, Wheel Cyl	Kits Calipers, Wheel Cyl	Brake Hoses	Master Cylinders
E105 OEM Type E107 Semi-Met E109 Prem Pad E110 Ceramic E111 HD Pad <b>Shoes</b> E116 Std Shoe E117 HD Shoe  E121 Sensor Wire E124 Shoe Adjuster	E125 Prem Rotor E126 Std Rotor E127 Prem Drum E128 Std Drum E129 Hub L = Left R = Right V = Vented S = Solid	E122 Rotor E123 Drum	E139 Prem Cyl E140 Std Cyl E146 Semi-Loaded Cal E147 Loaded Cal	E148 Cal Kit E149 Cyl Kit	E155 Hose	E135 Prem M/C E136 Std M/C
DISCARD		DIAMETER		DIAMETER		DIAMETER

## DODGE (Cont'd)

### RAM 3500 1 Ton 4WD Pickup, Cab & Chassis (Cont'd)

E111-1400-0 PB Shoe E116-0854-0	V E125-72-078 32.4	E122-72-023 PB Kit E123-70-020	L E146-72-529 45 R E146-72-528 45	E148-72-020	up E155-72-364 lo L E155-72-355 lo R E155-72-356	E135-72-047 1 5/16"
E111-1400-0 PB Shoe E116-0854-0	V E125-72-078 32.4	E122-72-023 PB Kit E123-70-020	L E146-72-531 51 R E146-72-530 51	E148-72-021	up E155-72-364 lo L E155-72-355 lo R E155-72-356	E135-72-047 1 5/16"
E111-1400-0 PB Shoe E116-0854-0	V E125-72-078 32.4	E122-72-023 PB Kit E123-70-020	L E146-72-529 45 R E146-72-528 45	E148-72-020	up E155-72-398 lo L E155-72-397 lo R E155-72-402	E135-72-047 1 5/16"
E111-1400-0 PB Shoe E116-0854-0	V E125-72-078 32.4	E122-72-023 PB Kit E123-70-020	L E146-72-531 51 R E146-72-530 51	E148-72-021	up E155-72-398 lo L E155-72-397 lo R E155-72-402	E135-72-047 1 5/16"
E111-1400-0 PB Shoe E116-0854-0	V E125-72-078 32.4	E122-72-023 PB Kit E123-70-020	L E146-72-529 45 R E146-72-528 45	E148-72-020	up E155-72-364 lo L E155-72-355 lo R E155-72-356	E135-72-047 1 5/16"
E111-1400-0 PB Shoe E116-0854-0	V E125-72-078 32.4	E122-72-023 PB Kit E123-70-020	L E146-72-531 51 R E146-72-530 51	E148-72-021	up E155-72-364 lo L E155-72-355 lo R E155-72-356	E135-72-047 1 5/16"
E111-1400-0 PB Shoe E116-0854-0	V E125-72-078 32.4	E122-72-023 PB Kit E123-70-020	L E146-72-529 45 R E146-72-528 45	E148-72-020	up E155-72-398 lo L E155-72-397 lo R E155-72-402	E135-72-047 1 5/16"
E111-1400-0 PB Shoe E116-0854-0	V E125-72-078 32.4	E122-72-023 PB Kit E123-70-020	L E146-72-531 51 R E146-72-530 51	E148-72-021	up E155-72-398 lo L E155-72-397 lo R E155-72-402	E135-72-047 1 5/16"
E111-1400-0 PB Shoe E116-0854-0	V E125-72-078 32.4	E122-72-023 PB Kit E123-70-020	L E146-72-529 45 R E146-72-528 45	E148-72-020	up E155-72-364 lo L E155-72-355 lo R E155-72-356	E135-72-047 1 5/16"
E111-1400-0 PB Shoe E116-0854-0	V E125-72-078 32.4	E122-72-023 PB Kit E123-70-020	L E146-72-531 51 R E146-72-530 51	E148-72-021	up E155-72-398 lo L E155-72-397 lo R E155-72-402	E135-72-047 1 5/16"
E111-1400-0 PB Shoe E116-0854-0	V E125-72-078 32.4	E122-72-023 PB Kit E123-70-020	L E146-72-529 45 R E146-72-528 45	E148-72-020	up E155-72-398 lo L E155-72-397 lo R E155-72-402	E135-72-047 1 5/16"
E111-1400-0 PB Shoe E116-0854-0	V E125-72-078 32.4	E122-72-023 PB Kit E123-70-020	L E146-72-531 51 R E146-72-530 51	E148-72-021	up E155-72-398 lo L E155-72-397 lo R E155-72-402	E135-72-047 1 5/16"
E111-1400-0 PB Shoe E116-0854-0	V E125-72-078 32.4	E122-72-023 PB Kit E123-70-020	L E146-72-529 45 R E146-72-528 45	E148-72-020	up E155-72-398 lo L E155-72-397 lo R E155-72-402	E135-72-047 1 5/16"
E111-1400-0 PB Shoe E116-0854-0	V E125-72-078 32.4	E122-72-023 PB Kit E123-70-020	L E146-72-531 51 R E146-72-530 51	E148-72-021	up E155-72-398 lo L E155-72-397 lo R E155-72-402	E135-72-047 1 5/16"

# F R O N T

*Many products are available in multiple grades or configurations. Refer to page 5 for details.*

Make & Model	Year Notes	Pads	Rotor, Drum	DISCARD	Hardware Kits	Calipers, Wheel Cyl	DIAMETER	Kits Calipers, Wheel Cyl	Brake Hoses
		E105 OEM Type E107 Semi-Met E109 Prem Pad E110 Ceramic E111 HD Pad <b>Shoes</b> E116 Std Shoe E117 HD Shoe  E121 Sensor Wire E124 Shoe Adjuster	E125 Prem Rotor E126 Std Rotor E127 Prem Drum E128 Std Drum E129 Hub <b>L = Left</b> <b>R = Right</b> <b>V = Vented</b> <b>S = Solid</b>		E122 Rotor E123 Drum	E139 Prem Cyl E140 Std Cyl E146 Semi-Loaded Cal E147 Loaded Cal		E148 Cal Kit E149 Cyl Kit	E155 Hose

## DODGE (Cont'd)

### RAM 4500, 5500

2008 - 2011	E111-1335-0	V E125-72-075 37.4	E122-72-020	L E146-72-063 66 R E146-72-062 66	E148-85-007	L E155-72-131 R E155-72-132
2012	E111-1335-0	V E125-72-075 37.4	E122-72-020	L E146-72-063 66 R E146-72-062 66	E148-85-007	

### SPRINTER 2500

2007 - 2009	E109-1316-0  E121-40-015 (2)	V E130-40-111 25.0	E122-90-006	L E146-40-167 48 R E146-40-166 48	E148-40-047	E155-40-106
-------------	------------------------------------	--------------------	-------------	--------------------------------------	-------------	-------------

### SPRINTER 3500

2007 - 2009	SRW  DRW	E111-1268-0  E121-40-015 (2)  E111-1268-0  E121-40-015 (2)	V E130-40-111 25.0	E122-90-006	L E146-90-006 52 R E146-90-007 52  L E146-90-006 52 R E146-90-007 52	E148-90-006	E155-40-106
-------------	----------------	--	--------------------	-------------	--	-------------	-------------

## FORD

### CROWN VICTORIA

2007 - 2010	Except Police E110-0931-0 Police E111-0931-0	V E125-66-077 26.35	E122-66-042	L E146-66-093 48 R E146-66-092 48	E148-70-021	L E155-66-109 R E155-66-104
2011	Except Police E110-0931-0 Police E111-0931-0	V E125-66-077 26.35				L E155-66-109 R E155-66-104

### EDGE

2007 - 2008	FWD  AWD	E110-1258-0  E110-1258-0	V E125-66-097 26.0  V E125-66-095 26.0	E122-50-050	L E146-66-127 45.5 R E146-66-126 45.5  L E146-66-129 45.5 R E146-66-128 45.5	E148-45-029	E155-66-124
2009		E110-1258-0	V E125-66-095 26.0	E122-50-050	L E146-66-129 45.5 R E146-66-128 45.5	E148-45-029	E155-66-124
2010		E110-1258-0	V E125-66-095 26.0	E122-50-050	L E146-66-135 45.5 R E146-66-134 45.5	E148-45-029	E155-66-124

Many products are available in multiple grades or configurations. Refer to page 5 for details.

# R E A R

Pads	Rotor, Drum	Hardware Kits	Calipers, Wheel Cyl	Kits Calipers, Wheel Cyl	Brake Hoses	Master Cylinders
E105 OEM Type E107 Semi-Met E109 Prem Pad E110 Ceramic E111 HD Pad	E125 Prem Rotor E126 Std Rotor E127 Prem Drum E128 Std Drum E129 Hub	E122 Rotor E123 Drum	E139 Prem Cyl E140 Std Cyl E146 Semi-Loaded Cal E147 Loaded Cal	E148 Cal Kit E149 Cyl Kit	E155 Hose	E135 Prem M/C E136 Std M/C
<b>Shoes</b> E116 Std Shoe E117 HD Shoe	L = Left R = Right V = Vented S = Solid	DISCARD	DIAMETER	DIAMETER		DIAMETER
E121 Sensor Wire E124 Shoe Adjuster						

## DODGE (Cont'd)

### RAM 4500, 5500

E111-1335-0 PB Shoe	V E125-70-120 37.4	E122-72-020 PB Kit	L E146-72-063 66 R E146-72-062 66	E148-85-007	up E155-72-405 lo L E155-72-401 lo R E155-72-400	E135-72-050 1 1/2"
E116-0847-0		E123-70-021				
E111-1335-0 PB Shoe	V E125-70-120 37.4	E122-72-020 PB Kit	L E146-72-063 66 R E146-72-062 66	E148-85-007	up E155-72-405 lo L E155-72-401 lo R E155-72-400	E135-72-050 1 1/2"
E116-0847-0		E123-70-021				

### SPRINTER 2500

E109-1317-0 PB Shoe	S E130-40-112 14.0	E122-40-050 PB Kit	L E146-40-603 51 R E146-40-602 51	E148-40-048	E155-40-106	E135-40-507 27mm
E116-0938-0		E123-40-010				
E121-40-015 (2)						

### SPRINTER 3500

E109-1317-0 PB Shoe	S E130-40-112 14.0	E122-40-050 PB Kit	L E146-40-603 51 R E146-40-602 51	E148-40-048	E155-40-106	E135-40-507 27mm
E116-0938-0		E123-40-010				
E121-40-015 (4)						
E109-1318-0 PB Shoe	V E130-40-113 25.0	E122-40-051 PB Kit	L E146-40-605 48 R E146-40-604 48	E148-40-049	E155-40-506	E135-40-507 27mm
E116-0940-0		E123-40-012				
E121-40-015 (4)						

## FORD

### CROWN VICTORIA

E110-0932-0 PB Shoe	V E125-66-078 18.0	E122-66-043 PB Kit	L E146-66-525 48 R E146-66-524 48	E148-66-035	L E155-66-433 R E155-66-434	T/C E135-66-122 1" Except T/C
E116-0809-0		E123-66-043				E135-66-123 1"
E110-0932-0 PB Shoe	V E125-66-078 18.0		L E146-66-525 48 R E146-66-524 48	E148-66-035	L E155-66-433 R E155-66-434	T/C E135-66-122 1" Except T/C
E116-0809-0						E135-66-123 1"

### EDGE

E110-1259-0 PB Shoe	V E125-66-096 16.0	E122-50-051 PB Kit	L E146-50-567 43 R E146-50-566 43	E148-50-030	E155-66-432	E135-66-137 7/8"
E116-0784-0		E123-50-027				
E110-1259-0 PB Shoe	V E125-66-096 16.0	E122-50-051 PB Kit	L E146-50-567 43 R E146-50-566 43	E148-50-030	E155-66-432	E135-66-137 7/8"
E116-0784-0		E123-50-027				
E110-1259-0 PB Shoe	V E125-66-096 16.0	E122-50-051 PB Kit	L E146-50-567 43 R E146-50-566 43	E148-50-030	E155-66-432	E135-66-137 7/8"
E116-0784-0		E123-50-027				
E110-1259-0 PB Shoe	V E125-66-096 16.0	E122-50-051 PB Kit	L E146-50-567 43 R E146-50-566 43	E148-50-030	E155-66-432	E135-66-137 7/8"
E116-0784-0		E123-50-027				



# F R O N T

*Many products are available in multiple grades or configurations. Refer to page 5 for details.*

Make & Model	Year Notes	Pads	Rotor, Drum	DISCARD	Hardware Kits	Calipers, Wheel Cyl	DIAMETER	Kits Calipers, Wheel Cyl	Brake Hoses
		E105 OEM Type E107 Semi-Met E109 Prem Pad E110 Ceramic E111 HD Pad <b>Shoes</b> E116 Std Shoe E117 HD Shoe  E121 Sensor Wire E124 Shoe Adjuster	E125 Prem Rotor E126 Std Rotor E127 Prem Drum E128 Std Drum E129 Hub <b>L = Left</b> <b>R = Right</b> <b>V = Vented</b> <b>S = Solid</b>		E122 Rotor E123 Drum	E139 Prem Cyl E140 Std Cyl E146 Semi-Loaded Cal E147 Loaded Cal		E148 Cal Kit E149 Cyl Kit	E155 Hose

## FORD (Cont'd)

### EDGE (Cont'd)

2011	E110-1258-0	V E125-66-095	26.0		L E146-66-135 45.5 R E146-66-134 45.5	E148-45-029	E155-66-124
2012	E110-1258-0	V E125-66-095	26.0		L E146-66-135 45.5 R E146-66-134 45.5	E148-45-029	E155-66-124

### ESCAPE

2007	Rear Drum 2.3L 3.0L FWD	E110-0843-0	V E125-70-094	22.0	E122-95-006	L E146-70-027 60 R E146-70-026 60	E148-67-039	E155-70-155
	Rear Disc 3.0L 4WD	E110-1047-0	V E125-70-112	24.0	E122-70-032	L E146-70-087 66 R E146-70-086 66	E148-70-030	E155-70-155
	Hybrid	E110-1047-0	V E125-70-112	24.0	E122-70-032	L E146-70-087 66 R E146-70-086 66	E148-70-030	E155-70-155
2008	Rear Drum	E110-1047-0	V E125-70-112	24.0	E122-70-032	L E146-70-087 66 R E146-70-086 66	E148-70-030	E155-70-199
	Rear Disc Hybrid	E110-1047-1	V E125-70-112	24.0	E122-70-032	L E146-70-087 66 R E146-70-086 66	E148-70-030	E155-70-199
2009	Except Hybrid	E110-1047-0	V E125-70-112	24.0	E122-70-032	L E146-70-087 66 R E146-70-086 66	E148-70-030	E155-70-199
	Hybrid	E110-1047-1	V E125-70-112	24.0	E122-70-032	L E146-70-087 66 R E146-70-086 66	E148-70-030	E155-70-199
2010 - 2012	Except Hybrid	E110-1047-2	V E125-70-112	24.0	E122-72-013	L E146-70-103 66 R E146-70-102 66	E148-70-030	E155-70-199
	Hybrid	E110-1047-3	V E125-70-112	24.0	E122-72-013	L E146-70-103 66 R E146-70-102 66	E148-70-030	E155-70-199

Many products are available in multiple grades or configurations. Refer to page 5 for details.

# R E A R

Pads	Rotor, Drum	Hardware Kits	Calipers, Wheel Cyl	Kits Calipers, Wheel Cyl	Brake Hoses	Master Cylinders
E105 OEM Type E107 Semi-Met E109 Prem Pad E110 Ceramic E111 HD Pad <b>Shoes</b> E116 Std Shoe E117 HD Shoe  E121 Sensor Wire E124 Shoe Adjuster	E125 Prem Rotor E126 Std Rotor E127 Prem Drum E128 Std Drum E129 Hub L = Left R = Right V = Vented S = Solid	E122 Rotor E123 Drum	E139 Prem Cyl E140 Std Cyl E146 Semi-Loaded Cal E147 Loaded Cal	E148 Cal Kit E149 Cyl Kit	E155 Hose	E135 Prem M/C E136 Std M/C
DISCARD		DIAMETER		DIAMETER		DIAMETER

## FORD (Cont'd)

### EDGE (Cont'd)

E110-1377-0	S E125-66-086	0.39"	E122-72-021	L E146-66-567 43 R E146-66-566 43	E148-72-018	L E155-66-455 R E155-66-454	E135-66-137	7/8"
E110-1377-0	S E125-66-086	0.39"			E148-72-018	L E155-66-455 R E155-66-454	E135-66-137	7/8"

### ESCAPE

E116-0760-0 228 x 41	E127-70-049	230.1	E123-70-011	E139-70-029	15/16"	L E155-70-449 R E155-70-379	A/T E135-70-101	1"
L E124-70-012 R E124-70-013							M/T E135-70-102	1"
E110-1055-0	S E125-70-113	11.0		L E146-70-527 40 R E146-70-526 40	E148-39-023	L E155-70-419 R E155-70-420	A/T E135-70-099	1 1/16"
PB Shoe E116-0877-0			PB Kit E123-70-022				M/T E135-70-100	1 1/16"
E110-1055-0	S E125-70-113	11.0		L E146-70-527 40 R E146-70-526 40	E148-39-023	L E155-70-419 R E155-70-420	E135-70-107	1"
PB Shoe E116-0877-0			PB Kit E123-70-022					
E116-0936-0 254 x 55	E127-70-051	256.3	E123-70-023	E139-70-034	15/16"	L E155-70-455 R E155-70-456	A/T E135-70-120	1 1/16"
L E124-70-015 R E124-70-014							M/T E135-70-121	1 1/16"
E110-1055-0	S E125-70-113	11.0		L E146-70-527 40 R E146-70-526 40	E148-39-023	L E155-70-457 R E155-70-458	E135-70-126	1"
PB Shoe E116-0877-0			PB Kit E123-70-022					
E116-0936-0 254 x 55	E127-70-051	256.3	E123-70-023	E139-70-034	15/16"	L E155-70-455 R E155-70-456	A/T E135-70-128	1 1/16"
L E124-70-015 R E124-70-014							M/T E135-70-129	1 1/16"
E116-0936-0 254 x 55	E127-70-051	256.3	E123-70-023	E139-70-034	15/16"	L E155-70-455 R E155-70-456	E135-70-131	1 1/16"
L E124-70-015 R E124-70-014								
E116-0936-0 254 x 55	E127-70-051	256.3	E123-70-023	E139-70-034	15/16"	L E155-70-455 R E155-70-456	A/T E135-70-128	1 1/16"
L E124-70-015 R E124-70-014							M/T E135-70-129	1 1/16"
E116-0936-0 254 x 55	E127-70-051	256.3	E123-70-023	E139-70-034	15/16"	L E155-70-455 R E155-70-456	E135-70-131	1 1/16"
L E124-70-015 R E124-70-014								

# F R O N T

Many products are available in multiple grades or configurations. Refer to page 5 for details.

Make & Model	Year Notes	Pads	Rotor, Drum	Hardware Kits	Calipers, Wheel Cyl	Kits	Brake Hoses
		E105 OEM Type E107 Semi-Met E109 Prem Pad E110 Ceramic E111 HD Pad <b>Shoes</b> E116 Std Shoe E117 HD Shoe  E121 Sensor Wire E124 Shoe Adjuster	E125 Prem Rotor E126 Std Rotor E127 Prem Drum E128 Std Drum E129 Hub <b>L = Left</b> <b>R = Right</b> <b>V = Vented</b> <b>S = Solid</b>	E122 Rotor E123 Drum	E139 Prem Cyl E140 Std Cyl E146 Semi-Loaded Cal E147 Loaded Cal	E148 Cal Kit E149 Cyl Kit	E155 Hose

DISCARD

DIAMETER

## FORD (Cont'd)

### EXPEDITION

Year	Pads	Rotor, Drum	Hardware Kits	Calipers, Wheel Cyl	Kits	Brake Hoses
2007 - 2009	E111-1278-0	V E125-70-124 32.0	E122-70-036	L E146-70-091 57 R E146-70-090 57	E148-70-034	L E155-70-195 R E155-70-194
2010	E111-1414-0	V E125-70-124 32.0	E122-70-039	L E146-70-101 54 R E146-70-100 54	E148-70-038	L E155-70-195 R E155-70-194
2011	E111-1414-0	V E125-70-124 32.0	E122-70-039	L E146-70-101 54 R E146-70-100 54	E148-70-038	L E155-70-227 R E155-70-226
2012	E111-1414-0	V E125-70-124 32.0	E122-70-039	L E146-70-101 54 R E146-70-100 54	E148-70-038	L E155-70-227 R E155-70-226

### EXPLORER, SPORT, SPORT TRAC

Year	Pads	Rotor, Drum	Hardware Kits	Calipers, Wheel Cyl	Kits	Brake Hoses
2006	E110-1158-0	V E125-70-123 28.5	E122-70-034	L E146-70-083 51 R E146-70-082 51	E148-70-033	L E155-70-189 R E155-70-188
2007 - 2010	E110-1158-0	V E125-70-123 28.5	E122-70-034	L E146-70-083 51 R E146-70-082 51	E148-70-033	L E155-70-191 R E155-70-190
2011 - 2012	E110-1508-0	E125-66-107	E122-70-042	L E146-70-095 47.5 R E146-70-094 47.5	E148-70-035	L E155-70-229 R E155-70-228

### E150 1/2 Ton Full Size Van

Year	Pads	Rotor, Drum	Hardware Kits	Calipers, Wheel Cyl	Kits	Brake Hoses
2006	E111-1045-0	V E125-70-110 29.2	E122-70-028	L E146-70-069 54 R E146-70-068 54	E148-72-016	L E155-70-171 R E155-70-170
2007	E111-0655-0	V E125-70-051 28.0	E122-70-014	L E146-70-037 56 R E146-70-036 56	E148-70-016	L E155-70-187 R E155-70-186
2008	E111-1328-0	V E125-70-129 38.4	E122-70-039	L E146-70-093 60 R E146-70-092 60	E148-70-036	L E155-70-207 R E155-70-206
2009 - 2011	E111-1328-0	V E125-70-129 38.4	E122-70-039	L E146-70-093 60 R E146-70-092 60	E148-70-036	L E155-70-207 R E155-70-206

Many products are available in multiple grades or configurations. Refer to page 5 for details.

# R E A R

Pads	Rotor, Drum	Hardware Kits	Calipers, Wheel Cyl	Kits Calipers, Wheel Cyl	Brake Hoses	Master Cylinders
E105 OEM Type E107 Semi-Met E109 Prem Pad E110 Ceramic E111 HD Pad	E125 Prem Rotor E126 Std Rotor E127 Prem Drum E128 Std Drum E129 Hub	E122 Rotor E123 Drum	E139 Prem Cyl E140 Std Cyl E146 Semi-Loaded Cal E147 Loaded Cal	E148 Cal Kit E149 Cyl Kit	E155 Hose	E135 Prem M/C E136 Std M/C
<b>Shoes</b> E116 Std Shoe E117 HD Shoe	L = Left R = Right V = Vented S = Solid	DISCARD	DIAMETER	DIAMETER		DIAMETER
E121 Sensor Wire E124 Shoe Adjuster						

## FORD (Cont'd)

### EXPEDITION

E111-1279-0 PB Shoe E116-0811-0	V E125-70-125 20.0	E122-70-037 PB Kit E123-70-013	L E146-70-535 57 R E146-70-534 57	E148-39-027	Except RSC L E155-70-451 R E155-70-452 RSC L E155-70-453 R E155-70-452	E135-70-114 1 3/16"
E111-1279-0 PB Shoe E116-0811-0	V E125-70-125 20.0	E122-70-037 PB Kit E123-70-013	L E146-70-535 57 R E146-70-534 57	E148-39-027	Except RSC L E155-70-451 R E155-70-452 RSC L E155-70-453 R E155-70-452	E135-70-140 1 3/16" - 1 3/8"
E111-1279-0 PB Shoe E116-0811-0	V E125-70-125 20.0	E122-70-037 PB Kit E123-70-013	L E146-70-535 57 R E146-70-534 57	E148-39-027	L E155-70-453 R E155-70-452	E135-70-146 1 3/16" - 1 3/8"
E111-1279-0 PB Shoe E116-0811-0	V E125-70-125 20.0	E122-70-037	L E146-70-535 57 R E146-70-534 57	E148-39-027	L E155-70-453 R E155-70-452	E135-70-146 1 3/16" - 1 3/8"

### EXPLORER, SPORT, SPORT TRAC

E110-0964-0 PB Shoe E116-0791-0	S E125-70-095 11.0	E122-70-017 PB Kit E123-70-014	L E146-70-551 48 R E146-70-550 48	E148-66-024	L E155-70-441 R E155-70-442	E135-70-093 1 1/16"
E110-0964-0 PB Shoe E116-0791-0	S E125-70-095 11.0	E122-70-017 PB Kit E123-70-014	L E146-70-551 48 R E146-70-550 48	E148-66-024	L E155-70-441 R E155-70-442	E135-70-127 1 1/16"
E110-1377-0	S E125-66-086 0.39"	E122-72-021	L E146-66-563 45 R E146-66-562 45	E148-66-036		E135-70-145 1 1/8"

### E150 1/2 Ton Full Size Van

E111-1046-0 PB Shoe E116-0852-0	V E125-70-111 20.4	E122-70-027 PB Kit E123-72-006	L E146-70-533 54 R E146-70-532 54	E148-68-011	L E155-70-454 R E155-70-412	E135-70-111 1 1/4"
E111-0802-0 PB Shoe E116-0854-0	V E125-70-083 28.0	E122-66-032	L E146-70-515 45 R E146-70-514 45	E148-70-023	up E155-70-337 lo L E155-70-373 lo R E155-70-376	E135-70-112 1 5/16"
E111-1329-0 PB Shoe E116-0952-0	V E125-70-128 34.4	E122-70-038 PB Kit E123-70-024	L E146-70-539 48 R E146-70-538 48	E148-70-035	L E155-70-373 R E155-70-470	E135-70-123 1 5/16"
E111-1329-0 PB Shoe E116-0952-0	V E125-70-128 34.4	E122-70-038 PB Kit E123-70-024	L E146-70-539 48 R E146-70-538 48	E148-70-035	Except RSC L E155-70-373 R E155-70-470 RSC L E155-70-465 R E155-70-470	Except RSC 2 Ports E135-70-135 1 5/16" 3 Ports E135-70-136 1 5/16" RSC 2 Ports E135-70-134 1 5/16" 3 Ports E135-70-137 1 5/16"

# F R O N T

*Many products are available in multiple grades or configurations. Refer to page 5 for details.*

Make & Model	Year Notes	Pads	Rotor, Drum	DISCARD	Hardware Kits	Calipers, Wheel Cyl	DIAMETER	Kits Calipers, Wheel Cyl	Brake Hoses
		E105 OEM Type E107 Semi-Met E109 Prem Pad E110 Ceramic E111 HD Pad <b>Shoes</b> E116 Std Shoe E117 HD Shoe  E121 Sensor Wire E124 Shoe Adjuster	E125 Prem Rotor E126 Std Rotor E127 Prem Drum E128 Std Drum E129 Hub <b>L = Left</b> <b>R = Right</b> <b>V = Vented</b> <b>S = Solid</b>		E122 Rotor E123 Drum	E139 Prem Cyl E140 Std Cyl E146 Semi-Loaded Cal E147 Loaded Cal		E148 Cal Kit E149 Cyl Kit	E155 Hose

## FORD (Cont'd)

### E150 1/2 Ton Full Size Van (Cont'd)

2012	E111-1328-0		E122-70-039	L E146-70-093 60 R E146-70-092 60	E148-70-036	L E155-70-207 R E155-70-206
------	-------------	--	-------------	--------------------------------------	-------------	--------------------------------

### E250 3/4 Ton Full Size Van

2006 - 2007	Rear Disc E111-0655-0	V E125-70-051 28.0	E122-70-014	L E146-70-037 56 R E146-70-036 56	E148-70-016	L E155-70-187 R E155-70-186
2008	E111-1328-0	V E125-70-129 38.4	E122-70-039	L E146-70-093 60 R E146-70-092 60	E148-70-036	L E155-70-207 R E155-70-206
2009 - 2011	E111-1328-0	V E125-70-129 38.4	E122-70-039	L E146-70-093 60 R E146-70-092 60	E148-70-036	L E155-70-207 R E155-70-206
2012	E111-1328-0	V E125-70-129 38.4	E122-70-039	L E146-70-093 60 R E146-70-092 60	E148-70-036	L E155-70-207 R E155-70-206

Many products are available in multiple grades or configurations. Refer to page 5 for details.

# R E A R

Pads	Rotor, Drum	Hardware Kits	Calipers, Wheel Cyl	Kits Calipers, Wheel Cyl	Brake Hoses	Master Cylinders
E105 OEM Type E107 Semi-Met E109 Prem Pad E110 Ceramic E111 HD Pad	E125 Prem Rotor E126 Std Rotor E127 Prem Drum E128 Std Drum E129 Hub	E122 Rotor E123 Drum	E139 Prem Cyl E140 Std Cyl E146 Semi-Loaded Cal E147 Loaded Cal	E148 Cal Kit E149 Cyl Kit	E155 Hose	E135 Prem M/C E136 Std M/C
<b>Shoes</b> E116 Std Shoe E117 HD Shoe	L = Left R = Right V = Vented S = Solid					
E121 Sensor Wire E124 Shoe Adjuster						

DISCARD

DIAMETER

DIAMETER

## FORD (Cont'd)

### E150 1/2 Ton Full Size Van (Cont'd)

E111-1329-0 PB Shoe E116-0952-0	V E125-70-128 34.4				RSC L E155-70-465 R E155-70-470  Except RSC L E155-70-373 R E155-70-470	RSC 2 Ports E135-70-134 1 5/16" 3 Ports E135-70-137 1 5/16" Except RSC 2 Ports E135-70-135 1 5/16" 3 Ports E135-70-136 1 5/16"
---------------------------------------	--------------------	--	--	--	---	---

### E250 3/4 Ton Full Size Van

E111-0802-0 PB Shoe E116-0854-0	V E125-70-083 28.0	E122-66-032 PB Kit E123-70-020	L E146-70-515 45 R E146-70-514 45	E148-70-023	Reg & Extended Van / Wagon up E155-70-337 lo L E155-70-373 lo R E155-70-376 Stripped Ch 9600lb GVW up E155-70-337 lo L E155-70-439 lo R E155-70-438 Stripped Ch Except 9600lb up E155-70-337 lo L E155-70-439 lo R E155-70-374	E135-70-112 1 5/16"
E111-1329-0 PB Shoe E116-0952-0	V E125-70-128 34.4	E122-70-038 PB Kit E123-70-024	L E146-70-539 48 R E146-70-538 48	E148-70-035	L E155-70-373 R E155-70-470	E135-70-123 1 5/16"
E111-1329-0 PB Shoe E116-0952-0	V E125-70-128 34.4	E122-70-038 PB Kit E123-70-024	L E146-70-539 48 R E146-70-538 48	E148-70-035	Except RSC L E155-70-373 R E155-70-470 RSC L E155-70-465 R E155-70-470	Except RSC 2 Port E135-70-135 1 5/16" 3 Port E135-70-136 1 5/16" RSC 2 Port E135-70-134 1 5/16" 3 Port E135-70-137 1 5/16"
E111-1329-0 PB Shoe E116-0952-0	V E125-70-128 34.4				RSC L E155-70-465 R E155-70-470  Except RSC L E155-70-373 R E155-70-470	RSC 2 Ports E135-70-134 1 5/16" 3 Ports E135-70-137 1 5/16" Except RSC 2 Ports E135-70-135 1 5/16" 3 Ports E135-70-136 1 5/16"

# F R O N T

Many products are available in multiple grades or configurations. Refer to page 5 for details.

Make & Model	Year Notes	Pads	Rotor, Drum	DISCARD	Hardware Kits	Calipers, Wheel Cyl	DIAMETER	Kits Calipers, Wheel Cyl	Brake Hoses
		E105 OEM Type E107 Semi-Met E109 Prem Pad E110 Ceramic E111 HD Pad <b>Shoes</b> E116 Std Shoe E117 HD Shoe  E121 Sensor Wire E124 Shoe Adjuster	E125 Prem Rotor E126 Std Rotor E127 Prem Drum E128 Std Drum E129 Hub <b>L = Left</b> <b>R = Right</b> <b>V = Vented</b> <b>S = Solid</b>	DISCARD	E122 Rotor E123 Drum	E139 Prem Cyl E140 Std Cyl E146 Semi-Loaded Cal E147 Loaded Cal	DIAMETER	E148 Cal Kit E149 Cyl Kit	E155 Hose

## FORD (Cont'd)

### E350 1 Ton Full Size Van, Wagon, Stripped & RV Chassis including Super Duty

2007	E111-0655-0	SRW V E125-70-051 28.0  DRW V E125-70-047 28.0	E122-70-014	L E146-70-037 56 R E146-70-036 56	E148-70-016	L E155-70-187 R E155-70-186
2008	E111-1328-0	SRW V E125-70-129 38.4  DRW V E125-70-131 38.4	E122-70-039	L E146-70-093 60 R E146-70-092 60	E148-70-036	L E155-70-207 R E155-70-206
2009 - 2011	E111-1328-0	SRW V E125-70-129 38.4  DRW V E125-70-131 38.4	E122-70-039	L E146-70-093 60 R E146-70-092 60	E148-70-036	L E155-70-207 R E155-70-206

Many products are available in multiple grades or configurations. Refer to page 5 for details.

# R E A R

Pads	Rotor, Drum	Hardware Kits	Calipers, Wheel Cyl	Kits Calipers, Wheel Cyl	Brake Hoses	Master Cylinders
E105 OEM Type E107 Semi-Met E109 Prem Pad E110 Ceramic E111 HD Pad	E125 Prem Rotor E126 Std Rotor E127 Prem Drum E128 Std Drum E129 Hub	E122 Rotor E123 Drum	E139 Prem Cyl E140 Std Cyl E146 Semi-Loaded Cal E147 Loaded Cal	E148 Cal Kit E149 Cyl Kit	E155 Hose	E135 Prem M/C E136 Std M/C
<b>Shoes</b> E116 Std Shoe E117 HD Shoe	<b>L = Left</b> <b>R = Right</b> <b>V = Vented</b> <b>S = Solid</b>					
E121 Sensor Wire E124 Shoe Adjuster						

DISCARD

DIAMETER

DIAMETER

## FORD (Cont'd)

### E350 1 Ton Full Size Van, Wagon, Stripped & RV Chassis including Super Duty

E111-0802-0 PB Shoe To 11/04	SRW V E125-70-083 28.0	E122-66-032 PB Kit Except Axle Tag XC25-AEE, AFC, AFE	L E146-70-515 45 R E146-70-514 45	E148-70-023	Except Stripped Ch up E155-70-337 lo L E155-70-373 lo R E155-70-376 Stripped Ch up E155-70-337 lo L E155-70-443 lo R E155-70-374	Except RSC SRW E135-70-112 1 5/16" DRW E135-70-086 1 5/16" RSC E135-70-115 1 5/16"
E116-0771-0 From 12/04	DRW V E125-70-084 28.0	E123-70-017 Axle Tag XC25-AEE, AFC, AFE				
E116-0854-0		E123-71-012				
E111-1329-0 PB Shoe E116-0952-0	SRW V E125-70-128 34.4 DRW V E125-70-130 34.4	E122-70-038 PB Kit E123-70-024	L E146-70-539 48 R E146-70-538 48	E148-70-035	Except RSC SRW 6340 LB Axle L E155-70-373 R E155-70-470 7800 LB Axle L E155-70-439 R E155-70-470 DRW L E155-70-439 R E155-70-470 RSC L E155-70-465 R E155-70-470	Except RSC SRW E135-70-123 1 5/16" DRW E135-70-124 1 3/4" RSC E135-70-122 1 5/16"
E111-1329-0 PB Shoe E116-0952-0	SRW V E125-70-128 34.4 DRW V E125-70-130 34.4	E122-70-038 PB Kit E123-70-024	L E146-70-539 48 R E146-70-538 48	E148-70-035	SRW Except RSC L E155-70-439 R E155-70-470 SRW & RSC L E155-70-465 R E155-70-468 DRW L E155-70-373 R E155-70-470	SRW Except RSC 2 Ports E135-70-135 1 5/16" 3 Ports E135-70-136 1 5/16" DRW Except RSC E135-70-138 1 3/4" RSC 2 Ports E135-70-134 1 5/16" 3 Ports E135-70-137 1 5/16"



# F R O N T

Many products are available in multiple grades or configurations. Refer to page 5 for details.

Make & Model	Year Notes	Pads	Rotor, Drum	DISCARD	Hardware Kits	Calipers, Wheel Cyl	DIAMETER	Kits Calipers, Wheel Cyl	Brake Hoses
		E105 OEM Type E107 Semi-Met E109 Prem Pad E110 Ceramic E111 HD Pad <b>Shoes</b> E116 Std Shoe E117 HD Shoe  E121 Sensor Wire E124 Shoe Adjuster	E125 Prem Rotor E126 Std Rotor E127 Prem Drum E128 Std Drum E129 Hub <b>L = Left</b> <b>R = Right</b> <b>V = Vented</b> <b>S = Solid</b>		E122 Rotor E123 Drum	E139 Prem Cyl E140 Std Cyl E146 Semi-Loaded Cal E147 Loaded Cal		E148 Cal Kit E149 Cyl Kit	E155 Hose

## FORD (Cont'd)

### E350 1 Ton Full Size Van, Wagon, Stripped & RV Chassis including Super Duty (Cont'd)

2012	E111-1328-0	SRW V E125-70-129 38.4		E122-70-039	L E146-70-093 60 R E146-70-092 60	E148-70-036		L E155-70-207 R E155-70-206
------	-------------	---------------------------	--	-------------	--------------------------------------	-------------	--	--------------------------------

### E-SUPER DUTY Van & Cutaway

2004 - 2007	E111-0655-0	V E125-70-047 28.0		E122-70-014	L E146-70-037 56 R E146-70-036 56	E148-70-016	To 9/6/05 L E155-70-106 R E155-70-107 Fr. 9/6/05 L E155-70-187 R E155-70-186
2008 - 2011	E111-1328-0	V E125-70-131 38.4		E122-70-039	L E146-70-093 60 R E146-70-092 60	E148-70-036	L E155-70-207 R E155-70-206
2012	E111-1328-0			E122-70-039	L E146-70-093 60 R E146-70-092 60	E148-70-036	L E155-70-207 R E155-70-206

### F150 1/2 Ton RWD Truck

12/04 - 2008	6 Lug E111-1011-0	Upgrade Kit Hub & Rotor Assy V E125-70-133 28.5 After Upgrade Service with: Rotor Only V E125-70-105 28.5 Hub Only E129-70-907 Spindle Nut E129-70-906		E122-70-030	L E146-70-081 54 R E146-70-080 54	E148-70-032	12/04 - 11/05 L E155-70-167 R E155-70-166  12/05 - 2008 L E155-70-193 R E155-70-192
--------------	----------------------	---	--	-------------	--------------------------------------	-------------	---

Cont'd Next Pg

Many products are available in multiple grades or configurations. Refer to page 5 for details.

# R E A R

Pads	Rotor, Drum	Hardware Kits	Calipers, Wheel Cyl	Kits Calipers, Wheel Cyl	Brake Hoses	Master Cylinders
E105 OEM Type E107 Semi-Met E109 Prem Pad E110 Ceramic E111 HD Pad <b>Shoes</b> E116 Std Shoe E117 HD Shoe  E121 Sensor Wire E124 Shoe Adjuster	E125 Prem Rotor E126 Std Rotor E127 Prem Drum E128 Std Drum E129 Hub L = Left R = Right V = Vented S = Solid	E122 Rotor E123 Drum	E139 Prem Cyl E140 Std Cyl E146 Semi-Loaded Cal E147 Loaded Cal	E148 Cal Kit E149 Cyl Kit	E155 Hose	E135 Prem M/C E136 Std M/C

DISCARD

DIAMETER

DIAMETER

## FORD (Cont'd)

### E350 1 Ton Full Size Van, Wagon, Stripped & RV Chassis including Super Duty (Cont'd)

E111-1329-0	SRW				SRW & RSC	RSC
PB Shoe	V E125-70-128 34.4				L E155-70-465 6340lb Axle	2 Port E135-70-134 1 5/16"
E116-0952-0	DRW				R E155-70-470 7800lb Axle	3 Port E135-70-137 1 5/16"
	V E125-70-130 34.4				R E155-70-492 SRW Except RSC	2 Ports E135-70-135 1 5/16"
					L E155-70-373 6340lb Axle	3 Ports E135-70-136 1 5/16"
					R E155-70-470 7800lb Axle	DRW Except RSC E135-70-138 1 3/4"
					L E155-70-439 DRW	
					R E155-70-492 DRW	
					L E155-70-373	
					R E155-70-470	

### E-SUPER DUTY, E450, 47 Super Duty Van & Cutaway

E111-0411-0	V E125-70-069 36.3	E122-70-011	L E146-70-021 60 R E146-70-020 60	E148-70-013	up E155-70-370 lo L E155-70-407 lo R E155-70-408	E135-70-086 1 5/16"
PB Shoe		PB Kit				
E116-0771-0		E123-70-017				
E111-1330-0	V E125-70-132 40.4	E122-70-038	L E146-70-541 54 R E146-70-540 54	E148-70-037	L E155-70-373 R E155-70-466	2008 E135-70-124 1 3/4"
PB Shoe		PB Kit				2009 - 2011
E116-0952-0		E123-70-024				E135-70-138 1 3/4"
E111-1330-0	V E125-70-132 40.4				L E155-70-373 R E155-70-466	E135-70-138 1 3/4"
PB Shoe		PB Kit				
E116-0952-0		E123-70-024				

### F150 1/2 Ton RWD Truck

E111-1012-0	V E125-70-107 18.5	E122-70-025	L E146-70-523 51 R E146-70-522 51	E148-72-013	up E155-70-387 12/04 - 11/05 lo L E155-70-385 lo R E155-70-388	E135-70-094 1 1/4"
PB Shoe		PB Kit				
E116-0752-0		E123-70-012			12/05 - 2008 lo L E155-70-447 lo R E155-70-448	

# F R O N T

Many products are available in multiple grades or configurations. Refer to page 5 for details.

Make & Model Year Notes	Pads	Rotor, Drum	Hardware Kits	Calipers, Wheel Cyl	Kits Calipers, Wheel Cyl	Brake Hoses	
	E105 OEM Type E107 Semi-Met E109 Prem Pad E110 Ceramic E111 HD Pad <b>Shoes</b> E116 Std Shoe E117 HD Shoe  E121 Sensor Wire E124 Shoe Adjuster	E125 Prem Rotor E126 Std Rotor E127 Prem Drum E128 Std Drum E129 Hub <b>L = Left</b> <b>R = Right</b> <b>V = Vented</b> <b>S = Solid</b>	DISCARD	E122 Rotor E123 Drum	DIAMETER	E139 Prem Cyl E140 Std Cyl E146 Semi-Loaded Cal E147 Loaded Cal	E148 Cal Kit E149 Cyl Kit  E155 Hose

## FORD (Cont'd)

### F150 1/2 Ton RWD Truck (Cont'd)

12/04 - 2008 (Cont'd)	7 Lug E111-1011-0	Upgrade Kit Hub & Rotor Assy V E125-70-134 28.5 After Upgrade Service with: Rotor Only V E125-70-106 28.5 Hub Only E129-70-908 Spindle Nut E129-70-906	E122-70-030	L E146-70-081 54 R E146-70-080 54	E148-70-032	12/04 - 11/05 L E155-70-167 R E155-70-166  12/05 - 2008 L E155-70-193 R E155-70-192
2009	E111-1392-0	6 Lug V E125-70-135 28.5 7 Lug V E125-70-136 28.5	E122-70-041	L E146-70-097 54 R E146-70-096 54	E148-70-032	L E155-70-213 R E155-70-212
2010	E110-1414-0	6 Lug V E125-70-124 32.0 7 Lug V E125-70-139 32.0	E122-70-039	L E146-70-101 54 R E146-70-100 54	E148-70-038	L E155-70-213 R E155-70-212
2011	E110-1414-0	6 Lug V E125-70-124 32.0 7 Lug V E125-70-139 32.0	E122-70-039	L E146-70-101 54 R E146-70-100 54	E148-70-038	L E155-70-213 R E155-70-212
2012	E110-1414-0	6 Lug V E125-70-124 32.0 7 Lug V E125-70-139 32.0				

### F150 1/2 Ton 4WD Truck

12/05 - 2008	E111-1011-0	6 Lug V E125-70-105 28.5 7 Lug V E125-70-106 28.5	E122-70-030	L E146-70-081 54 R E146-70-080 54	E148-70-032	L E155-70-193 R E155-70-192
2009	E111-1392-0	6 Lug V E125-70-135 28.5 7 Lug V E125-70-136 28.5	E122-70-041	L E146-70-097 54 R E146-70-096 54	E148-70-032	L E155-70-213 R E155-70-212
2010	6 Lug E110-1414-0	V E125-70-124 32.0	E122-70-039	L E146-70-101 54 R E146-70-100 54	E148-70-038	Except Raptor SVT L E155-70-213 R E155-70-212 Raptor SVT L E155-70-219 R E155-70-218
	7 Lug E110-1414-0	V E125-70-139 32.0	E122-70-039	L E146-70-101 54 R E146-70-100 54	E148-70-038	L E155-70-213 R E155-70-212

Many products are available in multiple grades or configurations. Refer to page 5 for details.

**R E A R**

Pads	Rotor, Drum	Hardware Kits	Calipers, Wheel Cyl	Kits, Calipers, Wheel Cyl	Brake Hoses	Master Cylinders
E105 OEM Type E107 Semi-Met E109 Prem Pad E110 Ceramic E111 HD Pad <b>Shoes</b> E116 Std Shoe E117 HD Shoe  E121 Sensor Wire E124 Shoe Adjuster	E125 Prem Rotor E126 Std Rotor E127 Prem Drum E128 Std Drum E129 Hub L = Left R = Right V = Vented S = Solid	E122 Rotor E123 Drum	E139 Prem Cyl E140 Std Cyl E146 Semi-Loaded Cal E147 Loaded Cal	E148 Cal Kit E149 Cyl Kit	E155 Hose	E135 Prem M/C E136 Std M/C

DISCARD

DIAMETER

DIAMETER

**FORD (Cont'd)**

**F150 1/2 Ton RWD Truck (Cont'd)**

E111-1012-0 PB Shoe E116-0752-0	V E125-70-108 18.5 6 Lug V E125-70-107 18.5 7 Lug V E125-70-108 18.5	E122-70-025 PB Kit E123-70-012	L E146-70-523 51 R E146-70-522 51	E148-72-013	up E155-70-387 12/04 - 11/05 lo L E155-70-385 lo R E155-70-388 12/05 - 2008 lo L E155-70-447 lo R E155-70-448	E135-70-094 1 1/4"
E111-1012-0 PB Shoe E116-0961-0	V E125-70-107 18.5 6 Lug V E125-70-108 18.5 7 Lug	E122-70-025 PB Kit E123-70-025	L E146-70-523 51 R E146-70-522 51	E148-72-013	up E155-70-471 lo L E155-70-473 lo R E155-70-474	E135-70-130 1 1/4"
E110-1012-0 PB Shoe E116-0961-0	V E125-70-107 18.5 6 Lug V E125-70-108 18.5 7 Lug	E122-70-025 PB Kit E123-70-025	L E146-70-523 51 R E146-70-522 51	E148-72-013	up E155-70-471 lo L E155-70-473 lo R E155-70-474	E135-70-140 1 3/16" - 1 3/8"
E110-1012-0 PB Shoe E116-0961-0	V E125-70-107 18.5 6 Lug V E125-70-108 18.5 7 Lug	E122-70-025 PB Kit E123-70-025	L E146-70-523 51 R E146-70-522 51	E148-72-013		
E110-1602-0	V E125-70-140 23.0 6 Lug V E125-70-138 23.0 7 Lug					

**F150 1/2 Ton 4WD Truck**

E111-1012-0 PB Shoe E116-0752-0	V E125-70-107 18.5 6 Lug V E125-70-108 18.5 7 Lug	E122-70-025 PB Kit E123-70-012	L E146-70-523 51 R E146-70-522 51	E148-72-013	up E155-70-387 lo L E155-70-447 lo R E155-70-448	E135-70-094 1 1/4"
E111-1012-0 PB Shoe E116-0961-0	V E125-70-107 18.5 6 Lug V E125-70-108 18.5 7 Lug	E122-70-025 PB Kit E123-70-025	L E146-70-523 51 R E146-70-522 51	E148-72-013	up E155-70-471 lo L E155-70-473 lo R E155-70-474	E135-70-130 1 1/4"
E110-1012-0 PB Shoe E116-0961-0	V E125-70-107 18.5 6 Lug V E125-70-108 18.5 7 Lug	E122-70-025 PB Kit E123-70-025	L E146-70-523 51 R E146-70-522 51	E148-72-013	up E155-70-471 Except Raptor lo L E155-70-473 lo R E155-70-474 Raptor SVT lo L E155-70-481 lo R E155-70-482	E135-70-140 1 3/16" - 1 3/8"
E110-1012-0 PB Shoe E116-0961-0	V E125-70-108 18.5 6 Lug V E125-70-138 23.0 7 Lug	E122-70-025 PB Kit E123-70-025	L E146-70-523 51 R E146-70-522 51	E148-72-013	up E155-70-471 lo L E155-70-473 lo R E155-70-474	E135-70-140 1 3/16" - 1 3/8"

# F R O N T

Many products are available in multiple grades or configurations. Refer to page 5 for details.

Make & Model	Year Notes	Pads	Rotor, Drum	DISCARD	Hardware Kits	Calipers, Wheel Cyl	DIAMETER	Kits Calipers, Wheel Cyl	Brake Hoses
		E105 OEM Type E107 Semi-Met E109 Prem Pad E110 Ceramic E111 HD Pad <b>Shoes</b> E116 Std Shoe E117 HD Shoe  E121 Sensor Wire E124 Shoe Adjuster	E125 Prem Rotor E126 Std Rotor E127 Prem Drum E128 Std Drum E129 Hub <b>L = Left</b> <b>R = Right</b> <b>V = Vented</b> <b>S = Solid</b>		E122 Rotor E123 Drum	E139 Prem Cyl E140 Std Cyl E146 Semi-Loaded Cal E147 Loaded Cal		E148 Cal Kit E149 Cyl Kit	E155 Hose

## FORD (Cont'd)

### F150 1/2 Ton 4WD Truck (Cont'd)

2011	E110-1414-0	6 Lug V E125-70-124 32.0 7 Lug V E125-70-139 32.0	E122-70-039	L E146-70-101 54 R E146-70-100 54	E148-70-038	Except Raptor SVT L E155-70-213 R E155-70-212
2012	E110-1414-0	6 Lug V E125-70-124 32.0 7 Lug V E125-70-139 32.0				

### F250, F250 Super Duty 3/4 Ton RWD Truck

2005 - 12/17/06	E111-1069-0	V E125-70-121 36.4	E122-70-033	L E146-70-079 60 R E146-70-078 60	E148-80-006	L E155-70-177 R E155-70-176
12/18/06 - 2/12/10	E111-1069-0	V E125-70-126 36.4	E122-70-033	L E146-70-079 60 R E146-70-078 60	E148-80-006	L E155-70-205 R E155-70-204
2/22/10 - 7/24/11	2/22/10 - 9/15/10 E111-1069-0  9/16/10 - 7/24/11 E111-1333-0	V E125-70-126 36.4	E122-70-033	L E146-70-079 60 R E146-70-078 60	E148-80-006	L E155-70-205 R E155-70-204
7/25/11 - 2012	E111-1333-0	V E125-70-126 36.4		L E146-70-079 60 R E146-70-078 60	E148-80-006	L E155-70-205 R E155-70-204

Many products are available in multiple grades or configurations. Refer to page 5 for details.

**R E A R**

<b>Pads</b>	<b>Rotor, Drum</b>	<b>Hardware Kits</b>	<b>Calipers, Wheel Cyl</b>	<b>Kits Calipers, Wheel Cyl</b>	<b>Brake Hoses</b>	<b>Master Cylinders</b>
E105 OEM Type E107 Semi-Met E109 Prem Pad E110 Ceramic E111 HD Pad	E125 Prem Rotor E126 Std Rotor E127 Prem Drum E128 Std Drum E129 Hub	E122 Rotor E123 Drum	E139 Prem Cyl E140 Std Cyl E146 Semi-Loaded Cal E147 Loaded Cal	E148 Cal Kit E149 Cyl Kit	E155 Hose	E135 Prem M/C E136 Std M/C
<b>Shoes</b> E116 Std Shoe E117 HD Shoe	<b>L = Left</b> <b>R = Right</b> <b>V = Vented</b> <b>S = Solid</b>					
E121 Sensor Wire E124 Shoe Adjuster						

DISCARD

DIAMETER

DIAMETER

**FORD (Cont'd)**

**F150 1/2 Ton 4WD Truck (Cont'd)**

To 3/11 E110-1012-0	6 Lug V E125-70-107 18.5 7 Lug	E122-70-025	L E146-70-523 51 R E146-70-522 51	E148-72-013		
PB Shoe E116-0961-0		PB Kit E123-70-025				
E110-1602-0	6 Lug V E125-70-140 23.0 7 Lug V E125-70-138 23.0					

**F250, F250 Super Duty 3/4 Ton RWD Truck**

E111-1068-0	V E125-70-118 32.4	E122-70-035	L E146-70-529 48 R E146-70-528 48	E148-66-032	up E155-70-437 lo L E155-70-431 lo R E155-70-428	Except Brk Control Gas Eng E135-70-103 1 5/16" Diesel Eng E135-70-105 1 1/2" Integrated Brake Control Gas Eng E135-70-104 1 5/16" Diesel Eng E135-70-106 1 1/2"
PB Shoe E116-0854-0		PB Kit E123-70-020				
E111-1067-0	V E125-70-118 32.4	E122-70-040	L E146-70-537 48 R E146-70-536 48	E148-66-032	up E155-70-437 lo L E155-70-431 lo R E155-70-428	Except Brk Control Gas Eng E135-70-133 1 5/16" Diesel Eng E135-70-116 1 1/2" Integrated Brake Control Gas Eng E135-70-132 1 5/16" Diesel Eng E135-70-117 1 1/2"
PB Shoe E116-0854-0		PB Kit E123-70-020				
E111-1334-0	V E125-70-118 32.4	E122-70-040	L E146-70-537 48 R E146-70-536 48	E148-66-032	up E155-70-484	Vacuum Booster E135-70-142 1 5/16" Hydro Boost Except Trailer Cntrl E135-70-143 1 1/2" Hydro Boost & Trailer Cntrl E135-70-144 1 1/2"
PB Shoe E116-0854-0						
E111-1334-0	V E125-70-118 32.4		L E146-70-537 48 R E146-70-536 48	E148-66-032		
PB Shoe E116-0854-0						

# F R O N T

Many products are available in multiple grades or configurations. Refer to page 5 for details.

Make & Model	Year Notes	Pads	Rotor, Drum	DISCARD	Hardware Kits	Calipers, Wheel Cyl	DIAMETER	Kits Calipers, Wheel Cyl	Brake Hoses
		E105 OEM Type E107 Semi-Met E109 Prem Pad E110 Ceramic E111 HD Pad <b>Shoes</b> E116 Std Shoe E117 HD Shoe  E121 Sensor Wire E124 Shoe Adjuster	E125 Prem Rotor E126 Std Rotor E127 Prem Drum E128 Std Drum E129 Hub <b>L = Left</b> <b>R = Right</b> <b>V = Vented</b> <b>S = Solid</b>		E122 Rotor E123 Drum	E139 Prem Cyl E140 Std Cyl E146 Semi-Loaded Cal E147 Loaded Cal		E148 Cal Kit E149 Cyl Kit	E155 Hose

## FORD (Cont'd)

### F250, F250 Super Duty 3/4 Ton 4WD Truck

2005 - 12/17/06	E111-1069-0	V E125-70-117 36.4	E122-70-033	L E146-70-079 60 R E146-70-078 60	E148-80-006	L E155-70-179 R E155-70-178
12/18/06 - 2/12/10	E111-1069-0	V E125-70-117 36.4	E122-70-033	L E146-70-079 60 R E146-70-078 60	E148-80-006	12/18/05 - 2009 L E155-70-201 R E155-70-200 2010 L E155-70-215 R E155-70-214
2/22/10 - 2012	2/22/10 - 9/15/10 E111-1069-0 9/16/10 - 2012 E111-1333-0	V E125-70-117 36.4	E122-70-033	L E146-70-079 60 R E146-70-078 60	E148-80-006	L E155-70-223 R E155-70-222

### F350 SUPER DUTY 1 Ton Pickup, Cab & Chassis RWD

1/07 - 2/12/10 SRW	E111-1069-0	V E125-70-126 36.4	E122-70-033	L E146-70-079 60 R E146-70-078 60	E148-80-006	L E155-70-205 R E155-70-204
--------------------	-------------	--------------------	-------------	--------------------------------------	-------------	--------------------------------

Cont'd Next Pg

Many products are available in multiple grades or configurations. Refer to page 5 for details.

# R E A R

Pads	Rotor, Drum	Hardware Kits	Calipers, Wheel Cyl	Kits Calipers, Wheel Cyl	Brake Hoses	Master Cylinders
E105 OEM Type E107 Semi-Met E109 Prem Pad E110 Ceramic E111 HD Pad	E125 Prem Rotor E126 Std Rotor E127 Prem Drum E128 Std Drum E129 Hub	E122 Rotor E123 Drum	E139 Prem Cyl E140 Std Cyl E146 Semi-Loaded Cal E147 Loaded Cal	E148 Cal Kit E149 Cyl Kit	E155 Hose	E135 Prem M/C E136 Std M/C
<b>Shoes</b> E116 Std Shoe E117 HD Shoe	<b>L = Left</b> <b>R = Right</b> <b>V = Vented</b> <b>S = Solid</b>	DISCARD	DIAMETER	DIAMETER		DIAMETER
E121 Sensor Wire E124 Shoe Adjuster						

## FORD (Cont'd)

### F250, F250 Super Duty 3/4 Ton 4WD Truck

E111-1068-0 PB Shoe E116-0854-0	V E125-70-118 32.4	E122-70-035 PB Kit E123-70-020	L E146-70-529 48 R E146-70-528 48	E148-66-032	up E155-70-433 lo L E155-70-431 lo R E155-70-428	Gas Eng Except Brake Control E135-70-103 1 5/16" Integrated Brake Control E135-70-104 1 5/16" Diesel Eng Except Brake Control E135-70-105 1 1/2" Integrated Brake Control E135-70-106 1 1/2"
E111-1067-0 PB Shoe E116-0854-0	V E125-70-118 32.4	E122-70-040 PB Kit E123-70-020	L E146-70-537 48 R E146-70-536 48	E148-66-032	up E155-70-433 lo L E155-70-431 lo R E155-70-428	Diesel Eng Except Brake Control E135-70-116 1 1/2" Integrated Brake Control E135-70-117 1 1/2" Gas Eng Except Brake Control E135-70-133 1 5/16" Integrated Brake Control E135-70-132 1 5/16"
E111-1334-0 PB Shoe E116-0854-0	V E125-70-118 32.4	E122-70-040	L E146-70-537 48 R E146-70-536 48	E148-66-032	up E155-70-484	Vacuum Booster E135-70-142 1 5/16" Hydro Boost Except Trailer Cntrl E135-70-143 1 1/2" Hydro Boost & Trailer Cntrl E135-70-144 1 1/2"

### F350 SUPER DUTY 1 Ton Pickup, Cab & Chassis RWD

E111-1067-0 PB Shoe E116-0854-0	V E125-70-118 32.4	E122-70-040 PB Kit E123-70-020	L E146-70-537 48 R E146-70-536 48	E148-66-032	Pick-up up E155-70-437 lo L E155-70-431 lo R E155-70-428  Cab & Chassis up E155-70-460 lo L E155-70-427 lo R E155-70-464	Diesel Eng Except Brake Cntrl Valve E135-70-116 1 1/2" Integrated Brake Control E135-70-117 1 1/2" Gas Engine Except Brake Cntrl Valve E135-70-133 1 5/16" Integrated Brake Control E135-70-132 1 5/16"
---------------------------------------	--------------------	--------------------------------------	--------------------------------------	-------------	--	--



# F R O N T

Many products are available in multiple grades or configurations. Refer to page 5 for details.

Make & Model	Year Notes	Pads	Rotor, Drum	DISCARD	Hardware Kits	Calipers, Wheel Cyl	DIAMETER	Kits Calipers, Wheel Cyl	Brake Hoses
		E105 OEM Type E107 Semi-Met E109 Prem Pad E110 Ceramic E111 HD Pad <b>Shoes</b> E116 Std Shoe E117 HD Shoe  E121 Sensor Wire E124 Shoe Adjuster	E125 Prem Rotor E126 Std Rotor E127 Prem Drum E128 Std Drum E129 Hub <b>L = Left</b> <b>R = Right</b> <b>V = Vented</b> <b>S = Solid</b>		E122 Rotor E123 Drum	E139 Prem Cyl E140 Std Cyl E146 Semi-Loaded Cal E147 Loaded Cal		E148 Cal Kit E149 Cyl Kit	E155 Hose

## FORD (Cont'd)

### F350 SUPER DUTY 1 Ton Pickup, Cab & Chassis RWD (Cont'd)

1/07 - 2/12/10 <i>(Cont'd)</i>	DRW	E111-1069-0	V E125-70-127 36.4	E122-70-033	L E146-70-085 60 R E146-70-084 60	E148-80-006	L E155-70-205 R E155-70-204
2/22/10 - 7/24/11	SRW	2/22/10 - 9/15/10 E111-1069-0 9/16/10 - 7/24/11 E111-1333-0	V E125-70-126 36.4	E122-70-033	L E146-70-079 60 R E146-70-078 60	E148-80-006	L E155-70-205 R E155-70-204
	DRW	E111-1069-0	V E125-70-127 36.4	E122-70-033	L E146-70-085 60 R E146-70-084 60	E148-80-006	L E155-70-205 R E155-70-204
7/25/11 - 2012	SRW	E111-1333-0	V E125-70-126 36.4	E122-70-033	L E146-70-079 60 R E146-70-078 60	E148-80-006	L E155-70-205 R E155-70-204
	DRW	E111-1069-0	V E125-70-127 36.4	E122-70-033	L E146-70-085 60 R E146-70-084 60	E148-80-006	L E155-70-205 R E155-70-204

Many products are available in multiple grades or configurations. Refer to page 5 for details.

**R E A R**

<b>Pads</b> E105 OEM Type E107 Semi-Met E109 Prem Pad E110 Ceramic E111 HD Pad <b>Shoes</b> E116 Std Shoe E117 HD Shoe  E121 Sensor Wire E124 Shoe Adjuster	<b>Rotor, Drum</b> E125 Prem Rotor E126 Std Rotor E127 Prem Drum E128 Std Drum E129 Hub L = Left R = Right V = Vented S = Solid	DISCARD	<b>Hardware Kits</b> E122 Rotor E123 Drum	<b>Calipers, Wheel Cyl</b> E139 Prem Cyl E140 Std Cyl E146 Semi-Loaded Cal E147 Loaded Cal	DIAMETER	<b>Kits Calipers, Wheel Cyl</b> E148 Cal Kit E149 Cyl Kit	<b>Brake Hoses</b> E155 Hose	<b>Master Cylinders</b> E135 Prem M/C E136 Std M/C	DIAMETER

**FORD (Cont'd)**

**F350 SUPER DUTY 1 Ton Pickup, Cab & Chassis RWD (Cont'd)**

E111-1067-0	v E125-70-119 32.4	E122-70-031	L E146-70-531 54 R E146-70-530 54	E148-70-031	Pick-up up E155-70-437 lo L E155-70-431 lo R E155-70-428	Diesel Eng Except Brake Cntrl Valve E135-70-116 1 1/2" Integrated Brake Control E135-70-117 1 1/2" Gas Engine Except Brake Cntrl Valve E135-70-133 1 5/16" Integrated Brake Control E135-70-132 1 5/16"
PB Shoe E116-0854-0		PB Kit E123-70-020			Cab & Chassis up E155-70-460 lo L E155-70-427 lo R E155-70-428	Vacuum Booster E135-70-142 1 5/16" Hydro Boost Except Trailer Cntrl E135-70-143 1 1/2" Hydro Boost & Trailer Cntrl E135-70-144 1 1/2"
E111-1334-0	v E125-70-118 32.4	E122-70-040	L E146-70-537 48 R E146-70-536 48	E148-66-032	up E155-70-484	E135-70-142 1 5/16" E135-70-143 1 1/2" E135-70-144 1 1/2"
PB Shoe E116-0854-0		PB Kit E123-70-020				
E111-1334-0	v E125-70-119 32.4	E122-70-031	2/22/10 - 10/10 L E146-70-531 54 R E146-70-530 54 11/10 - 7/24/11 L E146-70-530 54 R E146-70-531 54	E148-70-031	up E155-70-469	Except Trailer Cntrl E135-70-143 1 1/2" Trailer Cntrl E135-70-144 1 1/2"
PB Shoe E116-0854-0		PB Kit E123-70-020				
E111-1334-0	v E125-70-118 32.4	E122-70-040	L E146-70-537 48 R E146-70-536 48	E148-66-032		Vacuum Booster E135-70-142 1 5/16" Hydro Boost Except Trailer Cntrl E135-70-143 1 1/2" Hydro Boost & Trailer Cntrl E135-70-144 1 1/2"
PB Shoe E116-0854-0						
E111-1334-0	v E125-70-119 32.4	E122-70-031	L E146-70-530 54 R E146-70-531 54			
PB Shoe E116-0854-0						

# F R O N T

Many products are available in multiple grades or configurations. Refer to page 5 for details.

Make & Model	Year Notes	Pads	Rotor, Drum		Hardware Kits	Calipers, Wheel Cyl		Kits Calipers, Wheel Cyl	Brake Hoses
		E105 OEM Type E107 Semi-Met E109 Prem Pad E110 Ceramic E111 HD Pad <b>Shoes</b> E116 Std Shoe E117 HD Shoe  E121 Sensor Wire E124 Shoe Adjuster	E125 Prem Rotor E126 Std Rotor E127 Prem Drum E128 Std Drum E129 Hub <b>L = Left</b> <b>R = Right</b> <b>V = Vented</b> <b>S = Solid</b>	DISCARD	E122 Rotor E123 Drum	E139 Prem Cyl E140 Std Cyl E146 Semi-Loaded Cal E147 Loaded Cal	DIAMETER	E148 Cal Kit E149 Cyl Kit	E155 Hose

## FORD (Cont'd)

### F350 1 Ton Pickup, Cab & Chassis 4WD including Super Duty

1/07 - 2/12/10	SRW	E111-1069-0	V E125-70-117 36.4	E122-70-033	L E146-70-079 60 R E146-70-078 60	E148-80-006	L E155-70-201 R E155-70-200
	DRW	E111-1069-0	V E125-70-115 36.4	E122-70-033	L E146-70-085 60 R E146-70-084 60	E148-80-006	Pick-up L E155-70-209 R E155-70-208 Cab & Chassis 12/18/06 - 2009 L E155-70-201 R E155-70-200 2010 L E155-70-215 R E155-70-214
2/22/10 - 2012	SRW	2/22/10 - 9/15/10 E111-1069-0 9/16/10 - 2011 E111-1333-0	V E125-70-117 36.4	E122-70-033	L E146-70-079 60 R E146-70-078 60	E148-80-006	L E155-70-223 R E155-70-222
	DRW	E111-1069-0	V E125-70-115 36.4	E122-70-033	L E146-70-085 60 R E146-70-084 60	E148-80-006	Except Fat Boy L E155-70-223 R E155-70-222 Fat Boy L E155-70-221 R E155-70-220

Many products are available in multiple grades or configurations. Refer to page 5 for details.

**R E A R**

Pads	Rotor, Drum	Hardware Kits	Calipers, Wheel Cyl	Kits Calipers, Wheel Cyl	Brake Hoses	Master Cylinders
E105 OEM Type E107 Semi-Met E109 Prem Pad E110 Ceramic E111 HD Pad	E125 Prem Rotor E126 Std Rotor E127 Prem Drum E128 Std Drum E129 Hub	E122 Rotor E123 Drum	E139 Prem Cyl E140 Std Cyl E146 Semi-Loaded Cal E147 Loaded Cal	E148 Cal Kit E149 Cyl Kit	E155 Hose	E135 Prem M/C E136 Std M/C
<b>Shoes</b> E116 Std Shoe E117 HD Shoe	<b>L = Left</b> <b>R = Right</b> <b>V = Vented</b> <b>S = Solid</b>					
E121 Sensor Wire E124 Shoe Adjuster						

DISCARD

DIAMETER

DIAMETER

**FORD (Cont'd)**

**F350 1 Ton Pickup, Cab & Chassis 4WD including Super Duty**

E111-1067-0 PB Shoe E116-0854-0	V E125-70-118 32.4	E122-70-040 PB Kit E123-70-020	L E146-70-537 48 R E146-70-536 48	E148-66-032	Cab & Chassis up E155-70-435 lo L E155-70-427 lo R E155-70-464 Pick-up up E155-70-433 lo L E155-70-431 lo R E155-70-428	Diesel Eng Except Brake Cntrl Valve E135-70-116 1 1/2" Integrated Brake Control E135-70-117 1 1/2" Gas Engine Except Brake Cntrl Valve E135-70-133 1 5/16" Integrated Brake Control E135-70-132 1 5/16"
E111-1067-0 PB Shoe E116-0854-0	V E125-70-119 32.4	E122-70-031 PB Kit E123-70-020	L E146-70-531 54 R E146-70-530 54	E148-70-031	Cab & Chassis up E155-70-435 lo L E155-70-427 lo R E155-70-428 Pick-up up E155-70-433 lo L E155-70-431 lo R E155-70-428	Gas Engine Except Brake Cntrl Valve E135-70-133 1 5/16" Integrated Brake Control E135-70-132 1 5/16" Diesel Eng Except Brake Cntrl Valve E135-70-116 1 1/2" Integrated Brake Control E135-70-117 1 1/2"
E111-1334-0	V E125-70-118 32.4	E122-70-040	L E146-70-537 48 R E146-70-536 48	E148-66-032	up E155-70-484	Vacuum Booster E135-70-142 1 5/16" Hydro Boost Except Trailer Cntrl E135-70-143 1 1/2" Hydro Boost & Trailer Cntrl E135-70-144 1 1/2"
E111-1334-0 PB Shoe E116-0854-0	V E125-70-119 32.4	E122-70-031	2/22/10 - 10/10 L E146-70-531 54 R E146-70-530 54 11/10 - 2012 L E146-70-530 54 R E146-70-531 54	E148-70-031	up E155-70-469	Except Trailer Cntrl E135-70-143 1 1/2" Trailer Cntrl E135-70-144 1 1/2"

# F R O N T

Many products are available in multiple grades or configurations. Refer to page 5 for details.

Make & Model	Year Notes	Pads	Rotor, Drum	Hardware Kits	Calipers, Wheel Cyl	Kits	Brake Hoses		
		E105 OEM Type E107 Semi-Met E109 Prem Pad E110 Ceramic E111 HD Pad <b>Shoes</b> E116 Std Shoe E117 HD Shoe  E121 Sensor Wire E124 Shoe Adjuster	E125 Prem Rotor E126 Std Rotor E127 Prem Drum E128 Std Drum E129 Hub <b>L = Left</b> <b>R = Right</b> <b>V = Vented</b> <b>S = Solid</b>	DISCARD	E122 Rotor E123 Drum	DIAMETER	E139 Prem Cyl E140 Std Cyl E146 Semi-Loaded Cal E147 Loaded Cal	E148 Cal Kit E149 Cyl Kit	E155 Hose

## FORD (Cont'd)

### RANGER RWD

5/06 - 2009	9" Rear Drums	E111-0833-0	V E125-70-056	24.5	E122-70-022	L E146-70-055 46 R E146-70-054 46	E148-70-017	L E155-70-121 R E155-70-122
	10" Rear Drums	E111-0833-0	V E125-70-056	24.5	E122-70-022	L E146-70-055 46 R E146-70-054 46	E148-70-017	L E155-70-121 R E155-70-122
2010 - 2011		E111-0833-0	V E125-70-056	24.5	E122-70-022	L E146-70-055 46 R E146-70-054 46	E148-70-017	Coil Spring Susp. L E155-70-121 R E155-70-122 Torsion Bar Susp L E155-70-197 R E155-70-196

### RANGER 4WD

5/06 - 5/07	9" Rear Drums	E111-0833-0	V E125-70-087	24.5	E122-70-022	L E146-70-055 46 R E146-70-054 46	E148-70-017	L E155-70-115 R E155-70-114
	10" Rear Drums	E111-0833-0	V E125-70-087	24.5	E122-70-022	L E146-70-055 46 R E146-70-054 46	E148-70-017	L E155-70-115 R E155-70-114
6/07 - 2009	9" Rear Drums	E111-0833-0	V E125-70-087	24.5	E122-70-022	L E146-70-055 46 R E146-70-054 46	E148-70-017	L E155-70-197 R E155-70-196
	10" Rear Drums	E111-0833-0	V E125-70-087	24.5	E122-70-022	L E146-70-055 46 R E146-70-054 46	E148-70-017	L E155-70-197 R E155-70-196
2010 - 2011		E111-0833-0	V E125-70-087	24.5	E122-70-022	L E146-70-055 46 R E146-70-054 46	E148-70-017	L E155-70-197 R E155-70-196

### SPORT TRAC - see EXPLORER SPORT TRAC

Many products are available in multiple grades or configurations. Refer to page 5 for details.

# R E A R

Pads	Rotor, Drum	Hardware Kits	Calipers, Wheel Cyl	Kits Calipers, Wheel Cyl	Brake Hoses	Master Cylinders
E105 OEM Type E107 Semi-Met E109 Prem Pad E110 Ceramic E111 HD Pad	E125 Prem Rotor E126 Std Rotor E127 Prem Drum E128 Std Drum E129 Hub	E122 Rotor E123 Drum	E139 Prem Cyl E140 Std Cyl E146 Semi-Loaded Cal E147 Loaded Cal	E148 Cal Kit E149 Cyl Kit	E155 Hose	E135 Prem M/C E136 Std M/C
<b>Shoes</b> E116 Std Shoe E117 HD Shoe	L = Left R = Right V = Vented S = Solid	DISCARD	DIAMETER	DIAMETER		DIAMETER
E121 Sensor Wire E124 Shoe Adjuster						

## FORD (Cont'd)

### RANGER RWD

E116-0704-0 9 x 1 3/4	E127-70-045 9.09"	E123-66-034	E139-66-008 3/4"	E149-66-010	E155-70-329	E135-70-125 1 1/16"
L E124-69-011 R E124-69-012						
E116-0705-0 10 x 2 1/2	E127-70-042 10.09"	E123-66-035	E139-70-023 13/16"		E155-70-329	E135-70-125 1 1/16"
L E124-70-006 R E124-70-007						
E110-0932-0  PB Shoe E116-0809-0	E125-66-100 .71"	E122-66-043  PB Kit E123-66-043	L E146-66-525 48 R E146-66-524 48	E148-66-035	L E155-70-479 R E155-70-478 19" Long up E155-70-467 21 1/2" Long up E155-70-480	Ports 10 & 12mm E135-70-125 1 1/16" Ports 12 & 14mm E135-70-141 1 1/16"

### RANGER 4WD

E116-0704-0 9 x 1 3/4	E127-70-045 9.09"	E123-66-034	E139-66-008 3/4"	E149-66-010	E155-70-329	E135-70-125 1 1/16"
L E124-69-011 R E124-69-012						
E116-0705-0 10 x 2 1/2	E127-70-042 10.09"	E123-66-035	E139-70-023 13/16"		E155-70-329	E135-70-125 1 1/16"
L E124-70-006 R E124-70-007						
E116-0704-0 9 x 1 3/4	E127-70-045 9.09"	E123-66-034	E139-66-008 3/4"	E149-66-010	E155-70-329	E135-70-125 1 1/16"
L E124-69-011 R E124-69-012						
E116-0705-0 10 x 2 1/2	E127-70-042 10.09"	E123-66-035	E139-70-023 13/16"		E155-70-329	E135-70-125 1 1/16"
L E124-70-006 R E124-70-007						
E110-0932-0  PB Shoe E116-0809-0	E125-66-100 .71"	E122-66-043  PB Kit E123-66-043	L E146-66-525 48 R E146-66-524 48	E148-66-035	lo L E155-70-479 lo R E155-70-478 19" Long up E155-70-467 21 1/2" Long up E155-70-480	Ports 10 & 12mm E135-70-125 1 1/16" Ports 12 & 14mm E135-70-141 1 1/16"

### SPORT TRAC - see EXPLORER SPORT TRAC

# F R O N T

Many products are available in multiple grades or configurations. Refer to page 5 for details.

Make & Model	Year Notes	Pads	Rotor, Drum	DISCARD	Hardware Kits	Calipers, Wheel Cyl	DIAMETER	Kits	Brake Hoses
		E105 OEM Type E107 Semi-Met E109 Prem Pad E110 Ceramic E111 HD Pad <b>Shoes</b> E116 Std Shoe E117 HD Shoe  E121 Sensor Wire E124 Shoe Adjuster	E125 Prem Rotor E126 Std Rotor E127 Prem Drum E128 Std Drum E129 Hub <b>L = Left</b> <b>R = Right</b> <b>V = Vented</b> <b>S = Solid</b>		E122 Rotor E123 Drum	E139 Prem Cyl E140 Std Cyl E146 Semi-Loaded Cal E147 Loaded Cal		E148 Cal Kit E149 Cyl Kit	E155 Hose

## FORD (Cont'd)

### TAURUS - Except SHO & TAURUS X

2001 - 2007	Rear Drum	E110-0598-0	V E125-66-054	24.75	E122-66-029	L E146-66-097	66	E148-66-023	L E155-66-077
						R E146-66-096	66		R E155-66-078
	Rear Disc	E110-0598-0	V E125-66-054	24.75	E122-66-029	L E146-66-097	66	E148-66-023	L E155-66-077
						R E146-66-096	66		R E155-66-078
2008 - 2009		E109-1070-0	V E125-66-085	26.5	E122-68-026	L E146-66-141	45	E148-71-019	L E155-66-125
						R E146-66-140	45		R E155-66-126
2010		E111-1376-0	V E125-66-099	28.5	E122-70-034	L E146-70-095	48	E148-70-035	160mm Steel Line
						R E146-70-094	48		L E155-66-125
									R E155-66-126
									110mm Steel Line
									L E155-66-129
									R E155-66-130
2011 - 2012		E110-1508-0	V E125-66-107	28.5	E122-70-042	L E146-70-095	48	E148-70-035	160mm Steel Line
						R E146-70-094	48		L E155-66-125
									R E155-66-126
									110mm Steel Line
									L E155-66-129
									R E155-66-130

### TAURUS SHO

2010	Except Perf. Pkg	E111-1376-0	V E125-66-099	28.5	E122-70-034	L E146-70-095	48	E148-70-035	L E155-66-129
	Performance Package	E111-1158-0				R E146-70-094	48		R E155-66-130
2011 - 2012	Except Perf. Pkg	E111-1508-0	V E125-66-107	28.5	E122-70-042	L E146-70-095	48	E148-70-035	L E155-66-129
	Performance Package	E111-1158-0				R E146-70-094	48		R E155-66-130

### TAURUS X

2008 - 2009	E109-1070-0	V E125-66-085	26.5	E122-68-026	L E146-66-141	45	E148-71-019	L E155-66-127
					R E146-66-140	45		R E155-66-126

### TRANSIT CONNECT

2010 - 2012	E111-0970-0	V E125-70-137	22.0	E122-66-030	L E146-70-099	54	E148-66-028	E155-70-198
					R E146-70-098	54		

Many products are available in multiple grades or configurations. Refer to page 5 for details.

**R E A R**

Pads	Rotor, Drum	Hardware Kits	Calipers, Wheel Cyl	Kits Calipers, Wheel Cyl	Brake Hoses	Master Cylinders
E105 OEM Type E107 Semi-Met E109 Prem Pad E110 Ceramic E111 HD Pad	E125 Prem Rotor E126 Std Rotor E127 Prem Drum E128 Std Drum E129 Hub	E122 Rotor E123 Drum	E139 Prem Cyl E140 Std Cyl E146 Semi-Loaded Cal E147 Loaded Cal	E148 Cal Kit E149 Cyl Kit	E155 Hose	E135 Prem M/C E136 Std M/C
<b>Shoes</b> E116 Std Shoe E117 HD Shoe	L = Left R = Right V = Vented S = Solid					
E121 Sensor Wire E124 Shoe Adjuster						

DISCARD

DIAMETER

DIAMETER

**FORD (Cont'd)**

**TAURUS - Except SHO & TAURUS X**

E116-0599-0 225 x 38	E127-66-054 226.55	E123-66-011	E139-66-046 1"	E149-66-008	L E155-66-376 R E155-66-387	Except T/C E135-66-096 1" T/C E135-66-124 1"
L E124-66-011 R E124-66-012						
E111-0610-0	S E125-66-044 12.75	E122-66-028	L E146-66-529 43 R E146-66-528 43	E148-66-008	L E155-66-381 R E155-66-375	Except T/C E135-66-096 1" T/C E135-66-124 1"
E110-1071-0	S E125-66-086 10.0	E122-66-045	L E146-66-555 42 R E146-66-554 42	E148-66-039	E155-66-443	ABS, T/C E135-66-139 1" AdvanceTrac E135-66-138 1"
E110-1377-0	S E125-66-086 10.0	E122-72-021	To 11/09 43 L E146-66-551 43 R E146-66-550 43 12/09 - 2010 L E146-66-553 43 R E146-66-550 43	E148-72-018	To 11/09 E155-66-446 12/09 - 2010 L E155-66-451 R E155-66-452	ABS, T/C E135-66-139 1" AdvanceTrac E135-66-145 1 1/16"
E110-1377-0	S E125-66-086 10.0	E122-72-021	L E146-66-553 43 R E146-66-550 43	E148-72-018	L E155-66-451 R E155-66-452	E135-66-145 1 1/16"

**TAURUS SHO**

E110-1377-0	S E125-66-086 10.0	E122-72-021	L E146-66-551 43 R E146-66-550 43	E148-72-018	To 11/09 E155-66-446 12/09 - 2010 E155-66-452	E135-66-145 1 1/16"
E110-1377-0	S E125-66-086 10.0	E122-72-021	L E146-66-551 43 R E146-66-550 43	E148-72-018	E155-66-452	E135-66-145 1 1/16"

**TAURUS X**

E110-1071-0	S E125-66-086 10.0	E122-66-045	L E146-66-555 42 R E146-66-554 42	E148-66-039	E155-66-443	E135-66-139 1"
-------------	--------------------	-------------	--------------------------------------	-------------	-------------	----------------

**TRANSIT CONNECT**

E116-0974-0 229 x 57.2	E127-70-052 230.0	E123-70-026	E139-70-035 13/16"		E155-70-477	E135-70-139 23mm
---------------------------	-------------------	-------------	--------------------	--	-------------	------------------



# F R O N T

Many products are available in multiple grades or configurations. Refer to page 5 for details.

Make & Model	Year Notes	Pads	Rotor, Drum	Hardware Kits	Calipers, Wheel Cyl	Kits Calipers, Wheel Cyl	Brake Hoses	
		E105 OEM Type E107 Semi-Met E109 Prem Pad E110 Ceramic E111 HD Pad <b>Shoes</b> E116 Std Shoe E117 HD Shoe  E121 Sensor Wire E124 Shoe Adjuster	E125 Prem Rotor E126 Std Rotor E127 Prem Drum E128 Std Drum E129 Hub <b>L = Left</b> <b>R = Right</b> <b>V = Vented</b> <b>S = Solid</b>	DISCARD	E122 Rotor E123 Drum	DIAMETER	E139 Prem Cyl E140 Std Cyl E146 Semi-Loaded Cal E147 Loaded Cal	E148 Cal Kit E149 Cyl Kit  E155 Hose

## FREIGHTLINER

### SPRINTER 2500

2007 - 2009	E109-1316-0	v	E130-40-111	25.0	E122-90-006	L E146-40-167 48 R E146-40-166 48	E148-40-047	E155-40-106
	E121-40-015 (2)							

### SPRINTER 3500

2007 - 2009	SRW	E111-1268-0	v	E130-40-111	25.0	E122-90-006	L E146-90-006 52 R E146-90-007 52	E148-90-006	E155-40-106
		E121-40-015 (2)							
	DRW	E111-1268-0	v	E130-40-111	25.0	E122-90-006	L E146-90-006 52 R E146-90-007 52	E148-90-006	E155-40-106
		E121-40-015 (2)							

## GMC TRUCK / Van

### ACADIA

2007 - 2012	E110-1169-1	v	E125-71-074	27.5	E122-71-028	L E146-71-053 48 R E146-71-052 48	E148-63-010	L E155-71-139 R E155-71-138
-------------	-------------	---	-------------	------	-------------	--------------------------------------	-------------	--------------------------------

### CANYON

2004 - 2008	ZQ8 Sport, Z71	E110-1039-0	v	E125-71-061	25.6	E122-71-025	L E146-71-047 45 R E146-71-046 45	E148-71-019	L E155-71-127 R E155-71-128
	Z85 RWD	E110-1039-0	v	E125-71-061	25.6	E122-71-025	L E146-71-047 45 R E146-71-046 45	E148-71-019	L E155-71-125 R E155-71-126
	Z85 4WD	E110-1039-0	v	E125-71-061	25.6	E122-71-025	L E146-71-047 45 R E146-71-046 45	E148-71-019	L E155-71-127 R E155-71-128
2009 - 2012	RWD Except V8 Except Off Road Pkg	E110-1169-0	v	E125-71-077	27.5	E122-71-028	L E146-71-059 48 R E146-71-058 48	E148-63-010	L E155-71-125 R E155-71-126
	RWD V8 RWD Off Road Pkg 4WD	E110-1169-0	v	E125-71-077	27.5	E122-71-028	L E146-71-059 48 R E146-71-058 48	E148-63-010	L E155-71-127 R E155-71-128

Many products are available in multiple grades or configurations. Refer to page 5 for details.

# R E A R

Pads	Rotor, Drum	Hardware Kits	Calipers, Wheel Cyl	Kits Calipers, Wheel Cyl	Brake Hoses	Master Cylinders
E105 OEM Type E107 Semi-Met E109 Prem Pad E110 Ceramic E111 HD Pad	E125 Prem Rotor E126 Std Rotor E127 Prem Drum E128 Std Drum E129 Hub L = Left R = Right V = Vented S = Solid	E122 Rotor E123 Drum	E139 Prem Cyl E140 Std Cyl E146 Semi-Loaded Cal E147 Loaded Cal	E148 Cal Kit E149 Cyl Kit	E155 Hose	E135 Prem M/C E136 Std M/C
<b>Shoes</b> E116 Std Shoe E117 HD Shoe						
E121 Sensor Wire E124 Shoe Adjuster						

DISCARD

DIAMETER

DIAMETER

## FREIGHTLINER

### SPRINTER 2500

E109-1317-0 PB Shoe E116-0938-0 E121-40-015 (2)	S E130-40-112 14.0	E122-40-050 PB Kit E123-40-010	L E146-40-603 51 R E146-40-602 51	E148-40-048	E155-40-106	E135-40-507 27mm
--	--------------------	--------------------------------------	--------------------------------------	-------------	-------------	------------------

### SPRINTER 3500

E109-1317-0 PB Shoe E116-0938-0 E121-40-015 (4)	S E130-40-112 14.0	E122-40-050 PB Kit E123-40-010	L E146-40-603 51 R E146-40-602 51	E148-40-048	E155-40-106	E135-40-507 27mm
E109-1318-0 PB Shoe E116-0940-0 E121-40-015 (4)	V E130-40-113 25.0	E122-40-051 PB Kit E123-40-012	L E146-40-605 48 R E146-40-604 48	E148-40-049	E155-40-506	E135-40-507 27mm

## GMC TRUCK / Van

### ACADIA

E110-0883-0 PB Shoe 2007 - 2011 E116-0933-0	V E125-71-075 18.4	E122-71-019 PB Kit 2007 - 2011 E123-71-018	L E146-71-537 48 R E146-71-536 48	E148-96-020	L E155-71-381 R E155-71-382	E135-71-064 1 1/16"
--	--------------------	---	--------------------------------------	-------------	--------------------------------	---------------------

### CANYON

E116-0815-1 296 x 47 L E124-71-015 R E124-71-014	E127-71-048 296.5	E123-71-014	E139-71-032 15/16"		E155-71-366	E135-71-057 1"
E116-0815-1 296 x 47 L E124-71-015 R E124-71-014	E127-71-048 296.5	E123-71-014	E139-71-032 15/16"		E155-71-366	E135-71-057 1"
E116-0815-1 296 x 47 L E124-71-015 R E124-71-014	E127-71-048 296.5	E123-71-014	E139-71-032 15/16"		E155-71-366	E135-71-057 1"
E116-0959-0 295 x 45.5 L E124-71-017 R E124-71-016	E127-71-048 296.5	E123-71-020	E139-71-035 15/16"		E155-71-401	E135-71-072 1 1/16"
E116-0959-0 295 x 45.5 L E124-71-017 R E124-71-016	E127-71-048 296.5	E123-71-020	E139-71-035 15/16"		E155-71-401	E135-71-072 1 1/16"

# F R O N T

Many products are available in multiple grades or configurations. Refer to page 5 for details.

Make & Model	Year Notes	Pads	Rotor, Drum	Hardware Kits	Calipers, Wheel Cyl	Kits	Brake Hoses		
		E105 OEM Type E107 Semi-Met E109 Prem Pad E110 Ceramic E111 HD Pad <b>Shoes</b> E116 Std Shoe E117 HD Shoe  E121 Sensor Wire E124 Shoe Adjuster	E125 Prem Rotor E126 Std Rotor E127 Prem Drum E128 Std Drum E129 Hub <b>L = Left</b> <b>R = Right</b> <b>V = Vented</b> <b>S = Solid</b>	DISCARD	E122 Rotor E123 Drum	DIAMETER	E139 Prem Cyl E140 Std Cyl E146 Semi-Loaded Cal E147 Loaded Cal	E148 Cal Kit E149 Cyl Kit	E155 Hose

## GMC TRUCK / Van (Cont'd)

### ENVOY

2007 - 2009	4.2L Eng	E109-1169-0	V E125-71-068	27.5	E122-71-028	L E146-71-051 48 R E146-71-050 48	E148-63-010	L E155-71-111 R E155-71-110
	5.3L Eng	E109-1169-0	V E125-71-058	27.5	E122-71-028	L E146-71-053 48 R E146-71-052 48	E148-63-010	L E155-71-111 R E155-71-110

### SAVANA 1500 1/2 Ton Van

2005 - 2007		E110-0785-0	V E125-71-045	27.2	E122-71-015	L E146-71-013 51 R E146-71-012 51	E148-71-018	L E155-71-119 R E155-71-118
2008		E110-0785-0	V E125-71-045	27.2	E122-71-015	L E146-71-013 51 R E146-71-012 51	E148-71-018	L E155-71-143 R E155-71-146
2009 - 2010		E110-1363-0	V E125-71-062	28.0	E122-71-030	L E146-71-057 51 R E146-71-056 51	E148-71-018	L E155-71-143 R E155-71-146
2011 - 2012		E110-1363-0	V E125-71-062	28.0	E122-71-030	L E146-71-057 51 R E146-71-056 51	E148-71-018	L E155-71-143 R E155-71-146

### SAVANA 2500 3/4 Ton Van

2006 - 2007		E111-0784-0	V E125-71-047	36.5	E122-71-013	L E146-71-009 57 R E146-71-008 57	E148-71-016	L E155-71-121 R E155-71-120
2008		E111-0784-0	V E125-71-047	36.5	E122-71-013	L E146-71-009 57 R E146-71-008 57	E148-71-016	L E155-71-121 R E155-71-120
2009 - 2010		E111-0784-0	V E125-71-047	36.5	E122-71-013	L E146-71-009 57 R E146-71-008 57	E148-71-016	L E155-71-121 R E155-71-120

Many products are available in multiple grades or configurations. Refer to page 5 for details.

# R E A R

Pads	Rotor, Drum	Hardware Kits	Calipers, Wheel Cyl	Kits Calipers, Wheel Cyl	Brake Hoses	Master Cylinders
E105 OEM Type E107 Semi-Met E109 Prem Pad E110 Ceramic E111 HD Pad	E125 Prem Rotor E126 Std Rotor E127 Prem Drum E128 Std Drum E129 Hub	E122 Rotor E123 Drum	E139 Prem Cyl E140 Std Cyl E146 Semi-Loaded Cal E147 Loaded Cal	E148 Cal Kit E149 Cyl Kit	E155 Hose	E135 Prem M/C E136 Std M/C
<b>Shoes</b> E116 Std Shoe E117 HD Shoe	L = Left R = Right V = Vented S = Solid	DISCARD	DIAMETER	DIAMETER		DIAMETER
E121 Sensor Wire E124 Shoe Adjuster						

## GMC TRUCK / Van (Cont'd)

### ENVOY

E110-0883-0 PB Shoe E116-0781-0	V E125-71-057 18.5	E122-71-019 PB Kit E123-71-010	L E146-71-513 48 R E146-71-512 48	E148-96-020	E155-71-348	E135-71-060 1 1/16"
E110-0883-0 PB Shoe E116-0781-0	V E125-71-057 18.5	E122-71-019 PB Kit E123-71-010	L E146-71-513 48 R E146-71-512 48	E148-96-020	E155-71-348	E135-71-060 1 1/16"

### SAVANA 1500 1/2 Ton Van

E110-0974-1 PB Shoe E116-0781-0	V E125-71-050 28.5	E122-71-022 PB Kit E123-71-009	L E146-71-525 44.5 R E146-71-524 44.5	E148-71-024	L E155-71-355 R E155-71-354	E135-71-051 34mm
E110-0974-1 PB Shoe E116-0781-0	V E125-71-050 28.5	E122-71-022 PB Kit E123-71-009	L E146-71-525 44.5 R E146-71-524 44.5	E148-71-024	Except StabiliTrak L E155-71-355 R E155-71-354 StabiliTrak L E155-71-411 R E155-71-354	Except StabiliTrak E135-71-066 34mm StabiliTrak E135-71-068 34mm
E110-0974-1 PB Shoe E116-0781-0	V E125-71-050 28.5	E122-71-022 PB Kit E123-71-009	L E146-71-525 44.5 R E146-71-524 44.5	E148-71-024	Except StabiliTrak L E155-71-355 R E155-71-354 StabiliTrak L E155-71-411 R E155-71-354	Except StabiliTrak E135-71-076 34mm StabiliTrak E135-71-077 34mm
E110-0974-1 PB Shoe E116-0781-0	V E125-71-050 28.5	E122-71-022 PB Kit E123-71-009	L E146-71-525 44.5 R E146-71-524 44.5	E148-71-024		E135-71-077 34mm

### SAVANA 2500 3/4 Ton Van

E110-0974-0 PB Shoe E116-0771-0	Gas Eng V E125-71-048 26.5 Diesel Eng V E125-71-049 27.0	E122-71-022 PB Kit E123-71-012	L E146-71-521 50.8 R E146-71-520 50.8	E148-71-022	L E155-71-355 R E155-71-354	E135-71-050 1 7/16"
E110-0974-0 PB Shoe E116-0771-0	Gas Eng V E125-71-048 26.5 Diesel Eng V E125-71-049 27.0	E122-71-022 PB Kit E123-71-012	L E146-71-521 50.8 R E146-71-520 50.8	E148-71-022	Except StabiliTrak L E155-71-355 R E155-71-354 StabiliTrak L E155-71-411 R E155-71-354	Except StabiliTrak E135-71-062 37mm StabiliTrak E135-71-067 37mm
E110-0974-0 PB Shoe E116-0962-0	Gas Eng V E125-71-048 26.5 Diesel Eng V E125-71-049 27.0	E122-71-022 PB Kit E123-71-012	L E146-71-521 50.8 R E146-71-520 50.8	E148-71-022	Except StabiliTrak L E155-71-355 R E155-71-354 StabiliTrak L E155-71-411 R E155-71-354	Except StabiliTrak E135-71-073 38mm StabiliTrak E135-71-075 38mm

# F R O N T

Many products are available in multiple grades or configurations. Refer to page 5 for details.

Make & Model	Year Notes	Pads	Rotor, Drum	DISCARD	Hardware Kits	Calipers, Wheel Cyl	DIAMETER	Kits Calipers, Wheel Cyl	Brake Hoses
		E105 OEM Type E107 Semi-Met E109 Prem Pad E110 Ceramic E111 HD Pad <b>Shoes</b> E116 Std Shoe E117 HD Shoe  E121 Sensor Wire E124 Shoe Adjuster	E125 Prem Rotor E126 Std Rotor E127 Prem Drum E128 Std Drum E129 Hub <b>L = Left</b> <b>R = Right</b> <b>V = Vented</b> <b>S = Solid</b>		E122 Rotor E123 Drum	E139 Prem Cyl E140 Std Cyl E146 Semi-Loaded Cal E147 Loaded Cal		E148 Cal Kit E149 Cyl Kit	E155 Hose

## GMC TRUCK / Van (Cont'd)

### SAVANA 2500 3/4 Ton Van (Cont'd)

2011 - 2012	E111-0784-0	V E125-71-047	36.5	E122-71-013	L E146-71-009 57 R E146-71-008 57	E148-71-016	L R E155-71-120
-------------	-------------	---------------	------	-------------	--------------------------------------	-------------	--------------------

### SAVANA 3500 1 Ton Van

2006 - 2008	SRW	E111-0784-0	V E125-71-064	36.5	E122-71-013	L E146-71-009 57 R E146-71-008 57	E148-71-016	L E155-71-121 R E155-71-120
	DRW	E111-0784-0	V E125-71-064	36.5	E122-71-013	L E146-71-043 60 R E146-71-042 60	E148-71-020	L E155-71-121 R E155-71-120
2009 - 2010	SRW	E111-0784-0	V E125-71-064	36.5	E122-71-013	L E146-71-009 57 R E146-71-008 57	E148-71-016	L E155-71-121 R E155-71-120
	DRW	E111-0784-0	V E125-71-064	36.5	E122-71-013	L E146-71-043 60 R E146-71-042 60	E148-71-020	L E155-71-121 R E155-71-120

Many products are available in multiple grades or configurations. Refer to page 5 for details.

# R E A R

<b>Pads</b> E105 OEM Type E107 Semi-Met E109 Prem Pad E110 Ceramic E111 HD Pad <b>Shoes</b> E116 Std Shoe E117 HD Shoe  E121 Sensor Wire E124 Shoe Adjuster	<b>Rotor, Drum</b> E125 Prem Rotor E126 Std Rotor E127 Prem Drum E128 Std Drum E129 Hub L = Left R = Right V = Vented S = Solid	DISCARD	<b>Hardware Kits</b> E122 Rotor E123 Drum	<b>Calipers, Wheel Cyl</b> E139 Prem Cyl E140 Std Cyl E146 Semi-Loaded Cal E147 Loaded Cal	DIAMETER	<b>Kits Calipers, Wheel Cyl</b> E148 Cal Kit E149 Cyl Kit	<b>Brake Hoses</b> E155 Hose	<b>Master Cylinders</b> E135 Prem M/C E136 Std M/C	DIAMETER

## GMC TRUCK / Van (Cont'd)

### SAVANA 2500 3/4 Ton Van

E110-0974-0	Gas Eng	E122-71-022	L E146-71-521 50.8	E148-71-022	Except	Except StabiliTrak
PB Shoe	V E125-71-048 26.5	PB Kit	R E146-71-520 50.8		StabiliTrak	E135-71-073 38mm
E116-0962-0	Diesel Eng	E123-71-012			L E155-71-355	StabiliTrak
	V E125-71-049 27.0				R E155-71-410	E135-71-075 38mm
					StabiliTrak	
					L E155-71-411	
					R E155-71-410	

### SAVANA 3500 1 Ton Van

E110-0974-0	86mm High	E122-71-022	L E146-71-521 50.8	E148-71-022	StabiliTrak	2006 - 2007
PB Shoe	V E125-71-048 26.5	PB Kit	R E146-71-520 50.8		Passenger	Except StabiliTrak
E116-0771-0	91mm High	E123-71-012			L E155-71-371	E135-71-050 1 7/16"
	V E125-71-049 27.0				R E155-71-354	StabiliTrak
					Except StabiliTrak	E135-71-056 1 7/16"
					Conversion	2008
					L E155-71-355	Except StabiliTrak
					R E155-71-354	E135-71-062 37mm
					Commercial	StabiliTrak
					Cutaway	
					L E155-71-357	E135-71-067 37mm
					R E155-71-356	
E111-0989-0	V E125-71-055 28.5	E122-71-024	L E146-71-519 54	E148-71-021	Except Commercial	2006 - 2007
PB Shoe		PB Kit	R E146-71-518 54		Cutaway	
E116-0771-0		E123-71-019			L E155-71-407	E135-71-050 1 7/16"
					R E155-71-408	2008
					Commercial	E135-71-062 37mm
					Cutaway	
					L E155-71-373	
					R E155-71-374	
E110-0974-0	86mm High	E122-71-022	L E146-71-521 50.8	E148-71-022	StabiliTrak	Except StabiliTrak
PB Shoe	V E125-71-048 26.5	PB Kit	R E146-71-520 50.8		Passenger	E135-71-073 38mm
E116-0962-0	91mm High	E123-71-012			L E155-71-411	StabiliTrak
	V E125-71-049 27.0				R E155-71-354	E135-71-075 38mm
					Except StabiliTrak	
					Conversion	
					L E155-71-355	
					R E155-71-354	
					Commercial	
					Cutaway	
					L E155-71-357	
					R E155-71-356	
E110-1411-0	V E125-71-076 38.0	E122-70-038	L E146-71-541 54	E148-71-030	Except Cab & Chassis	Except StabiliTrak
PB Shoe		PB Kit	R E146-71-540 54			
JH6 & JH7		JH6 & JH7			L E155-71-373	E135-71-073 38mm
E116-0962-0		E123-71-012			R E155-71-374	StabiliTrak
JH9					Cab & Chassis	E135-71-075 38mm
E116-0973-0					L E155-71-407	
					R E155-71-408	

# F R O N T

Many products are available in multiple grades or configurations. Refer to page 5 for details.

Make & Model	Year Notes	Pads	Rotor, Drum	DISCARD	Hardware Kits	Calipers, Wheel Cyl	DIAMETER	Kits Calipers, Wheel Cyl	Brake Hoses
		E105 OEM Type E107 Semi-Met E109 Prem Pad E110 Ceramic E111 HD Pad <b>Shoes</b> E116 Std Shoe E117 HD Shoe  E121 Sensor Wire E124 Shoe Adjuster	E125 Prem Rotor E126 Std Rotor E127 Prem Drum E128 Std Drum E129 Hub <b>L = Left</b> <b>R = Right</b> <b>V = Vented</b> <b>S = Solid</b>	DISCARD	E122 Rotor E123 Drum	E139 Prem Cyl E140 Std Cyl E146 Semi-Loaded Cal E147 Loaded Cal	DIAMETER	E148 Cal Kit E149 Cyl Kit	E155 Hose

## GMC TRUCK / Van (Cont'd)

### SAVANA 3500 1 Ton Van (Cont'd)

2011 - 2012	SRW	E111-0784-0	V E125-71-064	36.5	E122-71-013	L E146-71-009 57 R E146-71-008 57		E148-71-016	L R E155-71-120
	DRW	E111-0784-0	V E125-71-064	36.5	E122-71-013	L E146-71-043 60 R E146-71-042 60		E148-71-020	L R E155-71-120

### SIERRA 1500, SIERRA 1500 DENALI 1/2 Ton RWD Pickup

2007	Classic (GMT 800) Rear Drum Front Caliper Bracket Cast # 2851C/286C	E110-1092-0	V E125-71-062	28.0	35mm Gap E122-71-026	L E146-71-049 51 R E146-71-048 51		E148-71-018	Except Crew Cab L E155-71-129 R E155-71-130 Crew Cab L E155-71-133 R E155-71-124
	Classic (GMT 800) Rear Disc, Except SS	E110-0785-0	V E125-71-045	27.2	E122-71-015	L E146-71-013 51 R E146-71-012 51		E148-71-018	L E155-71-129 R E155-71-130
	1500HD Classic Crew Cab (GMT 800) Rear Disc	E111-0784-0	V E125-71-047	36.5	E122-71-013	L E146-71-009 57 R E146-71-008 57		E148-71-016	L E155-71-115 R E155-71-114
	New Sierra (GMT 900) Rear Drum Front Caliper Bracket Cast # 351C/352C	E110-1363-0	V E125-71-062	28.0	38mm Gap E122-71-030	L E146-71-057 51 R E146-71-056 51		E148-71-018	L E155-71-137 R E155-71-142
	New Sierra (GMT 900) Rear Disc Front Caliper Bracket Cast # 351C/352C	E110-1363-0	V E125-71-062	28.0	38mm Gap E122-71-030	L E146-71-057 51 R E146-71-056 51		E148-71-018	L E155-71-137 R E155-71-142

Many products are available in multiple grades or configurations. Refer to page 5 for details.

# R E A R

<b>Pads</b> E105 OEM Type E107 Semi-Met E109 Prem Pad E110 Ceramic E111 HD Pad <b>Shoes</b> E116 Std Shoe E117 HD Shoe  E121 Sensor Wire E124 Shoe Adjuster	<b>Rotor, Drum</b> E125 Prem Rotor E126 Std Rotor E127 Prem Drum E128 Std Drum E129 Hub L = Left R = Right V = Vented S = Solid	DISCARD	<b>Hardware Kits</b> E122 Rotor E123 Drum	<b>Calipers, Wheel Cyl</b> E139 Prem Cyl E140 Std Cyl E146 Semi-Loaded Cal E147 Loaded Cal	DIAMETER	<b>Kits, Calipers, Wheel Cyl</b> E148 Cal Kit E149 Cyl Kit	<b>Brake Hoses</b> E155 Hose	<b>Master Cylinders</b> E135 Prem M/C E136 Std M/C	DIAMETER

## GMC TRUCK / Van (Cont'd)

### SAVANA 3500 1 Ton Van (Cont'd)

E110-0974-0	86mm High	E122-71-022	L E146-71-521 50.8	E148-71-022	StabiliTrak	Except StabiliTrak
PB Shoe	V E125-71-048 26.5	PB Kit	R E146-71-520 50.8		L E155-71-411	E135-71-073 38mm
E116-0962-0	91mm High	E123-71-012			R E155-71-410	StabiliTrak
	V E125-71-049 27.0				Except StabiliTrak	E135-71-075 38mm
					L E155-71-355	
E110-1411-0	V E125-71-076 38.0	E122-70-038	L E146-71-541 54	E148-71-030	R E155-71-410	
PB Shoe		PB Kit	R E146-71-540 54		L E155-71-407	Except StabiliTrak
JH6 & JH7		JH6 & JH7			R	E135-71-073 38mm
E116-0962-0		E123-71-012				StabiliTrak
JH9						E135-71-075 38mm
E116-0973-0						

### SIERRA 1500, SIERRA 1500 DENALI 1/2 Ton RWD Pickup

E116-0855-0 297 x 62	E127-71-049 296.5	E123-71-016	6400Lb GVW		E155-71-341	Rsvr Retained with Roll Pins
E124-71-015			E139-71-032 15/16"			E135-71-058 1 1/8"
			7000Lb GVW			Rsvr Retained by Plastic Straps
			E139-71-034 1 1/16"			E135-71-080 1 1/8"
E110-0792-0	V E125-71-046 18.5	E122-71-023	L E146-71-527 54	E148-71-017	up E155-71-341	E135-71-053 1 1/4"
PB Shoe		PB Kit	R E146-71-526 54		lo L E155-71-339	
E116-0781-0		E123-71-009			lo R E155-71-338	
E110-0785-0	V E125-71-048 26.5	E122-71-015	L E146-71-012 51	E148-71-018	up E155-71-341	E135-71-050 1 7/16"
PB Shoe		PB Kit	R E146-71-013 51		lo L E155-71-343	
E116-0771-0		E123-71-012			lo R E155-71-342	
E116-0855-0 297 x 62	E127-71-049 296.5	E123-71-016	6400lb GVW		Except StabiliTrak	Except StabiliTrak
E124-71-015			E139-71-032 15/16"		9.5" Eaton Axle	E135-71-065 1 1/8"
			7000lb GVW		E155-71-389	StabiliTrak
			E139-71-034 1 1/16"		8.6" Std Axle	E135-71-061 1 1/4"
					58" or 66" Bed	
					E155-71-387	
					8' Bed	
					E155-71-388	
					StabiliTrak	
					E155-71-390	
E110-1194-0	V E125-71-070 18.5	E122-71-027	L E146-71-535 51	E148-71-028	lo L E155-71-395	Except StabiliTrak
PB Shoe		PB Kit	R E146-71-534 51		lo R E155-71-394	E135-71-065 1 1/8"
E116-0781-0		E123-71-015			9.5" Eaton Axle	StabiliTrak
					up E155-71-397	E135-71-061 1 1/4"
					8.6" Std Axle	
					up E155-71-390	



# F R O N T

Many products are available in multiple grades or configurations. Refer to page 5 for details.

Make & Model	Year Notes	Pads	Rotor, Drum		Hardware Kits	Calipers, Wheel Cyl		Kits Calipers, Wheel Cyl	Brake Hoses
		E105 OEM Type E107 Semi-Met E109 Prem Pad E110 Ceramic E111 HD Pad <b>Shoes</b> E116 Std Shoe E117 HD Shoe  E121 Sensor Wire E124 Shoe Adjuster	E125 Prem Rotor E126 Std Rotor E127 Prem Drum E128 Std Drum E129 Hub <b>L = Left</b> <b>R = Right</b> <b>V = Vented</b> <b>S = Solid</b>	DISCARD	E122 Rotor E123 Drum	E139 Prem Cyl E140 Std Cyl E146 Semi-Loaded Cal E147 Loaded Cal	DIAMETER	E148 Cal Kit E149 Cyl Kit	E155 Hose

## GMC TRUCK / Van (Cont'd)

### SIERRA 1500, SIERRA 1500 DENALI 1/2 Ton RWD Pickup (Cont'd)

<b>2008</b>	Rear Drum	E110-1363-0	V E125-71-062	28.0	38mm Gap E122-71-030	L E146-71-057 51 R E146-71-056 51	E148-71-018	L E155-71-137 R E155-71-142
	Front Caliper Bracket Cast # 351C/352C							
	Rear Disc	E110-1363-0	V E125-71-062	28.0	38mm Gap E122-71-030	L E146-71-057 51 R E146-71-056 51	E148-71-018	L E155-71-137 R E155-71-142
	Front Caliper Bracket Cast # 351C/352C							
<b>2009 - 2010</b>	Rear Drum	E110-1363-0	V E125-71-062	28.0	E122-71-030	L E146-71-057 51 R E146-71-056 51	E148-71-018	L E155-71-145 R E155-71-142
	Rear Disc	E110-1363-0	V E125-71-062	28.0	E122-71-030	L E146-71-057 51 R E146-71-056 51	E148-71-018	L E155-71-145 R E155-71-142
<b>2011 - 2012</b>	Rear Drum	E110-1363-0	V E125-71-062	28.0	E122-71-030	L E146-71-057 51 R E146-71-056 51	E148-71-018	L E155-71-145 R E155-71-142
	Rear Disc	E110-1363-0	V E125-71-062	28.0	E122-71-030	L E146-71-057 51 R E146-71-056 51	E148-71-018	L E155-71-145 R E155-71-142

Many products are available in multiple grades or configurations. Refer to page 5 for details.

**R E A R**

Pads	Rotor, Drum	Hardware Kits	Calipers, Wheel Cyl	Kits Calipers, Wheel Cyl	Brake Hoses	Master Cylinders
E105 OEM Type E107 Semi-Met E109 Prem Pad E110 Ceramic E111 HD Pad	E125 Prem Rotor E126 Std Rotor E127 Prem Drum E128 Std Drum E129 Hub	E122 Rotor E123 Drum	E139 Prem Cyl E140 Std Cyl E146 Semi-Loaded Cal E147 Loaded Cal	E148 Cal Kit E149 Cyl Kit	E155 Hose	E135 Prem M/C E136 Std M/C
<b>Shoes</b> E116 Std Shoe E117 HD Shoe	<b>L = Left</b> <b>R = Right</b> <b>V = Vented</b> <b>S = Solid</b>	DISCARD	DIAMETER	DIAMETER		DIAMETER
E121 Sensor Wire E124 Shoe Adjuster						

**GMC TRUCK / Van (Cont'd)**

**SIERRA 1500, SIERRA 1500 DENALI 1/2 Ton RWD Pickup (Cont'd)**

E116-0855-0 297 x 62	E127-71-049 296.5	E123-71-016	6400lb GVW E139-71-032 15/16"		Except StabiliTrak 9.5" Eaton Axle	Except StabiliTrak E135-71-065 1 1/4"
E124-71-015			7000lb GVW E139-71-034 1 1/16"		E155-71-389 8.6" Std Axle 5'8" or 6'6" Bed E155-71-387 8' Bed E155-71-388 StabiliTrak E155-71-390	StabiliTrak E135-71-061 1 1/4"
E110-1194-0 PB Shoe E116-0781-0	V E125-71-070 18.5	E122-71-027 PB Kit E123-71-015	L E146-71-535 51 R E146-71-534 51	E148-71-028	lo L E155-71-395 lo R E155-71-394 up E155-71-397 up E155-71-390	Except StabiliTrak E135-71-065 1 1/4" StabiliTrak E135-71-061 1 1/4"
E116-0960-0 295 x 60.7	E127-71-050 296.5	E123-71-021	6400lb GVW E139-71-035 15/16"		Except StabiliTrak & 8' Bed E155-71-387 8' Bed E155-71-388 StabiliTrak Except 8' Bed E155-71-390 8' Bed E155-71-403	Except StabiliTrak E135-71-078 1 1/4" StabiliTrak E135-71-071 1 1/4"
E124-71-017			7000lb GVW E139-71-036 1 1/16"			
E110-1194-0 PB Shoe E116-0781-0	V E125-71-070 18.5	E122-71-027 PB Kit E123-71-015	L E146-71-535 51 R E146-71-534 51	E148-71-028	lo L E155-71-395 lo R E155-71-394 up E155-71-390 up E155-71-397	Except Hybrid E135-71-071 1 1/4" Crew Cab Hybrid E135-71-070 13/16"
E116-0960-0 295 x 60.7	E127-71-050 296.5	E123-71-021	6400lb GVW E139-71-035 15/16"		Except 8' Bed E155-71-390 8' Bed E155-71-403	Except StabiliTrak E135-71-078 1 1/4" StabiliTrak E135-71-071 1 1/4"
E124-71-017			7000lb GVW E139-71-036 1 1/16"			
E110-1194-0 PB Shoe E116-0781-0	V E125-71-070 18.5	E122-71-027 PB Kit E123-71-015	L E146-71-535 51 R E146-71-534 51	E148-71-028	lo L E155-71-395 lo R E155-71-394 up E155-71-390 up E155-71-397	Except Hybrid E135-71-071 1 1/4" Crew Cab Hybrid E135-71-070 13/16"

# F R O N T

Many products are available in multiple grades or configurations. Refer to page 5 for details.

Make & Model	Year Notes	Pads	Rotor, Drum	DISCARD	Hardware Kits	Calipers, Wheel Cyl	DIAMETER	Kits Calipers, Wheel Cyl	Brake Hoses
		E105 OEM Type E107 Semi-Met E109 Prem Pad E110 Ceramic E111 HD Pad <b>Shoes</b> E116 Std Shoe E117 HD Shoe  E121 Sensor Wire E124 Shoe Adjuster	E125 Prem Rotor E126 Std Rotor E127 Prem Drum E128 Std Drum E129 Hub <b>L = Left</b> <b>R = Right</b> <b>V = Vented</b> <b>S = Solid</b>		E122 Rotor E123 Drum	E139 Prem Cyl E140 Std Cyl E146 Semi-Loaded Cal E147 Loaded Cal		E148 Cal Kit E149 Cyl Kit	E155 Hose

## GMC TRUCK / Van (Cont'd)

### SIERRA 1500, SIERRA 1500 DENALI, C3 1/2 Ton 4WD Pickup

<b>2007</b>	Classic (GMT 800) Regular & Extended Cab 6400lb GVW & Rear Drums Front Caliper Bracket Cast # 2851C/286C	E110-1092-0	V E125-71-062	28.0	35mm Gap E122-71-026	L E146-71-049 51 R E146-71-048 51	E148-71-018	up E155-71-341 lo L E155-71-129 lo R E155-71-130
	Classic (GMT 800) Extended & Crew Cab Except HD Crew Cab 7000lb GVW & Rear Drums Front Caliper Bracket Cast # 2851C/286C	E110-1092-0	V E125-71-062	28.0	35mm Gap E122-71-026	L E146-71-049 51 R E146-71-048 51	E148-71-018	up E155-71-341 lo L E155-71-129 lo R E155-71-130
	Classic (GMT 800) Regular & Extended Cab Rear Disc Except Hybrid & SS	E110-0785-0	V E125-71-045	27.2	E122-71-015	L E146-71-013 51 R E146-71-012 51	E148-71-018	L E155-71-129 R E155-71-130
	Classic (GMT 800) Crew Cab Heavy Duty Rear Disc	E111-0784-0	V E125-71-047	36.5	E122-71-013	L E146-71-009 57 R E146-71-008 57	E148-71-016	L E155-71-115 R E155-71-114
	New Sierra (GMT 900) Rear Drum Front Caliper Bracket Cast # 351C/352C	E110-1363-0	V E125-71-062	28.0	38mm Gap E122-71-030	L E146-71-057 51 R E146-71-056 51	E148-71-018	L E155-71-137 R E155-71-142
	New Sierra (GMT 900) Rear Disc Front Caliper Bracket Cast # 351C/352C	E110-1363-0	V E125-71-062	28.0	38mm Gap E122-71-030	L E146-71-057 51 R E146-71-056 51	E148-71-018	L E155-71-137 R E155-71-142

Many products are available in multiple grades or configurations. Refer to page 5 for details.

**R E A R**

Pads	Rotor, Drum	Hardware Kits	Calipers, Wheel Cyl	Kits Calipers, Wheel Cyl	Brake Hoses	Master Cylinders
E105 OEM Type E107 Semi-Met E109 Prem Pad E110 Ceramic E111 HD Pad <b>Shoes</b> E116 Std Shoe E117 HD Shoe  E121 Sensor Wire E124 Shoe Adjuster	E125 Prem Rotor E126 Std Rotor E127 Prem Drum E128 Std Drum E129 Hub L = Left R = Right V = Vented S = Solid	E122 Rotor E123 Drum	E139 Prem Cyl E140 Std Cyl E146 Semi-Loaded Cal E147 Loaded Cal	E148 Cal Kit E149 Cyl Kit	E155 Hose	E135 Prem M/C E136 Std M/C

DISCARD

DIAMETER

DIAMETER

**GMC TRUCK / Van (Cont'd)**

**SIERRA 1500, SIERRA 1500 DENALI, C3 1/2 Ton 4WD Pickup**

E116-0855-0 297 x 62 E124-71-015	E127-71-049 296.5	E123-71-016	E139-71-032 15/16"		E155-71-341	Rsvr Retained with Roll Pins E135-71-058 1 1/4" Rsvr Retained by Plastic Straps E135-71-080 1 1/4"
E116-0855-0 297 x 62 E124-71-015	E127-71-049 296.5	E123-71-016	E139-71-034 1 1/16"		E155-71-341	Rsvr Retained with Roll Pins E135-71-058 1 1/4" Rsvr Retained by Plastic Straps E135-71-080 1 1/4"
E110-0792-0 PB Shoe E116-0781-0	v E125-71-046 18.5	E122-71-023 PB Kit E123-71-009	L E146-71-527 54 R E146-71-526 54	E148-71-017	up E155-71-341 lo L E155-71-339 lo R E155-71-338	E135-71-053 1 1/4"
E110-0785-0 PB Shoe E116-0771-0	v E125-71-048 26.5	E122-71-015 PB Kit E123-71-012	L E146-71-012 51 R E146-71-013 51	E148-71-018	up E155-71-341 lo L E155-71-343 lo R E155-71-342	E135-71-050 1 7/16"
E116-0855-0 297 x 62 E124-71-015	E127-71-049 296.5	E123-71-016	6400 lbs GVWR E139-71-032 15/16" 7000 lbs GVWR E139-71-034 1 1/16"		Except StabiliTrak 9.5" Eaton Axle E155-71-389 8.6" Std Axle 5'8" or 6'6" Bed E155-71-387 8' Bed E155-71-388 StabiliTrak E155-71-390	Except StabiliTrak E135-71-065 1 1/4" StabiliTrak E135-71-061 1 1/4"
E110-1194-0 PB Shoe E116-0781-0	v E125-71-070 18.5	E122-71-027 PB Kit E123-71-015	L E146-71-535 51 R E146-71-534 51	E148-71-028	lo L E155-71-395 lo R E155-71-394 9.5" Eaton Axle up E155-71-397 8.6" Std Axle up E155-71-390	Except StabiliTrak E135-71-065 1 1/4" StabiliTrak E135-71-061 1 1/4"

# F R O N T

*Many products are available in multiple grades or configurations. Refer to page 5 for details.*

Make & Model	Year Notes	Pads	Rotor, Drum	Hardware Kits	Calipers, Wheel Cyl	Kits Calipers, Wheel Cyl	Brake Hoses	
		E105 OEM Type E107 Semi-Met E109 Prem Pad E110 Ceramic E111 HD Pad <b>Shoes</b> E116 Std Shoe E117 HD Shoe  E121 Sensor Wire E124 Shoe Adjuster	E125 Prem Rotor E126 Std Rotor E127 Prem Drum E128 Std Drum E129 Hub L = Left R = Right V = Vented S = Solid	DISCARD	E122 Rotor E123 Drum	DIAMETER	E139 Prem Cyl E140 Std Cyl E146 Semi-Loaded Cal E147 Loaded Cal	E155 Hose

## GMC TRUCK / Van (Cont'd)

### SIERRA 1500, SIERRA 1500 DENALI, C3 1/2 Ton 4WD Pickup (Cont'd)

Year	Rear Drum	Part No	V	Part No	28.0	38mm Gap	L	Part No	51	E148-71-018	L	Part No
2008	Rear Drum	E110-1363-0	v	E125-71-062	28.0	38mm Gap	L	E146-71-057	51	E148-71-018	L	E155-71-137
						E122-71-030	R	E146-71-056	51		R	E155-71-142
	Rear Disc	E110-1363-0	v	E125-71-062	28.0	38mm Gap	L	E146-71-057	51	E148-71-018	L	E155-71-137
						E122-71-030	R	E146-71-056	51		R	E155-71-142
2009 - 2010	Rear Drum	E110-1363-0	v	E125-71-062	28.0	E122-71-030	L	E146-71-057	51	E148-71-018	L	E155-71-145
							R	E146-71-056	51		R	E155-71-142
	Rear Disc	E110-1363-0	v	E125-71-062	28.0	E122-71-030	L	E146-71-057	51	E148-71-018	L	E155-71-145
							R	E146-71-056	51		R	E155-71-142
2011 - 2012	Rear Drum	E110-1363-0	v	E125-71-062	28.0	E122-71-030	L	E146-71-057	51	E148-71-018	L	E155-71-145
							R	E146-71-056	51		R	E155-71-142
	Rear Disc	E110-1363-0	v	E125-71-062	28.0	E122-71-030	L	E146-71-057	51	E148-71-018	L	E155-71-145
							R	E146-71-056	51		R	E155-71-142

Many products are available in multiple grades or configurations. Refer to page 5 for details.

**R E A R**

Pads	Rotor, Drum	Hardware Kits	Calipers, Wheel Cyl	Kits Calipers, Wheel Cyl	Brake Hoses	Master Cylinders
E105 OEM Type E107 Semi-Met E109 Prem Pad E110 Ceramic E111 HD Pad <b>Shoes</b> E116 Std Shoe E117 HD Shoe  E121 Sensor Wire E124 Shoe Adjuster	E125 Prem Rotor E126 Std Rotor E127 Prem Drum E128 Std Drum E129 Hub L = Left R = Right V = Vented S = Solid	E122 Rotor E123 Drum	E139 Prem Cyl E140 Std Cyl E146 Semi-Loaded Cal E147 Loaded Cal	E148 Cal Kit E149 Cyl Kit	E155 Hose	E135 Prem M/C E136 Std M/C
DISCARD		DIAMETER		DIAMETER		DIAMETER

**GMC TRUCK / Van (Cont'd)**

**SIERRA 1500, SIERRA 1500 DENALI, C3 1/2 Ton 4WD Pickup (Cont'd)**

E116-0855-0 297 x 62	E127-71-049 296.5	E123-71-016	6400 lbs GVWR E139-71-032 15/16" 7000 lbs GVWR E139-71-034 1 1/16"		Except StabiliTrak 9.5" Eaton Axle E155-71-389 8.6" Std Axle 5'8" or 6'6" Bed E155-71-387 8' Bed E155-71-388 StabiliTrak E155-71-390	Except StabiliTrak E135-71-065 1 1/4" StabiliTrak E135-71-061 1 1/4"
E124-71-015						
E110-1194-0 PB Shoe E116-0781-0	V E125-71-070 18.5	E122-71-027 PB Kit E123-71-015	L E146-71-535 51 R E146-71-534 51	E148-71-028	lo L E155-71-395 lo R E155-71-394 up E155-71-397 up E155-71-390	Except StabiliTrak E135-71-065 1 1/4" StabiliTrak E135-71-061 1 1/4"
E116-0960-0 295 x 60.7	E127-71-050 296.5	E123-71-017	6400lb GVW E139-71-035 15/16" 7000lb GVW E139-71-036 1 1/16"		Except StabiliTrak & 8' Bed E155-71-387 8' Bed E155-71-388 StabiliTrak Except 8' Bed E155-71-390 8' Bed E155-71-403	Except StabiliTrak E135-71-078 1 1/4" StabiliTrak E135-71-071 1 1/4"
E124-71-017						
E110-1194-0 PB Shoe E116-0781-0	V E125-71-070 18.5	E122-71-027 PB Kit E123-71-015	L E146-71-535 51 R E146-71-534 51	E148-71-028	lo L E155-71-395 lo R E155-71-394 up E155-71-390 up E155-71-397	Except Hybrid E135-71-071 1 1/4" Crew Cab Hybrid E135-71-070 13/16"
E116-0960-0 295 x 60.7	E127-71-050 296.5	E123-71-017	6400lb GVW E139-71-035 15/16" 7000lb GVW E139-71-036 1 1/16"		Except 8' Bed E155-71-390 8' Bed E155-71-403	Except StabiliTrak E135-71-078 1 1/4" StabiliTrak E135-71-071 1 1/4"
E124-71-017						
E110-1194-0 PB Shoe E116-0781-0	V E125-71-070 18.5	E122-71-027 PB Kit E123-71-015	L E146-71-535 51 R E146-71-534 51	E148-71-028	lo L E155-71-395 lo R E155-71-394 up E155-71-390 up E155-71-397	Except Hybrid E135-71-071 1 1/4" Crew Cab Hybrid E135-71-070 13/16"

# F R O N T

Many products are available in multiple grades or configurations. Refer to page 5 for details.

Make & Model	Year Notes	Pads	Rotor, Drum	DISCARD	Hardware Kits	Calipers, Wheel Cyl	DIAMETER	Kits Calipers, Wheel Cyl	Brake Hoses
		E105 OEM Type E107 Semi-Met E109 Prem Pad E110 Ceramic E111 HD Pad <b>Shoes</b> E116 Std Shoe E117 HD Shoe  E121 Sensor Wire E124 Shoe Adjuster	E125 Prem Rotor E126 Std Rotor E127 Prem Drum E128 Std Drum E129 Hub <b>L = Left</b> <b>R = Right</b> <b>V = Vented</b> <b>S = Solid</b>	DISCARD	E122 Rotor E123 Drum	E139 Prem Cyl E140 Std Cyl E146 Semi-Loaded Cal E147 Loaded Cal	DIAMETER	E148 Cal Kit E149 Cyl Kit	E155 Hose

## GMC TRUCK / Van (Cont'd)

### SIERRA 2500 ¾ Ton RWD Pickup

2007 - 2008	E111-0784-0	V E125-71-064	36.5	E122-71-013	L E146-71-009 57 R E146-71-008 57	E148-71-016	L E155-71-383 R E155-71-384
2009 - 2010	E111-0784-0	V E125-71-064	36.5	E122-71-013	L E146-71-009 57 R E146-71-008 57	E148-71-016	L E155-71-383 R E155-71-384
2011 - 2012	2011 E110-1411-0	V E125-71-079	38.5	E122-71-032	L E146-71-061 60 R E146-71-060 60	E148-71-031	L E155-71-147 R E155-71-148

### SIERRA 2500 ¾ Ton 4WD Pickup

2007 - 2008	GMT900 E111-0784-0	V E125-71-064	36.5	E122-71-013	L E146-71-009 57 R E146-71-008 57	E148-71-016	L E155-71-383 R E155-71-384
2009 - 2010	E111-0784-0	V E125-71-064	36.5	E122-71-013	L E146-71-009 57 R E146-71-008 57	E148-71-016	L E155-71-383 R E155-71-384
2011 - 2012	E110-1411-0	V E125-71-079	38.5	E122-71-032	L E146-71-061 60 R E146-71-060 60	E148-71-031	L E155-71-147 R E155-71-148

### SIERRA 3500 1 Ton RWD Pickup

2007	GMT800 Series & SRW E111-0784-0	V E125-71-064	36.5	E122-71-013	L E146-71-009 57 R E146-71-008 57	E148-71-016	L E155-71-115 R E155-71-114
	GMT800 Series & DRW E111-0784-0	V E125-71-064	36.5	E122-71-013	L E146-71-043 60 R E146-71-042 60	E148-71-020	L E155-71-115 R E155-71-114
	GMT900 Series & SRW E111-0784-0	V E125-71-064	36.5	E122-71-013	L E146-71-009 57 R E146-71-008 57	E148-71-016	L E155-71-383 R E155-71-384
	GMT900 Series & DRW E111-0784-0	V E125-71-064	36.5	E122-71-013	L E146-71-043 60 R E146-71-042 60	E148-71-020	L E155-71-383 R E155-71-384

Many products are available in multiple grades or configurations. Refer to page 5 for details.

**R E A R**

Pads	Rotor, Drum	Hardware Kits	Calipers, Wheel Cyl	Kits Calipers, Wheel Cyl	Brake Hoses	Master Cylinders
E105 OEM Type E107 Semi-Met E109 Prem Pad E110 Ceramic E111 HD Pad <b>Shoes</b> E116 Std Shoe E117 HD Shoe  E121 Sensor Wire E124 Shoe Adjuster	E125 Prem Rotor E126 Std Rotor E127 Prem Drum E128 Std Drum E129 Hub L = Left R = Right V = Vented S = Solid	E122 Rotor E123 Drum	E139 Prem Cyl E140 Std Cyl E146 Semi-Loaded Cal E147 Loaded Cal	E148 Cal Kit E149 Cyl Kit	E155 Hose	E135 Prem M/C E136 Std M/C

DISCARD

DIAMETER

DIAMETER

**GMC TRUCK / Van (Cont'd)**

**SIERRA 2500 3/4 Ton RWD Pickup**

E110-0785-0 PB Shoe E116-0771-0	V E125-71-049 27.0	E122-71-015 PB Kit E123-71-012	L E146-71-012 51 R E146-71-013 51	E148-71-018	up E155-71-378 lo L E155-71-379 lo R E155-71-380	Except Trailer Brake E135-71-062 37mm Trailer Brake E135-71-063 37mm
E110-0785-0 PB Shoe E116-0771-0	V E125-71-049 27.0	E122-71-015 PB Kit E123-71-012	L E146-71-012 51 R E146-71-013 51	E148-71-018	Except StabiliTrak up E155-71-388 lo L E155-71-379 lo R E155-71-380 StabiliTrak up E155-71-403 lo L E155-71-406 lo R E155-71-380	Except StabiliTrak & Trailer Brake E135-71-073 38mm Trailer Brake Except StabiliTrak E135-71-074 38mm StabiliTrak E135-71-075 38mm
E110-1411-0 PB Shoe E116-0989-0	V E125-71-082 32.5	E122-71-031	L E146-71-542 48 R E146-71-543 48	E148-70-035	up E155-71-420 lo L E155-71-415 lo R E155-71-416	E135-71-075 38mm E135-71-075 38mm

**SIERRA 2500 3/4 Ton 4WD Pickup**

E110-0785-0 PB Shoe E116-0771-0	V E125-71-049 27.0	E122-71-015 PB Kit E123-71-012	L E146-71-012 51 R E146-71-013 51	E148-71-018	up E155-71-388 lo L E155-71-379 lo R E155-71-380	Except Trailer Brake E135-71-062 37mm Trailer Brake E135-71-063 37mm
E110-0785-0 PB Shoe E116-0771-0	V E125-71-049 27.0	E122-71-015 PB Kit E123-71-012	L E146-71-012 51 R E146-71-013 51	E148-71-018	Except StabiliTrak up E155-71-388 lo L E155-71-379 lo R E155-71-380 StabiliTrak up E155-71-403 lo L E155-71-406 lo R E155-71-380	Except StabiliTrak Except Trailer Brake E135-71-073 38mm Trailer Brake E135-71-074 38mm StabiliTrak E135-71-075 38mm
E110-1411-0 PB Shoe E116-0989-0	V E125-71-082 32.5	E122-71-031	L E146-71-542 48 R E146-71-543 48	E148-70-035	up E155-71-420 lo L E155-71-415 lo R E155-71-416	Except StabiliTrak E135-71-073 38mm StabiliTrak E135-71-075 38mm

**SIERRA 3500 1 Ton RWD Pickup**

E110-0785-0 PB Shoe E116-0771-0	V E125-71-049 27.0	E122-71-015 PB Kit E123-71-012	L E146-71-012 51 R E146-71-013 51	E148-71-018	up E155-71-341 lo L E155-71-343 lo R E155-71-342	E135-71-050 1 7/16"
E111-0909-0 PB Shoe E116-0771-0	V E125-71-055 28.5	E122-71-021 PB Kit E123-71-013	L E146-71-515 60 R E146-71-514 60	E148-71-020	up E155-71-341 lo L E155-71-345 lo R E155-71-344	E135-71-050 1 7/16"
E110-0785-0 PB Shoe E116-0771-0	V E125-71-049 27.0	E122-71-015 PB Kit E123-71-012	L E146-71-012 51 R E146-71-013 51	E148-71-018	up E155-71-388 lo L E155-71-379 lo R E155-71-380	Except Trailer Brake E135-71-062 37mm Trailer Brake E135-71-063 37mm
E111-0909-0 PB Shoe E116-0771-0	V E125-71-055 28.5	E122-71-021 PB Kit E123-71-013	L E146-71-515 60 R E146-71-514 60	E148-71-020	up E155-71-388 lo L E155-71-385 lo R E155-71-386	Except Trailer Brake E135-71-062 37mm Trailer Brake E135-71-063 37mm



# F R O N T

Many products are available in multiple grades or configurations. Refer to page 5 for details.

Make & Model	Year Notes	Pads	Rotor, Drum	DISCARD	Hardware Kits	Calipers, Wheel Cyl	DIAMETER	Kits Calipers, Wheel Cyl	Brake Hoses
		E105 OEM Type E107 Semi-Met E109 Prem Pad E110 Ceramic E111 HD Pad <b>Shoes</b> E116 Std Shoe E117 HD Shoe  E121 Sensor Wire E124 Shoe Adjuster	E125 Prem Rotor E126 Std Rotor E127 Prem Drum E128 Std Drum E129 Hub <b>L = Left</b> <b>R = Right</b> <b>V = Vented</b> <b>S = Solid</b>		E122 Rotor E123 Drum	E139 Prem Cyl E140 Std Cyl E146 Semi-Loaded Cal E147 Loaded Cal		E148 Cal Kit E149 Cyl Kit	E155 Hose

## GMC TRUCK / Van (Cont'd)

### SIERRA 3500 1 Ton RWD Pickup (Cont'd)

<b>2008</b>	SRW	E111-0784-0	V E125-71-064	36.5	E122-71-013	L E146-71-009 57 R E146-71-008 57	E148-71-016	L E155-71-383 R E155-71-384
	DRW	E111-0784-0	V E125-71-064	36.5	E122-71-013	L E146-71-043 60 R E146-71-042 60	E148-71-020	L E155-71-383 R E155-71-384
<b>2009 - 2010</b>	SRW	E111-0784-0	V E125-71-064	36.5	E122-71-013	L E146-71-009 57 R E146-71-008 57	E148-71-016	L E155-71-383 R E155-71-384
	DRW	E111-0784-0	V E125-71-064	36.5	E122-71-013	L E146-71-043 60 R E146-71-042 60	E148-71-020	L E155-71-383 R E155-71-384
<b>2011 - 2012</b>	SRW	2011 E110-1411-0	V E125-71-079	38.5	E122-71-032	L E146-71-061 60 R E146-71-060 60	E148-71-031	L E155-71-147 R E155-71-148
	DRW	2011 E110-1411-0	V E125-71-079	38.5	E122-71-032	L E146-71-061 60 R E146-71-060 60	E148-71-031	L E155-71-147 R E155-71-148

### SIERRA 3500 1 Ton 4WD Pickup

<b>2007</b>	GMT800 Series & SRW	E111-0784-0	V E125-71-064	36.5	E122-71-013	L E146-71-009 57 R E146-71-008 57	E148-71-016	L E155-71-115 R E155-71-114
	GMT800 Series & DRW	E111-0784-0	V E125-71-064	36.5	E122-71-013	L E146-71-043 60 R E146-71-042 60	E148-71-020	L E155-71-115 R E155-71-114
	GMT900 Series & SRW	E111-0784-0	V E125-71-064	36.5	E122-71-013	L E146-71-009 57 R E146-71-008 57	E148-71-016	L E155-71-383 R E155-71-384
	GMT900 Series & DRW	E111-0784-0	V E125-71-064	36.5	E122-71-013	L E146-71-043 60 R E146-71-042 60	E148-71-020	L E155-71-383 R E155-71-384

Many products are available in multiple grades or configurations. Refer to page 5 for details.

# R E A R

Pads	Rotor, Drum	Hardware Kits	Calipers, Wheel Cyl	Kits Calipers, Wheel Cyl	Brake Hoses	Master Cylinders
E105 OEM Type E107 Semi-Met E109 Prem Pad E110 Ceramic E111 HD Pad <b>Shoes</b> E116 Std Shoe E117 HD Shoe  E121 Sensor Wire E124 Shoe Adjuster	E125 Prem Rotor E126 Std Rotor E127 Prem Drum E128 Std Drum E129 Hub L = Left R = Right V = Vented S = Solid	E122 Rotor E123 Drum	E139 Prem Cyl E140 Std Cyl E146 Semi-Loaded Cal E147 Loaded Cal	E148 Cal Kit E149 Cyl Kit	E155 Hose	E135 Prem M/C E136 Std M/C
DISCARD		DIAMETER		DIAMETER		DIAMETER

## GMC TRUCK / Van (Cont'd)

### SIERRA 3500 1 Ton RWD Pickup (Cont'd)

E110-0785-0 PB Shoe E116-0771-0	v E125-71-049 27.0	E122-71-015 PB Kit E123-71-012	L E146-71-012 51 R E146-71-013 51	E148-71-018	up E155-71-388 lo L E155-71-379 lo R E155-71-380	Except Trailer Brake E135-71-062 37mm Trailer Brake E135-71-063 37mm
E111-0909-0 PB Shoe E116-0771-0	v E125-71-055 28.5	E122-71-021 PB Kit E123-71-013	L E146-71-515 60 R E146-71-514 60	E148-71-020	up E155-71-388 lo L E155-71-385 lo R E155-71-386	Except Trailer Brake E135-71-062 37mm Trailer Brake E135-71-063 37mm
E110-0785-0 PB Shoe E116-0771-0	v E125-71-049 27.0	E122-71-015 PB Kit E123-71-012		E148-71-018	up E155-71-388 lo L E155-71-379 lo R E155-71-380	Except Trailer Brake E135-71-073 38mm Trailer Brake E135-71-074 38mm
E111-0909-0 PB Shoe E116-0962-0	v E125-71-055 28.5	E122-71-021 PB Kit E123-71-012		E148-71-020	up E155-71-388 lo L E155-71-385 lo R E155-71-386	Except Trailer Brake E135-71-073 38mm Trailer Brake E135-71-074 38mm
E110-1411-0 PB Shoe E116-0989-0	v E125-71-082 32.5	E122-71-031 PB Kit E123-71-012	L E146-71-542 48 R E146-71-543 48	E148-70-035	up E155-71-420 lo L E155-71-415 lo R E155-71-416	E135-71-075 38mm
E110-1411-0 PB Shoe E116-0989-0	v E125-71-080 38.0	E122-71-031 PB Kit E123-71-012	L E146-71-545 57 R E146-71-544 57		Pickup up E155-71-422 Cab & Chassis up E155-71-412 Except Wide Track Axle lo L E155-71-413 lo R E155-71-414 Wide Track Axle lo L E155-71-417 lo R E155-71-418	Except Trailer Brake E135-71-073 38mm Trailer Brake E135-71-074 38mm

### SIERRA 3500 1 Ton 4WD Pickup

E110-0785-0 PB Shoe E116-0771-0	v E125-71-049 27.0	E122-71-015 PB Kit E123-71-012	L E146-71-012 51 R E146-71-013 51	E148-71-018	up E155-71-341 lo L E155-71-343 lo R E155-71-342	E135-71-050 1 7/16"
E111-0909-0 PB Shoe E116-0771-0	v E125-71-055 28.5	E122-71-021 PB Kit E123-71-013	L E146-71-515 60 R E146-71-514 60	E148-71-020	up E155-71-341 lo L E155-71-345 lo R E155-71-344	E135-71-050 1 7/16"
E110-0785-0 PB Shoe E116-0771-0	v E125-71-049 27.0	E122-71-015 PB Kit E123-71-012	L E146-71-012 51 R E146-71-013 51	E148-71-018	up E155-71-388 lo L E155-71-379 lo R E155-71-380	Except Trailer Brake E135-71-062 37mm Trailer Brake E135-71-063 37mm
E111-0909-0 PB Shoe E116-0771-0	v E125-71-055 28.5	E122-71-021 PB Kit E123-71-013	L E146-71-515 60 R E146-71-514 60	E148-71-020	up E155-71-388 lo L E155-71-385 lo R E155-71-386	Except Trailer Brake E135-71-062 37mm Trailer Brake E135-71-063 37mm

# F R O N T

Many products are available in multiple grades or configurations. Refer to page 5 for details.

Make & Model	Year Notes	Pads	Rotor, Drum	Hardware Kits	Calipers, Wheel Cyl	Kits Calipers, Wheel Cyl	Brake Hoses		
		E105 OEM Type E107 Semi-Met E109 Prem Pad E110 Ceramic E111 HD Pad <b>Shoes</b> E116 Std Shoe E117 HD Shoe  E121 Sensor Wire E124 Shoe Adjuster	E125 Prem Rotor E126 Std Rotor E127 Prem Drum E128 Std Drum E129 Hub <b>L = Left</b> <b>R = Right</b> <b>V = Vented</b> <b>S = Solid</b>	DISCARD	E122 Rotor E123 Drum	DIAMETER	E139 Prem Cyl E140 Std Cyl E146 Semi-Loaded Cal E147 Loaded Cal	E148 Cal Kit E149 Cyl Kit	E155 Hose

## GMC TRUCK / Van (Cont'd)

### SIERRA 3500 1 Ton 4WD Pickup (Cont'd)

2008	SRW	E111-0784-0	V E125-71-064	36.5	E122-71-013	L E146-71-009 57 R E146-71-008 57	E148-71-016	L E155-71-383 R E155-71-384
	DRW	E111-0784-0	V E125-71-064	36.5	E122-71-013	L E146-71-043 60 R E146-71-042 60	E148-71-020	L E155-71-383 R E155-71-384
2009 - 2010	SRW	E111-0784-0	V E125-71-064	36.5	E122-71-013	L E146-71-009 57 R E146-71-008 57	E148-71-016	L E155-71-383 R E155-71-384
	DRW	E111-0784-0	V E125-71-064	36.5	E122-71-013	L E146-71-043 60 R E146-71-042 60	E148-71-020	L E155-71-383 R E155-71-384
2011 - 2012	SRW	E110-1411-0	V E125-71-079	38.5	E122-71-032	L E146-71-061 60 R E146-71-060 60	E148-71-031	L E155-71-147 R E155-71-148
	DRW	E110-1411-0	V E125-71-079	38.5	E122-71-032	L E146-71-061 60 R E146-71-060 60	E148-71-031	L E155-71-147 R E155-71-148

## TERRAIN

2010 - 2011	E110-1125-0	V E125-67-125	27.0	E122-67-079	L E146-67-197 60 R E146-67-196 60	E148-56-026	L E155-67-175 R E155-67-176
-------------	-------------	---------------	------	-------------	--------------------------------------	-------------	--------------------------------

## YUKON, YUKON DENALI RWD Except XL

2007	Front Bracket Cast # 285C/286C	E110-1092-0	V E125-71-062	28.0	35mm Gap E122-71-026	L E146-71-049 51 R E146-71-048 51	E148-71-018	L E155-71-137 R E155-71-136
	2008	Front Bracket Cast # 351C/352C	E110-1363-0	V E125-71-062	28.0	38mm Gap E122-71-030	L E146-71-057 51 R E146-71-056 51	E148-71-018

Many products are available in multiple grades or configurations. Refer to page 5 for details.

# R E A R

Pads	Rotor, Drum	Hardware Kits	Calipers, Wheel Cyl	Kits Calipers, Wheel Cyl	Brake Hoses	Master Cylinders
E105 OEM Type E107 Semi-Met E109 Prem Pad E110 Ceramic E111 HD Pad	E125 Prem Rotor E126 Std Rotor E127 Prem Drum E128 Std Drum E129 Hub	E122 Rotor E123 Drum	E139 Prem Cyl E140 Std Cyl E146 Semi-Loaded Cal E147 Loaded Cal	E148 Cal Kit E149 Cyl Kit	E155 Hose	E135 Prem M/C E136 Std M/C
<b>Shoes</b> E116 Std Shoe E117 HD Shoe	L = Left R = Right V = Vented S = Solid	DISCARD	DIAMETER	DIAMETER		DIAMETER
E121 Sensor Wire E124 Shoe Adjuster						

## GMC TRUCK / Van (Cont'd)

### SIERRA 3500 1 Ton 4WD Pickup (Cont'd)

E110-0785-0 PB Shoe E116-0771-0	v E125-71-049 27.0	E122-71-015 PB Kit E123-71-012	L E146-71-012 51 R E146-71-013 51	E148-71-018	up E155-71-388 lo L E155-71-379 lo R E155-71-380	Except Trailer Brake E135-71-062 37mm Trailer Brake E135-71-063 37mm
E111-0909-0 PB Shoe E116-0771-0	v E125-71-055 28.5	E122-71-021 PB Kit E123-71-013	L E146-71-515 60 R E146-71-514 60	E148-71-020	up E155-71-388 lo L E155-71-385 lo R E155-71-386	Except Trailer Brake E135-71-062 37mm Trailer Brake E135-71-063 37mm
E110-0785-0 PB Shoe E116-0771-0	v E125-71-049 27.0	E122-71-015 PB Kit E123-71-012	L E146-71-012 51 R E146-71-013 51	E148-71-018	up E155-71-388 lo L E155-71-379 lo R E155-71-380	Except Trailer Brake E135-71-073 38mm Trailer Brake E135-71-074 38mm
E111-0909-0 PB Shoe E116-0962-0	v E125-71-055 28.5	E122-71-021 PB Kit E123-71-012	L E146-71-515 60 R E146-71-514 60	E148-71-020	up E155-71-388 lo L E155-71-385 lo R E155-71-386	Except Trailer Brake E135-71-073 38mm Trailer Brake E135-71-074 38mm
E110-1411-0 PB Shoe E116-0989-0	v E125-71-082 32.5	E122-71-031	L E146-71-542 48 R E146-71-543 48	E148-70-035	up E155-71-420 lo L E155-71-415 lo R E155-71-416	E135-71-075 38mm
E110-1411-0 PB Shoe E116-0989-0	v E125-71-080 38.0	E122-71-031	L E146-71-545 57 R E146-71-544 57		Pickup up E155-71-422 Cab & Chassis up E155-71-412 Pickup or Cab & Chassis Except Wide Track Axle lo L E155-71-413 lo R E155-71-414 Cab & Chassis, & Wide Track Axle lo L E155-71-417 lo R E155-71-418	Except Trailer Brake E135-71-073 38mm Trailer Brake E135-71-074 38mm

### TERRAIN

E110-1275-0 PB Shoe E116-0932-0	v E125-71-078 18.4	E122-71-029 PB Kit E123-67-040	L E146-71-539 40 R E146-71-538 40	E148-44-020	L E155-67-447 R E155-67-438	E135-67-180 1"
---------------------------------------	--------------------	--------------------------------------	--------------------------------------	-------------	--------------------------------	----------------

### YUKON, YUKON DENALI RWD Except XL

E110-1194-0 PB Shoe E116-0781-0	v E125-71-070 18.5	E122-71-027 PB Kit E123-71-015	L E146-71-535 51 R E146-71-534 51	E148-71-028	up E155-71-377 lo L E155-71-375 lo R E155-71-376	E135-71-061 1 1/4"
E110-1194-0 PB Shoe E116-0781-0	v E125-71-070 18.5	E122-71-027 PB Kit E123-71-015	L E146-71-535 51 R E146-71-534 51	E148-71-028	up E155-71-377 lo L E155-71-375 lo R E155-71-398	E135-71-061 1 1/4"

# F R O N T

Many products are available in multiple grades or configurations. Refer to page 5 for details.

Make & Model	Year Notes	Pads	Rotor, Drum		Hardware Kits	Calipers, Wheel Cyl		Kits	Brake Hoses
		E105 OEM Type E107 Semi-Met E109 Prem Pad E110 Ceramic E111 HD Pad <b>Shoes</b> E116 Std Shoe E117 HD Shoe  E121 Sensor Wire E124 Shoe Adjuster	E125 Prem Rotor E126 Std Rotor E127 Prem Drum E128 Std Drum E129 Hub <b>L = Left</b> <b>R = Right</b> <b>V = Vented</b> <b>S = Solid</b>	DISCARD	E122 Rotor E123 Drum	E139 Prem Cyl E140 Std Cyl E146 Semi-Loaded Cal E147 Loaded Cal	DIAMETER	E148 Cal Kit E149 Cyl Kit	E155 Hose

## GMC TRUCK / Van (Cont'd)

### YUKON, YUKON DENALI RWD Except XL (Cont'd)

2009 - 2010	E110-1363-0	V E125-71-062	28.0	E122-71-030	L E146-71-057 51 R E146-71-056 51	E148-71-018	L E155-71-145 R E155-71-142
2011	E110-1363-0	V E125-71-062	28.0	E122-71-030	L E146-71-057 51 R E146-71-056 51	E148-71-018	L E155-71-145 R E155-71-142

### YUKON, YUKON DENALI 4WD Except XL

2007	Front Bracket Cast # 285C/286C	E110-1092-0	V E125-71-062	28.0	35mm Gap E122-71-026	L E146-71-049 51 R E146-71-048 51	E148-71-018	L E155-71-137 R E155-71-136
2008	Front Bracket Cast # 351C/352C	E110-1363-0	V E125-71-062	28.0	38mm Gap E122-71-030	L E146-71-057 51 R E146-71-056 51	E148-71-018	L E155-71-137 R E155-71-142
2009 - 2010		E110-1363-0	V E125-71-062	28.0	E122-71-030	L E146-71-057 51 R E146-71-056 51	E148-71-018	L E155-71-145 R E155-71-142
2011		E110-1363-0	V E125-71-062	28.0	E122-71-030	L E146-71-057 51 R E146-71-056 51	E148-71-018	L E155-71-145 R E155-71-142

### YUKON XL 1500, YUKON DENALI XL 1/2 Ton

2007	Front Bracket Cast # 285C/286C	E110-1092-0	V E125-71-062	28.0	35mm Gap E122-71-026	L E146-71-049 51 R E146-71-048 51	E148-71-018	L E155-71-137 R E155-71-136
2008	Front Bracket Cast # 351C/352C	E110-1363-0	V E125-71-062	28.0	38mm Gap E122-71-030	L E146-71-057 51 R E146-71-056 51	E148-71-018	L E155-71-137 R E155-71-142
2009 - 2010		E110-1363-0	V E125-71-062	28.0	E122-71-030	L E146-71-057 51 R E146-71-056 51	E148-71-018	L E155-71-145 R E155-71-142
2011		E110-1363-0	RWD V E125-71-062	28.0	E122-71-030	L E146-71-057 51 R E146-71-056 51	E148-71-018	L E155-71-145 R E155-71-142

### YUKON XL 2500 3/4 Ton

2007	E111-0784-0	V E125-71-047	36.5	E122-71-013	L E146-71-009 57 R E146-71-008 57	E148-71-016	L E155-71-383 R E155-71-384
2008	E111-0784-0	V E125-71-047	36.5	E122-71-013	L E146-71-009 57 R E146-71-008 57	E148-71-016	L E155-71-383 R E155-71-384

Many products are available in multiple grades or configurations. Refer to page 5 for details.

# R E A R

<b>Pads</b> E105 OEM Type E107 Semi-Met E109 Prem Pad E110 Ceramic E111 HD Pad <b>Shoes</b> E116 Std Shoe E117 HD Shoe  E121 Sensor Wire E124 Shoe Adjuster	<b>Rotor, Drum</b> E125 Prem Rotor E126 Std Rotor E127 Prem Drum E128 Std Drum E129 Hub L = Left R = Right V = Vented S = Solid	<b>Hardware Kits</b>  E122 Rotor E123 Drum	<b>Calipers, Wheel Cyl</b>  E139 Prem Cyl E140 Std Cyl E146 Semi-Loaded Cal E147 Loaded Cal	<b>Kits Calipers, Wheel Cyl</b> E148 Cal Kit E149 Cyl Kit	<b>Brake Hoses</b>  E155 Hose	<b>Master Cylinders</b>  E135 Prem M/C E136 Std M/C	<b>DISCARD</b>	<b>DIAMETER</b>	<b>DIAMETER</b>
--	--	---	--	---	-------------------------------------	--	----------------	-----------------	-----------------

## GMC TRUCK / Van (Cont'd)

### YUKON, YUKON DENALI RWD Except XL (Cont'd)

E110-1194-0 PB Shoe E116-0781-0 E110-1194-0	v E125-71-070 18.5	E122-71-027 PB Kit E123-71-015	L E146-71-535 51 R E146-71-534 51	E148-71-028	up E155-71-377 lo L E155-71-375 lo R E155-71-398	Except Hybrid E135-71-071 1 1/4" Hybrid E135-71-070 13/16"
E110-1194-0	v E125-71-070 18.5	E122-71-027	L E146-71-535 51 R E146-71-534 51	E148-71-028	up lo L E155-71-375 lo R E155-71-398	Except Hybrid E135-71-071 1 1/4" Hybrid E135-71-070 13/16"

### YUKON, YUKON DENALI 4WD Except XL

E110-1194-0 PB Shoe E116-0781-0	v E125-71-070 18.5	E122-71-027 PB Kit E123-71-015	L E146-71-535 51 R E146-71-534 51	E148-71-028	up E155-71-377 lo L E155-71-375 lo R E155-71-376	E135-71-061 1 1/4"
E110-1194-0 PB Shoe E116-0781-0	v E125-71-070 18.5	E122-71-027 PB Kit E123-71-015	L E146-71-535 51 R E146-71-534 51	E148-71-028	up E155-71-377 lo L E155-71-375 lo R E155-71-398	E135-71-061 1 1/4"
E110-1194-0 PB Shoe E116-0781-0	v E125-71-070 18.5	E122-71-027 PB Kit E123-71-015	L E146-71-535 51 R E146-71-534 51	E148-71-028	up E155-71-377 lo L E155-71-375 lo R E155-71-398	Except Hybrid E135-71-071 1 1/4" Hybrid E135-71-070 13/16"
E110-1194-0	v E125-71-070 18.5	E122-71-027	L E146-71-535 51 R E146-71-534 51	E148-71-028	up lo L E155-71-375 lo R E155-71-398	Except Hybrid E135-71-071 1 1/4" Hybrid E135-71-070 13/16"

### YUKON XL 1500, YUKON DENALI XL 1/2 Ton

E110-1194-0 PB Shoe E116-0781-0	v E125-71-070 18.5	E122-71-027 PB Kit E123-71-015	L E146-71-535 51 R E146-71-534 51	E148-71-028	up E155-71-377 lo L E155-71-375 lo R E155-71-376	E135-71-061 1 1/4"
E110-1194-0 PB Shoe E116-0781-0	v E125-71-070 18.5	E122-71-027 PB Kit E123-71-015	L E146-71-535 51 R E146-71-534 51	E148-71-028	up E155-71-377 lo L E155-71-375 lo R E155-71-398	E135-71-061 1 1/4"
E110-1194-0 PB Shoe E116-0781-0	v E125-71-070 18.5	E122-71-027 PB Kit E123-71-015	L E146-71-535 51 R E146-71-534 51	E148-71-028	up E155-71-377 lo L E155-71-375 lo R E155-71-398	E135-71-071 1 1/4"
E110-1194-0	v E125-71-070 18.5	E122-71-027	L E146-71-535 51 R E146-71-534 51	E148-71-028	up lo L E155-71-375 lo R E155-71-398	E135-71-071 1 1/4"

### YUKON XL 2500 3/4 Ton

E110-0785-0 PB Shoe E116-0771-0	v E125-71-048 26.5	E122-71-015 PB Kit E123-71-012	L E146-71-012 51 R E146-71-013 51	E148-71-018	up E155-71-378 lo L E155-71-379 lo R E155-71-380	E135-71-062 37mm
E110-0785-0 PB Shoe E116-0771-0	v E125-71-049 27.0	E122-71-015 PB Kit E123-71-012	L E146-71-012 51 R E146-71-013 51	E148-71-018	up E155-71-404 lo L E155-71-379 lo R E155-71-406	E135-71-067 37mm

# F R O N T

Many products are available in multiple grades or configurations. Refer to page 5 for details.

Make & Model	Year Notes	Pads	Rotor, Drum	DISCARD	Hardware Kits	Calipers, Wheel Cyl	DIAMETER	Kits Calipers, Wheel Cyl	Brake Hoses
		E105 OEM Type E107 Semi-Met E109 Prem Pad E110 Ceramic E111 HD Pad <b>Shoes</b> E116 Std Shoe E117 HD Shoe  E121 Sensor Wire E124 Shoe Adjuster	E125 Prem Rotor E126 Std Rotor E127 Prem Drum E128 Std Drum E129 Hub <b>L = Left</b> <b>R = Right</b> <b>V = Vented</b> <b>S = Solid</b>		E122 Rotor E123 Drum	E139 Prem Cyl E140 Std Cyl E146 Semi-Loaded Cal E147 Loaded Cal		E148 Cal Kit E149 Cyl Kit	E155 Hose

## GMC TRUCK / Van (Cont'd)

### YUKON XL 2500 ¾ Ton (Cont'd)

2009 - 2010	E111-0784-0	V E125-71-047	36.5	E122-71-013	L E146-71-009	57	E148-71-016	L E155-71-383
					R E146-71-008	57		R E155-71-384
2011	E111-0784-0	V E125-71-047	36.5	E122-71-013	L E146-71-009	57	E148-71-016	L E155-71-383
					R E146-71-008	57		R E155-71-384

## HUMMER

### H2

2003 - 2010	E111-0784-0	V E125-71-047	36.5	E122-71-013	L E146-71-009	57	E148-71-016	L E155-71-115
					R E146-71-008	57		R E155-71-114
2008	E111-0784-0	V E125-71-047	36.5	E122-71-013	L E146-71-009	57	E148-71-016	L E155-71-383
					R E146-71-008	57		R E155-71-384
2009	E111-0784-0	V E125-71-047	36.5	E122-71-013	L E146-71-009	57	E148-71-016	L E155-71-383
					R E146-71-008	57		R E155-71-384

### H3

2006 - 2007	E110-1119-0	V E125-74-006	26.5	E122-49-080	L E146-74-007	45.5	E148-49-074	L E155-74-007
					R E146-74-006	45.5		R E155-74-006
2008 - 2010	E110-1119-0	V E125-74-006	26.5	E122-49-080	L E146-74-007	45.5	E148-49-074	L E155-74-007
					R E146-74-006	45.5		R E155-74-006

Many products are available in multiple grades or configurations. Refer to page 5 for details.

# R E A R

<b>Pads</b> E105 OEM Type E107 Semi-Met E109 Prem Pad E110 Ceramic E111 HD Pad <b>Shoes</b> E116 Std Shoe E117 HD Shoe  E121 Sensor Wire E124 Shoe Adjuster	<b>Rotor, Drum</b> E125 Prem Rotor E126 Std Rotor E127 Prem Drum E128 Std Drum E129 Hub L = Left R = Right V = Vented S = Solid	DISCARD	<b>Hardware Kits</b> E122 Rotor E123 Drum	<b>Calipers, Wheel Cyl</b> E139 Prem Cyl E140 Std Cyl E146 Semi-Loaded Cal E147 Loaded Cal	DIAMETER	<b>Kits Calipers, Wheel Cyl</b> E148 Cal Kit E149 Cyl Kit	<b>Brake Hoses</b> E155 Hose	<b>Master Cylinders</b> E135 Prem M/C E136 Std M/C	DIAMETER

## GMC TRUCK / Van (Cont'd)

### YUKON XL 2500 3/4 Ton (Cont'd)

E110-0785-0	V E125-71-049	27.0	E122-71-015	L E146-71-012	51	E148-71-018	up	E155-71-404	12mm Ports	
PB Shoe			PB Kit	R E146-71-013	51		lo L	E155-71-379	E135-71-073	38mm
E116-0771-0			E123-71-012				lo R	E155-71-406	14mm Ports	
E110-0785-0	V E125-71-049	27.0	E122-71-015	L E146-71-012	51	E148-71-018	up	E155-71-404	E135-71-075	38mm
PB Shoe				R E146-71-013	51		lo L	E155-71-379		
E116-0962-0							lo R	E155-71-406		

## HUMMER

### H2

E110-0785-0	V E125-71-048	26.5	E122-71-015	L E146-71-013	51	E148-71-018	up L	E155-71-399	E135-71-047	37mm
PB Shoe			PB Kit	R E146-71-012	51		up R	E155-71-360		
E116-0771-0			E123-71-012				lo L	E155-71-353		
E110-0785-0	V E125-71-048	26.5	E122-71-015	L E146-71-013	51	E148-71-018	up L	E155-71-391	Integral Unit	
PB Shoe			PB Kit	R E146-71-012	51		up R	E155-71-400		
E116-0771-0			E123-71-012				lo L	E155-71-393		
E110-0785-0	V E125-71-048	26.5	E122-71-015	L E146-71-013	51	E148-71-018	up L	E155-71-391	Integral Unit	
PB Shoe			PB Kit	R E146-71-012	51		up R	E155-71-400		
E116-0962-0			E123-71-012				lo L	E155-71-393		
							lo R	E155-71-392		

### H3

E109-1120-0	S E125-74-007	10.5	E122-74-006	L E146-74-507	45.5	E148-27-011	up L	E155-74-309	Integral Unit	
PB Shoe			PB Kit	R E146-74-506	45.5		up R	E155-74-308		
E116-0908-0			E123-74-006				lo L	E155-74-307		
E109-1120-0	S E125-74-007	10.5	E122-74-006	L E146-74-507	45.5	E148-27-011	up L	E155-74-309	Integral Unit	
PB Shoe			PB Kit	R E146-74-506	45.5		up R	E155-74-308		
E116-0908-0			E123-74-006				lo L	E155-74-311		
							lo R	E155-74-310		



# F R O N T

Many products are available in multiple grades or configurations. Refer to page 5 for details.

Make & Model	Year Notes	Pads	Rotor, Drum	Hardware Kits	Calipers, Wheel Cyl	Kits Calipers, Wheel Cyl	Brake Hoses
		E105 OEM Type E107 Semi-Met E109 Prem Pad E110 Ceramic E111 HD Pad <b>Shoes</b> E116 Std Shoe E117 HD Shoe  E121 Sensor Wire E124 Shoe Adjuster	E125 Prem Rotor E126 Std Rotor E127 Prem Drum E128 Std Drum E129 Hub <b>L = Left</b> <b>R = Right</b> <b>V = Vented</b> <b>S = Solid</b>	E122 Rotor E123 Drum	E139 Prem Cyl E140 Std Cyl E146 Semi-Loaded Cal E147 Loaded Cal	E148 Cal Kit E149 Cyl Kit	E155 Hose

DISCARD

DIAMETER

## JEEP

### COMMANDER

<b>2006 - 2010</b>	E109-1080-0	V E125-63-006	28.5	E122-63-010	L E146-63-013 48 R E146-63-012 48	E148-63-010	L E155-63-024 R E155-63-023
--------------------	-------------	---------------	------	-------------	--------------------------------------	-------------	--------------------------------

### COMPASS

<b>2007 - 2008</b>	E110-0866-0	V E125-68-072	24.4	E122-51-021	L E146-68-083 57 R E146-68-082 57	E148-68-038	L E155-68-089 R E155-68-088
<b>2009 - 2012</b> FWD Rear Drums	E110-0866-0	V E125-68-072	24.4	E122-51-021	L E146-68-083 57 R E146-68-082 57	E148-68-038	L E155-68-089 R E155-68-088
4WD 262mm Rear Disc	E110-0866-0	V E125-68-072	24.4	E122-51-021	L E146-68-083 57 R E146-68-082 57	E148-68-038	L E155-68-089 R E155-68-088
4WD 302mm Rear Disc	E110-0866-0	V E125-68-072	24.4	E122-51-021	L E146-68-083 57 R E146-68-082 57	E148-68-038	L E155-68-089 R E155-68-088

### GRAND CHEROKEE

<b>2006 - 2010</b> Except SRT-8	E109-1080-0	V E125-63-006	28.5	E122-63-010	L E146-63-013 48 R E146-63-012 48	E148-63-010	L E155-63-024 R E155-63-023
<b>2011</b> 330mm Front Disc & Solid Rear Disc	E110-1455-0	V E125-63-011	30.5	E122-63-012	L E146-63-015 48 R E146-63-014 48	E148-63-006	L E155-63-035 R E155-63-034
350mm Front Disc & Vented Rear Disc	E110-1455-0	V E125-63-013	30.5	E122-63-012	L E146-63-017 48 R E146-63-016 48	E148-63-006	L E155-63-035 R E155-63-034
<b>2012</b> 330mm Front Disc & Solid Rear Disc	E110-1455-0	V E125-63-011	30.5	E122-63-012	L E146-63-015 48 R E146-63-014 48	E148-63-006	L E155-63-035 R E155-63-034
350mm Front Disc & 330mm Vented Rear Disc	E110-1455-0	V E125-63-013	30.5	E122-63-012	L E146-63-017 48 R E146-63-016 48	E148-63-006	L E155-63-035 R E155-63-034

## J8

<b>2008 - 2011</b>	E111-1084-0				54	E148-72-014	
--------------------	-------------	--	--	--	----	-------------	--

Many products are available in multiple grades or configurations. Refer to page 5 for details.

# R E A R

Pads	Rotor, Drum	Hardware Kits	Calipers, Wheel Cyl	Kits Calipers, Wheel Cyl	Brake Hoses	Master Cylinders
E105 OEM Type E107 Semi-Met E109 Prem Pad E110 Ceramic E111 HD Pad <b>Shoes</b> E116 Std Shoe E117 HD Shoe  E121 Sensor Wire E124 Shoe Adjuster	E125 Prem Rotor E126 Std Rotor E127 Prem Drum E128 Std Drum E129 Hub <b>L = Left</b> <b>R = Right</b> <b>V = Vented</b> <b>S = Solid</b>	E122 Rotor E123 Drum	E139 Prem Cyl E140 Std Cyl E146 Semi-Loaded Cal E147 Loaded Cal	E148 Cal Kit E149 Cyl Kit	E155 Hose	E135 Prem M/C E136 Std M/C

DISCARD

DIAMETER

DIAMETER

## JEEP

### COMMANDER

E109-1087-0  PB Shoe E116-0843-0	S E125-63-007 12.5	E122-66-043  PB Kit E123-47-026	L E146-63-511 48 R E146-63-510 48	E148-47-038	2006 L E155-63-309 R E155-63-310 2007 - 2010 L E155-63-319 R E155-63-320	E135-63-013 26mm
---	--------------------	--	--------------------------------------	-------------	---	------------------

### COMPASS

E110-1037-0 PB Shoe E116-0886-1	S E125-68-071 8.4	E122-51-020 PB Kit E123-68-028	L E146-68-539 35 R E146-68-538 35	E148-96-008	up L E155-68-389 up R E155-68-388 lo E155-68-390	E135-68-073 13/16"
E116-0919-0 228.6 x 36.6	E127-68-053 230.6	E123-68-027	E139-68-040 13/16"		2009 - 2010 L E155-68-399 R E155-68-400 2011 - 2012 L E155-68-389 R E155-68-388	E135-68-073 13/16"
L E124-68-029 R E124-68-028						
E110-1037-0 PB Shoe E116-0886-1	S E125-68-071 8.4	E122-51-020 PB Kit E123-68-028	L E146-68-539 35 R E146-68-538 35	E148-96-008	up L E155-68-399 up R E155-68-400 lo E155-68-392	E135-68-073 13/16"
E110-0868-0 PB Shoe E116-0886-1	S E125-68-074 8.4	E122-51-020 PB Kit E123-68-028	L E146-68-543 35 R E146-68-542 35	E148-96-008	up L E155-68-399 up R E155-68-400 lo E155-68-392	E135-68-073 13/16"

### GRAND CHEROKEE

E109-1087-0  PB Shoe E116-0843-0	S E125-63-007 12.5	E122-66-043  PB Kit E123-47-029	L E146-63-511 48 R E146-63-510 48	E148-47-038	2006 L E155-63-309 R E155-63-310 2007 - 2010 L E155-63-319 R E155-63-320	E135-63-013 26mm
E110-1498-0 PB Shoe E116-0986-0	S E125-63-010 12.5	E122-40-039 PB Shoe E123-63-010	L E146-63-515 48 R E146-63-514 48	E148-63-007	L E155-63-323 R E155-63-322	E135-63-014 27mm
E110-1498-0 PB Shoe E116-0986-0	V E125-63-012 20.5	E122-40-039 PB Shoe E123-63-010	L E146-63-517 48 R E146-63-516 48	E148-63-007	L E155-63-323 R E155-63-322	E135-63-014 27mm
E110-1498-0 PB Shoe E116-0986-0	S E125-63-010 12.5	E122-40-039 PB Shoe E123-63-010	L E146-63-515 48 R E146-63-514 48	E148-63-007	L E155-63-323 R E155-63-322	E135-63-014 27mm
E110-1498-0 PB Shoe E116-0986-0	V E125-63-012 20.5	E122-40-039 PB Shoe E123-63-010	L E146-63-517 48 R E146-63-516 48	E148-63-007	L E155-63-323 R E155-63-322	E135-63-014 27mm

### J8

E111-0898-0 PB Shoe E116-0947-0	V E125-72-059 20.4	E122-72-011	L E146-72-507 54 R E146-72-506 54	E148-68-011		
---------------------------------------	--------------------	-------------	--------------------------------------	-------------	--	--

# F R O N T

Many products are available in multiple grades or configurations. Refer to page 5 for details.

Make & Model	Year Notes	Pads	Rotor, Drum	DISCARD	Hardware Kits	Calipers, Wheel Cyl	DIAMETER	Kits Calipers, Wheel Cyl	Brake Hoses
		E105 OEM Type E107 Semi-Met E109 Prem Pad E110 Ceramic E111 HD Pad <b>Shoes</b> E116 Std Shoe E117 HD Shoe  E121 Sensor Wire E124 Shoe Adjuster	E125 Prem Rotor E126 Std Rotor E127 Prem Drum E128 Std Drum E129 Hub <b>L = Left</b> <b>R = Right</b> <b>V = Vented</b> <b>S = Solid</b>		E122 Rotor E123 Drum	E139 Prem Cyl E140 Std Cyl E146 Semi-Loaded Cal E147 Loaded Cal		E148 Cal Kit E149 Cyl Kit	E155 Hose

## JEEP (Cont'd)

### LIBERTY

2007		E109-0856-0	V E125-72-057 26.0	E122-73-006	L E146-63-009 66 R E146-63-008 66	E148-63-009	L E155-63-019 R E155-63-020
2008		E110-1273-0	V E125-68-076 26.4	E122-66-047	L E146-72-061 66 R E146-72-060 66	E148-72-017	L E155-63-031 R E155-63-030
2009 - 2011		E110-1273-0	V E125-68-076 26.4	E122-66-047	L E146-72-061 66 R E146-72-060 66	E148-72-017	L E155-63-031 R E155-63-030
2012	Standard Brakes	E110-1273-0	V E125-68-076 26.4	E122-66-047	L E146-72-061 66 R E146-72-060 66	E148-72-017	L E155-63-031 R E155-63-030
	Heavy Duty Brakes	E111-1273-0	V E125-68-083	E122-66-047		E148-72-017	L E155-63-031 R E155-63-030

### PATRIOT

2007 - 2008		E110-0866-0	V E125-68-072 24.4	E122-51-021	L E146-68-083 57 R E146-68-082 57	E148-68-038	L E155-68-089 R E155-68-088
2009 - 2012	FWD	E110-0866-0	V E125-68-072 24.4	E122-51-021	L E146-68-083 57 R E146-68-082 57	E148-68-038	L E155-68-089 R E155-68-088
	4WD 262mm Rear Disc	E110-0866-0	V E125-68-072 24.4	E122-51-021	L E146-68-083 57 R E146-68-082 57	E148-68-038	L E155-68-089 R E155-68-088
	4WD 302mm Rear Disc	E110-0866-0	V E125-68-072 24.4	E122-51-021	L E146-68-083 57 R E146-68-082 57	E148-68-038	L E155-68-089 R E155-68-088

### WRANGLER

2007 - 2010		E110-1273-0	V E125-72-073 26.4	E122-66-047	L E146-72-061 66 R E146-72-060 66	E148-72-017	L E155-63-029 R E155-63-028
2011		E110-1273-0	V E125-72-073 26.4	E122-66-047	L E146-72-061 66 R E146-72-060 66	E148-72-017	L E155-63-033 R E155-63-032
2012		E110-1273-0	V E125-72-073 26.4	E122-66-047	L E146-72-061 66 R E146-72-060 66	E148-72-017	

Many products are available in multiple grades or configurations. Refer to page 5 for details.

# R E A R

Pads	Rotor, Drum	Hardware Kits	Calipers, Wheel Cyl	Kits Calipers, Wheel Cyl	Brake Hoses	Master Cylinders
E105 OEM Type E107 Semi-Met E109 Prem Pad E110 Ceramic E111 HD Pad <b>Shoes</b> E116 Std Shoe E117 HD Shoe  E121 Sensor Wire E124 Shoe Adjuster	E125 Prem Rotor E126 Std Rotor E127 Prem Drum E128 Std Drum E129 Hub L = Left R = Right V = Vented S = Solid	E122 Rotor E123 Drum	E139 Prem Cyl E140 Std Cyl E146 Semi-Loaded Cal E147 Loaded Cal	E148 Cal Kit E149 Cyl Kit	E155 Hose	E135 Prem M/C E136 Std M/C

DISCARD

DIAMETER

DIAMETER

## JEEP (Cont'd)

### LIBERTY

E110-0964-0 PB Shoe E116-0745-0	S E125-72-068 11.0	Pad Clips E122-70-017 Caliper Strap E122-63-011 PB Kit E123-63-008	L E146-70-551 48 R E146-70-550 48	E148-66-024	up E155-63-314 lo L E155-72-399 lo R E155-72-374	E135-63-012 27mm
E109-1274-0 PB Shoe E116-0941-0	S E125-68-075 10.4	E122-66-047 PB Kit E123-72-009	L E146-72-523 48 R E146-72-522 48	E148-96-020	L E155-63-321 R E155-68-396	E135-68-075 1 1/16"
E109-1274-0 PB Shoe E116-0941-0	S E125-68-075 10.4	E122-66-047 PB Kit E123-72-009	L E146-72-523 48 R E146-72-522 48	E148-96-020	L E155-63-321 R E155-68-402	E135-68-075 1 1/16"
E109-1274-0 PB Shoe E116-0941-0	S E125-68-075 10.4	E122-66-047	L E146-72-523 48 R E146-72-522 48	E148-96-020	L E155-63-321 R E155-68-402	E135-68-075 1 1/16"
E109-1274-0 PB Shoe E116-0941-0	S E125-68-075 10.4	E122-66-047	L E146-72-523 48 R E146-72-522 48	E148-96-020	L E155-63-321 R E155-68-402	E135-68-075 1 1/16"

### PATRIOT

E110-1037-0 PB Shoe E116-0886-1	S E125-68-071 8.4	E122-51-020 PB Kit E123-68-028	L E146-68-539 35 R E146-68-538 35	E148-96-008	up L E155-68-389 up R E155-68-388 lo E155-68-390	E135-68-073 13/16"
E116-0919-0 228.6 x 36.6 L E124-68-029 R E124-68-028	E127-68-053 230.6	E123-68-027	E139-68-040 13/16"		2009 - 2010 L E155-68-399 R E155-68-400 2011 - 2012 L E155-68-389 R E155-68-388	E135-68-073 13/16"
E110-1037-0 PB Shoe E116-0886-1	S E125-68-071 8.4	E122-51-020 PB Kit E123-68-028	L E146-68-539 35 R E146-68-538 35	E148-96-008	up L E155-68-399 up R E155-68-400 lo E155-68-392	E135-68-073 13/16"
E110-0868-0 PB Shoe E116-0886-1	S E125-68-074 8.4	E122-51-020 PB Kit E123-68-028	L E146-68-543 35 R E146-68-542 35	E148-96-008	up L E155-68-399 up R E155-68-400 lo E155-68-392	E135-68-073 13/16"

### WRANGLER

E109-1274-0 PB Shoe E116-0941-0	S E125-72-072 10.4	E122-66-047 PB Kit E123-72-009	L E146-72-522 48 R E146-72-523 48	E148-96-020	L E155-63-317 R E155-63-318	E135-68-079 1"
E109-1274-0 PB Shoe E116-0941-0	S E125-72-072 10.4	E122-66-047 PB Kit E123-72-009	L E146-72-522 48 R E146-72-523 48	E148-96-020	L E155-63-317 R E155-63-318	E135-68-079 1"
E109-1274-0 PB Shoe E116-0941-0	S E125-72-072 10.4	E122-66-047 PB Kit E123-72-009	L E146-72-522 48 R E146-72-523 48	E148-96-020		E135-68-079 1"

# F R O N T

Many products are available in multiple grades or configurations. Refer to page 5 for details.

Make & Model	Year Notes	Pads	Rotor, Drum	Hardware Kits	Calipers, Wheel Cyl	Kits Calipers, Wheel Cyl	Brake Hoses		
		E105 OEM Type E107 Semi-Met E109 Prem Pad E110 Ceramic E111 HD Pad <b>Shoes</b> E116 Std Shoe E117 HD Shoe  E121 Sensor Wire E124 Shoe Adjuster	E125 Prem Rotor E126 Std Rotor E127 Prem Drum E128 Std Drum E129 Hub <b>L = Left</b> <b>R = Right</b> <b>V = Vented</b> <b>S = Solid</b>	DISCARD	E122 Rotor E123 Drum	DIAMETER	E139 Prem Cyl E140 Std Cyl E146 Semi-Loaded Cal E147 Loaded Cal	E148 Cal Kit E149 Cyl Kit	E155 Hose

## LINCOLN

### MARK LT

12/05 - 2008	Base Payload Pkg 6 Lug	E111-1011-0	RWD Upgrade Kit Hub & Rotor Assy V E125-70-133 28.5 After Upgrade Service with: Rotor Only V E125-70-105 28.5 Hub Only E129-70-907 Spindle Nut E129-70-906 4WD V E125-70-105 28.5	E122-70-030	L E146-70-081 54 R E146-70-080 54	E148-70-032	L E155-70-193 R E155-70-192
	Heavy Duty Payload Pkg 7 Lug	E111-1011-0	RWD Upgrade Kit Hub & Rotor Assy V E125-70-134 28.5 After Upgrade Service with: Rotor Only V E125-70-106 28.5 Hub Only E129-70-908 Spindle Nut E129-70-906 4WD V E125-70-106 28.5	E122-70-030	L E146-70-081 54 R E146-70-080 54	E148-70-032	L E155-70-193 R E155-70-192

### MKT

2010	E111-1376-0	V E125-66-099 28.5	E122-70-034	L E146-70-095 48 R E146-70-094 48	E148-70-035	L E155-66-129 R E155-66-130
2011 - 2012	E110-1508-0	V E125-66-107 28.4	E122-70-042	L E146-70-095 48 R E146-70-094 48	E148-70-035	L E155-66-129 R E155-66-130

### MKX

2007 - 2008	FWD	E110-1258-0	V E125-66-097 26.0	E122-50-050	L E146-66-127 45.5 R E146-66-126 45.5	E148-45-029	E155-66-124
	AWD	E110-1258-0	V E125-66-095 26.0	E122-50-050	L E146-66-129 45.5 R E146-66-128 45.5	E148-45-029	E155-66-124
2009		E110-1258-0	V E125-66-095 26.0	E122-50-050	L E146-66-129 45.5 R E146-66-128 45.5	E148-45-029	E155-66-124
2010		E110-1258-0	V E125-66-095 26.0	E122-50-050	L E146-66-135 45.5 R E146-66-134 45.5	E148-45-029	E155-66-124

Many products are available in multiple grades or configurations. Refer to page 5 for details.

# R E A R

Pads	Rotor, Drum	Hardware Kits	Calipers, Wheel Cyl	Kits Calipers, Wheel Cyl	Brake Hoses	Master Cylinders
E105 OEM Type E107 Semi-Met E109 Prem Pad E110 Ceramic E111 HD Pad <b>Shoes</b> E116 Std Shoe E117 HD Shoe  E121 Sensor Wire E124 Shoe Adjuster	E125 Prem Rotor E126 Std Rotor E127 Prem Drum E128 Std Drum E129 Hub L = Left R = Right V = Vented S = Solid	E122 Rotor E123 Drum	E139 Prem Cyl E140 Std Cyl E146 Semi-Loaded Cal E147 Loaded Cal	E148 Cal Kit E149 Cyl Kit	E155 Hose	E135 Prem M/C E136 Std M/C

DISCARD

DIAMETER

DIAMETER

## LINCOLN

### MARK LT

E111-1012-0  PB Shoe E116-0752-0	v E125-70-107 18.5	E122-70-025  PB Kit E123-70-012	L E146-70-523 51 R E146-70-522 51	E148-72-013	up E155-70-387 lo L E155-70-447 lo R E155-70-448	E135-70-094 1 1/8"
E111-1012-0  PB Shoe E116-0752-0	v E125-70-108 18.5	E122-70-025  PB Kit E123-70-012	L E146-70-523 51 R E146-70-522 51	E148-72-013	up E155-70-387 lo L E155-70-447 lo R E155-70-448	E135-70-094 1 1/8"

### MKT

E110-1377-0	s E125-66-086 10.0	E122-72-021	L E146-66-563 45 R E146-66-562 45	E148-66-036	E155-66-446	E135-66-145 1 1/16"
E110-1377-0	s E125-66-086 10.0	E122-72-021	L E146-66-563 45 R E146-66-562 45	E148-66-036	E155-66-446	E135-66-145 1 1/16"

### MXK

E110-1259-0 PB Shoe E116-0784-0	v E125-66-096 16.0	E122-50-051 PB Kit E123-50-027	L E146-50-567 43 R E146-50-566 43	E148-50-030	E155-66-432	E135-66-137 7/8"
E110-1259-0 PB Shoe E116-0784-0	v E125-66-096 16.0	E122-50-051 PB Kit E123-50-027	L E146-50-567 43 R E146-50-566 43	E148-50-030	E155-66-432	E135-66-137 7/8"
E110-1259-0 PB Shoe E116-0784-0	v E125-66-096 16.0	E122-50-051 PB Kit E123-50-027	L E146-50-567 43 R E146-50-566 43	E148-50-030	E155-66-432	E135-66-137 7/8"
E110-1259-0 PB Shoe E116-0784-0	v E125-66-096 16.0	E122-50-051 PB Kit E123-50-027	L E146-50-567 43 R E146-50-566 43	E148-50-030	E155-66-432	E135-66-137 7/8"

# F R O N T

*Many products are available in multiple grades or configurations. Refer to page 5 for details.*

Make & Model	Year Notes	Pads	Rotor, Drum	DISCARD	Hardware Kits	Calipers, Wheel Cyl	DIAMETER	Kits Calipers, Wheel Cyl	Brake Hoses
		E105 OEM Type E107 Semi-Met E109 Prem Pad E110 Ceramic E111 HD Pad <b>Shoes</b> E116 Std Shoe E117 HD Shoe  E121 Sensor Wire E124 Shoe Adjuster	E125 Prem Rotor E126 Std Rotor E127 Prem Drum E128 Std Drum E129 Hub <b>L = Left</b> <b>R = Right</b> <b>V = Vented</b> <b>S = Solid</b>	DISCARD	E122 Rotor E123 Drum	E139 Prem Cyl E140 Std Cyl E146 Semi-Loaded Cal E147 Loaded Cal	DIAMETER	E148 Cal Kit E149 Cyl Kit	E155 Hose

## LINCOLN (Cont'd)

### MKX (Cont'd)

2011		V E125-66-095	26.0		L E146-66-135 45.5 R E146-66-134 45.5	E148-45-029	E155-66-124
2012		V E125-66-095	26.0		L E146-66-135 45.5 R E146-66-134 45.5	E148-45-029	E155-66-124

### NAVIGATOR

2007 - 2009	E111-1278-0	V E125-70-124	32.0	E122-70-036	L E146-70-091 57 R E146-70-090 57	E148-70-034	L E155-70-195 R E155-70-194
2010	E111-1414-0	V E125-70-124	32.0	E122-70-039	L E146-70-101 54 R E146-70-100 54	E148-70-038	L E155-70-195 R E155-70-194
2011	E111-1414-0	V E125-70-124	32.0	E122-70-039	L E146-70-101 54 R E146-70-100 54	E148-70-038	L E155-70-227 R E155-70-226
2012		V E125-70-124	32.0		L E146-70-101 54 R E146-70-100 54	E148-70-038	L E155-70-227 R E155-70-226

### TOWN CAR

2005	Except Limo	E110-0931-0	V E125-66-077	26.35	E122-66-042	L E146-66-093 48 R E146-66-092 48	E148-70-021	L E155-66-109 R E155-66-104
	Limo	E111-0931-0	V E125-66-077	26.35	E122-66-042	L E146-66-093 48 R E146-66-092 48	E148-70-021	L E155-66-109 R E155-66-104
2006 - 2011	Except Limo	E110-0931-0	V E125-66-077	26.35	E122-66-042	L E146-66-093 48 R E146-66-092 48	E148-70-021	L E155-66-109 R E155-66-104
	Limo	E111-0931-0	V E125-66-077	26.35	E122-66-042	L E146-66-093 48 R E146-66-092 48	E148-70-021	L E155-66-109 R E155-66-104

Many products are available in multiple grades or configurations. Refer to page 5 for details.

# R E A R

Pads	Rotor, Drum	Hardware Kits	Calipers, Wheel Cyl	Kits Calipers, Wheel Cyl	Brake Hoses	Master Cylinders
E105 OEM Type E107 Semi-Met E109 Prem Pad E110 Ceramic E111 HD Pad	E125 Prem Rotor E126 Std Rotor E127 Prem Drum E128 Std Drum E129 Hub	E122 Rotor E123 Drum	L E139 Prem Cyl E140 Std Cyl E146 Semi-Loaded Cal E147 Loaded Cal	E148 Cal Kit E149 Cyl Kit	E155 Hose	E135 Prem M/C E136 Std M/C
<b>Shoes</b> E116 Std Shoe E117 HD Shoe	L = Left R = Right V = Vented S = Solid	DISCARD	DIAMETER	DIAMETER		DIAMETER
E121 Sensor Wire E124 Shoe Adjuster						

## LINCOLN (Cont'd)

### MKX (Cont'd)

E110-1377-0	To 9/20/10 S E125-66-086 0.39"	E122-72-021	L E146-66-567 43 R E146-66-566 43	E148-72-018	L E155-66-455 R E155-66-454	E135-66-137 7/8"
E110-1377-0			43	E148-72-018	L E155-66-455 R E155-66-454	E135-66-137 7/8"

### NAVIGATOR

E111-1279-0 PB Shoe E116-0811-0	V E125-70-125 20.0	E122-70-037 PB Kit E123-70-013	L E146-70-535 57 R E146-70-534 57	E148-39-027	Except RSC L E155-70-451 R E155-70-452 RSC L E155-70-453 R E155-70-452	E135-70-114 1 3/16"
E111-1279-0 PB Shoe E116-0811-0	V E125-70-125 20.0	E122-70-037 PB Kit E123-70-013	L E146-70-535 57 R E146-70-534 57	E148-39-027	L E155-70-453 R E155-70-452	E135-70-140 1 3/16" - 1 3/8"
E111-1279-0 PB Shoe E116-0811-0	V E125-70-125 20.0	E122-70-037 PB Kit E123-70-013	L E146-70-535 57 R E146-70-534 57	E148-39-027	L E155-70-453 R E155-70-452	E135-70-140 1 3/16" - 1 3/8"
E111-1279-0 PB Shoe E116-0811-0	V E125-70-125 20.0	E122-70-037 PB Kit E123-70-013	L E146-70-535 57 R E146-70-534 57	E148-39-027	L E155-70-453 R E155-70-452	E135-70-146 1 3/16" - 1 3/8"

### TOWN CAR

E110-0932-0 PB Shoe E116-0809-0	V E125-66-080 18.0	E122-66-043 PB Kit E123-66-043	L E146-66-525 48 R E146-66-524 48	E148-66-035	L E155-66-419 R E155-66-418	Except T/C E135-66-123 1" T/C E135-66-122 1"
E111-0711-0 PB Shoe E116-0752-0	S E125-66-081 12.0	E122-70-016 PB Kit E123-66-044	L E146-70-511 51 R E146-70-510 51	E148-70-019	L E155-66-419 R E155-66-418	Except T/C E135-66-123 1" T/C E135-66-122 1"
E110-0932-0 PB Shoe E116-0809-0	V E125-66-080 18.0	E122-66-043 PB Kit E123-66-043	L E146-66-525 48 R E146-66-524 48	E148-66-035	L E155-66-419 R E155-66-418	Except T/C E135-66-123 1" T/C E135-66-122 1"
E111-0711-0 PB Shoe E116-0752-0	S E125-66-081 12.0	E122-70-016 PB Kit E123-66-044	L E146-70-511 51 R E146-70-510 51	E148-70-019	L E155-66-433 R E155-66-434	Except T/C E135-66-123 1" T/C E135-66-122 1"



# F R O N T

Many products are available in multiple grades or configurations. Refer to page 5 for details.

Make & Model	Year Notes	Pads	Rotor, Drum	Hardware Kits	Calipers, Wheel Cyl	Kits Calipers, Wheel Cyl	Brake Hoses
		E105 OEM Type E107 Semi-Met E109 Prem Pad E110 Ceramic E111 HD Pad <b>Shoes</b> E116 Std Shoe E117 HD Shoe  E121 Sensor Wire E124 Shoe Adjuster	E125 Prem Rotor E126 Std Rotor E127 Prem Drum E128 Std Drum E129 Hub L = Left R = Right V = Vented S = Solid	E122 Rotor E123 Drum	E139 Prem Cyl E140 Std Cyl E146 Semi-Loaded Cal E147 Loaded Cal	E148 Cal Kit E149 Cyl Kit	E155 Hose

DISCARD

DIAMETER

## MAZDA

### B SERIES Pickup RWD

2003 - 2009	9" Rear Drums	E111-0833-0	V E125-70-056 24.5	E122-70-022	L E146-70-055 46 R E146-70-054 46	E148-70-017	L E155-70-121 R E155-70-122
	10" Rear Drums	E111-0833-0	V E125-70-056 24.5	E122-70-022	L E146-70-055 46 R E146-70-054 46	E148-70-017	L E155-70-121 R E155-70-122

### B SERIES Pickup 4WD

2003 - 2007	9" Rear Drums	E111-0833-0	V E125-70-087 24.5	E122-70-022	L E146-70-055 46 R E146-70-054 46	E148-70-017	L E155-70-115 R E155-70-114
	10" Rear Drums	E111-0833-0	V E125-70-087 24.5	E122-70-022	L E146-70-055 46 R E146-70-054 46	E148-70-017	L E155-70-115 R E155-70-114
2008 - 2009	9" Rear Drums	E111-0833-0	V E125-70-087 24.5	E122-70-022	L E146-70-055 46 R E146-70-054 46	E148-70-017	L E155-70-197 R E155-70-196
	10" Rear Drums	E111-0833-0	V E125-70-087 24.5	E122-70-022	L E146-70-055 46 R E146-70-054 46	E148-70-017	L E155-70-197 R E155-70-196

### CX-7

2007 - 2011		E110-1258-0	V E125-50-081 26.0	E122-50-050	L E146-50-101 45.5 R E146-50-100 45.5	E148-45-029	E155-50-055
-------------	--	-------------	--------------------	-------------	--	-------------	-------------

### CX-9

2007 - 2011		E110-1258-0	V E125-50-085 26.0	E122-50-050	L E146-50-105 45.5 R E146-50-104 45.5	E148-45-029	E155-50-055
-------------	--	-------------	--------------------	-------------	--	-------------	-------------

### TRIBUTE

2008	2.3L, 3.0L Except Hybrid Rear Drums	E110-1047-0	V E125-70-112 24.0	E122-70-032	L E146-70-087 66 R E146-70-086 66	E148-70-030	E155-70-199
	Hybrid 2.3L Rear Disc	E110-1047-1	V E125-70-112 24.0	E122-70-032	L E146-70-087 66 R E146-70-086 66	E148-70-030	E155-70-199

Many products are available in multiple grades or configurations. Refer to page 5 for details.

# R E A R

Pads	Rotor, Drum	Hardware Kits	Calipers, Wheel Cyl	Kits Calipers, Wheel Cyl	Brake Hoses	Master Cylinders
E105 OEM Type E107 Semi-Met E109 Prem Pad E110 Ceramic E111 HD Pad <b>Shoes</b> E116 Std Shoe E117 HD Shoe  E121 Sensor Wire E124 Shoe Adjuster	E125 Prem Rotor E126 Std Rotor E127 Prem Drum E128 Std Drum E129 Hub L = Left R = Right V = Vented S = Solid	E122 Rotor E123 Drum	E139 Prem Cyl E140 Std Cyl E146 Semi-Loaded Cal E147 Loaded Cal	E148 Cal Kit E149 Cyl Kit	E155 Hose	E135 Prem M/C E136 Std M/C
DISCARD		DIAMETER		DIAMETER		DIAMETER

## MAZDA

### B SERIES Pickup RWD

E116-0704-0 9 x 1 3/4	E127-70-045 9.09"	E123-66-034	E139-66-008 3/4"	E149-66-010	E155-70-329	Speed Control E135-70-066 1 1/16"
L E124-69-011 R E124-69-012						Except Speed Control E135-70-081 1 1/16"
E116-0705-0 10 x 2 1/2	E127-70-042 10.09"	E123-66-035	E139-70-023 13/16"		E155-70-329	E135-70-066 1 1/16"
L E124-70-006 R E124-70-007						

### B SERIES Pickup 4WD

E116-0704-0 9 x 1 3/4	E127-70-045 9.09"	E123-66-034	E139-66-008 3/4"	E149-66-010	E155-70-329	E135-70-066 1 1/16"
L E124-69-011 R E124-69-012						
E116-0705-0 10 x 2 1/2	E127-70-042 10.09"	E123-66-035	E139-70-023 13/16"		E155-70-329	E135-70-066 1 1/16"
L E124-70-006 R E124-70-007						
E116-0704-0 9 x 1 3/4	E127-70-045 9.09"	E123-66-034	E139-66-008 3/4"	E149-66-010	E155-70-329	E135-70-066 1 1/16"
L E124-69-011 R E124-69-012						
E116-0705-0 10 x 2 1/2	E127-70-042 10.09"	E123-66-035	E139-70-023 13/16"		E155-70-329	E135-70-066 1 1/16"
L E124-70-006 R E124-70-007						

### CX-7

E110-1259-0 PB Shoe E116-0880-0	v E125-50-082 16.0	E122-50-051 PB Kit E123-50-027	L E146-50-567 43 R E146-50-566 43	E148-50-030	E155-50-358	To 6/9/06 E135-50-124 7/8" 6/9/06 - 2011 E135-50-125 13/16"
---------------------------------------	--------------------	--------------------------------------	--------------------------------------	-------------	-------------	--

### CX-9

E110-1259-0 PB Shoe E116-0880-0	v E125-50-084 16.0	E122-50-051 PB Kit E123-50-027	L E146-50-573 43 R E146-50-572 43	E148-50-030	L E155-50-359 R E155-50-360	E135-50-126 7/8"
---------------------------------------	--------------------	--------------------------------------	--------------------------------------	-------------	--------------------------------	------------------

### TRIBUTE

E116-0936-0 254 x 55	E127-70-051 256.3	E123-70-023	E139-70-034 15/16"		L E155-70-455 R E155-70-456	A/T E135-70-120 1 1/16" M/T E135-70-121 1 1/16"
E110-1055-0 PB Shoe E116-0877-0	s E125-70-113 11.0	PB Kit E123-70-022	L E146-70-527 40 R E146-70-526 40	E148-39-023	L E155-70-457 R E155-70-458	E135-70-126 1"

# F R O N T

Many products are available in multiple grades or configurations. Refer to page 5 for details.

Make & Model	Year Notes	Pads	Rotor, Drum	Hardware Kits	Calipers, Wheel Cyl	Kits Calipers, Wheel Cyl	Brake Hoses
		E105 OEM Type E107 Semi-Met E109 Prem Pad E110 Ceramic E111 HD Pad <b>Shoes</b> E116 Std Shoe E117 HD Shoe  E121 Sensor Wire E124 Shoe Adjuster	E125 Prem Rotor E126 Std Rotor E127 Prem Drum E128 Std Drum E129 Hub <b>L = Left</b> <b>R = Right</b> <b>V = Vented</b> <b>S = Solid</b>	E122 Rotor E123 Drum	E139 Prem Cyl E140 Std Cyl E146 Semi-Loaded Cal E147 Loaded Cal	E148 Cal Kit E149 Cyl Kit	E155 Hose

DISCARD

DIAMETER

## MAZDA (Cont'd)

### TRIBUTE (Cont'd)

2009	Except Hybrid Rear Drums	E110-1047-0	V E125-70-112 24.0	E122-70-032	L E146-70-087 66 R E146-70-086 66	E148-70-030	E155-70-199
	Hybrid Rear Disc	E110-1047-1	V E125-70-112 24.0	E122-70-032	L E146-70-087 66 R E146-70-086 66	E148-70-030	E155-70-199
2010 - 2011		E110-1047-0	V E125-70-112 24.0	E122-70-032	L E146-70-087 66 R E146-70-086 66	E148-70-030	E155-70-199

## MERCEDES BENZ

### SPRINTER 2500

2010 - 2012	E109-1316-0	V E130-40-111 25.0	E122-90-006	L E146-40-167 48 R E146-40-166 48	E148-40-047	E155-40-106
	E121-40-015 (2)					

### SPRINTER 3500

2010 - 2012	SRW	E111-1268-0	V E130-40-111 25.0	E122-90-006	L E146-90-006 52 R E146-90-007 52	E148-90-006	E155-40-106
		E121-40-015 (2)					
	DRW	E111-1268-0	V E130-40-111 25.0	E122-90-006	L E146-90-006 52 R E146-90-007 52	E148-90-006	E155-40-106
		E121-40-015 (2)					

Many products are available in multiple grades or configurations. Refer to page 5 for details.

# R E A R

Pads	Rotor, Drum	Hardware Kits	Calipers, Wheel Cyl	Kits Calipers, Wheel Cyl	Brake Hoses	Master Cylinders
E105 OEM Type E107 Semi-Met E109 Prem Pad E110 Ceramic E111 HD Pad <b>Shoes</b> E116 Std Shoe E117 HD Shoe  E121 Sensor Wire E124 Shoe Adjuster	E125 Prem Rotor E126 Std Rotor E127 Prem Drum E128 Std Drum E129 Hub <b>L = Left</b> <b>R = Right</b> <b>V = Vented</b> <b>S = Solid</b>	E122 Rotor E123 Drum	E139 Prem Cyl E140 Std Cyl E146 Semi-Loaded Cal E147 Loaded Cal	E148 Cal Kit E149 Cyl Kit	E155 Hose	E135 Prem M/C E136 Std M/C

DISCARD

DIAMETER

DIAMETER

## MAZDA (Cont'd)

### TRIBUTE (Cont'd)

E116-0936-0 254 x 55	E127-70-051 256.3	E123-70-023	E139-70-034 15/16"		L E155-70-455 R E155-70-456	A/T E135-70-128 1 1/16" M/T E135-70-129 1 1/16"
E110-1055-0 PB Shoe	S E125-70-113 11.0	PB Kit	L E146-70-527 40 R E146-70-526 40	E148-39-023	L E155-70-457 R E155-70-458	
E116-0877-0		E123-70-022				
E116-0936-0 254 x 55	E127-70-051 256.3	E123-70-023	E139-70-034 15/16"		L E155-70-455 R E155-70-456	A/T E135-70-128 1 1/16" M/T E135-70-129 1 1/16"

## MERCEDES BENZ

### SPRINTER 2500

E109-1317-0 PB Shoe	S E130-40-112 14.0	E122-40-050 PB Kit	L E146-40-603 51 R E146-40-602 51	E148-40-048	E155-40-106	Bosch To 9/09 E135-40-507 27mm TRW 10/09- 2011 E135-40-510 27mm
E116-0938-0		E123-40-010				
E121-40-015 (2)						

### SPRINTER 3500

E109-1317-0 PB Shoe	S E130-40-112 14.0	E122-40-050 PB Kit	L E146-40-603 51 R E146-40-602 51	E148-40-048	E155-40-106	Bosch To 9/09 E135-40-507 27mm TRW 10/09- 2011 E135-40-510 27mm
E116-0938-0		E123-40-010				
E121-40-015 (2)						
E109-1318-0 PB Shoe	V E130-40-113 25.0	E122-40-051 PB Kit	L E146-40-605 48 R E146-40-604 48	E148-40-049	E155-40-106	Bosch To 9/09 E135-40-507 27mm TRW 10/09- 2011 E135-40-510 27mm
E116-0940-0		E123-40-010				
E121-40-019 (2)						

# F R O N T

Many products are available in multiple grades or configurations. Refer to page 5 for details.

Make & Model	Year Notes	Pads	Rotor, Drum	Hardware Kits	Calipers, Wheel Cyl	Kits Calipers, Wheel Cyl	Brake Hoses
		E105 OEM Type E107 Semi-Met E109 Prem Pad E110 Ceramic E111 HD Pad <b>Shoes</b> E116 Std Shoe E117 HD Shoe  E121 Sensor Wire E124 Shoe Adjuster	E125 Prem Rotor E126 Std Rotor E127 Prem Drum E128 Std Drum E129 Hub <b>L = Left</b> <b>R = Right</b> <b>V = Vented</b> <b>S = Solid</b>	E122 Rotor E123 Drum	E139 Prem Cyl E140 Std Cyl E146 Semi-Loaded Cal E147 Loaded Cal	E148 Cal Kit E149 Cyl Kit	E155 Hose

DISCARD

DIAMETER

## MERCURY

### GRAND MARQUIS

2003 - 2010	E110-0931-0	V	E125-66-077	26.35	E122-66-042	L E146-66-093 48 R E146-66-092 48	E148-70-021	L E155-66-109 R E155-66-104
-------------	-------------	---	-------------	-------	-------------	--------------------------------------	-------------	--------------------------------

### MARINER

2007	Rear Drums 2.3L 3.0L FWD	E110-0843-0	V	E125-70-094	22.0	E122-95-006	L E146-70-027 60 R E146-70-026 60	E148-67-039	E155-70-155
	Rear Disc 3.0L 4WD	E110-1047-0	V	E125-70-112	24.0	E122-70-032	L E146-70-087 66 R E146-70-086 66	E148-70-030	E155-70-155
	Hybrid	E110-1047-0	V	E125-70-112	24.0	E122-70-032	L E146-70-087 66 R E146-70-086 66	E148-70-030	E155-70-155
2008	Rear Drums	E110-1047-0	V	E125-70-112	24.0	E122-70-032	L E146-70-087 66 R E146-70-086 66	E148-70-030	E155-70-199
	Rear Disc Hybrid	E110-1047-1	V	E125-70-112	24.0	E122-70-032	L E146-70-087 66 R E146-70-086 66	E148-70-030	E155-70-199
2009	Except Hybrid	E110-1047-0	V	E125-70-112	24.0	E122-70-032	L E146-70-087 66 R E146-70-086 66	E148-70-030	E155-70-199
	Hybrid	E110-1047-1	V	E125-70-112	24.0	E122-70-032	L E146-70-087 66 R E146-70-086 66	E148-70-030	E155-70-199
2010	Except Hybrid	E110-1047-2	V	E125-70-112	24.0	E122-72-013	L E146-70-103 66 R E146-70-102 66	E148-70-030	E155-70-199
	Hybrid	E110-1047-3	V	E125-70-112	24.0	E122-72-013	L E146-70-103 66 R E146-70-102 66	E148-70-030	E155-70-199

Many products are available in multiple grades or configurations. Refer to page 5 for details.

# R E A R

<b>Pads</b> E105 OEM Type E107 Semi-Met E109 Prem Pad E110 Ceramic E111 HD Pad <b>Shoes</b> E116 Std Shoe E117 HD Shoe  E121 Sensor Wire E124 Shoe Adjuster	<b>Rotor, Drum</b> E125 Prem Rotor E126 Std Rotor E127 Prem Drum E128 Std Drum E129 Hub L = Left R = Right V = Vented S = Solid	DISCARD	<b>Hardware Kits</b> E122 Rotor E123 Drum	<b>Calipers, Wheel Cyl</b> L E139 Prem Cyl E140 Std Cyl E146 Semi-Loaded Cal E147 Loaded Cal	DIAMETER	<b>Kits Calipers, Wheel Cyl</b> E148 Cal Kit E149 Cyl Kit	<b>Brake Hoses</b> E155 Hose	<b>Master Cylinders</b> E135 Prem M/C E136 Std M/C	DIAMETER

## MERCURY

### GRAND MARQUIS

E110-0932-0	V E125-66-078	18.0	E122-66-043	L E146-66-525 48 R E146-66-524 48	E148-66-035	2003 - 2005 L E155-66-419 R E155-66-418	ABS & T/C E135-66-122 1" ABS except T/C
PB Shoe E116-0809-0			PB Kit E123-66-043			2006 - 2010 L E155-66-433 R E155-66-434	E135-66-123 1"

### MARINER

E116-0760-0 228 x 41	E127-70-049	230.1	E123-70-011	E139-70-029 15/16"		L E155-70-449 R E155-70-379	E135-70-101 1"
L E124-70-012 R E124-70-013							
E110-1055-0 PB Shoe E116-0877-0	S E125-70-113	11.0	PB Kit E123-70-022	L E146-70-527 40 R E146-70-526 40	E148-39-023	L E155-70-419 R E155-70-420	E135-70-099 1 1/16"
E110-1055-0 PB Shoe E116-0877-0	S E125-70-113	11.0	PB Kit E123-70-022	L E146-70-527 40 R E146-70-526 40	E148-39-023	L E155-70-419 R E155-70-420	E135-70-107 1"
E116-0936-0 254 x 55	E127-70-051	256.3	E123-70-023	E139-70-034 15/16"		L E155-70-455 R E155-70-456	Except Hybrid A/T E135-70-120 1 1/16" M/T E135-70-121 1 1/16" Hybrid E135-70-131 1 1/16"
L E124-70-015 R E124-70-014							
E110-1055-0 PB Shoe E116-0877-0	S E125-70-113	11.0	PB Kit E123-70-022	L E146-70-527 40 R E146-70-526 40	E148-39-023	L E155-70-457 R E155-70-458	E135-70-126 1"
E116-0936-0 254 x 55	E127-70-051	256.3	E123-70-023	E139-70-034 15/16"		L E155-70-455 R E155-70-456	A/T E135-70-128 1 1/16" M/T E135-70-129 1 1/16"
L E124-70-015 R E124-70-014							
E116-0936-0 254 x 55	E127-70-051	256.3	E123-70-023	E139-70-034 15/16"		L E155-70-455 R E155-70-456	E135-70-131 1 1/16"
L E124-70-015 R E124-70-014							
E116-0936-0 254 x 55	E127-70-051	256.3	E123-70-023	E139-70-034 15/16"		L E155-70-455 R E155-70-456	A/T E135-70-128 1 1/16" M/T E135-70-129 1 1/16"
L E124-70-015 R E124-70-014							
E116-0936-0 254 x 55	E127-70-051	256.3	E123-70-023	E139-70-034 15/16"		L E155-70-455 R E155-70-456	E135-70-131 1 1/16"
L E124-70-015 R E124-70-014							

# F R O N T

*Many products are available in multiple grades or configurations. Refer to page 5 for details.*

Make & Model	Year Notes	Pads	Rotor, Drum	DISCARD	Hardware Kits	Calipers, Wheel Cyl	DIAMETER	Kits Calipers, Wheel Cyl	Brake Hoses
		E105 OEM Type E107 Semi-Met E109 Prem Pad E110 Ceramic E111 HD Pad <b>Shoes</b> E116 Std Shoe E117 HD Shoe  E121 Sensor Wire E124 Shoe Adjuster	E125 Prem Rotor E126 Std Rotor E127 Prem Drum E128 Std Drum E129 Hub <b>L = Left</b> <b>R = Right</b> <b>V = Vented</b> <b>S = Solid</b>	DISCARD	E122 Rotor E123 Drum	E139 Prem Cyl E140 Std Cyl E146 Semi-Loaded Cal E147 Loaded Cal	DIAMETER	E148 Cal Kit E149 Cyl Kit	E155 Hose

## MERCURY (Cont'd)

### MOUNTAINEER

2006 - 2010	E110-1158-0	V E125-70-123	28.5	E122-70-034	L E146-70-083 51 R E146-70-082 51	E148-70-033		2006 L E155-70-189 R E155-70-188 2007 - 2010 L E155-70-191 R E155-70-190
-------------	-------------	---------------	------	-------------	--------------------------------------	-------------	--	---

## NISSAN

### ARMADA

10/06 - 3/07	E110-1286-0	V E125-47-099	28.5	E122-47-055	L E146-47-151 51 R E146-47-150 51	E148-47-040		L E155-47-113 R E155-47-114
4/07 - 2012	E110-1286-0	V E125-47-104	28.5	E122-47-055	L E146-47-151 51 R E146-47-150 51	E148-47-040		L E155-47-125 R E155-47-124

### CUBE

2010 - 2012	E110-0815-1	2010 - 2011 V E125-47-096	22.0	E122-47-040	L E146-47-157 57 R E146-47-156 57	E148-96-018		L E155-47-111 R E155-47-112
-------------	-------------	------------------------------	------	-------------	--------------------------------------	-------------	--	--------------------------------

### FRONTIER RWD

2005 - 2009	4 Cyl E110-1094-0	V E125-47-094	26.0	E122-47-051	L E146-47-147 46 R E146-47-146 46	E148-47-034		L E155-47-099 R E155-47-100
	6 Cyl E110-1094-0	V E125-47-090	26.0	E122-47-051	L E146-47-141 46 R E146-47-140 46	E148-47-034		L E155-47-099 R E155-47-100
2010	4 Cyl E110-1094-0	V E125-47-094	26.0	E122-47-051	L E146-47-147 46 R E146-47-146 46	E148-47-034		L E155-47-099 R E155-47-100
	6 Cyl E110-1094-0	V E125-47-090	26.0	E122-47-051	L E146-47-141 46 R E146-47-140 46	E148-47-034		L E155-47-099 R E155-47-100

Many products are available in multiple grades or configurations. Refer to page 5 for details.

# R E A R

Pads	Rotor, Drum	Hardware Kits	Calipers, Wheel Cyl	Kits Calipers, Wheel Cyl	Brake Hoses	Master Cylinders
E105 OEM Type E107 Semi-Met E109 Prem Pad E110 Ceramic E111 HD Pad	E125 Prem Rotor E126 Std Rotor E127 Prem Drum E128 Std Drum E129 Hub L = Left R = Right V = Vented S = Solid	E122 Rotor E123 Drum	E139 Prem Cyl E140 Std Cyl E146 Semi-Loaded Cal E147 Loaded Cal	E148 Cal Kit E149 Cyl Kit	E155 Hose	E135 Prem M/C E136 Std M/C
<b>Shoes</b> E116 Std Shoe E117 HD Shoe						
E121 Sensor Wire E124 Shoe Adjuster						

## MERCURY (Cont'd)

### MOUNTAINEER

E110-0964-0	S E125-70-095 11.0	E122-70-017	L E146-70-551 48 R E146-70-550 48	E148-66-024	L E155-70-441 R E155-70-442	2006 E135-70-093 1 1/16" 2007 - 2010 E135-70-127 1 1/16"
PB Shoe E116-0791-0		PB Kit E123-70-014				

## NISSAN

### ARMADA

E110-1041-0	S E125-47-086 12.0	E122-66-043	L E146-47-571 48 R E146-47-570 48	E148-47-038	L E155-47-385 R E155-47-384	E135-47-905 1 3/16"
PB Shoe E116-0868-0		PB Kit E123-47-029				
E110-1041-0	S E125-47-086 12.0	E122-66-043	L E146-47-571 48 R E146-47-570 48	E148-47-038	L E155-47-385 R E155-47-384	4/07 - 3/08 E135-47-905 1 3/16" 4/08 - 2012 E135-47-910 1 3/16"
PB Shoe E116-0868-0		PB Kit E123-47-029				

### CUBE

E116-0919-0 228.6 x 37	E127-47-032 230.0	E123-68-027	E139-47-009 3/4"		E155-47-008	M/T E135-47-823 15/16" CVT E135-47-822 15/16"
---------------------------	-------------------	-------------	------------------	--	-------------	--

### FRONTIER RWD

E110-1100-0	V E125-47-092 16.0	E122-47-053	L E146-47-579 38 R E146-47-578 38	E148-50-028	L E155-47-389 R E155-47-388	A/T E135-47-339 1" M/T E135-47-335 1"
PB Shoe E116-0869-0		PB Kit E123-47-028				
E110-1100-0	V E125-47-092 16.0	E122-47-053	L E146-47-579 38 R E146-47-578 38	E148-50-028	L E155-47-389 R E155-47-388	A/T & 2 Ports E135-47-339 1" A/T & 3 Ports E135-47-336 1" M/T & 2 Ports E135-47-335 1" M/T & 3 Ports E135-47-338 1"
PB Shoe E116-0869-0		PB Kit E123-47-028				
E110-1100-0	V E125-47-092 16.0	E122-47-053	L E146-47-579 38 R E146-47-578 38	E148-50-028	L E155-47-389 R E155-47-388	A/T E135-47-339 1" M/T E135-47-335 1"
PB Shoe E116-0869-0		PB Kit E123-47-028				
E110-1100-0	V E125-47-092 16.0	E122-47-053	L E146-47-579 38 R E146-47-578 38	E148-50-028	L E155-47-389 R E155-47-388	A/T & 2 Ports E135-47-341 1" A/T & 3 Ports E135-47-336 1" M/T & 2 Ports E135-47-340 1" M/T & 3 Ports E135-47-338 1"
PB Shoe E116-0869-0		PB Kit E123-47-028				



# F R O N T

Many products are available in multiple grades or configurations. Refer to page 5 for details.

Make & Model	Year Notes	Pads	Rotor, Drum	Hardware Kits	Calipers, Wheel Cyl	Kits Calipers, Wheel Cyl	Brake Hoses
		E105 OEM Type E107 Semi-Met E109 Prem Pad E110 Ceramic E111 HD Pad <b>Shoes</b> E116 Std Shoe E117 HD Shoe  E121 Sensor Wire E124 Shoe Adjuster	E125 Prem Rotor E126 Std Rotor E127 Prem Drum E128 Std Drum E129 Hub <b>L = Left</b> <b>R = Right</b> <b>V = Vented</b> <b>S = Solid</b>	E122 Rotor E123 Drum	E139 Prem Cyl E140 Std Cyl E146 Semi-Loaded Cal E147 Loaded Cal	E148 Cal Kit E149 Cyl Kit	E155 Hose

DISCARD

DIAMETER

## NISSAN (Cont'd)

### FRONTIER RWD (Cont'd)

2011	4 Cyl	E110-1094-0	V E125-47-094	26.0	E122-47-051	L E146-47-147 46 R E146-47-146 46	E148-47-034	L E155-47-099 R E155-47-100
	6 Cyl	E110-1094-0	V E125-47-090	26.0	E122-47-051	L E146-47-141 46 R E146-47-140 46	E148-47-034	L E155-47-099 R E155-47-100
2012	4 Cyl	E110-1094-0	V E125-47-094	26.0	E122-47-051	L E146-47-147 46 R E146-47-146 46	E148-47-034	L E155-47-099 R E155-47-100
	6 Cyl	E110-1094-0	V E125-47-090		E122-47-051	L E146-47-141 46 R E146-47-140 46	E148-47-034	L E155-47-099 R E155-47-100

### FRONTIER 4WD

2005 - 1/07		E110-1094-0	V E125-47-090	26.0	E122-47-051	L E146-47-141 46 R E146-47-140 46	E148-47-034	L E155-47-099 R E155-47-100
2/07 - 2008		E110-1094-0	V E125-47-090	26.0	E122-47-051	L E146-47-141 46 R E146-47-140 46	E148-47-034	L E155-47-099 R E155-47-100

Many products are available in multiple grades or configurations. Refer to page 5 for details.

# R E A R

<b>Pads</b> E105 OEM Type E107 Semi-Met E109 Prem Pad E110 Ceramic E111 HD Pad <b>Shoes</b> E116 Std Shoe E117 HD Shoe  E121 Sensor Wire E124 Shoe Adjuster	<b>Rotor, Drum</b> E125 Prem Rotor E126 Std Rotor E127 Prem Drum E128 Std Drum E129 Hub L = Left R = Right V = Vented S = Solid	<b>Hardware Kits</b>  E122 Rotor E123 Drum	<b>Calipers, Wheel Cyl</b>  E139 Prem Cyl E140 Std Cyl E146 Semi-Loaded Cal E147 Loaded Cal	<b>Kits Calipers, Wheel Cyl</b> E148 Cal Kit E149 Cyl Kit	<b>Brake Hoses</b>  E155 Hose	<b>Master Cylinders</b>  E135 Prem M/C E136 Std M/C	<b>DIAMETER</b>
--	--	---	--	---	-------------------------------------	--	-----------------

## NISSAN (Cont'd)

### FRONTIER RWD (Cont'd)

E110-1100-0 PB Shoe E116-0869-0	V E125-47-092 16.0	E122-47-053 PB Kit E123-47-028	L E146-47-579 38 R E146-47-578 38	E148-50-028	L E155-47-389 R E155-47-388	A/T E135-47-339 M/T E135-47-335	1"
E110-1100-0 PB Shoe E116-0869-0	V E125-47-092 16.0	E122-47-053 PB Kit E123-47-028	L E146-47-579 38 R E146-47-578 38	E148-50-028	L E155-47-389 R E155-47-388	A/T E135-47-341 M/T E135-47-340	1"
E110-1100-0 PB Shoe E116-0869-0	V E125-47-092 16.0	E122-47-053 PB Kit E123-47-028	L E146-47-579 38 R E146-47-578 38	E148-50-028	L E155-47-389 R E155-47-388	A/T E135-47-341 M/T E135-47-340	1"
E110-1100-0 PB Shoe E116-0869-0	V E125-47-092 16.0	E122-47-053 PB Kit E123-47-028	L E146-47-579 38 R E146-47-578 38	E148-50-028	L E155-47-389 R E155-47-388	A/T E135-47-341 M/T E135-47-340	1"

### FRONTIER 4WD

E110-1100-0 PB Shoe E116-0869-0	V E125-47-092 16.0	E122-47-053 PB Kit E123-47-028	L E146-47-579 38 R E146-47-578 38	E148-50-028	L E155-47-389 R E155-47-388	A/T & 2 Ports E135-47-339 A/T & 3 Ports E135-47-336 A/T & 4 Ports E135-47-337 M/T & 2 Ports E135-47-335 M/T & 3 Ports E135-47-338	1"
E110-1100-0 PB Shoe E116-0869-0	V E125-47-092 16.0	E122-47-053 PB Kit E123-47-028	L E146-47-579 38 R E146-47-578 38	E148-50-028	L E155-47-389 R E155-47-388	A/T & 2 10mm Ports E135-47-339 A/T & 2 12mm Ports E135-47-341 A/T & 3 Ports E135-47-336 A/T & 4 Ports E135-47-337 M/T & 2 Ports E135-47-335 M/T & 3 Ports E135-47-338	1"

# F R O N T

*Many products are available in multiple grades or configurations. Refer to page 5 for details.*

Make & Model	Year Notes	Pads	Rotor, Drum	DISCARD	Hardware Kits	Calipers, Wheel Cyl	DIAMETER	Kits Calipers, Wheel Cyl	Brake Hoses
		E105 OEM Type E107 Semi-Met E109 Prem Pad E110 Ceramic E111 HD Pad <b>Shoes</b> E116 Std Shoe E117 HD Shoe  E121 Sensor Wire E124 Shoe Adjuster	E125 Prem Rotor E126 Std Rotor E127 Prem Drum E128 Std Drum E129 Hub <b>L = Left</b> <b>R = Right</b> <b>V = Vented</b> <b>S = Solid</b>		E122 Rotor E123 Drum	E139 Prem Cyl E140 Std Cyl E146 Semi-Loaded Cal E147 Loaded Cal		E148 Cal Kit E149 Cyl Kit	E155 Hose

## NISSAN (Cont'd)

### FRONTIER 4WD (Cont'd)

2009	E110-1094-0	V E125-47-090 26.0	E122-47-051	L E146-47-141 46 R E146-47-140 46	E148-47-034	L E155-47-099 R E155-47-100
2010	E110-1094-0	V E125-47-090 26.0	E122-47-051	L E146-47-141 46 R E146-47-140 46	E148-47-034	L E155-47-099 R E155-47-100
2011	E110-1094-0	V E125-47-090 26.0	E122-47-051	L E146-47-141 46 R E146-47-140 46	E148-47-034	L E155-47-099 R E155-47-100
2012	E110-1094-0	V E125-47-090	E122-47-051	L E146-47-141 46 R E146-47-140 46	E148-47-034	L E155-47-099 R E155-47-100

### NV1500, NV2500 HD, NV3500 HD

2012	E110-1565-0	V E125-47-115	E122-70-038	L E146-47-183 57 R E146-47-182 57	E148-47-053	L E155-47-143 R E155-47-142
------	-------------	---------------	-------------	--------------------------------------	-------------	--------------------------------

### PATHFINDER

2006 - 2007	E110-1094-0	V E125-47-090 26.0	E122-47-051	L E146-47-141 46 R E146-47-140 46	E148-47-034	L E155-47-099 R E155-47-100
2008 - 2009	4.0L V6 E110-1094-0	V E125-47-090 26.0	E122-47-051	L E146-47-141 46 R E146-47-140 46	E148-47-034	L E155-47-099 R E155-47-100
	5.6L V8 E110-0888-0	V E125-47-107 26.0	E122-47-037	L E146-47-149 45 R E146-47-148 45	E148-66-029	L E155-47-099 R E155-47-100

Many products are available in multiple grades or configurations. Refer to page 5 for details.

# R E A R

Pads	Rotor, Drum	Hardware Kits	Calipers, Wheel Cyl	Kits Calipers, Wheel Cyl	Brake Hoses	Master Cylinders
E105 OEM Type E107 Semi-Met E109 Prem Pad E110 Ceramic E111 HD Pad <b>Shoes</b> E116 Std Shoe E117 HD Shoe  E121 Sensor Wire E124 Shoe Adjuster	E125 Prem Rotor E126 Std Rotor E127 Prem Drum E128 Std Drum E129 Hub <b>L = Left</b> <b>R = Right</b> <b>V = Vented</b> <b>S = Solid</b>	E122 Rotor E123 Drum	E139 Prem Cyl E140 Std Cyl E146 Semi-Loaded Cal E147 Loaded Cal	E148 Cal Kit E149 Cyl Kit	E155 Hose	E135 Prem M/C E136 Std M/C

DISCARD

DIAMETER

DIAMETER

## NISSAN (Cont'd)

### FRONTIER 4WD (Cont'd)

E110-1100-0  PB Shoe E116-0869-0	V E125-47-092 16.0	E122-47-053  PB Kit E123-47-028	L E146-47-579 38 R E146-47-578 38	E148-50-028	L E155-47-389 R E155-47-388	A/T & 2 10mm Ports E135-47-339 1" A/T & 2 12mm Ports E135-47-341 1" A/T & 3 Ports E135-47-336 1" M/T & 2 Ports E135-47-335 1" M/T & 3 Ports E135-47-338 1"
E110-1100-0  PB Shoe E116-0869-0	V E125-47-092 16.0	E122-47-053  PB Kit E123-47-028	L E146-47-579 38 R E146-47-578 38	E148-50-028	L E155-47-389 R E155-47-388	A/T & 2 Ports E135-47-341 1" A/T & 3 Ports E135-47-336 1" M/T & 2 Ports E135-47-340 1" M/T & 3 Ports E135-47-338 1"
E110-1100-0  PB Shoe E116-0869-0	V E125-47-092 16.0	E122-47-053  PB Kit E123-47-028	L E146-47-579 38 R E146-47-578 38	E148-50-028	L E155-47-389 R E155-47-388	A/T E135-47-341 1" M/T E135-47-340 1"
E110-1100-0  PB Shoe E116-0869-0	V E125-47-092 16.0	E122-47-053  PB Kit E123-47-028	L E146-47-579 38 R E146-47-578 38	E148-50-028	L E155-47-389 R E155-47-388	A/T E135-47-341 1" M/T E135-47-340 1"

### NV1500, NV2500 HD, NV3500 HD

E110-1565-1 PB Shoe E116-0952-0	S E125-47-114	E122-70-038	L E146-47-607 43 R E146-47-606 43	E148-47-052	up E155-47-392 lo L E155-47-431 lo R E155-47-432	Integral Unit
---------------------------------------	---------------	-------------	--------------------------------------	-------------	--	---------------

### PATHFINDER

E110-1101-0  PB Shoe E116-0869-0	V E125-47-091 16.0	E122-47-052  PB Kit E123-47-028	L E146-47-593 38 R E146-47-592 38	E148-50-028	L E155-47-387 R E155-47-386	Except 4WD Off-Road E135-47-336 1" 4WD Off-Road E135-47-337 1"
E110-1101-0  PB Shoe E116-0869-0	V E125-47-091 16.0	E122-47-052  PB Kit E123-47-028	L E146-47-593 38 R E146-47-592 38	E148-50-028	L E155-47-387 R E155-47-386	Except 4WD Off-Road E135-47-336 1" 4WD Off-Road E135-47-337 1"
E110-1101-0 PB Shoe E116-0869-0	V E125-47-091 16.0	E122-47-052 PB Kit E123-47-028	L E146-47-593 38 R E146-47-592 38	E148-50-028	L E155-47-387 R E155-47-386	E135-47-342 1 1/16"

# F R O N T

Many products are available in multiple grades or configurations. Refer to page 5 for details.

Make & Model	Year Notes	Pads	Rotor, Drum	DISCARD	Hardware Kits	Calipers, Wheel Cyl	DIAMETER	Kits Calipers, Wheel Cyl	Brake Hoses
		E105 OEM Type E107 Semi-Met E109 Prem Pad E110 Ceramic E111 HD Pad <b>Shoes</b> E116 Std Shoe E117 HD Shoe  E121 Sensor Wire E124 Shoe Adjuster	E125 Prem Rotor E126 Std Rotor E127 Prem Drum E128 Std Drum E129 Hub <b>L = Left</b> <b>R = Right</b> <b>V = Vented</b> <b>S = Solid</b>		E122 Rotor E123 Drum	E139 Prem Cyl E140 Std Cyl E146 Semi-Loaded Cal E147 Loaded Cal		E148 Cal Kit E149 Cyl Kit	E155 Hose

## NISSAN (Cont'd)

### PATHFINDER (Cont'd)

2010 - 2012	4.0L V6	E110-1094-0	V E125-47-090	26.0	E122-47-051	L E146-47-141 46 R E146-47-140 46	E148-47-034	L E155-47-099 R E155-47-100
	5.6L V8	E110-0888-0	V E125-47-107	26.0	E122-47-037	L E146-47-149 45 R E146-47-148 45	E148-66-029	L E155-47-099 R E155-47-100

### ROGUE

2008 - 2012		E110-1338-0	V E125-47-102	24.0	E122-47-060	L E146-47-163 60.4 R E146-47-162 60.4	E148-47-045	L E155-47-121 R E155-47-120
-------------	--	-------------	---------------	------	-------------	--	-------------	--------------------------------

### TITAN

2004 - 2/05		E110-1183-0	V E125-47-089	24.5	E122-47-049	L E146-47-137 51 R E146-47-136 51	E148-72-012	L E155-47-091 R E155-47-092
3/05 - 3/07		E110-1183-0	V E125-47-095	24.5	E122-47-049	L E146-47-137 51 R E146-47-136 51	E148-72-012	L E155-47-091 R E155-47-092
4/07 - 3/08		E110-1286-0	V E125-47-104	28.5	E122-47-055	L E146-47-151 51 R E146-47-150 51	E148-47-040	L E155-47-125 R E155-47-124
4/08 - 2010		E110-1286-0	V E125-47-104	28.5	E122-47-055	L E146-47-151 51 R E146-47-150 51	E148-47-040	L E155-47-125 R E155-47-124
2011 - 2012		E110-1509-0	V E125-47-104	28.5	E122-47-055	L E146-47-151 51 R E146-47-150 51	E148-47-040	L E155-47-125 R E155-47-124

Many products are available in multiple grades or configurations. Refer to page 5 for details.

# R E A R

<b>Pads</b> E105 OEM Type E107 Semi-Met E109 Prem Pad E110 Ceramic E111 HD Pad <b>Shoes</b> E116 Std Shoe E117 HD Shoe  E121 Sensor Wire E124 Shoe Adjuster	<b>Rotor, Drum</b> E125 Prem Rotor E126 Std Rotor E127 Prem Drum E128 Std Drum E129 Hub L = Left R = Right V = Vented S = Solid	DISCARD	<b>Hardware Kits</b> E122 Rotor E123 Drum	<b>Calipers, Wheel Cyl</b> E139 Prem Cyl E140 Std Cyl E146 Semi-Loaded Cal E147 Loaded Cal	DIAMETER	<b>Kits Calipers, Wheel Cyl</b> E148 Cal Kit E149 Cyl Kit	<b>Brake Hoses</b> E155 Hose	<b>Master Cylinders</b> E135 Prem M/C E136 Std M/C	DIAMETER

## NISSAN (Cont'd)

### PATHFINDER (Cont'd)

E110-1101-0 PB Shoe E116-0869-0	V E125-47-091 16.0	E122-47-052 PB Kit E123-47-028	L E146-47-593 38 R E146-47-592 38	E148-50-028	L E155-47-387 R E155-47-386	E135-47-341 1"
E110-1101-0 PB Shoe E116-0869-0	V E125-47-091 16.0	E122-47-052 PB Kit E123-47-028	L E146-47-593 38 R E146-47-592 38	E148-50-028	L E155-47-387 R E155-47-386	E135-47-342 1 1/16"

### ROGUE

E110-0905-0 PB Shoe E116-0916-0	V E125-47-082 14.0	E122-47-043 PB Kit E123-49-038	L E146-47-585 35 R E146-47-584 35	E148-47-051	up E155-47-404 lo L E155-47-399 lo R E155-47-398	E135-47-816 15/16"
---------------------------------------	--------------------	--------------------------------------	--------------------------------------	-------------	--	--------------------

### TITAN

E110-1041-0 PB Shoe E116-0868-0	S E125-47-086 12.0	E122-66-043 PB Kit E123-47-029	L E146-47-571 48 R E146-47-570 48	E148-47-038	Except VDC up E155-47-358 lo E155-47-383 VDC up E155-47-375 lo E155-47-383	2WD, 2 Port E135-47-907 1 1/8" All, 4 Port, Except VDC E135-47-906 1 1/8" All, 4 Port & VDC E135-47-905 1 3/16"
E110-1041-0 PB Shoe E116-0868-0	S E125-47-086 12.0	E122-66-043 PB Kit E123-47-029	L E146-47-571 48 R E146-47-570 48	E148-47-038	Except VDC up E155-47-358 lo E155-47-383 VDC up E155-47-375 lo E155-47-383	2WD, 2 Port E135-47-907 1 1/8" All, 4 Port, Except VDC E135-47-906 1 1/8" All, 4 Port & VDC E135-47-905 1 3/16"
E110-1041-0 PB Shoe E116-0868-0	S E125-47-086 12.0	E122-66-043 PB Kit E123-47-029	L E146-47-571 48 R E146-47-570 48	E148-47-038	Except VDC up E155-47-358 lo E155-47-383 VDC up E155-47-375 lo E155-47-383	2WD, 2 Port E135-47-909 1 5/16" All, 4 Port, Except Active Brakes E135-47-905 1 3/16" All, 4 Port & Active Brakes E135-47-908 1 5/16"
E110-1041-0 PB Shoe E116-0868-0	S E125-47-086 12.0	E122-66-043 PB Kit E123-47-029	L E146-47-571 48 R E146-47-570 48	E148-47-038	Except VDC up E155-47-358 lo E155-47-383 VDC up E155-47-375 lo E155-47-383	2WD, 2 Port E135-47-909 1 5/16" All, 4 Port, Except Active Brakes E135-47-910 1 3/16" 4 Port & Active Brakes E135-47-908 1 5/16"
E110-1041-0 PB Shoe E116-0868-0	2011 S E125-47-086 12.0	E122-66-043 PB Kit E123-47-029	L E146-47-571 48 R E146-47-570 48	E148-47-038	up E155-47-375 lo E155-47-383	E135-47-910 1 3/16"

# FRONT

Many products are available in multiple grades or configurations. Refer to page 5 for details.

Make & Model	Year Notes	Pads	Rotor, Drum	Hardware Kits	Calipers, Wheel Cyl	Kits	Brake Hoses
		E105 OEM Type E107 Semi-Met E109 Prem Pad E110 Ceramic E111 HD Pad <b>Shoes</b> E116 Std Shoe E117 HD Shoe  E121 Sensor Wire E124 Shoe Adjuster	E125 Prem Rotor E126 Std Rotor E127 Prem Drum E128 Std Drum E129 Hub <b>L = Left</b> <b>R = Right</b> <b>V = Vented</b> <b>S = Solid</b>	E122 Rotor E123 Drum	E139 Prem Cyl E140 Std Cyl E146 Semi-Loaded Cal E147 Loaded Cal	E148 Cal Kit E149 Cyl Kit	E155 Hose

DISCARD

DIAMETER

## NISSAN (Cont'd)

### XTERRA

2006 - 2007	RWD	E110-1094-0	V E125-47-090 26.0	E122-47-051	L E146-47-141 46 R E146-47-140 46	E148-47-034	L E155-47-099 R E155-47-100
	4WD	E110-1094-0	V E125-47-090 26.0	E122-47-051	L E146-47-141 46 R E146-47-140 46	E148-47-034	L E155-47-099 R E155-47-100
2008 - 2010		E110-1094-0	V E125-47-090 26.0	E122-47-051	L E146-47-141 46 R E146-47-140 46	E148-47-034	L E155-47-099 R E155-47-100
2011 - 2012		E110-1094-0	V E125-47-090 26.0	E122-47-051	L E146-47-141 46 R E146-47-140 46	E148-47-034	L E155-47-099 R E155-47-100

## PONTIAC

### MONTANA

2005	FWD Except SV6 Rear Drums	E111-0699-0	V E125-67-062 30.7	E122-67-040	L E146-67-125 63.5 R E146-67-124 63.5	E148-67-024	E155-67-092
	SV6 FWD Beam Rear Axle	E109-1075-0	V E125-67-078 30.7	E122-67-053	L E146-67-137 63.5 R E146-67-136 63.5	E148-67-024	L E155-71-131 R E155-71-132
	SV6 FWD & AWD Independent Rear Suspension	E109-1075-0	V E125-67-078 30.7	E122-67-053	L E146-67-137 63.5 R E146-67-136 63.5	E148-67-024	L E155-71-131 R E155-71-132
2006	FWD Beam Rear Axle	E109-1075-0	V E125-71-066 30.7	E122-67-053	L E146-67-137 63.5 R E146-67-136 63.5	E148-67-024	L E155-71-131 R E155-71-132
	FWD & AWD Independent Rear Suspension	E109-1075-0	V E125-71-066 30.7	E122-67-053	L E146-67-137 63.5 R E146-67-136 63.5	E148-67-024	L E155-71-131 R E155-71-132
2007 - 2009	Canada	E109-1075-0	V E125-71-066 30.7	E122-67-053	L E146-67-137 63.5 R E146-67-136 63.5	E148-67-024	L E155-71-131 R E155-71-132

### TORRENT

2007 - 2008		E110-1264-0	V E125-71-072 27.4	E122-67-065	L E146-67-175 45 R E146-67-174 45	E148-67-040	L E155-67-151 R E155-67-150
	2009	E110-1264-0	V E125-71-072 27.4	E122-67-065	L E146-67-175 45 R E146-67-174 45	E148-67-040	L E155-67-151 R E155-67-150

Many products are available in multiple grades or configurations. Refer to page 5 for details.

# R E A R

<b>Pads</b> E105 OEM Type E107 Semi-Met E109 Prem Pad E110 Ceramic E111 HD Pad <b>Shoes</b> E116 Std Shoe E117 HD Shoe  E121 Sensor Wire E124 Shoe Adjuster	<b>Rotor, Drum</b> E125 Prem Rotor E126 Std Rotor E127 Prem Drum E128 Std Drum E129 Hub L = Left R = Right V = Vented S = Solid	<b>Hardware Kits</b>  E122 Rotor E123 Drum	<b>Calipers, Wheel Cyl</b>  E139 Prem Cyl E140 Std Cyl E146 Semi-Loaded Cal E147 Loaded Cal	<b>Kits Calipers, Wheel Cyl</b> E148 Cal Kit E149 Cyl Kit	<b>Brake Hoses</b>  E155 Hose	<b>Master Cylinders</b>  E135 Prem M/C E136 Std M/C
--	--	---	--	---	-------------------------------------	--

DISCARD

DIAMETER

DIAMETER

## NISSAN (Cont'd)

### XTERRA

E110-1100-0 PB Shoe E116-0869-0	V E125-47-092 16.0	E122-47-053 PB Kit E123-47-028	L E146-47-579 38 R E146-47-578 38	E148-50-028	up E155-47-392 lo E155-47-311	A/T E135-47-336 1" M/T E135-47-338 1"
E110-1100-0 PB Shoe E116-0869-0	V E125-47-092 16.0	E122-47-053 PB Kit E123-47-028	L E146-47-579 38 R E146-47-578 38	E148-50-028	up E155-47-392 lo E155-47-311	A/T & 3 Ports E135-47-336 1" A/T & 4 Ports E135-47-337 1" M/T E135-47-338 1"
E110-1100-0 PB Shoe E116-0869-0	V E125-47-092 16.0	E122-47-053 PB Kit E123-47-028	L E146-47-579 38 R E146-47-578 38	E148-50-028	up E155-47-392 lo E155-47-311	A/T E135-47-341 1" M/T E135-47-340 1"
E110-1100-0 PB Shoe E116-0869-0	V E125-47-092 16.0	E122-47-053 PB Kit E123-47-028	L E146-47-579 38 R E146-47-578 38	E148-50-028	up E155-47-392 lo E155-47-311	A/T E135-47-341 1" M/T E135-47-340 1"

## PONTIAC

### MONTANA

E116-0636-0 225 x 45	E127-67-028 226.3	E123-67-034	E139-71-027 15/16"	E149-67-009	E155-67-380	E135-67-116 1"
L E124-67-045 R E124-67-044						
E110-1093-0	S E125-71-065 10.5	E122-67-061	L E146-71-533 41 R E146-71-532 41	E148-71-027	L E155-71-369 R E155-71-370	E135-71-059 1"
E110-1093-0	S E125-71-063 10.5	E122-67-061	L E146-71-533 41 R E146-71-532 41	E148-71-027	L E155-71-367 R E155-71-368	E135-71-059 1"
E110-1093-0	S E125-71-067 10.5	E122-67-061	L E146-71-533 41 R E146-71-532 41	E148-71-027	L E155-71-369 R E155-71-370	E135-71-059 1"
E110-1093-0	S E125-71-071 10.5	E122-67-061	L E146-71-533 41 R E146-71-532 41	E148-71-027	L E155-71-367 R E155-71-368	E135-71-059 1"
E110-1093-0	S E125-71-067 10.5	E122-67-061	L E146-71-533 41 R E146-71-532 41	E148-71-027	L E155-71-369 R E155-71-370	E135-71-059 1"

### TORRENT

E110-1275-0 PB Shoe E116-0932-0	V E125-71-073 18.4	E122-71-029 PB Kit E123-67-040	L E146-71-539 40 R E146-71-538 40	E148-44-020	Except Soft Ride Susp. L E155-67-447 R E155-67-438 Soft Ride & Sport Susp. L E155-67-439 R E155-67-438	E135-67-155 1"
E110-1275-0 PB Shoe E116-0932-0	V E125-71-073 18.4	E122-71-029 PB Kit E123-67-040	L E146-71-539 40 R E146-71-538 40	E148-44-020	L E155-67-447 R E155-67-438	E135-67-155 1"



# F R O N T

Many products are available in multiple grades or configurations. Refer to page 5 for details.

Make & Model	Year Notes	Pads	Rotor, Drum	Hardware Kits	Calipers, Wheel Cyl	Kits Calipers, Wheel Cyl	Brake Hoses
		E105 OEM Type E107 Semi-Met E109 Prem Pad E110 Ceramic E111 HD Pad <b>Shoes</b> E116 Std Shoe E117 HD Shoe  E121 Sensor Wire E124 Shoe Adjuster	E125 Prem Rotor E126 Std Rotor E127 Prem Drum E128 Std Drum E129 Hub <b>L = Left</b> <b>R = Right</b> <b>V = Vented</b> <b>S = Solid</b>	E122 Rotor E123 Drum	E139 Prem Cyl E140 Std Cyl E146 Semi-Loaded Cal E147 Loaded Cal	E148 Cal Kit E149 Cyl Kit	E155 Hose

DISCARD

DIAMETER

## SATURN OUTLOOK

2007 - 2010	E111-1169-1	V E125-71-074 27.5	E122-71-028	L E146-71-053 48 R E146-71-052 48	E148-63-010	L E155-71-139 R E155-71-138
-------------	-------------	--------------------	-------------	--------------------------------------	-------------	--------------------------------

## RELAY

2007	FWD	E109-1075-0	V E125-71-066 30.7	E122-67-053	L E146-67-137 63.5 R E146-67-136 63.5	E148-67-024	L E155-71-131 R E155-71-132
------	-----	-------------	--------------------	-------------	--	-------------	--------------------------------

## VUE

2005 - 2007	E110-0833-0	V E125-67-073 24.5	E122-70-022	L E146-67-155 46 R E146-67-154 46	E148-70-017	L E155-67-117 R E155-67-118
2008 - 2009	E110-1264-0	V E125-71-072 27.4	E122-67-065	L E146-67-175 45 R E146-67-174 45	E148-67-040	L E155-67-173 R E155-67-172
2010	E110-1264-0	V E125-71-072 27.4	E122-67-065	L E146-67-175 45 R E146-67-174 45	E148-67-040	L E155-67-173 R E155-67-172

## TOYOTA

### FJ CRUISER

2007 - 2009	E110-0976-0	V E125-49-134 26.0	E122-49-080	L E146-49-251 45.5 R E146-49-250 45.5	E148-49-079	E155-49-367
2010 - 2011	E110-0976-0	V E125-49-134 26.0	E122-49-080	L E146-49-251 45.5 R E146-49-250 45.5	E148-49-079	E155-49-367

### HIGHLANDER

2006 - 2007	Except Hybrid	E110-0884-0	V E125-49-093 26.0	E122-49-056	L E146-49-209 63.5 R E146-49-208 63.5	E148-49-056	L E155-49-087 R E155-49-086
	Hybrid	E110-1005-0	V E125-49-135 26.0	E122-49-083	L E146-49-249 63.5 R E146-49-248 63.5	E148-49-071	L E155-49-087 R E155-49-086
2008 - 2009		E110-1324-0	V E125-49-163 25.0	E122-49-097	L E146-49-279 44.5 R E146-49-278 44.5	E148-49-081	L E155-49-147 R E155-49-148

Many products are available in multiple grades or configurations. Refer to page 5 for details.

# R E A R

<b>Pads</b> E105 OEM Type E107 Semi-Met E109 Prem Pad E110 Ceramic E111 HD Pad <b>Shoes</b> E116 Std Shoe E117 HD Shoe  E121 Sensor Wire E124 Shoe Adjuster	<b>Rotor, Drum</b> E125 Prem Rotor E126 Std Rotor E127 Prem Drum E128 Std Drum E129 Hub L = Left R = Right V = Vented S = Solid	<b>Hardware Kits</b>  E122 Rotor E123 Drum	<b>Calipers, Wheel Cyl</b>  E139 Prem Cyl E140 Std Cyl E146 Semi-Loaded Cal E147 Loaded Cal	<b>Kits Calipers, Wheel Cyl</b> E148 Cal Kit E149 Cyl Kit	<b>Brake Hoses</b>  E155 Hose	<b>Master Cylinders</b>  E135 Prem M/C E136 Std M/C
DISCARD		DIAMETER		DIAMETER		DIAMETER

## SATURN

### OUTLOOK

E111-0883-0 PB Shoe E116-0933-0	V E125-71-075 18.4	E122-71-019	L E146-71-537 48 R E146-71-536 48	E148-96-020	L E155-71-381 R E155-71-382	E135-71-064 1 1/16"
		E123-71-018				

### RELAY

E110-1093-0	S E125-71-067 10.5	E122-67-061	L E146-71-533 41 R E146-71-532 41	E148-71-027	L E155-71-369 R E155-71-370	E135-71-059 1"
-------------	--------------------	-------------	--------------------------------------	-------------	--------------------------------	----------------

### VUE

E116-0780-0 250 x 45.2	E127-71-047 251.5	E123-69-008	E139-67-072 7/8"	E149-71-006	L E155-67-407 R E155-67-406	E135-67-135 1"
L E124-67-051 R E124-67-050						
E110-1275-0 PB Shoe E116-0932-0	V E125-71-073 18.4	E122-71-029 PB Kit E123-67-040	L E146-71-539 40 R E146-71-538 40	E148-44-020	L E155-67-457 R E155-67-456	E135-67-155 1"
E110-1275-0 PB Shoe E116-0932-0	V E125-71-073 18.4	E122-71-029 PB Kit E123-67-040	L E146-71-539 40 R E146-71-538 40	E148-44-020	L E155-67-457 R E155-67-456	Except Hybrid E135-67-155 1"

## TOYOTA

### FJ CRUISER

E110-0606-0 PB Shoe E116-0850-0	V E125-49-133 16.0	E122-96-006 PB Kit E123-49-039	L E146-49-521 45.5 R E146-49-520 45.5	E148-27-011	up E155-49-402 lo L E155-49-413 lo R E155-49-412	Integral Unit
E110-0606-0 PB Shoe E116-0850-0	V E125-49-180 16.0	E122-96-006 PB Kit E123-49-039	L E146-49-521 45.5 R E146-49-520 45.5	E148-27-011	up E155-49-402 lo L E155-49-413 lo R E155-49-412	Integral Unit

### HIGHLANDER

E110-0996-0 PB Shoe E116-0851-0	S E125-49-136 8.5	E122-49-082 PB Kit E123-49-033	L E146-49-609 38 R E146-49-608 38	E148-49-073	FWD L E155-49-385 R E155-49-386 AWD L E155-49-403 R E155-49-404	E135-49-825 7/8"
E110-0996-0 PB Shoe E116-0851-0	S E125-49-136 8.5	E122-49-082 PB Kit E123-49-033	L E146-49-613 41 R E146-49-612 41	E148-49-070	FWD L E155-49-385 R E155-49-386 4WD L E155-49-403 R E155-49-404	E135-49-826 3/4"
E110-1325-0 PB Shoe E116-0851-0	S E125-49-164 8.5	E122-49-098 PB Kit E123-49-033	L E146-49-635 41.5 R E146-49-634 41.5	E148-49-070	FWD L E155-49-437 R E155-49-438 AWD L E155-49-439 R E155-49-440	Except Hybrid E135-49-828 7/8" Hybrid E135-49-829 3/4"

# F R O N T

Many products are available in multiple grades or configurations. Refer to page 5 for details.

Make & Model	Year Notes	Pads	Rotor, Drum	Hardware Kits	Calipers, Wheel Cyl	Kits Calipers, Wheel Cyl	Brake Hoses
		E105 OEM Type E107 Semi-Met E109 Prem Pad E110 Ceramic E111 HD Pad <b>Shoes</b> E116 Std Shoe E117 HD Shoe  E121 Sensor Wire E124 Shoe Adjuster	E125 Prem Rotor E126 Std Rotor E127 Prem Drum E128 Std Drum E129 Hub <b>L = Left</b> <b>R = Right</b> <b>V = Vented</b> <b>S = Solid</b>	E122 Rotor E123 Drum	E139 Prem Cyl E140 Std Cyl E146 Semi-Loaded Cal E147 Loaded Cal	E148 Cal Kit E149 Cyl Kit	E155 Hose

DISCARD

DIAMETER

## TOYOTA (Cont'd)

### HIGHLANDER (Cont'd)

2010 - 2011	Made In Japan	E110-1324-0	V E125-49-163 25.0	E122-49-097	L E146-49-279 44.5 R E146-49-278 44.5	E148-49-081	L E155-49-147 R E155-49-148
	Made in USA	E110-1324-0	V E125-49-163 25.0	E122-49-097	L E146-49-287 44.5 R E146-49-286 44.5	E148-49-091	L E155-49-147 R E155-49-148

### LAND CRUISER

2003 - 2007		E110-0772-0	V E125-49-091 30.0	E122-49-072	L E146-49-235 51/45.5 R E146-49-234 51/45.5	E148-49-067	L E155-49-116 R E155-49-117
2008 - 2011		E110-1303-0	V E125-49-167 29.0	E122-49-094	L E146-49-283 51 R E146-49-282 51	E148-49-078	L E155-49-157 R E155-49-156
2012	NOT PRODUCED						
2013		E110-1303-0	V E125-49-167 29.0	E122-49-094	L E146-49-283 51 R E146-49-282 51	E148-49-078	

### SEQUOIA

2003 - 2007		E110-0976-0	V E125-49-123 26.0	E122-49-080	L E146-49-237 45.5 R E146-49-236 45.5	E148-49-074	E155-49-367
2008 - 2011		E110-1303-0	V E125-49-161 29.0	E122-49-094	L E146-49-275 51 R E146-49-274 51	E148-49-078	E155-49-146

### SIENNA

2004 - 2010	Rear Drums	E110-0906-1	V E125-49-130 26.0	E122-49-075	L E146-49-241 63.5 R E146-49-240 63.5	E148-49-065	L E155-49-089 R E155-49-088
	Rear Disc	E110-0906-1	V E125-49-130 26.0	E122-49-075	L E146-49-241 63.5 R E146-49-240 63.5	E148-49-065	L E155-49-089 R E155-49-088
2011		E110-1324-0	V E125-49-163 25.0	E122-49-097	L E146-49-287 44.5 R E146-49-286 44.5	E148-49-091	L E155-49-161 R E155-49-160

Many products are available in multiple grades or configurations. Refer to page 5 for details.

# R E A R

<b>Pads</b> E105 OEM Type E107 Semi-Met E109 Prem Pad E110 Ceramic E111 HD Pad <b>Shoes</b> E116 Std Shoe E117 HD Shoe  E121 Sensor Wire E124 Shoe Adjuster	<b>Rotor, Drum</b> E125 Prem Rotor E126 Std Rotor E127 Prem Drum E128 Std Drum E129 Hub L = Left R = Right V = Vented S = Solid	<b>DISCARD</b>	<b>Hardware Kits</b> E122 Rotor E123 Drum	<b>Calipers, Wheel Cyl</b> E139 Prem Cyl E140 Std Cyl E146 Semi-Loaded Cal E147 Loaded Cal	<b>DIAMETER</b>	<b>Kits Calipers, Wheel Cyl</b> E148 Cal Kit E149 Cyl Kit	<b>Brake Hoses</b> E155 Hose	<b>Master Cylinders</b> E135 Prem M/C E136 Std M/C	<b>DIAMETER</b>
--	--	----------------	---	--	-----------------	---	---------------------------------	--	-----------------

## TOYOTA (Cont'd)

### HIGHLANDER (Cont'd)

E110-1325-0 PB Shoe E116-0851-0	S E125-49-164 8.5	E122-49-098 PB Kit E123-49-033	L E146-49-635 41.5 R E146-49-634 41.5	E148-49-070	FWD L E155-49-437 R E155-49-438 AWD L E155-49-439 R E155-49-440	Except Hybrid E135-49-828 7/8" Hybrid E135-49-829 3/4"
E110-1325-0 PB Shoe E116-0851-0	S E125-49-164 8.5	E122-49-098 PB Kit E123-49-033	L E146-49-635 41.5 R E146-49-634 41.5	E148-49-070	FWD L E155-49-437 R E155-49-438 AWD L E155-49-439 R E155-49-440	E135-49-828 7/8"

### LAND CRUISER

E110-0773-0 PB Shoe E116-0844-0	V E125-49-092 16.0	E122-49-067 PB Kit E123-49-036	L E146-49-575 48 R E146-49-574 48	E148-96-020	up L E155-49-024 up R E155-49-387 lo L E155-49-412 lo R E155-49-413	Integral ABS
E110-1304-0 PB Shoe E116-0943-0	V E125-49-162 16.0	E122-49-095 PB Kit E123-49-042	L E146-49-633 45.5 E146-49-632 45.5	E148-49-080	up L E155-49-449 up R E155-49-450 lo E155-49-436	Integral Unit
PB Shoe E116-0943-0	V E125-49-162 16.0	E122-49-095 PB Kit E123-49-042	L E146-49-633 45.5 E146-49-632 45.5	E148-49-080		Integral Unit

### SEQUOIA

E110-0606-0 PB Shoe E116-0850-0	V E125-49-133 16.0	E122-96-006 PB Kit E123-49-039	L E146-49-593 48 R E146-49-592 48	E148-96-020	up L E155-49-390 up R E155-49-400 lo L E155-49-389 lo R E155-49-388	E135-49-746 23mm
E110-1304-0 PB Shoe E116-0943-0	V E125-49-162 16.0	E122-49-095 PB Kit E123-49-042	L E146-49-629 48 R E146-49-628 48	E148-25-012	L E155-49-453 R E155-49-454	E135-49-749 7/8"

### SIENNA

E116-0804-0 254 x 50.5 L E124-49-013 R E124-49-012	E127-49-049 256.0	E123-49-031	E139-49-807 7/8"		E155-49-414	E135-49-830 3/4"
E110-0995-0 PB Shoe E116-0851-0	S E125-49-137 10.5	E122-49-081 PB Kit E123-49-033	L E146-49-607 43 R E146-49-606 43	E148-49-069	up E155-49-414 lo E155-49-321	E135-49-830 3/4"
E110-1391-0	S E125-49-171 8.5	E122-49-104	L E146-49-647 40.5 R E146-49-646 40.5	E148-49-087	E155-49-459	E135-49-828 7/8"

# F R O N T

Many products are available in multiple grades or configurations. Refer to page 5 for details.

Make & Model	Year Notes	Pads	Rotor, Drum	Hardware Kits	Calipers, Wheel Cyl	Kits Calipers, Wheel Cyl	Brake Hoses
		E105 OEM Type E107 Semi-Met E109 Prem Pad E110 Ceramic E111 HD Pad <b>Shoes</b> E116 Std Shoe E117 HD Shoe  E121 Sensor Wire E124 Shoe Adjuster	E125 Prem Rotor E126 Std Rotor E127 Prem Drum E128 Std Drum E129 Hub <b>L = Left</b> <b>R = Right</b> <b>V = Vented</b> <b>S = Solid</b>	E122 Rotor E123 Drum	E139 Prem Cyl E140 Std Cyl E146 Semi-Loaded Cal E147 Loaded Cal	E148 Cal Kit E149 Cyl Kit	E155 Hose

DISCARD

DIAMETER

## TOYOTA (Cont'd)

### TACOMA

<b>2005 - 2008</b>	RWD, 5 Lug & Single Piston Caliper	E110-0906-1	V E125-49-141 23.0	E122-49-085	L E146-49-253 60 R E146-49-252 60	E148-47-013	L E155-49-091 R E155-49-092
	RWD & 4WD, 6 Lug & 4 Piston Caliper	E110-0976-0	V E125-49-134 26.0	E122-49-080	L E146-49-251 45.5 R E146-49-250 45.5 45.5	w/o Boot Spring E148-49-074 w/ Boot Spring E148-49-079	E155-49-367
<b>2009 - 2011</b>	RWD, 5 Lug & Single Piston Caliper	E110-0906-1	V E125-49-141 23.0	E122-49-085	L E146-49-253 60 R E146-49-252 60	E148-47-013	L E155-49-091 R E155-49-092
	RWD & 4WD, 6 Lug Wheels & 4 Piston Cal	E110-0976-0	V E125-49-134 26.0	E122-49-080	L E146-49-251 45.5 R E146-49-250 45.5 45.5	w/o Boot Spring E148-49-074 w/ Boot Spring E148-49-079	E155-49-367

### TUNDRA

<b>2007 - 2011</b>	E110-1303-0	V E125-49-161 29.0	E122-49-094	L E146-49-275 51 R E146-49-274 51	E148-49-078	E155-49-146
--------------------	-------------	--------------------	-------------	--------------------------------------	-------------	-------------

### 4RUNNER

<b>2003 - 2009</b>	16" Wheels & 319mm Front Disc	E110-0976-0	V E125-49-134 26.0	E122-49-080	L E146-49-251 45.5 R E146-49-250 45.5 45.5	w/o Boot Spring E148-49-074 w/ Boot Spring E148-49-079	E155-49-367
	17" Wheels & 338mm Front Disc	E110-0976-0	V E125-49-132 26.0	E122-49-080	L E146-49-233 45.5 R E146-49-232 45.5 45.5	w/o Boot Spring E148-49-074 w/ Boot Spring E148-49-079	E155-49-367
<b>2010 - 2011</b>		E110-0976-0	V E125-49-179 29.0	E122-49-106	L E146-49-293 48 R E146-49-292 48	E148-49-090	E155-49-367

Many products are available in multiple grades or configurations. Refer to page 5 for details.

# R E A R

Pads	Rotor, Drum	Hardware Kits	Calipers, Wheel Cyl	Kits Calipers, Wheel Cyl	Brake Hoses	Master Cylinders
E105 OEM Type E107 Semi-Met E109 Prem Pad E110 Ceramic E111 HD Pad <b>Shoes</b> E116 Std Shoe E117 HD Shoe  E121 Sensor Wire E124 Shoe Adjuster	E125 Prem Rotor E126 Std Rotor E127 Prem Drum E128 Std Drum E129 Hub <b>L = Left</b> <b>R = Right</b> <b>V = Vented</b> <b>S = Solid</b>	E122 Rotor E123 Drum	E139 Prem Cyl E140 Std Cyl E146 Semi-Loaded Cal E147 Loaded Cal	E148 Cal Kit E149 Cyl Kit	E155 Hose	E135 Prem M/C E136 Std M/C

DISCARD

DIAMETER

DIAMETER

## TOYOTA (Cont'd)

### TACOMA

E116-0804-0 254 x 50.5	E127-49-049 256.0	E123-49-040	E139-49-807 7/8"		L E155-49-419 R E155-49-418	MT Except VSC E135-49-747 13/16" A/T Except VSC E135-49-748 13/16" VSC Integral Unit
L E124-49-013 R E124-49-012						
E116-0804-0 254 x 50.5	E127-49-051 256.0	E123-49-040	E139-49-711 15/16"	E149-49-024	L E155-49-421 R E155-49-420	MT Except VSC E135-49-747 13/16" A/T Except VSC E135-49-748 13/16" VSC Integral Unit
L E124-49-013 R E124-49-012						
E116-0804-0 254 x 50.5	E127-49-049 256.0	E123-49-040	E139-49-807 7/8"		L E155-49-419 R E155-49-418	MT Except VSC E135-49-751 13/16" A/T Except VSC E135-49-750 13/16" VSC Integral Unit
L E124-49-013 R E124-49-012						
E116-0804-0 254 x 50.5	E127-49-051 256.0	E123-49-040	E139-49-711 15/16"	E149-49-024	L E155-49-421 R E155-49-420	MT Except VSC E135-49-751 13/16" A/T Except VSC E135-49-750 13/16" VSC Integral Unit
L E124-49-013 R E124-49-012						

### TUNDRA

E110-1304-0 PB Shoe E116-0943-0	V E125-49-162 16.0	E122-49-095 PB Kit E123-49-042	L E146-49-629 48 R E146-49-628 48	E148-25-012	up L E155-49-435 up R E155-49-434 lo E155-49-436	E135-49-749 7/8"
---------------------------------------	--------------------	--------------------------------------	--------------------------------------	-------------	--	------------------

### 4RUNNER

E110-0606-0 PB Shoe E116-0850-0	V E125-49-133 16.0	E122-96-006 PB Kit E123-49-039	L E146-49-521 45.5 R E146-49-520 45.5	E148-27-011	up E155-49-402 lo L E155-49-413 lo R E155-49-412	Integral Unit
E110-0606-0 PB Shoe E116-0850-0	V E125-49-133 16.0	E122-96-006 PB Kit E123-49-039	L E146-49-521 45.5 R E146-49-520 45.5	E148-27-011	up E155-49-402 lo L E155-49-413 lo R E155-49-412	Integral Unit
E110-0606-0 PB Shoe E116-0850-0	V E125-49-180 16.0	E122-96-006 PB Kit E123-49-039	L E146-49-593 48 R E146-49-592 48	E148-96-020	up E155-49-402 lo L E155-49-413 lo R E155-49-412	Integral Unit

# NOTES

---

---

**HAVE QUESTIONS? NEED ASSISTANCE? TALK TO THE FORMULA BLUE® TECH LINE.  
Call 1-866-610-9709, option 2  
Representatives are available Monday – Friday, 8:00 a.m. – 8:30 p.m. EST.**



# Medium-Duty Vehicle Application Guide

## Hydraulic Brake Parts

Import & Domestic

*Heavy Duty Parts for Hard Working Vehicles*

**Bendix Spicer Foundation Brake LLC**

901 Cleveland Street • Elyria, Ohio 44035

Phone: 440-329-9709

Toll-Free: 1-866-610-9709

Fax: 440-329-9203

Tech Support: 1-866-610-9709, option 2

[www.foundationbrakes.com](http://www.foundationbrakes.com)



# NOTES

---

---

**HAVE QUESTIONS? NEED ASSISTANCE? TALK TO THE FORMULA BLUE® TECH LINE.  
Call 1-866-610-9709, option 2  
Representatives are available Monday – Friday, 8:00 a.m. – 8:30 p.m. EST.**

Many products are available in multiple grades or configurations. Refer to page 5 for details.

MAKE MODEL PART DESC	YEAR	QUALIFIER	POSITION	PART #	DISCARB / DIAMETER	E122 / E123 HARDWARE KIT E124 SELF ADJUSTER E148 / E149 REPAIR KIT
----------------------------	------	-----------	----------	--------	-----------------------	--

## BLUEBIRD BUS

### VISION

Frt & Rr Pads	2003 - 2012			E111-0769-0		E122-85-006 <sup>4</sup>
Frt & Rr Rotor	2003 - 2012			E125-85-019	36.06mm	
Brake M/Cyl	2003 - 2012	Cylinder with Reservoir		E135-87-013	2"	
		Cylinder for Remote Type Reservoir		E135-88-022	2"	
Front Caliper	2003 - 2012		L	E146-84-015	64mm	E148-84-010
			R	E146-84-014	64mm	
Rear Caliper	2003 - 2012		L	E146-84-013	70mm	E148-84-009
			R	E146-84-012	70mm	

### TC2000 with Hydraulic Disc Brakes

Frt & Rr Pads	1998 - 2004	66mm 2 piston Pin Slide Caliper		E111-0786-1		E122-88-006 <sup>4</sup>
		73mm 2 piston Pin Slide Caliper		E111-0786-0		E122-88-006 <sup>4</sup>
		2.88" Rail Slide Caliper		E111-0225-0		E122-71-012
		4 piston Caliper		E111-0769-0		E122-85-006 <sup>4</sup>
Front Rotor	1990 - 2004	2 piston Caliper & 5 Hole Hat Shaped Rotor		E125-88-021	1.32"	
		2 piston Caliper & 5 Hole U Shaped		E125-88-022	1.32"	
		2 piston Caliper & 6 Hole Hat Shaped Rotor		E125-88-020	1.32"	
		2 piston Caliper & 10 Hole Hat Shaped Rotor, 3.20" Tall		E125-88-019	1.32"	
		2 piston Caliper & 10 Hole Hat Shaped Rotor, 4.45" Tall		E125-88-018	1.32"	
		2 piston Caliper & 10 Hole U Shaped Rotor		E125-88-012	1.32"	
Rear Rotor	1990 - 2004	4 piston Caliper & Hat Shaped Rotor		E125-85-019	36.06mm	
		2 piston Caliper & 5 Hole U Shaped		E125-88-013	1.32"	
		2 piston Caliper & 6 Hole Hat Shaped Rotor		E125-88-020	1.32"	
		2 piston Caliper & 10 Hole Hat Shaped Rotor, 3.20" Tall		E125-88-019	1.32"	
		2 piston Caliper & 10 Hole Hat Shaped Rotor, 4.45" Tall		E125-88-018	1.32"	
Brake M/Cyl	1990 - 2004	Cylinder with Reservoir		E135-87-013	2"	
		Cylinder for Remote Type Reservoir		E135-88-022	2"	
		4 piston Caliper & U Shaped Rotor		E125-85-020	36.06mm	
Front Hose	1990 - 2004	4 piston Caliper & Hat Shaped Rotor		E125-85-019	36.06mm	
		33" Hose		E155-88-019		
		35" Hose		E155-88-022		
Rear Hose	1990 - 2004	38" Hose		E155-88-021		
		37" hose		E155-88-315		
		39" Hose		E155-88-314		
Frt & Rr Caliper	1998 - 2004	43" Hose		E155-88-317		
		66mm Pin Slide Caliper Cast # 4153269	L & R	E146-88-008	66mm	E148-88-009
		73mm Pin Slide Caliper Cast # 4153222	L & R	E146-88-010	73mm	E148-88-008
		2.88" Rail Slide Caliper & Air Ride Suspension	L & R	E146-88-006	2.88"	E148-71-007
		2.88" Rail Slide Caliper Except Air Ride Suspension	L & R	E146-85-008	2.88"	E148-71-007
		64mm Meritor 4 piston Caliper	L	E146-84-015	64mm	E148-84-010
70mm Meritor 4 piston Caliper	R	E146-84-014	64mm			
	L	E146-84-013	70mm	E148-84-009		
	R	E146-84-012	70mm			

Notes<sup>4</sup> Major Kit.

Many products are available in multiple grades or configurations. Refer to page 5 for details.

MAKE MODEL PART DESC	YEAR	QUALIFIER	POSITION	PART #	DISCARD/ DIAMETER	E122 / E123 HARDWARE KIT E124 SELF ADJUSTER E148 / E149 REPAIR KIT
----------------------------	------	-----------	----------	--------	----------------------	--

## CHEVROLET

### B6P042 School Bus with Front Disc Brakes

Front Caliper	1979 - 1987	1 <sup>st</sup> Design Bendix Soft Boot Cliper <sup>5</sup>	L & R	E146-85-009	2.88"	E148-87-007
		Dayton 6 Hole Caliper, Casting # 472	L & R	E146-84-106	2.50"	E148-87-006
		Dayton 4 Hole Caliper, Casting # 563	L & R	E146-85-012	2.50"	E148-87-006
	1988 - 1991	2 <sup>nd</sup> Design Bendix Hard Boot Caliper <sup>5</sup>	L & R	E146-85-008	2.88"	E148-71-007
		Dayton 6 Hole Caliper, Casting # 472	L & R	E146-84-106	2.50"	E148-87-006
		Dayton 4 Hole Caliper, Casting # 563	L & R	E146-85-012	2.50"	E148-87-006
Rear W/Cyl	1979 - 1987		L	E139-71-016	1 1/2"	
			R	E139-71-017	1 1/2"	
Rear Caliper	1979 - 1987	1 <sup>st</sup> Design Bendix Soft Boot Cliper <sup>5</sup>	L & R	E146-85-009	2.88"	E148-87-007
		Dayton 6 Hole Caliper, Casting # 472	L & R	E146-84-106	2.50"	E148-87-006
		Dayton 4 Hole Caliper, Casting # 563	L & R	E146-85-012	2.50"	E148-87-006
	1988 - 1991	2 <sup>nd</sup> Design Bendix Hard Boot Caliper <sup>5</sup>	L & R	E146-85-008	2.88"	E148-71-007
		Dayton 6 Hole Caliper, Casting # 472	L & R	E146-84-106	2.50"	E148-87-006
		Dayton 4 Hole Caliper, Casting # 563	L & R	E146-85-012	2.50"	E148-87-006

### B7T042 School Bus with Disc Brakes

Front Caliper	1993 - 2002	Bendix		E146-85-008	2.88"	E148-71-007
		Dayton 6 Hole - Casting # 472	L & R	E146-84-106	2.50"	E148-87-006
		Dayton 4 Hole - Casting # 563	L & R	E146-85-012	2.50"	E148-87-006
Rear Caliper	1993 - 2002	Bendix		E146-85-008	2.88"	E148-71-007
		Dayton 6 Hole - Casting # 472	L & R	E146-84-106	2.50"	E148-87-006
		Dayton 4 Hole - Casting # 563	L & R	E146-85-012	2.50"	E148-87-006

### C4500 Kodiak

Front Pads	2003 - 2010	2 Piston Caliper		E111-1010-0		E122-85-007
		4 Piston Caliper		E111-0769-0		E122-85-006 <sup>4</sup>
Rear Pads	2003			E111-1010-0		E122-85-007
	2004 - 2010	2 Piston Cal, w/o Drum-in-Hat Rear Rotor		E111-1010-0		E122-85-007
		2 Piston Cal, w/ Drum-in-Hat Rear Rotor		E111-1064-0		E122-85-007
		4 Piston Cal		E111-0769-0		E122-85-006 <sup>4</sup>
Front Rotor	2003 - 2010	5 Hole Rotor		E125-85-018	36.1mm	
		8 Hole Rotor		E125-85-023	36.07mm	
		10 Hole Rotor		E125-85-019	36.06mm	
Rear Rotor	2003			E125-85-018	36.1mm	
	2004 - 2010	w/o Drum-in-Hat Rear Rotor - 5 Hole Rotor		E125-85-018	36.1mm	
		w/ Drum-in-Hat Rear Rotor - 10 Hole Rotor		E125-85-022	37.4mm	
PB Shoe	2003	9 x 3"		E116-0647-0		
	2004 - 2010	9 x 3" Except Drum-in-Hat Rear Rotor		E116-0647-0		
		9 1/2" x 2 1/2" Drum-in-Hat Rear Rotor		E116-0847-0		
Brake M/Cyl	2003 - 2010	6250 lb Frt Axle Except School Bus		E135-71-069	40mm	
		6250, 7000, 8000 lb Axle & School Bus		E135-87-012	2"	
Front Caliper	2003	60mm 2 Piston Caliper	L & R	E146-85-016	60mm	E148-70-024
		66mm 2 Piston Caliper	L & R	E146-85-014	66mm	E148-85-007
		70mm 4 Piston Caliper	L	E146-84-018	70mm	E148-85-006
	2004 - 2010	66mm 2 Piston Caliper	R	E146-84-019	70mm	
		66mm 2 Piston Caliper	L & R	E146-85-014	66mm	E148-85-007
		64mm 4 Piston Caliper	L	E146-84-016	64mm	E148-84-010
Rear Caliper	2003	60mm 2 Piston Caliper	R	E146-84-017	64mm	
		60mm 2 Piston Caliper	L & R	E146-85-016	60mm	E148-70-024
	2004 - 2010	66mm 2 Piston Cal w/ DIH Rear Rotor	L & R	E146-85-018	66mm	E148-85-007
		66mm 2 Piston Cal w/o DIH Rear Rotor	L & R	E146-85-014	66mm	E148-85-007
		64mm 4 Piston Caliper	L	E146-84-016	64mm	E148-84-010
		R	E146-84-017	64mm		

Notes <sup>4</sup> Major Kit. <sup>5</sup> 1st and 2nd Design Calipers are interchangeable; their components are not.

Many products are available in multiple grades or configurations. Refer to page 5 for details.

MAKE MODEL PART DESC	YEAR	QUALIFIER	POSITION	PART #	DISCARD / DIAMETER	E122 / E123 HARDWARE KIT E124 SELF ADJUSTER E148 / E149 REPAIR KIT
----------------------------	------	-----------	----------	--------	-----------------------	--

### CHEVROLET (Cont'd)

#### C5D064 with Disc Brakes

Front Caliper	1988 - 1990	2.60" Caliper - cast 4151733 w/ Soft Boot	L & R	E146-75-006	2.60"	E148-88-006
		2.60" Caliper - cast 4151733 w/ Hard Boot	L & R	E146-75-006	2.60"	E148-88-007
		2.60" Caliper - cast 2238229 w/ Cross Over Tube	L & R	E146-75-011	2.60"	E148-88-006
		2.60" Caliper - cast 4151020 w/o Cross Over Tube	L & R	E146-75-012	2.60"	E148-88-006
Rear Caliper	1988 - 1990	Dayton 6 Hole - Casting # 472	L & R	E146-84-106	2.50"	E148-87-006
		Dayton 4 Hole - Casting # 563	L & R	E146-85-012	2.50"	E148-87-006

#### C5H042 Kodiak with Disc Brakes

PB Shoe	1990 - 2002	9 x 3"		E116-0647-0		
		12 x 3"		E116-0824-0		
Front Caliper	1990 - 2002	Dayton 6 Hole - Casting # 472	L & R	E146-84-106	2.50"	E148-87-006
		Dayton 4 Hole - Casting # 563	L & R	E146-85-012	2.50"	E148-87-006
Rear Caliper	1990 - 2002	Dayton 6 Hole - Casting # 472	L & R	E146-84-106	2.50"	E148-87-006
		Dayton 4 Hole - Casting # 563	L & R	E146-85-012	2.50"	E148-87-006

#### C5500 Kodiak

Front Pads	2003 - 2010	2 Piston Caliper		E111-1010-0		E122-85-007
		4 Piston Caliper		E111-0769-0		E122-85-006 <sup>4</sup>
Rear Pads	2003	2 Piston Caliper		E111-1010-0		E122-85-007
		4 Piston Caliper		E111-0769-0		E122-85-006 <sup>4</sup>
	2004 - 2010	2 Piston Caliper, w/o Drum-in-Hat Rear Rotor		E111-1010-0		E122-85-007
		2 Piston Caliper, w/ Drum-in-Hat Rear Rotor		E111-1064-0		E122-85-007
Front Rotor	2003 - 2010	6000, 7000 lb Axle - 5 Hole Rotor		E125-85-018	36.1mm	
		8000 lb Axle - 8 Hole Rotor		E125-85-023	36.07mm	
		8000 lb Axle - 10 Hole Rotor		E125-85-019	36.06mm	
		Rear Rotor	2003	11,000, 13,500 lb Axle - 5 Hole Rotor		E125-85-018
Rear Rotor	2004 - 2010	15,000, 17,900, 19,000 lb Axle - 10 Hole Rotor		E125-85-019	36.06mm	
		11,000, 13,500 lb Axle - Except DIH Rear Rotor		E125-85-018	36.1mm	
		13,500 lb Axle - Drum-in-Hat Rear Rotor		E125-85-022	37.4mm	
		15,000, 17,900, 19,000 lb Axle		E125-85-019	36.06mm	
Brake M/Cyl	2003 - 2010	6250 lb Frt Axle Except School Bus		E135-71-069	40mm	
		6250, 7000, 8000 lb Axle & School Bus		E135-87-012	2"	
PB Shoe	2004 - 2010	9 x 3 Except Drum-in-Hat Rear Rotor		E116-0647-0		
		9 1/2" x 2 1/2" Drum-in-Hat Rear Rotor		E116-0847-0		
Front Caliper	2003	60mm 2 Piston Caliper	L & R	E146-85-016	60mm	E148-70-024
		66mm 2 Piston Caliper	L & R	E146-85-014	66mm	E148-85-007
		70mm 4 Piston - 7k lb Axle	L	E146-84-018	70mm	E148-85-006
			R	E146-84-019	70mm	
		64mm 4 Piston - 8k lb Axle	L	E146-84-016	64mm	E148-84-010
			R	E146-84-017	64mm	
	2004 - 2010	66mm 2 Piston Caliper	L & R	E146-85-014	66mm	E148-85-007
		64mm 4 Piston 7,8k lb Axle	L	E146-84-016	64mm	E148-84-010
			R	E146-84-017	64mm	
		70mm 4 Piston Caliper	L	E146-84-018	70mm	E148-85-006
Rear Caliper	2003	60mm 2 Piston Caliper	L & R	E146-85-016	60mm	E148-70-024
		64mm 4 Piston Caliper	L	E146-84-016	64mm	E148-84-010
			R	E146-84-017	64mm	
		2004 - 2010	66mm 2 Piston Caliper - w/o DIH Rr Rotor	L & R	E146-85-014	66mm
	66mm 2 Piston Caliper - w/ DIH Rr Rotor		L & R	E146-85-018	66mm	E148-85-007
	64mm 4 Piston Caliper		L	E146-84-016	64mm	E148-84-010
			R	E146-84-017	64mm	

Notes <sup>4</sup> Major Kit.

Many products are available in multiple grades or configurations. Refer to page 5 for details.

MAKE MODEL PART DESC	YEAR	QUALIFIER	POSITION	PART #	DISCARD / DIAMETER	E122 / E123 HARDWARE KIT E124 SELF ADJUSTER E148 / E149 REPAIR KIT
----------------------------	------	-----------	----------	--------	-----------------------	--

### CHEVROLET (Cont'd)

#### C60 C6D042 with Disc Brakes

Front Caliper	1983 - 1987	Dayton 6 Hole - Casting # 472	L & R	E146-84-106	2.50"	E148-87-006
		Dayton 4 Hole - Casting # 563	L & R	E146-85-012	2.50"	E148-87-006
	1988 - 1990	Bendix - Single Piston	L	E146-71-015	3.38"	E148-73-006
			R	E146-71-014	3.38"	
		Bendix - Dual Piston		E146-85-008	2.88"	E148-71-007
		Dayton 6 Hole - Casting # 472	L & R	E146-84-106	2.50"	E148-87-006
	Dayton 4 Hole - Casting # 563	L & R	E146-85-012	2.50"	E148-87-006	
Rear Caliper	1983 - 1987	Bendix - 1st Design - Soft Boot <sup>5</sup>	L & R	E146-85-009	2.88"	E148-87-007
		1988 - 1990	Bendix - Single Piston	L	E146-71-015	3.38"
			R	E146-71-014	3.38"	
		Bendix - 2nd Design - Hard Boot <sup>5</sup>	L & R	E146-85-008	2.88"	E148-71-007
		Dayton 6 Hole - Casting # 472	L & R	E146-84-106	2.50"	E148-87-006
		Dayton 4 Hole - Casting # 563	L & R	E146-85-012	2.50"	E148-87-006
Front Hose	1988 - 1990	5M FA		E155-85-015		
		exc 5M FA		E155-85-007		

#### C6500 Kodiak with Disc Brakes

Front Pads	2003 - 2010			E111-0769-0		E122-85-006 <sup>4</sup>	
Rear Pads	2003 - 2010			E111-0769-0		E122-85-006 <sup>4</sup>	
Front Rotor	2003 - 2010			E125-85-019	36.06mm		
Rear Rotor	2003 - 2010	exc 21,000 lb axle		E125-85-019	36.06mm		
		21,000 lb Axle		E125-85-020	36.06mm		
Brake M/Cyl	2003 - 2010			E135-87-012	2"		
Front Caliper	1990 - 2002	Dayton 6 Hole Caliper - Casting # 472 - 8100 Lb FA	L & R	E146-84-106	2.50"	E148-87-006	
		Dayton 4 Hole Caliper - Casting # 563	L & R	E146-85-012	2.50"	E148-87-006	
		Bendix Caliper	L & R	E146-85-008	2.88"	E148-71-007	
	2003 - 2010	64mm Caliper - 8K Lb Axle	L	E146-84-016	64mm	E148-84-010	
			R	E146-84-017	64mm		
		70mm Caliper - 10, 12K Lb Axle	L	E146-84-018	70mm	E148-85-006	
	R	E146-84-019	70mm				
Rear Caliper	1990 - 1994	Dayton 6 Hole Caliper - Casting # 472 - 8100 Lb FA	L & R	E146-84-106	2.50"	E148-87-006	
		Dayton 4 Hole Caliper - Casting # 563	L & R	E146-85-012	2.50"	E148-87-006	
		Bendix Caliper	L & R	E146-85-008	2.88"	E148-71-007	
	1995 - 2002	Dayton 2 Piston 6 Hole Cal - Casting # 472 - 8100 Lb FA	L & R	E146-84-106	2.50"	E148-87-006	
		Dayton 2 Piston 4 Hole Caliper - Casting # 563	L & R	E146-85-012	2.50"	E148-87-006	
		Bendix 2 Piston Caliper	L & R	E146-85-008	2.88"	E148-71-007	
		Dayton 4 Steel Piston Caliper w/ 10x1.50mm inlet	L	E146-85-011	70mm	E148-85-006	
			R	E146-85-010	70mm		
		Dayton 4 Steel Piston Caliper w/ 7/16"x24 inlet	L	E146-85-023	70mm	E148-85-006	
			R	E146-85-022	70mm		
		Dayton 4 Phenolic Piston Caliper	L	E146-85-021	70mm	E148-84-009	
			R	E146-85-020	70mm		
		2003 - 2010	64mm Caliper - 15K Lb Axle	L	E146-84-016	64mm	E148-84-010
				R	E146-84-017	64mm	
	70mm Caliper - 19, 21K Lb Axle	L	E146-84-018	70mm	E148-85-006		
		R	E146-84-019	70mm			
Front Hose	1990 - 1994			E155-85-016			
	1995 - 2002	w/ABS		E155-85-012			
		w/o ABS		E155-85-023			
Center Hose	1990 - 1993			E155-85-308			

Notes<sup>4</sup> Major Kit. <sup>5</sup> 1st and 2nd Design Calipers are interchangeable; their components are not.

Many products are available in multiple grades or configurations. Refer to page 5 for details.

MAKE MODEL PART DESC	YEAR	QUALIFIER	POSITION	PART #	DISCARD/ DIAMETER	E122 / E123 HARDWARE KIT E124 SELF ADJUSTER E148 / E149 REPAIR KIT
----------------------------	------	-----------	----------	--------	----------------------	--

## CHEVROLET (Cont'd)

### C6500 Kodiak with Disc Brakes (Cont'd)

Rear Hose	1990 - 2002	Flat Low w/Rear Disc, w/ ABS	L	E155-85-306		
			R	E155-85-307		
		Flat Low w/Rear Disc, w/o ABS	L	E155-85-313		
			R	E155-85-312		
		Exc Flat Low w/Rear Disc	L	E155-85-315		
			R	E155-85-314		
	w/Rear Drum	L	E155-85-319			
		R	E155-85-318			

### C70 C7D042, C7D064 with Disc Brakes

Front Caliper	1983 - 1987	Bendix - 1st Design - Soft Boot <sup>5</sup>	L & R	E146-85-009	2.88"	E148-87-007
		Dayton 6 Hole - Casting # 472	L & R	E146-84-106	2.50"	E148-87-006
		Dayton 4 Hole - Casting # 563	L & R	E146-85-012	2.50"	E148-87-006
	1988 - 1990	Bendix - Single Piston	L	E146-71-015	3.38"	E148-73-006
			R	E146-71-014	3.38"	
		Bendix - 2nd Design - Hard Boot <sup>5</sup>	L & R	E146-85-008	2.88"	E148-71-007
	Dayton 6 Hole - Casting # 472	L & R	E146-84-106	2.50"	E148-87-006	
		Dayton 4 Hole - Casting # 563	L & R	E146-85-012	2.50"	E148-87-006
Rear Caliper	1983 - 1987	Bendix - 1st Design - Soft Boot <sup>5</sup>	L & R	E146-85-009	2.88"	E148-87-007
			L	E146-71-015	3.38"	E148-73-006
	1988 - 1990	Bendix - Single Piston	R	E146-71-014	3.38"	
			Bendix - 2nd Design - Hard Boot <sup>5</sup>	L & R	E146-85-008	2.88"
		Dayton 6 Hole - Casting # 472	L & R	E146-84-106	2.50"	E148-87-006
			Dayton 4 Hole - Casting # 563	L & R	E146-85-012	2.50"

### C7500 Kodiak with Disc Brakes

Front Pads	2003 - 2010			E111-0769-0		E122-85-006 <sup>4</sup>
Rear Pads	2003 - 2010			E111-0769-0		E122-85-006 <sup>4</sup>
Front Rotor	1990 - 2002	Bendix Calipers - 10 Hole		E125-85-006	33.53mm	
		Dayton Calipers - 5 Hole		E125-85-013	31.12mm	
	2003 - 2010	10 Hole Rotor		E125-85-019	36.06mm	
Rear Rotor	2003 - 2010	exc 21,000 lb Axle		E125-85-019	36.06mm	
		21,000 lb Axle		E125-85-020	36.06mm	
PB Shoe	1990 - 2010	9 x 3		E116-0647-0		
		12 x 3" w/ M/T		E116-0824-0		
		12 x 3" w/ A/T		E116-0692-0		
Brake M/Cyl	2003 - 2010			E135-87-012	2"	
Front Caliper	2003 - 2010	64mm Caliper - 8K Lb Axle	L	E146-84-016	64mm	E148-84-010
			R	E146-84-017	64mm	
		70mm Caliper - 10, 12K Lb Axle	L	E146-84-018	70mm	E148-85-006
			R	E146-84-019	70mm	

Notes<sup>5</sup> 1st and 2nd Design Calipers are interchangeable; their components are not.

Many products are available in multiple grades or configurations. Refer to page 5 for details.

MAKE MODEL PART DESC	YEAR	QUALIFIER	POSITION	PART #	DISCARD/ DIAMETER	E122 / E123 HARDWARE KIT E124 SELF ADJUSTER E148 / E149 REPAIR KIT
----------------------------	------	-----------	----------	--------	----------------------	--

## CHEVROLET (Cont'd)

### C7500 Kodiak with Disc Brakes (Cont'd)

Rear Caliper	1990 - 1994	Dayton 6 Hole Caliper - Casting # 472 - 8100 Lb FA	L & R	E146-84-106	2.50"	E148-87-006
		Dayton 4 Hole Caliper - Casting # 563	L & R	E146-85-012	2.50"	E148-87-006
1995 - 2002		Bendix Caliper	L & R	E146-85-008	2.88"	E148-71-007
		Dayton 2 Piston 6 Hole Cal - Casting # 472 - 8100 Lb FA	L & R	E146-84-106	2.50"	E148-87-006
		Dayton 2 Piston 4 Hole Caliper - Casting # 563	L & R	E146-85-012	2.50"	E148-87-006
		Bendix 2 Piston Caliper	L & R	E146-85-008	2.88"	E148-71-007
		Dayton 4 Steel Piston Caliper w/ 10x1.50mm inlet	L	E146-85-011	70mm	E148-85-006
			R	E146-85-010	70mm	
		Dayton 4 Steel Piston Caliper w/ 7/16"x24 inlet	L	E146-85-023	70mm	E148-85-006
			R	E146-85-022	70mm	
Dayton 4 Phenolic Piston Caliper	L	E146-85-021	70mm	E148-84-009		
	R	E146-85-020	70mm			
2003 - 2010		64mm Caliper - 15K Lb Axle	L	E146-84-016	64mm	E148-84-010
		R	E146-84-017	64mm		
70mm Caliper - 19, 21K Lb Axle	L	E146-84-018	70mm	E148-85-006		
	R	E146-84-019	70mm			

### P4T042 with Disc Brakes

Front Caliper	1988 - 1996	Bendix	L	E146-71-015	3.38"	E148-73-006
			R	E146-71-014	3.38"	
		Dayton 6 Hole - Casting # 472	L & R	E146-84-106	2.50"	E148-87-006
			Dayton 4 Hole - Casting # 563	L & R	E146-85-012	2.50"
Rear Caliper	1988 - 1996	Bendix	L	E146-71-015	3.38"	E148-73-006
			R	E146-71-014	3.38"	
		Dayton 6 Hole - Casting # 472	L & R	E146-84-106	2.50"	E148-87-006
			Dayton 4 Hole - Casting # 563	L & R	E146-85-012	2.50"

### P6S with Disc Brakes

Front Caliper	1992 - 1996	Bendix		E146-85-008	2.88"	E148-71-007
		Dayton 6 Hole - Casting # 472	L & R	E146-84-106	2.50"	E148-87-006
		Dayton 4 Hole - Casting # 563	L & R	E146-85-012	2.50"	E148-87-006
Rear Caliper	1992 - 1996	Bendix		E146-85-008	2.88"	E148-71-007
		Dayton 6 Hole - Casting # 472	L & R	E146-84-106	2.50"	E148-87-006
		Dayton 4 Hole - Casting # 563	L & R	E146-85-012	2.50"	E148-87-006
Front Hose	1995 - 1996			E155-85-012		
Rear Hose	1992 - 1996		L	E155-85-306		

### P6T042 with Disc Brakes

Front Caliper	1983 - 1987	Bendix - 1st Design - Soft Boot <sup>5</sup>	L & R	E146-85-009	2.88"	E148-87-007
		Dayton 6 Hole - Casting # 472	L & R	E146-84-106	2.50"	E148-87-006
		Dayton 4 Hole - Casting # 563	L & R	E146-85-012	2.50"	E148-87-006
	1988 - 1990	Bendix - Single Piston	L	E146-71-015	3.38"	E148-73-006
			R	E146-71-014	3.38"	
		Bendix - 2nd Design - Hard Boot <sup>5</sup>	L & R	E146-85-008	2.88"	E148-71-007
Dayton 6 Hole - Casting # 472	L & R	E146-84-106	2.50"	E148-87-006		
	Dayton 4 Hole - Casting # 563	L & R	E146-85-012	2.50"	E148-87-006	
	Rear Caliper	1983 - 1987	Bendix - 1st Design - Soft Boot <sup>5</sup>	L & R	E146-85-009	2.88"
Dayton 6 Hole - Casting # 472			L & R	E146-84-106	2.50"	E148-87-006
Dayton 4 Hole - Casting # 563			L & R	E146-85-012	2.50"	E148-87-006
1988 - 1990		Bendix - Single Piston	L	E146-71-015	3.38"	E148-73-006
			R	E146-71-014	3.38"	
		Bendix - 2nd Design - Hard Boot <sup>5</sup>	L & R	E146-85-008	2.88"	E148-71-007
Dayton 6 Hole - Casting # 472	L & R	E146-84-106	2.50"	E148-87-006		
	Dayton 4 Hole - Casting # 563	L & R	E146-85-012	2.50"	E148-87-006	

Notes <sup>5</sup> 1st and 2nd Design Calipers are interchangeable; their components are not.

Many products are available in multiple grades or configurations. Refer to page 5 for details.

MAKE MODEL PART DESC	YEAR	QUALIFIER	POSITION	PART #	DISCARD / DIAMETER	E122 / E123 HARDWARE KIT E124 SELF ADJUSTER E148 / E149 REPAIR KIT
<b>CHEVROLET (Cont'd)</b>						
<b>T5500, T6500 with Disc Brakes, T7500, T8500 Tilt Cab with Disc Brakes</b>						
Front Pads	2004 - 2010			E111-0769-0		E122-85-006 <sup>4</sup>
Rear Pads	2004 - 2010			E111-0769-0		E122-85-006 <sup>4</sup>
Front Rotor	3/96 - 2002	8100 lb FA - Dayton Caliper		E125-85-013	31.12mm	
		11000, 12000 lb FA - Bendix Caliper		E125-85-006	33.53mm	
	2004 - 2010	10000 lb FA		E125-85-019	36.06mm	
Rear Rotor	2004 - 2010	15000, 19000 lb RA - 10 Hole - Behind the hub type		E125-85-019	36.06mm	
		21000 lb RA - 10 Hole - U Shaped Rotor		E125-85-020	36.06mm	
PB Shoe	2004 - 2010	9 x 3		E116-0647-0		
		12 x 3		E116-0824-0		
Brake M/Cyl	2004 - 2010			E135-87-012	2"	
Front Caliper	3/96 - 2002	Dayton 6 Hole Caliper - Casting # 472 - 8100 Lb FA	L & R	E146-84-106	2.50"	E148-87-006
		Dayton 4 Hole Caliper - Casting # 563	L & R	E146-85-012	2.50"	E148-87-006
		Bendix Caliper - 11, 12K FA	L & R	E146-85-008	2.88"	E148-71-007
	2004 - 2010	64mm Caliper	L	E146-84-016	64mm	E148-84-010
			R	E146-84-017	64mm	
		70mm Caliper	L	E146-84-018	70mm	E148-85-006
	R	E146-84-019	70mm			
Rear Caliper	3/96 - 2/98	Dayton 6 Hole Caliper - Casting # 472 - 8100 Lb FA	L & R	E146-84-106	2.50"	E148-87-006
		Dayton 4 Hole Caliper - Casting # 563	L & R	E146-85-012	2.50"	E148-87-006
		Bendix Caliper	L & R	E146-85-008	2.88"	E148-71-007
	3/98 - 2002	Dayton 2 Piston 6 Hole Cal - Casting # 472 - 8100 Lb FA	L & R	E146-84-106	2.50"	E148-87-006
		Dayton 2 Piston 4 Hole Caliper - Casting # 563	L & R	E146-85-012	2.50"	E148-87-006
		Bendix 2 Piston Caliper	L & R	E146-85-008	2.88"	E148-71-007
		Dayton 4 Steel Piston Caliper w/ 10x1.50mm inlet	L	E146-85-011	70mm	E148-85-006
			R	E146-85-010	70mm	
		Dayton 4 Steel Piston Caliper w/ 7/16"x24 inlet	L	E146-85-023	70mm	E148-85-006
			R	E146-85-022	70mm	
		Dayton 4 Phenolic Piston Caliper	L	E146-85-021	70mm	E148-84-009
			R	E146-85-020	70mm	
	2004 - 2010	64mm Caliper - 15K Lb Axle	L	E146-84-016	64mm	E148-84-010
			R	E146-84-017	64mm	
	70mm Caliper - 19, 21K Lb Axle	L	E146-84-018	70mm	E148-85-006	
		R	E146-84-019	70mm		
Front Hose	1997 - 2009		L	E155-81-011		
			R	E155-81-012		
		w/o ABS		E155-85-023		
Rear Hose	2004 - 2009	Eaton Axle - Except Low Profile	L	E155-81-013		
		Eaton Axle - Except Low Profile	R	E155-81-014		
		Dana Axle - Except Low Profile	L	E155-81-015		
		Dana Axle - Except Low Profile	R	E155-81-016		
		21000 lb RA - w/ Air Suspension	L	E155-81-017		
		21000 lb RA - w/ Air Suspension	R	E155-81-018		

Notes<sup>4</sup> Major Kit.



Many products are available in multiple grades or configurations. Refer to page 5 for details.

MAKE MODEL PART DESC	YEAR	QUALIFIER	POSITION	PART #	DISCARD / DIAMETER	E122 / E123 HARDWARE KIT E124 SELF ADJUSTER E148 / E149 REPAIR KIT
----------------------------	------	-----------	----------	--------	-----------------------	--

## CHEVROLET (Cont'd)

### W3500 Gas Engine

Front Pads	10/97 - 2008	10,001 - 14,000 GVW		E111-0825-0		E122-81-007
		14,001 - 16,000 GVW		E111-0827-0		E122-81-007
Rear Shoes	7/01 - 2008	10001 - 14000 Lbs GVWR - 320mm x 100mm		E117-0699-0		
		14001 - 16000 Lbs GVWR - 311.2mm x 121.9mm		E117-0792-0		
Front Rotor	10/97 - 2008	10,000 - 14,000 GVW		E125-48-021	37mm	
		14,001 - 16,000 GVW		E125-48-024	39mm	
Rear Drum	7/01 - 2008	10,001 - 14,000 GVW - 320mm x 75mm		E127-81-006	321.5mm	
		14,001 - 16,000 GVW - 320mm x 100mm		E127-81-012	321.5mm	
PB Shoe	1995 - 2008	11" x 2"		E116-0823-0		
Brake M/Cyl	11/95 - 10/97			E135-81-013	1 1/4"	
	11/97 - 2008	Exc HD		E135-81-015	1 1/4"	
		HD		E135-81-017	1 3/8"	
Front Caliper	7/04 - 2008	10,001 - 14,000 GVW - Cast # 5407 A934X	L	E146-81-015	54mm	E148-81-008
			R	E146-81-014	54mm	
		14,001 - 16,000 GVW - Cast # 5705 A940	L	E146-81-017	57mm	E148-81-009
			R	E146-81-016	57mm	
Rear W/Cyl	7/02 - 2008		L Fr	E139-81-045	1 3/16"	
			L Rr	E139-81-054	1 3/16"	
			R Fr	E139-81-053	1 3/16"	
			R Rr	E139-81-052	1 3/16"	
Front Hose	1995 - 2007	16 1/4" Hose		E155-81-008		
		15 1/2" Hose		E155-81-021		
	2008			E155-81-020		
Rear Hose	1995 - 2008			E155-81-009		

### W3500 Diesel Engine

Front Pads	1/98 - 2008			E111-0825-0		E122-81-007
Rear Shoes	1995 - 2008	320mm x 75mm		E117-0612-0		E123-85-009
		320mm x 100mm		E117-0699-0		E123-85-009
Front Rotor	8/97 - 12/97			E125-81-006	32mm	
	1/98 - 2008			E125-48-021	37mm	
Rear Drum	1995 - 2008			E127-81-005	321.5mm	
PB Shoe	1995 - 2006	7 1/2" Shoes		E116-0733-0		
		8" Shoes		E116-0979-0		
	2007 - 2008			E116-0979-0		
Brake M/Cyl	11/97 - 2008			E135-81-015	1 1/4"	
Front Caliper	1/04 - 2008		L	E146-81-015	54mm	E148-81-008
			R	E146-81-014	54mm	
Rear W/Cyl	3/03 - 2008		L Fr	E139-81-069	1 1/16"	
			L Rr	E139-81-067	1 1/16"	
			R Fr	E139-81-070	1 1/16"	
			R Rr	E139-81-068	1 1/16"	
Front Hose	1995 - 10/04	16 1/4" Hose		E155-81-008		
		15 1/2" Hose		E155-81-021		
	11/04 - 2008			E155-81-019		
Rear Hose	1995 - 2008			E155-81-009		
Clutch M/Cyl	1995 - 2006			E141-81-009	3/4"	
Clutch S/Cyl	1/98 - 2006	5 Speed		E143-81-011	1"	
		6 Speed		E143-81-010	1"	

Many products are available in multiple grades or configurations. Refer to page 5 for details.

MAKE MODEL PART DESC	YEAR	QUALIFIER	POSITION	PART #	DISCARD / DIAMETER	E122 / E123 HARDWARE KIT E124 SELF ADJUSTER E148 / E149 REPAIR KIT
----------------------------	------	-----------	----------	--------	-----------------------	--

## CHEVROLET (Cont'd)

### W4500 Gas Engine

Front Pads	7/99 - 2008	10,001 - 14,000 GVW		E111-0825-0		E122-81-007
		14,001 - 16,000 GVW		E111-0827-0		E122-81-007
Rear Shoes	1995 - 2008	320mm x 100mm		E117-0699-0		
		311.2mm x 121.9mm		E117-0792-0		
Front Rotor	7/99 - 2008	10,000 - 14,000 GVW - 293.4mm rotor		E125-48-021	37mm	
		14,001 - 16,000 GVW - 363.0mm rotor		E125-48-024	39mm	
Rear Drum	9/94 - 2008	10,001 - 14,000 GVW		E127-81-006	321.5mm	
		14,001 - 16,000 GVW		E127-81-012	321.5mm	
PB Shoe	1995 - 2008	11" x 2"		E116-0823-0		
Brake M/Cyl	10/97 - 2008	Exc HD		E135-81-015	1 1/4"	
		HD		E135-81-017	1 3/8"	
Front Caliper	7/04 - 2008	10,001 - 14,000 GVW - Cast # 5407 A934X	L	E146-81-015	54mm	E148-81-008
			R	E146-81-014	54mm	
		14,001 - 16,000 GVW - Cast # 5705 A940	L	E146-81-017	57mm	E148-81-009
			R	E146-81-016	57mm	
Rear W/Cyl	7/02 - 2008		L Fr	E139-81-051	1 5/16"	
			L Rr	E139-81-047	1 5/16"	
			R Fr	E139-81-056	1 5/16"	
			R Rr	E139-81-049	1 5/16"	
Front Hose	1995 - 9/97			E155-81-008		
	10/97 - 2003	15 1/2" Hose		E155-81-021		
		16 1/2" Hose		E155-81-022		
	2004 - 2007	w/ 16" Wheels - 16 1/4" Hose		E155-81-008		
		w/ 16" Wheels - 15 1/2" Hose		E155-81-021		
		w/ 19 1/2" Wheels - 16 1/2" Hose		E155-81-022		
	2008	w/ 19 1/2" Wheels - 11 7/8" Hose		E155-81-020		
				E155-81-020		
Rear Hose	1995 - 2008			E155-81-009		

### W4500 Diesel Engine

Front Pads	1/98 - 2009	14,001 - 16,000 GVW		E111-0825-0		E122-81-007
		16,001 - 19,500 GVW		E111-0827-0		E122-81-007
Rear Shoes	1995 - 2009	14,001 - 16,000 GVW		E117-0699-0		
		16,001 - 19,500 GVW		E117-0792-0		
Front Rotor	1/98 - 2009	14,001 - 16,000 GVW - 293.4mm rotor		E125-48-021	37mm	
		16,001 - 19,500 GVW - 363.0mm rotor		E125-48-024	39mm	
Rear Drum	9/94 - 2009	14,001 - 16,000 GVW		E127-81-006	321.5mm	
		16,001 - 19,500 GVW		E127-81-012	321.5mm	
PB Shoe	1995 - 2007	7 1/2" Shoes		E116-0733-0		
		8" Shoes		E116-0979-0		
	2008 - 2009			E116-0979-0		
Brake M/Cyl	11/97 - 2009	14,001 - 16,000 GVW		E135-81-015	1 1/4"	
		16,001 - 19,500 GVW		E135-81-017	1 3/8"	
Front Caliper	1/04 - 2009	14,001 - 16,000 GVW - Cast # 5407 A934X	L	E146-81-015	54mm	E148-81-008
			R	E146-81-014	54mm	
		16,001 - 19,500 GVW - Cast # 5705 A940	L	E146-81-017	57mm	E148-81-009
			R	E146-81-016	57mm	
Rear W/Cyl	1/03 - 2009		L Fr	E139-81-045	1 3/16"	
			L Rr	E139-81-054	1 3/16"	
			R Fr	E139-81-053	1 3/16"	
			R Rr	E139-81-052	1 3/16"	

Many products are available in multiple grades or configurations. Refer to page 5 for details.

MAKE MODEL PART DESC	YEAR	QUALIFIER	POSITION	PART #	DISCARD/ DIAMETER	E122 / E123 HARDWARE KIT E124 SELF ADJUSTER E148 / E149 REPAIR KIT
----------------------------	------	-----------	----------	--------	----------------------	--

## CHEVROLET (Cont'd)

### W4500 Diesel Engine (Cont'd)

Front Hose	1995 - 10/04	16 1/4" Hose		E155-81-008		
		15 1/2" Hose		E155-81-021		
	11/04 - 2007			E155-81-019		
	2008 - 2009	13 3/8" Hose		E155-81-019		
		12" Hose		E155-81-020		
Rear Hose	1995 - 2003			E155-81-009		
Clutch M/Cyl	1995 - 2007			E141-81-009	3/4"	
Slave Cyl	1995 - 12/97			E143-81-006	1"	
	1/98 - 2007	5 Speed		E143-81-011	1"	
		6 Speed		E143-81-010	1"	

### W5500 exc HD

Front Pads	1/99 - 2009			E111-0827-0		E122-81-007
Rear Shoes	1/98 - 2009	HD 311.2mm x 121.9mm		E117-0792-0		
Front Rotor	1/99 - 2009			E125-48-024	39mm	
Rear Drum	1/98 - 2009			E127-81-012	321.5mm	
PB Shoe	1/98 - 2007	7 1/2" Shoes		E116-0733-0		
		8" Shoes		E116-0979-0		
	2008 - 2009			E116-0979-0		
Brake M/Cyl	1/98 - 2009			E135-81-017	1 3/8"	
Front Caliper	1/04 - 2009		L	E146-81-017	57mm	E148-81-009
			R	E146-81-016	57mm	
Rear W/Cyl	1/03 - 2009		L Fr	E139-81-047	1 5/16"	
			L Rr	E139-81-051	1 5/16"	
			R Fr	E139-81-056	1 5/16"	
			R Rr	E139-81-049	1 5/16"	
Front Hose	1/98 - 12/03			E155-81-022		
	1/04 - 2009			E155-81-020		
Rear Hose	1/98 - 2009			E155-81-009		
Clutch M/Cyl	1/98 - 2009			E141-81-009	3/4"	
Slave Cyl	1/98 - 2009	5 Speed		E143-81-011	1"	
		6 Speed		E143-81-010	1"	

### W5500HD

Front Pads	2005 - 2010			E111-0827-0		E122-81-007
Rear Shoes	2005 - 2010			E117-0833-0		
Front Rotor	2005 - 2010			E125-48-024	39mm	
Rear Drum	2005 - 2010			E127-81-013	372mm	
PB Shoe	2005 - 2010			E116-0979-0		
Brake M/Cyl	2005 - 2010			E135-81-017	1 3/8"	
Front Caliper	2005 - 2010		L	E146-81-017	57mm	E148-81-009
			R	E146-81-016	57mm	
Rear W/Cyl	2005 - 2010		L Fr	E139-81-048	1 5/16"	
			L Rr	E139-81-071	1 5/16"	
			R Fr	E139-81-046	1 5/16"	
			R Rr	E139-81-050	1 5/16"	
Front Hose	2005 - 2010			E155-81-020		
Rear Hose	2005 - 2010			E155-81-009		
Clutch M/Cyl	2005 - 2010			E141-81-009	3/4"	
Slave Cyl	2005 - 2007			E143-81-010	1"	
	2008 - 2010			E143-81-012	1"	

Many products are available in multiple grades or configurations. Refer to page 5 for details.

MAKE MODEL PART DESC	YEAR	QUALIFIER	POSITION	PART #	DISCARD / DIAMETER	E122 / E123 HARDWARE KIT E124 SELF ADJUSTER E148 / E149 REPAIR KIT
----------------------------	------	-----------	----------	--------	-----------------------	--

### CHEVROLET (Cont'd)

#### WT5500

Front Drum	2000 - 2004			E127-81-010		
Rear Drum	2000 - 2004			E127-81-011		
PB Shoe	2000 - 2004	to 5/2001 254mm x 60mm		E116-1008-0		
		from 6/2001 254mm x 60mm		E116-1007-0		
Front W/Cyl	2000 - 2004		L	E139-81-057	1 1/2"	
			R	E139-81-058	1 1/2"	
Rear W/Cyl	2000 - 2004		L Fr	E139-81-063	1 5/8"	
			L Rr	E139-81-064	1 5/8"	
			R Fr	E139-81-065	1 5/8"	
			R Rr	E139-81-066	1 5/8"	
Clutch M/Cyl	2000 - 2004			E141-81-010	7/8"	
Slave Cyl	2000 - 2004			E143-81-007	1"	

#### W6 M

Front Shoes	9/86 - 12/93	410mm x 140mm - Air Over Hydraulic		E117-0613-0		
	1/94 - 9/94	410mm x 140mm - Air Over Hydraulic-Manual		E117-0613-0		
		410mm x 140mm - Air Over Hydraulic-Auto		E117-0718-0		
	10/94 - 1996	410mm x 140mm - Air Over Hydraulic		E117-0718-0		
Rear Shoes	9/86 - 12/93	410mm x 140mm - Air Over Hydraulic		E117-0613-0		
	1/94 - 9/94	410mm x 140mm - Air Over Hydraulic-Manual		E117-0613-0		
		410mm x 140mm - Air Over Hydraulic-Auto		E117-0718-0		
	10/94 - 1996	410mm x 140mm - Air Over Hydraulic		E117-0718-0		
PB Shoes	1987 - 1996	8 1/2"		E116-1009-0		
		10x2" - MT		E116-1007-0		
		10x2" - AT		E116-1008-0		
Front W/Cyl	9/86 - 12/93		L	E139-81-114	47.5mm	E149-85-010
			R	E139-81-115	47.5mm	
	1/94 - 9/94	w/ Auto Adjuster	L	E139-81-155	47.5mm	
			R	E139-81-156	47.5mm	
	10/94 - 1996	w/ Manual Adjuster	L	E139-81-114	47.5mm	E149-85-010
			R	E139-81-115	47.5mm	
			L	E139-81-155	47.5mm	
			R	E139-81-156	47.5mm	
Rear W/Cyl	9/86 - 12/93			E139-81-113	53.5mm	E149-85-011
				E139-81-154	53.5mm	
	1/94 - 9/94	w/ Auto Adjuster		E139-81-113	53.5mm	E149-85-011
				E139-81-154	53.5mm	
10/94 - 1996	w/ Manual Adjuster		E139-81-113	53.5mm	E149-85-011	
			E139-81-154	53.5mm		
Clutch M/Cyl	11/87 - 1996			E141-81-007	7/8"	
Slave Cyl	11/87 - 1996			E143-81-007	1"	

Many products are available in multiple grades or configurations. Refer to page 5 for details.

MAKE MODEL PART DESC	YEAR	QUALIFIER	POSITION	PART #	DISCARD / DIAMETER	E122 / E123 HARDWARE KIT E124 SELF ADJUSTER E148 / E149 REPAIR KIT
----------------------------	------	-----------	----------	--------	-----------------------	--

## DODGE

### RAM 4500, 5500

Frt & Rr Pads	2008 - 2012			E111-1335-0		E122-72-020
PB Shoes	2008 - 2012			E116-0847-0		E123-70-021
Brake M/Cyl	2008 - 2012			E135-72-050	1 1/2"	
Front Rotor	2008 - 2012			E125-72-075	37.4mm	
Rear Rotor	2008 - 2012			E125-70-120	37.4mm	
Frt & Rr Caliper	2008 - 2012		L	E146-72-063	66mm	E148-85-007
			R	E146-72-062	66mm	
Front Hose	2008 - 2011		L	E155-72-131		
			R	E155-72-132		
Rear Hose	2008 - 2012		L	E155-72-401		
			R	E155-72-400		
			Center	E155-72-405		

## FORD

### B600 Bus with Front Disc Brakes

Brake M/Cyl	1984 - 1991	w/ Built-in Check Valve		E135-84-030	1 3/4"	
		w/o Built-in Check Valve		E135-84-027	1 3/4"	
	1992 - 1995			E135-84-022	1 1/2"	
Front Caliper	1984 - 1985	Dayton 6 Hole - Casting # 472	L & R	E146-84-106	2.50"	E148-87-006
		Dayton 4 Hole - Casting # 563	L & R	E146-85-012	2.50"	E148-87-006
	1986 - 1995	Dayton 6 Hole - Casting # 472	L & R	E146-84-106	2.50"	E148-87-006
		Dayton 4 Hole - Casting # 563	L & R	E146-85-012	2.50"	E148-87-006
		2.88" Caliper		E146-84-006	2.88"	E148-84-006

### B700 Bus with Front Disc Brakes

Brake M/Cyl	1984 - 1991	w/ Built-in Check Valve		E135-84-030	1 3/4"	
		w/o Built-in Check Valve		E135-84-027	1 3/4"	
	1992 - 1995			E135-84-022	1 1/2"	
Front Caliper	1984 - 1995	Dayton 6 Hole - Casting # 472	L & R	E146-84-106	2.50"	E148-87-006
		Dayton 4 Hole - Casting # 563	L & R	E146-85-012	2.50"	E148-87-006
		2.88" Caliper		E146-84-006	2.88"	E148-84-006

### C600 Tilt Cab with Front Disc Brakes

Brake M/Cyl	1984 - 1990	w/ Built-in Check Valve		E135-84-030	1 3/4"	
		w/o Built-in Check Valve		E135-84-027	1 3/4"	
Front Caliper	1984 - 1990	Dayton 6 Hole - Casting # 472	L & R	E146-84-106	2.50"	E148-87-006
		Dayton 4 Hole - Casting # 563	L & R	E146-85-012	2.50"	E148-87-006

### C700 Tilt Cab with Front Disc Brakes

Brake M/Cyl	1984 - 1990	2.50" Front Caliper - w/ Built-in Check Valve		E135-84-030	1 3/4"	
		2.50" Front Caliper - w/o Built-in Check Valve		E135-84-027	1 3/4"	
		2.88" Front Caliper		E135-84-026	2"	
Front Caliper	1984 - 1990	Dayton 6 Hole - Casting # 472	L & R	E146-84-106	2.50"	E148-87-006
		Dayton 4 Hole - Casting # 563	L & R	E146-85-012	2.50"	E148-87-006
		2.88" Caliper		E146-84-006	2.88"	E148-84-006

### C800 Tilt Cab with Front Disc Brakes

Brake M/Cyl	1984 - 1990	2.50" Front Caliper - w/ Built-in Check Valve		E135-84-030	1 3/4"	
		2.50" Front Caliper - w/o Built-in Check Valve		E135-84-027	1 3/4"	
		2.88" Front Caliper - 2.00" Bore Master		E135-84-026	2"	
Front Caliper	1984 - 1990	Dayton 6 Hole - Casting # 472	L & R	E146-84-106	2.50"	E148-87-006
		Dayton 4 Hole - Casting # 563	L & R	E146-85-012	2.50"	E148-87-006
		2.88" Caliper		E146-84-006	2.88"	E148-84-006

Many products are available in multiple grades or configurations. Refer to page 5 for details.

MAKE MODEL PART DESC	YEAR	QUALIFIER	POSITION	PART #	DISCARD / DIAMETER	E122 / E123 HARDWARE KIT E124 SELF ADJUSTER E148 / E149 REPAIR KIT
<b>FORD (Cont'd)</b>						
<b>E450, 47 (1 Ton) Super Duty Van &amp; Cutaway</b>						
Front Pads	1996 - 2007			E111-0655-0		E122-70-014
	2008 - 2012			E111-1328-0		E122-70-039
Rear Pads	1996 - 2007			E111-0411-0		E122-70-011
	2008 - 2012			E111-1330-0		E122-70-038
PB Shoe	1999 - 2007			E116-0771-0		
	2008 - 2012			E116-0952-0		E123-70-024
Front Rotor	1996 - 2001	w/ Rear ABS		E125-70-048	28mm	
		w/ 4 Wheel ABS		E125-70-047	28mm	
	2002 - 2007			E125-70-047	28mm	
		2008 - 2011			E125-70-131	38.4mm
Rear Rotor	1996 - 2007			E125-70-069	36.3mm	
	2008 - 2012			E125-70-132	40.4mm	
Brake M/Cyl	1996 - 1998	w/ Hydro Boost		E135-70-047	1 5/16"	
		w/ Vac Booster - w/o Speed Control		E135-70-056	1 1/4"	
		w/ Vac Booster - w/ Speed Control - Except SRW		E135-70-057	1 1/4"	
		w/ Vac Booster - w/ Speed Control - SRW		E135-70-065	1 1/4"	
	1999 - 2001	w/ Hydro Boost		E135-70-079	1 5/16"	
		w/ Vac Booster - w/o Speed Control		E135-70-067	1 5/16"	
		w/ Vac Booster - w/ Speed Control		E135-70-068	1 5/16"	
	2002 - 2007			E135-70-086	1 5/16"	
		2008			E135-70-124	1 3/8"
	2009 - 2011	DRW Except RSC		E135-70-138	1 3/8"	
		RSC No Brake Control Valve		E135-70-134	1 5/16"	
2012	Brake Control Valve		E135-70-137	1 5/16"		
			E135-70-138	1 3/8"		
Front Caliper	1996 - 2007		L	E146-70-037	56mm	E148-70-016
			R	E146-70-036	56mm	E148-70-016
	2008 - 2012		L	E146-70-093	60mm	E148-70-036
			R	E146-70-092	60mm	E148-70-036
Rear Caliper	1996 - 2007		L	E146-70-021	60mm	E148-70-013
			R	E146-70-020	60mm	
	2008 - 2011		L	E146-70-541	54mm	E148-70-037
			R	E146-70-540	54mm	E148-70-037
Front Hose	1996 - 2001	w/ 4 Whl ABS	L	E155-70-106		
			R	E155-70-107		
		w/ Rear Whl ABS	L	E155-70-108		
			R	E155-70-107		
	2002 - 2003		L	E155-70-106		
			R	E155-70-107		
	2004 - 9/6/05		L	E155-70-106		
			R	E155-70-107		
	9/6/05 - 2007		L	E155-70-186		
			R	E155-70-187		
2008 - 2012		L	E155-70-207			
		R	E155-70-206			
Rear Hose	1996 - 2003		up	E155-70-370		
			lo L	E155-70-362		
			up R	E155-70-363		
	2004 - 2007		up	E155-70-370		
			lo L	E155-70-407		
			lo R	E155-70-408		
	2008 - 2012		L	E155-70-373		
			R	E155-70-466		

Many products are available in multiple grades or configurations. Refer to page 5 for details.

MAKE MODEL PART DESC	YEAR	QUALIFIER	POSITION	PART #	DISCARD/ DIAMETER	E122 / E123 HARDWARE KIT E124 SELF ADJUSTER E148 / E149 REPAIR KIT
----------------------------	------	-----------	----------	--------	----------------------	--

## FORD (Cont'd)

### E550

Frt & Rr Pads	2002 - 2005			E111-0777-0		E122-70-020
Front Rotor	2002 - 2005			E125-70-092	36mm	
Rear Rotor	2002 - 2005			E125-70-074	36mm	
Brake M/Cyl	2002 - 2005	w/o Speed Control		E135-70-064	1 3/8"	
		w/ Speed Control		E135-70-087	1 3/8"	
Frt & Rr Caliper	2002 - 2005		L	E146-70-049	60mm	E148-70-024
			R	E146-70-048	60mm	
Front Hose	2002 - 2005		L	E155-70-163		
			R	E155-70-162		
Rear Hose	2002 - 2005		up	E155-70-384		
			lo L	E155-70-417		
			lo R	E155-70-418		

### F53, 59 (1 Ton) RV Motor Home & Stripped Chassis

Front Pads	1988 - 1998			E111-0411-0		E122-70-011
	1999 - 2004			E111-0777-0		E122-70-020
	2005 - 10/07			E111-1066-0		E122-70-029
	11/07 - 2011	Except 24,000, 26,000 LB GVW		E111-1066-0		E122-70-029
		w/24,000, 26,000 LB GVW		E111-0786-0		E122-88-006
Rear Pads	1988 - 1998			E111-0411-0		E122-70-011
	1999 - 2004			E111-0777-0		E122-70-020
	2005 - 10/07			E111-1066-0		E122-70-029
	11/07 - 2011	Except 24,000, 26,000 LB GVW		E111-1066-0		E122-70-029
		w/24,000, 26,000 LB GVW		E111-0786-1		E122-88-006
PB Shoe	1999 - 2010	Inside Disc		E116-0772-0		E123-70-016
		Transmission		E116-0647-0		E123-85-015
Front Rotor	1988 - 1998			E125-70-025	36.3mm	
	1999 - 10/07			E125-70-074	36mm	
	11/07 - 2011	Except 24,000, 26,000 LB GVW		E125-70-074	36mm	
		w/24,000, 26,000 LB GVW		E125-88-019	1.32"	
Rear Rotor	1988 - 1998			E125-70-025	36.3mm	
	1999 - 2001			E125-70-074	36mm	
	2002 - 10/07	w/o ABS		E125-70-074	36mm	
		w/ ABS		E125-70-097	36mm	
	11/07 - 2011	Except 24K, 26K LB GVW		E125-70-097	36mm	
		w/24,000, 26,000 LB GVW		E125-88-018	1.32"	
Brake M/Cyl	1988 - 1998	w/o Speed Control		E135-70-039	1 5/16"	
		w/ Speed Control		E135-70-047	1 5/16"	
	1999 - 2001	15,500 & 18,000 GVW		E135-70-063	1 3/8"	
		20,500 GVW		E135-84-036	2"	
	2002 - 2003	w/o Speed Control		E135-70-064	1 3/8"	
		w/ Speed Control		E135-70-063	1 3/8"	
	2004 - 10/07	w/ Hydro Boost		E135-70-063	1 3/8"	
		w/ Hydro Max		E135-87-013	2"	
	11/07 - 2011	16,000, 18,000, 19,500, 20,500, 22,000 Lb GVW - Hydro Boost		E135-70-063	1 3/8"	
		16,000, 18,000, 19,500, 20,500, 22,000 Lb GVW - Hydro Max		E135-87-013	2"	
	24,000, 26,000 LB GVW		E135-87-013	2"		

Many products are available in multiple grades or configurations. Refer to page 5 for details.

MAKE MODEL PART DESC	YEAR	QUALIFIER	POSITION	PART #	DISCARD / DIAMETER	E122 / E123 HARDWARE KIT E124 SELF ADJUSTER E148 / E149 REPAIR KIT
<b>FORD (Cont'd)</b>						
<b>F53, 59 (1 Ton) RV Motor Home &amp; Stripped Chassis (Cont'd)</b>						
Front Caliper	1988 - 1998		L	E146-70-021	60mm	E148-70-013
			R	E146-70-020	60mm	
	1999 - 12/04		L	E146-70-049	60mm	E148-70-024
			R	E146-70-048	60mm	
	1/05 - 10/07		L	E146-70-077	60mm	E148-70-024
			R	E146-70-076	60mm	
	11/07 - 2010	Except 24K, 26K LB GVW	L	E146-70-077	60mm	E148-70-024
			R	E146-70-076	60mm	
2011	24K, 26K LB GVW	L & R	E146-88-010	73mm	E148-88-008	
		Except 24K, 26K LB GVW	L	E146-70-049	60mm	E148-70-024
			R	E146-70-048	60mm	
	24K, 26K LB GVW	L & R	E146-88-010	73mm	E148-88-008	
Rear Caliper	1988 - 1998		L	E146-70-021	60mm	E148-70-013
			R	E146-70-020	60mm	
	1999 - 10/3/00	Front & Rear Staggered Mounted Calipers Rear of Axle mounted Calipers	L & R	E146-70-048	60mm	E148-70-024
			L	E146-70-049	60mm	
	10/4/00 - 2004		R	E146-70-048	60mm	
			L	E146-70-049	60mm	E148-70-024
	2005 - 2010	Except 24K, 26K LB GVW	R	E146-70-048	60mm	
			L	E146-70-077	60mm	E148-70-024
2011	24K, 26K LB GVW	L & R	E146-88-008	66mm	E148-88-009	
		Except 24K, 26K LB GVW	L & R	E146-70-048	60mm	E148-70-024
			L & R	E146-88-008	66mm	E148-88-009
Front Hose	1988 - 1996		L	E155-84-006		
			R	E155-84-007		
	1997 - 1998		L	E155-84-009		
			R	E155-84-010		
	1999 - 2003		L	E155-70-127		
			R	E155-70-128		
	2004 - 10/07		L	E155-70-169		
			R	E155-70-168		
11/07 - 2011	Except 24K, 26K LB GVW	L	E155-70-169			
		R	E155-70-168			
		L	E155-70-211			
	24K, 26K LB GVW	R	E155-70-210			
Rear Hose	1989 - 1991		up	E155-84-311		
			loL	E155-84-312		
			loR	E155-84-313		
	1992 - 1998		up	E155-84-314		
			loL	E155-84-312		
			loR	E155-84-313		
	1999 - 10/3/00	15,500 & 18,000 GVW	up	E155-70-354		
			loL	E155-70-389		
			loR	E155-70-390		
			up	E155-70-357		
	20,500 GVW	loL	E155-70-389			
		loR	E155-70-390			
<i>Cont'd Next Pg</i>						



Many products are available in multiple grades or configurations. Refer to page 5 for details.

MAKE MODEL PART DESC	YEAR	QUALIFIER	POSITION	PART #	DISCARD/ DIAMETER	E122 / E123 HARDWARE KIT E124 SELF ADJUSTER E148 / E149 REPAIR KIT
----------------------------	------	-----------	----------	--------	----------------------	--

## FORD (Cont'd)

### F53, 59 (1 Ton) RV Motor Home & Stripped Chassis (Cont'd)

Rear Hose (Cont'd)	10/3/00 - 2001	15,500 & 18,000 GVW	up	E155-70-354			
			lo L	E155-70-389			
			lo R	E155-70-390			
		20,500, 22,000 GVW		up	E155-70-372		
				lo L	E155-70-389		
			lo R	E155-70-390			
	2002 - 2003	15,500 & 18,000 GVW		up	E155-70-354		
				lo L	E155-70-389		
			lo R	E155-70-390			
		20,500, 22,000 GVW		up	E155-70-372		
				lo L	E155-70-389		
			lo R	E155-70-390			
	2004 - 12/5/05	15,700 & 18,000 GVW		up	E155-70-415		
				lo L	E155-70-389		
			lo R	E155-70-390			
		20,500, 22,000 GVW		up	E155-70-413		
				lo L	E155-70-389		
			lo R	E155-70-390			
	12/05/05 - 10/07	w/Hydro Boost		up	E155-70-415		
				lo L	E155-70-389		
		lo R	E155-70-390				
	w/Hydro Max		up	E155-70-413			
			lo L	E155-70-389			
		lo R	E155-70-446				
11/07 - 2010	w/Hydro Boost Except 24K, 26K GVW		up	E155-70-415			
			lo L	E155-70-389			
		lo R	E155-70-442				
	w/Hydro Max Except 24K, 26K GVW		up	E155-70-413			
			lo L	E155-70-389			
		lo R	E155-70-446				
	w/24K, 26K GVW		up	E155-70-413			
			lo L	E155-70-475			
		lo R	E155-70-476				

### F450, F47 (1 Ton) 2WD & 4WD Super Duty

Front Pads	2005 - 2/12/10			E111-1066-0		E122-70-029
	2/22/10 - 2012	Pickup		E111-1069-0		E122-70-033
		Cab & Chassis		E111-1066-0		E122-70-029
Rear Pads	2005 - 2/12/10			E111-1066-0		E122-70-029
	2/22/10 - 2012	Pickup		E111-1334-0		E122-70-031
		Cab & Chassis		E111-1066-0		E122-70-029
PB Shoe	1988 - 1991			E116-0647-0		E123-85-015
	1999 - 2004	Inside Disc SRW		E116-0772-0		E123-70-015
		Inside Disc DRW		E116-0772-0		E123-70-016
		Transmission		E116-0647-0		E123-85-015
	2005 - 2/12/10	Pickup		E116-0854-0		
2/22/10 - 2012	Cab & Chassis		E116-0847-0		E123-70-021	
Front Rotor	1999 - 2001	2WD		E125-70-092	36.0mm	
		4WD		E126-70-073	36.0mm	
	2002 - 2004			E125-70-092	36.0mm	
				E125-70-116	37.4mm	
	2005 - 2/12/10			E125-70-115	36.4mm	
	2/22/10 - 2012	Pickup		E125-70-115	36.4mm	
	Cab & Chassis		E125-70-116	37.4mm		

Many products are available in multiple grades or configurations. Refer to page 5 for details.

MAKE MODEL PART DESC	YEAR	QUALIFIER	POSITION	PART #	DISCARD / DIAMETER	E122 / E123 HARDWARE KIT E124 SELF ADJUSTER E148 / E149 REPAIR KIT	
<b>FORD (Cont'd)</b>							
<b>F450, F47 (1 Ton) 2WD &amp; 4WD Super Duty (Cont'd)</b>							
Rear Rotor	2005 - 2/12/10			E125-70-120	37.4mm		
	2/22/10 - 2012	Pickup		E125-70-119	32.4mm		
		Cab & Chassis		E125-70-120	37.4mm		
Brake M/Cyl	2005 - 12/17/06	Gas Engine w/o Brake Control Valve		E135-70-103	1 5/16"		
		Gas Engine w/ Integrated Brake Control		E135-70-104	1 5/16"		
		Diesel Engine w/o Brake Control Valve		E135-70-105	1 1/2"		
		Diesel Engine/ Integrated Brake Control		E135-70-106	1 1/2"		
	12/18/06 - 11/07	Gas Engine w/o Brake Control Valve		E135-70-133	1 5/16"		
		Gas Engine w/ Integrated Brake Control		E135-70-132	1 5/16"		
		Diesel Engine w/o Brake Control Valve		E135-70-116	1 1/2"		
		Diesel Engine/ Integrated Brake Control		E135-70-117	1 1/2"		
	12/07 - 2/12/10	Except Brake Control Valve		E135-70-116	1 1/2"		
		Integrated Brake Control		E135-70-117	1 1/2"		
		2/22/10 - 2012	Except Trailer Control		E135-70-143	1 1/2"	
			Trailer Control		E135-70-144	1 1/2"	
Front Caliper	2005 - 2/12/10		L	E146-70-077	60mm	E148-70-024	
			R	E146-70-076	60mm		
	2/22/10 - 2012	Pickup	L	E146-70-085	60mm	E148-80-006	
			R	E146-70-084	60mm		
		Cab & Chassis	L	E146-70-077	60mm	E148-70-024	
			R	E146-70-076	60mm		
Rear Caliper	1999 - 2001	Front & Rear Staggered Mounted Calipers	L & R	E146-70-048	60mm	E148-70-024	
		Rear of Axle mounted Calipers	L	E146-70-049	60mm		
			R	E146-70-048	60mm		
	2002 - 2004		L	E146-70-049	60mm	E148-70-024	
			R	E146-70-048	60mm		
	2005 - 2/12/10		L	E146-70-077	60mm	E148-70-024	
			R	E146-70-076	60mm		
	2/22/10 - 10/10	Pickup	L	E146-70-531	54mm	E148-70-031	
			R	E146-70-530	54mm		
		Cab & Chassis	L	E146-70-077	60mm	E148-70-024	
			R	E146-70-076	60mm		
	11/10 - 2012	Pickup	L	E146-70-530	54mm	E148-70-031	
			R	E146-70-531			
		Cab & Chassis	L	E146-70-077	60mm	E148-70-024	
R			E146-70-076	60mm			
Front Hose	2005 - 12/17/06		L	E155-70-181			
			R	E155-70-180			
	12/18/06 - 2009		L	E155-70-203			
			R	E155-70-202			
	2010 - 2/21/10		L	E155-70-217			
			R	E155-70-216			
	2/22/10 - 2012	Pickup	L	E155-70-225			
			R	E155-70-224			
Cab & Chassis - 2WD		L	E155-70-223				
		R	E155-70-222				

Many products are available in multiple grades or configurations. Refer to page 5 for details.

MAKE MODEL PART DESC	YEAR	QUALIFIER	POSITION	PART #	DISCARD/ DIAMETER	E122 / E123 HARDWARE KIT E124 SELF ADJUSTER E148 / E149 REPAIR KIT
----------------------------	------	-----------	----------	--------	----------------------	--

### FORD (Cont'd)

#### F450, F47 (1 Ton) 2WD & 4WD Super Duty (Cont'd)

Rear Hose	2005 - 12/17/06		up	E155-70-436		
			lo L	E155-70-403		
			lo R	E155-70-432		
	12/18/60 - 11/07	Pickup SRW	up	E155-70-461		
			lo L	E155-70-431		
			lo R	E155-70-462		
		Pickup DRW	lo L	E155-70-463		
			lo R	E155-70-462		
		Cab & Chassis	up	E155-70-436		
			lo L	E155-70-403		
			lo R	E155-70-390		
		12/07 - 2/12/10	Pickup	up	E155-70-461	
			lo L	E155-70-463		
			lo R	E155-70-462		
Cab & Chassis		up	E155-70-436			
		lo L	E155-70-403			
		lo R	E155-70-390			
	2/22/10 - 2012	Pickup	up	E155-70-469		
	Cab & Chassis	up	E155-70-484			
		lo L	E155-70-493			
		lo R	E155-70-494			

#### F550 (1 Ton) 2WD & 4WD Super Duty

Frt & Rr Pads	2005 - 2012			E111-1066-0		E122-70-029
PB Shoe	1988 - 1998			E116-0647-0		E123-85-015
	1999 - 2004	Inside Disc		E116-0772-0	SRW	E123-70-015
		Inside Disc		E116-0772-0	DRW	E123-70-016
		Transmission		E116-0647-0		E123-85-015
	2005 - 2012			E116-0847-0		E123-70-021
Front Rotor	1999 - 2001	2WD		E125-70-092	36mm	
		4 WD		E126-70-073	36mm	
	2002 - 2004		E125-70-092	36mm		
	2005 - 2012		E125-70-116	37.4mm		
Rear Rotor	2005 - 2012		E125-70-120	37.4mm		
Brake M/Cyl	2005 - 12/17/06	Gas Eng. w/o Brake Control Valve		E135-70-103	1 5/16"	
		Gas Eng. w/ Integrated Brake Control		E135-70-104	1 5/16"	
		Diesel Eng. w/o Brake Control Valve		E135-70-105	1 1/2"	
		Diesel Eng. w/ Integrated Brake Control		E135-70-106	1 1/2"	
	12/18/06 - 2/12/10	Gas Eng. w/o Brake Control Valve		E135-70-133	1 5/16"	
		Gas Eng. w/ Integrated Brake Control		E135-70-132	1 5/16"	
		Diesel Eng. w/o Brake Control Valve		E135-70-116	1 1/2"	
		Diesel Eng. w/ Integrated Brake Control		E135-70-117	1 1/2"	
	2/22/10 - 2012	Except Trailer Control		E135-70-143	1 1/2"	
		Trailer Control		E135-70-144	1 1/2"	
Front Caliper	2005 - 2012		L	E146-70-077	60mm	E148-70-024
			R	E146-70-076	60mm	
Rear Caliper	2005 - 2012		L	E146-70-077	60mm	E148-70-024
			R	E146-70-076	60mm	

Many products are available in multiple grades or configurations. Refer to page 5 for details.

MAKE MODEL PART DESC	YEAR	QUALIFIER	POSITION	PART #	DISCARD / DIAMETER	E122 / E123 HARDWARE KIT E124 SELF ADJUSTER E148 / E149 REPAIR KIT
----------------------------	------	-----------	----------	--------	-----------------------	--

## FORD (Cont'd)

### F550 (1 Ton) 2WD & 4WD Super Duty (Cont'd)

Front Hose	2005 - 12/17/06		L	E155-70-181		
			R	E155-70-180		
	12/18/06 - 2009		L	E155-70-203		
			R	E155-70-202		
	2010		L	E155-70-217		
			R	E155-70-216		
Rear Hose	2008 - 2/12/2010		lo L	E155-70-403		
			lo R	E155-70-390		
			Center	E155-70-436		
	2/13/2010 - 2012		up	E155-70-469		
			Lo L	E155-70-493		
			Lo R	E155-70-494		

### F600 Conventional with Front Disc Brakes

Brake M/Cyl	1984 - 1998	w/ Built-in Check Valve		E135-84-030	1 3/4"	
		w/o Built-in Check Valve		E135-84-027	1 3/4"	
Front Caliper	1984 - 1998	Dayton 6 Hole - Casting # 472	L & R	E146-84-106	2.50"	E148-87-006
		Dayton 4 Hole - Casting # 563	L & R	E146-85-012	2.50"	E148-87-006
		2.88" Caliper		E146-84-006	2.88"	E148-84-006

### F650 Conventional with Disc Brakes

Front Pads	2004 - 2008	w/ 66mm Caliper Cast # 4153269		E111-0786-1		E122-88-006 <sup>4</sup>	
		w/ 73mm Caliper Cast # 4153222		E111-0786-0		E122-88-006 <sup>4</sup>	
	2009 - 2012			E111-0769-0		E122-85-006 <sup>4</sup>	
Rear Pads	2004 - 2008	w/ 66mm Caliper Cast # 4153269		E111-0786-1		E122-88-006 <sup>4</sup>	
		w/ 73mm Caliper Cast # 4153222		E111-0786-0		E122-88-006 <sup>4</sup>	
	2009 - 2012			E111-0769-0		E122-85-006 <sup>4</sup>	
Brake M/Cyl	2000 - 2008	Bosch Brake Master Cylinder		E135-87-013	2"		
	2009 - 2012	Meritor Wabco Master Cylinder		E135-88-027	13/16"		
PB Shoe	2000 - 2012	12x3" Air actuated		E116-0980-0			
		12x3" Manual actuated		E116-0978-0			
Front Rotor	2004 - 2008	5 Hole Hat Shaped Disc		E125-88-021	1.32"		
		10 Hole - Hat Shaped Disc - 3.20" Tall		E125-88-019	1.32"		
		10 Hole - Hat Shaped Disc - 4.45" Tall		E125-88-018	1.32"		
	2009 - 2012			E125-88-025	1.42"		
Rear Rotor	2004 - 2008	5 Hole Hat Shaped Disc		E125-88-021	1.32"		
		10 Hole - Hat Shaped Disc - 3.20" Tall		E125-88-019	1.32"		
		10 Hole - Hat Shaped Disc - 4.45" Tall		E125-88-018	1.32"		
	2009 - 2012			E125-88-025	1.42"		
Front Caliper	2000 - 2003		L	E146-84-019	70mm	E148-84-009	
			R	E146-84-018	70mm		
	2004 - 2008	66mm Caliper Cast # 4153269			E146-88-008	66mm	E148-88-009
		73mm Caliper Cast # 4153222			E146-88-010	73mm	E148-88-008
	2009 - 2012		L	E146-88-015	70mm	E148-84-009	
			R	E146-88-014	70mm		
Rear Caliper	2004 - 2008	66mm Caliper Cast # 4153269		E146-88-008	66mm	E148-88-009	
		73mm Caliper Cast # 4153222		E146-88-010	73mm	E148-88-008	
	2009 - 2012	4 piston - 70mm Caliper	L	E146-88-014	70mm	E148-84-009	
			R	E146-88-015	70mm		
		4 piston - 64mm Caliper	L	E146-88-017	64mm	E148-84-010	
			R	E146-88-016	64mm		

Notes<sup>4</sup> Major Kit.

Many products are available in multiple grades or configurations. Refer to page 5 for details.

MAKE MODEL PART DESC	YEAR	QUALIFIER	POSITION	PART #	DISCARD / DIAMETER	E122 / E123 HARDWARE KIT E124 SELF ADJUSTER E148 / E149 REPAIR KIT
----------------------------	------	-----------	----------	--------	-----------------------	--

## FORD (Cont'd)

### F650 Conventional with Disc Brakes (Cont'd)

Front Hose	2004 - 2012	33" Hose		E155-88-019		
		35" Hose		E155-88-022		
		38" Hose		E155-88-021		
Rear Hose	2004 - 2012	37" Hose		E155-88-315		
		39" Hose		E155-88-314		
		43" Hose		E155-88-317		
Clutch M/Cyl	2000 - 2007			E141-70-023	11/16"	
Slave Cyl	2000 - 2007			E143-70-017	13/16"	
Pre-Filled Kit	2004 - 2007	Includes Clutch Hose, Master and Slave Cylinders		E141-84-506		

### F700 Conventional with Front Disc Brakes

Brake M/Cyl	1984 - 1998	w/ Built-in Check Valve		E135-84-030	1 3/4"	
		w/o Built-in Check Valve		E135-84-027	1 3/4"	
Front Caliper	1984 - 1998	Dayton 6 Hole - Casting # 472	L & R	E146-84-106	2.50"	E148-87-006
		Dayton 4 Hole - Casting # 563	L & R	E146-85-012	2.50"	E148-87-006
		2.88" Caliper		E146-84-006	2.88"	E148-84-006

### F750 Conventional with Disc Brakes

Front Pads	2004 - 2008	w/ 66mm Caliper Cast # 4153269		E111-0786-1		E122-88-006 <sup>4</sup>
		w/ 73mm Caliper Cast # 4153222		E111-0786-0		E122-88-006 <sup>4</sup>
	2009 - 2012			E111-0769-0		E122-85-006 <sup>4</sup>
Rear Pads	2004 - 2008	w/ 66mm Caliper Cast # 4153269		E111-0786-1		E122-88-006 <sup>4</sup>
		w/ 73mm Caliper Cast # 4153222		E111-0786-0		E122-88-006 <sup>4</sup>
	2009 - 2012			E111-0769-0		E122-85-006 <sup>4</sup>
Brake M/Cyl	2000 - 2008	Bosch Brake Master Cylinder		E135-87-013	2"	
	2009 - 2012	Meritor Wabco Master Cylinder		E135-88-027	13/16"	
PB Shoe	2000 - 2012	12x3" Air actuated		E116-0980-0		
		12x3" Manual actuated		E116-0978-0		
Front Rotor	2004 - 2008	5 Hole Hat Shaped Disc		E125-88-021	1.32"	
		10 Hole - Hat Shaped Disc - 3.20" Tall		E125-88-019	1.32"	
		10 Hole - Hat Shaped Disc - 4.45" Tall		E125-88-018	1.32"	
	2009 - 2012			E125-88-025	1.42"	
Rear Rotor	2004 - 2008	5 Hole Hat Shaped Disc		E125-88-021	1.32"	
		10 Hole - Hat Shaped Disc - 3.20" Tall		E125-88-019	1.32"	
		10 Hole - Hat Shaped Disc - 4.45" Tall		E125-88-018	1.32"	
	2009 - 2012			E125-88-025	1.42"	
Front Caliper	2000 - 2003		L	E146-84-019	70mm	E148-84-009
			R	E146-84-018	70mm	
	2004 - 2008	66mm Caliper Cast # 4153269		E146-88-008	66mm	E148-88-009
		73mm Caliper Cast # 4153222		E146-88-010	73mm	E148-88-008
	2009 - 2012		L	E146-88-015	70mm	E148-84-009
			R	E146-88-014	70mm	
Rear Caliper	2000 - 2003	Dayton 2 Piston - 6 Hole - Casting # 472	L & R	E146-84-106	2.50"	E148-87-006
		Dayton 2 Piston - 4 Hole - Casting # 563	L & R	E146-85-012	2.50"	E148-87-006
		Dayton 64mm 4 Piston - 17.5M, 19M lb RA	L	E146-84-017	64mm	E148-84-010
			R	E146-84-016	64mm	
		Dayton 70mm 4 Piston - 21M, 23M lb RA	L	E146-84-019	70mm	E148-84-010
			R	E146-84-018	70mm	
	2004 - 2008	66mm Caliper Cast # 4153269		E146-88-008	66mm	E148-88-009
		73mm Caliper Cast # 4153222		E146-88-010	73mm	E148-88-008
	2009 - 2012		L	E146-88-014	70mm	E148-84-009
			R	E146-88-015	70mm	

Notes<sup>4</sup> Major Kit.

Many products are available in multiple grades or configurations. Refer to page 5 for details.

MAKE MODEL PART DESC	YEAR	QUALIFIER	POSITION	PART #	DISCARD / DIAMETER	E122 / E123 HARDWARE KIT E124 SELF ADJUSTER E148 / E149 REPAIR KIT
----------------------------	------	-----------	----------	--------	-----------------------	--

## FORD (Cont'd)

### F750 Conventional with Disc Brakes (Cont'd)

Front Hose	2004 - 2012	33" Hose		E155-88-019		
		35" Hose		E155-88-022		
		38" Hose		E155-88-021		
Rear Hose	2004 - 2012	37" Hose		E155-88-315		
		39" Hose		E155-88-314		
		43" Hose		E155-88-317		
Clutch M/Cyl	2004 - 2007			E141-70-023	11/16"	
Slave Cyl	2004 - 2007			E143-70-017	13/16"	
Pre-Filled Kit	2004 - 2007	Includes Clutch Hose, Master and Slave Cylinders		E141-84-506		

### F800 Conventional with Front Disc Brakes

Brake M/Cyl	1983			E135-84-025	1 3/4"	
	1984 - 1999	2.50" Front Caliper - w/ Built-in Check Valve		E135-84-030	1 3/4"	
		2.50" Front Caliper - w/o Built-in Check Valve		E135-84-027	1 3/4"	
		2.88" Front Caliper - 2.00" Bore Master Cyl		E135-84-026	2"	
Front Caliper	1983 - 1999	Dayton 6 Hole - Casting # 472	L & R	E146-84-106	2.50"	E148-87-006
		Dayton 4 Hole - Casting # 563	L & R	E146-85-012	2.50"	E148-87-006
		2.88" Caliper		E146-84-006	2.88"	E148-84-006

### FT800 Conventional with Front Disc Brakes

Front Caliper	1983 - 1998	Dayton 6 Hole - Casting # 472	L & R	E146-84-106	2.50"	E148-87-006
		Dayton 4 Hole - Casting # 563	L & R	E146-85-012	2.50"	E148-87-006
		2.88" Caliper		E146-84-006	2.88"	E148-84-006

### L800 Conventional with Front Disc Brakes

Brake M/Cyl	1984 - 1994	w/ Built-in Check Valve		E135-84-030	1 3/4"	
		w/o Built-in Check Valve		E135-84-027	1 3/4"	
Front Caliper	1984 - 1994	Dayton 6 Hole - Casting # 472	L & R	E146-84-106	2.50"	E148-87-006
		Dayton 4 Hole - Casting # 563	L & R	E146-85-012	2.50"	E148-87-006
		2.88" Caliper		E146-84-006	2.88"	E148-84-006

### L900 Conventional with Front Disc Brakes

Brake M/Cyl	1984 - 1994	w/ Built-in Check Valve		E135-84-030	1 3/4"	
		w/o Built-in Check Valve		E135-84-027	1 3/4"	
Front Caliper	1984 - 1994	Dayton 6 Hole - Casting # 472	L & R	E146-84-106	2.50"	E148-87-006
		Dayton 4 Hole - Casting # 563	L & R	E146-85-012	2.50"	E148-87-006
		2.88" Caliper		E146-84-006	2.88"	E148-84-006

### LCF Series

Frt & Rr Pads	2006 - 2010			E111-1066-0		E122-70-029
Frt & Rr Rotor	2006 - 2010			E125-70-120	37.4mm	
Frt & Rr Caliper	2006 - 2010		L	E146-70-077	60mm	E148-70-024
			R	E146-70-076	60mm	
PB Shoe	2006 - 2007	9 1/2" x 2 1/2"		E116-0847-0		E123-70-021
	2008 - 2010			E116-0854-0		
Brake M/Cyl	2006 - 2010			E135-70-108	1 1/2"	
Front Hose	2006 - 2010		L	E155-88-020		
			R	E155-88-023		
Rear Hose	2006 - 2010	25" Hose		E155-88-316		
		39 1/2" Hose		E155-88-318		

### LN600 Short Conventional with Front Disc Brakes

Brake M/Cyl	1984 - 1988	w/ Built-in Check Valve		E135-84-030	1 3/4"	
		w/o Built-in Check Valve		E135-84-027	1 3/4"	
Front Caliper	1984 - 1988	Dayton 6 Hole - Casting # 472	L & R	E146-84-106	2.50"	E148-87-006
		Dayton 4 Hole - Casting # 563	L & R	E146-85-012	2.50"	E148-87-006
		2.88" Caliper		E146-84-006	2.88"	E148-84-006

Many products are available in multiple grades or configurations. Refer to page 5 for details.

MAKE MODEL PART DESC	YEAR	QUALIFIER	POSITION	PART #	DISCARD/ DIAMETER	E122 / E123 HARDWARE KIT E124 SELF ADJUSTER E148 / E149 REPAIR KIT
----------------------------	------	-----------	----------	--------	----------------------	--

### FORD (Cont'd)

#### LN700 Short Conventional with Front Disc Brakes

Brake M/Cyl	1984 - 1998	w/ Built-in Check Valve		E135-84-030	1 3/4"	
		w/o Built-in Check Valve		E135-84-027	1 3/4"	
Front Caliper	1984 - 1998	Dayton 6 Hole - Casting # 472	L & R	E146-84-106	2.50"	E148-87-006
		Dayton 4 Hole - Casting # 563	L & R	E146-85-012	2.50"	E148-87-006
		2.88" Caliper		E146-84-006	2.88"	E148-84-006

#### LN800, 900 Short Conventional with Front Disc Brakes

Brake M/Cyl	1984 - 1998	w/ Built-in Check Valve		E135-84-030	1 3/4"	
		w/o Built-in Check Valve		E135-84-027	1 3/4"	
Front Caliper	1984 - 1998	Dayton 6 Hole - Casting # 472	L & R	E146-84-106	2.50"	E148-87-006
		Dayton 4 Hole - Casting # 563	L & R	E146-85-012	2.50"	E148-87-006
		2.88" Caliper		E146-84-006	2.88"	E148-84-006

#### LNT800 Short Conventional Tandem with Front Disc Brakes

Front Caliper	1984 - 1994	Dayton 6 Hole - Casting # 472	L & R	E146-84-106	2.50"	E148-87-006
		Dayton 4 Hole - Casting # 563	L & R	E146-85-012	2.50"	E148-87-006
		2.88" Caliper		E146-84-006	2.88"	E148-84-006

#### LT800 Short Conventional Tandem with Front Disc Brakes

Front Caliper	1984 - 1994	Dayton 6 Hole - Casting # 472	L & R	E146-84-106	2.50"	E148-87-006
		Dayton 4 Hole - Casting # 563	L & R	E146-85-012	2.50"	E148-87-006
		2.88" Caliper		E146-84-006	2.88"	E148-84-006

#### LT, LTL900 Short Conventional Tandem with Front Disc Brakes

Front Pads	1984 - 1994			E111-0236-0		E122-84-008
Rear Shoes	1984 - 1994	15" x 7"		E117-0544-0		E123-84-006 E124-84-014
Front Rotor	1984 - 1994	6 Hole - 4.75" Tall - 11.25" BC		E125-84-019	35.94mm	
		6 Hole - 6.02" Tall - 8.75" BC		E126-84-022	35.94mm	
		10 Hole on - 6 Hole Hub - 6.07" Tall - 11.25" BC		E125-84-021	35.94mm	
Brake M/Cyl	1984 - 1994			E135-84-026	2"	
Front Caliper	1984 - 1994			E146-84-006	2.88"	E148-84-006
Rear Adj Cyl	1984 - 1994	1 5/8" Bore	L	E139-84-026	1 5/8"	E149-84-011 E149-84-007 <sup>4</sup>
			R	E139-84-027	1 5/8"	
Rear Park Cyl	1984 - 1994	1 5/8" Bore	L	E139-84-022	1 5/8"	E149-84-013 L E149-84-016 <sup>4</sup>
			R	E139-84-023	1 5/8"	R E149-84-017 <sup>4</sup>
Front Hose	1984 - 1994			E155-84-011		
Rear Hose	1984 - 1994			E155-84-315		

#### LTS800 Short Conventional Tandem with Front Disc Brakes

Front Caliper	1984 - 1994	Dayton 6 Hole - Casting # 472	L & R	E146-84-106	2.50"	E148-87-006
		Dayton 4 Hole - Casting # 563	L & R	E146-85-012	2.50"	E148-87-006
		2.88" Caliper		E146-84-006	2.88"	E148-84-006

#### 8000 Series (air over hydraulics)

Front Pads	1984 - 1994					E122-84-009
Front Rotors	1984 - 1994	6 hole rotor		E125-84-033	1.63"	
		10 hole rotor		E125-84-034	1.63"	
Front Caliper	1984 - 1994			E146-84-010	92mm	E148-84-008

Notes <sup>4</sup> Major Kit.

Many products are available in multiple grades or configurations. Refer to page 5 for details.

MAKE MODEL PART DESC	YEAR	QUALIFIER	POSITION	PART #	DISCARD / DIAMETER	E122 / E123 HARDWARE KIT E124 SELF ADJUSTER E148 / E149 REPAIR KIT
----------------------------	------	-----------	----------	--------	-----------------------	--

## FREIGHTLINER

### FL50, FL60, FL70 with Disc Brakes

Frt & Rr Pads	1992 - 2004	w/ 2 piston - 2.60" Caliper		E111-0717-0		E122-72-006
		w/ 2 piston - 2.88" Caliper		E111-0225-0		E122-71-012
		w/ 4 piston Caliper		E111-0769-0		E122-85-006 <sup>4</sup>
Front Rotor	1998 - 2004	w/ 2 piston Caliper		E125-88-019	1.32"	
Rear Rotor	1998 - 2004	w/ 4 piston cal - Except 21K, 23K axle		E125-85-019	36.06mm	
		w/ 4 piston cal - w/ 21K, 23K axle		E125-85-020	36.06mm	
		w/ 2 piston cal - 10 Hole Disc - 3.20" Tall		E125-88-019	1.32"	
		w/ 2 piston cal - 10 Hole Disc - 4.45" Tall		E125-88-018	1.32"	
		w/ 2 piston cal - 6x19.4mm Hole Disc		E125-88-020	1.32"	
		w/ 2 piston cal - 6x14.6mm Hole Disc		E125-89-007	1.32"	
Brake M/Cyl	1999 - 2004	1 3/4" Cylinder with Reservoir		E135-89-006	1 3/4"	
		1 3/4" Cylinder for Remote Type Reservoir		E135-89-007	1 3/4"	
		2" Bore (Casting # 2239045)		E135-84-036	2"	
Frt & Rr Caliper	1992 - 2004	2 Piston 2.60" casting 4151733 - w/o Air Ride Susp		E146-75-006	2.60"	E148-88-007
		2 Piston 2.60" casting 4151733 - w/ Air Ride Susp		E146-75-008	2.60"	E148-88-007
		2 Piston 2.88" casting 4150844 w/o Air Ride Susp		E146-85-008	2.88"	E148-71-007
		2 Piston 2.88" casting 4152279 w/ Air Ride Susp		E146-88-006	2.88"	E148-71-007
		4 Piston 64mm Caliper	L	E146-84-015	64mm	E148-84-010
			R	E146-84-014	64mm	
		4 Piston 70mm Caliper	L	E146-84-013	70mm	E148-84-009
	R	E146-84-012	70mm			

### FRED Chassis

Frt & Rr Pads	2006 - 2012	66mm Caliper		E111-0786-1		E122-88-006 <sup>4</sup>
		73mm Caliper		E111-0786-0		E122-88-006 <sup>4</sup>
Frt & Rr Rotors	2006 - 2012	5 Hole Disc		E125-88-021	1.32"	
		6x19.4mm Hole Disc - Gunitite D6194A, D6194AM		E125-88-020	1.32"	
		6x14.6mm Hole Disc - Gunitite D6194, D6194M		E125-89-007	1.32"	
		10 Hole Disc - 3.20" Tall		E125-88-019	1.32"	
		10 Hole Disc - 4.45" Tall		E125-88-018	1.32"	
PB Shoes	2006 - 2012			E116-0780-0		
Frt & Rr Caliper	2006 - 2012	66mm Caliper Casting # 4153269		E146-88-008	66mm	E148-88-009
		73mm Caliper Casting # 4153222		E146-88-010	73mm	E148-88-008

### FS65, FW700 with Hydraulic Disc Brakes

Frt & Rr Pads	1996 - 1998	2.60" Caliper		E111-0717-0		
		2.88" Caliper		E111-0225-0		
	1999 - 2012	66mm Caliper		E111-0786-1		E122-88-006 <sup>4</sup>
		73mm Caliper		E111-0786-0		E122-88-006 <sup>4</sup>
Frt & Rr Rotors	1996 - 2012	5 Hole Disc		E125-88-021	1.32"	
		6x19.4mm Hole Disc - Gunitite D6194A, D6194AM		E125-88-020	1.32"	
		6x14.6mm Hole Disc - Gunitite D6194, D6194M		E125-89-007	1.32"	
		10 Hole Disc - 3.20" Tall		E125-88-019	1.32"	
		10 Hole Disc - 4.45" Tall		E125-88-018	1.32"	
PB Shoes	1996 - 1998			E116-0647-0		
	1999 - 2012			E116-0980-0		
Brake M/Cyl	1998 - 2012	Master Cylinder w/o Reservoir Level Switch		E135-84-036	2"	
		Master Cylinder w/ Reservoir Level Switch		E135-87-013	2"	
Frt & Rr Caliper	1996 - 1998	2.60" Caliper		E146-75-007	2.60"	Soft Boot E148-88-006 Hard Boot E148-88-007
		2.88" Caliper		E146-88-006	2.88"	E148-71-007
	1999 - 2012	66mm Caliper Casting # 4153269		E146-88-008	66mm	E148-88-009
		73mm Caliper Casting # 4153222		E146-88-010	73mm	E148-88-008

Notes<sup>4</sup> Major Kit.



Many products are available in multiple grades or configurations. Refer to page 5 for details.

MAKE MODEL PART DESC	YEAR	QUALIFIER	POSITION	PART #	DISCARD/ DIAMETER	E122 / E123 HARDWARE KIT E124 SELF ADJUSTER E148 / E149 REPAIR KIT
----------------------------	------	-----------	----------	--------	----------------------	--

## FREIGHTLINER (Cont'd)

### M2 100/106 with Hydraulic Disc Brakes

Frt & Rr Pads	2003 - 2012	66mm Caliper		E111-0786-1		E122-88-006 <sup>4</sup>
		73mm Caliper		E111-0786-0		E122-88-006 <sup>4</sup>
Frt & Rr Rotors	2003 - 2012	5 Hole Disc		E125-88-021	1.32"	
		6x19.4mm Hole Disc - Gunitite D6194A, D6194AM		E125-88-020	1.32"	
		6x14.6mm Hole Disc - Gunitite D6194, D6194M		E125-89-007	1.32"	
		10 Hole Disc - 3.20" Tall		E125-88-019	1.32"	
		10 Hole Disc - 4.45" Tall		E125-88-018	1.32"	
PB Shoes	2003 - 2012			E116-0980-0		
Brake M/Cyl	2003 - 2012			E135-87-013	2"	
Frt & Rr Caliper	2003 - 2012	66mm Caliper Casting # 4153269		E146-88-008	66mm	E148-88-009
		73mm Caliper Casting # 4153222		E146-88-010	73mm	E148-88-008

### MB50, MB60, MB70 with Disc Brakes

Frt & Rr Pads	1992 - 1996	2.60" Caliper		E111-0717-0		E122-72-006
		2.88" Caliper		E111-0225-0		E122-71-012
Frt & Rr Rotors	1992 - 1996	5 Hole Disc		E125-88-021	1.32"	
		6x19.4mm Hole Disc - Gunitite D6194A, D6194AM		E125-88-020	1.32"	
		6x14.6mm Hole Disc - Gunitite D6194, D6194M		E125-89-007	1.32"	
		10 Hole Disc - 3.20" Tall		E125-88-019	1.32"	
		10 Hole Disc - 4.45" Tall		E125-88-018	1.32"	
Frt & Rr Caliper	1992 - 1996	2.60" Caliper, Except Air Ride Suspension		E146-75-006	2.60"	E148-88-007
		2.60" Caliper, w/ Air Ride Suspension		E146-75-008	2.60"	E148-88-007
		2.88" Caliper, Except Air Ride Suspension		E146-85-008	2.88"	E148-71-007
		2.88" Caliper, w/ Air Ride Suspension		E146-88-006	2.88"	E148-71-007

### MC, MC-L Series Motorhome Chassis

Frt & Rr Pads	2006 - 2010	66mm Caliper		E111-0786-1		E122-88-006 <sup>4</sup>
		73mm Caliper		E111-0786-0		E122-88-006 <sup>4</sup>
Frt & Rr Rotors	2006 - 2010	5 Hole Disc		E125-88-021	1.32"	
		6x19.4mm Hole Disc - Gunitite D6194A, D6194AM		E125-88-020	1.32"	
		6x14.6mm Hole Disc - Gunitite D6194, D6194M		E125-89-007	1.32"	
		10 Hole Disc - 3.20" Tall		E125-88-019	1.32"	
		10 Hole Disc - 4.45" Tall		E125-88-018	1.32"	
PB Shoes	2006 - 2010			E116-0780-0		
Frt & Rr Caliper	2006 - 2010	66mm Caliper Casting # 4153269		E146-88-008	66mm	E148-88-009
		73mm Caliper Casting # 4153222		E146-88-010	73mm	E148-88-008

### MT10, MT35, MT45, MT55, MT-E with Hydraulic Disc Brakes

Frt & Rr Pads	1998 - 2003	2.60" Caliper		E111-0717-0		
		2.88" Caliper		E111-0225-0		
	2004 - 2012	66mm Caliper		E111-0786-1		E122-88-006 <sup>4</sup>
		73mm Caliper		E111-0786-0		E122-88-006 <sup>4</sup>
Frt & Rr Rotors	1998 - 2012	5 Hole Disc		E125-88-021	1.32"	
		6x19.4mm Hole Disc - Gunitite D6194A, D6194AM		E125-88-020	1.32"	
		6x14.6mm Hole Disc - Gunitite D6194, D6194M		E125-89-007	1.32"	
		10 Hole Disc - 3.20" Tall		E125-88-019	1.32"	
		10 Hole Disc - 4.45" Tall		E125-88-018	1.32"	
PB Shoes	2004 - 2012			E116-0980-0		
Brake M/Cyl	1998 - 2012	Master Cylinder w/o Reservoir Level Switch		E135-84-036	2"	
		Master Cylinder w/ Reservoir Level Switch		E135-87-013	2"	

Notes<sup>4</sup> Major Kit.

Many products are available in multiple grades or configurations. Refer to page 5 for details.

MAKE MODEL PART DESC	YEAR	QUALIFIER	POSITION	PART #	DISCARD / DIAMETER	E122 / E123 HARDWARE KIT E124 SELF ADJUSTER E148 / E149 REPAIR KIT
----------------------------	------	-----------	----------	--------	-----------------------	--

## FREIGHTLINER (Cont'd)

### MT10, MT35, MT45, MT55, MT-E with Hydraulic Disc Brakes (Cont'd)

Frt & Rr Caliper	1998 - 2003	2.60" Caliper		E146-75-007	2.60	Soft Boot E148-88-006
						Hard Boot E148-88-007
		2.88" Caliper		E146-88-006	2.88"	E148-71-007
	2004 - 2012	66mm Caliper Casting # 4153269		E146-88-008	66mm	E148-88-009
		73mm Caliper Casting # 4153222		E146-88-010	73mm	E148-88-008

## GMC

### B6P042 School Bus with Front Disc Brakes

Front Caliper	1979 - 1987	Bendix - 1st Design - Soft Boot <sup>5</sup>	L & R	E146-85-009	2.88"	E148-87-007
		Dayton 6 Hole - Casting # 472	L & R	E146-84-106	2.50"	E148-87-006
		Dayton 4 Hole - Casting # 563	L & R	E146-85-012	2.50"	E148-87-006
	1988 - 1991	Bendix - 2nd Design - Hard Boot <sup>5</sup>	L & R	E146-85-008	2.88"	E148-71-007
		Dayton 6 Hole - Casting # 472	L & R	E146-84-106	2.50"	E148-87-006
		Dayton 4 Hole - Casting # 563	L & R	E146-85-012	2.50"	E148-87-006
Rear W/Cyl	1979 - 1987		L	E139-71-016	1 1/2"	
			R	E139-71-017	1 1/2"	
Rear Caliper	1979 - 1987	Bendix - 1st Design - Soft Boot <sup>5</sup>	L & R	E146-85-009	2.88"	E148-87-007
		Dayton 6 Hole - Casting # 472	L & R	E146-84-106	2.50"	E148-87-006
		Dayton 4 Hole - Casting # 563	L & R	E146-85-012	2.50"	E148-87-006
	1988 - 1991	Bendix - 2nd Design - Hard Boot <sup>5</sup>	L & R	E146-85-008	2.88"	E148-71-007
		Dayton 6 Hole - Casting # 472	L & R	E146-84-106	2.50"	E148-87-006
		Dayton 4 Hole - Casting # 563	L & R	E146-85-012	2.50"	E148-87-006

### B7T School Bus with Disc Brakes

Front Caliper	1993 - 2002	Bendix		E146-85-008	2.88"	E148-71-007
		Dayton 6 Hole - Casting # 472	L & R	E146-84-106	2.50"	E148-87-006
		Dayton 4 Hole - Casting # 563	L & R	E146-85-012	2.50"	E148-87-006
Rear Caliper	1993 - 2002	Bendix		E146-85-008	2.88"	E148-71-007
		Dayton 6 Hole - Casting # 472	L & R	E146-84-106	2.50"	E148-87-006
		Dayton 4 Hole - Casting # 563	L & R	E146-85-012	2.50"	E148-87-006

### C4500 Topkick

Front Pads	2003 - 2010	2 Piston Caliper		E111-1010-0		E122-85-007
		4 Piston Caliper		E111-0769-0		E122-85-006 <sup>4</sup>
Rear Pads	2004 - 2010	2 Piston Cal, w/o Drum-in-Hat Rear Rotor		E111-1010-0		E122-85-007
		2 Piston, w/ Drum-in-Hat Rear Rotor		E111-1064-0		E122-85-007
		4 Piston Cal		E111-0769-0		E122-85-006 <sup>4</sup>
Front Rotor	2003 - 2010	5 Hole Rotor		E125-85-018	36.1mm	
		8 Hole Rotor		E125-85-023	36.07mm	
		10 Hole Rotor		E125-85-019	36.06mm	
Rear Rotor	2004 - 2010	w/o Drum-in-Hat Rear Rotor - 5 Hole Rotor		E125-85-018	36.1mm	
		w/ Drum-in-Hat Rear Rotor - 10 Hole Rotor		E125-85-022	37.4mm	
PB Shoe	2004 - 2010	9 x 3 Except Drum-in-Hat Rear Rotor		E116-0647-0		
		9 1/2" x 2 1/2" Drum-in-Hat Rear Rotor		E116-0847-0		
Brake M/Cyl	2003 - 2010	6250 lb Frt Axle Except School Bus		E135-71-069	40mm	
		6250, 7000, 8000 lb Axle & School Bus		E135-87-012	2"	

Notes <sup>4</sup> Major Kit. <sup>5</sup> 1st and 2nd Design Calipers are interchangeable; their components are not.

Many products are available in multiple grades or configurations. Refer to page 5 for details.

MAKE MODEL PART DESC	YEAR	QUALIFIER	POSITION	PART #	DISCARD/ DIAMETER	E122 / E123 HARDWARE KIT E124 SELF ADJUSTER E148 / E149 REPAIR KIT
----------------------------	------	-----------	----------	--------	----------------------	--

### GMC (Cont'd)

#### C4500 Topkick (Cont'd)

Front Caliper	2003	60mm 2 Piston Caliper	L & R	E146-85-016	60mm	E148-70-024
		66mm 2 Piston Caliper	L & R	E146-85-014	66mm	E148-85-007
		70mm 4 Piston Caliper	L	E146-84-018	70mm	E148-85-006
	2004 - 2010	66mm 2 Piston Caliper	L & R	E146-85-014	66mm	E148-85-007
		64mm 4 Piston Caliper	L	E146-84-016	64mm	E148-84-010
			R	E146-84-017	64mm	
Rear Caliper	2003	60mm 2 Piston Caliper	L & R	E146-85-016	60mm	E148-70-024
	2004 - 2010	66mm 2 Piston Cal - w/o DIH Rr Rotor	L & R	E146-85-014	66mm	E148-85-007
		66mm 2 Piston Cal - w/ DIH Rr Rotor	L & R	E146-85-018	66mm	E148-85-007
		64mm 4 Piston Caliper	L	E146-84-016	64mm	E148-84-010
		R	E146-84-017	64mm		

#### C5D042, C5D064 with Front Disc Brakes

Front Caliper	1988 - 1989			E146-75-006	2.60"	E148-88-006
		Bendix - Casting # 2238229 - w/ Cross Over Tube		E146-75-011	2.60"	E148-88-006
		Bendix - Casting # 4151020 - w/o Cross Over Tube		E146-75-012	2.60"	E148-88-006
	1990			E146-75-007	2.60"	E148-88-007
Rear Caliper	1988 - 1990	Dayton 6 Hole - Casting # 472	L & R	E146-84-106	2.50"	E148-87-006
		Dayton 4 Hole - Casting # 563	L & R	E146-85-012	2.50"	E148-87-006

#### C5H042 Topkick with Front Disc Brakes

Front Caliper	1990 - 2002	Dayton 6 Hole - Casting # 472	L & R	E146-84-106	2.50"	E148-87-006
		Dayton 4 Hole - Casting # 563	L & R	E146-85-012	2.50"	E148-87-006
Rear Caliper	1990 - 2002	Dayton 6 Hole - Casting # 472	L & R	E146-84-106	2.50"	E148-87-006
		Dayton 4 Hole - Casting # 563	L & R	E146-85-012	2.50"	E148-87-006

#### C5500 Topkick

Front Caliper	2003	60mm 2 Piston Caliper	L & R	E146-85-016	60mm	E148-70-024
		66mm 2 Piston Caliper	L & R	E146-85-014	66mm	E148-85-007
		64mm 4 Piston - 8k lb Axle	R	E146-84-017	64mm	E148-84-010
			L	E146-84-016	64mm	
		70mm 4 Piston - 7k lb Axle	R	E146-84-019	70mm	E148-85-006
			L	E146-84-018	70mm	
	2004 - 2010	66mm 2 Piston Caliper	L & R	E146-85-014	66mm	E148-85-007
		64mm 4 Piston 7,8k lb Axle	L	E146-84-016	64mm	E148-84-010
			R	E146-84-017	64mm	
		70mm 4 Piston Caliper	L	E146-84-018	70mm	E148-85-006
	R	E146-84-019	70mm			
Rear Caliper	2003	60mm 2 Piston Caliper	L & R	E146-85-016	60mm	E148-70-024
		64mm 4 Piston Caliper	R	E146-84-017	64mm	E148-84-010
			L	E146-84-016	64mm	
	2004 - 2010	66mm 2 Piston Caliper - w/o DIH Rr Rotor	L & R	E146-85-014	66mm	E148-85-007
		66mm 2 Piston Caliper - w/ DIH Rr Rotor	L & R	E146-85-018	66mm	E148-85-007
		64mm 4 Piston Caliper	L	E146-84-016	64mm	E148-84-010
			R	E146-84-017	64mm	

Many products are available in multiple grades or configurations. Refer to page 5 for details.

MAKE MODEL PART DESC	YEAR	QUALIFIER	POSITION	PART #	DISCARD / DIAMETER	E122 / E123 HARDWARE KIT E124 SELF ADJUSTER E148 / E149 REPAIR KIT
----------------------------	------	-----------	----------	--------	-----------------------	--

### GMC (Cont'd)

#### C6D042 with Front Disc Brakes

Front Caliper	1983 - 1987	Dayton 6 Hole - Casting # 472	L & R	E146-84-106	2.50"	E148-87-006
		Dayton 4 Hole - Casting # 563	L & R	E146-85-012	2.50"	E148-87-006
	1988 - 1990	Bendix - Single Piston	L	E146-71-015	3.38"	E148-73-006
		Bendix - Dual Piston		E146-85-008	2.88"	E148-71-007
		Dayton 6 Hole - Casting # 472	L & R	E146-84-106	2.50"	E148-87-006
		Dayton 4 Hole - Casting # 563	L & R	E146-85-012	2.50"	E148-87-006
Rear Caliper	1983 - 1987	Bendix - 1st Design - Soft Boot <sup>5</sup>	L & R	E146-85-009	2.88"	E148-87-007
		Bendix - Single Piston	L	E146-71-015	3.38"	E148-73-006
	1988 - 1990	Bendix - 2nd Design - Hard Boot <sup>5</sup>	L & R	E146-85-008	2.88"	E148-71-007
		Dayton 6 Hole - Casting # 472	L & R	E146-84-106	2.50"	E148-87-006
		Dayton 4 Hole - Casting # 563	L & R	E146-85-012	2.50"	E148-87-006

#### C6500 Topkick with Front Disc Brakes

Front Pads	2003 - 2010			E111-0769-0		E122-85-006 <sup>4</sup>
Rear Pads	2003 - 2010			E111-0769-0		E122-85-006 <sup>4</sup>
Front Rotor	2003 - 2010			E125-85-019	36.06mm	
Rear Rotor	2003 - 2010	exc 21,000 lb Axle		E125-85-019	36.06mm	
		21,000 lb Axle		E125-85-020	36.06mm	
PB Shoe	1990 - 2010	9 x 3		E116-0647-0		
		12 x 3 w/ M/T		E116-0824-0		
		12 x 3 w/ A/T		E116-0692-0		
Brake M/Cyl	2003 - 2010			E135-87-012	2"	
Front Caliper	1990 - 2002	Dayton 6 Hole Caliper - Casting # 472 - 8100 Lb FA	L & R	E146-84-106	2.50"	E148-87-006
		Dayton 4 Hole Caliper - Casting # 563	L & R	E146-85-012	2.50"	E148-87-006
		Bendix Caliper	L & R	E146-85-008	2.88"	E148-71-007
	2003 - 2010	64mm Caliper - 8K Lb Axle	L	E146-84-016	64mm	E148-84-010
			R	E146-84-017	64mm	
		70mm Caliper - 10, 12K Lb Axle	L	E146-84-018	70mm	E148-85-006
	R	E146-84-019	70mm			
Rear Caliper	1990 - 1994	Dayton 6 Hole Caliper - Casting # 472 - 8100 Lb FA	L & R	E146-84-106	2.50"	E148-87-006
		Dayton 4 Hole Caliper - Casting # 563	L & R	E146-85-012	2.50"	E148-87-006
		Bendix Caliper	L & R	E146-85-008	2.88"	E148-71-007
	1995 - 2002	Dayton 2 Piston 6 Hole Cal - Casting # 472 - 8100 Lb FA	L & R	E146-84-106	2.50"	E148-87-006
		Dayton 2 Piston 4 Hole Caliper - Casting # 563	L & R	E146-85-012	2.50"	E148-87-006
		Bendix 2 Piston Caliper	L & R	E146-85-008	2.88"	E148-71-007
		Dayton 4 Steel Piston Caliper w/ 10x1.50mm inlet	L	E146-85-011	70mm	E148-85-006
			R	E146-85-010	70mm	
		Dayton 4 Steel Piston Caliper w/ 7/16"x24 inlet	L	E146-85-023	70mm	E148-85-006
			R	E146-85-022	70mm	
		Dayton 4 Phenolic Piston Caliper	L	E146-85-021	70mm	E148-84-009
			R	E146-85-020	70mm	
	2003 - 2010	64mm Caliper - 15K Lb Axle	L	E146-84-016	64mm	E148-84-010
			R	E146-84-017	64mm	
		70mm Caliper - 19, 21K Lb Axle	L	E146-84-018	70mm	E148-85-006
	R	E146-84-019	70mm			

Notes<sup>4</sup> Major Kit. <sup>5</sup> 1st and 2nd Design Calipers are interchangeable; their components are not.

Many products are available in multiple grades or configurations. Refer to page 5 for details.

MAKE MODEL PART DESC	YEAR	QUALIFIER	POSITION	PART #	DISCARD / DIAMETER	E122 / E123 HARDWARE KIT E124 SELF ADJUSTER E148 / E149 REPAIR KIT
----------------------------	------	-----------	----------	--------	-----------------------	--

## GMC (Cont'd)

### C7D042, C7D064 with Front Disc Brakes

Front Caliper	1983 - 1987	Bendix - 1st Design - Soft Boot <sup>5</sup>	L & R	E146-85-009	2.88"	E148-87-007
		Dayton 6 Hole - Casting # 472	L & R	E146-84-106	2.50"	E148-87-006
		Dayton 4 Hole - Casting # 563	L & R	E146-85-012	2.50"	E148-87-006
	1988 - 1990	Bendix - Single Piston	L	E146-71-015	3.38"	E148-73-006
			R	E146-71-014	3.38"	
		Bendix - 2nd Design - Hard Boot <sup>5</sup>	L & R	E146-85-008	2.88"	E148-71-007
		Dayton 6 Hole - Casting # 472	L & R	E146-84-106	2.50"	E148-87-006
	Dayton 4 Hole - Casting # 563	L & R	E146-85-012	2.50"	E148-87-006	
Rear Caliper	1983 - 1987	Bendix - 1st Design - Soft Boot <sup>5</sup>	L & R	E146-85-009	2.88"	E148-87-007
	1988 - 1990	Bendix - Single Piston	L	E146-71-015	3.38"	E148-73-006
			R	E146-71-014	3.38"	
		Bendix - 2nd Design - Hard Boot <sup>5</sup>	L & R	E146-85-008	2.88"	E148-71-007
		Dayton 6 Hole - Casting # 472	L & R	E146-84-106	2.50"	E148-87-006
		Dayton 4 Hole - Casting # 563	L & R	E146-85-012	2.50"	E148-87-006

### C7500 Topkick with Front Disc Brakes

Front Pads	2003 - 2010			E111-0769-0		E122-85-006 <sup>4</sup>
Rear Pads	2003 - 2010			E111-0769-0		E122-85-006 <sup>4</sup>
Front Rotor	2003 - 2010	10 Hole Rotor		E125-85-019	36.06mm	
Rear Rotor	2003 - 2010	exc 21,000 lb Axle		E125-85-019	36.06mm	
		21,000 lb Axle		E125-85-020	36.06mm	
Brake M/Cyl	2003 - 2010			E135-87-012	2"	
Front Caliper	1990 - 2002	Dayton 6 Hole Caliper - Casting # 472 - 8100 Lb FA	L & R	E146-84-106	2.50"	E148-87-006
		Dayton 4 Hole Caliper - Casting # 563	L & R	E146-85-012	2.50"	E148-87-006
		Bendix Caliper	L & R	E146-85-008	2.88"	E148-71-007
	2003 - 2010	64mm Caliper - 8K Lb Axle	L	E146-84-016	64mm	E148-84-010
			R	E146-84-017	64mm	
		70mm Caliper - 10, 12K Lb Axle	L	E146-84-018	70mm	E148-85-006
	R	E146-84-019	70mm			
Rear Caliper	1990 - 1994	Dayton 6 Hole Caliper - Casting # 472 - 8100 Lb FA	L & R	E146-84-106	2.50"	E148-87-006
		Dayton 4 Hole Caliper - Casting # 563	L & R	E146-85-012	2.50"	E148-87-006
		Bendix Caliper	L & R	E146-85-008	2.88"	E148-71-007
	1995 - 2002	Dayton 2 Piston 6 Hole Cal - Casting # 472 - 8100 Lb FA	L & R	E146-84-106	2.50"	E148-87-006
		Dayton 2 Piston 4 Hole Caliper - Casting # 563	L & R	E146-85-012	2.50"	E148-87-006
		Bendix 2 Piston Caliper	L & R	E146-85-008	2.88"	E148-71-007
		Dayton 4 Steel Piston Caliper w/ 10x1.50mm inlet	L	E146-85-011	70mm	E148-85-006
			R	E146-85-010	70mm	
		Dayton 4 Steel Piston Caliper w/ 7/16"x24 inlet	L	E146-85-023	70mm	E148-85-006
			R	E146-85-022	70mm	
	Dayton 4 Phenolic Piston Caliper	L	E146-85-021	70mm	E148-84-009	
		R	E146-85-020	70mm		
	2003 - 2010	64mm Caliper - 15K Lb Axle	L	E146-84-016	64mm	E148-84-010
			R	E146-84-017	64mm	
70mm Caliper - 19, 21K Lb Axle		L	E146-84-018	70mm	E148-85-006	
	R	E146-84-019	70mm			

Notes <sup>4</sup> Major Kit. <sup>5</sup> 1st and 2nd Design Calipers are interchangeable; their components are not.

Many products are available in multiple grades or configurations. Refer to page 5 for details.

MAKE MODEL PART DESC	YEAR	QUALIFIER	POSITION	PART #	DISCARD/ DIAMETER	E122 / E123 HARDWARE KIT E124 SELF ADJUSTER E148 / E149 REPAIR KIT
----------------------------	------	-----------	----------	--------	----------------------	--

### GMC (Cont'd)

#### G4500 Commercial Cutaway Chassis

Front Pads	2010 - 2011			E111-0784-0		E122-71-013
Rear Pads	2010 - 2011			E110-1411-0		E122-70-038
Front Rotor	2010 - 2011			E125-71-064	36.5mm	
Rear Rotor	2010 - 2011			E125-71-076	38.0	
PB Shoe	2010 - 2011			E116-0973-0		E123-71-012
Brake M/Cyl	2010 - 2011	Except StabiliTrak		E135-71-073	38mm	
		StabiliTrak		E135-71-075	38mm	
Front Caliper	2010 - 2011		L	E146-71-043	60mm	E148-71-020
			R	E146-71-042	60mm	
Rear Caliper	2010 - 2011		L	E146-71-541	54mm	E148-71-030
			R	E146-71-540	54mm	
Front Hose	2010 - 2011		L	E155-71-121		
			R	E155-71-120		
Rear Hose	2010 - 2011		L	E155-71-407		
			R	E155-71-408		

#### P4T042 with Front Disc Brakes

Front Caliper	1988 - 1996	Bendix	L	E146-71-015	3.38"	E148-73-006
			R	E146-71-014	3.38"	
		Dayton 6 Hole - Casting # 472	L & R	E146-84-106	2.50"	E148-87-006
		Dayton 4 Hole - Casting # 563	L & R	E146-85-012	2.50"	E148-87-006
Rear Caliper	1988 - 1996	Bendix	L	E146-71-015	3.38"	E148-73-006
			R	E146-71-014	3.38"	
		Dayton 6 Hole - Casting # 472	L & R	E146-84-106	2.50"	E148-87-006
		Dayton 4 Hole - Casting # 563	L & R	E146-85-012	2.50"	E148-87-006

#### P6S with Front Disc Brakes

Front Caliper	1992 - 1996	Bendix		E146-85-008	2.88"	E148-71-007
		Dayton 6 Hole - Casting # 472	L & R	E146-84-106	2.50"	E148-87-006
		Dayton 4 Hole - Casting # 563	L & R	E146-85-012	2.50"	E148-87-006
Rear Caliper	1992 - 1996	Bendix		E146-85-008	2.88"	E148-71-007
		Dayton 6 Hole - Casting # 472	L & R	E146-84-106	2.50"	E148-87-006
		Dayton 4 Hole - Casting # 563	L & R	E146-85-012	2.50"	E148-87-006

#### P6T042 with Front Disc Brakes

Front Caliper	1983 - 1987	Bendix - 1st Design - Soft Boot <sup>5</sup>	L & R	E146-85-009	2.88"	E148-87-007
		Dayton 6 Hole - Casting # 472	L & R	E146-84-106	2.50"	E148-87-006
		Dayton 4 Hole - Casting # 563	L & R	E146-85-012	2.50"	E148-87-006
	1988 - 1990	Bendix - Single Piston	L	E146-71-015	3.38"	E148-73-006
			R	E146-71-014	3.38"	
		Bendix - 2nd Design - Hard Boot <sup>5</sup>	L & R	E146-85-008	2.88"	E148-71-007
		Dayton 6 Hole - Casting # 472	L & R	E146-84-106	2.50"	E148-87-006
		Dayton 4 Hole - Casting # 563	L & R	E146-85-012	2.50"	E148-87-006
Rear W/Cyl	1983 - 1987		L	E139-71-016	1 1/2"	
			R	E139-71-017	1 1/2"	
Rear Caliper	1983 - 1987	Bendix - 1st Design - Soft Boot <sup>5</sup>	L & R	E146-85-009	2.88"	E148-87-007
		Dayton 6 Hole - Casting # 472	L & R	E146-84-106	2.50"	E148-87-006
		Dayton 4 Hole - Casting # 563	L & R	E146-85-012	2.50"	E148-87-006
	1988 - 1990	Bendix - Single Piston	L	E146-71-015	3.38"	E148-73-006
			R	E146-71-014	3.38"	
		Bendix - 2nd Design - Hard Boot <sup>5</sup>	L & R	E146-85-008	2.88"	E148-71-007
		Dayton 6 Hole - Casting # 472	L & R	E146-84-106	2.50"	E148-87-006
		Dayton 4 Hole - Casting # 563	L & R	E146-85-012	2.50"	E148-87-006

Notes<sup>5</sup> 1st and 2nd Design Calipers are interchangeable; their components are not.

Many products are available in multiple grades or configurations. Refer to page 5 for details.

MAKE MODEL PART DESC	YEAR	QUALIFIER	POSITION	PART #	DISCARD/ DIAMETER	E122 / E123 HARDWARE KIT E124 SELF ADJUSTER E148 / E149 REPAIR KIT
----------------------------	------	-----------	----------	--------	----------------------	--

## GMC (Cont'd)

### S7T042 Forward Control with Front Disc Brakes

Front Caliper	1983 - 1987	Bendix - 1st Design - Soft Boot <sup>5</sup>	L & R	E146-85-009	2.88"	E148-87-007
	1988 - 1990	Bendix - 2nd Design - Hard Boot <sup>5</sup>	L & R	E146-85-008	2.88"	E148-71-007
Rear Caliper	1983 - 1987	Bendix - 1st Design - Soft Boot <sup>5</sup>	L & R	E146-85-009	2.88"	E148-87-007
	1988 - 1990	Bendix - 2nd Design - Hard Boot <sup>5</sup>	L & R	E146-85-008	2.88"	E148-71-007

### T5500, T6500, T7500, T8500 Tilt Cab with Disc Brakes

Front Pads	2004 - 2010			E111-0769-0		E122-85-006 <sup>4</sup>	
Rear Pads	2004 - 2010			E111-0769-0		E122-85-006 <sup>4</sup>	
Front Rotor	2004 - 2010	10000 lb FA		E125-85-019	36.06mm		
Rear Rotor	2004 - 2010	15000, 19000 lb RA - 10 Hole - Hat Shaped Rotor		E125-85-019	36.06mm		
		21000 lb RA - 10 Hole - U Shaped Rotor		E125-85-020	36.06mm		
PB Shoe	2004 - 2010	9 x 3		E116-0647-0			
		12 x 3		E116-0824-0			
Brake M/Cyl	2004 - 2010			E135-87-012	2"		
Front Caliper	3/96 - 2002	8100 lb FA - Dayton 6 Hole - Casting # 472	L & R	E146-84-106	2.50"	E148-87-006	
		Dayton 4 Hole - Casting # 563	L & R	E146-85-012	2.50"	E148-87-006	
		11000, 12000 lb FA - Bendix Cal	L & R	E146-85-008	2.88"	E148-71-007	
	2004 - 2010	70mm - 4 Piston Caliper	R	E146-84-019	70mm	E148-85-006	
		64mm - 4 Piston Caliper	L	E146-84-018	70mm		
			R	E146-84-017	64mm	E148-84-010	
			L	E146-84-016	64mm		
Frt Brk Hose	2004 - 2010		L	E155-81-011			
			R	E155-81-012			
Rear Caliper	3/96 - 2/98	Dayton 6 Hole - Casting # 472	L & R	E146-84-106	2.50"	E148-87-006	
		Dayton 4 Hole - Casting # 563	L & R	E146-85-012	2.50"	E148-87-006	
		Bendix Caliper	L & R	E146-85-008	2.88"	E148-71-007	
	3/98 - 2002	Dayton 2 Piston 6 Hole Cal - Casting # 472 - 8100 Lb FA	L & R	E146-84-106	2.50"	E148-87-006	
		Dayton 2 Piston 4 Hole Caliper - Casting # 563	L & R	E146-85-012	2.50"	E148-87-006	
		Bendix 2 Piston Caliper	L & R	E146-85-008	2.88"	E148-71-007	
			Dayton 4 Steel Piston Caliper w/ 10x1.50mm inlet	L	E146-85-011	70mm	E148-85-006
				R	E146-85-010	70mm	
			Dayton 4 Steel Piston Caliper w 7/16"x24 inlet	L	E146-85-023	70mm	E148-85-006
				R	E146-85-022	70mm	
	2004 - 2010		Dayton 4 Phenolic Piston Caliper	L	E146-85-021	70mm	E148-84-009
				R	E146-85-020	70mm	
			64mm Caliper - 15K Lb Axle	R	E146-84-017	64mm	E148-84-010
			L	E146-84-016	64mm		
		70mm Caliper - 19, 21K Lb Axle	R	E146-84-019	70mm	E148-85-006	
			L	E146-84-018	70mm		

### W3500 Gas Engine

Front Pads	10/97 - 2008	10,000 - 14,000 GVW		E111-0825-0		E122-81-007
		14,001 - 16,000 GVW		E111-0827-0		E122-81-007
Rear Shoes	7/01 - 2008	320mm x 100mm		E117-0699-0		
		311.2mm x 121.9mm		E117-0792-0		
Front Rotor	10/97 - 2008	10,000 - 14,000 GVW / 293.4mm rotor		E125-48-021	37mm	
		14,001 - 16,000 GVW / 363.0mm rotor		E125-48-024	39mm	
Rear Drum	7/01 - 2008	10,001 - 14,000 GVW - 320mm x 75mm		E127-81-006	321.5mm	
		14,001 - 16,000 GVW - 320mm x 100mm		E127-81-012	321.5mm	
PB Shoe	1995 - 2008	11" x 2"		E116-0823-0		

Notes <sup>4</sup> Major Kit. <sup>5</sup> 1st and 2nd Design Calipers are interchangeable; their components are not.

Many products are available in multiple grades or configurations. Refer to page 5 for details.

MAKE MODEL PART DESC	YEAR	QUALIFIER	POSITION	PART #	DISCARD / DIAMETER	E122 / E123 HARDWARE KIT E124 SELF ADJUSTER E148 / E149 REPAIR KIT
----------------------------	------	-----------	----------	--------	-----------------------	--

### GMC (Cont'd)

#### W3500 Gas Engine (Cont'd)

Brake M/Cyl	11/95 -10/97			E135-81-013	1 1/4"	
	11/97 - 2008	HD		E135-81-015	1 1/4"	
		Exc HD		E135-81-017	1 3/8"	
Front Caliper	7/04 - 2008	10,001 - 14,000 GVW - Cast # 5407 A934X	L	E146-81-015	54mm	E148-81-008
			R	E146-81-014	54mm	
		14,001 - 16,000 GVW - Cast # 5705 A940	L	E146-81-017	57mm	E148-81-009
			R	E146-81-016	57mm	
Rear W/Cyl	7/02 - 2008		L Fr	E139-81-045	1 3/16"	
			L Rr	E139-81-054	1 3/16"	
			R Fr	E139-81-053	1 3/16"	
			R Rr	E139-81-052	1 3/16"	
Front Hose	1995 - 2007	16 1/4" Hose		E155-81-008		
		15 1/2" Hose		E155-81-021		
	2008			E155-81-020		
Rear Hose	1995 - 2008			E155-81-009		

#### W3500 Diesel Engine

Front Pads	1/98 - 2008			E111-0825-0		E122-81-007
Rear Shoes	1995 - 2008	320mm x 75mm		E117-0612-0		E123-85-009
		320mm x 100mm		E117-0699-0		E123-85-009
Front Rotor	8/87 - 12/97			E125-81-006	32mm	
	1/98 - 2008			E125-48-021	37mm	
Rear Drum	1995 - 2008			E127-81-005	321.5mm	
PB Shoe	1995 - 2006	7 1/2" Shoes		E116-0733-0		
		8" Shoes		E116-0979-0		
	2007 - 2008			E116-0979-0		
Brake M/Cyl	11/97 - 2008			E135-81-015	1 1/4"	
Front Caliper	1/04 - 2008		L	E146-81-015	54mm	E148-81-008
Rear W/Cyl	3/03 - 2008		L Fr	E139-81-069	1 1/16"	
			L Rr	E139-81-067	1 1/16"	
			R Fr	E139-81-070	1 1/16"	
			R Rr	E139-81-068	1 1/16"	
Front Hose	1995 - 10/04	16 1/4" Hose		E155-81-008		
		15 1/2" Hose		E155-81-021		
	11/04 - 2008			E155-81-019		
Rear Hose	1995 - 2008			E155-81-009		
Clutch M/Cyl	1995 - 2006			E141-81-009	3/4"	
Slave Cyl	1/98 - 2006	5 Speed		E143-81-011	1"	
		6 Speed		E143-81-010	1"	

#### W4500 Gas Engine

Front Pads	7/99 - 2008	10,001 - 14,000 GVW		E111-0825-0		E122-81-007
		14,001 - 16,000 GVW		E111-0827-0		E122-81-007
Rear Shoes	10/97 - 2008	311.2mm x 121.9mm		E117-0792-0		
Front Rotor	7/99 - 2008	10,000 - 14,000 GVW / 293.4mm rotor		E125-48-021	37mm	
		14,001 - 16,000 GVW / 363.0mm rotor		E125-48-024	39mm	
Rear Drum	9/94 - 2008	10,000 - 14,000 GVW		E127-81-006	321.5mm	
		14,001 - 16,000 GVW		E127-81-012	321.5mm	
PB Shoe	1995 - 2008	11" x 2"		E116-0823-0		
Brake M/Cyl	10/97 - 2008	Exc HD		E135-81-015	1 1/4"	
		HD		E135-81-017	1 3/8"	



Many products are available in multiple grades or configurations. Refer to page 5 for details.

MAKE MODEL PART DESC	YEAR	QUALIFIER	POSITION	PART #	DISCARD/ DIAMETER	E122 / E123 HARDWARE KIT E124 SELF ADJUSTER E148 / E149 REPAIR KIT
----------------------------	------	-----------	----------	--------	----------------------	--

### GMC (Cont'd)

#### W4500 Gas Engine (Cont'd)

Front Caliper	7/04 - 2008	10,001 - 14,000 GVW - Cast # 5407 A934X	L	E146-81-015	54mm	E148-81-008
			R	E146-81-014	54mm	
		14,001 - 16,000 GVW - Cast # 5705 A940	L	E146-81-017	57mm	E148-81-009
			R	E146-81-016	57mm	
Rear W/Cyl	7/02 - 2008		L Fr	E139-81-051	1 5/16"	
			L Rr	E139-81-047	1 5/16"	
			R Fr	E139-81-056	1 5/16"	
			R Rr	E139-81-049	1 5/16"	
Rear Hose	1995 - 9/97			E155-81-008		
	10/97 - 2003	15 1/2" Hose		E155-81-021		
		16 1/2" Hose		E155-81-022		
	2004 - 2007	w/ 16" Wheels - 16 1/4" Hose		E155-81-008		
		w/ 16" Wheels - 15 1/2" Hose		E155-81-021		
		w/ 19 1/2" Wheels - 16 1/2" Hose		E155-81-022		
	2008	w/ 19 1/2" Wheels - 11 7/8" Hose		E155-81-020		
			E155-81-020			
Rear Hose	1995 - 2008			E155-81-009		

#### W4500 Diesel Engine

Front Pads	1/98 - 2009	14,001 - 16,000 GVW		E111-0825-0		E122-81-007
		16,001 - 19,500 GVW		E111-0827-0		E122-81-007
Rear Shoes	1995 - 2009	320mm x 100mm		E117-0699-0		
		311.2mm x 121.9mm		E117-0792-0		
Front Rotor	1/98 - 2009	14,001 - 16,000 GVW / 293.4mm rotor		E125-48-021	37mm	
		16,001 - 19,500 GVW / 363mm rotor		E125-48-024	39mm	
Rear Drum	9/94 - 2009	14,001 - 16,000 GVW		E127-81-006	321.5mm	
		16,001 - 19,500 GVW		E127-81-012	321.5mm	
PB Shoe	1995 - 2007	7 1/2" Shoes		E116-0733-0		
		8" Shoes		E116-0979-0		
	2008 - 2009			E116-0979-0		
Brake M/Cyl	11/97 - 2009	14,001 - 16,000 GVW		E135-81-015	1 1/4"	
		16,001 - 19,500 GVW		E135-81-017	1 3/8"	
Front Caliper	1/04 - 2009	14,001 - 16,000 GVW - Cast # 5407 A934X	L	E146-81-015	54mm	E148-81-008
			R	E146-81-014	54mm	
		16,001 - 19,500 GVW - Cast # 5705 A940	L	E146-81-017	57mm	E148-81-009
			R	E146-81-016	57mm	
Rear W/Cyl	1/03 - 2009		L Fr	E139-81-045	1 3/16"	
			L Rr	E139-81-054	1 3/16"	
			R Fr	E139-81-053	1 3/16"	
			R Rr	E139-81-052	1 3/16"	
Front Hose	1995 - 10/04	16 1/4" Hose		E155-81-008		
		15 1/2" Hose		E155-81-021		
	11/04 - 2007 2008 - 2009			E155-81-019		
		13 3/8" Hose		E155-81-019		
		12" Hose		E155-81-020		
Rear Hose	1995 - 2009			E155-81-009		
Clutch M/Cyl	1995 - 2007			E141-81-009	3/4"	
Slave Cyl	1/98 - 2007	5 Speed		E143-81-011	1"	
		6 Speed		E143-81-010	1"	

Many products are available in multiple grades or configurations. Refer to page 5 for details.

MAKE MODEL PART DESC	YEAR	QUALIFIER	POSITION	PART #	DISCARD / DIAMETER	E122 / E123 HARDWARE KIT E124 SELF ADJUSTER E148 / E149 REPAIR KIT
----------------------------	------	-----------	----------	--------	-----------------------	--

### GMC (Cont'd)

#### W5500 exc HD

Front Pads	1/99 - 2009			E111-0827-0		E122-81-007
Rear Shoes	1/98 - 2009	311.2mm x 121.9mm		E117-0792-0		
Front Rotor	1/99 - 2009			E125-48-024	39mm	
Rear Drum	1/98 - 2009			E127-81-012	321.5mm	
PB Shoe	1/98 - 2007	7 1/2" Shoes		E116-0733-0		
		8" Shoes		E116-0979-0		
	2008 - 2009			E116-0979-0		
Brake M/Cyl	1/98 - 2009			E135-81-017	1 3/8"	
Front Caliper	1/04 - 2009		L	E146-81-017	57mm	E148-81-009
			R	E146-81-016	57mm	
Rear W/Cyl	1/03 - 2009		L Fr	E139-81-047	1 5/16"	
			L Rr	E139-81-051	1 5/16"	
			R Fr	E139-81-056	1 5/16"	
			R Rr	E139-81-049	1 5/16"	
Front Hose	1/98 - 12/03			E155-81-022		
	1/04 - 2009			E155-81-020		
Rear Hose	1/98 - 2009			E155-81-009		
Clutch M/Cyl	1/98 - 2007			E141-81-009	3/4"	
Slave Cyl	1/98 - 2007	5 Speed		E143-81-011	1"	
		6 Speed		E143-81-010	1"	

#### W5500HD

Front Pads	2005 - 2010			E111-0827-0		E122-81-007
Rear Shoes	2005 - 2010			E117-0833-0		
Front Rotor	2005 - 2010			E125-48-024	39mm	
Rear Drum	2005 - 2010			E127-81-013	372mm	
PB Shoe	2005 - 2010			E116-0979-0		
Brake M/Cyl	2005 - 2010			E135-81-017	1 3/8"	
Front Caliper	2005 - 2010		L	E146-81-017	57mm	E148-81-009
			R	E146-81-016	57mm	
Rear W/Cyl	2005 - 2010		L Fr	E139-81-048	1 5/16"	
			L Rr	E139-81-071	1 5/16"	
			R Fr	E139-81-046	1 5/16"	
			R Rr	E139-81-050	1 5/16"	
Front Hose	2005 - 2010			E155-81-020		
Rear Hose	2005 - 2010			E155-81-009		
Clutch M/Cyl	2005 - 2010			E141-81-009	3/4"	
Slave Cyl	2005 - 2007			E143-81-010	1"	
	2008 - 2010			E143-81-012	1"	

#### WT5500

Front Drum	2000 - 2004			E127-81-010		
Rear Drum	2000 - 2004			E127-81-011		
PB Shoe	2000 - 2004	to 5/2001 254mm x 60mm		E116-1008-0		
		from 6/2001 254mm x 60mm		E116-1007-0		
Front W/Cyl	2000 - 2004		L	E139-81-057	1 1/2"	
			R	E139-81-058	1 1/2"	

Many products are available in multiple grades or configurations. Refer to page 5 for details.

MAKE MODEL PART DESC	YEAR	QUALIFIER	POSITION	PART #	DISCARD/ DIAMETER	E122 / E123 HARDWARE KIT E124 SELF ADJUSTER E148 / E149 REPAIR KIT
----------------------------	------	-----------	----------	--------	----------------------	--

### GMC (Cont'd)

#### WT5500 (Cont'd)

Rear W/Cyl	2000 - 2004		L Fr	E139-81-063	1 5/8"	
			L Rr	E139-81-064	1 5/8"	
			R Fr	E139-81-065	1 5/8"	
			R Rr	E139-81-066	1 5/8"	
Clutch M/Cyl	2000 - 2004			E141-81-010	7/8"	
Slave Cyl	2000 - 2004			E143-81-007	1"	

#### W6 M

Front Shoes	9/86 - 12/93	410mm x 140mm - Air Over Hydraulic		E117-0613-0		
	1/94 - 9/94	410mm x 140mm - Air Over Hydraulic-Manual		E117-0613-0		
		410mm x 140mm - Air Over Hydraulic-Auto		E117-0718-0		
	10/94 - 1996	410mm x 140mm - Air Over Hydraulic		E117-0718-0		
Rear Shoes	9/86 - 12/93	410mm x 140mm - Air Over Hydraulic		E117-0613-0		
	1/94 - 9/94	410mm x 140mm - Air Over Hydraulic-Manual		E117-0613-0		
		410mm x 140mm - Air Over Hydraulic-Auto		E117-0718-0		
	10/94 - 1996	410mm x 140mm - Air Over Hydraulic		E117-0718-0		
PB Shoes	1987 - 1996	8 1/2"		E116-1009-0		
		10x2" - MT		E116-1007-0		
		10x2" - AT		E116-1008-0		
Front W/Cyl	9/86 - 12/93		L	E139-81-114	47.5mm	E149-85-010
			R	E139-81-115	47.5mm	
	1/94 - 9/94	w/ Auto Adjuster	L	E139-81-155	47.5mm	
			R	E139-81-156	47.5mm	
	10/94 - 1996	w/ Manual Adjuster	L	E139-81-114	47.5mm	E149-85-010
			R	E139-81-115	47.5mm	
		L	E139-81-155	47.5mm		
		R	E139-81-156	47.5mm		
Rear W/Cyl	9/86 - 12/93			E139-81-113	53.5mm	E149-85-011
	1/94 - 9/94	w/ Auto Adjuster		E139-81-154	53.5mm	
		w/ Manual Adjuster		E139-81-113	53.5mm	E149-85-011
	10/94 - 1996			E139-81-154	53.5mm	
Clutch M/Cyl	11/87 - 1996			E141-81-007	7/8"	
Slave Cyl	11/87 - 1996			E143-81-007	1"	

#### W7 H

Clutch M/Cyl	12/87 - 1996			E141-81-007	7/8"	
Slave Cyl	7/87 - 5/89			E143-81-008	1"	
	6/89 - 5/90	Spicer Trans		E143-81-008	1"	
		exc Spicer Trans		E143-81-007	1"	
	6/90 - 12/93			E143-81-007	1"	

Many products are available in multiple grades or configurations. Refer to page 5 for details.

MAKE MODEL PART DESC	YEAR	QUALIFIER	POSITION	PART #	DISCARD / DIAMETER	E122 / E123 HARDWARE KIT E124 SELF ADJUSTER E148 / E149 REPAIR KIT
----------------------------	------	-----------	----------	--------	-----------------------	--

## HINO

### 145 14,050 GVW

Frt & Rr Pads	2005 - 2010			E111-1062-0		E122-80-006
Front Rotor	2005 - 2010			E125-80-007	1.035"	
Rear Rotor	2005 - 2010			E125-80-008	1.035"	
PB Shoe	2005 - 2010	9 x 3"		E116-0647-0		
		10 x 3"		E116-0842-0		
Brake M/Cyl	2005 - 2010			E135-87-013	2"	
Front Caliper	2005 - 2010		L	E146-80-007	60mm	E148-80-006
			R	E146-80-006	60mm	
Rear Caliper	2005 - 2010		L	E146-80-507	60mm	E148-80-006
			R	E146-80-506	60mm	
Front Hose	2005 - 2010			E155-80-007		
Rear Hose	2005 - 2010			E155-80-507		
Clutch M/Cyl	2005 - 2010			E141-80-007	19mm	
Slave Cyl	2005 - 2010			E143-80-006	7/8"	

### 165 16,000 GVW

Frt & Rr Pads	2005 - 2010			E111-1062-0		E122-80-006
Front Rotor	2005 - 2010			E125-80-006	1.035"	
Rear Rotor	2005 - 2010			E125-80-009	1.035"	
PB Shoe	2005 - 2010	9 x 3"		E116-0647-0		
		10 x 3"		E116-0842-0		
Brake M/Cyl	2005 - 2010			E135-87-013	2"	
Front Caliper	2005 - 2010		L	E146-80-007	60mm	E148-80-006
			R	E146-80-006	60mm	
Rear Caliper	2005 - 2010		L	E146-80-007	60mm	E148-80-006
			R	E146-80-006	60mm	
Front Hose	2005 - 2010			E155-80-007		
Rear Hose	2005 - 2010					
Clutch M/Cyl	2005 - 2010			E141-80-007	19mm	
Slave Cyl	2005 - 2010			E143-80-006	7/8"	

### 185 18,500 LBS GVW

Front Pads	2005 - 2010			E111-1062-0		E122-80-006
Rear Pads	2005 - 2010			E111-0769-0		E122-85-006 <sup>4</sup>
Front Rotor	2005 - 2010			E125-80-006	1.035"	
Rear Rotor	2005 - 2010			E125-80-010	36.05mm	
PB Shoe	2005 - 2010	9 x 3"		E116-0647-0		
		10 x 3"		E116-0842-0		
Brake M/Cyl	2005 - 2010			E135-87-013	2"	
Front Caliper	2005 - 2010		L	E146-80-007	60mm	E148-80-006
			R	E146-80-006	60mm	
Rear Caliper	2005 - 2010		L	E146-84-016	64mm	E148-84-010
			R	E146-84-017	64mm	
Front Hose	2005 - 2010			E155-80-007		
Rear Hose	2005 - 2010			E155-80-508		
Clutch M/Cyl	2005 - 2010			E141-80-007	19mm	
Slave Cyl	2005 - 2010			E143-80-006	7/8"	

Notes <sup>4</sup> Major Kit.

Many products are available in multiple grades or configurations. Refer to page 5 for details.

MAKE MODEL PART DESC	YEAR	QUALIFIER	POSITION	PART #	DISCARD/ DIAMETER	E122 / E123 HARDWARE KIT E124 SELF ADJUSTER E148 / E149 REPAIR KIT
----------------------------	------	-----------	----------	--------	----------------------	--

### HINO (Cont'd)

#### 238 23,000, 25,500 LBS GVW

Frt & Rr Pads	2005 - 2012			E111-0769-0		E122-85-006 <sup>4</sup>
Frt & Rr Rotor	2005 - 2012			E125-85-019	36.06mm	
PB Shoe	2005 - 2012	9 x 3"		E116-0647-0		
		12 x 3"		E116-0824-0		
Brake M/Cyl	2005 - 2012			E135-87-013	2"	
Front Caliper	2005 - 2012		L	E146-84-016	64mm	E148-84-010
			R	E146-84-017	64mm	
Rear Caliper	2005 - 2012		L	E146-84-016	64mm	E148-84-010
			R	E146-84-017	64mm	
Front Hose	2005 - 2010					
Rear Hose	2005 - 2010					
Clutch M/Cyl	2005 - 2012			E141-80-007	19mm	
Slave Cyl	2005 - 2012			E143-80-008	7/8"	

#### 258LP 23,000, 25,000 LBS GVW (Low Profile)

Frt & Rr Pads	2005 - 2012			E111-0769-0		E122-85-006 <sup>4</sup>
Frt & Rr Rotor	2005 - 2012			E125-85-019	36.06mm	
PB Shoe	2005 - 2012	9 x 3"		E116-0647-0		
		12 x 3"		E116-0824-0		
Brake M/Cyl	2005 - 2012			E135-87-013	2"	
Front Caliper	2005 - 2012		L	E146-84-016	64mm	E148-84-010
			R	E146-84-017	64mm	
Rear Caliper	2005 - 2012		L	E146-84-016	64mm	E148-84-010
			R	E146-84-017	64mm	
Front Hose	2005 - 2012					
Rear Hose	2005 - 2012					
Clutch M/Cyl	2005 - 2012			E141-80-007	19mm	
Slave Cyl	2005 - 2012			E143-80-008	7/8"	

#### 268 25,950GVW LBS with Hydraulic Disc Brakes

Frt & Rr Pads	2005 - 2012			E111-0769-0		E122-85-006 <sup>4</sup>
Frt & Rr Rotor	2005 - 2012			E125-85-019	36.06mm	
PB Shoe	2005 - 2012	9 x 3"		E116-0647-0		
		12 x 3"		E116-0824-0		
Brake M/Cyl	2005 - 2012			E135-87-013	2"	
Front Caliper	2005 - 2012	64mm 4 Piston	L	E146-84-016	64mm	E148-84-010
			R	E146-84-017	64mm	
		70mm 4 Piston	L	E146-84-018	70mm	E148-85-006
			R	E146-84-019	70mm	
Rear Caliper	2005 - 2012		L	E146-84-018	70mm	E148-85-006
			R	E146-84-019	70mm	
Front Hose	2005 - 2012			E155-80-006		
Rear Hose	2005 - 2012			E155-80-506		
Clutch M/Cyl	2005 - 2012			E141-80-007	19mm	
Slave Cyl	2005 - 2012			E143-80-008	7/8"	

Notes <sup>4</sup> Major Kit.

Many products are available in multiple grades or configurations. Refer to page 5 for details.

MAKE MODEL PART DESC	YEAR	QUALIFIER	POSITION	PART #	DISCARD / DIAMETER	E122 / E123 HARDWARE KIT E124 SELF ADJUSTER E148 / E149 REPAIR KIT
<b>IC BUS</b>						
<b>BE, CE, HC, LC with Hydraulic Disc Brakes</b>						
Frt & Rr Pads	2002 - 2008	w/ 66mm Caliper		E111-0786-1		E122-88-006 <sup>4</sup>
		w/ 73mm Caliper		E111-0786-0		E122-88-006 <sup>4</sup>
	2009	w/ 2 Piston 66mm Bosch Caliper Cast # 4153269		E111-0786-1		E122-88-006 <sup>4</sup>
		w/ 2 Piston 73mm Bosch Caliper Cast # 4153222		E111-0786-0		E122-88-006 <sup>4</sup>
	2010 - 2012	w/ 4 piston Meritor Caliper		E111-0769-0		E122-85-006 <sup>4</sup>
			E111-0769-0		E122-85-006 <sup>4</sup>	
Brake M/Cyl	2002 - 2008			E135-87-013	2"	
	2009	w/ Bosch Brake Master Cylinder		E135-87-013	2"	
		w/ Wabco - Meritor Brake Master Cylinder		E135-88-027	13/16"	
	2010 - 2012			E135-88-027	13/16"	
Frt & Rr Rotor	2002 - 2008	5 Hole Hat Shaped Disc		E125-88-021	1.32"	
		10 Hole - Hat Shaped Disc - 3.20" Tall		E125-88-019	1.32"	
		10 Hole - Hat Shaped Disc - 4.45" Tall		E125-88-018	1.32"	
	2009	5 Hole Hat Shaped Disc <sup>3</sup>		E125-88-021	1.32"	
		10 Hole - Hat Shaped Disc - 3.20" Tall <sup>3</sup>		E125-88-019	1.32"	
		10 Hole - Hat Shaped Disc - 4.45" Tall <sup>3</sup>		E125-88-018	1.32"	
	2010 - 2012	10 Hole Behind the Hub Mounted Disc - 1.89" Tall		E125-88-025	1.42"	
			E125-88-025	1.42"		
PB Shoe	2002 - 2012	12x3" Air actuated		E116-0980-0		
		12x3" Manual actuated		E116-0978-0		
Front Caliper	2002 - 2008	66mm Caliper Cast # 4153269		E146-88-008	66mm	E148-88-009
		73mm Caliper Cast # 4153222		E146-88-010	73mm	E148-88-008
	2009	66mm 2 Piston Bosch Caliper Cast # 4153269		E146-88-008	66mm	E148-88-009
		73mm 2 Piston Bosch Caliper Cast # 4153222		E146-88-010	73mm	E148-88-008
	2010 - 2012	70mm 4 Piston Meritor Caliper	L	E146-88-015	70mm	E148-84-009
			R	E146-88-014	70mm	
			L	E146-88-015	70mm	E148-84-009
		R	E146-88-014	70mm		
Rear Caliper	2002 - 2008	66mm Caliper Cast # 4153269		E146-88-008	66mm	E148-88-009
		73mm Caliper Cast # 4153222		E146-88-010	73mm	E148-88-008
	2009	66mm 2 Piston Bosch Caliper Cast # 4153269		E146-88-008	66mm	E148-88-009
		73mm 2 Piston Bosch Caliper Cast # 4153222		E146-88-010	73mm	E148-88-008
		70mm 4 Piston Meritor Caliper	L	E146-88-014	70mm	E148-84-009
			R	E146-88-015	70mm	
		64mm 4 Piston Meritor Caliper	L	E146-88-017	64mm	E148-84-010
			R	E146-88-016	64mm	
	2010 - 2012	70mm 4 Piston Meritor Caliper	L	E146-88-014	70mm	E148-84-009
			R	E146-88-015	70mm	
		L	E146-88-017	64mm	E148-84-010	
		R	E146-88-016	64mm		
Front Hose	2009 - 2012	35" Hose		E155-88-022		
Rear Hose	2002 - 2012	39" Hose		E155-88-314		
		43" Hose		E155-88-317		

Note<sup>3</sup> ABS exciter teeth in casting; <sup>4</sup> Major Kit

Many products are available in multiple grades or configurations. Refer to page 5 for details.

MAKE MODEL PART DESC	YEAR	QUALIFIER	POSITION	PART #	DISCARD/ DIAMETER	E122 / E123 HARDWARE KIT E124 SELF ADJUSTER E148 / E149 REPAIR KIT
----------------------------	------	-----------	----------	--------	----------------------	--

## INTERNATIONAL ( NAVISTAR, INTERNATIONAL HARVESTER)

### CF500, CF600

Frt & Rr Pads	2006 - 2010			E111-1066-0		E122-70-029
Frt & Rr Rotor	2006 - 2010			E125-70-120	37.4mm	
Frt & Rr Caliper	2006 - 2010		L	E146-70-077	60mm	E148-70-024
			R	E146-70-076	60mm	
PB Shoe	2006 - 2007	9 1/2" x 2 1/2"		E116-0847-0		E123-70-021
	2008 - 2010			E116-0854-0		
Brake M/Cyl	2006 - 2010			E135-70-108	1 1/2"	
Front Hose	2006 - 2010		L	E155-88-020		
			R	E155-88-023		
Rear Hose	2006 - 2010	25" Hose		E155-88-316		
		39 1/2" Hose		E155-88-318		

### LFE Series

#### MXT, RXT

Frt & Rr Pads	2006 - 2009			E111-0786-1		E122-88-006 <sup>4</sup>
Brake M/Cyl	2006 - 2009			E135-88-027	13/16"	
Front Rotor	2006 - 2009			E125-88-023	33.3mm	
Rear Rotor	2006 - 2009			E125-88-021	33.3mm	
Frt & Rr Calipers	2006 - 2009			E146-88-008	66mm	E148-88-009
Front Hose	2006 - 2009	33" Hose		E155-88-019		
Rear Hose	2006 - 2009			E155-88-314		

### TERRA STAR

Frt & Rr Pads	2010 - 2012			E111-1066-0		E122-70-029
Frt & Rr Rotor	2010 - 2012			E125-70-120	37.4mm	
PB Shoe	2010 - 2012			E116-0854-0		
Frt & Rr Caliper	2010 - 2012		L	E146-70-077	60mm	E148-70-024
			R	E146-70-076	60mm	
Brake M/Cyl	2010 - 2012			E135-70-108	1 1/2"	
Front Hose	2010 - 2012		L	E155-88-020		
			R	E155-88-023		
Rear Hose	2010 - 2012	25" Hose		E155-88-316		
		39 1/2" Hose		E155-88-318		

### 140, 1400 Series M Models

#### M1400, 1452 with Disc Brakes

Front Rotor	1988 - 1993	5 Hole - Hat Shaped Disc		E125-88-021	1.32"	
		5 Hole - U Shaped Disc		E125-88-011	1.32"	
		6 Hole - Hat Shaped Disc		E125-88-015	1.32"	
		10 Hole - Hat Shaped Disc		E125-88-018	1.32"	
		10 Hole - U Shaped Disc		E125-88-012	1.32"	
	1994 - 1998	6 Hole - Hat Shaped Disc		E125-88-020	1.32"	
		10 Hole - Hat Shaped Disc - 3.21" Tall		E125-88-019	1.32"	
		10 Hole - Hat Shaped Disc - 4.43" Tall		E125-88-018	1.32"	
Rear Rotor	1988 - 1993	6 Hole - Hat Shaped Disc		E125-88-015	1.32"	
		10 Hole - Hat Shaped Disc		E125-88-018	1.32"	
	1994 - 1998	5 Hole - U Shaped Disc		E125-88-013	1.32"	
		6 Hole - Hat Shaped Disc		E125-88-020	1.32"	
		10 Hole - Hat Shaped Disc - 3.21" Tall		E125-88-019	1.32"	
		10 Hole - Hat Shaped Disc - 4.43" Tall		E125-88-018	1.32"	

Notes <sup>4</sup> Major Kit.

Many products are available in multiple grades or configurations. Refer to page 5 for details.

MAKE MODEL PART DESC	YEAR	QUALIFIER	POSITION	PART #	DISCARD / DIAMETER	E122 / E123 HARDWARE KIT E124 SELF ADJUSTER E148 / E149 REPAIR KIT
----------------------------	------	-----------	----------	--------	-----------------------	--

### INTERNATIONAL ( NAVISTAR, INTERNATIONAL HARVESTER) (Cont'd)

#### M1400, 1452 with Disc Brakes (Cont'd)

Brake M/Cyl	1990	exc UPS		E135-87-013	2"	
		UPS		E135-88-021	2"	
Front Caliper	1988 - 1998	2.60" Caliper - cast 4151733 w/ Soft Boot		E146-75-006	2.60"	E148-88-006
		2.60" Caliper - cast 4151733 w/ Hard Boot		E146-75-006	2.60"	E148-88-007
		2.60" Caliper - cast 2238229 w/ Cross Over Tube		E146-75-011	2.60"	E148-88-006
		2.60" Caliper - cast 4151020 w/o Cross Over Tube		E146-75-012	2.60"	E148-88-006
		2.88" Caliper		E146-85-008	2.88"	E148-71-007
		3.38" Caliper	L	E146-71-015	3.38"	E148-73-006
			R	E146-71-014	3.38"	
Rear Caliper	1988 - 1998	2.60" Caliper - cast 4151733 w/ Soft Boot		E146-75-006	2.60"	E148-88-006
		2.60" Caliper - cast 4151733 w/ Hard Boot		E146-75-006	2.60"	E148-88-007
		2.60" Caliper - cast 2238229 w/ Cross Over Tube		E146-75-011	2.60"	E148-88-006
		2.60" Caliper - cast 4151020 w/o Cross Over Tube		E146-75-012	2.60"	E148-88-006
		2.88" Caliper		E146-85-008	2.88"	E148-71-007

#### 140, 1400 Series S Models

#### S1452, 1452FC

Front Rotor	1984 - 1998	5 Hole - Hat Shaped Disc		E125-88-021	1.32"	
		5 Hole - U Shaped Disc w/ .663" Stud Hole		E125-88-007	1.32"	
		5 Hole - U Shaped Disc w/ .781" Stud Hole		E125-88-011	1.32"	
		6 Hole - U Shaped Disc		E125-88-006	1.32"	
		6 Hole - Hat Shaped Disc		E125-88-020	1.32"	
		10 Hole - Hat Shaped Disc		E125-88-018	1.32"	
Rear Rotor	1984 - 1998	5 Hole - U Shaped 5.24" Tall (Spoke Wheel)		E125-88-014	1.32"	
		5 Hole - U Shaped Disc w/ .662" Stud Hole		E125-88-008	1.32"	
		5 Hole - U Shaped Disc w/ .765" Stud Hole		E125-88-013	1.32"	
		6 Hole - Hat Shaped Disc		E125-88-020	1.32"	
		6 Hole - U Shaped Disc		E125-88-006	1.32"	
		10 Hole - Hat Shaped Disc		E125-88-018	1.32"	
		10 Hole - U Shaped Disc		E125-88-012	1.32"	
Front Caliper	1984 - 1998	2.60" Caliper - cast 4151733 w/ Soft Boot		E146-75-006	2.60"	E148-88-006
		2.60" Caliper - cast 4151733 w/ Hard Boot		E146-75-006	2.60"	E148-88-007
		2.60" Caliper - cast 2238229 w/ Cross Over Tube		E146-75-011	2.60"	E148-88-006
		2.60" Caliper - cast 4151020 w/o Cross Over Tube		E146-75-012	2.60"	E148-88-006
		2.88" Caliper - 1st design <sup>5</sup>		E146-85-009	2.88"	E148-87-007
		2.88" Caliper - 2nd Design <sup>5</sup>		E146-85-008	2.88"	E148-71-007
		3.38" Caliper	L	E146-71-015	3.38"	E148-73-006
			R	E146-71-014	3.38"	
Rear Caliper	1984 - 1998	2.60" Caliper - cast 4151733 w/ Soft Boot		E146-75-006	2.60"	E148-88-006
		2.60" Caliper - cast 4151733 w/ Hard Boot		E146-75-006	2.60"	E148-88-007
		2.60" Caliper - cast 2238229 w/ Cross Over Tube		E146-75-011	2.60"	E148-88-006
		2.60" Caliper - cast 4151020 w/o Cross Over Tube		E146-75-012	2.60"	E148-88-006
		2.88" Caliper - 1st design <sup>5</sup>		E146-85-009	2.88"	E148-87-007
		2.88" Caliper - 2nd Design <sup>5</sup>		E146-85-008	2.88"	E148-71-007

Notes <sup>4</sup> Major Kit. <sup>5</sup> 1st and 2nd Design Calipers are interchangeable; their components are not.



Many products are available in multiple grades or configurations. Refer to page 5 for details.

MAKE MODEL PART DESC	YEAR	QUALIFIER	POSITION	PART #	DISCARD/ DIAMETER	E122 / E123 HARDWARE KIT E124 SELF ADJUSTER E148 / E149 REPAIR KIT
----------------------------	------	-----------	----------	--------	----------------------	--

**INTERNATIONAL ( NAVISTAR, INTERNATIONAL HARVESTER) (Cont'd)**

**160, 1600 Series**

**M1600, 1652 Metro**

Front Rotor	1988 - 1993	5 Hole - Hat Shaped Disc		E125-88-021	1.32"	
		5 Hole - U Shaped Disc		E125-88-011	1.32"	
		6 Hole - Hat Shaped Disc		E125-88-015	1.32"	
		10 Hole - Hat Shaped Disc		E125-88-018	1.32"	
	1994 - 1995	10 Hole - U Shaped Disc		E125-88-012	1.32"	
		6 Hole - Hat Shaped Disc		E125-88-015	1.32"	
		10 Hole - Hat Shaped Disc - 3.21" Tall		E125-88-019	1.32"	
		10 Hole - Hat Shaped Disc - 4.43" Tall		E125-88-018	1.32"	
Rear Rotor	1988 - 1993	6 Hole - Hat Shaped Disc		E125-88-015	1.32"	
		10 Hole - Hat Shaped Disc		E125-88-018	1.32"	
	1994 - 1995	5 Hole - U Shaped Disc		E125-88-013	1.32"	
		6 Hole - Hat Shaped Disc		E125-88-015	1.32"	
		10 Hole - Hat Shaped Disc - 3.21" Tall		E125-88-019	1.32"	
		10 Hole - Hat Shaped Disc - 4.43" Tall		E125-88-018	1.32"	
Brake M/Cyl	1990	exc UPS		E135-87-013	2"	
		UPS		E135-88-021	2"	
Front Caliper	1988 - 1995	2.60" Caliper - cast 4151733 w/ Soft Boot		E146-75-006	2.60"	E148-88-006
		2.60" Caliper - cast 4151733 w/ Hard Boot		E146-75-006	2.60"	E148-88-007
		2.60" Caliper - cast 2238229 w/ Cross Over Tube		E146-75-011	2.60"	E148-88-006
		2.60" Caliper - cast 4151020 w/o Cross Over Tube		E146-75-012	2.60"	E148-88-006
		2.88" Caliper		E146-85-008	2.88"	E148-71-007
		3.38" Caliper	L	E146-71-015	3.38"	E148-73-006
			R	E146-71-014	3.38"	
Rear Caliper	1988 - 1995	2.60" Caliper - cast 4151733 w/ Soft Boot		E146-75-006	2.60"	E148-88-006
		2.60" Caliper - cast 4151733 w/ Hard Boot		E146-75-006	2.60"	E148-88-007
		2.60" Caliper - cast 2238229 w/ Cross Over Tube		E146-75-011	2.60"	E148-88-006
		2.60" Caliper - cast 4151020 w/o Cross Over Tube		E146-75-012	2.60"	E148-88-006
		2.88" Caliper		E146-85-008	2.88"	E148-71-007

**160, 1600 Series Cargostar**

**Cargostar Models**

Rear Rotor	1983 - 1985	2.60" Caliper - 6 Hole Disc - 6.75" BC, 3.50" Tall		E125-88-015	1.32"	
		2.60" Caliper - 6 Hole Disc - 8.75" BC, 6.80" Tall		E125-88-006	1.32"	
		2.60", 2.88" Caliper - 10 Hole Disc		E125-88-018	1.32"	
		2.88" Caliper - 5 Hole Disc		E125-88-007	1.32"	
Frt & Rr Caliper	1983 - 1985	2.60" Caliper - cast 4151733 w/ Soft Boot		E146-75-006	2.60"	E148-88-006
		2.60" Caliper - cast 4151733 w/ Hard Boot		E146-75-006	2.60"	E148-88-007
		2.60" Caliper - cast 2238229 w/ Cross Over Tube		E146-75-011	2.60"	E148-88-006
		2.60" Caliper - cast 4151020 w/o Cross Over Tube		E146-75-012	2.60"	E148-88-006
		2.88" Caliper - 1st design <sup>5</sup>		E146-85-009	2.88"	E148-87-007
		2.88" Caliper - 2nd Design <sup>5</sup>		E146-85-008	2.88"	E148-71-007
		3.38" Caliper	L	E146-71-015	3.38"	E148-73-006
R	E146-71-014		3.38"			

Notes <sup>5</sup> 1st and 2nd Design Calipers are interchangeable; their components are not.

Many products are available in multiple grades or configurations. Refer to page 5 for details.

MAKE MODEL PART DESC	YEAR	QUALIFIER	POSITION	PART #	DISCARD / DIAMETER	E122 / E123 HARDWARE KIT E124 SELF ADJUSTER E148 / E149 REPAIR KIT
<b>INTERNATIONAL ( NAVISTAR, INTERNATIONAL HARVESTER) (Cont'd)</b>						
<b>1600, 1624 Loadstar except 4WD</b>						
Front Rotor	1973 - 1982	5 Hole - Hat Shaped Disc		E125-88-021	1.32"	
		5 Hole - U Shaped Disc w/ .663" Stud Hole		E125-88-007	1.32"	
		5 Hole - U Shaped Disc w/ .781" Stud Hole		E125-88-011	1.32"	
		6 Hole - Hat Shaped Disc		E125-88-015	1.32"	
		6 Hole - U Shaped Disc		E125-88-006	1.32"	
		10 Hole - Hat Shaped Disc		E125-88-018	1.32"	
Rear Rotor	1973 - 1982	5 Hole - U Shaped Disc		E125-88-014	1.32"	
		6 Hole - U Shaped Disc		E125-88-006	1.32"	
		6 Hole - Hat Shaped Disc		E125-88-015	1.32"	
		10 Hole - Hat Shaped Disc		E125-88-018	1.32"	
Frt & Rr Caliper	1973 - 1982	2.60" Caliper - cast 4151733 w/ Soft Boot		E146-75-006	2.60"	E148-88-006
		2.60" Caliper - cast 4151733 w/ Hard Boot		E146-75-006	2.60"	E148-88-007
		2.60" Caliper - cast 2238229 w/ Cross Over Tube		E146-75-011	2.60"	E148-88-006
		2.60" Caliper - cast 4151020 w/o Cross Over Tube		E146-75-012	2.60"	E148-88-006

**160, 1600 Series S Models**

**S1624, S1652FC, S1652SC UPS, S1654**

Frt & Rr Pads	1998 - 2006	w/ 66mm Caliper		E111-0786-1		E122-88-006 <sup>4</sup>
		w/ 73mm Caliper		E111-0786-0		E122-88-006 <sup>4</sup>
Front Rotor	1983 - 1997	5 Hole - Hat Shaped Disc		E125-88-021	1.32"	
		5 Hole - U Shaped Disc - 4.25" Tall		E125-88-005	1.32"	
		5 Hole - U Shaped 4.5" Tall w/ .663" Stud Hole		E125-88-007	1.32"	
		5 Hole - U Shaped 4.5" Tall w/ .781" Stud Hole		E125-88-011	1.32"	
		6 Hole - U Shaped Disc		E125-88-006	1.32"	
		6 Hole - Hat Shaped Disc		E125-88-015	1.32"	
	1998 - 2006	10 Hole - Hat Shaped Disc		E125-88-018	1.32"	
		5 Hole - Hat Shaped Disc <sup>3</sup>		E125-88-021	1.32"	
		6 Hole - Hat Shaped Disc <sup>3</sup>		E125-88-020	1.32"	
		10 Hole - Hat Shaped Disc - 3.20" Tall <sup>3</sup>		E125-88-019	1.32"	
Rear Rotor	1983 - 1998	5 Hole - U Shaped Disc - 4.25" Tall		E125-88-005	1.32"	
		5 Hole - U Shaped Disc - 5.25 Tall		E125-88-014	1.32"	
		6 Hole - Hat Shaped Disc		E125-88-020	1.32"	
		6 Hole - U Shaped Disc		E125-88-006	1.32"	
		10 Hole - Hat Shaped Disc		E125-88-018	1.32"	
		1998 - 2006	5 Hole - Hat Shaped Disc <sup>3</sup>		E125-88-021	1.32"
	6 Hole - Hat Shaped Disc <sup>3</sup>		E125-88-020	1.32"		
	10 Hole - Hat Shaped Disc - 3.20" Tall <sup>3</sup>		E125-88-019	1.32"		
	10 Hole - Hat Shaped Disc - 4.45" Tall <sup>3</sup>		E125-88-018	1.32"		
	Brake M/Cyl	1992 - 2006	UPS Truck		E135-88-021	2"
exc UPS Truck				E135-87-013	2"	
Frt & Rr Caliper	1983 - 1997	2.60" Caliper - cast 4151733 w/ Soft Boot		E146-75-006	2.60"	E148-88-006
		2.60" Caliper - cast 4151733 w/ Hard Boot		E146-75-006	2.60"	E148-88-007
		2.60" Caliper - cast 2238229 w/ Cross Over Tube		E146-75-011	2.60"	E148-88-006
		2.60" Caliper - cast 4151020 w/o Cross Over Tube		E146-75-012	2.60"	E148-88-006
		2.88" Caliper - 1st design 5		E146-85-009	2.88"	E148-87-007
		2.88" Caliper - 2nd Design 5		E146-85-008	2.88"	E148-71-007
		Front Only 3.38" Caliper	L	E146-71-015	3.38"	E148-73-006
			R	E146-71-014	3.38"	
	1998 - 2006	66mm Caliper Cast # 4153269		E146-88-008	66mm	E148-88-009
		73mm Caliper Cast # 4153222		E146-88-010	73mm	E148-88-008

Note <sup>3</sup> ABS exciter teeth in casting; <sup>4</sup> Major Kit; <sup>5</sup> 1st and 2nd Design Calipers are interchangeable, their components are not.

Many products are available in multiple grades or configurations. Refer to page 5 for details.

MAKE MODEL PART DESC	YEAR	QUALIFIER	POSITION	PART #	DISCARD/ DIAMETER	E122 / E123 HARDWARE KIT E124 SELF ADJUSTER E148 / E149 REPAIR KIT
----------------------------	------	-----------	----------	--------	----------------------	--

## INTERNATIONAL ( NAVISTAR, INTERNATIONAL HARVESTER) (Cont'd)

### 160, 1600 Series S Models, Binder

#### S Models, Binder

Front Rotor	1973 - 1982	5 Hole - Hat Shaped Disc	E125-88-021	1.32"		
		5 Hole - U Shaped Disc w/ .663" Stud Hole	E125-88-007	1.32"		
		5 Hole - U Shaped Disc w/ .781" Stud Hole	E125-88-011	1.32"		
		6 Hole - U Shaped Disc	E125-88-006	1.32"		
		6 Hole - Hat Shaped Disc	E125-88-015	1.32"		
		10 Hole - Hat Shaped Disc	E125-88-018	1.32"		
Rear Rotor	1973 - 1982	5 Hole - U Shaped Disc	E125-88-014	1.32"		
		6 Hole - Hat Shaped Disc	E125-88-015	1.32"		
		6 Hole - U Shaped Disc	E125-88-006	1.32"		
		10 Hole - Hat Shaped Disc	E125-88-018	1.32"		
Frt & Rr Caliper	1973 - 1982	2.60" Caliper - cast 4151733 w/ Soft Boot	E146-75-006	2.60"	E148-88-006	
		2.60" Caliper - cast 4151733 w/ Hard Boot	E146-75-006	2.60"	E148-88-007	
		2.60" Caliper - cast 2238229 w/ Cross Over Tube	E146-75-011	2.60"	E148-88-006	
		2.60" Caliper - cast 4151020 w/o Cross Over Tube	E146-75-012	2.60"	E148-88-006	

### 170, 1700 Series Cargostar

#### CO1710A, B Cargostar

Rear Shoes	1969 - 1982	15" x 5" - w/ Auto Adjuster	E117-0346-0		E123-87-008	L E124-87-010 R E124-87-011	
		15" x 5" - w/ Manual Adjuster	E117-0346-0		E123-87-008		
		15" x 6" - w/ Auto Adjuster	E117-0381-0		E123-87-008	L E124-87-010 R E124-87-011	
		15" x 6" - w/ Manual Adjuster	E117-0381-0		E123-87-008	E124-87-009	
		15" x 7" - w/ Auto Adjuster	E117-0383-0		E123-87-008		
		15" x 7" - w/ Manual Adjuster	E117-0383-0		E123-87-008	E124-87-009	
		16" x 5" - w/ Auto Adjuster - 1.67" Adj Ratio	E117-0385-0		E123-87-008		
		16" x 5" - w/ Auto Adjuster - 2.0" Adj Ratio	E117-0385-0		E123-87-008		
		16" x 5" - w/ Manual Adjuster	E117-0385-0		E123-87-008		
		16" x 6" - w/ Auto Adjuster - 1.67" Adj Ratio	E117-0386-0		E123-87-008		
		16" x 6" - w/ Auto Adjuster - 2.0" Adj Ratio	E117-0386-0		E123-87-008		
		16" x 6" - w/ Manual Adjuster	E117-0386-0		E123-87-008		
		1983 - 1985	15" x 5"	E117-0346-0		E123-87-008	
			15" x 6"	E117-0381-0		E123-87-008	E124-87-009
			15" x 7"	E117-0383-0		E123-87-008	E124-87-009
			16" x 5"	E117-0385-0		E123-87-008	
Frt & Rr Caliper	1983 - 1985	2.60" Caliper - cast 4151733 w/ Soft Boot	E146-75-006	2.60"	E148-88-006		
		2.60" Caliper - cast 4151733 w/ Hard Boot	E146-75-006	2.60"	E148-88-007		
		2.60" Caliper - cast 2238229 w/ Cross Over Tube	E146-75-011	2.60"	E148-88-006		
		2.60" Caliper - cast 4151020 w/o Cross Over Tube	E146-75-012	2.60"	E148-88-006		
		2.88" Caliper - 1st design <sup>5</sup>	E146-85-009	2.88"	E148-87-007		
		2.88" Caliper - 2nd Design <sup>5</sup>	E146-85-008	2.88"	E148-71-007		

#### CO1750A, B Cargostar

Frt & Rr Caliper	1983 - 1985	2.60" Caliper - cast 4151733 w/ Soft Boot	E146-75-006	2.60"	E148-88-006	
		2.60" Caliper - cast 4151733 w/ Hard Boot	E146-75-006	2.60"	E148-88-007	
		2.60" Caliper - cast 2238229 w/ Cross Over Tube	E146-75-011	2.60"	E148-88-006	
		2.60" Caliper - cast 4151020 w/o Cross Over Tube	E146-75-012	2.60"	E148-88-006	
		2.88" Caliper - 1st design <sup>5</sup>	E146-85-009	2.88"	E148-87-007	
		2.88" Caliper - 2nd Design <sup>5</sup>	E146-85-008	2.88"	E148-71-007	

Notes <sup>5</sup> 1st and 2nd Design Calipers are interchangeable; their components are not.

Many products are available in multiple grades or configurations. Refer to page 5 for details.

MAKE MODEL PART DESC	YEAR	QUALIFIER	POSITION	PART #	DISCARD / DIAMETER	E122 / E123 HARDWARE KIT E124 SELF ADJUSTER E148 / E149 REPAIR KIT
----------------------------	------	-----------	----------	--------	-----------------------	--

## INTERNATIONAL ( NAVISTAR, INTERNATIONAL HARVESTER) (Cont'd)

### 170, 1700 Series Loadstar

#### 1700 Loadstar Conventional

Frt & Rr Caliper	1973 - 1982	2.60" Caliper - cast 4151733 w/ Soft Boot		E146-75-006	2.60"	E148-88-006
		2.60" Caliper - cast 4151733 w/ Hard Boot		E146-75-006	2.60"	E148-88-007
		2.60" Caliper - cast 2238229 w/ Cross Over Tube		E146-75-011	2.60"	E148-88-006
		2.60" Caliper - cast 4151020 w/o Cross Over Tube		E146-75-012	2.60"	E148-88-006

#### 1724 Loadstar

Frt & Rr Caliper	1973 - 1982	2.60" Caliper - cast 4151733 w/ Soft Boot		E146-75-006	2.60"	E148-88-006
		2.60" Caliper - cast 4151733 w/ Hard Boot		E146-75-006	2.60"	E148-88-007
		2.60" Caliper - cast 2238229 w/ Cross Over Tube		E146-75-011	2.60"	E148-88-006
		2.60" Caliper - cast 4151020 w/o Cross Over Tube		E146-75-012	2.60"	E148-88-006

### 170, 1700 Series S Models

#### S1723, S1724, S1753, S1754 S Models

Front Rotor	1973 - 1989	5 Hole - Hat Shaped Disc		E125-88-021	1.32"	
		5 Hole - U Shaped Disc - 4.25" Tall		E125-88-005	1.32"	
		5 Hole - U Shaped - 4.5" Tall w/ .663" Stud Hole		E125-88-007	1.32"	
		5 Hole - U Shaped - 4.5" Tall w/ .781" Stud Hole		E125-88-011	1.32"	
		6 Hole - Hat Shaped Disc		E125-88-015	1.32"	
		6 Hole - U Shaped Disc		E125-88-006	1.32"	
	1993 - 1998	10 Hole - Hat Shaped Disc		E125-88-018	1.32"	
		5 Hole - U Shaped Disc - 4.75" Tall		E125-88-022	1.32"	
		5 Hole - U Shaped Disc - 6.1" Tall		E125-88-013	1.32"	
		5 Hole - U Shaped Disc - 5.25" Tall		E125-88-014	1.32"	
Rear Rotor	1973 - 1998	6 Hole - Hat Shaped Disc		E125-88-020	1.32"	
		6 Hole - U Shaped Disc		E125-88-006	1.32"	
		10 Hole - Hat Shaped Disc		E125-88-018	1.32"	
		5 Hole - U Shaped Disc - 4.25" Tall		E125-88-005	1.32"	
		5 Hole - U Shaped Disc - 5.25" Tall		E125-88-014	1.32"	
Front Caliper	1973 - 1982	2.60" Caliper - cast 4151733 w/ Soft Boot		E146-75-006	2.60"	E148-88-006
		2.60" Caliper - cast 4151733 w/ Hard Boot		E146-75-006	2.60"	E148-88-007
		2.60" Caliper - cast 2238229 w/ Cross Over Tube		E146-75-011	2.60"	E148-88-006
		2.60" Caliper - cast 4151020 w/o Cross Over Tube		E146-75-012	2.60"	E148-88-006
	1983 - 1998	2.60" Caliper - cast 4151733 w/ Soft Boot		E146-75-006	2.60"	E148-88-006
		2.60" Caliper - cast 4151733 w/ Hard Boot		E146-75-006	2.60"	E148-88-007
		2.60" Caliper - cast 2238229 w/ Cross Over Tube		E146-75-011	2.60"	E148-88-006
		2.60" Caliper - cast 4151020 w/o Cross Over Tube		E146-75-012	2.60"	E148-88-006
		2.88" Caliper - 1st design <sup>5</sup>		E146-85-009	2.88"	E148-87-007
		2.88" Caliper - 2nd Design <sup>5</sup>		E146-85-008	2.88"	E148-71-007
		3.38" Caliper	L	E146-71-015	3.38"	E148-73-006
			R	E146-71-014	3.38"	

Many products are available in multiple grades or configurations. Refer to page 5 for details.

MAKE MODEL PART DESC	YEAR	QUALIFIER	POSITION	PART #	DISCARD/ DIAMETER	E122 / E123 HARDWARE KIT E124 SELF ADJUSTER E148 / E149 REPAIR KIT
----------------------------	------	-----------	----------	--------	----------------------	--

### INTERNATIONAL ( NAVISTAR, INTERNATIONAL HARVESTER) (Cont'd)

#### S1723, S1724, S1753, S1754 S Models (Cont'd)

Rear Caliper	1973 - 1982	2.60" Caliper - cast 4151733 w/ Soft Boot		E146-75-006	2.60"	E148-88-006	
		2.60" Caliper - cast 4151733 w/ Hard Boot		E146-75-006	2.60"	E148-88-007	
		2.60" Caliper - cast 2238229 w/ Cross Over Tube		E146-75-011	2.60"	E148-88-006	
		2.60" Caliper - cast 4151020 w/o Cross Over Tube		E146-75-012	2.60"	E148-88-006	
	1983 - 1985	2.60" Caliper - cast 4151733 w/ Soft Boot		E146-75-006	2.60"	E148-88-006	
		2.60" Caliper - cast 4151733 w/ Hard Boot		E146-75-006	2.60"	E148-88-007	
		2.60" Caliper - cast 2238229 w/ Cross Over Tube		E146-75-011	2.60"	E148-88-006	
		2.60" Caliper - cast 4151020 w/o Cross Over Tube		E146-75-012	2.60"	E148-88-006	
			2.88" Caliper - 1st design <sup>5</sup>		E146-85-009	2.88"	E148-87-007
			2.88" Caliper - 2nd Design <sup>5</sup>		E146-85-008	2.88"	E148-71-007
			3.38" Caliper	L	E146-71-015	3.38"	E148-73-006
				R	E146-71-014	3.38"	
			1986 - 1988	2.60" Caliper - cast 4151733 w/ Soft Boot		E146-75-006	2.60"
	2.60" Caliper - cast 4151733 w/ Hard Boot			E146-75-006	2.60"	E148-88-007	
2.60" Caliper - cast 2238229 w/ Cross Over Tube		E146-75-011		2.60"	E148-88-006		
2.60" Caliper - cast 4151020 w/o Cross Over Tube		E146-75-012		2.60"	E148-88-006		
2.88" Caliper - 1st design <sup>5</sup>		E146-85-009		2.88"	E148-87-007		
		2.88" Caliper - 2nd Design <sup>5</sup>		E146-85-008	2.88"	E148-71-007	

#### 1723 Bus

Front Rotor	1983 - 1985	5 Hole - Hat Shaped Disc		E125-88-021	1.32"	
		5 Hole - U Shaped Disc w/ .663" Stud Hole		E125-88-007	1.32"	
		5 Hole - U Shaped Disc w/ .781" Stud Hole		E125-88-011	1.32"	
		6 Hole - Hat Shaped Disc		E125-88-015	1.32"	
		6 Hole - U Shaped Disc		E125-88-006	1.32"	
		10 Hole - Hat Shaped Disc		E125-88-018	1.32"	
Rear Rotor	1983 - 1985	5 Hole - U Shaped Disc		E125-88-014	1.32"	
		6 Hole - Hat Shaped Disc		E125-88-015	1.32"	
		6 Hole - U Shaped Disc		E125-88-006	1.32"	
		10 Hole - Hat Shaped Disc		E125-88-018	1.32"	
Frt & Rr Caliper	1983 - 1985	2.60" Caliper - cast 4151733 w/ Soft Boot		E146-75-006	2.60"	E148-88-006
		2.60" Caliper - cast 4151733 w/ Hard Boot		E146-75-006	2.60"	E148-88-007
		2.60" Caliper - cast 2238229 w/ Cross Over Tube		E146-75-011	2.60"	E148-88-006
		2.60" Caliper - cast 4151020 w/o Cross Over Tube		E146-75-012	2.60"	E148-88-006
		2.88" Caliper - 1st design <sup>5</sup>		E146-85-009	2.88"	E148-87-007
		2.88" Caliper - 2nd Design <sup>5</sup>		E146-85-008	2.88"	E148-71-007
		3.38" Caliper	L	E146-71-015	3.38"	E148-73-006
R	E146-71-014		3.38"			

Notes <sup>5</sup> 1st and 2nd Design Calipers are interchangeable; their components are not.

Many products are available in multiple grades or configurations. Refer to page 5 for details.

MAKE MODEL PART DESC	YEAR	QUALIFIER	POSITION	PART #	DISCARD / DIAMETER	E122 / E123 HARDWARE KIT E124 SELF ADJUSTER E148 / E149 REPAIR KIT
----------------------------	------	-----------	----------	--------	-----------------------	--

**INTERNATIONAL ( NAVISTAR, INTERNATIONAL HARVESTER) (Cont'd)**

**180, 1800 Series Cargostar**

**CO1810A, B Cargostar**

Frt & Rr Caliper	1983 - 1985	2.60" Caliper - cast 4151733 w/ Soft Boot	E146-75-006	2.60"	E148-88-006	
		2.60" Caliper - cast 4151733 w/ Hard Boot	E146-75-006	2.60"	E148-88-007	
		2.60" Caliper - cast 2238229 w/ Cross Over Tube	E146-75-011	2.60"	E148-88-006	
		2.60" Caliper - cast 4151020 w/o Cross Over Tube	E146-75-012	2.60"	E148-88-006	
		2.88" Caliper - 1st design <sup>5</sup>	E146-85-009	2.88"	E148-87-007	
		2.88" Caliper - 2nd Design <sup>5</sup>	E146-85-008	2.88"	E148-71-007	
Front Hose	1969 - 1982	15" x 3" Brakes	E155-73-010			
		15" x 3 1/2" Brakes	E155-73-005			
	1983 - 1985	Disc Brakes - w/ 2.60" Caliper	E155-88-015			
		Disc Brakes - w/ 2.88" Caliper	E155-88-016			
		Drum Brakes	E155-73-005			
Rear Hose	1983 - 1985	Disc Brakes	E155-88-305			
		Disc Brakes Center Hose	E155-88-306			
		Drum Brakes	E155-73-023			

**CO1850A, B Cargostar**

Frt & Rr Caliper	1983 - 1985	2.60" Caliper - cast 4151733 w/ Soft Boot	E146-75-006	2.60"	E148-88-006	
		2.60" Caliper - cast 4151733 w/ Hard Boot	E146-75-006	2.60"	E148-88-007	
		2.60" Caliper - cast 2238229 w/ Cross Over Tube	E146-75-011	2.60"	E148-88-006	
		2.60" Caliper - cast 4151020 w/o Cross Over Tube	E146-75-012	2.60"	E148-88-006	
		2.88" Caliper - 1st design <sup>5</sup>	E146-85-009	2.88"	E148-87-007	
		2.88" Caliper - 2nd Design <sup>5</sup>	E146-85-008	2.88"	E148-71-007	

**180, 1800 Series Loadstar**

**1800, 1824 Loadstar**

Frt & Rr Caliper	1973 - 1982	2.60" Caliper - cast 4151733 w/ Soft Boot	E146-75-006	2.60"	E148-88-006	
		2.60" Caliper - cast 4151733 w/ Hard Boot	E146-75-006	2.60"	E148-88-007	
		2.60" Caliper - cast 2238229 w/ Cross Over Tube	E146-75-011	2.60"	E148-88-006	
		2.60" Caliper - cast 4151020 w/o Cross Over Tube	E146-75-012	2.60"	E148-88-006	

**180, 1800 Series S Models, School Bus**

**S1823, S1853 School Bus, S1853FC, S1824, S1854 Conventional**

Front Rotor	1983 - 1989	5 Hole - Hat Shaped Disc	E125-88-021	1.32"		
		5 Hole - U Shaped 4.5" Tall w/ .663" Stud Hole	E125-88-007	1.32"		
		5 Hole - U Shaped 4.5" Tall w/ .781" Stud Hole	E125-88-011	1.32"		
		5 Hole - U Shaped 6.1" Tall w/ .662" Stud Hole	E125-88-008	1.32"		
		5 Hole - U Shaped 6.1" Tall w/ .765" Stud Hole	E125-88-013	1.32"		
		6 Hole - Hat Shaped Disc	E125-88-015	1.32"		
		6 Hole - U Shaped Disc	E125-88-006	1.32"		
		10 Hole - Hat Shaped Disc	E125-88-018	1.32"		
		Rear Rotor	1983 - 1989	5 Hole - U Shaped 4.5" Tall w/ .663" Stud Hole	E125-88-007	1.32"
5 Hole - U Shaped 4.5" Tall w/ .781" Stud Hole	E125-88-011			1.32"		
5 Hole - U Shaped Disc 5.35" Tall	E125-88-014			1.32"		
5 Hole - U Shaped 6.1" Tall w/ .662" Stud Hole	E125-88-008			1.32"		
5 Hole - U Shaped 6.1" Tall w/ .765" Stud Hole	E125-88-013			1.32"		
6 Hole - Hat Shaped Disc	E125-88-015			1.32"		
6 Hole - U Shaped Disc	E125-88-006			1.32"		
10 Hole - Hat Shaped Disc	E125-88-018			1.32"		
10 Hole - U Shaped Disc	E125-88-012			1.32"		

Notes <sup>5</sup> 1st and 2nd Design Calipers are interchangeable; their components are not.

Many products are available in multiple grades or configurations. Refer to page 5 for details.

MAKE MODEL PART DESC	YEAR	QUALIFIER	POSITION	PART #	DISCARD / DIAMETER	E122 / E123 HARDWARE KIT E124 SELF ADJUSTER E148 / E149 REPAIR KIT
----------------------------	------	-----------	----------	--------	-----------------------	--

### INTERNATIONAL ( NAVISTAR, INTERNATIONAL HARVESTER) (Cont'd)

#### S1823, S1853 School Bus, S1853FC, S1824, S1854 Conventional (Cont'd)

Front Caliper	1973 - 1982	2.60" Caliper - cast 4151733 w/ Soft Boot		E146-75-006	2.60"	E148-88-006
		2.60" Caliper - cast 4151733 w/ Hard Boot		E146-75-006	2.60"	E148-88-007
		2.60" Caliper - cast 2238229 w/ Cross Over Tube		E146-75-011	2.60"	E148-88-006
		2.60" Caliper - cast 4151020 w/o Cross Over Tube		E146-75-012	2.60"	E148-88-006
	1983 - 1989	2.60" Caliper - cast 4151733 w/ Soft Boot		E146-75-006	2.60"	E148-88-006
		2.60" Caliper - cast 4151733 w/ Hard Boot		E146-75-006	2.60"	E148-88-007
		2.60" Caliper - cast 2238229 w/ Cross Over Tube		E146-75-011	2.60"	E148-88-006
		2.60" Caliper - cast 4151020 w/o Cross Over Tube		E146-75-012	2.60"	E148-88-006
		2.88" Caliper - 1st design <sup>5</sup>		E146-85-009	2.88"	E148-87-007
		2.88" Caliper - 2nd Design <sup>5</sup>		E146-85-008	2.88"	E148-71-007
3.38" Caliper	L	E146-71-015	3.38"	E148-73-006		
	R	E146-71-014	3.38"			
Rear Caliper	1973 - 1982	2.60" Caliper - cast 4151733 w/ Soft Boot		E146-75-006	2.60"	E148-88-006
		2.60" Caliper - cast 4151733 w/ Hard Boot		E146-75-006	2.60"	E148-88-007
		2.60" Caliper - cast 2238229 w/ Cross Over Tube		E146-75-011	2.60"	E148-88-006
		2.60" Caliper - cast 4151020 w/o Cross Over Tube		E146-75-012	2.60"	E148-88-006
	1983 - 1989	2.60" Caliper - cast 4151733 w/ Soft Boot		E146-75-006	2.60"	E148-88-006
		2.60" Caliper - cast 4151733 w/ Hard Boot		E146-75-006	2.60"	E148-88-007
		2.60" Caliper - cast 2238229 w/ Cross Over Tube		E146-75-011	2.60"	E148-88-006
		2.60" Caliper - cast 4151020 w/o Cross Over Tube		E146-75-012	2.60"	E148-88-006
		2.88" Caliper - 1st design <sup>5</sup>		E146-85-009	2.88"	E148-87-007
		2.88" Caliper - 2nd Design <sup>5</sup>		E146-85-008	2.88"	E148-71-007

#### 190, 1900 Series Cargostar

##### CO1910A, B Cargostar, Forward Cab

Front Rotor	1983 - 1985	5 Hole - Hat Shaped Disc		E125-88-021	1.32"	
		5 Hole - U Shaped Disc w/ .663" Stud Hole		E125-88-007	1.32"	
		5 Hole - U Shaped Disc w/ .781" Stud Hole		E125-88-011	1.32"	
		6 Hole - Hat Shaped Disc		E125-88-015	1.32"	
		6 Hole - U Shaped Disc		E125-88-006	1.32"	
		10 Hole - Hat Shaped Disc		E125-88-018	1.32"	
Rear Rotor	1983 - 1985	6 Hole - Hat Shaped Disc		E125-88-015	1.32"	
		6 Hole - U Shaped Disc		E125-88-006	1.32"	
		10 Hole - Hat Shaped Disc		E125-88-018	1.32"	
Frt & Rr Caliper	1983 - 1985	2.60" Caliper - cast 4151733 w/ Soft Boot		E146-75-006	2.60"	E148-88-006
		2.60" Caliper - cast 4151733 w/ Hard Boot		E146-75-006	2.60"	E148-88-007
		2.60" Caliper - cast 2238229 w/ Cross Over Tube		E146-75-011	2.60"	E148-88-006
		2.60" Caliper - cast 4151020 w/o Cross Over Tube		E146-75-012	2.60"	E148-88-006
		2.88" Caliper - 1st design <sup>5</sup>		E146-85-009	2.88"	E148-87-007
		2.88" Caliper - 2nd Design <sup>5</sup>		E146-85-008	2.88"	E148-71-007

Notes <sup>5</sup> 1st and 2nd Design Calipers are interchangeable; their components are not.

Many products are available in multiple grades or configurations. Refer to page 5 for details.

MAKE MODEL PART DESC	YEAR	QUALIFIER	POSITION	PART #	DISCARD / DIAMETER	E122 / E123 HARDWARE KIT E124 SELF ADJUSTER E148 / E149 REPAIR KIT
----------------------------	------	-----------	----------	--------	-----------------------	--

## INTERNATIONAL ( NAVISTAR, INTERNATIONAL HARVESTER) (Cont'd)

### 1900 Series F Models

#### F1910A, F1924 Tandem

Front Rotor	1973 - 1982	5 Hole - Hat Shaped Disc		E125-88-021	1.32"	
		5 Hole - U Shaped Disc w/ .663" Stud Hole		E125-88-007	1.32"	
		5 Hole - U Shaped Disc w/ .781" Stud Hole		E125-88-011	1.32"	
		6 Hole - Hat Shaped Disc		E125-88-015	1.32"	
		6 Hole - U Shaped Disc		E125-88-006	1.32"	
		10 Hole - Hat Shaped Disc		E125-88-018	1.32"	
Rear Rotor	1973 - 1982	5 Hole - U Shaped Disc		E125-88-014	1.32"	
		6 Hole - Hat Shaped Disc		E125-88-015	1.32"	
		6 Hole - U Shaped Disc		E125-88-006	1.32"	
		10 Hole - Hat Shaped Disc		E125-88-018	1.32"	
Frt & Rr Caliper	1973 - 1982	2.60" Caliper - cast 4151733 w/ Soft Boot		E146-75-006	2.60"	E148-88-006
		2.60" Caliper - cast 4151733 w/ Hard Boot		E146-75-006	2.60"	E148-88-007
		2.60" Caliper - cast 2238229 w/ Cross Over Tube		E146-75-011	2.60"	E148-88-006
		2.60" Caliper - cast 4151020 w/o Cross Over Tube		E146-75-012	2.60"	E148-88-006

### 1900 Series S Models

#### S Models Conventional

Front Rotor	1973 - 1985	5 Hole - Hat Shaped Disc		E125-88-021	1.32"	
		5 Hole - U Shaped Disc w/ .663" Stud Hole		E125-88-007	1.32"	
		5 Hole - U Shaped Disc w/ .781" Stud Hole		E125-88-011	1.32"	
		6 Hole - Hat Shaped Disc		E125-88-015	1.32"	
		6 Hole - U Shaped Disc		E125-88-006	1.32"	
		10 Hole - Hat Shaped Disc		E125-88-018	1.32"	
Rear Rotor	1973 - 1985	5 Hole - U Shaped 5.35" Tall		E125-88-014	1.32"	
		5 Hole - U Shaped 6.1" Tall w/ .662" Stud Hole		E125-88-008	1.32"	
		5 Hole - U Shaped 6.1" Tall w/ .765" Stud Hole		E125-88-013	1.32"	
		6 Hole - Hat Shaped Disc		E125-88-015	1.32"	
		6 Hole - U Shaped Disc		E125-88-006	1.32"	
		10 Hole - Hat Shaped Disc		E125-88-018	1.32"	
		10 Hole - U Shaped		E125-88-012	1.32"	
Frt & Rr Caliper	1973 - 1982	2.60" Caliper - cast 4151733 w/ Soft Boot		E146-75-006	2.60"	E148-88-006
		2.60" Caliper - cast 4151733 w/ Hard Boot		E146-75-006	2.60"	E148-88-007
		2.60" Caliper - cast 2238229 w/ Cross Over Tube		E146-75-011	2.60"	E148-88-006
		2.60" Caliper - cast 4151020 w/o Cross Over Tube		E146-75-012	2.60"	E148-88-006
	1983 - 1985	2.60" Caliper - cast 4151733 w/ Soft Boot		E146-75-006	2.60"	E148-88-006
		2.60" Caliper - cast 4151733 w/ Hard Boot		E146-75-006	2.60"	E148-88-007
		2.60" Caliper - cast 2238229 w/ Cross Over Tube		E146-75-011	2.60"	E148-88-006
		2.60" Caliper - cast 4151020 w/o Cross Over Tube		E146-75-012	2.60"	E148-88-006
		2.88" Caliper - 1st design <sup>5</sup>		E146-85-009	2.88"	E148-87-007
		2.88" Caliper - 2nd Design <sup>5</sup>		E146-85-008	2.88"	E148-71-007
		3.38" Caliper	L	E146-71-015	3.38"	E148-73-006
			R	E146-71-014	3.38"	

Notes <sup>5</sup> 1st and 2nd Design Calipers are interchangeable; their components are not.



Many products are available in multiple grades or configurations. Refer to page 5 for details.

MAKE MODEL PART DESC	YEAR	QUALIFIER	POSITION	PART #	DISCARD/ DIAMETER	E122 / E123 HARDWARE KIT E124 SELF ADJUSTER E148 / E149 REPAIR KIT
----------------------------	------	-----------	----------	--------	----------------------	--

## INTERNATIONAL ( NAVISTAR, INTERNATIONAL HARVESTER) (Cont'd)

### S1924, S1954 Conventional

Front Rotor	1973 - 1989	5 Hole - Hat Shaped Disc		E125-88-021	1.32"	
		5 Hole - U Shaped Disc - w/ .663" Stud Hole		E125-88-007	1.32"	
		5 Hole - U Shaped Disc - w/ .781" Stud Hole		E125-88-011	1.32"	
		6 Hole - Hat Shaped Disc		E125-88-015	1.32"	
		6 Hole - U Shaped Disc		E125-88-006	1.32"	
		10 Hole - Hat Shaped Disc		E125-88-018	1.32"	
		Rear Rotor	1973 - 1989	5 Hole - U Shaped 5.35" Tall		E125-88-014
5 Hole - U Shaped 6.1" Tall w/ .662" Stud Hole				E125-88-008	1.32"	
5 Hole - U Shaped 6.1" Tall w/ .765" Stud Hole				E125-88-013	1.32"	
6 Hole - Hat Shaped Disc				E125-88-015	1.32"	
6 Hole - U Shaped Disc				E125-88-006	1.32"	
10 Hole - Hat Shaped Disc				E125-88-018	1.32"	
10 Hole - U Shaped				E125-88-012	1.32"	
Frt & Rr Caliper	1973 - 1982	2.60" Caliper - cast 4151733 w/ Soft Boot		E146-75-006	2.60"	E148-88-006
		2.60" Caliper - cast 4151733 w/ Hard Boot		E146-75-006	2.60"	E148-88-007
		2.60" Caliper - cast 2238229 w/ Cross Over Tube		E146-75-011	2.60"	E148-88-006
		2.60" Caliper - cast 4151020 w/o Cross Over Tube		E146-75-012	2.60"	E148-88-006
		2.60" Caliper - cast 4151733 w/ Soft Boot		E146-75-006	2.60"	E148-88-006
	1983 - 1985	2.60" Caliper - cast 4151733 w/ Hard Boot		E146-75-006	2.60"	E148-88-007
		2.60" Caliper - cast 2238229 w/ Cross Over Tube		E146-75-011	2.60"	E148-88-006
		2.60" Caliper - cast 4151020 w/o Cross Over Tube		E146-75-012	2.60"	E148-88-006
		2.88" Caliper - 1st design <sup>5</sup>		E146-85-009	2.88"	E148-87-007
		2.88" Caliper - 2nd Design <sup>5</sup>		E146-85-008	2.88"	E148-71-007
	1986 - 1989	3.38" Caliper	L	E146-71-015	3.38"	E148-73-006
			R	E146-71-014	3.38"	
		2.60" Caliper - cast 4151733 w/ Soft Boot		E146-75-006	2.60"	E148-88-006
		2.60" Caliper - cast 4151733 w/ Hard Boot		E146-75-006	2.60"	E148-88-007
		2.60" Caliper - cast 2238229 w/ Cross Over Tube		E146-75-011	2.60"	E148-88-006
		2.60" Caliper - cast 4151020 w/o Cross Over Tube		E146-75-012	2.60"	E148-88-006
		2.88" Caliper - 1st design <sup>5</sup>		E146-85-009	2.88"	E148-87-007
		2.88" Caliper - 2nd Design <sup>5</sup>		E146-85-008	2.88"	E148-71-007

### 2000 Series S Models

#### S Models

Front Rotor	1979 - 1986	5 Hole - Hat Shaped Disc		E125-88-021	1.32"	
		5 Hole - U Shaped Disc - w/ .663" Stud Hole		E125-88-007	1.32"	
		5 Hole - U Shaped Disc - w/ .781" Stud Hole		E125-88-011	1.32"	
		6 Hole - Hat Shaped Disc		E125-88-015	1.32"	
		6 Hole - U Shaped Disc		E125-88-006	1.32"	
		10 Hole - Hat Shaped Disc		E125-88-018	1.32"	
Rear Rotor	1979 - 1986	6 Hole - Hat Shaped Disc		E125-88-015	1.32"	
		6 Hole - U Shaped Disc		E125-88-006	1.32"	
		10 Hole - Hat Shaped Disc		E125-88-018	1.32"	

Notes <sup>5</sup> 1st and 2nd Design Calipers are interchangeable; their components are not.

Many products are available in multiple grades or configurations. Refer to page 5 for details.

MAKE MODEL PART DESC	YEAR	QUALIFIER	POSITION	PART #	DISCARD / DIAMETER	E122 / E123 HARDWARE KIT E124 SELF ADJUSTER E148 / E149 REPAIR KIT
----------------------------	------	-----------	----------	--------	-----------------------	--

## INTERNATIONAL ( NAVISTAR, INTERNATIONAL HARVESTER) (Cont'd)

### S Models (Cont'd)

Frt & Rr Caliper	1979 - 1985	2.60" Caliper - cast 4151733 w/ Soft Boot		E146-75-006	2.60"	E148-88-006
		2.60" Caliper - cast 4151733 w/ Hard Boot		E146-75-006	2.60"	E148-88-007
		2.60" Caliper - cast 2238229 w/ Cross Over Tube		E146-75-011	2.60"	E148-88-006
		2.60" Caliper - cast 4151020 w/o Cross Over Tube		E146-75-012	2.60"	E148-88-006
	1986	2.88" Caliper - 1st design <sup>5</sup>		E146-85-009	2.88"	E148-87-007
		2.88" Caliper - 2nd Design <sup>5</sup>		E146-85-008	2.88"	E148-71-007
		3.38" Caliper	L	E146-71-015	3.38"	E148-73-006
			R	E146-71-014	3.38"	
		2.88" Caliper - 1st design <sup>5</sup>		E146-85-009	2.88"	E148-87-007
			2.88" Caliper - 2nd Design <sup>5</sup>		E146-85-008	
3.38" Caliper	L	E146-71-015	3.38"	E148-73-006		
	R	E146-71-014	3.38"			

### 3000 Series

#### 3000, 3200, 3600, 3700, 3800, 3900FC School Bus with Hydraulic Disc Brakes

Frt & Rr Pads	1998 - 2008	w/ 66mm Pin Slide Caliper		E111-0786-1		E122-88-006 <sup>4</sup>	
		w/ 73mm Pin Slide Caliper		E111-0786-0		E122-88-006 <sup>4</sup>	
	2009	w/ 2 Piston 66mm Bosch Caliper Cast # 4153269		E111-0786-1		E122-88-006 <sup>4</sup>	
		w/ 2 Piston 73mm Bosch Caliper Cast # 4153222		E111-0786-0		E122-88-006 <sup>4</sup>	
	2010 - 2012	w/ 4 piston Meritor Caliper		E111-0769-0		E122-85-006 <sup>4</sup>	
			E111-0769-0		E122-85-006 <sup>4</sup>		
Front Rotor	1990 - 1993	5 Hole - Hat Shaped Disc		E125-88-021	1.32"		
		5 Hole - U Shaped Disc		E125-88-011	1.32"		
		6 Hole - Hat Shaped Disc		E125-88-015	1.32"		
		10 Hole - Hat Shaped Disc		E125-88-018	1.32"		
		10 Hole U Shaped Disc		E125-88-012	1.32"		
	1994 - 1997	6 Hole - Hat Shaped Disc		E125-88-015	1.32"		
		10 Hole - Hat Shaped Disc - 3.20" Tall		E125-88-019	1.32"		
		10 Hole - Hat Shaped Disc - 4.43" Tall		E125-88-018	1.32"		
		10 Hole U Shaped Disc		E125-88-012	1.32"		
	1998 - 2008	5 Hole - Hat Shaped Disc <sup>3</sup>		E125-88-021	1.32"		
		6 Hole - Hat Shaped Disc <sup>3</sup>		E125-88-020	1.32"		
		10 Hole - Hat Shaped Disc - 3.20" Tall <sup>3</sup>		E125-88-019	1.32"		
		10 Hole - Hat Shaped Disc - 4.45" Tall <sup>3</sup>		E125-88-018	1.32"		
	2009	5 Hole Hat Shaped Disc <sup>3</sup>		E125-88-021	1.32"		
		10 Hole - Hat Shaped Disc - 3.20" Tall <sup>3</sup>		E125-88-019	1.32"		
		10 Hole - Hat Shaped Disc - 4.45" Tall <sup>3</sup>		E125-88-018	1.32"		
10 Hole - Hat Shaped Disc - 1.89" Tall			E125-88-025	1.42"			
2010 - 2012			E125-88-025	1.42"			
			E125-88-025	1.42"			
Rear Rotor	1990 - 1993	6 Hole - Hat Shaped Disc		E125-88-015	1.32"		
		10 Hole - Hat Shaped Disc		E125-88-018	1.32"		
	1994 - 1997	6 Hole - Hat Shaped Disc		E125-88-015	1.32"		
		10 Hole - Hat Shaped Disc - 3.20" Tall		E125-88-019	1.32"		
		10 Hole - Hat Shaped Disc - 4.43" Tall		E125-88-018	1.32"		
	1998 - 2008	5 Hole - Hat Shaped Disc <sup>3</sup>		E125-88-021	1.32"		
		6 Hole - Hat Shaped Disc <sup>3</sup>		E125-88-020	1.32"		
		10 Hole - Hat Shaped Disc - 3.20" Tall <sup>3</sup>		E125-88-019	1.32"		
	Cont'd Next Pg		10 Hole - Hat Shaped Disc - 4.45" Tall <sup>3</sup>		E125-88-018	1.32"	

Note <sup>3</sup> ABS exciter teeth in casting; <sup>4</sup> Major Kit; <sup>5</sup> 1st and 2nd Design Calipers are interchangeable, their components are not.

Many products are available in multiple grades or configurations. Refer to page 5 for details.

MAKE MODEL PART DESC	YEAR	QUALIFIER	POSITION	PART #	DISCARD/ DIAMETER	E122 / E123 HARDWARE KIT E124 SELF ADJUSTER E148 / E149 REPAIR KIT	
<b>INTERNATIONAL ( NAVISTAR, INTERNATIONAL HARVESTER) (Cont'd)</b>							
<b>3000, 3200, 3600, 3700, 3800, 3900FC School Bus with Hydraulic Disc Brakes (Cont'd)</b>							
Rear Rotor (Cont'd)	2009	5 Hole Hat Shaped Disc <sup>3</sup>		E125-88-021	1.32"		
		10 Hole - Hat Shaped Disc - 3.20" Tall <sup>3</sup>		E125-88-019	1.32"		
		10 Hole - Hat Shaped Disc - 4.45" Tall <sup>3</sup>		E125-88-018	1.32"		
		10 Hole - Hat Shaped Disc - 1.89" Tall		E125-88-025	1.42"		
	2010 - 2012			E125-88-025	1.42"		
PB Shoe	1990 - 2012	12x3" Air actuated		E116-0980-0			
		12x3" Manual actuated		E116-0978-0			
Brake M/Cyl	1990 - 2008	exc 3900FC		E135-87-013	2"		
		3900FC		E135-88-022	2"		
	2009	Bosch Brake Master Cylinder		E135-87-013	2"		
		Wabco - Meritor Brake Master Cylinder		E135-88-027	13/16"		
	2010 - 2012			E135-88-027	13/16"		
Front Caliper	1990 - 1997	2.60" Caliper Except Air Ride Suspension		E146-75-006	2.60"	E148-88-007	
		2.60" Caliper w/ Air Ride Suspension		E146-75-008	2.60"	E148-88-007	
		2.88" Caliper Except Air Ride Suspension		E146-85-008	2.88"	E148-71-007	
		2.88" Caliper w/ Air Ride Suspension		E146-88-006	2.88"	E148-71-007	
		3.38" Caliper	L	E146-71-015	3.38"	E148-73-006	
		R	E146-71-014	3.38"			
	1998 - 2008	66mm Caliper Cast # 4153269		E146-88-008	66mm	E148-88-009	
		73mm Caliper Cast # 4153222		E146-88-010	73mm	E148-88-008	
	2009	66mm - 2 Piston Bosch Caliper Cast # 4153269		E146-88-008	66mm	E148-88-009	
		73mm - 2 Piston Bosch Caliper Cast # 4153222		E146-88-010	73mm	E148-88-008	
		70mm - 4 piston Meritor Caliper	L	E146-88-015	70mm	E148-84-009	
		R	E146-88-014	70mm			
	2010 - 2012			L	E146-88-015	70mm	E148-84-009
				R	E146-88-014	70mm	
				L	E146-88-015	70mm	E148-84-009
			R	E146-88-014	70mm		
Rear Caliper	1990 - 1997	2.60" Caliper Except Air Ride Suspension		E146-75-006	2.60"	E148-88-007	
		2.60" Caliper w/ Air Ride Suspension		E146-75-008	2.60"	E148-88-007	
		2.88" Caliper Except Air Ride Suspension		E146-85-008	2.88"	E148-71-007	
		2.88" Caliper w/ Air Ride Suspension		E146-88-006	2.88"	E148-71-007	
		1998 - 2008	66mm Caliper Casting # 4153269		E146-88-008	66mm	E148-88-009
	73mm Caliper Casting # 4153222			E146-88-010	73mm	E148-88-008	
	2009	66mm - 2 Piston Bosch Caliper Cast # 4153269		E146-88-008	66mm	E148-88-009	
		73mm - 2 Piston Bosch Caliper Cast # 4153222		E146-88-010	73mm	E148-88-008	
		70mm - 4 Piston Meritor Caliper	L	E146-88-014	70mm	E148-84-009	
		R	E146-88-015	70mm			
	2010 - 2012	64mm - 4 Piston Meritor Caliper	L	E146-88-017	64mm	E148-84-010	
			R	E146-88-016	64mm		
		70mm - 4 Piston Meritor Caliper	L	E146-88-014	70mm	E148-84-009	
			R	E146-88-015	70mm		
		64mm - 4 Piston Meritor Caliper	L	E146-88-017	64mm	E148-84-010	
	R	E146-88-016	64mm				
Front Hose	1990 - 1997	w/ 2.60" Caliper		E155-88-010			
		w/ 2.88" Caliper		E155-88-009			
	1998 - 2012	33" Hose		E155-88-019			
		35" Hose		E155-88-022			
		38" Hose		E155-88-021			

Note <sup>3</sup> ABS exciter teeth in casting

Many products are available in multiple grades or configurations. Refer to page 5 for details.

MAKE MODEL PART DESC	YEAR	QUALIFIER	POSITION	PART #	DISCARD / DIAMETER	E122 / E123 HARDWARE KIT E124 SELF ADJUSTER E148 / E149 REPAIR KIT
----------------------------	------	-----------	----------	--------	-----------------------	--

**INTERNATIONAL ( NAVISTAR, INTERNATIONAL HARVESTER) (Cont'd)**

**3000, 3200, 3600, 3700, 3800, 3900FC School Bus with Hydraulic Disc Brakes (Cont'd)**

Rear Hose	1990 - 1997	6M FA		E155-88-006		
		exc 6MFA		E155-88-305		
		Center Hose To Frame		E155-88-306		
	1998 - 2012	37" Hose		E155-88-315		
		39" Hose		E155-88-314		
		43" Hose		E155-88-317		

**4000, 7000 Series**

**4100, 4200, 4300, 4400, 4600, 4700, 4800, 4900, 7100 Conventional Cab with Hydraulic Disc Brakes**

Frt & Rr Pads	1998 - 2008	w/ 66mm Caliper		E111-0786-1		E122-88-006 <sup>4</sup>	
		w/ 73mm Caliper		E111-0786-0		E122-88-006 <sup>4</sup>	
	2009	w/ 2 Piston 66mm Bosch Caliper Cast # 4153269		E111-0786-1		E122-88-006 <sup>4</sup>	
		w/ 2 Piston 73mm Bosch Caliper Cast # 4153222		E111-0786-0		E122-88-006 <sup>4</sup>	
		w/ 4 piston Meritor Caliper		E111-0769-0		E122-85-006 <sup>4</sup>	
	2010 - 2012			E111-0769-0		E122-85-006 <sup>4</sup>	
Front Rotor	1990 - 1993	5 Hole - Hat Shaped Disc		E125-88-021	1.32"		
		5 Hole - U Shaped Disc 4.5" Tall		E125-88-011	1.32"		
		5 Hole - U Shaped Disc 6.1" Tall		E125-88-013	1.32"		
		6 Hole - Hat Shaped Disc		E125-88-015	1.32"		
		10 Hole - Hat Shaped Disc		E125-88-018	1.32"		
		10 Hole - U Shaped Disc		E125-88-012	1.32"		
	1994 - 1997	5 Hole - Hat Shaped Disc		E125-88-021	1.32"		
		5 Hole - U Shaped Disc		E125-88-013	1.32"		
		6 Hole - Hat Shaped Disc		E125-88-015	1.32"		
		10 Hole - Hat Shaped Disc - 3.20" Tall		E125-88-019	1.32"		
		10 Hole - Hat Shaped Disc - 4.43" Tall		E125-88-018	1.32"		
		10 Hole U Shaped Disc		E125-88-012	1.32"		
	1998 - 2008	5 Hole - Hat Shaped Disc <sup>3</sup>		E125-88-021	1.32"		
		6 Hole - Hat Shaped Disc <sup>3</sup>		E125-88-020	1.32"		
		10 Hole - Hat Shaped Disc - 3.20" Tall <sup>3</sup>		E125-88-019	1.32"		
		10 Hole - Hat Shaped Disc - 4.45" Tall <sup>3</sup>		E125-88-018	1.32"		
		2009	5 Hole Hat Shaped Disc <sup>3</sup>		E125-88-021	1.32"	
		10 Hole - Hat Shaped Disc - 3.20" Tall <sup>3</sup>		E125-88-019	1.32"		
	2010 - 2012	10 Hole - Hat Shaped Disc - 4.45" Tall <sup>3</sup>		E125-88-018	1.32"		
		10 Hole - Hat Shaped Disc - 1.89" Tall		E125-88-025	1.42"		
				E125-88-025	1.42"		
			E125-88-013	1.32"			
			E125-88-015	1.32"			
			E125-88-019	1.32"			
Rear Rotor	1990 - 1997	5 Hole - U Shaped Disc		E125-88-013	1.32"		
		6 Hole - Hat Shaped Disc		E125-88-015	1.32"		
		10 Hole - Hat Shaped Disc - 3.20" Tall		E125-88-019	1.32"		
		10 Hole - Hat Shaped Disc - 4.43" Tall		E125-88-018	1.32"		
	1998 - 2008	5 Hole - Hat Shaped Disc <sup>3</sup>		E125-88-021	1.32"		
		6 Hole - Hat Shaped Disc <sup>3</sup>		E125-88-020	1.32"		
		10 Hole - Hat Shaped Disc - 3.20" Tall <sup>3</sup>		E125-88-019	1.32"		
		10 Hole - Hat Shaped Disc - 4.45" Tall <sup>3</sup>		E125-88-018	1.32"		
	2009	5 Hole Hat Shaped Disc <sup>3</sup>		E125-88-021	1.32"		
		10 Hole - Hat Shaped Disc - 3.20" Tall <sup>3</sup>		E125-88-019	1.32"		
		10 Hole - Hat Shaped Disc - 4.45" Tall <sup>3</sup>		E125-88-018	1.32"		
		10 Hole - Hat Shaped Disc - 1.89" Tall		E125-88-025	1.42"		
	2010 - 2012			E125-88-025	1.42"		

Note<sup>3</sup> ABS exciter teeth in casting; <sup>4</sup> Major Kit

Many products are available in multiple grades or configurations. Refer to page 5 for details.

MAKE MODEL PART DESC	YEAR	QUALIFIER	POSITION	PART #	DISCARD/ DIAMETER	E122 / E123 HARDWARE KIT E124 SELF ADJUSTER E148 / E149 REPAIR KIT
<b>INTERNATIONAL ( NAVISTAR, INTERNATIONAL HARVESTER) (Cont'd)</b>						
<b>4100, 4200, 4300, 4400, 4600, 4700, 4800, 4900, 7100 Conventional Cab with Hydraulic Disc Brakes (Cont'd)</b>						
PB Shoe	1990 - 2012	12x3" Air actuated		E116-0980-0		
		12x3" Manual actuated		E116-0978-0		
Brake M/Cyl	1990 - 2008			E135-87-013	2"	
	2009	w/ Bosch Brake Master Cylinder		E135-87-013	2"	
		w/ Wabco - Meritor Brake Master Cylinder		E135-88-027	13/16"	
	2010 - 2012			E135-88-027	13/16"	
Front Caliper	1990 - 1997	2.60" Caliper Except Air Ride Suspension		E146-75-006	2.60"	E148-88-007
		2.60" Caliper w/ Air Ride Suspension		E146-75-008	2.60"	E148-88-007
		2.88" Caliper Except Air Ride Suspension		E146-85-008	2.88"	E148-71-007
		2.88" Caliper w/ Air Ride Suspension		E146-88-006	2.88"	E148-71-007
		3.38" Caliper	L	E146-71-015	3.38"	E148-73-006
		R	E146-71-014	3.38"		
	1998 - 2008	66mm Caliper Cast # 4153269		E146-88-008	66mm	E148-88-009
		73mm Caliper Cast # 4153222		E146-88-010	73mm	E148-88-008
	2009	66mm - 2 Piston Bosch Caliper Cast # 4153269		E146-88-008	66mm	E148-88-009
		73mm - 2 Piston Bosch Caliper Cast # 4153222		E146-88-010	73mm	E148-88-008
	2010 - 2012	70mm - 4 Piston Meritor Caliper	L	E146-88-015	70mm	E148-84-009
			R	E146-88-014	70mm	
		70mm - 4 Piston Meritor Caliper	L	E146-88-015	70mm	E148-84-009
			R	E146-88-014	70mm	
Rear Caliper	1990 - 1997	2.60" Caliper Except Air Ride Suspension		E146-75-006	2.60"	E148-88-007
		2.60" Caliper w/ Air Ride Suspension		E146-75-008	2.60"	E148-88-007
		2.88" Caliper Except Air Ride Suspension		E146-85-008	2.88"	E148-71-007
		2.88" Caliper w/ Air Ride Suspension		E146-88-006	2.88"	E148-71-007
	1998 - 2008	66mm Caliper Cast # 4153269		E146-88-008	66mm	E148-88-009
		73mm Caliper Cast # 4153222		E146-88-010	73mm	E148-88-008
	2009	66mm - 2 Piston Bosch Caliper Cast # 4153269		E146-88-008	66mm	E148-88-009
		73mm - 2 Piston Bosch Caliper Cast # 4153222		E146-88-010	73mm	E148-88-008
	2010 - 2012	70mm - 4 Piston Meritor Caliper	L	E146-88-015	70mm	E148-84-009
			R	E146-88-014	70mm	
		64mm - 4 Piston Meritor Caliper	L	E146-88-017	64mm	E148-84-010
			R	E146-88-016	64mm	
		70mm - 4 Piston Meritor Caliper	L	E146-88-014	70mm	E148-84-009
			R	E146-88-015	70mm	
64mm - 4 Piston Meritor Caliper	L	E146-88-017	64mm	E148-84-010		
	R	E146-88-016	64mm			
Front Hose	1990 - 1997	w/ 2.60" Rail Slide Caliper		E155-88-010		
		w/ 2.88" Rail Slide Caliper		E155-88-009		
	1998 - 2012	33" Hose		E155-88-019		
		35" Hose		E155-88-022		
	38" Hose		E155-88-021			
Rear Hose	1990 - 1997			E155-88-305		
	1998 - 2012	37" Hose		E155-88-315		
		39" Hose		E155-88-314		
		43" Hose		E155-88-317		

Many products are available in multiple grades or configurations. Refer to page 5 for details.

MAKE MODEL PART DESC	YEAR	QUALIFIER	POSITION	PART #	DISCARD / DIAMETER	E122 / E123 HARDWARE KIT E124 SELF ADJUSTER E148 / E149 REPAIR KIT
----------------------------	------	-----------	----------	--------	-----------------------	--

## ISUZU

### EVR

Front Shoes	9/86 - 12/93	410mm x 140mm - Air Over Hydraulic		E117-0613-0		
	1/94 - 9/94	410mm x 140mm - Air Over Hydraulic-Auto		E117-0718-0		
		410mm x 140mm - Air Over Hydraulic-Manual		E117-0613-0		
	10/94 - 1996	410mm x 140mm - Air Over Hydraulic		E117-0718-0		
Rear Shoes	9/86 - 12/93	410mm x 140mm - Air Over Hydraulic		E117-0613-0		
	1/94 - 9/94	410mm x 140mm - Air Over Hydraulic-Auto		E117-0718-0		
		410mm x 140mm - Air Over Hydraulic-Manual		E117-0613-0		
	10/94 - 1996	410mm x 140mm - Air Over Hydraulic		E117-0718-0		
Front W/Cyl	9/86 - 12/93		L	E139-81-114	47.5mm	E149-85-010
			R	E139-81-115	47.5mm	
	1/94 - 9/94	w/ Auto Adjuster	L	E139-81-155	47.5mm	
			R	E139-81-156	47.5mm	
	10/94 - 1996	w/ Manual Adjuster	L	E139-81-114	47.5mm	E149-85-010
			R	E139-81-115	47.5mm	
			L	E139-81-155	47.5mm	
			R	E139-81-156	47.5mm	
Rear W/Cyl	9/86 - 12/93			E139-81-113	53.5mm	E149-85-011
	1/94 - 9/94	w/ Manual Adjuster		E139-81-113	53.5mm	E149-85-011
				E139-81-154	53.5mm	
	10/94 - 1996	w/ Auto Adjuster		E139-81-154	53.5mm	
Clutch M/Cyl	11/87 - 1996			E141-81-007	7/8"	
Slave Cyl	11/87 - 1996			E143-81-007	1"	

### FRR

Front Shoes	2/94 - 1/99	320mm x 110mm		E117-0672-0		E123-85-011
	2/99 - 2004			E117-0834-0		
Rear Shoes	2/94 - 1/99	320mm x 145mm		E117-0727-0		E123-85-012
	2/99 - 2004			E117-0833-0		
PB Shoe	1995 - 2004	254mm x 61mm - MT Transmission		E116-1007-0		
		254mm x 62mm - AT Transmission		E116-1008-0		

### FSR with Front Disc Brakes

Front Pads	3/96 - 2003	8100 lb FA - Dayton Caliper		E111-0224-0		E122-84-006
		11000, 12000 lb FA - Bendix Caliper		E111-0225-0		E122-71-012
Rear Pads	3/98 - 2003	2 Piston - Bendix Calipers		E111-0225-0		E122-71-012
		2 Piston - Dayton Calipers		E111-0224-0		E122-84-006
		4 Piston - Dayton Caliper		E111-0769-0		E122-85-006 <sup>4</sup>
Front Rotor	3/96 - 2003	8100 lb FA - Dayton Caliper		E125-85-013	31.12mm	
		11000, 12000 lb FA - Bendix Caliper		E125-85-006	33.53mm	
Rear Rotor	3/98 - 2003	All 4 Piston Calipers		E125-85-017	36.06mm	
		15000 lb Axle		E125-85-013	31.12mm	
		19k Single, 34k Tandem Axle - 11.25" BC		E125-85-006	33.53mm	
		19k Single, 34k Tandem Axle - 275mm BC		E125-85-016	31.12mm	
		21k, 23k lb Single, 38k, 46k Tandem Axle		E125-85-007	33.40mm	
PB Shoe	3/96 - 2003	9 x 3"		E116-0647-0		
		10 x 2 1/2"		E116-1007-0		
Brake M/Cyl	3/96 - 2003			E135-87-009	2"	
Front Caliper	3/96 - 2003	Dayton 6 Hole Caliper - Casting # 472 - 8100 Lb FA	L & R	E146-84-106	2.50"	E148-87-006
		Dayton 4 Hole Caliper - Casting # 563	L & R	E146-85-012	2.50"	E148-87-006
		Bendix Caliper - 11000, 12000 Lb FA	L & R	E146-85-008	2.88"	E148-71-007

Notes<sup>4</sup> Major Kit.

Many products are available in multiple grades or configurations. Refer to page 5 for details.

MAKE MODEL PART DESC	YEAR	QUALIFIER	POSITION	PART #	DISCARD/ DIAMETER	E122 / E123 HARDWARE KIT E124 SELF ADJUSTER E148 / E149 REPAIR KIT
----------------------------	------	-----------	----------	--------	----------------------	--

## ISUZU (Cont'd)

### FSR with Front Disc Brakes (Cont'd)

Rear Caliper	3/96 - 2/98	Bendix Caliper	L & R	E146-85-008	2.88"	E148-71-007
		Dayton 6 Hole - Casting # 472	L & R	E146-84-106	2.50"	E148-87-006
		Dayton 4 Hole - Casting # 563	L & R	E146-85-012	2.50"	E148-87-006
	3/98 - 2003	Bendix Caliper - 2 Piston	L & R	E146-85-008	2.88"	E148-71-007
		Dayton 6 Hole 2 Piston Caliper - Casting # 472	L & R	E146-84-106	2.50"	E148-87-006
		Dayton 4 Hole 2 Piston Caliper - Casting # 563	L & R	E146-85-012	2.50"	E148-87-006
		Dayton 4 Steel Piston Caliper w/ 10x1.50mm inlet	L	E146-85-011	70mm	E148-85-006
			R	E146-85-010	70mm	
		Dayton 4 Steel Piston Caliper w/ 7/16"x24 inlet	L	E146-85-023	70mm	E148-85-006
			R	E146-85-022	70mm	
Dayton 4 Phenolic Piston Caliper	L	E146-85-021	70mm	E148-84-009		
	R	E146-85-020	70mm			
Clutch M/Cyl	3/96 - 2003			E141-85-006	13/16"	
Slave Cyl	3/96 - 2003			E143-85-006	13/16"	

### FTR with Front Disc Brakes

Front Pads	4/03 - 2009	11000, 12000 lb FA		E111-0769-0		E122-85-006 <sup>4</sup>
Rear Pads	3/98 - 2002	Bendix Calipers - 2 Piston		E111-0225-0		E122-71-012
		Dayton Calipers - 2 Piston		E111-0224-0		E122-84-006
	3/98 - 2009	Dayton Caliper - 4 Piston		E111-0769-0		E122-85-006 <sup>4</sup>
Front Rotor	4/03 - 2009			E125-85-019	36.06mm	
Rear Rotor	3/98 - 2002	All 4 Piston Calipers		E125-85-017	36.06mm	
		15000 lb Axle		E125-85-013	31.12mm	
		19k Single, 34k Tandem Axle - 11.25" BC		E125-85-006	33.53mm	
		19k Single, 34k Tandem Axle - 275mm BC		E125-85-016	31.12mm	
		21k, 23k lb Single, 38k, 46k Tandem Axle		E125-85-007	33.40mm	
	4/03 - 2009	15000 & 19000 lb RA		E125-85-019	36.06mm	
		21000 lb RA		E125-85-020	36.06mm	
PB Shoe	3/96 - 2003	9 x 3"		E116-0647-0		
		10 x 2 1/2"		E116-1007-0		
	4/03 - 2009	9 x 3"		E116-0647-0		
		12" x 3"		E116-0824-0		
Brake M/Cyl	4/03 - 2009		E135-87-012	2"		
Front Caliper	3/96 - 2002	8100 lb FA - Dayton 6 Hole - Casting # 472	L & R	E146-84-106	2.50"	E148-87-006
		Dayton 4 Hole - Casting # 563	L & R	E146-85-012	2.50"	E148-87-006
		11000, 12000 lb FA - Bendix Cal	L & R	E146-85-008	2.88"	E148-71-007
	4/03 - 2009	64mm Caliper piston	R	E146-84-017	64mm	E148-84-010
			L	E146-84-016	64mm	
		70mm Caliper piston	R	E146-84-019	70mm	E148-85-006
	L	E146-84-018	70mm			
Rear Caliper	3/96 - 2/98	Bendix Caliper	L & R	E146-85-008	2.88"	E148-71-007
		Dayton 6 Hole - Casting # 472	L & R	E146-84-106	2.50"	E148-87-006
		Dayton 4 Hole - Casting # 563	L & R	E146-85-012	2.50"	E148-87-006
	3/98 - 2002	2 Piston - Bendix Caliper	L & R	E146-85-008	2.88"	E148-71-007
		Dayton 6 Hole - Casting # 472	L & R	E146-84-106	2.50"	E148-87-006
		Dayton 4 Hole - Casting # 563	L & R	E146-85-012	2.50"	E148-87-006
		Dayton 4 Steel Piston Caliper w/ 10x1.50mm inlet	L	E146-85-011	70mm	E148-85-006
			R	E146-85-010	70mm	
		Dayton 4 Steel Piston Caliper w/ 7/16"x24 inlet	L	E146-85-023	70mm	E148-85-006
			R	E146-85-022	70mm	
		Dayton Caliper - 4 Piston Phenolic Type	L	E146-85-021	70mm	E148-84-009
	R	E146-85-020	70mm			

Cont'd Next Pg

Note <sup>4</sup> Major Kit

Many products are available in multiple grades or configurations. Refer to page 5 for details.

MAKE MODEL PART DESC	YEAR	QUALIFIER	POSITION	PART #	DISCARD / DIAMETER	E122 / E123 HARDWARE KIT E124 SELF ADJUSTER E148 / E149 REPAIR KIT
<b>ISUZU (Cont'd)</b>						
<b>FTR with Front Disc Brakes (Cont'd)</b>						
Rear Caliper (Cont'd)	4/03 - 2009	64mm Caliper piston	L	E146-84-016	64mm	E148-84-010
			R	E146-84-017	64mm	
		70mm Caliper piston	L	E146-84-018	70mm	E148-85-006
			R	E146-84-019	70mm	
Front Hose	4/03 - 2009		L	E155-81-011		
			R	E155-81-012		
Rear Hose	4/03 - 2009	w/ Leaf Springs, Dana Axles, Except Low Profile Veh	L	E155-81-015		
			R	E155-81-016		
	w/ Leaf Springs, Eaton Axles, Except Low Profile Veh	L	E155-81-013			
		R	E155-81-014			
	w/ Air Suspension	L	E155-81-017			
		R	E155-81-018			

**FVR, FXR with Front Disc Brakes**

Front Pads	4/03 - 2009	11000, 12000 lb FA		E111-0769-0		E122-85-006 <sup>4</sup>
Rear Pads	3/98 - 2002	Dayton Calipers - 2 Piston		E111-0224-0		E122-84-006
		Bendix Calipers - 2 Piston		E111-0225-0		E122-71-012
	3/98 - 2009	Dayton Caliper - 4 Piston		E111-0769-0		E122-85-006 <sup>4</sup>
Front Rotor	4/03 - 2009			E125-85-019	36.06mm	
Rear Rotor	4/03 - 2009	15000 & 19000 lb RA		E125-85-019	36.06mm	
		21000 lb RA		E125-85-020	36.06mm	
PB Shoe	3/98 - 2009	9 x 3"		E116-0647-0		
		10 x 2 1/2"		E116-1007-0		
		12 x 3"		E116-0824-0		
Brake M/Cyl	4/03 - 2009			E135-87-012	2"	
Front Caliper	3/98 - 2002	8100 lb FA - Dayton 6 Hole - Casting # 472	L & R	E146-84-106	2.50"	E148-87-006
		Dayton 4 Hole - Casting # 563	L & R	E146-85-012	2.50"	E148-87-006
		11000, 12000 lb FA - Bendix Cal	L & R	E146-85-008	2.88"	E148-71-007
	4/03 - 2009	64mm Caliper piston	L	E146-84-016	64mm	E148-84-010
			R	E146-84-017	64mm	
		70mm Caliper piston	L	E146-84-018	70mm	E148-85-006
	R	E146-84-019	70mm			
Rear Caliper	3/98 - 2002	Bendix Caliper - 2 Piston	L & R	E146-85-008	2.88"	E148-71-007
		8100 lb FA - Dayton 6 Hole - Casting # 472	L & R	E146-84-106	2.50"	E148-87-006
		Dayton 4 Hole - Casting # 563	L & R	E146-85-012	2.50"	E148-87-006
		Dayton 4 Steel Piston Caliper w/ 10x1.50mm inlet	L	E146-85-011	70mm	E148-85-006
			R	E146-85-010	70mm	
		Dayton 4 Steel Piston Caliper w/ 7/16"x24 inlet	L	E146-85-023	70mm	E148-85-006
			R	E146-85-022	70mm	
		Dayton Caliper - 4 Piston Phenolic Type	L	E146-85-021	70mm	E148-84-009
		R	E146-85-020	70mm		
	4/03 - 2009	64mm Caliper piston	L	E146-84-016	64mm	E148-84-010
			R	E146-84-017	64mm	
70mm Caliper piston		L	E146-84-018	70mm	E148-85-006	
	R	E146-84-019	70mm			
Front Hose	4/03 - 2009		L	E155-81-011		
			R	E155-81-012		

Note <sup>4</sup> Major Kit



Many products are available in multiple grades or configurations. Refer to page 5 for details.

MAKE MODEL PART DESC	YEAR	QUALIFIER	POSITION	PART #	DISCARD/ DIAMETER	E122 / E123 HARDWARE KIT E124 SELF ADJUSTER E148 / E149 REPAIR KIT
----------------------------	------	-----------	----------	--------	----------------------	--

### ISUZU (Cont'd)

#### FVR, FXR with Front Disc Brakes (Cont'd)

Rear Hose	4/03 - 2009	w/ Leaf Springs, Dana Axles, Except Low Profile Veh	L	E155-81-015		
			R	E155-81-016		
		w/ Leaf Springs, Eaton Axles, Except Low Profile Veh	L	E155-81-013		
			R	E155-81-014		
		w/ Air Suspension	L	E155-81-017		
			R	E155-81-018		
Clutch M/Cyl	2005 - 2009			E141-85-009	13/16"	
Slave Cyl	2005 - 2009			E143-85-010	3/4"	

#### H Series HTR, HVR

Front Pads	2005 - 2008			E111-0769-0		E122-85-006
Rear Pads	2005 - 2008			E111-0769-0		E122-85-006
Front Rotor	2005 - 2008			E125-85-019	36.06mm	
Rear Rotor	2005 - 2008	Hat shaped rotor		E125-85-019	36.06mm	
		U shaped rotor		E125-85-020	36.06mm	
PB Shoe	2005 - 2008	9 x 3"		E116-0647-0		
		12 x 3" w/ M/T		E116-0824-0		
		12 x 3" w/ A/T		E116-0692-0		
Brake M/Cyl	2005 - 2008			E135-87-012	2"	
Front Caliper	2005 - 2008	64mm Caliper - 8K Lb Axle	L	E146-84-016	64mm	E148-84-010
			R	E146-84-017	64mm	
		70mm Caliper - 10, 12K Lb Axle	L	E146-84-018	70mm	E148-85-006
			R	E146-84-019	70mm	
Rear Caliper	2005 - 2008	64mm Caliper - 15K Lb Axle	L	E146-84-016	64mm	E148-84-010
			R	E146-84-017	64mm	
		70mm Caliper - 19, 21K Lb Axle	L	E146-84-018	70mm	E148-85-006
			R	E146-84-019	70mm	

#### NPR with Front Disc Brakes, Gas Engine

Front Pads	8/87 - 9/97	Cal Casting # AD76T / 35-16		E111-0546-0		E122-81-006
	10/97 - 1/99	Class 3 - Cal Casting # AD54T		E111-0825-0		E122-81-007
		Class 4 HD - Cal Casting # AD57T / A918		E111-0826-0		E122-81-007
	2/99 - 6/99	Class 3 - Cal Casting # AD54T		E111-0825-0		E122-81-007
		Class 4 HD - Cal Casting # AD57T / A918 - w/o ABS		E111-0826-0		E122-81-007
	7/99 - 2012	Class 4 HD - Cal Casting # AD57T / 5702 - w/ ABS		E111-0827-0		E122-81-007
		Class 3 - 10001 - 14000 Lbs GVWR		E111-0825-0		E122-81-007
		Class 4 HD - 14001 - 16000 Lbs GVWR		E111-0827-0		E122-81-007
Rear Shoes	10/97 - 2011	Class 3 - 10001 - 14000 Lbs GVWR		E117-0699-0		
		Class 4 HD - 14001 - 16000 Lbs GVWR		E117-0792-0		
	2012	exc HD		E117-0612-0		E123-85-009
		HD		E117-0699-0		
Front Rotor	7/99 - 2012	Class 3 - 10001 - 14000 Lbs GVWR		E125-48-021	37mm	
		Class 4 HD - 14001 - 16000 Lbs GVWR		E125-48-024	39mm	
Rear Drum	7/01 - 2011	Class 3 - 10001 - 14000 Lbs GVWR		E127-81-006	321.5mm	
		Class 4 HD - 14001 - 16000 Lbs GVWR		E127-81-012	321.5mm	
	2012	exc HD		E127-81-005	321.5mm	
		HD		E127-81-006	321.5mm	
PB Shoe	8/87 - 8/94	7 1/2" Shoes		E116-0733-0		
		11" Shoes		E116-0823-0		
	1995 - 2011	11" x 2"		E116-0823-0		
		2012		E116-0979-0		

Many products are available in multiple grades or configurations. Refer to page 5 for details.

MAKE MODEL PART DESC	YEAR	QUALIFIER	POSITION	PART #	DISCARD / DIAMETER	E122 / E123 HARDWARE KIT E124 SELF ADJUSTER E148 / E149 REPAIR KIT	
<b>ISUZU (Cont'd)</b>							
<b>NPR with Front Disc Brakes, Gas Engine (Cont'd)</b>							
Brake M/Cyl	11/97 - 2012	exc HD		E135-81-015	1 1/4"		
		HD		E135-81-017	1 3/8"		
Front Caliper	8/87 - 9/97	Cal Casting # - AD76T / 35-16	L	E146-81-007	54mm	E148-81-006	
			R	E146-81-006	54mm		
	10/97 - 1/99	Class 3 - Cal Casting # AD54T	L	E146-81-009	54mm	E148-81-006	
			R	E146-81-008	54mm		
		Class 4 HD - Cal Casting # AD57T / A918	L	E146-81-011	57mm	E148-81-007	
			R	E146-81-010	57mm		
	2/99 - 6/99	Class 3 - Cal Casting # AD54T	L	E146-81-009	54mm	E148-81-006	
			R	E146-81-008	54mm		
		Class 4 HD - Cal Casting # AD57T / A918 - w/o ABS	L	E146-81-011	57mm	E148-81-007	
			R	E146-81-010	57mm		
		Class 4 HD - Cal Casting # AD57T / 5702 - w/ ABS	L	E146-81-013	57mm	E148-81-007	
			R	E146-81-012	57mm		
	7/99 - 6/04	Class 3 - Cal Casting # AD54T	L	E146-81-009	54mm	E148-81-006	
			R	E146-81-008	54mm		
	Class 4 HD - Cal Casting # AD57T / 5702 - w/ ABS	L	E146-81-013	57mm	E148-81-007		
		R	E146-81-012	57mm			
7/04 - 2012	Class 3 - 10001 - 14000 Lbs GVWR	L	E146-81-015	54mm	E148-81-008		
		R	E146-81-014	54mm			
	Class 4 HD - 14001 - 16000 Lbs GVWR	L	E146-81-017	57mm	E148-81-009		
		R	E146-81-016	57mm			
Rear W/Cyl	7/02 - 2011	Class 3 - 10001 - 14000 Lbs GVWR	L Fr	E139-81-045	1 3/16"		
			L Rr	E139-81-054	1 3/16"		
			R Fr	E139-81-053	1 3/16"		
			R Rr	E139-81-052	1 3/16"		
			Class 4 HD - 14001 - 16000 Lbs GVWR	L Fr	E139-81-051	1 5/16"	
				L Rr	E139-81-047	1 5/16"	
	2012	Exc HD	R Fr	E139-81-056	1 5/16"		
			R Rr	E139-81-049	1 5/16"		
	HD	Exc HD	L Fr	E139-81-069	1 1/16"		
			L Rr	E139-81-067	1 1/16"		
			R Fr	E139-81-070	1 1/16"		
			R Rr	E139-81-068	1 1/16"		
			L Fr	E139-81-045	1 3/16"		
			L Rr	E139-81-054	1 3/16"		
	HD	R Fr	E139-81-053	1 3/16"			
		R Rr	E139-81-052	1 3/16"			
Front Hose	8/87 - 9-97			E155-81-008			
	10/97 - 2003	15 1/2" Hose		E155-81-021			
		16 1/2" Hose		E155-81-022			
	2004 - 2007	w/ 16" Wheels - 16 1/4" Hose		E155-81-008			
		w/ 16" Wheels - 15 1/2" Hose		E155-81-021			
		w/ 19 1/2" Wheels - 16 1/2" Hose		E155-81-022			
		w/ 19 1/2" Wheels - 11 7/8" Hose		E155-81-020			
	2008 - 2011	Class 3		E155-81-019			
		Class 4 HD		E155-81-020			
	2012			E155-81-019			
Rear Hose	8/87 - 2012			E155-81-009			
Clutch M/Cyl	8/87 - 8/94			E141-81-008	3/4"		
Slave Cyl	8/87 - 8/94			E143-81-006	1"		

Many products are available in multiple grades or configurations. Refer to page 5 for details.

MAKE MODEL PART DESC	YEAR	QUALIFIER	POSITION	PART #	DISCARD/ DIAMETER	E122 / E123 HARDWARE KIT E124 SELF ADJUSTER E148 / E149 REPAIR KIT
----------------------------	------	-----------	----------	--------	----------------------	--

### ISUZU (Cont'd)

#### NPR with Front Disc Brakes, Diesel Engine

Front Pads	1/98 - 2003	Class 5 to 12/1998 - 16001 - 19500 Lbs GVWR		E111-0826-0		E122-81-007
		Class 5 from 01/1999 - 16001 - 19500 Lbs GVWR		E111-0827-0		E122-81-007
		Class 3 - 10001 - 14000 Lbs GVWR		E111-0825-0		E122-81-007
		Class 4 HD - 14001 - 16000 Lbs GVWR		E111-0825-0		E122-81-007
	2004 - 2007	Class 4 HD - 14001 - 16000 Lbs GVWR		E111-0825-0		E122-81-007
		Class 5 - 16001 - 19500 Lbs GVWR		E111-0827-0		E122-81-007
	2008 - 2012			E111-0825-0		E122-81-007
Rear Shoes	1/98 - 2010	320mm x 75mm - Class 3		E117-0612-0		E123-85-009
		320mm x 100mm - Class 4		E117-0699-0		
	2011 - 2012			E117-0699-0		
Front Rotor	1/98 - 2007	Class 4 HD		E125-48-021	37mm	
		Class 5		E125-48-024	39mm	
	2008 - 2012			E125-48-021	37mm	
Rear Drum	1/98 - 2010	Class 4 HD - 14001 - 16000 Lbs GVWR		E127-81-006	321.5mm	
		Class 5 - 16001 - 19500 Lbs GVWR		E127-81-012	321.5mm	
		Class 3 - 10001 - 14000 Lbs GVWR		E127-81-005	321.5mm	
	2011 - 2012			E127-81-006	321.5mm	
PB Shoe	8/87 - 8/94	190mm x 45mm		E116-0733-0		
		276mm x 52mm		E116-0823-0		
	1995 - 2007	190mm x 45mm		E116-0733-0		
		201mm x 52mm		E116-0979-0		
	2008 - 2012			E116-0979-0		
Brake M/Cyl	8/87 - 8/94	Cab & Chassis		E135-81-008	1 1/4"	
		Stripped Chassis		E135-81-009	1 1/4"	
	9/94 - 10/95			E135-81-015	1 1/4"	
	11/95 - 10/97			E135-81-013	1 1/4"	
	11/97 - 2007	Class 4 HD		E135-81-015	1 1/4"	
		Class 5		E135-81-017	1 3/8"	
	2008 - 2012			E135-81-015	1 1/4"	
Front Caliper	1/04 - 2007	Class 4 HD	L	E146-81-015	54mm	E148-81-008
			R	E146-81-014	54mm	
		Class 5	L	E146-81-017	57mm	E148-81-009
			R	E146-81-016	57mm	
	2008 - 2012		L	E146-81-015	54mm	E148-81-008
			R	E146-81-014	54mm	
Rear W/Cyl	1/99 - 2/03	Class 3	L Fr	E139-81-023	1 1/16"	
			L Rr	E139-81-043	1 1/16"	
			R Fr	E139-81-024	1 1/16"	
			R Rr	E139-81-025	1 1/16"	
	3/03 - 2007	Class 3	L Fr	E139-81-069	1 1/16"	
			L Rr	E139-81-067	1 1/16"	
			R Fr	E139-81-070	1 1/16"	
			R Rr	E139-81-068	1 1/16"	
	1/99 - 12/02	Class 4 HD	L Fr	E139-81-037	1 3/16"	
			L Rr	E139-81-044	1 3/16"	
			R Fr	E139-81-035	1 3/16"	
			R Rr	E139-81-036	1 3/16"	
	1/03 - 2007	Class 4 HD - 14001 - 16000 Lbs GVWR	L Fr	E139-81-045	1 3/16"	
			L Rr	E139-81-054	1 3/16"	
			R Fr	E139-81-053	1 3/16"	
		R Rr	E139-81-052	1 3/16"		

Cont'd Next Pg

Many products are available in multiple grades or configurations. Refer to page 5 for details.

MAKE MODEL PART DESC	YEAR	QUALIFIER	POSITION	PART #	DISCARD / DIAMETER	E122 / E123 HARDWARE KIT E124 SELF ADJUSTER E148 / E149 REPAIR KIT
----------------------------	------	-----------	----------	--------	-----------------------	--

### ISUZU (Cont'd)

#### NPR with Front Disc Brakes, Diesel Engine (Cont'd)

Rear W/Cyl (Cont'd)	1/03 - 2007	Class 5 - 16001 - 19500 Lbs GVWR	L Fr	E139-81-051	1 5/16"	
			R Rr	E139-81-049	1 5/16"	
			L Rr	E139-81-047	1 5/16"	
			R Fr	E139-81-056	1 5/16"	
	2008 - 2012	Except HD	L Fr	E139-81-069	1 1/16"	
			L Rr	E139-81-067	1 1/16"	
			R Fr	E139-81-070	1 1/16"	
			R Rr	E139-81-068	1 1/16"	
		HD	L Fr	E139-81-045	1 3/16"	
			L Rr	E139-81-054	1 3/16"	
R Fr			E139-81-053	1 3/16"		
R Rr			E139-81-052	1 3/16"		
Front Hose	8/87 - 12/97			E155-81-008		
	1/98 - 2003	15 1/2" Hose		E155-81-021		
		16 1/4" Hose		E155-81-008		
		16 1/2" Hose		E155-81-022		
	2004 - 2006	13 3/8" Hose		E155-81-019		
		15 1/2" Hose		E155-81-021		
	2007 - 2012	16 1/4" Hose		E155-81-008		
				E155-81-019		
Rear Hose	8/87 - 2012			E155-81-009		
Clutch M/Cyl	9/94 - 2009			E141-81-009	3/4"	
Slave Cyl	8/87 - 12/97			E143-81-006	1"	
	1/98 - 12/03	5 Speed		E143-81-011	1"	
	1/98 - 2007	6 Speed		E143-81-010	1"	
	2008 - 2009			E143-81-012	1"	

#### NQR

Front Pads	1/98 - 12/98			E111-0826-0		E122-81-007
	1/99 - 2012			E111-0827-0		E122-81-007
Rear Shoes	1/98 - 2012			E117-0792-0		
Front Rotor	1/98 - 12/98			E125-48-022	39mm	
	1/99 - 2010			E125-48-024	39mm	
	6/10 - 2012			E125-48-025	39mm	
Rear Drum	1/98 - 2012			E127-81-012	321.5mm	
PB Shoe	2004 - 2007	190mm x 45mm		E116-0733-0		
		200mm x 50mm		E116-0979-0		
	2008 - 2012			E116-0979-0		
Brake M/Cyl	1/98 - 2012			E135-81-017	1 3/8"	
Front Caliper	1/98 - 12/98		L	E146-81-011	57mm	E148-81-007
			R	E146-81-010	57mm	
	1/99 - 12/03		L	E146-81-013	57mm	E148-81-007
			R	E146-81-012	57mm	
	1/04 - 2012		L	E146-81-017	57mm	E148-81-009
R	E146-81-016	57mm				
Rear W/Cyl	1/03 - 2012		L Fr	E139-81-047	1 5/16"	
			L Rr	E139-81-051	1 5/16"	
			R Fr	E139-81-056	1 5/16"	
			R Rr	E139-81-049	1 5/16"	

Many products are available in multiple grades or configurations. Refer to page 5 for details.

MAKE MODEL PART DESC	YEAR	QUALIFIER	POSITION	PART #	DISCARD/ DIAMETER	E122 / E123 HARDWARE KIT E124 SELF ADJUSTER E148 / E149 REPAIR KIT
----------------------------	------	-----------	----------	--------	----------------------	--

### ISUZU (Cont'd)

#### NQR (Cont'd)

Front Hose	2004 - 2007	16 1/2" Hose		E155-81-022		
		12" Hose		E155-81-020		
	2008 - 2011			E155-81-020		
	2012			E155-81-007		
Rear Hose	1/98 - 2012			E155-81-009		
Clutch M/Cyl	1/98 - 2012			E141-81-009	3/4"	
Slave Cyl	1/98 - 12/03	5 Speed		E143-81-011	1"	
	1/98 - 2007	6 Speed		E143-81-010	1"	
	2008 - 2012			E143-81-012	1"	

#### NRR

Front Pads	1/04 - 2012			E111-0827-0		E122-81-007
Rear Shoes	1988 - 1994	320mm x 120mm		E117-0669-0		
	1/04 - 2012			E117-0833-0		
Front Rotor	1/04 - 2010			E125-48-024	39mm	
	6/10 - 2012			E125-48-025	39mm	
Rear Drum	1/04 - 2012			E127-81-013	372mm	
PB Shoe	1988 - 1994	216mm x 52mm - w/MT Transmission		E116-1009-0		
		254mm x 62mm - w/AT Transmission		E116-1008-0		
	1/04 - 2012			E116-0979-0		
Brake M/Cyl	1/04 - 2012			E135-81-017	1 3/8"	
Front Caliper	1/04 - 2012		L	E146-81-017	57mm	E148-81-009
			R	E146-81-016	57mm	
Rear W/Cyl	1/04 - 2012		L Fr	E139-81-048	1 5/16"	
			L Rr	E139-81-071	1 5/16"	
			R Fr	E139-81-046	1 5/16"	
			R Rr	E139-81-050	1 5/16"	
Front Hose	1/04 - 2010			E155-81-020		
	6/10 - 2012			E155-81-007		
Rear Hose	1/04 - 2012			E155-81-009		
Clutch M/Cyl	11/87 - 1994			E141-81-007	7/8"	
	1/04 - 2012			E141-81-009	3/4"	
Slave Cyl	1/04 - 2007			E143-81-010	1"	
	2008 - 2012			E143-81-012	1"	

#### REACH VAN (UTILIMASTER BODY)

Front Pads	2012			E111-0825-0		E122-81-007
Rear Shoes	2012			E117-0699-0		
Front Rotor	2012			E125-48-021	37mm	
Rear Drum	2012			E127-81-006	321.5mm	
PB Shoe	2012			E116-0979-0		
Brake M/Cyl	2012			E135-81-015	1 1/4"	
Front Caliper	2012		L	E146-81-015	54mm	
			R	E146-81-014	54mm	
Rear W/Cyl	2012		L Fr	E139-81-045	1 3/16"	
			L Rr	E139-81-054	1 3/16"	
			R Fr	E139-81-053	1 3/16"	
			R Rr	E139-81-052	1 3/16"	
Front Hose	2012			E155-81-019		
Rear Hose	2012			E155-81-009		

Many products are available in multiple grades or configurations. Refer to page 5 for details.

MAKE MODEL PART DESC	YEAR	QUALIFIER	POSITION	PART #	DISCARD / DIAMETER	E122 / E123 HARDWARE KIT E124 SELF ADJUSTER E148 / E149 REPAIR KIT
----------------------------	------	-----------	----------	--------	-----------------------	--

## IVECO

### EURO RANGE 110, 120T

Clutch M/Cyl	1987 - 1988			E141-77-005	19mm	
Slave Cyl	1987 - 1988			E143-77-005	19mm	

### EURO RANGE 230T

Front Rotor	1987 - 1988			E126-77-005	23mm	
Clutch M/Cyl	1987 - 1988			E141-77-005	19mm	
Slave Cyl	1987 - 1988			E143-77-005	19mm	

### EURO TURBO RANGE 10-14, 12-11, 12-12, 12-14, 13-14, 15-14, 18-14, 18-16

Front Pads	1987 - 1991			E111-0494-0		
Front Rotor	1987 - 1991			E126-77-005	23mm	
Clutch M/Cyl	1987 - 1991	Except 10-14		E141-77-005	19mm	
Slave Cyl	1987 - 1991	Except 10-14		E143-77-005	19mm	

### EURO TURBO RANGE 23-16

Clutch M/Cyl	1989 - 1991			E141-77-005	19mm	
--------------	-------------	--	--	-------------	------	--

### Z100, 110, 120TA, 220, 220T

Clutch M/Cyl	1980 - 1987			E141-77-005	19mm	
Slave Cyl	1980 - 1987	Auto Adj.		E143-77-005	19mm	

### Z230T

Clutch M/Cyl	1980 - 1987			E141-77-005	19mm	
Slave Cyl	1980 - 1987			E143-77-005	19mm	

### Z340T

Clutch M/Cyl	1980 - 1987			E141-77-005	19mm	
--------------	-------------	--	--	-------------	------	--

## Kenworth

### T170, T270, T370 w/ Hydraulic Disc Brakes

Front Pads	2008 - 2012	66mm Caliper Cast # 4153269	E111-0786-1		E122-88-006 <sup>4</sup>	
		73mm Caliper Cast # 4153222	E111-0786-0		E122-88-006 <sup>4</sup>	
Rear Pads	2008 - 2012	66mm Caliper Cast # 4153269	E111-0786-1		E122-88-006 <sup>4</sup>	
		73mm Caliper Cast # 4153222	E111-0786-0		E122-88-006 <sup>4</sup>	
Brake M/Cyl	2008 - 2012		E135-87-013	2"		
Front Rotor	2008 - 2012	5 Hole Hat Shaped Disc	E125-88-021	1.32"		
		6 Hole Hat Shaped Disc	E125-88-020	1.32"		
		10 Hole - Hat Shaped Disc - 3.20" Tall	E125-88-019	1.32"		
		10 Hole - Hat Shaped Disc - 4.45" Tall	E125-88-018	1.32"		
Rear Rotor	2008 - 2012	5 Hole Hat Shaped Disc	E125-88-021	1.32"		
		6 Hole Hat Shaped Disc	E125-88-020	1.32"		
		10 Hole - Hat Shaped Disc - 3.20" Tall	E125-88-019	1.32"		
		10 Hole - Hat Shaped Disc - 4.45" Tall	E125-88-018	1.32"		
Front Caliper	2008 - 2012	66mm Caliper Cast # 4153269	E146-88-008	66mm	E148-88-009	
		73mm Caliper Cast # 4153222	E146-88-010	73mm	E148-88-008	
Rear Caliper	2008 - 2012	66mm Caliper Cast # 4153269	E146-88-008	66mm	E148-88-009	
		73mm Caliper Cast # 4153222	E146-88-010	73mm	E148-88-008	

## MACK

### CS200, MS200

Brake Pads	1980 - 1997			E111-0225-0		E122-71-012
Front Caliper	1980 - 1987	Bendix - 1st Design - Soft Boot <sup>5</sup>	L & R	E146-85-009	2.88"	E148-87-007
	1988 - 1997	Bendix - 2nd Design - Hard Boot <sup>5</sup>	L & R	E146-85-008	2.88"	E148-71-007
Front Rotor	1980 - 1997			E125-87-008		

Notes<sup>4</sup> Major Kit. <sup>5</sup> 1st and 2nd Design Calipers are interchangeable; their components are not.

Many products are available in multiple grades or configurations. Refer to page 5 for details.

MAKE MODEL PART DESC	YEAR	QUALIFIER	POSITION	PART #	DISCARD/ DIAMETER	E122 / E123 HARDWARE KIT E124 SELF ADJUSTER E148 / E149 REPAIR KIT
----------------------------	------	-----------	----------	--------	----------------------	--

## MITSUBISHI FUSO

### FE Series

Front Pads	1987 - 11/88			E107-0624-0		E122-79-007
	12/88 - 3/95	2 Sets Req'd		E111-0433-0		E122-96-019
	4/95 - 1999	FE639		E111-0735-0		E122-96-019
		FE640, FE649		E111-0734-0		E122-50-013
	2000 - 2005	FE639 L		E111-0735-0		E122-96-019
		FE639 T, FE640, FE649		E111-0734-0		E122-50-013
2005 - 2012	FE120, FE140, FE145, FE145CC, FG150, FE180		E111-1265-0		E122-79-006	
Frt Sensor Wire	4/95 - 2005	With rear drum brakes		E121-79-006		
		With rear disc brakes		E121-79-011		
	2005 - 2012	FE120, FE140, FE145, FE145CC, FG150, FE180	L	E121-79-007		
			R	E121-79-008		
Rear Pads	2005 - 2012	FE120, FE140, FE145, FE145CC, FG150, FE180		E111-1265-0		E122-79-006
Rr Sensor Wire	1995 - 2005	FE639, FE640, FE649		E121-79-010		
	2005 - 2012	FE120, FE140, FE145, FE145CC, FG150, FE180		E121-79-009		
Front Rotor	2000 - 2005	FE 439, FE639 L		E125-51-060	22mm	
		FE639 T		E125-79-006	No Spec	
		FE640, FE649		E125-51-061	38mm	
	2005 - 2012	FE120, FE140		E125-79-006	No Spec	
		FE145, FE145CC, FG150		E125-51-061	38mm	
		FE180		E125-79-007	No Spec	
Rear Rotor	1995 - 2005	FE639 L FE639 T, FE640, FE649		E125-51-064	No Spec	
	2005 - 2012	FE120, FE140, FE145, FE145CC, FG150		E125-51-064	No Spec	
		FE180		E125-79-008	No Spec	
PB Shoes	1985 - 1995	7x1 1/2"		E116-1014-0		
	1996 - 2012	7 1/2x1 7/8" Shoes		E116-0733-0		
Brake M/Cyl	1987 - 3/95			E135-79-005	1 1/8"	
	1996 - 2005	1 1/4" Cylinder		E135-79-006	1 1/4"	
		1 3/16" Cylinder		E135-79-007	1 3/16"	
		2006 - 2012	1 1/4" Cylinder		E135-79-009	1 1/4"
		1 3/16" Cylinder		E135-79-008	1 3/16"	
Front Caliper	2000 - 2005	FE639 L	L up	E146-79-009	51mm	E148-45-005
			L lo	E146-79-011	51mm	
			R up	E146-79-008	51mm	
			R lo	E146-79-010	51mm	
		FE639 T, FE640, FE649	L up	E146-79-013	51mm	E148-45-005
			L lo	E146-79-015	51mm	
			R up	E146-79-012	51mm	
			R lo	E146-79-014	51mm	
	2006 - 2012	FE120, FE140, FE145, FE145CC, FG150	L up	E146-79-019	51mm	E148-45-005
			L lo	E146-79-017	51mm	
			R up	E146-79-018	51mm	
			R lo	E146-79-016	51mm	
	FE180	L up	E146-79-023	54mm	E148-79-007	
		L lo	E146-79-021	54mm		
		R up	E146-79-022	54mm		
		R lo	E146-79-020	54mm		

Many products are available in multiple grades or configurations. Refer to page 5 for details.

MAKE MODEL PART DESC	YEAR	QUALIFIER	POSITION	PART #	DISCARD / DIAMETER	E122 / E123 HARDWARE KIT E124 SELF ADJUSTER E148 / E149 REPAIR KIT
----------------------------	------	-----------	----------	--------	-----------------------	--

## MITSUBISHI FUSO (Cont'd)

### FE Series (Cont'd)

Rear Caliper	1995 - 2005		L Fr	E146-79-507	51mm	E148-45-005
			L Rr	E146-79-509	51mm	
			R Fr	E146-79-506	51mm	
			R Rr	E146-79-508	51mm	
	2005 - 2012	FE120, FE140, FE145	L up	E146-79-513	51mm	E148-45-005
			L lo	E146-79-511	51mm	
			R up	E146-79-512	51mm	
			R lo	E146-79-510	51mm	
		FE145 Crew Cab	L up	E146-79-513	51mm	E148-45-005
			L lo	E146-79-511	51mm	
			R up	E146-79-512	51mm	
			R lo	E146-79-510	51mm	
	FE180	L up	E146-79-515	54mm	E148-79-007	
		L lo	E146-79-517	54mm		
		R up	E146-79-514	54mm		
		R lo	E146-79-516	54mm		

### FG

PB Shoes	1990 - 2001	7x1 1/2"		E116-1014-0		
----------	-------------	----------	--	-------------	--	--

### FG140 4X4

Frt & Rr Shoes	2005 - 2012			E117-0682-0		
Brake M/Cyl	2005 - 2012			E135-79-008	1 3/16"	
Front Drum	2005 - 2012			E127-79-006		
Rear Drum	2005 - 2012			E127-79-007		
PB Shoes	2005 - 2012			E116-1014-0		
Front W/Cyl	2005 - 2012		L	E139-79-019	1 1/4"	
			R	E139-79-018	1 1/4"	
Rear W/Cyl	2005 - 2012		L Fr	E139-79-010	1 1/8"	
			L Rr	E139-79-011	1 1/8"	
			R Fr	E139-79-012	1 1/8"	
			R Rr	E139-79-013	1 1/8"	

### FH Series

PB Shoes	1988 - 2004	8 x 2"		E116-1013-0		
		7 1/2x1 7/8" Shoes		E116-0733-0		
Rear W/Cyl	1988 - 1995		LF	E139-79-014	1 3/8"	
			LR	E139-79-015	1 3/8"	
			RF	E139-79-016	1 3/8"	
			RR	E139-79-017	1 3/8"	

### FK Series

PB Shoes	1987 - 2004	8 x 2"		E116-1013-0		
----------	-------------	--------	--	-------------	--	--



Many products are available in multiple grades or configurations. Refer to page 5 for details.

MAKE MODEL PART DESC	YEAR	QUALIFIER	POSITION	PART #	DISCARD/ DIAMETER	E122 / E123 HARDWARE KIT E124 SELF ADJUSTER E148 / E149 REPAIR KIT
----------------------------	------	-----------	----------	--------	----------------------	--

## PETERBILT

### 325, 330, 335 w/ Hydraulic Disc Brakes

Front Pads	2008 - 2012	66mm Caliper Cast # 4153269		E111-0786-1		E122-88-006 <sup>4</sup>
		73mm Caliper Cast # 4153222		E111-0786-0		E122-88-006 <sup>4</sup>
Rear Pads	2008 - 2012	66mm Caliper Cast # 4153269		E111-0786-1		E122-88-006 <sup>4</sup>
		73mm Caliper Cast # 4153222		E111-0786-0		E122-88-006 <sup>4</sup>
Brake M/Cyl	2008 - 2012			E135-87-013	2"	
Front Rotor	2008 - 2012	5 Hole Hat Shaped Disc		E125-88-021	1.32"	
		6 Hole Hat Shaped Disc		E125-88-020	1.32"	
		10 Hole - Hat Shaped Disc - 3.20" Tall		E125-88-019	1.32"	
		10 Hole - Hat Shaped Disc - 4.45" Tall		E125-88-018	1.32"	
Rear Rotor	2008 - 2012	5 Hole Hat Shaped Disc		E125-88-021	1.32"	
		6 Hole Hat Shaped Disc		E125-88-020	1.32"	
		10 Hole - Hat Shaped Disc - 3.20" Tall		E125-88-019	1.32"	
		10 Hole - Hat Shaped Disc - 4.45" Tall		E125-88-018	1.32"	
Front Caliper	2008 - 2012	66mm Caliper Cast # 4153269		E146-88-008	66mm	E148-88-009
		73mm Caliper Cast # 4153222		E146-88-010	73mm	E148-88-008
Rear Caliper	2008 - 2012	66mm Caliper Cast # 4153269		E146-88-008	66mm	E148-88-009
		73mm Caliper Cast # 4153222		E146-88-010	73mm	E148-88-008

## SMITH

### NEWTON

Frnt & Rr Pads	2011 - 2012			E111-1518-0		
----------------	-------------	--	--	-------------	--	--

## STERLING

### ACTERRA with Hydraulic Disc Brakes

Frnt & Rr Pads	1998 - 2008	w/ 66mm, Pin Slide Caliper Cast# 4153269		E111-0786-1		E122-88-006 <sup>4</sup>
		w/ 73mm, Pin Slide Caliper Cast# 4153222		E111-0786-0		E122-88-006 <sup>4</sup>
		w/ 2.50", Rail Slide Caliper		E111-0224-0		E122-84-006
		w/ 2.60", Rail Slide Caliper		E111-0717-0		E122-72-006
		w/ 2.88", Rail Slide Caliper		E111-0225-0		E122-71-012
Front Rotor	1998 - 2008	5 Hole Disc		E125-88-021	1.32"	
		10 Hole - 3.20" Tall <sup>3</sup>		E125-88-019	1.32"	
		10 Hole - 4.45" Tall <sup>3</sup>		E125-88-018	1.32"	
Rear Rotor	1998 - 2008	5 Hole - Hat Shaped Disc <sup>3</sup>		E125-88-021	1.32"	
		10 Hole - Hat Shaped Disc - 3.20" Tall <sup>3</sup>		E125-88-019	1.32"	
		10 Hole - Hat Shaped Disc - 4.45" Tall <sup>3</sup>		E125-88-018	1.32"	
		10x20.5mm Mounting Hole Diameter - U Shape Disc <sup>3</sup>		E125-89-006	1.32"	
		10x27.0mm Mounting Hole Diameter - U Shape Disc <sup>3</sup>		E125-89-008	1.32"	
Frnt & Rr Caliper	2001 - 2008	2.60" Bosch Caliper Castint # 4153269		E146-88-008	66mm	E148-88-009
		2.88" Bosch Caliper Casting # 4153222		E146-88-010	73mm	E148-88-008
		2.60" Dayton Caliper Casting # 472	L & R	E146-84-106	2.50"	E148-87-006
		2.60" Dayton Caliper Casting # 563	L & R	E146-85-012	2.50"	E148-87-006
		2.60" Bendix Caliper Casting # 4151733	L & R	E146-75-006	2.60"	E148-88-007
		2.88" Bendix Caliper Casting # 4150844	L & R	E146-85-008	2.88"	E148-71-007

Note<sup>3</sup> ABS exciter teeth in casting; <sup>4</sup> Major Kit

Many products are available in multiple grades or configurations. Refer to page 5 for details.

MAKE MODEL PART DESC	YEAR	QUALIFIER	POSITION	PART #	DISCARD / DIAMETER	E122 / E123 HARDWARE KIT E124 SELF ADJUSTER E148 / E149 REPAIR KIT
----------------------------	------	-----------	----------	--------	-----------------------	--

## STERLING (Cont'd)

### BULLET

Frt & Rr Pads	2008 - 2009			E111-1335-0		E122-72-020
Brake M/Cyl	2008 - 2009			E135-72-050	1 1/2"	
Front Rotor	2008 - 2009			E125-72-075	37.4mm	
Rear Rotor	2008 - 2009			E125-70-120	37.4mm	
PB Shoes	2008 - 2009			E116-0847-0		E123-70-021
Frt & Rr Caliper	2008 - 2009		L	E146-72-063	66mm	E148-85-007
			R	E146-72-062	66mm	E148-85-007
Front Hose	2008 - 2009		L	E155-72-131		
			R	E155-72-132		
Rear Hose	2008 - 2009		L	E155-72-401		
			R	E155-72-400		
			Center	E155-72-405		

### 360 Series

Front Pads	2006 - 2009			E111-1265-0		E122-79-006
Frt Sensor Wire	2006 - 2009		L	E121-79-007		
			R	E121-79-008		
Rear Pads	2006 - 2009			E111-1265-0		E122-79-006
Rr Sensor Wire	2006 - 2009			E121-79-009		
Front Rotor	2006 - 2009			E125-51-061	38mm	
Rear Rotor	2006 - 2009			E125-51-064	No Spec	
PB Shoes	2006 - 2009			E116-0733-0		
Brake M/Cyl	2006 - 2009	1 1/4" Cylinder		E135-79-009	1 1/4"	
		1 3/16" Cylinder		E135-79-008	1 3/16"	
Front Caliper	2006 - 2009		L up	E146-79-019	51mm	E148-45-005
			L lo	E146-79-017	51mm	
			R up	E146-79-018	51mm	
			R lo	E146-79-016	51mm	
Rear Caliper	2006 - 2009		L Fr	E146-79-513	51mm	E148-45-005
			L Rr	E146-79-511	51mm	
			R Fr	E146-79-512	51mm	
			R Rr	E146-79-510	51mm	

## THOMAS BUILT

### C2

Frt & Rr Pads	2004 - 2012			E111-0769-0		E122-85-006 <sup>4</sup>
Frt & Rr Rotor	2004 - 2012			E125-85-019	36.06mm	
Frt & Rr Caliper	2004 - 2012	70mm - Caliper w/ Inlet Brass Insert	L	E146-84-013	70mm	E148-85-006
			R	E146-84-012	70mm	
		70mm - Caliper w/o Inlet Brass Insert	L	E146-84-019	70mm	E148-85-006
			R	E146-84-018	70mm	
		64mm - Caliper w/ Inlet Brass Insert	L	E146-84-015	64mm	E148-84-010
			R	E146-84-014	64mm	
		64mm - Caliper w/o Inlet Brass Insert	L	E146-84-017	64mm	E148-84-010
			R	E146-84-016	64mm	

Note <sup>4</sup> Major Kit

Many products are available in multiple grades or configurations. Refer to page 5 for details.

MAKE MODEL PART DESC	YEAR	QUALIFIER	POSITION	PART #	DISCARD/ DIAMETER	E122 / E123 HARDWARE KIT E124 SELF ADJUSTER E148 / E149 REPAIR KIT
----------------------------	------	-----------	----------	--------	----------------------	--

## UD

### UD 18CS

Front Shoes	1999 - 2010			E117-0602-0		E123-87-012
Rear Shoes	1999 - 2010			E117-0679-0		E123-87-013

### UD 18HD

Front Shoes	1999 - 2010	320mm x 110mm		E117-0602-0		E123-87-012
		370mm x 100mm		E117-0603-0		E123-87-009
Rear Shoes	1999 - 2004	320mm x 135mm - w/o Wheel Park @ Driveline		E117-0679-0		E123-87-013
		320mm x 135mm - w/ Wheel Park		E117-0717-0		E123-81-006
	2005 - 2007	370mm x 135mm		E117-0604-0		E123-87-009
		320mm x 135mm - w/ Wheel Park		E117-0717-0		E123-81-006
		320mm x 135mm - w/o Wheel Park		E117-0679-0		E123-87-013

### UD 1100

Brake M/Cyl	1989 - 1991			E135-82-008	1"	
-------------	-------------	--	--	-------------	----	--

### UD 1200

Front Pads	1999 - 2004			E111-0701-0		E122-81-007
Brake M/Cyl	1999 - 2000	w/o ABS		E135-82-006	1 1/8"	
		w/ABS		E135-82-007	1 1/8"	
	2001 - 2004			E135-82-007	1 1/8"	
Rear W/Cyl	2001 - 2004		L Rr	E139-82-009	1 1/16"	
			L Fr	E139-82-007	1 1/16"	
			R Rr	E139-82-008	1 1/16"	
			R Fr	E139-82-006	1 1/16"	
Front Hose	1999 - 2004			E155-82-007		

### UD 1300

Front Pads	2005 - 2007			E111-0701-0		E122-81-007
Rear W/Cyl	2005 - 2007		L Rr	E139-82-009	1 1/16"	
			L Fr	E139-82-007	1 1/16"	
			R Rr	E139-82-008	1 1/16"	
			R Fr	E139-82-006	1 1/16"	
Front Hose	2005 - 2007			E155-82-006		
Rear Hose	2005 - 2007	Center Hose		E155-82-305		
Clutch M/Cyl	1992 - 1993					
Slave Cyl	1992 - 1993					

### UD 1400

Front Pads	1994 - 2010			E111-0701-0		E122-81-007
Rear Shoes	1994 - 2010	320mm x 90mm		E117-0695-0		E123-85-009
Brake M/Cyl	1994 - 1998			E135-82-006	1 1/8"	
				E135-82-006	1 1/8"	
	1999 - 2000	w/o ABS		E135-82-006	1 1/8"	
		w/ABS		E135-82-007	1 1/8"	
2001 - 2010			E135-82-007	1 1/8"		
Front Rotor	1994 - 2010	6 Hole Rotor		E125-82-006	33mm	
Front Caliper	1994 - 2010		L	E146-82-007	54mm	E148-82-006
			R	E146-82-006	54mm	
Rear W/Cyl	2001 - 2010		L Rr	E139-82-009	1 1/16"	
			L Fr	E139-82-007	1 1/16"	
			R Rr	E139-82-008	1 1/16"	
			R Fr	E139-82-006	1 1/16"	
Front Hose	1994 - 2004			E155-82-007		
	2005 - 2010			E155-82-006		
Rear Hose	1994 - 1998	Center Hose		E155-47-358		
	1999 - 2004			E155-47-375		
	2005 - 2010			E155-82-305		

Many products are available in multiple grades or configurations. Refer to page 5 for details.

MAKE MODEL PART DESC	YEAR	QUALIFIER	POSITION	PART #	DISCARD / DIAMETER	E122 / E123 HARDWARE KIT E124 SELF ADJUSTER E148 / E149 REPAIR KIT
----------------------------	------	-----------	----------	--------	-----------------------	--

### UD (Cont'd)

#### UD 1800, CS, HD

Front Shoes	1989 - 2012	320mm x 110mm		E117-0602-0		E123-87-012
		370mm x 100mm		E117-0603-0		E123-87-009
Rear Shoes	1995 - 2012	370mm x 135mm		E117-0604-0		E123-87-009
		320mm x 135mm - w/o Wheel Park		E117-0679-0		E123-87-013
		320mm x 135mm - w/ Wheel Park		E117-0717-0		E123-81-006

#### UD 2300, DH, LP

Front Shoes	1989 - 2012	320mm x 110mm		E117-0602-0		E123-87-012
		370mm x 100mm		E117-0603-0		E123-87-009
Rear Shoes	1989 - 2012	370mm x 135mm - w/o Wheel Park		E117-0604-0		E123-87-009
		320mm x 135mm - w/ Wheel Park		E117-0717-0		E123-81-006
		320mm x 135mm - w/o Wheel Park		E117-0679-0		E123-87-013

#### UD 2600, UD2800, UD3000

Front Shoes	1989 - 2010	400mm x 120mm		E117-0617-0		E123-87-009
Rear Shoes	1989 - 2010	400mm x 154mm		E117-0614-0		E123-81-007

### WORKHORSE Custom Chassis

#### LF72 Bus 19,000 GVWR

Frt & Rr Pads	2005 - 2009	66mm Caliper Cast # 4153269		E111-0786-1		E122-88-006 <sup>4</sup>
		73mm Caliper Cast # 4153222		E111-0786-0		E122-88-006 <sup>4</sup>
Brake M/Cyl	2005 - 2009			E135-87-013	2"	
Front Rotor	2005 - 2009			E125-88-023	1.32"	
Rear Rotor	2005 - 2009			E125-88-018	1.32"	
PB Shoe	2005 - 2009	12x3" Air actuated		E116-0980-0		
		12x3" Manual actuated		E116-0978-0		
Frt & Rr Caliper	2005 - 2009	66mm Caliper Cast # 4153269		E146-88-008	66mm	E148-88-009
		73mm Caliper Cast # 4153222		E146-88-010	73mm	E148-88-008

#### P32, P42

Front Pads	1985 - 1994	13" x 2 1/2" Rear Brakes		E111-0153-0		E122-67-009
		13" x 3 1/2" Rear Brakes		E111-0543-0		E122-72-006
	1995 - 2003 2004 - 2010	Single Piston Caliper		E111-0543-0		E122-72-006
		Dual Piston Caliper - Cast # 4152828		E111-1027-0		E122-90-007
		Dual Piston Caliper - Cast # 4153269		E111-0717-0		E122-71-011
Rear Pads	1985 - 1994			E111-0786-1		E122-88-006 <sup>4</sup>
Rear Pads	1985 - 1994			E111-0543-0		E122-72-006
		1995 - 2003	Single Piston Caliper		E111-0543-0	E122-72-006
	2004 - 2010	Dual Piston Caliper - Cast # 4152828		E111-0717-0		E122-71-011
		Dual Piston Caliper - Cast # 4153269		E111-0786-0		E122-88-006 <sup>4</sup>
Rear Shoes	1985 - 2003	13" x 2 1/2" Rear Brakes		E117-0451-0		E123-71-007
		13" x 3 1/2" Rear Brakes		E117-0452-0		E123-71-007
Front Rotor	1985 - 1994	All 4 Wheel Disc		E125-71-020	1.465"	
		13" x 2 1/2" Rear Brakes		E126-71-010	1.215"	
		13" x 3 1/2" Rear Brakes - SRW		E126-71-007	1.465"	
		13" x 3 1/2" Rr Brakes - DRW w/ I Beam Frt Susp		E126-71-042	1.465"	
		13" x 3 1/2" Rr Brakes - DRW w/ Ind Frt Susp		E126-71-006	1.465"	

Cont'd Next Pg

Note <sup>4</sup> Major Kit

Many products are available in multiple grades or configurations. Refer to page 5 for details.

MAKE MODEL PART DESC	YEAR	QUALIFIER	POSITION	PART #	DISCARD/ DIAMETER	E122 / E123 HARDWARE KIT E124 SELF ADJUSTER E148 / E149 REPAIR KIT
<b>WORKHORSE Custom Chassis (Cont'd)</b>						
<b>P32, P42 (Cont'd)</b>						
Front Rotor (Cont'd)	1995 - 2003	13" x 2 1/2" Rear Brakes - 2 Wheel ABS		E126-71-007	1.465"	
		13" x 2 1/2" Rear Brakes - 4 Wheel ABS		E126-71-035	1.465"	
		13" x 3 1/2" Rear Brakes - SRW		E126-71-007	1.465"	
		13" x 3 1/2" Rr Brakes - DRW w/ I Beam Frt Susp		E126-71-042	1.465"	
		13" x 3 1/2" Rr Brakes - DRW w/ Ind Frt Susp		E126-71-006	1.465"	
		13" x 3 1/2" Rr Brakes - DRW w/ 4 Whl ABS - w/ Ind Frt Susp		E126-71-026	1.465"	
	2004 - 2010	All 4 Wheel Disc w/ 4 wheel ABS - 6 hole		E125-88-020	1.320"	
		4 Wheel Disc - 5 Stud Disc		E125-71-036	34.7mm	
		4 Wheel Disc - 10 Stud Disc		E126-71-023	1.465"	
				E125-90-006	27.75mm	
Rear Rotor	1985 - 1996			E126-71-023	1.465"	
	1997 - 2003	Single Piston Caliper		E126-71-023	1.465"	
		Dual Piston Caliper - 10 hole		E125-71-037	34.7mm	
		Dual Piston Caliper - 6 hole		E125-88-020	1.320"	
2004 - 2010			E125-90-007	1.06"		
PB Drum	1985 - 2003			E127-71-005	11.09"	
PB Shoe	1985 - 1990	11" x 2"		E117-0449-0		
	1991 - 2003	11" x 2"		E116-0823-0		
Front Caliper	1985 - 1994	13" x 2 1/2" Rear Brakes	L	E146-71-019	80mm	E148-71-009
			R	E146-71-018	80mm	
		13" x 3 1/2" Rear Brakes	L	E146-71-015	3.38"	E148-73-006
			R	E146-71-014	3.38"	
	1995 - 2003	Single Piston Caliper	L	E146-71-015	3.38"	E148-73-006
			R	E146-71-014	3.38"	
		Dual Piston Caliper - Cast # 4152828	L & R	E146-85-006	2.60"	E148-88-007
	2004 - 2010	Dual Piston Caliper - Cast # 4153269	L & R	E146-88-008	66mm	E148-88-009
L			E146-90-009	68mm	E148-77-006	
R		E146-90-008	68mm			
Rear Caliper	1985 - 2003	Single Piston Caliper	L	E146-71-015	3.38"	E148-73-006
			R	E146-71-014	3.38"	
		Dual Piston Caliper Casting # 4152828	L & R	E146-85-006	2.60"	E148-88-007
	2004 - 2010	Dual Piston Caliper Casting # 4153269	L & R	E146-88-008	66mm	E148-88-009
			L	E146-90-507	68mm	E148-77-006
R	E146-90-506	68mm				
Rear Drum	1985 - 2003	13" x 2 1/2" Rear Brakes		E127-71-014	332.5mm	E123-71-007 L E124-73-010 R E124-73-011
		13" x 3 1/2" Rear Brakes		E127-71-034	332.5mm	E123-71-007 L E124-73-010 R E124-73-011
Brake M/Cyl	1985 - 1991	13" x 2 1/2" Rear Brakes		E135-71-019	32/40mm	
		13" x 3 1/2" Rear Brakes		E135-71-017	1 5/16"	
	1992 - 1994	13" x 2 1/2" Rear Brakes - Gas Eng		E135-71-019	32/40mm	
		13" x 3 1/2" Rear Brakes - Diesel Eng		E135-71-017	1 5/16"	
	1995 - 2003			E135-71-017	1 5/16"	
	2004 - 2010			E135-71-069	40mm	
Rear W/Cyl	1985 - 2003	1 1/16" Bore		E139-71-019	1 1/16"	E149-67-022
		1 3/16" Bore		E139-71-018	1 3/16"	E149-67-019

Many products are available in multiple grades or configurations. Refer to page 5 for details.

MAKE MODEL PART DESC	YEAR	QUALIFIER	POSITION	PART #	DISCARD / DIAMETER	E122 / E123 HARDWARE KIT E124 SELF ADJUSTER E148 / E149 REPAIR KIT
----------------------------	------	-----------	----------	--------	-----------------------	--

## WORKHORSE Custom Chassis (Cont'd)

### P500 (Fedex Delivery Truck)

Frt & Rr Pads	2004 - 2005			E111-0717-0		E122-71-011
	2006 - 2009			E111-1027-0		E122-90-007
Brake M/Cyl	2004 - 2005			E135-71-032	40mm	
	2006 - 2009			E135-71-069	40mm	
Front Rotor	2004 - 2005			E125-71-036	34.7mm	
	2006 - 2009			E125-90-006	27.75mm	
Rear Rotor	2004 - 2005			E125-71-037	34.7mm	
	2006 - 2009			E125-90-007	1.06"	
Front Caliper	2004 - 2005 2006 - 2009		L&R	E146-85-006	66mm	E148-88-007
			L	E146-90-009	68mm	E148-77-006
			R	E146-90-008	68mm	
Rear Caliper	2004 - 2005 2006 - 2009		L&R	E146-85-006	66mm	E148-88-007
			L	E146-90-507	68mm	E148-77-006
			R	E146-90-506	68mm	

### W16, W18 - 16,000, 18,000 GVWR

Frt & Rr Pads	2001 - 2009			E111-1027-0		E122-90-007
Brake M/Cyl	2001 - 2009			E135-71-069	40mm	
Front Rotor	2001 - 2009			E125-90-006	27.75mm	
Rear Rotor	2001 - 2009			E125-90-007	1.06"	
Front Caliper	2001 - 2009		L	E146-90-009	68mm	E148-77-006
			R	E146-90-008	68mm	
Rear Caliper	2001 - 2009		L	E146-90-507	68mm	E148-77-006
			R	E146-90-506	68mm	

### W20, W20D, W21, W22 - 20,70, 22,000 GVWR

Frt & Rr Pads	2001 - 2011	66mm Caliper Cast # 4153269		E111-0786-1		E122-88-006 <sup>4</sup>
		73mm Caliper Cast # 4153222		E111-0786-0		E122-88-006 <sup>4</sup>
Brake M/Cyl	2001 - 2011			E135-87-013	2"	
Frt & Rr Rotor	2001 - 2011	5 Hole Hat Shaped Disc		E125-88-021	1.32"	
		6 Hole Hat Shaped Disc		E125-88-020	1.32"	
		10 Hole - Hat Shaped Disc - 3.20" Tall		E125-88-019	1.32"	
		10 Hole - Hat Shaped Disc - 4.45" Tall		E125-88-018	1.32"	
PB Shoes	2001 - 2011			E116-0980-0		
Frt & Rr Caliper	2001 - 2011	66mm Caliper Cast # 4153269		E146-88-008	66mm	E148-88-009
		73mm Caliper Cast # 4153222		E146-88-010	73mm	E148-88-008

### W24, W25.5 - 24,000, 25,500 GVWR

Frt & Rr Pads	2001 - 2009			E111-0769-0		E122-85-006 <sup>4</sup>
Brake M/Cyl	2001 - 2009			E135-87-012	2"	
Front Rotor	2001 - 2009			E125-85-019	36.06mm	
Rear Rotor	2001 - 2009	10 hole disc - hat shaped disc		E125-85-019	36.06mm	
		10 hole disc - U shaped disc		E125-85-020	36.06mm	
Frt & Rr Caliper	2001 - 2009		L	E146-84-019	70mm	E148-85-006
			R	E146-84-018	70mm	

Note <sup>4</sup> Major Kit

Many products are available in multiple grades or configurations. Refer to page 5 for details.

MAKE MODEL PART DESC	YEAR	QUALIFIER	POSITION	PART #	DISCARD / DIAMETER	E122 / E123 HARDWARE KIT E124 SELF ADJUSTER E148 / E149 REPAIR KIT
----------------------------	------	-----------	----------	--------	-----------------------	--

### WORKHORSE Custom Chassis (Cont'd)

#### W42 - 14,001, 16,000 GVWR

Front Pads	2004 - 2005			E111-0717-0		E122-71-011
	2006 - 2011	w/52mm Piston Diameter		E111-1268-0		E122-90-006
		w/68mm Piston Diameter		E111-1027-0		E122-90-007
Rear Pads	2004 - 2005			E111-0717-0		E122-71-011
	2006 - 2011	w/52mm Piston Diameter		E111-1268-0		E122-90-006
		w/68mm Piston Diameter		E111-1027-0		E122-90-007
Brake M/Cyl	2004 - 2005			E135-71-032	40mm	
	2006 - 2011			E135-71-069	40mm	
Front Rotor	2004 - 2005			E125-71-036	34.7mm	
	2006 - 2011	8 Hole Rotor		E125-90-005	25mm	
		10 Hole Rotor		E125-90-006	27.75mm	
Rear Rotor	2004 - 2005			E125-71-037	34.7mm	
	2006 - 2011	5 Hole		E125-90-007	1.06"	
		10 Hole		E125-90-008	1"	
Front Caliper	2004 - 2005			E146-85-006	66mm	E148-88-007
	2006 - 2011	52mm - Caliper Casting # 2x 52/28 - 929305	L	E146-90-007	52mm	E148-90-006
			R	E146-90-006	52mm	
		68mm - Caliper Casting # 5662.02	L	E146-90-009	68mm	E148-77-006
			R	E146-90-008	68mm	
Rear Caliper	2004 - 2005			E146-85-006	66mm	
	2006 - 2011	52mm - Caliper Casting # 2x 52/28 - 929305	L	E146-90-509	52mm	E148-90-006
			R	E146-90-508	52mm	
		68mm - Caliper Casting # 5662.02	L	E146-90-507	68mm	E148-77-006
			R	E146-90-506	68mm	

#### W62, UFO - 17,000, 19,500, 23,000, 23,500 GVWR

Frt & Rr Pads	2001 - 2012			E111-0769-0		E122-85-006 <sup>4</sup>
Brake M/Cyl	2001 - 2012			E135-87-012	2"	
Front Rotor	2001 - 2012			E125-85-019	36.06mm	
Rear Rotor	2001 - 2012	10 hole disc - hat shaped disc		E125-85-019	36.06mm	
		10 hole disc - U shaped disc		E125-85-020	36.06mm	
Front Caliper	2001 - 2012	19,500 GVWR	L	E146-84-016	64mm	E148-84-010
			R	E146-84-017	64mm	
		23,500 GVWR	L	E146-84-018	70mm	E148-85-006
			R	E146-84-019	70mm	
Rear Caliper	2001 - 2012	19,500 GVWR	L	E146-84-016	64mm	E148-84-010
			R	E146-84-017	64mm	
		23,500 GVWR	L	E146-84-018	70mm	E148-85-006
			R	E146-84-019	70mm	

Note <sup>4</sup> Major Kit



# Illustrated Parts Guide

## Hydraulic Brake Parts For Light- and Medium-Duty Vehicles

Import & Domestic

*Heavy Duty Parts for Hard Working Vehicles*

**Bendix Spicer Foundation Brake LLC**  
901 Cleveland Street • Elyria, Ohio 44035  
Phone: 440-329-9709  
Toll-Free: 1-866-610-9709  
Fax: 440-329-9203  
Tech Support: 1-866-610-9709, option 2  
[www.foundationbrakes.com](http://www.foundationbrakes.com)



# NOTES

---

---

**HAVE QUESTIONS? NEED ASSISTANCE? TALK TO THE FORMULA BLUE® TECH LINE.  
Call 1-866-610-9709, option 2  
Representatives are available Monday – Friday, 8:00 a.m. – 8:30 p.m. EST.**

**E111-0153-0**

2 pads with wear sensor

FMSI:  
7084A-D153, 7280A-D392, 7280-D392

**E111-0224-0**

FMSI:  
7141-D224, 7807-D224

**E111-0225-0**

FMSI:  
7142-D225, 7808-D225, 7813-D225, 7818-D225, 7819-D225

**E111-0236-0**

FMSI:  
7149-D236, 7809-D236

# Brake Pads

**E111-0411-0**

FMSI:  
7299-D411

**E111-0433-0**

FMSI:  
7500-D433, 7548-D433

**E111-0494-0**

FMSI:  
7817-D494, 7930-D1026

**E111-0543-0**

2 pads with wear sensor

FMSI:  
7024-D89, 7024A-D89, 7024B-D89, 7024A-129, 7024B-D129,  
7081-D149, 7081A-D149, 7081-D543

**E111-0546-0**

2 pads with wear sensor

FMSI:  
7425-D546, 7425-D675

**E110-0598-0**

FMSI:  
7476-D598, 7633-D765

**E110-0606-0**

FMSI:  
7487-D606

**E111-0610-0**

FMSI:  
7489-D610, 7489A-D610

# Brake Pads

E107-0624-0

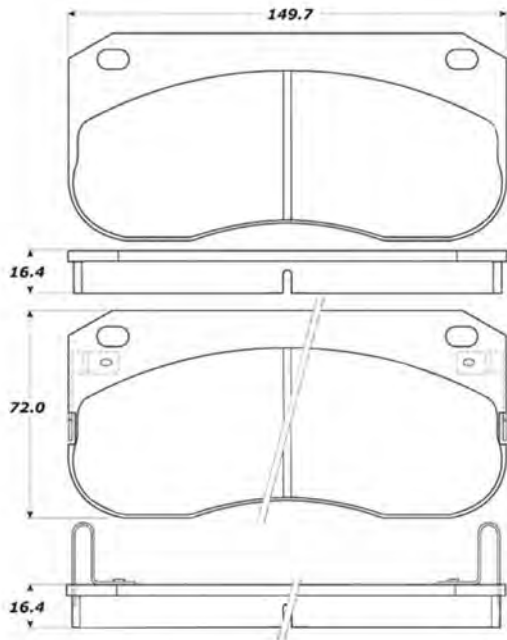

FMSI:  
7499-D624

E111-0655-0

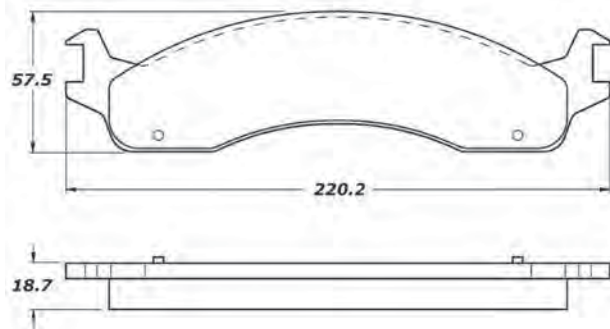

FMSI:  
7535-D655

E110-0698-0

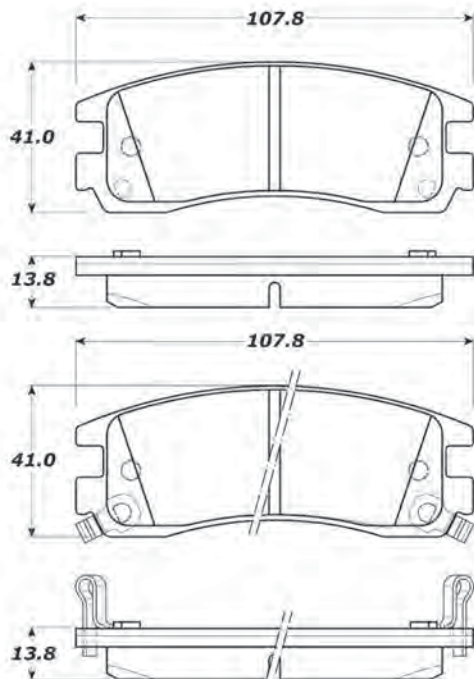

FMSI:  
7387-D698, 7387-D814

E111-0699-0

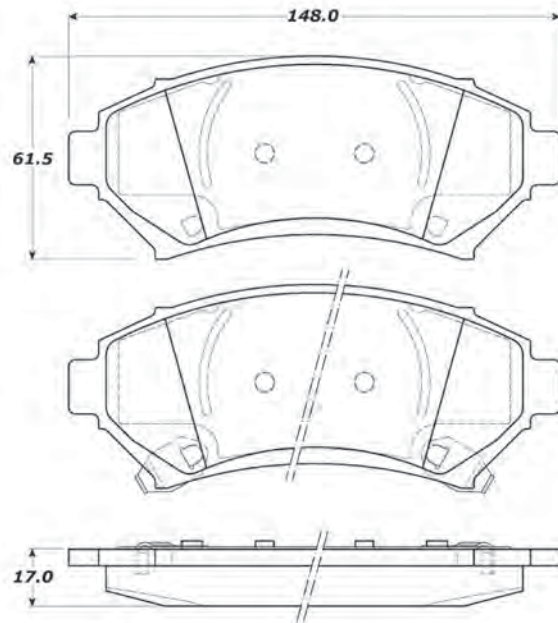

2 pads with wear sensor

FMSI:  
7574-D699, 7693-D818



**E111-0701-0**

4 pads with wear sensor  
FMSI:  
7527-D646, M7575-D701

**E111-0702-1**

2 pads with wear sensor  
FMSI:  
7865-D702, 7752-D1096, 7865-D1096

**E111-0711-0**

2LH & 2RH pads  
FMSI:  
7584-D711, 7584-D879

**E111-0717-0**

2 pads with wear sensor  
FMSI:  
7108-D184, 7815-D380, 7815-D717

# Brake Pads

**E111-0734-0**

2 pads with sensor hole (LH/RH)  
6 pads plain  
FMSI:  
7603-D734

**E111-0735-0**

FMSI:  
7604-D735

**E111-0769-0**

FMSI:  
7636-D769, 7636-D1032, 7636-D1418

**E111-0772-0**

FMSI:  
7639-D772

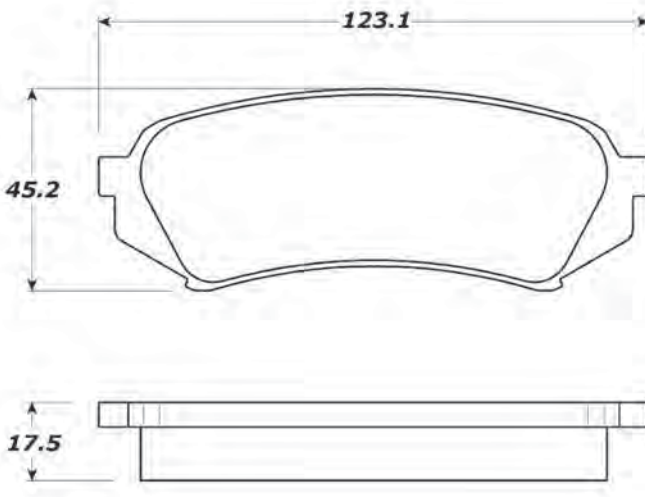
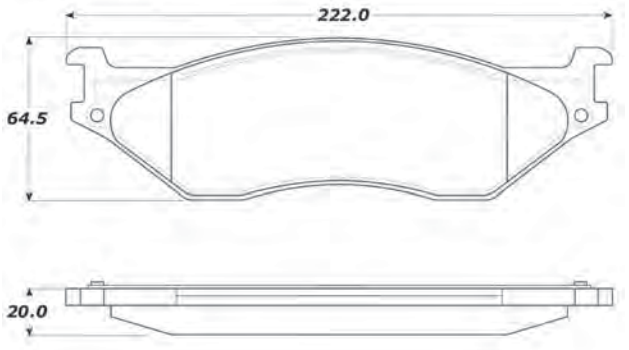
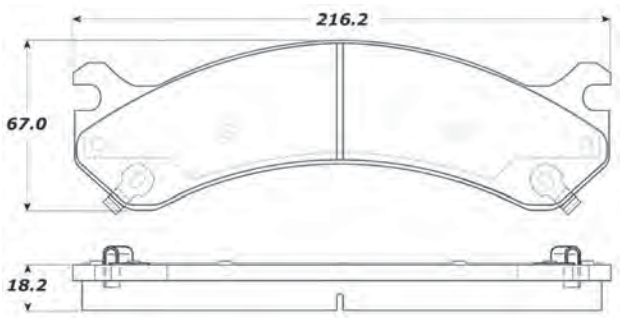
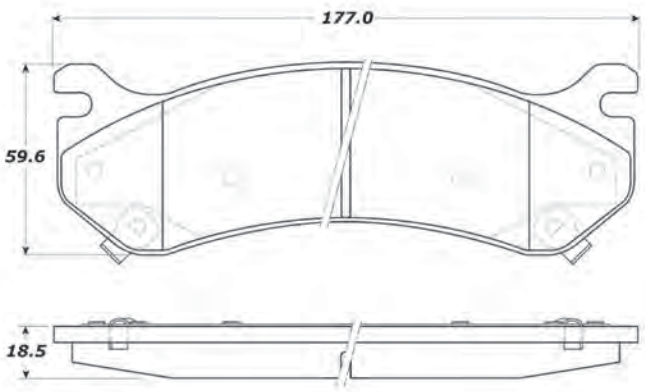
E111-0773-0	E111-0777-0
 <p>2 pads with sensor hole (LH/RH) 6 pads plain FMSI: 7640-D773</p>	 <p>FMSI: 7644-D777</p>
E111-0784-0	E110-0785-0
 <p>4 pads with 2 wear sensors FMSI: 7652-D784</p>	 <p>2 pads with 1 wear sensor 2 pads with 2 wear sensors FMSI: 7653-D785</p>

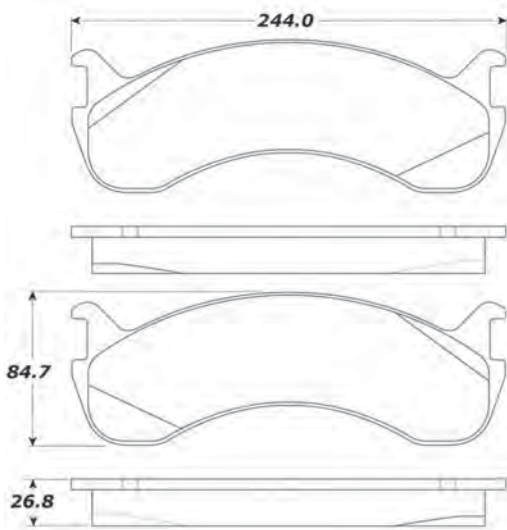
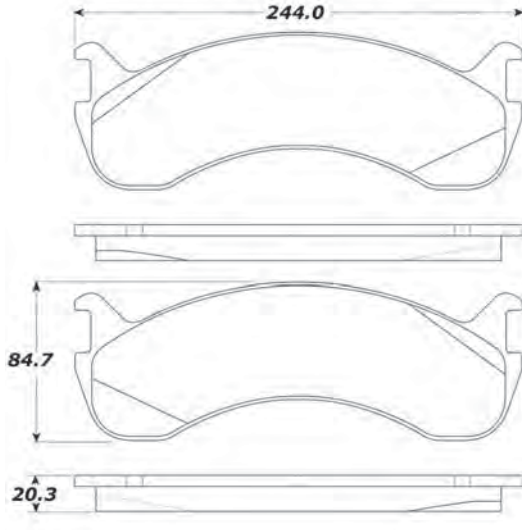
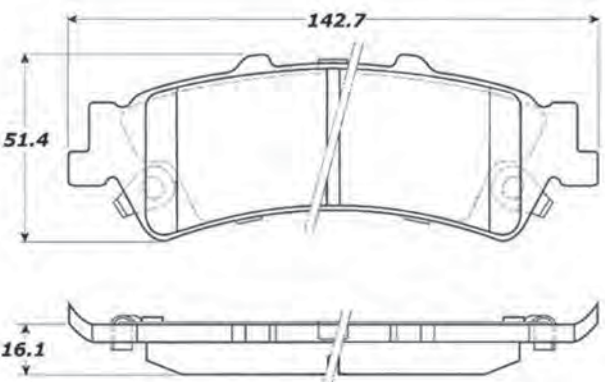
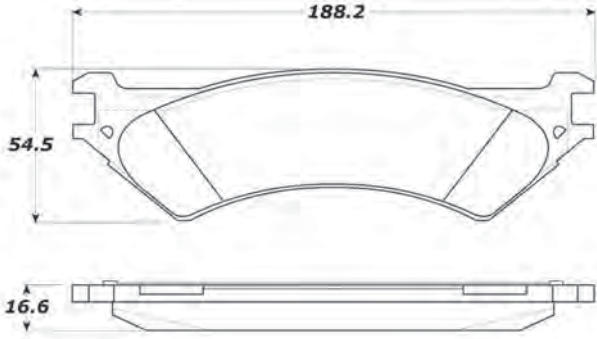

# Brake Pads

E111-0786-0	E111-0786-1
 <p>FMSI: 7655-D786</p>	 <p>FMSI: 7654-D786</p>
E110-0792-0	E111-0802-0
 <p>FMSI: 7662-D792, 7700-D792</p>	 <p>FMSI: 7673-D802</p>

E110-0815-1

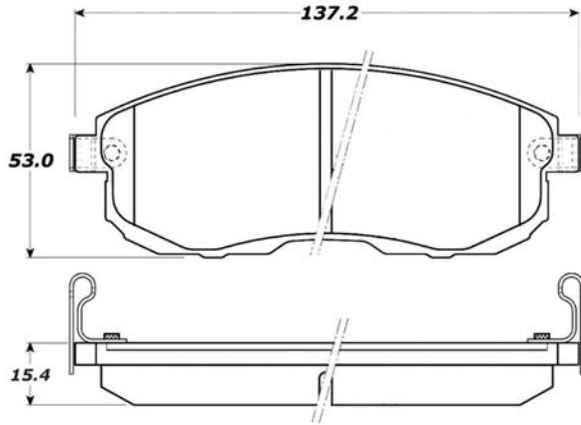

4 pads with wear sensor

FMSI:  
7783-D815

E111-0825-0

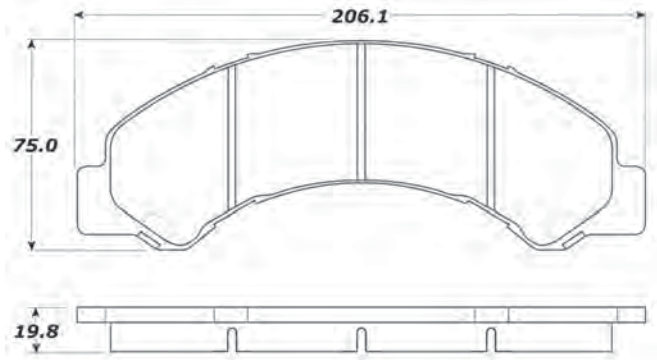

FMSI:  
7697-D825

E111-0826-0

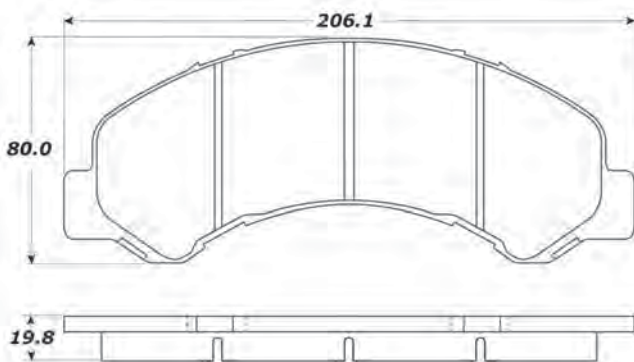

FMSI:  
7698-D826

E111-0827-0

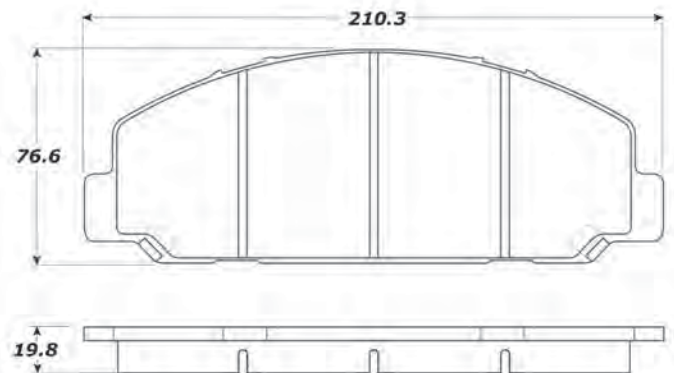

FMSI:  
7699-D827

# Brake Pads

E110-0833-0, E111-0833-0

2 pads with wear sensors  
FMSI:  
7706-D833, 7793-D833, 7794-D833, 7794-D913

E110-0834-0

4 pads with wear sensor  
FMSI:  
7707-D834, 7707-D975

E110-0843-0

FMSI:  
7719-D843

E109-0856-0

2 pads with wear sensor  
FMSI:  
7732-D856

**E109-0857-0**

Technical drawing of brake pad E109-0857-0. The drawing includes three views: a top view showing a width of 172.4, a side view showing a height of 66.0, and a rear view showing a thickness of 17.8. The pad has a curved shape with mounting tabs on the sides and a central mounting point.

FMSI:  
7733-D857

**E109-0858-0**

Technical drawing of brake pad E109-0858-0. The drawing includes three views: a top view showing a width of 155.4 and a height of 51.0, a side view showing a thickness of 16.0, and a rear view showing a height of 51.0 and a thickness of 16.0. The pad has a curved shape with mounting tabs on the sides and a central mounting point.

FMSI:  
7734-D858

**E110-0866-0**

Technical drawing of brake pad E110-0866-0. The drawing includes two views: a top view showing a width of 144.8 and a height of 54.6, and a side view showing a thickness of 15.9. The pad has a curved shape with mounting tabs on the sides and a central mounting point.

FMSI:  
7741-D866, 8402-D1285

**E110-0868-0**

Technical drawing of brake pad E110-0868-0. The drawing includes three views: a top view showing a width of 111.4 and a height of 44.5, a side view showing a thickness of 15.3, and a rear view showing a width of 91.0, a height of 45.2, and a thickness of 15.3. The pad has a curved shape with mounting tabs on the sides and a central mounting point.

FMSI:  
7743-D868, 7743-D1343

# Brake Pads

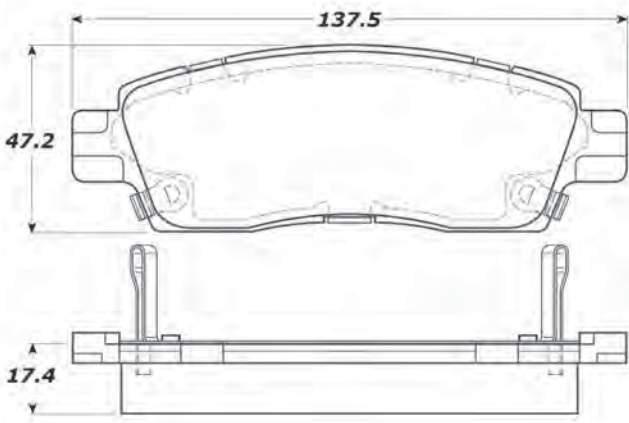
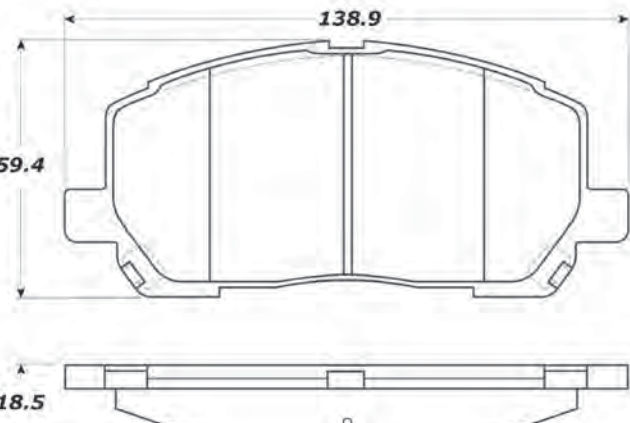
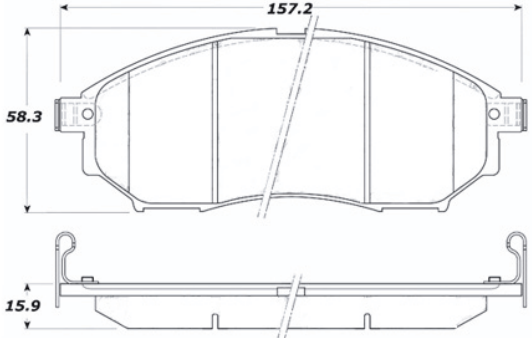
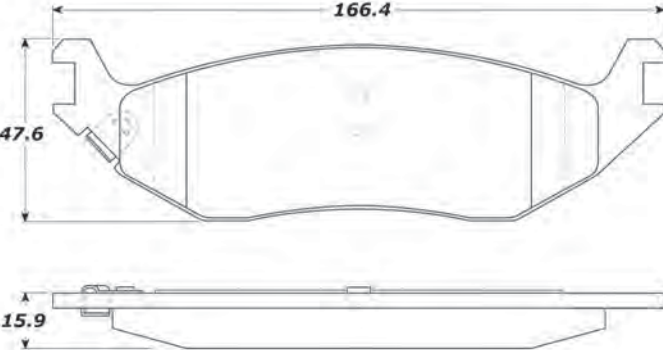
E110-0883-0,E111-0883-0	E110-0884-0
 <p>FMSI: 7760-D883, 7760-D1507</p>	 <p>FMSI: 7761-D884</p>
E110-0888-0	E111-0898-0
 <p>FMSI: 7766-D888, 8221-D888</p>	 <p>FMSI: 7775-D898, 7867-D898, 7867-D967, 7869-D967</p>



**E110-0905-0**

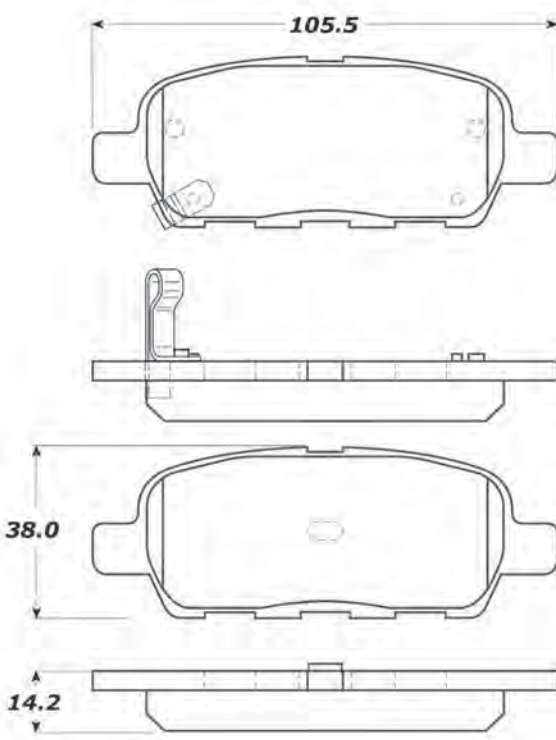

FMSI:  
7784-D905, 8405-D1288, 8405-D1415, 8501-D1393

**E110-0906-1**

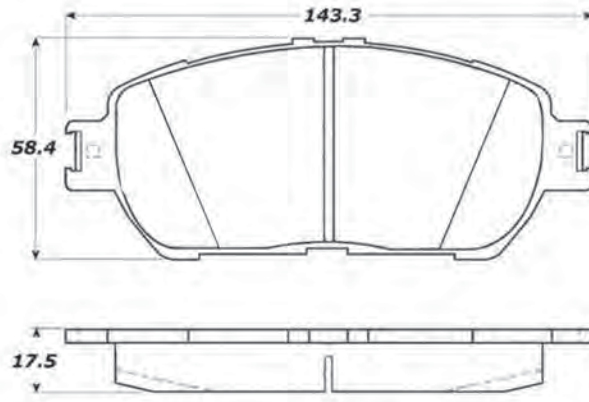

FMSI:  
7896-D906

**E111-0909-0**

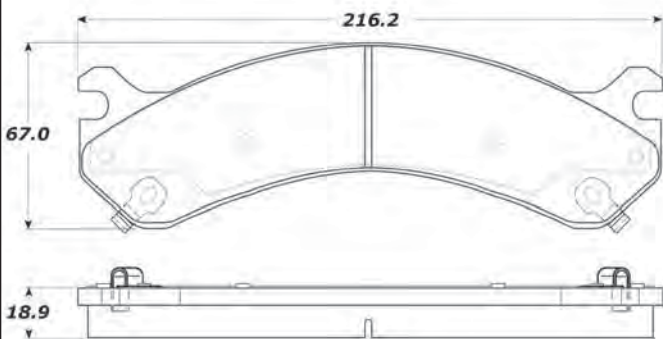

FMSI:  
7788-D909

**E110-0931-0, E111-0931-0**

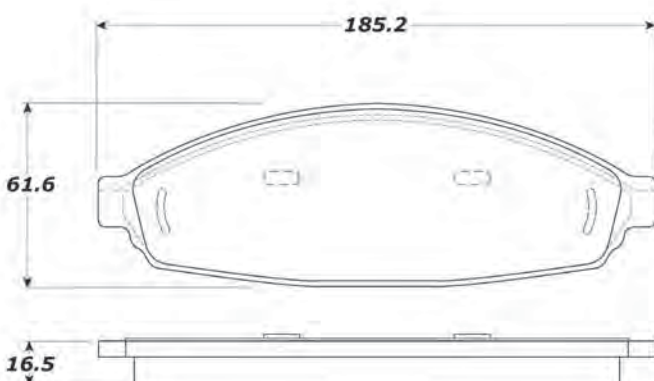

FMSI:  
7834-D931

# Brake Pads

**E110-0932-0**

Technical drawings of brake pad E110-0932-0. The top view shows a width of 150.0 and a height of 50.2. The side view shows a thickness of 15.6. The bottom view shows the reverse side of the pad with mounting tabs.

FMSI:  
7835-D932, 7944-D1040

**E110-0964-0**

Technical drawings of brake pad E110-0964-0. The top view shows a width of 140.4 and a height of 14.0. The side view shows a thickness of 48.8. The bottom view shows the reverse side of the pad with mounting tabs.

1LH & 1RH outer pad  
FMSI:  
7863-D964, 7863-D981

**E111-0965-0**

Technical drawings of brake pad E111-0965-0. The top view shows a width of 220.2 and a height of 63.3. The side view shows a thickness of 18.3. The bottom view shows the reverse side of the pad with mounting tabs.

2 pads with wear sensor  
FMSI:  
7864-D965

**E111-0970-0**

Technical drawings of brake pad E111-0970-0. The top view shows a width of 156.5 and a height of 63.0. The side view shows a thickness of 67.2. The bottom view shows the reverse side of the pad with mounting tabs.

FMSI:  
7871-D970

**E110-0974-0**

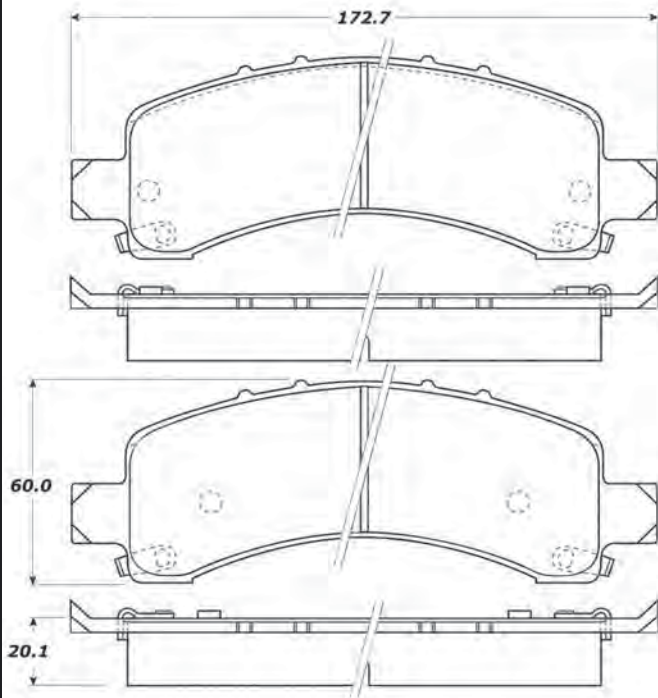

4 pads with 1 wear sensor  
 FMSI:  
 7875-D974

**E110-0974-1**

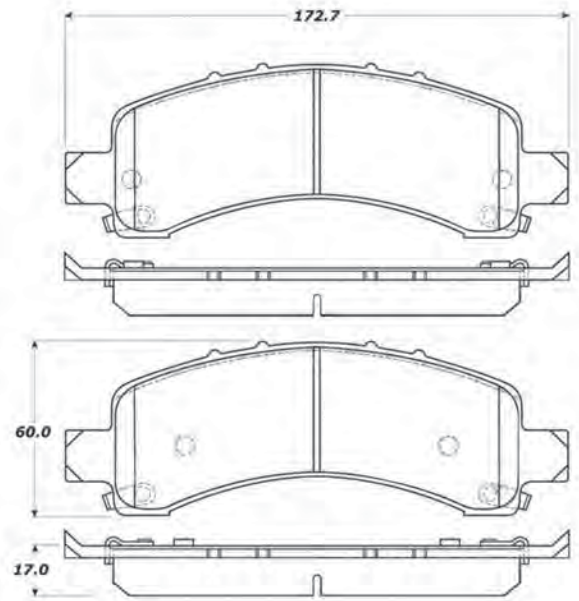

4 pads with 2 wear sensor  
 FMSI:  
 7881-D974

**E110-0976-0**

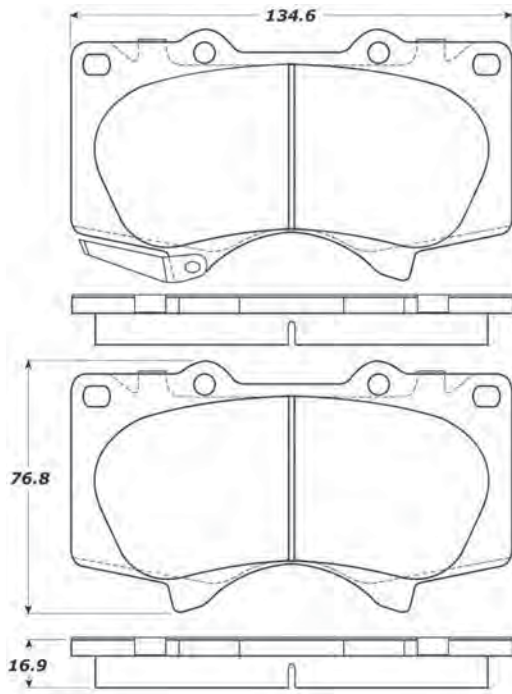

2 pads with wear sensor LH/RH  
 FMSI:  
 7877-D976

**E111-0989-0**

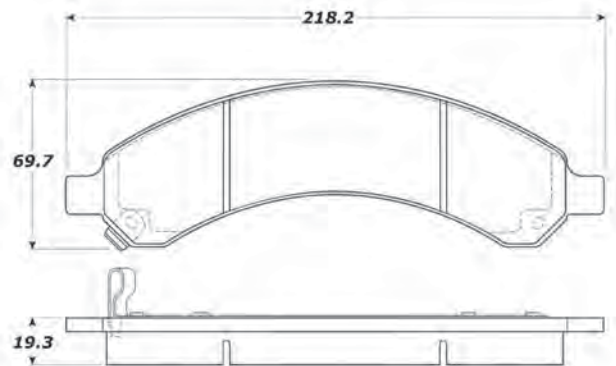

4 pads with wear sensor LH/RH  
 FMSI:  
 7891-D989

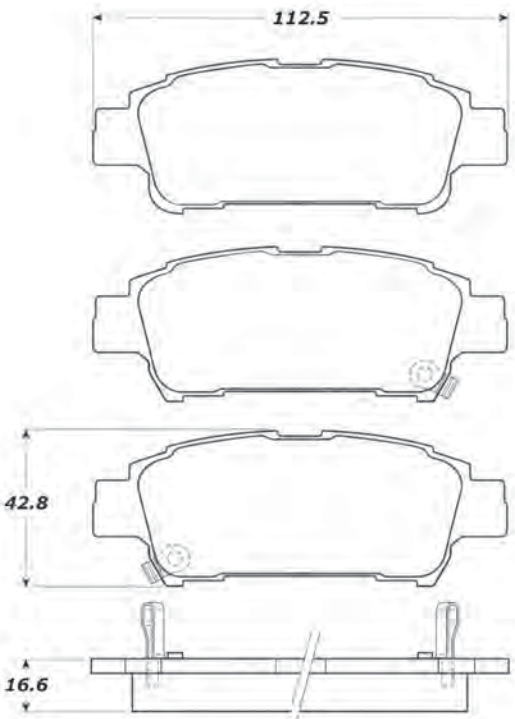
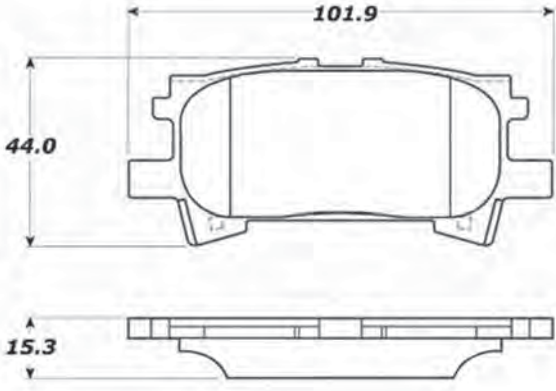
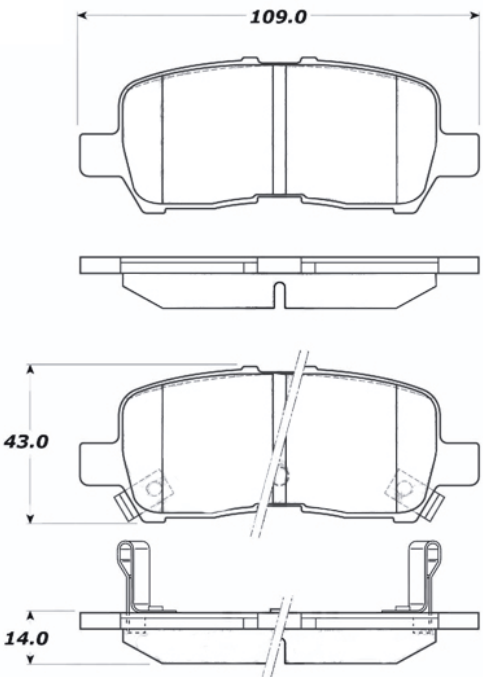
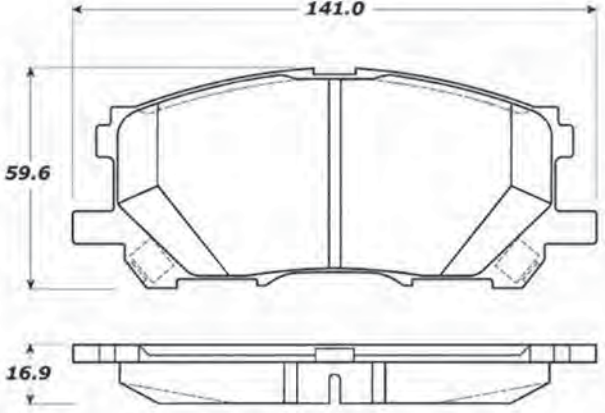

# Brake Pads

E110-0995-0	E110-0996-0
 <p>2 pads with wear sensor FMSI: 7895-D995</p>	 <p>FMSI: 7897-D996</p>
E110-0999-0,E111-0999-0	E110-1005-0
 <p>2 pads with wear sensor FMSI: 7900-D999</p>	 <p>FMSI: 7906-D1005</p>

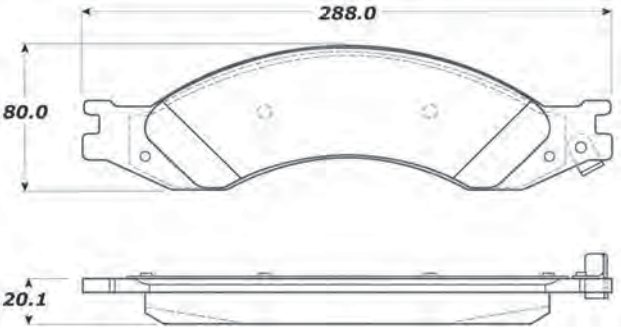
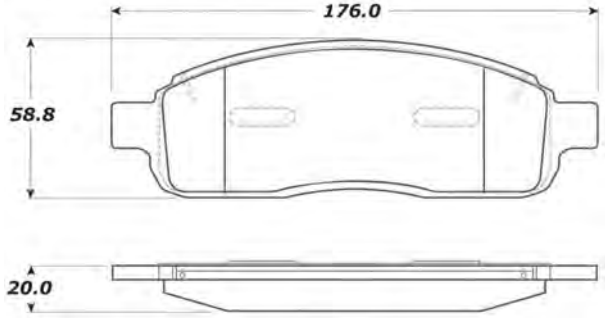
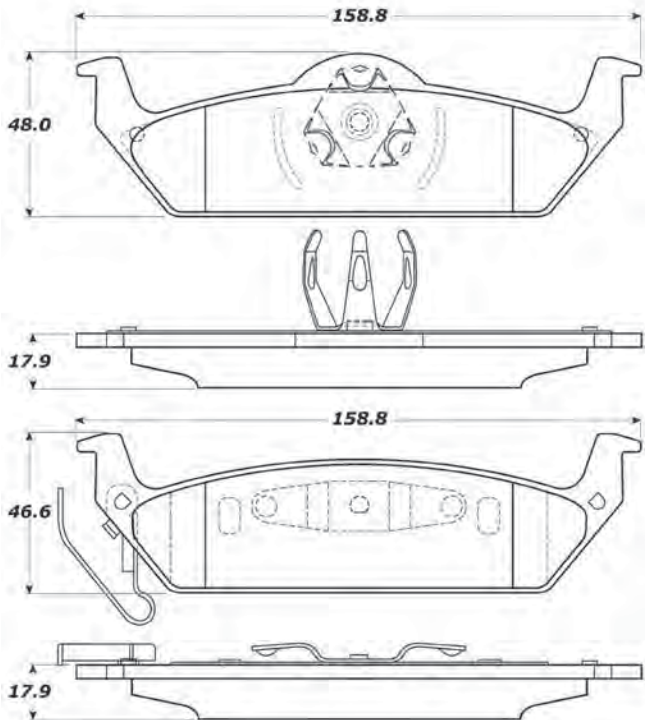
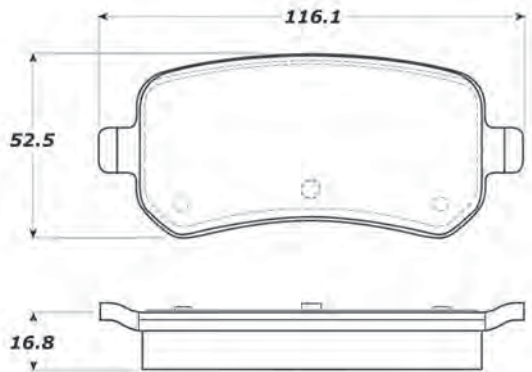
E111-1010-0	E111-1011-0
 <p>FMSI: 7914-D1010</p>	 <p>FMSI: 7915-D1011, 7915-D1083</p>
E110-1012-0,E111-1012-0	E110-1021-0
 <p>4 pads with wear sensor LH/RH FMSI: 7916-D1012</p>	 <p>FMSI: 7926-D1021, 8438-D1326</p>

# Brake Pads

**E111-1027-0**

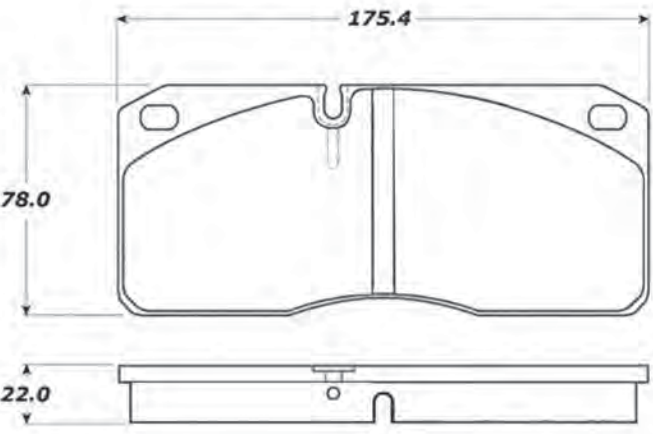

FMSI:  
7816-D442, 7931-D1027

**E110-1028-0**

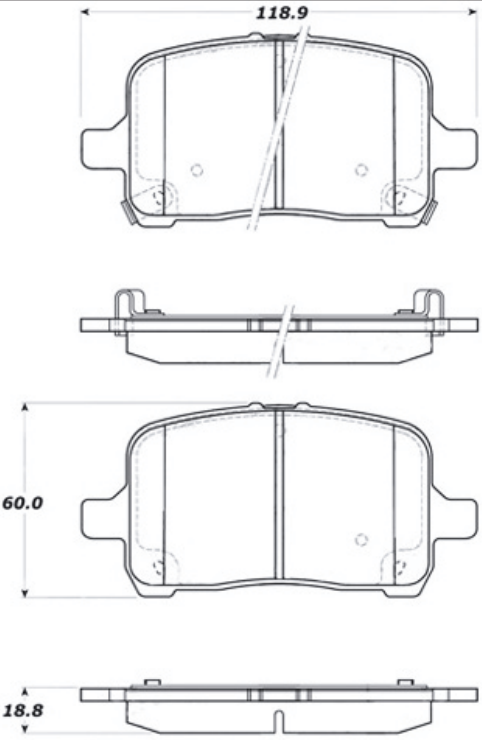

FMSI:  
7932-D1028, 8473-D1028

**E110-1033-0**

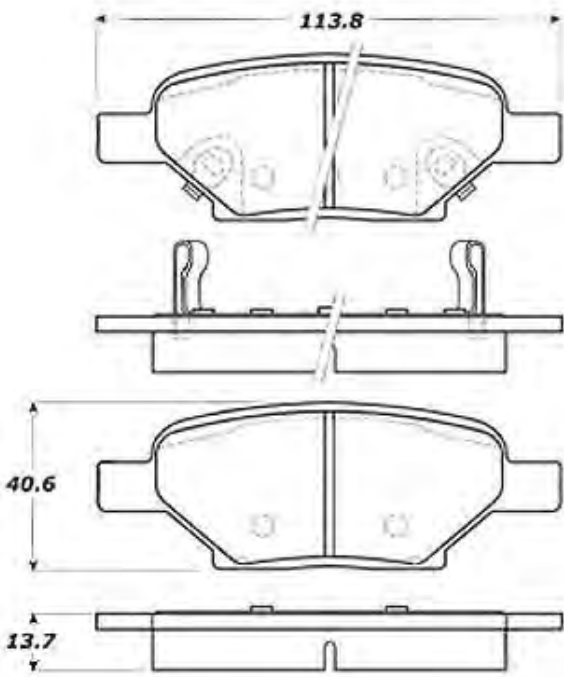

2 pads with wear sensor LH/RH  
FMSI:  
7937-D1033, 8474-D1364

**E110-1037-0**

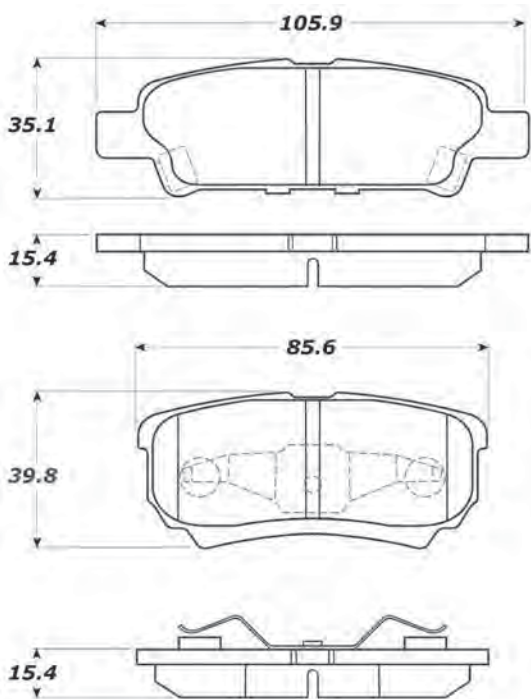

FMSI:  
7940-D1037

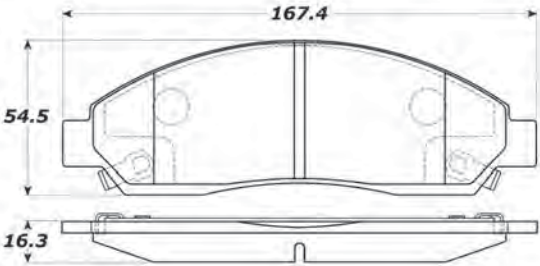
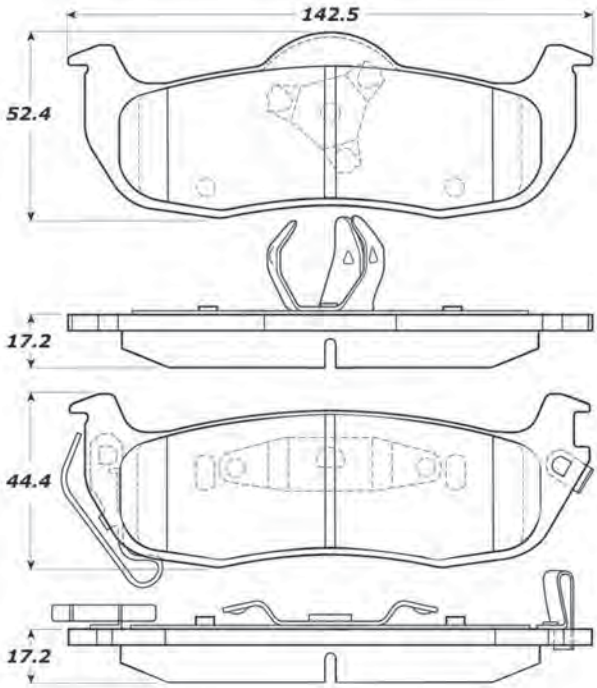
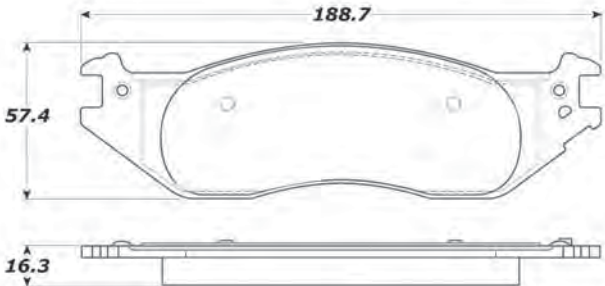
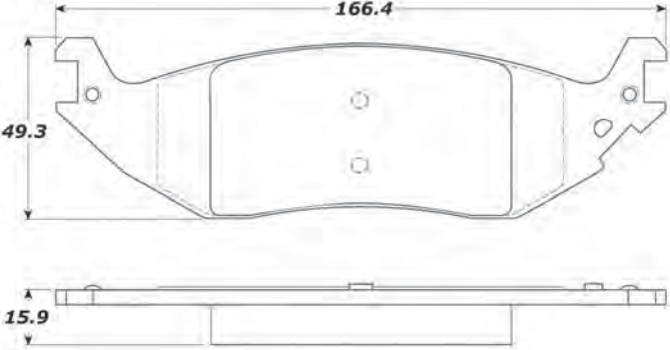
E110-1039-0	E110-1041-0
 <p>4 pads with wear sensors 2LH / 2RH FMSI: 7943-D1039</p>	 <p>2 pads with wear sensor (LH / RH) FMSI: 7945-D1041</p>
E111-1045-0	E111-1046-0
 <p>FMSI: 7948-D1045</p>	 <p>FMSI: 7949-D1046</p>

# Brake Pads

**E110-1047-0**

Technical drawing of brake pad E110-1047-0. It includes three views: a top view showing a width of 172.5, a side view showing a height of 67.5, and a bottom view showing a thickness of 15.0. The bottom view also indicates a width of 170.7. The drawing shows a central vertical slot and two side tabs.

FMSI:  
7950-D1047

**E110-1047-1**

Technical drawing of brake pad E110-1047-1. It includes three views: a top view showing a width of 172.5, a side view showing a height of 67.5, and a bottom view showing a thickness of 17.0. The bottom view also indicates a width of 170.7. The drawing shows a central vertical slot and two side tabs.

FMSI:  
8445-D1047

**E110-1047-2**

Technical drawing of brake pad E110-1047-2. It includes three views: a top view showing a width of 172.5, a side view showing a height of 67.5, and a bottom view showing a thickness of 15.0. The bottom view also indicates a width of 170.7. The drawing shows a central vertical slot and two side tabs.

FMSI:  
7950-D1047

**E110-1047-3**

Technical drawing of brake pad E110-1047-3. It includes three views: a top view showing a width of 172.5, a side view showing a height of 67.5, and a bottom view showing a thickness of 17.0. The bottom view also indicates a width of 170.7. The drawing shows a central vertical slot and two side tabs.

FMSI:  
8445-D1047

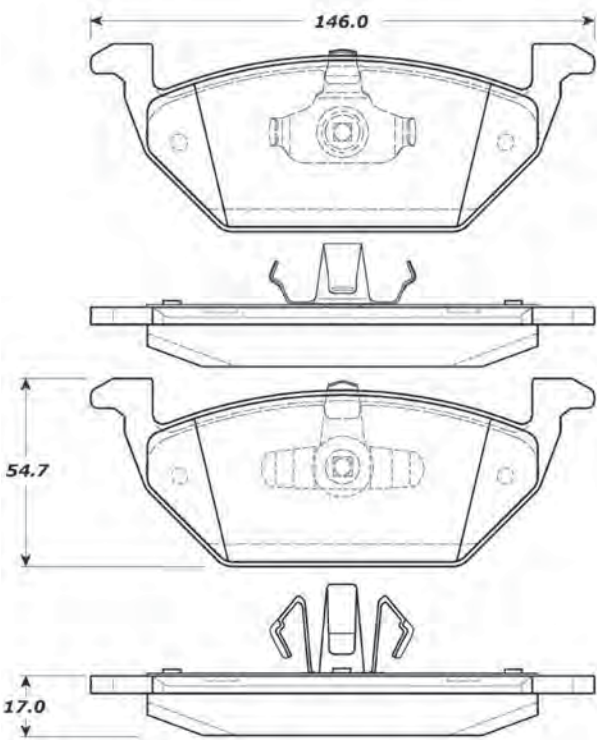
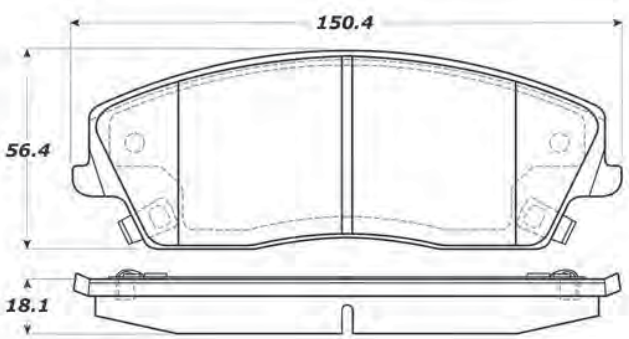
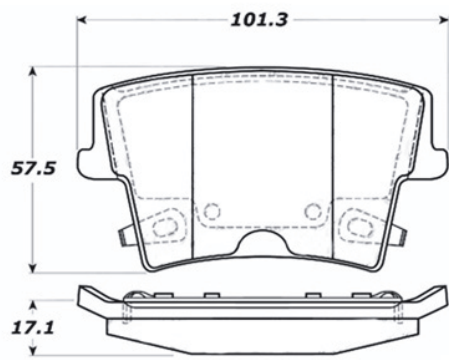
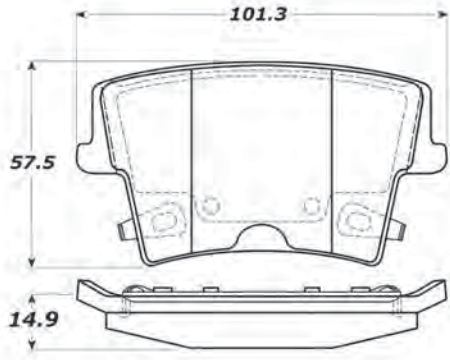

E110-1055-0	E110-1056-0
 <p style="text-align: center;">FMSI: 7961-D1055</p>	 <p style="text-align: center;">4 pads with wear sensor 2LH / 2RH FMSI: 7962-D1056</p>
E110-1057-0,E111-1057-0	E111-1057-1
 <p style="text-align: center;">4 pads with wear sensor 2LH / 2RH FMSI: 7963-D1057, 7964-D1057</p>	 <p style="text-align: center;">4 pads with wear sensor 2LH / 2RH FMSI: 8292-D1057, 8495-D1057</p>

# Brake Pads

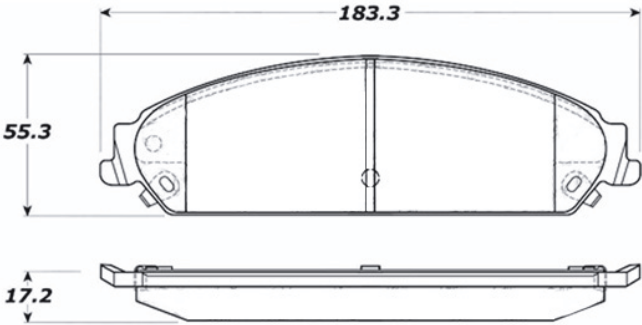
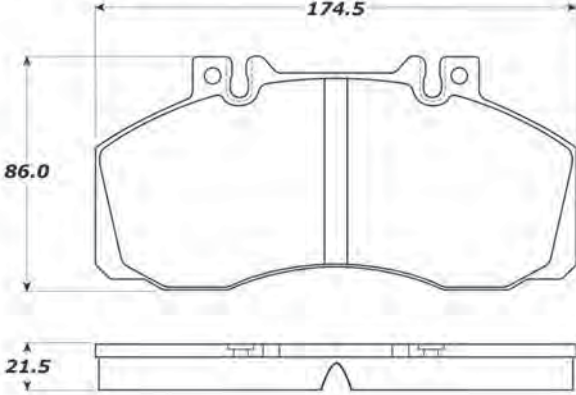
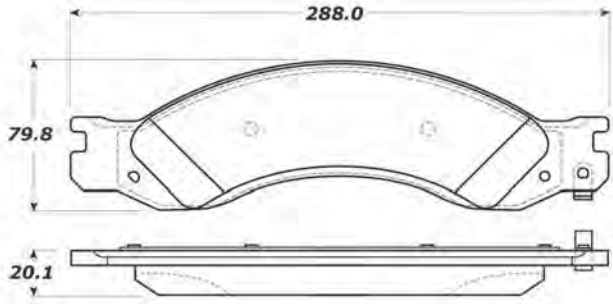
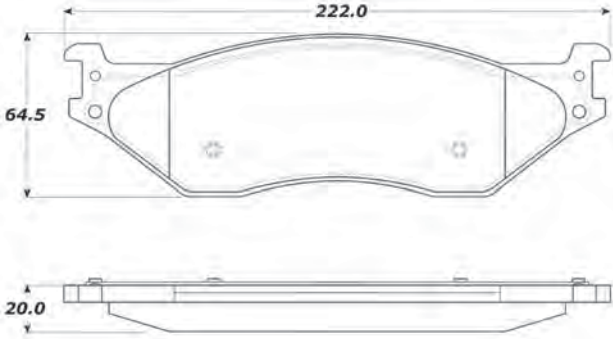
E110-1058-0,E111-1058-0	E111-1062-0
 <p>4 pads with wear sensor 2LH / 2RH FMSI: 7965-D1058</p>	 <p>FMSI: 7968-D1062</p>
E111-1064-0	E111-1066-0
 <p>4 pads with wear sensor FMSI: 7969-D1064</p>	 <p>FMSI: 7972-D1066, 7972-D1353</p>

**E111-1067-0**

Technical drawing of brake pad E111-1067-0. The top view shows a width of 177.3 and a height of 59.3. The side view shows a thickness of 18.0. The pad has a curved shape with two mounting tabs on the sides.

FMSI:  
7973-D1067, 7973-D1334

**E111-1068-0**

Technical drawing of brake pad E111-1068-0. The top view shows a width of 177.3 and a height of 55.6. The side view shows a thickness of 18.0. The pad has a curved shape with two mounting tabs on the sides.

FMSI:  
7973-D1068

**E111-1069-0**

Technical drawing of brake pad E111-1069-0. The top view shows a width of 177.3 and a height of 63.3. The side view shows a thickness of 20.6. The pad has a curved shape with two mounting tabs on the sides.

FMSI:  
7974-D1069, 7974-D1333

**E109-1070-0**

Technical drawing of brake pad E109-1070-0. The top view shows a width of 182.4 and a height of 52.5. The side view shows a thickness of 16.9. The pad has a curved shape with two mounting tabs on the sides.

FMSI:  
7975-D1070



# Brake Pads

E110-1071-0

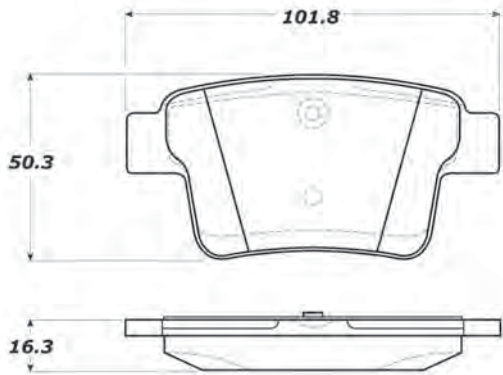

FMSI:  
7976-D1071

E109-1075-0

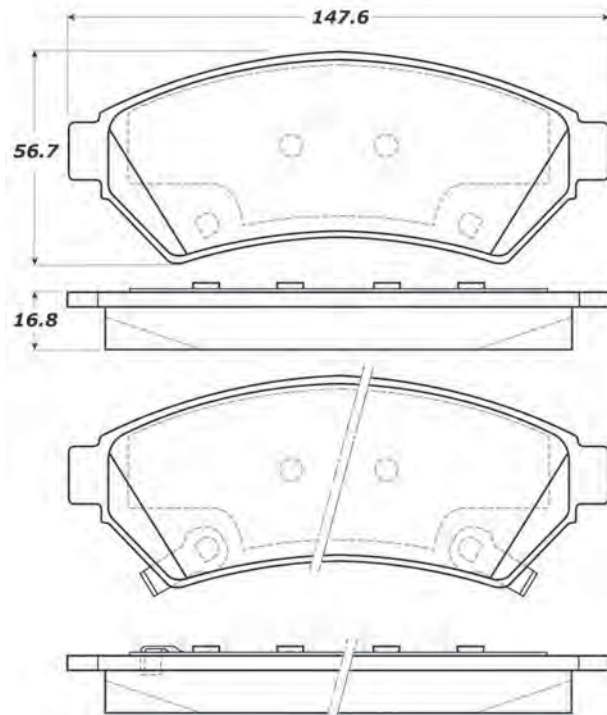

2 pads with wear sensor LH/RH

FMSI:  
7980-D1075

E109-1080-0

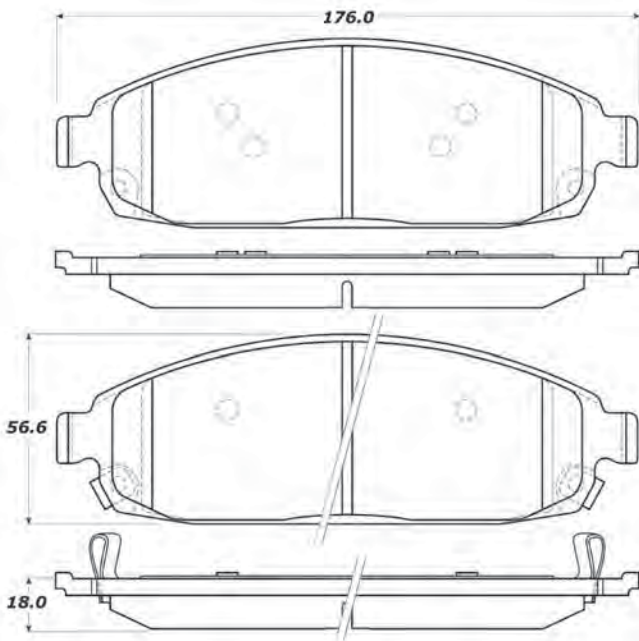

FMSI:  
7985-D1080

E111-1084-0

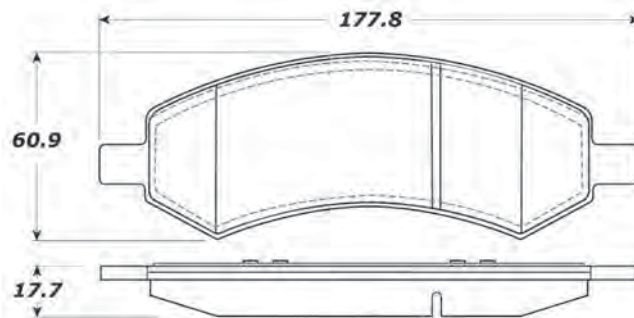

2 pads with wear sensor LH/RH

FMSI:  
7991-D1084

**E109-1087-0**

Technical drawing of brake pad E109-1087-0. The drawing includes three views: a top view showing a width of 142.5 and a height of 52.4; a side view showing a thickness of 17.2; and a rear view showing a height of 49.2 and a thickness of 17.2. The pad has a complex shape with mounting tabs and a central slot.

FMSI:  
7945-D1087

**E110-1092-0**

Technical drawing of brake pad E110-1092-0. The drawing includes three views: a top view showing a width of 184.2 and a height of 64.0; a side view showing a thickness of 18.0; and a rear view showing a height of 60.0. The pad has a curved shape with mounting tabs.

2 pads with wear sensor LH/RH  
FMSI:  
7997-D1092, 7997-D1380

**E110-1093-0**

Technical drawing of brake pad E110-1093-0. The drawing includes three views: a top view showing a width of 125.0 and a height of 51.1; a side view showing a thickness of 14.1; and a rear view showing a height of 51.1. The pad has a rectangular shape with mounting tabs.

FMSI:  
7999-D1093

**E110-1094-0**

Technical drawing of brake pad E110-1094-0. The drawing includes three views: a top view showing a width of 163.6 and a height of 54.0; a side view showing a thickness of 15.9; and a rear view showing a height of 54.0. The pad has a curved shape with mounting tabs.

1 pad with wear sensor  
FMSI:  
8200-D1094, 8757-D1548

# Brake Pads

**E110-1100-0**

110.7

38.2

15.9

FMSI:  
8206-D1100

**E110-1101-0**

110.5

40.8

16.0

1 pad with wear sensor  
FMSI:  
8204-D1101

**E110-1119-0,**

134.6

72.5

75.5

16.9

1 pad with wear sensor  
FMSI:  
8225-D1119

**E109-1120-0**

145.0

55.5

15.3

2 pads with wear sensor LH/RH  
FMSI:  
8226-D1120

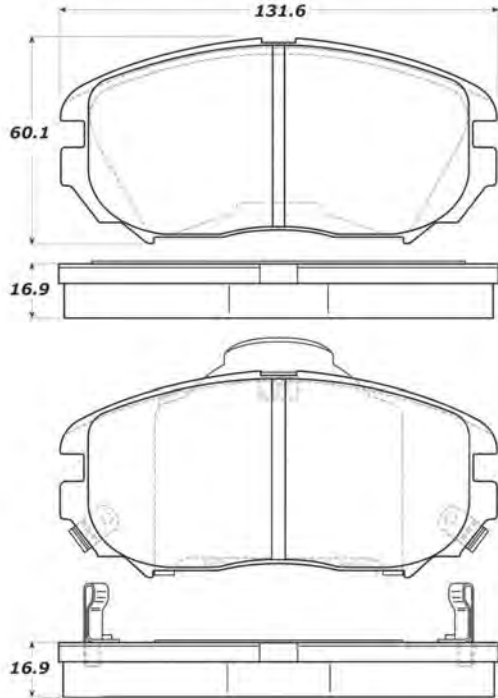
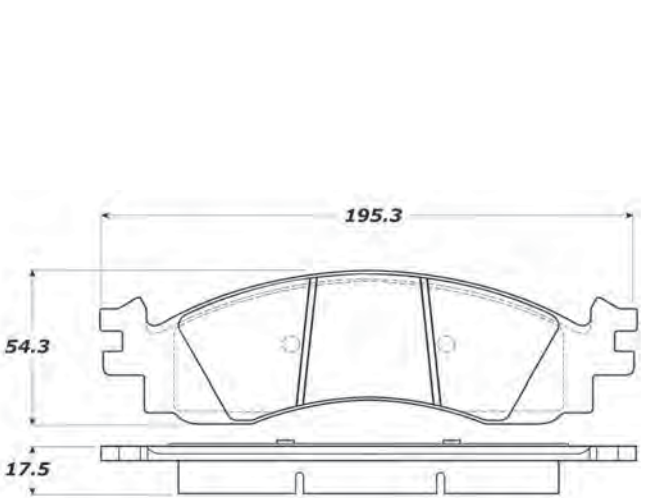
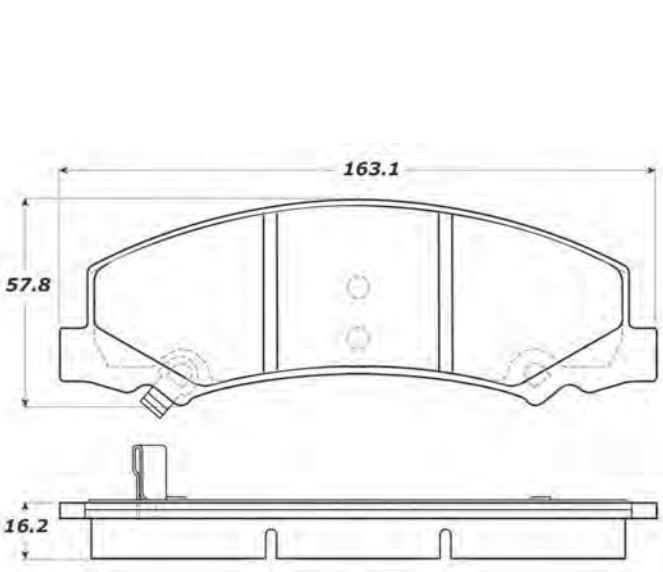
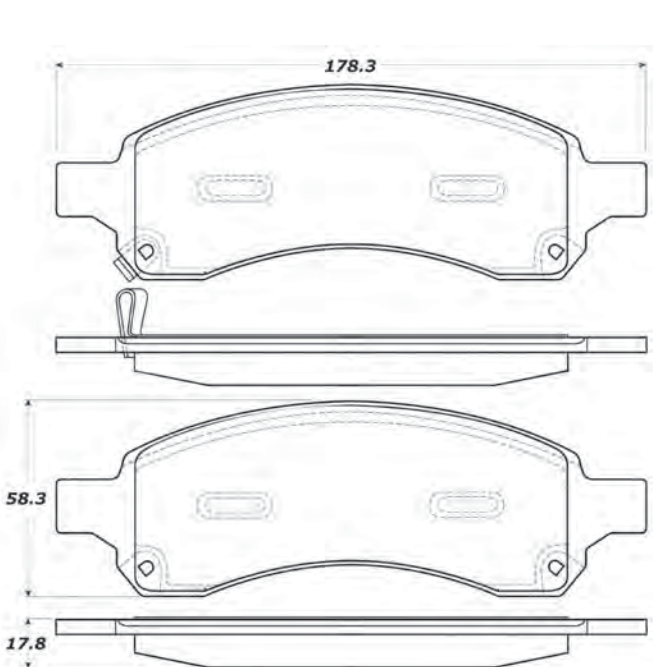
E110-1125-0	E110-1158-0, E111-1158-0
 <p>2 pads with wear sensor LH/RH FMSI: 8233-D1125 , 8306-D1125, 8536-D1421</p>	 <p>FMSI: 8268-D1158, 8533-D1158</p>
E109-1159-0, E111-1159-0	E109-1169-0, E110-1169-0
 <p>4 pads with wear sensor 2LH /2RH FMSI: 8269-D1159</p>	 <p>2 pads with wear sensor LH /RH FMSI: 8282-D1169</p>



# Brake Pads

E110-1169-1, E111-1169-1

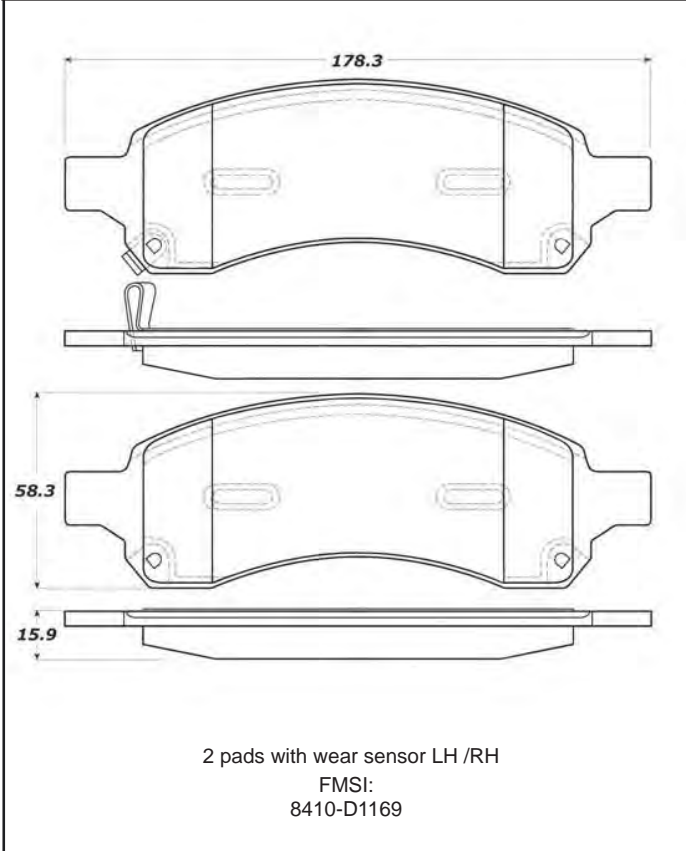

E110-1183-0

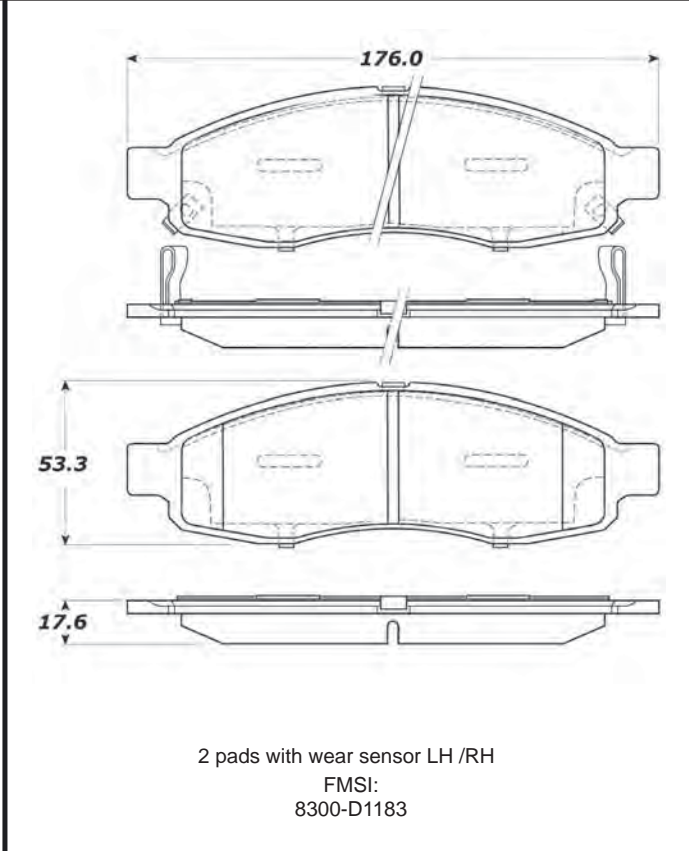

E110-1194-0

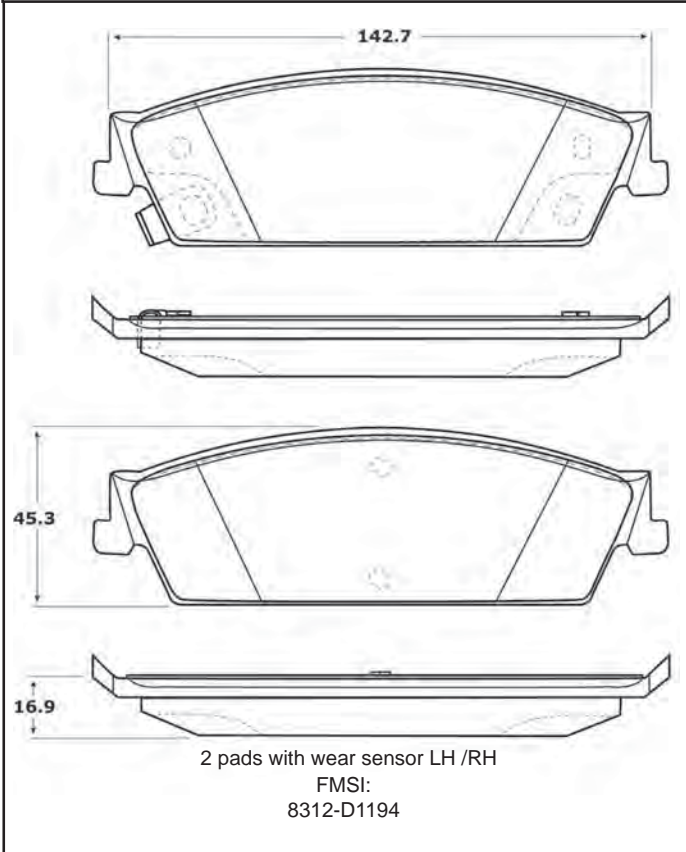

E110-1258-0

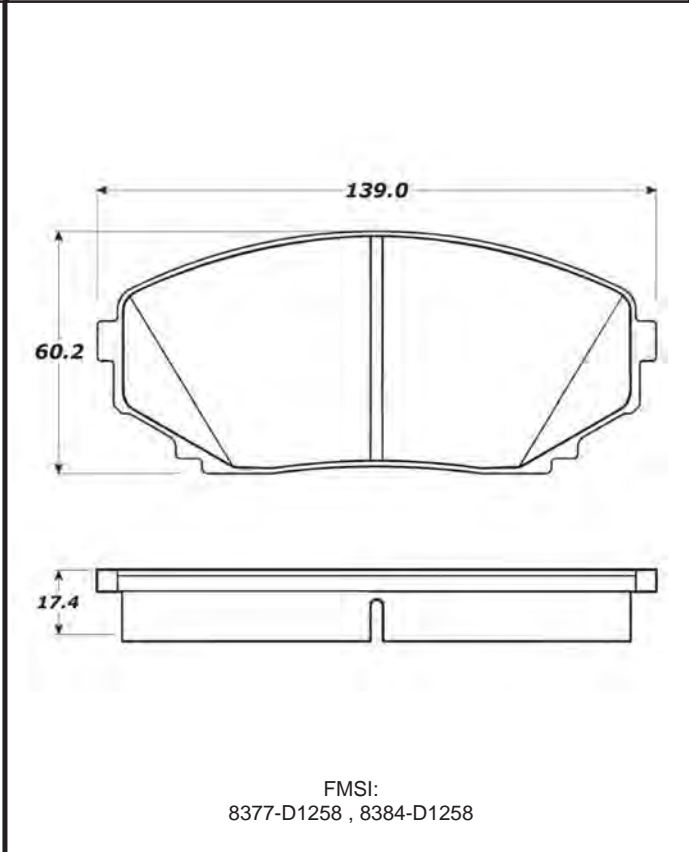

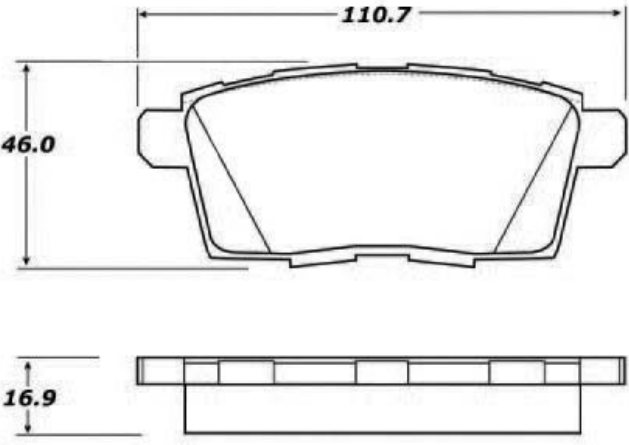
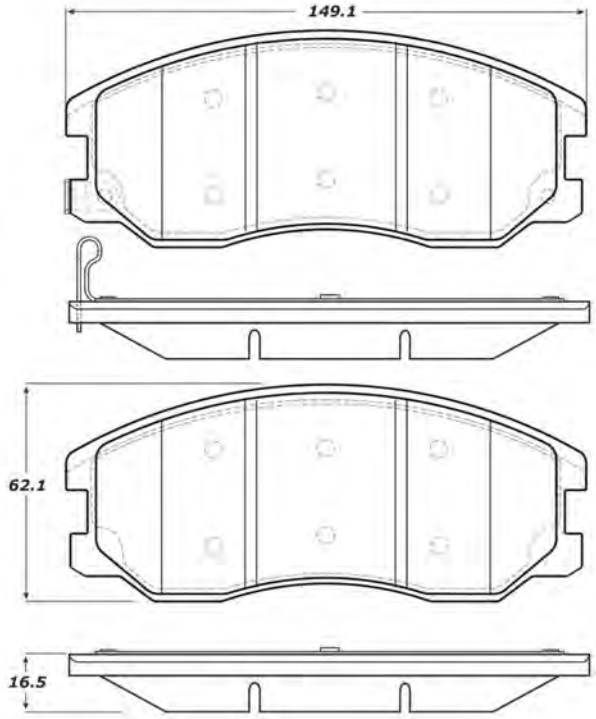
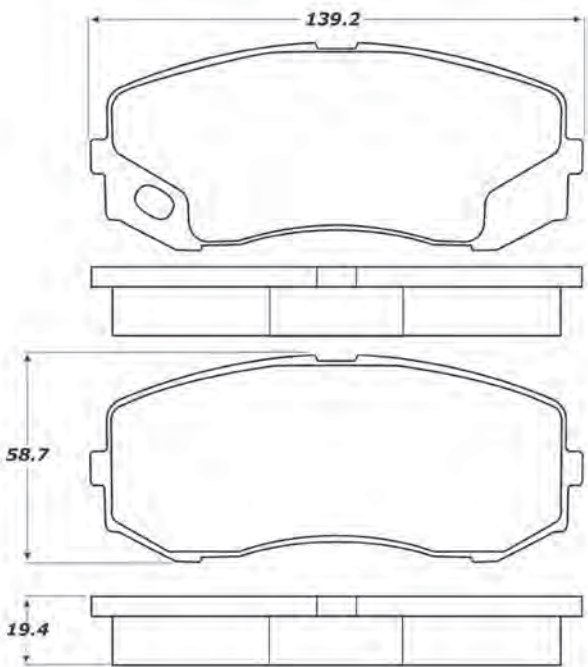
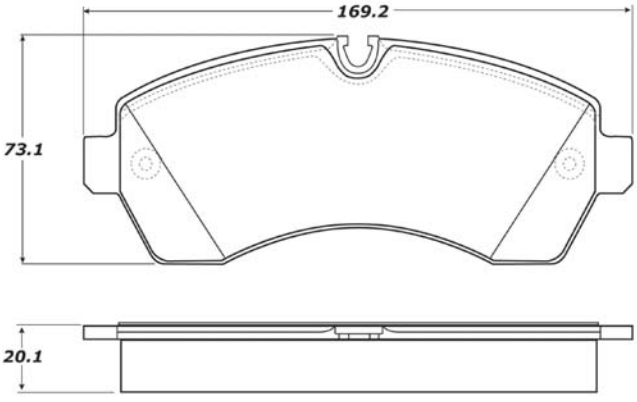
E110-1259-0	E110-1264-0
 <p style="text-align: center;">FMSI: 8378-D1259</p>	 <p style="text-align: center;">2 pads with wear sensor LH /RH FMSI: 8381-D1264</p>
E111-1265-0	E111-1268-0
 <p style="text-align: center;">8 pad set 2 pads with sensor hole LH /RH 6 pads plain FMSI: 8382-D1265</p>	 <p style="text-align: center;">FMSI: 8383-D1268</p>

# Brake Pads

**E110-1273-0, E111-1273-0**

2 pads with wear sensor LH /RH  
FMSI:  
8389-D1273 , 8439-D1327, 8703-D1327, 8481-D1327

**E109-1274-0**

2 pads with wear sensor LH /RH  
FMSI:  
8390-D1274

**E110-1275-0**

2 pads with wear sensor LH /RH  
FMSI:  
8391-D1275

**E111-1278-0**

FMSI:  
8394-D1278

**E111-1279-0**

Technical drawing of brake pad E111-1279-0. It includes three views: a top view showing a width of 166.1 and a height of 60.0; a side view showing a thickness of 21.0; and a rear view showing a height of 53.3 and a thickness of 19.9. The drawing shows a central mounting tab and two side tabs.

FMSI:  
8395-D1279

**E110-1286-0**

Technical drawing of brake pad E110-1286-0. It includes three views: a top view showing a width of 169.9 and a height of 62.7; a side view showing a thickness of 17.9; and a rear view showing a height of 62.7 and a thickness of 17.9. The drawing shows a central mounting tab and two side tabs.

2 pads with wear sensor LH /RH  
FMSI:  
8403-D1286

**E110-1303-0**

Technical drawing of brake pad E110-1303-0. It includes three views: a top view showing a width of 143.8 and a height of 83.2; a side view showing a thickness of 17.9; and a rear view showing a height of 83.2 and a thickness of 17.9. The drawing shows a central mounting tab and two side tabs.

FMSI:  
8419-D1303

**E110-1304-0**

Technical drawing of brake pad E110-1304-0. It includes two views: a top view showing a width of 116.3 and a height of 44.5; and a side view showing a thickness of 17.3. The drawing shows a central mounting tab and two side tabs.

FMSI:  
8420-D1304



# Brake Pads

E109-1316-0

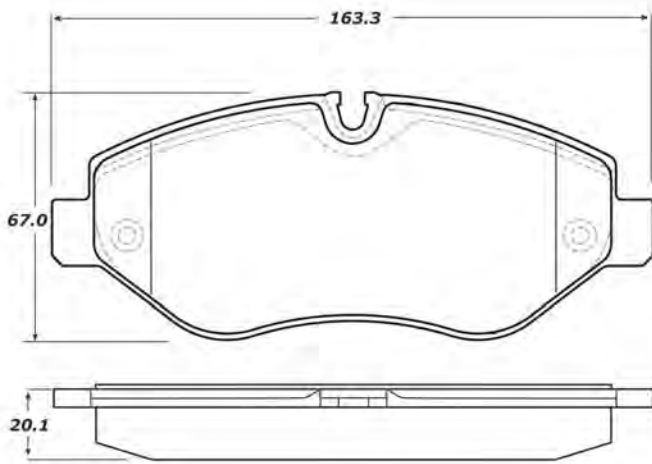

FMSI:  
8430-D1316

E109-1317-0

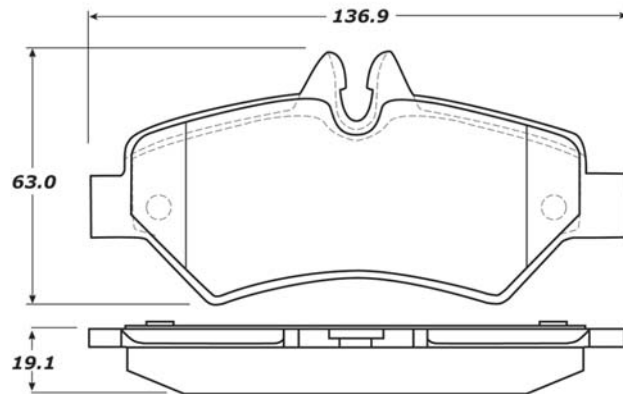

FMSI:  
8431-D1317

E109-1318-0

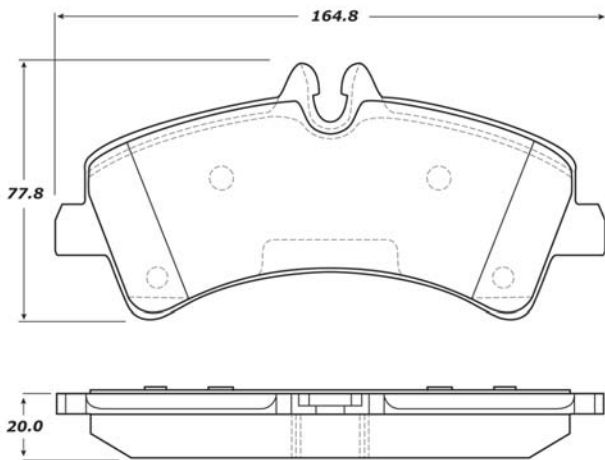

FMSI:  
8432-D1318

E110-1324-0

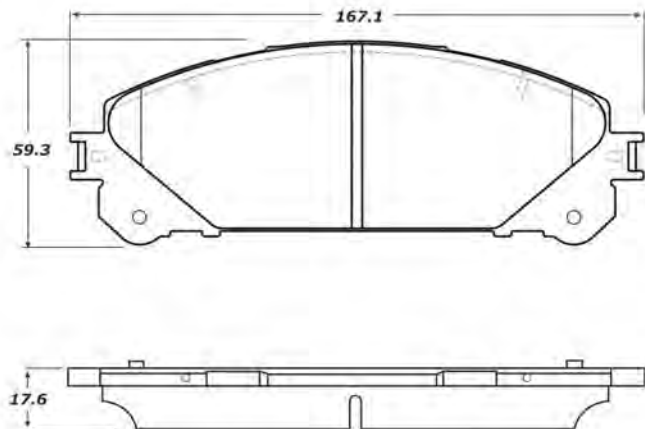

FMSI:  
8436-D1324

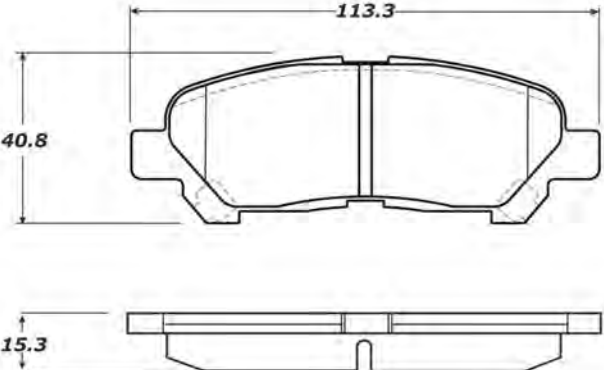
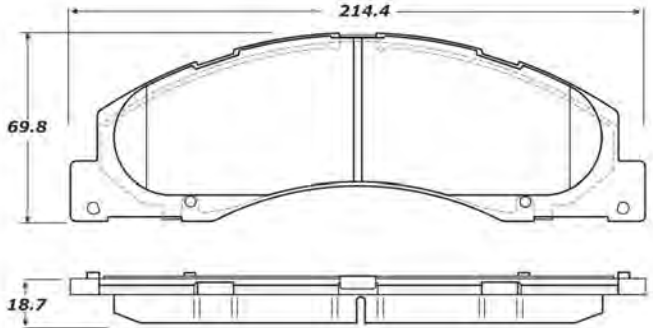
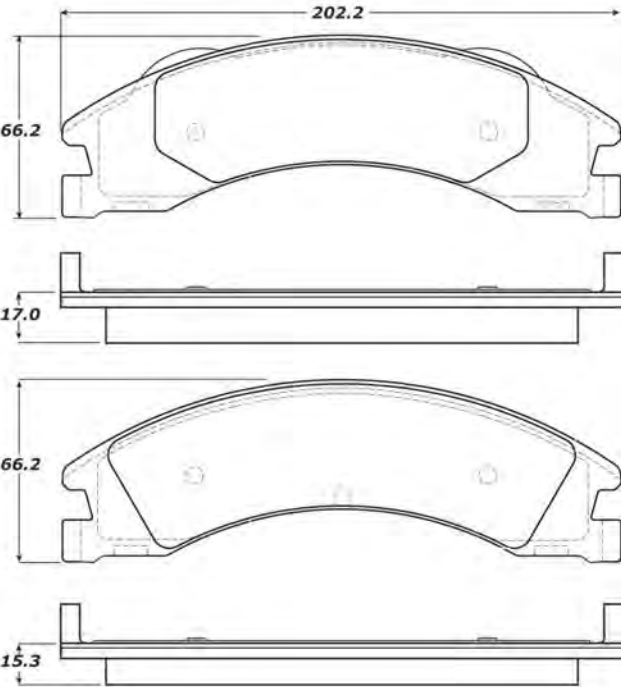
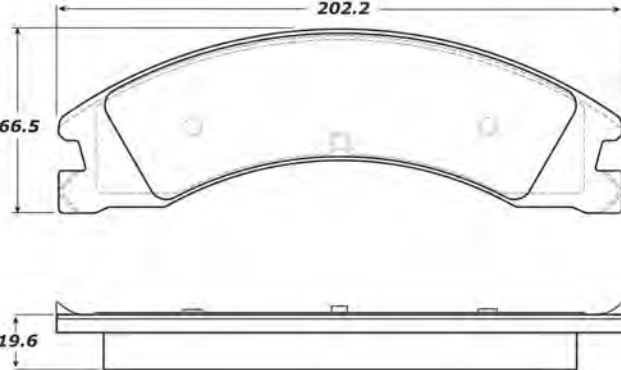
E110-1325-0	E111-1328-0
 <p>FMSI: 8437-D1325</p>	 <p>FMSI: 8440-D1328</p>
E111-1329-0	E111-1330-0
 <p>FMSI: 8441-D1329</p>	 <p>FMSI: 8442-D1330</p>

# Brake Pads

E111-1334-0

E111-1335-0

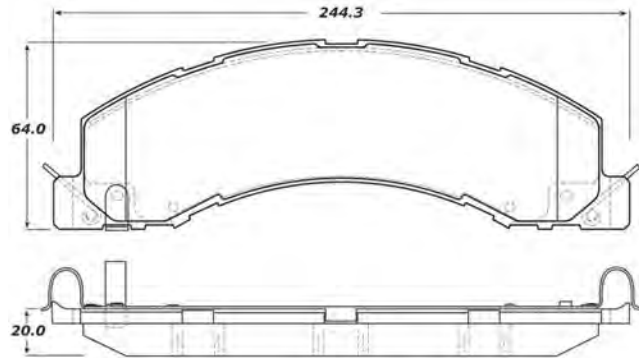
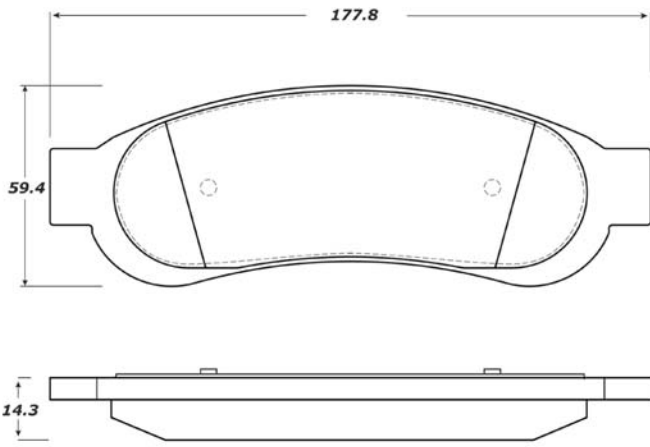

FMSI:  
8652-1334

FMSI:  
8446-D1335

E110-1338-0

E110-1352-0

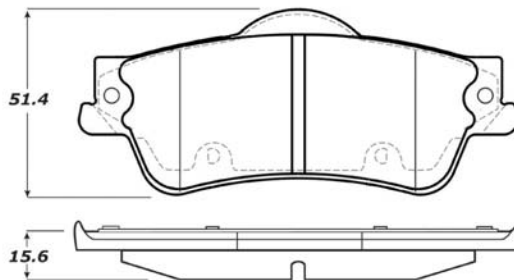
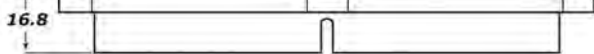
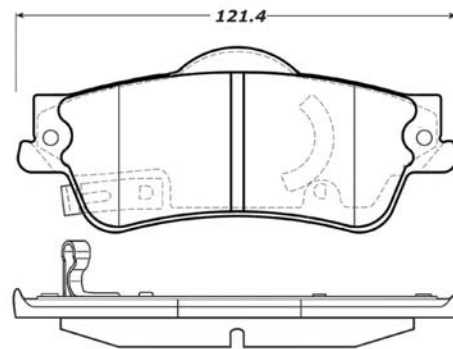
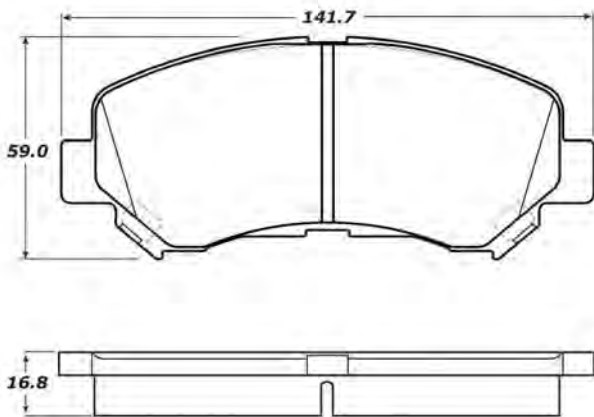

FMSI:  
8449-D1338

FMSI:  
8462-D1352

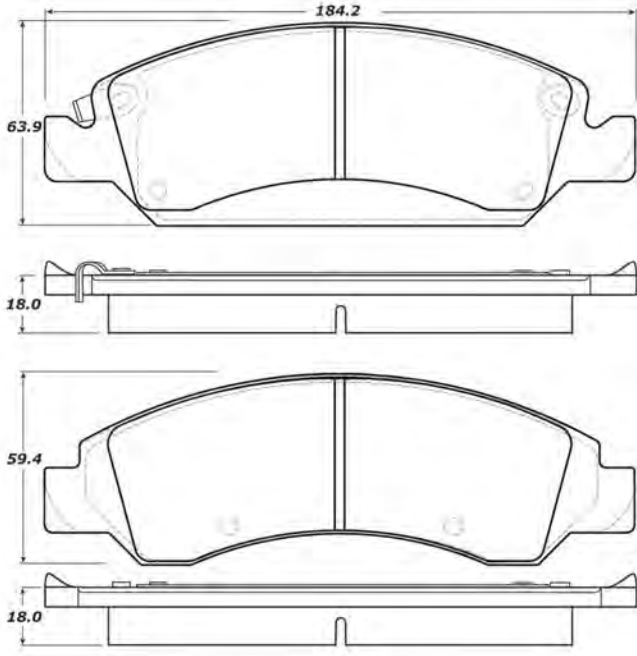
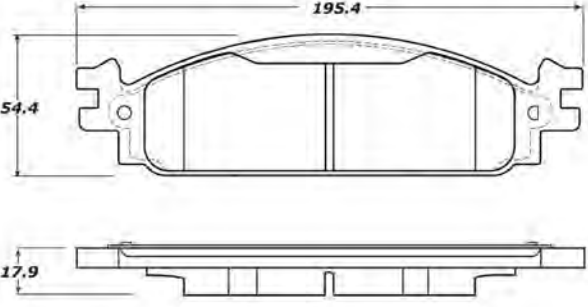
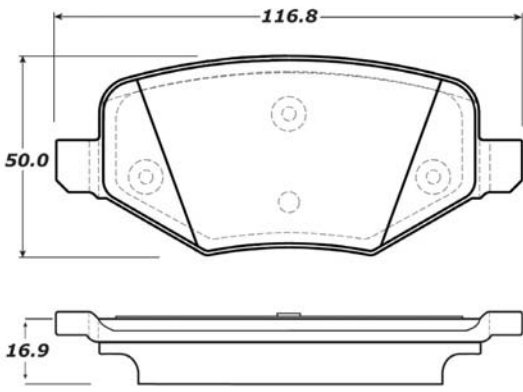
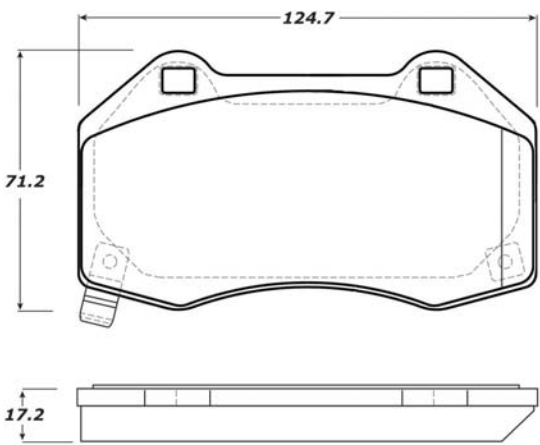
E110-1363-0	E111-1376-0
 <p>2 pads with wear sensor LH /RH FMSI: 8472-D1363 , 8472-D1367, 8803-D1363</p>	 <p>FMSI: 8487-D1376</p>
E110-1377-0	E109-1379-0
 <p>FMSI: 8488-D1377</p>	 <p>2 pads with LH Chambers 2 pads with RH Chambers 4 pads with wear sensor FMSI: 8489-D1379</p>

# Brake Pads

**E110-1391-0**

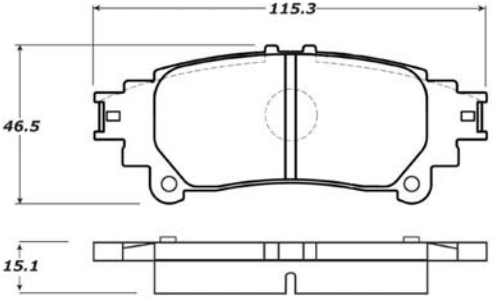

FMSI:  
8500-D1391, 8809, D1391

**E111-1392-0**

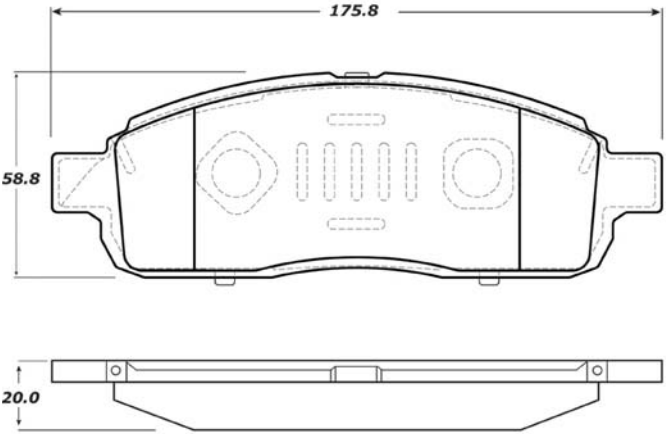

FMSI:  
7915-D1392

**E111-1399-0**

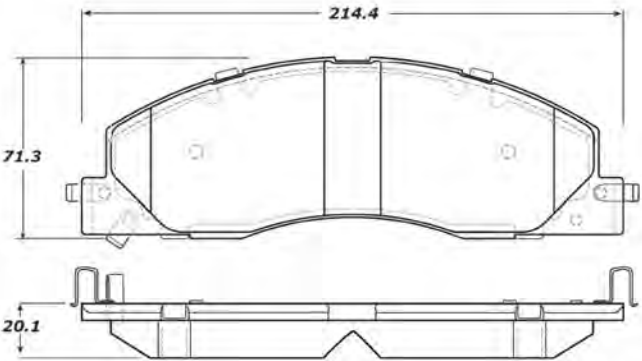

FMSI:  
8507-D1399

**E111-1400-0**

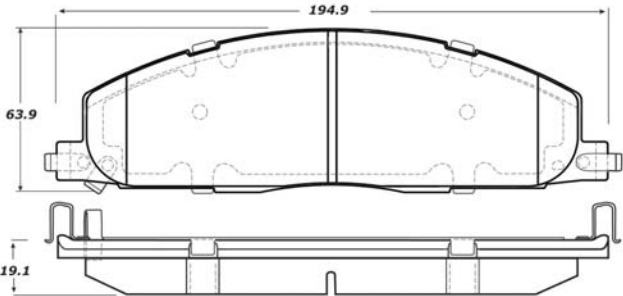

FMSI:  
8508-D1400

**E109-1404-0**

FMSI:  
8512-D1404, 8769-D1557

**E110-1411-0**

FMSI:  
8523-D1411

**E110-1414-0, E111-1414-0**

FMSI:  
8528-D1414

**E110-1455-0**

2 pads with wear sensor LH /RH  
FMSI:  
8655-D1455

# Brake Pads

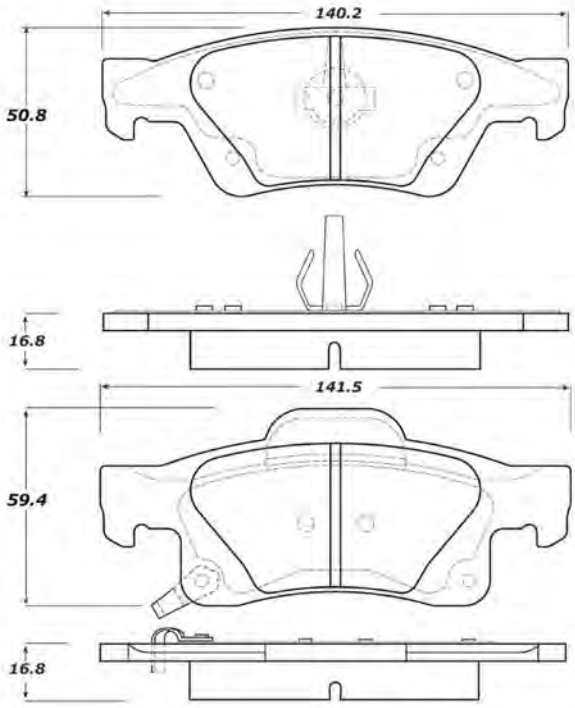
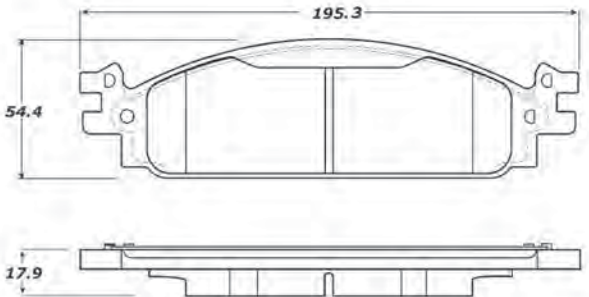
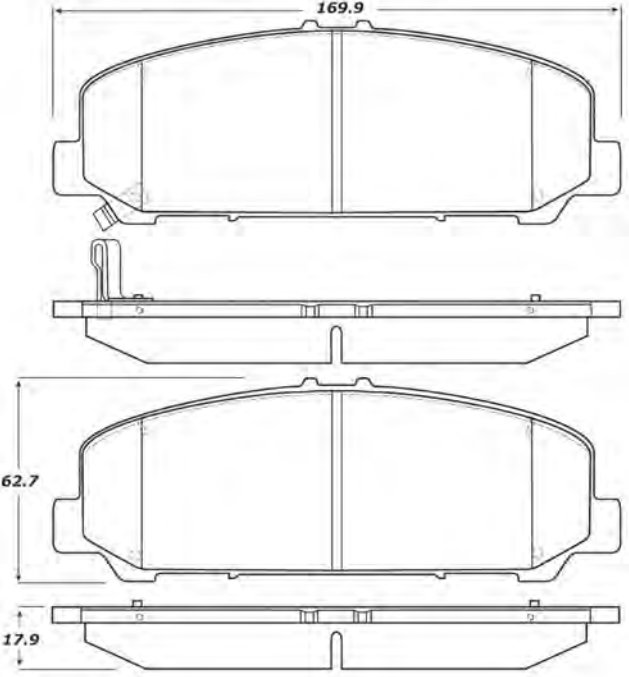
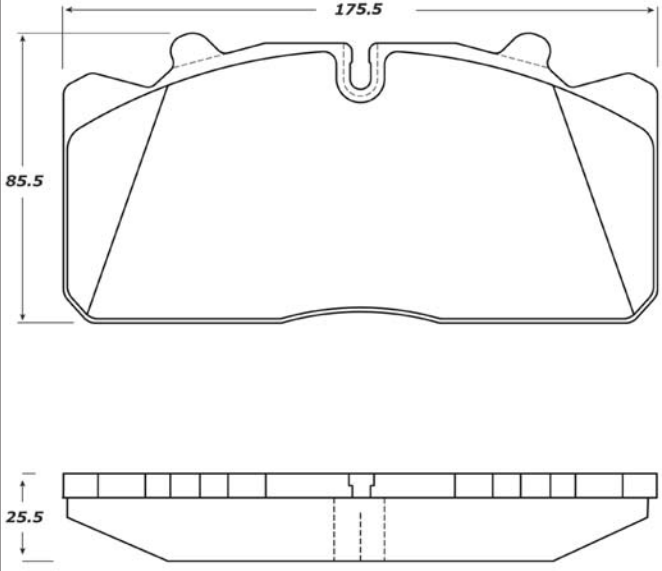
E110-1498-0	E110-1508-0,E111-1508-0
 <p>FMSI: 8698-D1498</p>	 <p>FMSI: 8715-D1508</p>
E110-1509-0	E111-1518-0
 <p>FMSI: 8403-D1509</p>	 <p>FMSI: 8727-D1518</p>



E110-1565-0

201.9

65.2

19.6

FMSI:  
8773-D1565

E110-1565-1

201.9

65.2

17.6

2 pads with wear sensor LH /RH  
FMSI:  
8774-D1565

E110-1589-0

130.0

45.2

16.6

FMSI:  
8800-D1589

E110-1596-0

130.0

55.2

16.6

FMSI:  
8811-D1596







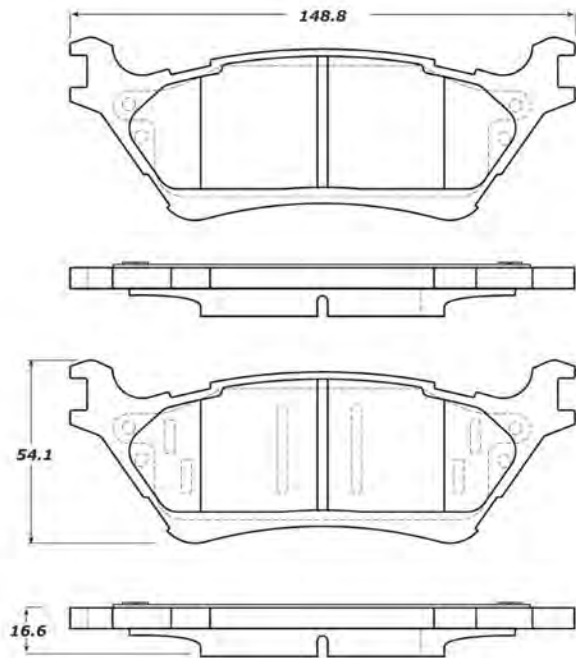







# Brake Pads

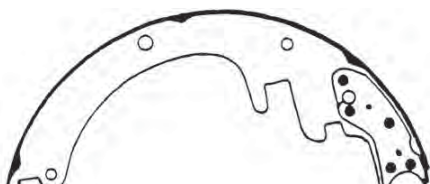
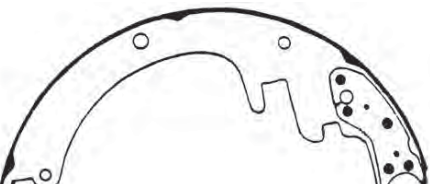
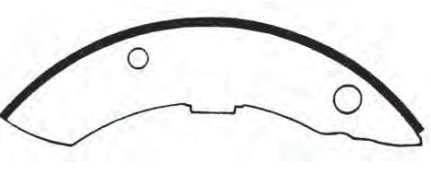



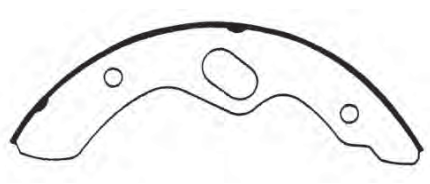

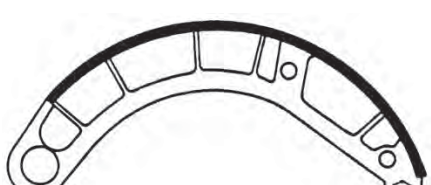

E110-1602-0



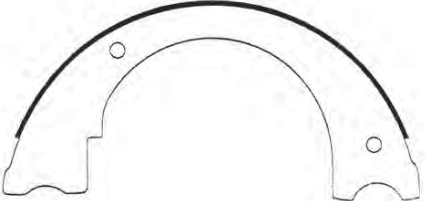

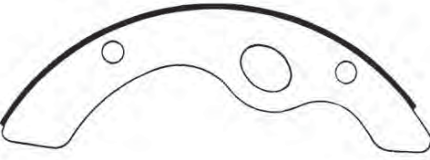
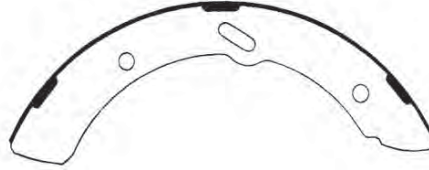
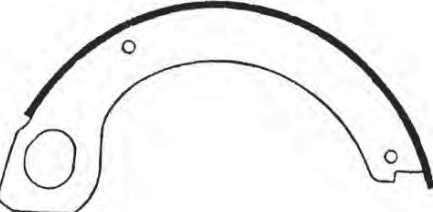

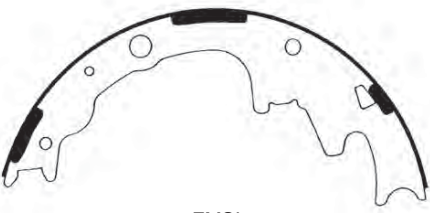
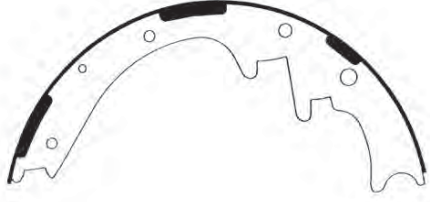
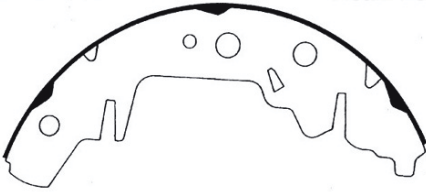

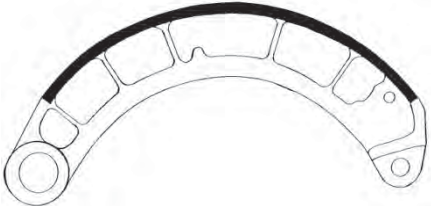

FMSI:  
8816-D1602

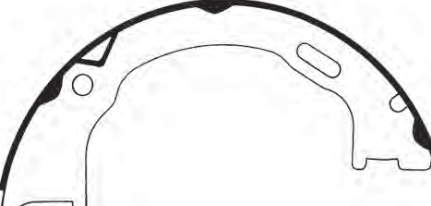
<p>E117-0346-0</p>  <p>FMSI: 1252-346</p>	<p>E117-0381-0</p>  <p>FMSI: 4596-381</p>	<p>E117-0383-0</p>  <p>FMSI: 4597-383</p>
<p>E117-0385-0</p>  <p>FMSI: 1254-385</p>	<p>E117-0386-0</p>  <p>FMSI: 1255-386</p>	<p>E117-0449-0</p>  <p>FMSI: 2159TT-449</p>
<p>E117-0451-0</p>  <p>FMSI: 2042AT-451, 2042BT-S655</p>	<p>E117-0452-0</p>  <p>FMSI: 2157T-418, 2157T-452, 2157AT-S656</p>	<p>E117-0544-0</p>  <p>FMSI: 4505A-544</p>
<p>E116-0599-0</p>  <p>FMSI: 1395-599</p>	<p>E117-0602-0</p>  <p>FMSI: 1410-602</p>	<p>E117-0603-0</p>  <p>FMSI: 1411-603</p>
<p>E117-0604-0</p>  <p>FMSI: 1412-604</p>	<p>E117-0612-0</p>  <p>FMSI: 1416-S612</p>	<p>E117-0613-0</p>  <p>FMSI: 1418-S613</p>

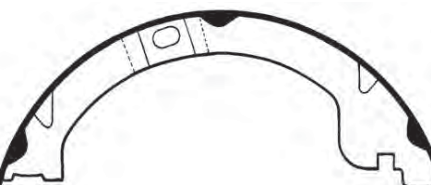
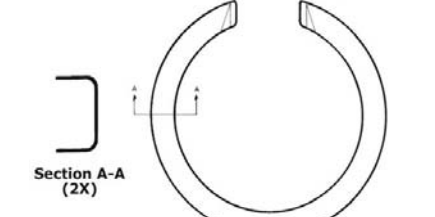



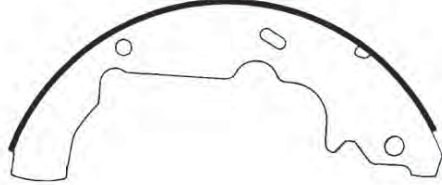
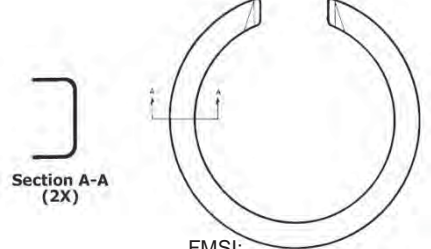
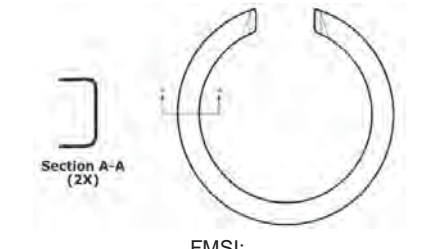
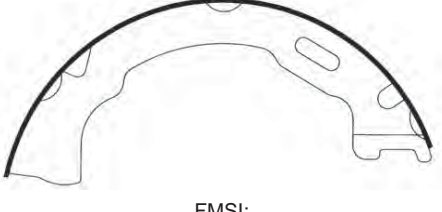





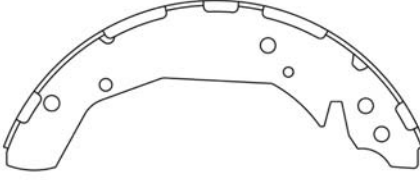
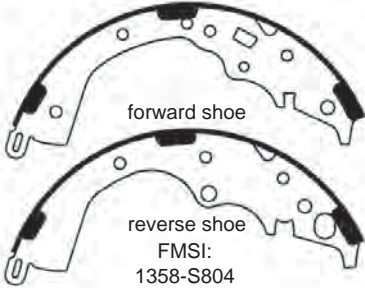

# Brake Shoes

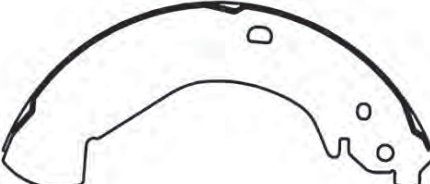



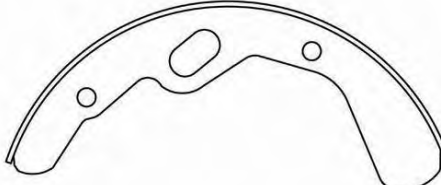

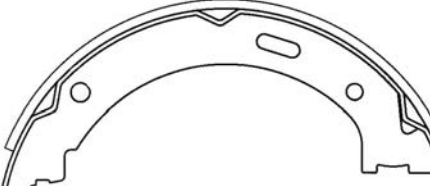



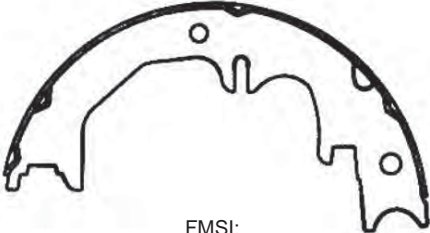

<p>E117-0614-0</p>  <p>FMSI: 1419-S614</p>	<p>E117-0617-0</p>  <p>FMSI: 1422-S617</p>	<p>E116-0636-0</p>  <p>2 shoes with pin FMSI: 1394-S636, 1487-S636</p>
<p>E116-0647-0</p>  <p>FMSI: 2086-S647</p>	<p>E117-0669-0</p>  <p>FMSI: 1455-S669</p>	<p>E117-0672-0</p>  <p>FMSI: 1458-S672</p>
<p>E117-0679-0</p>  <p>FMSI: 1464-S679</p>	<p>E117-0682-0</p>  <p>FMSI: 1467-S682</p>	<p>E116-0692-0</p>  <p>FMSI: 2079-S692</p>
<p>E117-0695-0</p>  <p>FMSI: 1478-S695</p>	<p>E117-0699-0</p>  <p>FMSI: 1482-S699</p>	<p>E116-0704-0</p>  <p>FMSI: 2180T-S704, 2185T-S704</p>
<p>E116-0705-0</p>  <p>FMSI: 2089AT-S705, 2184T-S705</p>	<p>E116-0714-0</p>  <p>FMSI: 1485TT-S703, 1485ATT-S714</p>	<p>E117-0717-0</p>  <p>FMSI: 1464-S717</p>

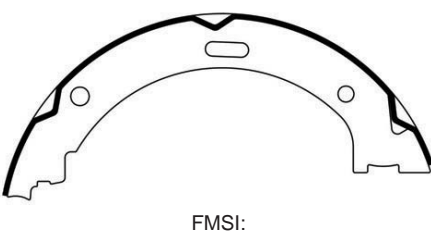
E117-0718-0	E117-0727-0	E116-0733-0
 <p>FMSI: 1418-S718</p>	 <p>FMSI: 1498-S727</p>	 <p>FMSI: 2183-S733</p>
E116-0745-0	E116-0752-0	E116-0760-0
 <p>FMSI: 1484-S745</p>	 <p>FMSI: 1517-S752</p>	 <p>2 shoes with pin (LH/RH) FMSI: 1524-S760</p>
E116-0761-0	E116-0770-0	E116-0771-0
 <p>FMSI: 2187-S761</p>	 <p>Section A-A (2X) FMSI: 2191-S770, 2191-S925</p>	 <p>parking brake shoe FMSI: 2192-S771</p>
E116-0772-0	E116-0777-0	E116-0780-0
 <p>FMSI: 2193-S772</p>	 <p>FMSI: 2195-S777</p>	 <p>FMSI: 1500-S780</p>
E116-0781-0	E116-0784-0	E116-0791-0
 <p>Section A-A (2X) FMSI: 2196-S781</p>	 <p>Section A-A (2X) FMSI: 2199-S784</p>	 <p>FMSI: 1533-S791</p>



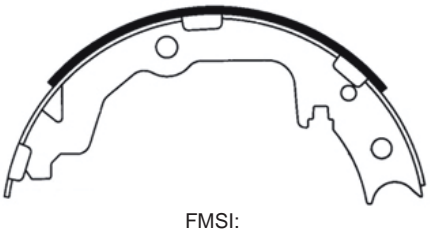

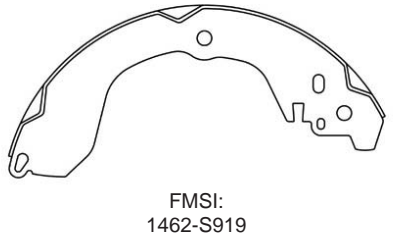
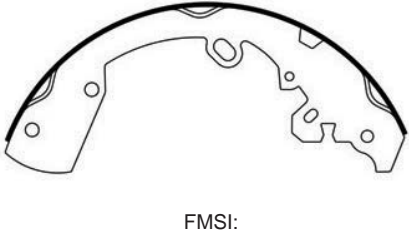







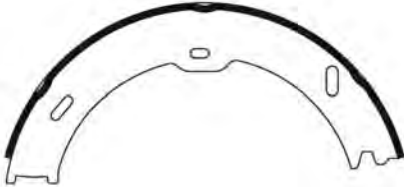

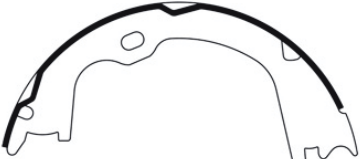
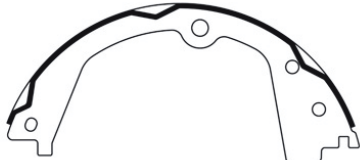
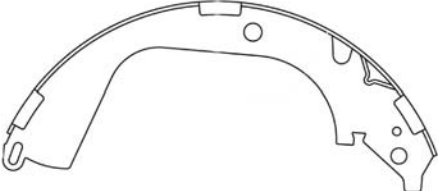
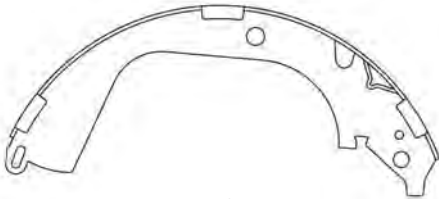

# Brake Shoes

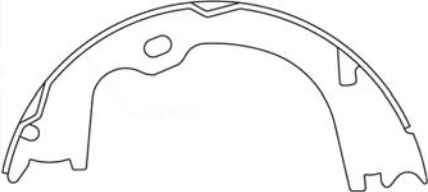
<p>E117-0792-0</p>  <p>FMSI: 1534-S792</p>	<p>E116-0795-1</p>  <p>FMSI: 1535-S795</p>	<p>E116-0800-1</p>  <p>FMSI: 1540-S800</p>
<p>E116-0804-0</p>  <p>forward shoe reverse shoe FMSI: 1358-S804</p>	<p>E116-0809-0</p>  <p>FMSI: 2195-S809</p>	<p>E116-0811-0</p>  <p>FMSI: 1545-S811</p>
<p>E116-0815-1</p>  <p>FMSI: 1548-S815</p>	<p>E116-0823-0</p>  <p>FMSI: 1555T-823</p>	<p>E116-0824-0</p>  <p>FMSI: 1556-S824</p>
<p>E117-0833-0</p>  <p>FMSI: 4733-S833</p>	<p>E117-0834-0</p>  <p>FMSI: 4735-S834</p>	<p>E116-0842-0</p>  <p>Parking brake shoe FMSI: 1303A-S842</p>
<p>E116-0843-0</p>  <p>FMSI: 1573-S843</p>	<p>E116-0844-0</p>  <p>Parking brake shoe FMSI: 1574-S844</p>	<p>E116-0847-0</p>  <p>Parking brake shoe FMSI: 1577-S847</p>

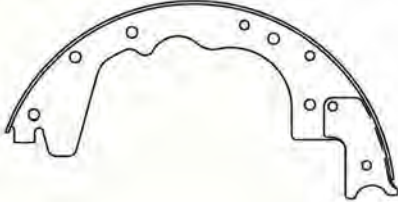
<p>E116-0850-0</p>  <p>FMSI: 1580-S850</p>	<p>E116-0851-0</p>  <p>Parking brake shoe FMSI: 1576-S846, 1576-S851</p>	<p>E116-0852-0</p>  <p>Parking brake shoe FMSI: 1581-S852</p>
<p>E116-0854-0</p>  <p>Parking brake shoe FMSI: 2192-S854</p>	<p>E116-0855-0</p>  <p>Parking brake shoe FMSI: 1583-S855</p>	<p>E116-0868-0</p>  <p>FMSI: 1543-S868</p>
<p>E116-0869-0</p>  <p>FMSI: 1592-S869</p>	<p>E116-0877-0</p>  <p>FMSI: 1598-S877</p>	<p>E116-0880-0</p>  <p><i>Park brake shoe</i></p> <p>FMSI: 2203-S880</p>
<p>E116-0886-1</p>  <p>FMSI: 2175-S886</p>	<p>E116-0908-0</p>  <p>FMSI: 1615-S908</p>	<p>E116-0916-0</p>  <p>Parking brake shoe FMSI: 1620-S916</p>
<p>E116-0919-0</p>  <p>FMSI: 1462-S919</p>	<p>E116-0922-0</p>  <p>FMSI: 1582-S922</p>	<p>E116-0932-0</p>  <p>Parking brake shoe FMSI: 1627-S932</p>

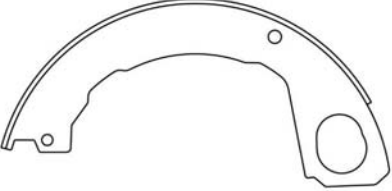
# Brake Shoes

<p>E116-0933-0</p>  <p>Parking brake shoe            FMSI:            1628-S933</p>	<p>E116-0936-0</p>  <p>FMSI:            1629-S936</p>	<p>E116-0938-0</p>  <p>FMSI:            1595-S938</p>
<p>E116-0940-0</p>  <p>FMSI:            1632-S940</p>	<p>E116-0941-0</p>  <p>Parking brake shoe            FMSI:            1580-S941</p>	<p>E116-0943-0</p>  <p>FMSI:            1634-S943</p>
<p>E116-0947-0</p>  <p>FMSI:            1637-S947</p>	<p>E116-0952-0</p>  <p>Parking brake shoe            FMSI:            1640-S952</p>	<p>E116-0959-0</p>  <p>FMSI:            1643-S959</p>
<p>E116-0960-0</p>  <p>FMSI:            1644-S960</p>	<p>E116-0961-0</p>  <p>Parking brake shoe            FMSI:            1645-S961</p>	<p>E116-0962-0</p>  <p>FMSI:            2192-S962</p>
<p>E116-0973-0</p>  <p>Parking brake shoe            FMSI:            1640-S973</p>	<p>E116-0974-0</p>  <p>FMSI:            1651-S974</p>	<p>E116-0978-0</p>  <p>FMSI:            1653-S978</p>

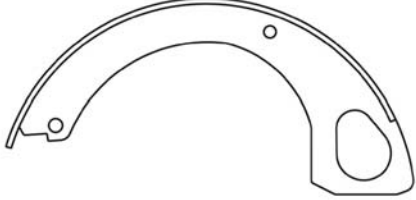
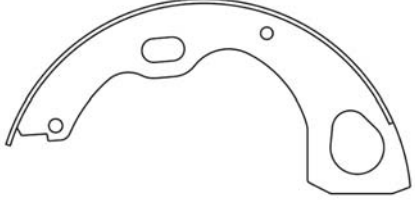
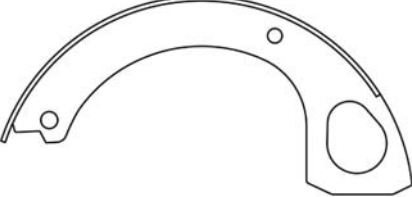
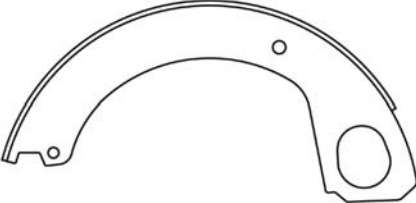
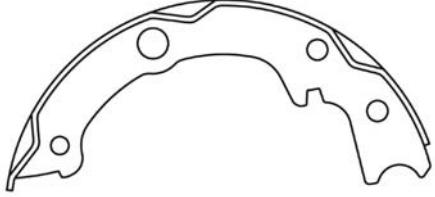
E116-0979-0	E116-0980-0	E116-0986-0
 <p>Driveline Parking brake shoe FMSI: 1654-S979</p>	 <p>Parking brake shoe FMSI: 1653-S980</p>	 <p>Parking brake shoe FMSI: 1659-S986</p>
E116-0989-0	E116-1007-0	E116-1008-0
 <p>Parking brake shoe FMSI: 1640-S989</p>	 <p>FMSI: 1676-S1007</p>	 <p>FMSI: 1677-S1008</p>
E116-1009-0	E116-1013-0	E116-1014-0
 <p>FMSI: 1678-S1009</p>	 <p>FMSI: 1682-S1013</p>	 <p>FMSI: 1683-S1014</p>





# NOTES



---

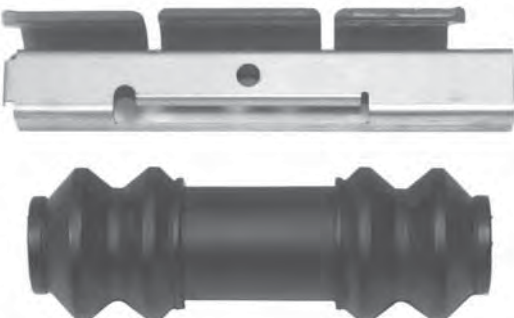
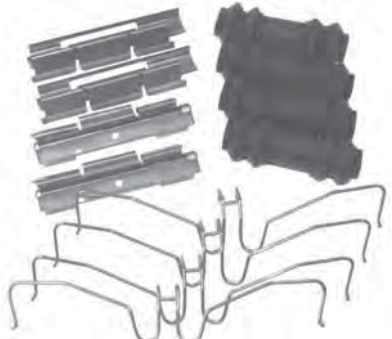
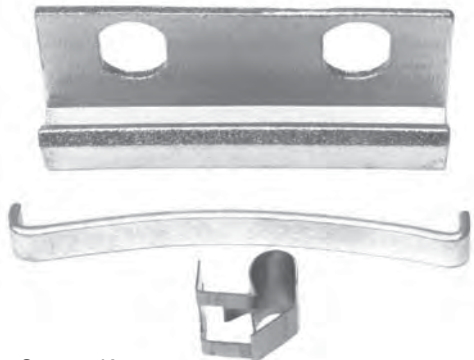

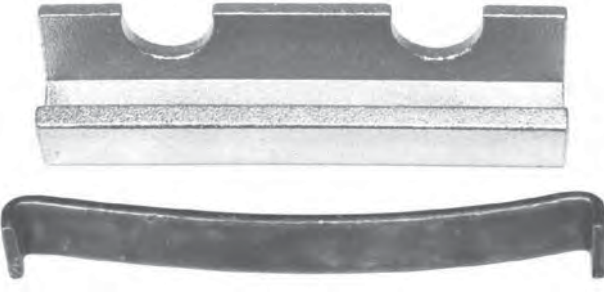

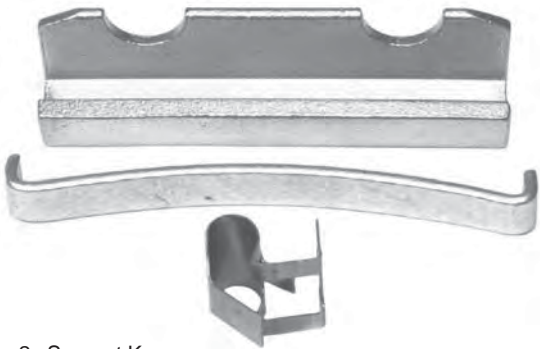
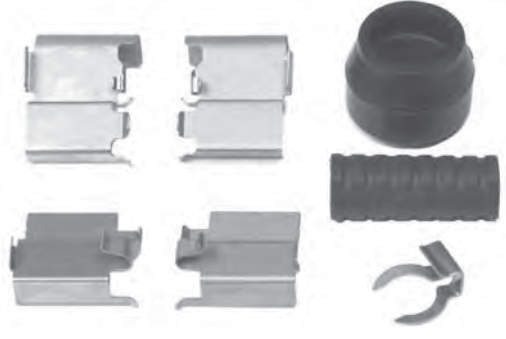
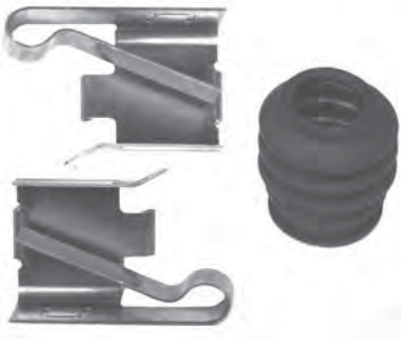
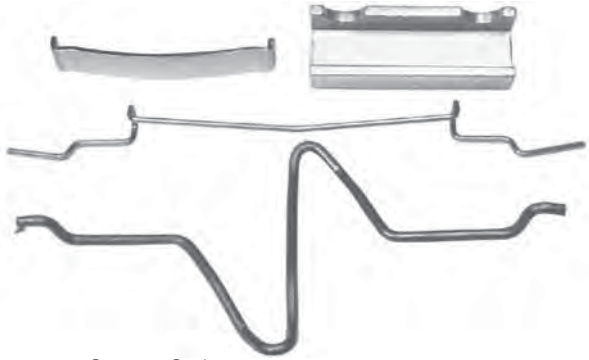

---

**HAVE QUESTIONS? NEED ASSISTANCE? TALK TO THE FORMULA BLUE® TECH LINE.  
Call 1-866-610-9709, option 2  
Representatives are available Monday – Friday, 8:00 a.m. – 8:30 p.m. EST.**



<p>E122-50-013</p>	<p>E122-70-020</p>
 <p>4x Left Pad Clips 4x Right Pad Clips</p>	 <p>4x Rubber Bushings 4x Pad Clips</p>
<p>E122-70-029</p>	<p>E122-71-007 (H5605)</p>
 <p>4x Pad Spreader Springs 4x Rubber Bushings 4x Pad Clips</p>	 <p>2x Support Keys 2x Spring Keys 2x Pad Clips</p>
<p>E122-71-011</p>	<p>E122-71-012</p>
 <p>2x Support Keys 2x Spring Keys</p>	 <p>2x Support Keys 2x Spring Keys</p>

# Hardware Kits

<p>E122-72-006</p>	<p>E122-79-006</p>
 <p>2x Support Keys 2x Spring Keys 2x Pad Clips</p>	 <p>4x Left in-Board Pad Clips 4x Right In-Board Pad Clips 4x Left Out-Board Pad Clips 4x Right Out-Board Pad Clips 4x Guide Pin Bushings 8x Rubber Bushings 2x Pin Clips</p>
<p>E122-81-007</p>	<p>E122-84-006</p>
 <p>4x Left Pad Clips 4x Right Pad Clips 4x Rubber Bushings</p>	 <p>4x Support Springs 2x Pad Retaining Spring 2x Support Keys 2x Spring Key</p>
<p>E122-84-008</p>	<p>E122-84-009</p>
 <p>2x Pad Tensioner Springs 2x Support Keys 2x Bolts 2x Retainers</p>	 <p>4x Retainers 8x Bolts</p>

<p>E122-84-010</p>	<p>E122-84-011</p>
 <p>2x Pad Retainers 4x Bolts</p>	 <p>8x Shims</p>
<p>E122-84-012 (H5663)</p>	<p>E122-85-006</p>
 <p>10 x Shims</p>	 <p>4x Pad Slipper Plates 2 Pad Retainers 2x Bolts 4x Allen Bolts</p>
<p>E122-85-007</p>	<p>E122-85-009</p>
 <p>4x Pad Clips 4x Rubber Bushings</p>	 <p>6x Shims 2x Spring Key 2x Support Key</p>

# Hardware Kits

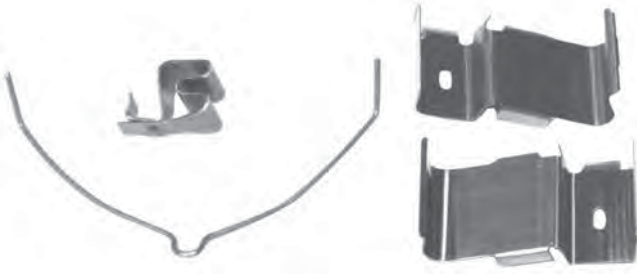
<p>E122-88-006</p>	<p>E122-90-006</p>
 <p>4x Pad Slipper Plates 4x Rubber Bushings 2x Guide Pin Rubber Bushings 4x Guide Pins 4x Bolts</p>	 <p>4x Pad Clips 4x Rubber Bushings 4x Rubber Caps</p>
<p>E122-81-019</p>	
 <p>4x Spreader Springs 4x Left Pad Clips 4x Right Pad Clips 4x Wear Indicators</p>	

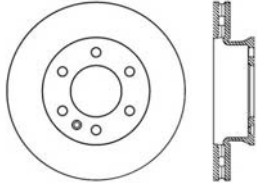
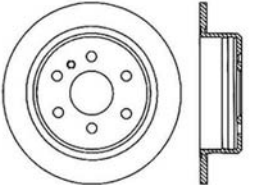
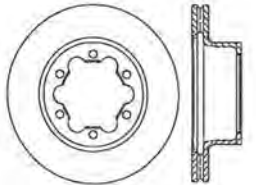
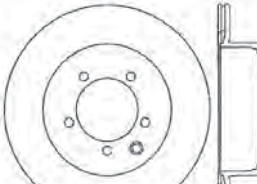
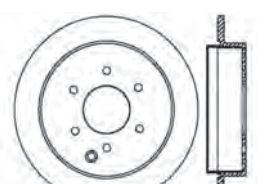
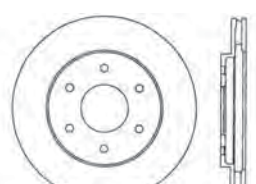
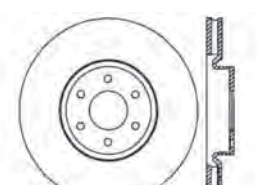
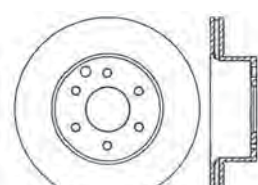
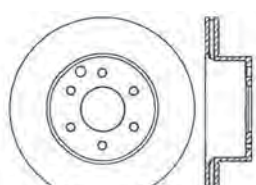
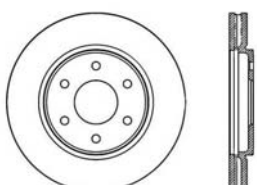
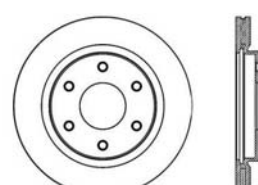
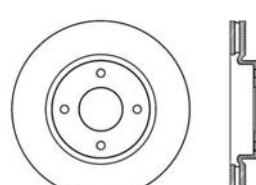
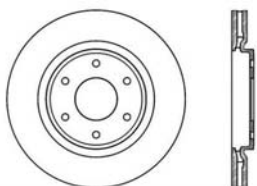
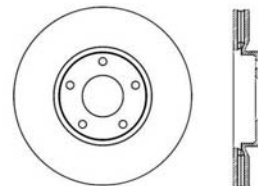
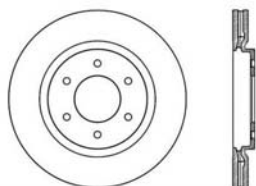
<p>E130-40-111</p>  <p>Outer Dia: 299.6mm    Hub Reg: 85.0mm Height: 68.4mm    Bolt Size: 15.3mm Nom. Thick: 28.00mm    Bolt Circle: 6x130.2mm Min. Thick: 25.00mm    Weight: 20.20 lbs</p>	<p>E130-40-112</p>  <p>Outer Dia: 298.0mm    Hub Reg: 85.0mm Height: 71.2mm    Bolt Size: 15.3mm Nom. Thick: 16.00mm    Bolt Circle: 6x130.2mm Min. Thick: 14.00mm    Weight: 15.90 lbs</p>	<p>E130-40-113</p>  <p>Outer Dia: 303.3mm    Hub Reg: 120.0mm Height: 93.0mm    Bolt Size: 15.0mm Nom. Thick: 28.0mm    Bolt Circle: 6x145.2mm Min. Thick: 25.0mm    Weight: 21.95 lbs</p>
<p>E125-47-082</p>  <p>Outer Dia: 291.8mm    Hub Reg: 68.00mm Height: 62.00mm    Bolt Size: 12.7mm Nom. Thick: 16.00mm    Bolt Circle: 5x114.3mm Min. Thick: 14.00mm    Weight: 12.00 lbs</p>	<p>E125-47-086</p>  <p>Outer Dia: 320.0mm    Hub Reg: 82.0mm Height: 58.0mm    Bolt Size: 13.4mm Nom. Thick: 14.00mm    Bolt Circle: 6x139.7mm Min. Thick: 12.00mm    Weight: 17.00 lbs</p>	<p>E125-47-089</p>  <p>Outer Dia: 320.0mm    Hub Reg: 82.2mm Height: 43.3mm    Bolt Size: 13.6mm Nom. Thick: 25.90mm    Bolt Circle: 6x139.7mm Min. Thick: 24.50mm    Weight: 18.00 lbs</p>
<p>E125-47-090</p>  <p>Outer Dia: 295.8mm    Hub Reg: 68.0mm Height: 38.2mm    Bolt Size: 12.8mm Nom. Thick: 28.00mm    Bolt Circle: 6x114.3mm Min. Thick: 26.00mm    Weight: 18.35 lbs</p>	<p>E125-47-091</p>  <p>Outer Dia: 307.7mm    Hub Reg: 68.0mm Height: 62.8mm    Bolt Size: 12.8mm Nom. Thick: 18.00mm    Bolt Circle: 6x114.3mm Min. Thick: 16.00mm    Weight: 14.40 lbs</p>	<p>E125-47-092</p>  <p>Outer Dia: 285.5mm    Hub Reg: 68.0mm Height: 61.9mm    Bolt Size: 12.8mm Nom. Thick: 18.00mm    Bolt Circle: 6x114.3mm Min. Thick: 16.00mm    Weight: 11.80 lbs</p>
<p>E125-47-094</p>  <p>Outer Dia: 282.7mm    Hub Reg: 68.0mm Height: 38.5mm    Bolt Size: 12.7mm Nom. Thick: 28.00mm    Bolt Circle: 6x114.3mm Min. Thick: 26.00mm    Weight: 16.15 lbs</p>	<p>E125-47-095</p>  <p>Outer Dia: 320.0mm    Hub Reg: 82.1mm Height: 43.4mm    Bolt Size: 13.4mm Nom. Thick: 26.00mm    Bolt Circle: 6x139.7mm Min. Thick: 24.50mm    Weight: 20.80 lbs</p>	<p>E125-47-096</p>  <p>Outer Dia: 280.0mm    Hub Reg: 68.0mm Height: 44.1mm    Bolt Size: 12.8mm Nom. Thick: 24.00mm    Bolt Circle: 4x114.3mm Min. Thick: 22.00mm    Weight: 14.90 lbs</p>
<p>E125-47-099</p>  <p>Outer Dia: 350.0mm    Hub Reg: 82.1mm Height: 43.3mm    Bolt Size: 13.4mm Nom. Thick: 30.00mm    Bolt Circle: 6x140.0mm Min. Thick: 28.50mm    Weight: 28.45 lbs</p>	<p>E125-47-102</p>  <p>Outer Dia: 295.8mm    Hub Reg: 68.0mm Height: 44.0mm    Bolt Size: 12.7mm Nom. Thick: 26.00mm    Bolt Circle: 5x114.3mm Min. Thick: 24.00mm    Weight: 16.20 lbs</p>	<p>E125-47-104</p>  <p>Outer Dia: 350.0mm    Hub Reg: 90.1mm Height: 43.1mm    Bolt Size: 13.5mm Nom. Thick: 30.00mm    Bolt Circle: 6x139.7mm Min. Thick: 28.50mm    Weight: 28.50 lbs</p>

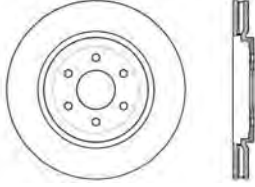
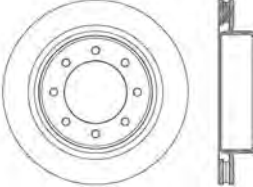
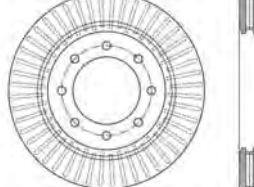
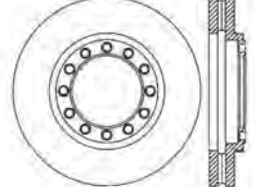
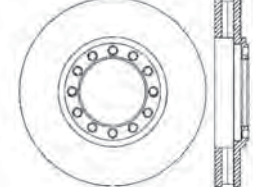
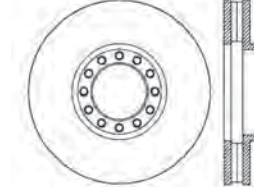
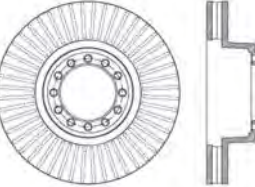
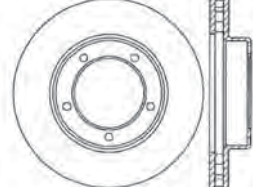
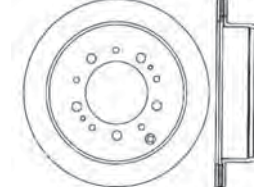
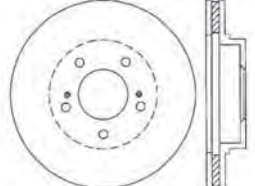
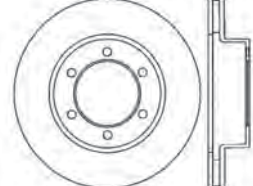
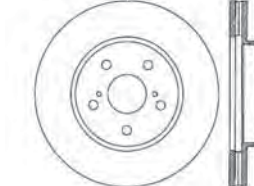
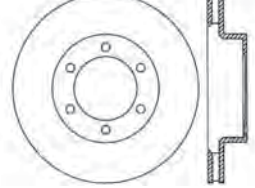
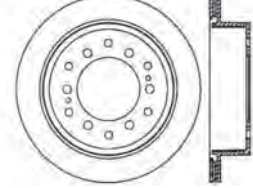
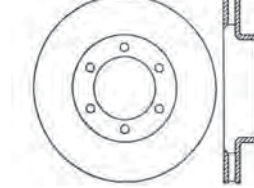

# Brake Rotors

<p>E125-47-107</p>  <p>Outer Dia: 320mm    Hub Reg: 68mm            Height: 38.2mm    Bolt Size: 12.8mm            Nom. Thick: 27.9mm    Bolt Circle: 6x114.3mm            Min. Thick: 26mm    Weight: 21.30 lbs</p>	<p>E125-47-114</p>  <p>Outer Dia: 364.0mm    Hub Reg: 123.0mm            Height: 91.40mm    Bolt Size: 14.70mm            Nom. Thick: 30.00mm    Bolt Circle: 8x165.3mm            Min. Thick: 28.50mm    Weight: 28.05 lbs</p>	<p>E125-47-115</p>  <p>Outer Dia: 360.0mm    Hub Reg: 123.0mm            Height: 96.0mm    Bolt Size: 14.70mm            Nom. Thick: 38.00mm    Bolt Circle: 8x165.3mm            Min. Thick: 36.50mm    Weight: 37.45 lbs.</p>
<p>E125-48-021</p>  <p>Outer Dia: 293.4mm    Hub Reg: 110mm            Height: 57.4mm    Bolt Size: 12.3mm            Nom. Thick: 40mm    Bolt Circle: 12x136mm            Min. Thick: 37mm    Weight: 26.75 lbs</p>	<p>E125-48-022</p>  <p>Outer Dia: 310.0mm    Hub Reg: 110.0mm            Height: 55.5mm    Bolt Size: 12.2mm            Nom. Thick: 42.00mm    Bolt Circle: 12x136.0mm            Min. Thick: 39.00mm    Weight: 27.00 lbs.</p>	<p>E125-48-024</p>  <p>Outer Dia: 363mm    Hub Reg: 110mm            Height: 100.0mm    Bolt Size: 12mm            Nom. Thick: 42.22mm    Bolt Circle: 12x136.6mm            Min. Thick: 39mm    Weight: 39.2 lbs</p>
<p>E125-48-025</p>  <p>Outer Dia: 363.0mm    Hub Reg: 110.0mm            Height: 100.5mm    Bolt Size: 12.00mm            Nom. Thick: 42.00mm    Bolt Circle: 12x136.0mm            Min. Thick: 39.00mm    Weight: 43.00 lbs.</p>	<p>E125-49-091</p>  <p>Outer Dia: 313.0mm    Hub Reg: 115.1mm            Height: 69.7mm    Bolt Size: 12.6mm            Nom. Thick: 32.0mm    Bolt Circle: 5x144. mm            Min. Thick: 30.0mm    Weight: 19.50 lbs.</p>	<p>E125-49-092</p>  <p>Outer Dia: 329.5mm    Hub Reg: 110.0mm            Height: 102.4mm    Bolt Size: 16.5mm            Nom. Thick: 18.0mm    Bolt Circle: 5x149. mm            Min. Thick: 16.0mm    Weight: 19.0 lbs.</p>
<p>E125-49-093</p>  <p>Outer Dia: 296mm    Hub Reg: 62mm            Height: 49.2mm    Bolt Size: 14.5mm            Nom. Thick: 28mm    Bolt Circle: 5x114.3mm            Min. Thick: 26mm    Weight: 17.00 lbs</p>	<p>E125-49-123</p>  <p>Outer Dia: 318.7mm    Hub Reg: 108.0mm            Height: 70.4mm    Bolt Size: 14.4mm            Nom. Thick: 28mm    Bolt Circle: 6x139.7mm            Min. Thick: 26mm    Weight: 21.00 lbs</p>	<p>E125-49-130</p>  <p>Outer Dia: 296.0mm    Hub Reg: 62.0mm            Height: 49.2mm    Bolt Size: 14.75mm            Nom. Thick: 28mm    Bolt Circle: 5x114.3mm            Min. Thick: 26mm    Weight: 17.00 lbs</p>
<p>E125-49-132</p>  <p>Outer Dia: 338.0mm    Hub Reg: 108.0mm            Height: 67.43mm    Bolt Size: 14.5mm            Nom. Thick: 27.5mm    Bolt Circle: 6x139.7mm            Min. Thick: 26mm    Weight: 20.50 lbs</p>	<p>E125-49-133</p>  <p>Outer Dia: 312.0mm    Hub Reg: 106.1mm            Height: 68.1mm    Bolt Size: 14.5mm            Nom. Thick: 18mm    Bolt Circle: 6x139.7mm            Min. Thick: 16mm    Weight: 14.00 lbs</p>	<p>E125-49-134</p>  <p>Outer Dia: 319.0mm    Hub Reg: 108.0mm            Height: 67.5mm    Bolt Size: 14.5mm            Nom. Thick: 28mm    Bolt Circle: 6x139.7mm            Min. Thick: 26mm    Weight: 18.50 lbs</p>

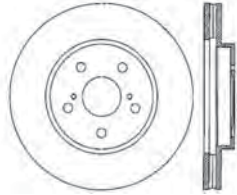
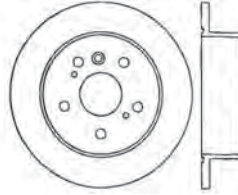
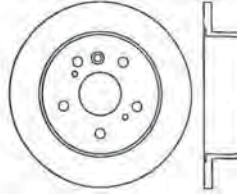
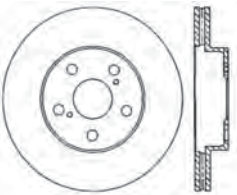
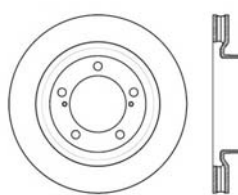
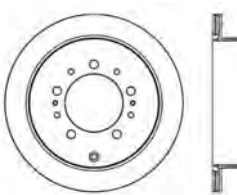
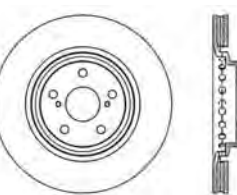
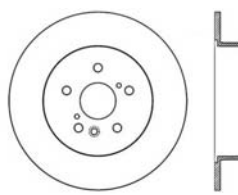
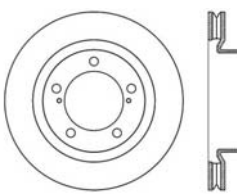
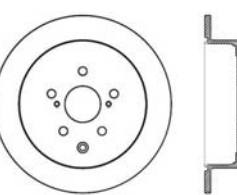
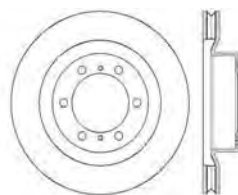
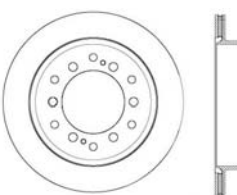
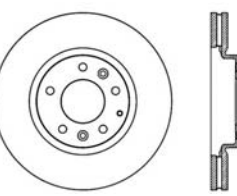
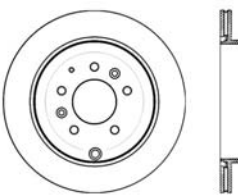
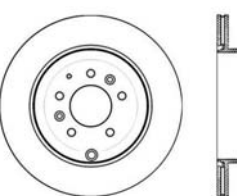
<p>E125-49-135</p>  <p>Outer Dia: 319mm    Hub Reg: 62.0mm Height: 49.3mm    Bolt Size: 14.5mm Nom. Thick: 28mm    Bolt Circle: 5x114.3mm Min. Thick: 26mm    Weight: 18.00 lbs</p>	<p>E125-49-136</p>  <p>Outer Dia: 288mm    Hub Reg: 62.0mm Height: 69.5mm    Bolt Size: 14.5mm Nom. Thick: 9.9mm    Bolt Circle: 5x114.3mm Min. Thick: 8.5mm    Weight: 11.50 lbs</p>	<p>E125-49-137</p>  <p>Outer Dia: 291mm    Hub Reg: 62mm Height: 68.5mm    Bolt Size: 14.5mm Nom. Thick: 12mm    Bolt Circle: 5x114.3mm Min. Thick: 10.5mm    Weight: 12.50 lbs</p>
<p>E125-49-141</p>  <p>Outer Dia: 275mm    Hub Reg: 62mm Height: 58.7mm    Bolt Size: 14.5mm Nom. Thick: 25.1mm    Bolt Circle: 5x114.5mm Min. Thick: 23mm    Weight: 14.50 lbs</p>	<p>E125-49-161</p>  <p>Outer Dia: 353.5mm    Hub Reg: 112.0mm Height: 83mm    Bolt Size: 16.3mm Nom. Thick: 32mm    Bolt Circle: 5x150mm Min. Thick: 29mm    Weight: 26.00 lbs</p>	<p>E125-49-162</p>  <p>Outer Dia: 345mm    Hub Reg: 112.0mm Height: 76mm    Bolt Size: 16.3mm Nom. Thick: 18mm    Bolt Circle: 5x150mm Min. Thick: 16mm    Weight: 18.10 lbs</p>
<p>E125-49-163</p>  <p>Outer Dia: 328mm    Hub Reg: 62.0mm Height: 49.4mm    Bolt Size: 4.5mm Nom. Thick: 28mm    Bolt Circle: 5x114.3mm Min. Thick: 25mm    Weight: 20.08 lbs</p>	<p>E125-49-164</p>  <p>Outer Dia: 308.8mm    Hub Reg: 62mm Height: 69.9mm    Bolt Size: 14.5mm Nom. Thick: 9.9mm    Bolt Circle: 5x114.3mm Min. Thick: 8.5mm    Weight: 13.30 lbs</p>	<p>E125-49-167</p>  <p>Outer Dia: 340.0mm    Hub Reg: 112.0mm Height: 83.20mm    Bolt Size: 16.6mm Nom. Thick: 32.00mm    Bolt Circle: 5x150mm Min. Thick: 29.00mm    Weight: 24.50 lbs.</p>
<p>E125-49-171</p>  <p>Outer Dia: 309.0mm    Hub Reg: 62.0mm Height: 62.5mm    Bolt Size: 14.5mm Nom. Thick: 10.0mm    Bolt Circle: 5x114.3mm Min. Thick: 8.5mm    Weight: 13.3 lbs</p>	<p>E125-49-179</p>  <p>Outer Dia: 338.0mm    Hub Reg: 108.0mm Height: 68.4mm    Bolt Size: 14.4mm Nom. Thick: 31.80mm    Bolt Circle: 6x138.4mm Min. Thick: 29.00mm    Weight: 21.80 lbs</p>	<p>E125-49-180</p>  <p>Outer Dia: 321.1mm    Hub Reg: 108.0mm Height: 68.10mm    Bolt Size: 14.40mm Nom. Thick: 18.00mm    Bolt Circle: 6x139.7 Min. Thick: 16.00mm    Weight: 14.10 lbs</p>
<p>E125-50-081</p>  <p>Outer Dia: 295.9mm    Hub Reg: 72mm Height: 48.4mm    Bolt Size: 13mm Nom. Thick: 28mm    Bolt Circle: 5x114.3mm Min. Thick: 26mm    Weight: 19.01 lbs</p>	<p>E125-50-082</p>  <p>Outer Dia: 301.7mm    Hub Reg: 72.0mm Height: 56.8mm    Bolt Size: 13.0mm Nom. Thick: 18.0mm    Bolt Circle: 5x114.3mm Min. Thick: 16.0mm    Weight: 15.30 lbs</p>	<p>E125-50-084</p>  <p>Outer Dia: 324.0mm    Hub Reg: 72.0mm Height: 56.0mm    Bolt Size: 13.0mm Nom. Thick: 18.0mm    Bolt Circle: 5x114.3mm Min. Thick: 16.0mm    Weight: 18.10 lbs</p>



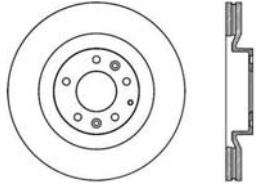
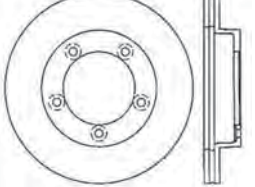
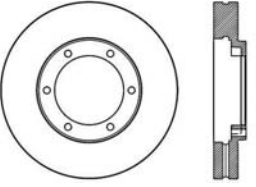
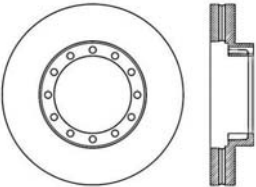
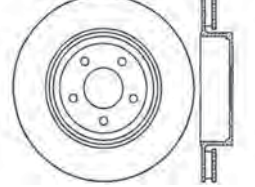
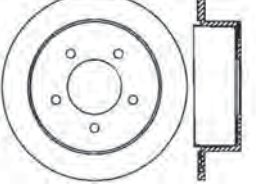
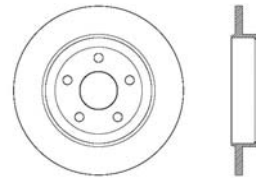
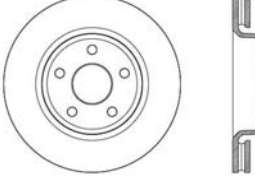
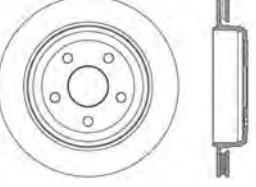
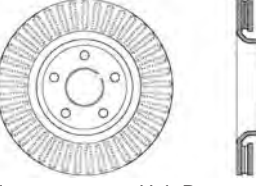
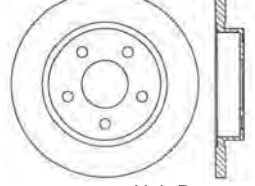
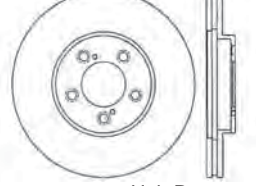
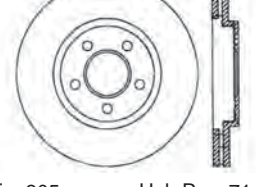
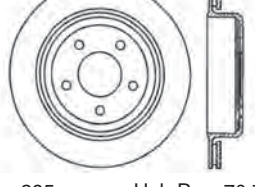
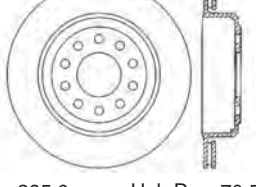

# Brake Rotors

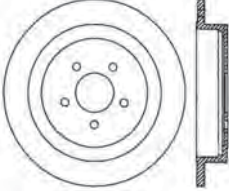
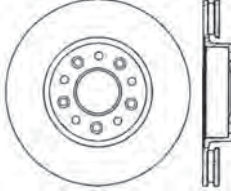
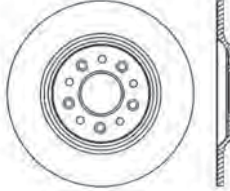
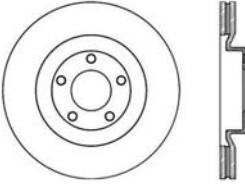
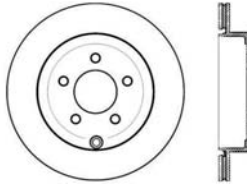
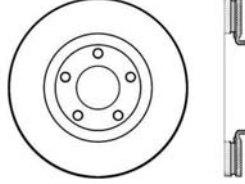
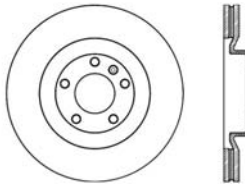
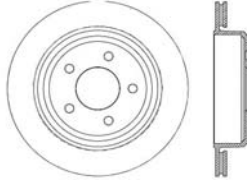
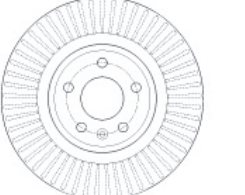
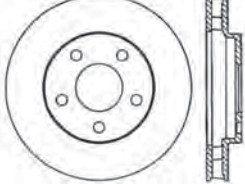
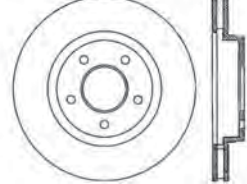
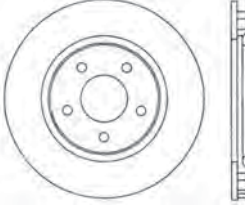
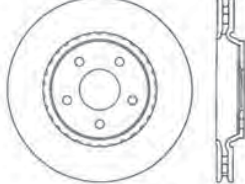
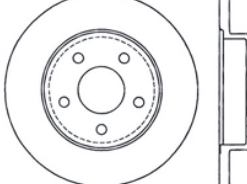
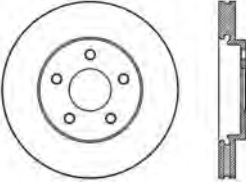
<p>E125-50-085</p>  <p>Outer Dia: 319.5mm Height: 48.0mm Nom. Thick: 28.0mm Min. Thick: 26.0mm</p> <p>Hub Reg: 72.0mm Bolt Size: 12.8mm Bolt Circle: 5x114.3mm Weight: 22.60 lbs</p>	<p>E125-51-060</p>  <p>Outer Dia: 288.0mm Height: 56.10mm Nom. Thick: 23.90mm Min. Thick: 22.00mm</p> <p>Hub Reg: 110.0mm Bolt Size: 12.2mm Bolt Circle: 5x136.0mm Weight: 15.5 lbs</p>	<p>E125-51-061</p>  <p>Outer Dia: 293mm Height: 53.9mm Nom. Thick: 40mm Min. Thick: 38mm</p> <p>Hub Reg: 114.0mm Bolt Size: 10x1.5mm Bolt Circle: 6x139.7mm Weight: 27.50 lbs</p>
<p>E125-51-064</p>  <p>Outer Dia: 293mm Height: 70.2mm Nom. Thick: 40mm Min. Thick: - mm</p> <p>Hub Reg: 124mm Bolt Size: 10.287mm Bolt Circle: 12x144.3mm Weight: 29.00 lbs</p>	<p>E125-63-006</p>  <p>Outer Dia: 327mm Height: 53mm Nom. Thick: 30mm Min. Thick: 28.5mm</p> <p>Hub Reg: 72mm Bolt Size: 16.24mm Bolt Circle: 5x126.8mm Weight: 22.00 lbs</p>	<p>E125-63-007</p>  <p>Outer Dia: 320mm Height: 66.4mm Nom. Thick: 14.1mm Min. Thick: 12.5mm</p> <p>Hub Reg: 71.9mm Bolt Size: 16.2mm Bolt Circle: 5x126.8mm Weight: 17.00 lbs</p>
<p>E125-63-010</p>  <p>Outer Dia: 330.0mm Height: 63.7mm Nom. Thick: 14.00mm Min. Thick: 12.50mm</p> <p>Hub Reg: 72.00mm Bolt Size: 17.0mm Bolt Circle: 5x127.0mm Weight: 17.50 lbs</p>	<p>E125-63-011</p>  <p>Outer Dia: 330.0mm Height: 54.5mm Nom. Thick: 32.00mm Min. Thick: 30.50mm</p> <p>Hub Reg: 72.0 mm Bolt Size: 17.00 mm Bolt Circle: 5x127.0mm Weight: 24.90 lbs</p>	<p>E125-63-012</p>  <p>Outer Dia: 330.0mm Height: 63.5mm Nom. Thick: 22.0mm Min. Thick: 20.50mm</p> <p>Hub Reg: 72.0mm Bolt Size: 17.0mm Bolt Circle: 5x127.0mm Weight: 18.00 lbs</p>
<p>E125-63-013</p>  <p>Outer Dia: 350.0mm Height: 54.5mm Nom. Thick: 31.90mm Min. Thick: 30.50mm</p> <p>Hub Reg: 72.0mm Bolt Size: 17.0mm Bolt Circle: 5x127.00mm Weight: 27.45 lbs</p>	<p>E125-66-044</p>  <p>Outer Dia: 256.2mm Height: 39.2mm Nom. Thick: 14.2mm Min. Thick: 12.75mm</p> <p>Hub Reg: 64.45mm Bolt Size: 14.6mm Bolt Circle: 5x108mm Weight: 10.50 lbs</p>	<p>E125-66-054</p>  <p>Outer Dia: 294mm Height: 46.6mm Nom. Thick: 26mm Min. Thick: 24.75mm</p> <p>Hub Reg: 71mm Bolt Size: 14.2mm Bolt Circle: 5x108mm Weight: 14.00 lbs</p>
<p>E125-66-077</p>  <p>Outer Dia: 305mm Height: 45mm Nom. Thick: 28mm Min. Thick: 26.35mm</p> <p>Hub Reg: 71.8mm Bolt Size: 16mm Bolt Circle: 5x114.3mm Weight: 21.50 lbs</p>	<p>E125-66-078</p>  <p>Outer Dia: 295mm Height: 58.6mm Nom. Thick: 19mm Min. Thick: 18mm</p> <p>Hub Reg: 70.7mm Bolt Size: 14.3mm Bolt Circle: 5x114.3mm Weight: 13.50 lbs</p>	<p>E125-66-080</p>  <p>Outer Dia: 295.0mm Height: 62.0 mm Nom. Thick: 19.0 mm Min. Thick: 18.0 mm</p> <p>Hub Reg: 70.5mm Bolt Size: 14mm Bolt Circle: 5x114.3mm Weight: 14.00 lbs</p>

<p>E125-66-081</p>  <p>Outer Dia: 333.8mm    Hub Reg: 70.7mm            Height: 56.3mm    Bolt Size: 14.1mm            Nom. Thick: 13.9mm    Bolt Circle: 5x114.3mm            Min. Thick: 12mm    Weight: 19.50 lbs</p>	<p>E125-66-085</p>  <p>Outer Dia: 315.0mm    Hub Reg: 68.0mm            Height: 47.0mm    Bolt Size: 14.34mm            Nom. Thick: 27.9mm    Bolt Circle: 5x114.3mm            Min. Thick: 26.5mm    Weight: 21.50 lbs</p>	<p>E125-66-086</p>  <p>Outer Dia: 330.0mm    Hub Reg: 68mm            Height: 37.5mm    Bolt Size: 14.34mm            Nom. Thick: 11.0mm    Bolt Circle: 5x114.3mm            Min. Thick: 10.0mm    Weight: 13.50 lbs</p>
<p>E125-66-095</p>  <p>Outer Dia: 320mm    Hub Reg: 72mm            Height: 48.3mm    Bolt Size: -            Nom. Thick: 28mm    Bolt Circle: 5x114.3mm            Min. Thick: 26mm    Weight: 22.50 lbs</p>	<p>E125-66-096</p>  <p>Outer Dia: 302.0mm    Hub Reg: 72.0mm            Height: 56.5mm    Bolt Size: 14.0mm            Nom. Thick: 18.0mm    Bolt Circle: 5x114.3mm            Min. Thick: 16.00mm    Weight: 15.00 lbs</p>	<p>E125-66-097</p>  <p>Outer Dia: 296.0mm    Hub Reg: 72.0mm            Height: 48.3mm    Bolt Size: 14.0mm            Nom. Thick: 28.0mm    Bolt Circle: 5x114.3mm            Min. Thick: 26.0mm    Weight: 19.00 lbs</p>
<p>E125-66-099</p>  <p>Outer Dia: 325.4mm    Hub Reg: 68.0mm            Height: 47.1mm    Bolt Size: 14.3mm            Nom. Thick: 30.0mm    Bolt Circle: 5x114.3mm            Min. Thick: 28.5mm    Weight: 23.30 lbs</p>	<p>E125-66-100</p>  <p>Outer Dia: 295.1mm    Hub Reg: 71.2mm            Height: 61.8mm    Bolt Size: 14.3mm            Nom. Thick: 19.00mm    Bolt Circle: 5x114.3mm            Min. Thick: 18.00mm    Weight: 14.20 lbs.</p>	<p>E125-66-107</p>  <p>Outer Dia: 325.0mm    Hub Reg: 68.0mm            Height: 47.1mm    Bolt Size: 14.2mm            Nom. Thick: 30.10mm    Bolt Circle: 5x114.0mm            Min. Thick: 28.50mm    Weight: 23.15 lbs.</p>
<p>E125-67-062</p>  <p>Outer Dia: 278.0mm    Hub Reg: 70.7mm            Height: 52.0mm    Bolt Size: 16.2mm            Nom. Thick: 32.3mm    Bolt Circle: 5x118mm            Min. Thick: 30.7mm    Weight: 15.00.lbs</p>	<p>E125-67-073</p>  <p>Outer Dia: 296.0mm    Hub Reg: 70.7mm            Height: 51.5mm    Bolt Size: 13.5mm            Nom. Thick: 26.0mm    Bolt Circle: 5x114.3mm            Min. Thick: 24.5mm    Weight: 17.25 lbs</p>	<p>E125-67-078</p>  <p>Outer Dia: 297.0mm    Hub Reg: 70.6mm            Height: 52.2mm    Bolt Size: 16.1mm            Nom. Thick: 32.2mm    Bolt Circle: 5x115mm            Min. Thick: 30.7mm    Weight: 20.00 lbs</p>
<p>E125-67-083</p>  <p>Outer Dia: 296.0mm    Hub Reg: 65.7mm            Height: 43.5mm    Bolt Size: 14.3mm            Nom. Thick: 26.0mm    Bolt Circle: 5x110.0mm            Min. Thick: 23.0mm    Weight: 17.00 lbs</p>	<p>E125-67-084</p>  <p>Outer Dia: 270.0mm    Hub Reg: 65.7mm            Height: 45.3mm    Bolt Size: 14.3mm            Nom. Thick: 14.0mm    Bolt Circle: 5x110.0mm            Min. Thick: 12.0mm    Weight: 11.50 lbs</p>	<p>E125-67-100</p>  <p>Outer Dia: 276mm    Hub Reg: 66.0mm            Height: 42.8mm    Bolt Size: 14.2mm            Nom. Thick: 26.1mm    Bolt Circle: 5x110.4mm            Min. Thick: 23.0mm    Weight: 16.50 lbs</p>

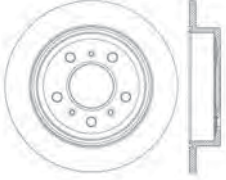
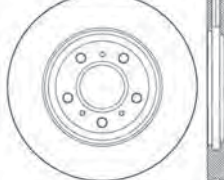
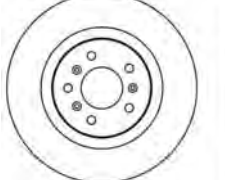
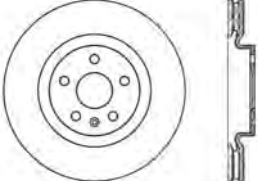
# Brake Rotors

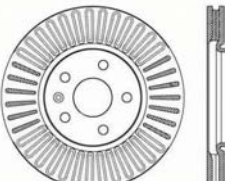
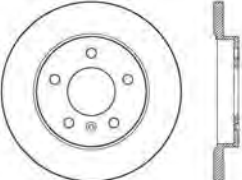
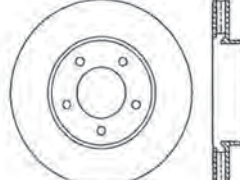
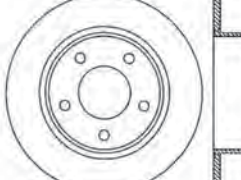
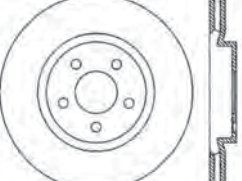
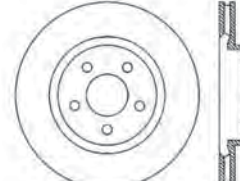
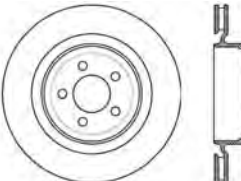
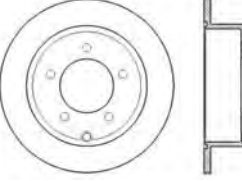
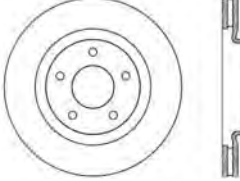
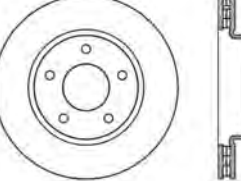
<p>E125-67-102</p>  <p>Outer Dia: 278.0mm    Hub Reg: 70.7mm            Height: 50.4mm    Bolt Size: 14.2mm            Nom. Thick: 11.0mm    Bolt Circle: 5x114.3mm            Min. Thick: 9.0mm    Weight: 11.10 lbs</p>	<p>E125-67-103</p>  <p>Outer Dia: 303.0mm    Hub Reg: 70.7mm            Height: 52.0mm    Bolt Size: 14.2mm            Nom. Thick: 30.1mm    Bolt Circle: 5x114.3mm            Min. Thick: 28.6mm    Weight: 19.30 lbs</p>	<p>E125-67-104</p>  <p>Outer Dia: 323.0mm    Hub Reg: 70.70mm            Height: 52.3mm    Bolt Size: 14.3mm            Nom. Thick: 30.0mm    Bolt Circle: 5x115.0mm            Min. Thick: 28.60mm    Weight: 22.50 lbs</p>
<p>E125-67-113</p>  <p>Outer Dia: 345.0mm    Hub Reg: 67.40lbs.            Height: 51.0mm    Bolt Size: 16.6mm            Nom. Thick: 30.0mm    Bolt Circle: 5x120.0mm            Min. Thick: 28.50mm    Weight: 25.60 lbs</p>	<p>E125-67-118</p>  <p>Outer Dia: 324.0mm    Hub Reg: 67.40mm            Height: 55.5mm    Bolt Size: 16.20mm            Nom. Thick: 22.0mm    Bolt Circle: 5x120.0mm            Min. Thick: 20.0mm    Weight: 18.20 lbs</p>	<p>E125-67-125</p>  <p>Outer Dia: 321.0mm    Hub Reg: 67.4mm            Height: 51.0mm    Bolt Size: 16.2mm            Nom. Thick: 29.9mm    Bolt Circle: 5x120.0mm            Min. Thick: 27.0mm    Weight: 21.95 lbs</p>
<p>E125-67-134</p>  <p>Outer Dia: 270.0mm    Hub Reg: 60.0mm            Height: 37.0mm    Bolt Size: 14.3mm            Nom. Thick: 14.0mm    Bolt Circle: 5x105.0mm            Min. Thick: 12.5mm    Weight: 10.60 lbs</p>	<p>E125-68-064</p>  <p>Outer Dia: 320.0mm    Hub Reg: 72.5mm            Height: 54.7mm    Bolt Size: 16.7mm            Nom. Thick: 28.1mm    Bolt Circle: 5x114.3mm            Min. Thick: 26.5mm    Weight: 19.50 lbs</p>	<p>E125-68-065</p>  <p>Outer Dia: 320.0mm    Hub Reg: 72.5mm            Height: 67.2mm    Bolt Size: 16.7mm            Nom. Thick: 10.0mm    Bolt Circle: 5x114.3mm            Min. Thick: 8.5mm    Weight: 14.00 lbs</p>
<p>E125-68-066</p>  <p>Outer Dia: 345.0mm    Hub Reg: 72.6mm            Height: 54.8mm    Bolt Size: 16.9mm            Nom. Thick: 28.1mm    Bolt Circle: 5x114.3mm            Min. Thick: 26.5mm    Weight: 23.00 lbs</p>	<p>E125-68-067</p>  <p>Outer Dia: 320.0mm    Hub Reg: 72.6mm            Height: 67.4mm    Bolt Size: 16.7mm            Nom. Thick: 22.0mm    Bolt Circle: 5x114.3mm            Min. Thick: 20.5mm    Weight: 18.00 lbs</p>	<p>E125-68-070</p>  <p>Outer Dia: 350.0mm    Hub Reg: 72.6mm            Height: 67.2mm    Bolt Size: 16.9mm            Nom. Thick: 26.1mm    Bolt Circle: 5x114.3mm            Min. Thick: 24.5mm    Weight: 24.20 lbs</p>
<p>E125-68-071</p>  <p>Outer Dia: 262.0mm    Hub Reg: 80.0mm            Height: 60.2mm    Bolt Size: 12.7 mm            Nom. Thick: 10.0mm    Bolt Circle: 5x114.3mm            Min. Thick: 8.4mm    Weight: 9.00 lbs</p>	<p>E125-68-072</p>  <p>Outer Dia: 294.0mm    Hub Reg: 69.0mm            Height: 45.7mm    Bolt Size: 13.15mm            Nom. Thick: 26.0mm    Bolt Circle: 5x114.3mm            Min. Thick: 24.4mm    Weight: 15.85 lbs</p>	<p>E125-68-073</p>  <p>Outer Dia: 276.0mm    Hub Reg: 69.0mm            Height: 45.7mm    Bolt Size: 13.0mm            Nom. Thick: 26.00mm    Bolt Circle: 5x114.3mm            Min. Thick: 24.4mm    Weight: 13.00 lbs</p>

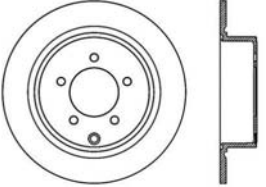
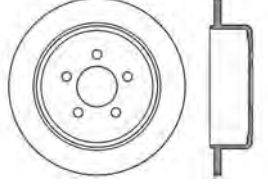
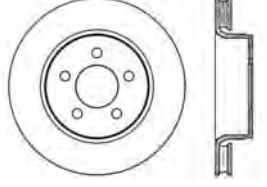
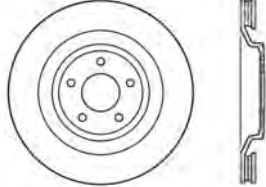
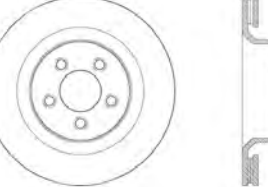
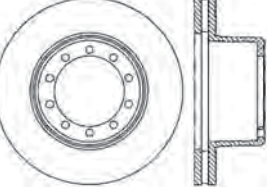
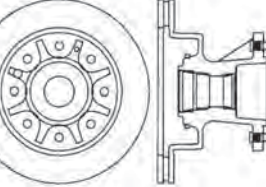
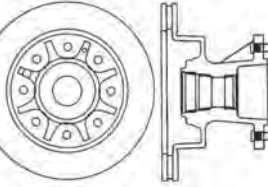
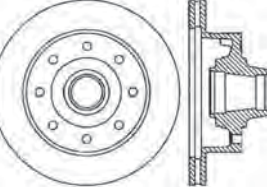
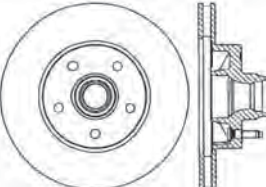
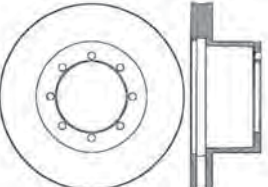
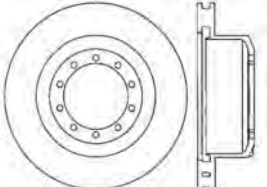
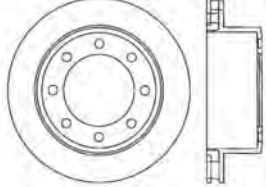
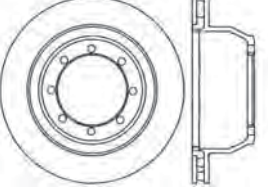
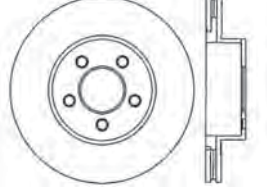

<p>E125-68-074</p>  <p>Outer Dia: 302.0mm    Hub Reg: 80.0mm            Height: 60.1mm    Bolt Size: 12.6mm            Nom. Thick: 10.0mm    Bolt Circle: 5x114.3mm            Min. Thick: 8.4mm    Weight: 12.10 lbs</p>	<p>E125-68-075</p>  <p>Outer Dia: 316mm    Hub Reg: 72.1mm            Height: 76.5mm    Bolt Size: 16.6mm            Nom. Thick: 12mm    Bolt Circle: 5x114.3mm            Min. Thick: 10.4mm    Weight: 16.60 lbs</p>	<p>E125-68-076</p>  <p>Outer Dia: 302.0mm    Hub Reg: 72.1mm            Height: 64.0mm    Bolt Size: 16.6mm            Nom. Thick: 28.0mm    Bolt Circle: 5x114.3mm            Min. Thick: 26.4mm    Weight: 17.30 lbs</p>
<p>E125-68-077</p>  <p>Outer Dia: 340.0mm    Hub Reg: 69.0mm            Height: 43.60mm    Bolt Size: 13.2mm            Nom. Thick: 28.0mm    Bolt Circle: 5x114.3mm            Min. Thick: 26.50mm    Weight: 23.00 lbs.</p>	<p>E125-68-083</p>  <p>Outer Dia: 332.0mm    Hub Reg: 72.1mm            Height: 64.1mm    Bolt Size: 16.7mm            Nom. Thick: 28.0mm    Bolt Circle: 5x114.4mm            Min. Thick: 26.40mm    Weight: 21.85 lbs</p>	<p>E125-70-025</p>  <p>Outer Dia: 327.7mm    Hub Reg: 123.3mm            Height: 124.0mm    Bolt Size: 13.1mm            Nom. Thick: 38.20mm    Bolt Circle: 10x144.8mm            Min. Thick: 36.30mm    Weight: 34.00 lbs</p>
<p>E125-70-047</p>  <p>Outer Dia: 331.0mm    Hub Reg: 123.8mm            Height: 200.5mm    Bolt Size: 9/16 x18 in            Nom. Thick: 30.00mm    Bolt Circle: 8x165.1mm            Min. Thick: 28.00mm    Weight: 48.50 lbs</p>	<p>E125-70-048</p>  <p>Outer Dia: 331.0mm    Hub Reg: 123.8mm            Height: 200.5mm    Bolt Size: 9/16 x 18 in            Nom. Thick: 30.0mm    Bolt Circle: 8x165.1mm            Min. Thick: 28.0mm    Weight: 48.50 lbs</p>	<p>E125-70-051</p>  <p>Outer Dia: 331.0mm    Hub Reg: 123.44mm            Height: 143.2mm    Bolt Size: 9/16x 18 in            Nom. Thick: 30.0mm    Bolt Circle: 8x165.1mm            Min. Thick: 28.0mm    Weight: 38.50 lbs</p>
<p>E125-70-056</p>  <p>Outer Dia: 286.5mm    Hub Reg: 70.4mm            Height: 108.0mm    Bolt Size: 12x20 in            Nom. Thick: 26.1mm    Bolt Circle: 5x114.3mm            Min. Thick: 24.5mm    Weight: 21.50 lbs</p>	<p>E125-70-069</p>  <p>Outer Dia: 327.6mm    Hub Reg: 123.19mm            Height: 123.8mm    Bolt Size: 12.9 mm            Nom. Thick: 38.1mm    Bolt Circle: 8x145 in            Min. Thick: 36.3mm    Weight: 32.00 lbs</p>	<p>E125-70-074</p>  <p>Outer Dia: 395.0mm    Hub Reg: 139.4mm            Height: 123.8mm    Bolt Size: 13.0mm            Nom. Thick: 38.1mm    Bolt Circle: 10x163.2mm            Min. Thick: 36.0mm    Weight: 43.50 lbs</p>
<p>E125-70-083</p>  <p>Outer Dia: 326.0mm    Hub Reg: 127.0mm            Height: 98.8mm    Bolt Size: 16.0mm            Nom. Thick: 30.0mm    Bolt Circle: 8x165.1mm            Min. Thick: 28.0mm    Weight: 24.00 lbs</p>	<p>E125-70-084</p>  <p>Outer Dia: 326.0mm    Hub Reg: 123.3mm            Height: 110.7mm    Bolt Size: 13.0mm            Nom. Thick: 30.0mm    Bolt Circle: 8x145mm            Min. Thick: 28.0mm    Weight: 25.00 lbs</p>	<p>E125-70-087</p>  <p>Outer Dia: 305.0mm    Hub Reg: 72.0mm            Height: 66.3mm    Bolt Size: 16.0mm            Nom. Thick: 26.0mm    Bolt Circle: 5x114.3mm            Min. Thick: 24.5mm    Weight: 19.50 lbs</p>

# Brake Rotors

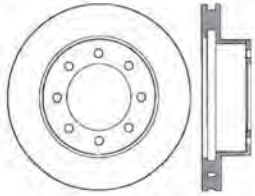
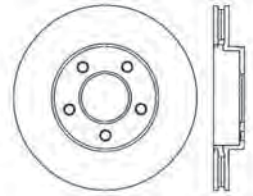
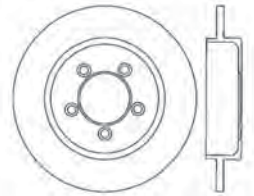
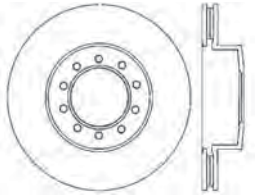
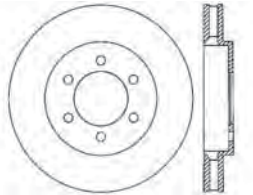
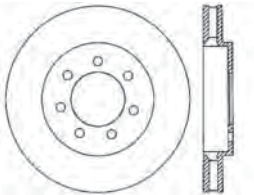
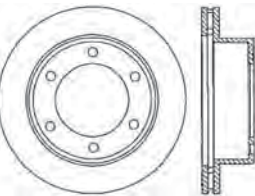
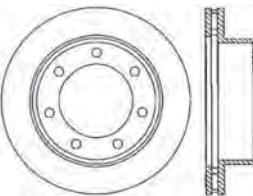
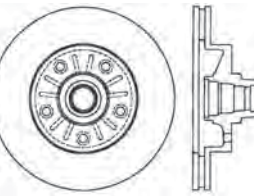
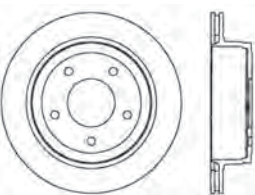
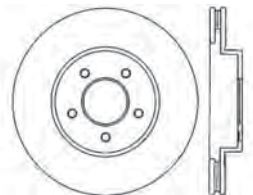
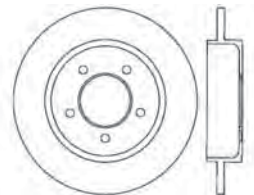
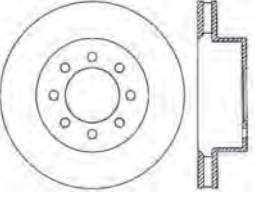
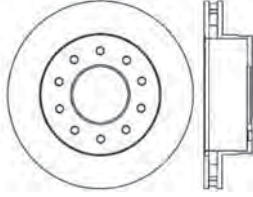
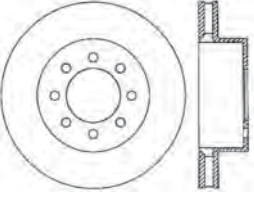
<p>E125-70-092</p>  <p>Outer Dia: 369.0mm Height: 97.8mm Nom. Thick: 37.97mm Min. Thick: 36.00mm</p> <p>Hub Reg: 129.2mm Bolt Size: 16.4mm Bolt Circle: 8x170.0mm Weight: 33.20 lbs</p>	<p>E125-70-094</p>  <p>Outer Dia: 278.0mm Height: 46.9mm Nom. Thick: 24.0mm Min. Thick: 22.0mm</p> <p>Hub Reg: 72.0mm Bolt Size: 14.0mm Bolt Circle: 5x114.3mm Weight: 13.57 lbs</p>	<p>E125-70-095</p>  <p>Outer Dia: 301.0mm Height: 58.2mm Nom. Thick: 12.1mm Min. Thick: 11.0mm</p> <p>Hub Reg: 82.0mm Bolt Size: 13.7mm Bolt Circle: 5x114.3mm Weight: 13.39 lbs</p>
<p>E125-70-097</p>  <p>Outer Dia: 395.0mm Height: 123.8mm Nom. Thick: 38.1mm Min. Thick: 36.0mm</p> <p>Hub Reg: 139.4mm Bolt Size: 13.0mm Bolt Circle: 10x163.2mm Weight: 45.54 lbs</p>	<p>E125-70-105</p>  <p>Outer Dia: 330.0mm Height: 54.0mm Nom. Thick: 30.0mm Min. Thick: 28.5mm</p> <p>Hub Reg: 90.2mm Bolt Size: 15.3mm Bolt Circle: 6x135mm Weight: 24.61 lbs</p>	<p>E125-70-106</p>  <p>Outer Dia: 330mm Height: 54mm Nom. Thick: 30mm Min. Thick: 28.5mm</p> <p>Hub Reg: 90.0mm Bolt Size: 15.3mm Bolt Circle: 7x150mm Weight: 24.62 lbs</p>
<p>E125-70-107</p>  <p>Outer Dia: 348.0mm Height: 86.0mm Nom. Thick: 20.0mm Min. Thick: 18.5mm</p> <p>Hub Reg: 90.0mm Bolt Size: 15.3mm Bolt Circle: 6x135mm Weight: 24.39 lbs</p>	<p>E125-70-108</p>  <p>Outer Dia: 348.0mm Height: 86.0mm Nom. Thick: 20.0mm Min. Thick: 18.5mm</p> <p>Hub Reg: 90.0mm Bolt Size: 15.3mm Bolt Circle: 7X150mm Weight: 23.80 lbs</p>	<p>E125-70-110</p>  <p>Outer Dia: 326.0mm Height: 124.8mm Nom. Thick: 31.6mm Min. Thick: 29.2mm</p> <p>Hub Reg: 189.7mm Bolt Size: 15.2 mm Bolt Circle: 5x139.7mm Weight: 35.59 lbs</p>
<p>E125-70-111</p>  <p>Outer Dia: 331.0mm Height: 75.6mm Nom. Thick: 22.0mm Min. Thick: 20.4mm</p> <p>Hub Reg: 87.6mm Bolt Size: 15.3mm Bolt Circle: 5x139.7mm Weight: 20.74 lbs</p>	<p>E125-70-112</p>  <p>Outer Dia: 302.8mm Height: 46.7mm Nom. Thick: 26.0mm Min. Thick: 24.0mm</p> <p>Hub Reg: 72.0mm Bolt Size: 14.15mm Bolt Circle: 5x114.3mm Weight: 17.67 lbs</p>	<p>E125-70-113</p>  <p>Outer Dia: 302.0mm Height: 56.0mm Nom. Thick: 12.0mm Min. Thick: 11.0mm</p> <p>Hub Reg: 72.0mm Bolt Size: 14.15mm Bolt Circle: 5x114.3mm Weight: 12.81 lbs</p>
<p>E125-70-115</p>  <p>Outer Dia: 347.0mm Height: 100.0mm Nom. Thick: 37.9mm Min. Thick: 36.4mm</p> <p>Hub Reg: 129.0mm Bolt Size: 16.0mm Bolt Circle: 8x169.8mm Weight: 35.71 lbs</p>	<p>E125-70-116</p>  <p>Outer Dia: 369.0mm Height: 98.4mm Nom. Thick: 38.9mm Min. Thick: 37.4mm</p> <p>Hub Reg: 129mm Bolt Size: 16mm Bolt Circle: 10x170mm Weight: 37.26 lbs</p>	<p>E125-70-117</p>  <p>Outer Dia: 347.0mm Height: 100.0mm Nom. Thick: 37.9mm Min. Thick: 36.4mm</p> <p>Hub Reg: 129.0mm Bolt Size: 16.0mm Bolt Circle: 8x169.8mm Weight: 32.14 lbs</p>

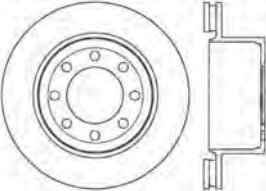
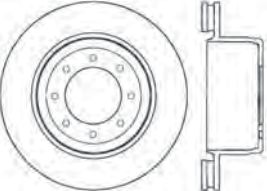
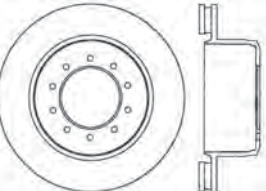
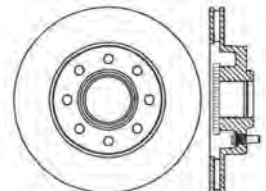
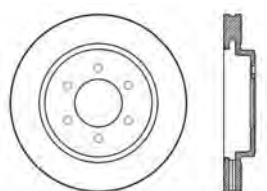
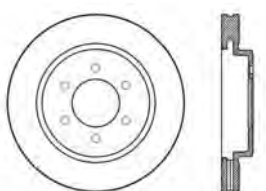
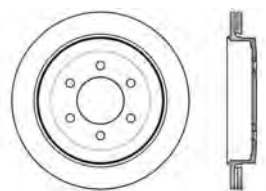
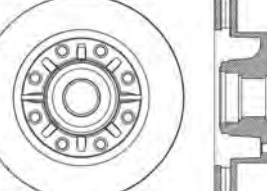
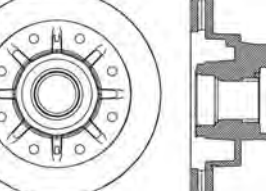
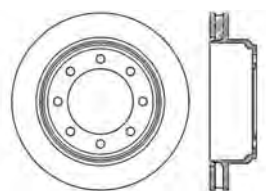
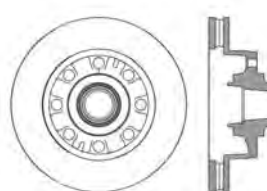
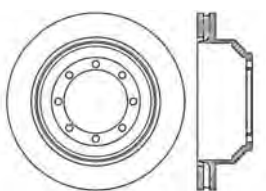
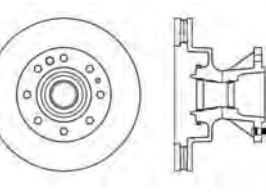
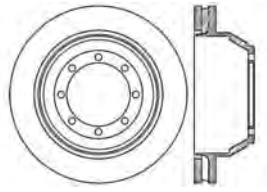
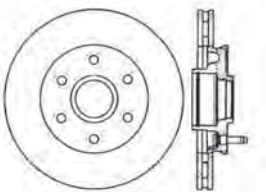
<p>E125-70-118</p>  <p>Outer Dia: 340.0mm    Hub Reg: 126.9mm            Height: 126.4mm    Bolt Size: 16.07mm            Nom. Thick: 34.0mm    Bolt Circle: 8x170mm            Min. Thick: 32.4mm    Weight: 30.82 lbs</p>	<p>E125-70-119</p>  <p>Outer Dia: 340.0mm    Hub Reg: 128.1mm            Height: 125mm    Bolt Size: 12.9mm            Nom. Thick: 34.0mm    Bolt Circle: 8x156.05mm            Min. Thick: 32.4mm    Weight: 30.82 lbs</p>	<p>E125-70-120</p>  <p>Outer Dia: 390.0mm    Hub Reg: 139.4mm            Height: 124.0mm    Bolt Size: 12.86mm            Nom. Thick: 39mm    Bolt Circle: 10x163.1mm            Min. Thick: 37.04mm    Weight: 43.16 lbs</p>
<p>E125-70-121</p>  <p>Outer Dia: 346.4mm    Hub Reg: 124.8mm            Height: 115.6mm    Bolt Size: 14x1.5mm            Nom. Thick: 38.0mm    Bolt Circle: 8x170mm            Min. Thick: 36.4mm    Weight: 52.2t lbs</p>	<p>E125-70-123</p>  <p>Outer Dia: 305.2mm    Hub Reg: 82.0mm            Height: 54.3mm    Bolt Size: 13.65mm            Nom. Thick: 30.0mm    Bolt Circle: 5x114.4mm            Min. Thick: 28.5mm    Weight: 21.16 lbs</p>	<p>E125-70-124</p>  <p>Outer Dia: 350.0mm    Hub Reg: 90.0mm            Height: 49.5mm    Bolt Size: 16.0mm            Nom. Thick: 34.0mm    Bolt Circle: 6x135mm            Min. Thick: 32.0mm    Weight: 28.97 lbs</p>
<p>E125-70-125</p>  <p>Outer Dia: 342.0mm    Hub Reg: 90.0mm            Height: 50.0mm    Bolt Size: 16.0mm            Nom. Thick: 22.0mm    Bolt Circle: 6x135mm            Min. Thick: 20.0mm    Weight: 20.37 lbs</p>	<p>E125-70-126</p>  <p>Outer Dia: 347.0mm    Hub Reg: 64.0mm            Height: 115.5mm    Bolt Size: 15.4mm            Nom. Thick: 38.0mm    Bolt Circle: 8x170mm            Min. Thick: 36.4mm    Weight: 52.65 lbs</p>	<p>E125-70-127</p>  <p>Outer Dia: 347.0mm    Hub Reg: 64.0mm            Height: 213.1mm    Bolt Size: 15.4mm            Nom. Thick: 38.0mm    Bolt Circle: 8x200.0mm            Min. Thick: 36.4mm    Weight: 72.25 lbs</p>
<p>E125-70-128</p>  <p>Outer Dia: 345.0mm    Hub Reg: 127.0mm            Height: 90.5mm    Bolt Size: 15.9mm            Nom. Thick: 36.0mm    Bolt Circle: 8x165.1mm            Min. Thick: 34.4mm    Weight: 29.94 lbs</p>	<p>E125-70-129</p>  <p>Outer Dia: 345.0mm    Hub Reg: 123.8mm            Height: 144.0mm    Bolt Size: - mm            Nom. Thick: 40.0mm    Bolt Circle: 8x165.1mm            Min. Thick: 38.4mm    Weight: 49.08 lbs</p>	<p>E125-70-130</p>  <p>Outer Dia: 345.0mm    Hub Reg: 123.3mm            Height: 107.0mm    Bolt Size: 13.0mm            Nom. Thick: 36.0mm    Bolt Circle: 8x145mm            Min. Thick: 34.4mm    Weight: 32.83 lbs</p>
<p>E125-70-131</p>  <p>Outer Dia: 354.0mm    Hub Reg: 123.8mm            Height: 204.0mm    Bolt Size: 15.4mm            Nom. Thick: 40.0mm    Bolt Circle: 8x165.1mm            Min. Thick: 38.4mm    Weight: 56.76 lbs</p>	<p>E125-70-132</p>  <p>Outer Dia: 345.0mm    Hub Reg: 123.3mm            Height: 116.7mm    Bolt Size: 13mm            Nom. Thick: 42.0mm    Bolt Circle: 8x145mm            Min. Thick: 40.4mm    Weight: 37.20 lbs</p>	<p>E125-70-133</p>  <p>Outer Dia: 329.9mm    Hub Reg: 86.6mm            Height: 92.2mm    Bolt Size: 14x50.8mm            Nom. Thick: 29.9mm    Bolt Circle: 6x134.8mm            Min. Thick: 28.4mm    Weight: 36.50 lbs</p>

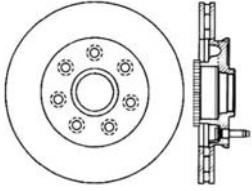
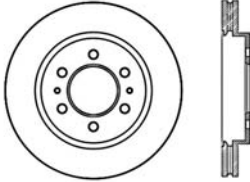
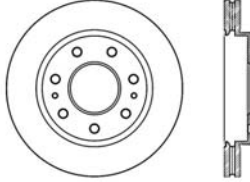
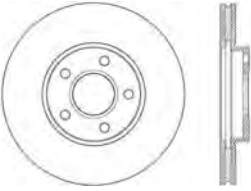
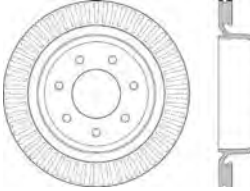
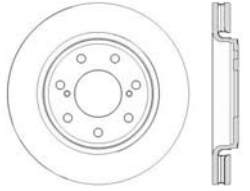
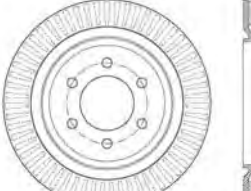
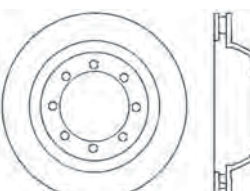
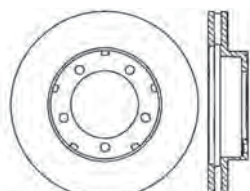
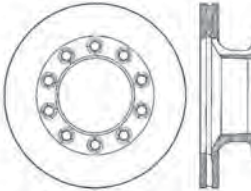
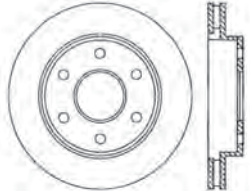
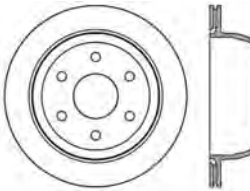
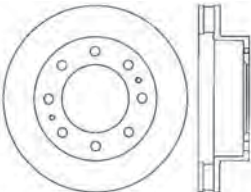
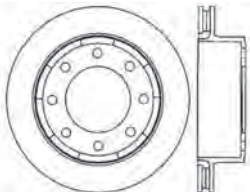
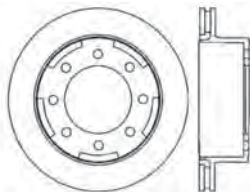

# Brake Rotors

<p>E125-70-134</p>  <p>Outer Dia: 329.9mm    Hub Reg: 86.6mm            Height: 92.2mm    Bolt Size: 14x50.8mm            Nom. Thick: 29.97mm    Bolt Circle: 7x150.11mm            Min. Thick: 28.44mm    Weight: 37.50 lbs</p>	<p>E125-70-135</p>  <p>Outer Dia: 330.0mm    Hub Reg: 90.1mm            Height: 52.5mm    Bolt Size: 15.5mm            Nom. Thick: 30.0mm    Bolt Circle: 6x135.0mm            Min. Thick: 28.5mm    Weight: 23.38 lbs</p>	<p>E125-70-136</p>  <p>Outer Dia: 330.0mm    Hub Reg: 90.1mm            Height: 52.5mm    Bolt Size: 15.5mm            Nom. Thick: 30.0mm    Bolt Circle: 7x150mm            Min. Thick: 28.5mm    Weight: 23.36 lbs</p>
<p>E125-70-137</p>  <p>Outer Dia: 278.0mm    Hub Reg: 63.5mm            Height: 44.5mm    Bolt Size: 13.8mm            Nom. Thick: 24.0mm    Bolt Circle: 5x108.0mm            Min. Thick: 22.0mm    Weight: 15.14 lbs</p>	<p>E125-70-138</p>  <p>Outer Dia: 348.0mm    Hub Reg: 90.0mm            Height: 80.0mm    Bolt Size: 15.7mm            Nom. Thick: 25.0mm    Bolt Circle: 7x150.0mm            Min. Thick: 23.0mm    Weight: 25.05 lbs</p>	<p>E125-70-139</p>  <p>Outer Dia: 279.0mm    Hub Reg: 90.1mm            Height: 49.5mm    Bolt Size: 15.7mm            Nom. Thick: 34.0mm    Bolt Circle: 7x150.0mm            Min. Thick: 32.0mm    Weight: 28.85 lbs.</p>
<p>E125-70-140</p>  <p>Outer Dia: 348.0mm    Hub Reg: 90.0mm            Height: 80.0mm    Bolt Size: 15.70mm            Nom. Thick: 25.0mm    Bolt Circle: 6x135.0mm            Min. Thick: 23.0mm    Weight: 25.15 lbs</p>	<p>E125-71-020</p>  <p>Outer Dia: 361.8mm    Hub Reg: 130.0mm            Height: 81.2mm    Bolt Size: 16.6mm            Nom. Thick: 39.0mm    Bolt Circle: 8x165.1mm            Min. Thick: 37.21mm    Weight: 34.38 lbs</p>	<p>E125-71-036</p>  <p>Outer Dia: 351.8mm    Hub Reg: 127.0mm            Height: 74.5mm    Bolt Size: 16.7mm            Nom. Thick: 36.5mm    Bolt Circle: 5x161mm            Min. Thick: 34.7mm    Weight: 34.50 lbs</p>
<p>E125-71-037</p>  <p>Outer Dia: 344.9mm    Hub Reg: 139.7mm            Height: 110.8mm    Bolt Size: 17.0mm            Nom. Thick: 36.1mm    Bolt Circle: 10x184.1mm            Min. Thick: 34.7mm    Weight: 36.00 lbs</p>	<p>E125-71-045</p>  <p>Outer Dia: 305.0mm    Hub Reg: 78.7mm            Height: 58.2mm    Bolt Size: 16.4mm            Nom. Thick: 29.1mm    Bolt Circle: 6x139.7mm            Min. Thick: 27.2mm    Weight: 19.80 lbs</p>	<p>E125-71-046</p>  <p>Outer Dia: 325.0mm    Hub Reg: 78.55mm            Height: 85.0mm    Bolt Size: 16.5mm            Nom. Thick: 20.0mm    Bolt Circle: 6x139.7mm            Min. Thick: 18.50mm    Weight: 19.30 lbs</p>
<p>E125-71-047</p>  <p>Outer Dia: 324.8mm    Hub Reg: 118.1mm            Height: 89.2mm    Bolt Size: 16.5mm            Nom. Thick: 38mm    Bolt Circle: 8x165.1mm            Min. Thick: 36.5mm    Weight: 25.72 lbs</p>	<p>E125-71-048</p>  <p>Outer Dia: 330.0mm    Hub Reg: 117.6mm            Height: 85.73mm    Bolt Size: 16.5mm            Nom. Thick: 29.0mm    Bolt Circle: 8x165.1mm            Min. Thick: 26.5mm    Weight: 24.00 lbs</p>	<p>E125-71-049</p>  <p>Outer Dia: 330.0mm    Hub Reg: 122.8mm            Height: 91.53mm    Bolt Size: 16.5mm            Nom. Thick: 29.0mm    Bolt Circle: 8x165.1mm            Min. Thick: 27.0mm    Weight: 25.00 lbs</p>

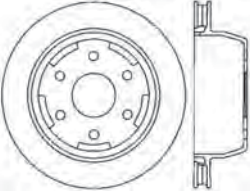
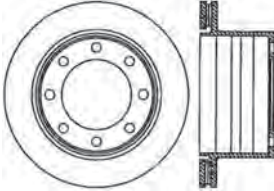
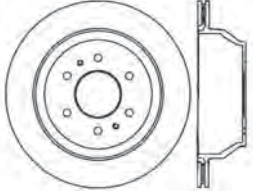
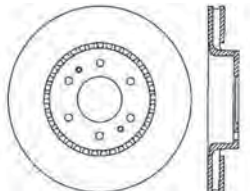
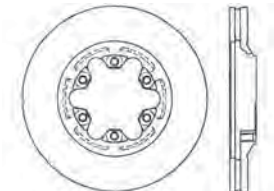
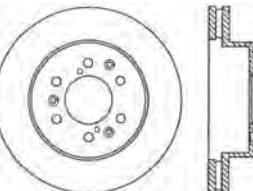
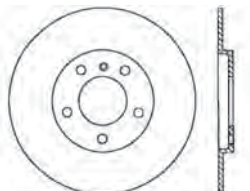
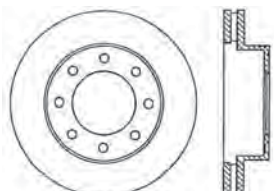
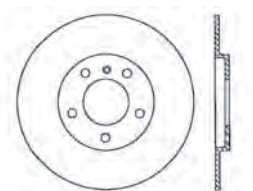
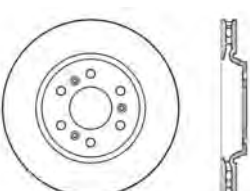
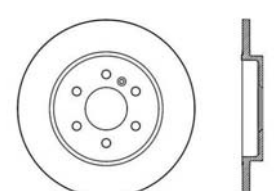
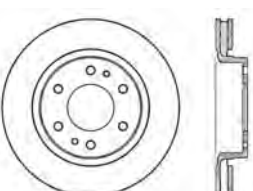
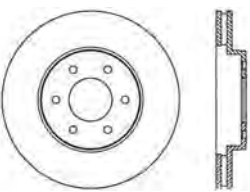
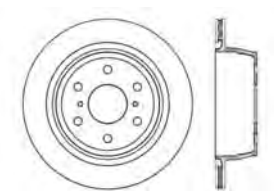
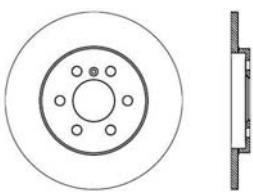
<p>E125-71-050</p>  <p>Outer Dia: 329.7mm    Hub Reg: 78.64mm            Height: 95.5mm    Bolt Size: 16.5mm            Nom. Thick: 30.0mm    Bolt Circle: 6x139.7mm            Min. Thick: 28.5mm    Weight: 20.85 lbs</p>	<p>E125-71-055</p>  <p>Outer Dia: 325.0mm    Hub Reg: 122.8mm            Height: 131.5mm    Bolt Size: 16.4mm            Nom. Thick: 30.0mm    Bolt Circle: 8x165.1mm            Min. Thick: 28.5mm    Weight: 29.00 lbs</p>	<p>E125-71-057</p>  <p>Outer Dia: 325.0mm    Hub Reg: 78.7mm            Height: 85.0mm    Bolt Size: 13.2mm            Nom. Thick: 20.0mm    Bolt Circle: 6x127mm            Min. Thick: 18.5mm    Weight: 18.0 lbs</p>
<p>E125-71-058</p>  <p>Outer Dia: 325.0mm    Hub Reg: 79.0mm            Height: 54.25mm    Bolt Size: 13.0mm            Nom. Thick: 29.0mm    Bolt Circle: 6x127mm            Min. Thick: 27.5mm    Weight: 22.50 lbs</p>	<p>E125-71-061</p>  <p>Outer Dia: 280.0mm    Hub Reg: 92.1mm            Height: 39.9mm    Bolt Size: 12.3mm            Nom. Thick: 26.9mm    Bolt Circle: 6x112mm            Min. Thick: 25.6mm    Weight: 15.00 lbs</p>	<p>E125-71-062</p>  <p>Outer Dia: 330.0mm    Hub Reg: 78.5mm            Height: 55.0mm    Bolt Size: 16.08mm            Nom. Thick: 30.0mm    Bolt Circle: 6x140.5mm            Min. Thick: 28.0mm    Weight: 25.50 lbs</p>
<p>E125-71-063</p>  <p>Outer Dia: 300.0mm    Hub Reg: 70.60mm            Height: 30.2mm    Bolt Size: 14.5mm            Nom. Thick: 12.00mm    Bolt Circle: 5x114.3mm            Min. Thick: 10.50mm    Weight: 12.57 lbs</p>	<p>E125-71-064</p>  <p>Outer Dia: 324.6mm    Hub Reg: 118.2mm            Height: 89.3mm    Bolt Size: 16.4mm            Nom. Thick: 37.8mm    Bolt Circle: 8x104.0mm            Min. Thick: 36.5mm    Weight: 31.0 lbs</p>	<p>E125-71-065</p>  <p>Outer Dia: 299.0mm    Hub Reg: 70.7mm            Height: 36.6mm    Bolt Size: 14.25mm            Nom. Thick: 12.0mm    Bolt Circle: 5x114.3mm            Min. Thick: 10.5mm    Weight: 12.50 lbs</p>
<p>E125-71-066</p>  <p>Outer Dia: 297.0mm    Hub Reg: 70.8mm            Height: 52.2mm    Bolt Size: 14.3mm            Nom. Thick: 32.2mm    Bolt Circle: 6x114.3mm            Min. Thick: 30.7mm    Weight: 19.70 lbs</p>	<p>E125-71-067</p>  <p>Outer Dia: 300.1mm    Hub Reg: 70.7mm            Height: 36.9mm    Bolt Size: 14.3mm            Nom. Thick: 12mm    Bolt Circle: 6x114.3mm            Min. Thick: 10.5mm    Weight: 13.3 lbs</p>	<p>E125-71-068</p>  <p>Outer Dia: 302.0mm    Hub Reg: 79.2mm            Height: 54.7mm    Bolt Size: 13.2mm            Nom. Thick: 29.1mm    Bolt Circle: 6x139.7mm            Min. Thick: 27.5mm    Weight: 20.40 lbs</p>
<p>E125-71-069</p>  <p>Outer Dia: 325.2mm    Hub Reg: 79.1mm            Height: 54.7mm    Bolt Size: 13.3mm            Nom. Thick: 29mm    Bolt Circle: 6x127mm            Min. Thick: 27.5mm    Weight: 23.70 lbs</p>	<p>E125-71-070</p>  <p>Outer Dia: 345.0mm    Hub Reg: 78.5mm            Height: 85.4mm    Bolt Size: 16.5mm            Nom. Thick: 20.0mm    Bolt Circle: 6x139.7mm            Min. Thick: 18.5mm    Weight: 21.50 lbs</p>	<p>E125-71-071</p>  <p>Outer Dia: 299.9mm    Hub Reg: 70.60mm            Height: 32.10mm    Bolt Size: 16.5mm            Nom. Thick: 12.0mm    Bolt Circle: 6x115mm            Min. Thick: 10.50mm    Weight: 13.10 lbs.</p>

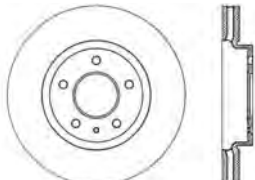
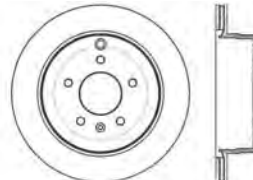
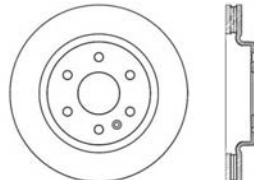
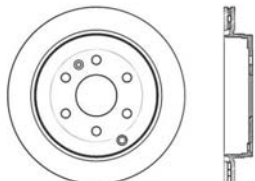
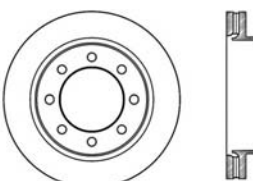
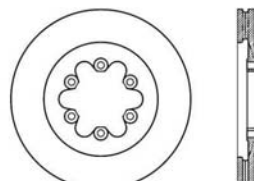
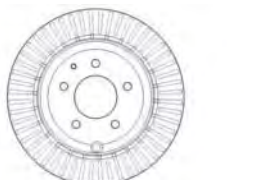
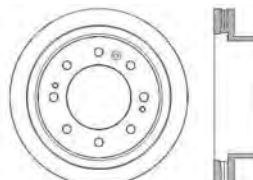
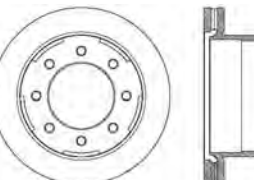
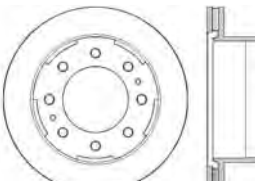
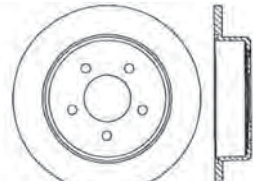
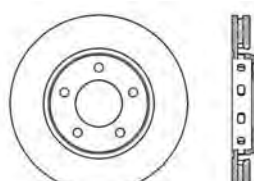
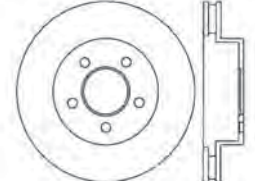
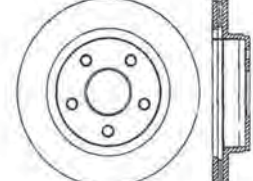
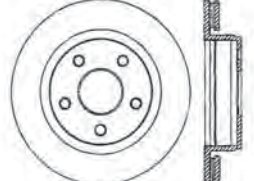

# Brake Rotors

<p>E125-71-072</p>  <p>Outer Dia: 295.8mm    Hub Reg: 70.7mm            Height: 51.8mm    Bolt Size: 12.5mm            Nom. Thick: 29mm    Bolt Circle: 5x114.3mm            Min. Thick: 27.4mm    Weight: 19.00 lbs</p>	<p>E125-71-073</p>  <p>Outer Dia: 303.0mm    Hub Reg: 70.6mm            Height: 71.7mm    Bolt Size: 12.6mm            Nom. Thick: 20.0mm    Bolt Circle: 5x114.3mm            Min. Thick: 18.4mm    Weight: 16.20 lbs</p>	<p>E125-71-074</p>  <p>Outer Dia: 325.0mm    Hub Reg: 75.6mm            Height: 54.5mm    Bolt Size: 15.7mm            Nom. Thick: 29.0mm    Bolt Circle: 6x132.0mm            Min. Thick: 27.5mm    Weight: 23.1 lbs</p>
<p>E125-71-075</p>  <p>Outer Dia: 331.0mm    Hub Reg: 75.6mm            Height: 53.4mm    Bolt Size: 16.2mm            Nom. Thick: 20mm    Bolt Circle: 6x132.0mm            Min. Thick: 18.4mm    Weight: 18.2 lbs</p>	<p>E125-71-076</p>  <p>Outer Dia: 345.5mm    Hub Reg: 123.1mm            Height: 146.2mm    Bolt Size: 16.2mm            Nom. Thick: 40.0mm    Bolt Circle: 8x165mm            Min. Thick: 38.0mm    Weight: 29.00 lbs</p>	<p>E125-71-077</p>  <p>Outer Dia: 298.0mm    Hub Reg: 92.1mm            Height: 40.2mm    Bolt Size: 10.4mm            Nom. Thick: 29mm    Bolt Circle: 6x112mm            Min. Thick: 27.5mm    Weight: 21.40 lbs</p>
<p>E125-71-078</p>  <p>Outer Dia: 303.0mm    Hub Reg: 67.4mm            Height: 71.7mm    Bolt Size: 16.2mm            Nom. Thick: 20.00mm    Bolt Circle: 5x120.0mm            Min. Thick: 18.40mm    Weight: 15.60 lbs.</p>	<p>E125-71-079</p>  <p>Outer Dia: 355.0mm    Hub Reg: 127.0mm            Height: 102.0mm    Bolt Size: 16.4mm            Nom. Thick: 40.00mm    Bolt Circle: 8x180mm            Min. Thick: 38.50mm    Weight: 36.90 lbs.</p>	<p>E125-71-080</p>  <p>Outer Dia: 430.0mm    Hub Reg: 130.00mm            Height: 114.6mm    Bolt Size: 16.4mm            Nom. Thick: 44.90mm    Bolt Circle: 8x180.0mm            Min. Thick: 37.0mm    Weight: 44.00 lbs</p>
<p>E125-71-082</p>  <p>Outer Dia: 360.0mm    Hub Reg: 127.00mm            Height: 119.2mm    Bolt Size: 16.20mm            Nom. Thick: 34.10mm    Bolt Circle: 8x180.0 mm            Min. Thick: 32.50mm    Weight: 35.60 lbs.</p>	<p>E125-72-042</p>  <p>Outer Dia: 289.8mm    Hub Reg: 72.0mm            Height: 56.0mm    Bolt Size: 14.3mm            Nom. Thick: 12.5mm    Bolt Circle: 5x114.3mm            Min. Thick: 11.25mm    Weight: 12.00 lbs</p>	<p>E125-72-054</p>  <p>Outer Dia: 281.0mm    Hub Reg: 73.4mm            Height: 38.0mm    Bolt Size: 14.2mm            Nom. Thick: 28.0mm    Bolt Circle: 5x114.3mm            Min. Thick: 25.3mm    Weight: 16.08 lbs</p>
<p>E125-72-057</p>  <p>Outer Dia: 288.0mm    Hub Reg: 72.1mm            Height: 64.8mm    Bolt Size: 15.5mm            Nom. Thick: 28.0mm    Bolt Circle: 5x114.3mm            Min. Thick: 26.0mm    Weight: 16.68 lbs</p>	<p>E125-72-058</p>  <p>Outer Dia: 336.0mm    Hub Reg: 78.5mm            Height: 67.3mm    Bolt Size: 17.0mm            Nom. Thick: 28.0mm    Bolt Circle: 5x139.7mm            Min. Thick: 26.40mm    Weight: 25.50 lbs</p>	<p>E125-72-059</p>  <p>Outer Dia: 352.0mm    Hub Reg: 78.5mm            Height: 72.0mm    Bolt Size: 17.0mm            Nom. Thick: 22.0mm    Bolt Circle: 5x140mm            Min. Thick: 20.4mm    Weight: 24.50 lbs</p>

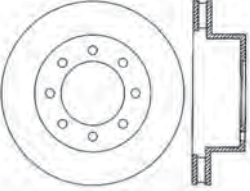
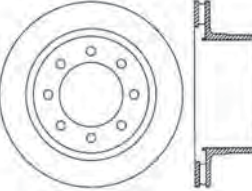
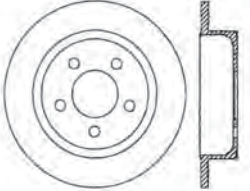
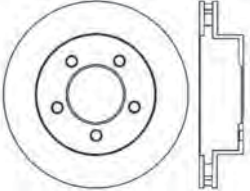
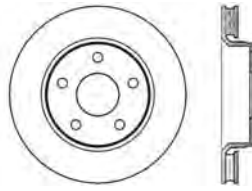
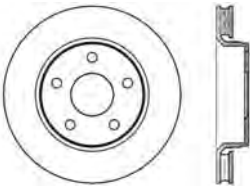
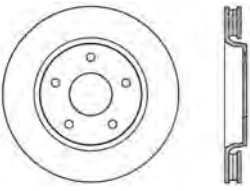
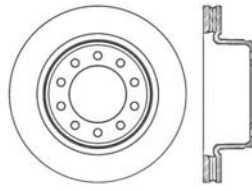
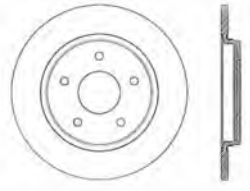
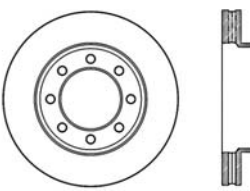
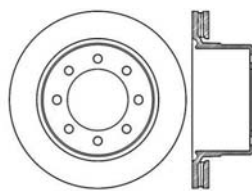
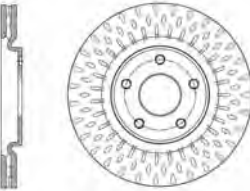
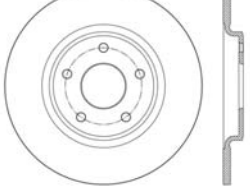
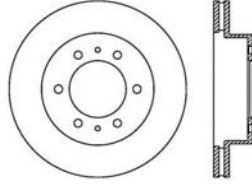
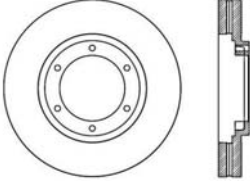
<p>E125-72-066</p>  <p>Outer Dia: 353.0mm    Hub Reg: 122.2mm            Height: 101.8mm    Bolt Size: 16.81mm            Nom. Thick: 35.4mm    Bolt Circle: 8x165.1mm            Min. Thick: 34.0mm    Weight: 35.00 lbs</p>	<p>E125-72-067</p>  <p>Outer Dia: 352.5mm    Hub Reg: 123.0mm            Height: 131.0mm    Bolt Size: 17.0mm            Nom. Thick: 30.0mm    Bolt Circle: 8x165.1mm            Min. Thick: 28.39mm    Weight: 35.00 lbs</p>	<p>E125-72-068</p>  <p>Outer Dia: 285.0mm    Hub Reg: 72.0mm            Height: 57.9mm    Bolt Size: 16.6mm            Nom. Thick: 12.0mm    Bolt Circle: 5x114.3mm            Min. Thick: 11.0mm    Weight: 12.21 lbs</p>
<p>E125-72-070</p>  <p>Outer Dia: 311.8mm    Hub Reg: 78.4mm            Height: 66.0mm    Bolt Size: 16.4mm            Nom. Thick: 28.0mm    Bolt Circle: 5x139.5mm            Min. Thick: 26.0mm    Weight: 17.50 lbs</p>	<p>E125-72-072</p>  <p>Outer Dia: 316.0mm    Hub Reg: 72.1mm            Height: 76.5mm    Bolt Size: 16.6mm            Nom. Thick: 12.0mm    Bolt Circle: 5x127mm            Min. Thick: 10.4mm    Weight: 16.80 lbs</p>	<p>E125-72-073</p>  <p>Outer Dia: 302.0 mm    Hub Reg: 72.1mm            Height: 55.0 mm    Bolt Size: 16.6mm            Nom. Thick: 28.0 mm    Bolt Circle: 5x127.0mm            Min. Thick: 26.4 mm    Weight: 16.50 lbs</p>
<p>E125-72-074</p>  <p>Outer Dia: 302.2mm    Hub Reg: 72.5mm            Height: 38.1mm    Bolt Size: 13.9mm            Nom. Thick: 28.0mm    Bolt Circle: 5x127mm            Min. Thick: 26.4mm    Weight: 16.90 lbs</p>	<p>E125-72-075</p>  <p>Outer Dia: 390.3mm    Hub Reg: 125.0mm            Height: 111.0mm    Bolt Size: 17.0mm            Nom. Thick: 39.0mm    Bolt Circle: 10x170.0mm            Min. Thick: 37.4mm    Weight: 43.40 lbs</p>	<p>E125-72-076</p>  <p>Outer Dia: 305.0mm    Hub Reg: 72.5mm            Height: 33.4mm    Bolt Size: 14mm            Nom. Thick: 11.8mm    Bolt Circle: 5x127.0mm            Min. Thick: 10.4mm    Weight: 11.99 lbs</p>
<p>E125-72-077</p>  <p>Outer Dia: 360.0mm    Hub Reg: 123.0mm            Height: 102.0mm    Bolt Size: 16.7 mm            Nom. Thick: 39.0mm    Bolt Circle: 8x165.0mm            Min. Thick: 37.4mm    Weight: 39.0 lbs</p>	<p>E125-72-078</p>  <p>Outer Dia: 358.0mm    Hub Reg: 123.0mm            Height: 125.0mm    Bolt Size: 16.8mm            Nom. Thick: 34.0mm    Bolt Circle: 8x165.1mm            Min. Thick: 32.4mm    Weight: 38.0 lbs</p>	<p>E125-72-079</p>  <p>Outer Dia: 330.0mm    Hub Reg: 72.55mm            Height: 38.00mm    Bolt Size: 14.50mm            Nom. Thick: 28.00mm    Bolt Circle: 5x127.00mm            Min. Thick: 26.40mm    Weight: 21.05 lbs</p>
<p>E125-72-080</p>  <p>Outer Dia: 328.0mm    Hub Reg: 72.55mm            Height: 33.30mm    Bolt Size: 14.50mm            Nom. Thick: 12.00mm    Bolt Circle: 5x127.00mm            Min. Thick: 10.40mm    Weight: 13.95 lbs</p>	<p>E125-74-006</p>  <p>Outer Dia: 315.0mm    Hub Reg: 100.7mm            Height: 70.0mm    Bolt Size: 13.8mm            Nom. Thick: 28.0mm    Bolt Circle: 6x139.7mm            Min. Thick: 26.5mm    Weight: 22.00 lbs</p>	<p>E125-74-007</p>  <p>Outer Dia: 312.0mm    Hub Reg: 101mm            Height: 68.0mm    Bolt Size: 13.8mm            Nom. Thick: 12.0mm    Bolt Circle: 6x139.7mm            Min. Thick: 10.5mm    Weight: 14.30 lbs</p>

# Brake Rotors

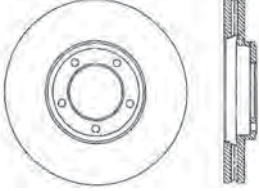
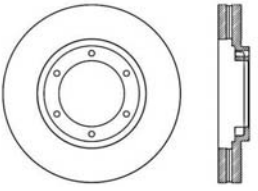
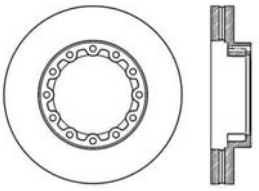
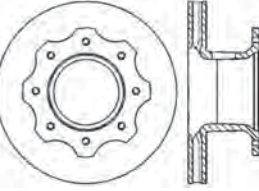
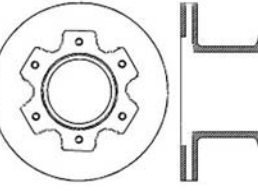
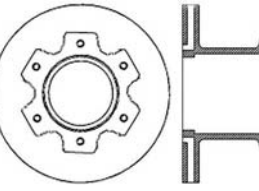
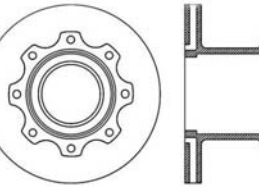
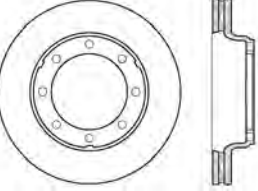
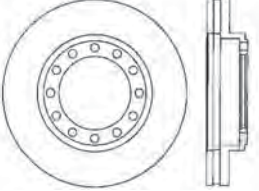
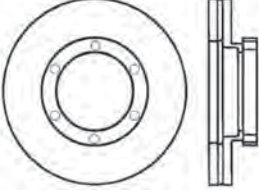
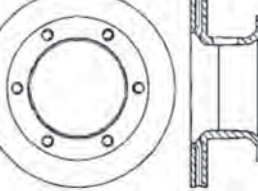
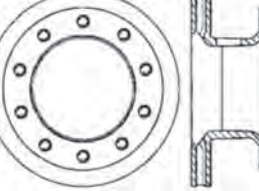
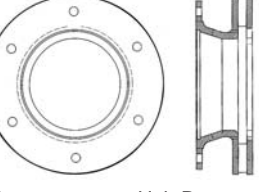
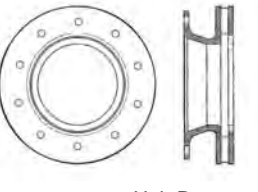
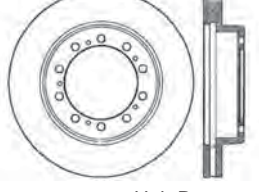
<p>E125-79-006</p>  <p>Outer Dia: 293.0mm    Hub Reg: 110.0mm Height: 54.3mm    Bolt Size: 10.4mm Nom. Thick: 40.1mm    Bolt Circle: 5x137.0mm Min. Thick: -mm    Weight: 27.00 lbs</p>	<p>E125-79-007</p>  <p>Outer Dia: 310.0mm    Hub Reg: 114.0mm Height: 54.1mm    Bolt Size: 10.2mm Nom. Thick: 40.0mm    Bolt Circle: 6x140.0mm Min. Thick: -mm    Weight: 29.60 lbs</p>	<p>E125-79-008</p>  <p>Outer Dia: 310.0mm    Hub Reg: 139.0mm Height: 71.3mm    Bolt Size: 10.0mm Nom. Thick: 39.9mm    Bolt Circle: 12x161.0mm Min. Thick: -mm    Weight: 30.40 lbs</p>
<p>E125-80-006</p>  <p>Outer Dia: 324.0mm    Hub Reg: 165.7mm Height: 118.0mm    Bolt Size: 10.7mm Nom. Thick: 29.9mm    Bolt Circle: 8x203.2mm Min. Thick: 26.28mm    Weight: 31.50 lbs</p>	<p>E125-80-007</p>  <p>Outer Dia: 303.7mm    Hub Reg: 116.7mm Height: 118.6mm    Bolt Size: 10.3mm Nom. Thick: 29.9mm    Bolt Circle: 6x190.7mm Min. Thick: 26.2mm    Weight: 27.70 lbs</p>	<p>E125-80-008</p>  <p>Outer Dia: 303.8mm    Hub Reg: 155.0mm Height: 154.0mm    Bolt Size: 10.4mm Nom. Thick: 29.9mm    Bolt Circle: 6x197.1mm Min. Thick: 26.2mm    Weight: 32.20 lbs</p>
<p>E125-80-009</p>  <p>Outer Dia: 323.0mm    Hub Reg: 144.1mm Height: 160.5mm    Bolt Size: 10.5mm Nom. Thick: 29.9mm    Bolt Circle: 8x196mm Min. Thick: 26.9mm    Weight: 34.20 lbs</p>	<p>E125-80-010</p>  <p>Outer Dia: 390.0mm    Hub Reg: 152.2mm Height: 86.3mm    Bolt Size: 15mm Nom. Thick: 39.1mm    Bolt Circle: 8x184mm Min. Thick: 36.05mm    Weight: 43.85 lbs</p>	<p>E125-81-006</p>  <p>Outer Dia: 282mm    Hub Reg: 110.0mm Height: 62.5mm    Bolt Size: 12.6mm Nom. Thick: 35mm    Bolt Circle: 12x136mm Min. Thick: 32mm    Weight: 23.50 lbs</p>
<p>E125-82-006</p>  <p>Outer Dia: 286.0mm    Hub Reg: 114mm Height: 91.9mm    Bolt Size: 14x1.5mm Nom. Thick: 34.9mm    Bolt Circle: 6x140.2mm Min. Thick: 33mm    Weight: 28.00 lbs</p>	<p>E125-84-019</p>  <p>Outer Dia: 374.5mm    Hub Reg: 137.20mm Height: 96.70mm    Bolt Size: 19.8mm Nom. Thick: 34.10mm    Bolt Circle: 6x184.20mm Min. Thick: 31.12mm    Weight: -N/A</p>	<p>E125-84-021</p>  <p>Outer Dia: 390.6mm    Hub Reg: 220.70mm Height: 154.2mm    Bolt Size: 21.4mm Nom. Thick: 38.90mm    Bolt Circle: 10x285.8mm Min. Thick: 35.90mm    Weight: 63.5 lbs</p>
<p>E125-84-033</p>  <p>Outer Dia: 396.7mm    Hub Reg: 241.6mm Height: 125.0mm    Bolt Size: 323.9mm Nom. Thick: 44.4mm    Bolt Circle: 6x 20.0 mm Min. Thick: 41.4mm    Weight: -N/A</p>	<p>E125-84-034</p>  <p>Outer Dia: 396.7mm    Hub Reg: 214.0mm Height: 162.0mm    Bolt Size: 32.7mm Nom. Thick: 44.45mm    Bolt Circle: 10x32.0mm Min. Thick: 41.4mm    Weight: -N/A</p>	<p>E125-85-006</p>  <p>Outer Dia: 390.3mm    Hub Reg: 152.4mm Height: 86.3mm    Bolt Size: 15.34mm Nom. Thick: 36.5mm    Bolt Circle: 10x184.1mm Min. Thick: 33.5mm    Weight: 45.00 lbs</p>

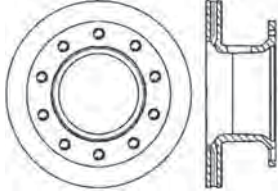
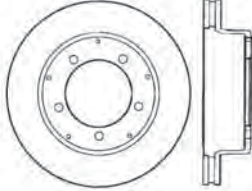
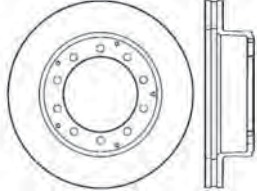
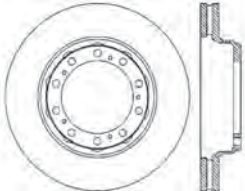
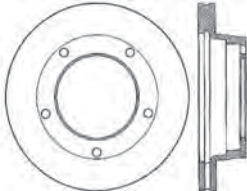
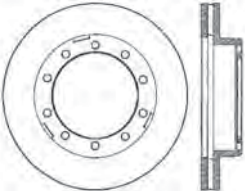
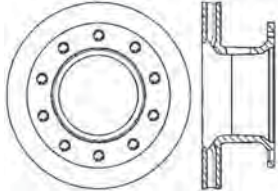
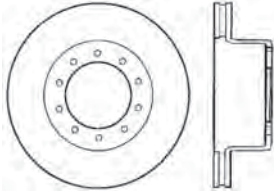
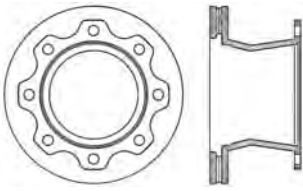
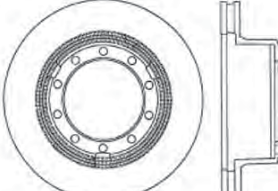
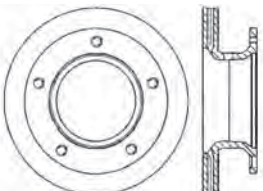
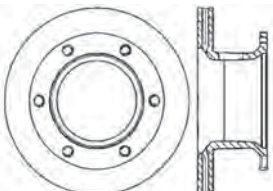
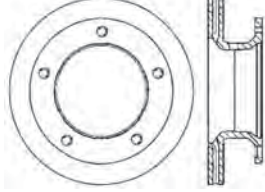
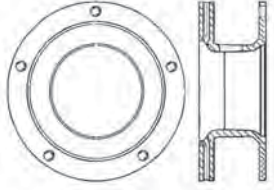
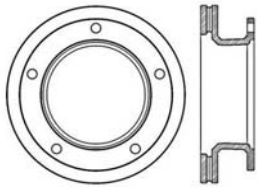

<p>E125-85-007</p>  <p>Outer Dia: 390.7mm    Hub Reg: 241.3mm Height: 157.0mm    Bolt Size: 20.50mm Nom. Thick: 38.99mm    Bolt Circle: 10x285.8mm Min. Thick: 33.40mm    Weight: 58.00 lbs</p>	<p>E125-85-013</p>  <p>Outer Dia: 374.6mm    Hub Reg: 137.2mm Height: 96.8mm    Bolt Size: 16.6mm Nom. Thick: 34.14mm    Bolt Circle: 5x171.45mm Min. Thick: 31.12mm    Weight: 35.50 lbs</p>	<p>E125-85-016</p>  <p>Outer Dia: 374.5mm    Hub Reg: 152.4mm Height: 96.8mm    Bolt Size: 15.0mm Nom. Thick: 34.00mm    Bolt Circle: 10x184.2mm Min. Thick: 31.12mm    Weight: 35.50 lbs</p>
<p>E125-85-017</p>  <p>Outer Dia: 390.5mm    Hub Reg: 152.5mm Height: 86.5mm    Bolt Size: 15.0mm Nom. Thick: 39.00mm    Bolt Circle: 10x184.2mm Min. Thick: 36.06mm    Weight: 44.50 lbs</p>	<p>E125-85-018</p>  <p>Outer Dia: 381mm    Hub Reg: 131mm Height: 106.5mm    Bolt Size: 16.7mm Nom. Thick: 39.1mm    Bolt Circle: 5x171.4mm Min. Thick: 36.1mm    Weight: 44.00 lbs</p>	<p>E125-85-019</p>  <p>Outer Dia: 390.0mm    Hub Reg: 152.4mm Height: 87.6mm    Bolt Size: 14.6mm Nom. Thick: 39.0mm    Bolt Circle: 10x184.1mm Min. Thick: 36.06mm    Weight: 43.50 lbs</p>
<p>E125-85-020</p>  <p>Outer Dia: 390mm    Hub Reg: -mm Height: 193.4mm    Bolt Size: 23.7mm Nom. Thick: 39mm    Bolt Circle: 10x285.7mm Min. Thick: 36.06mm    Weight: 60.00 lbs</p>	<p>E125-85-022</p>  <p>Outer Dia: 390.0mm    Hub Reg: 137.2mm Height: 110.9mm    Bolt Size: 12.9mm Nom. Thick: 39.05mm    Bolt Circle: 10x197.8mm Min. Thick: 37.4mm    Weight: 36.50 lbs</p>	<p>E125-85-023</p>  <p>Outer Dia: 381mm    Hub Reg: 190mm Height: 194.5mm    Bolt Size: 21.2mm Nom. Thick: 39mm    Bolt Circle: 8x274.7mm Min. Thick: 36.07mm    Weight: 56.15 lbs</p>
<p>E125-87-008</p>  <p>Outer Dia: 381.0mm    Hub Reg: 158.0mm Height: 107.2mm    Bolt Size: 12.3mm Nom. Thick: 36.40mm    Bolt Circle: 10x180.0mm Min. Thick: -N/A    Weight: 45.20 lbs</p>	<p>E125-88-005</p>  <p>Outer Dia: 381.0mm    Hub Reg: 228.6mm Height: 108.2mm    Bolt Size: 16.50mm Nom. Thick: 36.58mm    Bolt Circle: 5x266.7mm Min. Thick: 33.53mm    Weight: 48.22 lbs</p>	<p>E125-88-006</p>  <p>Outer Dia: 381.0mm    Hub Reg: 177.8mm Height: 172.7mm    Bolt Size: 20.32mm Nom. Thick: 36.45mm    Bolt Circle: 6x222.3mm Min. Thick: 33.53mm    Weight: 52.00 lbs</p>
<p>E125-88-007</p>  <p>Outer Dia: 381.0mm    Hub Reg: 233.3mm Height: 114.0mm    Bolt Size: 16.66mm Nom. Thick: 36.4mm    Bolt Circle: 5x285.7mm Min. Thick: 33.5mm    Weight: 48.00 lbs</p>	<p>E125-88-008</p>  <p>Outer Dia: 381.0mm    Hub Reg: 362.0mm Height: 149.8mm    Bolt Size: 16.8mm Nom. Thick: 36.3mm    Bolt Circle: 5x323.9mm Min. Thick: 33.5mm    Weight: 59.05 lbs</p>	<p>E125-88-011</p>  <p>Outer Dia: 381.0mm    Hub Reg: 233.172mm Height: 114.0mm    Bolt Size: 19.81mm Nom. Thick: 36.3mm    Bolt Circle: 5x285.75mm Min. Thick: 33.5mm    Weight: 49.00 lbs</p>

# Brake Rotors

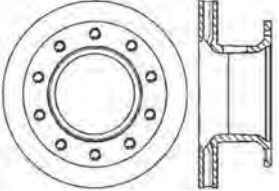
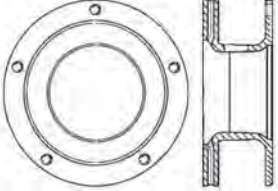
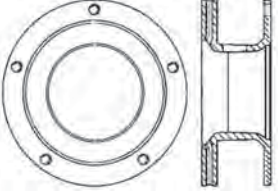
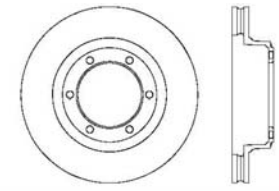
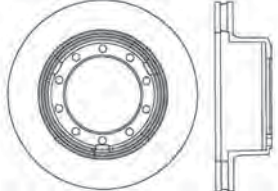
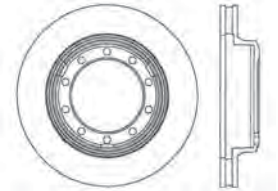
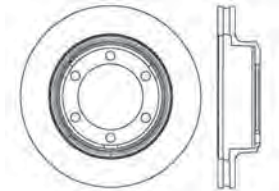
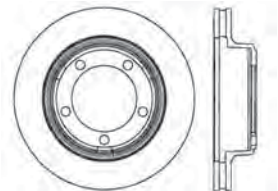
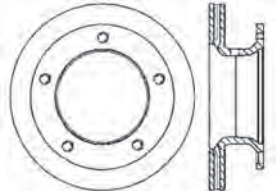
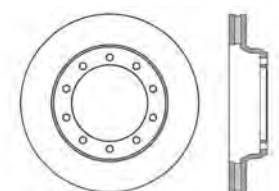
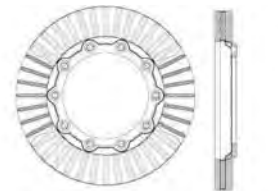
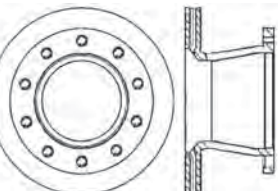
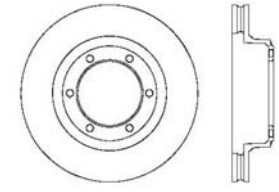
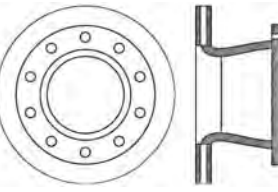
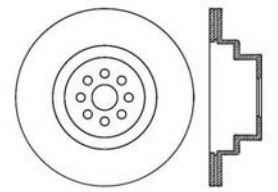
<p>E125-88-012</p>  <p>Outer Dia: 381.0mm    Hub Reg: 238.0mm Height: 172.7mm    Bolt Size: 19.3mm Nom. Thick: 36.3mm    Bolt Circle: 10x285.8mm Min. Thick: 33.5mm    Weight: 57.0 lbs</p>	<p>E125-88-013</p>  <p>Outer Dia: 381mm    Hub Reg: 362.0mm Height: 149.8mm    Bolt Size: 19.5mm Nom. Thick: 36.4mm    Bolt Circle: 5x323.8mm Min. Thick: 33.5mm    Weight: 60.00 lbs</p>	<p>E125-88-014</p>  <p>Outer Dia: 381.0mm    Hub Reg: 349.25mm Height: 133.3mm    Bolt Size: 16.5 mm Nom. Thick: 36.5mm    Bolt Circle: 5x285.7mm Min. Thick: 33.5mm    Weight: 54.00 lbs</p>
<p>E125-88-015</p>  <p>Outer Dia: 381.0mm    Hub Reg: 137.2mm Height: 89.0mm    Bolt Size: 19.6mm Nom. Thick: 36.6mm    Bolt Circle: 6x171.4mm Min. Thick: 33.53mm    Weight: 40.00 lbs</p>	<p>E125-88-018</p>  <p>Outer Dia: 381mm    Hub Reg: 152.2mm Height: 113mm    Bolt Size: 14.9mm Nom. Thick: 36.6mm    Bolt Circle: 10x184.1mm Min. Thick: 33.5mm    Weight: 37.40 lbs</p>	<p>E125-88-019</p>  <p>Outer Dia: 381.0mm    Hub Reg: 152.3mm Height: 81.6mm    Bolt Size: 15.2mm Nom. Thick: 36.6mm    Bolt Circle: 10x184.1mm Min. Thick: 33.53mm    Weight: 34.30 lbs</p>
<p>E125-88-020</p>  <p>Outer Dia: 381.0mm    Hub Reg: 137.2mm Height: 89.0mm    Bolt Size: 19.6mm Nom. Thick: 36.5mm    Bolt Circle: 6x171.4mm Min. Thick: 33.53mm    Weight: 36.00 lbs</p>	<p>E125-88-021</p>  <p>Outer Dia: 381.0mm    Hub Reg: 137.0mm Height: 89.0mm    Bolt Size: 19.60mm Nom. Thick: 36.50mm    Bolt Circle: 5x171.5mm Min. Thick: 33.53mm    Weight: 37.0 lbs</p>	<p>E125-88-022</p>  <p>Outer Dia: 381.0mm    Hub Reg: 234.7mm Height: 124.3mm    Bolt Size: 19.60mm Nom. Thick: 36.5mm    Bolt Circle: 5x285.8mm Min. Thick: 33.53mm    Weight: 51.05 lbs</p>
<p>E125-88-023</p>  <p>Outer Dia: 381.0mm    Hub Reg: 162.0mm Height: 61.50mm    Bolt Size: 14.4mm Nom. Thick: 36.50mm    Bolt Circle: 10x194.0mm Min. Thick: -N/A    Weight: 37.90 lbs</p>	<p>E125-88-025</p>  <p>Outer Dia: 390.0mm    Hub Reg: 1287.6mm Height: 48.6mm    Bolt Size: 13.4mm Nom. Thick: 39.1mm    Bolt Circle: 10x219.7mm Min. Thick: 36.1mm    Weight: 39.34 lbs</p>	<p>E125-89-006</p>  <p>Outer Dia: 382.0mm    Hub Reg: 240.7mm Height: 186.7mm    Bolt Size: 20.5mm Nom. Thick: 36.5mm    Bolt Circle: 10x285.7mm Min. Thick: 33.53mm    Weight: 59.00lbs</p>
<p>E125-89-007</p>  <p>Outer Dia: 381.0mm    Hub Reg: 137.2mm Height: 89.0mm    Bolt Size: 14.6mm Nom. Thick: 36.6mm    Bolt Circle: 6x171.4mm Min. Thick: 33.53mm    Weight: 40.74 lbs</p>	<p>E125-89-008</p>  <p>Outer Dia: 382.0mm    Hub Reg: 240.7mm Height: 186.7mm    Bolt Size: 26.9mm Nom. Thick: 36.5mm    Bolt Circle: 10x285.7mm Min. Thick: 33.53mm    Weight: 59.00 lbs</p>	<p>E125-90-005</p>  <p>Outer Dia: 306.5mm    Hub Reg: 44.0mm Height: 97.5mm    Bolt Size: 14.9mm Nom. Thick: 27.6mm    Bolt Circle: 8x82.1mm Min. Thick: 25mm    Weight: 23.40 lbs</p>

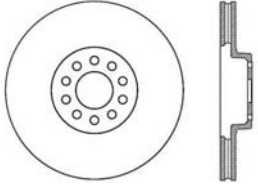
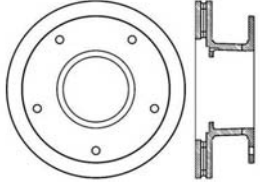
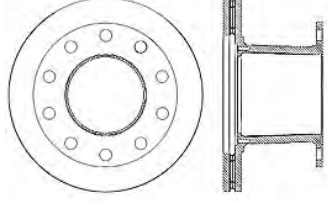
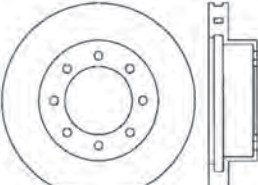
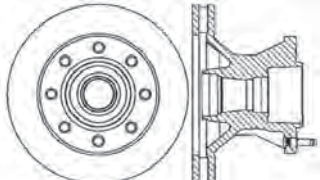
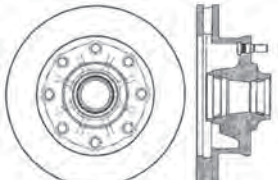
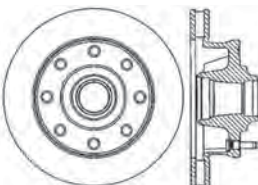
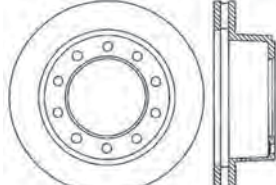
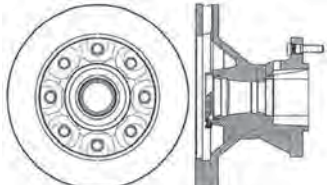
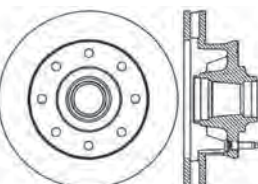
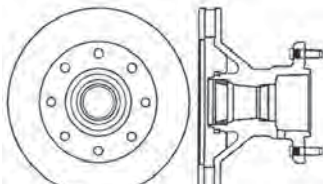
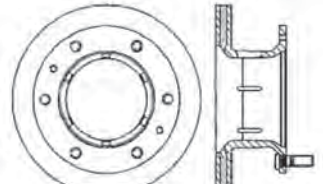
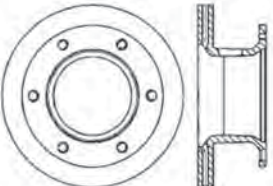
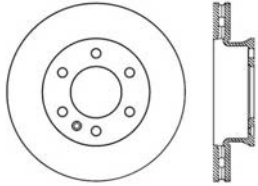
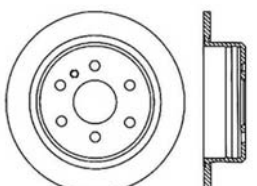
<p>E125-90-006</p>  <p>Outer Dia: 322mm    Hub Reg: 67.1mm            Height: 58.6mm    Bolt Size: 14.9mm            Nom. Thick: 30mm    Bolt Circle: 10x107.6mm            Min. Thick: 27.75mm    Weight: 25.10 lbs</p>	<p>E125-90-007</p>  <p>Outer Dia: 322.0mm    Hub Reg: 119.0mm            Height: 106.3mm    Bolt Size: 13.6mm            Nom. Thick: 30.0mm    Bolt Circle: 5x222.0mm            Min. Thick: 26.9mm    Weight: 35.4 lbs</p>	<p>E125-90-008</p>  <p>Outer Dia: 299.8mm    Hub Reg: 118.1mm            Height: 153.5mm    Bolt Size: 17.4mm            Nom. Thick: 28.0mm    Bolt Circle: 10x184.4mm            Min. Thick: 25.4mm    Weight: 32.30 lbs</p>
<p>E126-70-073</p>  <p>Outer Dia: 369.0mm    Hub Reg: 129.1mm            Height: 93.0mm    Bolt Size: 16.20mm            Nom. Thick: 38.10mm    Bolt Circle: 8x170.0mm            Min. Thick: 36.00mm    Weight: 34.95 lbs</p>	<p>E126-71-006</p>  <p>Outer Dia: 317.7mm    Hub Reg: 115.60mm            Height: 195.0mm    Bolt Size: 9/16x18            Nom. Thick: 38.99mm    Bolt Circle: 8x165.1mm            Min. Thick: 37.21mm    Weight: 54.85 lbs</p>	<p>E126-71-007</p>  <p>Outer Dia: 317.5mm    Hub Reg: 116.5mm            Height: 131.3mm    Bolt Size: 9/16x18            Nom. Thick: 38.90mm    Bolt Circle: 8x165.1mm            Min. Thick: 37.21mm    Weight: - N/A</p>
<p>E126-71-010</p>  <p>Outer Dia: 317.5    Hub Reg: 116.6mm            Height: 121.0mm    Bolt Size: 9/16x18            Nom. Thick: 32.80mm    Bolt Circle: 8x165.1mm            Min. Thick: 30.86mm    Weight: - N/A</p>	<p>E126-71-023</p>  <p>Outer Dia: 349.0mm    Hub Reg: 139.8mm            Height: 111.2mm    Bolt Size: 17.0mm            Nom. Thick: 39.00mm    Bolt Circle: 184.1mm            Min. Thick: 37.21mm    Weight: 34.5 lbs</p>	<p>E126-71-026</p>  <p>Outer Dia: 317.5mm    Hub Reg: 115.7mm            Height: 195.1mm    Bolt Size: 9/16x18 in            Nom. Thick: 38.9mm    Bolt Circle: 8x165.1mm            Min. Thick: 37.2mm    Weight: 42.35 lbs</p>
<p>E126-71-035</p>  <p>Outer Dia: 317.4mm    Hub Reg: 116.5mm            Height: 131.9mm    Bolt Size: 9/16x18in            Nom. Thick: 38.9mm    Bolt Circle: 8x165.1mm            Min. Thick: 37.2mm    Weight: 39.38 lbs</p>	<p>E126-71-042</p>  <p>Outer Dia: 317.3mm    Hub Reg: 115.8mm            Height: 195.9mm    Bolt Size: 9/16x18in            Nom. Thick: 38.8mm    Bolt Circle: 8x165.1mm            Min. Thick: 37.2mm    Weight: 52.97 lbs</p>	<p>E126-77-005</p>  <p>Outer Dia: 315.0mm    Hub Reg: 160.1mm            Height: 118.5mm    Bolt Size: 18x1.50mm            Nom. Thick: 26.0mm    Bolt Circle: 6x8.00mm            Min. Thick: 23.0mm    Weight: 31.00 lbs</p>
<p>E126-84-022</p>  <p>Outer Dia: 390.7mm    Hub Reg: 163.7mm            Height: 152.9mm    Bolt Size: 21.4mm            Nom. Thick: 38.99mm    Bolt Circle: 6x222.3mm            Min. Thick: 35.94mm    Weight: -N/A</p>	<p>E130-40-111</p>  <p>Outer Dia: 299.6mm    Hub Reg: 85.0mm            Height: 68.4mm    Bolt Size: 15.3mm            Nom. Thick: 28.00mm    Bolt Circle: 6x130.2mm            Min. Thick: 25.00mm    Weight: 20.20 lbs</p>	<p>E130-40-112</p>  <p>Outer Dia: 298.0mm    Hub Reg: 85.0mm            Height: 71.2mm    Bolt Size: 15.3mm            Nom. Thick: 16.00mm    Bolt Circle: 6x130.2mm            Min. Thick: 14.00mm    Weight: 15.90 lbs</p>

# Brake Rotors

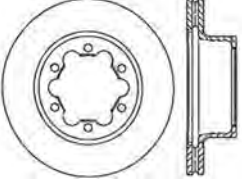
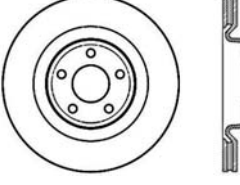
E130-40-113	E130-67-121	
 <p>Outer Dia: 303.3mm    Hub Reg: 120.0mm            Height: 93.0mm    Bolt Size: 15.0mm            Nom. Thick: 28.0mm    Bolt Circle: 6x145.2mm            Min. Thick: 25.0mm    Weight: 21.95 lbs</p>	 <p>Outer Dia: 315.5mm    Hub Reg: 65.6mm            Height: 42.8mm    Bolt Size: 14.3mm            Nom. Thick: 25.7mm    Bolt Circle: 5x110.0mm            Min. Thick: 24.0mm    Weight: 18.20 lbs</p>	



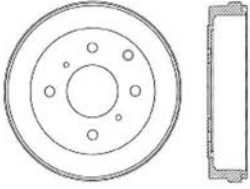
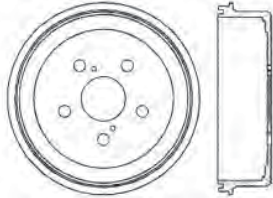
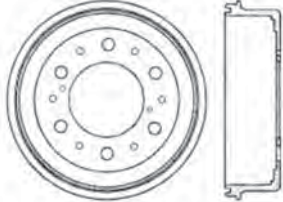
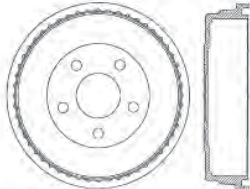
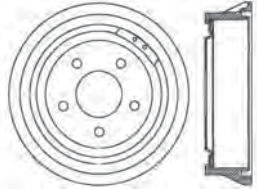
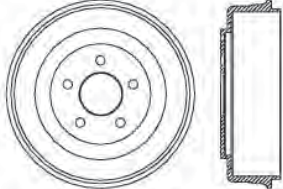
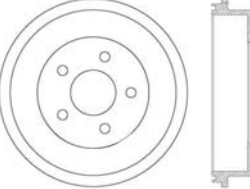
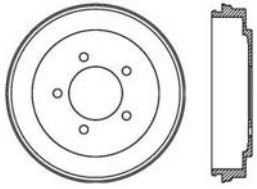
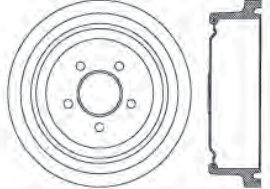
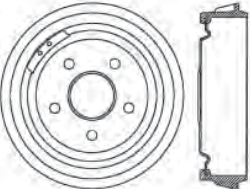
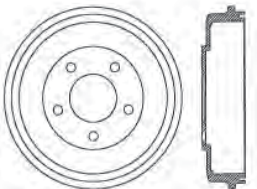
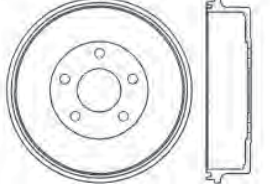
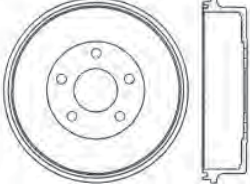
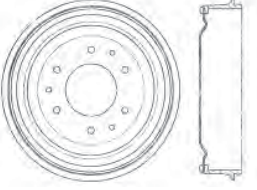
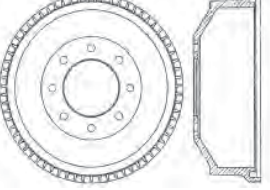







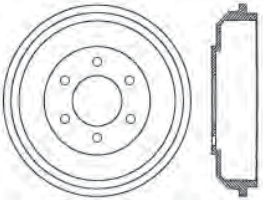
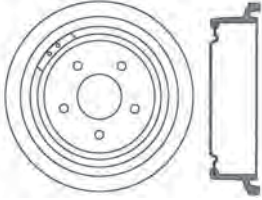
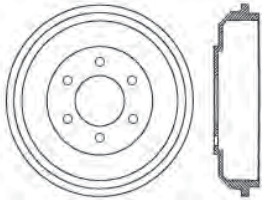
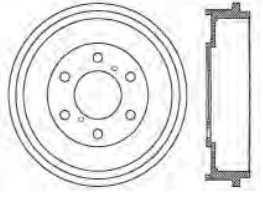
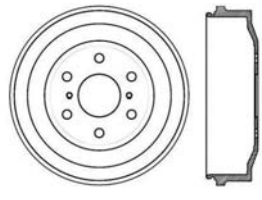
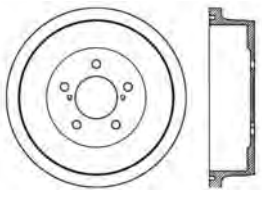
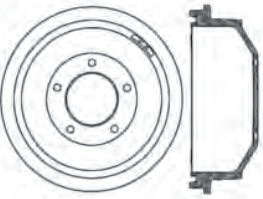
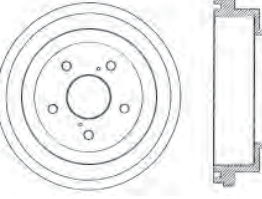
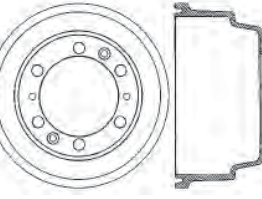
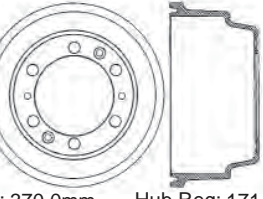
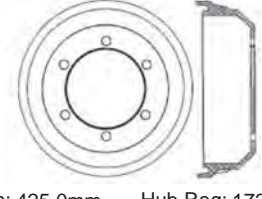
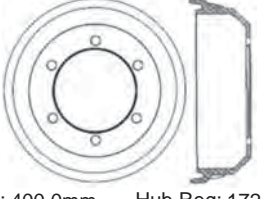
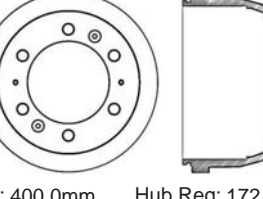
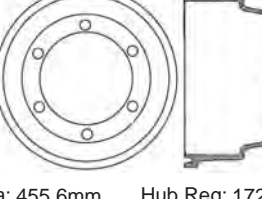







<p>E127-47-032</p>  <p>Outer Dia: 264.5mm    Hub Reg: 68.0mm            Height: 60.4mm    Bolt Size: 12.8mm            Nom. Dia: 228.50mm    Bolt Circle: 4x114.3mm            Max. Dia: 230.00mm    Weight: 11.85 lbs</p>	<p>E127-49-049</p>  <p>Outer Dia: 306.0mm    Hub Reg: 62.0mm            Height: 73.6mm    Bolt Size: 14.5mm            Nom. Dia: 254.2mm    Bolt Circle: 5 x114.3mm            Max. Dia: 256.0mm    Weight: 24.50 lbs</p>	<p>E127-49-051</p>  <p>Outer Dia: 306.0mm    Hub Reg: 108.0mm            Height: 73.7mm    Bolt Size: 14.4mm            Nom. Dia: 254.0mm    Bolt Circle: 6x140mm            Max. Dia: 256.0mm    Weight: 20.50 lbs</p>
<p>E127-66-054</p>  <p>Outer Dia: 267.0mm    Hub Reg: 64.4mm            Height: 67.7mm    Bolt Size: 14.6mm            Nom. Dia: 225.00mm    Bolt Circle: 5x108.0mm            Max. Dia: 226.55mm    Weight: 11.50 lbs</p>	<p>E127-67-028</p>  <p>Outer Dia: 276.0mm    Hub Reg: 70.6mm            Height: 70.0mm    Bolt Size: -mm            Nom. Dia: 223.52mm    Bolt Circle: 5x114.3            Max. Dia: 226.30mm    Weight: 13.50 lbs</p>	<p>E127-67-041</p>  <p>Outer Dia: 271.0mm    Hub Reg: 65.5mm            Height: 73.5mm    Bolt Size: 14.0mm            Nom. Dia: 217.50mm    Bolt Circle: 5x110.4mm            Max. Dia: 231.00mm    Weight: 12.00 lbs</p>
<p>E127-67-044</p>  <p>Outer Dia: 274.6mm    Hub Reg: 65.5mm            Height: 71.7mm    Bolt Size: 14.0mm            Nom. Dia: 228.70mm    Bolt Circle: 5x110.0mm            Max. Dia: 230.60mm    Weight: 11.97 lbs</p>	<p>E127-68-053</p>  <p>Outer Dia: 268.2mm    Hub Reg: 80.0mm            Height: 60.2mm    Bolt Size: 12.8mm            Nom. Dia: 228.50mm    Bolt Circle: 5x114.3mm            Max. Dia: 230.60mm    Weight: 11.95 lbs</p>	<p>E127-70-042</p>  <p>Outer Dia: 298.0 mm    Hub Reg: 71.1            Height: 87.9mm    Bolt Size: -mm            Nom. Dia: 254.00mm    Bolt Circle: 5x114.3            Max. Dia: 256.29mm    Weight: 14.00 lbs</p>
<p>E127-70-045</p>  <p>Outer Dia: 269.0mm    Hub Reg: 71.3mm            Height: 70.0mm    Bolt Size: 14.5mm            Nom. Dia: 228.60mm    Bolt Circle: 5x114.3mm            Max. Dia: 230.12mm    Weight: 11.00 lbs</p>	<p>E127-70-049</p>  <p>Outer Dia: 274.0mm    Hub Reg: 72.1mm            Height: 66.5mm    Bolt Size: 14.0mm            Nom. Dia: 228.60mm    Bolt Circle: 5x114.3mm            Max. Dia: 230.10mm    Weight: 14.50 lbs</p>	<p>E127-70-051</p>  <p>Outer Dia: 297.1mm    Hub Reg: 72.1mm            Height: 72.3mm    Bolt Size: 13.5mm            Nom. Dia: 254.20mm    Bolt Circle: 5x114.3mm            Max. Dia: 256.30mm    Weight: 18.65 lbs</p>
<p>E127-70-052</p>  <p>Outer Dia: 279.2mm    Hub Reg: 63.3mm            Height: 89.6mm    Bolt Size: 13.0mm            Nom. Dia: 228.30mm    Bolt Circle: 5x108.0mm            Max. Dia: 230.20mm    Weight: 18.35 lbs</p>	<p>E127-71-005</p>  <p>Outer Dia: 314.5mm    Hub Reg: 90.5mm            Height: 75.0mm    Bolt Size: 11.4mm            Nom. Dia: 279.10mm    Bolt Circle: 6x139.7mm            Max. Dia: 281.60mm    Weight: 15.00 lbs</p>	<p>E127-71-014</p>  <p>Outer Dia: 389.0mm    Hub Reg: 116.7mm            Height: 142.0mm    Bolt Size: 15.6mm            Nom. Dia: 329.00mm    Bolt Circle: 8x165.1m            Max. Dia: 332.50mm    Weight: 45.50 lbs</p>



# Brake Drums















**FORMULABLUE**

<p>E127-71-034</p>  <p>Outer Dia: 411.5mm    Hub Reg: 116.8mm            Height: 193.4mm    Bolt Size: 15.6mm            Nom. Dia: 330.20mm    Bolt Circle: 8x165.1mm            Max. Dia: 332.50mm    Weight: 55.00 lbs</p>	<p>E127-71-047</p>  <p>Outer Dia: 296.0mm    Hub Reg: 70.6mm            Height: 73.8mm    Bolt Size: 14.3mm            Nom. Dia: 250.00mm    Bolt Circle: 5x114.3mm            Max. Dia: 251.50mm    Weight: 15.00 lbs</p>	<p>E127-71-048</p>  <p>Outer Dia: 335.0mm    Hub Reg: 101.1mm            Height: 80.6mm    Bolt Size: 13.3mm            Nom. Dia: 295.00mm    Bolt Circle: 6x140.0mm            Max. Dia: 296.50mm    Weight: 19.85 lbs</p>
<p>E127-71-049</p>  <p>Outer Dia: 336.0mm    Hub Reg: 78.5mm            Height: 97.1mm    Bolt Size: 16.3mm            Nom. Dia: 295.00mm    Bolt Circle: 6x140.0mm            Max. Dia: 296.50mm    Weight: 23.00 lbs</p>	<p>E127-71-050</p>  <p>Outer Dia: 336.0mm    Hub Reg: 78.6mm            Height: 96.6mm    Bolt Size: 16.4mm            Nom. Dia: 295.00mm    Bolt Circle: 6x140.0mm            Max. Dia: 296.50mm    Weight: 25.25 lbs</p>	<p>E127-72-034</p>  <p>Outer Dia: 307.6mm    Hub Reg: 72.0mm            Height: 77.4mm    Bolt Size: 14.3mm            Nom. Dia: 250.00mm    Bolt Circle: 5x114.3mm            Max. Dia: 251.20mm    Weight: 18.70 lbs</p>
<p>E127-72-048</p>  <p>Outer Dia: 355.0mm    Hub Reg: 78.5mm            Height: 112.1mm    Bolt Size: 17.1mm            Nom. Dia: 293.00mm    Bolt Circle: 5x139.7mm            Max. Dia: 297.50mm    Weight: 28.50 lbs</p>	<p>E127-72-049</p>  <p>Outer Dia: 342.1mm    Hub Reg: 78.9mm            Height: 111.9mm    Bolt Size: 17.2mm            Nom. Dia: 294.80mm    Bolt Circle: 5x139.7 mm            Max. Dia: 297.50mm    Weight: 12.00 lbs</p>	<p>E127-81-005</p>  <p>Outer Dia: 78.9mm    Hub Reg: 171.9mm            Height: 17.2mm    Bolt Size: 22.5mm            Nom. Dia: 5x 39.7mm    Bolt Circle: 6x222.3mm            Max. Dia: 12.00lbs    Weight: 47.00 lbs</p>
<p>E127-81-006</p>  <p>Outer Dia: 370.0mm    Hub Reg: 171.9mm            Height: 192.0mm    Bolt Size: 22.5mm            Nom. Dia: 320.80mm    Bolt Circle: 6x222.3mm            Max. Dia: 321.50mm    Weight: 51.50 lbs</p>	<p>E127-81-010</p>  <p>Outer Dia: 425.0mm    Hub Reg: 172.0mm            Height: 163.0mm    Bolt Size: 22.2mm            Nom. Dia: 370.0mm    Bolt Circle: 6x222.3mm            Max. Dia: -N/A    Weight: 69.50 lbs</p>	<p>E127-81-011</p>  <p>Outer Dia: 400.0mm    Hub Reg: 172.0mm            Height: 194.0mm    Bolt Size: 22.2mm            Nom. Dia: 370.0mm    Bolt Circle: 6x222.3mm            Max. Dia: -N/A    Weight: 81.50 lbs</p>
<p>E127-81-012</p>  <p>Outer Dia: 400.0mm    Hub Reg: 172.0mm            Height: 194.0mm    Bolt Size: 22.2mm            Nom. Dia: 370.0mm    Bolt Circle: 6x222.3mm            Max. Dia: -mm    Weight: 81.50 lbs</p>	<p>E127-81-013</p>  <p>Outer Dia: 455.6mm    Hub Reg: 172.0mm            Height: 220.0mm    Bolt Size: 22.6mm            Nom. Dia: 357.40mm    Bolt Circle: 6x222.3mm            Max. Dia: 372.00mm    Weight: 94.30 lbs.</p>	















E135-40-507	E135-47-335	E135-47-336
 <p><b>Bore Size:</b> 27mm  <b>Port #1:</b> LF 12x1 bbl  <b>Port #2:</b> LR 12x1 bbl  <b>Port #3:</b> -  <b>Port #4:</b> -  <b>Port #5:</b> -  <b>Push Rod:</b> Depth 2.27"</p>	 <p><b>Bore Size:</b> 1"  <b>Port #1:</b> RF 10x1 bbl  <b>Port #2:</b> RR 10x1 bbl  <b>Port #3:</b> F Bttm not drilled  <b>Port #4:</b> -  <b>Port #5:</b> -  <b>Push Rod:</b> Depth 1.44"</p>	 <p><b>Bore Size:</b> 1"  <b>Port #1:</b> RF 12x1 bbl  <b>Port #2:</b> RR 12x1 bbl  <b>Port #3:</b> RR Bttm 12x1 bbl  <b>Port #4:</b> F Bttm not drilled  <b>Port #5:</b> -  <b>Push Rod:</b> Depth 1.45"</p>
E135-47-337	E135-47-338	E135-47-339
 <p><b>Bore Size:</b> 1"  <b>Port #1:</b> RF 12x1 bbl  <b>Port #2:</b> RR 12x1 bbl  <b>Port #3:</b> RR Bttm 12x1 bbl  <b>Port #4:</b> F Bttm 12x1 bbl  <b>Port #5:</b> -  <b>Push Rod:</b> Depth 1.45"</p>	 <p><b>Bore Size:</b> 1"  <b>Port #1:</b> RF 12x1 bbl  <b>Port #2:</b> RR 12x1 bbl  <b>Port #3:</b> RR 12x1 bbl  <b>Port #4:</b> -  <b>Port #5:</b> -  <b>Push Rod:</b> Depth 1.43"</p>	 <p><b>Bore Size:</b> 1"  <b>Port #1:</b> RF 10x1 bbl  <b>Port #2:</b> RR 10x1 bbl  <b>Port #3:</b> RF not drilled  <b>Port #4:</b> RR not drilled  <b>Port #5:</b> -  <b>Push Rod:</b> Depth 1.44"</p>
E135-47-340	E135-47-341	E135-47-342
 <p><b>Bore Size:</b> 1"  <b>Port #1:</b> RF 12x1 bbl  <b>Port #2:</b> RR 12x1 bbl  <b>Port #3:</b> -  <b>Port #4:</b> -  <b>Port #5:</b> -  <b>Push Rod:</b> Depth 1.44"</p>	 <p><b>Bore Size:</b> 1"  <b>Port #1:</b> RF 12x1 bbl  <b>Port #2:</b> RR 12x1 bbl  <b>Port #3:</b> -  <b>Port #4:</b> -  <b>Port #5:</b> -  <b>Push Rod:</b> Depth 1.44"</p>	 <p><b>Bore Size:</b> 1 1/16"  <b>Port #1:</b> RF 12x1 bbl  <b>Port #2:</b> RR 12x1 bbl  <b>Port #3:</b> R Bttm 12x1 bbl  <b>Port #4:</b> F Bttm 12x1 bbl  <b>Port #5:</b> -  <b>Push Rod:</b> Depth 1.23"</p>
E135-47-816	E135-47-822	E135-47-823
 <p><b>Bore Size:</b> 15/16"  <b>Port #1:</b> LR 12x1 Inv  <b>Port #2:</b> RF 12x1 Inv  <b>Port #3:</b> -  <b>Port #4:</b> -  <b>Port #5:</b> -  <b>Push Rod:</b> Depth 1.62"</p>	 <p><b>Bore Size:</b> 15/16"  <b>Port #1:</b> RF 12x1 bbl  <b>Port #2:</b> RR 12x1 bbl  <b>Port #3:</b> -  <b>Port #4:</b> -  <b>Port #5:</b> -  <b>Push Rod:</b> Depth 1.19"</p>	 <p><b>Bore Size:</b> 15/16"  <b>Port #1:</b> RF 12x1 bbl  <b>Port #2:</b> RR 12x1 bbl  <b>Port #3:</b> -  <b>Port #4:</b> -  <b>Port #5:</b> -  <b>Push Rod:</b> Depth 1.19"</p>
E135-47-905	E135-47-906	E135-47-907
 <p><b>Bore Size:</b> 1 3/16"  <b>Port #1:</b> RF 12x1 bbl  <b>Port #2:</b> RR 12x1 bbl  <b>Port #3:</b> RR Bttm 12x1 bbl  <b>Port #4:</b> F Bttm 12x1 bbl  <b>Port #5:</b> -  <b>Push Rod:</b> Depth 1.55"</p>	 <p><b>Bore Size:</b> 1 1/8"  <b>Port #1:</b> RF 12x1 bbl  <b>Port #2:</b> RR 12x1 bbl  <b>Port #3:</b> RR Bttm 12x1 bbl  <b>Port #4:</b> F Bttm 12x1 bbl  <b>Port #5:</b> -  <b>Push Rod:</b> Depth 1.55"</p>	 <p><b>Bore Size:</b> 1 1/8"  <b>Port #1:</b> RF 10x1 bbl  <b>Port #2:</b> RR 10x1 bbl  <b>Port #3:</b> -  <b>Port #4:</b> -  <b>Port #5:</b> -  <b>Push Rod:</b> Depth 1.17"</p>

# Brake Master Cylinders

**FORMULABLUE**  
HYDRAULIC BRAKE PARTS

E135-47-908	E135-47-909	E135-47-910
 <p> <b>Bore Size:</b> 1 15/16"  <b>Port #1:</b> RF 12x1 bbl  <b>Port #2:</b> RR 12x1 bbl  <b>Port #3:</b> F Bttm 12x1 bbl  <b>Port #4:</b> R Bttm 12x1 bbl  <b>Port #5:</b> -  <b>Push Rod:</b> Depth 2.30"                 </p>	 <p> <b>Bore Size:</b> 1 15/16"  <b>Port #1:</b> RF 12x1 bbl  <b>Port #2:</b> RR 12x1 bbl  <b>Port #3:</b> -  <b>Port #4:</b> -  <b>Port #5:</b> -  <b>Push Rod:</b> Depth 1.55"                 </p>	 <p> <b>Bore Size:</b> 1 3/16"  <b>Port #1:</b> RF 12x1 bbl  <b>Port #2:</b> RR 12x1 bbl  <b>Port #3:</b> R Bttm port 12x1 bbl  <b>Port #4:</b> F Bttm Port 12x1 bbl  <b>Port #5:</b> -  <b>Push Rod:</b> Depth 1.11"                 </p>
E135-49-746	E135-49-747	E135-49-748
 <p> <b>Bore Size:</b> 23"  <b>Port #1:</b> LF 12x1 bbl  <b>Port #2:</b> LR 12x1 bbl  <b>Port #3:</b> R Bttm port 12x1 bbl  <b>Port #4:</b> F Bttm 12x bbl  <b>Port #5:</b> -  <b>Push Rod:</b> Depth 1.65"                 </p>	 <p> <b>Bore Size:</b> 13/16"  <b>Port #1:</b> RF 10x1 inv  <b>Port #2:</b> RR 10x1 inv  <b>Port #3:</b> -  <b>Port #4:</b> -  <b>Port #5:</b> -  <b>Push Rod:</b> Depth 1.37"                 </p>	 <p> <b>Bore Size:</b> 13/16"  <b>Port #1:</b> LF not drilled  <b>Port #2:</b> LR not drilled  <b>Port #3:</b> RF 10x1 inv  <b>Port #4:</b> RR 10x1 inv  <b>Port #5:</b> -  <b>Push Rod:</b> Depth 1.38"                 </p>
E135-49-749	E135-49-750	E135-49-751
 <p> <b>Bore Size:</b> 15/16"  <b>Port #1:</b> LF 12x1 inv  <b>Port #2:</b> LR 12x1 inv  <b>Port #3:</b> -  <b>Port #4:</b> -  <b>Port #5:</b> -  <b>Push Rod:</b> Depth 1.46"                 </p>	 <p> <b>Bore Size:</b> 13/16"  <b>Port #1:</b> RF 12x1 inv  <b>Port #2:</b> RR 12x1 inv  <b>Port #3:</b> -  <b>Port #4:</b> -  <b>Port #5:</b> -  <b>Push Rod:</b> Depth 1.57"                 </p>	 <p> <b>Bore Size:</b> 13/16"  <b>Port #1:</b> RF 12x1 inv  <b>Port #2:</b> RR 12x1 inv  <b>Port #3:</b> -  <b>Port #4:</b> -  <b>Port #5:</b> Nipple on reservoir 1  <b>Push Rod:</b> Depth 1.57"                 </p>
E135-49-825	E135-49-826	E135-49-828
 <p> <b>Bore Size:</b> 7/8"  <b>Port #1:</b> LF not drilled  <b>Port #2:</b> LR not drilled  <b>Port #3:</b> RF 10x1 inv  <b>Port #4:</b> RR 10x1 inv  <b>Port #5:</b> -  <b>Push Rod:</b> Depth 1.58"                 </p>	 <p> <b>Bore Size:</b> 3/4"  <b>Port #1:</b> F Up 10x1 inv  <b>Port #2:</b> RR 10x1 inv  <b>Port #3:</b> -  <b>Port #4:</b> -  <b>Port #5:</b> -  <b>Push Rod:</b> Integrated                 </p>	 <p> <b>Bore Size:</b> 7/8"  <b>Port #1:</b> LR 12x1 inv  <b>Port #2:</b> RF 12x1 inv  <b>Port #3:</b> -  <b>Port #4:</b> -  <b>Port #5:</b> -  <b>Push Rod:</b> Depth 1.57"                 </p>
E135-49-829	E135-49-830	E135-50-124
 <p> <b>Bore Size:</b> 3/4"  <b>Port #1:</b> RR 10x inv  <b>Port #2:</b> Front up 10x1 inv  <b>Port #3:</b> -  <b>Port #4:</b> -  <b>Port #5:</b> -  <b>Push Rod:</b> Integrated                 </p>	 <p> <b>Bore Size:</b> 3/4"  <b>Port #1:</b> RF 10x1 inv  <b>Port #2:</b> RR 10x1 inv  <b>Port #3:</b> -  <b>Port #4:</b> -  <b>Port #5:</b> -  <b>Push Rod:</b> Depth.088"                 </p>	 <p> <b>Bore Size:</b> 7/8"  <b>Port #1:</b> LF 12x1 inv  <b>Port #2:</b> LR 12x1 inv  <b>Port #3:</b> -  <b>Port #4:</b> -  <b>Port #5:</b> -  <b>Push Rod:</b> Depth 1.96"                 </p>

# Brake Master Cylinders

E135-50-125	E135-50-126	E135-63-012
 <p>Bore Size: 13/16"          Port #1: LF 10x1 inv          Port #2: LR 10x1 inv          Port #3: -          Port #4: -          Port #5: -          Push Rod: Depth 1.62"</p>	 <p>Bore Size: 7/8"          Port #1: LF 14x1.5 inv          Port #2: LR 14x1. inv          Port #3: -          Port #4: -          Port #5: -          Push Rod: Depth 2.01"</p>	 <p>Bore Size: 1 1/16"          Port #1: RF 3/8 - 24" inv          Port #2: RR 7/16 - 24" inv          Port #3: -          Port #4: -          Port #5: -          Push Rod: Depth 1.61"</p>
E135-63-013	E135-63-014	E135-66-096
 <p>Bore Size: 26mm          Port #1: RF 12x1 bbl          Port #2: RR 12x1 bbl          Port #3: -          Port #4: -          Port #5: -          Push Rod: Depth 1.81"</p>	 <p>Bore Size: 27mm          Port #1: LF 14x1.5 inv          Port #2: LR 14x1.5 inv          Port #3: -          Port #4: -          Port #5: -          Push Rod: Depth 1.32"</p>	 <p>Bore Size: 1"          Port #1: LF 12x1 bbl          Port #2: RR 10x1 bbl          Port #3: -          Port #4: -          Port #5: -          Push Rod: Depth.675"</p>
E135-66-122	E135-66-123	E135-66-124
 <p>Bore Size: 1"          Port #1: LR not drilled          Port #2: RF 12x1 bbl          Port #3: R Ctr not drilled          Port #4: RR 10x1 bbl          Port #5: -          Push Rod: Depth 1.42"</p>	 <p>Bore Size: 1"          Port #1: LR 10x1 bleeder          Port #2: RF 10x1 bbl          Port #3: RR 12x1 bbl          Port #4: -          Port #5: -          Push Rod: Depth 1.41"</p>	 <p>Bore Size: 1"          Port #1: LF 12x1 bbl          Port #2: RR 12x1 bbl          Port #3: -          Port #4: -          Port #5: -          Push Rod: Depth.672"</p>
E135-66-137	E135-66-138	E135-66-139
 <p>Bore Size: 7/8"          Port #1: LF 14x1.5 inv          Port #2: LF 14x1.5 inv          Port #3: -          Port #4: -          Port #5: -          Push Rod: Depth 2.02"</p>	 <p>Bore Size: 1"          Port #1: RF 10x1 inv          Port #2: RF 10x1 inv          Port #3: -          Port #4: -          Port #5: -          Push Rod: Dimple</p>	 <p>Bore Size: 1"          Port #1: RF 14x1.5 inv          Port #2: RR 14x1.5 inv          Port #3: -          Port #4: -          Port #5: -          Push Rod: Dimple</p>
E135-66-145	E135-67-087	E135-67-116
 <p>Bore Size: 1 1/16"          Port #1: RF 14x1.5 inv          Port #2: RR 14x1.5 inv          Port #3: -          Port #4: -          Port #5: -          Push Rod: Dimple</p>	 <p>Bore Size: 7/8"          Port #1: LF 12x1bbl          Port #2: LR 11x1.5 bbl          Port #3: LF 10x1 bbl          Port #4: LR 13x1.5 bbl          Port #5: -          Push Rod: Dimple</p>	 <p>Bore Size: 1"          Port #1: LF 12x1 bbl          Port #2: LR 12x1 bbl          Port #3: -          Port #4: -          Port #5: -          Push Rod: Dimple</p>



# Brake Master Cylinders

**FORMULABLUE**  
INDUSTRIAL GRADE















E135-67-135	E135-67-149	E135-67-150
 <p><b>Bore Size:</b> 1"  <b>Port #1:</b> LF 12x1 bbl  <b>Port #2:</b> LR 10x1 bbl  <b>Port #3:</b> -  <b>Port #4:</b> -  <b>Port #5:</b> -  <b>Push Rod:</b> Depth 1.53"</p>	 <p><b>Bore Size:</b> 7/8"  <b>Port #1:</b> LR 12x1 inv  <b>Port #2:</b> LR 10x1 inv  <b>Port #3:</b> -  <b>Port #4:</b> -  <b>Port #5:</b> -  <b>Push Rod:</b> Dimple</p>	 <p><b>Bore Size:</b> 15/16"  <b>Port #1:</b> LF 12x1 inv  <b>Port #2:</b> LR 10x1 inv  <b>Port #3:</b> -  <b>Port #4:</b> -  <b>Port #5:</b> -  <b>Push Rod:</b> Depth 2.32"</p>
E135-67-152	E135-67-153	E135-67-155
 <p><b>Bore Size:</b> 1"  <b>Port #1:</b> LF 10x1 inv  <b>Port #2:</b> LR 12x1 inv  <b>Port #3:</b> LF 12x1 inv  <b>Port #4:</b> LR 10x1 inv  <b>Port #5:</b> -  <b>Push Rod:</b> Dimple</p>	 <p><b>Bore Size:</b> 1"  <b>Port #1:</b> LF 13x1.50 inv  <b>Port #2:</b> LR 13x1.50 inv  <b>Port #3:</b> -  <b>Port #4:</b> -  <b>Port #5:</b> -  <b>Push Rod:</b> Dimple</p>	 <p><b>Bore Size:</b> 1"  <b>Port #1:</b> LF 12x1 inv  <b>Port #2:</b> LR 12x1 inv  <b>Port #3:</b> -  <b>Port #4:</b> -  <b>Port #5:</b> -  <b>Push Rod:</b> Depth 1.67"</p>
E135-67-156	E135-67-157	E135-67-175
 <p><b>Bore Size:</b> 15/16"  <b>Port #1:</b> LF 12x1 inv  <b>Port #2:</b> LR 12x1 inv  <b>Port #3:</b> -  <b>Port #4:</b> -  <b>Port #5:</b> -  <b>Push Rod:</b> Depth 2.40"</p>	 <p><b>Bore Size:</b> 15/16"  <b>Port #1:</b> LF 12x1 inv  <b>Port #2:</b> LR 12x1 inv  <b>Port #3:</b> -  <b>Port #4:</b> -  <b>Port #5:</b> -  <b>Push Rod:</b> Depth 2.40"</p>	 <p><b>Bore Size:</b> 1"  <b>Port #1:</b> LF 12x1.5 inv  <b>Port #2:</b> LR 12x1.5 inv  <b>Port #3:</b> -  <b>Port #4:</b> -  <b>Port #5:</b> -  <b>Push Rod:</b> Depth 1.58"</p>
E135-67-178	E135-67-180	E135-68-073
 <p><b>Bore Size:</b> 1"  <b>Port #1:</b> LF 14x1.i inv  <b>Port #2:</b> LR 14x1.5 Inv  <b>Port #3:</b> -  <b>Port #4:</b> -  <b>Port #5:</b> -  <b>Push Rod:</b> Depth 1.58"</p>	 <p><b>Bore Size:</b> 1"  <b>Port #1:</b> LF 12x1 inv  <b>Port #2:</b> LR 12x1 inv  <b>Port #3:</b> -  <b>Port #4:</b> -  <b>Port #5:</b> -  <b>Push Rod:</b> Depth 1.58"</p>	 <p><b>Bore Size:</b> 13/16"  <b>Port #1:</b> RF 12x1 bbl  <b>Port #2:</b> RR 12x1 bbl  <b>Port #3:</b> -  <b>Port #4:</b> -  <b>Port #5:</b> -  <b>Push Rod:</b> Depth 1.70"</p>
E135-68-074	E135-68-075	E135-68-076
 <p><b>Bore Size:</b> 13/16"  <b>Port #1:</b> RF 12x1 bbl  <b>Port #2:</b> RR 10x1 bbl  <b>Port #3:</b> RB10x1 bbl  <b>Port #4:</b> FB12x1 bbl  <b>Port #5:</b> -  <b>Push Rod:</b> Depth 1.70"</p>	 <p><b>Bore Size:</b> 1 1/16"  <b>Port #1:</b> RF 3/8-24" inv  <b>Port #2:</b> RR 7/16-24" inv  <b>Port #3:</b> -  <b>Port #4:</b> -  <b>Port #5:</b> -  <b>Push Rod:</b> Depth 1.82"</p>	 <p><b>Bore Size:</b> 1"  <b>Port #1:</b> LF 7/16-24" inv  <b>Port #2:</b> LR 7/16-24" inv  <b>Port #3:</b> -  <b>Port #4:</b> -  <b>Port #5:</b> -  <b>Push Rod:</b> Depth 1.40"</p>

<p>E135-68-079</p>  <p><b>Bore Size:</b> 1"  <b>Port #1:</b> RF 3/8-24" inv  <b>Port #2:</b> RR 7/16-24 inv  <b>Port #3:</b> -  <b>Port #4:</b> -  <b>Port #5:</b> -  <b>Push Rod:</b> Depth 1.76"</p>	<p>E135-68-081</p>  <p><b>Bore Size:</b> 1"  <b>Port #1:</b> LF 14x1. inv  <b>Port #2:</b> LR 14x1.5 inv  <b>Port #3:</b> -  <b>Port #4:</b> -  <b>Port #5:</b> -  <b>Push Rod:</b> Depth 1.41"</p>	<p>E135-68-082</p>  <p><b>Bore Size:</b> 1 1/16"  <b>Port #1:</b> LF 14x1.5 inv  <b>Port #2:</b> LR 14x1.5 inv  <b>Port #3:</b> -  <b>Port #4:</b> -  <b>Port #5:</b> -  <b>Push Rod:</b> Depth 1.10"</p>
<p>E135-68-083</p>  <p><b>Bore Size:</b> 1 5/16"  <b>Port #1:</b> LF 12x1 bbl  <b>Port #2:</b> LR 12x1 bbl  <b>Port #3:</b> -  <b>Port #4:</b> -  <b>Port #5:</b> -  <b>Push Rod:</b> Depth 1.72"</p>	<p>E135-70-039</p>  <p><b>Bore Size:</b> 1 5/16"  <b>Port #1:</b> RF 9/16"- 18 inv  <b>Port #2:</b> RR 18x1.5  <b>Port #3:</b> -  <b>Port #4:</b> -  <b>Port #5:</b> -  <b>Push Rod:</b> Depth 1.41"</p>	<p>E135-70-047</p>  <p><b>Bore Size:</b> 1 5/16"  <b>Port #1:</b> RF 9/16"- 18 inv  <b>Port #2:</b> RR 18x1.5  <b>Port #3:</b> RF 3/8"- 24 inv  <b>Port #4:</b> -  <b>Port #5:</b> -  <b>Push Rod:</b> Depth 1.41"</p>
<p>E135-70-056</p>  <p><b>Bore Size:</b> 1 1/4"  <b>Port #1:</b> RF angled up 9/16"- 18 inv  <b>Port #2:</b> RR angled up 7/16"- 24 inv  <b>Port #3:</b> -  <b>Port #4:</b> -  <b>Port #5:</b> -  <b>Push Rod:</b> Depth 1.75"</p>	<p>E135-70-057</p>  <p><b>Bore Size:</b> 1 1/4"  <b>Port #1:</b> RF angled up 9/ 16-18" inv  <b>Port #2:</b> RR angled up 7/16-24" inv  <b>Port #3:</b> F B 3/8-24" inv  <b>Port #4:</b> -  <b>Port #5:</b> -  <b>Push Rod:</b> Depth 1.75"</p>	<p>E135-70-063</p>  <p><b>Bore Size:</b> 1 3/8"  <b>Port #1:</b> RF 9/16"- 18 inv  <b>Port #2:</b> RF 3/8 - 24 inv  <b>Port #3:</b> RR 7/16 - 24 inv  <b>Port #4:</b> -  <b>Port #5:</b> -  <b>Push Rod:</b> Depth 1.40"</p>
<p>E135-70-064</p>  <p><b>Bore Size:</b> 1 3/8"  <b>Port #1:</b> RF 9/16"- 18 inv  <b>Port #2:</b> RR 7/16"- 24 inv  <b>Port #3:</b> RR not drilled  <b>Port #4:</b> -  <b>Port #5:</b> -  <b>Push Rod:</b> Depth 1.40"</p>	<p>E135-70-065</p>  <p><b>Bore Size:</b> 1 1/4"  <b>Port #1:</b> RF angled up 9/16-18" inv  <b>Port #2:</b> RR angled up 18x1.50"  <b>Port #3:</b> F Bttm 3/8-24" inv  <b>Port #4:</b> -  <b>Port #5:</b> -  <b>Push Rod:</b> Depth 1.75"</p>	<p>E135-70-066</p>  <p><b>Bore Size:</b> 1 1/16"  <b>Port #1:</b> LF 10x1 bbl  <b>Port #2:</b> LR 12x1 bbl  <b>Port #3:</b> RR 10x1  <b>Port #4:</b> F Up 3/8"- 24 inv  <b>Port #5:</b> -  <b>Push Rod:</b> Depth 1.41"</p>
<p>E135-70-067</p>  <p><b>Bore Size:</b> 1 5/16"  <b>Port #1:</b> RF 7/16-24" inv  <b>Port #2:</b> RR 9/16-18" inv  <b>Port #3:</b> -  <b>Port #4:</b> -  <b>Port #5:</b> -  <b>Push Rod:</b> Depth.785"</p>	<p>E135-70-068</p>  <p><b>Bore Size:</b> 1 5/16"  <b>Port #1:</b> RF 7/16-24" inv  <b>Port #2:</b> RR 9/16-18" inv  <b>Port #3:</b> F Bttm 3/8"- 24 inv  <b>Port #4:</b> -  <b>Port #5:</b> -  <b>Push Rod:</b> Depth.785"</p>	<p>E135-70-079</p>  <p><b>Bore Size:</b> 1 5/16"  <b>Port #1:</b> LF angled down 3/8-24" inv  <b>Port #2:</b> RF angled up 9/16-18" inv  <b>Port #3:</b> RR angled up 18x 1.50  <b>Port #4:</b> -  <b>Port #5:</b> -  <b>Push Rod:</b> Depth 1.41"</p>

# Brake Master Cylinders

**FORMULABLUE**  
HYDRAULIC BRAKE PARTS













E135-70-081	E135-70-086	E135-70-087
 <p><b>Bore Size:</b> 1 1/16"  <b>Port #1:</b> LF 10x1 bbl  <b>Port #2:</b> LR 12x1 bbl  <b>Port #3:</b> F Up not drilled  <b>Port #4:</b> RR 10x1  <b>Port #5:</b> -  <b>Push Rod:</b> Depth 1.41"</p>	 <p><b>Bore Size:</b> 1 5/16"  <b>Port #1:</b> RF 9/16" - 18 inv  <b>Port #2:</b> RR 7/16" - 24 inv  <b>Port #3:</b> R Bttm 3/8" - 24 inv  <b>Port #4:</b> -  <b>Port #5:</b> -  <b>Push Rod:</b> Depth.773"</p>	 <p><b>Bore Size:</b> 1 3/8"  <b>Port #1:</b> RF angled up 9/16-x18" inv  <b>Port #2:</b> RR angled up 7/16-24" inv  <b>Port #3:</b> RR angled down 3/8-24" inv  <b>Port #4:</b> RR 10x1  <b>Port #5:</b> -  <b>Push Rod:</b> Depth 1.40"</p>
E135-70-093	E135-70-094	E135-70-099
 <p><b>Bore Size:</b> 1 1/16"  <b>Port #1:</b> LF 12x1 bbl  <b>Port #2:</b> LR 12x1 bbl  <b>Port #3:</b> RR Bttm 12x1 bbl  <b>Port #4:</b> -  <b>Port #5:</b> -  <b>Push Rod:</b> Depth 1.90"</p>	 <p><b>Bore Size:</b> 1 1/8"  <b>Port #1:</b> RF 10x1 bbl  <b>Port #2:</b> RR 12x1 bbl  <b>Port #3:</b> -  <b>Port #4:</b> -  <b>Port #5:</b> -  <b>Push Rod:</b> Depth 1.44"</p>	 <p><b>Bore Size:</b> 1 1/16"  <b>Port #1:</b> LR not drilled  <b>Port #2:</b> RR 12x1 bbl  <b>Port #3:</b> F End 12x1 bbl  <b>Port #4:</b> -  <b>Port #5:</b> -  <b>Push Rod:</b> Depth 1.73"</p>
E135-70-100	E135-70-101	E135-70-102
 <p><b>Bore Size:</b> 1 1/16"  <b>Port #1:</b> LR not drilled  <b>Port #2:</b> RR 12x1 bbl  <b>Port #3:</b> F End 12x1 bbl  <b>Port #4:</b> -  <b>Port #5:</b> -  <b>Push Rod:</b> Depth 1.73"</p>	 <p><b>Bore Size:</b> 1"  <b>Port #1:</b> LR not drilled  <b>Port #2:</b> RR 12x1 bbl  <b>Port #3:</b> F End 12x1 bbl  <b>Port #4:</b> -  <b>Port #5:</b> -  <b>Push Rod:</b> Depth 1.89"</p>	 <p><b>Bore Size:</b> 1"  <b>Port #1:</b> LR not drilled  <b>Port #2:</b> RR 12x1 bbl  <b>Port #3:</b> F End 12x1 bbl  <b>Port #4:</b> -  <b>Port #5:</b> -  <b>Push Rod:</b> Depth 1.89"</p>
E135-70-103	E135-70-104	E135-70-105
 <p><b>Bore Size:</b> 1 5/16"  <b>Port #1:</b> LF 12x1 bbl  <b>Port #2:</b> F Bttm 3/8 - 24" inv  <b>Port #3:</b> LR 10x1 bbl  <b>Port #4:</b> -  <b>Port #5:</b> -  <b>Push Rod:</b> Depth 1.98"</p>	 <p><b>Bore Size:</b> 1 5/16"  <b>Port #1:</b> LF 12x1 bbl  <b>Port #2:</b> LR 10x1 bbl  <b>Port #3:</b> R Bttm 12x1 bbl  <b>Port #4:</b> F Bttm 3/8 - 24" inv  <b>Port #5:</b> -  <b>Push Rod:</b> Depth 1.98"</p>	 <p><b>Bore Size:</b> 1 1/2"  <b>Port #1:</b> LF 12x1 bbl  <b>Port #2:</b> F Bttm 3/8 - 24" inv  <b>Port #3:</b> LR 10x1 bbl  <b>Port #4:</b> -  <b>Port #5:</b> -  <b>Push Rod:</b> Depth 1.56"</p>
E135-70-106	E135-70-107	E135-70-108
 <p><b>Bore Size:</b> 1 1/2"  <b>Port #1:</b> LF 12x1 bbl  <b>Port #2:</b> LR 10x1 bbl  <b>Port #3:</b> R Bttm 12x1 bbl  <b>Port #4:</b> F Bttm 3/8 - 24" inv  <b>Port #5:</b> -  <b>Push Rod:</b> Depth 1.56"</p>	 <p><b>Bore Size:</b> 25mm  <b>Port #1:</b> RF 12x1 bbl  <b>Port #2:</b> RF 10x1 bbl  <b>Port #3:</b> F End 12x1 bbl  <b>Port #4:</b> -  <b>Port #5:</b> -  <b>Push Rod:</b> Integrated</p>	 <p><b>Bore Size:</b> 1 1/8"  <b>Port #1:</b> LF 12 x 1 bbl  <b>Port #2:</b> FT Bottom 3/8 - 24" inv  <b>Port #3:</b> LR 10x1 bbl  <b>Port #4:</b> -  <b>Port #5:</b> -  <b>Push Rod:</b> Depth 1.57"</p>

E135-70-111	E135-70-112	E135-70-114
 <p> <b>Bore Size:</b> 1 1/4"  <b>Port #1:</b> RF 1/16"-24 inv  <b>Port #2:</b> RR 9/16"-20 inv  <b>Port #3:</b> 3/8"- 24 Inv  <b>Port #4:</b> -  <b>Port #5:</b> -  <b>Push Rod:</b> Depth.921"                 </p>	 <p> <b>Bore Size:</b> 1 5/16"  <b>Port #1:</b> RF 1/2-20" inv  <b>Port #2:</b> RR 9/16-20" inv  <b>Port #3:</b> F Bttm 3/8-24" inv  <b>Port #4:</b> -  <b>Port #5:</b> -  <b>Push Rod:</b> Depth.928                 </p>	 <p> <b>Bore Size:</b> 1 1/2"- 1 3/16"  <b>Port #1:</b> RF 10x1 inv  <b>Port #2:</b> RR 12x1 inv  <b>Port #3:</b> -  <b>Port #4:</b> -  <b>Port #5:</b> -  <b>Push Rod:</b> Depth 2.23"                 </p>
E135-70-115	E135-70-116	E135-70-117
 <p> <b>Bore Size:</b> 1 5/16"  <b>Port #1:</b> RF 12x1 bbl  <b>Port #2:</b> RR 14x1.5 bbl  <b>Port #3:</b> F Bttm 3/8-24" inv  <b>Port #4:</b> -  <b>Port #5:</b> -  <b>Push Rod:</b> Depth 2.23"                 </p>	 <p> <b>Bore Size:</b> 1 1/2"  <b>Port #1:</b> LF 10 x 1 inv  <b>Port #2:</b> LR 12 x 1 inv  <b>Port #3:</b> F 3/8-24" inv  <b>Port #4:</b> R Bttm not drilled  <b>Port #5:</b> -  <b>Push Rod:</b> Depth 1.39                 </p>	 <p> <b>Bore Size:</b> 1 1/16"  <b>Port #1:</b> LF 12 x 1 Inv  <b>Port #2:</b> LR 12x 1 Inv  <b>Port #3:</b> -  <b>Port #4:</b> -  <b>Port #5:</b> -  <b>Push Rod:</b> Depth 1.74"                 </p>
E135-70-120	E135-70-121	E135-70-122
 <p> <b>Bore Size:</b> 1 1/16"  <b>Port #1:</b> LF 14x1.5 inv  <b>Port #2:</b> RR 14x1.5 inv  <b>Port #3:</b> -  <b>Port #4:</b> -  <b>Port #5:</b> -  <b>Push Rod:</b> Depth 1.65"                 </p>	 <p> <b>Bore Size:</b> 1 1/16"  <b>Port #1:</b> LF 14x1.5 inv  <b>Port #2:</b> RR 14x1.5 inv  <b>Port #3:</b> -  <b>Port #4:</b> -  <b>Port #5:</b> -  <b>Push Rod:</b> Depth 1.65"                 </p>	 <p> <b>Bore Size:</b> 1 5/16"  <b>Port #1:</b> RF 10x1 bbl  <b>Port #2:</b> RR 14x1.5 bbl  <b>Port #3:</b> Front Bttm 3/8 - 24" inv  <b>Port #4:</b> -  <b>Port #5:</b> -  <b>Push Rod:</b> Dimple                 </p>
E135-70-123	E135-70-124	E135-70-125
 <p> <b>Bore Size:</b> 1 5/16"  <b>Port #1:</b> RF 10x1.5 inv  <b>Port #2:</b> RR 12x1.5 inv  <b>Port #3:</b> F Bttm 3/8-24 inv  <b>Port #4:</b> -  <b>Port #5:</b> -  <b>Push Rod:</b> Dimple                 </p>	 <p> <b>Bore Size:</b> 1 3/8"  <b>Port #1:</b> RF 10x1.5 inv  <b>Port #2:</b> R Ctr port 12x15 inv  <b>Port #3:</b> Ctr Dwn 3/8-24" inv  <b>Port #4:</b> -  <b>Port #5:</b> -  <b>Push Rod:</b> Depth 1.40"                 </p>	 <p> <b>Bore Size:</b> 1 1/16"  <b>Port #1:</b> RF 12x1 bbl  <b>Port #2:</b> L Ctr port 10x1 bbl  <b>Port #3:</b> -  <b>Port #4:</b> -  <b>Port #5:</b> -  <b>Push Rod:</b> Depth 1.62"                 </p>
E135-70-126	E135-70-127	E135-70-128
 <p> <b>Bore Size:</b> 1"  <b>Port #1:</b> RF 12x1 bbl  <b>Port #2:</b> F End 12x1 bbl  <b>Port #3:</b> -  <b>Port #4:</b> -  <b>Port #5:</b> -  <b>Push Rod:</b> Integrated                 </p>	 <p> <b>Bore Size:</b> 1 1/16"  <b>Port #1:</b> LF 12x1 inv  <b>Port #2:</b> LR 12x1 inv  <b>Port #3:</b> -  <b>Port #4:</b> -  <b>Port #5:</b> -  <b>Push Rod:</b> Depth                 </p>	 <p> <b>Bore Size:</b> 1 1/16"  <b>Port #1:</b> LF Port 14x1.5 inv  <b>Port #2:</b> R Bttm port 14x1.5 inv  <b>Port #3:</b> -  <b>Port #4:</b> -  <b>Port #5:</b> A/T  <b>Push Rod:</b> Depth 1.65"                 </p>



# Brake Master Cylinders

**FORMULABLUE™**  
HYDRAULIC BRAKE PARTS

E135-70-129	E135-70-130	E135-70-131
 <p><b>Bore Size:</b> 1 1/16"  <b>Port #1:</b> LF Port 14x1.5 inv  <b>Port #2:</b> R Bttm 14x1.5 inv  <b>Port #3:</b> -  <b>Port #4:</b> -  <b>Port #5:</b> -  <b>Push Rod:</b> Depth 1.65"</p>	 <p><b>Bore Size:</b> 1 1/8"  <b>Port #1:</b> RF 10x1 inv  <b>Port #2:</b> RR 14x1.5 inv  <b>Port #3:</b> -  <b>Port #4:</b> -  <b>Port #5:</b> -  <b>Push Rod:</b> Depth 1.00"</p>	 <p><b>Bore Size:</b> 1 1/16"  <b>Port #1:</b> RF 14x1.5 inv  <b>Port #2:</b> RR 14x1.5 inv  <b>Port #3:</b> -  <b>Port #4:</b> -  <b>Port #5:</b> -  <b>Push Rod:</b> Depth 1.38"</p>
E135-70-132	E135-70-133	E135-70-134
 <p><b>Bore Size:</b> 1 5/16"  <b>Port #1:</b> LF 10x1 inv  <b>Port #2:</b> LR 12x1 inv  <b>Port #3:</b> F Bttm 3/8"- 24 inv  <b>Port #4:</b> R Bttm 12x1 bbl  <b>Port #5:</b> -  <b>Push Rod:</b> Depth 1.99"</p>	 <p><b>Bore Size:</b> 1 5/16"  <b>Port #1:</b> LF 101 inv  <b>Port #2:</b> LR 12x1 inv  <b>Port #3:</b> F Bttm 3/8"- 24 inv  <b>Port #4:</b> -  <b>Port #5:</b> -  <b>Push Rod:</b> Depth 1.98"</p>	 <p><b>Bore Size:</b> 1 5/16"  <b>Port #1:</b> RF 12x1 bbl  <b>Port #2:</b> RR 14 1.5 bbl  <b>Port #3:</b> -  <b>Port #4:</b> -  <b>Port #5:</b> -  <b>Push Rod:</b> Dimple</p>
E135-70-135	E135-70-136	E135-70-137
 <p><b>Bore Size:</b> 1 5/16"  <b>Port #1:</b> RF 10x1.5 inv  <b>Port #2:</b> RR 14x1.5 inv  <b>Port #3:</b> -  <b>Port #4:</b> -  <b>Port #5:</b> -  <b>Push Rod:</b> Dimple</p>	 <p><b>Bore Size:</b> 1 5/16"  <b>Port #1:</b> RF 10x1.5 inv  <b>Port #2:</b> RR 14x1.5 inv  <b>Port #3:</b> F Bttm 12x1 bbl  <b>Port #4:</b> -  <b>Port #5:</b> -  <b>Push Rod:</b> Dimple</p>	 <p><b>Bore Size:</b> 1 5/16"  <b>Port #1:</b> RF 12x1 bbl  <b>Port #2:</b> RR 14x1.5 bbl  <b>Port #3:</b> F Bttm 12x1 bbl  <b>Port #4:</b> -  <b>Port #5:</b> -  <b>Push Rod:</b> Depth</p>
E135-70-138	E135-70-139	E135-70-140
 <p><b>Bore Size:</b> 1 3/8"  <b>Port #1:</b> RF 10x1.5 inv  <b>Port #2:</b> RR 12x1.5 inv  <b>Port #3:</b> R Bttm 12x1 bbl  <b>Port #4:</b> -  <b>Port #5:</b> -  <b>Push Rod:</b> Depth 1.40"</p>	 <p><b>Bore Size:</b> 23" mm  <b>Port #1:</b> RF 12x1 Bbl  <b>Port #2:</b> RR 12x1 Bbl  <b>Port #3:</b> -  <b>Port #4:</b> -  <b>Port #5:</b> -  <b>Push Rod:</b> Depth 1.58"</p>	 <p><b>Bore Size:</b> 1 3/16"- 1 3/8"  <b>Port #1:</b> RF 12x1.5 inv  <b>Port #2:</b> RR 14x1.5 inv  <b>Port #3:</b> -  <b>Port #4:</b> -  <b>Port #5:</b> -  <b>Push Rod:</b> Depth 2.25"</p>
E135-70-141	E135-70-142	E135-70-143
 <p><b>Bore Size:</b> 1 1/16"  <b>Port #1:</b> LF 12x1.5 Bbl  <b>Port #2:</b> LR 14x1.5 Bbl  <b>Port #3:</b> -  <b>Port #4:</b> -  <b>Port #5:</b> -  <b>Push Rod:</b> Depth 1.77"</p>	 <p><b>Bore Size:</b> 1 15/16 inv  <b>Port #1:</b> LF 12x1.5 inv  <b>Port #2:</b> LR 14x1.5 Bbl  <b>Port #3:</b> -  <b>Port #4:</b> -  <b>Port #5:</b> -  <b>Push Rod:</b> Dimple</p>	 <p><b>Bore Size:</b> 1 1/2"  <b>Port #1:</b> 12x1.5 inv  <b>Port #2:</b> 14x1.5 bbl  <b>Port #3:</b> -  <b>Port #4:</b> -  <b>Port #5:</b> -  <b>Push Rod:</b> Depth.57"</p>

E135-70-144	E135-70-145	E135-70-146
 <p> <b>Bore Size:</b> 1 1/2"  <b>Port #1:</b> LF 12x1.5 Inv  <b>Port #2:</b> LR 14x1.5 bbl  <b>Port #3:</b> R Bttm 12x1 bbl  <b>Port #4:</b> -  <b>Port #5:</b> -  <b>Push Rod:</b> Depth .57"         </p>	 <p> <b>Bore Size:</b> 1 1/8"  <b>Port #1:</b> RF angled up 14x1.50  <b>Port #2:</b> RR 14x1.50" inv  <b>Port #3:</b> -  <b>Port #4:</b> -  <b>Port #5:</b> -  <b>Push Rod:</b> Depth 1.77"         </p>	 <p> <b>Bore Size:</b> 13/16" 1 3/8"  <b>Port #1:</b> RF 12x1.50 inv  <b>Port #2:</b> RR 14x1.50 inv  <b>Port #3:</b> -  <b>Port #4:</b> -  <b>Port #5:</b> -  <b>Push Rod:</b> Depth 2.25         </p>
E135-71-017	E135-71-019	E135-71-032
 <p> <b>Bore Size:</b> 1 5/16"  <b>Port #1:</b> LF 9/16"- 18 inv  <b>Port #2:</b> LR 1/2"- 20 inv  <b>Port #3:</b> -  <b>Port #4:</b> -  <b>Port #5:</b> -  <b>Push Rod:</b> Dimple         </p>	 <p> <b>Bore Size:</b> 31.8 / 40 mm  <b>Port #1:</b> LF 9/16"- 18 inv  <b>Port #2:</b> LR 1/2"- 20 inv  <b>Port #3:</b> -  <b>Port #4:</b> -  <b>Port #5:</b> -  <b>Push Rod:</b> Dimple         </p>	 <p> <b>Bore Size:</b> 10mm  <b>Port #1:</b> LF 1/2"- 20 inv  <b>Port #2:</b> LR 9/16 - 18" inv  <b>Port #3:</b> -  <b>Port #4:</b> -  <b>Port #5:</b> -  <b>Push Rod:</b> Dimple         </p>
E135-71-046	E135-71-047	E135-71-050
 <p> <b>Bore Size:</b> 34mm  <b>Port #1:</b> LF 1/2"- 20 inv  <b>Port #2:</b> LR 1/2"- 20 inv  <b>Port #3:</b> -  <b>Port #4:</b> -  <b>Port #5:</b> -  <b>Push Rod:</b> Dimple         </p>	 <p> <b>Bore Size:</b> 37mm  <b>Port #1:</b> LF 1/2"- 20 inv  <b>Port #2:</b> LR 1/2"- 20 inv  <b>Port #3:</b> -  <b>Port #4:</b> -  <b>Port #5:</b> -  <b>Push Rod:</b> Dimple         </p>	 <p> <b>Bore Size:</b> 1 7/16"  <b>Port #1:</b> LF 1/2"- 20 inv  <b>Port #2:</b> LR 1/2"- 20 inv  <b>Port #3:</b> -  <b>Port #4:</b> -  <b>Port #5:</b> -  <b>Push Rod:</b> Dimple         </p>
E135-71-051	E135-71-052	E135-71-053
 <p> <b>Bore Size:</b> 34mm  <b>Port #1:</b> LF 1/2"- 20 inv  <b>Port #2:</b> LR 1/2"- 20 inv  <b>Port #3:</b> -  <b>Port #4:</b> -  <b>Port #5:</b> -  <b>Push Rod:</b> Dimple         </p>	 <p> <b>Bore Size:</b> 1 1/4"  <b>Port #1:</b> LF 1/2"- 20 inv  <b>Port #2:</b> LR 1/2"- 20 inv  <b>Port #3:</b> -  <b>Port #4:</b> -  <b>Port #5:</b> -  <b>Push Rod:</b> Dimple         </p>	 <p> <b>Bore Size:</b> 1 1/4" Inv  <b>Port #1:</b> LF 1/2"- 20 inv  <b>Port #2:</b> LR 1/2"- 20 inv  <b>Port #3:</b> -  <b>Port #4:</b> -  <b>Port #5:</b> -  <b>Push Rod:</b> Dimple         </p>
E135-71-054	E135-71-056	E135-71-057
 <p> <b>Bore Size:</b> 34mm  <b>Port #1:</b> LF 1/2"- 20 inv  <b>Port #2:</b> LR 1/2"- 20 inv  <b>Port #3:</b> -  <b>Port #4:</b> -  <b>Port #5:</b> -  <b>Push Rod:</b> Dimple         </p>	 <p> <b>Bore Size:</b> 1 7/16"  <b>Port #1:</b> LF 1/2"- 20 inv  <b>Port #2:</b> LR 1/2"- 20 inv  <b>Port #3:</b> -  <b>Port #4:</b> -  <b>Port #5:</b> -  <b>Push Rod:</b> Dimple         </p>	 <p> <b>Bore Size:</b> 1"  <b>Port #1:</b> LF 10x1 inv  <b>Port #2:</b> LR 10x1 inv  <b>Port #3:</b> -  <b>Port #4:</b> -  <b>Port #5:</b> -  <b>Push Rod:</b> Depth 2.18"         </p>

# Brake Master Cylinders

















<p>E135-71-058</p>  <p><b>Bore Size:</b> 1 1/8"  <b>Port #1:</b> LF 1/2" - 20 inv  <b>Port #2:</b> LR 1/2" - 20 inv  <b>Port #3:</b> -  <b>Port #4:</b> -  <b>Port #5:</b> -  <b>Push Rod:</b> Dimple</p>	<p>E135-71-059</p>  <p><b>Bore Size:</b> 1"  <b>Port #1:</b> LF 12x1 inv  <b>Port #2:</b> LR 12x1 inv  <b>Port #3:</b> -  <b>Port #4:</b> -  <b>Port #5:</b> -  <b>Push Rod:</b> Dimple</p>	<p>E135-71-060</p>  <p><b>Bore Size:</b> 1"  <b>Port #1:</b> LF 1/2 - 20" inv  <b>Port #2:</b> LR 1/2 - 20" inv  <b>Port #3:</b> -  <b>Port #4:</b> -  <b>Port #5:</b> -  <b>Push Rod:</b> Dimple</p>
<p>E135-71-061</p>  <p><b>Bore Size:</b> 1 1/4"  <b>Port #1:</b> LF 12x1 inv  <b>Port #2:</b> LR 12x1 inv  <b>Port #3:</b> -  <b>Port #4:</b> -  <b>Port #5:</b> -  <b>Push Rod:</b> Dimple</p>	<p>E135-71-062</p>  <p><b>Bore Size:</b> 37mm  <b>Port #1:</b> LF 12x1 inv  <b>Port #2:</b> LR 12x1 inv  <b>Port #3:</b> -  <b>Port #4:</b> -  <b>Port #5:</b> -  <b>Push Rod:</b> Dimple</p>	<p>E135-71-063</p>  <p><b>Bore Size:</b> 37 mm  <b>Port #1:</b> LF 12x1 inv  <b>Port #2:</b> LR 12x1 inv  <b>Port #3:</b> R Ctr Port 10x1.50 inv  <b>Port #4:</b> switch  <b>Port #5:</b> -  <b>Push Rod:</b> Dimple</p>
<p>E135-71-064</p>  <p><b>Bore Size:</b> 1 1/16"  <b>Port #1:</b> LF 12x1 inv  <b>Port #2:</b> LR 12x1 inv  <b>Port #3:</b> -  <b>Port #4:</b> -  <b>Port #5:</b> -  <b>Push Rod:</b> Depth 1.69"</p>	<p>E135-71-065</p>  <p><b>Bore Size:</b> 1 1/8"  <b>Port #1:</b> LF 12x1 inv  <b>Port #2:</b> LR 12x1 inv  <b>Port #3:</b> -  <b>Port #4:</b> -  <b>Port #5:</b> -  <b>Push Rod:</b> Dimple</p>	<p>E135-71-066</p>  <p><b>Bore Size:</b> 34mm  <b>Port #1:</b> LF 12x1 inv  <b>Port #2:</b> LR 12x1 inv  <b>Port #3:</b> -  <b>Port #4:</b> -  <b>Port #5:</b> -  <b>Push Rod:</b> Dimple</p>
<p>E135-71-067</p>  <p><b>Bore Size:</b> 37mm  <b>Port #1:</b> LF 14x1.5 inv  <b>Port #2:</b> LR 14x1.5 inv  <b>Port #3:</b> -  <b>Port #4:</b> -  <b>Port #5:</b> -  <b>Push Rod:</b> Dimple</p>	<p>E135-71-068</p>  <p><b>Bore Size:</b> 34mm  <b>Port #1:</b> LF 14x1.5 inv  <b>Port #2:</b> LR 14x1.5 inv  <b>Port #3:</b> -  <b>Port #4:</b> -  <b>Port #5:</b> -  <b>Push Rod:</b> Dimple</p>	<p>E135-71-069</p>  <p><b>Bore Size:</b> 40mm  <b>Port #1:</b> LF 1/2 - 20" inv  <b>Port #2:</b> LR 9/16 - 18" inv  <b>Port #3:</b> -  <b>Port #4:</b> -  <b>Port #5:</b> -  <b>Push Rod:</b> Dimple</p>
<p>E135-71-070</p>  <p><b>Bore Size:</b> 13/16"  <b>Port #1:</b> LF 12x1.5 inv  <b>Port #2:</b> LF 12x1.5 inv  <b>Port #3:</b> LR 12x1.5 inv  <b>Port #4:</b> LR 12x1.5 inv  <b>Port #5:</b> -  <b>Push Rod:</b> Integrated</p>	<p>E135-71-071</p>  <p><b>Bore Size:</b> 1 1/4"  <b>Port #1:</b> LF 14x1.5 inv  <b>Port #2:</b> LR 4x1.5 inv  <b>Port #3:</b> -  <b>Port #4:</b> -  <b>Port #5:</b> -  <b>Push Rod:</b> Dimple</p>	<p>E135-71-072</p>  <p><b>Bore Size:</b> 1 1/16"  <b>Port #1:</b> LF 12x1.5 inv  <b>Port #2:</b> LR 12x1.5 inv  <b>Port #3:</b> -  <b>Port #4:</b> -  <b>Port #5:</b> -  <b>Push Rod:</b> Depth 1.62"</p>















E135-71-073	E135-71-074	E135-71-075
 <p> <b>Bore Size:</b> 1 1/2"  <b>Port #1:</b> LF 12x1 inv  <b>Port #2:</b> LR 12x1 inv  <b>Port #3:</b> -  <b>Port #4:</b> -  <b>Port #5:</b> Dimple  <b>Push Rod:</b> </p>	 <p> <b>Bore Size:</b> 1 1/2"  <b>Port #1:</b> LF 12x1 inv  <b>Port #2:</b> LR 12x1 inv  <b>Port #3:</b> R Ctr port 12x1.5 bbl  <b>Port #4:</b> -  <b>Port #5:</b> -  <b>Push Rod:</b> Dimple                 </p>	 <p> <b>Bore Size:</b> 1 1/2"  <b>Port #1:</b> LF 14x1.5 inv  <b>Port #2:</b> LR 14x1.5 inv  <b>Port #3:</b> -  <b>Port #4:</b> -  <b>Port #5:</b> -  <b>Push Rod:</b> Dimple                 </p>
E135-71-076	E135-71-077	E135-71-078
 <p> <b>Bore Size:</b> 1 5/16"  <b>Port #1:</b> LF 12x1 inv  <b>Port #2:</b> LR 12x1 inv  <b>Port #3:</b> -  <b>Port #4:</b> -  <b>Port #5:</b> -  <b>Push Rod:</b> Dimple                 </p>	 <p> <b>Bore Size:</b> 1 5/16"  <b>Port #1:</b> LF 14x1.5 inv  <b>Port #2:</b> LR 14x1. inv  <b>Port #3:</b> -  <b>Port #4:</b> -  <b>Port #5:</b> -  <b>Push Rod:</b> Dimple                 </p>	 <p> <b>Bore Size:</b> 1 1/8"  <b>Port #1:</b> LF 12x1 inv  <b>Port #2:</b> LR 12x1 inv  <b>Port #3:</b> -  <b>Port #4:</b> -  <b>Port #5:</b> -  <b>Push Rod:</b> Dimple                 </p>
E135-71-080	E135-72-021	E135-72-033
 <p> <b>Bore Size:</b> 1 1/8"  <b>Port #1:</b> 1/2 - 20" inv  <b>Port #2:</b> 1  <b>Port #3:</b> -  <b>Port #4:</b> -  <b>Port #5:</b> -  <b>Push Rod:</b> </p>	 <p> <b>Bore Size:</b> 15/16  <b>Port #1:</b> LF 7/16"- 24 inv  <b>Port #2:</b> LR 7/16"- 24 inv  <b>Port #3:</b> -  <b>Port #4:</b> -  <b>Port #5:</b> -  <b>Push Rod:</b> Depth 2.52"                 </p>	 <p> <b>Bore Size:</b> 1 5/16"  <b>Port #1:</b> LF 12x1 bbl  <b>Port #2:</b> LR 10x1 bbl  <b>Port #3:</b> -  <b>Port #4:</b> -  <b>Port #5:</b> -  <b>Push Rod:</b> Depth 1.98"                 </p>
E135-72-036	E135-72-040	E135-72-041
 <p> <b>Bore Size:</b> 1"  <b>Port #1:</b> LF 12x1 bbl  <b>Port #2:</b> LR 12x1 bbl  <b>Port #3:</b> -  <b>Port #4:</b> -  <b>Port #5:</b> -  <b>Push Rod:</b> Depth 2.52"                 </p>	 <p> <b>Bore Size:</b> 15/16"  <b>Port #1:</b> LF 12x1 bbl  <b>Port #2:</b> LR 12x1 bbl  <b>Port #3:</b> -  <b>Port #4:</b> -  <b>Port #5:</b> -  <b>Push Rod:</b> Depth 2.52"                 </p>	 <p> <b>Bore Size:</b> 1 1/8"  <b>Port #1:</b> LF 12x1mm  <b>Port #2:</b> LR 10x1mm  <b>Port #3:</b> -  <b>Port #4:</b> -  <b>Port #5:</b> -  <b>Push Rod:</b> Depth 2.02"                 </p>
E135-72-042	E135-72-046	E135-72-047
 <p> <b>Bore Size:</b> 1 1/8"  <b>Port #1:</b> LF 12x1 bbl  <b>Port #2:</b> LR 10x1 bbl  <b>Port #3:</b> -  <b>Port #4:</b> -  <b>Port #5:</b> -  <b>Push Rod:</b> Depth 2.02"                 </p>	 <p> <b>Bore Size:</b> 1"  <b>Port #1:</b> RF 1/2 - 20" inv  <b>Port #2:</b> RR 7/16 - 24" inv  <b>Port #3:</b> -  <b>Port #4:</b> -  <b>Port #5:</b> -  <b>Push Rod:</b> Depth .663"                 </p>	 <p> <b>Bore Size:</b> 1 5/16"  <b>Port #1:</b> LF 12x1 bbl  <b>Port #2:</b> LR 10x1 bbl  <b>Port #3:</b> -  <b>Port #4:</b> -  <b>Port #5:</b> -  <b>Push Rod:</b> Depth .897"                 </p>

# Brake Master Cylinders

**FORMULABLUE**  
FORMULA BLUE

<p>E135-72-048</p>  <p><b>Bore Size:</b> 1 1/4"  <b>Port #1:</b> LF 7/16" - 24 inv  <b>Port #2:</b> LR 1/2 - 20" inv  <b>Port #3:</b> -  <b>Port #4:</b> -  <b>Port #5:</b> -  <b>Push Rod:</b> 1.67"</p>	<p>E135-72-050</p>  <p><b>Bore Size:</b> 1 1/2"  <b>Port #1:</b> LF 7/16 - 24" inv  <b>Port #2:</b> LR 7/16 - 24" inv  <b>Port #3:</b> -  <b>Port #4:</b> -  <b>Port #5:</b> -  <b>Push Rod:</b> 0.81"</p>	<p>E135-72-052</p>  <p><b>Bore Size:</b> 1 3/16"  <b>Port #1:</b> LF 1/2" - 20 inv  <b>Port #2:</b> LR 7/16" - 24 inv  <b>Port #3:</b> R Ctr port 10x1 w/plug  <b>Port #4:</b> -  <b>Port #5:</b> -  <b>Push Rod:</b> 1.61"</p>
<p>E135-79-005</p>  <p><b>Bore Size:</b> 1 1/8"  <b>Port #1:</b> LF 10x1 inv  <b>Port #2:</b> LR 10x1 inv  <b>Port #3:</b> -  <b>Port #4:</b> -  <b>Port #5:</b> -  <b>Push Rod:</b> Depth 1.16"</p>	<p>E135-79-006</p>  <p><b>Bore Size:</b> 1 1/4"  <b>Port #1:</b> RF 10x1m inv  <b>Port #2:</b> RR 10x1mm inv  <b>Port #3:</b> -  <b>Port #4:</b> -  <b>Port #5:</b> -  <b>Push Rod:</b> Depth 1.16"</p>	<p>E135-79-007</p>  <p><b>Bore Size:</b> 1 3/16"  <b>Port #1:</b> RF 10x1 bbl  <b>Port #2:</b> RR10x1bbl  <b>Port #3:</b> R Bttm 10x1 inv  <b>Port #4:</b> F Bttm 10x1 inv  <b>Port #5:</b> -  <b>Push Rod:</b> Depth 1.11"</p>
<p>E135-79-008</p>  <p><b>Bore Size:</b> 1 3/16"  <b>Port #1:</b> LF 10x1mm  <b>Port #2:</b> R Bttm 10x1 inv  <b>Port #3:</b> F Bttm 10x1 inv  <b>Port #4:</b> -  <b>Port #5:</b> -  <b>Push Rod:</b> Depth 1.94"</p>	<p>E135-79-009</p>  <p><b>Bore Size:</b> 1 1/4"  <b>Port #1:</b> LR 10x1mm  <b>Port #2:</b> R Bttm 10x1mm  <b>Port #3:</b> F Bttm 10x1 inv  <b>Port #4:</b> -  <b>Port #5:</b> -  <b>Push Rod:</b> Depth 1.94"</p>	<p>E135-81-008</p>  <p><b>Bore Size:</b> 1 1/4"  <b>Port #1:</b> LF 10x1mm  <b>Port #2:</b> LR 10x1 inv  <b>Port #3:</b> Front Bttm 10x1 inv  <b>Port #4:</b> -  <b>Port #5:</b> -  <b>Push Rod:</b> Depth 1.17"</p>
<p>E135-81-009</p>  <p><b>Bore Size:</b> 1 1/4"  <b>Port #1:</b> LF 10x1mm inv  <b>Port #2:</b> LR 10x1mm inv  <b>Port #3:</b> -  <b>Port #4:</b> -  <b>Port #5:</b> -  <b>Push Rod:</b> Depth 1.17"</p>	<p>E135-81-013</p>  <p><b>Bore Size:</b> 1 1/4"  <b>Port #1:</b> LF 10x1mm inv  <b>Port #2:</b> LR 10x1mm inv  <b>Port #3:</b> -  <b>Port #4:</b> -  <b>Port #5:</b> -  <b>Push Rod:</b> Depth 1.30"</p>	<p>E135-81-015</p>  <p><b>Bore Size:</b> 1 1/4"  <b>Port #1:</b> LF 10x1 inv  <b>Port #2:</b> LR 10x1 inv  <b>Port #3:</b> -  <b>Port #4:</b> -  <b>Port #5:</b> -  <b>Push Rod:</b> Depth 1.30"</p>
<p>E135-81-017</p>  <p><b>Bore Size:</b> 1 3/8"  <b>Port #1:</b> LF 10x1mm inv  <b>Port #2:</b> LR 10x1mm inv  <b>Port #3:</b> -  <b>Port #4:</b> -  <b>Port #5:</b> -  <b>Push Rod:</b> Depth 1.30"</p>	<p>E135-82-006</p>  <p><b>Bore Size:</b> 1 1/8"  <b>Port #1:</b> LR 10x1 inv  <b>Port #2:</b> F Up 10x1 inv  <b>Port #3:</b> -  <b>Port #4:</b> -  <b>Port #5:</b> -  <b>Push Rod:</b> Depth 1.01"</p>	<p>E135-82-007</p>  <p><b>Bore Size:</b> 1 1/8"  <b>Port #1:</b> Rr 10x1 inv  <b>Port #2:</b> F 10x1 inv  <b>Port #3:</b> -  <b>Port #4:</b> -  <b>Port #5:</b> -  <b>Push Rod:</b> Depth 1.01"</p>



<p>E135-82-008</p>  <p><b>Bore Size:</b> 1 1/2" <b>Port #1:</b> LF 1/2"- 20 inv <b>Port #2:</b> Ctr Down <b>Port #3:</b> - <b>Port #4:</b> - <b>Port #5:</b> - <b>Push Rod:</b> Depth 1.63"</p>	<p>E135-84-022</p>  <p><b>Bore Size:</b> 1 1/2" <b>Port #1:</b> LF 1 2-20" inv <b>Port #2:</b> - <b>Port #3:</b> - <b>Port #4:</b> - <b>Push Rod::</b> Depth 1.63" <b>Casting:</b> 31026C</p>	<p>E135-84-025</p>  <p><b>Bore Size:</b> 1 3/4" <b>Port #1:</b> LF 11/16 - 18" inv <b>Port #2:</b> LR 3/4 - 18 inv <b>Port #3:</b> - <b>Port #4:</b> - <b>Push Rod::</b> Depth .566" <b>Casting:</b> 30955C</p>
<p>E135-84-026</p>  <p><b>Bore Size:</b> 2" <b>Port #1:</b> LF 1/2"- 20 inv <b>Port #2:</b> LR 9/16"- 18 inv <b>Port #3:</b> - <b>Port #4:</b> - <b>Port #5:</b> - <b>Push Rod:</b> Depth .573"</p>	<p>E135-84-027</p>  <p><b>Bore Size:</b> 1 3/4" <b>Port #1:</b> LF 1/2"- 20 bbl <b>Port #2:</b> LR 9/16"- 18 bbl <b>Port #3:</b> w/banjo bolt 1/2"- 20 inv <b>Port #4:</b> w/banjo bolt 9/16"- 18 inv <b>Port #5:</b> - <b>Push Rod:</b> Depth .565"</p>	<p>E135-84-030</p>  <p><b>Bore Size:</b> 1 3/4" <b>Port #1:</b> LF 1/2"- 20 inv <b>Port #2:</b> LR 9/16 - 18 inv <b>Port #3:</b> L Ctr 3/8"- 24 <b>Port #4:</b> - <b>Port #5:</b> - <b>Push Rod:</b> Depth .565"</p>
<p>E135-84-036</p>  <p><b>Bore Size:</b> 2" <b>Port #1:</b> LF 1/2"- 20 inv <b>Port #2:</b> LR 9/16"- 18 inv <b>Port #3:</b> L Ctr 3/8 - 24 <b>Port #4:</b> - <b>Port #5:</b> - <b>Push Rod:</b> Depth .576"</p>	<p>E135-87-009</p>  <p><b>Bore Size:</b> 2.00" <b>Port #1:</b> LF 1/2 - 20" inv <b>Port #2:</b> LR 9/16 - 18" inv <b>Port #3:</b> - <b>Port #4:</b> - <b>Port #5:</b> - <b>Push Rod:</b> Depth .575"</p>	<p>E135-87-012</p>  <p><b>Bore Size:</b> 2.00" <b>Port #1:</b> LF 1/2-20" for switch <b>Port #2:</b> LR 9/16 - 18"inv <b>Port #3:</b> - <b>Port #4:</b> - <b>Push Rod:</b> - <b>Casting#:</b> Depth .968</p>
<p>E135-87-013</p>  <p><b>Bore Size:</b> 2.00" <b>Port #1:</b> LF 1/2 - 20" inv <b>Port #2:</b> L Ctr 9/16 - 18" for switch <b>Port #3:</b> LR 9/16"- 18 inv <b>Port #4:</b> - <b>Port #5:</b> - <b>Push Rod:</b> Depth .578"</p>	<p>E135-88-021</p> <p>Image not available</p>	<p>E135-88-022</p>  <p><b>Bore Size:</b> 2" <b>Port #1:</b> LF 1/2 - 20" inv <b>Port #2:</b> LR 9/16 - 18 inv <b>Port #3:</b> Ctr 3/8x24" for switch <b>Port #4:</b> - <b>Push Rod:</b> - <b>Casting:</b> Depth .576</p>
<p>E135-88-027</p>  <p><b>Bore Size:</b> 13/16" <b>Port #1:</b> LF 1/2 - 20 bbl <b>Port #2:</b> LR 9/16 - 18 bbl <b>Port #3:</b> - <b>Port #4:</b> - <b>Port #5:</b> - <b>Push Rod:</b> Integrat</p>	<p>E135-89-006</p>  <p><b>Bore Size:</b> 1" <b>Port #1:</b> LF 9/16 - 18" inv <b>Port #2:</b> LR 1/2 - 20" inv <b>Port #3:</b> - <b>Port #4:</b> - <b>Port #5:</b> - <b>Push Rod:</b> Depth .928</p>	<p>E135-89-007</p>  <p><b>Bore Size:</b> 1 3/4" <b>Port #1:</b> 1/2"- 20 inv <b>Port #2:</b> 9/16"- 18 inv <b>Port #3:</b> - <b>Port #4:</b> - <b>Port #5:</b> - <b>Push Rod:</b> .565"</p>

# NOTES

---

---

**HAVE QUESTIONS? NEED ASSISTANCE? TALK TO THE FORMULA BLUE® TECH LINE.  
Call 1-866-610-9709, option 2  
Representatives are available Monday – Friday, 8:00 a.m. – 8:30 p.m. EST.**















<p>E139-47-009</p>  <p><b>Bore Size: 3/4"</b> <b>Port 1: 10x1mm inv</b> <b>Port 2:</b> <b>Casting#:</b></p>	<p>E139-49-711</p>  <p><b>Bore Size: 15/16"</b> <b>Port 1: 10x1mm inv</b> <b>Port 2: -</b> <b>Casting#:</b> -</p>	<p>E139-49-807</p>  <p><b>Bore Size: 7/8"</b> <b>Port 1: 10x1mm inv</b> <b>Port 2: -</b> <b>Casting#:</b> -</p>
<p>E139-55-007</p>  <p><b>Bore Size: 13/16"</b> <b>Port 1: 3/8-24"</b> <b>Port 2:</b> <b>Casting#:</b></p>	<p>E139-56-019</p>  <p><b>Bore Size: 3/4"</b> <b>Port 1: 10x1 mm inv</b> <b>Port 2:</b> <b>Casting#:</b></p>	<p>E139-56-020</p>  <p><b>Bore Size: 3/4"</b> <b>Port 1: 10x1 mm inv</b> <b>Port 2:</b> <b>Casting#:</b></p>
<p>E139-66-008</p>  <p><b>Bore Size: 3/4"</b> <b>Port 1: 3/8"- 24 inv</b> <b>Port 2: -</b> <b>Casting#:</b> BOSCH</p>	<p>E139-66-046</p>  <p><b>Bore Size: 1"</b> <b>Port 1: 10x1mm bbl</b> <b>Port 2: -</b> <b>Casting#:</b> 112973</p>	<p>E139-67-072</p>  <p><b>Bore Size: 7/8"</b> <b>Port 1: 10x1 inv</b> <b>Port 2:</b> <b>Casting#:</b></p>
<p>E139-67-073</p>  <p><b>Bore Size: 13/16"</b> <b>Port 1: 10x1mm inv</b> <b>Port 2:</b> <b>Casting#:</b></p>	<p>E139-68-040</p>  <p><b>Bore Size: 13/16"</b> <b>Port 1: 3/8-24" bbl</b> <b>Port 2:</b> <b>Casting#:</b></p>	<p>E139-70-023</p>  <p><b>Bore Size: 13/16"</b> <b>Port 1: 3/8 - 24 inv</b> <b>Port 2:</b> <b>Casting#:</b></p>
<p>E139-70-029</p>  <p><b>Bore Size: 15/16"</b> <b>Port 1: 10x1mm</b> <b>Port 2:</b> <b>Casting#:</b></p>	<p>E139-70-034</p>  <p><b>Bore Size: 15/16"</b> <b>Port 1: 10x1mm</b> <b>Port 2:</b> <b>Casting#:</b></p>	<p>E139-70-035</p>  <p><b>Bore Size: 13/16"</b> <b>Port 1: 10x1 bbl</b> <b>Port 2:</b> <b>Casting#:</b></p>



# Wheel Cylinders













<p>E139-71-016</p>  <p><b>Bore Size: 1 1/2"</b>  <b>Port 1: 7/16"- 24 inv</b>  <b>Port 2:</b>  <b>Casting#:</b></p>	<p>E139-71-017</p>  <p><b>Bore Size: 1 1/2"</b>  <b>Port 1: 7/16"- 24 inv</b>  <b>Port 2:</b>  <b>Casting#:</b></p>	<p>E139-71-018</p>  <p><b>Bore Size: 1 3/16"</b>  <b>Port 1: 3/8-24" inv</b>  <b>Port 2:</b>  <b>Casting#:</b></p>
<p>E139-71-019</p>  <p><b>Bore Size: 1 1/16"</b>  <b>Port 1: 3/8-24" inv</b>  <b>Port 2:</b>  <b>Casting#:</b></p>	<p>E139-71-027</p>  <p><b>Bore Size: 15/16"</b>  <b>Port 1: 10x1 mm bbl</b>  <b>Port 2:</b>  <b>Casting#:</b></p>	<p>E139-71-032</p>  <p><b>Bore Size: 15/16"</b>  <b>Port 1: 10x1 inv</b>  <b>Port 2:</b>  <b>Casting#:</b></p>
<p>E139-71-034</p>  <p><b>Bore Size: 1 1/16"</b>  <b>Port 1: 10x1mm inv</b>  <b>Port 2:</b>  <b>Casting#:</b></p>	<p>E139-71-035</p>  <p><b>Bore Size: 15/16"</b>  <b>Port 1: 10x1 inv</b>  <b>Port 2:</b>  <b>Casting#:</b></p>	<p>E139-71-036</p>  <p><b>Bore Size: 1 1/16"</b>  <b>Port 1: 10x inv</b>  <b>Port 2:</b>  <b>Casting#: 2510</b></p>
<p>E139-72-019</p>  <p><b>Bore Size: 1 1/16"</b>  <b>Port 1: 10x1 bbl</b>  <b>Port 2:</b>  <b>Casting#:</b></p>	<p>E139-79-010</p>  <p><b>Bore Size: 1 1/8"</b>  <b>Port 1: 10x1mm</b>  <b>Port 2:</b>  <b>Casting#:</b></p>	<p>E139-79-011</p>  <p><b>Bore Size: 1 1/8"</b>  <b>Port 1: 10x1mm</b>  <b>Port 2:</b>  <b>Casting#:</b></p>
<p>E139-79-012</p>  <p><b>Bore Size: 1 1/8"</b>  <b>Port 1: 10x1mm</b>  <b>Port 2:</b>  <b>Casting#:</b></p>	<p>E139-79-013</p>  <p><b>Bore Size: 1 1/8"</b>  <b>Port 1: 10x1mm inv</b>  <b>Port 2: 10x1mm inv</b>  <b>Casting#:</b></p>	<p>E139-79-014</p>  <p><b>Bore Size: 1 3/8"</b>  <b>Port 1: 10x1mm inv</b>  <b>Port 2: 10x1mm inv</b>  <b>Casting#:</b></p>

<p>E139-79-015</p>  <p><b>Bore Size:</b> 1 1/8" <b>Port 1:</b> 10x1mm inv <b>Port 2:</b> 10x1mm inv <b>Casting#:</b></p>	<p>E139-79-016</p>  <p><b>Bore Size:</b> 1 3/8" <b>Port 1:</b> 10x1mm inv <b>Port 2:</b> 10x1mm inv <b>Casting#:</b></p>	<p>E139-79-017</p>  <p><b>Bore Size:</b> 1 3/8" <b>Port 1:</b> 10x1mm inv <b>Port 2:</b> 10x1mm inv <b>Casting#:</b></p>
<p>E139-79-018</p>  <p><b>Bore Size:</b> 1 1/4" <b>Port 1:</b> 10x1mm <b>Port 2:</b> 10x1mm <b>Casting#:</b></p>	<p>E139-79-019</p>  <p><b>Bore Size:</b> 1 1/4" <b>Port 1:</b> 10x1mm inv <b>Port 2:</b> 10x1mm inv <b>Casting#:</b></p>	<p>E139-81-023</p>  <p><b>Bore Size:</b> 1 1/16" <b>Port 1:</b> 10x1mm inv <b>Port 2:</b> 10x1mm inv <b>Casting#:</b></p>
<p>E139-81-024</p>  <p><b>Bore Size:</b> 1 1/16" <b>Port 1:</b> 10x1mm inv <b>Port 2:</b> 10x1mm inv <b>Casting#:</b></p>	<p>E139-81-025</p>  <p><b>Bore Size:</b> 1 1/16" <b>Port 1:</b> 10x1mm inv <b>Port 2:</b> 10x1mm inv <b>Casting#:</b></p>	<p>E139-81-035</p>  <p><b>Bore Size:</b> 1 3/16" <b>Port 1:</b> 10x1mm inv <b>Port 2:</b> 10x1mm inv <b>Casting#:</b> 63213R</p>
<p>E139-81-036</p>  <p><b>Bore Size:</b> 1 3/6" <b>Port 1:</b> 10x1mm inv <b>Port 2:</b> 10x1mm inv <b>Casting#:</b> 63213R</p>	<p>E139-81-037</p>  <p><b>Bore Size:</b> 1 3/16" <b>Port 1:</b> 10x1mm inv <b>Port 2:</b> 10x1mm inv <b>Casting#:</b> 63213L</p>	<p>E139-81-043</p>  <p><b>Bore Size:</b> 1 1/16" <b>Port 1:</b> 10x1mm inv <b>Port 2:</b> 10x1mm inv <b>Casting#:</b></p>
<p>E139-81-044</p>  <p><b>Bore Size:</b> 1 3/16" <b>Port 1:</b> 10x1mm inv <b>Port 2:</b> 10x1mm inv <b>Casting#:</b> 63254</p>	<p>E139-81-045</p>  <p><b>Bore Size:</b> 1 3/16" <b>Port 1:</b> 10x1mm inv <b>Port 2:</b> - <b>Casting#:</b> 63250</p>	<p>E139-81-046</p>  <p><b>Bore Size:</b> 1 5/16" <b>Port 1:</b> 10x1mm inv <b>Port 2:</b> 10x1mm inv <b>Casting#:</b></p>





# Wheel Cylinders







<p>E139-81-047</p>  <p><b>Bore Size: 1 5/16"</b>  <b>Port 1: 10x1mm inv</b>  <b>Port 2: -</b>  <b>Casting#: 63244L</b></p>	<p>E139-81-048</p>  <p><b>Bore Size: 1 5/16"</b>  <b>Port 1: 10x1mm inv</b>  <b>Port 2: 10x1mm inv</b>  <b>Casting#: 63244R</b></p>	<p>E139-81-049</p>  <p><b>Bore Size: 1 5/16"</b>  <b>Port 1: 10x1mm inv</b>  <b>Port 2: 10x1mm inv</b>  <b>Casting#: 63244R</b></p>
<p>E139-81-050</p>  <p><b>Bore Size: 1 5/16"</b>  <b>Port 1: 10x1mm inv</b>  <b>Port 2: -</b>  <b>Casting#: 63244R</b></p>	<p>E139-81-051</p>  <p><b>Bore Size: 1 5/16"</b>  <b>Port 1: 10x1mm inv</b>  <b>Port 2: 10x1mm inv</b>  <b>Casting#: 63244L</b></p>	<p>E139-81-052</p>  <p><b>Bore Size: 1 3/16"</b>  <b>Port 1: 10x1mm inv</b>  <b>Port 2: 10x1mm inv</b>  <b>Casting#: 63254</b></p>
<p>E139-81-053</p>  <p><b>Bore Size: 1 3/16"</b>  <b>Port 1: 10x1mm inv</b>  <b>Port 2: -</b>  <b>Casting#: 63254</b></p>	<p>E139-81-054</p>  <p><b>Bore Size: 1 3/16"</b>  <b>Port 1: 10x1mm inv</b>  <b>Port 2: 10x1mm inv</b>  <b>Casting#: 63254</b></p>	<p>E139-81-057</p>  <p><b>Bore Size: 1 1/2"</b>  <b>Port 1: 10x1mm inv</b>  <b>Port 2: -</b>  <b>Casting#: A3720L</b></p>
<p>E139-81-058</p>  <p><b>Bore Size: 1 1/2"</b>  <b>Port 1: 10x1mm inv</b>  <b>Port 2: -</b>  <b>Casting#: A3720R</b></p>	<p>E139-81-063</p>  <p><b>Bore Size: 1 5/8"</b>  <b>Port 1: 10x1mm inv</b>  <b>Port 2: -</b>  <b>Casting#: A3719L</b></p>	<p>E139-81-064</p>  <p><b>Bore Size: 1 5/8"</b>  <b>Port 1: 10x1mm inv</b>  <b>Port 2: 12x1.5mm inv</b>  <b>Casting#: A3719L</b></p>
<p>E139-81-065</p>  <p><b>Bore Size: 1 5/8"</b>  <b>Port 1: 10x1mm inv</b>  <b>Port 2: -</b>  <b>Casting#: B3719R</b></p>	<p>E139-81-066</p>  <p><b>Bore Size: 1 5/8"</b>  <b>Port 1: 10x1mm inv</b>  <b>Port 2: 12x1.5mm inv</b>  <b>Casting#: B3719R</b></p>	<p>E139-81-067</p>  <p><b>Bore Size: 1 1/16"</b>  <b>Port 1: 10x1mm inv</b>  <b>Port 2: 10x1mm inv</b>  <b>Casting#: 63259L</b></p>

<p>E139-81-068</p>  <p><b>Bore Size:</b> 1 1/16" <b>Port 1:</b> 10x1mm inv <b>Port 2:</b> 10x1mm inv <b>Casting#:</b> 63259R</p>	<p>E139-81-069</p>  <p><b>Bore Size:</b> 1 1/16" <b>Port 1:</b> 10x1mm inv <b>Port 2:</b> <b>Casting#:</b></p>	<p>E139-81-070</p>  <p><b>Bore Size:</b> 1 1/16" <b>Port 1:</b> 10x1mm inv <b>Port 2:</b> <b>Casting#:</b> 63259Rt</p>
<p>E139-81-071</p>  <p><b>Bore Size:</b> 1 5/16" <b>Port 1:</b> 10x1mm inv <b>Port 2:</b> 10x1mm inv <b>Casting#:</b></p>	<p>E139-81-113</p>  <p><b>Bore Size:</b> 53.5mm <b>Port 1:</b> 12x1.5mm inv <b>Port 2:</b> <b>Casting#:</b></p>	<p>E139-81-114</p>  <p><b>Bore Size:</b> 47.5mm <b>Port 1:</b> 12x1.5mm <b>Port 2:</b> <b>Casting#:</b></p>
<p>E139-81-115</p>  <p><b>Bore Size:</b> 47.5mm <b>Port 1:</b> 2x1.5mm <b>Port 2:</b> <b>Casting#:</b></p>	<p>E139-81-154</p>  <p><b>Bore Size:</b> 53.5mm <b>Port 1:</b> 12x1.5mm <b>Port 2:</b> <b>Casting#:</b></p>	<p>E139-81-155</p>  <p><b>Bore Size:</b> 47.5mm <b>Port 1:</b> 12x1.5mm <b>Port 2:</b> <b>Casting#:</b></p>
<p>E139-81-156</p>  <p><b>Bore Size:</b> 47.5mm <b>Port 1:</b> 12x1.5mm <b>Port 2:</b> <b>Casting#:</b></p>	<p>E139-82-006</p>  <p><b>Bore Size:</b> 1 1/6 <b>Port 1:</b> 10x1 inv <b>Port 2:</b> <b>Casting#:</b></p>	<p>E139-82-007</p>  <p><b>Bore Size:</b> 1 1/6 <b>Port 1:</b> 10x1 inv <b>Port 2:</b> <b>Casting#:</b></p>
<p>E139-82-008</p>  <p><b>Bore Size:</b> 1 1/6" <b>Port 1:</b> 10x1 inv <b>Port 2:</b> <b>Casting#:</b></p>	<p>E139-82-009</p>  <p><b>Bore Size:</b> 1 1/6" <b>Port 1:</b> 10x1 inv <b>Port 2:</b> <b>Casting#:</b></p>	<p>E139-84-022</p>  <p><b>Bore Size:</b> 1 5/8" <b>Port 1:</b> 7/16" 24 inv <b>Port 2:</b> 7/16" 24 inv <b>Casting#:</b> 68690579</p>

# Wheel Cylinders

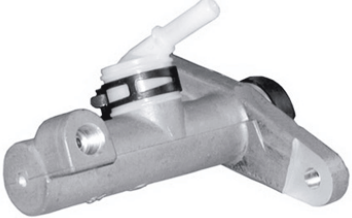
E139-84-023	E139-84-026	E139-84-027
 <p> <b>Bore Size: 1 5/8"</b>  <b>Port 1: 7/16"- 24 inv</b>  <b>Port 2: 7/16"- 24 inv</b>  <b>Casting#: 68690580</b> </p>	 <p> <b>Bore Size: 1 5/8"</b>  <b>Port 1: 7/16"- 24 inv</b>  <b>Port 2: 7/16"- 24 inv</b>  <b>Casting#: 68660520</b> </p>	 <p> <b>Bore Size: 1 5/8"</b>  <b>Port 1: 7/16"- 24 inv</b>  <b>Port 2: 7/16"- 24 inv</b>  <b>Casting#: 68660521</b> </p>

E141-70-023	E141-77-005	E141-80-007
 <p><b>Bore Size: 11/16"</b> <b>Port 1: O Ring/ Pin Type Style</b> <b>Port 2:</b></p>	 <p><b>Bore Size: 3/4"</b> <b>Port 1: 12x1.5 Open</b> <b>Port 2:</b></p>	 <p><b>Bore Size: 19,mm</b> <b>Port 1: 3/8"- 24 Bbl</b> <b>Port 2: 12x1 Inv</b></p>
E141-81-007	E141-81-008	E141-81-009
 <p><b>Bore Size: 7/8"</b> <b>Port 1: 14x1.5mm</b> <b>Port 2:</b></p>	 <p><b>Bore Size: 3/4"</b> <b>Port 1:</b> <b>Port 2:</b></p>	 <p><b>Bore Size: 13/16"</b> <b>Port 1:</b> <b>Port 2:</b></p>
E141-81-010	E141-85-006	E141-85-009
 <p><b>Bore Size: 7/8"</b> <b>Port 1:</b> <b>Port 2:</b></p>	 <p><b>Bore Size: 13/16"</b> <b>Port 1:</b> <b>Port 2:</b></p>	 <p><b>Bore Size: 13/16"</b> <b>Port 1:</b> <b>Port 2:</b></p>

# NOTES

---

---

**HAVE QUESTIONS? NEED ASSISTANCE? TALK TO THE FORMULA BLUE® TECH LINE.  
Call 1-866-610-9709, option 2  
Representatives are available Monday – Friday, 8:00 a.m. – 8:30 p.m. EST.**



<p>E143-70-017</p>	<p>E143-77-005</p>	<p>E143-80-006</p>
 <p><b>Bore Size: 13/16"</b>  <b>Port 1:</b>  <b>Port 2:</b></p>	 <p><b>Bore Size: 19mm</b>  <b>Port 1: 12x1.25 Bbl</b>  <b>Port 2:</b></p>	 <p><b>Bore Size: 7/8"</b>  <b>Port 1: 7/6"- 20 Open</b>  <b>Port 2:</b></p>
<p>E143-80-008</p>	<p>E143-81-006</p>	<p>E143-81-007</p>
 <p><b>Bore Size: 7/8"</b>  <b>Port 1: 12x1.5 Open</b>  <b>Port 2:</b></p>	 <p><b>Bore Size: 1"</b>  <b>Port 1:</b>  <b>Port 2:</b></p>	 <p><b>Bore Size: 1"</b>  <b>Port 1:</b>  <b>Port 2:</b></p>
<p>E143-81-008</p>	<p>E143-81-010</p>	<p>E143-81-011</p>
 <p><b>Bore Size: 1"</b>  <b>Port 1:</b>  <b>Port 2:</b></p>	 <p><b>Bore Size: 1"</b>  <b>Port 1:</b>  <b>Port 2:</b></p>	 <p><b>Bore Size: 1"</b>  <b>Port 1:</b>  <b>Port 2:</b></p>
<p>E143-81-012</p>	<p>E143-85-006</p>	<p>E143-85-010</p>
 <p><b>Bore Size: 1"</b>  <b>Port 1: 10x1 open</b>  <b>Port 2:</b></p>	 <p><b>Bore Size: 13/16"</b>  <b>Port 1:</b>  <b>Port 2:</b></p>	 <p><b>Bore Size: 13/16"</b>  <b>Port 1: Snap Style</b>  <b>Port 2:</b></p>

















# NOTES

---















---















**HAVE QUESTIONS? NEED ASSISTANCE? TALK TO THE FORMULA BLUE® TECH LINE.  
Call 1-866-610-9709, option 2  
Representatives are available Monday – Friday, 8:00 a.m. – 8:30 p.m. EST.**

<p>E146-40-167</p>  <p><b>Bore Size: 48.0mm</b> <b>Port Size: 10x1mm</b> <b>Casting#: 2x48/28</b> <b>Casting#: 928900</b> <b>Casting#:</b></p>	<p>E146-40-603</p>  <p><b>Bore Size: 51.0mm</b> <b>Port Size: 10x1mm</b> <b>Casting#: Y04126</b> <b>Casting#: 51/16</b> <b>Casting#: 1196</b></p>	<p>E146-40-605</p>  <p><b>Bore Size: 48.0mm</b> <b>Port Size: 10x1mm</b> <b>Casting#: 2x48/28 303</b> <b>Casting#: Y04133</b> <b>Casting#:</b></p>
<p>E146-47-137</p>  <p><b>Bore Size: 50.8mm</b> <b>Port Size: 10x1mm</b> <b>Casting#: 262 569</b> <b>Casting#:</b> <b>Casting#:</b></p>	<p>E146-47-141</p>  <p><b>Bore Size: 46.0mm</b> <b>Port Size: 10x1mm</b> <b>Casting#: Z33</b> <b>Casting#: 4230</b> <b>Casting#:</b></p>	<p>E146-47-147</p>  <p><b>Bore Size: 46.0mm</b> <b>Port Size: 10x1mm</b> <b>Casting#: Z33</b> <b>Casting#: WF3</b> <b>Casting#:</b></p>
<p>E146-47-149</p>  <p><b>Bore Size: 45.0mm</b> <b>Port Size: 10x1mm</b> <b>Casting#: T</b> <b>Casting#:</b> <b>Casting#:</b></p>	<p>E146-47-151</p>  <p><b>Bore Size: 50.8mm</b> <b>Port Size: 10x1mm</b> <b>Casting#: 5112</b> <b>Casting#: 271</b> <b>Casting#: 6283</b></p>	<p>E146-47-157</p>  <p><b>Bore Size: 57.0mm</b> <b>Port Size: 10x1mm</b> <b>Casting#: 44</b> <b>Casting#:</b> <b>Casting#:</b></p>
<p>E146-47-163</p>  <p><b>Bore Size: 60.0mm</b> <b>Port Size: 10x1mm</b> <b>Casting#: 6059</b> <b>Casting#: 76M</b> <b>Casting#:</b></p>	<p>E146-47-183</p>  <p><b>Bore Size: 57.0mm</b> <b>Port Size: 10x1mm</b> <b>Casting#: 5713</b> <b>Casting#:</b> <b>Casting#:</b></p>	<p>E146-47-571</p>  <p><b>Bore Size: 48.0mm</b> <b>Port Size: 10x1mm</b> <b>Casting#: 383</b> <b>Casting#:</b> <b>Casting#:</b></p>
<p>E146-47-579</p>  <p><b>Bore Size: 38.0mm</b> <b>Port Size: 10x1mm</b> <b>Casting#: T4</b> <b>Casting#:</b> <b>Casting#:</b></p>	<p>E146-47-585</p>  <p><b>Bore Size: 35.0mm</b> <b>Port Size: 10x1mm</b> <b>Casting#: 3520</b> <b>Casting#: 79U</b> <b>Casting#:</b></p>	<p>E146-47-593</p>  <p><b>Bore Size: 38.0mm</b> <b>Port Size: 10x1mm</b> <b>Casting#: T</b> <b>Casting#: 59F</b> <b>Casting#:</b></p>

# Brake Calipers

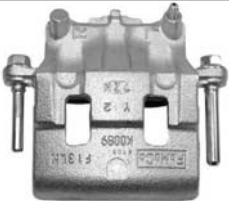













**FORMULA BLUE**  
HYDRAULIC BRAKE PARTS

<p>E146-47-607</p>  <p><b>Bore Size: 60mm</b> <b>Port Size: 10x1mm</b> <b>Casting#: 4330</b> <b>Casting#:</b> <b>Casting#:</b></p>	<p>E146-49-209</p>  <p><b>Bore Size: 63.5.0mm</b> <b>Port Size: 10x1mm</b> <b>Casting#: 6404 L</b> <b>Casting#:</b> <b>Casting#:</b></p>	<p>E146-49-233</p>  <p><b>Bore Size: 45.5mm</b> <b>Port Size: 10x1mm</b> <b>Casting#: 13WH</b> <b>Casting#: 13WH 17</b> <b>Casting#: 13WH</b></p>
<p>E146-49-235</p>  <p><b>Bore Size: 45.5/51mm</b> <b>Port Size: 10x1mm</b> <b>Casting#: S15+13A</b> <b>Casting#:</b> <b>Casting#:</b></p>	<p>E146-49-237</p>  <p><b>Bore Size: 45.5mm</b> <b>Port Size: 10x1mm</b> <b>Casting#: 13WL</b> <b>Casting#: 16 2</b> <b>Casting#: 13</b></p>	<p>E146-49-241</p>  <p><b>Bore Size: 63.5mm</b> <b>Port Size: 10x1mm</b> <b>Casting#: 63-28</b> <b>Casting#: L 3</b> <b>Casting#: 10</b></p>
<p>E146-49-249</p>  <p><b>Bore Size: 63.5mm</b> <b>Port Size: 10x1mm</b> <b>Casting#: L 6408</b> <b>Casting#:</b> <b>Casting#:</b></p>	<p>E146-49-251</p>  <p><b>Bore Size: 45.5mm</b> <b>Port Size: 10x1mm</b> <b>Casting#: 13WG</b> <b>Casting#:</b> <b>Casting#:</b></p>	<p>E146-49-253</p>  <p><b>Bore Size: 60.0mm</b> <b>Port Size: 10x1mm</b> <b>Casting#: 60-25</b> <b>Casting#: 12</b> <b>Casting#: ADVICS L1</b></p>
<p>E146-49-275</p>  <p><b>Bore Size: 51.0mm</b> <b>Port Size: 10x1mm</b> <b>Casting#: GR 1</b> <b>Casting#: 712507</b> <b>Casting#:</b></p>	<p>E146-49-279</p>  <p><b>Bore Size: 44.5mm</b> <b>Port Size: 10x1mm</b> <b>Casting#: 4533</b> <b>Casting#: 3</b> <b>Casting#:</b></p>	<p>E146-49-283</p>  <p><b>Bore Size: 51.0mm</b> <b>Port Size: 10x1mm</b> <b>Casting#: 15WA</b> <b>Casting#:</b> <b>Casting#:</b></p>
<p>E146-49-287</p>  <p><b>Bore Size: 44.5mm</b> <b>Port Size: 10x1mm</b> <b>Casting#: 1116</b> <b>Casting#:</b> <b>Casting#:</b></p>	<p>E146-49-293</p>  <p><b>Bore Size: 48mm</b> <b>Port Size: 10x1mm</b> <b>Casting#: 14W4</b> <b>Casting#:</b> <b>Casting#:</b></p>	<p>E146-49-521</p>  <p><b>Bore Size: 45.5mm</b> <b>Port Size: 10x1mm</b> <b>Casting#: F13 L</b> <b>Casting#:</b> <b>Casting#:</b></p>

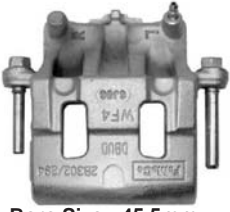
E146-49-574	E146-49-575	E146-49-593
Image not available	 <p>Bore Size: 48.0mm Port Size: 10x1mm Casting#: FSX14B L Casting#: Casting#:</p>	 <p>Bore Size: 48.0mm Port Size: 10x1mm Casting#: F14 Casting#: 9 Casting#:</p>
E146-49-607	E146-49-609	E146-49-613
 <p>Bore Size: 43.0mm Port Size: 10x1mm Casting#: 2YL 3H 3 Casting#: Casting#:</p>	 <p>Bore Size: 38.0mm Port Size: 10x1mm Casting#: 3849 Casting#: 56 Casting#:</p>	 <p>Bore Size: 41.0mm Port Size: 10x1mm Casting#: 4107 Casting#: Casting#:</p>
E146-49-629	E146-49-633	E146-49-635
 <p>Bore Size: 48.0mm Port Size: 10x1mm Casting#: F14G Casting#: TD09 Casting#:</p>	 <p>Bore Size: 45.5.0mm Port Size: 10x1mm Casting#: F13C Casting#: L Casting#:</p>	 <p>Bore Size: 41.5mm Port Size: 10x1mm Casting#: 4112 Casting#: Casting#:</p>
E146-49-647	E146-50-101	E146-50-105
 <p>Bore Size: 40.5mm Port Size: 10x1mm Casting#: 40 Casting#: Casting#:</p>	 <p>Bore Size: 45.5mm Port Size: 10x1mm Casting#: F13WN Casting#: K0089 Casting#: 718</p>	 <p>Bore Size: 45.5mm Port Size: 10x1mm Casting#: F13WN Casting#: K0089 Casting#: 758</p>
E146-50-567	E146-50-573	E146-63-009
 <p>Bore Size: 43.0mm Port Size: 10x1mm Casting#: 73T Casting#: Casting#:</p>	 <p>Bore Size: 43.0mm Port Size: 10x1mm Casting#: 17 Casting#: T9 Casting#: FoMoCo</p>	 <p>Bore Size: 66.0mm Port Size: 3/8-24 Casting#: Casting#: Casting#:</p>

# Brake Calipers

**FORMULABLUE**  
HYDRAULIC BRAKE PARTS

E146-63-013	E146-63-015	E146-63-017
 <p><b>Bore Size: 48.0mm</b> <b>Port Size: 3/8-24</b> <b>Casting#: 414RH</b> <b>Casting#: 415LH</b> <b>Casting#: 262482</b></p>	 <p><b>Bore Size: 48mm</b> <b>Port Size: 10x1mm</b> <b>Casting#: 4865 LH</b> <b>Casting#:</b> <b>Casting#:</b></p>	 <p><b>Bore Size: 48mm</b> <b>Port Size: 10x1mm</b> <b>Casting#: 4865 LH</b> <b>Casting#:</b> <b>Casting#:</b></p>
E146-63-511	E146-63-515	E146-63-517
 <p><b>Bore Size: 48.0mm</b> <b>Port Size: 3/8-24</b> <b>Casting#: 938</b> <b>Casting#: R276 L277</b> <b>Casting#:</b></p>	 <p><b>Bore Size: 48mm</b> <b>Port Size: 10x1mm</b> <b>Casting#: 4883 LH</b> <b>Casting#:</b> <b>Casting#:</b></p>	 <p><b>Bore Size: 48mm</b> <b>Port Size: 10x1mm</b> <b>Casting#: 4887 LH</b> <b>Casting#:</b> <b>Casting#:</b></p>
E146-66-093	E146-66-097	E146-66-127
 <p><b>Bore Size: 48.0mm</b> <b>Port Size: 3/8-24</b> <b>Casting#: 202220</b> <b>Casting#: 202220 5</b> <b>Casting#:</b></p>	 <p><b>Bore Size: 66.0mm</b> <b>Port Size: 10x1.50mm</b> <b>Casting#: 5171</b> <b>Casting#: R9</b> <b>Casting#:</b></p>	 <p><b>Bore Size: 46.0mm</b> <b>Port Size: 10x1.5mm</b> <b>Casting#: 2B302/394</b> <b>Casting#: WF3</b> <b>Casting#:</b></p>
E146-66-129	E146-66-135	E146-66-141
 <p><b>Bore Size: 45.5mm</b> <b>Port Size: 10x1mm</b> <b>Casting#: 2B302/294</b> <b>Casting#: WF3</b> <b>Casting#:</b></p>	 <p><b>Bore Size: 45.5mm</b> <b>Port Size: 8x1mm</b> <b>Casting#: 2B302/294</b> <b>Casting#:</b> <b>Casting#:</b></p>	 <p><b>Bore Size: 45mm</b> <b>Port Size: 10x1.5mm</b> <b>Casting#: K247-289C</b> <b>Casting#:</b> <b>Casting#:</b></p>
E146-66-525	E146-66-529	E146-66-551
 <p><b>Bore Size: 48.0mm</b> <b>Port Size: 3/8-24</b> <b>Casting#: 742</b> <b>Casting#:</b> <b>Casting#:</b></p>	 <p><b>Bore Size: 42.9mm</b> <b>Port Size: 10x1.50mm</b> <b>Casting#: VFCC 2332-43 LH</b> <b>Casting#: VFCC2423-6</b> <b>Casting#: 43</b></p>	 <p><b>Bore Size: 43.0mm</b> <b>Port Size: 10x1mm</b> <b>Casting#: VFCC 4130</b> <b>Casting#: V300D</b> <b>Casting#:</b></p>

















E146-66-553	E146-66-563	E146-66-567
 <p>Bore Size: 43.0mm Port Size: 10x1mm Casting#: 3002 Casting#: N10DE Casting#:</p>	 <p>Bore Size: 45mm Port Size: 10x1mm Casting#: VFCC4340 Casting#: V300D Casting#:</p>	 <p>Bore Size: 43.0mm Port Size: 10x1mm Casting#: 3002 Casting#: Casting#:</p>
E146-67-125	E146-67-137	E146-67-145
 <p>Bore Size: 63.5mm Port Size: 10x1.5mm Casting#: 456 15 L Casting#: 1G18 Casting#:</p>	 <p>Bore Size: 63.5mm Port Size: 10x1.5mm Casting#: DELPHI Casting#: 127 Casting#:</p>	 <p>Bore Size: 60.0mm Port Size: 10x1.50mm Casting#: 6035L Casting#: Casting#:</p>
E146-67-155	E146-67-157	E146-67-165
 <p>Bore Size: 46.0mm Port Size: 10x1.50mm Casting#: 3076A Casting#: C123 Casting#: 262862</p>	 <p>Bore Size: 54.0mm Port Size: 10x1.50mm Casting#: 5427 Casting#: Casting#:</p>	 <p>Bore Size: 45.0mm Port Size: 10x1.50mm Casting#: 5122 Casting#: 16" Casting#: 979</p>
E146-67-167	E146-67-175	E146-67-185
 <p>Bore Size: 45.0mm Port Size: 10x1.50mm Casting#: 853.1/17 Casting#: Casting#:</p>	 <p>Bore Size: 45.0mm Port Size: 10x1.50mm Casting#: BC140107 Casting#: Casting#:</p>	 <p>Bore Size: 38.0mm Port Size: 10x1.5mm Casting#: 20.A207.05 Casting#: Casting#:</p>
E146-67-197	E146-67-211	E146-67-559
 <p>Bore Size: 60mm Port Size: 10x1.5mm Casting#: 139 Casting#: Casting#:</p>	 <p>Bore Size: 0000 Port Size: 0000 Casting#: 0000 Casting#: 0000 Casting#: 0000</p>	 <p>Bore Size: 38.0mm Port Size: 10x1.5mm Casting#: WL/UR Casting#: 3811 / 009 Casting#: AD38 / 11-15</p>

# Brake Calipers

**FORMULABLUE**  
HYDRAULIC BRAKE PARTS

<p>E146-67-585</p>  <p>Bore Size: 38.0 mm Port Size: 10x1.50mm Casting#: B3815 Casting#: Casting#:</p>	<p>E146-67-595</p>  <p>Bore Size: 38mm Port Size: 10x1mm Casting#: B3815 Casting#: Casting#:</p>	<p>E146-67-609</p>  <p>Bore Size: 45.0mm Port Size: 10x1mm Casting#: K242-099C Casting#: Casting#:</p>
<p>E146-68-031</p>  <p>Bore Size: 66.0 mm Port Size: 7/16-20 Casting#: 8320 Casting#: 4260 Casting#:</p>	<p>E146-68-051</p>  <p>Bore Size: 42.0 mm Port Size: 10x1.50mm Casting#: K247-185C Casting#: 143335 Casting#:</p>	<p>E146-68-075</p>  <p>Bore Size: 60.5 mm Port Size: 10x1.50mm Casting#: K246-059C Casting#: Casting#:</p>
<p>E146-68-081</p>  <p>Bore Size: 57.0 mm Port Size: 10x1mm Casting#: 5739 Casting#: Casting#:</p>	<p>E146-68-083</p>  <p>Bore Size: 57.0 mm Port Size: 10x1mm Casting#: 5739 Casting#: Casting#:</p>	<p>E146-68-514</p>  <p>Bore Size: 42.0 mm Port Size: 7/16-20 Casting#: 4203 Casting#: Casting#:</p>
<p>E146-68-533</p>  <p>Bore Size: 42.0 mm Port Size: 10x1.50mm Casting#: K242-049C Casting#: Casting#:</p>	<p>E146-68-535</p>  <p>Bore Size: 42.0 mm Port Size: 10x1.50mm Casting#: K242-051C Casting#: Casting#:</p>	<p>E146-68-539</p>  <p>Bore Size: 35.0 mm Port Size: 10x1mm Casting#: 3502 Casting#: Casting#:</p>
<p>E146-68-541</p>  <p>Bore Size: 42.0 mm Port Size: 10x1.50mm Casting#: K242-051C Casting#: Casting#:</p>	<p>E146-68-543</p>  <p>Bore Size: 35.0 mm Port Size: 10x1mm Casting#: 3503 Casting#: 6X07 Casting#:</p>	<p>E146-70-021</p>  <p>Bore Size: 60.0 mm Port Size: 3/8-24 Casting#: KH12068401 Casting#: 12068401 Casting#:</p>

<p>E146-70-027</p>  <p>Bore Size: 60.0 mm Port Size: 10x1mm Casting#: 6057 Casting#: t1005 Casting#:</p>	<p>E146-70-037</p>  <p>Bore Size: 56.0 mm Port Size: 3/8-24 Casting#: 12795101 DW17 Casting#: 134247 Casting#:</p>	<p>E146-70-049</p>  <p>Bore Size: 60.0 mm Port Size: 3/8-24 Casting#: KH130307 Casting#: 130307 Casting#:</p>
<p>E146-70-055</p>  <p>Bore Size: 46.0 mm Port Size: 3/8-.24 Casting#: 5456 Casting#: 17 Casting#:</p>	<p>E146-70-069</p>  <p>Bore Size: 54.0 mm Port Size: 3/8-24 Casting#: 145861 Casting#: 54 Casting#: TRW</p>	<p>E146-70-077</p>  <p>Bore Size: 60.0 mm Port Size: 3/8-24 Casting#: 142298 Casting#: 60 Casting#: TRW</p>
<p>E146-70-079</p>  <p>Bore Size: 60.0 mm Port Size: 3/8-24 Casting#: 144296 Casting#: 60 Casting#:</p>	<p>E146-70-081</p>  <p>Bore Size: 54.0 mm Port Size: 3/8-24 Casting#: 302694 Casting#: 22-054 Casting#:</p>	<p>E146-70-083</p>  <p>Bore Size: 51.0 mm Port Size: 3/8-24 Casting#: 6L24-2B120/1 Casting#: 5110 Casting#:</p>
<p>E146-70-085</p>  <p>Bore Size: 60.0 mm Port Size: 3/8-24 Casting#: 154518 Casting#: Casting#:</p>	<p>E146-70-087</p>  <p>Bore Size: 66.0 mm Port Size: 10x1mm Casting#: 6L84-2011-A Casting#: 6661 Casting#: T0833</p>	<p>E146-70-091</p>  <p>Bore Size: 57.0 mm Port Size: 3/8-24 Casting#: 7L14-2B302-A Casting#: 6158 Casting#: T0833</p>
<p>E146-70-093</p>  <p>Bore Size: 60.0 mm Port Size: 3/8-24 Casting#: 157693-A Casting#: 8C242B120 / 1-C Casting#: FoMoCo</p>	<p>E146-70-095</p>  <p>Bore Size: 48.0 mm Port Size: 3/8-24 Casting#: 8A83-2B118/9 Casting#: 4814 Casting#:</p>	<p>E146-70-097</p>  <p>Bore Size: 54.0 mm Port Size: 10x1mm Casting#: 302 694 Casting#: 2B120 Casting#:</p>



# Brake Calipers

**FORMULA BLUE**  
WEIGHTS & MEASUREMENTS















E146-70-099	E146-70-101	E146-70-103
 <p>Bore Size: 54.0 mm            Port Size: 10x1mm            Casting#: 577            Casting#:            Casting#:</p>	 <p>Bore Size: 54mm            Port Size: 3/8-24            Casting#: 16905101            Casting#: 2B120/1            Casting#:</p>	 <p>Bore Size: 66mm            Port Size: 10x1mm            Casting#: 7L84-2011-A            Casting#:            Casting#:</p>
E146-70-511	E146-70-515	E146-70-523
 <p>Bore Size: 50.8 mm            Port Size: 3/8-24            Casting#: 799            Casting#: 064            Casting#: 15</p>	 <p>Bore Size: 44.0 mm            Port Size: 44mm            Casting#: KH 132705 L            Casting#: KH132705            Casting#:</p>	 <p>Bore Size: 50.8 mm            Port Size: 3/8-24            Casting#: 244            Casting#:            Casting#:</p>
E146-70-527	E146-70-529	E146-70-531
 <p>Bore Size: 40.0 mm            Port Size: 3/8-24            Casting#: 4007L            Casting#: GD2            Casting#:</p>	 <p>Bore Size: 48.0 mm            Port Size: 3/8-24            Casting#: 144150            Casting#: 4269            Casting#: 48</p>	 <p>Bore Size: 54.0 mm            Port Size: 3/8-24            Casting#: 144138            Casting#: 6122            Casting#: 54</p>
E146-70-533	E146-70-535	E146-70-537
 <p>Bore Size: 54.0 mm            Port Size: 3/8-24            Casting#: 145868            Casting#: 54            Casting#: TRW</p>	 <p>Bore Size: 57.0 mm            Port Size: 3/8-24            Casting#: 7L14-2553-A            Casting#: 6199            Casting#: T0833</p>	 <p>Bore Size: 48.0 mm            Port Size: 3/8-24"            Casting#: 166111            Casting#: 6335            Casting#:</p>
E146-70-539	E146-70-541	E146-70-551
 <p>Bore Size: 48 mm            Port Size: 3/8x24mm            Casting#: 8242K327/8-A            Casting#: C            Casting#:</p>	 <p>Bore Size: 54 mm            Port Size: 10x1mm            Casting#: 8C242K327/8-B            Casting#:            Casting#:</p>	 <p>Bore Size: 48.0 mm            Port Size: 3/8-24            Casting#: 722            Casting#:            Casting#:</p>

<p>E146-71-009</p>  <p><b>Bore Size: 57.0 mm</b>  <b>Port Size: 10x1.50mm</b>  <b>Casting#: 18025722 L</b>  <b>Casting#:</b>  <b>Casting#:</b></p>	<p>E146-71-013</p>  <p><b>Bore Size: 50.8 mm</b>  <b>Port Size: 10x1.50mm</b>  <b>Casting#: 18025700</b>  <b>Casting#:</b>  <b>Casting#:</b></p>	<p>E146-71-015</p>  <p><b>Bore Size: 86.0 mm</b>  <b>Port Size: 10x1.50mm</b>  <b>Casting#: 2238451</b>  <b>Casting#:</b>  <b>Casting#:</b></p>
<p>E146-71-019</p>  <p><b>Bore Size: 80.0 mm</b>  <b>Port Size: 10x1.5mm</b>  <b>Casting#: 18003532 L</b>  <b>Casting#: 10</b>  <b>Casting#:</b></p>	<p>E146-71-043</p>  <p><b>Bore Size: 51.0 mm</b>  <b>Port Size: 10x1.50mm</b>  <b>Casting#: K247-245C 5</b>  <b>Casting#: PBR</b>  <b>Casting#: 18025829</b></p>	<p>E146-71-047</p>  <p><b>Bore Size: 45.5 mm</b>  <b>Port Size: 10x1.50mm</b>  <b>Casting#: 15" 846 WHC2</b>  <b>Casting#:</b>  <b>Casting#:</b></p>
<p>E146-71-049</p>  <p><b>Bore Size: 51.0mm</b>  <b>Port Size: 10x1.5mm</b>  <b>Casting#: K247-245C 5</b>  <b>Casting#:</b>  <b>Casting#:</b></p>	<p>E146-71-051</p>  <p><b>Bore Size: 48.0 mm</b>  <b>Port Size: 10x1.50mm</b>  <b>Casting#: 2J2416-C</b>  <b>Casting#:</b>  <b>Casting#:</b></p>	<p>E146-71-053</p>  <p><b>Bore Size: 48.0 mm</b>  <b>Port Size: 10x1.50mm</b>  <b>Casting#: 2J2416-C</b>  <b>Casting#:</b>  <b>Casting#:</b></p>
<p>E146-71-057</p>  <p><b>Bore Size: 51.0 mm</b>  <b>Port Size: 10x1.50mm</b>  <b>Casting#: 245C6</b>  <b>Casting#: PBR</b>  <b>Casting#:</b></p>	<p>E146-71-059</p>  <p><b>Bore Size: 48.0 mm</b>  <b>Port Size: 10x1.50mm</b>  <b>Casting#: 2J2416-C</b>  <b>Casting#:</b>  <b>Casting#:</b></p>	<p>E146-71-061</p>  <p><b>Bore Size: 60.2mm</b>  <b>Port Size: 10x1mm</b>  <b>Casting#: 6006</b>  <b>Casting#:</b>  <b>Casting#:</b></p>
<p>E146-71-511</p>  <p><b>Bore Size: 45.0 mm</b>  <b>Port Size: 10x1mm</b>  <b>Casting#: K247-049C</b>  <b>Casting#:</b>  <b>Casting#:</b></p>	<p>E146-71-513</p>  <p><b>Bore Size: 48.0 mm</b>  <b>Port Size: 10x1mm</b>  <b>Casting#: BC140053</b>  <b>Casting#:</b>  <b>Casting#:</b></p>	<p>E146-71-515</p>  <p><b>Bore Size: 60.0 mm</b>  <b>Port Size: 10x1.50mm</b>  <b>Casting#: 18043771</b>  <b>Casting#:</b>  <b>Casting#:</b></p>

# Brake Calipers

**FORMULA BLUE**  
FORMULA BLUE

<p>E146-71-519</p>  <p><b>Bore Size: 54.0 mm</b>  <b>Port Size: 10x1mm</b>  <b>Casting#: 5410</b>  <b>Casting#: 68-009</b>  <b>Casting#:</b></p>	<p>E146-71-521</p>  <p><b>Bore Size: 50.8 mm</b>  <b>Port Size: 10x1mm</b>  <b>Casting#: 5106</b>  <b>Casting#: 68-004</b>  <b>Casting#:</b></p>	<p>E146-71-525</p>  <p><b>Bore Size: 44.5 mm</b>  <b>Port Size: 10x1mm</b>  <b>Casting#: akebono</b>  <b>Casting#: E4527</b>  <b>Casting#: A-50</b></p>
<p>E146-71-527</p>  <p><b>Bore Size: 54mm</b>  <b>Port Size: 10x1mm</b>  <b>Casting#: K244-079C</b>  <b>Casting#:</b>  <b>Casting#:</b></p>	<p>E146-71-533</p>  <p><b>Bore Size: 41.0 mm</b>  <b>Port Size: 10x1.50mm</b>  <b>Casting#: 4103</b>  <b>Casting#:</b>  <b>Casting#:</b></p>	<p>E146-71-535</p>  <p><b>Bore Size: 50.8 mm</b>  <b>Port Size: 10x1mm</b>  <b>Casting#: K244-093C</b>  <b>Casting#:</b>  <b>Casting#:</b></p>
<p>E146-71-537</p>  <p><b>Bore Size: 48.0 mm</b>  <b>Port Size: 10x1mm</b>  <b>Casting#: BC140109</b>  <b>Casting#: MANDO</b>  <b>Casting#: GM</b></p>	<p>E146-71-541</p>  <p><b>Bore Size: 54mm</b>  <b>Port Size: 10x1mm</b>  <b>Casting#: 5418</b>  <b>Casting#:</b>  <b>Casting#:</b></p>	<p>E146-71-543</p>  <p><b>Bore Size: 48mm</b>  <b>Port Size: 10x1.5mm</b>  <b>Casting#: 4816</b>  <b>Casting#:</b>  <b>Casting#:</b></p>
<p>E146-71-545</p>  <p><b>Bore Size: 57mm</b>  <b>Port Size: 10x1.5mm</b>  <b>Casting#: 5710</b>  <b>Casting#:</b>  <b>Casting#:</b></p>	<p>E146-72-031</p>  <p><b>Bore Size: 56.0 mm</b>  <b>Port Size: 10x1mm</b>  <b>Casting#: 134248</b>  <b>Casting#:</b>  <b>Casting#:</b></p>	<p>E146-72-049</p>  <p><b>Bore Size: 54.0 mm</b>  <b>Port Size: 10x1mm</b>  <b>Casting#: 14900801</b>  <b>Casting#: D12S</b>  <b>Casting#:</b></p>
<p>E146-72-057</p>  <p><b>Bore Size: 66.0 mm</b>  <b>Port Size: 7/16-20</b>  <b>Casting#: 146702</b>  <b>Casting#: 66</b>  <b>Casting#: TRW</b></p>	<p>E146-72-059</p>  <p><b>Bore Size: 54.0 mm</b>  <b>Port Size: 10x1mm</b>  <b>Casting#: 14900801</b>  <b>Casting#: D12S</b>  <b>Casting#:</b></p>	<p>E146-72-061</p>  <p><b>Bore Size: 66.0 mm</b>  <b>Port Size: 10x1mm</b>  <b>Casting#: 16018401</b>  <b>Casting#: 5227</b>  <b>Casting#:</b></p>















<p>E146-72-063</p>  <p><b>Bore Size: 66.0 mm</b>  <b>Port Size: 10x1mm</b>  <b>Casting#: 160048</b>  <b>Casting#: 7164</b>  <b>Casting#:</b></p>	<p>E146-72-067</p>  <p><b>Bore Size: 60.0 mm</b>  <b>Port Size: 10x1mm</b>  <b>Casting#: 15883001</b>  <b>Casting#:</b>  <b>Casting#:</b></p>	<p>E146-72-507</p>  <p><b>Bore Size: 54.0 mm</b>  <b>Port Size: 10x1mm</b>  <b>Casting#: 135361</b>  <b>Casting#: 54</b>  <b>Casting#: 145184</b></p>
<p>E146-72-517</p>  <p><b>Bore Size: 45.0 mm</b>  <b>Port Size: 10x1mm</b>  <b>Casting#: 1354440245</b>  <b>Casting#: LV</b>  <b>Casting#:</b></p>	<p>E146-72-519</p>  <p><b>Bore Size: 51.0 mm</b>  <b>Port Size: 10x1mm</b>  <b>Casting#: 13544401</b>  <b>Casting#: LV</b>  <b>Casting#:</b></p>	<p>E146-72-523</p>  <p><b>Bore Size: 48</b>  <b>Port Size: 10x1mm</b>  <b>Casting#: 160185016207</b>  <b>Casting#:</b>  <b>Casting#:</b></p>
<p>E146-72-525</p>  <p><b>Bore Size: 43mm</b>  <b>Port Size: 10x1mm</b>  <b>Casting#: 15812301</b>  <b>Casting#: 03980</b>  <b>Casting#:</b></p>	<p>E146-72-529</p>  <p><b>Bore Size: 45mm</b>  <b>Port Size: 10x1mm</b>  <b>Casting#: 15884101</b>  <b>Casting#:</b>  <b>Casting#:</b></p>	<p>E146-72-531</p>  <p><b>Bore Size: 51mm</b>  <b>Port Size: 10x1mm</b>  <b>Casting#: 16277401</b>  <b>Casting#:</b>  <b>Casting#:</b></p>
<p>E146-72-535</p>  <p><b>Bore Size: 45.5mm</b>  <b>Port Size: 10x1mm</b>  <b>Casting#: 179913</b>  <b>Casting#:</b>  <b>Casting#:</b></p>	<p>E146-74-007</p>  <p><b>Bore Size: 45.5mm</b>  <b>Port Size: 10x1.50mm</b>  <b>Casting#: 13WQ</b>  <b>Casting#: RS</b>  <b>Casting#: R4</b></p>	<p>E146-74-507</p>  <p><b>Bore Size: 45.5 mm</b>  <b>Port Size: 10x1.50mm</b>  <b>Casting#: PE45A</b>  <b>Casting#:</b>  <b>Casting#:</b></p>
<p>E146-75-006</p>  <p><b>Bore Size: 66.0 mm</b>  <b>Port Size: 7/16-24</b>  <b>Casting#: 4151733</b>  <b>Casting#:</b>  <b>Casting#:</b></p>	<p>E146-75-007</p>  <p><b>Bore Size: 66.0 mm</b>  <b>Port Size: 7/16-24</b>  <b>Casting#: 4151733</b>  <b>Casting#: BENDIX3</b>  <b>Casting#:</b></p>	<p>E146-75-008</p>  <p><b>Bore Size: 66.0 mm</b>  <b>Port Size: 7/16-24</b>  <b>Casting#: 4151733</b>  <b>Casting#: BENDIX</b>  <b>Casting#:</b></p>



# Brake Calipers

**FORMULA BLUE**  
HYDRAULIC BRAKE PARTS





<p>E146-75-011</p>  <p><b>Bore Size: 66mm</b> <b>Port Size: 7/16-24</b> <b>Casting#: 2238229</b> <b>Casting#:</b> <b>Casting#:</b></p>	<p>E146-75-012</p>  <p><b>Bore Size: 66mm</b> <b>Port Size: 7/16-24</b> <b>Casting#: 4151020</b> <b>Casting#:</b> <b>Casting#:</b></p>	<p>E146-79-009</p>  <p><b>Bore Size: 51.0mm</b> <b>Port Size: 10x1mm</b> <b>Casting#: FS15T</b> <b>Casting#:</b> <b>Casting#:</b></p>
<p>E146-79-011</p>  <p><b>Bore Size: 50.8 mm</b> <b>Port Size: 10x1mm</b> <b>Casting#: FS15T</b> <b>Casting#:</b> <b>Casting#:</b></p>	<p>E146-79-013</p>  <p><b>Bore Size: 51.0mm</b> <b>Port Size: 10x1mm</b> <b>Casting#:</b> <b>Casting#:</b> <b>Casting#:</b></p>	<p>E146-79-015</p>  <p><b>Bore Size: 51.0mm</b> <b>Port Size: 10x1mm</b> <b>Casting#: 15L</b> <b>Casting#:</b> <b>Casting#:</b></p>
<p>E146-79-017</p>  <p><b>Bore Size: 51.0mm</b> <b>Port Size: 10x1mm</b> <b>Casting#: FX15C</b> <b>Casting#: 5712B</b> <b>Casting#: 6T</b></p>	<p>E146-79-019</p>  <p><b>Bore Size: 51.0 mm</b> <b>Port Size: 10x1mm</b> <b>Casting#: FX15C</b> <b>Casting#: 4624B</b> <b>Casting#: 2T</b></p>	<p>E146-79-021</p>  <p><b>Bore Size: 54.0 mm</b> <b>Port Size: 10x1mm</b> <b>Casting#: FX15C</b> <b>Casting#:</b> <b>Casting#:</b></p>
<p>E146-79-023</p>  <p><b>Bore Size: 54.0 mm</b> <b>Port Size: 10x1mm</b> <b>Casting#: FX15C</b> <b>Casting#: 4622B</b> <b>Casting#: 1T</b></p>	<p>E146-79-507</p>  <p><b>Bore Size: 51.0mm</b> <b>Port Size: 10x1mm</b> <b>Casting#: 15L</b> <b>Casting#: 15M</b> <b>Casting#: 15AM</b></p>	<p>E146-79-509</p>  <p><b>Bore Size: 50.8 mm</b> <b>Port Size: 10x1mm</b> <b>Casting#: 15L</b> <b>Casting#: 15M</b> <b>Casting#: 15AM</b></p>
<p>E146-79-511</p>  <p><b>Bore Size: 51.0mm</b> <b>Port Size: 10x1mm</b> <b>Casting#: FX15C</b> <b>Casting#: 5516B</b> <b>Casting#: 5T</b></p>	<p>E146-79-513</p>  <p><b>Bore Size: 50.8 mm</b> <b>Port Size: 10x1mm</b> <b>Casting#: FX15C</b> <b>Casting#: 6721B</b> <b>Casting#: 3T</b></p>	<p>E146-79-515</p>  <p><b>Bore Size: 54mm</b> <b>Port Size: 10x1mm</b> <b>Casting#: FX15C</b> <b>Casting#:</b> <b>Casting#:</b></p>

<p>E146-79-517</p>  <p><b>Bore Size: 54mm</b> <b>Port Size: 10xmm</b> <b>Casting#: FX15C</b> <b>Casting#:</b> <b>Casting#:</b></p>	<p>E146-80-007</p>  <p><b>Bore Size: 60.0 mm</b> <b>Port Size: 10x1mm</b> <b>Casting#: 31320083-8</b> <b>Casting#:</b> <b>Casting#: 760-3</b></p>	<p>E146-80-507</p>  <p><b>Bore Size: 60.0 mm</b> <b>Port Size: 10x1mm</b> <b>Casting#: 31320083-8</b> <b>Casting#: 68320338</b> <b>Casting#:</b></p>
<p>E146-81-007</p>  <p><b>Bore Size: 54.0 mm</b> <b>Port Size: 10x1mm</b> <b>Casting#: AD76T</b> <b>Casting#: 35-16</b> <b>Casting#: 42107</b></p>	<p>E146-81-009</p>  <p><b>Bore Size: 54.0 mm</b> <b>Port Size: 10x1mm</b> <b>Casting#: AD54T</b> <b>Casting#:</b> <b>Casting#:</b></p>	<p>E146-81-011</p>  <p><b>Bore Size: 57.0 mm</b> <b>Port Size: 10x1mm</b> <b>Casting#: AD57T</b> <b>Casting#: A918</b> <b>Casting#:</b></p>
<p>E146-81-013</p>  <p><b>Bore Size: 57.0 mm</b> <b>Port Size: 10x1mm</b> <b>Casting#: AD57T</b> <b>Casting#: 5702</b> <b>Casting#:</b></p>	<p>E146-81-015</p>  <p><b>Bore Size: 54.0 mm</b> <b>Port Size: 10x1mm</b> <b>Casting#: 5407</b> <b>Casting#: A934X</b> <b>Casting#:</b></p>	<p>E146-81-017</p>  <p><b>Bore Size: 57.0 mm</b> <b>Port Size: 10x1mm</b> <b>Casting#: A940</b> <b>Casting#: 5705</b> <b>Casting#:</b></p>
<p>E146-82-007</p>  <p><b>Bore Size: 54.0 mm</b> <b>Port Size: 10x1mm</b> <b>Casting#: AD45V</b> <b>Casting#: 2112</b> <b>Casting#:</b></p>	<p>E146-84-006</p>  <p><b>Bore Size: 73.0 mm</b> <b>Port Size: 7/16-24</b> <b>Casting#: 456</b> <b>Casting#: 578</b> <b>Casting#:</b></p>	<p>E146-84-010</p>  <p><b>Bore Size: 92.0 mm</b> <b>Port Size: 7/16-24</b> <b>Casting#: D5HA-2B120-BB</b> <b>Casting#: KHMV2287</b> <b>Casting#: D5HA2B120BB</b></p>
<p>E146-84-013</p>  <p><b>Bore Size: 70.0 mm</b> <b>Port Size: 7/16-24</b> <b>Casting#: 595</b> <b>Casting#:</b> <b>Casting#:</b></p>	<p>E146-84-015</p>  <p><b>Bore Size: 64mm</b> <b>Port Size: 7/16-24</b> <b>Casting#: 602A/603A</b> <b>Casting#:</b> <b>Casting#:</b></p>	<p>E146-84-017</p>  <p><b>Bore Size: 64mm</b> <b>Port Size: 7/16-24 open</b> <b>Casting#: 602A/603A</b> <b>Casting#:</b> <b>Casting#:</b></p>

# Brake Calipers

**FORMULABLUE**  
FORMULA BLUE

<p>E146-84-019</p>  <p><b>Bore Size: 70.0 mm</b>  <b>Port Size: 7/16-24 OPEN</b>  <b>Casting#: 595</b>  <b>Casting#: 597</b>  <b>Casting#:</b></p>	<p>E146-84-106</p>  <p><b>Bore Size: 63.5 mm</b>  <b>Port Size: 7/16-24</b>  <b>Casting#: 472</b>  <b>Casting#:</b>  <b>Casting#:</b></p>	<p>E146-85-006</p>  <p><b>Bore Size: 66.0 mm</b>  <b>Port Size: 10x1.50mm</b>  <b>Casting#: 4152828</b>  <b>Casting#:</b>  <b>Casting#:</b></p>
<p>E146-85-008</p>  <p><b>Bore Size: 73.0 mm</b>  <b>Port Size: 7/16-24</b>  <b>Casting#: 4150844</b>  <b>Casting#:</b>  <b>Casting#:</b></p>	<p>E146-85-009</p>  <p><b>Bore Size: 73mm</b>  <b>Port Size: 7/16-24</b>  <b>Casting#: 4150844</b>  <b>Casting#:</b>  <b>Casting#:</b></p>	<p>E146-85-011</p>  <p><b>Bore Size: 70.0 mm</b>  <b>Port Size: 10x1.50mm</b>  <b>Casting#: 581 F</b>  <b>Casting#: 583 F</b>  <b>Casting#:</b></p>
<p>E146-85-014</p>  <p><b>Bore Size: 66.0 mm</b>  <b>Port Size: 7/16-24</b>  <b>Casting#: 135607</b>  <b>Casting#: TRW</b>  <b>Casting#:</b></p>	<p>E146-85-016</p>  <p><b>Bore Size: 60.0 mm</b>  <b>Port Size: 7/16-24</b>  <b>Casting#: 136743 TRW</b>  <b>Casting#:</b>  <b>Casting#:</b></p>	<p>E146-85-018</p>  <p><b>Bore Size: 66.0mm</b>  <b>Port Size: 7/16-24</b>  <b>Casting#: 145513</b>  <b>Casting#: GD2</b>  <b>Casting#:</b></p>
<p>E146-85-021</p>  <p><b>Bore Size: 70.0mm</b>  <b>Port Size: 10x1.5mm</b>  <b>Casting#: 581F</b>  <b>Casting#:</b>  <b>Casting#:</b></p>	<p>E146-85-023</p>  <p><b>Bore Size: 70.0mm</b>  <b>Port Size: 7/16-24</b>  <b>Casting#: 581F</b>  <b>Casting#:</b>  <b>Casting#:</b></p>	<p>E146-88-006</p>  <p><b>Bore Size: 73.0mm</b>  <b>Port Size: 7/16-24</b>  <b>Casting#: 4152279</b>  <b>Casting#:</b>  <b>Casting#:</b></p>
<p>E146-88-008</p>  <p><b>Bore Size: 66.0 mm</b>  <b>Port Size: 7/16-24</b>  <b>Casting#: 4153269</b>  <b>Casting#:</b>  <b>Casting#:</b></p>	<p>E146-88-010</p>  <p><b>Bore Size: 73.0 mm</b>  <b>Port Size: 7/16-24</b>  <b>Casting#: 4153222</b>  <b>Casting#:</b>  <b>Casting#:</b></p>	<p>E146-88-015</p>  <p><b>Bore Size: 70.0 mm</b>  <b>Port Size: 7/16"-24</b>  <b>Casting#: 9187</b>  <b>Casting#: 9188</b>  <b>Casting#: WHB3</b></p>

E146-88-017	E146-90-007	E146-90-009
 <p> <b>Bore Size: 64mm</b>  <b>Port Size: 7/16-24</b>  <b>Casting#: 602</b>  <b>Casting#: 603</b>  <b>Casting#:</b> </p>	 <p> <b>Bore Size: 52.0 mm</b>  <b>Port Size: 10x1mm</b>  <b>Casting#: 929305</b>  <b>Casting#: 5245</b>  <b>Casting#: 2x52/28</b> </p>	 <p> <b>Bore Size: 68.0 mm</b>  <b>Port Size: 12x1mm</b>  <b>Casting#: 5662.02</b>  <b>Casting#: 5F03</b>  <b>Casting#: 566101</b> </p>
E146-90-507	E146-90-509	
 <p> <b>Bore Size: 68.0 mm</b>  <b>Port Size: 12x1mm</b>  <b>Casting#: 566101</b>  <b>Casting#: 5662.02</b>  <b>Casting#: 5F03</b> </p>	 <p> <b>Bore Size: 52.0 mm</b>  <b>Port Size: 10x1mm</b>  <b>Casting#: 05J021</b>  <b>Casting#: 929305</b>  <b>Casting#:</b> </p>	









# NOTES







---







---

**HAVE QUESTIONS? NEED ASSISTANCE? TALK TO THE FORMULA BLUE® TECH LINE.  
Call 1-866-610-9709, option 2  
Representatives are available Monday – Friday, 8:00 a.m. – 8:30 p.m. EST.**

<p>E148-45-005</p>	<p>E148-66-032</p>
 <p>1x Dust Boot 1x O-ring</p>	 <p>2x Dust Boots 2x O-rings</p>
<p>E148-70-024</p>	<p>E148-71-007</p>
 <p>2x Dust Boots 2x O-rings</p>	 <p>2x Dust Boots 4x O-rings 2x metal heat shields</p>
<p>E148-73-006</p>	<p>E148-80-006</p>
 <p>1x Dust Boots 1x O-rings</p>	 <p>2x Dust Boots 2x O-rings</p>

# Caliper Kits

E148-81-006	E148-81-007
 <p data-bbox="162 567 357 651">2x Dust Boots 2x O-rings 2x retainer springs</p>	 <p data-bbox="836 567 1031 651">2x Dust Boots 2x O-rings 2x retainer springs</p>
E148-81-008	E148-81-009
 <p data-bbox="162 1186 308 1249">2x Dust Boots 2x O-rings</p>	 <p data-bbox="836 1186 982 1249">2x Dust Boots 2x O-rings</p>
E148-82-006	E148-84-006
 <p data-bbox="162 1795 357 1879">2x Dust Boots 2x O-rings 2x retainer springs</p>	 <p data-bbox="836 1795 982 1858">2x Dust Boots 2x O-rings</p>

<p>E148-84-007</p>	<p>E148-84-008</p>
 <p>2x Dust Boots          2x O-rings          2x retainer springs</p>	 <p>2x Dust Boots          2x O-rings          2x retainer springs</p>
<p>E148-84-009</p>	<p>E148-84-010</p>
 <p>2x Dust Boots          2x O-rings</p>	 <p>4x Dust Boots          4x O-rings</p>
<p>E148-85-006</p>	<p>E148-85-007</p>
 <p>4x Dust Boots          4x O-rings          4x Heat shields</p>	 <p>4x Piston Seals          4x Dust Boots          4x Heat Shields</p>

# Caliper Kits

**FORMULABLUE**  
HYDRAULIC BRAKE PARTS

E148-87-006



2x Dust Boots  
2x O-rings

E148-88-006



2x Dust Boots  
2x O-rings

E148-88-007



2x Dust Boots  
2x O-rings  
2x metal heat shields

E148-88-008



2x Soft Dust Boots  
2x O-rings

E148-88-009



2x Dust Boots  
2x O-rings

E148-90-006



2x Dust Boots  
2x O-rings

Formula Blue Part Number	Core Group	22
E14685008	Core Class	49
	Casting number	4150844
	Piston Size	2.88"

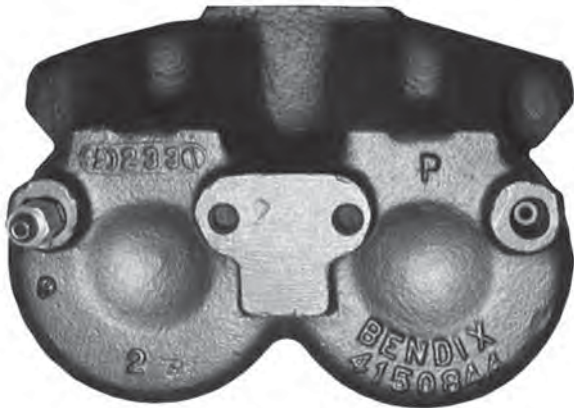

Formula Blue Part Number	Core Group	21
E14675006	Core Class	48
	Casting number	4151733
	Piston Size	2.60"
Note inlet location		





# Caliper Core Identification

Formula Blue Part Number	Core Group	23
E14684106	Core Class	50
	Casting number	472
	Piston Size	2.50" (63.5mm)



Formula Blue Part Number	Core Group	23
E14684006	Core Class	51
	Casting number	578
	Piston Size	2.88" (73mm)

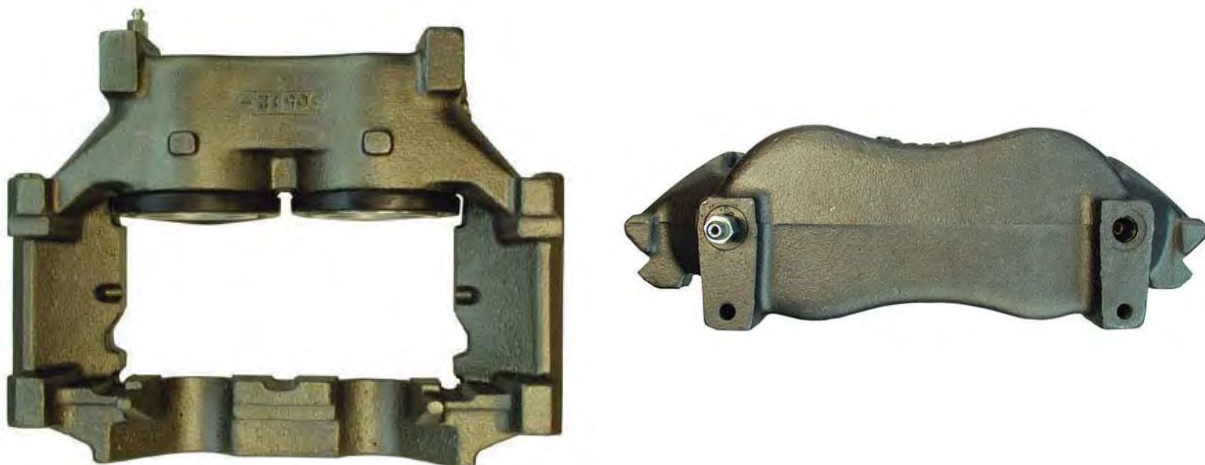

Formula Blue Part Number	Core Group	22
E14688010	Core Class	49
	Casting number	4153222
	Piston Size	73mm

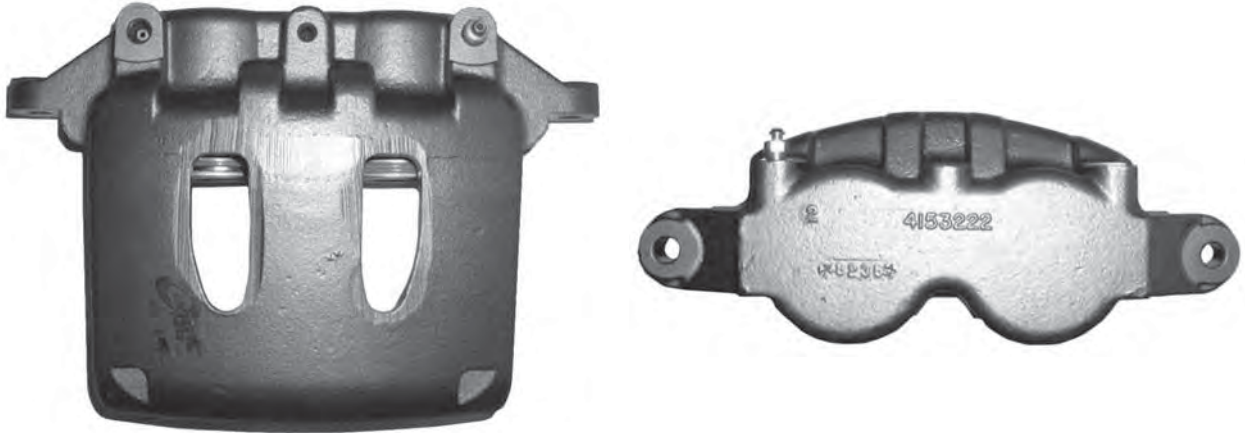

Formula Blue Part Number	Core Group	24
E14688008	Core Class	52
	Casting number	4153269
	Piston Size	66mm

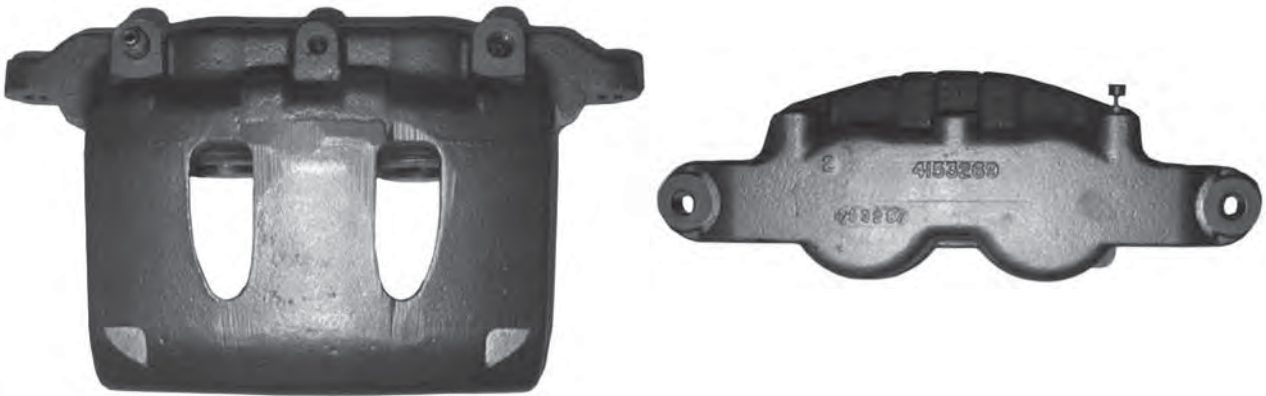

Representative information. For reference only.  
Part Numbers listed are semi-loaded version unless noted otherwise.



Part Number (non-Formula Blue part number)	Core Group	3W
L55245M (loaded caliper)	Core Class	W3
	Casting number	4151020 or 2238229
	Piston Size	2.6"

Very similar to other Bendix 2.6" castings. Note casting number for difference. Also, this core may have an external joining tube. This core has a unique casting that is machined to accommodate the boot.



or



Part Number (non-Formula Blue part number)	Core Group	69
R55803 (bare caliper)	Core Class	D1

Core is very similar to E14684106, however R55803 core has four (4) holes instead of six (6).

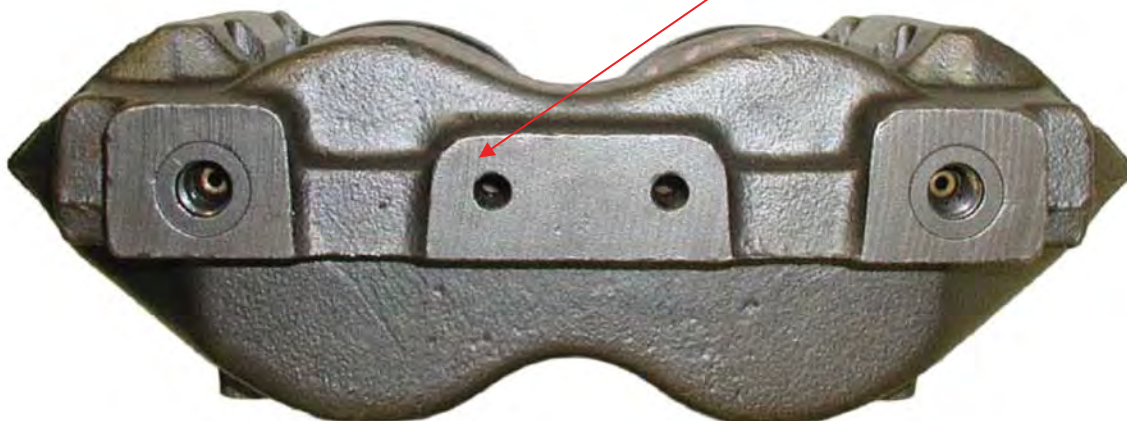

Formula Blue Part Number	Core Group	21
E14675007	Bendix Core Class	48
	Casting number	4151733
	Piston Size	2.60"
Note mounting bolt hole location to identify core		



Formula Blue Part Number	Core Group	24
E14675008	Bendix Core Class	52
	Casting number	4151733
	Piston Size	2.60"
Note inlet ports are low		



Representative information. For reference only.  
Part Numbers listed are semi-loaded version unless noted otherwise.

# Caliper Core Identification

Formula Blue Part Number	Core Group	22
E14670036 and E14670037	Bendix Core Class	49
	Casting number	12795101 OR 127951 OR 134247
Note inlet port location for right or left	Piston Size	56mm



Formula Blue Part Number	Core Group	3E
E14670020 and E14670021	Bendix Core Class	Y7
	Casting number	KH12068401
Note inlet port location for right or left	Piston Size	60mm

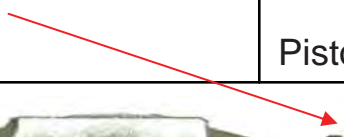



# BENDIX HYDRAULIC DISC BRAKE (3.38" Single Piston)



CALIPER:	CASTING:	SEAL KIT:
LEFT E146-71-015	2238451	E148-73-006
RIGHT E146-71-014	2238452	E148-73-006

**FORMULABLUE**  
HYDRAULIC BRAKE PARTS

# BENDIX HYDRAULIC DISC BRAKE (3.38" Single Piston)



CALIPER:	CASTING:	SEAL KIT:
LEFT E146-71-017	2238451	E148-73-006
RIGHT E146-71-016	2238452	E148-73-006

**BENDIX HYDRAULIC DISC BRAKE  
(2.60" Twin Piston)  
First Design  
(Pre-1989)**

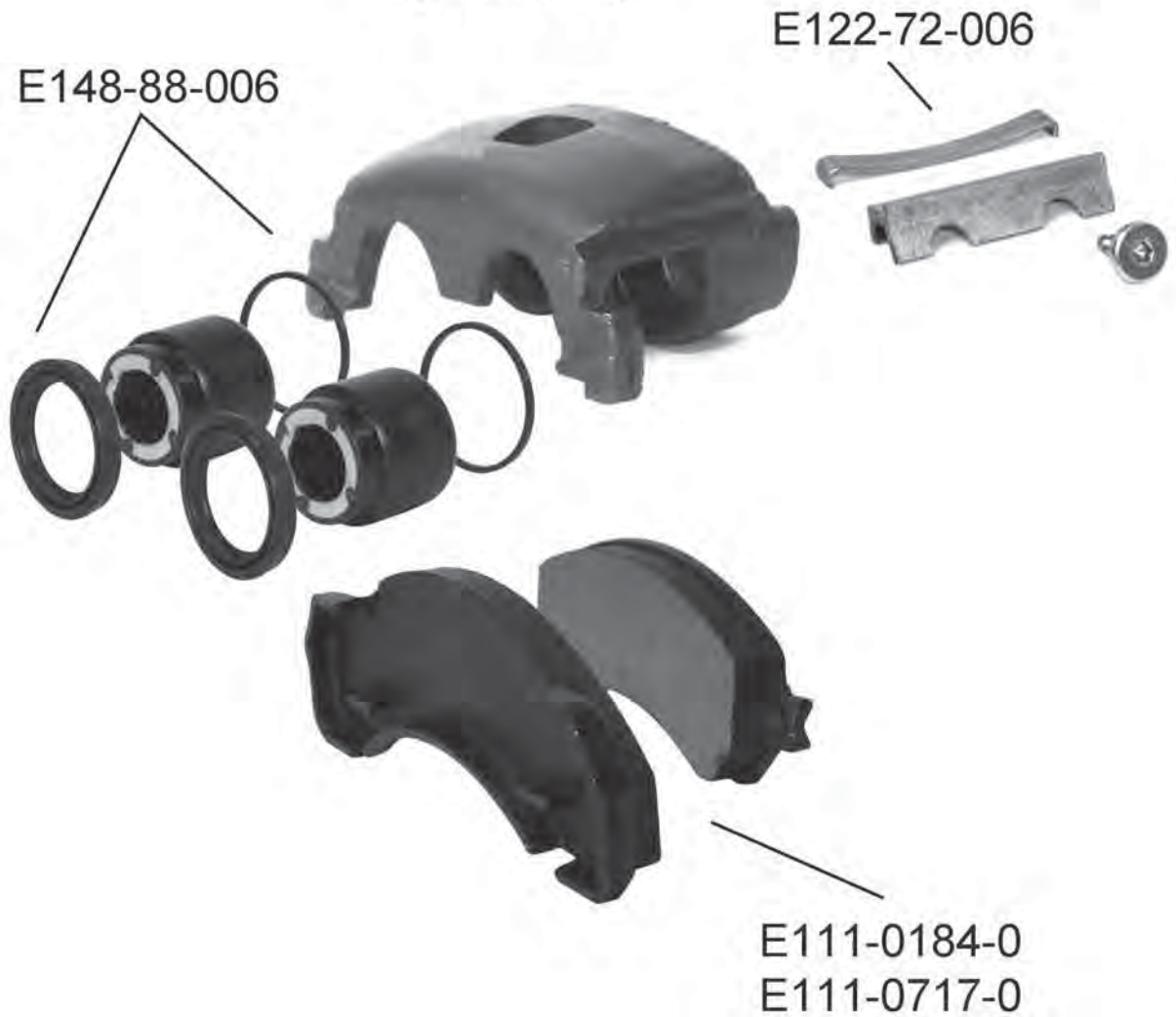

CALIPER:	CASTING:	SEAL KIT:	NOTE:
E146-75-006	4151733	E148-88-006	W/O MOUNTING BOLT HOLES
E146-75-007	4151733	E148-88-006	W/ MOUNTING BOLT HOLES

Note: The first design caliper and second design caliper are interchangeable as assemblies, but their component parts are not.

**FORMULABLUE**  
HYDRAULIC BRAKE PARTS

**BENDIX HYDRAULIC DISC BRAKE  
(2.60" Twin Piston)  
Second Design  
(Effective with model year 1989)**



CALIPER:	CASTING:	SEAL KIT:	NOTE:
E146-75-007	4151733	E148-88-007	W/ MOUNTING BOLT HOLES
E146-75-008	4151733	E148-88-007	FREIGHTLINER WITH AIR SUSPENSION INLET PORT LOCATION IS LOW



Note: The first design caliper and second design caliper are interchangeable as assemblies, but their component parts are not.



**BENDIX HYDRAULIC DISC BRAKE  
(2.88" Twin Piston)  
First Design  
(Pre-1989)**

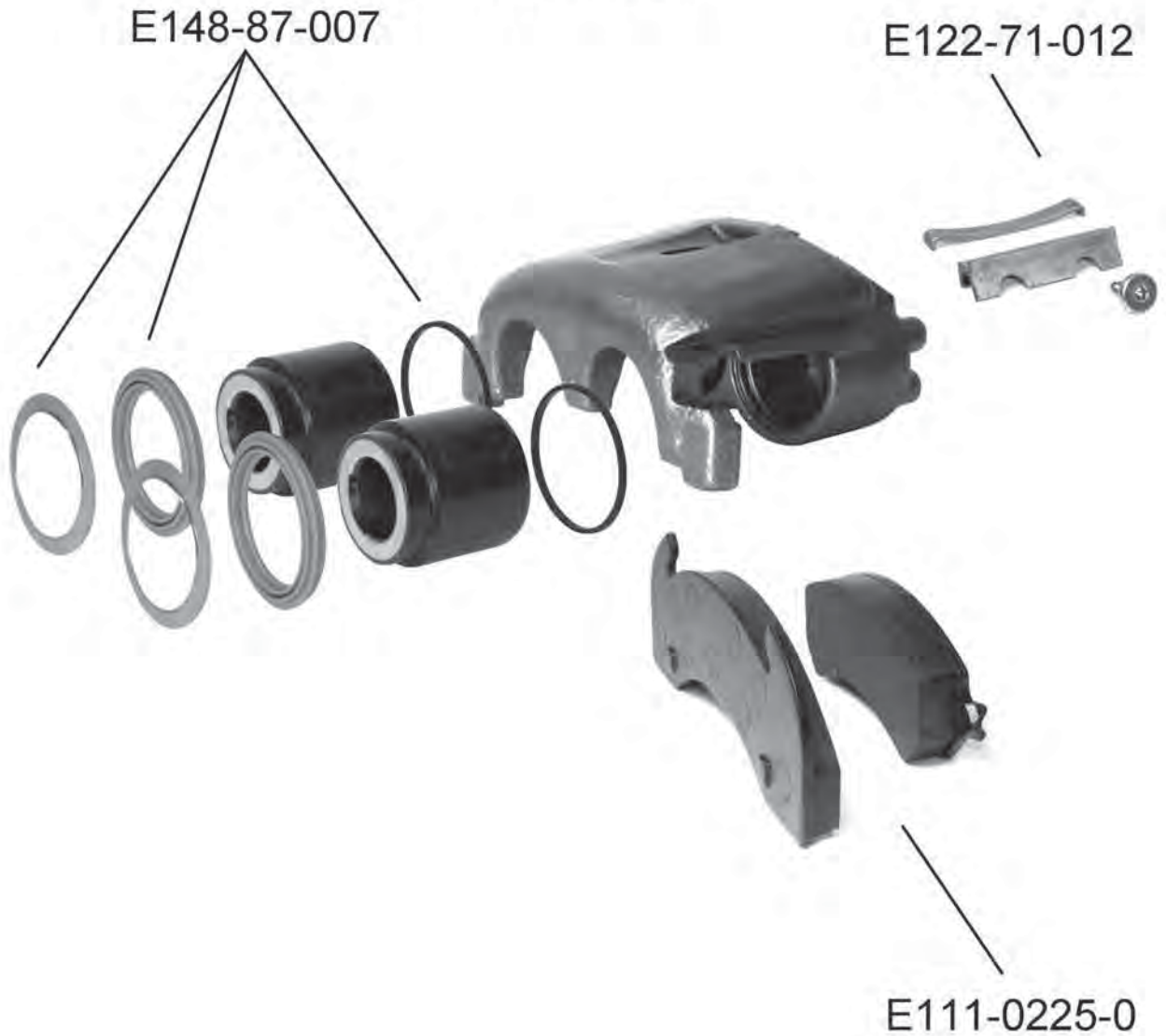

CALIPER:	CASTING:	SEAL KIT:
E146-85-009	4150844	E148-87-007

**Note:**  
The first design caliper and second design caliper are interchangeable as assemblies, but their component parts are not.

**FORMULABLUE**  
HYDRAULIC BRAKE PARTS



# BENDIX HYDRAULIC DISC BRAKE (2.88" Twin Piston) Second Design

(Effective with model year 1988 Navistar and Medium-Duty Trucks)

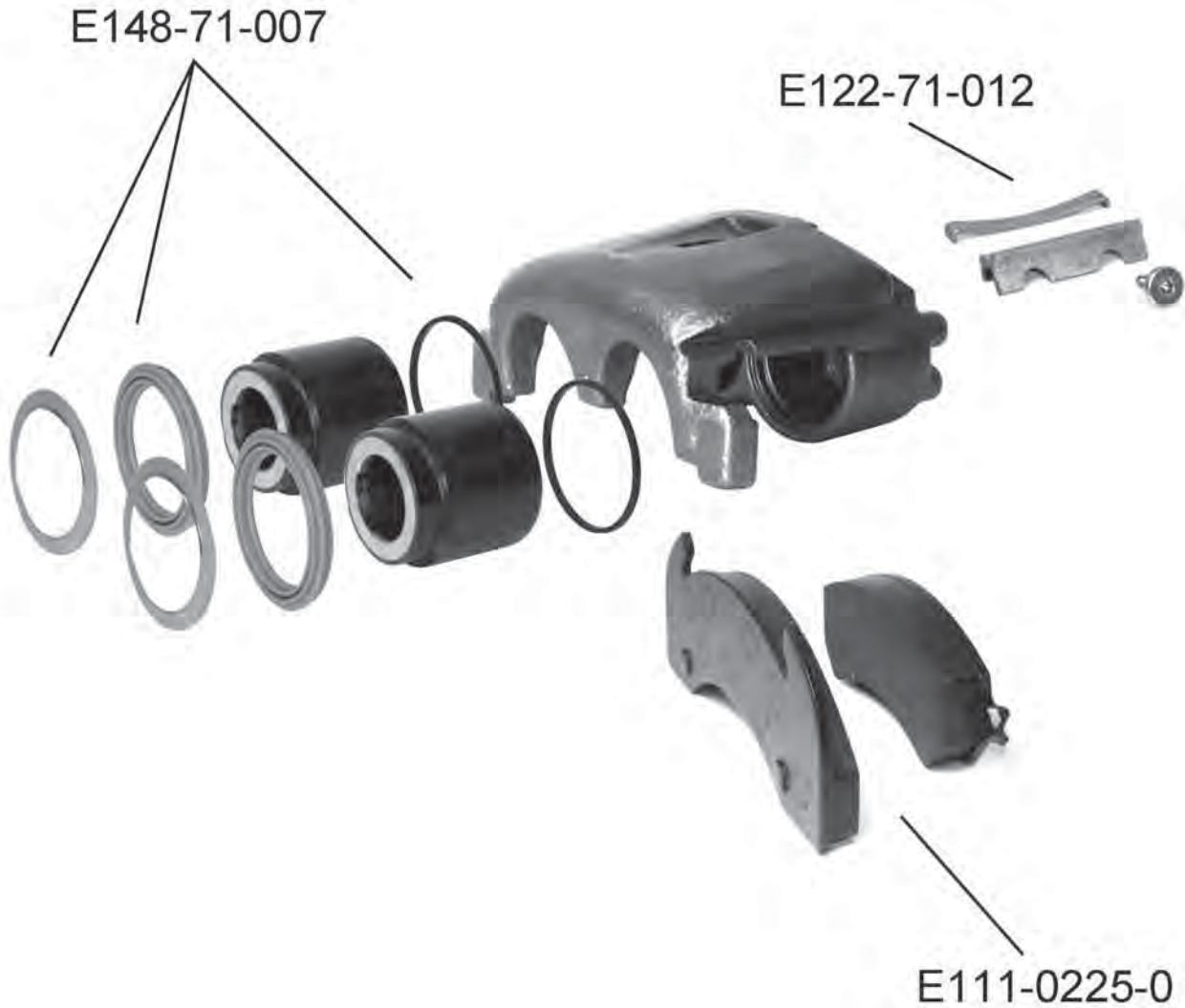

CALIPER:	CASTING:	SEAL KIT:	NOTE:
E146-85-008	4150844	E148-71-007	
E146-88-006	4152279	E148-71-007	FREIGHTLINER WITH AIR SUSPENSION



**Note:**  
The first design caliper and second design caliper are interchangeable as assemblies, but their component parts are not.

# BENDIX HYDRAULIC DISC BRAKE

## Pin Slide Disc Brake Components (66mm)

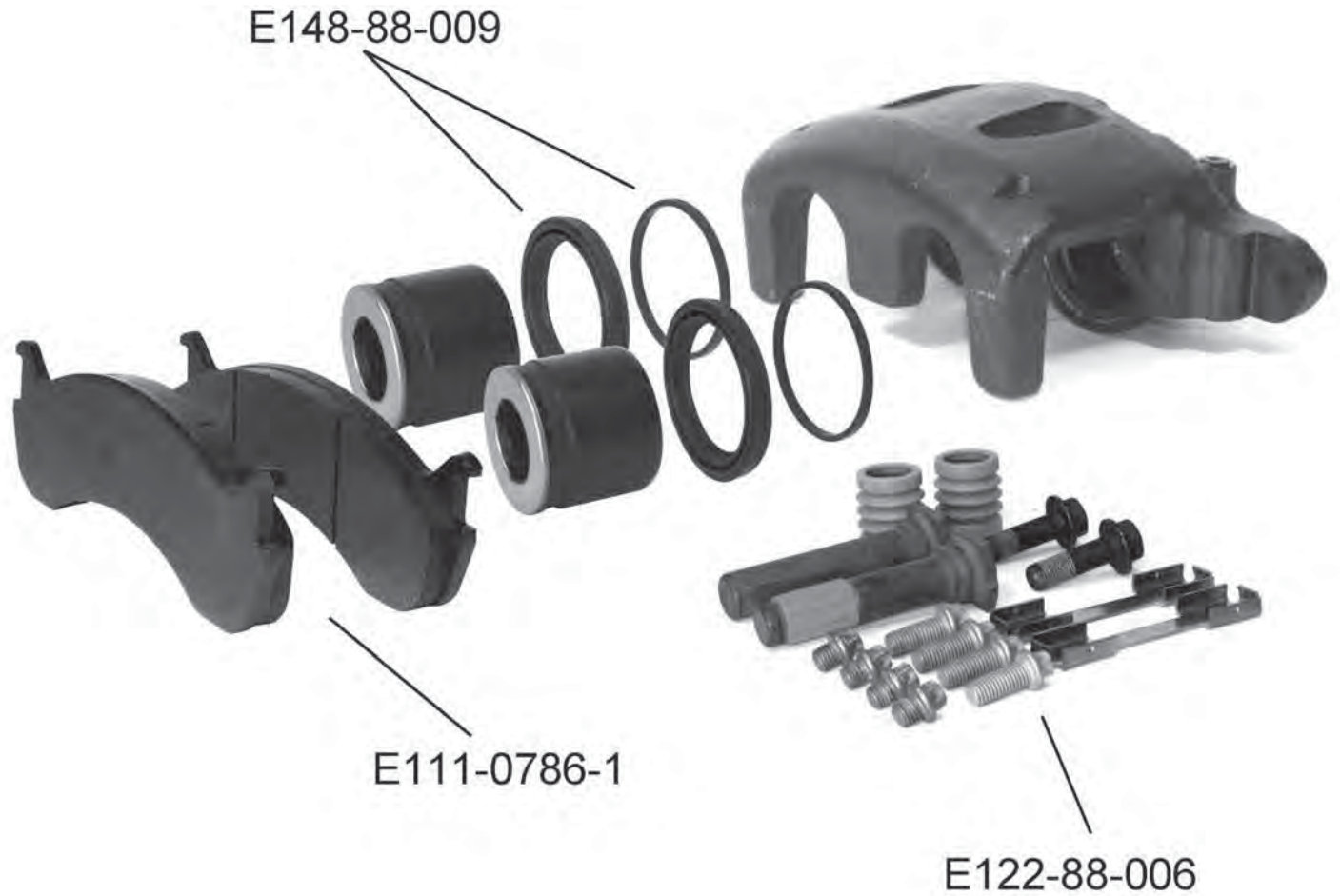

CALIPER:	CASTING:	SEAL KIT:
E146-88-008	4153269	E148-88-009

**FORMULABLUE**  
HYDRAULIC BRAKE PARTS

# BENDIX HYDRAULIC DISC BRAKE

## Pin Slide Disc Brake Components (73mm)

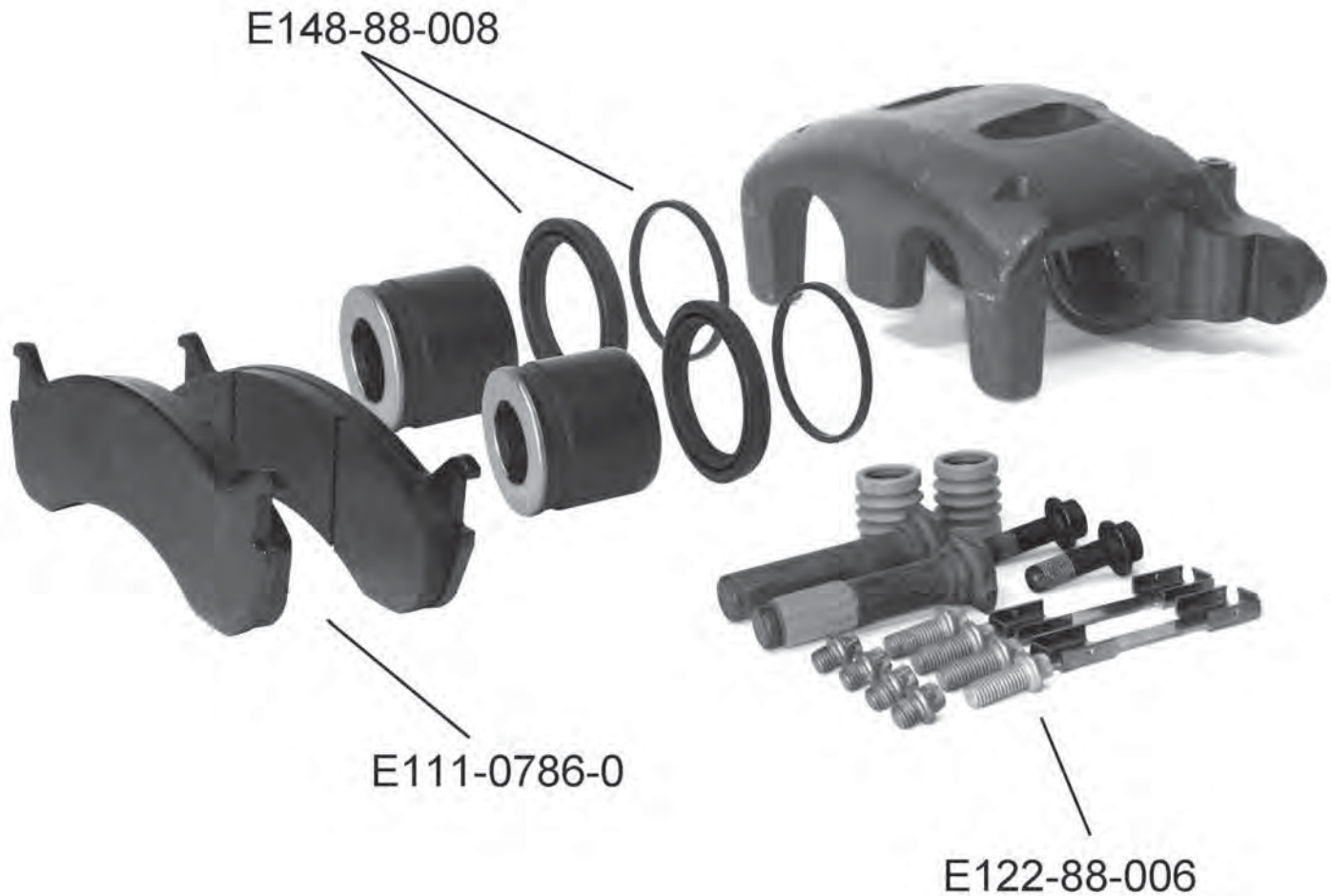

CALIPER:	CASTING:	SEAL KIT:
E146-88-010	4153222	E148-88-008

**GUNITE (KELSEY-HAYES)  
HYDRAULIC DISC BRAKE  
For Ford F450 Super Duty**



CALIPER:	CASTING:	SEAL KIT:
LEFT E146-70-021	KH12068401	E148-70-013
RIGHT E146-70-020	KH12068401	E148-70-013

**FORMULABLUE**  
HYDRAULIC BRAKE PARTS



# MERITOR HYDRAULIC DISC BRAKE (2.50" Twin Piston)

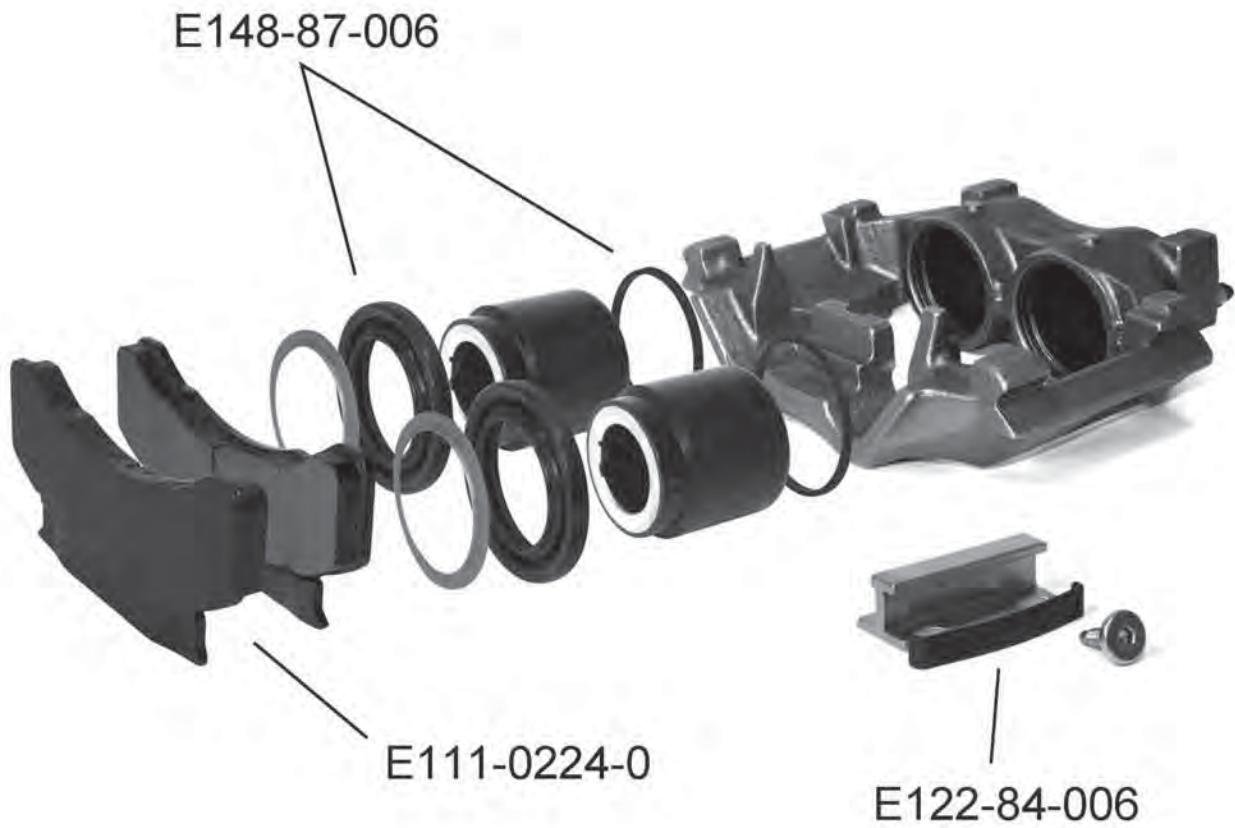

CALIPER:	CASTING:	SEAL KIT:
E146-84-106	472	E148-87-006

**FORMULABLUE**  
HYDRAULIC BRAKE PARTS

# MERITOR HYDRAULIC DISC BRAKE (2.88" Twin Piston)

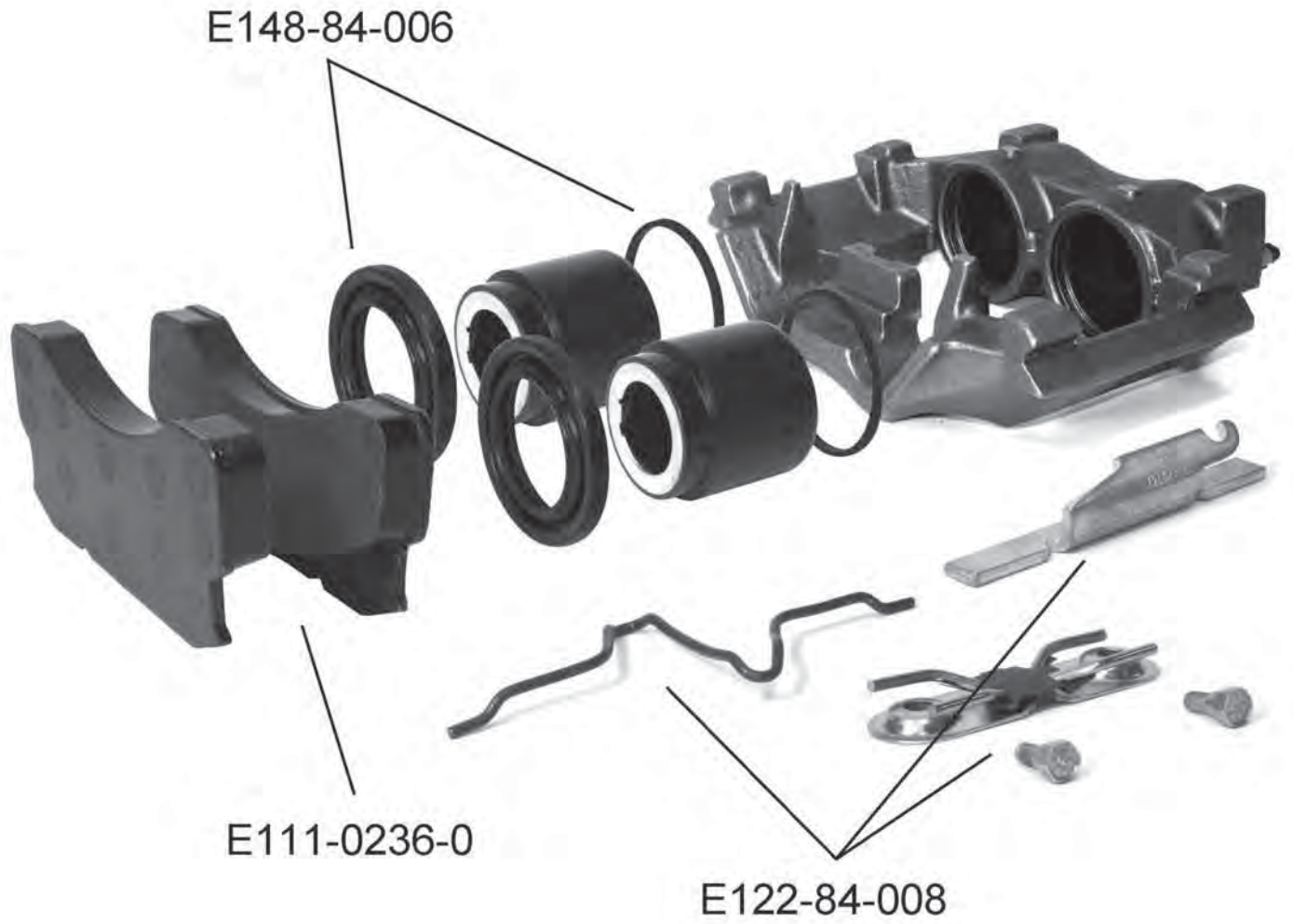

CALIPER:	CASTING:	SEAL KIT:
E146-84-006	578	E148-84-006

**FORMULABLUE**  
HYDRAULIC BRAKE PARTS

# MERITOR HYDRAULIC DISC BRAKE

## 4 x 70mm Quadraulic Phenolic Piston

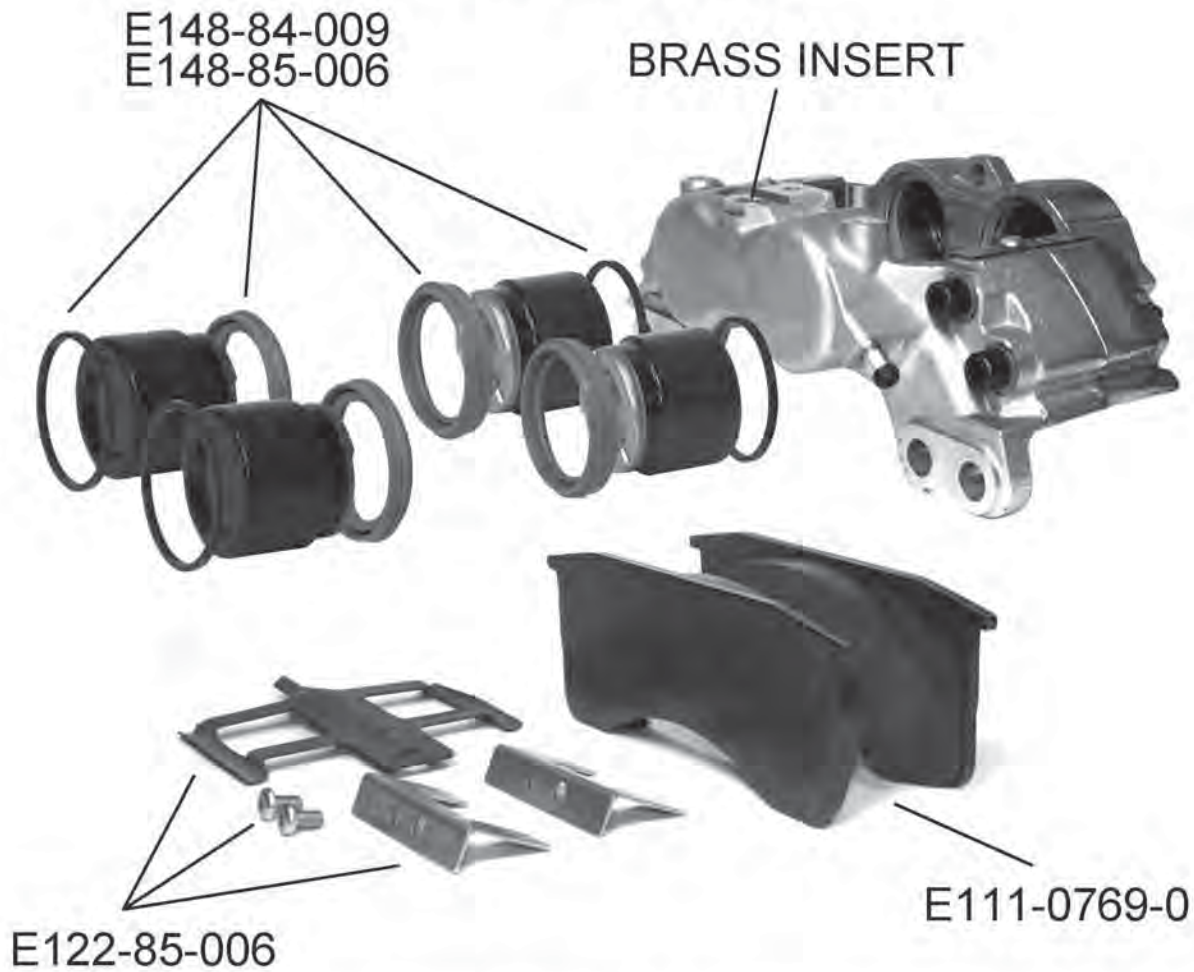

CALIPER:	CASTING:	SEAL KIT:	NOTE:
L E146-84-013	595-597	E148-84-009	W/ INLET BRASS INSERT
R E146-84-012	595-597	E148-84-009	W/ INLET BRASS INSERT
L E146-84-019	595-597	E148-84-009	W/O INLET BRASS INSERT
R E146-84-018	595-597	E148-84-009	W/O INLET BRASS INSERT
L E146-85-011	581-583	E148-85-006	W/ STEEL PISTONS
R E146-85-010	581-583	E148-85-006	W/ STEEL PISTONS
L E146-85-021	581-583	E148-84-009	W/ PHENOLIC PISTONS
R E146-85-020	581-583	E148-84-009	W/ PHENOLIC PISTONS
L/R E146-88-015	595-597 / 9187-9188	E148-84-009	W/ 3 MOUNTING HOLES
L/R E146-88-014	595-597 / 9187-9188	E148-84-009	W/ 3 MOUNTING HOLES



# MERITOR HYDRAULIC DISC BRAKE

## 4 x 64mm Quadraulic Phenolic Piston

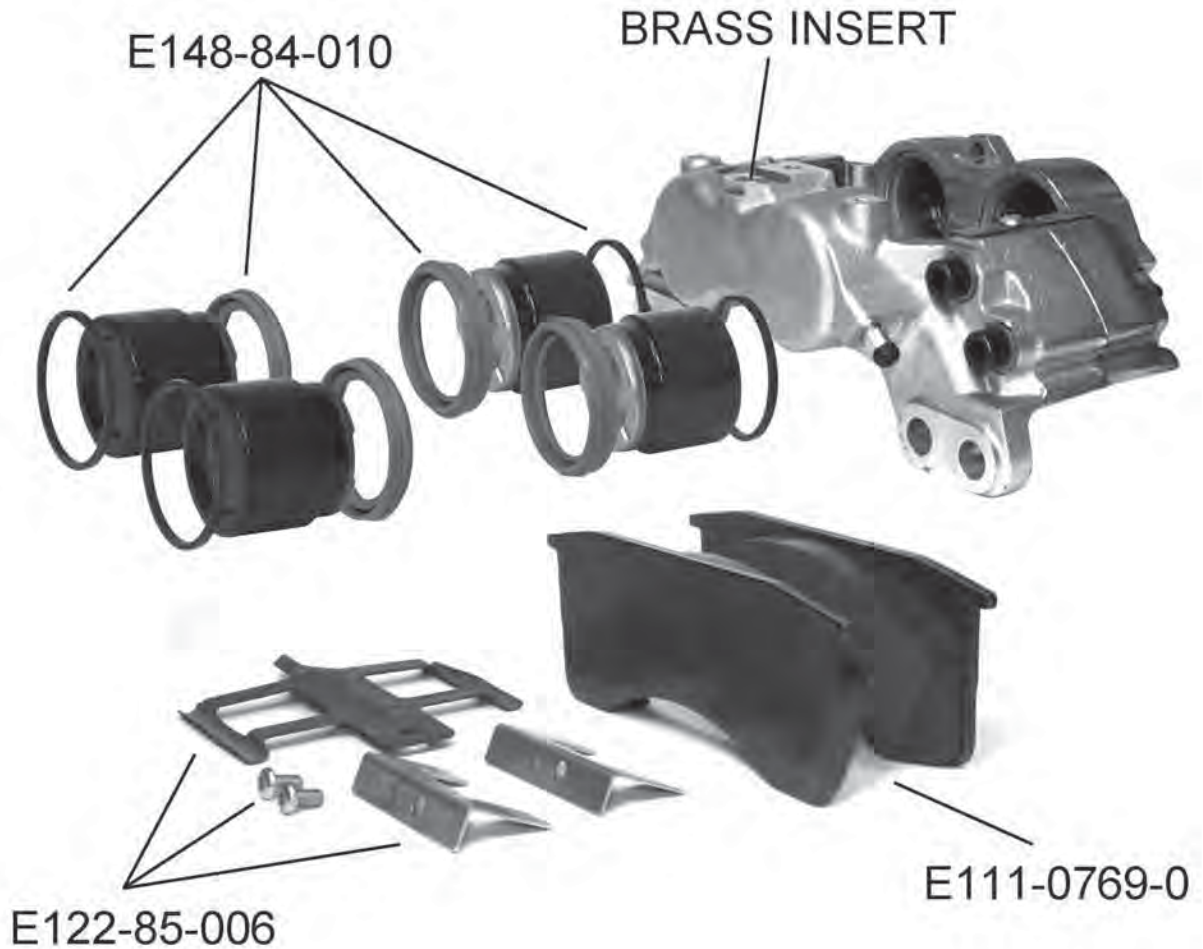

CALIPER:	CASTING:	SEAL KIT:	NOTE:
L E146-84-015	602A-603A	E148-84-009	W/ INLET BRASS INSERT
R E146-84-014	602A-603A	E148-84-009	W/ INLET BRASS INSERT
L E146-84-017	602A-603A	E148-84-009	W/O INLET BRASS INSERT
R E146-84-016	602A-603A	E148-84-009	W/O INLET BRASS INSERT
L E146-88-017	602-603	E148-84-009	CALIPER W/ 3 MOUNTING HOLES
R E146-88-016	602-603	E148-84-009	CALIPER W/ 3 MOUNTING HOLES

**FORMULABLUE**  
HYDRAULIC BRAKE PARTS

# NOTES

---

---

**HAVE QUESTIONS? NEED ASSISTANCE? TALK TO THE FORMULA BLUE® TECH LINE.  
Call 1-866-610-9709, option 2  
Representatives are available Monday – Friday, 8:00 a.m. – 8:30 p.m. EST.**



**2012 Edition**

# **Buyer's Guide**

Import & Domestic

*Heavy Duty Parts for Hard Working Vehicles*

**Bendix Spicer Foundation Brake LLC**

901 Cleveland Street • Elyria, Ohio 44035

Phone: 440-329-9709

Toll-Free: 1-866-610-9709

Fax: 440-329-9203

Tech Support: 1-866-610-9709, option 2

[www.foundationbrakes.com](http://www.foundationbrakes.com)

# NOTES

---

---

**HAVE QUESTIONS? NEED ASSISTANCE? TALK TO THE FORMULA BLUE® TECH LINE.  
Call 1-866-610-9709, option 2  
Representatives are available Monday – Friday, 8:00 a.m. – 8:30 p.m. EST.**

PART NO	DESCRIPTION	POSITION	YEAR	MAKE	MODEL
E107-0624-0	Brake Pads	Fr	1987 - 1988	mitsubishi FUSO	FE Series
E109-0856-0	Brake Pads	Fr	2006 - 2007	CHRYSLER, DODGE, JEEP	TOWN & COUNTRY VAN, CARAVAN, GRAND CARAVAN, LIBERTY
E109-0857-0	Brake Pads	Fr	2006 - 2007	CHRYSLER, DODGE	TOWN & COUNTRY VAN, CARAVAN, GRAND CARAVAN
E109-0858-0	Brake Pads	Rr	2006 - 2007	CHRYSLER, DODGE	TOWN & COUNTRY VAN, CARAVAN, GRAND CARAVAN
E109-1070-0	Brake Pads	Fr	2008 - 2009	FORD	TAURUS, TAURUS X
E109-1075-0	Brake Pads	Fr	2005 - 2009	CHEVROLET, PONTIAC, SATURN	UPLANDER, MONTANA, RELAY
E109-1080-0	Brake Pads	Fr	2006 - 2010	JEEP	COMMANDER, GRAND CHEROKEE
E109-1087-0	Brake Pads	Rr	2006 - 2010	JEEP	COMMANDER, GRAND CHEROKEE
E109-1120-0	Brake Pads	Rr	2006 - 2010	HUMMER	H3
E109-1159-0	Brake Pads	Fr	2007 - 2012	CHEVROLET	IMPALA
E109-1169-0	Brake Pads	Fr	2007 - 2009	CHEVROLET, GMC	TRAILBLAZER, ENVOY
E109-1274-0	Brake Pads	Rr	2007 - 2012	JEEP	LIBERTY, WRANGLER
E109-1316-0	Brake Pads	Fr	2007 - 2012	DODGE, FREIGHTLINER, MERCEDES BENZ	SPRINTER 2500
E109-1317-0	Brake Pads	Rr	2007 - 2012	DODGE, FREIGHTLINER, MERCEDES BENZ	SPRINTER 2500, 3500
E109-1318-0	Brake Pads	Rr	2007 - 2012	DODGE, FREIGHTLINER, MERCEDES BENZ	SPRINTER 3500
E109-1379-0	Brake Pads	Fr	2009 - 2010	CHEVROLET	HHR
E109-1404-0	Brake Pads	Fr	2011 - 2011	CHEVROLET	CAPRICE
E110-0598-0	Brake Pads	Fr	2001 - 2007	FORD	TAURUS
E110-0606-0	Brake Pads	Rr	2003 - 2011	TOYOTA	FJ CRUISER, SEQUOIA, 4RUNNER
E110-0698-0	Brake Pads	Rr	2007 - 2010	CHEVROLET	IMPALA
E110-0772-0	Brake Pads	Fr	2003 - 2007	TOYOTA	LAND CRUISER
E110-0773-0	Brake Pads	Rr	2003 - 2007	TOYOTA	LAND CRUISER
E110-0785-0	Brake Pads	Fr & Rr	2002 - 2011	CHEVROLET, GMC, HUMMER	AVALANCHE 1500, EXPRESS 1500 ½ Ton Van, SILVERADO 1500, 2500, 3500, SUBURBAN 1500, 2500, TAHOE, SAVANA 1500 ½ Ton Van, SIERRA 1500, 2500, 3500, DENALI, YUKON XL 2500 ¾ Ton, H2
E110-0792-0	Brake Pads	Rr	2007 - 2007	CHEVROLET, GMC	SILVERADO 1500 ½ Ton, SIERRA 1500 DENALI, C3 ½ Ton Pickup
E110-0815-1	Brake Pads	Fr	2010 - 2012	NISSAN	CUBE
E110-0833-0	Brake Pads	Fr	2005 - 2007	SATURN	VUE
E110-0834-0	Brake Pads	Rr	2002 - 2007	CHEVROLET	AVALANCHE 1500, SILVERADO 1500 ½ Ton, SUBURBAN 1500 ½ Ton 4WD, TAHOE
E110-0843-0	Brake Pads	Fr	2007 - 2007	FORD, MERCURY	ESCAPE, MARINER
E110-0866-0	Brake Pads	Fr	2007 - 2012	DODGE, JEEP	CALIBER, COMPASS, PATRIOT
E110-0868-0	Brake Pads	Rr	2007 - 2012	DODGE, JEEP	CALIBER, COMPASS, PATRIOT
E110-0883-0	Brake Pads	Rr	2007 - 2012	CHEVROLET, GMC	TRAILBLAZER, TRAVERSE, ACADIA, ENVOY
E110-0884-0	Brake Pads	Fr	2006 - 2007	TOYOTA	HIGHLANDER
E110-0888-0	Brake Pads	Fr	2008 - 2012	NISSAN	PATHFINDER
E110-0905-0	Brake Pads	Rr	2008 - 2012	NISSAN	ROGUE
E110-0906-1	Brake Pads	Fr	2004 - 2011	TOYOTA	SIENNA, TACOMA
E110-0931-0	Brake Pads	Fr	2003 - 2011	FORD, LINCOLN, MERCURY	CROWN VICTORIA, TOWN CAR, GRAND MARQUIS
E110-0932-0	Brake Pads	Rr	2003 - 2011	FORD, LINCOLN, MERCURY	CROWN VICTORIA, RANGER, TOWN CAR, GRAND MARQUIS

PART NO	DESCRIPTION	POSITION	YEAR	MAKE	MODEL
E110-0964-0	Brake Pads	Rr	2006 - 2010	FORD, JEEP, MERCURY	EXPLORER, SPORT, SPORT TRAC, LIBERTY, MOUNTAINEER
E110-0974-0	Brake Pads	Rr	2006 - 2012	CHEVROLET, GMC	EXPRESS 2500, 3500, SAVANA 2500, 3500 Van
E110-0974-1	Brake Pads	Rr	2002 - 2012	CHEVROLET, GMC	AVALANCHE 1500, EXPRESS 1500 ½ Ton Van, SUBURBAN 1500 ½ Ton RWD, TAHOE RWD, SAVANA 1500 ½ Ton Van
E110-0976-0	Brake Pads	Fr	2003 - 2011	TOYOTA	FJ CRUISER, SEQUOIA, TACOMA, 4RUNNER
E110-0995-0	Brake Pads	Rr	2004 - 2010	TOYOTA	SIENNA
E110-0996-0	Brake Pads	Rr	2006 - 2007	TOYOTA	HIGHLANDER
E110-0999-0	Brake Pads	Rr	2011 - 2012	CHEVROLET	IMPALA
E110-1005-0	Brake Pads	Fr	2006 - 2007	TOYOTA	HIGHLANDER
E110-1012-0	Brake Pads	Rr	2010 - 2011	FORD	F150 ½ Ton Truck
E110-1021-0	Brake Pads	Rr	2008 - 2012	CHRYSLER, DODGE	TOWN & COUNTRY VAN, CARAVAN, GRAND CARAVAN
E110-1028-0	Brake Pads	Fr	2006 - 2011	CHEVROLET	HHR
E110-1033-0	Brake Pads	Rr	2008 - 2010	CHEVROLET	HHR
E110-1037-0	Brake Pads	Rr	2007 - 2012	DODGE, JEEP	CALIBER, COMPASS, PATRIOT
E110-1039-0	Brake Pads	Fr	2004 - 2008	CHEVROLET, GMC	COLORADO, CANYON
E110-1041-0	Brake Pads	Rr	2004 - 2012	NISSAN	ARMADA, TITAN
E110-1047-0	Brake Pads	Fr	2007 - 2011	FORD, MAZDA, MERCURY	ESCAPE, TRIBUTE, MARINER
E110-1047-1	Brake Pads	Fr	2008 - 2009	FORD, MAZDA, MERCURY	ESCAPE, TRIBUTE, MARINER
E110-1047-2	Brake Pads	Fr	2010 - 2012	FORD, MERCURY	ESCAPE, MARINER
E110-1047-3	Brake Pads	Fr	2010 - 2012	FORD, MERCURY	ESCAPE, MARINER
E110-1055-0	Brake Pads	Rr	2007 - 2009	FORD, MAZDA, MERCURY	ESCAPE, TRIBUTE, MARINER
E110-1056-0	Brake Pads	Fr	2008 - 2012	DODGE	CHARGER
E110-1057-0	Brake Pads	Rr	2008 - 2012	DODGE	CHARGER
E110-1058-0	Brake Pads	Fr	2011 - 2012	DODGE	CHARGER
E110-1071-0	Brake Pads	Rr	2008 - 2009	FORD	TAURUS, TAURUS X
E110-1092-0	Brake Pads	Fr	2007 - 2007	CHEVROLET, GMC	AVALANCHE 1500, SILVERADO 1500 ½ Ton, SUBURBAN 1500 ½ Ton, TAHOE, SIERRA 1500, SIERRA 1500 DENALI, C3 ½ Ton Pickup, YUKON, YUKON DENALI, YUKON XL 1500, YUKON DENALI XL ½ Ton
E110-1093-0	Brake Pads	Rr	2005 - 2009	CHEVROLET, PONTIAC, SATURN	UPLANDER, MONTANA, RELAY
E110-1094-0	Brake Pads	Fr	2005 - 2012	NISSAN	FRONTIER, PATHFINDER, XTERRA
E110-1100-0	Brake Pads	Rr	2005 - 2012	NISSAN	FRONTIER, XTERRA
E110-1101-0	Brake Pads	Rr	2006 - 2012	NISSAN	PATHFINDER
E110-1119-0	Brake Pads	Fr	2006 - 2010	HUMMER	H3
E110-1125-0	Brake Pads	Fr	2010 - 2012	CHEVROLET, GMC	EQUINOX, TERRAIN
E110-1158-0	Brake Pads	Fr	2006 - 2010	FORD, MERCURY	EXPLORER, SPORT, SPORT TRAC, MOUNTAINEER
E110-1169-0	Brake Pads	Fr	2009 - 2012	CHEVROLET, GMC	COLORADO, CANYON
E110-1169-1	Brake Pads	Fr	2007 - 2012	CHEVROLET, GMC	TRAVERSE, ACADIA
E110-1183-0	Brake Pads	Fr	2004 - 2007	NISSAN	TITAN
E110-1194-0	Brake Pads	Rr	2007 - 2012	CHEVROLET, GMC	AVALANCHE 1500, SILVERADO 1500 ½ Ton, SUBURBAN 1500 ½ Ton, TAHOE, SIERRA 1500, SIERRA 1500 DENALI, C3 ½ Ton Pickup, YUKON, YUKON DENALI, YUKON XL 1500, YUKON DENALI XL ½ Ton
E110-1258-0	Brake Pads	Fr	2007 - 2012	FORD, LINCOLN, MAZDA	EDGE, MKX, CX-7, CX-9
E110-1259-0	Brake Pads	Rr	2007 - 2011	FORD, LINCOLN, MAZDA	EDGE, MKX, CX-7, CX-9

PART NO	DESCRIPTION	POSITION	YEAR	MAKE	MODEL
E110-1264-0	Brake Pads	Fr	2007 - 2010	CHEVROLET, PONTIAC, SATURN	EQUINOX, TORRENT, VUE
E110-1273-0	Brake Pads	Fr	2007 - 2012	CHRYSLER, DODGE, JEEP	TOWN & COUNTRY VAN, CARAVAN, GRAND CARAVAN, LIBERTY, WRANGLER
E110-1275-0	Brake Pads	Rr	2007 - 2012	CHEVROLET, GMC, PONTIAC, SATURN	EQUINOX, TERRAIN, TORRENT, VUE
E110-1286-0	Brake Pads	Fr	2006 - 2012	NISSAN	ARMADA, TITAN
E110-1303-0	Brake Pads	Fr	2007 - 2011	TOYOTA	SEQUOIA, TUNDRA
E110-1304-0	Brake Pads	Rr	2007 - 2011	TOYOTA	SEQUOIA, TUNDRA
E110-1324-0	Brake Pads	Fr	2008 - 2011	TOYOTA	HIGHLANDER, SIENNA
E110-1325-0	Brake Pads	Rr	2008 - 2011	TOYOTA	HIGHLANDER
E110-1338-0	Brake Pads	Fr	2008 - 2012	NISSAN	ROGUE
E110-1352-0	Brake Pads	Rr	2011 - 2011	CHEVROLET	CAPRICE
E110-1363-0	Brake Pads	Fr	2007 - 2012	CHEVROLET, GMC	AVALANCHE 1500, EXPRESS 1500 ½ Ton Van, SILVERADO 1500 ½ Ton, SUBURBAN 1500 ½ Ton, TAHOE, SAVANA 1500 ½ Ton Van, SIERRA 1500 DENALI, C3 ½ Ton Pickup, YUKON, YUKON DENALI, YUKON XL 1500, YUKON DENALI XL ½ Ton
E110-1377-0	Brake Pads	Rr	2010 - 2012	FORD, LINCOLN	EDGE, EXPLORER, SPORT, SPORT TRAC, TAURUS, TAURUS SHO, MKT, MKX
E110-1391-0	Brake Pads	Rr	2011 - 2011	TOYOTA	SIENNA
E110-1411-0	Brake Pads	Fr & Rr	2009 - 2012	CHEVROLET, GMC	SILVERADO 2500, 3500, SIERRA 2500, 3500 Pickup, Cab & Chassis, EXPRESS 3500 1 Ton Van, SAVANA 3500 1 Ton Van, G4500 Commercial Cutaway Chassis
E110-1414-0	Brake Pads	Fr	2010 - 2012	FORD	F150 ½ Ton Truck
E110-1455-0	Brake Pads	Fr	2011 - 2012	DODGE, JEEP	DURANGO, GRAND CHEROKEE
E110-1498-0	Brake Pads	Rr	2011 - 2012	DODGE, JEEP	DURANGO, GRAND CHEROKEE
E110-1508-0	Brake Pads	Fr	2011 - 2012	FORD, LINCOLN	EXPLORER, SPORT, SPORT TRAC, TAURUS, MKT
E110-1509-0	Brake Pads	Fr	2011 - 2012	NISSAN	TITAN
E110-1565-0	Brake Pads	Fr	2012 - 2012	NISSAN	NV1500, NV2500 HD, NV3500 HD
E110-1565-1	Brake Pads	Rr	2012 - 2012	NISSAN	NV1500, NV2500 HD, NV3500 HD
E110-1589-0	Brake Pads	Fr	2012 - 2012	CHRYSLER, DODGE	TOWN & COUNTRY VAN, CARAVAN, GRAND CARAVAN
E110-1596-0	Brake Pads	Rr	2012 - 2012	CHRYSLER, DODGE	TOWN & COUNTRY VAN, CARAVAN, GRAND CARAVAN
E110-1602-0	Brake Pads	Rr	2012 - 2012	FORD	F150 ½ Ton Truck
E111-0153-0	Brake Pads	Fr	1985 - 1994	WORKHORSE	P32, P42,
E111-0224-0	Brake Pads	Fr & Rr	1996 - 2008	ISUZU, STERLING	FSR with Front Disc Brakes, ACTERRA with Hydraulic Disc Brakes, FTR with Front Disc Brakes, FVR, FXR with Front Disc Brakes
E111-0225-0	Brake Pads	Fr & Rr	1980 - 2008	ISUZU, BLUEBIRD BUS, FREIGHTLINER, STERLING, MACK	FSR with Front Disc Brakes, TC2000 with Hydraulic Disc Brakes, FL50, FL60, FL70 with Disc Brakes, FS65, FW700 with Hydraulic Disc Brakes, MB50, MB60, MB70 with Disc Brakes, MT10, MT35, MT45, MT55, MT-E with Hydraulic Disc Brakes, ACTERRA with Hydraulic Disc Brakes, FTR with Front Disc Brakes, FVR, FXR with Front Disc Brakes, CS200, MS200
E111-0236-0	Brake Pads	Fr	1984 - 1994	FORD	LT, LTL900 Short Conventional Tandem with Front Disc Brakes
E111-0411-0	Brake Pads	Fr & Rr	1988 - 2007	FORD	E-SUPER DUTY Van & Cutaway, F53, 59 (1 Ton) RV Motor Home & Stripped Chassis, E450, 47 (1 Ton) Super Duty Van & Cutaway



PART NO	DESCRIPTION	POSITION	YEAR	MAKE	MODEL
E111-0433-0	Brake Pads	Fr	1988 - 1995	MINITRUCK FUSO	FE Series
E111-0494-0	Brake Pads	Fr	1987 - 1991	IVECO	EURO TURBO RANGE 10-14, 12-11, 12-12, 12-14, 13-14, 15-14, 18-14, 18-16
E111-0543-0	Brake Pads	Fr & Rr	1985 - 2003	WORKHORSE	P32, P42,
E111-0546-0	Brake Pads	Fr	1987 - 1997	ISUZU	NPR with Front Disc Brakes, Gas Engine
E111-0610-0	Brake Pads	Rr	2001 - 2007	FORD	TAURUS
E111-0655-0	Brake Pads	Fr	1996 - 2007	FORD	E150 ½ Ton Full Size Van, E250 ¾ Ton Full Size Van, E350 1 Ton Full Size Van, Wagon, Stripped & RV Chassis including Super Duty, E-SUPER DUTY Van & Cutaway, E450, 47 (1 Ton) Super Duty Van & Cutaway
E111-0699-0	Brake Pads	Fr	2005 - 2005	PONTIAC	MONTANA
E111-0701-0	Brake Pads	Fr	1994 - 2010	UD	UD 1200, UD 1300, UD 1400
E111-0702-1	Brake Pads	Rr	2006 - 2008	DODGE	RAM 1500 ½ Ton Pickup, RAM 2500 ¾ Ton Pickup, RAM 3500 1 Ton Pickup
E111-0711-0	Brake Pads	Rr	2005 - 2011	LINCOLN	TOWN CAR
E111-0717-0	Brake Pads	Fr & Rr	1992 - 2010	WORKHORSE, FREIGHTLINER, STERLING	P32, P42, W42 - 14,001, 16,000 GVWR, FL50, FL60, FL70 with Disc Brakes, FS65, FW700 with Hydraulic Disc Brakes, MB50, MB60, MB70 with Disc Brakes, MT10, MT35, MT45, MT55, MT-E with Hydraulic Disc Brakes, ACTERRA with Hydraulic Disc Brakes, P500 (Fedex Delivery Truck)
E111-0734-0	Brake Pads	Fr	1995 - 2005	MINITRUCK FUSO	FE Series
E111-0735-0	Brake Pads	Fr	1995 - 2005	MINITRUCK FUSO	FE Series
E111-0769-0	Brake Pads	Fr & Rr	1992 - 2012	CHEVROLET, FORD, GMC, ISUZU, BLUEBIRD BUS, FREIGHTLINER, HINO, IC BUS, INTERNATIONAL, THOMAS BUILT, WORKHORSE	C4500 Kodiak, C5500 Kodiak, C6500 Kodiak with Disc Brakes, C7500 Kodiak with Disc Brakes, T5500, T6500 with Disc Brakes, T7500, T8500 Tilt Cab with Disc Brakes, F650 Conventional with Disc Brakes, F750 Conventional with Disc Brakes, C4500 Topkick, C6500 Topkick with Front Disc Brakes, C7500 Topkick with Front Disc Brakes, T5500, T6500, T7500, T8500 Tilt Cab with Disc Brakes, FTR with Front Disc Brakes, FVR, FXR with Front Disc Brakes, H Series HTR, HVR, VISION, TC2000 with Hydraulic Disc Brakes, FL50, FL60, FL70 with Disc Brakes, 238 23,000, 25,500 LBS GVW, 258LP 23,000, 25,000 LBS GVW (Low Profile), 268 25,950GVW LBS with Hydraulic Disc Brakes, BE, CE, HC, LC with Hydraulic Disc Brakes, 3000, 3200, 3600, 3700, 3800, 3900FC School Bus with Hydraulic Disc Brakes, 4100, 4200, 4300, 4400, 4600, 4700, 4800, 4900, 7100 Conventional Cab with Hydraulic Disc Brakes, C2, W24, W25.5 - 24,000, 25,500 GVWR, W62, UFO - 17,000, 19,500, 23,000, 23,500 GVWR, 185 18,500 LBS GVW, FSR with Front Disc Brakes
E111-0777-0	Brake Pads	Fr & Rr	1999 - 2005	FORD	F53, 59 (1 Ton) RV Motor Home & Stripped Chassis, E550
E111-0784-0	Brake Pads	Fr	2003 - 2012	CHEVROLET, GMC, HUMMER	EXPRESS 2500, 3500 Van, SILVERADO 1500, 2500, 3500, SUBURBAN 2500 ¾ Ton, SAVANA 2500, 3500, SIERRA 1500, 2500, 3500 SIERRA DENALI, C3 ½ Ton Pickup, YUKON XL 2500 ¾ Ton, H2, G4500 Commercial Cutaway Chassis

PART NO	DESCRIPTION	POSITION	YEAR	MAKE	MODEL
E111-0786-0	Brake Pads	Fr & Rr	1998 - 2012	FORD, KENWORTH, PETERBILT, BLUEBIRD BUS, FREIGHTLINER, IC BUS, INTERNATIONAL, STERLING, WORKHORSE	F53, 59 (1 Ton) RV Motor Home & Stripped Chassis, F650 Conventional with Disc Brakes, F750 Conventional with Disc Brakes, T170, T270, T370 w/ Hydraulic Disc Brakes, 325, 330, 335 w/ Hydraulic Disc Brakes, TC2000 with Hydraulic Disc Brakes, Fred Chassis, FS65, FW700 with Hydraulic Disc Brakes, M2 100/106 with Hydraulic Disc Brakes, MC, MC-L Series Motorhome Chassis, MT10, MT35, MT45, MT55, MT-E with Hydraulic Disc Brakes, BE, CE, HC, LC with Hydraulic Disc Brakes, S1624, S1652FC, S1652SC UPS, S1654, 3000, 3200, 3600, 3700, 3800, 3900FC School Bus with Hydraulic Disc Brakes, 4100, 4200, 4300, 4400, 4600, 4700, 4800, 4900, 7100 Conventional Cab with Hydraulic Disc Brakes, ACTERRA with Hydraulic Disc Brakes, LF72 Bus 19,000 GVWR, W20, W20D, W21, W22 - 20,70, 22,000 GVWR
E111-0786-1	Brake Pads	Fr & Rr	1995 - 2012	FORD, KENWORTH, PETERBILT, WORKHORSE, BLUEBIRD BUS, FREIGHTLINER, IC BUS, INTERNATIONAL, STERLING	F650 Conventional with Disc Brakes, F750 Conventional with Disc Brakes, T170, T270, T370 w/ Hydraulic Disc Brakes, 325, 330, 335 w/ Hydraulic Disc Brakes, P32, P42, TC2000 with Hydraulic Disc Brakes, Fred Chassis, FS65, FW700 with Hydraulic Disc Brakes, M2 100/106 with Hydraulic Disc Brakes, MC, MC-L Series Motorhome Chassis, MT10, MT35, MT45, MT55, MT-E with Hydraulic Disc Brakes, BE, CE, HC, LC with Hydraulic Disc Brakes, MXT, RXT, S1624, S1652FC, S1652SC UPS, S1654, 3000, 3200, 3600, 3700, 3800, 3900FC School Bus with Hydraulic Disc Brakes, 4100, 4200, 4300, 4400, 4600, 4700, 4800, 4900, 7100 Conventional Cab with Hydraulic Disc Brakes, ACTERRA with Hydraulic Disc Brakes, LF72 Bus 19,000 GVWR, W20, W20D, W21, W22 - 20,70, 22,000 GVWR, F53, 59 (1 Ton) RV Motor Home & Stripped Chassis
E111-0802-0	Brake Pads	Rr	2006 - 2007	FORD	E150, E250, E350 Van including Super Duty
E111-0825-0	Brake Pads	Fr	1997 - 2012	CHEVROLET, GMC, ISUZU	W3500 Gas Engine, W3500 Diesel Engine, W4500 Gas Engine, W4500 Diesel Engine, NPR with Front Disc Brakes, Gas Engine, NPR with Front Disc Brakes, Diesel Engine, REACH VAN (UTILIMASTER BODY)
E111-0826-0	Brake Pads	Fr	1997 - 2003	ISUZU	NPR with Front Disc Brakes, Gas Engine, NPR with Front Disc Brakes, Diesel Engine, NQR
E111-0827-0	Brake Pads	Fr	1997 - 2012	CHEVROLET, GMC, ISUZU	W3500 Gas Engine, W4500 Gas Engine, W4500 Diesel Engine, W5500, W5500HD, NPR with Front Disc Brakes, Gas Engine, NPR with Front Disc Brakes, Diesel Engine, NQR, NRR
E111-0833-0	Brake Pads	Fr	2003 - 2011	FORD, MAZDA	RANGER, B SERIES Pickup
E111-0883-0	Brake Pads	Rr	2007 - 2010	SATURN	OUTLOOK
E111-0898-0	Brake Pads	Rr	2007 - 2012	DODGE, JEEP	DURANGO, RAM 1500 ½ Ton Pickup
E111-0909-0	Brake Pads	Rr	2004 - 2010	CHEVROLET, GMC	SILVERADO 3500 1 Ton, SIERRA 3500 1 Ton Pickup
E111-0931-0	Brake Pads	Fr	2005 - 2011	FORD, LINCOLN	CROWN VICTORIA, TOWN CAR
E111-0965-0	Brake Pads	Fr	2006 - 2008	DODGE	RAM 1500, 2500, 3500 Pickup
E111-0970-0	Brake Pads	Fr	2010 - 2012	FORD	TRANSIT CONNECT
E111-0989-0	Brake Pads	Rr	2006 - 2008	CHEVROLET, GMC	EXPRESS 3500 1 Ton Van, SAVANA 3500 1 Ton Van
E111-0999-0	Brake Pads	Rr	2012 - 2012	CHEVROLET	IMPALA

PART NO	DESCRIPTION	POSITION	YEAR	MAKE	MODEL
E111-1010-0	Brake Pads	Fr & Rr	2003 - 2010	CHEVROLET, GMC	C4500 Kodiak, C5500 Kodiak, C4500 Topkick
E111-1011-0	Brake Pads	Fr	2004 - 2008	FORD, LINCOLN	F150 ½ Ton Truck
E111-1012-0	Brake Pads	Rr	2004 - 2009	FORD, LINCOLN	F150 ½ Ton Truck
E111-1027-0	Brake Pads	Fr & Rr	2001 - 2011	WORKHORSE	P32, P42, W42 - 14,001, 16,000 GVWR, P500 (Fedex Delivery Truck), W16, W18 - 16,000, 18,000 GVWR
E111-1045-0	Brake Pads	Fr	2006 - 2006	FORD	E150 ½ Ton Full Size Van
E111-1046-0	Brake Pads	Rr	2006 - 2006	FORD	E150 ½ Ton Full Size Van
E111-1057-0	Brake Pads	Rr	2008 - 2012	DODGE	CHARGER
E111-1057-1	Brake Pads	Rr	2008 - 2012	DODGE	CHARGER
E111-1058-0	Brake Pads	Fr	2007 - 2010	DODGE	CALIBER, CHARGER
E111-1062-0	Brake Pads	Fr & Rr	2005 - 2010	HINO	185 18,500 LBS GVW, 145 14,050 GVW, 165 16,000 GVW
E111-1064-0	Brake Pads	Rr	2004 - 2010	CHEVROLET, GMC	C4500 Kodiak, C5500 Kodiak, C4500 Topkick
E111-1066-0	Brake Pads	Fr & Rr	2005 - 2012	FORD, INTERNATIONAL	F53, 59 (1 Ton) RV Motor Home & Stripped Chassis, F450, F47 (1 Ton) 2WD & 4WD Super Duty, F550 (1 Ton) 2WD & 4WD Super Duty, LCF Series, CF500, CF600, TERRA STAR
E111-1067-0	Brake Pads	Rr	2006 - 2010	FORD	F250, F250 Super Duty ¾ Ton Truck, F350 SUPER DUTY 1 Ton Pickup, Cab & Chassis including Super Duty
E111-1068-0	Brake Pads	Rr	2005 - 2006	FORD	F250, F250 Super Duty ¾ Ton Truck
E111-1069-0	Brake Pads	Fr	2005 - 2012	FORD	F250, F250, F350, F450, F47 Including Super Duty Truck
E111-1084-0	Brake Pads	Fr	2005 - 2012	DODGE, JEEP	DAKOTA, DURANGO, RAM 1500 ½ Ton Pickup
E111-1158-0	Brake Pads	Fr	2010 - 2012	FORD	TAURUS SHO
E111-1159-0	Brake Pads	Fr	2012 - 2012	CHEVROLET	IMPALA
E111-1169-1	Brake Pads	Fr	2007 - 2010	SATURN	OUTLOOK
E111-1265-0	Brake Pads	Fr & Rr	2005 - 2012	MINI, MITSUBISHI FUSO, STERLING	FE Series, 360 Series
E111-1268-0	Brake Pads	Fr, Fr & Rr	2006 - 2012	DODGE, FREIGHTLINER, MERCEDES BENZ, WORKHORSE	SPRINTER 3500, W42 - 14,001, 16,000 GVWR
E111-1273-0	Brake Pads	Fr	2011 - 2012	CHRYSLER, DODGE, JEEP	TOWN & COUNTRY VAN, CARAVAN, GRAND CARAVAN, LIBERTY
E111-1278-0	Brake Pads	Fr	2007 - 2009	FORD, LINCOLN	EXPEDITION, NAVIGATOR
E111-1279-0	Brake Pads	Rr	2007 - 2012	FORD, LINCOLN	EXPEDITION, NAVIGATOR
E111-1328-0	Brake Pads	Fr	2008 - 2012	FORD	E150 ½ Ton Full Size Van, E250 ¾ Ton Full Size Van, E350 1 Ton Full Size Van, Wagon, Stripped & RV Chassis including Super Duty, E-SUPER DUTY Van & Cutaway, E450, 47 (1 Ton) Super Duty Van & Cutaway
E111-1329-0	Brake Pads	Rr	2008 - 2012	FORD	E150 ½, E250, E350 Van including Super Duty
E111-1330-0	Brake Pads	Rr	2008 - 2012	FORD	E-SUPER DUTY Van & Cutaway, E450, 47 (1 Ton) Super Duty Van & Cutaway
E111-1333-0	Brake Pads	Fr	2010 - 2012	FORD	F250, F350 Pickup 4WD including Super Duty
E111-1334-0	Brake Pads	Rr	2010 - 2012	FORD	F250, F250, F350, F450, F47 Including Super Duty Truck
E111-1335-0	Brake Pads	Fr & Rr	2008 - 2012	DODGE, STERLING	RAM 4500, 5500, RAM 4500, 5500, BULLET
E111-1376-0	Brake Pads	Fr	2010 - 2010	FORD, LINCOLN	TAURUS, TAURUS SHO, MKT
E111-1392-0	Brake Pads	Fr	2009 - 2009	FORD	F150 ½ Ton Truck
E111-1399-0	Brake Pads	Fr	2009 - 2012	DODGE	RAM 2500, 3500 Pickup
E111-1400-0	Brake Pads	Rr	2009 - 2012	DODGE	RAM 2500, 3500 Pickup

PART NO	DESCRIPTION	POSITION	YEAR	MAKE	MODEL
E111-1414-0	Brake Pads	Fr	2010 - 2012	FORD, LINCOLN	EXPEDITION, NAVIGATOR
E111-1508-0	Brake Pads	Fr	2011 - 2012	FORD	TAURUS SHO
E111-1518-0	Brake Pads	Fr & Rr	2011 - 2012	SMITH	NEWTON
E116-0599-0	Brake Shoes	Rr	2001 - 2007	FORD	TAURUS
E116-0636-0	Brake Shoes	Rr	2005 - 2005	PONTIAC	MONTANA
E116-0647-0	Brake Shoes	PB	1988 - 2012	CHEVROLET, FORD, FREIGHTLINER, GMC, HINO, ISUZU	C4500 Kodiak, C5H042 Kodiak with Disc Brakes, C5500 Kodiak, C7500 Kodiak with Disc Brakes, T5500, T6500 with Disc Brakes, T7500, T8500 Tilt Cab with Disc Brakes, F53, 59 (1 Ton) RV Motor Home & Stripped Chassis, F450, F47 (1 Ton) 2WD & 4WD Super Duty, F550 (1 Ton) 2WD & 4WD Super Duty, FS65, FW700 with Hydraulic Disc Brakes, C4500 Topkick, C6500 Topkick with Front Disc Brakes, T5500, T6500, T7500, T8500 Tilt Cab with Disc Brakes, 145 14,050 GVW, 165 16,000 GVW, 185 18,500 LBS GVW, 238 23,000, 25,500 LBS GVW, 258LP 23,000, 25,000 LBS GVW (Low Profile), 268 25,950GVW LBS with Hydraulic Disc Brakes, FSR with Front Disc Brakes, FTR with Front Disc Brakes, FVR, FXR with Front Disc Brakes, H Series HTR, HVR
E116-0692-0	Brake Shoes	PB	1990 - 2010	CHEVROLET, GMC, ISUZU	C7500 Kodiak with Disc Brakes, C6500 Topkick with Front Disc Brakes, H Series HTR, HVR
E116-0704-0	Brake Shoes	Rr	2003 - 2009	FORD, MAZDA	RANGER, B SERIES Pickup
E116-0705-0	Brake Shoes	Rr	2003 - 2009	FORD, MAZDA	RANGER, B SERIES Pickup
E116-0714-0	Brake Shoes	Rr	2006 - 2007	CHRYSLER, DODGE	TOWN & COUNTRY VAN, CARAVAN, GRAND CARAVAN
E116-0733-0	Brake Shoes	PB	1987 - 2012	CHEVROLET, GMC, ISUZU, MITSUBISHI FUSO, STERLING	W3500 Diesel Engine, W4500 Diesel Engine, W5500, NPR with Front Disc Brakes, Gas Engine, NPR with Front Disc Brakes, Diesel Engine, NQR, FE Series, FH Series, 360 Series
E116-0745-0	Brake Shoes	Rr	2007 - 2007	JEEP	LIBERTY
E116-0752-0	Brake Shoes	Rr	2004 - 2011	FORD, LINCOLN	F150 ½ Ton Truck, TOWN CAR
E116-0760-0	Brake Shoes	Rr	2007 - 2007	FORD, MERCURY	ESCAPE, MARINER
E116-0761-0	Brake Shoes	Rr	2006 - 2007	CHRYSLER, DODGE	TOWN & COUNTRY VAN, CARAVAN, GRAND CARAVAN
E116-0770-0	Brake Shoes	Rr	2007 - 2010	CHEVROLET	IMPALA
E116-0771-0	Brake Shoes	Rr	1999 - 2010	CHEVROLET, FORD, GMC, HUMMER, FORD	EXPRESS 2500, 3500 Van, SILVERADO 1500, 2500, 3500, SUBURBAN 2500, E350, E450, 47 Full Size Van, Wagon, Stripped & RV Chassis including Super Duty, E-SUPER DUTY Van & Cutaway, SAVANA 2500, 3500 Van, SIERRA 1500, 2500, 3500 SIERRA DENALI, C3 ½ Ton Pickup, Cab & Chassis, YUKON XL 2500 ¾ Ton, H2
E116-0772-0	Brake Shoes	PB	1999 - 2010	FORD	F53, 59 (1 Ton) RV Motor Home & Stripped Chassis, F450, F47 (1 Ton) 2WD & 4WD Super Duty, F550 (1 Ton) 2WD & 4WD Super Duty
E116-0777-0	Brake Shoes	Rr	2008 - 2012	DODGE	CHARGER
E116-0780-0	Brake Shoes	Rr	2005 - 2012	SATURN, FREIGHTLINER	VUE, Fred Chassis, MC, MC-L Series Motorhome Chassis
E116-0781-0	Brake Shoes	Rr	2002 - 2012	CHEVROLET, GMC	AVALANCHE 1500, EXPRESS 1500 ½ Ton Van, SILVERADO 1500 ½ Ton, SUBURBAN 1500 ½ Ton, TAHOE, TRAILBLAZER, ENVOY, SAVANA 1500 ½ Ton Van, SIERRA 1500, SIERRA 1500, SIERRA 1500 DENALI, C3 ½ Ton Pickup, YUKON, YUKON DENALI, YUKON XL 1500, YUKON DENALI XL ½ Ton
E116-0784-0	Brake Shoes	Rr	2007 - 2011	CHEVROLET, FORD, LINCOLN	CAPRICE, EDGE, MKX

PART NO	DESCRIPTION	POSITION	YEAR	MAKE	MODEL
E116-0791-0	Brake Shoes	Rr	2006 - 2010	FORD, MERCURY	EXPLORER, SPORT, SPORT TRAC, MOUNTAINEER
E116-0795-1	Brake Shoes	Rr	2006 - 2008	CHEVROLET	HHR
E116-0800-1	Brake Shoes	Rr	2009 - 2011	CHEVROLET	HHR
E116-0804-0	Brake Shoes	Rr	2004 - 2011	TOYOTA	SIENNA, TACOMA
E116-0809-0	Brake Shoes	Rr	2003 - 2011	FORD, LINCOLN, MERCURY	CROWN VICTORIA, RANGER, TOWN CAR, GRAND MARQUIS
E116-0811-0	Brake Shoes	Rr	2007 - 2012	FORD, LINCOLN	EXPEDITION, NAVIGATOR
E116-0815-1	Brake Shoes	Rr	2004 - 2008	CHEVROLET, GMC	COLORADO, CANYON
E116-0823-0	Brake Shoes	PB	1987 - 2011	CHEVROLET, GMC, ISUZU, WORKHORSE	W3500 Gas Engine, W4500 Gas Engine, NPR with Front Disc Brakes, Gas Engine, NPR with Front Disc Brakes, Diesel Engine, P32, P42,
E116-0824-0	Brake Shoes	PB	1990 - 2012	CHEVROLET, GMC, HINO, ISUZU	C5H042 Kodiak with Disc Brakes, C7500 Kodiak with Disc Brakes, T5500, T6500 with Disc Brakes, T7500, T8500 Tilt Cab with Disc Brakes, C6500 Topkick with Front Disc Brakes, T5500, T6500, T7500, T8500 Tilt Cab with Disc Brakes, 238 23,000, 25,500 LBS GVW, 258LP 23,000, 25,000 LBS GVW (Low Profile), 268 25,950GVW LBS with Hydraulic Disc Brakes, FTR with Front Disc Brakes, FVR, FXR with Front Disc Brakes, H Series HTR, HVR
E116-0842-0	Brake Shoes	PB	2005 - 2010	HINO	145 14,050 GVW, 165 16,000 GVW, 185 18,500 LBS GVW
E116-0843-0	Brake Shoes	Rr	2006 - 2010	JEEP	COMMANDER, GRAND CHEROKEE
E116-0844-0	Brake Shoes	PB	2003 - 2007	TOYOTA	LAND CRUISER
E116-0847-0	Brake Shoes	Rr	2004 - 2012	DODGE, CHEVROLET, DODGE, FORD, GMC, INTERNATIONAL, STERLING	RAM 4500, 5500, C4500 Kodiak, C5500 Kodiak, RAM 4500, 5500, F450, F47 (1 Ton) 2WD & 4WD Super Duty, F550 (1 Ton) 2WD & 4WD Super Duty, LCF Series, C4500 Topkick, CF500, CF600, BULLET
E116-0850-0	Brake Shoes	Rr	2003 - 2011	TOYOTA	FJ CRUISER, SEQUOIA, 4RUNNER
E116-0851-0	Brake Shoes	Rr	2004 - 2011	TOYOTA	HIGHLANDER, SIENNA
E116-0852-0	Brake Shoes	Rr	2006 - 2008	DODGE, FORD	DURANGO, RAM 1500 ½ Ton Pickup, E150 ½ Ton Full Size Van
E116-0854-0	Brake Shoes	Rr	2005 - 2012	DODGE, FORD, INTERNATIONAL	RAM 1500, 2500, 3500 Pickup, Cab & Chassis, E150, E250, E350 Full Size Van, Wagon, Stripped & RV Chassis including Super Duty, F250, F250, F350, F450, F47 Super Duty Truck, LCF Series, CF500, CF600, TERRA STAR
E116-0855-0	Brake Shoes	Rr	2007 - 2008	CHEVROLET, GMC	SILVERADO 1500 ½ Ton, SIERRA 1500, SIERRA 1500 DENALI, C3 ½ Ton Pickup
E116-0868-0	Brake Shoes	Rr	2004 - 2012	NISSAN	ARMADA, TITAN
E116-0869-0	Brake Shoes	Rr	2005 - 2012	NISSAN	FRONTIER, PATHFINDER, XTERRA
E116-0877-0	Brake Shoes	Rr	2007 - 2009	FORD, MAZDA, MERCURY	ESCAPE, TRIBUTE, MARINER
E116-0880-0	Brake Shoes	Rr	2007 - 2011	MAZDA	CX-7, CX-9
E116-0886-1	Brake Shoes	Rr	2007 - 2012	DODGE, JEEP	CALIBER, COMPASS, PATRIOT
E116-0908-0	Brake Shoes	Rr	2006 - 2010	HUMMER	H3
E116-0916-0	Brake Shoes	Rr	2008 - 2012	NISSAN	ROGUE
E116-0919-0	Brake Shoes	Rr	2007 - 2012	DODGE, JEEP, NISSAN	CALIBER, COMPASS, PATRIOT, CUBE
E116-0922-0	Brake Shoes	Rr	2005 - 2011	DODGE	DAKOTA
E116-0932-0	Brake Shoes	Rr	2007 - 2012	CHEVROLET, GMC, PONTIAC, SATURN	EQUINOX, TERRAIN, TORRENT, VUE
E116-0933-0	Brake Shoes	Rr	2007 - 2012	CHEVROLET, GMC, SATURN	TRAVERSE, ACADIA, OUTLOOK

PART NO	DESCRIPTION	POSITION	YEAR	MAKE	MODEL
E116-0936-0	Brake Shoes	Rr	2008 - 2012	FORD, MAZDA, MERCURY	ESCAPE, TRIBUTE, MARINER
E116-0938-0	Brake Shoes	Rr	2007 - 2012	DODGE, FREIGHTLINER, MERCEDES BENZ	SPRINTER 2500, 3500
E116-0940-0	Brake Shoes	Rr	2007 - 2012	DODGE, FREIGHTLINER, MERCEDES BENZ	SPRINTER 3500
E116-0941-0	Brake Shoes	Rr	2007 - 2012	JEEP	LIBERTY, WRANGLER
E116-0943-0	Brake Shoes	Rr	2007 - 2011	TOYOTA	SEQUOIA, TUNDRA
E116-0947-0	Brake Shoes	Rr	2007 - 2012	DODGE, JEEP	DURANGO, RAM 1500 ½ Ton Pickup
E116-0952-0	Brake Shoes	Rr	2008 - 2012	FORD, NISSAN, FORD	E150 ½ Ton Full Size Van, E250 ¾ Ton Full Size Van, E350 1 Ton Full Size Van, Wagon, Stripped & RV Chassis including Super Duty, E-SUPER DUTY Van & Cutaway, NV1500, NV2500 HD, NV3500 HD, E450, 47 (1 Ton) Super Duty Van & Cutaway
E116-0959-0	Brake Shoes	Rr	2009 - 2012	CHEVROLET, GMC	COLORADO, CANYON
E116-0960-0	Brake Shoes	Rr	2009 - 2012	CHEVROLET, GMC	SILVERADO 1500 ½ Ton, SIERRA 1500, SIERRA 1500 DENALI, C3 ½ Ton Pickup
E116-0961-0	Brake Shoes	Rr	2009 - 2011	FORD	F150 ½ Ton Truck
E116-0962-0	Brake Shoes	Rr	2009 - 2012	CHEVROLET, GMC, HUMMER	EXPRESS 2500, 3500 Van, SILVERADO 3500 1 Ton, SUBURBAN 2500, SAVANA 2500, 3500 Van, SIERRA 3500 1 Ton Pickup, Cab & Chassis, YUKON XL 2500 ¾ Ton, H2
E116-0973-0	Brake Shoes	Rr	2009 - 2012	CHEVROLET, GMC, GMC	EXPRESS 3500 1 Ton Van, SAVANA 3500 1 Ton Van, G4500 Commercial Cutaway Chassis
E116-0974-0	Brake Shoes	Rr	2010 - 2012	FORD	TRANSIT CONNECT
E116-0978-0	Brake Shoes	PB	1990 - 2012	FORD, IC BUS, INTERNATIONAL, WORKHORSE	F650 Conventional with Disc Brakes, F750 Conventional with Disc Brakes, BE, CE, HC, LC with Hydraulic Disc Brakes, 3000, 3200, 3600, 3700, 3800, 3900FC School Bus with Hydraulic Disc Brakes, 4100, 4200, 4300, 4400, 4600, 4700, 4800, 4900, 7100 Conventional Cab with Hydraulic Disc Brakes, LF72 Bus 19,000 GVWR
E116-0979-0	Brake Shoes	PB	1995 - 2012	CHEVROLET, GMC, ISUZU	W3500 Diesel Engine, W4500 Diesel Engine, W5500, W5500HD, NPR with Front Disc Brakes, Gas Engine, NPR with Front Disc Brakes, Diesel Engine, NQR, NRR, REACH VAN (UTILIMASTER BODY)
E116-0980-0	Brake Shoes	PB	1990 - 2012	FORD, FREIGHTLINER, IC BUS, INTERNATIONAL, WORKHORSE	F650 Conventional with Disc Brakes, F750 Conventional with Disc Brakes, FS65, FW700 with Hydraulic Disc Brakes, M2 100/106 with Hydraulic Disc Brakes, MT10, MT35, MT45, MT55, MT-E with Hydraulic Disc Brakes, BE, CE, HC, LC with Hydraulic Disc Brakes, 3000, 3200, 3600, 3700, 3800, 3900FC School Bus with Hydraulic Disc Brakes, 4100, 4200, 4300, 4400, 4600, 4700, 4800, 4900, 7100 Conventional Cab with Hydraulic Disc Brakes, LF72 Bus 19,000 GVWR, W20, W20D, W21, W22 - 20,70, 22,000 GVWR
E116-0986-0	Brake Shoes	Rr	2011 - 2012	DODGE, JEEP	DURANGO, GRAND CHEROKEE
E116-0989-0	Brake Shoes	Rr	2011 - 2012	CHEVROLET, GMC	SILVERADO 2500, 3500, SIERRA 2500, 3500 Pickup
E116-1007-0	Brake Shoes	PB	1987 - 2009	CHEVROLET, GMC, ISUZU	WT5500, W6 M, FRR, FSR with Front Disc Brakes, FTR with Front Disc Brakes, FVR, FXR with Front Disc Brakes
E116-1008-0	Brake Shoes	PB	1987 - 2004	CHEVROLET, GMC, ISUZU	WT5500, W6 M, FRR, NRR
E116-1009-0	Brake Shoes	PB	1987 - 1996	CHEVROLET, GMC, ISUZU	W6 M, NRR
E116-1013-0	Brake Shoes	PB	1987 - 2004	MINITUBISHI FUSO	FH Series, FK Series



PART NO	DESCRIPTION	POSITION	YEAR	MAKE	MODEL
E116-1014-0	Brake Shoes	PB	1985 - 2012	mitsubishi fuso	FE Series, FG, FG140 4X4
E117-0346-0	Brake Shoes	Rr	1969 - 1985	INTERNATIONAL	C01710A, B Cargostar
E117-0381-0	Brake Shoes	Rr	1969 - 1985	INTERNATIONAL	C01710A, B Cargostar
E117-0383-0	Brake Shoes	Rr	1969 - 1985	INTERNATIONAL	C01710A, B Cargostar
E117-0385-0	Brake Shoes	Rr	1969 - 1985	INTERNATIONAL	C01710A, B Cargostar
E117-0386-0	Brake Shoes	Rr	1969 - 1985	INTERNATIONAL	C01710A, B Cargostar
E117-0449-0	Brake Shoes	PB	1985 - 1990	WORKHORSE	P32, P42,
E117-0451-0	Brake Shoes	Rr	1985 - 2003	WORKHORSE	P32, P42,
E117-0452-0	Brake Shoes	Rr	1985 - 2003	WORKHORSE	P32, P42,
E117-0544-0	Brake Shoes	Rr	1984 - 1994	FORD	LT, LTL900 Short Conventional Tandem with Front Disc Brakes
E117-0602-0	Brake Shoes	Fr	1989 - 2012	UD	UD 18CS, UD 18HD, UD 1800, CS, HD, UD 2300, DH, LP
E117-0603-0	Brake Shoes	Fr	1989 - 2012	UD	UD 18HD, UD 1800, CS, HD, UD 2300, DH, LP
E117-0604-0	Brake Shoes	Rr	1989 - 2012	UD	UD 18HD, UD 1800, CS, HD, UD 2300, DH, LP
E117-0612-0	Brake Shoes	Rr	1995 - 2012	CHEVROLET, GMC, ISUZU	W3500 Diesel Engine, NPR with Front Disc Brakes, Gas Engine, NPR with Front Disc Brakes, Diesel Engine
E117-0613-0	Brake Shoes	Fr & Rr	1986 - 1994	CHEVROLET, GMC, ISUZU	W6 M, EVR
E117-0614-0	Brake Shoes	Rr	1989 - 2010	UD	UD 2600, UD2800, UD3000
E117-0617-0	Brake Shoes	Fr	1989 - 2010	UD	UD 2600, UD2800, UD3000
E117-0669-0	Brake Shoes	Rr	1988 - 1994	ISUZU	NRR
E117-0672-0	Brake Shoes	Fr	1994 - 1999	ISUZU	FRR
E117-0679-0	Brake Shoes	Rr	1989 - 2012	UD	UD 18CS, UD 18HD, UD 1800, CS, HD, UD 2300, DH, LP
E117-0682-0	Brake Shoes	Fr & Rr	2005 - 2012	mitsubishi fuso	FG140 4X4
E117-0695-0	Brake Shoes	Rr	1994 - 2010	UD	UD 1400
E117-0699-0	Brake Shoes	Rr	1995 - 2012	CHEVROLET, GMC, ISUZU	W3500 Gas Engine, W3500 Diesel Engine, W4500 Gas Engine, W4500 Diesel Engine, NPR with Front Disc Brakes, Gas Engine, NPR with Front Disc Brakes, Diesel Engine, REACH VAN (UTILIMASTER BODY)
E117-0717-0	Brake Shoes	Rr	1989 - 2012	UD	UD 18HD, UD 1800, CS, HD, UD 2300, DH, LP
E117-0718-0	Brake Shoes	Fr & Rr	1994 - 1996	CHEVROLET, GMC, ISUZU	W6 M, EVR
E117-0727-0	Brake Shoes	Rr	1994 - 1999	ISUZU	FRR
E117-0792-0	Brake Shoes	Rr	1995 - 2012	CHEVROLET, GMC, ISUZU	W3500 Gas Engine, W4500 Gas Engine, W4500 Diesel Engine, W5500, NPR with Front Disc Brakes, Gas Engine, NQR
E117-0833-0	Brake Shoes	Rr	1999 - 2012	CHEVROLET, GMC, ISUZU	W5500HD, FRR, NRR
E117-0834-0	Brake Shoes	Fr	1999 - 2004	ISUZU	FRR
E121-40-015	Sensor Wires	Fr & Rr	2007 - 2012	DODGE, FREIGHTLINER, MERCEDES BENZ	SPRINTER 2500, 3500
E121-40-019	Sensor Wires	Rr	2010 - 2012	MERCEDES BENZ	SPRINTER 3500
E121-79-006	Sensor Wires	Fr	1995 - 2005	mitsubishi fuso	FE Series
E121-79-007	Sensor Wires	Fr L	2005 - 2012	mitsubishi fuso, STERLING	FE Series, 360 Series
E121-79-008	Sensor Wires	Fr R	2005 - 2012	mitsubishi fuso, STERLING	FE Series, 360 Series
E121-79-009	Sensor Wires	Rr	2005 - 2012	mitsubishi fuso, STERLING	FE Series, 360 Series
E121-79-010	Sensor Wires	Rr	1995 - 2005	mitsubishi fuso	FE Series
E121-79-011	Sensor Wires	Fr	1995 - 2005	mitsubishi fuso	FE Series



PART NO	DESCRIPTION	POSITION	YEAR	MAKE	MODEL
E122-40-039	Disc Hardware	Rr	2011 - 2012	DODGE, JEEP	DURANGO, GRAND CHEROKEE
E122-40-050	Disc Hardware	Rr	2007 - 2012	DODGE, FREIGHTLINER, MERCEDES BENZ	SPRINTER 2500, 3500
E122-40-051	Disc Hardware	Rr	2007 - 2012	DODGE, FREIGHTLINER, MERCEDES BENZ	SPRINTER 3500
E122-47-037	Disc Hardware	Fr	2008 - 2012	NISSAN	PATHFINDER
E122-47-040	Disc Hardware	Fr	2010 - 2012	NISSAN	CUBE
E122-47-043	Disc Hardware	Rr	2008 - 2012	NISSAN	ROGUE
E122-47-049	Disc Hardware	Fr	2004 - 2007	NISSAN	TITAN
E122-47-051	Disc Hardware	Fr	2005 - 2012	NISSAN	FRONTIER, PATHFINDER, XTERRA
E122-47-052	Disc Hardware	Rr	2006 - 2012	NISSAN	PATHFINDER
E122-47-053	Disc Hardware	Rr	2005 - 2012	NISSAN	FRONTIER, XTERRA
E122-47-055	Disc Hardware	Fr	2006 - 2012	NISSAN	ARMADA, TITAN
E122-47-060	Disc Hardware	Fr	2008 - 2012	NISSAN	ROGUE
E122-49-056	Disc Hardware	Fr	2006 - 2007	TOYOTA	HIGHLANDER
E122-49-067	Disc Hardware	Rr	2003 - 2007	TOYOTA	LAND CRUISER
E122-49-072	Disc Hardware	Fr	2003 - 2007	TOYOTA	LAND CRUISER
E122-49-075	Disc Hardware	Fr	2004 - 2010	TOYOTA	SIENNA
E122-49-080	Disc Hardware	Fr	2003 - 2011	HUMMER, TOYOTA	H3, FJ CRUISER, SEQUOIA, TACOMA, 4RUNNER
E122-49-081	Disc Hardware	Rr	2004 - 2010	TOYOTA	SIENNA
E122-49-082	Disc Hardware	Rr	2006 - 2007	TOYOTA	HIGHLANDER
E122-49-083	Disc Hardware	Fr	2006 - 2007	TOYOTA	HIGHLANDER
E122-49-085	Disc Hardware	Fr	2005 - 2011	TOYOTA	TACOMA
E122-49-094	Disc Hardware	Fr	2007 - 2011	TOYOTA	SEQUOIA, TUNDRA
E122-49-095	Disc Hardware	Rr	2007 - 2011	TOYOTA	SEQUOIA, TUNDRA
E122-49-097	Disc Hardware	Fr	2008 - 2011	TOYOTA	HIGHLANDER, SIENNA
E122-49-098	Disc Hardware	Rr	2008 - 2011	TOYOTA	HIGHLANDER
E122-49-104	Disc Hardware	Rr	2011 - 2011	TOYOTA	SIENNA
E122-49-106	Disc Hardware	Fr	2010 - 2011	TOYOTA	4RUNNER
E122-50-013	Disc Hardware	Fr	1995 - 2005	MINI	FE Series
E122-50-050	Disc Hardware	Fr	2007 - 2011	FORD, LINCOLN, MAZDA	EDGE, MKX, CX-7, CX-9
E122-50-051	Disc Hardware	Rr	2007 - 2011	FORD, LINCOLN, MAZDA	EDGE, MKX, CX-7, CX-9
E122-51-020	Disc Hardware	Rr	2007 - 2012	DODGE, JEEP	CALIBER, COMPASS, PATRIOT
E122-51-021	Disc Hardware	Fr	2007 - 2012	DODGE, JEEP	CALIBER, COMPASS, PATRIOT
E122-63-010	Disc Hardware	Fr	2006 - 2010	JEEP	COMMANDER, GRAND CHEROKEE
E122-63-011	Disc Hardware	Rr	2007 - 2007	JEEP	LIBERTY
E122-63-012	Disc Hardware	Fr	2011 - 2012	DODGE, JEEP	DURANGO, GRAND CHEROKEE
E122-66-028	Disc Hardware	Rr	2001 - 2007	FORD	TAURUS
E122-66-029	Disc Hardware	Fr	2001 - 2007	FORD	TAURUS
E122-66-030	Disc Hardware	Fr	2010 - 2012	FORD	TRANSIT CONNECT
E122-66-032	Disc Hardware	Rr	2006 - 2007	FORD	E150, E250, E350 Full Size Van including Super Duty
E122-66-042	Disc Hardware	Fr	2003 - 2011	FORD, LINCOLN, MERCURY	CROWN VICTORIA, TOWN CAR, GRAND MARQUIS
E122-66-043	Disc Hardware	Rr	2003 - 2012	FORD, JEEP, LINCOLN, MERCURY, NISSAN	CROWN VICTORIA, RANGER, COMMANDER, GRAND CHEROKEE, TOWN CAR, GRAND MARQUIS, ARMADA, TITAN
E122-66-045	Disc Hardware	Rr	2008 - 2009	FORD	TAURUS, TAURUS X

PART NO	DESCRIPTION	POSITION	YEAR	MAKE	MODEL
E122-66-047	Disc Hardware	Fr & Rr	2007 - 2012	CHRYSLER, DODGE, JEEP	TOWN & COUNTRY VAN, CARAVAN, GRAND CARAVAN, LIBERTY, WRANGLER
E122-67-009	Disc Hardware	Fr	1985 - 1994	WORKHORSE	P32, P42,
E122-67-038	Disc Hardware	Rr	2007 - 2010	CHEVROLET	IMPALA
E122-67-040	Disc Hardware	Fr	2005 - 2005	PONTIAC	MONTANA
E122-67-053	Disc Hardware	Fr	2005 - 2009	CHEVROLET, PONTIAC, SATURN	UPLANDER, MONTANA, RELAY
E122-67-054	Disc Hardware	Rr	2011 - 2012	CHEVROLET	IMPALA
E122-67-058	Disc Hardware	Fr	2006 - 2011	CHEVROLET	HHR
E122-67-059	Disc Hardware	Rr	2008 - 2010	CHEVROLET	HHR
E122-67-061	Disc Hardware	Rr	2005 - 2009	CHEVROLET, PONTIAC, SATURN	UPLANDER, MONTANA, RELAY
E122-67-062	Disc Hardware	Fr	2007 - 2012	CHEVROLET	IMPALA
E122-67-065	Disc Hardware	Fr	2007 - 2010	CHEVROLET, PONTIAC, SATURN	EQUINOX, TORRENT, VUE
E122-67-073	Disc Hardware	Rr	2011 - 2011	CHEVROLET	CAPRICE
E122-67-074	Disc Hardware	Fr	2009 - 2010	CHEVROLET	HHR
E122-67-076	Disc Hardware	Fr	2011 - 2011	CHEVROLET	CAPRICE
E122-67-079	Disc Hardware	Fr	2010 - 2012	CHEVROLET, GMC	EQUINOX, TERRAIN
E122-68-024	Disc Hardware	Rr	2008 - 2011	DODGE	CHARGER
E122-68-025	Disc Hardware	Rr	2008 - 2012	DODGE	CHARGER
E122-68-026	Disc Hardware	Fr	2007 - 2011	DODGE, FORD	CALIBER, CHARGER, TAURUS, TAURUS X
E122-68-029	Disc Hardware	Rr	2008 - 2012	DODGE	CHARGER
E122-70-011	Disc Hardware	Fr & Rr	1988 - 2007	FORD	E-SUPER DUTY Van & Cutaway, F53, 59 (1 Ton) RV Motor Home & Stripped Chassis, E450, 47 (1 Ton) Super Duty Van & Cutaway
E122-70-014	Disc Hardware	Fr	1996 - 2007	FORD	E150 ½ Ton Full Size Van, E250 ¾ Ton Full Size Van, E350 1 Ton Full Size Van, Wagon, Stripped & RV Chassis including Super Duty, E-SUPER DUTY Van & Cutaway, E450, 47 (1 Ton) Super Duty Van & Cutaway
E122-70-016	Disc Hardware	Rr	2005 - 2011	LINCOLN	TOWN CAR
E122-70-017	Disc Hardware	Rr	2006 - 2010	FORD, JEEP, MERCURY	EXPLORER, SPORT, SPORT TRAC, LIBERTY, MOUNTAINEER
E122-70-020	Disc Hardware	Fr & Rr	1999 - 2005	FORD	F53, 59 (1 Ton) RV Motor Home & Stripped Chassis, E550
E122-70-022	Disc Hardware	Fr	2003 - 2011	FORD, MAZDA, SATURN	RANGER, B SERIES Pickup, VUE
E122-70-025	Disc Hardware	Rr	2004 - 2011	FORD, LINCOLN	F150 ½ Ton Truck
E122-70-027	Disc Hardware	Rr	2006 - 2006	FORD	E150 ½ Ton Full Size Van
E122-70-028	Disc Hardware	Fr	2006 - 2006	FORD	E150 ½ Ton Full Size Van
E122-70-029	Disc Hardware	Fr & Rr	2005 - 2012	FORD, INTERNATIONAL	F53, 59 (1 Ton) RV Motor Home & Stripped Chassis, F450, F47 (1 Ton) 2WD & 4WD Super Duty, F550 (1 Ton) 2WD & 4WD Super Duty, LCF Series, CF500, CF600, TERRA STAR
E122-70-030	Disc Hardware	Fr	2004 - 2008	FORD, LINCOLN	F150 ½ Ton Truck
E122-70-031	Disc Hardware	Rr	2007 - 2012	FORD	F350, F450, F47 SUPER DUTY Pickup, Cab & Chassis
E122-70-032	Disc Hardware	Fr	2007 - 2011	FORD, MAZDA, MERCURY	ESCAPE, TRIBUTE, MARINER
E122-70-033	Disc Hardware	Fr	2005 - 2012	FORD	F250, F250, F350, F450, F47 Including Super Duty Truck
E122-70-034	Disc Hardware	Fr	2006 - 2010	FORD, LINCOLN, MERCURY	EXPLORER, SPORT, SPORT TRAC, TAURUS, TAURUS SHO, MKT, MOUNTAINEER
E122-70-035	Disc Hardware	Rr	2005 - 2006	FORD	F250, F250 Super Duty ¾ Ton Truck

PART NO	DESCRIPTION	POSITION	YEAR	MAKE	MODEL
E122-70-036	Disc Hardware	Fr	2007 - 2009	FORD, LINCOLN	EXPEDITION, NAVIGATOR
E122-70-037	Disc Hardware	Rr	2007 - 2012	FORD, LINCOLN	EXPEDITION, NAVIGATOR
E122-70-038	Disc Hardware	Fr & Rr	2008 - 2012	CHEVROLET, FORD, GMC, NISSAN	NV1500, NV2500 HD, NV3500 HD, EXPRESS 3500 1 Ton Van, E150 ½ Ton Full Size Van, E250 ¾ Ton Full Size Van, E350 1 Ton Full Size Van, Wagon, Stripped & RV Chassis including Super Duty, E-SUPER DUTY Van & Cutaway, SAVANA 3500 1 Ton Van, E450, 47 (1 Ton) Super Duty Van & Cutaway, G4500 Commercial Cutaway Chassis
E122-70-039	Disc Hardware	Fr	2008 - 2012	FORD, LINCOLN	EXPEDITION, E150, E250, E350, E450, 47 Full Size Van, Wagon, Stripped & RV Chassis including Super Duty, E-SUPER DUTY Van & Cutaway, F150 ½ Ton Truck, NAVIGATOR
E122-70-040	Disc Hardware	Rr	2006 - 2012	FORD	F250, F250, F350 Pickup including Super Duty
E122-70-041	Disc Hardware	Fr	2009 - 2009	FORD	F150 ½ Ton Truck
E122-70-042	Disc Hardware	Fr	2011 - 2012	FORD, LINCOLN	EXPLORER, SPORT, SPORT TRAC, TAURUS, TAURUS SHO, MKT
E122-71-011	Disc Hardware	Fr & Rr	1995 - 2010	WORKHORSE	P32, P42, W42 - 14,001, 16,000 GVWR, P500 (Fedex Delivery Truck)
E122-71-012	Disc Hardware	Fr & Rr	1980 - 2008	ISUZU, BLUEBIRD BUS, FREIGHTLINER, STERLING, MACK	FSR with Front Disc Brakes, TC2000 with Hydraulic Disc Brakes, FL50, FL60, FL70 with Disc Brakes, MB50, MB60, MB70 with Disc Brakes, ACTERRA with Hydraulic Disc Brakes, FTR with Front Disc Brakes, FVR, FXR with Front Disc Brakes, CS200, MS200
E122-71-013	Disc Hardware	Fr	2003 - 2012	CHEVROLET, GMC, HUMMER	EXPRESS 2500, 3500 Van, SILVERADO 1500, 2500, 3500, SUBURBAN 2500 ¾ Ton, SAVANA 2500, 3500, SIERRA 1500, 2500, 3500 SIERRA DENALI, C3 ½ Ton Pickup, YUKON XL 2500 ¾ Ton, H2, G4500 Commercial Cutaway Chassis
E122-71-015	Disc Hardware	Fr & Rr	2002 - 2011	CHEVROLET, GMC, HUMMER	AVALANCHE 1500, EXPRESS 1500 ½ Ton Van, SILVERADO 1500, 2500, TAHOE, SAVANA 1500 ½ Ton Van, SIERRA 1500, 2500 DENALI, C3 ½ Ton Pickup, 2500, 3500 SILVERADO, SUBURBAN 2500 ¾ Ton, p, SIERRA 2500, 3500 Pickup, YUKON XL 2500 ¾ Ton, H2
E122-71-018	Disc Hardware	Rr	2002 - 2007	CHEVROLET	AVALANCHE 1500, SILVERADO 1500 ½ Ton, SUBURBAN 1500 ½ Ton 4WD, TAHOE
E122-71-019	Disc Hardware	Rr	2007 - 2012	CHEVROLET, GMC, SATURN	TRAILBLAZER, TRAVERSE, ACADIA, ENVOY, OUTLOOK
E122-71-021	Disc Hardware	Rr	2004 - 2010	CHEVROLET, GMC	SILVERADO 3500 1 Ton, SIERRA 3500 1 Ton Pickup, Cab & Chassis
E122-71-022	Disc Hardware	Rr	2002 - 2012	CHEVROLET, GMC	AVALANCHE 1500, EXPRESS 1500, 2500, 3500 Van, SUBURBAN 1500 ½ Ton RWD, TAHOE RWD, SAVANA 1500, 2500, 3500 Van
E122-71-023	Disc Hardware	Rr	2007 - 2007	CHEVROLET, GMC	SILVERADO 1500 ½ Ton, SIERRA 1500, SIERRA 1500 DENALI, C3 ½ Ton 4WD Pickup
E122-71-024	Disc Hardware	Rr	2006 - 2008	CHEVROLET, GMC	EXPRESS 3500 1 Ton Van, SAVANA 3500 1 Ton Van
E122-71-025	Disc Hardware	Fr	2004 - 2008	CHEVROLET, GMC	COLORADO, CANYON
E122-71-026	Disc Hardware	Fr	2007 - 2007	CHEVROLET, GMC	AVALANCHE 1500, SILVERADO 1500 ½ Ton, SUBURBAN 1500 ½ Ton, TAHOE, SIERRA 1500, SIERRA 1500 DENALI, C3 ½ Ton Pickup, YUKON, YUKON DENALI, YUKON XL 1500, YUKON DENALI XL ½ Ton

PART NO	DESCRIPTION	POSITION	YEAR	MAKE	MODEL
E122-71-027	Disc Hardware	Rr	2007 - 2012	CHEVROLET, GMC	AVALANCHE 1500, SILVERADO 1500 ½ Ton, SUBURBAN 1500 ½ Ton, TAHOE, SIERRA 1500, SIERRA 1500 DENALI, C3 ½ Ton Pickup, YUKON, YUKON DENALI, YUKON, YUKON DENALI, YUKON XL 1500, YUKON DENALI XL ½ Ton
E122-71-028	Disc Hardware	Fr	2007 - 2012	CHEVROLET, GMC, SATURN	COLORADO, TRAILBLAZER, TRAVERSE, ACADIA, CANYON, ENVOY, OUTLOOK
E122-71-029	Disc Hardware	Rr	2007 - 2012	CHEVROLET, GMC, PONTIAC, SATURN	EQUINOX, TERRAIN, TORRENT, VUE
E122-71-030	Disc Hardware	Fr	2007 - 2012	CHEVROLET, GMC	AVALANCHE 1500, EXPRESS 1500 ½ Ton Van, SILVERADO 1500 ½ Ton, SUBURBAN 1500 ½ Ton, TAHOE, SAVANA 1500 ½ Ton Van, SIERRA 1500, SIERRA 1500 DENALI, C3 ½ Ton Pickup, YUKON, YUKON DENALI, YUKON XL 1500, YUKON DENALI XL ½ Ton
E122-71-031	Disc Hardware	Rr	2011 - 2012	CHEVROLET, GMC	SILVERADO 2500, 3500, SIERRA 2500, 3500 Pickup, Cab & Chassis
E122-71-032	Disc Hardware	Fr	2011 - 2012	CHEVROLET, GMC	SILVERADO 2500, 3500, SIERRA 2500, 3500 Pickup, Cab & Chassis
E122-72-006	Disc Hardware	Fr & Rr	1985 - 2008	WORKHORSE, FREIGHTLINER, STERLING	P32, P42, FL50, FL60, FL70 with Disc Brakes, MB50, MB60, MB70 with Disc Brakes, ACTERRA with Hydraulic Disc Brakes
E122-72-009	Disc Hardware	Rr	2006 - 2008	DODGE	RAM 1500, 2500, 3500 Pickup, Cab & Chassis
E122-72-011	Disc Hardware	Rr	2007 - 2012	DODGE, JEEP	DURANGO, RAM 1500 ½ Ton Pickup, J8
E122-72-013	Disc Hardware	Fr	2006 - 2012	CHRYSLER, DODGE, FORD, MERCURY	TOWN & COUNTRY VAN, CARAVAN, GRAND CARAVAN, ESCAPE, MARINER
E122-72-017	Disc Hardware	Fr	2006 - 2008	DODGE	RAM 1500, 2500, 3500 Pickup, Cab & Chassis
E122-72-018	Disc Hardware	Fr	2005 - 2012	DODGE	DAKOTA, DURANGO, RAM 1500 ½ Ton Pickup
E122-72-020	Disc Hardware	Fr & Rr	2008 - 2012	DODGE, STERLING	RAM 4500, 5500, RAM 4500, 5500, BULLET
E122-72-021	Disc Hardware	Rr	2008 - 2012	CHRYSLER, DODGE, FORD, LINCOLN	TOWN & COUNTRY VAN, CARAVAN, GRAND CARAVAN, EDGE, EXPLORER, SPORT, SPORT TRAC, TAURUS, TAURUS SHO, MKT, MKX
E122-72-022	Disc Hardware	Fr	2009 - 2012	DODGE	RAM 1500, 2500, 3500 Pickup, Cab & Chassis
E122-72-023	Disc Hardware	Rr	2009 - 2012	DODGE	RAM 1500, 2500, 3500 Pickup, Cab & Chassis
E122-72-024	Disc Hardware	Rr	2012 - 2012	CHRYSLER, DODGE	TOWN & COUNTRY VAN, CARAVAN, GRAND CARAVAN
E122-73-006	Disc Hardware	Fr	2006 - 2007	CHRYSLER, DODGE, JEEP	TOWN & COUNTRY VAN, CARAVAN, GRAND CARAVAN, LIBERTY
E122-74-006	Disc Hardware	Rr	2006 - 2010	HUMMER	H3
E122-79-006	Disc Hardware	Fr & Rr	2005 - 2012	MITSUBISHI FUSO, STERLING	FE Series, 360 Series
E122-79-007	Disc Hardware	Fr	1987 - 1988	MITSUBISHI FUSO	FE Series
E122-80-006	Disc Hardware	Fr & Rr	2005 - 2010	HINO	185 18,500 LBS GWV, 145 14,050 GWV, 165 16,000 GWV
E122-81-006	Disc Hardware	Fr	1987 - 1997	ISUZU	NPR with Front Disc Brakes, Gas Engine
E122-81-007	Disc Hardware	Fr	1994 - 2012	CHEVROLET, GMC, ISUZU, UD	W3500 Gas Engine, W3500 Diesel Engine, W4500 Gas Engine, W4500 Diesel Engine, W5500, W5500HD, NPR with Front Disc Brakes, Gas Engine, NPR with Front Disc Brakes, Diesel Engine, NQR, NRR, REACH VAN (UTILIMASTER BODY), UD 1200, UD 1300, UD 1400
E122-84-006	Disc Hardware	Fr & Rr	1996 - 2008	ISUZU, STERLING	FSR with Front Disc Brakes, ACTERRA with Hydraulic Disc Brakes, FTR with Front Disc Brakes, FVR, FXR with Front Disc Brakes

PART NO	DESCRIPTION	POSITION	YEAR	MAKE	MODEL
E122-84-008	Disc Hardware	Fr	1984 - 1994	FORD	LT, LTL900 Short Conventional Tandem with Front Disc Brakes
E122-84-009	Disc Hardware	Fr	1984 - 1994	FORD	8000 Series (air over hydraulics)
E122-85-006	Disc Hardware	Fr & Rr	1992 - 2012	ISUZU, GMC, HINO, IC BUS, INTERNATIONAL, THOMAS BUILT, WORKHORSE, CHEVROLET, FORD, BLUEBIRD BUS, FREIGHTLINER	H Series HTR, HVR, C6500 Topkick with Front Disc Brakes, C7500 Topkick with Front Disc Brakes, T5500, T6500, T7500, T8500 Tilt Cab with Disc Brakes, FTR with Front Disc Brakes, FVR, FXR with Front Disc Brakes, 238 23,000, 25,500 LBS GVW, 258LP 23,000, 25,000 LBS GVW (Low Profile), 268 25,950GVW LBS with Hydraulic Disc Brakes, BE, CE, HC, LC with Hydraulic Disc Brakes, 3000, 3200, 3600, 3700, 3800, 3900FC School Bus with Hydraulic Disc Brakes, 4100, 4200, 4300, 4400, 4600, 4700, 4800, 4900, 7100 Conventional Cab with Hydraulic Disc Brakes, C2, W24, W25.5 - 24,000, 25,500 GVWR, W62, UFO - 17,000, 19,500, 23,000, 23,500 GVWR, 185 18,500 LBS GVW, FSR with Front Disc Brakes, C4500 Kodiak, C5500 Kodiak, C6500 Kodiak with Disc Brakes, C7500 Kodiak with Disc Brakes, T5500, T6500 with Disc Brakes, T7500, T8500 Tilt Cab with Disc Brakes, F650 Conventional with Disc Brakes, F750 Conventional with Disc Brakes, C4500 Topkick, VISION, TC2000 with Hydraulic Disc Brakes, FL50, FL60, FL70 with Disc Brakes
E122-85-007	Disc Hardware	Fr & Rr	2003 - 2010	CHEVROLET, GMC	C4500 Kodiak, C5500 Kodiak, C4500 Topkick
E122-88-006	Disc Hardware	Fr & Rr	1995 - 2012	FORD, KENWORTH, PETERBILT, WORKHORSE, IC BUS, INTERNATIONAL, STERLING, FORD, BLUEBIRD BUS, FREIGHTLINER	F53, 59 (1 Ton) RV Motor Home & Stripped Chassis, T170, T270, T370 w/ Hydraulic Disc Brakes, 325, 330, 335 w/ Hydraulic Disc Brakes, P32, P42, BE, CE, HC, LC with Hydraulic Disc Brakes, MXT, RXT, S1624, S1652FC, S1652SC UPS, S1654, 3000, 3200, 3600, 3700, 3800, 3900FC School Bus with Hydraulic Disc Brakes, 4100, 4200, 4300, 4400, 4600, 4700, 4800, 4900, 7100 Conventional Cab with Hydraulic Disc Brakes, ACTERRA with Hydraulic Disc Brakes, LF72 Bus 19,000 GVWR, W20, W20D, W21, W22 - 20,70, 22,000 GVWR, F650 Conventional with Disc Brakes, F750 Conventional with Disc Brakes, TC2000 with Hydraulic Disc Brakes, Fred Chassis, FS65, FW700 with Hydraulic Disc Brakes, M2 100/106 with Hydraulic Disc Brakes, MC, MC-L Series Motorhome Chassis, MT10, MT35, MT45, MT55, MT-E with Hydraulic Disc Brakes
E122-90-006	Disc Hardware	Fr, Fr & Rr	2006 - 2012	DODGE, FREIGHTLINER, MERCEDES BENZ, WORKHORSE	SPRINTER 2500, 3500, W42 - 14,001, 16,000 GVWR
E122-90-007	Disc Hardware	Fr & Rr	2001 - 2011	WORKHORSE	P32, P42, W42 - 14,001, 16,000 GVWR, P500 (Fedex Delivery Truck), W16, W18 - 16,000, 18,000 GVWR
E122-95-006	Disc Hardware	Fr	2007 - 2007	FORD, MERCURY	ESCAPE, MARINER
E122-96-006	Disc Hardware	Rr	2003 - 2011	TOYOTA	FJ CRUISER, SEQUOIA, 4RUNNER
E122-96-019	Disc Hardware	Fr	1988 - 2005	MINISUBISHI FUSO	FE Series
E123-40-010	Drum Hardware	Rr	2007 - 2012	DODGE, FREIGHTLINER, MERCEDES BENZ	SPRINTER 2500, 3500
E123-40-012	Drum Hardware	Rr	2007 - 2009	DODGE, FREIGHTLINER	SPRINTER 3500
E123-47-026	Drum Hardware	Rr	2006 - 2010	JEEP	COMMANDER
E123-47-028	Drum Hardware	Rr	2005 - 2012	NISSAN	FRONTIER, PATHFINDER, XTERRA
E123-47-029	Drum Hardware	Rr	2004 - 2012	JEEP, NISSAN	GRAND CHEROKEE, ARMADA, TITAN

PART NO	DESCRIPTION	POSITION	YEAR	MAKE	MODEL
E123-49-031	Drum Hardware	Rr	2004 - 2010	TOYOTA	SIENNA
E123-49-033	Drum Hardware	Rr	2004 - 2011	TOYOTA	HIGHLANDER, SIENNA
E123-49-036	Drum Hardware	PB	2003 - 2007	TOYOTA	LAND CRUISER
E123-49-038	Drum Hardware	Rr	2008 - 2012	NISSAN	ROGUE
E123-49-039	Drum Hardware	Rr	2003 - 2011	TOYOTA	FJ CRUISER, SEQUOIA, 4RUNNER
E123-49-040	Drum Hardware	Rr	2005 - 2011	TOYOTA	TACOMA
E123-49-042	Drum Hardware	Rr	2007 - 2011	TOYOTA	SEQUOIA, TUNDRA
E123-50-027	Drum Hardware	Rr	2007 - 2011	FORD, LINCOLN, MAZDA	EDGE, MKX, CX-7, CX-9
E123-63-008	Drum Hardware	Rr	2007 - 2007	JEEP	LIBERTY
E123-63-010	Drum Hardware	Rr	2011 - 2012	DODGE, JEEP	DURANGO, GRAND CHEROKEE
E123-66-011	Drum Hardware	Rr	2001 - 2007	FORD	TAURUS
E123-66-034	Drum Hardware	Rr	2003 - 2009	FORD, MAZDA	RANGER, B SERIES Pickup
E123-66-035	Drum Hardware	Rr	2003 - 2009	FORD, MAZDA	RANGER, B SERIES Pickup
E123-66-043	Drum Hardware	Rr	2003 - 2012	DODGE, FORD, LINCOLN, MERCURY	CHARGER, CROWN VICTORIA, RANGER, TOWN CAR, GRAND MARQUIS
E123-66-044	Drum Hardware	Rr	2005 - 2011	LINCOLN	TOWN CAR
E123-67-032	Drum Hardware	Rr	2006 - 2008	CHEVROLET	HHR
E123-67-034	Drum Hardware	Rr	2005 - 2005	PONTIAC	MONTANA
E123-67-038	Drum Hardware	Rr	2007 - 2010	CHEVROLET	IMPALA
E123-67-040	Drum Hardware	Rr	2007 - 2011	CHEVROLET, GMC, PONTIAC, SATURN	EQUINOX, TERRAIN, TORRENT, VUE
E123-68-021	Drum Hardware	Rr	2006 - 2007	CHRYSLER, DODGE	TOWN & COUNTRY VAN, CARAVAN, GRAND CARAVAN
E123-68-022	Drum Hardware	Rr	2006 - 2007	CHRYSLER, DODGE	TOWN & COUNTRY VAN, CARAVAN, GRAND CARAVAN
E123-68-026	Drum Hardware	Rr	2009 - 2011	CHEVROLET	HHR
E123-68-027	Drum Hardware	Rr	2007 - 2012	DODGE, JEEP, NISSAN	CALIBER, COMPASS, PATRIOT, CUBE
E123-68-028	Drum Hardware	Rr	2007 - 2012	DODGE, JEEP	CALIBER, COMPASS, PATRIOT
E123-69-008	Drum Hardware	Rr	2005 - 2007	SATURN	VUE
E123-70-011	Drum Hardware	Rr	2007 - 2007	FORD, MERCURY	ESCAPE, MARINER
E123-70-012	Drum Hardware	Rr	2004 - 2008	FORD, LINCOLN	F150 ½ Ton Truck
E123-70-013	Drum Hardware	Rr	2007 - 2011	FORD, LINCOLN	EXPEDITION, NAVIGATOR
E123-70-014	Drum Hardware	Rr	2006 - 2010	FORD, MERCURY	EXPLORER, SPORT, SPORT TRAC, MOUNTAINEER
E123-70-015	Drum Hardware	PB	1999 - 2004	FORD	F450, F47 (1 Ton) 2WD & 4WD Super Duty, F550 (1 Ton) 2WD & 4WD Super Duty
E123-70-016	Drum Hardware	Rr	1999 - 2010	FORD	F53, 59 (1 Ton) RV Motor Home & Stripped Chassis, F450, F47 (1 Ton) 2WD & 4WD Super Duty, F550 (1 Ton) 2WD & 4WD Super Duty
E123-70-017	Drum Hardware	Rr	2004 - 2007	FORD	E350 1 Ton Full Size Van, Wagon, Stripped & RV Chassis including Super Duty, E-SUPER DUTY Van & Cutaway
E123-70-020	Drum Hardware	Rr	2005 - 2012	DODGE, FORD	RAM 2500, 3500 Pickup, Cab & Chassis, E250 ¾ Ton Full Size Van, F250, F350 Super Duty Truck, Cab & Chassis
E123-70-021	Drum Hardware	Rr	2005 - 2012	DODGE, FORD, INTERNATIONAL, STERLING	RAM 4500, 5500, F450, F47 (1 Ton) 2WD & 4WD Super Duty, F550 (1 Ton) 2WD & 4WD Super Duty, LCF Series, CF500, CF600, RAM 4500, 5500, BULLET
E123-70-022	Drum Hardware	Rr	2007 - 2009	FORD, MAZDA, MERCURY	ESCAPE, TRIBUTE, MARINER
E123-70-023	Drum Hardware	Rr	2008 - 2012	FORD, MAZDA, MERCURY	ESCAPE, TRIBUTE, MARINER



PART NO	DESCRIPTION	POSITION	YEAR	MAKE	MODEL
E123-70-024	Drum Hardware	Rr	2008 - 2012	FORD	E150 ½ Ton Full Size Van, E250 ¾ Ton Full Size Van, E350 1 Ton Full Size Van, Wagon, Stripped & RV Chassis including Super Duty, E-SUPER DUTY Van & Cutaway, E450, 47 (1 Ton) Super Duty Van & Cutaway
E123-70-025	Drum Hardware	Rr	2009 - 2011	FORD	F150 ½ Ton Truck
E123-70-026	Drum Hardware	Rr	2010 - 2012	FORD	TRANSIT CONNECT
E123-71-007	Drum Hardware	Rr	1985 - 2003	WORKHORSE	P32, P42,
E123-71-009	Drum Hardware	Rr	2002 - 2012	CHEVROLET, GMC	AVALANCHE 1500, EXPRESS 1500 ½ Ton Van, SILVERADO 1500 ½ Ton, SUBURBAN 1500 ½ Ton, TAHOE, SAVANA 1500 ½ Ton Van, SIERRA 1500, SIERRA 1500 DENALI, C3 ½ Ton Pickup
E123-71-010	Drum Hardware	Rr	2007 - 2009	CHEVROLET, GMC	TRAILBLAZER, ENVOY
E123-71-012	Drum Hardware	Rr	2003 - 2012	CHEVROLET, FORD, GMC, HUMMER, GMC	EXPRESS 2500, 3500 Van, SILVERADO 1500, 2500, 3500, SUBURBAN 2500 ¾ Ton, E350 1 Ton Full Size Van, Wagon, Stripped & RV Chassis including Super Duty, SAVANA 2500, 3500 Van, SIERRA 1500, 2500, 3500 SIERRA DENALI, C3 Pickup & Chassis, YUKON XL 2500 ¾ Ton, H2, G4500 Commercial Cutaway Chassis
E123-71-013	Drum Hardware	Rr	2004 - 2008	CHEVROLET, GMC	SILVERADO 3500 1 Ton, SIERRA 3500 1 Ton Pickup, Cab & Chassis
E123-71-014	Drum Hardware	Rr	2004 - 2008	CHEVROLET, GMC	COLORADO, CANYON
E123-71-015	Drum Hardware	Rr	2007 - 2012	CHEVROLET, GMC	AVALANCHE 1500, SILVERADO 1500 ½ Ton, SUBURBAN 1500 ½ Ton, TAHOE, SIERRA 1500, SIERRA 1500 DENALI, C3 ½ Ton Pickup, YUKON, YUKON DENALI, YUKON XL 1500, YUKON DENALI XL ½ Ton
E123-71-016	Drum Hardware	Rr	2007 - 2008	CHEVROLET, GMC	SILVERADO 1500 ½ Ton, SIERRA 1500, SIERRA 1500 DENALI, C3 ½ Ton Pickup
E123-71-017	Drum Hardware	Rr	2006 - 2012	CHEVROLET, GMC	AVALANCHE 1500, SILVERADO 1500 ½ Ton RWD, SIERRA 1500, SIERRA 1500 DENALI, C3 ½ Ton 4WD Pickup
E123-71-018	Drum Hardware	Rr	2007 - 2012	CHEVROLET, GMC, SATURN	TRAVERSE, ACADIA, OUTLOOK
E123-71-019	Drum Hardware	Rr	2006 - 2008	CHEVROLET, GMC	EXPRESS 3500 1 Ton Van, SAVANA 3500 1 Ton Van
E123-71-020	Drum Hardware	Rr	2009 - 2012	CHEVROLET, GMC	COLORADO, CANYON
E123-71-021	Drum Hardware	Rr	2009 - 2012	CHEVROLET, GMC	SILVERADO 1500 ½ Ton, SIERRA 1500, SIERRA 1500 DENALI ½ Ton RWD Pickup
E123-72-006	Drum Hardware	Rr	2006 - 2012	DODGE, FORD	DURANGO, RAM 1500 ½ Ton Pickup, E150 ½ Ton Full Size Van
E123-72-009	Drum Hardware	Rr	2007 - 2012	JEEP	LIBERTY, WRANGLER
E123-72-010	Drum Hardware	Rr	2005 - 2011	DODGE	DAKOTA
E123-74-006	Drum Hardware	Rr	2006 - 2010	HUMMER	H3
E123-81-006	Drum Hardware	Rr	1989 - 2012	UD	UD 18HD, UD 1800, CS, HD, UD 2300, DH, LP
E123-81-007	Drum Hardware	Rr	1989 - 2010	UD	UD 2600, UD2800, UD3000
E123-84-006	Drum Hardware	Rr	1984 - 1994	FORD	LT, LTL900 Short Conventional Tandem with Front Disc Brakes
E123-85-009	Drum Hardware	Rr	1994 - 2012	CHEVROLET, GMC, ISUZU, UD	W3500 Diesel Engine, NPR with Front Disc Brakes, Gas Engine, NPR with Front Disc Brakes, Diesel Engine, UD 1400
E123-85-011	Drum Hardware	Fr	1994 - 1999	ISUZU	FRR
E123-85-012	Drum Hardware	Rr	1994 - 1999	ISUZU	FRR



PART NO	DESCRIPTION	POSITION	YEAR	MAKE	MODEL
E123-85-015	Drum Hardware	Rr	1988 - 2010	FORD	F53, 59 (1 Ton) RV Motor Home & Stripped Chassis, F450, F47 (1 Ton) 2WD & 4WD Super Duty, F550 (1 Ton) 2WD & 4WD Super Duty
E123-87-008	Drum Hardware	Rr	1969 - 1985	INTERNATIONAL	C01710A, B Cargostar
E123-87-009	Drum Hardware	Fr & Rr	1989 - 2012	UD	UD 18HD, UD 1800, CS, HD, UD 2300, DH, LP, UD 2600, UD2800, UD3000
E123-87-012	Drum Hardware	Fr	1989 - 2012	UD	UD 18CS, UD 18HD, UD 1800, CS, HD, UD 2300, DH, LP
E123-87-013	Drum Hardware	Rr	1989 - 2012	UD	UD 18CS, UD 18HD, UD 1800, CS, HD, UD 2300, DH, LP
E124-49-012	Self Adjuster Kits	Rr R	2004 - 2011	TOYOTA	SIENNA, TACOMA
E124-49-013	Self Adjuster Kits	Rr L	2004 - 2011	TOYOTA	SIENNA, TACOMA
E124-66-011	Self Adjuster Kits	Rr L	2001 - 2007	FORD	TAURUS
E124-66-012	Self Adjuster Kits	Rr R	2001 - 2007	FORD	TAURUS
E124-67-044	Self Adjuster Kits	Rr R	2005 - 2005	PONTIAC	MONTANA
E124-67-045	Self Adjuster Kits	Rr L	2005 - 2005	PONTIAC	MONTANA
E124-67-048	Self Adjuster Kits	Rr R	2006 - 2008	CHEVROLET	HHR
E124-67-049	Self Adjuster Kits	Rr L	2006 - 2008	CHEVROLET	HHR
E124-67-050	Self Adjuster Kits	Rr R	2005 - 2007	SATURN	VUE
E124-67-051	Self Adjuster Kits	Rr L	2005 - 2007	SATURN	VUE
E124-68-024	Self Adjuster Kits	Rr R	2009 - 2011	CHEVROLET	HHR
E124-68-025	Self Adjuster Kits	Rr L	2009 - 2011	CHEVROLET	HHR
E124-68-028	Self Adjuster Kits	Rr R	2007 - 2012	DODGE, JEEP	CALIBER, COMPASS, PATRIOT
E124-68-029	Self Adjuster Kits	Rr L	2007 - 2012	DODGE, JEEP	CALIBER, COMPASS, PATRIOT
E124-69-011	Self Adjuster Kits	Rr L	2003 - 2009	FORD, MAZDA	RANGER, B SERIES Pickup
E124-69-012	Self Adjuster Kits	Rr R	2003 - 2009	FORD, MAZDA	RANGER, B SERIES Pickup
E124-70-006	Self Adjuster Kits	Rr L	2003 - 2009	FORD, MAZDA	RANGER, B SERIES Pickup
E124-70-007	Self Adjuster Kits	Rr R	2003 - 2009	FORD, MAZDA	RANGER, B SERIES Pickup
E124-70-012	Self Adjuster Kits	Rr L	2007 - 2007	FORD, MERCURY	ESCAPE, MARINER
E124-70-013	Self Adjuster Kits	Rr R	2007 - 2007	FORD, MERCURY	ESCAPE, MARINER
E124-70-014	Self Adjuster Kits	Rr R	2008 - 2012	FORD, MERCURY	ESCAPE, MARINER
E124-70-015	Self Adjuster Kits	Rr L	2008 - 2012	FORD, MERCURY	ESCAPE, MARINER
E124-71-012	Self Adjuster Kits	Rr L	2006 - 2007	CHRYSLER, DODGE	TOWN & COUNTRY VAN, CARAVAN, GRAND CARAVAN
E124-71-013	Self Adjuster Kits	Rr R	2006 - 2007	CHRYSLER, DODGE	TOWN & COUNTRY VAN, CARAVAN, GRAND CARAVAN
E124-71-014	Self Adjuster Kits	Rr R	2004 - 2008	CHEVROLET, GMC	COLORADO, CANYON
E124-71-015	Self Adjuster Kits	Rr L	2004 - 2008	CHEVROLET, GMC	COLORADO, CANYON, SILVERADO 1500 ½ Ton, SIERRA 1500, SIERRA 1500 DENALI, C3 ½ Ton Pickup
E124-71-016	Self Adjuster Kits	Rr R	2009 - 2012	CHEVROLET, GMC	COLORADO, CANYON
E124-71-017	Self Adjuster Kits	Rr L	2009 - 2012	CHEVROLET, GMC	COLORADO, CANYON, SILVERADO 1500 ½ Ton, SIERRA 1500, SIERRA 1500 DENALI, C3 ½ Ton Pickup
E124-72-008	Self Adjuster Kits	Rr R	2005 - 2011	DODGE	DAKOTA
E124-72-009	Self Adjuster Kits	Rr L	2005 - 2011	DODGE	DAKOTA
E124-73-010	Self Adjuster Kits	Rr L	1985 - 2003	WORKHORSE	P32, P42,
E124-73-011	Self Adjuster Kits	Rr R	1985 - 2003	WORKHORSE	P32, P42,
E124-84-014	Self Adjuster Kits	Rr	1984 - 1994	FORD	LT, LTL900 Short Conventional Tandem with Front Disc Brakes

PART NO	DESCRIPTION	POSITION	YEAR	MAKE	MODEL
E124-87-009	Self Adjuster Kits	Rr	1969 - 1985	INTERNATIONAL	CO1710A, B Cargostar
E124-87-010	Self Adjuster Kits	Rr L	1969 - 1982	INTERNATIONAL	CO1710A, B Cargostar
E124-87-011	Self Adjuster Kits	Rr R	1969 - 1982	INTERNATIONAL	CO1710A, B Cargostar
E125-47-082	Brake Rotor	Rr	2008 - 2012	NISSAN	ROGUE
E125-47-086	Brake Rotor	Rr	2004 - 2012	NISSAN	ARMADA, TITAN
E125-47-089	Brake Rotor	Fr	2004 - 2005	NISSAN	TITAN
E125-47-090	Brake Rotor	Fr	2005 - 2012	NISSAN	FRONTIER, PATHFINDER, XTERRA
E125-47-091	Brake Rotor	Rr	2006 - 2012	NISSAN	PATHFINDER
E125-47-092	Brake Rotor	Rr	2005 - 2012	NISSAN	FRONTIER, XTERRA
E125-47-094	Brake Rotor	Fr	2005 - 2012	NISSAN	FRONTIER RWD
E125-47-095	Brake Rotor	Fr	2005 - 2007	NISSAN	TITAN
E125-47-096	Brake Rotor	Fr	2010 - 2012	NISSAN	CUBE
E125-47-099	Brake Rotor	Fr	2006 - 2007	NISSAN	ARMADA
E125-47-102	Brake Rotor	Fr	2008 - 2012	NISSAN	ROGUE
E125-47-104	Brake Rotor	Fr	2007 - 2012	NISSAN	ARMADA, TITAN
E125-47-107	Brake Rotor	Fr	2008 - 2012	NISSAN	PATHFINDER
E125-47-114	Brake Rotor	Rr	2012 - 2012	NISSAN	NV1500, NV2500 HD, NV3500 HD
E125-47-115	Brake Rotor	Fr	2012 - 2012	NISSAN	NV1500, NV2500 HD, NV3500 HD
E125-48-021	Brake Rotor	Fr	1997 - 2012	CHEVROLET, GMC, ISUZU	W3500 Gas Engine, W3500 Diesel Engine, W4500 Gas Engine, W4500 Diesel Engine, NPR with Front Disc Brakes, Gas Engine, NPR with Front Disc Brakes, Diesel Engine, REACH VAN (UTILIMASTER BODY)
E125-48-022	Brake Rotor	Fr	1998 - 1998	ISUZU	NQR
E125-48-024	Brake Rotor	Fr	1997 - 2012	CHEVROLET, GMC, ISUZU	W3500 Gas Engine, W4500 Gas Engine, W4500 Diesel Engine, W5500, W5500HD, NPR with Front Disc Brakes, Gas Engine, NPR with Front Disc Brakes, Diesel Engine, NQR, NRR
E125-48-025	Brake Rotor	Fr	2010 - 2012	ISUZU	NQR, NRR
E125-49-091	Brake Rotor	Fr	2003 - 2007	TOYOTA	LAND CRUISER
E125-49-092	Brake Rotor	Rr	2003 - 2007	TOYOTA	LAND CRUISER
E125-49-093	Brake Rotor	Fr	2006 - 2007	TOYOTA	HIGHLANDER
E125-49-123	Brake Rotor	Fr	2003 - 2007	TOYOTA	SEQUOIA
E125-49-130	Brake Rotor	Fr	2004 - 2010	TOYOTA	SIENNA
E125-49-132	Brake Rotor	Fr	2003 - 2009	TOYOTA	4RUNNER
E125-49-133	Brake Rotor	Rr	2003 - 2009	TOYOTA	FJ CRUISER, SEQUOIA, 4RUNNER
E125-49-134	Brake Rotor	Fr	2003 - 2011	TOYOTA	FJ CRUISER, TACOMA, 4RUNNER
E125-49-135	Brake Rotor	Fr	2006 - 2007	TOYOTA	HIGHLANDER
E125-49-136	Brake Rotor	Rr	2006 - 2007	TOYOTA	HIGHLANDER
E125-49-137	Brake Rotor	Rr	2004 - 2010	TOYOTA	SIENNA
E125-49-141	Brake Rotor	Fr	2005 - 2011	TOYOTA	TACOMA
E125-49-161	Brake Rotor	Fr	2007 - 2011	TOYOTA	SEQUOIA, TUNDRA
E125-49-162	Brake Rotor	Rr	2007 - 2011	TOYOTA	SEQUOIA, TUNDRA
E125-49-163	Brake Rotor	Fr	2008 - 2011	TOYOTA	HIGHLANDER, SIENNA
E125-49-164	Brake Rotor	Rr	2008 - 2011	TOYOTA	HIGHLANDER
E125-49-167	Brake Rotor	Fr	2008 - 2013	TOYOTA	LAND CRUISER
E125-49-171	Brake Rotor	Rr	2011 - 2011	TOYOTA	SIENNA
E125-49-179	Brake Rotor	Fr	2010 - 2011	TOYOTA	4RUNNER

PART NO	DESCRIPTION	POSITION	YEAR	MAKE	MODEL
E125-49-180	Brake Rotor	Rr	2010 - 2011	TOYOTA	FJ CRUISER, 4RUNNER
E125-50-081	Brake Rotor	Fr	2007 - 2011	MAZDA	CX-7
E125-50-082	Brake Rotor	Rr	2007 - 2011	MAZDA	CX-7
E125-50-084	Brake Rotor	Rr	2007 - 2011	MAZDA	CX-9
E125-50-085	Brake Rotor	Fr	2007 - 2011	MAZDA	CX-9
E125-51-060	Brake Rotor	Fr	2000 - 2005	MINIBUS, MITSUBISHI FUSO	FE Series
E125-51-061	Brake Rotor	Fr	2000 - 2012	MINIBUS, MITSUBISHI FUSO, STERLING	FE Series, 360 Series
E125-51-064	Brake Rotor	Rr	1995 - 2012	MINIBUS, MITSUBISHI FUSO, STERLING	FE Series, 360 Series
E125-63-006	Brake Rotor	Fr	2006 - 2010	JEEP	COMMANDER, GRAND CHEROKEE
E125-63-007	Brake Rotor	Rr	2006 - 2010	JEEP	COMMANDER, GRAND CHEROKEE
E125-63-010	Brake Rotor	Rr	2011 - 2012	DODGE, JEEP	DURANGO, GRAND CHEROKEE
E125-63-011	Brake Rotor	Fr	2011 - 2012	DODGE, JEEP	DURANGO, GRAND CHEROKEE
E125-63-012	Brake Rotor	Rr	2011 - 2012	DODGE, JEEP	DURANGO, GRAND CHEROKEE
E125-63-013	Brake Rotor	Fr	2011 - 2012	DODGE, JEEP	DURANGO, GRAND CHEROKEE
E125-66-044	Brake Rotor	Rr	2001 - 2007	FORD	TAURUS
E125-66-054	Brake Rotor	Fr	2001 - 2007	FORD	TAURUS
E125-66-077	Brake Rotor	Fr	2003 - 2011	FORD, LINCOLN, MERCURY	CROWN VICTORIA, TOWN CAR, GRAND MARQUIS
E125-66-078	Brake Rotor	Rr	2003 - 2011	FORD, MERCURY	CROWN VICTORIA, GRAND MARQUIS
E125-66-080	Brake Rotor	Rr	2005 - 2011	LINCOLN	TOWN CAR
E125-66-081	Brake Rotor	Rr	2005 - 2011	LINCOLN	TOWN CAR
E125-66-085	Brake Rotor	Fr	2008 - 2009	FORD	TAURUS, TAURUS X
E125-66-086	Brake Rotor	Rr	2008 - 2012	FORD, LINCOLN	EDGE, EXPLORER, SPORT, SPORT TRAC, TAURUS, TAURUS SHO, TAURUS X, MKT, MKX
E125-66-095	Brake Rotor	Fr	2007 - 2012	FORD, LINCOLN	EDGE, MKX
E125-66-096	Brake Rotor	Rr	2007 - 2010	FORD, LINCOLN	EDGE, MKX
E125-66-097	Brake Rotor	Fr	2007 - 2008	FORD, LINCOLN	EDGE, MKX
E125-66-099	Brake Rotor	Fr	2010 - 2010	FORD, LINCOLN	TAURUS, TAURUS SHO, MKT
E125-66-100	Brake Rotor	Rr	2010 - 2011	FORD	RANGER
E125-66-107	Brake Rotor	Fr	2011 - 2012	FORD, LINCOLN	EXPLORER, SPORT, SPORT TRAC, TAURUS, TAURUS SHO, MKT
E125-67-062	Brake Rotor	Fr	2005 - 2005	PONTIAC	MONTANA
E125-67-073	Brake Rotor	Fr	2005 - 2007	SATURN	VUE
E125-67-078	Brake Rotor	Fr	2005 - 2005	PONTIAC	MONTANA
E125-67-083	Brake Rotor	Fr	2008 - 2010	CHEVROLET	HHR
E125-67-084	Brake Rotor	Rr	2008 - 2010	CHEVROLET	HHR
E125-67-100	Brake Rotor	Fr	2006 - 2011	CHEVROLET	HHR
E125-67-102	Brake Rotor	Rr	2007 - 2010	CHEVROLET	IMPALA
E125-67-103	Brake Rotor	Fr	2007 - 2012	CHEVROLET	IMPALA
E125-67-104	Brake Rotor	Fr	2012 - 2012	CHEVROLET	IMPALA
E125-67-113	Brake Rotor	Fr	2011 - 2011	CHEVROLET	CAPRICE
E125-67-118	Brake Rotor	Rr	2011 - 2011	CHEVROLET	CAPRICE
E125-67-125	Brake Rotor	Fr	2010 - 2012	CHEVROLET, GMC	EQUINOX, TERRAIN
E125-67-134	Brake Rotor	Rr	2011 - 2012	CHEVROLET	IMPALA
E125-68-064	Brake Rotor	Fr	2008 - 2012	DODGE	CHARGER
E125-68-065	Brake Rotor	Rr	2008 - 2012	DODGE	CHARGER
E125-68-066	Brake Rotor	Fr	2008 - 2012	DODGE	CHARGER
E125-68-067	Brake Rotor	Rr	2008 - 2012	DODGE	CHARGER

PART NO	DESCRIPTION	POSITION	YEAR	MAKE	MODEL
E125-68-070	Brake Rotor	Rr	2008 - 2012	DODGE	CHARGER
E125-68-071	Brake Rotor	Rr	2007 - 2012	DODGE, JEEP	CALIBER, COMPASS, PATRIOT
E125-68-072	Brake Rotor	Fr	2007 - 2012	DODGE, JEEP	CALIBER, COMPASS, PATRIOT
E125-68-073	Brake Rotor	Fr	2007 - 2012	DODGE	CALIBER
E125-68-074	Brake Rotor	Rr	2007 - 2012	DODGE, JEEP	CALIBER, COMPASS, PATRIOT
E125-68-075	Brake Rotor	Rr	2008 - 2012	JEEP	LIBERTY
E125-68-076	Brake Rotor	Fr	2008 - 2012	JEEP	LIBERTY
E125-68-077	Brake Rotor	Fr	2007 - 2009	DODGE	CALIBER
E125-68-083	Brake Rotor	Fr	2012 - 2012	JEEP	LIBERTY
E125-70-025	Brake Rotor	Fr & Rr	1988 - 1998	FORD	F53, 59 (1 Ton) RV Motor Home & Stripped Chassis
E125-70-047	Brake Rotor	Fr	1996 - 2007	FORD	E350 1 Ton Full Size Van, Wagon, Stripped & RV Chassis including Super Duty, E-SUPER DUTY Van & Cutaway, E450, 47 (1 Ton) Super Duty Van & Cutaway
E125-70-048	Brake Rotor	Fr	1996 - 2001	FORD	E450, 47 (1 Ton) Super Duty Van & Cutaway
E125-70-051	Brake Rotor	Fr	2006 - 2007	FORD	E150 ½ Ton Full Size Van, E250 ¾ Ton Full Size Van, E350 1 Ton Full Size Van, Wagon, Stripped & RV Chassis including Super Duty
E125-70-056	Brake Rotor	Fr	2003 - 2011	FORD, MAZDA	RANGER RWD, B SERIES Pickup RWD
E125-70-069	Brake Rotor	Rr	1996 - 2007	FORD	E-SUPER DUTY Van & Cutaway, E450, 47 (1 Ton) Super Duty Van & Cutaway
E125-70-074	Brake Rotor	Fr & Rr	1999 - 2011	FORD	F53, 59 (1 Ton) RV Motor Home & Stripped Chassis, E550
E125-70-083	Brake Rotor	Rr	2006 - 2007	FORD	E150 ½ Ton Full Size Van, E250 ¾ Ton Full Size Van, E350 1 Ton Full Size Van, Wagon, Stripped & RV Chassis including Super Duty
E125-70-084	Brake Rotor	Rr	2007 - 2007	FORD	E350 1 Ton Full Size Van, Wagon, Stripped & RV Chassis including Super Duty
E125-70-087	Brake Rotor	Fr	2003 - 2011	FORD, MAZDA	RANGER 4WD, B SERIES Pickup 4WD
E125-70-092	Brake Rotor	Fr	1999 - 2005	FORD	E550, F450, F47 (1 Ton) 2WD & 4WD Super Duty, F550 (1 Ton) 2WD & 4WD Super Duty
E125-70-094	Brake Rotor	Fr	2007 - 2007	FORD, MERCURY	ESCAPE, MARINER
E125-70-095	Brake Rotor	Rr	2006 - 2010	FORD, MERCURY	EXPLORER, SPORT, SPORT TRAC, MOUNTAINEER
E125-70-097	Brake Rotor	Rr	2002 - 2011	FORD	F53, 59 (1 Ton) RV Motor Home & Stripped Chassis
E125-70-105	Brake Rotor	Fr	2004 - 2008	FORD	F150 ½ Ton Truck
E125-70-106	Brake Rotor	Fr	2004 - 2008	FORD	F150 ½ Ton Truck
E125-70-107	Brake Rotor	Rr	2004 - 2011	FORD	F150 ½ Ton Truck
E125-70-108	Brake Rotor	Rr	2004 - 2010	FORD	F150 ½ Ton Truck
E125-70-110	Brake Rotor	Fr	2006 - 2006	FORD	E150 ½ Ton Full Size Van
E125-70-111	Brake Rotor	Rr	2006 - 2006	FORD	E150 ½ Ton Full Size Van
E125-70-112	Brake Rotor	Fr	2007 - 2012	FORD, MAZDA, MERCURY	ESCAPE, TRIBUTE, MARINER
E125-70-113	Brake Rotor	Rr	2007 - 2009	FORD, MAZDA, MERCURY	ESCAPE, TRIBUTE, MARINER
E125-70-115	Brake Rotor	Fr	2007 - 2012	FORD	F350 1 Ton Pickup, Cab & Chassis 4WD including Super Duty, F450, F47 (1 Ton) 2WD & 4WD Super Duty
E125-70-116	Brake Rotor	Fr	2005 - 2012	FORD	F450, F47 (1 Ton) 2WD & 4WD Super Duty, F550 (1 Ton) 2WD & 4WD Super Duty

PART NO	DESCRIPTION	POSITION	YEAR	MAKE	MODEL
E125-70-117	Brake Rotor	Fr	2005 - 2012	FORD	F250, F250 Super Duty ¾ Ton 4WD Truck, F350 1 Ton Pickup, Cab & Chassis 4WD including Super Duty
E125-70-118	Brake Rotor	Rr	2005 - 2012	FORD	F250, F250, F350 Super Duty Truck, Cab & Chassis Including Super Duty
E125-70-119	Brake Rotor	Rr	2007 - 2012	FORD	F350, F450, F47 SUPER DUTY Pickup, Cab & Chassis
E125-70-120	Brake Rotor	Fr & Rr	2005 - 2012	DODGE, FORD, INTERNATIONAL, STERLING	RAM 4500, 5500, LCF Series, CF500, CF600, TERRA STAR, RAM 4500, 5500, F450, F47 (1 Ton) 2WD & 4WD Super Duty, F550 (1 Ton) 2WD & 4WD Super Duty, BULLET
E125-70-121	Brake Rotor	Fr	2005 - 2006	FORD	F250, F250 Super Duty ¾ Ton RWD Truck
E125-70-123	Brake Rotor	Fr	2006 - 2010	FORD, MERCURY	EXPLORER, SPORT, SPORT TRAC, MOUNTAINEER
E125-70-124	Brake Rotor	Fr	2007 - 2012	FORD, LINCOLN	EXPEDITION, F150 ½ Ton Truck, NAVIGATOR
E125-70-125	Brake Rotor	Rr	2007 - 2012	FORD, LINCOLN	EXPEDITION, NAVIGATOR
E125-70-126	Brake Rotor	Fr	2006 - 2012	FORD	F250, F250, F350 Super Duty RWD Truck, Cab & Chassis
E125-70-127	Brake Rotor	Fr	2007 - 2012	FORD	F350 SUPER DUTY 1 Ton Pickup, Cab & Chassis RWD
E125-70-128	Brake Rotor	Rr	2008 - 2012	FORD	E150 ½ Ton Full Size Van, E250 ¾ Ton Full Size Van, E350 1 Ton Full Size Van, Wagon, Stripped & RV Chassis including Super Duty
E125-70-129	Brake Rotor	Fr	2008 - 2012	FORD	E150 ½ Ton Full Size Van, E250 ¾ Ton Full Size Van, E350 1 Ton Full Size Van, Wagon, Stripped & RV Chassis including Super Duty
E125-70-130	Brake Rotor	Rr	2008 - 2012	FORD	E350 1 Ton Full Size Van, Wagon, Stripped & RV Chassis including Super Duty
E125-70-131	Brake Rotor	Fr	2008 - 2011	FORD	E350 1 Ton Full Size Van, Wagon, Stripped & RV Chassis including Super Duty, E-SUPER DUTY Van & Cutaway, E450, 47 (1 Ton) Super Duty Van & Cutaway
E125-70-132	Brake Rotor	Rr	2008 - 2012	FORD	E-SUPER DUTY Van & Cutaway, E450, 47 (1 Ton) Super Duty Van & Cutaway
E125-70-133	Brake Rotor	Fr	2004 - 2008	FORD, LINCOLN	F150 ½ Ton Truck, LT
E125-70-134	Brake Rotor	Fr	2004 - 2008	FORD, LINCOLN	F150 ½ Ton Truck, LT
E125-70-135	Brake Rotor	Fr	2009 - 2009	FORD	F150 ½ Ton Truck
E125-70-136	Brake Rotor	Fr	2009 - 2009	FORD	F150 ½ Ton Truck
E125-70-137	Brake Rotor	Fr	2010 - 2012	FORD	TRANSIT CONNECT
E125-70-138	Brake Rotor	Rr	2012 - 2012	FORD	F150 ½ Ton Truck
E125-70-139	Brake Rotor	Fr	2010 - 2012	FORD	F150 ½ Ton Truck
E125-70-140	Brake Rotor	Rr	2012 - 2012	FORD	F150 ½ Ton Truck
E125-71-020	Brake Rotor	Fr	1985 - 1994	WORKHORSE	P32, P42,
E125-71-036	Brake Rotor	Fr	1995 - 2005	WORKHORSE	P32, P42, P500 (Fedex Delivery Truck), W42 - 14,001, 16,000 GVWR
E125-71-037	Brake Rotor	Rr	1997 - 2005	WORKHORSE	P32, P42, P500 (Fedex Delivery Truck), W42 - 14,001, 16,000 GVWR
E125-71-045	Brake Rotor	Fr	2002 - 2008	CHEVROLET, GMC	AVALANCHE 1500, EXPRESS 1500 ½ Ton Van, SILVERADO 1500 ½ Ton, SUBURBAN 1500 ½ Ton, TAHOE, SAVANA 1500 ½ Ton Van, SIERRA 1500, SIERRA 1500 DENALI, C3 ½ Ton Pickup
E125-71-046	Brake Rotor	Rr	2007 - 2007	CHEVROLET, GMC	SILVERADO 1500 ½ Ton, SIERRA 1500, SIERRA 1500 DENALI, C3 ½ Ton Pickup

PART NO	DESCRIPTION	POSITION	YEAR	MAKE	MODEL
E125-71-047	Brake Rotor	Fr	2003 - 2012	CHEVROLET, GMC, HUMMER	EXPRESS 2500 ¾ Ton Van, SILVERADO 1500 ½ Ton, SUBURBAN 2500 ¾ Ton, SAVANA 2500 ¾ Ton Van, SIERRA 1500, SIERRA 1500 DENALI, C3 ½ Ton Pickup, YUKON XL 2500 ¾ Ton, H2
E125-71-048	Brake Rotor	Rr	2003 - 2012	CHEVROLET, GMC, HUMMER	EXPRESS 2500, 3500 1 Ton Van, SILVERADO 1500, 2500, SAVANA 2500, 3500 Van, SIERRA 1500, 2500, SIERRA, DENALI, C3 ½ Ton Pickup, YUKON XL 2500 ¾ Ton, H2
E125-71-049	Brake Rotor	Rr	2004 - 2012	CHEVROLET, GMC	EXPRESS 2500, 3500 Van, SILVERADO 2500, 3500, SUBURBAN 2500 ¾ Ton, SAVANA 2500, 3500 Van, SIERRA 2500, 3500 Pickup, Cab & Chassis, YUKON XL 2500 ¾ Ton
E125-71-050	Brake Rotor	Rr	2002 - 2012	CHEVROLET, GMC	AVALANCHE 1500, EXPRESS 1500 ½ Ton Van, SILVERADO 1500 ½ Ton, SUBURBAN 1500 ½ Ton, TAHOE, SAVANA 1500 ½ Ton Van
E125-71-055	Brake Rotor	Rr	2004 - 2010	CHEVROLET, GMC	EXPRESS 3500 1 Ton Van, SILVERADO 3500 1 Ton, SAVANA 3500 1 Ton Van, SIERRA 3500 1 Ton Pickup, Cab & Chassis
E125-71-057	Brake Rotor	Rr	2007 - 2009	CHEVROLET, GMC	TRAILBLAZER, ENVOY
E125-71-058	Brake Rotor	Fr	2007 - 2009	CHEVROLET, GMC	TRAILBLAZER, ENVOY
E125-71-061	Brake Rotor	Fr	2004 - 2008	CHEVROLET, GMC	COLORADO, CANYON
E125-71-062	Brake Rotor	Fr	2007 - 2012	CHEVROLET, GMC	AVALANCHE 1500, EXPRESS 1500 ½ Ton Van, SILVERADO 1500 ½ Ton, SUBURBAN 1500 ½ Ton, TAHOE, SAVANA 1500 ½ Ton Van, SIERRA 1500, SIERRA 1500 DENALI, C3 ½ Ton Pickup, YUKON, YUKON DENALI, YUKON XL 1500, YUKON DENALI XL ½ Ton
E125-71-063	Brake Rotor	Rr	2005 - 2005	PONTIAC	MONTANA
E125-71-064	Brake Rotor	Fr	2004 - 2012	CHEVROLET, GMC	EXPRESS 3500 1 Ton Van, SILVERADO 2500, 3500, SAVANA 3500 1 Ton Van, SIERRA 2500, 3500 Pickup, Cab & Chassis, G4500 Commercial Cutaway Chassis
E125-71-065	Brake Rotor	Rr	2005 - 2005	PONTIAC	MONTANA
E125-71-066	Brake Rotor	Fr	2006 - 2009	CHEVROLET, PONTIAC, SATURN	UPLANDER, MONTANA, RELAY
E125-71-067	Brake Rotor	Rr	2006 - 2009	CHEVROLET, PONTIAC, SATURN	UPLANDER, MONTANA, RELAY
E125-71-068	Brake Rotor	Fr	2007 - 2009	CHEVROLET, GMC	TRAILBLAZER, ENVOY
E125-71-069	Brake Rotor	Fr	2007 - 2009	CHEVROLET	TRAILBLAZER
E125-71-070	Brake Rotor	Rr	2007 - 2012	CHEVROLET, GMC	AVALANCHE 1500, SILVERADO 1500 ½ Ton, SUBURBAN 1500 ½ Ton, TAHOE, SIERRA 1500, SIERRA 1500 DENALI, C3 ½ Ton Pickup, YUKON, YUKON DENALI, YUKON XL 1500, YUKON DENALI XL ½ Ton
E125-71-071	Brake Rotor	Rr	2006 - 2006	CHEVROLET, PONTIAC	UPLANDER, MONTANA
E125-71-072	Brake Rotor	Fr	2007 - 2010	CHEVROLET, PONTIAC, SATURN	EQUINOX, TORRENT, VUE
E125-71-073	Brake Rotor	Rr	2007 - 2010	CHEVROLET, PONTIAC, SATURN	EQUINOX, TORRENT, VUE
E125-71-074	Brake Rotor	Fr	2007 - 2012	CHEVROLET, GMC, SATURN	TRAVERSE, ACADIA, OUTLOOK
E125-71-075	Brake Rotor	Rr	2007 - 2012	CHEVROLET, GMC, SATURN	TRAVERSE, ACADIA, OUTLOOK
E125-71-076	Brake Rotor	Rr	2009 - 2012	CHEVROLET, GMC	EXPRESS 3500 1 Ton Van, SAVANA 3500 1 Ton Van, G4500 Commercial Cutaway Chassis
E125-71-077	Brake Rotor	Fr	2009 - 2012	CHEVROLET, GMC	COLORADO, CANYON
E125-71-078	Brake Rotor	Rr	2010 - 2012	CHEVROLET, GMC	EQUINOX, TERRAIN
E125-71-079	Brake Rotor	Fr	2011 - 2012	CHEVROLET, GMC	SILVERADO 2500, 3500, SIERRA 2500, 3500 Pickup



PART NO	DESCRIPTION	POSITION	YEAR	MAKE	MODEL
E125-71-080	Brake Rotor	Rr	2011 - 2012	CHEVROLET, GMC	SILVERADO 3500 1 Ton Pickup, SIERRA 3500 1 Ton Pickup,
E125-71-082	Brake Rotor	Rr	2011 - 2012	CHEVROLET, GMC	SILVERADO 2500, 3500, SIERRA 2500, 3500 Pickup
E125-72-042	Brake Rotor	Rr	2006 - 2007	CHRYSLER, DODGE	TOWN & COUNTRY VAN, CARAVAN, GRAND CARAVAN
E125-72-054	Brake Rotor	Fr	2006 - 2007	CHRYSLER, DODGE	TOWN & COUNTRY VAN, CARAVAN, GRAND CARAVAN
E125-72-057	Brake Rotor	Fr	2007 - 2007	JEEP	LIBERTY
E125-72-058	Brake Rotor	Fr	2007 - 2012	DODGE	DURANGO, RAM 1500 ½ Ton Pickup
E125-72-059	Brake Rotor	Rr	2007 - 2012	DODGE, JEEP	DURANGO, RAM 1500 ½ Ton Pickup, J8
E125-72-066	Brake Rotor	Fr	2006 - 2008	DODGE	RAM 1500, 2500, 3500 Pickup
E125-72-067	Brake Rotor	Rr	2006 - 2008	DODGE	RAM 1500, 2500, 3500 Pickup
E125-72-068	Brake Rotor	Rr	2007 - 2007	JEEP	LIBERTY
E125-72-070	Brake Rotor	Fr	2005 - 2011	DODGE	DAKOTA
E125-72-072	Brake Rotor	Rr	2007 - 2012	JEEP	WRANGLER
E125-72-073	Brake Rotor	Fr	2007 - 2012	JEEP	WRANGLER
E125-72-074	Brake Rotor	Fr	2008 - 2012	CHRYSLER, DODGE	TOWN & COUNTRY VAN, CARAVAN, GRAND CARAVAN
E125-72-075	Brake Rotor	Fr	2008 - 2012	DODGE, STERLING	RAM 4500, 5500, RAM 4500, 5500, BULLET
E125-72-076	Brake Rotor	Rr	2008 - 2012	CHRYSLER, DODGE	TOWN & COUNTRY VAN, CARAVAN, GRAND CARAVAN
E125-72-077	Brake Rotor	Fr	2009 - 2012	DODGE	RAM 2500, 3500 Pickup
E125-72-078	Brake Rotor	Rr	2009 - 2012	DODGE	RAM 2500, 3500 Pickup
E125-72-079	Brake Rotor	Fr	2012 - 2012	CHRYSLER, DODGE	TOWN & COUNTRY VAN, CARAVAN, GRAND CARAVAN
E125-72-080	Brake Rotor	Rr	2012 - 2012	CHRYSLER, DODGE	TOWN & COUNTRY VAN, CARAVAN, GRAND CARAVAN
E125-74-006	Brake Rotor	Fr	2006 - 2010	HUMMER	H3
E125-74-007	Brake Rotor	Rr	2006 - 2010	HUMMER	H3
E125-79-006	Brake Rotor	Fr	2000 - 2012	MINI, MITSUBISHI FUSO	FE Series
E125-79-007	Brake Rotor	Fr	2005 - 2012	MINI, MITSUBISHI FUSO	FE Series
E125-79-008	Brake Rotor	Rr	2005 - 2012	MINI, MITSUBISHI FUSO	FE Series
E125-80-006	Brake Rotor	Fr	2005 - 2010	HINO	165 16,000 GVW, 185 18,500 LBS GVW
E125-80-007	Brake Rotor	Fr	2005 - 2010	HINO	145 14,050 GVW
E125-80-008	Brake Rotor	Rr	2005 - 2010	HINO	145 14,050 GVW
E125-80-009	Brake Rotor	Rr	2005 - 2010	HINO	165 16,000 GVW
E125-80-010	Brake Rotor	Rr	2005 - 2010	HINO	185 18,500 LBS GVW
E125-81-006	Brake Rotor	Fr	1987 - 1997	CHEVROLET, GMC	W3500 Diesel Engine
E125-82-006	Brake Rotor	Fr	1994 - 2010	UD	UD 1400
E125-84-019	Brake Rotor	Fr	1984 - 1994	FORD	LT, LTL900 Short Conventional Tandem with Front Disc Brakes
E125-84-021	Brake Rotor	Fr	1984 - 1994	FORD	LT, LTL900 Short Conventional Tandem with Front Disc Brakes
E125-84-033	Brake Rotor	Fr	1984 - 1994	FORD	8000 Series (air over hydraulics)
E125-84-034	Brake Rotor	Fr	1984 - 1994	FORD	8000 Series (air over hydraulics)
E125-85-006	Brake Rotor	Fr & Rr	1990 - 2003	CHEVROLET, ISUZU	C7500 Kodiak with Disc Brakes, T5500, T6500 with Disc Brakes, T7500, T8500 Tilt Cab with Disc Brakes, FSR with Front Disc Brakes, FTR with Front Disc Brakes



PART NO	DESCRIPTION	POSITION	YEAR	MAKE	MODEL
E125-85-007	Brake Rotor	Rr	1998 - 2003	ISUZU	FSR with Front Disc Brakes, FTR with Front Disc Brakes
E125-85-013	Brake Rotor	Fr & Rr	1990 - 2003	CHEVROLET, ISUZU	C7500 Kodiak with Disc Brakes, T5500, T6500 with Disc Brakes, T7500, T8500 Tilt Cab with Disc Brakes, FSR with Front Disc Brakes, FTR with Front Disc Brakes
E125-85-016	Brake Rotor	Rr	1998 - 2003	ISUZU	FSR with Front Disc Brakes, FTR with Front Disc Brakes
E125-85-017	Brake Rotor	Rr	1998 - 2003	ISUZU	FSR with Front Disc Brakes, FTR with Front Disc Brakes
E125-85-018	Brake Rotor	Fr & Rr	2003 - 2010	CHEVROLET, GMC	C4500 Kodiak, C5500 Kodiak, C4500 Topkick
E125-85-019	Brake Rotor	Fr & Rr	1990 - 2012	BLUEBIRD BUS, CHEVROLET, GMC, ISUZU, WORKHORSE, HINO, THOMAS BUILT, FREIGHTLINER	TC2000 with Hydraulic Disc Brakes, C4500 Kodiak, C5500 Kodiak, C6500 Kodiak with Disc Brakes, C7500 Kodiak with Disc Brakes, T5500, T6500 with Disc Brakes, T7500, T8500 Tilt Cab with Disc Brakes, C4500 Topkick, C6500 Topkick with Front Disc Brakes, C7500 Topkick with Front Disc Brakes, T5500, T6500, T7500, T8500 Tilt Cab with Disc Brakes, FTR with Front Disc Brakes, FVR, FXR with Front Disc Brakes, H Series HTR, HVR, W24, W25.5 - 24,000, 25,500 GVWR, W62, UFO - 17,000, 19,500, 23,000, 23,500 GVWR, VISION, 238 23,000, 25,500 LBS GVW, 258LP 23,000, 25,000 LBS GVW (Low Profile), 268 25,950GVW LBS with Hydraulic Disc Brakes, C2, FL50, FL60, FL70 with Disc Brakes
E125-85-020	Brake Rotor	Rr	1990 - 2012	BLUEBIRD BUS, CHEVROLET, FREIGHTLINER, GMC, ISUZU, WORKHORSE	TC2000 with Hydraulic Disc Brakes, C6500 Kodiak with Disc Brakes, C7500 Kodiak with Disc Brakes, T5500, T6500 with Disc Brakes, T7500, T8500 Tilt Cab with Disc Brakes, FL50, FL60, FL70 with Disc Brakes, C6500 Topkick with Front Disc Brakes, C7500 Topkick with Front Disc Brakes, T5500, T6500, T7500, T8500 Tilt Cab with Disc Brakes, FTR with Front Disc Brakes, FVR, FXR with Front Disc Brakes, H Series HTR, HVR, W24, W25.5 - 24,000, 25,500 GVWR, W62, UFO - 17,000, 19,500, 23,000, 23,500 GVWR
E125-85-022	Brake Rotor	Rr	2004 - 2010	CHEVROLET, GMC	C4500 Kodiak, C5500 Kodiak, C4500 Topkick
E125-85-023	Brake Rotor	Fr	2003 - 2010	CHEVROLET, GMC	C4500 Kodiak, C5500 Kodiak, C4500 Topkick
E125-87-008	Brake Rotor	Fr	1980 - 1997	MACK	CS200, MS200
E125-88-005	Brake Rotor	Fr & Rr	1973 - 1998	INTERNATIONAL	S1624, S1652FC, S1652SC UPS, S1654, S1723, S1724, S1753, S1754 S Models
E125-88-006	Brake Rotor	Fr & Rr	1973 - 1998	INTERNATIONAL	S1452, 1452FC, 1600, 1624 Loadstar, S1624, S1652FC, S1652SC UPS, S1654, S Models, Binder, S1723, S1724, S1753, S1754 S Models, 1723 Bus, S1823, S1853 School Bus, S1853FC, S1824, S1854 Conventional, C01910A, B Cargostar, Forward Cab, F1910A, F1924 Tandem, S Models Conventional, S1924, S1954 Conventional, S Models, Cargostar Models
E125-88-007	Brake Rotor	Fr & Rr	1973 - 1998	INTERNATIONAL	S1452, 1452FC, 1600, 1624 Loadstar, S1624, S1652FC, S1652SC UPS, S1654, S Models, Binder, S1723, S1724, S1753, S1754 S Models, 1723 Bus, S1823, S1853 School Bus, S1853FC, S1824, S1854 Conventional, C01910A, B Cargostar, Forward Cab, F1910A, F1924 Tandem, S Models Conventional, S1924, S1954 Conventional, S Models, Cargostar Models

PART NO	DESCRIPTION	POSITION	YEAR	MAKE	MODEL
E125-88-008	Brake Rotor	Fr & Rr	1973 - 1998	INTERNATIONAL	S1823, S1853 School Bus, S1853FC, S1824, S1854 Conventional, S1452, 1452FC, S Models Conventional, S1924, S1954 Conventional
E125-88-011	Brake Rotor	Fr & Rr	1973 - 1998	INTERNATIONAL	M1400, 1452 with Disc Brakes, S1452, 1452FC, M1600, 1652 Metro, 1600, 1624 Loadstar, S1624, S1652FC, S1652SC UPS, S1654, S Models, Binder, S1723, S1724, S1753, S1754 S Models, 1723 Bus, S1823, S1853 School Bus, S1853FC, S1824, S1854 Conventional, C01910A, B Cargostar, Forward Cab, F1910A, F1924 Tandem, S Models Conventional, S1924, S1954 Conventional, S Models, 3000, 3200, 3600, 3700, 3800, 3900FC School Bus with Hydraulic Disc Brakes, 4100, 4200, 4300, 4400, 4600, 4700, 4800, 4900, 7100 Conventional Cab with Hydraulic Disc Brakes
E125-88-012	Brake Rotor	Fr & Rr	1973 - 2004	BLUEBIRD BUS, INTERNATIONAL	TC2000 with Hydraulic Disc Brakes, M1400, 1452 with Disc Brakes, M1600, 1652 Metro, 3000, 3200, 3600, 3700, 3800, 3900FC School Bus with Hydraulic Disc Brakes, 4100, 4200, 4300, 4400, 4600, 4700, 4800, 4900, 7100 Conventional Cab with Hydraulic Disc Brakes, S1452, 1452FC, S1823, S1853 School Bus, S1853FC, S1824, S1854 Conventional, S Models Conventional, S1924, S1954 Conventional
E125-88-013	Brake Rotor	Fr & Rr	1973 - 2004	INTERNATIONAL, BLUEBIRD BUS	S1723, S1724, S1753, S1754 S Models, S1823, S1853 School Bus, S1853FC, S1824, S1854 Conventional, 4100, 4200, 4300, 4400, 4600, 4700, 4800, 4900, 7100 Conventional Cab with Hydraulic Disc Brakes, TC2000 with Hydraulic Disc Brakes, M1400, 1452 with Disc Brakes, S1452, 1452FC, M1600, 1652 Metro, S Models Conventional, S1924, S1954 Conventional
E125-88-014	Brake Rotor	Fr & Rr	1973 - 1998	INTERNATIONAL	S1723, S1724, S1753, S1754 S Models, S1452, 1452FC, 1600, 1624 Loadstar, S1624, S1652FC, S1652SC UPS, S1654, S Models, Binder, 1723 Bus, S1823, S1853 School Bus, S1853FC, S1824, S1854 Conventional, F1910A, F1924 Tandem, S Models Conventional, S1924, S1954 Conventional
E125-88-015	Brake Rotor	Fr & Rr	1973 - 1997	INTERNATIONAL	M1400, 1452 with Disc Brakes, M1600, 1652 Metro, 1600, 1624 Loadstar, S1624, S1652FC, S1652SC UPS, S1654, S Models, Binder, S1723, S1724, S1753, S1754 S Models, 1723 Bus, S1823, S1853 School Bus, S1853FC, S1824, S1854 Conventional, C01910A, B Cargostar, Forward Cab, F1910A, F1924 Tandem, S Models Conventional, S1924, S1954 Conventional, S Models, 3000, 3200, 3600, 3700, 3800, 3900FC School Bus with Hydraulic Disc Brakes, 4100, 4200, 4300, 4400, 4600, 4700, 4800, 4900, 7100 Conventional Cab with Hydraulic Disc Brakes, Cargostar Models

PART NO	DESCRIPTION	POSITION	YEAR	MAKE	MODEL
E125-88-018	Brake Rotor	Fr & Rr	1973 - 2012	BLUEBIRD BUS, FORD, INTERNATIONAL, KENWORTH, PETERBILT, STERLING, FREIGHTLINER, IC BUS, WORKHORSE	TC2000 with Hydraulic Disc Brakes, F650 Conventional with Disc Brakes, F750 Conventional with Disc Brakes, M1400, 1452 with Disc Brakes, S1452, 1452FC, M1600, 1652 Metro, 1600, 1624 Loadstar, S1624, S1652FC, S1652SC UPS, S1654, S Models, Binder, S1723, S1724, S1753, S1754 S Models, 1723 Bus, S1823, S1853 School Bus, S1853FC, S1824, S1854 Conventional, CO1910A, B Cargostar, Forward Cab, F1910A, F1924 Tandem, S Models Conventional, S1924, S1954 Conventional, S Models, 3000, 3200, 3600, 3700, 3800, 3900FC School Bus with Hydraulic Disc Brakes, 4100, 4200, 4300, 4400, 4600, 4700, 4800, 4900, 7100 Conventional Cab with Hydraulic Disc Brakes, T170, T270, T370 w/ Hydraulic Disc Brakes, 325, 330, 335 w/ Hydraulic Disc Brakes, ACTERRA with Hydraulic Disc Brakes, Fred Chassis, FS65, FW700 with Hydraulic Disc Brakes, M2 100/106 with Hydraulic Disc Brakes, MB50, MB60, MB70 with Disc Brakes, MC, MC-L Series Motorhome Chassis, MT10, MT35, MT45, MT55, MT-E with Hydraulic Disc Brakes, BE, CE, HC, LC with Hydraulic Disc Brakes, W20, W20D, W21, W22 - 20,70, 22,000 GVWR, F53, 59 (1 Ton) RV Motor Home & Stripped Chassis, FL50, FL60, FL70 with Disc Brakes, Cargostar Models, LF72 Bus 19,000 GVWR
E125-88-019	Brake Rotor	Fr & Rr	1990 - 2012	BLUEBIRD BUS, FORD, FREIGHTLINER, INTERNATIONAL, KENWORTH, PETERBILT, STERLING, IC BUS, WORKHORSE	TC2000 with Hydraulic Disc Brakes, F53, 59 (1 Ton) RV Motor Home & Stripped Chassis, F650 Conventional with Disc Brakes, F750 Conventional with Disc Brakes, FL50, FL60, FL70 with Disc Brakes, M1400, 1452 with Disc Brakes, M1600, 1652 Metro, S1624, S1652FC, S1652SC UPS, S1654, 3000, 3200, 3600, 3700, 3800, 3900FC School Bus with Hydraulic Disc Brakes, 4100, 4200, 4300, 4400, 4600, 4700, 4800, 4900, 7100 Conventional Cab with Hydraulic Disc Brakes, T170, T270, T370 w/ Hydraulic Disc Brakes, 325, 330, 335 w/ Hydraulic Disc Brakes, ACTERRA with Hydraulic Disc Brakes, Fred Chassis, FS65, FW700 with Hydraulic Disc Brakes, M2 100/106 with Hydraulic Disc Brakes, MB50, MB60, MB70 with Disc Brakes, MC, MC-L Series Motorhome Chassis, MT10, MT35, MT45, MT55, MT-E with Hydraulic Disc Brakes, BE, CE, HC, LC with Hydraulic Disc Brakes, W20, W20D, W21, W22 - 20,70, 22,000 GVWR
E125-88-020	Brake Rotor	Fr & Rr	1973 - 2012	BLUEBIRD BUS, INTERNATIONAL, KENWORTH, PETERBILT, WORKHORSE, FREIGHTLINER	TC2000 with Hydraulic Disc Brakes, M1400, 1452 with Disc Brakes, S1452, 1452FC, S1624, S1652FC, S1652SC UPS, S1654, S1723, S1724, S1753, S1754 S Models, 3000, 3200, 3600, 3700, 3800, 3900FC School Bus with Hydraulic Disc Brakes, 4100, 4200, 4300, 4400, 4600, 4700, 4800, 4900, 7100 Conventional Cab with Hydraulic Disc Brakes, T170, T270, T370 w/ Hydraulic Disc Brakes, 325, 330, 335 w/ Hydraulic Disc Brakes, P32, P42, Fred Chassis, FS65, FW700 with Hydraulic Disc Brakes, M2 100/106 with Hydraulic Disc Brakes, MB50, MB60, MB70 with Disc Brakes, MC, MC-L Series Motorhome Chassis, MT10, MT35, MT45, MT55, MT-E with Hydraulic Disc Brakes, W20, W20D, W21, W22 - 20,70, 22,000 GVWR, FL50, FL60, FL70 with Disc Brakes

PART NO	DESCRIPTION	POSITION	YEAR	MAKE	MODEL
E125-88-021	Brake Rotor	Fr & Rr	1973 - 2012	BLUEBIRD BUS, FORD, INTERNATIONAL, KENWORTH, PETERBILT, STERLING, FREIGHTLINER, IC BUS, WORKHORSE	TC2000 with Hydraulic Disc Brakes, F650 Conventional with Disc Brakes, F750 Conventional with Disc Brakes, M1400, 1452 with Disc Brakes, S1452, 1452FC, M1600, 1652 Metro, 1600, 1624 Loadstar, S1624, S1652FC, S1652SC UPS, S1654, S Models, Binder, S1723, S1724, S1753, S1754 S Models, 1723 Bus, S1823, S1853 School Bus, S1853FC, S1824, S1854 Conventional, C01910A, B Cargostar, Forward Cab, F1910A, F1924 Tandem, S Models Conventional, S1924, S1954 Conventional, S Models, 3000, 3200, 3600, 3700, 3800, 3900FC School Bus with Hydraulic Disc Brakes, 4100, 4200, 4300, 4400, 4600, 4700, 4800, 4900, 7100 Conventional Cab with Hydraulic Disc Brakes, T170, T270, T370 w/ Hydraulic Disc Brakes, 325, 330, 335 w/ Hydraulic Disc Brakes, ACTERRA with Hydraulic Disc Brakes, Fred Chassis, FS65, FW700 with Hydraulic Disc Brakes, M2 100/106 with Hydraulic Disc Brakes, MB50, MB60, MB70 with Disc Brakes, MC, MC-L Series Motorhome Chassis, MT10, MT35, MT45, MT55, MT-E with Hydraulic Disc Brakes, BE, CE, HC, LC with Hydraulic Disc Brakes, W20, W20D, W21, W22 - 20,70, 22,000 GVWR, MXT, RXT
E125-88-022	Brake Rotor	Fr	1990 - 2004	BLUEBIRD BUS, INTERNATIONAL	TC2000 with Hydraulic Disc Brakes, S1723, S1724, S1753, S1754 S Models
E125-88-023	Brake Rotor	Fr	2005 - 2009	INTERNATIONAL, WORKHORSE	MXT, RXT, LF72 Bus 19,000 GVWR
E125-88-025	Brake Rotor	Fr & Rr	2009 - 2012	FORD, INTERNATIONAL, IC BUS	F650 Conventional with Disc Brakes, F750 Conventional with Disc Brakes, 3000, 3200, 3600, 3700, 3800, 3900FC School Bus with Hydraulic Disc Brakes, 4100, 4200, 4300, 4400, 4600, 4700, 4800, 4900, 7100 Conventional Cab with Hydraulic Disc Brakes, BE, CE, HC, LC with Hydraulic Disc Brakes
E125-89-006	Brake Rotor	Rr	1998 - 2008	STERLING	ACTERRA with Hydraulic Disc Brakes
E125-89-007	Brake Rotor	Fr & Rr	1992 - 2012	FREIGHTLINER	Fred Chassis, FS65, FW700 with Hydraulic Disc Brakes, M2 100/106 with Hydraulic Disc Brakes, MB50, MB60, MB70 with Disc Brakes, MC, MC-L Series Motorhome Chassis, MT10, MT35, MT45, MT55, MT-E with Hydraulic Disc Brakes, FL50, FL60, FL70 with Disc Brakes
E125-89-008	Brake Rotor	Rr	1998 - 2008	STERLING	ACTERRA with Hydraulic Disc Brakes
E125-90-005	Brake Rotor	Fr	2006 - 2011	WORKHORSE	W42 - 14,001, 16,000 GVWR
E125-90-006	Brake Rotor	Fr	2001 - 2011	WORKHORSE	P32, P42, P500 (Fedex Delivery Truck), W16, W18 - 16,000, 18,000 GVWR, W42 - 14,001, 16,000 GVWR
E125-90-007	Brake Rotor	Rr	2001 - 2011	WORKHORSE	P32, P42, P500 (Fedex Delivery Truck), W16, W18 - 16,000, 18,000 GVWR, W42 - 14,001, 16,000 GVWR
E125-90-008	Brake Rotor	Rr	2006 - 2011	WORKHORSE	W42 - 14,001, 16,000 GVWR
E126-70-073	Brake Rotor	Fr	1999 - 2001	FORD	F450, F47 (1 Ton) 2WD & 4WD Super Duty, F550 (1 Ton) 2WD & 4WD Super Duty
E126-71-006	Brake Rotor	Fr	1985 - 2003	WORKHORSE	P32, P42,
E126-71-007	Brake Rotor	Fr	1985 - 2003	WORKHORSE	P32, P42,
E126-71-010	Brake Rotor	Fr	1985 - 1994	WORKHORSE	P32, P42,
E126-71-023	Brake Rotor	Fr & Rr	1985 - 2003	WORKHORSE	P32, P42,
E126-71-026	Brake Rotor	Fr	1995 - 2003	WORKHORSE	P32, P42,
E126-71-035	Brake Rotor	Fr	1995 - 2003	WORKHORSE	P32, P42,

PART NO	DESCRIPTION	POSITION	YEAR	MAKE	MODEL
E126-71-042	Brake Rotor	Fr	1985 - 2003	WORKHORSE	P32, P42,
E126-77-005	Brake Rotor	Fr	1987 - 1991	IVECO	EURO RANGE 230T, EURO TURBO RANGE 10-14, 12-11, 12-12, 12-14, 13-14, 15-14, 18-14, 18-16
E126-84-022	Brake Rotor	Fr	1984 - 1994	FORD	LT, LTL900 Short Conventional Tandem with Front Disc Brakes
E127-47-032	Brake Drum	Rr	2010 - 2012	NISSAN	CUBE
E127-49-049	Brake Drum	Rr	2004 - 2011	TOYOTA	SIENNA, TACOMA
E127-49-051	Brake Drum	Rr	2005 - 2011	TOYOTA	TACOMA
E127-66-054	Brake Drum	Rr	2001 - 2007	FORD	TAURUS
E127-67-028	Brake Drum	Rr	2005 - 2005	PONTIAC	MONTANA
E127-67-041	Brake Drum	Rr	2006 - 2008	CHEVROLET	HHR
E127-67-044	Brake Drum	Rr	2009 - 2011	CHEVROLET	HHR
E127-68-053	Brake Drum	Rr	2007 - 2012	DODGE, JEEP	CALIBER, COMPASS, PATRIOT
E127-70-042	Brake Drum	Rr	2003 - 2009	FORD, MAZDA	RANGER, B SERIES Pickup
E127-70-045	Brake Drum	Rr	2003 - 2009	FORD, MAZDA	RANGER, B SERIES Pickup
E127-70-049	Brake Drum	Rr	2007 - 2007	FORD, MERCURY	ESCAPE, MARINER
E127-70-051	Brake Drum	Rr	2008 - 2012	FORD, MAZDA, MERCURY	ESCAPE, TRIBUTE, MARINER
E127-70-052	Brake Drum	Rr	2010 - 2012	FORD	TRANSIT CONNECT
E127-71-005	Brake Drum	Rr	1985 - 2003	WORKHORSE	P32, P42,
E127-71-014	Brake Drum	Rr	1985 - 2003	WORKHORSE	P32, P42,
E127-71-034	Brake Drum	Rr	1985 - 2003	WORKHORSE	P32, P42,
E127-71-047	Brake Drum	Rr	2005 - 2007	SATURN	VUE
E127-71-048	Brake Drum	Rr	2004 - 2012	CHEVROLET, GMC	COLORADO, CANYON
E127-71-049	Brake Drum	Rr	2007 - 2008	CHEVROLET, GMC	SILVERADO 1500 ½ Ton, SIERRA 1500, SIERRA 1500 DENALI, C3 ½ Ton Pickup
E127-71-050	Brake Drum	Rr	2009 - 2012	CHEVROLET, GMC	SILVERADO 1500 ½ Ton, SIERRA 1500, SIERRA 1500 DENALI, C3 ½ Ton Pickup
E127-72-034	Brake Drum	Rr	2006 - 2007	CHRYSLER, DODGE	TOWN & COUNTRY VAN, CARAVAN, GRAND CARAVAN
E127-72-048	Brake Drum	Rr	2005 - 2008	DODGE	DAKOTA
E127-72-049	Brake Drum	Rr	2005 - 2011	DODGE	DAKOTA
E127-79-006	Brake Drum	Fr	2005 - 2012	MINI, MITSUBISHI FUSO	FG140 4X4
E127-79-007	Brake Drum	Rr	2005 - 2012	MINI, MITSUBISHI FUSO	FG140 4X4
E127-81-005	Brake Drum	Rr	1995 - 2012	CHEVROLET, GMC, ISUZU	W3500 Diesel Engine, NPR with Front Disc Brakes, Gas Engine, NPR with Front Disc Brakes, Diesel Engine
E127-81-006	Brake Drum	Rr	1994 - 2012	CHEVROLET, GMC, ISUZU	W3500 Gas Engine, W4500 Gas Engine, W4500 Diesel Engine, NPR with Front Disc Brakes, Gas Engine, NPR with Front Disc Brakes, Diesel Engine, REACH VAN (UTILIMASTER BODY)
E127-81-010	Brake Drum	Fr	2000 - 2004	CHEVROLET, GMC	WT5500
E127-81-011	Brake Drum	Rr	2000 - 2004	CHEVROLET, GMC	WT5500
E127-81-012	Brake Drum	Rr	1994 - 2012	CHEVROLET, GMC, ISUZU	W3500 Gas Engine, W4500 Gas Engine, W4500 Diesel Engine, W5500, NPR with Front Disc Brakes, Gas Engine, NPR with Front Disc Brakes, Diesel Engine, NQR
E127-81-013	Brake Drum	Rr	2004 - 2012	CHEVROLET, GMC, ISUZU	W5500HD, NRR
E129-70-906	Nut/Retainer	Fr	2004 - 2008	FORD, LINCOLN	F150 ½ Ton Truck
E129-70-907	Brake Hub	Fr	2004 - 2008	FORD, LINCOLN	F150 ½ Ton Truck
E129-70-908	Brake Hub	Fr	2004 - 2008	FORD, LINCOLN	F150 ½ Ton Truck

PART NO	DESCRIPTION	POSITION	YEAR	MAKE	MODEL
E130-40-111	Brake Rotor	Fr	2007 - 2012	DODGE, FREIGHTLINER, MERCEDES BENZ	SPRINTER 2500, 3500
E130-40-112	Brake Rotor	Rr	2007 - 2012	DODGE, FREIGHTLINER, MERCEDES BENZ	SPRINTER 2500, 3500
E130-40-113	Brake Rotor	Rr	2007 - 2012	DODGE, FREIGHTLINER, MERCEDES BENZ	SPRINTER 3500
E130-67-121	Brake Rotor	Fr	2009 - 2010	CHEVROLET	HHR
E135-40-507	Brake Master		2007 - 2012	DODGE, FREIGHTLINER, MERCEDES BENZ	SPRINTER 2500, 3500
E135-40-510	Brake Master		2010 - 2012	MERCEDES BENZ	SPRINTER 2500, 3500
E135-47-335	Brake Master		2005 - 2011	NISSAN	FRONTIER
E135-47-336	Brake Master		2005 - 2010	NISSAN	FRONTIER, PATHFINDER, XTERRA
E135-47-337	Brake Master		2005 - 2009	NISSAN	FRONTIER 4WD, PATHFINDER, XTERRA
E135-47-338	Brake Master		2005 - 2010	NISSAN	FRONTIER, XTERRA
E135-47-339	Brake Master		2005 - 2011	NISSAN	FRONTIER
E135-47-340	Brake Master		2008 - 2012	NISSAN	FRONTIER, XTERRA
E135-47-341	Brake Master		2007 - 2012	NISSAN	FRONTIER, PATHFINDER, XTERRA
E135-47-342	Brake Master		2008 - 2012	NISSAN	PATHFINDER
E135-47-816	Brake Master		2008 - 2012	NISSAN	ROGUE
E135-47-822	Brake Master		2010 - 2012	NISSAN	CUBE
E135-47-823	Brake Master		2010 - 2012	NISSAN	CUBE
E135-47-905	Brake Master		2004 - 2012	NISSAN	ARMADA, TITAN
E135-47-906	Brake Master		2004 - 2007	NISSAN	TITAN
E135-47-907	Brake Master		2004 - 2007	NISSAN	TITAN
E135-47-908	Brake Master		2007 - 2010	NISSAN	TITAN
E135-47-909	Brake Master		2007 - 2010	NISSAN	TITAN
E135-47-910	Brake Master		2007 - 2012	NISSAN	ARMADA, TITAN
E135-49-746	Brake Master		2003 - 2007	TOYOTA	SEQUOIA
E135-49-747	Brake Master		2005 - 2008	TOYOTA	TACOMA
E135-49-748	Brake Master		2005 - 2008	TOYOTA	TACOMA
E135-49-749	Brake Master		2007 - 2011	TOYOTA	SEQUOIA, TUNDRA
E135-49-750	Brake Master		2009 - 2011	TOYOTA	TACOMA
E135-49-751	Brake Master		2009 - 2011	TOYOTA	TACOMA
E135-49-825	Brake Master		2006 - 2007	TOYOTA	HIGHLANDER
E135-49-826	Brake Master		2006 - 2007	TOYOTA	HIGHLANDER
E135-49-828	Brake Master		2008 - 2011	TOYOTA	HIGHLANDER, SIENNA
E135-49-829	Brake Master		2008 - 2011	TOYOTA	HIGHLANDER
E135-49-830	Brake Master		2004 - 2010	TOYOTA	SIENNA
E135-50-124	Brake Master		2007 - 2011	MAZDA	CX-7
E135-50-125	Brake Master		2007 - 2011	MAZDA	CX-7
E135-50-126	Brake Master		2007 - 2011	MAZDA	CX-9
E135-63-012	Brake Master		2007 - 2007	JEEP	LIBERTY
E135-63-013	Brake Master		2006 - 2010	JEEP	COMMANDER, GRAND CHEROKEE
E135-63-014	Brake Master		2011 - 2012	DODGE, JEEP	DURANGO, GRAND CHEROKEE
E135-66-096	Brake Master		2001 - 2007	FORD	TAURUS
E135-66-122	Brake Master		2003 - 2011	FORD, LINCOLN, MERCURY	CROWN VICTORIA, TOWN CAR, GRAND MARQUIS
E135-66-123	Brake Master		2003 - 2011	FORD, LINCOLN, MERCURY	CROWN VICTORIA, TOWN CAR, GRAND MARQUIS



PART NO	DESCRIPTION	POSITION	YEAR	MAKE	MODEL
E135-66-124	Brake Master		2001 - 2007	FORD	TAURUS
E135-66-137	Brake Master		2007 - 2012	FORD, LINCOLN	EDGE, MKX
E135-66-138	Brake Master		2008 - 2009	FORD	TAURUS
E135-66-139	Brake Master		2008 - 2010	FORD	TAURUS, TAURUS X
E135-66-145	Brake Master		2010 - 2012	FORD, LINCOLN	TAURUS, TAURUS SHO, MKT
E135-67-087	Brake Master		2010 - 2012	CHEVROLET	EQUINOX
E135-67-116	Brake Master		2005 - 2005	PONTIAC	MONTANA
E135-67-135	Brake Master		2005 - 2007	SATURN	VUE
E135-67-149	Brake Master		2006 - 2008	CHEVROLET	HHR
E135-67-150	Brake Master		2006 - 2008	CHEVROLET	HHR
E135-67-152	Brake Master		2007 - 2008	CHEVROLET	IMPALA
E135-67-153	Brake Master		2007 - 2008	CHEVROLET	IMPALA
E135-67-155	Brake Master		2007 - 2010	CHEVROLET, PONTIAC, SATURN	EQUINOX, TORRENT, VUE
E135-67-156	Brake Master		2008 - 2011	CHEVROLET	HHR
E135-67-157	Brake Master		2008 - 2011	CHEVROLET	HHR
E135-67-175	Brake Master		2011 - 2011	CHEVROLET	CAPRICE
E135-67-178	Brake Master		2009 - 2012	CHEVROLET	IMPALA
E135-67-180	Brake Master		2010 - 2012	CHEVROLET, GMC	EQUINOX, TERRAIN
E135-68-073	Brake Master		2007 - 2012	DODGE, JEEP	CALIBER, COMPASS, PATRIOT
E135-68-074	Brake Master		2007 - 2009	DODGE	CALIBER
E135-68-075	Brake Master		2008 - 2012	JEEP	LIBERTY
E135-68-076	Brake Master		2008 - 2012	CHRYSLER, DODGE	TOWN & COUNTRY VAN, CARAVAN, GRAND CARAVAN
E135-68-079	Brake Master		2007 - 2012	JEEP	WRANGLER
E135-68-081	Brake Master		2008 - 2012	DODGE	CHARGER
E135-68-082	Brake Master		2008 - 2012	DODGE	CHARGER
E135-68-083	Brake Master		2007 - 2009	DODGE	CALIBER
E135-70-039	Brake Master		1988 - 1998	FORD	F53, 59 (1 Ton) RV Motor Home & Stripped Chassis
E135-70-047	Brake Master		1988 - 1998	FORD	E450, 47 (1 Ton) Super Duty Van & Cutaway, F53, 59 (1 Ton) RV Motor Home & Stripped Chassis
E135-70-056	Brake Master		1996 - 1998	FORD	E450, 47 (1 Ton) Super Duty Van & Cutaway
E135-70-057	Brake Master		1996 - 1998	FORD	E450, 47 (1 Ton) Super Duty Van & Cutaway
E135-70-063	Brake Master		1999 - 2011	FORD	F53, 59 (1 Ton) RV Motor Home & Stripped Chassis
E135-70-064	Brake Master		2002 - 2005	FORD	E550, F53, 59 (1 Ton) RV Motor Home & Stripped Chassis
E135-70-065	Brake Master		1996 - 1998	FORD	E450, 47 (1 Ton) Super Duty Van & Cutaway
E135-70-066	Brake Master		2003 - 2009	MAZDA	B SERIES Pickup
E135-70-067	Brake Master		1999 - 2001	FORD	E450, 47 (1 Ton) Super Duty Van & Cutaway
E135-70-068	Brake Master		1999 - 2001	FORD	E450, 47 (1 Ton) Super Duty Van & Cutaway
E135-70-079	Brake Master		1999 - 2001	FORD	E450, 47 (1 Ton) Super Duty Van & Cutaway
E135-70-081	Brake Master		2003 - 2009	MAZDA	B SERIES Pickup RWD
E135-70-086	Brake Master		2002 - 2007	FORD	E350 1 Ton Full Size Van, Wagon, Stripped & RV Chassis including Super Duty, E-SUPER DUTY Van & Cutaway, E450, 47 (1 Ton) Super Duty Van & Cutaway
E135-70-087	Brake Master		2002 - 2005	FORD	E550



PART NO	DESCRIPTION	POSITION	YEAR	MAKE	MODEL
E135-70-093	Brake Master		2006 - 2010	FORD, MERCURY	EXPLORER, SPORT, SPORT TRAC, MOUNTAINEER
E135-70-094	Brake Master		2004 - 2008	FORD, LINCOLN	F150 ½ Ton Truck
E135-70-099	Brake Master		2007 - 2007	FORD, MERCURY	ESCAPE, MARINER
E135-70-100	Brake Master		2007 - 2007	FORD	ESCAPE
E135-70-101	Brake Master		2007 - 2007	FORD, MERCURY	ESCAPE, MARINER
E135-70-102	Brake Master		2007 - 2007	FORD	ESCAPE
E135-70-103	Brake Master		2005 - 2006	FORD	F250, F250, F450, F47, F550 Super Duty
E135-70-104	Brake Master		2005 - 2006	FORD	F250, F250, F450, F47, F550 Super Duty
E135-70-105	Brake Master		2005 - 2006	FORD	F250, F250, F450, F47, F550 Super Duty
E135-70-106	Brake Master		2005 - 2006	FORD	F250, F250, F450, F47, F550 Super Duty
E135-70-107	Brake Master		2007 - 2007	FORD, MERCURY	ESCAPE, MARINER
E135-70-108	Brake Master		2006 - 2012	FORD, INTERNATIONAL	LCF Series, CF500, CF600, TERRA STAR
E135-70-111	Brake Master		2006 - 2006	FORD	E150 ½ Ton Full Size Van
E135-70-112	Brake Master		2006 - 2007	FORD	E150, E250, E350 Full Size Van
E135-70-114	Brake Master		2007 - 2009	FORD, LINCOLN	EXPEDITION, NAVIGATOR
E135-70-115	Brake Master		2007 - 2007	FORD	E350 1 Ton Full Size Van, Wagon, Stripped & RV Chassis including Super Duty
E135-70-116	Brake Master		2006 - 2010	FORD	F250, F250, F350, F450, F47, F550 Including Super Duty Truck
E135-70-117	Brake Master		2006 - 2010	FORD	F250, F250, F350, F450, F47, F550 Including Super Duty Truck
E135-70-120	Brake Master		2008 - 2008	FORD, MAZDA, MERCURY	ESCAPE, TRIBUTE, MARINER
E135-70-121	Brake Master		2008 - 2008	FORD, MAZDA, MERCURY	ESCAPE, TRIBUTE, MARINER
E135-70-122	Brake Master		2008 - 2008	FORD	E350 1 Ton Full Size Van, Wagon, Stripped & RV Chassis including Super Duty
E135-70-123	Brake Master		2008 - 2008	FORD	E150, E250, E350 Full Size Van
E135-70-124	Brake Master		2008 - 2011	FORD	E350 1 Ton Full Size Van, Wagon, Stripped & RV Chassis including Super Duty, E-SUPER DUTY Van & Cutaway, E450, 47 (1 Ton) Super Duty Van & Cutaway
E135-70-125	Brake Master		2006 - 2011	FORD	RANGER
E135-70-126	Brake Master		2008 - 2008	FORD, MAZDA, MERCURY	ESCAPE, TRIBUTE, MARINER
E135-70-127	Brake Master		2006 - 2010	FORD, MERCURY	EXPLORER, SPORT, SPORT TRAC, MOUNTAINEER
E135-70-128	Brake Master		2009 - 2012	FORD, MAZDA, MERCURY	ESCAPE, TRIBUTE, MARINER
E135-70-129	Brake Master		2009 - 2012	FORD, MAZDA, MERCURY	ESCAPE, TRIBUTE, MARINER
E135-70-130	Brake Master		2009 - 2009	FORD	F150 ½ Ton Truck
E135-70-131	Brake Master		2008 - 2012	FORD, MERCURY	ESCAPE, MARINER
E135-70-132	Brake Master		2006 - 2010	FORD	F250, F250, F350, F450, F47, F550 Including Super Duty Truck
E135-70-133	Brake Master		2006 - 2010	FORD	F250, F250, F350, F450, F47, F550 Including Super Duty Truck
E135-70-134	Brake Master		2009 - 2012	FORD	E150 ½ Ton Full Size Van, E250 ¾ Ton Full Size Van, E350 1 Ton Full Size Van, Wagon, Stripped & RV Chassis including Super Duty, E450, 47 (1 Ton) Super Duty Van & Cutaway
E135-70-135	Brake Master		2009 - 2012	FORD	E150, E250, E350 Full Size Van
E135-70-136	Brake Master		2009 - 2012	FORD	E150, E250, E350 Full Size Van
E135-70-137	Brake Master		2009 - 2012	FORD	E150 ½ Ton Full Size Van, E250 ¾ Ton Full Size Van, E350 1 Ton Full Size Van, Wagon, Stripped & RV Chassis including Super Duty, E450, 47 (1 Ton) Super Duty Van & Cutaway

PART NO	DESCRIPTION	POSITION	YEAR	MAKE	MODEL
E135-70-138	Brake Master		2008 - 2012	FORD	E350 1 Ton Full Size Van, Wagon, Stripped & RV Chassis including Super Duty, E-SUPER DUTY Van & Cutaway, E450, 47 (1 Ton) Super Duty Van & Cutaway
E135-70-139	Brake Master		2010 - 2012	FORD	TRANSIT CONNECT
E135-70-140	Brake Master		2010 - 2011	FORD, LINCOLN	EXPEDITION, F150 ½ Ton Truck, NAVIGATOR
E135-70-141	Brake Master		2010 - 2011	FORD	RANGER
E135-70-142	Brake Master		2010 - 2012	FORD	F250, F250, 350 Super Duty Truck
E135-70-143	Brake Master		2010 - 2012	FORD	F250, F250, F350, F450, F47 Including Super Duty Truck
E135-70-144	Brake Master		2010 - 2012	FORD	F250, F250, F350, F450, F47 Including Super Duty Truck
E135-70-145	Brake Master		2011 - 2012	FORD	EXPLORER, SPORT, SPORT TRAC
E135-70-146	Brake Master		2011 - 2012	FORD, LINCOLN	EXPEDITION, NAVIGATOR
E135-71-017	Brake Master		1985 - 2003	WORKHORSE	P32, P42,
E135-71-019	Brake Master		1985 - 1994	WORKHORSE	P32, P42,
E135-71-032	Brake Master		2004 - 2005	WORKHORSE	P500 (Fedex Delivery Truck), W42 - 14,001, 16,000 GVWR
E135-71-046	Brake Master		2002 - 2002	CHEVROLET	TAHOE RWD
E135-71-047	Brake Master		2003 - 2007	HUMMER	H2
E135-71-050	Brake Master		2004 - 2008	CHEVROLET, GMC	EXPRESS 2500, 3500 Van, SILVERADO 1500, 3500, SAVANA 2500, 3500 Van, SIERRA 1500, 3500, SIERRA DENALI, C3 Pickup, Cab & Chassis
E135-71-051	Brake Master		2003 - 2007	CHEVROLET, GMC	EXPRESS 1500 ½ Ton Van, SUBURBAN 1500 ½ Ton, TAHOE, SAVANA 1500 ½ Ton Van
E135-71-052	Brake Master		2003 - 2005	CHEVROLET	SUBURBAN 1500 ½ Ton RWD, TAHOE RWD
E135-71-053	Brake Master		2007 - 2007	CHEVROLET, GMC	SILVERADO 1500 ½ Ton, SIERRA 1500, SIERRA 1500 DENALI, C3 ½ Ton Pickup
E135-71-054	Brake Master		2003 - 2006	CHEVROLET	AVALANCHE 1500, SUBURBAN 1500 ½ Ton, SUBURBAN, TAHOE
E135-71-056	Brake Master		2006 - 2008	CHEVROLET, GMC	EXPRESS 3500 1 Ton Van, SAVANA 3500 1 Ton Van
E135-71-057	Brake Master		2004 - 2008	CHEVROLET, GMC	COLORADO, CANYON
E135-71-058	Brake Master		2007 - 2007	CHEVROLET, GMC	SILVERADO 1500 ½ Ton, SIERRA 1500, SIERRA 1500 DENALI, C3 ½ Ton Pickup
E135-71-059	Brake Master		2005 - 2009	CHEVROLET, PONTIAC, SATURN	UPLANDER, MONTANA, RELAY
E135-71-060	Brake Master		2007 - 2009	CHEVROLET, GMC	TRAILBLAZER, ENVOY
E135-71-061	Brake Master		2007 - 2008	CHEVROLET, GMC	AVALANCHE 1500, SILVERADO 1500 ½ Ton, SUBURBAN 1500 ½ Ton, TAHOE, SIERRA 1500, SIERRA 1500 DENALI, C3 ½ Ton Pickup, YUKON, YUKON DENALI, YUKON XL 1500, YUKON DENALI XL ½ Ton
E135-71-062	Brake Master		2006 - 2008	CHEVROLET, GMC	EXPRESS 2500, 3500 Van, SILVERADO 2500, 3500, SUBURBAN 2500 ¾ Ton, SAVANA 2500, 3500 Van, SIERRA 2500, 3500 Pickup, Cab & Chassis, YUKON XL 2500 ¾ Ton
E135-71-063	Brake Master		2007 - 2008	CHEVROLET, GMC	SILVERADO 2500, 3500, SIERRA 2500, 3500 Pickup, Cab & Chassis
E135-71-064	Brake Master		2007 - 2012	CHEVROLET, GMC, SATURN	TRAVERSE, ACADIA, OUTLOOK
E135-71-065	Brake Master		2007 - 2008	CHEVROLET, GMC	SILVERADO 1500 ½ Ton, SIERRA 1500, SIERRA 1500 DENALI, C3 ½ Ton Pickup
E135-71-066	Brake Master		2008 - 2008	CHEVROLET, GMC	EXPRESS 1500 ½ Ton Van, SAVANA 1500 ½ Ton Van

PART NO	DESCRIPTION	POSITION	YEAR	MAKE	MODEL
E135-71-067	Brake Master		2006 - 2008	CHEVROLET, GMC	EXPRESS 2500, 3500 Van, SUBURBAN 2500 ¾ Ton, SAVANA 2500, 3500 Van, YUKON XL 2500 ¾ Ton
E135-71-068	Brake Master		2008 - 2008	CHEVROLET, GMC	EXPRESS 1500 ½ Ton Van, SAVANA 1500 ½ Ton Van
E135-71-069	Brake Master		2001 - 2011	CHEVROLET, GMC, WORKHORSE	C4500 Kodiak, C5500 Kodiak, C4500 Topkick, P32, P42, P500 (Fedex Delivery Truck), W16, W18 - 16,000, 18,000 GVWR, W42 - 14,001, 16,000 GVWR
E135-71-070	Brake Master		2008 - 2012	CHEVROLET, GMC	SILVERADO 1500 ½ Ton, TAHOE, SIERRA 1500, SIERRA 1500 DENALI, C3 ½ Ton Pickup, YUKON, YUKON DENALI
E135-71-071	Brake Master		2009 - 2012	CHEVROLET, GMC	AVALANCHE 1500, SILVERADO 1500 ½ Ton, SUBURBAN 1500 ½ Ton, TAHOE, SIERRA 1500, SIERRA 1500 DENALI, C3 ½ Ton Pickup, YUKON, YUKON DENALI, YUKON XL 1500, YUKON DENALI XL ½ Ton
E135-71-072	Brake Master		2009 - 2012	CHEVROLET, GMC	COLORADO, CANYON
E135-71-073	Brake Master		2009 - 2012	CHEVROLET, GMC	EXPRESS 2500, 3500 Van, SILVERADO 2500, 3500, SUBURBAN 2500 ¾ Ton, SAVANA 2500, 3500 Van, SIERRA 2500, 3500 Pickup, Cab & Chassis, YUKON XL 2500 ¾ Ton, G4500 Commercial Cutaway Chassis
E135-71-074	Brake Master		2009 - 2012	CHEVROLET, GMC	SILVERADO 2500, 3500, SIERRA 2500, 3500 Pickup, Cab & Chassis
E135-71-075	Brake Master		2009 - 2012	CHEVROLET, GMC	EXPRESS 2500, 3500 Van, SILVERADO 2500, 3500, SUBURBAN 2500 ¾ Ton, SAVANA 2500, 3500 Van, SIERRA 2500, 3500 Pickup, Cab & Chassis, YUKON XL 2500 ¾ Ton, G4500 Commercial Cutaway Chassis
E135-71-076	Brake Master		2009 - 2010	CHEVROLET, GMC	EXPRESS 1500 ½ Ton Van, SAVANA 1500 ½ Ton Van
E135-71-077	Brake Master		2009 - 2012	CHEVROLET, GMC	EXPRESS 1500 ½ Ton Van, SAVANA 1500 ½ Ton Van
E135-71-078	Brake Master		2009 - 2012	CHEVROLET, GMC	SILVERADO 1500 ½ Ton, SIERRA 1500, SIERRA 1500 DENALI, C3 ½ Ton Pickup
E135-71-080	Brake Master		2007 - 2007	CHEVROLET, GMC	SILVERADO 1500 ½ Ton, SIERRA 1500, SIERRA 1500 DENALI, C3 ½ Ton Pickup
E135-72-021	Brake Master		2006 - 2007	CHRYSLER, DODGE	TOWN & COUNTRY VAN, CARAVAN, GRAND CARAVAN
E135-72-033	Brake Master		2006 - 2011	DODGE	RAM 1500, 2500, 3500 Pickup, Cab & Chassis
E135-72-036	Brake Master		2006 - 2007	CHRYSLER, DODGE	TOWN & COUNTRY VAN, CARAVAN, GRAND CARAVAN
E135-72-040	Brake Master		2006 - 2007	CHRYSLER, DODGE	TOWN & COUNTRY VAN, CARAVAN, GRAND CARAVAN
E135-72-041	Brake Master		2005 - 2011	DODGE	DAKOTA
E135-72-042	Brake Master		2005 - 2011	DODGE	DAKOTA
E135-72-046	Brake Master		2007 - 2009	DODGE	DURANGO
E135-72-047	Brake Master		2006 - 2011	DODGE	RAM 2500, 3500 Pickup
E135-72-048	Brake Master		2007 - 2012	DODGE	RAM 1500 ½ Ton Pickup
E135-72-050	Brake Master		2008 - 2012	DODGE, STERLING	RAM 4500, 5500, RAM 4500, 5500, BULLET
E135-72-052	Brake Master		2009 - 2009	DODGE	DURANGO
E135-79-005	Brake Master		1987 - 1995	MINITUBISHI FUSO	FE Series
E135-79-006	Brake Master		1996 - 2005	MINITUBISHI FUSO	FE Series
E135-79-007	Brake Master		1996 - 2005	MINITUBISHI FUSO	FE Series
E135-79-008	Brake Master		2005 - 2012	MINITUBISHI FUSO, STERLING	FE Series, FG140 4X4, 360 Series

PART NO	DESCRIPTION	POSITION	YEAR	MAKE	MODEL
E135-79-009	Brake Master		2006 - 2012	mitsubishi FUSO, STERLING	FE Series, 360 Series
E135-81-008	Brake Master		1987 - 1994	ISUZU	NPR with Front Disc Brakes, Diesel Engine
E135-81-009	Brake Master		1987 - 1994	ISUZU	NPR with Front Disc Brakes, Diesel Engine
E135-81-013	Brake Master		1995 - 1997	CHEVROLET, GMC, ISUZU	W3500 Gas Engine, NPR with Front Disc Brakes, Diesel Engine
E135-81-015	Brake Master		1994 - 2012	CHEVROLET, GMC, ISUZU	W3500 Gas Engine, W3500 Diesel Engine, W4500 Gas Engine, W4500 Diesel Engine, NPR with Front Disc Brakes, Gas Engine, NPR with Front Disc Brakes, Diesel Engine, REACH VAN (UTILIMASTER BODY)
E135-81-017	Brake Master		1997 - 2012	CHEVROLET, GMC, ISUZU	W3500 Gas Engine, W4500 Gas Engine, W4500 Diesel Engine, W5500, W5500HD, NPR with Front Disc Brakes, Gas Engine, NPR with Front Disc Brakes, Diesel Engine, NQR, NRR
E135-82-006	Brake Master		1994 - 2000	UD	UD 1200, UD 1400
E135-82-007	Brake Master		1999 - 2010	UD	UD 1200, UD 1400
E135-82-008	Brake Master		1989 - 1991	UD	UD 1100
E135-84-022	Brake Master		1992 - 1995	FORD	B600 Bus with Front Disc Brakes, B700 Bus with Front Disc Brakes
E135-84-025	Brake Master		1983 - 1983	FORD	F800 Conventional with Front Disc Brakes
E135-84-026	Brake Master		1984 - 1999	FORD	C700 Tilt Cab with Front Disc Brakes, C800 Tilt Cab with Front Disc Brakes, F800 Conventional with Front Disc Brakes, LT, LTL900 Short Conventional Tandem with Front Disc Brakes
E135-84-027	Brake Master		1984 - 1999	FORD	B600 Bus with Front Disc Brakes, B700 Bus with Front Disc Brakes, C600 Tilt Cab with Front Disc Brakes, C700 Tilt Cab with Front Disc Brakes, C800 Tilt Cab with Front Disc Brakes, F600 Conventional with Front Disc Brakes, F700 Conventional with Front Disc Brakes, F800 Conventional with Front Disc Brakes, L800 Conventional with Front Disc Brakes, L900 Conventional with Front Disc Brakes, LN600 Short Conventional with Front Disc Brakes, LN700 Short Conventional with Front Disc Brakes, LN800, 900 Short Conventional with Front Disc Brakes
E135-84-030	Brake Master		1984 - 1999	FORD	B600 Bus with Front Disc Brakes, B700 Bus with Front Disc Brakes, C600 Tilt Cab with Front Disc Brakes, C700 Tilt Cab with Front Disc Brakes, C800 Tilt Cab with Front Disc Brakes, F600 Conventional with Front Disc Brakes, F700 Conventional with Front Disc Brakes, F800 Conventional with Front Disc Brakes, L800 Conventional with Front Disc Brakes, L900 Conventional with Front Disc Brakes, LN600 Short Conventional with Front Disc Brakes, LN700 Short Conventional with Front Disc Brakes, LN800, 900 Short Conventional with Front Disc Brakes
E135-84-036	Brake Master		1998 - 2012	FORD, FREIGHTLINER	F53, 59 (1 Ton) RV Motor Home & Stripped Chassis, FL50, FL60, FL70 with Disc Brakes, FS65, FW700 with Hydraulic Disc Brakes, MT10, MT35, MT45, MT55, MT-E with Hydraulic Disc Brakes
E135-87-009	Brake Master		1996 - 2003	ISUZU	FSR with Front Disc Brakes

PART NO	DESCRIPTION	POSITION	YEAR	MAKE	MODEL
E135-87-012	Brake Master		2001 - 2012	CHEVROLET, GMC, ISUZU, WORKHORSE	C4500 Kodiak, C5500 Kodiak, C6500 Kodiak with Disc Brakes, C7500 Kodiak with Disc Brakes, T5500, T6500 with Disc Brakes, T7500, T8500 Tilt Cab with Disc Brakes, C4500 Topkick, C6500 Topkick with Front Disc Brakes, C7500 Topkick with Front Disc Brakes, T5500, T6500, T7500, T8500 Tilt Cab with Disc Brakes, FTR with Front Disc Brakes, FVR, FXR with Front Disc Brakes, H Series HTR, HVR, W24, W25.5 - 24,000, 25,500 GVWR, W62, UFO - 17,000, 19,500, 23,000, 23,500 GVWR
E135-87-013	Brake Master		1990 - 2012	BLUEBIRD BUS, FORD, FREIGHTLINER, HINO, IC BUS, INTERNATIONAL, KENWORTH, PETERBILT, WORKHORSE	VISION, TC2000 with Hydraulic Disc Brakes, F53, 59 (1 Ton) RV Motor Home & Stripped Chassis, F650 Conventional with Disc Brakes, F750 Conventional with Disc Brakes, FS65, FW700 with Hydraulic Disc Brakes, M2 100/106 with Hydraulic Disc Brakes, MT10, MT35, MT45, MT55, MT-E with Hydraulic Disc Brakes, 145 14,050 GVW, 165 16,000 GVW, 185 18,500 LBS GVW, 238 23,000, 25,500 LBS GVW, 258LP 23,000, 25,000 LBS GVW (Low Profile), 268 25,950GVW LBS with Hydraulic Disc Brakes, BE, CE, HC, LC with Hydraulic Disc Brakes, M1400, 1452 with Disc Brakes, M1600, 1652 Metro, S1624, S1652FC, S1652SC UPS, S1654, 3000, 3200, 3600, 3700, 3800, 3900FC School Bus with Hydraulic Disc Brakes, 4100, 4200, 4300, 4400, 4600, 4700, 4800, 4900, 7100 Conventional Cab with Hydraulic Disc Brakes, T170, T270, T370 w/ Hydraulic Disc Brakes, 325, 330, 335 w/ Hydraulic Disc Brakes, LF72 Bus 19,000 GVWR, W20, W20D, W21, W22 - 20,70, 22,000 GVWR
E135-88-021	Brake Master		1990 - 2006	INTERNATIONAL	M1400, 1452 with Disc Brakes, M1600, 1652 Metro, S1624, S1652FC, S1652SC UPS, S1654
E135-88-022	Brake Master		1990 - 2012	BLUEBIRD BUS, INTERNATIONAL	VISION, TC2000 with Hydraulic Disc Brakes, 3000, 3200, 3600, 3700, 3800, 3900FC School Bus with Hydraulic Disc Brakes
E135-88-027	Brake Master		2006 - 2012	FORD, IC BUS, INTERNATIONAL	F650 Conventional with Disc Brakes, F750 Conventional with Disc Brakes, BE, CE, HC, LC with Hydraulic Disc Brakes, MXT, RXT, 3000, 3200, 3600, 3700, 3800, 3900FC School Bus with Hydraulic Disc Brakes, 4100, 4200, 4300, 4400, 4600, 4700, 4800, 4900, 7100 Conventional Cab with Hydraulic Disc Brakes
E135-89-006	Brake Master		1999 - 2004	FREIGHTLINER	FL50, FL60, FL70 with Disc Brakes
E135-89-007	Brake Master		1999 - 2004	FREIGHTLINER	FL50, FL60, FL70 with Disc Brakes
E139-47-009	Wheel Cylinder	Rr	2010 - 2012	NISSAN	CUBE
E139-49-711	Wheel Cylinder	Rr	2005 - 2011	TOYOTA	TACOMA
E139-49-807	Wheel Cylinder	Rr	2004 - 2011	TOYOTA	SIENNA, TACOMA
E139-55-007	Wheel Cylinder	Rr	2006 - 2007	CHRYSLER, DODGE	TOWN & COUNTRY VAN, CARAVAN, GRAND CARAVAN
E139-56-019	Wheel Cylinder	Rr L	2009 - 2011	CHEVROLET	HHR
E139-56-020	Wheel Cylinder	Rr R	2009 - 2011	CHEVROLET	HHR
E139-66-008	Wheel Cylinder	Rr	2003 - 2009	FORD, MAZDA	RANGER, B SERIES Pickup
E139-66-046	Wheel Cylinder	Rr	2001 - 2007	FORD	TAURUS
E139-67-072	Wheel Cylinder	Rr	2005 - 2007	SATURN	VUE
E139-67-073	Wheel Cylinder	Rr	2006 - 2008	CHEVROLET	HHR



PART NO	DESCRIPTION	POSITION	YEAR	MAKE	MODEL
E139-68-040	Wheel Cylinder	Rr	2007 - 2012	DODGE, JEEP	CALIBER, COMPASS, PATRIOT
E139-70-023	Wheel Cylinder	Rr	2003 - 2009	FORD, MAZDA	RANGER, B SERIES Pickup
E139-70-029	Wheel Cylinder	Rr	2007 - 2007	FORD, MERCURY	ESCAPE, MARINER
E139-70-034	Wheel Cylinder	Rr	2008 - 2012	FORD, MAZDA, MERCURY	ESCAPE, TRIBUTE, MARINER
E139-70-035	Wheel Cylinder	Rr	2010 - 2012	FORD	TRANSIT CONNECT
E139-71-016	Wheel Cylinder	Rr L	1979 - 1987	CHEVROLET, GMC	B6P042 School Bus with Front Disc Brakes, P6T042 with Front Disc Brakes
E139-71-017	Wheel Cylinder	Rr R	1979 - 1987	CHEVROLET, GMC	B6P042 School Bus with Front Disc Brakes, P6T042 with Front Disc Brakes
E139-71-018	Wheel Cylinder	Rr	1985 - 2003	WORKHORSE	P32, P42,
E139-71-019	Wheel Cylinder	Rr	1985 - 2003	WORKHORSE	P32, P42,
E139-71-027	Wheel Cylinder	Rr	2005 - 2005	PONTIAC	MONTANA
E139-71-032	Wheel Cylinder	Rr	2004 - 2008	CHEVROLET, GMC	COLORADO, SILVERADO 1500 ½ Ton, CANYON, SIERRA 1500, SIERRA 1500 DENALI, C3 ½ Ton Pickup
E139-71-034	Wheel Cylinder	Rr	2007 - 2008	CHEVROLET, GMC	SILVERADO 1500 ½ Ton, SIERRA 1500, SIERRA 1500 DENALI, C3 ½ Ton Pickup
E139-71-035	Wheel Cylinder	Rr	2009 - 2012	CHEVROLET, GMC	COLORADO, SILVERADO 1500 ½ Ton, CANYON, SIERRA 1500, SIERRA 1500 DENALI, C3 ½ Ton Pickup
E139-71-036	Wheel Cylinder	Rr	2009 - 2012	CHEVROLET, GMC	SILVERADO 1500 ½ Ton, SIERRA 1500, SIERRA 1500 DENALI, C3 ½ Ton Pickup
E139-72-019	Wheel Cylinder	Rr	2005 - 2011	DODGE	DAKOTA
E139-79-010	Wheel Cylinder	Fr & Rr	2005 - 2012	mitsubishi FUSO	FG140 4X4
E139-79-011	Wheel Cylinder	Rr L	2005 - 2012	mitsubishi FUSO	FG140 4X4
E139-79-012	Wheel Cylinder	Fr & Rr	2005 - 2012	mitsubishi FUSO	FG140 4X4
E139-79-013	Wheel Cylinder	Rr R	2005 - 2012	mitsubishi FUSO	FG140 4X4
E139-79-014	Wheel Cylinder	Fr & Rr	1988 - 1995	mitsubishi FUSO	FH Series
E139-79-015	Wheel Cylinder	Rr L & R	1988 - 1995	mitsubishi FUSO	FH Series
E139-79-016	Wheel Cylinder	Fr & Rr	1988 - 1995	mitsubishi FUSO	FH Series
E139-79-017	Wheel Cylinder	Rr R	1988 - 1995	mitsubishi FUSO	FH Series
E139-79-018	Wheel Cylinder	Fr R	2005 - 2012	mitsubishi FUSO	FG140 4X4
E139-79-019	Wheel Cylinder	Fr L	2005 - 2012	mitsubishi FUSO	FG140 4X4
E139-81-023	Wheel Cylinder	Fr & Rr	1999 - 2003	ISUZU	NPR with Front Disc Brakes, Diesel Engine
E139-81-024	Wheel Cylinder	Fr & Rr	1999 - 2003	ISUZU	NPR with Front Disc Brakes, Diesel Engine
E139-81-025	Wheel Cylinder	Rr R	1999 - 2003	ISUZU	NPR with Front Disc Brakes, Diesel Engine
E139-81-035	Wheel Cylinder	Fr & Rr	1999 - 2002	ISUZU	NPR with Front Disc Brakes, Diesel Engine
E139-81-036	Wheel Cylinder	Rr R	1999 - 2002	ISUZU	NPR with Front Disc Brakes, Diesel Engine
E139-81-037	Wheel Cylinder	Fr & Rr	1999 - 2002	ISUZU	NPR with Front Disc Brakes, Diesel Engine
E139-81-043	Wheel Cylinder	Rr L	1999 - 2003	ISUZU	NPR with Front Disc Brakes, Diesel Engine
E139-81-044	Wheel Cylinder	Rr L	1999 - 2002	ISUZU	NPR with Front Disc Brakes, Diesel Engine
E139-81-045	Wheel Cylinder	Fr & Rr	2002 - 2012	CHEVROLET, GMC, ISUZU	W3500 Gas Engine, W4500 Diesel Engine, NPR with Front Disc Brakes, Gas Engine, NPR with Front Disc Brakes, Diesel Engine, REACH VAN (UTILIMASTER BODY)
E139-81-046	Wheel Cylinder	Fr & Rr	2004 - 2012	CHEVROLET, GMC, ISUZU	W5500HD, NRR
E139-81-047	Wheel Cylinder	Fr & Rr	2002 - 2012	CHEVROLET, GMC, ISUZU	W5500, NQR, W4500 Gas Engine, NPR with Front Disc Brakes, Gas Engine, NPR with Front Disc Brakes, Diesel Engine
E139-81-048	Wheel Cylinder	Fr & Rr	2004 - 2012	CHEVROLET, GMC, ISUZU	W5500HD, NRR

PART NO	DESCRIPTION	POSITION	YEAR	MAKE	MODEL
E139-81-049	Wheel Cylinder	Rr R	2002 - 2012	CHEVROLET, GMC, ISUZU	W4500 Gas Engine, W5500, NPR with Front Disc Brakes, Gas Engine, NPR with Front Disc Brakes, Diesel Engine, NQR
E139-81-050	Wheel Cylinder	Rr R	2004 - 2012	CHEVROLET, GMC, ISUZU	W5500HD, NRR
E139-81-051	Wheel Cylinder	Fr & Rr	2002 - 2012	CHEVROLET, GMC, ISUZU	W4500 Gas Engine, NPR with Front Disc Brakes, Gas Engine, NPR with Front Disc Brakes, Diesel Engine, W5500, NQR
E139-81-052	Wheel Cylinder	Rr R	2002 - 2012	CHEVROLET, GMC, ISUZU	W4500 Diesel Engine, W3500 Gas Engine, NPR with Front Disc Brakes, Gas Engine, NPR with Front Disc Brakes, Diesel Engine, REACH VAN (UTILIMASTER BODY)
E139-81-053	Wheel Cylinder	Fr & Rr	2002 - 2012	CHEVROLET, GMC, ISUZU	W3500 Gas Engine, W4500 Diesel Engine, NPR with Front Disc Brakes, Gas Engine, NPR with Front Disc Brakes, Diesel Engine, REACH VAN (UTILIMASTER BODY)
E139-81-054	Wheel Cylinder	Rr L	2002 - 2012	CHEVROLET, GMC, ISUZU	W3500 Gas Engine, W4500 Diesel Engine, NPR with Front Disc Brakes, Gas Engine, NPR with Front Disc Brakes, Diesel Engine, REACH VAN (UTILIMASTER BODY)
E139-81-056	Wheel Cylinder	Fr & Rr	2002 - 2012	CHEVROLET, GMC, ISUZU	W4500 Gas Engine, W5500, NPR with Front Disc Brakes, Gas Engine, NPR with Front Disc Brakes, Diesel Engine, NQR
E139-81-057	Wheel Cylinder	Fr L	2000 - 2004	CHEVROLET, GMC	WT5500
E139-81-058	Wheel Cylinder	Fr R	2000 - 2004	CHEVROLET, GMC	WT5500
E139-81-063	Wheel Cylinder	Fr & Rr	2000 - 2004	CHEVROLET, GMC	WT5500
E139-81-064	Wheel Cylinder	Rr L	2000 - 2004	CHEVROLET, GMC	WT5500
E139-81-065	Wheel Cylinder	Fr & Rr	2000 - 2004	CHEVROLET, GMC	WT5500
E139-81-066	Wheel Cylinder	Rr R	2000 - 2004	CHEVROLET, GMC	WT5500
E139-81-067	Wheel Cylinder	Rr L	2003 - 2012	CHEVROLET, GMC, ISUZU	W3500 Diesel Engine, NPR with Front Disc Brakes, Gas Engine, NPR with Front Disc Brakes, Diesel Engine
E139-81-068	Wheel Cylinder	Rr R	2003 - 2012	CHEVROLET, GMC, ISUZU	W3500 Diesel Engine, NPR with Front Disc Brakes, Gas Engine, NPR with Front Disc Brakes, Diesel Engine
E139-81-069	Wheel Cylinder	Fr & Rr	2003 - 2012	CHEVROLET, GMC, ISUZU	W3500 Diesel Engine, NPR with Front Disc Brakes, Gas Engine, NPR with Front Disc Brakes, Diesel Engine
E139-81-070	Wheel Cylinder	Fr & Rr	2003 - 2012	CHEVROLET, GMC, ISUZU	W3500 Diesel Engine, NPR with Front Disc Brakes, Gas Engine, NPR with Front Disc Brakes, Diesel Engine
E139-81-071	Wheel Cylinder	Rr L	2004 - 2012	CHEVROLET, GMC, ISUZU	W5500HD, NRR
E139-81-113	Wheel Cylinder	Rr	1986 - 1994	CHEVROLET, GMC, ISUZU	W6 M, EVR
E139-81-114	Wheel Cylinder	Fr L	1986 - 1994	CHEVROLET, GMC, ISUZU	W6 M, EVR
E139-81-115	Wheel Cylinder	Fr R	1986 - 1994	CHEVROLET, GMC, ISUZU	W6 M, EVR
E139-81-154	Wheel Cylinder	Rr	1994 - 1996	CHEVROLET, GMC, ISUZU	W6 M, EVR
E139-81-155	Wheel Cylinder	Fr L	1994 - 1996	CHEVROLET, GMC, ISUZU	W6 M, EVR
E139-81-156	Wheel Cylinder	Fr R	1994 - 1996	CHEVROLET, GMC, ISUZU	W6 M, EVR
E139-82-006	Wheel Cylinder	Fr & Rr	2001 - 2010	UD	UD 1200, UD 1300, UD 1400
E139-82-007	Wheel Cylinder	Fr & Rr	2001 - 2010	UD	UD 1200, UD 1300, UD 1400
E139-82-008	Wheel Cylinder	Rr R	2001 - 2010	UD	UD 1200, UD 1300, UD 1400
E139-82-009	Wheel Cylinder	Rr L	2001 - 2010	UD	UD 1200, UD 1300, UD 1400
E139-84-022	Wheel Cylinder	Rr L	1984 - 1994	FORD	LT, LTL900 Short Conventional Tandem with Front Disc Brakes



PART NO	DESCRIPTION	POSITION	YEAR	MAKE	MODEL
E139-84-023	Wheel Cylinder	Rr R	1984 - 1994	FORD	LT, LTL900 Short Conventional Tandem with Front Disc Brakes
E139-84-026	Wheel Cylinder	Rr L	1984 - 1994	FORD	LT, LTL900 Short Conventional Tandem with Front Disc Brakes
E139-84-027	Wheel Cylinder	Rr R	1984 - 1994	FORD	LT, LTL900 Short Conventional Tandem with Front Disc Brakes
E141-70-023	Clutch Master Cyl		2000 - 2007	FORD	F650 Conventional with Disc Brakes, F750 Conventional with Disc Brakes
E141-77-005	Clutch Master Cyl		1980 - 1991	IVECO	EURO RANGE 110, 120T, EURO RANGE 230T, EURO TURBO RANGE 10-14, 12-11, 12-12, 12-14, 13-14, 15-14, 18-14, 18-16, EURO TURBO RANGE 23-16, Z100, 110, 120TA, 220, 220T, Z230T, Z340T
E141-80-007	Clutch Master Cyl		2005 - 2012	HINO	145 14,050 GVW, 165 16,000 GVW, 185 18,500 LBS GVW, 238 23,000, 25,500 LBS GVW, 258LP 23,000, 25,000 LBS GVW (Low Profile), 268 25,950GVW LBS with Hydraulic Disc Brakes
E141-81-007	Clutch Master Cyl		1987 - 1996	CHEVROLET, GMC, ISUZU	W6 M, W7 H, EVR, NRR
E141-81-008	Clutch Master Cyl		1987 - 1994	ISUZU	NPR with Front Disc Brakes, Gas Engine
E141-81-009	Clutch Master Cyl		1994 - 2012	CHEVROLET, GMC, ISUZU	W3500 Diesel Engine, W4500 Diesel Engine, W5500, W5500HD, NPR with Front Disc Brakes, Diesel Engine, NQR, NRR
E141-81-010	Clutch Master Cyl		2000 - 2004	CHEVROLET, GMC	WT5500
E141-84-506	Clutch Master Cyl		2004 - 2007	FORD	F650 Conventional with Disc Brakes, F750 Conventional with Disc Brakes
E141-85-006	Clutch Master Cyl		1996 - 2003	ISUZU	FSR with Front Disc Brakes
E141-85-009	Clutch Master Cyl		2005 - 2009	ISUZU	FVR, FXR with Front Disc Brakes
E143-70-017	Clutch Slave Cyl		2000 - 2007	FORD	F650 Conventional with Disc Brakes, F750 Conventional with Disc Brakes
E143-77-005	Clutch Slave Cyl		1980 - 1991	IVECO	EURO RANGE 110, 120T, EURO RANGE 230T, EURO TURBO RANGE 10-14, 12-11, 12-12, 12-14, 13-14, 15-14, 18-14, 18-16, Z100, 110, 120TA, 220, 220T, Z230T
E143-80-006	Clutch Slave Cyl		2005 - 2010	HINO	145 14,050 GVW, 165 16,000 GVW, 185 18,500 LBS GVW
E143-80-008	Clutch Slave Cyl		2005 - 2012	HINO	238 23,000, 25,500 LBS GVW, 258LP 23,000, 25,000 LBS GVW (Low Profile), 268 25,950GVW LBS with Hydraulic Disc Brakes
E143-81-006	Clutch Slave Cyl		1987 - 1997	CHEVROLET, ISUZU	W4500 Diesel Engine, NPR with Front Disc Brakes, Gas Engine, NPR with Front Disc Brakes, Diesel Engine
E143-81-007	Clutch Slave Cyl		1987 - 2004	CHEVROLET, GMC, ISUZU	WT5500, W6 M, W7 H, EVR
E143-81-008	Clutch Slave Cyl		1987 - 1990	GMC	W7 H
E143-81-010	Clutch Slave Cyl		1998 - 2009	CHEVROLET, GMC, ISUZU	W3500 Diesel Engine, W4500 Diesel Engine, W5500, W5500HD, NPR with Front Disc Brakes, Diesel Engine, NQR, NRR
E143-81-011	Clutch Slave Cyl		1998 - 2009	CHEVROLET, GMC, ISUZU	W3500 Diesel Engine, W4500 Diesel Engine, W5500, NPR with Front Disc Brakes, Diesel Engine, NQR
E143-81-012	Clutch Slave Cyl		2008 - 2012	CHEVROLET, GMC, ISUZU	W5500HD, NPR with Front Disc Brakes, Diesel Engine, NQR, NRR
E143-85-006	Clutch Slave Cyl		1996 - 2003	ISUZU	FSR with Front Disc Brakes
E143-85-010	Clutch Slave Cyl		2005 - 2009	ISUZU	FVR, FXR with Front Disc Brakes
E146-40-166	Brake Caliper	Fr R	2007 - 2012	DODGE, FREIGHTLINER, MERCEDES BENZ	SPRINTER 2500

PART NO	DESCRIPTION	POSITION	YEAR	MAKE	MODEL
E146-40-167	Brake Caliper	Fr L	2007 - 2012	DODGE, FREIGHTLINER, MERCEDES BENZ	SPRINTER 2500
E146-40-602	Brake Caliper	Rr R	2007 - 2012	DODGE, FREIGHTLINER, MERCEDES BENZ	SPRINTER 2500, 3500
E146-40-603	Brake Caliper	Rr L	2007 - 2012	DODGE, FREIGHTLINER, MERCEDES BENZ	SPRINTER 2500, 3500
E146-40-604	Brake Caliper	Rr R	2007 - 2012	DODGE, FREIGHTLINER, MERCEDES BENZ	SPRINTER 3500
E146-40-605	Brake Caliper	Rr L	2007 - 2012	DODGE, FREIGHTLINER, MERCEDES BENZ	SPRINTER 3500
E146-47-136	Brake Caliper	Fr R	2004 - 2007	NISSAN	TITAN
E146-47-137	Brake Caliper	Fr L	2004 - 2007	NISSAN	TITAN
E146-47-140	Brake Caliper	Fr R	2005 - 2012	NISSAN	FRONTIER, PATHFINDER, XTERRA
E146-47-141	Brake Caliper	Fr L	2005 - 2012	NISSAN	FRONTIER, PATHFINDER, XTERRA
E146-47-146	Brake Caliper	Fr R	2005 - 2012	NISSAN	FRONTIER RWD
E146-47-147	Brake Caliper	Fr L	2005 - 2012	NISSAN	FRONTIER RWD
E146-47-148	Brake Caliper	Fr R	2008 - 2012	NISSAN	PATHFINDER
E146-47-149	Brake Caliper	Fr L	2008 - 2012	NISSAN	PATHFINDER
E146-47-150	Brake Caliper	Fr R	2006 - 2012	NISSAN	ARMADA, TITAN
E146-47-151	Brake Caliper	Fr L	2006 - 2012	NISSAN	ARMADA, TITAN
E146-47-156	Brake Caliper	Fr R	2010 - 2012	NISSAN	CUBE
E146-47-157	Brake Caliper	Fr L	2010 - 2012	NISSAN	CUBE
E146-47-162	Brake Caliper	Fr R	2008 - 2012	NISSAN	ROGUE
E146-47-163	Brake Caliper	Fr L	2008 - 2012	NISSAN	ROGUE
E146-47-182	Brake Caliper	Fr R	2012 - 2012	NISSAN	NV1500, NV2500 HD, NV3500 HD
E146-47-183	Brake Caliper	Fr L	2012 - 2012	NISSAN	NV1500, NV2500 HD, NV3500 HD
E146-47-570	Brake Caliper	Rr R	2004 - 2012	NISSAN	ARMADA, TITAN
E146-47-571	Brake Caliper	Rr L	2004 - 2012	NISSAN	ARMADA, TITAN
E146-47-578	Brake Caliper	Rr R	2005 - 2012	NISSAN	FRONTIER, XTERRA
E146-47-579	Brake Caliper	Rr L	2005 - 2012	NISSAN	FRONTIER, XTERRA
E146-47-584	Brake Caliper	Rr R	2008 - 2012	NISSAN	ROGUE
E146-47-585	Brake Caliper	Rr L	2008 - 2012	NISSAN	ROGUE
E146-47-592	Brake Caliper	Rr R	2006 - 2012	NISSAN	PATHFINDER
E146-47-593	Brake Caliper	Rr L	2006 - 2012	NISSAN	PATHFINDER
E146-47-606	Brake Caliper	Rr R	2012 - 2012	NISSAN	NV1500, NV2500 HD, NV3500 HD
E146-47-607	Brake Caliper	Rr L	2012 - 2012	NISSAN	NV1500, NV2500 HD, NV3500 HD
E146-49-208	Brake Caliper	Fr R	2006 - 2007	TOYOTA	HIGHLANDER
E146-49-209	Brake Caliper	Fr L	2006 - 2007	TOYOTA	HIGHLANDER
E146-49-232	Brake Caliper	Fr R	2003 - 2009	TOYOTA	4RUNNER
E146-49-233	Brake Caliper	Fr L	2003 - 2009	TOYOTA	4RUNNER
E146-49-234	Brake Caliper	Fr R	2003 - 2007	TOYOTA	LAND CRUISER
E146-49-235	Brake Caliper	Fr L	2003 - 2007	TOYOTA	LAND CRUISER
E146-49-236	Brake Caliper	Fr R	2003 - 2007	TOYOTA	SEQUOIA
E146-49-237	Brake Caliper	Fr L	2003 - 2007	TOYOTA	SEQUOIA
E146-49-240	Brake Caliper	Fr R	2004 - 2010	TOYOTA	SIENNA
E146-49-241	Brake Caliper	Fr L	2004 - 2010	TOYOTA	SIENNA
E146-49-248	Brake Caliper	Fr R	2006 - 2007	TOYOTA	HIGHLANDER

PART NO	DESCRIPTION	POSITION	YEAR	MAKE	MODEL
E146-49-249	Brake Caliper	Fr L	2006 - 2007	TOYOTA	HIGHLANDER
E146-49-250	Brake Caliper	Fr R	2003 - 2011	TOYOTA	FJ CRUISER, TACOMA, 4RUNNER
E146-49-251	Brake Caliper	Fr L	2003 - 2011	TOYOTA	FJ CRUISER, TACOMA, 4RUNNER
E146-49-252	Brake Caliper	Fr R	2005 - 2011	TOYOTA	TACOMA
E146-49-253	Brake Caliper	Fr L	2005 - 2011	TOYOTA	TACOMA
E146-49-274	Brake Caliper	Fr R	2007 - 2011	TOYOTA	SEQUOIA, TUNDRA
E146-49-275	Brake Caliper	Fr L	2007 - 2011	TOYOTA	SEQUOIA, TUNDRA
E146-49-278	Brake Caliper	Fr R	2008 - 2011	TOYOTA	HIGHLANDER
E146-49-279	Brake Caliper	Fr L	2008 - 2011	TOYOTA	HIGHLANDER
E146-49-282	Brake Caliper	Fr R	2008 - 2013	TOYOTA	LAND CRUISER
E146-49-283	Brake Caliper	Fr L	2008 - 2013	TOYOTA	LAND CRUISER
E146-49-286	Brake Caliper	Fr R	2010 - 2011	TOYOTA	HIGHLANDER, SIENNA
E146-49-287	Brake Caliper	Fr L	2010 - 2011	TOYOTA	HIGHLANDER, SIENNA
E146-49-292	Brake Caliper	Fr R	2010 - 2011	TOYOTA	4RUNNER
E146-49-293	Brake Caliper	Fr L	2010 - 2011	TOYOTA	4RUNNER
E146-49-520	Brake Caliper	Rr R	2003 - 2011	TOYOTA	FJ CRUISER, 4RUNNER
E146-49-521	Brake Caliper	Rr L	2003 - 2011	TOYOTA	FJ CRUISER, 4RUNNER
E146-49-574	Brake Caliper	Rr R	2003 - 2007	TOYOTA	LAND CRUISER
E146-49-575	Brake Caliper	Rr L	2003 - 2007	TOYOTA	LAND CRUISER
E146-49-592	Brake Caliper	Rr R	2003 - 2011	TOYOTA	SEQUOIA, 4RUNNER
E146-49-593	Brake Caliper	Rr L	2003 - 2011	TOYOTA	SEQUOIA, 4RUNNER
E146-49-606	Brake Caliper	Rr R	2004 - 2010	TOYOTA	SIENNA
E146-49-607	Brake Caliper	Rr L	2004 - 2010	TOYOTA	SIENNA
E146-49-608	Brake Caliper	Rr R	2006 - 2007	TOYOTA	HIGHLANDER
E146-49-609	Brake Caliper	Rr L	2006 - 2007	TOYOTA	HIGHLANDER
E146-49-612	Brake Caliper	Rr R	2006 - 2007	TOYOTA	HIGHLANDER
E146-49-613	Brake Caliper	Rr L	2006 - 2007	TOYOTA	HIGHLANDER
E146-49-628	Brake Caliper	Rr R	2007 - 2011	TOYOTA	SEQUOIA, TUNDRA
E146-49-629	Brake Caliper	Rr L	2007 - 2011	TOYOTA	SEQUOIA, TUNDRA
E146-49-632	Brake Caliper	Rr R	2008 - 2013	TOYOTA	LAND CRUISER
E146-49-633	Brake Caliper	Rr L	2008 - 2013	TOYOTA	LAND CRUISER
E146-49-634	Brake Caliper	Rr R	2008 - 2011	TOYOTA	HIGHLANDER
E146-49-635	Brake Caliper	Rr L	2008 - 2011	TOYOTA	HIGHLANDER
E146-49-646	Brake Caliper	Rr R	2011 - 2011	TOYOTA	SIENNA
E146-49-647	Brake Caliper	Rr L	2011 - 2011	TOYOTA	SIENNA
E146-50-100	Brake Caliper	Fr R	2007 - 2011	MAZDA	CX-7
E146-50-101	Brake Caliper	Fr L	2007 - 2011	MAZDA	CX-7
E146-50-104	Brake Caliper	Fr R	2007 - 2011	MAZDA	CX-9
E146-50-105	Brake Caliper	Fr L	2007 - 2011	MAZDA	CX-9
E146-50-566	Brake Caliper	Rr R	2007 - 2011	FORD, LINCOLN, MAZDA	EDGE, MKX, CX-7
E146-50-567	Brake Caliper	Rr L	2007 - 2011	FORD, LINCOLN, MAZDA	EDGE, MKX, CX-7
E146-50-572	Brake Caliper	Rr R	2007 - 2011	MAZDA	CX-9
E146-50-573	Brake Caliper	Rr L	2007 - 2011	MAZDA	CX-9
E146-63-008	Brake Caliper	Fr R	2007 - 2007	JEEP	LIBERTY
E146-63-009	Brake Caliper	Fr L	2007 - 2007	JEEP	LIBERTY
E146-63-012	Brake Caliper	Fr R	2006 - 2010	JEEP	COMMANDER, GRAND CHEROKEE

PART NO	DESCRIPTION	POSITION	YEAR	MAKE	MODEL
E146-63-013	Brake Caliper	Fr L	2006 - 2010	JEEP	COMMANDER, GRAND CHEROKEE
E146-63-014	Brake Caliper	Fr R	2011 - 2012	DODGE, JEEP	DURANGO, GRAND CHEROKEE
E146-63-015	Brake Caliper	Fr L	2011 - 2012	DODGE, JEEP	DURANGO, GRAND CHEROKEE
E146-63-016	Brake Caliper	Fr R	2011 - 2012	DODGE, JEEP	DURANGO, GRAND CHEROKEE
E146-63-017	Brake Caliper	Fr L	2011 - 2012	DODGE, JEEP	DURANGO, GRAND CHEROKEE
E146-63-510	Brake Caliper	Rr R	2006 - 2010	JEEP	COMMANDER, GRAND CHEROKEE
E146-63-511	Brake Caliper	Rr L	2006 - 2010	JEEP	COMMANDER, GRAND CHEROKEE
E146-63-514	Brake Caliper	Rr R	2011 - 2012	DODGE, JEEP	DURANGO, GRAND CHEROKEE
E146-63-515	Brake Caliper	Rr L	2011 - 2012	DODGE, JEEP	DURANGO, GRAND CHEROKEE
E146-63-516	Brake Caliper	Rr R	2011 - 2012	DODGE, JEEP	DURANGO, GRAND CHEROKEE
E146-63-517	Brake Caliper	Rr L	2011 - 2012	DODGE, JEEP	DURANGO, GRAND CHEROKEE
E146-66-092	Brake Caliper	Fr R	2003 - 2011	FORD, LINCOLN, MERCURY	CROWN VICTORIA, TOWN CAR, GRAND MARQUIS
E146-66-093	Brake Caliper	Fr L	2003 - 2011	FORD, LINCOLN, MERCURY	CROWN VICTORIA, TOWN CAR, GRAND MARQUIS
E146-66-096	Brake Caliper	Fr R	2001 - 2007	FORD	TAURUS
E146-66-097	Brake Caliper	Fr L	2001 - 2007	FORD	TAURUS
E146-66-126	Brake Caliper	Fr R	2007 - 2008	FORD, LINCOLN	EDGE, MKX
E146-66-127	Brake Caliper	Fr L	2007 - 2008	FORD, LINCOLN	EDGE, MKX
E146-66-128	Brake Caliper	Fr R	2007 - 2009	FORD, LINCOLN	EDGE, MKX
E146-66-129	Brake Caliper	Fr L	2007 - 2009	FORD, LINCOLN	EDGE, MKX
E146-66-134	Brake Caliper	Fr R	2010 - 2012	FORD, LINCOLN	EDGE, MKX
E146-66-135	Brake Caliper	Fr L	2010 - 2012	FORD, LINCOLN	EDGE, MKX
E146-66-140	Brake Caliper	Fr R	2008 - 2009	FORD	TAURUS, TAURUS X
E146-66-141	Brake Caliper	Fr L	2008 - 2009	FORD	TAURUS, TAURUS X
E146-66-524	Brake Caliper	Rr R	2003 - 2011	FORD, LINCOLN, MERCURY	CROWN VICTORIA, RANGER, TOWN CAR, GRAND MARQUIS
E146-66-525	Brake Caliper	Rr L	2003 - 2011	FORD, LINCOLN, MERCURY	CROWN VICTORIA, RANGER, TOWN CAR, GRAND MARQUIS
E146-66-528	Brake Caliper	Rr R	2001 - 2007	FORD	TAURUS
E146-66-529	Brake Caliper	Rr L	2001 - 2007	FORD	TAURUS
E146-66-550	Brake Caliper	Rr R	2010 - 2012	FORD	TAURUS, TAURUS SHO
E146-66-551	Brake Caliper	Rr L	2010 - 2012	FORD	TAURUS, TAURUS SHO
E146-66-553	Brake Caliper	Rr L	2010 - 2012	FORD	TAURUS
E146-66-554	Brake Caliper	Rr R	2008 - 2009	FORD	TAURUS, TAURUS X
E146-66-555	Brake Caliper	Rr L	2008 - 2009	FORD	TAURUS, TAURUS X
E146-66-562	Brake Caliper	Rr R	2010 - 2012	FORD, LINCOLN	EXPLORER, SPORT, SPORT TRAC, MKT
E146-66-563	Brake Caliper	Rr L	2010 - 2012	FORD, LINCOLN	EXPLORER, SPORT, SPORT TRAC, MKT
E146-66-566	Brake Caliper	Rr R	2011 - 2011	FORD, LINCOLN	EDGE, MKX
E146-66-567	Brake Caliper	Rr L	2011 - 2011	FORD, LINCOLN	EDGE, MKX
E146-67-124	Brake Caliper	Fr R	2005 - 2005	PONTIAC	MONTANA
E146-67-125	Brake Caliper	Fr L	2005 - 2005	PONTIAC	MONTANA
E146-67-136	Brake Caliper	Fr R	2005 - 2009	CHEVROLET, PONTIAC, SATURN	UPLANDER, MONTANA, RELAY
E146-67-137	Brake Caliper	Fr L	2005 - 2009	CHEVROLET, PONTIAC, SATURN	UPLANDER, MONTANA, RELAY
E146-67-144	Brake Caliper	Fr R	2006 - 2011	CHEVROLET	HHR
E146-67-145	Brake Caliper	Fr L	2006 - 2011	CHEVROLET	HHR
E146-67-154	Brake Caliper	Fr R	2005 - 2007	SATURN	VUE
E146-67-155	Brake Caliper	Fr L	2005 - 2007	SATURN	VUE
E146-67-156	Brake Caliper	Fr R	2008 - 2010	CHEVROLET	HHR

PART NO	DESCRIPTION	POSITION	YEAR	MAKE	MODEL
E146-67-157	Brake Caliper	Fr L	2008 - 2010	CHEVROLET	HHR
E146-67-164	Brake Caliper	Fr R	2007 - 2012	CHEVROLET	IMPALA
E146-67-165	Brake Caliper	Fr L	2007 - 2012	CHEVROLET	IMPALA
E146-67-166	Brake Caliper	Fr R	2012 - 2012	CHEVROLET	IMPALA
E146-67-167	Brake Caliper	Fr L	2012 - 2012	CHEVROLET	IMPALA
E146-67-174	Brake Caliper	Fr R	2007 - 2010	CHEVROLET, PONTIAC, SATURN	EQUINOX, TORRENT, VUE
E146-67-175	Brake Caliper	Fr L	2007 - 2010	CHEVROLET, PONTIAC, SATURN	EQUINOX, TORRENT, VUE
E146-67-184	Brake Caliper	Fr R	2009 - 2010	CHEVROLET	HHR
E146-67-185	Brake Caliper	Fr L	2009 - 2010	CHEVROLET	HHR
E146-67-196	Brake Caliper	Fr R	2010 - 2012	CHEVROLET, GMC	EQUINOX, TERRAIN
E146-67-197	Brake Caliper	Fr L	2010 - 2012	CHEVROLET, GMC	EQUINOX, TERRAIN
E146-67-210	Brake Caliper	Fr R	2011 - 2011	CHEVROLET	CAPRICE
E146-67-211	Brake Caliper	Fr L	2011 - 2011	CHEVROLET	CAPRICE
E146-67-558	Brake Caliper	Rr R	2007 - 2010	CHEVROLET	IMPALA
E146-67-559	Brake Caliper	Rr L	2007 - 2010	CHEVROLET	IMPALA
E146-67-584	Brake Caliper	Rr R	2008 - 2010	CHEVROLET	HHR
E146-67-585	Brake Caliper	Rr L	2008 - 2010	CHEVROLET	HHR
E146-67-594	Brake Caliper	Rr R	2011 - 2012	CHEVROLET	IMPALA
E146-67-595	Brake Caliper	Rr L	2011 - 2012	CHEVROLET	IMPALA
E146-67-608	Brake Caliper	Rr R	2011 - 2011	CHEVROLET	CAPRICE
E146-67-609	Brake Caliper	Rr L	2011 - 2011	CHEVROLET	CAPRICE
E146-68-030	Brake Caliper	Fr R	2006 - 2007	CHRYSLER, DODGE	TOWN & COUNTRY VAN, CARAVAN, GRAND CARAVAN
E146-68-031	Brake Caliper	Fr L	2006 - 2007	CHRYSLER, DODGE	TOWN & COUNTRY VAN, CARAVAN, GRAND CARAVAN
E146-68-050	Brake Caliper	Fr	2007 - 2011	DODGE	CALIBER, CHARGER
E146-68-051	Brake Caliper	Fr	2007 - 2011	DODGE	CHARGER, CALIBER
E146-68-075	Brake Caliper	Fr	2008 - 2011	DODGE	CHARGER
E146-68-080	Brake Caliper	Fr R	2007 - 2012	DODGE	CALIBER
E146-68-081	Brake Caliper	Fr L	2007 - 2012	DODGE	CALIBER
E146-68-082	Brake Caliper	Fr R	2007 - 2012	DODGE, JEEP	CALIBER, COMPASS, PATRIOT
E146-68-083	Brake Caliper	Fr L	2007 - 2012	DODGE, JEEP	CALIBER, COMPASS, PATRIOT
E146-68-514	Brake Caliper	Rr	2006 - 2007	CHRYSLER, DODGE	TOWN & COUNTRY VAN, CARAVAN, GRAND CARAVAN
E146-68-533	Brake Caliper	Rr	2008 - 2012	DODGE	CHARGER
E146-68-535	Brake Caliper	Rr	2008 - 2012	DODGE	CHARGER
E146-68-538	Brake Caliper	Rr R	2007 - 2012	DODGE, JEEP	CALIBER, COMPASS, PATRIOT
E146-68-539	Brake Caliper	Rr L	2007 - 2012	DODGE, JEEP	CALIBER, COMPASS, PATRIOT
E146-68-541	Brake Caliper	Rr	2008 - 2012	DODGE	CHARGER
E146-68-542	Brake Caliper	Rr R	2007 - 2012	DODGE, JEEP	CALIBER, COMPASS, PATRIOT
E146-68-543	Brake Caliper	Rr L	2007 - 2012	DODGE, JEEP	CALIBER, COMPASS, PATRIOT
E146-70-020	Brake Caliper	Fr & Rr	1988 - 2007	FORD	E-SUPER DUTY Van & Cutaway, F53, 59 (1 Ton) RV Motor Home & Stripped Chassis, E450, 47 (1 Ton) Super Duty Van & Cutaway
E146-70-021	Brake Caliper	Fr & Rr	1988 - 2007	FORD	E-SUPER DUTY Van & Cutaway, F53, 59 (1 Ton) RV Motor Home & Stripped Chassis, E450, 47 (1 Ton) Super Duty Van & Cutaway
E146-70-026	Brake Caliper	Fr R	2007 - 2007	FORD, MERCURY	ESCAPE, MARINER
E146-70-027	Brake Caliper	Fr L	2007 - 2007	FORD, MERCURY	ESCAPE, MARINER

PART NO	DESCRIPTION	POSITION	YEAR	MAKE	MODEL
E146-70-036	Brake Caliper	Fr R	1996 - 2007	FORD	E150 ½ Ton Full Size Van, E250 ¾ Ton Full Size Van, E350 1 Ton Full Size Van, Wagon, Stripped & RV Chassis including Super Duty, E-SUPER DUTY Van & Cutaway, E450, 47 (1 Ton) Super Duty Van & Cutaway
E146-70-037	Brake Caliper	Fr L	1996 - 2007	FORD	E150 ½ Ton Full Size Van, E250 ¾ Ton Full Size Van, E350 1 Ton Full Size Van, Wagon, Stripped & RV Chassis including Super Duty, E-SUPER DUTY Van & Cutaway, E450, 47 (1 Ton) Super Duty Van & Cutaway
E146-70-048	Brake Caliper	Fr & Rr	1999 - 2011	FORD	F53, 59 (1 Ton) RV Motor Home & Stripped Chassis, E550, F450, F47 (1 Ton) 2WD & 4WD Super Duty
E146-70-049	Brake Caliper	Fr & Rr	1999 - 2011	FORD	F53, 59 (1 Ton) RV Motor Home & Stripped Chassis, E550, F450, F47 (1 Ton) 2WD & 4WD Super Duty
E146-70-054	Brake Caliper	Fr R	2003 - 2011	FORD, MAZDA	RANGER, B SERIES Pickup
E146-70-055	Brake Caliper	Fr L	2003 - 2011	FORD, MAZDA	RANGER, B SERIES Pickup
E146-70-068	Brake Caliper	Fr R	2006 - 2006	FORD	E150 ½ Ton Full Size Van
E146-70-069	Brake Caliper	Fr L	2006 - 2006	FORD	E150 ½ Ton Full Size Van
E146-70-076	Brake Caliper	Fr & Rr	2005 - 2012	FORD, INTERNATIONAL	F53, 59 (1 Ton) RV Motor Home & Stripped Chassis, F450, F47 (1 Ton) 2WD & 4WD Super Duty, F550 (1 Ton) 2WD & 4WD Super Duty, LCF Series, CF500, CF600, TERRA STAR
E146-70-077	Brake Caliper	Fr & Rr	2005 - 2012	FORD, INTERNATIONAL	F53, 59 (1 Ton) RV Motor Home & Stripped Chassis, F450, F47 (1 Ton) 2WD & 4WD Super Duty, F550 (1 Ton) 2WD & 4WD Super Duty, LCF Series, CF500, CF600, TERRA STAR
E146-70-078	Brake Caliper	Fr R	2005 - 2012	FORD	F250, F250, F350 Super Duty Truck
E146-70-079	Brake Caliper	Fr L	2005 - 2012	FORD	F250, F250, F350 Super Duty Truck
E146-70-080	Brake Caliper	Fr R	2004 - 2008	FORD, LINCOLN	F150 ½ Ton Truck
E146-70-081	Brake Caliper	Fr L	2004 - 2008	FORD, LINCOLN	F150 ½ Ton Truck
E146-70-082	Brake Caliper	Fr R	2006 - 2010	FORD, MERCURY	EXPLORER, SPORT, SPORT TRAC, MOUNTAINEER
E146-70-083	Brake Caliper	Fr L	2006 - 2010	FORD, MERCURY	EXPLORER, SPORT, SPORT TRAC, MOUNTAINEER
E146-70-084	Brake Caliper	Fr R	2007 - 2012	FORD	F350, F450, F47 SUPER DUTY Pickup, Cab & Chassis
E146-70-085	Brake Caliper	Fr L	2007 - 2012	FORD	F350, F450, F47 SUPER DUTY Pickup, Cab & Chassis
E146-70-086	Brake Caliper	Fr R	2007 - 2011	FORD, MAZDA, MERCURY	ESCAPE, TRIBUTE, MARINER
E146-70-087	Brake Caliper	Fr L	2007 - 2011	FORD, MAZDA, MERCURY	ESCAPE, TRIBUTE, MARINER
E146-70-090	Brake Caliper	Fr R	2007 - 2009	FORD, LINCOLN	EXPEDITION, NAVIGATOR
E146-70-091	Brake Caliper	Fr L	2007 - 2009	FORD, LINCOLN	EXPEDITION, NAVIGATOR
E146-70-092	Brake Caliper	Fr R	2008 - 2012	FORD	E150 ½ Ton Full Size Van, E250 ¾ Ton Full Size Van, E350 1 Ton Full Size Van, Wagon, Stripped & RV Chassis including Super Duty, E-SUPER DUTY Van & Cutaway, E450, 47 (1 Ton) Super Duty Van & Cutaway
E146-70-093	Brake Caliper	Fr L	2008 - 2012	FORD	E150 ½ Ton Full Size Van, E250 ¾ Ton Full Size Van, E350 1 Ton Full Size Van, Wagon, Stripped & RV Chassis including Super Duty, E-SUPER DUTY Van & Cutaway, E450, 47 (1 Ton) Super Duty Van & Cutaway
E146-70-094	Brake Caliper	Fr R	2010 - 2012	FORD, LINCOLN	EXPLORER, SPORT, SPORT TRAC, TAURUS, TAURUS SHO, MKT



PART NO	DESCRIPTION	POSITION	YEAR	MAKE	MODEL
E146-70-095	Brake Caliper	Fr L	2010 - 2012	FORD, LINCOLN	EXPLORER, SPORT, SPORT TRAC, TAURUS, TAURUS SHO, MKT
E146-70-096	Brake Caliper	Fr R	2009 - 2009	FORD	F150 ½ Ton Truck
E146-70-097	Brake Caliper	Fr L	2009 - 2009	FORD	F150 ½ Ton Truck
E146-70-098	Brake Caliper	Fr R	2010 - 2012	FORD	TRANSIT CONNECT
E146-70-099	Brake Caliper	Fr L	2010 - 2012	FORD	TRANSIT CONNECT
E146-70-100	Brake Caliper	Fr R	2010 - 2012	FORD, LINCOLN	EXPEDITION, F150 ½ Ton Truck, NAVIGATOR
E146-70-101	Brake Caliper	Fr L	2010 - 2012	FORD, LINCOLN	EXPEDITION, F150 ½ Ton Truck, NAVIGATOR
E146-70-102	Brake Caliper	Fr R	2010 - 2012	FORD, MERCURY	ESCAPE, MARINER
E146-70-103	Brake Caliper	Fr L	2010 - 2012	FORD, MERCURY	ESCAPE, MARINER
E146-70-510	Brake Caliper	Rr R	2005 - 2011	LINCOLN	TOWN CAR
E146-70-511	Brake Caliper	Rr L	2005 - 2011	LINCOLN	TOWN CAR
E146-70-514	Brake Caliper	Rr R	2006 - 2007	FORD	E150, E250, E350 Full Size Van
E146-70-515	Brake Caliper	Rr L	2006 - 2007	FORD	E150, E250, E350 Full Size Van
E146-70-522	Brake Caliper	Rr R	2004 - 2011	FORD, LINCOLN	F150 ½ Ton Truck
E146-70-523	Brake Caliper	Rr L	2004 - 2011	FORD, LINCOLN	F150 ½ Ton Truck
E146-70-526	Brake Caliper	Rr R	2007 - 2009	FORD, MAZDA, MERCURY	ESCAPE, TRIBUTE, MARINER
E146-70-527	Brake Caliper	Rr L	2007 - 2009	FORD, MAZDA, MERCURY	ESCAPE, TRIBUTE, MARINER
E146-70-528	Brake Caliper	Rr R	2005 - 2006	FORD	F250, F250 Super Duty ¾ Ton Truck
E146-70-529	Brake Caliper	Rr L	2005 - 2006	FORD	F250, F250 Super Duty ¾ Ton Truck
E146-70-530	Brake Caliper	Rr	2007 - 2012	FORD	F350, F450, F47 Pickup, Cab & Chassis
E146-70-531	Brake Caliper	Rr	2007 - 2012	FORD	F350, F450, F47 SUPER DUTY Pickup, Cab & Chassis
E146-70-532	Brake Caliper	Rr R	2006 - 2006	FORD	E150 ½ Ton Full Size Van
E146-70-533	Brake Caliper	Rr L	2006 - 2006	FORD	E150 ½ Ton Full Size Van
E146-70-534	Brake Caliper	Rr R	2007 - 2012	FORD, LINCOLN	EXPEDITION, NAVIGATOR
E146-70-535	Brake Caliper	Rr L	2007 - 2012	FORD, LINCOLN	EXPEDITION, NAVIGATOR
E146-70-536	Brake Caliper	Rr R	2006 - 2012	FORD	F250, F250, F350 Super Duty Truck
E146-70-537	Brake Caliper	Rr L	2006 - 2012	FORD	F250, F250, F350 Super Duty Truck
E146-70-538	Brake Caliper	Rr R	2008 - 2011	FORD	E150, E250, E350 Full Size Van
E146-70-539	Brake Caliper	Rr L	2008 - 2011	FORD	E150, E250, E350 Full Size Van
E146-70-540	Brake Caliper	Rr R	2008 - 2011	FORD	E-SUPER DUTY Van & Cutaway, E450, 47 (1 Ton) Super Duty Van & Cutaway
E146-70-541	Brake Caliper	Rr L	2008 - 2011	FORD	E-SUPER DUTY Van & Cutaway, E450, 47 (1 Ton) Super Duty Van & Cutaway
E146-70-550	Brake Caliper	Rr R	2006 - 2010	FORD, JEEP, MERCURY	EXPLORER, SPORT, SPORT TRAC, LIBERTY, MOUNTAINEER
E146-70-551	Brake Caliper	Rr L	2006 - 2010	FORD, JEEP, MERCURY	EXPLORER, SPORT, SPORT TRAC, LIBERTY, MOUNTAINEER
E146-71-008	Brake Caliper	Fr R	2003 - 2012	CHEVROLET, GMC, HUMMER	EXPRESS 2500, 3500 1 Ton Van, SILVERADO 1500, 2500, 3500, SUBURBAN 2500 ¾ Ton, SAVANA 2500, 3500 Van, SIERRA 1500, 2500, 3500 SIERRA DENALI, C3 ½ Ton, YUKON XL 2500 ¾ Ton, H2
E146-71-009	Brake Caliper	Fr L	2003 - 2012	CHEVROLET, GMC, HUMMER	EXPRESS 2500, 3500 1 Ton Van, SILVERADO 1500, 2500, 3500, SUBURBAN 2500 ¾ Ton, SAVANA 2500, 3500 Van, SIERRA 1500, 2500, 3500 SIERRA DENALI, C3 ½ Ton, YUKON XL 2500 ¾ Ton, H2



PART NO	DESCRIPTION	POSITION	YEAR	MAKE	MODEL
E146-71-012	Brake Caliper	Fr R, Rr	2002 - 2011	CHEVROLET, GMC, HUMMER	AVALANCHE 1500, EXPRESS 1500 ½ Ton Van, SILVERADO 1500, 2500, 3500, SUBURBAN 1500, 2500, TAHOE, SAVANA 1500 ½ Ton Van, SIERRA 1500, 2500, 3500 DENALI, C3 Pickup, YUKON XL 2500 ¾ Ton, H2
E146-71-013	Brake Caliper	Fr L, Rr	2002 - 2011	CHEVROLET, GMC, HUMMER	AVALANCHE 1500, EXPRESS 1500 ½ Ton Van, SILVERADO 1500, 2500, 3500, SUBURBAN 1500, 2500, TAHOE, SAVANA 1500 ½ Ton Van, SIERRA 1500, 2500, 3500 SIERRA DENALI, C3 Pickup, YUKON XL 2500 ¾ Ton, H2
E146-71-014	Brake Caliper	Fr & Rr	1979 - 2003	CHEVROLET, GMC, INTERNATIONAL, WORKHORSE	C60 C6D042 with Disc Brakes, C70 C7D042, C7D064 with Disc Brakes, P4T042 with Disc Brakes, P6T042 with Disc Brakes, C6D042 with Front Disc Brakes, C7D042, C7D064 with Front Disc Brakes, P4T042 with Front Disc Brakes, P6T042 with Front Disc Brakes, M1400, 1452 with Disc Brakes, S1452, 1452FC, M1600, 1652 Metro, S1723, S1724, S1753, S1754 S Models, S1823, S1853 School Bus, S1853FC, S1824, S1854 Conventional, 3000, 3200, 3600, 3700, 3800, 3900FC School Bus with Hydraulic Disc Brakes, 4100, 4200, 4300, 4400, 4600, 4700, 4800, 4900, 7100 Conventional Cab with Hydraulic Disc Brakes, P32, P42, Cargostar Models, S1624, S1652FC, S1652SC UPS, S1654, 1723 Bus, S Models Conventional, S1924, S1954 Conventional, S Models
E146-71-015	Brake Caliper	Fr & Rr	1979 - 2003	CHEVROLET, GMC, INTERNATIONAL, WORKHORSE	C60 C6D042 with Disc Brakes, C70 C7D042, C7D064 with Disc Brakes, P4T042 with Disc Brakes, P6T042 with Disc Brakes, C6D042 with Front Disc Brakes, C7D042, C7D064 with Front Disc Brakes, P4T042 with Front Disc Brakes, P6T042 with Front Disc Brakes, M1400, 1452 with Disc Brakes, S1452, 1452FC, M1600, 1652 Metro, S1723, S1724, S1753, S1754 S Models, S1823, S1853 School Bus, S1853FC, S1824, S1854 Conventional, 3000, 3200, 3600, 3700, 3800, 3900FC School Bus with Hydraulic Disc Brakes, 4100, 4200, 4300, 4400, 4600, 4700, 4800, 4900, 7100 Conventional Cab with Hydraulic Disc Brakes, P32, P42, Cargostar Models, S1624, S1652FC, S1652SC UPS, S1654, 1723 Bus, S Models Conventional, S1924, S1954 Conventional, S Models
E146-71-018	Brake Caliper	Fr R	1985 - 1994	WORKHORSE	P32, P42,
E146-71-019	Brake Caliper	Fr L	1985 - 1994	WORKHORSE	P32, P42,
E146-71-042	Brake Caliper	Fr R	2004 - 2012	CHEVROLET, GMC	EXPRESS 3500 1 Ton Van, SILVERADO 2500, 3500, SAVANA 3500 1 Ton Van, SIERRA 2500, 3500 Pickup, Cab & Chassis, G4500 Commercial Cutaway Chassis
E146-71-043	Brake Caliper	Fr L	2004 - 2012	CHEVROLET, GMC	EXPRESS 3500 1 Ton Van, SILVERADO 2500, 3500, SAVANA 3500 1 Ton Van, SIERRA 2500, 3500 Pickup, Cab & Chassis, G4500 Commercial Cutaway Chassis
E146-71-046	Brake Caliper	Fr R	2004 - 2008	CHEVROLET, GMC	COLORADO, CANYON
E146-71-047	Brake Caliper	Fr L	2004 - 2008	CHEVROLET, GMC	COLORADO, CANYON
E146-71-048	Brake Caliper	Fr R	2007 - 2007	CHEVROLET, GMC	AVALANCHE 1500, SILVERADO 1500 ½ Ton, SUBURBAN 1500 ½ Ton, TAHOE, SIERRA 1500, SIERRA 1500 DENALI, C3 ½ Ton Pickup, YUKON, YUKON DENALI, YUKON XL 1500, YUKON DENALI XL ½ Ton

PART NO	DESCRIPTION	POSITION	YEAR	MAKE	MODEL
E146-71-049	Brake Caliper	Fr L	2007 - 2007	CHEVROLET, GMC	AVALANCHE 1500, SILVERADO 1500 ½ Ton, SUBURBAN 1500 ½ Ton, TAHOE, SIERRA 1500, SIERRA 1500 DENALI, C3 ½ Ton Pickup, YUKON, YUKON DENALI, YUKON XL 1500, YUKON DENALI XL ½ Ton
E146-71-050	Brake Caliper	Fr R	2007 - 2009	CHEVROLET, GMC	TRAILBLAZER, ENVOY
E146-71-051	Brake Caliper	Fr L	2007 - 2009	CHEVROLET, GMC	TRAILBLAZER, ENVOY
E146-71-052	Brake Caliper	Fr R	2007 - 2012	CHEVROLET, GMC, SATURN	TRAILBLAZER, TRAVERSE, ACADIA, ENVOY, OUTLOOK
E146-71-053	Brake Caliper	Fr L	2007 - 2012	CHEVROLET, GMC, SATURN	TRAILBLAZER, TRAVERSE, ACADIA, ENVOY, OUTLOOK
E146-71-056	Brake Caliper	Fr R	2007 - 2012	CHEVROLET, GMC	AVALANCHE 1500, EXPRESS 1500 ½ Ton Van, SILVERADO 1500 ½ Ton, SUBURBAN 1500 ½ Ton, TAHOE, SAVANA 1500 ½ Ton Van, SIERRA 1500, SIERRA 1500 DENALI, C3 ½ Ton Pickup, YUKON, YUKON DENALI, YUKON XL 1500
E146-71-057	Brake Caliper	Fr L	2007 - 2012	CHEVROLET, GMC	AVALANCHE 1500, EXPRESS 1500 ½ Ton Van, SILVERADO 1500 ½ Ton, SUBURBAN 1500 ½ Ton, TAHOE, SAVANA 1500 ½ Ton Van, SIERRA 1500, SIERRA 1500 DENALI, C3 ½ Ton Pickup, YUKON, YUKON DENALI, YUKON XL 1500
E146-71-058	Brake Caliper	Fr R	2009 - 2012	CHEVROLET, GMC	COLORADO, CANYON
E146-71-059	Brake Caliper	Fr L	2009 - 2012	CHEVROLET, GMC	COLORADO, CANYON
E146-71-060	Brake Caliper	Fr R	2011 - 2012	CHEVROLET, GMC	SILVERADO 2500, 3500, SIERRA 2500, 3500 Pickup, Cab & Chassis
E146-71-061	Brake Caliper	Fr L	2011 - 2012	CHEVROLET, GMC	SILVERADO 2500, 3500, SIERRA 2500, 3500 Pickup, Cab & Chassis
E146-71-510	Brake Caliper	Rr R	2002 - 2007	CHEVROLET	AVALANCHE 1500, SILVERADO 1500 ½ Ton, SUBURBAN 1500 ½ Ton, TAHOE
E146-71-511	Brake Caliper	Rr L	2002 - 2007	CHEVROLET	AVALANCHE 1500, SILVERADO 1500 ½ Ton, SUBURBAN 1500 ½ Ton, TAHOE
E146-71-512	Brake Caliper	Rr R	2007 - 2009	CHEVROLET, GMC	TRAILBLAZER, ENVOY
E146-71-513	Brake Caliper	Rr L	2007 - 2009	CHEVROLET, GMC	TRAILBLAZER, ENVOY
E146-71-514	Brake Caliper	Rr R	2004 - 2010	CHEVROLET, GMC	SILVERADO 3500 1 Ton, SIERRA 3500 1 Ton Pickup, Cab & Chassis
E146-71-515	Brake Caliper	Rr L	2004 - 2010	CHEVROLET, GMC	SILVERADO 3500 1 Ton, SIERRA 3500 1 Ton Pickup, Cab & Chassis
E146-71-518	Brake Caliper	Rr R	2006 - 2008	CHEVROLET, GMC	EXPRESS 3500 1 Ton Van, SAVANA 3500 1 Ton Van
E146-71-519	Brake Caliper	Rr L	2006 - 2008	CHEVROLET, GMC	EXPRESS 3500 1 Ton Van, SAVANA 3500 1 Ton Van
E146-71-520	Brake Caliper	Rr R	2006 - 2012	CHEVROLET, GMC	EXPRESS 2500 ¾ Ton Van, EXPRESS 3500 1 Ton Van, SAVANA 2500 ¾ Ton Van, SAVANA 3500 1 Ton Van
E146-71-521	Brake Caliper	Rr L	2006 - 2012	CHEVROLET, GMC	EXPRESS 2500 ¾ Ton Van, EXPRESS 3500 1 Ton Van, SAVANA 2500 ¾ Ton Van, SAVANA 3500 1 Ton Van
E146-71-524	Brake Caliper	Rr R	2002 - 2012	CHEVROLET, GMC	AVALANCHE 1500, EXPRESS 1500 ½ Ton Van, SUBURBAN 1500 ½ Ton RWD, TAHOE RWD, SAVANA 1500 ½ Ton Van
E146-71-525	Brake Caliper	Rr L	2002 - 2012	CHEVROLET, GMC	AVALANCHE 1500, EXPRESS 1500 ½ Ton Van, SUBURBAN 1500 ½ Ton RWD, TAHOE RWD, SAVANA 1500 ½ Ton Van
E146-71-526	Brake Caliper	Rr R	2007 - 2007	CHEVROLET, GMC	SILVERADO 1500 ½ Ton, SIERRA 1500, SIERRA 1500 DENALI, C3 ½ Ton Pickup

PART NO	DESCRIPTION	POSITION	YEAR	MAKE	MODEL
E146-71-527	Brake Caliper	Rr L	2007 - 2007	CHEVROLET, GMC	SILVERADO 1500 ½ Ton, SIERRA 1500, SIERRA 1500 DENALI, C3 ½ Ton Pickup
E146-71-532	Brake Caliper	Rr R	2005 - 2009	CHEVROLET, PONTIAC, SATURN	UPLANDER, MONTANA, RELAY
E146-71-533	Brake Caliper	Rr L	2005 - 2009	CHEVROLET, PONTIAC, SATURN	UPLANDER, MONTANA, RELAY
E146-71-534	Brake Caliper	Rr R	2007 - 2012	CHEVROLET, GMC	AVALANCHE 1500, SILVERADO 1500 ½ Ton, SUBURBAN 1500 ½ Ton, TAHOE, SIERRA 1500, SIERRA 1500 DENALI, C3 ½ Ton Pickup, YUKON, YUKON DENALI, YUKON XL 1500, YUKON DENALI XL ½ Ton
E146-71-535	Brake Caliper	Rr L	2007 - 2012	CHEVROLET, GMC	AVALANCHE 1500, SILVERADO 1500 ½ Ton, SUBURBAN 1500 ½ Ton, TAHOE, SIERRA 1500, SIERRA 1500 DENALI, C3 ½ Ton Pickup, YUKON, YUKON DENALI, YUKON XL 1500, YUKON DENALI XL ½ Ton
E146-71-536	Brake Caliper	Rr R	2007 - 2012	CHEVROLET, GMC, SATURN	TRAVERSE, ACADIA, OUTLOOK
E146-71-537	Brake Caliper	Rr L	2007 - 2012	CHEVROLET, GMC, SATURN	TRAVERSE, ACADIA, OUTLOOK
E146-71-538	Brake Caliper	Rr R	2007 - 2012	CHEVROLET, GMC, PONTIAC, SATURN	EQUINOX, TERRAIN, TORRENT, VUE
E146-71-539	Brake Caliper	Rr L	2007 - 2012	CHEVROLET, GMC, PONTIAC, SATURN	EQUINOX, TERRAIN, TORRENT, VUE
E146-71-540	Brake Caliper	Rr R	2009 - 2012	CHEVROLET, GMC	EXPRESS 3500 1 Ton Van, SAVANA 3500 1 Ton Van, G4500 Commercial Cutaway Chassis
E146-71-541	Brake Caliper	Rr L	2009 - 2012	CHEVROLET, GMC	EXPRESS 3500 1 Ton Van, SAVANA 3500 1 Ton Van, G4500 Commercial Cutaway Chassis
E146-71-542	Brake Caliper	Rr L	2011 - 2012	CHEVROLET, GMC	SILVERADO 2500, 3500, SIERRA 2500, 3500 Pickup, Cab & Chassis
E146-71-543	Brake Caliper	Rr R	2011 - 2012	CHEVROLET, GMC	SILVERADO 2500, 3500, SIERRA 2500, 3500 Pickup, Cab & Chassis
E146-71-544	Brake Caliper	Rr R	2011 - 2012	CHEVROLET, GMC	SILVERADO 3500 1 Ton, SIERRA 3500 1 Ton Pickup, Cab & Chassis
E146-71-545	Brake Caliper	Rr L	2011 - 2012	CHEVROLET, GMC	SILVERADO 3500 1 Ton, SIERRA 3500 1 Ton Pickup, Cab & Chassis
E146-72-030	Brake Caliper	Fr R	2006 - 2008	DODGE	RAM 1500, 2500, 3500 Pickup, Cab & Chassis
E146-72-031	Brake Caliper	Fr L	2006 - 2008	DODGE	RAM 1500, 2500, 3500 Pickup, Cab & Chassis
E146-72-048	Brake Caliper	Fr	2007 - 2012	DODGE	DAKOTA, DURANGO, RAM 1500 ½ Ton Pickup
E146-72-049	Brake Caliper	Fr	2007 - 2012	DODGE	DAKOTA, RAM 1500 ½ Ton Pickup, DURANGO
E146-72-056	Brake Caliper	Fr R	2006 - 2007	CHRYSLER, DODGE	TOWN & COUNTRY VAN, CARAVAN, GRAND CARAVAN
E146-72-057	Brake Caliper	Fr L	2006 - 2007	CHRYSLER, DODGE	TOWN & COUNTRY VAN, CARAVAN, GRAND CARAVAN
E146-72-058	Brake Caliper	Fr R	2005 - 2008	DODGE	DAKOTA, RAM 1500 ½ Ton Pickup
E146-72-059	Brake Caliper	Fr L	2005 - 2008	DODGE	DAKOTA, RAM 1500 ½ Ton Pickup
E146-72-060	Brake Caliper	Fr	2007 - 2012	CHRYSLER, DODGE, JEEP	TOWN & COUNTRY VAN, CARAVAN, GRAND CARAVAN, LIBERTY, WRANGLER
E146-72-061	Brake Caliper	Fr	2007 - 2012	CHRYSLER, DODGE, JEEP	LIBERTY, WRANGLER, TOWN & COUNTRY VAN, CARAVAN, GRAND CARAVAN
E146-72-062	Brake Caliper	Fr & Rr	2008 - 2012	DODGE, STERLING	RAM 4500, 5500, RAM 4500, 5500, BULLET
E146-72-063	Brake Caliper	Fr & Rr	2008 - 2012	DODGE, STERLING	RAM 4500, 5500, RAM 4500, 5500, BULLET
E146-72-066	Brake Caliper	Fr R	2009 - 2012	DODGE	RAM 2500, 3500 Pickup
E146-72-067	Brake Caliper	Fr L	2009 - 2012	DODGE	RAM 2500, 3500 Pickup
E146-72-506	Brake Caliper	Rr R	2007 - 2012	DODGE, JEEP	DURANGO, RAM 1500 ½ Ton Pickup, J8
E146-72-507	Brake Caliper	Rr L	2007 - 2012	DODGE, JEEP	DURANGO, RAM 1500 ½ Ton Pickup, J8

PART NO	DESCRIPTION	POSITION	YEAR	MAKE	MODEL
E146-72-516	Brake Caliper	Rr R	2006 - 2008	DODGE	RAM 1500, 2500, 3500 Pickup
E146-72-517	Brake Caliper	Rr L	2006 - 2008	DODGE	RAM 1500, 2500, 3500 Pickup
E146-72-518	Brake Caliper	Rr R	2007 - 2008	DODGE	RAM 3500 1 Ton Pickup, Cab & Chassis
E146-72-519	Brake Caliper	Rr L	2007 - 2008	DODGE	RAM 3500 1 Ton Pickup, Cab & Chassis
E146-72-522	Brake Caliper	Rr	2007 - 2012	JEEP	WRANGLER, LIBERTY
E146-72-523	Brake Caliper	Rr	2007 - 2012	JEEP	LIBERTY, WRANGLER
E146-72-524	Brake Caliper	Rr R	2008 - 2012	CHRYSLER, DODGE	TOWN & COUNTRY VAN, CARAVAN, GRAND CARAVAN
E146-72-525	Brake Caliper	Rr L	2008 - 2012	CHRYSLER, DODGE	TOWN & COUNTRY VAN, CARAVAN, GRAND CARAVAN
E146-72-528	Brake Caliper	Rr R	2009 - 2012	DODGE	RAM 2500, 3500 Pickup
E146-72-529	Brake Caliper	Rr L	2009 - 2012	DODGE	RAM 2500, 3500 Pickup
E146-72-530	Brake Caliper	Rr R	2009 - 2012	DODGE	RAM 3500 1 Ton Pickup
E146-72-531	Brake Caliper	Rr L	2009 - 2012	DODGE	RAM 3500 1 Ton Pickup
E146-72-534	Brake Caliper	Rr R	2012 - 2012	CHRYSLER, DODGE	TOWN & COUNTRY VAN, CARAVAN, GRAND CARAVAN
E146-72-535	Brake Caliper	Rr L	2012 - 2012	CHRYSLER, DODGE	TOWN & COUNTRY VAN, CARAVAN, GRAND CARAVAN
E146-74-006	Brake Caliper	Fr R	2006 - 2010	HUMMER	H3
E146-74-007	Brake Caliper	Fr L	2006 - 2010	HUMMER	H3
E146-74-506	Brake Caliper	Rr R	2006 - 2010	HUMMER	H3
E146-74-507	Brake Caliper	Rr L	2006 - 2010	HUMMER	H3
E146-75-006	Brake Caliper	Fr & Rr	1973 - 2008	CHEVROLET, GMC, INTERNATIONAL, STERLING, FREIGHTLINER	C5D064 with Disc Brakes, C5D042, C5D064 with Front Disc Brakes, M1400, 1452 with Disc Brakes, S1452, 1452FC, M1600, 1652 Metro, S1723, S1724, S1753, S1754 S Models, S1823, S1853 School Bus, S1853FC, S1824, S1854 Conventional, 3000, 3200, 3600, 3700, 3800, 3900FC School Bus with Hydraulic Disc Brakes, 4100, 4200, 4300, 4400, 4600, 4700, 4800, 4900, 7100 Conventional Cab with Hydraulic Disc Brakes, ACTERRA with Hydraulic Disc Brakes, FL50, FL60, FL70 with Disc Brakes, MB50, MB60, MB70 with Disc Brakes, Cargostar Models, 1600, 1624 Loadstar, S1624, S1652FC, S1652SC UPS, S1654, S Models, Binder, CO1710A, B Cargostar, CO1750A, B Cargostar, 1700 Loadstar Conventional, 1724 Loadstar, 1723 Bus, CO1810A, B Cargostar, CO1850A, B Cargostar, 1800, 1824 Loadstar, CO1910A, B Cargostar, Forward Cab, F1910A, F1924 Tandem, S Models Conventional, S1924, S1954 Conventional, S Models
E146-75-007	Brake Caliper	Fr & Rr	1990 - 2004	GMC, FREIGHTLINER	C5D042, C5D064 with Front Disc Brakes, FS65, FW700 with Hydraulic Disc Brakes, MT10, MT35, MT45, MT55, MT-E with Hydraulic Disc Brakes
E146-75-008	Brake Caliper	Fr & Rr	1990 - 2004	INTERNATIONAL, FREIGHTLINER	3000, 3200, 3600, 3700, 3800, 3900FC School Bus with Hydraulic Disc Brakes, 4100, 4200, 4300, 4400, 4600, 4700, 4800, 4900, 7100 Conventional Cab with Hydraulic Disc Brakes, FL50, FL60, FL70 with Disc Brakes, MB50, MB60, MB70 with Disc Brakes

PART NO	DESCRIPTION	POSITION	YEAR	MAKE	MODEL
E146-75-011	Brake Caliper	Fr & Rr	1973 - 1998	CHEVROLET, GMC, INTERNATIONAL	C5D064 with Disc Brakes, C5D042, C5D064 with Front Disc Brakes, M1400, 1452 with Disc Brakes, S1452, 1452FC, M1600, 1652 Metro, S1723, S1724, S1753, S1754 S Models, S1823, S1853 School Bus, S1853FC, S1824, S1854 Conventional, Cargostar Models, 1600, 1624 Loadstar, S1624, S1652FC, S1652SC UPS, S1654, S Models, Binder, C01710A, B Cargostar, C01750A, B Cargostar, 1700 Loadstar Conventional, 1724 Loadstar, 1723 Bus, C01810A, B Cargostar, C01850A, B Cargostar, 1800, 1824 Loadstar, C01910A, B Cargostar, Forward Cab, F1910A, F1924 Tandem, S Models Conventional, S1924, S1954 Conventional, S Models
E146-75-012	Brake Caliper	Fr & Rr	1973 - 1998	CHEVROLET, GMC, INTERNATIONAL	C5D064 with Disc Brakes, C5D042, C5D064 with Front Disc Brakes, M1400, 1452 with Disc Brakes, S1452, 1452FC, M1600, 1652 Metro, S1723, S1724, S1753, S1754 S Models, S1823, S1853 School Bus, S1853FC, S1824, S1854 Conventional, Cargostar Models, 1600, 1624 Loadstar, S1624, S1652FC, S1652SC UPS, S1654, S Models, Binder, C01710A, B Cargostar, C01750A, B Cargostar, 1700 Loadstar Conventional, 1724 Loadstar, 1723 Bus, C01810A, B Cargostar, C01850A, B Cargostar, 1800, 1824 Loadstar, C01910A, B Cargostar, Forward Cab, F1910A, F1924 Tandem, S Models Conventional, S1924, S1954 Conventional, S Models
E146-79-008	Brake Caliper	Fr R Up	2000 - 2005	mitsubishi fuso	FE Series
E146-79-009	Brake Caliper	Fr L Up	2000 - 2005	mitsubishi fuso	FE Series
E146-79-010	Brake Caliper	Fr R Lo	2000 - 2005	mitsubishi fuso	FE Series
E146-79-011	Brake Caliper	Fr L Lo	2000 - 2005	mitsubishi fuso	FE Series
E146-79-012	Brake Caliper	Fr R Up	2000 - 2005	mitsubishi fuso	FE Series
E146-79-013	Brake Caliper	Fr L Up	2000 - 2005	mitsubishi fuso	FE Series
E146-79-014	Brake Caliper	Fr R Lo	2000 - 2005	mitsubishi fuso	FE Series
E146-79-015	Brake Caliper	Fr L Lo	2000 - 2005	mitsubishi fuso	FE Series
E146-79-016	Brake Caliper	Fr R Lo	2006 - 2012	mitsubishi fuso, sterling	FE Series, 360 Series
E146-79-017	Brake Caliper	Fr L Lo	2006 - 2012	mitsubishi fuso, sterling	FE Series, 360 Series
E146-79-018	Brake Caliper	Fr R Up	2006 - 2012	mitsubishi fuso, sterling	FE Series, 360 Series
E146-79-019	Brake Caliper	Fr L Up	2006 - 2012	mitsubishi fuso, sterling	FE Series, 360 Series
E146-79-020	Brake Caliper	Fr R Lo	2006 - 2012	mitsubishi fuso	FE Series
E146-79-021	Brake Caliper	Fr L Lo	2006 - 2012	mitsubishi fuso	FE Series
E146-79-022	Brake Caliper	Fr R Up	2006 - 2012	mitsubishi fuso	FE Series
E146-79-023	Brake Caliper	Fr L Up	2006 - 2012	mitsubishi fuso	FE Series
E146-79-506	Brake Caliper	Fr & Rr	1995 - 2005	mitsubishi fuso	FE Series
E146-79-507	Brake Caliper	Fr & Rr	1995 - 2005	mitsubishi fuso	FE Series
E146-79-508	Brake Caliper	Rr R	1995 - 2005	mitsubishi fuso	FE Series
E146-79-509	Brake Caliper	Rr L	1995 - 2005	mitsubishi fuso	FE Series
E146-79-510	Brake Caliper	Rr R	2005 - 2012	mitsubishi fuso, sterling	FE Series, 360 Series
E146-79-511	Brake Caliper	Rr L	2005 - 2012	mitsubishi fuso, sterling	FE Series, 360 Series
E146-79-512	Brake Caliper	Fr & Rr	2005 - 2012	sterling, mitsubishi fuso	360 Series, FE Series
E146-79-513	Brake Caliper	Fr & Rr	2005 - 2012	sterling, mitsubishi fuso	360 Series, FE Series
E146-79-514	Brake Caliper	Rr R Up	2005 - 2012	mitsubishi fuso	FE Series



PART NO	DESCRIPTION	POSITION	YEAR	MAKE	MODEL
E146-79-515	Brake Caliper	Rr L Up	2005 - 2012	mitsubishi FUSO	FE Series
E146-79-516	Brake Caliper	Rr R Lo	2005 - 2012	mitsubishi FUSO	FE Series
E146-79-517	Brake Caliper	Rr L Lo	2005 - 2012	mitsubishi FUSO	FE Series
E146-80-006	Brake Caliper	Fr & Rr	2005 - 2010	HINO	145 14,050 GVW, 165 16,000 GVW, 185 18,500 LBS GVW
E146-80-007	Brake Caliper	Fr & Rr	2005 - 2010	HINO	145 14,050 GVW, 165 16,000 GVW, 185 18,500 LBS GVW
E146-80-506	Brake Caliper	Rr R	2005 - 2010	HINO	145 14,050 GVW
E146-80-507	Brake Caliper	Rr L	2005 - 2010	HINO	145 14,050 GVW
E146-81-006	Brake Caliper	Fr R	1987 - 1997	ISUZU	NPR with Front Disc Brakes, Gas Engine
E146-81-007	Brake Caliper	Fr L	1987 - 1997	ISUZU	NPR with Front Disc Brakes, Gas Engine
E146-81-008	Brake Caliper	Fr R	1997 - 2004	ISUZU	NPR with Front Disc Brakes, Gas Engine
E146-81-009	Brake Caliper	Fr L	1997 - 2004	ISUZU	NPR with Front Disc Brakes, Gas Engine
E146-81-010	Brake Caliper	Fr R	1997 - 1999	ISUZU	NPR with Front Disc Brakes, Gas Engine, NQR
E146-81-011	Brake Caliper	Fr L	1997 - 1999	ISUZU	NPR with Front Disc Brakes, Gas Engine, NQR
E146-81-012	Brake Caliper	Fr R	1999 - 2004	ISUZU	NPR with Front Disc Brakes, Gas Engine, NQR
E146-81-013	Brake Caliper	Fr L	1999 - 2004	ISUZU	NPR with Front Disc Brakes, Gas Engine, NQR
E146-81-014	Brake Caliper	Fr R	2004 - 2012	CHEVROLET, GMC, ISUZU	W3500 Gas Engine, W3500 Diesel Engine, W4500 Gas Engine, W4500 Diesel Engine, NPR with Front Disc Brakes, Gas Engine, NPR with Front Disc Brakes, Diesel Engine, REACH VAN (UTILIMASTER BODY)
E146-81-015	Brake Caliper	Fr L	2004 - 2012	CHEVROLET, GMC, ISUZU	W3500 Gas Engine, W3500 Diesel Engine, W4500 Gas Engine, W4500 Diesel Engine, NPR with Front Disc Brakes, Gas Engine, NPR with Front Disc Brakes, Diesel Engine, REACH VAN (UTILIMASTER BODY)
E146-81-016	Brake Caliper	Fr R	2004 - 2012	CHEVROLET, GMC, ISUZU	W3500 Gas Engine, W4500 Gas Engine, W4500 Diesel Engine, W5500, W5500HD, NPR with Front Disc Brakes, Gas Engine, NPR with Front Disc Brakes, Diesel Engine, NQR, NRR
E146-81-017	Brake Caliper	Fr L	2004 - 2012	CHEVROLET, GMC, ISUZU	W3500 Gas Engine, W4500 Gas Engine, W4500 Diesel Engine, W5500, W5500HD, NPR with Front Disc Brakes, Gas Engine, NPR with Front Disc Brakes, Diesel Engine, NQR, NRR
E146-82-006	Brake Caliper	Fr R	1994 - 2010	UD	UD 1400
E146-82-007	Brake Caliper	Fr L	1994 - 2010	UD	UD 1400
E146-84-006	Brake Caliper	Fr	1983 - 1999	FORD	B600 Bus with Front Disc Brakes, B700 Bus with Front Disc Brakes, C700 Tilt Cab with Front Disc Brakes, C800 Tilt Cab with Front Disc Brakes, F600 Conventional with Front Disc Brakes, F700 Conventional with Front Disc Brakes, F800 Conventional with Front Disc Brakes, FT800 Conventional with Front Disc Brakes, L800 Conventional with Front Disc Brakes, L900 Conventional with Front Disc Brakes, LN600 Short Conventional with Front Disc Brakes, LN700 Short Conventional with Front Disc Brakes, LN800, 900 Short Conventional with Front Disc Brakes, LNT800 Short Conventional Tandem with Front Disc Brakes, LT800 Short Conventional Tandem with Front Disc Brakes, LT, LTL900 Short Conventional Tandem with Front Disc Brakes, LTS800 Short Conventional Tandem with Front Disc Brakes
E146-84-010	Brake Caliper	Fr	1984 - 1994	FORD	8000 Series (air over hydraulics)

PART NO	DESCRIPTION	POSITION	YEAR	MAKE	MODEL
E146-84-012	Brake Caliper	Fr & Rr	1992 - 2012	BLUEBIRD BUS, FREIGHTLINER, THOMAS BUILT	TC2000 with Hydraulic Disc Brakes, FL50, FL60, FL70 with Disc Brakes, C2, VISION
E146-84-013	Brake Caliper	Fr & Rr	1992 - 2012	BLUEBIRD BUS, FREIGHTLINER, THOMAS BUILT	TC2000 with Hydraulic Disc Brakes, FL50, FL60, FL70 with Disc Brakes, C2, VISION
E146-84-014	Brake Caliper	Fr & Rr	1992 - 2012	BLUEBIRD BUS, FREIGHTLINER, THOMAS BUILT	VISION, TC2000 with Hydraulic Disc Brakes, FL50, FL60, FL70 with Disc Brakes, C2
E146-84-015	Brake Caliper	Fr & Rr	1992 - 2012	BLUEBIRD BUS, FREIGHTLINER, THOMAS BUILT	VISION, TC2000 with Hydraulic Disc Brakes, FL50, FL60, FL70 with Disc Brakes, C2
E146-84-016	Brake Caliper	Fr & Rr	2000 - 2012	CHEVROLET, GMC, HINO, ISUZU, WORKHORSE, THOMAS BUILT, FORD	C4500 Kodiak, C5500 Kodiak, C6500 Kodiak with Disc Brakes, C7500 Kodiak with Disc Brakes, T5500, T6500 with Disc Brakes, T7500, T8500 Tilt Cab with Disc Brakes, C4500 Topkick, C5500 Topkick, C6500 Topkick with Front Disc Brakes, C7500 Topkick with Front Disc Brakes, T5500, T6500, T7500, T8500 Tilt Cab with Disc Brakes, 238 23,000, 25,500 LBS GVW, 258LP 23,000, 25,000 LBS GVW (Low Profile), 268 25,950GVW LBS with Hydraulic Disc Brakes, FTR with Front Disc Brakes, FVR, FXR with Front Disc Brakes, H Series HTR, HVR, W62, UFO - 17,000, 19,500, 23,000, 23,500 GVWR, C2, 185 18,500 LBS GVW, F750 Conventional with Disc Brakes
E146-84-017	Brake Caliper	Fr & Rr	2000 - 2012	CHEVROLET, GMC, HINO, ISUZU, WORKHORSE, THOMAS BUILT, FORD	C4500 Kodiak, C5500 Kodiak, C6500 Kodiak with Disc Brakes, C7500 Kodiak with Disc Brakes, T5500, T6500 with Disc Brakes, T7500, T8500 Tilt Cab with Disc Brakes, C4500 Topkick, C5500 Topkick, C6500 Topkick with Front Disc Brakes, C7500 Topkick with Front Disc Brakes, T5500, T6500, T7500, T8500 Tilt Cab with Disc Brakes, 238 23,000, 25,500 LBS GVW, 258LP 23,000, 25,000 LBS GVW (Low Profile), 268 25,950GVW LBS with Hydraulic Disc Brakes, FTR with Front Disc Brakes, FVR, FXR with Front Disc Brakes, H Series HTR, HVR, W62, UFO - 17,000, 19,500, 23,000, 23,500 GVWR, C2, F750 Conventional with Disc Brakes, 185 18,500 LBS GVW
E146-84-018	Brake Caliper	Fr & Rr	2000 - 2012	CHEVROLET, GMC, HINO, ISUZU, WORKHORSE, FORD, THOMAS BUILT	C4500 Kodiak, C5500 Kodiak, C6500 Kodiak with Disc Brakes, C7500 Kodiak with Disc Brakes, T5500, T6500 with Disc Brakes, T7500, T8500 Tilt Cab with Disc Brakes, C4500 Topkick, C5500 Topkick, C6500 Topkick with Front Disc Brakes, C7500 Topkick with Front Disc Brakes, T5500, T6500, T7500, T8500 Tilt Cab with Disc Brakes, 268 25,950GVW LBS with Hydraulic Disc Brakes, FTR with Front Disc Brakes, FVR, FXR with Front Disc Brakes, H Series HTR, HVR, W62, UFO - 17,000, 19,500, 23,000, 23,500 GVWR, F650 Conventional with Disc Brakes, F750 Conventional with Disc Brakes, C2, W24, W25.5 - 24,000, 25,500 GVWR



PART NO	DESCRIPTION	POSITION	YEAR	MAKE	MODEL
E146-84-019	Brake Caliper	Fr & Rr	2000 - 2012	FORD, CHEVROLET, GMC, HINO, ISUZU, WORKHORSE, THOMAS BUILT	F650 Conventional with Disc Brakes, F750 Conventional with Disc Brakes, C4500 Kodiak, C5500 Kodiak, C6500 Kodiak with Disc Brakes, C7500 Kodiak with Disc Brakes, T5500, T6500 with Disc Brakes, T7500, T8500 Tilt Cab with Disc Brakes, C4500 Topkick, C5500 Topkick, C6500 Topkick with Front Disc Brakes, C7500 Topkick with Front Disc Brakes, T5500, T6500, T7500, T8500 Tilt Cab with Disc Brakes, 268 25,950GVW LBS with Hydraulic Disc Brakes, FTR with Front Disc Brakes, FVR, FXR with Front Disc Brakes, H Series HTR, HVR, W62, UFO - 17,000, 19,500, 23,000, 23,500 GVWR, C2, W24, W25.5 - 24,000, 25,500 GVWR
E146-84-106	Brake Caliper	Fr & Rr	1979 - 2008	CHEVROLET, FORD, GMC, ISUZU, STERLING	B6P042 School Bus with Front Disc Brakes, B7T042 School Bus with Disc Brakes, C5H042 Kodiak with Disc Brakes, C60 C6D042 with Disc Brakes, C6500 Kodiak with Disc Brakes, C70 C7D042, C7D064 with Disc Brakes, P4T042 with Disc Brakes, P6S with Disc Brakes, P6T042 with Disc Brakes, T5500, T6500 with Disc Brakes, T7500, T8500 Tilt Cab with Disc Brakes, B600 Bus with Front Disc Brakes, B700 Bus with Front Disc Brakes, C600 Tilt Cab with Front Disc Brakes, C700 Tilt Cab with Front Disc Brakes, C800 Tilt Cab with Front Disc Brakes, F600 Conventional with Front Disc Brakes, F700 Conventional with Front Disc Brakes, F800 Conventional with Front Disc Brakes, FT800 Conventional with Front Disc Brakes, L800 Conventional with Front Disc Brakes, L900 Conventional with Front Disc Brakes, LN600 Short Conventional with Front Disc Brakes, LN700 Short Conventional with Front Disc Brakes, LN800, 900 Short Conventional with Front Disc Brakes, LNT800 Short Conventional Tandem with Front Disc Brakes, LT800 Short Conventional Tandem with Front Disc Brakes, LTS800 Short Conventional Tandem with Front Disc Brakes, B7T School Bus with Disc Brakes, C5H042 Topkick with Front Disc Brakes, C6D042 with Front Disc Brakes, C6500 Topkick with Front Disc Brakes, C7D042, C7D064 with Front Disc Brakes, C7500 Topkick with Front Disc Brakes, P4T042 with Front Disc Brakes, P6S with Front Disc Brakes, P6T042 with Front Disc Brakes, T5500, T6500, T7500, T8500 Tilt Cab with Disc Brakes, FSR with Front Disc Brakes, FTR with Front Disc Brakes, FVR, FXR with Front Disc Brakes, ACTERRA with Hydraulic Disc Brakes, C5D064 with Disc Brakes, C7500 Kodiak with Disc Brakes, F750 Conventional with Disc Brakes, C5D042, C5D064 with Front Disc Brakes
E146-85-006	Brake Caliper	Fr & Rr	1985 - 2005	WORKHORSE	P32, P42, P500 (Fedex Delivery Truck), W42 - 14,001, 16,000 GVWR

PART NO	DESCRIPTION	POSITION	YEAR	MAKE	MODEL
E146-85-008	Brake Caliper	Fr & Rr	1979 - 2008	CHEVROLET, GMC, ISUZU, MACK, INTERNATIONAL, BLUEBIRD BUS, STERLING, FREIGHTLINER	B6P042 School Bus with Front Disc Brakes, C6500 Kodiak with Disc Brakes, C70 C7D042, C7D064 with Disc Brakes, P6T042 with Disc Brakes, T5500, T6500 with Disc Brakes, T7500, T8500 Tilt Cab with Disc Brakes, C6500 Topkick with Front Disc Brakes, C7D042, C7D064 with Front Disc Brakes, C7500 Topkick with Front Disc Brakes, P6T042 with Front Disc Brakes, S7T042 Forward Control with Front Disc Brakes, T5500, T6500, T7500, T8500 Tilt Cab with Disc Brakes, FSR with Front Disc Brakes, FTR with Front Disc Brakes, FVR, FXR with Front Disc Brakes, CS200, MS200, B7T042 School Bus with Disc Brakes, C60 C6D042 with Disc Brakes, P6S with Disc Brakes, B7T School Bus with Disc Brakes, C6D042 with Front Disc Brakes, P6S with Front Disc Brakes, M1400, 1452 with Disc Brakes, S1452, 1452FC, M1600, 1652 Metro, S1723, S1724, S1753, S1754 S Models, S1823, S1853 School Bus, S1853FC, S1824, S1854 Conventional, 3000, 3200, 3600, 3700, 3800, 3900FC School Bus with Hydraulic Disc Brakes, 4100, 4200, 4300, 4400, 4600, 4700, 4800, 4900, 7100 Conventional Cab with Hydraulic Disc Brakes, TC2000 with Hydraulic Disc Brakes, ACTERRA with Hydraulic Disc Brakes, FL50, FL60, FL70 with Disc Brakes, MB50, MB60, MB70 with Disc Brakes, Cargostar Models, S1624, S1652FC, S1652SC UPS, S1654, C01710A, B Cargostar, C01750A, B Cargostar, 1723 Bus, C01810A, B Cargostar, C01850A, B Cargostar, C01910A, B Cargostar, Forward Cab, S Models Conventional, S1924, S1954 Conventional, S Models, C7500 Kodiak with Disc Brakes
E146-85-009	Brake Caliper	Fr & Rr	1979 - 1998	CHEVROLET, GMC, MACK, INTERNATIONAL	B6P042 School Bus with Front Disc Brakes, C70 C7D042, C7D064 with Disc Brakes, P6T042 with Disc Brakes, C7D042, C7D064 with Front Disc Brakes, P6T042 with Front Disc Brakes, S7T042 Forward Control with Front Disc Brakes, CS200, MS200, S1452, 1452FC, S1723, S1724, S1753, S1754 S Models, S1823, S1853 School Bus, S1853FC, S1824, S1854 Conventional, Cargostar Models, S1624, S1652FC, S1652SC UPS, S1654, C01710A, B Cargostar, C01750A, B Cargostar, 1723 Bus, C01810A, B Cargostar, C01850A, B Cargostar, C01910A, B Cargostar, Forward Cab, S Models Conventional, S1924, S1954 Conventional, S Models, C60 C6D042 with Disc Brakes, C6D042 with Front Disc Brakes
E146-85-010	Brake Caliper	Rr R	1995 - 2003	CHEVROLET, GMC, ISUZU	C6500 Kodiak with Disc Brakes, C7500 Kodiak with Disc Brakes, T5500, T6500 with Disc Brakes, T7500, T8500 Tilt Cab with Disc Brakes, C6500 Topkick with Front Disc Brakes, C7500 Topkick with Front Disc Brakes, T5500, T6500, T7500, T8500 Tilt Cab with Disc Brakes, FSR with Front Disc Brakes, FTR with Front Disc Brakes, FVR, FXR with Front Disc Brakes

PART NO	DESCRIPTION	POSITION	YEAR	MAKE	MODEL
E146-85-011	Brake Caliper	Rr L	1995 - 2003	CHEVROLET, GMC, ISUZU	C6500 Kodiak with Disc Brakes, C7500 Kodiak with Disc Brakes, T5500, T6500 with Disc Brakes, T7500, T8500 Tilt Cab with Disc Brakes, C6500 Topkick with Front Disc Brakes, C7500 Topkick with Front Disc Brakes, T5500, T6500, T7500, T8500 Tilt Cab with Disc Brakes, FSR with Front Disc Brakes, FTR with Front Disc Brakes, FVR, FXR with Front Disc Brakes
E146-85-012	Brake Caliper	Fr & Rr	1979 - 2008	CHEVROLET, FORD, GMC, ISUZU, STERLING	B6P042 School Bus with Front Disc Brakes, B7T042 School Bus with Disc Brakes, C5H042 Kodiak with Disc Brakes, C60 C6D042 with Disc Brakes, C6500 Kodiak with Disc Brakes, C70 C7D042, C7D064 with Disc Brakes, P4T042 with Disc Brakes, P6S with Disc Brakes, P6T042 with Disc Brakes, T5500, T6500 with Disc Brakes, T7500, T8500 Tilt Cab with Disc Brakes, B600 Bus with Front Disc Brakes, B700 Bus with Front Disc Brakes, C600 Tilt Cab with Front Disc Brakes, C700 Tilt Cab with Front Disc Brakes, C800 Tilt Cab with Front Disc Brakes, F600 Conventional with Front Disc Brakes, F700 Conventional with Front Disc Brakes, F800 Conventional with Front Disc Brakes, FT800 Conventional with Front Disc Brakes, L800 Conventional with Front Disc Brakes, L900 Conventional with Front Disc Brakes, LN600 Short Conventional with Front Disc Brakes, LN700 Short Conventional with Front Disc Brakes, LN800, 900 Short Conventional with Front Disc Brakes, LNT800 Short Conventional Tandem with Front Disc Brakes, LT800 Short Conventional Tandem with Front Disc Brakes, LTS800 Short Conventional Tandem with Front Disc Brakes, B7T School Bus with Disc Brakes, C5H042 Topkick with Front Disc Brakes, C6D042 with Front Disc Brakes, C6500 Topkick with Front Disc Brakes, C7D042, C7D064 with Front Disc Brakes, C7500 Topkick with Front Disc Brakes, P4T042 with Front Disc Brakes, P6S with Front Disc Brakes, P6T042 with Front Disc Brakes, T5500, T6500, T7500, T8500 Tilt Cab with Disc Brakes, FSR with Front Disc Brakes, FTR with Front Disc Brakes, FVR, FXR with Front Disc Brakes, ACTERRA with Hydraulic Disc Brakes, C5D064 with Disc Brakes, C7500 Kodiak with Disc Brakes, F750 Conventional with Disc Brakes, C5D042, C5D064 with Front Disc Brakes
E146-85-014	Brake Caliper	Fr & Rr	2003 - 2010	CHEVROLET, GMC	C4500 Kodiak, C5500 Kodiak, C4500 Topkick, C5500 Topkick
E146-85-016	Brake Caliper	Fr & Rr	2003 - 2003	CHEVROLET, GMC	C4500 Kodiak, C5500 Kodiak, C4500 Topkick, C5500 Topkick
E146-85-018	Brake Caliper	Rr L & R	2004 - 2010	CHEVROLET, GMC	C4500 Kodiak, C5500 Kodiak, C4500 Topkick, C5500 Topkick
E146-85-020	Brake Caliper	Rr R	1995 - 2003	CHEVROLET, GMC, ISUZU	C6500 Kodiak with Disc Brakes, C7500 Kodiak with Disc Brakes, T5500, T6500 with Disc Brakes, T7500, T8500 Tilt Cab with Disc Brakes, C6500 Topkick with Front Disc Brakes, C7500 Topkick with Front Disc Brakes, T5500, T6500, T7500, T8500 Tilt Cab with Disc Brakes, FSR with Front Disc Brakes, FTR with Front Disc Brakes, FVR, FXR with Front Disc Brakes

PART NO	DESCRIPTION	POSITION	YEAR	MAKE	MODEL
E146-85-021	Brake Caliper	Rr L	1995 - 2003	CHEVROLET, GMC, ISUZU	C6500 Kodiak with Disc Brakes, C7500 Kodiak with Disc Brakes, T5500, T6500 with Disc Brakes, T7500, T8500 Tilt Cab with Disc Brakes, C6500 Topkick with Front Disc Brakes, C7500 Topkick with Front Disc Brakes, T5500, T6500, T7500, T8500 Tilt Cab with Disc Brakes, FSR with Front Disc Brakes, FTR with Front Disc Brakes, FVR, FXR with Front Disc Brakes
E146-85-022	Brake Caliper	Rr R	1995 - 2003	CHEVROLET, GMC, ISUZU	C6500 Kodiak with Disc Brakes, C7500 Kodiak with Disc Brakes, T5500, T6500 with Disc Brakes, T7500, T8500 Tilt Cab with Disc Brakes, C6500 Topkick with Front Disc Brakes, C7500 Topkick with Front Disc Brakes, T5500, T6500, T7500, T8500 Tilt Cab with Disc Brakes, FSR with Front Disc Brakes, FTR with Front Disc Brakes, FVR, FXR with Front Disc Brakes
E146-85-023	Brake Caliper	Rr L	1995 - 2003	CHEVROLET, GMC, ISUZU	C6500 Kodiak with Disc Brakes, C7500 Kodiak with Disc Brakes, T5500, T6500 with Disc Brakes, T7500, T8500 Tilt Cab with Disc Brakes, C6500 Topkick with Front Disc Brakes, C7500 Topkick with Front Disc Brakes, T5500, T6500, T7500, T8500 Tilt Cab with Disc Brakes, FSR with Front Disc Brakes, FTR with Front Disc Brakes, FVR, FXR with Front Disc Brakes
E146-88-006	Brake Caliper	Fr & Rr	1990 - 2004	INTERNATIONAL, BLUEBIRD BUS, FREIGHTLINER	3000, 3200, 3600, 3700, 3800, 3900FC School Bus with Hydraulic Disc Brakes, 4100, 4200, 4300, 4400, 4600, 4700, 4800, 4900, 7100 Conventional Cab with Hydraulic Disc Brakes, TC2000 with Hydraulic Disc Brakes, FL50, FL60, FL70 with Disc Brakes, FS65, FW700 with Hydraulic Disc Brakes, MB50, MB60, MB70 with Disc Brakes, MT10, MT35, MT45, MT55, MT-E with Hydraulic Disc Brakes
E146-88-008	Brake Caliper	Fr & Rr	1985 - 2012	WORKHORSE, FORD, IC BUS, INTERNATIONAL, KENWORTH, PETERBILT, BLUEBIRD BUS, FREIGHTLINER, STERLING	P32, P42, F650 Conventional with Disc Brakes, F750 Conventional with Disc Brakes, BE, CE, HC, LC with Hydraulic Disc Brakes, 3000, 3200, 3600, 3700, 3800, 3900FC School Bus with Hydraulic Disc Brakes, 4100, 4200, 4300, 4400, 4600, 4700, 4800, 4900, 7100 Conventional Cab with Hydraulic Disc Brakes, T170, T270, T370 w/ Hydraulic Disc Brakes, 325, 330, 335 w/ Hydraulic Disc Brakes, TC2000 with Hydraulic Disc Brakes, Fred Chassis, FS65, FW700 with Hydraulic Disc Brakes, M2 100/106 with Hydraulic Disc Brakes, MC, MC-L Series Motorhome Chassis, MT10, MT35, MT45, MT55, MT-E with Hydraulic Disc Brakes, MXT, RXT, S1624, S1652FC, S1652SC UPS, S1654, ACTERRA with Hydraulic Disc Brakes, LF72 Bus 19,000 GVWR, W20, W20D, W21, W22 - 20,70, 22,000 GVWR, F53, 59 (1 Ton) RV Motor Home & Stripped Chassis

PART NO	DESCRIPTION	POSITION	YEAR	MAKE	MODEL
E146-88-010	Brake Caliper	Fr & Rr	1998 - 2012	FORD, IC BUS, INTERNATIONAL, KENWORTH, PETERBILT, BLUEBIRD BUS, FREIGHTLINER, STERLING, WORKHORSE	F53, 59 (1 Ton) RV Motor Home & Stripped Chassis, F650 Conventional with Disc Brakes, F750 Conventional with Disc Brakes, BE, CE, HC, LC with Hydraulic Disc Brakes, 3000, 3200, 3600, 3700, 3800, 3900FC School Bus with Hydraulic Disc Brakes, 4100, 4200, 4300, 4400, 4600, 4700, 4800, 4900, 7100 Conventional Cab with Hydraulic Disc Brakes, T170, T270, T370 w/ Hydraulic Disc Brakes, 325, 330, 335 w/ Hydraulic Disc Brakes, TC2000 with Hydraulic Disc Brakes, Fred Chassis, FS65, FW700 with Hydraulic Disc Brakes, M2 100/106 with Hydraulic Disc Brakes, MC, MC-L Series Motorhome Chassis, MT10, MT35, MT45, MT55, MT-E with Hydraulic Disc Brakes, S1624, S1652FC, S1652SC UPS, S1654, ACTERRA with Hydraulic Disc Brakes, LF72 Bus 19,000 GVWR, W20, W20D, W21, W22 - 20,70, 22,000 GVWR
E146-88-014	Brake Caliper	Fr & Rr	2009 - 2012	FORD, IC BUS, INTERNATIONAL	F650 Conventional with Disc Brakes, F750 Conventional with Disc Brakes, BE, CE, HC, LC with Hydraulic Disc Brakes, 3000, 3200, 3600, 3700, 3800, 3900FC School Bus with Hydraulic Disc Brakes, 4100, 4200, 4300, 4400, 4600, 4700, 4800, 4900, 7100 Conventional Cab with Hydraulic Disc Brakes
E146-88-015	Brake Caliper	Fr & Rr	2009 - 2012	FORD, IC BUS, INTERNATIONAL	F650 Conventional with Disc Brakes, F750 Conventional with Disc Brakes, BE, CE, HC, LC with Hydraulic Disc Brakes, 3000, 3200, 3600, 3700, 3800, 3900FC School Bus with Hydraulic Disc Brakes, 4100, 4200, 4300, 4400, 4600, 4700, 4800, 4900, 7100 Conventional Cab with Hydraulic Disc Brakes
E146-88-016	Brake Caliper	Rr R	2009 - 2012	FORD, IC BUS, INTERNATIONAL	F650 Conventional with Disc Brakes, BE, CE, HC, LC with Hydraulic Disc Brakes, 3000, 3200, 3600, 3700, 3800, 3900FC School Bus with Hydraulic Disc Brakes, 4100, 4200, 4300, 4400, 4600, 4700, 4800, 4900, 7100 Conventional Cab with Hydraulic Disc Brakes
E146-88-017	Brake Caliper	Rr L	2009 - 2012	FORD, IC BUS, INTERNATIONAL	F650 Conventional with Disc Brakes, BE, CE, HC, LC with Hydraulic Disc Brakes, 3000, 3200, 3600, 3700, 3800, 3900FC School Bus with Hydraulic Disc Brakes, 4100, 4200, 4300, 4400, 4600, 4700, 4800, 4900, 7100 Conventional Cab with Hydraulic Disc Brakes
E146-90-006	Brake Caliper	Fr	2006 - 2012	DODGE, FREIGHTLINER, MERCEDES BENZ, WORKHORSE	SPRINTER 3500, W42 - 14,001, 16,000 GVWR
E146-90-007	Brake Caliper	Fr R, Fr L	2006 - 2012	DODGE, FREIGHTLINER, MERCEDES BENZ, WORKHORSE	SPRINTER 3500, W42 - 14,001, 16,000 GVWR
E146-90-008	Brake Caliper	Fr R	2001 - 2011	WORKHORSE	P32, P42, P500 (Fedex Delivery Truck), W16, W18 - 16,000, 18,000 GVWR, W42 - 14,001, 16,000 GVWR
E146-90-009	Brake Caliper	Fr L	2001 - 2011	WORKHORSE	P32, P42, P500 (Fedex Delivery Truck), W16, W18 - 16,000, 18,000 GVWR, W42 - 14,001, 16,000 GVWR
E146-90-506	Brake Caliper	Rr R	2001 - 2011	WORKHORSE	P32, P42, P500 (Fedex Delivery Truck), W16, W18 - 16,000, 18,000 GVWR, W42 - 14,001, 16,000 GVWR
E146-90-507	Brake Caliper	Rr L	2001 - 2011	WORKHORSE	P32, P42, P500 (Fedex Delivery Truck), W16, W18 - 16,000, 18,000 GVWR, W42 - 14,001, 16,000 GVWR

PART NO	DESCRIPTION	POSITION	YEAR	MAKE	MODEL
E146-90-508	Brake Caliper	Rr R	2006 - 2011	WORKHORSE	W42 - 14,001, 16,000 GVWR
E146-90-509	Brake Caliper	Rr L	2006 - 2011	WORKHORSE	W42 - 14,001, 16,000 GVWR
E148-25-012	Caliper Kits	Rr	2007 - 2011	TOYOTA	SEQUOIA, TUNDRA
E148-27-011	Caliper Kits	Rr	2003 - 2011	HUMMER, TOYOTA	H3, FJ CRUISER, 4RUNNER
E148-39-023	Caliper Kits	Rr	2007 - 2009	FORD, MAZDA, MERCURY	ESCAPE, TRIBUTE, MARINER
E148-39-027	Caliper Kits	Rr	2007 - 2012	FORD, LINCOLN	EXPEDITION, NAVIGATOR
E148-40-047	Caliper Kits	Fr	2007 - 2012	DODGE, FREIGHTLINER, MERCEDES BENZ	SPRINTER 2500
E148-40-048	Caliper Kits	Rr	2007 - 2012	DODGE, FREIGHTLINER, MERCEDES BENZ	SPRINTER 2500, 3500
E148-40-049	Caliper Kits	Rr	2007 - 2012	DODGE, FREIGHTLINER, MERCEDES BENZ	SPRINTER 3500
E148-42-021	Caliper Kits	Fr	2009 - 2010	CHEVROLET	HHR
E148-44-020	Caliper Kits	Rr	2007 - 2012	CHEVROLET, GMC, PONTIAC, SATURN	EQUINOX, TERRAIN, TORRENT, VUE
E148-45-005	Caliper Kits	Fr & Rr	1995 - 2012	MINI, MITSUBISHI FUSO, STERLING	FE Series, 360 Series
E148-45-029	Caliper Kits	Fr	2007 - 2012	FORD, LINCOLN, MAZDA	EDGE, MKX, CX-7, CX-9
E148-47-013	Caliper Kits	Fr	2005 - 2011	TOYOTA	TACOMA
E148-47-034	Caliper Kits	Fr	2005 - 2012	NISSAN	FRONTIER, PATHFINDER, XTERRA
E148-47-038	Caliper Kits	Rr	2004 - 2012	JEEP, NISSAN	COMMANDER, GRAND CHEROKEE, ARMADA, TITAN
E148-47-040	Caliper Kits	Fr	2006 - 2012	NISSAN	ARMADA, TITAN
E148-47-045	Caliper Kits	Fr	2008 - 2012	NISSAN	ROGUE
E148-47-051	Caliper Kits	Rr	2008 - 2012	NISSAN	ROGUE
E148-47-052	Caliper Kits	Rr	2012 - 2012	NISSAN	NV1500, NV2500 HD, NV3500 HD
E148-47-053	Caliper Kits	Fr	2012 - 2012	NISSAN	NV1500, NV2500 HD, NV3500 HD
E148-49-056	Caliper Kits	Fr	2006 - 2007	TOYOTA	HIGHLANDER
E148-49-065	Caliper Kits	Fr	2004 - 2010	TOYOTA	SIENNA
E148-49-067	Caliper Kits	Fr	2003 - 2007	TOYOTA	LAND CRUISER
E148-49-069	Caliper Kits	Rr	2004 - 2010	TOYOTA	SIENNA
E148-49-070	Caliper Kits	Rr	2006 - 2011	TOYOTA	HIGHLANDER
E148-49-071	Caliper Kits	Fr	2006 - 2007	TOYOTA	HIGHLANDER
E148-49-073	Caliper Kits	Rr	2006 - 2007	TOYOTA	HIGHLANDER
E148-49-074	Caliper Kits	Fr	2003 - 2011	HUMMER, TOYOTA	H3, SEQUOIA, TACOMA, 4RUNNER
E148-49-078	Caliper Kits	Fr	2007 - 2011	TOYOTA	SEQUOIA, TUNDRA
E148-49-079	Caliper Kits	Fr	2003 - 2011	TOYOTA	FJ CRUISER, TACOMA, 4RUNNER
E148-49-080	Caliper Kits	Rr	2008 - 2013	TOYOTA	LAND CRUISER
E148-49-081	Caliper Kits	Fr	2008 - 2011	TOYOTA	HIGHLANDER
E148-49-087	Caliper Kits	Rr	2011 - 2011	TOYOTA	SIENNA
E148-49-090	Caliper Kits	Fr	2010 - 2011	TOYOTA	4RUNNER
E148-49-091	Caliper Kits	Fr	2010 - 2011	TOYOTA	HIGHLANDER, SIENNA
E148-50-028	Caliper Kits	Rr	2005 - 2012	NISSAN	FRONTIER, PATHFINDER, XTERRA
E148-50-030	Caliper Kits	Rr	2007 - 2011	FORD, LINCOLN, MAZDA	EDGE, MKX, CX-7, CX-9
E148-51-018	Caliper Kits	Fr	2006 - 2011	CHEVROLET	HHR
E148-52-012	Caliper Kits	Rr	2007 - 2010	CHEVROLET	IMPALA
E148-56-026	Caliper Kits	Fr	2010 - 2012	CHEVROLET, GMC	EQUINOX, TERRAIN
E148-63-006	Caliper Kits	Fr	2011 - 2012	DODGE, JEEP	DURANGO, GRAND CHEROKEE
E148-63-007	Caliper Kits	Rr	2011 - 2012	DODGE, JEEP	DURANGO, GRAND CHEROKEE



PART NO	DESCRIPTION	POSITION	YEAR	MAKE	MODEL
E148-63-009	Caliper Kits	Fr	2006 - 2007	CHRYSLER, DODGE, JEEP	TOWN & COUNTRY VAN, CARAVAN, GRAND CARAVAN, LIBERTY
E148-63-010	Caliper Kits	Fr	2006 - 2012	CHEVROLET, GMC, JEEP, SATURN	COLORADO, TRAILBLAZER, TRAVERSE, ACADIA, CANYON, ENVOY, COMMANDER, GRAND CHEROKEE, OUTLOOK
E148-66-008	Caliper Kits	Rr	2001 - 2007	FORD	TAURUS
E148-66-019	Caliper Kits	Rr	2012 - 2012	CHRYSLER, DODGE	TOWN & COUNTRY VAN, CARAVAN, GRAND CARAVAN
E148-66-023	Caliper Kits	Fr	2001 - 2007	FORD	TAURUS
E148-66-024	Caliper Kits	Rr	2006 - 2010	FORD, JEEP, MERCURY	EXPLORER, SPORT, SPORT TRAC, LIBERTY, MOUNTAINEER
E148-66-028	Caliper Kits	Fr	2010 - 2012	FORD	TRANSIT CONNECT
E148-66-029	Caliper Kits	Fr	2008 - 2012	NISSAN	PATHFINDER
E148-66-032	Caliper Kits	Rr	2005 - 2012	FORD	F250, F250, F350 Super Duty Truck
E148-66-035	Caliper Kits	Rr	2003 - 2011	FORD, LINCOLN, MERCURY	CROWN VICTORIA, RANGER, TOWN CAR, GRAND MARQUIS
E148-66-036	Caliper Kits	Rr	2010 - 2012	FORD, LINCOLN	EXPLORER, SPORT, SPORT TRAC, MKT
E148-66-039	Caliper Kits	Rr	2008 - 2009	FORD	TAURUS, TAURUS X
E148-67-024	Caliper Kits	Fr	2005 - 2009	CHEVROLET, PONTIAC, SATURN	UPLANDER, MONTANA, RELAY
E148-67-039	Caliper Kits	Fr	2007 - 2007	FORD, MERCURY	ESCAPE, MARINER
E148-67-040	Caliper Kits	Fr	2007 - 2010	CHEVROLET, PONTIAC, SATURN	EQUINOX, TORRENT, VUE
E148-67-048	Caliper Kits	Rr	2008 - 2012	CHEVROLET	IMPALA, HHR
E148-67-051	Caliper Kits	Fr	2007 - 2012	CHEVROLET	IMPALA
E148-67-057	Caliper Kits	Rr	2011 - 2011	CHEVROLET	CAPRICE
E148-67-059	Caliper Kits	Fr	2011 - 2011	CHEVROLET	CAPRICE
E148-68-011	Caliper Kits	Rr	2006 - 2012	DODGE, FORD, JEEP	DURANGO, RAM 1500 ½ Ton Pickup, E150 ½ Ton Full Size Van, J8
E148-68-025	Caliper Kits	Rr	2006 - 2007	CHRYSLER, DODGE	TOWN & COUNTRY VAN, CARAVAN, GRAND CARAVAN
E148-68-030	Caliper Kits	Fr	2006 - 2007	CHRYSLER, DODGE	TOWN & COUNTRY VAN, CARAVAN, GRAND CARAVAN
E148-68-035	Caliper Kits	Fr	2007 - 2012	DODGE	CALIBER, CHARGER
E148-68-036	Caliper Kits	Fr	2008 - 2012	DODGE	CHARGER
E148-68-037	Caliper Kits	Rr	2008 - 2012	DODGE	CHARGER
E148-68-038	Caliper Kits	Fr	2007 - 2012	DODGE, JEEP	CALIBER, COMPASS, PATRIOT
E148-70-013	Caliper Kits	Fr & Rr	1988 - 2007	FORD	E-SUPER DUTY Van & Cutaway, F53, 59 (1 Ton) RV Motor Home & Stripped Chassis, E450, 47 (1 Ton) Super Duty Van & Cutaway
E148-70-016	Caliper Kits	Fr	1996 - 2008	DODGE, FORD	RAM 1500, 2500, 3500 Pickup, Cab & Chassis
E148-70-017	Caliper Kits	Fr	2003 - 2011	FORD, MAZDA, SATURN	RANGER, B SERIES Pickup, VUE
E148-70-019	Caliper Kits	Rr	2005 - 2011	LINCOLN	TOWN CAR
E148-70-020	Caliper Kits	Rr	2007 - 2008	DODGE	RAM 3500 1 Ton Pickup, Cab & Chassis
E148-70-021	Caliper Kits	Fr	2003 - 2011	FORD, LINCOLN, MERCURY	CROWN VICTORIA, TOWN CAR, GRAND MARQUIS
E148-70-023	Caliper Kits	Rr	2006 - 2007	FORD	E150, E250, E350 Full Size Van including Super Duty
E148-70-024	Caliper Kits	Fr, Fr & Rr	1999 - 2012	DODGE, CHEVROLET, FORD, GMC, INTERNATIONAL	RAM 2500, 3500 Pickup, Cab & Chassis, C4500 Kodiak, C5500 Kodiak, F53, 59 (1 Ton) RV Motor Home & Stripped Chassis, F450, F47, F550 (1 Ton) Super Duty, C4500 Topkick, C5500 Topkick, E550, LCF Series, CF500, CF600, TERRA STAR
E148-70-030	Caliper Kits	Fr	2007 - 2012	FORD, MAZDA, MERCURY	ESCAPE, TRIBUTE, MARINER



PART NO	DESCRIPTION	POSITION	YEAR	MAKE	MODEL
E148-70-031	Caliper Kits	Rr	2007 - 2012	FORD	F350, F450, F47 SUPER DUTY Pickup, Cab & Chassis
E148-70-032	Caliper Kits	Fr	2004 - 2009	FORD, LINCOLN	F150 ½ Ton Truck
E148-70-033	Caliper Kits	Fr	2006 - 2010	FORD, MERCURY	EXPLORER, SPORT, SPORT TRAC, MOUNTAINEER
E148-70-034	Caliper Kits	Fr	2007 - 2009	FORD, LINCOLN	EXPEDITION, NAVIGATOR
E148-70-035	Caliper Kits	Fr & Rr	2008 - 2012	CHEVROLET, FORD, GMC, LINCOLN	EXPLORER, SPORT, SPORT TRAC, TAURUS, TAURUS SHO, MKT, SILVERADO 2500, 3500, E150, E250, E350 Full Size Van including Super Duty, SIERRA 2500, 3500 Pickup
E148-70-036	Caliper Kits	Fr	2008 - 2012	FORD	E150 ½ Ton Full Size Van, E250 ¾ Ton Full Size Van, E350 1 Ton Full Size Van, Wagon, Stripped & RV Chassis including Super Duty, E-SUPER DUTY Van & Cutaway, E450, 47 (1 Ton) Super Duty Van & Cutaway
E148-70-037	Caliper Kits	Rr	2008 - 2011	FORD	E-SUPER DUTY Van & Cutaway, E450, 47 (1 Ton) Super Duty Van & Cutaway
E148-70-038	Caliper Kits	Fr	2010 - 2012	FORD, LINCOLN	EXPEDITION, F150 ½ Ton Truck, NAVIGATOR
E148-71-007	Caliper Kits	Fr & Rr	1979 - 2008	CHEVROLET, GMC, INTERNATIONAL, ISUZU, MACK, BLUEBIRD BUS, FREIGHTLINER, STERLING	B6P042 School Bus with Front Disc Brakes, B7T042 School Bus with Disc Brakes, C60 C6D042 with Disc Brakes, C6500 Kodiak with Disc Brakes, C70 C7D042, C7D064 with Disc Brakes, P6S with Disc Brakes, P6T042 with Disc Brakes, T5500, T6500 with Disc Brakes, T7500, T8500 Tilt Cab with Disc Brakes, B7T School Bus with Disc Brakes, C6D042 with Front Disc Brakes, C6500 Topkick with Front Disc Brakes, C7D042, C7D064 with Front Disc Brakes, C7500 Topkick with Front Disc Brakes, P6S with Front Disc Brakes, P6T042 with Front Disc Brakes, S7T042 Forward Control with Front Disc Brakes, T5500, T6500, T7500, T8500 Tilt Cab with Disc Brakes, M1400, 1452 with Disc Brakes, S1452, 1452FC, M1600, 1652 Metro, S1723, S1724, S1753, S1754 S Models, S1823, S1853 School Bus, S1853FC, S1824, S1854 Conventional, 3000, 3200, 3600, 3700, 3800, 3900FC School Bus with Hydraulic Disc Brakes, 4100, 4200, 4300, 4400, 4600, 4700, 4800, 4900, 7100 Conventional Cab with Hydraulic Disc Brakes, FSR with Front Disc Brakes, FTR with Front Disc Brakes, FVR, FXR with Front Disc Brakes, CS200, MS200, TC2000 with Hydraulic Disc Brakes, FL50, FL60, FL70 with Disc Brakes, FS65, FW700 with Hydraulic Disc Brakes, MB50, MB60, MB70 with Disc Brakes, MT10, MT35, MT45, MT55, MT-E with Hydraulic Disc Brakes, Cargostar Models, S1624, S1652FC, S1652SC UPS, S1654, C01710A, B Cargostar, C01750A, B Cargostar, 1723 Bus, C01810A, B Cargostar, C01850A, B Cargostar, C01910A, B Cargostar, Forward Cab, S Models Conventional, S1924, S1954 Conventional, S Models, ACTERRA with Hydraulic Disc Brakes, C7500 Kodiak with Disc Brakes
E148-71-009	Caliper Kits	Fr	1985 - 1994	WORKHORSE	P32, P42,
E148-71-016	Caliper Kits	Fr	2003 - 2012	CHEVROLET, GMC, HUMMER	EXPRESS 2500, 3500 1 Ton Van, SILVERADO 1500, 2500, 3500, SUBURBAN 2500 ¾ Ton, SAVANA 2500, 3500 Van, SIERRA 1500, 2500, 3500 SIERRA DENALI, C3 ½ Ton, YUKON XL 2500 ¾ Ton, H2
E148-71-017	Caliper Kits	Rr	2007 - 2007	CHEVROLET, GMC	SILVERADO 1500 ½ Ton, SIERRA 1500, SIERRA 1500 DENALI, C3 ½ Ton Pickup

PART NO	DESCRIPTION	POSITION	YEAR	MAKE	MODEL
E148-71-018	Caliper Kits	Fr & Rr	2002 - 2012	CHEVROLET, GMC, HUMMER	AVALANCHE 1500, EXPRESS 1500 ½ Ton Van, SILVERADO 1500, 2500, 3500, SUBURBAN 1500, 2500, TAHOE, SAVANA 1500 ½ Ton Van, SIERRA 1500, 2500, 3500 SIERRA DENALI, C3 Pickup, YUKON DENALI, YUKON XL 1500, YUKON DENALI XL ½ Ton, YUKON XL 2500 ¾ Ton, H2
E148-71-019	Caliper Kits	Fr & Rr	2002 - 2009	CHEVROLET, FORD, GMC	COLORADO, TAURUS, TAURUS X, CANYON, AVALANCHE 1500, SILVERADO 1500 ½ Ton, SUBURBAN 1500 ½ Ton, TAHOE
E148-71-020	Caliper Kits	Fr & Rr	2004 - 2012	CHEVROLET, GMC	EXPRESS 3500 1 Ton Van, SILVERADO 2500, 3500, SAVANA 3500 1 Ton Van, SIERRA 2500, 3500 Pickup, Cab & Chassis, G4500 Commercial Cutaway Chassis
E148-71-021	Caliper Kits	Rr	2006 - 2008	CHEVROLET, GMC	EXPRESS 3500 1 Ton Van, SAVANA 3500 1 Ton Van
E148-71-022	Caliper Kits	Rr	2006 - 2012	CHEVROLET, GMC	EXPRESS 2500 ¾ Ton Van, EXPRESS 3500 1 Ton Van, SAVANA 2500 ¾ Ton Van, SAVANA 3500 1 Ton Van
E148-71-024	Caliper Kits	Rr	2002 - 2012	CHEVROLET, GMC	AVALANCHE 1500, EXPRESS 1500 ½ Ton Van, SUBURBAN 1500 ½ Ton RWD, TAHOE RWD, SAVANA 1500 ½ Ton Van
E148-71-027	Caliper Kits	Rr	2005 - 2009	CHEVROLET, PONTIAC, SATURN	UPLANDER, MONTANA, RELAY
E148-71-028	Caliper Kits	Rr	2007 - 2012	CHEVROLET, GMC	AVALANCHE 1500, SILVERADO 1500 ½ Ton, SUBURBAN 1500 ½ Ton, TAHOE, SIERRA 1500, SIERRA 1500 DENALI, C3 ½ Ton Pickup, YUKON, YUKON DENALI, YUKON XL 1500, YUKON DENALI XL ½ Ton
E148-71-030	Caliper Kits	Rr	2009 - 2012	CHEVROLET, GMC	EXPRESS 3500 1 Ton Van, SAVANA 3500 1 Ton Van, G4500 Commercial Cutaway Chassis
E148-71-031	Caliper Kits	Fr	2011 - 2012	CHEVROLET, GMC	SILVERADO 2500, 3500, SIERRA 2500, 3500 Pickup, Cab & Chassis
E148-72-010	Caliper Kits	Rr	2006 - 2008	DODGE	RAM 1500, 2500, 3500 Pickup
E148-72-012	Caliper Kits	Fr	2004 - 2007	NISSAN	TITAN
E148-72-013	Caliper Kits	Rr	2004 - 2011	FORD, LINCOLN	F150 ½ Ton Truck
E148-72-014	Caliper Kits	Fr	2005 - 2012	DODGE, JEEP	DAKOTA, DURANGO, RAM 1500 ½ Ton Pickup, J8
E148-72-016	Caliper Kits	Fr	2006 - 2006	FORD	E150 ½ Ton Full Size Van
E148-72-017	Caliper Kits	Fr	2007 - 2012	CHRYSLER, DODGE, JEEP	TOWN & COUNTRY VAN, CARAVAN, GRAND CARAVAN, LIBERTY, WRANGLER
E148-72-018	Caliper Kits	Rr	2008 - 2012	CHRYSLER, DODGE, FORD, LINCOLN	TOWN & COUNTRY VAN, CARAVAN, GRAND CARAVAN, EDGE, TAURUS, TAURUS SHO, MKX
E148-72-020	Caliper Kits	Rr	2009 - 2012	DODGE	RAM 1500, 2500, 3500 Pickup, Cab & Chassis
E148-72-021	Caliper Kits	Rr	2009 - 2012	DODGE	RAM 3500 1 Ton Pickup, Cab & Chassis

PART NO	DESCRIPTION	POSITION	YEAR	MAKE	MODEL
E148-73-006	Caliper Kits	Fr & Rr	1979 - 2003	CHEVROLET, GMC, INTERNATIONAL, WORKHORSE	C60 C6D042 with Disc Brakes, C70 C7D042, C7D064 with Disc Brakes, P4T042 with Disc Brakes, P6T042 with Disc Brakes, C6D042 with Front Disc Brakes, C7D042, C7D064 with Front Disc Brakes, P4T042 with Front Disc Brakes, P6T042 with Front Disc Brakes, M1400, 1452 with Disc Brakes, S1452, 1452FC, M1600, 1652 Metro, S1723, S1724, S1753, S1754 S Models, S1823, S1853 School Bus, S1853FC, S1824, S1854 Conventional, 3000, 3200, 3600, 3700, 3800, 3900FC School Bus with Hydraulic Disc Brakes, 4100, 4200, 4300, 4400, 4600, 4700, 4800, 4900, 7100 Conventional Cab with Hydraulic Disc Brakes, P32, P42, Cargostar Models, S1624, S1652FC, S1652SC UPS, S1654, 1723 Bus, S Models Conventional, S1924, S1954 Conventional, S Models
E148-77-006	Caliper Kits	Fr & Rr	2001 - 2011	WORKHORSE	P32, P42, P500 (Fedex Delivery Truck), W16, W18 - 16,000, 18,000 GVWR, W42 - 14,001, 16,000 GVWR
E148-79-007	Caliper Kits	Fr & Rr	2005 - 2012	MITSUBISHI FUSO	FE Series
E148-80-006	Caliper Kits	Fr, Fr & Rr	2005 - 2012	FORD, HINO	F250, F250, F350, F450, F47 Super Duty Truck, Cab & Chassis, 145 14,050 GVW, 165 16,000 GVW, 185 18,500 LBS GVW
E148-81-006	Caliper Kits	Fr	1987 - 2004	ISUZU	NPR with Front Disc Brakes, Gas Engine
E148-81-007	Caliper Kits	Fr	1997 - 2004	ISUZU	NPR with Front Disc Brakes, Gas Engine, NQR
E148-81-008	Caliper Kits	Fr	2004 - 2012	CHEVROLET, GMC, ISUZU	W3500 Gas Engine, W3500 Diesel Engine, W4500 Gas Engine, W4500 Diesel Engine, NPR with Front Disc Brakes, Gas Engine, NPR with Front Disc Brakes, Diesel Engine
E148-81-009	Caliper Kits	Fr	2004 - 2012	CHEVROLET, GMC, ISUZU	W3500 Gas Engine, W4500 Gas Engine, W4500 Diesel Engine, W5500, W5500HD, NPR with Front Disc Brakes, Gas Engine, NPR with Front Disc Brakes, Diesel Engine, NQR, NRR
E148-82-006	Caliper Kits	Fr	1994 - 2010	UD	UD 1400
E148-84-006	Caliper Kits	Fr	1983 - 1999	FORD	B600 Bus with Front Disc Brakes, B700 Bus with Front Disc Brakes, C700 Tilt Cab with Front Disc Brakes, C800 Tilt Cab with Front Disc Brakes, F600 Conventional with Front Disc Brakes, F700 Conventional with Front Disc Brakes, F800 Conventional with Front Disc Brakes, FT800 Conventional with Front Disc Brakes, L800 Conventional with Front Disc Brakes, L900 Conventional with Front Disc Brakes, LN600 Short Conventional with Front Disc Brakes, LN700 Short Conventional with Front Disc Brakes, LN800, 900 Short Conventional with Front Disc Brakes, LNT800 Short Conventional Tandem with Front Disc Brakes, LT800 Short Conventional Tandem with Front Disc Brakes, LT, LTL900 Short Conventional Tandem with Front Disc Brakes, LTS800 Short Conventional Tandem with Front Disc Brakes
E148-84-008	Caliper Kits	Fr	1984 - 1994	FORD	8000 Series (air over hydraulics)

PART NO	DESCRIPTION	POSITION	YEAR	MAKE	MODEL
E148-84-009	Caliper Kits	Fr & Rr	1992 - 2012	FORD, IC BUS, INTERNATIONAL, BLUEBIRD BUS, FREIGHTLINER, CHEVROLET, GMC, ISUZU	F650 Conventional with Disc Brakes, F750 Conventional with Disc Brakes, BE, CE, HC, LC with Hydraulic Disc Brakes, 3000, 3200, 3600, 3700, 3800, 3900FC School Bus with Hydraulic Disc Brakes, 4100, 4200, 4300, 4400, 4600, 4700, 4800, 4900, 7100 Conventional Cab with Hydraulic Disc Brakes, TC2000 with Hydraulic Disc Brakes, FL50, FL60, FL70 with Disc Brakes, VISION, C6500 Kodiak with Disc Brakes, C7500 Kodiak with Disc Brakes, T5500, T6500 with Disc Brakes, T7500, T8500 Tilt Cab with Disc Brakes, C6500 Topkick with Front Disc Brakes, C7500 Topkick with Front Disc Brakes, T5500, T6500, T7500, T8500 Tilt Cab with Disc Brakes, FSR with Front Disc Brakes, FTR with Front Disc Brakes, FVR, FXR with Front Disc Brakes
E148-84-010	Caliper Kits	Fr & Rr	1992 - 2012	BLUEBIRD BUS, CHEVROLET, GMC, HINO, ISUZU, WORKHORSE, FREIGHTLINER, THOMAS BUILT, FORD, IC BUS, INTERNATIONAL	VISION, C4500 Kodiak, C5500 Kodiak, C6500 Kodiak with Disc Brakes, C7500 Kodiak with Disc Brakes, T5500, T6500 with Disc Brakes, T7500, T8500 Tilt Cab with Disc Brakes, C4500 Topkick, C5500 Topkick, C6500 Topkick with Front Disc Brakes, C7500 Topkick with Front Disc Brakes, T5500, T6500, T7500, T8500 Tilt Cab with Disc Brakes, 238 23,000, 25,500 LBS GVW, 258LP 23,000, 25,000 LBS GVW (Low Profile), 268 25,950GVW LBS with Hydraulic Disc Brakes, FTR with Front Disc Brakes, FVR, FXR with Front Disc Brakes, H Series HTR, HVR, W62, UFO - 17,000, 19,500, 23,000, 23,500 GVWR, TC2000 with Hydraulic Disc Brakes, FL50, FL60, FL70 with Disc Brakes, C2, F650 Conventional with Disc Brakes, F750 Conventional with Disc Brakes, 185 18,500 LBS GVW, BE, CE, HC, LC with Hydraulic Disc Brakes, 3000, 3200, 3600, 3700, 3800, 3900FC School Bus with Hydraulic Disc Brakes, 4100, 4200, 4300, 4400, 4600, 4700, 4800, 4900, 7100 Conventional Cab with Hydraulic Disc Brakes
E148-85-006	Caliper Kits	Fr & Rr	1995 - 2012	CHEVROLET, GMC, HINO, ISUZU, WORKHORSE, THOMAS BUILT	C4500 Kodiak, C5500 Kodiak, C6500 Kodiak with Disc Brakes, C7500 Kodiak with Disc Brakes, T5500, T6500 with Disc Brakes, T7500, T8500 Tilt Cab with Disc Brakes, C4500 Topkick, C5500 Topkick, C6500 Topkick with Front Disc Brakes, C7500 Topkick with Front Disc Brakes, T5500, T6500, T7500, T8500 Tilt Cab with Disc Brakes, 268 25,950GVW LBS with Hydraulic Disc Brakes, FTR with Front Disc Brakes, FVR, FXR with Front Disc Brakes, H Series HTR, HVR, W62, UFO - 17,000, 19,500, 23,000, 23,500 GVWR, C2, W24, W25.5 - 24,000, 25,500 GVWR, FSR with Front Disc Brakes
E148-85-007	Caliper Kits	Fr & Rr	2003 - 2012	DODGE, CHEVROLET, GMC, DODGE, STERLING	RAM 4500, 5500, C4500 Kodiak, C5500 Kodiak, C4500 Topkick, C5500 Topkick, RAM 4500, 5500, BULLET

PART NO	DESCRIPTION	POSITION	YEAR	MAKE	MODEL
E148-87-006	Caliper Kits	Fr & Rr	1979 - 2008	CHEVROLET, FORD, GMC, ISUZU, STERLING	B6P042 School Bus with Front Disc Brakes, B7T042 School Bus with Disc Brakes, C5H042 Kodiak with Disc Brakes, C60 C6D042 with Disc Brakes, C6500 Kodiak with Disc Brakes, C70 C7D042, C7D064 with Disc Brakes, P4T042 with Disc Brakes, P6S with Disc Brakes, P6T042 with Disc Brakes, T5500, T6500 with Disc Brakes, T7500, T8500 Tilt Cab with Disc Brakes, B600 Bus with Front Disc Brakes, B700 Bus with Front Disc Brakes, C600 Tilt Cab with Front Disc Brakes, C700 Tilt Cab with Front Disc Brakes, C800 Tilt Cab with Front Disc Brakes, F600 Conventional with Front Disc Brakes, F700 Conventional with Front Disc Brakes, F800 Conventional with Front Disc Brakes, FT800 Conventional with Front Disc Brakes, L800 Conventional with Front Disc Brakes, L900 Conventional with Front Disc Brakes, LN600 Short Conventional with Front Disc Brakes, LN700 Short Conventional with Front Disc Brakes, LN800, 900 Short Conventional with Front Disc Brakes, LNT800 Short Conventional Tandem with Front Disc Brakes, LT800 Short Conventional Tandem with Front Disc Brakes, LTS800 Short Conventional Tandem with Front Disc Brakes, B7T School Bus with Disc Brakes, C5H042 Topkick with Front Disc Brakes, C6D042 with Front Disc Brakes, C6500 Topkick with Front Disc Brakes, C7D042, C7D064 with Front Disc Brakes, C7500 Topkick with Front Disc Brakes, P4T042 with Front Disc Brakes, P6S with Front Disc Brakes, P6T042 with Front Disc Brakes, T5500, T6500, T7500, T8500 Tilt Cab with Disc Brakes, FSR with Front Disc Brakes, FTR with Front Disc Brakes, FVR, FXR with Front Disc Brakes, ACTERRA with Hydraulic Disc Brakes, C5D064 with Disc Brakes, C7500 Kodiak with Disc Brakes, F750 Conventional with Disc Brakes, C5D042, C5D064 with Front Disc Brakes
E148-87-007	Caliper Kits	Fr & Rr	1979 - 1998	CHEVROLET, GMC, INTERNATIONAL, MACK	B6P042 School Bus with Front Disc Brakes, C70 C7D042, C7D064 with Disc Brakes, P6T042 with Disc Brakes, C7D042, C7D064 with Front Disc Brakes, P6T042 with Front Disc Brakes, S7T042 Forward Control with Front Disc Brakes, S1452, 1452FC, S1723, S1724, S1753, S1754 S Models, S1823, S1853 School Bus, S1853FC, S1824, S1854 Conventional, CS200, MS200, Cargostar Models, S1624, S1652FC, S1652SC UPS, S1654, C01710A, B Cargostar, C01750A, B Cargostar, 1723 Bus, C01810A, B Cargostar, C01850A, B Cargostar, C01910A, B Cargostar, Forward Cab, S Models Conventional, S1924, S1954 Conventional, S Models, C60 C6D042 with Disc Brakes, C6D042 with Front Disc Brakes

PART NO	DESCRIPTION	POSITION	YEAR	MAKE	MODEL
E148-88-006	Caliper Kits	Fr & Rr	1973 - 2004	CHEVROLET, GMC, INTERNATIONAL, FREIGHTLINER	C5D064 with Disc Brakes, C5D042, C5D064 with Front Disc Brakes, M1400, 1452 with Disc Brakes, S1452, 1452FC, M1600, 1652 Metro, S1723, S1724, S1753, S1754 S Models, S1823, S1853 School Bus, S1853FC, S1824, S1854 Conventional, FS65, FW700 with Hydraulic Disc Brakes, MT10, MT35, MT45, MT55, MT-E with Hydraulic Disc Brakes, Cargostar Models, 1600, 1624 Loadstar, S1624, S1652FC, S1652SC UPS, S1654, S Models, Binder, C01710A, B Cargostar, C01750A, B Cargostar, 1700 Loadstar Conventional, 1724 Loadstar, 1723 Bus, C01810A, B Cargostar, C01850A, B Cargostar, 1800, 1824 Loadstar, C01910A, B Cargostar, Forward Cab, F1910A, F1924 Tandem, S Models Conventional, S1924, S1954 Conventional, S Models
E148-88-007	Caliper Kits	Fr & Rr	1973 - 2008	CHEVROLET, GMC, INTERNATIONAL, WORKHORSE, FREIGHTLINER, STERLING	C5D064 with Disc Brakes, C5D042, C5D064 with Front Disc Brakes, M1400, 1452 with Disc Brakes, S1452, 1452FC, M1600, 1652 Metro, S1723, S1724, S1753, S1754 S Models, S1823, S1853 School Bus, S1853FC, S1824, S1854 Conventional, 3000, 3200, 3600, 3700, 3800, 3900FC School Bus with Hydraulic Disc Brakes, 4100, 4200, 4300, 4400, 4600, 4700, 4800, 4900, 7100 Conventional Cab with Hydraulic Disc Brakes, P32, P42, P500 (Fedex Delivery Truck), W42 - 14,001, 16,000 GVWR, FL50, FL60, FL70 with Disc Brakes, FS65, FW700 with Hydraulic Disc Brakes, MB50, MB60, MB70 with Disc Brakes, MT10, MT35, MT45, MT55, MT-E with Hydraulic Disc Brakes, Cargostar Models, 1600, 1624 Loadstar, S1624, S1652FC, S1652SC UPS, S1654, S Models, Binder, C01710A, B Cargostar, C01750A, B Cargostar, 1700 Loadstar Conventional, 1724 Loadstar, 1723 Bus, C01810A, B Cargostar, C01850A, B Cargostar, 1800, 1824 Loadstar, C01910A, B Cargostar, Forward Cab, F1910A, F1924 Tandem, S Models Conventional, S1924, S1954 Conventional, S Models, ACTERRA with Hydraulic Disc Brakes
E148-88-008	Caliper Kits	Fr & Rr	1998 - 2012	FORD, IC BUS, INTERNATIONAL, KENWORTH, PETERBILT, BLUEBIRD BUS, FREIGHTLINER, STERLING, WORKHORSE	F53, 59 (1 Ton) RV Motor Home & Stripped Chassis, F650 Conventional with Disc Brakes, F750 Conventional with Disc Brakes, BE, CE, HC, LC with Hydraulic Disc Brakes, 3000, 3200, 3600, 3700, 3800, 3900FC School Bus with Hydraulic Disc Brakes, 4100, 4200, 4300, 4400, 4600, 4700, 4800, 4900, 7100 Conventional Cab with Hydraulic Disc Brakes, T170, T270, T370 w/ Hydraulic Disc Brakes, 325, 330, 335 w/ Hydraulic Disc Brakes, TC2000 with Hydraulic Disc Brakes, Fred Chassis, FS65, FW700 with Hydraulic Disc Brakes, M2 100/106 with Hydraulic Disc Brakes, MC, MC-L Series Motorhome Chassis, MT10, MT35, MT45, MT55, MT-E with Hydraulic Disc Brakes, S1624, S1652FC, S1652SC UPS, S1654, ACTERRA with Hydraulic Disc Brakes, LF72 Bus 19,000 GVWR, W20, W20D, W21, W22 - 20,70, 22,000 GVWR



PART NO	DESCRIPTION	POSITION	YEAR	MAKE	MODEL
E148-88-009	Caliper Kits	Fr & Rr	1985 - 2012	FORD, IC BUS, INTERNATIONAL, KENWORTH, PETERBILT, WORKHORSE, BLUEBIRD BUS, FREIGHTLINER, STERLING	F650 Conventional with Disc Brakes, F750 Conventional with Disc Brakes, BE, CE, HC, LC with Hydraulic Disc Brakes, 3000, 3200, 3600, 3700, 3800, 3900FC School Bus with Hydraulic Disc Brakes, 4100, 4200, 4300, 4400, 4600, 4700, 4800, 4900, 7100 Conventional Cab with Hydraulic Disc Brakes, T170, T270, T370 w/ Hydraulic Disc Brakes, 325, 330, 335 w/ Hydraulic Disc Brakes, P32, P42, TC2000 with Hydraulic Disc Brakes, Fred Chassis, FS65, FW700 with Hydraulic Disc Brakes, M2 100/106 with Hydraulic Disc Brakes, MC, MC-L Series Motorhome Chassis, MT10, MT35, MT45, MT55, MT-E with Hydraulic Disc Brakes, MXT, RXT, S1624, S1652FC, S1652SC UPS, S1654, ACTERRA with Hydraulic Disc Brakes, LF72 Bus 19,000 GVWR, W20, W20D, W21, W22 - 20,70, 22,000 GVWR, F53, 59 (1 Ton) RV Motor Home & Stripped Chassis
E148-90-006	Caliper Kits	Fr, Fr & Rr	2006 - 2012	DODGE, FREIGHTLINER, MERCEDES BENZ, WORKHORSE	SPRINTER 3500, W42 - 14,001, 16,000 GVWR
E148-96-008	Caliper Kits	Rr	2007 - 2012	DODGE, JEEP	CALIBER, COMPASS, PATRIOT
E148-96-018	Caliper Kits	Fr	2010 - 2012	NISSAN	CUBE
E148-96-020	Caliper Kits	Rr	2003 - 2012	CHEVROLET, GMC, JEEP, SATURN, TOYOTA	TRAILBLAZER, TRAVERSE, ACADIA, ENVOY, LIBERTY, WRANGLER, OUTLOOK, SEQUOIA, 4RUNNER
E148-96-021	Caliper Kits	Fr	2008 - 2010	CHEVROLET	HHR
E149-49-006	Wheel Cyl Kits	Rr	2006 - 2007	CHRYSLER, DODGE	TOWN & COUNTRY VAN, CARAVAN, GRAND CARAVAN
E149-49-024	Wheel Cyl Kits	Rr	2005 - 2011	TOYOTA	TACOMA
E149-66-008	Wheel Cyl Kits	Rr	2001 - 2007	FORD	TAURUS
E149-66-010	Wheel Cyl Kits	Rr	2003 - 2009	FORD, MAZDA	RANGER, B SERIES Pickup
E149-67-009	Wheel Cyl Kits	Rr	2005 - 2005	PONTIAC	MONTANA
E149-67-019	Wheel Cyl Kits	Rr	1985 - 2003	WORKHORSE	P32, P42,
E149-67-022	Wheel Cyl Kits	Rr	1985 - 2003	WORKHORSE	P32, P42,
E149-71-006	Wheel Cyl Kits	Rr	2005 - 2007	SATURN	VUE
E149-84-007	Wheel Cyl Kits	Rr	1984 - 1994	FORD	LT, LTL900 Short Conventional Tandem with Front Disc Brakes
E149-84-011	Wheel Cyl Kits	Rr	1984 - 1994	FORD	LT, LTL900 Short Conventional Tandem with Front Disc Brakes
E149-84-013	Wheel Cyl Kits	Rr	1984 - 1994	FORD	LT, LTL900 Short Conventional Tandem with Front Disc Brakes
E149-84-016	Wheel Cyl Kits	Rr L	1984 - 1994	FORD	LT, LTL900 Short Conventional Tandem with Front Disc Brakes
E149-84-017	Wheel Cyl Kits	Rr R	1984 - 1994	FORD	LT, LTL900 Short Conventional Tandem with Front Disc Brakes
E149-85-010	Wheel Cyl Kits	Fr	1986 - 1994	CHEVROLET, GMC, ISUZU	W6 M, EVR
E149-85-011	Wheel Cyl Kits	Rr	1986 - 1994	CHEVROLET, GMC, ISUZU	W6 M, EVR
E155-40-106	Brake Hoses	Fr & Rr	2007 - 2012	DODGE, FREIGHTLINER, MERCEDES BENZ	SPRINTER 2500, 3500
E155-40-506	Brake Hoses	Rr	2007 - 2009	DODGE, FREIGHTLINER	SPRINTER 3500
E155-47-008	Brake Hoses	Rr	2010 - 2012	NISSAN	CUBE
E155-47-091	Brake Hoses	Fr L	2004 - 2007	NISSAN	TITAN
E155-47-092	Brake Hoses	Fr R	2004 - 2007	NISSAN	TITAN



PART NO	DESCRIPTION	POSITION	YEAR	MAKE	MODEL
E155-47-099	Brake Hoses	Fr L	2005 - 2012	NISSAN	FRONTIER, PATHFINDER, XTERRA
E155-47-100	Brake Hoses	Fr R	2005 - 2012	NISSAN	FRONTIER, PATHFINDER, XTERRA
E155-47-111	Brake Hoses	Fr L	2010 - 2012	NISSAN	CUBE
E155-47-112	Brake Hoses	Fr R	2010 - 2012	NISSAN	CUBE
E155-47-113	Brake Hoses	Fr L	2006 - 2007	NISSAN	ARMADA
E155-47-114	Brake Hoses	Fr R	2006 - 2007	NISSAN	ARMADA
E155-47-120	Brake Hoses	Fr R	2008 - 2012	NISSAN	ROGUE
E155-47-121	Brake Hoses	Fr L	2008 - 2012	NISSAN	ROGUE
E155-47-124	Brake Hoses	Fr R	2007 - 2012	NISSAN	ARMADA, TITAN
E155-47-125	Brake Hoses	Fr L	2007 - 2012	NISSAN	ARMADA, TITAN
E155-47-142	Brake Hoses	Fr R	2012 - 2012	NISSAN	NV1500, NV2500 HD, NV3500 HD
E155-47-143	Brake Hoses	Fr L	2012 - 2012	NISSAN	NV1500, NV2500 HD, NV3500 HD
E155-47-311	Brake Hoses	Rr Lo	2006 - 2012	NISSAN	XTERRA
E155-47-358	Brake Hoses	Rr	1994 - 2010	NISSAN, UD	TITAN, UD 1400
E155-47-375	Brake Hoses	Rr	1999 - 2012	NISSAN, UD	TITAN, UD 1400
E155-47-383	Brake Hoses	Rr Lo	2004 - 2012	NISSAN	TITAN
E155-47-384	Brake Hoses	Rr R	2006 - 2012	NISSAN	ARMADA
E155-47-385	Brake Hoses	Rr L	2006 - 2012	NISSAN	ARMADA
E155-47-386	Brake Hoses	Rr R	2006 - 2012	NISSAN	PATHFINDER
E155-47-387	Brake Hoses	Rr L	2006 - 2012	NISSAN	PATHFINDER
E155-47-388	Brake Hoses	Rr R	2005 - 2012	NISSAN	FRONTIER
E155-47-389	Brake Hoses	Rr L	2005 - 2012	NISSAN	FRONTIER
E155-47-392	Brake Hoses	Rr Up	2006 - 2012	NISSAN	NV1500, NV2500 HD, NV3500 HD, XTERRA
E155-47-398	Brake Hoses	Rr Lo R	2008 - 2012	NISSAN	ROGUE
E155-47-399	Brake Hoses	Rr Lo L	2008 - 2012	NISSAN	ROGUE
E155-47-404	Brake Hoses	Rr Up	2008 - 2012	NISSAN	ROGUE
E155-47-431	Brake Hoses	Rr Lo L	2012 - 2012	NISSAN	NV1500, NV2500 HD, NV3500 HD
E155-47-432	Brake Hoses	Rr Lo R	2012 - 2012	NISSAN	NV1500, NV2500 HD, NV3500 HD
E155-49-024	Brake Hoses	Rr Up L	2003 - 2007	TOYOTA	LAND CRUISER
E155-49-086	Brake Hoses	Fr R	2006 - 2007	TOYOTA	HIGHLANDER
E155-49-087	Brake Hoses	Fr L	2006 - 2007	TOYOTA	HIGHLANDER
E155-49-088	Brake Hoses	Fr R	2004 - 2010	TOYOTA	SIENNA
E155-49-089	Brake Hoses	Fr L	2004 - 2010	TOYOTA	SIENNA
E155-49-091	Brake Hoses	Fr L	2005 - 2011	TOYOTA	TACOMA
E155-49-092	Brake Hoses	Fr R	2005 - 2011	TOYOTA	TACOMA
E155-49-116	Brake Hoses	Fr L	2003 - 2007	TOYOTA	LAND CRUISER
E155-49-117	Brake Hoses	Fr R	2003 - 2007	TOYOTA	LAND CRUISER
E155-49-146	Brake Hoses	Fr	2007 - 2011	TOYOTA	SEQUOIA, TUNDRA
E155-49-147	Brake Hoses	Fr L	2008 - 2011	TOYOTA	HIGHLANDER
E155-49-148	Brake Hoses	Fr R	2008 - 2011	TOYOTA	HIGHLANDER
E155-49-156	Brake Hoses	Fr R	2008 - 2011	TOYOTA	LAND CRUISER
E155-49-157	Brake Hoses	Fr L	2008 - 2011	TOYOTA	LAND CRUISER
E155-49-160	Brake Hoses	Fr R	2011 - 2011	TOYOTA	SIENNA
E155-49-161	Brake Hoses	Fr L	2011 - 2011	TOYOTA	SIENNA
E155-49-321	Brake Hoses	Rr Lo	2004 - 2010	TOYOTA	SIENNA
E155-49-367	Brake Hoses	Fr	2003 - 2011	TOYOTA	FJ CRUISER, SEQUOIA, TACOMA, 4RUNNER

PART NO	DESCRIPTION	POSITION	YEAR	MAKE	MODEL
E155-49-385	Brake Hoses	Rr L	2006 - 2007	TOYOTA	HIGHLANDER
E155-49-386	Brake Hoses	Rr R	2006 - 2007	TOYOTA	HIGHLANDER
E155-49-387	Brake Hoses	Rr Up R	2003 - 2007	TOYOTA	LAND CRUISER
E155-49-388	Brake Hoses	Rr Lo R	2003 - 2007	TOYOTA	SEQUOIA
E155-49-389	Brake Hoses	Rr Lo L	2003 - 2007	TOYOTA	SEQUOIA
E155-49-390	Brake Hoses	Rr Up L	2003 - 2007	TOYOTA	SEQUOIA
E155-49-400	Brake Hoses	Rr Up R	2003 - 2007	TOYOTA	SEQUOIA
E155-49-402	Brake Hoses	Rr Up	2003 - 2011	TOYOTA	FJ CRUISER, 4RUNNER
E155-49-403	Brake Hoses	Rr L	2006 - 2007	TOYOTA	HIGHLANDER
E155-49-404	Brake Hoses	Rr R	2006 - 2007	TOYOTA	HIGHLANDER
E155-49-412	Brake Hoses	Rr Lo R	2003 - 2011	TOYOTA	FJ CRUISER, 4RUNNER
E155-49-413	Brake Hoses	Rr Lo L	2003 - 2011	TOYOTA	FJ CRUISER, 4RUNNER
E155-49-414	Brake Hoses	Rr	2004 - 2010	TOYOTA	SIENNA
E155-49-418	Brake Hoses	Rr R	2005 - 2011	TOYOTA	TACOMA
E155-49-419	Brake Hoses	Rr L	2005 - 2011	TOYOTA	TACOMA
E155-49-420	Brake Hoses	Rr R	2005 - 2011	TOYOTA	TACOMA
E155-49-421	Brake Hoses	Rr L	2005 - 2011	TOYOTA	TACOMA
E155-49-434	Brake Hoses	Rr Up R	2007 - 2011	TOYOTA	TUNDRA
E155-49-435	Brake Hoses	Rr Up L	2007 - 2011	TOYOTA	TUNDRA
E155-49-436	Brake Hoses	Rr Lo	2007 - 2011	TOYOTA	TUNDRA
E155-49-437	Brake Hoses	Rr L	2008 - 2011	TOYOTA	HIGHLANDER
E155-49-438	Brake Hoses	Rr R	2008 - 2011	TOYOTA	HIGHLANDER
E155-49-439	Brake Hoses	Rr L	2008 - 2011	TOYOTA	HIGHLANDER
E155-49-440	Brake Hoses	Rr R	2008 - 2011	TOYOTA	HIGHLANDER
E155-49-449	Brake Hoses	Rr Up L	2008 - 2011	TOYOTA	LAND CRUISER
E155-49-450	Brake Hoses	Rr Up R	2008 - 2011	TOYOTA	LAND CRUISER
E155-49-453	Brake Hoses	Rr L	2008 - 2011	TOYOTA	SEQUOIA
E155-49-454	Brake Hoses	Rr R	2008 - 2011	TOYOTA	SEQUOIA
E155-49-459	Brake Hoses	Rr	2011 - 2011	TOYOTA	SIENNA
E155-50-055	Brake Hoses	Fr	2007 - 2011	MAZDA	CX-7, CX-9
E155-50-358	Brake Hoses	Rr	2007 - 2011	MAZDA	CX-7
E155-50-359	Brake Hoses	Rr L	2007 - 2011	MAZDA	CX-9
E155-50-360	Brake Hoses	Rr R	2007 - 2011	MAZDA	CX-9
E155-63-019	Brake Hoses	Fr L	2007 - 2007	JEEP	LIBERTY
E155-63-020	Brake Hoses	Fr R	2007 - 2007	JEEP	LIBERTY
E155-63-023	Brake Hoses	Fr R	2006 - 2010	JEEP	COMMANDER, GRAND CHEROKEE
E155-63-024	Brake Hoses	Fr L	2006 - 2010	JEEP	COMMANDER, GRAND CHEROKEE
E155-63-028	Brake Hoses	Fr R	2007 - 2010	JEEP	WRANGLER
E155-63-029	Brake Hoses	Fr L	2007 - 2010	JEEP	WRANGLER
E155-63-030	Brake Hoses	Fr R	2008 - 2012	JEEP	LIBERTY
E155-63-031	Brake Hoses	Fr L	2008 - 2012	JEEP	LIBERTY
E155-63-032	Brake Hoses	Fr R	2011 - 2011	JEEP	WRANGLER
E155-63-033	Brake Hoses	Fr L	2011 - 2011	JEEP	WRANGLER
E155-63-034	Brake Hoses	Fr R	2011 - 2012	DODGE, JEEP	DURANGO, GRAND CHEROKEE
E155-63-035	Brake Hoses	Fr L	2011 - 2012	DODGE, JEEP	DURANGO, GRAND CHEROKEE
E155-63-309	Brake Hoses	Rr L	2006 - 2010	JEEP	COMMANDER, GRAND CHEROKEE

PART NO	DESCRIPTION	POSITION	YEAR	MAKE	MODEL
E155-63-310	Brake Hoses	Rr R	2006 - 2010	JEEP	COMMANDER, GRAND CHEROKEE
E155-63-314	Brake Hoses	Rr Up	2007 - 2007	JEEP	LIBERTY
E155-63-317	Brake Hoses	Rr L	2007 - 2011	JEEP	WRANGLER
E155-63-318	Brake Hoses	Rr R	2007 - 2011	JEEP	WRANGLER
E155-63-319	Brake Hoses	Rr L	2006 - 2010	JEEP	COMMANDER, GRAND CHEROKEE
E155-63-320	Brake Hoses	Rr R	2006 - 2010	JEEP	COMMANDER, GRAND CHEROKEE
E155-63-321	Brake Hoses	Rr L	2008 - 2012	JEEP	LIBERTY
E155-63-322	Brake Hoses	Rr R	2011 - 2012	DODGE, JEEP	DURANGO, GRAND CHEROKEE
E155-63-323	Brake Hoses	Rr L	2011 - 2012	DODGE, JEEP	DURANGO, GRAND CHEROKEE
E155-66-077	Brake Hoses	Fr L	2001 - 2007	FORD	TAURUS
E155-66-078	Brake Hoses	Fr R	2001 - 2007	FORD	TAURUS
E155-66-104	Brake Hoses	Fr R	2003 - 2011	FORD, LINCOLN, MERCURY	CROWN VICTORIA, TOWN CAR, GRAND MARQUIS
E155-66-109	Brake Hoses	Fr L	2003 - 2011	FORD, LINCOLN, MERCURY	CROWN VICTORIA, TOWN CAR, GRAND MARQUIS
E155-66-124	Brake Hoses	Fr	2007 - 2012	FORD, LINCOLN	EDGE, MKX
E155-66-125	Brake Hoses	Fr L	2008 - 2012	FORD	TAURUS
E155-66-126	Brake Hoses	Fr R	2008 - 2012	FORD	TAURUS, TAURUS X
E155-66-127	Brake Hoses	Fr L	2008 - 2009	FORD	TAURUS X
E155-66-129	Brake Hoses	Fr L	2010 - 2012	FORD, LINCOLN	TAURUS, TAURUS SHO, MKT
E155-66-130	Brake Hoses	Fr R	2010 - 2012	FORD, LINCOLN	TAURUS, TAURUS SHO, MKT
E155-66-375	Brake Hoses	Rr R	2001 - 2007	FORD	TAURUS
E155-66-376	Brake Hoses	Rr L	2001 - 2007	FORD	TAURUS
E155-66-381	Brake Hoses	Rr L	2001 - 2007	FORD	TAURUS
E155-66-387	Brake Hoses	Rr R	2001 - 2007	FORD	TAURUS
E155-66-418	Brake Hoses	Rr R	2003 - 2011	LINCOLN, MERCURY	TOWN CAR, GRAND MARQUIS
E155-66-419	Brake Hoses	Rr L	2003 - 2011	LINCOLN, MERCURY	TOWN CAR, GRAND MARQUIS
E155-66-432	Brake Hoses	Rr	2007 - 2010	FORD, LINCOLN	EDGE, MKX
E155-66-433	Brake Hoses	Rr L	2003 - 2011	FORD, LINCOLN, MERCURY	CROWN VICTORIA, TOWN CAR, GRAND MARQUIS
E155-66-434	Brake Hoses	Rr R	2003 - 2011	FORD, LINCOLN, MERCURY	CROWN VICTORIA, TOWN CAR, GRAND MARQUIS
E155-66-443	Brake Hoses	Rr	2008 - 2009	FORD	TAURUS, TAURUS X
E155-66-446	Brake Hoses	Rr	2010 - 2012	FORD, LINCOLN	TAURUS, TAURUS SHO, MKT
E155-66-451	Brake Hoses	Rr L	2010 - 2012	FORD	TAURUS
E155-66-452	Brake Hoses	Rr	2010 - 2012	FORD	TAURUS, TAURUS SHO
E155-66-454	Brake Hoses	Rr R	2011 - 2012	FORD, LINCOLN	EDGE, MKX
E155-66-455	Brake Hoses	Rr L	2011 - 2012	FORD, LINCOLN	EDGE, MKX
E155-67-092	Brake Hoses	Fr	2005 - 2005	PONTIAC	MONTANA
E155-67-116	Brake Hoses	Fr	2006 - 2010	CHEVROLET	HHR
E155-67-117	Brake Hoses	Fr L	2005 - 2007	SATURN	VUE
E155-67-118	Brake Hoses	Fr R	2005 - 2007	SATURN	VUE
E155-67-142	Brake Hoses	Fr R	2007 - 2012	CHEVROLET	IMPALA
E155-67-143	Brake Hoses	Fr L	2007 - 2012	CHEVROLET	IMPALA
E155-67-150	Brake Hoses	Fr R	2007 - 2009	CHEVROLET, PONTIAC	EQUINOX, TORRENT
E155-67-151	Brake Hoses	Fr L	2007 - 2009	CHEVROLET, PONTIAC	EQUINOX, TORRENT
E155-67-162	Brake Hoses	Fr	2009 - 2010	CHEVROLET	HHR
E155-67-172	Brake Hoses	Fr R	2008 - 2010	SATURN	VUE
E155-67-173	Brake Hoses	Fr L	2008 - 2010	SATURN	VUE
E155-67-175	Brake Hoses	Fr L	2010 - 2012	CHEVROLET, GMC	EQUINOX, TERRAIN

PART NO	DESCRIPTION	POSITION	YEAR	MAKE	MODEL
E155-67-176	Brake Hoses	Fr R	2010 - 2012	CHEVROLET, GMC	EQUINOX, TERRAIN
E155-67-182	Brake Hoses	Fr R	2011 - 2011	CHEVROLET	CAPRICE
E155-67-183	Brake Hoses	Fr L	2011 - 2011	CHEVROLET	CAPRICE
E155-67-380	Brake Hoses	Rr	2005 - 2005	PONTIAC	MONTANA
E155-67-406	Brake Hoses	Rr R	2005 - 2007	SATURN	VUE
E155-67-407	Brake Hoses	Rr L	2005 - 2007	SATURN	VUE
E155-67-409	Brake Hoses	Rr	2006 - 2011	CHEVROLET	HHR
E155-67-422	Brake Hoses	Rr Lo R	2008 - 2010	CHEVROLET	HHR
E155-67-423	Brake Hoses	Rr Lo L	2008 - 2010	CHEVROLET	HHR
E155-67-437	Brake Hoses	Rr	2007 - 2010	CHEVROLET	IMPALA
E155-67-438	Brake Hoses	Rr R	2007 - 2012	CHEVROLET, GMC, PONTIAC	EQUINOX, TERRAIN, TORRENT
E155-67-439	Brake Hoses	Rr L	2007 - 2009	CHEVROLET, PONTIAC	EQUINOX, TORRENT
E155-67-447	Brake Hoses	Rr L	2007 - 2012	CHEVROLET, GMC, PONTIAC	EQUINOX, TERRAIN, TORRENT
E155-67-456	Brake Hoses	Rr R	2008 - 2010	SATURN	VUE
E155-67-457	Brake Hoses	Rr L	2008 - 2010	SATURN	VUE
E155-67-458	Brake Hoses	Rr R	2011 - 2012	CHEVROLET	IMPALA
E155-67-459	Brake Hoses	Rr L	2011 - 2012	CHEVROLET	IMPALA
E155-67-464	Brake Hoses	Rr	2011 - 2011	CHEVROLET	CAPRICE
E155-68-079	Brake Hoses	Fr L	2008 - 2010	DODGE	CHARGER
E155-68-080	Brake Hoses	Fr R	2008 - 2011	DODGE	CHARGER
E155-68-081	Brake Hoses	Fr L	2008 - 2010	DODGE	CHARGER
E155-68-082	Brake Hoses	Fr R	2008 - 2010	DODGE	CHARGER
E155-68-085	Brake Hoses	Fr	2008 - 2012	DODGE	CHARGER
E155-68-088	Brake Hoses	Fr R	2007 - 2012	DODGE, JEEP	CALIBER, COMPASS, PATRIOT
E155-68-089	Brake Hoses	Fr L	2007 - 2012	DODGE, JEEP	CALIBER, COMPASS, PATRIOT
E155-68-093	Brake Hoses	Fr L	2011 - 2011	DODGE	CHARGER
E155-68-094	Brake Hoses	Fr R	2011 - 2011	DODGE	CHARGER
E155-68-380	Brake Hoses	Rr R	2008 - 2012	DODGE	CHARGER
E155-68-381	Brake Hoses	Rr L	2008 - 2012	DODGE	CHARGER
E155-68-386	Brake Hoses	Rr R	2008 - 2012	DODGE	CHARGER
E155-68-387	Brake Hoses	Rr L	2008 - 2012	DODGE	CHARGER
E155-68-388	Brake Hoses	Rr	2007 - 2012	DODGE, JEEP	CALIBER, COMPASS, PATRIOT
E155-68-389	Brake Hoses	Rr	2007 - 2012	DODGE, JEEP	CALIBER, COMPASS, PATRIOT
E155-68-390	Brake Hoses	Rr Lo	2007 - 2012	DODGE, JEEP	CALIBER, COMPASS, PATRIOT
E155-68-392	Brake Hoses	Rr Lo	2007 - 2012	DODGE, JEEP	CALIBER, COMPASS, PATRIOT
E155-68-393	Brake Hoses	Rr L	2008 - 2012	DODGE	CHARGER
E155-68-394	Brake Hoses	Rr R	2008 - 2012	DODGE	CHARGER
E155-68-396	Brake Hoses	Rr R	2008 - 2008	JEEP	LIBERTY
E155-68-399	Brake Hoses	Rr	2009 - 2012	DODGE, JEEP	COMPASS, PATRIOT, CALIBER
E155-68-400	Brake Hoses	Rr	2009 - 2012	DODGE, JEEP	COMPASS, PATRIOT, CALIBER
E155-68-402	Brake Hoses	Rr R	2009 - 2012	JEEP	LIBERTY
E155-70-106	Brake Hoses	Fr L	1996 - 2007	FORD	E-SUPER DUTY Van & Cutaway, E450, 47 (1 Ton) Super Duty Van & Cutaway
E155-70-107	Brake Hoses	Fr R	1996 - 2007	FORD	E-SUPER DUTY Van & Cutaway, E450, 47 (1 Ton) Super Duty Van & Cutaway
E155-70-108	Brake Hoses	Fr L	1996 - 2001	FORD	E450, 47 (1 Ton) Super Duty Van & Cutaway

PART NO	DESCRIPTION	POSITION	YEAR	MAKE	MODEL
E155-70-114	Brake Hoses	Fr R	2003 - 2007	FORD, MAZDA	RANGER 4WD, B SERIES Pickup 4WD
E155-70-115	Brake Hoses	Fr L	2003 - 2007	FORD, MAZDA	RANGER 4WD, B SERIES Pickup 4WD
E155-70-121	Brake Hoses	Fr L	2003 - 2011	FORD, MAZDA	RANGER RWD, B SERIES Pickup RWD
E155-70-122	Brake Hoses	Fr R	2003 - 2011	FORD, MAZDA	RANGER RWD, B SERIES Pickup RWD
E155-70-127	Brake Hoses	Fr L	1999 - 2003	FORD	F53, 59 (1 Ton) RV Motor Home & Stripped Chassis
E155-70-128	Brake Hoses	Fr R	1999 - 2003	FORD	F53, 59 (1 Ton) RV Motor Home & Stripped Chassis
E155-70-155	Brake Hoses	Fr	2007 - 2007	FORD, MERCURY	ESCAPE, MARINER
E155-70-162	Brake Hoses	Fr R	2002 - 2005	FORD	E550
E155-70-163	Brake Hoses	Fr L	2002 - 2005	FORD	E550
E155-70-166	Brake Hoses	Fr R	2004 - 2008	FORD	F150 ½ Ton Truck
E155-70-167	Brake Hoses	Fr L	2004 - 2008	FORD	F150 ½ Ton Truck
E155-70-168	Brake Hoses	Fr R	2004 - 2011	FORD	F53, 59 (1 Ton) RV Motor Home & Stripped Chassis
E155-70-169	Brake Hoses	Fr L	2004 - 2011	FORD	F53, 59 (1 Ton) RV Motor Home & Stripped Chassis
E155-70-170	Brake Hoses	Fr R	2006 - 2006	FORD	E150 ½ Ton Full Size Van
E155-70-171	Brake Hoses	Fr L	2006 - 2006	FORD	E150 ½ Ton Full Size Van
E155-70-176	Brake Hoses	Fr R	2005 - 2006	FORD	F250, F250 Super Duty ¾ Ton RWD Truck
E155-70-177	Brake Hoses	Fr L	2005 - 2006	FORD	F250, F250 Super Duty ¾ Ton RWD Truck
E155-70-178	Brake Hoses	Fr R	2005 - 2006	FORD	F250, F250 Super Duty ¾ Ton 4WD Truck
E155-70-179	Brake Hoses	Fr L	2005 - 2006	FORD	F250, F250 Super Duty ¾ Ton 4WD Truck
E155-70-180	Brake Hoses	Fr R	2005 - 2006	FORD	F450, F47 (1 Ton) 2WD & 4WD Super Duty, F550 (1 Ton) 2WD & 4WD Super Duty
E155-70-181	Brake Hoses	Fr L	2005 - 2006	FORD	F450, F47 (1 Ton) 2WD & 4WD Super Duty, F550 (1 Ton) 2WD & 4WD Super Duty
E155-70-186	Brake Hoses	Fr R, Fr L	2004 - 2007	FORD	E150 ½ Ton Full Size Van, E250 ¾ Ton Full Size Van, E350 1 Ton Full Size Van, Wagon, Stripped & RV Chassis including Super Duty, E-SUPER DUTY Van & Cutaway, E450, 47 (1 Ton) Super Duty Van & Cutaway
E155-70-187	Brake Hoses	Fr	2004 - 2007	FORD	E150 ½ Ton Full Size Van, E250 ¾ Ton Full Size Van, E350 1 Ton Full Size Van, Wagon, Stripped & RV Chassis including Super Duty, E-SUPER DUTY Van & Cutaway, E450, 47 (1 Ton) Super Duty Van & Cutaway
E155-70-188	Brake Hoses	Fr R	2006 - 2010	FORD, MERCURY	EXPLORER, SPORT, SPORT TRAC, MOUNTAINEER
E155-70-189	Brake Hoses	Fr L	2006 - 2010	FORD, MERCURY	EXPLORER, SPORT, SPORT TRAC, MOUNTAINEER
E155-70-190	Brake Hoses	Fr R	2006 - 2010	FORD, MERCURY	EXPLORER, SPORT, SPORT TRAC, MOUNTAINEER
E155-70-191	Brake Hoses	Fr L	2006 - 2010	FORD, MERCURY	EXPLORER, SPORT, SPORT TRAC, MOUNTAINEER
E155-70-192	Brake Hoses	Fr R	2004 - 2008	FORD, LINCOLN	F150 ½ Ton Truck
E155-70-193	Brake Hoses	Fr L	2004 - 2008	FORD, LINCOLN	F150 ½ Ton Truck
E155-70-194	Brake Hoses	Fr R	2007 - 2010	FORD, LINCOLN	EXPEDITION, NAVIGATOR
E155-70-195	Brake Hoses	Fr L	2007 - 2010	FORD, LINCOLN	EXPEDITION, NAVIGATOR
E155-70-196	Brake Hoses	Fr R	2007 - 2011	FORD, MAZDA	RANGER, B SERIES Pickup 4WD
E155-70-197	Brake Hoses	Fr L	2007 - 2011	FORD, MAZDA	RANGER, B SERIES Pickup 4WD
E155-70-198	Brake Hoses	Fr	2010 - 2012	FORD	TRANSIT CONNECT
E155-70-199	Brake Hoses	Fr	2008 - 2012	FORD, MAZDA, MERCURY	ESCAPE, TRIBUTE, MARINER

PART NO	DESCRIPTION	POSITION	YEAR	MAKE	MODEL
E155-70-200	Brake Hoses	Fr R	2006 - 2010	FORD	F250, F250 Super Duty ¾ Ton 4WD Truck, F350 1 Ton Pickup, Cab & Chassis 4WD including Super Duty
E155-70-201	Brake Hoses	Fr L	2006 - 2010	FORD	F250, F250 Super Duty ¾ Ton 4WD Truck, F350 1 Ton Pickup, Cab & Chassis 4WD including Super Duty
E155-70-202	Brake Hoses	Fr R	2006 - 2009	FORD	F450, F47 (1 Ton) 2WD & 4WD Super Duty, F550 (1 Ton) 2WD & 4WD Super Duty
E155-70-203	Brake Hoses	Fr L	2006 - 2009	FORD	F450, F47 (1 Ton) 2WD & 4WD Super Duty, F550 (1 Ton) 2WD & 4WD Super Duty
E155-70-204	Brake Hoses	Fr R	2006 - 2012	FORD	F250, F250, F350 Super Duty RWD Truck, Cab & Chassis
E155-70-205	Brake Hoses	Fr L	2006 - 2012	FORD	F250, F250, F350 Super Duty RWD Truck, Cab & Chassis
E155-70-206	Brake Hoses	Fr R	2008 - 2012	FORD	E150 ½ Ton Full Size Van, E250 ¾ Ton Full Size Van, E350 1 Ton Full Size Van, Wagon, Stripped & RV Chassis including Super Duty, E-SUPER DUTY Van & Cutaway, E450, 47 (1 Ton) Super Duty Van & Cutaway
E155-70-207	Brake Hoses	Fr L	2008 - 2012	FORD	E150 ½ Ton Full Size Van, E250 ¾ Ton Full Size Van, E350 1 Ton Full Size Van, Wagon, Stripped & RV Chassis including Super Duty, E-SUPER DUTY Van & Cutaway, E450, 47 (1 Ton) Super Duty Van & Cutaway
E155-70-208	Brake Hoses	Fr R	2007 - 2010	FORD	F350 1 Ton Pickup, Cab & Chassis 4WD including Super Duty
E155-70-209	Brake Hoses	Fr L	2007 - 2010	FORD	F350 1 Ton Pickup, Cab & Chassis 4WD including Super Duty
E155-70-210	Brake Hoses	Fr R	2007 - 2011	FORD	F53, 59 (1 Ton) RV Motor Home & Stripped Chassis
E155-70-211	Brake Hoses	Fr L	2007 - 2011	FORD	F53, 59 (1 Ton) RV Motor Home & Stripped Chassis
E155-70-212	Brake Hoses	Fr R	2009 - 2011	FORD	F150 ½ Ton Truck
E155-70-213	Brake Hoses	Fr L	2009 - 2011	FORD	F150 ½ Ton Truck
E155-70-214	Brake Hoses	Fr R	2006 - 2010	FORD	F250, F250 Super Duty ¾ Ton 4WD Truck, F350 1 Ton Pickup, Cab & Chassis 4WD including Super Duty
E155-70-215	Brake Hoses	Fr L	2006 - 2010	FORD	F250, F250 Super Duty ¾ Ton 4WD Truck, F350 1 Ton Pickup, Cab & Chassis 4WD including Super Duty
E155-70-216	Brake Hoses	Fr R	2010 - 2010	FORD	F450, F47 (1 Ton) 2WD & 4WD Super Duty, F550 (1 Ton) 2WD & 4WD Super Duty
E155-70-217	Brake Hoses	Fr L	2010 - 2010	FORD	F450, F47 (1 Ton) 2WD & 4WD Super Duty, F550 (1 Ton) 2WD & 4WD Super Duty
E155-70-218	Brake Hoses	Fr R	2010 - 2010	FORD	F150 ½ Ton 4WD Truck
E155-70-219	Brake Hoses	Fr L	2010 - 2010	FORD	F150 ½ Ton 4WD Truck
E155-70-220	Brake Hoses	Fr R	2010 - 2012	FORD	F350 1 Ton Pickup, Cab & Chassis 4WD including Super Duty
E155-70-221	Brake Hoses	Fr L	2010 - 2012	FORD	F350 1 Ton Pickup, Cab & Chassis 4WD including Super Duty
E155-70-222	Brake Hoses	Fr R	2010 - 2012	FORD	F250, F250 Super Duty ¾ Ton 4WD Truck, F350 1 Ton Pickup, Cab & Chassis 4WD including Super Duty, F450, F47 (1 Ton) 2WD & 4WD Super Duty, F550 (1 Ton) 2WD & 4WD Super Duty



PART NO	DESCRIPTION	POSITION	YEAR	MAKE	MODEL
E155-70-223	Brake Hoses	Fr L	2010 - 2012	FORD	F250, F250 Super Duty ¾ Ton 4WD Truck, F350 1 Ton Pickup, Cab & Chassis 4WD including Super Duty, F450, F47 (1 Ton) 2WD & 4WD Super Duty, F550 (1 Ton) 2WD & 4WD Super Duty
E155-70-224	Brake Hoses	Fr R	2010 - 2012	FORD	F450, F47 (1 Ton) 2WD & 4WD Super Duty
E155-70-225	Brake Hoses	Fr L	2010 - 2012	FORD	F450, F47 (1 Ton) 2WD & 4WD Super Duty
E155-70-226	Brake Hoses	Fr R	2011 - 2012	FORD, LINCOLN	EXPEDITION, NAVIGATOR
E155-70-227	Brake Hoses	Fr L	2011 - 2012	FORD, LINCOLN	EXPEDITION, NAVIGATOR
E155-70-228	Brake Hoses	Fr R	2011 - 2012	FORD	EXPLORER, SPORT, SPORT TRAC
E155-70-229	Brake Hoses	Fr L	2011 - 2012	FORD	EXPLORER, SPORT, SPORT TRAC
E155-70-329	Brake Hoses	Rr	2003 - 2009	FORD, MAZDA	RANGER, B SERIES Pickup
E155-70-337	Brake Hoses	Rr Up	2006 - 2007	FORD	E150 ½ Ton Full Size Van, E250 ¾ Ton Full Size Van, E350 1 Ton Full Size Van, Wagon, Stripped & RV Chassis including Super Duty
E155-70-354	Brake Hoses	Rr Up	1999 - 2003	FORD	F53, 59 (1 Ton) RV Motor Home & Stripped Chassis
E155-70-357	Brake Hoses	Rr Up	1999 - 2000	FORD	F53, 59 (1 Ton) RV Motor Home & Stripped Chassis
E155-70-362	Brake Hoses	Rr Lo L	1996 - 2003	FORD	E450, 47 (1 Ton) Super Duty Van & Cutaway
E155-70-363	Brake Hoses	Rr Up	1996 - 2003	FORD	E450, 47 (1 Ton) Super Duty Van & Cutaway
E155-70-370	Brake Hoses	Rr Up	1996 - 2007	FORD	E-SUPER DUTY Van & Cutaway, E450, 47 (1 Ton) Super Duty Van & Cutaway
E155-70-372	Brake Hoses	Rr Up	2000 - 2003	FORD	F53, 59 (1 Ton) RV Motor Home & Stripped Chassis
E155-70-373	Brake Hoses	Rr L	2006 - 2012	FORD	E150 ½ Ton Full Size Van, E250 ¾ Ton Full Size Van, E350 1 Ton Full Size Van, Wagon, Stripped & RV Chassis including Super Duty, E-SUPER DUTY Van & Cutaway, E450, 47 (1 Ton) Super Duty Van & Cutaway
E155-70-374	Brake Hoses	Rr Lo R	2006 - 2007	FORD	E250 ¾ Ton Full Size Van, E350 1 Ton Full Size Van, Wagon, Stripped & RV Chassis including Super Duty
E155-70-376	Brake Hoses	Rr Lo R	2006 - 2007	FORD	E150 ½ Ton Full Size Van, E250 ¾ Ton Full Size Van, E350 1 Ton Full Size Van, Wagon, Stripped & RV Chassis including Super Duty
E155-70-379	Brake Hoses	Rr R	2007 - 2007	FORD, MERCURY	ESCAPE, MARINER
E155-70-384	Brake Hoses	Rr Up	2002 - 2005	FORD	E550
E155-70-385	Brake Hoses	Rr Lo L	2004 - 2008	FORD	F150 ½ Ton Truck
E155-70-387	Brake Hoses	Rr Up	2004 - 2008	FORD, LINCOLN	F150 ½ Ton Truck
E155-70-388	Brake Hoses	Rr Lo R	2004 - 2008	FORD	F150 ½ Ton Truck
E155-70-389	Brake Hoses	Rr Lo L	1999 - 2010	FORD	F53, 59 (1 Ton) RV Motor Home & Stripped Chassis
E155-70-390	Brake Hoses	Rr Lo R	1960 - 2010	FORD	F53, 59 (1 Ton) RV Motor Home & Stripped Chassis, F450, F47 (1 Ton) 2WD & 4WD Super Duty, F550 (1 Ton) 2WD & 4WD Super Duty
E155-70-403	Brake Hoses	Rr Lo L	1960 - 2010	FORD	F450, F47 (1 Ton) 2WD & 4WD Super Duty, F550 (1 Ton) 2WD & 4WD Super Duty
E155-70-407	Brake Hoses	Rr Lo L	2004 - 2007	FORD	E-SUPER DUTY Van & Cutaway, E450, 47 (1 Ton) Super Duty Van & Cutaway
E155-70-408	Brake Hoses	Rr Lo R	2004 - 2007	FORD	E-SUPER DUTY Van & Cutaway, E450, 47 (1 Ton) Super Duty Van & Cutaway
E155-70-412	Brake Hoses	Rr R	2006 - 2006	FORD	E150 ½ Ton Full Size Van
E155-70-413	Brake Hoses	Rr Up	2004 - 2010	FORD	F53, 59 (1 Ton) RV Motor Home & Stripped Chassis
E155-70-415	Brake Hoses	Rr Up	2004 - 2010	FORD	F53, 59 (1 Ton) RV Motor Home & Stripped Chassis
E155-70-417	Brake Hoses	Rr Lo L	2002 - 2005	FORD	E550
E155-70-418	Brake Hoses	Rr Lo R	2002 - 2005	FORD	E550



PART NO	DESCRIPTION	POSITION	YEAR	MAKE	MODEL
E155-70-419	Brake Hoses	Rr L	2007 - 2007	FORD, MERCURY	ESCAPE, MARINER
E155-70-420	Brake Hoses	Rr R	2007 - 2007	FORD, MERCURY	ESCAPE, MARINER
E155-70-427	Brake Hoses	Rr Lo L	2007 - 2010	FORD	F350 SUPER DUTY 1 Ton Pickup, Cab & Chassis
E155-70-428	Brake Hoses	Rr Lo R	2005 - 2010	FORD	F250, F250, F350 Super Duty Truck, Cab & Chassis
E155-70-431	Brake Hoses	Rr Lo L	1960 - 2010	FORD	F250, F250, F350, F450, F47 Including Super Duty Truck
E155-70-432	Brake Hoses	Rr Lo R	2005 - 2006	FORD	F450, F47 (1 Ton) 2WD & 4WD Super Duty
E155-70-433	Brake Hoses	Rr Up	2005 - 2010	FORD	F250, F250 Super Duty ¾ Ton 4WD Truck, F350 1 Ton Pickup, Cab & Chassis 4WD including Super Duty
E155-70-435	Brake Hoses	Rr Up	2007 - 2010	FORD	F350 1 Ton Pickup, Cab & Chassis 4WD including Super Duty
E155-70-436	Brake Hoses	Rr	1960 - 2010	FORD	F550 (1 Ton) 2WD & 4WD Super Duty, F450, F47 (1 Ton) 2WD & 4WD Super Duty
E155-70-437	Brake Hoses	Rr Up	2005 - 2010	FORD	F250, F250, F350 Super Duty RWD Truck, Cab & Chassis
E155-70-438	Brake Hoses	Rr Lo R	2006 - 2007	FORD	E250 ¾ Ton Full Size Van
E155-70-439	Brake Hoses	Rr	2006 - 2012	FORD	E350 1 Ton Full Size Van, Wagon, Stripped & RV Chassis including Super Duty, E250 ¾ Ton Full Size Van
E155-70-441	Brake Hoses	Rr L	2006 - 2010	FORD, MERCURY	EXPLORER, SPORT, SPORT TRAC, MOUNTAINEER
E155-70-442	Brake Hoses	Rr R	2006 - 2010	FORD, MERCURY	EXPLORER, SPORT, SPORT TRAC, MOUNTAINEER, F53, 59 (1 Ton) RV Motor Home & Stripped Chassis
E155-70-443	Brake Hoses	Rr Lo L	2007 - 2007	FORD	E350 1 Ton Full Size Van, Wagon, Stripped & RV Chassis including Super Duty
E155-70-446	Brake Hoses	Rr Lo R	2005 - 2010	FORD	F53, 59 (1 Ton) RV Motor Home & Stripped Chassis
E155-70-447	Brake Hoses	Rr Lo L	2004 - 2008	FORD, LINCOLN	F150 ½ Ton Truck
E155-70-448	Brake Hoses	Rr Lo R	2004 - 2008	FORD, LINCOLN	F150 ½ Ton Truck
E155-70-449	Brake Hoses	Rr L	2007 - 2007	FORD, MERCURY	ESCAPE, MARINER
E155-70-451	Brake Hoses	Rr L	2007 - 2010	FORD, LINCOLN	EXPEDITION, NAVIGATOR
E155-70-452	Brake Hoses	Rr R	2007 - 2012	FORD, LINCOLN	EXPEDITION, NAVIGATOR
E155-70-453	Brake Hoses	Rr L	2007 - 2012	FORD, LINCOLN	EXPEDITION, NAVIGATOR
E155-70-454	Brake Hoses	Rr L	2006 - 2006	FORD	E150 ½ Ton Full Size Van
E155-70-455	Brake Hoses	Rr L	2008 - 2012	FORD, MAZDA, MERCURY	ESCAPE, TRIBUTE, MARINER
E155-70-456	Brake Hoses	Rr R	2008 - 2012	FORD, MAZDA, MERCURY	ESCAPE, TRIBUTE, MARINER
E155-70-457	Brake Hoses	Rr L	2008 - 2009	FORD, MAZDA, MERCURY	ESCAPE, TRIBUTE, MARINER
E155-70-458	Brake Hoses	Rr R	2008 - 2009	FORD, MAZDA, MERCURY	ESCAPE, TRIBUTE, MARINER
E155-70-460	Brake Hoses	Rr Up	2007 - 2010	FORD	F350 SUPER DUTY 1 Ton Pickup, Cab & Chassis RWD
E155-70-461	Brake Hoses	Rr Up	1960 - 2010	FORD	F450, F47 (1 Ton) 2WD & 4WD Super Duty
E155-70-462	Brake Hoses	Rr Lo R	1960 - 2010	FORD	F450, F47 (1 Ton) 2WD & 4WD Super Duty
E155-70-463	Brake Hoses	Rr Lo L	1960 - 2010	FORD	F450, F47 (1 Ton) 2WD & 4WD Super Duty
E155-70-464	Brake Hoses	Rr Lo R	2007 - 2010	FORD	F350 SUPER DUTY 1 Ton Pickup, Cab & Chassis
E155-70-465	Brake Hoses	Rr L	2008 - 2012	FORD	E150 ½ Ton Full Size Van, E250 ¾ Ton Full Size Van, E350 1 Ton Full Size Van, Wagon, Stripped & RV Chassis including Super Duty
E155-70-466	Brake Hoses	Rr R	2008 - 2012	FORD	E-SUPER DUTY Van & Cutaway, E450, 47 (1 Ton) Super Duty Van & Cutaway
E155-70-467	Brake Hoses	Rr Up	2010 - 2011	FORD	RANGER

PART NO	DESCRIPTION	POSITION	YEAR	MAKE	MODEL
E155-70-468	Brake Hoses	Rr R	2009 - 2011	FORD	E350 1 Ton Full Size Van, Wagon, Stripped & RV Chassis including Super Duty
E155-70-469	Brake Hoses	Rr Up	2010 - 2012	FORD	2/22/10 - 7/24/11, F350 1 Ton Pickup, Cab & Chassis 4WD including Super Duty, F450, F47 (1 Ton) 2WD & 4WD Super Duty
E155-70-470	Brake Hoses	Rr R	2008 - 2012	FORD	E150 ½ Ton Full Size Van, E250 ¾ Ton Full Size Van, E350 1 Ton Full Size Van, Wagon, Stripped & RV Chassis including Super Duty
E155-70-471	Brake Hoses	Rr Up	2009 - 2010	FORD	F150 ½ Ton Truck
E155-70-473	Brake Hoses	Rr Lo L	2009 - 2010	FORD	F150 ½ Ton Truck
E155-70-474	Brake Hoses	Rr Lo R	2009 - 2010	FORD	F150 ½ Ton Truck
E155-70-475	Brake Hoses	Rr Lo L	2007 - 2010	FORD	F53, 59 (1 Ton) RV Motor Home & Stripped Chassis
E155-70-476	Brake Hoses	Rr Lo R	2007 - 2010	FORD	F53, 59 (1 Ton) RV Motor Home & Stripped Chassis
E155-70-477	Brake Hoses	Rr	2010 - 2012	FORD	TRANSIT CONNECT
E155-70-478	Brake Hoses	Rr	2010 - 2011	FORD	RANGER
E155-70-479	Brake Hoses	Rr	2010 - 2011	FORD	RANGER
E155-70-480	Brake Hoses	Rr Up	2010 - 2011	FORD	RANGER
E155-70-481	Brake Hoses	Rr Lo L	2010 - 2010	FORD	F150 ½ Ton 4WD Truck
E155-70-482	Brake Hoses	Rr Lo R	2010 - 2010	FORD	F150 ½ Ton 4WD Truck
E155-70-484	Brake Hoses	Rr Up	2010 - 2012	FORD	F250, F250, F350, F450, F47 Including Super Duty Truck
E155-70-492	Brake Hoses	Rr R	2012 - 2012	FORD	E350 1 Ton Full Size Van, Wagon, Stripped & RV Chassis including Super Duty
E155-70-493	Brake Hoses	Rr Lo L	2010 - 2012	FORD	F450, F47 (1 Ton) 2WD & 4WD Super Duty
E155-70-494	Brake Hoses	Rr Lo R	2010 - 2012	FORD	F450, F47 (1 Ton) 2WD & 4WD Super Duty
E155-71-102	Brake Hoses	Fr R	2002 - 2005	CHEVROLET	AVALANCHE 1500, SUBURBAN 1500 ½ Ton, SUBURBAN, TAHOE
E155-71-103	Brake Hoses	Fr L	2002 - 2005	CHEVROLET	AVALANCHE 1500, SUBURBAN 1500 ½ Ton, SUBURBAN, TAHOE
E155-71-110	Brake Hoses	Fr R	2007 - 2009	CHEVROLET, GMC	TRAILBLAZER, ENVOY
E155-71-111	Brake Hoses	Fr L	2007 - 2009	CHEVROLET, GMC	TRAILBLAZER, ENVOY
E155-71-114	Brake Hoses	Fr R	2003 - 2007	CHEVROLET, GMC, HUMMER	SILVERADO 1500, 3500, SIERRA 1500, 3500 DENALI, C3 Pickup, H2
E155-71-115	Brake Hoses	Fr L	2003 - 2007	CHEVROLET, GMC, HUMMER	SILVERADO 1500, 3500, SIERRA 1500, 3500 DENALI, C3 Pickup, H2
E155-71-118	Brake Hoses	Fr R	2005 - 2007	CHEVROLET, GMC	EXPRESS 1500 ½ Ton Van, SAVANA 1500 ½ Ton Van
E155-71-119	Brake Hoses	Fr L	2005 - 2007	CHEVROLET, GMC	EXPRESS 1500 ½ Ton Van, SAVANA 1500 ½ Ton Van
E155-71-120	Brake Hoses	Fr R	2006 - 2012	CHEVROLET, GMC	EXPRESS 2500 ¾ Ton Van, EXPRESS 3500 1 Ton Van, SAVANA 2500 ¾ Ton Van, SAVANA 3500 1 Ton Van, G4500 Commercial Cutaway Chassis
E155-71-121	Brake Hoses	Fr L	2006 - 2011	CHEVROLET, GMC	EXPRESS 2500 ¾ Ton Van, EXPRESS 3500 1 Ton Van, SAVANA 2500 ¾ Ton Van, SAVANA 3500 1 Ton Van, G4500 Commercial Cutaway Chassis
E155-71-124	Brake Hoses	Fr R	2007 - 2007	CHEVROLET, GMC	SILVERADO 1500 ½ Ton RWD, SIERRA 1500, SIERRA 1500 DENALI ½ Ton RWD Pickup
E155-71-125	Brake Hoses	Fr L	2004 - 2012	CHEVROLET, GMC	COLORADO, CANYON
E155-71-126	Brake Hoses	Fr R	2004 - 2012	CHEVROLET, GMC	COLORADO, CANYON
E155-71-127	Brake Hoses	Fr L	2004 - 2012	CHEVROLET, GMC	COLORADO, CANYON

PART NO	DESCRIPTION	POSITION	YEAR	MAKE	MODEL
E155-71-128	Brake Hoses	Fr R	2004 - 2012	CHEVROLET, GMC	COLORADO, CANYON
E155-71-129	Brake Hoses	Fr L, Fr Lo L	2006 - 2007	CHEVROLET, GMC	AVALANCHE 1500, SILVERADO 1500 ½ Ton, SUBURBAN 1500 ½ Ton, TAHOE, SIERRA 1500, SIERRA 1500 DENALI, C3 ½ Ton Pickup
E155-71-130	Brake Hoses	Fr Lo R, Fr R	2006 - 2007	CHEVROLET, GMC	SILVERADO 1500 ½ Ton, SIERRA 1500, SIERRA 1500 DENALI, C3 ½ Ton Pickup, AVALANCHE 1500, SUBURBAN 1500 ½ Ton, TAHOE
E155-71-131	Brake Hoses	Fr L	2005 - 2009	CHEVROLET, PONTIAC, SATURN	UPLANDER, MONTANA, RELAY
E155-71-132	Brake Hoses	Fr R	2005 - 2009	CHEVROLET, PONTIAC, SATURN	UPLANDER, MONTANA, RELAY
E155-71-133	Brake Hoses	Fr L	2007 - 2007	CHEVROLET, GMC	SILVERADO 1500 ½ Ton RWD, SIERRA 1500, SIERRA 1500 DENALI ½ Ton RWD Pickup
E155-71-136	Brake Hoses	Fr R	2007 - 2007	CHEVROLET, GMC	AVALANCHE 1500, SUBURBAN 1500 ½ Ton, TAHOE, YUKON, YUKON DENALI, YUKON XL 1500, YUKON DENALI XL ½ Ton
E155-71-137	Brake Hoses	Fr L	2007 - 2008	CHEVROLET, GMC	AVALANCHE 1500, SILVERADO 1500 ½ Ton, SUBURBAN 1500 ½ Ton, TAHOE, SIERRA 1500, SIERRA 1500 DENALI, C3 ½ Ton Pickup, YUKON, YUKON DENALI, YUKON XL 1500, YUKON DENALI XL ½ Ton
E155-71-138	Brake Hoses	Fr R	2007 - 2012	CHEVROLET, GMC, SATURN	TRAVERSE, ACADIA, OUTLOOK
E155-71-139	Brake Hoses	Fr L	2007 - 2012	CHEVROLET, GMC, SATURN	TRAVERSE, ACADIA, OUTLOOK
E155-71-142	Brake Hoses	Fr R	2007 - 2012	CHEVROLET, GMC	AVALANCHE 1500, SILVERADO 1500 ½ Ton, SUBURBAN 1500 ½ Ton, TAHOE, SIERRA 1500, SIERRA 1500 DENALI, C3 ½ Ton Pickup, YUKON, YUKON DENALI, YUKON XL 1500, YUKON DENALI XL ½ Ton
E155-71-143	Brake Hoses	Fr L	2008 - 2012	CHEVROLET, GMC	EXPRESS 1500 ½ Ton Van, SAVANA 1500 ½ Ton Van
E155-71-145	Brake Hoses	Fr L	2009 - 2012	CHEVROLET, GMC	AVALANCHE 1500, SILVERADO 1500 ½ Ton, SUBURBAN 1500 ½ Ton, TAHOE, SIERRA 1500, SIERRA 1500 DENALI, C3 ½ Ton Pickup, YUKON, YUKON DENALI, YUKON XL 1500, YUKON DENALI XL ½ Ton
E155-71-146	Brake Hoses	Fr R	2008 - 2012	CHEVROLET, GMC	EXPRESS 1500 ½ Ton Van, SAVANA 1500 ½ Ton Van
E155-71-147	Brake Hoses	Fr L	2011 - 2012	CHEVROLET, GMC	SILVERADO 2500, 3500, SIERRA 2500, 3500 Pickup, Cab & Chassis
E155-71-148	Brake Hoses	Fr R	2011 - 2012	CHEVROLET, GMC	SILVERADO 2500, 3500, SIERRA 2500, 3500 Pickup, Cab & Chassis
E155-71-335	Brake Hoses	Rr Up	2002 - 2003	CHEVROLET	SUBURBAN 1500 ½ Ton, TAHOE
E155-71-336	Brake Hoses	Rr Lo R	2002 - 2006	CHEVROLET	AVALANCHE 1500, SUBURBAN 1500 ½ Ton, SUBURBAN, TAHOE
E155-71-337	Brake Hoses	Rr Lo L	2002 - 2006	CHEVROLET	AVALANCHE 1500, SUBURBAN 1500 ½ Ton, SUBURBAN, TAHOE
E155-71-338	Brake Hoses	Rr Lo R	2007 - 2007	CHEVROLET, GMC	SILVERADO 1500 ½ Ton, SIERRA 1500, SIERRA 1500 DENALI, C3 ½ Ton Pickup
E155-71-339	Brake Hoses	Rr Lo L	2007 - 2007	CHEVROLET, GMC	SILVERADO 1500 ½ Ton, SIERRA 1500, SIERRA 1500 DENALI, C3 ½ Ton Pickup
E155-71-341	Brake Hoses	Fr Up, Rr	2004 - 2007	CHEVROLET, GMC	SILVERADO 1500, 3500, SIERRA 1500, 3500 DENALI, C3 ½ Ton Pickup, Cab & Chassis
E155-71-342	Brake Hoses	Rr Lo R	2004 - 2007	CHEVROLET, GMC	SILVERADO 1500, 3500, SIERRA 1500, SIERRA 1500 DENALI, C3 Pickup, Cab & Chassis
E155-71-343	Brake Hoses	Rr Lo L	2004 - 2007	CHEVROLET, GMC	SILVERADO 1500, 3500, SIERRA 1500, SIERRA 1500 DENALI, C3 Pickup, Cab & Chassis

PART NO	DESCRIPTION	POSITION	YEAR	MAKE	MODEL
E155-71-344	Brake Hoses	Rr Lo R	2004 - 2007	CHEVROLET, GMC	SILVERADO 3500 1 Ton, SIERRA 3500 1 Ton Pickup, Cab & Chassis
E155-71-345	Brake Hoses	Rr Lo L	2004 - 2007	CHEVROLET, GMC	SILVERADO 3500 1 Ton, SIERRA 3500 1 Ton Pickup, Cab & Chassis
E155-71-348	Brake Hoses	Rr	2007 - 2009	CHEVROLET, GMC	TRAILBLAZER, ENVOY
E155-71-352	Brake Hoses	Rr Lo R	2003 - 2007	HUMMER	H2
E155-71-353	Brake Hoses	Rr Lo L	2003 - 2007	HUMMER	H2
E155-71-354	Brake Hoses	Rr R	2005 - 2010	CHEVROLET, GMC	EXPRESS 1500 ½ Ton Van, EXPRESS 2500 ¾ Ton Van, EXPRESS 3500 1 Ton Van, SAVANA 1500 ½ Ton Van, SAVANA 2500 ¾ Ton Van, SAVANA 3500 1 Ton Van
E155-71-355	Brake Hoses	Rr L	2005 - 2012	CHEVROLET, GMC	EXPRESS 1500 ½ Ton Van, EXPRESS 2500 ¾ Ton Van, EXPRESS 3500 1 Ton Van, SAVANA 1500 ½ Ton Van, SAVANA 2500 ¾ Ton Van, SAVANA 3500 1 Ton Van
E155-71-356	Brake Hoses	Rr R	2006 - 2010	CHEVROLET, GMC	EXPRESS 3500 1 Ton Van, SAVANA 3500 1 Ton Van
E155-71-357	Brake Hoses	Rr L	2006 - 2010	CHEVROLET, GMC	EXPRESS 3500 1 Ton Van, SAVANA 3500 1 Ton Van
E155-71-360	Brake Hoses	Rr Up R	2003 - 2007	HUMMER	H2
E155-71-362	Brake Hoses	Rr Up	2004 - 2004	CHEVROLET	SUBURBAN 1500 ½ Ton, TAHOE
E155-71-363	Brake Hoses	Rr Up	2003 - 2006	CHEVROLET	AVALANCHE 1500, SUBURBAN 1500 ½ Ton, SUBURBAN, TAHOE
E155-71-366	Brake Hoses	Rr	2004 - 2008	CHEVROLET, GMC	COLORADO, CANYON
E155-71-367	Brake Hoses	Rr L	2005 - 2006	CHEVROLET, PONTIAC	UPLANDER, MONTANA
E155-71-368	Brake Hoses	Rr R	2005 - 2006	CHEVROLET, PONTIAC	UPLANDER, MONTANA
E155-71-369	Brake Hoses	Rr L	2005 - 2009	CHEVROLET, PONTIAC, SATURN	UPLANDER, MONTANA, RELAY
E155-71-370	Brake Hoses	Rr R	2005 - 2009	CHEVROLET, PONTIAC, SATURN	UPLANDER, MONTANA, RELAY
E155-71-371	Brake Hoses	Rr L	2006 - 2008	CHEVROLET, GMC	EXPRESS 3500 1 Ton Van, SAVANA 3500 1 Ton Van
E155-71-373	Brake Hoses	Rr L	2006 - 2010	CHEVROLET, GMC	EXPRESS 3500 1 Ton Van, SAVANA 3500 1 Ton Van
E155-71-374	Brake Hoses	Rr R	2006 - 2010	CHEVROLET, GMC	EXPRESS 3500 1 Ton Van, SAVANA 3500 1 Ton Van
E155-71-375	Brake Hoses	Rr Lo L	2007 - 2011	CHEVROLET, GMC	AVALANCHE 1500, SUBURBAN 1500 ½ Ton, TAHOE, YUKON, YUKON DENALI, YUKON XL 1500, YUKON DENALI XL ½ Ton
E155-71-376	Brake Hoses	Rr Lo R	2007 - 2007	CHEVROLET, GMC	AVALANCHE 1500, SUBURBAN 1500 ½ Ton, TAHOE, YUKON, YUKON DENALI, YUKON XL 1500, YUKON DENALI XL ½ Ton
E155-71-377	Brake Hoses	Rr Up	2007 - 2011	CHEVROLET, GMC	AVALANCHE 1500, SUBURBAN 1500 ½ Ton, TAHOE, YUKON, YUKON DENALI, YUKON XL 1500, YUKON DENALI XL ½ Ton
E155-71-378	Brake Hoses	Rr Up	2007 - 2008	CHEVROLET, GMC	SUBURBAN 2500 ¾ Ton, SIERRA 2500 ¾ Ton RWD Pickup, YUKON XL 2500 ¾ Ton
E155-71-379	Brake Hoses	Rr Lo L	2007 - 2011	CHEVROLET, GMC	SILVERADO 2500, 3500, SUBURBAN 2500 ¾ Ton, SIERRA 2500, 3500 Pickup, Cab & Chassis, YUKON XL 2500 ¾ Ton
E155-71-380	Brake Hoses	Rr Lo R	2007 - 2010	CHEVROLET, GMC	SILVERADO 2500, 3500, SUBURBAN 2500 ¾ Ton, SIERRA 2500, 3500 Pickup, Cab & Chassis, YUKON XL 2500 ¾ Ton
E155-71-381	Brake Hoses	Rr L	2007 - 2012	CHEVROLET, GMC, SATURN	TRAVERSE, ACADIA, OUTLOOK
E155-71-382	Brake Hoses	Rr R	2007 - 2012	CHEVROLET, GMC, SATURN	TRAVERSE, ACADIA, OUTLOOK

PART NO	DESCRIPTION	POSITION	YEAR	MAKE	MODEL
E155-71-383	Brake Hoses	Fr L	2007 - 2011	CHEVROLET, GMC, HUMMER	SILVERADO 2500, 3500, SUBURBAN 2500 ¾ Ton, SIERRA 2500, 3500 Pickup, Cab & Chassis, YUKON XL 2500 ¾ Ton, H2
E155-71-384	Brake Hoses	Fr R	2007 - 2011	CHEVROLET, GMC, HUMMER	SILVERADO 2500, 3500, SUBURBAN 2500 ¾ Ton, SIERRA 2500, 3500 Pickup, Cab & Chassis, YUKON XL 2500 ¾ Ton, H2
E155-71-385	Brake Hoses	Rr Lo L	2007 - 2010	CHEVROLET, GMC	SILVERADO 3500 1 Ton, SIERRA 3500 1 Ton Pickup, Cab & Chassis
E155-71-386	Brake Hoses	Rr Lo R	2007 - 2010	CHEVROLET, GMC	SILVERADO 3500 1 Ton, SIERRA 3500 1 Ton Pickup, Cab & Chassis
E155-71-387	Brake Hoses	Rr	2007 - 2010	CHEVROLET, GMC	SILVERADO 1500 ½ Ton, SIERRA 1500, SIERRA 1500 DENALI, C3 ½ Ton Pickup
E155-71-388	Brake Hoses	Rr	2007 - 2010	CHEVROLET, GMC	SILVERADO 1500, 2500, 3500, SIERRA 1500, 2500, 3500 Pickup, Cab & Chassis
E155-71-389	Brake Hoses	Rr	2007 - 2008	CHEVROLET, GMC	SILVERADO 1500 ½ Ton, SIERRA 1500, SIERRA 1500 DENALI, C3 ½ Ton Pickup
E155-71-390	Brake Hoses	Rr	2007 - 2012	CHEVROLET, GMC	SILVERADO 1500 ½ Ton, SIERRA 1500, SIERRA 1500 DENALI, C3 ½ Ton Pickup
E155-71-391	Brake Hoses	Rr Up L	2008 - 2009	HUMMER	H2
E155-71-392	Brake Hoses	Rr Lo R	2008 - 2009	HUMMER	H2
E155-71-393	Brake Hoses	Rr Lo L	2008 - 2009	HUMMER	H2
E155-71-394	Brake Hoses	Rr Lo R	2007 - 2012	CHEVROLET, GMC	SILVERADO 1500 ½ Ton, SIERRA 1500, SIERRA 1500 DENALI, C3 ½ Ton Pickup
E155-71-395	Brake Hoses	Rr Lo L	2007 - 2012	CHEVROLET, GMC	SILVERADO 1500 ½ Ton, SIERRA 1500, SIERRA 1500 DENALI, C3 ½ Ton Pickup
E155-71-397	Brake Hoses	Rr Up	2007 - 2012	CHEVROLET, GMC	SILVERADO 1500 ½ Ton, SIERRA 1500, SIERRA 1500 DENALI, C3 ½ Ton Pickup
E155-71-398	Brake Hoses	Rr Lo R	2008 - 2011	CHEVROLET, GMC	AVALANCHE 1500, SUBURBAN 1500 ½ Ton, TAHOE, YUKON, YUKON DENALI, YUKON XL 1500, YUKON DENALI XL ½ Ton
E155-71-399	Brake Hoses	Rr Up L	2003 - 2007	HUMMER	H2
E155-71-400	Brake Hoses	Rr Up R	2008 - 2009	HUMMER	H2
E155-71-401	Brake Hoses	Rr	2009 - 2012	CHEVROLET, GMC	COLORADO, CANYON
E155-71-403	Brake Hoses	Rr	2009 - 2012	CHEVROLET, GMC	SILVERADO 1500, 2500 Pickup, SIERRA 1500, 2500, SIERRA 1500, 2500 DENALI, C3 ½ Ton Pickup
E155-71-404	Brake Hoses	Rr Up	2008 - 2011	CHEVROLET, GMC	SUBURBAN 2500 ¾ Ton, YUKON XL 2500 ¾ Ton
E155-71-406	Brake Hoses	Rr Lo L, Rr Lo R	2008 - 2011	CHEVROLET, GMC	SILVERADO 2500 ¾ Ton, SIERRA 2500 ¾ Ton Pickup, SUBURBAN 2500 ¾ Ton, YUKON XL 2500 ¾ Ton
E155-71-407	Brake Hoses	Rr L	2006 - 2012	CHEVROLET, GMC	EXPRESS 3500 1 Ton Van, SAVANA 3500 1 Ton Van, G4500 Commercial Cutaway Chassis
E155-71-408	Brake Hoses	Rr R	2006 - 2011	CHEVROLET, GMC	EXPRESS 3500 1 Ton Van, SAVANA 3500 1 Ton Van, G4500 Commercial Cutaway Chassis
E155-71-409	Brake Hoses	Rr Up	2003 - 2006	CHEVROLET	AVALANCHE 1500, SUBURBAN 1500 ½ Ton, SUBURBAN, TAHOE
E155-71-410	Brake Hoses	Rr R	2011 - 2012	CHEVROLET, GMC	EXPRESS 2500 ¾ Ton Van, EXPRESS 3500 1 Ton Van, SAVANA 2500 ¾ Ton Van, SAVANA 3500 1 Ton Van
E155-71-411	Brake Hoses	Rr L	2008 - 2012	CHEVROLET, GMC	EXPRESS 1500 ½ Ton Van, EXPRESS 2500 ¾ Ton Van, EXPRESS 3500 1 Ton Van, SAVANA 1500 ½ Ton Van, SAVANA 2500 ¾ Ton Van, SAVANA 3500 1 Ton Van



PART NO	DESCRIPTION	POSITION	YEAR	MAKE	MODEL
E155-71-412	Brake Hoses	Rr Up	2011 - 2012	CHEVROLET, GMC	SILVERADO 3500 1 Ton, SIERRA 3500 1 Ton Pickup, Cab & Chassis
E155-71-413	Brake Hoses	Rr Lo L	2011 - 2012	CHEVROLET, GMC	SILVERADO 3500 1 Ton, SIERRA 3500 1 Ton Pickup, Cab & Chassis
E155-71-414	Brake Hoses	Rr Lo R	2011 - 2012	CHEVROLET, GMC	SILVERADO 3500 1 Ton, SIERRA 3500 1 Ton Pickup, Cab & Chassis
E155-71-415	Brake Hoses	Rr Lo L	2011 - 2012	CHEVROLET, GMC	SILVERADO 2500, 3500, SIERRA 2500, 3500 Pickup, Cab & Chassis
E155-71-416	Brake Hoses	Rr Lo R	2011 - 2012	CHEVROLET, GMC	SILVERADO 2500, 3500, SIERRA 2500, 3500 Pickup, Cab & Chassis
E155-71-417	Brake Hoses	Rr Lo L	2011 - 2012	CHEVROLET, GMC	SILVERADO 3500 1 Ton, SIERRA 3500 1 Ton Pickup, Cab & Chassis
E155-71-418	Brake Hoses	Rr Lo R	2011 - 2012	CHEVROLET, GMC	SILVERADO 3500 1 Ton, SIERRA 3500 1 Ton Pickup, Cab & Chassis
E155-71-420	Brake Hoses	Rr Up	2011 - 2012	CHEVROLET, GMC	SILVERADO 2500, 3500, SIERRA 2500, 3500 Pickup, Cab & Chassis
E155-71-422	Brake Hoses	Rr Up	2011 - 2012	CHEVROLET, GMC	SILVERADO 3500 1 Ton, SIERRA 3500 1 Ton Pickup, Cab & Chassis
E155-72-093	Brake Hoses	Fr L	2006 - 2007	CHRYSLER, DODGE	TOWN & COUNTRY VAN, CARAVAN, GRAND CARAVAN
E155-72-094	Brake Hoses	Fr R	2006 - 2007	CHRYSLER, DODGE	TOWN & COUNTRY VAN, CARAVAN, GRAND CARAVAN
E155-72-111	Brake Hoses	Fr L	2006 - 2012	DODGE	RAM 1500, 2500, 3500 Pickup, Cab & Chassis
E155-72-112	Brake Hoses	Fr R	2006 - 2012	DODGE	RAM 1500, 2500, 3500 Pickup, Cab & Chassis
E155-72-114	Brake Hoses	Fr R	2006 - 2012	DODGE	RAM 1500 ½ Ton 4WD Pickup, RAM 2500 ¾ Ton 4WD Pickup, RAM 3500 1 Ton Pickup, Cab & Chassis
E155-72-116	Brake Hoses	Fr R	2007 - 2009	DODGE	DURANGO
E155-72-117	Brake Hoses	Fr L	2007 - 2009	DODGE	DURANGO
E155-72-123	Brake Hoses	Fr L	2006 - 2012	DODGE	RAM 1500 ½ Ton 4WD Pickup, RAM 2500 ¾ Ton 4WD Pickup, RAM 3500 1 Ton Pickup, Cab & Chassis
E155-72-124	Brake Hoses	Fr R	2007 - 2011	DODGE	RAM 1500 ½ Ton RWD Pickup
E155-72-125	Brake Hoses	Fr L	2007 - 2011	DODGE	RAM 1500 ½ Ton RWD Pickup
E155-72-128	Brake Hoses	Fr	2005 - 2011	DODGE	DAKOTA
E155-72-129	Brake Hoses	Fr L	2007 - 2012	DODGE	RAM 1500 ½ Ton Pickup
E155-72-130	Brake Hoses	Fr R	2007 - 2012	DODGE	RAM 1500 ½ Ton Pickup
E155-72-131	Brake Hoses	Fr L	2008 - 2011	DODGE, STERLING	RAM 4500, 5500, RAM 4500, 5500, BULLET
E155-72-132	Brake Hoses	Fr R	2008 - 2011	DODGE, STERLING	RAM 4500, 5500, RAM 4500, 5500, BULLET
E155-72-133	Brake Hoses	Fr L	2008 - 2012	CHRYSLER, DODGE	TOWN & COUNTRY VAN, CARAVAN, GRAND CARAVAN
E155-72-134	Brake Hoses	Fr R	2008 - 2012	CHRYSLER, DODGE	TOWN & COUNTRY VAN, CARAVAN, GRAND CARAVAN
E155-72-346	Brake Hoses	Rr R	2006 - 2007	CHRYSLER, DODGE	TOWN & COUNTRY VAN, CARAVAN, GRAND CARAVAN
E155-72-347	Brake Hoses	Rr L	2006 - 2007	CHRYSLER, DODGE	TOWN & COUNTRY VAN, CARAVAN, GRAND CARAVAN
E155-72-348	Brake Hoses	Rr Lo	2006 - 2007	CHRYSLER, DODGE	TOWN & COUNTRY VAN, CARAVAN, GRAND CARAVAN
E155-72-353	Brake Hoses	Rr Lo L	2007 - 2008	DODGE	RAM 1500 ½ Ton Pickup
E155-72-355	Brake Hoses	Rr Lo L	2006 - 2012	DODGE	RAM 1500, 2500, 3500 Pickup, Cab & Chassis
E155-72-356	Brake Hoses	Rr Lo R	2006 - 2012	DODGE	RAM 1500, 2500, 3500 Pickup, Cab & Chassis
E155-72-364	Brake Hoses	Rr Up	2006 - 2011	DODGE	RAM 1500, 2500, 3500 Pickup, Cab & Chassis
E155-72-371	Brake Hoses	Rr	2007 - 2009	DODGE	DURANGO
E155-72-374	Brake Hoses	Rr Lo R	2007 - 2007	JEEP	LIBERTY
E155-72-380	Brake Hoses	Rr	2005 - 2011	DODGE	DAKOTA

PART NO	DESCRIPTION	POSITION	YEAR	MAKE	MODEL
E155-72-383	Brake Hoses	Rr Lo R	2007 - 2008	DODGE	RAM 1500 ½ Ton Pickup
E155-72-386	Brake Hoses	Rr R	2006 - 2007	CHRYSLER, DODGE	TOWN & COUNTRY VAN, CARAVAN, GRAND CARAVAN
E155-72-387	Brake Hoses	Rr L	2006 - 2007	CHRYSLER, DODGE	TOWN & COUNTRY VAN, CARAVAN, GRAND CARAVAN
E155-72-388	Brake Hoses	Rr Up R	2006 - 2007	CHRYSLER, DODGE	TOWN & COUNTRY VAN, CARAVAN, GRAND CARAVAN
E155-72-389	Brake Hoses	Rr Up L	2006 - 2007	DODGE	CARAVAN, GRAND CARAVAN
E155-72-390	Brake Hoses	Rr Up R	2006 - 2007	CHRYSLER	TOWN & COUNTRY Van
E155-72-391	Brake Hoses	Rr Up L	2006 - 2007	CHRYSLER	TOWN & COUNTRY Van
E155-72-393	Brake Hoses	Rr Up L	2006 - 2007	CHRYSLER, DODGE	TOWN & COUNTRY VAN, CARAVAN, GRAND CARAVAN
E155-72-395	Brake Hoses	Rr Up	2007 - 2008	DODGE	RAM 1500 ½ Ton Pickup
E155-72-396	Brake Hoses	Rr Up	2007 - 2008	DODGE	RAM 1500 ½ Ton Pickup
E155-72-397	Brake Hoses	Rr Lo L	2007 - 2012	DODGE	RAM 3500 1 Ton Pickup, Cab & Chassis
E155-72-398	Brake Hoses	Rr Up	2007 - 2012	DODGE	RAM 3500 1 Ton Pickup, Cab & Chassis
E155-72-399	Brake Hoses	Rr Lo L	2007 - 2007	JEEP	LIBERTY
E155-72-400	Brake Hoses	Rr R	2008 - 2012	DODGE, STERLING	RAM 4500, 5500, RAM 4500, 5500, BULLET
E155-72-401	Brake Hoses	Rr L	2008 - 2012	DODGE, STERLING	RAM 4500, 5500, RAM 4500, 5500, BULLET
E155-72-402	Brake Hoses	Rr Lo R	2007 - 2012	DODGE	RAM 3500 1 Ton Pickup, Cab & Chassis
E155-72-403	Brake Hoses	Rr	2008 - 2011	CHRYSLER, DODGE	TOWN & COUNTRY VAN, CARAVAN, GRAND CARAVAN
E155-72-404	Brake Hoses	Rr	2008 - 2011	CHRYSLER, DODGE	TOWN & COUNTRY VAN, CARAVAN, GRAND CARAVAN
E155-72-405	Brake Hoses	Rr Ctr	2008 - 2012	DODGE, STERLING	RAM 4500, 5500, RAM 4500, 5500, BULLET
E155-72-407	Brake Hoses	Rr Lo R	2007 - 2008	DODGE	RAM 1500 ½ Ton Pickup
E155-72-412	Brake Hoses	Rr R	2009 - 2011	DODGE	RAM 1500 ½ Ton Pickup
E155-72-413	Brake Hoses	Rr L	2009 - 2011	DODGE	RAM 1500 ½ Ton Pickup
E155-72-416	Brake Hoses	Rr L	2011 - 2011	CHRYSLER, DODGE	TOWN & COUNTRY VAN, CARAVAN, GRAND CARAVAN
E155-72-417	Brake Hoses	Rr R	2011 - 2011	CHRYSLER, DODGE	TOWN & COUNTRY VAN, CARAVAN, GRAND CARAVAN
E155-73-005	Brake Hoses	Fr	1969 - 1985	INTERNATIONAL	C01810A, B Cargostar
E155-73-010	Brake Hoses	Fr	1969 - 1982	INTERNATIONAL	C01810A, B Cargostar
E155-73-023	Brake Hoses	Rr	1983 - 1985	INTERNATIONAL	C01810A, B Cargostar
E155-74-006	Brake Hoses	Fr R	2006 - 2010	HUMMER	H3
E155-74-007	Brake Hoses	Fr L	2006 - 2010	HUMMER	H3
E155-74-306	Brake Hoses	Rr Lo R	2006 - 2007	HUMMER	H3
E155-74-307	Brake Hoses	Rr Lo L	2006 - 2007	HUMMER	H3
E155-74-308	Brake Hoses	Rr Up R	2006 - 2010	HUMMER	H3
E155-74-309	Brake Hoses	Rr Up L	2006 - 2010	HUMMER	H3
E155-74-310	Brake Hoses	Rr Lo R	2008 - 2010	HUMMER	H3
E155-74-311	Brake Hoses	Rr Lo L	2008 - 2010	HUMMER	H3
E155-80-006	Brake Hoses	Fr	2005 - 2012	HINO	268 25,950GVW LBS with Hydraulic Disc Brakes
E155-80-007	Brake Hoses	Fr	2005 - 2010	HINO	145 14,050 GVW, 165 16,000 GVW, 185 18,500 LBS GVW
E155-80-506	Brake Hoses	Rr	2005 - 2012	HINO	268 25,950GVW LBS with Hydraulic Disc Brakes
E155-80-507	Brake Hoses	Rr	2005 - 2010	HINO	145 14,050 GVW
E155-80-508	Brake Hoses	Rr	2005 - 2010	HINO	185 18,500 LBS GVW



PART NO	DESCRIPTION	POSITION	YEAR	MAKE	MODEL
E155-81-007	Brake Hoses	Fr	2010 - 2012	ISUZU	NQR, NRR
E155-81-008	Brake Hoses	Fr & Rr	1987 - 2007	CHEVROLET, GMC, ISUZU	W3500 Gas Engine, W3500 Diesel Engine, W4500 Gas Engine, W4500 Diesel Engine, NPR with Front Disc Brakes, Gas Engine, NPR with Front Disc Brakes, Diesel Engine
E155-81-009	Brake Hoses	Rr	1987 - 2012	CHEVROLET, GMC, ISUZU	W3500 Gas Engine, W3500 Diesel Engine, W4500 Gas Engine, W4500 Diesel Engine, W5500, W5500HD, NPR with Front Disc Brakes, Gas Engine, NPR with Front Disc Brakes, Diesel Engine, NQR, NRR, REACH VAN (UTILIMASTER BODY)
E155-81-011	Brake Hoses	Fr L	1997 - 2010	CHEVROLET, GMC, ISUZU	T5500, T6500 with Disc Brakes, T7500, T8500 Tilt Cab with Disc Brakes, T5500, T6500, T7500, T8500 Tilt Cab with Disc Brakes, FTR with Front Disc Brakes, FVR, FXR with Front Disc Brakes
E155-81-012	Brake Hoses	Fr R	1997 - 2010	CHEVROLET, GMC, ISUZU	T5500, T6500 with Disc Brakes, T7500, T8500 Tilt Cab with Disc Brakes, T5500, T6500, T7500, T8500 Tilt Cab with Disc Brakes, FTR with Front Disc Brakes, FVR, FXR with Front Disc Brakes
E155-81-013	Brake Hoses	Rr L	2003 - 2009	CHEVROLET, ISUZU	T5500, T6500 with Disc Brakes, T7500, T8500 Tilt Cab with Disc Brakes, FTR with Front Disc Brakes, FVR, FXR with Front Disc Brakes
E155-81-014	Brake Hoses	Rr R	2003 - 2009	CHEVROLET, ISUZU	T5500, T6500 with Disc Brakes, T7500, T8500 Tilt Cab with Disc Brakes, FTR with Front Disc Brakes, FVR, FXR with Front Disc Brakes
E155-81-015	Brake Hoses	Rr L	2003 - 2009	CHEVROLET, ISUZU	T5500, T6500 with Disc Brakes, T7500, T8500 Tilt Cab with Disc Brakes, FTR with Front Disc Brakes, FVR, FXR with Front Disc Brakes
E155-81-016	Brake Hoses	Rr R	2003 - 2009	CHEVROLET, ISUZU	T5500, T6500 with Disc Brakes, T7500, T8500 Tilt Cab with Disc Brakes, FTR with Front Disc Brakes, FVR, FXR with Front Disc Brakes
E155-81-017	Brake Hoses	Rr L	2003 - 2009	CHEVROLET, ISUZU	T5500, T6500 with Disc Brakes, T7500, T8500 Tilt Cab with Disc Brakes, FTR with Front Disc Brakes, FVR, FXR with Front Disc Brakes
E155-81-018	Brake Hoses	Rr R	2003 - 2009	CHEVROLET, ISUZU	T5500, T6500 with Disc Brakes, T7500, T8500 Tilt Cab with Disc Brakes, FTR with Front Disc Brakes, FVR, FXR with Front Disc Brakes
E155-81-019	Brake Hoses	Fr	2004 - 2012	CHEVROLET, GMC, ISUZU	W3500 Diesel Engine, W4500 Diesel Engine, NPR with Front Disc Brakes, Gas Engine, NPR with Front Disc Brakes, Diesel Engine, REACH VAN (UTILIMASTER BODY)
E155-81-020	Brake Hoses	Fr & Rr	2004 - 2011	CHEVROLET, GMC, ISUZU	W3500 Gas Engine, W4500 Gas Engine, W4500 Diesel Engine, W5500, W5500HD, NPR with Front Disc Brakes, Gas Engine, NQR, NRR
E155-81-021	Brake Hoses	Fr & Rr	1995 - 2007	CHEVROLET, GMC, ISUZU	W3500 Gas Engine, W3500 Diesel Engine, W4500 Gas Engine, W4500 Diesel Engine, NPR with Front Disc Brakes, Gas Engine, NPR with Front Disc Brakes, Diesel Engine
E155-81-022	Brake Hoses	Fr & Rr	1997 - 2007	CHEVROLET, GMC, ISUZU	W4500 Gas Engine, W5500, NPR with Front Disc Brakes, Gas Engine, NPR with Front Disc Brakes, Diesel Engine, NQR
E155-82-006	Brake Hoses	Fr	2005 - 2010	UD	UD 1300, UD 1400
E155-82-007	Brake Hoses	Fr	1994 - 2004	UD	UD 1200, UD 1400
E155-82-305	Brake Hoses	Rr	2005 - 2010	UD	UD 1300, UD 1400
E155-84-006	Brake Hoses	Fr L	1988 - 1996	FORD	F53, 59 (1 Ton) RV Motor Home & Stripped Chassis
E155-84-007	Brake Hoses	Fr R	1988 - 1996	FORD	F53, 59 (1 Ton) RV Motor Home & Stripped Chassis

PART NO	DESCRIPTION	POSITION	YEAR	MAKE	MODEL
E155-84-009	Brake Hoses	Fr L	1997 - 1998	FORD	F53, 59 (1 Ton) RV Motor Home & Stripped Chassis
E155-84-010	Brake Hoses	Fr R	1997 - 1998	FORD	F53, 59 (1 Ton) RV Motor Home & Stripped Chassis
E155-84-011	Brake Hoses	Fr	1984 - 1994	FORD	LT, LTL900 Short Conventional Tandem with Front Disc Brakes
E155-84-311	Brake Hoses	Rr Up	1989 - 1991	FORD	F53, 59 (1 Ton) RV Motor Home & Stripped Chassis
E155-84-312	Brake Hoses	Rr Lo L	1989 - 1998	FORD	F53, 59 (1 Ton) RV Motor Home & Stripped Chassis
E155-84-313	Brake Hoses	Rr Lo R	1989 - 1998	FORD	F53, 59 (1 Ton) RV Motor Home & Stripped Chassis
E155-84-314	Brake Hoses	Rr Up	1992 - 1998	FORD	F53, 59 (1 Ton) RV Motor Home & Stripped Chassis
E155-84-315	Brake Hoses	Rr	1984 - 1994	FORD	LT, LTL900 Short Conventional Tandem with Front Disc Brakes
E155-85-007	Brake Hoses	Fr	1988 - 1990	CHEVROLET	C60 C6D042 with Disc Brakes
E155-85-012	Brake Hoses	Fr	1995 - 2002	CHEVROLET	C6500 Kodiak with Disc Brakes, P6S with Disc Brakes
E155-85-015	Brake Hoses	Fr	1988 - 1990	CHEVROLET	C60 C6D042 with Disc Brakes
E155-85-016	Brake Hoses	Fr	1990 - 1994	CHEVROLET	C6500 Kodiak with Disc Brakes
E155-85-023	Brake Hoses	Fr	1995 - 2009	CHEVROLET	C6500 Kodiak with Disc Brakes, T5500, T6500 with Disc Brakes, T7500, T8500 Tilt Cab with Disc Brakes
E155-85-306	Brake Hoses	Rr L	1990 - 2002	CHEVROLET	C6500 Kodiak with Disc Brakes, P6S with Disc Brakes
E155-85-307	Brake Hoses	Rr R	1990 - 2002	CHEVROLET	C6500 Kodiak with Disc Brakes
E155-85-308	Brake Hoses	Center	1990 - 1993	CHEVROLET	C6500 Kodiak with Disc Brakes
E155-85-312	Brake Hoses	Rr R	1990 - 2002	CHEVROLET	C6500 Kodiak with Disc Brakes
E155-85-313	Brake Hoses	Rr L	1990 - 2002	CHEVROLET	C6500 Kodiak with Disc Brakes
E155-85-314	Brake Hoses	Rr R	1990 - 2002	CHEVROLET	C6500 Kodiak with Disc Brakes
E155-85-315	Brake Hoses	Rr L	1990 - 2002	CHEVROLET	C6500 Kodiak with Disc Brakes
E155-85-318	Brake Hoses	Rr R	1990 - 2002	CHEVROLET	C6500 Kodiak with Disc Brakes
E155-85-319	Brake Hoses	Rr L	1990 - 2002	CHEVROLET	C6500 Kodiak with Disc Brakes
E155-88-006	Brake Hoses	Rr	1990 - 1997	INTERNATIONAL	3000, 3200, 3600, 3700, 3800, 3900FC School Bus with Hydraulic Disc Brakes
E155-88-009	Brake Hoses	Fr	1990 - 1997	INTERNATIONAL	3000, 3200, 3600, 3700, 3800, 3900FC School Bus with Hydraulic Disc Brakes, 4100, 4200, 4300, 4400, 4600, 4700, 4800, 4900, 7100 Conventional Cab with Hydraulic Disc Brakes
E155-88-010	Brake Hoses	Fr	1990 - 1997	INTERNATIONAL	3000, 3200, 3600, 3700, 3800, 3900FC School Bus with Hydraulic Disc Brakes, 4100, 4200, 4300, 4400, 4600, 4700, 4800, 4900, 7100 Conventional Cab with Hydraulic Disc Brakes
E155-88-015	Brake Hoses	Fr	1983 - 1985	INTERNATIONAL	C01810A, B Cargostar
E155-88-016	Brake Hoses	Fr	1983 - 1985	INTERNATIONAL	C01810A, B Cargostar
E155-88-019	Brake Hoses	Fr	1990 - 2012	BLUEBIRD BUS, FORD, INTERNATIONAL	TC2000 with Hydraulic Disc Brakes, F650 Conventional with Disc Brakes, MXT, RXT, 3000, 3200, 3600, 3700, 3800, 3900FC School Bus with Hydraulic Disc Brakes, 4100, 4200, 4300, 4400, 4600, 4700, 4800, 4900, 7100 Conventional Cab with Hydraulic Disc Brakes

PART NO	DESCRIPTION	POSITION	YEAR	MAKE	MODEL
E155-88-020	Brake Hoses	Fr L	2006 - 2012	FORD, INTERNATIONAL	LCF Series, CF500, CF600, TERRA STAR
E155-88-021	Brake Hoses	Fr	1990 - 2012	BLUEBIRD BUS, FORD, INTERNATIONAL	TC2000 with Hydraulic Disc Brakes, F650 Conventional with Disc Brakes, F750 Conventional with Disc Brakes, 3000, 3200, 3600, 3700, 3800, 3900FC School Bus with Hydraulic Disc Brakes, 4100, 4200, 4300, 4400, 4600, 4700, 4800, 4900, 7100 Conventional Cab with Hydraulic Disc Brakes
E155-88-022	Brake Hoses	Fr	1990 - 2012	BLUEBIRD BUS, FORD, IC BUS, INTERNATIONAL	TC2000 with Hydraulic Disc Brakes, F650 Conventional with Disc Brakes, F750 Conventional with Disc Brakes, BE, CE, HC, LC with Hydraulic Disc Brakes, 3000, 3200, 3600, 3700, 3800, 3900FC School Bus with Hydraulic Disc Brakes, 4100, 4200, 4300, 4400, 4600, 4700, 4800, 4900, 7100 Conventional Cab with Hydraulic Disc Brakes
E155-88-023	Brake Hoses	Fr R	2006 - 2012	FORD, INTERNATIONAL	LCF Series, CF500, CF600, TERRA STAR
E155-88-305	Brake Hoses	Rr	1983 - 1997	INTERNATIONAL	C01810A, B Cargostar, 3000, 3200, 3600, 3700, 3800, 3900FC School Bus with Hydraulic Disc Brakes, 4100, 4200, 4300, 4400, 4600, 4700, 4800, 4900, 7100 Conventional Cab with Hydraulic Disc Brakes
E155-88-306	Brake Hoses	Rr	1983 - 1997	INTERNATIONAL	C01810A, B Cargostar, 3000, 3200, 3600, 3700, 3800, 3900FC School Bus with Hydraulic Disc Brakes
E155-88-314	Brake Hoses	Rr	1990 - 2012	BLUEBIRD BUS, FORD, IC BUS, INTERNATIONAL	TC2000 with Hydraulic Disc Brakes, F650 Conventional with Disc Brakes, F750 Conventional with Disc Brakes, BE, CE, HC, LC with Hydraulic Disc Brakes, MXT, RXT, 3000, 3200, 3600, 3700, 3800, 3900FC School Bus with Hydraulic Disc Brakes, 4100, 4200, 4300, 4400, 4600, 4700, 4800, 4900, 7100 Conventional Cab with Hydraulic Disc Brakes
E155-88-315	Brake Hoses	Rr	1990 - 2012	BLUEBIRD BUS, FORD, INTERNATIONAL	TC2000 with Hydraulic Disc Brakes, F650 Conventional with Disc Brakes, F750 Conventional with Disc Brakes, 3000, 3200, 3600, 3700, 3800, 3900FC School Bus with Hydraulic Disc Brakes, 4100, 4200, 4300, 4400, 4600, 4700, 4800, 4900, 7100 Conventional Cab with Hydraulic Disc Brakes
E155-88-316	Brake Hoses	Rr	2006 - 2012	FORD, INTERNATIONAL	LCF Series, CF500, CF600, TERRA STAR
E155-88-317	Brake Hoses	Rr	1990 - 2012	BLUEBIRD BUS, FORD, IC BUS, INTERNATIONAL	TC2000 with Hydraulic Disc Brakes, F650 Conventional with Disc Brakes, F750 Conventional with Disc Brakes, BE, CE, HC, LC with Hydraulic Disc Brakes, 3000, 3200, 3600, 3700, 3800, 3900FC School Bus with Hydraulic Disc Brakes, 4100, 4200, 4300, 4400, 4600, 4700, 4800, 4900, 7100 Conventional Cab with Hydraulic Disc Brakes
E155-88-318	Brake Hoses	Rr	2006 - 2012	FORD, INTERNATIONAL	LCF Series, CF500, CF600, TERRA STAR

# NOTES

---

---

**HAVE QUESTIONS? NEED ASSISTANCE? TALK TO THE FORMULA BLUE® TECH LINE.  
Call 1-866-610-9709, option 2  
Representatives are available Monday – Friday, 8:00 a.m. – 8:30 p.m. EST.**

# NOTES

---

---

**HAVE QUESTIONS? NEED ASSISTANCE? TALK TO THE FORMULA BLUE® TECH LINE.  
Call 1-866-610-9709, option 2  
Representatives are available Monday – Friday, 8:00 a.m. – 8:30 p.m. EST.**

# NOTES

---

---

**HAVE QUESTIONS? NEED ASSISTANCE? TALK TO THE FORMULA BLUE® TECH LINE.  
Call 1-866-610-9709, option 2  
Representatives are available Monday – Friday, 8:00 a.m. – 8:30 p.m. EST.**

# NOTES

---

---

**HAVE QUESTIONS? NEED ASSISTANCE? TALK TO THE FORMULA BLUE® TECH LINE.  
Call 1-866-610-9709, option 2  
Representatives are available Monday – Friday, 8:00 a.m. – 8:30 p.m. EST.**



# NOTES

---

---

**HAVE QUESTIONS? NEED ASSISTANCE? TALK TO THE FORMULA BLUE® TECH LINE.  
Call 1-866-610-9709, option 2  
Representatives are available Monday – Friday, 8:00 a.m. – 8:30 p.m. EST.**

## Also from Bendix Spicer Foundation Brake ... durable, dependable components for all of your commercial vehicle braking needs.

Bendix Spicer Foundation Brake is the complete one-stop source for all of your OE-quality, all-makes air foundation brake replacement parts in one trusted brand – Bendix®. We offer a full range of air and hydraulic brake parts, friction materials, and air brake chambers. All backed by a powerful warranty, and supported by our highly seasoned, professional sales, service and technical specialists. Plus, ordering Bendix® brand parts from Bendix Spicer Foundation Brake is straightforward and simple.

Talk to your Bendix representative about these proven foundation brake components:



### Air Drum Brakes

- OE-certified stopping power
- Lined brake shoes
- Relined shoes and kits
- FMVSS 121-certified
- Complete all-makes product offering



### Slack Adjusters

- Bendix® automatic slack adjusters
  - Industry leading service life
  - Improved designs
  - Easy to install
  - No special brackets, attachments or tools
  - Infinite adjustment rate
- Full line of manual slack adjusters



### Air Brake Chambers

- OE-quality
- Corrosion-resistant
- Complete line to fit every need
- Competitively priced
- Complete units, piggybacks and complete components available



### Air Disc Brakes

- Enhanced vehicle safety
- Industry leading technology
- Passenger-car-like feel
- Aftermarket service kits available
- More than 8 million in service worldwide
- USA manufacturing in Bowling Green, Ky.

### Foundation brake training

We offer a complete array of foundation brake training opportunities to meet your needs, from full-line, multi-day training schools to local, on-site sessions. Each uses a hands-on approach and is taught by our 100% ASE-certified team. To learn more, talk to your Bendix Account Manager.



Bendix Spicer  
Foundation Brake LLC



HEAVY DUTY PARTS FOR HARD WORKING VEHICLES

*To learn more about Formula Blue hydraulic brake parts, or any of the products and services available from Bendix Spicer Foundation Brake LLC, contact your Bendix representative, call 1-866-610-9709 or visit [www.foundationbrakes.com](http://www.foundationbrakes.com) today.*

