

| | | | | | |
|---|--|--|--|--|-----------|
| 1. Report No. FHWA/TX-12/0-6729-1 | | 2. Government Accession No. | | 3. Recipient's Catalog No. | |
| 4. Title and Subtitle SYNTHESIS ON COST-EFFECTIVENESS OF EXTRADOSED BRIDGES: TECHNICAL REPORT | | | | 5. Report Date October 2012 Rwdrkuj gf <O ctej '4238 | |
| | | | | 6. Performing Organization Code | |
| 7. Author(s) Jiong Hu, Yoo Jae Kim, and Soon-Jae Lee | | | | 8. Performing Organization Report No. Report 0-6729-1 | |
| 9. Performing Organization Name and Address Texas State University–San Marcos The Texas State University System San Marcos, Texas 78666-4684 | | | | 10. Work Unit No. (TRAIS) | |
| | | | | 11. Contract or Grant No. Project 0-6729 | |
| 12. Sponsoring Agency Name and Address Texas Department of Transportation Research and Technology Implementation Office P.O. Box 5080 Austin, Texas 78763-5080 | | | | 13. Type of Report and Period Covered Technical Report: September 2011–August 2012 | |
| | | | | 14. Sponsoring Agency Code | |
| 15. Supplementary Notes Project performed in cooperation with the Texas Department of Transportation and the Federal Highway Administration. Project Title: Synthesis on Cost-Effectiveness of Extradosed Bridges URL: http://tti.tamu.edu/documents/0-6729-1.pdf | | | | | |
| 16. Abstract An extradosed bridge is a unique bridge type that utilizes both prestressed girder bridge and cable-stayed bridge concepts. Since the concept of an extradosed bridge is still relatively new, there is no clear definition and specification of the type of bridge. Also, due to the unique characteristics of an extradosed bridge, it is likely to initially cost more than a conventional girder bridge but less expensive compared to a cable-stayed bridge. This synthesis study identified and collected information on 120 extradosed bridges from Asia, Europe, North America, South America and Africa through a comprehensive literature review of over 350 technical papers, reports, and websites. Cost information on 58 extradosed bridges and bridge selection reasons for 47 extradosed bridges were collected and summarized. Over 100 individuals with experience in the design and/or construction of extradosed bridges were contacted. Telephone and email interviews of eight experts in extradosed bridges (three from Asia, three from Europe, and two from North America) were conducted. A statistical analysis was conducted to summarize general configurations, bridge selections, constructions, and costs of extradosed bridges. Four case studies regarding extradosed bridge selection were also included in the report. In addition, this study summarized the advantages and disadvantages of utilizing extradosed bridges, best practices, and existing methodologies. While there is a variety of advantages and disadvantages comparing extradosed bridges to girder bridges and cable-stayed bridges, the team identified aesthetic (signature bridge and landmark structure), underneath (navigation/vehicular) clearance and higher restriction, and construction and structure considerations were identified as top reasons for selecting extradosed bridges over other alternatives. A bridge selection process specifying considerations for determining how and when an extradosed bridge is cost-effective and in the best interest of the public was also recommended. | | | | | |
| 17. Key Words Extradosed, Cable-Stayed, Girder, Cost-Effectiveness, Bridge Selection | | | 18. Distribution Statement No restrictions. This document is available to the public through NTIS: National Technical Information Service Alexandria, Virginia 22312 http://www.ntis.gov | | |
| 19. Security Classif. (of this report) Unclassified | | 20. Security Classif. (of this page) Unclassified | | 21. No. of Pages 192 | 22. Price |

**SYNTHESIS ON COST-EFFECTIVENESS OF EXTRADOSED BRIDGES:
TECHNICAL REPORT**

by

Jiong Hu, Ph.D.
Assistant Professor
Texas State University–San Marcos

Yoo Jae Kim, Ph.D.
Assistant Professor
Texas State University–San Marcos

and

Soon-Jae Lee, Ph.D.
Assistant Professor
Texas State University–San Marcos

Report 0-6729-1
Project 0-6729

Project Title: Synthesis on Cost-Effectiveness of Extradosed Bridges

Performed in cooperation with the
Texas Department of Transportation
and the
Federal Highway Administration

October 2012
Rwdrkuj gf <O ctej "4238

TEXAS STATE UNIVERSITY-SAN MARCOS
The Texas State University System
San Marcos, Texas 78666-4684

DISCLAIMER

This research was performed in cooperation with the Texas Department of Transportation (TxDOT) and the Federal Highway Administration (FHWA). The contents of this report reflect the views of the authors, who are responsible for the facts and the accuracy of the data presented herein. The contents do not necessarily reflect the official view or policies of the FHWA or TxDOT. This report does not constitute a standard, specification, or regulation. The researcher in charge of the project was Jiong Hu.

ACKNOWLEDGMENTS

This project was conducted in cooperation with the Texas Department of Transportation (TxDOT) and the Federal Highway Administration (FHWA). The authors express their appreciation to TxDOT personnel for their support throughout this study. Special thanks are extended to Nicholas Nemecek as the project director (PD), Wade Odell as Research Engineer, Project Monitoring Committee (PMC) members Alanna Bettis, Brian Merrill, Dean Van Landuyt, Gregg Freeby, Paul Cepak, and Sandra Kaderka as contract specialist. Akio Kasuga (Sumitomo Mitsui Construction), Christopher Scollard (Buckland & Taylor Ltd.), Steven L. Stroh (URS Corporation), Jiri Strasky (Strasky, Husty and Partners, Ltd.), Deong-Hwan Park (DongMyeong Engineering Consultants Co. LTD), Sun-Joo Choi (Yooshin Engineering Corp), Viktor Markelj (PONTING d.o.o. Maribor), and Aivar-Oskar Saar (Järelpinge Inseneribüroo OÜ) for their input regarding extradosed bridges and help during data collection and interviews. The authors also thank research assistants Zhuo Wang, Ashley Kotwel, Michael Grams, and Chase David for their assistance in this study.

TABLE OF CONTENTS

| | Page |
|--|-------------|
| List of Figures | ix |
| List of Tables | xi |
| Chapter 1. Introduction | 1 |
| Research Background | 1 |
| Research Objectives..... | 2 |
| Research Approaches..... | 2 |
| Literature Review..... | 2 |
| Interviews..... | 2 |
| Case Studies..... | 4 |
| Scope of Research and Organization of the Report | 4 |
| Chapter 2. General Aspects of Extradosed Bridges | 7 |
| History of Extradosed Bridges..... | 7 |
| Configuration and Definitions of Extradosed Bridges..... | 11 |
| Extradosed Bridge Construction | 13 |
| Extradosed Bridge Maintenance | 15 |
| Summary | 16 |
| Chapter 3. Review of Extradosed Bridges | 17 |
| General Information of Extradosed Bridges | 17 |
| Locations and Construction Time of Extradosed Bridges | 26 |
| Purposes and Usage of Extradosed Bridges..... | 29 |
| Configurations of Extradosed Bridges..... | 30 |
| Summary | 45 |
| Chapter 4. Cost of Extradosed Bridges Construction | 47 |
| Cost Analysis through General Surveys | 47 |
| Cost Comparison through Specific Resources..... | 58 |
| Summary | 63 |
| Chapter 5. Bridge Selection Procedures and Considerations | 65 |
| Commonly Used Bridge Selection Procedures and Considerations | 65 |
| Life Cycle Cost Analysis (LCCA)..... | 66 |
| Value Engineering (VE) and Criteria-Based Bridge Selection Procedures..... | 69 |
| Advantages and Disadvantages of Extradosed Bridges..... | 72 |
| Major Reasons for Selecting Extradosed Bridges | 74 |
| Aesthetics Considerations..... | 77 |
| Economic Considerations | 78 |
| Height Restriction and Clearance | 78 |
| Compatibility and Environmental Considerations..... | 80 |
| Construction and Structure Considerations | 82 |
| Statistics of Bridge Selection Reasons..... | 86 |
| Case Studies for Bridge Selection..... | 88 |
| Case #1 Sunniberg Bridge | 89 |
| Case #2 Zhangzhou Zhanbei Bridge..... | 92 |
| Case #3 St. Croix River Crossing | 96 |
| Case #4 Walterdale River Bridge Replacement..... | 99 |

| | |
|--|------------|
| Recommended Bridge Selection Procedure and Considerations..... | 106 |
| Summary | 109 |
| Chapter 6. Conclusions and Recommendations..... | 111 |
| Conclusions..... | 111 |
| Recommendations..... | 113 |
| References..... | 115 |
| Appendix A: List of References for Each Extradosed Bridges..... | 135 |
| Appendix B: Summary of Extradosed Bridges | 141 |
| Appendix C: Interview Questions and Records..... | 167 |

LIST OF FIGURES

| | Page |
|---|------|
| Figure 1. “Extradosed” Concept at Arrêt-Darré Viaduct (picture adapted from Virlogeux 1999). | 7 |
| Figure 2. Finback Bridge–Barton Creek Bridge (photo from the Authors)..... | 8 |
| Figure 3. Cable-Panel Bridge–Ganter Bridge (photo adapted from lookbridges.com 2012). | 9 |
| Figure 4. Typical Layouts of Finback, Cable-Panel and Extradosed Bridges. | 10 |
| Figure 5. First Extradosed Bridge–Odawara Blueway Bridge. | 11 |
| Figure 6. Construction of Extradosed Bridge (adapted from vsl.cz 2012). | 13 |
| Figure 7. Major Extradosed Bridge Erection Sequence (adapted from Stroh 2012) | 14 |
| Figure 8. Example of Free Balanced Cantilever Method for Extradosed Bridge Construction (Ritto Bridge) (adapted from tripod.com 2012)..... | 15 |
| Figure 9. Distribution of Extradosed Bridges (by Continents). | 26 |
| Figure 10. Distribution of Extradosed Bridges (by Countries)..... | 27 |
| Figure 11. Distribution of Extradosed Bridges (by Completion Year)..... | 28 |
| Figure 12. Distribution of Construction Duration..... | 28 |
| Figure 13. Extradosed Bridges Serving Different Purposes. | 29 |
| Figure 14. Distributions of Bridge Purposes..... | 30 |
| Figure 15. Distribution of Quantities of Spans. | 31 |
| Figure 16. Examples of Bridges with the Highest and Lowest Number of Spans..... | 31 |
| Figure 17. Distribution of Number of Towers..... | 32 |
| Figure 18. Examples of Extradosed Bridges with Different Numbers of Towers..... | 32 |
| Figure 19. Distributions of Maximum Span Lengths. | 33 |
| Figure 20. Distribution of Total Span Length..... | 33 |
| Figure 21. Extradosed Bridges with Longest and Shortest Main and Total Span Lengths. | 34 |
| Figure 22. Distribution of Tower Height. | 34 |
| Figure 23. Extradosed Bridges with the Tallest and Shortest Towers..... | 35 |
| Figure 24. Distribution of Main Span-Height Ratio. | 36 |
| Figure 25. Extradosed Bridges with Highest and Lowest Span-Tower Height Ratios..... | 36 |
| Figure 26. Examples of Extradosed Bridges with Constant and Variable Girder Thickness. | 37 |
| Figure 27. Distribution of Girder Thickness (Constant or Variable)..... | 37 |
| Figure 28. Distribution of Superstructure Materials. | 38 |
| Figure 29. Examples of Extradosed Bridges with Different Superstructure Materials. | 39 |
| Figure 30. Examples of Girder with Different Numbers of Cells in Box Girders..... | 40 |
| Figure 31. Distribution of Number of Cells..... | 40 |
| Figure 32. Distribution of Girder Depth at Midspan. | 41 |
| Figure 33. Distribution of Girder Depth at Tower..... | 41 |
| Figure 34. Examples of Bridges with Different Girder Thicknesses..... | 42 |
| Figure 35. Distribution of Span/Depth Ratio (Midspan). | 43 |
| Figure 36. Distribution of Span/Depth Ratio (Tower)..... | 43 |
| Figure 37. Distribution of Girder Width..... | 44 |
| Figure 38. Distribution of Total Construction Cost..... | 51 |
| Figure 39. Distribution of Superstructure Cost..... | 52 |
| Figure 40. Distribution of Substructure Cost..... | 53 |
| Figure 41. Distribution of Superstructure Cost %. | 54 |

| | |
|--|-----|
| Figure 42. Distribution of Unit Cost. | 56 |
| Figure 43. Distribution of Unit Cost of Superstructure. | 57 |
| Figure 44. Cost Index of Different Types of Bridges from Sumitomo Mitsui Construction..... | 62 |
| Figure 45. Span Ranges for Different Types of Bridges. | 66 |
| Figure 46. BLCCA Process (adapted from Hawk 2003). | 68 |
| Figure 47. Examples of Bridges Selected for Aesthetic Reasons. | 77 |
| Figure 48. Example of Consideration of Aviation Restriction (North Arm Bridge). | 78 |
| Figure 49. Example of Height Restriction to Fit Adjacent Structures (Second Vivekananda Bridge). | 79 |
| Figure 50. Example of Bridge with Navigation Clearance Requirement (Odawara Bridge)..... | 80 |
| Figure 51. Example of Bridge with Vehicular Clearance Requirement (Pont de Saint-Rémy-de-Maurienne Bridge). | 80 |
| Figure 52. Examples of Bridges Selected due to Less Environmental Impact (Ailan Bridge). ... | 81 |
| Figure 53. Example of Bridge with Low Visual Impact (Sunniberg Bridge). | 81 |
| Figure 54. Example of Bridge with Span at Deep Valley (Trois-Bassins Viaduct). | 82 |
| Figure 55. Example of Bridge with Least Navigation Interference in Flood Zone (Liuzhou Sanmenjiang Bridge). | 83 |
| Figure 56. Example of Bridge with Proper Span for Curvature (Puh Bridge). | 83 |
| Figure 57. Examples of Bridge in Unique Site Conditions. | 84 |
| Figure 58. Example of Bridge with Construction Consideration (New Pearl Harbor Memorial Bridge). | 85 |
| Figure 59. Example of Bridge with Structure Consideration (Golden Ears Bridge). | 86 |
| Figure 60. Statistics of Considerations in Selecting Extradosed Bridges. | 87 |
| Figure 61. Summary of Bridge Selection Reasons. | 88 |
| Figure 62. Alternative Designs of the Sunniberg Bridge (adapted from Drinkwater 2012)..... | 90 |
| Figure 63. Final Design of Sunniberg Bridge with Extradosed Concept (adapted from Drinkwater 2012). | 91 |
| Figure 64. Sunniberg Bridge (Wilhelm Ernst & Sohn 2012). | 92 |
| Figure 65. Alternative Designs for Zhangzhou Zhanbei Bridge..... | 93 |
| Figure 66. Zhangzhou Zhanbei Bridge (adapted from China.com 2012). | 96 |
| Figure 67. Stillwater Lift Bridge. | 97 |
| Figure 68. Selected “Build” Alternatives for St. Croix River Crossing Project Selection. | 98 |
| Figure 69. Existing Walterdale Bridge. | 100 |
| Figure 70. Alternatives of Walterdale Bridge Replacement. | 102 |
| Figure 71. Recommended Bridge Selection Process Flowchart. | 108 |

LIST OF TABLES

| | Page |
|--|-------------|
| Table 1. Information of Interviewees..... | 3 |
| Table 2. Comparison of Girder, Extradosed, and Cable-Stayed Bridges. | 12 |
| Table 3. General Information of Extradosed Bridges. | 18 |
| Table 4. Summary of Configurations of Extradosed Bridges..... | 22 |
| Table 5. Statistics of Configurations of Extradosed Bridges..... | 44 |
| Table 6. General Statistics of Configuration of Extradosed Bridges..... | 45 |
| Table 7. Historical Costs of Extradosed Bridges. | 48 |
| Table 8. Historical Costs of Superstructure and Substructure of Extradosed Bridges. | 50 |
| Table 9. Statistics of Extradosed Bridge Construction Costs. | 58 |
| Table 10. Unit Costs based on Types of Bridges (data obtained from Company A). | 60 |
| Table 11. Cost Index of Different Extradosed Bridges (data obtained from Sumitomo Mitsui Construction)..... | 61 |
| Table 12. Prototype of Bridge Selection Matrix Based on LCCA with Dummy Data..... | 68 |
| Table 13. Example of Analysis Matrix using VE Method (from Basha and Gab-Allah 1991)... | 71 |
| Table 14. Example of Criteria-Based Bridge Selection Matrix..... | 72 |
| Table 15. Example of Criteria-Based Bridge Selection Scoring System with Dummy Data. | 72 |
| Table 16. Advantages and Disadvantages of Extradosed Bridges..... | 73 |
| Table 17. Extradosed Bridge Selection Reasons. | 75 |
| Table 18. List of Cases Included in the Case Studies. | 89 |
| Table 19. Configuration Comparisons of Different Bridges. | 94 |
| Table 20. Materials Consumption Comparisons of Different Bridges. | 95 |
| Table 21. Comparison of Different Alternatives of Walterdale Bridge Replacement..... | 104 |
| Table 22. Capital Costs of Different Alternatives in Walterdale Bridge Replacement. | 105 |
| Table 23. Life Cycle Costs of Different Alternatives in Walterdale Bridge Replacement..... | 105 |
| Table 24. Recommended Bridge Selection Preferences under Different Considerations. | 106 |

CHAPTER 1. INTRODUCTION

RESEARCH BACKGROUND

An extradosed bridge is a relatively new type of bridge that provides a cross between prestressed girder bridges and cable-stayed bridges. Generally speaking, the extradosed bridge has the appearance of a cable-stayed bridge with shorter towers; however, the bridge behaves structurally closer to a prestressed girder bridge with external prestressing. In an extradosed bridge, the main girder is directly supported by resting on part of the towers. Therefore, in close proximity to the towers, the girder in an extradosed bridge can act as a continuous beam. Cables from lower towers in an extradosed bridge intersect with the girder only further out, and at a lower angle. With this reason, in an extradosed bridge, tension forces in the girder act more to compress the bridge girder horizontally, rather than support it vertically; thus, the cables act as prestressing cables for a concrete girder. The girder in an extradosed bridge can be thinner than that of a girder bridge of a comparable span, but thicker than that of a conventional cable-stayed bridge. Since the first extradosed bridge built in Japan in 1994, there has been a steady increase of this type of bridge, especially in Asia. However, in most other countries, this typology still remains unfamiliar to many engineers; the cost-effectiveness of the bridge and when this type of bridge should be considered or selected is still not clear.

Given the intermediate design of an extradosed bridge, it is unsurprising that this type of bridge is relatively expensive (compared to a girder bridge) and material inefficient (compared to a cable-stayed bridge). A synthesis study examines basic configurations; overall cost-effectiveness, together with selection processes and considerations of the extradosed bridge, is therefore needed. This study summarizes the advantages and disadvantages of utilizing extradosed bridges, and the methods for cost-effectiveness analyses and bridge selection procedures through a comprehensive literature review. Surveys and interviews were conducted to obtain additional information and insights concerning selecting an extradosed bridge. While there is no standard method/procedure in bridge selection, the feasibility of applying methods including Life Cycle Cost Analysis (LCCA), Value Engineering (VE) analysis, criteria-based bridge selection approaches in cost-effectiveness analyses and bridge selections will be evaluated. This synthesis study summarizes the best practices and existing methodologies in determining how and when an extradosed bridge is cost-

effective. Information collected through this study will help TxDOT leaders and bridge engineers in deciding whether to build an extradosed bridge in specific situations.

RESEARCH OBJECTIVES

The objective of this project is to gather a baseline analysis of the cost-effectiveness of extradosed bridges. This was achieved by examining extradosed bridges from a global perspective, and looking at the advantages and disadvantages of utilizing this unique type of bridge. Results from the project will assist TxDOT management personnel and bridge designers in determining how and when an extradosed bridge is cost-effective and also in the best interest of the public.

RESEARCH APPROACHES

Literature Review

A total of 120 extradosed bridges from Asia, Europe, North America, South America, and Africa were identified through a review of over 350 technical papers, reports, theses, dissertations, and websites. Documents in different languages including English, Japanese, Chinese, Korean, Vietnamese, German, Spanish, Polish, Croatian, Slovenian, Serbian, Czech, and Portuguese were included in the study. Tools including Google translation were used for documents with languages other than English, Chinese, Korean, and Japanese. Information regarding configurations, bridge selections, constructions, and costs from these bridges were collected through the literature review. Statistical analyses were performed to provide a better understanding of existing extradosed bridge configurations, costs, and bridge selection considerations.

Interviews

As most of the literature regarding extradosed bridges identified through the review focused mainly on technical features of extradosed bridges, obtaining valid data on costs and selections of extradosed bridges is challenging. Based on the information collected from the literature review, the research team worked with the Project Director (PD) and the Project Monitoring Committee (PMC) to develop a set of questions that will help obtain additional information and insights concerning the selection of an extradosed bridge. Factors in bridge type

selection and major considerations in selecting a new type of bridge (such as an extradosed bridge) were examined. The research team contacted over 100 individuals that have been involved in extradosed bridge design and/or construction regarding their willingness to participate in telephone/email interviews. Seven experts responded and participated in the interview. Table 1 shows a list of interviewees (three from Asia, two from Europe, and two from North America), together with their positions, affiliations, qualifications, and specific extradosed bridges that they have been involved in.

Table 1. Information of Interviewees.

| Names | Positions (Affiliations) | Qualifications | Extradosed Bridges |
|---------------------------------|--|--|--|
| Christopher Scollard, P. Eng. | Project Manager and Specialist (Buckland & Taylor Ltd.) | Involved in designs of Golden Ears Bridge and North Arm Bridge. Perform erection engineering for the Pearl Harbor Memorial Bridge | North Arm Bridge Golden Ear Bridge |
| Akio Kasuga, Ph.D., P. Eng. | Deputy Division Director and Chief Engineer (Sumitomo Mitsui Construction) | Designed the first extradosed bridge (Odawara Blueway Bridge), together with more than five other extradosed bridges. Chief Engineer of Sumitomo Mitsui Construction (constructed more than 10 extradosed bridges). Published multiple technical papers related to extradosed bridges. | Odawara Blueway Bridge Tsukuhara Bridge Ibi River Bridge |
| Steven L. Stroh, Ph.D., P. Eng. | Vice President (URS Corporation) | Engineer of record on the Pearl Harbor Memorial Bridge. Recently completed a dissertation entitled "On the Development of the Extradosed Bridge Concept" from the University of South Florida. Involved in the design of the St. Croix River Crossing Bridge. | Pearl Harbor Memorial Bridge |
| Jiri Strasky, Prof., DSc., P.E. | Technical Director and Partner (Strasky, Husty and Partners, Ltd.) | Engineer of record on the Povazska Bystrica Bridge. Involved in the design of the St. Croix River Crossing Bridge | Povazska Bystrica Bridge |
| Deong-Hwan Park | Engineer (DongMyeong Engineering Consultants Co., Ltd) | Designed multiple extradosed bridges | NA |
| Sun-Joo Choi | Engineer (Yooshin Engineering Corp.) | Designed Gack-Hwa 1st Bridge, Dae-Ho Grand Bridge, and Guemgang 1st Bridge. | Guemgang 1st Bridge |
| Viktor Markelj, P. Eng. | Structural Engineer and Manager (PONTING d.o.o. Maribor) | Architect and constructor of the Puhov Bridge. Published multiple articles regarding the Puhov Bridge. Faculty member of Civil Engineering, University of Maribor, Slovenia. | Puhov Bridge |
| Aivar-Oskar Saar | Engineer (Järelpinge Inseneribüroo OÜ) | Responsible for Smuuli extradosed bridge design and construction. | Smuuli Bridge |

In order to increase response rates, the research team originally considered using forms for both online surveys and telephone/email interviews in collecting feedback. However, because of the small number of interviewees identified, with the consulting of PD and PMC, the research team decided to use only interviews in this study. Also, as English is not their native language, most of the interviewees preferred email interviews. Interview questions developed in the study targeted contractors, designers, and architects who have experience in extradosed bridges. A set of 18 questions covering bridge constructions, reasons of bridge selection, costs of construction, advantages and disadvantages, and maintenance and repairs was included in the interview. A template of email and a list of interview questions are included in Appendix C. At the request of two interviewees, the interview questions were translated in Korean and provided to the individuals. Appendix C has a copy of the responses from all seven interviewees.

Case Studies

The main object of the research project is to better understand how and why extradosed bridges were selected or not selected. However, the selection of final bridge alternatives depended on specific site conditions, together with many other considerations. Case studies could therefore serve as a better channel in explaining bridge selection among different alternatives. A total of four case studies with detailed information of bridge alternatives, bridge selection criteria, considerations, cost analyses, and processes were included in the study.

SCOPE OF RESEARCH AND ORGANIZATION OF THE REPORT

The report represents the project summary report for TxDOT Project 0-6729. The following describes the report's organization by chapter.

- Chapter 1 presents the general background, research objectives, research approaches, and scope of the project.
- Chapter 2 summarizes the history, general concept and configuration, practices and considerations in the construction and maintenance of extradosed bridges.
- Chapter 3 presents the results from statistical analyses of extradosed bridges through information collected from literature reviews and interviews.
- Chapter 4 summarizes the cost information of extradosed bridges collected from literature review, and interviews, together with special sources.

- Chapter 5 summarizes the advantages and disadvantages of extradosed bridge and major reasons in selecting extradosed bridges. Case studies with detailed information of bridge alternatives, bridge selection criteria and considerations, and cost analysis were also included in the chapter. Recommended bridge selection considerations and processes were also included.
- Chapter 6 summarizes the major findings and conclusions from the study. Recommendations for future research are also presented.

CHAPTER 2. GENERAL ASPECTS OF EXTRADOSED BRIDGES

HISTORY OF EXTRADOSED BRIDGES

The structural concept of extradosed bridge was first proposed by Jacques Mathivat in France at 1988 (Mathivat, 1988). In the document, the concept of extradosed referred to situation where tendons were installed outside and above the main girder and deviated by short towers located at supports. While the intrados is defined as the interior curve of an arch, or in the case of a cantilever-constructed girder bridge, i.e., the soffit of the girder, the extrados is defined as the uppermost surface of the arch. The term “extradosed” was used by Mathivat to appropriately describe an innovative cabling concept he developed for the Arrêt-Darré Viaduct (see Figure 1), in which external tendons were placed above the girder instead of within the cross-section as would be the case in a girder bridge. To differentiate these shallow external tendons from stay cables found in a cable-stayed bridge, Mathivat called them “extradosed” prestressing.

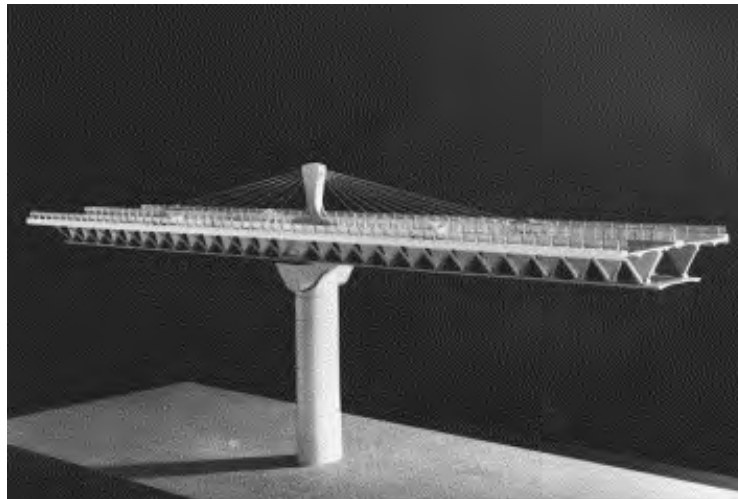

Figure 1. “Extradosed” Concept at Arrêt-Darré Viaduct (picture adapted from Virlogeux 1999).

The development of the extradosed bridge may have been influenced by other types of unconventional cantilevered bridges in which top tendons rise above the girder level in the negative moment regions. By locating prestressing cables in the walls above the girder, the capacity of girder slab in compression can be utilized in negative moment regions (over the piers), which leads to a more efficient structure comparing to a conventional box girder bridge. Cable-panel bridges and finback bridges, both inspired by the desire to reduce the self-weight of cantilever constructed girder bridge, were two of the bridge types that were generally considered

to have influenced the evolution of the extradosed bridge concept (Stroh 2012; Mermigas 2008; Benjumea et al. 2010).



Figure 2. Finback Bridge–Barton Creek Bridge (photo from the Authors).

While a finback bridge has a wall containing the negative moment tendons that are monolithic with the girder creating a single section, a cable-panel bridge has a wall that is detached from the girder section, serving more as passive protection for the cables. The “finback” is a prestressed beam with a highly variable depth of prestressing. The finback design is unique for having internal cables at their highest as they pass over piers, which are enclosed in a wall or ‘fin’ of concrete. The double hump profile may look similar to a cable-stayed or an extradosed bridge, but the engineering concept is more in common with a pure beam bridge. Many people consider the lower profile of a finback bridge to be more attractive than a conventional prestressed beam bridge. In other words, a finback bridge is a prestressed concrete beam bridge in which haunches are inverted above the road girder at piers, rather than below. Haunches are defined as part of girders that are thicker over piers, usually coming to a downward point. The finback is unique because only a single girder is haunched as fins in the center of the structure.

The Barton Creek Boulevard Bridge at Austin, Texas, is one of the few prestressed concrete finback bridges constructed and America’s only example of a concrete finback beam bridge (see Figure 2). The bridge connects Austin to the estates of Barton Creek over an

environmentally sensitive gorge. The finback bridge design was chosen as it would be a visible landmark into estates from above the bridge and it would consequently attract publicity to the development (Gee 1991). Also, preliminary design costs estimated found that the finback bridge with a main span of 341 feet was comparable to a conventional cantilever box girder bridge (Gee 1991).



Figure 3. Cable-Panel Bridge–Ganter Bridge (photo adapted from lookbridges.com 2012).

The Ganter Bridge (see Figure 3), located in Switzerland, is the first and most well-known cable-panel bridge with a main span of 571 feet, which takes a roadway over a deep valley at heights of up to 459 feet above the valley floor. The Ganter Bridge applied a superstructure composed of a prestressed box girder by concrete wall-embedded cables and stiff piers, which enable the bridge to withstand strong winds in the zone. The roadway runs parallel to the valley on either side, while the bridge crosses at a skew, which necessitates sharp curves at both ends of the bridge. Besides, the bridge had two unique design requirements: tall and stiff piers for a better resistance against high winds through the valley and a very narrow roadway for a bridge of this maximum span length. While a conventional cantilever constructed box girder bridge would have been technically feasible, the design decision was made with aesthetics in mind (Mermigas 2008; Benjumea et al. 2010).

Figure 4 shows a comparison of general layouts of finback, cable-panel, and extradosed bridges. While cable-panel bridges and finback bridges bear some resemblance to extradosed bridges, they differed in appearance and stiffness, and cables cannot be easily replaced since these

are encased in concrete walls. According to Virlogeux (1999), concrete walls in cable-panel and finback bridges have two drawbacks: (1). tendons cannot be replaced; and (2). there is a cost to construct concrete walls. Even though the additional cost of the protection system for stay-cables would have exceeded the cost of walls, their use is only economical in shorter spans since concrete walls add dead load to cable-panel and finback bridges. In terms of aesthetics, the stay-cable extradosed bridges offer a lighter appearance than heavy concrete walls of finback and cable-panel bridges. Even with a similar structure concept compared to extradosed bridges, as finback and cable-panel bridges types have the stays encased in concrete and exhibit different behavior under live loads, they are not to be considered in this study.

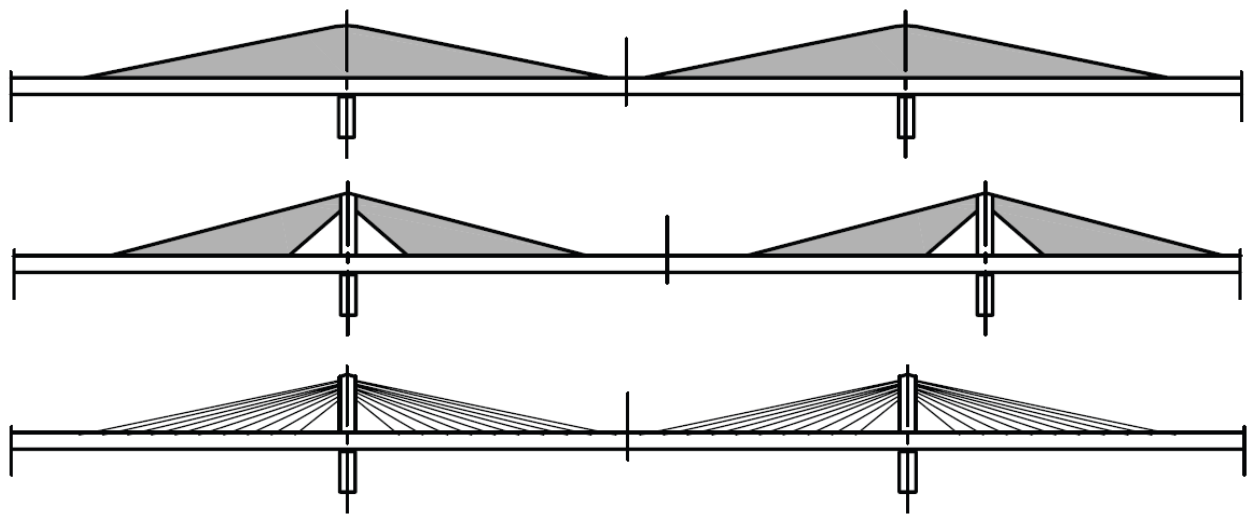

Figure 4. Typical Layouts of Finback, Cable-Panel and Extradosed Bridges.

Odawara Blueway Bridge (Figure 5), completed in 1994, was the first extradosed bridge constructed in the world. A 400-foot main span was required at the bridge location in order to provide sufficient navigation clearances. As the very first bridge of its kind, the design of Odawara Blueway followed Mathivat’s “extradosed” theory with a lower tower height compared to conventional cable-stayed bridges (Ogawa and Kasuga 2008). During the bridge selection process, several bridge types appropriate for this span length were considered: the conventional rigid frame girder bridge, cable-stayed bridge, and extradosed prestressed bridge. Although no examples of this bridge type had been previously built, the Japan Highway Public Corporation made a decision in selecting the extradosed bridge type due to the superior appearance provided local landmark and “gateway” to the port, together with lower costs (Mermigas 2008; Benjumea et al. 2010; Kasuga 2012). It should be pointed out that as it is commonly expected that an

extradosed bridge design generally leads to a lower cost compared to that of a cable-stayed bridge; the extradosed bridge also provides a lower cost compared to a girder bridge when the total cost is considered. Cost savings include reduced costs required to raise bridge elevations to provide the necessary navigation clearances as compared to the deeper girders of conventional girder bridges.



Figure 5. First Extradosed Bridge—Odawara Blueway Bridge.

CONFIGURATION AND DEFINITIONS OF EXTRADOSED BRIDGES







An extradosed bridge has a hybrid design combining the concepts of a girder bridge and a cable-stayed bridge, with the girder directly supported by resting on part of towers while cable-stays act as prestressing cables for a concrete girder. While girders in an extradosed bridge are normally stiffer than those in a typical cable-stayed bridge, the cable angle in an extradosed bridge is generally flatter and functions essentially as external post-tensioning. The term “extradosed bridge” is used to describe a cable-stayed bridge with a stiff girder that carries live loads through flexural behavior.

As mentioned earlier, Mathivat (1988) made the fundamental distinction that the basic role of cables in an extradosed bridge is to provide horizontal prestress to the girder instead of to develop elastic vertical actions, as is the case of traditional cable-stays. In the same paper, Mathivat proposed the extradosed bridge as an alternative bridge concept and suggested using the tower height-to-span ratio as a differentiating feature between the two bridge types, with cable-stayed bridges defined by tower height-to-span ratios of approximately 1/5 and extradosed bridges defined by ratios of approximately 1/15.

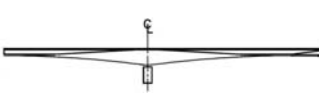
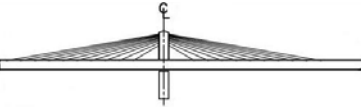
Ogawa and Kasuga (1998), on the other hand, suggested defining an extradosed bridge

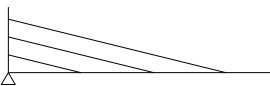
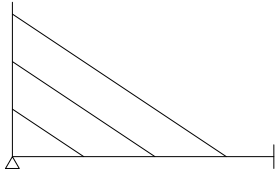
by the so-called stiffness ratio between stay cables and the girders, in which the stiffness ratio was defined as “load carried by stay cables divided by total vertical load.” A boundary of 30% is recommended between cable-stayed and extradosed bridges, with a ratio of less than 30% to be defined as extradosed bridges. Consequently, stays in cable-stayed bridges are designed to a maximum allowable tensile stress of $0.45f_{pu}$ (where f_{pu} is the ultimate tensile stress of the cable), and a value of 0.60 can be used for extradosed bridges. Table 2 summarizes comparisons among girder bridges, extradosed bridges, and cable-stayed bridges. In the table, L refers to main span length.

Table 2. Comparison of Girder, Extradosed, and Cable-Stayed Bridges.

| | Girder Bridge | Extradosed Bridge | Cable-stayed Bridge |
|---------------------------|---|--|---|
| Typical Layout |  |  |  |
| Cable Support Arrangement |  |  |  |
| Shear Diagram |  |  |  |
| Girder Thickness | Variable $L/50$ to $L/15$ | Constant/Variable $L/50$ to $L/30$ | Constant $L/100$ to $L/50$ |
| Tower Height | NA | $L/15$ to $L/8$ | $L/5$ to $L/4$ |
| Prestress | Internal and external prestress | External prestress | Cable stays |
| Max cable stress | NA | $0.60f_{pu}$ | $0.45f_{pu}$ |

While there are more than 100 extradosed bridges constructed or currently under construction worldwide, in general, there is no widely accepted definition of extradosed bridges. Due to the similar appearance and lack of a clear definition, extradosed bridges are often mistaken as cable-stayed bridges, or vice versa. During the course of literature surveys and interviews of this study, the research team identified several cable-stayed bridges that were previously classified as extradosed bridges in other literatures.

With the exception of Japan, there is no widely accepted design rule and/or code that provide design standards for extradosed bridges. According to Kasuga (2006), a design method for stay cables is allowed to be used for extradosed bridges in the Japanese design code (*Specifications for Design and Construction of Cable-Stayed Bridges and Extradosed Bridges*), in which the allowable tensile strength was varied for the stay cables based on the fatigue design. The reference is available only in Japanese language. In addition, the method does not define extradosed bridges; rather, it provides a transition between extradosed bridge cables and stay cables.

EXTRADOSED BRIDGE CONSTRUCTION

According to the information collected, most extradosed bridges used the same construction method, i.e., free/balanced cantilever (Stroh 2012). The method is often used in a medium or long main span (200 to 500 feet) bridge. The free cantilever technology consists of developing the bridge structure by individual parts, i.e., the so-called segments. During the construction, segments of spans are usually cast in-situ with 10 to 15 feet per piece. Spans extend from the top of a pier with segments adding to each side of the pier once a time until meet at the mid span. When it is difficult or impossible to erect scaffolding such as building a bridge in deep valley or river, the free/balanced cantilever method is the proper technology to use. A sketch of the construction concept and the sequence of free cantilever extradosed bridge construction can be found in Figure 6 and Figure 7 respectively.

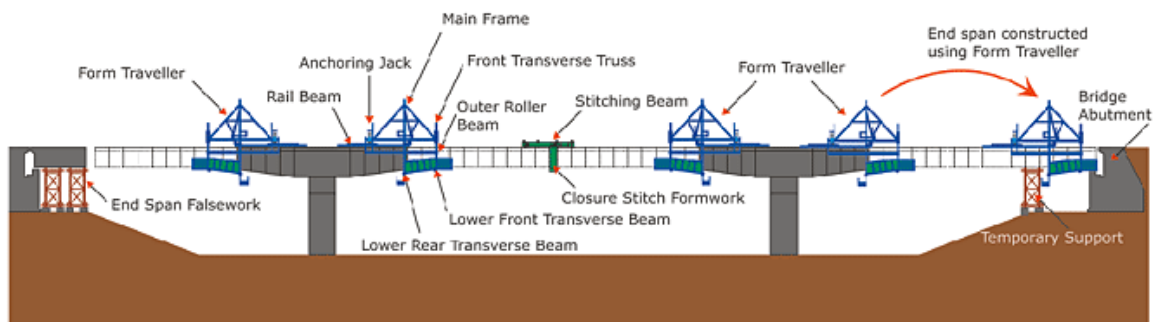

Figure 6. Construction of Extradosed Bridge (adapted from vsl.cz 2012).

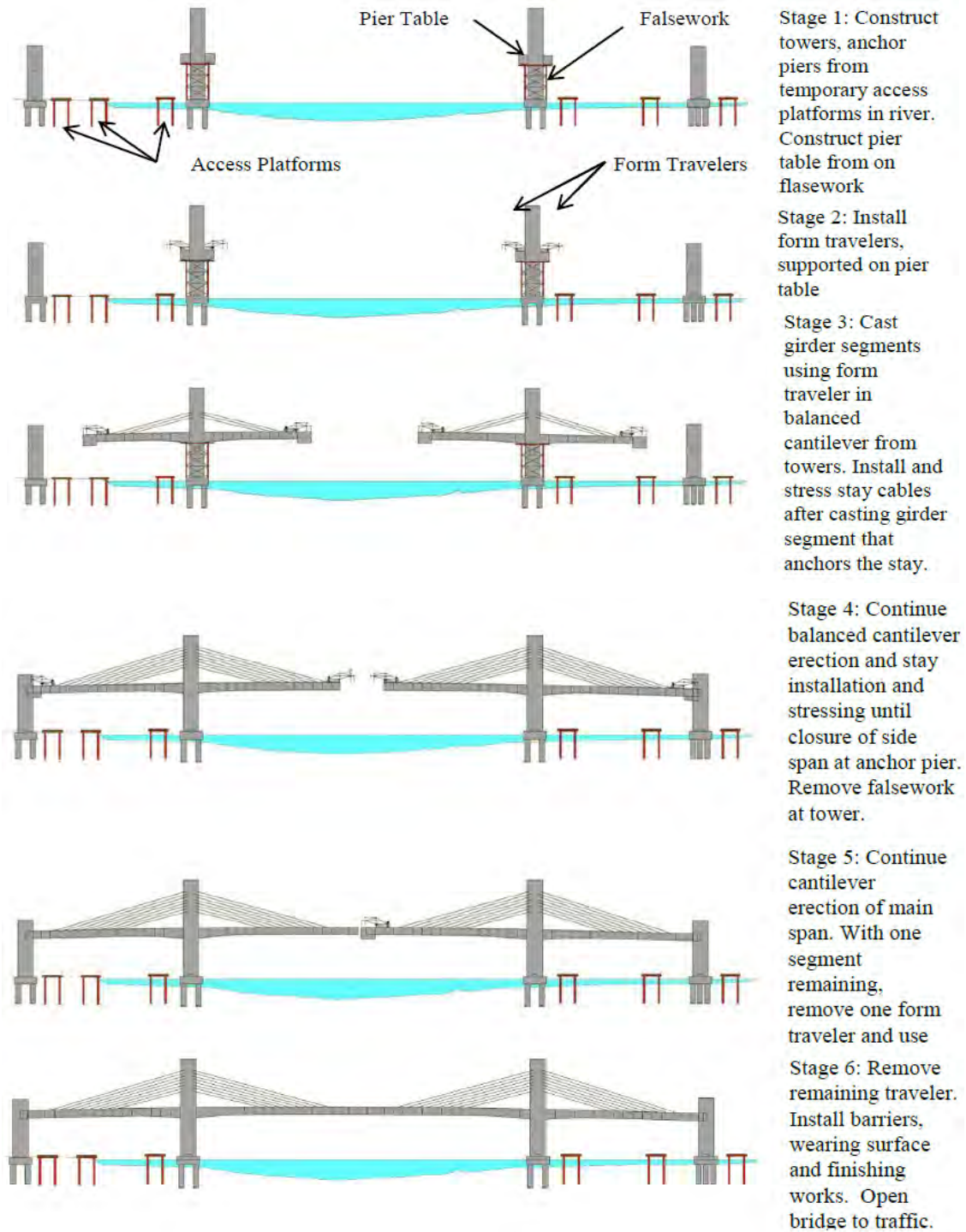

Figure 7. Major Extradosed Bridge Erection Sequence (adapted from Stroh 2012)

The main advantage of the free/balanced cantilever construction method is its structural efficiency. In this type of method, bridge segments can be prepared rapidly in-situ because the installation and casting of segments can be processed at the same time. As an alternative,

segments can also be cast during the substructure construction period. An example of pylons and pier tables, together with travelers in extradosed bridge construction with the free/balanced cantilever method is shown in Figure 8. The disadvantage of the free/balanced cantilever method is shown in Figure 8. The disadvantage of the free/balanced cantilever method is the possible limitation of in-situ casting space. If segments are prepared elsewhere and then delivered to the jobsite, the transportation method needs to be considered carefully. For example, the transportation route should be selected well and help with traffic control during transportation will be needed.



(a) Pylon and Pier Table



(b) Form Traveler

Figure 8. Example of Free Balanced Cantilever Method for Extradosed Bridge Construction (Ritto Bridge) (adapted from tripod.com 2012).

EXTRADOSED BRIDGE MAINTENANCE

As most of extradosed bridges are still relatively new, there is not much information regarding maintenance and repair of such bridges. However, information collected from

interviews conducted from this study indicated that even though there is no specific data to support the statement, there is no reason to expect that extradosed bridges will result in higher maintenance costs or efforts compared to other common bridge types. Compared to cable-stayed bridges, extradosed bridges have similar inspection items, but there is likely to be lower maintenance/inspect efforts or costs due to the lower numbers of cables and lower towers. However, compared to girder bridges, extradosed bridges could involve higher costs and efforts in maintenance or inspection due to the stay cables, anchorages, vibration dampers, towers, internal anchor boxes, and grounding system (lighting protection) that would not be expected in a typical girder bridge.

SUMMARY

The extradosed bridge has a hybrid design with the girder directly supported by resting on part of towers while cable stays act as prestressing cables for a concrete girder. The basic role of cables in an extradosed bridge is to provide horizontal prestress to the girder instead of to develop elastic vertical actions, as is the case of traditional cable stays. However, there is no widely accepted definition of an extradosed bridge. Mathivat suggested using the tower height-to-span ratio as the differentiating feature between the two bridge types, with cable-stayed bridges defined by tower height-to-span ratios of approximately 1/5 and extradosed bridges defined by ratios of approximately 1/15. Meanwhile, Ogawa and Kasuga suggested defining an extradosed bridge by the stiffness ratio (the load carried by stay cables divided by total vertical load) of less than 30%. Further study is needed to justify what is the most appropriate definition of an extradosed bridge. With the exception of Japan, there is no widely accepted design rule or code that provides design standards for the extradosed bridge type. The Japanese design code (*Specifications for Design and Construction of Cable-Stayed Bridges and Extradosed Bridges*) is available only in Japanese language. The method does not define an extradosed bridge; rather, it provides a transition between an extradosed bridge cable and a stay cable. Most of extradosed bridges documented used the free/balanced cantilever construction method. Even though there is no specific data to reflect maintenance costs and efforts of extradosed bridges, costs or efforts are not expected to be higher compared to other common bridge types.

CHAPTER 3. REVIEW OF EXTRADOSED BRIDGES

GENERAL INFORMATION OF EXTRADOSED BRIDGES

Since the first extradosed bridge constructed in 1994, the number of extradosed bridges being built or have been built rose quickly over the last couple decades. In order to better understand the general configurations of extradosed bridges and trends of development, a literature survey was conducted to summarize statuses, structural features, costs, and major reason(s) in bridge selection from all extradosed bridges identified from literature. A total of 120 extradosed bridges from Asia, Europe, North America, South America, and Africa were identified through the review of nearly 350 technical papers, reports, theses, dissertations, and websites. Documents in different languages including English, Japanese, Chinese, Korean, Vietnamese, German, Spanish, Polish, Croatian, Slovenian, Serbian, Czech, and Portuguese were included in the study. Tools including GoogleTM translation were used for languages other than English, Chinese, Korean, and Japanese. Appendix A lists the 120 extradosed bridges, together with references identified for each of the bridge. A list of the 120 bridges and configurations of bridges are presented in Table 3 and Table 4 respectively. Appendix B presents detailed information of the 120 bridges, including photos and drawings of layouts and cross sections of the bridges.

Table 3. General Information of Extradosed Bridges.

| | Bridge | Location | Year | Use | Construction Duration (mth) |
|----|---|---|------|--------|-----------------------------|
| 1 | Odawara Blueway Bridge | Odawara, Japan | 1994 | Road | 22 |
| 2 | Tsukuhara Bridge | Hyogo, Japan | 1997 | Road | 44 |
| 3S | Yashiro Bridge-South Bound | Nagano, Japan | 1997 | Rail | |
| 3N | Yashiro Bridge-North Bound | Nagano, Japan | 1997 | Rail | |
| 4 | Kanisawa Bridge | Japan | 1998 | Road | |
| 5E | Shin-Karato Bridge (Okuyama Bridge)-East Bound | Kobe, Japan | 1998 | | 23 |
| 5W | Shin-Karato Bridge (Okuyama Bridge)-West Bound | Kobe, Japan | 1998 | | 23 |
| 6 | Sunniberg Bridge | Klosters, Switzerland | 1998 | Road | 30 |
| 7 | Mitanigawa Bridge (Santanigawa Bridge) | Japan | 1998 | Road | |
| 8 | Sapporo Railway Bridge | Sapporo, Japan | 1999 | Rail | 27 |
| 9 | Second Mactan-Mandaue Bridge | Mandaue, Philippines | 1999 | Road | 37 |
| 10 | Pont de Saint-Rémy-de-Maurienne Bridge | Saint-Rémy-de-Maurienne, France | 1999 | Road | |
| 11 | King Hussein Bridge | Jordan | 1999 | Road | |
| 12 | Pakse Bridge | Between Pakse Laos and Phonthong Thailand | 2000 | Road | 24 |
| 13 | Sajiki Bridge | Japan | 2000 | Road | |
| 14 | Shikari Bridge | Hokkaido, Japan | 2000 | Road | 29 |
| 15 | Surikamigawa Bridge | Japan | 2000 | | |
| 16 | Wuhu Yangtze River Bridge | Wuhu, China | 2000 | Hybrid | 42 |
| 17 | Yukizawa Bridge | Japan | 2000 | Road | |
| 18 | Hozu Bridge | Kyoto, Japan | 2001 | Road | |
| 19 | Ibi River Bridge (Ibigawa Bridge) | Nagashima-cho, Japan | 2001 | Road | 33 |
| 20 | Kiso River Bridge (Kisogawa Bridge) | Nagashima-cho, Japan | 2001 | Road | 33 |
| 21 | Miyakoda River Bridge (Miyakodagawa Bridge) | Shizuoka, Japan | 2001 | Road | 55 |
| 22 | Nakanoike Bridge | Japan | 2001 | | |
| 23 | Zhangzhou Zhanbei Bridge | Zhangzhou, China | 2001 | Road | |
| 24 | Fukaura Bridge | Japan | 2002 | | |
| 25 | Koror-Babeldaob (Japan-Palau Friendship) Bridge | Koror, Palau | 2002 | Road | 60 |
| 26 | Sashikubo Bridge | Shingou-mura Japan | 2002 | Road | |
| 27 | Shinkawa (Tobiuo) Bridge | Hamamatsu, Japan | 2002 | Road | 33 |
| 28 | Tongan Yinhu Bridge | Xiamen, China | 2002 | Road | |
| 29 | Changcheng Yunhe Bridge | Changzhou, China | 2003 | Road | 15 |
| 30 | Deba River Bridge | Guipuzcoa, Spain | 2003 | Road | |
| 31 | Xiaoxihu Yellow River Bridge | Lanzhou, China | 2003 | Road | 24 |

| | Bridge | Location | Year | Use | Construction Duration (mth) |
|-----|-----------------------------------|---|------|------|-----------------------------|
| 32 | Shanxi Fenhe Bridge | Linfen, China | 2003 | Road | |
| 33 | JR Arakogawa Bridge | Aichi, Japan | 2003 | Rail | 15 |
| 34 | Himi Bridge | Nagasaki, Japan | 2004 | Road | |
| 35 | Korong Bridge | Budapest, Hungary | 2004 | | |
| 36 | Tatekoshi (Matakina) Bridge | Okinawa, Japan | 2004 | | |
| 37 | Shin-Meisei Bridge | Japan | 2004 | | |
| 38 | Yinchuan Beierhuan I Bridge | Yinchuan, China | 2005 | Road | 25 |
| 39 | Shuqian Nanerhuan Bridge | Shuqian, China | 2005 | Road | 24 |
| 40 | Brazil-Peru Integration Bridge | Between Assis Brasilm, Brazil and Iñapari, Peru | 2005 | Road | |
| 41 | Sannohe–Boukyo Bridge | Aomori, Japan | 2005 | Road | |
| 42 | Lishi Gaojia Bridge | Sanxi, China | 2005 | Road | |
| 43 | Lita Bridge | Yinchuan, China | 2006 | Road | |
| 44 | Pingdingshan Zhanhe I Bridge | Pingdingshan, China | 2006 | Road | |
| 45T | Ritto (Rittoh) Bridge–Tokyo Bound | Japan | 2006 | Road | |
| 45O | Ritto (Rittoh) Bridge–Osaka Bound | Japan | 2006 | Road | |
| 46 | Nanchiku Bridge | Japan | 2006 | Road | |
| 47 | Rio Branco Third Bridge | Rio Branco, Brazil | 2006 | Road | |
| 48 | Liuzhou Sanmenjiang Bridge | Liuzhou, China | 2006 | Road | 25 |
| 49 | Tagami Bridge | Japan | 2006 | | |
| 50 | Tokunoyamahattoku Bridge | Ibigawa, Japan | 2006 | Road | 22 |
| 51 | Yanagawa Bridge | Nagasaki, Japan | 2006 | Road | 34 |
| 52 | Huiqing Huanghe Bridge | Shandong, China | 2006 | Road | 32 |
| 53 | Kaifeng Huanghe II Bridge | Kaifeng, China | 2006 | Road | 26 |
| 54 | Fuzhou Pushang Bridge | Fuzhou, China | 2006 | Road | 28 |
| 55 | Chaobaihe Bridge | Beijing, China | 2006 | Road | |
| 56 | Homeland (Domovinski) Bridge | Zagreb, Croatia | 2007 | Rail | 60 |
| 57 | Bridge of the European Union | Konin, Poland | 2007 | Road | |
| 58 | Hemaxi Bridge | Guangdong, China | 2007 | Road | |
| 59 | Yudaihe Bridge | Beijing, China | 2007 | Road | |
| 60 | Ailan Bridge | Puli, Taiwan | 2007 | Road | |
| 61 | Nymburk Bypass Bridge | Nymburk, Czech Republic | 2007 | Road | |
| 62 | Puh (Puhov) Bridge | Ptuj, Slovenia | 2007 | Road | 19 |
| 63 | Shindae First Bridge | Chungcheongnam-do, Korea | 2007 | Road | |
| 64 | Smuuli Bridge | Tallinn, Estonia | 2007 | | |
| 65 | Gum-Ga Grand Bridge | Chung Ju, Korea | 2007 | Road | |
| 66 | Second Vivekananda Bridge | Kolkata, India | 2007 | Road | |
| 67 | Gack-Hwa First Bridge | Gwangju, Korea | 2007 | Road | 33 |

| | Bridge | Location | Year | Use | Construction Duration (mth) |
|-----|---------------------------------------|---------------------------------|------|--------|-----------------------------|
| 68 | Pyung-Yeo II Bridge | Yeosu, Korea | 2008 | Road | |
| 69 | Dae-Ho Grand (Cho-Rack) Bridge | Dangjin, Korea | 2008 | Road | 44 |
| 70 | Hirano Bridge | Osaka, Japan | 2008 | Rail | |
| 71 | Sannai–Maruyama Bypass Bridge | Hachinole to Shin-Aomori, Japan | 2008 | Rail | 36 |
| 72 | Ma-Tsu Bridge | Yunlin, Taiwan | 2008 | Road | |
| 73 | North Arm Bridge | Vancouver, Canada | 2008 | Rail | |
| 74 | Sannai–Maruyama Bridge | Aomori, Japan | 2008 | Road | |
| 75 | Trois-Bassins Viaduct Bridge | Reunion, France | 2008 | Road | 33 |
| 76 | Hidasie Bridge | Blue Nile Gorge, Ethiopia | 2008 | Road | |
| 77 | Riga South(ern) Bridge | Riga, Latvia | 2009 | Road | 48 |
| 78 | Golden Ears Bridge | Vancouver, Canada | 2009 | Road | |
| 79 | Karnaphuli III Bridge | Chittagong, Bangladesh | 2009 | Road | 38 |
| 80 | Kyong-An Bridge | Kyong-An, Korea | 2009 | | |
| 81 | Husong Bridge | Zhuzhou, China | 2009 | Road | |
| 82 | Xianshen River Bridge | Shanxi, China | 2009 | Road | |
| 83 | Ankang Qiligou Bridge | Shanxi, China | 2009 | Road | |
| 84 | Incheon Bridge | Incheon, Korea | 2009 | Road | 36 |
| 85 | Qishan Bridge | Gaoxiong, Taiwan | 2010 | Road | |
| 86 | Choqueyapu Bridge | La Paz, Bolivia | 2010 | Road | |
| 87 | Kantutani Bridge | La Paz, Bolivia | 2010 | Road | |
| 88 | Orkojahaira Bridge | La Paz, Bolivia | 2010 | Road | |
| 89 | Povazska Bystrica D1 Motorway Viaduct | Povazska Bystrica, Slovakia | 2010 | Road | 22 |
| 90 | Teror Viaduct | Gran Canaria Island, Spain | 2010 | Road | 22 |
| 91 | New Amarube Bridge | Japan | 2010 | Rail | |
| 92 | Immobility Bridge | Japan | 2011 | Road | 84 |
| 93 | Un-am Grand Bridge | Jeonbuk, Korea | 2011 | Road | 86 |
| 94 | Panyu Shanwan Bridge | Guangzhou, China | 2011 | Road | |
| 95 | Jiayue (Nanping) Bridge | Chongqing, China | 2011 | Hybrid | |
| 96 | Tisza Bridge | More Ferenc, Hungary | 2011 | Road | |
| 97 | Hwangdo Grand Bridge | Changgi-ri, Korea | 2011 | Road | 61 |
| 98 | Nokan Bridge | Busan, Korea | 2011 | Road | |
| 99 | Guemgang I Bridge | Sejong City, Korea | 2012 | Hybrid | 52 |
| 100 | Qinxiu Bridge | Lugu, Taiwan | 2012 | Road | |
| 101 | Hualiantai Fengping Bridge | Hualian, Taiwan | 2012 | Road | 30 |
| 102 | Dazhihe Bridge | Shanghai, China | 2012 | Road | |
| 103 | Najin Bridge | Tibet, China | 2012 | Road | 22 |
| 104 | La Massana Bridge | La Massana, Andorra | 2012 | Road | |

| | Bridge | Location | Year | Use | Construction Duration (mth) |
|-----|---|------------------------------------|------|------|-----------------------------|
| 105 | Naluchi Bridge | Muzaffarabad, Pakistan | 2012 | Road | 33 |
| 106 | Waschmuhl Viaduct | Kreos, Germany | 2012 | Road | |
| 107 | New Pearl Harbor Memorial (Quinnipiac) Bridge | New Haven, US | 2012 | Road | 60 |
| 108 | Changshan Bridge | Daliang, China | 2013 | Road | 24 |
| 109 | Ningjiang Shonghuajiang Bridge | Jilin, China | 2013 | Road | 36 |
| 110 | Half Sky Overpass Bridge | Lugu, Taiwan | 2013 | Road | 20 |
| 111 | Yongjin Bridge | Sang-ri, Korea | 2014 | Road | 31 |
| 112 | Gangchon 2nd Bridge | Banggok-ri, Korea | 2014 | Road | |
| 113 | Saint Croix River Bridge | Houlton/Still Water, United States | 2014 | Road | |
| 114 | Sanguanjiang Bridge | Wuhan, China | 2015 | Road | 42 |
| 115 | Brazos River Bridge | Waco, United States | 2015 | Road | |
| 116 | Naericheon Bridge | Sangnam Inje Kangwon, Korea | 2015 | Road | |
| 117 | Yaro Grand Bridge | Yaro Myun, Korea | 2015 | Road | 54 |
| 118 | Pyung-Taik Grand Bridge | Pyung-Taik City, Korea | 2016 | Road | 60 |
| 119 | Beixi Hechuan Bridge | Nanao, Taiwan | 2016 | Road | |
| 120 | Kinmen Bridge | Kinmen, Taiwan | 2016 | Road | |

Note: In the table, the term of “hybrid” refers to bridges serve the purpose of both road and rail (or light rail), or road with pedestrian or bike underneath.

Table 4. Summary of Configurations of Extradosed Bridges.

| | Bridge Name | # _c | Mat | # _s | # _T | S _m (ft) | S _t (ft) | H _t (ft) | S _m /H _t | D _{c/v} | D _m (ft) | D _t (ft) | D _w (ft) | S _m /D _m | S _m / D _t |
|----|---|----------------|----------------|----------------|----------------|------------------------|------------------------|---------------------|--------------------------------|------------------|------------------------|------------------------|------------------------|--------------------------------|------------------------------------|
| 1 | Odawara Blueway Bridge | 2 | C | 3 | 2x2 | 400 | 886 | 35.1 | 11.4 | Var | 7.2 | 11.5 | 43.6 | 55.5 | 34.9 |
| 2 | Tsukuhara Bridge | 1 | C | 3 | 2x2x2 | 591 | 1060 | 52.5 | 11.3 | Var | 9.8 | 18.0 | 42.0 | 60.0 | 32.7 |
| 3S | Yashiro Bridge-South Bound | | C | 4 | 3x2 | 344 | 1115 | 39.4 | 8.8 | | | | | | |
| 3N | Yashiro Bridge-North Bound | | C | 3 | 2x2 | 295 | 656 | 32.8 | 9.0 | | | | | | |
| 4 | Kanisawa Bridge | | C | 3 | 2x2 | 591 | 1242 | 72.5 | 8.1 | Var | 10.8 | 18.4 | 57.4 | 54.5 | 32.1 |
| 5E | Shin-Karato (Okuyama) Bridge-East | 2 | C | 3 | 2x2x2 | 394 | 847 | 39.4 | 10.0 | Var | 8.2 | 11.5 | 31.8 | 48.0 | 34.3 |
| 5W | Shin-Karato (Okuyama) Bridge-West | 3 | C | 3 | 2x2x2 | 459 | 929 | 39.4 | 11.7 | Var | 8.2 | 11.5 | 41.5 | 56.0 | 40.0 |
| 6 | Sunniberg Bridge | | C | 5 | 4x2 | 459 | 1726 | 48.6 | 9.5 | Con | 3.6 | 3.6 | 40.6 | 127.3 | 127.3 |
| 7 | Mitanigawa (Santanigawa) Bridge | 2 | C | 2 | 1x1 | 305 | 495 | 41.3 | 7.4 | Var | 8.2 | 21.3 | 66.9 | 37.2 | 14.3 |
| 8 | Sapporo Railway Bridge | | C | 2 | | 182 | 364 | 32.5 | | | | | | | |
| 9 | Second Mactan-Mandaua Bridge | 3 | C | 3 | 2x2 | 607 | 1339 | 59.1 | 10.3 | Var | 10.8 | 16.7 | 59.1 | 56.1 | 36.3 |
| 10 | Pont de Saint-Rémy-de-Maurienne Bridge | | C | 2 | 2x1 | 172 | 331 | 19.4 | 8.9 | Con | 7.1 | 7.1 | 44.0 | 24.4 | 24.4 |
| 11 | King Hussein Bridge | 3 | C | 3 | 2x2 | 171 | 394 | | | Var | 4.9 | 8.2 | 62.0 | 34.7 | 20.8 |
| 12 | Pakse Bridge | 1 | C | 3 | 2x2 | 469 | 1173 | 49.2 | 9.5 | Var | 9.8 | 21.3 | 45.3 | 47.7 | 22.0 |
| 13 | Sajiki Bridge | | C | 3 | 2x2 | 344 | 736 | 38.5 | 8.9 | Var | 6.9 | 10.5 | 36.1 | 50.0 | 32.8 |
| 14 | Shikari Bridge | | C | 5 | 4x1 | 459 | 1995 | 32.8 | 14.0 | Var | 9.8 | 19.7 | 92.1 | 46.7 | 23.3 |
| 15 | Surikamigawa Bridge | | C | 1 | | 278 | | 54.1 | 5.1 | Var | 9.2 | 16.4 | 30.2 | 30.3 | 17.0 |
| 16 | Wuhu Yangtze River Bridge | | H _A | 3 | 2x2 | 1024 | 2205 | 114.8 | 8.9 | Con | 44.3 | 44.3 | 76.8 | 23.1 | 23.1 |
| 17 | Yukizawa Bridge | 2 | C | 2 | | 233 | 464 | 37.7 | 6.2 | Var | 6.6 | 11.5 | 51.8 | 35.5 | 20.3 |
| 18 | Hozu Bridge | 1 | C | 3 | 2x2 | 328 | 827 | 32.8 | 10.0 | Con | 9.2 | 9.2 | 53.5 | 35.7 | 35.7 |
| 19 | Ibi River Bridge (Ibigawa Bridge) | 4 | H _B | 6 | 5x1 | 891 | 4583 | 98.4 | 9.1 | Var | 14.1 | 24.0 | 108.3 | 63.1 | 37.2 |
| 20 | Kiso River Bridge (Kisogawa Bridge) | 4 | H _B | 5 | 4x1 | 902 | 3757 | 98.4 | 9.2 | Var | 14.1 | 24.0 | 108.3 | 64.0 | 37.7 |
| 21 | Miyakoda River (Miyakodagawa) Bridge | 2 | C | 2 | 1x3 | 440 | 879 | 65.6 | 6.7 | Var | 13.1 | 21.3 | 65.3 | 33.5 | 20.6 |
| 22 | Nakanoike Bridge | | | 2 | | 199 | 398 | 38.7 | 5.1 | Var | 8.2 | 13.1 | 70.2 | 24.2 | 15.2 |
| 23 | Zhangzhou Zhanbei Bridge | 3 | C | 3 | 2x1 | 433 | 963 | 54.1 | 8.0 | Var | 7.9 | 12.5 | 88.6 | 55.0 | 34.7 |
| 24 | Fukaura Bridge | | | 5 | | 295 | 959 | 27.9 | 10.6 | Var | 8.2 | 9.8 | 44.9 | 36.0 | 30.0 |
| 25 | Koror-Babeldaob (Japan-Palau Friendship) Bridge | | H _B | 3 | 2x2 | 810 | 1348 | 87.3 | 9.3 | Var | 11.5 | 23.0 | 38.1 | 70.6 | 35.3 |
| 26 | Sashikubo Bridge | | C | 2 | 1x2 | 374 | 748 | 72.2 | 5.2 | Var | 10.5 | 21.3 | 37.1 | 35.6 | 17.5 |
| 27 | Shinkawa (Tobiuo) Bridge | 3 | C | 3 | 2x1 | 427 | 986 | 42.7 | 10.0 | Var | 7.9 | 13.1 | 84.6 | 54.2 | 32.5 |
| 28 | Tongan Yinhu Bridge | 3 | C | 2 | 1x1 | 262 | 525 | 103.3 | 2.5 | Var | 7.9 | 12.5 | 88.6 | 33.3 | 21.1 |
| 29 | Changcheng Yunhe Bridge | 3 | C | 3 | 2x2 | 394 | 854 | 101.7 | 3.9 | Var | 8.5 | 13.5 | 91.9 | 46.2 | 29.3 |
| 30 | Deba River Bridge | | C | 3 | 2x2 | 217 | 492 | 39.0 | 5.5 | Con | 8.9 | 8.9 | 45.6 | 24.4 | 24.4 |
| 31 | Xiaoxihu Yellow River Bridge | 3 | C | 3 | 2x2 | 446 | 979 | 55.8 | 8.0 | Var | 8.5 | 14.8 | 90.2 | 52.3 | 30.2 |
| 32 | Shanxi Fenhe Bridge | | C | 3 | 2x3 | 492 | 1083 | 118.1 | 4.2 | | | | 85.3 | | |

| | Bridge Name | # _c | Mat | # _s | # _T | S _m (ft) | S _t (ft) | H _t (ft) | S _m /H _t | D _{c/v} | D _m (ft) | D _t (ft) | D _w (ft) | S _m /D _m | S _m /D _t |
|-----|-----------------------------------|----------------|----------------|----------------|----------------|------------------------|------------------------|---------------------|--------------------------------|------------------|------------------------|------------------------|------------------------|--------------------------------|--------------------------------|
| 33 | JR Arakogawa Bridge | | C | 3 | | 295 | 659 | 29.5 | 10.0 | Con | 8.5 | 8.5 | 41.7 | 34.6 | 34.6 |
| 34 | Himi Bridge | 1 | H _A | 3 | 2x2 | 591 | 1193 | 65.0 | 9.1 | Con | 13.1 | 13.1 | 42.5 | 45.0 | 45.0 |
| 35 | Korong Bridge | 3 | C | 2 | 1x2 | 203 | 375 | 32.2 | 6.3 | Con | 8.2 | 8.2 | 52.0 | 24.8 | 24.8 |
| 36 | Tatekoshi (Matakina) Bridge | | C | 2 | 1x2 | 185 | 369 | 34.4 | 5.4 | Var | 5.9 | 9.5 | 62.8 | 31.3 | 19.4 |
| 37 | Shin-Meisei Bridge | 3 | C | 3 | 2x1 | 401 | 958 | 54.1 | 7.4 | Con | 11.5 | 11.5 | 62.3 | 35.0 | 35.0 |
| 38 | Yinchuan Beierhuan I Bridge | 4 | C | 2 | 1x2 | 230 | 459 | 95.1 | 2.4 | Con | 7.9 | 7.9 | 196.2 | 28.9 | 28.9 |
| 39 | Shuqian Nanerhuan Bridge | 3 | C | 3 | 2x1 | 361 | 794 | 45.9 | 7.9 | Var | 7.2 | 11.5 | 65.6 | 50.0 | 31.4 |
| 40 | Brazil-Peru Integration Bridge | 1 | C | 3 | 2x2 | 361 | 787 | 49.2 | 7.3 | Var | 7.7 | 11.0 | 55.1 | 46.8 | 32.8 |
| 41 | Sannohe-Boukyo Bridge | 2 | C | 3 | 2x2 | 656 | 1312 | 82.0 | 8.0 | Var | 11.5 | 21.3 | 44.1 | 57.1 | 30.8 |
| 42 | Lishi Gaojia Bridge | 3 | C | 3 | 2x1 | 443 | 1001 | 59.1 | 7.5 | Var | 7.9 | 13.8 | 85.3 | 56.3 | 32.1 |
| 43 | Lita Bridge | 2 | C | | | | | 94.5 | | | | | 196.8 | | |
| 44 | Pingdingshan Zhanhe I Bridge | | C | 2 | 1x1 | 289 | 525 | 74.5 | 3.9 | Var | 7.2 | 13.1 | 98.4 | 40.0 | 22.0 |
| 45T | Ritto (Rittoh) Bridge–Tokyo Bound | 3 | H _A | 2 | 1x2 | 558 | 1009 | 100.1 | 5.6 | Var | 14.8 | 24.6 | 64.3 | 37.8 | 22.7 |
| 45O | Ritto (Rittoh) Bridge–Osaka Bound | 3 | H _A | 2 | 1x2 | 525 | 1026 | 100.1 | 5.2 | Var | 14.8 | 24.6 | 64.3 | 35.6 | 21.3 |
| 46 | Nanchiku Bridge | 3 | C | 3 | 2x2 | 361 | 807 | 36.1 | 10.0 | Var | 8.5 | 11.5 | 67.4 | 42.3 | 31.4 |
| 47 | Rio Branco Third Bridge | | C | 3 | 2x2 | 295 | 650 | 39.7 | 7.4 | Var | 6.6 | 8.2 | 69.2 | 45.0 | 36.0 |
| 48 | Liuzhou Sanmenjiang Bridge | 2 | C | 3 | 2x2 | 525 | 1181 | 72.2 | 7.3 | Var | 8.2 | 22.0 | 134.5 | 64.0 | 23.9 |
| 49 | Tagami Bridge | | | 2 | | 263 | 526 | 47.6 | 5.5 | Var | 9.8 | 14.8 | 58.4 | 26.7 | 17.8 |
| 50 | Tokunoyamahattoku Bridge | 1 | C | 3 | 2x2 | 722 | 1638 | 73.8 | 9.8 | Var | 11.5 | 21.3 | 31.5 | 62.9 | 33.8 |
| 51 | Yanagawa Bridge | 2 | C | 2 | 1x2 | 429 | 858 | 78.7 | 5.4 | Var | 13.1 | 21.3 | 57.1 | 32.7 | 20.1 |
| 52 | Huiqing Huanghe Bridge | 3 | C | 3 | 2x1 | 722 | 1594 | 99.4 | 7.3 | Var | 13.1 | 24.6 | 65.6 | 55.0 | 29.3 |
| 53 | Kaifeng Huanghe II Bridge | | | 8 | 7x2 | 459 | 3314 | 118.1 | 3.9 | | | | 98.4 | | |
| 54 | Fuzhou Pushang Bridge | | | 4 | 3x2 | 361 | 1194 | 88.6 | 4.1 | | | | 109.9 | | |
| 55 | Chaobaihe Bridge | 3 | C | 4 | 3x1 | 394 | 1260 | 70.5 | 5.6 | Var | 7.2 | 13.8 | 96.8 | 54.5 | 28.6 |
| 56 | Homeland (Domovinski) Bridge | 5 | C | 3 | 2x2 | 394 | 866 | 54.1 | 7.3 | Con | 11.6 | 11.6 | 109.9 | 33.8 | 33.8 |
| 57 | Bridge of the European Union | | | 3 | 2x3 | 262 | 656 | 33.8 | 7.8 | | | | 82.3 | | |
| 58 | Hemaxi Bridge | 3 | C | 3 | 2x1 | 755 | 1575 | 128.0 | 5.9 | Var | 9.8 | 21.3 | 92.8 | 76.7 | 35.4 |
| 59 | Yudaihe Bridge | | | 4 | 3x2 | 279 | 853 | 92.2 | 3.0 | | | | 109.9 | | |
| 60 | Ailan Bridge | | C | 3 | 2x1 | 459 | 984 | 65.6 | 7.0 | Var | 9.8 | 16.7 | 85.1 | 46.7 | 27.5 |
| 61 | Nymburk Bypass Bridge | | H _A | 3 | 2x2 | 433 | 702 | 52.5 | 8.3 | Var | 7.5 | | 54.6 | 57.4 | |
| 62 | Puh (Puhov) Bridge | 1 | C | 5 | 4x2 | 328 | 1411 | 27.9 | 11.8 | Con | 8.9 | 8.9 | 61.4 | 37.0 | 37.0 |
| 63 | Shindae First Bridge | | | 4 | | 256 | 807 | 39.4 | 6.5 | | | | 70.8 | | |
| 64 | Smuuli Bridge | | C | 3 | 2x2 | 279 | 554 | | | | | | | | |
| 65 | Gum-Ga Grand Bridge | | C | 7 | 6x2 | 410 | 2610 | 29.0 | 14.1 | | | | 75.5 | | |
| 66 | Second Vivekananda Bridge | | C | 9 | 8x2 | 361 | 2707 | 45.9 | 7.9 | Con | 11.2 | 11.2 | 95.1 | 32.4 | 32.4 |
| 67 | Gack-Hwa First Bridge | | C | 2 | 1x2 | 377 | 705 | 75.5 | 5.0 | Var | 11.6 | 16.3 | 102.0 | 32.5 | 23.1 |
| 68 | Pyung-Yeo II Bridge | 4 | C | 3 | 2x2 | 394 | 820 | 34.4 | 11.4 | Var | 11.5 | 13.1 | 68.9 | 34.3 | 30.0 |

| | Bridge Name | # _c | Mat | # _s | # _T | S _m (ft) | S _t (ft) | H _t (ft) | S _m /H _t | D _{c/v} | D _m (ft) | D _t (ft) | D _w (ft) | S _m /D _m | S _m /D _t |
|-----|---------------------------------------|----------------|----------------|----------------|----------------|------------------------|------------------------|---------------------|--------------------------------|------------------|------------------------|------------------------|------------------------|--------------------------------|--------------------------------|
| 69 | Dae-Ho Grand (Cho-Rack) Bridge | 2 | C | 5 | 4x2 | 427 | 1739 | 54.1 | 7.9 | Var | 8.2 | 11.5 | 45.9 | 52.0 | 37.1 |
| 70 | Hirano Bridge | | C | | | 207 | | | | | | | | | |
| 71 | Sannai-Maruyama Bypass Bridge | 2 | C | 4 | 3x2 | 492 | 1476 | | | | | | | | |
| 72 | Ma-Tsu Bridge | | C | | | 410 | 820 | 114.8 | 3.6 | Var | 8.2 | 19.7 | 88.6 | 50.0 | 20.8 |
| 73 | North Arm Bridge | 1 | C | 3 | 2x1 | 591 | 1503 | 59.1 | 10.0 | Var | 9.2 | 19.0 | 33.8 | 64.3 | 31.0 |
| 74 | Sannai-Maruyama Bridge | 4 | C | 4 | 3x2 | 492 | 1471 | 57.4 | 8.6 | Var | 12.5 | 26.2 | 45.4 | 39.5 | 18.8 |
| 75 | Trois-Bassins Viaduct Bridge | 1 | H _A | | | 413 | 1004 | 62.3 | 6.6 | Var | 13.1 | 23.0 | 72.2 | 31.5 | 18.0 |
| 76 | Hidasie Bridge | | | | | 476 | 994 | | | | | | | | |
| 77 | Riga South(ern) Bridge | | | 7 | 6x1 | 361 | 2635 | 43.7 | 8.3 | | | | 112.5 | | |
| 78 | Golden Ears Bridge | 1 | H _B | | | 794 | 3176 | 136.2 | 5.8 | Var | 8.9 | 14.8 | 105.0 | 89.6 | 53.8 |
| 79 | Karnaphuli III Bridge | 1 | C | 5 | | 656 | 2723 | 84.5 | 7.8 | Var | 13.1 | 22.1 | 80.3 | 50.0 | 29.6 |
| 80 | Kyong-An Bridge | 4 | C | 3 | 2x1 | 427 | 886 | 53.5 | 8.0 | Con | 9.8 | 9.8 | 98.4 | 43.3 | 43.3 |
| 81 | Husong Bridge | 3 | C | 4 | 3x1 | 459 | 1411 | 61.7 | 7.4 | Var | 9.2 | 14.3 | 95.1 | 50.0 | 32.2 |
| 82 | Xianshen River Bridge | | C | 2 | 1x1 | 446 | 876 | 160.8 | 2.8 | | | | | | |
| 83 | Ankang Qiligou Bridge | | C | 3 | 2x1 | 410 | 886 | 114.2 | 3.6 | | | | 98.4 | | |
| 84 | Incheon Bridge | 3 | C | 3 | 2x2 | 459 | 1010 | | | Var | | | 59.3 | | |
| 85 | Qishan Bridge | | | | | 328 | 656 | | | Var | 9.2 | 16.4 | 72.8 | 35.7 | 20.0 |
| 86 | Choqueyapu Bridge | 1 | C | 3 | 2x1 | 303 | 628 | 49.2 | 6.2 | Var | 6.9 | 11.5 | 45.9 | 44.0 | 26.4 |
| 87 | Kantutani Bridge | 1 | C | 3 | 2x1 | 372 | 766 | 49.2 | 7.6 | Var | 6.9 | 11.5 | 45.9 | 54.0 | 32.4 |
| 88 | Orkojahuiria Bridge | 1 | C | 3 | 2x1 | 338 | 718 | 49.2 | 6.9 | Var | 6.9 | 11.5 | 45.9 | 49.0 | 29.4 |
| 89 | Povazska Bystrica D1 Motorway Viaduct | | H _A | 8 | 7x1 | 400 | 2857 | 46.3 | 8.7 | Con | 19.7 | 19.7 | 100.6 | 20.3 | 20.3 |
| 90 | Teror Viaduct | | C | 3 | 2x2 | 476 | 856 | 52.5 | 9.1 | | | | | | |
| 91 | New Amarube Bridge | 1 | C | 4 | 3x2 | 271 | 886 | 16.4 | 16.5 | Con | 11.5 | 11.5 | 23.8 | 23.6 | 23.6 |
| 92 | Immobility Bridge | 1 | C | 4 | 3x2 | 509 | 1717 | | | Var | | | 42.7 | | |
| 93 | Un-am Grand Bridge | | C | 6 | 5x1 | 427 | 2198 | 26.2 | 16.3 | Var | 10.8 | 13.8 | 75.5 | 39.4 | 31.0 |
| 94 | Panyu Shanwan Bridge | 3 | C | 3 | 2x1 | 338 | 728 | 123.0 | 2.7 | Var | 13.1 | 27.9 | 111.5 | 25.8 | 12.1 |
| 95 | Jiayue (Nanping) Bridge | | C | 3 | 2x2 | 623 | 1260 | | | | | | 90.2 | | |
| 96 | Tisza Bridge | 3 | H _A | 3 | 2x1 | 591 | | 52.5 | 11.3 | Var | 13.1 | 19.7 | 98.2 | 45.0 | 30.0 |
| 97 | Hwangdo Grand Bridge | 2 | C | 3 | 2x2 | 459 | 984 | 45.9 | 10.0 | Var | 8.2 | 13.1 | 47.2 | 56.0 | 35.0 |
| 98 | Nokan Bridge | | H _A | | | 230 | 459 | | | Var | | | 73.3 | | |
| 99 | Guemgang I Bridge | 3 | C | 5 | 4x2 | 591 | 2428 | 85.3 | 6.9 | | | | 98.4 | | |
| 100 | Qinxu Bridge | | C | 3 | 2x1 | | 384 | | | | | | 39.4 | | |
| 101 | Hualiantai Fengping Bridge | 5 | C | 4 | 3x1 | 459 | 1470 | 55.8 | 8.2 | Var | 8.7 | 15.7 | 92.5 | 52.8 | 29.2 |
| 102 | Dazhihe Bridge | | C | 3 | 2x1 | 459 | 984 | 67.3 | 6.8 | | | | | | |
| 103 | Najin Bridge | 1 | C | 4 | 3x1 | 361 | 1181 | | | | | | 108.3 | | |
| 104 | La Massana Bridge | | | | 1x2x2 | | | | | | | | | | |
| 105 | Naluchi Bridge | | C | 2 | 1x2 | 400 | 800 | 78.7 | 5.1 | Var | 11.5 | 23.0 | 51.2 | 34.8 | 17.4 |

| | Bridge Name | # _c | Mat | # _s | # _T | S _m (ft) | S _t (ft) | H _t (ft) | S _m /H _t | D _{c/v} | D _m (ft) | D _t (ft) | D _w (ft) | S _m /D _m | S _m /D _t |
|-----|---|----------------|-----|----------------|----------------|------------------------|------------------------|------------------------|--------------------------------|------------------|------------------------|------------------------|------------------------|--------------------------------|--------------------------------|
| 106 | Waschmuhl Viaduct | | | 3 | 2x2 | | | | | | | | 62.8 | | |
| 107 | New Pearl Harbor Memorial (Quinnipiac) Bridge | 5 | C | 3 | 2x3 | 515 | 1013 | 69.9 | 7.4 | Var | 11.3 | 16.2 | 110.6 | 45.7 | 45.7 |
| 108 | Changshan Bridge | | | 3 | 2x2 | 853 | 1772 | 84.5 | 10.1 | | | | 75.5 | | |
| 109 | Ningjiang Shonghuajiang Bridge | 3 | C | 5 | 4x1 | 492 | 2100 | | | Var | 9.8 | 18.0 | 86.9 | 50.0 | 27.3 |
| 110 | Half Sky Overpass Bridge | | | 3 | 2x1 | 1214 | | | | | | | 49.2 | | |
| 111 | Yongjin Bridge | 3 | C | 3 | 2x2 | 443 | 984 | 44.3 | 10.0 | Var | 8.2 | 14.8 | 50.9 | 54.0 | 30.0 |
| 112 | Gangchon 2nd Bridge | 3 | C | 3 | 2x2 | 459 | 1004 | 59.1 | 7.8 | Var | 9.0 | 16.4 | 64.6 | 50.9 | 28.0 |
| 113 | Saint Croix River Bridge | 3 | C | 8 | 7x2 | 480 | 3460 | 60.0 | 8.0 | Con | 16.0 | 16.0 | 110.0 | 30.0 | 30.0 |
| 114 | Sanguanjiang Bridge | | | 3 | 2x1 | 623 | 1411 | | | | | | 109.9 | | |
| 115 | Brazos River Bridge | | S | 3 | 2x2x2 | 250 | 620 | 46.0 | 5.4 | Con | | | 56.5 | | |
| 116 | Naericheon Bridge | | C | 2 | 1x1 | 509 | 902 | | | Var | | | 100.1 | | |
| 117 | Yaro Grand Bridge | | | 3 | 2x1 | 623 | 1804 | 89.2 | 7.0 | Var | 11.5 | 23.0 | 88.6 | 54.3 | 27.1 |
| 118 | Pyung-Taik Grand Bridge | | | 8 | 7x1 | 525 | 3806 | 67.3 | 7.8 | Var | 11.5 | 18.0 | 98.1 | 45.7 | 29.1 |
| 119 | Beixi Hechuan Bridge | | | 3 | 2x1 | 525 | 1181 | | | | | | | | |
| 120 | Kinmen Bridge | | | 6 | 5x1 | 919 | 4593 | | | | | | | | |

Note: In the table, #_c refers to the number of cells, Mat refers to girder materials (concrete, steel, or hybrid), #_s refers to number of spans, #_T refers to number of towers, S_m refers to main span length (in feet), S_t refers to total span length (in feet), H_t refers to tower height (in feet), S_m/H_t refers main span to tower height ratio, D_{c/v} refers to thickness of girder (constant or variance), D_m refers to girder thickness at mid-spans (in feet), D_t refers to girder thickness at towers (in feet), D_w refers to girder width (in feet), S_m/D_m refers to main span length to girder thickness at mid-span ratio, and S_m/D_t refers to main span length to girder thickness at tower ratio.

Statistical analyses were performed based on the information collected through literature survey and interviews. Results are shown in the following sections.

LOCATIONS AND CONSTRUCTION TIME OF EXTRADOSED BRIDGES

Table 3 shows a total of 120 extradosed bridges identified by the research team. Distribution of the 120 bridges in different continents is shown in Figure 9. Among the 120 extradosed bridges, the majority is in Asia, which counts for 98 (78% of the total numbers). In addition to the 98 bridges in Asia, there are 16 (13%), 5 (4%), 5 (4%) and 1 (1%) extradosed located in Europe, North America, South America, and Africa, respectively.

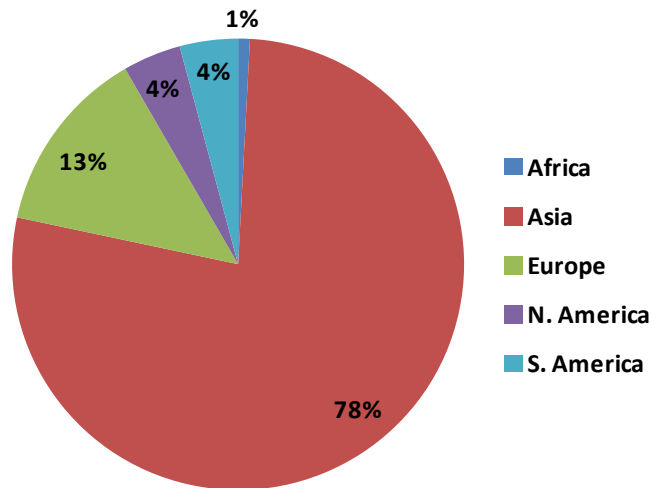

Figure 9. Distribution of Extradosed Bridges (by Continents).

The distribution of extradosed bridges by countries is shown in Figure 10. There are 30 countries with extradosed bridges built, or currently under construction identified in the study. As shown in the figure, Japan (34 bridges), China (28 bridges), Korea (16 bridges), and Taiwan (8 bridges) are the four countries with the highest number of extradosed bridges (86), which is 72% of the total number of extradosed bridges identified through the literature review.

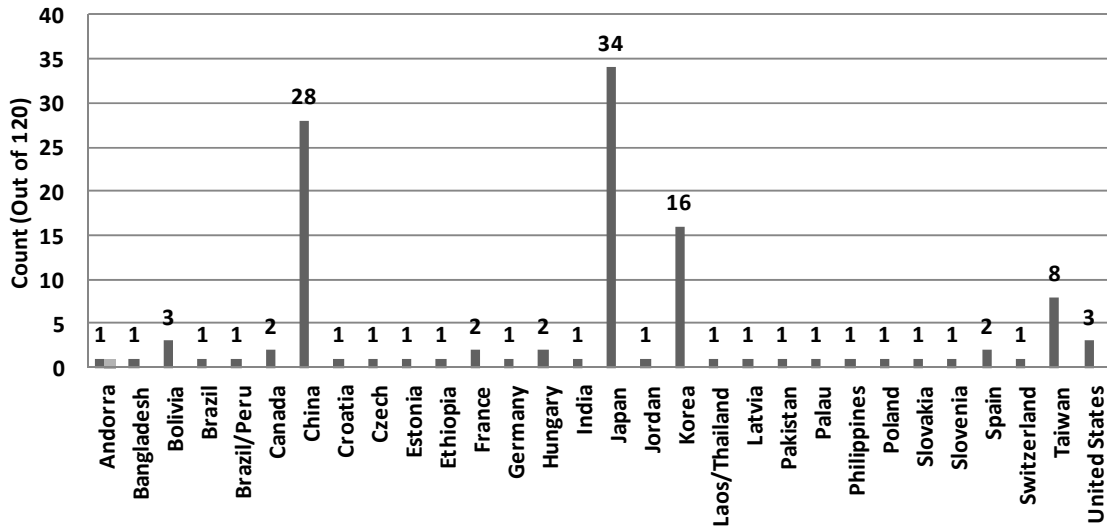

Figure 10. Distribution of Extradosed Bridges (by Countries).

As shown in Figure 11, since construction of the very first extradosed bridge (Odawara Blueway Bridge) was completed in 1994, there is a steady growth in the number of extradosed bridges, with most of the bridges constructed in the last decade. The highest number of extradosed bridges identified is in 2006, with a total of 14 bridges constructed. Due to the limitation of available information, the list of extradosed bridges identified in the study, especially in recent years (since 2006), might not be completed and therefore the number of extradosed bridges could be lower than the actual number. There are also approximately 20 identified bridges currently under construction or in the design phase. Among the five bridges identified in North America, there are two in Canada and three in the United States. The two bridges in Canada are North Arm Bridge (completed in 2008) and Golden Ear Bridge (completed in 2009). The three bridges in United States are the New Pearl Harbor Memorial Bridge (to be completed in 2015; north bound was opened in summer 2012) in Connecticut, the St. Croix River Bridge (to be completed in 2014) between Minnesota and Wisconsin, and the Brazos River Bridge at Waco, Texas (broke ground in summer 2012 and to be completed in 2015).

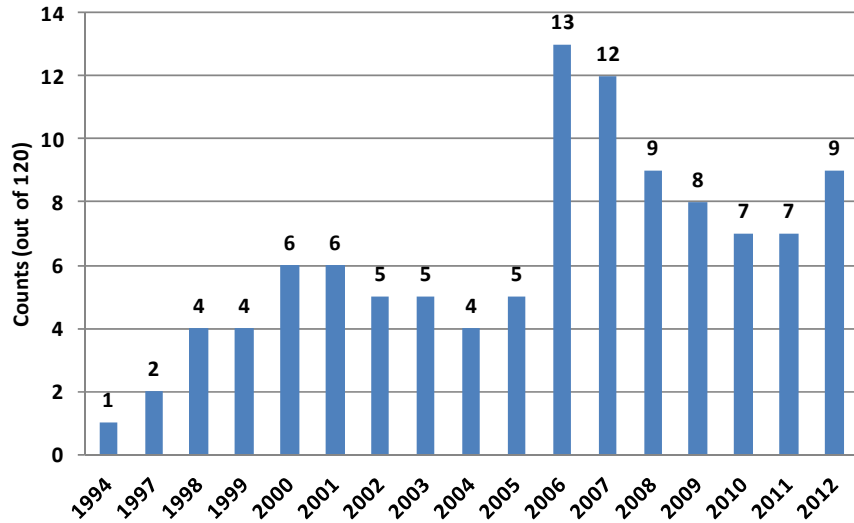

Figure 11. Distribution of Extradosed Bridges (by Completion Year).

As shown in Figure 12, construction duration of the extradosed bridges spread in a wide range, with a minimum of 15 months (Changcheng Yunhe Bridge and JR Arakogawa Bridge, both completed in 2003) and a maximum of 86 months (Unam Grand Bridge, completed in 2011). While most of the bridges were constructed within 20 and 40 months, the average construction duration was found to be 36 months.

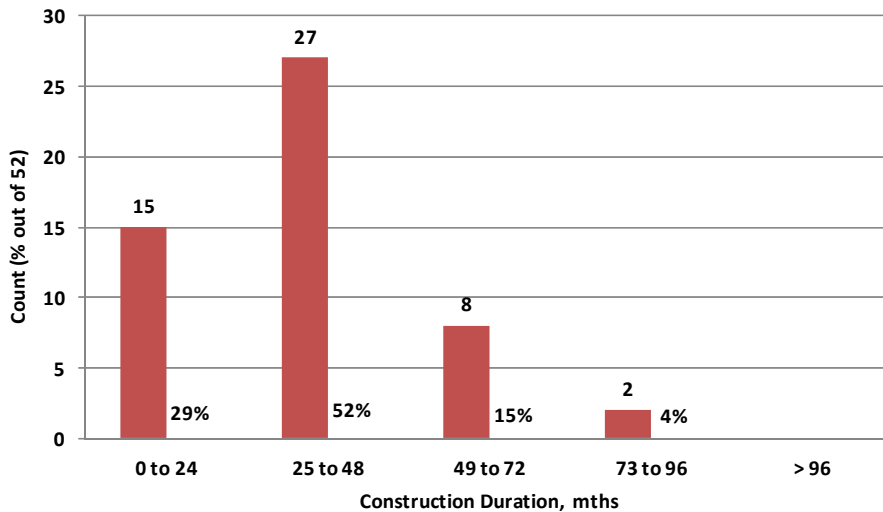

Figure 12. Distribution of Construction Duration.

PURPOSES AND USAGE OF EXTRADOSSED BRIDGES

According to the literature review, the four typical purposes (uses) of extradosed bridges are road bridge, railway or light rail bridge, road and railway hybrid bridge, and road and pedestrian hybrid bridge. Examples of these typical purposes (uses) of extradosed bridges are shown in Figure 13.



**(a). Road
(Ritto Bridge)**



**(b). Railway or Light Rail
(North Arm Bridge)**



**(c). Road and Railway Hybrid
(Wuhu Yangtze River Bridge)**



**(d). Road and Pedestrian Hybrid
(Guemgang I Bridge)**

Figure 13. Extradosed Bridges Serving Different Purposes.

Statistics on the different purposes (uses) of extradosed bridges are shown in Figure 14. As shown in the figure, the majority of extradosed bridges are road bridges, with 98 bridges and 89% of the total extradosed bridges identified. Road bridges connect the different sides of rivers, valleys, and viaducts, etc. A typical example is the Ritto Bridge, located in Siga Prefecture on the

New Meishin Expressway in Japan. Nine extradosed bridges are railway or light rail bridges. A typical example is North Arm Bridge in Canada, which is used by trains on the Canada Line. The bridge spans the north arm of the Fraser River, linking Vancouver to Richmond. There is only one extradosed bridge identified as road and railway hybrid. Wuhu Yangtze River Bridge, the first extradosed bridge constructed in China, has a four-lane roadway on top and a two-lane railway underneath. The bridge crosses the Yangtze River, the longest river in China. Because of the unique function, the bridge was constructed with a cross of concrete girders on top and steel trusses underneath. There are two bridges with roadways and pedestrian/bicycle paths underneath: the Guemgang I Bridge in Korea and Jiayu (Nanping) Bridge in China. The pedestrian/bicycle paths underneath the roadways mainly serve as an alternative scenic route.

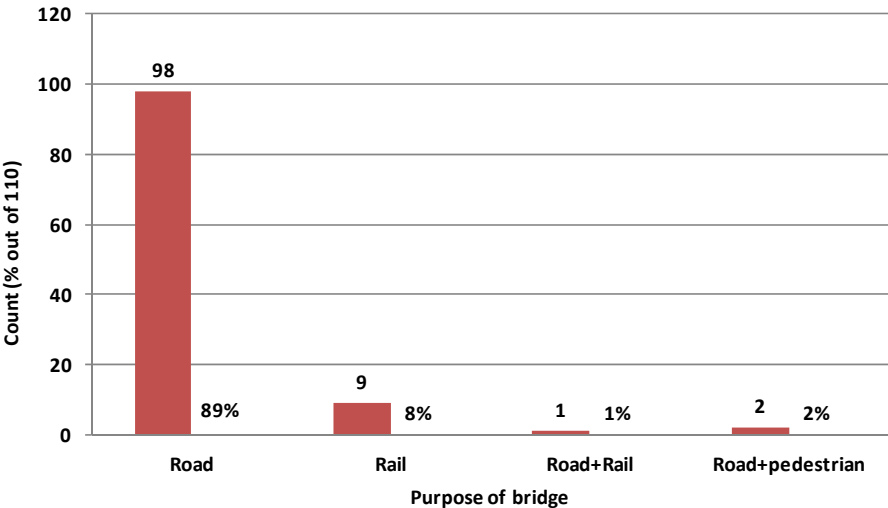

Figure 14. Distributions of Bridge Purposes.

CONFIGURATIONS OF EXTRADOSED BRIDGES

The following sections summarize configurations of extradosed bridges, including quantities of spans, quantities of towers, main span lengths, total span lengths, tower heights, girder thicknesses, and girder widths.

Figure 15 presents statistics on quantities of extradosed bridge spans. Results showed that 81 extradosed bridges identified in this study have two to five spans, which counts for 74% of the total number. Sixty bridges were found to have three spans, which account for 55% of the total number. The highest number of spans identified is nine spans, which is the Second

Vivekananda Bridge in India (see Figure 16a), with a main span of 361 feet and a total span of 2707 feet. There are a total of 19 bridges with only two spans; an example is the Yanagawa Bridge in Japan (see Figure 16b), with a main span of 429 feet and a total span of 858 feet.

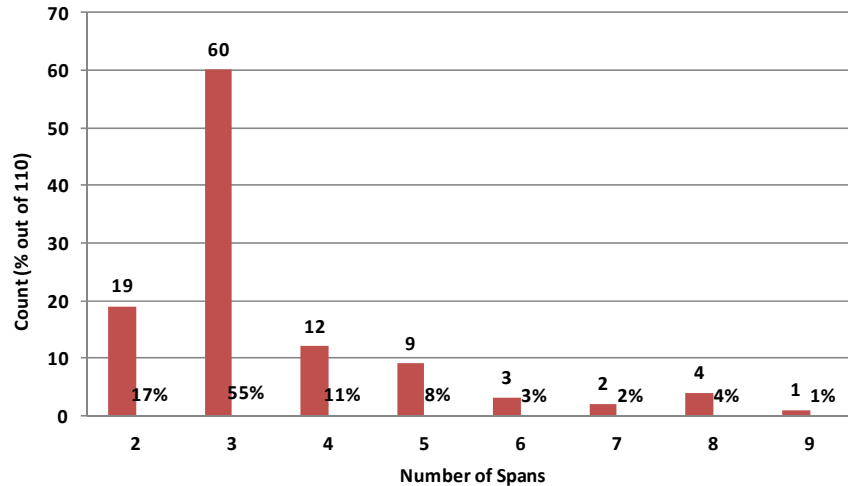

Figure 15. Distribution of Quantities of Spans.



(a). Second Vivekananda Bridge (9 spans) (b). Yanagawa Bridge (2 spans)

Figure 16. Examples of Bridges with the Highest and Lowest Number of Spans.

Figure 17 presents statistics on quantities of extradosed bridge towers. Note that, in this report, the first number indicated the quantity of towers in girder direction and the second number indicated the quantity of towers across the girder. For example, a 4×2 tower quantity of the Golden Ear Bridge (shown in Figure 18b) indicated four towers in traffic direction (five spans) and two towers across the girder, with a total of eight towers. Results showed that, as the majority of extradosed bridges have three spans; the majority of tower quantities are 2×1 and 2×2. Overall, most of the bridges have either one (Figure 18c) or two (Figure 18b) towers across the girder. There are a total of four bridges with three towers across the girder (Figure 18a), with

the middle tower separating the two lanes in opposite directions. In addition, four bridges identified in the study have two separate sets of towers (Figure 18d), with each set supporting each opposite direction.

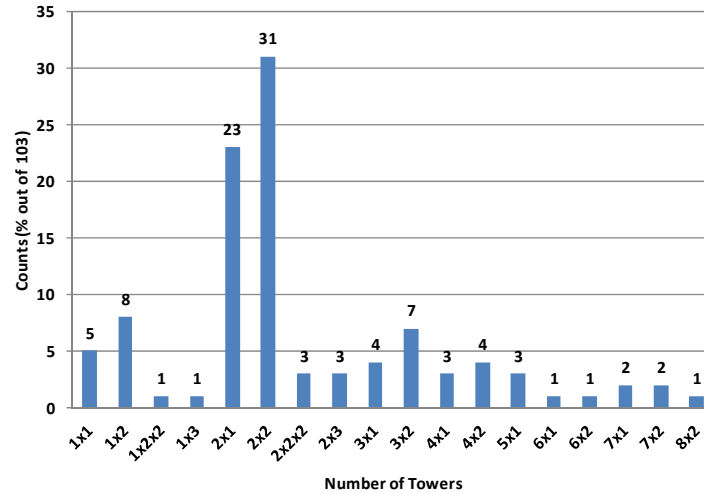

Figure 17. Distribution of Number of Towers.



(a). Miyakoda River (Miyakodagawa) Bridge (1×3)



(b). Golden Ear Bridge (4×2)



(c). Zhangzhou Zhanbei Bridge (2×1)

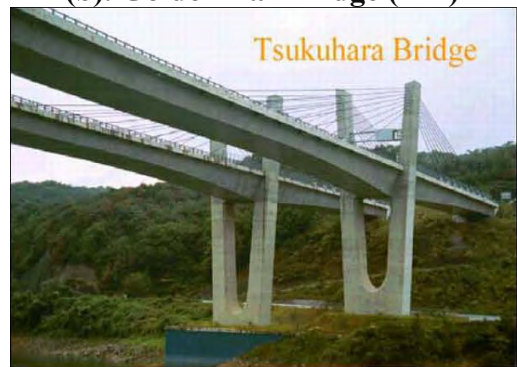

(d). Tsukuhara Bridge (2×2×2)

Figure 18. Examples of Extradosed Bridges with Different Numbers of Towers.

Figure 19 and Figure 20 show the statistics on main span and total span lengths. Note that all numbers included here represent the number of extradosed spans; the traditional girder spans

are not included here. There are 115 bridges with information on main span lengths and 116 bridges with information on total span lengths identified. Most of the extradosed bridges identified in the study have a main span length between 200 and 600 feet, with an average of 441 feet. The majority of bridges have total span lengths between 500 and 2000 feet, with an average of 1245 feet. Figure 21 presents examples of bridges with short and long main spans and total spans. The bridge with the shortest main span is the King Hussein Bridge in Jordan, with a main span of 171 feet and three spans for a total length of 395 feet. The Pont de Saint-Rémy-de-Maurienne Bridge (Figure 21a) in France has a main span of 172 feet, with two spans and a total span length of 331 feet. The longest extradosed main span is 1024 feet from the Yangtze River Bridge in China. The road bridge with the longest main span and total span is the Kinmen Bridge in Taiwan, with a main span of 919 feet, a total of six spans, and a total span length of 4594 feet. The bridge is still under construction and expected to be completed in 2016.

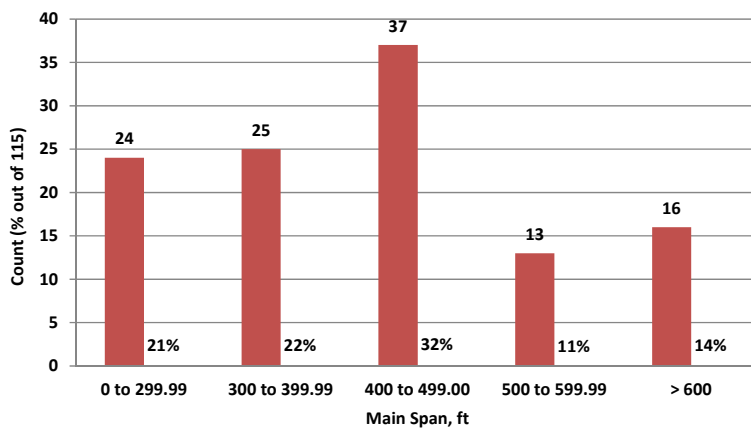

Figure 19. Distributions of Maximum Span Lengths.

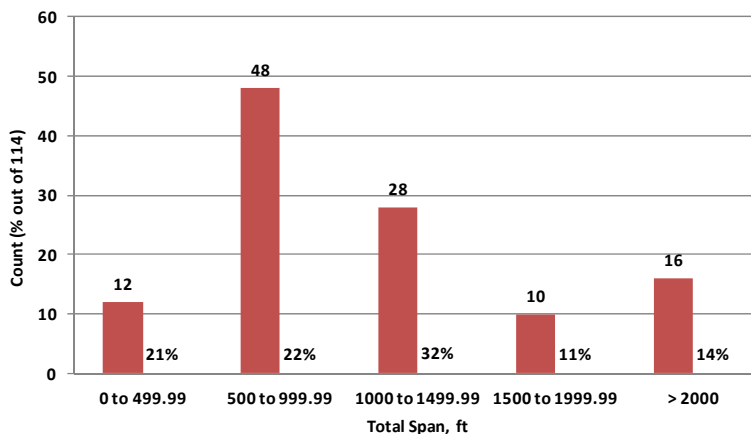
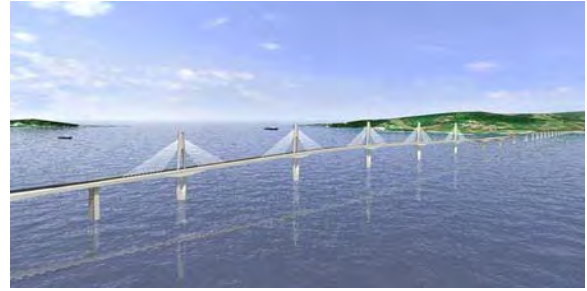

Figure 20. Distribution of Total Span Length.



(a) Pont de Saint-Rémy-de-Maurienne Bridge (Main Span: 172 feet, Total Span: 311 feet)



(b). Kinmen Bridge (Main Span: 919 feet, Total Span: 4594 feet)

Figure 21. Extradosed Bridges with Longest and Shortest Main and Total Span Lengths.

Figure 22 shows statistics on tower heights. Results indicated that there is a wide range of tower heights, which varies from below 25 feet to more than 100 feet. The extradosed bridge with the shortest tower identified from the study is the New Amarube Bridge in Japan (Figure 23b), with a tower height of 16.5 feet. The extradosed bridge with the tallest tower identified from the study is the Xianshen River Bridge in China (Figure 23a), with a tower height of 160.08 feet. (The Xianshen River Bridge was built across a very deep valley and has a very tall pier height at 492 feet.)

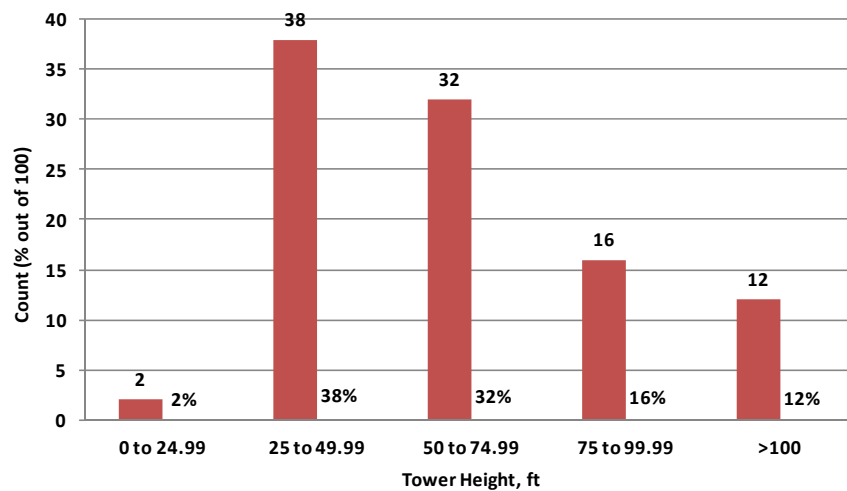

Figure 22. Distribution of Tower Height.



**(a) Xianshen River Bridge
(Tower Height 160.8 Feet)**



**(b) New Amarube Bridge
(Tower Height 16.5 Feet)**

Figure 23. Extradosed Bridges with the Tallest and Shortest Towers.

Main span length to tower height ratios were calculated and shown in Figure 24. Results indicated that, in a total of 98 bridges with the information identified, most of the bridges have the ratio between 4 and 12, with a maximum value of 16.5 (the New Amarube Bridge, completed in 2010 in Japan; see Figure 25b) and a minimum value of 2.4 (the Yinchuan Beierhuan I Bridge, completed in 2004 in China; see Figure 25a). Note that, while most of bridges have their cables reach (or nearly reach) the highest points of the towers, there are approximately 10% of the extradosed bridges constructed with towers approximately 15% to 25% taller than the highest points of the cables (Figure 25a). The main span-to-height ratio therefore could be 15% to 25% higher in these specific bridges. While it is believed that this is likely due to aesthetic considerations, there is generally no accurate data available regarding the exact heights of cables.

Regardless of the abovementioned impacts, the majority of extradosed bridges identified in the study have main span-to-tower height ratios between $1/6$ and $1/9$, with an average of $1/7.7$. The result is very different from what Mathivat stated (extradosed bridges generally have a main span-to-tower height ratio of approximately $1/15$, comparing to a value of approximately $1/5$ for cable-stayed bridges). The trend indicated that the definition of extradosed bridges according to Mathivat (1998) might not be appropriate. Ogawa and Kasuga's (1998) definition of using the stiffness ratio (the load carried by stay cables divided by the total vertical load) and a boundary value of 30% to distinguish a cable-stayed bridge and an extradosed bridge (with a stiffness ratio of less than 30% to be considered as an extradosed bridge) therefore might be more appropriate.

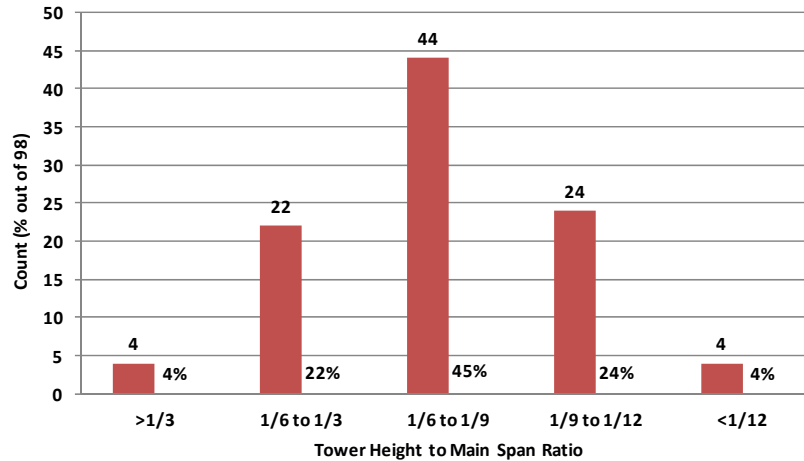

Figure 24. Distribution of Main Span-Height Ratio.



(a). Yinchuan Beierhuan I Bridge (Ratio of 2.4)



(b). New Amarube Bridge (Ratio of 16.5)

Figure 25. Extradosed Bridges with Highest and Lowest Span-Tower Height Ratios.

While cable-stayed bridges typically have constant girder thicknesses, girder bridges normally have variable girder thicknesses, i.e., with a thicker girder at the piers and thinner girder at the mid-spans. Extradosed bridges can have either a constant (Figure 26a) or various girder thickness (Figure 26b). As shown in Figure 27, within the 92 extradosed bridges identified with such kind of information, 73 bridges (79% of the total) have variable girder thicknesses, and 19 bridges (21% of the total) have constant girder thicknesses.



(a). Deba River Bridge (Constant Girder Thickness)



(b). Pakse Bridge (Variable Girder Thickness)

Figure 26. Examples of Extradosed Bridges with Constant and Variable Girder Thickness.

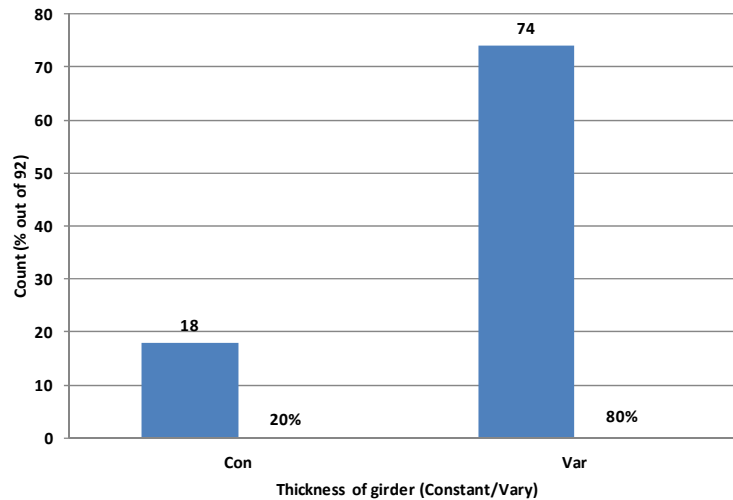

Figure 27. Distribution of Girder Thickness (Constant or Variable).

In general, there are four different kinds of superstructure materials used in extradosed bridges. As shown in Figure 28, the majority of extradosed bridges are built with prestress concrete as superstructure materials (Figure 29a), which counts for 86 (89% of the total) in the 97 bridges identified with bridge superstructure material information. There are six bridges with composite superstructure materials; a typical example is the Povazska Bystrica D1 Motorway Bridge in Slovakia (Figure 29c), which was constructed with single cell box girders with large overhangs

supported by precast struts. Another type of composite superstructure material is the concrete box girders near piers and steel box girders in center. Examples of this kind of bridge are the Koror-Babeldaob (Japan–Palau Friendship) Bridge in Palau (Figure 29d), and the Ibi River Bridge and the Kiso River Bridge, both in Japan. According to Kasuga (1998), in the construction of the Ibi River Bridge and the Kiso River Bridge, the free cantilevering method was adapted using 400 tons precast segments, and the 328-foot center parts are steel girders constructed by a lifting method. The method was considered the most economic for bridges over the mouth of the wide river. There is one bridge identified in the study with steel girders: the Brazos River Bridge in Waco, Texas, which is to be constructed with continuous steel trapezoidal box girders.

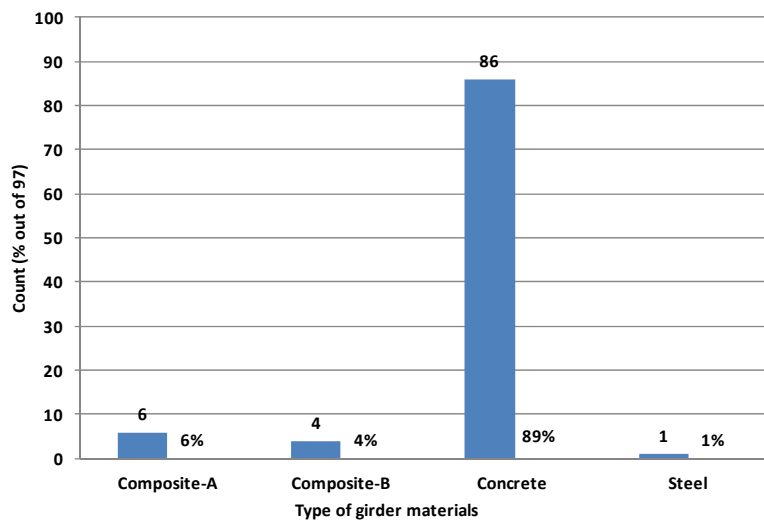

Figure 28. Distribution of Superstructure Materials.



(a). Concrete girder–Sannai-Maruyama Bridge



(b) Steel girder–Brazos River Bridge



(c). Composite A–Povazska Bystrica D1 Motorway Bridge

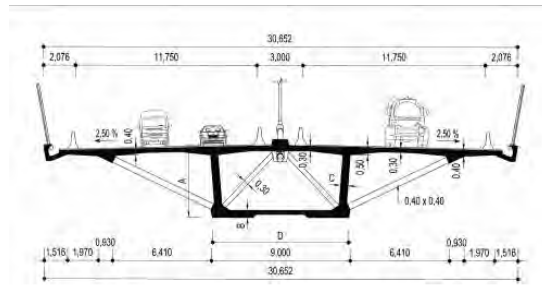

(d). Composite B–Koror-Babeldaob (Japan–Palau Friendship) Bridge

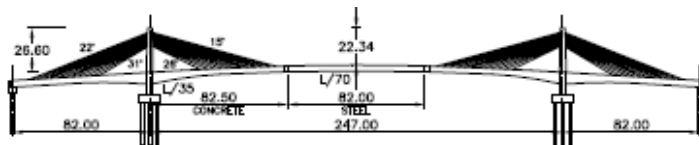

Figure 29. Examples of Extradosed Bridges with Different Superstructure Materials.

Figure 30 shows examples of girder cross sections with different quantities of cells in box girders. Details of girders with various numbers of cells, together with drawings of cross sections of different bridges, can be found in Appendix A. As summarized in Figure 31, the majority of extradosed bridges were constructed with one to three cells, within which 37% of the total bridges were constructed with three-cell box girders. The example showed with two and three cells is the Shin-Karato Bridge (Okuyama Bridge), which has two cells east bound and three cells west bound.

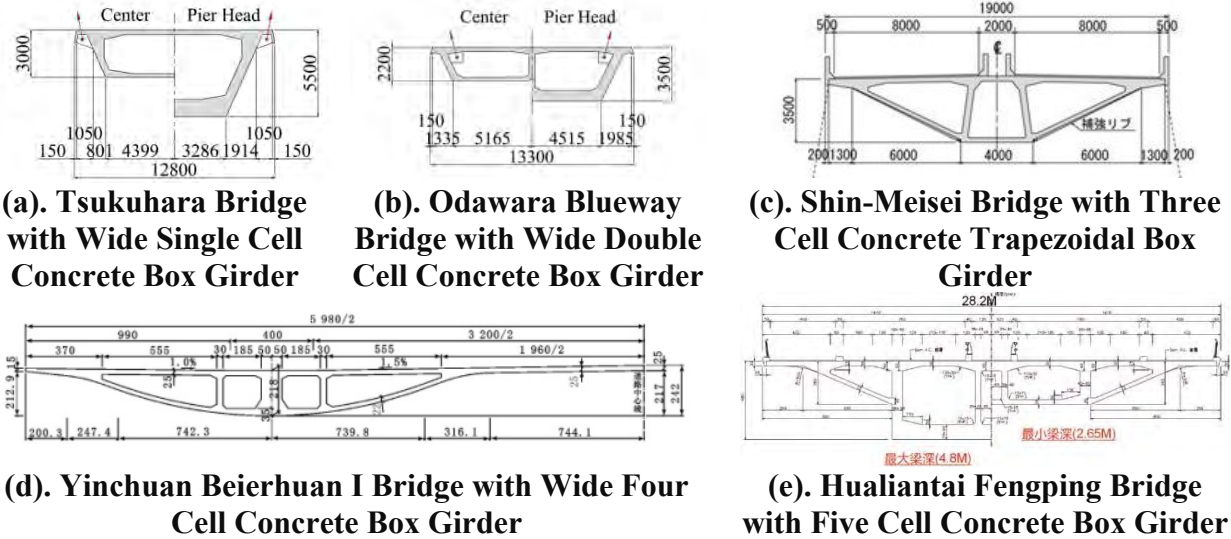

Figure 30. Examples of Girder with Different Numbers of Cells in Box Girders.

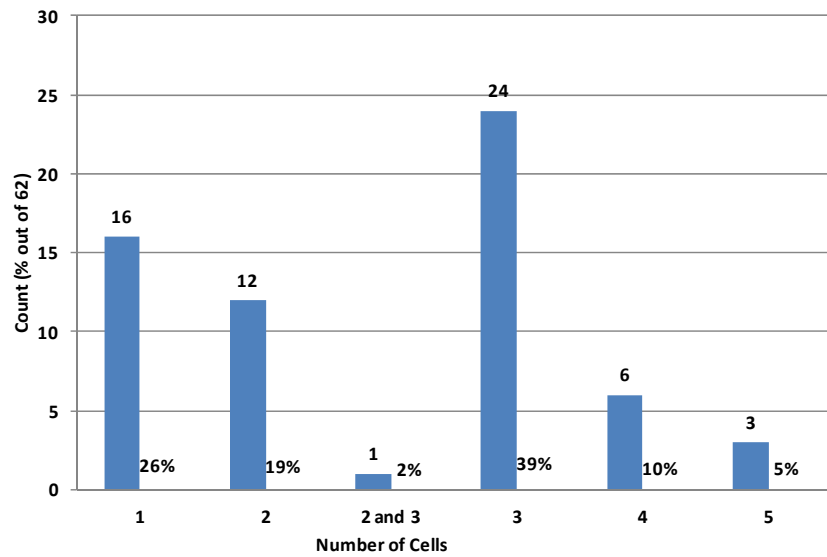

Figure 31. Distribution of Number of Cells.

As shown in Figure 32 and Figure 33, while most of extradosed bridges show girder depths at midspan between 5 to 15 feet, girder depths at piers range from 5 feet up to 30 feet. The thinnest girder was identified as Sunniberg Bridge in Switzerland, with a constant girder thickness of 3.6 feet (Figure 34a). The thickest girder was identified as Wuhu Yangtze River Bridge in China, with a constant girder thickness of 44.3 feet. It should be noted that the bridge was constructed with a double-girder steel truss with composite girder slabs on the top roadway

and rail lines at the bottom level. The constant girder road bridge with the girder thickness was identified as the Povazska Bystrica D1 Motorway Viaduct in Slovakia, with a girder thickness of 19.7 feet (Figure 34b). The variable girder thickness bridge with the thickest girder was identified as the Panyu Shawan Bridge in China, with a variable girder thickness of 13.1 feet at midspan and 27.9 at piers (Figure 34c).

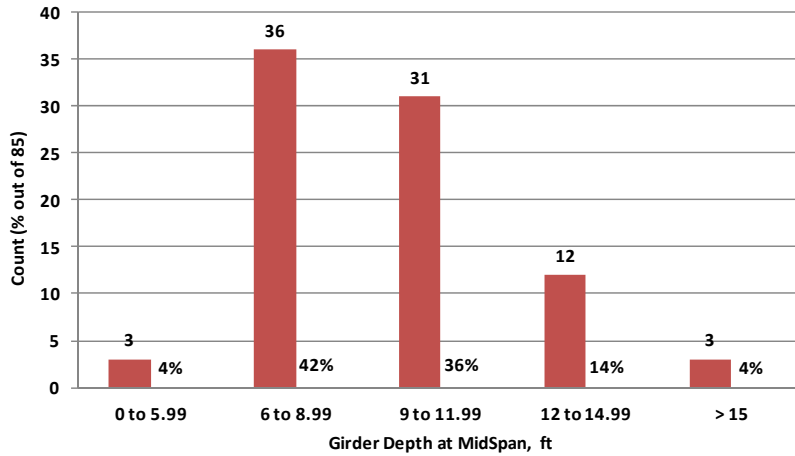

Figure 32. Distribution of Girder Depth at Midspan.

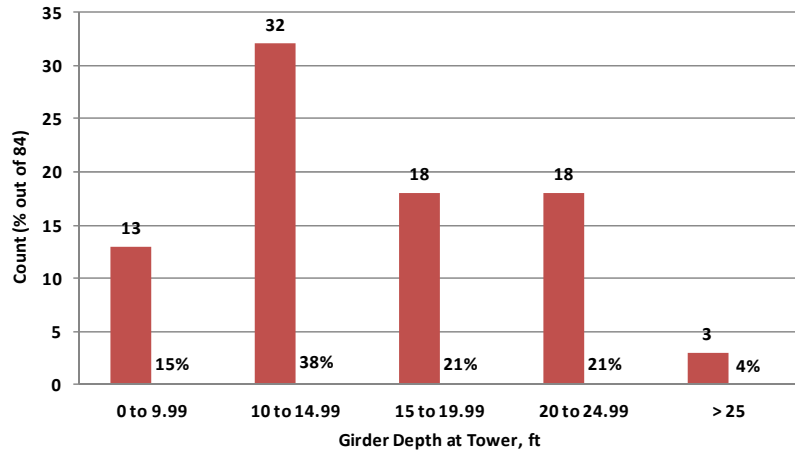

Figure 33. Distribution of Girder Depth at Tower.



(a). Sunniberg Bridge (with Constant Girder Thickness of 3.6 Feet)



(b). Wuhu Yangtze River Bridge (with Constant Girder Thickness of 44.3 Feet)

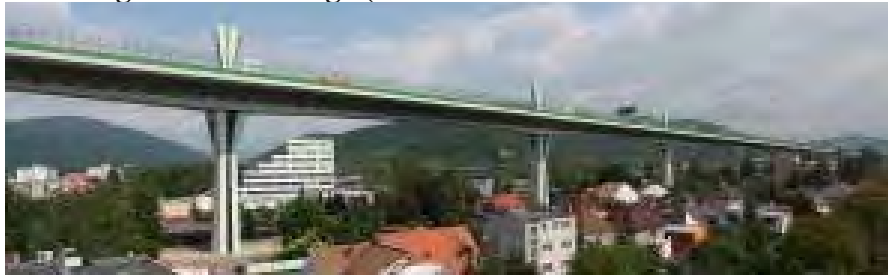

(c). Povazska Bystrica D1 Motorway Viaduct (with Constant Girder Thickness of 19.7 Feet)



(d). Panyu Shawan Bridge (with Variable Girder Thickness of 13.1 Feet at Midspans and 27.9 Feet at Piers)

Figure 34. Examples of Bridges with Different Girder Thicknesses.

Calculated span length to girder thickness at midspan and pier ratios are shown in Figure 35 and Figure 36. Average values of span length to girder thickness at midspan and pier ratios were found to be 45.4 and 30.0, respectively.

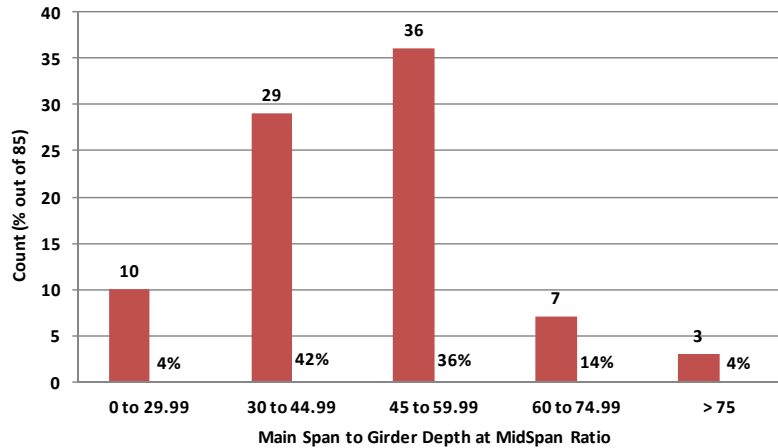

Figure 35. Distribution of Span/Depth Ratio (Midspan).

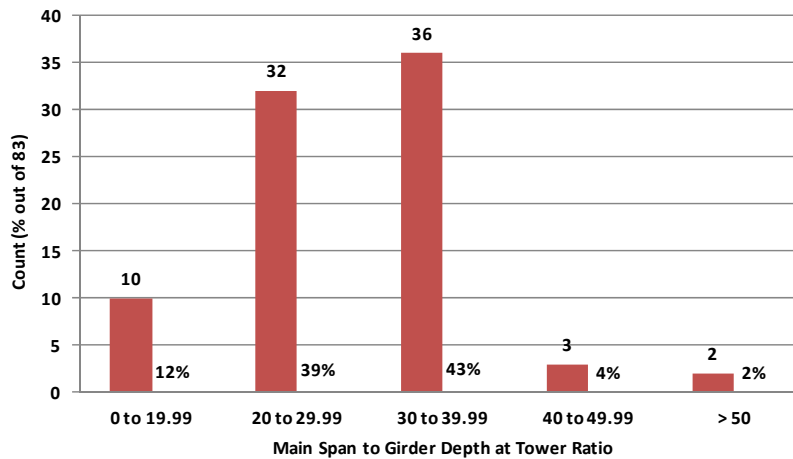

Figure 36. Distribution of Span/Depth Ratio (Tower).

The bridge with the highest span-to-deck depth ratio at both midspan and piers is the Sunniberg Bridge in Switzerland (completed in 1998). It was constructed with a very thin constant girder thickness of 3.6 feet and a relatively long main span of 459 feet, which resulted in a span-to-deck depth ratio of 127.3. The bridge with the lowest span-to-deck depth ratio at midspan is the Povazska Bystrica D1 Motorway Viaduct in Slovakia (completed in 2010). This was constructed with a main span length of 400 feet, and a constant girder thickness of 19.7 feet, which resulted in a calculated span-to-depth ratio of 20.3. The bridge with the lowest span to deck depth ratio at towers is the Panyu Shanwan Bridge in China (completed in 2011). It was constructed with 814 feet of main span, and a girder thickness of 27.9 feet at the towers, which resulted in a calculated span-to-depth ratio of 12.1.

There are 108 bridges identified with girder width information. The average girder width was found to be at 74.0 feet. The widest girder identified was the Lita Bridge in China (completed in 2006) with a girder width of 196.8 feet and the narrowest girder identified was the New Amarube Bridge in Japan (completed in 2010). The bridge was a railway bridge, with a girder width of 23.8 feet.

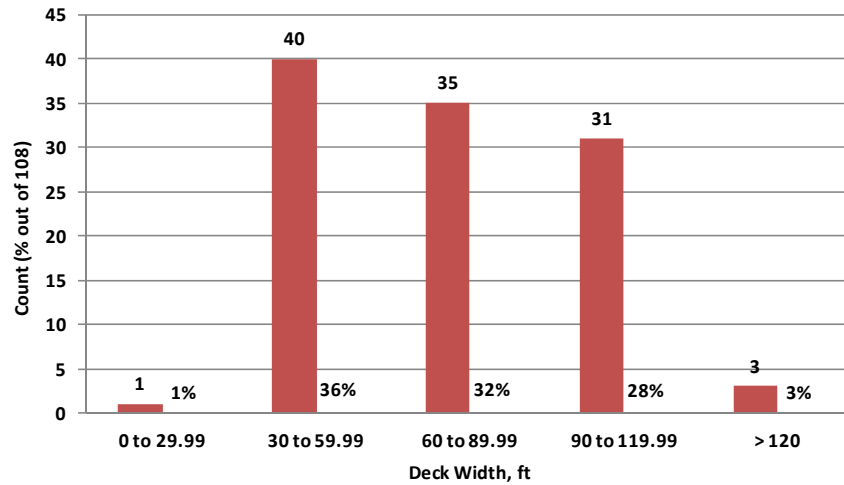

Figure 37. Distribution of Girder Width.

Table 5 shows a summary of statistics on extradosed bridge configurations, including main span lengths, total span lengths, tower heights, main span-to-tower height ratios, girder depths at midspan and tower, girder widths, main span to girder depths ratios at midspan and tower. Detailed information of configurations, together with drawings of plan view and cross sections of bridge girders and towers, can be found in Appendix A.

Table 5. Statistics of Configurations of Extradosed Bridges.

| | Mean | Max | Min | STDEV | Std Err Mean | Upper 95% Mean | Lower 95% Mean | Counts |
|----------------------------|--------|--------|-------|-------|--------------|----------------|----------------|--------|
| Max Span (ft) | 440.8 | 1024.0 | 171.0 | 169.7 | 15.8 | 472.2 | 409.5 | 115 |
| Total Span (ft) | 1244.7 | 4593.0 | 207.0 | 866.0 | 80.4 | 1404.0 | 1085.4 | 116 |
| Tower Height (ft) | 63.4 | 160.8 | 16.4 | 28.6 | 2.9 | 69.1 | 57.7 | 100 |
| Span/Height Ratio | 7.7 | 16.5 | 2.4 | 2.7 | 0.3 | 8.2 | 7.2 | 98 |
| Depth Midspan (ft) | 10.2 | 44.3 | 3.6 | 4.6 | 0.5 | 11.1 | 9.2 | 85 |
| Depth Tower (ft) | 15.8 | 44.3 | 3.6 | 6.1 | 0.7 | 17.2 | 14.5 | 84 |
| Girder Width (ft) | 74.1 | 196.8 | 23.8 | 30.1 | 2.9 | 79.9 | 68.4 | 108 |
| Span/Depth Ratio (Midspan) | 45.4 | 127.3 | 20.3 | 16.0 | 1.7 | 48.9 | 42.0 | 85 |
| Span/Depth Ratio (Tower) | 29.8 | 127.3 | 12.1 | 13.1 | 1.4 | 32.7 | 27.0 | 84 |

SUMMARY

The study identified 120 extradosed bridges in use, under construction, or in the planned phase. A literature survey was conducted to summarize status, and structural features from all the extradosed bridges identified from documents and interviews. Table 6 summarizes the statistics of general information and configuration of the 120 extradosed bridges.

Table 6. General Statistics of Configuration of Extradosed Bridges.

| Competition Year | | 2000 | 2001 to 2006 | 2007 to 2011 | 2012 | | Total |
|----------------------------|-----------|------------------|-------------------|------------------------|----------------------|----------|-------|
| | Count (%) | | 19 (16%) | 39 (33%) | 43 (35%) | 22 (18%) | |
| Location | | Asia | Europe | N. America | S. America | Africa | Total |
| | Count (%) | 98 (78%) | 16 (13%) | 5 (4%) | 5 (4%) | 1 (1%) | 120 |
| Construction Duration (m) | | 0 to 24 | 25 to 48 | 49 to 72 | 73 to 96 | > 96 | Total |
| | Count (%) | 15 (28%) | 27 (52%) | 8 (15%) | 2 (4%) | 0 (0%) | 52 |
| Usage | | Road/ Freeway | Road & Railway | Light Rail/ Railway | Road & Pedestrian | | Total |
| | Count (%) | 98 (89%) | 1 (1%) | 9 (8%) | 2 (2%) | | 110 |
| Number of Spans | | 2 | 3 | 4 | 5 | 6-9 | Total |
| | Count (%) | 19 (17%) | 60 (55%) | 12 (11%) | 9 (8%) | 10 (9%) | 110 |
| #of Towers Cross Girder | | 1 | 2 | 3 | 2×2 | | Total |
| | Count (%) | 41 (41%) | 54 (52%) | 4 (4%) | 4 (4%) | | 103 |
| Main Span (ft) | | <299 | 300 to 399 | 400 to 499 | 500 to 599 | >600 | Total |
| | Count (%) | 24 (21%) | 25 (22%) | 37 (32%) | 13 (11%) | 16 (14%) | 115 |
| Total Span (ft) | | 0 to 499 | 500 to 999 | 1000 to 1499 | 1500 to 1999 | >2000 | Total |
| | Count (%) | 12 (11%) | 48 (42%) | 28 (25%) | 10 (9%) | 16 (14%) | 114 |
| Tower Height (ft) | | 0 to 25 | 25 to 50 | 50 to 75 | 75 to 100 | >100 | Total |
| | Count (%) | 2 (2%) | 38 (38%) | 32 (32%) | 17 (17%) | 12 (12%) | 101 |
| Tower Height/ Main Span | | >1/3 | 1/6 to 1/3 | 1/6 to 1/9 | 1/9 to 1/12 | <1/12 | Total |
| | Count (%) | 4 (4%) | 22 (22%) | 44 (44%) | 24 (24%) | 4 (4%) | 98 |
| Girder Thickness | | Constant | Variable | | | | Total |
| | Count (%) | 18 (20%) | 74 (80%) | | | | 92 |
| Girder Materials | | Concrete | Composite-A | Composite-B | Steel | | Total |
| | Count (%) | 86 (89%) | 6 (6%) | 6 (6%) | 1 (1%) | | 97 |
| Number of Cells | | 1 | 2 | 3 | 4 | 5 | Total |
| | Count (%) | 16 (26%) | 12.5** (20%) | 24.5 (40%) | 6 (10%) | 3 (5%) | 62 |
| Girder Depth Midspan (ft) | | 0 to 5.99 | 6 to 8.99 | 9 to 11.99 | 12 to 14.99 | >15 | Total |
| | Count (%) | 3 (4%) | 36 (42%) | 31 (36%) | 12 (14%) | 3 (4%) | 85 |
| Girder Depth Tower (ft) | | 0 to 9.99 | 10 to 14.99 | 15 to 19.99 | 20 to 24.99 | >25 | Total |
| | Count (%) | 13 (16%) | 32 (38%) | 18 (21%) | 18 (21%) | 3 (4%) | 84 |
| Span/Depth Midspan | | 0 to 29.99 | 30 to 44.99 | 45 to 59.99 | 60 to 74.99 | >75 | Total |
| | Count (%) | 10 (12%) | 29 (34%) | 36 (42%) | 7 (8%) | 3 (4%) | 85 |
| Span/Depth Tower | | 0 to 19.99 | 20 to 29.99 | 30 to 39.99 | 40 to 49.99 | >50 | Total |
| | Count (%) | 10 (12%) | 32 (39%) | 36 (43%) | 3 (4%) | 2 (2%) | 84 |
| Girder Width (ft) | | 0 to 29.99 | 30 to 59.99 | 60 to 89.99 | 90 to 119.99 | >120.01 | Total |
| | Count (%) | 1 (1%) | 40 (36%) | 35 (32%) | 31 (28%) | 3 (3%) | 108 |

* Note: 1. Total counts from each category are different due to the completeness of information collected;

** Shinekarto Bridge, with two cells in eastbound direction and three cells in westbound direction

CHAPTER 4. COST OF EXTRADOSED BRIDGES CONSTRUCTION

COST ANALYSIS THROUGH GENERAL SURVEYS

Construction cost is one of the major considerations in bridge alternatives selection. In addition to the general information and configurations of the extradosed bridges identified, the research team collected the information regarding construction costs of such bridges from technical papers, reports, websites, and interviews.

Generally, initial construction costs and future maintenance costs of extradosed bridges are considered to be higher than girder bridges and lower than cable-stayed bridges (Mermigas 2008). However, as each bridge site has its unique circumstance, the costs of constructing specific bridges could be highly variable. Variances of unit costs are not only affected by different site circumstances, but also determined by specific countries where the bridges are built and the currencies in those countries.

In this study, the construction costs of 58 extradosed bridges were collected through literature and interviews. The construction cost was first converted to the U.S. dollar equivalent according to currency conversion rates. Since the bridges were built at different times, and in order to have the cost information comparable, the researchers converted all costs to the present value (PV) in the year 2012 using equation 1:

$$PV=P(1+A)^n, \quad (1)$$

where PV refers to the present value, P refers to the cost of the bridge (at the year of project completion), A refers to the inflation (discount) rate, and n refers to the difference of year that the project was completed (comparing to the year 2012).

To simplify the cost analysis, researchers used a constant inflation (discount) rate of 4%. Total construction costs were also converted to unit cost per area ($\$/\text{ft}^2$) according to total girder areas constructed. For example, the total construction cost of the Korong Bridge was approximately 3.0 million euro in 2004. As 1 euro equals approximately 1.2 U.S. dollars, the total cost of the Korong Bridge was calculated as equal to 3.6 million U.S. dollars in 2004 and 4.9 million U.S. dollars in present value. A total cost of 3.6 million and 4.9 million dollars divided by the girder area of the Korong Bridge of $19,500\text{ft}^2$ resulted in $\$185/\text{ft}^2$ and $\$253/\text{ft}^2$ of unit costs at project completion time and at present value, respectively.

Table 7. Historical Costs of Extradosed Bridges.

| | Bridge Name | Year | Total Cost | Total Cost (M\$) | Total Cost PV (M\$) | Unit Cost Total (\$/ft ²) | Unit Cost PV (\$/ft ²) | Reference |
|----|---|------|-------------------------|------------------|---------------------|---------------------------------------|------------------------------------|--|
| 1 | Odawara Blueway Bridge | 1994 | 2.4 billion JY | 24.0 | 48.6 | 575 | 1165 | Kasuga 2012; Chilstrom et al. 2001; Stroh 2012 |
| 2 | Tsukuhara Bridge | 1997 | 6.5 billion JY | 65.0 | 117.1 | 1004 | 1809 | Kasuga 2012; Chilstrom et al. 2001; Stroh 2012 |
| 5 | Shin-Karato (Okuyama) Bridge | 1998 | \$34 million | 34.0 | 58.9 | 519 | 899 | Chilstrom et al. 2001; Stroh 2012; |
| 6 | Sunniberg Bridge | 1998 | 20 million Swiss francs | 20.4 | 35.3 | 291 | 504 | Drinkwater 2007; Structurae.de 2012 |
| 9 | Second Mactan–Mandaue Bridge | 1999 | 15,565 million Yen | 165.7 | 275.8 | 2096 | 3489 | Carada 2002 |
| 12 | Pakse Bridge | 1999 | \$48 million | 48.0 | 79.9 | 904 | 1505 | Structurae.de 2012 |
| 16 | Wuhu Yangtze River Bridge | 2000 | 4600 million RMB | 575.0 | 920.6 | 3397 | 5439 | baidu.com 2012; lqgs.com |
| 19 | Ibi River (Ibigawa) Bridge* | 2001 | 83.7 billion JY | 837.0 | 1288.5 | 966 | 1487 | Kasuga 2012; Chilstrom et al. 2001; |
| 20 | Kiso River (Kisogawa) Bridge* | 2001 | 83.7 billion JY | 837.0 | 1288.5 | 966 | 1487 | Kasuga 2012; Chilstrom et al. 2001; |
| 21 | Miyakoda River (Miyakodagawa) Bridge | 2001 | \$55 million | 55.0 | 84.7 | 958 | 1474 | Chilstrom et al. 2001 |
| 25 | Koror-Babeldaob (Japan–Palau Friendship) Bridge | 2002 | \$25 million | 25.0 | 37.0 | 487 | 721 | Structurae.de 2012 |
| 27 | Shinkawa (Tobiuo) Bridge | 2002 | \$50 million | 50.0 | 74.0 | 599 | 887 | Chilstrom et al. 2001; Stroh 2012; |
| 29 | Changcheng Yunhe Bridge | 2003 | 263 million RMB | 32.9 | 46.8 | 419 | 596 | Yang 2003 |
| 31 | Xiaoxihu Yellow River Bridge | 2003 | 400 million RMB | 50.0 | 71.2 | 566 | 806 | Shu 2002 |
| 32 | Shanxi Fenhe Bridge | 2003 | 499 million RMB | 62.4 | 88.8 | 675 | 961 | cctv.com 2012 |
| 35 | Korong Bridge | 2004 | 3 million EUR | 3.6 | 4.9 | 185 | 253 | Becze and Barta 2006 |
| 39 | Shuqian Nanerhuan Bridge | 2005 | 363 million RMB | 45.4 | 59.7 | 871 | 1147 | cscec7bjt.com 2012 |
| 40 | Brazil–Peru Integration Bridge | 2005 | 28 million Reais | 12.0 | 15.8 | 276 | 364 | bnamericas.com 2012 |
| 48 | Liuzhou Sanmenjiang Bridge | 2006 | 191 million RMB | 23.9 | 30.2 | 150 | 190 | ctcecc.com 2012 |
| 52 | Huiqing Huanghe Bridge | 2006 | 380 million RMB | 47.5 | 60.1 | 454 | 574 | huimin.gov 2012; yellowriver.gov.cn 2012; |
| 53 | Kaifeng Huanghe II Bridge | 2006 | 2000 million RMB | 250.0 | 316.3 | 767 | 970 | Eemap.org 2012 |
| 54 | Fuzhou Pushang Bridge | 2006 | 473 million RMB | 59.1 | 74.8 | 450 | 570 | china.com.cn 2012 |
| 56 | Homeland (Domovinski) Bridge | 2007 | 40 million EUR | 48.0 | 58.4 | 504 | 613 | Dnevnik.hr 2012 |
| 57 | Bridge of the European Union | 2007 | 203,755,614,42 zl | 64.7 | 78.7 | 1197 | 1456 | nowymost.konin.pl 2012 |
| 61 | Nymburk Bypass Bridge | 2007 | 248 million CZK | 11.9 | 14.4 | 309 | 376 | Kalny et al. |
| 62 | Puh (Puhov) Bridge | 2007 | 8.8 million Euros | 10.6 | 12.8 | 122 | 148 | www.izs.si 2012; Markelj 2012 |
| 64 | Smuuli Bridge | 2007 | 2.5 million Euros | 3.0 | 3.6 | 89 | 109 | Saar 2012 |
| 66 | Second Vivekananda Bridge | 2007 | \$37 million | 37.0 | 45.0 | 144 | 175 | Binns 2005; www.lntidpl.com 2012 |
| 67 | Gack-Hwa First Bridge | 2007 | \$19 million | 19.0 | 23.1 | 264 | 321 | blog.naver.com 2012 |
| 68 | Pyung-Yeo II Bridge | 2008 | \$146 million | 146.0 | 170.8 | 2584 | 3022 | blog.naver.com 2012 |

| | Bridge Name | Year | Total Cost | Total Cost (M\$) | Total Cost PV (M\$) | Unit Cost Total (\$/ft ²) | Unit Cost PV (\$/ft ²) | Reference |
|-----|---|------|----------------------------|------------------|---------------------|---------------------------------------|------------------------------------|--|
| 69 | Dae-Ho Grand (Cho-Rack) Bridge | 2008 | \$30 million | 30.0 | 35.1 | 376 | 439 | blog.naver.com 2012 |
| 73 | North Arm Bridge | 2008 | \$30–\$40 million Canadian | 35.0 | 40.9 | 689 | 806 | Scollard 2012; b-t.com 2012 |
| 75 | Trois-Bassins Viaduct Bridge | 2008 | 30 million Euros | 36.0 | 42.1 | 497 | 581 | Structurae.de 2012 |
| 77 | Riga South(ern) Bridge | 2009 | 120 million Euros | 144.0 | 162.0 | 486 | 547 | www.LongStarBridges.com 2012 |
| 78 | Golden Ears Bridge | 2009 | \$250 million Canadian | 250.0 | 281.2 | 750 | 843 | Scollard 2012; b-t.com 2012; CEI 2010; dcnonl.com 2012 |
| 79 | Karnaphuli III Bridge | 2009 | \$50 million | 50.0 | 56.2 | 229 | 257 | Astin et al. 2010a; Astin 2010b; AECCafe.com 2012 |
| 80 | Kyong-An Bridge | 2009 | \$380 million | 380.0 | 427.4 | 4358 | 4903 | blog.naver.com 2012 |
| 81 | Husong Bridge | 2009 | 440 million RMB | 62.9 | 70.7 | 468 | 527 | blog.163.com 2012 |
| 83 | Ankang Qiligou Bridge | 2009 | 110 million RMB | 15.7 | 17.7 | 180 | 203 | Baidu.com 2012 |
| 85 | Qishan Bridge | 2010 | NT\$600 million | 20.3 | 21.9 | 424 | 459 | taiwantoday.tw 2012 |
| 89 | Povazska Bystrica D1 Motorway Viaduct | 2010 | \$57million | 57.0 | 61.7 | 198 | 215 | Strasky 2012 |
| 90 | Teror Viaduct | 2010 | 7.887 million Euros | 9.5 | 10.2 | | | skyscrapercity.com 2012 |
| 93 | Un-am Grand Bridge | 2011 | \$93 million | 93.0 | 96.7 | 561 | 583 | blog.naver.com 2012 |
| 95 | Jiayue (Nanping) Bridge | 2011 | 268 million RMB | 38.3 | 39.8 | 337 | 350 | Baidu.com 2012 |
| 97 | Hwangdo Grand Bridge | 2011 | \$19.6 million | 19.6 | 20.4 | 422 | 438 | blog.naver.com 2012; BNG 2012 |
| 99 | Guemgang I Bridge | 2012 | \$61.27 million | 61.3 | 61.3 | 256 | 256 | KESTA 2012; Choi 2012 |
| 101 | Hualiantai Fengping Bridge | 2012 | 1071 million NT | 35.9 | 35.9 | 264 | 264 | tw.myblog.yahoo.com 2012 |
| 103 | Najin Bridge | 2012 | 379 million RMB | 54.1 | 54.1 | 423 | 423 | cctv.com 2012 |
| 107 | New Pearl Harbor Memorial (Quinnipiac) Bridge | 2012 | \$517 million | 517.0 | 517.0 | 4615 | 4615 | Stroh 2012; Dunham et al. 2010 |
| 108 | Changshan Bridge | 2013 | 579 million RMB | 82.7 | 79.5 | 619 | 595 | tumukeji.com 2012 |
| 109 | Ningjiang Shonghuajiang Bridge | 2013 | 260 million RMB | 37.1 | 35.7 | 203 | 196 | Cr13g-lc.com 2011; rbtmm.com 2012 |
| 111 | Yongjin Bridge | 2014 | 5874 million KRW | 5.9 | 5.4 | 117 | 109 | BNG 2012 |
| 112 | Gangchon 2nd Bridge | 2014 | 8580 million KRW | 8.6 | 7.9 | 132 | 122 | BNG 2012 |
| 113 | St. Croix River Bridge | 2014 | \$292 million | 292.0 | 270.0 | 767 | 709 | MnRoad 2011 |
| 115 | Brazos River Bridge | 2015 | \$212 million | 8.6 | 7.7 | 122 | 108 | ourdailybears.com 2012; TxDOT 2012 |
| 117 | Yaro Grand Bridge | 2015 | \$64.90 million | 64.9 | 57.7 | 406 | 361 | KESTA 2012; |
| 118 | Pyung-Taik Grand Bridge | 2016 | \$75.96 million | 76.0 | 64.9 | 194 | 166 | KESTA 2012; |
| 120 | Kinmen Bridge | 2016 | 7.5 million NT | 250.0 | 213.7 | 194 | 166 | www.wantchinatimes.com 2012 |

* Total construction costs of both Ibi River Bridge and Kiso River Bridge

Table 7 summarized the documented cost information of the 58 extradosed bridges identified. Information on superstructure costs and substructure costs together with superstructure cost percentages were also collected; the results are summarized in Table 8. Note that the scope of each bridge cost is often not clear due to the lack of information; therefore some of the bridge cost information could be misleading. For example, some of the cost information collected may include not only the construction cost of extradosed bridge sections, but also conventional girder bridge spans; some others even include approaching roadwork construction.

Table 8. Historical Costs of Superstructure and Substructure of Extradosed Bridges.

| | Bridge Name | Superstructure Cost | | Substructure | | Superstructure Cost % | Unit Cost | |
|-----|--------------------------------------|---------------------|----------|--------------|----------|-----------------------|--------------------------------------|---|
| | | (M\$) | PV (M\$) | Cost (M\$) | PV (M\$) | | Superstructure (\$/ft ²) | Superstructure PV (\$/ft ²) |
| 1 | Odawara Blueway Bridge | 15.0 | 30.4 | 9.0 | 18.2 | 63% | 362 | 734 |
| 2 | Tsukuhara Bridge | 34.0 | 61.2 | 31.0 | 55.8 | 53% | 532 | 959 |
| 19 | Ibi River (Ibigawa) Bridge | 630.0 | 969.9 | 207.0 | 318.7 | 75% | 725 | 1116 |
| 20 | Kiso River (Kisogawa) Bridge | 630.0 | 969.9 | 207.0 | 318.7 | 75% | 725 | 1116 |
| 21 | Miyakoda River (Miyakodagawa) Bridge | 38.0 | 58.5 | 17.0 | 26.2 | 69% | 662 | 1019 |
| 62 | Puh (Puhov) Bridge | | | | | 50% | | |
| 64 | Smuuli Bridge | | | | | 70% | | |
| 67 | Gack-Hwa First Bridge | 14.5 | 17.6 | 4.5 | 5.5 | 76% | | |
| 99 | Guemgang I Bridge | 45.7 | 45.7 | 15.5 | 15.5 | 75% | 191 | 191 |
| 117 | Yaro Grand Bridge | 43.7 | 38.9 | 21.2 | 18.8 | 67% | 273 | 243 |
| 118 | Pyung-Taik Grand Bridge | 55.3 | 47.3 | 20.7 | 17.7 | 73% | 141 | 121 |

Figure 38 shows the distribution of total construction costs. In the figure, there is a wide range of overall construction costs, ranging from \$3 million (\$4 million in PV) to \$837 million (\$1289 million in PV). The average construction cost is \$110.3 million (142.8 million in PV); the majority of bridges have total construction costs between \$0 and \$100 million. The bridge with the lowest construction cost is the Smuuli Bridge, which was constructed in Estonia in 2007 at a cost of \$3 million (\$4 million in PV). The bridge with the highest construction cost is \$838 million (\$1289 million in PV), which is the construction cost of both the Ibi River Bridge and the Kiso River Bridge. The two bridges were constructed in Japan in 2001.

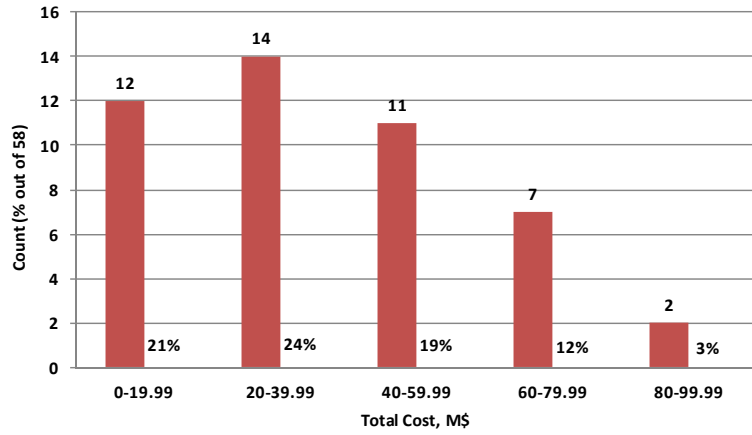

(a). Cost at Project Completion (within 0 to 100 M\$ Range)

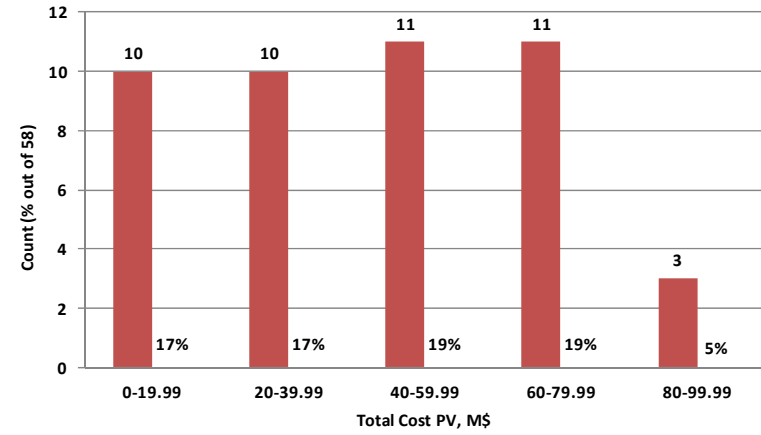

(b). Cost at PV (within 0 to 100 M\$ Range)

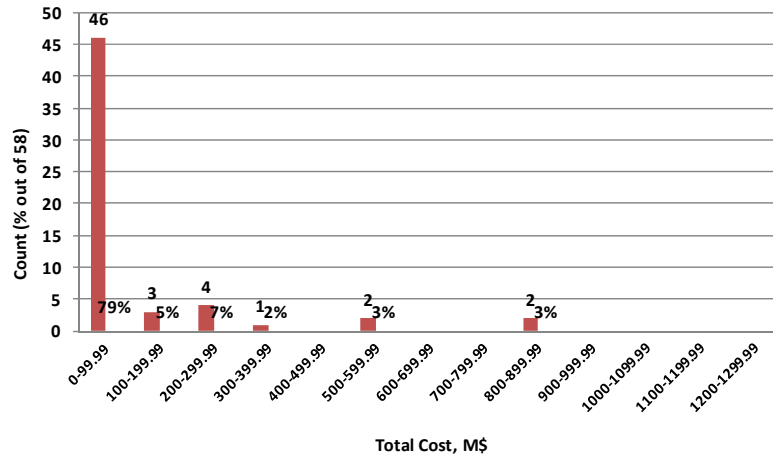

(c). Cost at Project Completion

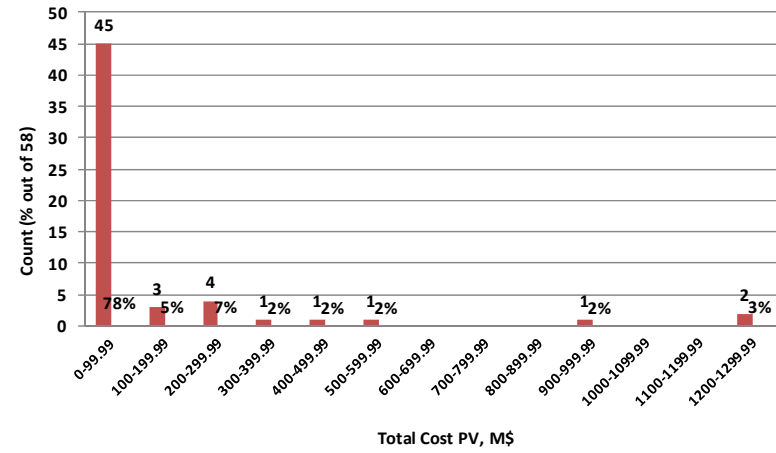

(d). Cost at PV

Figure 38. Distribution of Total Construction Cost.

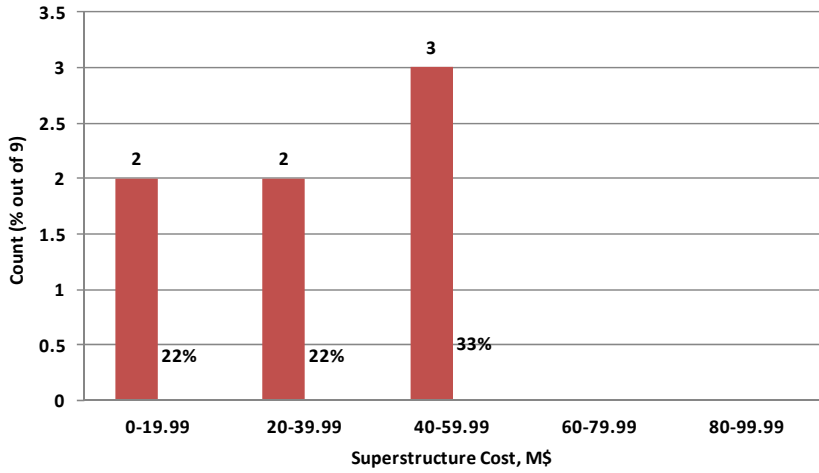

(a). Cost at Project Completion (within 0 to 100 M\$ Range)

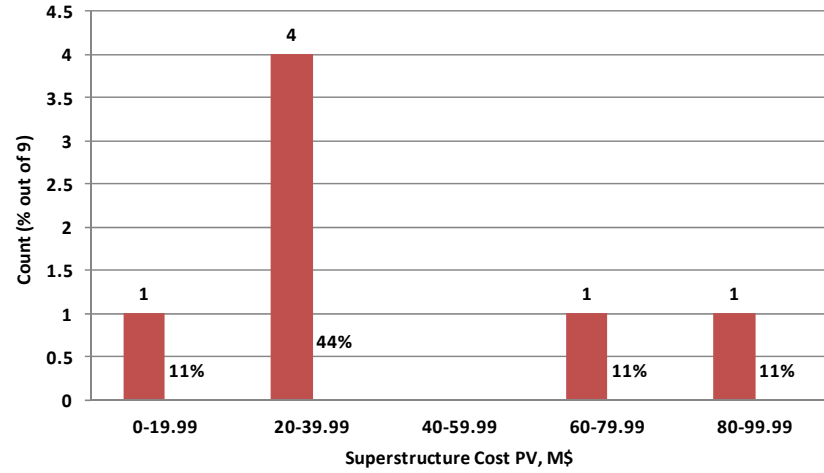

(b). Cost at PV (within 0 to 100 M\$ Range)

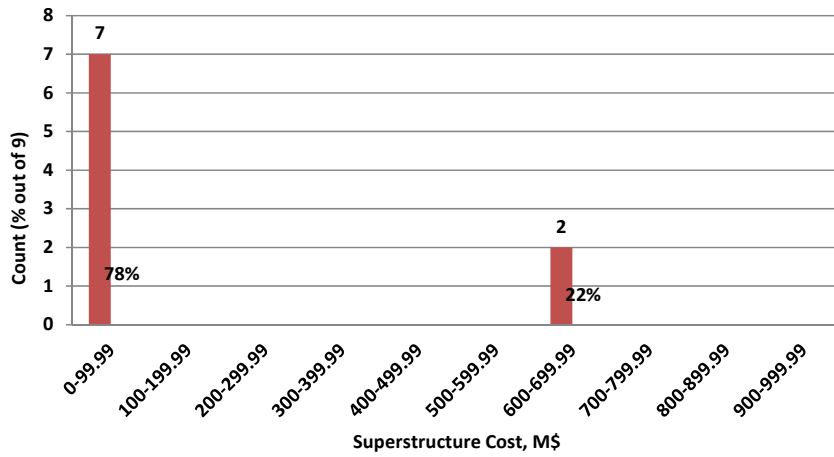

(c). Cost at Project Completion

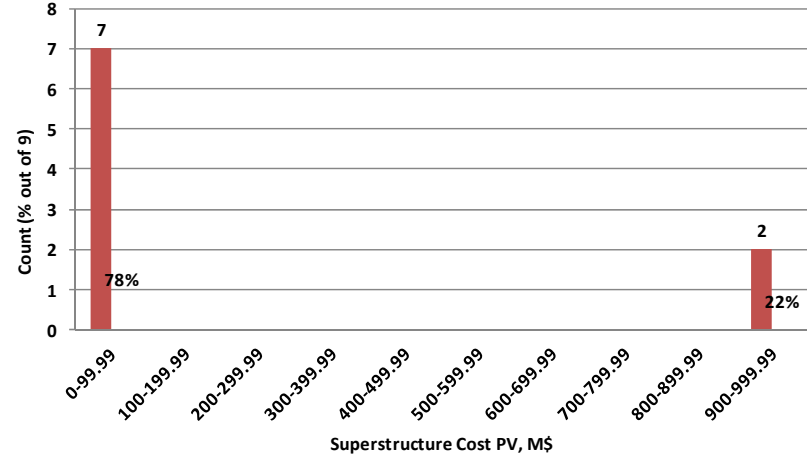

(d). Cost at PV

Figure 39. Distribution of Superstructure Cost.

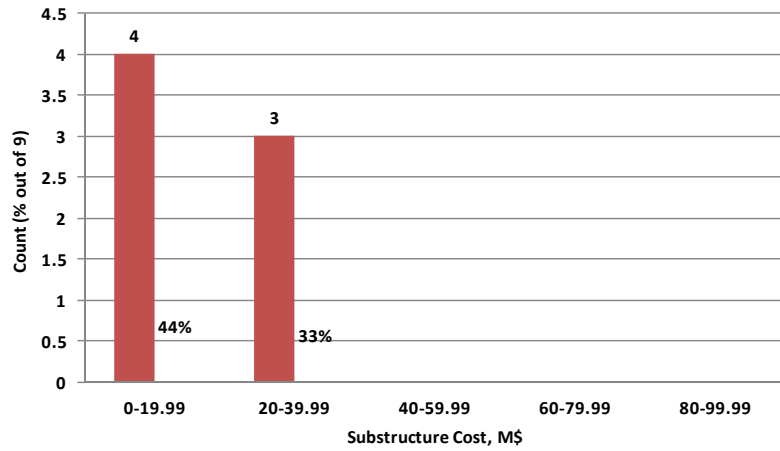

(a). Cost at Project Completion (within 0 to 100 M\$ Range)

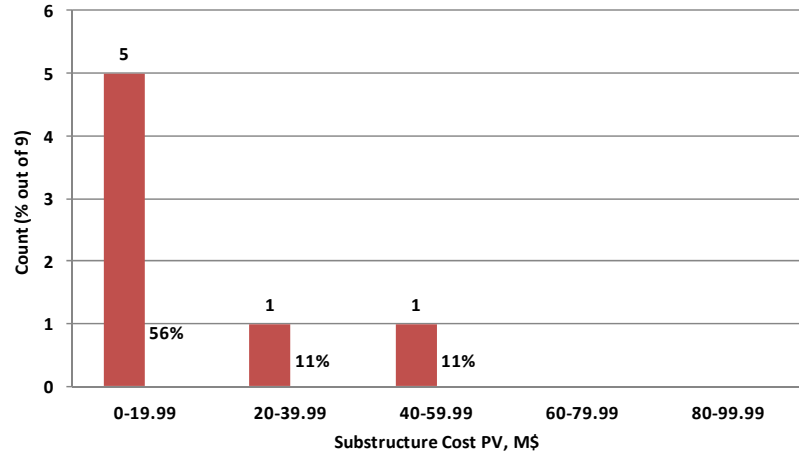

(b). Cost at PV (within 0 to 100 M\$ Range)

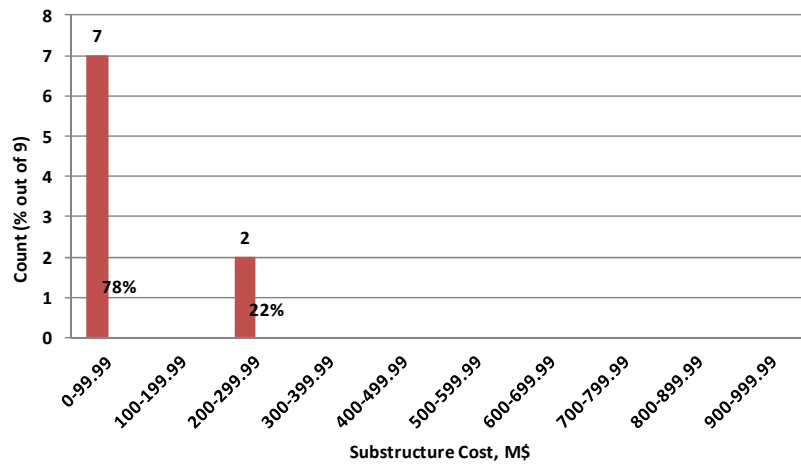

(c). Cost at Project Completion

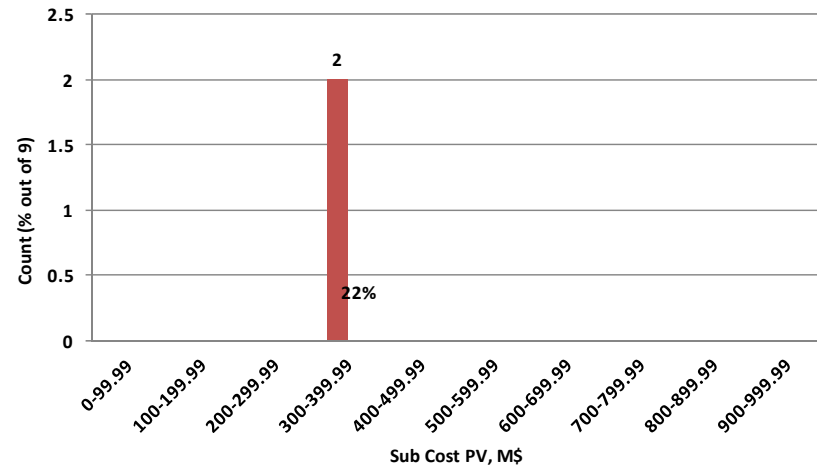

(d). Cost at PV

Figure 40. Distribution of Substructure Cost.

There are only a very limited number of bridges identified with separated substructure and superstructure costs; the information is shown in Figure 39 and Figure 40, respectively. The average superstructure cost collected in this research was found to be \$167.4 million (\$248.8 million in PV). The bridge with the highest superstructure cost is the Ibi River Bridge and the Kiso River Bridge; both were constructed in Japan in 2001 and cost \$630 million (\$930 million in PV). The bridge with the lowest superstructure cost of \$14.5 million (\$17.6 million in PV) is the Gack-Hwa First Bridge constructed in Korea in 2007.

The average substructure cost collected in this research was found to be \$59.2 million (\$88.3 million in PV). The bridges with the highest substructure cost are the Ibi River Bridge and the Kiso River Bridge, both of which were constructed with a substructure cost of \$207 million (\$319 million in PV). The bridge with the lowest substructure cost is the Gack-Hwa First Bridge, which has a substructure cost of \$4.5 million (\$5.5 million in PV). According to the information collected, costs of the superstructure portions count for an average of 68% of total costs, which range from 50% (Puh Bridge) to 76% (Gack-Hwa First Bridge) (see Figure 41).

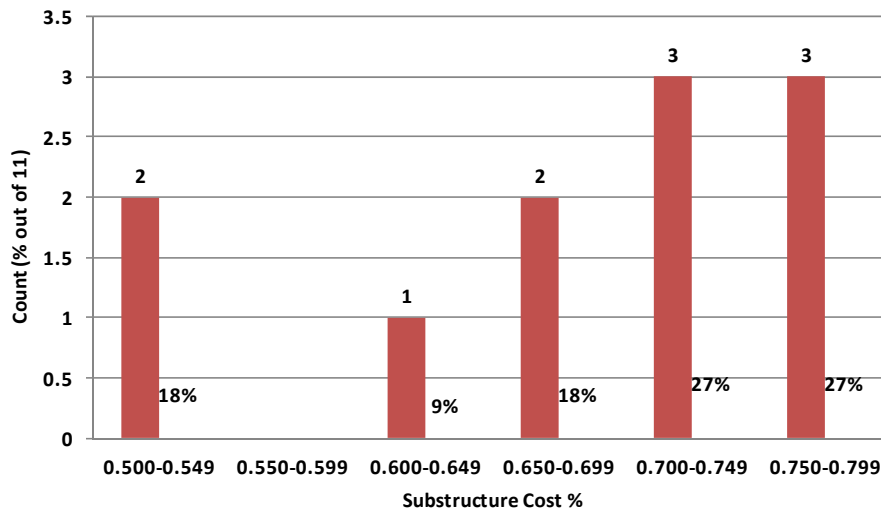
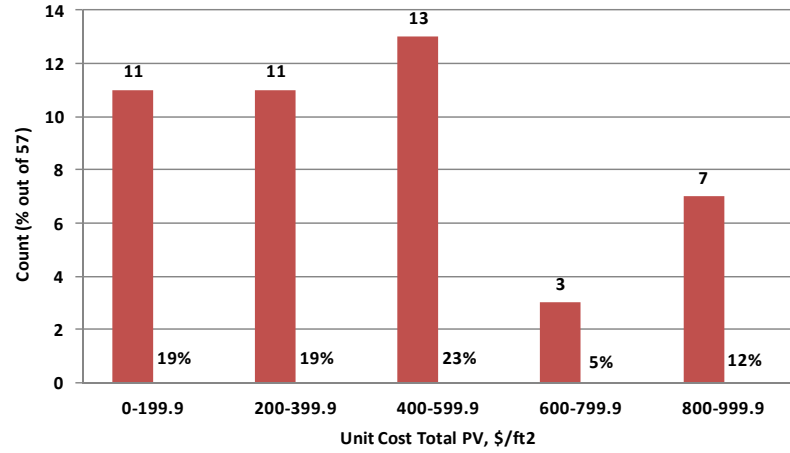
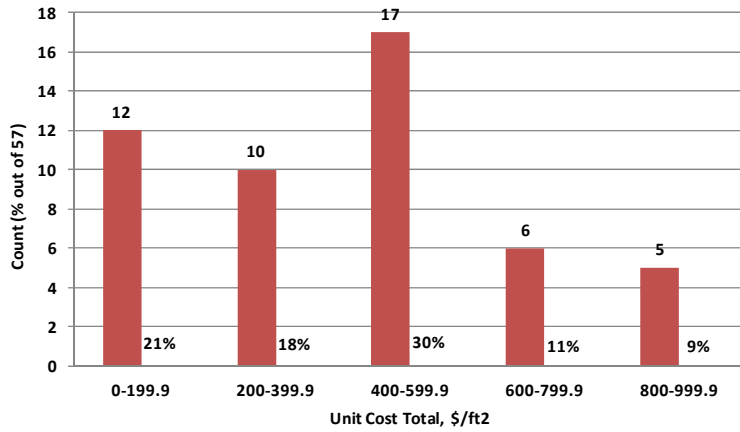

Figure 41. Distribution of Superstructure Cost %.

Distributions of calculated overall unit costs and of superstructure unit costs are shown in Figure 42 and Figure 43, respectively. Results showed that the average overall unit cost is \$720.7/ft² (\$925.7/ft² in PV). The bridge identified with the lowest unit cost is the Smuuli Bridge, with a unit cost of \$89/ft² (\$108/ft² in PV). The bridge identified with the highest unit cost is the Kyong-An Bridge, with a unit cost of \$4358/ft² (\$4903/ft² in PV). The calculated average superstructure unit cost is \$451.5/ft² (\$687.2/ft² in PV). The bridge identified with the

lowest superstructure unit cost is the Pyung-Taik Grand Bridge, with a superstructure unit cost of \$141/ft² (\$121/ft² in PV). The bridge identified with the lowest superstructure unit cost is the Ibi River and Kiso River Bridges, with a superstructure unit cost of \$725/ft² (\$1116/ft² in PV). Note that the results of calculated unit costs of superstructure constructions are much higher than the cost between \$50/ft² to \$250/ft² that is usually known for normal TxDOT balanced cantilever construction. As mentioned earlier, the disagreement is likely due to unclear scopes of cost information included in the study.



(a). Cost at Project Completion (within 0 to 1000\$/ft² Range)

(b). Cost at PV (within 0 to 1000\$/ft² Range)

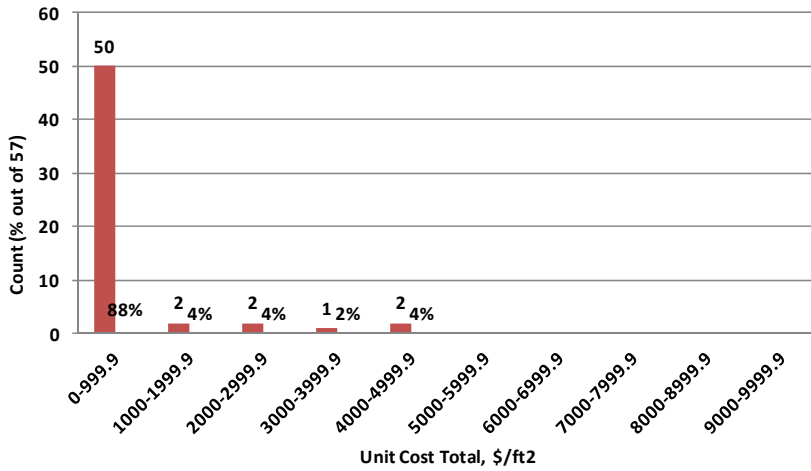

(c). Cost at Project Completion

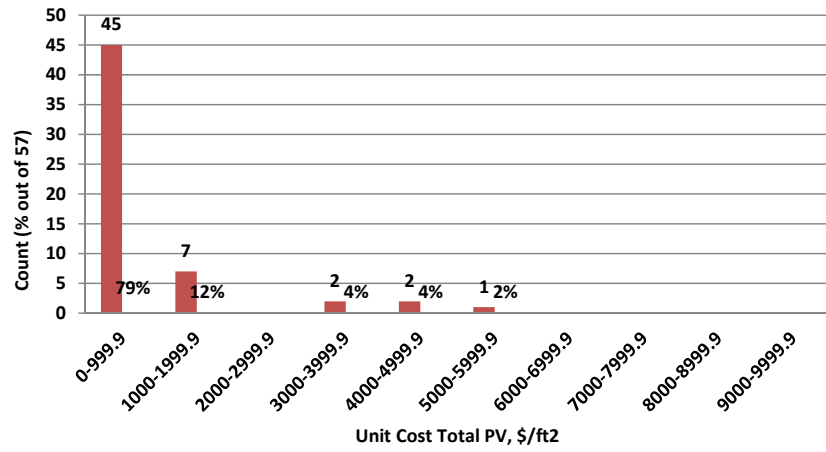

(d). Cost at PV

Figure 42. Distribution of Unit Cost.

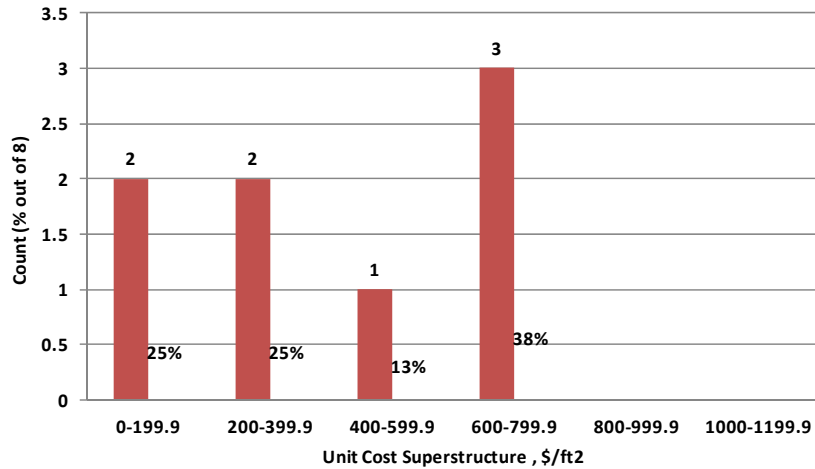

(a) Cost at Project Completion

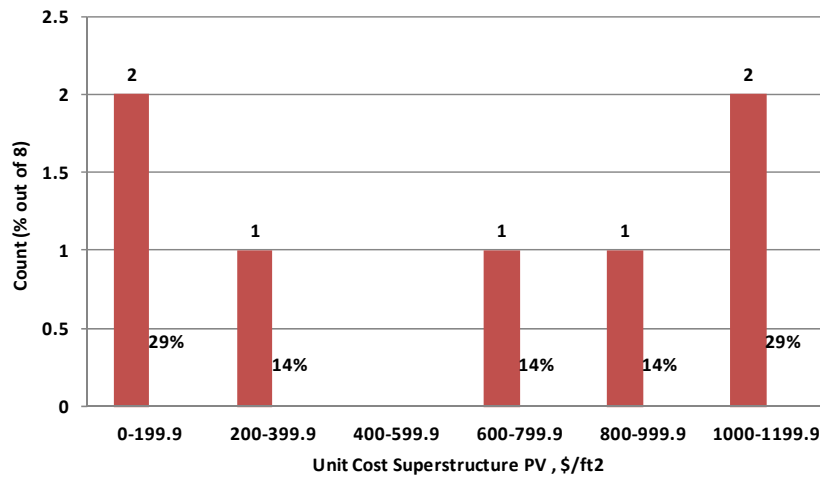

(b). Cost at PV

Figure 43. Distribution of Unit Cost of Superstructure.

A statistical analysis was performed based on the cost information collected; the results are summarized in Table 9. As shown in Table 7 and Table 8, the cost information collected in the study is highly variable and might not be appropriate to provide baseline information regarding cost of a normal extradosed bridge construction. There is a small number of bridges, including the Kyong-An Bridge and the New Pearl Harbor Memorial Bridge, that show significantly higher costs comparing to other bridges. The significant difference might lead to a distortion of cost analysis. Adjusted average values were therefore calculated by excluding outliers, i.e., values outside of average values plus or minus one standard deviation.

Table 9. Statistics of Extradosed Bridge Construction Costs.

| | Avg | Max | Min | Count | Stdev | Avg+Stdev | Avg-Stdev | Adj. Avg.* |
|--|-------|------|-----|-------|--------|-----------|-----------|------------|
| Total Cost (M\$) | 110.3 | 837 | 3 | 58 | 181.1 | 291.4 | -70.8 | 61.4 |
| Total Cost PV (M\$) | 142.8 | 1289 | 4 | 58 | 264.9 | 407.7 | -122.2 | 72.4 |
| Super Cost (M\$) | 167.4 | 630 | 15 | 9 | 262.6 | 430 | -95.3 | 35.2 |
| Super Cost PV (M\$) | 248.8 | 970 | 18 | 9 | 409 | 657.8 | -160.2 | 42.8 |
| Sub Cost (M\$) | 59.2 | 207 | 5 | 9 | 84.1 | 143.3 | -24.9 | 17 |
| Sub Cost PV (M\$) | 88.3 | 319 | 5 | 9 | 131.3 | 219.6 | -43 | 22.5 |
| Super % | 68% | 76% | 50% | 11 | 9% | 77% | 59% | 71% |
| Unit Cost Total (\$/ft ²) | 720.7 | 4615 | 89 | 57 | 929 | 1649.7 | -208.3 | 468.8 |
| Unit Cost Total PV (\$/ft ²) | 925.7 | 5439 | 108 | 57 | 1165.3 | 2091 | -239.7 | 611.5 |
| Unit Cost Super (\$/ft ²) | 451.5 | 725 | 141 | 8 | 240.1 | 691.5 | 211.4 | 601.1 |
| Unit Cost Super PV (\$/ft ²) | 687.2 | 1116 | 121 | 8 | 433.7 | 1120.9 | 253.5 | 988.5 |

Cost Comparison through Specific Resources

The previous section shows that, as the cost information collected from literature and project documents is highly variable and often the scope of cost of each bridge is not clear due to the lack of information, some of the bridge cost information is questionable for using in cost comparison. In order to conduct a more meaningful cost analysis of extradosed bridges, the research team approached several companies with experience in multiple extradosed bridges. In particular, the team asked about the costs associated with different types of bridges. As the researchers expected, most of companies approached were hesitant to provide such information.

However, two companies provided extradosed bridge construction cost information to the research team. Company A, located in Asia, provided a cost comparison of three extradosed bridges with two prestress concrete box girder bridges and one cable-stayed bridge. Proprietary information has been withheld to protect the anonymity of the company. As shown in Table 10, the superstructure unit costs of the two girder bridges were \$103.4/ft² and \$135.6/ft², which account for 70% and 50% of total unit costs, respectively. The superstructure unit costs of the three extradosed bridges shown were \$197.6/ft², \$191.3/ft² and \$141.4/ft², which account for 67%, 75%, and 73% of total unit costs, respectively. Results are expected as the average cost of extradosed bridges at approximately \$175/ft² is about 50% higher than the average cost of girder bridges (at around \$120/ft²). The cost of the cable-stayed bridge included in the table, however, shows the lowest value at \$100.4/ft², which is even lower than the two girder bridges. The unexpected result is likely due to the size of the specific cable-stayed bridge project. The total length of 23,983 feet of the bridge is approximately 10 times or more than most other projects included in the study. Also, the percentage of superstructure cost of this specific project is 35%, which was also significantly lower than the other projects included in the study.

Dr. Kasuga from Sumitomo Mitsui Construction provided another very valuable data set with cost information on 12 extradosed bridges, 215 girder bridges, and 29 cable-stayed bridges; all from actual constructed projects. Sumitomo Mitsui Construction is a major bridge construction company in Japan. Dr. Kasuga is the Deputy Division Director and Chief Engineer of the company; he designed the first extradosed bridge (Odawara Blueway Bridge) and was the engineer of record and designer for most of the 12 extradosed bridges in the study. As the currency in Japan is different than in the United States and bridges were constructed in different times, a cost index, instead of actual cost data, was used in this cost study. In the cost index, 1.00 means the average cost of 100-meter (328 feet) span ordinal box girder bridges. Also, the cost information shown here only refers to the superstructure; the costs of piers and foundations are not included. Table 11 shows the cost index and basic span information of the 12 extradosed bridges included in the study. Due to the limited space in the report, detailed information on the 29 cable-stayed bridges and 215 girder bridges are not shown here. As expected, construction costs depend on factors such as site limitation, soil condition, or construction methods; the data shown in Table 11 vary widely in individual bridges.

Table 10. Unit Costs based on Types of Bridges (Data Obtained from Company A).

| Types of Bridge | Bridge | Total Lanes | Length by Width (ft) | Area (ft ²) | Construction Cost (Direct Cost: Material, Labor, and Equipment) | | | | | |
|------------------------|--------|-------------|----------------------|-------------------------|---|-----------------------------|-------------|---------------------------|--|-----------------------|
| | | | | | Slab and Girder (M\$) | Column and Foundation (\$M) | Total (M\$) | Unit Cost/ft ² | Superstructure Unit Cost/ft ² | Superstructure Cost % |
| Prestressed Box Girder | N/A | 4 | 1760 by 69 | 121,440 | \$12.6 | \$5.3 | \$17.8 | \$147 | \$103.4 | 70% |
| | N/A | 4 | 2313 by 99.6 | 230,375 | \$31.3 | \$31.3 | \$62.5 | \$271 | \$135.6 | 50% |
| Extradosed Bridge | N/A | 4 | 2494 by 88.7 | 221,218 | \$43.7 | \$21.2 | \$64.9 | \$293 | \$197.6 | 67% |
| | N/A | 6 | 2428 by 98.5 | 239,158 | \$45.8 | \$15.5 | \$61.3 | \$256 | \$191.3 | 75% |
| | N/A | 6 | 3970 by 98.5 | 391,045 | \$55.3 | \$20.7 | \$76.0 | \$194 | \$141.4 | 73% |
| Cable-Stayed | N/A | 6 | 23983 by 98.5 | 2,362,326 | \$237.2 | \$440.5 | \$677.7 | \$287 | \$100.4 | 35% |

Table 11. Cost Index of Different Extradosed Bridges (Data Obtained from Sumitomo Mitsui Construction).

| Bridge Name | Year | Structure Type | Number of Span | Total Length (ft) | Road Width (ft) | Main Span Length (ft) | *Equivalent Length of Main Span | Cost Index |
|------------------------|------|------------------------|----------------|-------------------|-----------------|-----------------------|---------------------------------|------------|
| Odawara Blueway Bridge | 1994 | rigid frame | 3 | 886 | 31 | 400 | 400 | 1.00 |
| Tsukuhara Bridge | 1998 | rigid frame | 3 | 1,060 | 30 | 591 | 591 | 1.64 |
| Ibi Bridge | 2002 | Continuous (composite) | 6 | 4,583 | 92 | 891 | 891 | 2.23 |
| Hozu Bridge | 2001 | rigid frame | 3 | 1,207 | 48 | 328 | 328 | 1.05 |
| Tobiuo Bridge | 2003 | continuous | 3 | 1,266 | 82 | 427 | 427 | 1.11 |
| Akatonobo Bridge | 2004 | rigid frame | 3 | 965 | 52 | 401 | 401 | 1.51 |
| Arakogawa Bridge | 2004 | rigid frame | 3 | 807 | 30 | 295 | 295 | 1.09 |
| Tatekoshi Bridge | 2004 | rigid frame | 2 | 371 | 51 | 185 | 370 | 1.34 |
| Yanagawa Bridge | 2006 | rigid frame | 2 | 866 | 46 | 430 | 860 | 1.81 |
| Nanchiku Bridge | 2006 | rigid frame | 3 | 814 | 50 | 361 | 361 | 1.26 |
| Satonojo Bridge | 2006 | rigid frame | 3 | 610 | 49 | 253 | 253 | 1.05 |
| Asagiri Bridge | 2006 | rigid frame | 2 | 545 | 49 | 279 | 558 | 1.08 |

*Equivalent length of main span: Equivalent length = $2.0 \times$ maximum length for a 2-span structure

Figure 44 shows the relationship between main span lengths and cost indices of the three different types of bridges. The figure shows that although there is no clear trend in the costs of the three different types of bridges observed, generally speaking, extradosed bridges are more economical than cable-stayed bridges. Also, even though the cost of cable-stayed bridges could be significantly higher, this is not necessarily higher than traditional girder bridges. Even though cost indices are highly variable, compared to girder bridges, especially within 500 feet of the main span length, extradosed bridges could be a cost-effective option. As shown in Figure 44, at the span length ranging from 300 to 800 feet, an extradosed bridge could be a competitive bridge form compared to a cable-stayed bridge.

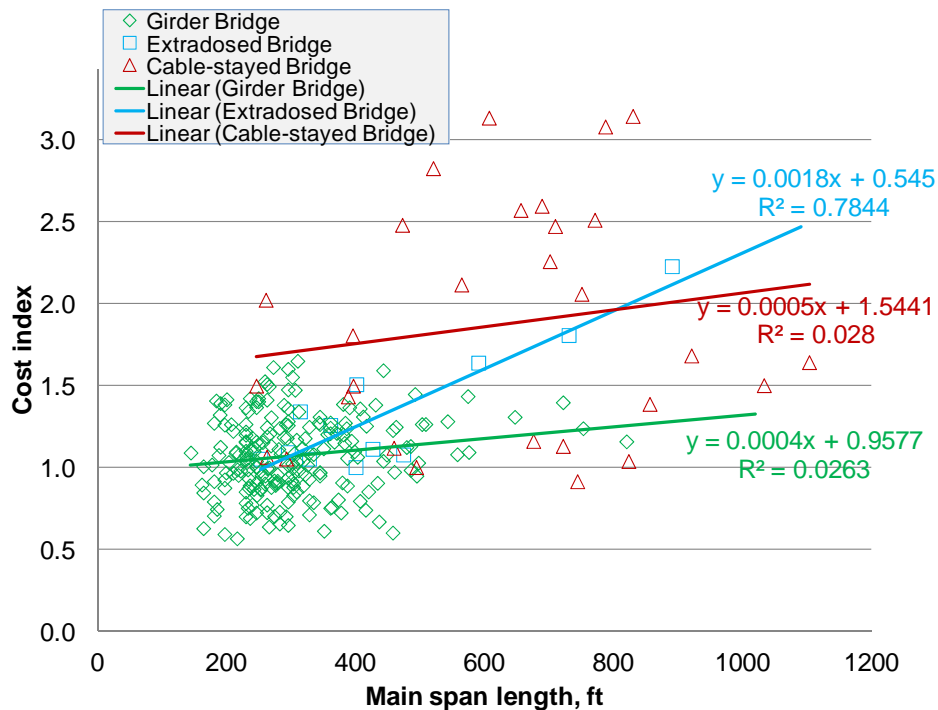

Figure 44. Cost Index of Different Types of Bridges from Sumitomo Mitsui Construction.

Note that even though construction costs of bridges are highly dependable on site conditions, the cost of bridges constructed by a same company, likely with the same setup and crews, should provide a more reliable comparison. Therefore, compared to construction costs from different sources collected through literature review and interviews, cost information collected from the two abovementioned specific companies is considered to be more representative.

An extradosed bridge generally requires a comparable amount of prestressing as a girder bridge, but a reduced quantity of concrete. If the cost of towers is excluded, the superstructure cost of an extradosed bridge can be on a par with or less than that of a girder bridge. Since concrete accounts for a significant portion of the superstructure cost, the extradosed bridge could be at an advantage in the total material cost. Due to the reduced superstructure weight and the resulting potential reduced cost of the substructure, the overall cost of an extradosed bridge construction might not necessarily be higher than that of a girder bridge and therefore could be a more cost-effective alternative.

SUMMARY

While construction of extradosed bridges spread out in different countries and different times, and each bridge was constructed under different site conditions, construction costs collected from this study were found to be highly variable. Cost information collected from selected companies with experience in building girder bridges, extradosed bridges, and cable-stay bridges showed that extradosed bridges are generally found to be less expensive than cable-stayed bridges. The information also showed that extradosed bridges could be at an advantage to prestressed girder bridges in total material costs due to the reduced quantities of concrete because of the use of extradosed cables. In addition, considering the reduced superstructure weight and potential reduced substructure cost, the overall cost of extradosed bridges is not necessarily higher than girder bridges.

CHAPTER 5. BRIDGE SELECTION PROCEDURES AND CONSIDERATIONS

COMMONLY USED BRIDGE SELECTION PROCEDURES AND CONSIDERATIONS

Bridge selection is a complicated process as many parameters need to be evaluated. Information such as span length, site geology and foundation requirements, design loads, surrounding geographical features, width requirement, clearance requirement below the bridges, transportation of construction materials, erection procedures, and construction cost and duration etc. generally need to be considered during a bridge selection process. Within all the bridge selection considerations, the two primary factors are estimated cost and constructability. As a major consideration for selecting different types of bridges, a desirable project design must meet budget requirements and also has low operation and maintenance costs. The task of construction requires an optimum amount of work and a minimum length of infrastructure closures during construction. Aesthetics consideration, on the other hand, is to have a design compatible with the surrounding community and sometimes to provide an attractive gateway. Other evaluation criteria are safety and environmental impact.

Most big bridge projects will need to go through a design-build or public-private partnership during the bidding phase. Depending on the required span, a number of different options should be considered. For example, if the span falls into a range of 400 to 1600 feet, it is very likely that an extradosed bridge will be one of the bridge types to be considered. Figure 45 shows appropriate span lengths for various bridge types. Depending on the span, a preliminary screening process can generally remove some bridge types from further consideration. However, the final decision among different alternatives (of bridges) normally requires a comprehensive analysis. While a bridge is required to fulfill its function as a thoroughfare and at the same time blend and harmonize with its surroundings, cost is generally one of the other major considerations. For example, information collected from one of the telephone interviews indicated that during the bridge type selection process of the Golden Ear Bridge, the contractor considered various options such as box girder, truss, cable-stayed, and extradosed. Eventually an extradosed bridge design was selected through a comprehensive cost comparison. The evaluation indicated that if the span is right, such as in the case of the Golden Ear Bridge, an extradosed bridge can be competitive in the cost-based analysis.

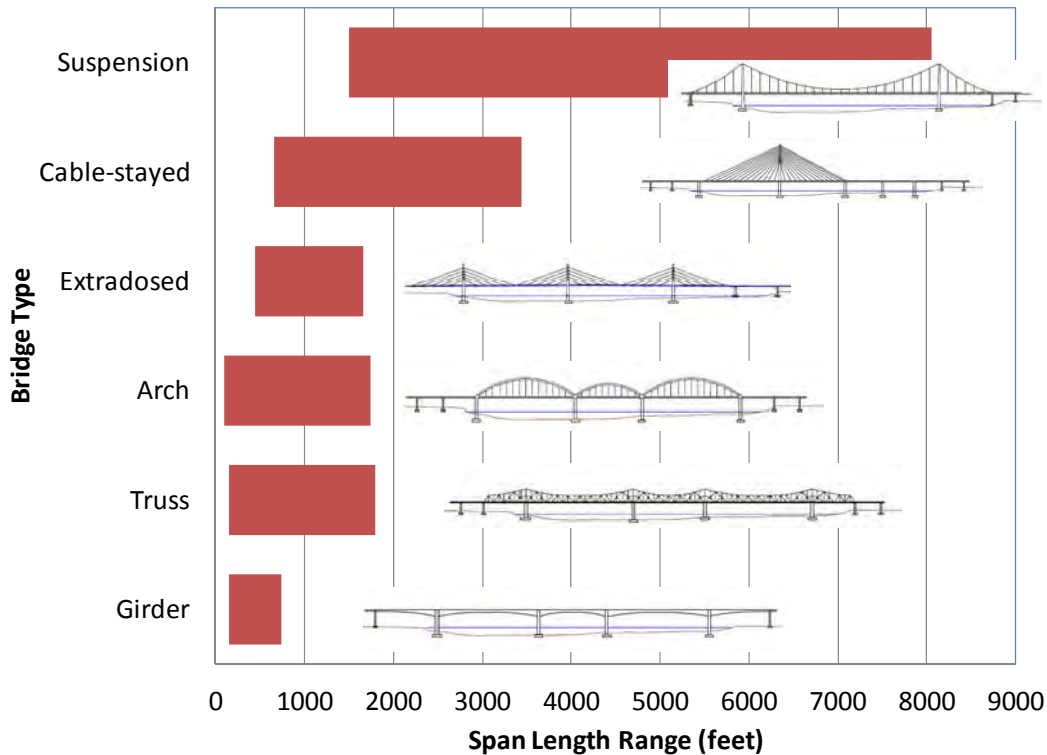

Figure 45. Span Ranges for Different Types of Bridges.

Beside the abovementioned considerations, the methods for cost-effectiveness analyses including Life Cycle Cost Analysis, Value Engineering (VE), and criteria-based bridge selection procedures that can be used for general bridge selection are summarized below.

Life Cycle Cost Analysis (LCCA)

Bridge construction involves fabrication and erection operations needed for safe and efficient building of the structures in accordance with the construction documents. Bridge maintenance, on the other hand, involves ensuring public safety, i.e., to reduce life cycle costs and earn public confidence. As shown in Chapter 4, an extradosed bridge will probably initially cost more than a conventional girder bridge, yet would cost less than a cable-stayed bridge of the same length. However, an extradosed bridge is also expected to be less expensive to maintain over a longer term basis, compared to a cable-stayed bridge. Therefore, it is important to examine the overall cost-effectiveness of extradosed bridges over other types of bridges. LCCA is a process for evaluating the total economic cost of an asset by analyzing initial costs and

discounted future expenditures, such as operation, maintenance, and repair (O, M&R) costs, and user and social costs over the service life of the asset.

While a bridge with a longer service life is generally preferable, the maintenance fee increases along with the time or use of a bridge. The LCCA methodology has some important characteristics that allow composites to be evaluated on an equal basis with existing construction materials. The method is project-based, which means that materials are compared based on costs to build typical structures, instead of measures such as “dollars per pound of material.” Costs of constructing and demolishing bridges can be obtained from the engineer who designed the bridge, and the general contractor who was awarded the bridge contract. Operation, maintenance, and repair figures can be obtained from maintenance officials. All agency costs involved in each alternative over the planning period are factored into the LCCA, potentially including the costs of design, construction, contingency and administration, right-of-way, inspection and routine maintenance, painting and repair, rehabilitation and strengthening, girder widening, complete bridge demolition and replacement. The concept of LCCA used in infrastructure is not new for TxDOT, as an LCCA program has been developed through TxDOT Projects 0-1734 and 0-1739 (Beg et al. 1998; Waalkes 1999). TxDOT is currently considering LCCA for selecting pavement alternates, i.e., rigid versus flexible pavement (Wimsatt et al. 2009).

A procedure for bridge alternatives selection could be established based on previous researches of bridge LCCA. Parameters—such as bridge span, width, depth of the valley or seabed—should be considered as factors of influence on bridge LCCA. An example of the process and basic steps of a BLCCA program, NCHRP’s Bridge Life-Cycle Cost Analysis (Hawk 2003) is illustrated in Figure 46.

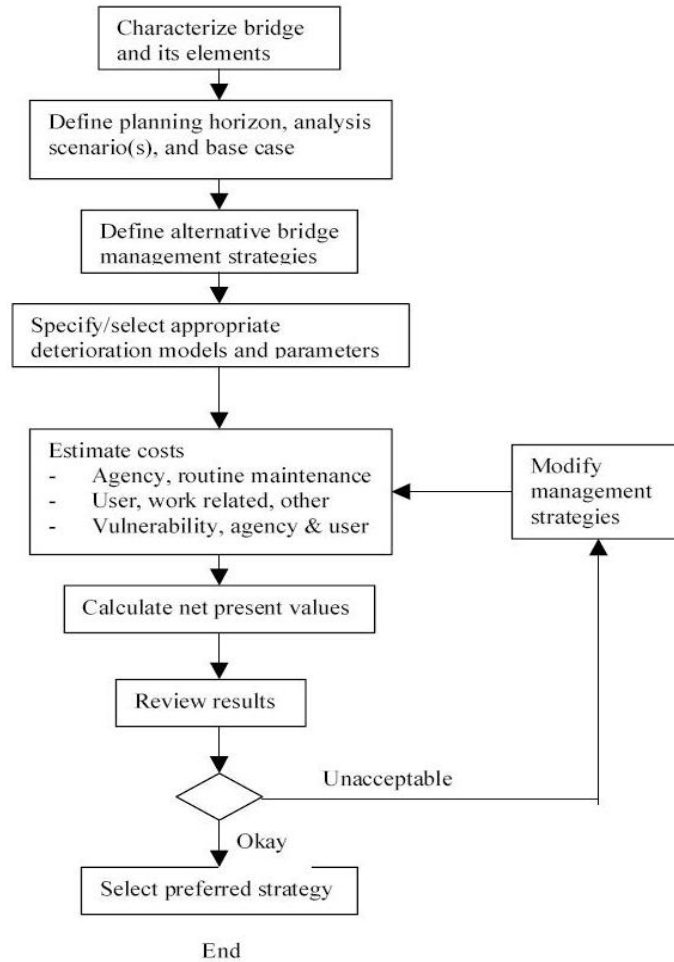

Figure 46. BLCCA Process (adapted from Hawk 2003).

A prototype of a bridge selection matrix based on LCCA can be developed accordingly. An example of a developed prototype is shown in Table 12, in which the bolded number indicates the optimum alternative based on LCCA.

Table 12. Prototype of Bridge Selection Matrix Based on LCCA with Dummy Data.

| | | Alternative A (Girder) | Alternative B (Extradosed) | Alternative C (Cable-stayed) |
|--------------------|--------------------|---------------------------|-------------------------------|---------------------------------|
| Construction Costs | Design Costs | \$3,000 | \$6,000 | \$10,000 |
| | Construction Costs | \$80,000 | \$100,000 | \$150,000 |
| O, M, & R Costs | Operation | \$10,000 | \$10,000 | \$10,000 |
| | Maintenance | \$5,000 | \$2,000 | \$3,000 |
| | Repair | \$30,000 | \$5,000 | \$0 |
| Salvage Value | Salvage Value | \$0 | \$2,000 | \$5,000 |
| Life Cycle Cost | | \$128,000 | \$121,000 | \$168,000 |

Note: All data here have been converted into Net Present Value (NPV)

It should be pointed out that the analysis of LCC is often challenging as some cost data are hard to collect; it is also difficult to provide a precise prediction of the service life of an infrastructure. While the NCHRP synthesis 483 (Bridge Life-Cycle Cost Analysis) indicated that LCCA can be a promising tool in bridge selection base on cost-effectiveness, the application of the LCCA concept in bridges is still very limited. Issues such as target reliability level, whole-life performance assessment rules, and optimum inspection-repair-replacement strategies for bridges must be analyzed and resolved from a life-cycle cost perspective. Cost estimates will probably be preliminary in nature and based primarily on historical cost data from other relevant structures. As it is difficult to completely predict the service life of an infrastructure asset, it is equally difficult to anticipate or forecast its LCC.

At present, only selected state departments of transportation are considering life-cycle cost methodologies and software with the goal of developing a standard method for assessing the cost-effectiveness of concrete bridges. As most of extradosed bridges are relatively new, it is expected that maintenance costs or estimation might not be available from contractors and agencies. Models and simulations are therefore needed to predict maintenance and repairing costs, which will inevitably further increase the difficulty in LCCA. While TxDOT is still not practically ready to adopt the LCCA concept in the bridge selection process, it clearly recognized the advantages of LCCA in the decision-making process. LCCA can be used in TxDOT bridge selection when necessary information is available in the future.

Value Engineering (VE) and Criteria-Based Bridge Selection Procedures

Bridge management is the decision-making process for selecting and prioritizing the actions necessary to maintain a bridge within acceptable limits of safety and serviceability. While the lowest agency cost option may not necessarily be implemented when other considerations such as aesthetical and cultural value, user cost, and environmental concerns are taken into account, current decision-making approaches including LCCA normally do not include indirect impact from the abovementioned considerations. A criteria-based bridge selection process was therefore developed for deciding on bridge maintenance and bridge type selection. The difference between criteria-based selection and traditional cost-based selection is that instead of comparing the exact dollar amounts (costs) that are often difficult to obtain, a grading (or ranking) system is normally developed so that input from different groups (agencies,

engineers, experts, and publics etc.) can be considered and translated into a composite score for the decision.

Value Engineering (VE) analysis (or multi-attribute ranking method) is another tool that is commonly used in alternative selection, which covers a broader area compared to an LCCA (Wilson 2005). VE is a systematic application of recognized analysis techniques normally used by a multi-disciplined team. The analysis:

- Identifies the necessary functions of a product or service.
- Establishes a monetary value or worth for that function.
- Generates alternatives through the use of creative thinking.
- Provides the necessary function reliably, at the lowest life-cycle cost consistent with performance, maintainability, safety, and aesthetics.

In addition, costs not normally included in traditional LCCA, such as performance, maintainability, safety, and aesthetics are also to be quantified and taken into account during the decision-making process. VE may be viewed as a multi-peer review of project recommendations, and it is designed to gather expertise and experiences of individuals in order to produce the most effective solution for transportation needs. Since there are different concerns caused by differing preferences, experiences, and background, a support system is generally required to enable each stakeholder to evaluate and rank solution alternatives before engaging in negotiation with the other stakeholders. The support system can be developed based on a combination of value-based analysis, multicriteria group decision making based on satisfying options, and negotiation process based on coalition formation. A VE therefore was used for bridge management decision through balanced consideration of multiple and conflicting criteria involving different decision makers, such as estate managers, project managers, and engineers (Dabous and Alkass 2008 & 2010; Utomo and Idrus 2010). Different VE programs have already been adapted by some state agencies in decision making regarding infrastructure management. Table 13 shows an example of the analysis matrix of decision of three alternatives using VE methods:

Table 13. Example of Analysis Matrix using VE Method (adapted from Basha and Gab-Allah 1991).

| Evaluation criteria | Normalized weight | Alternatives | | | | | |
|-----------------------|-------------------|--------------------------|-------|-----------------------|-------|----------------------------------|-------|
| | | Precast Concrete Girders | | Incremental Launching | | Prefabricated Steel Construction | |
| | | Rank | Score | Rank | Score | Rank | Score |
| Construction cost | 24 | 3.7 | 88.9 | 1.7 | 40.8 | 1.4 | 33.6 |
| Maintenance | 5 | 4.0 | 20.0 | 3.0 | 15.0 | 2.0 | 10.0 |
| Durability | 12 | 4.0 | 48.0 | 4.0 | 48.0 | 3.0 | 36.0 |
| Service life | 10 | 4.0 | 40.0 | 4.0 | 40.0 | 2.0 | 20.0 |
| Resource availability | 16 | 3.2 | 51.2 | 3.3 | 52.8 | 1.0 | 16.0 |
| Ease of construction | 14 | 3.0 | 42.0 | 2.0 | 28.0 | 3.0 | 42.0 |
| Progress rate | 12 | 3.4 | 40.8 | 2.6 | 31.2 | 4.9 | 57.6 |
| Design efficiency | 7 | 3.9 | 27.3 | 3.0 | 21.0 | 4.0 | 28.0 |
| Total scores | - | - | 358 | - | 277 | - | 243 |

Note: 1. Ranks are excellent = 5; very good = 4, good = 3, fair = 2, and poor = 1; 2. Score = rank × weight

A similar approach called “criteria-based bridge selection” is also used for bridge maintenance or bridge type decisions. Generally, various categories to be used in this analysis will be identified based on literature review, construction documents, collection of public opinions, and feedback from bridge engineers. A survey can be used to obtain input on the various bridge types being considered to determine weights of each category and scores from each alternative. During the bridge selection process, a set of design guidelines that represent aesthetic, environmental and context sensitive considerations is developed first. Alternatives are then to be developed based on public inputs, together with engineering, context, constructability assessments, and budgets. In order to select the appropriate bridge type, the public can also be polled on the degree of importance that should be given over different categories such as aesthetics, construction costs, maintenance, and construction impacts. Table 14 presents an example of a criteria-based bridge selection matrix that can be used for bridge selection between extradosed bridges, concrete, and steel girder bridges.

Table 14. Example of Criteria-Based Bridge Selection Matrix.

| Criteria | Concrete box girder | Steel box girder | Extradosed |
|--|---------------------|------------------|------------|
| Aesthetics | | | |
| Compatible with tram and historic district | ☹ | ☹ | ☺ |
| Pleasing views from community | ☹ | ☺ | ☺ |
| Pleasing view from gateway | ☹ | ☺ | ☺ |
| Attractive screening | ☺ | ☺ | ☺ |
| Cost | | | |
| Meets design budget | ☺ | ☺ | ☺ |
| Low operations and maintenance costs | ☺ | ☺ | ☹ |
| Construction | | | |
| Limits disruption to traffic | ☹ | ☺ | ☺ |
| Overall Evaluation | ☺ | ☹ | ☺ |

Note: ☺ High ☹ Medium ☹ Low

Instead of using the grade system of High, Medium, and Low shown in Table 14, analysts can use systems with numerical scores and weights for different criteria for a quantitative criteria-based bridge selection process. Table 15 shows an example of a potential prototype of bridge selection matrix from criteria-based bridge decisions, with the highest number indicating the best alternative.

Table 15. Example of Criteria-Based Bridge Selection Scoring System with Dummy Data.

| | Scores | | | Weight (%) |
|--------------------|------------------------|----------------------------|------------------------------|------------|
| | Alternative A (Girder) | Alternative B (Extradosed) | Alternative C (Cable-stayed) | |
| Environment impact | 60 | 70 | 80 | 10 |
| Constructability | 70 | 50 | 40 | 20 |
| Maintenance | 40 | 70 | 50 | 20 |
| Structural safety | 50 | 40 | 20 | 10 |
| Durability | 50 | 70 | 70 | 10 |
| Aesthetic | 30 | 50 | 60 | 30 |
| Composite Score* | 47 | 57 | 53 | 100 |

Note: Composite score = $\sum \text{Weight} \times \text{Individual Scores}$

ADVANTAGES AND DISADVANTAGES OF EXTRADOSED BRIDGES

In order to find the best situation to adopt an extradosed bridge design, it is important to understand the advantages and disadvantages of this type of bridge. Because of their unique structure, extradosed bridges have several positive characteristics. An extradosed bridge design lends itself to spans greater than traditional girder systems, yet less than typical cable-stayed bridges. Compared to conventional girder bridges, while longer spans of extradosed bridges

provide better navigation/vehicular clearance below bridges through a wider navigation channel, longer spans also lessen impact to the environment. Extradosed bridges are often more economical at sites with curved roadways, where conventional cable-stayed bridges would be uneconomically short due to the limited lengths of available straight spans.

Bridge aesthetics generally figure heavily into the proportioning of both superstructure and substructure elements. The girder thickness of an extradosed bridge is normally lower than that of a traditional girder bridge, thus reducing negative visual impact from the superstructure. In addition, the thinner superstructure will result in reduced self-weight of structures, which will lessen foundation costs as well as seismic loads on the substructure and foundation. Because of lower main towers in extradosed bridges (comparing to cable-stayed bridges), vertical loads are partially resisted by the main girders. Therefore, stress variations in stay cables in extradosed bridges produced by live loads are smaller than those in cable-stayed bridges. As a result, the safety factor recommended for stay cables in extradosed bridges under design loads is 1.67 (Mermigas 2008), which is the same as that for tendons in ordinary girder bridges; the number is significantly lower than the value of 2.5 as specified for cable-stayed bridges. While towers in extradosed bridges are generally lower than those in cable-stayed bridges, less efforts (and costs) in construction and future maintenance is expected. In addition, the stay cables in extradosed bridges need no tension adjustment as would be required for a conventional cable-stayed bridge, which could result in further reduction of future maintenance costs for extradosed bridges.

Table 16. Advantages and Disadvantages of Extradosed Bridges.

| | Compared to girder bridges | Compared to cable-stayed bridges |
|---------------|---|---|
| Advantages | <ul style="list-style-type: none"> • Aesthetics (tower, longer span) • Longer span • Lower girder height (and weight) • More clearance under girder • Lower self-weight and foundation costs | <ul style="list-style-type: none"> • Easier in construction and maintenance • Lower main tower (height restriction) • Less sensitive in vibration and fatigue, lower safety factor needed in design • No tension adjustment needed before service |
| Disadvantages | <ul style="list-style-type: none"> • Lack of design standards • Relatively expensive during construction | <ul style="list-style-type: none"> • Lack of design standards • Material inefficient |

Table 16 summarizes the advantages and disadvantages of extradosed bridges compared to girder and cable-stayed bridges. One major reason that extradosed bridge construction methods have not come into widespread use is the lack of specific design standards as in some

countries. As mentioned in Chapter 2, with the exception of Japan, there is no widely accepted design rule and/or code that provide design standards for extradosed bridges. The reference is available only in Japanese language. It is often challenging to revise the design of an extradosed bridge so it will conform to the local design code, owing to regulations specifying that the external cable system must not be placed on the outside of the girders. On the other hand, given the extradosed bridge's intermediate design, it is often considered as relatively expensive (compared to girder bridges) and material inefficient (compared to cable-stayed bridges). In many cases, the spans of extradosed bridges are short enough that the use of cables is more for aesthetic purposes rather than as an engineering-necessitated choice. However, this does not necessarily mean it is a bad choice; the extradosed bridge type is a very elegant form especially when the difference in cost and efficiency is small.

MAJOR REASONS FOR SELECTING EXTRADOSED BRIDGES

Through literature and interviews, bridge selection reasons for a total of 47 extradosed bridges were identified and summarized in Table 17. As shown in the table, major reasons in which extradosed bridges were selected include:

- Aesthetic consideration (signature bridge).
- Structure and construction consideration (proper span lengths, unique site conditions, and seismic consideration).
- Underneath (navigation/vehicular/hydraulic) clearance and height (aviation) restriction.
- Economic, together with compatibility and environmental considerations.

Table 17. Extradosed Bridge Selection Reasons.

| | Bridge Name | Reasons | Reference |
|----|---|---|---|
| 1 | Odawara Blueway Bridge | Lower cost, landmark structure, underneath clearance, height restriction | Mermigas 2008, Kasuga 2012, Stroh 2012 |
| 2 | Tsukuhara Bridge | Economic, aesthetic, fit with adjacent CS pedestrian bridge | Mermigas 2008, Kasuga 2012 |
| 5 | Shin-Karato (Okuyama) Bridge | Shallow depth girder spans over unstable slope | Mermigas 2008 |
| 6 | Sunniberg Bridge | Sensitive landscape, justified the increased cost, least visual impact on the idyllic Alpine view. Tall piers, emphasis on aesthetics | Mermigas 2008; Drinkwater, 2007 |
| 9 | Second Mactan–Mandaue Bridge | Height restriction from airport | Mermigas 2008 |
| 10 | Pont de Saint-Rémy-de-Maurienne Bridge | Shallow clearance over highway underneath | Stroh 2012 |
| 12 | Pakse Bridge | Long navigational span of long viaduct | Mermigas 2008 |
| 16 | Wuhu Yangtze River Bridge | Navigation clearance, aviation restriction, proper span for navigation | Fang 2002 |
| 19 | Ibi River Bridge (Ibigawa Bridge) | Economic, aesthetic, heavy prefabrication. Lightweight design, shortened construction period, design against fatigue for the stays. | Mermigas 2008, Kasuga 2012; Ikeda and Kasuga 2010 |
| 20 | Kiso River Bridge (Kisogawa Bridge) | Economic, aesthetic, heavy prefabrication. Lightweight design, shortened construction period, design against fatigue for the stays. | Mermigas 2008, Kasuga 2012; Ikeda and Kasuga 2010 |
| 21 | Miyakoda River Bridge (Miyakodagawa Bridge) | Landmark structure with good seismic resistance | Mermigas 2008 |
| 23 | Zhangzhou Zhanbei Bridge | Fit adjacent buildings, proper span for navigation, aesthetic, shorten construction period, relative low cost, use of unique site condition (island in the river) | Tang et al. 2002, |
| 25 | Koror-Babeldaob (Japan-Palau Friendship) Bridge | Navigational clearance, height restriction from airport | Mermigas 2008 |
| 27 | Shinkawa (Tobiuo) Bridge | Clearance under bridge | Mermigas 2008 |
| 28 | Tongan Yinhu Bridge | Aesthetic | Li and Zeng, 2002 |
| 30 | Deba River Bridge | Compactable with surrounding landscape, shallow clearance over highway underneath | Llombart and Revoltos 2004, Mermigas 2008 |
| 31 | Xiaoxihu Yellow River Bridge | Navigation clearance, aesthetic, height restriction, anti-sedimentation | Zhang and Kang 2002 |
| 39 | Shuqian Nanerhuan Bridge | Seismic resistance for earthquake, navigation clearance, aesthetic, signature bridge, shorten construction time | Zhang 2004 |
| 41 | Sannohe–Boukyo Bridge | Span of 200 meters to cross protected river and train line | Mermigas 2008 |
| 42 | Lishi Gaojia Bridge | Aesthetic, low cost, minimum span of 120 meters | He 2004a, He 2004b |
| 45 | Ritto (Rittoh) Bridge–Tokyo Bound | Gateway structure to reflect the cultural context of Kansai District. | Mermigas 2008 |
| 48 | Liuzhou Sanmenjiang Bridge | Navigation clearance, proper span for navigation and flood release | Bandu, 2012 |
| 55 | Fuzhou Pushang Bridge | Aesthetic, economic compared to cable-stayed bridges | Eemap, 2012 |
| 57 | Homeland (Domovinski) Bridge | Long span of viaduct to cross the river | Mermigas 2008 |

| | Bridge Name | Reasons | Reference |
|-----|---|---|--|
| 61 | Ailan Bridge | Signature bridge, aesthetic, long span to reduce number of piers, least environment impact | Ko 2008 |
| 62 | Nymburk Bypass Bridge | Navigation clearance, appropriate span | Lusas.com, 2012 |
| 63 | Puh (Puhov) Bridge | Preserve views of historical heritage, large span, thin structure, and severe restrictions on support layout, low bridge elevation and requested waterway and shipping clearance, road geometry in a sharp curvature (not allowing longer spans). | Slovenia Chapter of Engineers 2012, Makelj 2010; Makelj 2012 |
| 65 | Smuuli Bridge | Impossible to put scaffolding or pier in the middle of roadway part station | Saar 2012 |
| 67 | Second Vivekananda Bridge | Comparable to the temple on the Calcutta side, navigation clearance, height less than nearby temple | Mermigas 2008; Binns 2005 |
| 74 | North Arm Bridge | Navigation clearance, height restriction from airport, seismic consideration to decrease superstructure weight | Mermigas 2008; Scollard 2012 |
| 76 | Trois-Bassins Viaduct Bridge | Tall piers, access from one side of gorge only, harmonious to the environment | Stroh 2012; Mermigas 2008; Charlon and Frappart 2008 |
| 79 | Golden Ears Bridge | Navigation clearance, height restriction from airport, seismic consideration to decrease superstructure weight | Mermigas 2008; Scollard 2012 |
| 80 | Karnaphuli III Bridge | Geographical uniqueness, possible impact of siltation | Finical Express, 2012 |
| 82 | Husong Bridge | Aesthetic and compatible with the river | 163.com 2012 |
| 86 | Choqueyapu Bridge | Signature bridge | Sobrino 2011 |
| 89 | Povazska Bystrica D1 Motorway Viaduct | Signature bridge | Strasky 2012 |
| 90 | Teror Viaduct | The grandeur of the landscape and dimensions of the valley require a structure to provide great clearance | Skyscrapercity.com 2012 |
| 95 | Jiayue (Nanping) Bridge | Navigation clearance, aesthetic | Baidu.com 2012 |
| 96 | Tisza Bridge | Proper span and navigation clearance in flood area | Matyassy 2010 |
| 99 | Guemgang I Bridge | Construction method, environment, cost, aesthetic. Does not overshadow its neighbor. | Choi 2012, BD&E 2008 |
| 103 | Najin Bridge | Aesthetic, low maintenance, compatible to nearby buildings | cctv.com 2012, qikan.com.cn 2012 |
| 107 | New Pearl Harbor Memorial (Quinnipiac) Bridge | Aviation limitation, navigation clearance, desired span length, reasonable cost, signature bridge | Stroh 2012 |
| 109 | Ningjiang Shonghuajiang Bridge | Proper span for navigation and flood, navigation clearance, compatible to environment, aesthetic | Liu et al. 2010 |
| 113 | Saint Croix River Bridge | Signature bridge, geometric, and physical restriction | Strasky 2012 |
| 115 | Brazos River Bridge | Aesthetics requirement | Finley 2012 |

Aesthetics Considerations

According to information collected, aesthetics is often an important reason why designers and owners selected extradosed bridges. The towers of extradosed bridges provide architects and engineers room for creative yet more economically affordable designs compared to cable-stayed bridges. Many documents stated that one of the major reasons in selecting the extradosed bridge (over other bridge alternatives) is the need for a signature/landmark bridge. Ritto Bridge (Figure 47a) is one typical example of a bridge with aesthetic consideration, in which case the city needed a gateway structure to reflect the cultural context of Kansai District. The New Pearl Harbor Memorial Bridge (Figure 47b) is another example of a signature bridge.



(a). Ritto Bridge



(b). New Pearl Harbor Memorial Bridge

Figure 47. Examples of Bridges Selected for Aesthetic Reasons.

Economic Considerations

As stated in Chapter 4, initial construction cost is one of the major considerations in bridge selection. Generally, initial and future maintenance costs of extradosed bridges are considered to be higher than that of girder bridges and lower than that of cable-stayed bridges. Compared to the prestressed girder bridge, the extradosed bridge design could be at an advantage in total materials costs due to the reduced quantity of concrete. In addition, considering the reduced superstructure weight and potential reduced substructure cost, overall costs of extradosed bridges are not necessarily higher than girder bridges. According to the survey from the research team, economics is one of the major reasons that extradosed bridges were selected over other alternatives.

Height Restriction and Clearance

Comparing to cable-stayed bridges, extradosed bridges have shorter towers. The tower height of an extradosed bridge is usually around one-eighth of the main span length. In contrast, the tower height of a cable-stayed bridge is usually around one-fifth of the main span. For example, the two extradosed bridges built in Canada, North Arm Bridge (Figure 5) and Golden Ears Bridge; are adjacent to the Vancouver Airport. In order to provide a sufficient glide clearance for the airplanes, the heights of the towers are closely restricted. The height restriction therefore resulted in the selection of extradosed bridges over traditional cable-stayed bridges.



Figure 48. Example of Consideration of Aviation Restriction (North Arm Bridge).

Besides aviation restriction, some other bridges also have restrictions for different considerations. One example is the Second Vivekananda Bridge (Figure 49) constructed in India, where the bridge towers were required to be lower than the nearby temple and comparable to adjacent structures.



Figure 49. Example of Height Restriction to Fit Adjacent Structures (Second Vivekananda Bridge).

Compared to girder bridges, extradosed bridges generally have shallow structures. Girder thicknesses of extradosed bridges are usually between 6 to 13 feet, which is approximately half of the girder thicknesses of conventional girder bridges. The shallow structure can provide better clearance for the underneath traffic, either by land or waterway. The first extradosed bridge, the Odawara Blueway Bridge (Figure 50) is a good example of bridges requiring navigation clearance for boat traffic underneath the bridge. An example with a vehicular clearance requirement is the Pont de Saint-Rémy-de-Maurienne Bridge (Figure 51). The bridge was constructed above an existing roadway and a river. To avoid building piers in the road or the river, span lengths were set to be 172 feet and 159 feet, respectively, due to the unique site location. With the fixed span lengths, a girder bridge design would have much deeper girders than the extradosed bridge design, which will reduce the clearance underneath the bridge. It was also not possible to increase the elevation of the bridge or build an arch bridge to provide underneath clearance in such short spans. As a result, the extradosed bridge was the proper design in this special case.



Figure 50. Example of Bridge with Navigation Clearance Requirement (Odawara Bridge)



Figure 51. Example of Bridge with Vehicular Clearance Requirement (Pont de Saint-Rémy-de-Maurienne Bridge).

Compatibility and Environmental Considerations

Depending on their locations, many bridges built recently have significant considerations on environmental impact over bodies of water. Before Ailan Bridge in Taiwan (see Figure 52) was planned, a study was performed to evaluate the environmental impact of the bridge before construction began (Ko 2008). As extradosed bridges generally have longer spans compared to

girder bridges, the quantities of piers (in water) can be reduced, which will result in less environmental impact over bodies of water.



Figure 52. Examples of Bridges Selected due to Less Environmental Impact (Ailan Bridge).

Visual compatibility is the consideration of a bridge alternative that is compatible to adjacent structures or natural appearances, or constructed with the least visual impact or interference. The Sunniberg Bridge (Figure 53) in Switzerland is located adjacent to a ski resort. Since the beginning of the project planning stage, having a design that fits the landscape was the highest priority. The tall piers and thin girders of the extradosed bridge design provide the least visual impact on the idyllic Alpine view.



Figure 53. Example of Bridge with Low Visual Impact (Sunniberg Bridge).

Construction and Structure Considerations

Proper span length is probably one of the most important reasons that extradosed bridges are selected over other bridge alternatives. An example of long span designs that were used in crossing deep valleys or rivers is the Trois-Bassins Viaduct in France. As shown in Figure 54, the bridge crosses a deep ravine. In order to minimize the number of piers, a cable-stayed bridge design or an extradosed bridge design is preferable. Between the two alternatives, the extradosed bridge option is more competitive under similar span lengths owing to the lower construction cost, better constructability, and easier maintenance.



Figure 54. Example of Bridge with Span at Deep Valley (Trois-Bassins Viaduct).

Another reason that extradosed bridges were commonly selected is that these can provide proper spans for navigation, particularly in flood zones. An example is the Liuzhou Sanmenjiang Bridge (Figure 55). As the bridge is in a flood zone, the selection of an extradosed bridge design (over a traditional girder bridge design) can reduce quantities of piers in the water, which not only provides better a navigation clearance, but also significantly reduces the dangers of potential impact during flood season.



Figure 55. Example of Bridge with Least Navigation Interference in Flood Zone (Liuzhou Sanmenjiang Bridge).

Another reason associated with proper spans is related to the horizontal curvatures of structures. An example is the Puh Bridge shown in Figure 56. Because of the complex geometry of horizontal curvature, the span lengths of the Puh Bridge have to be reduced to match the curvature. Alternatives such as the cable-stayed bridge design therefore have become less attractive.



Figure 56. Example of Bridge with Proper Span for Curvature (Puh Bridge).

As each bridge is to be constructed at a unique site circumstance, in some cases, an extradosed bridge design might come across to be the most feasible and cost-effective alternative. An example is Zhangzhou Zhanbei Bridge (Figure 57a), which was constructed in China in 2001. As there is an island within the water path at the location of the bridge, the

extradosed bridge design turned out to be more attractive compared to the alternative of the concrete-filled steel tube arch bridge. As one of the piers sits right on the island in the river, there is only one foundation that needs excavation under the water. As a result, construction cost and duration can be significantly reduced.

Another example of how the extradosed bridge turned out to be an optimum alternative is the Deba River Bridge (Figure 57b). As one side of the bridge connects to a channel, the bridge needs to be built in a relatively low altitude in order to meet the elevation of the channel. In addition, the underneath water traffic passing capacity also needed to be assured. The extradosed bridge design that has shallow girders eventually turned out to be the ultimate design for this case (Llombart 2004).



(a). Zhangzhou Zhanbei Bridge



(b). Deba River Bridge

Figure 57. Examples of Bridge in Unique Site Conditions.

Construction consideration is one of many other reasons that may lead to decisions of constructing extradosed bridges. During the construction of the New Pearl Harbor Memorial Bridge (Figure 58), the design of an extradosed bridge has the advantage of providing appropriate span lengths through avoiding existing bridge piers, whereas the old bridge can still be of service during the period of the new bridge construction (CDOT 2012).



Figure 58. Example of Bridge with Construction Consideration (New Pearl Harbor Memorial Bridge).

Compared to a girder bridge, the extradosed bridge has a shallow structure that also provides lighter structure weight. In situations where the soil condition cannot support heavy structures, the extradosed bridge design is preferred. Other seismic considerations, such as bridges constructed in earthquake zones, also require decreased superstructure weights through the reduction of girder depth. The better seismic stability was considered one of the benefits of the final designs of North Arm Bridge and Golden Ears Bridge (Figure 59).



Figure 59. Example of Bridge with Structure Consideration (Golden Ears Bridge).

It should be noted that while the reasons for bridge selection listed above might not be complete or appropriate for other bridge types, some could also be interrelated. For example, an appropriate span range might reduce the environmental impact through the reduction of quantities of piers in bodies of water. In most cases, an extradosed bridge was selected as the ultimate design due to more than one of the reasons mentioned above. In general, there are two most common situations in which extradosed bridges are better choices than either girder bridges or cable-stayed bridges. When longer spans and thinner girder depths are needed, the extradosed type is usually surpassed by the girder bridge type. When a bridge is to be constructed in deep valleys or rivers, an extradosed bridge is generally a better choice compared to a cable-stayed bridge because of its better constructability, which in turn leads to lower cost. As a hybrid of a girder bridge and a cable-stayed bridge, the extradosed bridge design provides another option when neither girder nor cable-stayed bridges is the ultimate choice.

STATISTICS OF BRIDGE SELECTION REASONS

Results showed that while there is a variety of reasons for selecting extradosed bridges (over other alternatives), the major reasons are:

- Aesthetic considerations or needs for signature bridges.

- Underneath clearance and height restriction.
- Compatibility or environmental consideration.
- Construction and structure considerations.

Using the identified bridge selection reasons of the 47 extradosed bridges, the researchers performed a statistic analysis and the results are summarized in Figure 60. The majority (77%) of bridges have either construction or structure considerations because of the appropriate span length or unique site conditions. The analysis revealed that 60% of the bridges have considerations such as height restriction or navigation/vehicular clearance, and that 57% of the bridges were selected with aesthetic considerations, i.e., the need for a signature bridge or landmark structure. Also, it noted that 43% of the bridges were selected with compatibility and environmental considerations, and 21% of the bridges were selected with economic considerations in mind.

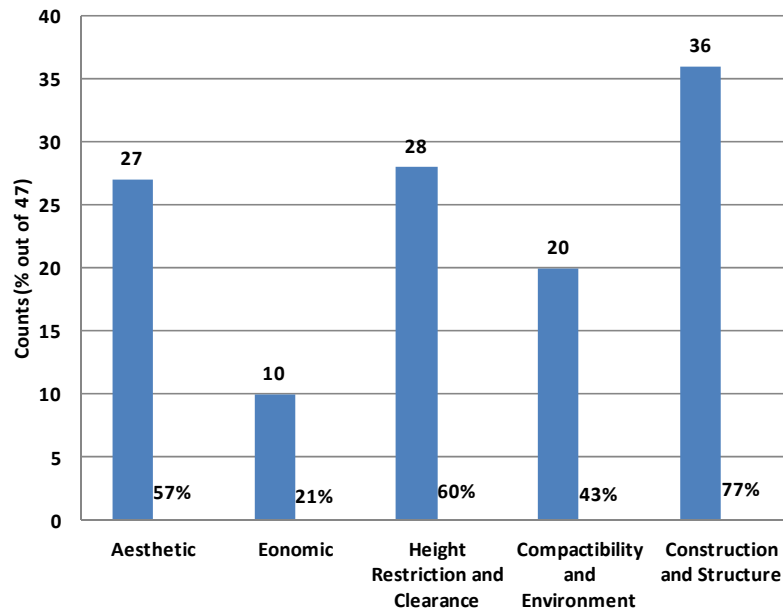

Figure 60. Statistics of Considerations in Selecting Extradosed Bridges.

As most of bridges were selected based upon multiple reasons, the percentages shown in Figure 60 referred to percentages of bridges selected with specific reasons as the only or one of the considerations. The total percentages in the figure therefore added up to over 100%. Another approach was adapted by considering partial counts for individual categories. For example, in the case of Odawara Blueway Bridge, there are four major reasons (economic, aesthetic, clearance,

and height restrictions) identified as primary reasons for bridge selection; each of them therefore counts for 0.25 in the matrix for bridge selection. These adjusted factors were then used and the distribution of bridge selection reasons is displayed in Figure 61. Similar to the results shown in Figure 60, the top three reasons for selecting extradosed bridges were aesthetics, construction and structure, and height restriction and clearance, which account for 28%, 28%, and 24%, respectively. Only 7% of the bridges are decided by economic reasons, which indicated that most of the bridges were selected without the cost consideration, or at least not as a primary consideration.

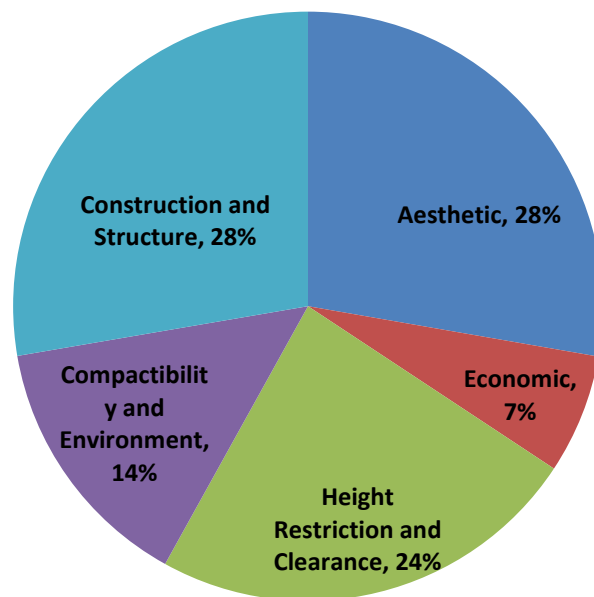

Figure 61. Summary of Bridge Selection Reasons.

CASE STUDIES FOR BRIDGE SELECTION

The selection of a final bridge alternative is typically based upon specific site conditions and many other considerations. Case studies could therefore serve as a better channel in analyzing when extradosed bridges should be selected. Four projects were identified and included as case studies. In addition to project background, information such as bridge configuration, constructability (site constraints and construction duration), and costs were collected based on literature review and data collected through surveys and interviews. Case studies were focused on how and why extradosed bridges were selected (or not selected) in specified projects. Table 18 lists the cases included in this study.

Table 18. List of Cases Included in the Case Studies.

| Bridge | Location | Year Built | Major Bridge Alternatives |
|--------------------------|-------------|------------|---|
| Sunniberg Bridge | Switzerland | 1998 | Truss, girder, extradosed |
| Zhangzhou Zhanbei Bridge | China | 2001 | Extradosed, arch, girder |
| St. Croix River Crossing | U.S. | 2014 | Extradosed, cable-stayed, girder |
| Walterdale Bridge | Canada | 2015 | Through-arch bridge, girder, extradosed, cable-stayed |

Case #1 Sunniberg Bridge

The Sunniberg Bridge was planned to be constructed in the mid-1970s. However, it did not happen until a final plan was formulated in 1996, when an extradosed bridge design was carried out. The main reason for the long planning period is the critical concern to limit the environmental impact. A proposal for the Sunniberg Bridge construction to cross the Lanquart Valley and connect to the town of Klosters was carried out in the mid-1970s. However, the initial design was rejected by the local government due to the environmental concerns (Figi et al. 1997). In 1993, the government decided to restart this project, and a design competition was conducted. The extradosed concept design was presented by a Swiss engineer, Christian Menn, and this design was finally detailed and completed by one of the companies involved in this competition (Drinkwater 2012).

Aside from the extradosed bridge design, there were four alternative designs. Design (a) is a six-span composite truss bridge with span lengths of 221.8 feet, 305.0 feet, 305.0 feet, 305.0 feet, 277.2 feet, and 249.5 feet, respectively. Design (b) is a six-span concrete cantilever bridge with span lengths of 187.0 feet, 341.2 feet, 341.2 feet, 341.2 feet, 341.2 feet, and 178.0 feet, respectively. Design (c) is a seven-span triangular composite box girder bridge with two 196.9-foot side spans and five 262.5-foot main spans. Design (d) is a nine-span continuous concrete beam bridge that contains two 155.8-foot side spans and seven 205.1-foot main spans (Drinkwater 2012). Drawings of the four designs are shown in Figure 62. In this case, the cable-stayed bridge design was not considered for several reasons. Firstly, a cable-stayed bridge has a higher cost than an extradosed bridge and a girder bridge. Secondly, the high towers of a cable-stayed bridge may break the harmony with nature. Lastly, the bridge was to be designed with a curved girder, which limited the maximum span length, and the cable-stayed bridge designed in this span range does not have advantages over other bridge types.

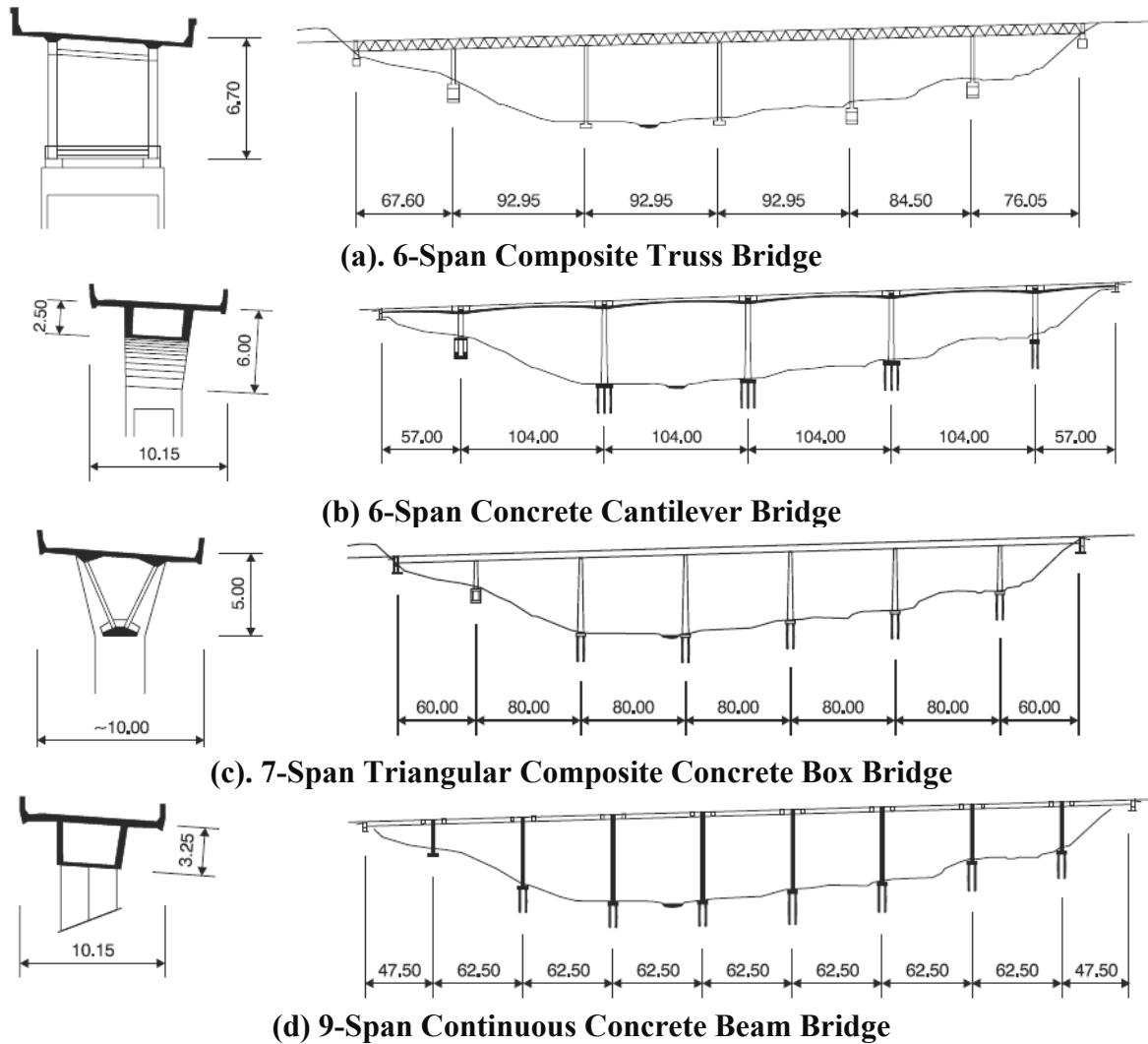

Figure 62. Alternative Designs of the Sunniberg Bridge (adapted from Drinkwater 2012).

The extradosed design of the Sunniberg Bridge has five spans with a total length of 1726 feet. The girder has a curved radius 1650 feet at an inclination of 3.2%. Lengths of five spans are 194 feet, 420 feet, 459 feet, 440 feet, and 213 feet. The girder carries two lanes with a girder width of 40.6 feet. There are eight short towers with the same height of 48.6 feet (above the girder surface). The tallest pylon is 203.4 feet high, from the valley floor to the girder surface. The center span length to tower height ratio is about 9.46:1.

Because the construction site was located near a natural resort and this bridge would be the only engineering structure in the Lanquart Valley, the local citizens of Klosters requested that the structure of bridge should be as thin and transparent as possible in order to minimize the visual impact on the natural view. The unique topography and the requirement to minimize the

construction footprint on the ecology, together with characteristics of the extradosed concept, finally led to this decision to choose an extradosed bridge design. Structural advantages of the extradosed bridge made it possible for the bridge to be designed to have longer spans, thinner girders, and fewer pylons compared to a girder bridge or a truss bridge. These characteristics fulfilled the request of less environmental impact very well. According to Drinkwater (2012), slender piers, low pylons, and transparently thin girders blended effortlessly into the magnificent Alpine landscape. When viewed from the valley floor, the narrow pier legs blended into the wooded environment, which gave an impression that the bridge has been grown rather than constructed. Additionally, because of the low pylons, the bridge is below eye level, which allows it to be obscured by vegetation and to appear unobtrusive when viewed from most locations in Klosters. Furthermore, since the bridge was to cross the wide and deep valley, fewer pylons reduced the construction cost and at the same time, minimized the environmental impact. This design perfectly met the design requirements as well as the major concerns of this project, which are aesthetics and environmental impact. The five-span extradosed bridge design (Figure 63) was finally selected and constructed because it fulfills both project functions and provides an aesthetically pleasing structure.

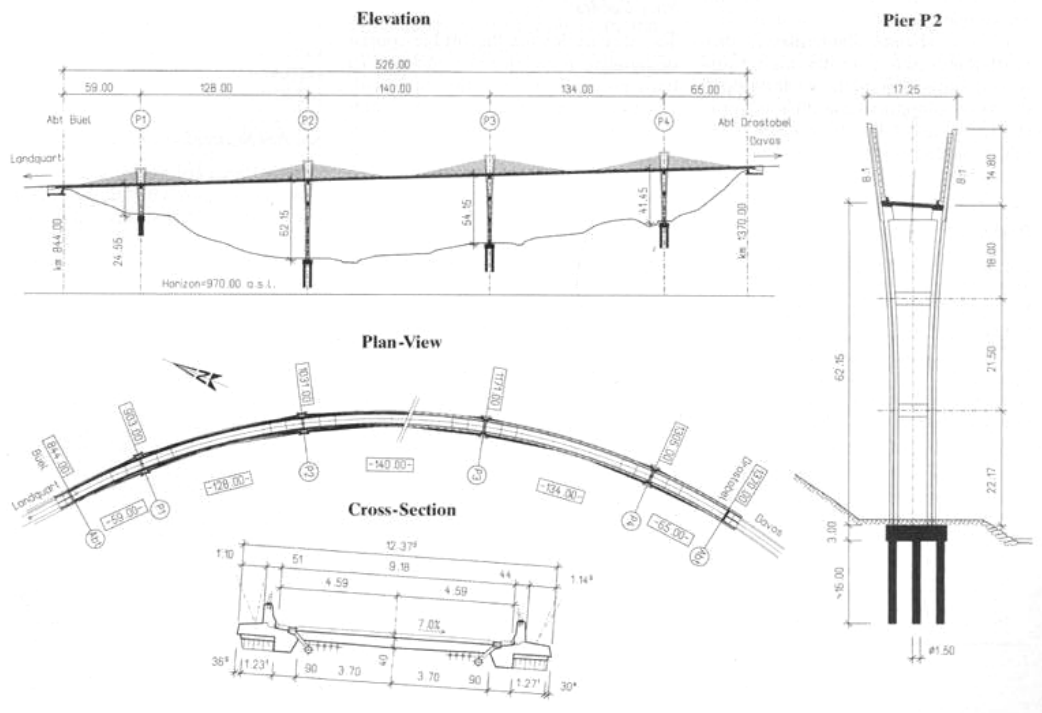

Figure 63. Final Design of Sunniberg Bridge with Extradosed Concept (adapted from Drinkwater 2012).

One disadvantage of the extradosed design is its construction cost, which was approximately 14% higher than the most economical design. However, since this bridge was part of the Klosters Bypass project, the increased cost of this bridge only resulted in a 0.5% increase in the cost of the whole project. The government believed this was acceptable and worthy (Drinkwater 2012).



Figure 64. Sunniberg Bridge (Wilhelm Ernst & Sohn 2012).

The Sunniberg Bridge was eventually constructed near Klosters in Switzerland and located in the Lanquart Valley below an international Swiss ski resort (Drinkwater 2012). The construction period of this bridge was between 1996 and 1998 (Wilhelm Ernst & Sohn 2012). The bridge is one of the largest in the Alps (Drinkwater 2012). The construction cost of this bridge is 17,000,000 1996 Swiss francs (18,601,570 U.S. dollars) (Wilhelm Ernst & Sohn 2012; Drinkwater 2012).

Case #2 Zhangzhou Zhanbei Bridge

The Zhanbei Bridge is located in Zhangzhou City, Fujian Province, China. The bridge was design to replace an old bridge at the same location that was to be demolished after the new bridge was completed. Three different types of bridges were designed as alternatives, which include a girder bridge, an extradosed bridge, and a concrete-filled steel tube arch bridge. The cable-stayed bridge design was not considered, because of the much higher cost; also, the river is not wide enough to use such a long-spanning bridge. Detailed drawings of the three alternative designs can be found in Figure 65.

The girder bridge design has five spans with lengths of 148 feet, three 233 feet (midspan), and 148 feet, with a total span length of 965 feet. The extradosed bridge design has three spans of

265 feet, 433 feet, and 265 feet, with a total span length of 963 feet. The two towers are 54.1 feet in height and eight cables go through each tower. The concrete-filled steel tube arch bridge design has three spans of 131 feet, 492 feet, and 131 feet, with a total span length of 623 feet. Suspension rods were set every 16.4 ft through the whole bridge length (Tang, 2002).

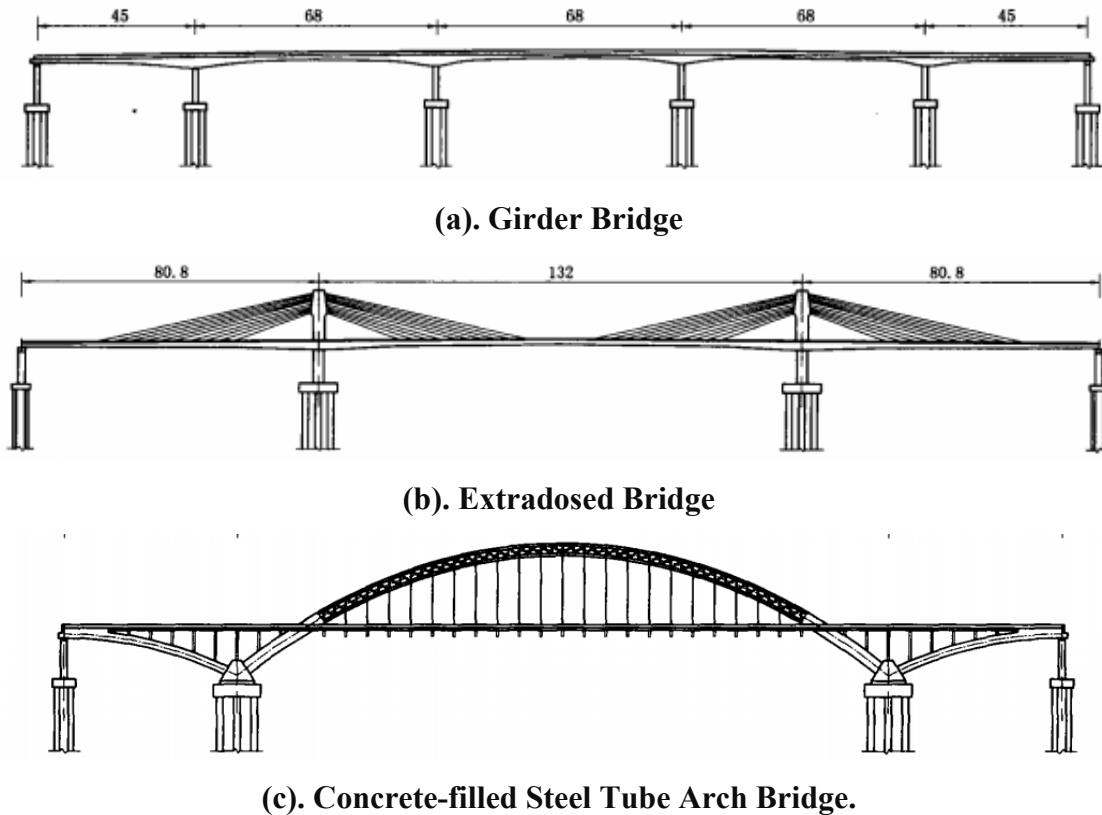

Figure 65. Alternative Designs for Zhangzhou Zhanbei Bridge.

Among the three different types of bridge designs, the girder bridge design is the easiest one to construct and has the lowest cost. However, two more piers with foundations were needed when the girder bridge design was compared to the other two designs. Because the central span is relatively small, the navigation ability is also low. Compared to the concrete-filled steel tube arch bridge, the extradosed bridge design is easier to be constructed, and at a lower cost. With the extradosed bridge design, one of the piers sits right on the island in the river. There is therefore only one foundation that needs excavation under the water, and this reduces both the cost and the construction period. The longer central span of the extradosed bridge provides a better navigation capability compared to that of the girder bridge. The towers and cables of the extradosed bridge also have a better appearance compared to the girder bridge. The concrete-filled steel tube arch bridge

design is the hardest one to be constructed, which in turn results in the highest cost as well as the longest construction period. Additionally, the high maintenance fee during the service period is another reason why this design was not favored at the very beginning of the selection process. The extradosed bridge design was eventually selected and the new bridge was built according to this design. The enhanced navigation ability, better appearance, and relatively low cost are main reasons why this design was chosen.

The part of the river where the bridge was built is 1181 feet wide and has a maximum depth of 16 feet. There is an island measuring 164 feet \times 984 feet that lies 328 feet away from the north bank of the river. As the river is used for water transportation, the central span width and the minimum clearance under the girder was one of the major considerations in bridge type selection. Another aspect that should be noted is that the new bridge piers under the riverbed have to be located to avoid the remaining foundations from the demolished bridge (Tang, 2002).

Great interest was shown to this new type of bridge as it was the first extradosed road bridge constructed in China. Comparisons between this new type of bridge and other conventional bridges have been performed. Information and data such as the material usage and the costs of this bridge are accessible. In order to have a better understanding of the advantages of the extradosed bridge, the Zhanbei Bridge was also compared to other in-use bridges with similar span lengths, including both girder bridges and cable-stayed bridges. Table 19 lists the girder depths-to-central span ratios of the Zhanbei Bridge and four other girder bridges. The extradosed bridge has a smaller girder depth. The maximum girder depth-to-span ratio of an extradosed bridge is almost half that of a traditional girder bridge (Wang, 2003).

Table 19. Configuration Comparisons of Different Bridges.

| Bridge name | Bridge type | L_m , ft | D_t , ft | D_t/L_m | D_m , ft | D_m/L_m |
|-------------------------|-------------|------------|------------|-----------|------------|-----------|
| Zhanbei Bridge | Extradosed | 433 | 12.5 | 1:34.7 | 7.9 | 1:55.0 |
| Letianxi Bridge | Girder | 410 | 25.3 | 1:16.2 | 10.5 | 1:39.1 |
| Dongming Huanghe Bridge | Girder | 394 | 21.3 | 1:18.5 | 8.5 | 1:46.2 |
| Fengpu Bridge | Girder | 410 | 23.0 | 1:17.9 | 9.2 | 1:44.6 |
| Ruanshui Bridge | Girder | 394 | 22.3 | 1:17.6 | 9.8 | 1:40.0 |

Note: In the table, L_m refers to main span length; D_m refers to girder depth at midspan; D_t refers to girder depth at tower.

The smaller girder depth of the extradosed bridge enables less material to be used, which then reduces the weight of the superstructure. The decreased requirement of the superstructure

results in reduced material consumption, labor costs, and construction period. The smaller girder depth of the extradosed bridge also shortens the bridge approach (Wang, 2003).

The towers of an extradosed bridge are generally shorter than the towers of a cable-stayed bridge. In the case of the Zhanbei Bridge, the tower height of the extradosed bridge is approximately half that of a traditional cable-stayed bridge (Wang, 2003). The lower tower height not only decreases materials consumption but also reduces the construction difficulty. For example, the technique of cable anchoring in an extradosed bridge is simpler than the anchoring technique used in a traditional cable-stayed bridge. The simpler technique allows a shorter construction period, lower requirements for skilled labor, and better construction quality.

Table 20. Materials Consumption Comparisons of Different Bridges.

| Bridge name | Bridge type | Concrete ft ³ /ft ² | Steel strand lb/ft ² | Rebar lb/ft ² | Steel cable lb/ft ² |
|------------------------------|-------------|--|------------------------------------|-----------------------------|-----------------------------------|
| Zhanbei Bridge | Extradosed | 2.46 | 5.86 | 25.11 | 3.13 |
| Letianxi Bridge | Girder | 2.95 | 9.07 | 23.21 | - |
| Dongming Yellow River Bridge | Girder | 3.08 | 11.86 | 22.65 | - |
| Fengpu Bridge | Girder | 2.99 | 14.17 | 19.56 | - |
| Ruanshui Bridge | Girder | 2.79 | 9.54 | 18.33 | - |

Table 20 shows the concrete and steel consumptions of the Zhanbei Bridge and the same four other girder bridges previously shown in Table 19 (Wang, 2003). The concrete consumption of the extradosed bridge decreased by approximately 16.7% compared to the other bridges. In addition, the rebar consumption of the extradosed bridge increased by approximately 19.6% compared to the other bridges. Even though steel cables were used only in the extradosed bridge, depending on the amount of concrete and steel used as well as their prices, the total material costs of concrete and steel in an extradosed bridge are comparable to that of girder bridges of similar length.



Figure 66. Zhangzhou Zhanbei Bridge (adapted from China.com 2012).

The construction of the Zhanbei Bridge (Figure 66) started in 2000 and was finished in 2001. The Zhanbei Bridge is the first extradosed road bridge constructed in China. Since this project was completed and put to use in good condition, the extradosed bridge design has been considered as a new alternative and a substitute for traditional girder bridges as well as other types of bridges. More than 20 extradosed bridges either have been constructed or are under construction in China since then.

Case #3 St. Croix River Crossing

The Stillwater Lift Bridge (Figure 67) is a critical crossing over the St. Croix River between Minnesota and Wisconsin. Because of the long-standing congestion and safety issues on both the Minnesota and Wisconsin sides of the bridge, a new river crossing to replace the aging lift bridge near Stillwater had been discussed for decades.



Figure 67. Stillwater Lift Bridge.

Formal efforts to revive the river crossing began in 2002. The focus of the project’s context was the visual appearance of the St. Croix River Crossing and the setting of the bridge within the Wild and Scenic River way. During the development of the supplemental final environmental impact statement (SFEIS), the stakeholders, including local, state, and federal government agencies (Minnesota Department of Transportation [MnDOT], Wisconsin Department of Transportation [WisDOT] and Federal Highway Administration [FHWA]), as well as local and national citizen organizations, have studied four “build” alternatives and a “no-build” alternative to determine a safe and efficient river crossing over the St. Croix River. Parallel with the SFEIS process, a Visual Quality Manual (VQM) was developed to outline the aesthetic values for the project. A Visual Quality Review Committee (VQRC), with member participation from stakeholder groups, was a key part of the visual quality process. In addition, the process in developing the VQM included a public open house to gather input for the aesthetic development of the bridge (URS 2012).

In addition to the no-build alternative, which was determined to be infeasible due to the obvious congestion and safety issues, four build alternatives were developed. Figure 68 shows selected examples from different alternatives; note that there could be more than one option under each alternative.

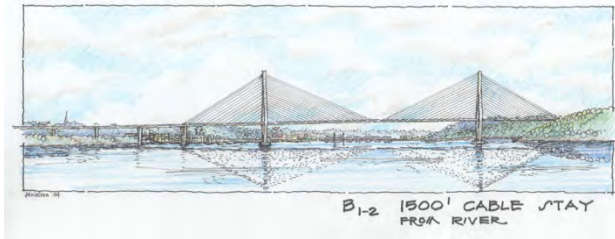

(a) B1-2–1500-Foot Cable Stay



(b) B1-3–Six 500-Foot Extradosed Box Girders



(c) B1-4–Ten 360-Foot Haunched Concrete Box Girders



(d) C2–500-Foot Concrete Girder Arch and Box Girder Approaches



(e) D1–Three 350-Foot Steel Thru Trusses



(f) D2–500-Foot Steel Bowstring Main Span with Five 250-Foot Haunched Concrete Girders

Figure 68. Selected “Build” Alternatives for St. Croix River Crossing Project Selection.

The preferred alternative was identified through a balanced decision-making process, which considered the transportation purpose and needs to provide safe and efficient mobility. During the process, environmental, economic, social, and historic resource concerns present within the project area were considered. Among all different alternatives, the St. Croix Visual Quality Review Committee and Project Team (Wisconsin DOT, Minnesota DOT, and Consultant Team) chose the B1-3 Six 500 Ft Extradosed Box Girders architectural bridge concept for further development. This concept successfully balances the engineering and functional criteria of cost, maintenance, and construction means with visual, aesthetic, and architectural project criteria. Several areas of concern were considered in identifying the optimum bridge type (visibility, height of towers, quantity of piers in the river) and the effects of piers on the natural environment, including wildlife, aquatic life, wetlands, and the Wisconsin bluffs.

The final project involves a new river crossing structure of segmental concrete construction, including 3,460 feet of extradosed spans (six 480-foot spans and two 290-foot end spans). The bridge will provide 40-foot wide roadways in each direction and a 12-foot wide pedestrian trail. The superstructure will be integrally connected to the substructure at every pier. Both a double- and a single-box girder cross section are considered viable. Under the preferred alternative, the old lift bridge will be converted to a pedestrian/bicycle facility and will be a component of a loop trail connecting Minnesota and Wisconsin via the lift bridge and new river crossing.

The new St. Croix River Crossing is characterized by three key features. The first feature is the extradosed bridge type, which is new to the United States. The second feature is the use of only two expansion joints in the long, continuous length of structure to accommodate thermal and long-term creep and shrinkage movements of the superstructure. The third feature is the emphasis on the bridge aesthetics, with particular attention paid to creating a structure with an “organic” appearance to complement the scenic river setting. The total anticipated project cost is \$299 to \$334 million (2004 dollars) with 10% to 90% bid probability and \$373 million (2004 dollars) with 100% bid probability.

Case #4 Walterdale River Bridge Replacement

The Walterdale Bridge (see Figure 69) was constructed from 1912 to 1913 with a three-span structural steel truss design. The bridge was originally designed to carry two lanes of roadway traffic and a street railway across the North Saskatchewan River in Edmonton, Alberta, Canada. Through some changes of traffic needs, the bridge currently carries two lanes of northbound traffic, along with pedestrians and bicyclists on sidewalks on both sides, and a number of utilities across the river. While the Walterdale Bridge has served Edmonton for a century and is reaching the end of its service life, a new Walterdale Bridge is needed to replace the existing bridge.



Figure 69. Existing Walterdale Bridge

In Phase I of the “Walterdale Bridge Replacement and Approach Roads Evaluation,” extradosed, arch, and cable-stayed bridge replacement alternatives were compared to a more conventional girder bridge alternative. Conceptual bridge designs for the Base Road Option were developed. The geometry and appearance of the structure will be similar for the East and West Side Road Options.

According to Peacock et al. (2011), the following are brief descriptions of the four alternatives considered:

1. A three-span girder bridge: The bridge alternative will balance economy with aesthetics at the site. A bridge with three spans requires two piers in the water that will have less impact on the river when compared to a four-span or five-span structure. An odd number of spans is generally considered to be more aesthetically pleasing, and will allow pier placement away from the middle of the river. A span arrangement of approximately 230 feet, 328 feet, and 230 feet will give the best balance between aesthetics, pier placement, and structural efficiency.
2. A three-span extradosed bridge: The bridge alternative will balance economy with aesthetics at this site. A bridge with three spans requires two piers in the water. A symmetric cable layout was chosen for this report to show a structurally efficient form. A span arrangement of approximately 197 feet, 394 feet, and 197 feet will give the best balance between aesthetics, pier placement, and structural efficiency.

3. A single span arch bridge: The bridge alternative will carry pedestrians and traffic over the river without requiring piers in the river. A symmetric arch layout with vertical hanger cables was chosen for this report to show a simple, clean form. A 787-foot span will be used, with a height of 131 feet, giving a span to depth ratio of 6. Span to depth ratios can vary; a shallower arch will have a sleeker appearance but will be less efficient structurally.
4. A single span cable-stayed bridge: The bridge alternative will carry pedestrians and traffic over the river without requiring piers in the river. An asymmetric, single-tower layout has been chosen for this report to show a simple, clean form. A 787-foot span will be used, with a tower height of 394 feet. A shorter tower could be used, but will be less structurally efficient.

Conceptual bridge designs of the four alternatives are shown in Figure 70.

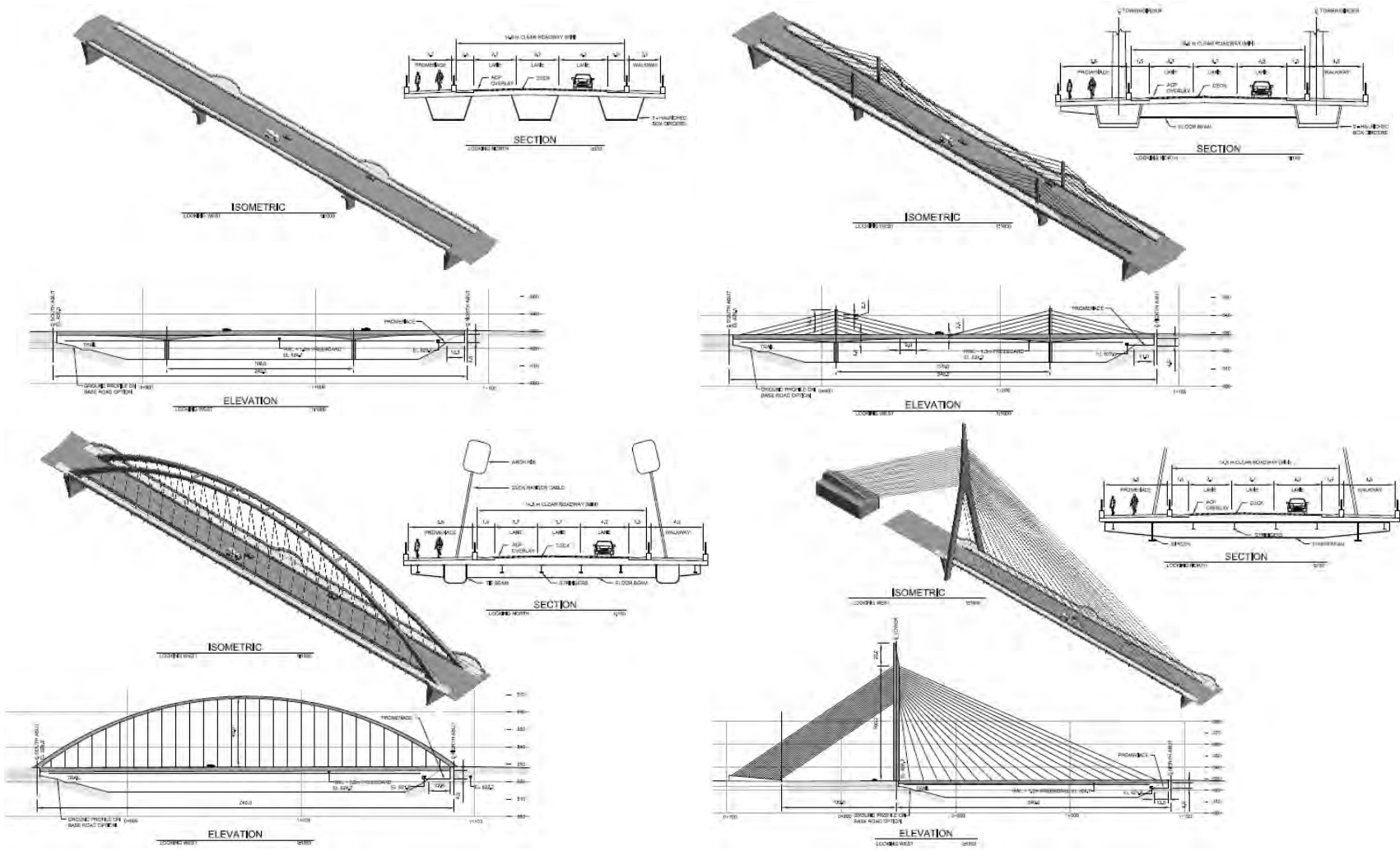

Figure 70. Alternatives of Walterdale Bridge Replacement.

In evaluating bridge replacement alternatives, the project team made reference to the following selection criteria: user experience, views, pedestrian and bicyclist movement, visual lightness, tower and piers and utilities. According to Peacock et al. (2011), the outstanding advantages and disadvantages of the four structural alternatives are as follows:

The girder alternative is economical to construct in the Alberta marketplace, and has a low profile that will have little visual impact on the river valley and adjacent structures. Since it does not rise above the roadway, the girder alternative will do little to announce the entrance to downtown Edmonton. The girder alternative will require a deeper girder than the other alternatives, which will require the approach roadways to be higher and, in turn, will also increase the footprint in the river valley. Because modern bridges in Alberta are generally constructed from girders, most people consider this alternative to be commonplace.

- The extradosed alternative has been used successfully for bridges throughout the world, with two notable examples constructed recently in Vancouver. Since the appearance is considered utilitarian, many people do not believe that this alternative will become a point of pride for the citizens of Edmonton. This alternative also has the disadvantage of requiring two piers in the North Saskatchewan River.
- The classic arch form has been used for the construction of iconic bridges since Roman times. This alternative pays homage to the existing bridge, and relates well to the river valley and the adjacent low level and high level bridges. With arches that rise above a slender girder, this alternative will become the gateway to downtown and a point of pride for the citizens of Edmonton if properly designed. To avoid having piers in the river, a single arch span between the south and north banks was proposed. Because the erection requires care and attention on the part of the contractor, the cost of an arch bridge will be in the range of 10 to 20% more than other functional signature bridges.
- In the past 30 years, cable-stayed bridges have been constructed throughout the world. By virtue of a high tower on the south bank and a slender girder, this alternative has the potential to become a signature structure in and of itself. However, many people believe that this alternative will overwhelm the river valley and detract from the surrounding facilities. The backstay cables and tie-down required for this

alternative on the south bank have the potential to complicate the design and construction of the approach roadways.

Table 21 presents the selected comparison of the girder, extradosed, arch and cable-stayed alternatives to replace the existing bridge from consideration of the evaluation criteria.

Table 21. Comparison of Different Alternatives of Walterdale Bridge Replacement.

| | Girder | Extradosed | Arch | Cable-Stayed |
|---------------------------------|--|--|--|--|
| Profile | Low profile | Higher profile than girder; girder more slender | Girder very slender; arch quite prominent | Girder very slender; tower about 3 times higher than high level bridge |
| Impact on river | Two piers in river; removal of existing piers | Two piers in river; removal of existing piers | No piers in river; removal of existing piers | No piers in river; removal of existing piers |
| Constructability | Common bridge type. Segmental construction required. | Less common bridge type; more complex than girder | Arch erection complex Requires well-thought-out girder erection procedures | Very tall tower Requires well-thought-out girder erection procedures |
| Capital cost | Lowest | Medium | Highest | Medium |
| Operating and maintenance costs | Lowest | Careful detailing will be required to reduce cable maintenance costs | Careful detailing will be required to reduce cable maintenance costs; requires upkeep if paint is used for steel arch ribs | Careful detailing will be required to reduce cable maintenance costs; expensive to work at heights when maintaining bridge |
| Life cycle cost | Lowest | Medium | Highest | Medium |

Table 22 tabulates preliminary cost estimates for the various bridge alternatives in 2011 dollars. Costs are for the complete construction of the bridge structures including the superstructure, towers, piers, and abutments, but not including the approach fills, ramps, retaining walls or other structures required to bring the roads, pedestrians, and bicyclists to the new bridge.

Table 22. Capital Costs of Different Alternatives in Walterdale Bridge Replacement.

| Bridge Alternatives | Bridge Area (ft ²) | Unit Cost (\$/ft ²) | Cost | 30% Contingency | Construction Cost | 15% Eng. and Admin | Project Cost |
|---------------------|--------------------------------|---------------------------------|--------|-----------------|-------------------|--------------------|--------------|
| Girder | 60,278 | 604 | \$36.4 | \$10.9 | \$47.3 | \$7.1 | \$54.4 |
| Extradosed | 60,278 | 743 | \$44.8 | \$13.4 | \$58.2 | \$8.7 | \$66.9 |
| Arch | 60,278 | 929 | \$56.0 | \$16.8 | \$72.8 | \$10.9 | \$83.7 |
| Cable-Stayed | 61,892 | 836 | \$51.8 | \$15.5 | \$67.3 | \$10.1 | \$77.4 |

Note: All costs are in millions

Table 23 tabulates life cycle costs for the various bridge alternatives over a 50-year period (assuming a 75-year lifespan). In preparing the life cycle cost analyses, it was assumed that minor bridge maintenance will be undertaken every five years, and major rehabilitation will be needed every 25 years. Minor rehab will include concrete sealer and cable inspections. Major rehab includes the work completed in a minor rehabilitation plus steel coating replacement, girder rehabilitation, and cable repairs. A discount rate of 4% was assumed. The total residual value includes 15% engineering and administration costs.

Table 23. Life Cycle Costs of Different Alternatives in Walterdale Bridge Replacement.

| Bridge Alternatives | Bridge Area (ft ²) | Minor Rehab (Every 5 yrs) | Major Rehab (Year 25) | Major Rehab (Year 50) | 50-Year PV Total + Residual |
|---------------------|--------------------------------|---------------------------|-----------------------|-----------------------|-----------------------------|
| Girder | 60,278 | \$1.5 | \$5.0 | \$7.0 | \$55.1 |
| Extradosed | 60,278 | \$2.5 | \$7.0 | \$9.0 | \$68.4 |
| Arch | 60,278 | \$2.5 | \$10.0 | \$12.0 | \$86.0 |
| Cable-Stayed | 61,892 | \$2.5 | \$7.0 | \$9.0 | \$78.4 |

As shown in Table 22 and Table 23, both capital and life cycle costs of the extradosed bridge design were calculated to be relatively low among the four alternatives. Regardless of the highest cost, as the study progressed in Phase 2, a through-arch bridge was selected as the preferred alternative. This alternative will carry three lanes of northbound traffic on the alignment of the approved roadway option, which is located to the east of the existing bridge. Although any of the four alternatives considered can be designed to be a signature functional bridge, from consideration of the advantages and disadvantages of each we recommend that the arch alternative be used for the Walterdale Bridge replacement. The bridge is currently scheduled for replacement. Construction is scheduled to begin in early 2013, and will continue through 2015. The old bridge is scheduled to be removed from 2015–2016.

RECOMMENDED BRIDGE SELECTION PROCEDURE AND CONSIDERATIONS

Based on information as summarized in previous sections, the bridge selection process can be a complicated process with considerations including engineering requirement, site condition, constructability, structure, aesthetic, economic, compatibility and environment impact, and other potential policies and considerations. As different bridges will have different considerations, it is practically impossible to provide a standard bridge selection process according to findings from the study. Table 24 shows bridge selection preferences under different considerations recommended by the research team. Noted that the table is developed based upon selection among a girder bridge, an extradosed bridge, and a cable-stayed bridge; some other less common bridge type such as truss and arch bridges are not considered here. In the table, while “No” generally indicated the alternative should be eliminated from the consideration, there are 1st, 2nd, and 3rd levels of preference under the category, with 1st indicated as the most preferable alternative and 3rd indicated as the least preferable alternative.

Table 24. Recommended Bridge Selection Preferences under Different Considerations.



| | |  |  |  |
|-------------------------|------------------------------|--|--|--|
| Engineering Requirement | Span <400ft | 1st | 2nd | No |
| | Span 400 to 600ft | 1st/2nd | 1st/2nd | No |
| | Span 600 to 1200 ft | No | 1st/2nd | 1st /2nd |
| | Span >1200 ft | No | No | Yes |
| Site Condition | Require Navigation Clearance | 3rd | 2nd | 1st |
| | Height Restriction | 1st | 2nd | 3rd |
| | Sharp Curves | 1st | 2nd | 3rd |
| Structure Consideration | Seismic Consideration | 3rd | 2nd | 1st |
| Aesthetic Consideration | Signature Bridge | 3rd | 2nd | 1st |
| Other Considerations | Economic | 1st | 2nd | 3rd |
| | Environment Impact | 3rd | 2nd | 1st |

Figure 71 provided a recommended flowchart for the bridge alternatives selection process. There are many different considerations included in the selection process. In order to provide a clear flowchart, instead of providing a flowchart with specific alternatives, the figure presents preferred bridge alternatives. Generally speaking, it is recommended to have *engineering requirements*, i.e., main span range as the first parameter to be considered. While a girder bridge

is likely to be the most appropriate alternative for a shorter main span length (particularly those less than 400 feet), a cable-stayed bridge is more appropriate for a longer main span (particularly those more than 1200 feet). All three alternatives are feasible for spans ranging between 400 and 1200 feet.

Site condition is the next major factor to be considered in the recommended bridge alternatives selection process. In a situation where the navigation clearance is required (i.e., either a wider space between the bottom of the girder or longer spans for navigation is needed), a girder bridge often becomes not appropriate due to the thicker girder and shorter span. Height restriction, either due to limits of aviation or adjacent building heights, will usually lead to the elimination of the cable-stayed bridge alternative. Sharp curves due to specific site condition, on the other hand, will make the cable-stayed bridge alternative not feasible due to the longer span length.

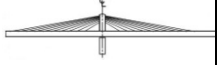
Structure considerations, such as the need to reduce superstructure weight due to the seismic consideration in earthquake zones, could lead to the elimination of the girder bridge alternative.

Aesthetic considerations, such as the need for signature bridges, normally lead to either extradosed bridges or cable-stayed bridges. Other considerations, such as *economic*, and *environment impact* (e.g., the need of less piers in bodies of water) could also lead to the selection among different alternatives. While a girder bridge is normally the most cost-effective option, especially in shorter spans, the alternative could also lead to less compatibility and/or higher environmental impact.

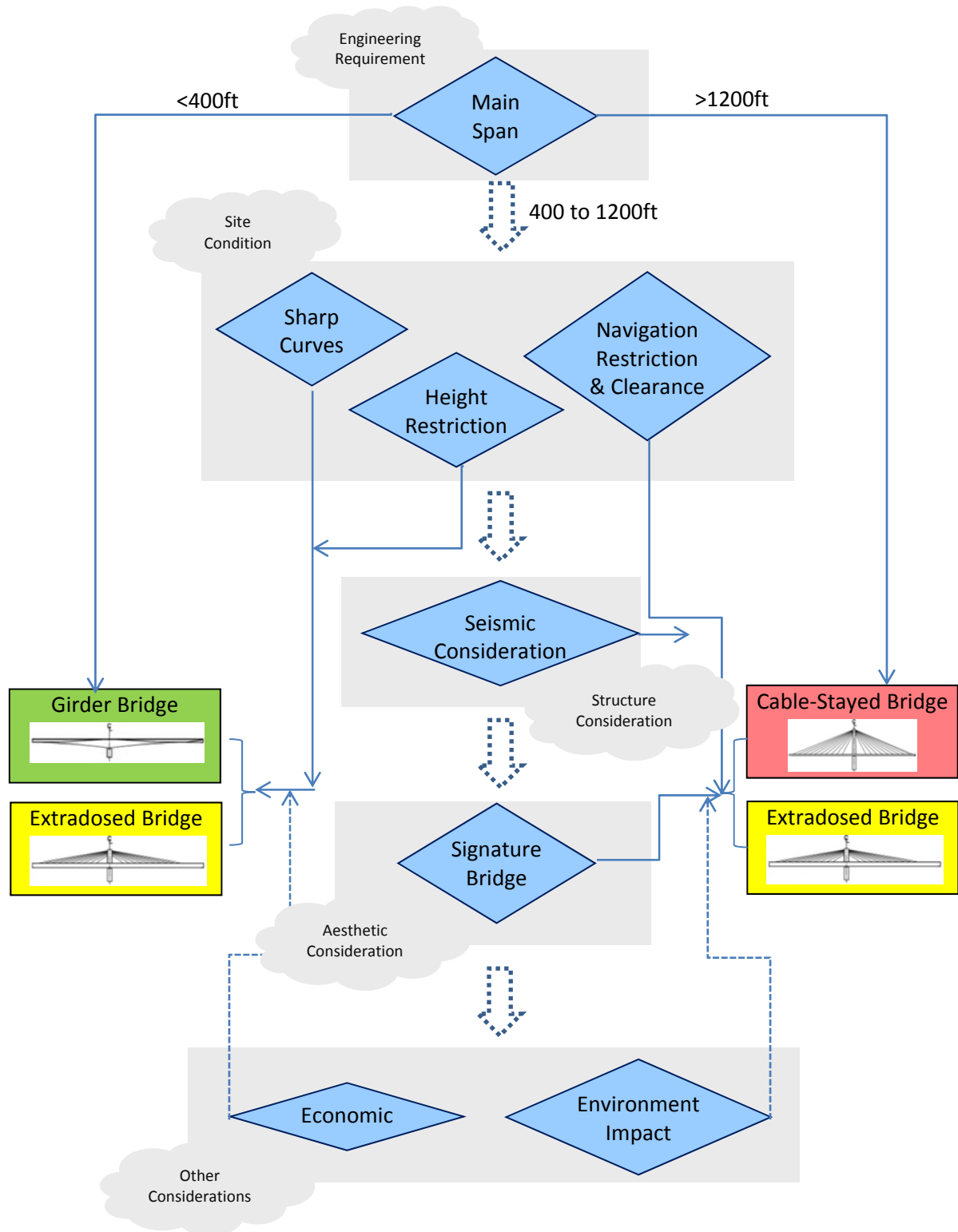

Figure 71. Recommended Bridge Selection Process Flowchart.

SUMMARY

Besides the initial construction costs comparison, life cycle cost analysis (LCCA), value engineering (VE), and criteria-based bridge selection procedures are commonly used in a bridge selection process. While there are various advantages and disadvantages noted when extradosed bridges were compared to girder bridges and cable-stayed bridges, in the long run, aesthetic (signature bridge and landmark structure), underneath clearance and height restriction, and construction and structure considerations were identified as the top reasons for selecting the extradosed bridge over other alternatives. The process of bridge selection should be a combination of considerations of needs from the public (owners), cost-effectiveness, jobsite condition, and site restrictions. While bridge selection is a complicated process with many factors and considerations to be taken into account, span range is usually served as the preliminary criterion to screen out bridge type alternatives. Other considerations including aesthetic, constructability, and environmental impact can all be weighed in the decision. The research team developed the recommended bridge type selection procedure. It proposes using such considerations as engineering requirement, site conditions, structure considerations, aesthetic consideration, etc. in screening bridge alternatives.

CHAPTER 6. CONCLUSIONS AND RECOMMENDATIONS

CONCLUSIONS

Through a team review of over 350 technical papers, reports, and websites, a total of 120 extradosed bridges from Asia, Europe, North America, South America, and Africa was identified. A comprehensive literature survey was conducted to summarize status, structural features, costs, and major reason(s) in selecting extradosed bridges. Interviews of eight experts with experience in extradosed bridge design and construction were conducted to better understand extradosed bridges. Questions related to bridge construction, reasons for bridge selection, cost of construction, advantages and disadvantages, and maintenance and repair were included in the interview. The following conclusions can be made from the study:

- The extradosed bridge is a hybrid design with the girder directly supported by resting on part of the tower while cable stays act as prestressing cables for a concrete girder. The basic role of cables in an extradosed bridge is to provide horizontal prestress to the girder instead of developing elastic vertical actions, as is the case of traditional cable stays. In addition to those commonly used cable-stayed bridges, girder bridges, arch bridges, and truss bridges, the unique configuration of extradosed bridge provides an alternative for bridge selection;
- While there is no widely accepted definition of extradosed bridges, according to a statistics analysis from data of extradosed bridge configurations collected through literature review, it is recommended to use Ogawa's and Kasuga's definition of an extradosed bridge by the stiffness ratio (load carried by stay cables divided by total vertical load) of less than 30%.
- All extradosed bridges identified from the study were found to be using the free balanced cantilever construction method. Even though there is no specific data to support the maintenance cost and effort of maintaining extradosed bridges, these are not expected to be higher compared to typical cable-stayed bridges.
- As construction of extradosed bridges spreads out in different countries and different times, and each bridge was constructed under different site conditions, construction costs collected from this study were found to be highly variable. Additional cost analyses were performed with cost information collected from companies with experience in girder bridges, extradosed bridges, and cable-stayed bridges. Results showed that while an

extradosed bridge is generally found to be less expensive compared to a cable-stayed bridge, the extradosed bridge could be at an advantage to the prestressed girder bridge in total materials cost due to the resulting reduced quantity of concrete when extradosed cables are used. In addition, due to the reduced superstructure weight and the resulting reduced substructure costs, the overall cost of constructing an extradosed bridge might not be necessarily higher than a girder bridge and therefore could be a more cost-effective alternative.

- While bridge selection is a complicated process with many factors and considerations to be taken into account, span range is usually served as the preliminary criteria to screen out bridge type alternatives. Besides cost analyses (both initial construction costs and life cycle costs), value engineering (VE) and criteria-based bridge selection procedures are commonly used in the bridge selection process. While there is a variety of advantages and disadvantages comparing to girder bridge and cable-stayed bridges, aesthetic (signature bridge and landmark structure), underneath (navigation) clearance, and proper span lengths were identified as the top reasons for selecting the extradosed bridge over other alternatives.
- The process of bridge selection should combine a consideration of needs from the public (owners), cost-effectiveness, and jobsite condition and restrictions. The research team recommended a bridge alternatives selection procedure whereby parameters including engineering requirement, site conditions, structure considerations, aesthetic and other considerations are to be used in screening bridge alternatives.

RECOMMENDATIONS

The following recommendations were made based on the data collected and knowledge obtained from the present research work:

1. As the extradosed bridge is still a relatively new concept, one of the major challenges of constructing this type of bridge is the lack of specifications for bridge design. With the exception of Japan, there are no widely accepted design rules in the codes that provide design standards for this bridge type. The Japanese design code (*Specifications for Design and Construction of Cable-Stayed Bridges and Extradosed Bridges*) is available only in Japanese language and the method does not define the extradosed bridge; rather, it provides a transition between an extradosed bridge cable and a stay cable. A bridge design specification or guideline is needed for engineers to better understand and utilize this new type of bridge.
2. While the process of bridge selection can be a combination of considered needs from the public (owners), cost-effectiveness, and jobsite condition and restrictions, the recommended bridge type selection procedure that the research team developed can only serve as a preliminary guideline for bridge selection (with regard to extradosed bridges). A detailed and comprehensive bridge selection procedure with consideration of life cycle cost analysis (LCCA), value engineering (VE) and criteria-base bridge selection procedures could be beneficial to TxDOT.

REFERENCES

1. 1000 Friends of Waco, *Brazos River Bridge Hearing this Thursday*, February 1, 2011. <http://www.1000friendsofwaco.com/?p=243>. Accessed February 15, 2012.
2. 114NEWS, *Hemaxi Technique Study Passing China Railway Company Examination*, <http://www.114news.com/build/index.html>, Accessed April 29, 2012. [in Chinese]
3. 123RF Limited, *South bridge in Riga Over the Daugava River*. http://www.123rf.com/photo_9949352_south-bridge-in-riga-over-the-daugava-river.html. Accessed February 15, 2012.
4. 163.com, *Zhuzhou Lusong Bridge Technology Radiate Splendor*, <http://a4367007.blog.163.com/blog/static/53124422200910803635990/>, Accessed October 28, 2012. [in Chinese]
5. A2C03: Committee on Concrete Bridges, Concrete Bridges. In *Transportation Research Board's Transportation in the New Millennium: State of the Art and Future Directions*, Perspectives from Transportation Research Board Standing Committees, 2000
6. AASHTO, *Guidelines for Value Engineering 1987*, American Association of State Highway and Transportation Officials, Washington, D.C., 2001.
7. ABES Wagner & Partner ZT-GmbH, *Smuuli Bridge*, <http://www.abes.at/eng/portfolio/bridges/smuuli.htm>. Accessed February 15, 2012.
8. AEC-INC.JP, *The Project for Construction of Naluchi Bridge, Muzaffarabad*, <http://www.aec-inc.jp/index-6-06E.htm>, Accessed October 28, 2012.
9. AECCAFE, *Third Karnaphuli Bridge, Bangladesh*, <http://www10.aeccafe.com/blogs/arch-showcase/2011/02/02/third-karnaphuli-bridge-bangladesh/>, Accessed October 28, 2012.
10. Adesanya, A., *Frontage Bridges to Enhance Downtown, I-35*. The Baylor Lariat, February 4, 2011. <http://baylorlariat.com/2011/02/04/frontage-bridges-to-enhance-downtown>, Accessed June 25, 2012.
11. Akita, *Kanisawa Bridge – Extradosed Bridge (Span 180.0m) – in Akita Prefecture*, http://www.ce.akita-u.ac.jp/album/2007/album_0701a_e.htm. Accessed April 22, 2012.
12. Alpine, *Domovinski Most Zagreb*, <http://www.alpine.at/en/bereiche/bruckenbau/domovinski-most-zagreb-hrdomovinski-most-zagreb-hr/>. Accessed February 15, 2012.
13. Al-Wazeer, A., Harris, B., and Nutakor, C., Applying LCCA to Bridges, *Public Roads*, Vol. 69, No. 3, 2005.
14. Anderson R., *Use of High Performance Concrete in the Seismic Design of the New Pearl Harbor Memorial Bridge*, Presented at ACI Fall 2011 Convention, Pittsburg, 2011.
15. BMEMA.org, *Anhui Hailuo Group Co., Ltd., Wuhu Yangtze River Bridge*, <http://www.bmemma.org/user/shili2.asp?pid=20>. Accessed April 22, 2012. [in Chinese]
16. Astin, D. Design of the Third Karnaphuli Bridge. In *IABSE-JSCE Joint Conference on Advances in Bridge Engineering-II*, August 8, 2010a, pp. 257-265.
17. Astin, D., H. Xye, and A. Gillarduzzi. Design and Construction of Third Karnaphuli Bridge, Bangladesh. *Bridge Engineering*, Vol. 163, No. 4, December 2010b, pp. 161-171.

18. Autohome.com.cn, *New Bridge to Cross Han River - Sanguanjiang Bridge to Construct*, <http://www.autohome.com.cn/news/201202/296045.html>, Accessed October 28, 2012. [in Chinese]
19. Baidu, *Ankang Qiligou Hanjiang Bridge*, <http://baike.baidu.com/view/2281634.htm?fromTaglist>. Accessed February 15, 2012. [in Chinese]
20. Basha, I.M, and A.A. Gab-Allah, Value Engineering in Egyptian Bridge Construction, *Journal of Construction Engineering and Management*, Vol. 117, No. 3, 1991.
21. Beg, M.A., Z. Zhang, and W.R. Hudson, *A Rational Pavement Type Selection Procedure*, TxDOT Project Report 0-1734-S, 1998.
22. BBG.CO.KR, *Hwangdo Bridge*, www.bng.co.kr, Accessed July 20, 2012. [in Korean]
23. Becze, J., and J. Bartz, Korong Prestressed Extradosed Bridge, *Structures Engineering Internal*, No. 1, 2006.
24. Benguela, http://benguela.zzl.org/catumbela_bridge.html. Accessed April 24, 2012.
25. Benjumea, J., G. Chio, and E. Maldonado, Structural Behavior and Design Criteria of Extradosed Bridges: General Insight and State of the Art, *Revista Ingenieria de Construccion*, Vol. 24, No. 3, 2010.
26. Bergman, D., D. Radojevic, and H. Ibrahim. Design of the Golden Ears Bridge. *IABSE Report*, No. 93, 2007, pp. 58-61.
27. Bergman, D., A. Griezic, and C. Scollard, *Custom Fit. Civil Engineering*, Vol. 79, No. 8, 2009, pp. 64-71.
28. Bilfinger Berger Ingenieurbau GmbH, *Goldfinger Bridge*, <http://www.civil.bilfinger.com/>, Accessed February 15, 2012.
29. Binns, J. Extra-Dosed Bridge Distinguishes Tollway Project in India, *Civil Engineering News*, 2005, pp. 20.
30. BJTZS, *Tongzhou will start Building a Fifth Bridge Across Canal Bridge (Tentative planned to be completed in October next year)*, <http://www.bjtzs.gov.cn/html/xinwenzixun/20061231/257.html>, Accessed October 28, 2012. [in Chinese]
31. BlogSpot.com, *Sannohe Suspension Bridge*, July 26, 2011, <http://shari-willinglylostinjapan.blogspot.com/2011/07/sannohe-suspension-bridge.html>. Accessed April 22, 2012.
32. BNAMERICAS, Business News Americas, *Border Bridge Expected to Open Nov*, Business News Americas, August 9, 2005. http://www.bnamericas.com/news/infrastructure/border_bridge_expe... Accessed June 21, 2012.
33. Bridgeworld.net, *Seiun Bridge*, <http://bridgeworld.net/seiun-bridge/>, Accessed October 29, 2012. [in Korean]
34. Brinckerhoff, P., *St. Croix River Crossing Preliminary Engineering Concept Refinement Report*, 2010.
35. Buckland & Taylor Ltd., Design Build of the Canada Line's River Crossing- The North Arm Bridge. *Canadian Consulting Engineer*, Vol. 49, No. 6, 2008, pp. 40-42.
36. Buckland & Taylor Ltd., Pearl Harbor Memorial Bridge. *Worldwide Bridge Engineering*, June 2011. <http://www.b-t.com/menu/project/bridgesbytype/extradosedbridges/Pages.aspx>. Accessed June 7, 2012.

37. Buckland & Taylor. Design and Construction of the Main Span of the Golden Ears Bridge, June 2011. Ltd., <http://www.b-t.com/menu/project/designbuild/Pages/Golden-Ears-Bridge.aspx>. Accessed February 15, 2012.
38. Buckland & Taylor Ltd., *North Arm Bridge*, <http://www.b-t.com/menu/project/designbuild/Pages/North-Arm-Bridge.aspx>. Accessed February 15, 2012.
39. Buyric. *Golden Ears Bridge- Costing \$5 Million More a Year Than Expected*. June 2, 2010. <http://www.buyric.com/news/2010/06/golden-ears-bridge-costing-5-milli...> Accessed February 15, 2012.
40. B-T.COM, *Pearl Harbor Memorial Bridge*, <http://www.b-t.com/menu/project/bridgesbytype/extradosedbridges/pages/pearl-harbor-memorial-bridge.aspx>, Accessed October 28, 2012.
41. Cai, W., Z. Zhou, and T. Lei, Main Bridge Constriction General of Zhangzhou War Preparation Bridge, *Bridge Construction*, 2002.
42. ABC.es, *El viaducto acorta 1,5 kilometros el trayecto de Teror a Las Palmas*, <http://www.abc.es/20101221/comunidad-canarias/viaducto-acorta-kilometros-trayecto-20101221.html>. Accessed February 15, 2012. [In Spanish]
43. CCTV.com, <http://jt.cctv.com/html/>, Accessed June 20, 2012. [in Chinese]
44. Ceci.com.tw, *Taiwan No. 9 Road Improvement Plan*, <http://hipcm.ceci.com.tw/public/home.aspx?pd=p00025&ID=cnb1>, Accessed October 28 2012. [in Chinese]
45. CEI Report. Golden Ears Bridge Vancouver, Canada. *Concrete Engineering International*, Vol. 44, No. 3, 2010, pp. 30-32.
46. CH2M HILL, <http://www.ch2m.com/corporate/markets/transportation/highways-bridges.asp>. Accessed February 15, 2012.
47. Charlon, P., and J. Frappart. Ravine des Trois Bassins Bridge in La Reunion Island. A Successful Application of Extradosed Prestressing. *Tailor Made Concrete Structures*, 2008, pp. 1147-1148.
48. Chen, C., H. Zhou, and R. Xiao, Recent development of Extradosed Bridges, *World Bridges*, No. 1, 2006.[in Chinese]
49. Chinatibetnews.com, *Eleven Sections of Najin Bridge to be Completed Next Month*, http://www.chinatibetnews.com/shehui/2012-10/19/content_1082989.htm, Accessed October 28, 2012. [in Chinese]
50. CSCEC7bjt.com, China Construction Seventh Engineering Division Traffic Co., Ltd., http://www.cscec7bjt.com/gczs_show.asp?id=42. Accessed February 15, 2012. [in Chinese]
51. Chilstrom, J., Triandafilou, L.N., Stark, W.R., Zaffetti, R.P., Gallucci, C.P., Liberatore, F.R., Stroh, S., Platosh, J., Stahnke, D., Moretti, A.A., Chandra, V., and Giordano, K.E. *Extradosed Bridge Technology in Japan and the New Pearl Harbor Memorial Bridge*. FHWA, U.S. Department of Transportation, 2001.
52. CCSEBISC.com.cn, China Construction Sixth Engineering Bureau Infrastructure Services Company, *Pingdingshan Kaifa Road Zhanhe Bridge*, July 11, 2011, http://www.ccsebisc.com.cn/Heda_content.asp?channelid=45&classid=13&id=97. Accessed February 15, 2012. [in Chinese]
53. CRFSDI.com.cn, China Railway Siyuan Survey and Design Group Co., Ltd., <http://www.crfsvdi.com.cn/show.asp?id=248>. Accessed February 15, 2012.

54. China.com, *Zhangzhou Zhanbei Bridge to be Renamed*, http://club.china.com/data/thread/1011/2730/19/50/7_1.html. Accessed April 22, 2012.
55. ChnRoad.com, *Shaanxi Ankang Qiligou Bridge to Complete Closure*, August 1, 2008, <http://www.chnroad.com/industrynews/newsread.asp?id=7026>. Accessed April 23, 2012. [in Chinese]
56. Cho, Y., S. Kim, J. Park, and S. Lee, *Design & Construction of PSC Box-Girder Bridge With Central Suspension by Extradosed Cables and Constant Girder Depth*, 2003. [in Korean]
57. Christian, J. and L. Newton, Highway Construction and Maintenance Costs, *Canadian Journal of Civil Engineering*, 26, 1999
58. City of Konin, *Crossing the Warta- A New Course of National Road 25*. <http://www.nowymost.konin.pl/index.php?page=7>. Accessed February 15, 2012. [in Polish]
59. Clark, J.A., Value Engineering for Small Transportation Projects, Thesis, *Worcester Polytechnic Institute*, 1999
60. CNBRIDGE, China Bridge Web, <http://baike.cnbridge.cn>, Accessed October 28, 2012. [in Chinese]
61. CNKI, *Ankang Qiligou Han River Bridge Dwarf Tower Cable-Stayed Main Beam Construction Technology*, <http://mall.cnki.net/magazine/article/xbjt200803018.htm>, Accessed October 28, 2012. [in Chinese]
62. Construction News, *Mota-Engil in Angola in the final stage of the Catumbela Bridge*, <http://home.nestor.minsk.by/build/news/2009/08/3104.html>. Accessed April 24, 2012.
63. Cr13g-lc.com, *The Smooth Wrap up of the Main Bridge Underwater Engineering Jian'an Company Ningjiang Songhua River Bridge*, November 11, 2011, <http://www.cr13g-lc.com/ReadNews.asp?NewsID=747>, Accessed October 28, 2012. [in Chinese]
64. Criddlebaugh, B. Bridge Basics. *Bridges & Tunnels of Allegheny County & Pittsburg, PA*. <http://pghbridges.com/basics.htm>. Accessed March 3, 2011.
65. Crototis, R., B. Beams, D. Hattan. *Comprehensive Risk Analysis for Structure Type Selection*. Report No. CDOT-2010-2, Colorado Department of Transportation, 2010.
66. CSCEC7BJT, China Construction Seventh Engineering Division Traffic Co. LTD., http://www.cscec7bjt.com/gczs_show.asp?id=42, Accessed October 28, 2012. [in Chinese]
67. CTCECC, <http://ctcecc.com/>, Accessed June 16, 2012. [in Chinese]
68. CTDOT, Project Description: I-95 new Haven Harbor Crossing Corridor Improvement Program, Colorado Department of Transportation, 2012.
69. Dabous, S.A. and S. Alkass, A Multi-attribute Ranking Method for Bridge Management, *Engineering, Construction and Architectural Management*, Vol. 17, No. 3, 2010.
70. Dabous, S.A. and S. Alkass, Decision support method for multi-criteria selection of bridge rehabilitation strategy, *Construction Management and Economics*, No. 26, 2008.
71. DAHE.com, *Kaifeng Yellow River Bridge: Natural Moat Thoroughfare Henan Bridge*, http://www.dahe.cn/hnxw/shmtdd/dhb/t20060718_580505.htm, Accessed October 28, 2012. [in Chinese]
72. DAUM, <http://cafe.daum.net/projectgroup>, Accessed October 28, 2012. [in Korean]
73. Dienvidu Tilts, http://www.dienvidutilts.lv/index.php?lang_id=2&menu_id=40. Accessed February 15, 2012.

74. DM Engineering Co., Ltd., *Extradosed & Arch Bridges*, www.dm-eng.com/img/main/DM_Engineering_Brochure.pdf, Accessed October 28, 2012.
75. Dnevnik Mucke, *The bridge that Connects Zagreb with Nothing*, <http://politika.com/most-koji-spaja-zagreb-sa-nicim>. Accessed February 15, 2012. [in Croatian]
76. Dnevnik.hr, *Homeland Bridge is Finally Open*. May 5, 2007. <http://dnevnik.hr/vijesti/hrvatska/otvoren-najveci-most-u-hrvatskoj.html>. Accessed February 15, 2012. [in Serbian]
77. Dong, J., *Construction of Pile Caps of Pushang Bridge, Fuzhou with Combined Steel Sheet Pile and Steel Boxed Cofferdam*, The 2nd Engineering Co., Ltd., March 2006, pp. 68-70. [in Chinese]
78. Drinkwater, L. J. Analysis of the Sunniberg Bridge. *Proceedings of Bridge Engineering 2 Conference*, Bath University, Bath, UK, 2007.
79. Dunham, J.S, W. Bonzon, K. Stiff, S. Stroh, and A. Moretti. New England's Gateway: the Pearl Harbor Memorial Bridge. *Concrete Technology Today*, Vol. 2, 2010, pp. 48-52.
80. DYWIDAG-Systems International, <http://www.dywidag-systems.com/references/bridges/sannai-maruyama-overpass-bridge-japan.html>. Accessed April 24, 2012.
81. E-KONSTRUKCIJE.SI, "*Puh Bridge*" over the river Drava Ptuj, <http://www.e-konstrukcije.si/index.php?PageID=65>, Accessed October 28, 2012. [in Slovenian]
82. Echizenya, H., M. Hasegawa, K. Tachibana, and H. Nunoshita, *Design and Construction of Yukizawa Bridge*, Vol. 42, No. 5, 2000. [in Japanese]
83. Edmonton.ca, Walterdale Bridge FAQ, http://www.edmonton.ca/transportation/RoadsTraffic/H3-WalterdaleBridge_HistoricalResourcesFAQ_08022012.pdf, Accessed October 30, 2012.
84. EEmap.org, *Liaoning Dalian Changhai Changshan Bridge*, <http://www.eemap.org/id/66502>. Accessed April 22, 2012. [in Chinese]
85. Ehlen, M.A., Agencies Gain a Bridge Lifecycle Assessment Tool-Software Program Standardizes Materials and Design Comparisons. *Bridge Builder*, 1999.
86. Ehlen, M.A., Life-cycle Costs of New Construction Material", *Journal of Infrastructure Systems*, 1997.
87. Ehlen, M.A., *The Economics of Composites in Highway Bridges*, CDA Winter, 1996
88. Eipsa S.L., *Bridge over the River Deba*, http://www.eipsa.net/es/ficha_proyecto.asp?id_proyecto=11. Accessed February 15, 2012. [in Spanish]
89. Epitos.blog.hu, *Suspended Bridges, Prestressed*, http://epitos.blog.hu/2009/07/30/feszitett_fuggesztett_hidak. Accessed February 15, 2012. [in Hungarian]
90. Faber, M., R. Rackwitz. Sustainable Decision Making in Civil Engineering. *Structural Engineering International*, 2004.
91. Fang, Q. The Wuhu Yangtze River Bridge, *Journal of Huazhong University of Science and Technology*, Vol. 19, No. 1, 2002, pp. 1-3.
92. **Feng, M. China's Major Bridges, International Association for Bridge and Structural Engineers, undated.**
93. Figi, H., C. Menn, D.J. Bänziger, and A. Bacchetta, Sunniberg Bridge, Klosters, Switzerland, *Structural Engineering International*, Vol. 7, No. 1, 1997, pp. 6-8.

94. Lusas.com, Finite Element Analysis Ltd., *Cable Stayed Bridge over the River Labe at Nymburk*. January 2010. http://www.lusas.com/case/bridge/river_labe_nymburk.html. Accessed February 15, 2012.
95. Finley Engineering Group. *Finley Provides Bridge Construction Engineering Service for First "Extradosed" Bridge Design in Texas*. June 27, 2012. www.finleyengineering.com. Accessed July 5, 2012.
96. Frangopol, D.M., J.S. Kong, and E.S. Gharaibeh, Reliability-Based Life-Cycle Management of Highway Bridges, *Journal of Computing in Civil Engineering*, 2001.
97. GangaRao H.V.S., R. Wade, R., and V. Howser, Value Engineering Approach to Low-Volume Road Bridge Selection. *Journal of Structural Engineering*, Vol. 114, No. 9, 1988.
98. Gao, F., Z. Chen, L. Yang, and Y. Wang, Mechanical Characteristics Analysis of Partially Cable-stayed Bridge. *Journal of Zhengzhou University*, Vol. 26, No. 1, 2005, pp.54-56.
99. Grc.com.pk,
100. Go.JP, *Construction of the Immobility Bridge*, http://www.ktr.mlit.go.jp/ktr_content/content/000041527.pdf, Accessed October 28, 2012. [in Japanese]
101. Godzwon, G. Bridge Asset Management. *Government Engineering*, No. 5, 2004.
102. Gov.cn, *Chongqing Jiayue Bridge Opens for Traffic*, February 11, 2010, http://www.gov.cn/jrzg/2010-02/11/content_1533644.htm, Accessed October 28, 2012. [in Chinese]
103. GRC.COM.PK, Ghulam Rasool & Company(Pvt) Ltd. *Construction of West Bank Bypass Project (Package-01) Muzaffarabad, AJK Extradosed Box Girder Bridge*. <http://grc.com.pk/br8.php>. Accessed June 26, 2012.
104. TOPIX.COM, *New bridge to come up in Muzaffarabad*, <http://www.topix.com/forum/world/pakistan/TBRVBT7IT2TJOI0HE>, Accessed October 28, 2012.
105. GRID, Ltd., <http://www.grid.pt/homeE.htm>. Accessed February 15, 2012.
106. Gridnev, A. The South Bridge Project, Riga, Latvia. *Tilts*, undated.
107. Griezic, A., Scollard C.R., Bergman D.W., Design of the First Extradosed Transit Bridge in North America, undated.
108. Guardian News and Media Limited, Pacific-Atlantic Route Drives up Fears of Crime and Destruction, <http://www.guardian.co.uk/environment/2011/jul/14/pacific-atlantic-route-brazil-peru>. Accessed February 15, 2012.
109. H2L2, *Quinnipiac Bridge*, http://www.h2l2.com/infrastructure_gallery_13.php. Accessed February 15, 2012.
110. Hawk, H., Bridge Life-Cycle Cost Analysis, *NCHRP Synthesis 483*, Transportation Research Board, 2003.
111. He, X. Structural Analysis of Main Spans of Lishi Viaduct. *Highway*, No. 5, 2004a, pp. 68-70. [in Chinese]
112. He, X., Design of Low Tower Cable-Stayed Bridge, *Journal of Highway and Transportation Research and Development*, Vol. 21, No. 4, 2004b, pp.66-69. [in Chinese]
113. He, X., Y. Hu, Q. Ding, and J. Chen. Liuzhou Sanmenjiang Bridge Stayed Cable Construction Technique, *Railway Engineering*, Vol. 4, 2007, pp. 14-15. [in Chinese]

114. Hearn, G., Purvis, R.L., Thompson, P., Bushman, W.H., McGhee, K.K., and McKeel W.T. Jr., Bridge Maintenance and Management – A look to the future, *Transportation Research Board A306*, undated.
115. Heller, A. *The Third Karnaphuli Bridge, Bangladesh*. Internet Business Systems, Inc., February 2011. <http://www10.aecafe.com/blogs/arch-showcase/2011/02/02/third-karnaphuli-bridge-bangladesh/>. Accessed April 24, 2012.
116. HighestBridges.com, *Tounoyamahattoku Bridge*, <http://www.highestbridges.com/wiki/index.php?title=tokunoyamahattoku...> Accessed June 20, 2012.
117. Hino, S. The Great Himiyume Bridge, Highway Entrance to Nagasaki; The World First Extra-Dosed Bridge Using Corrugated Steel Plate Webs. *Kyushu University*, 2005, pp. 1-6.
118. Hoher, *The Puli Line - Acer Bees Ecological Farm*, July 13, 2010, <http://hoher.idv.tw/blog/read-1597.html>. Accessed February 15, 2012. [in Chinese]
119. Hohmann, D. Project Development and Design. *Bridge Engineering Program-Distinguished Speaker Series*. University at Buffalo. 2011.
120. Honigmann, C., D. P. Billington, and M. Hon. Conceptual Design for the Sunniberg Bridge. *Journal of Bridge Engineering*, Vol. 8, No. 3, 2003, pp.122-130.
121. Hu, Y. Control Technology for the Temperature of Massive Concrete for Liuzhou Sanmenjiang Bridge, *Journal of Railway Engineering Society*, Vol. 130, No. 7, 2009, pp. 62-66. [in Chinese]
122. Hu, Y., Q. Ding, and Z. Yan, Wide Girder Bridge Guyed Travelers Design and Stress Analysis. *Hunan Communication Science and Technology*, Vol.33, No. 1, 2007, pp. 105-108. [in Chinese]
123. Huang R., A Performance-based Bridge LCCA Model Using Visual Inspection Inventory Data, *Construction Management and Economic*, 24, 2006.
124. Hui X., Overview of Chang Cheng Road Beijing-Hangzhou Canal Bridge Construction Management, *Jiangsu Transportation Engineering*, No. 5, 2003. [in Chinese]
125. HUIMIN.gov.cn, *Huiqing Yellow River Bridge Style Show*, http://www.huimin.gov.cn/art/2008/12/23/art_121_9126.html, Accessed October 28, 2012. [in Chinese]
126. HWM2, *Cable-stayed Bridges, Fin Back Bridges, and Extradosed Bridges*, <http://hwm2.gyao.ne.jp/kappaclub/bridge05.html>, Accessed October 28, 2012. [in Japanese]
127. Hyundai. *Construction, Design and Construction of Extradosed Bridges*, undated. [in Korean]
128. I95newhaven.com, *I-95 New Haven Harbor Crossing Corridor Improvement Program*, <http://www.i95newhaven.com/>. Accessed February 15, 2012.
129. Ikeda, S., and A. Kasuga, Development of Extradosed Structures in the Bridge Construction. *25th Conference on Our World in Concrete & Structures*. Singapore, 2010.
130. Ikeda, S., and A. Kasuga, Performance-Creative Design Concept for Concrete Infrastructure. *25th Conference on Our World in Concrete & Structures*. Singapore, 2010.

131. Infonortedigital.com, *Teror Celebrates Viaduct on 28 and 29 January*, <http://www.infonortedigital.com/portada/portada/6-interes/2921-teror-celebra-la-apertura-del-viaducto-el-28-y-29-de-enero>. Accessed February 15, 2012.
132. Institute of Metal Constructions, *Puhova Bridge in Ptuj*. <http://www.e-konstrukcije.si/index.php?PageID=65>. Accessed February 15, 2012.
133. IBT, International Bridge Technologies, Inc., *Second Vivekananda Bridge Tollway- Kolkata, India*, <http://www.ibtengineers.com/PROJECTS/Vivekananda/Vivekananda1.html>. Accessed April 24, 2012.
134. Ishii, M., *Structural Systems for Extradosed Bridges*, Dissertation, Polytechnic School of the University of São Paulo, 2006. [in Portuguese]
135. IZS, *Puh Bridge in Ptuj*, <http://www.izs.si/dobra-praksa/primeri-dobre-prakse/inzenirski-objekti/puhov-most-na-ptuju/>, Accessed October 28, 2012.
136. JBSI, Japan Bridge & Structure Institute, Inc., *Prize Winning Cable-Stayed and Extradosed Bridges*, <http://www.jbsi.co.jp/works/03.html>, Access October 28, 2012. [in Japanese]
137. Jica.go.jp, Japan International Cooperation Agency, *Second Mandaue – Mactan Bridge Construction Project*, http://www.jica.go.jp/english/operations/evaluation/oda_loan/post/2002/pdf/082_full.pdf, 2002.
138. Jsce.or.jp, Japan Society of Civil Engineering, <http://www.jsce.or.jp/committee/tanaka-sho/jyushou/sakuhin.htm>. Accessed April 22, 2012. [in Japanese]
139. Jau, W. and S. Li The Monitoring of an Extra-Dosed Bridge, The Rational and Design. National Chiao-Tung University, Hsinchu 300, Taiwan.
140. Jawad, D., and K.Ozbay, *Probabilistic Lifecycle Cost Optimization for Pavement Management at the Project-Level*. Transportation Research Board, 2006.
141. Joseph, E. C. *et. al.* Extradosed Bridge Technology in Japan and the New Pearl Harbor Memorial Bridge. *Federal Highway Administration, Connecticut. Dept. of Transportation*, 2001.
142. JPCEA Awards, *Sannai Maruyama Bridge*, <http://www.jpcea.or.jp/eng-jjjj/eng-h20-gijyutu-kyoukai-syou-soukai.htm>. Accessed April 24, 2012.
143. JSCE, Japan Society of Civil Engineers Tanka Prize Work for 2000. [in Japanese]
144. Kajima Co., *Shikari Bridge*, <http://www.kajima.co.jp/project/works/ex/shikari-bridge.html>. Accessed April 22, 2012. [in Japanese]
145. Kalny, M., V. Kvasnicka, P. Nemeč, I. Batal, J. Chmelik, and P. Stedronsky. Cable Stayed Bridge Over the Labe At Nymburk. *Bridges Mostly*, No. 3, 2009, pp. 18-23.
146. Taiwan Today, *Kaohsiung City's New Qishan Bridge Inaugurated*, January 2011. <http://taiwantoday.tw/ct.asp?xItem=144606&CtNode=436>. Accessed June 25, 2012.
147. Kasuga, A., Development of a New Bridge Construction Method using Suspension Structures, *Structural Concrete*, Vol. 12, No. 2, 2011, pp. 65-75.
148. Kasuga, A., Construction of Arch Bridges in Japan, in *fib Symposium PRAGUE 2011*.
149. Kasuga, A. Extradosed bridges in Japan. *Structural Concrete*, Vol. 7, No. 3, 2006, pp. 91-103.

150. Kazimierz P., *Konin is to Bridge the European Union*, <http://www.palasz.konin.pl/index.php?page=3>. Accessed February 15, 2012.
151. Keoleian, G.A., A. Kendall, R. Chandler, G.E. Helfand, M. Lepech, and V.C. Li, Life Cycle Cost Model for Evaluating the Sustainability of Bridge Girders, in *Advances in Life-Cycle Cost Analysis and Design of Civil Infrastructure Systems*, 2001.
152. Kim, S.H., J.W. Seo, Y.B. Lee, I.H. Seo, *Construction Planning and Analysis of Six Continuous Extradosed PSC Bridge*, Taylor & Francis Group, London, 2008.
153. Klaiber F.W., T.J. Wipf, and F.M. Russo, *Cost-Effective Practices for Off-System and Local Interest Bridges*, NCHRP Synthesis 327, 2004.
154. Ko, T. *The Environmental Consideration in Planning and Construction of the National Highway No. 6*, In Proceedings of Fourth U.S.-Taiwan Bridge Engineering Workshop, Princeton, New Jersey. 2008.
155. Koh, H., J. Choo, Recent Major Bridges in Korea, *International Association for Bridge and Structural Engineering*, undated.
156. Komiya, M., *A Characteristics and Design of PC Bridges with large Eccentric Cables (PC Extradosed Bridge)*, Japan Bridge & Structure Institute, Inc., 1999.
157. Konstrukce Media, s.r.o., *Highway Viaduct over Povazska Bystrica*, <http://www.silnice-zeleznice.cz/clanek/dalnicni-estakada-nad-povazskou-bystricou/>. Accessed February 15, 2012. [in Czech]
158. Konstrukce Media, s.r.o., *Urban overpass in Považská Bystrica*, <http://www.silnice-zeleznice.cz/clanek/mestska-estakada-v-povazskej-bystrici/>. Accessed February 15, 2012.
159. Kurita, A., O. Ohyama. Recent Steel-Concrete Hybrid Bridges in Japan. *Steel Structures*, 2003, pp. 271-279.
160. L&T IDPL., *Second Vivekananda Bridge (Kolkata)*, <http://www.lntidpl.com/second-vivekananda-bridge.aspx>. Accessed April 24, 2012.
161. News.lnd.com.cn, *The Changshan Bridge to be Delivered Next Year*, http://news.lnd.com.cn/htm/2012-02/29/content_2184174.htm, Accessed October 28, 2012. [in Chinese]
162. Lai Z., *Review of National Highway Construction*, 2009. [in Chinese]
163. LBM.RLP.DE, Landesbetrieb Mobilitat Rheinland-Pfalz, Wash Mühlthal Bridge and Sounds, <http://www.lbm.rlp.de/icc/Internet/nav/c5f/broker.jsp?uMen=c5f2eb9d-9139-9219-13a7-697a7fd72763&uCon=142605a2-9ce3-6a21-c770-0bb40a7fd727&uTem=aaaaaaaa-aaaa-aaaa-aaaa-000000000011>. Accessed February 15, 2012. [in German]
164. Lane Construction Corporation, *I-35 Improvements*, Mcclennan County, TX. Laneconstruct.com, April 2012.
165. Leonhardt, Andra und Partner. *Gumgang Bridge No.1*. www.lap-consult.com/english/e_projekt.php?sp=00306&kat=. Accessed April 29, 2012.
166. Li B., Line-type Control of 3# Cable-Stayed Bridge of Lishi Viaduct, *Shanxi Architecture*, Vol. 34, No. 21, 2008. [in Chinese]
167. Li, H., Designing the Type for Lanzhou Xiaoxihu Major Bridge Over Yellow River. *Journal of Northwest Institute of Architectural Engineering*, Vol 19, No. 4, 2002, pp. 29-36. [in Chinese]
168. Li, J., Wide Girder Extradosed Bridge Design and Construction, *Railway Construction*, Vol. 8, 2006, pp. 9-10. [in Chinese]

169. Li, S., and M. Zeng, Design of Yinhu Bridge in Xiamen. *Bridge Design*, Vol. 4, 2002. pp. 43-46. [in Chinese]
170. Li, X., and R. Xiao, Mechanical Behavior Analysis and Design Experience of Low-Pylon Cable-Stayed Bridge. *Structural Engineers*, Vol. 21. No. 4. 2005. [in Chinese]
171. Liao, J., and T.Chen, Design of Zhuzhou Husong Bridge partial Cable-Stayed Bridge, *China and International Road*, vol. 26, No., 3, 2006. [in Chinese]
172. LibertyTimes.com, *Halfsky Viaduct Breakgound on the 20th*, <http://www.libertytimes.com.tw/>, Accessed October 28, 2012. [in Chinese]
173. Lin, P., F. Liu, S. Zhou, S. Liu. Mechanical Characteristics and Defining of Extradosed Bridges. *Journal of the China Railway Society*, Vol. 29, No. 2, 2007. [in Chinese]
174. Lin S., and Y. Guo, Design and Construction of National Highway 6 Doushan No. 2 Viaduct, *Zhongxin Engineering*, No. 105, pp. 43-50, 2009. [in Chinese]
175. Liu, S. Q. Chen, and S. Li. Tongan Yinhu Single Pylon Partial One-Side Cable-Stayed Bridge. *Journal of Highway and Transportation Research and Development*, Vol. 23, No. 5, 2006, pp. 57-59. [in Chinese]
176. Liu, X., Z. Qin, Y.W. Leung, and L. Yue, *Construction of the Precast Segmental Approach Structures for Sutong Bridge*, undated.
177. Liu, X., C. Guo and J. Li, Stay Cables Design of Pingdingshan Kaifa Road Zhanhe No. 1 Bridge, *Henan Science*, Vol. 22, No. 4, 2004. [in Chinese]
178. Liu, Z., S. Meng, H. Zang, and Y. Zhang, Model Test and Design Investigation on Saddle Deviator Zone of Extra-dosed Bridge, *Journal of Southeast University*, Vol. 37, No. 2, 2007. [in Chinese]
179. Liu Z. and K. Zheng, Optimization of Rigidity of Extradosed Bridge Piers, *Shanxi Architecture*, Vol. 33, No. 31, 2007. [in Chinese]
180. Liuzhou OVM Machinery Co., Ltd., *Extra-Dosed Bridge*, <http://www.ovmchina.com/ovmweb-e/EECenter/InfoView.aspx?infoId=310&eetypeId=3&SearchValue=>. Accessed April 24, 2012.
181. Llombart Jaques, J. A., J. Revoltós Fort, and J. Fernández Vega, Viaducto Sobre el Barranco de Teror. Accessed February 15, 2012.
182. Llombart, J. A., and J. Revoltós. Extradosed Bridge over the river Deba. *Realizaciones*, 2004.
183. Lookbridges.com, *Ganter Bridge in Brig, Switzerland*, <http://lookbridges.com/ganter-bridge-in-brig-switzerland>, Accessed October 29, 2012.
184. Lopez-Anido, R., Life-Cycle Cost Survey of Concrete Bridge Girders – A Benchmark for FRP Bridge Girder Replacement, in Transportation Research Board, Washington D.C., 201.
185. LQBK, Road and Bridge Engineers, <http://baike.lqgcs.com/>, Accessed October 28, 2012. [in Chinese]
186. lumontad_777, <http://wikimapia.org/showphoto/?obj=1266735&type=1&lng=0&id=422988>. Accessed April 22, 2012.
187. LUSAS Bridge, *Cable Stayed Bridge over the River Labe at Nymburk*, <http://lusas.com/case/bridge/>, Accessed March 19, 2012.

188. Markelj, V., The First Extradosed Bridge in Slovenia, *Structural Engineering International*, 2010, pp. 462-467.
189. Matascik, M., *Municipal Flyover In Povazska Bystrica, Silnice Zeleznice*, July 2010.
Translate.googleusercontent.com/translate_c?client=tmpg&hl=en&langpair=cs%7Cen&rurl=translate.go... Accessed March 19, 2012.
190. Matyassy, L., Construction of the Tisza-Bridge Spanning the River on the Motor Road M43, *Concrete Structures*, 2010, pp. 29-31.
191. May, Korea's Newest City to Have Two Dramatic Bridges. *Bridge Design & Engineering*, Vol. 51, 2008, pp. 35.
192. McGowan, C., *Brazos River Bridge Hearing This Thursday*. February 2011.
www.1000friendsofwaco.com/?p=243. Accessed April 25, 2012.
193. Merko, <http://www.merko.ee/eng/contact>. Accessed February 15, 2012.
194. Mermigas, K.K., Behavior and Design of Extradosed Bridges, Master thesis, Analysis: State-of-the-practice vs. State-of-the-art, University of Toronto, 2008, 83rd in *Annual Meeting of the Transportation Research Board*, 2004.
195. Metrostav, <http://www.metrostav.cz/en/contacts/adresar>. Accessed February 15, 2012.
196. Middlesex Companies,
<http://www.middlesexcompanies.com/withoutsound/contact.html>. Accessed February 15, 2012.
197. Minnesota Department of Transportation,
<http://www.dot.state.mn.us/metro/projects/stcroix/contacts.html>. Accessed February 15, 2012.
198. MnDOT, WIDOT and FHWA, *Supplemental Final Environmental Impact Statement – St. Croix River Crossing Project*, Minnesota Department of Transportation, Wisconsin Department of Transportation and Federal Highway Administration, June 2006.
199. Mohammadi, J., S. Guralnick, Y, Li. Incorporating Life-Cycle Cost in Highway-Bridge Planning and Design. *Journal of Transportation Engineering*, 1995, pp. 417-424.
200. Moore, M., *TxDOT to Break Ground on New Brazos Bridges in Late Summer 2012. Our Daily Bears, April 17, 2012*. Ourdailybears.com/...txdot-to-break-ground-on-new-brazos-bridges-in-late-summer-2012-baylor-stad... Accessed April 29, 2012.
201. Mutsuyoshi, H., D.H. Nguyen, and A. Kasuga, Recent Technology of Prestressed Concrete Bridges in Japan, in *IABSE-JSCE Joint Conference on Advances in Bridge Engineering-II*, Dhaka, Bangladesh, 2010.
202. Myaena.net, *Halfsky Viaduct Bridge to Break Ground, to become the Tallest Extradosed Bridge in Taiwan*,
http://myaena.net/newspaper.php?nn_id=54&news_id=1067, Accessed October 28, 2012. [in Chinese]
203. Nantou.gov.tw, The Overpass Construction in HalfSky area Begins, Will be the Tallest Extradosed Bridge in Taiwan,
<http://www.nantou.gov.tw/english/hotnewsdetail.asp?dptid=376480000&catetype=02&cid=519&cid1=522&mcid=63642>, Accessed October 28, 2012. [in Chinese]

204. Nazret.com, *Ethiopia's First Extradosed Bridge to Span the Blue Nile Gorge*, http://nazret.com/blog/index.php/2008/09/06/ethiopia_s_first_extradosed_bridge_to_sp, Accessed October 28, 2012.
205. Naver.com, *Start Extradosed School*, <http://blog.naver.com/PostView.nhn?blogId=bi1he2s3&logNo=100014722735&redirect=Dlog&widgetTypeCall=true>. Accessed April 22, 2012. [in Korean]
206. Naqash, T. *New Bridge to Come Up in Muzaffarabad*. Greater Kashmir, March 2009. www.greaterkashmir.com/news/2009/mar/3/new-bridge-to-come-up-in-muzaffarabad-34.asp. Accessed April 29, 2012.
207. News.cn, *The Najin Bridge to be bided, to be Built as a Low Tower Cable-stayed Bridge*, November 11, 2010, http://tibet.news.cn/gdbb/2010-11/11/content_21367711.htm. Accessed February 15, 2012. [in Chinese]
208. NewsToday, *Karnaphuli Bridge-III opens to Traffic*, http://www.newstoday.com.bd/index.php?option=details&news_id=7008&date=2010-09-09, Accessed October 28, 2012.
209. NiPic.com, *Pictures of the Xiaoxihu Yellow River Bridge from South Band of the Yellow River*, <http://www.nipic.com/show/1/62/4533804k812a7f9d.html>. Accessed April 22, 2012.
210. Niwa J., *The Transition of Bridge Technology seen from the Construction of Amarube Bridge Replacement*, Kawada Technical Report, Vol. 2010. [in Japanese]
211. Normile, D., *Extradosed Box Girder Span Exposes Prestressed Cables*, Odawara. *ENR*, February 21, 1994. pp. 20
212. Soil and Structures, *Noteworthy Strapped Cables and Multitube Saddles*, Soil and Structures, 2007, pp.18.
213. konin.pl, *Bridge of the European Union*, December 15, 2007, <http://nowymost.konin.pl/>, Accessed March 19, 2012.
214. Nuruzzaman, A.S., *Lessons Learnt From the Design and Construction of Third Karnaphuli Bridge: The First Extra-Dosed Cable Stayed Bridge of Bangladesh*, in *Proceedings of IABSE-JSCE Joint Conference on Advances in Bridge Engineering- 2*, Dahka, Bangladesh, 2010pp.77-92.
215. O&G Industries, Inc., <http://www.ogind.com/contact.aspx?id=136>. Accessed February 15, 2012.
216. bandadeteror.com, *Opening of the New Viaduct Teror, La Banda*, January 2011. www.bandadeteror.com/web/content/inauguracion-del-nuevo-viaducto-de-teror. Accessed April 29, 2012. [in Spanish]
217. Orangebd Ltd. *Karnaphuli Bridge Opens to Traffic*. 2010. http://www.thefinancialexpress-bd.com/more.php?news_id=111569&date=2010-09-08, Accessed February 15, 2012.
218. Tok2.com, *Overview of the Bridge East Chestnut*, www.42.tok2.com/home/h-nagai/bridge/rittoh-br/rittoh-bridge.htm. Accessed April 23, 2012.
219. Ozbay, K., D. Jawad, N.A. Parker, S. Hussain, and J. Pang. *Life Cycle Cost*
220. *Key Construction Technology in Prestressed Concrete Partial Cable-stayed Bridges*. *Railway Construction Technology*, Vol. 4, 2006, pp.7-10.
221. konin.pl, *Konin is to bridge the European Union*, <http://www.palasz.konin.pl/index.php?page=3>, Accessed October 28, 2012. [in Polish]

222. Pang, J., Key Construction Technology in Prestressed Concrete Partial Cable-stayed Bridges, *Railway Construction Technology*, No. 4, 2006. [in Chinese]
223. Park, E., K. Jung, Y. Shin., Construction of Extradosed Bridge in the Government Financed Section, undated.
224. PBS&J. *St. Croix River Crossing Cost Estimate Review*, FHWA. February 2006.
225. Peacock, R., C. Broks, and J. Montgomery, *Walterdale Bridge Replacement and Approach Roads Evaluation – Concept Planning Study*, City of Edmonton, 2011.
226. Peng, W., T. Cui, and M. Zhu, Hemaxi Bridge Partial Extradosed Design, *Highway*, No.5, 2007, pp. 87-89.
227. People.com.cn, *Wuhan Sanguanjiang Bridge to be Constructed*, <http://hb.people.com.cn/n/2012/0215/c194174-16752433.html>, Accessed October 28, 2012. [in Chinese]
228. Phipps, A. Marine Builds Longest-Span Precast Segmental Bridge With Unique Design-Build Selection Process. *Transportation Research Record 1696*, 2000, pp. 71-75.
229. Pont-TERV Engineering Consultants, *M43 Motorway, Mora Ferenc Tisza Bridge*. http://www.pontterv.com/m43_e.htm. Accessed July 27, 2012.
230. Pontex, s.r.o., *Cable Stayed Bridge over the Labe at Nymburk*,. <http://www.pontex.cz/references>. Accessed February 15, 2012.
231. PORR, *Bridge Puhov*, http://www.porr-group.com/typo3temp/references_pdf/8035_en.pdf. Accessed February 15, 2012.
232. Qiaoliangren.net, *Chongqing Nanping Bridge*, www.quaoliangren.net, Accessed July 24, 2012. [in Chinese]
233. QLJG8.com, The three new low tower cable-stayed bridges in La Paz, Bolivia, <http://www.qljg8.com/post/70.html>, Accessed October 28, 2012. [in Chinese]
234. Quan, H., Study of Shandong Huiqin Yellow River Bridge Main Bridge Design, *Science and Technology Innovation Herald*, No. 28, 2008. [in Chinese]
235. Racansky, M., *Highway Viaduct Over Povazska Bystrica, Silnice Zeleznice*, July 2010.
[Translate.googleusercontent.com/translate_c?client=tmpg&hl=en&langpair=cs%7Cen&url=translate.go...](http://translate.googleusercontent.com/translate_c?client=tmpg&hl=en&langpair=cs%7Cen&url=translate.go...) Accessed March 19, 2012.
236. Rahman, S. and D.J. Vanier, Life Cycle Cost Analysis as a Decision Support Tool for Managing Municipal Infrastructure, *National Research Council Canada, NRCC-46774*, 2004.
237. Ran L., Determination and Proceed of Hemaxi Bridge T-o Construction, *Railway Engineering*, No. 9, 2006. [in Chinese]
238. RBSCE.com, *Guangzhou Panyu Shawan Bridge Opened to Traffic*, <http://www.rbsce.com/news/ReadNews.asp?NewsID=3333>, Accessed October 28, 2012.
239. RBTMM.com, *Ankang Qiligou Hanjiang Bridge*, <http://baike.rbtmm.com/?doc-view-4018.html>. Accessed April 23, 2012. [in Chinese]
240. Rbtmm.com, *Ningjiang Songhua River Bridge*, <http://baike.rbtmm.com/?doc-view-4366.html>, Accessed October 28, 2012. [in Chinese]
241. Reed Business Information, North Arm Fraser River Bridge Marks a First for North America. *Journal of Commerce*, October 1, 2007.
<http://www.joconl.com/article/id24546>. Accessed February 15, 2012.
242. Reed Business Information, *Sky-High View in Vancouver. Daily Commercial News*, August 29, 2008. <http://www.dcnonl.com/cgi->

- bin/dcnhome.pl?rm=print_story&story_id=30348&source=article. Accessed March 18, 2012.
243. panoramio.com, South Bridge over Daugava in Riga, <http://www.panoramio.com/photo/1093088>. Accessed February 15, 2012. [in Chinese]
 244. Road.jp, <http://precious.road.jp/hyogo/tsukuhararoad.htm>. Accessed February 15, 2012.
 245. Road Traffic Technology. *Golden Ears Bridge, Canada*. <http://www.roadtraffic-technology.com/projects/golden-ears-bridge>. Accessed February 2012.
 246. Roberts, J. Life-Cycle Cost Analysis for Bridges. *American Segmental Bridge Institute*, Vol. 48, 2006, pp. 1-15.
 247. Rowson, J. *Andorra Bridge Collapse*, *New Civil Engineer*, November 2009. <http://www.nce.co.uk/andorra-bridge-collapse/5210764.article>. Accessed June 26, 2012.
 248. Ruiz-Teran, A.M., and Aparicio, A.C., Two New Types of Bridges: Under-Girder Cable-Stayed Bridges and Combined Cable-Stayed Bridges – the State of the Art, *Canadian Journal of Civil Engineering*, 34, 2007
 249. Runa59, <http://www.flickr.com/photos/dan59/3952664035/sizes/z/in/photostream/>. Accessed April 24, 2012.
 250. Safi, M. *Bridge Life Cycle Cost Optimization – Analysis, Evaluation, & Implementation*, Thesis, Stockholm, Sweden, 2009.
 251. Sakran, M., D.S. Rao, Cable Stayed Bridges for Elegance and Economy, undated.
 252. Silva Barbara, M.J., Study Bridges with Pre-effort Extradorsal, Dissertation, Technical University of Lisbon, 2011. [in Portuguese]
 253. Shanxi Today, Taiyuan Northwest Central Expressway Fenhe Cable-Stayed Bridge, <http://www.jrsx.com.cn/onews.asp?id=6574&owen1=%BB%F9%B4%A1%BD%A8%C9%E8>, Accessed October 28, 2012. [in Chinese]
 254. Shane, J.S., D.D. Gransberg, and T. Busch. Project Management Tools for Design-bid-Build Mega-Projects. *Proceedings of 47th ASC Annual International Conference*, Omaha, Nebraska 2012.
 255. Shanghai Civil Engineering Co., *Liuzhou Jinglan Bridge*, <http://www.crecsh.com/show.aspx?id=382>. Accessed April 24, 2012. [in Chinese]
 256. Sherif, Y.A., M.A. Haroun, and I.A.E. Nosair, Optimal Construction Method Optimal Construction Method For Bridge Girders: A Value Engineering Spirit Approach, *The Construction, Building and Real Estate Research Conference of the Royal Institution of Chartered Surveyors*, Paris, 2010.
 257. Shimizu Co., *Osaka Outside Loop Line, Hirano Region Viaduct*, <http://www.shimz.co.jp/english/theme/bridges/pakse.html>. Accessed April 22, 2012. [in Japanese]
 258. SHP.ED, Bridge 206, *Freeway D1, Povazska Bystricia, Slovakia*, <http://www.shp.eu/en/strasky-husty-a-partneri/projects/bridges/highway-bridges/cable-stayed-bridges/bridge-206-freeway-d1-povazska-bystricia-slovakia/>, Accessed October 28, 2012.
 259. SHSZ.ORG.CN, *Largest Domestic Span Extradosed Rail Traisit Construction*, <http://www.shsz.org.cn/book/shownews.asp?num=szzz-20121612185>, Accessed October 28, 2012. [in Chinese]

260. SINA.com.cn., *Jinji Highway Xianshen River Bridge Main Bridge Completion*, <http://news.sina.com.cn/c/p/2008-10-15/075216456651.shtml>. Accessed April 24, 2012. [in Chinese]
261. SK Engineering & Construction, *Extradosed Bridges*, undated. [in Korean]
262. Skyscraper Source Media, *Puentes Trillizos*, <http://skyscraperpage.com/cities/?builingID=83669>. Accessed June 26, 2012.
263. Slovenian Chamber of Engineers, *Puh Bridge in Ptuj*. <http://www.izs.si/dobra-praksa/primeri-dobre-prakse/inzenirski-objekti/puhov-most-na-ptuju/>. Accessed February 15, 2012.
264. Slovenian Chamber of Engineers, <http://www.izs.si/en/about-izs/>. Accessed February 15, 2012.
265. SOGO Engineering, Inc., *Hozu Bridge*, <http://www.sogo-eng.co.jp/english/service/hozu.htm>. Accessed April 22, 2012.
266. Sobrino, J., *Building Triplets, Roads & Bridges*, 2011, pp. 26-33.
267. SRBG.com.cn, *New Roads and Bridges*, <http://www.srbg.com.cn/upload/pdf/20111118/1.pdf>, Accessed October 28, 2012.
268. MnRoad, *St. Croix River Crossing Project - Total Project Cost Estimate*, February 2011, <http://www.dot.state.mn.us/metro/projects/stcroix/pdfs/status/CHAP%20152TotalProjCostEstimateFeb2011.pdf>. Accessed February 15, 2012.
269. Standard Practice for Measuring Life-Cycle Costs of Buildings and Building Systems, *ASTM International*, Designation: E917-05, February 28, 2011.
270. Strasky, Husty and Partners Ltd., <http://www.shp.eu/en/strasky-husty-a-partneri/projects/bridges/highway-bridges/cable-stayed-bridges/bridge-206-freeway-d1-povazska-bystricia-slovakia/>. Accessed February 15, 2012.
271. Strasky, J., M. Matascik, R. Novak, K. Taborska, *Urban Viaduct in Povazska Bystrica, Slovakia*, *Structural Engineering International*, Vol. 21, No. 3, 2011 , pp. 356-359.
272. Strasky, J., M. Matascik, R. Novak, K. Taborska, *Multi-Span Extradosed Viaduct in Povaska Bystrica, Slovakia*, in *3rd FIB International Congress*, 2010.
273. Stroh, S. L., *On the Development of the Extradosed Bridge Concept*, Dissertation, University of South Florida, 2012.
274. Suha Road Construction, <http://www.suhua.gov.tw/default.aspx>, Accessed July 30, 2012. [in Chinese]
275. Sumitomo Electric Industries, Ltd., *Tower Saddles Delivered for the First Time to the Sannai Maruyama Overbridge of the Tohoku Shinkansen Super-Express Line*, <http://global-sei.com/sn/2008/372/3.html>. Accessed April 24, 2012.
276. Sumitomo Mitsui Construction Co., Ltd., *Bridge Works*, <http://www.smcon.co.jp/english/works/bridge.html>. Accessed April 26, 2012.
277. SXHighway, *Fuzhou Pushang Bridge to Break Ground next Month*, <http://xy.sxhighway.gov.cn/constructread.gl?id=1748>, Accessed October 28, 2012. [in Chinese]
278. T. Y. Lin International Group, *Beigang Matsu Bridge*, http://www.tylin.com/en/projects/beigang_matsu_bridge. Accessed February 15, 2012.
279. TABIKAPPA, <http://tabikappa.blog55.fc2.com/>, Accessed October 28, 2012. [in Japanese]

280. TaiwanToday.com, *Kaosiung City's New Qishan Bridge Inaugurated*, taiwantoday.tw, Accessed October 28, 2012.
281. Takami, K., and S. Hamada. *Composite Construction in Steel and Concrete IV: Behavior of Extradosed Bridge with Composite Girder*, undated, pp. 63-71.
282. Tamai, S., T. Tanaka, T. Suzuki, and T. Sakamoto. Design and Construction of the Longest Span Shinkansen Bridge. *The Concrete Journal*, Vol. 46, No. 7, 2008, pp. 31-37.
283. Tang, D., and S. Chen. Ankang Qiligou Hanjiang Bridge Stayed-Cable Installation, *Prestress Technology*, Vol. 2, No. 73, 2009, pp. 23-27.
284. Tang, S., W. Cai, and H. Chen. Overall Design of Zhangzhou War Preparation (Zhanbei) Bridge. *Bridge Construction*, 2002, No. 1, pp. 1-4. [Chinese]
285. Tang, S., W. Cai, H. Chen, and G. Peng. Design and analysis of Xiyangping Bridge in Zhangzhou, China. *ARCH'07- 5th International Conference on Arch Bridges*. Madiera, Portugal, 2007, pp. 897-902.
286. TCOC, <http://www.tcoc.org.tw/index.aspx?AspxAutoDetectCookieSupport=1>, Accessed June 23, 2012. [in Chinese]
287. Tie J., Jingcheng Highway Changbaihe Bridge Square Piers Construction Technique, *Department of Defense Transportation Engineering and Technique*, No. 2, 2006.
288. The McGraw-Hill Companies. Highway Bridge. *McGraw-Hill's Access Science Encyclopedia of Science and Technology Online*. <http://www.accessscience.com/popu.aspx?id=800420&name=print>. Accessed September 23, 2008.
289. Tjsznet.com, *Shanxi Linfen Fenhe Bridge*, <http://www.tjsznet.com/newsShow.asp?ArticleID=738>, Accessed October 28, 2012. [in Chinese]
290. The Zenitaka Co., http://www.zenitaka.co.jp/english/works2_04.html. Accessed April 22, 2012.
291. TOK2.com, *Yashiro Bridge, Nagano Shinkansen*, <http://www42.tok2.com/home/h-nagai/bridge/ritto-br/ritto-bridge.htm>. Accessed April 22, 2012.
292. Torok, Z., Construction Technology of Extradosed Tisza Bridge of M43 Motorway in Hungary, *Concrete Structures*, 2011, pp. 32-37.
293. Toshimitsu, H. 2-Span Continuous Extra-Dose Prestressed Concrete Bridge, *VSL News*, No. 2, 1999, pp. 3.
294. Travel-Images.com, www.travel-images.com/photo/photo-bolivia119.html. Accessed April 24, 2012.
295. Trimbath, K. Hybrid Extradosed Bridge Underway in British Columbia. *Civil Engineering News*, October 2006, pp. 28-30.
296. Trimet.org/pm, *Portland-Milwaukie Light Rail Bridge Fact Sheet*, August 2011 Trimet.org/pm, Accessed June 18, 2012.
297. Tripmondo, www.tripmondo.com/china/jiangsu-sheng/ershilian/picture-gallery-of-ershilian/. Accessed April 22, 2012.
298. Tripod.com, *Ritto Ohashi*, <http://kyoto609.tripod.com/426bridge/index.html>, Accessed October 29, 2012.

299. Tumukeji.com, *Shanghai Dazhi River Extradosed Bridge*, <http://www.tumukeji.com/article/7402.html>, Accessed October 28, 2012. [in Chinese]
300. TxDOT, *Public Hearing-Interstate 35 Frontage Road Bridges at the Brazos River. Texas Ranger Museum Education Center*, February 3, 2011.
301. T.Y.Lin International, *St. Croix River Crossing-Final Design*. 2012.
302. URS, *Proposal for St. Croix Crossing Project – Final Bridge Design*, 2012.
303. URS Co., <http://www.urscorp.com/Contact/index.php>. Accessed February 15, 2012.
304. Utomo C. and Idrus A., Value-based Group Decision on Support Bridge Selection, *International Journal of Human and Social Sciences*, 5 (12), 2010.
305. SAVE International, *Value Standard and Body of Knowledge*. SAVE International Value Standard, 2007.
306. vBulletin Solutions, Inc., Bridge of the European Union, <http://www.skyscrapercity.com/showthread.php?t=424935&page=30>. Accessed February 15, 2012. [in Polish]
307. STEC, <http://www.stec.net/>, Accessed June 16, 2012. [in Chinese]
308. *Stewardship Practices, Procedures, and Policies for Highway Construction and Maintenance*, Chapter 7 – Bridge Maintenance, NCHRP Project 25-25, 2004.
309. Vineyard, P. J. Strongly Dosed. *Roads & Bridges*, Vol. 48, No. 11, 2010, pp. 32.
310. Virlogeux, M., Recent Evolution of Cable-Stayed Bridges, *Engineering Structures*, Vol. 21, 1999, pp. 737-755.
311. Vonganan, B. The Second Mekong International Bridge, Thailand, *Structural Engineering International*, January 2009, pp. 67-68.
312. VSL. *Kisosansen Bridge- Japan*, www.vsl.com. Accessed March, 2012.
313. Vsl.cz, *Free Cantilever Method*, http://www.vsl.cz/en/prod_betonaz.html, Accessed October 29, 2012.
314. Waalkes, S.M, T. Dossey, B.F. McCullough and R. Harrison, *A Sensitivity Analysis of the Rigid Pavement Life-Cycle Cost Analysis Program*, TxDOT Project Report 0-1739, 1999.
315. Wang, J. The First Extradosed Bridge in China – Zhangzhou Beizhan Bridge Design. *East China Highway*, 2003, No. 1, pp. 13-15. [in Chinese]
316. Wantchinatimes.com, *Kinmen Bridge Construction Given the Go Ahead, China Times*, January 10, 2011. <http://www.wantchinatimes.com/news-subclass-cnt.aspx?id=201101100>, Accessed June 25, 2012.
317. Warne T.R., Columbia River Crossing Project Bridge Review Panel Final Report, Tom Warne & Associates, 2011.
318. WEBLINE, <http://weblines.jp/info/prsc.co.jp>, Accessed June 22, 2012. [in Japanese]
319. Welch, R. Golden Ears Bridge. *Canadian Consulting Engineer*, June-July 2010. Pp. 18-21.
320. Weyer, R.R., Cady, P.D., and McClure R.M., Cost-Effective Decision Models for Maintenance, Rehabilitation, and Replacement of Bridges, *Journal of TRB*, 950, 1984.
321. Wiecon. No. 6 National Highway, Contract C 608, Taiwan Extra-Dosed Bridge. *Project Reference Catalogue*, 2012.
322. Wikipedia, <http://www.wikipedia.org/>, Accessed October 28, 2012.

323. Wilhelm Ernst & Sohn, <http://en.structurae.de/firms/data/index.cfm?id=f001714>. Accessed February 15, 2012.
324. Wilcox, T., Statement of the Landscape Designer, Tanja Wilcox, in *Proceedings of the First FIB Congress*, Osaka 2002.
325. Wilson, D.C, NCHRP Synthesis 352, Value Engineering Applications in Transportation, *Transportation Research Board*, 2005.
326. Wimsatt, A.J., C.M. Chang-Albitres, P. E. Krugler, T. Scullion, T.J. Freeman, and M.B. Valdovinos, *Considerations for Rigid vs. Flexible Pavement Designs when allowed as Alternate Bids*, TxDOT Report 0-6085-1, 2009.
327. Wood, D., TxDOT, *Contractors Make Big Moves on I-35*, *ENR* August 15, 2011. http://www.texas.construction/texas_construction_news/2011/0815-TxDOT, Accessed June 25, 2012.
328. Xie, H., *Look for the most Difficult Bridge in Asia - Xianshen River Bridge*, <http://xiehongjian.blshe.com/post/4942/264873>. Accessed April 24, 2012.
329. XINHUANET.com, http://www.js.xinhuanet.com/xin_wen_zhong_xin/2007-07/03/content_10465677.htm. Accessed April 22, 2012.
330. XINHUA News Agency, *Brazil, Peru, Bolivia Strengthen Integration*, *China.org*, August 12, 2004. <http://www.china.org.cn/english/international/103749.htm>. Accessed June 21, 2012.
331. Xu, L., *Study of the Construction Control Technique for Low Tower Cable-Stayed Bridge*, Thesis, undated. [in Chinese].
332. Xuan G. and G. Yang, Analysis of Large Span Concrete Extradosed Bridge Structure System, *Sichuan Architecture*, Vol. 29, No. 1, 2009. [in Chinese]
333. Yamazaki J., The Scheme and Its Management of Autonomous Public Authority in Realizing Innovations onto Expressway Bridges, in *Symposium on Social Management Systems (SSMS)*, Kochi, Japan, 2009.
334. Yang, C., *Chang Cheng Road, Beijing-Hangzhou Canal Bridge held ceremoniously folded ceremony*, <http://www.rbsce.com/news/ReadNews.asp?NewsID=127>, 2003. [in Chinese]
335. Yan, F., *Safety Hazard under the Lishi Viaduct Bridge has been Removed*, <http://yanfenqin.blshe.com/post/8624/291502>. Accessed April 24, 2012.
336. Yang, H., The New Model of Road Bridge in Mountain Areas – Partial Oblique Bridge, *Shanxi Architecture*, Vol. 30, No. 18, 2004. [in Chinese]
337. YAHOO.com.cn, <http://tw.blog.yahoo.com/>, Accessed June 23, 2012. [in Chinese]
338. Yasublog, *Shinkansen Bridge*, <http://d.hatena.ne.jp/ysdk1/20090714/p1>, Accessed October 28, 2012. [in Japanese]
339. YELLOWRIVER, *Huiqing Huaghe Bridge*, http://www.yellowriver.gov.cn/zlcp/sjcx/qlsd/201108/t20110811_82150.html, Accessed October 28, 2012. [in Chinese]
340. Yogi, *Construction Set to Begin on the IH-35 Bridges Over Brazos*, *BaylorFans.com*, February 12, 2012. <http://www.baylorfans.com/forums/archive/index.php/t-235464.html>. Accessed June 25, 2012.
341. Yoosin Corporation, *Design Guide for Extradosed Bridges*, undated. [in Korean]

342. Zenitaka Corporation, *The Tohoku Shinkansen III Maruyama Viaduct Fortifications*, <http://www.zenitaka.co.jp/reports/sannaireport.html>, Accessed October 28, 2012. [in Japanese]
343. Zenitaka Corporation, *Yashiro Bridge, Nagano Shinkansen*, www.zenitaka.co.jp/english/works2_04.html. Accessed April 22, 2012.
344. Zeroboard, *Tsurumi Tsubasa Bridge*, http://bridgeworld.net/zboard/zboard.php?id=japan&page=1&sn1=&divpage=1&sn=off&ss=on&sc=on&select_arrange=headnum&desc=asc&no=32. Accessed April 22, 2012. [in Korean]
345. Zhang, D., and W. Kang. Design Analysis of Xiaoxihu Yellow River Bridge in Lanzhou City, *Journal of Lanzhou Railway University*, Vol. 21, No. 6, 2002, pp. 69-72. [in Chinese]
346. Zhang, G. Jinghang River Suqian Nanerhuan Bridge Desing, *China International Highway*, Vol. 2, 2004, pp. 41-44.
347. Zhang, X., S. Sun, and A. Gu. Study on the Beam for Extradosed Prestressed Bridges. *Advanced Material Research*, Vols. 255-260, 2011, pp. 931-937.
348. Zhao L, Liu Y., Yang Z., and Li Z., Design and Construction of Ningjiang the Songhuajiang Extradosed Bridge Main Beam, *Northern Transportation*, No. 10, 2010. [in Chinese]
349. Zhao, L., M. Shaoping, Z. Hua, and Z. Yufeng. Model Test and Design Investigation on Saddle Deviator Zone of Extra-Dosed Bridge. *Journal of Southeast University*, Vol. 37, No. 2, 2007, pp. 291-295. [in Chinese]
350. Zhao, X., and Li, M., Discuss on Construction Controlling Method for Prestressed Concrete Partition Cable-Stayed Bridge, *Modern Transportation Technique*, 2005. [in Chinese]
351. Zheng, M., X. Chen, S. Liu, and M. Chen. Design of the First Extradosed Bridge in Taiwan. *China Technology*, Vol. 89, 2011, pp. 52-58. [in Chinese]

APPENDIX A:**LIST OF REFERENCES FOR EACH EXTRADOSED BRIDGES**

| | Bridge | Location | Year | References |
|----|---|---|------|---|
| 1 | Odawara Blueway Bridge | Odawara, Japan | 1994 | Kasuga 2012; Chilstrom et al. 2001; Mermigas 2008; Stroh 2012; Wilhelm 2012; Kasuga 2006; TABIKAPPA, 2012 |
| 2 | Tsukuhara Bridge | Hyogo, Japan | 1997 | Kasuga 2012; Chilstrom et al. 2001; Mermigas 2008; Stroh 2012; Wilhelm 2012 |
| 3 | Yashiro Bridge | Nagano, Japan | 1997 | Wilhelm 2012; Zenitaka 2012; TABIKAPPA, 2012 |
| 4 | Kanisawa Bridge | Japan | 1998 | Mermigas 2008; Stroh 2012; Akita 2012 |
| 5 | Shin-Karato Bridge (Okuyama Bridge) | Kobe, Japan | 1998 | Mermigas 2008; Stroh 2012; Wilhelm 2012; Chilstrom et al. 2001 |
| 6 | Sunniberg Bridge | Klosters, Switzerland | 1998 | Drinkwater 2007; Honigmann 2003; Mermigas 2008; Stroh 2012; Wilhelm 2012; Figi et al. 1997 |
| 7 | Mitanigawa Bridge (Santanigawa Bridge) | Japan | 1998 | Mermigas 2008; Stroh 2012 |
| 8 | Sapporo Railway Bridge | Sapporo, Japan | 1999 | Toshimitsu 1999; Wilhelm 2012 |
| 9 | Second Mactan–Mandaue Bridge | Mandaue, Philippines | 1999 | Chilstrom et al. 2001; Japan 2002; Mermigas 2008; Stroh 2012; Wilhelm 2012 |
| 10 | Pont de Saint-Rémy-de-Maurienne Bridge | Saint-Remy-de-Maurienne, France | 1999 | Mermigas 2004; Mermigas 2008; Stroh 2012; Wilhelm 2012 |
| 11 | King Hussein Bridge | Jordan | 1999 | Sumitomo 2012 |
| 12 | Pakse Bridge | Between Pakse Laos and Phonthong Thailand | 2000 | Mermigas 2008; Stroh 2012; Shimizu 2012; Wikipedia 2012; Wilhelm 2012 |
| 13 | Sajiki Bridge | Japan | 2000 | Mermigas 2008; Stroh 2012 |
| 14 | Shikari Bridge | Hokkaido, Japan | 2000 | Mermigas 2008; Stroh 2012; Wilhelm 2012; JASC 2000; Wikipedia, 2012. |
| 15 | Surikamigawa Bridge | Japan | 2000 | Mermigas 2008; Stroh 2012 |
| 16 | Wuhu Yangtze River Bridge | Wuhu, China | 2000 | Baidu 2012; Fang 2002; LQBK 2012; bmema.org 2012 |
| 17 | Yukizawa Bridge | Japan | 2000 | Mermigas 2008; Stroh 2012; Echizenya et al. 2000 |
| 18 | Hozu Bridge | Kyoto, Japan | 2001 | TABIKAPPA, 2012; Mermigas 2008; Stroh 2012; Wilhelm 2012 |
| 19 | Ibi River Bridge (Ibigawa Bridge) | Nagashima-cho, Japan | 2001 | Chilstrom et al. 2001; Ikeda 2010; TABIKAPPA, 2012; Mermigas 2008; Stroh 2012; Wilhelm 2012 |
| 20 | Kiso River Bridge (Kisogawa Bridge) | Nagashima-cho, Japan | 2001 | Chilstrom et al. 2001; Ikeda 2010; TABIKAPPA, 2012; Mermigas 2008; Stroh 2012; VSL 2008; Wilhelm 2012 |
| 21 | Miyakoda River Bridge (Miyakodagawa Bridge) | Shizuoka, Japan | 2001 | Chilstrom et al. 2001; TABIKAPPA, 2012; Mermigas 2008; Stroh 2012; Wilhelm 2012 |
| 22 | Nakanoike Bridge | Japan | 2001 | Mermigas 2008; Stroh 2012 |
| 23 | Zhangzhou Zhanbei Bridge | Zhangzhou, China | 2001 | Baidu 2012; Tang et al. 2002; Tang et al. 2007; Wang 2003; Cai et al. 2002; China.com 2012 |
| 24 | Fukaura Bridge | Japan | 2002 | Mermigas 2008; Stroh 2012; |
| 25 | Pont de Saint-Rémy-de-Maurienne Bridge | Koror, Palau | 2002 | Mermigas 2008; Stroh 2012; Wilhelm 2012; Wikipedia 2012 |

| | Bridge | Location | Year | References |
|----|--------------------------------|--|------|---|
| 26 | Sashikubo Bridge | Shingou-mura Japan | 2002 | Mermigas 2008; Stroh 2012 |
| 27 | Shinkawa (Tobiuo) Bridge | Hamamatsu, Japan | 2002 | TABIKAPPA, 2012; DYWIDAG 2012; Mermigas 2008; Stroh 2012; Wilhelm 2012; Chilstrom et al. 2001 |
| 28 | Tongan Yinhu Bridge | Xiamen, China | 2002 | Li and Zeng 2002; Liu et al. 2006; CNBRIDGE 2012 |
| 29 | Changcheng Yunhe Bridge | Changzhou, China | 2003 | Pang 2006; Zhao 2007; Yang 2003; Hui 2003; Liu et al. 2007 |
| 30 | Deba River Bridge | Guipuzcoa, Spain | 2003 | Eipsa 2012; Llombart 2004; Mermigas 2008; Stroh 2012; Wilhelm 2012 |
| 31 | Xiaoxihu Yellow River Bridge | Lanzhou, China | 2003 | Li 2002; Zhang and Kang 2002; NiPic.com 2012 |
| 32 | Shanxi Fenhe Bridge | Linfen, China | 2003 | CCTV 2012; Shangxi Today 2012; TJSZNET 2012 |
| 33 | JR Arakogawa Bridge | Aichi, Japan | 2003 | TABIKAPPA, 2012 |
| 34 | Himi Bridge | Nagasaki, Japan | 2004 | Hino 2005; TABIKAPPA, 2012; Mermigas 2008; Stroh 2012; Wilhelm 2012 |
| 35 | Korong Bridge | Budapest, Hungary | 2004 | Becze and Bartz 2006; Fricy 2009; Wilhelm 2012 |
| 36 | Tatekoshi (Matakina) Bridge | Okinawa, Japan | 2004 | DYWIDAG 2012; Mermigas 2008; Stroh 2012; Wilhelm 2012 |
| 37 | Shin-Meisei Bridge | Japan | 2004 | Mermigas 2008; Stroh 2012 |
| 38 | Yinchuan Beierhuan I Bridge | Yinchuan, China | 2005 | XINHUANET 2012 |
| 39 | Shuqian Nanerhuan Bridge | Shuqian, China | 2005 | Zhang 2004; CNBRIDGE 2012; CSCEC7BJT 2012 |
| 40 | Brazil-Peru Integration Bridge | Between Assis Brasilm Brazill and Inapari Peru | 2005 | Border 2005; Mermigas 2008; Stroh 2012; Wilhelm 2012; XINHUA 2004; BNAMERICAS 2012 |
| 41 | Sannohe–Boukyo Bridge | Aomori, Japan | 2005 | DYWIDAG 2012; Mermigas 2008; Stroh 2012; Wilhelm 2012; blogspot.com 2011 |
| 42 | Lishi Gaojia Bridge | Sanxi, China | 2005 | He 2004a; He 2004b; Li 2008; Li 2008 |
| 43 | Lita Bridge | Yinchuan, China | 2006 | Li 2006; SINA 2012 |
| 44 | Pingdingshan Zhanhe I Bridge | Pingdingshan, China | 2006 | Gao et al. 2005; Liu et al. 2004; CCSEBISC.com.cn 2011 |
| 45 | Ritto (Rittoh) Bridge | Japan | 2006 | Mermigas 2008; Stroh 2012; Overview 2012; Wikipedia 2012; Wilhelm 2012; TABIKAPPA, 2012; NAVER 2012 |
| 46 | Nanchiku Bridge | Japan | 2006 | Mermigas 2008; Stroh 2012 |
| 47 | Rio Branco Third Bridge | Rio Branco, Brazil | 2006 | Mermigas 2008; Stroh 2012; Wilhelm 2012 |
| 48 | Liuzhou Sanmenjiang Bridge | Liuzhou, China | 2006 | Hu et al. 2007; Hu 2009; STEC 2012; BAIDU 2012; CTCECC 2012; SINA 2012 |
| 49 | Tagami Bridge | Japan | 2006 | Mermigas 2008; Stroh 2012 |
| 50 | Tokunoyamahattoku Bridge | Ibigawa, Japan | 2006 | Highestbridges 2012; Mermigas 2008; Stroh 2012; Wilhelm 2012; Wikipedia 2012; WEBLINE 2012; TABIKAPPA, 2012 |
| 51 | Yanagawa Bridge | Nagasaki, Japan | 2006 | Mermigas 2008; Stroh 2012 |
| 52 | Huiqing Huanghe Bridge | Shandong, China | 2006 | YELLOWRIVER 2012; HUIMIN 2012; Quan 2008 |
| 53 | Kaifeng Huanghe II Bridge | Kaifeng, China | 2006 | CHINA 2012; HAHE.com 2012 |
| 54 | Fuzhou Pushang Bridge | Fuzhou, China | 2006 | Dong 2006; BAIDU 2012; SXHighway 2012; CNBRIDGE 2012 |
| 55 | Chaobaihe Bridge | Beijing, China | 2006 | BAIDU 2012; CNBRIDGE 2012; Tie 2006 |

| | Bridge | Location | Year | References |
|----|--------------------------------|---------------------------------|------|--|
| 56 | Homeland (Domovinski) Bridge | Zagreb, Croatia | 2007 | Alpine, 2012; Dnevnik.hr 2007; Wikipedia 2012; Wilhelm 2012; Mermigas 2008; Stroh 2012 |
| 57 | Bridge of the European Union | Konin, Poland | 2007 | Wilhelm 2012; City 2012; Kazimierz 2012; Mermigas 2008; Stroh 2012; konin.pl 2012; Palasz 2012 |
| 58 | Hemaxi Bridge | Guangdong, China | 2007 | Peng et al. 2007; Ran 2006; 114NEWS 2012 |
| 59 | Yudaihe Bridge | Beijing, China | 2007 | BJTZZS 2012 |
| 60 | Ailan Bridge | Puli, Taiwan | 2007 | TCOC 2012; Ko 2008; Jau and Li 2012; Wiecon 2012; DYWIDAG 2012; YAHOO 2012; Lai 2009; Lin and Guo 2009; Hoher 2010 |
| 61 | Nymburk Bypass Bridge | Nymburk, Czech Republic | 2007 | Pontex 2012, Finite 2010, Kalnyet al. 2009; Mermigas 2008; Stroh 2012; Wilhelm 2012; LUSAS.com 2012 |
| 62 | Puh (Puhov) Bridge | Ptuj, Slovenia | 2007 | Slovenian 2012; Markelj 2010; PORR 2012; Wikipedia 2012; Institute 2012; Mermigas 2008; Stroh 2012, Wilhelm 2012; IZS2012; E-KONSTRUKCIJE, 2012 |
| 63 | Shindae First Bridge | Chungcheongnam-do, Korea | 2007 | Soil and Structures 2007, Stroh 2012; Wilhelm 2012 |
| 64 | Smuuli Bridge | Tallinn, Estonia | 2007 | Wilhelm 2012; ABES 2012 |
| 65 | Gum-Ga Grand Bridge | Chung Ju, Korea | 2007 | Wilhelm 2012, Stroh 2012 |
| 66 | Second Vivekananda Bridge | Kolkata, India | 2007 | Binns 2005; Stroh 2012; L&T 2012; Wilhelm 2012; IBT 2012 |
| 67 | Gack-Hwa First Bridge | Gwangju, Korea | 2007 | Wilhelm 2012; Stroh 2012; Liuzhou 2012 |
| 68 | Pyung-Yeo II Bridge | Yeosu, Korea | 2008 | Wilhelm 2012; Stroh 2012 |
| 69 | Dae-Ho Grand (Cho-Rack) Bridge | Dangjin, Korea | 2008 | Wilhelm 2012; Stroh 2012 |
| 70 | Hirano Bridge | Osaka, Japan | 2008 | DYWIDAG 2012; Wilhelm 2012 |
| 71 | Sannai-Maruyama Bypass Bridge | Hachinole to Shin-Aomori, Japan | 2008 | Tamai et al.2008; Shimize Co. 2012 |
| 72 | Ma-Tsu Bridge | Yunlin, Taiwan | 2008 | Wiecon 2012; Stroh 2012; T.Y. Lin 2012; Wilhelm 2012 |
| 73 | North Arm Bridge | Vancouver, Canada | 2008 | Reed 2007; Buckland et al. 2011; Buckland et al. 2008; Bergman et al. 2009; Wilhelm 2012; Buckland & Taylor 2008 |
| 74 | Sannai-Maruyama Bridge | Aomori, Japan | 2008 | Wilhelm, 2012; JPCEA 2012; DYWIDAG 2012; Zenitaka 2012 |
| 75 | Trois-Bassins Viaduct Bridge | Reunion, France | 2008 | Wilhelm 2012; Mermigas 2008; Charlon 2008, Stroh 2012 |
| 76 | Hidasie Bridge | Blue Nile Gorge, Ethiopia | 2008 | Nazret.com 2012 |
| 77 | Riga South(ern) Bridge | Riga, Latvia | 2009 | Wilhelm 2012; Dienvidu 2012; Stroh 2012; vBulliten 2012; Gridnev; 123RF Limited 2012 |
| 78 | Golden Ears Bridge | Vancouver, Canada | 2009 | Bergman et al. 2007; Bergman et al. 2009; CEI 2010; Buckland 2011; Road Traffic Technology 2012; Wilhelm 2012; Trimbath 2006; Buyric 2010; Welch 2010; Reed 2008; Stroh 2012; Bilfinger 2012 |
| 79 | Karnaphuli III Bridge | Chittagong, Bangladesh | 2009 | Orangebd 2010; Astin 2010a; Astin 2010b; Wilhelm, 2012; Nuruzzaman 2010; Heller 2011; Stroh 2012; AECCAFE 2012; NewsToday 2012 |
| 80 | Kyong-An Bridge | Kyong-An, Korea | 2009 | Wilhelm 2012; Stroh 2012 |
| 81 | Lusong Bridge | Zhuzhou, China | 2009 | 163.com 2012;Liao and Chen 2006 |

| | Bridge | Location | Year | References |
|-----|---|-----------------------------|------|---|
| 82 | Xianshen River Bridge | Shanxi, China | 2009 | Wilhelm 2012; CNKI 2012; Baidu 2012; Tang and Chen 2009; Sina.com.cn |
| 83 | Ankang Qiligou Bridge | Shanxi, China | 2009 | Baidu 2012; RBTMM.com; ChnRoad.com 2008 |
| 84 | Incheon Bridge | Incheon, Korea | 2009 | Park et al. |
| 85 | Qishan Bridge | Gaoxiong, Taiwan | 2010 | TaiwanToday 2012 |
| 86 | Choqueyapu Bridge | La Paz, Bolivia | 2010 | Wilhelm 2012; Sobrino 2011; Skyscraper 2012; Stroh 2012; QLJG8.com 2012 |
| 87 | Kantutani Bridge | La Paz, Bolivia | 2010 | Wilhelm 2012; Sobrino 2011; Skyscraper 2012; Stroh 2012; QLJG8.com 2012 |
| 88 | Orkojahaira Bridge | La Paz, Bolivia | 2010 | Wilhelm 2012; Sobrino 2011; Skyscraper 2012; Stroh 2012; QLJG8.com 2012 |
| 89 | Povazska Bystrica D1 Motorway Viaduct | Povazska Bystrica, Slovakia | 2010 | Wilhelm 2012; Strasky et al. 2011; Strasky 2010; Strasky 2012; Matascik 2012; Racansky 2012; Stroh 2012; SHP.ED 2012 |
| 90 | Teror Viaduct | Gran Canaria Island, Spain | 2010 | Wilhelm 2012' Eispa 2012; Skyscraper 2012; bandadeteror.com 2012; abc.es 2012 |
| 91 | New Amarube Bridge | Japan | 2010 | Wikipedia 2012, Niwa 2010 |
| 92 | Immobility Bridge | Japan | 2011 | Wikipedia 2012, Go.JP 2012 |
| 93 | Un-am Grand Bridge | Jeonbuk, Korea | 2011 | Wilhelm 2012 |
| 94 | Panyu Shanwan Bridge | Guangzhou, China | 2011 | RBSCE.com 2012; Liu and Zheng 2007; Xuang and Yang 2009 |
| 95 | Jiayue (Nanping) Bridge | Chongqing, China | 2011 | Baidu 2012; CNBridge 2012; Gov.cn 2010; Qiaoliangren.net 2012 |
| 96 | Tisza Bridge | More Ferenc, Hungary | 2011 | Pont-Terv 2012; Matyassy 2010; Torok 2011 |
| 97 | Hwangdo Grand Bridge | Changgi-ri, Korea | 2011 | BBG.CO.KR 2012 |
| 98 | Nokan Bridge | Busan, Korea | 2011 | DM Engineering Co. Ltd. 2012 |
| 99 | Guemgang I Bridge | Sejong City, Korea | 2012 | Wilhelm 2012; Naver.com 2012(122); Leonhardt 2012; |
| 100 | Qinxiu Bridge | Lugu, Taiwan | 2012 | TaiwanToday.com 2012; |
| 101 | Hualiantai Fengping Bridge | Hualian, Taiwan | 2012 | Yahoo.com 2012 |
| 102 | Dazhihe Bridge | Shanghai, China | 2012 | Tumukeji.com 2012; SHSZ.ORG.CN 2012 |
| 103 | Najin Bridge | Tibet, China | 2012 | Wilhelm 2012; News.CN 2010; Chinatibetnews.com 2012, CCTV.com 2012 |
| 104 | La Massana Bridge | La Massana, Andorra | 2012 | Wilhelm 2012; Rowson 2012; Stroh 2012 |
| 105 | Naluchi Bridge | Muzaffarabad, Pakistan | 2012 | Wilhelm 2012; Nagash 2012; Ghulam 2012; TOPIX.COM 2012; AEC-INC.JP 2012; GRC.COM.PK 2012 |
| 106 | Waschmuhl Viauct | Kreos, Germany | 2012 | Wilhelm 2012; Landesbetrieb 2012; LBM.RLP.DE 2012 |
| 107 | New Pearl Harbor Memorial (Quinnipiac) Bridge | New Haven, US | 2012 | Wilhelm 2012; Dunham et al. 2010; Buckland 2012(20); Shane et al. 2012; Wikipedia 2012; Stroh 2012; CTDOT 2012; B-T.com 2012; Anderson 2011; i95newhaven.com 2012 |
| 108 | Changshan Bridge | Daliang, China | 2013 | EEmap.org 2012; Tumukeji.com 2012; News.lnd.com.cn 2012 |
| 109 | Ningjiang Shonghuajiang Bridge | Jilin, China | 2013 | Zhao et al. 2010; Cr13g-lc.com 2011; rbtmm.com 2012 |
| 110 | Halfsky Overpass Bridge | Lugu, Taiwan | 2013 | Nantou.gov.tw 2012; LibertyTimes.com 2012; Myaena.net 2012 |
| 111 | Yongjin Bridge | Sang-ri, Korea | 2014 | BNG.CO.KR 2012 |
| 112 | Gangchon 2nd Bridge | Banggok-ri, Korea | 2014 | BNG.CO.KR 2012 |

| | Bridge | Location | Year | References |
|-----|--------------------------|------------------------------------|------|--|
| 113 | Saint Croix River Bridge | Houlton/Still Water, United States | 2014 | Brinckerhoff 2010; URS 2012; Wilhelm 2012; Vineyard 2010; Minnesota 2012; Brinckerhoff 2012; PBS&J 2006 |
| 114 | Sanguanjiang Bridge | Wuhan, China | 2015 | 163.com 2012; people.com.cn 2012; autohome.com.cn 2012 |
| 115 | Brazos River Bridge | Waco, United States | 2015 | McGowan 2011; Moore 2012; Finley 2012; TxDOT 2011; TxDOT 2012; Lane 2012; Adesanya 2012; Yogi 2012; Wood 2012; 1000 Friends of Waco 2012 |
| 116 | Naericheon Bridge | Sangnam Inje Kangwon, Korea | 2015 | DM Engineering Co. Ltd. 2012 |
| 117 | Yaro Grand Bridge | Yaro myun, Korea | 2015 | Naver 2012 |
| 118 | Pyung-Taik Grand Bridge | Pyung-Taik City, Korea | 2016 | Naver 2012 |
| 119 | Beixi Hechuan Bridge | Nanao, Taiwan | 2016 | Ceci.com.tw 2012 |
| 120 | Kinmen Bridge | Kinmen, Taiwan | 2016 | Wantchinatimes.com 2012 |

APPENDIX B: SUMMARY OF EXTRADOSED BRIDGES

| | Name | Span Lengths (ft) | Picture |
|---|--|--------------------------------------|--|
| | Country | Tower Height (ft) (#) | Drawings |
| | Year Built (Construction Duration, mth) | Girder Depth (ft) x Width (ft) | |
| | | Girder Description | |
| 1 | Odawara Blueway Bridge (小田原ブルーウェイブリッジ, 小田原港橋) | 243+433+243 |  |
| | Japan 1994 (35) | Wide double cell concrete box girder | |

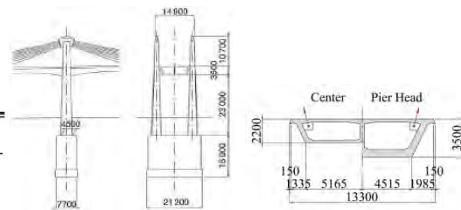
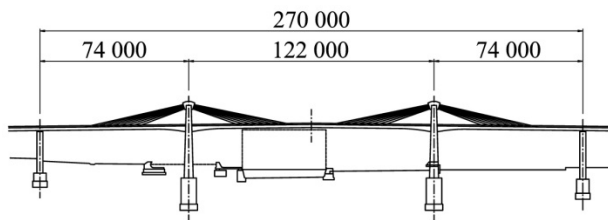

| | | | |
|---|-----------------------------------|--|--|
| 2 | Tsukuhara Bridge (つくはら橋, 佐敷大橋) | 217+519+253 |  |
| | Japan 1997 (36) | Wide single cell concrete box girder. Two separate bounds. | |

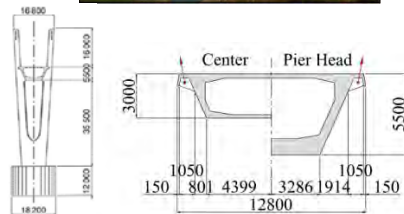
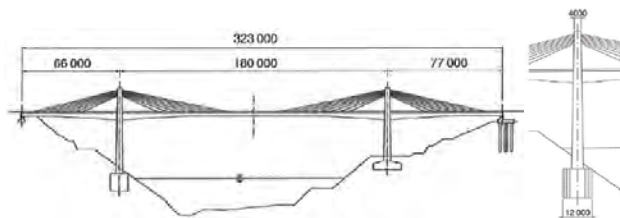

| | | | |
|---|-------------------------|--|--|
| 3 | Yashiro Bridge (屋代橋) | 213+344+344+213 (S) 180+295+180 (N) |  |
| | Japan 1997 | Concrete box girder | |

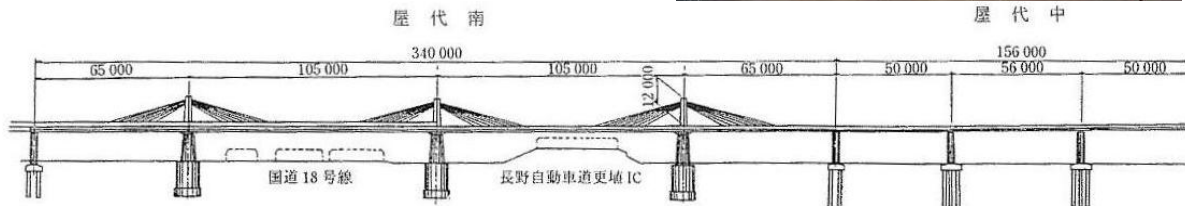

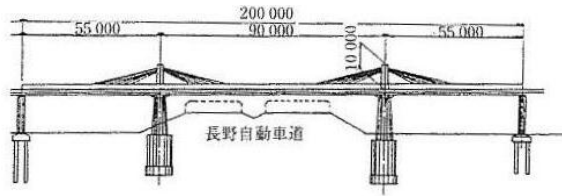

4 Kanisawa Bridge
(蟹沢大橋)
Japan
1998

326+591+326
72.5 (2x2)
(10.8-18.4)x57.4
Concrete box girder

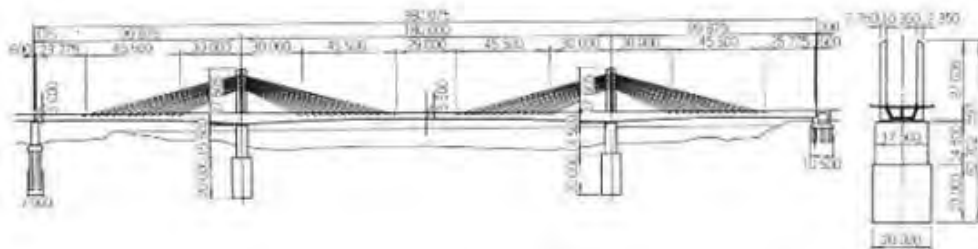

5 Shin-Karato (Okuyama)
Bridge (唐櫃新橋)
Japan
1998

217+394+236 (E)
243+459+227 (W)
39.4 (2x2 Both bounds)
(8.2-11.5)x31.8 (E)
(8.2-11.5)x41.5 (W)
Two and three cell concrete
box girder

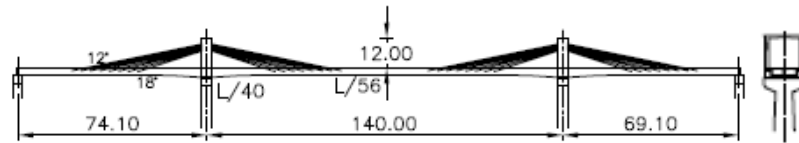

(West Bound)

6 Sunniberg Bridge
Switzerland
1998 (30)

194+420+459+440+213
48.6 (4x2)
3.6x40.6
Concrete slab with edge
stiffening beams

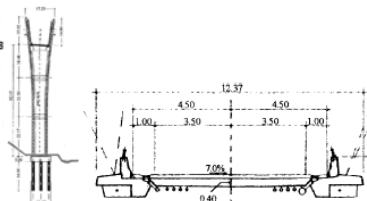
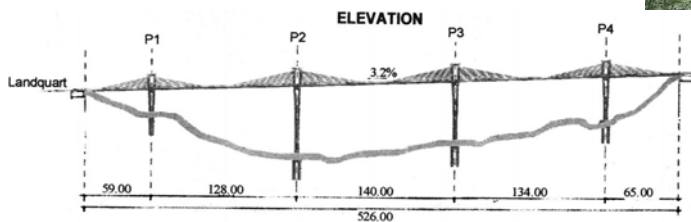

7 Mitanigawa Bridge
(Santanigawa Bridge)
Japan
1999

190+305
41.3 (1x1)
(8.2-21.3)x66.9
Double cell concrete box
girder



8 Sapporo Railway Bridge
(新川高架橋)
Japan
1999 (27)

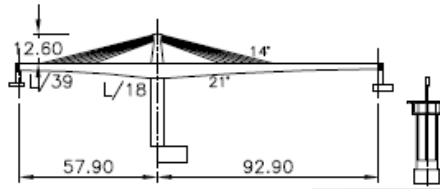

182+182
32.5 (1x2)
NA
Continuous prestressed
concrete bridge



9 Second Mactan–Mandaue
Bridge
Philippines
1999 (27)

366+607+366
59.1 (2x2)
(10.8-16.7)x59.1
Three cell concrete box
girder



10 Pont de Saint-Rémy-de-
Maurienne Bridge
France
1999

172+159
19.4 (1x2)
7.1x44.0
U-shape concrete girder
with transverse ribs between
edge beams



11 King Hussein Bridge
Jordan
1999

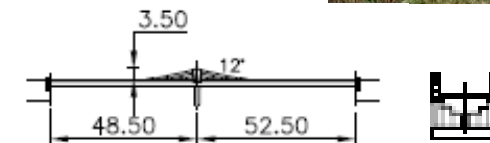

112+171+112
-(2x2)
(4.9-8.2)x62.0
Three cell concrete box
girder



12 Pakse Bridge
Laos and Thailand
2000

404+469+300
49.2 (2x2)
(9.8-21.3)x45.3
Single cell concrete box
girder

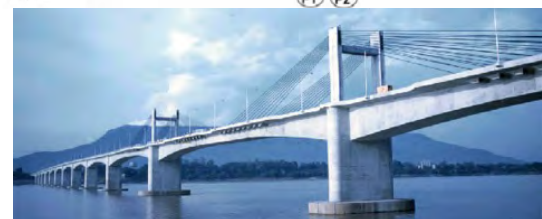
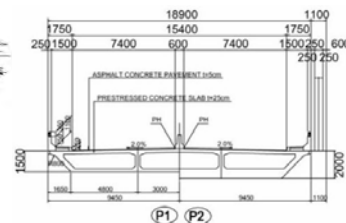
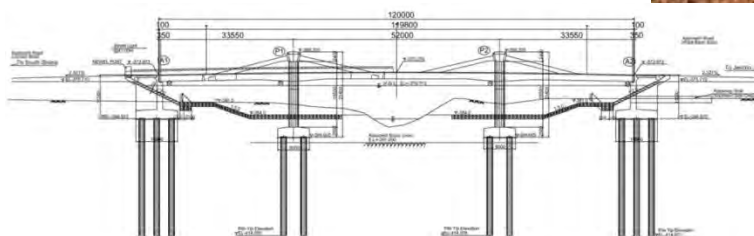

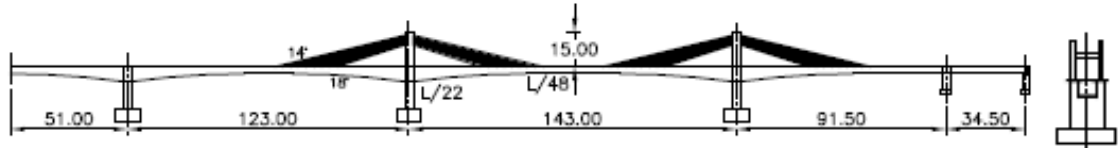

13 Sajiki Bridge (佐敦大桥) 201+344+191
 Japan 38.5 (2x2)
 2000 (6.9-10.5)x36.1
 Concrete box girder

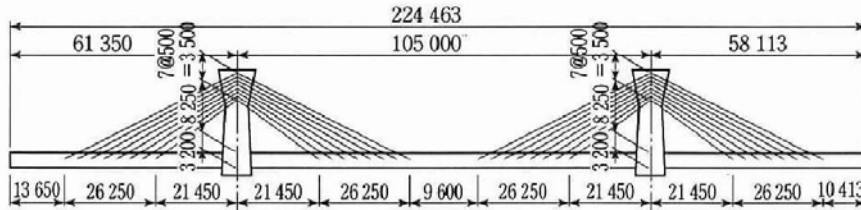

14 Shikari Bridge (土狩大橋) 308+459+459+459+308
 Japan 32.8 (4x1)
 2000 (9.8-19.7)x92.1
 Concrete box girder

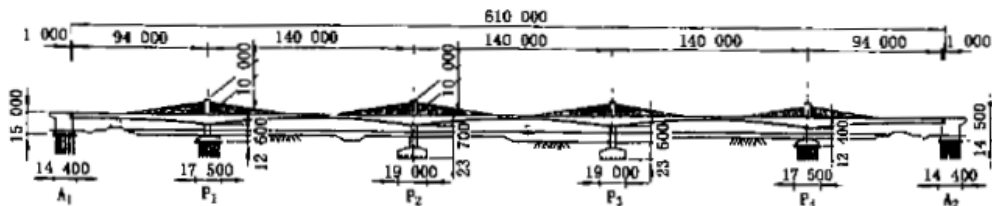
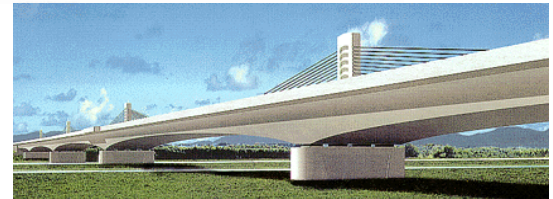

15 Surikamigawa Bridge 278
 Japan 54.1
 2000 (9.2-16.4)x30.2
 Concrete box girder

16 Wuhu Yangtze River Bridge (芜湖长江大桥) 591+1024+591
 China 114.8 (2x2)
 2002 (42) 44.3x76.8
 Double-girderer steel truss with composite girder slab on top roadway, two rail lines on bottom level.

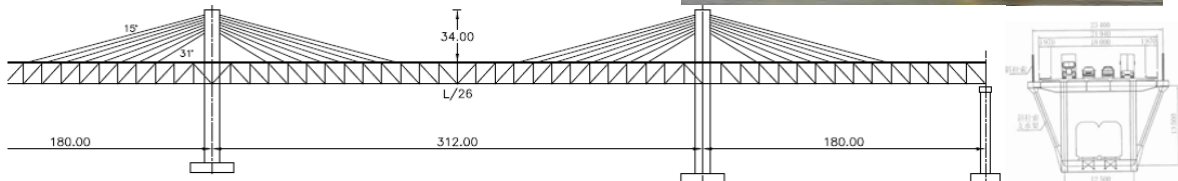

17 Yukizawa Bridge (雪沢大橋) 231+233
 Japan 37.7 (2x2)
 2000 (6.6-11.5)x51.8
 Two cell concrete box girder



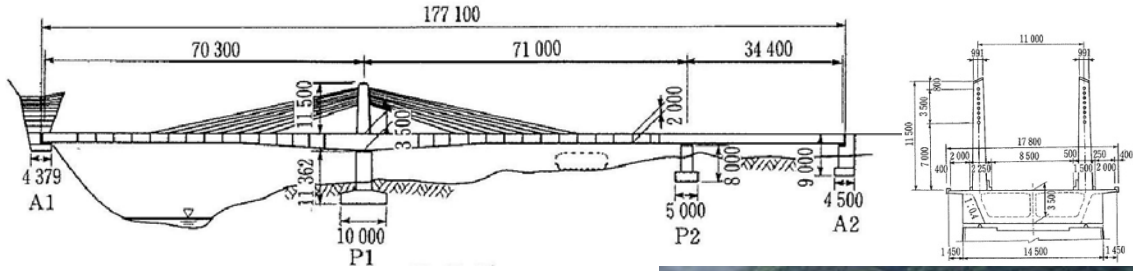

18 Hozu Bridge (保津橋) Japan 2001
 249+328+249
 32.8 (2x2)
 9.2x53.5
 Single cell concrete box girder

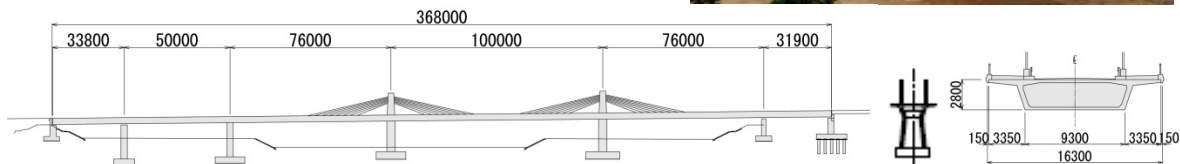

19 Ibi River (Ibigawa) Bridge (揖斐川橋) Japan 2001 (33)
 505+891+891+891+891+515
 98.4 (5x1)
 (14.1-24.0)x108.3
 Hybrid cross section: four cell concrete box girder near piers and steel box girder in center with moment and shear connection

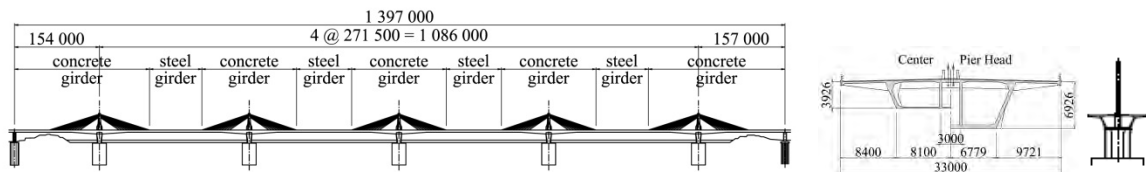

20 Kiso River (Kisogawa) Bridge (木曾川橋) Japan 2001 (33)
 525+902+902+902+525
 98.4 (4x1)
 (14.1-24.0)x108.3
 Hybrid cross section: four cell concrete box girder near piers and steel box girder in center with moment and shear connection

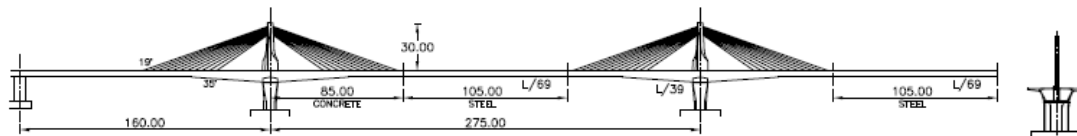

21 Miyakoda
(Miyakodagawa) River
Bridge (都田川橋)
Japan
2001 (55)

440+440
65.6 (1x3)
(13.1-21.3)x65.3
Parallel double cell concrete
box girder

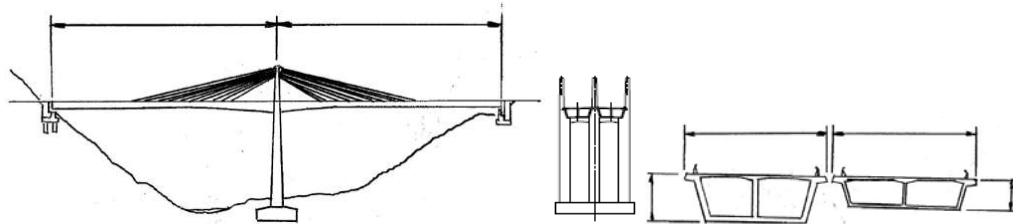

22 Nakanoike Bridge
Japan
2001

199+199
38.7
(8.2-13.1)x70.2

23 Zhangzhou Zhanbei Bridge
(漳州战备大桥)
China
2001 (17)

265+433+265
54.1 (2x1)
(7.9-12.5)x88.6
Three cell concrete box
girder

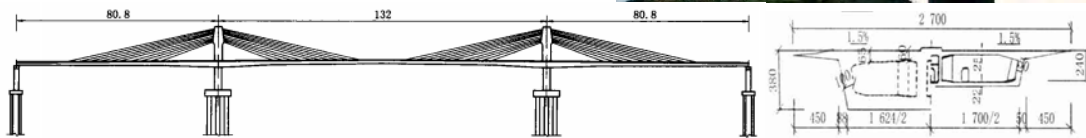

24 Fukaura Bridge
(長者ヶ橋)
Japan
2002

204+293+217+148+96
27.9
(8.2-9.8)x44.9



25 Koror-Babeldaob (Japan-
Palau Friendship) Bridge
Palau
2002 (60)

269+810+269
97.3 (2x2)
(11.5-23.0)x38.1
Hybrid cross section: wide
single concrete box girder
near piers and steel box
girder in central.

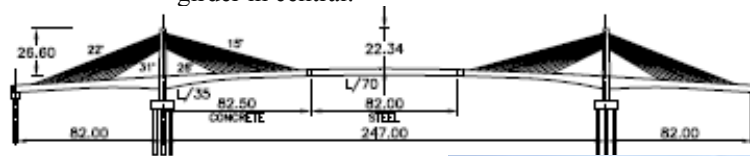

26 Sashikubo Bridge
Japan
2002

374+374
72.2 (1x2)
(10.5-21.3)x37.1
Concrete box girder



27 Shinkawa (Tobiuo) Bridge
 (とびうお大橋,
 新川大橋)
 Japan
 2002

295+427+264
 42.7 (2x1)
 (7.9-13.1)x84.6
 Three cell concrete box
 girder

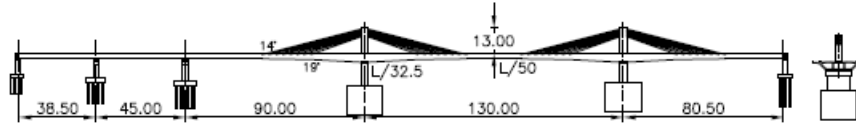

28 Tongan Yinhu Bridge
 (同安银湖大桥)
 China
 2002

262.5+262.5
 103.3 (1x1)
 (7.9-12.5)x88.6
 Three cell concrete box
 girder

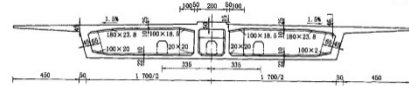
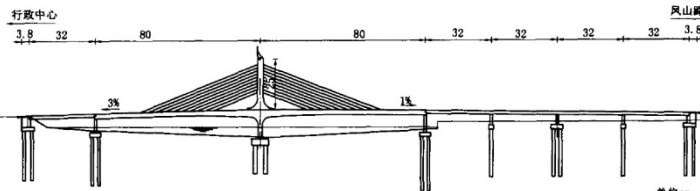

29 Changcheng Yunhe Bridge
 (常澄路京杭运河特大桥)
 China
 2003 (15)

230+394+230
 101.7 (2x2)
 (8.5-13.5)x91.9
 Three cell concrete girder
 box

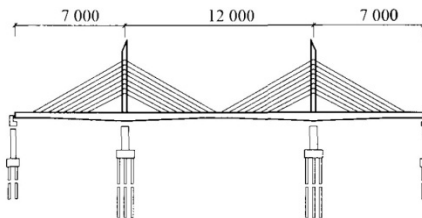

30 Deba River Bridge
 Spain
 2003

138+217+138
 39.0 (2x2)
 (8.9-8.9)x45.6
 U shaped concrete girder
 with transverse ribs between
 edge beams

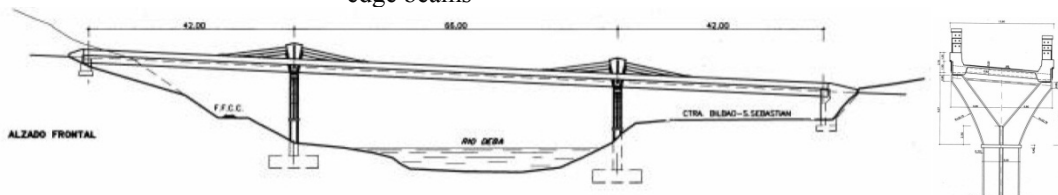

31 Xiaoxihu Yellow River
 Bridge (小西湖黄河大桥)
 China
 2003 (22)

266+446+266
 55.8 (2x2)
 (8.5-14.8)x88.6
 Three cell concrete girder
 box



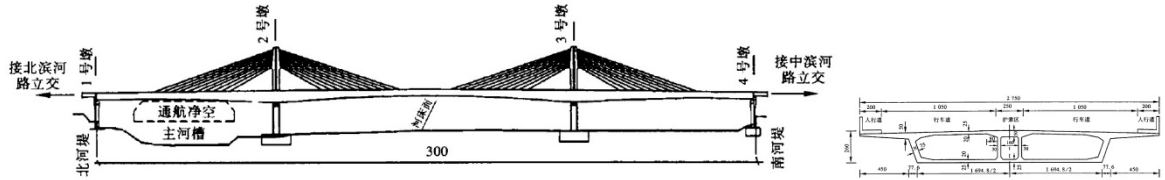

32 Shanxi Fenhe Bridge
(山西汾河大桥)
China
2003

295+492+295
118.1 (2x3)
NAx85.3



33 JR Arakogawa Bridge
(JR荒子川橋梁)
Japan
2003 (15)

178+295+185
29.5 (2x2)
8.5x41.7
Concrete box girder

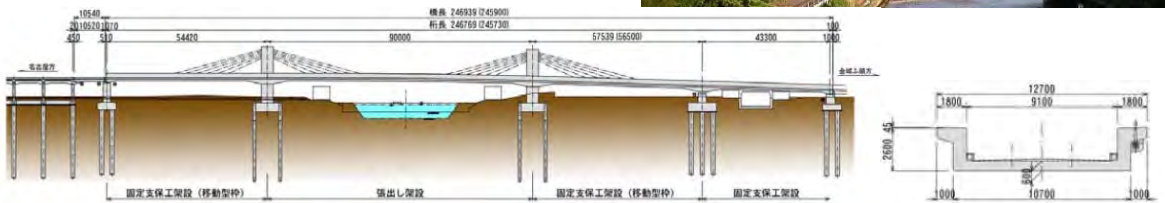

34 Himi Bridge
(日見夢大橋)
Japan
2004

301+591+301
65 (2x2)
13.1x40.8
Single cell doubly
composite box girder with
corrugated steel webs

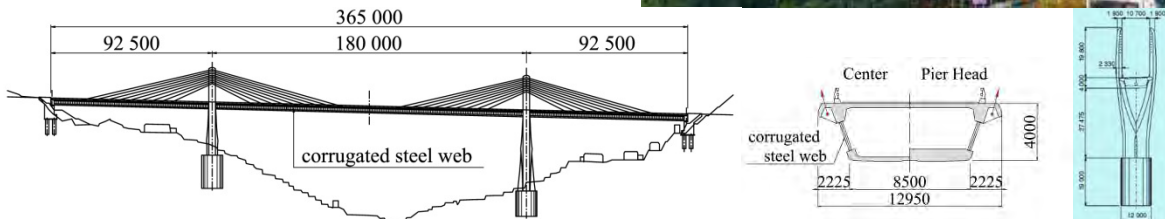

35 Korong Bridge
Hungary
2004

172+203
31.0 (1x2)
8.2x52.0
Three cell concrete box
girder stiffened with
transverse ribs



36 Tatekoshi (Matakina) Bridge
Japan
2004
185+185
34.4 (1x2)
(5.9-9.5)x62.8
Concrete box girder



37 Shin-Meisei Bridge (赤とんぼ橋)
Japan
2004
290+401+266
54.1 (2x1)
11.5x62.3
Three cell concrete trapezoidal box girder.

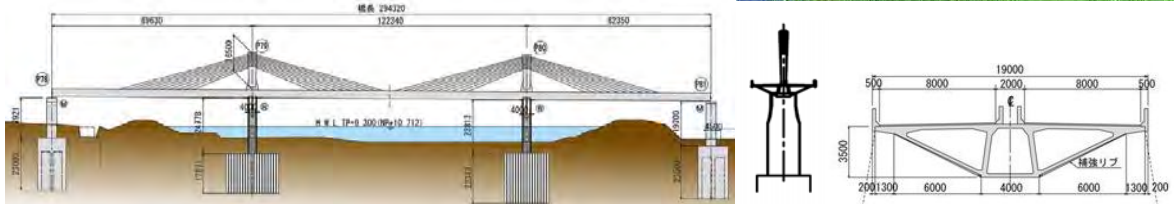

38 Yinchuan Beierhuan I Bridge (银川市北二环路一号桥)
China
2004 (25)
230+230
95.1 (1x2)
7.9x196.2
Wide four cell concrete box girder

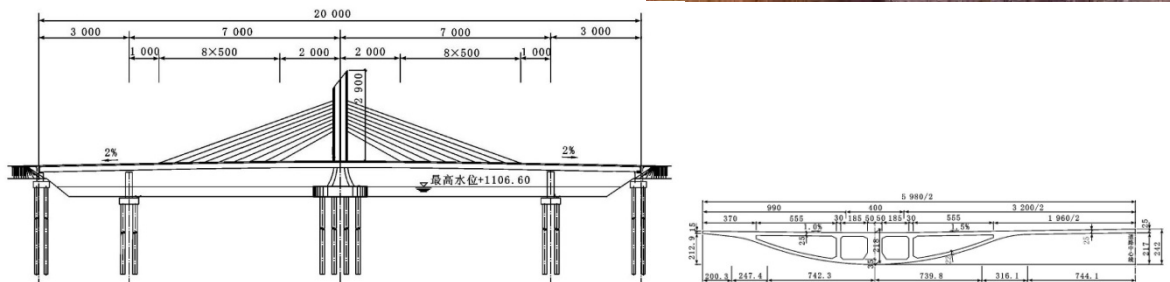

39 Shuqian Nanerhuan Bridge (宿迁南京路运河大桥)
China
2005 (24)
217+361+217
45.9 (2x1)
(7.2-11.5)x65.6
Three cell concrete box girder

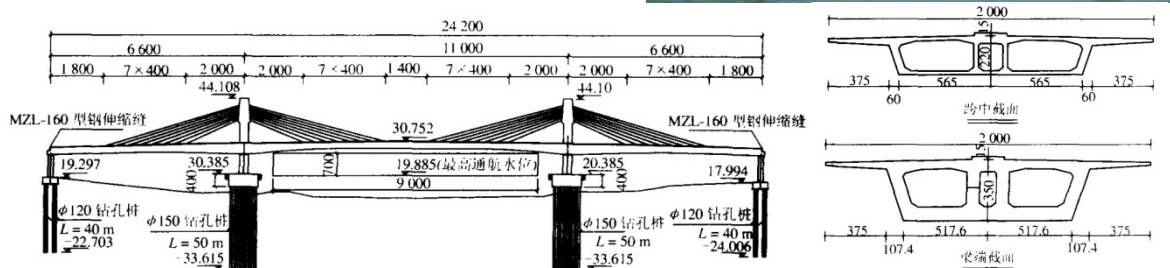

40 Brazil-Peru Integration Bridge
Brazil/Peru
2005
213+361+213
49.2 (2x2)
(7.1-11.0)x55.1
Wide single cell concrete box girder

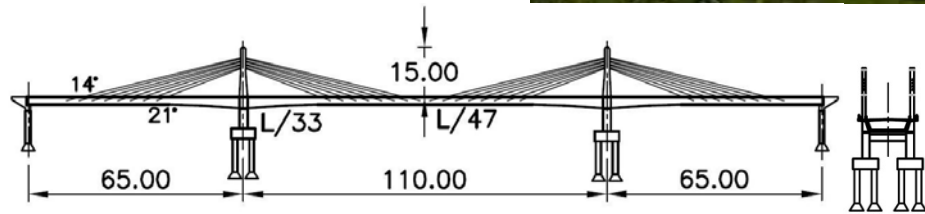

41 Sannohe-Boukyo Bridge
(三戸望郷大橋)
Japan
2005
328+656+328
82.0 (2x2)
(11.5-21.3)x44.1
Two cell concrete box girder

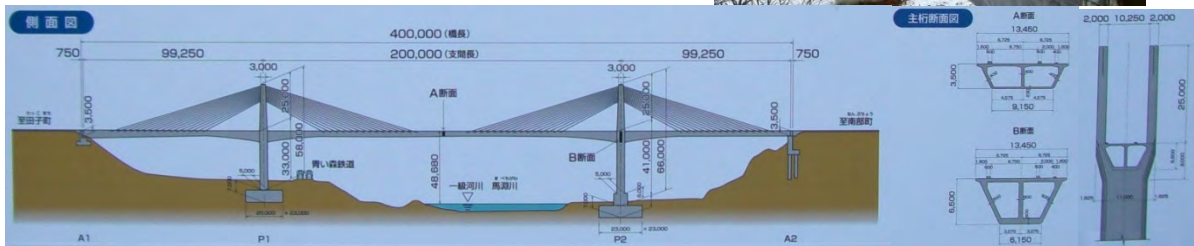

42 Lishi Gaojia Bridge
(离石高架桥)
China
2005
279+443+279
59.1 (2x1)
(7.9-13.8)x85.3
Three cell concrete box girder

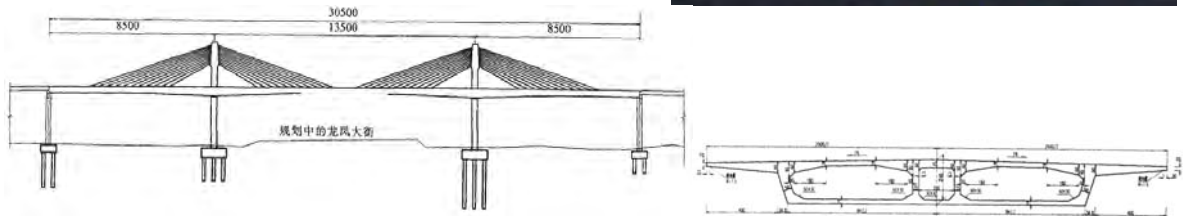

43 Yinchuan Lixinglu I Bridge
(银川丽兴路一号桥)
China
2006
-
94.5
-x196.8
Two cell concrete box girder



44 Pingdingshan Zhanhe I
 Bridge (平顶山湛河一桥)
 China
 2006

289+236
 74.5 (1x1)
 (7.2-13.1)x98.4
 Concrete box girder

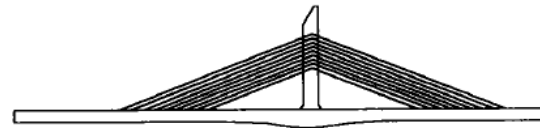
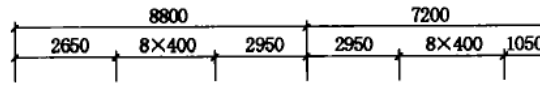

45 Ritto (Rittoh, or
 Oumi-Ohtori) Bridge
 (近江大鳥橋)
 Japan
 2005

451+558+377+222 (Tokyo
 Bound)
 501+525+246+295+238
 (Osaka Bound)
 100.1 (1x2x2)
 (14.8-24.6)x64.3
 Three cell doubly composite
 box girder with corrugated
 steel webs.

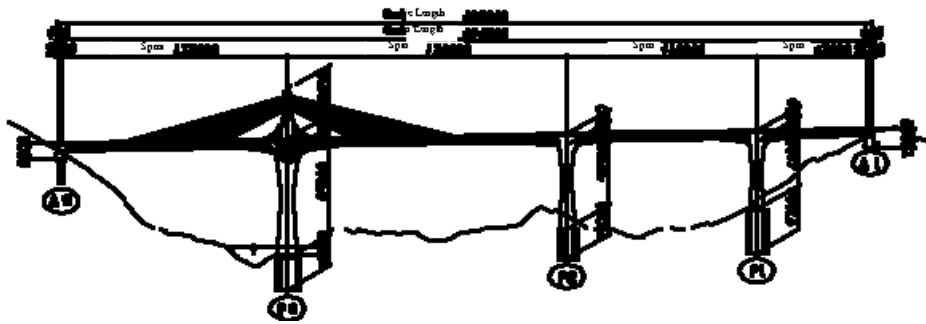

(Tokyo Bound)

46 Nanchiku Bridge
 Japan
 2006

223+361+223
 36.1 (2x2)
 (8.5-11.5)x67.4
 Three cell concrete box
 girder

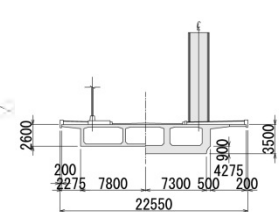
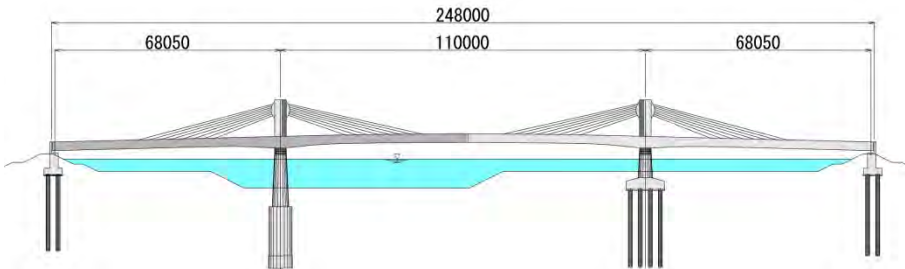

51 Yanagawa Bridge
 Japan
 2006 (34)
 429+429
 78.7 (1x2)
 (13.1-21.3)x57.1
 Two cell concrete box girder

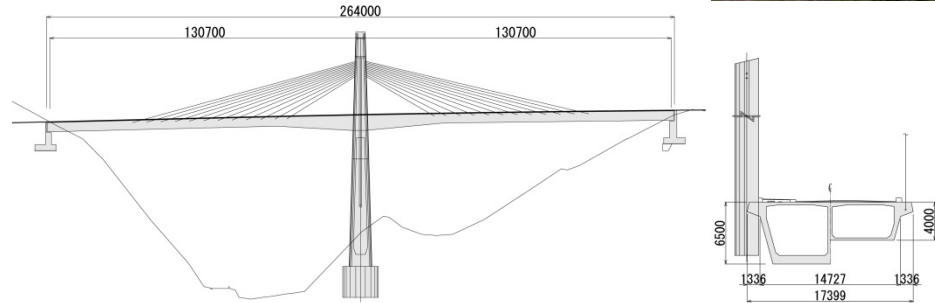

52 Huiqing Huanghe Bridge
 (惠青黄河大桥)
 China
 2006 (32)
 436+722+439
 99.4 (2x1)
 (13.1-24.6)x65.6
 Three cell concrete box girder



53 Kaifeng Huanghe II Bridge
 (开封黄河二桥)
 China
 2006 (26)

279+6x459+279
 118.1 (7x2)
 -x98.4



54 Fuzhou Pushang Bridge
 (福州浦上大桥)
 China
 2006 (28)

236+361+361+236
 88.6 (3x2)
 -x109.9



55 Chaobaihe Bridge
 (京承高速潮白河大桥)
 China
 2006

236+394+394+236
 70.5 (3x1)
 (7.2-13.8)x96.8
 Three cell concrete girder



56 Homeland (Domovinski) Bridge
Croatia
2007
236+394+236
54.1 (2x2)
11.6x109.9
Five cell concrete box girder supported light rail between cable planes

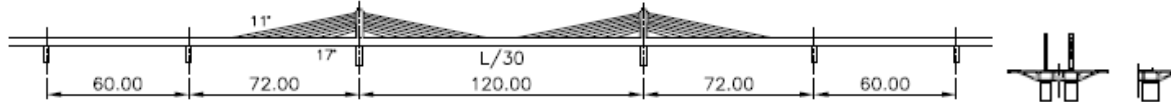

57 Bridge of the European Union
Poland
2007
197+262+197
33.8 (2x2)
-x82.3



58 Hemaxi Bridge (荷麻溪大桥)
China
2007
410+755+410
128
(9.8-21.3)x92.8
Three cell concrete box girder

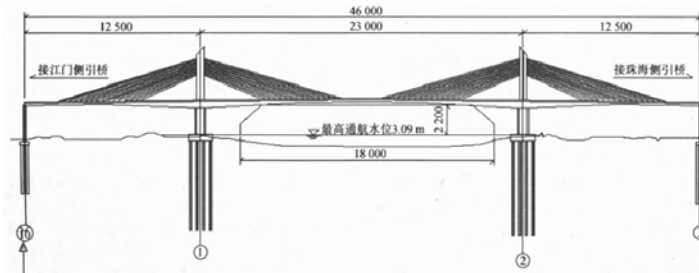

59 Yudaihe Bridge (玉带河大桥)
China
2007
148+279+279+148
92.2 (3x2)
-x109.9



60 Ailan Bridge (國道六號愛蘭橋)
Taiwan
2007
262+459+262
65.6 (2x1)
(9.8-16.7)x85.1
Multi-cell concrete box girder.

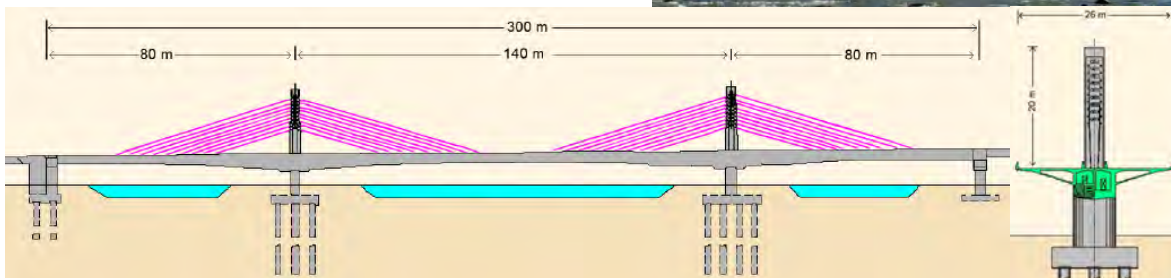

61 Nymburk Bypass Bridge
 Czech
 2007

135+443+135
 52.5 (2x2)
 (7.5-)x54.6

Composite steel-concrete structure built into the ends of the concrete structure.

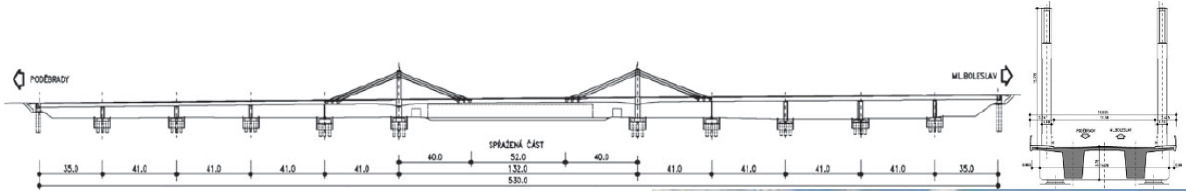

62 Puh (Puhov) Bridge
 Slovenia
 2007 (19)

231+328+328+328+213
 27.9 (6x3)
 8.9x61.4

Single cell concrete box girder

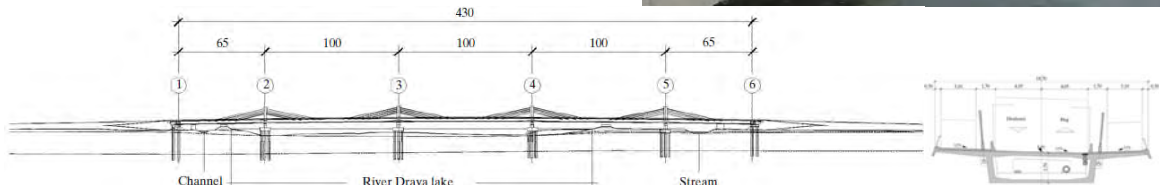

63 Shindae Bridge
 Korea
 2007

148+256+256+148
 39.4
 -x70.8



64 Smuuli Bridge
 Estonia
 2007

138+279+138
 - (2x2)
 -

Concrete box girder



65 Gum-Ga Grand (Kumga) Bridge
 Korea
 2007

85.35+125+125+125+125+
 125+85.25
 8.85 (6x2)
 -x23

Multiple cell concrete box girder



66 Second Vivekananda Bridge
 India
 2007

180+7x361+180
 45.9 (8x2)
 11.2x95.1

Concrete box girder



67 Gack-Hwa First Bridge
Korea
2007 (33)

377+328
75.5 (1x2)
(11.6-16.3x102)
Multiple cell concrete box girder

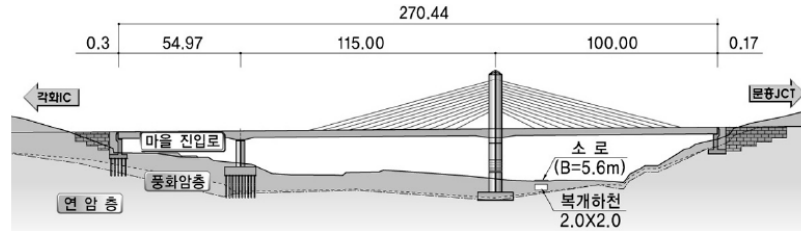

68 Pyung-Yeo II Bridge
Korea
2008

213+394+213
34.4 (2x2)
(11.5-13.1)x68.9
Four cell concrete box girder

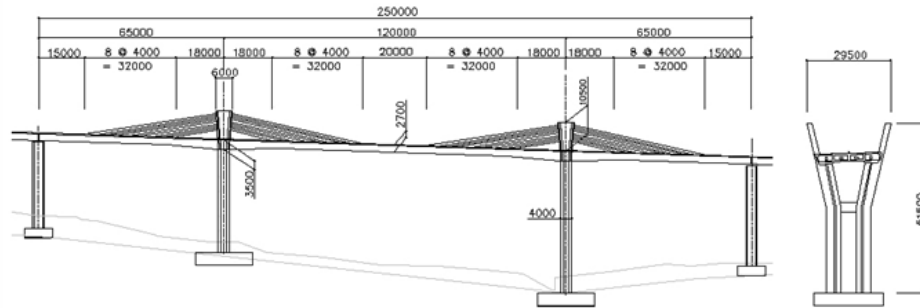

69 Dae-Ho Grand (Cho-Rack) Bridge
Korea
2008

230+427+427+427+230
54.1 (4x2)
(8.2-11.5)x45.19
Two cell concrete box girder

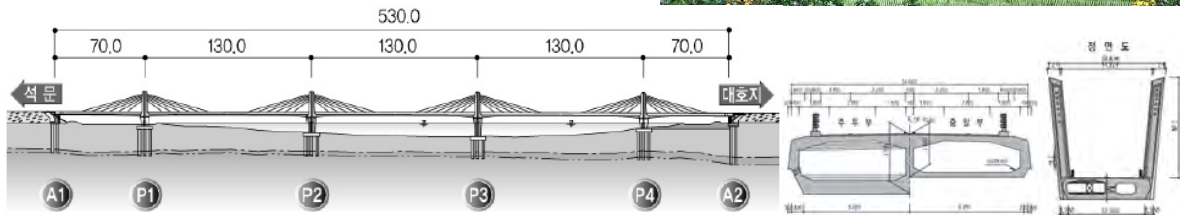

70 Hirano Bridge
Japan
2008

207 (main span)
-
-
Concrete box girder



71 Sannai-Maruyama Bypass
Bridge (三内丸高架桥)
Japan
2008 (36)

246+492+492+246
- (3x2)
-
Two cell concrete box
girder.

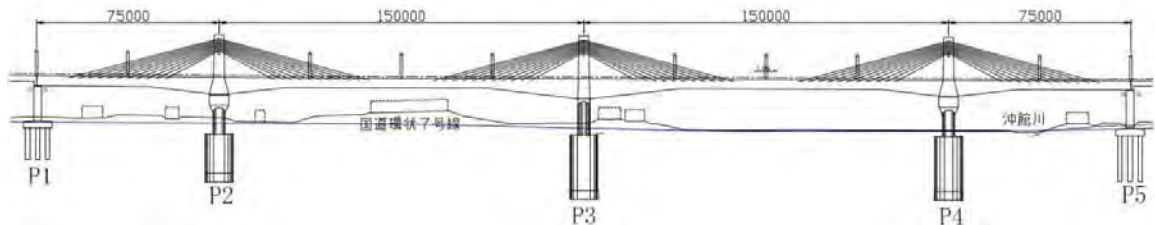

72 Ma-Tsu Bridge
(媽祖大橋)
Taiwan
2008

410+410
114.8 (1x1)
(8.2-19.7)x88.6
Concrete box girder

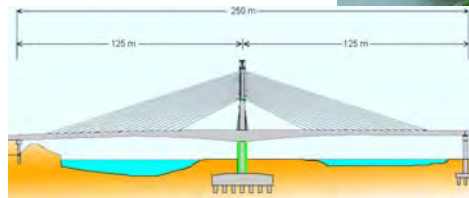

73 North Arm (Canada Line
Extradosed Transit) Bridge
Canada
2008

456+591+456
59.1 (2x1)
(9.2-19.0)x33.8
Single cell concrete box
girder

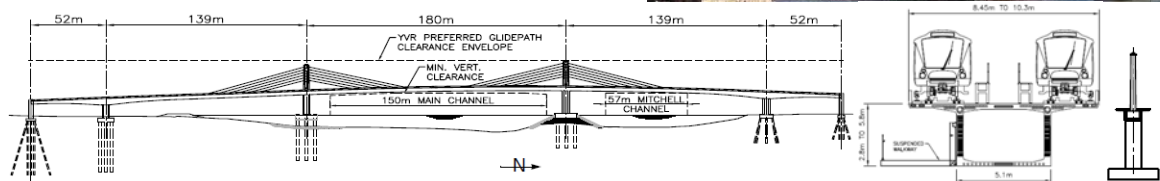

74 Sannai-Maruyama Bridge
Japan
2008

243+492+492+243
57.4 (3x2)
(12.5-24.2)x45.4
Four cell concrete box
girder

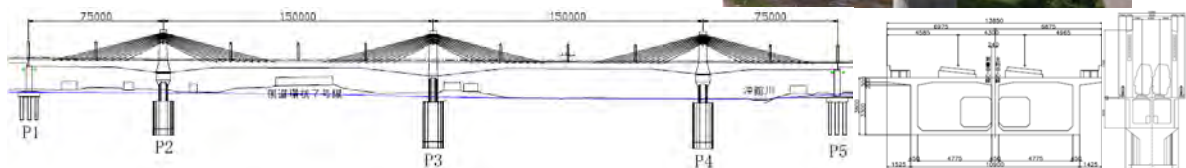

75 Trois-Bassins Viaduct Bridge
 France
 2008 (33)
 413+343+248
 32.8 & 62.3 (1x1 & 1x1)
 (13.1-23.0)x72.2
 Single cell concrete box girder with steel struts supporting long girder cantilevers.

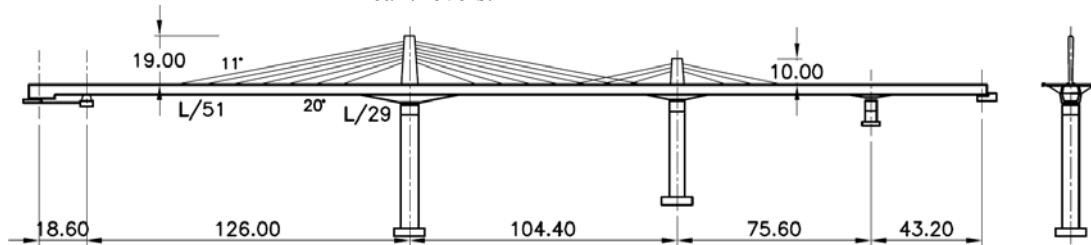

76 Hidasie Bridge
 Ethiopia
 2008
 476 (994 Total)
 -(2x2)



77 Riga South(ern) Bridge
 Latvia
 2008 (48)
 361 (main)
 43.7 (6x1)
 -x112.5



78 Golden Ear Bridge
 Canada
 2009
 397+794+794+794+397
 136.2 (4x2)
 (8.9-14.8)x105.0
 Steel box girders at edge of girder with transverse floor beams composite with precast concrete girder.

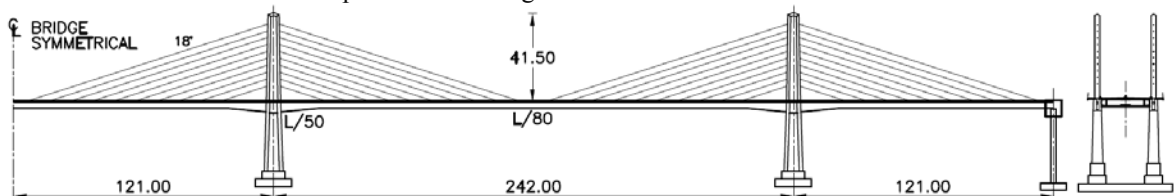

79 Karnaphuli III (Shah Amanat) Bridge
 Bangladesh
 2009
 377+656x3+377
 84.5 (4x1)
 (13.1-22.1)x80.3
 Single cell concrete box girder

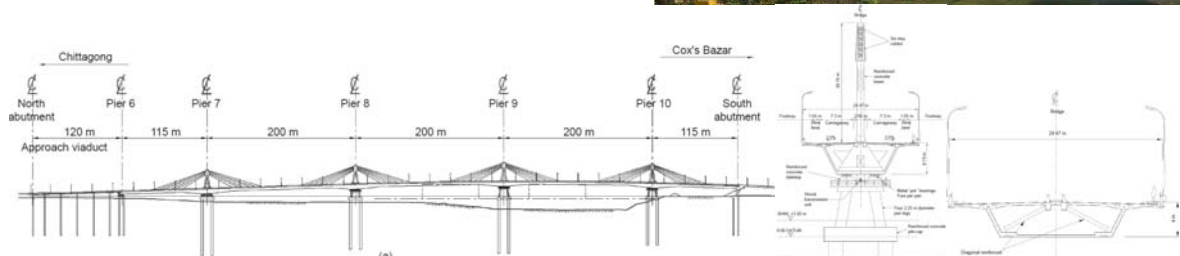

80 Keong-An Bridge
 Korea
 2009
 230+427+230
 53.5 (2x1)
 9.8x98.4
 Four cell concrete box girder

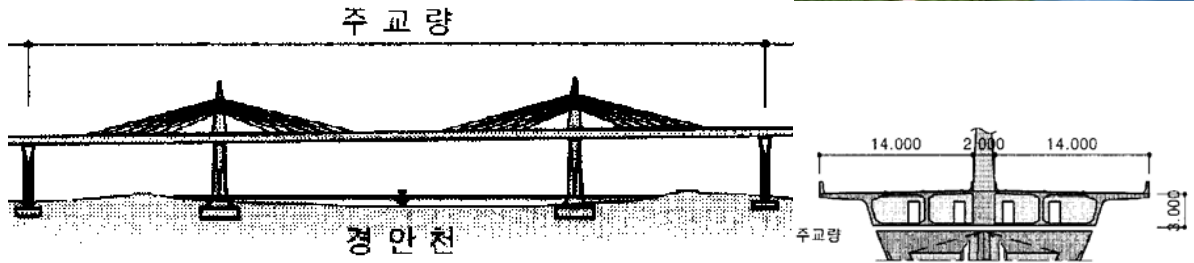

81 Husong Bridge
 (株洲芦淞大桥)
 China
 2009
 246+459+459+246
 61.7 (3x1)
 (9.2-14.3)x95.1
 Three cell concrete box girder



82 Xianshen River Bridge
 (仙神河大桥)
 China
 2009
 430+446
 160.8 (1x1)
 -
 Concrete box girder



83 Ankang Qiliegou Bridge
 (安康七里沟汉江大桥)
 China
 2009 (33)
 238+410+238
 114.2 (3x1)
 -x98.4
 Concrete box girder



84 Incheon Bridge
 Korea
 2009 (32)
 276+459+276
 - (2x2)
 - x (56.1-62.5)
 Concrete box girder

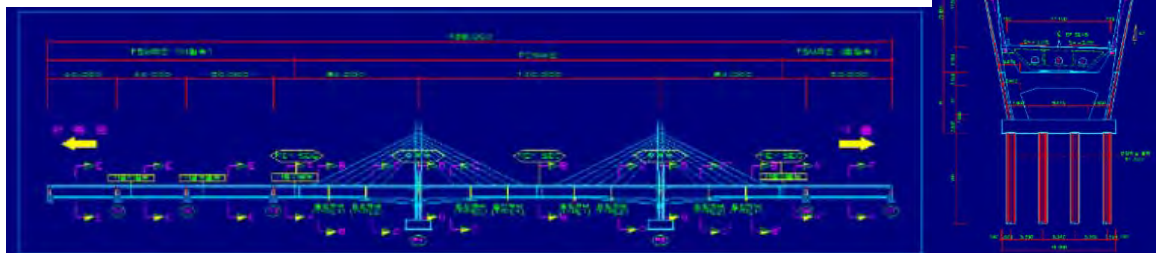

85 Qishan Bridge (旗山橋)
Taiwan
2010
328+328
-(1x1)
(9.2-16.4)x72.8



86 Choqueyapu Bridge
87 Bolivia
88 2010
172+303+153
49.2 (2x1)
(6.9-11.5)x45.9
Single cell concrete box girder



Kantutani Bridge Bolivia
2010
173+372+221
49.2 (2x1)
(6.9-11.5)x45.9
Single cell concrete box girder



Orkojahaira Bridge Bolivia
2010
165+338+215
49.2 (2x1)
(6.9-11.5)x45.9
Single cell concrete box girder

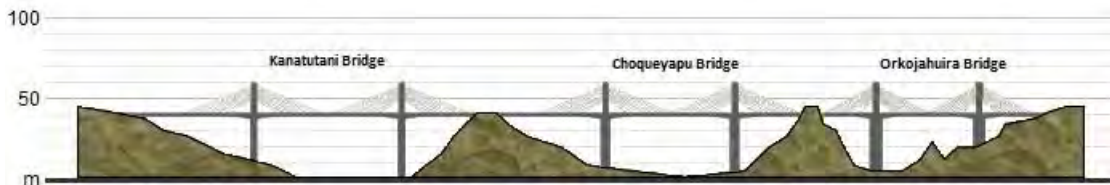

89 Povazska Bystrica D1
Motorway Viaduct
Slovakia
2010 (22)
232+400x6+223
46.3 (7x1)
19.7x100.6
Single cell box girder with
large overhangs supported
by precast struts

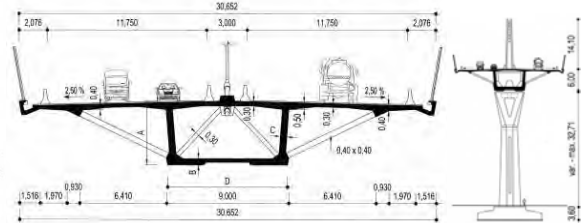
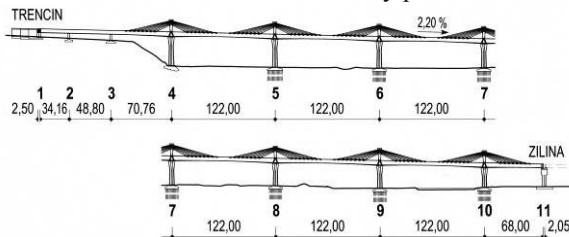

90 Teror Viaduct
Spain
2010 (22)
203+476+177
52.5 (2x2)
-



91 New Amarube Bridge
 余部橋梁 (新橋梁)
 Japan 2010

164+271+271+180
 16.5 (3x2)
 11.5x23.8
 Single cell concrete box girder

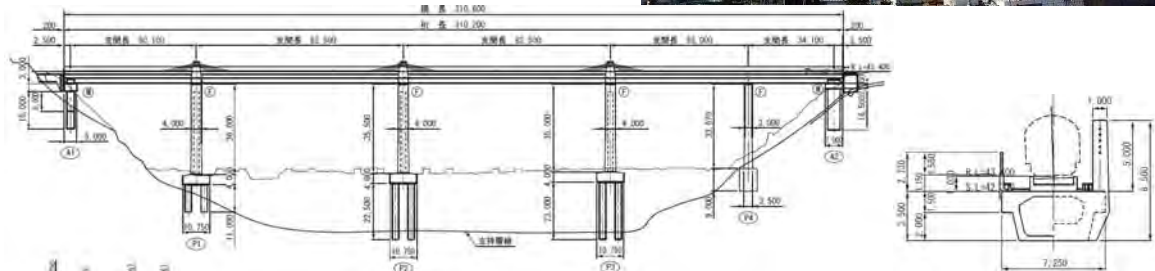

92 Immobility Bridge
 不動大橋
 Japan 2011 (84)

410+509+509+290
 -(3x2)
 -x42.7
 Single cell concrete box girder

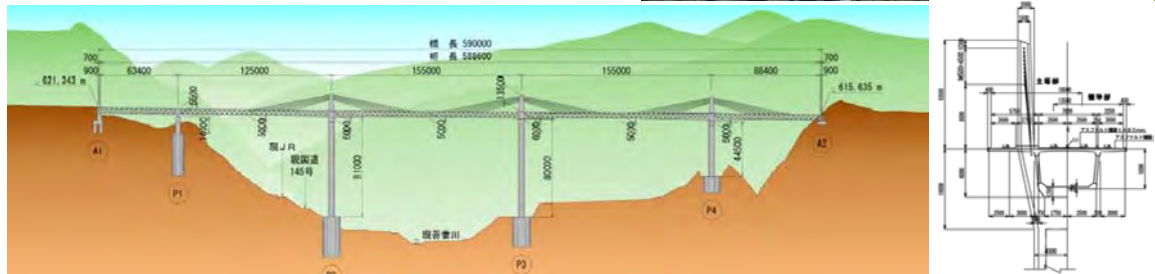

93 Un-am Grand Bridge
 Korea 2011 (86)

246+427x4+246
 26.2 (5x1)
 (10.8-13.5)x75.5
 Concrete box girder

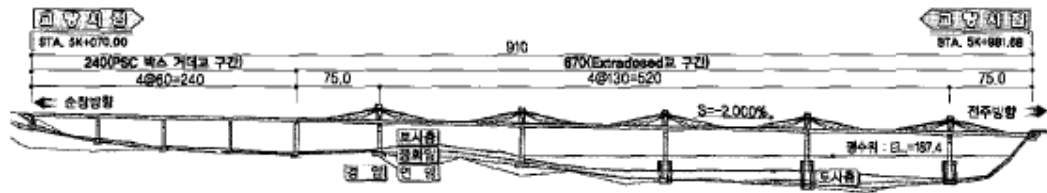

94 Panyu Shawan Bridge
 (番禺沙湾大桥)
 China 2011

451+814+451
 123.0 (2x1)
 (13.1-27.9)x111.5
 Three cell concrete box girder



95 Jiayue (Nanping) Bridge
 (嘉陵江南屏大桥, 嘉悦大桥)
 China 2011

335+623+302
 -(2x2)
 -x90.2
 Concrete box girder



96 Tisza Bridge
Hungary
2011
312+591+312
52.5 (2x1)
(13.1-19.7)x98.2
Three cell box girder with
corrugated steel web

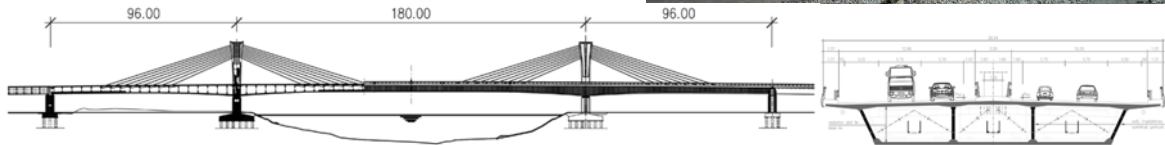

97 Hwangdo Grand Bridge
Korea
2011 (11)
262+459+262
45.9 (2x2)
(8.2-13.5)x47.2
Two cell concrete box girder

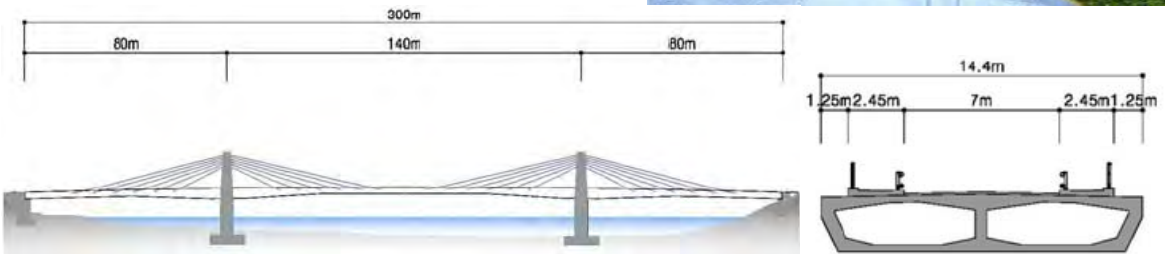

98 Noksan Bridge
Korea
2011
230+230
-(1x1)
-x73.3
Concrete box girder and
orthotropic steel girder
girder



99 Guemgang I Bridge
Korea
2012 (52)
328+591x3+328
85.2 (4x2)
-x98.4
Three cell continuous
concrete beam



100 Qinxiu Bridge
(鹿谷清秀橋)
Taiwan
2012
384 Total
-(2x1)
-x39.4
Concrete box girder



101 Hualiantai Fengping Bridge (花蓮縣豐平橋)
Taiwan
2012 (30)
276+459+459+276
55.8 (3x1)
(8.7-15.7)x92.5
Five cell concrete box girder

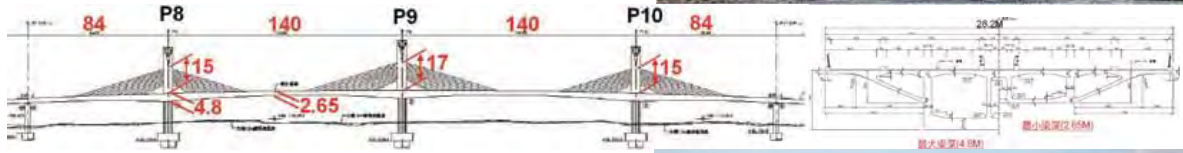

102 Dazhihe Bridge (上海大治河桥)
China
2012
262+459+262
67.3 (2x1)
-
Concrete box girder



103 Najin Bridge (纳金大桥)
China
2012 (22)
230+361+361+230
-(3x1)
x108.3
Single cell concrete box girder



104 La Massana Bridge
Andorra
2012
-
-(1x2x2)
-



105 Naluchi Bridge
Pakistan
2012 (33)
400+400
78.7 (1x2)
(11.5-23)x51.2
Concrete box girder

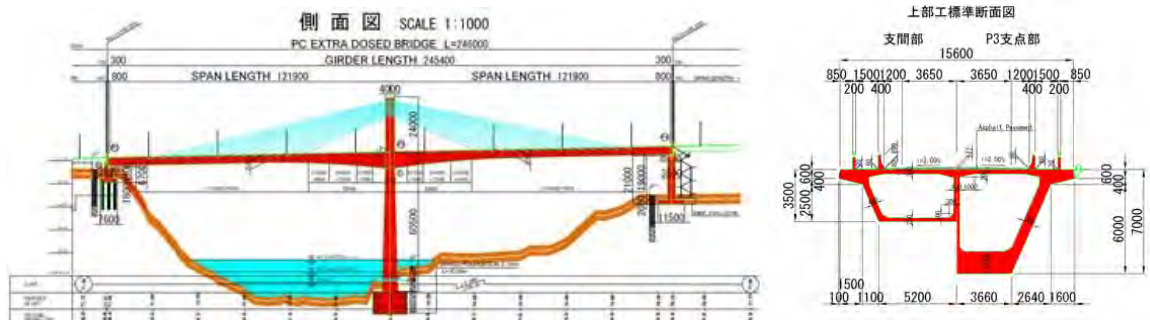

106 Waschmuhl Viaduct
Germany
2012
-
-(2x2)
-x62.8



107 New Pearl Harbor Memorial (Quinnipiac) Bridge
United States
2012/2015 (60)

249+515+249
69.9 (2x3)
(11.3-16.2)x110.6
Five cell concrete box girder

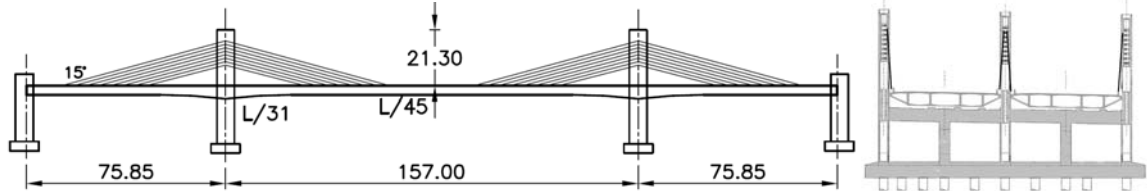

108 Changshan Bridge
(长山大桥)
China
2013 (24)

459+853+459
84.5 (2x2)
-x75.5



109 Ningjiang Shonghuajiang Bridge
(宁江松花江特大桥)
China
2013 (36)

312+3x492+312
- (4x1)
(9.8-18)x86.9
Three cell concrete box girder



110 Halfsky Overpass Bridge
(小半天高架橋)
Taiwan
2013 (20)

1214 (Total)
-(2x1)



111 Yongjin Bridge
Korea
2014 (18)

271+443+271
44.3 (2x2)
(8.2-14.8)x50.9
Three cell concrete box girder

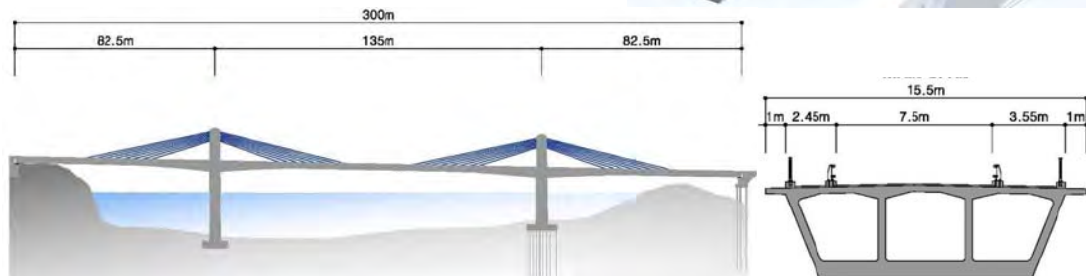
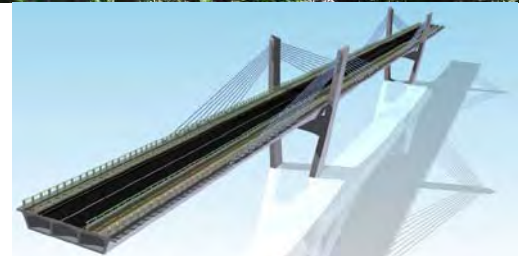

112 Gangchon 2nd Bridge
Korea
2014 (32)

272+459+272
59.1 (2x2)
(9-16.4)x64.6
Three cell concrete box girder



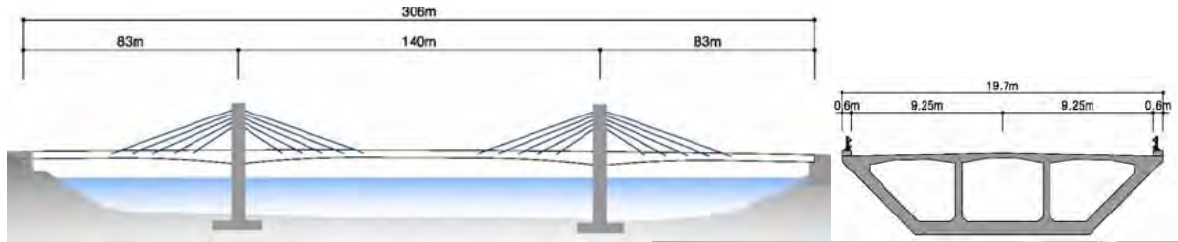

113 Saint Croix River Bridge
 United States
 2014
 290+6x480+290
 60 (7x2)
 16x110
 Three cell concrete box
 girder (each direction)

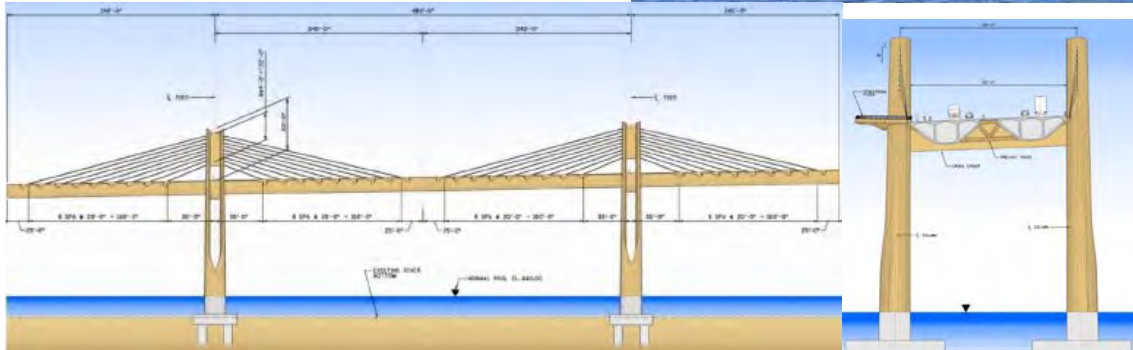

114 Sanguanjiang Bridge
 (三关江大桥)
 China
 2015 (42)
 394+623+394
 - (2x1)
 -x109.9



115 Brazos River Bridge
 United States
 2015
 185+185+185
 46 (2x2x2)
 - x 56.5 (each direction)
 Continuous steel trapezoidal
 box girders



116 Naerincheon Bridge
 Korea
 2015
 394+509
 -(1x1)
 -x100.1
 Concrete box girder



117 Yaro Grand Bridge
 Korea
 2015 (54)
 591+623+591
 89.2 (2x1)
 (11.5-23.0)x88.6



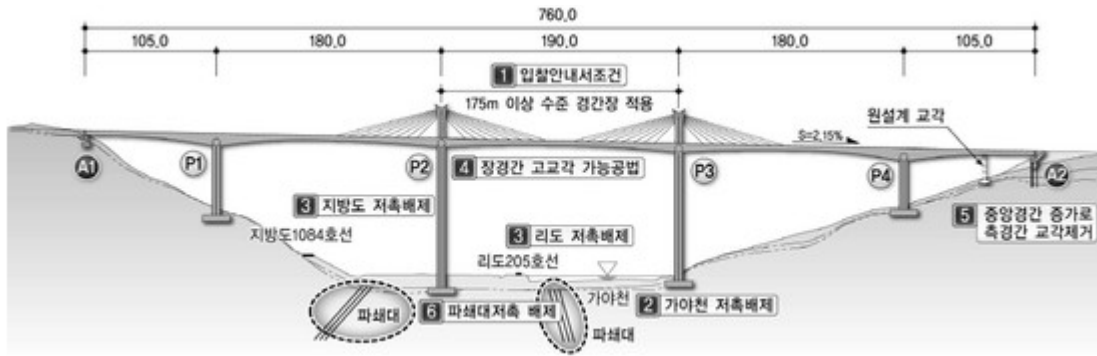

118 Pyung-Taik Grand Bridge
 Korea
 2016 (60) 361+525x6+295
 67.3 (7x1)
 (11.5-18)x98.1

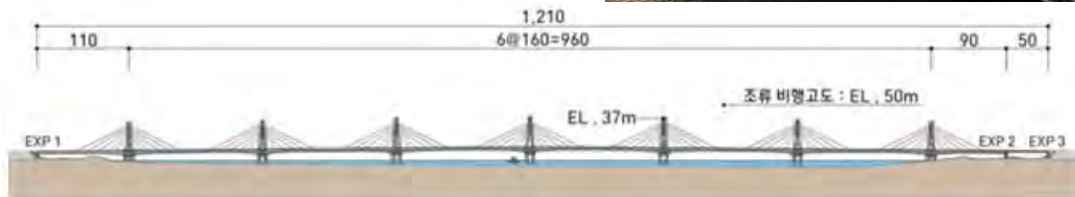

119 Beixi Hechuan Bridge
 (南澳北溪河川橋)
 Taiwan
 2016 312+525+344
 - (2x1)



120 Kinmen Bridge
 (金門大橋)
 Taiwan
 2016 919 (4593 Total)
 - (5x1)



APPENDIX C: INTERVIEW QUESTIONS AND RECORDS

Interview Questions

Research Questions Regarding Extradosed Bridge

Dear XXXX,

First of all, thanks for sharing the photos with us and thanks again for willing to participate in our research. As I mentioned earlier, the study is associate with Texas Department of Transportation Project 0-6729 (Synthesis on Cost Effectiveness of Extradosed Bridges). Since extradosed bridge is still a fairly new concept, there is not much information out there regarding extradosed bridge, practically to help making decision in selecting this kind of bridge. We are seeking inputs from personnel with experiences on extradosed bridges. Our record shows that you have been involving in the design and construction of XXXX Bridge and would like to receive your inputs regarding this bridges and general concept of extradosed bridge.

Following are a series of questions related to the particular bridge and some general questions related to extradosed bridges. We are estimating that the whole set of questions will take approximately 15 to 20 minutes to complete. Should there be any question that you feel better to communicate through phone call, or any other comments that you would like to share we will be more than happy to do that as well.

Your responds will be summarized and included in our project report and we will be more than happy to share it with you after we finalize the report, should you be interested. Once again, on behalf of the research team, I will like to thank you for your time and support on this research.

Regards,
Jiong Hu

XXXX Bridge

1. Bridge Construction
 - a. What was the construction duration of the bridge?
 - b. What was the construction method of the extradosed part of the bridge? What were the major reasons that this method was used?
 - c. Based on your experience, is there any challenge or advantage in adopting this construction method during the construction of the bridge?
2. Reasons of selecting extradosed bridge
 - a. Can you list the major reasons that led to the decision of selecting extradosed design over other bridge designs (i.e., cable-stayed bridge and girder bridge)? Among them, what reason is the most critical one?
 - b. Among all the options during the bridge selection process, what type of bridge was the second best option for this case?

3. Cost of extradosed bridges construction (Please note that we understand that this information might be sensitive, we can have the information remain anonymous if you request so.)

- a. What was the total cost of the bridge? What was the total cost of extradosed section of the bridge?
- b. What was the proportion of the extradosed part (superstructure of the extradosed part, including labor, material, and so forth) of this bridge in the total cost?
- c. What was the unit cost (in \$/m² or any other units that you are using)?
- d. Can you compare the cost this bridge to an alternate bridge type (the second best option in this case)?
- e. Comparing to the alternate bridge type (the second best option in this case), what part(s) of the extradosed bridge increased/decreased the total cost most?

4. Advantages and disadvantages of extradosed bridges.

- a. Based on your experiences, what are the advantages of extradosed bridges?
- b. Based on your experiences, what are the disadvantages of extradosed bridges?
- c. Can you compare the following aspects of this bridge to an alternate bridge type (the second best option of this case)?
 - i. Cost effectiveness:
 - ii. Construction period and method:
 - iii. Future maintenance and repair difficulties:

5. Maintenance and repair cost

- a. Do you experience or expect higher or lower maintenance cost comparing to cable-stayed bridge, by how much percentage?
- b. Do you experience or expect higher or lower maintenance cost comparing to girder bridge, by how much percentage?
- c. Do you experience or expect higher or lower repair cost comparing to cable-stayed bridge, by how much percentage?
- d. Do you experience or expect higher or lower repair cost comparing to girder bridge, by how much percentage?
- e. Is there any special issue related to maintenance and repair of extradosed bridge (comparing to cable-stayed bridge and girder bridge)?

Should there be any question list above that is not clear or need clarification, please let me know.

Interview Record #1

Interviewee: Christopher Scollard

Bridge Name: North Arm Bridge

1. Bridge Construction
 - a. Approximately 2 years.
 - b. Balanced cantilever - that is the way these bridges are built. Other options are not practical for bridges of moderate spans.
 - c. Many challenges as there always are, but none related to this construction method being chosen over another.
2. Reasons of selecting extradosed bridge
 - a. The extradosed bridge was selected because it satisfied the span requirement and had short pylons that were outside of the flight path leading up to the adjacent airport.
 - b. No other options met the span requirements and were consistent with the precast segmental system being used throughout the project, which was much larger than just the construction of the extradosed bridge.
3. Cost of extradosed bridges construction
Insufficient information available to answer.
4. Advantages and disadvantages of extradosed bridges.
 - a. Moderate spans with short pylons and moderate superstructure weight.
 - b. Heavier and with all the added complications of a cable-stayed bridge.
 - c.
 - i. Cost effectiveness: Unproven - cost effectiveness is not the primary driver for this type of bridge; geometry is more influential;
 - ii. Construction period and method: No real difference;
 - iii. Future maintenance and repair difficulties: No real difference.
5. Maintenance and repair cost
We don't have specific data to support answers to these questions, but don't expect maintenance costs to be any higher than for other more common bridge types.

Bridge Name: Golden Ears Bridge

Answers for the North Arm Bridge are generally applicable to the Golden Ears Bridge. There are very few differences between this bridge and a more conventional cable-stayed bridge other than slightly shallower cable angles (and thus lower live load stress range in the cables) and a slightly deeper and stiffer superstructure. Construction period was longer than the North Arm Bridge because the bridge length is much longer.

Interview Record #2

Interviewee: Akio Kasuga

Bridge Name: Odawara Blueway Bridge

1. Bridge Construction
 - a. 1992/12 to 1994/10
 - b. Free cantilevering method.
Most economical method for the bridge over the port.
 - c. Free cantilevering method for extradosed bridges is the same as conventional one.
2. Reasons of selecting extradosed bridge
 - a. Major reason is the cost. And another reason is aesthetics for harbor bridge.
 - b. Conventional box girder bridge.
3. Cost of extradosed bridges construction
 - a. Total cost : 2.4 Billion JY, Superstructure : 1.5 Billion JY
 - b. 63%
 - c. 390,000 JY/m² (superstructure)
 - d. No information
 - e. Cheaper substructure cost because of lighter superstructure.
4. Advantages and disadvantages of extradosed bridges.
 - a. Easy construction (No stay cable force adjustment during construction, easy camber control due to stiffer girder, cheaper stay cable system because of low fatigue stress due to live load)
 - b. Shorter tower sometimes leads difficulties of elegant design of tower and pier.
 - c.
 - i. Cost effectiveness: Cheaper;
 - ii. Construction period and method: A little bit longer because of stay cable construction;
 - iii. Future maintenance and repair difficulties: Maintenance and possibility of stay cable replacement are added.
5. Maintenance and repair cost
 - a. I think the maintenance cost is almost the same as CSB. In Odawara Buleway bridge, we did the detail inspection once for extradosed cables. One lane was shut down during the night inspection. (One tower and one side took one night. Totally four nights)
 - b. No information of percentage.
 - c. I think the maintenance cost is higher than girder bridge because of extradosed cables. No information of percentage.
 - d. No experience and information.
 - e. I think there is no special issue.

Bridge Name: Tsukuhara Bridge

1. Bridge Construction
 - a. 1994/12 to 1998/7
 - b. Free cantilevering method.
Most economical method for the bridge over the lake.
 - c. Free cantilevering method for extradosed bridges is the same as conventional one.
2. Reasons of selecting extradosed bridge

See Odawara Blueway Bridge

3. Cost of extradosed bridges construction
 - a. Total cost : 6.5 Billion JY, Superstructure : 3.4 Billion JY
 - b. 53%
 - c. 573,000 JY/m² (superstructure)
 - d. No information
 - e. Cheaper substructure cost because of lighter superstructure.

4. Advantages and disadvantages of extradosed bridges.
See Odawara Blueway Bridge

5. Maintenance and repair cost
See Odawara Blueway Bridge. But we have not inspected extradosed cables of Tsukuhara Bridge yet.

Bridge Name: Ibi River Bridge

1. Bridge Construction
 - a. 1997/3 to 2001/7
 - b. Free cantilevering method using 400 tons precast segments. 100m center part is steel girder constructed by lifting method.
Most economical method for the bridge over the mouth of the wide river.
 - c. First application of 400-ton heavy segments.
Extradosed with composite girder (100m center part is steel box girder.)
2. Reasons of selecting extradosed bridge
See Odawara Blueway Bridge
3. Cost of extradosed bridges construction
 - a. Total cost : 83.7 Billion JY, Superstructure : 63.0 Billion JY (This cost includes Ibi and Kiso River bridge. Kiso Bridge is 5-span type. Structure is the same as Ibi River Bridge.)
 - b. 75%
 - c. 780,000 JY/m² (superstructure)
 - d. No information
 - e. Cheaper substructure cost because of lighter superstructure.
4. Advantages and disadvantages of extradosed bridges.
See Odawara Blueway Bridge
5. Maintenance and repair cost
See Odawara Blueway Bridge

Interview Record #3

Interviewee: Deong-Hwan Park

Bridge Name: NA

1. Bridge Construction

- a. In general, the construction duration of the ED Bridge is similar to the duration of PSC Box bridge added the duration of its main tower on the bridge; construction period for main tower per each is 3 to 5 months, in case of Free Cantilever Method (FCM), the duration of substructure is 1 to 2 months, and each segment which is upper girder is about 20days. (일반적으로 PSC BOX교량의 공기와 비슷하며 주탑시공기간이 추가됨
공사기간은 주탑시공(기당) 3~5개월, 주두부(FCM공법 적용시) 1~2개월,
상부시공(Seg 당) 20일 정도임.)
- b. The construction method of ED Bridge is depended on site conditions which are the types of foundations, substructures, and span length. Typically FCM method would be used at ED Bridge for crossing the river and long span at sea bridge.(ED교는 하부시공조건에 따라 시공방법이 다르나, 일반적으로 하천횡단이나 해상교량에 적용되는 장경간 교량으로 FCM공법을 많이 적용함)
- c. It would be able to use for curved bridge. Also, when Form traveler can be applied for the construction, it will improve the constructability and come out better quality of material management by the repetitive task without site conditions under the bridge. (하부 조건에 구애받지 않고 곡선교량에 적용 가능하며, F/T를 이용한 반복작업으로 시공성이 좋고 재료의 품질관리가 양호함.)

2. Reasons of selecting extradosed bridge

- a. As you know, since cable-stayed bridge has to support the main structures using the cable, the load imposed on the plate girder is relatively smaller than PSC Box bridge. To ensure the stiffness of the cable, the height of the tower would be enhanced. Therefore, economic feasibility and constructability is not as good as its ED Bridge. In addition, cable stayed bridge is vulnerable to the dynamic behavior due to the low structural rigidity. On the other hand, ED bridge is supported by both girder and cable with lower tower so it has much better structural rigidity and excellent dynamic behavior compared with cable stayed bridge. (사장교는 말 그대로 케이블이 주 지지구조물로 보강형이 지지하는 하중의 비율이 작음. 따라서 케이블의 강성확보를 위해 주탑의 높이가 높아져야 하고 이로 인한 시공성, 경제성이 ED교에 비해 좋지 않으며, 구조적으로 강성이 크지 않아 동적거동에 취약한 측면이 있음. 반면 ED교의 경우, 주형과 케이블이 함께 지지하는 구조물로 주탑이 높지 않아도 되고, 강성이 커 사장교에 비해 동적거동이 우수함.)
- b. PSC BOX Bridge and Cable Stayed Bridge (PSC BOX 교, 사장교)

3. Cost of extradosed bridges construction

- a. Not sure exact number because detailed construction cost must include design cost as well. The unit construction cost, including sub, superstructure and main tower, of the ED Bridges that have already built is about \$465 to \$511 per ft². (currency rate 1 dollar = 1000 won) (구체적인 공사비는 설계를 통해야 하고, 현재 시공된 ED교의 면적당 공사비(상,하부 포함)는 500~550만원 정도임.)

- b. It varies, but the construction cost of superstructure is about 75 to 80% of total construction cost depending on site condition. (총 공사비중 상부공사비는 약 75~80% 정도로 보이거나 하부조건에 따라 틀리므로 정확한 수치를 알수는 없음.)
- c. See above “a” (위 a 참조)
- d. It varies, but in case of PSC BOX Bridge, The unit construction cost, including sub, superstructure and main tower, applied FCM is about \$372 to \$418 per ft². (PSC BOX교의 경우, 시공방법에 따라 차이가 있으나 FCM공법 적용시 면적당 공사비(상,하부 포함)는 보통400~450만원 정도임.)
It is varies due to different types of materials such as steel, concrete, and composite bridge, but the unit construction cost of Concrete Cable stayed bridge is \$697 per ft². (사장교의 경우는 재료(강, 콘크리트, 복합구조 등)에 따라 다르며 콘크리트 사장교의 경우는 면적당 750만원 정도임.)
- e. Since ED Bridge has main tower, ED Bridge has longer span than PSC BOX bridge so that ED Bridge is lower construction cost of substructure. However ED bridge gets much bigger eccentricity than its PSC BOX bridge so ED Bridge uses more strands that increase construction cost than PSC BOX bridge. Finally, overall construction cost of ED Bridge is little more. The construction cost of cable stayed bridge is very expensive due to the cable and main tower. (PSC BOX교의 경우, ED교는 주탑이 추가되므로 하부 공사비가 적으며 또한 ED교는 대편심교량으로 텐던(강연선)량이 PSC BOX교보다 다소 많음 따라서 PSC BOX교의 공사비가 저렴하며, 사장교는 케이블과 주탑공사비로 인해 공사비가 고가임.)

4. Advantages and disadvantages of extradosed bridges.

- a. It can be possible to make the long span with low price compared to cable-stayed bridge and can be secured due to the higher stiffness of the bridge. (저렴한 가격(사장교에 비해)으로 장대교량 적용이 가능하며, 교량강성이 커 안전성 확보가 우수함.)
- b. Since the installation of Cable outside would be dropped the constructability and brought out safety issues, it has disadvantages over PSC BOX bridge. (당연히 외부에 설치되는 케이블의 시공성과 안전성(케이블의 부가응력 등)이 일반 PSC BOX교 보다 불리함.)
- c. i. Cost effectiveness: See previous answers (위의 내용들로 대체);
ii. Construction period and method: See previous answers (위의 내용들로 대체);
iii. Future maintenance and repair difficulties: In the Maintenance and repair PSC Box, ED Bridge, and Cable –stayed Bridge is advantageous in order due to the cable and fatigue at the anchorage (유지관리차원에서는 PSC BOX > ED교 > 사장교 순으로 유리하며, 이유는 외부 케이블 및 정착부 피로 등에 대한 유지관리 측면에서 외부 케이블이 있는 교량이 불리함.).

5. Maintenance and repair cost

It would be difficult that the maintenance aspect can be expressed as a certain portion of total project (budget).

(유지관리 측면을 비율로 나타내기는 좀 어려울 듯)

- a. N/A

- b. N/A
- c. N/A
- d. N/A
- e. I think it would be fatigue problem (역시 피로에 대한 부분이 아닐까 생각됨.)

Interview Record #4

Interviewee: Sun-Joo Choi

Bridge: Guemgang 1st Bridge

1. Bridge Construction

- a. 5 Years (5년)
- b. Free Cantilever Methods, Because the bridge cross the river (F.C.M, 하천를 횡단하기 때문에)
- c. N/A

2. Reasons of selecting extradosed bridge

- a. Construction method, Environment, Construction cost, Aesthetics, Etc... The most important factor among all motioned above was aesthetic. (시공방법, 환경문제, 공사비, 주변경관과의 조화등. 가장 주요했던 부분은 경관을 고려했기때문임.)
- b. PSC-Box Girder (PSC-BOX거더)

3. Cost of extradosed bridges construction

- a. \$53 Million (total length of ED bridge is 2,362.2 ft) (530억원 (720m 전체 E/D교) (Currency Rate \$1 = 1,000won)
- b. 55%
- c. \$557.4/ft² (600만원/ m²)
- d. \$45 Million (PSC-Box Girder Bridge) (450억원(PSC-BOX 거더교))
- e. Main Tower and Cable (주탑, 케이블)

4. Advantages and disadvantages of extradosed bridges.

- a. Can be reduced H/L ratio and increased span (거더지점부 형고 감소, 지간장 증가)
- b. Higher Construction cost (공사비 증가)
- c. i. Cost effectiveness: bridge is higher than PSC BOX (E/D < PSC BOX ED);
ii. Construction period and method: Almost same construction period (E/D = PSC BOX (거의 비슷함));
iii. Future maintenance and repair difficulties: Not able to answer the question, you should contact a person who is a construction engineer (E/D > PSC BOX 아래질문은 유지관리 비용으로 설계 분야에서는 답이 조금 곤란합니다.시공분야에서 조언을 구하시는 것이).

5. Maintenance and repair cost

- a. N/A
- b. N/A
- c. N/A
- d. N/A
- e. N/A

Interview Record #5

Interviewee: Steven L. Stroh

Bridge: New Pearl Harbor Memorial Bridge

1. Bridge Construction

- a. Project was bid summer of 2009 and completion is summer of 2015. 6 year duration. First bridge (northbound) is opened summer 2012.
- b. Balanced Cantilever erection, cast-in-place using form travelers. The large segment size, poor access for lifting large segments, and lack of a nearby land with water access to set up a casting yard led decision away from precast.
- c. This erection method was a good choice for the PHMB.

2. Reasons of selecting extradosed bridge

- a. Nearby airport clearances precluded tower height necessary for a cable stayed bridge. Profile grade restrictions set by adjacent interchange precluded the necessary depth for a girder bridge with a 515 foot main span. Therefore a girder bridge at this site would have a shorter span and less favorable navigation conditions.
Extradosed bridge provided desired span length while allowing the required profile grades to be compatible with adjacent interchange (primary reason)
Cost for extradosed bridge was within reasonable comparison with shorter span girder bridge (about 15%)
Extradosed bridge provided the opportunity for a signature bridge, worthy of the designation of a memorial bridge at this site.
- b. A girder bridge, but with a shorter span.

3. Cost of extradosed bridges construction

- a. Overall contract \$517 million, including extradosed bridge, approach bridges and ramps, at-grade roadway, retaining walls, maintenance of traffic, utilities, etc. Extradosed portion – not available
- b. Not available
- c. Not Available
- d. During the type study, the extradosed concept was compared with a girder bridge that had a shorter span, and the cost delta was about 15% (extradosed being higher)
- e. The stay cables, the more costly superstructure and the towers.

4. Advantages and disadvantages of extradosed bridges.

- a. For the span range between 300 and 700 feet they can be:
cost effective with other bridge types (Girder, cable stayed, arch, truss);
can accommodate four or more spans efficiently (no backstay cables required) (Cable stayed bridge are not efficient under for multiple spans);
can provide some geometric advantages for some site conditions, such as shorter towers than a cable stayed and shallower girders than a girder bridge;
Can provide a visually appealing bridge.
- b. More complex to construct than a girder bridge. Under some conditions may not be more costly than other bridge types.

Can only accommodate limited width tapers of girder.

Extremely wide girders (over 100') can be difficult to accommodate

- c. i. Cost effectiveness: Comparable, or only slightly more costly;
- ii. Construction period and method: Construction period slightly longer. Erection method same (Balanced Cantilever);
- iii. Future maintenance and repair difficulties: Added maintenance and repair to address stay cables and dampers.

5. Maintenance and repair cost

- a. Extradosed and cable stayed have similar inspection items, but extradosed bridge has less cables, lower tower and would therefore to have a slightly less inspection effort. Cost delta unknown.
- b. Higher inspection effort for an extradosed versus a girder bridge. Extradosed bridge includes stay cables, anchorages, vibration dampers, towers, internal anchor boxes, grounding system (lighting protection) aesthetic lighting that would not be expected on a typical girder bridge. Cost percentage delta unknown.
- c. Expect similar
- d. Probably higher, due to stay cables.
- e. Compared to cable stayed: similar. Compared to girder bridge: extradosed has additional elements as noted in 5b.

Interview Record #6

Interviewee: Jiri Strasky

Bridge: Povazska Bystrica Bridge

1. Bridge Construction

- a. 22 months
- b. Cast-in-place segmental structure erected in 2x7 symmetrical cantilevers. This is a common and economical technology. It allows simultaneous construction of all cantilevers.
- c. It is common technology.

2. Reasons of selecting extradosed bridge

- a. City of Povazska Bystrica wanted to have a 'Signature Bridge'. According to my opinion a typical cantilever structure would be more appropriate. There is no reason for a cable-stayed bridge – see Elevation.
- b. A typical cantilever structure would be more appropriate.

3. Cost of extradosed bridges construction

- a. \$57millions.
- b. Extradosed portion was 91% of the bridge. I am not able to determine the portion of the cost.
- c. \$1,940/m².
- d. It would be cheaper; however, we have not done it. As I informed you, the reason for the extradosed bridge was not economy.
- e. Pylon and stay cables

4. Advantages and disadvantages of extradosed bridges.
 - a. It is a suitable solution where a tall pylons of the cable-stayed bridge are not appropriate – in cities, mountains, etc.
 - b. Pylon and stay cables. Unfortunately, I have not seen any beautiful extradosed bridge.
 - c.
 - i. Cost effectiveness: It is more expensive than cantilever structure;
 - ii. Construction period and method: The same as cantilever structure;
 - iii. Future maintenance and repair difficulties: Stay cables requires a special attention.

5. Maintenance and repair cost
 - a. I do not have this experience
 - b. Yes, but I am not able to estimate it.
 - c. Lower, since fatigue is smaller, but I am not able to estimate it.
 - d. Higher, due to the stay cables, but I am not able to estimate it.
 - e. Compare to girder structure there are stay cables that have to maintained.

Interview Record #7

Interviewee: Viktor Markelj

Bridge: Puhov Bridge

1. Bridge Construction
 - a. November 2005 – May 2007
 - b. Free cantilevering, due to building over water (artificial accumulation lake)
 - c. Challenge: road axis in curvature; Advantage: other method was not possible

2. Reasons of selecting extradosed bridge
 - a. Very severe boundary conditions for bridge concept:
 Severe restrictions on the support layout due to the slurry walls on the banks of the lake and other obstacles dictated the longitudinal layout;
 Low bridge elevation and requested waterway and shipping clearance of 4.0 m underneath dictated the thickness of structure;
 Road geometry in a sharp curvature of radius $R = 460$ m (not allowing longer spans for cable-stayed bridge);
 Very strict limitations have been set due to the historical heritage, preserving of the old city views, which limited the height of structures (pylons) on maximum 10 m.
 - b. Steel continuous girder of constant depth

3. Cost of extradosed bridges construction (Please note that we understand that this information might be sensitive, we can have the information remain anonymous if you request so.)
 - a. Total cost 8,8 mio Eur; Extradosed section 4,4 mio, Rest (foundation, substructure, equipment, furniture etc) 4,4 mio Eur
 - b. 50%
 - c. $8,8\text{mio}/8097\text{m}^2=1086$ Eur/m²
 - d. N/A
 - e. N/A

4. Advantages and disadvantages of extradosed bridges.
 - a. More slender structure than in case of girder, Active controlling of deformations in construction stages; Sometimes more attractive appearance
 - b. Very complex construction; High cost, much higher than girder
 - c. Cost effectiveness: usually higher than other solutions; ii. Construction period and method: construction period approximately the same; iii. Future maintenance and repair difficulties: higher than girder, lower than Cable-stayed

5. Maintenance and repair cost
 - a. Lower - %NA
 - b. Higher
 - c. Lower
 - d. Higher
 - e. The maintenance concept is similar (changing of cables under the partially restricted traffic), new element is maintenance of saddles in short pylons)

Interview Record #8

Interviewee: Aivar-Oskar Saar

Bridge: Smuuli Bridge

1. Bridge Construction
 - a. Piles, Structure about 6 Months, Superstructure about 9 Months
 - b. From one side the construction method was drop-down formwork, from another side mostly due the time factor scaffolding. This viaduct is over 8 pair of railway park and it was all the time filled with trains.
 - c. Yes

2. Reasons of selecting extradosed bridge
 - a. Impossible was to put scaffolding or pier in middle of Railway park (station)
 - b. Launching or precast beams, but same issue, we didn't receive possibility or access to the railways, especially for piling

3. Cost of extradosed bridges construction
 - a. Full bridge length was about 370 meters and more than 12 meters wide, the cost were about 2,5 M€. What was the total cost of extradosed section of the bridge? About 1,3 M€
 - b. The superstructure part was probably some 70 %
 - c. It was probably about 700-900€/m²
 - d. More expensive than the bridge with launching or precast beams.
 - e. The total cost was increased due the design, which was late, also due the drop-down formwork, also due the weak concrete subcontractor

4. Advantages and disadvantages of extradosed bridges.
 - a. Advantages are small amount of materials, especially concrete to the m², possibility to cover quite big openings without supports.
 - b. Probably weak designer and concrete contractor

- c.
 - i. Cost effectiveness: It depend completely about context, in some conditions it can be even cheaper than the another solutions;
 - ii. Construction period and method: Extradosed bridge needs;
 - iii. Future maintenance and repair difficulties: More difficult will be the cables and anchorages service probably

5. Maintenance and repair cost

- a. Probably same
- b. Higher maintenance cost than for girder bridges
- c. Same
- d. Higher
- e. I think that the situation of cables should be checked at least once per year from side of trained staff.

