



| | |
|---|----|
| Technical Writing | |
| rapidograph | 7 |
| isograph | 10 |
| Inks and accessories | 13 |
| ArtPen | 14 |
| rapid PRO / rotring 300 | 15 |
| Tikky Liner | 17 |
| Tikky Graphic | 18 |
| Tikky 3 in 1 / Tikky Ballpoint | 19 |
| Tikky Mechanical pencils | 20 |
| Fine leads / Erasers / Refills | 21 |
| | |
| Compasses | |
| COMPACT | 23 |
| CENTRO | 24 |
| CONVEX | 25 |
| Compass accessories | 27 |
| | |
| Drawing Aids | |
| CENTRO | 29 |
| rulers, set squares, protractors etc. | |
| Triangular reduction scales | 31 |
| | |
| Drawing Boards | |
| rapid | 33 |
| profil | 34 |
| Accessories | 35 |
| Collegeboard | 36 |
| Drawing table / T-square-set | 37 |
| | |
| Lettering Stencils and Templates | |
| Lettering stencils | 39 |
| Templates | 40 |

An idea makes history

The idea came in 1928 - the perfect writing instrument. One that would write evenly, make carbon copies, and not drip or blot. No small matter in the pre-ballpoint era! The result was an inkpen that used a tube instead of a nib - the rotring Tiku or Inkograph. It became a byword for precision writing.

The Tiku was an innovative solution and since then the meeting of writing and drawing challenges through innovation has become the hallmark of the rotring company

Hence, in 1950 a dialogue with draftsmen and designers gave rise to the idea of further developing the Tiku tubular tip to create the world's first technical pen - the original Rapidograph. It was refillable, created precise sharp-edged lines and had a capillary ink feed that gave a consistently smooth flow of ink. It set the standard, and indeed became synonymous with technical drawing.

Over the years the Rapidograph was followed by many other drawing products. Rotring created an interlinking system for the professional drafter, from compasses and templates to the latest generation of the Rapidograph.

Functionality and technical perfection make rotring drawing instruments symbols for quality and precision. They continue on in the tradition laid down by founder Wilhelm Riepe back in 1928.



The Tiku Patent

Today, rotring drawing instruments can be found wherever individuals actively create their own lifestyles. People who understand the power of their thoughts and visions, and express them.



Tikky fine-lead pencil

This need to create, understand, and express is an integral part of the development of every rotring drawing instrument. Today rotring provides a comprehensive system of products offering the optimum solution for every application within technical drawing and design, for professional drafters, students and private individuals alike.

The perfection of technology, ergonomics and design creates a universe that is ideal for drawing, also enhancing the perfect expression of ideas and visions.



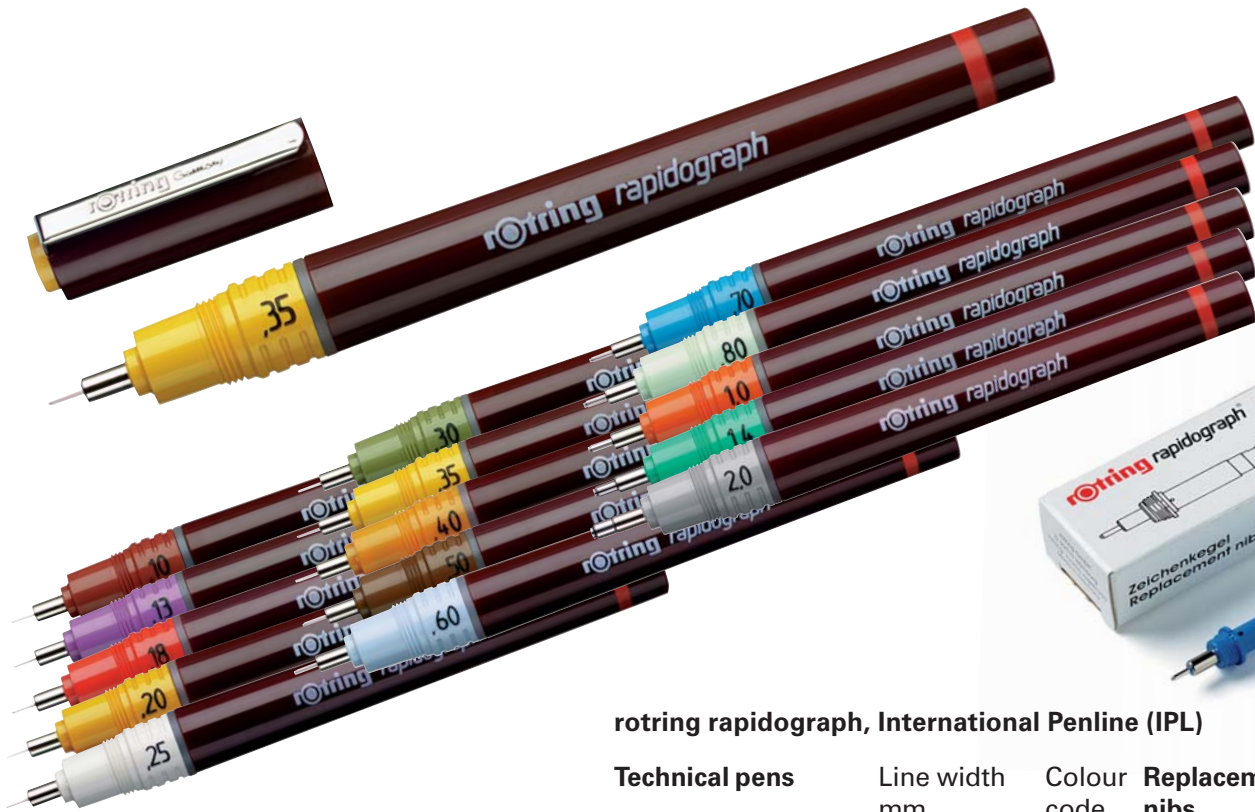

rotring rapidograph

For tracing paper, vellum drawing paper and lineboard.

The rapidograph uses rotring's unique capillary cartridge. The pressure-equalization system, including ink helix is part of the ink cartridge which ensures that every time you change the cartridge, you get a clean new ink helix. This means that you never need to clean the ink helix and top reliability is guaranteed.

* Line widths for drawing per ISO 128 and DIN 15 and for lettering per ISO 3098/I-DIN 6776.
Drawing tube in 3 mm dia. metal bushing.

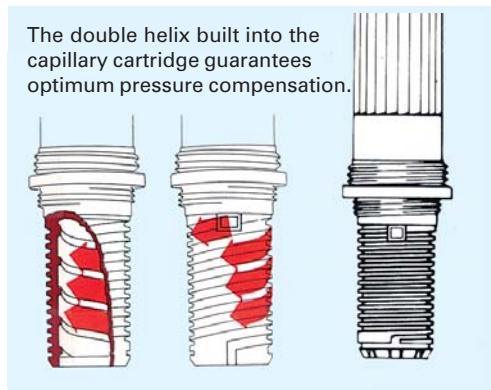

rotring rapidograph, International Penline (IPL)

| Technical pens | Line width mm | Colour code | Replacement nibs |
|--------------------|---------------|----------------|--------------------|
| S0203000 (R155010) | 0.1 | [Red] | S0218960 (R755010) |
| S0203070 (R155013) | 0.13 * | [Purple] | S0219030 (R755013) |
| S0203150 (R155018) | 0.18 * | [Orange] | S0219110 (R755018) |
| S0203230 (R155020) | 0.2 | [Yellow] | S0219200 (R755020) |
| S0194270 (R155025) | 0.25 * | [Light Green] | S0219270 (R755025) |
| S0203430 (R155030) | 0.3 | [Green] | S0219360 (R755030) |
| S0194290 (R155035) | 0.35 * | [Yellow-Green] | S0219430 (R755035) |
| S0203630 (R155040) | 0.4 | [Orange-Green] | S0219520 (R755040) |
| S0203700 (R155050) | 0.5 * | [Brown] | S0219590 (R755050) |
| S0203780 (R155060) | 0.6 | [Light Blue] | S0219670 (R755060) |
| S0203850 (R155070) | 0.7 * | [Blue] | S0219740 (R755070) |
| S0203930 (R155080) | 0.8 | [Light Green] | S0219820 (R755080) |
| S0204000 (R155100) | 1.0 * | [Orange] | S0219890 (R755100) |
| S0204080 (R155140) | 1.4 * | [Light Green] | S0219970 (R755140) |
| S0204140 (R155200) | 2.0 * | [Dark Green] | S0220050 (R755200) |



rotring rapidograph capillary cartridges
(Box of 3)

Product features see page 13.

| | Ink Colour |
|--------------------|---------------|
| S0215710 (R590503) | red [Red] |
| S0215870 (R590509) | blue [Blue] |
| S0194640 (R590517) | black [Black] |

rotring rapidograph
Set of 4
S0204440*
 (R155743)

| | |
|---|------|
| — | 0.25 |
| — | 0.35 |
| — | 0.5 |
| — | 0.7 |



rotring rapidograph
Sets of 8
S0204610*
 (R155903)

| | |
|---|------|
| — | 0.18 |
| — | 0.25 |
| — | 0.35 |
| — | 0.5 |
| — | 0.7 |
| — | 1.0 |
| — | 1.4 |
| — | 2.0 |

S0227240*
 (R155913)

| | |
|---|-----|
| — | 0.1 |
| — | 0.2 |
| — | 0.3 |
| — | 0.4 |
| — | 0.5 |
| — | 0.6 |
| — | 0.8 |
| — | 1.4 |



rotring rapidograph with pen station

The rapidograph work sets with pen stations keep your technical pens ready to draw instantly. Simply place the pen in the pen station with light pressure. The ideal horizontal position and a grip flexible double seal prevent the pen from drying. Individual pen stations can be taken from the set and affixed to table or drawing board with double-sided tape (provided with the work set).

* All sets include compass attachment for 3.5/4 mm dia. and stencilling joint.

Junior Set

Contents: 3 rapidograph pens, 1 Tikky burgundy 0.5, 6 ink cartridges



S0699460 S0699470 S0699480 S0699490

| | |
|---|-----|
| — | 0.1 |
| — | 0.2 |
| — | 0.3 |

| | |
|---|-----|
| — | 0.2 |
| — | 0.3 |
| — | 0.5 |

| | |
|---|------|
| — | 0.25 |
| — | 0.35 |
| — | 0.5 |

| | |
|---|-----|
| — | 0.2 |
| — | 0.4 |
| — | 0.6 |

College Set (Pen Station)

Contents: 3 rapidograph pens, 1 Tikky burgundy 0.5, 12 hi-Polymer HB leads, 1 B20 eraser, 3 pen stations, 3 ink cartridges, 1 compass attachment



S0699530 S0699550

| | |
|---|------|
| — | 0.25 |
| — | 0.35 |
| — | 0.5 |

| | |
|---|-----|
| — | 0.2 |
| — | 0.4 |
| — | 0.8 |

College Set

Contents: 3 rapidograph pens, 1 Tikky burgundy 0.5, 12 hi-Polymer HB leads, 1 B20 eraser, 6 ink cartridges, 1 compass attachment



S0699500 S0699510 S0699520 S0699540

| | |
|---|-----|
| — | 0.1 |
| — | 0.3 |
| — | 0.5 |

| | |
|---|------|
| — | 0.2 |
| — | 0.35 |
| — | 0.5 |

| | |
|---|------|
| — | 0.25 |
| — | 0.35 |
| — | 0.5 |

| | |
|---|-----|
| — | 0.2 |
| — | 0.4 |
| — | 0.6 |

College Set (4 pens)

Contents: 4 rapidograph pens, 12 hi-Polymer HB leads, 1 B20 eraser, 6 ink cartridges, 1 compass attachment



S0699560 S0699570 S0699580

| | |
|---|-----|
| — | 0.1 |
| — | 0.2 |
| — | 0.3 |
| — | 0.5 |

| | |
|---|------|
| — | 0.25 |
| — | 0.35 |
| — | 0.5 |
| — | 0.7 |

| | |
|---|-----|
| — | 0.2 |
| — | 0.4 |
| — | 0.5 |
| — | 0.8 |

Master Set

Contents: 3 rapidograph pens, 1 Tikky burgundy 0.5, 12 hi-Polymer HB leads, 1 B20 eraser, 6 ink cartridges, 1 Centro compass, 1 compass attachment



S0699590 S0699600 S0699610

| | |
|---|-----|
| — | 0.1 |
| — | 0.3 |
| — | 0.5 |

| | |
|---|-----|
| — | 0.2 |
| — | 0.3 |
| — | 0.5 |

| | |
|---|------|
| — | 0.25 |
| — | 0.35 |
| — | 0.5 |



rotring isograph

For tracing paper, vellum drawing paper and lineboard.

The isograph has a refillable ink reservoir. Its patented push-on sleeve makes for easy access to the ink helix for fast cleaning.

* Line widths for drawing per ISO 128 and DIN 15 and for lettering per ISO 3098/I-DIN 6776.

Drawing tube in 3 mm dia. metal bushing.

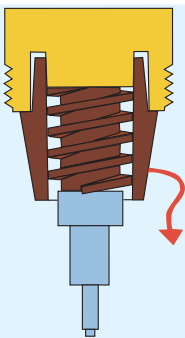

The push-on sleeve can be easily removed to facilitate cleaning, even when the ink reservoir is full.

rotring isograph, International Penline (IPL)

| Technical pens | Line width mm | Colour code | Replacement nibs |
|--------------------|---------------|-------------|--------------------|
| S0201850 (R151010) | 0.1 | 0.1 | S0217870 (R751010) |
| S0201910 (R151013) | 0.13 * | 0.13 | S0217940 (R751013) |
| S0201990 (R151018) | 0.18 * | 0.18 | S0218020 (R751018) |
| S0202070 (R151020) | 0.2 | 0.2 | S0218100 (R751020) |
| S0202130 (R151025) | 0.25 * | 0.25 | S0218170 (R751025) |
| S0202210 (R151030) | 0.3 | 0.3 | S0218250 (R751030) |
| S0202270 (R151035) | 0.35 * | 0.35 | S0218320 (R751035) |
| S0202350 (R151040) | 0.4 | 0.4 | S0218400 (R751040) |
| S0202410 (R151050) | 0.5 * | 0.5 | S0218460 (R751050) |
| S0202490 (R151060) | 0.6 | 0.6 | S0218540 (R751060) |
| S0202550 (R151070) | 0.7 * | 0.7 | S0218600 (R751070) |
| S0202630 (R151080) | 0.8 | 0.8 | S0218680 (R751080) |
| S0202690 (R151100) | 1.0 * | 1.0 | S0218740 (R751100) |
| S0202770 (R151140) | 1.4 * | 1.4 | S0218810 (R751140) |
| S0202840 (R151200) | 2.0 * | 2.0 | S0218880 (R751200) |

Drawing inks for paper

rotring drawing inks in bottles and cartridges (Box of 5).

Product features see page 13.

| | | Volume | Ink Colour |
|--------------------|------------|--------|------------|
| S0216040 (R591003) | 23 ml | red | ■ |
| S0216200 (R591007) | 23 ml | green | ■ |
| S0216280 (R591009) | 23 ml | blue | ■ |
| S0194660 (R591017) | 23 ml | black | ■ |
| S0216550 (R591018) | 23 ml | white | □ |
| S0216630 (R591217) | 250 ml | black | ■ |
| S0215630 (R590217) | Cartridges | black | ■ |



**rotring isograph
Sets of 4**

S0202940*
(R151973)

| | |
|---|------|
| — | 0.25 |
| — | 0.35 |
| — | 0.5 |
| — | 0.7 |

S0226890*
(R151983)

| | |
|---|-----|
| — | 0.2 |
| — | 0.3 |
| — | 0.4 |
| — | 0.5 |



**rotring isograph
Sets of 8**

S0226810*
(R151903)

| | |
|---|------|
| — | 0.18 |
| — | 0.25 |
| — | 0.35 |
| — | 0.5 |
| — | 0.7 |
| — | 1.0 |
| — | 1.4 |
| — | 2.0 |

S0226860*
(R151913)

| | |
|---|-----|
| — | 0.1 |
| — | 0.2 |
| — | 0.3 |
| — | 0.4 |
| — | 0.5 |
| — | 0.6 |
| — | 0.8 |
| — | 1.4 |



rotring isograph with pen stations

The isograph work sets with pen stations keep your technical pens ready to draw instantly. Simply place the pen in the pen station with light pressure. The ideal horizontal position and a flexible double seal prevent the pen from drying. Individual pen stations can be taken from the set and affixed to table or drawing board with double-sided tape (provided with the work set).

* All sets include compass attachment for 3.5/4 mm dia. and stencilling joint and 23 ml bottle of drawing ink.

isograph Combi Sets



Junior Set

Contents: 3 isograph pens, 1 Tikky burgundy 0.5, 4 ink cartridges

S0699300

| | |
|---|-----|
| — | 0.1 |
| — | 0.2 |
| — | 0.3 |

S0699310

| | |
|---|-----|
| — | 0.1 |
| — | 0.3 |
| — | 0.5 |

S0699320

| | |
|---|-----|
| — | 0.2 |
| — | 0.3 |
| — | 0.5 |

S0699330

| | |
|---|------|
| — | 0.25 |
| — | 0.35 |
| — | 0.5 |

S0699340

| | |
|---|-----|
| — | 0.2 |
| — | 0.4 |
| — | 0.6 |

College Set

Contents: 3 isograph pens, 1 Tikky burgundy 0.5, 12 hi-polymer HB leads, 1 B20 eraser, 1 bottle of ink 23ml, 1 compass attachment

S0699350

| | |
|---|-----|
| — | 0.1 |
| — | 0.2 |
| — | 0.3 |

S0699360

| | |
|---|-----|
| — | 0.1 |
| — | 0.3 |
| — | 0.5 |

S0699370

| | |
|---|-----|
| — | 0.2 |
| — | 0.3 |
| — | 0.5 |

S0699380

| | |
|---|------|
| — | 0.25 |
| — | 0.35 |
| — | 0.5 |

S0699390

| | |
|---|-----|
| — | 0.2 |
| — | 0.4 |
| — | 0.6 |

S0706970

| | |
|---|-----|
| — | 0.2 |
| — | 0.4 |
| — | 0.8 |

S0699400

| | |
|---|------|
| — | 0.2 |
| — | 0.35 |
| — | 0.7 |



Master Set

Contents: 3 isograph pens, 1 Tikky burgundy 0.5, 12 hi-polymer HB leads, 1 B20 eraser, 1 Centro compass, 1 bottle of ink 23ml, 1 compass attachment

S0699410

| | |
|---|-----|
| — | 0.1 |
| — | 0.2 |
| — | 0.3 |

S0699420

| | |
|---|-----|
| — | 0.1 |
| — | 0.3 |
| — | 0.5 |

S0699430

| | |
|---|-----|
| — | 0.2 |
| — | 0.3 |
| — | 0.5 |

S0699440

| | |
|---|------|
| — | 0.25 |
| — | 0.35 |
| — | 0.5 |

S0699450

| | |
|---|-----|
| — | 0.2 |
| — | 0.4 |
| — | 0.6 |





Capillary cartridges for rotring rapidograph

For tracing paper, vellum drawing paper and lineboard. (Box of 3)

Special characteristics:

For tracing paper, vellum drawing paper and lineboard. Easy flowing, high opacity, good adhesion, smudge-proof when dry, not erasable with rotring pencil erasers B20 or B30, lightfast, suitable for all forms of reproduction.

Ink Colour

| | | |
|---------------------------|-------|---|
| S0215710 (R590503) | red |  |
| S0215870 (R590509) | blue |  |
| S0194640 (R590517) | black |  |



rotring pen cleaning unit for technical pens

For cleaning technical pens overnight. Fill cup half-full with water, add cleaner concentrate, place disassembled pen parts in the basket, and screw shut. Turning the unit over causes the cleaning solution to rinse through the pen parts, for thorough cleaning of even the most stubborn ink residues.

R S0215490 (R585281) with 10 sachets of cleaner concentrate

rotring cleaner concentrate

For cleaning dirty, encrusted technical pens and nibs. Dissolve concentrate in water in the rotring pen cleaning unit. Cleaning time will depend on how dirty the pens are.

S0215340 (R585270) Pack of 10 sachets



rapid-eraser B20 / B30

For erasing polymer/graphite pencil lines from all drawing media. The elastic white plastic eraser contains no abrasives, so it will not affect ink lines. It works by rolling up graphite and dirt particles in eraser dust. The erased surface stays clean, with no smears or marks. The dust brushes easily off the media surface.

rapid-eraser B20

S0194570 (R551120A)
(box of 20)

rapid-eraser B30

S0233921 (R551130A)
(box of 30)









Drawing inks for paper for rotring isograph and Variant (II)

rotring drawing inks in bottles and cartridges (Box of 5)

Special characteristics:

Suitable for tracing paper, vellum, drawing paper and lineboard. Easy-flowing, high opacity, good adhesion. Smudge-proof when dry, not erasable with rotring pencil erasers B20 or B30, lightfast, suitable for all forms of reproduction, coloured inks can be mixed with one another, high colour purity.

Ink Colour

| | | | |
|---------------------------|------------|-------|---|
| S0216040 (R591003) | 23 ml | red |  |
| S0216200 (R591007) | 23 ml | green |  |
| S0216280 (R591009) | 23 ml | blue |  |
| S0194660 (R591017) | 23 ml | black |  |
| S0216550 (R591018) | 23 ml | white |  |
| S0216630 (R591217) | 250 ml | black |  |
| S0215630 (R590217) | Cartridges | black |  |



rotring cleaning fluid for technical pens

For cleaning drawing instruments used with non-etching drawing inks.

S0215410 (R585280) 100 ml



rapid-eraser TB20

Combined eraser for pencil and ink lines.

$\frac{2}{3}$ for erasing non-etching drawing ink, $\frac{1}{3}$ for erasing polymer/graphite pencil lines from all drawing media.

S0194611

(R551320A)
(box of 20)





rotring ArtPen

Writing is also an art. Our hectic daily lifestyle often makes us forget this. The rotring ArtPen breathes new life into this art form. Its calligraphy nibs, crafted from the finest stainless steel, turn every piece of writing into a small work of art. This pen is a must for people who also want to put a personal stamp on their written work.



Brilliant ink

| | | |
|-----------------|------------|-------------------|
| S0194751 | (R598217N) | ArtPen ink, black |
| S0194681 | (R598205N) | royal blue |
| S0216961 | (R598207N) | brown |



rotring converter

S0227850 (R251300)

rotring ArtPen

| | | | |
|-----------------|-----------|-----------------|-----|
| S0204980 | (R250000) | Sketch | EF |
| S0205070 | (R250001) | Sketch | F |
| S0205160 | (R250100) | Lettering | M |
| S0205250 | (R250101) | Lettering | B |
| S0205340 | (R250201) | Calligraphy | 1.1 |
| S0205510 | (R250203) | Calligraphy | 1.5 |
| S0205600 | (R250205) | Calligraphy | 1.9 |
| S0205690 | (R250207) | Calligraphy | 2.3 |
| S0227700 | (R250290) | Calligraphy-Set | |
| S0205870 | (R250292) | Calligraphy-Set | |

rotring ArtPen front sections

| | | | |
|-----------------|-----------|-------------|-----|
| S0270810 | (R251000) | Sketch | EF |
| S0270820 | (R251001) | Sketch | F |
| S0270830 | (R251100) | Lettering | M |
| S0324620 | (R251101) | Lettering | B |
| S0270850 | (R251201) | Calligraphy | 1.1 |
| S0270870 | (R251203) | Calligraphy | 1.5 |
| S0270880 | (R251205) | Calligraphy | 1.9 |
| S0270890 | (R251207) | Calligraphy | 2.3 |

Greetings

Sketch EF

Festival

Sketch F

New York

Lettering M

PARTY

Lettering B

Richard

Calligraphy 1.1

Maria

Calligraphy 1.5

Musik

Calligraphy 1.9

Menu

Calligraphy 2.3



rotring rapid PRO

Solid metal - satin and shiny chrome plated - , the hexagonal barrel shape and a knurled grip underline its technical expertise.

The 2.0 mm pencil offers an innovative push mechanism for controlled lead transportation that provides unlimited drawing precision and features a sharpener integrated in the push cap.

Mechanical pencils in 0.5 and 0.7 mm are equipped with a cushion point mechanism with sliding pipe to support a convenient and highly comfortable long writing distance.

The perfect professional tool for all sketching, writing and drawing applications!

rotring rapid PRO

| | | | |
|-----------------|----|--|--------|
| S0914520 | HB | | 0.5 mm |
| S0914530 | HB | | 0.7 mm |
| S0914540 | HB | | 2.0 mm |



rotring 300 clutch pencil

2.0 mm clutch pencil with adjustable lead hardness grade indicator and a sharpener integrated in the push cap. Hexagonal barrel shape and knurled grip - the economical 2.0 mm alternative.

rotring leads for clutch pencils, 12 pcs.

| | | | | |
|-----------------|------------|----|--|--------|
| S0230351 | (R505206N) | 2B | | 2.0 mm |
| S0230401 | (R505207N) | B | | 2.0 mm |
| S0230451 | (R505208N) | HB | | 2.0 mm |
| S0230491 | (R505210N) | H | | 2.0 mm |
| S0230541 | (R505211N) | 2H | | 2.0 mm |

rotring 300, clutch pencil, plastic

S0207300 (R502320) HB 2.0 mm



Rotring Tikker

0.5

Rotring



Tikky Liner

Smooth & precise writing performance with constant line quality.

Tikky Liner with needlepoint tip in different line width and gel ink technology. Metal pen barrel & cap - satin chrome plated -, with an ergonomical waved, transparent grip zone for comfortable writing experience and ink level control.

Precise and functional - perfect for daily writing and drawing use.

Tikky Liner

- S0919070** 0.3 mm
- S0919080** 0.5 mm
- S0919090** 0.7 mm

Tikky Liner Refills

- S0919110** 0.3 mm
- S0919120** 0.5 mm
- S0919130** 0.7 mm

Colour
gel ink, black
gel ink, black
gel ink, black



rotring Tikky Graphic

A fine fibre-tip pen with non-fading water resistant pigmented ink and a metal-jacketed fibre-tip nib for accurate drawing on straightedges or templates. Free-ink technology ensures consistently high line quality to the very last drop. The ink-level window shows the amount of ink left in the reservoir at any time.

Free Ink – The intelligent solution

Free Ink technology is a perfect example of rotring's innovative force. Our Free Ink writing instruments have clear advantages. The ink feed module gives a free yet controlled flow of ink from the reservoir onto the paper, eliminating the need for a conventional ink storage plug. This makes it possible to use 100% of the ink contents, down to the last drop.

Free Ink is efficient but it's also carefree, even fun to use.

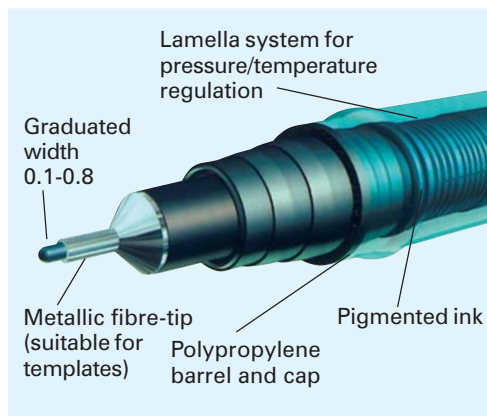

| | Ink Colour | |
|-----------------|------------|-----|
| S0814730 | black | 0.1 |
| S0814740 | black | 0.2 |
| S0814750 | black | 0.3 |
| S0814760 | black | 0.4 |
| S0814770 | black | 0.5 |
| S0814780 | black | 0.7 |
| S0814790 | black | 0.8 |

Set of 3 in pouch

| | | |
|-----------------|-------|-----|
| S0814940 | black | 0.2 |
| 0,2 • 0,4 • 0,8 | | 0.4 |
| | | 0.8 |

Set of 3 on blister

| | | |
|-----------------|-------|-----|
| S0814870 | black | 0.1 |
| 0,1 • 0,3 • 0,5 | | 0.3 |
| | | 0.5 |

| | | |
|-----------------|-------|-----|
| S0814880 | black | 0.2 |
| 0,2 • 0,4 • 0,8 | | 0.4 |
| | | 0.8 |

| | | |
|-----------------|-------|-----|
| S0814890 | black | 0.3 |
| 0,3 • 0,5 • 0,7 | | 0.5 |
| | | 0.7 |

Set of 3, with Tikky burgundy 0.5, hi-polymer leads 0.5 HB and rapid-eraser B30

| | | |
|-----------------|-------|-----|
| S0814910 | black | 0.3 |
| 0,3 • 0,5 • 0,7 | | 0.5 |
| | | 0.7 |



Tikky 3 in 1 Multipen

TIKKY 3 in 1 Multipen is the ultimate all-round talent ! Ergonomical design and convincing functionality through a technically advanced "magic view" mechanism. Easy to use, TIKKY 3 in 1 is a technical and efficient multi-functional tool for all writing , drawing and sketching needs.

Magic view

This highly convenient mechanism turns the multipen optionally into a mechanical pencil, a ballpoint pen to highlight or a ballpoint pen to write. Holding the pen in your hand, just look at the desired mode icon, press the push button and simply write !

Also available as Tikky ballpoint with Jumbo refill.



Tikky 3 in 1

BP blue / BP red / PCL 0.7 mm

S0891150 black

S0891170 white

BP black / BP red / PCL 0.5 mm

S0891160 black

S0891180 white

Tikky Ballpoint

S0770890 white

S0770910 black

S0770920 blue

S0770900 red

S0770930 yellow



Tikky





The ergonomic wave-form grip area offers a good hold. With its classic design, the Tikky is the ideal mechanical pencil for school and office. The fixed sleeve offers an unimpeded view of the page, making the Tikky excellent for drawing with a straight-edge or template.

The professional tool in classic black and burgundy. Additional colour coding analogous to ISO 3098 displays the available line widths at a glance: 0.35/0.5/0.7/1.0

Hi-Polymer leads ensure high flexibility and durability while keeping the lead-support tip clean.



Tikky, black barrel with colour-coding

| | | |
|----------|---|---------------------|
| S0770490 |  | 0.35 mm |
| S0770500 |  | 0.5 mm |
| S0770510 |  | 0.7 mm |
| S0770520 |  | 1.0 mm |
| Set of 3 | | |
| S0801310 | | 0.35 / 0.5 / 0.7 mm |

Tikky, burgundy barrel with colour-coding

| | | |
|----------|---|---------|
| S0770450 |  | 0.35 mm |
| S0770460 |  | 0.5 mm |
| S0770470 |  | 0.7 mm |
| S0770480 |  | 1.0 mm |

Tikky 0.5 mm

| | |
|----------|--------|
| S0770530 | white |
| S0770550 | black |
| S0770560 | blue |
| S0770540 | red |
| S0770570 | yellow |



Tikky fine leads

High-polymer fine leads are a solid foundation for you to build on. Their extra-strong formula turns your mechanical pencil into something more than just a refillable pencil.

Tikky fine leads, high-polymer

| | | | | |
|-----------------|------------|----|--|---------|
| S0312400 | (R505307N) | B | | 0.35 mm |
| S0312410 | (R505308N) | HB | | 0.35 mm |
| S0312630 | (R505506N) | 2B | | 0.5 mm |
| S0312640 | (R505507N) | B | | 0.5 mm |
| S0312650 | (R505508N) | HB | | 0.5 mm |
| S0312660 | (R505510N) | H | | 0.5 mm |
| S0312670 | (R505511N) | 2H | | 0.5 mm |
| S0231230 | (R505706N) | 2B | | 0.7 mm |
| S0312680 | (R505707N) | B | | 0.7 mm |
| S0312690 | (R505708N) | HB | | 0.7 mm |
| S0312700 | (R505908N) | HB | | 1.0 mm |



Jumbo refills for ballpoints

| | | |
|-----------------|-----------|-------|
| S0195360 | (R074450) | blue |
| S0195390 | (R074456) | black |



Tikky erasers

The Tikky erasers can be relied upon to remove pencil and coloured pencil lines without a trace. By using dirt-catching additives and avoiding hard abrasives, they make sure that the media surface always remains clean.

Tikky erasers



| | | |
|-----------------|-----------------|------------|
| Tikky 20 | S0195831 | (R551420A) |
| Tikky 30 | S0234101 | (R551430A) |
| Tikky 40 | S0234151 | (R551440A) |

Eraser refills for mechanical pencils

S0271220 (R502721)



D1 refills for Tikky 3 in 1

| | |
|-----------------|-------|
| S0891220 | blue |
| S0891230 | black |
| S0891240 | red |



Rapid adjustment compass

Fast and precise radius adjustment
 Mobility of the spindle can be fixed by set screw
 Both legs with joint
 Ergonomic plastic application and handhold depressions
 Circles up to Ø 360 mm
 Pivot: Ø 4.0 mm
 Length: 170 mm
 Lead box and spare needle
S0676580



Giant Universal Compass

Fast and smooth radius adjustment
 Both legs with joint
 Ergonomic plastic applications and handhold depressions
 Circles up to Ø 360 mm
 Pivot: Ø 3.5 mm
 Length: 160 mm
 Lead box and spare needle
S0676550

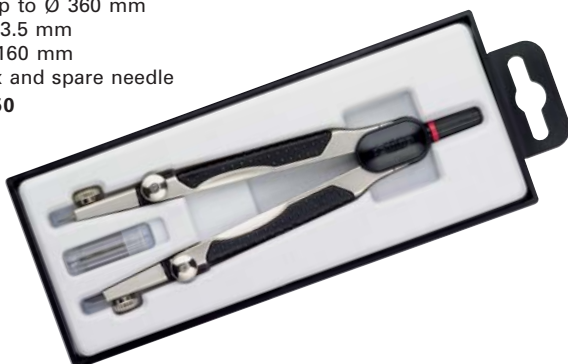

Geometry Compass

Precision radius adjustment through central wheel spindle
 Both legs with joint
 Ergonomic plastic applications and handhold depressions
 Circles up to Ø 360 mm
 Pivot: Ø 4.0 mm
 Length: 170 mm
 Lead box and spare needle
S0676570



Compass Set (6-pieces)

Contents: giant universal compass, stable extension bar, compass attachment with universal holding device, drawing pen, drawing pen holder, lead box and spare needle
 Circles up to Ø 520 mm
S0676560



Universal Compass

Fast and smooth radius adjustment
 Convenient handhold depressions
 Circles up to Ø 320 mm
 Pivot: Ø 3.5 mm
 Length: 130 mm
 Lead box
S0676530



Universal Compass Set

Contents: Universal compass, extension bar, compass attachment with universal holding device and lead box
 Circles up to Ø 480 mm
S0676540



Giant bow compass with rapid adjustment

Infinitely variable radius setting through convenient button mechanism
Precision adjustment through central spindle
Both legs with joint
Pivot: \varnothing 4.0 mm
Length: 170 mm
Lead box and spare needle

S0214470 without extension bar
(R530115) circles up to 400 mm dia.
S0214540 with extension bar
(R530116) circles up to 640 mm dia.

Geometry Compass

Precision radius adjustment with central wheel spindle
Spindle with end stop
Circles up to \varnothing 250 mm
Length: 160 mm
Lead box and spare needle

S0233300
(R529130)



Universal Compass

Fast and smooth running radius adjustment
Insert leg with joint
Circles up to \varnothing 380 mm
Pivot: \varnothing 3.5 mm
Length: 140 mm
Lead box and spare needle

S0214320
(R529117)

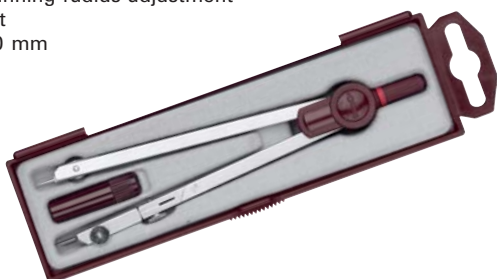

Universal Compass Set

Contents: universal compass, extension bar, drawing pen, drawing pen holder, lead box and spare needle
Circles up to \varnothing 540 mm

S0214390
(R529118)

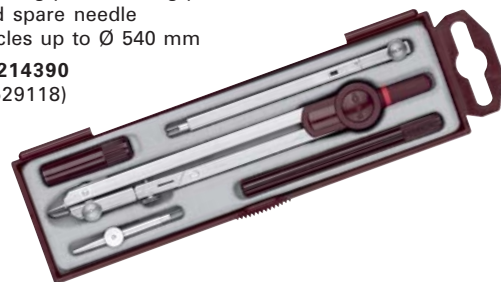

Compass Set (8 pieces)

Contents: universal compass, extension bar, dividers, small bow compass, bow compass, drawing pen, drawing pen holder, lead box and spare needle
Circles up to \varnothing 540 mm

S0233410
(R529216)



Compass Set (7 pieces)

Contents: universal compass, extension bar, dividers, small bow compass, drawing pen, drawing pen holder, lead box and spare needle
Circles up to \varnothing 540 mm

S0233370
(R529215)



Giant bow compass with rapid adjustment and extension bar

Infinitely variable radius adjustment through high-quality button mechanism
 Precision fine adjustments through central wheel
 Both legs with joint
 Circles up to Ø 640 mm
 Pivot: Ø 4.0 mm
 Length: 170 mm
 Lead box and spare needle
S0233800
 (R530224)



Giant bow compass with rapid adjustment and pen adaptor

Infinitely variable radius adjustment through high-quality button mechanism
 Precision fine adjustments through central wheel
 Swivelling pen adaptor with fine lead insert 0.5 mm
 Insert leg with joint
 Length: 182 mm
 Lead box and spare needle
S0233750 with extension bar,
 (R530147) circles up to Ø 620 mm



Geometry Compass

Precision radius adjustment through central wheel spindle

Both legs with joint

Pivot: \varnothing 4.0 mm

Length: 160 mm

Lead box and spare needle

S0233601 without extension bar,
(R5301350) circles up to \varnothing 400 mm

S0233631 with extension bar,
(R5301360) circles up to \varnothing 640 mm



Universal Compass with Telescopic Extension

Quick and smooth running radius adjustment

Convenient integrated extension bar

Insert leg with joint

Circles up to \varnothing 520 mm

Pivot: \varnothing 3.5 mm

Length: 150 mm

lead box and spare needle

S0233471
(R5301090)

Compass Set (8 pieces)

Contents: universal compass, small dividing compass, extension bar, dividers, bow compass, drawing pen, drawing pen holder, lead box and spare needle

Circles up to \varnothing 600 mm

Pivot: \varnothing 3.5 mm

S0233821
(R5302260)



Dual compass attachment

With stepped peg to fit 3.5 and 4.0 mm dia.
Peg slot adjustable by 90°.

S0322070
(R533345)



Lead inserts with button mechanism

For master bow and pump compasses with pen adaptor.
Brass mechanism in burgundy plastic housing.

S0271530 (R538235) with 0.5 mm lead



Compass attachment with universal holding device

for CENTRO and CONVEX series
With stepped peg to fit 3.5 mm and 4.0 mm dia.

S0451450 (R5333600)



Compass attachment with universal holding device

for COMPACT series
With stepped peg to fit 4.0 mm dia.

S0830620
With stepped peg to fit 3.5 mm dia.
S0897800

The universal holding devices takes pens/pencils up to 11.5 mm dia.

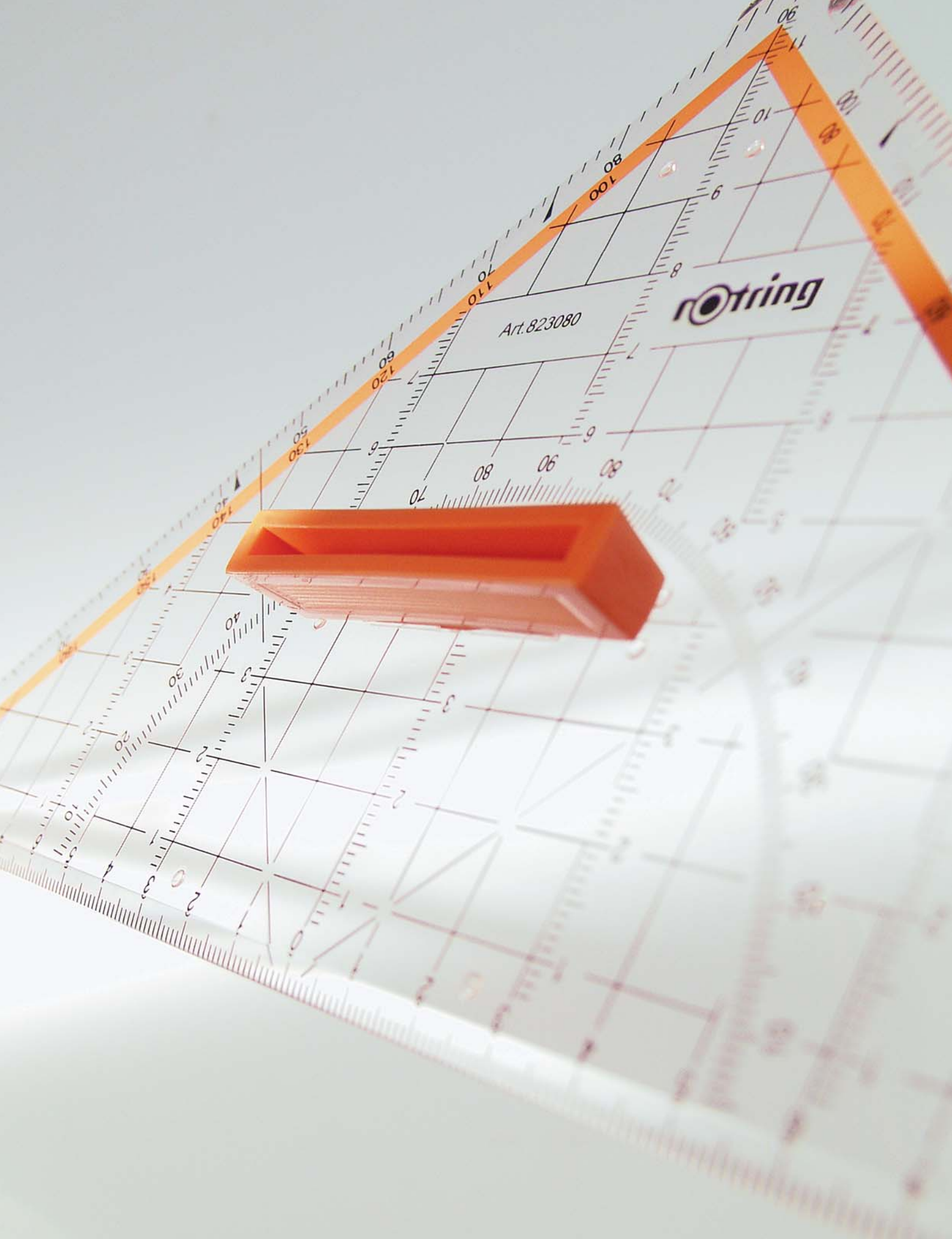

Art. 823080

rotring

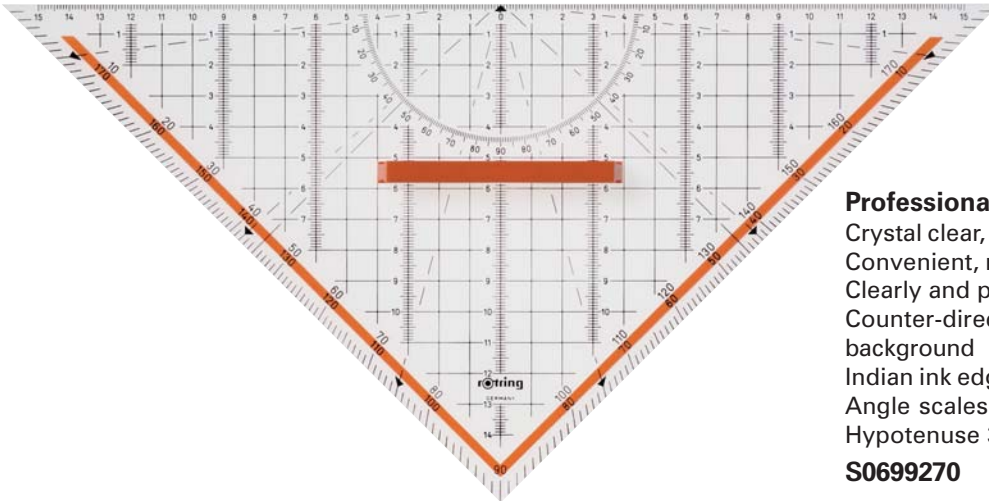

Professional Set Square

Crystal clear, robust plastic
 Convenient, removable grip
 Clearly and precisely embossed
 Counter-directional numbering with coloured background
 Indian ink edges and naps
 Angle scales 180°/1°
 Hypotenuse 32 cm with 30 cm / 1 mm scale
S0699270

Large Geometry Set Square with Handle

Crystal-clear, stable plastic
 Robust handle
 Contrary scale with coloured background
 Bevelled edges and ink naps
 Hypotenuse 25 cm with 22 cm/1 mm scale
S0220800 (R823004)



Professional Set Square

High-quality plexiglas
 Convenient removable handle
 Clear and precise fine imprinting
 Contrary scale with coloured background
 Tracing edges and ink naps
 Angle scale 180°/1°
 Hypotenuse 25 cm with 22cm/1 mm scale
S0451820 (R823080)

Geometry Set Square

Crystal-clear, stable plastic
 Contrary scale with coloured background
 Bevelled edges and ink naps
 Hypotenuse 16 cm with 14 cm/1 mm scale
S0237630 (R823028)

Geometry Set Square with Handle

Crystal-clear, stable plastic
 Robust handle
 Contrary scale with coloured background
 Bevelled edges and ink naps
 Hypotenuse 16 cm with 14 cm/1 mm scale
S0237690 (R823042)



Geometry Set (4 pieces)

Crystal-clear, stable plastic
Bevelled edges and/or tracing edges

Contents: 30 cm ruler,
semicircular protractor
set square 30°/60°, hypotenuse 23 cm,
set square 45°, hypotenuse 20 cm

S0221370 (R823509)

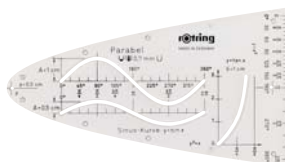
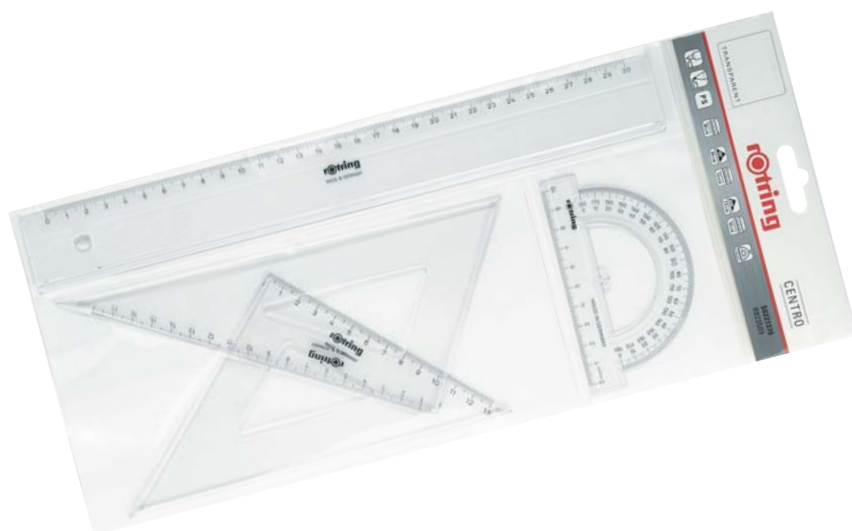
**Standard Parabola ($y = x^2$)**

Crystal-clear, stable plastic
Bevelled edges on the outside contours
Sine/cosine curves $A = 1$ and $A = 0.5$
Tangent curve

Size: 123 × 70 × 1.8 mm

S0673400

**Semicircular Protractor**

Crystal-clear, stable plastic
Contrary scale
Centring point and bevelled edges
Scaling: 10 cm

S0221230 (R823301)

**Set Square 45°**

Crystal-clear, stable plastic
tracing edges all round
Angle: 45°
Hypotenuse 20 cm, 13 cm/1 mm scale

S0221160 (R823226)

**Set Square 30°/60°**

Crystal-clear, stable plastic
tracing edges all round
Angles: 30°/60°
Hypotenuse 23 cm, 18 cm/1 mm scale

S0221090 (R823202)

All set squares have 0 point directly
on tracing edge to enable direct
measurement of line segments.

**Set Squares Sets of 2
one 45° and one 30°/60° set square**

Crystal-clear, stable plastic
Tracing edges all round
1 mm scale

S0237840 45°, hypotenuse 25 cm
(R823523) 30°/60°, hypotenuse 29 cm

S0237870 45°, hypotenuse 32 cm
(R823530) 30°/60°, hypotenuse 37 cm

S0237900 45°, hypotenuse 36 cm
(R823547) 30°/60°, hypotenuse 41 cm



**Burmester Curves Set
(3 pieces)**

For drawing of universal curves
Crystal-clear, stable plastic
Double-sided tracing edges all round
S0221301 (R8234000)



Flat Ruler

Crystal-clear, stable plastic
Bevelled edge and tracing edge
1 mm increments

- S0220870** (R823103) Scaling: 16 cm
- S0220950** (R823127) Scaling: 30 cm
- S0221450** (R823578) Scaling: 40 cm
- S0221500** (R823585) Scaling: 50 cm

Plate Ruler

Crystal-clear, stable plastic
Textured plate
Scale on both sides
1 × 1-mm scale
1 × 0.5-mm scale

S0221020 (R823141) Scaling: 30 cm



Wooden Ruler

Natural beech wood
Bevelled edge
1 mm increments

- S0237930** (R823593) Scaling: 17 cm
- S0237950** (R823594) Scaling: 30 cm

Triangular reduction scales

Of white dimensionally stable plastic.
The precision divisions are numerated both ways.
Dimension markings in cm and m for easier working.
With 2 coloured flutings.



- S0236961** Engineer/DIN ISO 5455
(R8020190)
- | | | | |
|---------|--------|---------|-----|
| 5 : 1 | 2 : 1 | 1 : 1 | DIN |
| 1 : 2 | 1 : 5 | 1 : 10 | |
| 1 : 20 | 1 : 50 | 1 : 100 | |
| 1 : 500 | | | |

- S0220641** Architect
(R8020220)
- | | | | |
|---------|---------|---------|---|
| 1 : 10 | 1 : 20 | 1 : 25 | 4 |
| 1 : 30 | 1 : 40 | 1 : 50 | |
| 1 : 100 | 1 : 200 | 1 : 250 | |
| 1 : 300 | 1 : 400 | 1 : 500 | |

- S0220481** Architect
(R8020200)
- | | | | |
|---------|---------|----------|---|
| 1 : 10 | 1 : 20 | 1 : 25 | 1 |
| 1 : 50 | 1 : 75 | 1 : 100 | |
| 1 : 125 | 1 : 200 | 1 : 250 | |
| 1 : 500 | 1 : 750 | 1 : 1250 | |

- S0220721** Surveying
(R8020230)
- | | | | |
|----------|----------|----------|---|
| 1 : 25 | 1 : 50 | 1 : 100 | 6 |
| 1 : 125 | 1 : 150 | 1 : 200 | |
| 1 : 250 | 1 : 500 | 1 : 1000 | |
| 1 : 1250 | 1 : 1500 | 1 : 2000 | |
| 1 : 2500 | | | |

- S0220561** School
(R8020210)
- | | | | |
|------------------------------------|---------|---------|---|
| 1 : 10 | 1 : 20 | 1 : 25 | 2 |
| 1 : 33 ¹ / ₃ | 1 : 50 | 1 : 75 | |
| 1 : 100 | 1 : 200 | 1 : 250 | |
| 1 : 500 | 1 : 750 | | |

- S0237031** Mechanical design
(R8020240)
- | | | | |
|---------|------------------------------------|---------|---|
| 1 : 10 | 1 : 15 | 1 : 20 | 9 |
| 1 : 25 | 1 : 33 ¹ / ₃ | 1 : 50 | |
| 1 : 100 | 1 : 200 | 1 : 150 | |
| 1 : 250 | 1 : 500 | | |

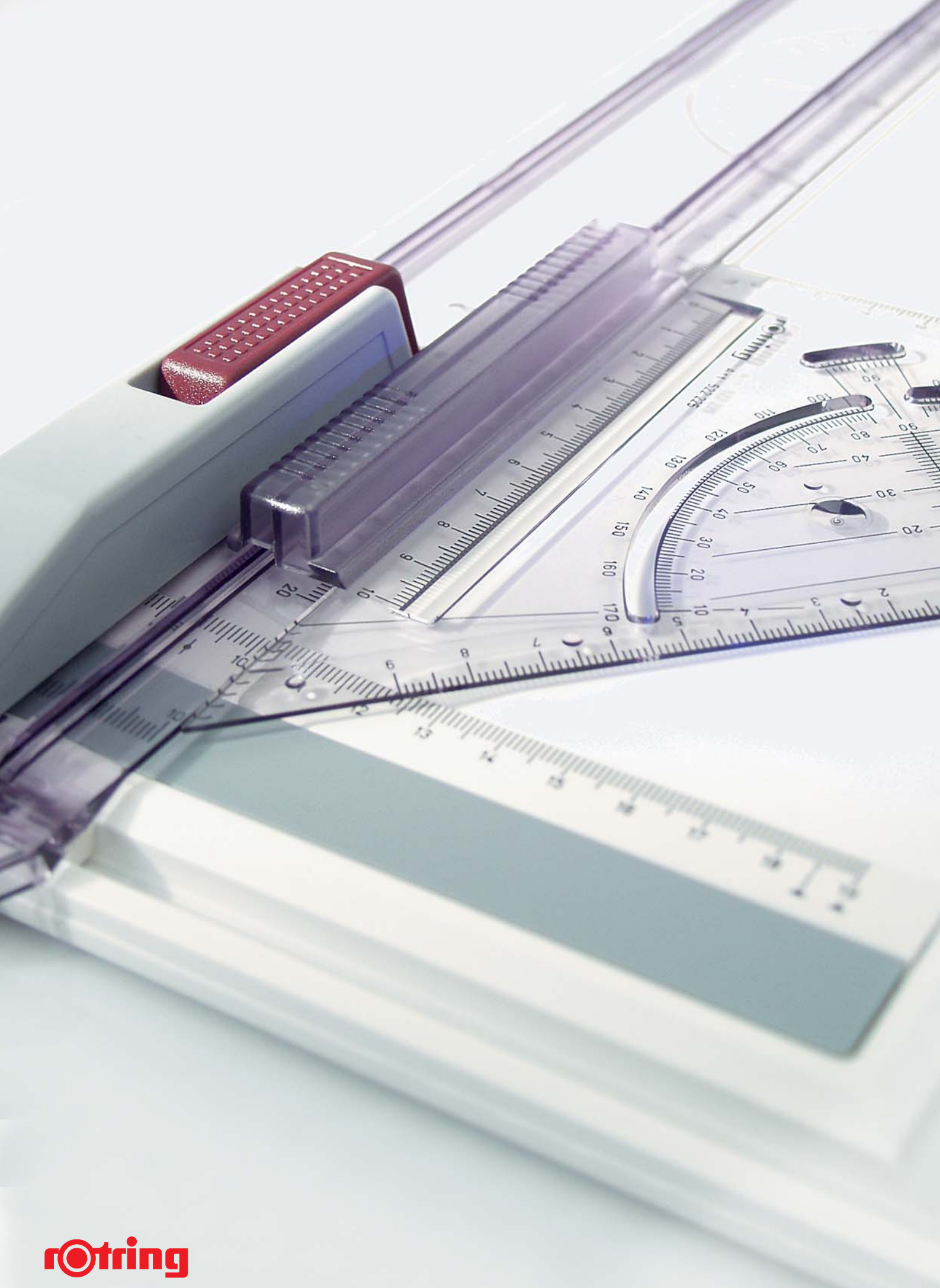



rotring rapid drawing board

The full-featured drawing board for speed, precision and ease of use.

- Robust board of unbreakable, non-warping material.
- Ergonomic design for easy, comfortable working.
- Parallel straightedge with STOP-and-GO locking/unlocking action.
- **The L-system straightedge design** - allows drawing along the top edge of the straightedge right down to the bottom of the sheet, with full accuracy and stability.
- Two magnetic clamp strips with central pushbutton operation plus additional corner clamp, for exact media positioning and absolutely secure holding.
- Guide rails designed for permanently smooth, featherlight straightedge movement.
- End lock on A3 straightedge for added stability.
- Comes complete with rapid set square for drawing vertical and horizontal lines and angles.
- Includes tilters for comfortable working.



rotring rapid drawing boards

- S0213910** (R522403) rapid A3
- S0232710** (R522404) rapid A4



rotring rapid drawing boards in the college case

This rigid case features guides to hold drawing board securely, as well as space for utensils, books, etc.

- S0232980** (R523403) rapid A3 + college case



rotring profil drawing board

For precise drawings and easy, comfortable working.

- Robust board of unbreakable, non-warping material.
- Ergonomic design for easy, comfortable working.
- Parallel straightedge with STOP-and-GO locking/unlocking action.
- **The L-system straightedge design** - allows drawing along the top edge of the straightedge right down to the bottom of the sheet, with full accuracy and stability.
- Magnetic clamp strip plus additional corner clamp to hold media securely.
- Guide rails designed for permanently smooth, featherlight straightedge movement.
- End lock on A3 straightedges for added stability.
- Can be used with tilters (purchased separately) for added working comfort.



rotring profil drawing boards

S0213750 (R522231) profil A3
S0232430 (R522241) profil A4



Tilters for profil and rapid drawing boards. Enable board to be tilted at either of two angles for comfortable working.

S0232330 (R522227) 1 pair

Professional drawing head
with automatic setting every 15° and locking of any angle in between, plus free-swinging setting. Contra-rotating 0-90° scale, brake mechanism to lock in position on straightedge.

S0213830 (R522346)



Junior drawing head
with 15° ratchet action.

S0213680
(R522230)

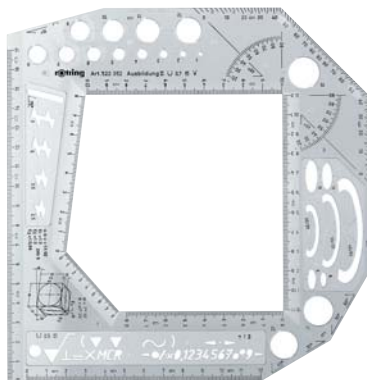

Multipurpose drawing template II
With 15°, 30°, 45°, 60°, 90° angles, circles with diameters from 1 - 15 mm in steps of 1 mm, ellipses with large axes 12, 15, 20, 25, 30, 35, 40, 50 mm, surface symbols, dimensioning arrows, line device for standard lettering, 7°/42° angles for dimetric projection.

S0232590 (R522352) 180 x 180 x 1,6 mm
0.7 - 0.5 mm

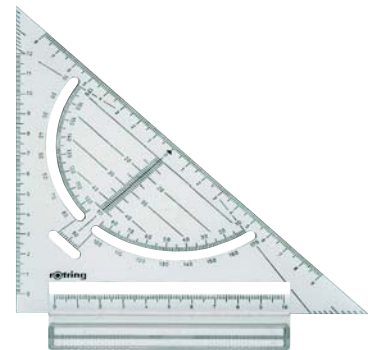

Rapid set square
For direct measurement and drawing of vertical and horizontal lines and angles, and for hatching.

S0232240 (R522225)

rotring college case, empty
This rigid case features guides to hold drawing board securely, as well as space for drawing instruments.

S0232510 (R522273) for A3 boards
S0232550 (R522274) for A4 boards



**rotring collegeboard A3**

For sheet sizes up to 450 x 325 mm.

- Magnetic clamp with scale.
- Straightedge guide slots on all four sides with signal humps.
- Parallel straightedge with grip area and STOP-and-GO button.
- Additional metal clamp.

S0213660 (R522110)

Protective carry bag

Tough weatherproof nylon.
Has detachable shoulder strap and
space for books and utensils.

S0232160 (R522213)

for A3 boards

S0232200 (R522214)

for A4 boards





rotring A2 drawing table

A complete drawing system with drawing board laminated on all sides, **anodized aluminium guide track with plastic guide coating**, parallel straightedge with STOP-and-GO mechanism, drawing head with STOP-and-GO mechanism and adjustable plastic tilter.

S0213920 (R522433) A2 (board size 700 x 600 x 16 mm)

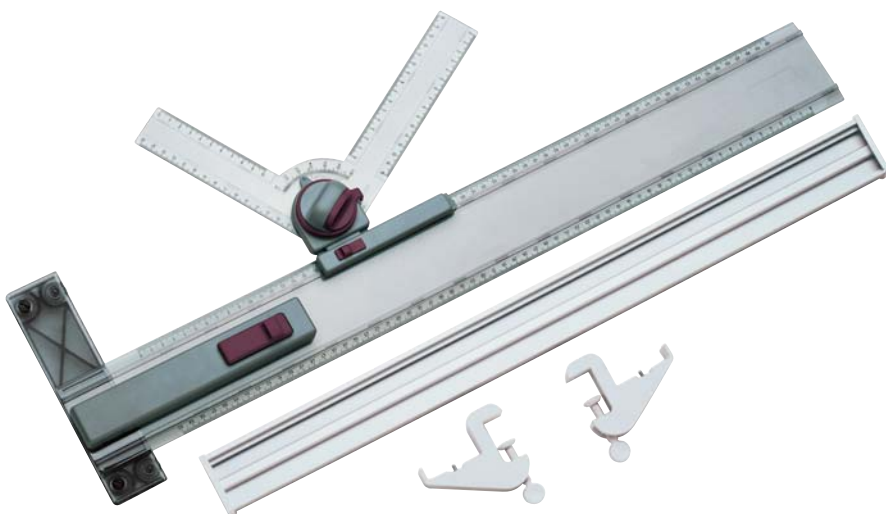

rotring T-square-set A2

With precision anodised-aluminium guide track and plastic glide coating. Fast, simple mounting on drawing board or other work surface with special clamps.

- Parallel straightedge with STOP-and-GO mechanism.
- Drawing head with STOP-and-GO mechanism.
- 2 special clamps made of plastic.
- Without drafting table

S0232880 (R522442) A2



Lettering - as neatly as if printed

A precise technical drawing is not complete without true-to-standard lettering, and for that you need rotring's precision lettering stencils. The rotring lettering stencils are stamped with markings to show the line width and character height. This ensures that the right pen and the right stencil are used together for true-to-standards lettering.

rotring lettering stencils are made of high-quality plastic and are especially resistant to warping and breakage. The clear, yellow-tinted material provides for high contrast so that even the finest lines are clearly visible. All edges are highly precise.

rotring lettering stencils are available with H-profile and Z-profile.

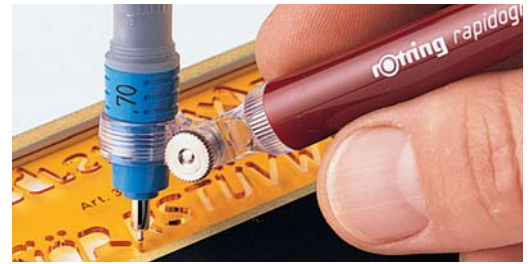

Stencilling joint

Attaches between nib and barrel for a more comfortable working angle.

S0314140 (R515270)

Lettering stencils in Z-profile per ISO 3098/I, lettering type B



| Roman | Character height | rapido-graph | iso-graph | Colour code |
|---------------------------|------------------|--------------|-----------|-------------|
| S0228430 (R342025) | 2.5 mm | S0194270 | S0202130 | white |
| S0228480 (R342035) | 3.5 mm | S0194290 | S0202270 | yellow |
| S0228530 (R342050) | 5.0 mm | S0203700 | S0202410 | brown |
| S0228580 (R342070) | 7.0 mm | S0203850 | S0202550 | blue |

duo-combi Lettering stencil for fibre-tip pens and fine-lead mechanical pencils

2 character heights: 3.5 and 5 mm, roman lettering per ISO 3098/I B. Includes several frequently-used Greek characters.

S0228181 (R3400050)

244 x 75 x 1 mm
 Ψ 0.3-0.5-0.7-0.9
 Ψ 0.1-0.3-0.5-0.7



H-profile lettering stencils Type 1451

| Roman | Character height | rapido-graph | iso-graph |
|----------------------------|------------------|--------------|-----------|
| S0227961 (R3060300) | 3.0 mm | S0203430 | S0202210 |
| S0228021 (R3060400) | 4.0 mm | S0203630 | S0202350 |
| S0228061 (R3060500) | 5.0 mm | S0203700 | S0202410 |
| S0228111 (R3060600) | 6.0 mm | S0203780 | S0202490 |



rotring technical templates

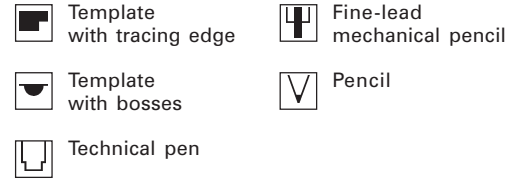

rotring precision templates are robust and non-warping, with perfectly formed, true-to-standards symbols selected for the most varied applications.

The transparent, yellow-tinted material leaves even the finest of lines (e. g. ones drawn with a rotring fine-lead pencil) clearly visible through the template.



“Studio” electrical engineering angle template

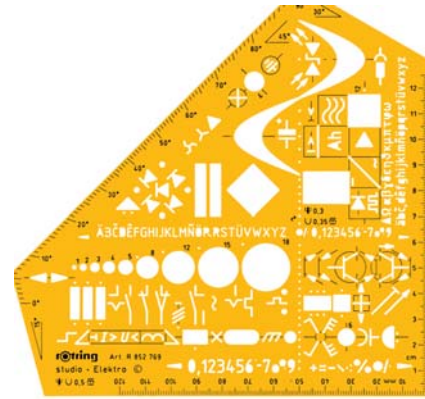

A drawing aid for metalworking students. With 15°, 30°, 45°, 60°, 75°, and 90° angles, mm coordinate graduation, protractor, circles from 1-18 mm dia., and holes for hatching. Symbols and easy-to-combine symbol elements per DIN 40700, Latin and Greek characters in 3.5 mm and numerals in 3.5 and 5.0 mm sizes per ISO 3098/I Bv.

S0238591 
(R8527690)
162 x 160 x 1 mm
□ 0.35   0.3



Circles templates

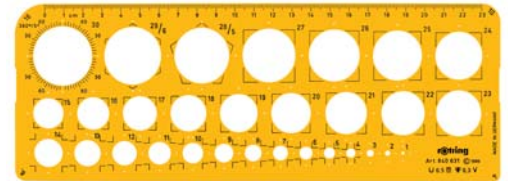

Circles of 1-30 mm dia. in 1 mm increments. With polygon guides and protractor. Radii 4, 6, 10, 16 mm. With millimetre ruler and fingerlift.

S0221621 
(R8406310)
255 x 92 x 1.6 mm
□ 0.5  



Circles templates

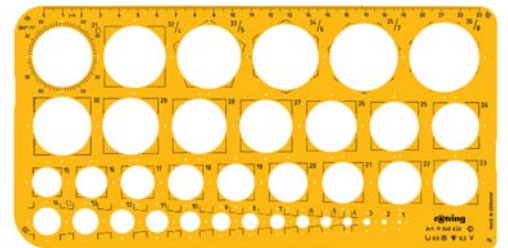

Circles of 1-36 mm dia. in 1 mm increments. With polygon guides and protractor. Radii 6, 10, 16, 20 mm. With millimetre ruler and fingerlift.

S0221691 
(R8406330)
255 x 129 x 1.6 mm
□ 0.5  



Radii templates

48 radii from 0.5-40 mm, 0.5-2 mm in 0.1 mm increments, radii per DIN 250 underlined. Built-in semicircular protractor. With surface symbols.

S0238341 
(R8426830)
∅ 160 x 1.6 mm
□ 0.5-0.35  



Architect's combination template

Separate layout of symbols for furniture, sanitary fittings, electrical fittings, door openings, level and direction symbols, insulation.

S0238711 ▼
(R8537780)
Scale 1:50
250 x 150 x 1.2 mm
U 0.35 mm

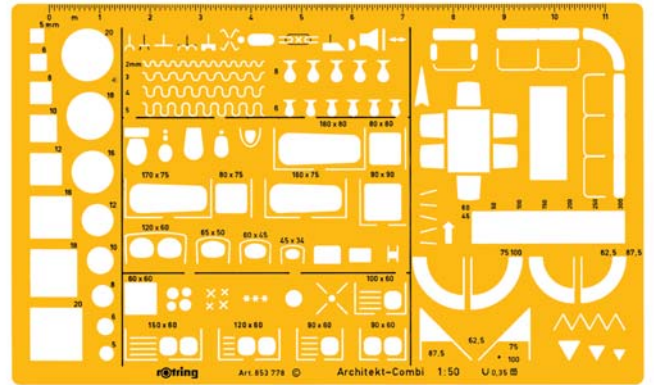

See above

S0238781 ▼
(R8537790)
Scale 1:100
190 x 95 x 1.2 mm
U 0.35 mm

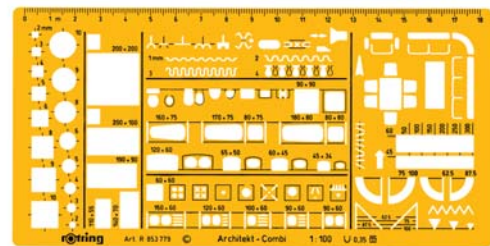

Furniture templates

Modern furnishings for living room, bedroom, kitchen, bathroom and toilet.

S0238921 ▼
(R8537830)
Scale 1:50
300 x 155 x 1.2 mm
U 0.5 mm

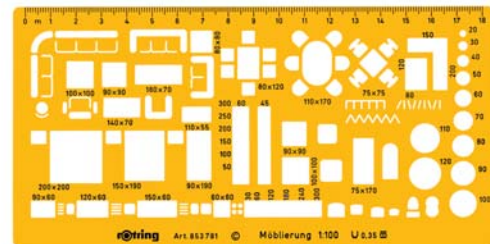

S0238851 ▼
(R8537810)
Scale 1:100
190 x 95 x 1.1 mm
U 0.35 mm

See above, also includes door openings, symbols for level and direction, circles and squares for illustrations from 20 to 130 cm.

S0238981 ▼
(R8537850)
Scale 1:200
170 x 70 x 1.1 mm
U 0.25 mm

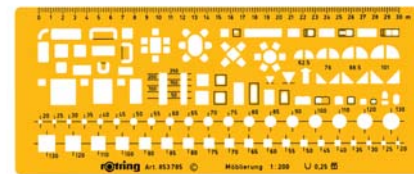

ISOMETRIC ellipses template

Axial ratio 0.707 : 1.225 (1 : 1.732)/35° 16', isometric axes 2-60 mm.

The template edges are designed to enable the ellipses to be positioned in the major isometric planes.

S0238021 ▼
(R8316450)
295 x 145 x 1.2 mm
U 0.5 mm

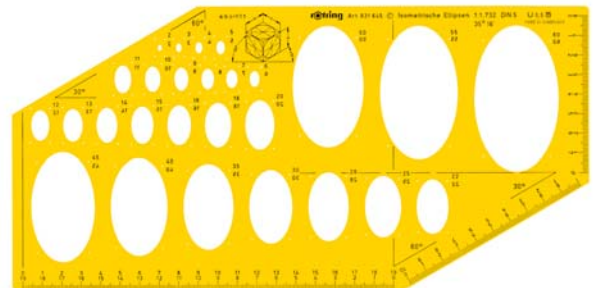

Newell RubbermaidTM
Brands That Matter

Sanford GmbH
P. O. Box 54 10 60
D - 22510 Hamburg

Tel. 0049 40 85 55 0
Fax. 0049 40 850 13 96

Newell Rubbermaid
Halifax Avenue
Fradley Park
Lichfield
Staffordshire
WS13 8SS

Telephone: +44 1543447002
Fax: +44 1915167889

www.rotring.com

