



YORK ARCHAEOLOGICAL TRUST



# ROMAN, ANGLIAN AND ANGLO-SCANDINAVIAN ACTIVITY AND A MEDIEVAL CEMETERY ON LAND AT THE JUNCTION OF DIXON LANE AND GEORGE STREET, YORK

PRINCIPAL AUTHOR J.M. MCCOMISH

**WEB PUBLICATION**

*Report number AYW9*



# YORK ARCHAEOLOGICAL TRUST



York Archaeological Trust undertakes a wide range of urban and rural archaeological consultancies, surveys, evaluations, assessments and excavations for commercial, academic and charitable clients. We manage projects, provide professional advice and fieldwork to ensure a high quality, cost effective archaeological and heritage service. Our staff have a considerable depth and variety of professional experience and an international reputation for research, development and maximising the public, educational and commercial benefits of archaeology. Based in York, Sheffield, Nottingham and Glasgow the Trust's services are available throughout Britain and beyond.

**York Archaeological Trust, Cuthbert Morrell House, 47 Aldwark, York YO1 7BX**

Phone: +44 (0)1904 663000 Fax: +44 (0)1904 663024

Email: [archaeology@yorkat.co.uk](mailto:archaeology@yorkat.co.uk) Website: <http://www.yorkarchaeology.co.uk>

© 2015 York Archaeological Trust for Excavation and Research Limited

Registered Office: 47 Aldwark, York YO1 7BX

A Company Limited by Guarantee. Registered in England No. 1430801

A registered Charity in England & Wales (No. 509060) and Scotland (No. SCO42846)

## CONTENTS

<b>SUMMARY</b> .....	<b>1</b>
<b>1 INTRODUCTION</b> .....	<b>2</b>
1.1 Archaeological and historical background .....	3
<b>2 THE EXCAVATIONS</b> .....	<b>5</b>
2.1 Methodology.....	6
2.2 Geology and Topography .....	8
2.3 The Deposit Sequence.....	8
2.3.1 Phase 1 (natural deposits).....	9
2.3.2 Phase 2 Roman Late 1st- 4th century .....	11
2.3.3 Phases 3 and 4 Features that could be Roman, Anglian or Anglo-Scandinavian (late 1 <sup>st</sup> -mid 11 <sup>th</sup> century) .....	15
2.3.4 Phase 5 Anglian (8 <sup>th</sup> to mid-9 <sup>th</sup> century) .....	17
2.3.5 Phase 6 Anglo-Scandinavian (mid-9th to early 11th century) .....	23
2.3.6 Phase 7 Norman (late 11th century).....	33
2.3.7 Phase 8 The cemetery of St Stephen’s church (later 11th to mid-14th century).....	34
2.3.8 Phase 9 Post-cemetery medieval features (mid-14th to 15th century) .....	40
2.3.9 Phase 10 Modern features (19th–20th century).....	41
2.3.10 Results of the watching brief .....	42
<b>3 THE INTERPRETATION OF THE SITE</b> .....	<b>42</b>
3.1 Phase 1 Natural deposits.....	43
3.2 Phase 2 Roman (late 1st–late 4th/early 5th century) .....	43
3.3 Phases 3–4 Undated, possibly Roman, Anglian or Anglo-Scandinavian.....	45
3.4 Phase 5 Anglian (8th to mid-9th century) .....	45
3.5 Phase 6 Anglo-Scandinavian .....	48
3.5.1 Sub-phase 6a (mid-9th–10th century) .....	50
3.5.2 Sub-phase 6b (10th century).....	50
3.5.2 Sub-phase 6b (10th century).....	50
3.5.3 Sub-phase 6c (late 10th–early 11th century).....	51
3.5.4 Sub-phase 6d burial ground (early–mid-11th century).....	51
3.6 Phase 7 Norman .....	56
3.7 Phase 8 The cemetery of St Stephen’s church (later 11th–mid-14th century) .....	57
3.7.1 Chronological change .....	57
3.7.2 Layout of the cemetery .....	57
3.7.3 Burial zones.....	59

3.7.4	<i>Orientation</i> .....	61
3.7.5	<i>Intercutting of graves</i> .....	62
3.7.6	<i>Burial method</i> .....	63
3.7.7	<i>Demography</i> .....	67
3.7.8	<i>Skeletal features of interest</i> .....	68
3.8	Phase 9 Post-cemetery medieval features (mid-14th–15th century).....	70
3.9	Phase 10 Modern features.....	70
<b>4</b>	<b>THE ARTEFACTS AND ENVIRONMENTAL EVIDENCE</b> .....	<b>70</b>
<b>4.1</b>	<b>THE ROMAN POTTERY</b> .....	<b>70</b>
4.1.1	<i>The Amphorae</i> .....	95
4.1.2	<i>The Mortarium</i> .....	99
4.2	The post-Roman pottery .....	99
4.3	The ceramic building material (CBM) .....	112
4.4	The Artefacts .....	113
4.4.1	<i>Antler-, bone- and horn-working</i> .....	114
4.4.2	<i>Craft equipment and tools</i> .....	118
4.4.3	<i>Dress Accessories</i> .....	121
4.4.4	<i>Glass vessels</i> .....	128
4.4.5	<i>Other objects</i> .....	131
4.4.6	<i>Metal- and glass-working waste</i> .....	134
4.4.7	<i>Coin catalogue</i> .....	137
4.5	Animal bone .....	138
4.5.1	<i>Vertebrate Remains: Summary</i> .....	138
4.5.2	<i>Vertebrate Remains: Introduction</i> .....	139
4.5.3	<i>Vertebrate Remains: Methods</i> .....	139
4.5.4	Vertebrate Remains: Results .....	140
4.5.5	Vertebrate Remains: Discussion .....	152
4.6	Then Human Bone.....	154
4.6.1	<i>Introduction</i> .....	154
4.6.2	<i>Preservation</i> .....	154
4.6.3	<i>Methodology</i> .....	154
4.6.4	<i>Discussion</i> .....	156
4.6.5	<i>Disarticulated human bone</i> .....	165
4.6.6	<i>Catalogue of burials</i> .....	165
4.6.7	<i>Summary of inhumations</i> .....	226

<b>5</b>	<b>CONCLUSION .....</b>	<b>234</b>
<b>6</b>	<b>BIBLIOGRAPHY .....</b>	<b>235</b>
<b>7</b>	<b>ACKNOWLEDGEMENTS.....</b>	<b>249</b>

#### Tables

Table 1	Radiocarbon date information (calibrated using OxCal Version 3.10, Bronk Ramsey 1995; atmospheric data from Reimer <i>et al</i> 2004).....	33
Table 2	Findings from Anglo-Scandinavian contexts .....	49
Table 3	Burial position in relation to age and sex (given as a percentage of the total for each group .....	67
Table 4	Proportion of vessels in each fabric using rim % values. Abbreviations as Figure 27. ....	91
Table 5	Summary of wares from excavation .....	93
Table 6	Medieval roofing tile fabrics .....	113
Table 7	Material types present, by weight .....	135
Table 8	Industrial debris, weight (in grams), by phase .....	136
Table 9	Smithing hearth bottoms .....	136
Table 10	Glass-working crucibles.....	137
Table 11	George Street/Dixon Lane, York: Details of the bone-producing deposits of Anglian date.....	141
Table 12	George Street/Dixon Lane, York: Hand-collected vertebrate remains from Anglian deposits .	142
Table 13	George Street/Dixon Lane, York: Relative frequencies of the main domestic mammals calculated using total fragment (NISP) and minimum number of individuals (MNI) counts.....	144
Table 14	George Street/Dixon Lane, York: Relative frequencies of the main domestic mammals calculated using total fragment (NISP) counts by individual context (only deposits with more than 10 fragments are represented).....	144
Table 15	George Street/Dixon Lane, York: Total fragment counts for selected skeletal elements for cattle, sheep and pig.....	150
Table 16	George Street/Dixon Lane, York: Minimum number of individuals (MNI) values for selected skeletal elements for cattle, sheep and pig.....	151
Table 17	George Street/Dixon Lane, York: Reconstructed withers heights for cattle and sheep. Key: GL = greatest length; WH = estimated withers height.....	152
Table 19	Age and sex distribution of the inhumations (? means sex is indeterminate, a combination of male and female characteristics; Unsexed means impossible to assign a sex because juvenile or poor preservation) .....	157
Table 18	Summary information about the inhumations .....	226

#### Figures

Figure 1	The location of the stie .....	2
Figure 2	The location of the trenches .....	8
Figure 3	Location of the 2005/6 excavations and the 1990 excavation in relation to the 1890 OS map ....	9
Figure 4	Phase 1 natural deposits .....	10
Figure 5	Phase 2 Roman features .....	11
Figure 6	Late Roman features.....	14
Figure 7	Phases 3 and 4 .....	16
Figure 8	Anglian features.....	17
Figure 9	Detail of Anglian buildings .....	18
Figure 10	South-eastern facing section of Test Trench 4 showing the Anglian boundary ditches .....	19
Figure 11	Later Anglian contexts of sub-phase 5b.....	23
Figure 12	Sub-phase 6a.....	25
Figure 13	Sub-phase 6b .....	27

Figure 14 Sub-phase 6c .....	30
Figure 15 Sub-phase 6d .....	33
Figure 16 Phase 7 .....	34
Figure 17 Phase 8 burials and boundary ditch .....	36
Figure 18 Detail of the Phase 8 burials at the western limits of excavation .....	37
Figure 19 Phases 9 and 10 .....	41
Figure 20 <i>Anglian features of late 7th-/early 8th-century to early 9th-century date at 46–54 Fishergate</i> .....	47
Figure 21 Female and possibly female burials .....	60
Figure 22 Male and possibly male burials .....	60
Figure 23 Child and adolescent burials .....	61
Figure 24 Graves containing redeposited human bone .....	63
Figure 25 Depth of Phase 8 graves .....	64
Figure 26 Graves of particular interest .....	65
Figure 27 Rim % values for vessel types by phase (A=amphora, B=bowl, B/D=bowl or dish, D=dish, BKR=beaker, Box=Castor box, C=cup, F=flagon, J=medium necked jar, JMINI=small jar/beaker, L=lid, M=mortarium, NNJ= narrow-necked jar, P=platter, TA=tazze, WMJ=wide mouthed jar) .....	79
Figure 28 <i>Comparison of wares from each phase (using sherd count). A=amphora, B=burnished wares, C=colour coated, E=Ebor, F= fine grey, G=grey, H= Dales, K= calcite-gritted, M=mortarium, O=oxidised, P=white and parchment, S=samian, W= white slip Ebor</i> .....	80
Figure 29 <i>Comparison of wares from each phase using sherd weight (abbreviations as Figure 28)</i> .....	81
Figure 30 <i>Comparison of proportions of vessel types present on contemporary York sites (after AY 16/8, tables 133–9) using EVEs</i> .....	86
Figure 31 <i>Proportion of assemblages made up of samian and colour coated wares in mid- to late 3rd-century groups in York using weight (from AY 16/8)</i> .....	89
Figure 32 Anglian pottery .....	101
Figure 33 Anglian imported pottery .....	101
Figure 34 Anglo-Scandinavian pottery .....	103
Figure 35 Torksey type pottery .....	104
Figure 36 Stamford wares .....	105
Figure 37 Crucibles .....	106
Figure 38 Early glazed wares .....	107
Figure 39 Norman pottery .....	107
Figure 40 George Street/Dixon Lane, York: Relative frequencies of the main domestic mammals calculated using total fragment (NISP) and minimum number of individuals (MNI) counts .....	143
Figure 41 George Street/Dixon Lane, York: Relative frequencies of the main domestic mammals calculated using total fragment (NISP) counts by individual context (only deposits with more than 10 fragments are represented) .....	144
Figure 42 a-c. George Street/Dixon Lane, York: Relative frequency of main skeletal elements of the major domestic mammals based on total fragment counts for each element, the values being calculated by comparing each element with the most frequently occurring ones (i.e. the element or elements represented by 100% in each graph) .....	146
Figure 43 George Street/Dixon Lane, York: Relative frequency of main skeletal elements of the major domestic mammals based on minimum number of individuals (MNI) counts for each element, the values being calculated by comparing each element with the most frequently occurring ones (i.e. the element or elements represented by 100% in each graph) .....	148

## SUMMARY

In winter 2005/6 York Archaeological Trust undertook an archaeological watching brief at a site at the junction of Dixon Lane and George Street, York (NGR: SE 607 515). This turned into a full-scale excavation following the discovery of abundant human remains. The excavations uncovered the remains of activity or occupation of Roman, Anglian, Anglo-Scandinavian and medieval date, including a medieval cemetery. The site was severely truncated during the late 19th century, an event which had removed most of the later medieval and post-medieval deposits from the site. Among the unusual artefacts recovered from the site were a gold ring and a jet pendant in the shape of a bear, both of Roman date.

The excavations, the post-excavation work and the production of this web-based publication were all generously funded by the developers of the site, Evans Property Group.

This Pdf report represents a copy of a report which was designed as an interactive web report that was originally hosted on York Archaeological Trust's website. Due to changes in the design of this website the original interactive report is no longer available. This Pdf was produced to ensure that the information held in the original report remained widely available. As the original report was designed for web-viewing, its' design did not follow conventional publication formats, notably the figures, while perfectly clear when viewed on the web are slightly blurred when transferred into pdf format. In addition, there are no Plate numbers in the text, as the photographs were originally simply embedded in the text at the relevant point. This pdf follows the layout of the original web report exactly, and readers should bear these limitations in mind while reading the report.

## 1 INTRODUCTION

From 7 November 2005 to 27 January 2006 an archaeological intervention was undertaken by York Archaeological Trust (YAT) on a site at the junction of Dixon Lane and George Street, York (NGR: SE 607 515). This began as a watching brief but turned into a full-scale excavation following the discovery of abundant human remains on the site. The excavation area consisted of a trench c. 25m x 20m in size which was excavated by hand (with the exception of one arbitrary spit of soil in the north-eastern corner of the site; see Methodology). The primary aim of the excavation was to recover all the human remains on the site prior to redevelopment; in addition, as many pre-cemetery features as possible were excavated within the time limits of the excavation.

All works were carried out on behalf of the developers, Evans Property Group, and were monitored by John Oxley, Principal Archaeologist of the City of York Council. The site records are stored by YAT under the Yorkshire Museum accession code YORYM: 2005.3203. The YAT project number is 1307.

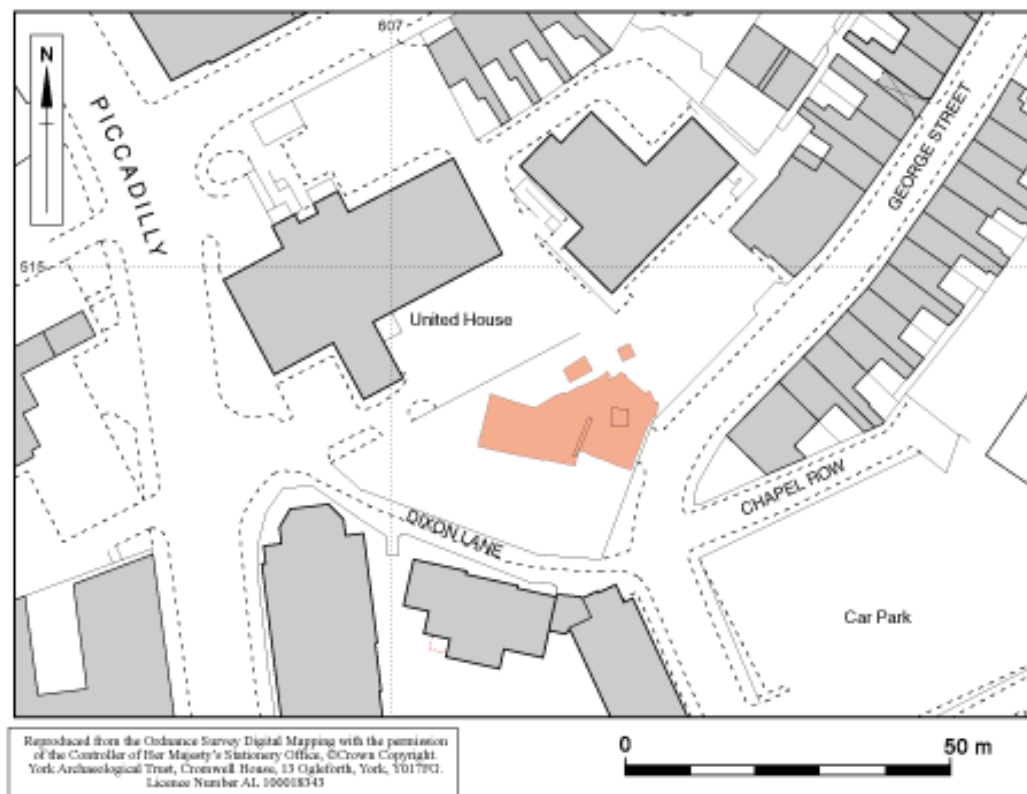

Figure 1 The location of the site





Roman ring



Roman jet pendant



Roman mortarium

### 1.1 Archaeological and historical background

The area between the north-western bank of the River Foss and the legionary fortress was, in the 1st and 2nd centuries at least, heavily dominated by the needs of the army. There is evidence for grain warehouses at Coney Street and for military pottery and ceramic building material (CBM) production at Peasholme Green (Ottaway 1993, 43, 67). This area developed in the late 2nd century with new roads (seen at Ousegate and Spurriergate) and a possible bath house at High Ousegate. A temple dedicated to Hercules, a goddess whose name began IOV, and to the spirit of the Emperors is indicated by an inscription found in Nessgate (*ibid*, 69).

The precise nature of Roman settlement to the south-east of the River Foss is difficult to determine as relatively little evidence for Roman activity has been excavated in the vicinity; clearly though the area was in use throughout the Roman period. Tentative evidence of riverside structures has been found: a line of stone pillars beneath the Tax Office on Piccadilly was thought to have been part of a jetty (Ottaway 1993, 69). A major Roman road ran along the south-western side of the fortress, crossed the Foss and continued roughly parallel to, and c. 50m south of, Dixon Lane before branching into two, the northernmost of these two branches leading to Brough-on-Humber (*Petuaria*) (Ordnance Survey 1988).

As Roman law forbade burial within inhabited areas, cemeteries were typically located alongside the approach roads to settlements. The road to *Petuaria* was no exception as there was a cemetery immediately south of Dixon Lane. Several burials were excavated to the south of Dixon Lane by MAP Archaeological Consultancy Ltd., but a report on these is not currently in the public domain (John Oxley, pers. comm.). A Roman altar dedicated to the native god Arciaco was found at St Denys Church (50m to the north) and two Roman burials, one in a stone and one in a lead coffin, were found nearby (RCHMY 1, 69–70, 118).

Although relatively little is known of York in the immediate aftermath of the Roman Empire, clearly by the 7th century York was an important centre (AY 7/2, 117f). In AD 601 St Gregory divided Britain into two sees, one of which was to be based at York. A church, probably on the site of the present Minster, was founded in AD 626 and was restored by St Wilfrid in the late 7th century, and in AD 735 the bishopric became an archbishopric. Aldfrid's 'Life of St Liudger' records that a colony of Frisian merchants lived in or near York in the early 8th century (AY 1, 131–2). Despite this historical evidence, traces of settlement relating to the period have proved elusive, for although numerous sites have yielded stray finds or isolated features of

Anglian date (AY 7/2; cf AY 8/4, 489), relatively few have provided stratified Anglian deposits.

Excavations at 46–54 Fishergate revealed the remains of an extensive trading settlement of two Phases dating from the late 7th to mid-9th centuries. This settlement was not occupied for long after the Viking capture of the city in AD 866 and remained largely abandoned until c. AD 1000 (*ibid*,12). Further traces of this settlement were located in excavations by Field Archaeology Specialists in 2000 at Blue Bridge Lane and in 2002 at Fishergate House (<http://www.archaeologicalplanningconsultancy.co.uk/mono/001/index.html>). Although no structures were found at either site, there were a number of pits containing craft working waste including evidence for bone, antler and horn working, wool processing and metalworking. Some of the pits seemed to follow an alignment which may have been an internal property division within the settlement. In addition to the site at Fishergate/Blue Bridge Lane a number of other sites in the general area have revealed features of Anglian date. A well at the Barbican Baths site, 2 Paragon Street, which was infilled with wattle and daub and abundant animal bones was dated as Anglian by the presence of an 8th-century brooch and two coins from AD 737–58. The adjacent Barbican Leisure Centre site also yielded a pit with Anglian finds, but no extensive occupation (AY 7/2, 252–3, 263). Investigations of the City Walls at Walmgate Bar revealed pits and possible structural elements which pre-dated the construction of ramparts c. 1200 and were associated with a coin dating to c. 840–48 (*ibid*, 263).

Archaeological excavations have uncovered evidence for Anglo-Scandinavian occupation in the general area, notably along the Walmgate street frontages, and the present-day pattern of property boundaries on Walmgate, as in other parts of York, probably has its origins in the Anglo-Scandinavian period. Although not mentioned in documentary sources before 1154, the church of St Denys may be pre-Conquest in origin, as two Anglo-Scandinavian tomb slabs have been found there (RCHMY 5, 15; Lang 1991, l 81–2).

Evidence from archaeological excavations indicates that during the later medieval period the frontages of Walmgate were continuously and intensively settled. The original name for the northern end of George Street was Nowtgate or Nowtgail, the ‘Nowt’ referring to cattle and the ‘Gail’ implying a narrow lane (Raine 1955, 101). The original name for Dixon Lane was Church Lane. A feature (shown on the 1852 Ordnance Survey map) described variously as the King’s Dike, King’s Drain or King’s Gutter ran across the site from the northern end of Church Lane to part way along George Street. The precise function or origin of this feature are unclear, but during the 15th–16th centuries it seems to have served as a sewer (VCH 1961, 511).

There were a large number of medieval churches in the vicinity (St Denys, St Margaret, St Mary, St Stephen, St George and St Peter-le-Willows); the presence of so many churches may be a result of each major landowner in the area endowing their own individual chapel, which then came to serve as a parish church. The present site seems to be connected with the church of St Stephen. Though the precise location of the church building has not been identified, the site of the churchyard can be linked to that of the present excavations from the will of Thomas Catour in 1405. This states ‘I give to William Catour, my son, my tenement and

garden which Walter del Burgh holds for rent in the parish of St Stephen in Fishergate; it lies between the churchyard of St Stephen on the one side and the gutter of our Lord the King to the north on the other side and in length from the lane called Noutgayle to the water of the Foss' (Raine 1955, 102–3). It is unclear if the churchyard was still in use for burials at this stage.

Unfortunately relatively little is known about St Stephen's Church from historical sources. The church was first mentioned in documents in 1093–94 when William II granted it to the Archbishop of York in return for four acres of land in Bootham (Raine 1955, 101) and the graveyard is mentioned in a document of late 13th- or early 14th-century date (VCH 1961, 403). It is assumed that the church was demolished as early as 1331, when it was annexed to St Martin-le-Grand church (Wilson and Mee 1998, 154). The disappearance of St Stephen's, and the merger of St Mary's and St Margaret's in c.1308, may indicate that this was an area of declining population even before the Black Death, or that the density of population from the immediate post-Norman Conquest period onwards was insufficient to support the large numbers of churches in the area (Lilley 1990, 3). The church was not mentioned in a list of churches in the city compiled in 1428 (VCH 1961, 366) and so had clearly gone out of use by this time.

The site seems to have been little used from the 14th century onwards. The area is depicted as gardens on F. White's map of 1785, J. Todd's map of 1810, Baines's map of 1822, the Ordnance Survey map of 1852 and Skaife's map of 1864. The site was developed sometime in the late 19th century, as the 1891 Ordnance Survey 1:500 map depicts the Tadcaster Tower Brewery and associated stores on the site. The brewery extended over the property within which the excavations took place and the adjacent plot to the north-east (which was redeveloped in the 1990s). The brewery consisted of buildings on a roughly T-shaped ground plan along the north-easternmost property boundary, with buildings ranged around an open courtyard to the south-west. A search of records in York Library and the York City Archives failed to clarify the precise date at which the brewery was constructed.

An archaeological evaluation took place on the site in 1990 (Lilley 1990), but unfortunately the trenches excavated were located within the brewery buildings, which had destroyed all underlying archaeological deposits. The evaluation trenches proved to be archaeologically void and the works therefore failed to pick up the intensive pattern of land use preserved in the brewery yard area. It was for this reason that the initial archaeological response was specified as a watching brief.

## 2 THE EXCAVATIONS

The excavations were extraordinarily rich in terms of the staggering density of features present, which ranged from Roman to medieval in date. In addition the site was exceptional for the quality of the artefacts recovered and for the presence of both a pre- and post-Conquest cemetery. The sheer array of remains uncovered was something of a surprise, given that on the basis of the archaeological evaluation the site was thought to have so little potential that a watching brief would suffice.

## 2.1 Methodology

Initially, an archaeological watching brief was undertaken at the site, comprising the machine clearance of modern deposits under archaeological supervision. It immediately became apparent that human remains were present in large numbers. Following consultations with the City of York Council's Principal Archaeologist, John Oxley, the developers, Evans Property Group, and the site contractors, William Birch Ltd, the decision was taken to convert the watching brief into a full-scale excavation with the aim of removing all the burials from the site before any building works began.

The excavation trench was laid out within the footprint of the proposed buildings to the north-east of an archaeologically void area c.13m wide along the Dixon Lane frontage. The archaeological trench was c. 25m by 20m in size and highly irregular in shape. The strip of land immediately adjacent to the north-eastern property boundary of the site was not excavated due to the presence of modern services in the area, including a live gas pipe and a major live sewer.

Two c. 3 x 3m trenches were dug within the excavation area to assess the density of burials across the site (Test Trenches 1 and 2). On the basis of the results from these trenches it was estimated that some 150 burials would be present within the excavation area. A strict timetable was worked out whereby all the burials would be cleared from the site by 27 January 2006. The burials were removed in accordance with a Home Office Licence (Licence Number 30490). The deadline was achieved, with 117 burials and large quantities of charnel deposits being recovered. In addition to the burials nearly all features down to natural subsoil were excavated in the western half of the site. It must be noted that a portion of brick wall from a modern building was left in place throughout the excavation period to provide an access route onto the site. In mid-January an arbitrary spit of soil was excavated in the north-eastern corner of the site using a mechanical mini-digger (under close archaeological supervision) to be absolutely sure that all burials had been recovered in that area. In the final week of excavation two further test trenches were excavated. Test Trench 3, 2.2 x 10m, was excavated to assess the depth of naturally occurring deposits, and Test Trench 4, 2 x 2m, was dug using a mechanical mini-digger in order to recover the alignment of some ditches that were considered by the site director to be of importance to the understanding of the stratigraphic sequence of the site. A c. 3 x 5m cut was created by the machine removal of a large petrol tank to the north of the excavation area; this cut was far too unstable for any archaeological work to be undertaken within it, but levels AOD were taken on the top of the natural subsoil within the cut. A machine-cut trench was excavated adjacent to the petrol tank cut, again to try to determine the uppermost level of natural deposits. Following on from the excavation a small watching brief was undertaken to observe the removal of deposits immediately adjacent to the northernmost corner of the excavation area.

Post-excavation work followed a standard YAT methodology, using the Integrated Archaeological Database (IADB) for both storage of the site records and post-excavation analysis. Links to the IADB are present throughout this text.

The terminology used in both IADB and this report requires some definition. The records (all of which are stored on IADB) are organised in a hierarchical system in ascending order of Contexts, Sets, Groups and Phases. A Context is defined as the archaeological evidence for an

individual event or activity (for example, the digging of pit would be allocated a context number, as would each separate layer in its backfilling). Each context is recorded on a pro-forma record sheet and a 1:20 plan drawn at the time of excavation. A Set is a number of related contexts (for example a grave cut, the associated skeleton and the grave backfill). A Group is a number of related sets (for example, several graves in a row) and a Phase is a number of related groups (for example, all the groups dated to a particular chronological period).

For this particular project the skeletons were digitised as 'stick-men'; a photograph of each skeleton is available for anyone wishing to view the skeleton in full. In addition grave backfills were not digitised; this was so that the skeletons would not be obscured by the backfill when set plans were generated.

For ease of reading every effort has been made to keep lists of numbers to a minimum; only those contexts directly relevant to dating or interpretation are individually mentioned; in other cases, where convenient, the set, group or Phase numbers are given instead. Small finds are referred to as sf throughout the text.

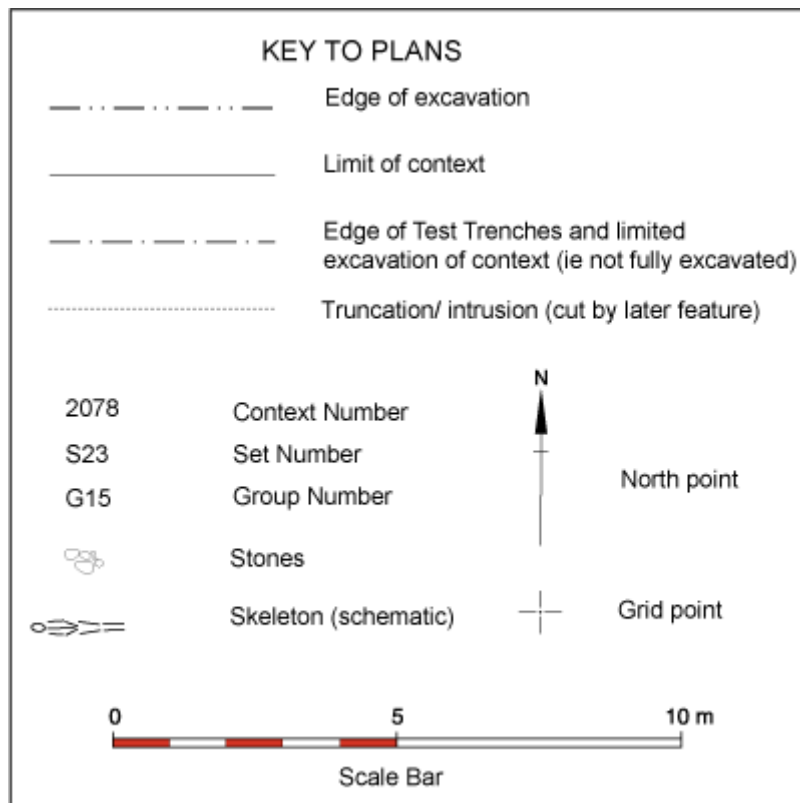

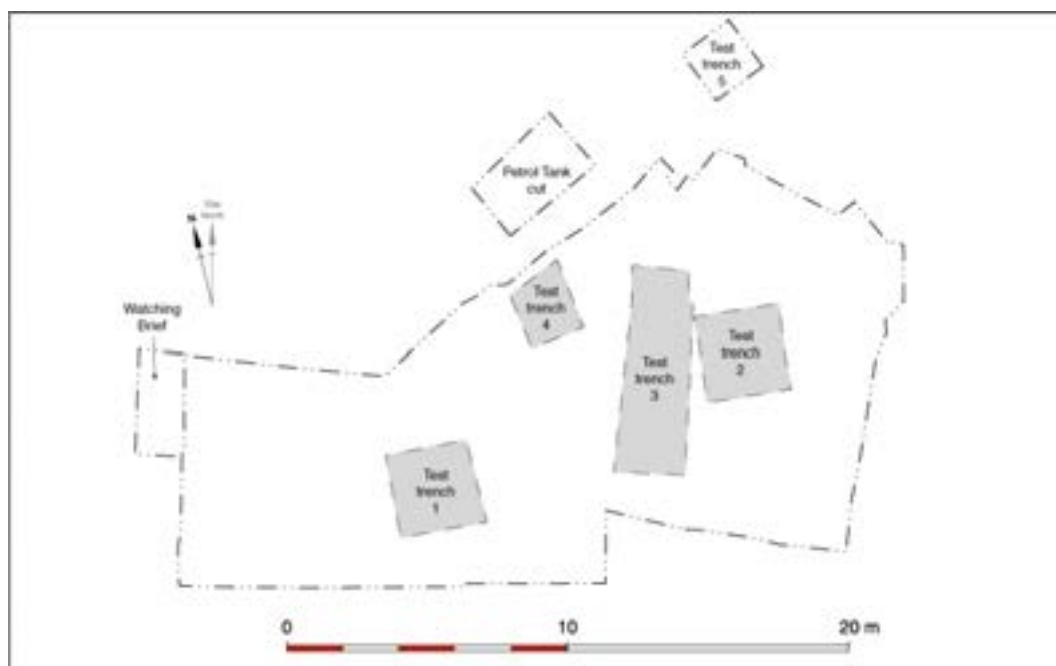

Figure 2 The location of the trenches

## 2.2 Geology and Topography

The site is situated on the eastern side of Piccadilly at the junction of George Street and Dixon Lane. The site is roughly triangular and measures c.40 x 45m. Before excavation the ground surface was at c.10.5m AOD, though there was a slope down towards the site entrance on the Piccadilly frontage.

The solid geology of the area is Bunter Sandstone (British Geological Survey England and Wales, Sheet No. 63 1967) laid down in the Triassic period, 225 million years ago. This is overlain by glacial till laid down during the last glaciations within the Vale of York, and subsequently truncated by the course of the River Foss. The site is situated slightly to the east of the original course of the River Foss.

## 2.3 The Deposit Sequence

The location of the brewery is of critical importance to the survival of archaeological deposits in the area; absolutely nothing survived beneath 19th-century brewery buildings bordering Dixon Lane, and it would seem that the ground in this area was extensively levelled prior to the construction of the brewery. Archaeological remains were better preserved within the brewery yard area, though the uppermost skeletons had been badly damaged by the construction of the brewery. Those skeletons beneath the south-eastern range of brewery buildings had also been badly crushed by the weight of the brewery buildings directly above them.

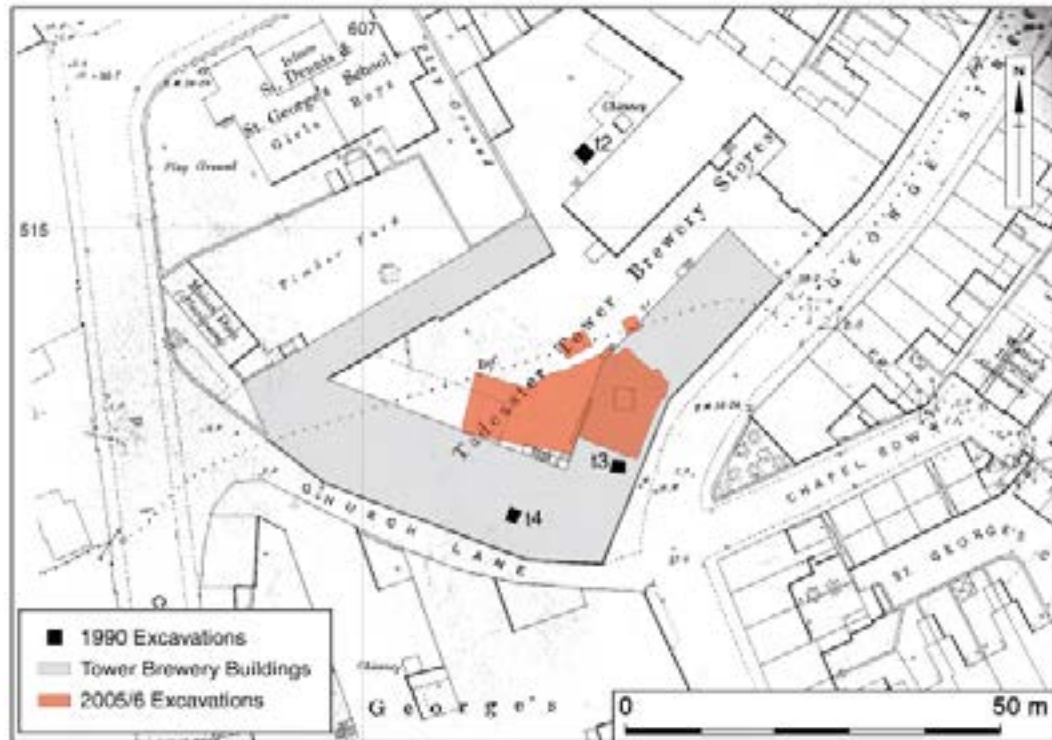

**Figure 3** Location of the 2005/6 excavations and the 1990 excavation in relation to the 1890 OS map

### 2.3.1 Phase 1 (natural deposits).

The natural sub-soil on the site was boulder-clay of glacial origin. The pale-pink clay was exceptionally pure, being totally devoid of any pebble or cobble content, though there was a pocket of naturally occurring gravel (Context 1604) within the clay in the central part of the excavations. Also included in Phase 1 were two deposits of slightly silty clay that were interpreted as natural that had been disturbed by plant roots.

The level of the upper surface of natural depth was highly variable. In a strip between the south-western edge of the excavations and the Dixon Lane frontage the top of the natural was at 9.38-9.49m AOD (this was also seen in the 1990 trial excavations on the site where natural was recorded at 9.35-9.59m AOD). Within the western half of the excavations the upper surface of the natural fell away to 9-9.12m AOD on line roughly parallel to the Dixon Lane frontage. Natural was not encountered over much of the eastern half of the site, despite the fact that this area was excavated to a greater depth than the western portion of the site (c. 8.7m AOD). Within Test Trenches 2 and 3 natural was seen at between 8.21-8.29m AOD. Natural was present in the base of a large petrol tank cut located to the immediate north of the excavation area at 7.86-8.17m AOD. A test hole excavated by machine to c. 5m below ground level (i.e. c. 5.5m AOD) near the north-eastern corner of the site failed to locate natural. Clearly, therefore, the natural fell away steeply over the eastern half of the site, and dropped markedly to the north of the excavation area and the petrol tank cut.

Where natural was seen, i.e. in the southern and western portions of the excavations, the upper surface had been heavily truncated by later cut-features including stake- and post-holes, beam-slots, pits and ditches. These features created a highly uneven upper surface on the natural deposits.



Natural boulder-clay truncated by later features. Scale unit 0.5m.

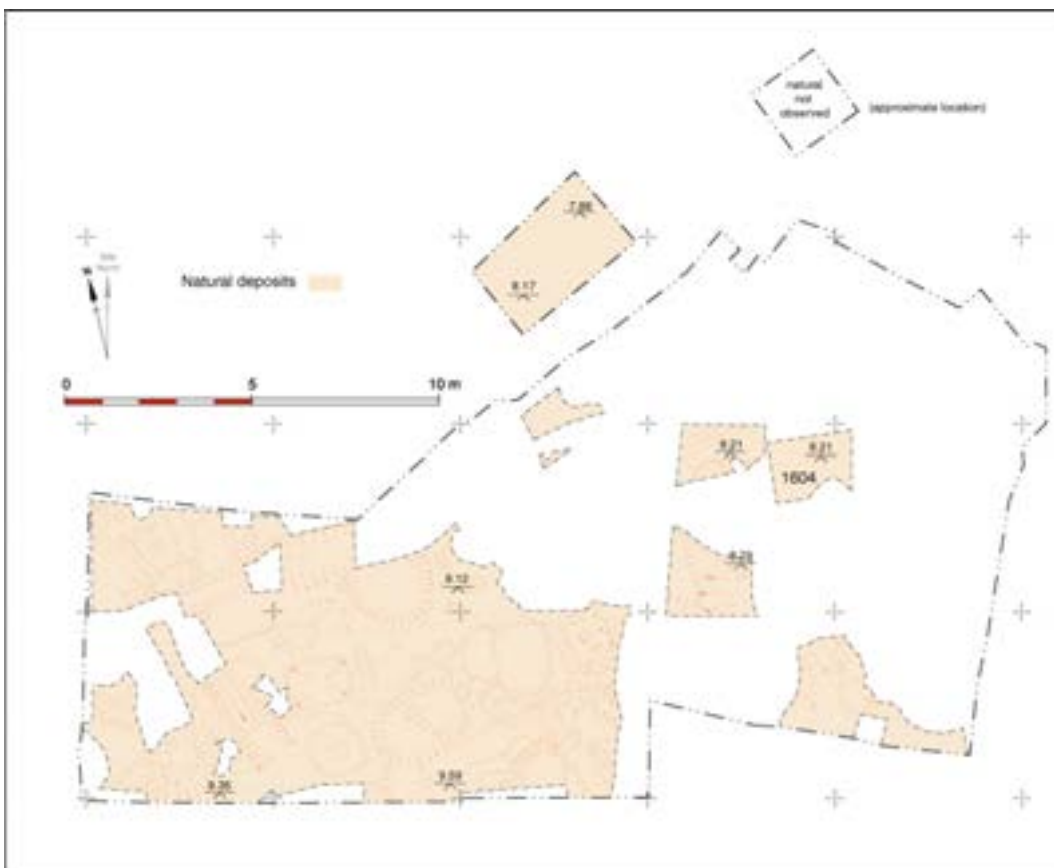

Figure 4 Phase 1 natural deposits



### 2.3.2 Phase 2 Roman Late 1st- 4th century

The earliest activity on the site dated to the Roman period. The Roman features were largely confined to Test Trenches 2-4, but a scatter of Roman remains also occurred across the western half of the excavation area. No Roman deposits were found in the north-eastern portion of the site as this was not excavated to a sufficient depth for Roman remains to be uncovered. The Roman features on site were divided into four groups; three of these were closely dated by the pottery recovered from the to the late 1st-early 2nd century (Group 3), the mid 2nd-late 3rd century (Group 4) and the mid 4th century (Group 12), while the fourth group, though containing Roman artefacts, was less closely datable (Group 13). A number of undated features were also interpreted as being Roman on the basis of their position within the stratigraphic sequence (Groups 11 and 14).

#### Late 1st-early 2nd century features

There was a series of pits stratigraphically above natural (Group 3). (It must be noted that one of the pits, Context 1503, contained 2 sherds of 13-16th century CBM which almost certainly represents intrusive material, as the pit was both immediately adjacent to the edge of excavation and heavily truncated by later features). The pits varied in size and shape; the largest was 2.3m in diameter and 0.5m deep (Context 1951), while the smallest was 0.6 x 0.8m in area and 0.84m deep (Context 1976). The original dimensions of the remaining pits in the group are less clear as they were either partly beyond the area of excavation, or were truncated by later features. All these pits seem have been rubbish pits as they contained objects such as pottery, CBM, animal bone, slag and iron nail fragments. Context 1951, in particular, contained abundant pottery and CBM. Pit 1353 contained fragments of human bone that almost certainly represent contamination from the medieval cemetery above.

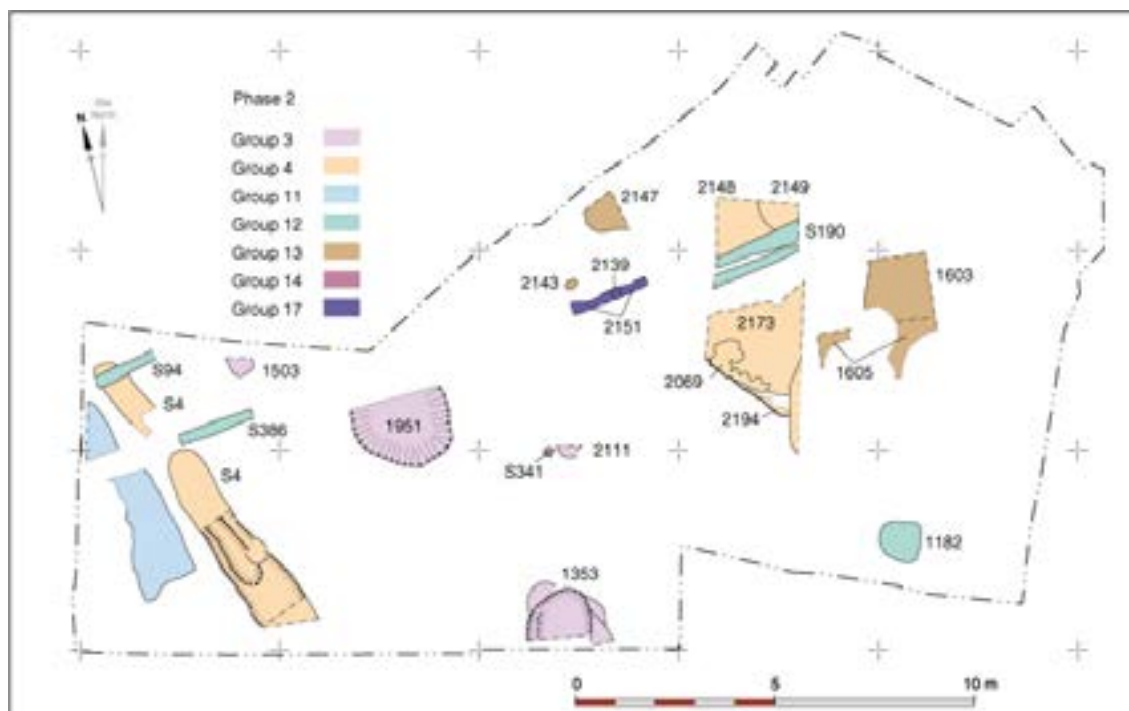

Figure 5 Phase 2 Roman features



Context 1951. Scale unit 0.5m

Context 2194. Scale unit 0.1m

### Mid 2nd-late 3rd century

Group 12 comprised a linear cut (Context 2194) that ran diagonally across Test Trench 3. Context 2194 was dug into a north-eastern facing slope in the underlying natural deposits and may represent a terracing operation to create useable flat-land on a steeply sloping site. The full dimensions of Context 2194 are unknown, but it was in excess of 3.5m in length and 0.53m deep. The terrace, seen from the south-west and north-east respectively, is shown running diagonally across the centre of the accompanying photographs.

A deposit was present in the base of the terrace, but as this could not be excavated due to lack of time its' precise function is unclear (Context 2173). A row, or double row, of stake- and post-holes (Context 2069) was inserted above Context 2173; this row followed the edge of the terrace. The precise function of Context 2069 is unclear; it could represent part of a timber revetment along the terrace, or it could be part of a timber building butting up against the terrace. The stake- and post-holes were later removed and the resultant voids infilled (Context 2068).

Above 2068 was a cut feature (Context 2171) that was largely outside the area of excavation, so its precise function is unclear. A deposit was either dumped in, or built up in, the terrace cut, partially infilling it (Contexts 2049 and 2148). Above this deposit were two further pits (Contexts 1989 and 2149). Context 1989 was a rubbish pit containing pottery, shell, plaster, CBM, animal bone and an iron nail. Context 2149 could not be excavated due to lack of time, but it was probably also a rubbish pit. Pottery of mid 2nd-late 3rd century date was associated with seven of the contexts described above; the remaining contexts, though undated, were stratigraphically part of this sequence.



Set 4. Scale unit 0.1m Mortarium in Context 1969

Lifting of mortarium

To the west of the features described above was a ditch aligned north-north-east to south-south-west, which was re-dug on one occasion following partial silting (Set 4). This ditch had a stepped profile in parts resembling a Roman 'ankle-breaker' ditch, and was butt-ended at the north. This implies that it was not for drainage; it is more likely to have been a boundary ditch. Above the ditch was a small pit and backfill (Context 1969) which contained an exceptionally large fragment of a mortarium rim, and an isolated post-hole (Context 1673, not shown on plan).

### Mid 4th century

Two parallel, vertically sided slots 0.4m deep (Set 190), 0.15m apart, aligned almost east-west, were located within Test Trench 3. The northernmost slot varied was 0.24-0.46m in width, while the southernmost was 0.24m wide. A portion of a similar feature, 0.38m wide and 0.44m deep (Set 386), was located at a similar depth close to the north-western limits of excavation. These three slots were all aligned exactly parallel to one another, which may imply that they are related. The original length of these features is unclear; the slots in Set 190 were not present to the west, and while this may have been due to exceptionally heavy truncation of the area by later features it could also be that they did not extend beyond the limits of the earlier terracing cut. Set 386 clearly continued eastwards for at least another 2.7m giving a total length in excess of 4.6m, but its relationship to the earlier terrace-cut is unclear. The sharp nature of their edges implies that these cuts were not in use for a long period before being backfilled with deposits of 4th-century date.



Set 190. Scale unit 0.1m



Set 386. Scale unit 0.2m

It must be noted that the bases of both features in Set 190 were over-dug during excavation; this confusion was caused because the lower portions of the features were cut into a pocket of natural gravel within the boulder-clay. Since gravel was coming out of the feature the excavator wrongly assumed natural had not been reached, when in fact it had, and continued digging. The true base of these cuts was at 7.98-8.14m AOD.

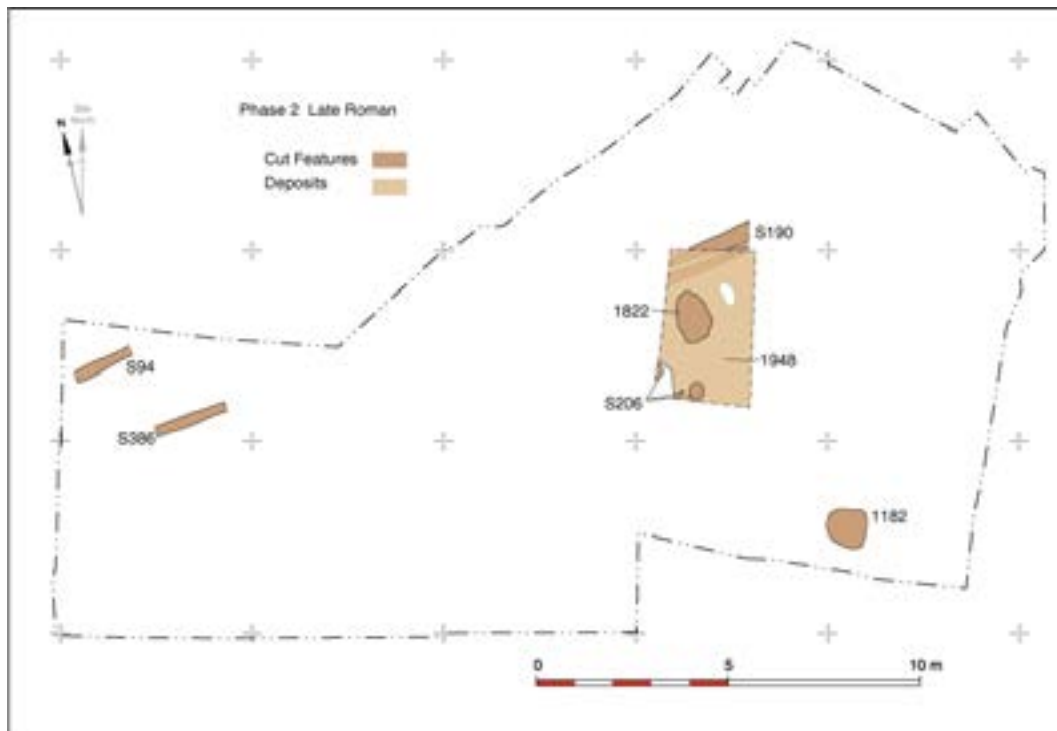

**Figure 6 Late Roman features**

A badly truncated, undated slot (Set 94), located close to the north-western limits of excavation, may be related to those of Sets 190 and 386. It is on a similar, though not quite identical, alignment to Sets 190 and 386, and is of similar dimensions.

The area above Set 190 was sealed by a build-up deposit 0.4m thick (Contexts 1948) which contained mid 4th-century pottery. This was truncated by a small rubbish pit 0.8 x 1.2m in area and 0.12m deep (Context 1822), which contained residual pottery, animal bone, a bone hair pin, iron nails and hob nails. Context 1948 was also cut by a group of stake- and post-holes (Set 206). Given the limited area within which these cuts were seen it is impossible to determine whether or not they were part of a structure. The stakes and posts were later removed and the resultant voids were infilled.



**SF 32**



**SE31. Actual length 17.5mm**

Slightly to the south-east of these features was a pit cut, roughly 1m in diameter and 0.04m deep (Context 1182). Its fill contained pottery of 4th-century date, together with two exceptional objects, a small jet pendant in the shape of a bear and a shale bracelet (sfs 31-2).

### **Other Roman, or possibly Roman, features**

The only other feature of Roman date was a post-hole (Group 13) containing Roman CBM which could not be closely dated. As this cut was in an area that had been heavily truncated by later features, it is impossible to suggest its original function.

A number of undated contexts were interpreted as being Roman. Group 11 was a heavily truncated c. 1.4m wide ditch, aligned parallel to and slightly west of the Roman ditch of Set 4. As the ditch seems to have been placed in relation to Set 4 it has been interpreted as being of the same period. Group 14 included a number of largely unexcavated build-up deposits in Test Trench 2 (Contexts 1603 and 1605) and Test Trench 4 (Context 2147 and 2151) that were directly above natural. Given their relationship to the natural, these deposits were interpreted as being probably Roman. Context 2151 was beneath a badly truncated feature, possibly a beam-slot (Context 2139), which predated Anglian features on the site and is therefore interpreted as probably Roman. Also in Test Trench 4 there were two post-holes, Contexts 2143 and 2162 (the latter was seen in section only) that were directly above natural, again perhaps suggesting a Roman origin.

#### *2.3.3 Phases 3 and 4 Features that could be Roman, Anglian or Anglo-Scandinavian (late 1<sup>st</sup>-mid 11<sup>th</sup> century)*

Various features were excavated that could not be closely phased. These were split into two groups; Phase 3 contained undated features that were stratigraphically above natural (or in the case of Contexts 1697-8 above a Roman feature of Phase 2), while Phase 4 was similar to and stratigraphically above the Phase 3 contexts. The only difference between the two phases is the presence of small quantities of Roman finds within the Phase 4 features. This need not, however, mean that the Phase 4 features were of Roman date; the finds could simply be residual.

All the Phase 3-4 contexts were stratigraphically earlier than Anglo-Scandinavian deposits. As it is clear that there was settlement activity on the site during the Roman, Anglian and Anglo-Scandinavian periods, the Phase 3-4 features could relate to any, or all, of these chronological periods.

### **Phase 3**

A large number of stake- and post-holes (Group 5) were difficult to interpret, as they did not form coherent patterns suggestive of structures. It was also impossible to determine which ones within this group were exactly contemporaneous.

Group 6 comprised two large pits, both largely outside the area of excavation. Context 1608 was in excess of 0.4m deep and probably c. 2.2m in diameter. The backfill contained abundant animal bones and large fragments of rubble. As stone is rare on this site the presence of rubble within the backfill may be of significance; it could indicate the dumping of debris resultant from the demolition of a nearby stone-built structure. Context 2036 could not be excavated within the time-scale for the archaeological works; its function is therefore unclear, but it was probably also a rubbish pit.



**Group 19 (located beneath the scale on the photograph). Scale unit 0.2m**

A number of deposits were largely unexcavated due to lack of time (Group 19) and are therefore of uncertain function and date; they have been phased here because it is the highest point stratigraphically at which they can occur. A small cut 0.3 x 0.6m in size and 0.19m deep (Group 25) may have part of a beam slot, but as there were no other features in the immediate vicinity suggestive of a building it could equally be interpreted as a small pit.

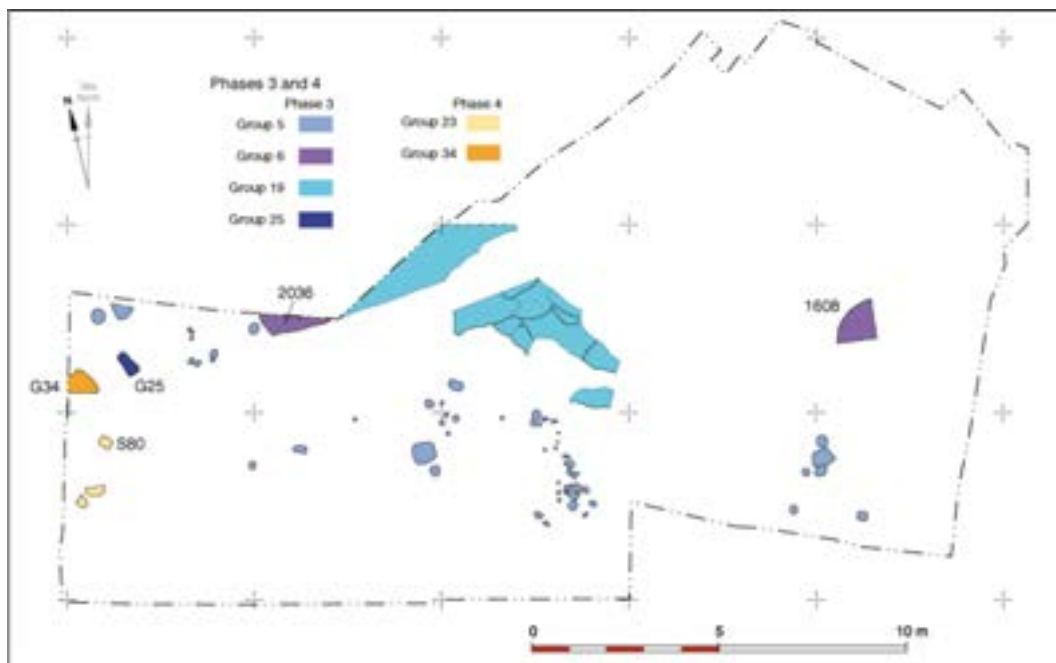

**Figure 7 Phases 3 and 4**

## Phase 4

A group of stake- and post-holes may have been in an alignment, though this was far from convincing (Group 23). There was also a cut (Group 34), the bulk of which lay beyond the excavation area, so its precise dimensions and function are uncertain. It could represent a rubbish pit or could be the butt-end of a linear feature.

### 2.3.4 Phase 5 Anglian (8<sup>th</sup> to mid-9<sup>th</sup> century)

An important collection of Anglian pottery was recovered from this site, although unfortunately much of this occurred as residual material in contexts of later date. While relatively few contexts could be securely dated to the Anglian period, the quantity of pottery recovered clearly suggests that the site must have been intensively occupied in this phase. This is of great significance for the study of Anglian York, especially in the light of the site's proximity to the Anglian settlement site at 46-54 Fishergate (Kemp, AY7/1, 1996).

Although many of the features allocated to this phase were clearly dated as such, many undated features are interpreted as being of Anglian date (notably Buildings 3-7, Set 6 and Set 65) due to the similarities of the layout seen here with that of the first phase of Anglian settlement (Period 3a) at 46-54 Fishergate (AY 7/1, 38, fig. 16).

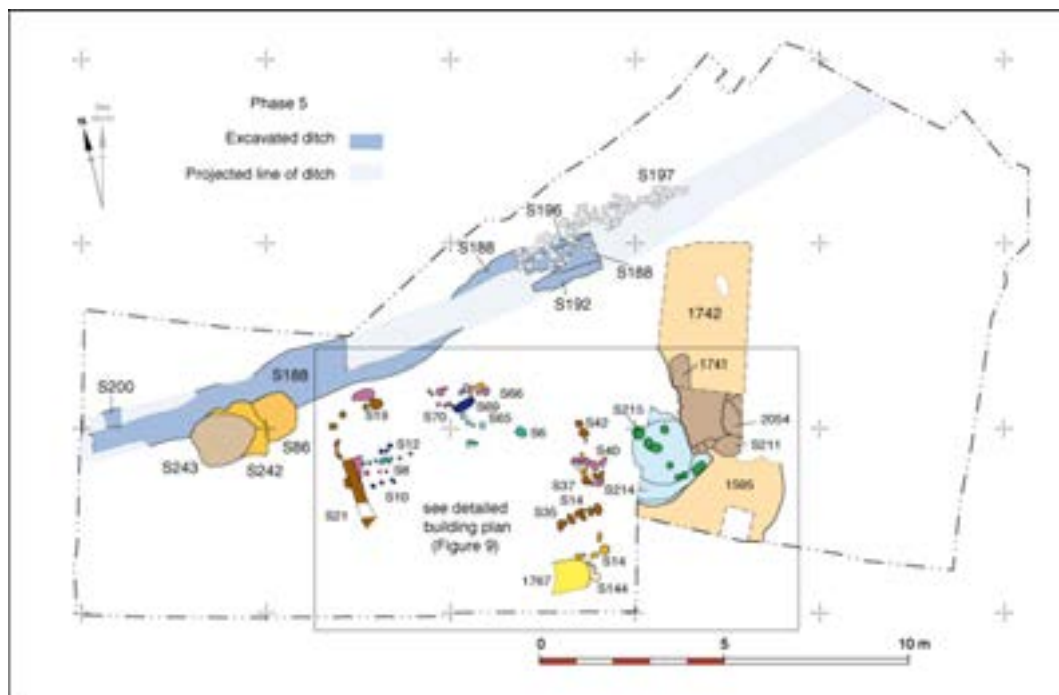

Figure 8 Anglian features

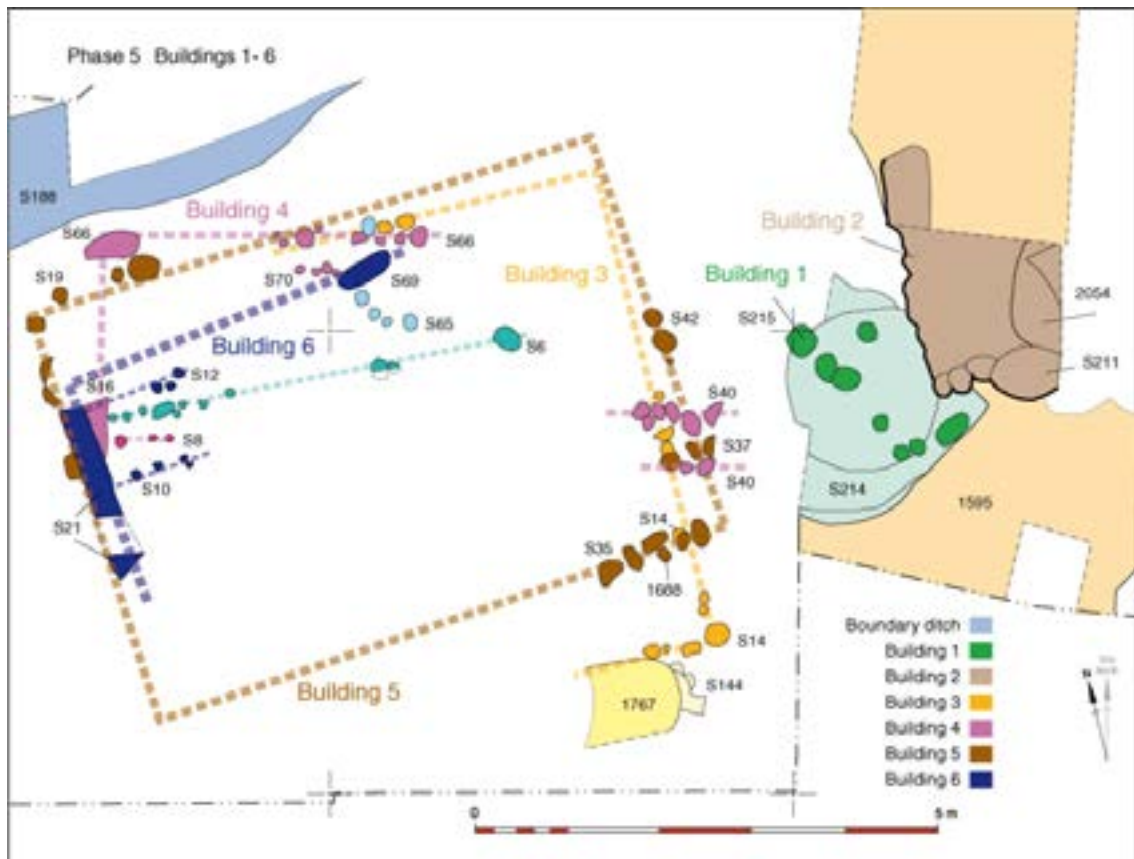

Figure 9 Detail of Anglian buildings

### Contexts dated to the Anglian period

A major feature on the Dixon Lane/George Street site was a linear ditch cut aligned east-north-east to west-south-west (Group 47). The ditch was re-cut on at least five occasions, and must have been in use for a considerable length of time. Most of the cuts were only seen in the western and eastern sections of Test Trench 4, and do not therefore appear on plan. In addition they were so heavily intercut that the dimensions and profiles of many of the ditch phases were impossible to determine.

The earliest of the ditches (Set 194) was truncated on the northern side by a second ditch, Set 196. This was in turn directly beneath a flat-bottomed ditch c. 1m wide and in excess of 0.6m deep (Set 197). One backfill of Set 197 (Context 2076) comprised stone rubble; as there was very little stone on the site this is highly unusual. Slightly to the south of 2076 was a further ditch (Set 192). Cutting all these ditches was a V-profiled ditch (Set 188), up to 1.45m wide and in excess of 0.75m deep. A short length of ditch 0.45m wide and 0.15m deep, located close to the western limits of excavation, probably also belonged to this grouping (Set 200). Despite every effort to recover dateable material from these ditches, very few artefacts were found. Context 1754 contained residual Roman pottery, Anglian pottery and artefacts dated to the Anglian or Anglo-Scandinavian period, but none of the other ditches yielded any artefacts.





**Context 2076. Scale unit 0.5m**

**Ditch-cut Set 188. Scale unit 0.2m**

A 0.2m thick deposit (Context 1742) either accumulated in, or was deliberately dumped, above the earlier Roman terrace cut in Test Trench 3. This deposit contained 368 sherds of residual Roman pottery and three sherds of Anglian pottery. A similar deposit to the south-west (Context 1595) is probably related.

Cutting into these deposits was a roughly circular pit (Set 214), c. 2m in diameter and 0.83m deep. This was interpreted as a rubbish pit as the backfill contained four sherds of Anglian pottery together with residual Roman pottery, shell and animal bone.

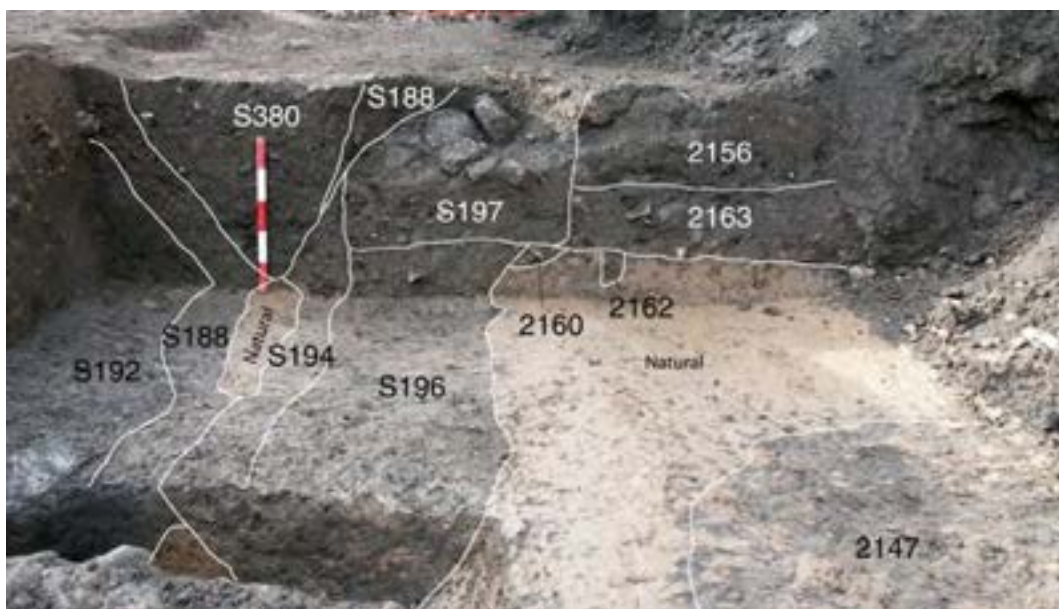

**Figure 10 South-eastern facing section of Test Trench 4 showing the Anglian boundary ditches**

A timber structure, Building 1 was stratigraphically above Set 214 This comprised two lines of circular post-holes at right angles to one another, with one possibly internal post (Set 215); no

internal surfaces survived. The post-holes ranged from 0.15m to 0.3m in diameter and were spaced unevenly 0.2-0.37m apart. Curiously, the corner post was one of the smaller posts in this building. Unfortunately, as so little of the ground plan was recovered the overall plan of the building and the orientation of its long-axis are unknown. If this building was placed in relation to the boundary ditches, however, its maximum dimension on the south-eastern side was 6.2m. Building 1 was later removed and the post-holes infilled (Set 216). No dateable finds were recovered from this building.

A series of stake-holes c. 0.1m in diameter (Set 144) and a pit (Context 1767) seemed to be spatially related. The stake-holes could represent a pit-lining, or the fragmentary remains of a second sunken-featured building. One of the stake-holes contained a single sherd of Anglian pottery. It must be noted that the stake-holes were recorded as being stratigraphically earlier than the pit, though this may have been excavator error.

Group 60 comprised three intercut, securely dated, Anglian pits (Sets 86 and 242-3). These slightly impinged on the boundary ditches, though the northernmost and most recent of the ditches could have remained open while these pits were dug. The pits all measured c. 1.5 x 1.7m in area and were c. 0.5m deep. The pits in Sets 242-3 both contained fragments of Tating ware, which is an unusual find of high status imported pottery.



**Sets 86 and 242-3 (directly beneath photographic scale). Scale unit 0.5m**

Cutting both Context 1742 and Building 1 was a group of features interpreted as a sunken-featured building (Building 2). The full ground plan of Building 2 could not be determined, as the northern end was not recognised during excavation, while the eastern portion lay beyond the area excavated, but it was in excess of 2.7 x 1.7m in area. The sunken-featured building comprised a roughly rectangular cut (Context 1741) that was partially infilled (Context 2054) before a series of post-holes was inserted in a continuous line along its south-western edge, and with a single post adjacent to the north-western edge (Set 211). The posts were all of circular cross-section and in the range of 0.2-0.3m in diameter, with the exception of one

larger post-hole 0.5 x 0.7m in size. This larger post-hole was not located at the corner of the building, but on the side, and as such may represent a door post. Building 2 was on a different alignment to Building 1, being almost exactly either north-south or east-west. Building 2 was subsequently infilled. Only residual Roman pottery was associated with this building.



**The post-holes of Buildings 3 and 5, and Set 40. Scale unit 0.2m**

### **Contexts interpreted as being of Anglian date**

The contexts in this grouping were all either undated or contained small quantities of Roman material (which could be residual). Despite the lack of dating evidence they have all been interpreted as Anglian (see 3.4). Numerous beam-slots and alignments of stake- and post-holes are suggestive of a series of superimposed timber buildings. Unfortunately, due to severe truncation by later features, the evidence for these suggested buildings is extremely tenuous; no complete ground plans were recovered, neither were any internal surfaces present.

Building 3 (Set 14) was a rectangular post-built structure of which only the eastern end was present. The building was presumably aligned with the long axis east-north-east to west-south-west and was c. 5.4m in width, the length being unknown. This building was clearly aligned parallel to, and c. 1m south of, the Anglian boundary ditches described above. The posts were of circular cross-section and ranged from 0.05 to 0.25m in size, with the largest post being located at the south-eastern corner of the building. The posts seem to have been closely spaced, being just 0.05–0.1m apart.

The south-western wall of Building 4 comprised a beam-slot (Set 16), while the north-western wall was a line of stake- and post-holes and a beam-slot (Set 66). The beam slots were 0.25m wide while the posts were of circular cross-section and 0.05–0.17m in diameter. The spacing of the posts is difficult to determine due to later truncation. This building was aligned with its long axis north-west to south-east, i.e. it was not parallel to the boundary ditches. There were also two short lines of stake-holes parallel to the north-eastern side of the building that may

represent internal features (Sets 8 and 70). Set 70 was c. 0.3m south of the proposed north-eastern wall of the building, while Set 8 was c. 2.2m to the south. Two other lines of post-holes on an identical north-west to south-east alignment (Set 40) were located slightly to the south-east of Building 4; these may be associated but this is by no means clear. If Set 40 is associated with Building 4, then it was over 6.75m in length and 2.5m in width. The Set 40 posts were, however, far more closely spaced than those of Building 4, and were larger, being 0.15–0.3m in diameter, which perhaps suggests that they were unrelated to Building 4. If so, Set 40 may be all that remains of a further building. These post-holes were later infilled with material containing Roman pottery and CBM, though this could have been residual.

A rectangular structure aligned east-north-east to west-south-west (Building 5) was constructed parallel to and less than 1m south of the boundary ditches. Portions of all four walls survived (Sets 19, 35 and 42), giving dimensions for the building of 6.5m in length and 4.6m in width. The posts were 0.15–0.3m in size; most of the timbers were of circular cross-section, but some were clearly squared. The north-western corner post, though small, was a squared timber. One of the post-holes in the south-eastern wall seems to have been infilled and replaced at some stage with a new post (Context 1688) which was again a squared timber. The timbers of the south-eastern corner of the building seem to be closely spaced with gaps of just 0.05m; those of the north-western corner were 0.3–0.6m apart, though this apparent variation may be due to poor preservation of the building in this area. Parallel to, and c. 0.7m to the north of, the south-eastern wall of the building was a post-alignment (Set 37) that may represent an internal partition within the building.

Buildings 4 and 5 were replaced by a further structure (Building 6) which was again aligned east-north-east to west-south-west. Building 6 comprised two beam-slots 0.3m wide (Sets 21 and 69), at right-angles to one another, which probably formed external walls of the building. Parallel to the north-western wall were two rows of stake-holes (Sets 10 and 12) which may represent internal fixtures within the building; these were 0.3m and 1.1m south of the north-western wall of the building. The building was in excess of 4 x 2m in area, and was parallel to and c. 1.75m south of the boundary ditch. Building 6 was subsequently demolished and the features infilled. There were two post-holes that were recorded as being stratigraphically above Building 6, (Group18, Contexts 1083 and 1392). It is possible that 1083 represents a replacement for part of the southernmost line of internal stakes in Set 10, while 1392 may be the corner post of the building which was incorrectly recorded at the time of excavation as cutting the beam-slot of the north-western wall.

A line of stake-holes (Set 6) was present that did not align exactly with any of the buildings described above, but was in the same general area. These were of circular cross-section, 0.05–0.2m in diameter, and were spaced unevenly, though this may be due to accidental survival. These may be all that remains of another building or a misaligned internal partition for one of the buildings already described. There were also a number of stake-holes in a semi-circular pattern (Set 65) that may have had some kind of structural function.

The chronological relationship between Buildings 3 and 4 is impossible to determine, but Building 5 definitely post-dated Building 3, and Building 6 clearly post-dated both Buildings 4 and 5. Given the similarity in their location and alignment it is suggested that Building 3 was replaced by Building 5, which was in turn replaced by Building 6.

## Phase 5b

Sealing the buildings described above were a number of build-up or dumped deposits ranging from 0.04 to 0.1m thick (Group 27). The deposits contained some Roman pottery and CBM, together with a sherd of possibly Anglian pottery. Above Group 27 were the fragmentary remains of another timber structure (Group 31, Building 7). This comprised two lines of stake-and post-holes at right-angles to one another, forming the exterior walls of the north-easternmost corner of the building. The posts, 0.15–0.3m in diameter, were closely spaced in the north-western wall but more widely spaced on the north-eastern side. The spacing of the timbers may not have any significance as it could simply be an accident of survival. A narrow gully or beam-slot, 0.15m wide, was located 2m from, and parallel to, the north-eastern wall of the building, and may represent part of an internal partition. The overall dimensions of the building are unknown, but it seems to have been placed parallel to the boundary ditches. The building was later demolished and the post-holes infilled (Group 32).

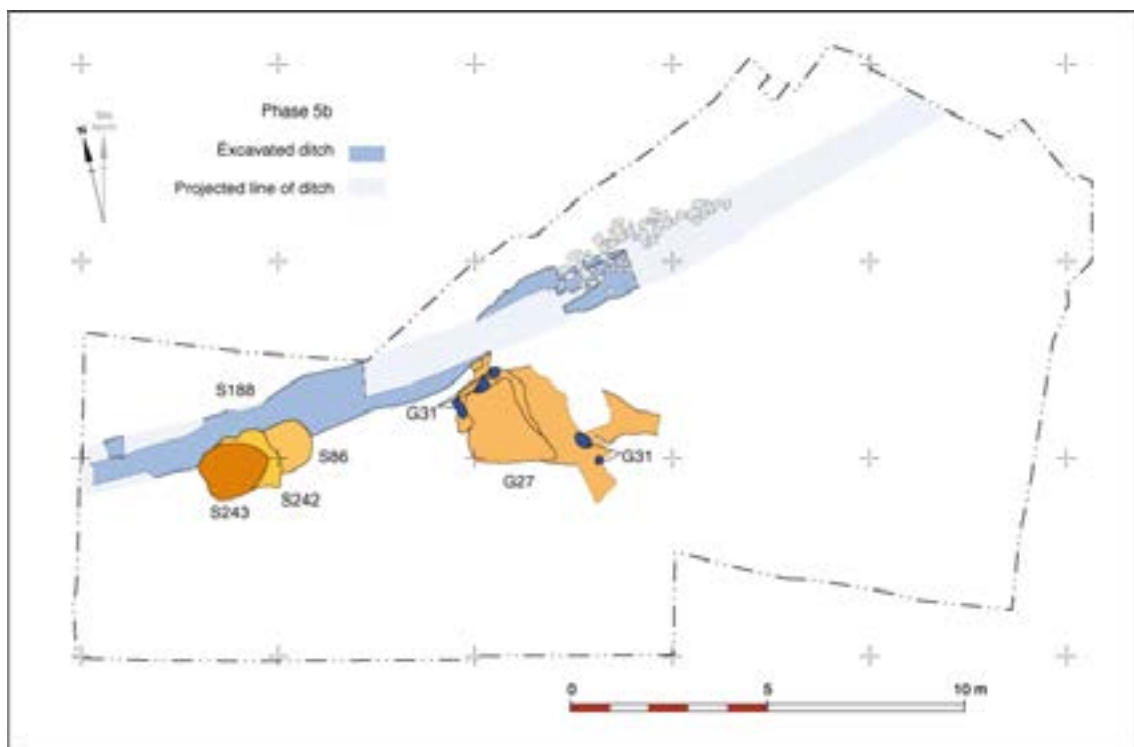

**Figure 11** Later Anglian contexts of sub-phase 5b

### 2.3.5 Phase 6 Anglo-Scandinavian (mid-9th to early 11th century)

The site was clearly very intensively used during the Anglo-Scandinavian period and numerous contexts of this date were excavated. The large quantity of residual Anglo-Scandinavian material recovered in later medieval contexts is also indicative of intensive settlement during the Anglo-Scandinavian period.

The Anglo-Scandinavian activity could be split into three sub-phases of mid-9th–10th century, 10th century and late 10th–11th century on the basis of the pottery recovered. In addition there were a number of features that, though clearly Anglo-Scandinavian, could not be closely

dated.

### **Phase 6a Mid-9th–10th century**

The features within this sub-phase can be divided into two groups. The first were largely undated or contained only residual Roman material, while the second were clearly dated as mid-9th–10th century. During this sub-phase the site seems to have been largely used for pit digging. There are some post-holes, but these do not form patterns suggestive of buildings.

Two pits (Sets 140 and 156 in Group 42) truncated Anglian deposits. Set 156 was sub-rectangular and measured 1.1 x 1.4m and was 0.31m deep; it was clearly a rubbish pit as the backfill contained Roman pottery, Roman CBM and animal bone. The precise size of Set 140 is unknown but it seems to have been sub-rectangular and in excess of 1.1 x 1.75m in size and 0.22m deep. The lack of artefacts in the backfill of this cut suggests that it was not a rubbish pit, but its precise function is unclear. (It must be noted that on plan Set 140, Group 42, looks as if it has been truncated by the Anglian boundary ditches. This is misleading; the pit is in fact later than the ditches, but its northern portions had been removed as part of the machine excavated spit 1400, creating a false impression of its relationship to the ditches when viewed in plan).



**Pit-cits Groups 16, 30 and 79. Scale unit 0.2m**

Groups 16, 30 and 79 form a sequence of constantly re-cut pits in a specific portion of the site. The pits were so heavily intercut that original dimensions were often difficult to assess, but, the largest were in the region of 2.5 x 3m in area and c. 0.7m in depth. The earliest two groups, Groups 16 and 79, were of interest in that their backfills contained absolutely no finds with the exception of a small quantity of animal bone in Context 2057. The total lack of artefacts within these pits is curious; clearly they were not rubbish pits, but their original

function is unknown. Two of the pits in Group 30 were clearly rubbish pits – Sets 127 and 134 contained daub, animal bone, residual Roman CBM, residual Roman pottery, plaster and slag. There were a number of stake-holes associated with the Group 30 pits that seem to be related; due to heavy intercutting it was, however, impossible to say if these represented portions of pit-linings. Set 117 in Group 16 contained fragments of both adult male and female human bones, together with iron nails. The shape of the cut may imply that this was a grave, but the bone could represent contamination from the medieval cemetery above.

A number of other cuts were excavated including post-holes up to 0.2m in diameter, together with some cuts c. 0.5 x 0.7m in size that could be either large post-holes or the bases of small pits (Group 43). This grouping did not form any coherent patterns suggestive of structures.

None of these groups contained any dating evidence linking them to the Anglo-Scandinavian period. They have, however, been phased here as they cut the earlier Anglian structures (Buildings 3–7), and they are therefore interpreted as being unrelated to them.

Groups 35–6 were clearly dated to the mid-9th–10th century. Group 35 comprised two pits (Sets 106 and 141) and the infilling of a hollow above an earlier Roman ditch (Set 5). Above the infilled ditch were a number of features (Group 36) including a line of three stake-holes up to 0.1m in diameter and associated backfills (Set 75), a curving cut that could be either a gully or the remains of a badly truncated pit (Sets 55–6), and a number of shallow pits (Sets 73, 76 and 181) up to 1.4m in diameter. Set 76 contained two sherds of 9th-/10th-century pottery. Slightly to the west was a further badly truncated pit with a possibly associated post-hole (Set 78); the original dimensions of this pit could not be determined.

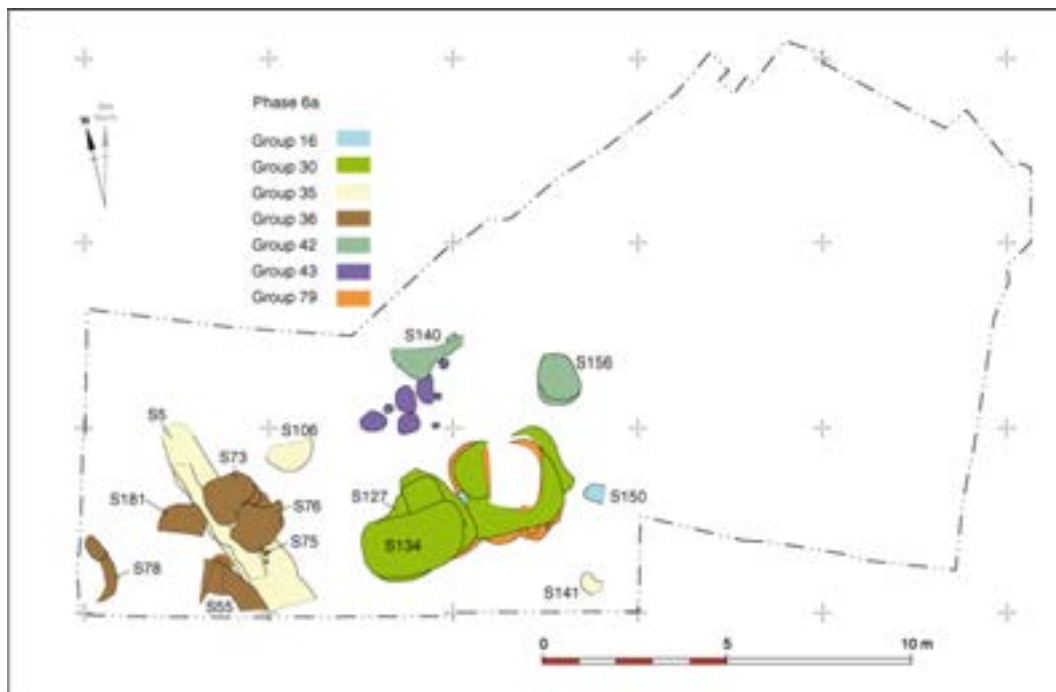

Figure 12 Sub-phase 6a

### Phase 6b 10th century

With the exception of a cobble surface and a few isolated post-holes, the activity in sub-phase 6b seems to comprise mainly of pit digging, presumably for the disposal of rubbish.



**Cobble surface Set 179. Scale unit 0.2m**

Three deep pits (Sets 81–3 in Group 24) included one which contained bone offcuts, including comb plate fragments of Anglo-Scandinavian date. These pits all extended beyond the limits of excavation so their dimensions are unknown. Set 83 was associated with a small post-hole (Context 1507–8, not shown on plan). To the north-east were two smaller, stratigraphically linked cuts (Sets 88 and 102), each c. 0.5m in diameter; the earlier of these also contained a bone offcut. These features could belong to either phase 6a, or phase 6b. They have been phased here because it is the highest stratigraphic point at which they can occur.

A number of contexts could be securely dated to the 10th century (Group 38). Adjacent to the north-western edge of excavation there was a pit (Set 176) in excess of 1.5 x 1.4m in area. This pit could not be fully bottomed during excavation, so its depth is unknown, but it was over 1m deep. Above the infilled pit was a post-hole c. 0.2m in diameter (Set 177) which may have been associated with a second post-hole of similar size (Set 178) slightly to the north. Sealing Set 178 were the remains of a very badly truncated cobble surface which was visible in patches across the site (Set 179). This surface was in turn cut by a large pit that seems to have been re-dug at some stage (Sets 182 and 184). The pit was 2 x 2.2m in area and 1.2m deep. A further pit was located at the western limits of excavation (Set 385). The precise shape of this



pit is unclear as there was some confusion as to its northern edge during excavation, but it was probably sub-rectangular and c. 1.0 x 2.5m in size and 0.35m deep. Elsewhere there was a scatter of features of this date including a gully or ditch (Set 91) that was so severely truncated that its original size or function is impossible to determine, a number of extensive build-up deposits (Sets 151 and 160) and three badly truncated pits (Sets 147, 152 and 157).

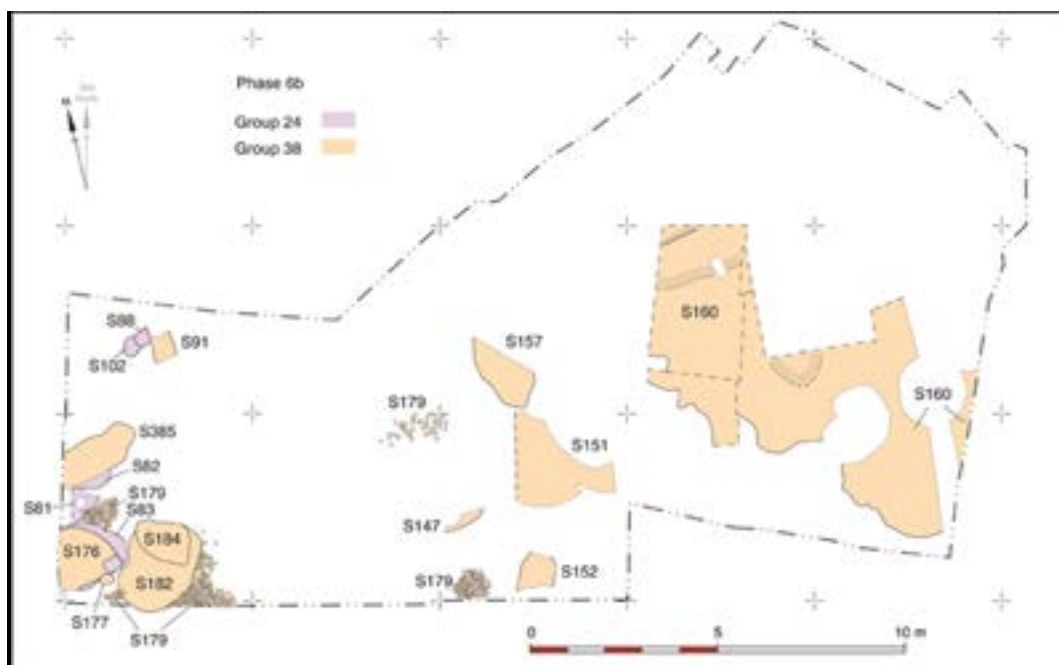

Figure 13 Sub-phase 6b

### Phase 6c Late 10th–early 11th century

The land use during sub-phase 6c mainly comprised of the excavation of rubbish pits, but there is also evidence for hearths which had not been seen on the site before this stage.

There were a series of undated features above the 10th-century contexts that could relate to either sub-phase 6b or 6c (Groups 39–40). They have been placed here as it is the highest possible stratigraphic position at which they can occur. This group included a number of pits and backfills that ranged in size from c. 0.5m in diameter to 1.8 x 1.5m. All these pits seem to have been rubbish pits as their backfills included material such as daub, residual pottery and CBM, shell, animal bone, human bone (contamination from the cemetery above), a bone pin, copper alloy slag, iron nails, bone offcuts, iron fragments, horn cores and, within Set 130, a loom weight (SF47). There were also the remains of two animal burrows (Set 183). The phasing of the animal burrows was problematic; they could be far more recent features that happen to have penetrated early deposits on site. A small group of build-up deposits (Set 213) were located together with a number of pits (Sets 161, 172–3, 304–5 and 384) ranging in size from 0.25m to almost 2m in diameter.



**Pit-cut Set 107, Group 39. Scale unit 0.2m**



**Pit cute Set 130, Group 39. Scale unit 0.2m**

A small number of contexts (Group 41) were dated as late 10th–11th century. Set 164 was c. 2.5m in diameter and over 1.1m deep. This was clearly a rubbish pit as the backfill contained pottery, residual Roman pottery and CBM, daub, bone and antler offcuts, shell, iron and a

copper alloy fragment. There was also some human bone present which undoubtedly represents contamination from the medieval graveyard above. A sequence of build-up deposits that had slumped into earlier pits was present, above which were a couple of post-holes (Group 55). It is impossible to know if these represent part of a building or not, as the area was very heavily truncated by the medieval cemetery above.

Several hearths were in use at this stage (Group 37 and Set 180). There was no clear evidence for any structures associated with these hearths in the form of walls or post-holes, largely due to truncation by later features. The presence of daub in Set 180 may, however, imply that there were structures in the area. It is impossible to say, therefore, if these hearths were inside or outside buildings.



**Context 1644. Scale unit 0.5m.**

Set 180 was a sub-rectangular hearth cut c. 0.8 x 0.8m in size, together with its associated use deposits. Group 37 included three hearths and their associated use deposits. The first of these was c. 1.5m in diameter (Context 1616), while the remaining two hearths were irregular in shape and c. 1 x 0.5m in size (Contexts 1614 and 1644). Set 219 was a large shallow rubbish pit containing residual Roman pottery, animal bone and daub, together with some human bone that clearly represents contamination from the medieval cemetery above. Most of these contexts were undated, but were stratigraphically above contexts of 10th-century or later date and earlier than the earliest graves in the overlying cemetery.

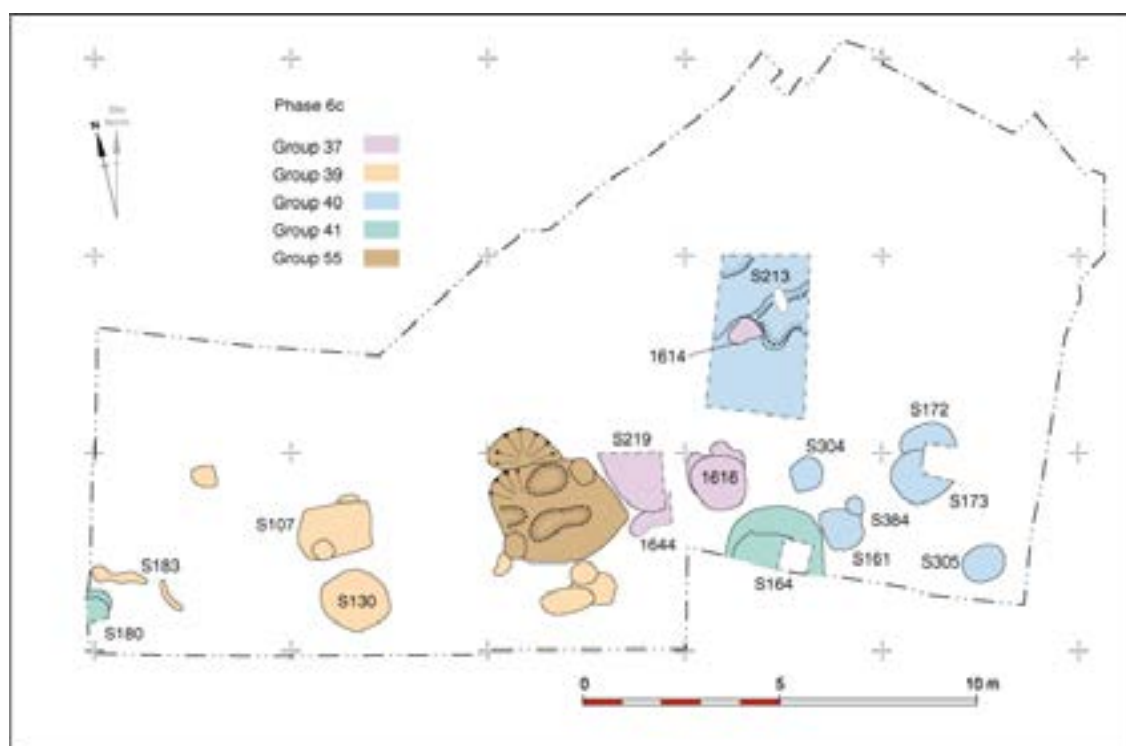

Figure 14 Sub-phase 6c

#### Phase 6d Pre-Norman Conquest burial ground (early to mid-11th century)

Thirteen graves (Sets 222, 234, 257, 263–4, 266–7, 269, 274–5, 282, 287 and 312) are stratigraphically the earliest burials on site. Only two of the graves within this group were directly linked stratigraphically, with Set 266 being above Set 264. The only damage to the earlier skeleton was the partial removal of the right leg. The burials were aligned west-north-west/east-south-east. One of the burials (Set 222) was cut from a considerably deeper level than other nearby burials (upper edge of cut at 8.68m AOD, as opposed to 8.96–9.01m AOD for adjacent burials); this burial was beneath a sequence of pits (Sets 227–8) that clearly pre-date the main Phase 8 cemetery, implying that this burial at least is of an earlier phase. None of these thirteen graves contained material post-dating the Norman Conquest; the pottery was all 10th–11th century in date. Set 263 contained a sherd of 13th- to 16th-century CBM which probably represents contamination from a later grave directly above. In one case, Set 269, a number of clench bolts were recovered, indicative of a pre-Conquest date. It is therefore suggested that these burials are of late Anglo-Scandinavian (i.e. pre-Norman) date.

Some of the burials in this grouping exhibited features not present in the Phase 8 graves. Set 269 was the only example on site with clench bolts in the grave fill (three clench bolts were found in association with five iron nails which were arranged in a cross shape across the top of the skeleton), the two burials in Sets 266–7 were backfilled with pure clay (redeposited natural) and Set 282 probably had a stone lining to the grave (though much of this grave was beyond the excavation area so it is impossible to be sure).



Sets 222, 269 and 266. Scale unit 0.2m



Sets 267, 234 and 275. Scale unit 0.2m

Other burials within the group exhibited characteristics that, while present among the Phase 8 burials, were rare. Set 234 had cobbles (also known as 'ear muffs') to either side of the skull and Set 274 had redeposited human bones adjacent to the northern edge of the grave. It is also of interest that while none of the Phase 8 burials had more than two nails present in the grave fill, three burials within Phase 6 were associated with five or more coffin nails or clench bolts (Sets 222, 263 and 269). In addition Set 222 was the only grave where the outline of the coffin was clearly delineated by rows of nails.

Few archaeological sites yield preserved wooden coffins, and it is often necessary to look for other indicators that a coffin was present. Nails within graves are often assumed to be the crucial indicator for the use of coffins, but they are not an infallible guide. Excavations at St Peter's Barton-upon-Humber yielded 31 oak coffins that were dated by dendrochronology within the period 1034 to 1134, while at St Benet's, Swinegate, York, 41 coffins of a similar date range were present. At both these sites most of the coffins were made entirely from wood (Panter 1994, 28, 31). The absence of nails need not therefore mean the absence of a coffin. Often there are only one or two nails per grave, which may seem an inadequate number, but the presence of minimal numbers of nails within graves may simply mean that additional strength was needed at a weak point on an otherwise entirely timber coffin.

Another indicator of the absence or presence of a coffin comes from analysis of grave shape. If a grave is flat-bottomed and square-cut it can be assumed to have held a coffin; conversely where a grave follows the outline of the body or has rounded ends it can be interpreted as having held an uncoffined burial. Pieces of stone and tile standing on edge against the sides of a grave are also indicators of the backfilling around a coffin (Rodwell 2005, 182). The shape of the grave cuts for these burials was rectangular in all cases except for Set 275. The rectangular shape of the graves implies that they were excavated to accommodate rectangular coffins.

The position of the right arm of Set 275, together with the shape of the grave cut, suggests that this skeleton was uncoffined.



Sets 274 and 282. Scale unit 0.2m

The skeletons were arranged in their respective graves in a number of positions; with the arms by the sides (two examples), right arm by side, left hand on left pelvis (one example), left arm by side, right hand on right pelvis (one example), both hands on pelvis (two examples), left arm flexed at the elbow, right hand on left pelvis (one example), and both arms flexed at the elbow (two examples). The numbers involved were too small to assess if there was any link between burial position and either age at death or sex.

Three of the graves cuts may have had markers; soil-stains at the head end of Sets 264 and 257, and at the foot end of Set 269, may have been post- or socket-holes. There is no indication as to what form these markers could have taken.

Grave depth in this phase clearly relates to the level of truncation by later features rather than being any reflection of the age, sex or status of the person concerned. The six graves closest to the north-western and south-western limit of excavation were 0.07–0.28m in depth, but the shallowness here was caused by later truncation of the upper portions of the graves. The

graves in the central portion of the site which had been less severely truncated were 0.22–0.45m in depth, while the north-easternmost burial, the upper portions of which were not truncated at all, was 0.47m deep.

Samples of two of the skeletons consisting of three teeth per skeleton (Contexts 1085 and 1094) were sent for radiocarbon dating analysis (at Beta Analytic Radiocarbon Dating laboratory, Florida, USA). The results are shown in the table below.

Laboratory sample number	Context	Conventional radiocarbon date	$^{13}\text{C}/^{12}\text{C}$ Ratio	Calibrated date at 95% confidence
Beta-230569	1085	1010 $\pm$ 40 BP	-19.6 o/oo	AD 990–1160
Beta-230570	1094	980 $\pm$ 40 BP	-20.4 o/oo	AD 900–1160

**Table 1 Radiocarbon date information (calibrated using OxCal Version 3.10, Bronk Ramsey 1995; atmospheric data from Reimer *et al* 2004)**

The standard British calibration curve, gave 2 sigma calibration dates of AD 990–1160 and AD 900–1160 respectively. While the 2 sigma calibration results cannot prove a pre-Conquest date for the two burials concerned the conventional radiocarbon ages may suggest a pre-Conquest date.

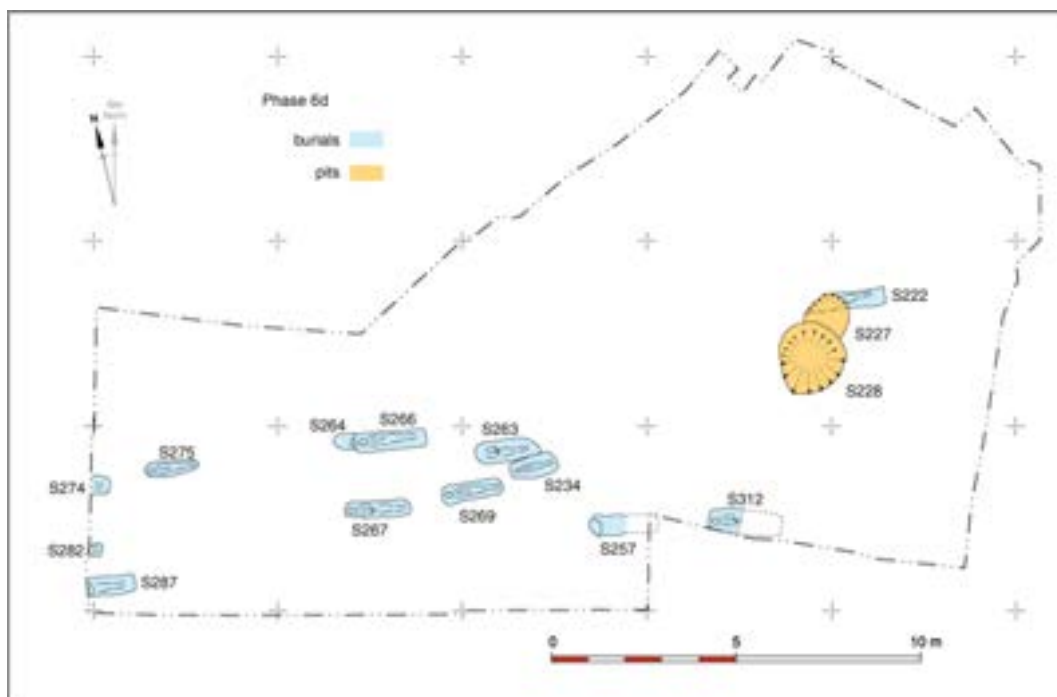

**Figure 15 Sub-phase 6d**

### 2.3.6 Phase 7 Norman (late 11th century)

This phase comprises a small number of non-burial features that were dated by pottery to the Norman period. The earliest of these (Group 76) was a V-profiled ditch c. 1m wide and 0.75m deep, aligned east-north-east to west-south-west. The ditch was located above and on the

same line as the earlier Phase 6 boundary ditches, which were in turn above at least one linear feature of Roman date. The fact that the Group 76 ditch directly overlies those of Phase 6 suggests that the earlier ditches were still partially visible within the landscape at this stage. The backfill of the V-profiled ditch (Group 51) contained Anglian to Anglo-Scandinavian bone offcuts and a small quantity of Norman pottery (see 4.2).

In terms of layout there is a striking correlation between the location of the Phase 8 burials and the Group 76 ditch. The burials and ditch follow the same overall alignment and all but ten of the burials were located to the south of the ditch. It seems likely therefore that the ditch represents the Phase 8 cemetery boundary during most of the lifespan of the cemetery. Eventually the ditch was infilled; above it was a small post (Set 203) and a possibly timber-lined pit (Sets 97 and 99–100). Elsewhere there was a pit and two small post-holes (Sets 93 and 109). With the exception of Sets 93 and 109 these features were definitely beneath graves from the Phase 8 burial ground. Although these features collectively contain pottery of Norman date it is possible that this material is residual and that the features are in fact of later medieval date. If this were the case the infilling of the ditch could be seen as happening late on during the use of the cemetery in order to create more useable land within an overcrowded cemetery. The features in Sets 97 and 99–100, together with the burials directly above the infilled ditch, could then be seen as the most recent cemetery features.

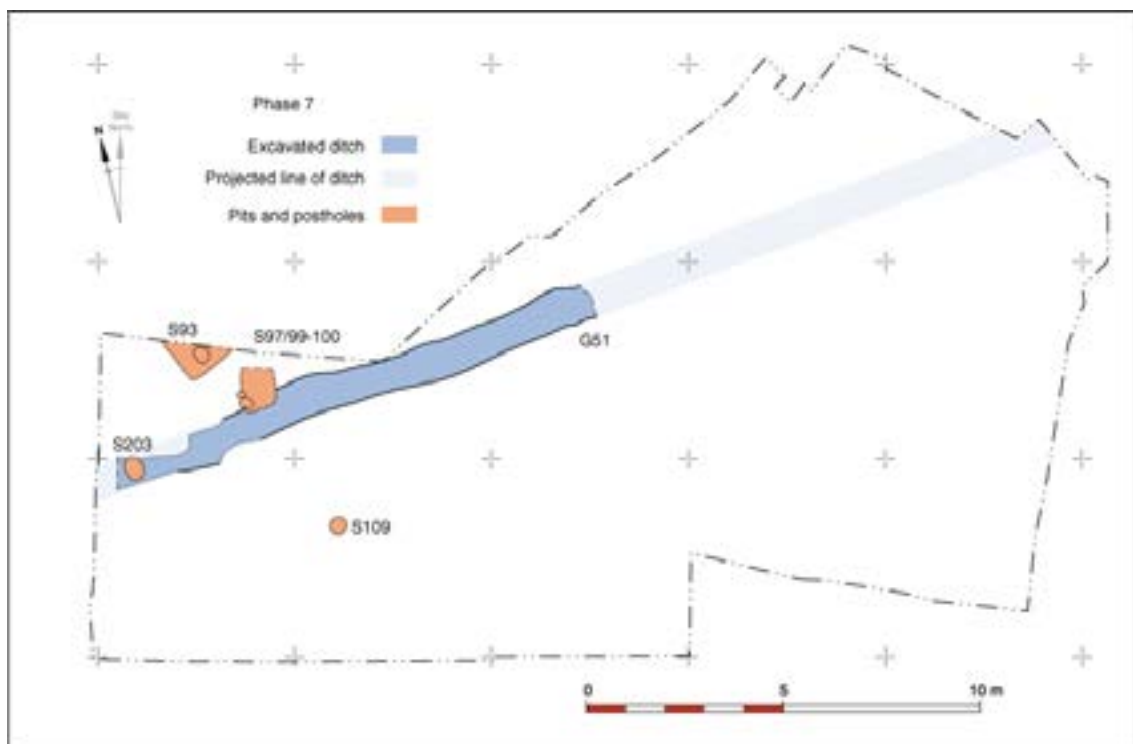

Figure 16 Phase 7

### 2.3.7 Phase 8 The cemetery of St Stephen's church (later 11th to mid-14th century)

A large number of burials were located that formed part of the cemetery associated with the church of St Stephen, Fishergate (see 1.1). The group numbers relating to this phase are 56–9, 61–2, 64 and 66–7. No direct traces of the church were found on the site, and this strongly



implies that the church was to the immediate south of the excavation area. It seems likely that, given the profile of natural deposits seen on the site, this area was originally a ridge of higher land. The location of a church on such a site would make geographical sense, especially in an area close to both the River Foss and the King's Ditch. Unfortunately this very area between Dixon Lane and the south-western limits of excavation had been severely truncated in the 19th century by the erection of a brewery which destroyed all traces of the church; its precise location and size are unknown.

The excavation methodology for the cemetery deserves some comment. The cemetery was excavated under 'rescue' conditions, with every effort being made to adhere to a strict timetable for clearing all human remains located within the footprint of the proposed building. Machine clearance of the site revealed an upper tier of graves, which were excavated. An arbitrary spit of soil (Group 65) was then removed across most of the site in an attempt to reveal any earlier burials. In the case of a strip c. 5m wide running parallel to the south-western edge of excavation, the removal of Group 65 lowered the site to a second tier of burials. Elsewhere it was necessary to remove a second arbitrary spit of soil (Group 59) in order to recover additional burials located at a greater depth. In the north-easternmost portion of the site a third arbitrary spit (Context 1400) was removed by use of a mini-digging machine towards the end of the excavation, in order to be absolutely sure that all burials had been located. The problem with these arbitrary spits is that they were, to all intents, horizontal layers across what is clearly a sloping landscape. The spits may therefore imply a false internal chronology for the cemetery. There is the additional problem that within intensively re-cut cemeteries it is virtually impossible to recognise soil horizons, as the earth was constantly turned over by the cutting of new graves. The spits should therefore be regarded as a build up of soil occurring throughout the life of the cemetery. In the discussion of the burials that follows, therefore, the spits of soil are largely ignored in terms of the chronological development of the cemetery. For the sake of clarity the spits are not illustrated on any of the plans.

A total of 105 burials from the cemetery of St Stephen's were excavated; they occurred in a band c. 9m wide running roughly east-north-east to west-south-west across the area of excavation. In addition to the burials there were five cuts interpreted as empty grave cuts (Sets 38, 187, 193, 221 and 289). There were relatively few burials in the south-western corner of the excavations, and immediately adjacent to the south-western edge of the excavation, but this was clearly due to later truncation. It must also be noted that most of the burials located in the south-western portion of the site were severely crushed by 19th-century building foundations directly above. There were relatively few burials in the north-eastern portion of the site, and this is not due to any later truncation; this part of the site therefore seems to have been less favoured for burial. Burials are often assumed to increase in density the closer to the church they are located. Unfortunately, the original density of burial is uncertain over much of the southern and western portion of the site; burial density cannot, therefore, be used to predict the location of the church on this site.

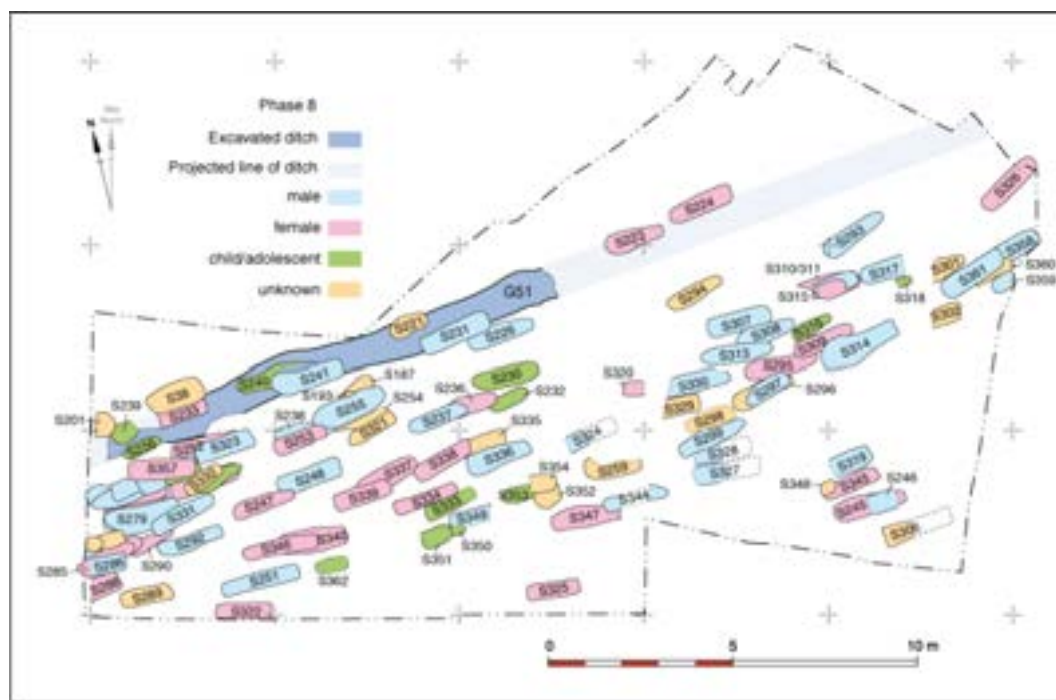

**Figure 17 Phase 8 burials and boundary ditch**

As is typical in a medieval cemetery, the burials were heavily intercut. Only 19 burials were not intercut, and many of these may originally have been beneath other burials that were truncated in the 19th century.

Nearly all of the burials were aligned east–west, but a couple were aligned south–west to north–east (Sets 326 and 332) and three were aligned south–east to north–west (Sets 320, 322 and 354). The significance of these variations is unclear. Two of the south–east to north–west aligned burials could be considered as part of the Anglo-Scandinavian burial ground, but only if the stratigraphy implied by the cemetery soil spits is totally ignored. The third clearly overlies other burials on the standard east–west alignment for the site, and cannot therefore be an early burial.

Some graves had deliberate inclusions in their backfills. Set 337 had animal longbones placed to either side of the skeleton’s legs and a large cobble by the feet. Set 361 had stone cobbles to either side of the head (ear-muffs); Set 245 had a cobble at one elbow, Set 344 had a cobble to either side of the head and cobbles at the left elbow and two at the left foot, Sets 296 and 299 each had a cobble to the right of the head, and Set 279 had a cobble to the right of the head and three to the left; in addition, human longbones from earlier graves that had been disturbed by the cutting of this grave were rearranged adjacent to the right hand side of the body. Twenty-two of the graves contained one or two iron nails within their backfills, but it is unclear in many cases if these represent stray finds or are evidence for coffins.

The shape of most of the grave cuts was rectangular, implying that they had been dug to accommodate a rectangular wooden coffin. There were some exceptions, however, where grave cuts were shaped to fit the body, or had rounded ends which may imply that coffins were not used (Set 230, 232, 238, 240, 247, 250, 254, 277, 279, 285, 290, 293, 295, 301, 308, 309, 313, 314, 316, 340, 344 and 347). There were also some skeletons in burial positions that suggest uncoffined burial (Sets 248, 256, 275, 279, 295, 331, 335 and 345). The majority of the

body positions were suggestive of the corpse having been placed in a parallel-sided coffin (e.g. Sets 226 and 231). Both the legs and head of a skeleton weigh a considerable amount, and it is not uncommon to find examples where these skeletal areas have separated from the body and rolled sideways or backwards during decay. This implies the presence of a coffin within which such movement could occur; had the burial been directly covered with soil, such movement would be unlikely. Examples of this type of movement were seen; in most cases a leg had rotated and separated from the body during decay (e.g. Set 311), but there was one skeleton where the head had separated from the body during decay and rolled backwards (Set 280) and another where the head and neck had twisted sideways (Set 266). In addition there were two burials where the bones of the torso had become displaced, probably through the processes of decay (Sets 224 and 279).

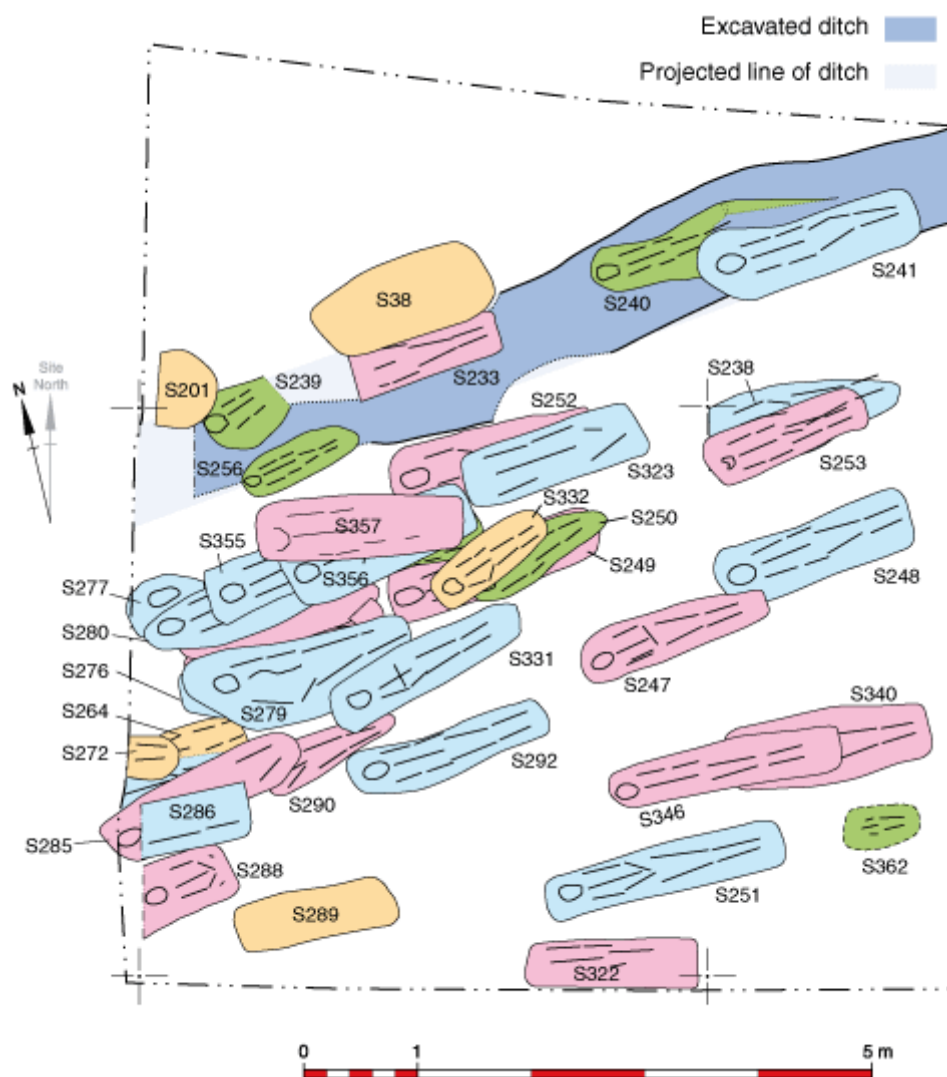

**Figure 18 Detail of the Phase 8 burials at the western limits of excavation**



**Set 361. Scale unit 0.2m**



**Set 344 Scale unit 0.2m. Skeleton partly obscured by a Victorian wall**

Only limited evidence for the way in which the skeletons were clothed for burial was present. A copper-alloy pin interpreted as a shroud-pin was present within Set 224. In addition some skeletons had the ankles close together or the jaws firmly shut, both of which may indicate that the corpse had been tied or tightly wrapped in a winding sheet prior to burial (e.g. Sets 231 and 255). A single skeleton was in a highly constricted burial position suggestive of tight binding (Set 291)

All the burials were extended, supine inhumations, but thirteen different burial positions were seen (1 = arms fully extended at sides; 2 = right hand on right pelvis, left arm extended at side; 3 = left hand on left pelvis, right arm extended at side; 4 = hands over groin; 5 = left hand on right pelvis, right hand on left pelvis; 6 = both hand on pelvis; 7 = right hand on pelvis, left arm flexed over stomach; 8 = both arms flexed over stomach; 9 = right arm flexed over stomach, left arm extended at side; 10 = left hand on right pelvis, right arm flexed over stomach; 11 = left hand on stomach, right hand on pelvis; 12 = right hand on right shoulder, left hand on right pelvis; and 13 = arms fully flexed, hands on sternum and legs slightly flexed). There were three burials with slightly flexed legs (Sets 237, 291 and 295), but in the case of Set 237 this was due to disease rather than any deliberate choice on the part of those burying the dead. The slightly unusual leg position seen in Set 241 was due to injury.



Sets 226, 275 and 231. Scale unit 0.2m



Sets 311, 280 and 266. Scale unit 0.2m



Sets 255, 237, 291 and 295. Scale unit 0.2m



Set 421. Scale unit 0.2m

Set 358 had a pair of Roman tweezers close to the head of the skeleton, and Set 340 contained a Roman gold finger ring set with carnelian (SF16). There is no indication in either case that these are deliberate grave goods rather than accidental inclusions.

Almost half of the burials on site contained only residual material of Roman to Anglo-Scandinavian date. The most recent pottery date for a burial is early 14th century. It is notable that none of the burials contained fragments of medieval brick which comes into use in the 14th century. Both the pottery dates and the absence of brick imply that the cemetery had largely gone out of use by the 14th century, which ties in well with the documentary evidence. There was a single fragments of glass waste (SF374) from one grave fill which may be of post-medieval date; this almost certainly represents contamination.

A single pit is phased together with the cemetery (Set 352) as it occurred stratigraphically between burials in this phase; its function is unclear.

#### 2.3.8 Phase 9 Post-cemetery medieval features (mid-14th to 15th century)

Virtually no post-cemetery medieval features were seen on the site. There was, however, a butt-ended ditch-cut aligned approximately north-north-east to south-south-west (Context

1091). The lowest portion of the backfill (Context 1092) was pebbly in nature, suggesting that this may have been a drainage gully. Pottery of 14th-century date and 13th- to 16th-century CBM fragments were recovered from the backfill of the ditch. There were also two pits (Set 90 and 1002), interpreted as rubbish pits.

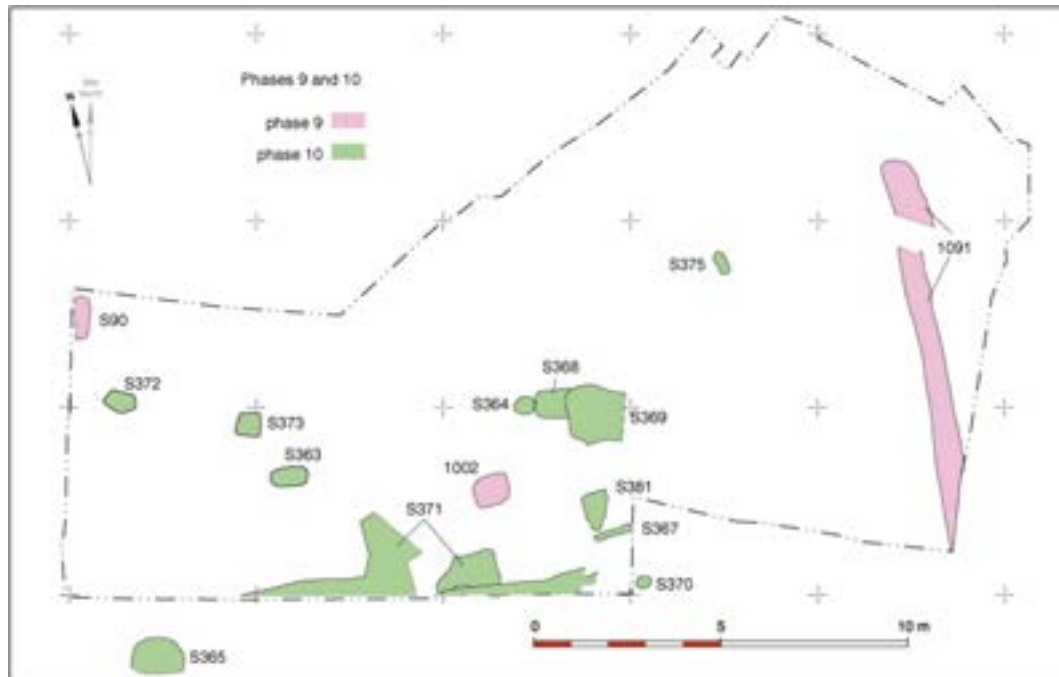

**Figure 19 Phases 9 and 10**

### 2.3.9 Phase 10 Modern features (19th–20th century)

A number of features relating to the construction of a late 19th-century brewery were excavated. These buildings were in three wings that fronted onto George Street, Dixon Lane and the north-western property boundary of the site. It was clear during the excavations that the entire site had been very heavily truncated prior to the erection of these buildings, a process which had reduced the ground level along the Dixon Lane frontage down to natural subsoil, effectively removing all archaeological layers in that area. Remains of the brewery included the rear brick wall of the portion of the building fronting onto George Street, together with various brick piles to support this structure (these features were not allocated context numbers during excavation). The construction cut for the rear wall of the building fronting onto Dixon Lane was present along the southernmost limits of the excavation (Set 371). In addition to the brewery buildings there were a number of charnel pits and dumps of human bone that seem to have been dug to dispose of the human remains disturbed by the building of the brewery (Sets 363–70 and 381). (Set 366 is not visible on Figure 19 as it is stratigraphically beneath the Victorian brewery wall.)

A few features post-dated the brewery buildings. These included a modern bore-hole (Set 375) and two post-holes (one with the post still intact) with tarmac in their backfills (Sets 372–3). The material removed by machine at the start of the excavations was allocated to Set 376.



**Charnel associated with the construction of the brewery. Scale unit 0.2m**

#### *2.3.10 Results of the watching brief*

The area removed was parallel to the north-western wall of the building, and was 1.7m wide on the north-eastern side, 4.6m wide on the north-western and south-eastern sides and 2.6m on the south-western side. This area was stripped to a maximum of 1.3m below present ground level. The uppermost 0.37m of deposits comprised brick rubble with large sandstone sets (from the brewery yard). This was above a build-up deposit of moderately compacted medium-brown silty-clay with moderate rounded cobbles, occasional patches of pink clay, flecks of shell, CBM, charcoal and limestone. Within this deposit were frequent horse bones and some chicken bones, none of which were retained. This was above natural deposits which were visible only at the northern end of the watching brief trench.

### **3 THE INTERPRETATION OF THE SITE**

Though small in terms of geographical area, the excavations at Dixon Lane/George Street are of great importance for understanding York's topographical development. The site's value lies in the fact that, unusually for York, there is clear archaeological evidence of settlement activity for virtually all historical periods from Roman to late medieval date. In particular the deposits of Anglian (7th- to 9th-century) date are of primary importance since remains of this date are very rarely located in York.

The sheer density of features present created some problems in terms of interpretation. The Roman and Anglian remains were heavily truncated by later activity, somewhat obscuring the precise nature of activity or settlement in these periods.

It must not be forgotten that the primary reason for the excavations was the clearance of a medieval cemetery. The cemetery seems to be of two distinct phases, interpreted as being of



pre- and post-Conquest date. The burials assigned to the pre-Conquest phase were aligned west-north-west to east-south-east, while those of post-Conquest date were from east-west to east-north-east/west-south-west. The cemetery seems to have gone out of use before the mid-14th century, i.e. before the Black Death of 1348–9. It is unfortunate that 19th-century levelling prior to the construction of a brewery had removed not only the upper portions of the graveyard, but also all trace of the church of St Stephen, to which the cemetery related. This is a sad loss, as it is impossible to determine if the two differing alignments seen among the burials relate to a church of two distinct phases on differing alignments.

This cemetery is in itself of interest as it offers the chance both to extend knowledge of pre-Conquest Christian burial methods, and to determine the effect, if any, that the arrival in York of the Normans had upon burial practices. The relatively short-lived nature of the cemetery also helps to date some of the burial practices to a relatively limited timespan, thereby adding to a growing corpus of sites for which such information is available.

### 3.1 Phase 1 Natural deposits

The most interesting aspect of the natural boulder-clay was the level of its upper surface; this dropped from 9.59m AOD to below 5.5m AOD between the southern and northern extremities of the plot of land within which the excavation took place. The natural rises again to the north and was seen at 8.15m AOD c. 25m due north of the northern corner of the present site (Lilley 1990, 19 and Fig. 1). It seems highly probable that the drop in the level of natural is a geological feature, perhaps representing a naturally occurring drainage channel. The feature was clearly prominent in the landscape for a considerable length of time, being known in medieval and post-medieval times as the King's Dike, King's Drain or King's Gutter. It was subsequently infilled. For a plan of Phase 1 see Figure 4

### 3.2 Phase 2 Roman (late 1st–late 4th/early 5th century)

The precise nature of the Roman activity on the site is difficult to determine due both to exceptionally heavy truncation by later features and to the fact that Roman levels were not reached over the north-eastern portion of the site.

In the late 1st–early 2nd century the only activity was the occasional digging of rubbish pits. Although no structures were present at this stage, the pits imply settlement activity nearby. The backfills of the pits largely contain domestic rubbish (shell, iron nails, pottery, ceramic building material [CBM], animal bone and an iron hinge). Only one pit contained slag (Set 93), which implies that there was little if any craft-working or industry in the area at this stage. Evidence from elsewhere in York suggests that in the 1st and 2nd centuries a range of crafts were practised to the south-east of the legionary fortress, largely to supply the needs of the military (Ottaway 1993, 16). This craft production activity does not seem to have extended as far as the Dixon Lane/George Street area.

During the mid-2nd to late 3rd centuries there was increased activity on the site, though land use was still far from intensive. A terrace cut was dug into the underlying sloping natural, to create flat useable land. A line of stake-holes immediately adjacent to the terrace cut probably represents a revetment for the north-east facing slope of the terrace. Parallels for this terracing activity have been suggested elsewhere in York, for example to the south-west of the River Ouse in the Roman *colonia* (AY 4/1, 1 and 30). A slightly different terracing method was

utilised at Tanner Row, where the land was built up using layers of turf and clay to create two level platforms suitable for building divided by a low revetment (*ibid.*, 79). The function of the lower terrace at Dixon Lane/George Street is difficult to determine as it was exposed over such a limited area; there were some rubbish pits, but no clear evidence for buildings. On the upper terrace there was a butt-ended linear cut with an 'ankle-breaker' profile that may represent some form of boundary. The ditch and terrace-cut are not aligned parallel to one another, so may be unrelated. The finds recovered from these features again suggested that the immediate area was largely domestic in function; shell, iron nails and fragments, pottery, animal bone, CBM, glass and plaster were all present, but no craft/industry related finds such as metal-working debris were recovered.

The level of activity on the site seems to have increased during the mid-4th century, with the cutting of three, possibly four, vertically sided slots between 0.24 and 0.46m wide and up to 0.44m deep. Unfortunately it was not possible to excavate any of these features fully within the time limits of excavation, making their interpretation difficult. The most likely explanation is that they are beam-slots for buildings. The total lack of masonry or mortar fragments in the area implies that the buildings were constructed from timber rather than stone. No traces of timber survived in any of these slots, which may imply that they had been carefully dismantled at some stage; such robbing may explain why the northernmost of the two slots on the lower terrace (Set 190) varied from 0.24 to 0.46m in width. No traces of any floor surfaces were seen in association with these slots, which may suggest that the buildings had timber floors that were also removed once the building was no longer in use. It seems unlikely that the slots are from a single building because two were on the lower terrace (cut from 8.28 to 8.35m AOD) and two were on the upper terrace (cut from 8.69 to 9.09m AOD). The two slots on the lower terrace were spaced 0.15m apart, which is unusually close; for example, the joist slots from the second phase of a Roman warehouse at Coney Street, York, though of similar width to the slots seen here, were spaced 0.6–0.7m apart (AY 6/1, 18). This need not mean, however, that the two slots are from two separate buildings. Whatever these slots represent they do not seem to have been in use for long prior to infilling. The lower terrace then seems to have been partially infilled prior to further rubbish disposal. A number of post-holes imply a structure, but this was impossible to interpret as it was exposed over such a limited area.

There are hints that the area was already being used for burials at this stage. A small pit that had been almost entirely removed by later features contained a small jet pendant in the shape of a bear, and a shale bracelet. This may be all that remains of a late Roman burial, and the diameter of the bracelet clearly implies a child burial. Given the date of these objects (4th century) the pit it is likely to represent a truncated inhumation burial, as cremation had largely gone out of favour by this stage (Ottaway 1993, 79). Other finds from the site were suggestive of cemetery use: some pottery types from the site are known to have been used for cremation burials (see 4.1). Collectively these finds suggest that burials were once present on the site, and these must represent the northern extremities of the Roman cemetery seen in earlier excavations immediately to the south of Dixon Lane by MAP Archaeological Consultancy Ltd (report unpublished; J. Oxley, pers. comm.).



**Roman gold ring**

A number of other features were interpreted as possibly Roman on the basis of their stratigraphic position, but these do not add significantly to an understanding of the settlement pattern.

A Roman gold finger ring set with a carnelian is a particularly significant item. It was a residual find in a later medieval grave, so the circumstances of its original deposition are unknown. The ring is of late 4th- to 5th-century type, and similar rings found elsewhere have been associated with hoards (see 4.4.3). This discovery provides a tantalizing possibility that in this area there may be evidence for that most elusive era in York's history and archaeology, the sub-Roman period of the 5th century. For plans of Phase 2 see Figure 5 and Figure 6.

### **3.3 Phases 3–4 Undated, possibly Roman, Anglian or Anglo-Scandinavian**

A large number of features that could not be firmly dated mainly consisted of stake-holes, though a few pits and build-up deposits also fall into this category. For a plan of Phases 3–4 see Figure 7.

### **3.4 Phase 5 Anglian (8th to mid-9th century)**

While knowledge of York during the 5th–6th centuries is minimal, historical evidence clearly shows that York was a major centre in the kingdom of Northumbria from at least the 7th century onwards (see 1.1). It has long been suggested that Anglian York was a polyfocal settlement, with separate areas for royal, religious, secular and trading/industrial use (AY 7/1, 3; AY 7/2, 298). York is recorded as both Eoforwicceastre and Eoforwic, perhaps a reflection of polyfocal settlement in the same way as the names Lundenburhand Lundenwic may indicate distinct defended administrative and commercial areas of contemporary London (Rumble 1980).

Evidence for a settlement based on craft production and international trade was uncovered at 46–54 Fishergate on the eastern bank of the River Foss, just c. 360m south of the site under consideration here, in the early 1980s (AY 7/1,109). Based on the size of similar trading sites

at Hamwic (Southampton) and Ipswich, Kemp suggested that the remains seen at Fishergate were part of a much larger settlement that might continue along the banks of the River Foss as far north as Foss Bridge and possibly beyond (*ibid.*, 75–6). This has indeed proved to be the case, with an Anglian settlement at Dixon Lane/George Street that is strikingly similar to that seen at 46–54 Fishergate. It has also been suggested (see 4.2) that the trading settlement at York extended along those parts of the banks of the Ouse that ran within the defended limits of the Roman settlements, though stratified structural evidence for similar forms of occupation there has not yet been uncovered.

The settlements at 46–54 Fishergate and Dixon Lane/George Street bear close comparison. In terms of overall layout they are very similar. Both are defined by boundary ditches, rectangular post-built structures were placed close to the ditches, and pits and sunken-featured buildings were located around the structures. In addition there are no clear property divisions between the buildings, though in the case of Fishergate, two lines of pits interpreted as possible palisades along major property divisions were located to the south of the buildings (AY 7/1, 23, 25). A similar lack of evidence for formal property divisions between buildings has been identified at *Hamwic*, though there is some evidence there for pits being used to demarcate boundaries, and the likelihood that fences made from stake and wattlework formed boundaries is also acknowledged (Andrews 1997, 46).

The rectangular post-built structures at both Fishergate and Dixon Lane/George Street were poorly preserved; in addition no internal surfaces were seen at either site to help interpret the function of the buildings. Despite these limitations comparisons between the two can be made. Buildings at both sites were clearly placed very close to the boundary ditches, less than 1.5m away. At both sites the stake- and post-holes of the external walls of the buildings were exceptionally shallow, often less than 0.15m deep; this has been noted at other sites both rural and urban such as West Hestlerton and Ipswich (*ibid.*, 70). No obvious doorways were excavated at either site (largely due to poor preservation) though these were usually placed midway along the long sides of buildings (*ibid.*, 70). Very little daub from these buildings was present at either site. There was limited evidence at both sites of slots for internal partitions; in the case of Fishergate these were located between 3.0 and 3.5m from one gable end (*ibid.*, 29, 33), while at Dixon Lane/George Street Building 7 had a slot 2m from the gable end. Within Buildings 4 and 6 at Dixon Lane/George Street there were longitudinally placed lines of stake-holes perhaps from internal partitions; no similar features were seen in the Fishergate buildings.

The buildings at the two sites were clearly different in terms of size, those at Dixon Lane/George Street being noticeably smaller, and therefore possibly served a different function. The Fishergate buildings (Structures 1–3) ranged from over 11m to over 14m in length, but were consistently 5.5m wide (AY 7/1, 27–8, 33–4). Building 3 at Dixon Lane/George Street was 5.4m wide, and Building 5 was c. 6.5m in length and c. 4.5m wide.

The Fishergate site shows that buildings could be aligned with the long axis parallel to or at right-angles to the boundary ditch. It is difficult to determine if this was also the case at Dixon Lane/George Street because the orientation of Buildings 1 and 2 is unknown. Buildings 3–7 were aligned with their long axes parallel to the boundary ditch, though Building 4 was slightly

off this alignment. These buildings may represent the continual replacement of a structure on a single plot, which may explain why they are all orientated the same way.



**Figure 20 Anglian features of late 7th-/early 8th-century to early 9th-century date at 46–54 Fishergate (AY 7/1, Fig. 16)**

Sunken-featured buildings were excavated at both Fishergate and Dixon Lane/George Street. At both sites they seem to have been ancillary to the main buildings, but were located close to them. The example at Fishergate was 3.25 x 1.6m in area and 0.5m deep with stake-holes around the edges (ibid., 31), while the Dixon Lane/George Street example was over 2.7 x 1.7m in area. Sunken-featured buildings of broadly contemporary date are known from many sites including Hamwic, London and (somewhat closer to York) West Heslerton (ibid., 71).

At Fishergate the area around the buildings was peppered with rubbish pits, together with numerous stake-holes interpreted as representing light temporary structures involved in specialist craft activities such as fur preparation (*ibid.*, 53–4). It is possible that the mass of undated stake-holes placed in Phase 3 at Dixon Lane/George Street may represent something similar.

There is a notable absence of wells at both Fishergate and Dixon Lane/George Street, but given that both sites were close to the river this could have provided both the water supply and an easy method of rubbish disposal (*ibid.*, 68–9).

Although the site at Dixon Lane/George Street was small in terms of both the area excavated and the number of Anglian features present, it yielded evidence both for manufacturing and trade. Slag, antler tine tips and bone offcuts are indicative of iron-working and antler- and bone-working in the area. A fragment of lead sheet may hint at lead-working. Imported pottery and glass were also present, showing both the trade in, and use of, high-status objects. A significant proportion of the pottery recovered was imported from both elsewhere in England and from Europe, including Ipswich ware, pottery from the Low Countries/Northern France and high-status Tating Ware (see 4.2). In addition, a small fragment of imported glass was found (see 4.4.4). Residual Anglian pottery in contexts of later date also included Bardorf Ware and Northern French Black Ware. The nature of the finds suggests the site had similar functions to 46–54 Fishergate, where abundant evidence for craft/industrial production, and trade both with other parts of Britain and continental Europe, was seen (AY 7/1, 71–3).

There was clear evidence that the settlement at Fishergate was re-organised in the later 8th or early 9th century and soil from domestic middens mixed with charcoal was spread across the site to seal it (*ibid.*, 50). The settlement was subsequently re-occupied, though on a lesser scale than before, and without the evidence for foreign contacts and trade. It is possible that the levelling deposits of Group 27 at Dixon Lane/George Street followed by re-occupation in the form of Building 7, may mirror this pattern, though a lack of good dating evidence makes this impossible to prove.

Clearly there are broad similarities between the remains seen at Dixon Lane/George Street and 46–54 Fishergate, suggesting that they follow similar patterns of development, and probably represent part of a single *wic* or trading settlement. For plans of Phase 5 see Figure 8 and Figure 11.

### 3.5 Phase 6 Anglo-Scandinavian

Anglo-Scandinavian activity is divided into three sub-phases on the basis of the date of the pottery recovered. For each sub-phase the majority of the contexts excavated were pits and associated backfills. There were some post-holes but none were in patterns suggestive of buildings. Although no clear evidence for Anglo-Scandinavian structures was found, the sheer number of rubbish pits present throughout this period indicates that a settlement must have been located nearby. It is possible that the buildings associated with these pits may have fronted onto the proposed Roman road c. 50m to the south of the site (OS 1988), with Dixon Lane/George Street representing associated disposal of rubbish.

It is of interest that settlement was continuous throughout the Anglian and Anglo-Scandinavian periods. Kemp noted that in the mid-9th century the settlement at 46–54

Fishergate was abandoned at the same time as intensive settlement began at the 16–22 Coppergate site, and suggested that this reflected a desire to move closer to the walled area of the city in the light of Viking aggression. Similar abandonment of extra-mural settlements in favour of occupation within walled areas was seen at both London and *Hamwic* in the mid-9th century (AY 7/1, 83). The Dixon Lane/George Street site clearly does not fit into this pattern; it was not abandoned despite the fact that its position on the River Foss would have made it highly vulnerable to any waterborne aggression. This suggests that defence was not a primary consideration for the settlement here.

The most extensive and detailed excavation of Anglo-Scandinavian levels in York took place at 16–22 Coppergate, located c. 360m to the north-west of the Dixon Lane/George Street site. The three Anglo-Scandinavian sub-phases seen at Dixon Lane/George Street equate to Phases 4b, 5a and 5b at 16–22 Coppergate in terms of date (AY 17/12, 1976). It is unfortunate that no structures survived at Dixon Lane/George Street as this makes comparisons with the Coppergate material difficult.

There is evidence from Dixon Lane/George Street that the site was primarily domestic throughout, but the artefacts suggest that there was a marked increase in the disposal of industrial waste from the 10th century onwards (bone-, antler- and horn-working, iron-working, copper-working and textile production), which may indicate a change of function for any adjacent settlement. All these activities were seen at the Coppergate site, though a far wider range of crafts was represented there, and the evidence suggests a far greater density of craft-working activity. Dixon Lane/George Street lacked evidence for the widespread international trade that was provided by imported goods at Coppergate, such as lava quernstones and pottery from the Rhine, Norwegian schist stones for hones, amber from the Baltic, or silk from Byzantium (AY 16/5, 477-84; AY 17/11, 1825-6 and AY 17/14, 2605-9). Dixon Lane/George Street therefore seems to be less commercial and industrial in nature than 16–22 Coppergate, perhaps representing an outlying, primarily domestic settlement, though it is possible that the differences seen may simply be a reflection of a less intensive pattern of settlement at Dixon Lane/George Street rather than a difference in function.

Analysis of the contexts with finds from the Anglo-Scandinavian period at Dixon Lane/George Street showed that there were high levels of residuality throughout (see Table 2 below). For this reason the animal bones from the deposits were not analysed, as they were probably of mixed date. There was also clearly contamination of many deposits with human bone from cemetery levels above. The presence of an animal burrow among the Anglo-Scandinavian deposits suggests one method by which this contamination occurred.

**Table 2 Finds from Anglo-Scandinavian contexts**

	number of contexts with finds	% with residual material	% with later contamination	% with industrial waste
Mid-9th–10th century	22	81.8	18.2	9
10th century	19	47.4	31.6	36.8
10th–11th century	36	55.5	25.0	38.9

### 3.5.1 Sub-phase 6a (mid-9th–10th century)

Of the 117 contexts in this sub-phase, just 22 contained artefacts. There was clearly a high degree of residuality, with eighteen contexts containing residual Roman material (pottery, CBM, plaster and glass); there was also evidence of contamination from later material (two contexts contained human bone, and two contexts contained a fragment of 13th- to 16th-century CBM). There is no clear evidence for manufacturing in any of the contexts from this phase. The contexts contained a mixture of animal bone, pottery, iron nails, daub, shell, residual Roman material, a lead strip and slag. The tiny quantity of slag was present in just two contexts; in one case the material could be residual, while in the other it could represent contamination from later pits containing slag. Some of the pottery was also suggestive of domestic use (see 4.2).

Groups 16, 30 and 79 formed a sequence of heavily intercut pits up to 3 x 2.5m in size. It is clear from their backfills that these pits were not rubbish pits as only five of the 52 contexts in these groups were associated with artefacts (Contexts 1086, 1387, 1709, 2057 and 2062) and in each case the quantity involved was small. The pits were dug into pure clay, but were for the most part backfilled with the same clay, redeposited. Clearly, therefore, they were not clay pits and their function is unclear. For a plan of Phase 6a see Figure 12.

### 3.5.2 Sub-phase 6b (10th century)

Superficially the 10th-century contexts on site resembled those of mid-9th- to 10th-century date, largely comprising pits with a few random stake- and post-holes and a badly truncated cobble surface. None of the features formed clear patterns suggestive either of buildings or of specific zones of use.

There was residual material within nine of the 45 contexts of this date, consisting mainly of Roman material (pottery, CBM, glass and a coin [SF179]), but there was also a coin dating to AD 841–50 (SF117). There was contamination from the medieval cemetery above, with six contexts containing human bone. Some contexts of this date were directly below contexts of 19th-century or later date, so unsurprisingly one context was contaminated by a fragment of modern wall tile.

Despite the similarities between features of the mid-9th–10th century and the 10th century (i.e. mainly pits), there was clearly a change in function. Seven of the 10th-century pit fills contained evidence for the disposal of manufacturing waste including bone comb-making debris, antler-working offcuts, horn cores and slag. Although there were no structures associated with these pits, the implication is that there was an adjacent settlement involved in craft industries similar to those seen at 16–22 Coppergate. It must be noted, however, that there were more contexts that contained debris typical of domestic rubbish disposal than contexts with industrial waste. The domestic rubbish included animal bone, shell, pottery, iron objects (largely nails), iron fragments, a bone needle and copper alloy fragments. This would imply that manufacturing, though present, was not the sole or dominant activity in the area. For a plan of Phase 6b see Figure 13.

### 3.5.2 Sub-phase 6b (10th century)



Superficially the 10th-century contexts on site resembled those of mid-9th- to 10th-century date, largely comprising pits with a few random stake- and post-holes and a badly truncated cobble surface. None of the features formed clear patterns suggestive either of buildings or of specific zones of use.

There was residual material within nine of the 45 contexts of this date, consisting mainly of Roman material (pottery, CBM, glass and a coin [SF179]), but there was also a coin dating to AD 841–50 (SF117). There was contamination from the medieval cemetery above, with six contexts containing human bone. Some contexts of this date were directly below contexts of 19th-century or later date, so unsurprisingly one context was contaminated by a fragment of modern wall tile.

Despite the similarities between features of the mid-9th–10th century and the 10th century (i.e. mainly pits), there was clearly a change in function. Seven of the 10th-century pit fills contained evidence for the disposal of manufacturing waste including bone comb-making debris, antler-working offcuts, horn cores and slag. Although there were no structures associated with these pits, the implication is that there was an adjacent settlement involved in craft industries similar to those seen at 16–22 Coppergate. It must be noted, however, that there were more contexts that contained debris typical of domestic rubbish disposal than contexts with industrial waste. The domestic rubbish included animal bone, shell, pottery, iron objects (largely nails), iron fragments, a bone needle and copper alloy fragments. This would imply that manufacturing, though present, was not the sole or dominant activity in the area.

For a plan of Phase 6b see Figure 13.

### **3.5.3 Sub-phase 6c (late 10th–early 11th century)**

The contexts of late 10th- to 11th-century date again largely comprised pits scattered across the site, though there were also three hearths. Again, there is no clear evidence either of zones across the site or of buildings. Analysis of samples from two of the hearths produced small quantities of slag and cinder, but also charred grain, fish and animal bones. Despite the presence of the organic remains the hearths were probably of an industrial nature (McComish 2006, 59) and probably relate to smithing rather than iron smelting (see 4.4.6).

As with the earlier Anglo-Scandinavian contexts there was a high degree of both residuality and contamination within the 10th- to 11th-century contexts; of 76 contexts with finds, twenty contained residual Roman and Anglian material while nine were contaminated with human bone. Fourteen of the contexts of this date produced evidence for craft industries in the form of iron slag, copper alloy slag, bone offcuts, antler offcuts, horn cores, two crucibles (probably for glass-making) and a loom weight. For a plan of Phase 6c see Figure 14.

### **3.5.4 Sub-phase 6d burial ground (early–mid-11th century)**

Thirteen graves were interpreted as being of pre-Conquest date. The pottery dating for the sub-phase as a whole was late 10th century, but six of the burials were above features dating to the late 10th–11th centuries; they should perhaps therefore be seen as occurring in the 50 years before the Norman Conquest.

The graves were aligned west-north-west to east-south-east, which was notably different from the alignment of the burials in Phase 8, which varied from east–west to east-north-east/ west-

south-west, suggesting they are of differing periods. Similar changes in alignment relating to phasing have been seen at other sites; for example, at York Minster the pre-Conquest graves were aligned to the underlying Roman buildings while the later burials were aligned to the Anglo-Norman and later cathedral (Phillips and Heywood 1995, 81). At Wells, Somerset, burials post-dating AD 1200 were aligned to the present cathedral, while earlier burials followed the alignment of the Anglo-Saxon cathedral (Rodwell 1989, 147).

Although the foundation date for St Stephen's church is unknown, the dedication is more common in the post-Conquest period (Farmer 1996, 441). It has been noted that boundaries seem to have been added to cemeteries at the time when these sites also become places of worship (Richards 2002, 203). If the Phase 7 ditch, which is of Norman date, is seen as relating to the founding of St Stephen's church, it is of interest that while the Phase 8 burials clearly relate to the ditch, the Phase 6 burials do not. This may imply that the Phase 6 burials pre-date both the church and the associated cemetery boundary ditch.

The Phase 6 burials need not have been associated with a church. Many examples of cemeteries without churches are known: in Lincolnshire there are examples at Swaby, Fillingham, Whitton, Torksey, Hackthorn and Normanby-le-Wold, and there was a cemetery of 660 burials with no associated church at Newcastle-upon-Tyne (Hadley 2002, 222). In addition, no canon laws are known from the period requiring burial in a churchyard (Richards 2002, 202).

The siting of the cemetery above a domestic settlement site can be compared with other sites, for example at Holton-le-Clay, Lincolnshire, where a Middle Saxon domestic settlement was overlain by a Late Saxon cemetery (Hadley 2002, 218).

The burials were all interred in individual grave cuts; this is standard for burials between the 7th and 11th centuries, though exceptions are known such as Ailcy Hill, Ripon, and St Andrew's, Fishergate, York (Hadley 2001, 106).

Three of the graves seem to have been marked, though whether by wooden posts or upright stones is unclear. Post-holes for wooden markers were excavated at Raunds Furnells, Northamptonshire, and at St Mark's Wigford, Lincoln (Daniell 2002, 242), and, although of a later date, wooden crosses are depicted in medieval illustrations of Christ's crucifixion (Daniell 1997, 148). Upright stone markers are known from a pre-11th-century cemetery at York Minster (Phillips and Heywood 1995, 84).

There were no clear rows or patterns within this group suggestive of deliberate cemetery planning. This is in contrast to the burial rows seen at the pre-11th-century cemetery at York Minster (Phillips and Heywood 1995, 81) and at the 10th- to 11th-century cemetery at St Andrew's Fishergate, York (AY 12/2 1993, fig 33). Although there was plenty of land available for burial, some of the graves were located close together. There is one example where a male burial overlies that of a child; as the earlier burial may have been marked at the head end, this seems deliberate. There is also an example of a female and child close to one another; it is impossible to know if this represents the desire to be buried close to a relative. It is also possible that a male burial containing redeposited human bones had disturbed an earlier grave, but as the bulk of this grave was beyond the limits of excavation it is impossible to be sure.

The thirteen graves in Phase 6 exhibited a wide range of mortuary practices. Three burials were definitely in coffins, a further eight were probably coffined, and one had clench bolts indicative of timber above the skeleton. Only one burial seemed to be uncoffined. The group also included a burial with head-support stones sometimes known as ear muffs, a burial with a possible stone lining around a coffin, and one with redeposited human bones lining the grave cut. Two graves were infilled with pure clay, a characteristic not seen among any of the Phase 8 burials, and one grave cut was empty except for an adult scapula. There were also six different arm positions among this group, clearly showing that they were not laid out for burial in a uniform way.

Burial practices clearly varied greatly within this cemetery. Similarly diverse burial methods are seen at other pre-Conquest cemeteries, both within York and further afield (those examples within York being the most directly comparable with the Dixon Lane/George Street site). The pre-11th-century cemetery at York Minster included evidence for burials with stone markers (both recumbent and upright), wooden coffins, possible re-use of domestic chests as coffins, one burial with possible re-used boat timbers and head-support stones, burial on a plank or bier, burials (both coffined and uncoffined) on beds of charcoal, burial on a bed of mortar, the use of head-support stones, and stone-lined graves (Phillips and Heywood 1995, 81–7). At St Andrew's, Fishergate, York, a 10th- to 11th-century cemetery, though less diverse than that at York Minster, contained double burials, a triple burial, evidence for wooden coffins, a burial in a re-used domestic chest which seems to have been covered with a pall, a tightly bound burial, a decapitated burial with head-support stones, and an infant with a stone grave marker (AY 12/2, 131, 133, 153). At St Benet's Swinegate, York, while the majority of burials were in wooden coffins, one was buried in a hollowed-out tree trunk and two were beneath wooden planks (Panter 1994, 31). St Peter's church Barton-upon-Humber, Lincolnshire, also provided evidence of a burial in a hollowed-out tree trunk and one possibly on a re-used bed (Panter 1994, 30). Hadley's summary of 9th- to 11th-century burial practices includes a number of cemeteries, such as St Mark's, Lincoln, Newark (Nottinghamshire) and Barton-upon-Humber (Lincolnshire), each of which exhibited a variety of burial practices including wooden coffins, uncoffined burials, stone cists or grave linings, head-support stones, charcoal burials, upright stone markers and post-holes for wooden markers (Hadley 2002, 219–20). It is clear, therefore, that the Dixon Lane/George Street pre-Conquest burials fit into a widespread pattern of variable burial rites within a single cemetery seen from the 9th to 11th centuries. A lack of legislation relating to burial practices suggests that the Church was not especially concerned about the precise method of burial at this time (Daniell 1997, 174).

The original depth of the individual grave cuts in this phase is unclear due to the heavy truncation of many. The less truncated examples were relatively shallow, ranging from 0.22 to 0.45m in depth. One grave cut for an adult female burial (Set 312) is notably wider than the others, though whether this related to the status of the person in life is unclear. The shape of the grave cuts implies that all, with the exception of Set 275, were dug to accommodate wooden coffins.

One burial had a possible stone grave-lining (Set 282); this, however, was largely outside the area of excavation, and the upper portions of the grave had been severely truncated, so the precise form is unclear. The surviving portion comprised two flat limestone fragments 0.10 x

0.15m in size, set on edge adjacent to the lower right leg of the skeleton, and a cluster of cobbles adjacent to the left foot. Linings are fairly common in pre-Conquest and early post-Conquest graves. As already mentioned stone-lined graves were seen at York Minster, while half of the burials in the early 10th- to late 11th-/early 12th-century churchyard at Raunds Furnells, Northamptonshire, had stones arranged in the grave (Boddington 1996, 38). Stone-lined burials were also seen at Fillingham, Lincolnshire, St Mark's Lincoln, Newark, Nottinghamshire (Hadley 2001, 106), and at Mitre Street, London, where the majority of the 66 burials were in stone- or mortar-lined graves (Daniell 1997, 162). The function of such linings is debatable; they could simply be to protect the burial, possibly from later intercutting, but they could also reflect the deceased's social status during life. While less prestigious than burial in a monolithic stone coffin, stone linings may have represented one step further up the social ladder than burial in a wooden coffin.

A single child burial had head-support stones (ear muffs) to either side of the skull. Ear muffs are commonly found in cemeteries of pre-Conquest to 12th-century date, for example at Kellington, Yorkshire (Mytum 1993, 16), Raunds Furnells, Northamptonshire (Boddington 1996, 39), Fillingham, Lincolnshire, and Newark, Nottinghamshire (Hadley 2001, 106), and Repton, Derbyshire (Hadley 2002, 214). Various reasons have been suggested for the placing of such stones around the head. They could be purely practical, representing an attempt to keep the skull in place (the skull frequently detaches from the body during the processes of decay). The fact that stones were used to hold a decapitated skull in the position in a burial at St Andrew's, Fishergate, may lend weight to this idea (AY12/2, 153). Evidence has been found which shows that such stones could support pillows stuffed with organic materials, which may suggest an alternative function in some cases (Rodwell 2005, 188). Another possibility is that the stones were placed in the grave as an act of repentance; this idea is discussed more fully in Phase 8. Alternatively, the presence of such stones may relate to beliefs in a bodily resurrection at the Last Judgement; such a belief would require the body to rise to face Christ, and the stones would help to keep the head in the correct position to achieve this goal. The growing use of head niches within monolithic stone coffins from the 9th to the 12th centuries may also be a reflection of this idea (Daniell 1997, 180). The fact that the ear muffs in this case are associated with a child is of interest, since they are normally associated with adults (Gilchrist and Sloane 2005, 138).

As no wood was preserved on the site, direct evidence for coffins is not present; the shape of the grave cuts and position of the bodies suggests, however, that all but one were in wooden coffins. Nails were only found in three graves but this need not indicate a lack of coffins; all-wood coffins have been seen on other sites of a similar date range, notably at St Benet's, Swinegate, York, and at St Peter's, Barton-upon-Humber, Lincolnshire (Panter 1994).

The burial associated with clench bolts (Set 269) is of particular interest as it adds to a small number of such burials found across Britain. The clench bolts of Set 269 together with five iron nails formed a cross shape above the body; none was found beneath it. This may imply that a pair of timbers from a clinker-built boat were cut to size and placed above the body as a cover. Alternatively, the arrangement of the bolts and nails in a cross shape may suggest a decorated wooden cover above the burial rather than a fragment of a boat.

Other sites have yielded burials associated with clench bolts. At Caister-by-Yarmouth, Norfolk, nine graves were associated with clench bolts spread above the body implying that boat timbers were re-used as covers (Kjølbye-Biddle 1995, 503), and one grave at Caister-by-Yarmouth had bolts beneath the body implying planks had been used as a bier (Richards 2002, 162). Other evidence for the re-use of parts of ships comes from York Minster where clench bolts found beneath a burial were interpreted as part of a boat re-used as a bier (*ibid*, 500). Burials with clench bolts at St Peter's, Barton-upon-Humber, Lincolnshire, were interpreted as being lined with sections taken from clinker-built boats (Rodwell 2007, 23). Clench bolts are also known in association with burials at Catfield and Thorpe-by-Norwich, both in Norfolk, Jarrow and Monkwearmouth in Tyne and Wear, and Cnoc nan Gall and Kiloran Bay on Colonsay (Kjølbye-Biddle 1995, 503). It is of interest that all of the examples cited were within the Danelaw or in areas settled by Vikings. The use of loose timbers, though not boat timbers, as burial covers is also known elsewhere in the pre-Conquest period. For example, at the cemetery of St Benet's, Swinegate, York, two infant burials (excavated by the author) each had a plank placed above them, and in one case a 'nine Men's Morris' game had been incised onto the board.

One of the grave cuts, which seemed to have had a grave marker, was found to be devoid of skeletal remains save for an adult scapula (only the western half the grave survived due to later truncation). Empty graves have been noted on other sites: nine empty graves were excavated at an 8th- to 10th-century cemetery at Addingham (West Yorkshire) and it has been suggested that these were the result of deliberate exhumation and re-interment elsewhere as the focus of the cemetery moved eastwards (Adams 1996, 163).

Three of the graves contained redeposited human remains, and in two of these the bones clearly could not have come from the disturbance of earlier burials at that very spot (Sets 263 and 275). The 55 graves at Addingham contained the bones of 80 individuals; the 'extra' bones were not the result of redeposition following intercutting, which clearly implies that bones were exhumed from elsewhere for deliberate reburial within the graves seen (*ibid*, 151). The redeposited bones in the Dixon Lane/George Street cemetery suggest that a similar practice may have occurred here.

There is no surviving evidence for how these bodies were dressed for burial and no grave goods were recovered.

The backfilling of two of the graves with pure clay is of interest; the purity may suggest that the material was poured into the grave in a liquid form, possibly deliberately to seal it. It may be that this was to prevent contamination from disease, or there may have been some more symbolic motive.

The group of thirteen burials comprised four males or possibly males, two females, two unsexed adults, two adolescents and three children; children seem to be under-represented in this group. It is clear that no specific zones were being set aside for burials of a particular sex or age. The number of burials was too small to assess links between specific burial practices or burial positions, but it was noted that the most variable group in terms of burial rite were the children/adolescents; all five differed both from one another and from most of other graves

within the group (one with head-support stones, one with a possible grave marker, one with timber/s above the body and a possible grave marker, one uncoffined and one with a possible stone lining). The males were slightly less variable, all being coffined, but one had redeposited human bones arranged along the edge of the cut and two were backfilled with pure clay. The two female burials were not unusual in any way. For a plan of Phase 6d see Figure 15.

### 3.6 Phase 7 Norman

The principal feature of this phase is a V-profiled ditch c. 1m wide and 0.75m deep, aligned east-north-east to west-south-west, which has been interpreted as the boundary ditch for the graveyard of St Stephen's church. As noted above, it has been suggested that cemeteries were often enclosed when a church was first built; since the ditch seems to be of Norman date, this may imply that the church of St Stephen was a post-Conquest foundation. The fact that a few burials were stratigraphically above this ditch suggests that it was eventually infilled to create additional space for burials; presumably a new cemetery boundary was created further north. The presence of a boundary ditch around the cemetery is typical of medieval churches. The need for a suitable boundary is mentioned frequently in statutes, reflecting the need to keep animals out of the graveyard (Daniell 1997, 110–11). The fact that George Street's original name of Nowtgail refers to cattle may have made this a particular requirement for this church.

The Phase 8 burials clearly correlate in terms of layout with the Phase 7 boundary ditch, but the stratigraphic links between them were impossible to prove in most cases. The precise relationship of individual burials to the ditch is therefore unclear.

There was a scatter of non-burial features of Norman or later date (two post-holes and two pits); these were of uncertain interpretation.

No trace of St Stephen's church was found within the excavated area, nor was it seen in earlier excavations to the south of Dixon (formerly Church) Lane. It seems most likely therefore that the church was located to the immediate north of Dixon Lane, and south of the excavation area. The church would have been sited upon a naturally occurring ridge of higher land, both away from the dangers of flooding and clearly visible from the river. All trace of the church was destroyed by extensive levelling that preceded the construction of a brewery in the late 19th century.

Stratigraphically the Phase 6d and Phase 8 cemeteries at Dixon Lane/George Street seem to form a continuous sequence. If the church of St Stephen was indeed post-Conquest this suggests that the church was deliberately sited within an existing cemetery. The placing of a church above an earlier cemetery has been noted elsewhere, in both the 10th and 11th centuries. At both Barrow-upon-Humber and Barton-upon-Humber in Lincolnshire, Late Saxon churches were sited above existing cemeteries (Hadley 2001, 30), while at Kellington, Yorkshire, and Holton-le-Clay, Lincolnshire, late 11th-century churches were placed above cemeteries of 10th- to early 11th-century date (Mytum 1993, 16; Hadley 2001, 31). In all these cases the earlier cemetery could have been associated with a church of which no trace survives. As early as 960–62 a law-code of King Edgar distinguished between churches with graveyards and those without them (Hadley 2001, 36); a burial ground around a church brought greater status and lucrative burial rights. It is known that increasing numbers of churches were being founded in the 10th and 11th centuries, and it is possible that the

deliberate siting of a new church above an existing cemetery may have been an attempt to gain status and burial rights for the church. For a plan of Phase 7 see Figure 16.

### **3.7 Phase 8 The cemetery of St Stephen's church (later 11th–mid-14th century)**

A total of 105 burials and five empty grave cuts were identified from the cemetery of St Stephen's church, Fishergate. For plans of Phase 8 see Figure 17.

#### *3.7.1 Chronological change*

The timespan covered by the cemetery (late 11th to early 14th century) is of interest because, though relatively short, it encompasses two major episodes of change. The first change came with the Norman Conquest. Excavations elsewhere have revealed that this event, though politically devastating, had a negligible effect upon burial methods. Many of the burial rites seen in pre-Conquest cemeteries, such as stone grave linings, head-support stones and the use of charcoal or mortar bedding within graves, continued unchanged. The second episode of change was theological, relating to the development of the idea of purgatory. Prior to the 12th century it was believed that the dead would rise up on the Day of Judgement to face Christ; quite what happened to the soul between death and judgement was debatable, with some scholars suggesting that the soul rested in the grave, others that they went to the bosom of Abraham (Daniell 1997, 176). From the 12th century onwards the idea that the soul had to be purged before reaching heaven grew in popularity, developing into the notion of a specific place for purging (purgatory). This finally became official church doctrine in 1254 (*ibid.*, 177). This led to a fundamental shift in religious practices with an emphasis on a bodily resurrection being replaced by the need to remember the souls of the dead and to pray for them in order to ease their time in purgatory. Daniell believes that this shift in belief was responsible for a change in burial practices seen towards the end of the 12th century. For while burials of the 13th–15th centuries still exhibit variation in terms of the use of coffins, the position of the body in the grave and even the occasional inclusion of grave goods, most of the earlier burial methods, such as head-support stones and the use of charcoal or mortar bedding within graves, largely ceased by the 13th century. Care for the bones within a grave was to an extent replaced by increasing emphasis on above-ground display in the form of tombs to encourage prayers for the dead (Daniell 2002, 253–4).

While the burials of Phase 8 are clearly less varied in terms of grave type than those of Phase 6, it is of interest that six burials had cobbles deliberately placed in the graves, one had carefully placed animal bones and a cobble within the grave cut, while another had disarticulated human bones arranged within the grave cut. These variations suggest a pre-13th-century date for sixteen of the graves (both those listed and those stratigraphically beneath them). They also confirm the picture seen elsewhere of pre-Conquest rites continuing after the Norman-Conquest. They also suggest, however, that for the group as a whole, burial rites were becoming more uniform throughout the period of cemetery use, which confirms the pattern seen elsewhere. If Daniell is correct this may reflect the growth in acceptance of the idea of purgatory.

#### *3.7.2 Layout of the cemetery*

Burials are often assumed to increase in density the closer to the church they are located. Unfortunately, the original density of burial is uncertain over much of the southern and

western portion of the site; burial density cannot, therefore, be used to predict the location of the church. The greatest density of burial was seen adjacent to the north-western edge of the excavation. There were a number of deep underlying pits in this area backfilled with soils that were considerably softer than the surrounding ground; this may have made the area more desirable for the gravediggers as it was easier to excavate grave cuts in the area.

It is difficult to determine if there were ever areas devoid of burial within the cemetery which might indicate the position of graveyard features such as crosses, or of areas that were not favoured for burials. The north-easternmost portion of the cemetery does seem to have had a lower density of burials, and this was not due to truncation; elsewhere it is impossible to determine the original layout. As far as it is possible to determine, there are no obvious paths or access routes through the cemetery.

Although the precise location of St Stephen's church is unknown, it seems to have been to the north of Dixon Lane. The excavated burials, indeed the bulk of the churchyard, must have been located to the north of the church. While modern superstition is that the northern side of the church is less desirable for burial, this does not seem to have been the case prior to the 16th century (Daniell 2002, 244) and was certainly not the case in this instance.

The excavated burials were clearly outside the church, but this need not be a reflection of the status of the people concerned. Burial within the church was relatively rare before the 13th century (Binski 1996, 57), and many of these burials must have been of pre-13th-century date.

It is often difficult to determine whether graves within medieval cemeteries were laid out in a logical way, for example in closely packed rows. Where cemeteries were in use for a relatively short timespan it is often clear that they were fairly well organised. At Raunds Furnells, Northamptonshire, for example, a cemetery of 10th- to 12th-century date was mainly laid out in rows (these were often curving or irregular in shape), though there was a small area to the east of the church where burial was in a less ordered pattern (Boddington 1996, 54–4). Cemeteries that were in use for prolonged periods are more problematical, as the constant recutting of the ground tends to obscure any patterns. If a burial row is determined by the skulls of adjacent skeletons being aligned, then analysis of this cemetery suggests that there may have been some rows. From south-east to south-west across the site possible rows are Row 1 = Sets 358–9; Row 2 = Sets 314 and 317; Row 3 = Sets 309 and 316; Row 4 = Sets 295 and 308; Row 5 = Sets 245, 307, 319, 345 and possibly 224; Row 6 = Sets 297 and 348; Row 7 = Sets 294, 296 and 313; Row 8 = Sets 298–9; Row 9 = Sets 327–30; Row 10 = Sets 226, 230, 232, 325 and 353; Row 11 = Sets 331 and 336; Row 12 = Sets 236 and 335; Row 13 = Set 237, 333, 338 and possibly 221; Row 14 = 187, 254, 321 and 337; Row 15 = Sets 255 and 339; Row 16 = Sets 238, 248, 253 and 312; Row 17 = Sets 247, 323 and 346; Row 18 = Set 38, 233 and 252; and Row 19 = Sets 279–80. In many cases these are far from convincing, as they represent just pairs of burials. Most of the burials do not fall into clear rows, especially at the western end of the cemetery, which has a chaotic arrangement. The possible rows can also be combined in an infinite number of ways, so they are of little help in determining the overall development of the cemetery; for example, Row 5 is below Row 4, which is below Row 3 which is below Row 2; Row 5 is also below Row 7, but Row 7 could relate to any or none of Rows 3–5.

It is impossible to know if people were buried in the cemetery on a first-come-first-served basis or were placed in relation to other family members. Research into post-medieval



gravestones in English churchyards often shows a clear preference for burial close to other family members, but in the absence of headstones this is impossible to detect without DNA analysis (Parker Pearson 1999, 14). Daniell's research into medieval and post-medieval wills also clearly shows that family ties featured strongly in burial requests, with wives and husbands, parents and children, and siblings requesting burial together; in a few cases burial was requested near an uncle (Daniell 1997, 101–2). Their desire for burial near a close relative may have existed earlier in the medieval period; the few examples at Dixon Lane/George Street where one burial lies directly above an earlier burial (Sets 315 and 317, and Sets 270, 273 and 276) may represent the desire to be buried in a family plot, though they could also be purely coincidental.

### 3.7.3 *Burial zones*

There is no clear evidence of zones of burials in terms of gender, with male and female burials evenly spread throughout the cemetery. Children/adolescents are also present across the site, though they are more common in the western half of the excavation.

Children/adolescents below the age of eighteen made up 21% of the burial population. The proportion of children to adults that might be expected in a pre-industrial society has been estimated at 50:50 (Daniell 1997, 125), so clearly there are fewer children present than would be expected. This is especially striking for children under the age of one, who are totally absent from this cemetery. Analysis of the disarticulated bones showed that some foetal and infant bones were present, but these may account for just two foetal/neonate individuals and two infant individuals (see 4.6.6). The absence of very young at the site cannot therefore simply be explained as the result of later disturbance. Children are often seriously under-represented in cemeteries; for example, at St Helen-on-the-Walls, York, few babies were recovered, and those that were found were generally buried with adults (AY 12/1, 27), while at St Nicholas Shambles, London, only 17.5% of burials were of 0–12 year olds (Daniell 1997, 124).

There are several possible explanations for this under-representation. Firstly children's bones, especially infant bones, are less robust than those of adults and therefore more prone to decay; for example at St Peter's, Barton-on-Humber, Lincolnshire, grave-like slots containing only a few nails and no bone were interpreted as infant graves from which the bodies had dissolved (Rodwell 2005, 178). In addition to decay, infant burials in shallow graves could be entirely consumed by rats and other burrowing animals. It is also possible that the missing children were simply buried on another part of the site. Examples of clusters of child burials are known elsewhere; at Taunton, for example, most of the infant burials were found at the western end of excavation, at St Margaret's-in-Combusto, Norwich, the few child and infant burials were close to the west end of the church, and at Kellington, Yorkshire, a group of juveniles were located by the east end of the chancel (Daniell 1997, 127). Against this, it must be noted that some cemeteries, though excavated extensively, did not have specific areas reserved for children; for example, St Nicholas Shambles, London, or St Andrew's, Fishergate, York (Daniell 1997, 128). There is some suggestion that children were buried under the eaves of the church so that the rainwater, sanctified by running over the church roof, would drip onto the children and bless them (Daniell 1997, 128). Unfortunately as there was no church on this site it is impossible to determine if this was the case here.

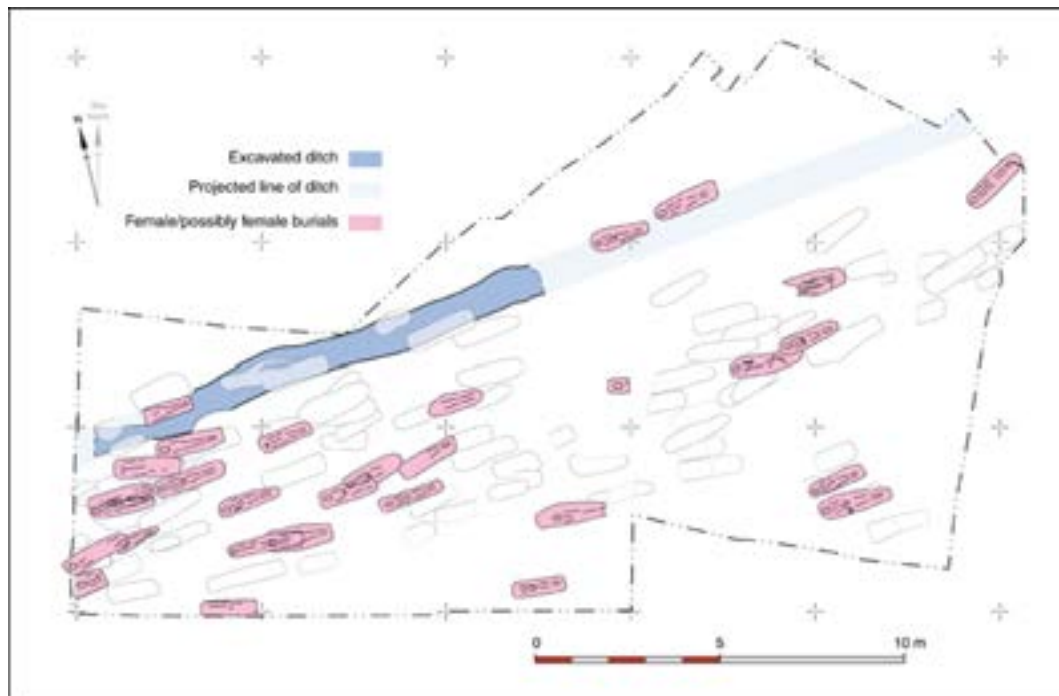

Figure 21 Female and possibly female burials

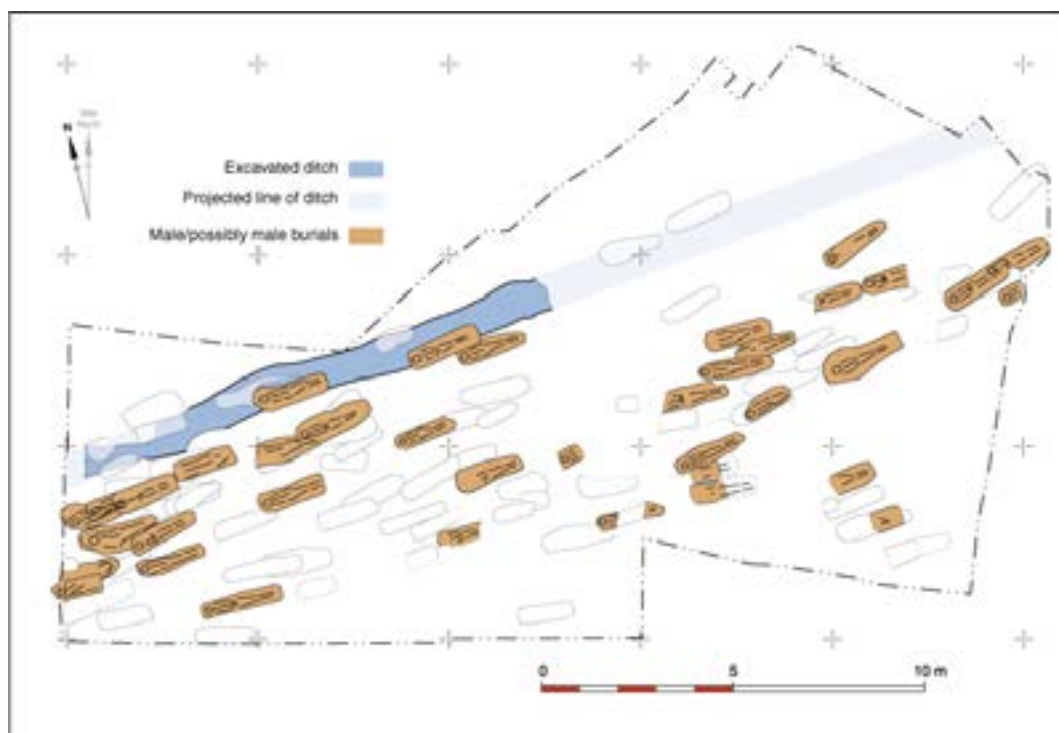
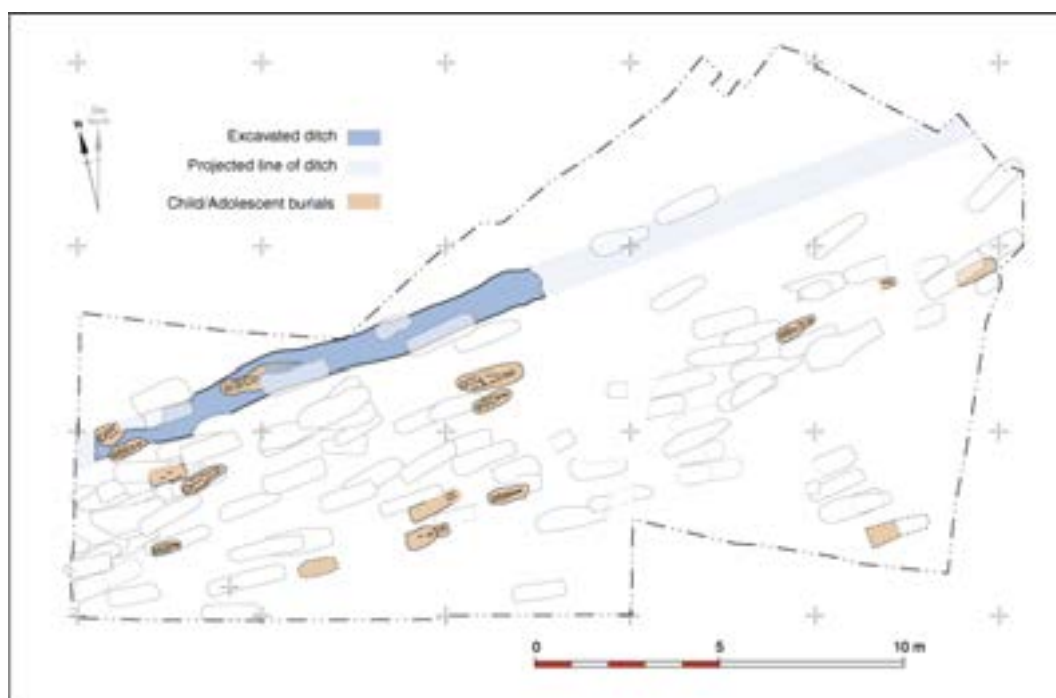

Figure 22 Male and possibly male burials

Documentary sources show that unbaptised children were not allowed burial in churchyards, which may account for the lack of infants and neonates on many sites, including Dixon Lane/George Street. In the 15th century John Kirk wrote 'A woman that died in childing shall not be buried in the church, but in the churchyard, so that the child first be taken out of her and buried outwith the churchyard' (Daniell 1997, 127). In 1398 a royal licence was given to enclose Hereford Cathedral cemetery to stop 'the secret burial of unbaptised infants' (*ibid.*,

127–8). Both these examples imply that unbaptised children were excluded from cemeteries and were buried elsewhere. A group of 24 children excavated at Castle Green, Hereford, in shallow graves with little or no attempt at regularity, were interpreted as being unbaptised infants (*ibid.*, 127–8).



**Figure 23** Child and adolescent burials

#### 3.7.4 Orientation

It is difficult to know precisely what factors determined the placing of graves in the medieval period. There is evidence that while the church building exerted the primary influence on grave alignment, other cemetery features such as crosses, walls and pathways are also influential (Daniell 1997, 148). In the case of the Dixon Lane/George Street burials the boundary ditch seems to have exerted a very strong influence on the alignment of the graves in the cemetery. Even the twelve graves that were stratigraphically above the ditch were still aligned with it. However, one of the most recent graves in the cemetery (Set 357) is noticeably on a different alignment, which may imply that the ditch had been obliterated from the landscape by the time this burial was interred.

The precedent of alignment set by existing graves must also have exerted a strong influence upon the orientation of subsequent burials. At St Andrew's, Fishergate, York, graves were consistently aligned within ten degrees of one another (AY12/2, 145), and the graves at Dixon Lane/George Street must inevitably have followed this trend.

All of the burials had the head at the western end of the grave, which was standard practice throughout the medieval period. The placing of the head at the western end was, according to the 13th-century liturgist Durandus, Bishop of Mende, so that the dead were pointing in the right direction to stand up and face Christ at the Day of Judgement (Binski 1996, 56).

A few of the burials were located above the cemetery boundary ditch, and the most logical explanation is that as pressure for space increased the ditch was infilled to create room for

more burials. There is, however, another possibility. It could be that these burials represent people who were socially excluded in some way. In the early 15th century the Augustinian John Mirk wrote that women who died in childbirth, thieves who had not made 'satisfaction' or were slain whilst thieving, lechers and the cursed were excluded from burial. John de Burgo listed pagans, heretics and the excommunicated as people excluded from burial (Daniell 1997, 103). It is possible, therefore, that these burials may be people who were socially undesirable in some way. One fact which may lend weight to this suggestion is that one of the burials concerned was that of a leper (Set 224). While leper burials are known from medieval cemeteries (Rawcliffe 2006, 204) the positioning of this particular individual at the extremities of the cemetery may be significant.

### 3.7.5 *Intercutting of graves*

Its urban location meant that the cemetery was restricted in terms of area; it could not expand to the north because of a marked slope in the landscape, and was restricted to the south-west and south-east by roads or paths. Lack of space clearly became a problem within the cemetery, forcing later burials to be placed above or cutting into earlier graves. It would even seem that the original boundary ditch was infilled to create further space for burials.

There were no post-holes suggestive of wooden markers in the Phase 8 burials, and the fact that most of the graves were intercut suggests that the earlier burials were either not marked or were marked by a low earth mound which gradually disappeared. It is, however, also possible that pressure of space caused gravediggers simply to ignore earlier graves even when they were visible.

The graves were heavily intercut. Only 19 graves were not intercut or overlain, and even some of these may originally have been beneath other burials that had been truncated in the 19th century. Such intercutting is common in medieval graveyards: at St Nicholas Shambles, London, only 36 skeletons were complete out of a total of 234 (Daniell 1997, 123). At St Helen-on-the-Walls, York, there were even examples of articulated fragments of skeletons overlying later burials, suggesting that the earlier corpse had been disturbed and redeposited before decomposition was complete (AY 12/1, 10). In some cases there is evidence that once the graveyard was full it was deliberately levelled, thereby removing any markers, in order to create an even space for more burials. At Whithorn, Dumfries and Galloway, analysis of burials of late 13th- to mid-15th-century date suggested that once the cemetery was full it was deliberately reorganised by the removal of any markers and possibly levelling of the area, before further burials took place. Five such reorganisations took place over the 150-year period of use of this cemetery, i.e. approximately every 30 years (Hill 1997, 253). There is, however, no firm evidence for deliberate levelling of this sort at Dixon Lane/George Street. Two groups of burials were directly on top of one another (Sets 291–2 and Sets 310–11), and a third group (Sets 270, 273 and 276) were almost directly above one another. This may suggest that the earlier grave in each case was deliberately marked and acted as a focus for later burial in what may have been a family plot. The burials concerned comprise a child and male burial, a male and female burial, and two females and a male.

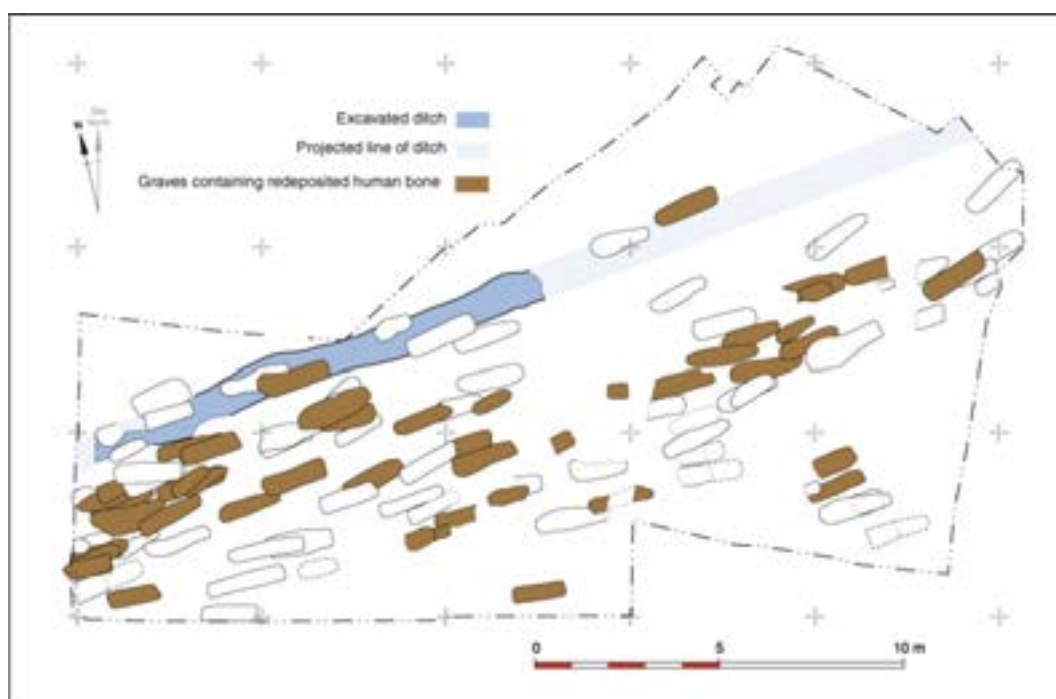

**Figure 24 Graves containing redeposited human bone**

Intercutting is the norm in many medieval cemeteries, notably urban cemeteries where space was at a premium. The total disregard for earlier burials has been summarised as ‘Gravediggers have never been respecters of past interments, and they normally hack through them without concern. Consequently, many ancient burials have been destroyed, the bones now being loose in the topsoil and backfills of later graves’ (Rodwell 2005, 166). In the case of Dixon Lane/George Street 53% of the graves contained redeposited human bones. The fact that the earlier occupants of a cemetery were shown so little respect brings into question the idea that the skeleton had to stay intact until the Day of Judgement; clearly there was little or no attempt to avoid earlier bones. The distribution of the graves containing redeposited bones is of interest: while the majority are from clearly intercut graves, several did not truncate earlier burials (Sets 224, 248, 316, 324–5, 337, 344 and 349) and one just clipped an earlier grave (Set 247). Set 316 contained redeposited remains from two children, a juvenile and an adult within the grave-backfill, despite the fact it did not truncate any earlier graves. These graves imply that random fragments of human bone were widely present across the cemetery area and were randomly incorporated into grave fills. There was only one example where the redeposited bones had been carefully arranged within a later grave; in the remaining 51 examples they were placed randomly in the grave fill. These may be of 12th-century or later date since at Kellington, Yorkshire, any bones that were discovered while excavating new graves prior to the 12th century were treated with reverence, while after that date less care was taken with the disturbed bones which were randomly incorporated into the backfill of the later grave without any particular reverence (Daniell 1997, 146).

### 3.7.6 Burial method

#### **Grave shape, size and depth**

Most of the graves on the site were rectangular, but 22 were either shaped to fit a body or had rounded ends, which suggests that they were not dug to accommodate rectangular wooden

coffins. These less regularly shaped graves were located throughout the site, but there were two clusters (Sets 295, 208–9, 313–14 and 316, and Sets 277, 279–80, 285 and 290). The significance of these clusters is difficult to determine; the fact that burials in both clusters are intercut does, however, clearly show that they were not all buried at the same time. Body-shaped grave cuts did not relate to the age or sex of the individual buried as four were children/adolescents, nine were male and seven were female (the remainder were adults of indeterminate sex).

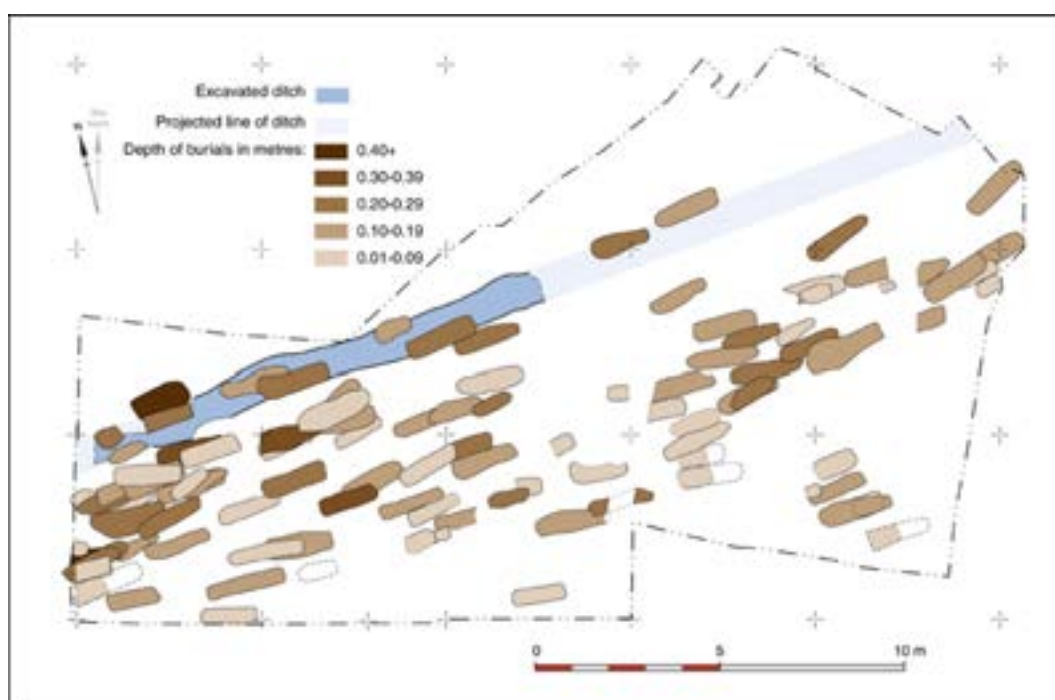

**Figure 25 Depth of Phase 8 graves**

Only two of the graves, both for male burials, were significantly larger than required (Sets 279 and 314), but it is impossible to determine whether the extra size was a reflection of the person's status during life.

The grave depths ranged from virtually nothing to 0.45m deep, but most were less than 0.20m deep. This is clearly largely the result of truncation by later features, but since only eighteen graves were over 0.20m deep it would seem that the graves were, on the whole, fairly shallow. There was no link between grave depth and either the sex or the age of the

### **Empty graves**

There were five cuts on site that were interpreted as empty graves. Empty grave cuts have been noted on other sites, for example at Addingham, West Yorkshire (Adams 1996, 163). Two of the examples at Dixon Lane/George Street are almost certainly empty due to later truncation (Sets 193 and 187), while two more may have been for children whose bones had totally decayed (Sets 221 and 289). The other cut is of a size suggestive of an adult burial, and lay above, though largely to the north of, the cemetery boundary ditch. Why this grave is empty is unclear.

### Inclusions in the grave fill

Seven of the graves had cobbles placed in the grave fill; on a site that was virtually devoid of stones and cobbles their presence is notable. The cobbles were placed at various locations within these graves including to either side of the skull, to one side of the skull, by an elbow or by the feet. Five of these burials were adult males and two were adult females, suggesting that inclusions were more common in male burials. No children/infants were buried in this way. Examples of burials with head-support stones are said by Gilchrist and Sloane to continue to the 16th century but to be more common in the 11th–12th centuries. They also state that there is no clear discrimination by age although no infants have yet been found in association with this rite (Gilchrist and Sloane 2005, 138).

As mentioned in Phase 6 (see 3.5.2), the function of head-support stones can be interpreted as a purely practical means of keeping the head in place during the processes of decay, or to keep the head facing forwards, in order to have a direct line of sight to Christ when the body was resurrected on Judgement Day. Another possibility is that the placing of stones in graves was connected with ideas of penance. An account of the death in 1183 of Henry, Count of Anjou, is of particular interest. As Henry lay dying he was put onto sack-cloth and ashes, had stones placed under his head and feet, and the noose of a condemned criminal around his neck; all of these were signs of penance and repentance (Daniell 2002, 253). Daniell argues that in the early and mid-12th century visible penance was a concern at the moment of death and that ‘a strong case can be made that the grave-goods in the 12th century and by extension back into the Late Saxon era, can be attributed to notions of penance’ (ibid., 252). The fact that the account of Henry’s death specifically mentions stones at the head and feet is of interest because this was where the stones were placed in five of the Dixon Lane/George Street burials – perhaps these could be seen as signs of penance.

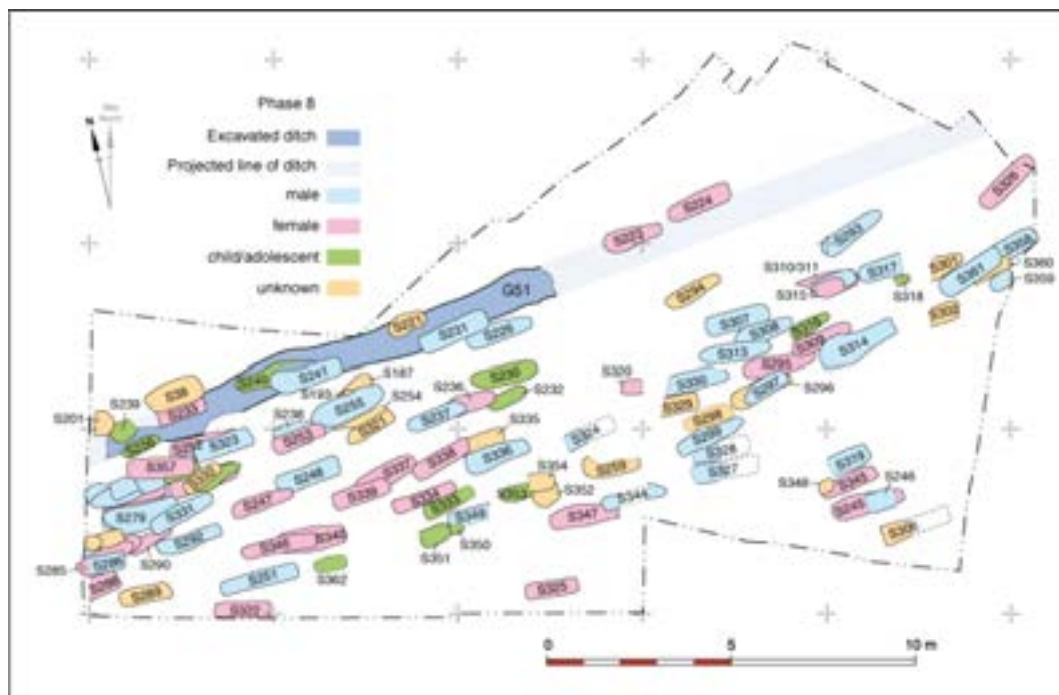

Figure 26 Graves of particular interest

Although occasional medieval graves contain deliberately placed objects, on the whole the dead were buried without grave goods and the Dixon Lane/George Street site fits into this pattern. The only two objects of note recovered from any of the graves were a pair of tweezers and a gold ring set with carnelian; both these objects were of Roman date and clearly represent stray finds within the backfill.

### **Coffins**

Fifty-six of the burials were assumed to be in coffins as they were either in rectangular cuts, or the body had a parallel-sided appearance, or bones had rotated during decay implying that a coffin was present. In addition twenty-two burials had up to two iron nails in the backfill, interpreted as indicating the presence of a coffin. It is not uncommon to find only a few coffin nails in a grave, for example at St Helen-on-the-Walls, York, some graves had fewer than six nails per grave (AY 12/1, 14). Clearly these small numbers of nails could not have held a coffin together and they must have been used in conjunction with wooden pegs or joints. There was no evidence for coffin handles in any of the graves. No wood was preserved on the site, so the form of the coffins is unknown. The size of the grave cuts at the site implies that the coffins, and indeed the grave cuts, were made-to-measure, which has been noted elsewhere, for example at St Mary Sptial, London, and at Hull Augustinian friary (Gilchrist and Sloane 2005, 112).

Twenty-eight of the burials seem to have been uncoffined (either on the basis of the grave shape or the burial position). Lack of a coffin was not related to the sex or age of the person buried.

It might be assumed that the lower jaw would become detached from the skull more often within a wooden coffin, but an analysis at St Helen-on-the-Walls, York, which compared the presence of coffin nails and open jaws showed that this was not a reliable method for determining coffin presence (AY 12/1, 14–15). At Dixon Lane/George Street there were twenty-four burials with open jaws and a parallel-sided body position suggestive of a coffin and only one with an open jaw that was not parallel-sided. This may suggest that there was a link between coffins and open jaws at this site.

### **Dressing the dead for burial**

The only evidence for the way in which the skeletons were clothed for burial consists of a single skeleton in a constricted burial position suggestive of tight binding (Set 291), though it must be noted that the same effect could be achieved in a narrow coffin. An 8th-century style copper-alloy dress-pin was found in one grave (SF183, Context 2051) but this probably represents a stray find within a much later grave fill.

It has been suggested that the lack of evidence for clothing within medieval graves indicates that people were buried naked apart from a shroud (Daniell 1997, 156). Quite what form the shrouds took is unclear. The Bedford Hours (c. 1423) show the shroud tightly wrapped around the body and a stained-glass burial scene from Leicester depicts the shroud as a large piece of cloth put over the head and then tied at the feet (Daniell 1997, 43).

### **Burial position**

There does not seem to be any standard burial position across medieval cemeteries (Daniell 1997, 118). Thirteen burial positions were seen on this site (see 2.3.7), but these can be



divided into four broad groups. Firstly, there are those with the arms straight and hands either by the side or one hand on the pelvis (burial positions 1–3, 39 examples); secondly, those with both hands on the pelvis or over the groin (burial positions 4–6, 21 examples); thirdly those with one or both arms at 90 degrees at the elbow joint (burial positions 7–11, twelve examples); and fourthly those with both arms fully flexed at the elbow (burial positions 12–13, two examples). Burial positions 1–3 form by far the largest group overall; gender does not seem to be a determining factor in burial position. Children/adolescents were far more likely to be buried in positions 1–3 than the adults; whether this reflects greater care taken over their burial is unclear.

**Table 3 Burial position in relation to age and sex (given as a percentage of the total for each group)**

	CHILDREN ADOLESCENTS	FEMALES	MALES
Burial positions 1–3	76%	46%	47%
Burial positions 4–6	18%	31%	33%
Burial positions 7–11	6%	15%	20%
Burial positions 12–13		8%	

One of the female burials (Set 295) is of interest as it was laid partially on its side with slightly flexed legs and both arms fully flexed at the elbow. There is no pathology that might account for the unusual burial position, and it is unclear why this burial alone should have been placed in such a position. The slightly unusual leg positions of Sets 241 and 237 were due in both cases to medical problems.

In terms of skull position, eight had the chin on the chest, sixteen looked directly upwards, eighteen faced the left shoulder and thirteen the right shoulder (the remainder could not be determined). It is probable that those with the jaw on the chest or looking upwards from the grave were buried with the head resting in a natural manner. The skeletons looking right or left may be a reflection of the processes of decay within the grave, with the head rolling sideways under its own weight. Such movement is facilitated if the body is contained within a coffin.

This site did not produce clear evidence for differential decay along the length of a single body which has been noted at other sites such as Jewbury, York (AY 12/3, 353–7).

### 3.7.7 Demography

Generally speaking the smaller the area of cemetery excavation the more difficult it is to draw conclusions about demography. It is clear that this cemetery does not represent a cross-section of the parish it served; only part of the graveyard had survived and even this had been

heavily truncated. In addition, the excavated graves cannot be precisely dated without the considerable extra expenditure incurred by a large-scale programme of radiocarbon dating, so determining a cross-section of the population at any given time is impossible. Another problem is that children, notably infants, are clearly seriously under-represented on this site, preventing any overall analysis of life expectancy within this population.

The average height of the males was 172cm, with a range of 162–81cm; for females the average height was 160cm, with a range of 153–72cm. This is little different from modern British populations: in 1981 the average height of for males was 173.8cm for males and 160.9cm for females (Daniell 1997, 135).

### 3.7.8 *Skeletal features of interest*

#### **Ancestry**

Two of the burials (Sets 230 and 252) have facial characteristics that suggest they may have had non-European ancestry (see 4.6.5). These individuals were not buried in any distinctive way, but both were placed close to the cemetery boundary ditch, which may suggest a liminal position, possibly reflective of status during life (see 3.7.6 Figure 26).

Evidence for non-Europeans within earlier populations is both rare and somewhat contentious. A Roman cemetery in Trentholme Drive, York, had a number of burials with what was interpreted as a negroid physique in terms of limb length, but it was noted that ‘none of these show completely negroid characteristics in their proportions. Inspection of the skulls belonging to the skeletons provides no clear case of a negroid skull associated with a skeleton of negroid proportions’. The conclusion in this case was that the evidence for negroids was ‘therefore again disappointingly natural’ (Wenham 1968, 157). A 10th-century burial at North Elmham, Norfolk, was regarded as being a woman with predominantly negroid genes (Wells and Cayton 1980, 259), while a skull from excavations of the north-east bailey of Norwich Castle was thought to be of a woman who was partially negroid but who shared some facial characteristics with other skeletons in the cemetery (Ayers 1985, 53).

#### **Leprosy**

A single burial (Skeleton 116, Set 224) was identified as a leprosy sufferer (see 4.6.5). Leprosy, which can cause severe disfigurement, is thought to have come to Britain in Roman times and to have persisted until the 16th century. This particular individual would probably have had a skin condition identifiable as leprosy, even though severe deformity was not present.

Contradictory views concerning leprosy were held during the medieval period. On one hand Bernard of Clairvaux regarded severe illness as a divine gift focusing the mind on repentance prior to death. The French surgeon Guy de Chauliac (d. 1368) stated that the clergy should reassure their patients that leprosy was a mark of divine election not a curse (Rawcliffe 2006, 55–7). Comparisons were even made between the bodily torment of lepers and those of Christ during his scourging and crucifixion. St Francis of Assisi converted to a mendicant life on seeing a leper who made him think of Christ (*ibid*, 63). Leprosy could even be seen as shortening the individual’s stay in purgatory, since the leper was undergoing purgatorial torments during life. On the other hand there was the widespread belief that physical illness was the punishment for sin, the corruption of the soul causing corresponding corruption of the body. Leprosy was seen as a punishment for sexual sin and was considered to be a sexually transmissible disease

(Daniell 1997, 204). The corrupt behaviour of the lepers was seen as a threat to the morals and therefore the health of society as a whole. In addition, concern about the danger of physical infection that they posed became apparent in the mid-13th century and increased significantly after the Black Death (Rawcliffe 2006, 102).

Fear of leprosy grew from the 11th century and continued more strongly throughout the 12th, when the church began to legislate for the physical separation of lepers (Cullum 1994, 24). Exclusion by secular law occurred from the 13th century onwards. Lepers were banned from the streets of London by 1200 and again in 1273 (suggesting the original law had not worked) and from the streets of Exeter by 1244 (*ibid*, 29). The first recorded use of a rite by which a leper who refused to go into seclusion could be forcibly removed from the community occurred in 1220 (*ibid*, 29–30). Despite such legislation it is clear that lepers were not always forced to live apart from society; indeed there are examples of lepers who continued with their normal life despite being diseased. King Baldwin IV of Jerusalem (d. 1185) ruled despite his leprosy and was admired for his bravery; comparisons were made between the corruption of his body and the good order of his soul (Rawcliffe 2006, 54). Richard Wallingford, abbot of St Albans (d. 1336), was allowed to continue in his role despite his leprosy, though he was assisted by a coadjutor who assumed many of his duties during the final stages of the disease (*ibid*, 254). Priests who developed leprosy were also allowed to continue until their appearance gave too much offence to their congregations, at which point an assistant was appointed (*ibid*, 266). While some lepers did enter leper hospitals, others clearly stayed in their own homes, being cared for by their families. Between 1369 and 1500 twenty-one out of thirty-six leprous women named in the borough leet rolls of Yarmouth were living with their husbands (*ibid*, 270).

The presence of leper burials in parish church cemeteries is not in itself unusual, as it has been noted in at least 33 other sites (*ibid.*, 204). Documentary evidence suggests that even though the third Lateran Council of 1179 demanded the creation of cemeteries adjacent to leper houses (*ibid.*, 261), the inmates did not always choose to be buried there. For example, the lepers Henry Wellys (d. 1448) and Richard Wellys (d. 1466) both made wills asking for burial in the parish churchyard of All Saints, Norwich, even though they were both living in a leper hospital at the time of death (*ibid*, 263).

The positioning of the leper burial at this site is of interest (see 3.7.6 Figure 26), however, as it is at the very limits of the cemetery, above the projected line of the cemetery boundary ditch, in a marginal position. It is tempting to see this exclusion from the main part of the cemetery in death as reflecting prejudices towards the disease and its sufferers in life.

### **Rickets**

The presence of eleven individuals with evidence of rickets is of interest. Though evidence for this disease has been recovered on other sites including the north-east bailey at Norwich Castle, at Rivenhall, Essex (Daniell 1997, 140), and St Helen-on-the-Walls, York (AY 12/1, 59), it is comparatively rare. The disease is caused by lack of vitamin D in the diet; although this can normally be countered by exposure to sunlight it can be assumed that these parishioners had a poor diet.

### **Blade wounds**

Four of the burials at the site exhibited blade wounds (Sets 271, 279 and 355–6); this is not uncommon in medieval cemeteries. Although all four were located physically close together near the north-western limits of excavation, one of the burials overlay another, suggesting that these two at least were not directly contemporary. One of these burials (Set 279) was in a larger than average grave and had stones placed to either side of the head; whether this was done to support the head or as a sign of penitence for the sin of fighting is impossible to determine.

### **3.8 Phase 9 Post-cemetery medieval features (mid-14th–15th century)**

The relative lack of post-cemetery medieval features on the site is difficult to assess. It is possible that there was relatively little activity on the site following the abandonment of St Stephen's churchyard, which would fit with the early 19th-century map evidence showing the area as open land. It is also possible that any features of this date were removed when the area was severely truncated in the 19th century. For a plan of Phase 9 see Figure 19.

### **3.9 Phase 10 Modern features**

The Tadcaster Tower Brewery was constructed sometime in the late 19th century. The southern portion of the site seems to have been extensively levelled to create an even site for the brewery, resulting in the total removal of all archaeological deposits in a strip c. 13m wide along the Dixon Lane frontage. Much of the brewery had itself been stripped away when the site was converted into a car park, and the only remains uncovered were portions of the range fronting onto George Street together with a series of dumps of human bone left by the brewery builders. For a plan of Phase 10 see Figure 19.

## **4 THE ARTEFACTS AND ENVIRONMENTAL EVIDENCE**

### **4.1 THE ROMAN POTTERY**

**By R.S. Leary with contributions by K. Hartley and D. Williams**

*An archive catalogue was compiled for all the pottery according to the standard laid down by the Study Group for Romano-British Pottery (Darling 2004) and based on the type series compiled by Jason Monaghan (AY 16/8). Pottery was recorded detailing specific fabrics and forms, decorative treatment, condition, cross-joins/same vessel and was quantified by sherd count, weight and rim percentage values, giving estimated vessel equivalents. All the pottery from the site was catalogued in the archive and the stratified pottery was examined in order to date the features. Key groups are illustrated and catalogued below and unillustrated material is summarised. The fabric series was cross-referenced with National Fabric Reference Collection codes (NFRC, Tomber and Dore 1998). Throughout the report form x, e.g. form BK1, refers to the Monaghan 1997 form series. Where necessary slight modifications have been made to the type series to allow bodysherds to be assigned to a broader group but the basic groups are intact. Similarly the fabric codes are based on the series established in this volume although modifications have been made as knowledge and understanding increases.*

The excavations recovered just over 1,280 sherds of Romano-British pottery (30,545g) much of which was in good condition. By far the bulk of the vessels represented were common in the

period covered by Monaghan's ceramic period 3b (AY 16/8), stretching from around AD 225 to 280. Although this period marked the end of the distinctive African-type pottery being made in response to the presence of the Emperor Severus and his imperial court at York in the early 3rd century, it was a time of prosperity at York which was accompanied by an increase in pottery kilns in the countryside around York (Swan 2002, 62) as well as a rise in some traded wares such as black burnished ware from Dorset, large numbers of fine wares and mortaria from the Nene Valley kilns and imported fine black slip beakers from Trier. In this period fine wares were at an all-time high (AY 16/8, 865) and the material recovered from the excavations reflects this both in the number of fine vessels present and also in the absence of any repaired items. Monaghan notes that East and Central Gaulish samian vessels were more commonly repaired than South Gaulish vessels at York (AY 16/8, 949) so this lack of repair may indicate the ease with which such vessels could be obtained.

### **Evidence for dating**

#### **Late 1st–early 2nd century**

Most of the pottery from the pits and build-up layers could be dated to mid- to late 3rd century. A small number of isolated features belong to an earlier phase. A single Ebor sherd from Context 1352 came from a carinated bowl of a type made from the late 1st–2nd century. Material from pit 1952 included sherds from two flagons, a type common in the late 1st and 2nd centuries, and a lid common in 2nd-century phases. The later fill 1951 contained a grey burnished ware everted-rim jar and lid of the 2nd century with two late 1st- to early 2nd-century Ebor ware carinated reeded-rim bowls as well as much later pottery suggesting the initial use of this feature may belong in the early 2nd century. The later sherds, an Ebor ware bowl belonging to the African repertoire (type BA1, early 3rd century) and a calcite-gritted sherd, a fabric appearing in small quantities from the late 2nd century onwards, may have arrived in the feature when it was a silted-up hollow rather than date its final usage. A sherd from a fine grey barbotine dot beaker in Context 1667 may also belong to this early phase. Such beakers were found in the late 1st–early 2nd century but the small sherd does not reveal sufficient details of the form of the vessel to allow more precise dating. None of these earlier features can be given close dating but their pottery contrasts with the 3rd-century date of most of the vessels represented on the site. The sherds are also smaller than those of later date which tend to be large and unabraded, indicating differences in the processes leading to their deposition here.

The coarse pottery sherds from Contexts 1503, 1975 and 2111 were all undiagnostic and provided little in the way of close dating. The basal sherd from 1503 came from a Dressel 20 amphora, a type imported during the mid-1st–3rd century. A scrap Ebor ware from 1975 can only be assigned to a broad range of late 1st–3rd century.

#### **Mid- to late 3rd century**

The majority of Roman features lay in Test Trenches 2, 3 and 4, and it was from these features that fresh, large Roman sherds were recovered in some quantity. The earliest features in the stratigraphic sequence with pottery found within them contained sherds datable to the 3rd century. Unfortunately no sherds were found associated with the earliest timber structure. A

small group of sherds from overlying layer 2068 included a scrap from a Trier black slip beaker (fabric C24), a type common in York in the 3rd century (AY 16/8, 896 and Symonds 1992, 51, dated AD 200–276+), and a bodysherd from a calcite-gritted jar (fabric H1) of similar date range. This dating is further narrowed by the pottery from pit 2172 dug through this layer. A sherd from a BB1 cooking pot has a form of decoration, obtuse lattice burnish, which is dated to after around AD 225. Two plain rimmed dishes were identified copying BB1 dishes from Dorset, one plain and one with intersecting burnished arcs. This type of decoration was also found on a BB1 bowl with a grooved flat rim; this type first appeared in the late 2nd/early 3rd century and continued to be made until the mid-/late 3rd century. A fragment from a Nene Valley mortarium with upstanding bead rim and reeded flange was also present (Perrin 1999, M18 3rd century). No Ebor ware was present and, taken together, the pottery points to a date range within Monaghan's ceramic period 3b, AD 225–80. The scorched condition of the BB1 jar with traces of sooting suggest this is domestic debris while the low level of wear on the mortarium grits may indicate relative affluence with pottery replacements readily available – a picture confirmed by the vessels redeposited in the later features and layers. Layer 2049 contained considerably greater numbers of sherds of similar date. These included fairly fresh unabraded sherds from a Nene Valley colour-coated flagon, a Castor ware box, several funnel-necked indented beakers of the mid- to late 3rd century and a black-slip beaker with long neck and bead rim from Trier of 3rd-century type. A Dales ware jar (type JD1, Swan 1992 and 2002, 62, common from the early–late 3rd century, probably after c. AD 225) and various undiagnostic coarse ware sherds do not add to the dating provided by the fine ware beakers. The pottery from pit fill 1989 is of the same type and date with small and abraded sherds from a Nene Valley funnel-necked beaker and a BB1 jar with obtuse lattice and a shoulder groove. This last feature is dated to after c. AD 240 on present evidence and the use of jars of this type is thought to have declined at York by the 4th century (Monaghan 1997, 891). The BB1 jar was well used and the interior was covered with limescale, presumably the result of regular use in boiling water. The exterior surface of the base and lower body is flaked and pitted, a condition which can result from deterioration of the original burnished surface as the vessel is frequently heated up and cooled down.



**A Nene valley colour-coated flagon and Castor ware box (Context 2049)**

### ***Mid-4th century***

The slots 1985 and 1987 contained an interesting group of pottery in that it included one of the latest types from the site, a proto-Huntcliff ware jar dating from a little before the middle of the 4th century. Although lacking the grooved lid seating of classic Huntcliff jars, this vessel had a rim form closely approximating to these types and the inner surface of the rim bore a distinct worn mark just where classic Huntcliff jars have their grooved rebate. A date around AD 360 may be appropriate for such a vessel on present evidence. Bidwell (2005) has argued that the early date for the introduction of Huntcliff jars, c. AD 340, based on a group from Birdoswald, is not tenable in the face of compelling evidence from elsewhere for a date of introduction around AD 360. The vessel from 1985 is not a true Huntcliff form but contrasts in form with calcite-gritted jars from groups dated to AD 330–60. For example the jars from earliest fill of the Rudston well, dated AD 295–330, have a quite different rim form (Rigby 1980, fig.49, 249–62) and even the vessels from the middle fill lack the Huntcliff type rim and have a rather triangular rim shape (Rigby 1980, fig.51, nos 279–80). By contrast the late fill group includes classic Huntcliff jars and jars of the type found in 1985 (Rigby 1980, fig.55 no. 335 and fig.56 no. 357) and this group is given a *terminus post quem* by coins of the Emperor Valentinian dating to AD 367. The remaining material included large sherds from a somewhat earlier grooved flat rim BB1 bowl of the same type as that from Context 2172, a Nene Valley funnel-necked beaker and a Nene Valley reeded rim mortarium similar to that from Context 2172. A small grey ware sherd with a distinctive long indentation with a central groove is a close match to a vessel from the 3rd-century kilns at Norton (Hayes and Whitley 1950, fig.12, no. 9a). A rim and upper body sherd from a BB1 jar with widely splayed rim is also of late type, perhaps late 3rd or early 4th century. Sherds from this vessel and perhaps another BB1 jar bore evidence of use in the form of sooting and limescale, and a Nene Valley mortarium from 1985 was scorched all along the rim. The late date of the proto-Huntcliff jar suggests that most of the fresh, large sherds found in these contexts are redeposited from the activity dating to the mid- to late 3rd century and the features in fact date to just after the mid-4th century.



**Huntcliffe jar rim showing wear and sooting (Context 1985/1987)**



**A late 3<sup>rd</sup>-/early 4<sup>th</sup>-century multi-reebed greyware handle 9Context 1948)**

The group from layer 1948 included further sherds of mid- to late 3rd-century date. This was a large group but the presence of mid-4th-century sherds suggests it included redeposited material from the earlier occupation. Ceramics dating to the 4th century included a parchment ware sherd with linear brown painted decoration from a small jar or beaker. This compared closely with samples of Crambeck Parchment ware, a type not likely to be present before the mid-4th century (Bidwell 2005). Two other sherds indicate a late date – a small sherd from a narrow-necked jar with moulded rim and a wide, multi-reebed grey ware handle. The rim sherd compares with types made at Throlam (Corder 1930, fig.13), probably dating to the end of the 3rd or more likely the 4th century (Swan 2002, 59, fig.15, nos 196–7) while the broad ribbed handle compares with the handles of such jars as represented by the rim sherd (Halkon and Millett 1999, form FO3, late 3rd–early 4th century). One basal sherd from a Nene Valley bowl or dish of the late 3rd–4th century was present and at least two late long-necked Nene Valley beakers, one with round indentations typical of the late 3rd–4th century indented beaker group. The remaining sherds are overwhelmingly of mid- to late 3rd-century date including late BB1 jars, dishes, bead and flange bowls and BB2 pie dishes, Dales ware, funnel-necked indented beakers, a 3rd-century Mancetter-Hartshill reeded, hammerhead rim mortarium and much East Gaulish samian ware including a lion spouted mortarium. Some of these types such as the BB1 developed bead and flange bowls, the BB1 late jars and the plain-rim dishes have date ranges which continue into the 4th century so some of these could be contemporary pottery but the beaker types did not include 4th-century types and Monaghan notes that BB1 and BB2 types have disappeared at this late phase (AY 16/8, 866) so it seems



more likely that this material is redeposited pottery of the mid- to late 3rd century. Abraded sherds from an Ebor headpot with stamped bosses representing hair was present, dating to c. AD 225–early 4th century (see 'Interpretation of the dating evidence' below). The absence of types common in the mid-4th century such as Crambeck wares and classic Huntcliff wares rather argue that whatever activity was taking place in the 4th century, it did not produce much ceramic debris.

Very little pottery was obtained from the structure represented by Contexts 1818, 1820 and 1711, and most was indeterminate except a BB2 bodysherd giving a date after the introduction of this ware in AD 140. Pit 1822 yielded a small group of mostly small sherds of mid- to late 3rd century including Nene Valley beakers although a large sherd from a well-used Dales ware jar (type JD1 and Swan 1992 and 2002, 62, common from the early to late 3rd century, probably after c. AD 225) was present encrusted with burnt on matter, presumably food, on the outside and inner rim, and limescale on the inside. The overlying layer 1742 contained a great deal of Roman pottery sherds typical of ceramic period 3b and dating to c. AD 240–80. Some of the sherds came from vessels already encountered in previous layers including the Crambeck parchment ware beaker or small jar and the facepot from layer 1948. The presence of half of the base of a handmade shell-gritted jar of Anglian type indicates that all of this pottery is redeposited. The group lacked types such as Crambeck grey wares and calcite-gritted wares typical of ceramic group 4a, introduced at the end of the 3rd and into the 4th century, but included a good number of coarse wares typical of the mid- to late 3rd century namely Dales ware and Dales ware type jars, a Throlam type wide-mouthed jar, BB1 late jars with obtuse lattice and grooved shoulder, several plain rim and grooved-dishes, developed bead and flange bowls and bead-rim pie dishes in black burnished fabrics copying BB1 and BB2 types of the late 2nd–late 3rd century. Several large jars with burnished decoration on the girth are similar to those made at Norton and at the east Yorkshire kilns, and are frequently provided with lug handles (type JL) in the 3rd century; the mortaria included reeded rim vessels from both Mancetter-Hartshill kilns near Coventry and the kilns in the Nene Valley common in the mid-3rd to mid-4th centuries. The fine wares comprised the indented funnel-necked beakers of the mid- to late 3rd century and also some later indented types with bead rims and long necks dating to the late 3rd–4th century. These included vessels based on the imported black slip beakers which had round indentations. The 3rd-century imported Trier black slip beakers included the tear drop form and the indented type. Eleven very abraded W1 sherds from a headpot of the 'Romano-Saxon' type with raised bosses were identified from this context. Further sherds from this vessel came from Contexts 1666 (an Anglo-Scandinavian context), 1822 and 1948, and included a fragment of an ear (from 1822). Most of the sherds bore raised bosses, pushed out from the inside with concentric circles stamped around them. These belong to a group dated to c. AD 225–early 4th century which follow on from the well-known headpot group from York and are discussed fully in AY 16/8, 921–6 and Swan 1993, 29). The distribution of the sherds from this vessel within the Phase 2 features, with one sherd from Phase 6, show clearly the reworking of pottery sherds within the features on the site.



**Dales ware jar showing burnt on food and limescale residues (Context 1822)**



**Dales ware jar showing burnt on food and limescale residues (Context 1822)**



**Fragments, including part of an ear from a head pit (Contexts 1666,1822 and 1948)**

A small group of pottery from fill 2054 included a BB1 jar with the rim wider than girth giving a date after c. AD 270 (Gillam 1976, nos 12–13, early–mid-4th century, c. 270–330). Another BB1 type sherd probably came from a developed bead and flange bowl also dating to the mid- or more probably the late 3rd century or later (Holbrook and Bidwell 1991, 98–9). A BB1 type plain rim dish would be compatible with these dates and an everted rim from a small G7 jar is similar to ones made at the 3rd-century kiln at Little London, Lincolnshire, on the River Trent (Oswald 1937, nos 81–2). Four sherds from fill 1740 included fragments from a 3rd-century, black slip teardrop shaped beaker from Trier and a Dales ware jar most common in the mid- to late 3rd century (type JD1 and Swan 1992 and 2002, 62, common from the early–late 3rd century, probably after c. AD 225) and sherds from vessels of similar date came from fill 2035 including a B10 plain-rim dish decorated with intersecting wavy lines, a common vessel in the late 2nd–3rd century, and sherds from a Dales ware jar. Sherds from the fills of post-holes around 1741 included late 2nd- to 3rd-century Nene Valley beakers sherds and another B10 plain rim dish with intersecting burnished arcs, probably of mid- to late 3rd-century date (copying BB1 types, Gillam 1976, nos 80–1 dated mid- to late 3rd century) in 2045 and a single sherd from a black burnished type bead and flange bowl with the flange close to the level of the bead rim from 2055. This last vessel has been dated to the mid- to late 3rd century (type DF2) although a slightly earlier date is suggested by some researchers (late 2nd/early 3rd to mid-/late 3rd century; Holbrook and Bidwell 1991, 98).



**A BB1 wide-rimmed jar (Context 2054)**

Context 1182 contained sherds from two 4th-century vessels, a Huntcliff jar of the mid- to late 4th century and a Crambeck grey ware dish of the late 3rd–4th century. Two other sherds, an Ebor ware bodysherd and a B3 bodysherd, are not closely datable and are residual.

One assemblage of Roman pottery were assigned to Phase 3: a group of sherds from Context 1943 which included Crambeck grey ware belonging to the end of the 3rd century or the 4th century and a sherd from Nene Valley beaker of 4th-century type with slit indentations. A small pit 1970 assigned to Group 4, Phase 2, contained a Rhineland mortarium of mid-2nd- to mid-3rd-century type from Context 1969 of which the rim and upper body were complete and which had been extensively burnt outside the body and rim, probably in use. Although in a later feature the fresh and near complete condition of this vessel demonstrated it had been redeposited from a fresh Roman group, perhaps from the earlier pits in the area.

#### **Interpretation of the dating evidence**

There appear to be three main phases of activity in the Roman period: sparsely represented activity in the late 1st–2nd century leaving small amounts of ceramic debris, apparently intense activity in the mid- to late 3rd century leaving a large amount of well-preserved sherds of pottery of all types and ill-defined activity in the 4th century leaving very small numbers of sherds occurring in groups with large amounts of mid- to late 3rd-century material. This last phase is the most difficult to assess since some of the sherds occur in stratigraphically early contexts pre-dating large groups of pottery dating predominantly to the mid- to late 3rd century. For example, the proto-Huntcliff ware jar from Context 1985 may be as much as 100 years earlier than much of the pottery from large assemblages from build-up layers 1948 and

1742. If these late sherds are intrusive then most of the occupation layers may be dated to mid- to late 3rd century before the arrival of Crambeck ware c. AD 280 and after the 'African' phase in c. AD 200–25. If on the other hand the 4th-century sherds are securely stratified then these build-up layers and later features cut into them belong to the mid 4th-century or later and mid- to late 3rd-century sherds pre-dating Context 1985 have been redeposited in these later layers, perhaps as earlier build-up layers were used to level the site.

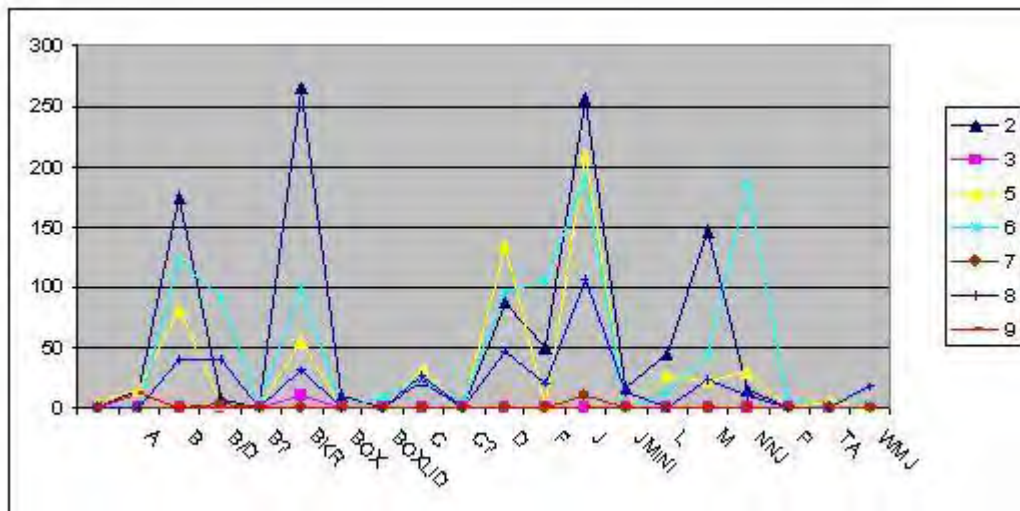
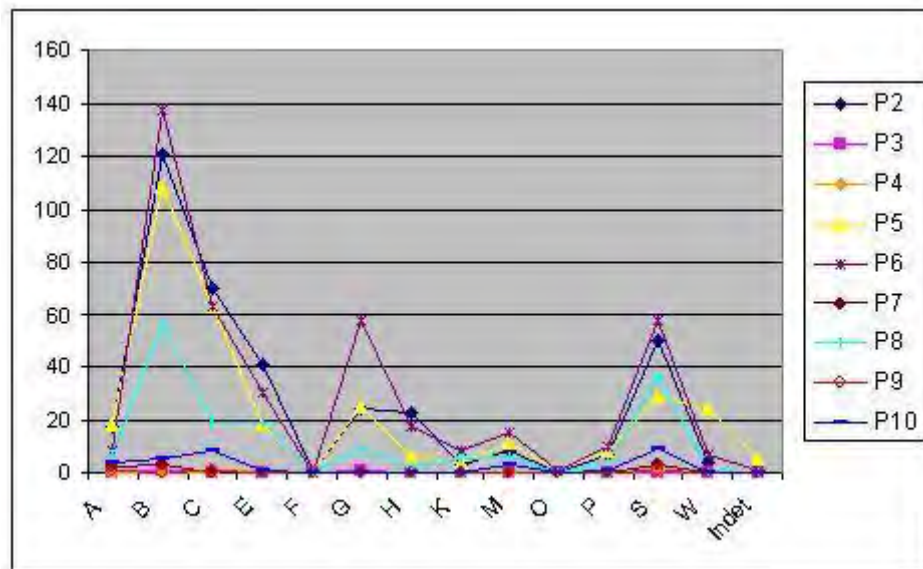

**Figure 27** Rim % values for vessel types by phase (A=amphora, B=bowl, B/D=bowl or dish, D=dish, BKR=beaker, Box=Castor box, C=cup, F=flagon, J=medium necked jar, JMINI=small jar/beaker, L=lid, M=mortarium, NNJ= narrow-necked jar, P=platter, TA=tazze, WMJ=wide mouthed jar)

At York Monaghan noted that in the late 3rd- to mid-4th century there is a dip in absolute quantities of Roman pottery and outlined a number of factors which may contribute to this: increased unrest in the province, a failure in sea-borne trade, a diminution in rebuilding activity resulting in well-curated buildings with little ceramic rubbish coupled with a lack of excavated early 4th-century rubbish dumps. It is notable that a very similar situation to that seen at George Street was found at Coppergate. Here 4th-century pottery occurred in small quantities in the stratified groups (AY 16/8, 1080–1). A likely explanation lay in the nature of the activity in P1/4 (c. AD 325+) which relates to graveside rites and ritual activities. At Coppergate these activities are manifested in the presence of a more than average number of fine table wares and beakers as well as the presence of specifically ritual vessels such as headpots, Romano-Saxon pots and candlesticks. There is a possibility that the small numbers of 4th-century ceramics at George Street may be related to a similar activity since at least one Romano-Saxon facepot was present, together with a candlestick. In addition to these ceramics, some of the late finds such as the jet bear figurine found with a shale bracelet in Context 1182 may be of ritual significance. This was thought to be a disturbed cremation but a ritual deposit is also possible.

The presence of half of the base of an Anglian jar in layer 1742 as well as a lipped rim of Anglian date supports a theory involving the redeposition of fresh mid- to late 3rd-century ceramics in later features as would the large groups of Roman pottery from demonstrably later features such as Phase 6 dump layers 2037, 1645, 1646, 1666 and 1754, and Contexts 1335 and 1745. The pottery from these layers and features did not differ markedly from that

in the earlier layers although Contexts 1645 and 2037 had slightly more 4th-century Crambeck ware.



**Figure 28 Comparison of wares from each phase (using sherd count). A=amphora, B=burnished wares, C=colour coated, E=Ebor, F= fine grey, G=grey, H= Dales, K= calcite-gritted, M=mortarium, O=oxidised, P=white and parchment, S=samian, W= white slip Ebor**

If the make up of the Roman pottery from the different phases is studied in terms of vessel types present (Figure 27) the assemblage from Phase 2 can be seen to be fairly close to that from Phase 6 (with the exception of the narrow-necked jars from Phase 6). These come from contexts 1335, 1969, 2037, 1645, 1666 and 1754 and are burnished ware jars of the type decorated with linear burnishing and compare with vessels from Norton in the 3rd century (Hayes and Whitley 1950, type 4). It is not quite clear why these occur more frequently in Phase 6 but they need not be of later date than the mid- to late 3rd-century pottery from Phase 2. The high proportion of mortaria from Phase 2 is chiefly due to a near complete vessel from pit fill 1969. The chart suggests that the other differences, in most cases merely a diminishing of the number of vessels represented, would be expected if the Phase 6 pottery derives from that current in Phase 2. The greater number of bowl/dish forms reflects the break up of vessels resulting in sherds being attributed to the bowl/dish group rather than the separate bowl and dish groups. Similarly a consideration of the ware groups present indicates a closely comparable pattern for the Roman pottery from Phases 2 and 6 (Figure 28). When the wares are compared using weight values a similar pattern emerges, with early wares such as Ebor being represented by lighter, smaller sherds. The overall pattern points to a redeposition process which did not involve excessive attrition of sherds until after Phase 6 when redeposition of Roman sherds is dramatically reduced. This is best interpreted as evidence for the dumping and spreading of material which included primary Roman ceramic refuse on the site during the later Roman period and again during the Anglo-Scandinavian period. The small number of 4th-century pottery sherds may be linked to the function of the site. Although this function is not altogether certain, aspects of the pottery indicate a ritual or sepulchral element may have been present.

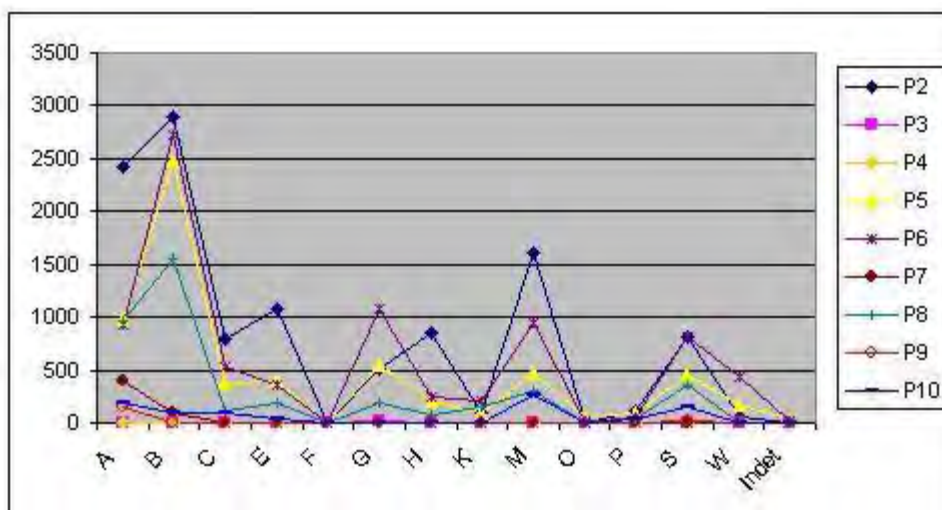

**Figure 29 Comparison of wares from each phase using sherd weight (abbreviations as Figure 28)**

### Vessel types

The earliest vessel types represented comprised several carinated bowls (types BC1 and BC2, a barbotine dot beaker, two everted jars with grooved shoulders (type JE2), a tazze and some flagons of uncertain form in white and white slipped wares. Such small amounts of material could not be used to extrapolate any details of the character of the settlement during this period.

As already determined above, the majority of the pottery belonged to the mid- to late 3rd century, with a small amount of material dating to the early–mid-4th century. Ebor wares were uncommon and reduced wares account for some 38–42% of the group as would be expected of a group of this date. The most common vessel type was the medium-necked jar (Table 4) and most of these were either in grey ware or burnished wares. Some 22% of these were in Dorset BB1 and were late splayed rim jars with obtuse lattice. Only 4.5% were in BB2 and a further 25% each were in Dales ware and grey ware. This last group were for the most part Dales ware type jars. One butt-shaped jar (type JB2) and one indented jar (type JI), both of the late 2nd–early 3rd century, were present in the residual groups. Two Huntcliff/proto-Huntcliff jars were present. Throlam type wide-mouthed jars were in burnished grey ware and the narrow-necked jars, which comprised of long-lived necked jars with everted rims and narrow-necked large jars with zones of burnished decoration sometimes with looped handles, were both in grey burnished wares. The coarse ware bowls and dishes were predominantly in BB1, BB2 and their copies, while samian ware provided all the fine ware bowls and dishes except one Nene Valley bowl or dish represented by a bodysherd. The coarse ware bowls were either grooved flat rim bowls or developed bead and flange bowls. Dishes were made up of BB1 plain rim dishes (over 50%), BB2 bead rim dishes (c. 20%) and their copies with the addition of samian fine ware dishes. Two African-style Ebor bowls (type BA1), one U-shaped bowl (BU3) and one Ebor platter (type PA, 3rd century) were present. Sherds from two ring-necked flagons, a cupped-rim flagon, and a flagon with everted rim, all in white slip Ebor wares (FR, late 1st–2nd century; type FC, late 2nd–early 3rd century; and type FE2, late 2nd–early 3rd century respectively), were present in the residual groups. Fine table ware other than samian was supplied by the small amount of black-slip beakers from Trier and a larger number

of Nene Valley colour-coated beakers and flagons. Two pinch-necked flagons from this last source were identified and c. 90% of the beakers came from here, predominantly funnel-necked indented beakers, plain or scale, and some plain rim beakers with rouletted zones. Smaller numbers of fragments from Hunt cups of the late 2nd–early 3rd century and of scroll beakers and long-necked globular beakers of the late 3rd–4th century were represented and the base and lid of at least two Castor boxes were present. Around thirteen of the Nene Valley beakers were in forms generally dated to the late 2nd–early 3rd century (types KC and KB bag beakers and cornice rim beakers with hunt scenes, underslip scroll and rouletted decoration) and this may indicate that the occupation producing the majority of the sherds fell closer to the beginning of ceramic period 3b in the mid-3rd century when these types would still be circulating than the end. The cups were exclusively samian examples. The most common source for the mortaria was the Nene Valley kilns but some samian mortaria were identified and small numbers of Ebor examples were recognised, along with examples from the Rhineland and Mancetter-Hartshill. Most of these were reeded rim hammerhead or hammerhead forms although the samian examples were wall-sided types (form Dr 45). This last group included a lion spouted example. A Rhineland mortarium of mid-2nd- to mid-3rd-century date was found almost complete in Context 1969. The lower body and base of this vessel was missing and it was scorched around the rim. A sherd from a second Rhineland mortarium was found in Context 1000. This was of late 1st- 2nd-century date. Curiously 70% of the lids were in an Ebor-like ware but these appeared slightly misfired and may be reduced ware. Wares and vessel types not represented by EVEs values include a pale ware tazze and a painted parchment ware beaker or jar from the Nene Valley kilns.

The pottery wares and types dating to the 4th century did not come from exclusively 4th-century assemblages but were found in groups with predominantly mid- to late 3rd-century pottery with the exception of the very small groups from 1182 and 1985. The proportions of different wares and vessel types cannot, therefore, be reconstructed. The wares present dating to this period comprise Crambeck grey wares, Huntcliff ware, Nene Valley colour-coated ware, late red ware (fabric O3) and Crambeck parchment ware. The forms identified as dating to this late phase included proto-Huntcliff and Huntcliff jars, Crambeck grey ware bead and flange bowl with interior wavy line burnish, a grooved rim dish and a large jar, a late red ware flanged hemispherical bowl with white painted stripes on the flange, sherds from a Crambeck parchment beaker with brown painted stripes, Nene Valley long-necked globular beakers with slit and round indentations and with painted decoration, a flagon or jar and a bowl or dish and a Crambeck white ware mortarium (type 6 with grooved wavy line but nearly wall-sided). Some of the Mancetter-Hartshill and Nene Valley mortaria dated mid-3rd to mid-4th century may belong to this phase. In addition some of the large jars with zones of burnished decoration may belong to this period. The Romano-Saxon facepot fragments have been given a date range of AD 225–early 4th century and the candlestick is dated from the early 3rd to the late 4th century so these both may belong with this group rather than the mid- to late 3rd-century group.





A lion-headed spout from a samian mortarium (Context 3203)



A late red ware flanged hemispherical bowl with white painted stripes on the flange (Context 1669)

#### Site function and status

The earliest group of Roman pottery is too small for its character to be assessed in any detail. A fragment from a fine tazze in a non-local cream ware, redeposited in build-up layer 1742, raises the possibility that the postulated later ritual activity was preceded by activity of similar character in the late 1st–2nd century. This vessel has clear signs of scorching where fragrant oils or incense have been burnt, probably in a small shrine or perhaps a graveside.



**A creamware tazza fragment showing scorching (Context 1742)**

The mid- to late 3rd-century pottery includes well-used domestic rubbish. Sherds from 34 vessels were burnt and sixteen vessels, nearly all burnished ware jars, retained sooting, most likely to be the result of being used for cooking. Limescale, such as that found on kettles in hard water areas, was identified on ten vessels, all of which were jars, both burnished ware vessels and shell-tempered Dales ware jars. These aspects of the assemblage suggest the pottery is predominantly domestic rubbish. There are signs that some of the vessels had scarcely been used while other showed some wear. Some of the samian mortaria were well worn but the grits on some of the Nene Valley mortaria were scarcely worn at all. In Context 1988 a complete base was found which has a worn ring around the edge perhaps where it has been pulled across a rough surface such as a floor or a stone counter. The complete rim and upper part of a mortarium was found in Phase 6 feature 1969 although the base and lower body were broken off and missing. Others such as two samian bowls have contrasting wear patterns on the inside of the vessel resulting from use. The surface on a small bowl from 1948 is completely worn away on the lower half while on the bowl from 2049 tiny vertical stress cracks can be seen which would eventually result in the surface finish deteriorating and wearing away. Other samian bowl sherds had extensive worn patches on their inner surfaces suggestive of long use and careful curation.



**Stress cracks on a samian bowl (Context 1948/2049)**

All major vessel groups were represented (Figure 27). Both tableware and kitchen ware were found and large storage vessels such as amphora and large jars were also identified. Compared with published groups from other York sites of this date (Figure 30) the George Street assemblage is poor in cups and lids and quite average in respect of bowls and dishes. The beaker component is high and compares with that from Coppergate Period 1/5. Monaghan noted that the proportion of Nene Valley colour coat, most of which will be beakers, was exceptionally high in the residual contexts of P1/5 at Coppergate although in the stratified group P1/4 it was unremarkable (AY 16/8, 1080). The P1/4 activity may have been related to ritual and certainly sepulchral activities and it is suggested that the high colour-coated ware content in P1/5 related to this earlier activity. The other site with a similarly high beaker count is Wellington Row Period 4. During this period Monaghan suggested that occupation at Wellington Row included a highly exotic element (AY 16/8, 114) and Dickinson noted curious characteristics amongst the samian from the site which suggested the possibility of ritual activity (see below). The pit groups were described by Monaghan as having the nature of offerings although he recognised that it was purely speculative to suggest a ritual function for the buildings. It may be that activity of a similar character was present at George Street. There is no reason to suppose that this could not co-exist with regular domestic settlement, suggested by the evidence for use in cooking on the vessels and the generally unspecialised make up of the pottery population. The quantities of samian and colour-coated fine wares, predominantly of 3rd-century date, were high (12–13% and 20–28% respectively by sherd count) and may indicate similar ritual activities such as that postulated at Coppergate (AY 16/8, 1080–1) at an earlier period.

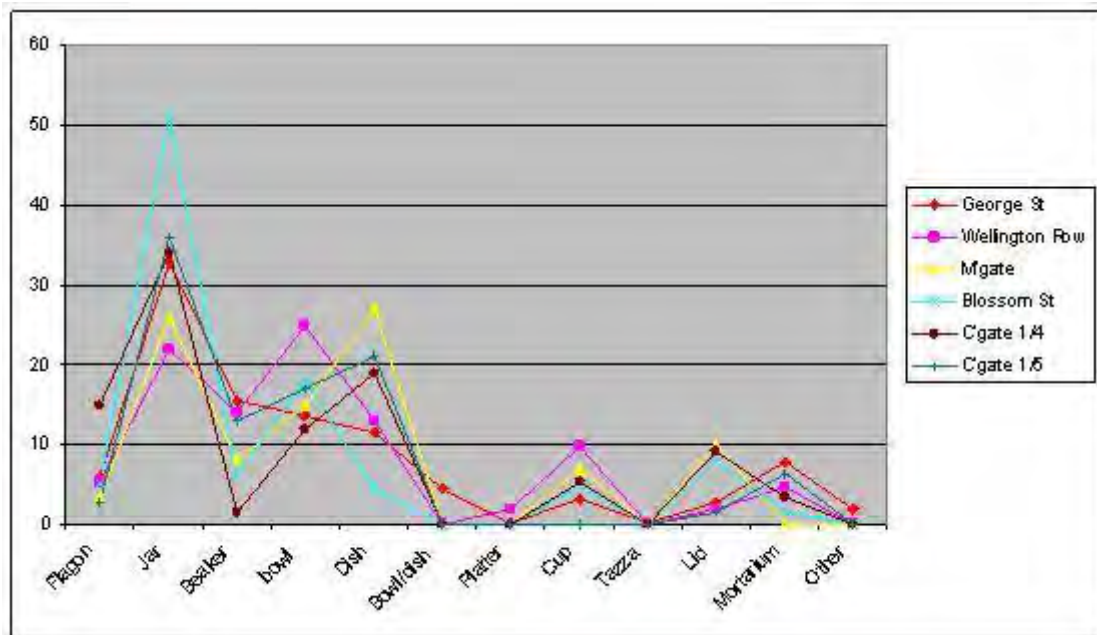

Figure 30 Comparison of *proportions of vessel types present on contemporary York sites (after AY 16/8, tables 133–9) using EVEs*



**A near complete BB1 jar (Context 1989)**

Although no complete vessels were found a near complete BB1 jar was found in Phase 2 context 1989. The rim of this jar slightly over sails the body suggesting a date in the late 3rd century or later. The lower body is severely burnt and the surface has deteriorated and spalled. Such damage is typical of cremation urns which have been put on the cremation pyre before burial. Limescale on the inside indicated domestic usage had preceded this use. Sherds from a second grey ware pot from this feature were coated with limescale internally. This vessel was not burnt and need not be connected to the putative cremation urn. Complete

bases of three jars (1988) and three beakers (1948) were found together with large sections of an elegant castor box and lid (2049), a substantial proportion of a Nene Valley scroll beaker (1754) and the complete rim and upper body of a wall-sided mortarium. Two of the complete jar bases, a Dales ware jar from 1989 and a BB1 late splayed-rim jar from 1742, were extensively burnt. Although this could have happened on a domestic fire, and indeed the Dales ware jar has limescale coating the interior so was clearly well used, this kind of heat damage, like that on the BB1 jar from 1307, is also very common on cremation urns resulting from them being offered on the pyre and then re-used as cremation urns.



**Fragment of an NVCC scroll beaker (Context 1742)**

These near complete vessels, coupled with the fresh condition of some of the pottery, indicates that the collection, essentially rubbish disposal of broken Roman pottery, has not been extensively trampled but has been either dumped here directly or has been obtained with other material from a domestic midden fairly quickly after being broken and used to level the ground in this area.

Some special vessels provide further evidence for the carrying out of ritual activities in the vicinity. A fine, if somewhat battered, Ebor ware candlestick was found in Phase 6 Context 1335. Evidence from elsewhere points to such vessels being often associated with religious sites such as shrines and temples but at York the candlestick fragments seem to show a distributional bias towards cemetery sites, perhaps linked to graveside rites and the need to provide the dead with light (Hunter-Mann and Johnson AYweb publication forthcoming). There is another ceramic vessel which adds to this non-utilitarian aspect of the assemblage. A group of abraded fragments from a so-called Romano-Saxon type headpot had been

redistributed through the later layers and appeared in Phase 2 Contexts 1822 and 1948 and Phase 6 Context 1666. The small sherds cannot be reconstructed to show the form of the vessel but bosses with concentric circles stamped around them gave the impression of hair, and an applied strip may be an ear or another part of the face. Headpots such as this are associated with ritual rather than funerary contexts at York (*AY 16/8*, 914; Swan and Monaghan 1993) although graveside rites would be a possibility (Hunter-Mann and Johnson *AY* web publication forthcoming).



**Ebor ware candlestick (Context 1335)**

To these may be added the samian lion spout and a reworked samian bowl from layer 1948. The spout of this vessel had been carefully worked to form a rough roundel. At the Carrawburgh Mithraeum two Dr 45 mortaria with lion spouts were found broken, although almost completely present in sherd form and with little wear, in two separate deposits. The vessels were considered 'ceremonial' deposits (Richmond and Gillam 1951, 70–1) and the appeal of lion symbols to the worshippers of Mithras was noted. At Wellington Row, York, Dickinson (in *AY 16/8*, 946–7) associated the high number of unused samian mortaria with a possible ritual function. In this group one of the lion's head spouts had been stopped with lead, a metal associated with sinister rituals both in curse tablets and other rites (Merrifield 1987, 137–42). At Manchester a lead figurine found upside down within a probable temple building has similar connotations, perhaps relating to the gods of the underworld (Cool 2004). The carefully shaped lion spout from 1948 may, therefore, have had more than novelty appeal. Also from this layer came a small samian bowl form 38 which had had its flange deliberately removed. The reworking of Roman pottery, particularly samian, into counters and spindle whorls has been isolated by Cool as a specifically late 4th-century phenomenon (Cool 2000, 52–3). This reworking of samian vessels may be part of a trend which particularly favoured red items (Cool 2000, 54).

Drawing on Jeremy Evans' work on the character of pottery assemblages from different site types and different periods (1993 and 2001), compared with the mid- to late 3rd-century material, the numbers of beakers represented lies towards the top end of the quantity

expected on northern fort sites (1993, table 2 and Appendix 1) and the proportion of fine wares is very high (over 30% by sherd count, Table 5). The jar to beakers ratio is 33:16, which compares favourably with other 3rd-century sites, but Evans did not detect as much variation in the ratio of beakers to jars and jars to bowl/dishes relating to site type and status in the groups he examined in the 3rd century (1993, 100). Compared with other sites at York the quantity of samian ware is average and the proportion of colour-coated wares is relatively high. The sites with a greater proportion of colour-coated wares are Coppergate and Wellington Row at which a ritual element has been suggested.

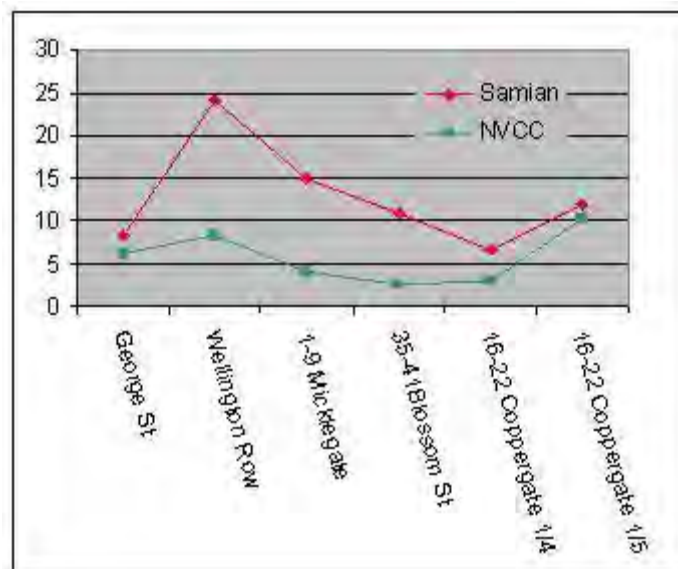

**Figure 31 Proportion of assemblages made up of samian and colour coated wares in mid- to late 3rd-century groups in York using weight (from AY 16/8)**

### Pottery supply

The pottery dating to the late 1st–early 2nd century from the excavations is predominantly local Ebor wares with table ware provided by the samian wares from Gaul. In the 3rd century the samian ware drinking vessels were supplemented by large numbers of beakers (16% of the assemblage) principally from the Nene Valley kilns (90% of the beakers) and the remainder from Trier and the Rhenish sources. The cups, in samian ware (3% of the assemblage), were largely replaced by beakers at this time (AY 16/8, 855). Ceramic flagons seem to largely fall out of use excepting rare colour-coated examples, also from the Nene Valley. More than a quarter of the jars (Table 4, grey and grey b) are likely to be from a local origin although Monaghan reported difficulties in distinguishing and sourcing these grey wares (AY 16/8, 900–1). Some vessels similar to those made in East Yorkshire in the Holme-on-Spalding industry were identified and in some cases, for example the Throlam wide-mouthed jar, identification seems firm. However, many of the grey burnished wares were closer to samples from the Norton kilns and some vessels were firmly identified as Norton types. A slightly smaller amount came from the Dales ware industries of Humberside and north Lincolnshire, with still less from Dorset (BB1). Some BB1 jar copies were made, perhaps locally, and a very small number of BB2 jars were identified. The bowls and dishes were similarly obtained from local but as yet unspecified sources making BB1 and BB2 copies. Around one-fifth of the bowls and dishes were from Dorset but, as with the jars, only c.3% each of the bowls and dishes were in BB2

ware with a much larger number of BB2 copies. Nearly half of the mortaria came from the Nene Valley kilns supplemented by c. 30% from Mancetter-Hartshill, 10% from the samian industries in East Gaul and small amounts from York itself with one Crambeck mortarium. Calcite-gritted wares from East Yorkshire occur in small quantities, perhaps a result of the nature of the 4th-century occupation of the site which seems to have used minimal ceramics.

### **Summary**

The Romano-British pottery indicates some activity on the site in the late 1st–early 2nd century although the numbers of sherds are too small to permit close dating and detailed interpretation. A much larger proportion of the sherds dated to the mid- to late 3rd century and tally with our existing understanding of York at this time of prosperity. Much of this material was either disturbed in the mid-4th century or moved onto the site at that time perhaps as part of a levelling operation. During this period very small amounts of pottery were being deposited and some vessels suggest the site may have been used for some ritual and sepulchral activity. Two near complete vessels were heavily burnt and their surfaces showed deterioration of a type typical of cremation urns which had been put on the cremation pyres as offerings then re-used to contain the ashes. Examples of special vessels such as candlesticks and headpots were present and an example of a shaped lion head spout broken from an earlier vessel illustrates the late Roman interest in red artefacts which has been found on other Roman sites in the late 4th and 5th centuries. At Coppergate lion spouted mortaria were similarly selected, perhaps for use in some ritual, and at the Mithraeum at Carrawburgh two lion spouted mortaria were found in significant positions within the shrine. The make up of the mid- to late 3rd-century group points towards a domestic function for the most part but the amounts of fine wares and beakers may indicate some special function existing on the site at that time.



**Table 4 Proportion of vessels in each fabric using rim % values. Abbreviations as Figure 27.**

Ware group	Monaghan fabric groups	Total Of RimP	A	B	B/D	B?	BKR	BOX	BOXLID	C	C?	D	F	J	JMINI	L	M	NNJ	P	TA	WMJ
A	DR2-4	12	12																		
A	GAL AM	30	30																		
B	BB1	272		74								84		114							
B	BB1T	180		12	4							110		54							
B	BB2	18			5							13									
B	BB2T	240		74	68							55		43							
B	Crambeck grey	24		7								17									
B	Grey B	472		11	4		11					43		104	30	7		241			21
C	NVCC	488					419	10	9				50								
C	Trier	21					21														
E	Ebor	174		41		1							25	38		60	5		4		
E	Ebor RS	100											100								
G	Grey	242		23								4		197		18					
H	Dales	173												173							

Ware group	Monaghan fabric groups	Total Of RimP	A	B	B/D	B?	BKR	BOX	BOXLID	C	C?	D	F	J	JMINI	L	M	NNJ	P	TA	WMJ	
K	C-gritted	42												42								
M	M1	5															5					
Ware group	Monaghan fabric groups	Total Of RimP	A	B	B/D	B?	BKR	BOX	BOXLID	C	C?	D	F	J	JMINI	L	M	NNJ	P	TA	WMJ	
M	M15	41															41					
M	M16	51															51					
M	M16C	15															15					
M	M17	10															10					
M	M20	5															5					
M	M27	115															115					
P	Misc white wares	6																		6		
S	Samian	430		190	69		10			103	5	39					14					
Indet	Indet	8												8								
		3174	42	432	150	1	461	10	9	103	5	365	175	773	30	85	261	241	4	6	21	

## Fabrics

The fabric series used follows that published by Monaghan (AY 16/8) for York, except for the amphora sherds, and is summarised in Table 5. The details of the fabrics can be consulted in that document.

**Table 5 Summary of wares from excavation**

Ware group	Monaghan fabric groups	Count	Weight	Rim %	Rel % count	Rel % weight	Rel % of weight excl amphora	Rel % RE
A	AMP	3	69.4		0.2	0.2	0.3	0.0
A	CAM AM	1	34.7		0.1	0.1	0.1	0.0
A	DR20	20	2897		1.5	9.2	11.4	0.0
A	DR2-4	6	462.2	12	0.5	1.5	1.8	0.4
A	GAL AM	18	614	30	1.4	2.0	2.4	0.9
A	N African	9	1951.2		0.7	6.2	7.7	0.0
<b>A Total</b>			6028.5	42	4.3	19.2	23.7	1.3
B	BB1	117	2916.9	272	8.9	9.3	11.5	8.6
B	BB1T	43	1261.3	180	3.3	4.0	5.0	5.7
B	BB2	7	116.8	18	0.5	0.4	0.5	0.6
B	BB2T	50	1232	240	3.8	3.9	4.9	7.6
B	Crambeck grey	18	333	24	1.4	1.1	1.3	0.8
B	Grey B	197	3986	472	15.0	12.7	15.7	14.9
<b>B Total</b>			9846	1206	32.9	31.3	38.8	38.0
C	CCW	3	15.1		0.2	0.0	0.1	0.0
C	KOL	2	4.9		0.2	0.0	0.0	0.0
C	NVCC	203	1859.7	488	15.5	5.9	7.3	15.4
C	Rhenish	2	2.2		0.2	0.0	0.0	0.0
C	Trier	14	34.1	21	1.1	0.1	0.1	0.7
<b>C Total</b>			1916	509	17.1	6.1	7.5	16.0
E	Ebor	106	1873.6	174	8.1	6.0	7.4	5.5
E	Ebor RS	4	196.6	100	0.3	0.6	0.8	3.2
<b>E Total</b>			2070.2	274	8.4	6.6	8.2	8.6

Ware group	Monaghan fabric groups	Count	Weight	Rim %	Rel % count	Rel % weight	Rel % of weight excl amphora	Rel % RE
F	Fine grey	2	9.2		0.2	0.0	0.0	0.0
<b>F Total</b>			9.2	0	0.2	0.0	0.0	0.0
G	Grey	116	2332.3	242	8.8	7.4	9.2	7.6
<b>G Total</b>			2332.3	242	8.8	7.4	9.2	7.6
H	Dales	48	1395.2	173	3.7	4.4	5.5	5.5
<b>H Total</b>			1395.2	173	3.7	4.4	5.5	5.5
Indet	Indet	6	57.1	8	0.5	0.2	0.2	0.3
<b>Indet Total</b>			57.1	8	0.5	0.2	0.2	0.3
K	C. gritted	1	43.4		0.1	0.1	0.2	0.0
K	C-gritted	19	492.2	42	1.4	1.6	1.9	1.3
<b>K Total</b>			535.6	42	1.5	1.7	2.1	1.3
M	M1	1	70.1	5	0.1	0.2	0.3	0.2
M	M15	9	455.2	41	0.7	1.4	1.8	1.3
M	M16	16	1025.6	51	1.2	3.3	4.0	1.6
M	M16B	3	55.2		0.2	0.2	0.2	0.0
M	M16C	1	196.4	15	0.1	0.6	0.8	0.5
M	M17	2	76	10	0.2	0.2	0.3	0.3
M	M20	3	139.9	5	0.2	0.4	0.6	0.2
M	M27	3	1322.3	115	0.2	4.2	5.2	3.6
M	M3	2	120.3		0.2	0.4	0.5	0.0
M	M4	1	35		0.1	0.1	0.1	0.0
M	Mortarium	2	101		0.2	0.3	0.4	0.0
<b>M Total</b>			3597	242	3.3	11.4	14.2	7.6
O	Misc. oxidised	2	57.2		0.2	0.2	0.2	0.0
<b>O Total</b>			57.2	0	0.2	0.2	0.2	0.0

Ware group	Monaghan fabric groups	Count	Weight	Rim %	Rel % count	Rel % weight	Rel % of weight excl amphora	Rel % RE
P	Crambeck parchment	4	28.7		0.3	0.1	0.1	0.0
P	Misc white wares	18	243.3	6	1.4	0.8	1.0	0.2
P	Nene Valley parchment	8	55.9		0.6	0.2	0.2	0.0
<b>P Total</b>			327.9	6	2.3	1.0	1.3	0.2
S	Samian	186	2591	430	14.2	8.2	10.2	13.5
<b>S Total</b>			2591	430	14.2	8.2	10.2	13.5
W	Ebor white	36	656.9		2.7	2.1	2.6	0.0
<b>W Total</b>			656.9	0	2.7	2.1	2.6	0.0
<b>Grand Total</b>		1312	31420.1	3174	100.0	100.0	123.7	100.0
Total excl amphora			25391.1					

## Acknowledgements

I would like to thank Dr Vivien Swan for advice, and Margaret Ward and Hilary Cool for access to unpublished data and papers.

## Catalogue

The full pottery catalogue can be obtained in either CSV or XLS format from YAT.

### 4.1.1 *The Amphorae*

by **D Williams, University of Southampton**

## Comments

The amphorae assemblage from George Street, though small, with only 57 sherds, nevertheless displays a variety of imported vessels. Nearly half of these belong to accepted wine amphorae types, the Gauloise series, Dressel 2-4 and the 'black sand' fabric. While the remainder are from the Baetican globular olive-oil container Dressel 20 and the cylindrical North African series, which carried a variety of contents (Bonifay 2004). The majority of the Gauloise series almost certainly belong to the flat-based Gauloise 4

form from southern France (Laubenheimer 1985). Unfortunately, it is not possible to say to which of the North African cylindrical series the George Street sherds belong as a range of forms were exported to Britain (Williams and Carerras 1995). The remaining identified sherds include a rim with attached bifid stump which belongs to the Dressel 2-4 type, a common form which was produced at a geographically dispersed range of production sites. A small number of bodysherds including three with a black resinous coating on the inside probably belong to this form as well, and a single bodysherd in the easily recognisable 'black sand' fabric. The latter was produced in the Bay of Naples region but this particular fabric was not confined to any one amphora type (Williams and Peacock 2005). Thus the George Street sherd could come from a Dressel 2-4 form or equally the later almond-rimmed type (Arthur and Williams 1992). It is worth noting that the almond-rimmed, as well as North African types, are already known from York (Williams 1990; 1993).



**Amphora Dressel 2-4 bifid stump (Context 1532)**

It is difficult to be at all precise about dating here, given the lack of closely dated vessels. The Dressel 20 and Gauloise material could be anything from the 1st to the 3rd century AD (Peacock and Williams 1986). The Dressel 2-4 sherd is likely to be 1st century AD but the form continued in use up to the early 3rd century AD, while the 'black sand' sherd, if an almond-rimmed type rather than a Dressel 2-4, should belong to the period around the mid-3rd century to mid-4th century AD (Arthur and Williams 1992).

Fabric	Contents	Count	Weight/g	Rim %
<b>Dressel 20</b>	Olive oil	20	2897	0
<b>Dressel 2-4</b>	Wine	6	462.2	12
<b>Gauloise 4</b>	Wine	8	256	30
<b>Gauloise series</b>	Wine	18	614	0
<b>North African</b>	Various	9	1951.2	0
<b>Black sand</b>	Wine	1	34.7	0
<b>Undesignated</b>	Unknown	3	69.4	0
<b>Grand Total</b>				

**Catalogue  
Dressel 20**

Phase	Context	Fabric	Part	Count	Weight	Condition
2	1503	DR20	base	1	144.4	
2	1742	DR20	bodysherd	3	164.6	
2	1948	DR20	bodysherd	1	118.3	Burnt
2	1951	DR20	handle	1	627	
2	2035	DR20	bodysherd	1	313.6	
6	1069	DR20	bodysherd	1	33.4	
6	1515	DR20	bodysherd	1	99.5	
6	1617	DR20	bodysherd	1	12.9	
6	1619	DR20	bodysherd	1	55.6	
6	1754	DR20	bodysherd	1	17.5	
7	1752	DR20	bodysherd	2	404.8	
8	1100	DR20	bodysherd	1	213.3	
8	1107	DR20	handle	1	415.2	
8	1235	DR20	bodysherd	1	47.1	
8	1372	DR20	bodysherd	1	113.1	
10	1190	DR20	bodysherd	2	116.7	

**Dressel 2-4**

Phase	Context	Fabric	Part	Count	Weight	Condition
2	1742	DR2-4	bodysherd	3	185	with black resinous coating
2	1948	DR2-4	bodysherd	1	44	with black resinous coating
2	1822	DR2-4	bodysherd	1	89.7	
6	1669	DR2-4	Bead rim and bifid stump	1	143.5	

**Gauloise 4**

Phase	Context	Fabric	Part	Count	Weight	Condition
2	1742	Gauloise	Rim	1	71.4	
2	1742	Gauloise	bodysherd	6	113.1	
2	1948	Gauloise	Rim	1	71.3	

**Gauloise series**

Phase	Context	Fabric	Part	Count	Weight
2	1822	GAL AM	bodysherd	1	18.1
2	1948	GAL AM	bodysherd	1	71.7
2	1948	GAL AM	bodysherd	1	46.5
2	1948	GAL AM	bodysherd	1	28.8
6	1675	GAL AM	bodysherd	1	62
6	2037	GAL AM	bodysherd	1	16.1
8	1400	GAL AM	bodysherd	1	38.9
8	1100	GAL AM	bodysherd	1	12.2
10	1000	GAL AM	bodysherd	2	63.9

**North African**

Phase	Context	Fabric	Part	Count	Weight
2	1948	N African	bodysherd	2	573.2
2	1948	N African	bodysherd	1	136.5
2	2035	N African	bodysherd	1	49.2
2	2049	N African	bodysherd	1	3.8
2	2049	N African	bodysherd	1	377.2
6	1619	N African	bodysherd	1	48.2
6	2037	N African	bodysherd	1	628.9
8	1066	N African	bodysherd	1	134.2

**'Black sand' fabric**

Phase	Context	Fabric	Part	Count	Weight
2	1742	Black sand	bodysherd	1	34.7

**Undesignated**

Phase	Context	Fabric	Part	Count	Weight
2	1182	AMP undesig	bodysherd	1	4.5
2	1742	AMP undesig	bodysherd	1	29
6	1646	AMP undesig	bodysherd	1	35.9



#### 4.1.2 *The Mortarium*

**by K. Hartley**

(Fabric examined with hand lens at x20 magnification. NB 'right-facing' and 'left-facing' when applied to stamps indicates the relation of the stamp to the spout looking at the mortarium from the outside.)

Context 1335: Diameter 340mm, 18% of vessel present. A mortarium in fairly fine-textured fabric, Munsell 7.5YR 7/6 (reddish-yellow), fired to a paler colour at the surface. Inclusions: moderate to fairly frequent, ill-sorted, transparent and slightly brownish quartz, ?limestone, rare opaque, brown and black and at least one fleck of gold mica. Trituration grit: due to breakage only one quartz grit survives.

The right-facing stamp is in very poor condition and even the border is not clear enough for identification. The mortarium has an unusual spout and this combined with the fabric should help in identifying the potter in due course. It was almost certainly made in the north of England, perhaps at or relatively near to York. It is certainly 2nd-century in date, probably not later than AD 150.

## 4.2 **The post-Roman pottery**

**By A. Mainman**

### **Introduction**

The pottery from George Street provides one of the most complete Roman to early medieval ceramic sequences recovered from a single site in York. The assemblage is small and the sequence is not unbroken; there is the now familiar break in continuity after the Roman period, from the 5th to the late 7th century. Nevertheless, it demonstrates activity in the area from the 2nd century to the early/mid-14th century and therefore provides a useful tool in the interpretation of urban development in this extra-mural part of the city.

The continuous sequence from the late Anglian period through the Anglo-Scandinavian period to the medieval is of particular interest. The site bridges the gap in the ceramic sequences recovered from 46–54 Fishergate (AY 16/6) and 16–22 Coppergate (AY 16/5), as well as occupying a geographical position between the two sites. Occupation at Fishergate seems to have ceased in the middle decades of the 9th century at a time when the first traces of post-Roman activity could be recognised at Coppergate. Activity at George Street/Dixon Lane apparently continued through the 9th century, an assertion supported not only by the pottery but also by two 9th-century stycas. What this tells us of urban development is discussed below.

There are two challenges to understanding the pottery from the site; firstly, the presence of large quantities of Roman pottery raises the possibility that individual sherds of fine imported black and grey wares of Anglian date could be overlooked amongst the range of reduced fine Roman wares (not a problem encountered on Fishergate where there was no underlying Roman occupation), and secondly, the cutting of graves for several phases of cemetery use has disturbed much of the earlier evidence. The absence of pottery, or any other dating evidence in many features, also causes difficulties in interpretation.

The pottery is discussed initially phase by phase following the stratigraphic sequence. The different types, their currency and significance are then discussed in more detail.

### Phases 3–4

These phases produced only Roman pottery from the various features, and their possible interpretation is discussed elsewhere.

### Phase 5 Anglian

A few features, pits, cut and post-holes can be attributed to an Anglian phase of activity on the site. They are dated by the pottery to the late 7th–early 9th century, by comparison with similar assemblages at 46–54 Fishergate (AY 16/6).

Several contexts produced fragments of different vessels of Anglian date, together with varying amounts of residual Roman pottery. These Anglian sherds derived particularly from Context 1742, a deposit which overlay an earlier Roman terrace in Test Trench 3, and which may represent accumulation or dumped material. A rubbish pit (pit 2044) which cut into a linear ditch (Group 47) produced further Anglian pottery from its fill (1760), while the fill of a post-hole of a possible sunken building (Context 1774) supplied further stratified evidence. The substantial size of the vessel fragments suggests that these sherds are from contemporary rubbish and provide the evidence that these features are indeed Anglian. There is also one questionable sherd which could be either an Anglian import or Roman buff ware (Context 1620).

Amongst these (A1 Figure 32) (Context 1760) is the rim and part of the body of a substantial handmade, straight-sided jar with a flat-topped, slightly everted rim. The fabric is heavily grass-tempered and the exterior surfaces have been knife-trimmed. There are patches of external sooting under the rim. Grass-tempered wares have been recovered from other sites in the city (AY 16/6, 557–9, 568), but are not common; this particular vessel is more solid and thick-walled than the usual examples. A small neck and shoulder sherd from Context 1774 is probably from a similar, though smaller, pot of which little survives. This second vessel is coarsely sand-tempered as opposed to grass-tempered, and fits easily with the range of fabrics noted at 46–54 Fishergate (*ibid*, 567–8) and in some of the early deposits at 16–22 Coppergate where it was classed as Handmade Type 1 (AY 16/5, 396–8). These two sites offer a broad date range for this type of coarse gritty fabric; at Fishergate it was dated to the 8th century while it probably belongs to the mid-/late 9th century at Coppergate. It is almost certainly a local product with its antecedents in the early Anglo-Saxon period when similar fabrics were noted on decorated 6th-century ‘pagan’ Anglo-Saxon pottery from Heslington Hill, approximately 4km from York city centre (Mainman forthcoming).

The flat base and lower body of a substantial and heavy vessel (A2 Figure 32) from Context 1742 has a shell-tempered fabric. It has been well made and is unlike the typical, more simple, shell-tempered vessels recovered previously from Anglian contexts at 46–54 Fishergate (AY 16/6, 566). Quite distinct from all these, also from Context 1742, is the pulled lip of an imported black/grey ware jug of the type previously identified as coming from Northern France or the Low Countries. Although the fabric is comparable with the small black ware jug with the trefoil tubular spout from Fishergate (*ibid*, fig.250, 2524), the form is more like that of an imported buff ware jug from that site (*ibid*, fig.246, 2471). Both the George Street/Dixon Lane vessels are likely to be contemporary with the Fishergate finds and an 8th- or early 9th-century date is indicated.

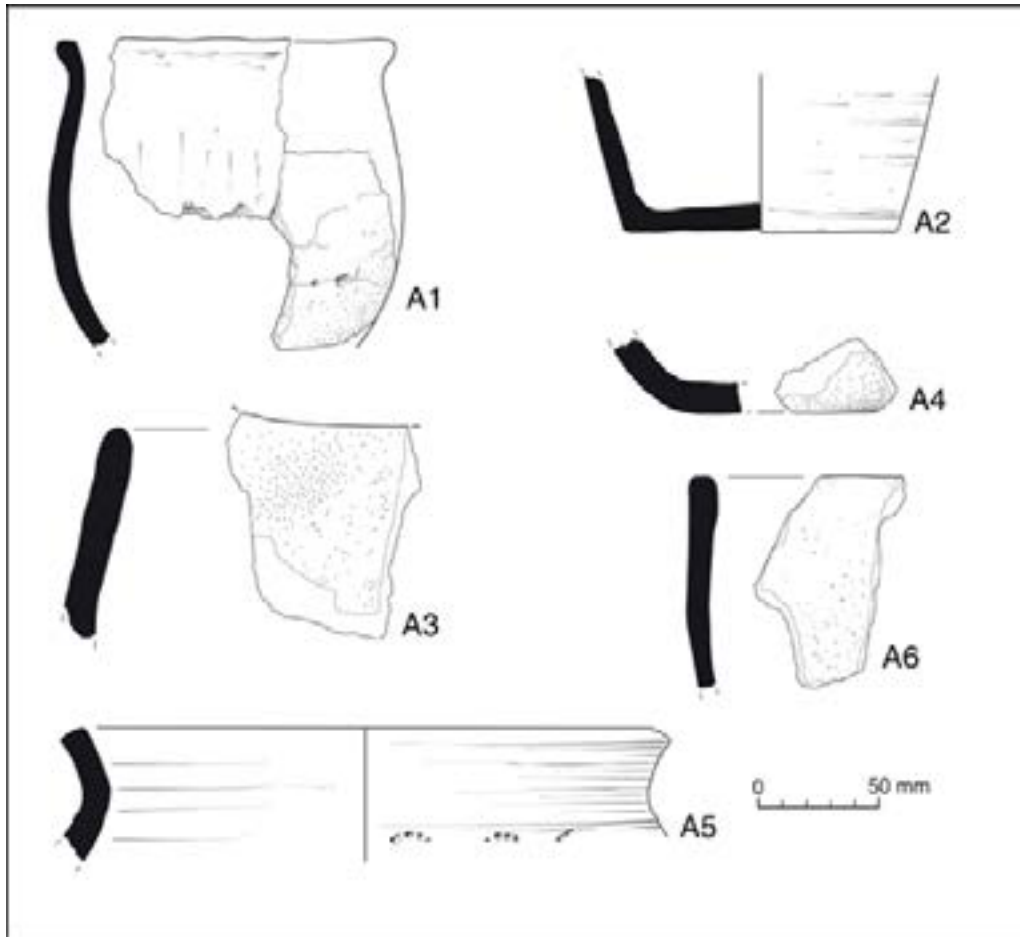

Figure 32 Anglian pottery

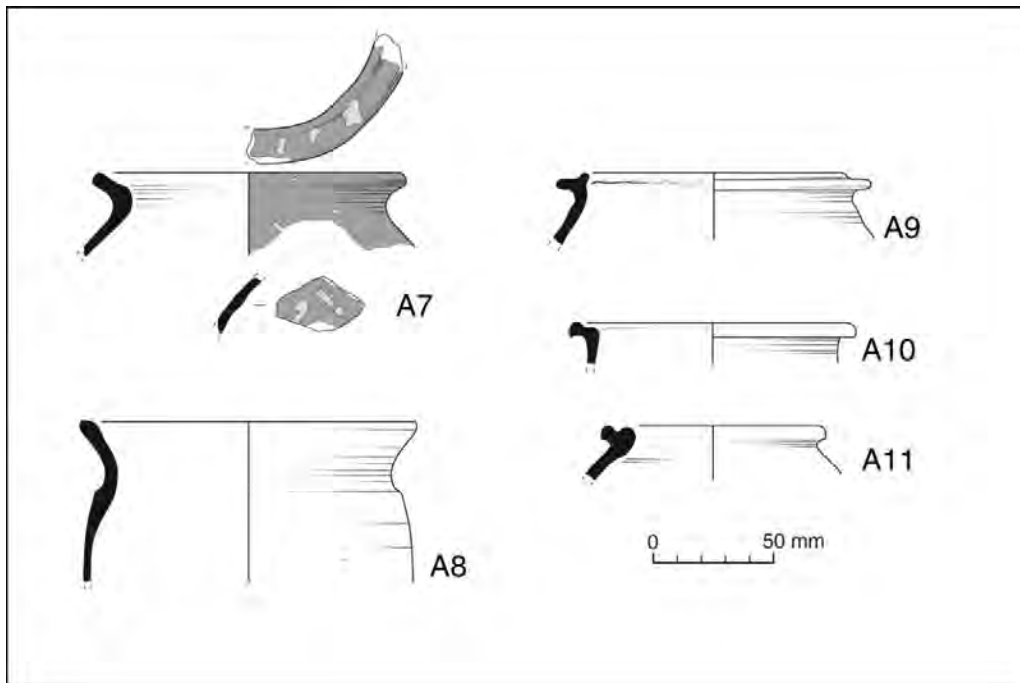

Figure 33 Anglian imported pottery

The most interesting group of sherds, however, comes from Contexts 1628 and 1483 which are fills of pits (Group 60) which cut into a linear ditch (Group 47). These pits contain a few residual Roman sherds but also fragments of three foreign imports and two English imports. The foreign examples include two different Tating ware vessels, one in each pit. Three sherds from a jug with the typical Tating ware rim form and applied tin-foil decoration (A7 Figure 33) were recovered from Context 1628, and two neck sherds from a second vessel were recovered from Context 1483. The two vessels have distinctive surface treatments, the former being matt and the latter highly burnished. Context 1628 also produced the narrow flanged rim from a wheel-thrown grey ware vessel of the type known to have come from the Low Countries or Northern France (A9 Figure 33). This has the characteristic hard-fired matt grey surface and brick-red section of these vessels. The two English imports include a thick featureless sherd, which is almost certainly a fine-tempered Ipswich ware, found together with the neck and high shoulder of a shell-tempered vessel.

These few features are the only ones which can be dated on the basis of their assemblages to the Anglian period. There are other features, however, which are considered contemporary for reasons of their character, position and stratigraphic relationship. Nevertheless, the small collection of pottery recovered comprises the full range of wares typical of the pits from 46–54 Fishergate which were dated to the 8th/early 9th century. The fact that the George Street/Dixon Lane Phase 5 features include a comparable range of ditches and pits associated with possible sunken-featured and rectangular buildings to those found at 46–54 Fishergate suggests that the two sites are not only contemporary but may have been similar in character.

### **Phase 6 Anglo-Scandinavian**

Three phases of activity are ascribed to the Anglo-Scandinavian period. These were distinguished on the basis of the different combinations of pottery types recovered from them.

#### **Phase 6a mid-9th-10th century**

Features placed in Groups 16, 30, 32, 37, 42 and 43, which have been assigned to Phase 6a, produced only residual Roman pottery. Those in Groups 35 and 36 described below, however, produced post-Roman material. As the Groups assigned to Phase 6a are all stratigraphically related, the material from Groups 35 and 36 offers the latest date for all these features.

#### ***Group 35, Contexts 1626, 1808, 1981, 1745***

Pottery recovered from a hollow above an infilled Roman ditch (Contexts 1745 and 1981) comprised sherds of York ware and the related York 'd' ware (Holdsworth 1978, 6) (AS5 Figure 34) together with Anglo-Scandinavian grey wares (one of which might be Torksey-type ware) and Roman residual material.

Pit fill 1808 has further sherds of York 'd' ware and a buff pitcher sherd. The latter may be an Anglian import or possibly a Roman vessel, but it has been badly burned at the point where the handle attaches to the body. A second buff sherd, this one much grittier, is also likely to be an Anglian import. A sandy hard fabric with a splash of glaze is believed to be an intrusive splashed ware. The other pit fill, context 1626, has a single sherd of York ware and a styca (SF117) of Aethlred II, AD 841–50.

The presence of York wares and the absence of clearly identifiable Torksey-type wares, together with the stratigraphic associations on site, suggests that this phase represents early Anglo-Scandinavian activity, comparable with Period 3 at 16–22 Coppergate (mid-/late 9th–early 10th century) (AY 16/5, 487–9).

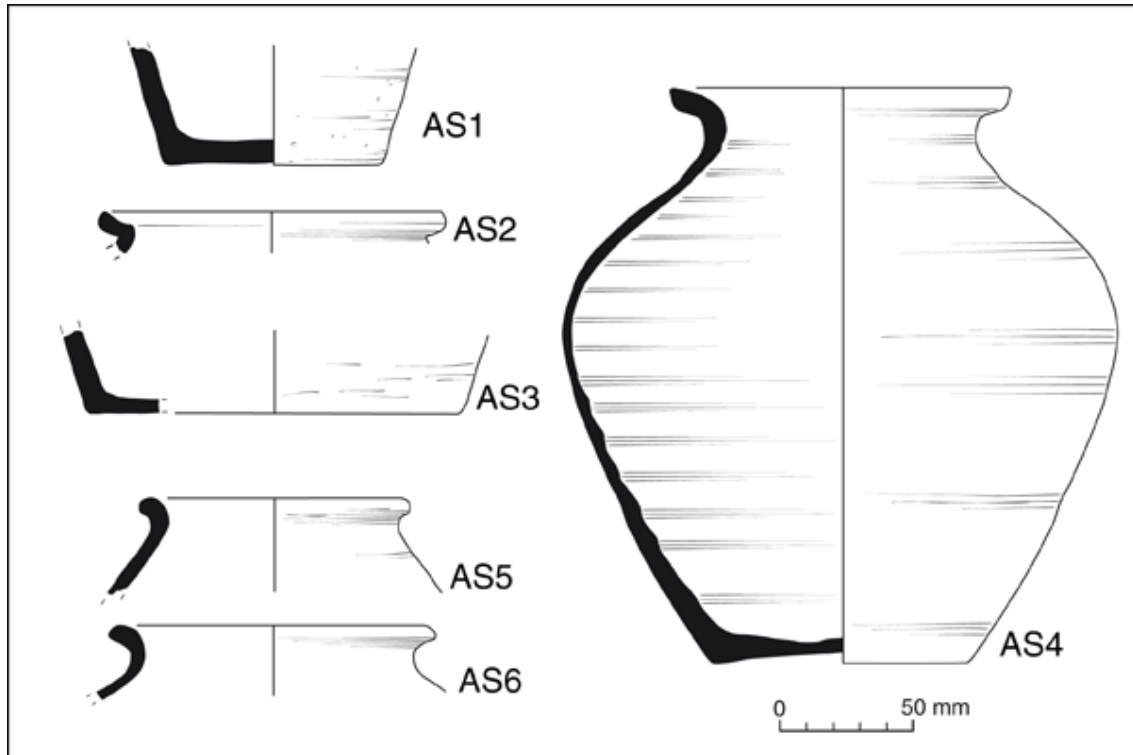

**Figure 34 Anglo-Scandinavian pottery**

### **Group 36**

Again the majority of the pottery is residual Roman material upcast from earlier deposits. The fills of two pits (Contexts 1335 and 1646) which cut into the hollow described above, however, contain what has been published elsewhere as Handmade Type 1 (HM1), a forerunner of York ware (AY 16/5, 396–8, fig.151), and a small handmade flat-based vessel (AS1 Figure 34) which is clearly similar to York ware, being coarsely tempered. The form, however, is smaller, more heavily tempered and would be unusual for York ware. The exterior is sooted suggesting its use in food preparation. Both these vessels are thought to be transitional 9th-century types as York ware develops out of the handmade traditions which preceded it. Other contexts in Group 36 (1744,1761,1765 and 1949) contained only single sherds of Roman pottery.

### **Phase 6b 10th century**

Group 24 produced no pottery. Group 38, on the other hand produced pottery from Contexts 1285, 1309, 1350, 1440, 1493, 1515, 1580, 1617, 1652, 1653, 1666 and 2037.

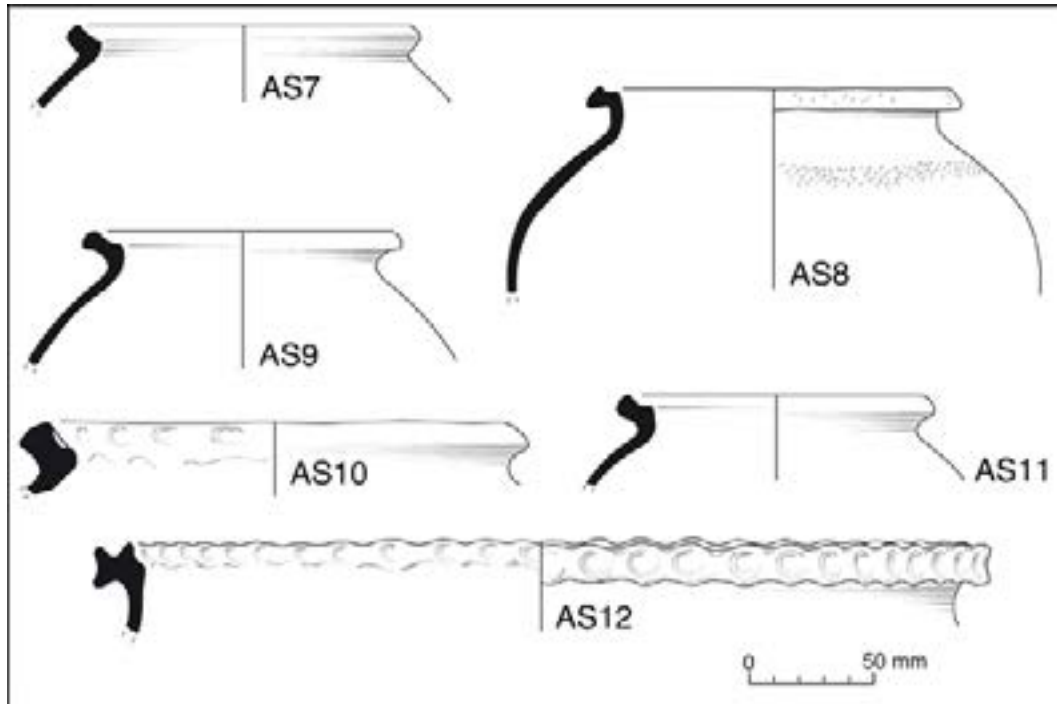

**Figure 35 Torksey type pottery**

This group forms a tight assemblage of probably early/mid-10th-century date. York ware and 'd' ware continue to be recovered and there are likely to be both residual and contemporary examples. York ware cooking pots (AS2, AS3, Figure 34) and a fragment from a pedestal lamp represent the range of forms known in this fabric. Torksey-type wares begin to make an appearance (AS7, AS8, AS9 and AS10, Figure 35) and a high proportion of the cooking pots have decoration on the rim edges and shoulders, a feature more common on Torksey-type wares in the middle decades of the 10th century (AY 16/5, 432, figs.172–3). Sherds from Torksey-type ware pitchers with applied thumbed strips were recovered from Contexts 1617 and 1493. Other contemporary pottery includes three sherds of glazed and unglazed Stamford ware from Contexts 1515 and 1617 (AS13 Figure 36); the latter also produced a sherd of Anglo-Scandinavian shelly ware.

Residual material includes not only Roman pottery but also residual Anglian material. An Ipswich ware sherd was recovered from Context 1617, a thick, abraded, handmade, flat-based sherd in a fine fabric with some grass-tempering from Context 1666 and a further handmade coarse tempered sherd from Context 2037. The latter context also produced joining sherds from a high-necked Mayen-type vessel (A8 Figure 33), again echoing discoveries at 46–54 Fishergate (AY 16/6, 579) where vessels with the same provenance were recovered from 8th-century contexts.

### **Phase 6c Late 10th–11th century**

Further pits and cuts were assigned to Period 6c in Groups 37, 39, 55, 41 and 40. Group 37 had only Roman pottery in Contexts 1641 and 1648. All the other groups had material which suggests this intensification of activity was of late 10th- or early 11th-century date.

### Group 39

Group 39 produced further residual Roman sherds together with post-Roman material. Handmade sherds from Contexts 1299 (A4 Figure 32) and 1213 could be of Anglian date, although conceivably the handmade tradition could have continued into the 9th and 10th century. A large vessel from Context 1291 (A3 Figure 32), whose rim suggests it had an upright pierced lug, is, however, more likely to be of 8th- or early 9th-century date. This vessel has a well-sorted sandy fabric and thick walls (c.10mm) and a very large diameter. Previously examples of this form have been in a shell-tempered fabric (AY 16/6, fig.242,2412, 2421–3). This vessel was associated with a wheel-thrown buff ware sherd, which is soapy to the feel, and has large (1.0–1.5mm) quartz sand inclusions; it is probably an import. No other post-Roman sherds were recovered from this group.

### Group 40

Contexts 1248, 1265, 1316, 1551, 1619, 1645 and 1650 all produced Roman pottery; only Context 1645 provided the evidence that these features were post-Roman. This deposit contained a sherd of Torksey ware, a crucible (C1 Figure 37) with an oxidised gritty fabric and a rim sherd of gritty ware (N1 Figure 39). Two further sherds (A10 Figure 33) represent a small hard-fired vessel with flanged rim which is probably an Anglian black/grey ware import. They were found together with an abraded undiagnostic buff ware sherd which might be Anglian or Roman in date. The crucible, on the other hand, has a thick internal glassy deposit and is of an oxidised gritty type recovered from late 10th- /early 11th-century levels at Coppergate (AY 16/5, 471). The latter were examined by Justine Bayley and found to have been used for high-lead glass melting and were found in association with Stamford ware glass melting crucibles (*ibid*). None of the Stamford ware crucibles have been recovered from George Street/Dixon Lane but one or two other sherds of oxidised gritty crucibles (conceivably the same vessel) were recovered later in the sequence (see below). This evidence of possible glass-melting might suggest a use for the hearths which were uncovered in Phase 6c, although there is also evidence for lead-working and iron-working slag.

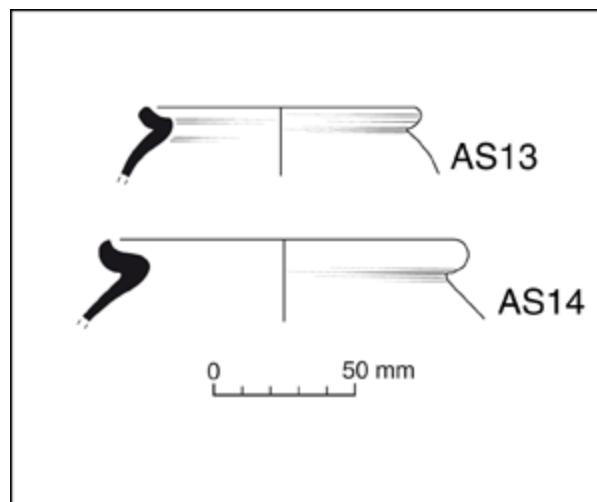

Figure 36 Stamford wares

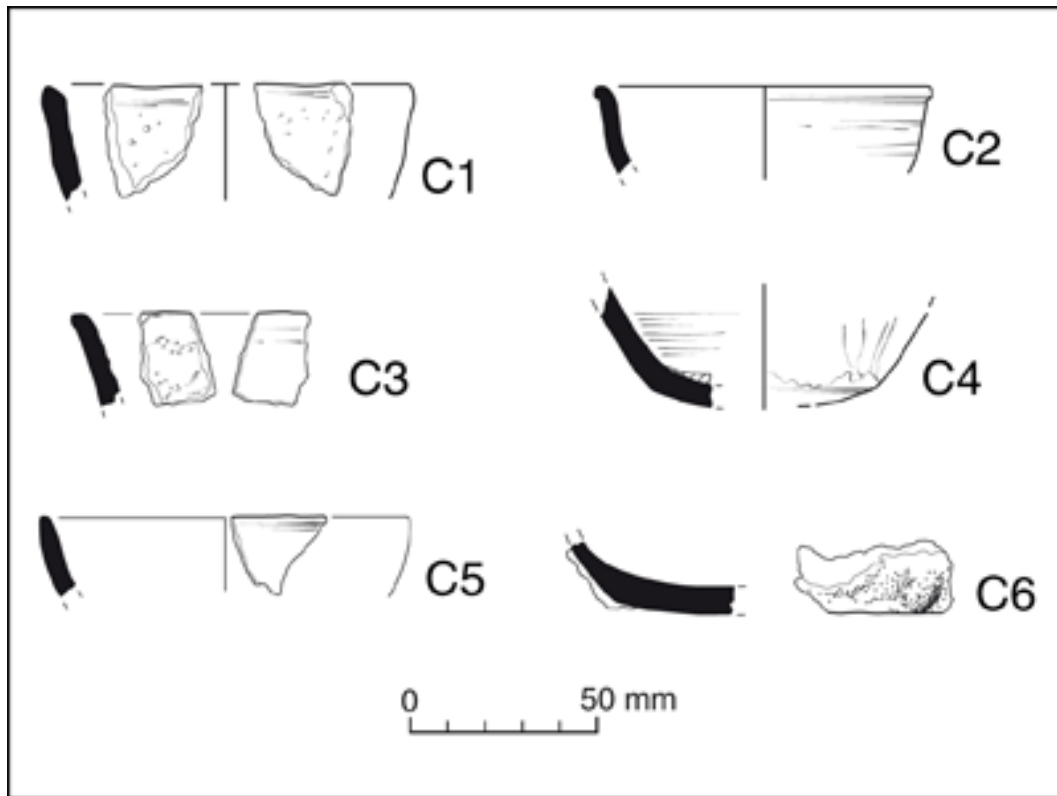

Figure 37 Crucibles

### Group 41

Three contexts, 1325, 1389 and 1469, produced pottery. Context 1389 had only Roman sherds but the other two contained a range of wares which date Group 41 to the mid-10th century. In the case of Context 1325 these comprise seventeen sherds of Torksey-type ware, typically small cooking pots with everted rims and sagging bases (AS11 Figure 35). Four sherds from a single Early Glazed ware type 1 vessel were also recovered (AY 16/5, 445–50) (EG1 Figure 38). This has a thick yellow glaze on both external and internal surfaces and traces of rectangular rouletting on the rim edge and shoulder. The same context produced a small rim sherd from an open form (C2 Figure 37) which has an oxidised sandy fabric and thin copper-green internal glaze. This might represent an attempt to glaze the surface, but the small open form is more probably that of a crucible, possibly related to the more coarsely gritted crucible found in Group 40 (see above). Context 1469 produced further sherds of Torksey-type wares.



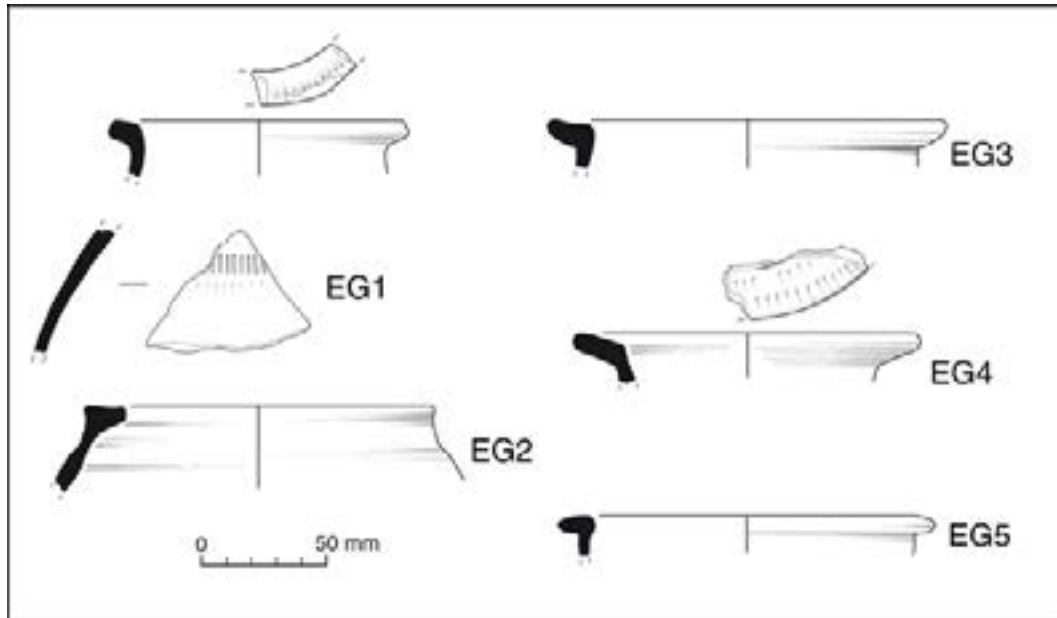

Figure 38 Early glazed wares

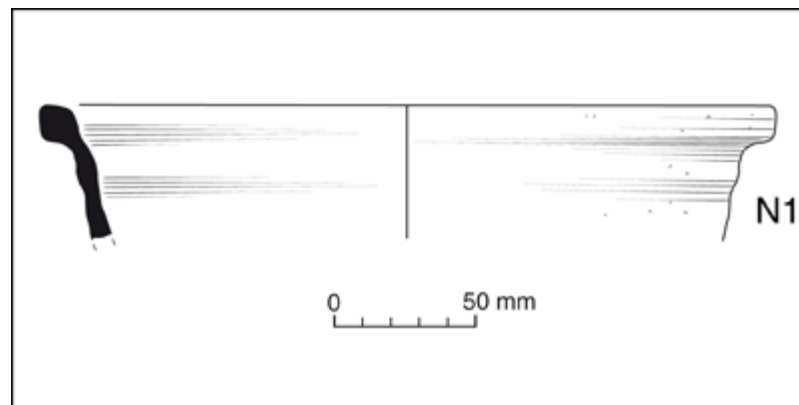

Figure 39 Norman pottery

**Group 55, Contexts 1269, 1271, 1521, 1549, 1547**

These contexts contained the same range of Anglo-Scandinavian wares together with residual Roman material. Both 1269 and 1521 have Stamford wares (AS14 Figure 36), 1269 and 1549 have York and York 'd' wares, while 1549 also has Torksey-type wares. Context 1547 produced a featureless grey ware sherd which might be either Roman or Anglo Scandinavian. Of interest is the base of a large, thick, abraded pinkish-buff base with quartz sand tempering and large red inclusions. This had clearly been a substantial vessel but its provenance and dating remains uncertain; the much abraded surface might indicate that it is a residual Roman or Anglian import.

**Phase 6d Pre-Norman Conquest burial ground**

One of the most interesting episodes in the site's history is the series of graves found to be on a different alignment to the later medieval graveyard; the question arises as to which side of the Norman Conquest these burials belong. The latest dated pottery from the grave fills is from Context 1311 (Set 275) which has a single sherd of gritty ware of the early type, believed to be mid-/late 11th century. All the other grave fills have material of which the latest date is Anglo-Scandinavian.

To examine this in detail, Context 1579 (Set 264) has York ware and Torksey-type ware; Context 1093 (Set 269) has a jar with an unusually tall neck like the Handmade Type 1 referred to above, but whose fabric appears to be York ware. These were found together with an abraded sherd of York ware, two Anglo-Scandinavian shell-tempered wares, two Stamford wares with splashes of glaze and fifteen sherds from Torksey-type ware cooking pots. This assemblage is from the fill of a grave containing clenched bolts, similar to others recovered from pre-Conquest burials at St Peter's Church, Barton on Humber (Rodwell 2007, 23). Context 1279 (Set 263) has a further sherd of Torksey-type ware, an early glazed ware sherd (part of the vessel recovered from 1325) and a crucible sherd (C4 Figure 37) similar to the one from Context 1645 (C1 Figure 37) (see Group 40 above). Context 1320 (Set 312) has four Torksey-type ware sherds.

A cluster of contemporary intercutting pits and an isolated burial (Set 222) produced further pottery. Context 1134 (Set 222) produced two York 'd' wares (AS6 Figure 34), one shelly ware and two possible Torksey-type wares (one badly burned). Context 1180 (Set 227), which cuts, and therefore post-dates, the burial, produced nine sherds of York ware, three Anglo-Scandinavian 'd' wares and residual Roman sherds. One of these York ware sherds joins the remains of a substantial York ware cooking pot (AS4 Figure 34) which was recovered from a machine-cleared spit (Context 1100) in Phase 8. Much of the vessel could be reconstructed and fresh breaks suggest that this vessel had been substantially complete, raising the possibility that it had been in use towards the end of the 10th century, a century after York wares were first introduced. Either this individual vessel was very old at the time of discard into the pit or else the production of York ware continued through to the end of the 10th century. Contexts 1490 and 1491 (Set 228) contained only Anglian pottery, including a handmade coarse tempered ware from context 1490 and an early shelly ware from Context 1491.

There would seem to be no reason, therefore, to date the fills of these oddly aligned graves to the post-Conquest period. With the exception of Set 275, which produced a single sherd of gritty ware, every other grave fill could be of late 10th-century date on the basis of the pottery. To insist upon these graves being post-Conquest would require all the pottery in all the graves to be residual as well as the pottery from the pits which cut into them.

One isolated burial (Set 222), cut by a sequence of more or less contemporary rubbish pits (Sets 227 and 228), suggests a somewhat informal character to this group of burials.

### **Phase 7**

A series of features including a linear ditch (Group 51) and pits (Group 49), some of which cut the ditch, are grouped into Phase 7.

### **Group 51**

The assemblage from the ditch fill (Context 1752) is dated to the mid-/late 11th century on the basis of a gritty ware and a splashed ware sherd. Earlier, residual, material includes Anglo-Scandinavian (two York 'd' wares and two Torksey-type wares), Anglian (one handmade and one Ipswich ware) and Roman material (thirteen sherds).

**Group 49 Contexts 1224, 1446, 1499, 1569, 1574**

A series of pits, which either cut or are isolated from the ditch, contained a small assemblage of pottery with generally small sherd sizes. Again, the latest material is gritty ware (five sherds) and splashed wares (two sherds) which suggests a date in the mid-/late 11th century. There are one or two sherds which are suggestive of a transitional pottery type between the York wares and the gritty wares, being less gritty and thinner-walled than the York ware but retaining the flat base typical of these products.

Of interest is the continuing quantity of Anglian material from these contexts. This includes stamped Ipswich ware, rouletted Badorf ware, Low Countries/Northern French black wares, shell-tempered wares and coarse tempered wares. Quantities are not great but the range of wares is consistent with the material in the stratified Anglian pits.

The Anglo-Scandinavian wares are also consistent with the material recovered from the stratified Anglo-Scandinavian phases and sub-phases, and include Stamford wares, Torksey wares and early glazed wares.

**Phase 8**

Phase 8 is the main medieval cemetery phase. The circumstances of its discovery, recovery and the methodology employed are described in the site report. The grave cuts, their fills and the series of spits (e.g. Contexts 1066 and 1588) which were used to locate and identify the graves, contain a quantity of Roman, Anglian, Anglo-Scandinavian, Norman and early medieval pottery (A5 and A6 Figure 32; A11 Figure 33; AS12 Figure 35; C3, C5 and C6 Figure 37; and EG2, EG3, EG4 and EG5 Figure 38).

There is nothing in any of the grave fills later than early types of Brandsby-type ware pottery. This provides a latest date in the first half of the 14th century, consistent with the understood end date of the cemetery in the 1330s. There is also later material in the spits mainly of later 14th and 15th century, a date provided by Humber and Hambleton-type wares, from where intrusive post-medieval and modern material has also been recovered.

Most grave fills contain only one or two sherds of Anglo-Scandinavian or Anglo-Norman pottery suggesting that this has been redeposited from earlier, pre-cemetery, occupation on the site. Large quantities, and some large sherds, of 11th- and 12th-century gritty and splashed wares recovered mainly from the spits, suggest that there were pits or dumps of domestic debris from this period on the fringes of the cemetery before the expansion of use in Phase 8.

**Phase 9**

There were virtually no post-cemetery medieval features on the site. A butt-ended ditch cut (1091) and its fill 1092 contained mainly residual material, the latest date of which is 14th century. Two rubbish pits (Sets 90 and 1002) also contained mostly residual material, although the foot from a Low Countries redware pipkin and further Humber ware indicate some contemporary rubbish.

The relative lack of post-cemetery medieval features on the site suggests either that there was relatively little activity on the site following the abandonment of St Stephen's churchyard, or that any features of this date were destroyed before the construction of a modern brewery (see Phase 10).

**Phase 10**

Although features relating to the construction of the late 19th-century brewery buildings were present there was little contemporary pottery. The residual material is listed in the site archive.

### Discussion

The post-Roman ceramic sequence from the site is of considerable interest. The composition of the Anglian assemblage, with the imported material from the Rhineland and from northern France/the Low Countries, together with Ipswich ware, shell-tempered wares, grass-tempered ware and local handmade products, makes it exactly comparable with the assemblage recovered from 46–54 Fishergate. Although the quantities are small, there is a higher proportion of imported wares than was recovered from Fishergate.

This assemblage provides a geographical link between the Fishergate site and other sites throughout the city where material of Anglian date has been found. Deeply stratified deposits 150m to the north, at 17–21 Piccadilly, produced a sherd of a Badorf relief-band amphora. Further towards the old city centre, 16–22 Coppergate produced a few Anglian sherds including further Badorf (and later Pingsdorf wares), North French/Low Countries black burnished wares and Tating wares, as well as English imports in the form of Ipswich ware, Maxey-type shell-tempered wares and other local handmade wares. Again many of these sherds were residual in later contexts, but clearly there had been some form of Anglian activity on the site. Further Ipswich ware was recovered from 5–13 Clifford Street, 75m closer to the River Ouse from the Coppergate site in an easterly direction, while 150m to the north-west of Coppergate, Ipswich ware was reported from Hungate on the banks of the River Foss (Hurst 1959, 76, fig. 15).

On the south-west bank of the River Ouse, Tating ware was recovered from 58–9 Skeldergate (AY 16/1, 18–19, fig. 4.6), 1–9 Micklegate (AY 16/6, 561, fig. 238) and at Wellington Row (*ibid*) associated with imported black burnished North French wares and with Ipswich wares.

In most of the cases discussed above these discoveries constitute only a handful of sherds, often redeposited in later levels or recovered from small trenches. While other sites in the city have produced Ipswich ware and foreign imports, for example, King's Square (Le Patourel 1968 155), 11–13 Parliament Street (Moorhouse 1972, 221), Museum Gardens (Stead 1958, 426), York Minster (Holdsworth 1995, 468–9), the sites which have produced significant stratified material cluster less than 15m from the banks of the Rivers Ouse and Foss as they might have been in the Anglian period.

This new evidence from George Street/Dixon Lane, situated as it is about 50m to the south-west of the possible old course of the River Foss almost 400m upriver from the settlement at Fishergate, might suggest that the focus of the Anglian *wic* was not as far downriver as 46–54 Fishergate but was nearer the old Roman centre and more spread out along the river banks. 46–54 Fishergate may in fact have marked the southern edge of Anglian settlement; there was certainly less Anglian evidence encountered 100m downstream at Fishergate House and Blue Bridge Lane, off Fishergate ([www.archaeologicalplanningconsultancy.co.uk/mono/001/](http://www.archaeologicalplanningconsultancy.co.uk/mono/001/)). If foreign imports can be used to indicate the presence of sites with a *wic*-like function then Eoforwic is perhaps not confined to a single location but was a diffused settlement.

The Fishergate sequence was dated, on the basis of coinage, to the late 7th/early 8th century with an end date in the mid-9th century. There were two distinct phases of occupation there, Period 3a and Period 3c, which were separated by an episode of levelling (Period 3b). The second phase of occupation

was both less intensive and less extensive than the first, and there is no evidence that it continued beyond the middle years of the 9th century, the latest coin being that of Aethelbert of Wessex (858–66). Unlike George Street/Dixon Lane there is no continuing ceramic sequence, but instead there is a gap until c. 1000 when (in Period 4) the Fishergate sequence picks up again with late Torksey-type wares and Stamford wares, followed by splashed gritty wares and a sequence of medieval types.

At George Street/Dixon Lane the quantities of York ware, York ware 'd', shelly wares and early Torksey-type wares suggest that the sequence of occupation there might have continued unbroken from the late 7th/early 8th century into the period following the arrival of the Viking Great Army in 866. The break in occupation observed at 46–54 Fishergate may well be tied in to these developments as the 9th-century Anglo-Scandinavian town grew up closer to the old Roman fortress and then expanded in the 10th and 11th centuries. This expansion is charted by the occurrence of different pottery types throughout the city (Mainman and Rogers 2004, figs 118–20).

The character of the occupation at the site in both the Anglian and the Anglo-Scandinavian phases is difficult to discern from the available evidence. The quantities of 8th- and early 9th-century imports might indicate a high-status site where imported objects gave status to wealthy inhabitants. They might, perhaps more convincingly, suggest mercantile activity, with the pottery representing trade items, containers for traded goods or the possessions of the foreign traders themselves. Whether this was part of a riverine strip which constituted a dedicated zone for trade and traders cannot be discerned from the available evidence but as more data accumulates this might become clearer.

The character of the assemblage in the 9th and 10th centuries appears to more clearly domestic. Utilitarian cooking vessels in York ware and Torksey-type wares dominated the stratified assemblages, together with a small amount of Stamford and shell-tempered wares. Notably absent are sherds of the Stamford ware metal-working and glass-making crucibles so common at 16–22 Coppergate (AY 16/5, 469–77). There are, however, sherds of the other main type of oxidised gritty crucibles, also believed to have been used for melting high-lead glass, typically in the 11th century (*ibid*, 471). Perhaps only four or five vessels are represented but this indicates that small-scale glass-making may have occurred alongside the other crafts indicated by the finds.

The pottery dates also supply good evidence of a pre-Norman Conquest date for the group of burials in Phase 6d. Their distinct alignment and the evidence for different burial practices supports the claim that this group of graves is in some way distinct from the later medieval burials. How far back into the pre-Conquest era this places them is debatable; with the exception of the sherd of gritty ware from Context 1311 which dates to the mid-/late 11th century, none of the pottery need be later than late 10th century. Unfortunately the particular conditions which pertain to the site, i.e. the disturbance caused by later burials and the rescue conditions under which the site was dug, combined with the usual problems of dating graves from their backfilled soils, precludes any closer dating of these burials.

What is interesting, and perhaps surprising, is that these burials were either adjacent to, or cut into, existing recently filled rubbish pits (Phase 6a–c), and one grave was relatively soon cut by pits used for rubbish disposal, presumably from a nearby occupation area. All this begs the question as to why this area became a focus of burial at this time when pit digging and rubbish disposal was clearly on-going around them. Within little more than a generation, however, soon after the Norman Conquest, the area seems to have become an established burial ground almost certainly associated with St Stephen's

church. The key might lie with the reason why a church, particularly one dedicated to Stephen who was martyred outside the walls of Jerusalem, was established at this place outside the walls of the Roman fortress. One can only speculate about the possible significance of the area which had served once before as a place of burial in Roman times.

The subsequent medieval burials can also only be dated by the material in the backfill of the gravecuts. This included a lot of residual material but also typical wares of the 11th, 12th and 13th centuries. The latest material in most cases is Brandsby-type ware or early Humber ware which would be consistent with an end of use of the cemetery in the mid-14th century.

The site offered little ceramic evidence for the post-churchyard medieval or post-medieval periods. Although this excavation grew out of rescue circumstances aimed primarily at removing burials ahead of redevelopment, it has provided very important new evidence. Archaeological attention should be drawn to this area of the city as this site suggests it might hold important keys to understanding how the medieval city grew from its Anglian origins in the late 7th century.

### **4.3 The ceramic building material (CBM)**

By J. McComish

A total of 63.335kg of CBM was recovered from the site. The material was recorded using standard YAT methodology and ranged in date from Roman to modern.

Just over half the material recovered was of Roman date (52.14%), consisting of brick, tegulae and imbrices. Most of the Roman material (76.2%) was residual in contexts of Anglian, Anglo-Scandinavian and medieval date. A few features of interest were present among the Roman material including two bricks with signature marks (Betts types 1 and possibly 5; Betts 1985, 192), a brick with a cat's paw print on the upper surface, and two tegulae with upper cut-aways.

The medieval material made up 42.84% of the total CBM from the site and was almost exclusively roofing tiles. There was a single fragment of curved roof tile of 11th- to early 13th-century date; the remaining material was plain, peg and ridge tiles of 13th- to 16th-century date. One of the plain tiles had been cut for re-use as a pot lid. There were no other features of particular note present on these tiles.

There were relatively few fabrics present among the medieval tiles (most were in fabrics M1 and M4, with smaller quantities of M2, M3, M6, M15, M33, M39 and M60). Roofing tiles were in general use from the 13th century onwards, but as this site went out of use in the mid-14th century the CBM seen here represents just 150 years of roof tile deposition. The relatively small number of fabric types present may suggest that there were few major suppliers during this period.

There were only four fragments of medieval brick of 14th- to 16th-century date. This fits in with the documentary evidence which suggests that the church went out of use in the early 14th century.

No post-medieval material was recovered from the site, and the only modern material present was late 19th-century brick from Victorian brewery buildings on the site.

FABRIC	% OF TOTAL
M0 (fragments too small to identify)	10.43
M1	53.14
M2	0.37
M3	2.21
M4	21.32
M6	3.69
M15	5.80
M33	0.92
M39	1.94
M60	0.18

**Table 6 Medieval roofing tile fabrics**



**Context 1100 and Context 1620 Roman signatures**



**Context 1588 tile re-used as a pot lid and Context 1886 tile with paw print**

#### **4.4 The Artefacts**

**By N.S.H. Rogers**

##### **The Roman period**

The nature of the activity and settlement on the site throughout the Roman period appears unclear, although possible timber buildings were identified dating from the mid-4th century. Small finds from this period were not numerous, and unfortunately do not help to clarify the nature of the site: three bone needles and an iron awl are the only tools associated with Roman crafts that were recovered, and none

were found in Phase 2 Roman levels, all being from later deposits. The majority of the Roman finds are of a domestic or personal nature; the vessel glass fragments appear to be 2nd–3rd century in date, while the bone hair pins, gold finger ring, copper-alloy bracelet, jet bear and shale bangle all appear to date from the late Roman period.

### **The Anglian and Anglo-Scandinavian periods**

Evidence of bone and antler comb-making on the site points to the origin of this craft activity in the Anglian period, contemporary with manufacture at the nearby site of 46–54 Fishergate (AY 17/9). Indeed, it has been suggested that similarities between the remains seen at Dixon Lane/George Street and 46–54 Fishergate indicate such similar patterns of development that both may represent part of the same *wic* or trading settlement (see 3.4). Unlike 46–54 Fishergate, however, occupation and activity at the site at Dixon Lane/George Street clearly continued into the Anglo-Scandinavian period, when larger concentrations of comb-making debris were deposited than in the earlier period. Very similar debris in the form of split rib offcuts was also found at another nearby site on Leadmill Lane (AY 17/3); this debris was recovered from unstratified spoil, but was interpreted as deriving from a pit or dump of the Anglo-Scandinavian period (AY 17/3, 72). An Anglian date for this material is possible.

Textile manufacture as indicated by the loom weights may also have occurred on or near the site, as it also did at Fishergate, although the latter site produced evidence of other stages of the textile manufacture process – such as spinning and fibre preparation (AY17/9, 1441) – which appear to be lacking at Dixon Lane/George Street.

Other finds also complement artefacts from Fishergate: the copper-alloy dress pins, the glass beads, the polychrome vessel glass fragment (SF99) and possible iron key are all similar to examples found at the *wic* site. Unlike Fishergate, personal items from the Anglo-Scandinavian period were also found: these comprise bone dress pins, a twisted wire ring and an arm ring.

The ironwork associated with the Phase 6 burials was limited to clench bolts possibly used in loose timbers which had been re-used as a burial cover in grave 1063. The only comparable use of such bolts in York comes from York Minster where clench bolts found beneath a burial were interpreted as part of a boat re-used as a bier (Kjølbbye-Biddle 1995, 500).

### **The medieval period**

The use of the site as a cemetery in the medieval period resulted in few objects from this period being recovered: those that were found include an iron arrowhead, three horseshoe nails, four knives and a fragment of shears. Nails were found scattered within some burials, but in small numbers, and were indicative of use in conjunction with wooden pegs rather than of nailed coffins.

#### **4.4.1 *Antler-, bone- and horn-working***

**By N.S.H. Rogers**

#### **Antler**

Antler was favoured as a material for making composite combs, and analysis of waste produced by antler-working found at other sites across York and elsewhere has revealed the methods by which the usable pieces of antler were recovered. The most useful pieces were the straight elements of the beam



or the main body of the antler: the curved parts, including the tines and the top or crown, could not be used to make combs and so these were usually discarded, as was the burr or base. Two burrs (SF493, SF502) are from antlers which had been naturally shed in the wild, and subsequently collected. This corresponds to antlers recovered elsewhere in York, which are much more commonly shed antlers rather than antlers attached to slaughtered animals.



**Antler burr SF493 Actual length 180mm**

After removal of the unusable pieces, the straight beams were typically divided lengthways into quadrants (see for example SF39), and the inner porous tissue removed, leaving plates of the stronger outer tissue. These formed the blanks from which combs were constructed. Short offcuts of outer tissue, such as SF490, and shavings (for example SF499) may have been trimmed off comb blanks. A total of 35 antler offcuts were recovered during the excavations.

### **Bone**

Although antler appears to have been preferred as a material for the construction of composite combs, bone was also used, and, on this particular site, comprised the vast majority of the debris (229 offcuts). Where it was possible to identify the bone types, most proved to be ribs, usually offcuts of split rib. In some Phase 6 pit backfills, these offcuts were found in significant concentrations: the greatest amounts were found in Context 1265 (17), Context 1942 (33), Context 1490 (34) and Context 1617 (86). ]

Some of these deposits also produced unfinished bone comb fragments: four comb plate fragments (SF454) were found in Context 1617, another in Context 1490 (SF455) and also a possibly unfinished comb from Context 1942 (SF43). Further comb blanks were found in other deposits (see for example SF462, SF504). All these suggest that bone comb-making was occurring on or in the vicinity of the site.



**Bone offcuts SF460. Largest actual length 96mm**

#### **The products: combs or comb cases**

All the comb fragments recovered appear to be plates from unfinished composite combs: these combs were composed of a pair of connecting plates, usually decorated, which held tooth plates in place between them. Once the plates had been fixed together with metal rivets, the teeth would be cut into the tooth plates: one of the fragments (SF456) appears to be an unfinished tooth plate which was discarded before any teeth were cut. The form of the other plates (see for example SF454) would be appropriate for connecting plates, but none has tooth cutting marks along the edges, which suggests that they may have been discarded before that stage of construction had been reached. This is true even of the plates with decoration (e.g. SF43), as the plates were decorated before the comb was assembled and the teeth cut. Alternatively, some of these plates could have been destined to become side plates of comb cases: although very similar in form to comb connecting plates, comb case side plates may be distinguished by the restriction of rivets to the ends only. Of all the plates recovered, only one (part of SF454 with decoration and rivet) which retains a rivet and second rivet hole is certainly part of a comb. Comb cases were designed to protect the more fragile parts of the combs, that is the teeth, and usually comprised one or two pairs of side plates attached to a pair of end plates, with a gap to enable a comb to be slotted in from above.

Similar fragments of plates, also mostly made of ribs, and identified as comb case plates, were found during excavations in 1973 on Leadmill Lane, a site only about 50m away (AY 17/3, 151–2, fig. 49, nos.653–7).



Comb fragments SF454. Largest actual length 78.5mm

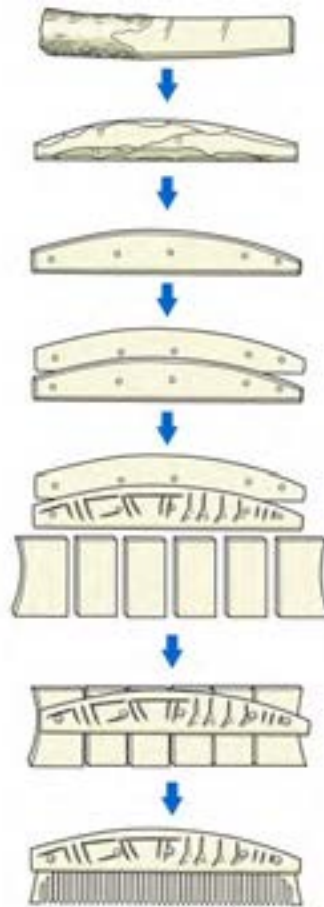

Comb construction

### Evidence of comb and comb case making

It has been noted above that bone and antler offcuts, and incomplete plates, point to the manufacture of combs and comb cases. In addition to the small finds, other finds of antler and bone also indicate such craft activity in the area. Amongst fragments of butchered animal bone, chopped ribs were particularly evident, and offcuts of antler were also identified. These offcuts were especially numerous amongst waste recovered from Phase 6 deposits. One Phase 6 pit fill, Context 1291, produced almost 400 butchered fragments, including numerous chopped ribs, all similarly sized, which were interpreted as possible comb-making blanks: these were in addition to the two offcuts which were recorded as a small find (SF452). Bone-working waste from Contexts 1265 and 1490 again featured ribs: Context 1265 also produced 20 offcuts in small finds (SFs281, 450, 501, 507), and 38 offcuts were identified in small finds from Context 1490 (SFs453, 455, 459, 492). Antler waste from Context 1617 was also noted: this can be added to the 98 offcuts of bone and antler in the small finds (SFs451, 454, 460, 499, 503). Bone- and antler-working, perhaps producing combs and/or comb cases, was clearly undertaken on or near the site, and is probably part of the same activity noted at Leadmill Lane nearby, although it is uncertain whether this craft activity occurred on both sites, or one, or whether these finds signify merely the areas where debris was dumped.

In terms of dating the activity, it appears that this could have begun in the Anglian period: one Phase 5 pit (Context 1483) produced fourteen split rib offcuts and two other bone offcuts. The concentrations in several Phase 6 pits, however, suggests that this craft working may have become more large scale in the Anglo-Scandinavian period, from the 10th century onwards. It should be noted that one antler offcut was retrieved from a Phase 2 stake-hole (SF466), and is possibly intrusive in this context.

### Horn-working

Offcuts of cattle, sheep and goat horncores were recovered amongst both the small finds (see for example SF296, SF297) and amongst the other animal bones, and as with the bone and antler offcuts, appear to have occurred primarily in Phase 5 and 6 deposits. There was much less of this type of waste, however, and the scale of working is impossible to determine. The waste represents the debris following the removal of horn sheaths from animal horns: horn itself is rarely recovered archaeologically, but the bony horncores often survive to provide evidence of horn-working.



**Horncore offcut SF489. Actual length 120mm**

#### 4.4.2 Craft equipment and tools

### Textile manufacture

## Roman textile equipment

By H. Cool

### Bone needles

Both of the needles (SFs180, 366) found have flat spatulate heads of a very common form in use throughout the Roman period (Crummy 1983, 65, Type 2), so although SF180 (for image see 4.4.3) came from a 10th-century context, it is best considered as a residual Roman find as by that period needles were being more commonly made in iron (Walton Rogers 1999, 1968). A third possible Roman needle (SF5) was found in a Phase 8 rubbish pit.

## Anglian/Anglo-Scandinavian textile equipment

By N.S.H. Rogers

### Loom weights

One complete fired clay loom weight (SF47) and fragments of up to half a dozen more were found on the site (SF89, SF333, SF426). These weights would have been used on a warp-weighted loom, the loom type used in weaving in England throughout the Anglo-Saxon period, but apparently on the decline in York in the later 9th century. It was largely superseded by the arrival of the two-beam vertical loom in the city around AD 900 (AY 17/11, 1753), although it is thought to have continued in use amongst suburban weavers – such as those in the Fishergate area – into the 11th century (AY 17/9, 1269). SF47 has a groove where the fastening cord attaching it to the loom has rubbed against the clay: it weighs 439g, which places it in the middle of the range for Anglo-Saxon loom weights. SF333 may originally have been slightly larger than SF47: approximately half survives, weighing 290g. In her survey of textile tools from Coppergate, Penelope Walton Rogers notes that although there is no absolute correlation between weight of loomweight and quality of cloth, weights of this size would probably have been used for weaving the more ordinary types of fabric (see AY 17/11, 1753).



Loom weight SF47. Actual diameter 110mm

SF47 was recovered from a Phase 6 rubbish pit, and probably dates from the earlier part of the phase. SFs89 and 426 in Phase 8 deposits, and SF333 from a modern clearance level, must all be residual in their contexts.

### **Needle**

An iron needle, SF7, was found in Phase 8 grave fill, presumably residually. It has a sub-circular eye, and is of a medium size, perhaps for use on fabrics such as linen, silk or fine wool (AY 17/11, 1785). Similar iron needles were found in Anglo-Scandinavian and medieval contexts at Coppergate (AY 17/11, 1781). SF15 is another possible needle, also from a Phase 8 grave fill.

### **Other tools**

#### **Roman tool**

##### **By H. Cool**

The only item likely to be a tool of Roman date in the assemblage is an awl of Manning (1985) Type 3a form (SF144).

#### **Anglian/Anglo-Scandinavian tools**

##### **By N.S.H. Rogers**

#### **Metal-working tools**

SF102 from a Phase 5 rubbish pit backfill may be a punch used in metal-working, probably to make holes in hot iron (AY 17/6, 517). Another possible tool fragment is SF129, found in Phase 6 build up. It has a wedge-shaped tip, and could be part of a punch or wedge.

#### **Medieval tools, knives and shears**

##### ***Metal-working too***

Another possible punch, SF397, was found in Phase 8 horticultural soil.

##### ***Knives***

Knives may be divided into two types based on the form of the handle. Whittle tang knives incorporate a tapering tang which was driven into a socketed handle, while scale tang knives had a handle formed from two plates which were riveted to a flat tang. The latter form appears to have been an innovation of the mid-13th century but whittle tang knives continued in use alongside scale tang knives after their introduction (AY 17/15, 2751).

##### ***Whittle tang knives***

Whittle tang knives from Coppergate were classified according to the shape of the back, or top, of the blade, as this part of a knife is least likely to have changed through wear or sharpening: five different blade back forms were identified and defined as Types A–E (AY17/6, 559), and this typology has been applied to the knives from Dixon Lane/George Street. Five whittle tang knives were identified, of which three (SFs 177, 305, 309) conformed to Ottaway's Type C, the most commonly found in both Anglo-Scandinavian and medieval levels at Coppergate (AY 17/6, 565; AY 17/15, 2753). SFs 97 and 107 with slightly convex blade backs fit into Ottaway's Type D, the second most numerous form recovered at Coppergate (AY 17/6, 572). SFs 97 and 177 were found in Phase 6 pit backfills, while SF107 came from

Phase 8 cemetery soil, and SFs305 and 309 from Phase 8 grave fills, in which they are likely to be residual rather than to have been deliberately placed.

#### *Scale tang knives*

Two incomplete scale tang knives were found, one (SF34) appearing to be post-medieval. SF371 was found in the Phase 8 cemetery soil and has lost its blade but retains its handle, the plates of which have been decorated with non-ferrous pins in lozenge-shaped groups of four, with a border of pins along both edges. Although the metal of the pins has not been analysed, other examples of such decorated handles would suggest that these could be of lead – as found on a scale tang knife handle from The Vicars Choral College, Bedern (AY 17/15, 13805) – or of tin, as seen on two 14th-century knives from London (Cowgill *et al* 1987, 27, 138, 166), with which SF371 may be contemporary.



**Knife SF372. Actual length 86mm**



**Knife SF371. Actual length 86mm**

#### *Shears*

Recovered from Phase 8 grave fill, SF254 is possibly a fragmentary pair of iron shears, comprising a loop and parts of both arms: no blades have survived. Shears were used for a range of tasks such as leather-working, cloth manufacture and sheep shearing, as well as for cutting hair, and have been found previously in medieval levels in York (AY 17/15, 2749–51).

#### 4.4.3 *Dress Accessories*

##### **Roman dress and dress accessories**

##### **By H. Cool**

##### ***Hob nails***

Hob nails were used in the construction of some Roman shoes, and three finds of groups of hob nails and fragments were made in Phase 2 levels (SFs151, 154, 197), with others found residually in Phase 6 (SF135) and Phase 8 levels (SF209). The largest number of hob nails found together is fifteen, found in three groups within SF154, but none of the finds is indicative of any particular type of shoe. Several different shoe types were in use during the Roman period, and amongst these, sandals and nailed shoes made use of hobnails, primarily to provide resistance to wear (Hooley 2002, 324-328). Patterns of nailing have been identified and categorised on leather shoes found elsewhere on Roman sites (see for example

Hooley 2002, 328–31) and examples have also been identified from the site at 3 Driffield Terrace, in York (AYW, Rogers in prep.)

### ***Personal ornaments and equipment***

The site produced two items in this category that are quite exceptional. The gold finger ring set with a carnelian (SF16) from a Phase 8 grave fill belongs to a family of gold rings in use at the end of the 4th century and into the 5th. They are characterised by being made up of elements of gold wire, sheet and granules often in very individual styles. As such there is no precise parallel for this ring, but that is to be expected. The best group of comparanda is the rings in the Thetford hoard (Johns and Potter 1983, 86–93 nos.10–18). By the time this hoard was declared any coins that might have accompanied it had gone missing, so there is no independent dating for it, but all of the other items would fit happily into a 4th-century or later milieu. There are grounds for thinking that a group of ten gold solidi issued by Magnus Maximus (AD 383–8) sold in London had originally been part of the hoard which would confirm this late date (Chadburn 1995). Examples of rings from hoards where the coins are known include a pair from Terling Place, Witham, Essex, where the coins terminated with issues of Arcadius (383–395) and Honorius (392–423) (Talbot 1846; VCH Essex, pl.VIII, nos. C1–2). The wire used to form the hoops is frequently beaded rather than plain as here, but plain square-sectioned wire was used in a ring from Silchester where two bands formed the frame for an openwork hoop infilled by other strips which were bent to form a scroll pattern. The upper scrolls adjoining the oval box bezel were very similar to the scrolls on the shoulders of SF16 and were also decorated with gold granules (Fox 1895, fig.5; see Cool 1983, fig.126, no.3 for a detailed drawing). Though some of the rings in this group are set with intaglios, e.g. that from Havering (Marshall 1907, pl.XVI, no.571), a decided preference for plain stones is noticeable. The Silchester ring is set with a cabochon garnet, one of the Terling Place examples has what appears to be crystal and several of the Thetford rings have plain coloured glass settings (Johns and Potter 1983, nos.15, 18-0), whilst another (*ibid*, no.18) has a garnet. SF16, with its plain stone, thus fits into a common pattern.

It is of some interest that in both cases where rings of this general type in the Thetford hoard have been set with intaglios (*ibid*, nos.13 and 16), the stone itself can be dated to the 2nd to 3rd century and has clearly been re-set. This fits a pattern where it is clear from very late assemblages of the end of the 4th century to the 5th century that people were deliberately seeking out and re-using selected aspects of earlier material culture (Cool 2000). This may well suggest that we should be favouring a 5th-century date for this style. Coin dates, of course, only take hoards to the early 5th century because coin was no longer supplied to Britain after that date. As such they can only provide a *terminus post quem*.

In earlier discussion of this piece, it was suggested that it might have come from a disturbed burial. That seems unlikely as the others in this family have either been found in hoards or as site finds and to my knowledge none have been found as grave goods.





Gold finger ring SF16



YORYM 2005.3205

1182

SF00031

0 20 mm

Jet near SF31



**Shale ring SF32**

The other unusual item is a small figurine of a bear made in jet (SF31). It has a rectangular base plate which allows it to stand upright and so it could have been a freestanding model but the circular longitudinal perforation between the legs would have allowed it to be threaded to be worn as part of a necklace or bracelet. It was found in a heavily truncated pit together with an annular shale ring (SF32) and 4th-century pottery. The juxtaposition of these two items initially led to the suggestion that the feature might originally have been a cremation burial and that these two items were grave goods. This is a plausible suggestion as small rings like SF32 are a feature of 4th-century graves at York (Allason-Jones 1996, 35–6), and small jet figurines of bears have been found in graves. One which is almost identical in shape and size to SF31 was recovered from a grave found during the excavation of the railway line at Bootham in 1845 which also contained a coin of AD 312–15 (Brushfield 1853; RCHMY 1, 72, no.III biii). Two have been recovered from infants graves, one at Malton (Corder 1948 173-5) and the other from recent excavations at Colchester (Pooley and Crummy 2007). A fourth bear came from another grave at Colchester (May 1930, 277 no. 79). Of the two found in the Rhineland, one was also found in a grave (Hagen 1937, 139, no.2 (2), Taf.29.1). A collection of jet ornaments has, however, been found in circumstances where they are clearly not directly accompanying a burial at Chelmsford (Drury 1988, 46–8; Henig and Wickenden 1988). This consisted of necklaces, bracelets, hair pins and a small model of a lion devouring a head. The model is about twice the size of the bear but like it stands on a little base plate. The jet items together with a glass pipette unguent bottle were found in a wooden box placed in a pit. The pit was within a cemetery but the excavator explicitly ruled out the possibility that it accompanied a human body. The group certainly has funerary overtones not only given its position but also from the contents. The imagery of the lion devouring a skull and the gorgon head on one of the necklaces is often found in funerary contexts, and the type of bottle associated with the group is one

that is found overwhelmingly as a grave good rather as a site find (Cool 2002a). On balance it seems reasonable to add this little group of black shiny items to the evidence for ritual and sepulchral activity seen in the pottery at Dixon Lane, but the Chelmsford group shows that they need not have been part of a grave.

The other ornaments are much commoner types. Most numerous were hair pins. Four examples (SFs150, 159, 332, 369) came from both Roman and residual contexts. They are all of the simple knob-headed form (Crummy 1983, 21, type 3) which was very common in the later Roman period. The heads have not been so smoothly worked as is normal and show a degree of faceting but this appears to be the result of a less than competent craftsman, rather than a deliberate attempt to produce faceted heads in a diamond and triangle pattern (Crummy 1983, 22, type 4) as one of the shanks (SF150) also shows careless faceting.

There is also one fragment consisting of a copper alloy wire with a second wire spiralling around it (SF156). This may well be a fragment of a ribbon twist bracelet where several wires aligned as a band were wrapped around a central core (Cool 1983, 129, Bracelet Group II). The current arrangement as seen clearly on the X-radiograph would be consistent with some of the wires being of a different alloy which has corroded away. Thin bands of iron might have been a possibility as there is a certain amount of powdery iron corrosion products preserved around it. Contrasting metals would have produced an attractive effect appropriate for an ornament and the effect was sometimes used on the much commoner cable twist bracelet. Ribbon twist bracelets were in use throughout the Roman period but, like all bracelets, were probably commonest in the 4th century when bracelet wearing was at its peak.



**Roman bone pin SF150 and SF180. Actual lengths 95mm (left) and 110mm (right)**

***Anglian/Anglo-Scandinavian dress accessories***

***By N.S.H. Rogers***

***Dress pins***

### **Copper-alloy pins**

Two copper-alloy dress pins were found residually in Phase 8 deposits. SF183 has a flat polygonal head with a perforation which contains the remains of a tiny chain. This pin is of a type known as a 'linked pin' because it would have been used as part of a pair, each pin being linked to the other by the chain. This pin type has been found particularly in Anglo-Saxon cemeteries, such as that at Castledyke, Barton-on-Humber, and is generally dated to the 7th–early 8th centuries (Ross 1998, 269). In the north of England, parallels from non-cemetery contexts come from Flixborough, Lincs. (Rogers in prep.), an 8th-century deposit at the monastery at Hartlepool (Jackson 1988, 182, fig.33, no.5), and late 8th-century deposits at Fishergate, York (AY 17/9, 1363, 5366–7).

SF35 has a globular head, with a collar below, and represents the form of metal dress pin most commonly found in both Anglian levels at 46–54 Fishergate (AY 17/09, 1361–3), and early Anglo-Scandinavian levels at 16–22 Coppergate (AY 17/14, 2577). Other sites in the north of England that have produced these pins include Whitby, North Yorkshire (Peers and Radford 1943, 63–4), Flixborough (Rogers in prep.), and sites in East Yorkshire including South Newbald (Leahy 2000, 65–71) and Cottam (Haldenby 1990, 53; 1992, 27; 1994, 52). Copper-alloy dress pins such as SF35 appear to date slightly later than the linked pin type, although the globular head is a predominantly Middle Saxon form. Excavations at Late Saxon cities such as London, Ipswich and Winchester have produced very few pins, suggesting that this form of dress fastening was much less commonly used in the later Saxon period (Ross 1991, 45).

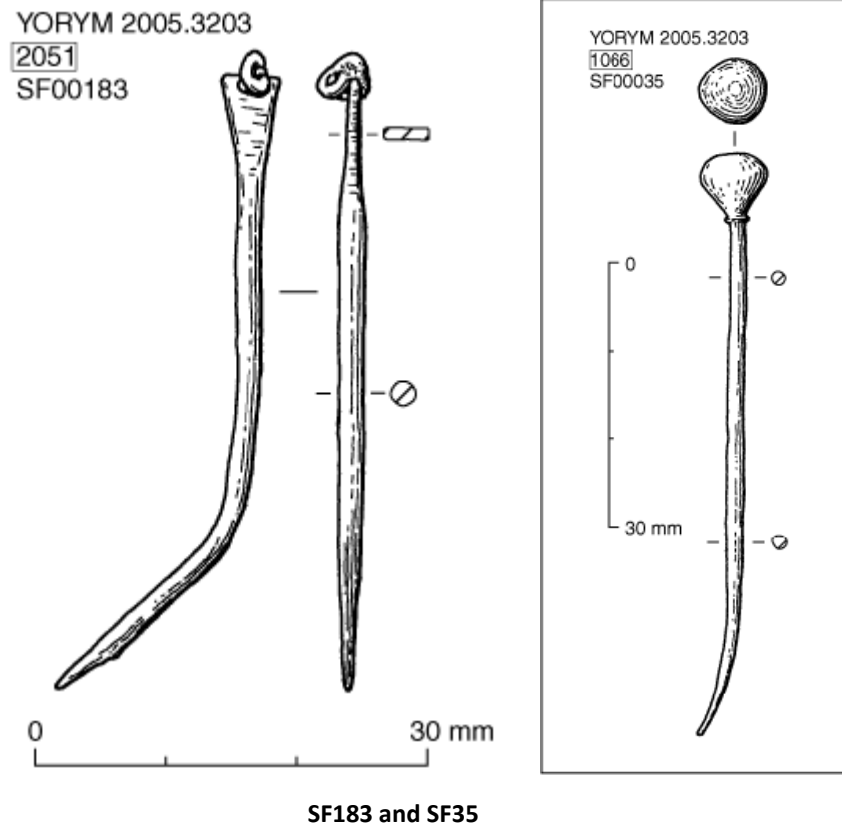

### **Bone pins**

SFs27 and 221 are both made from pig fibula bones. A well-known type, in some instances the bones have been barely modified, apart from the perforation of the articular end, to form a simple pin, and SF27 is an example of this, with only slight trimming of the head. SF221 has been shaped a little more precisely, having a discoidal perforated head. Both pins were recovered from pit fills, SF221 from a Phase 6 pit, and SF27 from a Phase 8 pit, in which it will have been residual. These pins correlate to the Group 2 pig fibula pins from Coppergate where more than 70 were recovered, predominantly from Anglo-Scandinavian deposits (AY 17/12, 1950–1). Whether these bone objects were pins rather than needles has been a matter of debate for some time (see MacGregor 1985, 120–1), but a pin of this type with a leather thong was found in a grave at the Castledyke cemetery at Barton-on-Humber and its position in the grave led to the interpretation that it was pinning together the front of a gown just below the throat (Walton Rogers 1998, 276).



**Bone pins SFs 27 and 221. Actual length SF27 (right) 100mm**

#### ***Twisted wire ring***

Although now incomplete, SF92 appears to be a twisted wire ring, made of three strands of copper-alloy wire plaited together. It was found in Phase 8 grave fill, but may be residual from the Anglo-Scandinavian period, when similar rings fulfilled a variety of functions, including use in jewellery, on brooches, necklaces and pendants, as well as acting as suspension loops for implements such as tweezers and hones (AY 17/14, 2583).

#### ***Glass beads***

Three monochrome glass beads (SFs96, 223, 542) were found, all being of forms found previously in Anglian and Anglo-Scandinavian York (AY 17/14, 2594): SFs96 and 542 are small cylindrical beads, SF96 being blue and SF542 green. SF223 is green and globular. SF542 was found in Phase 5 ditch backfill, and is thus likely to be an Anglian example of this type of bead. SFs96 and 223 were both recovered residually in Phase 8 contexts.



**Glass beads SF96 (bottom), SF223 (top left) and SF524 (top right). Actual height of SF96 7mm**

#### ***Arm ring***

SF182 is a possible arm ring or armlet fragment, made of copper alloy and found in a Phase 6 pit. Too little survives to provide a definitive identification, but it could be part of a Roman armlet or an Anglo-Scandinavian arm ring. The latter rings could be made of precious metals, where they represented a method of storing and exhibiting wealth (Graham-Campbell 1980, 30), but imitations in cheaper metals were also made. Anglo-Scandinavian arm rings of precious and non-precious metals have been found previously in York (AY 17/14, 2583–4).

#### ***Buckle pin***

Although no buckles were found on the site, a possible copper-alloy buckle pin was retrieved from a Phase 5 deposit (SF109).

#### ***Medieval personal equipment***

##### ***Tweezers***

A pair of copper-alloy tweezers found in Phase 8 grave fill (SF26), made from a strip of copper alloy bent to form a loop at one end and with tips of both arms inturned, is of a form found from the Roman through to the medieval period (Biddle 1990, 690). A similar pair was recovered from a 13th-century deposit at Fishergate (AY 17/14, 2932, 15229).

#### **4.4.4 *Glass vessels***

##### **Roman glass vessels**

##### **By H. Cool**

Eighteen fragments of Roman vessel glass were recovered. Most were relatively undiagnostic body fragments which cannot be closely identified but the combination of blue/green and colourless glass indicates a 2nd- and 3rd-century date. Of particular interest was a very small fragment from the lower body of a cast polychrome vessel found residually in a Phase 6 context (SF56). Where such vessels occur

on Romano-British sites, they normally indicate mid-1st-century occupation, but there are grounds for thinking that this piece comes from the much less common later production (see Price 2002, 115–16 for summary). Though its size means that it is not possible to get a complete cane pattern for either of the two canes present, it seems likely that at least one of them is a type with a rosette of petals that occurs in the later production (see for example a bowl from Llandovery, *ibid*, fig.9.6). If the canes do not extend through the entire thickness of the vessel wall as seems possible, this too would point to the later production. A third reason for favouring this identification is that early polychrome cast vessels are very rarely found at York because the main period of occupation started after the style had passed from use (Cool 1998, 302–3). The chronology of this later production is still not fully understood, but the recovery of a substantial part of a small dish from a context of late 2nd- to early 3rd-century date at Piercebridge (Cool and Price forthcoming) shows that vessels in this style were certainly getting to the north-east in the later 2nd century. The only other example that may have come from York is an unprovenanced piece now in the collections of the Yorkshire Museum (YORYM 1995.370).

Also of interest is a blue/green chip with impurities and iron corrosion products on one face (SF130). It has features that suggest it might have been from a cylindrical moile, i.e. that part of the waste that is left attached to the blowing iron after the vessel is blown, though the identification cannot be made with total certainty. Evidence for the blowing of vessels at York during the Roman period comes from Coppergate and the Royal Hotel (Cool 2002b, 6). At both those sites there are substantial amounts of glass melting pots as well as the blowing debris. The recovery of a single fragment from this site is not evidence that blowing was taking place in this area. It is more likely to have been transported here as part of make-up layers such as the possible dump layers Contexts 1742/1595 in Phase 5.

In addition to the vessel glass there were also two fragments of 1st- to 3rd-century window glass found in residual contexts (SFs124 and 58).



**Roman polychrome glass SF56. Actual length 17mm**



**Roman polychrome glass SF56. Actual length 17mm**

### **Anglian vessel glass**

**By N.S.H. Rogers**

A single fragment of Anglian vessel glass was found in a Phase 5 rubbish pit fill (SF99). This body fragment is light blue/green with applied yellow trails; unfortunately, too little survives to establish the form of vessel from which the fragment derives. It resembles several examples found at 46–54 Fishergate (AY 17/9, 1337), and its opaque yellow trails that have been marvered – or smoothed – are characteristic of imported high-status middle Saxon glass in particular (*ibid*, 1338), indicating an 8th- to mid-9th-century date for this fragment.



**Anglain polychrome glass SF99. Actual length 9mm**



#### 4.4.5 *Other objects*

##### **Vessels**

##### **?Roman iron vessel**

##### **By H. Cool**

SF231 came from the fill of a pit assigned to Phase 2. It would appear to be a small ladle bowl which retains the stump of a handle. It would be tempting to suggest that it originally came from a multi-purpose implement with a ladle at one end and a flesh-hook at the other such as that found in a grave at Kelvedon (Rodwell 1988, 76 no. 81, fig. 59). The bowl is of the right dimensions and the handle projects in the right plane, though the stump is somewhat narrower than might be expected. Such items were in use from the later 2nd century to the 4th century, but are not normally found on major urban sites suggesting they may have been associated with some quite specialised cooking practice (Cool 2006, 50). For this reason the identification of SF231 as another example has to be made with some caution.

##### **Iron fittings**

##### **By N.S.H. Rogers**

Nails were found in considerable numbers, but only possible coffin nails are reported on (see below). Clench bolts, also used to join timbers, were found only in grave fills, and are discussed alongside the coffin nails.

L-shaped iron fittings were used with hinges on doors or window shutters from the Roman period right through until the medieval period. The longer arm would be driven into masonry or a wooden frame and the hinge, which had a looped eye at one end, would pivot around the shorter arm. Two such hinge pivots were found on the site, one in a Phase 2 pit fill (SF174), the second in a Phase 6 pit backfill (SF110).

A looped staple such as SF264 could be used on a stapled hasp, for example on a chest lid, but would also have been suitable for holding a drop handle, such as SF122: both SF264 and SF122 were recovered from Phase 8 grave fills, but at this date such fittings did not tend to be used on coffins (Gilchrist and Sloane 2005, 112–13).

##### **Locks and keys**

##### ***Roman padlock bolt***

##### **By H. Cool**

A padlock bolt in two fragments (SF144A, E) was recovered from the Phase 5 dump deposit 1742 which contained a considerable amount of residual Roman pottery. It is typical of the barb spring padlocks in use during the Roman period (Manning 1985, 95, type 1).

##### ***Anglian/Anglo-Scandinavian key?***

##### **By N.S.H. Rogers**

Found in the Phase 5 backfill of a possible rubbish pit, SF103 is fragmentary but may comprise the remains of a slide key, which would have operated a fixed lock with a sliding bolt and springs. The looped end and long stem would have terminated in a T-shaped or L-shaped bit, as found on keys recovered at

Fishergate (AY 17/9, 1423, 5234–9) and Coppergate (AY 17/6, 673–5). These keys and locks appear to go out of use during the 9th century (AY 17/9, 1423).

### **Coffin-related ironwork**

Twelve clench bolts, some complete with roves, were found in association with a Phase 6 grave (1093). The bolts within SFs13, 20 and 338 had been arranged in a cross shape across the top of the skeleton, and appear to represent the remains of timbers used in the burial. Five nails, possibly associated with a coffin, were also recovered from this burial (SFs203, 322 and 410). The significance of the presence of clench bolts in the burial is explained elsewhere (see 3.5.4).

Nails were found in several other burials, of both Phases 6 and 8. In most cases, a single nail was recovered: these are most likely unrelated to the burial itself. Two Phase 6 burials produced four nails (Contexts 1134 and 1279), but there is insufficient evidence to indicate whether these derived from coffins. Some coffins dating to this period are known to have been made without nails, being jointed with wood (see 3.5.4).

### **Buzz bone**

Made from a pig metapodial which has been transversely perforated, but is otherwise largely unmodified, SF224 was recovered from Phase 8 grave fill. Similar objects have in the past been described as toggles or bobbins, but it is now thought that they could be simple musical instruments. To make one, the bone would have been threaded on a string via its central perforation, and could then be made to hum by spinning the string rapidly (Brown and Lawson 1990, 589–90). They are commonly found artefacts on sites of both pre- and post-Conquest date.



**Buzz bone SF224. Actual length 54.5mm**

### **Arrowhead**

Although found in levels associated with machine clearance of the site, SF1 is clearly a medieval arrowhead. Made of iron, SF1 is a form of arrowhead that could have been used in either hunting or warfare, thus known as 'multi-purpose': in the typology identified by Jessop, it corresponds to his form MP2 with a small triangular head and extended socket, which he dates to the 11th–14th centuries (Jessop 1996, 196). Amongst the medieval arrowheads found at Coppergate, the triangular blade form was the most common (AY17/15, 2967).

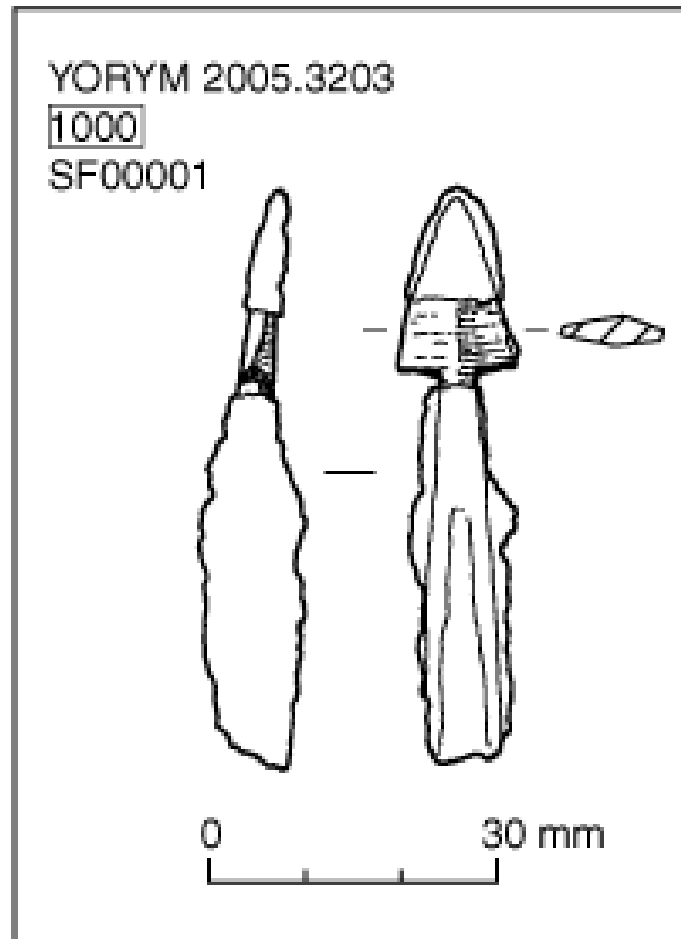

SF1

### Horseshoe nails

Medieval horseshoe nails were found in a Phase 6 pit backfill (SF308) and Phase 8 grave fills (SFs299, 528): SFs299 and 528 are of fiddle key form with a semi-circular head, while SF308 has a trapezoid-shaped head. Different nails were used with different horseshoe forms: the fiddle key type nails were used with horseshoes of 11th- to mid-14th-century date, while SF308 would have been used on a 13th- to 14th-century shoe (Clark 1995, 86–7).

### Miscellaneous objects

#### *Roman objects*

##### By H. Cool

All of the items in this section come from post-Roman contexts but may well be of Roman date. Loop-headed spikes such as SF144B, for example, were a common form of fastening driven into masonry and timber (Manning 1985, 129). The disc SF484 might have been used as the lid for a cooking jar, though as the burning extends across the broken edge, this cannot be certain.

#### *Bone objects*

##### By N.S.H. Rogers

Bone objects of uncertain function were recovered from contexts of Phases 5–10. SF368 is unmodified apart from two perforations of differing diameters which have been cut through one face. It was found in the Phase 5 backfill of a possible rubbish pit.

Possibly a skate discarded during manufacture, SF513 has a hole at one end, but much of the rest of the bone has broken away. It was recovered from a Phase 6 cut backfill.

Found in Phase 7 ditch backfill, SF518 appears to be the end of a long bone which has been shaped and had a socket drilled through it.

SF367 may be a plaque or mount fragment; unfortunately much of it has been broken away, but a corner remains, one side of which has broken across a small rivet hole. Part of the upper face has been cut away to produce a design in relief, and there is some green staining which may have been deliberate. SF367 was found in Phase 8 cemetery soil build up; this deposit produced some apparently very mixed material, but itself is thought to date no later than the end of the 14th century.

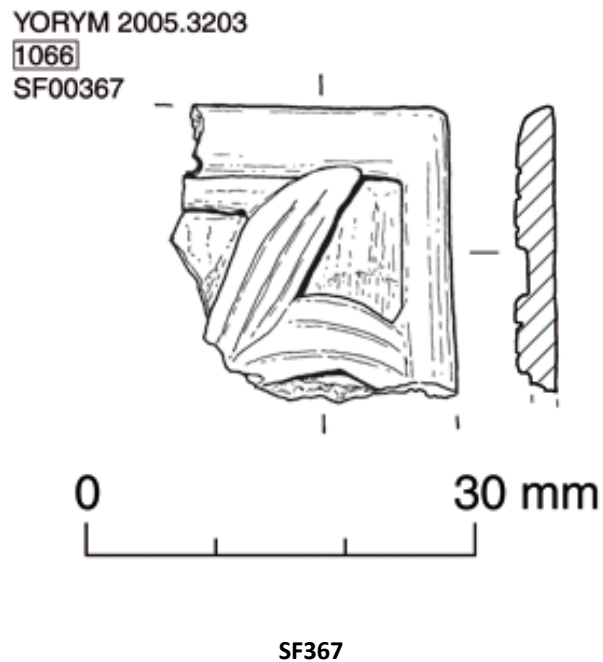

Finally, SF249 is a strip fragment decorated with incised chevrons. This came from a Phase 10 level, but probably originated in earlier disturbed levels.

#### 4.4.6 *Metal- and glass-working waste*

##### **By C. Mortimer**

About 14.7kg of industrial waste was recovered from the site and was classified by material type (Table 7). This is a relatively modest amount of material, considering the volume excavated. The excavation revealed some hearths in Phase 6c although truncation meant that it was difficult to interpret them. The industrial waste mainly comprised iron-working slag (12.7kg), along with small amounts of fired clay and vitrified clay, some or all of which may also be related to iron-working processes. There are also traces of other high-temperature processes, in the form of copper-alloy waste and glass waste, but these are present at low levels.

	<b>Weight (g)</b>
Ferrous slag	12683
Ferrous slag with vitrified furnace lining	534
Unidentified slag	577
Vitrified furnace lining	251
Vitrified furnace lining, with other	158
Glassy waste/slag	218
Lead waste	3
Copper-alloy waste	50
Fuel ash slag	<1
Fired clay	142
Glass-working crucibles	59
<b>Total</b>	<b>14675</b>

**Table 7 Material types present, by weight**

### **Iron-working evidence**

The ferrous slag is most likely to have been produced during smithing; there is no clear evidence for iron smelting. The majority of the iron-working waste is in the form of quite small irregularly shaped lumps of smithing slag, although there are six samples which are probably incomplete smithing hearth bottoms (SFs42, 229, 271, 289, 294, 323). During iron smithing, iron- and silica-rich slags would build up below the working surfaces to form distinctive plano-convex deposits, known as smithing hearth bottoms, which would be regularly cleared away from the hearth area and dumped nearby.

The majority of the slag, and of the industrial waste overall, comes from two phases, Phase 6 and Phase 8 (Table 8); hearths have been identified in Phase 6. Given this clear patterning, it is not surprising that all but one of the smithing hearth bottoms come from these two phases, as do all the contexts with the greatest amount of diagnostic slag (1180, 1265 and 1645, Phase 6; 1066, 1400 and 1635, Phase 8), but most of these contexts are general spreads rather than discrete dumps.

None of the six smithing hearth bottoms is complete. As they stand, they have an average weight of 266g and their maximum diameters range from 71 to 103mm (Table 9). However, it is interesting to note that the four smallest Dixon Lane/George Street examples are all from Phase 8 or 9 contexts, whereas the two examples from Phase 6 contexts are larger and comparable in size to the thirteen 11th-/12th - century examples from Fishergate (McDonnell 1993, 1225), which have an average weight of 545g. Other similar contemporary examples from Coppergate and Blue Bridge Lane are of similar sizes (McDonnell 1992; Mortimer 2005). It is interesting that the smaller smithing hearth bottoms at the site are also smaller than the mostly 14th- to 16th-century examples from neighbouring Walmgate (AYW1, Macnab 2003). However, there are substantial deviations from the calculated means at all three sites, and hence

substantial overlap of the weight and size ranges at the sites, and too much emphasis must not be placed on a small sample

	<b>total material</b>	<b>Fe slag only</b>	<b>Fe slag and vfl</b>
Phase 1	13		13
Phase 2	17		17
Phase 3	33		33
Phase 5	187	183	187
Phase 6	6490	6303	6447
Phase 7	188	188	288
Phase 8	7354	6845	7004
Phase 9	245	192	225
Phase 10	96	9	89
<b>total</b>	<b>14623</b>	<b>13720</b>	<b>14303</b>

**Table 8 Industrial debris, weight (in grams), by phase**

Other material types which may be connected to iron-working include fired clay, fuel ash slag and vitrified furnace lining (vfl). These material types could equally have originated in other high-temperature processes but at this site are often found co-located with ferrous slag, so may well be related to iron-working.

<b>Sf</b>	<b>Context</b>	<b>Phase</b>	<b>Wt</b>	<b>Maximum diameter, depth (mm)</b>
229	1653	6	459	d = 103, depth = 56
289	1645	6	446	d=98, depth = 51
42	1215	8	174	
271	1372	8	169	d= 81, depth = 37
294	1066	8	156	d= 71, depth = 30
323	1091	9	192	d= 102, depth = 40

**Table 9 Smithing hearth bottoms**

### **Other high-temperature industries**

A substantial piece of glass waste (SF374) from Context 1488 is probably post-medieval. The high-fired, grey clay used in a fired clay sample, SF351, also stands out; this has a very dark vitrified layer on one side. Although they are from Phase 8 contexts, it is possible that these both came from the post-medieval York Flint Glass Company further down the Foss at Fishergate. They are unlikely to be related to

the high-lead glass-working thought to be carried out at or near the site, as suggested by the crucible sherds (Table 10). These crucible sherds are made in oxidised gritty fabrics, which were also used at 16–22 Coppergate, 34 Shambles and 22 Piccadilly, although they were in the minority at the other sites. Analysis on sherds from other sites confirms that these crucibles were used for making high-lead glass, not just remelting (Bayley and Doonan 2000). Most of the George Street/Dixon Lane sherds have green or yellowish glazing inside; the sample from 1588 has much darker glazing inside but there are green deposits on the outside. On some of the pieces, the glazing extends over the rim and down the outside, in the form of drips. Although there are no obvious joins, the two base sherds and the four wall sherds are comparable, and it is possible that some or all of these sherds are from the same vessel.

Context	Area	Glaze colour	Wall thickness (mm)
1066	2 rim fragments	Yellowy or clear	5.7
1279	Base and part of wall	green	6.1
1325	rim	green	5
1588	base	Dark inside, green outside	10
1645	rim	green	6.4

**Table 10 Glass-working crucibles**

There are only very small amounts of copper-alloy and lead-working waste. The 50g of copper alloy is in the form of dross or accidental melting (SF307, 324 and 437); there is no definite evidence for deliberate metal melting such as the crucibles found frequently at Coppergate. The lead waste is a single 3g item (SF431), again in the form of a dribble or spill, which may have been accidental; there are also possible lead-rich spots on a piece of ferrous slag (SF274).

#### 4.4.7 *Coin catalogue*

##### **By C. Barclay**

AE Dupondius/As; 1st–2nd century

SF98; Context 1483

AE core of counterfeit Denarius; Caracalla; AD 208

Obv.) ANTONINVS PIVS AVG; head, laur., right

Rev.) PONTIF TR P XI COS III; Mars stg. Right, with spear and shield

RIC 100

SF179; Context 2037

Note traces of silvering on surface.

AE Radiate; Carausius; AD 287–93

Rev.) PAX AVG

SF90; Context 1066

AE 3; mid–late 4th century

SF128; Context 1645

AE minim; probably late 4th century AD

SF145; Context 1742

AE 4; Magnus Maximus; AD 383–88

Obv.) D N MAG MAXIMVS P F AVG, pearl-diademed, draped and cuirassed bust right

Rev.) SPES ROMANORVM, camp-gate with star between turrets

Mint of Trier, SMTR

RIC 9, Trier 87(a)

SF83; Context 1372

Base AR (?) Sceatta; Aethelred I

2nd reign, c. 789–96

‘Shrine’ type

SF117; Context 1626

AE Styca; Aethelred II

1st reign; c. 841–43/4

Moneyer: Monne

SF8; Context 1047

## 4.5 Animal bone

### 4.5.1 *Vertebrate Remains: Summary*

A small assemblage of hand-collected vertebrate remains, recovered from deposits of Anglian date encountered during excavations on land at the junction of Dixon Lane and George Street, York, was examined in detail and compared with previously recorded vertebrate material from contemporary deposits revealed nearby at 46–54 Fishergate, York.

The bone from George Street/Dixon Lane was of somewhat variable preservation suggesting that the remains derived from several different sources. It could not be established conclusively whether or not the different components of the assemblage were contemporary but the material included a mix of



refuse, mainly representing primary and secondary butchery waste, together with some domestic rubbish. Hints of waste associated with craft activities such as the working of bone, antler and horn, were apparent, but this did not form a significant component of the assemblage. A restricted suite of species was identified, mostly the remains of the main domestic mammals, with cattle being prevalent. Age-at-death profiles suggested an emphasis on adult individuals, with little evidence of the presence of young animals. Many characteristics of the assemblage correlated well with the vertebrate material from 46–54 Fishergate and from other nearby sites of similar date.

Given the similarities between the Anglian vertebrate assemblages from Fishergate and from George Street/Dixon Lane, it seems likely that material from the latter relates to occupation of a similar nature to the former. The paucity of vertebrate remains recovered from George Street/Dixon Lane renders interpretation of this assemblage somewhat tentative. The presence at the site of imported pottery, evidence for manufacturing and trade, and other indicators of activities associated with *wic*-type settlements, lends some support to this interpretation, however.

#### 4.5.2 *Vertebrate Remains: Introduction*

Archaeological excavations were carried out by York Archaeological Trust on land at the junction of Dixon Lane and George Street between 7 November 2005 and 27 January 2006. The work was initially undertaken as a watching brief but became a full-scale excavation following the discovery of a plethora of human remains. Consequently, a large number of intercutting archaeological features ranging in date from Roman through to the post-medieval period were revealed.

Overall, 25 boxes (each box approximately 20 litres) of vertebrate remains were recovered from 131 deposits. Many of the features produced bone, including pits, post-holes, layers and general deposits representing all phases of activity at the site. Following an assessment of the remains, a more detailed study of the assemblage was recommended, subject to the successful resolution of questions concerning residuality (Jaques *et al*/2006). These issues were addressed by the excavator, who felt that it was only the animal bone from the Anglian deposits which warranted further consideration, features of other date being either heavily disturbed by later burials or by modern activity at the site.

The Anglian material was of particular interest because of the site's close proximity (some 400m) to 46–54 Fishergate. Here excavations revealed evidence of occupation associated with trade and craft activities dating to the late 7th to mid-9th century and the site was interpreted as a trading *emporium* or *wic* (AY 15/4).

This report records the vertebrate assemblage from 22 deposits of Anglian date (8th to 9th century) which includes the remains from deposits dated directly by pottery and from others interpreted as Anglian on the basis of stratigraphic evidence.

#### 4.5.3 *Vertebrate Remains: Methods*

Data concerning the vertebrate remains were recorded electronically directly into a series of tables using a purpose-built graphical input system and Paradox software. Semi-subjective, non-quantitative data were recorded for the material from each context regarding the state of preservation, colour, and the appearance of broken surfaces ('angularity'). Additionally, semi-quantitative information was recorded for the bone from each context, concerning fragment size, dog gnawing, burning, butchery and fresh breakage.

Identification was carried out using the PRS modern comparative reference collection. Detailed recording of the assemblage followed the protocol outlined by Dobney *et al*(1999). In brief, selected elements were recorded using the diagnostic zones method described by Dobney and Rielly (1988). Remaining elements which could be identified to species were merely counted. Other fragments (classified as ‘unidentified’) were, where possible, grouped into categories: large mammal (assumed to be horse, cow or large cervid), medium-sized mammal (assumed to be sheep, pig or small cervid), unidentified bird and totally unidentified. As well as counts of fragments, total weights were recorded for all identifiable and unidentifiable categories.

Caprovid tooth wear stages were recorded using those outlined by Payne (1973; 1987), and those for cattle and pig followed the scheme set out by Grant (1982). Cattle, caprovid and pig mandibles and isolated teeth were assigned to the general age categories outlined by O’Connor (AY 15/3) and Payne (1973; 1987). Mandibles with incomplete tooth rows were assigned to age groups on the basis of comparison with the more complete aged mandibles from the assemblage. The same was true for loose deciduous 4th pre-molars (Dp4) and third molars (M3).

Mammal bones were described as ‘juvenile’ if the epiphyses were unfused and the associated shaft fragment appeared spongy and porous. They were recorded as ‘neonatal’ if they were also of small size. Measurements followed von den Driesch (1976) unless otherwise specified. Additional measurements, not detailed by von den Driesch, followed those described by Dobney *et al* (1999). Withers heights were estimated using calculations devised by Foch (1966), Matolsci (1970) and Teichert (1975).

Differentiation between sheep and goat bones was undertaken using comparative material and with reference to Boessneck (1969). The following elements are those where distinctions were routinely attempted: horncore, Dp4, distal humerus, distal radius, distal tibia, calcaneus, astragalus, metacarpal, metatarsal and phalanges. No goat bones were identified and it has been assumed for the purposes of this report that all the remains represent those of sheep.

#### 4.5.4 Vertebrate Remains: Results

The Anglian vertebrate assemblage was recovered by hand-collection and amounted to 1396 fragments. Table 11 gives details of the 22 contexts which produced bone, of which only six gave more than ten fragments. These were: Context 1754 (Group 47), the final fill of a sequence of recut ?boundary ditches; Contexts 1483, 1628 and 1979 (Group 60), the fills of several associated rubbish pits which had been cut into the linear ditch sequence; Context 1742, a build-up deposit (Group 15); Context 1760 (Group 15), a fill of a rubbish pit cutting into Layer 1742. Pit fill 1483 produced the largest concentration of bones (872 fragments) which formed approximately 63% of the entire assemblage from this period. Other features (mostly post- or stake-hole fills, with a small group of build-up and dump deposits), either dated to the Anglian period or interpreted as of Anglian date, gave very little bone.

In general, preservation of the remains from the larger assemblages was somewhat varied. Within each of these groups of material, the condition of the bone differed considerably, ranging from fragments that were well preserved to those that were in a very poor state. The more poorly preserved fragments suffered from surface erosion, with a few being so degraded that the original surfaces of the bones had been completely destroyed. This was particularly true for some of the fragments from Contexts 1483, 1628, 1742 and 1754. In contrast, bones from Context 1760 were of good preservation, as were the fragments recovered from the build-up deposits, Contexts 1602, 1620, 1632 and 1749. Generally, where

only one or two bones were recovered, e.g. Contexts 1391, 1517 and 1840, these tended to be of reasonable preservation.

**Table 11 George Street/Dixon Lane, York: Details of the bone-producing deposits of Anglian date**

Group/Set	Context	Context description	Total fragments
18/128	Context 1391	backfill	6
60/243	Context 1483	fill of rubbish pit	872
31/138	Context 1517	fill of post-hole	1
9/19	Context 1523	fill of post-hole	2
27/389	Context 1602	build up	10
27/389	Context 1620	dump	5
10/69	Context 1621	backfill of slot?	2
10/69	Context 1621	backfill of slot?	2
60/242	Context 1628	fill of rubbish pit	103
27/389	Context 1632	build up	1
81/41	Context 1715	fill of post-hole	1
29/216	Context 1728	fill of post-hole	6
26/210	Context 1740	fill of pit	7
15/208	Context 1742	build up	133
27/389	Context 1749	build up	5
47/188	Context 1754	backfill of ditch	100
15/214	Context 1759	fill of rubbish pit	10
15/214	Context 1760	fill of rubbish pit	92
21/144	Context 1840	fill of stake-hole	1
29/216	Context 1961	fill of post-hole	1
60/86	Context 1979	fill of rubbish pit	34
26/212	Context 2045	fill of pit	3
77/7	Context 2109	fill of post-hole	1

Variability of colour was also recorded for several of the larger assemblages (e.g. Contexts 1483, 1628, 1754), and this, combined with the heterogeneous nature of some of the collections, suggests that the material may have been of mixed derivation. However, it could not be ascertained from the bones alone whether fragments representing different origins were of the same date or whether some parts of the assemblage represented residual material disturbed during pit and grave digging in the medieval period. In some cases, the presence of bones of differing preservation may simply be a reflection of the formation of that deposit. If a deposit, such as Context 1742, had accumulated over time rather than being dumped in a single event, preservation of the bones may vary depending on the length of time taken for the fragments to be incorporated into the matrix. Indeed, material from Context 1742 showed a higher degree of fragmentation than that seen in material from other deposits and this may be a consequence of the remains being gradually deposited rather than rapidly incorporated into the deposit.

### Overview of the assemblages

The vertebrate assemblage was dominated by remains of the main domestic mammals, cattle, caprovid and pig (Table 12). Chicken and geese remains formed 5% and 6% of the identified material respectively, whilst other species present were relatively insignificant in terms of actual numbers of fragments.

Remains of dog and cat were scarce and recovered mainly from Context 1483, with a single dog metatarsal from Context 1628. Context 1483 also produced a horse lateral metapodial, one of only two horse bones recovered from the deposits of this period. The other fragment, a loose deciduous mandibular premolar from Context 1754, represented an animal of less than three-and-a-half years of age.

Wild mammals were represented by two fragments (a tibia and a radius) of roe deer (from Contexts 1483 and 1760, respectively) and a single cranium and attached antler fragment of red deer (Context 1483). The latter showed evidence for the antler having been chopped off below or around the burr, so had clearly been removed from a dead animal rather than collected once shed naturally. [Another fragment of deer, an antler tine, was recorded as a small find from Context 1754 and not seen by the author].

**Table 12 George Street/Dixon Lane, York: Hand-collected vertebrate remains from Anglian deposits**

Species		Total
<i>Canis f. domestic</i>	dog	2
<i>Felis f. domestic</i>	cat	2
<i>Equus f. domestic</i>	horse	2
<i>Sus f. domestic</i>	pig	67
<i>Cervus elaphus</i> L.	red deer	1
<i>Capreolus capreolus</i> (L.)	roe deer	2
<i>Bos f. domestic</i>	cow	167
Large mammal		558
Medium-sized mammal		286
Unidentified bird		21
Unidentified		169
<i>Sub-total</i>		<i>1034</i>
<b>Total</b>		<b>1396</b>

Geese bones were consistent in size with those of both domestic geese and of larger wild geese, such as the greylag (*Anser anser* (L.)). Unfortunately, there is little morphological variation between the different geese species, and it was, therefore, impossible to determine whether the individuals represented were wild or domestic birds or a mixture of the two. It has been assumed (given the nature of the assemblage as a whole) for this report that these remains probably represent domestic birds. Four bones were identified as those of wild birds; black grouse (3 fragments) and wood pigeon (1 fragment).

The unidentified fraction formed almost three-quarters of the Anglian assemblage, with a high proportion (54%) of this component being fragments from large mammals (presumably mostly cattle).

Whilst a diverse selection of skeletal elements was apparent, large mammal rib fragments were particularly numerous (42% of the large mammal remains), especially from Contexts 1742, 1754 and 1483. Material from the last deposit also included many shaft and vertebra fragments. Medium-sized mammal fragments were generally less well represented, but rib fragments were abundant from Context 1483, as were, albeit to a lesser extent, shaft fragments.

### The main domesticates

Using total fragment counts (NISP – number of identified specimens) for the major domesticates only, just over half (54%) of these remains were cattle, whilst sheep formed 25% of the assemblage and pig 21% (Table 13; Figure 40). However, these proportions changed considerably when the values produced by MNI (minimum number of individuals) counts were used. As can be seen from Table 13 and Figure 40, cattle, although still prevalent at 36%, decreased in frequency, with sheep increasing to 32%. Pig also constituted a larger component of the assemblage than was apparent from the basic fragment counts, the frequency from MNI values matching that for sheep. Despite this disparity between the techniques, the overall trend remained roughly the same, showing a predominance of cattle, followed by sheep and pig in equivalent frequencies.

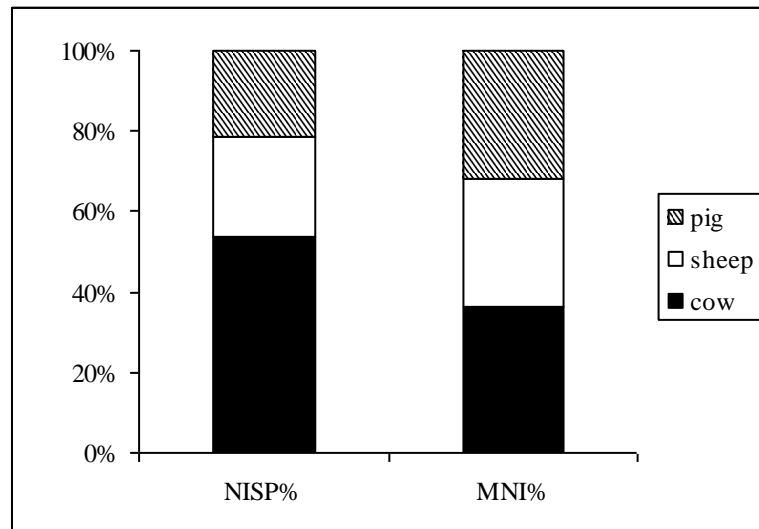

**Figure 40 George Street/Dixon Lane, York: Relative frequencies of the main domestic mammals calculated using total fragment (NISP) and minimum number of individuals (MNI) counts**

When the six largest assemblages were considered individually, the relative importance of the three main species varied (Figure 41) between deposits. The pit fill assemblages, from Contexts 1483, 1628, 1979 and 1760, all had similar frequencies (on the basis of fragment counts) of cattle (between 50 and 57%), but the proportions of sheep and pigs fluctuated. Pig remains from these deposits ranged from 12% to 29% and sheep from 14% to 33%, the highest figure for pig being found in Context 1760 and for sheep in Context 1628. The three associated pit fills from Group 60 all gave higher values for sheep than for pig, whilst this was reversed in Context 1760. Values for the ditch fill, Context 1754, showed an abundance of cattle remains (71%), which formed a far greater proportion of the assemblage, with correspondingly lower values for pigs and sheep, although here, as for Context 1760, pig remains outnumbered those of sheep. Build-up deposit, Context 1742, diverged from the general trend of the pit fills, with cattle and sheep being of equal importance. However, it must be noted that for most of these

deposits, the numbers of fragments were small and, consequently, the relative frequencies may be misleading.

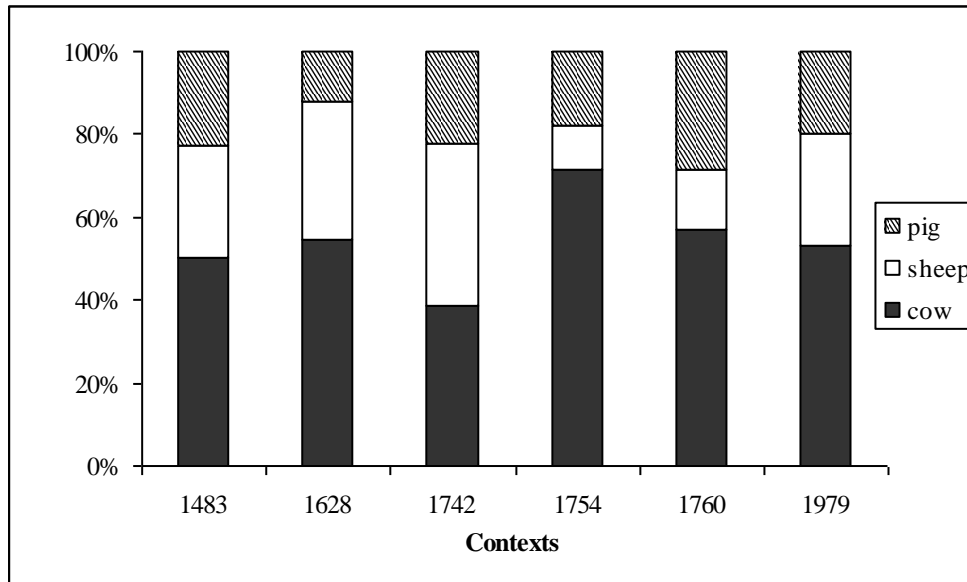

Figure 41 George Street/Dixon Lane, York: Relative frequencies of the main domestic mammals calculated using total fragment (NISP) counts by individual context (only deposits with more than 10 fragments are represented)

Table 13 George Street/Dixon Lane, York: Relative frequencies of the main domestic mammals calculated using total fragment (NISP) and minimum number of individuals (MNI) counts

Species	NISP
cattle	167
sheep	78
pig	67

Table 14 George Street/Dixon Lane, York: Relative frequencies of the main domestic mammals calculated using total fragment (NISP) counts by individual context (only deposits with more than 10 fragments are represented)

	Contexts					
	1483	1628	1742	1754	1760	1979
<b>Species</b>	no.	%	no.	%	no.	%
cattle	86	50	18	55	7	39
sheep	46	27	11	33	7	39
pig	39	23	4	12	4	22

### Skeletal element representation

Figures 42 and 43 show the relative frequencies of the main skeletal elements of the major domestic mammals (cattle, sheep and pig) based on the NISP or the MNI counts for each element, the values being calculated by comparing each element with the most frequently occurring ones (i.e. the element or elements represented by 100% in each graph).

For cattle, it can be seen that a range of skeletal elements representing all parts of the body were present. Comparing Figures 42a and 43a, the main differences are the decrease in the significance of metacarpals and phalanges and increase in the prevalence of tibiae. In general, though, the overall pattern for both figures is very similar; frequencies for mandibles and lower limb elements (e.g. astragali, calcanea and metapodials) were high, with major meat-bearing elements (scapulae, humeri, pelvis and femora) being somewhat less well represented.

Large mammal remains (assigned to the unidentified fraction) from these deposits cannot be ignored, however. Shaft fragments from this component were not particularly numerous from most deposits but from Context 1483, where quantities were greater, pieces of femur were included, together with other long bone fragments. Femurs can be one of the hardest elements to identify to species when only small fragments are available or when diagnostic characteristics are absent. These remains could be those of horse or large red deer, but given the small numbers of these taxa identified, the femur fragments are more likely to be cattle.

It must be borne in mind that the scarcity of lower limb elements, such as carpals, tarsals and phalanges, for both sheep and pigs may be a result of recovery techniques, given that the hand-collection of bone favours the recovery of larger fragments.

By far the most numerous fragments within the unidentified component of the assemblage were those of large mammal rib. This was particularly noticeable in the remains from Contexts 1742 and 1760, deposits for which ribs formed 75% and 60%, respectively, of the large mammal fragments. Context 1483 also produced large quantities of ribs, but these only formed approximately 30% of the large mammal remains which included quantities of shaft, vertebra, cranium and pelvis fragments.

Given the presence of these bones in the unidentified fraction, it is clear that cattle remains represent a mixture of waste, chiefly refuse from primary and secondary carcass preparation, but also with some domestic refuse included. There were no large concentrations of remains clearly indicative of craft activities (such as tanning or horn working), although a few horncores that had been deliberately removed from the rest of the cranium were recorded. Traces of bone working waste, including bone 'blanks' made from ribs (from Context 1483), were recovered and quantities of rib fragments were found in pit fill 1760 and build-up deposit 1742, which may also have been destined for such activities. However, these were only a minor part of the assemblage and this type of waste was clearly more evident in later deposits (not recorded for this analysis but noted during assessment (Jaques *et al* 2006) and corroborated by antler fragments, chopped horncores, bone blanks etc).

**Figure 42 a-c. George Street/Dixon Lane, York: Relative frequency of main skeletal elements of the major domestic mammals based on total fragment counts for each element, the values being calculated by comparing each element with the most frequently occurring ones (i.e. the element or elements represented by 100% in each graph)**

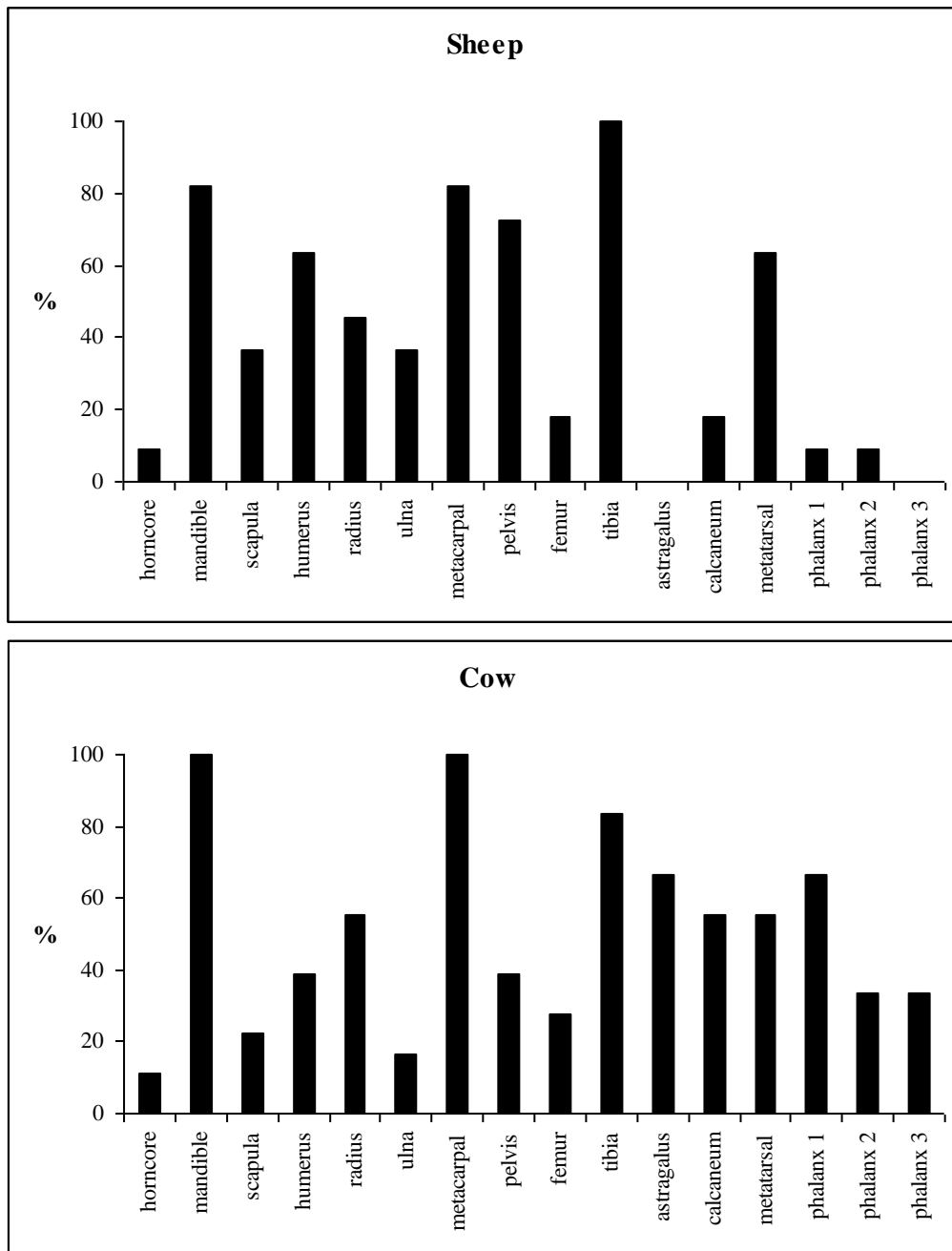



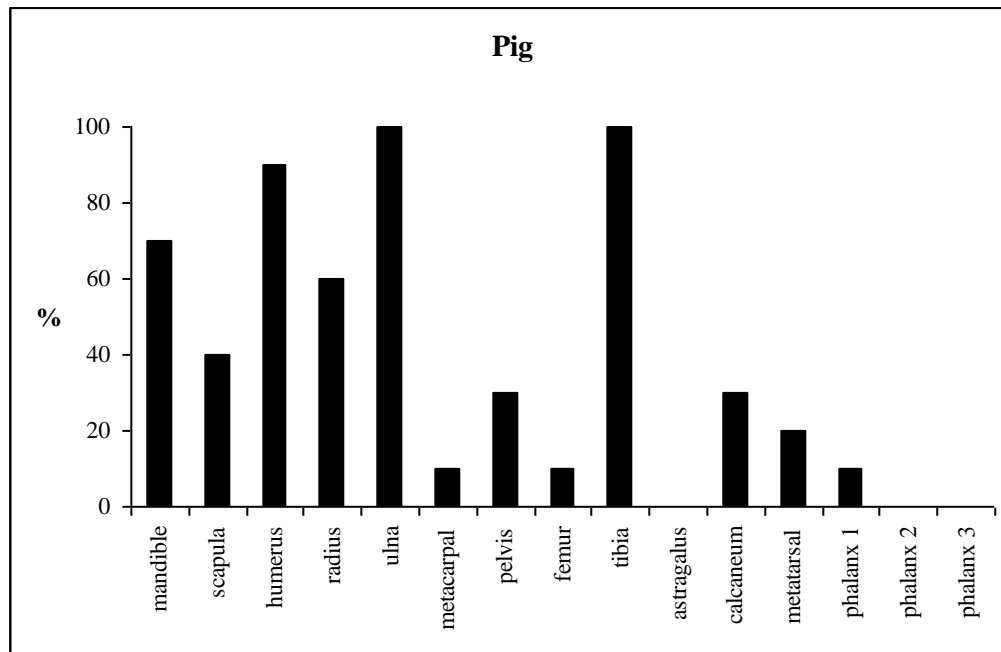

For sheep, most parts of the body were again represented, but both NISP and MNI values (Figures 42b and 43b) showed mandibles, tibiae and metapodials to be predominant. Some variations between the two plots were apparent, however. Whilst NISP values suggested that meat-bearing bones, e.g. pelvis and humeri, and to a lesser extent scapulae and radii, were also relatively numerous, MNI values decreased the frequencies of the main meat-bearing bones, indicating a pattern not dissimilar to that for cattle (albeit without the high frequencies for calcanei and astragali). As for cattle, these remains represent waste from butchery and food consumption, but perhaps with a greater proportion from domestic refuse.

In contrast to the cattle and caprovid remains, values for pig skeletal elements were clearly biased in favour of major and minor meat-bearing elements, with NISP and MNI values (Figures 42c and 43c) showing a rather similar picture. Tibiae and ulnae were prevalent, with humeri, radii and mandibles also being numerous. Metapodials, calcanei and phalanges, together with femora, were the least numerous fragments. Pig remains may, therefore, represent carcasses that had already been part-processed elsewhere, i.e. their lower limbs (metapodials and phalanges) removed prior to being transported to the settlement or at least to this part of the settlement. However, the high occurrence/incidence of mandibles suggests that heads had not been removed.

**Figure 43 George Street/Dixon Lane, York: Relative frequency of main skeletal elements of the major domestic mammals based on minimum number of individuals (MNI) counts for each element, the values being calculated by comparing each element with the most frequently occurring ones (i.e. the element or elements represented by 100% in each graph)**

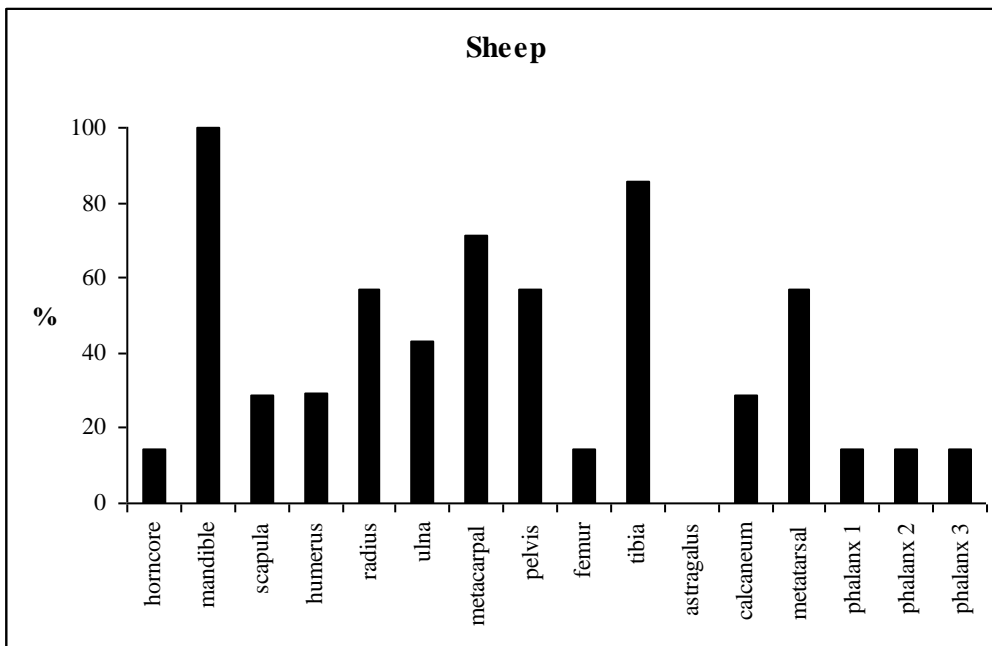
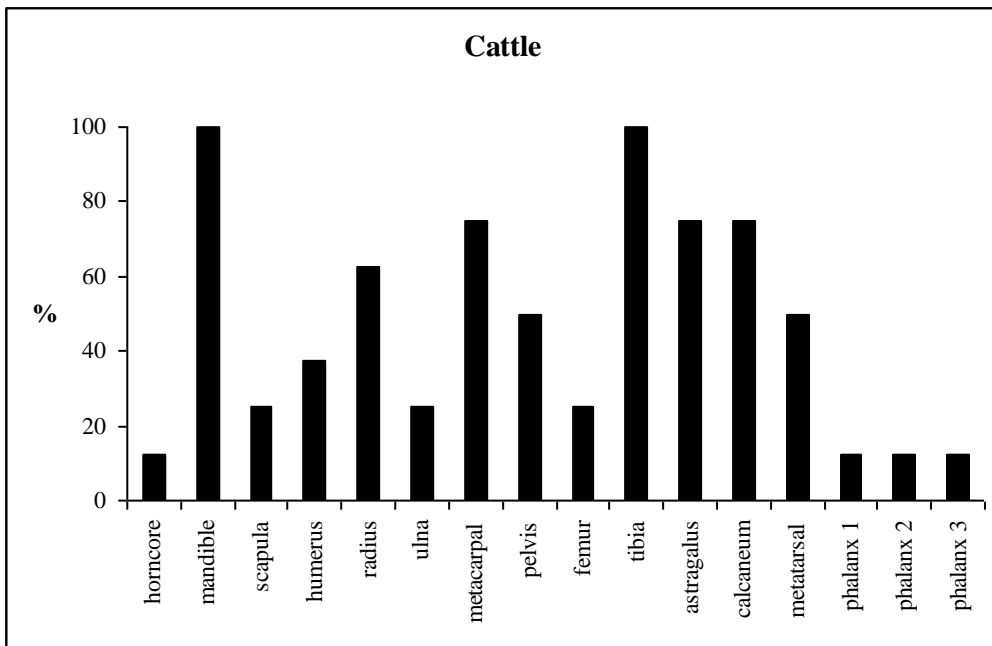

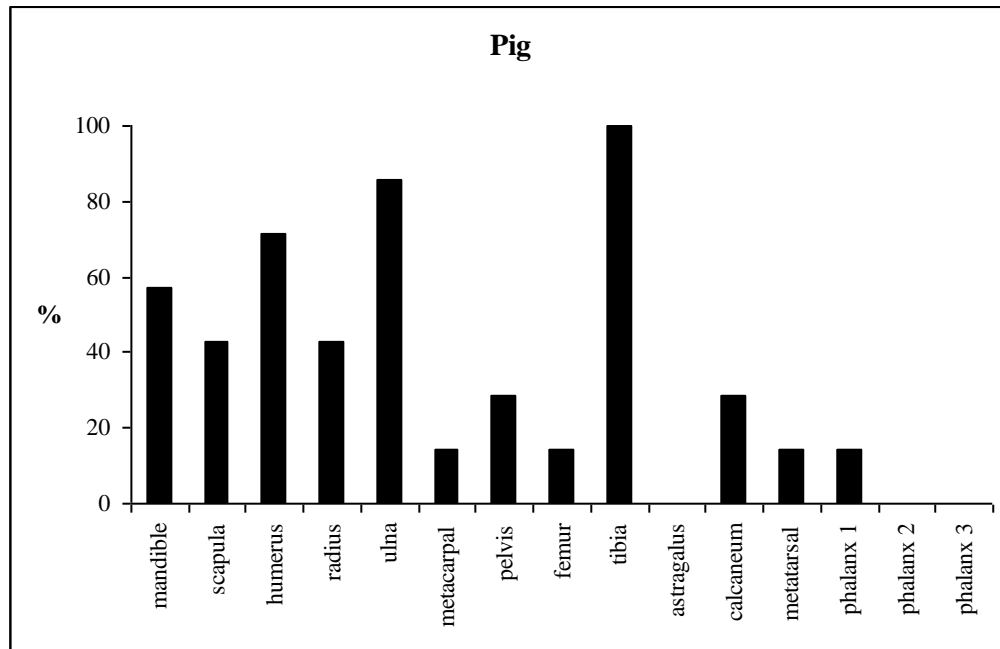

### Butchery

Butchered fragments were fairly frequently observed, mainly of cattle bones. There were split and chopped shaft fragments, mostly metapodials but also humeri, radii and tibiae. This type of butchery was probably undertaken for the retrieval of the marrow. Chopped pelvises and mandibles were also recorded. The latter were mostly chopped either horizontally or vertically through the ascending ramus, which may have been to remove the jaw from the skull and perhaps to provide access to the tongue. However, Rixson (1989) has suggested that this was by far the hardest way of freeing the tongue from the rest of the head and the most likely reason for this butchery (probably in combination with a chopped diastema) was for the removal of the cheek meat. Large mammal vertebrae were chopped both transversely and longitudinally (including axes), with no conclusive evidence that carcasses had been chopped into sides. Many of the vertebra fragments represented the centrum of the vertebrae, the spines having been removed. Remains of caprovid and pig showed far less evidence of butchery. Humeri representing both taxa had been chopped transversely through the middle of the shaft, whilst shallow chops and knife marks were recorded from two sheep pelvises. Knife marks were also recorded on several goose and chicken bones, whilst a goose carpometacarpus had been chopped across its proximal articulation.

**Table 15 George Street/Dixon Lane, York: Total fragment counts for selected skeletal elements for cattle, sheep and pig**

Element	Cattle	Sheep	Pig
horncore	2	1	n/a
mandible	18	9	7
scapula	4	4	4
humerus	7	7	9
radius	10	5	6
ulna	3	4	10
metacarpal	18	9	1
pelvis	7	8	3
femur	5	2	1
tibia	15	11	10
astragalus	12	0	0
calcaneum	10	2	3
metatarsal	10	7	2
phalanx 1	12	1	1
phalanx 2	6	1	0
phalanx 3	6	0	0

**Age-at-death**

Only three mandibles with teeth in situ and an isolated third mandibular molar were available for providing age-at-death data for cattle. Two of the three mandibles represented adult individuals (Adult 3 category – after AY 15/3 and 15/4) of at least five years old when slaughtered, whilst the third was from a juvenile animal of under eighteen months in age. The isolated tooth fell within the same category as the two adult mandibles.

Epiphyseal fusion data suggested that most animals were adults of over (approximately) four years of age when slaughtered. Many of the vertebrae (in the unidentified fraction) were fused or in the process of fusing indicating that some animals represented in the assemblage survived until they reached the age of at least seven years. Evidence of young individuals was scarce, although two cattle fragments from one deposit (Context 1621) were the unfused left and right sides of the same bone, a metatarsal. Fusion of the diaphysis of metapodials 3 and 4 of cattle is thought to take place prior to birth (Prummel 1987), suggesting that the fragments recovered from this deposit represented a foetal individual.

Data from caprovid mandibles were assigned to broad age categories outlined by O'Connor (1989), whilst the same data were also categorised according to a system devised by Payne (1973; 1987). Caprovid mandibles were only slightly more numerous than for cattle and seven were able to provide age-at-death data. Four of these could be assigned to O'Connor's adult categories (one Adult 1; one Adult 2; two Adult 3), representing individuals of between approximately three and seven years in age (after AY15/4), with two of the others probably between the ages of one and two years and the third representing an immature animal (?less than twelve months old). These last had incomplete tooth rows so were more difficult to allocate to the various categories. Payne's method mostly concurs, with the complete mandibles representing adults ranging in age from approximately two to six years when slaughtered. Two mandibles were assigned to category 'E' (aged between two and three), one to

category 'F' (three to four years) and one to 'G'/'H' (four to eight years). Using Payne's system, the three incomplete mandibles represented younger animals, with the youngest individuals falling into category 'C' (six to twelve months of age) and the remaining mandible representing a sheep of between one and two years old.

**Table 16 George Street/Dixon Lane, York: Minimum number of individuals (MNI) values for selected skeletal elements for cattle, sheep and pig**

Element	Cattle	Sheep	Pig
horncore	1	1	n/a
mandible	8	7	4
scapula	2	2	3
humerus	3	2	5
radius	5	4	3
ulna	2	3	6
metacarpal	6	5	1
pelvis	4	4	2
femur	2	1	1
tibia	8	6	7
astragalus	6	0	0
calcaneum	6	2	2
metatarsal	4	4	1
phalanx 1	1	1	1
phalanx 2	1	1	0
phalanx 3	1	0	0

When considering the fusion data, most of the animals represented were older than ten months, with 88% of the 'early' fusing epiphyses being fused. This decreased for both of the two intermediate fusing phases (representing animals of between one and two years and two and three years) to 63% of the bones being fused, whilst half of all late fusing bones (those bones fusing between three and three-and-a-half years) were unfused. Both the tooth wear and the fusion data were somewhat limited, but both suggested that only a few animals died before the age of approximately ten to twelve months, followed by a gradual cull of individuals between the ages of one and three, with half of the animals represented (from the fusion data) slaughtered before they reached three-and-a-half years.

Data from the pig mandibles, of which there were six, were grouped into age categories as outlined by O'Connor (AY 15/3 and 15/4). Four of the individuals were adult, representing O'Connor's Adult 2 category and assigned to an age range of two to two-and-a-half years. The remaining mandibles were classed as Immature 1 suggesting animals aged approximately twelve months. Evidence from epiphyseal fusion suggested that most animals lived beyond the age of twelve months, with only 9% of bones in the 'early fusing' category (i.e. those which fuse at approximately twelve months) remaining unfused. Just over half of the bones which fuse at approximately two to two-and-a-half years of age were unfused and there were only two bones representing animals that could possibly have been aged over three-and-a-

half years (late fusing elements). This correlates well with the mandibles representing O'Connor's Adult 2 category in that few animals lived beyond the age of two years.

**Table 17 George Street/Dixon Lane, York: Reconstructed withers heights for cattle and sheep. Key: GL = greatest length; WH = estimated withers height**

Context	Species	Element	GL (mm)	WH (mm)
1483	cattle	metatarsal	198.59	1082.32
1483	cattle	metatarsal	200.9	1094.91
1628	cattle	metatarsal	220.00	1199.00
1628	cattle	radius	248.00	1066.4
1754	cattle	metacarpal	182.41	1116.35
1979	cattle	metacarpal	180.54	1104.90
1483	sheep	metacarpal	129.42	626.39
1483	sheep	metacarpal	107.05	518.12
1483	sheep	tibia	199.63	600.89
1628	sheep	radius	122.22	488.88
1742	sheep	metatarsal	120.03	541.34

### Biometry

As a consequence of the small size of the assemblage, the biometrical dataset was somewhat sparse and insufficient to provide any useful information regarding the size and shape of the animals represented or indications of sexual dimorphism.

However, a few complete bones of cattle and sheep were available for the estimation of withers heights. For cattle, the greatest length measurements of two metacarpals, three metatarsals and a radius were used, the resulting heights ranging from 1066.4mm to 1116.4mm, with a mean height of 1110.7mm (Table 17).

Measurements from five sheep bones (a radius, a tibia, two metacarpals and a metatarsal) gave heights varying from 488.9mm to 626.4mm, with an average height of 555.1mm (Table 17).

An archive of all the measurements taken can be found in the Appendix. (pdf 17kb)

### 4.5.5 Vertebrate Remains: Discussion

Although the vertebrate assemblage recovered from the Anglian deposits at George Street/Dixon Lane was constrained somewhat by its small size, some useful points can be drawn from analysis of these remains and there is some scope for comparison with the vertebrate material recovered from excavations at the nearby 46–54 Fishergate.

The animal economy represented at George Street/Dixon Lane was based almost entirely on the main domestic mammals, cattle being of particular importance. Evidence for the utilisation of wild resources was scarce, with very few wild mammals and birds identified. The restricted suite of species represented shows a marked similarity to the material recovered from Fishergate (AY 15/4), although at Fishergate, fish provided an additional component to the diet. No fish remains were present in the George

Street/Dixon Lane assemblage, but this is not surprising given that the bone was collected by hand and none of the material analysed came from sieved deposits. Few sediment samples were examined from this site, with just six (representing several different periods) being investigated during the assessment; those which were produced few or no fish remains, however.

On the basis of fragment counts, the proportions of the major domesticates from George Street/Dixon Lane suggest that cattle were predominant, with sheep and pig remains present in lesser but similar proportions. The MNI figures support this pattern, although, using this method of quantification, a reduction in the importance of cattle was observed; their larger body mass would still support the argument for their dominance in the diet, however. Cattle were also prevalent at Fishergate and clearly provided the basis of the settlement's subsistence, whilst sheep and pig were less well represented. Overall, the data from the vertebrate assemblages from the two sites correspond well, although the proportion of pig remains in the smaller body of material from George Street/Dixon Lane, almost 20% of the identified assemblage, was somewhat higher than the 10% at Fishergate.

A predominance of cattle is commonly seen in other assemblages of 7th- to 10th-century date and this is particularly apparent from Saxon *wic* sites where, in general, assemblages are characterised by high proportions of cattle (40–75%) and with proportions of sheep and pig being similar to each other (Dobney *et al* in press). Sykes (2006) has suggested that this may reflect the increased need for draught cattle in this period of agricultural intensification and expansion.

The vertebrate assemblages from these 'urban' sites show a marked contrast to those from contemporary rural sites in the region. At West Heslerton, for example (albeit on the basis of limited information from an assessment report) a broad range of taxa was exploited (Powlesland 1996). Although somewhat further afield, the large rural Saxon settlement at Flixborough, North Lincolnshire, produced a vast quantity of bone and, although the frequencies of wild mammals was low, a wide variety of birds were identified, together with a small quantity of cetacean remains, all clearly indicating the exploitation of a wide array of habitats (Dobney *et al* in press).

Age profiles for the major domesticates at George Street/Dixon Lane were hampered by the limited age-at-death data sets. Nevertheless, at both sites, cattle and sheep slaughter patterns were, in general, found to correlate, with an emphasis on older animals, typically maintained beyond three years of age, and a dearth of evidence for on-site breeding. Age-at-death data for pigs at Fishergate seemed to show specific peaks of slaughter, with one group culled at just over twelve months of age and the second at approximately two to two-and-a-half years old. The rather sparse data from George Street/Dixon Lane hints at a comparable pattern.

Both sites showed a similar trend of skeletal element representation for cattle and sheep which indicated that all parts of the carcass were present. In all likelihood, as suggested by O'Connor (2001 and AY 15/4), these settlements were being provisioned from elsewhere, with live animals being brought from the rural hinterlands and dispatched and redistributed in the settlement. However, for pigs the significant under-representation of metapodials and phalanges, when compared with major meat-bearing elements, may indicate the delivery of part-processed carcasses.

A similar picture can be seen from other contemporary assemblages recovered from the nearby sites at Blue Bridge Lane and Fishergate House (Rowland 2005). Here, the limited resource base was replicated

and the species frequencies (based on simple fragment counts) and mortality patterns concur with those seen at 46–54 Fishergate and George Street/Dixon Lane. Overall, the similarities between these assemblages and that from 46–54 Fishergate led Rowland (2005) to conclude that occupation at the sites was comparable and may represent part of the same *wic* settlement, and the same could perhaps be said for the material from George Street/Dixon Lane.

Many of the characteristics of the bone assemblages outlined above fit well with patterns observed in vertebrate material recovered from other Saxon *wic* sites (O'Connor 2001; Sykes 2006; Dobney *et al* in press). These strongly favour the interpretation that the settlements were consumer rather than producer sites, with little evidence to suggest that animals were reared at the settlement itself. On the basis of the low diversity of resources seen at *wic* sites, O'Connor (2001) suggested that these settlements were being provisioned from elsewhere, the animals possibly being derived from food renders received and redistributed by a ruling elite. He argued that the inhabitants of these types of settlement had no control over what was supplied, hence the prevalence of the remains of mature animals that had been kept primarily for their secondary products rather than for the provision of meat.

In summary, given the similarities between the vertebrate assemblages from Fishergate and from George Street/Dixon Lane, it seems likely that material from the latter relates to contemporary occupation of a similar nature to the former. The paucity of vertebrate remains recovered from the Anglian deposits at George Street/Dixon Lane renders interpretation of this assemblage somewhat tentative. The presence at the site of imported pottery, evidence for manufacturing and trade, and other indicators of activities associated with *wic*-type settlements, lends some support to this interpretation, however.

## 4.6 Then Human Bone

By K. Tucker

### 4.6.1 Introduction

The remains of 118 articulated skeletons (including one that was excavated as a charnel deposit above the burial of another individual) and a large amount of disarticulated bone from the cemetery of the lost church of St Stephen were analysed by this author during 2006 and 2007.

### 4.6.2 Preservation

The bone from the articulated inhumations was generally well preserved, although there had been some disturbance and fragmentation by later activity, most significantly the levelling of the site for the construction of a brewery in the 1800s and the initial machine clearance of the site in 2005 before the cemetery was discovered. The collection of the small bones, particularly of the hands and feet, was generally good, although the numbers present for each inhumation did vary greatly depending on the archaeologist responsible for their excavation.

### 4.6.3 Methodology

An inventory of skeletal elements was compiled, and age and sex were attributed to each individual where possible. Metrical and non-metrical data were collected, and pathological changes were recorded and photographed where appropriate.

An assessment of age for the adult individuals was determined from, where possible, the changes to the pubic symphysis (Brooks and Suchey 1990), and the auricular surface of the ilium (Buikstra and Ubelaker



1994). Immature skeletons were aged from dental development, long bone length and epiphyseal fusion (Scheuer and Black 2000). The age of immature skeletons can be determined with a much greater degree of accuracy than that of adults, due to the fact that the growth of the bones and development of the teeth follow a relatively predictable course, up to the time when the final epiphyseal fusion takes place, around the age of 25. However, the degeneration of the pelvis of the adult skeleton depends on the sex, health and lifestyle of each individual, and tends to vary to a greater extent with increasing age. Therefore, the age of adult skeletons can only be assessed to within five to ten years, and cannot be reliably determined beyond 46+ years.

The age of the individuals was divided into a number of categories, starting with foetus (up to 40 weeks in utero), neonate (40 weeks in utero to one month), infant (one month to one year), younger childhood (1–6 years), older childhood (7–12), adolescent (13–18 years), young adult (19–25 years), young middle adult (26–35 years), old middle adult (36–45 years) and mature adult (46+ years). There may be overlaps between categories, or a broad category, such as adult, may be used where insufficient evidence was present to age an individual more accurately.

The sex of the adult individuals was determined from, where possible, the assessment of several sexually dimorphic features of the pelvis and skull (as given in Buikstra and Ubelaker 1994). A five-sex classification (female, ?female, undeterminable, ?male, male) was used. Sex cannot easily be determined for immature individuals, as the skeleton only becomes truly sexually dimorphic during puberty. Several methods have been devised to try to sex the immature skeleton (for example, Weaver 1980; Schutkowski 1993; Mollesonet *al.* 1998), but, during this analysis, no attempt was made to sex immature individuals.

Upper right	1	2	3	4	5	6	7	8	9	10	11	12	13	14	15	16	Upper left
Lower right	32	31	30	29	28	27	26	25	24	23	22	21	20	19	18	17	Lower left
Upper right	51	52	53	54	55	56	57	58	59	60	Upper left						
Lower right	70	69	68	67	66	65	64	63	62	61	Lower left						

/ tooth lost post-mortem

/ tooth lost post-mortem

X tooth lost ante-mortem

--- jaw and teeth not present

np tooth not present

c caries in tooth

a abscess

e tooth erupting

u tooth unerupted

The statures of the adult individuals were calculated, where possible, from long bone lengths, which were placed into the regression formulae developed by Trotter (1970). The cranial index, which records the shape of the head, was also calculated, where possible, as given in Brothwell (1981).

The dentition, where it could be analysed, is recorded as follows (permanent and deciduous dentition respectively):

The disarticulated bone was rapidly scanned and an inventory of elements was made. Elements were assigned an age and sex, where possible, as given in Buikstra and Ubelaker (1994), and pathological and other changes were recorded and photographed where appropriate.

#### 4.6.4 Discussion

A total of 118 inhumations, including one that was excavated as a discrete charnel deposit above the burial of SK14 (1048), were examined for the purposes of this report. One hundred and six of these are thought to be from the medieval cemetery of St Stephen, while twelve (SKs20, 23, 25, 37, 73, 81, 82, 101, 102, 112, 113, 114) are assumed to pre-date the medieval church and be Anglo-Scandinavian in date. As these early burials are so few in number, the 118 skeletons have been treated as a single group in the discussion that follows.

The distribution of the age categories and sexes represented among the inhumations are given in Table 19.

It can be seen from the table that there are no individuals in the foetal, neonate or infant categories, i.e. no individuals under one year of age, represented among the articulated skeletons. Twenty-five individuals of the 118 (21%) were under the age of 18 at the time of death, with a further two (1.7%) being either adolescent or young adult. Six individuals were in the young adult category (19–25), representing 5% of the total number of skeletons, or 6% of the 98 skeletons which could be assigned a precise age category (rather than 'middle adult +' or simply 'adult'). The young middle adult category (26–35) was represented by sixteen individuals (14% of 118, or 16% of 98), the old middle adult category (36–45) by 28 individuals (24% of 118, or 29% of 98), while 21 individuals survived into mature adulthood (46+) (18% of 118, or 21% of 98). The lack of very young individuals is also noted for the St Helen-on-the-Walls cemetery (AY 12/1, 27), the Fishergate cemetery, where only ten individuals out of 131 (7.6%) from Period 4 were younger than one year of age at the time of death (AY 12/2, 261–75), and for Jewbury, where thirteen individuals out of 471 (2.8%) were under one year of age (AY 12/3, 541–52). The lack of very young individuals in many cemetery populations has been interpreted as being due to easier truncation and disturbance of the smaller burials of young individuals and a lower likelihood of recovery due to them not being recognised as human remains, or from being missed during time-constrained commercial excavations (Chamberlain 2000, 105). However, even with these considerations, it is very unusual for there to be no very young individuals represented among the articulated inhumations. This may suggest that they were not being accorded burial in the same area as older individuals. However, on examination of the deposits of disarticulated bone, six contexts were judged to contain remains of foetal/neonate individuals, while infant remains were found in fifteen contexts. If it is assumed that different contexts could contain parts of the same individual skeleton, there are minimum numbers (not including any comparisons of size difference which would probably increase the minimum number) of two foetal/neonate individuals and two infant individuals. While these calculations do not make any real

contribution to the numbers of very young individuals that should be represented in a normal archaeological cemetery population, it does at least demonstrate that they were being buried in the same area, or a close enough area that their bones could be incorporated into features, as older individuals.

**Table 18 Age and sex distribution of the inhumations**  
(? means sex is indeterminate, a combination of male and female characteristics; Unsexed means impossible to assign a sex because juvenile or poor preservation)

	Male	?Male	?	?Female	Female	Unsexed	Total
Foetal							
Neonate							
Infant							
Younger childhood						12	12
Older childhood						7	7
Adolescent		1		1		4	6
Adolescent/young adult	1		1				2
Young adult	1	2	1	1	1		6
Young middle adult	10	3		2	1		16
Old middle adult	10	3	1	4	10		28
Middle adult +	2	1		1		1	5
Mature adult	4	3		5	9		21
Adult		1	1	2		11	15
<b>Total</b>	<b>28</b>	<b>14</b>	<b>4</b>	<b>16</b>	<b>21</b>	<b>35</b>	<b>118</b>

Other than the absence of very young individuals among the articulated skeletons, the population does seem to reflect the normal age distribution observed for archaeological cemeteries with a significant number of younger subadults, a decline during adolescence and then a second peak in the middle adult category with a good minority of adults surviving into mature adulthood (McKinley 1994, 68). The percentages of individuals in each age category compare well with those from the St Helen-on-the-Walls cemetery, where 27% of the total number of individuals were subadult, 9.5% were young adult, 19% were young middle adult, 19% were old middle adult and 14% were mature adult (of the number of individuals who could be assigned a specific age category) (AY 12/1, 65). At Fishergate, the percentage of individuals under fifteen years of age was 31%, while at Jewbury it was 26% (AY 12/3, 433), which are also similar figures to the number of subadult individuals in the present sample.

The sex ratio of the population also reflects what would be expected from a normal archaeological cemetery sample, with roughly equal numbers of males and female. The ratio of males and ?males to females and ?females in the present sample is 1.14:1. This compares with a ratio of 1.4:1 for the Period 4 cemetery of Fishergate (AY 12/2, 252), 1.08:1 for Jewbury, and 0.86:1 for St Helen-on-the-Walls (AY 12/3, 433). When specific age categories are compared by sex, it can be seen that for the present sample the majority of males were dying in the young and old middle adult categories (26 out of 42, or 62%), while the majority of females were dying in the old middle and mature adult categories (28 out of 37, or 76%).

Only 17% of males survived past the age of 45 years, while 38% of females survived past the same age. This is very different to the findings from St Helen-on-the-Walls, where 16% of females and 32% of males were older than 45 years, and at Jewbury, where 30% of females and 27.5% of males survived past that age (AY 12/3, 434–5). At St Helen-on-the-Walls, 56% of females had died by the age of 35 (16% in the present sample), compared to 36% of males (43% in the present sample) (AY12/3, 434), which is attributed to the hazards associated with childbirth (AY 12/1, 63). It is interesting that the present sample does not seem to support these findings, suggesting that the females from St Stephen were not succumbing to the hazards of childbirth and were not only living as long as males, but were actually outliving them.

Stature could be calculated for 37 males, 34 females, four individuals of indeterminate sex, and seven individuals of unknown sex (the statures given in Table 18 [see document 'The Human Bone' in IADB] for the indeterminate and unknown sex individuals are calculated from the regression formulae for males but are not used in the average stature calculations below). The average stature for males was 172cm with a range of 162–81cm, and for females was 160cm with a range of 153–172cm. The average statures from other medieval cemeteries in York were 172cm for males and 158cm for females at Fishergate Period 4 (AY 12/2, 174), 169cm for males and 157cm for females at St Helen-on-the-Walls (AY 12/1, 28) and 167cm for males and 156cm for females at Jewbury (AY 12/3, 436). The average statures from the present sample are therefore very similar to those from other medieval York populations.

The cranial index, which records the general shape of the cranial vault, could only be recorded for fifteen individuals due to the high level of fragmentation of crania on the site and with no subsequent reconstruction of crania taking place. Of these, eight individuals had a narrow cranial vault (dolichocephalic), four had an average vault shape (mesocephalic), two had a broad vault (brachycephalic) and only one had a very broad vault (hyperbrachycephalic). This tendency towards narrow cranial vaults is in contrast to the other medieval cemeteries from York, which tend to have more individuals with broad vaults (AY 12/1, 27; AY 12/2, 178; AY 12/3, 437), but reflects the pattern seen in Anglo-Scandinavian populations from York Minster (AY 12/1, 71) and the rest of Yorkshire (AY12/1, 76). This may be a consequence of the cemetery going out of use earlier in the medieval period than others from York, as it has been reported that there is a tendency for medieval populations in Western Europe to become increasingly broad headed compared to earlier periods (AY 12/2, 178).

An interesting made through examination of the crania and mandibles of the articulated skeletons was that two individuals (SK94 and SK104) possessed cranial features that identified them as Negroid in type rather than Caucasoid (Negroid and Caucasoid are used here in their anthropological sense). This was also noted for a small number of crania from York Minster seen by the author during a recent project to wash, package and assess Anglo-Saxon and medieval human remains excavated in the 1970s. The crania from George Street were also examined by Dr Christopher Knüsel from the University of Bradford who agreed with the Negroid interpretation. Cranial and mandibular measurements from the two individuals were placed into the FORDISC computer program, which assesses ancestry, and this also supported the initial assessment. Four other crania from the assemblage were also analysed using FORDISC, to confirm that the Negroid individuals were different from the rest of the population, and these were all found to be Caucasoid in type. As York was a very important trading centre from the Roman period onwards, the presence of non-European individuals among its cemetery populations should come as no great surprise,

although the present study appears to be the first time that they have been definitely identified for the medieval period.

FORDISC (version 2.0) is a computer program designed to determine ancestry by cranial, mandibular and post-cranial measurements. It was designed in North America for forensic cases and uses data sets based on American ethnic groups that may not necessarily be applicable to European and African individuals. However, it can still give an indication of non-European individuals in European assemblages.

Anomalous development of the spine (vertebrae showing features of more than one type, or incorrect numbers of thoracic or lumbar vertebrae) was recorded in 24 individuals (20% of the total number). A similar frequency was recorded for Fishergate and also noted in the St Bride's cemetery, London (AY 12/2, 194–5). Other examples of abnormal skeletal development were recorded for SK8, which had defects at the midline of the maxilla and mandible, and for SK45, which had defects in the formation of the arches of the mid-thoracic vertebrae.

Dental diseases are some of the most commonly recorded pathological conditions in archaeological skeletons because of the high survival of teeth in the burial environment. Of the 118 individuals in the present sample, 73 had surviving dentition (a total of 1,550 teeth). Of these, 48 individuals (66%) had evidence for dental caries (172 out of 1,550 teeth, or 11.1%). Caries are caused by the actions of bacteria on food residue on teeth and are most often related to high levels of sugar consumption. In the Period 4 cemetery at Fishergate, 38% of the individuals with teeth present had caries (4.3% of the total number of teeth) (AY 12/2, 201), while at St Helen-on-the-Walls, the number of teeth with carious cavities was 6.1% of the total number of teeth (AY 12/1, 52). These figures are both considerably lower than the findings for the present sample, possibly suggesting a greater sugar consumption for the population buried at St Stephen. However, at Jewbury, the figure was higher, and comparable to the present sample, of 59.5% of individuals (AY12/3, 496). The majority of caries in the present sample were located on the surfaces of the tooth adjacent to other teeth (interproximal surfaces), suggesting that trapped food was probably the cause of most caries. This was also the finding for the Jewbury population (AY 12/3, 497) and for Fishergate (AY 12/2, 200). This could suggest that there may have been a poorer dental hygiene at St Stephen and Jewbury than at Fishergate, as while the position of most dental caries in this population is the same, the total number of carious cavities is fewer.

An indication of the levels of dental hygiene in the present sample is also indicated by the presence of calculus deposits on the teeth. Of the 73 individuals with surviving dentition, 70 (96%, or 88% of the total number of teeth) had some degree of calculus. At St-Helen-on-the-Walls, 73% of individuals had calculus deposits (AY 12/1, 54), and at Fishergate the 'majority' of individuals were affected (AY 12/2, 200), while, unfortunately, no indication of the numbers of affected individuals were given for the Jewbury population. The higher numbers of individuals in the St Stephen's population with calculus deposits than at St-Helen-on-the-Walls may also indicate poorer dental hygiene at St Stephen. This is also implied by the high number of individuals (63%) with periodontal disease, which can be initiated by calculus irritating the gums. Over half of the individuals from St Helen-on-the-Walls were recorded as having some degree of periodontal disease (AY 12/1, 54), while the figures for Jewbury were exceedingly high with 92% of individuals recorded as being affected to some degree (Roberts and Cox 2003, 261), although the method of scoring the presence of the condition at this site may have contributed towards producing an inflated prevalence rate. This would suggest that the percentage of individuals at St Stephen's with periodontal disease is not unusual for medieval York. Dental abscesses can also be a

complication of dental caries and poor dental hygiene, and the percentage of affected individuals in the present sample is 27%. No figures are given for the number of affected individuals at any of the other medieval cemeteries from York, but in Roberts and Cox (2003, 260) the combined average percentage of affected individuals from a number of medieval cemetery populations across the country is 26%, a very similar percentage to that found in the present sample.

An interesting observation made during the analysis of the dentition was that three individuals (SK28, SK30, SK48) had grooves across the occlusal surfaces of teeth that did not appear to be the result of normal dental attrition and may have indicated that these individuals were using their teeth as tools. Three other individuals (SK34, SK56, SK106) had grooves on the interproximal cemento-enamel junction of teeth that probably indicates the (over)use of a toothpick. A similar lesion was seen on one molar of an individual at Fishergate and was also attributed to toothpick use (AY 12/2, 247).

Another very common pathological condition recorded in archaeological skeletons is degenerative joint disease and osteoarthritis. Of the 118 individuals, 59 had evidence for spinal joint disease (50%, or 65% of the adults), a slightly higher percentage than found at St Helen-on-the-Walls (42%; AY 12/1, 57), and only slightly lower than the 70% of adults affected at Fishergate (AY 12/2, 207). The percentage of individuals with at least one joint affected by extra-spinal joint disease was 46% of the total number of individuals (or 59% of the adults). This is slightly higher than the percentage of adults affected at Fishergate (46%; AY 12/2, 209), and at Jewbury (also 46%; AY 12/3, 488). This suggests that the population from St Stephen's were subjecting their joints to similar amounts of wear and tear as other medieval populations from York. The extra-spinal sites most commonly affected by degenerative changes in the present sample were the hips, knees, hands, shoulders and elbows, which was also the pattern seen at the other medieval cemeteries from York (AY 12/1, 57; AY 12/2, 210; AY 12/3, 489). Joint disease was most commonly seen in the older individuals, with no young adults, and only a few young middle adults affected. A similar pattern was observed at Fishergate (AY 12/2, 209) and is to be expected, as, today as well as in the past, degeneration of the joints increases with age.

Another form of joint disease tentatively identified in the present sample is ankylosing spondylitis. This condition causes the fusion of vertebrae through ossification of spinal ligaments and is more common in males. Three individuals (two males and one ?female) were recorded as having spinal fusion that appeared to follow the pattern expected for this condition. At least one individual at St Helen-on-the-Walls was recorded as having the condition (AY 12/1, 57), while four adult males from Fishergate exhibited ankylosis of the sacro-iliac joints that is a feature of the condition (AY 12/2, 211).

Schmorl's Nodes were seen on the vertebrae of 62 individuals (65% of the total number of adults and older adolescents, or 83% of the number of spines present). Of these, 32 were male (76% of the total number of males, or 86% of the number of male spines present), and 27 were female (73% of the total number of females, or 79% of the number of female spines present). At Fishergate, 48% of female spines and 77% of male spines were affected (AY 12/2, 214). Schmorl's Nodes are probably related to stress and strain on the back, such as from repeated bending and lifting, and the figures from St Stephen's would suggest that while males were subjecting their spines to slightly increased levels of stress compared with those from Fishergate, females were experiencing much more stress and strain on the back.

Evidence for strenuous activity among the population can also be implied by the presence of activity related changes to the skeleton. Nine individuals (14.8% of the 61 who had scapulae present) had

evidence for a condition called *os acromiale*, which is when the acromial process of the scapula remains unfused, due to severe stress on the rotator cuff, muscles responsible for rotation and elevation of the arm, during adolescence. The percentage of affected individuals from Fishergate was 9.7% (AY 12/2, 189–92), suggesting that the population from St Stephen's may have had a higher involvement in activities that cause *os acromiale*. Cortical defects, which occur at sites of muscle attachment and are due to repeated microtrauma through heavy use of a particular muscle or muscle group, were seen on elements from 46 individuals (39% of the total number of individuals), and were most commonly seen at the attachment sites for the costoclavicular ligament on the clavicle and for *M. pectoralis major*, *M. teres major* and *M. latissimus dorsi* on the proximal humerus. The muscles of the proximal humerus are involved in adduction and medial and external rotation of the arm, while the costoclavicular ligament stabilises the sternoclavicular joint in these actions, so it is probable that a number of individuals in the present sample were repeatedly involved in these types of movement.

Another indication of possible stress on joints and sites of muscle attachment are avulsion fractures. These can occur when there is trauma to the site of a tendon or ligament attachment. A small fragment of bone can be pulled away by the ligament or tendon and then does not reattach during the healing process. Twenty individuals had avulsion fractures, seven of which were to the area of attachment of the bifurcate ligament on the calcaneus (which stabilises the foot), and three of which were to the area of attachment of *M. extensor carpi radialis brevis* on the third metacarpal (which extends and abducts the hand at the wrist joint). A number of other fractures were recorded among the population. Of the 118 individuals, 48 had evidence for one or more healed fractures (41%). The percentage of affected individuals from Fishergate was 16% of the total number (AY 12/2, 225), a prevalence which is two and a half times lower than that at St Stephen's. This could suggest that the St Stephen's population was much more prone to injuries that lead to bone fracture than the Fishergate population, although it appears that the figures reported from Fishergate do not include fractures of articular surfaces of bones, particularly of the hand and foot phalanges, which actually accounted for a significant minority of the fractures in the present sample. However, there were only five individuals from St Stephen's who exclusively had articular surface fractures, and excluding these, the percentage of individuals with fractures is 36%, which is still more than double that at Fishergate. Although the percentage of affected individuals is much higher in the present sample, the distribution of fractures by element is similar in part, with ribs, vertebrae, hands and feet being very commonly affected at both sites (AY 12/2, 227). However, in the present sample, depressed cranial fractures were also very common (twelve individuals), while only one case was recorded at Fishergate (AY 12/2, 227). The most interesting example of a healed fracture from the present sample was SK93, which had a severely fractured left ischium. This had resulted in the acetabulum being disrupted with subsequent osteoarthritis of the hip joint. The position of the body in the grave, with the left leg flexed at the hip and knee, suggests that the fracture led to very limited movement at the hip that prevented the body being laid in an extended position for burial. The individual had also sustained a second fracture, this time to their left ilium, not long before death, and it is possible that this may have been the result of a fall due to reduced mobility from the previous fracture.

Other conditions that may be associated with trauma are osteochondritis dissecans and Scheuermann's disease. Osteochondritis dissecans is a condition in which circulatory disturbance leads to necrosis of the bone of a joint. The bone fragment may subsequently detach from the rest of the bone leaving a rounded lesion on the joint surface. Nineteen individuals had evidence for lesions that may represent the

condition, while eleven individuals at Jewbury were considered to have the condition (AY 12/3, 490), and a number of similar lesions were observed at Fishergate (AY 12/2, 214). Scheuermann's disease is a condition of the spine usually seen in younger males where stress or trauma during growth leads to destruction of the anterior of vertebral bodies and subsequent kyphosis. Two individuals from St Stephen's, both male, had evidence for anterior vertebral destruction with wedging of the vertebrae and kyphosis, which seems consistent with a diagnosis of Scheuermann's disease.

The final example of healed trauma is from SK16, which had a fractured left first metatarsal, extremely atrophied left metatarsals, calcaneus and talus that were smaller on the left than the right, and a very gracile left fibula. This seems to be an example of trauma to the foot that has fractured the first metatarsal and led to subsequent disuse and atrophy of the lower leg and foot.

In addition to these forms of trauma, there were also four individuals with blade injuries, and one with peri-mortem blunt force cranial trauma. One of the examples of a blade injury, a cut into the posterior shaft of the left MC2 of SK28 with evidence for small amounts of healing, and the blunt force cranial trauma to the frontal of SK27, may have occurred accidentally, but the others seem very likely to have been the result of deliberate action. SK28 had penetrating injuries into the external surface of two left ribs and an unside fragment, with four wounds in total, and with limited healing of the edges of the lesions. They appear to be consistent with stabbing injuries made with the tip of a bladed weapon. SK65 had cuts from a bladed weapon to the left and right ribs, a lumbar vertebra, the left ilium, and the second cervical vertebra, none of which had any evidence for healing, indicating that they occurred at the time of death. The individual also had peri-mortem fractures of the right clavicle and right fifth metacarpal. SK86 had a large peri-mortem cut from a bladed weapon into the left side of the frontal with fractures of the orbit, sphenoid, zygomatic and temporal, and three peri-mortem cuts into the proximal humerus which is also fractured into pieces, probably also peri-mortem. Of these individuals, four were male while SK86 was a young adult female. At St Helen-on-the-Walls, the four individuals with blade injuries were all male (AY 12/1, 56), as was the case for the 31 affected individuals at Fishergate (AY 12/2, 231–2). At Jewbury, however, the six individuals with blade injuries comprised three males and three females (AY 12/3, 480–1). Interestingly, one of these females was an adolescent/young adult with unhealed cuts to the cranium and facial skeleton (AY 12/3, 481). It would be easy to speculate on the nature of the assault upon these young women, but it is probably safe to say that it indicates females were not immune to violence in medieval York.

Infectious disease, in the form of porous woven bone and compact bone that cannot be attributed to a specific infective process (non-specific infections), was recorded on elements from 35 individuals (33 cases of periosteal new bone, and two cases of osteomyelitis with cloacae) or 30% of the total number of individuals. The percentage of affected individuals at Jewbury was approximately 20% (AY 12/3, 469), and 22% at Fishergate (AY 12/2, 219), suggesting that the population from St Stephen's was slightly more susceptible to general infection than other communities from medieval York. New bone on the surface of the ribs was seen in eight individuals. Six individuals from Fishergate were recorded as having new bone and lesions on the surface of the ribs in association with other lesions characteristic of tuberculosis, while two other individuals exhibited only new bone on the ribs, but were still tentatively identified as suffering from tuberculosis (AY 12/2, 220–3). In addition to tuberculosis, new bone on the ribs can be caused by respiratory infections or infections of other internal organs within the ribcage, and as the individuals from St Stephen's do not exhibit other lesions characteristic of tuberculosis, the rib lesions are



more likely to represent these types of infection. Three individuals also exhibited new bone on the anterior surface of the sacrum, which would appear to be related to an infection of the organs of the lower abdomen.

Four individuals had diffuse porous woven bone on the shafts of many long bones and on the metacarpals and metatarsals. This seems to be consistent with a condition called hypertrophic osteoarthropathy which is often associated with neoplastic disease. Only one of the individuals (SK11) showed evidence for both conditions, but it may be the case that the other individuals had neoplastic disease that had not manifested itself on the skeleton by the time of their death. Sinusitis, in the form of spiculated bone in the cranial sinuses, was recorded for thirteen individuals (11% of the total). At Jewbury, the percentage was 5.9% (AY 12/3, 475), and at St Helen-on-the-Walls it was 7.9% (corrected from Roberts and Cox 2003, 233). Sinusitis is associated with infection from abscesses penetrating into the maxillary sinuses, or from irritation of the sinuses by sooty or dirty air as a result of living and working conditions. While a number of the individuals from St Stephen's had sinusitis that could have been associated with maxillary abscesses and caries, there were three individuals (23% of those affected) which had no evidence for any association, while at Jewbury, this was 39% (AY 12/3, 475). This suggests that air pollution could have been the cause and indicates that this may have been a hazard for medieval populations in York.

Stress during childhood, either in the form of ill health or poor nutrition, is suggested by the presence of enamel hypoplastic lines on the teeth, caused by stress that prevents the laying down of enamel during dental development, and cribra orbitalia, porosity in the roof of the orbits due to anaemia. Forty-one individuals out of 73 with surviving dentition (56%) had evidence for enamel hypoplasia on one or more teeth. The percentage at Jewbury was 46% (AY 12/3, 495). When the figures are separated into categories according to sex, 70% of males with surviving dentition were affected and 56% of females. This compares with 59% of males and 48% of females at Fishergate, and 36% of males and 46% of females at St Helen-on-the-Walls (AY 12/2, 204). Cribra orbitalia was recorded in eleven individuals (9.3% of the total number of individuals). The percentage was 10.7% at Fishergate (AY 12/2, 205) and 15.3% at Jewbury (AY 12/3, 460). Three individuals in the younger childhood category (SK35, SK55, SK100) and one old middle adult male (SK48) also had other skeletal lesions indicative of childhood anaemia (healed in the case of the adult). The percentages of individuals with evidence for periods of stress or illness in childhood suggests that this may have been slightly more common in individuals from St Stephen's than in other medieval York populations, but not greatly so.

Other evidence for childhood illness was seen in the presence of lesions indicative of rickets (vitamin D deficiency) and delayed skeletal growth and maturation of subadult individuals. Eleven individuals were recorded as having abnormal curvature of the long bones indicative of rickets. The condition was seen in between 30 and 40 individuals at St Helen-on-the-Walls (AY 12/1, 59), and six individuals at Jewbury (AY 12/3, 466). Twelve subadult individuals had long bone lengths and epiphyseal fusion that appeared delayed compared with their dental development (dental development is less likely to be affected by illness and stress than the rest of the skeleton). The most extreme example of this was SK84, an individual aged 17–19 years by dental development, but only 10–12 years by long bone length. This suggests that the subadult population from St Stephen's was likely to suffer from nutritional deficiencies and other periods of stress that restricted growth and skeletal maturation.

Evidence for neoplastic disease was seen in nine individuals, six of which had benign tumours (button osteoma) on the external surface of the cranial vault (5% of the total number of individuals). This benign form of neoplastic disease is the one most commonly found in archaeological skeletons, and was also seen in 4.2% of individuals from Fishergate (AY 12/2, 223), 1.1% of those from Jewbury (AY 12/3, 466) and on 'several' crania from St Helen-on-the-Walls (AY 12/1, 58). Three other individuals were recorded as having skeletal lesions secondary to soft tissue malignant neoplastic disease. These were SK11, which had a number of sharp edged subchondral lesions, SK12 whose frontal had a large area of missing bone with sharp edges, and SK57, which had a sharp edged lesion on the sacrum with a localised area of trabecular bone in the interior.

Lesions on the bones of the hands and feet suggestive of gout were found in nine individuals. Gout is caused by a build up of uric acid crystals in joints and is associated with excessive alcohol consumption, obesity, kidney problems and high blood pressure, and is seen more in males than females. This is the case for the present sample where seven males and two unsexed adults were affected. Three individuals, all older adult males, were recorded as having changes possibly representative of gout at St Helen-on-the-Walls (AY 12/1, 84–109). Obesity and diabetes may also be factors in another condition, Diffuse Idiopathic Skeletal Hyperostosis (DISH), which is also more common in males and manifests as large osteophytes of a 'candle-wax' appearance with fusion of adjacent vertebrae and of new bone at ligamentous attachments. Six individuals (five males and one ?female) had evidence for DISH, while fifteen individuals were affected at Fishergate (AY 12/2, 212), and three at Jewbury (AY 12/3, 488).

Two conditions which are most commonly associated with older adult females were seen in the St Stephen's population. Osteoporosis, which manifests in skeletal remains as thinning of the cortical bone, loss of trabecular bone and compression fractures of the vertebrae, was identified in five individuals (one old middle adult female, three mature adult females and one old middle adult of indeterminate sex), and tentatively identified in at least five individuals from Fishergate (AY 12/2, 241), and three individuals from Jewbury (AY 12/3, 490–1). Hyperostosis frontalis interna, which is a nodular thickening of the endocranial surface of the frontal of unknown cause, was seen in two older females from the present sample, and in four older females from Fishergate (AY 12/2, 241).

Single cases of certain other conditions were recorded among the population. An oval-shaped shell of ossified material of approximately 2.5cm in length was recovered from the chest cavity of SK11. It is probable that this represents an ossified cyst of the Echinococcus tapeworm, which usually infects canids but can be ingested by humans through the faecal-oral route and suggests poor sanitary conditions. SK37 was of short stature with increased robusticity, prominent muscle attachments and short metacarpals. All of these features are seen in a condition called Albright's Hereditary Osteodystrophy, although there are other features, such as a distinctive cranial and facial shape, that cannot be assessed in this skeleton due to its incompleteness and, therefore, any diagnosis of such a specific condition will have to remain very tentative in this case. SK108 was represented only by parts of both legs, but both femorae had areas of shaft expansion with a porous appearance to the cortical bone. It is possible that these are fractures, but it is more likely to represent Paget's disease. This condition is of unknown cause but usually affects older individuals and is more common in males. It causes thickening of bones, with cortical and trabecular bone replaced by weak and disorganised bone that is prone to deformation and fracture. A number of disarticulated bones found in various contexts also appeared to show evidence for the condition, including a grossly thickened and deformed tibia. As SK108 is very incomplete, it is very

probable that these bones were originally part of this individual, suggesting that Paget's disease had affected much of the skeleton. Possible cases of Paget's disease were also found among the skeletons and disarticulated bone from St Helen-on-the-Walls (AY 12/1, 58), and one individual was recorded as being affected at Jewbury (AY 12/3, 492). Finally, SK116 demonstrated a widened and rounded nasal aperture with loss of the nasal spine, a porous and extremely thin palate, some wasting of the hand and foot phalanges, flexion grooves on the hand phalanges and infections of the lower legs. These features are consistent with a diagnosis of leprosy. No other definitive diagnoses of leprosy have previously been made among the individuals from York's medieval cemeteries, although one individual from St Helen-on-the-Walls was described as possibly exhibiting slight erosion of the nasal spine (AY 12/1, 58), one of the early signs of leprosy.

In summary, the population from St Stephen's appears to be a normal archaeological attritional cemetery population with a normal ratio of males and females but with an absence of very young individuals and a higher than expected number of older females. The stature of individuals is as expected for medieval populations from York and they appeared to be eating a similar diet, as evidenced by dental disease, and had similar levels of dental hygiene. The levels of wear and tear on joints was also similar, but there appeared to have been higher levels of stress to the back, especially for females. There was also a much higher number of fractures than in other medieval York populations, and slightly increased levels of stress in childhood and susceptibility to infection. Levels of violence, including violent death, were similar to the other populations, with evidence that women were not immune to violent attack in medieval York. There was also evidence for a number of conditions, including neoplastic disease, ankylosing spondylitis, DISH, gout, osteoporosis and Paget's disease, that have previously been recorded in skeletons from York, and also the first definite evidence for a case of leprosy.

#### 4.6.5 *Disarticulated human bone*

Disarticulated human bone from a large number of contexts was examined for evidence of pathology and trauma, and to indicate whether there were elements present from younger age categories than represented among the articulated inhumations (see 4.6.4). A number of very common pathological conditions, such as dental disease, degenerative joint disease, non-specific conditions and fractures were recognised among the disarticulated bone, as well as examples of more unusual conditions, such as Paget's (see 4.6.4), scurvy, possible leprosy, healed cranial blunt force and sharp force trauma, peri-mortem sharp force cranial and post-cranial trauma, and a number of examples of possible peri-mortem blunt force and sharp force trauma. These latter examples are difficult to ascribe definitely to trauma as they are on bones disturbed after their original burial and the damage may have occurred as a result of this disturbance. A full inventory of disarticulated bone, including photographs of interesting pathologies and trauma, is held in the archive.

#### 4.6.6 *Catalogue of burials*

The preservation, completeness, age, sex, stature and cranial index of each individual analysed, as well as any non-metric traits and pathologies observed, are catalogued below. The information is summarised in Table 18, at the end of the report.

##### **SK1 (1005)**

Age: ?younger childhood (1-6 years) Preservation: excellent

Completeness: only part of the right leg and both feet are present

Pathology: none observed

**SK2 (1009)**

Age: younger childhood (2-4 years) Preservation: excellent

Completeness: only the legs and feet are present

Pathology: none observed

**SK3 (1012)**

Age: mature adult (46+) Sex: ?male

Stature: 162 ± 3.27cm (femur)

Cranial index: - Preservation: moderate

Completeness: the left clavicle, scapula and arm, the right lower arm, both hands, thoracic and lumbar vertebrae, ribs, sacrum and pelvis and both femorae are present.

Non-metric traits: none observed

Pathology: DJD (degenerative joint disease) of the thoracic vertebrae, six lumbar vertebrae with L6 sacralised, large osteophytes on the right margin of the vertebral bodies of T10 and T11 that may indicate early DISH (Diffuse Idiopathic Skeletal Hyperostosis), DJD of the left shoulder, right elbow, left wrist, and both hips, possible well remodelled avulsion fracture of the styloid process of the left ulna, enthesophytes at the attachment for the costotransverse ligament on four left ribs, for the coraco-acromial ligament and M. coracobrachialis and M. biceps on the left

**SK4 (1015)**

Age: old middle adult (36-45) Sex: female

Stature: 168 ± 3.55cm (femur + tibia) Cranial index: -

Preservation: excellent

Completeness: the majority of the bones are present. Dentition:

	c	c	c,a		c						c	c		c	c		
Upper right	1	2	3	4	5	6	/	/	9	10	11	12	13	X	15	16	Upper left
Lower right	32	31	X	29	28	/	26	/	24	23	22	21	20	19	X	X	Lower left
	c	c															

Dental pathology: caries (11/24), calculus (22/24), slight to moderate periodontal disease of the maxilla, buccal and lingual abscesses of the maxillary right M1, ante-mortem tooth chipping of the mandibular left M1.

Non-metric traits: tibial squatting facet, distal septal aperture, transverse foramen bipartite (right)

Pathology: DJD of the thoracic vertebrae, SN (Schmorl's Nodes) of the lower thoracic and upper lumbar vertebrae, well remodelled fracture of the shaft of one unsided rib fragment, porous woven bone on the visceral surface of one unsided rib fragment near to the sternal end that represents a chest infection active at the time of death, healing fracture of the acromial end of the left clavicle and of the anterior of the acromion of the left scapula, healing crush fracture of the proximal joint surface of a proximal hand phalanx, spiculated bone in both maxillary antra, indicating sinusitis.

**SK5 (1018)**

Age: middle adult or older (26+) Sex: -

Stature: - Cranial index: - Preservation: good

Completeness: part of the cranium, both clavicles and scapulae, the ribs and vertebrae, parts of both humeri and left radius and ulna, parts of both femorae, left tibia and fibula are present.

Non-metric traits: none observed

Pathology: DJD of the thoracic and lumbar vertebrae, SN of the thoracic and lumbar vertebrae, healed compression fracture of the body of L2, the lower facets of T11 and the upper of T12 are of the lumbar type, DJD of both shoulders, well remodelled fracture of one right rib near to the vertebral end and of two unsided shaft fragments, small button osteoma on the surviving fragment of occipital, cortical defect at the attachment site for M. teres major on the left humerus.

**SK6 (1021)**

Age: older childhood (10-12 years) Preservation: excellent

Completeness: part of the cranium, the cervical vertebrae, the right scapula, part of the left femur, both tibiae and fibulae and part of both feet are present.

Dentition:

Upper right	-	-	-	-	-	-	-	-	-	-	-	-	-	-	-	-	Upper left
Lower right	-	31	-	-	-	-	-	-	-	-	-	-	-	-	-	-	Lower left

Pathology: the tibiae and fibulae are bent medio-laterally and the distal shafts appear unusually thickened, diffuse porous woven bone on both tibiae and a small area on the left fibula, indicating an active infection. All these features probably indicate rickets.

### SK7 (1024)

Age: mature adult (46+) Sex: female

Stature: 165 ± 3.66cm (tibia) Cranial index: -

Preservation: good

Completeness: the right lower arm and hand, some ribs and vertebrae, the sacrum and pelvis, both legs and parts of both feet are present.

Non-metric traits: tibial squatting facet.

Pathology: DJD of the lumbar vertebrae, DJD of the hands, well remodelled compression fracture of the superior facet of the left talus, small exostosis of bone on the medial margin of the distal joint surface of the left tibia that possibly represents some form of soft tissue trauma, development of the lateral ridges on the hand phalanges, enthesophytes at the attachment site for tendo calcaneus on both calcanei, for M. rectus femoris on the right patella, and for M. gluteus minimus on the left femur.

### SK8 (1029)

Age: mature adult (46+) Sex: female

Stature: 160 ± 3.72cm (femur)

Cranial index: 70.2

Preservation: moderate

Completeness: the majority of bones apart from the distal tibiae, fibulae and feet are present.

Dentition:

Upper right	np	2	3	4	5	6	7	8	9	/	/	12	13	14	15	np	Upper left
Lower right	np	31	X	29	28	27	26	/	/	23	22	21	20	19	18	np	Lower left

Dental pathology: caries (2/22), calculus (21/22), slight periodontal disease Non-metric traits: parietal foramen (left)

Pathology: OA of the cervical, thoracic and lumbar vertebrae, SN of the lower thoracic and lumbar vertebrae, healed fractures of the bodies of T9, T11 and T12, OA of the left shoulder and left hip, DJD of both temporomandibular joints, remodelled fractures of the midshaft or sternal end of four right ribs, remodelled fracture of the midshaft of the left radius with overlapping of the ends and subsequent shortening, sharp exostoses of bone on the anterior and distal shaft of both humeri that indicate some form of soft tissue trauma, slight cribra orbitalia of the left orbit, there is a defect at the site of the foramen for the incisal canal on the maxilla and of the alveolar bone for the

mandibular incisors that probably indicates a midline defect or cysts, enthesophytes of the attachment site of the costotransverse ligament on three left and five right ribs.

**SK9 (1031)**

Age: older childhood (7-9 years) Preservation: excellent

Completeness: the lower arms and hands, some ribs, the lumbar vertebrae, sacrum, pelvis and both femorae are present.

Pathology: the left femur is slightly bent medio-laterally, which possibly indicates rickets.

**SK10 (1033)**

Age: old middle adult (36-45) Sex: indeterminate

Stature: 158 ± 2.99cm (femur + tibia) Cranial index: -

Preservation: excellent

Completeness: the majority of the bones, apart from the right arm, hand, os coxa and sacrum are present.

Dentition:

	c		c		c												
Upper right	1	2	X	X	5	/	-	-	-	10	-	/	/	X	X	16	Upper left
Lower right	32	31	30	29	28	27	26	25	24	23	22	21	20	19	18	17	Lower left
																	c

Dental pathology: caries (4/21), calculus (20/21), slight to moderate periodontal disease, enamel hypoplasia of the molars, premolars, canines and incisors, ante-mortem tooth chipping of the mandibular left M3

Non-metric traits: palatine torus, parietal foramen, mastoid foramen exsutural (right), tibial squatting facet, posterior atlas bridge (right), transverse foramen bipartite (left).

Pathology: DJD of the cervical and thoracic vertebrae, SN of T8, 11 thoracic vertebrae, fractures of the proximal joint surface of a proximal foot phalanx, and of the proximal joint surface of a distal foot phalanx, thinning of the cortical bone and sparse trabecular bone of the humerus, possibly indicating osteoporosis, probable hydatid cyst present in the chest cavity representing infection with the Echinococcus tapeworm, enthesophytes at the attachment site for the costo-transverse ligament on four left ribs and three right ribs, for M. triceps on the left ulna, and for tendo calcaneus on both calcanei

**SK11 (1036)**

Age: mature adult (46+) Sex: female

Stature: 162 ± 4.24cm (radius) Cranial index: -

Preservation: good

Completeness: the majority of the bones apart from the cranium, mandible and cervical vertebrae are present

Non-metric traits: femoral plaque, transverse foramen bipartite (right)

Pathology: DJD of the thoracic vertebrae, OA of the right hand, DJD of the left shoulder and both knees, recent fracture of one unisided rib fragment, lytic lesions with ragged edges of four unisided rib fragments, C7, the left ilium and the right pubis that are probably representative of metastatic carcinoma, thick porous woven bone on the right humerus, both radii, right clavicle, both scapulae, both ilia, right pubis, very diffuse on both femorae, tibiae and fibulae, right calcaneus, and left and right metatarsals that may represent hypertrophic osteoarthropathy associated with the metastatic carcinoma, area of shaft expansion and a small exostosis of bone on the medial midshaft of the left tibia that probably represents some form of soft tissue trauma, cortical defect at the attachment site for M. teres major on the left humerus, enthesophytes at the attachment site for tendo calcaneus on the right calcaneus

**SK12 (1039)**

Age: mature adult (46+) Sex: ?female

Stature: -

Cranial index: - Preservation: good

Completeness: the majority of bones, apart from the lower legs and feet, are present

Dentition:

Upper right	1	/	-	-	-	-	-	-	-	-	-	-	-	-	-	Upper left	
Lower right	32	/	X	29	28	27	26	X	X	23	22	21	20	19	/	17	Lower left
	c			c								c	c		c		

Dental pathology: caries (5/11), calculus (12/12), slight to moderate periodontal disease, enamel hypoplasia of the molars and premolars

Non-metric traits: none observed

Pathology: OA of the cervical and thoracic vertebrae, SN of the lower thoracic vertebrae, fusion, possible congenital, of T5 and T6 through the anterior of the body, healed compression fractures of the bodies of T7, T8 and T10, kyphosis and scoliosis to the left of the upper thoracic vertebrae, OA of the hands, DJD of the left hip, porous woven bone on the posterior of

the mandible associated with the socket for the right M1 that represents an infection probably associated with the carious cavities of that tooth, fracture of the proximal end of the left MC1 with associated OA of the proximal and distal joint surfaces, of the proximal joint surface of the proximal phalanx and of the trapezium, which also has a probable fracture, osteoporosis of the ribs, vertebrae,



clavicles and scapulae, lytic lesions of the right capitate and hamate, plaques of bone on the endocranial surface of the cranium that is probably hyperostosis frontalis interna, large lytic lesion of the left side of the frontal with well defined margins and no reactive bone that probably represents some form of neoplastic disease

**SK13 (1042)**

Age: old middle adult (36-45) Sex: ?female

Stature: 156 ± 3.72cm (femur)

Cranial index: - Preservation: good

Completeness: the majority of the bones apart from the lower legs and feet are present

Dentition:

Upper right	-	-	-	-	-	-	-	-	/	/	11	12	13	<sup>c</sup> 14	<sup>c</sup> 15	16	Upper left
Lower right	32	31	30	29	28	27	26	25	/	/	-	21	20	19	18	-	Lower left

c

Dental pathology: caries (3/18), calculus (18/18), slight periodontal disease, enamel hypoplasia of the molars, premolars and canines

Non-metric traits: parietal foramen (left), transverse foramen bipartite

Pathology: developmental defect of the superior body of T4, partial destruction of the right inferior facet of L4, 6 lumbar vertebrae, enthesophyte at the attachment site for M. triceps on the right ulna

**SK14 (1049)**

Age: adolescent/young adult (17-20 years) Sex: male

Stature: 176 ± 2.99cm (femur + tibia) Cranial index: -

Preservation: good

Completeness: the majority of the bones are present

Dentition:

Upper right	1	2	<sup>c</sup> 3	<sup>c</sup> 4	<sup>c</sup> 5	6	7	8	9	10	11	12	13	14	15	16	Upper left
Lower right	32	31	30	29	28	27	26	25	24	23	22	21	20	19	18	17	Lower left

Dental pathology: caries (3/32), calculus (32/32), slight periodontal disease, enamel hypoplasia of the canines and incisors

Non-metric traits: parietal foramen (left), tibial squatting facet, distal septal aperture, transverse foramen bipartite

Pathology: SN of the lower thoracic vertebrae, unusually large vascular foramen on the anterior of the bodies of T10-T12, incompletely fused neural arches of T11 and S1, destruction of the bodies of L5 and S1 that represents some form of infectious process, the inferior facets of T11 and the superior of T12 are of the lumbar type, avulsion fracture of the tubercle of the left MC3, facets on the distal shaft of five proximal hand phalanges and development of the medial ridge of seven medial hand phalanges that suggests the fingers were being held in flexion, the tibiae are bent medio-laterally and the soleal lines are depressed possibly indicating rickets, spiculated bone in both maxillary antra indicating sinusitis, cortical defects at the attachment sites for the costoclavicular ligament on both clavicles and for the anterior talofibular ligament on the right fibula, prominent attachment site for M. deltoideus on the right clavicle, spurs of bone at the attachment sites for M. flexor digitorum brevis on the medial foot phalanx and for M. extensor hallucis longus on the distal foot phalanges for MT1.

**SK15 (1052)**

Age: younger childhood (5-6 years) Preservation: good

Completeness: the majority of the bones are present

Dentition:

	c											
Upper right	51	52	/	/	/	/	/	/	58	59	60	Upper left
Lower right	70	69	68	67	66	65	64	63	62	61	Lower left	

c

Upper right	U	U	U	U	U	U	U	U	U	U	U	U	U	U	U	U	Upper left
Lower right	U	U	30	U	U	U	U	U	U	U	U	U	U	19	U	U	Lower left

Dental pathology: caries (2/15 deciduous), calculus (14/15 deciduous)

Pathology: porous woven bone on the posterior of the right body of the mandible that represents a NSPI active at the time of death, moderate to severe cribra orbitalia of both orbits, pronounced spur of bone on the medial and distal shaft of the right humerus that probably represents some form of soft tissue trauma

**SK16 (1055)**

Age: young middle adult (26-35) Sex: male

Stature: 179 ± 3.27cm (femur) Cranial index: -

Preservation: good

Completeness: the majority of the bones are present

Dentition:

	c	c														
Upper right	1	2	-	-	-	-	-	-	-	-	-	-	-	-	-	Upper left
Lower right	32	31	30	/	/	/	-	-	-	-	-	-	-	-	-	Lower left

Dental pathology: caries (2/5), calculus (5/5)

Non-metric traits: tibial squatting facet, vastus notch (right), transverse foramen bipartite Pathology: DJD of the cervical, thoracic and lumbar vertebrae, SN of the lower thoracic to lower lumbar vertebrae, slight scoliosis to the left of the mid-thoracic vertebrae, well remodelled fractures of the spinous processes of T8 and T9, lytic lesion on the right trapezium, avulsion fracture of the anterior of the right calcaneus, the left fibula is much more gracile than the right, the left talus and calcaneus are slightly smaller than the right, there is a remodelled fracture of the left MT1 that has led to shortening and lateral twisting of the distal end and there is a sharp exostosis of bone on the lateral shaft, the left MT4 and MT5 are very atrophied compared with the right. All this seems to indicate trauma to the left foot with subsequent disuse atrophy.

### SK17 (1058)

Age: old middle adult (36-45) Sex: male

Stature: 171 ± 2.99cm (femur + tibia) Cranial index: -

Preservation: moderate

Completeness: the majority of bones apart from the cranium, mandible, clavicles, scapulae, upper vertebrae, most of the ribs, sternum and right arm are present

Non-metric traits: tibial squatting facet

Pathology: well remodelled fracture of the proximal joint surface of the proximal foot phalanx for the right MT1 with contour change of the distal joint surface of the MT1, well remodelled fracture of a proximal foot phalanx, enthesophytes at the attachment site for M. rectus femoris on the right patella and for tendo calcaneus on both calcanei.

### SK18 (1061)

Age: young adult (19-25) Sex: ?male

Stature: - Cranial index: - Preservation: excellent

Completeness: the cranium and mandible, vertebrae, ribs, clavicles, scapulae, sternum, part of both arms, right hand and parts of the sacrum and pelvis are present

Dentition:

		c															
Upper right	np	2	3	4	5	/	np	/	-	-	-	-	-	-	-	-	Upper left
Lower right	np	31	30	29	28	27	26	25	24	23	/	21	20	19	18	17	Lower left
		c															

Dental pathology: caries (2/18), calculus (16/18), slight periodontal disease of maxilla, enamel hypoplasia of the molars, premolars and incisors, absent maxillary right I2 with retained di2, roots of dm present between right maxillary M1 and PM4, probable retained right maxillary dc Non-metric traits: none observed

Pathology: os acromiale of the left scapula, cortical defect at the attachment site for the costoclavicular ligament on both clavicles

**SK19 (1064)**

Age: mature adult (46+) Sex: ?female

Stature: 158 ± 4.24cm (radius) Cranial index: -

Preservation: good

Completeness: the majority of bones apart from the cranium, sternum, left hand, left os coxa, left leg and foot and part of the right leg and foot are present

Dentition:

Upper right	-	-	-	-	-	-	-	-	-	-	-	-	-	-	-	-	Upper left	
Lower right	32	31	X	29	/	/	/	/	-	/	/	-	20	-	18	/	Lower left	
	c		c												c		c	

Dental pathology: caries (4/5), calculus (5/5), slight to moderate periodontal disease

Non-metric traits: none observed

Pathology: OA of the cervical and thoracic vertebrae, SN of T8, DJD of the right elbow, hand and foot and both TMJs, OA of the inferior of the acromion of the right scapula indicating dislocation of the humerus, remodelled fracture of the sternal end of one unsided rib fragment, cortical defect of the attachment site for the costoclavicular ligament on the left clavicle

**SK20 (1070)**

Age: young middle adult (26-35) Sex: male

Stature: 166 ± 2.99cm (femur + tibia) Cranial index: -

Preservation: moderate

Completeness: the majority of the bones are present

Dentition:

		c															
Upper right	np	2	3	4	5	6	7	8	9	10	11	12	13	14	15	np	Upper left
Lower right	np	31	30	29	28	27	/	25	24	23	22	21	20	19	18	np	Lower left

Dental pathology: caries (1/27), calculus (19/27), enamel hypoplasia of the canines, ante-mortem tooth chipping of the maxillary right PM4

Non-metric traits: parietal foramen, mastoid foramen exsutural (left), transverse foramen bipartite (left)

Pathology: DJD of the thoracic and lumbar vertebrae, SN of the lower thoracic vertebrae, lesions of the bodies of L2 and L3 that may represent collapse of the body due to a cyst, well remodelled fracture of the right superior facet of L5, the right inferior facet of T11 and right superior facet of T12 are of the lumbar type, no rib facets on T12 so probably only 11 ribs, diffuse compact bone on the anterior of the sacrum indicating a healed infection of the soft tissues of the lower abdomen, avulsion fracture of the tubercle of the left MC3, well remodelled fractures of the midshaft of the right tibia, and the proximal shaft of the right fibula with some overlapping of the ends with shortening but little misalignment, cortical defect at the attachment site for the costoclavicular ligament on the left clavicle

### SK21 (1073)

Age: young middle adult (26-35) Sex: ?female

Stature: 172 ± 3.55cm (femur + tibia) Cranial index: -

Preservation: excellent

Completeness: the sacrum, pelvis, legs and feet are present

Non-metric traits: tibial squatting facet

Pathology: incompletely fused neural arch of S1 and possibly S2, small areas of compact bone on the medial midshaft of the left tibia and fibula that represent healed NSPIs, plaque of bone on the lateral and distal shaft of the right fibula that represents soft tissue trauma, destruction of the joint between a proximal and medial foot phalanx for MT1 that may be related to a fracture or an infectious process, enthesophyte at the attachment site for M. abductor hallucis on the left calcaneus

### SK22 (1076)

Age: old middle adult (36-45) Sex: ?male

Stature: 160 ± 3.27cm (femur)

Cranial index: - Preservation: moderate

Completeness: the majority of bones apart from the left humerus, sternum and lower legs and feet are present

Dentition:

Upper right	1	2	3	4	5	6	7	8	9	10	11	12	13	14	15	16	Upper left
Lower right	32	31	30	29	28	27	26	25	24	23	22	21	20	19	18	17	Lower left

Dental pathology: calculus (32/32)

Non-metric traits: parietal foramen (left), epiteric bones (left), femoral plaque (right), transverse foramen bipartite (left)

Pathology: DJD of the cervical and thoracic vertebrae, SN of T5, T9 and the upper lumbar vertebrae, the right inferior facet of T11 and the right superior facet of T12 are of the lumbar type, DJD of the hips, cortical defect at the attachment site for M. teres major on the right humerus, enthesophytes at the attachment site for M. triceps on both ulnae, and for M. rectus femoris on both patellae.

### SK23 (1085)

Age: old middle adult (36-45) Sex: male

Stature: 173 ± 4.32cm (radius) Cranial index: 75.5

Preservation: good

Completeness: the majority of the bones, apart from the sternum, are present

Dentition:

				c													
Upper right	X	X	X	4	5	6	7	8	9	10	11	12	13	X	15	16	Upper left
Lower right	32	31	30	29	28	27	/	25	24	/	/	/	/	X	18	17	Lower left

Dental pathology: caries (1/22), calculus (22/22), slight periodontal disease, enamel hypoplasia of the canines

Non-metric traits: lambdoid wormians (right), parietal foramen (left), fronto-temporal articulation (left), distal septal aperture (left), transverse foramen bipartite (right)

Pathology: DJD of the cervical and lumbar vertebrae, SN of the lower thoracic and lumbar vertebrae, DJD of the hips and both TMJs, area of compact bone on the distal, posterior and lateral shaft of the right femur representing a healed NSPI, healed fracture of the tubercle of the right MC3, small (8mm in diameter) healed lesion of the right frontal near to the coronal suture that possibly represents a healed depressed fracture, enthesophytes at the attachment site for the

common flexors on both humeri, development of the medial and lateral ridges of the hand phalanges

### SK24 (1089)

Age: adolescent (15-17 years) Sex: -

Stature: - Cranial index: - Preservation: moderate

Completeness: only part of both legs and the left hand are present

Non-metric traits: none observed

Pathology: none observed

### SK25 (1094)

Age: older childhood (11-12 years) Preservation: good

Completeness: the majority of the bones, apart from part of the right humerus and left foot, are present

Dentition:

Upper right	U	U	3	4	5	6	7	8	9	10	/	12	13	14	U	U	Upper left
Lower right	U	U	30	29	U	27	26	25	24	23	22	21	20	19	U	U	Lower left

Dental pathology: calculus (17/21), enamel hypoplasia of the molars, premolars, canines and incisors

Pathology: small area of porous woven bone on the posterior of the left acromion representing an NSPI active at the time of death, small (10mm in diameter) healed depressed cranial fracture of the right parietal, the length of the long bones suggests an age of 6-8 years and the epiphyseal fusion an age of 3-5 years which indicates delayed skeletal growth and maturation, cortical defects at the attachment site for the costoclavicular ligament on both clavicles

### SK26 (1097)

Age: old middle adult (36-45)

Sex: female

Stature: 166 ± 3.55cm (femur + tibia) Cranial index: 74.6

Preservation: excellent

Completeness: the majority of the bones are present

Dentition:

	a	a										c	a	a	a		
Upper right	X	X	X	4	5	/	/	/	/	/	/	12	/	X	X	X	Upper left
Lower right	X	X	X	29	28	27	26	/	/	23	22	/	20	19	18	17	Lower left
												a	c,a	c			

Dental pathology: caries (3/14), calculus (14/14), moderate to severe periodontal disease, enamel hypoplasia of the incisors, buccal abscesses of the right maxillary M3 and M2, left maxillary PM4, M1 and M3, and left mandibular PM3 and PM4, ante-mortem tooth chipping of the right maxillary I2

Non-metric traits: palatine torus, parietal foramen (right), tibial squatting facet (right), distal septal aperture

Pathology: OA of the cervical, thoracic and lumbar vertebrae, SN of the lumbar vertebrae, the inferior facets of T11 and superior of T12 are of the lumbar type, no rib facets on the body of T12 and only 11 ribs present, OA of the hands, DJD of both shoulders, hips, knees and the left TMJ, small areas of compact bone on the distal and posterior shaft of the left tibia and on the distal and medial shaft of the left fibula, representing healed NSPIs, exostosis of bone on the medial and posterior of the right hamate, possibly representing some form of soft tissue trauma, cortical defect of the attachment site for the costoclavicular ligament on the right clavicle, enthesophytes at the attachment site for tendo calcaneus on both calcanei, for the interosseous ligament on the left fibula, and for M. rectus femoris on both patellae, roughening of the attachment site for M. subscapularis on the left humerus and for M. semimembranosus, M. semitendinosus and M. biceps on both ischia, prominent attachment for M. deltoideus on the left clavicle

**SK27 (1102)**

Age: young middle adult (26-35) Sex: ?male

Stature: 171 ± 2.99cm (femur + tibia) Cranial index: -

Preservation: good

Completeness: the majority of bones, apart from the humeri and left foot are present

Dentition:

	c	c									c	c			c		
Upper right	1	2	3	-	-	-	-	-	9	10	11	12	13	/	/	16	Upper left
Lower right	32	31	30	29	28	27	26	25	24	23	22	21	20	19	18	17	Lower left
																	c c

Dental pathology: caries (7/25), calculus (24/25), slight periodontal disease, enamel hypoplasia of the premolars and canines, ante-mortem tooth chipping of the mandibular left M1 and right I2

Non-metric traits: parietal foramen (right), mastoid foramen bipartite (left), tibial squatting facet (right), transverse foramen bipartite



Pathology: DJD of the thoracic vertebrae, SN of the mid to lower thoracic and upper lumbar vertebrae, six lumbar vertebrae, DJD of the left TMJ, possible well remodelled impacted fracture of the styloid process of the right ulna, roughening and expansion of the distal joint surface of the right radius with osteophytic lipping, and roughening of the radius facet of the right trapezoid, which represents some form of trauma to the right wrist, well remodelled fractures of the shafts of the left MC4 and MC5 with shortening of the shafts and palmar displacement of the distal ends of the shafts, probable well remodelled fracture of the distal joint surface of a medial foot phalanx, small (8mm in diameter) healed lesion on the right parietal near to the sagittal suture that may represent a healed depressed fracture, cribra orbitalia of the right orbit, smooth exostosis of bone on the proximal and lateral shaft of a proximal hand phalanx for MC5, cortical defect at the attachment site for the costoclavicular ligament on the right clavicle, the superior of the left frontal has an area of missing bone with an internal bevel and a fracture line running to the coronal suture and there are three fragments of bone that have split along the diploe. This possibly represents peri-mortem blunt force cranial trauma.

**SK28 (1105)**

Age: middle adult or older (26+) Sex: male

Stature: 179 ± 4.05cm (humerus) Cranial index: -

Preservation: good

Completeness: the cranium and mandible, cervical and thoracic vertebrae, ribs, sternum, scapulae, clavicles and humeri are present

Dentition:

											c	c	a				
Upper right	X	X	X	X	X	/	/	8	9	10	11	12	13	X	X	X	Upper left
Lower right	32	31	30	29	28	27	26	25	24	/	22	21	20	19	18	17	Lower left
		c,a	c,a	c									c	c,a			

Dental pathology: caries (7/21), calculus (9/21), moderate to severe periodontal disease, enamel hypoplasia of the canines and incisors, buccal abscesses of the maxillary left PM4, mandibular left M1, and right M1 and M2 with associated porous woven and compact bone, indicating an infection associated with the abscesses, the maxillary teeth have mesial-distal grooves across the occlusal surface that may represent use of the teeth as tools

Non-metric traits: parietal foramen (right), double superior atlas facets

Pathology: OA of the cervical and thoracic vertebrae with fusion of C6 and C7, SN of the lower thoracic vertebrae, slight scoliosis to the left of the mid-thoracic vertebrae, avulsion fracture of the end of the spinous process of T1, DJD of both TMJs, shoulders and elbows, osteophytic lipping and porosity of the inferior of the acromion of the right scapula indicating probable humeral dislocation, healed fracture of the midshaft of the left clavicle with severe shortening and a 3cm overlap of the edges, probable healed depressed fracture of the right parietal near to the temporal, cortical defects at the attachment site for the costoclavicular ligament on the right clavicle, for M. teres major on the left humerus, and for M. pectoralis major on the right humerus, roughening of the attachment sites for M. supraspinatus, M. subscapularis and M. infraspinatus on both humeri, two left ribs have probable

sharp force penetrating injuries, one into the external surface and one into the superior and visceral surface. An unsided rib fragment has two similar injuries to the external surface with the largest being 10mm in length by 3mm at the widest point. There is some bony reaction with sclerosis of the edges of the lesions, indicating that they occurred ante-mortem but there was only limited time for healing prior to death

### SK29 (1108)

Age: old middle adult (36-45) Sex: female

Stature: 160 ± 3.55cm (femur + tibia)

Cranial index: - Preservation: excellent

Completeness: the majority of the bones are present

Dentition:

	c	c											c	c			
Upper right	1	2	3	4	5	6	7	8	9	10	11	12	13	14	15	16	Upper left
Lower right	32	31	30	29	28	27	26	25	24	23	22	21	20	19	18	17	Lower left
			c	c										c			

Dental pathology: caries (7/32), calculus (32/32), slight periodontal disease, enamel hypoplasia of the canines

Non-metric traits: parietal foramen, parietal notch bones (right), tibial squatting facet, posterior atlas bridge, transverse foramen bipartite (right)

Pathology: DJD of the thoracic and lumbar vertebrae, SN of T10, DJD of both shoulders and right hip, possible osteochondritis dissecans of the proximal joint surface of the left MT1, button osteoma on the left parietal near to lambda, slight cribra orbitalia of both orbits, spiculated compact bone in both maxillary antra, representing sinusitis, smooth exostosis of bone on the medial midshaft of the left femur, enthesophytes at the attachment site for M. soleus on both fibulae and for tendo calcaneus on both calcanei

### SK30 (1111)

Age: mature adult (46+) Sex: female

Stature: 157 ± 3.55cm (femur + tibia) Cranial index: -

Preservation: good

Completeness: the majority of the bones apart from the sacrum are present

Dentition:

	c	a	a														
Upper right	1	X	X	4	5	/	7	8	9	10	11	12	13	14	X	X	Upper left
Lower right	32	31	30	29	28	27	/	25	24	23	22	21	20	X	18	17	Lower left

Dental pathology: caries (1/25), calculus (24/25), slight to severe periodontal disease, buccal abscesses of the maxillary right M3 and M2, mesio-distal groove across the occlusal surface of the maxillary right I1 that possibly represents use of the tooth as a tool

Non-metric traits: tibial squatting facet, transverse foramen bipartite

Pathology: SN of T2 and T9, DJD of both elbows, hips, ankles and feet and of the right TMJ, fracture of the proximal joint surface of a medial hand phalanx and of the proximal joint surface of a distal foot phalanx, osteoporosis of the long bones, enthesophytes at the attachment site for tendo calcaneus on both calcanei, roughening of the attachment site for M. subscapularis on both humeri

### SK31 (1114)

Age: young middle adult (26-35) Sex: male

Stature: 171 ± 2.99cm (femur + tibia) Cranial index: -

Preservation: excellent

Completeness: the majority of bones inferior of the midshaft of both humeri are present

Non-metric traits: none observed

Pathology: SN of the lumbar vertebrae, the sacrum has 6 segments, reattached avulsion fracture of the posterior of the right talus, healed fracture with callus present of the distal shaft of the left MT5 with the distal end displaced slightly laterally, area of compact bone on the lateral and distal shaft of the right tibia representing a healed NSPI, small exostosis of bone on the medial and distal shaft of the left humerus in the area of attachment of M. brachialis that represents some form of trauma to the muscle, prominent attachment site for the second palmar interosseus on the right MC2 and for the third palmar interosseous on the right MC3, sunken attachment for M. soleus on the left tibia

### SK32 (1118)

Age: young middle adult (26-35) Sex: male

Stature: 177 ± 4.32cm (radius) Cranial index: -

Preservation: good

Completeness: the majority of bones apart from the cranium, right os coxa and ulna, and lower legs and feet are present

Dentition:

Upper right	-	-	-	-	-	-	-	-	-	-	-	12	-	-	-	-	Upper left
Lower right	-	-	30	29	28	27	26	/	24	23	22	21	20	19	18	17	Lower left
			c											c			

Dental pathology: caries (2/14), calculus (13/14), slight periodontal disease, enamel hypoplasia of the molars, canines and incisors, socket for a fifth mandibular incisor between both I1s

Non-metric traits: transverse foramen bipartite

Pathology: DJD of the cervical, thoracic and lumbar vertebrae, SN of the lower thoracic and upper lumbar vertebrae, kyphosis of the lower thoracic and upper lumbar vertebrae with anterior lesions of the vertebral bodies that probably represents Scheuermann's disease, avulsion fracture of the left transverse process of T1, 11 thoracic and 6 lumbar vertebrae with L1 having superior facets of the thoracic type. Only the 11 thoracic vertebrae have rib facets, suggesting there are only 11 ribs, DJD of the left wrist, area of porous woven bone on the left ascending ramus of the mandible indicating a NSPI active at the time of death, cortical defect at the attachment site for the costoclavicular ligament on both clavicles

### SK33 (1121)

Age: mature adult (46+) Sex: male

Stature: 176 ± 2.99cm (femur + tibia)

Cranial index: - Preservation: good

Completeness: the lower arms and hands, sacrum and pelvis, legs and feet are present

Non-metric traits: vastus notch (left)

Pathology: DJD of the right elbow, both hands, right hip, both knees, areas of porous woven bone on the anterior of the distal shaft of both radii, on the shaft of the left MC2, on the shafts of both femorae, and diffuse porous woven bone on the shafts of the lower legs that may represent hypertrophic osteoarthropathy, scooped out lesions on the elements of both hands and feet that represents gout, grooves on the distal and palmar shaft of three proximal hand phalanges that may indicate the fingers were being held in flexion, exostosis of bone on the lateral and distal shaft of the left tibia that may represent some form of soft tissue trauma, cortical defect at the attachment site for M. biceps on the right radius

### SK34 (1124)

Age: middle adult or older (26+) Sex: ?female

Stature: - Cranial index: - Preservation: excellent

Completeness: only the cranium and mandible, cervical and upper thoracic vertebrae, some ribs, left clavicle and scapulae and parts of both humeri are present

Dentition:

			a												c		c	
Upper right	/	/	3	4	5	6	/	/	/	10	11	12	13	X	15	16	Upper left	
Lower right	np	31	30	29	28	X	/	/	24	23	22	21	20	19	18	np	Lower left	

Dental pathology: caries (2/21), calculus (21/21), slight to severe periodontal disease, enamel hypoplasia of the molars and premolars, buccal abscess of the maxillary right M1, groove of the interproximal CEJ of the mandibular left M1 that may represent toothpick use

Non-metric traits: lambdoid wormians (left), parietal foramen (right)

Pathology: OA of the cervical and thoracic vertebrae, avulsion fracture of the spinous process of T1, healed fractures of the superior of the bodies of T5 and T6, small healed lesion (approx. 8mm in diameter) on the right side of the frontal near to the orbit that may represent a healed depressed fracture, large subchondral hollowed out lesion of the acromial end of the left clavicle that may represent some form of cyst or bone tumour

### SK35 (1127)

Age: younger childhood (3-4 years) Preservation: excellent

Completeness: the majority of the bones are present

Dentition:

Upper right	51	52	53	54	/	/	57	58	59	60	Upper left
Lower right	70	69	68	67	66	/	64	/	62	61	Lower left

Dental pathology: calculus (16/16)

Pathology: slight cribra orbitalia of both orbits and porosity of the endocranial surface of the occipital and right parietal that represents iron deficiency anaemia, the length of the long bones would suggest an age of 1.5-2.5 years, indicating that there is delayed skeletal growth.

### SK36 (1130)

Age: young middle adult (26-35) Sex: ?male

Stature: 178 ± 3.37cm (tibia) Cranial index: -

Preservation: good

Completeness: the majority of the bones, apart from the cranium and mandible, upper vertebrae, left clavicle and scapula and part of the left humerus, are present

Non-metric traits: femoral plaque, tibial squatting facet

Pathology: DJD of the thoracic vertebrae, SN of T8 and T12, lesion of the anterior of the body of L5 that may represent anterior herniation of the intervertebral disc, the superior facets of L1 and the inferior of T12 are of the thoracic type, areas of compact bone on the lateral shaft of both tibiae and the lateral and proximal shafts of both fibulae, representing healed NSPIs.

**SK37 (1132)**

Age: old middle adult (36-45) Sex: male

Stature: 163 ± 2.99cm (femur + tibia) Cranial index: -

Preservation: good

Completeness: the left lower arm and hand, left os coxa, both legs and feet are present

Non-metric traits: tibial squatting facet

Pathology: exostosis of bone on the anterior and proximal shaft of the left ulna representing some form of soft tissue trauma, the metacarpals are very short with the MC4 and MC5 both shorter than 50mm, and the metacarpals and long bones are very robust. There is a possibility that this could represent Albright’s Hereditary Osteodystrophy, but as the skeleton is so incomplete, it is difficult to confirm, enthesophytes of the attachment site for tendo calcaneus on both calcanei, development of the medial and lateral ridges of the hand phalanges

**SK38 (1135)**

Age: middle adult or older (26+) Sex: ?male

Stature: 181 ± 4.05cm (humerus) Cranial index: -

Preservation: good

Completeness: only parts of the cranium and mandible, upper vertebrae, ribs, sternum, scapulae and clavicles, right humerus and part of the left humerus are present

Dentition:

Upper right	-	-	-	-	-	-	-	-	-	-	-	-	-	-	-	-	Upper left
Lower right	-	/	30	29	28	/	-	-	-	/	/	/	20	19	18	17	Lower left

c

Dental pathology: caries (1/7), calculus (7/7), slight periodontal disease

Non-metric traits: transverse foramen bipartite

Pathology: OA of the cervical and thoracic vertebrae, lesions on bodies of T5-T8 that may represent collapse of the bodies, possible early DISH of the thoracic vertebrae, cortical defect of the attachment site for the costoclavicular ligament on the left clavicle, for M. subclavius on the right clavicle and for M. pectoralis major on the right humerus, enthesophytes on the head of one right rib and at the

attachment site for M. deltoideus on the right clavicle, roughened attachment area for M. subscapularis on the left humerus

**SK39 (1138)**

Age: older childhood (11-12 years) Preservation: poor

Completeness: the majority of bones apart from the clavicles, scapulae, vertebrae, sternum, sacrum, left os coxa, right hand and right foot are present

Dentition:

Upper right	/	X	/	X	X	X	X	X	X	X	X	Upper left
Lower right	X	X	X	X	X	X	X	X	X	X	61	Lower left

Upper right	U	U	3	U	5	U	7	8	9	10	U	12	13	14	U	U	Upper left
Lower right	U	31	30	U	28	27	26	25	/	/	22	21	U	19	18	U	Lower left

Dental pathology: calculus (1/1 deciduous, 9/20 permanent), enamel hypoplasia of the premolars, canines and incisors

Pathology: moderate cribra orbitalia of both orbits, probable healed depressed fracture of the left side of the frontal near to the lateral side of the orbit, the length of the long bones suggests an age of 4-6 years indicating delayed skeletal growth.

**SK40 (1142)**

Age: adolescent (14-16 years) Sex: ?male

Stature: - Cranial index: - Preservation: moderate

Completeness: the left arm, ribs, lower vertebrae, right hand, pelvis and sacrum, left leg, part of the right leg, and both feet are present

Non-metric traits: tibial squatting facet

Pathology: OA of T10, possible osteochondritis dissecans of the proximal joint surface of the proximal phalanx for MT1, cortical defect at the attachment site for M. pectoralis major on the left humerus

**SK41 (1145)**

Age: mature adult (46+) Sex: ?male

Stature: 167 ± 4.32cm (radius)

Cranial index: - Preservation: excellent

Completeness: only the lower vertebrae, some ribs, sacrum, pelvis, both lower arms and hands and part of the left leg are present (there is a right humerus present that is possibly not from this individual)

Non-metric traits: distal septal aperture (right possibly extraneous humerus)

Pathology: OA of the thoracic and lumbar vertebrae, SN of the lower thoracic vertebrae, OA of the left hand, fracture of the posterior and proximal end of the right MC2 and of the proximal joint surface of the right MC3, cortical defect of the attachment site for M. biceps on the right radius, enthesophytes at the attachment site for the external oblique on the left ilium

**SK42 (1148)**

Age: young middle adult (26-35) Sex: ?male

Stature: 169 ± 3.27cm (femur)

Cranial index: - Preservation: excellent

Completeness: only the right scapula, some ribs and thoracic vertebrae, lower right arm, both hands, sacrum, pelvis, both femorae and part of the lower right leg are present

Non-metric traits: none observed

Pathology: OA of the thoracic vertebrae, SN of T12

**SK43 (1151)**

Age: old middle adult (36-45) Sex: ?female

Stature: 161 ± 3.55cm (femur + tibia)

Cranial index: - Preservation: good

Completeness: the majority of bones apart from the sternum, part of the right lower leg and both feet are present

Dentition:

			a	c										c,a			
Upper right	1	2	X	4	5	6	7	8	9	10	11	12	13	X	15	16	Upper left
Lower right	32	31	30	29	28	27	26	25	24	23	22	21	20	19	18	17	Lower left
								c							c		

Dental pathology: caries (4/30), calculus (29/30), slight to moderate periodontal disease, enamel hypoplasia of the molars, canines and incisors, buccal abscesses of the maxillary right M1 and maxillary left M2

Non-metric traits: parietal foramen, tibial squatting facet (left), transverse foramen bipartite

Pathology: SN of T7 and the lumbar vertebrae, DJD of the right elbow and both knees

**SK44 (1154)**



Age: mature adult (46+) Sex: ?male

Stature: - Cranial index: - Preservation: good

Completeness: only both hands, right os coxa and both legs are present

Non-metric traits: femoral plaque (right)

Pathology: DJD of the right hand, right hip and both knees, enthesophytes at the attachment site for M. psoas major and M. iliacus on the right femur

**SK45 (1157)**

Age: adolescent/young adult (17-20) Sex: indeterminate

Stature: 172 ± 3.27cm (femur) Cranial index: -

Preservation: good

Completeness: the majority of the bones, apart from the left lower leg and both feet, are present

Dentition:

Upper right	np	2	3	4	5	6	7	8	9	10	11	12	13	14	15	16	Upper left
Lower right	U	31	30	29	28	27	26	25	24	23	22	21	20	19	18	U	Lower left

Dental pathology: calculus (29/29)

Non-metric traits: ossicle at lambda, lambdoid wormians, parietal foramen (left), distal septal aperture (left), transverse foramen bipartite (left)

Pathology: SN of the lower thoracic and upper lumbar vertebrae, the superior arches of T4 are not fused together or to the inferior arch which is fused to the arch of T5. T5 has an incompletely developed right arch with no facets and T6 has no right superior facet with a knob of bone in its place. These are developmental defects. Incompletely fused neural arch of S1, the inferior facets of T11 and the superior of T12 are of the lumbar type, areas of new bone on the visceral surface of three unisided rib fragments near to the sternal end that represents a chest infection active at the time of death, areas of porous woven bone on the distal and medial shaft of the left femur, and on the anterior and lateral side of both ilia representing NSPIs active at the time of death, destruction of the joint between the proximal and medial hand phalanges for the left MC4 with the medial phalanx held in flexion and deviated laterally that probably represents an infection subsequent to a fracture, possible healed osteochondritis dissecans of the glenoid fossa of the right scapula, the manubrium is divided superior-inferiorly into two segments, the sternum is angulated antero-posteriorly with the midpoint placed further anteriorly

**SK46 (1160)**

Age: old middle adult (36-45) Sex: male

Stature: 179 ± 2.99cm (femur + tibia) Cranial index: -

Preservation: good

Completeness: the majority of bones, apart from the mandible, upper vertebrae, clavicles and right scapula, are present

Dentition:

Upper right	1	2	3	4	/	/	/	/	/	/	11	12	13	14	15	16	Upper left
Lower right	-	-	-	-	-	-	-	-	-	-	-	-	-	-	-	-	Lower left

Dental pathology: calculus (10/10), enamel hypoplasia of the premolars

Non-metric traits: mastoid foramen exsutural, tibial squatting facet, vastus notch (left) Pathology: SN of the thoracic and upper lumbar vertebrae, six lumbar vertebrae with left sided sacralisation of L6, avulsion fracture of the styloid process of the left ulna, probable avulsion fracture of a fragment of the distal and lateral shaft of the right tibia that has fused to the shaft of the right fibula, spiculated bone in the left maxillary antrum, indicating sinusitis, cortical defect at the attachment site for M. latissimus dorsi on both humeri

**SK47 (1163)**

Age: adult Sex: - Stature: -

Cranial index: - Preservation: good

Completeness: only parts of both legs and feet are present

Non-metric traits: none observable

Pathology: none observed

**SK48 (1166)**

Age: old middle adult (36-45) Sex: male

Stature: 172 ± 2.99cm (femur + tibia)

Cranial index: - Preservation: excellent

Completeness: the majority of the bones are present

Dentition:

					c														
Upper right	np	/	3	4	5	6	7	8	9	10	11	12	13	14	15	/	Upper left		
Lower right	32	31	30	29	28	27	26	25	/	23	22	21	20	19	18	17	Lower left		
	c		c															c	

Dental pathology: caries (5/28), calculus (28/28), slight to severe periodontal disease, EH of the canines, antemortem tooth chipping of the left maxillary canine and I2 and right maxillary

canine, slight buccal-lingual grooves across the occlusal surfaces of the maxillary I1s that may represent use of the teeth as tools

Non-metric traits: palatine torus, transverse foramen bipartite

Pathology: OA of the cervical, thoracic and lumbar vertebrae, SN of the lower thoracic vertebrae, L1 has no right transverse process with a possible small rib facet instead, indicating the possibility of a lumbar rib, 6 lumbar vertebrae with bilateral sacralisation of L6, OA of both shoulders with probable dislocation of both humeri, both hands, the left ankle and both feet, DJD of both TMJs, hips and right knee, osteochondritis dissecans of the medial condyle of the left femur, areas of porous woven bone on the shaft of the left fibula that represents an NSPI active at the time of death, two localised areas of shaft expansion on the left tibia and three on the right that represent leg ulcers, scooped out lesions of the metacarpals, tarsals and metatarsals that may represent gout, healed furrowed appearance to parietals and occipital that possibly represents evidence for healed anaemia, well remodelled fractures of the midshaft of one left and one right rib and of the sternal end of the shaft of one left rib, two healing fractures with a callus present of the sternal end of one left rib, cortical defect of the attachment site for the costoclavicular ligament on both clavicles, for M. deltoideus on the left clavicle, and for M. teres major on both humeri, enthesophytes at the attachment site for the lateral costotransverse ligament on one left and one right rib, for the common extensors on both humeri, for M. biceps on the right radius, for M. rectus femoris on both os coxae, for M. semitendinosus and M. biceps on the right ischium, for tendo calcaneus on both calcanei, and for the lateral talocalcanean ligament on the left talus, roughened appearance of the attachment site for M. subscapularis on the left humerus

#### **SK49 (1170)**

Age: adult Sex: - Stature: -

Cranial index: - Preservation: moderate

Completeness: only parts of both legs are present

Non-metric traits: none observable

Pathology: the left tibia has a large cloaca (20mm by 15.5mm) on the proximal and medial shaft with expansion of the shaft. The medullary cavity is filled with trabecular bone down to the midshaft but the proximal shaft is hollowed out and there is porous woven bone around the cloaca. The proximal shaft is bent to the left and antero-posteriorly. This represents osteomyelitis of the tibia that may be related to a fracture of the proximal shaft.

#### **SK50 (1172)**

Age: old middle adult (36-45) Sex: male

Stature: 169 ± 2.99cm (femur + tibia) Cranial index: -

Preservation: good

Completeness: the majority of bones, apart from the mandible, upper vertebrae, part of the cranium, part of the right humerus, ulna and radius and part of both feet, are present

Non-metric traits: mastoid foramen exsutural, femoral plaque (left), tibial squatting facet Pathology: OA of the thoracic and lumbar vertebrae, SN of the thoracic and lumbar vertebrae, kyphosis of the thoracic vertebrae with a lesion on the anterior and superior of the body of T6 that possibly represents Scheuermann's disease, six lumbar vertebrae with bilateral sacralisation of L6, bilateral spondylolysis of L5 with instability and associated OA, healed fractures of the left transverse processes of T7 and T8, OA of both shoulders, DJD of the left TMJ, left elbow, both hands, both hips, both knees and both feet, bilateral os acromiale, remodelled compact bone on the visceral surface of the neck of one left rib that represents a healed chest infection, the ilia and sacrum are fused at the anterior of both auricular surfaces with the joint space retained that probably represents early DISH, healed fracture of the left clavicle with a posterior overlap of 23mm and misalignment, avulsion fracture of the anterior of the right calcaneus, probable healed osteochondritis dissecans of the medial condyle of the right femur, cortical defect at the attachment site for M. pectoralis major on the left humerus, enthesophytes at the attachment site for the costotransverse ligament on three left and five right ribs, for M. soleus on the left fibula and for tendo calcaneus on both calcanei, development of the attachment site for the first dorsal interosseous on the left MC2

### **SK51 (1175)**

Age: adult Sex: - Stature: -

Cranial index: -

Preservation: good

Completeness: only part of the right lower leg and both feet are present

Non-metric traits: tibial squatting facet (right)

Pathology: DJD of both feet, fusion of a medial and distal foot phalanx, enthesophytes at the attachment site for tendo calcaneus on both calcanei, for M. extensor digitorum brevis on the right calcaneus and on the superior and posterior surface of both 3<sup>rd</sup> cuneiforms

### **SK52 (1178)**

Age: old middle adult (36-45) Sex: female

Stature: 158 ± 3.55cm (femur + tibia)

Cranial index: - Preservation: moderate

Completeness: the majority of the bones are present

Dentition:

Upper right	1	2	3	/	/	6	7	8	9	10	11	12	13	14	<sup>c</sup> 15	<sup>c</sup> 16	Upper left
Lower right	32	31	30	29	28	27	26	25	24	23	22	21	20	19	18	17	Lower left

Dental pathology: caries (4/30), calculus (30/30), slight periodontal disease of the maxilla

Non-metric traits: lambdoid wormians, mastoid foramen exsutural, distal septal aperture (left)  
 Pathology: DJD of the cervical and thoracic vertebrae, SN of the lower thoracic and upper lumbar vertebrae, slight scoliosis of the mid to upper thoracic vertebrae, possible avulsion fracture of the spinous process of C7, spina bifida of the sacrum, DJD of both hips and right knee, nodules of compact bone on the visceral surfaces of the shafts of two right ribs that represents a healed chest infection, small nodule of bone (5mm by 2mm) on the lateral midshaft of the right tibia that possibly represents some form of soft tissue trauma, spiculated bone in the left maxillary antrum that represents sinusitis, os acromiale of the left scapula, cortical defect of the attachment site for the costoclavicular ligament on both clavicles, porosity of the attachment site for M. subscapularis on both humeri

### SK53 (1185)

Age: younger childhood (4-5 years) Preservation: excellent

Completeness: the majority of the bones, apart from the sternum and left ribs, clavicle, scapula, arm, hand, ilium and femur, are present

Dentition:

Upper right	51	52	/	/	55	56	/	58	<sup>c</sup> 59	60	Upper left
Lower right	70	69	68	67	66	65	64	63	62	61	Lower left

Dental pathology: caries (1/17), calculus (15/16), enamel hypoplasia of the unerupted permanent premolars, canines and incisors

Pathology: the length of the long bones suggests an age of 2-3.5 years indicating slight delayed skeletal growth.

### SK54 (1188)

Age: young adult (19-25) Sex: ?male

Stature: 165 ± 2.99cm (femur + tibia)

Cranial index: - Preservation: excellent

Completeness: the majority of the bones, apart from the cranium, mandible, upper vertebrae, sternum, right clavicle and arm, and part of the left lower leg, are present

Non-metric traits: none observed

Pathology: SN of the thoracic and lumbar vertebrae, remodelled fracture of the shaft of a distal hand phalanx with angulation, area of porous woven bone on the medial midshaft of the left ulna that represents an NSPI active at the time of death, cortical defect at the attachment sites for M. pectoralis major and M. teres major on the left humerus and for M. soleus on the right tibia.

**SK55 (1195)**

Age: younger childhood (4-5 years) Preservation: excellent

Completeness: only part of the cranium, ribs, vertebrae, left scapula, right arm and hand, sacrum, pelvis and part of both femorae, are present

Pathology: slight porosity of the ectocranial surface of the parietals and porous woven bone of the posterior of the right temporal that probably represents anaemia, malformation of a lumbar body with the inferior projecting more than the superior that is probably congenital in nature, the long bone length suggests an age of 9 months to 1.5 years indicating delayed skeletal growth

**SK56 (1198)**

Age: mature adult (46+) Sex: ?female

Stature: 160 ± 4.32cm (ulna) Cranial index: -

Preservation: good

Completeness: the majority of the bones, apart from most of the cranium, are present

Dentition:

		c		c											c		
Upper right	/	2	-	4	5	-	-	8	9	10	11	12	13	X	15	16	Upper left

**SK57 (1201)**

Age: old middle adult (36-45) Sex: male

Stature: 171 ± 3.27cm (femur)

Cranial index: - Preservation: good

Completeness: the majority of the bones are present

Dentition:

Upper right	X	-	-	-	-	-	-	-	-	-	-	-	-	-	X	X	Upper left
Lower right	X	X	X	-	-	-	-	-	-	/	/	21	20	X	X	X	Lower left

Dental pathology: slight periodontal disease

Non-metric traits: lambdoid wormians, transverse foramen bipartite

Pathology: OA of the thoracic vertebrae, SN of the lower thoracic vertebrae, DISH of the lower thoracic vertebrae, fusion through the bodies and arches of L1-L3 that may represent ankylosing spondylitis, diffuse compact bone on the shafts of both tibiae and fibulae representing a healed NSPI, sharp edged lesion on the interior of the neural arch of the sacrum that probably represents some form of neoplastic disease, two button osteoma on the left parietal, one on the right parietal and two on the right side of the frontal, localised shaft expansion with compact bone on the shaft of the right femur that represents a healed leg ulcer, enthesophytes at the attachment site for the costotransverse ligament on two right ribs, for M. rectus femoris on both patellae, and for tendo calcaneus on both calcanei, exostosis of bone at the attachment site for the lateral head of M. gastrocnemius on the right femur, roughened appearance of the attachment site for M. biceps on the left radius, development of the medial and lateral ridges on the hand phalanges

### **SK58 (1204)**

Age: old middle adult (36-45) Sex: female

Stature: 166 ± 3.55cm (femur + tibia)

Cranial index: - Preservation: excellent

Completeness: the majority of the bones, apart from the cranium, mandible, upper vertebrae, sternum, left ribs, scapula, clavicle, arm, part of the femur, and both hands, are present

Non-metric traits: tibial squatting facet, distal septal aperture (right)

Pathology: DJD of the thoracic and lumbar vertebrae, SN of the lower thoracic and upper lumbar vertebrae, DJD of the right shoulder, right elbow, right hip and right knee, small area of porous woven bone on the distal shaft of the right tibia representing an NSPI active at the time of death, osteochondritis dissecans of the head of the right radius, healing fracture with callus of the blade of the right scapula, enthesophytes at the attachment site for the costotransverse ligament on two right ribs, for M. brachialis on the right ulna, for M. biceps on the right radius and for tendo calcaneus on both calcanei

### **SK59 (1207)**

Age: adult

Sex: indeterminable

Stature: 173 ± 3.37cm (tibia) Cranial index: -

Preservation: good

Completeness: only the lower right arm, both hands, left ilium and lower right leg are present

Non-metric traits: none observable

Pathology: scooped out lesions on the right capitate that possibly represents gout, porosity of the attachment site for M. biceps on the right radius

**SK60 (1216)**

Age: younger childhood (4-5 years) Preservation: excellent

Completeness: the majority of the bones are present

Dentition:

									c	c	
Upper right	51	52	53	54	55	56	57	58	59	60	Upper left
Lower right	70	69	68	67	/	65	64	63	62	61	Lower left

Dental pathology: caries (2/19), calculus (13/19), slight periodontal disease

Pathology: slight cribra orbitalia of the right orbit, the humeri are bent antero-posteriorly and the femorae are bent medio-laterally and slightly antero-posteriorly, which possibly represents rickets.

**SK61 (1219)**

Age: old middle adult (36-45) Sex: female

Stature: 163 ± 3.72cm (femur) Cranial index: 78.3

Preservation: good

Completeness: the majority of the bones, apart from the lower thoracic and lumbar vertebrae, part of the right humerus, right lower arm, part of the right femur, right lower leg, part of the left lower leg and feet, are present

Dentition:

		a	a	c	c						c	c	c,a				
Upper right	np	X	/	4	5	6	7	/	/	10	11	12	13	X	15	16	Upper left
Lower right	np	31	X	X	28	27	26	/	/	23	22	21	20	19	18	np	Lower left

Dental pathology: caries (5/18), calculus (16/18), slight to severe periodontal disease, enamel hypoplasia of the molars, premolars, canines and incisors, buccal abscesses of the maxillary right M2 and M1, left PM3 and mandibular left M1

Non-metric traits: parietal foramen, mastoid foramen exsutural, femoral plaque, transverse foramen bipartite

Pathology: OA of the thoracic and lumbar vertebrae, SN of the lower thoracic vertebrae, six lumbar vertebrae with sacralisation of L6, OA of the left hand, DJD of the left TMJ, both shoulders and the left knee, healed fracture of the shaft near to the neck of one left rib, healed fracture of the styloid process of the left ulna with associated DJD and healed fracture of the distal shaft of the left radius



with the distal shaft pushed posteriorly, healing fractures with bony calluses of the blade and the acromion of the right scapula, destruction of the joint of a right proximal and medial hand phalanx that is probably related to a fracture, spiculated bone in both maxillary antra and porous woven bone in the sphenoidal sinus that represents sinusitis, roughening of the attachment sites for M. semimembranosus, M. semitendinosus and M. biceps on both ischia

### SK62 (1222)

Age: old middle adult (36-45) Sex: ?female

Stature: -

Cranial index: 76.2

Preservation: good

Completeness: the majority of bones, apart from the lower legs and feet and part of both femorae, are present

Dentition:

Upper right	np	2	3	4	5	6	7	8	/	/	11	12	13	14	15	16	Upper left
Lower right	np	31	30	29	28	27	26	25	/	23	22	21	20	19	18	np	Lower left

Dental pathology: calculus (25/25), slight to moderate periodontal disease, enamel hypoplasia of the molars, canines and incisors

Non-metric traits: lambdoid wormians (right), parietal foramen

Pathology: DJD of the cervical, thoracic and lumbar vertebrae, SN of T12, fractures of the inferior of the bodies of T10 to T12, fusion through the bodies and arches of L1 and L2 that may represent ankylosing spondylitis, the inferior facets of T11 and the superior of T12 are of the lumbar type, DJD of the left shoulder, right elbow and right hand, small area of porous woven bone on the posterior of the acromion of the right scapula representing an NSPI active at the time of death, remodelled midshaft fracture of the right ulna with some overlapping of ends and medial misalignment of the distal shaft, remodelled distal shaft fracture of the left ulna with posterior and medial displacement of the distal shaft and associated DJD, and of the distal

shaft of the left radius with the distal shaft displaced posteriorly, the long bones show some thinning of the cortical bone which represents osteoporosis, enthesophytes at the attachment site for M. extensor carpi radialis longus on the left MC2, around the posterior of the glenoid fossae of both scapulae, and at the attachment site for M. triceps on the right ulna

### SK63 (1227)

Age: young middle adult (26-35) Sex: male

Stature: 167 ± 2.99cm (femur + tibia)

Cranial index: - Preservation: good

Completeness: the majority of the bones are present

Dentition:

Upper right	-	X	X	X	/	6	7	/	9	10	/	/	X	X	X	X	Upper left
Lower right	32	31	30	29	28	27	26	25	24	/	22	21	20	X	18	17	Lower left
			c	c											c,a	c	

Dental pathology: caries (4/18), calculus (14/18), slight to moderate periodontal disease of the mandible, buccal abscess of the left mandibular M2

Non-metric traits: femoral plaque, tibial squatting facet, double superior atlas facets (right), posterior atlas bridge (left)

Pathology: OA of the cervical vertebrae and DJD of the thoracic and lumbar vertebrae, SN of

the lower thoracic and lumbar vertebrae, six lumbar vertebrae with sacralisation of L6, compression fracture of the body of L1 with subsequent kyphosis of the thoracic vertebrae, large lesion on the posterior and inferior of the body of T12 that may represent posterior herniation of the intervertebral disc, DJD of the left TMJ, both shoulders, both hands and both hips, spiculated bone in the left maxillary antrum that represents sinusitis, remodelled fractures of the sternal end of two unisided rib fragments, remodelled fracture of the head of the right MC1, scooped out lesion of one hand phalanx that possibly represents gout, the left MC2 has a cut into the posterior midshaft that has removed a portion of bone and fractured the proximal end of the cut, indicating that the cut came from distally, the surface of the cut is slightly sclerotic and there is porous woven bone around it, indicating that it occurred slightly before death, destruction of the joint between one proximal and medial hand phalanx that probably represents a fracture, the femorae are bent medio-laterally and flattened with the proximal shafts bent posteriorly representing healed rickets, possible osteochondritis dissecans of the tibia facet of the right talus and of the calcaneus facet of the left talus, spurs of bone on the anterior and lateral of the right cuboid, small nodules of bone on the anterior and distal shaft of the left tibia and the anterior midshaft of the right tibia that possibly represent some form of soft tissue trauma, sharp edged lesion in the right acetabulum that possibly represents some form of cyst, cortical defect at the attachment site for M. pectoralis major on the right humerus, enthesophytes at the attachment site for the costotransverse ligament on two right ribs, for M. biceps on the left radius, around the margin of the glenoid fossa of the left scapula, for M. psoas major and M. iliacus on both femorae and for tendo calcaneus on both calcanei

**SK64 (1230)**

Age: young adult (19-25) Sex: indeterminate

Stature: 167 ± 4.05cm (humerus) Cranial index: 72.4

Preservation: good

Completeness: only the cranium and mandible, cervical and thoracic vertebrae, ribs, scapulae, clavicles, sternum and both humeri are present

Dentition:

Upper right	1	2	3	4	5	6	7	/	9	10	11	12	/	14	15	np	Upper left
Lower right	np	31	30	29	28	27	26	25	24	23	22	21	20	19	18	np	Lower left

Dental pathology: calculus (25/27), enamel hypoplasia of the molars, canines and incisors, peg maxillary right M3

Non-metric traits: transverse foramen bipartite (right)

Pathology: incompletely fused neural arch of T11, cortical defect at the attachment site for M. pectoralis major and M. teres major on the left humerus, and for the costoclavicular ligament on both clavicles

### SK65 (1233)

Age: old middle adult (36-45) Sex: male

Stature: 181 ± 3.27cm (femur)

Cranial index: - Preservation: good

Completeness: the majority of bone, apart from part of the left lower leg and foot are present

Dentition:

Upper right	np	2	3	4	5	6	7	8	9	10	11	12	13	14	15	np	Upper left
Lower right	32	31	30	29	28	27	26	25	24	23	22	21	20	19	18	17	Lower left

Dental pathology: calculus (28/30), ante-mortem tooth chipping of the right maxillary PM4 and M1, supernumerary tooth originating in the area of the roots of M2 in the right maxillary antrum Non-metric traits: parietal notch bones, femoral plaque, transverse foramen bipartite

Pathology: DJD of the thoracic and lumbar vertebrae, SN of the lower thoracic and lumbar vertebrae, 11 thoracic vertebrae and 6 lumbar vertebrae with L6 articulating with the left side of the sacrum, the right rib 2 has a cut into the anterior of the shaft that has come from anteriorly, two left rib shaft fragments have cuts into the shaft, one that has come from superior and the left and one that has come from inferior and anteriorly, L3 has a nick into the right transverse process that has come from superiorly, C2 has two cuts into the right side of the arch just posterior of the superior facet that have come from the right posterior and slightly superiorly,

inbetween the two cuts, the blade glanced across the bone producing many small nicks into the surface, there is another cut into the superior of the spinous process that has come from superiorly and one on the superior of the left arch that corresponds to the cuts on the right side of the arch, there is also a cut into the medial side of the superior border of the left ilium that has come from

superiorly and posteriorly. All of the cuts have a polished appearance to the surface that indicates they are peri-mortem in nature, peri-mortem fractures of the midshaft of the right clavicle, and of the midshaft of the right MC5, probable osteochondritis dissecans of the distal joint surface of the right fibula, exostosis of bone on the medial and distal shaft of the right humerus that represents some form of soft tissue trauma, cortical defects at the attachment site for the costoclavicular ligament on both clavicles, enthesophytes at the attachment site for the costotransverse ligament on two right ribs, new bone at the attachment site for M. semimembranosus, M. semitendinosus and M. biceps on the left ischium

**SK66 (1238)**

Age: middle adult or older (26+) Sex: male

Stature: 164 ± 4.05cm (humerus) Cranial index: 73.6

Preservation: good

Completeness: only the cranium and mandible, cervical and thoracic vertebrae, sternum, ribs, scapulae, clavicles, left humerus and part of the lower arm, part of the right humerus, parts of both lower legs and both feet, are present

Dentition:

	C	C	C									C	C				
Upper right	1	2	/	X	5	6	7	8	9	10	/	12	13	14	X	16	Upper left
Lower right	32	31	30	29	28	27	26	25	24	23	22	21	20	19	18	17	Lower left
			C	C								C	C				

Dental pathology: caries (9/28), calculus (26/28), slight to moderate periodontal disease, antemortem tooth chipping of the right mandibular M2

Non-metric traits: infra-orbital foramen (right), mastoid foramen exsutural, posterior atlas bridge, transverse foramen bipartite (left)

Pathology: DJD of the cervical and thoracic vertebrae, SN of the lower thoracic vertebrae, collapse of the inferior of the body of C3, healed fracture of the spinous process of T3, DJD of the right foot, porous woven bone on the necks of four right ribs and on one unisided shaft fragment representing a chest infection active at the time of death, well remodelled fracture of the shaft of one right rib, fracture of the posterior of the calcaneus facet on the left talus, large depressed area (19mm by 11mm) of the left lateral side of the supraorbital ridge that probably represents a healed depressed fracture, scooped out lesion on the posterior of the left calcaneus that may represent gout, os acromiale of the right scapula, cortical defect at the attachment site for M. teres major on the left humerus and for the costoclavicular ligament on both clavicles, enthesophytes at the attachment site for tendo calcaneus on both calcanei and for the anterior talofibular ligament on both fibulae

**SK67 (1241)**

Age: young middle adult (26-35) Sex: ?female

Stature: 153 ± 3.66cm (tibia) Cranial index: 81.5

Preservation: excellent

Completeness: only the cranium and mandible, cervical and thoracic vertebrae, ribs, sternum, scapulae, clavicles, right humerus, part of the right ulna, part of the left femur, both lower legs and feet, are present

Dentition:

Upper right	1	2	3	4	5	6	7	8	9	10	11	12	13	14	15	16	Upper left
Lower right	32	31	30	29	28	27	26	25	24	23	22	21	20	19	18	17	Lower left

Dental pathology: calculus (32/32), slight periodontal disease, enamel hypoplasia of the molars, canines and incisors

Non-metric traits: parietal foramen, parietal notch bones (right), tibial squatting facet, transverse foramen bipartite (right)

Pathology: DJD of the thoracic vertebrae, SN of the lower thoracic vertebrae, porous woven bone on the necks of one left and one right rib representing a chest infection active at the time of death, compact bone on the posterior of the sternum, representing a healed chest infection, areas of porous woven bone on the distal shaft of the right tibia, the medial side of both calcanei, the shafts of the right MT1, MT2 and MT3, and the shafts of the left MT2, MT3 and MT5, representing NSPIs active at the time of death, fusion of a medial and distal foot phalanx, spiculated bone in the left maxillary antrum, representing sinusitis, slight cribra orbitalia of both orbits, probable healed depressed fracture of the left side of the frontal superior of the orbit, cortical defect at the attachment site for M. teres major on the right humerus

**SK68 (1244)**

Age: young middle adult (26-35) Sex: male

Stature: 173 ± 2.99cm (femur + tibia)

Cranial index: 73.0

Preservation: good

Completeness: the majority of the bones, apart from the right fibula, are present

Dentition:

	a	c,a	a											c,a	a		
Upper right	/	2	3	4	5	6	7	8	9	10	11	12	13	X	15	/	Upper left
Lower right	32	31	30	29	28	27	26	/	24	23	22	21	20	19	18	17	Lower left
			c											c	c	c	

Dental pathology: caries (6/28), calculus (28/28), slight to severe periodontal disease, enamel hypoplasia of the premolars, canines and incisors, buccal abscesses of the maxillary right M3 and left M2 and M3, and buccal and lingual abscesses of the maxillary right M1 and M2

Non-metric traits: ossicle at lambda, lambdoid wormians, parietal notch bones (left), mastoid foramen exsutural, tibial squatting facet

Pathology: OA of the cervical, thoracic and lumbar vertebrae, SN of the lower thoracic vertebrae, OA of the right shoulder, right wrist and right foot, DJD of the left shoulder, left elbow, left wrist, both hands and both hips, porous woven bone around the midshaft of the right femur and the midshaft of the left fibula that represent NSPIs active at the time of death, porous woven bone and compact bone around the margin of the left acetabulum that represents an NSPI, porous woven bone on the shafts of the left MT1 and MT2 and of the proximal phalanx for MT1 with destruction of the joint between MT1 and the phalanx and severe osteoporosis that represents some form of infectious process, healed fractures of the left side of the manubrium and the proximal joint surface of two proximal foot phalanges, small exostosis of bone on the posterior shaft of one medial hand phalanx that possibly represents some form of soft tissue trauma, cortical defect at the attachment site for M. pectoralis major on both humeri, for the costoclavicular ligament and M. deltoideus on both clavicles, enthesophytes at the attachment site for M. triceps on both ulnae, for M. biceps on the right radius, for tendo calcaneus on both calcanei

**SK69 (1253)**

Age: old middle adult (36-45) Sex: female

Stature: 160 ± 3.55cm (femur + tibia) Cranial index: -

Preservation: good

Completeness: the majority of the bones, apart from the cervical and upper thoracic vertebrae, are present

Dentition:

	c												c							
Upper right	1	2	3	4	5	6	/	8	9	10	11	12	13	14	15	16	Upper left			
Lower right	32	31	30	X	28	27	26	/	24	23	22	21	np	19	18	17	Lower left			
	c		c																	

Dental pathology: caries (4/28), calculus (28/28), slight to severe periodontal disease, severe calculus of the left dentition with calculus over the occlusal surface that indicates disuse, probably as a result of pain from the caries cavity of the maxillary left M2 and the severe periodontal disease, congenitally absent or unerupted left mandibular PM4

Non-metric traits: mandibular torus (left), femoral plaque, tibial squatting facet

Pathology: DJD of the lower thoracic and lumbar vertebrae, SN of the lower thoracic and upper lumbar vertebrae, cortical defect at the attachment site for the costoclavicular ligament on the right clavicle, enthesophytes at the attachment site for M. rectus femoris on both patellae

### SK70 (1256)

Age: old middle adult (36-45) Sex: male

Stature: 172 ± 2.99cm (femur + tibia)

Cranial index: 69.0

Preservation: good

Completeness: the majority of bones, apart from the left arm and right femur, are present

Dentition:

Upper right	1	2	3	4	5	6	/	8	9	/	11	12	13	14	15	16	Upper left
Lower right	32	31	30	29	/	27	26	/	/	23	22	21	20	19	18	17	Lower left

Dental pathology: calculus (16/27), slight periodontal disease, enamel hypoplasia of the premolars, canines and incisors

Non-metric traits: mastoid foramen exsutural, femoral plaque (left), tibial squatting facet (left)

Pathology: SN of T10, osteomyelitis of the medial shaft of the right MT5, compact bone on the anterior of the right pubis that represents a healed NSPI, possible gout of the left hand, medio-lateral bending of the femur and tibiae that represents healed rickets

### SK71 (1259)

Age: younger childhood (4-6 years) Preservation: excellent

Completeness: the lower vertebrae and ribs, sacrum, pelvis, lower left arm, hands, both legs and part of the right foot are present

Pathology: none observed

### SK72 (1264)

Age: young middle adult (26-35) Sex: male

Stature: 171 ± 2.99cm (femur + tibia) Cranial index: 81.5

Preservation: excellent

Completeness: the majority of the bones are present

Dentition:

	a	c,a												c	c	c	
Upper right	/	2	3	4	5	6	7	8	9	10	11	12	13	14	15	16	Upper left
Lower right	32	31	30	29	28	27	26	25	24	23	22	21	20	19	18	17	Lower left

Dental pathology: caries (4/31), calculus (31/31), slight periodontal disease, enamel hypoplasia of the canines, buccal abscesses of the maxillary right M2 and M3

Non-metric traits: lambdoid wormians (right), parietal foramen (right), mastoid foramen exsutural, tibial squatting facet

Pathology: DJD of the thoracic vertebrae, SN of the lower thoracic and lumbar vertebrae, lesions of the bodies of T11 and T12 that may represent herniation of the intervertebral discs, incompletely fused neural arch of S1, sharp exostosis of bone on the medial and distal shaft of the right humerus that represents some form of soft tissue trauma, bilateral os acromiale, avulsion fracture of the anterior of the left calcaneus, shaft expansion of the proximal shaft of the left tibia with a sharp exostosis of bone at the superior of the soleal line that probably represents some form of soft tissue trauma, smooth edged lesion on the right ilium that may represent some form of cyst, cortical defect at the attachment site for M. pectoralis major on the left humerus and for the costoclavicular ligament on both clavicles, enthesophytes at the attachment sites for the costotransverse ligaments on one left and one right rib, for tendo calcaneus on both calcanei and on the superior of the right 3<sup>rd</sup> cuneiform, the distal shaft of the left femur is expanded in the area of attachment of the medial head of M. gastrocnemius

### SK73 (1278)

Age: mature adult (46+) Sex: female

Stature: 155 ± 3.55cm (femur + tibia)

Cranial index: - Preservation: moderate

Completeness: the majority of the bones, apart from the cranium and mandible, cervical and thoracic vertebrae, most of the ribs, sternum, scapulae, clavicles, part of the left humerus and most of the right arm, are present

Non-metric traits: tibial squatting facet

Pathology: DJD of the lumbar vertebrae, SN of the lumbar vertebrae, incompletely fused neural arch of S1, possible avulsion fracture of the anterior of the right calcaneus, avulsion fractures of the anterior of the left calcaneus and of the tubercle of the left navicular, the left hamate is reduced in size, probably congenitally, development of the attachment site for M. opponens digiti minimi on both MC5s, development of the medial and lateral ridges on the hand phalanges

### SK74 (1283)

Age: young middle adult (26-35) Sex: male

Dixon Lane and George Street  
York Archaeological Trust Web Publication Report

Report No AYW9



Stature: 179 ± 3.27cm (femur)

Cranial index: - Preservation: good

Completeness: the majority of the bones are present

Dentition:

	a																							
Upper right	-	-	-	-	/	6	7	8	9	10	11	12	13	X	-	-	Upper left							
Lower right	32	31	30	29	28	27	26	25	24	23	22	21	20	19	18	17	Lower left							
	c		c														c		c		c		c	

Dental pathology: caries (6/24), calculus (21/24), slight to moderate periodontal disease, enamel hypoplasia of the canines, buccal abscess of the maxillary right PM3

Non-metric traits: tibial squatting facet (right), double superior atlas facets (right), transverse foramen bipartite

Pathology: OA of the lower lumbar vertebrae, SN of the lower thoracic and lumbar vertebrae, possible osteochondritis dissecans of the left superior facet of C6, incompletely fused neural arch of S1, slight kyphosis of the lower thoracic vertebrae, compact bone on the shaft of the left tibia and around the midshaft of the left fibula representing healed NSPIs, porous woven bone on the right ischium and posterior of the right acetabulum and diffuse compact and porous woven bone on the anterior of the sacrum, representing an infection of the lower abdomen, healed fracture of the neck of one left rib, healing fracture with bony callus of the sternal end of the left rib 2, cribra orbitalia of both orbits, incompletely fused sternal body, cortical defect at the attachment site for the common flexors on the right humerus and for the costoclavicular ligament on both clavicles, enthesophyte at the attachment site for M. triceps on the left ulna

**SK75 (1287)**

Age: mature adult (46+) Sex: ?female

Stature: 157 ± 3.55cm (femur + tibia) Cranial index: -

Preservation: moderate

Completeness: the majority of the bones, apart from the sternum, right foot and most of the left foot, are present

Dentition:

	c		a														a		a		a	
Upper right	1	2	/	4	5	6	7	8	9	10	11	/	13	14	/	/	Upper left					
Lower right	32	31	30	29	28	27	/	25	-	/	/	/	20	19	18	17	Lower left					
																	a		a			

Dental pathology: caries (3/23), calculus (13/21), slight to moderate periodontal disease, buccal abscess of the maxillary right M1, buccal and lingual abscesses of the maxillary left M1 and abscesses

penetrating into the maxillary antrum of the left M2 and M3 with associated sinusitis Non-metric traits: parietal notch bones (left), tibial squatting facet (left), transverse foramen bipartite (right)

Pathology: OA of the lower lumbar vertebrae and DJD of the cervical and thoracic vertebrae, SN of the lower thoracic vertebrae, lesion on the posterior and superior of the body of T12 that represents posterior herniation of the intervertebral disc, OA of the right hip, DJD of both TMJs, both shoulders and right knee, possible dislocation of the right humerus with associated OA, cortical defect at the attachment site for the costoclavicular ligament on the left clavicle

### **SK76 (1294)**

Age: adult

Sex: -

Stature:  $178 \pm 2.99$ cm (femur + tibia) Cranial index: -

Preservation: excellent

Completeness: only the right lower arm and hand, right femur and both lower legs and feet are present

Non-metric traits: none observed

Pathology: DJD of the right elbow, right hip, both knees and both feet, compact bone on the posterior of the shaft of a proximal hand phalanx representing a healed NSPI, medio-lateral bending of the femur, tibiae and fibulae, representing healed rickets, fracture of the MT1 facet of the left 1<sup>st</sup> cuneiform and of the proximal joint surface of the distal foot phalanx for the right MT1, scooped out lesions on the tarsals and metatarsals representing gout, possible healed osteochondritis dissecans of the talar facet on the right calcaneus, probable congenital fusion of the right capitate and trapezoid, enthesophytes at the attachment site for M. triceps on the right ulna, for M. rectus femoris on the left patella, for tendo calcaneus on both calcanei and on the anterior of both 1<sup>st</sup> cuneiforms

### **SK77 (1297)**

Age: adult

Sex: -

Stature:  $179 \pm 3.27$ cm (femur) Cranial index: -

Preservation: good

Completeness: only part of the lower left arm and hand, the right femur, and part of the right lower leg and foot are present

Non-metric traits: none observed

Pathology: DJD of the left wrist, avulsion fracture of the tubercle of the left MC3, medio-lateral and antero-posterior bending of the femur and tibia representing healed rickets

**SK78 (1301)**

Age: mature adult (46+) Sex: male

Stature: 181 ± 3.27cm (femur)

Cranial index: - Preservation: good

Completeness: the majority of the bones, apart from the lower legs and feet, are present

Dentition:

		c										a					
Upper right	/	2	3	4	5	6	7	8	9	10	11	12	13	14	15	16	Upper left
Lower right	32	31	30	29	28	27	26	25	24	23	22	21	20	19	18	17	Lower left

Dental pathology: caries (1/31), calculus (26/31), enamel hypoplasia of the molars and canines

Non-metric traits: mastoid foramen exsutural, transverse foramen bipartite

Pathology: OA of the thoracic and lumbar vertebrae, SN of the thoracic and upper lumbar vertebrae, C7 has a small transverse process on the right arch with a cervical rib present, DJD of both TMJs, right shoulder, both elbows, both wrists, left hand and both hips, possible gout of the hands, enthesophytes at the attachment sites for M. biceps on the left radius, and for the costotransverse ligament on three right ribs

**SK79 (1304)**

Age: mature adult (46+) Sex: male

Stature: 175 ± 2.99cm (femur + tibia)

Cranial index: - Preservation: good

Completeness: the majority of the bones, apart from most of the cranium, are present

Dentition:

Upper right	-	-	-	-	-	-	-	-	-	-	-	-	-	-	-	-	Upper left
Lower right	X	X	X	X	28	/	/	/	/	-	/	21	20	19	18	17	Lower left

Dental pathology: calculus (3/6)

Non-metric traits: femoral plaque (right)

Pathology: OA of the cervical, thoracic and lumbar vertebrae, SN of the thoracic and lumbar vertebrae, DJD of the left shoulder, both elbows, both wrists, both hands, both hips and both knees, dislocation of the right humerus with associated OA, fracture of the posterior of the lateral condyle of the left tibia with the fragment pushed inferiorly, healed fracture of the distal shaft of one proximal foot phalanx with slight shortening, fracture of the proximal joint surface of a proximal foot phalanx, healing fracture with bony callus of the sternal body, porous woven bone on the proximal shaft of the

right tibia representing an NSPI active at the time of death, compact bone on the necks of four right ribs representing a healed chest infection, compact bone on the posterior of the blade of the left scapula, and on the shafts of the left tibia and fibula representing healed NSPIs, scooped out lesions on the tarsals and metatarsals possibly representing gout, the right radius and ulna are much larger and more robust than the left, cortical defects at the attachment sites for M. pectoralis major and M. teres major on the left humerus, enthesophytes at the attachment sites for M. triceps on the right ulna, for M. semimembranosus, M. semitendinosus and M. biceps on both ischia, for M. rectus femoris on both patellae, for tendo calcaneus on both calcanei, and for M. extensor digitorum longus and M. extensor digitorum brevis on a medial foot phalanx

**SK80 (1307)**

Age: adult

Sex: -

Stature: 175 ± 4.05cm (humerus) Cranial index: -

Preservation: good

Completeness: only the left humerus and ulna are present

Non-metric traits: none observed

Pathology: enthesophyte at the attachment site for M. triceps on the left ulna

**SK81 (1312)**

Age: adolescent (13-15 years) Preservation: excellent

Completeness: the majority of the bones, apart from the sternum, are present

Dentition:

Upper right	U	2	3	4	5	6	7	8	9	10	11	12	13	14	15	U	Upper left
Lower right	U	31	30	29	28	27	26	25	24	23	22	21	20	19	18	U	Lower left

c

Dental pathology: caries (1/28), calculus (28/28)

Pathology: incompletely fused neural arch of C1, 13 thoracic vertebrae with inferior facets of T12 and superior of T13 of the lumbar type and rib facets on the bodies of all 13 vertebrae, healed fractures of the proximal metaphyses of both tibiae with shaft expansion and sharp exostoses of bone, the length of the long bones suggests an age of 8-11 years indicating delayed skeletal growth, cortical defects at the attachment site for M. deltoideus on both clavicles and for M. teres major on both humeri

**SK82 (1321)**

Age: mature adult (46+) Sex: ?female

Stature: 165 ± 4.45cm (humerus) Cranial index: -

Preservation: good

Completeness: the cranium and mandible, vertebrae, ribs, scapulae, clavicles, left arm, and part of the right arm, sacrum and pelvis are present

Dentition:

Upper right	-	-	-	-	-	/	/	X	X	X	/	X	13	X	15	np	Upper left
Lower right	np	31	30	29	28	27	26	X	X	23	22	21	20	X	18	np	Lower left

Dental pathology: calculus (13/13), moderate to severe periodontal disease, severe calculus of the mandibular anterior and right dentition with calculus covering the crowns of the right I2 and PM4, indicating possible disuse of the teeth, ante-mortem tooth chipping of the mandibular right M1

Non-metric traits: palatine torus, parietal foramen

Pathology: OA of the cervical, thoracic and lumbar vertebrae with fusion of C2 and C3, and C6 and C7, SN of the lower thoracic vertebrae, bilateral unstable spondylolysis of L5 with associated OA, DJD of both TMJs and right shoulder, remodelled fracture of the proximal shaft of the left ulna with medial displacement of the proximal end of the shaft, button osteoma on the right side of the frontal near to the coronal suture, porosity of the attachment site for M. subscapularis on the left humerus

**SK83 (1327)**

Age: adult

Sex: ?female

Stature: 154 ± 3.66cm (tibia) Cranial index: -

Preservation: moderate

Completeness: the majority of the bones, apart from the ribs, thoracic vertebrae, left clavicle, sternum and right hand, are present

Dentition:

		c a												c,a c c			
Upper right	1	2	3	4	5	6	7	8	9	10	11	12	13	14	15	16	Upper left
Lower right	32	31	30	29	28	27	26	25	24	23	22	21	20	19	18	17	Lower left
		c c															

Dental pathology: caries (6/32), calculus (32/32), slight to moderate periodontal disease, enamel hypoplasia of the canines, buccal and lingual abscesses of the maxillary M1s, ante-mortem tooth chipping of the maxillary right PM4

Non-metric traits: parietal foramen, tibial squatting facet, double superior atlas facets Pathology: OA of the cervical and lumbar vertebrae, DJD of the thoracic vertebrae, SN of T5 and L4, bilateral sacralisation of L5, possible very early DISH of the mid-thoracic vertebrae, OA of the left shoulder, DJD of the right shoulder

### SK84 (1338)

Age: adolescent (17-19 years) Preservation: excellent

Completeness: the majority of the bones are present

Dentition:

Upper right	np	2	3	4	5	6	7	/	9	10	11	12	13	14	15	U	Upper left
Lower right	32	31	30	29	28	27	26	25	24	23	22	21	20	19	18	17	Lower left

c

Dental pathology: caries (1/29), calculus (18/29)

Pathology: slight cribra orbitalia of both orbits, remodelled fracture of the acromial end of the right clavicle with the acromial end displaced inferiorly, the length of the long bones suggests an age of 10-12 years and the epiphyseal fusion suggests an age under 16 years indicating delayed skeletal growth and maturation, cortical defect at the attachment site for M. teres major on the right humerus, for the costoclavicular ligament on the left clavicle, for M. soleus on the left tibia and for the medial head of M. gastrocnemius on the right femur

### SK85 (1341)

Age: adult

Sex: -

Stature: 170 ± 3.37cm (tibia) Cranial index: -

Preservation: good

Completeness: only the lower legs and feet are present

Non-metric traits: none observed

Pathology: OA of the right foot, exostosis of bone on the lateral shaft of the left MT3 that represents some form of soft tissue trauma, healed osteochondritis dissecans of the talar facet of the right navicular and of the proximal joint surface of the proximal foot phalanx for the right MT1, enthesophytes at the attachment site for tendo calcaneus on both calcanei

### SK86 (1344)

Age: young adult (19-25) Sex: ?female

Stature: 156 ± 3.55cm (femur + tibia) Cranial index: -

Preservation: good

Completeness: the majority of the bones are present

Dentition:

Upper right	np	2	3	4	5	6	7	8	/	10	11	/	13	14	15	16	Upper left
Lower right	32	31	30	29	/	/	/	/	/	/	22	21	20	19	18	17	Lower left

Dental pathology: calculus (23/23), slight periodontal disease, enamel hypoplasia of the molars, premolars and canines, peg maxillary right I2

Non-metric traits: parietal foramen (left), transverse foramen bipartite

Pathology: DJD of the thoracic and upper lumbar vertebrae, probable peri-mortem fracture of the distal shaft of the left ulna, the left side of the frontal has a large peri-mortem cut that runs into the orbit with fracture lines running through the orbital roof to the maxilla and with the lateral part of the frontal fractured off. There are also fractures to the sphenoid, left zygomatic and zygomatic arch of the left temporal. The occipital is also fractured, which possibly represents a contrecoup fracture of the cranial base but could also be post-mortem in nature as the cranium was disturbed after burial. There are three cuts on the proximal shaft of the left humerus, two of which have come from inferiorly and one that has come from superiorly. The polished appearance to the cut surfaces indicates that they are peri-mortem in nature, the proximal shaft of the humerus is also fractured into pieces, probably peri-mortem. Areas of compact bone on the midshaft of the left tibia and fibula representing a healed NSPI, cribra orbitalia of both orbits

### **SK87 (1347)**

Age: adult

Sex: -

Stature: 167 ± 4.32cm (radius) Cranial index: -

Preservation: good

Completeness: only part of the right humerus, some ribs, the right lower arm and hand, part of the right os coxa and right femur are present

Non-metric traits: none observed

Pathology: DJD of the right elbow and hand, enthesophyte at the attachment site for the common flexors on the right humerus

### **SK88 (1355)**

Age: younger childhood (3-4 years) Preservation: good

Completeness: the majority of the bones, apart from the left hand, sacrum, most of the pelvis, and both legs and feet, are present

Dentition:

Upper right	51	52	/	/	/	/	/	/	59	60	Upper left
Lower right	70	69	68	67	66	-	64	/	62	61	Lower left

Dental pathology: calculus (3/12)

Pathology: sharp exostosis of bone on the medial and distal shaft of the left humerus that probably represents some form of soft tissue trauma, slight cribra orbitalia of the right orbit, the long bone length suggests an age of 1.5-2.5 years indicating slightly delayed skeletal growth

### SK89 (1358)

Age: mature adult (46+) Sex: female

Stature: 162 ± 3.55cm (femur + tibia) Cranial index: -

Preservation: good

Completeness: the majority of bones, apart from the cranium and mandible, cervical and thoracic vertebrae, most of the ribs, sternum, scapulae, clavicles, right humerus and most of the left humerus, are present

Non-metric traits: femoral plaque, tibial squatting facet (right)

Pathology: DJD of the lumbar vertebrae, DJD of both elbows, both hands, left hip, left knee, remodelled fracture of the distal joint surface of the left MC1 and of the proximal joint surface of the proximal hand phalanx with associated DJD, fracture of the proximal joint surface of a left distal hand phalanx, remodelled fracture of the distal shaft of the right tibia with the distal shaft displaced posteriorly and medially, fractures of the distal joint surface of the left tibia with a fragment of bone at the junction of the fracture lines and of the distal joint surface of the right tibia, enthesophyte at the attachment site for the common flexors on the left humerus, for M. triceps on the right ulna, on the midpoint of the linea aspera on the right femur, for M. rectus femoris on both patellae, for tendo calcaneus on both calcanei and on the anterior and superior of the right 2<sup>nd</sup> cuneiform

### SK90 (1361)

Age: mature adult (46+) Sex: female

Stature: 156 ± 3.72cm (femur) Cranial index: -

Preservation: good

Completeness: the majority of the bones, apart from the cranium and mandible, some of the cervical vertebrae and the right humerus, are present

Non-metric traits: tibial squatting facet



Pathology: OA of the cervical, thoracic and lumbar vertebrae, SN of T7, OA of both hands and both knees, DJD of both hips, areas of compact bone on the spine of the left scapula and on the proximal shaft of the left femur representing healed NSPIs, area of porous woven bone on the shaft of the right MC2 representing an NSPI active at the time of death, healing fractures with bony calluses of the necks of three left ribs and three right ribs, of the shaft of one left rib and on one unisided rib fragment, healing fractures with calluses of a scapula blade fragment, fractures of the distal joint surface of a proximal foot phalanx and the proximal joint surface of a medial foot phalanx, dislocation of the right humerus with associated OA, thin and light cortical bone representing osteoporosis, enthesophytes at the attachment site for M. rectus femoris on both patellae and for tendo calcaneus on both calcanei

### SK91 (1364)

Age: old middle adult (36-45) Sex: male

Stature: 175 ± 2.99cm (femur + tibia) Cranial index: -

Preservation: excellent

Completeness: the majority of the bones are present

Dentition:

	a								c				c		c		
Upper right	X	X	X	X	5	6	7	8	9	10	11	12	13	X	X	16	Upper left
Lower right	32	31	30	/	/	/	/	/	24	23	22	21	20	X	X	17	Lower left
	c																

Dental pathology: caries (4/19), calculus (14/19), slight to moderate periodontal disease, enamel hypoplasia of the canines, buccal abscess of the maxillary right PM3

Non-metric traits: lambdoid wormians (right), parietal foramen (left), mastoid foramen exsutural, tibial squatting facet, double superior atlas facets (right), posterior atlas bridge, transverse foramen bipartite

Pathology: OA of the cervical vertebrae, DJD of the thoracic and lumbar vertebrae, SN of the lower thoracic vertebrae, spina bifida of the sacrum, six lumbar vertebrae with spondylolysis of the left inferior arch of L6 with an absent right inferior arch, DJD of the right knee, porous woven bone on the shafts of both MC1s, ulnae, radii, MT1s and MT5s, femorae, tibiae and fibulae, and on the left ilium, both calcanei and the anterior of the body of S1 that probably represents hypertrophic osteoarthropathy, healing fractures with bony calluses of the sterna end of two right ribs and one unisided rib fragment, remodelled shaft fractures with shortening of the left MC4 and right MC5, remodelled fracture of the midshaft of the left femur with overlapping of the ends and approximately 5cm of shortening. The proximal shaft is displaced medially and posteriorly and twisted posteriorly and there is compact bone and a cloaca that penetrates through the whole bone on the lateral side. This indicates that there had been an infection associated with the fracture but that it was healed at the time of death. There is also OA of the left knee, DJD of the left foot, expansion of the shaft of the left tibia in the area of attachment of M. soleus, and expansion of the distal shafts of the tibiae and

fibulae that are all probably related to the fracture, remodelled fracture of the distal joint surface of the right fibula with an associated large enthesophyte at the attachment site for the anterior talofibular ligament, avulsion fracture of the tubercle of the right MC3, smooth shaft expansion of the lateral midshaft of the right femur that possibly represents some form of soft tissue trauma, spiculated bone in the left maxillary antrum representing sinusitis, possible healed osteochondritis dissecans of the proximal joint surface of the proximal foot phalanx for the left MT1, enthesophytes at the attachment site for M. rectus femoris on the right patella, and on the anterior and superior of the left 3<sup>rd</sup> cuneiform

**SK92 (1367)**

Age: adolescent (13-14 years) Preservation: excellent

Completeness: the majority of bones, apart from part of the left lower arm, and the right lower leg and foot, are present

Dentition:

Upper right	X	X	X	X	X	X	X	X	X	X	X	Upper left
Lower right	X	X	X	X	X	X	X	X	X	61	Lower left	

c

c

Upper right	U	2	3	4	5	6	7	8	9	10	11	12	13	14	15	U	Upper left
Lower right	U	31	30	29	28	27	/	/	24	23	22	21	np	19	18	U	Lower left

c

c

Dental pathology: caries (1/1 deciduous; 3/25 permanent), calculus (1/1 deciduous; 22/25 permanent), severe enamel hypoplasia of the molars, canines and incisors, retained left mandibular dm1 and absent PM4

Pathology: diffuse porous woven bone on the anterior of the bodies of S2 to S5 representing an infection of the lower abdomen active at the time of death, the length of the long bones suggests an age of 8-10 years indicating delayed skeletal growth, cortical defects of the attachment sites for M. teres major on both humeri, for the costoclavicular ligament on both clavicles and for M. deltoideus on the right clavicle

**SK93 (1370)**

Age: mature adult (46+) Sex: male

Stature: 169 ± 3.27cm (femur)

Cranial index: 76.0

Preservation: moderate

Completeness: the majority of the bones are present

Dentition:

Upper right	X	X	X	X	X	/	/	8	/	10	11	X	X	X	X	X	Upper left
Lower right	32	31	30	29	28	27	26	X	X	23	22	21	20	19	18	17	Lower left
	c							c									

Dental pathology: caries (2/17), calculus (16/17), slight periodontal disease, enamel hypoplasia of the canines, buccal abscesses of the maxillary left canine and right I1, I2 and canine, with porous woven bone around the abscess for the right canine

Non-metric traits: parietal foramen, mastoid foramen exsutural (right)

Pathology: OA of the cervical, thoracic and lumbar vertebrae with fusion of C4 and C5, SN of the thoracic and lumbar vertebrae, fusion of L4, L5 and S1 through the bodies and arches that may represent traumatic ankylosis or ankylosing spondylitis, scoliosis to the right of the thoracic and upper lumbar vertebrae, kyphosis of the upper thoracic vertebrae, 11 thoracic and 6 lumbar vertebrae, OA of the left shoulder, right elbow, left hand and right foot, DJD of the left elbow, right wrist, right hand, both knees and right ankle, fracture of the proximal joint surface of a medial hand phalanx, fracture of the cuboid facet of the right calcaneus, remodelled fracture of the acetabulum and ischium of the left os coxa with overlap of the pieces of bone, deformation of the acetabulum and associated OA of the hip. Articulation of the os coxa and femur, as well as the posture of the skeleton in the grave, indicates that the femur was held in flexion as a result of the fracture, healing fracture with bony callus present of the lateral part of the ilium with slight inferior and medial displacement of the superior part, avulsion fracture of the tubercle of the right MC3, dislocation of the right humerus with associated OA, smooth exostosis of bone on the posterior of the shaft of a right proximal hand phalanx representing some form of soft tissue trauma, cortical defect of the attachment site for the costoclavicular ligament on both clavicles, enthesophytes at the attachment site for M. rectus femoris on the right patella, exostoses of bone at the attachment site for the fourth palmar interosseous on the right MC5, and for M. adductor policis on the left MC3 representing trauma to the muscles

**SK94 (1373)**

Age: adolescent (16-18 years) Sex: ?female

Stature: 157 ± 3.55cm (femur + tibia) Cranial index: -

Preservation: moderate

Completeness: the majority of the bones are present

Dentition:

Upper right	1	2	3	4	5	6	7	8	9	10	11	12	13	14	15	U	Upper left
Lower right	np	31	30	29	28	27	26	25	24	23	22	21	20	19	18	U	Lower left

Dental pathology: calculus (28/29), enamel hypoplasia of the molars, premolars, canines and incisors

Non-metric traits: mastoid foramen exsutural, tibial squatting facet, transverse foramen bipartite

Pathology: SN of the lower thoracic vertebrae, compact bone on the midshaft of the left fibula representing a healed NSPI, possible cyst or large cortical defect at the attachment site for the medial head of M. gastrocnemius

Other information: the cranial features of this skeleton are indicative of a Negroid individual.

### SK95 (1376)

Age: young adult (19-25) Sex: male

Stature: 168 ± 2.99cm (femur + tibia) Cranial index: 78.5

Preservation: excellent

Completeness: the majority of the bones are present

Dentition:

Upper right	1	2	3	4	5	6	7	8	9	10	11	12	13	14	15	16	Upper left
Lower right	np	31	30	29	28	27	26	25	24	23	22	21	20	19	18	17	Lower left

Dental pathology: calculus (29/31), enamel hypoplasia of the canines

Non-metric traits: transverse foramen bipartite (left)

Pathology: SN of the lower thoracic and upper lumbar vertebrae, lesions and destruction of the bodies of the lower thoracic vertebrae that could possibly represent brucellosis infection,

porous woven bone on the visceral surface of the necks and shafts of 10 left ribs representing a chest infection active at the time of death, area of porous woven bone on the midshaft of the right ulna and on the left side of the manubrium representing NSPIs active at the time of death, porous woven bone in the frontal sinus representing sinusitis, possible healed osteochondritis dissecans of the head of the right femur, the tibia facet of the left talus, the cuboid facet of the left calcaneus and of the calcaneus facet of the right cuboid, probable well remodelled depressed fracture of the right parietal near to lambda, cortical defect at the attachment site for M. teres major on the left humerus, for the costoclavicular ligament and M. deltoideus on both clavicles, enthesophytes at the attachment site for M. soleus on both fibulae, sunken attachment site for M. soleus on the left tibia

### SK96 (1379)

Age: old middle adult (36-45) Sex: female

Stature: 163 ± 3.55cm (femur + tibia)

Cranial index: - Preservation: moderate

Completeness: the majority of the bones, apart from the left hand, are present

Dentition:

Upper right	np	2	3	4	5	6	7	8	/	/	11	12	13	14	15	16	Upper left
Lower right	np	31	30	29	28	27	/	/	24	23	22	21	20	19	18	17	Lower left

Dental pathology: calculus (25/25), slight to moderate periodontal disease, enamel hypoplasia of the canines

Non-metric traits: ossicle at lambda, lambdoid wormians, tibial squatting facet (right), distal septal aperture, double superior atlas facets (right), transverse foramen bipartite (right) Pathology: DJD of the cervical, thoracic and lumbar vertebrae, SN of the lower thoracic and lumbar vertebrae, os acromiale of the right scapula, possible osteochondritis dissecans of the proximal joint surface of the proximal foot phalanx for MT1, cortical defect at the attachment site for M. teres major on the right humerus and for the costoclavicular ligament on the right clavicle

**SK97 (1382)**

Age: younger childhood (5-6 years) Preservation: good

Completeness: the majority of bones, apart from the left scapula, clavicle, some ribs and parts of the cranium, mandible, left humerus and left foot, are present

Dentition:

Upper right	51	52	53	54	55	/	/	/	<sup>c</sup> 59	60	Upper left
Lower right	70	69	68	67	-	-	-	-	-	-	Lower left

Upper right	U	U	3	U	U	U	U	U	U	U	U	U	U	U	U	U	Upper left
Lower right	U	U	30	U	U	U	-	-	-	-	-	-	-	-	-	-	Lower left

Dental pathology: caries (1/11 deciduous), calculus (8/11 deciduous; 2/3 permanent) Pathology: severe cribra orbitalia of both orbits, the long bones appear very gracile for their length

**SK98 (1385)**

Age: younger childhood (3-4 years) Preservation: good

Completeness: the majority of the bones, apart from the upper vertebrae, some ribs, left scapula and clavicle, and most of the left hand and feet, are present

Dentition:

Upper right	51	52	53	54	55	56	57	58	59	60	Upper left
Lower right	70	69	68	67	66	65	64	63	62	61	Lower left

Pathology: six lumbar vertebrae with unfused neural arches of L5 and L6, slight cribra orbitalia of both orbits, new bone on the endocranial surface of the occipital, the length of the long bones suggests an age of 2-3 years indicating slightly delayed skeletal growth

**SK99 (1402)**

Age: young middle adult (26-35) Sex: male

Stature: 177 ± 2.99cm (femur + tibia)

Cranial index: - Preservation: good

Completeness: the majority of the bones are present

Dentition:

			a											c,a			c	
Upper right	1	2	3	4	5	6	7	8	9	10	11	12	13	14	/	16	Upper left	
Lower right	32	31	30	29	28	27	26	25	24	23	22	21	20	19	18	17	Lower left	

Dental pathology: caries (2/31), calculus (31/31), slight to moderate periodontal disease, enamel hypoplasia of the premolars, canines and incisors, buccal and lingual abscesses of the maxillary M1s, antemortem tooth chipping of the mandibular right M2

Non-metric traits: femoral plaque

Pathology: DJD of the cervical, thoracic and lumbar vertebrae, SN of the lower thoracic and upper lumbar vertebrae, OA of the left ankle, DJD of the left hand and both hips, slight cribra orbitalia of both orbits, small button osteoma on the left parietal near to the sagittal suture, probable healed depressed fracture of the left side of the frontal near to the coronal suture, os acromiale of both scapulae, healed osteochondritis dissecans of the distal joint surface of both tibiae and of the tibia facet of the right talus, cortical defect of the attachment site for M. pectoralis major and M. subscapularis on both humeri, for M. teres major on the right humerus and for the costoclavicular ligament on both clavicles, enthesophytes at the attachment site for tendo calcaneus on both calcanei

**SK100 (1405)**

Age: younger childhood (1-2 years) Preservation: excellent

Completeness: the majority of the bones, apart from part of the cranium and most of the feet, are present

Dentition:

Upper right	U	52	53	54	55	56	-	58	-	-	Upper left
Lower right	U	69	68	67	66	65	64	63	62	U	Lower left

Pathology: six lumbar vertebrae, the heads of the ribs are enlarged and severely porous, cribra orbitalia of both orbits, severe porosity of the ectocranial surface of the parietals, slight porosity of the endocranial surface of the occipital and parietals, the distal shafts of the femorae appear widened. All of this indicates iron deficiency anaemia.

**SK101 (1408)**

Age: old middle adult (36-45) Sex: ?male

Stature: 179 ± 3.27cm (femur) Cranial index: -

Preservation: moderate

Completeness: only the left lower arm, parts of the right lower arm, hands, sacrum, pelvis, both femorae and parts of the lower legs and left foot are present

Non-metric traits: none observed

Pathology: DJD of the left knee, developed attachment sites for M. gluteus maximus on both femorae

**SK102 (1411)**

Age: older childhood (10-12 years) Preservation: good

Completeness: only the lower legs and feet are present

Pathology: cortical defect at the attachment site for M. semitendinosus on the right tibia

**SK103 (1414)**

Age: mature adult (46+) Sex: female

Stature: 164 ± 3.55cm (femur + tibia) Cranial index: -

Preservation: good

Completeness: the majority of the bones are present

Dentition:

					c	c											
Upper right	-	X	X	4	5	6	7	8	/	10	11	12	X	X	X	X	Upper left
Lower right	/	X	X	29	28	27	26	25	/	/	22	21	20	19	18	17	Lower left
														c	c	c	

Dental pathology: caries (5/18), calculus (18/18), slight to moderate periodontal disease

Non-metric traits: mastoid foramen exsutural, tibial squatting facet, transverse foramen bipartite (left)

Pathology: OA of the cervical and lumbar vertebrae, DJD of the thoracic vertebrae, SN of the thoracic vertebrae, six lumbar vertebrae, OA of both elbows and hands, DJD of both TMJs, left wrist, right hip and left knee, porous woven bone on the shafts of both ulnae, radii, MC1s, femorae, tibiae, fibulae, left MT1, right MT4 and both MT5s and on both ilia and calcanei that possibly represents hypertrophic osteoarthropathy, avulsion fracture of the anterior of the semi-lunar notch of the right ulna, possible well remodelled fracture of the nasal bones, remodelled depressed fracture of the left side of the frontal near to the coronal suture, spiculated bone in both maxillary antra representing sinusitis, grooves on the anterior and distal shaft of both tibiae indicating the feet were being held in extreme dorsiflexion with associated OA of the left ankle, cortical defect at the attachment site for M. teres major on the right humerus, enthesophytes at the attachment site for tendo calcaneus and M. flexor accessorius on both calcanei

**SK104 (1417)**

Age: old middle adult (36-45) Sex: female

Stature: 157 ± 3.55cm (femur + tibia) Cranial index: -

Preservation: good

Completeness: the majority of the bones are present

Dentition:

	c										c										a		
Upper right	1	2	3	4	5	6	7	8	9	10	11	12	13	14	X	X	Upper left						
Lower right	32	31	30	29	28	27	26	25	24	23	22	21	20	19	18	17	Lower left						

Dental pathology: caries (4/30), calculus (30/30), slight to moderate periodontal disease, buccal abscess of the maxillary left M1, possible peri-mortem fracture of the root of the maxillary right PM3

Non-metric traits: palatine torus, parietal foramen, epiteric bones, mastoid foramen exsutural (left), tibial squatting facet, distal septal aperture (left), suprascapular foramen (right), transverse foramen bipartite (left)

Pathology: DJD of the cervical, thoracic and lumbar vertebrae, SN of T6 and the lumbar vertebrae, the inferior right facet of T11 is of the T12 type, OA of both hands, DJD of both TMJS, both shoulders, both wrists, both hips, both knees, left ankle and both feet, remodelled fracture of the sternal end of one left rib, fracture of the distal joint surface of the right radius, fracture of the distal joint surface of a left medial hand phalanx, two button osteoma on the posterior of the left parietal, plaques of bone on the endocranial surface of the frontal that probably represents hyperostosis frontalis interna, spiculated bone in the left maxillary antrum representing sinusitis, enthesophytes at the attachment site for the common flexors and extensors on both humeri, for M. triceps on both ulnae, for M. biceps on the right radius, for M. gluteus minimus on both femorae, for M. psoas major and M. iliacus on the right femur, on the lateral side of the left iliac crest, and for tendo calcaneus on both calcanei, development of the medial and lateral ridges of the hand phalanges

Other information: the cranial features of this skeleton are indicative of a Negroid individual



**SK105 (1420)**

Age: young adult (19-25) Sex: female

Stature: 166 ± 3.55cm (femur + tibia)

Cranial index: - Preservation: excellent

Completeness: the majority of the bones, apart from the cranium, mandible, cervical and thoracic vertebrae, most of the ribs, the sternum, scapulae, clavicles, and part of both humeri are present

Non-metric traits: tibial squatting facet

Pathology: SN of the lumbar vertebrae, porous woven bone on the midshaft of both radii representing NSPIs active at the time of death, ununited fracture of the sesamoid for the right MT1, cyst of the right trapezium

**SK106 (1423)**

Age: old middle adult (36-45) Sex: ?male

Stature: 175 ± 2.99cm (femur + tibia) Cranial index: 92.5

Preservation: excellent

Completeness: the majority of the bones, apart from part of the left lower arm and hand and part of both feet, are present

Dentition:

	c			a													
Upper right	1	2	X	4	5	6	7	8	9	10	11	12	13	14	15	16	Upper left
Lower right	np	31	X	X	28	27	26	25	24	23	22	21	X	19	18	np	Lower left
	c																

Dental pathology: caries (3/26), calculus (22/26), slight periodontal disease, enamel hypoplasia of the molars and canines, buccal and lingual abscess of the maxillary left M1 that also penetrates into the maxillary antrum, groove on the distal CEJ of the maxillary left PM4 that may represent toothpick use

Non-metric traits: lambdoid wormians, parietal foramen (left), mastoid foramen exsutural, tibial squatting facet, transverse foramen bipartite

Pathology: OA of the thoracic vertebrae, DJD of the cervical and lumbar vertebrae, SN of the lower thoracic and lumbar vertebrae, kyphosis of the lower thoracic and upper lumbar vertebrae, the sacrum has six segments, lesion of the posterior and inferior of the body of T11 that represents posterior herniation of the intervertebral disc, DJD of both shoulders and right elbow, diffuse compact bone on the shafts of both tibiae and fibulae representing a healed NSPI, compact bone on the proximal shaft of the left ulna representing a healed NSPI, slight cribra orbitalia of both orbits, avulsion fracture of the anterior of the left calcaneus, possible healed osteochondritis dissecans of

the distal joint surface of the left tibia, destruction of the anterior of the left cuboid that represents some form of infectious process, antero-posterior bending of both humeri, cortical defects at the attachment site for M. teres major on the left humerus, for M. pectoralis major on the right humerus, enthesophytes at the attachment site for M. triceps on the left ulna, for the anterior talofibular ligament on both fibulae, for the medial collateral ligament on the right tibia, for tendo calcaneus on both calcanei, for the bifurcate ligament on the right navicular and for the long plantar ligament on the left calcaneus, porosity of the attachment sites for M. subscapularis on both humeri, for M. infraspinatus on the left humerus and for M. biceps on the right radius

### **SK107 (1426)**

Age: adult

Sex: ?female

Stature:  $160 \pm 3.55\text{cm}$  (femur + tibia) Cranial index: -

Preservation: excellent

Completeness: only part of the cranium, both hands and left os coxa, and the left femur, both lower legs and feet are present

Non-metric traits: parietal foramen

Pathology: OA of both hands, the left knee and both feet, DJD of the left hip, right knee and both ankles, healed depressed fracture of the midline of the frontal, button osteoma on the posterior of the right parietal, enthesophytes at the attachment site for M. rectus femoris on the left patella, on the lateral of the left iliac crest and for tendo calcaneus on both calcanei

### **SK108 (1464)**

Age: adult

Sex: -

Stature:  $164 \pm 3.27\text{cm}$  (femur) Cranial index: -

Preservation: good

Completeness: only the right femur and parts of the left femur and right lower leg are present

Non-metric traits: none observed

Pathology: DJD of both knees, compact bone on the midshaft of the left femur representing a healed NSPI, thickening of the shafts with compact bone and porosity of the distal left femur and the proximal right femur that may represent remodelled fractures or Paget's disease, possible osteochondritis dissecans of the head of the right femur

**SK109 (1467)**

Age: adult

Sex: -

Stature: 161 ± 3.37cm (tibia) Cranial index: -

Preservation: good

Completeness: only parts of both femorae, part of the left lower leg and foot and the right lower leg are present

Non-metric traits: none observed

Pathology: DJD of both knees, osteochondritis dissecans of the proximal joint surface of the proximal foot phalanx for MT1, enthesophytes at the attachment site for the interosseous ligament on the right tibia

**SK110 (1262)**

Age: adult Sex: ?male Stature: - Cranial index: -

Preservation: good

Completeness: only part of the cranium is present

Non-metric traits: parietal foramen

Pathology: none observed

**SK111 (1555)**

Age: adult Sex: - Stature: -

Cranial index: -

Preservation: excellent

Completeness: only parts of the lower legs and both feet are present

Non-metric traits: tibial squatting facet

Pathology: porous woven bone on the midshaft of the left tibia and the proximal shaft of the right tibia representing NSPIs active at the time of death, avulsion fracture of the anterior of the left calcaneus, possible healed osteochondritis dissecans of the proximal joint surface of the proximal foot phalanx for both MT1s, the tibiae are bent medio-laterally probably indicating healed rickets

**SK112 (1557)**

Age: older childhood (8-9 years) Preservation: good

Completeness: the majority of the bones, apart from the lumbar vertebrae, sternum, part of the sacrum and right os coxa, the right hand, part of the right lower leg, and both feet, are present

## Dentition:

Upper right	51	52	/	X	X	X	X	58	59	60	Upper left
Lower right	70	/	68	X	X	X	X	63	62	61	Lower left

Upper right	U	U	3	U	U	U	7	8	/	10	U	U	U	14	U	U	Upper left
Lower right	U	U	30	U	U	U	/	25	24	23	U	U	U	19	U	U	Lower left

Dental pathology: calculus (9/10 deciduous; 7/10 permanent)

Pathology: porous woven bone on the shaft of the left clavicle and right humerus, and on the right zygomatic and ascending ramus of the right side of the mandible that may possibly represent scurvy or a NSPI active at the time of death, exostosis of bone on the midshaft of the left fibula representing some form of soft tissue trauma, the length of the long bones suggests an age of 5-7 years indicating delayed skeletal growth, cortical defect at the attachment site for M. gastrocnemius on the left femur

**SK113 (1559)**

Age: old middle adult (36-45) Sex: female

Stature: 159 ± 3.55cm (femur + tibia)

Cranial index: - Preservation: moderate

Completeness: only some ribs, the sacrum, pelvis, both legs and feet are present

Non-metric traits: femoral plaque (right), tibial squatting facet

Pathology: DJD of both knees, medio-lateral and antero-posterior bending of the femorae that indicates healed rickets, enthesophytes at the attachment site for M. rectus femoris on both patellae and for tendo calcaneus on both calcanei

**SK114 (1577)**

Age: older childhood (7-8 years) Preservation: moderate

Completeness: the majority of the bones, apart from the left hand, both feet and part of the cranium are present

## Dentition:

Upper right	-	-	-	-	-	-	-	-	-	-	Upper left
Lower right	/	/	/	/	X	X	/	-	62	61	Lower left

Upper right	-	-	-	-	-	-	-	-	-	-	-	-	-	-	-	-	Upper left
Lower right	-	-	-	U	U	U	U	25	24	U	U	U	U	19	-	-	Lower left

Dental pathology: calculus (1/1 deciduous), enamel hypoplasia of the permanent canines Pathology: the length of the long bones suggests an age of 5-6 years and the epiphyseal fusion an age of 3-4 years, indicating delayed skeletal growth and maturation

### SK115 (1636)

Age: young middle adult (26-35) Sex: male

Stature: 171 ± 2.99cm (femur + tibia) Cranial index: -

Preservation: good

Completeness: the majority of the bones, apart from the cranium and mandible, cervical vertebrae, right clavicle and scapula, and part of the right humerus, are present

Non-metric traits: none observed

Pathology: DJD of the thoracic and lumbar vertebrae, SN of the thoracic and lumbar vertebrae, DISH of the thoracic vertebrae, lumbar ribs that articulate with L1, DJD of the left wrist and right hand, area of porous woven bone on the shaft of the right tibia representing a NSPI active at the time of death, fracture of the left triquetral, fracture of the shaft of a proximal hand phalanx with anterior displacement of the distal shaft and an active infection, cortical defects at the attachment sites for the costoclavicular ligament on the left clavicle, enthesophytes at the attachment site for M. biceps on the left radius, for M. gluteus minimus and M. gluteus medius on both femorae, for M. psoas major and M. iliacus on the right femur and for tendo calcaneus on both calcanei

### SK116 (2052)

Age: old middle adult (36-45) Sex: ?female

Stature: 161 ± 3.55cm (femur + tibia) Cranial index: -

Preservation: excellent

Completeness: the majority of the bones, apart from parts of both lower arms and hands, the sacrum and left os coxa, and part of the left femur, are present

Dentition:

		c															
Upper right	/	2	3	/	5	6	/	/	/	/	11	12	13	14	15	16	Upper left
Lower right	-	31	30	29	28	27	26	25	/	/	/	21	20	19	18	np	Lower left
		a a															

Dental pathology: caries (1/21), calculus (21/21), slight to moderate periodontal disease, buccal abscesses of the mandibular left I2 and canine

Non-metric traits: lambdoid wormians, infra-orbital foramen, parietal foramen (right), epiteric bones (right), tibial squatting facet, distal septal aperture, transverse foramen bipartite (right) Pathology: OA of the cervical and thoracic vertebrae, compression fractures of the bodies of T3, T6-T8, T10 and

T11 with subsequent kyphosis of the thoracic vertebrae, DJD of the left shoulder, right hip and left foot, avulsion fracture of the anterior of the right calcaneus, os acromiale of the right scapula, the tibiae are bent medio-laterally possibly representing healed rickets, the nasal aperture is widened and rounded with destruction of the nasal spine and thinning and porosity of the palate, there is some circumferential wasting of the hand and foot phalanges, grooves on the distal and palmar shafts of the proximal hand phalanges for MC4 and MC5 indicating that the fingers may have been held in flexion and compact bone on the shafts of the tibiae and fibulae indicating a healed infection. All of this represents leprosy, enthesophytes at the attachment sites for the common extensors on both humeri, porosity of the attachment site for M. subscapularis on the left humerus

**SK117 (2060)**

Age: mature adult (46+) Sex: female

Stature: 161 ± 3.55cm (femur + tibia)

Cranial index: - Preservation: excellent

Completeness: the majority of the bones are present

Dentition:

				a	a				a	a	a	c	a	a	c,a		
Upper right	X	X	X	/	/	6	/	X	X	/	/	12	13	X	X	16	Upper left
Lower right	32	X	X	X	28	27	26	25	/	/	22	21	20	X	X	17	Lower left
				a						c							

Dental pathology: caries (3/13), calculus (13/13), slight to severe periodontal disease, enamel hypoplasia of the canines, buccal abscesses of the maxillary left I2, canine, PM3, M1, M2 and M3, right canine and PM3 and mandibular right PM4

Non-metric traits: parietal foramen (left), tibial squatting facet (right), distal septal aperture (left)

Pathology: OA of the cervical, thoracic and lumbar vertebrae, SN of the lower thoracic vertebrae, OA of the left knee, DJD of both TMJs, both shoulders, right elbow, both wrists, both hands, both hips, right knee and both feet, spiculated bone in both maxillary antra representing sinusitis, remodelled fracture of the distal joint surface of one proximal foot phalanx, enthesophytes at the attachment site for M. semimembranosus, M. semitendinosus and M. biceps on the right ischium, for M. rectus femoris on both patellae and for tendo calcaneus on both calcanei, porosity of the attachment site for M. subscapularis on the left humerus, and for M. semimembranosus, M. semitendinosus and M. biceps on the left ischium

**SK118 (1047)**

(this skeleton was excavated as a discrete charnel deposit directly above the skeleton of SK14 (1048) but at analysis the elements within the deposit were found to belong to a single individual. It is possible that this was a primary burial disinterred by the burial of SK14 in the same grave, or secondary burial of an individual brought from elsewhere)

Age: young middle adult (26-35) Sex: female

Stature:  $156 \pm 3.55\text{cm}$  (femur + tibia) Cranial index: 73.0

Preservation: moderate

Completeness: the majority of the bones, apart from some vertebrae, parts of the left femur and both hands, and both feet, are present

Dentition:

Upper right	np	2	3	4	5	6	/	8	9	/	/	12	/	14	15	np	Upper left
Lower right	np	31	30	29	28	27	26	25	24	23	22	21	20	19	18	np	Lower left

Dental pathology: calculus (24/24)

Non-metric traits: lambdoid wormians (right), parietal foramen (left), epiteric bones (right), transverse foramen bipartite (left)

Pathology: SN of T8 and the upper lumbar vertebrae, compact bone on the midshaft of both fibulae and the left tibia representing healed NSPIs, localised area of shaft expansion on the midshaft of the right tibia that possibly represents some form of soft tissue trauma, os acromiale of the right scapula, enthesophytes at the attachment site for tendo calcaneus on the right calcaneus

## 4.6.7

Table 19 Summary information about the inhumations

SK No.	Context No.	Age	Sex	Stature	Cranial index	Dental pathology	Pathology
1	1005	?younger childhood	-	-	-	-	-
2	1009	younger childhood	-	-	-	-	-
3	1012	mature adult	?M	162cm	-	-	DJD, 6 lumbar vertebrae, sacralised L6, early DISH?, avulsion fracture – ulna, enthesophytes
4	1015	old middle adult	F	168cm	-	caries, calculus, periodontal disease, abscesses, am tooth chipping	DJD, SN, fracture – rib, clavicle, scapula, hand phalanx, new bone on ribs, sinusitis
5	1018	middle adult +	-	-	-	-	DJD, SN, transitional vertebrae, compression fracture – L2, fracture – ribs, button osteoma, cortical defect
6	1021	older childhood	-	-	-	calculus	rickets
7	1024	mature adult	F	165cm	-	-	DJD, fracture – talus, exostosis, enthesophytes, pronounced muscle attachments
8	1029	mature adult	F	160cm	70.2	caries, calculus, periodontal disease	OA, SN, fractures – T9, T11, T12, ribs, radius, exostoses, cribra orbitalia, midline defect, enthesophytes
9	1031	older childhood	-	-	-	-	rickets?
10	1033	old middle adult	?	158cm	-	caries, calculus, periodontal disease, EH, am tooth chipping	DJD, SN, 11 thoracic vertebrae, fracture – foot phalanges, osteoporosis, hydatid cyst present, enthesophytes
11	1036	mature adult	F	162cm	-	-	DJD, OA, fracture – rib, metastatic carcinoma, hypertrophic osteoarthropathy, exostosis, cortical defect, enthesophytes
12	1039	mature adult	?F	-	-	caries with infection, calculus, periodontal disease, EH	OA, SN, fusion of T5 and T6, compression fractures – T7, T8, T10, kyphosis, scoliosis, DJD, fracture – MC1, trapezium, osteoporosis, ?hyperostosis frontalis interna, neoplastic disease
13	1042	old middle adult	?F	156cm	-	caries, calculus, periodontal disease, EH	developmental defect, joint destruction, 6 lumbar vertebrae, enthesophytes
14	1049	adolescent/young adult	M	176cm	-	caries, calculus, periodontal disease, EH	SN, incompletely fused neural arches – T11, S1, infectious process, transitional vertebrae, avulsion fracture – MC3, fingers held in flexion, rickets, sinusitis, cortical defects, pronounced muscle attachments



SK No.	Context No.	Age	Sex	Stature	Cranial index	Dental pathology	Pathology
15	1052	younger childhood	-	-	-	caries, calculus	NSPI, cribra orbitalia, exostosis
16	1055	young middle adult	M	179cm	-	caries, calculus	DJD, SN, scoliosis, fractures – T8, T9, MT1, avulsion fracture – calcaneus, foot trauma with disuse atrophy
17	1058	old middle adult	M	171cm	-	-	fracture – foot phalanges, enthesophytes
18	1061	young adult	?M	-	-	caries, calculus, periodontal disease, EH, retained deciduous teeth	os acromiale, cortical defect
19	1064	mature adult	?F	158cm	-	caries, calculus, periodontal disease	OA, SN, DJD, dislocation - humerus, fracture – rib, cortical defect
20	1070	young middle adult	M	166cm	-	caries, calculus, EH, am tooth chipping	DJD, SN, collapse of bodies of L2 and L3, fracture – L5, tibia, fibula, transitional vertebrae, 11 ribs, lower abdomen infection, avulsion fracture – MC3, cortical defect
21	1073	young middle adult	?F	172cm	-	-	incompletely fused arch – S1, S2, NSPI, exostosis, joint destruction, enthesophytes
22	1076	old middle adult	?M	160cm	-	calculus	DJD, SN, transitional vertebrae, cortical defect, enthesophytes
23	1085	old middle adult	M	173cm	72.5	caries, calculus, periodontal disease, EH	DJD, SN, NSPI, fracture – MC3, depressed cranial fracture, enthesophytes
24	1089	adolescent	-	-	-	-	-
25	1094	older childhood	-	-	-	calculus, EH	NSPI, depressed cranial fracture, delayed skeletal growth and maturation, cortical defects
26	1097	old middle adult	F	166cm	74.6	caries, calculus, periodontal disease, EH, abscesses, am tooth chipping	OA, SN, transitional vertebrae, 11 ribs, DJD, NSPI, exostosis, cortical defects, enthesophytes, roughened muscle attachments, prominent muscle attachments
27	1102	young middle adult	?M	171cm	-	caries, calculus, periodontal disease, EH, am tooth chipping	DJD, SN, 6 lumbar vertebrae, fractures – ulna, MC4, MC5, foot phalanx, wrist trauma, depressed cranial fracture, cribra orbitalia, exostosis, cortical defects, ?perimortem blunt force cranial trauma
28	1105	middle adult +	M	179cm	-	caries, calculus, periodontal disease, EH, abscesses with infection, teeth used as tools	OA, SN, scoliosis, avulsion fracture – T1, DJD, ?dislocation – humerus, fracture – clavicle, depressed cranial fracture, cortical defects, roughened muscle attachments, slightly am sharp force penetrating trauma of ribs
29	1108	old middle adult	F	160cm	-	caries, calculus, periodontal disease, EH	DJD, SN, osteochondritis dissecans, button osteoma, cribra orbitalia, sinusitis, exostosis, enthesophytes

SK No.	Context No.	Age	Sex	Stature	Cranial index	Dental pathology	Pathology
30	1111	mature adult	F	157cm	-	caries, calculus, periodontal disease, abscesses, tooth used as tool	SN, DJD, fracture – hand phalanx, foot phalanx, osteoporosis, enthesophytes, roughened muscle attachments
31	1114	young middle adult	M	171cm	-	-	SN, sacrum with 6 segments, avulsion fracture – talus, fracture – MT5, NSPI, exostosis, prominent muscle attachment
32	1118	young middle adult	M	177cm	-	caries, calculus, periodontal disease, EH, five incisors	DJD, SN, Scheuermann's disease, kyphosis, avulsion fracture – T1, transitional vertebrae, 11 ribs, NSPI, cortical defect
33	1121	mature adult	M	176cm	-	-	DJD, hypertrophic osteoarthropathy, gout, fingers held in flexion, exostosis, cortical defect
34	1124	middle adult +	?F	-	-	caries, calculus, periodontal disease, EH, abscess, toothpick use	OA, avulsion fracture – T1, fractures – T5, T6, depressed cranial fracture, cyst
35	1127	younger childhood	-	-	-	calculus	anaemia, delayed skeletal growth
36	1130	young middle adult	?M	-	-	-	DJD, SN, intervertebral disc herniation, transitional vertebrae, NSPI
37	1132	old middle adult	M	163cm	-	-	exostosis, ?Albright's Hereditary Osteodystrophy, enthesophytes, prominent muscle attachments
38	1135	middle adult +	?M	181cm	-	caries, calculus, periodontal disease	OA, vertebral body collapse, ?DISH, cortical defects, enthesophytes, roughened muscle attachments
39	1138	older childhood	-	-	-	calculus, EH	cribra orbitalia, depressed cranial fracture, delayed skeletal growth
40	1142	adolescent	?M	-	-	-	OA, osteochondritis dissecans, cortical defect
41	1145	mature adult	?M	167cm	-	-	OA, SN, fracture – MC2, MC3, cortical defect, enthesophytes
42	1148	young middle adult	?M	169cm	-	-	OA, SN
43	1151	old middle adult	?F	161cm	-	caries, calculus, periodontal disease, EH, abscesses	SN, DJD
44	1154	mature adult	?M	-	-	-	DJD, enthesophytes
45	1157	adolescent/young adult	?	172cm	-	calculus	SN, developmental defect of vertebrae and sternum, incompletely fused arch of S1, transitional vertebrae, new bone on ribs, NSPI, joint destruction, osteochondritis dissecans
46	1160	old middle adult	M	179cm	-	calculus, EH	SN, 6 lumbar vertebrae, sacralised L6, avulsion fracture – ulna, tibia, sinusitis, cortical defect

SK No.	Context No.	Age	Sex	Stature	Cranial index	Dental pathology	Pathology
47	1163	adult	-	-	-	-	-
48	1166	old middle adult	M	172cm	-	caries, calculus, periodontal disease, EH, am tooth chipping, use of teeth as tools	OA, SN, transitional vertebrae, lumbar rib, 6 lumbar vertebrae, sacralisation of L6, dislocation – humerus, DJD, osteochondritis dissecans, NSPI, leg ulcers, gout, healed anaemia, fracture – ribs, cortical defects, enthesophytes, roughened muscle attachments
49	1170	adult	-	-	-	-	osteomyelitis
50	1172	old middle adult	M	169cm	-	-	OA, SN, Scheuermann's disease, kyphosis, 6 lumbar vertebrae, sacralisation of L6, spondylolysis, fractures – T7, T8, clavicle, DJD, os acromiale, new bone on ribs, ?DISH, avulsion fracture – calcaneus, osteochondritis dissecans, cortical defect, enthesophytes, prominent muscle attachment
51	1175	adult	-	-	-	-	DJD, fusion of foot phalanges, enthesophytes
52	1178	old middle adult	F	158cm	-	caries, calculus, periodontal disease	DJD, SN, scoliosis, avulsion fracture – C7, spina bifida, new bone on ribs, exostosis, sinusitis, os acromiale, cortical defect, roughened muscle attachment
53	1185	younger childhood	-	-	-	caries, calculus, EH	delayed skeletal growth
54	1188	young adult	?M	165cm	-	-	SN, fracture – hand phalanx, NSPI, cortical defect
55	1195	younger childhood	-	-	-	-	anaemia, developmental defect of vertebra, delayed skeletal growth
56	1198	mature adult	?F	160cm	-	caries, calculus, periodontal disease, EH, toothpick use	OA, SN, DJD, cyst, NSPI, cortical defect, prominent muscle attachments
57	1201	old middle adult	M	171cm	-	periodontal disease	OA, SN, DISH, ankylosing spondylitis, NSPI, neoplastic disease, button osteomae, leg ulcer, enthesophytes, exostosis, roughened muscle attachments, prominent muscle attachments
58	1204	old middle adult	F	166cm	-	-	DJD, SN, NSPI, osteochondritis dissecans, fracture – scapula, enthesophytes
59	1207	adult	?	173cm	-	-	gout, roughened muscle attachment
60	1216	younger childhood	-	-	-	caries, calculus, periodontal disease	cribra orbitalia, rickets
61	1219	old middle adult	F	163cm	78.3	caries, calculus, periodontal disease, EH, abscesses	OA, SN, 6 lumbar vertebrae, sacralised L6, DJD, fracture – rib, ulna, radius, scapula, joint destruction, sinusitis, roughened muscle attachments
62	1222	old middle adult	?F	-	76.2	calculus, periodontal disease, EH	DJD, SN, fracture – T10-T12, ulnae, radius, ankylosing spondylitis, transitional vertebrae, NSPI, osteoporosis, enthesophytes

SK No.	Context No.	Age	Sex	Stature	Cranial index	Dental pathology	Pathology
63	1227	young middle adult	M	167cm	-	caries, calculus, periodontal disease, abscess	OA, DJD, SN, 6 lumbar vertebrae, sacralisation of L6, compression fracture – L1, kyphosis, intervertebral disc herniation, sinusitis, fracture – ribs, MC1, gout, slightly am blade injury, joint destruction, healed rickets, osteochondritis dissecans, exostoses, cyst, cortical defects, enthesophytes
64	1230	young adult	?	167cm	72.4	calculus, EH, peg tooth	incompletely fused arch of T11, cortical defects
65	1233	old middle adult	M	181cm	-	calculus, am tooth chipping, supernumerary tooth	DJD, SN, 11 thoracic and 6 lumbar vertebrae, peri-mortem blade injuries – ribs, L3, C2, ilium, peri-mortem fractures – clavicle, MC5, osteochondritis dissecans, exostosis, cortical defects, enthesophytes, roughened muscle attachment
66	1238	middle adult +	M	164cm	73.6	caries, calculus, periodontal disease, am tooth chipping	DJD, SN, collapse of body of C3, fracture – T3, rib, talus, new bone on ribs, depressed cranial fracture, gout, os acromiale, cortical defect, enthesophytes
67	1241	young middle adult	?F	153cm	81.5	calculus, periodontal disease, EH	DJD, SN, new bone on ribs, NSPI, fusion of foot phalanges, sinusitis, cribra orbitalia, depressed cranial fracture, cortical defect
68	1244	young middle adult	M	173cm	73.0	caries, calculus, periodontal disease, EH, abscesses	OA, SN, DJD, NSPI, infectious process, fractures – manubrium, foot phalanges, exostosis, cortical defect, enthesophytes
69	1253	old middle adult	F	160cm	-	caries, calculus, periodontal disease, disuse of left dentition, absent PM4	DJD, SN, cortical defect, enthesophytes
70	1256	old middle adult	M	172cm	69.0	calculus, periodontal disease, EH	SN, osteomyelitis, NSPI, gout, healed rickets
71	1259	younger childhood	-	-	-	-	-
72	1264	young middle adult	M	171cm	81.5	caries, calculus, periodontal disease, EH, abscesses	DJD, SN, intervertebral disc herniation, incompletely fused arch of S1, exostosis, os acromiale, avulsion fracture – calcaneus, cyst, cortical defect, enthesophytes, prominent muscle attachment
73	1278	mature adult	F	155cm	-	-	DJD, SN, incompletely fused arch of S1, avulsion fracture – calcaneus, navicular, prominent muscle attachments
74	1283	young middle adult	M	179cm	-	caries, calculus, periodontal disease, EH, abscess	OA, SN, osteochondritis dissecans, incompletely fused neural arch of S1, kyphosis, NSPI, fracture – ribs, cribra orbitalia, infection of lower abdomen, incompletely fused sternal body, cortical defect, enthesophytes
75	1287	mature adult	?F	157cm	-	caries, calculus, periodontal disease, abscesses	OA, DJD, SN, intervertebral disc herniation, dislocation – humerus, sinusitis, cortical defect
76	1294	adult	-	178cm	-	-	DJD, NSPI, healed rickets, fracture – 1 <sup>st</sup> cuneiform, foot phalanx, gout, osteochondritis dissecans, fusion of capitate and trapezoid, enthesophytes

SK No.	Context No.	Age	Sex	Stature	Cranial index	Dental pathology	Pathology
77	1297	adult	-	179cm	-	-	DJD, avulsion fracture – MC3, healed rickets
78	1301	mature adult	M	181cm	-	caries, calculus, EH	OA, SN, cervical rib, DJD, gout, enthesophytes
79	1304	mature adult	M	175cm	-	calculus	OA, SN, DJD, dislocation – humerus, fracture – tibia, foot phalanx, sternal body, NSPI, new bone on ribs, gout, asymmetry of lower arms, cortical defects, enthesophytes
80	1307	adult	-	175cm	-	-	enthesophyte
81	1312	adolescent	-	-	-	caries, calculus	incompletely fused neural arch of C1, 13 thoracic vertebrae, transitional vertebrae, 13 ribs, fractures – tibiae, delayed skeletal growth, cortical defect
82	1321	mature adult	?F	165cm	-	calculus, periodontal disease, possible disuse of right teeth, am tooth chipping	OA, SN, spondylolysis, DJD, fracture – ulna, button osteoma, roughened muscle attachment
83	1327	adult	?F	154cm	-	caries, calculus, periodontal disease, EH, abscesses, am tooth chipping	OA, DJD, SN, sacralisation of L5, ?DISH
84	1338	adolescent	-	-	-	caries, calculus	cribra orbitalia, fracture – clavicle, delayed skeletal growth and maturation, cortical defect
85	1341	adult	-	170cm	-	-	OA, exostosis, osteochondritis dissecans, enthesophytes
86	1344	young adult	?F	156cm	-	calculus, periodontal disease, EH, peg tooth	DJD, peri-mortem fracture – ulna, cranium, humerus, peri-mortem blade injuries – cranium, humerus, NSPI, cribra orbitalia
87	1347	adult	-	167cm	-	-	DJD, enthesophyte
88	1355	younger childhood	-	-	-	calculus	exostosis, cribra orbitalia, delayed skeletal growth
89	1358	mature adult	F	162cm	-	-	DJD, fracture – MC1, hand phalanges, tibiae, enthesophytes
90	1361	mature adult	F	156cm	-	-	OA, SN, DJD, NSPI, fractures – ribs, scapula, foot phalanges, dislocation – humerus, osteoporosis, enthesophytes
91	1364	old middle adult	M	175cm	-	caries, calculus, periodontal disease, EH, abscess	OA, DJD, SN, 6 lumbar vertebrae, spondylolysis, hypertrophic osteoarthropathy, fractures – ribs, MC4, MC5, femur, fibula, avulsion fracture – MC3, exostosis, sinusitis, osteochondritis dissecans, enthesophytes
92	1367	adolescent	-	-	-	caries, calculus, EH, retained deciduous dm1, absent PM4	NSPI, infection of lower abdomen, delayed skeletal growth, cortical defects
93	1370	mature adult	M	169cm	76.0	caries, calculus, periodontal disease, EH, abscesses	OA, SN, traumatic ankylosis/ankylosing spondylitis, scoliosis, kyphosis, 11 thoracic and 6 lumbar vertebrae, DJD, fracture – hand phalanx, calcaneus, os coxa, leg held in flexion as result of fracture, dislocation – humerus, exostosis, cortical defect, enthesophytes
94	1373	adolescent	?F	157cm	-	calculus, EH	SN, NSPI, cyst/cortical defect Other info: Negroid cranial features

SK No.	Context No.	Age	Sex	Stature	Cranial index	Dental pathology	Pathology
95	1376	young adult	M	168cm	78.5	calculus, EH	SN, ?brucellosis, new bone on ribs, NSPI, sinusitis, osteochondritis dissecans, depressed cranial fracture, cortical defect, enthesophytes
96	1379	old middle adult	F	163cm	-	calculus, periodontal disease, EH	DJD, SN, os acromiale, osteochondritis dissecans, cortical defect
97	1382	younger childhood	-	-	-	caries, calculus	cribra orbitalia, gracile long bones
98	1385	younger childhood	-	-	-	-	6 lumbar vertebrae, incompletely fused arches of L5 and L6, cribra orbitalia, new bone on cranium, delayed skeletal growth
99	1402	young middle adult	M	177cm	-	caries, calculus, periodontal disease, EH, abscesses, am tooth chipping	DJD, SN, OA, cribra orbitalia, button osteoma, depressed cranial fracture, os acromiale, osteochondritis dissecans, cortical defect, enthesophytes
100	1405	younger childhood	-	-	-	-	6 lumbar vertebrae, anaemia
101	1408	old middle adult	?M	179cm	-	-	DJD, prominent muscle attachment
102	1411	older childhood	-	-	-	-	cortical defect
103	1414	mature adult	F	164cm	-	caries, calculus, periodontal disease	OA, DJD, SN, 6 lumbar vertebrae, hypertrophic osteoarthropathy, avulsion fracture – ulna, fracture – nasals, depressed cranial fracture, sinusitis, feet held in extreme dorsiflexion, cortical defect, enthesophytes
104	1417	old middle adult	F	157cm	-	caries, calculus, periodontal disease, abscess, ?peri-mortem root fracture	DJD, SN, transitional vertebrae, OA, fracture – rib, radius, hand phalanx, button osteomae, hyperostosis frontalis interna, sinusitis, enthesophytes, prominent muscle attachments Other info: Negroid cranial features
105	1420	young adult	F	166cm	-	-	SN, NSPI, fracture – sesamoid, cyst
106	1423	old middle adult	?M	175cm	92.5	caries, calculus, periodontal disease, EH, abscess, toothpick use	OA, DJD, SN, kyphosis, sacrum with 6 segments, intervertebral disc herniation, NSPI, cribra orbitalia, avulsion fracture – calcaneus, osteochondritis dissecans, infectious process, bent humeri, cortical defect, enthesophytes, roughened muscle attachments
107	1426	adult	?F	160cm	-	-	OA, DJD, depressed cranial fracture, button osteoma, enthesophytes
108	1464	adult	-	164cm	-	-	DJD, NSPI, fractures/Paget's disease – femorae, osteochondritis dissecans
109	1467	adult	-	161cm	-	-	DJD, osteochondritis dissecans, enthesophytes
110	1262	adult	?M	-	-	-	-
111	1555	adult	-	-	-	-	NSPI, avulsion fracture – calcaneus, osteochondritis dissecans, healed rickets
112	1557	older childhood	-	-	-	calculus	scurvy/NSPI, exostosis, delayed skeletal growth, cortical defect
113	1559	old middle adult	F	159cm	-	-	DJD, healed rickets, enthesophytes
114	1577	older childhood	-	-	-	calculus, EH	delayed skeletal growth and maturation

SK No.	Context No.	Age	Sex	Stature	Cranial index	Dental pathology	Pathology
115	1636	young middle adult	M	171cm	-	-	DJD, SN, DISH, lumbar ribs, NSPI, fracture – triquetral, hand phalanx, cortical defects, enthesophytes
116	2052	old middle adult	?F	161cm	-	caries, calculus, periodontal disease, abscesses	OA, compression fractures – T3, T6-T8, T10, T11, kyphosis, DJD, avulsion fracture – calcaneus, os acromiale, healed rickets, leprosy, enthesophytes, roughened muscle attachments
117	2060	mature adult	F	161cm	-	caries, calculus, periodontal disease, EH, abscesses	OA, SN, DJD, sinusitis, fracture – foot phalanx, enthesophytes, roughened muscle attachments
118	1047	young middle adult	F	156cm	73.0	calculus	SN, NSPI, exostosis, os acromiale, enthesophytes

## 5 CONCLUSION

The excavations at the junction of Dixon Lane and George Street in York proved to be of exceptional interest for a number of reasons including the chronology of the site's development, the presence of Anglian remains and the quality of the objects recovered (a Roman gold and carnelian finger ring, a Roman jet bear and shale bracelet, a small fragment of imported Anglian glass and Anglian Tating ware pottery).

Although the Roman remains were difficult to interpret due to heavy later truncation, there is evidence for terracing the site to provide suitable flat land for buildings, some evidence of possible timber structures (though this was difficult to interpret), and hints of the use of the area for a late Roman cemetery. In common with other sites in York there is no identifiable stratigraphic evidence for what happened here in the immediate aftermath of the withdrawal of Roman troops from Britain c. 410 AD, although the presence of a gold ring of a type attributed to the late 4th or 5th century suggests occupation or activity at around that time.

The site was settled again during the late 7th century. The Anglian remains included a boundary ditch, a series of timber buildings, one (possibly two) sunken-featured buildings and a number of rubbish pits. Excavated Anglian remains are comparatively rare in York; it seems that these features may represent the spatial continuation of the Anglian settlement seen in excavations some 360m to the south at 46–54 Fishergate, Blue Bridge Lane and Fishergate House (see 1.1). The economy of the site seems to have been based upon craft industries and trade with both southern Britain and Continental Europe.

The apparently unbroken continuity of occupation and activity here from the Anglian into the Anglo-Scandinavian period (see 4.2) is of significance for our understanding of how that political and economic transition affected the topography of York. The Anglo-Scandinavian remains mainly comprised large pits, with little evidence for structures of any kind, though these could have been located close by. The material from the pits was suggestive of craft-working in the vicinity. During the early 11th century the function of the site changed, with the establishment of a cemetery. Although only a small number of burials were present, they were of interest for the variety of burial practices they exhibited. There was no sign of an accompanying church; if it stood below the later medieval church, it too would have been destroyed by Victorian intrusions.



It is known that a church dedicated to St Stephen stood in this vicinity, and the medieval cemetery can confidently be associated with that church. It continued in use from Norman times to the early 14th century, when the church was closed. The post-Conquest graves were on a notably different alignment to those of pre-Conquest date, strongly correlating with the alignment of a boundary ditch. The post-Conquest burials were also far more uniform in terms of burial practices. Notable among this group of graves were the skeleton of a leper, and two burials interpreted as having possibly non-European ancestry. All three of these graves were placed close to the cemetery boundary ditch, which may imply that these individuals were considered marginal within contemporary society.

## 6 BIBLIOGRAPHY

Adams, M., 1996. 'Excavation of a pre-Conquest Cemetery at Addingham, West Yorkshire', *Medieval Archaeology* **40**, 151–91

Allason-Jones, L., 1996. *Roman Jet in the Yorkshire Museum* (York)

Andrews, P. (ed), 1997. Excavations at Hamwic Volume 2: excavations at Six Dials, *Council for British Archaeology Research Report* **109** (York)

Arthur, P. and Williams, D.F., 1992. 'Campanian wine, Roman Britain and the third century A.D.', *Journal of Roman Archaeology* **5**, 250–60

**AY. Addyman, P. V. or Hall, R. A. (eds). *The Archaeology of York***

### **AY 1 Sources for York History to AD 1100:**

Rollason, D. W., 1998. Sources for York History to AD 1100

### **AY 4 The Colonia:**

1 Carver, M. H. O., Donaghey, S. and Sumpter, A. B., 1978. Riverside Structures and a Well in Skeldergate and Buildings in Bishophill

### **AY 6 Roman Extra-mural Settlements and Roads**

1 Brinklow, D., Hall, R. A., Magilton, J. R. and Donaghey S., 1986. Coney Street, Aldwark and Clementhorpe, Minor Sites, and Roman Roads

**AY 7 Anglian York:**

- 1 Kemp, R. L., 1996. Anglian Settlement at 46–54 Fishergate
- 2 Tweddle, D., Moulden, J. and Logan, E., 1999. Anglian York: A Survey of the Evidence

**AY 8 Anglo-Scandinavian York:**

- 4 Hall, R. A., 2004. Aspects of Anglo-Scandinavian York

**AY 12 The Medieval Cemeteries:**

- 1 Dawes, J. D. and Magilton, J. R., 1980. The Cemetery of St Helen-on-the-Walls, Aldwark
- 2 Stroud, G. and Kemp, R. L. 1993. The Cemeteries of St Andrew Fishergate, York
- 3 Lilley, J. M., Stroud, G., Brothwell, D. R. and Williamson, M. H., 1994. The Jewish Burial Ground at Jewbury

**AY 15 The Animal Bones**

- 3 O'Connor, T. P., 1989. Bones from Anglo-Scandinavian Levels at 16–22 Coppergate
- 4 O'Connor, T. P., 1991. Bones from 46–54 Fishergate

**AY 16 The Pottery:**

- 1 Holdsworth, J., 1978. Selected Pottery Groups AD 650–1780
- 2 Perrin, J.R., 1981. Roman Pottery from the Colonia: Skeldergate and Bishophill
- 4 Perrin, J. R., 1990. Roman Pottery from the Colonia 2: General Accident and Rougier Street
- 5 Mainman, A.J., 1990. Anglo-Scandinavian Pottery from 16–22 Coppergate
- 6 Mainman, A.J., 1993. Pottery from 46–54 Fishergate
- 7 Monaghan, J. 1993. Roman Pottery from the Fortress: 9 Blake Street
- 8 Monaghan, J., 1997. Roman Pottery from York

**AY 17 The Small Finds:**

- 3 MacGregor, A., 1982. Anglo-Scandinavian Finds from Lloyds Bank, Pavement and Other Sites
- 6 Ottaway, P. 1992. Anglo-Scandinavian Ironwork from Coppergate
- 9 Rogers, N.S.H., 1993. Anglian and Other Finds from 46–54 Fishergate
- 11 Walton Rogers. P., 1997. Textile Production at 16–22 Coppergate
- 12 MacGregor, A., Mainman, A.J. and Rogers, N.S.H. 1999. Craft, Industry and Everyday Life: Bone, Antler, Ivory and Horn from Anglo-Scandinavian and Medieval York
- 14 Mainman, A.J., and Rogers, N. S. H., 2000. Finds from Anglo-Scandinavian York

15 Ottaway, P.J. and Rogers, N.S.H., 2002. Craft, Industry and Everyday Life: Finds from Medieval York

**AY Supplementary Series:**

1 Wilson, B. and Mee, F., 1998. The mMedieval Parish Churches of York: the Pictorial Evidence

**AY Web publications:**

1 Macnab, N., 2003. *Anglo-Scandinavian, medieval and post-medieval urban occupation at 41–49 Walmgate, York, UK*

- Hunter-Mann, K. and Johnson, M. (forthcoming) Excavation of a Roman cemetery at Driffield Terrace, York

- Rogers, N.S.H. (in prep.) The small finds from 3 and 6 Driffield Terrace

Ayers, B., 1985. Excavations within the North-east Bailey of Norwich Castle 1979, *East Anglian Archaeology* **28**

Bayley, J. and Doonan, R., 2000. 'Glass Manufacturing Evidence' in *AY* 17/14, 2519–28

Betts, I. M., 1985. *A scientific investigation of the brick and tile industry of York to the mid 18th century*, unpublished PhD thesis, University of Bradford

Biddle.M., 1990. 'Tweezers' in M. Biddle (ed.), 'Object and Economy in Medieval Winchester', *Winchester Studies* **7 ii** (Oxford), 690–2

Bidwell, P., 2005. 'The dating of Crambeck Parchment Ware', *Journal of Roman Pottery Studies* **12**, 15–21

Binski, P., 1996. *Medieval Death Ritual and Representation* (British Museum Press)

Boddington, A., 1996. Raunds Furnells, The Anglo-Saxon Church and Churchyard, *English Heritage Archaeological Report* **7**

Boessneck, J., 1969. Osteological differences between sheep (*Ovis aries* Linné) and goat (*Capra hircus* Linné), in D. Brothwell and E. S. Higgs, (eds.), *Science in Archaeology*. (London Thames and Hudson), 331-58

- Bonifay, M., 2004. Études sur la céramique romaine tardive d'Afrique, *BAR Int Series* **S1301** (Oxford)
- Bronk Ramsey, C., 1995. 'Radiocarbon Calibration and Analysis of Stratigraphy: The OxCal Program', *Radiocarbon* **37**, 425–30
- Brooks, S. and Suchey, J.M., 1990. 'Skeletal age determination based on the os pubis: a comparison of the Acsádi-Nemeskéri and Suchey-Brooks methods', *Human Evolution* **5**, 227–38
- Brothwell, D.R., 1981. *Digging Up Bones* (Oxford: Oxford University Press)
- Brothwell, D., Dobney, K. and Ervynck, A., 1996. 'On the cause of perforations in archaeological domestic cattle skulls', *International Journal of Osteoarchaeology* **6**, 471–87
- Brown, D. and Lawson, G., 1990. 'Toggles', in M. Biddle (ed), *Object and Economy in Medieval Winchester* **7** ii (Oxford), 589–91
- Brushfield, T.N. 1853. 'Communication', *Journal British Archaeological Association* **8**, 160–1
- Buikstra, J.E. and D.H. Ubelaker (eds.), 1994. 'Standards for Data Collection from Human Skeletal Remains', *Arkansas Archaeological Survey Research Series* **44**. (Fayetteville: Arkansas Archaeological Survey)
- Chadburn, A. 1995. 'More artefacts from the Thetford treasure?', *Britannia* **26**, 323
- Chamberlain, A., 2000. 'Problems and prospects in palaeodemography', in M. Cox and S. Mays (eds.) *Human Osteology in Archaeology and Forensic Science* (London: Greenwich Medical Media), 101–15
- Clark, J., 1995. *The Medieval Horse and its Equipment. Medieval finds from Excavations in London c.1150–c.1450* (London)
- Cool, H.E.M, 1983. *Roman personal ornaments made of metal, excluding brooches, from southern Britain*, unpublished PhD (University of Wales)

- Cool, H.E.M., 1998. 'Early occupation at St. Mary's Abbey, York: the evidence of the glass', in J. Bird (ed.), 'Form and Fabric; studies in Rome's material past in honour of B.R. Hartley', *Oxbow Monograph* **80** (Oxford), 301–5
- Cool, H.E.M., 2000. 'The parts left over: material culture into the fifth century', in T. Wilmott and P. Wilson (eds), 'The Late Roman transition in the North', *BAR British Series* **299**(Oxford), 47–65
- Cool, H.E.M. 2002a. 'Bottles for Bacchus?' in M. Aldhouse-Green and P. Webster, *Artefacts and Archaeology* (Cardiff), 132–51
- Cool, H.E.M., 2002b. 'Craft and industry in Roman York', in P. Wilson and J. Price (eds.), *Aspects of Industry in Roman Yorkshire and the North* (Oxford), 1–11
- Cool, H.E.M., 2004. *The non-ferrous metalwork from Barton Street, Manchester*. Report for University of Manchester Archaeological Unit
- Cool, H.E.M., 2006. *Eating and Drinking in Roman Britain* (Cambridge)
- Cool, H.E.M. and Price, J., forthcoming. 'The vessel glass' in H.E.M. Cool and D.J.P. Mason (eds.), *Roman Piercebridge: Excavations by D.W. Harding and Peter Scott 1969–1981*
- Corder, P., 1930. 'The Roman Pottery at Throlam, Spalding-on-the-Moor, East Yorkshire'. *Roman Malton and District Report* **3** (Hull)
- Corder, P. 1948. 'Miscellaneous objects from the Roman fort at Malton', *Antiquaries Journal* **28**, 173–7
- Cowgill, J., de Neergard, M. and Griffiths, N., 1987. *Knives and Scabbards. Medieval Finds from Excavations in London* **1** (London: HMSO)
- Crummy, N., 1983. 'The Roman Small Finds from Excavations in Colchester 1971–9', *Colchester Archaeological Reports* **2** (Colchester)
- Cullum, P. H., 1994. 'Leper-houses and leprosy during the Middle Ages', *Interim* **19/2**, 24–31
- Daniell, C., 1997. *Death and Burial in Medieval England 1066–1500*

Daniell, C., 2002. 'Conquest, Crime and Theology in the Burial record 1066–1200', in S. Lucy and A. Reynolds (eds), 'Burial in Early Medieval England and Wales', *Society for Medieval Archaeology Monograph* **17**, 240–54

Darling, M.J., 2004. 'Guidelines for the archiving of Roman Pottery', *Journal of Roman Pottery Studies* **11**, 67–74

Dobney, K. and Rielly, K., 1988. 'A method for recording archaeological animal bones: the use of diagnostic zones', *Circaea* **5**, 79–96

Dobney, K., Jaques, D. and Johnstone, C., 1999. *Protocol for recording vertebrate remains from archaeological sites*, Reports from the Environmental Archaeology Unit, York **99/15**

Dobney, K., Jaques, D., Barrett, J. and Johnstone, C. (in press). *Farmers, Monks and Aristocrats: The environmental archaeology of Anglo-Saxon Flixborough, North Lincolnshire, UK* (Oxford: Oxbow Books)

Drinkall, G. and Foreman, M. (eds.), 1998. 'The Anglo-Saxon Cemetery at Castledyke South, Barton-upon-Humber', *Sheffield Excavation Reports* **6** (Sheffield)

Drury, P.J. 1988. 'The Mansio and other Sites in the south-eastern sector of Caesaromagus', *Council for British Archaeology Research Report* **66** (London)

Evans, J., 1993. 'Pottery function and finewares in the Roman north', *Journal of Roman Pottery Studies* **6**, 95–119

Evans, J., 2001. 'Material approaches to the identification of different Romano-British site types', in S. James and M. Millett, 'Britons and Romans: advancing an archaeological agenda', *Council for British Archaeology Research Report* **125**, 26–35

Farmer, D.H., 1996. *The Oxford Dictionary of Saints* (Oxford University Press)

Foch, J., 1966. *Metrische Untersuchungen an Metapodien einiger europäischer Rinderrassen*. University of Munich, unpublished dissertation

Fox, G.E. 1895. 'Excavations on the Roman city at Silchester, Hants, 1895', *Archaeologia* **54**, 439–94

- Gilchrist, R. and Sloane, B., 2005. *Requiem. The Medieval Monastic Cemetery in Britain*(New North printers)
- Gillam, J.P., 1976. 'Coarse fumed ware in northern Britain and beyond', *Glasgow Archaeological Journal* **4**, 57–89
- Graham-Campbell, J., 1980. *Viking Artefacts* (London)
- Grant, A., 1982. 'The use of tooth wear as a guide to the age of domestic ungulates', in Wilson, B., Grigson, C. and Payne, S. (eds), *Ageing and sexing animal bones from archaeological sites*. British Archaeological Reports, British Series **109** (Oxford), 91–108
- Hadley, D.M., 2001. *Death in Medieval England* (Tempus Publishing, Stroud, Gloucestershire)
- Hadley, D.M., 2002. 'Burial Practices in Northern England in the Later Anglo-Saxon Period', in S. Lucy and A. Reynolds (eds), 'Burial in Early Medieval England and Wales', *Society for Medieval Archaeology Monograph* **17**, 209–28
- Hagen, W., 1937. 'Kaiserzeitliche Gagatarbeiten aus dem rheinischen Germanien', *Bonner Jahrbuch* **142**, 77–143
- Haldenby, D., 1990. 'An Anglian Site on the Yorkshire Wolds', *Yorkshire Archaeological Journal* **62**, 51–63
- Haldenby, D., 1992. 'An Anglian Site on the Yorkshire-Wolds - Continued', *Yorkshire Archaeological Journal* **64**, 25–39
- Haldenby, D., 1994. 'Further Saxon Finds from the Yorkshire Wolds', *Yorkshire Archaeological Journal* **66**, 51–8
- Halkon, P. and Millett, M. 1999. 'Rural Settlement and Industry: studies in the Iron Age and Roman Archaeology of Lowland East Yorkshire', *Yorkshire Archaeological Report* **4**(Yorkshire Archaeological Society, Roman Antiquities Section and East Riding Archaeological Society)

- Hayes, R.H. and Whitley, E., 1950. The Roman Pottery at Norton, East Yorkshire. *Roman Malton and District Report 7* (Oxford)
- Henig, M. and Wickenden, N.P., 1988. 'A hoard of jet and shale', in P.J. Drury, 'The Mansio and other Sites in the south-eastern sector of Caesaromagus', *Council for British Archaeology Research Report 66*, 107–10
- Hill, P., 1997. *Whithorn and St Ninian, the Excavation of a Monastic Town 1984–1991*
- Holbrook, N. and Bidwell, P.T., 1991. 'Roman Finds from Exeter', *Exeter Archaeological Report 4* (Exeter City Council and The University of Exeter)
- Holdsworth J., 1995. 'Post-Roman pottery', in D. Phillips and B. Heywood, *Excavations at York Minster Vol. 1 Part 2. The Finds*, 468–80
- Hooley, A.D., 2002. 'Leather from Catterick Bypass' in P.R. Wilson (ed.), 'Cataractonium: Roman Catterick and its hinterland. Excavations and research 1958–1997', *Council for British Archaeology Research Report 129* ii, 318–80
- Hurst J., 1959. 'Note on a middle Saxon sherd', in K. M. Richardson, 'Excavations in Hungate, York', *Archaeological Journal 116*, 76
- Jackson, S., 1988. 'Copper alloy objects', in R. Daniels (ed.), 'The Anglo-Saxon monastery at Church Close, Hartlepool, Cleveland', *Archaeological Journal 145*, 195–6
- Jaques, D., Carrott, J., Schmidl, A. and Gardner, S., 2006. *Evaluation of biological remains from excavations on land at the junction of Dixon Lane and George Street, York (site code: YORAT 2005.3203)*. **PRS2006/53**
- Jessop, O., 1996. 'A New Artefact Typology for the Study of Medieval Arrowheads', *Medieval Archaeology 40*, 192–205
- Johns, S. and Potter, T. 1983. *The Thetford Treasure* (London)



- Kjølbye-Biddle, B., 1995. 'Iron-bound coffins and coffin-fittings from the pre-Norman cemetery' in D. Phillips and B. Heywood, *Excavations at York Minster Volume 1, From Roman Fortress to Norman Cathedral Part 2 The Finds*, 489–521
- Lang, J. 1991. *York and Eastern Yorkshire. Corpus of Anglo-Saxon Stone Sculpture Volume III* (Oxford)
- Laubenheimer, F., 1985. *La Production des Amphores en Gaule Narbonnaise* (Paris)
- Leahy, K., 2000. 'Middle Anglo-Saxon Metalwork from South Newbald and the "Productive Site" Phenomenon in Yorkshire', in H. Geake and J. Kenny (eds.), *Early Deira. Archaeological Studies of the East Riding in the fourth to ninth centuries AD*, 51–82
- Le Patourel, H.E.J., 1968. 'Medieval pottery' in I. M. Stead, 'An excavation in King's Square, York, 1957, Yorkshire', *Archaeological Journal* **42**, 165–7
- Lilley, J.M., 1990. *Report of and Archaeological evaluations at 41–49 Walmgate and George Street, York*, York Archaeological Trust Field Report
- MacGregor, A., 1985. *Bone, Antler, Ivory and Horn, The Technology of Skeletal Materials since the Roman Period* (London: Croom Helm)
- Mainman, A.J., forthcoming. *The Anglo-Saxon pottery from Heslington Hill, York*
- Mainman, A.J. and Rogers, N.S.H., 2004. 'Craft and Economy in Anglo-Scandinavian York', in AY 8/4
- Manning, W.H., 1985. *Catalogue of the Romano-British Iron Tools, Fittings and Weapons in the British Museum* (London)
- Marshall, F.H. 1907. *Catalogue of the Finger Rings, Greek, Roman and Etruscan, in the Departments of Antiquities British Museum* (London)
- Matolski, J., 1970. 'Historische Erforschung der Körpergröße der Rinde auf Grund von ungarischem Knochenmaterial', *Zeitschrift für Tierzüchtung und Züchtungsbiologie* **87**, 89–137

- May, T., 1930. *Catalogue of the Roman Pottery in the Colchester and Essex Museum*(Cambridge)
- McComish, J., 2006. *Land at the Junction of Dixon Lane and George Street, York*, York Archaeological Trust Field Report 2006/53
- McDonnell, J.G., 1992. 'The Ironworking Residues', in *AY* 17/6, 471–80
- McDonnell, J.G., 1993. 'Ironworking', in *AY* 17/9, 1224–8
- McKinley, J.I., 1994. 'The Anglo-Saxon Cemetery at Spong Hill, North Elmham, Part VIII: the Cremations', *East Anglian Archaeology* **69**
- Merrifield, R., 1987. *The Archaeology of ritual and magic* (London)
- Molleson, T., Cruse, K. and Mays, S., 1998. 'Some sexually dimorphic features of the human juvenile skull and their value in sex determination in immature skeletal remains', *Journal of Archaeological Science* **25**, 719–28
- Moorhouse, S. (ed), 1972, 'The Yorkshire Archaeological Register 1971', *Yorkshire Archaeological Journal* **44**, 217–27
- Mortimer, C. 2005. In C.A.. Spall and N.J. Toop (eds), *Craft and Industries: Ferrous Metal-Working 2005, Blue Bridge Lane and Fishergate House, York*. <http://www.archaeologicalplanningconsultancy.co.uk/mono/001/index.html>
- Mytum, H., 1993. 'Kellington Church', *Current Archaeology* **133**, 15–17
- O'Connor, T. P., 2001. 'On the interpretation of animal bone assemblages from wics', in D. Hill and R. Cowie (eds), *Wics: The Early Medieval Trading Centres of Northern Europe*(Sheffield: Sheffield Academic Press), 54–60
- Oswald, A., 1937. *The Roman Pottery kilns at Little London, Torksey, Lincolnshire*(privately printed)
- Ordnance Survey 1988. *Historical Map and Guide, Roman and Anglian York* (Royal Commission on the Historical Monuments of England)
- Ottaway., P., 1993. *Roman York* (B T Batsford/English Heritage, London)

- Palliser, D.M., 1978. 'The Medieval Street-Names of York', *York Historian* **2**, 2–16
- Panter, I., 1994. 'Well Travelled Coffins', *Interim* **9/3**, 26–33
- Parker Pearson, M., 1999. *The Archaeology of Death and Burial*
- Payne, S., 1973. 'Kill-off patterns in sheep and goats: the mandibles from Asvan Kale', *Anatolian Studies* **23**, 281–303
- Payne, S., 1987. 'Reference codes for the wear state in the mandibular cheek teeth of sheep and goats', *Journal of Archaeological Science* **14**, 609–14
- Peacock, D.P.S. and Williams, D.F., 1986. *Amphorae and the Roman Economy*, London
- Peers, C. and Radford, C.A.R., 1943. 'The Saxon Monastery at Whitby', *Archaeologia* **89**, 27–88
- Perrin, J. R., 1999. 'Roman Pottery from Excavations at and near to the Roman Small Town of Durobrivae, Water Newton, Cambridgeshire, 1956–58', *Journal of Roman Pottery Studies* **8**
- Phillips, D. and Heywood, B., 1995. *Excavations at York Minster Volume 1, From Roman Fortress to Norman Cathedral Part 1 The Site*
- Pooley, L. and Crummy, N., 2007. 'Colchester Essex. Roman grave assemblage 2004 T3990', in Anon, *Treasure Annual Report 2004* (London), 57–8
- Powlesland, D., 1996. West Heslerton, the Anglian Settlement: assessment of potential for analysis 2. Unpublished report for English Heritage (London)
- Price, J., 2002. 'Two vessels from Llandovery, Carmarthenshire, and Piercebridge, County Durham: A note on Flavian and later polychrome mosaic glass in Britain', in M. Aldhouse-Green and P. Webster (eds), *Artefacts and Archaeology* (Cardiff), 112–31
- Prummel, W., 1987. 'Atlas for identification of foetal skeletal elements of cattle, horse, sheep and pig. Part 2', *Archaeozoologia* **1(2)**, 11–52
- Raine, A., 1955. *Medieval York*
- Rawcliffe, C., 2006. *Leprosy in Medieval England*

Reimer, P. J., Baillie, M. G. L., Bard, E., Bayliss, A., Beck, J. W., Bertrand, C. J. H., Blackwell, P. G., Buck, C. E., Burr, G. S., Cutler, K. B., Damon, P. E., Edwards, R. L., Fairbanks, R. G., Friedrich, M., Guilderson, T. P., Hogg, A. G., Hughen, K. A., Kromer, B., McCormac, F. G., Manning, S., Bronk Ramsey, C., Reimer, R. W., Remmele, S., Southon, J. R., Stuiver, M., Talamo, S., Taylor, F. W., van der Plicht, J., and Weyhenmeyer, C. E., 2004. 'IntCal04 Terrestrial Radiocarbon Age Calibration, 0–26 cal kyr BP', *Radiocarbon***46**, 1029–58

RCHMY **1**. Royal Commission on Historical Monuments (England). *An inventory of the Historical Monuments in the City of York. 1 Eburacum, Roman York* (1962) (London)

RCHMY **5**. Royal Commission on Historical Monuments (England). *The Central Area: An Inventory of the Historical Monuments in the City of York 5* (1981) (London)

Richards, J.D., 2002. 'The case of the Missing Vikings: Scandinavian Burial in the Danelaw', in S. Lucy and A. Reynolds (eds), 'Burial in Early Medieval England and Wales', *Society for Medieval Archaeology Monograph* **17**, 157–70

Richmond, I.A. and Gillam, J.P., 1951. 'The temple of Mithras at Carrawburgh', *Archaeologia Aeliana, fourth series* **29**, 1–92

Rigby, V. 1980. 'The pottery', in I. M. Stead, *Rudston Roman Villa*, 41–94

Rixson, D., 1989. 'Butchery evidence on animal bones', *Circaea* **6 (1)**, 49–62

Roberts, C. and Cox, M., 2003. *Health and Disease in Britain from Prehistory to the Present Day* (Stroud: Sutton Publishing)

Rodwell, K. A., 1988. 'The prehistoric and Roman Settlement at Kelvedon, Essex', Council for British Archaeology Research Report **63** (London)

Rodwell, W. and Rodwell, K., 1982. 'St Peter's Church, Barton-upon-Humber: Excavation and Structural Study 1978–81', *Antiquaries Journal* **LXII**, part 2, 283–315

Rodwell, W., 1989. *The Archaeology of Churches*

Rodwell, W., 2005. *The Archaeology of Churches* (Tempus)

Rodwell, W., 2007. 'Burial Archaeology', in T. Waldron, *St Peter's Church, Barton-upon-Humber, Lincolnshire: A Parish Church and its Community, Volume 2 The Human Remains*, 15–

Rogers, N.S.H., in prep. 'The Pins', in C. Loveluck and D. Atkinson (eds), *The Early Medieval Settlement Remains from Flixborough, Lincolnshire: The Occupation Sequence, c. AD 600–1000*

Ross, S., 1991. *Dress Pins from Anglo-Saxon England: their production and typo-chronological development*, Unpublished DPhil thesis, University of Oxford

Ross, S., 1998. 'The pins' in G. Drinkall and M. Foreman (eds.), 'The Anglo-Saxon Cemetery at Castledyke South, Barton-upon-Humber', *Sheffield Excavation Reports* **6**(Sheffield), 267–70

Rowland, S., 2005. 'The animal and fish bone', in C.A. Spall and N.J.Toop (eds), *Blue Bridge Lane & Fishergate House, York. Report on Excavations: July 2000 to July 2002*, [http://www.archaeologicalplanningconsultancy.co.uk/mono/001/rep\\_bone\\_animal.html](http://www.archaeologicalplanningconsultancy.co.uk/mono/001/rep_bone_animal.html)

Rumble, A. R. 1980. 'Hamton alias Hamwic (Saxon Southampton): the place-name traditions and their significance', in P Holdsworth (ed), 'Excavations at Melbourne Street, Southampton, 1971–76', *Council for British Archaeology Research Report* **33** (London)

Scheuer, L. and Black, S., 2000. *Developmental Juvenile Osteology* (San Diego: Academic Press)

Schutkowski, H. 1993. 'Sex determination of infant and juvenile skeletons. I Morphognostic features', *American Journal of Physical Anthropology* **90**, 199–205

Stace, C., 1997. *New Flora of the British Isles: second edition* (Cambridge: Cambridge University Press)

Stead I. M., 1958. 'Excavations at the south corner tower of the Roman fortress at York, 1956', *Yorkshire Archaeological Journal* **39**, 426

Stead, I.M., 1980. *Rudston Roman Villa* (Yorkshire Archaeological Society)

Swan, V.G., 1992. 'Legio VI and its men: African legionaries in Britain', *Journal of Roman Pottery Studies* **5**, 1–33

- Swan, V.G., 2002. 'The Roman pottery of Yorkshire in its wider historical context', in P. Wilson and J. Price (eds), *Aspects of industry in Roman Yorkshire and the North* (Oxford: Oxbow), 35–79
- Swan, V.G. and Monaghan, J., 1993. 'Head pots: a Northern African tradition in Roman York', *Yorkshire Archaeological Journal* **65**, 215038
- Sykes, N., 2006. 'From Cu and Scaep to Beffe and Motton. The management, distribution, and consumption of cattle and sheep in medieval England', in C.M. Woolgar, D. Serjeantson, and T. Waldron (eds), *Food in Medieval England*. (Oxford: Oxford University Press), 56–71
- Symonds, R.P., 1992. 'Rhenish wares', *Oxford University Committee for Archaeology. Monograph* **23**
- Talbot, J., 1846. 'A note on the Terling Place find', *Archaeological Journal* **3**, 162–3
- Teichert, M., 1975. 'Osteometrische Untersuchungen zur Berechnung der Widerristhöhe bei Schafen', in A.T. Clason (ed.), *Archaeological studies* (Amsterdam: Elsevier), 51–69
- Tomber, R. and Dore, J., 1998. 'The National Roman Fabric Reference Collection. A Handbook', *MOLAS Monograph* **2** (London)
- Trotter, M., 1970. 'Estimation of stature from intact limb bones', in T.D. Stewart (ed.), *Personal Identification in Mass Disasters* (Washington D.C.: National Museum of Natural History, Smithsonian Institution), 71–83
- Walton Rogers, P., 1998. 'Textiles and costume' in G. Drinkall and M. Foreman (eds.), 'The Anglo-Saxon Cemetery at Castledyke South, Barton-upon-Humber', *Sheffield Excavation Reports* **6** (Sheffield) 274–9
- Walton Rogers, P., 1999. 'Textile making equipment', in *AY* 17/12
- Weaver, D.S., 1980. 'Sex differences in the ilia of a known sex and age sample of fetal and infant skeletons', *American Journal of Physical Anthropology* **52**, 191–5
- Wells, C. and Cayton, H., 1980. 'North Elmham Volume 2', *East Anglian Archaeology* **9**(Norfolk Archaeology Unit, Norfolk Museums Service)

Wenham., L. P. 1968. 'The Romano-British Cemetery at Trentholme Drive, York', *Ministry of Public Buildings and Works Archaeological Reports* **5**

Wilmott, T. and Wilson, P. (eds), 2000. 'The Late Roman Transition in the North', *BAR British Series* **299** (Oxford)

Williams, D.F., 1990. 'Amphorae', in *AY* 16/4

Williams, D.F., 1993. 'Amphorae, in *AY* 16/7, 721–2

Williams, D.F. and Carreras, C., 1995. 'North African Amphorae in Roman Britain: a Re-Appraisal', *Britannia*, **XXVI**, 231–52

Williams, D.F. and Peacock, D.P.S., 2005. 'The eruption of Vesuvius and Campanian Dressel 2-4 amphorae', in J. Pollini (ed.), *Terra Marique* (Oxford), 140–8

Victoria County History of Essex, 1963. Volume III: Roman Essex

Victoria County History, 1961. Yorkshire: The City of York

Vince, A. and Young, J., 'The Pottery', in Blue Bridge Lane & Fishergate House, York, Report on Excavations, July 2000 to July 2002 @ [www.archaeologicalplanningconsultancy.co.uk/mono/001/](http://www.archaeologicalplanningconsultancy.co.uk/mono/001/)

von den Driesch, A., 1976. 'A guide to the measurement of animal bones from archaeological sites', *Peabody Museum Bulletin* **1** (Cambridge Mass.: Harvard University)

## **7 ACKNOWLEDGEMENTS**

Grateful thanks are expressed to Evans Property Group who funded the excavation, the post-excavation research and the web-based publication. Thanks are also expressed to the site contractors William Birch Ltd. for their immense enthusiasm and logistical support throughout the excavations. Thanks are also expressed to Dr C. Knusel of the University of Bradford for his advice regarding skeletal ancestry.

### **Excavation**

Watching Brief: J. Naranjo-Santana and J.M. McComish

Excavation Team: A. Alejandro, P. Dawson, E. Hamilton, E. Lobo, J. McComish (director), I. Milsted, S. Moss, D. Ramirez-Aguier, G. Shepherd, J. Smith, A. Thomson and A. Winterburn  
Photography: M. Andrews  
Finds Administration: C. McDonnell, R. Cubbit and G. Krause

Conservation: M. Felter

**Report text**

Roman Pottery: R. Leary

Amphorae: D. Williams, University of Southampton

Mortaria: K. Hartley

Post-Roman Pottery: A. Mainman

Ceramic Building Material: J. McComish

Post-Roman Artefacts: N. Rogers

Roman Artefacts: H. Cool

Metal-working Artefacts: C. Mortimer

The Human Bone: K. Tucker

The Animal Bone: Palaeoecology Research Services

All other web text: J. McComish

Illustrations: L. Collett

Photography: M. Andrews

**Report production**

Draft editing: R. Hall

Editor: F. Mee

IADB design and management: M. Rains