

Operation Manual

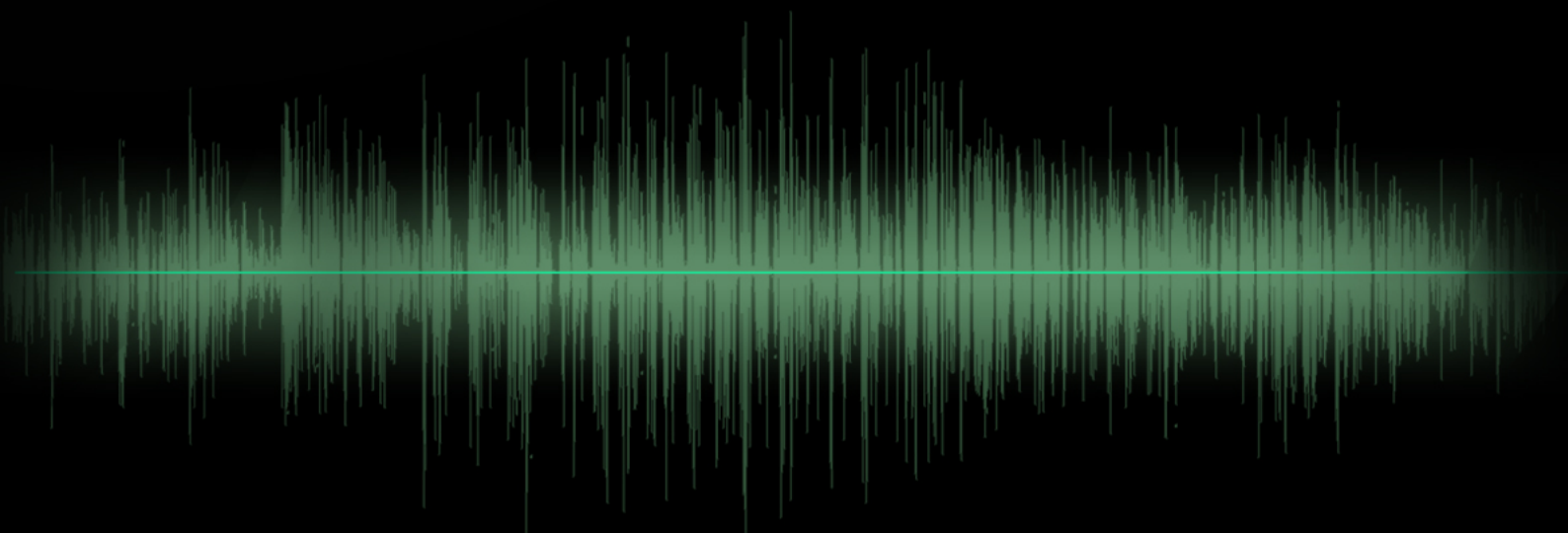

WAVELAB PRO 9.5

Audio Editing And Mastering Suite



Cristina Bachmann, Heiko Bischoff, Christina Kaboth, Insa Mingers, Matthias Obrecht, Sabine Pfeifer, Benjamin Schütte, Marita Sladek

This PDF provides improved access for vision-impaired users. Please note that due to the complexity and number of images in this document, it is not possible to include text descriptions of images.

The information in this document is subject to change without notice and does not represent a commitment on the part of Steinberg Media Technologies GmbH. The software described by this document is subject to a License Agreement and may not be copied to other media except as specifically allowed in the License Agreement. No part of this publication may be copied, reproduced, or otherwise transmitted or recorded, for any purpose, without prior written permission by Steinberg Media Technologies GmbH. Registered licensees of the product described herein may print one copy of this document for their personal use.

All product and company names are ™ or ® trademarks of their respective owners. For more information, please visit www.steinberg.net/trademarks.

© Steinberg Media Technologies GmbH, 2018.

All rights reserved.

WaveLab Pro_9.5.25_en-US_2018-04-19

Table of Contents

6	WaveLab Pro Introduction	59	Project Handling
6	Platform-Independent Documentation	59	Opening Files
6	Help System	60	WaveLab Projects
6	Conventions	63	File Groups
7	Key Commands	65	Value Editing
8	How You Can Reach Us	65	Drag Operations
9	Setting Up Your System	66	Undoing and Redoing Actions
9	Connecting the Equipment	68	Zooming
9	Audio Cards and Background Playback	73	Presets
9	Latency	75	File Operations
10	Defining Audio Connections	75	Recently Used Files
13	CD/DVD Recorders	76	Favorite Files
13	Remote Devices	77	Save and Save As
22	WaveLab Pro Concepts	79	Templates
22	General Editing Rules	84	File Renaming
22	Startup Dialog	84	Naming Schemes
23	Basic Window Handling	86	Deleting Files
24	Selecting Audio	86	Temporary Files
31	Sliders	86	Work Folders vs. Document Folders
31	Renaming Items in Tables	89	Exporting to SoundCloud
31	File Browser	89	Copying Audio Information to the Clipboard
33	Tab Groups	89	Setting the Focus on the Current File
35	Peak Files	90	Playback
36	Companion Files	90	Transport Bar
36	Processing Precision	101	Starting Playback From the Ruler
37	EBU Loudness Standard R-128	101	Using the Play Tool
39	Workspace Window	101	Playback Scrubbing
39	Audio Editor	102	Timecode Window
40	Audio Montage	103	Jog/Shuttle Function
40	Batch Processor	104	Scroll During Playback
40	Podcast Editor	105	Playback in the Audio Montage Window
40	Basic Audio CD	106	Speaker Configuration
40	DVD-Audio	108	Audio File Editing
41	Script Editor	108	Wave Window
41	Control Window	116	Audio Editor Tabs
42	File Tab	124	File Handling in the Audio Editor
43	Info Tab	145	Changing the Audio Properties
45	Tool Windows	146	Metadata
45	Meter Windows	151	Snapshots
45	Slide-Out Windows	152	Silence Generator Dialog
46	Docking and Undocking Tool Windows and Meter Windows	154	Bleep Censor
48	Command Bar	155	Waveform Restoration with the Pen Tool
49	Status Bar	156	Audio Analysis
50	Context Menus	156	Analyze Tab
51	Time Ruler and Level Ruler	157	Global Analysis
55	Managing Tabs	165	Audio File Comparator
57	Activating Full Screen Mode	167	3D Frequency Analysis
57	Log Window	169	Error Correction
		169	Correction Tab

172	Correcting Errors	358	Recording from an ASIO Input
173	Offline Processing	359	Smart Bypass
173	Process Tab	361	Saving Master Section Presets
175	Applying Processing	365	Monitoring Background Tasks
175	Gain Dialog	366	Dropouts
176	Level Normalizer Dialog	367	Markers
177	Loudness Normalizer	367	Marker Types
179	Pan Normalizer Dialog	368	Markers Window
179	Envelope Dialog	372	About Creating Markers
181	Fades in Audio Files	375	Deleting Markers
182	Crossfades	376	Moving Markers
183	Phase Inverting	376	Moving Multiple Markers
183	Reversing Audio	378	Navigating to Markers
183	DC Offset	378	Hiding Markers of a Specific Type
184	Time Stretching	378	Converting Marker Types
186	Pitch Shift	379	Renaming Markers
188	Pitch Quantizing Dialog	380	Selecting Markers
189	Pitch Bend	380	Selecting the Audio Between Markers
190	Resample	381	Binding Markers to Clips in the Audio Montage
191	Effect Morphing	381	Exporting the Markers List as Text
194	Audio Montage	382	How Marker Information is Saved
194	Montage Window	383	Metering
197	Audio Montage Tabs	383	Meter Windows
214	Signal Path in the Audio Montage	383	Real Time vs. Non-Real Time
214	Creating New Audio Montages	383	Metering Monitor Modes
216	Audio Montage Duplicates	384	Meter Settings
219	Creating an Audio Montage from an Audio File	384	Multichannel Metering
220	Import Options for Audio Montages	384	Resetting the Meters
221	Missing Files Dialog	385	Using Presets in the Meter Windows
221	Assembling the Audio Montage	385	Level Meter
232	Rearranging Clips	388	Loudness Meter
238	Clip Editing	390	Phasescope
255	Audio Montages within Audio Montages	391	Spectroscope
260	Managing Source Files of Clips	392	Spectrometer
264	Track Activity Indicator	394	Live Spectrogram
264	Envelopes for Clips	396	Bit Meter
272	Fades and Crossfades in Audio Montages	397	Oscilloscope
280	Clip Time Stretching	398	Wavescope
281	Clip Pitch Shifting	399	Basic Audio CD
281	Effects for Tracks, Clips, and the Montage Output	399	Basic Audio CD Window
296	CD Markers	402	CD Markers
296	CD Window	402	Preparing a Basic Audio CD
303	Snapshots	404	Opening CD Tracks for Editing
304	Mixing Down – The Render Function	404	Playing Back Files in the Track List
305	Loudness Meta Normalizer	405	Saving Basic Audio CD Tracks as Separate Files
307	Navigator Window	405	Saving Basic Audio CD Tracks as One File
308	Notes Window	406	DVD-Audio
308	Groups	406	Structure of a DVD-Audio Project
310	Audio Montage Backups	406	DVD-Audio Formats
311	Multichannel Operations in the Audio Montage	407	DVD-Audio Format Considerations
321	XML Export and Import of Audio Montages	407	DVD-Audio Window
321	AES-31 Files Export and Import	409	Preparing a DVD-Audio
324	Recording	410	Opening Audio Montages for Editing
324	Setting Up the Recording Dialog	411	Checking the DVD-Audio Conformity
325	Dropping Markers During Recording	412	Writing Operations
325	Recording Dialog	412	Write Audio CD or DDP Dialog
331	Recording in the Audio Montage Window	414	Erase Optical Media Dialog
332	Master Section	414	About Writing Audio Files
332	Bypassing the Master Section	417	About Writing Audio Montages
332	Master Section Window	429	Write DVD-Audio Function
350	Rendering	433	Data CD/DVD Projects

436	Audio CD Formats	542	Podcasts
440	Spectral Editing	542	Podcast Editor
440	Spectrogram	546	Global Podcast Options
441	Wavelet Display	546	Creating a Podcast
442	Spectrogram Options Dialog	547	Setting Up a FTP for Podcast Publishing
443	Spectrum Tab	547	Publishing Podcasts
449	Spectrum Processing	547	FTP Settings Dialog
453	Audio Inpainting	548	Checking the Podcast
454	Spectrum Watermark	549	Customizing
456	Master Section Processing	549	Workspace Layout
458	Auto Split	550	Customizing the Wave Window and the Montage Window
458	Auto Split in Audio Files	552	Customizing Shortcuts
461	Auto Split in Audio Montages	557	Customizing Command Bars
464	Loops	557	Plug-in Organization
464	Basic Looping	564	Variables and Text Snippets
465	About Refining Loops	567	Scripting
472	Looping Audio Which Is Not Very Well Suited for Looping	569	Touch Bar (macOS only)
474	Sample Attributes	570	Configuring WaveLab Pro
476	Generating Signals	570	Global Preferences
476	Signal Generator	576	Audio Files Preferences
480	DTMF Generator	581	Audio Montages Preferences
482	Importing Audio CD Tracks	586	Synchronizing WaveLab Pro Settings on Several Computers
482	Import Audio CD Dialog	587	Multi-User Settings
485	Importing Audio CD Tracks	587	External Tools
486	Searching Track Names on the Internet	591	Index
486	Submitting Track Names to the Internet		
487	Ultra-Safe Mode		
487	Converting Audio CD Tracks to an Audio Montage		
487	Converting Audio CD Tracks to a Basic Audio CD		
488	WaveLab Exchange		
488	WaveLab Pro as External Editor for Cubase/Nuendo		
489	Cubase/Nuendo as External Editor for WaveLab Pro		
490	Batch Processing		
491	Batch Processor Window		
498	Offline Processors		
499	Working with the Batch Processor		
506	Watch Folders		
519	XML Files in Batch Processing		
525	Batch Conversion		
525	Batch Conversion Dialog		
526	Batch Converting Files		
527	Batch Renaming		
527	Batch Renaming Dialogs		
527	Batch Renaming Files		
529	Batch Renaming Markers		
530	Batch Renaming Clips		
532	Renaming Operation Categories and Types		
535	List of Renaming Operations		
536	Preview Section		
536	Range Parameters		
538	Previewing and Performing All Renaming Operations		
538	Regular Expressions		

WaveLab Pro Introduction

Platform-Independent Documentation

The documentation applies to the operating systems Windows and macOS.

Features and settings that are specific to one of these platforms are clearly indicated. In all other cases, the descriptions and procedures in the documentation are valid for Windows and macOS.

Some points to consider:

- The screenshots are taken from Windows.
- Some functions that are available on the **File** menu on Windows can be found in the program name menu on macOS.

Help System

There are several ways of accessing the help system. The documentation is available online and most of it can be downloaded in PDF format from steinberg.help.

- To visit steinberg.help, enter `steinberg.help` in the address bar of your web browser or open WaveLab Pro and select **Help > steinberg.help**.
- To show tooltips, move the mouse over an interface icon.
- To open the help for an active dialog on steinberg.help, click the question mark icon on the title bar (Windows) or in the dialog (macOS) to show the **Help** button, and then click the **Help** button, or press **F1** (Windows) or **Cmd-?** (macOS).
- To use the menu help, move the mouse over a menu item.
- To see information on what kind of editing can be performed when using the mouse and modifier keys in the **Audio Montage** window, move the mouse over the montage window. The help text is displayed on the info line at the bottom of the window.

To open the “What’s This” help, you have the following possibilities:

- In any window, press **Shift-F1** and move the mouse over an interface item, or select **Help > What’s This?**.
- In a dialog, select the question mark icon on any title bar (Windows) or in the dialog (macOS), and move the mouse over an interface item or a menu option.
- Some “What’s this” tooltips include a link to a dedicated help topic.

RELATED LINKS

[Info Line](#) on page 234

Conventions

In our documentation, we use typographical and markup elements to structure information.

Typographical Elements

The following typographical elements mark the following purposes.

PREREQUISITE

Requires you to complete an action or to fulfill a condition before starting a procedure.

PROCEDURE

Lists the steps that you must take to achieve a specific result.

IMPORTANT

Informs you about issues that might affect the system, the connected hardware, or that might bring a risk of data loss.

NOTE

Informs you about issues that you should consider.

EXAMPLE

Provides you with an example.

RESULT

Shows the result of the procedure.

AFTER COMPLETING THIS TASK

Informs you about actions or tasks that you can perform after completing the procedure.

RELATED LINKS

Lists related topics that you can find in this documentation.

Markup

Bold text indicates the name of a menu, option, function, dialog, window, etc.

EXAMPLE

To open the **Metadata** dialog, open the **Metadata** window and click **Edit**.

If bold text is separated by a greater-than symbol, this indicates a sequence of different menus to open.

EXAMPLE

Select **File > Open**.

Key Commands

Many of the default key commands, also known as keyboard shortcuts, use modifier keys, some of which are different depending on the operating system.

When key commands with modifier keys are described in this manual, they are shown with the Windows modifier key first followed by the macOS and the key:

- Windows modifier key/macOS modifier key-Z

EXAMPLE

Ctrl/Cmd-Z means: press **Ctrl** on Windows or **Cmd** on macOS, then press **Z**.

How You Can Reach Us

On the **Help** menu in WaveLab Pro, you find items linking to additional information.

The menu contains links to various Steinberg web pages. Selecting a menu item automatically launches your browser and opens the page. On these pages, you can find support and compatibility information, answers to frequently asked questions, information about updates and other Steinberg products, etc. This requires that you have a web browser installed on your computer, and a working Internet connection.

Setting Up Your System

Before you start working, you need to make some settings.

IMPORTANT

Make sure that all equipment is turned off before making any connections.

Connecting the Equipment

Your system setup depends on many different factors, for example, the kind of project that you want to create, the external equipment that you want to use, or the computer hardware available to you.

Audio Cards and Background Playback

When you activate playback or recording in WaveLab Pro, other applications cannot access the audio card. Likewise, if another application uses the audio card, WaveLab Pro is unable to play back. The Windows MME driver is an exception from this.

You can run WaveLab Pro together with other applications and always give the active application access to the audio card.

PROCEDURE

1. Select **File > Preferences > Audio Connections**.
 2. Select the **Options** tab.
 3. Activate **Release Driver**.
 4. Do one of the following:
 - If you want to release the driver when WaveLab Pro is in the background, activate **When WaveLab Pro is in Background**.
 - If you want to release the driver only when Cubase is in the foreground, activate **When Cubase is in Foreground**.
-

Latency

Latency is the delay between when audio is sent from the program and when you actually hear it. While a very low latency can be crucial in a real-time DAW application such as Steinberg Nuendo or Cubase, this is not strictly the case with WaveLab Pro.

When working with WaveLab Pro, the important issues are optimum and stable playback and editing precision.

The latency in an audio system depends on the audio hardware, its drivers, and settings. In case of dropouts, crackles, or glitches during playback, raise the **Buffer Number** setting on the

Options tab in the **Audio Connections**, or increase the buffer size in the ASIO control panel, specific to the audio card.

RELATED LINKS

[Audio Connections Tab](#) on page 11

Defining Audio Connections

To be able to play back and record audio in WaveLab Pro, you must specify how the internal input and output channels in WaveLab Pro are connected to your sound card and which device you intend to use for audio playback and recording.

You can define the buffer settings for your device as well as set up connections to external gear, such as external effects units. You should select at least two channels for stereo playback and recording.

If you have no third-party audio card, you can select the **Windows MME** driver or **Built-in Audio** (Mac) options. You can also use MME with most third party audio cards, with the advantage that you can record and play at different sample rates. However, Windows MME drivers do not allow audio monitoring in the **Recording** dialog or multichannel operation, and other drivers generally offer better sound quality and performance.

RELATED LINKS

[Audio Connections Tab](#) on page 11

Selecting an ASIO Driver

Audio Stream Input/Output (ASIO) is a computer device driver protocol for digital audio specified by Steinberg. It provides a low-latency and high fidelity interface between a software application and the soundcard of a computer.

PROCEDURE

1. Select **File > Preferences > Audio Connections**.
 2. Open the **Audio Device** pop-up menu and select your ASIO driver.
The **ASIO Plug-ins** tab and the **Control Panel** button are activated.
 3. Optional: Click **Control Panel** and make your settings.
 4. On the **ASIO Plug-ins** tab, select the audio ports that are used for recording and monitor input of the ASIO plug-ins.
-

Selecting a Windows MME Driver

PROCEDURE

1. Select **File > Options > Audio Connections**.
 2. Open the **Audio Device** pop-up menu and select **Windows MME**.
 3. On the **Playback** tab, select the audio ports that are used for playback.
 4. On the **Recording** tab, select the audio ports that used for recording and monitor input.
-

Audio Connections Tab

This tab allows you to specify how the internal input and output channels in WaveLab Pro are connected to your sound card and which device you want to use for audio playback and recording.

- To open the **Audio Connections** tab, select **File > Preferences > Audio Connections**.

Global Settings

Audio Device

Allows you to select the audio device that you want to use for playback and recording audio. If you do not have a third-party audio card, you can select the **Windows MME** driver or **Built-in Audio** (Mac) options.

Control Panel

When you select an ASIO driver, the **Control Panel** button is activated. Click the button to open the settings application of your sound card, which is usually installed with the sound card. Depending on your sound card and driver, this provides settings for buffer size, digital formats, additional I/O connections, etc.

Refresh

This button causes audio devices to be evaluated again to reflect device changes.

Playback Tab

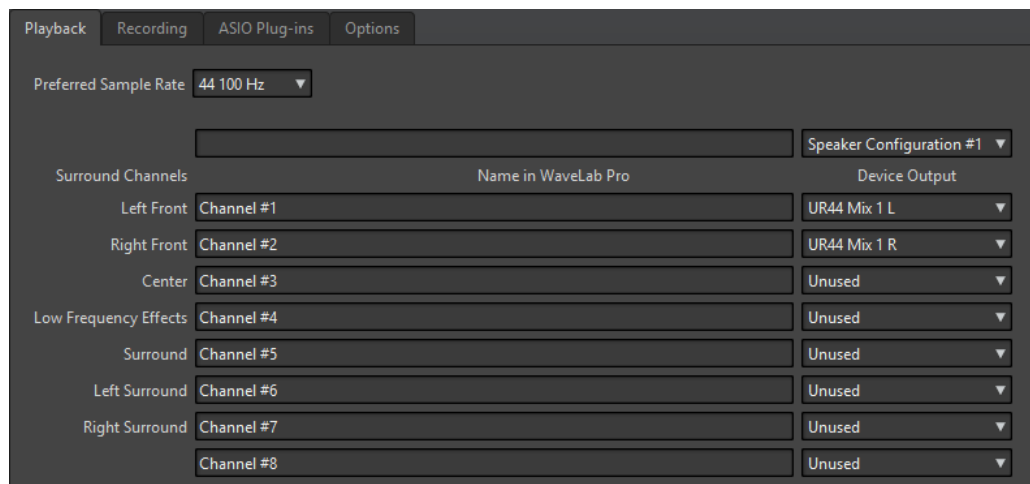

This tab allows you to select and name audio ports that are used for playback. If you are monitoring on a surround system, specify your surround speaker outputs here.

You can also specify the **Preferred Sample Rate** for playback. Furthermore, you can rename the channels and set up the **Speaker Configuration** to be able to switch between different speakers.

Recording Tab

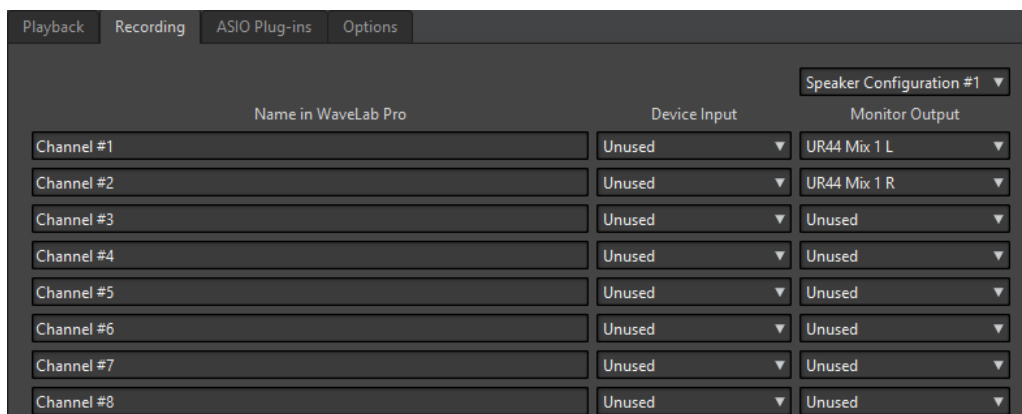

This tab allows you to select and name your audio ports that are used for recording and input monitoring. The inputs that you define here are then available in the **Recording** dialog. Furthermore, you can rename the channels and select the **Speaker Configuration**.

External Gear Tab

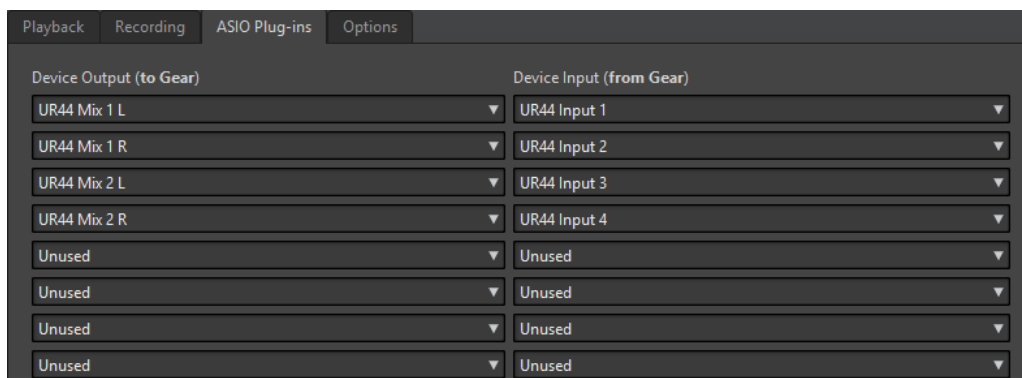

This tab allows you to select inputs from and outputs to external audio processing equipment. The name of this tab corresponds to the installed driver, for example, **ASIO Plug-ins**.

Options Tab

This tab allows you to specify the number of buffers and the control driver functionality.

Buffer Number

Increasing this value improves the elasticity of audio streaming to avoid dropouts.

MME Specific – Buffer Size

Increasing this value improves the elasticity of audio streaming to avoid dropouts. This is only available when an MME driver is selected.

Initialize Streaming Engine at First Use

Initializes the audio streaming engine when playback or recording are used for the first time. If this option is deactivated, the audio streaming engine is initialized at program startup.

Reset Driver When Changing Sample Rate

Resets the driver when sample rate is changed. When playback or recording must be set to a new sample rate, some audio device drivers must be fully reset to work properly. This operation takes some time.

Perform Short Fade In/Out When Starting/Stopping Playback

Performs a short fade in when starting playback and a short fade out when stopping playback. This avoids clicks that are caused by waveforms that are not starting on a zero-crossing point.

Release Driver

Allows you to run WaveLab Pro together with other applications and always give the active application access to the audio card.

- If **When WaveLab Pro is in Background** is activated, the driver is released when WaveLab Pro is in the background.
- If **When Cubase/Nuendo is in Foreground** is activated, the driver is released when Cubase/Nuendo is in the foreground.

CD/DVD Recorders

For general instructions on installing internal or connecting external recorders via USB or Firewire, refer to the instruction manual for your computer or your recorder.

Make sure to have the latest firmware version installed on your recorder unit. For CD recorders, the existing firmware must support disc-at-once mode. In addition, running a unit with older firmware can prevent you from writing sub-index markers into the tracks, for example.

Remote Devices

You can use remote devices to remote-control WaveLab Pro.

Several commands can be controlled with knobs and sliders of your remote control device. For all commands that can be assigned to a keyboard shortcut, a MIDI trigger can also be assigned.

Remote Devices Tab

This tab allows you to select a device to remote-control WaveLab Pro, and see and edit the control map of MIDI control devices.

- To open the **Remote Devices** tab, select **File > Preferences > Remote Devices**.

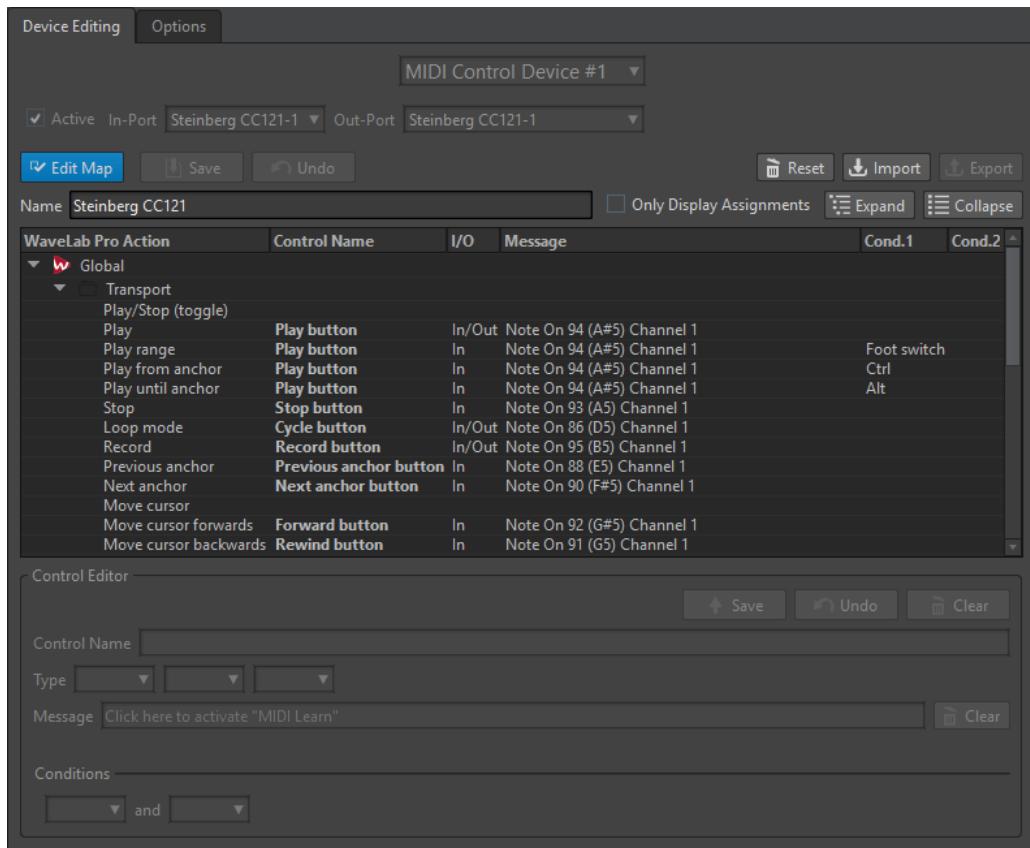

Device Editing Tab

This tab lets you select a MIDI control device, see the control map, assign WaveLab Pro commands to MIDI controls, and import/export control assignments.

Device Menu

Select the MIDI device to edit. Select **MIDI Shortcuts for Menus** to define the MIDI input port that is used for MIDI shortcuts. The shortcuts can then be assigned on the **Shortcuts** tab.

Select **MIDI Control Device #1 - #10** to select a slot for a connected MIDI control device. You can then assign a device by selecting a MIDI input port and output port.

Active

Activates the selected device and scans the MIDI ports.

In-Port/Out-Port

Select the MIDI input/output ports of the device that you want to use.

Edit Map

Activates the edit mode of the MIDI control map for the selected device. To leave the edit mode, click again.

Save

Saves the modifications that have been made to the MIDI control map.

Undo

Undoes the modifications that have been made to the MIDI control map.

Reset

If the map has a factory preset, clicking **Reset** resets all changes that have been made to the map. If the map has no factory preset, the map is cleared.

Import

Opens the file browser where you can select a map definition file (XML file). This kind of file can be supplied by a MIDI device manufacturer or another WaveLab Pro user, for example.

Export

Lets you export a map definition file (XML file). This file can be sent to another WaveLab Pro user, for example.

Name

Lets you enter a map name.

Only Display Assignments

If this option is activated, the control map only displays the parameters that are associated with a remote control.

Expand/Collapse

Expands/collapses the folder tree of the control map.

WaveLab Pro Action List

This folder tree lists the parameters that you can remote-control. The top folder represent contexts. The related parameters can only be controlled if the context is active. For example, if an audio file is active.

A remote control can be used in several contexts if these are exclusive. For example, parameters that can be used for an active audio file or an active audio montage.

The **Global** folder contain the parameters that can always be controlled.

Control Editor – Save

If a control has been created or modified, click this button to save it.

Control Editor – Undo

If a control has been modified, click this button to undo the changes.

Control Editor – Clear

Erases the selected control's definition.

Control Name

Lets you enter a name for the control. Each control must have a name.

Type

In the Type section, you can edit the type of the selected control.

When more than one type of control can be assigned to a parameter, you can select a type from the first pop-up menu. You can choose between relative and absolute editing for some parameters. For example, a **Master Section** slider can be associated to a remote motorized fader (absolute editing), or to an infinite knob (relative editing).

Several protocols are supported to interpret the MIDI messages. You can select the protocol that you want to use from the second menu. The **MIDI Learn** function can automatically change this protocol, according to the received MIDI messages.

Remote controls send messages but can also receive messages from WaveLab Pro, to light up a button or move a motorized fader, for example. You can select the mode to use from the third menu.

Message

Activates the **MIDI Learn** function. If this option is activated, you can use the control (knob, fader, etc.) on your MIDI controller. When MIDI messages are received, they are analyzed after the MIDI activity stops for several milliseconds. The result is

displayed in the **Message** field. The result is then used by WaveLab Pro as the control identifier.

Clear

Erases the MIDI event that identifies the control.

Conditions

A modifier is a WaveLab Pro parameter that can be activated by a MIDI control (for example, a foot switch) or a computer key (**Ctrl/Cmd**, **Shift**, etc.). By associating a remote control with one or two modifiers, you can use a single remote control to edit different parameters.

Options Tab

This tab lets you use the **MIDI Learn** function to assign a control of a MIDI remote control device to a function.

Emulate Mouse Wheel

If this option is activated, the AI knob of Steinberg controllers acts as a mouse wheel in the WaveLab Pro user interface, except for plug-ins.

Edit Focused Numeric Field

If this option is activated, the AI knob Steinberg controllers can be used to edit the focused numeric field that you find in many WaveLab Pro windows and dialogs.

Selecting a MIDI Remote Control Device

PREREQUISITE

The MIDI remote control device is connected to your PC/Mac.

PROCEDURE

1. Select **File > Preferences > Remote Devices**.
 2. On the **Device Editing** tab, select one of the MIDI control device slots or the **MIDI Shortcuts for Menus** option from the pop-up menu at the top.
 3. Select **Active** to activate the selected device.
 4. From the **In-Port** and **Out-Port** pop-up menus, select a MIDI input port and output port.
-

Assigning a MIDI Controller to a Parameter

If you are using a Steinberg remote control device, for example, the CC121, the controls are already assigned to parameters. You can customize these default settings.

PREREQUISITE

You have set up your MIDI remote control device.

PROCEDURE

1. Select **File > Preferences > Remote Devices**.
2. From the pop-up menu at the top of the dialog, select your MIDI control device.
3. On the **Device Editing** tab, click the **Edit Map** button.
4. In the tree structure, click the parameter that you want to remote-control.
5. In the **Control Editor** section, enter a name in the **Control Name** field.
6. Select the type of control.

Depending on the type of control on the MIDI remote control device, you must select a control with relative values (knob), trigger values (button), or absolute values (fader).

7. Click in the **Message** field, and on your MIDI remote control device, move the control that you want to assign.

The name of the controller is displayed in the **Message** field.

8. Click **Save** to the right of the **This Control is Modified** message.
 9. Click **Save** to the right of the **Edit Map** button.
-

RESULT

The MIDI controller is now assigned to the function.

Assigning Custom Parameters to Plug-ins

You can assign custom parameters to many VST 3 plug-ins.

PREREQUISITE

In the **Remote Devices** tab, assign the controls of your MIDI controller to the plug-in custom parameters. If you are using the Steinberg CC121 controller, the parameters are assigned by default.

PROCEDURE

1. From the **Master Section** or the **Effects** window, open the plug-in that you want to control with the MIDI remote control device.
2. **Ctrl/Cmd**-click the circle icon at the top of the plug-in window to enter the **Edit** mode.



3. Click **OK**.
The icon indicates that you are in MIDI learn mode.
 4. Move the mouse over a plug-in parameter, and move the MIDI control that you want to assign.
Repeat this for all the parameters and controls that you want to assign.
 5. When finished, click the tool icon to exit **Edit** mode, and click **OK**.
-

RESULT

The assignment is saved. You can now control the assigned parameters with your MIDI remote control device. A plug-in can be controlled via the custom parameter if the **Remote Control Mode** is activated and only one plug-in can be activated at a time.

When a plug-in is activated for remote control, it also has precedence over other application settings that are controlled by the same parameter.

To remove all remote control assignments on the plug-in, hold **Ctrl/Cmd** and **Shift**, and click the **Remote Control Mode** button.

RELATED LINKS

[CC121 Advanced Integration Controller](#) on page 18

Importing and Exporting Remote Control Definition Files

Map definition files are XML files, containing control assignments for your remote devices. You can exchange them with other users or save a backup copy.

In the **Remote Devices** tab, select the **Device Editing** tab.

- To import a map definition file, click **Import**, browse to the location of the map definition file, and select the file.
- To export a map definition file, click **Export**, and browse to the location where you want to save the file.

Editing Changes in the Remote Control Devices Settings

Changes that have been made to the map, for example, changing the name of a control, can be saved, reset, undone, and removed in the **Control Editor** section of the **Remote Devices** tab.

- To save any changes that you have made, click **Save**.
- To restore the factory preset of a MIDI remote control device, click **Reset**. If the control device does not have factory presets, the map is cleared.
- To undo your last action, click **Undo**.
- To remove the control definition of the selected control or to unassign the selected control, click **Clear**.

Using Modifiers for Remote Controlling Parameters

You can use the same controller for controlling different parameters, using one or two modifiers. A modifier can be a MIDI control (for example, a foot switch) or a modifier key on your computer keyboard (for example, **Shift** and/or **Ctrl/Cmd**).

To determine one or two modifiers, open the **Remote Devices** tab, and when editing a parameter, select the modifiers from the **Conditions** section.

You can use the **Shift** and **Alt** modifiers to alter the edit steps of infinite knob controls as follows:

- Press **Shift** to edit values in small steps.
- Press **Alt** to edit values in bigger steps.

CC121 Advanced Integration Controller

You can use Steinberg's CC121 Advanced Integration Controller to control WaveLab Pro.

This section describes the WaveLab Pro factory preset for the CC121. For detailed information on how to use the controller, refer to the manual that came with the CC121. Note that the CC121 was originally designed for Cubase. The following mapping combines the WaveLab Pro functionality with the CC121 controls. The controls that are not listed in the following paragraph are not assigned to a parameter.

Channel Section

You can use all controls of the CC121 channel section, except the fader, to control the elements of the selected track in a WaveLab Pro audio montage. You can use the fader for the **Master Section**.

Fader

Controls the **Master Section** fader.

PAN knob

Controls the gain of the selected track.

Mute

Mutes/Unmutes the selected track.

Solo

Activates/Deactivates solo for the selected track.

CHANNEL SELECT

Selects the previous/next track in the audio montage.

To move the cursor to the previous/next clip edge in the audio montage, hold **Alt**. To move the cursor to the previous/next region edge, hold **Shift**. To move the cursor to the previous/next marker in the **Audio Editor**, hold **Ctrl/Cmd**.

EQ Section

With the EQ section you can easily control the Steinberg Studio EQ plug-in.

If the EQ TYPE button is activated on the CC121, you can adjust the parameters of the focused Studio-EQ. All necessary EQ parameters, such as Q/F/G of each band, EQ TYPE selection, and ALL BYPASS on/off can be set. You can switch to WaveLab Pro navigation mode by turning off the EQ TYPE button. In WaveLab Pro navigation mode, you get access to alternative functions, such as scrolling, zooming, and switching between windows.

EQ TYPE activated:

Bandwidth knobs (Q)

Adjusts the Q (bandwidth) of each EQ band.

Frequency knobs (F)

Adjusts the center frequency of each EQ band.

Gain knobs (G)

Adjusts the gain of each EQ band.

ON

Activates/Deactivates the EQ bands.

ALL BYPASS

Activates/Deactivates bypass for all plug-ins in the **Master Section**.

EQ TYPE deactivated:

LOW ON

Opens the **Audio Editor**.

LOW-MID ON

Opens the **Audio Montage** window.

HIGH-MID ON

Opens the **Batch Processor** window.

HIGH ON

Opens the preferences tab.

EQ-1 knob for the EQ Gain (G)

Scrolls left/right on the timeline.

EQ-2 knob for the EQ Gain (G)

Adjusts the horizontal zoom on the timeline.

EQ-3 knob for the EQ Gain (G)

Adjusts the vertical zoom on the timeline.

EQ-4 knob for the EQ Gain (G)

Scrolls tracks on the **Audio Montage** window or scrolls vertically on the **Audio Editor**.

EQ-1 knob for the EQ Frequency (F)

Scrolls left/right on the overview timeline of the **Audio Editor**.

EQ-2 knob for the EQ Frequency (F)

Horizontally zooms in/out on the overview timeline of the **Audio Editor**.

EQ-3 knob for the EQ Frequency (F)

Vertically zooms in/out on the overview timeline of the **Audio Editor**.

EQ-4 knob for the EQ Frequency (F)

Vertically scrolls on the overview timeline of the **Audio Editor**.

Transport Section

In this section you can control the transport functions of WaveLab Pro.

Previous button

Moves the cursor position to the left.

Rewind button

Moves the edit cursor position to the left.

Forward button

Moves the edit cursor position to the right.

Next button

Moves the cursor position to the right.

Cycle button

Activates/Deactivates Cycle mode.

Stop button

Stops playback. Press again to move the cursor to the previous start position. Press a third time to move the cursor to the beginning of the project.

Play button

Starts playback.

Record button

Press once to open the **Recording** dialog. Press again to start the recording. Press a third time to stop recording. The recorded file opens in the **Audio Editor**.

Function Section

In this section, you can adjust functions, such as fades and envelope level, by using the VALUE knob.

VALUE knob

Rotate this knob to adjust the assigned function. Press the knob to reset the parameter to its default value.

FUNCTION button 1

Adjusts the fade in settings of the active clip.

FUNCTION button 2

Adjusts the fade out settings of the active clip.

FUNCTION button 3

Adjusts the envelope level of the active clip.

FUNCTION button 4

The element clicked last in the **Nudge** section of the **Edit** tab in the **Audio Montage** window is assigned to this button.

AI Knob Section

WaveLab Pro can be controlled with the AI knob of Steinberg's CC121, CI2+, and CMC-AI controllers. With the AI knob, you can control the parameter that the mouse points to.

NOTE

The AI knob only works on parameters that are automatable.

In this section you can control parameters via the AI knob.

AI KNOB

Controls the VST 3 plug-in parameters, emulates the mouse wheel, for example, for scrolling, and lets you edit a focused numeric field. To control a parameter with the AI knob, move the mouse cursor over the parameter that you want to control, and move the AI knob. You can activate/deactivate the emulation of the mouse wheel and the editing of the focused numeric field in the **Options** tab.

LOCK

When the mouse cursor points to a parameter, press LOCK to control this parameter regardless of the position of the mouse cursor.

JOG

Activates Jog mode. While Jog mode is activated, press LOCK to enter shuttle mode.

CUBASE READY Indicator

The CUBASE READY indicator has no function in WaveLab Pro.

Foot Switch Section

The foot switch has the same function as **Shift**. Press and hold the foot switch while turning the AI knob to fine tune parameters.

WaveLab Pro Concepts

This chapter describes general concepts that you will use when working with WaveLab Pro. Getting accustomed with these procedures allows you to work more effectively with the program.

General Editing Rules

The common editing operations apply to any Steinberg product.

- To select and move interface items, and to select ranges, click and drag with the mouse.
- Use the keys of your computer keyboard to enter numeric values and text, to navigate lists and other selectable interface items, and to control the transport functions.
- Common operations like cut, copy, paste, or the selection of multiple items can be performed using standard keyboard shortcuts.

NOTE

The behavior of your product is also governed by your preference settings.

Startup Dialog

When WaveLab Pro starts, the **Startup** dialog opens where you can select which project or project template you want to open.

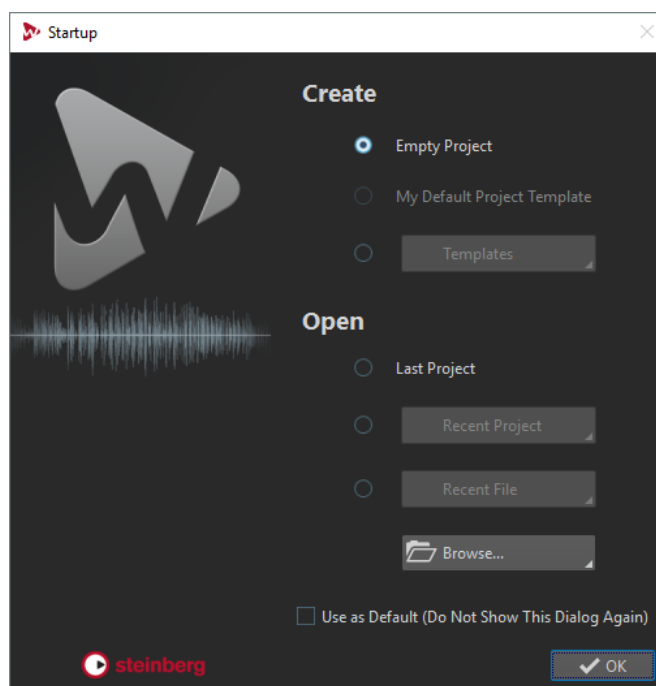

Create

Empty Project

Creates an empty project.

My Default Project Template

Opens the default startup project template. The default project is defined on the **Template** page. If no default project is defined, an empty project is created.

Templates

Allows you to open a template in a new project.

Open

Last Project

Opens the project that you last used in WaveLab Pro, including all files that were open.

Recent Project

Allows you to open a recently used project.

Recent File

Allows you to open a recently used file.

Browse

Allows you to select the files that you want to open.

Use as Default (Do Not Show This Dialog Again)

If this option is activated, the option that you select is used from now on and the startup screen does not open anymore. To display the **Startup** dialog, even if this option has been activated, press **Ctrl/Cmd** when starting WaveLab Pro.

RELATED LINKS

[Workspace Layout](#) on page 549

Basic Window Handling

WaveLab Pro follows the basic guidelines for the Windows/macOS interface, which means that Windows/macOS standard procedures apply.

Closing Windows

- To close a file group tab or a file tab, click the **X** button of the corresponding tab or press **Ctrl/Cmd-W**.
- To close a file tab without saving your changes, hold **Ctrl/Cmd-Shift**, and click the **X** button of the tab. This avoids having to confirm a warning message whenever you want to close an unsaved tab.
- To close all files of a file group at once, right-click a file group tab and select **Close All Files**.
- To close all file tabs but the selected file tab, right-click a file tab and select **Close All But This**.
- To individually select the file tabs that you want to close, right-click a file group tab and select **Select Files to Close**. This opens the **Files to Close** dialog, where you can select the files that you want to close.
- By default, files are removed from the project when you close them. To keep the files in the project even when you close them, right-click a file tab and activate **Keep in Project after Closing**.

RELATED LINKS

[Permanently in Project vs. Temporarily in Project](#) on page 63

Switching Between Files

You can have multiple files open and switch between them.

- To bring a file to the front, click the corresponding tab.
- To switch between the files, hold **Ctrl/Cmd**, and press **Tab** continuously.
- To switch back and forth between the last two active files, press **Ctrl/Cmd-Tab**. Between each step you have to release all keys.
- To switch backwards, press **Ctrl/Cmd-Shift-Tab**.
- To toggle between the active file and the last edited file, press **F5**.

Selecting Audio

Almost all types of editing and processing that you perform in WaveLab Pro operate on the audio selection. There are numerous ways to make an audio selection.

- To select the whole audio file, double-click it. If the audio file contains markers, triple-click it.

Selecting a Range by Dragging

The standard way to select a range in the wave window is to click and drag.

If you drag all the way to the left or right side of the wave window, it scrolls automatically, allowing you to select larger sections than what can be shown in the wave window. The speed of the scrolling depends on how far from the wave window edge you are.

Audio Range Selection in an Audio File

You can edit, process, or play back selections of an audio file.

- To access the audio range selection options, in the **Audio Editor**, select the **Edit** tab.

The following selection options are available in the **Time Selection** section:

Range

If you click **Range**, the **Range Selection** dialog opens. In this dialog, you can define selection ranges very accurately.

If you click the arrow to the right of the **Range** button, the presets list opens. In the presets list, you can select between the selection range factory presets and your custom presets.

All

Selects the entire waveform.

Toggle

Toggles the selection range on/off.

Extend

Opens a menu where you can select the following options:

- **Extend to Start of File** extends the selection to the start of the audio file. If there is no selection, a selection is created from the edit cursor position.
- **Extend to End of File** extends the selection to the end of the audio file. If there is no selection, a selection is created from the edit cursor position.

- **Extend to Previous Marker** extends the left edge of the selection to the nearest marker to the left or the start of the audio file. If there is no selection, a selection is extended until the edit cursor position.
- **Extend to Next Marker** extends the right edge of the selection to the nearest marker to the right or the end of the audio file. If there is no selection, a selection is extended until the next marker position.
- **Extend to Cursor** extends the selection to the edit cursor position.
- **From Start of File Until Cursor** selects the range between the start of the audio file and the edit cursor position.
- **From Cursor to End of File** selects the range between the edit cursor position and the end of the audio file.
- **From Cursor to Previous Marker** selects the range between the edit cursor position and the previous marker or the start of the audio file.
- **From Cursor to Next Marker** selects the range between the edit cursor position and the next marker or the end of the audio file.
- **From Playback Position to End of File** creates a selection range from the playback position to the end of the audio file. If no playback is taking place, the position of the edit cursor is used.
- **From Playback Position to Start of File** creates a selection range from the playback position to start of the audio file. If no playback is taking place, the position of the edit cursor is used.
- **Double Selection Length** doubles the length of the current selection range.
- **Halve Selection Length** halves the length of the current selection range.

Channels

Opens a menu where you can select the following options:

- **Extend to All Channels** extends the current selection range to all channels.
- **Left Channel Only** reduces the current selection range to the left channel only.
- **Right Channel Only** reduces the current selection range to the right channel only.

Regions

Opens a menu where you can select the following options:

- **CD Track** selects the range between the two CD track markers that encompass the edit cursor.
- **Loop Region** selects the range between the two loop markers that encompass the edit cursor.
- **Exclusion Region** selects the range between the two exclusion markers that encompass the edit cursor.
- **Generic Region** selects the range between the two generic markers that encompass the edit cursor.

RELATED LINKS

[Range Selection Dialog](#) on page 26

Audio Range Selection in an Audio Montage

You can edit, process, or play back selections of an audio montage.

- To access the audio range selection options, in the **Audio Montage** window, select the **Edit** tab.

The following selection options are available in the **Time Selection** section:

Range

If you click the **Range** button, the **Range Selection** dialog opens. In this dialog, you can define selection ranges very accurately.

If you click the arrow on the right of the **Range** button, the presets list opens. In the presets list, you can select between the selection range factory presets and your custom presets.

Extend

Opens a menu where you can select the following options:

- **Double Selection Length** doubles the length of the current selection range.
- **Half Selection Length** halves the length of the current selection range.
- **From Playback Position to End of File** creates a selection range from the playback position to the end of the audio montage. If no playback is taking place, the position of the edit cursor is used.
- **From Playback Position to Start of File** creates a selection range from the playback position to start of the audio montage. If no playback is taking place, the position of the edit cursor is used.

Toggle

Toggles the current selection range on/off.

RELATED LINKS

[Range Selection Dialog](#) on page 26

Range Selection Dialog

This dialog allows you to specify an audio range for editing, processing, or playing back.

- In the **Audio Editor** or the **Audio Montage** window, select the **Edit** tab, and click **Range**.

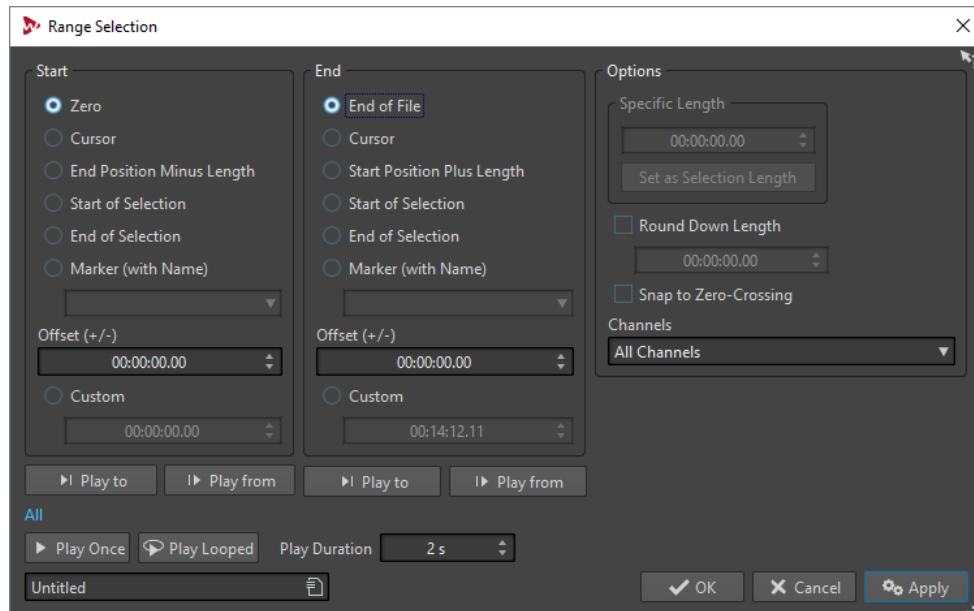

Start

Zero

The selection begins at the start of the file.

Cursor

The selection begins at the edit cursor.

End Position Minus Length

The selection begins at the specified end position minus the **Specific Length** value.

Start of Selection

The selection begins at the start of the current selection range.

End of Selection

The selection begins at the end of the current selection range.

Marker (with Name)

The selection begins at the marker that is selected from the pop-up menu below.

Offset (±)

Allows you to specify an offset for the selected start position.

Custom

Allows you to specify a start time for the selection. The time unit is the same as the time unit that is selected for the time ruler.

End

End of File

The selection ends at the end of the file.

Cursor

The selection ends at the edit cursor.

Start Position Plus Length

The selection ends at the specified start position plus the **Specific Length** value.

Start of Selection

The selection ends at the start of the current selection range.

End of Selection

The selection ends at the end of the current selection range.

Marker (with Name)

The selection ends at the marker that is selected from the pop-up menu below.

Offset (±)

Allows you to specify an offset for the selected end position.

Custom

Allows you to specify an end time for the selection. The time unit is the same as the time unit that is selected for the time ruler.

Options

Specific Length

Allows you to specify the selection length.

Set as Selection Length

Clicking this button freezes the current selection length. This is useful if you want to move the selection.

Round Down Length

If this option is activated, the selection length is rounded down to the length specified in the value field.

Snap to Zero-Crossing

If this option is activated, the start and the end of a selected range always snap to a zero-crossing point of the waveform.

Channels

Select whether the selection spans the left channel, the right channel, or both.

Play

With the play options, you can preview the specified audio range.

Play to

Plays the range before the specified position.

Play from

Plays the range after the specified position.

Play Once

Plays the selection once.

Play Looped

Plays the selection in a loop.

Play Duration

Sets the playback length. Note that this overrides the **From/To** parameters.

Memorizing Selection Length and Cursor Position

You can copy the length of a selection range and the edit cursor position to an internal memory. This is useful if you want to use these values in several places in WaveLab Pro.

- To save the length of the active selection range, in the **Audio Editor** or the **Audio Montage** window, select the **Edit** tab, and right-click **Copy**. Here, select **Memorize Selection Length**.
- To save the position of the edit cursor, in the **Audio Editor** or the **Audio Montage** window, select the **Edit** tab, and right-click **Copy**. Here, select **Memorize Cursor Position**.
- To apply the memorized information, right-click any time edit field and select **Set Memorized Position** or **Set Memorized Duration**.

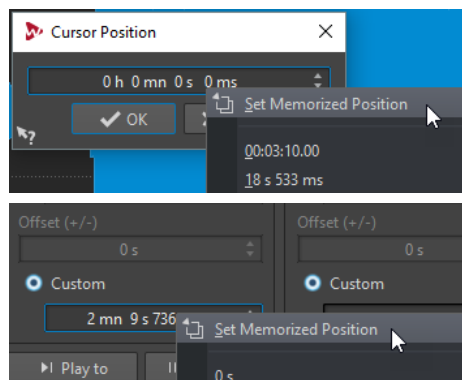

Selecting in Stereo Files

If you are working on stereo material in the **Audio Editor**, you can apply an operation to one channel only or to the entire stereo material.

Which channel is selected when you click and drag in the wave window depends on where you position the mouse cursor. The pointer shape indicates which channel will be affected.

The following pointer shapes are available:

Select left channel



Clicking in the upper half of the left channel selects the left channel.

Select both channels



Clicking in the middle area between the left and the right channel selects both channels.

Select right channel



Clicking in the lower half of the right channel selects the right channel.

Switching the Selection Between Channels

You can switch the channel selection that you have made for a channel to all channels or switch the selection to the other channel.

PROCEDURE

1. In the wave window of the **Audio Editor**, select a range.
2. Select the **Edit** tab.
3. In the **Time Selection** section, click **Channels** and select one of the following options:
 - **Extend to All Channels**
 - **Left Channel Only**
 - **Right Channel Only**

You can press **Tab** to switch between the different channel selections.

Selecting in the Overview of the Audio Editor

The ranges that you select in the overview of the **Audio Editor** also apply to the main view.

PROCEDURE

- In the wave window of the **Audio Editor**, hold down **Ctrl/Cmd** and click and drag in the overview.
-

Moving a Selection Range

If a selection range has the correct length, but the wrong position, you can move it.

PROCEDURE

1. In the wave window, hold down **Ctrl/Cmd-Shift**.

2. Click in the middle of the selection and drag to the left/right.
-

Extending and Reducing the Selection

You can resize a selection range in the wave window or the montage window.

There are several ways to extend/reduce the selection:

- Select a range, **Shift**-click outside the selection range, and drag to the left/right, or click and drag the edges of the selection range to the left/right.
- To extend the selection to the previous/next boundary (marker or start/end of file), press **Shift** and double-click the non-selected area between the boundaries.

Extending and Reducing the Selection Using the Cursor Keys

- To move the start/end of a selection in the wave window to the left/right, hold down **Shift** and press the left/right cursor keys. To move it in bigger steps, press the **Page Up/Page Down** keys.
- To extend a selection to the previous/next boundary in the wave window (marker or start/end of the audio file), hold down **Ctrl/Cmd+Shift** and press the left/right cursor keys.

Deleting Selections

There are several options for deleting a selected range.

Audio Editor

The following options can be found on the **Edit** tab in the **Cutting** section.

Crop

Removes the data outside the selection.

Delete

Removes the selection. The audio to the right of the selection is moved to the left to fill the gap.

Smooth Delete

Removes the selection. Crossfades are inserted at the edges. You can edit the default crossfade length and its type in the **Audio Files Preferences**, on the **Editing** tab.

Audio Montage Window

The following options can be found on the **Edit** tab in the **Removal** section.

Crop Clip

Removes the data outside the selection.

Erase Selected Range

Erases the clip parts inside the selection range on the selected track, without filling the gap.

Erase Selected Range on All Tracks

To access this option, click the arrow icon at the right of the **Erase Selected Range** option. Erases the clip parts inside the selection range on all tracks, without filling the gap.

Delete Selected Clip

If there is a selection range, the clip parts inside the selection range on the selected track are deleted and the right section of the clips is moved to the left to fill the gap.

If there is no selection, the selected clips are deleted.

Delete Selected Range on All Tracks

To access this option, click the arrow icon at the right of the **Delete Selected Clips** option. Deletes the clip parts inside the selection range on all tracks and moves the right section of the clips to the left to fill the gap.

Sliders

At various places in WaveLab Pro, slider controls are available to change parameters. There are a number of ways to change the value of a slider.

- Position the mouse over the slider and use the mouse wheel without clicking. Hold **Ctrl/Cmd** while using the mouse wheel to scroll faster. This modifier also applies to the zoom wheels. To move a slider, click and drag it.
- To move the slider handle to a position, click the slider at any position.
- To move the slider handle in smaller steps, right-click or click below the handle. Keep the mouse button pressed to automatically step to the next value.
- To reset the slider to the default value, if available, **Ctrl/Cmd**-click the slider, or click using the third mouse button, or double-click the handle.

Renaming Items in Tables

You can rename items in tables in the **Markers** window, the **CD** window, and the **Clips** window.

- To rename an item, double-click it or select it, and press **Return**, and enter the new name.
- To rename the previous/next item, press **Up Arrow** or **Down Arrow**. This way you move the focus on the previous/next item, while staying in the edit mode.

File Browser

The **File Browser** window allows you to browse files from within WaveLab Pro. The **Auto Play Mode** is useful for speeding up the process of auditioning sound files.

The **File Browser** window provides you with all the standard browsing functions. It features additional controls to audition audio files and any marker defined regions. You can use it to open or insert files by dragging them to another location.

You can also choose to only view specific file types.

File Browser Window

In this window, you can browse files and open them in WaveLab Pro.

- To open the **File Browser** window, select **Tool Windows > File Browser**.

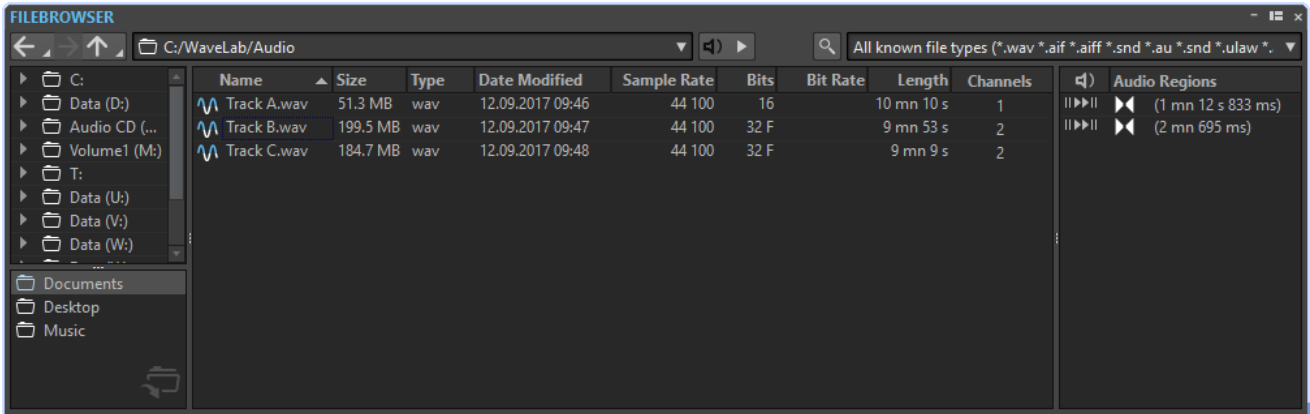

Back/Forward/Parent Directory

Allows you to navigate through the list and file hierarchy.

Location

This menu allows you to select a file location to browse and lists the recently used locations.

Auto-Play Mode

Automatically starts playback of the selected file.

Play Selected Audio File

Plays the selected audio file.

Search

If this button is activated, you can enter text in the search field.

File type list

Allows you to select which file type and file format to display.

Folder tree

Shows the folders that are available on your computer.

Favorite folders

You can add your favorite folders by dragging them from the folder tree. Each file type has its own favorite folder.

File list

Shows the following information about each file:

- **Name** shows the name of the audio file.
- **Size** shows the size of the audio file.
- **Type** shows the file type of the audio file.
- **Date Modified** shows the date on which the audio file was last saved.
- **Sample Rate** shows the sample rate in Hz.
- **Bits** shows the bit depth in bits. "32F" means 32-bit float and "64F" means 64-bit float.
- **Bit Rate** shows the bit rate in kbps.
- **Length** shows the length of the audio file.
- **Channels** shows the number of channels.

Create Folder

Allows you to create a new folder. Right-click in the file list and select **Create Folder**.

Audio Regions

If the selected file contains region markers, the regions are displayed in the **Audio Regions** section. You can drag regions onto a track.

RELATED LINKS

[Folders Tab](#) on page 87

Tab Groups

With tab groups, you can view the content of different files, tool windows, or meters at the same time, without having to navigate through different windows. Each tab group has its own content and tab bar.

In a **Control Window**, a tab group can contain tool windows and meters. You can have three file tab groups.

Empty File Tab Groups

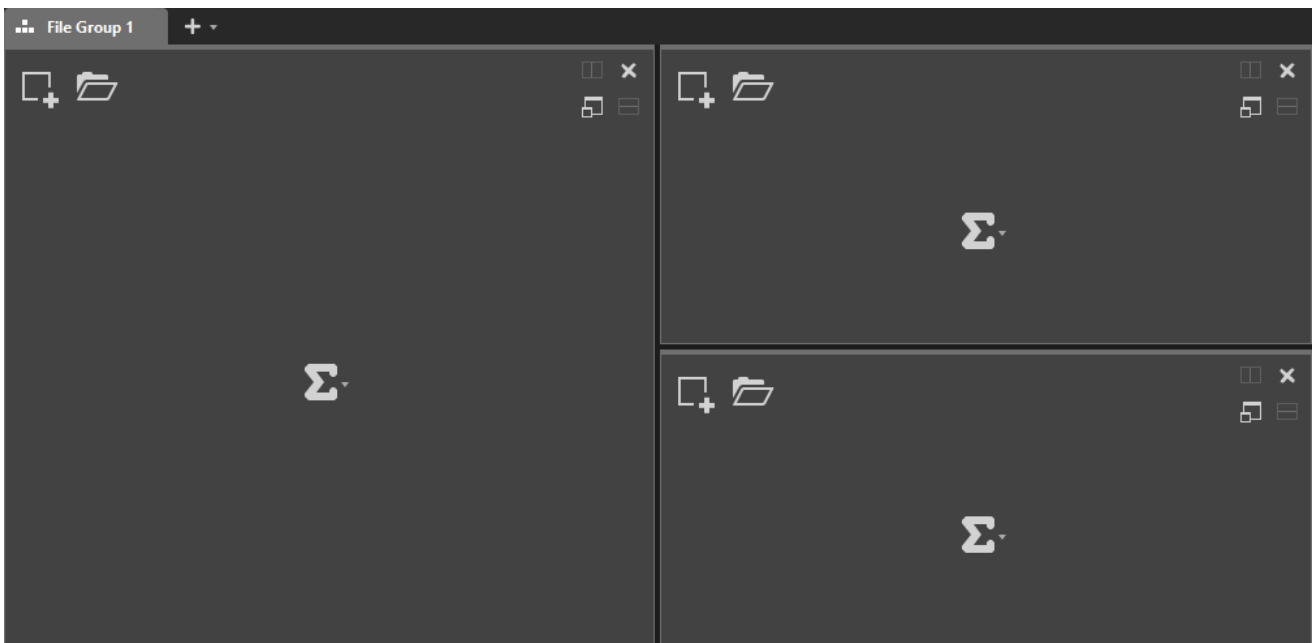

File Tab Groups with Audio Montages

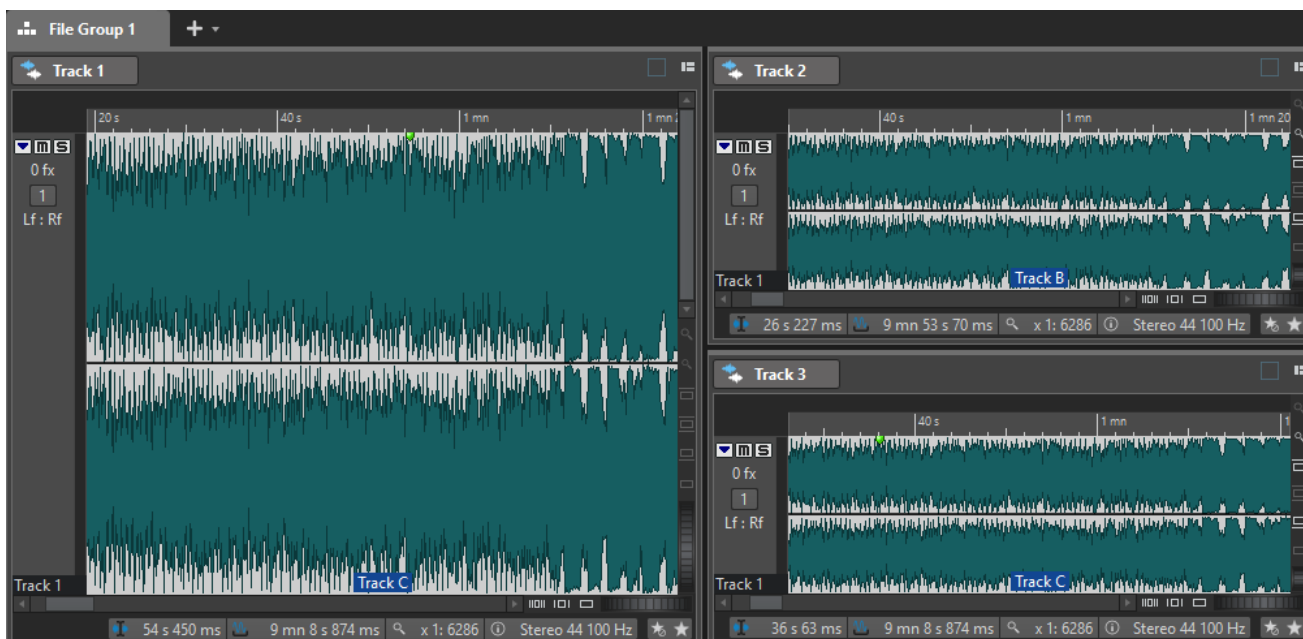

Tab Groups in Control Window

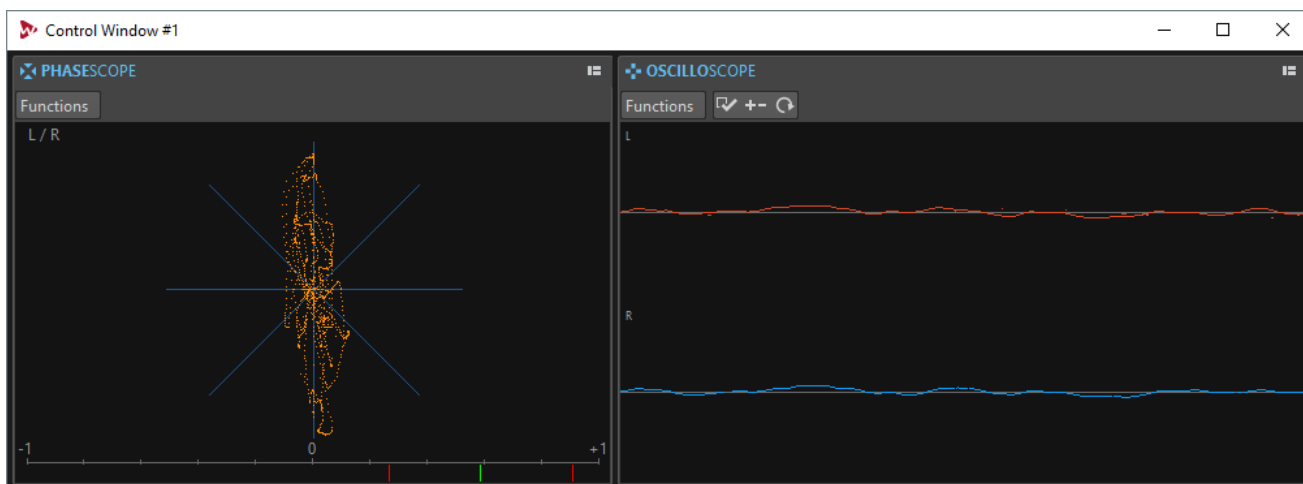

RELATED LINKS
[Control Window](#) on page 41

Creating File Tab Groups

PROCEDURE

1. In the top right of a file tab window, open the **Tab Group** pop-up menu.

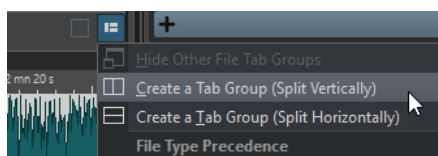

2. Select **Create a Tab Group (Split Vertically)** or **Create a Tab Group (Split Horizontally)**.

Creating File Tab Groups in Empty Tab Groups

PROCEDURE

- In the top right of an empty file tab group, click **Create a Tab Group (Split Vertically)** or **Create a Tab Group (Split Horizontally)**.
-

Using Tab Groups

The **Tab Group** button in the top right of each tab window allows you to maximize, move, and close tab groups. Tabs are used differently depending on the type of window.

Tool Window Tab Groups

- To hide a tool window tab group, open the **Tool Window Tab Group Options** pop-up menu and select **Hide All**.
- To reorder tabs in a tab group, drag the tab horizontally to a new position on the tab bar.
- To dock the tab group to another location, open the **Tool Window Tab Group Options** pop-up menu and select **Dock Tab Group Elsewhere**. Now you can select where to dock the tab group.
- To dock the tab group to the **Control Window**, open the **Tool Window Tab Group Options** pop-up menu and select **Dock Tab Group to Control Window**. Now you can select to which **Control Window** you want to dock the tab group.

File Tab Groups

- To close a file tab group, click the **Tab Group** button and select **Hide All**.
- To reorder tabs in a tab group, drag the tab horizontally to a new position on the tab bar.
- To move a tab to another project, drag the tab to another project.
- To paste the content of a tab into an audio file, drag the tab onto the waveform. The tab is inserted at the cursor position.
- To maximize the active file tab group, open the **File Tab Group Options** pop-up menu, and select **Hide Other File Tab Groups**.

To show all file tab groups, open the **File Tab Group Options** pop-up menu, and select **Show Other File Tab Groups**.

You can also double-click the file tab header of a tab group to show/hide other file tab groups.

Peak Files

A peak file (extension `.gpk`) is automatically created by WaveLab Pro each time an audio file is modified or opened in WaveLab Pro for the first time. The peak file contains information about the waveform and determines how it is drawn in the wave window or the montage window.

Peak files speed up the time it takes to draw the corresponding waveform. By default, the peak file is saved in the same location as the audio file.

Setting the Peak File Behavior

The peak file behavior can be set in the **Audio Files Preferences** on the **File** tab.

- To save peak files in another location, activate **Create Peak Files in an Independent Folder**, select **Edit**, and specify another file location.
- To create peak files when writing audio files, activate **Create Peak Files When Writing Audio Files**.

- To delete peak files when closing audio files, activate **Delete Peak Files When Closing Audio Files**.

RELATED LINKS

[Audio Files Preferences](#) on page 576

Rebuilding Peak Displays

Normally, peak files are automatically updated when the date of the peak file is older than the date of the audio file. However, it can happen that the date of the audio file is not automatically updated. In this case you can force a rebuild of the peak file.

PROCEDURE

1. In the **Audio Editor**, select the **View** tab.
 2. In the **Peaks** section, click **Rebuild Display**.
-

Companion Files

Companion files (extension `.vcs`) contain **Master Section** presets and view settings for audio files. If this feature is activated when you save a file, the settings are recreated the next time that you load the file.

Companion files are only available in the **Audio Editor**.

The following view settings are included in companion files:

- Window size and position
- Zoom level
- Scroll position
- Display mode (Waveform/Spectrum/Loudness)
- Snapshots
- **Master Section** presets associated with the file

Deleting a companion file does not alter the audio contents. **Master Section** presets are specific to WaveLab Pro and can therefore not be integrated inside the various audio file headers.

Storing Companion Files in Another Location

By default, companion files are saved in the same location as the audio file. However, you can select another file location.

PROCEDURE

1. Select **File > Preferences > Folders**.
 2. Click **Companion Files** and specify another file location.
-

Processing Precision

WaveLab Pro can load audio samples in many formats but processes them internally as 64-bit float samples.

Mixing inside WaveLab Pro is also done in 64-bit float. 32-bit PCM samples can be transferred to 64-bit float and back.

Plug-ins are processed in 64-bit float by default. You can also set the plug-in processing to 32-bit float.

You can set up the processing precision for plug-ins and for temporary files in the **Audio** tab of the **Global Preferences**.

NOTE

Processing in 64-bit float means double precision but slightly longer process time than 32-bit float.

Temporary files in 64-bit float have double precision but take longer to read and write than 32-bit float and their file size is twice as big.

RELATED LINKS

[Temporary Files](#) on page 86

[Audio Tab](#) on page 573

EBU Loudness Standard R-128

The EBU loudness recommendation R-128 establishes well-defined methods to measure loudness, dynamics, and peak values, and also defines reference values to achieve for these measurements. Though the reference values are intended for the broadcast world, the measurement methods are helpful in any application dealing with audio and loudness control.

WaveLab Pro supports these audio measurements in many places, for metering, audio analysis, and processing. The following text gives some basic information about the EBU R-128 standard.

Loudness Measurement

This method takes into account the frequency sensitivity of the human ear to loudness levels. There are 3 types of measurements:

1. Integrated loudness, also called program loudness: this reports how loud an audio piece is, on average. This measurement uses a gating method to ignore long periods of silence.
2. Short-term loudness: this measures the loudness every 1 second on an audio block of 3 seconds. This gives information about the loudest audio passages.
3. Momentary loudness: every 100 ms, a range of 400 ms of audio is measured. This gives instantaneous feedback about the loudness.

Loudness Range

This measures the dynamics of the audio signal. It reports the ratio between the loudest and the quietest (but non-silent) sections. The audio is divided into small blocks. There is one audio block every second and each block lasts 3 seconds (analyzed blocks overlap).

The top 10 % of the quiet blocks and the top 5 % of the loud blocks are excluded from the final analysis. The calculated loudness range is the ratio between the loudest and quietest remaining audio blocks. This measurement helps to decide if and how much compression or expansion can or should be applied to the audio.

True Peaks

When a digital signal is converted to an analog signal, the EBU R-128 recommends measuring an estimation of the real peaks, rather than relying on digital peaks, to avoid clipping and distortion. This is accomplished by over-sampling the signal 4 times and retaining the peak values.

Naming and Units

The EBU R-128 proposes naming and units conventions:

- A relative measurement, such as a value relative to a reference level: "LU" as "Loudness Unit" (1 LU is 1 dB).
- An absolute measurement, "LUFS" as "Loudness Unit Full Scale". 1 LUFS can be understood as 1 dB in the AES-17 scaling.

When WaveLab Pro relates to the EBU R-128 loudness, these units are used rather than dB.

Workspace Window

The **Workspace** window provides an editing and playback environment for each particular file type. Each environment contains functions that are tailored to the specific purpose of each file type.

- **Audio Editor** for viewing and editing audio files.
- **Audio Montage** window for assembling and editing audio montages.
- **Batch Processor** window for processing a list of audio files with offline effects, VST plugins, and **Master Section** presets.
- **Podcast Editor** for preparing and uploading podcasts.
- **Basic Audio CD** window for assembling and writing Basic Audio CDs.
- **DVD-Audio** window for authoring DVD-Audio and writing it to DVD.
- **Script Editor** for writing and executing scripts in WaveLab Pro.
- **Control Window** for hosting and organizing tool windows, especially in a multi-monitor setup.

The **Workspace** window is highly customizable to match your workflow.

Elements of the Workspace Window

The **Workspace** window contains the following elements:

- A menu bar
- Tab groups to host the files to edit. You can move the content of a tab to another tab, create a new empty tab, display the file path, and access other functions by right-clicking.
- A set of tool windows. Which tools are available depends on the file type you are working on. The tool windows can be activated/deactivated individually.

Audio Editor

The **Audio Editor** provides tools and functions for sample-accurate audio editing, high-quality analysis, and processing.

Features include various metering tools, a signal generator, a compare function, and a tool for correcting errors.

The wave window gives you a graphical representation of the audio file and allows you to view, play back, and edit the file.

RELATED LINKS

[Audio File Editing](#) on page 108

Audio Montage

In the **Audio Montage** window, you assemble audio clips into a montage. You can arrange, edit, and play back clips on an unlimited number of both stereo or mono tracks.

Features include track and clip-based effects, volume and pan automation, and wide-ranging fade and crossfade functions. You can use the **Audio Montage** window for creating music CDs, mastering, multimedia work, radio spot production, etc. You can create multitrack compositions and author professional audio CDs or DVD-Audio. Depending on the channel configuration of the montage, you can route each track to different surround channels (up to 6) or non-surround channels (up to 8).

You can place any number of clips on an audio track. A clip contains a reference to a source audio file on your hard disk, as well as start and end positions in the file.

The montage window gives you a graphical representation of clips on tracks. In it you can view, play back, and edit the tracks and clips.

RELATED LINKS

[Audio Montage](#) on page 194

Batch Processor

This editor allows you to batch process any number of audio files or audio montage files using the plug-ins and presets of the **Master Section**, offline effects, and other plug-ins that are unique to batch processing.

You can save the processed file in a different file format, rename files, and run an external application when the batch is finished.

RELATED LINKS

[Batch Processing](#) on page 490

Podcast Editor

In the **Podcast Editor**, you assemble, define, and publish your podcast to the Internet.

RELATED LINKS

[Podcasts](#) on page 542

Basic Audio CD

In the **Basic Audio CD** window, all tracks of the Basic Audio CD are listed. Here you can assemble and write Basic Audio CDs that are compatible with the Red Book standard.

RELATED LINKS

[Basic Audio CD](#) on page 399

DVD-Audio

In the **DVD-Audio** window, you author DVD-Audio and write it to DVD.

RELATED LINKS

[DVD-Audio](#) on page 406

Script Editor

In the **Script Editor**, you write and execute scripts.

RELATED LINKS

[Scripting](#) on page 567

Control Window

A **Control Window** can contain multiple tool windows and meter windows. This is useful if you have multiple monitors. You can place the **Control Window** on your secondary display and use it to manage the tool windows and meter windows that you use most.

You can create up to 4 different control windows.

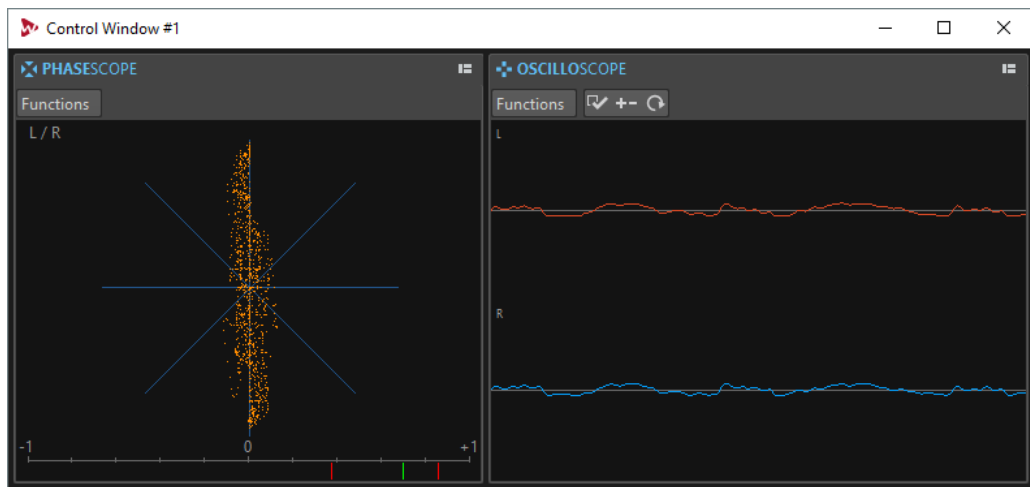

Docking Tool Windows and Meters in a Control Window

You can dock any tool window and meter window in a **Control Window**.

PROCEDURE

1. Right-click the tab of the tool window or meter that you want to dock in the **Control Window**.
 2. Select **Dock to Control Window** and select one of the **Control Windows** from the submenu.
-

Docking Tab Groups in a Control Window

You can dock tab groups in a **Control Window**.

PROCEDURE

1. Click the **Options** button on the right of the caption bar of a tab group.
 2. Select **Dock Tab Group to Control Window** and select a **Control Window** from the submenu.
-

File Tab

The **File** tab is the control center of WaveLab Pro. Here, you can save, open, render, import, and export files. It also gives you detailed information about your files and allows you to set up the WaveLab Pro preferences.

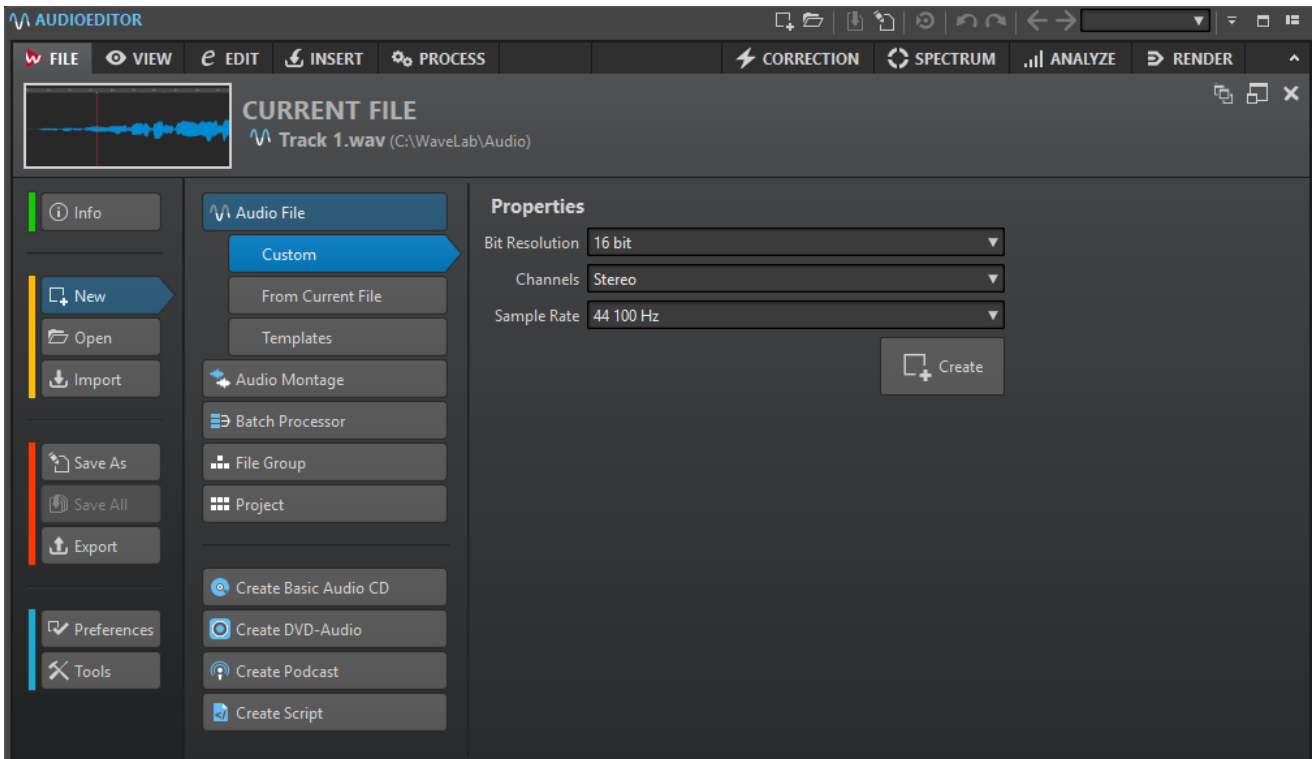

Info

Provides information about the active file and allows you to edit the audio properties of audio files and audio montages.

New

Allows you to create audio files, audio montages, batch processors, file groups, projects, Basic Audio CDs, DVD-Audio files, podcasts, and script files. You can create new files or use a template.

Open

Allows you to open audio files, audio montages, batch processors, projects, Basic Audio CDs, DVD-Audio files, podcasts, or script files.

You can also open files that you have previously copied to the clipboard in the File Explorer/macOS Finder.

Import

Allows you to open different file formats. The following formats are supported:

- Audio File to Montage
- DDP
- CD Cue
- AES-31
- XML
- Unknown Audio
- File Groups

You can also import audio CD tracks from an audio CD.

Save As

Allows you to save the active file or the project. You can specify the name, file format, and location. You can also save a copy of the active file.

Save All

Allows you to save all changed files of your project at once. The file list gives you an overview of all files that have been changed.

You can use the filter to show all changed files, only audio files, only audio montages, or all other files, for example, batch processor files.

Export

Allows you to render the active file, export the file group to a text file, export audio montages to AES-31 and XML, and upload the audio file to SoundCloud.

Preferences

Allows you to view and change the preferences of WaveLab Pro. You can set up the preferences for the following parts of WaveLab Pro:

- **Global**
- **Audio Connections**
- **Shortcuts**
- **Plug-ins**
- **Remote Devices**
- **Folders**
- **Variables**
- **Audio Files**
- **Audio Montages**

Tools

Allows you to access the following tools:

- **DDP to CD**
- **Data CD/DVD**
- **Auto Split Audio Files**
- **Signal Generator**
- **DTMF Generator**
- **Batch Conversion**
- **Batch Renaming**

RELATED LINKS

[Info Tab](#) on page 43

[Configuring WaveLab Pro](#) on page 570

Info Tab

The **Info** tab provides information about the active file and allows you to edit the audio properties of audio files and audio montages.

- To open the **Info** tab, select the **File** tab, and click **Info**.

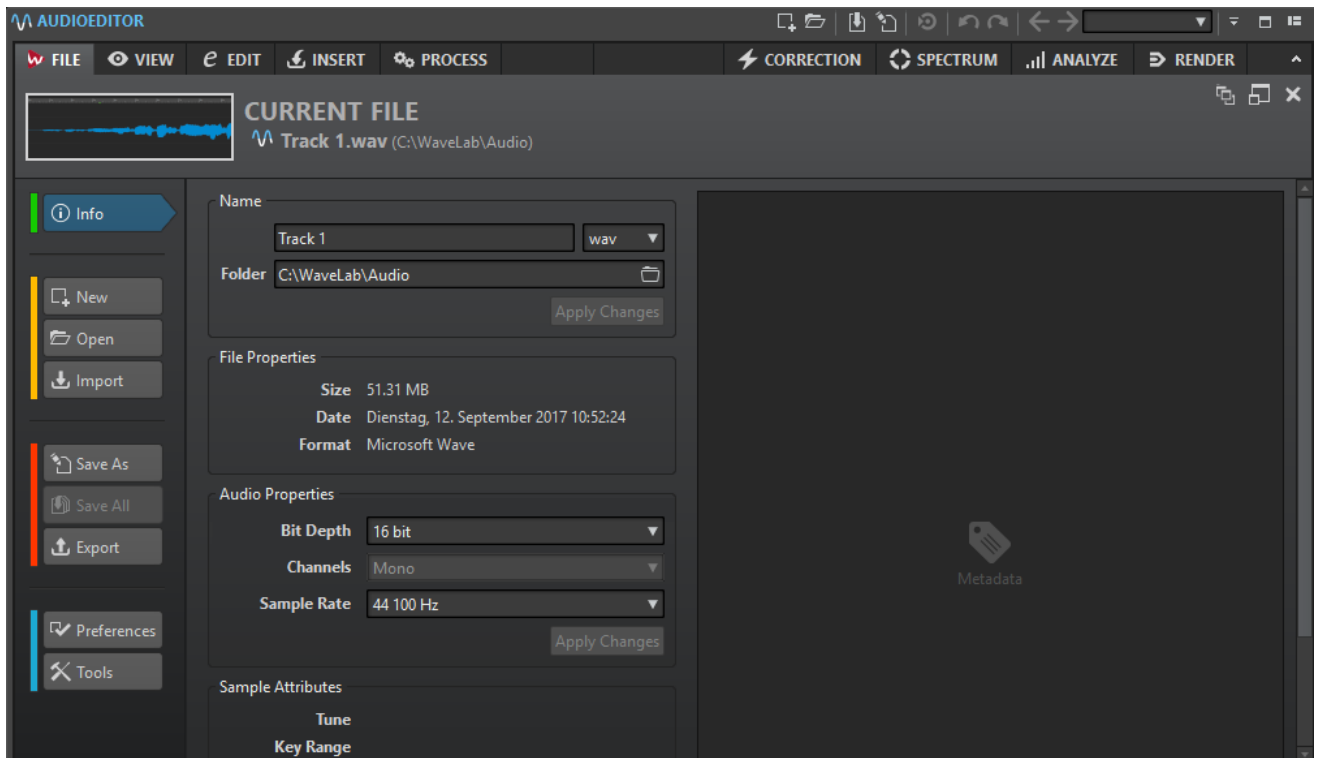

Depending on the selected file, different information and options are available.

Name

Displays the name, file extension, and file location of the active file. You can edit these attributes.

File Properties

Displays the size, date, and file format of the active file.

Audio Properties

For audio files, this displays the bit depth, channels, and sample rate of the active file.

For audio montages, this displays the mode, channels, and sample rate of the active file.

You can edit these attributes.

Sample Attributes (audio files only)

Displays the musical attributes tune, key range, and velocity range.

Metadata

Displays the metadata of the active file.

Copy to Clipboard

Opens a menu from which you can select which information about the active file you want to copy to the clipboard.

Reveal in File Explorer/macOS Finder

Opens the File Explorer/macOS Finder to show the location of the active file.

Delete

Deletes the active file.

Tool Windows

Throughout WaveLab Pro there are various tool windows available that allow you to view, analyze, and edit the active file.

Generally, the content of a tool window is synchronized with the active file, with the exception of the audio meters which displays the audio file being played back. Tool windows can be docked and undocked, and saved in your custom layouts. Some tool windows are only available for specific file types.

The tool windows can be accessed via the **Tool Windows** menu.

Opening and Closing Tool Windows

You can close all tool windows that you do not need for your project.

- To open a tool window, select **Tool Windows** and select a tool window.
- To close a docked tool window, right-click the tool window tab and select **Hide**.
- To close an undocked tool window, click its **X** button.

Meter Windows

WaveLab Pro contains a variety of audio meters that you can use for monitoring and analyzing audio. Meters can be used to monitor audio during playback, rendering, and recording. Furthermore, you can use them to analyze audio sections when playback is stopped.

The meter windows can be accessed via the **Meters** menu.

Opening and Closing Meter Windows

You can close all meter windows you do not need for your project.

- To open a meter window, select **Meters** and select a meter window.
- To close a docked meter window, right-click the meter window tab and select **Hide**.
- To close an undocked meter window, click its **X** button.

Slide-Out Windows

Slide-out windows are hidden in the frame of the **Workspace** window. When you hover the mouse pointer over the window name, the window slides out. It is hidden again, when you click anywhere else.

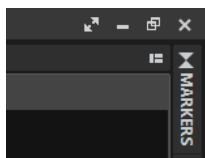

Slide-out window tab

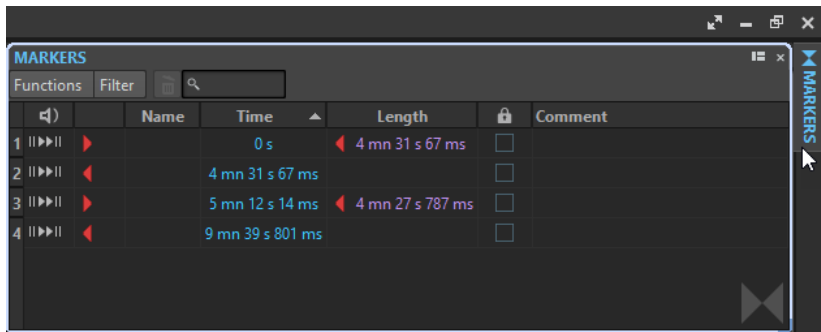

An open slide-out window

Docking and Undocking Tool Windows and Meter Windows

Tool windows and meter windows can be used as docked windows, as floating windows, or as a slide-out window. You can freely drag around the windows and dock them at various locations.

- To undock a tool window or meter window, drag the corresponding tab to another position.
Now the tool window or meter window is a floating window which can be freely moved.
- To dock a tool window or meter window, click and hold the caption bar or click the **Options** button on the right of the caption bar and select **Dock Tab Group Elsewhere**.
Yellow symbols indicate locations for docked windows, pink symbols indicate locations for slide-out windows. Drag the window to one of the locations.

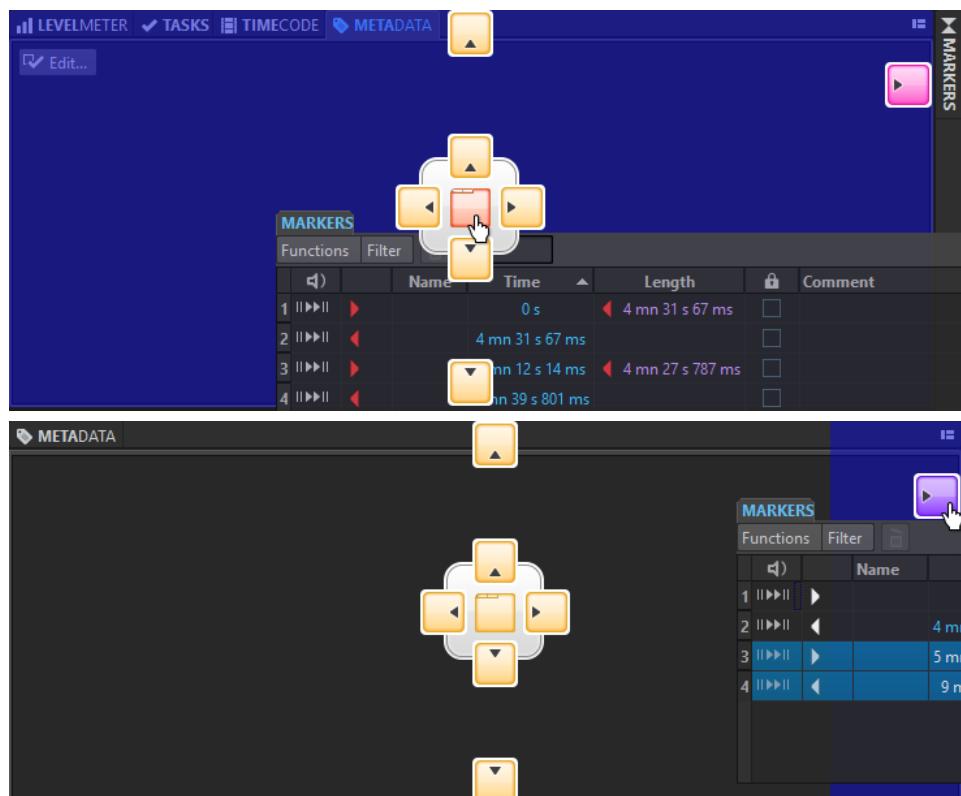

- To dock a floating tool window or meter window at its last docked position, click the **Options** button on the right of the caption bar and select **Dock to Last Place Again**.

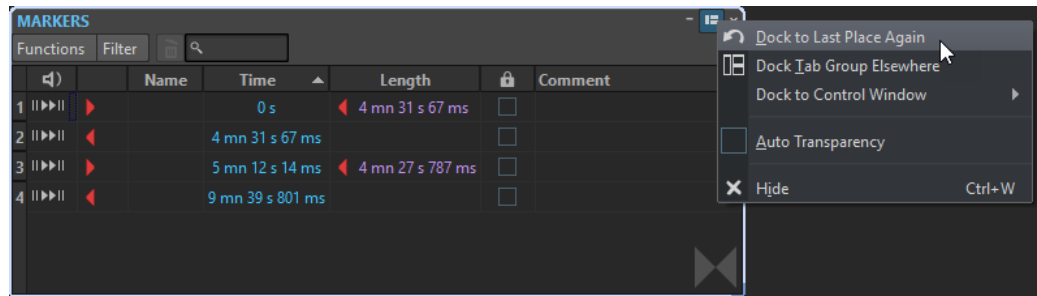

- To dock a tool window or meter window to the **Control Window**, click the **Options** button on the right of the caption bar and select **Dock to Control Window**. You can then select to which **Control Window** you want to dock the tool window or meter window. You can also drag and drop a tool window or meter window to the **Control Window**.

RELATED LINKS

[Slide-Out Windows](#) on page 45

[Control Window](#) on page 41

Setting the Transparency for Floating Windows

You can make the tool windows and meter windows become transparent if they are not the active window. For this, specify the transparency value in the global preferences and activate the transparency for each window individually.

- To specify the transparency value, select **File > Preferences > Global**, and select the **Display** tab. In the **Tool Windows** section, specify the value in the **Window Transparency** field.
- To activate the transparency for a tool window or meter window, click the **Tab Group** button at the top right of the window, and select **Auto Transparency**.

RELATED LINKS

[Global Preferences](#) on page 570

Hiding the Caption Bar in Floating Meter Windows

To save screen space, the caption bar of floating meter windows can automatically be hidden if the window is not the active window. This can be set individually for each floating window.

PROCEDURE

1. In a floating meter window, click the **Options** button at the top right of the window.
2. Select **Auto Caption Bar**.

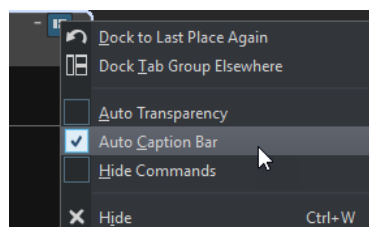

Command Bar

The command bar of file windows allows you to create, open, and save files, and undo/redo changes. You can also use the text field to quickly find and access open files, and to trigger keywords.



New

Allows you to create an audio file, audio montage, batch processor, file group, project, Basic Audio CD, DVD-Audio, podcast, and script file. You can create new files or use a template.

Open

Allows you to open an audio file, audio montage, batch processor, project, Basic Audio CD, DVD-Audio, podcast, or script file.

Save

Saves the active file.

Save As

Allows you to save the active file. You can specify the name, file format, and location. You can also save a copy of the active file.

Trigger Cubase Update

Updates the Cubase project if the active file was opened via the **Edit in WaveLab** option.

Undo

Allows you to undo changes.

Redo

Allows you to redo changes that were undone.

Navigate Backwards/Navigate Forwards

In the **Audio Editor** and **Audio Montage** window, this allows you to navigate to the previous/next cursor position, zoom factor, or selection range without undoing/redoing the edit operation.

File Search and Keywords

The text field allows you to search for open files and apply keywords.

Keywords are custom words that are assigned to a function in the **Customize Commands** dialog or to a preset in the **Shortcut Definitions** dialog.

Customize Command Bar

Allows you to select the buttons that you want to display on the command bar.

Maximize Window

Maximizes the window. To restore the window size, click the button again.

Layout Options

Allows you to determine the position of the command bar, transport bar, and file group tabs.

RELATED LINKS

[WaveLab Exchange](#) on page 488

Status Bar

The status bar at the bottom of the screen of the **Audio Editor** and the **Audio Montage** window shows information about the active window using the units specified in the rulers.

The information displayed on the status bar is updated depending on the cursor position and on the audio selection that you have made.

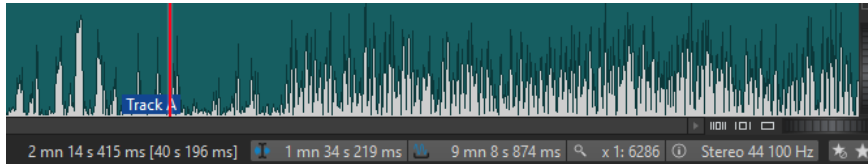

Time/Level (dB)

Displays the time of the audio file at the mouse cursor position. In the **Audio Editor**, it also displays the level.

The value in brackets shows the time from the edit cursor position to the mouse cursor position.

Audio Information at Edit Cursor

Displays the time at the position of the edit cursor. This information changes if you reposition the cursor.

- To define the cursor position, click the **Audio Information at Edit Cursor** field to open the **Cursor Position** dialog.
- To focus the cursor position, right-click the **Audio Information at Edit Cursor** field.

Audio Selection Indicator (Audio Editor)/Audio Range Indicator (Audio Montage)

In the **Audio Editor**, this displays the length of the current selection, or the total length of the audio file if no selection has been made.

In the **Audio Montage** window, this displays the length of the audio selection if a clip is selected, or the size of the audio montage.

If you have zoomed in, you can right-click the indicator to display the selected audio range, the active clip, or the whole file. Left-click the indicator to open the **Audio Range** dialog, where you can define or refine a selection.

Zoom Indicator

Displays the current zoom factor.

- To open a pop-up menu, that allows you to make additional zoom settings, click the indicator.
- To open the **Zoom Factor** dialog, that allows you to edit the zoom factor, right-click the indicator.

Sampler Key Indicator (Audio Editor only)

Indicates the key of the current audio file (if defined). Click the indicator to open the **Sample Attributes** window.

Audio File Properties/Audio Montage Properties

In the **Audio Editor**, this displays the bit depth and the sample rate. It also indicates whether the audio file is mono or stereo. Click the indicator to open the **Audio Properties** dialog.

In the **Audio Montage** window, this displays the number of audio channels and the sample rate of the audio montage. Click the indicator to open the **Audio Montage Properties** dialog.

Bypass Master Section

If this option is activated, only the **Playback Processing** pane of the **Master Section** is active during playback. All other **Master Section** panes are bypassed. However, rendering still takes all plug-ins into account.

Master Section Preset Setting pop-up menu

- **Save Master Section Preset** opens the **Save Master Section Preset** dialog, where you can save the active **Master Section** configuration inside the companion file or audio montage.
- **Load Master Section Preset** applies the **Master Section** with the configuration previously saved to the audio file or audio montage.
- If **Include Master Section Preset when Rendering as Super Clip** is activated, the **Master Section** preset that is saved with the audio montage is used when rendering super clips of audio montages (**Audio Montage** window only).

Background Information

The status bar shows the progress of some background operations, such as rendering an effect. The operation can be paused or canceled using the provided buttons.



Context Menu

Throughout WaveLab Pro, various context menus are available. These menus group the commands and/or options that are specific to the active window.

The context menus appear if you right-click specific areas and are useful for speeding up your workflow.

For example, right-click a file tab to open a context menu with some relevant file options. Right-clicking the ruler of the waveform window brings up the **Time Ruler** context menu that allows you to access a number of options for changing the time ruler display format.

You can find most context menu commands in the tabs, in the file window and in the main menus, but some commands are only available in context menus. If you search for a function, right-click the current working window to check if it has a context menu.

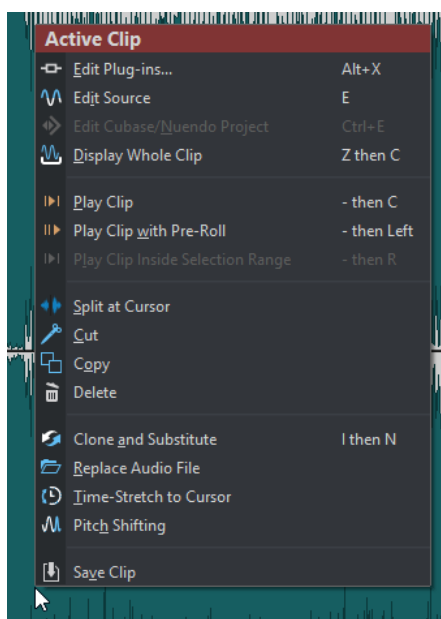

Context menu in the montage window

Time Ruler and Level Ruler

In the **Audio Editor**, you can display a time and a level ruler in the wave window. In the **Audio Montage** window, you can display a time ruler in the montage window.

You can also determine which time and level units the rulers show.

Time Ruler

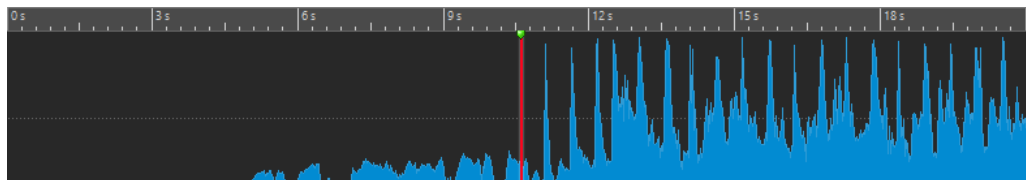

Level Ruler (Audio Editor only)

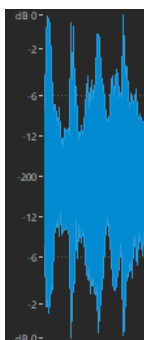

Time Ruler and Level Ruler Options

You can specify the time and level (amplitude) formats for each ruler in each wave window and the time formats for each ruler in the montage window separately by right-clicking the ruler and selecting a format from the pop-up menu.

Time Ruler Menu

Timecode

Displays frames per second for various SMPTE timecode types and for CD resolution. You can specify the timecode type in the **Time Format** dialog.

Clock

Displays time units.

Samples

Displays positions as number of samples. The number of samples per second depends on the sample rate of the audio file. For example, at 44.1 kHz, there are 44100 samples per second.

Bars and Beats

Displays bars and beats.

File Size (Audio Editor only)

Displays positions in megabytes. Decimals represent kilobytes.

Show grid (Audio Montage window only)

Displays vertical lines in the montage window, aligned with time ruler marks.

Time Format

Opens the **Time Format** dialog, that allows you to edit the appearance of the time ruler formats.

Save Current Settings as Default

If this option is activated, the time ruler uses the current time format in all new wave windows or montage windows.

Set Ruler's Origin to Start of File

If this option is activated, the ruler's zero position is set to the beginning of the first sample.

Set Ruler's Origin at Cursor

If this option is activated, the ruler's zero position is set to the current edit cursor position.

Set Ruler's Origin to BWF Reference (Audio Editor only)

If this option is activated, the first sample matches the BWF time reference, provided that the time reference is available.

Show Playback Range

If this option is activated, the time ruler displays the audio range that is played with the **Play Audio Range** command.

Show Playback Anchor

If this option is activated, a marker is displayed below the time ruler to indicate the audio anchor that corresponds to the **Play From** and **Play To** commands.

Show Pre-/Post-Roll

If this option is activated, the pre-roll and post-roll times are displayed.

RELATED LINKS

[Time Format Dialog](#) on page 53

Level Ruler Menu (Audio Editor only)

dB

Sets the level format to decibels.

+100 %

Sets the level format to percentage.

Normalized +1/-1

Sets the level format to a ruler gradation corresponding to 64-bit float audio.

16-bit Range

Sets the level format to a ruler gradation corresponding to 16-bit audio.

24-bit Range

Sets the level format to a ruler gradation corresponding to 24-bit audio.

Save Current Settings as Default

If this option is activated, the level ruler uses the current level format in all new wave windows.

Working With a Meter-Based Display

If your working material is tempo-based, you can select the meter format (bars, beats, and ticks) for the ruler legend. This makes it easier to find musically related cutting points.

PROCEDURE

1. In the wave window or the montage window, right-click the time ruler, and select **Bars and Beats**.
 2. Right-click the time ruler, and select **Time Format**.
 3. On the **Meter** tab, set the **Time Signature** and **Tempo** to values that match your audio file.
 4. Set **Ticks per Quarter Note** to a number that you feel comfortable with.
For example, this can be the same value that is used by your MIDI sequencer.
 5. Click **OK**.
-

Setting the Edit Cursor Position

Many operations, such as playback and selection, depend on the current edit cursor position. For example, playback often starts at the edit cursor position. The current edit cursor position is indicated by a vertical flashing line.

There are various ways to move the edit cursor:

- Click somewhere in the wave window, the montage window, or the time ruler. If you have made a selection, click the time ruler to prevent deselecting.
- Click and drag in the time ruler.
- Use the transport controls.
- In the **Audio Editor** and **Audio Montage** window, select the **View** tab and use the options in the **Cursor** section.
- Use the cursor keys.
- Double-click a marker.

Setting the Ruler Start Position

By default, the audio file starts at the ruler position 0. However, you can set the 0 position to another position of the file.

PROCEDURE

1. In the wave window or the montage window, right-click the time ruler, and select **Time Format**.
 2. Select the **Offset** tab.
 3. Select one of the **Time Ruler Offset** options, and click **OK**.
-

Time Format Dialog

In this dialog, you can customize the time format of the ruler. The time format of the ruler is also used in various time fields, for example, the status bar and some dialogs.

- To open the **Time Format** dialog, right-click the ruler in the **Audio Editor** or **Audio Montage** window, and select **Time Format**.
In the **Audio Editor**, you can set different time formats for the overview display and the main display.

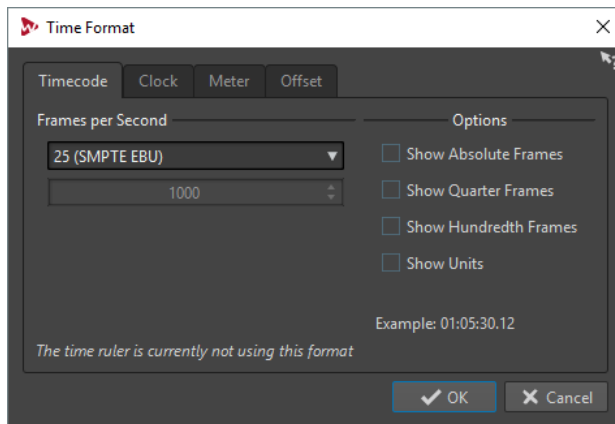

Timecode Tab

On this tab, you can configure the appearance of the **Timecode**.

Frames per Second

Lists standard frame rates. From the pop-up menu, select **Other** to enter a custom frame rate. You can also choose which frames or units are displayed.

Show Absolute Frames

Shows the time format as a number of frames, without other time elements.

Show Quarter Frames

Adds the quarter frame number to the time format.

Show Hundredth Frames

Adds the number of a hundredth of a frame to the time format.

Show Units

Adds time units to the time format of the ruler.

Clock Tab

On this tab, you can configure the appearance of the **Clock** option.

Show Units

Adds time units to the time format of the ruler.

Compact

Shows the time without unit indicators.

Meter Tab

On this tab, you can configure the appearance of the **Bars and Beats** option.

Time Signature

Lets you edit the time signature used to display the time represented as a musical notation.

Tempo

Lets you edit the tempo used to display the time represented as a musical notation.

Ticks per Quarter Note

Lets you edit the number of ticks per quarter note. These are used to display times that are compatible with your sequencer.

Offset Tab

On this tab, you can configure the **Time Ruler Offset**.

Zero (Default)

Deactivates the time offset in the ruler.

Set Zero-Point at Cursor Position

Sets the current cursor position to be the starting point of the ruler.

Set Zero-Point at BWF Time Reference (Audio Editor only)

If the audio file contains BWF metadata, the corresponding time reference value is used as offset.

Set Time of First Sample

Specifies the time that corresponds to the zero point of the ruler.

Managing Tabs

A tab is a container for a file in WaveLab Pro. There are file group tabs and file tabs. You can open several tabs, but only one can be active at a time. The **Tabs** context menu of the file group tabs and file tabs offer tab related options.

File Group Tabs

The following options are available when you right-click a file group tab.

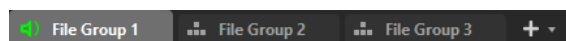

Save Modified Files

Allows you to specify which of the modified files of the file group you want to save.

Close All Files

Closes all file tabs.

Select Files to Close

Opens the **Files to Close** dialog which allows you to specify the files to be closed.

Set Temporary Files to Permanent Files

Adds all files to the file group that are not a permanent part of the file group.

Close and Remove from Project

Closes the file group and removes it from the project.

Remove Other File Groups from Project

Removes all file groups but the active file group from the project.

Rename

Allows you to rename the file group.

Export File Names

Allows you to create a text file that lists all files that are used in the file group.

File Tabs

The following options are available when you right-click a file tab.

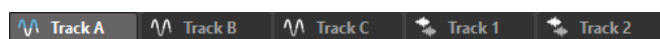

Check Tab/Uncheck Tab

Checks/Unchecks the tab. This allows you to render all file tabs at once via the **Render** tab.

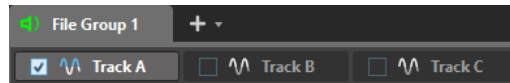

To check/uncheck all tabs at once, activate/deactivate the checkbox at the right of the file tabs.

You can also drag the selected tabs to another file tab.

Add to

Allows you to add the active file to another editor.

Close

Closes the active tab.

Close All But This

Closes all files but the active file.

Close All Audio Files

Closes all audio files.

Keep in Project after Closing

If this option is activated, the file remains in the project after you close the file.

You can open the file again from the **Project Manager** window.

Info

Displays information about the active file.

Reveal in File Explorer/macOS Finder

Opens the File Explorer/macOS Finder to show the location of the file.

Copy to Clipboard

Opens a menu, from which you can select which information about the file you want to copy to the clipboard.

Recent Files

Allows you to open recently used files.

New (Based on Active File)

Allows you to open a new file tab with the same settings of the source tab. This option is available if you right-click the empty area next to the file tabs.

Files to Close Dialog

In this dialog, you can specify which files you want to close.

- To open the **Files to Close** dialog, right-click a file group tab and select **Select Files to Close**.

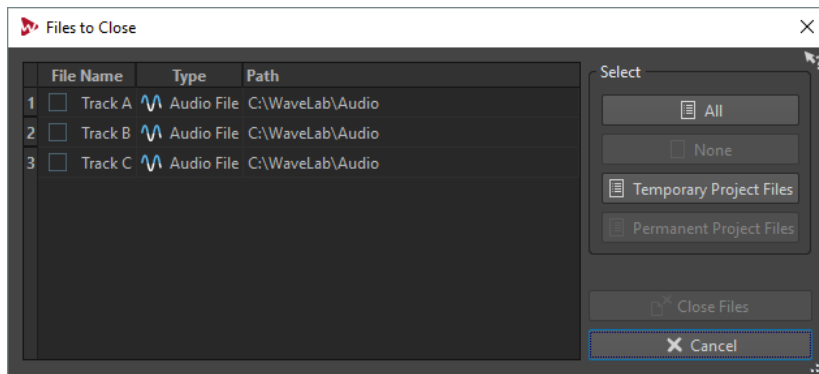

Files list

Displays all open files. You can set a checkmark for the files that you want to close. By default, only the active file will remain open and all other files will be closed.

All/None

Allows you to select and deselect all files.

Temporary Project Files

Allows you to select all files that are opened in WaveLab Pro, but not set to **Permanently in Project** in the **Project Manager**.

Permanent Project Files

Allows you to select all files that are opened in WaveLab Pro and set to **Permanently in Project** in the **Project Manager**.

Close Files

Closes the selected files.

RELATED LINKS

[Project Manager Window](#) on page 62

Activating Full Screen Mode

PROCEDURE

- Select **Workspace > Full Screen**.
-

Log Window

This window allows you to view log messages that have been issued by WaveLab Pro.

For example, when using the scripting language of WaveLab Pro, the `logWindow()` function outputs messages to this window. Toggle buttons allow you to filter the types of messages that are displayed.

- To open the **Log** window, select **Tool Windows > Log**.

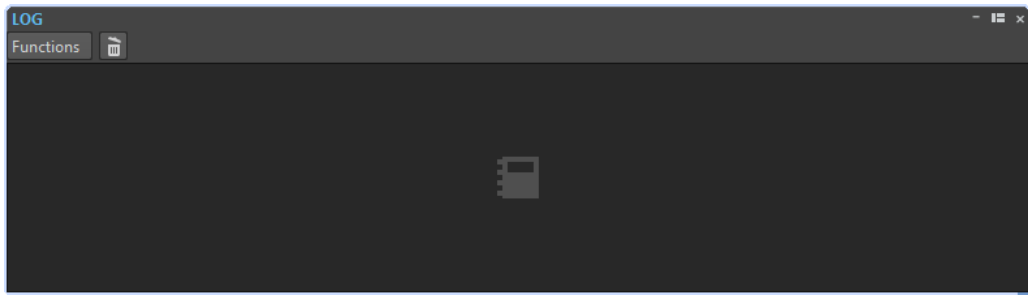

Clear

Removes all messages from the window.

Show Errors

If this option is activated, error messages are displayed.

Show Warnings

If this option is activated, warning messages are displayed.

Show Notes

If this option is activated, notes are displayed.

Project Handling

Opening Files

PROCEDURE

1. Select **File > Open**.
 2. Select the file type that you want to open.
For example, **Audio File**.
 3. From the file browser, select the file that you want to open.
 4. Click **Open**.
-

Opening Files from the Clipboard

You can open files in WaveLab Pro that you have previously copied to the clipboard in the File Explorer/macOS Finder.

PROCEDURE

1. In the File Explorer/macOS Finder, copy the files that you want to open to the clipboard.
 2. In WaveLab Pro, select **File > Open**.
 3. Click **Open Files from Clipboard**.
-

RESULT

The files open in new file tabs.

Automatically Opening Files in a Dedicated Tab Group

You can specify a predated file type for each tab group. Files that open after rendering, audio files that you open from an audio montage, or files that you open via the File Explorer/macOS Finder are automatically opened in the corresponding tab group for this file type.

- To specify a predated file type for a tab group, click **File Tab Group Options** at the header of a tab group, and select a file type.

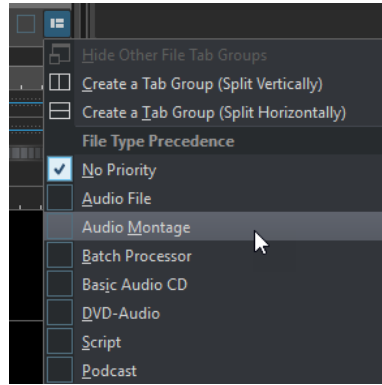

WaveLab Projects

A project file (extension *.wpr) is the central document in WaveLab Pro. A project file contains references to media data.

Only one project can be open at a time. When you open a previously saved project or create a new project, the currently opened project is closed.

Each project can contain multiple file groups. Each file group has its own tab.

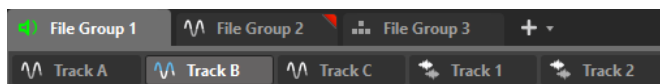

You can save your complete production as a project and open it on any WaveLab Pro workstation. For this, the source files must be available on the target workstation at the same relative or absolute path.

The **Project Manager** window gives you access to the files inside the project.

The active project is automatically saved and can be reloaded the next time that you start WaveLab Pro. If you create a new project, this will be the default project. The default project file is saved in the following location:

Windows

```
AppData\Roaming\Steinberg\WaveLab Pro 9.5\Cache\DefProject.wpr
```

Mac

```
/Users/YourName/Library/Preferences/WaveLab Pro 9.5/Cache/  
DefProject.wpr
```

RELATED LINKS

[File Groups](#) on page 63

[Project Manager Window](#) on page 62

Creating Projects

You can create empty projects or projects that are based on a template.

PROCEDURE

1. Select **File > New**.
2. Click **Project**.
3. Do one of the following:
 - To create an empty project, click **Create Empty**.

- To create a project that is based on a template, click **Templates**, and select a template.
-

RESULT

If you selected **Create Empty**, a new, untitled project is created. If you selected a template, the new project is based on this template and includes the corresponding layout and settings.

RELATED LINKS

[Templates](#) on page 79

[Creating Templates](#) on page 80

Creating Default Projects

You can define a default project that you can select when starting WaveLab Pro. You specify the default project when creating a template.

PROCEDURE

1. Select **File > New**.
 2. Select **Project > Templates**.
 3. Click **Add Template**.
 4. In the **Project Template** dialog, activate **Set as Default Project**.
 5. Enter a project name.
 6. Click **Save**.
-

RESULT

The default project is created. You can select it in the WaveLab Pro **Startup** dialog.

To set another project template as the default project template, right-click the corresponding template and select **Set as Default Project**.

RELATED LINKS

[Startup Dialog](#) on page 22

Saving Projects

The active project is automatically saved as a project file that can be reopened the next time that you start WaveLab Pro. However, you can also manually save the active project as a project file. This allows you to give the project a name and save the project file at another location.

To keep your projects as manageable as possible, make sure that you save project files and all related files in the corresponding project folders and subfolders.

PROCEDURE

1. Select **File > Save As**.
 2. Click **Project**.
 3. Enter the name and a file location.
 4. Click **Save**.
-

Project Manager Window

The **Project Manager** window gives you access to all project files in WaveLab Pro and allows you to edit them.

- To open the **Project Manager** window, select **Tool Windows > Project Manager**.

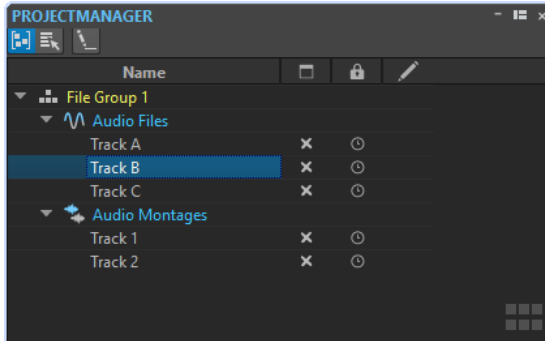

You can click on a file or file group to bring it to focus. If the file or file group is not already open in WaveLab Pro, it is opened.

The toolbar contains the following options:

Sort Files by Type

If this option is activated, the files are grouped in subfolders according to their file type.

Select Multiple Files (for Drag and Drop)

If this option is activated, you can select multiple files in the projects list. You can then drag the files to an audio montage, for example.

Rename Selected File Group

Allows you to rename the selected group.

The projects list contains the following options:

Open Status



This column shows if a file is open in WaveLab Pro or not. To close a file, click its **X** button.

If a file is set to **Permanently in Project**, the corresponding file tab is closed, but the file remains available in the **Project Manager**. You can click the file name to reopen the file. If the file is set to **Temporarily in Project**, the corresponding file tab is closed and the file is removed from the **Project Manager**.

Permanently in Project/Temporarily in Project



In this column, you can define if a file should be included as permanent part of the project or if the file is only temporarily needed in the project.

The lock icon indicates that the corresponding file is a permanent part of the project. The clock icon indicates that the corresponding file is temporarily in the project. Click the icon to change the file status.

If you drag files from the File Explorer/macOS Finder onto the file list in the **Project Manager**, the files are added permanently to the project. This allows you to quickly add multiple files to a project.

Modification Status



In this column, you can see if a file in the project has been modified. Files that have been modified are indicated by a checkmark.

RELATED LINKS

[Permanently in Project vs. Temporarily in Project](#) on page 63

Permanently in Project vs. Temporarily in Project

Project can contain files that are permanently or temporarily in the project.

Permanent files

Files that are set to be permanently in the project stay part of the project even when you close the file.

Temporary files

Files that are set to be temporarily in the project are removed from the project once you close the file. When you close the project file, these remain in the project just like permanent files do.

When you open a new file, it is considered a temporary file. If you want to keep the file in the project even when you close the project, you must set the file to permanent.

RELATED LINKS

[Project Manager Window](#) on page 62

[Changing the Permanent/Temporary Status of a File](#) on page 63

Changing the Permanent/Temporary Status of a File

To change the file status, do one of the following:

- Right-click a file tab of a temporary file and select **Keep in Project after Closing**.
- In the **Project Manager**, click the **Permanently in Project/Temporarily in Project** column of a file to change its status.

File Groups

File groups are part of WaveLab Pro projects. Each project can contain multiple file groups.

A file group can contain different file types. For example, audio files, audio montages, and batch processor files. This allows you to organize all files in one file group. You can also organize each file type in a different file group to have a better overview. In this case, the file group icon changes to the icon of the corresponding file type.

Each file group can contain multiple, customizable tab groups. For each tab group, you can define a type precedence to instruct WaveLab Pro in which tab group a file of a given type should be opened by default.

You can export file groups as text files. File groups can also be imported in a project via a text file that contains file paths. These file groups open as a new file group tab.

The file group options are available via the context menu of the file group tabs.

The tab color of a file group indicates whether a file group contains modified files that have not been saved yet.

RELATED LINKS

[Tab Colors](#) on page 78

Creating File Groups

You can create empty file groups or file groups that are based on a template.

PROCEDURE

1. Select **File > New**.
2. Click **File Group**.
3. Do one of the following:
 - To create an empty file group, click **Custom**, select one of the options, and click **Create**.
 - To create a file group that is based on a template, click **Templates**, and select a template.

RESULT

A new file group is created. If you selected a template, the new file group is based on this template and includes the corresponding layout and settings.

RELATED LINKS

[Project Manager Window](#) on page 62
[Templates](#) on page 79

Saving File Groups

File groups are automatically saved with the project.

RELATED LINKS

[Saving Projects](#) on page 61

Exporting File Groups as Text

You can export the names of the files inside a file group to a text file that contains the file paths.

PROCEDURE

1. Select **File > Export**.
 2. Click **File Group to TXT**.
 3. Specify a file name and location.
 4. Click **Export**.
-

Searching for Open Files

The **File Search and Keywords** field in the command bar allows you to search in all file tabs and access them. This allows you to quickly switch between file tabs if a lot of files are open.

- To open a file tab, click in the **File Search and Keywords** field or press **Ctrl/Cmd-F**, and start typing the file name that you want to access.
Once you stop typing or when you press **Return**, the first file tab that contains the search term is activated.
- To jump to the next file tab that contains the search term, press **Ctrl/Cmd-Tab**.
- To jump to the previous file tab that contains the search term, press **Ctrl/Cmd-Shift-Tab**.
- To switch back to the last file tab that was active before searching, delete the text in the search field.

RELATED LINKS

[Command Bar](#) on page 48

Value Editing

At various places in the program, numerical values can be edited by using a combination of text fields and knobs.

Values are sometimes composed of several elements, for example, 12 mn 30 sec 120 ms. Each value can be edited by using any of the following methods:

- To change a value, click in a value field and type a new value, or click the small arrows in the value field.
- To change the value by one unit at a time, press the **Left Arrow** and **Right Arrow** keys.
- To change the value by several units, press the **Page Up** and **Page Down** keys.
- To change the value using the mouse wheel, position the mouse cursor over a value, and use the mouse wheel, or use the AI knob of your MIDI controller.
- To change the value with the mouse, click a value and drag the mouse up or down.
- To jump to the maximum and minimum values, press the **Home** and **End** keys.
- To move from one element of the value to another, press the **Left Arrow** and **Right Arrow** keys.

Drag Operations

WaveLab Pro makes much use of drag-and-drop techniques to perform various operations, some of which can only be performed this way. These are referred to as drag operations in this documentation.

- To drag an object, click and hold with the mouse when positioned on the object and drag it. Drop the object by releasing the button.

Many types of objects can be dragged between different source and destination locations, for example, files, text, clips, items in a list, and markers.

NOTE

It is also possible to drag and drop files from WaveLab Pro to Steinberg's Nuendo.

- To reorder a tab within its own tabbed group, drag horizontally. To move a tab to another window, drag vertically.
- To open a file, drag it from the **File Browser** window of WaveLab Pro, from the file browser of your operating system, or from another application to the tab bar.
- To create a copy of a file, drag its tab vertically to another position of the tab bar, then press **Ctrl/Cmd**, and release the mouse button.
- You can dock and undock tool windows and meter windows via dragging.

RELATED LINKS

[Docking and Undocking Tool Windows and Meter Windows](#) on page 46

Dragging in the Audio Editor and Audio Montage Window

- To insert an audio file in another audio file, drag the title bar of the file onto the waveform of another file. You can also drag an audio file from the **File Browser** window, the file browser of your operating system, or from another application into the **Audio Editor**.
- To move a marker, drag it to another position on the time ruler.

- To create a copy of a marker, press **Shift**, and drag it to another position on the time ruler.
- To delete a marker, drag it upwards outside the time ruler.
- To copy an audio selection, drag a selected region of audio onto the waveform area of the same file or another file.
- To change the extent of a selection range, position the edit cursor at the start/end of the selection range, and drag to the left or right.
- To move the edit cursor without losing the current selection, and to snap it to an anchor, press **Shift**, and move the mouse near the audio file/montage cursor. The mouse cursor shape changes and you can drag the cursor left and right.
- To move the edit cursor without changing or losing the current selection, press **Shift**, click the edit cursor, and drag it to another position.
- To scroll the waveform horizontally, click the bar above the time ruler and drag left or right. You can also click anywhere on the waveform using the 3rd mouse button, and drag left or right.
- To create a generic marker from a selected text, drop the text that you have selected in an external application onto the time ruler. The text becomes the marker name.
- To create a stereo copy of a mono file, or a mixed copy of a stereo file, drag a tab to another position of the tab bar, press **Ctrl-Alt** (Windows) or **Option-Ctrl** (Mac), and release the mouse button.

Dragging in the Podcast Window

- To reorder episodes in the episodes list, drag them to another position.

Dragging in the Master Section

- To change the order of processing, drag effects between different effects slots.



Dragging in the Batch Processor Window

- To change the order in which plug-ins are processed, drag the plug-ins within the audio plug-in chain window.
- To add a file to a batch process, drag its file tab to the batch conversion tool or batch processor.

Undoing and Redoing Actions

You can undo and redo as many steps as you like. The only limitation is the available hard disk space.

By default, when undoing or redoing any operation in the **Audio Editor** or the **Audio Montage** window, the zoom factor, cursor position, scroll position, clip selection status, and time range are restored to the state before the operation.

- To exclude the scroll and zoom settings when undoing/redoing, select **File > Preferences > Global**, select the **Display** tab, and deactivate **Undo/Redo Does Not Scroll/Zoom Audio**.
This is useful if you make an operation, zoom in on the changed area, and then undo the step to see the change, for example. When you do this, you do not want snapshots to be restored and change your scroll and zoom settings.
- To undo or redo a step, click **Undo**  or **Redo**  in the title bar of the **Audio Editor** or **Audio Montage** window.

Undo/Redo and History in the Audio Montage

The **Undo/Redo** function in the **Audio Montage** window is identical with the **Undo/Redo** function in the **Audio Editor**. However, the **Audio Montage** window provides additional **Undo/Redo** functions and a **History** window. This window allows you to view a history of all recent editing activities in the audio montage and to revert to a previous state.

Each audio montage has its own history.

The following options are available in the **History** window.

- To open the **History** window, select **Tool Windows > History**.
- To revert the current audio montage to a previous state, double-click the operation to which you want to return.
- To undo all operations, select **Functions > Undo All Operations**.
- To undo all operations since the last saving command, select **Functions > Undo All Operations since the Last Saving Command**.
- To redo all operations, select **Functions > Redo All Operations**.
- To clear the history, select **Functions > Clear**.

This frees up memory, hard disk space, and any involved audio file.

NOTE

When you save an audio file, the undo history is cleared automatically. This is not the case for audio montages.

The following options are available in the **Audio Montages Preferences**.

- To group similar operations in the undo history, select **File > Preferences > Audio Montages**. On the **All Audio Montages** tab, activate **Group Similar Operations**. This groups all operations of the same type to one single operation, as soon as an operation of another type is performed.
- To clear the history after each saving, select **File > Preferences > Audio Montages**. On the **All Audio Montages** tab, activate **Clear After Each Saving**.

History Window

In this window, you can see all the operations that have been performed in the audio montage and revert to a previous state.

- To open the **History** window, open an audio montage and select **Tool Windows > History**.

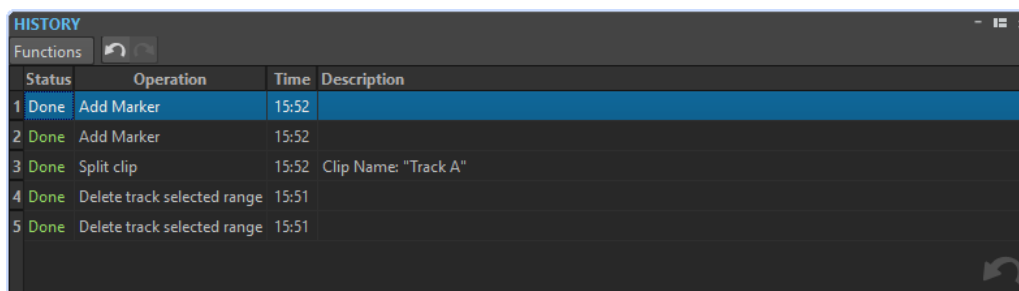

Status

Shows which operations are done and undone.

Operation

Shows the type of the performed operation.

Time



Shows the time at which the operation was performed.

Description

Describes the performed operation in detail.

Navigating Backwards and Forwards

In audio files and audio montages, you can navigate to the previous/next cursor position, zoom factor, and selection range without undoing/redoing the edit operation.

- To navigate backwards or forwards, click **Navigate Backwards**  or **Navigate Forwards**  in the title bar of the **Audio Editor** or **Audio Montage** window.

Zooming

Horizontal Zooming

- When you zoom out as far as possible, the entire file fits in the window.
- When you zoom in as far as possible, each sample occupies several pixels on the screen. This allows for sample-accurate editing of waveforms.

Vertical Zooming

- When you zoom out as far as possible, the height of the wave fits in the window.
- As you progressively zoom in, the display only shows a part of the total height. The vertical scrollbar lets you adjust exactly which section is shown. Check the ruler to see which part of the waveform is shown in the display.
- To optimize the vertical zoom of the waveform, press **Ctrl/Cmd**, the time ruler, keep the mouse button pressed, and drag the mouse up or down.

High Zoom Level

- When the zooming level is very high, each sample is shown with a step and a bullet. The steps show the real digitized state, while the bullets make it easier to see the samples, especially for zeroed samples.
- The curve also represents an estimation of the analog reconstructed signal to give hints on true peaks.

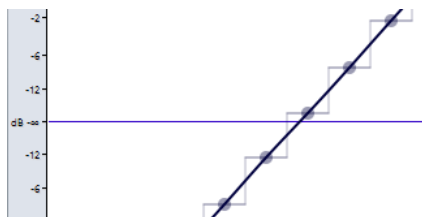

Zooming in the Overview and Main View Sections (Audio Editor Only)

- You can have different zoom levels in the overview and in the main view section. In the overview, a range indicator on the time ruler indicates which section of the file is displayed in the main view.

The range indicator is only shown if **Sync with Other View** is deactivated.

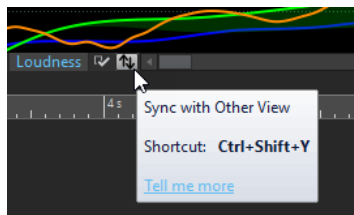

- To adjust the zoom level, drag the edges of the range indicator.
- To scroll in the main view, drag the range indicator. The range indicator is located at the top of the overview display.

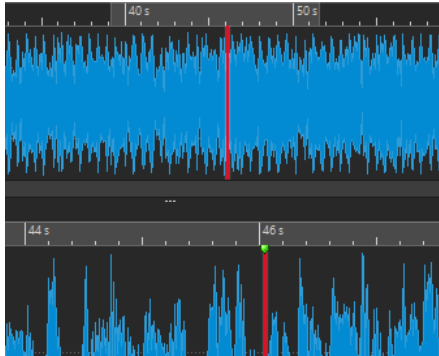

- To adjust the zoom level using the scrollbar, drag the edges of the scrollbar.

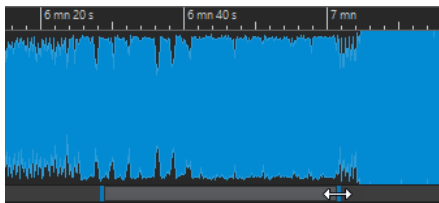

Zooming Using the Zoom Controls

Both the main view and the overview have horizontal and vertical zoom controls.



- To zoom horizontally, click the **Horizontal Zoom** control, and drag left or right, or use the mouse wheel.
- To zoom vertically, click the **Vertical Zoom** control, and drag up or down, or use the mouse wheel.
- To fully zoom-out, double-click the zoom controls.

Zooming Using the Zoom Tool

The **Zoom** tool is used to zoom in a specific section of the waveform so that it occupies the entire wave window. This is only available in the **Audio Editor**.

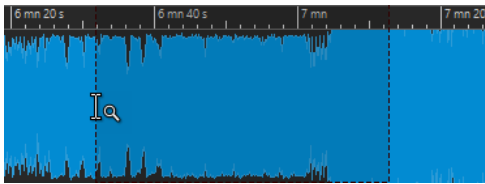

Using the Zoom Tool in the Main View

The selection that you make in the main view of the wave window is magnified and fills up the entire main view.

PROCEDURE

1. In the **Audio Editor**, select the **View** tab.
2. In the **Zoom** section, click **Zoom**.
3. In the main view of the wave window, click and drag left or right, and release the mouse button.

The selected part of the wave now occupies the entire main view.

Using the Zoom Tool in the Overview

The selection that you make in the overview of the wave window is displayed in the main view.

PROCEDURE

- In the overview of the wave window, click and drag left or right, and release the mouse button.

RESULT

The selected range of the waveform is shown in the main view.

Zooming Using the Mouse

With the mouse, you can change the zoom factor by clicking and dragging or by using the mouse wheel.

- To zoom horizontally, in the wave window or the montage window, position the mouse cursor over the time ruler, click, and drag up or down.
- To zoom horizontally while maintaining the cursor position, position the mouse cursor over the time ruler, press **Shift**, and drag up or down.
For this, you can also use the mouse wheel. Press **Ctrl/Cmd-Shift**, point at a waveform, and use the mouse wheel.
- To zoom horizontally around the mouse cursor position using the mouse wheel, press **Ctrl/Cmd**, point at a waveform, and use the mouse wheel.
- To zoom horizontally around the edit cursor position, press **Ctrl/Cmd-Shift**, point at a waveform, and use the mouse wheel.
- To zoom vertically using the mouse wheel, press **Shift**, point at a waveform, and use the mouse wheel.

Audio Editor Only

- To zoom vertically, in the wave window, position the mouse cursor over the level ruler, click, and drag left or right.
- To reset the vertical zoom to 0 dB, double-click the level ruler.
- To set the vertical zoom to the best value, that is, the current minimum and maximum displayed samples, make sure that the level ruler is set to 0 dB, and double-click the level ruler.

Zooming Using the Keyboard

A quick way to zoom the active wave or montage window is to use the arrow keys on the computer keyboard.

- To zoom horizontally in the active wave window or montage window, press **Up Arrow** or **Down Arrow**.
- To zoom vertically in the active wave/montage window, hold **Shift**, and press **Up Arrow** or **Down Arrow**.
- To zoom vertically to fit the available height, press **Ctrl/Cmd-Shift-Up Arrow**.
- To zoom out fully, press **Ctrl/Cmd-Down Arrow**.
- To zoom in fully, press **Ctrl/Cmd-Up Arrow**.

NOTE

You can increase or decrease the zoom steps with the **Interval for Zoom Key Command** option. You can set this option in the **Global Preferences** on the **Options** tab.

RELATED LINKS

[Global Preferences](#) on page 570

Zoom Options

The zoom options allow you to quickly access various zoom settings.

The zoom options are available in the **Audio Editor** and the **Audio Montage** window on the **View** tab in the **Zoom** section.

Time

Opens a pop-up menu that allows you to adjust the zoom to display the selected time range. **Zoom in 1:1** zooms in so that one pixel on the screen represents one sample.

To edit the zoom factor, click **Edit Zoom Factor**. This opens the **Zoom Factor** dialog, where you can edit the following settings:

- **Set Time Range** allows you to specify the time range that you want to display.
- **Samples per Screen Point** allows you to specify how many audio samples are summarized in each screen point.
- **Screen Points per Sample** allows you to specify how many screen points are used to represent a single audio sample.

Zoom

Activates the **Zoom** tool that allows you to define a time range that is zoomed in.

Zoom Selection

Zooms the window so that the current selection occupies the entire montage window.

Display Whole Clip (Audio Montage window only)

Adjusts the view to display the active clip.

View All

Displays the entire audio range.

Microscope

Zooms in as far as possible.

Zoom in Audio (10x)/Zoom out Audio (10x)

Zooms in/out in big steps.

Zoom in Audio/Zoom out Audio

Zooms in/out in small steps.

Level

Adjusts the zoom to only display samples below the selected dB value.

Optimize Vertical Zoom (Audio Editor only)

Changes the vertical zoom factor so that the peaks are clearly visible. This adjustment is done according to the section of the wave that is visible in the wave/montage window.

Reset Zoom to 0 dB

Adjusts the zoom to display audio levels up to 0 dB.

Zoom in Vertically/Zoom out Vertically

Zooms in/out to show waveforms with a lower/higher level.

Zooming in Audio Montages

Zooming options in the **Audio Montage** window are almost similar to those in the **Audio Editor**. However, there are additional zooming options for tracks and the Wave Matching window for displaying a close-up view of the beginning of the selected track.

RELATED LINKS

[Wave Matching Window](#) on page 279

Zoom Buttons in the Audio Montage

The zoom buttons in the **Audio Montage** window allow you to apply zoom presets.

- To only display the selected track, or also the tracks below and/or above the selected track, click the corresponding buttons.

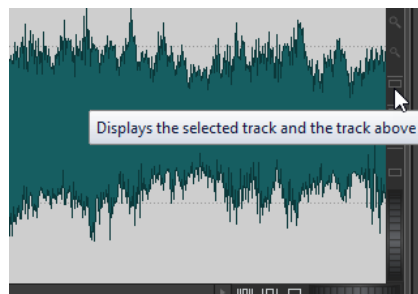

- To set the zoom setting to fit the active clips in 25 %, 50 %, or 100 % of the available space, click the corresponding buttons.

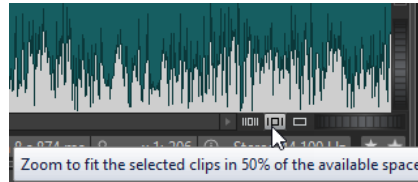

- To select a specific area, click **Ctrl/Cmd**, and drag the rectangle over the tracks and clips that you want to zoom in on.

Displaying More or Less Tracks

The number of tracks that are displayed in the **Audio Montage** window can be changed with the zoom controls in the lower right corner of the montage window.

- To display more tracks, click the smaller magnifying glass icon.

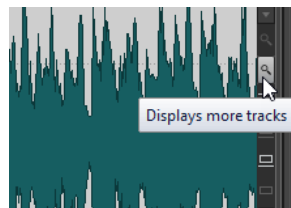

- To display fewer tracks, click the larger magnifying glass icon.
- To make a single track fit the whole montage window, click the numbered button in the track control area, and select **Zoom** from the pop-up menu.
You can also right-click the lower area of a track, and select **Display Whole Clip** from the pop-up menu.

Presets

You can create presets to save commonly used settings. WaveLab Pro provides a selection of factory presets that can be used by most dialogs.

You can save customized presets. The next time that you load the program, the presets are available.

Presets are saved as single files and can be organized in subfolders. The root folder of the preset is different for each type of preset and cannot be changed.

Saving a Preset

PROCEDURE

1. Open the dialog that you want to use and modify the parameters.
 2. Open the **Presets** pop-up menu and select **Save As**.
 3. Optional: Click the folder icon and enter a name for the subfolder that you want to use as the location for this preset.
 4. Type in a name.
 5. Click **Save**.
-

Loading Presets

To apply a saved preset or a factory preset to a dialog or plug-in, you must load the preset.

PROCEDURE

1. In the dialog, open the **Presets** pop-up menu.
 2. Select the preset that you want to apply.
-

Modifying a Preset

You can modify a preset and save the changes.

PROCEDURE

1. Open the dialog that you want to use.
 2. Load the preset that you want to modify.
 3. Modify the parameters of the dialog.
 4. Open the **Presets** pop-up menu and select **Save**.
-

Deleting a Preset

PROCEDURE

1. Open the dialog that you want to use.
 2. Select the preset that you want to delete.
 3. Open the **Presets** pop-up menu and select **Organize Presets**.
 4. In the File Explorer/macOS Finder, select the preset file that you want to delete, and press **Delete**.
-

Saving and Restoring Temporary Presets

Some dialogs allow you to save and load up to 5 temporary presets. This is useful if you want to quickly test and compare different settings.

Saving Presets Temporarily

PROCEDURE

1. Open the dialog that you want to use and make your settings.
 2. Open the **Presets** pop-up menu.
 3. From the **Store Temporarily** submenu, select a slot.
-

Restoring Temporary Presets

PROCEDURE

1. Open the dialog in which you have saved a preset.
 2. Open the **Presets** pop-up menu.
 3. From the **Restore** submenu, select a preset.
-

File Operations

Recently Used Files

All files that you have recently used in WaveLab Pro are saved in a list. This helps you to gain fast access to recent projects. You can open recently used files via the **File** menu or the **Recent Files** tab, which displays more files and offers additional options.

Opening Recently Used Files

PROCEDURE

1. Select **File > Open**.
2. Select the file type that you want to open.
3. Click **Recent Files**.
4. Optional: Use the search field to enter the name of the file that you are looking for.
5. Select the file that you want to open.
6. Click **Open**.

Recent Files Tab

This tab allows you to view and manage all the files that you have recently used in WaveLab Pro. You can search for files, open multiple files at once, and remove individual files or files that cannot be located.

- To open the **Recent Files** tab, select **File > Open**, select one of the file types, and click **Recent Files**.

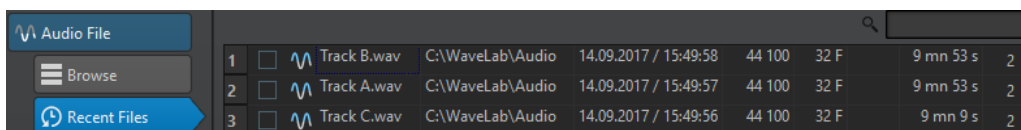

1	<input type="checkbox"/>	Track B.wav	C:\WaveLab\Audio	14.09.2017 / 15:49:58	44 100	32 F	9 mn 53 s	2
2	<input type="checkbox"/>	Track A.wav	C:\WaveLab\Audio	14.09.2017 / 15:49:57	44 100	32 F	9 mn 53 s	2
3	<input type="checkbox"/>	Track C.wav	C:\WaveLab\Audio	14.09.2017 / 15:49:56	44 100	32 F	9 mn 9 s	2

Only Show Files Created by WaveLab Pro

Only shows the files that have not been opened since they were created by WaveLab Pro. For example, a file that is rendered has this status until it is opened.

Search field

Lets you search for text in the **Name** or **Path** column, depending on which column is selected.

Remove Non-Existing Files

Removes those files from the list that cannot be located on the medium.

Remove Selected Files

Removes all selected files from the list.

Open

Opens the selected files.

Filtering Recently Used Files by Name

The search field in the **Recent Files** tab allows you to filter the files list by name.

- To specify whether the **Name** or the **Path** column is used, click the **Name** or **Path** column header.
- To search for a file, enter the text that you want to search for in the search field.
- To switch the focus from the search field to the list of recently used files, press **Down Arrow**.
- To switch the focus from the list of recently used files to the search field, press **Ctrl/Cmd-F**.

Setting the Number of Recently Used Files to Display

PROCEDURE

1. Select **File > Preferences > Global**.
 2. In the **Global Preferences** window, select the **Display** tab.
 3. In the **History** section, set the maximum number of items to be listed in the following areas:
 - **Recent File** menus
 - **Recent Files** tab
 - **Recent Folders** menu
-

Favorite Files

You can add files that you are using regularly to the favorite files list.

- To open the favorite files list, select **File > Open**, select the file type, and click **Favorites**.
- To add the open file to the favorite files list, click **Add Current File**.
- To open a file from the favorite files list, select a file from the file list, and click **Open**.
- To remove files from the favorite files list, select the files that you want to remove, and click **Remove Selected Files**.
- To remove files from the list that are no longer present on the medium, click **Remove Non-Existing Files**.

Favorite Files Tab

This tab allows you to display and edit the favorite files list.

- To open the **Favorite Files** tab, select **File > Open**, select the file type, and click **Favorites**.

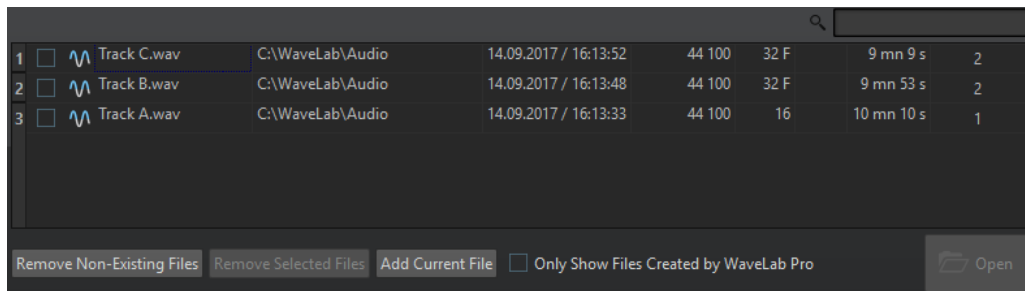

List of favorite files

Shows the favorite files.

Search

Lets you filter the favorite files list by name.

Remove Non-Existing Files

Removes files from the list that are no longer present on the medium.

Remove Selected Files

Removes all selected files from the list.

Add Current File

Adds the open file to the favorites list.

Only Show Files Created by WaveLab Pro

If this option is activated, the list displays only files that were created by WaveLab Pro, but have not yet been opened.

This allows you to quickly access files that were created in WaveLab Pro via the **Save As** or **Render** option, for example.

Open

Opens the selected files in WaveLab Pro.

Filtering Favorite Files

The search field in the **Favorite Files** tab allows you to filter the favorite files list by name.

- In the **Favorite Files** tab, enter the text that you want to search for in the search field.
- To switch the focus from the search field to the favorite files list, press **Down Arrow**.
- To switch the focus from the favorite files list to the search field, press **Ctrl/Cmd-F**.

RELATED LINKS

[Favorite Files Tab](#) on page 76

Save and Save As

- Once a file has been saved, select **File > Save**, or press **Ctrl/Cmd-S** to update the file and make the changes permanent.
- If you want to specify a new name, location, and/or file format, select **File > Save As**.

NOTE

In the **Audio Editor**, all save operations except **Save Copy** clear the undo history, which means that after saving you cannot undo or redo.

Tab Colors

The colored tab corner gives information on whether a file is saved or not, and whether the file has been rendered in Cubase.

White

The file is not modified.

Green (Audio Editor only)

The file uses a decoded file format and is saved.

Red

The file has been modified and changes have not been saved yet.

Yellow

The file has been rendered in Cubase.

Unsaved Changes Indicator

When you have made changes to a file, an asterisk is displayed next to the file name until you save the file.

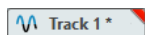

Saving Multiple Files at Once

You can save some or all open files at once.

PROCEDURE

1. Open the **File** window and click **Save All**.
 2. Select the files that you want to save.
 3. Click **Save**.
-

Saving Copies of Files

You can save copies of files that you are working on.

PROCEDURE

1. Select **File > Save As**.
 2. Specify a name and location.
 3. Right-click **Save** and select **Save Copy**.
-

Reverting to Saved File

You can revert the file that you are working on back to its last saved state. This undoes all the changes made to the file since it was last saved.

PROCEDURE

1. Select **File > Open**.
 2. Select the file type that you want to open.
 3. Click **Revert to Saved File**.
 4. In the warning dialog, click **Yes** to revert to the last saved state.
-

RESULT

The last saved version of the file is loaded from disk.

Automatic Backups

You can automatically create backups of your files.

For example, if you select **Save As** and specify a file name that is already used in that folder, you will be asked if you want to replace the existing file or replace the existing file and rename the old file. If you click **Replace and Keep Old**, the backup name of the audio file that is replaced will be the original name, with `.bak` added at the end.

Saving Audio Montages

The saving operations for audio montages are the same as for audio files. However, there are things to note when saving audio montages.

- Audio montage files only contain references to audio files. If you want to rename audio files that are referenced by audio montages, rename the audio files in the **Info** window of the **Audio Editor**. All clip references are updated automatically.
- If the audio montage contains clips that refer to untitled audio files, save these audio files before saving the audio montage.

RELATED LINKS

[Renaming Files](#) on page 84

[Save and Save As](#) on page 77

Templates

You can save file settings that you regularly use as templates. Templates are useful when creating new audio files, audio montages, podcasts, projects, or batch processors.

Templates Tab

This tab shows all templates, and allows you to create and open templates.

- To open the **Templates** tab, select **File > New**, select a file type, and click **Templates**.

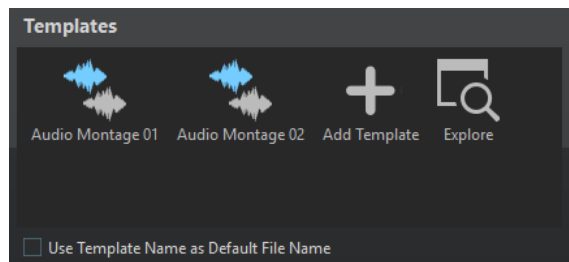

List of the available templates

Lists all saved templates.

Add Template

Allows you to add a new template or update an existing template.

Explore

Opens the folder where the template files are located. Here, you can rename and delete templates.

Use Template Name as Default File Name

If this option is activated and you click **Add Template**, a new file is created and uses the name of the template. If this option is deactivated, the name of the new file is "untitled".

Creating Templates

You can create a template from an active audio montage, audio file, podcast, project, or batch processor file and use it as a basis for newly created files.

PREREQUISITE

Select the file that you want to base your template on.

PROCEDURE

1. Select **File > New**.
2. Select the file type for which you want to create a template.
3. Click **Templates**.
4. In the **Templates** tab, do one of the following.
 - To create a new template, click **Add Template**, make your settings, and click **Create**.
 - To update an existing template, click **Add Template**, enter the name of the template that you want to update, and click **Create**.
5. Optional: If you want to use the template name as the default file name, activate **Use Template Name as Default File Name**.
6. When saving or updating an audio file template or an audio montage template, you can make additional settings.
 - When saving an audio file template, the **Audio File Template** dialog opens. Here, you can select whether WaveLab Pro should attach an audio file format.
 - When saving an audio montage template, the **Audio Montage Template** dialog opens. Here, you can select whether to include track plug-ins, clips, and/or markers. Also select whether WaveLab Pro should attach an audio file format.

Audio File Template Dialog

The **Audio File Template** dialog displays the audio properties of the audio file template that you are creating. You can also specify whether to always associate a specific audio file configuration with optional metadata when creating an audio file template or not.

- To open the **Audio File Template** dialog, select **File > New**, click **Audio File**, and click **Templates**. In the **Templates** tab, click **Add Template**.

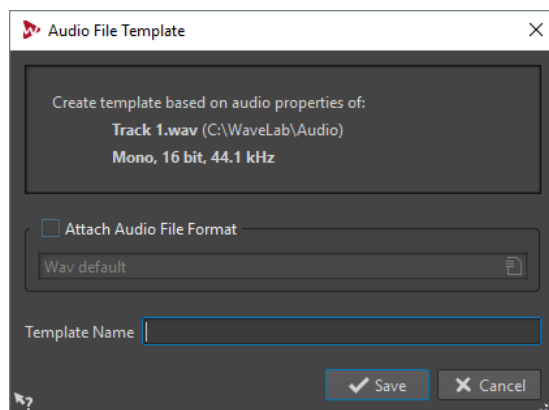

Attach Audio File Format

If this option is activated, whenever you open the **Render** or **Save As** dialogs, the audio file configuration specified below is proposed by default.

Template Name

Allows you to enter a name for the template.

Audio Montage Template Dialog

In the **Audio Montage Template** dialog, you can set various options when creating an audio montage template.

- To open the **Audio Montage Template** dialog, select **File > New**, click **Audio Montage**, and click **Templates**. In the **Templates** tab, click **Add Template**.

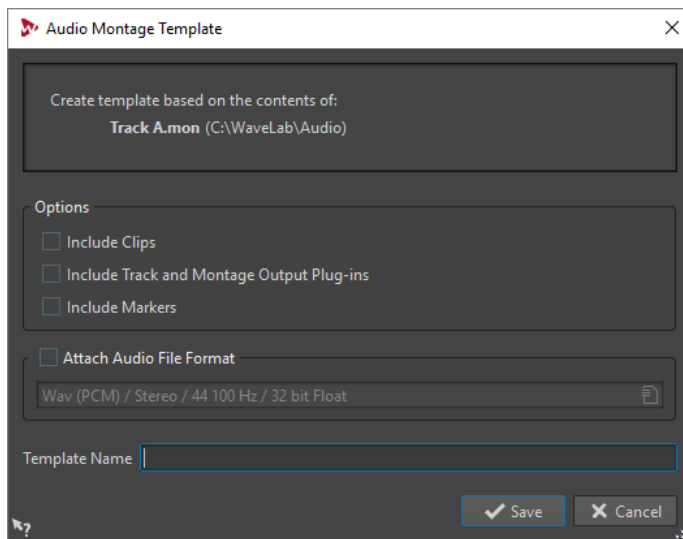

Include Clips

If this option is activated, clips are saved in the template.

Include Track and Master Plug-ins

If this option is activated, track plug-ins and master plug-ins are saved in the template.

Include Markers

If this option is activated, markers are saved in the template.

Attach Audio File Format

If this option is activated, whenever you open the **Render** dialog, the audio file configuration specified below is proposed by default.

Template Name

Allows you to enter a name for the template.

File Group Template Dialog

The **File Group Template** dialog displays the file group name on which the template that you are creating is based on. You can also specify whether to include links to the files inside the file group in the template and specify the template name.

- To open the **File Group Template** dialog, select **File > New**, click **File Group**, and click **Templates**. In the **Templates** tab, click **Add Template**.

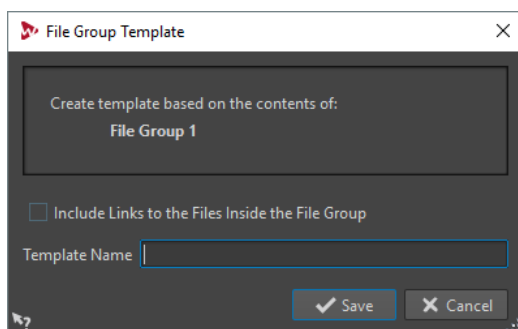

Include Links to the Files Inside the File Group

If this option is activated, the links to the files that are included in the file group are included in the template.

Template Name

Allows you to enter a name for the template.

Project Template Dialog

In the **Project Template** dialog, you can set various options when creating a project template.

- To open the **Project Template** dialog, select **File > New**, click **Project**, and click **Templates**. In the **Templates** tab, click **Add Template**.

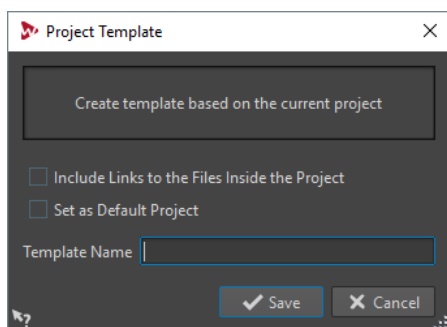

Include Links to the Files Inside the Project

If this option is activated, the links to the files that are included in the project are included in the template.

Set as Default Project

If this option is activated, the template is used as the default project when you start WaveLab Pro.

Template Name

Allows you to enter a name for the template.

Creating Files From Templates

You can create a file from a template to use its settings.

PROCEDURE

1. Select **File > New**.
2. Select the file type that you want to create.
3. Click **Templates**.

4. From the list of the available templates, select the template that you want to take as the basis of the new file.
-

Deleting Templates

PROCEDURE

1. Select **File > New**.
 2. Select the file type for which you want to delete templates.
 3. Click **Templates**.
 4. Click **Explore**.
 5. In the File Explorer/macOS Finder, delete the templates.
-

Renaming Templates

PROCEDURE

1. Select **File > New**.
 2. Select the file type for which you want to rename templates.
 3. Click **Templates**.
 4. Click **Explore**.
 5. In the File Explorer/macOS Finder, rename the templates.
-

Setting Templates as Default

You can set a template as the default template that opens when you click **New** on the command bar.

PROCEDURE

1. Select **File > New**.
 2. Select the file type that you want to open.
 3. Select **Templates**.
 4. Right-click a template and select **Set as Default**.
-

RELATED LINKS

[Command Bar](#) on page 48

Defining Shortcuts for Templates

You can define key sequences and keywords for templates. This allows you to quickly open a template.

PROCEDURE

1. Select **File > New**.
2. Select the file type that you want to open.
3. Select **Templates**.
4. Right-click a template and select **Define Shortcut**.
5. In the **Shortcut Definitions** dialog, edit the shortcut for the selected template.

6. Click **OK**.
-

File Renaming

You can rename a file and update all references automatically. For example, if you rename an audio file named *India* to *Sitar*, all open files that reference the file *India* are updated to reference the file as *Sitar*.

Audio files, peak files, and marker files are also renamed accordingly.

The following files use audio file references:

- Audio montages
- Basic Audio CDs
- DVD-Audio projects

Renaming Files

PREREQUISITE

If you want to rename a file that is referenced by other files, open the files that reference the file that you are about to rename in WaveLab Pro.

PROCEDURE

1. Open the file that you want to rename.
 2. Select the **File** tab.
 3. Click **Info**.
 4. In the **Name** section, enter the new name and/or a new file location.
 5. Select a file suffix from the pop-up menu.
 6. Click **Apply Changes**.
-

Naming Schemes

When rendering audio files or audio montages, you can create multiple files that are named according to a naming scheme.

Defining Naming Schemes

You can define a naming scheme by combining name attributes that determine the structure of the file names for the rendered audio files or audio montages.

PROCEDURE

1. In the **Naming Scheme** dialog, click **Add Attribute** and select which attributes you want to add.
 2. In the **Settings** section, make your settings.
 3. Click **OK**.
-

RELATED LINKS

[Naming Scheme Dialog](#) on page 85

Naming Scheme Dialog

The **Naming Scheme** dialog allows you to define naming schemes for the audio files or audio montages that you want to render. You can save naming schemes as presets.

- To open the **Naming Scheme** dialog, select the **Render** tab in the **Audio Editor** or **Audio Montage** window, and activate **Named File** in the **Result** section. Then open the **Scheme** pop-up menu in the **Output** section, and select **Edit Naming Scheme**.

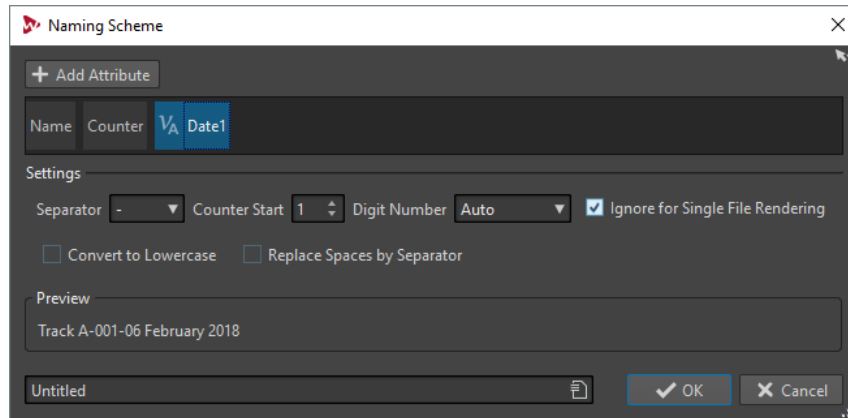

Add Attribute

Allows you to add a naming scheme attribute. You can add free text, counters, and variables.

Used Attributes

Shows the naming scheme attributes. You can rearrange the attributes by dragging.

Separator

Allows you to select a separator.

Counter Start

Allows you to select the counter start.

Digit Number

Allows you to select the style of the digit number.

Ignore for Single File Rendering

If this option is activated, the naming scheme is only applied when rendering more than one file.

Convert to Lowercase

If this option is activated, all letters of the generated name are converted to lowercase.

Replace Spaces by Separator

If this option is activated, all spaces are replaced by the selected separator.

Preview

Displays a preview of your current settings.

Presets

Allows you to save and apply naming scheme presets.

Deleting Files

You can delete the active file from within WaveLab Pro.

PREREQUISITE

The file that you want to delete is not copied to the clipboard, is not pasted into another file that is open, and is not open in another application.

PROCEDURE

1. Open the file that you want to delete.
2. Select the **File** tab.
3. Click **Info**.
4. Click **Delete**.
5. Click **OK**.

RESULT

The file, including its peak and marker files, is deleted.

Temporary Files

WaveLab Pro creates temporary files to store intermediary results of the audio file processing and for the undo/redo functions. You can specify where WaveLab Pro saves its temporary files and the processing precision of temporary files.

You can specify up to three different folders for saving temporary files. If you have access to more than one drive, saving your temporary files on a separate hard disk drive (not partitions) can speed up performance considerably.

For example, if your source files are located on the C: drive, you could specify `D:\temp` and `E:\temp` as temporary folders. This improves the performance and reduces disc fragmentation.

By default, WaveLab Pro creates temporary files in 32-bit float. Use the **64 bit float** option if you want to create 64-bit float audio files or 32-bit PCM files.

NOTE

Temporary files in 64-bit float have double precision but take longer to read and write than 32-bit float and their file size is twice as big.

You can change the processing precision of temporary files with the **Processing Precision** option. You can set this option in the **Global Preferences** on the **Audio** tab.

RELATED LINKS

- [Specifying Folders](#) on page 87
- [Audio Tab](#) on page 573

Work Folders vs. Document Folders

WaveLab Pro distinguishes between two types of folders: work folders and document folders.

- In work folders, temporary files are saved.
- Document folders contain WaveLab Pro-specific files, such as audio files, audio montages, etc.

Specifying Folders

You can specify which document folder should open when you perform an open or save operation. You can also specify up to three work folders for temporary files.

PROCEDURE

1. Open the file for which you want to specify folders.
2. Select **File > Preferences > Folders**.
3. On the **Folders** tab, click the type of folder for which you want to specify a location.
4. Specify a location in the **Folder** field.
5. Optional: Depending on the selected type of folder, you can make additional settings.

Folders Tab

On this tab, you can specify default document folders and work folders for each file type.

- To open the **Folders** tab, select **File > Preferences > Folders**.

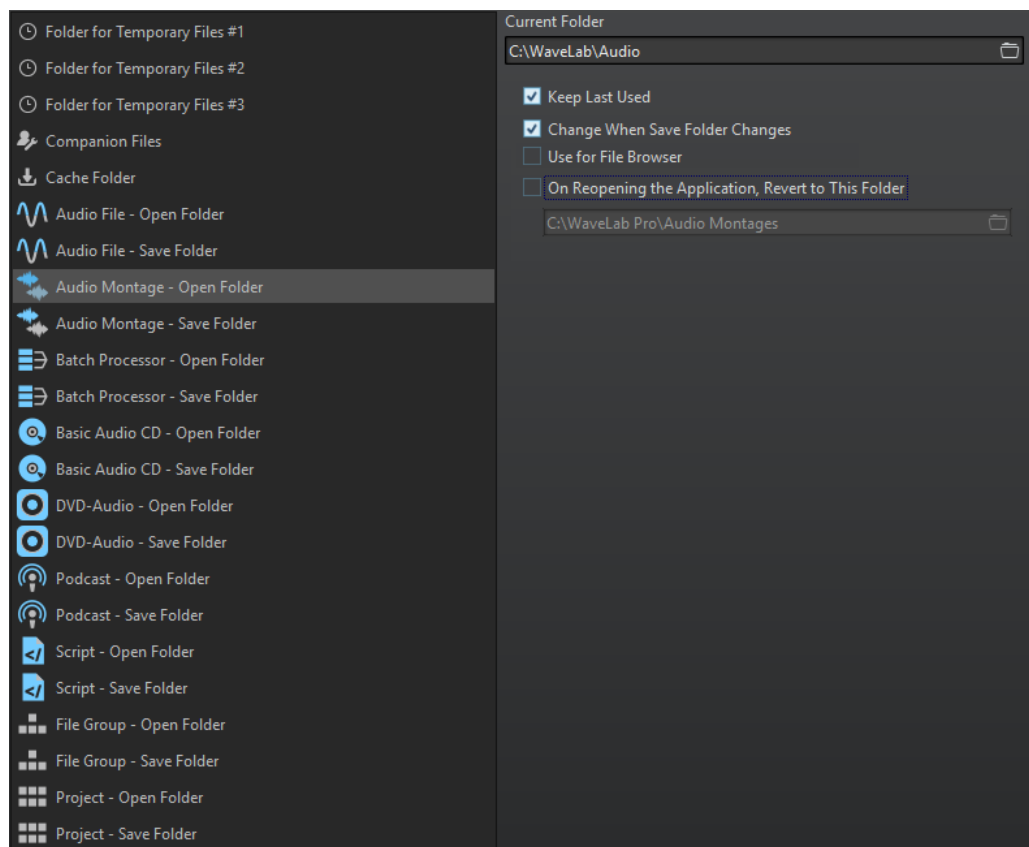

In the list on the left, you specify the folder type that you want to make settings for.

Folder for Temporary Files #1/#2/#3

You can specify three folders for saving temporary files. If your system comprises multiple hard disks, specifying one folder for temporary files on each of these hard disks can speed up file operations.

Companion Files

Specify a folder for saving companion files, that is, **Master Section** presets and view settings for audio files.

Cache Folder

Activate **Use Cache Folder for Decoded Files** to specify a cache folder. The cache folder contains wave files that are created when you are working with files in compressed file formats, such as MP3 files. To prevent the cache folder from growing indefinitely, WaveLab Pro checks the date of each file in this folder and deletes files that were created before a specific number of days. You can specify the number of days with the **Delete Files Older Than** option.

If **Use Cache Folder for Decoded Files** is deactivated, the compressed files are decoded each time they are opened.

Audio File – Open Folder/Save Folder

The default open and save folders for audio files.

Audio Montage – Open Folder/Save Folder

The default open and save folders for audio montage files.

Basic Audio CD – Open Folder/Save Folder

The default open and save folders for Basic Audio CD files.

Batch Processor – Open Folder/Save Folder

The default open and save folders for Batch Processor files.

DVD-Audio Project – Open Folder/Save Folder

The default open and save folders for DVD-Audio Project files.

File Group – Open Folder/Save Folder

The default open and save folders for File Group files.

Podcast – Open Folder/Save Folder

The default open and save folders for podcast files.

Project – Open Folder/Save Folder

The default open and save folders for project files.

Script (Audio File/Audio Montage) – Open Folder/Save Folder

The default open and save folders for script files.

Depending on the selected item, different settings are available on the right side of the dialog.

Current Folder

In this field, the folder that is used as default is displayed. You can click the folder button to the right to navigate to a folder, or to create a new folder.

Keep Last Used

Uses the last folder for saving or opening files of the selected type.

Change When Save Folder Changes/Change When Open Folder Changes

Updates the default open folder when you change the default save folder, and vice versa. Activate this option for both the save folder and the open folder if you want a specific file type to use the same folder for saving and for opening this type of file.

Use for File Browser

In the **File Browser**, the folder does not change when you switch between file types by default.

If you activate **Use for File Browser** and deactivate **Keep Last Used**, the folder location that you have selected in the **Current Folder** field of each file type is displayed when you switch between file types in the **File Browser**.

If you activate **Use for File Browser** and **Keep Last Used**, the folder that you have selected in the **Current Folder** field of each file type is displayed when you select

a file type for the first time. When you then browse to another folder in the **File Browser**, the **Keep Last Used** behavior is used. That is, the last used folder for this file type is displayed when you select the file type.

You can make these settings for each file type independently.

On Reopening the Application, Revert to This Folder

Activate this option to restore a specific folder each time you open WaveLab Pro. This way, any changes to save/open folders are only temporary and are reset when you restart WaveLab Pro.

Exporting to SoundCloud

SoundCloud is an online platform for uploading and sharing your audio recordings. You can export an audio file from WaveLab Pro to your SoundCloud account.

If you do not have a SoundCloud account, visit www.soundcloud.com to register.

PROCEDURE

1. Select **File > Export**.
2. Click **Export to SoundCloud**.
3. Once you have logged in to your SoundCloud account, the file upload starts.

AFTER COMPLETING THIS TASK

After uploading the audio file, you can edit the privacy settings and add metadata in SoundCloud.

Copying Audio Information to the Clipboard

You can copy information about the name and location of the selected audio file, including any selection information and cursor position. This information can be pasted into an external text application.

This is useful if you need accurate file path/selection information when writing a script, for example.

PROCEDURE

1. Click the **File** tab.
2. Click **Info**.
3. Click **Copy to Clipboard** and select the information that you want to copy to the clipboard.

Setting the Focus on the Current File

If you are editing inside a floating window or a tool window and you want to switch the focus back to a wave/montage window, you can use the **Set Focus on Current File** option.

PROCEDURE

- In any window, press **Ctrl/Cmd-F12**, to set the focus on the wave/montage window.
-

Playback

This chapter describes the methods for controlling playback and transport functions.

Transport Bar

With this command bar you can control playback of an audio file or audio montage, navigate between various positions in an audio file or audio montage, and open the **Recording** dialog.

The transport bar is available in the **Audio Editor** and in the **Audio Montage** window.

By default, the extended transport bar options are hidden.

- To activate the extended transport bar, click **Extend Transport Bar** on the transport bar.



Presets

Allows you to save and apply presets.

Jog and Shuttle

Activates the **Jog and Shuttle** mode.

Playback Speed

Opens a menu where you can specify the playback speed.

Perform Pre-Roll/Perform Post-Roll

Activates pre-roll or post-roll for the commands **Play from Anchor**, **Play until Anchor**, and **Play Audio Range**.

Right-click the button to select the pre-roll or post-roll length and to specify to which commands you want to apply pre-roll/post-roll to. To edit the pre-roll/post-roll times, select **Edit Pre-Roll and Post-Roll Times**.

Play Audio Range

Plays the selected audio range. Post-roll and pre-roll settings are taken into account. Right-click the button to open a menu with related options and auto selection modes.

- If **Auto Select Range** is activated, the range is automatically selected according to the editing actions.
- If **Auto Replay While Editing** is activated, playback is automatically restarted when you hold down the mouse button while editing ranges, and use the shortcuts to trigger playback. This is useful to find a loop, for example. This option works even if the automated selection mode is deactivated.
- If **Solo Track When Editing** is activated and you keep the mouse button pressed when editing ranges in the montage window, the track is soloed when you start playback using the shortcuts for **Play Audio Range**, **Play from Anchor**, or **Play until Anchor**. This option is only available in the **Audio Montage** window.

You can select different audio ranges for playback:

- **Time Selection**
- **Region between Marker Pairs**
- **Clip** (audio montage only)
- **Crossfade** (audio montage only)
- **Fade In** (audio montage only)
- **Fade Out** (audio montage only)

Play until Anchor/Play from Anchor

Plays until or from anchor. Pre-roll and post-roll settings are taken into account. Right-click the button to open a menu with related options and auto selection modes.

- If **Auto Select Anchor** is activated, the anchor is automatically selected according to the editing actions.
- If **Auto Replay While Editing** is activated, playback is automatically restarted when you hold down the mouse button while editing anchors, and use the shortcuts to trigger playback. This is useful to find a loop, for example. This option works even when the automated selection mode is deactivated.
- If **Solo Track When Editing** is activated and you keep the mouse button pressed when editing anchors in the montage window, the track is soloed when you start playback using the shortcuts for **Play Audio Range**, **Play from Anchor**, or **Play until Anchor**. This option is only available in the **Audio Montage** window.

You can select which anchor to use as reference for the commands **Play from Anchor** and **Play until Anchor**. When there are multiple possibilities, for example, multiple markers, the last selected item is used as a reference anchor or, if no item was selected, the closest item near the edit cursor position is used.

You can select one of the following anchors:

- **Edit Cursor**
- **Start of File**
- **Start of Selected Time Range**
- **End of Selected Time Range**
- **Any Marker**
- **Region Start Marker**
- **Region End Marker**
- **Clip Start** (audio montage only)
- **Clip End** (audio montage only)
- **Selected Envelope Point in Active Clip** (audio montage only)

When an anchor is detected, for example, a region marker pair, this is indicated by a green anchor marker.

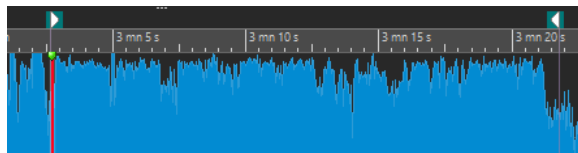

Move Cursor to Start of File/Move Cursor to End of File

Moves the edit cursor to the start/end of the file.

Move Playback Position Backwards/Move Playback Position Forwards

Moves the edit cursor position to the left/right. If you click during playback, playback jumps to the new edit cursor position.

To move the edit cursor to the start/end of the file, press **Ctrl/Cmd**, and click the **Move Playback Position Backwards/Move Playback Position Forwards** buttons.

Navigation anchors allow you to move the edit cursor to specific positions in the audio file or audio montage. Right-click the **Move Playback Position Backwards/Move Playback Position Forwards** buttons to open the **Navigation Anchors** pop-up menu. Here, you can set the type of navigation anchor. If you click during playback, playback continues from the anchor position.

Loop

Activates the loop mode. Right-click the loop button to select whether to loop continuously or only a few times.

Stop Playback

Stops playback. If playback is already stopped, the edit cursor is moved to the previous start position. Right-click the button to open the **Move Cursor Back to Start Position** pop-up menu.

- If **After Standard Playback** is activated, the edit cursor jumps back to the start position when regular playback stops.
- If **After Automated Playback** is activated, the edit cursor jumps back to the start position when playback stops after the **Play from Anchor**, **Play until Anchor**, or **Play Audio Range** options.

Start Playback from Edit Cursor

Starts playing back the active audio file or audio montage from the edit cursor position. This option can also be used to play back other sources, for example, the selected Basic Audio CD track or the active clip in the **Clips** window.

If the audio being played back is not the active audio file, the **Play** button has a different color. This happens if you switch to another file window during playback, for example.



The playback button when playing back in the active window (left) and when playing in another window (right).

You can also start playback from the last stop position. Right-click the button to open the **Lead Sequence** pop-up menu.

- If you select **Start**, playback starts from the cursor position.
- If you select **Resume from Last Interruption**, playback starts from the last stop position.

Record

Opens the **Recording** dialog.

Time Display

Displays the edit cursor or playback position. Click to select another time unit.

Transport Bar in the Podcast Editor and Batch Processor Window

In the **Podcast Editor** and **Batch Processor** window, a simplified transport bar allows you to play back the selected podcast episode and selected batch process source files and destination files.



Play Button

Clicking the **Play** button on the transport bar starts playing back the active audio file or audio montage from the edit cursor position. It can also be used to play back other sources, for example, the selected **Basic Audio CD** track or the active clip in the **Clips** window.

You can also use the Space bar or the **Enter** key on your keyboard to start playback. Pressing **Space** during playback stops playback, pressing **Enter** during playback makes playback restart from the last start position.

If the **Loop** button is activated, the audio selection is looped, if available. Otherwise, the region defined by loop markers is looped. If there are no selection ranges or loop markers, the entire file is looped.

The standard play command is not influenced by the **Play Audio Range**, **Play from Anchor**, and **Play until Anchor** options.

Stop Button

The result of clicking the **Stop** button or on the transport bar or **0** on your numeric keypad depends on the current situation.

- If you trigger **Stop** in stop mode, the edit cursor moves either to the previous playback start marker, or to the selection start (whatever is closer), until the start of the file is reached.
- If there is no selection or if the edit cursor is positioned to the left of the selection, it is moved to the beginning of the file instead.

Playing Back Audio Ranges

You can play back audio ranges using the **Play Audio Range** options on the transport bar.

PROCEDURE

1. On the transport bar, right-click **Play Audio Range** and select the range type that you want to play back.
2. Optional: Activate **Perform Pre-Roll** and/or **Perform Post-Roll**.
3. Position the edit cursor inside the range that you want to play back or make a selection range.

This selected range and, if activated, the pre-roll and post-roll times are displayed on the time ruler.

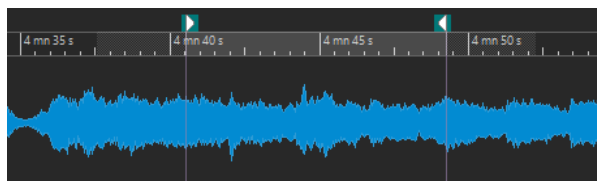

4. To play back the selected range, click **Play Audio Range** on the transport bar or press **F6**.
-

RESULT

The selected range is played back. Pre-roll and post-roll settings are taken into account. If the **Loop** mode is active, pre-roll is used before the first loop only, and post-roll is only used after the last loop.

Playing Back From an Anchor or Until an Anchor

You can play back audio from an anchor or until a specified anchor using the **Play from Anchor** or **Play until Anchor** options on the transport bar.

PROCEDURE

1. On the transport bar, right-click **Play from Anchor** or **Play until Anchor**, and select an anchor type.
2. Depending on the selected anchor type, position the edit cursor in the wave window or montage window inside the range that you want to play back.
For example, if you have selected **Region Start Marker**, click somewhere in the area of the region marker pair from which you want to play back from/to. The green anchor marker jumps to the selected anchor.

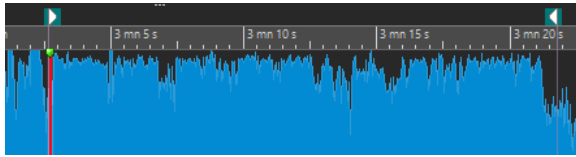

3. Optional: Activate **Perform Pre-Roll** and/or **Perform Post-Roll**.
4. To play back from the anchor marker, click the **Play From Anchor** button on the transport bar or press **F7**. To play back until the anchor marker, click the **Play Until Anchor** button on the transport bar or press **F8**.

RESULT

Playback starts from the anchor or stops at the anchor. Pre-roll and post-roll settings are taken into account.

“Play From Anchor” and “Play Until Anchor” Functions

You can play back audio from an anchor or until an anchor using the **Play from Anchor** or **Play until Anchor** functions on the transport bar. These playback functions behave differently depending on the pre-roll and post-roll settings.

Play from Anchor

- If post-roll is activated, playback starts at the anchor position and stops after the post-roll time. If no post-roll is selected, playback continues until the end of the audio file or audio montage.
- If pre-roll is activated, playback starts from the selected anchor, minus the pre-roll time.
- If pre-roll and post-roll are activated, playback starts from the selected anchor, minus the pre-roll time and stops after the anchor point plus the post roll time.
- If the loop mode is activated, the pre-roll and post-roll settings are taken into account. This way you can play a loop around the edit cursor position, without having to make further range settings.

Play until Anchor

- Playback starts from the cursor, and stops at the selected anchor. If the cursor is beyond the selected anchor, playback starts at the selected anchor. If pre-roll is activated, it is taken into account.
- If pre-roll is activated, playback starts from the selected anchor minus the pre-roll time, until the selected anchor.
- If no anchor is selected, **Play until Anchor** is deactivated.
- The loop settings have no effect.

Using the Auto Selection Mode

You can use the auto selection mode in combination with the playback shortcuts to play back audio ranges or anchors. This makes it easy to monitor your editing actions.

PROCEDURE

1. On the transport bar, right-click the **Play From Anchor** or **Play Until Anchor** button and activate **Auto Select Anchor**.
2. Right-click the **Play Audio Range** button and activate **Auto Select Range**.
3. In the wave window or the montage window, do one of the following:
 - Make a selection range.
 - Click inside the area of a marker pair.
 - Click a fade in, fade out, or crossfade.
 - Click anywhere in the wave/montage window.
 - Drag a marker.

Depending on your action, the most appropriate range, or anchor, is selected. For example, if you click inside a marker pair, this region is selected as playback range.

The time ruler shows the selected range or anchor.

NOTE

In **Auto Select Anchor** and **Auto Select Range** mode, you can still change some range and anchor options on the transport bar to play a different range/anchor. However, the range/anchor are reselected when you start editing again with the mouse.

-
4. Use the playback shortcuts to start playback.
 - To play back the selected audio range, press **F6**.
 - To play back from an anchor, press **F7**.
 - To play back until an anchor, press **F8**.

RESULT

The selection range is played back, or play back starts from the anchor or stops at the anchor. Pre-roll and post-roll settings are taken into account.

NOTE

A selection range has priority over any other range. To allow other ranges to be auto-selected, deselect the selection range.

Using Auto Replay While Editing

You can automatically re-trigger playback while editing audio with the mouse. This is useful if you want to monitor the adjustment of a selection boundary, for example.

PROCEDURE

1. On the transport bar, right-click the **Play From Anchor** or **Play Until Anchor** button and activate **Auto Replay While Editing**.
2. In the wave window or the montage window, make a selection range and keep the mouse button pressed.
3. Start playback by using one of the following shortcuts:
 - To play back the selected audio range, press **F6**.
 - To play back from an anchor, press **F7**.

- To play back until an anchor, press **F8**.
4. Drag the cursor to the right or left.
The selection range is adjusted and played back until you release the mouse button. When playback ends, the new selection range is played back.
-

Skipping Sections During Playback

You can automatically skip a selected audio range during playback. This way, you can audition what the material would sound like without specific sections.

PROCEDURE

1. On the transport bar, activate **Skip Range**.
2. Activate **Perform Pre-Roll** and **Perform Post-Roll**.
3. If you want to use the **Play Audio Range** function, activate one of the **Ranges** modes.
4. Depending on the **Ranges** mode, do one of the following:
 - If you have activated **Time Selection**, make an audio selection in the wave window.
 - If you have activated **Region Between Marker Pairs**, click between a marker pair.

The audio range that will be skipped is displayed on the time ruler along with the pre-roll and post-roll times.

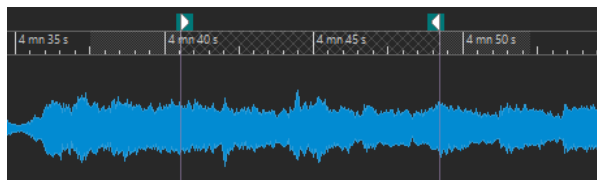

5. Select **Play Audio Range**, or press **F6**.
-

RESULT

The selected range is skipped during playback.

You can also use the factory preset for skipping selections during playback. Activate **Skip Range**, make an audio selection, and press **Shift-F6**.

NOTE

This mode also works with the **Start Playback from Edit Cursor** button if there is a time selection or if exclusion start and end markers are set. In this case, the pre-roll and post-roll times are ignored.

Loop Playback

Loop points are updated continuously during playback. If you change the loop start or end during playback, the loop changes. This way, you can audition selection points for rhythmic material.

If you loop a section in an audio montage, playback loops within the boundaries of the current selection range. This selection range may be on any track, even if it is empty. The vertical position of the selection range is of no relevance for loop playback, only the left and right selection boundaries matter.

Pre-Roll and Post-Roll

You can start playback slightly before a specific position (pre-roll) and stop playback slightly after another position (post-roll). This gives you a brief context if you are auditioning a clip, for example.

The position can be an anchor or the start or end of a range. The pre-roll and post-roll times are displayed in the time ruler.

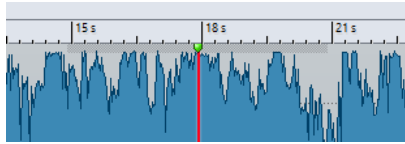

To activate pre-roll and/or post-roll, activate **Perform Post-Roll** and **Perform Pre-Roll** on the transport bar.

When right-clicking the pre-roll or post-roll button on the transport bar, you can select a pre-roll/post-roll time. Here, you can also select a play option for the pre-roll/post-roll, and you can open the **Pre-Roll and Post-Roll Times** dialog.

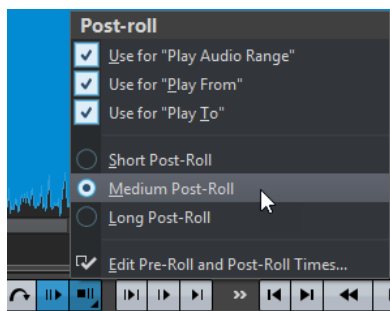

Pre-Roll and Post-Roll Times Dialog

This dialog allows you to define a short, an average, and a long pre-roll and post-roll time. These settings are global to WaveLab Pro.

- To open the **Pre-Roll and Post-Roll Times** dialog, right-click the pre-roll or post-roll button on the transport bar, and select **Edit Pre-Roll and Post-Roll Times**.

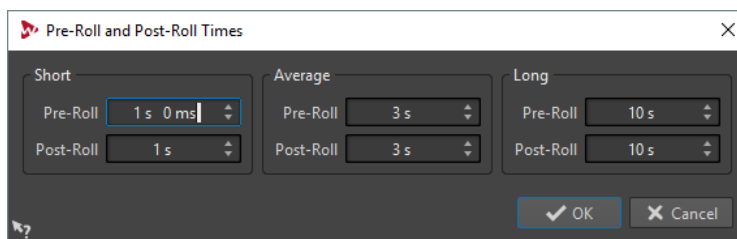

Playback Speed Dialog

This dialog allows you to specify the playback speed of the active audio file and all clips of the active audio montage.

- To open the **Playback Speed** dialog, right-click **Playback Speed** on the transport bar, and select **Edit Playback Speed**.

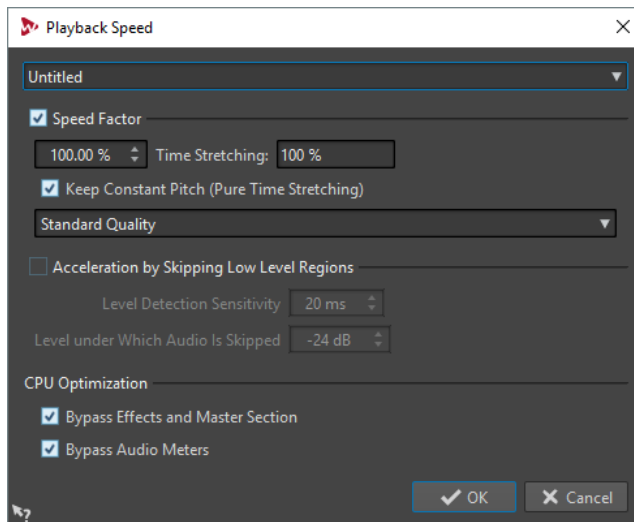

Presets

You can enter a name to save the settings as a preset and select them from the **Playback Speed** pop-up menu later.

Speed Factor

Sets the playback speed as a percentage of the normal speed.

Time Stretching

Compared to the speed coefficient, this is the inverse, a deceleration coefficient. This value is equivalent to the percentage found in the **Time Stretching** dialog.

Keep Constant Pitch (Pure Time Stretching)

Indicates the time stretching.

Quality

Allows you to select a quality. The **Best** and **High** quality modes provide the highest quality, but are also the most CPU intensive. In most cases, the **Standard** quality is sufficient.

Acceleration by Skipping Low Level Regions

If this option is activated, regions of the audio that are below the threshold level are skipped during playback.

Level Detection Sensitivity

Determines the sensitivity of the level detection analysis.

Level under Which Audio Is Skipped

Determines the threshold level for a region to be skipped during playback.

Bypass Effects and Master Section

If this option is activated, all active effects in the audio montage and all global effects in the **Master Section** are bypassed. This saves processing power and usually the plug-ins are not needed trying to locate audio material.

Bypass Audio Meters

If this option is activated, all meters are bypassed to save processing power.

NOTE

Changing the playback speed does not change the original audio, but only the playback speed in WaveLab Pro.

Playback Shortcuts

In addition to the buttons on the transport bar, there are shortcuts to control the playback.

Space bar

Start/Stop playback. This shortcut can be used even when the wave window or montage window is not the active window.

0 on numeric keypad

Stops playback. If the playback is stopped and you press this shortcut, the edit cursor moves either to the previous playback start marker, or to the selection start (whatever is closer), until the start of the file is reached. This is the same as clicking **Stop** on the transport bar. This shortcut can be used even if the wave window or montage window is not the active window.

Enter

Starts playback. If pressed during playback, playback restarts from the previous start position. This is the same as clicking **Start Playback from Edit Cursor** on the transport bar.

Alt-Space

Starts playback from the mouse cursor position.

F6

Starts playback of the selected range, depending on the selected option in the **Ranges** section of the transport bar.

F7

Starts playback from the selected anchor, depending on the selected option in the **Anchors** section of the transport bar.

F8

Starts playback until the selected anchor, depending on the selected option in the **Anchors** section of the transport bar.

Save Transport Bar Preset Dialog

In this dialog, you can save a transport bar setup as preset.

- To open the **Save Transport Bar Preset** dialog, click the **Presets** field on the transport bar, and select **Save As**.

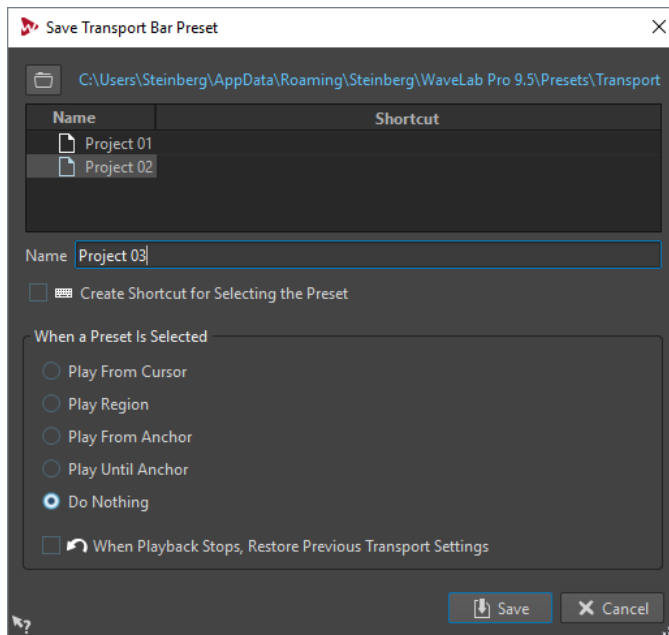

Path

Opens the root folder of the preset in the File Explorer/macOS Finder. Here, you can create subfolders for your presets.

Presets list

Lists all existing presets.

Name

Lets you specify a name for your preset.

Create Shortcut for Selecting the Preset

If this option is activated and you click **Save**, the **Shortcut Definitions** dialog opens, where you can define a shortcut for this preset.

If a preset already has an assigned shortcut, this option is grayed out. To change the existing shortcut, double-click the preset name in the presets list.

When a Preset Is Selected

This lets you assign a customized playback command to a shortcut. For example, you can set a shortcut to play a range with a short pre-roll/post-roll, and another shortcut to play a range without a pre-roll/post-roll.

When Playback Stops, Restore Previous Transport Settings

If this option is activated, the settings are restored to as they were before playback start. This is useful to trigger a special play task, and automatically switch back to the standard settings as soon as playback is finished.

Changing the Position of the Transport Bar

You can position the transport bar at the top, middle, or bottom of the file window.

PROCEDURE

1. In the title bar of the **Audio Editor** or **Audio Montage** window, click **Layout Options** .
 2. In the **Transport Bar** section, select whether to position the transport bar at the **Top**, **Middle**, or **Bottom**.
-

Hiding the Transport Bar

PROCEDURE

1. In the title bar of the **Audio Editor** or **Audio Montage** window, click **Layout Options**.
 2. In the **Transport Bar** section, select **Hidden**.
-

Starting Playback From the Ruler

You can use the ruler to jump to a position and start playback from there.

- Double-clicking the ruler starts playback from that position. Playback continues until you click **Stop Playback** or until the end of the audio file or audio montage.
- To set the playback position to a specific position, click the ruler during playback. This also applies for clicking the time rulers of another audio file or audio montage, which allows you to quickly switch playback between audio files or audio montages.
- To start playback from a marker position, press **Ctrl/Cmd** and double-click the marker.

Using the Play Tool

This tool allows you to play back from any position on one or both stereo channels.

PROCEDURE

1. In the **Audio Editor**, select the **Edit** tab.
 2. In the **Tools** section, select the **Play** tool, or press and hold **Alt**.
 3. In the wave window, click at the position where you want playback to start.
The cursor shape indicates whether the left (L) or the right (R) channel is played back. If mid/side mode is activated, the cursor shape indicates whether the mid (M) or the side (S) channel is played back. Using the Play tool in the middle of the channels plays back both channels.
-

RESULT

Playback continues for as long as you keep the mouse button pressed, or until the audio file ends. After playback has stopped, the cursor is moved to the playback start position.

RELATED LINKS

[Mid and Side Editing](#) on page 145

Playback Scrubbing

Playback scrubbing helps you find a specific position in an audio file, by restarting playback repeatedly when you click and drag on the time ruler during playback or when using the **Play** tool.

Scrubbing Using the Play Tool

PROCEDURE

1. In the **Audio Editor**, select the **Edit** tab.
2. In the **Tools** section, select the **Play** tool, or press and hold **Alt**.
3. Click in the wave window.

Playback starts at the position where you clicked.

RELATED LINKS

[Playback Scrubbing Preferences](#) on page 102

Scrubbing Using the Time Ruler

PROCEDURE

1. Start playback.
2. Click the time ruler and hold the mouse button pressed, and drag left or right.



3. When you are done scrubbing, release the mouse button.
The audio is played back from the edit cursor position and a small section is looped once.
-

Playback Scrubbing Preferences

You can define the behavior of the **Play** tool in the **Audio Files Preferences**.

Select **File > Preferences > Audio Files**. The following options are available in the **Playback Scrubbing** section.

- If **Restrict to Play Tool** is activated, scrubbing is not available when you click and drag on the time ruler during playback.
- The **Sensitivity** setting determines the length of the audio loop that is played once when click and drag on the time ruler with the **Play** tool.

Timecode Window

This window can display the recorded time, the time offset in relation to various positions, and dynamic colors according to the context. During playback, the song position is displayed. If nothing is played back, the edit cursor position is displayed.

- To open the **Timecode** window, select **Meters > Timecode**.

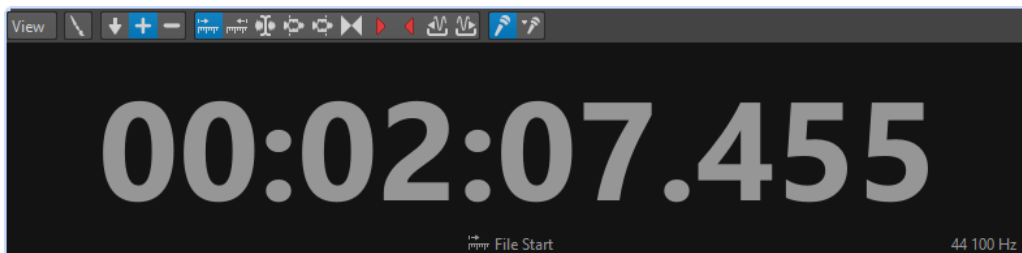

View Menu

Edit Colors

Opens the **Timecode Colors** dialog, where you can edit the colors of the **Timecode** window.

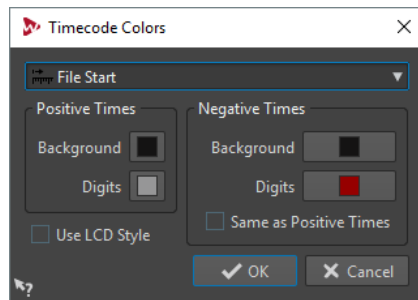

Reduced Precision

If this option is activated, the timecode display show less digits.

Positive Times

If this option is activated, positive values are displayed. If **Negative Times** is also activated, the closest offset, negative or positive, is displayed.

Negative Times

If this option is activated, negative values are displayed. If **Positive Times** is also activated, the closest offset, negative or positive, is displayed.

File Start/File End

Displays the position in relation to the origin of the time ruler. The time format is displayed according to the ruler.

Offset Display

Lets you select from which position you want to display the offset. The following positions are available: edit cursor, selection start/end, marker, CD track start/end, clip start/end.

Recorded Time

If this option is activated, the **Timecode** window displays the recorded time when you start recording.

Recorded Time (from Last Marker)

If this option is activated, the **Timecode** window displays the recorded time since the last dropped marker when you start recording.

Jog/Shuttle Function

This function allows you to play back audio forwards or backwards, at any speed. This is useful for finding exact spots in the audio file and audio montage.

NOTE

The **Jog and Shuttle** functions are CPU intensive. If you experience playback problems, try reducing the window size.

Using the Jog Function

This can be viewed as dragging the audio past a playback point, much like dragging a reel-to-reel tape past the playback head.

PROCEDURE

1. Zoom in on the wave window or the montage window, so that you get a good visual feedback.
2. On the transport bar, activate **Jog and Shuttle**.

A vertical line is shown in the middle of the wave/montage window. This is the playback point.

3. Click in the area above the time ruler and drag to the left or right, to play back the audio. Dragging to the left of the line plays the audio forwards, dragging to the right plays the audio backwards.
-

Using the Shuttle Function

This can be viewed as playing back with a continuous control for tape speed and direction.

PROCEDURE

1. Zoom in on the wave window or the montage window, so that you get a good visual feedback.
 2. On the transport bar, activate **Jog and Shuttle**.
A vertical line is shown in the middle of the wave/montage window. This is the playback point.
 3. Click in the wave/montage window and drag to the left or right of the vertical line. Clicking to the left of the line plays the audio backwards, clicking to the right plays the audio forwards.
The playback speed is determined by the distance from the line to the pointer. The further away from the line you move the pointer, the faster the playback.
 4. Release the mouse button to stop playback.
 5. Deactivate **Jog and Shuttle** on the transport bar.
-

Scroll During Playback

You can determine how the view should be scrolled in **Play** mode.

- To set the scroll mode, open the **Audio Editor** or the **Audio Montage** window, select the **View** tab, and activate one of the options in the **Playback** section.

Static View

Disables scrolling.

View Follows Cursor

The view automatically scrolls to keep the playback cursor visible.

Scroll View

Scrolls the view to keep the playback cursor centered.

NOTE

If you get dropouts during playback, activate **Static View**.

Playback in the Audio Montage Window

Playback in the **Audio Montage** window works the same way as in the **Audio Editor**. However, there are some things to note.

Mute and Solo Tracks

You can mute or solo tracks in an audio montage by using the corresponding buttons in the track control area.

- When a track is muted, the mute button is yellow.
- When a track is soloed, the solo button is red.
- **Solo** can only be activated for one track at a time. However, you can unmute other tracks when **Solo** is active if you want to listen to a combination of tracks.

RELATED LINKS

[Track Control Area](#) on page 195

Muting Individual Clips

PROCEDURE

1. Select **Tool Windows > Clips**.
 2. Select the clips that you want to mute, and select **Functions > Mute/Unmute Selected Clips**, or check the box in the **Mute** column.
-

Playing Back Individual Clips

You can play back an individual clip on a track. Overlapping clips or clips on other tracks are muted.

PROCEDURE

1. In the montage window, right-click the lower part of the clip that you want to play back.
 2. On the menu, select one of the following play options:
 - To play back the clip, select **Play Clip**.
 - To play back the clip with pre-roll, select **Play Clip with Pre-Roll**.
-

Playing Back a Selection Range of a Track

You can select a section of a clip and play it back. Overlapping clips or clips on other tracks are muted.

PROCEDURE

1. In the montage window, make a selection range, either in a clip or in an empty section of a track.
 2. Right-click the selection range, and select **Play Clip Inside Selection Range**.
-

Speaker Configuration

You can configure up to 8 speaker setups to switch between different audio speaker configuration without latency. This allows you to compare the sound on different speaker setups.

After setting up the speaker configurations in the **VST Audio Connections** tab, the configurations can be selected from the bottom of the **Master Section**.



The switching between different setups is done at the lowest level, right before sending the audio to the hardware, and without any plug-in processing.

A gain can be set individually for each configuration.

- The speaker gain is not taken into account by the meters. This means that the signal could clip even if the meters do not indicate clipping.
- The speaker gain has no effect on file rendering or CD writing.
- Because a gain affects samples, any dither settings are reset when changing the gain. This has an effect when monitoring quiet music passages.

The speaker configuration #1 is active on startup and should remain the default configuration, without a gain change.

The gain settings are saved with the active configuration. To save the gain settings of the speaker configurations as a preset, open the **VST Audio Connections** tab, and save the speaker configurations as a preset.

RELATED LINKS

[Speaker Configuration Pane](#) on page 350

[Audio Connections Tab](#) on page 11

Speaker Configuration LED Colors

The speaker configuration LEDs indicate if gain is applied to the audio. The LED is located in the **Speaker Configuration** pane at the bottom of the **Master Section**.

Dark green

No gain is applied and dithering is preserved.

Red

Positive gain is applied, dithering is canceled, and there is a risk of clipping.

Orange

Negative gain is applied without the risk of clipping, but dithering is canceled.

RELATED LINKS

[Master Section](#) on page 332

Setting Up the Speaker Configuration

PROCEDURE

1. Select **File > Preferences > Audio Connections**.
2. In the **Audio Connections** tab, select an **Audio Device**.
3. On the **Playback** tab, select the speaker configuration that you want to edit.
4. Select and name the audio ports used for playback.

5. On the **Recording** tab, select the speaker configuration that you want to edit.
6. Select and name the audio ports used for recording and input monitoring.

NOTE

The input selection is not affected by the speaker configuration.

Audio File Editing

Audio file editing refers to opening, editing, and saving audio files.

Wave Window

The wave window displays audio files graphically. Here, you view, play back, and edit individual audio files.

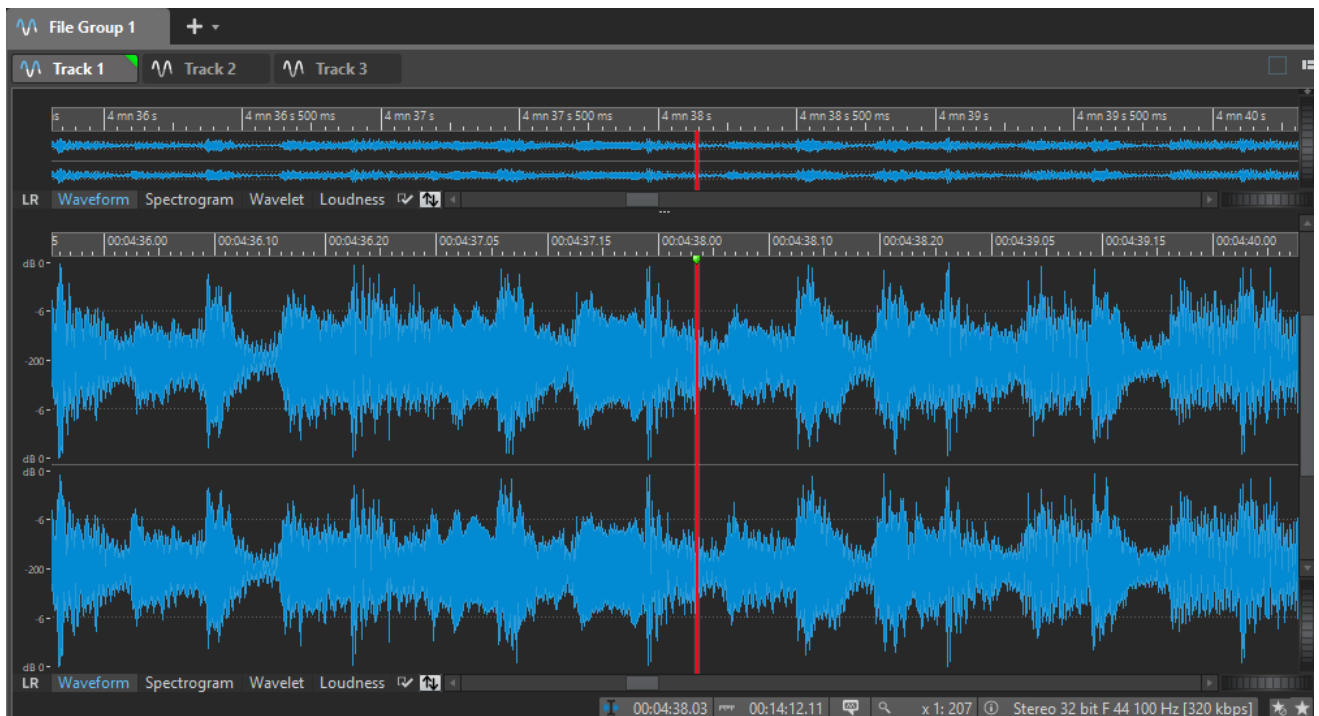

The wave window consists of two displays. You can use one display as an overview to navigate through the project and the other as the main view for editing.

You can select different display modes for the two displays. For example, one display can show the waveform and the other the loudness.



You can synchronize the waveform displays so that they display the same part of the audio file, by clicking **Sync with Other View**.

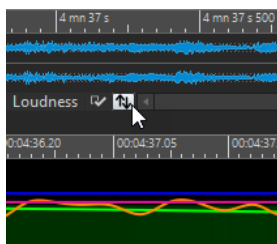

Display Modes

In the wave window, the upper and the lower displays can independently be set to one of three display modes.

- The **Waveform** tab displays the waveform of the audio file.
- The **Spectrum** tab displays the audio as a spectrogram.
- The **Loudness** tab displays the loudness graphs of the audio file.

Waveform Display

The **Waveform** display displays the waveform of the audio file. The horizontal axis shows the time and the vertical axis the amplitude.

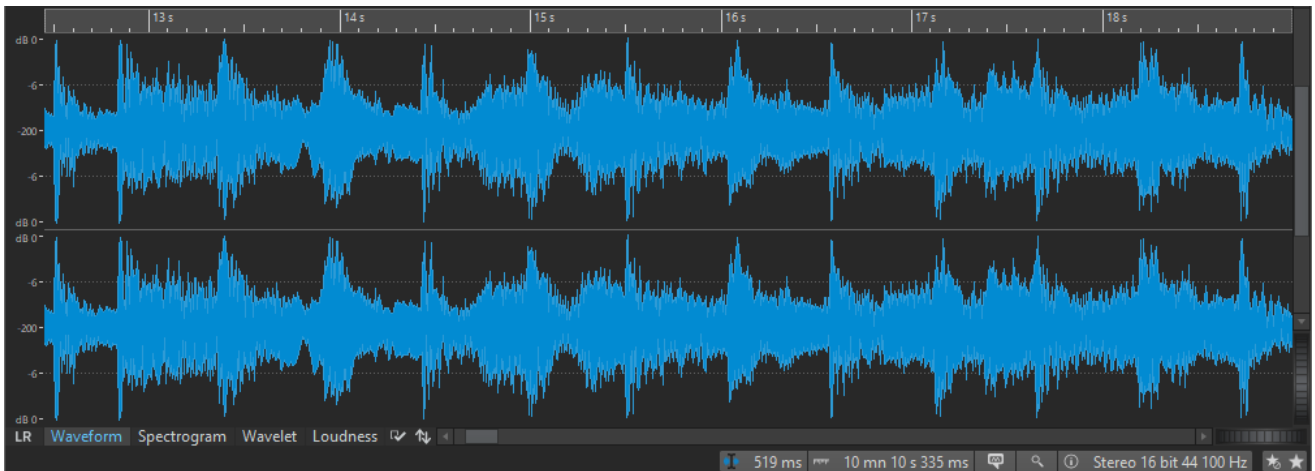

RELATED LINKS

[Audio Files Preferences on page 576](#)

Spectrogram

The **Spectrogram** allows you to view the level intensity of each area in the frequency spectrum. You can use the WaveLab Pro spectrum editing tools to edit the spectrogram.

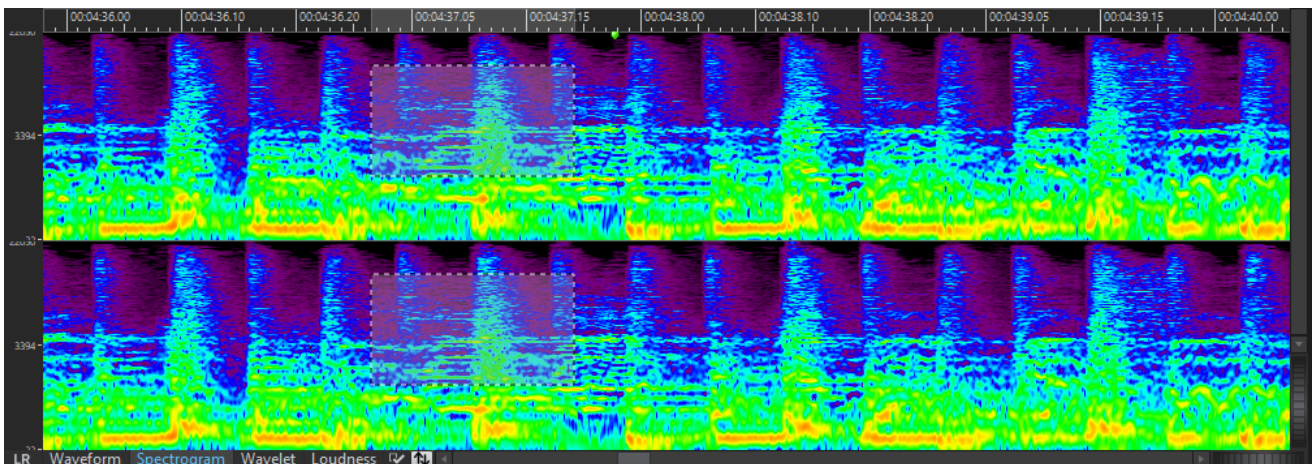

The **Spectrum** tab in conjunction with the **Spectrogram** is a unique editing and restoration tool.

RELATED LINKS

[Spectral Editing on page 440](#)

Wavelet Display

The **Wavelet** display shows a higher time resolution in high frequencies and a higher frequency resolution in lower frequencies. You can use the WaveLab Pro spectrum editing tools to edit the spectrogram.

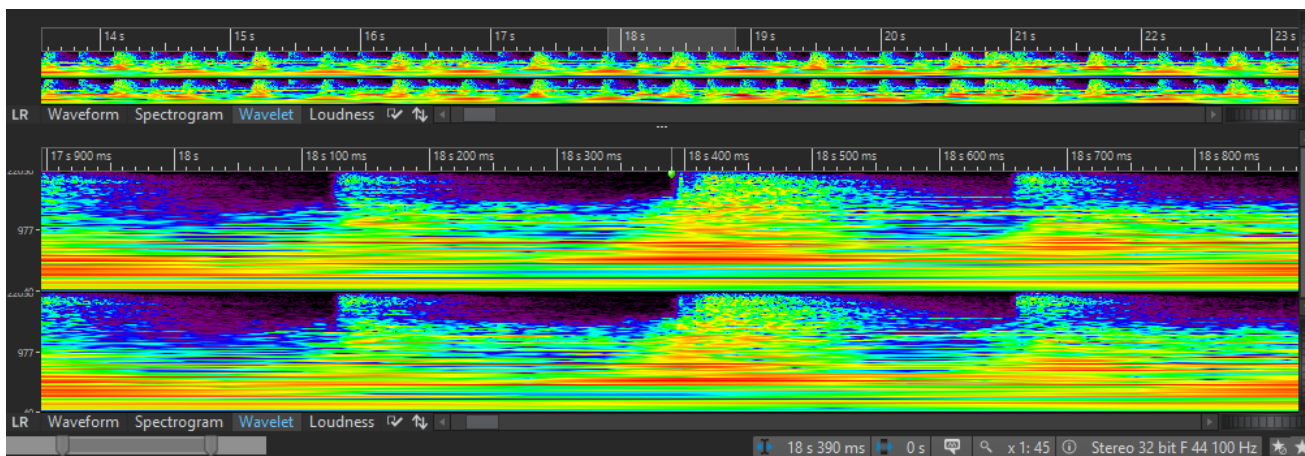

The **Wavelet** tab in conjunction with the **Spectrogram** is a unique editing and restoration tool.

RELATED LINKS

[Spectral Editing](#) on page 440

Loudness Display

The curves on the **Loudness** display represent the loudness over time in an audio file.

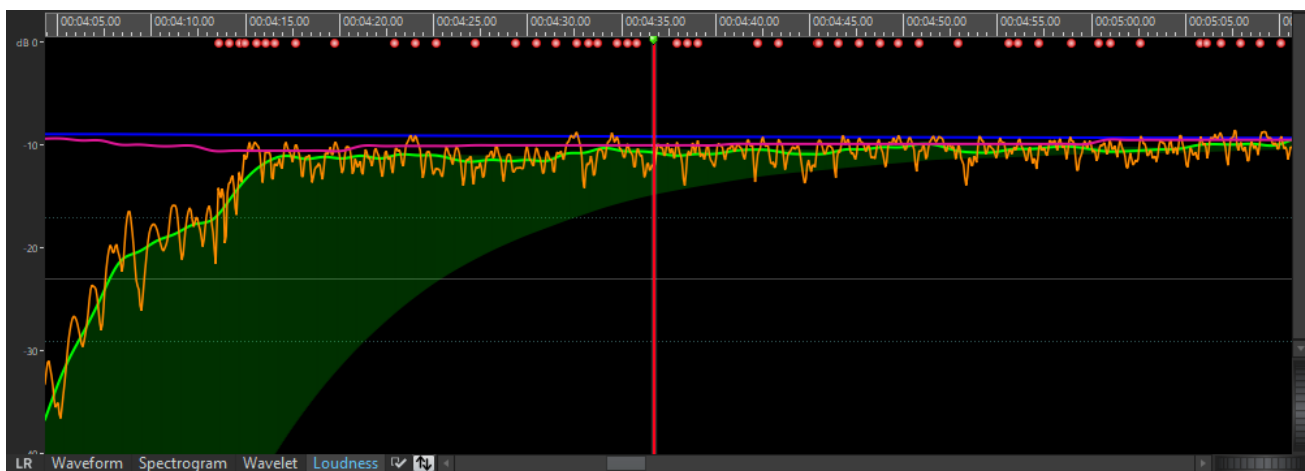

Because isolated peaks do not alter the perceived loudness of audio material very much, this display represents the loudness of an audio file more accurately than the waveform display.

This display mode also gives you an overview of the compression or dynamic range of an audio file. For example, the more peaks and valley expressions in the curve, the more dynamics in the audio. An even curve with few peaks indicates that the material is compressed with a limited dynamic range.

RELATED LINKS

[EBU Loudness Standard R-128](#) on page 37

Loudness Envelope Curves

The loudness envelope curves represent the average loudness of the signal in different areas of the frequency spectrum. These curves are shown in the **Loudness** display of the wave window.

The following loudness curves are available:

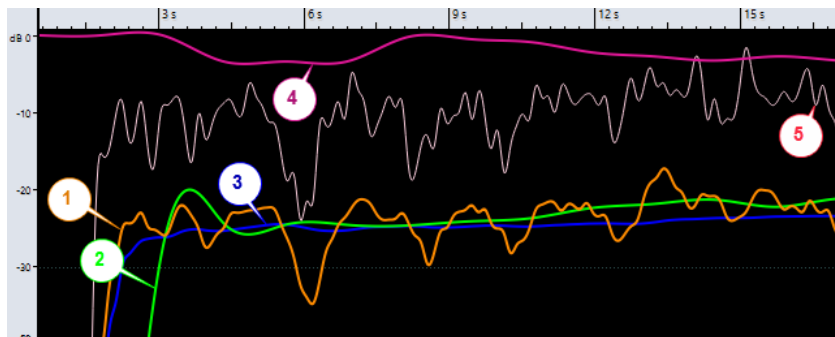

- 1 Momentary loudness (100 ms resolution)
- 2 Short-term loudness (1 sec resolution)
- 3 Integrated loudness (loudness of the entire file)
- 4 Loudness range
- 5 True peak hints

The curves can be shown individually or in any combination. Which curves are displayed and what frequency area they represent is specified in the **Loudness Display Settings** dialog.

NOTE

The resolution is 100 ms, which means the momentary loudness information is collected every 100 ms and the short-term loudness every second to match the EBU standard. This is the same for true peaks. A clipping indicator is displayed when a 400 ms audio region contains one or more over peaks.

RELATED LINKS

[Loudness Display Settings Dialog](#) on page 112

Loudness Display Settings Dialog

In this dialog, you can specify how the loudness waveform is displayed.

- To open the **Loudness Display Settings** dialog, select the **Loudness** tab in the **Audio Editor**, and click **Edit Settings**.

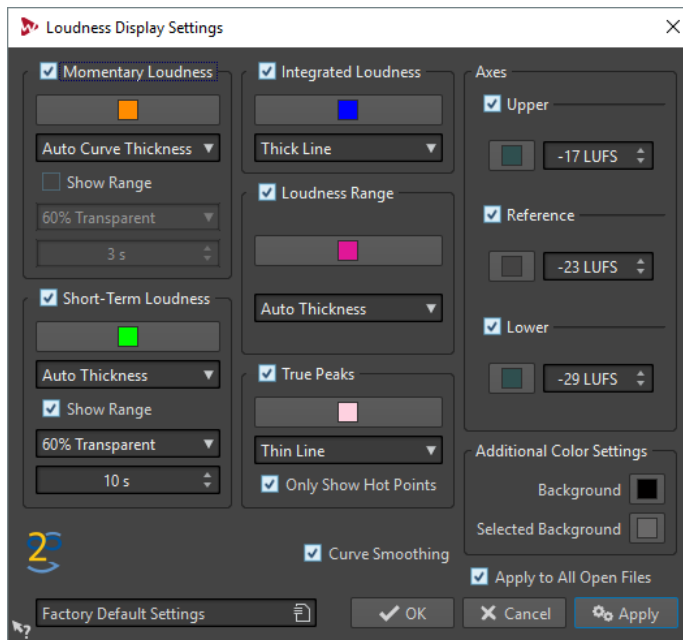

Momentary Loudness/Short-Term Loudness

Color

Lets you edit the color of the associated element.

Curve Thickness

Lets you customize the curve thickness. If **Auto Curve Thickness** is selected, the curve thickness increases when zooming in.

Show Range

If this option is activated, the dynamic range is visualized. This displays the difference between the recent minimum and maximum loudness values. The wider the band, the wider the dynamics.

Range Transparency

Lets you specify the transparency of the range section.

Range Inertia

Determines the inertia of the loudness range, that is, how fast the range edges meet each other after a new minimum or maximum loudness is reported.

Integrated Loudness/Loudness Range/True Peaks

Color

Lets you edit the color of the associated element.

Curve Thickness

Lets you customize the curve thickness. If **Auto Thickness** is selected, the curve thickness increases when zooming in.

Only Show Hot Points (True Peaks section only)

If this option is activated, the curve is hidden and only the peak overloads are displayed as red bullets.

Axes

Upper/Reference/Lower

Lets you activate several axes, and edit their color and position in the loudness tab to get a visual reference.

Additional Color Settings

Background/Selected Background

Lets you edit the color of the associated element.

Additional Options

Curve Smoothing

If this option is activated, the transitions between the loudness measurements are smoothly drawn. This is less accurate when abrupt changes occur.

Apply to All Open Files

If this option is activated, the settings are applied to all open audio files when you click **OK**.

Magnetic Bounds in Audio Files

Some positions, such as markers or selection edges, can be defined as magnetic. Dragged elements can snap to these positions. This makes it easier to position items accurately.

For example, if you move a marker and it gets close to one of the magnetic bounds, the marker snaps to this position. A label is displayed, indicating the snap position.

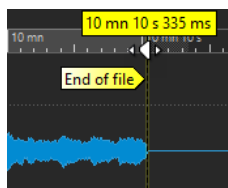

To place the cursor at a magnetic position, click the time line and keep the mouse button pressed. When you now move the cursor, it jumps to the next magnetic bound.

Magnets Menu

On this pop-up menu, you can specify which positions should be magnetic. If **Snap to Magnets** is activated, items that you move snap to these positions.

- To open the **Magnets** pop-up menu, select the **Edit** tab in the **Audio Editor**, and click **Magnets** in the **Snapping** section.

You can let items snap to the following positions:

Start of File/End of File

Elements snap to the start/end of the file when they are moved near these positions.

Time Ruler Marks

Elements snap to the time ruler grid when they are moved near these positions.

Markers

Elements snap to marker positions when they are moved near these positions.

Selection Edges

Elements snap to the selection edges when they are moved near these positions.

Cursor

Elements snap to the edit cursor when they are moved near the cursor.

Zero Crossing

A zero crossing is a point where the waveform crosses the zero level axis. When you perform editing operations, such as cutting, pasting, or dragging, make sure that the material is inserted at a zero crossing.

If you do not perform these operations at zero crossings, this can result in discontinuities in the wave, which are perceived as clicks or pops in the sound.

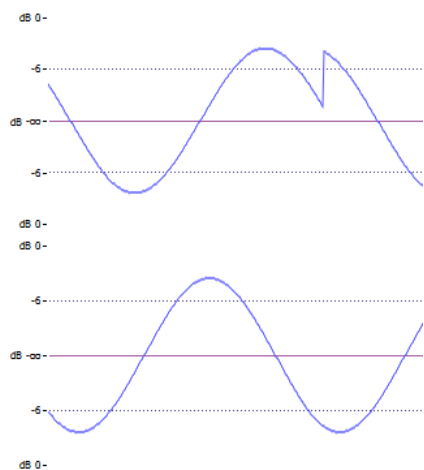

Activate **Zero-Crossing** on the **Edit** tab of the **Audio Editor** to make sure that the selections that you make are always adjusted so that they start and end at the nearest zero crossing.

Setting Up the Zero Crossing Detection

You can let selection edges automatically snap to the nearest zero crossing point. In the **Audio Files Preferences** dialog, you can specify whether to allow snap at high zoom factors, and specify the scan range for the zero crossing detection.

PROCEDURE

1. In the **Audio Editor**, select the **Edit** tab.
 2. In the **Snapping** section, activate **Zero-Crossing**.
 3. Select **File > Preferences > Audio Files**.
 4. In the **Audio Files Preferences** tab, select the **Editing** tab.
 5. Make your settings in the **Snap Selection to Zero-Crossing** section.
 6. Click **OK**.
-

Moving the Cursor Position to the Closest Zero Crossing

You can automatically move the cursor position to the closest zero crossing.

PROCEDURE

1. In the **Audio Editor**, select the **View** tab.
 2. In the **Cursor** section, click **Snap to Zero-Crossing**.
-

Audio Editor Tabs

The tabs in the **Audio Editor** give you access to the tools and options you need to edit audio files.

View Tab

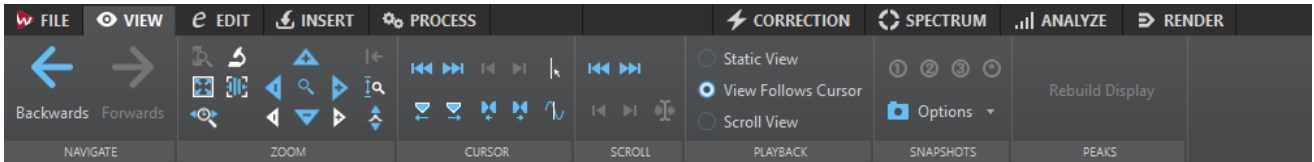

Navigate

Backwards/Forwards

Navigates to the previous/next cursor position, zoom factor, and selection range.

Zoom

Time

Opens a pop-up menu that allows you to adjust the zoom to display the selected time range. **Zoom in 1:1** zooms in so that one pixel on the screen represents one sample. To edit the zoom factor, click **Edit Zoom Factor**. This opens the **Zoom Factor** dialog, where you can edit the following settings:

- **Set Time Range** allows you to specify the time range that you want to display.
- **Samples per Screen Point** allows you to specify how many audio samples are summarized in each screen point.
- **Screen Points per Sample** allows you to specify how many screen points are used to represent a single audio sample.

Zoom

Activates the **Zoom** tool that allows you to define a time range that is zoomed in.

Zoom Selection

Zooms the window so that the current selection occupies the entire montage window.

Microscope

Zooms in as far as possible.

Zoom in Audio (10x)/Zoom out Audio (10x)

Zooms in/out in big steps.

View All

Zooms out as far as possible.

Zoom in Audio/Zoom out Audio

Zooms in/out in small steps.

Level

Adjusts the zoom to only display samples below the selected dB value.

Optimize Vertical Zoom

Changes the vertical zoom factor so that the peaks are clearly visible. This adjustment is done according to the section of the wave that is visible in the wave/montage window.

Reset Zoom to 0 dB

Adjusts the zoom to display audio levels up to 0 dB.

Zoom in Vertically/Zoom out Vertically

Zooms in/out to show waveforms with a lower/higher level.

Cursor

Move Cursor to Start of File/Move Cursor to End of File

Moves the cursor to the start/end of the file.

Previous Marker/Next Marker

Moves the cursor to the previous/next marker.

Start of Selection/End of Selection

Moves the cursor to the start/end of the selected time range.

Previous Region Edge/Next Region Edge

Moves the cursor to the previous/next region edge.

Snap to Zero-Crossing

Moves the edit cursor to the nearest zero crossing point.

Edit Cursor Position

Opens the **Cursor Position** dialog where you can edit the cursor position.

Scroll

Start/End

Displays the start/end of the audio without moving the cursor.

Start of Selection/End of Selection

Displays the start/end of the audio selection without moving the cursor.

Cursor

Displays the cursor position.

Playback

Static View

Deactivates scrolling.

View Follows Cursor

Automatically scrolls the view to keep the playback cursor visible.

Scroll View

Scrolls the view to keep the playback cursor centered.

Snapshots

Allows you to take, recall, and edit snapshots.

Presets

The buttons **1**, **2**, and **3** allow you to save a snapshot of the scroll position, zoom factor, cursor position, and audio selection. The rightmost preset button is a global preset that is available for all audio montages.

Options

Allows you to select which settings are restored when applying a snapshot preset. The following options are available:

- **Scroll Position and Zoom**
- **Cursor Position**
- **Audio Selection**

Peaks

Rebuild Peak Display

Normally, peak files are automatically updated when the date of the peak file is older than the date of the audio file. However, it can happen that the date of the audio file is wrong and therefore not automatically updated. In this option allows you to rebuild the peak file.

Edit Tab

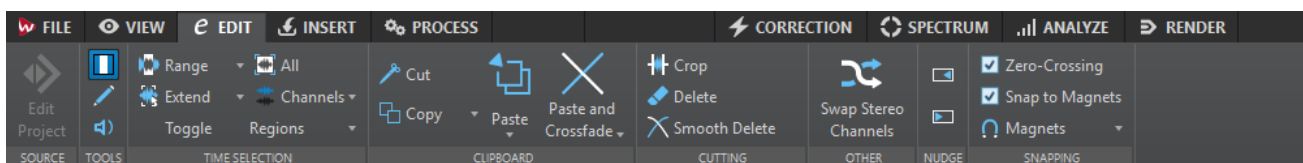

Tools

Time Selection

Tool that allows you to select a time range.

Pen

Tool that allows you to redraw the waveform in the wave window. This can be used to quickly repair waveform errors.

Play

Tool that allows you to play back the audio file at the position where you click.

Time Selection

Range

Opens the **Audio Range** dialog, where you can define selection ranges very accurately.

Extend

This pop-up menu contains various options for creating or extending selection ranges.

Toggle

Toggles the current audio selection.

All

Selects the entire waveform.

Channels

This pop-up menu allows you to change the channel selection.

- **Extend to All Channels** extends the current selection range to all channels.
- **Left Channel Only** reduces the current selection range to the left channel only.
- **Right Channel Only** reduces the current selection range to the right channel only.

Regions

This pop-up menu allows you to select a range between two markers.

- **CD Track** selects the range between the two CD track markers that encompass the edit cursor.
- **Loop Region** selects the range between the two loop markers that encompass the edit cursor.
- **Exclusion Region** selects the range between the two exclusion markers that encompass the edit cursor.
- **Generic Region** selects the range between the two generic markers that encompass the edit cursor.

Clipboard

Cut

Cuts the active clip to the clipboard.

Copy

Copies the active clip to the clipboard.

Right-click **Copy** to open a pop-up menu with additional options:

- **Memorize Cursor Position** copies the position of the edit cursor to the clipboard.
- **Memorize Selection Length** copies the length of the active selection range to the clipboard.

Paste

Pastes the clipboard content.

Right-click **Paste** to open a pop-up menu that allows you to select a paste type.

- **Overwrite** replaces the audio at the paste position.
- **Append** adds the pasted audio after the end of the file.
- **Prepend** adds the pasted audio before the beginning of the file.
- **Multiple Copies** opens a dialog in which you can enter the number of copies that you want to create.
- **Mix** blends two files into each other, starting at the selection or, if there is no selection, at the cursor position.

If you select **Mix**, a dialog opens, allowing you to specify the gain and phase for the audio on the clipboard and at the destination. The clipboard data is always mixed in, regardless of the length of the selection.

Paste and Crossfade

Pastes the clipboard content and creates a crossfade.

Right-click **Paste and Crossfade** to open a pop-up menu that allows you to select a crossfade type for pasting.

- **Linear (Equal Gain)** changes the level linearly.
- **Sinus (Equal Power)** changes the level according to a sine curve, the power of the mix remains constant.
- **Square-Root (Equal Power)** changes the level according to a square-root curve, the power of the mix remains constant.

Cutting

Crop

Deletes the data outside the selection.

Delete

Deletes the selection. The audio to the right of the selection is moved to the left to fill the gap.

Smooth Delete

Deletes the selection and inserts crossfades at the edges. You can edit the default length and type for the crossfade in the **Audio Files Preferences**, on the **Editing** tab.

Swap Stereo Channels

Moves the audio in the left channel to the right channel, and vice versa.

Nudge

Nudge Left

Nudges the audio selection to the left.

Nudge Right

Nudges the audio selection to the right.

Snapping

Zero-Crossing

If this option is activated, the start and the end of a selected range always snap to a zero-crossing point of the waveform.

Snap to Magnets

If this option is activated, moved elements such as clip edges, time selection edges, cursor, and markers snap to the magnets that are activated on the **Magnets** pop-up menu.

Insert Tab

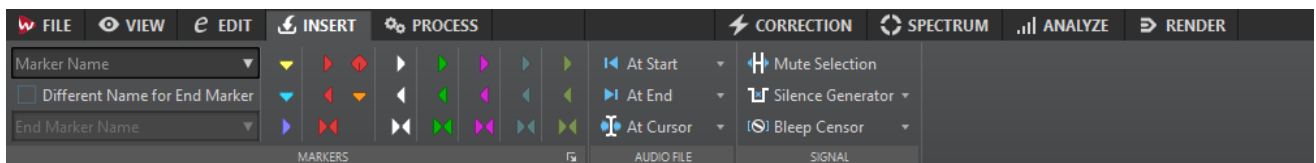

Markers

Marker Name

Allows you to enter the name of the start and end marker. If nothing is entered, a generic name is used.

To edit the default names, open the **Markers** window, and select **Functions > Default Marker Names**.

Different Name for End Marker

If this option is activated, you can enter a different name for the end marker.

If this option is deactivated, the name of the start marker is also used for the end marker.

Create Marker

Allows you to create different types of markers and marker pairs at the edit cursor position or at the selection range.

Audio File

At Start

Allows you to insert an audio file at the start of the active audio file.

At End

Allows you to insert an audio file at the end of the active audio file.

At Cursor

Allows you to insert an audio file at the cursor position.

Signal

Mute Selection

Replaces the audio selection with silence.

Silence Generator

Opens the **Silence Generator** dialog that allows you to insert silence or background noise in an audio file.

Bleep Censor

Opens the **Bleep Censor** dialog that allows you to replace a part in an audio file with a tone to cover a swear word, for example.

RELATED LINKS

[Silence Generator Dialog](#) on page 152

[Bleep Censor](#) on page 154

Process Tab

This tab provides access to the offline processing tools.

RELATED LINKS

[Offline Processing](#) on page 173

Correction Tab

This tab provides access to the error detection and correction tools.

RELATED LINKS

[Error Correction](#) on page 169

Spectrum Tab

The **Spectrum** tab allows you to use high-quality linear-phase filters to process a spectrum range selection for audio restoration and processing.

RELATED LINKS

[Spectral Editing](#) on page 440

Analyze Tab

The **Analyze** tab provides you with tools for analyzing your audio and for detecting any errors.

RELATED LINKS

[Audio Analysis](#) on page 156

Render Tab

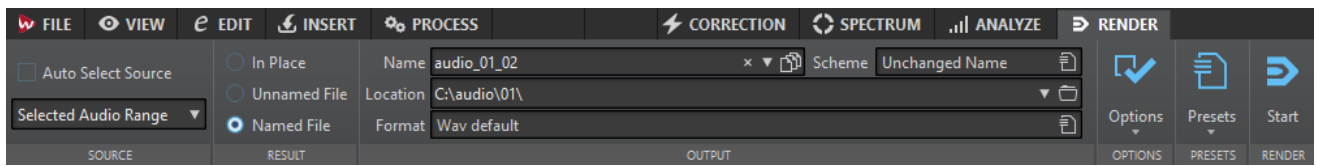

Source

Auto Select Source

If this option is activated, the source is automatically selected according to the selection that you make in the audio file. If there is no selection, the whole audio file is processed.

The **Source** pop-up menu allows you to select which part of the audio file you want to process. The following options are available:

Whole File

Processes and renders the whole audio range.

Selected Audio Range

Processes and renders the selected audio range.

Specific Region

Processes and renders a specific audio range to an independent file. Specify the region to process on the pop-up menu.

All Regions

Processes and renders each marked audio range to an independent file. By defining multiple isolated regions in an audio file, you can process them in one operation. Specify the type of regions to process on the pop-up menu.

Result

In Place

If this option is activated, the rendered audio range replaces the source audio range.

Unnamed File

If this option is activated, a temporary untitled file is rendered.

Named File

If this option is activated, you can specify a name for the rendered file.

Output

Name

Allows you to enter a name for the rendered file. Clicking the arrow icon opens a pop-up menu that offers you several naming options.

Scheme

Allows you to specify a naming scheme for the file name.

Location

Allows you to select a destination folder for the rendered files.

Format

Opens a pop-up menu where you can select a single file format or multiple file formats.

Options

Depending on the selected source, different options are available.

Bypass Master Section

If this option is activated, the plug-ins and gain of the **Master Section** are bypassed when rendering.

Auto Save Master Section Preset

If this option is activated, the **Master Section** preset is automatically saved in the companion file of the audio file when you render the file. You can load the **Master Section** preset via the **Load Master Section Preset** option in the lower right corner of the wave window.

Fade In/Out at Boundaries

If this option is activated, a fade is performed at the audio range boundaries when a new file is created, or a crossfade with the adjacent audio is created if the audio range is processed in place.

Crossfades allow for smooth transitions between the processed and the non-processed parts. The crossfade time and shape are set in the **Audio Files Preferences**. If the fade time is longer than half the length of the processed file, the fade is not performed.

No Reverb Tail

If this option is activated, the audio tail produced by effects such as reverb is not included in the rendered file.

Some plug-ins do not transfer information on the tail duration to WaveLab. In this case, this option has no effect. For such plug-ins, you can add the **Silence** plug-in to add extra samples at the end of the file.

Copy Markers

If this option is activated, the markers that are included in the range to process are copied to the rendered file.

Skip Exclusion Region

If this option is activated, muted audio ranges are skipped and not included in the result.

Open Resulting Audio File

If this option is activated, every rendered file is opened in a new window.

Open Files in New File Group

If this option is activated, the rendered audio file is imported in a new file group.

Bypass Master Section on Resulting Audio File

If this option is activated, playback of the resulting audio file bypasses the entire **Master Section** except the **Playback Processing** section. This setting can be toggled by clicking the button at the bottom right of the wave window or montage window.

NOTE

It is recommended to activate this option, because this way, you do not monitor new files through the effects that have already been applied to them.

Include Pause before Track

If this option is activated and you render CD tracks, a pause is included before each CD track in the rendered file.

Include Pause after Track

If this option is activated and you render CD tracks, a pause is included after each CD track in the rendered file.

Upload to SoundCloud

If this option is activated, the rendered file is uploaded to SoundCloud.

Presets

Presets

This pop-up menu allows you to save and restore render presets. All settings are saved and restored, except the file name and the file location.

Render

Start

Starts the rendering process.

RELATED LINKS

[Companion Files](#) on page 36

File Handling in the Audio Editor

Mono/Stereo Handling

WaveLab Pro is very flexible in its handling of stereo. All editing operations can be performed on either one channel or on both.

Supported File Formats

WaveLab Pro can open and save audio files in a number of file formats.

Wave (.wav)

The following bit depths are supported: 8 bit, 16 bit, 20 bit, 24 bit, 32 bit float, and 64 bit float.

Wave 64 (.w64)

This file format is very similar to the Wave format but with one important difference: it allows you to record and/or edit files of virtually any length. Standard Wave files are limited to 2 GB (stereo files) in WaveLab Pro.

NOTE

Wave 64 does not support metadata. If you need large files and metadata, use Wave files and activate the RF64 option.

WavPack (.wv/.wvc)

This file format allows digital audio to be losslessly compressed, including 32 bit float audio files.

RF64

In the **Audio Files Preferences**, on the **File** tab, you can activate the RF64 file format support. If this is activated, the standard Wave file format switches automatically to the RF64 file format as soon as the file size exceeds 2 GB, without any performance loss or interruption. This is useful when recording very long sessions. A RF64 file has the extension `.wav`, but it can only be opened with an application that supports the RF64 standard if the file exceeds 2 GB.

AIFF (.aif, .aiff, .snd)

Audio Interchange File Format, a standard defined by Apple Computers Inc. The following bit depths are supported: 8 bit, 16 bit, 20 bit, and 24 bit.

MPEG-1 Layer 3 (.mp3)

The most common audio compression format. The major advantage of MPEG compression is that the file size is significantly reduced, while there is little degradation of sound quality.

NOTE

When you open an MPEG compressed file in WaveLab Pro, the file is converted to a temporary wave file. On saving, the temporary wave file is converted back to MP3.

MPEG-1 Layer 2 (.mp2, .mpa, .mpg, .mus)

MP2 (sometimes referred to as "Musicam files") is a common file format in the broadcast industry.

Original Sound Quality (.osq, read-only)

This is the proprietary lossless compressed audio format of WaveLab.

Sound Designer II (.sd2)

This audio file format is used by Digidesign applications (such as Pro Tools). The following bit depths are supported: 8 bit, 16 bit, and 24 bit.

U-LAW (.ulaw, .vox)

This is an audio encoding and compression technique supported by Windows and Web phones, using 8 bit precision. The U.S. telephone system uses U-law encoding for digitization.

A-LAW (.alaw, .vox)

This is an audio encoding and compression technique for telephony, using 8-bit precision. The EU telephone system uses A-law encoding for digitization.

Sun/Java (.snd, .au)

This is an audio file format used on Sun and NeXT computers. The following bit depths are supported: 8 bit, 16 bit, and 24 bit.

ADPCM - Microsoft/Dialogic (.vox)

This is a format commonly used for games and telephony applications. It offers a lower bit rate than linear PCM and therefore requires less storage space/bandwidth.

Ogg Vorbis (.ogg)

Ogg Vorbis is a compressed file format that is open, patent-free, and which creates very small audio files maintaining comparatively high audio quality.

Text/Excel (.txt)

This is a text representation of a waveform. By saving an audio file as a text file and then opening it in a spreadsheet application such as Excel, you can view it in textual, decimal form, and edit the sample values. When you open a text file representing a waveform in WaveLab Pro, it is decoded and opened as an audio file. These files are not compressed in any way, so they can become very large.

When using 64-bit float files, the .txt format is not 100 % lossless. This is because it is not possible to express a binary floating point value in textual decimal form without some precision loss.

Windows Media Audio (.wma, .asf)

Microsoft's own compressed format. WaveLab Pro lets you import/export audio in this format (Windows only). To import/export audio in WMA surround format, Windows Media Player 9 or later must be installed on your system.

Ensoniq Paris (.paf)

Used by the Ensoniq Paris™ system. The following bit depths are supported: 16 bit and 24 bit.

Raw PCM files (.raw, .bin, .pcm, .\$\$\$)

In this format, no information about bit depth or sample rate is included. If you open a file in this format, WaveLab Pro asks you to specify the bit depth and sample rate. If this is not done correctly, the file will not play back as intended.

FLAC (.flac)

Free Lossless Audio Codec (FLAC) is a codec which allows digital audio to be losslessly compressed.

AAC (.aac)

Advanced Audio Coding (AAC) is a codec that allows lossy compression and encoding scheme for digital audio.

NOTE

The “\$\$\$” file type is a temporary file format of WaveLab Pro. If you experience a computer crash, you may restore some of your work by opening any “\$\$\$” files on your hard disk.

20-bit, 24-bit, and 32-bit Float Files

You do not need a 20-bit or 24-bit audio card to take advantage of the fact that WaveLab Pro can handle 20-bit and 24-bit audio files. Any processing or editing performed on the files is always done at full precision (64-bit float), even if your card does not support the full precision.

For playback, WaveLab Pro automatically adapts to the card that you have installed.

Creating a New Audio File

You can create an empty audio file, to assemble material from other audio files, for example.

PROCEDURE

1. Select **File > New**.
 2. Click **Audio File > Custom**.
 3. Specify the audio properties and click **Create**.
-

Audio Properties

You can define the channels, the sample rate, and the bit depth of the audio file.

You can set these properties when you create a new audio file.

- To change the properties for the selected audio file, select the **File** tab and click **Info**, or click the **Audio Properties** button at the bottom right of the wave window.

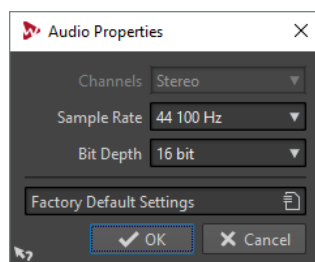

Channels

Allows you to select the number of audio channels.

Sample Rate

Allows you to select the number of audio samples per second.

Bit Depth

Allows you to select the accuracy of samples in the audio stream.

Saving an Audio File

PROCEDURE

1. Do one of the following:
 - To save an audio file that has never been saved before, select **File > Save As**.
 - To save an audio file that has been saved before, click the **Save** button, or select **File > Save**.
 2. In the **Save As** window, specify a file name and location.
 3. Click **Save**.
-

Saving in Another Format

You can change the file format, sampling frequency, bit depth, and stereo/mono status when saving.

PROCEDURE

1. Select **File > Save As**.
 2. In the **Save As** window, specify a file name and location.
 3. Click in the **Format** field and select **Edit**.
 4. In the **Audio File Format** dialog, set the file format and specify the properties.
 5. Click **OK**.
 6. Click **Save**.
-

RESULT

A new file is created. The original file is not affected by the operation.

Audio File Format Dialog

In this dialog, you can change various file settings when saving.

- To open the **Audio File Format** dialog, select **File > Export**, and select **Render > Single** or **Render > Multi**. Then activate **Named File**, click in the **Format** field, and select **Edit**.

This dialog can also be opened from various other locations in WaveLab Pro.

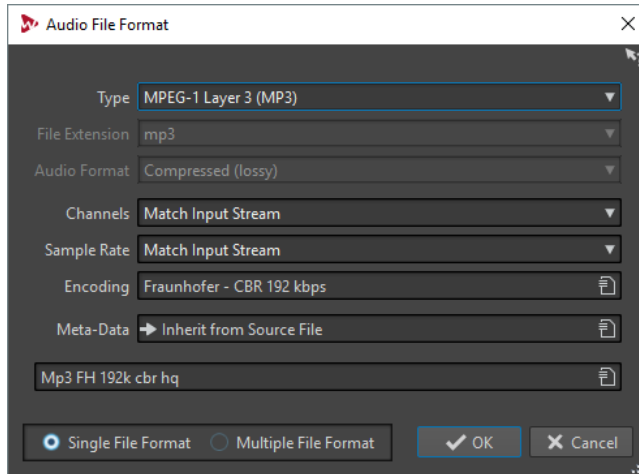

Type

Select an audio file type. This affects which options are available on the **Audio Format** menu.

File Extension

Select a file extension that is compatible with the current file type.

Audio Format

Select an audio format that is compatible with the current file type.

Channels

Specify the number of audio channels for the files to be created. For multichannel audio montages, you can create multiple files.

Sample Rate

Select a sample rate for the audio file. If you change this setting, a sample rate conversion takes place.

IMPORTANT

Use this only for simple conversions. For professional results, use the **Resample** plug-in and add limiting and dithering.

Bit Depth

Select a bit depth for the audio file. This option is only available for specific file types.

IMPORTANT

Reducing the bit depth is only advised for simple conversions. For professional results, it is recommended to add dithering in the **Master Section**.

Metadata

Lets you make metadata settings that are saved with the file. This option is only available for some file types.

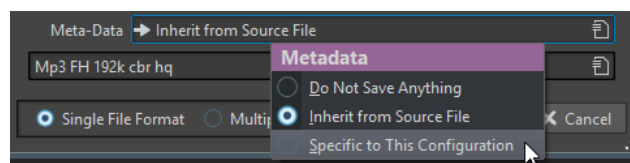

- If **Do Not Save Anything** is selected, no metadata are saved with the file.

- If **Inherit from Source File** is selected, the metadata of the source file are used. If the source metadata is empty, the default metadata is used, if available. For example, this can be used to create Wave files with a Unique Material Identifier (BWF standard).
- If selecting **Specific to This Configuration** is selected, you can edit the metadata, or replace it with a metadata preset. To edit the metadata, open the metadata pop-up menu again, and select **Edit**.

Single File Format/Multiple File Format

Switches between the **Audio File Format** dialog and the **Multi Audio File Format** dialog.

Changing the Format

When changing the sample rate, bit depth, and number of channels of an audio file, several operations are performed.

Sample Rate

If a new sample rate is specified, a sample rate conversion is performed.

Bit Depth

If a different bit depth is specified, the file is either truncated down to 8 bits, or padded up to 64 bits. If you are converting to a lower bit depth, you should consider adding dithering.

Mono/Stereo

If the file is converted from mono to stereo, the same material is used in both channels. If the conversion is from stereo to mono, a mix of the two channels is created.

NOTE

- If you only want to change the bit depth, you can do this in the **Audio Properties** section of the **Info** window instead, and then save the audio file.
 - For high quality mastering purposes, it is not recommended to change the sample rate and number of channels using the **Audio Properties** section, but instead use plug-ins and functions of the **Master Section**.
-

Saving a Selection as an Audio File

You can save a selection in the open audio file as a new audio file.

PROCEDURE

1. In the wave window, make a selection range.
 2. In the **Audio Editor**, select the **Render** tab.
 3. In the **Source** section, open the pop-up menu and select **Selected Audio Range**.
 4. In the **Output** section, specify a file name and location.
 5. Open the **Format** menu and select **Edit Single Format**.
 6. In the **Audio File Format** dialog, specify the output format and click **OK**.
 7. In the **Render** section, click **Start**.
-

Saving Left/Right Channel as Audio File

You can save each channel individually into a separate file. Use this option when editing dual mono files, for example.

PROCEDURE

1. In the **Audio Editor**, select the **Render** tab.
 2. In the **Output** section, specify a file name and location.
 3. Open the **Format** menu and select **Edit Single Format**.
 4. In the **Audio File Format** dialog, open the **Channels** pop-up menu, and select **Left Channel** or **Right Channel**.
 5. Make additional output settings and click **OK**.
 6. In the **Render** section, click **Start**.
-

Encoding Audio Files

Audio can be saved in different formats. The process of converting audio to another format is called encoding. When saving audio files, you can specify various encoding options for some file formats.

MP3 Encoding Dialog

You can edit the encoding options when you save an MP3 audio file.

You can open the **MP3 Encoding** dialog from most places where you can select an output file format. For example, open an audio file, select **File > Save As**, click in the **Format** field, and select **Edit**. In the **Audio File Format** dialog, select **MPEG-1 Layer 3 (MP3)** as type, click the **Encoding** field, and select **Edit**.

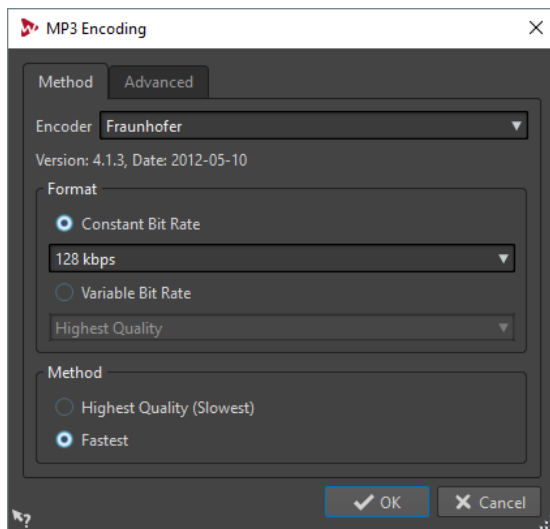

Encoder

Lets you select the encoder (**Fraunhofer** or **Lame**).

Constant/Variable Bit Rate

The bit rate is related to the quantity of data used to encode the audio signal. The higher the value, the better the quality, but the larger the output file. If you choose **Variable Bit Rate**, the rate changes, according to the complexity of the audio material.

Highest Quality (Slowest)/Fastest

Select the quality that you want to achieve. The higher the quality, the more resources and time are required to analyze and compress the audio signal.

NOTE

Highest Quality (Slowest) can require a specific sample rate for the audio file. If this is the case and the sample rate is different from the input sample rate, a message is displayed.

When you use the **Lame** encoder, you can make additional settings on the **Advanced** tab.

Add File Length and Playback Position Information to VBR Header

Adds additional data to the VBR header that allows the playback device to estimate the length of the MP3 file and to jump to any time position inside the MP3 file. This option is available for the Fraunhofer encoder only.

Embed Ancillary Data for Time and Delay Compensation

Embeds ancillary data so that the decoded file will exactly match the duration of the original file. This option is available for the Fraunhofer encoder only.

Allow Intensity Stereo Coding

Decreases the bit rate by reorganizing the intensity information between the channels.

Specify as Original Recording

Marks the encoded file as the original recording.

Write Private Bit

This is a custom flag.

Write Copyright Flag

Marks the encoded file as copyright-protected.

Write Check-Sum

Allows other applications to check the integrity of the file.

Create Long Frames

Saves space by writing fewer headers in the file (not compatible with all decoders).

AAC Encoding Dialog

You can edit the encoding options when you save an AAC audio file.

You can open the **AAC Encoding** dialog from most places where you can select an output file format. For example, open an audio file, select **File > Save As**, click in the **Format** field, and select **Edit**. In the **Audio File Format** dialog, select **AAC (Advanced Audio Coding)** as type, click the **Encoding** field, and select **Edit**.

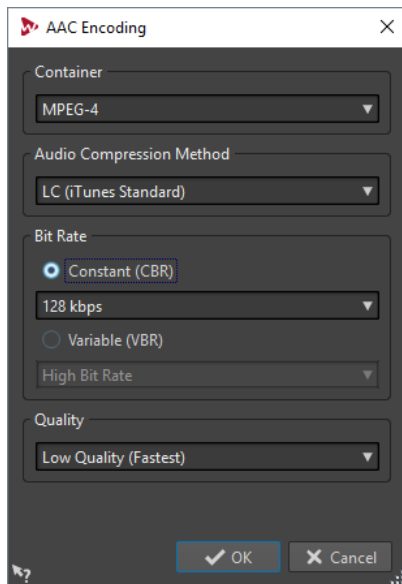

Container

Specifies the container for the AAC file. A container is a file format that can contain compressed audio data and metadata.

- MPEG-4 (recommended format for iTunes)
- 3GPP (3rd Generation Partnership Project)
- ADIF (Audio Data Interchange Format)
- ADTS (Audio Data Transport Stream)
- ADTS (with CRC)
- LATM LOAS (Low Overhead Audio Stream)

Audio Compression Method

Lets you select the audio compression method.

- LC (Low Complexity, iTunes standard)
- HE (High Efficiency)
- HE v2 (High Efficiency, Parametric Stereo)
- HD 16 bit (Lossless)
- HD 24 bit (Lossless)

LC (Low Complexity) does not mean lower quality, but less compression attempts. It is used for best audio quality.

HE (High Efficiency) is an extension of Low Complexity AAC (AAC LC) and is optimized for low-bit-rate applications, for example, streaming audio.

HE v2 enhances the compression efficiency of stereo signals. HE formats provide extremely compressed audio files with a high quality sound.

HD is an extension to the MPEG-4 standard and allows lossless audio compression that is scalable to lossy compression. This means that the decoding can be lossless or lossy, depending on the decoder settings. However, the file size is larger than with the other compression methods.

Constant/Variable Bit Rate

The bit rate is related to the quantity of data that is used to encode the audio signal. The higher the value, the better the quality, but the larger the output file. If you choose **Variable Bit Rate**, the rate changes over time according to the complexity of the audio material.

Quality

Select the quality that you want to achieve. The higher the quality, the more resources and time are required to analyze and compress the audio signal.

NOTE

Highest Quality can require a particular sample rate for the audio file.

MPEG-1 Layer 2 Encoding Dialog

You can edit the encoding options when you save an MPEG-1 Layer 2 (MP2) audio file.

You can open the **MPEG-1 Layer 2 Encoding** dialog from most places where you can select an output file format. For example, open an audio file, select **File > Save As**, click in the **Format** field, and select **Edit**. In the **Audio File Format** dialog, select **MPEG-1 Layer 2** as type, click the **Encoding** field, and select **Edit**.

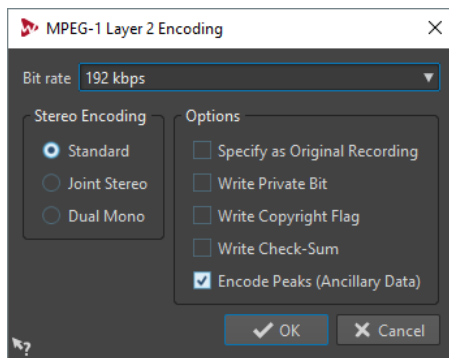

Bit Rate

Determines the bit rate. The bit rate is related to the quantity of data that is used to encode the audio signal. The higher the value, the better the quality, but the larger the output file.

Stereo Encoding

In **Standard** mode, the encoder does not use the correlation between channels. However, the encoder can take space from a channel that is easy to encode and use it for a complicated channel.

In **Joint** mode, the encoder uses the existing correlations between the two channels to increase the ratio quality/space.

In **Dual** mode, both channels are independently encoded. This mode is recommended for signals with independent channels.

Specify as Original Recording

Marks the encoded file as the original recording.

Write Private Bit

This is a custom flag.

Write Copyright Flag

Marks the encoded file as copyright-protected.

Write Check-Sum

Allows other applications to check the integrity of the file.

Encode Peaks (Ancillary Data)

This must be activated for compatibility with specific systems, for example, DIGAS.

FLAC Encoding Dialog

You can edit the encoding options when you save a FLAC audio file.

You can open the **FLAC Encoding** dialog from most places where you can select an output file format. For example, open an audio file, select **File > Save As**, click in the **Format** field, and select **Edit**. In the **Audio File Format** dialog, select **FLAC** as type, click the **Encoding** field, and select **Edit**.

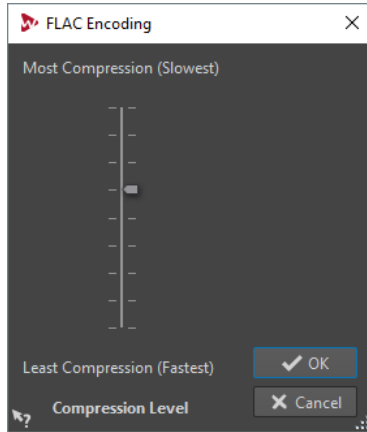

Compression Level

Lets you specify the compression level. The more compression, the slower the encoding.

Ogg Vorbis Dialog

You can edit the encoding options when you save an Ogg Vorbis audio file.

You can open the **Ogg Vorbis** dialog from most places where you can select an output file format. For example, open an audio file, select **File > Save As**, click in the **Format** field, and select **Edit**. In the **Audio File Format** dialog, select **Ogg Vorbis** as type, click the **Encoding** field, and select **Edit**.

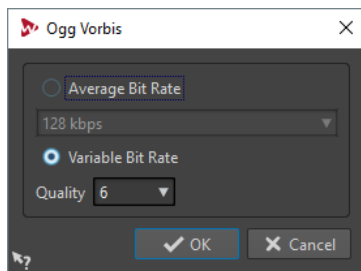

Average Bit Rate

If this option is activated, the average bit rate in the file remains constant during encoding. Because the file size is proportional to time, the localization of a given point is easier, but it can result in a lower quality compared to the **Variable Bit Rate** option.

Variable Bit Rate

If this option is activated, the bit rate in the file will vary during encoding, depending on the complexity of the material. This can give a better quality/size ratio in the resulting file.

In the **Quality** field, select the quality. Lower quality settings result in smaller files.

Windows Media Audio Encoding Dialog

You can edit the encoding options when you save a Windows Media Audio (WMA) audio file. This dialog is only available in on Windows systems.

You can open the **Windows Media Audio** dialog from most places where you can select an output file format. For example, open an audio file, select **File > Save As**, click in the **Format** field, and select **Edit**. In the **Audio File Format** dialog, select **Windows Media Audio (WMA)** as type, click the **Encoding** field, and select **Edit**.

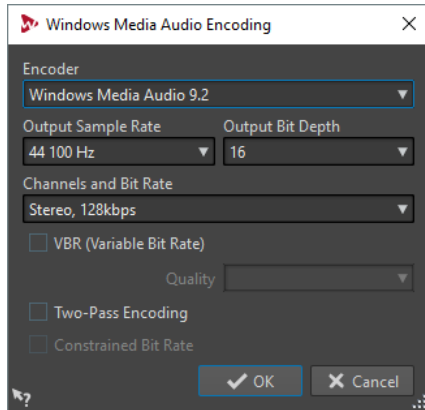

Encoder

Sets the encoder.

Output Sample Rate

Sets the output sample rate of the encoded file. The higher the sample rate, the higher the quality, but the larger the output file.

Output Bit Depth

Sets the output bit depth of the encoded file. This parameter is not available for all encoders.

Channels and Bit Rate

The available items here depend on the selected encoding method and the output sample rate.

VBR (Variable Bit Rate)

If this option is activated, the bit rate in the file will vary during the encoding, depending on the complexity of the material. This can produce a better quality/size ratio in the output file.

In the **Quality** field, select the quality. Lower quality settings result in smaller files.

Two-Pass Encoding

If this option is activated, the encoding quality increases, but the process takes twice as long.

Constrained Bit Rate

This option is available when the **VBR** and **Two-Pass Encoding** options are activated. This is used to maintain the bit rate within limits to avoid peaks. This is recommended for media, such as CD or DVD.

Creating an Audio Montage from an Audio File

You can export audio files to an audio montage, including all markers that you have set in the audio file.

PROCEDURE

1. In the **Audio Editor**, open the audio file that you want export to an audio montage.
 2. Optional: If you want to use a specific time range of the audio file, create a selection range in the wave window.
 3. Select **File > New**.
 4. Select **Audio Montage > From Current File**.
 5. In the **From Current Audio File** section, click **Insert Audio File in New Montage**.
 6. Click **Create**.
 7. In the **Create Audio Montage from Audio File** dialog, select whether to import the whole file or the selected audio range.
 8. Optional: Decide if you want to perform any of the following marker operations:
 - **Import Markers**
 - **Split at Generic Region Markers**
 - **Split at CD Track Markers**
 9. Click **OK**.
-

Inserting Audio Files into Another Audio File

You can assemble an audio file from several audio files.

PROCEDURE

1. In the **Audio Editor**, open the audio file in which you want to insert another audio file.
 2. If you want to insert an audio file at the edit cursor position, make sure that **Snap to Magnets** is activated, and that **Cursor** is activated on the **Magnet** pop-up menu.
The edit cursor snaps to the nearest zero crossing. This avoids glitches.
 3. Select the **Insert** tab.
 4. In the **Audio File** section, select one of the following insert options:
 - **At Start**
 - **At End**
 - **At Cursor**

If you select **At Cursor**, the audio file is cut at the insert position. The part after the cut is moved to the right.
 5. On the pop-up menu, select the audio file that you want to insert.
-

RELATED LINKS

[Magnetic Bounds in Audio Files](#) on page 114

Turning Selections Into New Files

You can turn selections into new files via drag and drop or by using the **Render** tab in the **Audio Editor**.

Turning Selections Into New Files By Dragging

PROCEDURE

1. Make a selection in the wave window.
 2. Drag the selection to the tab bar above the wave window and release the mouse button.
-

RESULT

The selection opens in a new stereo window.

Turning Selections Into New Files Using the Menu

PROCEDURE

1. Make a selection in the wave window.
 2. Right-click the selection and select **Copy Selection to New Window**.
 3. From the submenu, select one of the following options:
 - **Duplicate**
 - **Stereo Version**
 - **Mono Mixdown**
 - **Mono Mixdown (Subtract Right Channel from Left Channel)**
-

RESULT

The selection opens in a new stereo or mono window.

Special File Format Dialog

When opening files via the **Unknown Audio** option, you can specify how to interpret the format of the audio file that you want to open.

- To open the **Special File Format** dialog, select **File > Import**, click **Unknown Audio**, and select the file that you want to open.

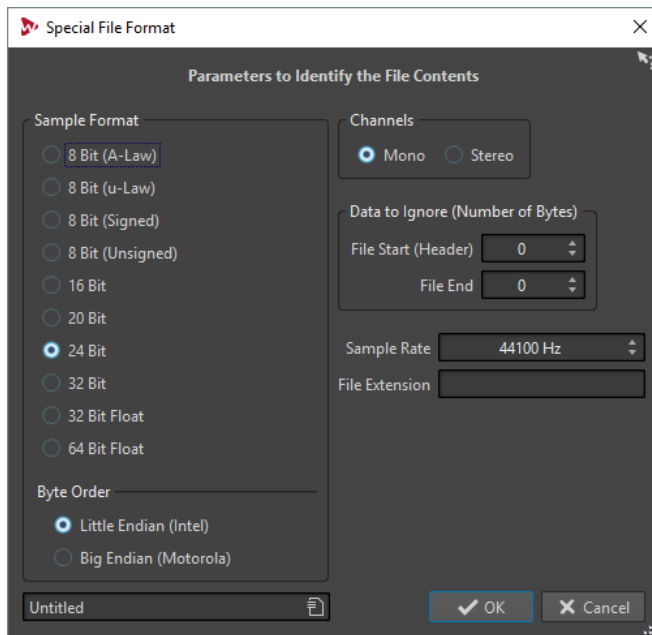

Sample Format

Specifies the binary representation of the samples in the file.

Byte Order

Specifies the order in which bytes should be interpreted. This only applies for 16 bit or more.

Channels

Specifies the number of audio channels in the audio file.

Data to Ignore (Number of Bytes)

Specifies how many bytes at the start and end of the audio file are ignored.

Sample Rate

Specifies the sample rate of the audio file.

File Extension

Specifies the default file name extension for the audio file. When the file selector opens after closing this dialog, only the file with this extension is displayed.

Dual Mono Files

Dual mono files are two mono files that are the left and right channels of a stereo recording. You can open several dual mono files at the same time and have them grouped automatically, provided the files have channel tags in their file names.

You can open dual mono files like stereo files in the **Audio Editor**, the **Audio Montage** window, and the **Batch Processor** window.

In the **Audio Files Preferences**, on the **File** tab, you can set the channel ID for the left and right channel, and the channel ID to add to dual mono files when saving the files. Up to 7 name descriptors can be defined, each of which can be of the type **Suffix** or **Advanced**.

In the **Advanced** mode, the channel ID can be located anywhere in a file name. For this purpose, a name pattern must be defined. This name pattern must have a {capture} section.

Name matching is not case sensitive and the file extension is ignored.

By default, WaveLab Pro recognizes the file name endings “.L/.R”, “-L/-R”, or “_L/_R” as the left and right channels.

Allowing Opening of Dual Mono Files

NOTE

To avoid accidentally opening two separate mono files as a dual mono file, you should only activate **Allow Opening of Dual Mono Files** when you are opening dual mono files.

PROCEDURE

1. Select **File > Preferences > Audio Files**.
 2. Select the **File** tab.
 3. Activate **Allow Opening of Dual Mono Files**.
 4. If you want to open several dual mono files at the same time, define the naming scheme of the dual mono files in the **Dual Mono File Identification** section.
-

Opening Dual Mono Files in the Audio Editor

PREREQUISITE

Activate **Allow Opening of Dual Mono Files** and place the dual mono files in the same folder.

PROCEDURE

1. Open the audio file in which you want to open the dual mono files.
 2. Select **File > Open**.
 3. Select **Audio File > Browse**.
 4. Browse to the file location.
 5. Select the dual mono files that you want to open and click **Open**.
-

RELATED LINKS

[Allowing Opening of Dual Mono Files](#) on page 139

Opening Dual Mono Files in the Audio Montage Window

PREREQUISITE

Activate **Allow Opening of Dual Mono Files** and place the dual mono files in the same folder.

PROCEDURE

1. Open the audio montage in which you want to open the dual mono files.
 2. Select **File > Open**.
 3. Select **Audio Files > Browse**.
 4. Browse to the file location.
 5. Select the dual mono files that you want to open, and click **Open**.
 6. In the **Insert Audio Files** dialog, make your settings.
 7. Click **OK**.
-

Opening Dual Mono Files in the Batch Processor Window

PREREQUISITE

Activate **Allow Opening of Dual Mono Files** and place the dual mono files in the same folder.

PROCEDURE

- In the **Batch Processor** window, drag the dual mono files from the **File Browser** window to the **Files to Process** list, or use the **Insert** options on the **Edit** tab.

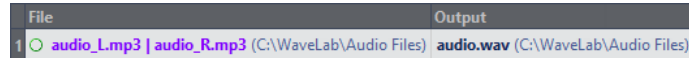

File	Output
1 audio_L.mp3 audio_R.mp3 (C:\WaveLab\Audio Files)	audio.wav (C:\WaveLab\Audio Files)

Dual mono files are displayed in purple in the list.

Converting From Stereo to Mono and From Mono to Stereo

You can convert audio files from mono to stereo and from stereo to mono. Converting a mono file into a stereo file produces an audio file that contains the same material in both channels, for example for further processing into real stereo. Converting a stereo file into a mono file mixes the stereo channels to a mono channel.

Converting a Selection From Stereo to Mono

PROCEDURE

1. Make a stereo selection in the wave window.
2. Select **File > New**.
3. Select **Audio File > From Current File**.
4. Select one of the following options:
 - To mix the left and right stereo channels when converting to mono, click **Mono Mixdown**.
 - To mix the left channel with the inverse of the right channel when converting to mono, click **Mono Mixdown (Subtract Right Channel from Left Channel)**.

The resulting mono wave contains the difference between the channels. For example, this allows you to verify that a wave file really is a true stereo file rather than a mono file converted to stereo format.

RESULT

The selection opens in a new mono window.

Converting From Stereo to Mono While Saving

PROCEDURE

1. Make a stereo selection in the wave window.
2. Select **File > Save As**.
3. In the **Save As** window, specify a file name and location.
4. Click in the **Format** field and select **Edit**.
5. In the **Audio File Format** dialog, open the **Channels** menu and select one of the mono settings.

For example, when selecting **Mono (Mix -3 dB)**, the resulting audio file is attenuated by 3 dB.
6. Click **OK**.

7. Click **Save**.
-

Converting a Selection From Mono to Stereo

PROCEDURE

1. Make a mono selection in the wave window.
 2. Select **File > New**.
 3. Select **Audio File > From Current File**.
 4. Click **Stereo Version**.
 5. Click **Create**.
-

RESULT

The selection opens in a new stereo window.

Swapping Channels in a Stereo File

You can swap the two channels in an audio file, that is, you can move the audio in the left channel to the right channel, and the audio in the right channel to the left channel.

- To swap the channels of the whole audio file in the **Audio Editor**, select the **Edit** tab, and in the **Cutting** section, click **Swap Stereo Channels**.
- To swap the channels only a selected range of the audio file, make a selection range in the wave window, select the **Edit** tab, and in the **Cutting** section, click **Swap Stereo Channels**.

Special Paste Options

On the **Paste** pop-up menu in the **Audio Editor**, you find additional paste options.

- To access the special paste option, open the **Audio Editor**, select the **Edit** tab, and in the **Clipboard** section, right-click **Paste**.

Overwrite

Overwrites data in the destination file, rather than moving data to make room for the inserted audio. How much is overwritten depends on the selection in the destination file:

- If there is no selection in the destination file, a section with the same length as the pasted selection is overwritten.
- If there is a selection in the destination file, the pasted selection replaces that selection.

Append

Adds the pasted audio after the end of the file.

Prepend

Adds the pasted audio before the beginning of the file.

Multiple Copies

Opens a dialog in which you can enter the number of copies that you want to create.

Mix

Blends two files into each other, starting at the selection or, if there is no selection, at the cursor position.

- When you select the **Mix** option, a dialog opens, allowing you to specify the gain for the audio on the clipboard and at the destination.

- All the data on the clipboard is always mixed in, regardless of the length of the selection.

Moving Audio

You can rearrange the order of the audio in a file by dragging, and cutting and pasting.

Moving Audio by Dragging

PREREQUISITE

Decide whether you want to use **Snap Selection to Zero-Crossing**.

PROCEDURE

1. In the wave window, make a selection.
 2. Drag the selection to a position outside the selection in the same file, or to another wave window.
-

RESULT

The selection is removed from its original position and inserted where you drop it.

NOTE

To undo a move between two files you must first undo the paste in the destination window and then undo the cut operation in the source window.

Moving Audio Using Cut and Paste

PREREQUISITE

Decide whether you want to use **Snap Selection to Zero-Crossing**.

PROCEDURE

1. In the wave window, make a selection.
 2. Use one of the following copy methods:
 - In the **Audio Editor**, select the **Edit** tab, and click **Cut**.
 - Press **Ctrl/Cmd-X**.
 3. Select how you want to insert the selection:
 - If you want to insert the audio, click once at the position in the same file or in another file.
 - If you want to replace a section of audio, select it.
 4. To paste the selection, do one of the following:
 - In the **Audio Editor**, select the **Edit** tab, and click **Paste**.
 - Press **Ctrl/Cmd-V**.
-

RESULT

The selection is removed from its original position and inserted where you drop it.

NOTE

To undo a move between two files you must first undo the paste in the destination window and then undo the cut operation in the source window.

Moving Audio by Nudging

The nudge left/right tools can be used to move the audio in small steps within a file.

PROCEDURE

1. In the wave window, make a selection.
 2. In the **Audio Editor**, select the **Edit** tab.
 3. In the **Nudge** section, click **Nudge Left** or **Nudge Right**.
-

RESULT

The audio is moved one pixel. Exactly how much this is depends on how far you are zoomed in. For example, if the status bar displays **x1:256**, the selection is moved 256 samples. The moved section overwrites the audio at that position.

Copying Audio

You can copy sections of audio within the same file or between audio files.

Stereo/Mono Handling

When you drag or copy stereo or mono files to other locations, the target location determines how the files are inserted.

Stereo/Mono is handled as follows when you drag between files:

Dragged section	Drop wave	Action
Stereo	Stereo	The dragged audio is always inserted into both channels.
Stereo	Mono	Only the left channel is inserted.
Mono	Stereo	What happens depends on the vertical drop position. This is indicated by the cursor shape. The selection can be inserted into only one of the channels, or the same material can be inserted into both channels.

Stereo/Mono is handled as follows when you copy and paste files:

Copied section	Paste wave	Action
Stereo	Stereo	If the wave cursor extends across both channels of the destination file, the material is inserted into both channels.
Stereo	Stereo	If the wave cursor is only in one channel, the audio is only pasted in that channel. Material from the left channel is pasted in the left channel and material from the right channel is pasted in the right channel.
Stereo	Mono	Only the left channel is pasted.

Copied section	Paste wave	Action
Mono	Stereo	What happens depends on whether the wave cursor is in one channel or both. The audio is either pasted in one of the channels, or the same material is inserted into both channels.

Sample Rate Conflicts

If you copy or move audio from one window to another, and the sample rates of the two files are not the same, the copied/moved sound plays back at the wrong pitch (speed). The program warns you if this is about to happen.

While mixing sample rates can be used as an effect, it is most often not intended. There are two ways to get around this:

- Convert the sample rate of the source file to the same rate as the destination file before editing.
- Convert the sample rate of the destination file to the same rate as the source file before adding the audio.

Copying Audio Using Copy and Paste

PREREQUISITE

Decide whether you want to use **Snap Selection to Zero-Crossing**.

PROCEDURE

1. In the wave window, make a selection.
 2. Use one of the following copy methods:
 - In the **Audio Editor**, select the **Edit** tab, and click **Copy**.
 - Press **Ctrl/Cmd-C**.
 3. Select how you want to insert the selection:
 - If you want to insert the audio, click once at the position in the same file or in another file.
 - If you want to replace a section of audio, select it.
 4. To paste the selection, do one of the following:
 - In the **Audio Editor**, select the **Edit** tab, and click **Paste**.
 - Press **Ctrl/Cmd-V**.
-

Copying Audio by Dragging

PREREQUISITE

Decide whether you want to use **Snap Selection to Zero-Crossing**.

PROCEDURE

1. In the wave window, make a selection.
 2. Click the middle of the selection, and drag it to a position outside the selection in the same file, or to another wave window.
-

RESULT

The selection is inserted at the indicated point. The audio that previously began at that point is moved to the right.

Mid and Side Editing

You can edit, process, and monitor audio material in the left/right and in the mid/side domain. Mid/Side editing can be applied on the waveform view and in spectral editing mode. This allows you to do spectral editing only on the mid or on the side channel, for example.

You can switch between left/right and mid/side mode with the **LR/MS** button at the bottom left of the overview and the main view. The upper track displays the mid signal and the lower track displays the side signal. The overview and main view have independent LR/MS controls. This allows you to display the left/right channels in the overview and the mid/side channels in the main view, for example.

When you render the audio, the channels are automatically encoded back to left/right mode.

The waveform display and the cursor shape indicate whether L/R or M/S mode is activated.

You can apply offline processes like **Gain** and **Level** independently on the mid and on the side channel. With the playback tool, you can play back the mid or side channel independently.

Changing the Audio Properties

You can change the sample rate and bit depth of audio files.

Changing these values does not process the audio file in any way (in contrast to using **Save As**). However, the following rules apply:

- If you change the sample rate, the file plays back at a new pitch.
- If you change the bit depth, the file is converted to the new precision the next time you save it.

NOTE

There is no undo for this. If you save a file with a lower bit depth, the file is converted permanently.

PROCEDURE

1. In the **Audio Editor**, open an audio file.
 2. Select the **File** tab.
 3. Click **Info**.
 4. In the **Audio Properties** section, specify a new **Sample Rate** and/or **Bit Depth**.
 5. Click **Apply Changes**.
-

RELATED LINKS

[Info Tab](#) on page 43

Metadata

Metadata consists of attributes that describe the audio contents, for example, the title of the track, the author, or the date the track was recorded. Depending on the file format of the selected audio file, this data varies.

When opening an audio file, audio montage, or batch process, the metadata found in the file is loaded. You can create different metadata presets for audio files, audio montages, and batch processes. When creating a new file from a template, this file can inherit the metadata of the preset, if available.

A preview of the metadata is displayed in the **Metadata** window. To view the complete metadata of a file and to be able to edit the metadata, select **Tool Windows > Metadata** and click the **Edit** button.

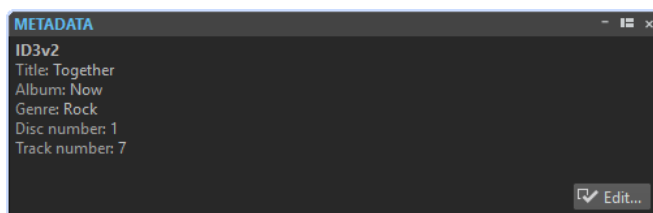

Not all file formats can save metadata. Depending on the output file format, all metadata or only part of the metadata is saved in an audio file. The following file formats can contain metadata:

- .wav
- .mp3
- .ogg
- .wma
- .flac
- .aac

For MP3, the following metadata types are available:

- ID3 v1 and ID3 v2, including picture support, and ReplayGain standard

AAC is used for MPEG-4 (iTunes compatible) and 3GPP containers.

NOTE

- AAC is not ID3v2 compatible. However, in WaveLab Pro it uses the same editor.
- The metadata codes that are followed by an "(i)" indicate the iTunes compatible fields. Lyrics and pictures are also iTunes compatible.

For WAV, the following metadata types are available:

- RIFF
- BWF markers
- BWF version 2 (EBU R-128 loudness support)
- BWF support for USID and UMID standards (Unique Source Identifier and Unique Material Identifier)
- iXML (with EBU R-128 loudness support)
- aXML (BWF standard to attach XML data)
- CART (AES standard, dedicated to broadcast needs)
- MD5 (**Extra** tab)
- ID3, including picture support

When saving or recording an audio file in the **Audio File Format** dialog, you can specify whether not to use any metadata, inherit the metadata from the source file, or edit the metadata of the file.

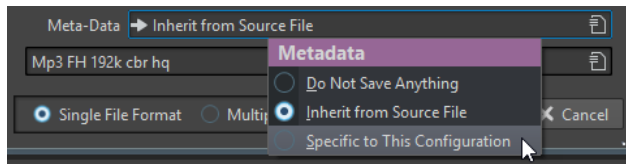

Metadata can be entered manually or generated automatically.

The following options can be generated automatically:

- Unique Source Identifier (**BWF, Basics** tab)
- UMID (**BWF, Unique Material Identifier (UMID)** tab)
- Loudness and true peak values* (**BWF, Loudness** tab)
- Insert BWF data (**iXML** tab)
- Time markers (**CART** tab)
- MD5 checksum* (**Extra** tab)
- ReplayGain information* (**ID3, ID3 v2** tab)
- USID (**BWF, Basics** tab)

(*) These options cause a file analysis while the file is written, which means that the file writing process can take longer.

WaveLab Pro includes several metadata presets. They are used as examples and can be customized to your needs. You can load metadata presets from the **Metadata Presets** pop-up menu in the **Audio File Format** dialog, or from the **Metadata** dialog.

RELATED LINKS

[Audio File Format Dialog](#) on page 127

Metadata Dialog

This dialog allows you to define the metadata to be embedded in your audio file.

- To open the **Metadata** dialog, open the **Metadata** window and click **Edit**.

Depending on the file type, the metadata is handled differently.

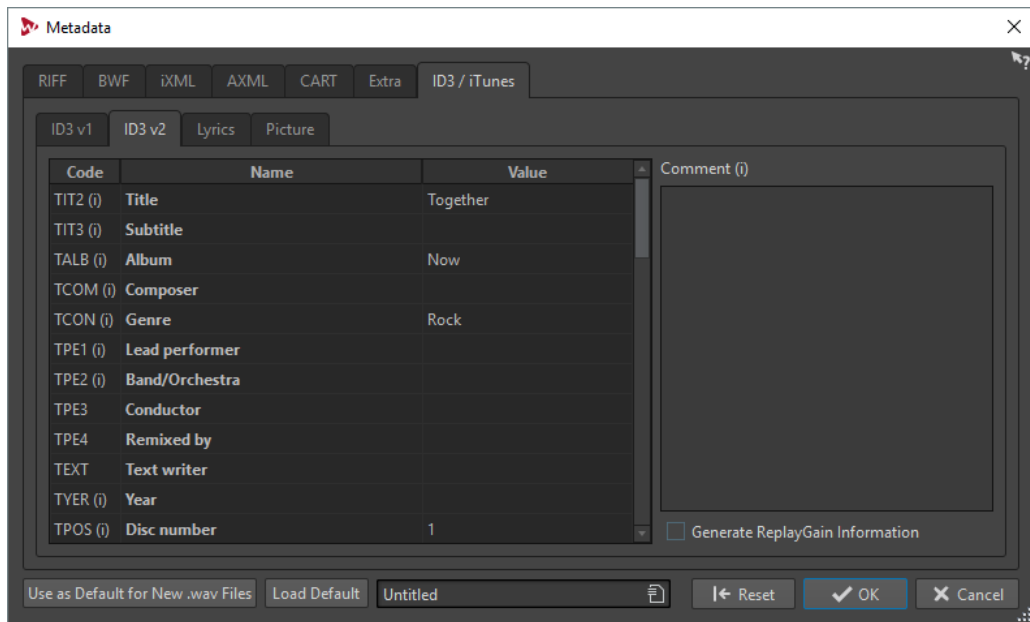

Metadata dialog for WAV files

When opening the **Metadata** dialog for files in the **Audio Editor**, you can edit the metadata that is saved in the audio file. This metadata is saved to disk later.

When opening the **Metadata** dialog for files in the **Audio Montage** window or the **Batch Processor** window, you can edit the metadata for the WAV, MP3, and AAC audio files that are created when rendering the audio montage or processing through the batch processor. If you render to WAV, MP3, or AAC formats, the metadata will be associated to these files.

NOTE

The metadata codes that are followed by an "(i)" indicate the iTunes compatible fields. Lyrics and pictures are also iTunes compatible.

Metadata Presets

In the **Metadata** dialog, you can save metadata presets and apply these presets to other files. Metadata presets can be applied to WAV, MP3, and AAC files.

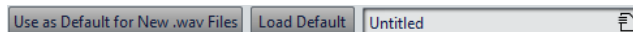

The **Use as Default for New .wav Files** option allows you to define a set of metadata as default.

When you create a new file, and do not add any metadata, this default metadata is applied to the file when saving or rendering it. For example, you can save or record WAV files with BWF metadata and automatically add a Unique Material Identifier.

To edit the default metadata preset, select **Load Default**, and edit the preset.

CART and Markers

WaveLab Pro reads the CART markers, if any, and merges them with the existing markers of the file.

The CART standard can contain up to 8 markers. WaveLab Pro saves them if their names conform to the CART standard.

If **Generate Time Markers** is activated in the **CART** tab of the **Metadata** dialog, the markers are generated if at least one CART text field has content. Otherwise, the CART data is meant to be unused.

To be able to merge the CART markers with the markers of a file when rendering a file, the option **Copy Markers** must be activated in the **Render** dialog.

Metadata and Variables

Variables make handling metadata more efficient. You can use the available variable options to quickly add metadata to a file, without having to type the same information multiple times.

You can also quickly add available information such as dates or file names.

The idea behind this is to set up the metadata and variables once, and then be able to output various file versions from the project.

Example of Using Metadata and Variables

Let's say you have an audio montage that contains CD tracks and want to render all CD tracks to individual audio files, including metadata information. You have already added some CD-Text to each track.

The CD-Text of each CD track is automatically available in the **CD Metadata** dialog and can be used as variables.

Now you want to add information that is not available as CD-Text, for example, the year of the CD track and a comment, to have these information available in the rendered audio files.

1. In the **CD** window, select **Functions > Edit CD Metadata**, and fill out the **@CdTrackYear@** and **@CdTrackInfo1@** fields. Use the scroll-bar on the right of the dialog to select the other tracks, and add the information for all tracks. Close the dialog.
2. Edit the metadata in the **Metadata** dialog. Set up the ID3 v2 fields using the variables. Click the arrow icon to open the variables and text snippets pop-up menu for a field. You can also fill out other metadata chunks, such as **BWF**, **RIFF**, or **CART**, or add an album picture. Or you could apply a previously set up metadata preset to add metadata.
3. Once the information is complete, open the **Render** tab in the **Audio Montage** window. In the **Source** section, open the pop-up menu and select **All Regions**. Open the **Marker** pop-up menu and select **CD Tracks**.
4. Click in the **Format** field, and click **Single File Format**. In the **Audio File Format** dialog, open the **Metadata** pop-up menu, and select **Inherit from Source File**. Click **OK** to close the dialog.
5. In the **Render** tab, in the **Render** section, click **Start** to render the files.

Result: When you now open the rendered audio files and look at the metadata, you can see that the variables were replaced with the metadata that has been set up for each track.

RELATED LINKS

[Variables and Text Snippets](#) on page 564

[CD Window](#) on page 296

Metadata in the Batch Processor Window

You can batch process metadata. For this, you must set up the **Metadata** dialog for batch processes, and apply the metadata to the files of the batch process.

In the **Batch Processor** window, on the **Format** tab, the following options are available in the **Batch Metadata** pop-up menu:

- If you do not want the batch metadata to change the metadata of the files in the batch, select **Ignore**.
- If you want to merge the metadata of the batch with the metadata of the source files (WAV files only), select **Merge**.
- If you want to replace the metadata of the source files with the metadata of the batch, select **Replace**.

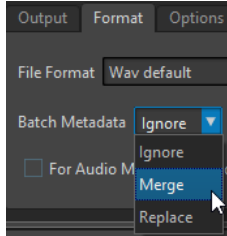

Examples for Merging Metadata

A simple example would be if you have 1000 files with a mistake in a copyright field of their metadata. With this batch option, you can preserve the metadata of the files, and edit only the copyright field.

However, the merge option can also be used for complex batch metadata. You can process an audio file and specify which metadata to use from the source audio file and which from the batch metadata. For this, use the **Merge Codes** options in the **Metadata** dialog for batch processes.

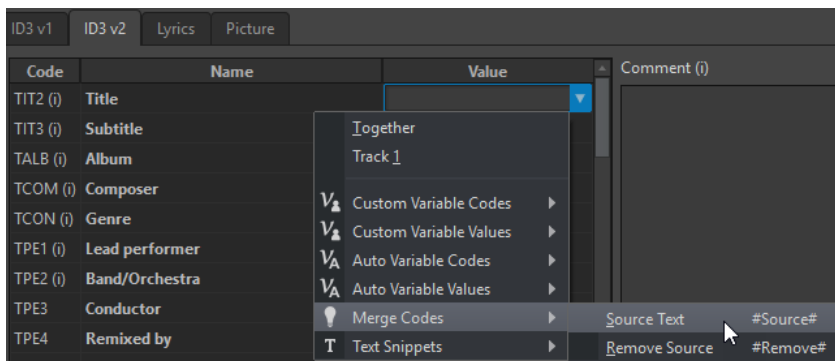

If you enter **#Source#** in a value field, the value of the source audio file's metadata is used when batch processing. If you enter **#Remove#** in a value field, the corresponding value of the source audio file's metadata is removed when batch processing. In order to set up the merging process, you must set up these codes in the value field that you want to merge.

An example on how to merge metadata while using the **#Source#** and **#Remove#** options:

- The batch process contains an audio file that already has metadata.
- The batch metadata is set up.

When starting the batch process, the metadata are merged in the following way:

- If value field "A" in the audio file metadata contains the text "Jazz", while value field "A" is empty in the batch metadata, the resulting output file has the text "Jazz" in value field "A".
- If value field "B" in the batch metadata contains the text "Modern", while value field "B" in the audio file metadata is empty, the resulting output file has the text "Modern" in value field "B".
- If value field "C" contains text both in the source audio file and in the batch metadata, some more editing in the **Metadata** dialog for batch processes is necessary to specify which metadata should be used.

Examples on how to use the **#Source#** and **#Remove#** codes:

- No code is used, the source audio file has the text “Piano”, and the batch metadata has the text “Trumpet”. Result: “Piano” is retained, because the source audio file metadata has precedence over the batch metadata.
- The source audio file has the text “Piano”, and the batch metadata has the text “Electric #Source#”. Result: The resulting output file has the text “Electric Piano”.
- The source audio file has the text “Piano”, and the batch metadata has the text “#Remove#”. Result: “Piano” is removed from the value field.
- The source audio file has the text “Piano”, and the batch metadata has the text “#Remove#Trumpet”. Result: “Piano” is removed, and “Trumpet” is added.

Snapshots

You can save a number of snapshots of your audio file, to capture the current scroll position, zoom factor, cursor position, and audio selection.

You can recall a snapshot at any time and update snapshots.

Selecting a saved snapshot restores all of its view settings. You can also choose to recall only specific view properties by activating the corresponding options for a snapshot.

RELATED LINKS

[View Tab](#) on page 116

Capturing the Current View

Capturing the current view saves the current zoom factor, cursor position, scroll position, and time range.

PROCEDURE

1. Set up the view of the wave window.
2. Select the **View** tab.
3. In the **Snapshots** section, click **Take Snapshot**.
4. Click one of the preset buttons to save the snapshot.

RESULT

The snapshot is saved and can be recalled by clicking the corresponding preset button.

Recalling a Snapshot

PROCEDURE

1. In the **Audio Editor**, select the **View** tab.
2. In the **Snapshots** section, open the **Options** pop-up menu.
3. Activate the view settings that you want to recall.
4. Click a **Preset** button.

Updating Snapshots

You can update a previously captured snapshot with the current view.

PROCEDURE

1. Set up the view of the wave window.

2. Select the **View** tab.
 3. In the **Snapshots** section, click **Take Snapshot**.
 4. Click the preset button that you want to update.
-

RESULT

The new snapshot replaces the selected snapshot.

Silence Generator Dialog

This dialog allows you to insert silence or background noise in an audio file.

- To open the **Silence Generator** dialog, select the **Insert** tab in the **Audio Editor**, and click **Silence Generator**.

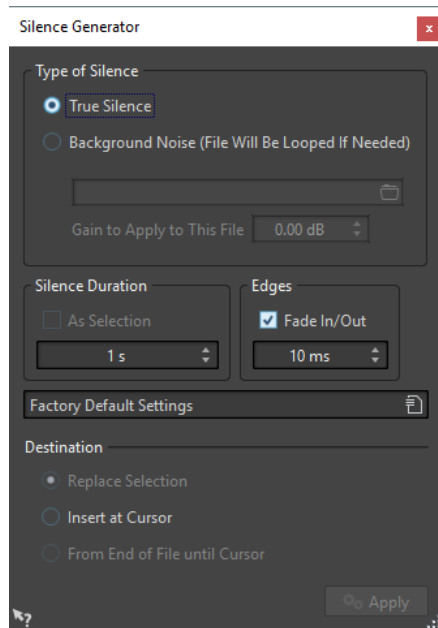

Type of Silence

- **True Silence** allows you to insert digital silence.
- **Background Noise (File Will Be Looped If Needed)** allows you to select an audio file containing ambient noise.
Gain to Apply to This File lowers or raises the gain of the background noise.

Silence Duration

As Selection uses the duration of the active audio selection as the duration of the silent section. Specify the duration of the silent section in the value field below.

Edges

Fade In/Fade Out performs a crossfade at the start and end of the silent section for smoother transitions. Specify the fade time in the value field below.

Destination

- **Replace Selection** replaces the current audio selection with the silent section.
- **Insert at Cursor** inserts the silent section at the cursor position.
- **From End of File Until Cursor** extends the audio file with silence up to the cursor position. Activating this option also defines the silence duration and ignores the **Silence Duration** setting.

True Silence vs. Background Noise

Recordings can sound unnatural when you insert true silence. This is particularly true for voice recordings and field recordings, where a natural background noise is often present. To produce more natural results, you can insert a file with background noise.

The file that you specify must have the same properties (stereo/mono, sample rate, etc.) as the file in which you want to insert the silence. The file can be any length – if the silence region is longer than the file, the file is looped.

Replacing a Selection with Silence

You can replace a section of an audio file with true silence or background noise.

PROCEDURE

1. In the **Audio Editor**, make a selection.
 2. Select the **Insert** tab.
 3. In the **Signal** section, click **Silence Generator**.
 4. In the **Silence Generator** dialog, select the type of silence:
 - **True Silence**
 - **Background Noise**
For this option you must select a file containing the background noise.
 5. Set the silence duration to **As Selection**, and the destination to **Replace Selection**.
 6. Click **Apply**.
-

Inserting Silence

You can insert a specified length of true silence or a background noise at any position of the audio file.

PROCEDURE

1. In the **Audio Editor**, set the cursor where you want the inserted silence to begin.
 2. Select the **Insert** tab.
 3. In the **Signal** section, click **Silence Generator**.
 4. In the **Silence Generator**, select the type of silence:
 - **True Silence**
 - **Background Noise**
For this option you need to select a file containing the background noise.
 5. Deactivate **As Selection**, and specify the length.
 6. Set the destination to **Insert at Cursor**.
 7. Click **Apply**.
-

Muting a Selection

The **Mute Selection** function replaces the selection with true silence.

PROCEDURE

1. In the wave window of the **Audio Editor**, make a selection.
2. Select the **Insert** tab.

3. In the **Signal** section, click **Mute Selection**.
-

Bleep Censor

The bleep censor allows you to replace a part in an audio file with a tone to cover a swear word, for example.

Bleep Censor Dialog

The **Bleep Censor** dialog allows you to define the bleep censor tone.

- To open the **Bleep Censor** dialog, select the **Insert** tab in the **Audio Editor**, and click **Bleep Censor** in the **Signal** section.

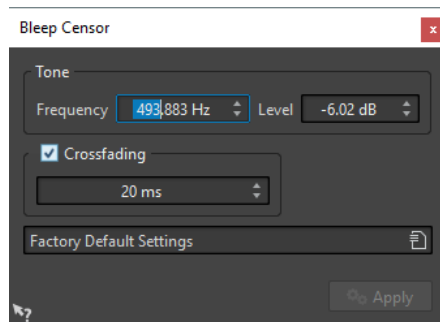

Frequency

Allows you to specify the frequency of the bleep censor tone.

Level

Allows you to specify the level of the bleep censor tone.

Crossfading

If this option is activated, WaveLab Pro creates a crossfade at the start and the end of the bleep censor region for a smoother transition. You can specify the crossfade time.

Presets

This pop-up menu allows you to save and restore bleep censor presets.

Replacing Audio with Tone

PROCEDURE

1. In the **Audio Editor**, make a selection.
 2. Select the **Insert** tab.
 3. In the **Signal** section, click **Bleep Censor**.
 4. In the **Bleep Censor** dialog, specify the frequency and the level of the bleep censor tone.
 5. Optional: Activate **Crossfading** and specify the crossfade time.
This creates a crossfade at the start and the end of the bleep censor region.
 6. Click **Apply**.
-

Waveform Restoration with the Pen Tool

The **Pen** tool allows you to redraw the waveform in the wave window. This can be used to quickly repair waveform errors. The **Pen** tool can be used if the zoom resolution is set to 1:8 (one pixel on the screen equals 8 samples) or higher.

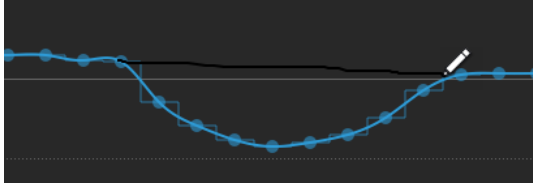

- To redraw the waveform, select the **Pen** tool on the **Edit** tab of the **Audio Editor**, click in the waveform, and draw the new waveform.
- To redraw the waveform of both channels at once, press **Shift** during the drawing process.

Audio Analysis

WaveLab Pro provides you with a comprehensive set of tools for analyzing your audio and for detecting any errors.

You can compare two audio files with the Audio File Comparator tool and view audio in a Spectrum or Loudness view.

For example, you can use the suite of audio meters or the 3D Frequency Analysis. There are also several tools that help you examine any sample of your audio for errors or anomalies.

Analyze Tab

The **Analyze** tab provides you with tools for analyzing your audio and for detecting any errors.

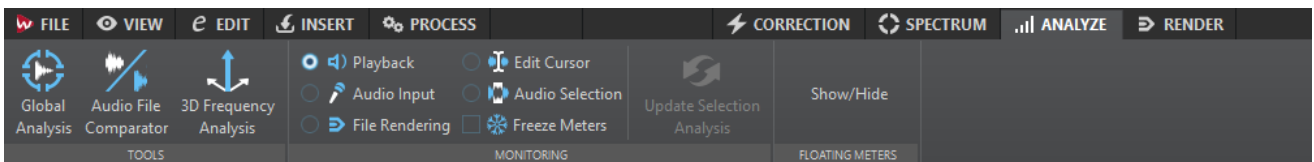

Tools

Global Analysis

Opens the **Global Analysis** dialog where you can analyze peaks, loudness, pitch, DC offset, and errors in the audio file.

Audio File Comparator

Opens the **Audio File Comparator** dialog where you can compare two audio files.

3D Frequency Analysis

Opens the **3D Frequency Analysis** dialog where you can define, which frequency range is analyzed and modify the appearance of the graph for the 3D frequency analysis.

Monitoring

Playback

This is the standard metering mode, in which the meters reflect the audio that is played back. Metering occurs after the **Master Section**, which means that effects, dithering, and master faders are taken into account. You can monitor playback in audio files, audio montages, audio CD track lists, etc.

Audio Input

In this mode, the meters reflect the audio input. Typically, this is the mode to use when recording. The **Master Section** settings are not taken into account.

File Rendering

In this mode, you can monitor what is being written to disk during file rendering or recording. Average and min/max peak values are calculated. After rendering, the meters freeze until you refresh or change the monitor mode.

Edit Cursor

In this mode, the meters are static, showing the levels and other values for the audio at the position of the edit cursor, in stop mode. This allows you to analyze a specific position in an audio file in real time. The **Master Section** settings are not taken into account.

Audio Selection

In this mode, the meters display the average values calculated for a selected range. The **Master Section** settings are not taken into account.

When you change the selection, you have to update the meter displays by clicking **Update Selection Analysis**.

Freeze Meters

This mode freezes the values for all open meters. The meters remain frozen until you select another monitor mode or deactivate **Freeze Meters**.

Floating Meters

Show/Hide

Shows/Hides floating meters.

Global Analysis

In WaveLab Pro, you can perform advanced analysis on your audio to identify areas with specific properties. This helps you find problem areas such as glitches or clipped samples. You can also check general information, such as the pitch of a sound.

If you analyze a section of an audio file, WaveLab Pro scans the section or the audio file and extracts information which is displayed in the dialog. WaveLab Pro also marks sections of the file that meet specific characteristics, for example, sections that are very loud or almost silent. You can then browse between these points, set markers, or zoom in on markers. On most of the tabs, you find settings that determine exactly how the analysis is performed. Each tab focuses on a particular analysis area.

You perform the global analysis in the **Global Analysis** dialog. This dialog consists of the following tabs that provide different analysis types:

- The **Peaks** tab allows you to find individual samples with very high values.
- The **Loudness** tab allows you to find sections with high intensity.
- The **Pitch** tab allows you to find the exact pitch of a sound or section.
- The **Extra** tab provides information about DC offsets and the significant bit depth.
- The **Errors** tab allows you to find glitches and sections where the audio has been clipped.

Most of the analysis types provide a number of positions in the file that indicate peaks, glitches, etc. These points are called "hot points".

Opening the Global Analysis Dialog

The **Global Analysis** dialog provides various analysis options.

PROCEDURE

1. In the wave window, select a range in the audio file that you want to analyze.

If you want to analyze the entire file, press **Ctrl/Cmd-A**. If **Process Whole File If There Is No Selection** is activated in the **Audio Files Preferences**, the whole file is analyzed automatically provided that no selection has been made.

2. In the **Audio Editor**, select the **Analyze** tab.
 3. In the **Tools** section, click **Global Analysis**.
 4. Optional: Click **Open New Global Analysis Dialog** at the top of the **Global Analysis** dialog to open another **Global Analysis** dialog.
-

Choosing the Analysis Type

Several types of analysis can be performed. Each of them takes some time, so make sure that only the types that you need are included in the analysis.

Select the analysis types in the **Global Analysis** dialog by activating them in the corresponding tabs.

- To include the peaks analysis, select the **Peaks** tab and activate **Find Peaks**.
- To include the loudness analysis, select the **Loudness** tab and activate **Analyze Loudness**.
- To include the pitch analysis, select the **Pitch** tab and activate **Find Average Pitch**.
- To include the extra analysis, select the **Extra** tab and activate **Find DC Offset**.
- To include the error analysis, select the **Errors** tab and activate **Find Possible Glitches** and **Find Clipped Samples**.

Global Analysis – Peaks Tab

On this tab, you can make settings that help you find digital peak and true peak values in the audio, that is, single samples with very high values.

- In the **Global Analysis** dialog, select the **Peaks** tab.

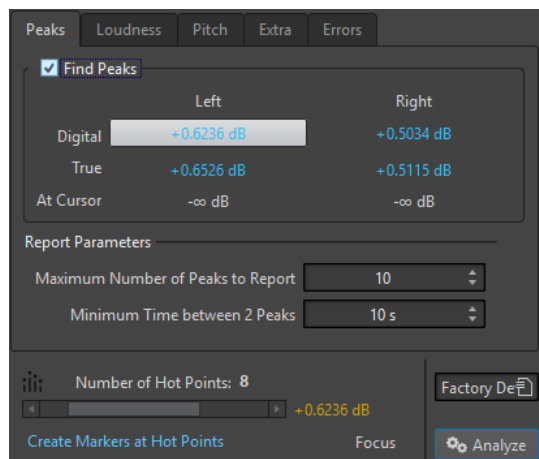

Find Peaks

Enables peak analysis.

Digital/True

Displays the highest peak in the analyzed section. When you click this value, the number of peaks that are detected in the selection is shown in the **Number of Hot Points** section in the lower left corner of the dialog. You can use the hot points to move the cursor between the peaks.

At Cursor

Displays the level at the current audio file cursor position at the time of the analysis.

Maximum Number of Peaks to Report

Restricts the number of reported peaks. For example, setting this to 1 reports only the highest peak.

Minimum Time between 2 Peaks

Controls the distance between peaks, so they do not appear too close to each other. For example, setting this to 1 s ensures that there is always at least one second between reported peaks.

Results of the Analysis

The **Find Peaks** fields show the highest peak in the analyzed section and the level of the sample at the wave cursor position at the time of the analysis.

Global Analysis – Loudness Tab

On this tab, you can make settings that help you find sections that are perceived by the human ear as louder or weaker in volume. To find sections that the ear perceives as significant in volume, you must look at a longer section of audio.

- In the **Global Analysis** dialog, select the **Loudness** tab.

The following options are available for the **Raw Loudness** tab and the **EBU R-128** tab:

Maximum Number of Loudness Points to Report

Restricts the number of reported hot points. Only the highest points are reported. For example, setting this to 1 reports only the loudest section or one of the sections that have the same highest value.

Minimum Time between 2 Points

Controls the distance between points, so they do not appear too close to each other. For example, setting this to 1 s ensures that there is always at least one second between reported points.

Raw Loudness

The screenshot shows the 'Raw Loudness' tab in a software interface. It features a table of results for 'Left' and 'Right' channels, a 'Parameters' section with 'Resolution' and 'Threshold' settings, and a 'Report Parameters' section with 'Maximum Number of Loudness Points to Report' and 'Minimum Time between 2 Points' settings. At the bottom, there is a 'Number of Hot Points' display, a 'Factory Default' button, and an 'Analyze' button.

	Left	Right
Average	-6.61 dB	-7.15 dB
Maximum	-3.28 dB	-3.77 dB
Minimum	-58.84 dB	-75.45 dB
Around Cursor	-	-

Parameters

Resolution: 50 ms

Threshold (for the Average): -50.00 dB

Report Parameters

Maximum Number of Loudness Points to Report: 10

Minimum Time between 2 Points: 10 s

Number of Hot Points: 8

+0.6236 dB

Create Markers at Hot Points

Factory Default

Analyze

Analyze Loudness

Enables RMS loudness analysis.

Average

Displays the overall loudness of the analyzed selection.

Maximum

Displays the level of the loudest section in the analyzed selection. Clicking this value displays the number of loud sections detected within the selection in the **Number of Hot Points** section in the lower left corner of the dialog.

Minimum

Displays the level of the quietest section in the analyzed selection. Clicking this value displays the number of weak sections that are detected within the selection in the **Number of Hot Points** section in the lower left corner of the dialog. This provides adequate information about the signal-to-noise ratio (SNR) of the audio material.

Around Cursor

Displays the loudness at the audio file cursor position at the time of the analysis.

Resolution

The length of audio to be measured and averaged. If this value is lowered, short passages of loud/weak audio are detected. If the value is raised, the sound must be loud/weak for a longer period to result in a hot point.

Threshold (for the Average)

Ensures that the average value is calculated correctly for recordings with pauses. The value that you set here determines a threshold below which any detected audio is considered to be silence, and is therefore excluded from average value calculations.

EBU R-128

The screenshot shows the 'Loudness' tab of an audio analysis software. The 'Analyze Loudness' checkbox is checked. The 'Raw Loudness' dropdown is set to 'EBU R-128'. The following metrics are displayed:

Integrated Loudness	-7.3 LUFS (reference + 15.7 LU)
Loudness Range	3.1 LU (-8.9 LUFS : -5.8 LUFS)
Short-Term Loudness: Maximum	-5.3 LUFS (reference + 17.7 LU)
Short-Term Loudness: Minimum	-9.4 LUFS (reference + 13.6 LU)
Momentary Loudness: Maximum	-4.8 LUFS (reference + 18.2 LU)
Momentary Loudness: Minimum	-13.9 LUFS (reference + 9.1 LU)

Report Parameters:

- Maximum Number of Loudness Points to Report: 10
- Minimum Time between 2 Points: 10 s

At the bottom, it shows 'Number of Hot Points: 8' and a volume level of '+0.6236 dB'. There are buttons for 'Create Markers at Hot Points', 'Focus', and 'Analyze'.

Integrated Loudness

Displays the integrated loudness of the analyzed selection, also known as programme loudness, according to the loudness analysis reference value. This indicates the average loudness of the audio.

Loudness Range

Displays the loudness range according to the loudness analysis reference value. It is based on a statistical distribution of loudness within a programme, thereby excluding the extremes.

Short-Term Loudness: Maximum

Displays the level of the loudest 3 seconds section in the analyzed selection. When you click this value, the number of loud sections that are detected within the selection is shown in the **Number of Hot Points** section in the lower left corner of the dialog.

Short-Term Loudness: Minimum

Displays the level of the quietest 3 seconds section in the analyzed selection. When you click this value, the number of quiet sections that are detected within the selection is shown in the **Number of Hot Points** section in the lower left corner of the dialog. This provides adequate information about the signal-to-noise ratio (SNR) of the audio material.

Momentary Loudness: Maximum

Displays the level of the loudest very short section (400 milliseconds) in the analyzed selection. When you click this value, the number of loud sections that are detected within the selection is shown in the **Number of Hot Points** section in the lower left corner of the dialog.

Momentary Loudness: Minimum

Displays the level of the quietest very short section (400 milliseconds) in the analyzed selection. When you click this value, the number of quiet sections that are detected within the selection is shown in the **Number of Hot Points** section in the lower left corner of the dialog.

RELATED LINKS

[EBU Loudness Standard R-128](#) on page 37

Global Analysis – Pitch Tab

On this tab, you can make settings that help you find the average pitch of an audio section.

- In the **Global Analysis** dialog, select the **Pitch** tab.

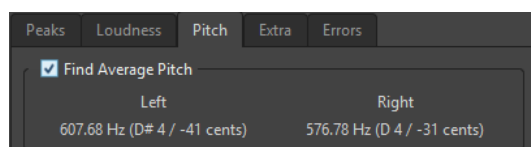

Settings on this tab allow you to gather information for pitch shifting, for example, to get one sound in tune with another. The display shows the pitch for each channel, in Hertz (Hz) and as semitones and cents (hundredths of a semitone). Because the display shows an overall value for the entire analyzed section, the hot point controls in the lower section of the dialog are not used on this tab.

Usage guidelines for the **Pitch** tab:

- The result is an average value for the whole selection.
- The method only works on monophonic material, not on chords or harmonies.
- The algorithm assumes that the analyzed section has a reasonably stable pitch.
- The material must be relatively well isolated from other sounds.
- It is preferable to analyze the sustain portion of a sound rather than the attack. The pitch is usually not stable during the attack.

- Some synthetic sounds may have a weak fundamental (first harmonic) which can irritate the algorithm.

Global Analysis – Extra Tab

This tab shows the average DC Offset of the analyzed section and the **Apparent Bit Depth**.

- In the **Global Analysis** dialog, select the **Extra** tab.

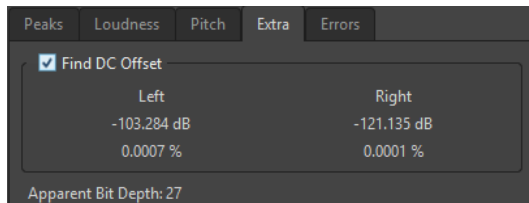

The **Apparent Bit Depth** attempts to detect the actual precision in the audio. This is useful, for example, if you want to check, whether a 24-bit file really uses 24 bits or if it was actually recorded with 16-bit precision and then expanded to 24 bits.

NOTE

For more accurate results on the bit depth, use the **Bit Meter**.

RELATED LINKS

[Bit Meter](#) on page 396

Global Analysis – Errors Tab

This tab helps you find glitches and sections where the audio has clipped.

- In the **Global Analysis** dialog, select the **Errors** tab.

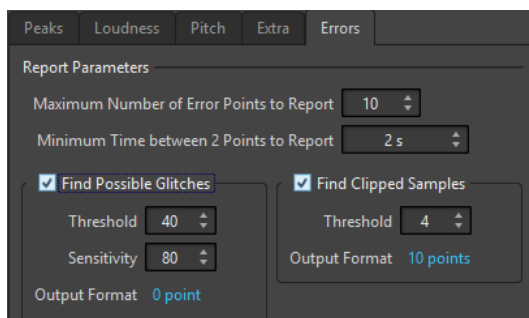

Maximum Number of Error Points to Report

Allows you to restrict the reported numbers of hot points.

Minimum Time between 2 Points to Report

Controls the distance between points, so they do not appear too close to each other. For example, setting this to 1 s ensures that there is always at least one second between reported points.

Find Possible Glitches

Enables glitch analysis.

- **Threshold** sets the value at which a change in level is considered to be a glitch. The higher the value, the less sensitive the detection.

- **Sensitivity** is a length value that represents the length of time in which the waveform must exceed the threshold to be reported as a glitch. The higher the value, the less sensitive the detection.
- **Output Format** displays the number of clipping occurrences that are detected by the analysis. Clicking this value displays the number of clips in the **Number of Hot Points** section in the lower left corner of the dialog.

NOTE

Make sure that the points that are detected by the algorithm are real glitches. Zoom in and play back to check whether the detected points really indicate a problem.

Find Clipped Samples

Enables clipping analysis.

- **Threshold** checks for a number of consecutive samples at full value to determine whether clipping has occurred. The **Threshold** setting determines the exact number of these consecutive samples that must occur for the program to report clipping.
- **Output Format** displays the number of clipping occurrences that are detected by the analysis. Clicking this value displays the number of clips in the **Number of Hot Points** section in the lower left corner of the dialog.

Error Detection

You can detect errors, such as glitches and sections where the audio has clipped. For a more advanced error detection, use the **Error Correction** window.

Glitches

- These are disruptions in the audio. Glitches may occur after problematic digital transfers, after careless editing, etc. They manifest themselves as “clicks” or “pops” in the audio.

Clipping

- A digital system has a finite number of levels that it can represent properly. When recorded sound levels are too high or when the system cannot handle levels that have been raised by digital processing, hard clipping occurs that you can hear as strong distortion.

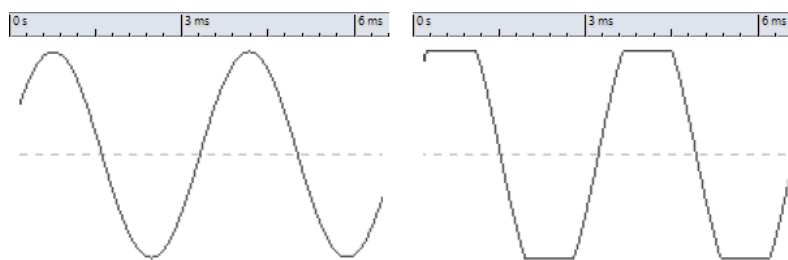

A sine waveform before clipping and after.

Result of the Analysis

This reports the number of glitches and clipping instances that have been detected.

Performing a Global Analysis

PREREQUISITE

In the **Audio Editor**, select the **Analyze** tab, click **Global Analysis**, and select the tab that you want to include in the analysis.

PROCEDURE

1. In the **Global Analysis** dialog, set up the parameters.
Most of the tabs have settings that determine how the analysis should be performed.
 2. If the **Peak** or **Loudness** tab is selected, move the cursor to the position that you want to analyze.
The **Peak** and **Loudness** tabs report values for the position of the cursor.
 3. Click **Analyze**.
-

Results of the Global Analysis

Depending on the analysis type, one or several values are returned for the analyzed audio.

For the **Pitch** and **Extra** analyses, only one value is returned. The other analysis types provide a number of positions in the file that indicate peaks, glitches, etc. These points are called hot points.

Checking the Results of the Global Analysis

The results of the global analysis are marked with hot points. You can browse through these points to see the results of the analysis.

PREREQUISITE

In the **Audio Editor**, select the **Analyze** tab, click **Global Analysis**, and perform the analysis.

PROCEDURE

1. In the **Global Analysis** dialog, click the tab that represents the values that you want to check.
2. Check the display for maximum/minimum values in the entire analyzed section.
3. Decide which of these values you want to check.
4. Click the value.
5. Check the **Number of Hot Points** value at the bottom of the dialog.
The value shows the number of positions that were detected by the analysis.
6. Use the scrollbar below the **Number of Hot Points** value to browse between the detected positions.
The edit cursor shows the position in the wave window.
7. To browse another property, click the corresponding tab, and then the value button.

NOTE

The result of the analysis is saved until you close the dialog or click **Analyze** again.

RELATED LINKS

[Performing a Global Analysis](#) on page 163

Creating Markers at Hot Points

Creating markers at hot points simplifies browsing the results of the global analysis.

PREREQUISITE

In the **Audio Editor**, select the **Analyze** tab, click **Global Analysis**, and perform the analysis.

PROCEDURE

1. In the **Global Analysis** dialog, select the analysis type for which you want to create markers at hot points.
You can add markers for only one channel at a time.
 2. Click the **Create Markers at Hot Points** button.
Temporary markers are added at all hot points.
-

RESULT

The markers are named using the following principle: "Hot point number (Channel)". For example, a marker at the third hot point in the left channel would be labeled "3 (L)".

RELATED LINKS

[Performing a Global Analysis](#) on page 163

Focusing Hot Points

After a global analysis, you can focus the display on a specific hot point.

PREREQUISITE

In the **Audio Editor**, select the **Analyze** tab, click **Global Analysis**, and perform the analysis.

PROCEDURE

1. Use the **Number of Hot Points** scroll bar to move the position indicator to the position in which you are.
 2. Click **Focus**.
The wave window zooms in on the selected point. The **Global Analysis** dialog is reduced to the bottom part.
 3. To return to the full view of the **Global Analysis** dialog, click **Focus** again.
-

Audio File Comparator

You can compare audio files to find differences.

Use the **Audio File Comparator** for the following:

- Seeing and hearing the effect of using an equalizer
- Checking the noise added by a processor
- Checking the effects of data compression
- Comparing two versions of an apparent similar recording to see if they are really the same

You can create a delta audio file that contains only the differences between the two compared audio files. To see and hear small differences easily, you can amplify them.

Markers can be automatically added at positions in the audio file where differences are detected.

Audio File Comparator Dialog

In this dialog, you can compare two audio files.

- To open the **Audio File Comparator** dialog, select the **Analyze** tab in the **Audio Editor** and click **Audio File Comparator**.

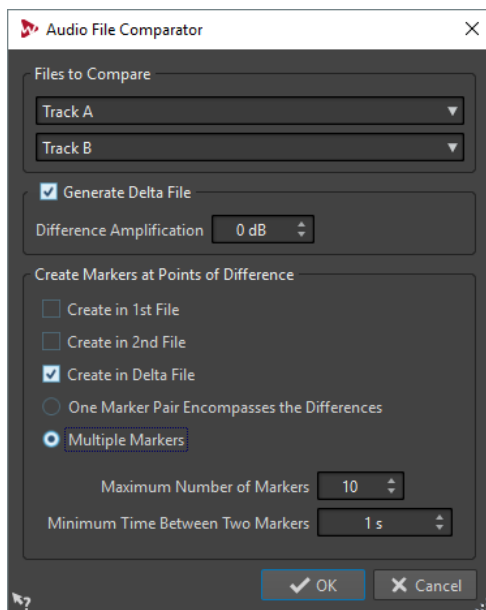

Files to Compare

Allows you to select the two audio files that you want to compare.

Generate Delta File

If this option is activated, a delta file is created that contains only the differences between the two compared files.

Difference Amplification

Amplifies the differences in the delta file to facilitate seeing and hearing them.

Create Markers at Points of Difference

Inserts markers at points where differences are detected. You can insert difference markers in the first, the second, or the delta file.

One Marker Pair Encompasses the Differences

If this option is activated, one marker pair is inserted that encompasses the range that contains differences.

Multiple Markers

If this option is activated, multiple markers are inserted according to the **Maximum Number of Markers** and **Minimum Time Between Two Markers** settings.

- **Maximum Number of Markers** sets the maximum number of markers to be inserted.
- **Minimum Time Between Two Markers** determines the density of the markers to be inserted.

Comparing Audio Files

The file comparator lets you see the differences between two files.

PROCEDURE

1. Open the audio files that you want to compare.
2. In the **Audio Editor**, select the **Analyze** tab.
3. In the **Tools** section, click **Audio File Comparator**.
4. If more than two audio files are open, select the two files that you want to compare.

5. Optional: Activate **Generate Delta File**.
This creates a new audio file that contains only the differences between the compared audio files.
 6. Optional: Make marker settings in the **Create Markers at Points of Differences** section.
This creates markers at differing points to facilitate finding the differences.
 7. Click **OK**.
-

3D Frequency Analysis

Using the 3D Frequency Analysis, you can view an audio file in the frequency domain.

Use the 3D Frequency Analysis for the following:

- Viewing the frequency spectrum distribution in a mix
- Identifying which frequencies can be reduced or boosted as a basis for equalizing
- Viewing parts of the frequency spectrum that are occupied by a background noise that you want to filter out

A wave display (time domain) informs you about the start and end of a sound in a file, but lacks information about the timbral contents of the file that a frequency graph (frequency domain) provides. The graph that is used in WaveLab Pro is often referred to as an FFT (Fast Fourier Transform) plot. If you select a stereo recording, a mix of the two channels is analyzed.

The wheel control allows you to view the frequency spectrum from different angles. For example, you can open several 3D Frequency Analysis windows, each with a different perspective. This allows you to get a better view of an otherwise crowded graph.

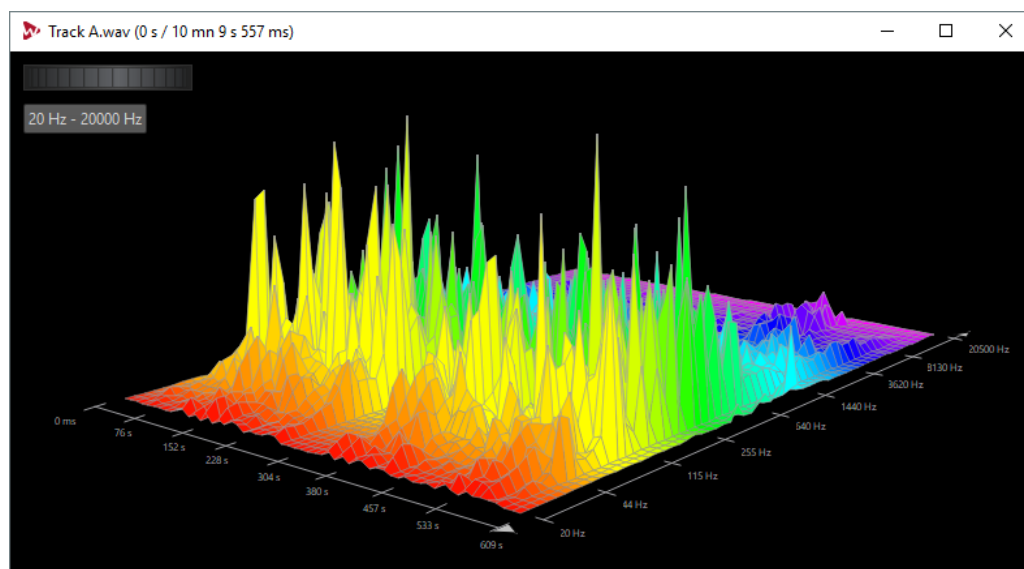

Creating a Graph for 3D Frequency Analysis

The length of the selected audio affects the accuracy of the analysis. For short selections, the result is more detailed. Consider making a separate analysis of the attack in which the most drastic variations occur.

PROCEDURE

1. In the wave window, select the section of the file that you want to analyze.
If you make no selection, the whole audio file is analyzed.

2. In the **Audio Editor**, select the **Analyze** tab.
3. In the **Tools** section, click **3D Frequency Analysis**.
The audio is analyzed.
4. To edit the analysis parameters, click **3D Analysis Options**.

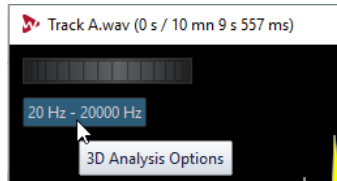

5. Adjust the parameters and click **OK**.
The audio is re-analyzed.
-

3D Analysis Options

In the options dialog of the **3D Frequency Analysis** dialog, you can define which frequency range is analyzed and modify the appearance of the graph for the 3D frequency analysis.

- In the **3D Frequency Analysis** dialog, click the **3D Analysis Options** button.

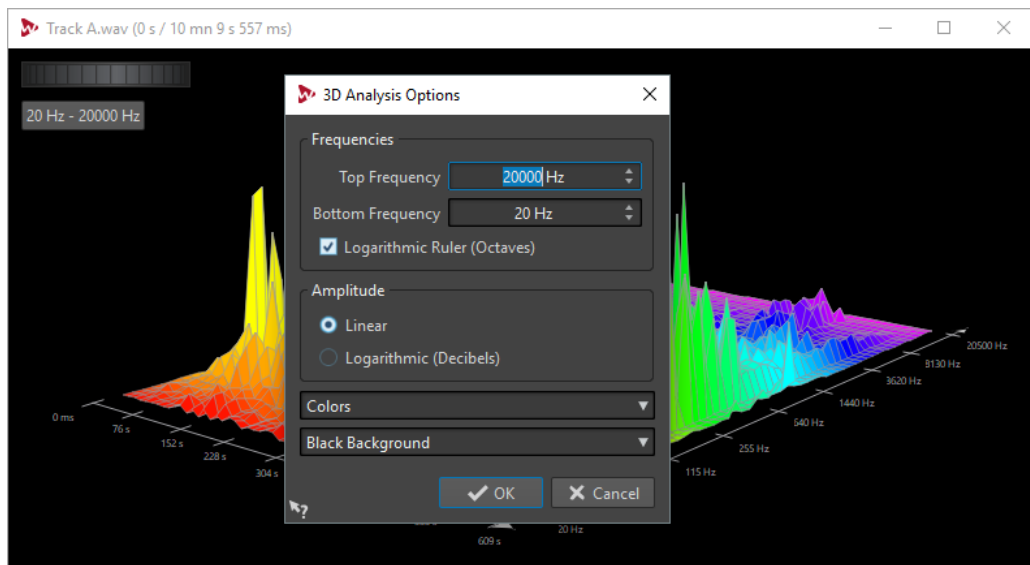

Top/Bottom Frequency

Specifies the highest/lowest frequency of the range.

Logarithmic Ruler (Octaves)

Divides the frequency ruler in equally spaced octaves.

Amplitude

Select whether you want the peaks to be proportional to their amplitude (**Linear**) or to their power (**Logarithmic with Decibel Scale**).

Colors

Defines the color scheme of the graph.

Background

Defines the background color.

Error Correction

You can search for unwanted clicks and digital artifacts in an audio file. You can use several detection and restoration methods to detect, mark and name, jump to, play back, and remove individual audio errors.

You can also restore damaged portions of an audio file by using waveform replacement. The **Correction** tab gives you access to the error detection and correction tools.

NOTE

Because errors can have multiple origins and effects, various algorithms are needed to cover these cases. Experiment with the settings to find the best parameters to detect the errors in your files.

Correction Tab

This tab provides access to the error detection and correction tools.

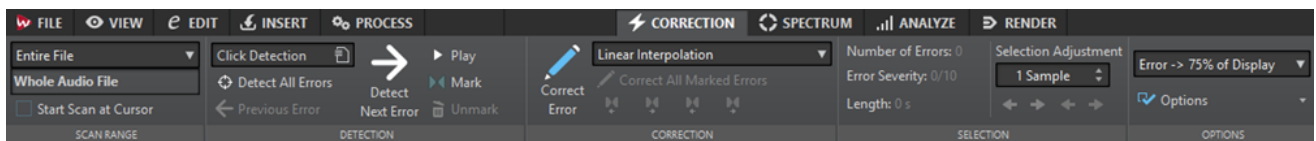

Scan Range

In this section, you can specify the range of audio that you want to search for errors.

Scan Range

- **Entire File** searches the whole audio file for errors.
- **Define as Current Selection** searches the selected audio range for errors. Once defined, you can change the audio selection without altering this search area. The search area indicator is displayed on the ruler.

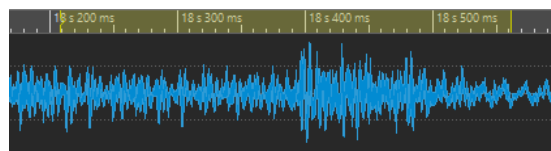

The text field displays the active scan area.

Start Scan at Cursor

If this option is activated, the scan starts at the edit cursor position. Once defined, you can change the cursor position without altering the defined scan start position. The scan start position indicator is displayed on the ruler.

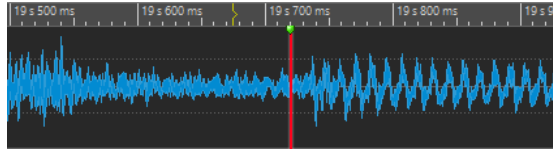

Detection

In this section, you can specify how to detect errors.

Presets

Allows you to save and restore error detection presets.

Detect All Errors

Searches the specified range from the beginning to the end and creates pairs of error markers for each detected error without performing any correction.

Previous Error

Returns to the last detected error.

Detect Next Error

Searches for the next error, starting at a specified position or at the end of the last detected error.

Play

Starts playback of the current audio selection while taking into account the pre-roll and post-roll settings. You can make pre-roll and post-roll settings on the transport bar.

Mark

Sets a pair of error markers to the audio selection without performing any correction.

Unmark

Deletes the error markers that are surrounding the audio selection.

Correction

In this section, you can specify the method that is used to correct errors.

Correct Error

Restores the audio selection with the default correction method. You can select another correction method from the pop-up menu.

Error Correction Method

Allows you to select the error correction method.

- **Linear Interpolation** draws a straight line between the first and the last selected samples.
- **Optimal for Small Clicks - 1 ms** is optimal to remove clicks smaller than 1 ms.
- **Optimal for Common Clicks - 3 ms** is optimal to remove clicks smaller than 3 ms.
- **Waveform Replacement - 500 ms** replaces the corrupt samples with the best match detected in the material up to 500 milliseconds to the left/right.
- **Waveform Replacement - 4 s** replaces the corrupt samples with the best match detected in the material up to 4 seconds to the left/right.
- **Waveform Replacement - Left 6 s** replaces the corrupt samples with the best match detected in the material up to 6 seconds to the left.

- **Waveform Replacement – Right 6 s** replaces the corrupt samples with the best match detected in the material up to 6 seconds to the right.
- **Inpainting** replaces the corrupt samples using spectral inpainting.

Correct All Marked Errors

Corrects all marked errors in the specified range.

Previous Error/Next Error

Jumps to the previous/next error marker pair.

Previous Correction/Next Correction

Jumps to the previous/next correction marker pair.

Selection

This section displays information about the detected errors and allows you to adjust the error area.

Selection Adjustment

Defines by how many samples the selection edges are moved, when you use the **Adjust Selection** buttons to adjust the error area.

Move Left Edge of Selection to the Left/Move Left Edge of Selection to the Right

Moves the left edge of the selection to the left/right.

This lets you finely adjust an audio selection that was suggested by the detection function.

Move Right Edge of Selection to the Left/Move Right Edge of Selection to the Right

Moves the right edge of the selection to the left/right.

This lets you finely adjust an audio selection that was suggested by the detection function.

Options

This section provides a range of preferences for playing back, viewing, and marking any detected errors.

Zoom Level

Specifies the zoom level when displaying an error.

Auto-Play

Automatically plays back the error area after it has been detected or corrected.

Set Markers around Corrected Errors

Creates correction markers around the audio section each time an error is corrected. This area can be larger than the marked error area when crossfades are performed by the corrector.

Remove Markers After Correction

Removes the error marker each time an error is corrected.

Jump to Previous Error After Correction/Jump to Next Error After Correction

Automatically jumps to the previous/next marked error when you click **Correct Error**.

Correcting Errors

PROCEDURE

1. In the **Audio Editor**, select the **Correction** tab.
2. In the **Scan Range** section, do one of the following:
 - To scan the whole audio file for errors, select **Entire File**.
 - To scan the selected audio range for errors, make a selection range in the audio file and select **Define as Current Selection**.
3. In the **Detection** section, select an error detection method from the **Presets** menu, and set the parameters.
Depending on the method that you have selected, different detection parameters are available.
4. In the **Detection** section, do one of the following:
 - To detect the next error, click **Detect Next Error**. WaveLab Pro analyzes the audio file from the beginning and stops at the first detected error. This allows you to individually correct each error with the specific correction method.
 - To detect all errors, click **Detect All Errors**. This allows you to quickly correct all errors.

The errors are marked by error markers.

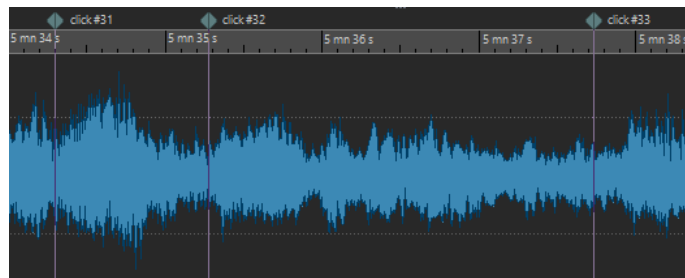

5. In the **Correction** section, select an error correction method from the **Error Correction Method** menu.

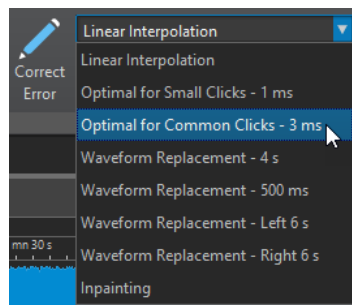

6. In the **Correction** section, do one of the following:
 - To correct an error, click inside an error marker pair and click **Correct Error**.
 - To correct all errors in the specified range, click **Correct All Marked Errors**.

RESULT

The errors are corrected with the selected correction method.

Offline Processing

Offline processes are useful for a variety of editing purposes and creative effects, for example, if the computer is too slow for real-time processing or if the editing requires more than one pass.

After the processing, the audio file is permanently altered.

Process Tab

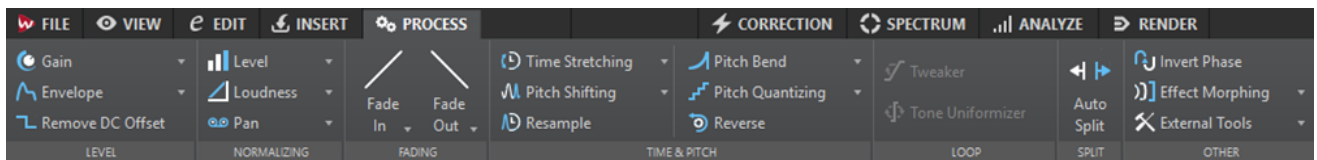

Level

Gain

Opens the **Gain** dialog where you can apply a gain to change the level of an audio file.

Envelope

Opens the **Envelope** dialog where you can create a level envelope which can be applied to a selected range or an entire audio file.

This is useful if you want to even out loud and quiet parts or create a sophisticated fade in/fade out, for example.

Remove DC Offset

DC offset in a file affects the loudness. **Remove DC Offset** sets the DC offset to zero.

Normalizing

Level

Opens the **Level Normalizer** dialog where you can change the peak level of an audio file.

Loudness

Opens the **Loudness Normalizer** dialog where you can specify the loudness of a file.

Pan

Opens the **Pan Normalizer** dialog which allows you to ensure that both channels of a stereo file have the same level or loudness, and helps you to get the best possible stereo balance.

Fading

Fade In/Fade Out

Allows you to apply a fade in or fade out. Right-click the button to open the **Curve** pop-up menu.

Curve

Allows you to select preset fade curves.

- **Linear** changes the level linearly.
- **Sinus (*)** changes the level according to a sine curve. When used in a crossfade, the loudness (RMS) remains constant during the transition.
- **Square-Root (*)** changes the level according to a square-root curve. When used in a crossfade, the loudness (RMS) remains constant during the transition.
- **Sinusoid** changes the level according to a sine curve.
- **Logarithmic** changes the level according to a logarithmic curve.
- **Exponential** changes the level according to an exponential curve.
- **Exponential+** changes the level according to a more pronounced exponential curve.

Time & Pitch

Time Stretching

Opens the **Time Stretching** dialog where you can change the duration of an audio selection.

Pitch Shifting

Opens the **Pitch Shifting** dialog where can change the pitch of your audio.

Resample

Opens the **Sample Rate** dialog where you can change the sample rate of your audio.

Pitch Bend

Opens the **Pitch Bend** dialog where you can gradually change the pitch of your audio using an envelope curve.

Pitch Quantizing

Opens the **Pitch Quantizing** dialog where you can automatically detect and correct the pitch of your audio. The input signal is quantized to discrete notes.

Reverse

Creates a backwards-tape effect.

Correct

Error Correction

Lets you select the default error correction method.

- **Linear Interpolation** draws a straight line between the first and the last selected samples.
- **Optimal for Small Clicks - 1 ms** is optimal to remove clicks smaller than 1 ms.
- **Optimal for Common Clicks - 3 ms** is optimal to remove clicks smaller than 3 ms.
- **Waveform Replacement - 500 ms** replaces the corrupt samples with the best match detected in the material up to 500 milliseconds to the left/right.
- **Waveform Replacement - 4 s** replaces the corrupt samples with the best match detected in the material up to 4 seconds to the left/right.
- **Waveform Replacement - Left 6 s** replaces the corrupt samples with the best match detected in the material up to 6 seconds to the left.
- **Waveform Replacement - Right 6 s** replaces the corrupt samples with the best match detected in the material up to 6 seconds to the right.

Loop

Tweaker

Opens the **Loop Tweaker** dialog where you can adjust the loop start and end points, and crossfade the loop boundaries.

Tone Uniformizer

Opens the **Loop Tone Uniformizer** dialog where you can create loops from sounds that are not optimal for looping.

Split

Auto Split

Opens the **Auto Split** dialog where you can specify how to split clips.

Other

Invert Phase

Turns the signal upside down.

Effect Morphing

Opens the **Effect Morphing** dialog, where you can gradually mix two audio ranges that have different effects/processing applied to them.

External Tools

Allows you to execute and configure external tools.

Applying Processing

Processing can be applied to a selection or to a whole file. For some operations processing the entire file is necessary.

NOTE

If **Process Whole File If There Is No Selection** is activated in the **Editing** tab of the **Audio Files Preferences**, the whole file is automatically processed if no selection exists.

PROCEDURE

1. In the wave window, make a selection.
 2. In the **Audio Editor**, select the **Process** tab.
 3. Select the type of processing that you want to apply.
 4. If a dialog opens, make the settings and click **Apply** to render the effect to file.
-

Gain Dialog

In this dialog, you can apply a gain to change the level of an audio file.

- To open the **Gain** dialog, select the **Process** tab in the **Audio Editor**, and click **Gain** in the **Level** section.

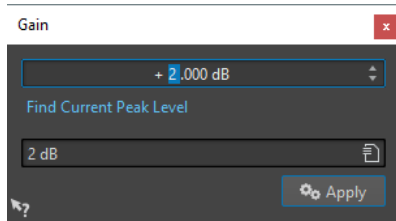

Click **Find Current Peak Level** to obtain a report on the peak level of the audio selection, or the whole file if there is no selection. This is useful if you want to calculate how much you can increase the overall gain of a file without clipping (exceeding 0 dB), for example.

This processor also lets you add clipping. Clipping happens when the gain is raised to a point where distortion is added. While this is normally not intended, mild clipping can add some punch, for example, to accentuate the attack of a drum sound.

Level Normalizer Dialog

In this dialog, you can change the peak level of an audio file.

- To open the **Level Normalizer** dialog, select the **Process** tab in the **Audio Editor**, and click **Level** in the **Normalizing** section.

This dialog is also available as a multipass plug-in in the **Batch Processor** window.

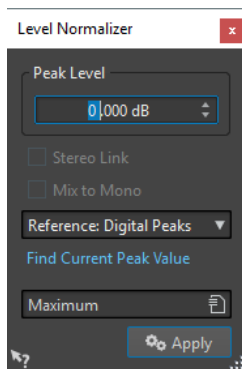

Peak Level

Enter the peak level (in dB) that you want the audio selection to have.

Stereo Link

Applies the gain to both channels.

Reference

In this pop-up menu, select whether WaveLab Pro uses sample values (digital peaks) or analog reconstructed values (true peaks).

Mix to Mono

Mixes the left and the right channel. The resulting mono file has the specified peak level. This ensures a mix without clipping.

Find Current Peak Value

Creates a report on the peak level of the current audio selection or the whole audio file if there is no selection.

Loudness Normalizer

You can use the **Loudness Normalizer** to achieve a specific loudness.

Increasing the loudness to a specific value can provoke clipping. To remedy this, a peak limiter (**Peak Master** plug-in) can be part of the process. The **Loudness Normalizer** raises the loudness and limits peaks in the signal at the same time if needed, to achieve the wanted loudness.

This process happens in several stages, first an analysis and then the final rendering.

Loudness Normalizer Dialog

In this dialog, you can specify the loudness of a file.

- To open the **Loudness Normalizer** dialog, select the **Process** tab in the **Audio Editor**, and click **Loudness** in the **Normalizing** section.

This dialog is also available as a multipass plug-in in the **Batch Processor** window.

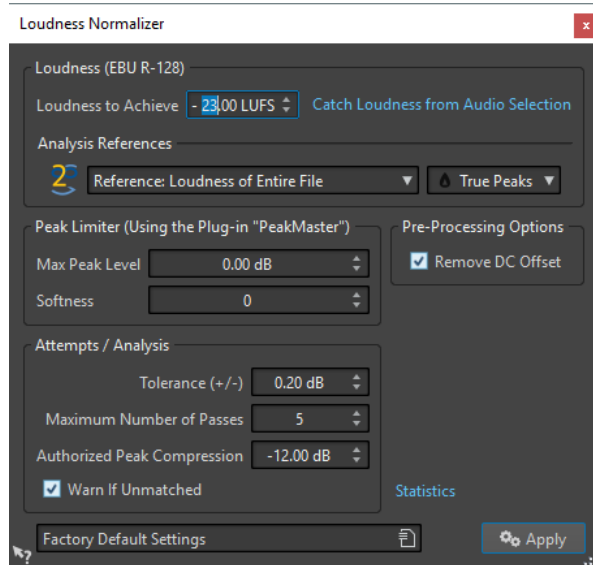

Loudness (EBU R-128)

Loudness to Achieve

If the loudness cannot be achieved with a simple positive gain change, a limiter must come into action to prevent clipping.

Here, specify the loudness that you want to achieve. The EBU R-128 recommendation for broadcast is -23 dB.

Specifying high values might require a gain outside the normal capabilities of the limiter, which can cause distortion.

It is recommended to use **Statistics** after specifying a loudness. This way, you know how much the gain needs to be raised and if peak limiting needs to be applied. If heavy limiting is necessary, this might degrade the audio quality. In such cases, a warning is shown after applying the process, allowing you to undo it.

Catch Loudness from Audio Selection

Sets the **Loudness to Achieve** value to the average loudness found in the audio file.

Reference

This pop-up menu allows you to select a reference: the loudness of the entire file (EBU R-128 recommendation), the average loudest 3 second audio section (**Top of**

Loudness Range), or the loudest 3 seconds audio section (**Maximum Short-Term Loudness**).

Peaks

In this pop-up menu, select whether WaveLab Pro should limit the sample values (**Digital Peaks**) or the analog reconstructed samples (**True Peaks**).

Peak Limiter

Max Peak Level

Here, specify the maximum peak level of the resulting audio. The lower this value, the lower the loudness.

Softness

Affects how the peak master operates. A high setting maximizes the perceived loudness effect, but can result in a slight harshness of the sound.

Adjust this parameter to optimize the balance between sound quality and the effect that you want to achieve.

Pre-Processing Options

Remove DC Offset

DC offset in the file affects the loudness computation. Therefore it is recommended that you keep this option activated.

Attempts/Analysis

Tolerance (+/-)

If the **Loudness to Achieve** requires peak limiting, this also reduces the loudness to some degree. This cannot be computed in advance and cannot be automatically applied to the gain change. Instead, several simulation passes are performed to find the best possible gain. This option lets you define the precision of the result that you want to achieve.

Maximum Number of Passes

WaveLab Pro performs as many analysis passes as needed to match the precision that you want to achieve. Use this option to specify the maximum number of passes to be performed.

Authorized Peak Compression

As too much compression degrades the audio quality, you can specify a limit for the applied compression. The value can be set between -1 and -20 dB. Consider to lower the **Loudness to Achieve**, as this renders better results.

Warn If Unmatched

If this option is activated, you are warned if the normalizing process does not meet the specified loudness/precision. This option is not available during batch processing.

Statistics

Opens a window that shows you information about the file to be processed. It shows any DC offset, the current loudness, the current peak level, and the required gain to achieve the specified loudness. Furthermore, you are informed if limiting is required.

RELATED LINKS

[EBU Loudness Standard R-128](#) on page 37

Pan Normalizer Dialog

This dialog allows you to ensure that both channels of a stereo file have the same level or loudness, and helps you to get the best possible stereo balance.

- To open the **Pan Normalizer** dialog, select the **Process** tab in the **Audio Editor**, and click **Pan** in the **Normalizing** section.

This dialog is also available as a multipass plug-in in the **Batch Processor** window.

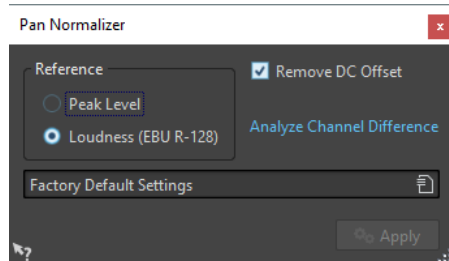

This process first analyzes the audio and then renders any required level changes. You must have a stereo selection in a stereo file to apply this process.

Peak Level

Raises the channel with the lowest peak level to match the peak level of the other channel.

Loudness (EBU R-128)

Analyzes the loudness of both channels and adjusts their gain so that both channels get the same loudness. No clipping can be introduced using the pan normalizer.

Remove DC Offset

Removes DC offsets which affect the loudness computation. We recommend to keep this option activated.

Analyze Channel Difference

Shows the current loudness ratio between the left and right channels. The result changes depending on the selected **Peak/Loudness** mode.

Envelope Dialog

In this dialog, you can create a level envelope which can be applied to a selected range or a whole audio file. This is useful if you want to even-out loud and quiet parts or create a sophisticated fade in or fade out, for example.

- To open the **Envelope** dialog, select the **Process** tab in the **Audio Editor**, and click **Envelope** in the **Level** section.

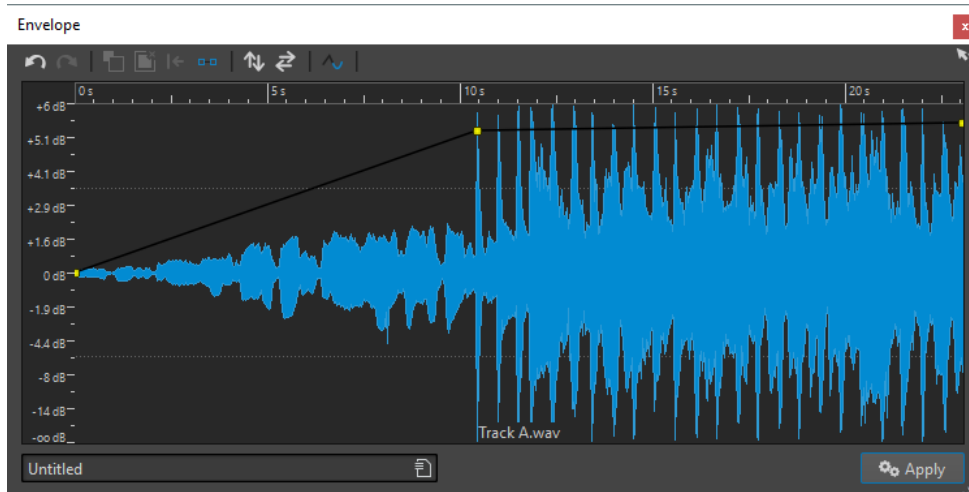

The dialog shows a waveform with an envelope curve (initially a straight line). A vertical ruler displays the level in dB, and the horizontal ruler displays the timeline.

The following options are available:

- **Undo/Redo the Last Operation**
- **Deselect the Envelope Points**
- **Delete the Selected Envelope Points**
- **Reset the Selected Envelope Points**
- **Reset the Whole Envelope**
- **Flip the Envelope Around the Horizontal Axis**
- **Reverse the Envelope Time Sequence**
- **Toggle the Envelope Smoothing**

Basic Envelope Operations

By adding points to the envelope curve, you can create an envelope curve that changes the volume of the material over time. When you point the mouse in the display or move a point, the current position and level change is shown in the field above the display.

- To add a point, double click the envelope curve.
- To select a point, click it.
- To select several points, click and drag the selection rectangle.
- To move a point, click and drag it. If more than one point is selected, all points are moved.
- To move the whole curve up or down, click the envelope curve, and drag up or down.

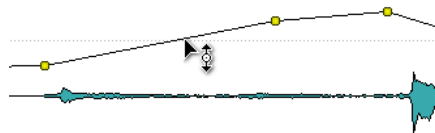

- To move the curve segments vertically, click the curve and drag up or down.
- To move two points horizontally, press **Shift**, click the curve segment between two points, and drag left or right.

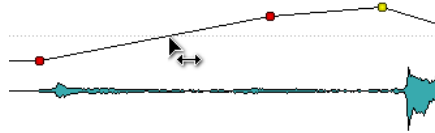

- To move two points vertically, press **Ctrl/Cmd**, click the curve segment between two points, and drag up or down.

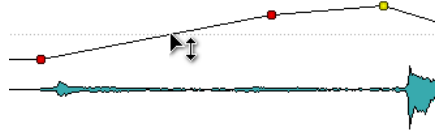

Fades in Audio Files

A fade in is a gradual increase in level and a fade out is a gradual decrease in level.

You can create fades by selecting an individual fading type for each fade in/fade out.

Creating a Fade In and Fade Out

PROCEDURE

1. In the wave window, make a selection.
 2. In the **Audio Editor**, select the **Process** tab.
 3. Depending whether you want to create a fade in or a fade out, select one of the following options in the **Fading** section:
 - To apply the default fade type, click the **Fade In** or **Fade Out** icon.
 - To select another fade type, click **Fade In** or **Fade Out** below the fade icon. From the pop-up menu, select the type of fade that you want to create.
-

Applying Easy Fades

The **Easy Fade** function allows you to quickly apply a default fade in or fade out to an audio file via shortcut.

The shape of the fade is governed by the **Fade In** and **Fade Out** settings in the **Fading** section of the **Process** tab.

PROCEDURE

1. In the **Audio Editor**, make one of the following selections:
 - From the start of the audio file to where you want the fade in to end.
 - From the position where you want the fade out to start to the end of the audio file.
 2. Click **Ctrl/Cmd-D**.
-

Crossfades

A crossfade is a gradual fade between two sounds, where one is faded in and the other faded out. You can automatically create a crossfade when pasting an audio section into another.

Creating Crossfades

The material that you want to crossfade can either be in two different sections of the same audio file or in two different audio files.

PROCEDURE

1. In the wave window, select the section that you want to fade in.
2. Select the **Edit** tab.
3. In the **Clipboard** section, click **Copy**.
4. Select the section that you want to fade out.
The length of this selection determines the length of the actual crossfade (check the length on the status bar). The section can be within the selected audio file or in another wave window. However, the selection must not be longer than the selection that you just copied.
5. Depending whether you want to create a fade in or a fade out, select one of the following options in the **Clipboard** section:
 - To apply the default crossfade type, click the **Paste and Crossfade** icon.
 - To select another crossfade type, click **Paste and Crossfade** below the crossfade icon. From the pop-up menu, select the type of crossfade that you want to create.

RESULT

The crossfade is created. Any material that originally appeared after the selection in the file into which you paste, is moved so that it now appears after the pasted material.

Any excess material in the copied selection appears after the fade at full level.

NOTE

If both files already have full level sections in the crossfade area (for example, if you have normalized both files), clipping and distortion might occur. If this happens, reduce the amplitude of both files by 3 dB to 6 dB and try again.

AFTER COMPLETING THIS TASK

Play back the file and adjust the crossfade if necessary.

Paste and Crossfade Options

These options allow you to select a crossfade type for pasting.

- Select the **Edit** tab in the **Audio Editor**, and click **Paste and Crossfade** in the **Clipboard** section.

Linear (Equal Gain)

Level changes linearly.

Sinus (Equal Power)

Level changes according to a sine curve, the power of the mix remains constant.

Square-Root (Equal Power)

Level changes according to a square-root curve, the power of the mix remains constant.

Phase Inverting

Inverting the phase turns the signal upside down. The most common use for this function is to fix a stereo recording if one of the channels has been recorded out of phase with the other.

Inverting the Audio Phase

PROCEDURE

1. Optional: If you only want to invert the phase for a specific time range of the audio file, create a selection range in the wave window.
 2. In the **Audio Editor**, select the **Process** tab.
 3. In the **Other** section, click **Invert Phase**.
-

Inverting the Phase of an Audio Montage Track

PROCEDURE

1. In the **Audio Montage** window, select the **Process** tab.
 2. In the **Process** section, click **Invert Phase**.
-

RESULT

An inverted phase is indicated by an icon in the montage window.



Reversing Audio

You can reverse an audio file or a part of an audio file as if playing a tape backwards.

PROCEDURE

1. Optional: If you only want to reverse a specific time range of the audio file, create a selection range in the wave window.
 2. In the **Audio Editor**, select the **Process** tab.
 3. In the **Time & Pitch** section, click **Reverse**.
-

DC Offset

DC offset means that there is a too large DC (direct current) component in the signal. This most often occurs due to mismatches between various types of recording equipment.

A DC offset is problematic for the following reasons:

- It affects the zero crossing position.
- Some processing options do not give optimal results when performed on files with a DC offset.

Removing DC Offset

PROCEDURE

1. In the **Audio Editor**, open the audio file that you want to check for DC offset and that you want to fix.
2. Select the **Process** tab.
3. In the **Level** section, click **Remove DC Offset**.
A dialog opens, stating the amount of DC offset in the audio file. You can also create a selection range in the wave window and select this option to only show the DC offset in the selection range.

NOTE

This function should be applied to whole files, because the problem is normally present throughout the entire recording.

4. Click **OK** to remove the DC offset.

Time Stretching

Time stretching is an operation that allows you to change the length of a recording without affecting its pitch.

With time stretching, you can make audio material longer or shorter. This function is most often used to make a section of audio fit in with some other material. You select the material to be stretched and use the options in the **Time Stretching** dialog to find a stretch factor. This is done by specifying a length or a tempo, according to what the situation requires.

Time Stretching Dialog

In this dialog, you can change the duration of an audio selection, usually without changing its pitch. You can stretch a selection to a specified duration (in minutes, seconds, and milliseconds), tempo (in bpm), or stretch factor (as percentage).

- To open the **Time Stretching** dialog, select the **Process** tab in the **Audio Editor** and click **Time Stretching** in the **Time & Pitch** section.

This dialog is also available as a monopass plug-in in the **Batch Processor** window.

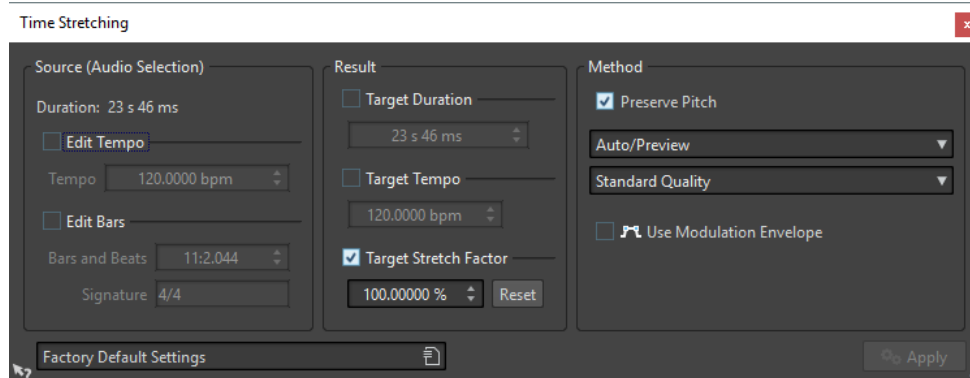

Source (Audio Selection)

Duration

If **Edit Tempo** is activated, you can change the tempo of the audio source. The number of bars and beats and the stretch factor is updated automatically.

If **Edit Bars** is activated, you can set the number of bars and beats and the signature for the audio source. The source tempo and according to the stretch factor is automatically updated.

Result

Target Duration

If this option is activated, the audio source changes its duration.

Target Tempo

If this option is activated, the audio source changes its tempo. For this to work, you must specify the original tempo or the number of bars and beats.

Target Stretch Factor

Indicates how much the audio duration changes. This parameter is automatically updated when you edit the other parameters, but you can also activate this option to edit it manually.

Reset

Resets the stretch factor to 100 %, that is, no stretch.

Method

Preserve Pitch

If this option is activated, the pitch of the audio material is not affected when you apply time stretch. If this option is deactivated, the pitch changes proportionally with the time stretch ratio.

Method pop-up menu

Auto/Preview: Automatically selects the best time/frequency trade-off for real-time/preview performance. This is the fastest setting, but might not provide optimal results in all cases.

Time Localization ++ (Instruments, Voices): Selects full-time localization. This is a good setting for single instruments and solo voices.

Time Localization +: Selects the time/frequency localization with the emphasis on time localization. If the previous mode produces echo artifacts, try this option.

Average Time/Frequency Localization: Sets the time/frequency localization halfway between the time and frequency domains. It is the best setting for all general purpose signals.

Frequency Localization +: Selects time/frequency localization with the emphasis on frequency localization. This is a good setting for classical music.

Frequency Localization ++ (Complex Mixes): Selects the highest possible frequency localization. This setting might not work well on material with many sharp attack transients, but it can produce good results with less transient/percussive material.

Transcribe Mode (for Large Changes): This uses a content-aware algorithm to time stretch and pitch shift music by up to 4 times the original length without losing information critical to transcription, such as attack transients.

Quality pop-up menu

The **High Quality** and **Best (Slow)** modes provide high-quality time stretching, but the processing takes longer. For most uses, the **Standard Quality** mode is sufficient.

Use Modulation Envelope

If this option is activated, the stretch factor is modulated over time. In the **Result** section, you can set the **Maximum Stretch Factor** for the modulation envelope.

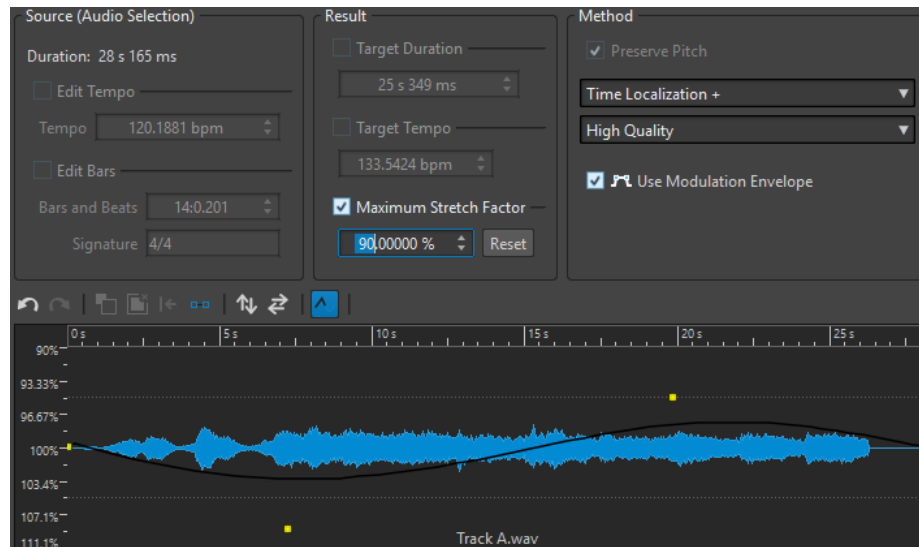

Time Stretching Limitations

Time stretch is a complicated Digital Signal Processing (DSP) operation, that always affects the sound quality to some extent.

- For speech, stretch factors within a $\pm 30\%$ range provide good results.
- For composite music, try to limit the range to $\pm 10\%$.
- For sensitive material, like solo piano, try to limit the range to $\pm 3\%$.

ZTX Time Stretching Processor

WaveLab Pro uses the ZTX technology for high quality time stretching.

Pitch Shift

Pitch shift allows you to detect and to change the pitch of a sound, with or without affecting its length. This is useful for fixing an off-key vocal note in a live recording, or for tuning the pitch of a kick drum sample to fit a particular song, for example.

Pitch Shifting Dialog

In this dialog, you can change the pitch of a sound.

- To open the **Pitch Shifting** dialog, select the **Process** tab in the **Audio Editor**, and click **Pitch Shifting** in the **Time & Pitch** section.

This dialog is also available as a monopass plug-in in the **Batch Processor** window.

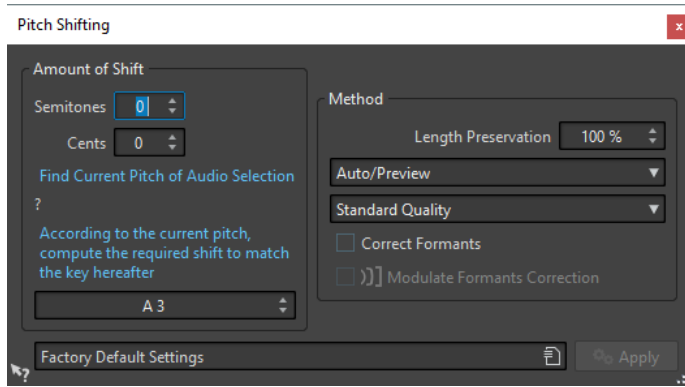

Semitones

Specifies the amount of pitch change in semitones.

Cents

Specifies the amount of pitch change in cents.

Find Current Pitch of Audio Selection

Analyzes the pitch of the selected audio and displays it below this button.

According to the current pitch, compute the required shift to match the key hereafter

Click to adjust **Amount of Pitch** parameters automatically, based on the detected pitch and the pitch specified in the value field below this button.

Pitch field

Specifies the resulting pitch.

Length Preservation

Specifies how the length of the selection is affected by the operation:

- A setting of 100 means that the length of the audio remains unchanged.
- A setting of 0 means that the program behaves like a tape recorder, when the speed of its tape is changed. For example, if you raise the pitch by one octave, the audio is half as long.
- Intermediate values give results in between these two extremes.

For large transposition values, the lower this setting, the better the quality of the effect.

Method pop-up menu

Auto/Preview: Automatically selects the best time/frequency trade-off for real-time/preview performance. This is the fastest setting, but might not provide optimal results in all cases.

Time Localization ++ (Instruments, Voices): Selects full time localization. This is a good setting for single instruments and solo voices.

Time Localization +: Selects the time/frequency localization with the emphasis on time localization. If the previous mode produces echo artifacts, try this option.

Average Time/Frequency Localization: Sets the time/frequency localization halfway between the time and frequency domains. It is the best setting for all general purpose signals.

Frequency Localization +: Selects the time/frequency localization with the emphasis on frequency localization. This is a good setting for classical music.

Frequency Localization ++ (Complex Mixes): Selects the highest possible frequency localization. This setting might not work well on material with many sharp attack transients, but it can produce good results with less transient/percussive material.

Transcribe Mode (for Large Changes): This uses a content-aware algorithm to time-stretch and pitch-shift music by up to 4 times the original length without losing information critical to transcription, such as attack transients.

Quality pop-up menu

The **High Quality** and **Best (Slow)** modes provide high-quality time stretching, but the processing takes longer. For most uses, the **Standard Quality** mode is sufficient.

Correct Formants

If this option is activated, changing the pitch of vocal material gives a more realistic result. When processing non-vocal material, leave this option deactivated, because it uses a slightly slower processing algorithm.

NOTE

This algorithm might cause a noticeable increase in signal level.

Modulate Formants Correction

If this option is activated, the formant correction is modulated over time.

NOTE

If the envelope is not used and the formant correction is activated, a 100 % correction is performed.

Pitch Quantizing Dialog

This dialog allows you to automatically detect and correct the pitch of an audio file. The input signal is quantized to discrete notes.

- To open the **Pitch Quantizing** dialog, select the **Process** tab in the **Audio Editor**, and click **Pitch Quantizing** in the **Time & Pitch** section.

This dialog is also available as a monopass plug-in in the **Batch Processor** window.

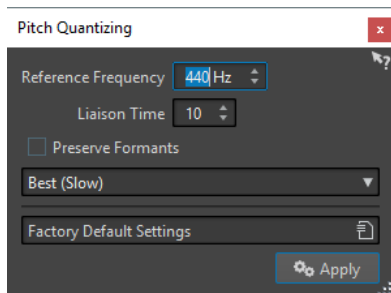

Pitch quantize works best on recordings that have monophonic signals, such as voice or single instruments.

Reference Frequency

Defines the reference tuning (in Hz) for the pitch shift.

Liaison Time

Defines the time it takes for the correction to reach the full correction amount. Typically, sung notes are slightly unstable at the beginning, because the attack phase of a sound has a higher amount of noise and because singers gradually adjust their tuning after the onset of the note.

The liaison time makes the pitch shift sound more natural, because it mimics this effect.

Preserve Formants

If this option is activated, the formants are corrected according to the pitch shift amount.

Quality pop-up menu

The **High Quality** and **Best (Slow)** modes provide high-quality time stretching, but the processing takes longer. For most uses, the **Standard Quality** mode is sufficient.

Pitch Bend

Pitch bend allows you to change the pitch of a sound over time. Changing the pitch using pitch bend affects its duration unless **Preserve Duration** is activated.

This function can be used for creating the classic tape stop effect, or for blending the tempo/pitch of one track into another, for example.

You can draw the curve that you want the pitch to follow. The pitch offset is displayed on the vertical ruler of the envelope and the range of the envelope effects can be adjusted. Positive pitch values produce sounds with a higher pitch and a shorter length, negative values produce sounds with a lower pitch and a longer length.

If **Preserve Duration** is activated, you can choose the algorithm that is used to perform the pitch bend operation. Depending on the type of audio material you are processing, choose the appropriate mode. You can also adjust the quality used when processing the pitch bend. The quality setting and the selected mode affect the processing time for this effect.

Pitch Bend Dialog

In this dialog, you can gradually change the pitch of a sound using an envelope curve.

- To open the **Pitch Bend** dialog, select the **Process** tab in the **Audio Editor**, and click **Pitch Bend** in the **Time & Pitch** section.

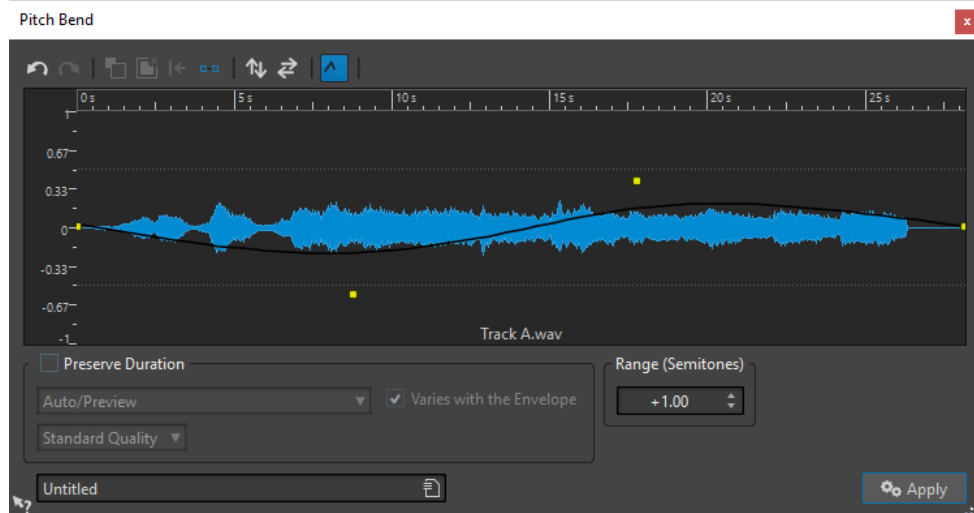

The following options are available at the top of the dialog:

- **Undo/Redo the Last Operation**
- **Deselect the Envelope Points**
- **Delete the Selected Envelope Points**
- **Reset the Selected Envelope Points**
- **Reset the Whole Envelope**

- **Flip the Envelope Around the Horizontal Axis**
- **Reverse the Envelope Time Sequence**
- **Toggle the Envelope Smoothing**

The following options are available at the bottom of the dialog:

Preserve Duration

If this option is activated, a time stretching process is applied to compensate for the change of duration caused by the pitch modifications.

Method pop-up menu

Auto/Preview: Automatically selects the best time/frequency trade-off for real-time/preview performance. This is the fastest setting, but might not provide optimal results in all cases.

Time Localization ++ (Instruments, Voices): Selects full time localization. This is a good setting for single instruments and solo voices.

Time Localization +: Selects the time/frequency localization with the emphasis on time localization. If the previous mode produces echo artifacts, try this option.

Average Time/Frequency Localization: Sets the time/frequency localization halfway between the time and frequency domains. It is the best setting for all general purpose signals.

Frequency Localization +: Selects the time/frequency localization with the emphasis on frequency localization. This is a good setting for classical music.

Frequency Localization ++ (Complex Mixes): Selects the highest possible frequency localization. This setting might not work well on material with many sharp attack transients, but it can produce good results with less transient/percussive material.

Transcribe Mode (for Large Changes): This uses a content aware algorithm to time stretch and pitch shift music by up to 4 times the original length without losing information critical to transcription, such as attack transients.

Varies with Envelope

If this option is activated, time stretching is continuously applied, but varies, depending on the pitch changes. If this option is deactivated, time stretching is applied equally to all audio parts.

In both cases, the global audio duration is preserved. The option is activated by default because this gives a more natural result. Note, however, that this affects the quality of the audio.

Quality pop-up menu

The **High Quality** and **Best (Slow)** modes provide high quality time stretching, but the processing takes longer. For most uses, the **Standard Quality** mode is sufficient.

Range (Semitones)

Specifies the maximum range in semitones for the pitch change. When you change this value, this is indicated in the vertical ruler.

Resample

You can change the sample rate of a recording. This is useful if the file that you want to use in an audio system was recorded at a sample rate that this system does not support.

NOTE

- Sample rate conversion from a low frequency upwards does not improve the sound quality. The high frequencies that were lost cannot be restored by a conversion.

- If you resample to a lower frequency, high frequency material is lost. Therefore, converting down and then up again leads to a degradation in sound quality.

NOTE

Using the **Resampler** plug-in in the quality mode **High** changes the sample rate results in the same quality as when using the **Resample** option in the **Audio Editor**. However, that is only the case if the sample rate in the **Sample Rate** dialog exists in the values of the **Resampler Sample Rate** pop-up menu. If you choose a custom sample rate, another algorithm is used, which results in a lower quality of what the **Resampler** can achieve.

Converting a Sample Rate

NOTE

Sample rate conversion is always applied to the entire file.

PROCEDURE

1. In the **Audio Editor**, select the **Process** tab.
2. In the **Time & Pitch** section, click **Resample**.
3. In the **Sample Rate** dialog, select a sample rate from the pop-up menu.
4. Click **OK**.

Effect Morphing

Effect morphing allows you to smoothly morph from one effect to another, or from an unprocessed audio segment to a processed audio segment.

Effect morphing always involves two audio ranges. For example, two versions of the same audio range, of which one is processed and the other unprocessed.

Effect Morphing Dialog

In this dialog, you can gradually mix two audio ranges that have different effects or processing applied to them.

- To open the **Effect Morphing** dialog, select the **Process** tab in the **Audio Editor**, and click **Effect Morphing** in the **Other** section.

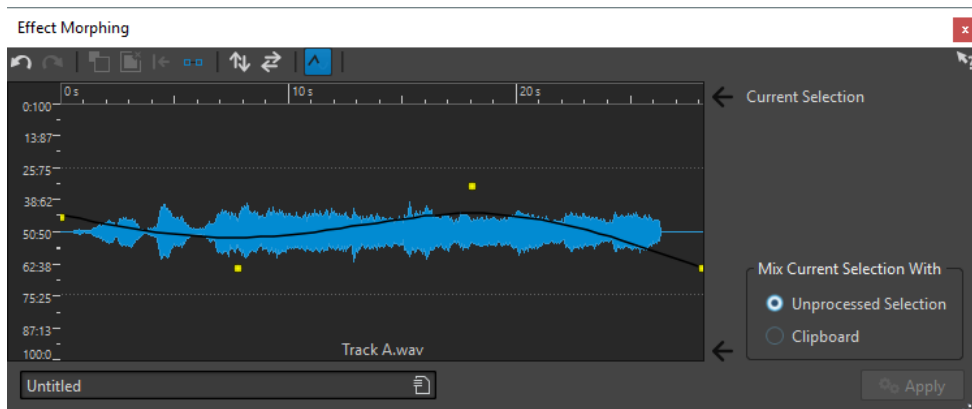

The dialog consists of a waveform display that shows the current selection and an envelope curve (by default a straight line) in the middle. By adding points to the envelope, you can create a curve that is used for the morphing process.

The following options are available at the top of the dialog:

- **Undo/Redo the Last Operation**
- **Deselect the Envelope Points**
- **Delete the Selected Envelope Points**
- **Reset the Selected Envelope Points**
- **Reset the Whole Envelope**
- **Flip the Envelope Around the Horizontal Axis**
- **Reverse the Envelope Time Sequence**
- **Toggle the Envelope Smoothing**

The following options are available in the lower right corner of the dialog:

Mix Current Selection With

Unprocessed Selection mixes the audio selection with the unprocessed version of the same audio.

Clipboard mixes the audio selection with the audio in the clipboard.

RELATED LINKS

[Basic Envelope Operations](#) on page 180

Setting Up the Effect Morphing

PROCEDURE

1. In the **Audio Editor**, open the two audio files for which you want to apply effect morphing. Effect morphing always involves two audio ranges.
2. In the wave window, make a selection range over the time that you want the effect morphing to take place.
3. Process this range by using any **Master Section** effects or offline processing. You cannot use processing/effects that alter the length of the selection, for example, time stretching.
4. Select the **Process** tab.
5. In the **Other** section, click **Effect Morphing**.
6. Make sure that **Unprocessed Selection** is activated. The current processed selection is mixed with an unprocessed version of the same selection.
7. Adjust your envelope points over time between 0 % and 100 %. This determines the level and direction of the morph. For example, starting at 100 % and ending at 0 % fades out the effect.

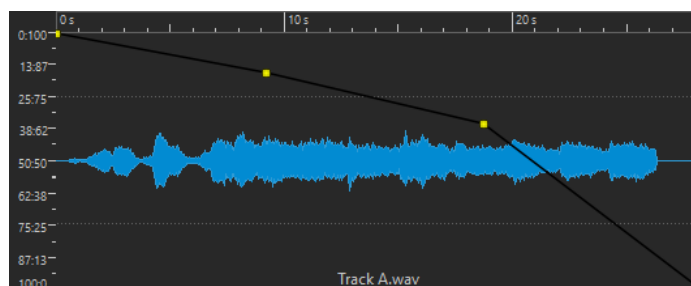

8. Click **Apply**.
-

Morphing Effects of Differently Processed Audio Segments

Effect morphing can take place between two differently processed audio segments.

PREREQUISITE

In the **Audio Editor**, make a range selection and process the selection.

PROCEDURE

1. Select the result, and press **Ctrl/Cmd-C**.
 2. Undo the processing.
 3. Process the selection again, this time with a different effect.
 4. Select the **Process** tab.
 5. In the **Other** section, click **Effect Morphing**.
 6. In the **Effect Morphing** dialog, activate **Clipboard**.
 7. Click **Apply**.
-

RESULT

The curve enables you to morph between two different processing methods.

NOTE

The clipboard can also be a copy from another wave file, but the clipboard size and the selection size must match.

Audio Montage

The audio montage is a multichannel and multitrack non-destructive editing environment that allows you to arrange, edit, play back, and record audio clips.

Non-destructive means that when you delete or change a part of an audio file, the audio is not deleted or permanently changed. Instead, a set of pointers keeps track of all the edits, so that these can be readily reversed.

The non-destructive editing functions include both track- and clip-based effects, volume and pan automation, as well as wide-ranging fade and crossfade functions. The multichannel support makes it possible to create surround mixes that can be written to DVD-Audio compatible discs.

The audio montage is a great tool for audio CD or DVD-Audio creation, mastering, multimedia work, radio spot production, etc.

Basic Terminology

Audio montages can contain an unlimited number of stereo or mono audio tracks. You can use them to structure your work graphically or logically. Depending on the channel configuration of the audio montage, you can route each track to a stereo output or route each track to different surround channels (up to 6) or non-surround audio channels (up to 8).

On an audio track, you can place any number of clips. Clips are containers for the audio, and include a number of settings and functions such as volume and pan curves, fades, etc.

A clip contains a reference to a source audio file on your hard disk, as well as start and end positions in the file, which means that clips can play back sections of the source audio files. Any number of clips can reference the same source file.

In addition to audio tracks, you can create DVD-Audio picture tracks in the audio montage.

Montage Window

The montage window is where you assemble your audio montage. This is where you view, play back, and edit audio montages.

The montage window gives you a graphical representation of the tracks and clips.

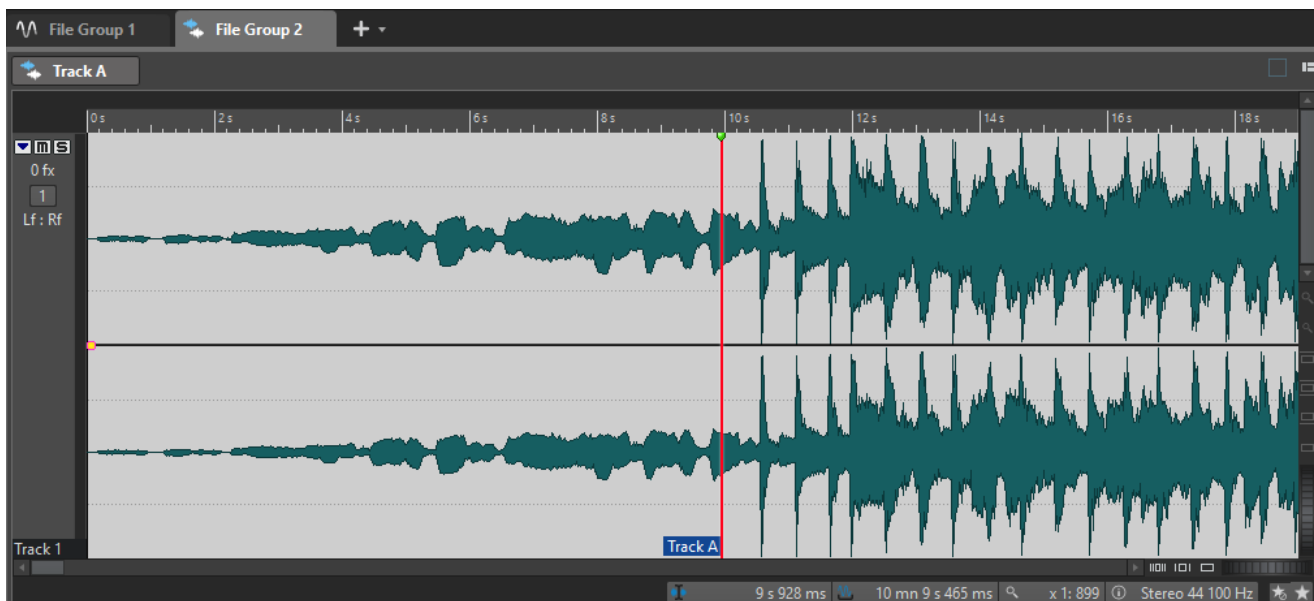

Track Control Area

The track control area offers several options regarding the track.

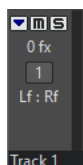

Fold/Unfold Track

Folds/Unfolds the track.

Mute

Mutes the track.

Solo

Solos the track.

FX

Opens the **Effects** pop-up menu where you can select effects for the track. A blue icon indicates that a track has track effects.

Track number button

Opens the track menu that contains track-related options.

Audio Track Dispatching

Opens the **Audio Track Dispatching** dialog where you can route a track to an output channel.

Track Name

Opens the **Track Name** dialog where you can enter a name for the track.

Track Pop-up Menu

This pop-up menu contains all track-related options.

- To open the **Track** pop-up menu, click the number button of a track in the track control area.

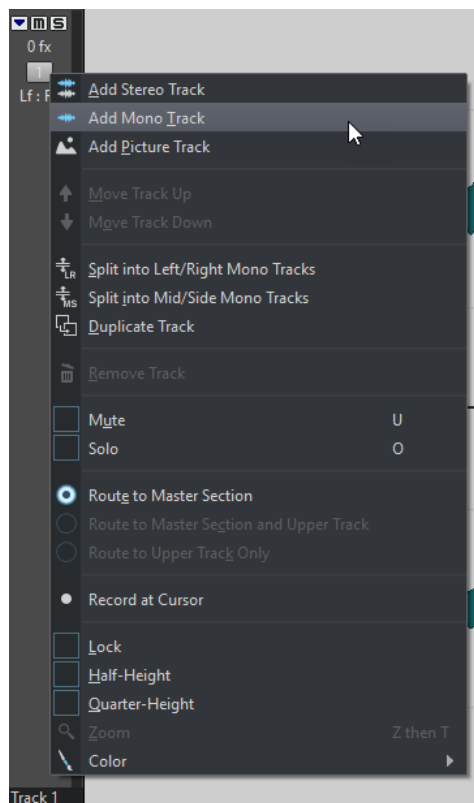

Add Stereo Track

Adds a stereo track below the active track.

Add Mono Track

Adds a mono track below the active track.

Add Picture Track

Adds a picture track below the active track.

Move Track Up

Moves the track one position up in the track list.

Move Track Down

Moves the track one position down in the track list.

Split into Left/Right Mono Tracks

Converts the stereo track into two mono tracks that represent the left and right channels of a stereo track. This does not alter the audio material.

Split into Mid/Side Mono Tracks

Converts the stereo track into two mono tracks that represent the mid and side channels. This assumes that each channel of a stereo track is a mid/side recording. This does not alter the audio material.

Duplicate Track

Creates a copy of the active track. The duplicate is added below the active track.

Remove Track

Deletes the active track.

Mute

Mutes the active track.

Solo

Solos the active track.

Route to Master Section

Routes the audio signal of the active track to the **Master Section** input.

Route to Master Section and Upper Track

Routes the audio signal of the active track to the **Master Section** input and to the modulation input of the **Ducker** clip plug-in.

Route to Upper Track Only

Routes the audio signal of the active track to the modulation input of the **Ducker** clip plug-in.

Record at Cursor

Opens the **Recording** dialog to start recording at the cursor position.

Lock

If this option is activated, you cannot edit the track.

Half-Height

Reduces the track height to half the current size.

Quarter-Height

Reduces the track height to a quarter of the current size.

Zoom

Shows the active track in the full available height.

Color

Opens a submenu where you can select a color for the active track.

Audio Montage Tabs

The tabs in the **Audio Montage** window give you access to the tools and options you need for editing audio montages. For example, you can edit the envelope curves and fades in clips, make zoom settings, analyze the audio, and render the audio montage.

View Tab

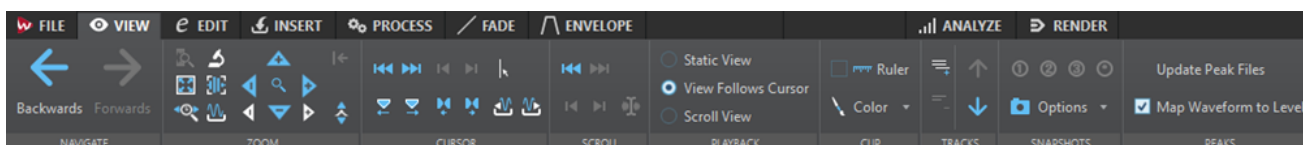

Navigate

Backwards/Forwards

Navigates to the previous/next cursor position, zoom factor, and selection range.

Zoom

Zoom

Activates the **Zoom** tool that allows you to define a time range that is zoomed in.

Time

Opens a pop-up menu that allows you to adjust the zoom to display the selected time range. **Zoom in 1:1** zooms in so that one pixel on the screen represents one sample.

To edit the zoom factor, click **Edit Zoom Factor**. This opens the **Zoom Factor** dialog, where you can edit the following settings:

- **Set Time Range** allows you to specify the time range that you want to display.
- **Samples per Screen Point** allows you to specify how many audio samples are summarized in each screen point.
- **Screen Points per Sample** allows you to specify how many screen points are used to represent a single audio sample.

Zoom Selection

Zooms the window so that the current selection occupies the entire montage window.

Microscope

Zooms in as far as possible.

View All

Zooms out as far as possible.

Display Whole Clip

Adjusts the view to display the active clip.

Zoom in Audio (10x)/Zoom out Audio (10x)

Zooms in/out in big steps.

Zoom in Audio/Zoom out Audio

Zooms in/out in small steps.

Zoom in Vertically/Zoom out Vertically

Zooms in/out to show waveforms with a lower/higher level.

Level

Adjusts the zoom to only display samples below the selected dB value.

Reset Zoom to 0 dB

Adjusts the zoom to display audio levels up to 0 dB.

Cursor

Move Cursor to Start of File/Move Cursor to End of File

Moves the cursor to the start/end of the file.

Previous Marker/Next Marker

Moves the cursor to the previous/next marker.

Start of Selection/End of Selection

Moves the cursor to the start/end of the selected time range.

Previous Region Edge/Next Region Edge

Moves the cursor to the previous/next region edge.

Edit Cursor Position

Opens the **Cursor Position** dialog where you can edit the cursor position.

Previous Clip Edge/Next Clip Edge

Moves the cursor to the previous/next clip edge.

Scroll

Start/End

Displays the start/end of the audio without moving the cursor.

Start of Selection/End of Selection

Displays the start/end of the audio selection without moving the cursor.

Cursor

Displays the cursor position.

Playback

Static View

Deactivates scrolling.

View Follows Cursor

Automatically scrolls the view to keep the playback cursor visible.

Scroll View

Scrolls the view to keep the playback cursor centered.

Clip

Ruler

If this option is activated, the markers of the source audio file are displayed in the clip, together with a ruler.

Color

Allows you to apply a color to the active clip.

Tracks

Display More Tracks/Display Fewer Tracks

Allows you to change the number of tracks that are displayed in the montage window.

Focus on Previous Track/Focus on Next Track

Sets the focus on the previous/next track.

Snapshots

Allows you to take, recall, and edit snapshots.

Take Snapshot

Activates/Deactivates the snapshot function. If this option is activated, click on a preset button to save a snapshot.

Presets

The buttons **1**, **2**, and **3** allow you to save a snapshot of the scroll position, zoom factor, cursor position, audio selection, and clip selection. The rightmost preset button is a global preset that is available for all audio montages.

Options

Allows you to select which settings are restored when applying a snapshot preset. The following options are available:

- **Scroll Position and Zoom**
- **Cursor Position**
- **Audio Selection**

- **Clip Selection**

Peaks

Update Peak Files

Updates the peak files of the audio file.

Map Waveform to Level

If this option is activated, changes in the level envelope are reflected in the waveform.

Edit Tab

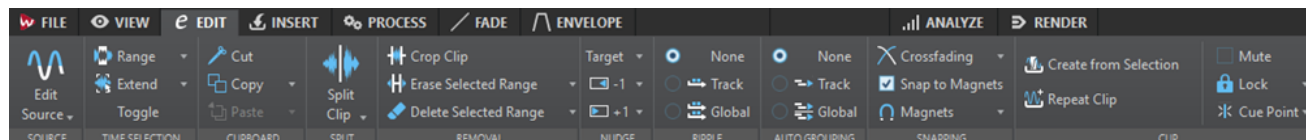

Source

Edit Source

Opens source file of the clip in the **Audio Editor**.

Edit Cubase Project

Opens the Cubase project relating to the clip.

Time Selection

Range

Opens the **Audio Range** dialog where you can define selection ranges very accurately.

Right-click **Range** to open the **Preset** pop-up menu. Here, you can select factory presets and custom presets.

Extend

Allows you to edit the selection range in the following ways:

- **Double Selection Length** doubles the length of the selection range.
- **Halve Selection Length** halves the length of the selection range.
- **From Playback Position to End of File** creates a selection range from the playback position to the end of the file. If playback is not active, the position of the edit cursor is used.
- **From Playback Position to Start of File** creates a selection range from the playback position to the start of the file. If playback is not active, the position of the edit cursor is used.

Toggle

Toggles the selection range on/off.

Clipboard

Cut

Cuts the active clip to the clipboard.

Copy

Copies the active clip to the clipboard.

Right-click **Copy** to open a pop-up menu with additional options:

- **Memorize Cursor Position** copies the position of the edit cursor to the clipboard.
- **Memorize Selection Length** copies the length of the active selection range to the clipboard.

Paste

Pastes the clipboard content.

Right-click **Paste** to open a pop-up menu with additional paste options.

Split

Split Selected Clips

Splits the selected clips at the edit cursor or playback cursor position.

Split Clips on All Tracks

Splits the clips on all tracks at the edit cursor or playback cursor position.

Removal

Crop Clip

Removes the areas of the clip that are outside the selection range.

Erase Selected Range

Erases the part of the clip that lies inside the selection range on the selected track, without filling the gap.

To erase the selection range on all tracks, right-click **Erase Selected Range** and select **Erase Selected Range on All Tracks**.

Delete Selected Clips

Deletes the part of the clip that lies inside the selection range on the selected track and moves the right section of the clip to the left to fill the gap.

If there is no selection range, the selected clip is deleted.

To delete the selection range on all tracks, right-click **Delete Selected Range** and select **Delete Selected Range on All Tracks**.

Nudge

Target

This pop-up menu allows you to select which items are affected by the nudge function.

- **Auto Select Item** automatically selects what should be nudged, depending on your last action. For example, if your last action was to select or move a clip, the **Clip Position** option is automatically selected.
- **Clip Position** moves the selected clips.
- **Clip's Left/Right Edge** resizes the active clip.
- **Clip's Fade In/Fade Out** moves the fade in/fade out junction points of the active clip. For stereo envelopes, both sides are adjusted.
- **Clip's Crossfade** narrows or widens the crossfade zone by moving the junction points of both clips in the crossfade. This only works if you select the second clip (the one on the right) in a crossfade pair.
- **Edit Cursor** moves the edit cursor.
- **Left Edge of Selected Time Range/Right Edge of Selected Time Range** moves the left/right edge of a selection range.
- **Selected Marker** moves the selected audio montage marker. To select a marker, click it in the area above the ruler.

- **Volume of Active Clip** adjusts the volume of the active clip step by step according to the **Gain** setting in the **Audio Montages Preferences**.
- **Volume of All Selected Clips** adjusts the volume of all selected clips step by step according to the **Gain** setting in the **Audio Montages Preferences**.
- **Pan of Active Clip** adjusts the pan of the active clip. **Nudge +** pans to the left and **Nudge -** to the right.
- **Pan of All Selected Clips** adjusts the pan of all selected clips. **Nudge +** pans to the left and **Nudge -** to the right.
- **Surround Pan of Active Clip** adjusts the Pan of the active clip. **Nudge +** pans to the left and **Nudge -** to the right.
- **Surround Pan of All Selected Clips** adjusts the Pan of all selected clips. **Nudge +** pans to the left and **Nudge -** to the right.

Nudge Left

Nudges the target to the left or down, by the amount that is defined in the **Audio Montages Preferences**.

Right-click **Nudge Left** to open a pop-up menu that allows you to change the nudge amplitude.

Nudge Right

Nudges the target to the right or up, by the amount that is defined in the **Audio Montages Preferences**.

Right-click **Nudge Right** to open a pop-up menu that allows you to change the nudge amplitude.

Ripple

None

Deactivates the auto-shift function.

Track

If this option is activated and you move a clip horizontally, all clips on the selected track that are located to the right of the edited clip are also moved. This option also applies when moving or resizing clips, and when inserting or pasting more than one clip at the same time.

Global

If this option is activated and you move a clip horizontally, all clips on all tracks that are located to the right of the edited clip are also moved. This option is taken into account when moving or resizing clips, and when inserting or pasting more than one clip at the same time.

Auto Grouping

None

Deactivates auto-grouping.

Track

If this option is activated and you move a clip horizontally, all overlapping or adjacent clips on the same track are also moved.

Global

If this option is activated and you move a clip horizontally, all vertically overlapping clips on all tracks are also moved.

Snapping

Crossfading

This pop-up menu allows you to make snapping settings for crossfades.

- If **Snap to Waveform When Crossfading** is activated and you create a crossfade by dragging a clip towards another one located on its left side, the position of the moved clip is automatically adjusted to obtain a good correspondence between the clip waveforms. This correlation process provides a crossfade that is aligned in phase.
- If **Create Crossfade and Snap to Waveform When Snapping to Left Clip** is activated and you move a clip to let its start snap to the end of another clip on its left, the clip is slightly moved to the left to create a short crossfade that is based on an optimal correlation between the two waveforms. This correlation process provides a crossfade that is aligned in phase.
- If **Create Crossfade When Snapping to Left Clip** is activated and you move a clip to let its start snap to the end of another clip on its left, the clip is slightly moved to the left to create a crossfade.

The length of the crossfade is the fade in length of the clip on the right. If the fade in length is zero, the fade out length of the left clip is used as a basis instead. If that length is also zero, the **Create Crossfade and Snap to Waveform When Snapping to Left Clip** function is performed if activated.

Snap to Magnets

If this option is activated, moved elements such as clip edges, time selection edges, cursor, and markers snap to the magnets that are activated on the **Magnets** pop-up menu.

Magnets

This pop-up menu allows you to select which items should be magnetic.

Clip

Create from Selection

Allows you to create clips from the selection range. If no clip is overlapping the selection, an empty clip is created.

Repeat Clip

Opens the **Repeat Clip** dialog where you can specify how clips should be repeated.

Mute

Mutes the active clip.

Lock

This pop-up menu allows you to lock the active clip.

- If **Full Lock** is activated, the clip is locked to prevent accidental editing.
- If **Time Lock** is activated, the position and size of a clip are locked. Other editing options are still possible.

Cue Point

This pop-up menu allows you to make cue point settings.

- **Set at Cursor** sets the cue point to a fixed position from the start of the clip.
- **Set at Default Gap Position** sets the cue point before the start of the clip, at a distance governed by the default pre-gap position.
- **Follows Fade In End Point** sets the cue point to the fade in end point.
- **Follows Fade Out Start Point** sets the cue point to the fade out start point.

- If **Custom Cue End** is activated, you can set the end cue point at a custom position from the end of the clip. This option allows you to edit the gap individually for each clip.
If this option is deactivated, the default gap that is defined in the **Audio Montages Preferences** is used.
- **End Offset** opens the **End Cue Point Offset** dialog that allows you to set the end cue point at a custom position from the end of the clip.

Insert Tab

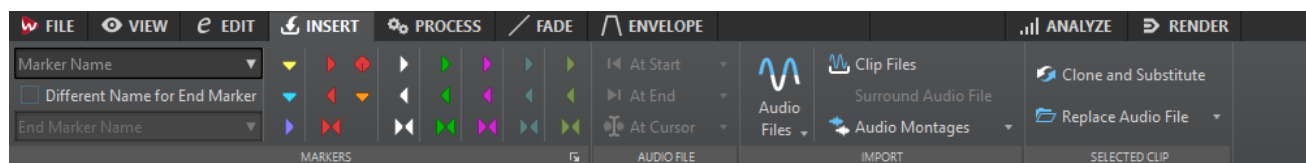

Markers

Marker Name

Allows you to enter the name of the start and end marker. If nothing is entered, a generic name is used.

To edit the default names, open the **Markers** window, and select **Functions > Default Marker Names**.

Different Name for End Marker

If this option is activated, you can enter a different name for the end marker.

If this option is deactivated, the name of the start marker is also used for the end marker.

Create Marker

Allows you to create different types of markers and marker pairs at the edit cursor position or at the selection range.

Import

Audio Files

Allows you to select one or more audio files to insert at the edit cursor position on the selected track.

Clip Files

Opens the file browser where you can select one or more clips to insert at the edit cursor position on the selected track. If you import several clips at the same time, they are lined up in alphabetical order, according to their file names, and separated according to the set pre-gap.

Surround Audio File

Allows you to select a surround audio file to insert at the edit cursor position on the selected track. For this, the audio montage must be set to **Multichannel (DVD-Audio Compatible)** with **6 Channels**. Each file is placed on a different track, and routed to the corresponding surround output. Mono surround channels are placed on mono tracks and stereo surround channels on stereo tracks.

Audio Montages

Allows you to select an audio montage to insert at the edit cursor position on the selected track.

Selected Clip

Replace Audio File

Allows you to make the clip refer to another audio file while retaining all clip settings. The audio file must be at least as long as the end position of the clip. You cannot substitute a stereo file with a mono file or vice versa. Clicking the arrow icon opens the list of recently used folders.

Clone and Substitute

Creates a copy of the source audio file and makes the clip refer to this new file. As a result, you can modify the new source file without affecting other clips of the original audio file. The cloned audio file is saved in the implicit folder that is specified in the **Audio Montages Preferences**.

Process Tab

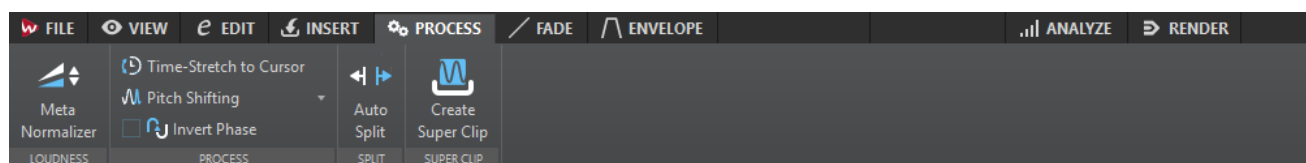

Loudness

Meta Normalizer

Opens the **Loudness Meta Normalizer** dialog where you can adjust the loudness of each clip in the audio montage so that they get the same loudness. You can also adjust the whole output, while taking the EBU R-128 audio measurement recommendation and a true peak analysis into account.

Process

Time-Stretch to Cursor

Opens the **Time Stretching** dialog that allows you to time-stretch the clip so that it ends at the audio montage edit cursor position. When this function is used, a clone of the original audio file is created, containing the audio range used in the clip. The process is applied to the clone, and the clip refers to this file instead. Neither the original audio file nor other clips that refer to the same audio file are affected. The cloned audio file is saved in the implicit folder that is specified in the **Audio Montages Preferences**.

Pitch Shifting

Opens the **Pitch Shifting** dialog where you can change the pitch of the clip. When this function is used, a clone of the original audio file is created that contains the audio range used in the clip. The process is applied to the clone, and the clip refers to this file instead. Neither the original audio file nor other clips that refer to the same audio file are affected. The cloned audio file is saved in the implicit folder that is specified in the **Audio Montages Preferences**.

Invert Phase

Inverts the phase of the clip. An inverted phase is indicated by an icon in the wave window.

Split

Auto Split

Opens the **Auto Split** dialog where you can specify how to split clips.

Fade Tab

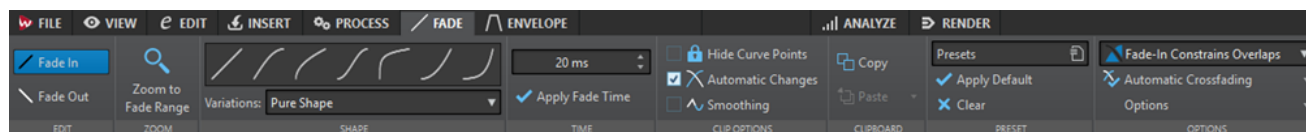

Edit

Fade In/Fade Out

Allows you to switch between the fade in and the fade out settings.

Zoom

Zoom to Fade Range

Adjusts the view to display the fade in/fade out part of the active clip.

Shape

Curve

Allows you to select preset fade curves.

- **Linear** changes the level linearly.
- **Sinus (*)** changes the level according to a sine curve. When used in a crossfade, the loudness (RMS) remains constant during the transition.
- **Square-Root (*)** changes the level according to a square-root curve. When used in a crossfade, the loudness (RMS) remains constant during the transition.
- **Sinusoid** changes the level according to a sine curve.
- **Logarithmic** changes the level according to a logarithmic curve.
- **Exponential** changes the level according to an exponential curve.
- **Exponential+** changes the level according to a more pronounced exponential curve.

Variations

When creating a crossfade, the fade in/fade out shape changes to optimize the volume evolution during the crossfade. The following options are available:

- If **Pure Shape** is selected, the fade shape is not changed and is used as defined. This is the default setting when any fade in/fade out preset is selected.
- If **Amplitude Compensation** is selected for a fade in/fade out curve in a crossfade, the summed fade in/fade out gains remain constant along the crossfade region. This option is recommended for short crossfades.
- **Medium Compensation** provides an intermediary between amplitude compensation and power compensation. This option is recommended if the other two compensation options do not provide the expected result.
- If **Power Compensation** is selected, the power of the crossfade remains constant along the crossfade region. Crossfading between completely different types of audio material can sometimes cause harmonics to cancel each other out at the crossfade splice point, causing the volume to drop. Constant power crossfades compensate for this. Using either the **Sinus (*)** or **Square-Root (*)** fade presets for a fade in/fade out provide a constant power crossfade without selecting this option.

NOTE

Selecting a compensation option for a single fade (not a crossfade) changes the shape of the curve. However, the actual compensation is only applied when the fade becomes part of a crossfade.

Time

Fade Time

Allows you to specify a fade in/fade out time for the clip.

Apply Fade Time

Applies the specified clip fade in/fade out time.

Clip Options

Hide Curve Points

Hides the envelope curve points. This way, they cannot be edited with the mouse. However, you can drag the whole curve up or down.

Automatic Changes

If this option is activated, the fade in/fade out is not changed automatically, for example, by automatic crossfading of overlapping clips. This option is useful if you have set a fade that you do not want to be altered, even though you may want to overlap the clip with another clip. This option is individual for each clip, as opposed to the global **No Automatic Crossfading**.

Smoothing

Rounds the resulting envelope curve angles. This produces smoother, more natural envelope curves.

Clipboard

Copy

Copies the fade in/fade out shape to the clipboard.

Paste

This pop-up menu allows you to set the paste behavior.

- **Paste Shape Only** replaces the fade in/fade out shape with the shape that was copied to the clipboard. The original length is preserved.
- **Paste to Selected Clips** replaces the fade in/fade out shape in all selected clips with the shape that was copied to the clipboard.

Preset

Presets

This pop-up menu allows you to save and restore fade presets, and set up the default settings for automatic fades and crossfades.

Apply Default

Replaces the current fade in/fade out with the default setting that is specified on the **Presets** pop-up menu.

Options

Overlaps

This pop-up menu allows you to set the automatic crossfading behavior.

- If **No Automatic Crossfading** is activated, no automatic crossfading is performed when clips overlap.
- If **Free Overlaps** is activated, automatic crossfades are created when a clip overlaps another clip on the same track. The length of the overlap determines the length of the crossfade.
- If **Fade In Constrains Overlaps** is activated, the fade in length of a clip constrains the maximum possible overlap, and thus the crossfade time. If the clip on the right side, that is, the clip with the fade in in the overlap, is moved to the left past the set overlap time, the other clip is progressively resized. Moving the other clip to the right into the clip that contains the fade in in the overlap produces the same result.
- If **Fade Out Constrains Overlaps** is activated, the fade out length of a clip constrains the maximum possible overlap, and thus the crossfade time. If the clip on the left side, that is, the clip with the fade out in the overlap, is moved to the right past the set overlap time, the other clip is progressively resized. Moving the other clip to the left into the clip that contains the fade out in the overlap produces the same result.

Automatic Crossfading

This pop-up menu allows you to make automatic crossfading settings.

- If **Allow Automatic Crossfading with Clips on Selected Track** is activated, crossfades are automatically created when you move a clip so that it overlaps another clip that is located on the selected track.
- If **Allow Multiple Automatic Crossfades** is activated, crossfades are automatically created for all moved clips that overlap other clips on their track. If this option is deactivated, a crossfade is only created for the clip that you drag, even if several clips are moved simultaneously.

Options

- If **Create Default Fades in New Clips** is activated, all new clips get the default fade in and fade out shape and length. For clips that are created by splitting a clip, only the default fade time is used.
- If **Lock Fade Times When Adjusting Clip Edges** is activated, the defined fade in and fade out lengths are locked to the clip start or end, even if you adjust the clip edges. This means that if you resize a clip by dragging its edge, the corresponding fade junction point moves accordingly, while maintaining the fade length.

Envelope Tab

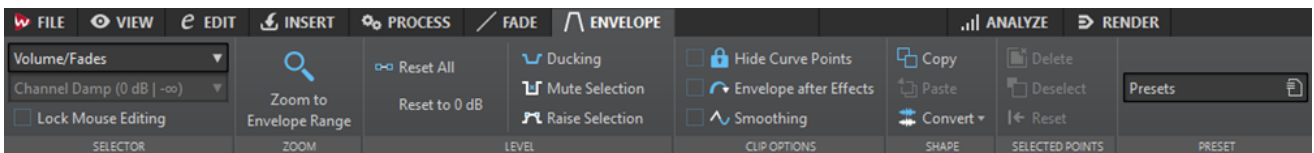

Selector

Envelope Type

Sets the type of the envelope. Depending on the selected type, different options are available.

Pan Law

Lets you select a pan mode. This option is only available if the **Pan** envelope type is selected.

Lock Mouse Editing

If this option is activated, all envelopes are locked and cannot be edited with the mouse. The envelopes and their points are still displayed.

Zoom

Zoom to Envelope Range

Adjusts the view to display the active envelope of the active clip.

Level

Reset All

Resets the envelope to its neutral form.

Reset to 0 dB

Replaces the segments between the fade in and fade out points with a single neutral segment.

Ducking

Opens the **Ducking Settings** dialog. This dialog allows you to create ducking effects between clips on two adjacent tracks where the level or send effect of one clip is modified every time that clips are present on the other track.

Mute Selection

Adds level envelope points and draws a curve to mute the selection by lowering the level to zero with default 20 ms fall and rise times.

Raise Selection

Adds level envelope points and draws a curve to raise the audio level of the selection with 20 ms fall and rise times. You can drag the created segment up and down to adjust the level.

Clip Options

Hide Curve Points

Hides the envelope curve points. This way, they cannot be edited with the mouse. However, you can drag the whole curve up or down.

Envelope after Effects

Places the level/fade envelope after the clip effect section. This is useful if you are using dynamic processors that alter the level of the clip.

Smoothing

Smooths the resulting envelope curve angles. This produces more natural envelope curves.

Shape

Copy

Copies the envelope shape into a dedicated clipboard while excluding any fade part.

Paste

Replaces the current envelope shape with the one in the clipboard without altering any fade part.

Convert

- **Convert to Stereo** creates independent envelopes for the left and right channels.

- **Convert to Mono** combines the envelopes of the left and right channels into a single envelope.

Selected Points

Delete

Deletes the selected envelope points in the active clip.

Deselect

Deselects the selected envelope points in the active clip.

Reset

Resets the selected points in the active clip to their default level.

Preset

Presets

This pop-up menu allows you to save and restore envelope presets.

Analyze Tab

The **Analyze** tab provides you with tools for monitoring your audio.

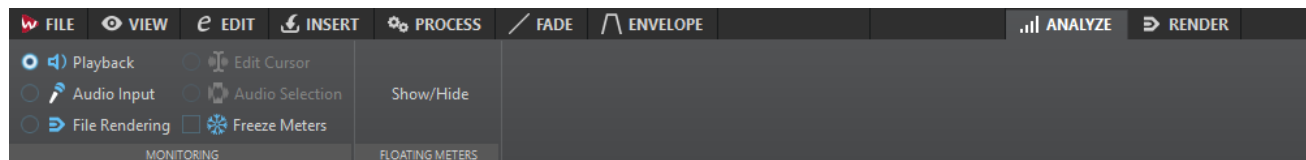

Monitoring

Playback

This is the standard metering mode, in which the meters reflect the audio that is played back. Metering occurs after the **Master Section**, which means that effects, dithering, and master faders are taken into account. You can monitor playback in audio files, audio montages, audio CD track lists, etc.

Audio Input

In this mode, the meters reflect the audio input. Typically, this is the mode to use when recording. The **Master Section** settings are not taken into account.

File Rendering

In this mode, you can monitor what is being written to disk during file rendering or recording. Average and min/max peak values are calculated. After rendering, the meters freeze until you refresh or change the monitor mode.

Freeze Meters

This mode freezes the values for all open meters. The meters remain frozen until you select another monitor mode or deactivate **Freeze Meters**.

Floating Meters

Show/Hide

Shows/Hides floating meters.

Render Tab

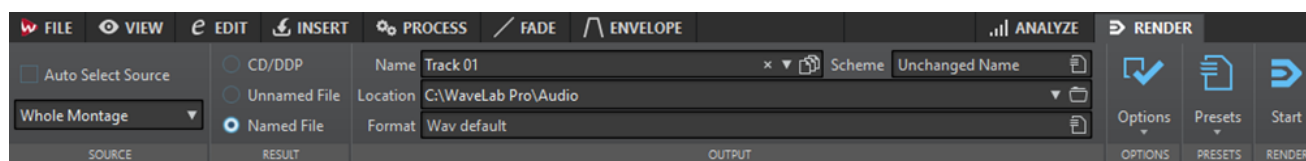

Source

Auto Select Source

If this option is activated, the source option changes according to the selection that you make in the audio file. If there is no selection, the whole audio montage is processed.

The **Source** pop-up menu allows you to select which part of the audio montage you want to process. The following options are available:

Whole Montage

Processes and renders the whole audio range.

Selected Audio Range

Processes and renders the selected audio range.

Union of Selected Clips

Processes and renders the audio range that starts with the first selected clip and ends with the last selected clip. Only the selected clips are included in the process.

Selected CD Track

Processes and renders the selected CD track in the CD window.

CD Track Group

Processes and renders the CD track group that you can select on the pop-up menu below this option.

Specific Region

Processes and renders a specific audio range to an independent file. Specify the region to process on the pop-up menu.

All CD Tracks in Group

Processes and renders all CD tracks in the selected CD track group.

All Regions

Processes and renders each marked audio range to an independent file. By defining multiple isolated regions in an audio file, you can process them in one operation. Specify the type of regions to process on the pop-up menu.

All Clip Groups

Processes and renders each audio montage group to an independent file. The group names are used as file names.

All Selected Clips

Processes and renders each selected clip to an independent file. The clip names are used as file names.

Result

CD/DDP

Allows you to burn a CD or generate a DDP file from the audio montage.

Unnamed File

If this option is activated, a temporary untitled file is rendered.

Named File

If this option is activated, you can specify a name for the rendered file.

Output

Name

Allows you to enter a name for the rendered file. Clicking the arrow icon opens a pop-up menu that offers you several naming options.

Scheme

Allows you to specify a naming scheme for the file name.

Location

Allows you to select a destination folder for the rendered files.

Format

Opens a pop-up menu where you can select a single file format or multiple file formats.

Options

Depending on the selected source, different options are available.

Bypass Master Section

If this option is activated, the plug-ins and gain of the **Master Section** are bypassed when rendering.

Auto Save Master Section Preset

If this option is activated, the **Master Section** preset is automatically saved in the audio montage when you render the file. You can load the **Master Section** preset via the **Load Master Section Preset** option in the lower right corner of the montage window.

Fade In/Out at Boundaries

If this option is activated, a fade is performed at the audio range boundaries when a new file is created, or a crossfade with the adjacent audio is created if the audio range is processed in place.

Crossfades allow for smooth transitions between the processed and the non-processed parts. The crossfade time and shape are set in the **Audio Files Preferences**. If the fade time is longer than half the length of the processed file, the fade is not performed.

No Reverb Tail

If this option is activated, the audio tail produced by effects such as reverb is not included in the rendered file.

Some plug-ins do not transfer information on the tail duration to WaveLab. In this case, this option has no effect. For such plug-ins, you can add the **Silence** plug-in to add extra samples at the end of the file.

Copy Markers

If this option is activated, the markers that are included in the range to process are copied to the rendered file.

Create Basic Audio CD

If this option is activated, a file of the whole audio montage, including clip effects and master effects, is created. Then a **Basic Audio CD** window opens.

Create CD Image and Cue Sheet

If this option is activated, the audio montage is exported as a CD image with an accompanying cue sheet. A cue sheet is a text file identifying the CD tracks in the image file. The cue sheet and the image file it describes can then be imported into any CD recording application that supports this function (including WaveLab Pro) and written onto a CD. You can use this option with any sample rate.

Create Audio Montage from Result

If this option is activated, the rendered audio file is imported in a new audio montage.

Open Resulting Audio File

If this option is activated, every rendered file is opened in a new window.

Open Files in New File Group

If this option is activated, the rendered audio file is imported in a new file group.

Bypass Master Section on Resulting Audio File

If this option is activated, playback of the resulting audio file bypasses the entire **Master Section** except the **Playback Processing** section. This setting can be toggled by clicking the button at the bottom right of the wave window or montage window.

NOTE

It is recommended to activate this option, because this way, you do not monitor new files through the effects that have already been applied to them.

Include Pause before Track

If this option is activated and you render CD tracks, a pause is included before each CD track in the rendered file.

Include Pause after Track

If this option is activated and you render CD tracks, a pause is included after each CD track in the rendered file.

Render Audio File, Do Not Change Audio Montage

If this option is activated, the selected CD track is rendered to a separate audio file.

Replace On Same Audio Montage Track

If this option is activated, the rendered file replaces the clips on the selected montage track.

Add to Next Empty Audio Montage Track

If this option is activated, the rendered file is added to the next empty audio montage track. The original clips are preserved.

Add to New Audio Montage Track

If this option is activated, the rendered file is added to a new audio montage track. The original clips are preserved.

Bypass Clip Plug-ins

If this option is activated, the selected clips are rendered without their clip effects.

Bypass Volume/Pan Envelopes

If this option is activated, the selected clips are rendered without volume and pan envelopes.

Replace Clips with Rendered Audio Files

If this option is activated, the rendered audio files replace the selected clips.

Upload to SoundCloud

If this option is activated, the rendered file is uploaded to SoundCloud.

Presets

Presets

This pop-up menu allows you to save and restore render presets. All settings are saved and restored, except the file name and the file location.

Render

Start

Starts the rendering process.

Signal Path in the Audio Montage

The audio signal passes through the various sections of WaveLab Pro in a certain way.

1. The audio samples are read.
2. Clip envelope (unless post-effects mode is active)
3. Clip effects
4. Clip envelope (if post-effects mode is active)
5. Clip pan
6. Individual clip gain (**Clips** window)
7. Clips are mixed into the track slot (for example, overlapping clips).
8. Track effects
9. Track level settings/surround pan
10. Each track is mixed into a bus that has as many channels as defined by the audio properties of the audio montage (between 1 to 8).
11. The audio channels are processed through the plug-ins of the master output.
12. The channels are sent to the **Master Section** input.

Signal Path in the Master Section

1. Channels/Sample rate can change at each plug-in slot.
2. **Master Section** meters
3. **Final Effects/Dithering** pane in the **Master Section**
4. **Playback Processing** pane
5. Independent meters
6. Speaker gain for playback
7. Playback or file format rendering

Creating New Audio Montages

PROCEDURE

1. Select **File > New**.
 2. Select **Audio Montage > Custom**.
 3. Specify the audio properties and click **Create**.
-

Audio Montage Properties

You can define the mode (stereo, mono, or multichannel), the number of audio channels, and the sample rate of the audio montage.

You can set these properties when you create a new audio montage.

- To change the properties for the selected audio montage, select the **File** tab and click **Info**, or click the **Audio Montage Properties** button at the bottom right of the montage window.

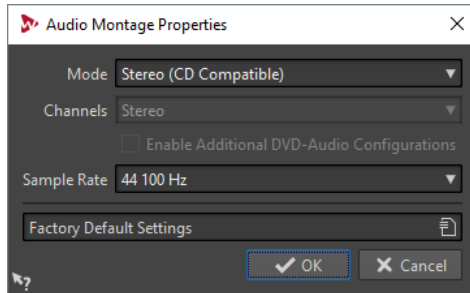

Mode

Lets you select the following modes for audio montage projects.

- **Stereo (CD Compatible)**
- **Multichannel (DVD-Audio Compatible)**
- **Multichannel (Free Configuration)**

Channels

Lets you define the number of audio channels and their configuration at the output of the audio montage. This is only available in **Multichannel (DVD-Audio Compatible)** mode.

Enable Additional DVD-Audio Configurations

Enables additional DVD-Audio channel configurations on the channels pop-up menu. This is only available in **Multichannel (DVD-Audio Compatible)** mode.

This option is only available if you access the **Audio Montage Properties** via the **Audio Montage Properties** button at the bottom right of the montage window.

Sample Rate

Lets you select the sample rate for the audio montage.

Alternative Ways of Creating New Audio Montages

There are several ways to create a new audio montage.

- Import cue sheets/CD images as audio montage
- Import audio CD tracks to an audio montage
- Convert a Basic Audio CD into an audio montage
- Create an audio montage from a wave file with the **Auto Split** function
- Import an AES-31 project file to an audio montage
- Import an XML text file to an audio montage
- Convert wave files to an audio montage
- When you render, you can open the resulting file into a montage.
- Duplicating audio montages
- Import DDP files to an audio montage.

- Press **Ctrl/Option** and drag a montage tab on the tab bar.
- From a script

RELATED LINKS

[Audio Montage Duplicates](#) on page 216

Audio Montage Duplicates

You can duplicate audio montages in various ways.

Empty (With Same Properties)

Creates a new audio montage with the channel settings and sample rate of the original audio montage, without any clips.

Exact Duplicate (Using the Same Audio Files)

Creates an exact duplicate of the original audio montage and lets the new clips reference to the original audio files. The duplicated audio montage uses the channel settings and sample rate of the original audio montage.

This is useful if you want to create several versions of the audio montage, for example, to experiment with variations. However, any processing or editing that you apply to the actual audio files are reflected in all audio montages.

You can also press **Ctrl/Cmd**, drag a tab, and drop it on the tab bar to create an exact duplicate of an audio montage.

Customized Duplicate

Allows you to specify which parts of the audio montage to include in the duplicate of this audio montage.

Duplicate (Recreate Audio Files)

Allows you to copy the audio montage together with its audio files to create a new self-contained audio montage. There are several uses for complete cloning:

- Edit and process the audio files without affecting other audio montages.
- Create different versions of the audio montage that focus on specific aspects of the audio montage by removing any unused audio sections.
- Split audio files and give them specific names.
- Reduce the size of an audio montage project by only using the needed audio material.

NOTE

Duplicate (Recreate Audio Files) does not render effects to files.

RELATED LINKS

[Duplicating Audio Montages](#) on page 216

Duplicating Audio Montages

PROCEDURE

1. Open the audio montage that you want to duplicate.
2. In the **Audio Montage** window, select the **File** tab.
3. Select **New > Audio Montage > From Current File**.
4. In the **From Current Audio Montage** section, select one of the following:
 - **Empty (With Same Properties)**

- **Exact Duplicate (Using the Same Audio Files)**
 - **Customized Duplicate**
 - **Duplicate (Recreate Audio Files)**
5. Do one of the following:
- If you have selected **Empty (With Same Properties)** or **Exact Duplicate (Using the Same Audio Files)**, click **Create**.
 - If you have selected **Customized Duplicate** or **Duplicate (Recreate Audio Files)**, make your settings and click **OK**.
-

RESULT

A duplicate of the audio montage opens in another tab.

Create Customized Audio Montage Duplicate Dialog

In this dialog, you can specify which parts of an audio montage you want to include in the duplicate.

- To open the **Create Customized Audio Montage Duplicate** dialog, open an audio montage and select the **File** tab. Select **New > Audio Montage > From Current File**, select **Customized Duplicate**, and click **Create**.

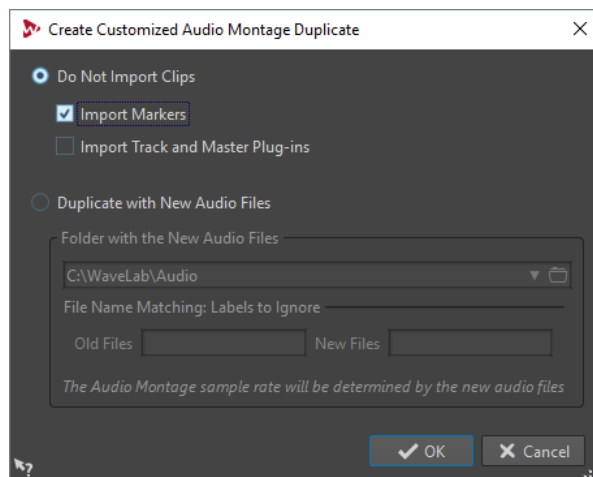

Do Not Import Clips

If this option is activated, the clips of the source audio montage are not imported. For example, this can be used to open an audio montage with all the CD markers in place and to insert alternate audio clips to compare them with the original audio montage.

Import Markers

If this option is activated, the markers of the source audio montage are imported.

Import Track and Master Plug-ins

If this option is activated, the track and master plug-ins of the source audio montage are imported.

Duplicate with New Audio Files

If this option is activated, you can replace the audio files of the source audio montage with new audio files. For this, specify the folder that contains the new audio files.

If the audio files that you want to use as replacement have different file names than the source audio files, you can specify the differences between the source files and the new files.

For example, if the file `piano_96k.wav` is replaced by the file `piano_44k.wav`, specify `96k` in the **Old Files** field and `44k` in the **New Files** field.

If no matching audio files are available, you can create empty clips instead and later replace the empty clips with audio files.

If there is a difference between the sample rate of the source montage and the sample rate of the new montage, the position, length, envelope, and marker settings are adjusted accordingly.

Duplicate Audio Montage by Recreating Audio Files Dialog

You can create a copy of the audio montage in which the actual audio files are duplicated to create a new self-contained audio montage. In this dialog, you can specify how the selected audio montage is duplicated.

- To open the **Duplicate Audio Montage by Recreating Audio Files** dialog, open an audio montage and select the **File** tab. Select **New > Audio Montage > From Current File**, select **Duplicate (Recreate Audio Files)**, and click **Create**.

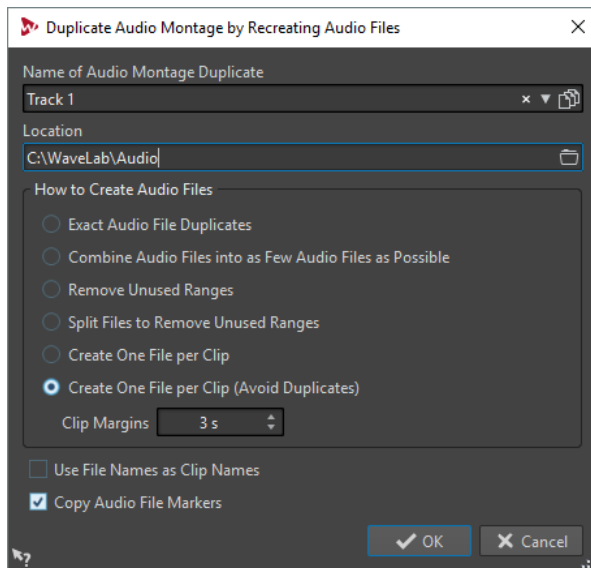

Name of Audio Montage Duplicate

Specifies the file name of the audio montage duplicate.

Location

The location where you want to create the audio montage duplicate and its audio files.

Exact Audio File Duplicates

If this option is activated, the cloned audio files are exact copies of the original files. Unused ranges are not removed.

The files are recreated and saved in an uncompressed format. For example, an MP3 file that is included in an audio montage will be recreated as a PCM file. In other words, the content is recreated, not the file format.

Combine Audio Files into as Few Audio Files as Possible

If this option is activated, all used ranges in the original audio files are copied and combined into a single audio file to which the clips in the clone refer. The file gets the same name as the audio montage clone file.

NOTE

If the audio montage contains both mono and stereo clips, there will be two combined audio files, one for mono material (with the suffix "M") and one for stereo material (with the suffix "S").

Remove Unused Ranges

If this option is activated, the same number of audio files is created, but any unused ranges in the files are removed. This reduces the file size.

Split Files to Remove Unused Ranges

If this option is activated, unused ranges in the files are removed, and the file is split into several new files when a range is removed.

Create One File per Clip

If this option is activated, every clip in the audio montage clone refers to a unique file, containing only the audio that is used in the clip. The files are named after the clips. A number is added if several clips have the same name.

Create One File per Clip (Avoid Duplicates)

If this option is activated, every clip in the audio montage clone refers to a unique file, containing only the audio that is used in the clip. The files are named after the clips. However, if two clips use the same audio range, a common file is created for these clips.

Clip Margins

Allows you to add a number of seconds before and after the beginning and end of the clip range in the created audio files. This allows you to lengthen the clips in the cloned audio montage at a later stage.

Use File Names as Clip Names

If this option is activated, the clips in the cloned audio montage get the name of the corresponding audio file.

Copy Audio File Markers

If this option is activated, the markers in the original audio files are included in the recreated files.

Creating an Audio Montage from an Audio File

You can export audio files to an audio montage, including all markers that you have set in the audio file.

PROCEDURE

1. In the **Audio Editor**, open the audio file that you want export to an audio montage.
2. Optional: If you want to use a specific time range of the audio file, create a selection range in the wave window.
3. Select **File > New**.
4. Select **Audio Montage > From Current File**.
5. In the **From Current Audio File** section, click **Insert Audio File in New Montage**.
6. Click **Create**.
7. In the **Create Audio Montage from Audio File** dialog, select whether to import the whole file or the selected audio range.
8. Optional: Decide if you want to perform any of the following marker operations:
 - **Import Markers**

- **Split at Generic Region Markers**
 - **Split at CD Track Markers**
9. Click **OK**.
-

Import Options for Audio Montages

You can import different files into your audio montage, for example, audio files, audio montages, and DDP images.

The following import options are available via the **Import** section on the **Insert** tab of the **Audio Montage** window:

- To import audio files, click **Audio Files** and select the audio files that you want to import at the edit cursor position on the selected track.
If you import a single audio file, the **Paste** pop-up menu opens. Here, you can specify how the clip should be inserted, whether existing clips should be affected, etc.
If you import multiple audio files, the **Insert Audio Files** dialog opens. Here, you can specify where to insert the files.
- To import clips, click **Clip Files** and select the clips that you want to import at the edit cursor position on the selected track.
If you import several clips at the same time, they are inserted in alphabetical order, according to their file names, and separated according to the set **Pre-Gap**.
- To import audio montages, click **Audio Montages** and select the audio montages that you want to import at the edit cursor position on the selected track.
- To import surround audio files, click **Surround Audio File** and select the file that you want to import at the edit cursor position on the selected track.
The audio montage must be set to **Multichannel (DVD-Audio Compatible)** mode with **6 Channels**. Each file is placed on a different track, and routed to the corresponding surround output. Mono surround channels are placed on mono tracks and stereo surround channels on stereo tracks.

To access the following import options, select **File > Import**.

- To import audio files, click **Audio File to Montage**, select the audio files that you want to import, and click **Import**.
- To import a DDP image, click **DDP**. In the file browser, select the file that you want to import, and click **Import**.
- To import a CD cue file with its audio data, click **CD Cue**. In the file browser, select the file that you want to import, and click **Import**.
- To import an AES-31 file, click **AES-31**. In the file browser, select the file that you want to import, and click **Import**.
- To import an audio montage that has been saved as an XML file, click **XML**. In the file browser, select the file that you want to import, and click **Import**.
- To open audio files that have an unknown format, click **Unknown Audio**. Via the **Special File Format** dialog, you can specify how to interpret the format of the audio file that you want to open.
- To import CD tracks from an audio CD, click **Audio CD**. Via the **Import Audio CD** dialog, browse for the audio CD tracks to extract.
- To import a file group, click **File Group**. In the file browser, select the file group that you want to import, and click **Import**.

RELATED LINKS

[Mismatched Sample Rates When Inserting Audio Files](#) on page 230

[Inserting Multiple Clips](#) on page 229

[Audio Montages within Audio Montages](#) on page 255

Missing Files Dialog

This dialog opens when you open an audio montage, and some audio files that the audio montage refers to cannot be found. You can then search for the files or select a replacement.

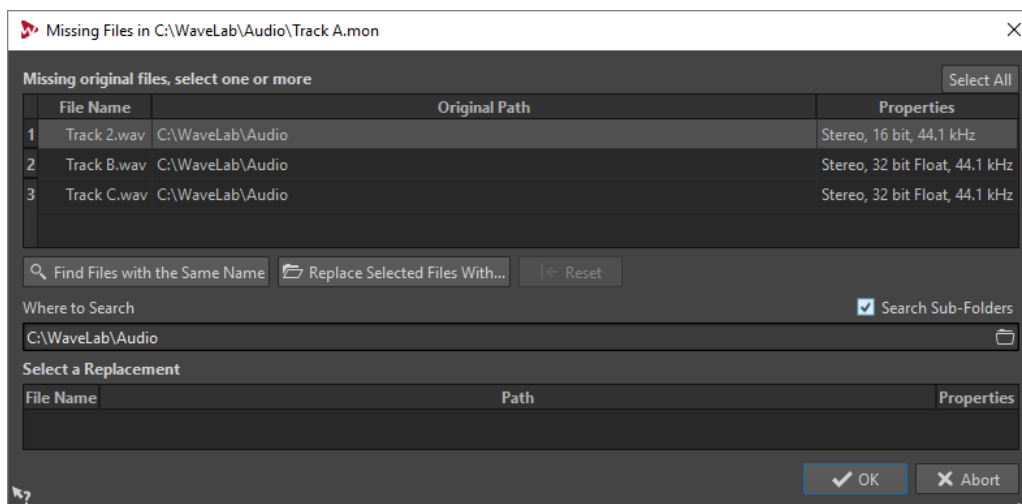

Missing Original Files

Lists the files that cannot be found. Each file can be replaced by an existing file. To search replacements for multiple files, select the files and specify a new path in the **Where to Search** field.

A file with a green checkmark is associated with a valid replacement. A file with a red checkmark is not yet associated with a valid replacement, but there are possible replacement candidates available at the bottom of this dialog.

Find Files with the Same Name

Instructs WaveLab Pro to find all files with the same name in the folder specified in the **Where to Search** field.

Replace Selected Files With

Replaces the missing files with a single specific file.

Reset

Removes all possible replacements for the selected missing files.

Where to Search

Lets you specify a location for searching files. Click **Find Files with the Same Name** to start the search.

Replacement List

Lists the files that can be used as a replacement. You can also drag a file into the list from the File Explorer/macOS Finder.

Assembling the Audio Montage

You assemble your audio montage by adding tracks and clips.

In the audio montage, only one track can be selected at a time. This selected track has a different color for the track control area. Some WaveLab Pro functions are always applied to the selected track.

Tracks

Tracks form the structure that is used to organize clips. The tracks can be mono/stereo audio tracks or picture tracks.

- Audio tracks allow you to add clips to an audio montage.
- Picture tracks allow you to add pictures to an audio montage. These are shown when you play back the final DVD-Audio.

Adding Tracks

You can add stereo tracks, mono tracks, and picture tracks.

PROCEDURE

1. In the **Audio Montage** window, click the number button of a track to open the **Track** pop-up menu.

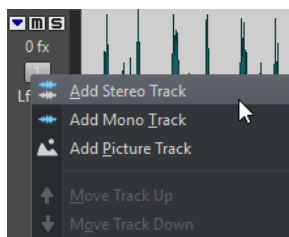

2. Select the track type that you want to add to your audio montage.

RESULT

The new track is added below the selected track. If you want to place it above the selected track, press **Ctrl/Cmd** when adding the new track.

Adding Pictures to a Picture Track

PREREQUISITE

In the **Audio Montage** window, add a picture track to your audio montage.

PROCEDURE

1. On the picture track, set the edit cursor to the position where you want to insert the picture.
2. Right-click an empty area of the picture track and click **Insert Files**.
3. Select a picture and click **Open**.

RELATED LINKS

[Adding Tracks](#) on page 222

Moving Tracks in the Track View

You can change the order of the tracks in the montage window.

PROCEDURE

1. In the **Audio Montage** window, click the number button of a track.
 2. On the pop-up menu, select **Move Track Up** or **Move Track Down**.
-

Removing Tracks

Removing a track with clips also removes the clips. However, the audio files to which the clips refer are not affected.

PROCEDURE

1. In the **Audio Montage** window, click the number button of the track that you want to remove.
 2. On the pop-up menu, select **Remove Track**.
-

Grouping CD Tracks

You can render grouped CD tracks simultaneously and create audio CD reports for grouped tracks.

PREREQUISITE

In the montage window, create CD tracks.

PROCEDURE

1. Select **Tool Windows > CD**.
 2. In the **CD** window, click in the **Group** column of a CD track and select a group.
-

RELATED LINKS

[CD Window](#) on page 296

[Audio CD Reports](#) on page 420

[Render Tab](#) on page 211

Folding and Unfolding Tracks

To save screen space, you can fold tracks that do not need to be visible.

- To fold a track, click the arrow button at the top left corner of the track control area.

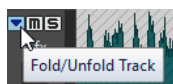

- To unfold a folded track, click the button again, or double-click anywhere on the folded track.

Locking and Unlocking Tracks

You can lock tracks to prevent them from being accidentally moved, edited, or deleted.

- To lock a track, click the number button of the track and activate **Lock**.

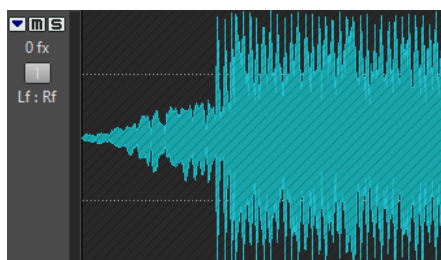

- To unlock a track, click the locked track, or click the number button of the track, and deactivate **Lock**.

Left/Right and Mid/Side Mono Tracks

You can split a stereo audio track into two mono tracks, either in **Left/Right** or **Mid/Side** mode. This is a virtual split which does not affect or create audio files.

When you split into mid/side mono tracks, the upper track displays the mid signal and the lower track displays the side signal. This allows you to process the mid or side signal with any effect plug-in independently, and use independent envelopes.

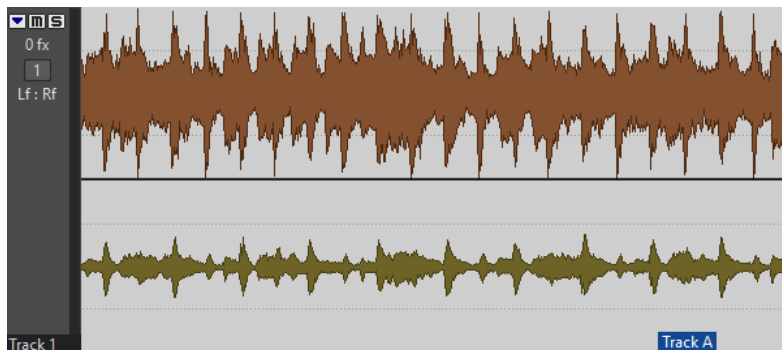

The mid/side signals are automatically converted back to left/right signal at the montage output.

Splitting Stereo Tracks into Mono Tracks

You can split stereo tracks into left/right or mid/side mono tracks. This is a virtual split which does not affect or create audio files.

PROCEDURE

1. In the **Audio Montage** window, click the number button of the track that you want to split.
2. Do one of the following:
 - To split the stereo track into two left/right mono tracks, select **Split into Left/Right Mono Tracks**.
 - To split the stereo track into two mid/side mono tracks, select **Split into Mid/Side Mono Tracks**.

RESULT

The track is split. If there are clips on the track, the two stereo sides are now separate clips, allowing you to move, edit, or process them independently. If the track has no clips, this is the same as deleting the track and inserting two new mono tracks.

The mono tracks are automatically grouped and can only be moved and resized together.

When you drag a stereo clip onto a mid/side mono track, the stereo clip is automatically split into mid and side signals. During playback and rendering, the mid/side channels are automatically combined to left/right channels at the montage output.

Clips

A clip contains a reference to a source audio file on your hard disk as well as start and end positions in the file, volume and pan curves, fades, etc. This allows clips to play back smaller sections of their source audio files.

Any number of clips can reference the same source file. Because a clip only references to the original source file, it contains no audio data. Any number of clips can reference the same source file.

You can also use envelopes and effects on clips.

You can see the clips of the active audio montage in the **Clips** window.

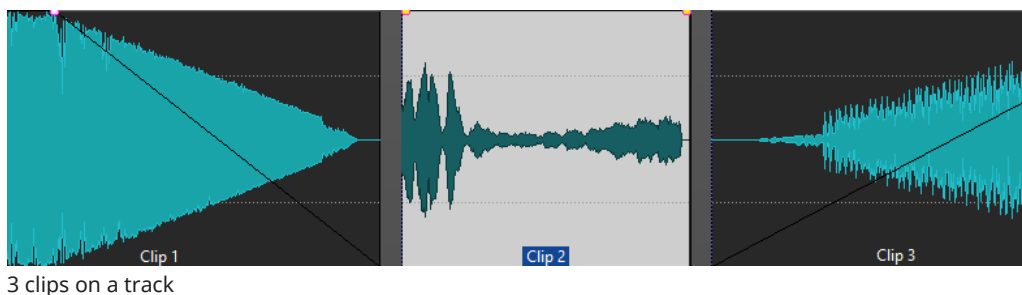

Adding Audio Clips to the Audio Montage

You create clips by inserting audio into the audio montage. There are several ways to do this.

NOTE

You cannot add a mono clip to a stereo track or vice versa.

Dragging Audio from the Wave Window

PROCEDURE

1. In the wave window of the **Audio Editor**, select the audio section that you want the clip to refer to.
 2. Drag the selection onto a track of the audio montage.
If you want to add the whole audio file, drag the tab on a track.
 3. Select an insert option from the pop-up menu that opens when you release the mouse button.
-

RESULT

A clip is created, named after the original file.

Inserting Audio from Open Wave Windows Using the Insert Menu

PROCEDURE

1. In the montage window, right-click an empty area of a track.
 2. From the pop-up menu, select the audio file that you want to insert as clip.
-

Inserting Audio Using Copy and Paste

PROCEDURE

1. In the wave window of the **Audio Editor**, select the audio section to which you want the clip to refer to.
 2. Select the **Edit** tab and click **Copy**, or press **Ctrl/Cmd-C**.
 3. In the montage window, select the track where you want to insert the clip.
The clip insert position is indicated by the edit cursor.
 4. Select the **Edit** tab and click **Paste**, or press **Ctrl/Cmd-V**.
 5. Select an insert option from the pop-up menu.
-

Inserting Audio from the File Explorer/macOS Finder Using Copy and Paste

PROCEDURE

1. In the File Explorer/macOS Finder, select an audio file and press **Ctrl/Cmd-C**.
 2. In the montage window, select the track where you want to insert the clip.
The clip insert position is indicated by the edit cursor.
 3. Select the **Edit** tab and click **Paste**, or press **Ctrl/Cmd-V**.
 4. Select an insert option from the pop-up menu.
-

Dragging Audio Files From the File Browser Tool Window

NOTE

The following can also be done from the File Explorer/macOS Finder.

PROCEDURE

1. Select **Tool Windows > File Browser**.
 2. In the **File Browser** window, select the audio files to which you want the clip to refer, and drag them on a track.
 - If you have selected a single audio file, the **Paste** pop-up menu opens.
 - If you have selected several audio files, the **Insert Audio Files** dialog opens.
 3. Do one of the following:
 - If you have selected a single audio file, select an insert option from the pop-up menu.
 - If you have selected several audio files, specify how the files should be ordered and placed, and click **OK**. Then select an insert option from the pop-up menu.
-

Dragging Regions From the File Browser Tool Window

If you have defined marker regions in an audio file, you can drag these regions from the **File Browser** window onto a track.

PROCEDURE

1. Select **Tool Windows > File Browser**.
 2. In the **File Browser** window, select the audio file to which you want the clip to refer.
On the right side of the **File Browser** window, a list shows the available audio regions of the selected file.
 3. Drag any region to the track.
 4. Select an insert option from the pop-up menu.
-

RELATED LINKS

[File Browser Window](#) on page 31

Importing Audio Files

PROCEDURE

1. In the montage window, select the track on which you want to insert the clip.
The clip insert position is indicated by the edit cursor.

2. Right-click an empty area on the track, and select **Insert Audio Files** from the pop-up menu.
 3. Select the files that you want to insert.
-

Copying Clips From Another Audio Montage

If you have opened more than one audio montage, you can copy clips from one audio montage to another, either by using drag and drop or by using copy and paste.

Dragging Clips From the Clips Tool Window

You can add clips by dragging them from the same audio montage.

PROCEDURE

1. Select **Tool Windows > Clips**.
 2. Select one or several clips, and drag them to a track.
If you drag a single clip on a clip on the track, you must select an insert option from the pop-up menu.
-

Clip Inserting Options

When dragging a single clip on another clip, you can choose between different clip inserting options. For example, you can create default fades. You can also insert multiple clips at the same time.

You can insert clips by pasting, importing from disk, using drag and drop, etc.

Single Clip Inserting

If you insert a single clip at a position in an audio montage that contains another clip, a pop-up menu opens. By selecting one of the menu items, you specify how the clip should be inserted, whether existing clips should be affected or not, etc.

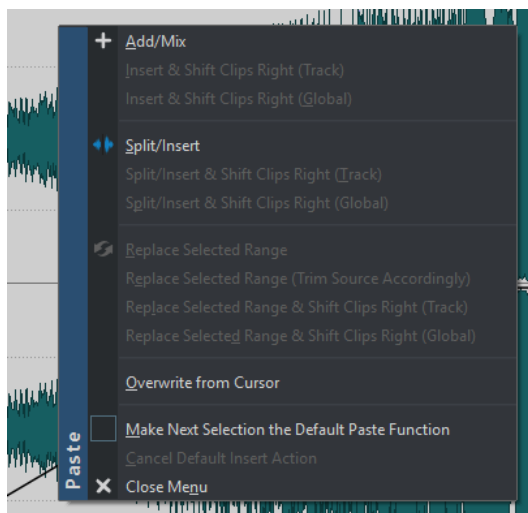

Add/Mix

Inserts the clip without affecting any clips that already exist on the destination track. However, if an inserted audio clip partially overlaps another audio clip, a crossfade is created in the overlapping zone provided that an auto crossfade option is active.

Insert & Shift Clips Right (Track)

All clips to the right of the inserted clip (on the same track) are moved to the right.

Insert & Shift Clips Right (Global)

All clips to the right of the inserted clip (on all tracks) are moved to the right.

Split/Insert

Only available if the insertion point is within an existing clip (audio tracks only). The existing clip is split and the right section is moved to the right. Other clips are not affected.

Split/Insert & Shift Clips Right (Track)

Applies the **Split/Insert** function and moves all other clips on the same track to the right (audio tracks only).

Split/Insert & Shift Clips Right (Global)

Applies the **Split/Insert** function and moves all other clips on all tracks to the right (audio tracks only).

Replace Selected Range

Only available if there is a selection range on the destination track. The clip with the selection range is split at the selection range edges, the inserted clip replaces the range, and the section to the right of the range is moved to the left or right (depending on the length of the inserted clip and the length of the selection range), to close gaps behind the inserted clip.

Replace Selected Range (Trim Source Accordingly)

Only available if there is a selection range on the destination track and if that selection range is shorter than the range of the clip that is to be inserted. The inserted clip overwrites only the selected range. If necessary, the range to be inserted is trimmed according to the current selection.

Replace Selected Range & Shift Clips Right (Track)

Applies the **Replace Selected Range** function and moves all other clips on the same track to the right.

Replace Selected Range & Shift Clips Right (Global)

Applies the **Replace Selected Range** function and moves all other clips on all tracks to the right.

Overwrite from Cursor

Inserts the clip at the edit cursor position. If the inserted clip overlaps any other clips, the overlapped regions are removed from the existing clips.

Make Next Selection the Default Paste Function

If this option is activated, you can select a default option from the menu. This default option is used when inserting audio. However, if the option is not compatible with the context, it is not processed and the default option is deactivated. For example, when using **Replace Selected Range** while there is no range selected.

- To deactivate the default insert action, select the **Edit** tab, right-click the **Paste** button, and select **Cancel Default Insert Action**.

Close Menu

No clip is added.

Inserting Multiple Clips

When you add multiple audio clips to an audio montage by importing them from disk or by using drag and drop, the **Insert Audio Files** dialog opens.

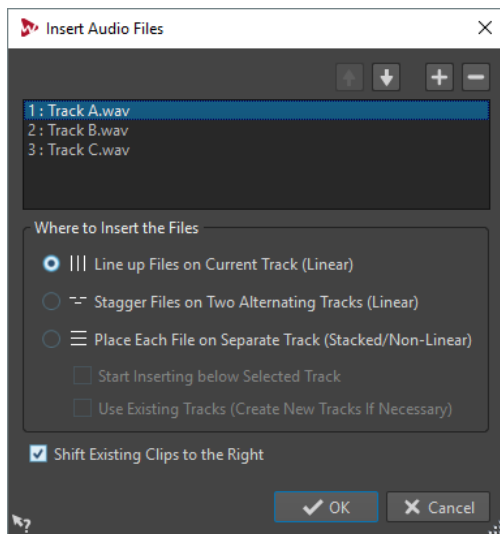

Arrow Up/Down

Moves the selected file up/down in the list.

Add File

Opens the file browser where you can select files to be added to the list.

Remove File

Removes the selected file from the list.

Line up Files on Current Track (Linear)

If this option is activated, the clips are added to the audio montage, lined up contiguously on a single track and spaced according to the **Pre-Gap**. The pre-gap can be defined in the **Audio Montages Preferences**.

Stagger Files on Two Alternating Tracks (Linear)

If this option is activated, the clips are added to the audio montage, lined up contiguously on two alternating tracks.

Place Each File on Separate Track (Stacked/Non-Linear)

If this option is activated, the clips are added to the audio montage on separate tracks, according to the following settings.

- If **Start Inserting below Selected Track** is activated, the new tracks for the added files are inserted below the selected track.
- If **Use Existing Tracks (Create New Tracks If Necessary)** is activated, the files are added to the existing tracks. If there are more files than existing tracks, new tracks are created.

Shift Existing Clips to the Right

If this option is activated, any existing clips in the audio montage are moved to the right by an amount equaling the length of the first new added file.

Mismatched Sample Rates When Inserting Audio Files

When inserting audio files with a different sample rate than the sample rates of the audio montage, WaveLab Pro can create and use resampled versions of the files.

The resampled file versions are created in the implicit folder that is defined in the **Audio Montages Preferences**. The name of the file is the name of the original file name with the new sample rate as suffix. If the resampled file already exists, it is not recreated. However, you can also activate the option **Recreate Resampled Files** in the **Mismatched Sample Rates** dialog.

This creates a 32-bit float file without any dithering process.

If you modify the original audio file, you must use the **Replace Audio File** option in the **Insert** tab of the **Audio Montage** window to select the modified audio file. This will recreate the resampled file.

Mismatched Sample Rates Dialog

This dialog opens when you insert an audio file with a different sample rate than the sample rate of the audio montage. It allows you to create a resampled copy of the audio file.

You can specify the quality of the resample conversion in the **Global Preferences**.

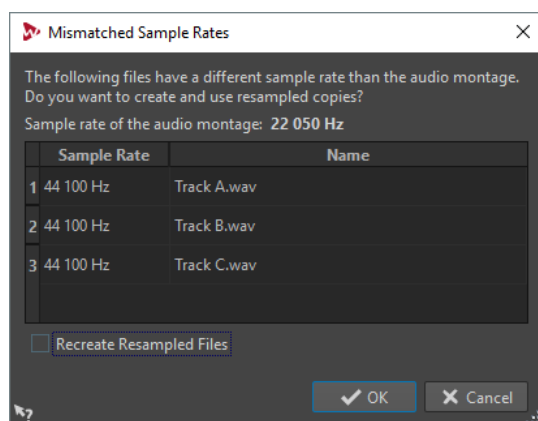

Recreate Resampled Files

If this option is activated and a resampled file exists, it is recreated. Otherwise, the existing version is used. Activate this option if the original audio file has been modified and you want to recreate its resampled version.

RELATED LINKS

[Resample Conversion Quality](#) on page

Empty Clips

If the audio file of a clip is missing, an empty clip displays the length and position of the missing clip.

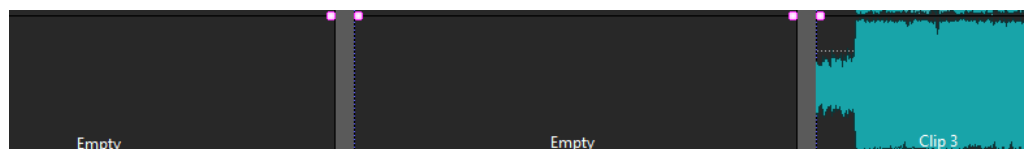

Empty clips are useful for the following:

- As place holders, to create audio montage templates with empty clips.

- As an alternative to muting a clip. The difference is that for empty clips no audio is copied when cloning the audio montage.
- To define regions. Because a clip has a start and end point in the audio montage, it defines a range which can be used as a reference for any purpose.

Creating Empty Clips

You can create an empty clip from a selection range.

PROCEDURE

1. In the montage window, select a range.
 2. Right-click an empty area of the track, and select **Create Empty Clip from Selection Range**.
-

Removing the Source of Clips

You can create an empty clip by removing a source file of a clip. This does not delete the audio file from the disk.

PROCEDURE

1. In the montage window, select the clip for which you want to remove the source audio file.
 2. Select the **Insert** tab.
 3. In the **Selected Clip** section, click **Replace Audio File**, and select **Remove Source**.
-

Saving and Loading Clips

You can save clips to disk as separate files. This is useful if you have, for example, created a perfect fade, envelope, or clip effect configuration, but want to continue experimenting with the clip in the audio montage.

By saving the clip, you can always revert to the perfect version by reloading it. However, saved clips are still a reference to the original source file and contain no audio data.

Saving Clips

PROCEDURE

1. In the montage window, right-click the bottom area of a clip.
 2. From the pop-up menu, select **Save Clip**.
 3. In the **Save Clip as** dialog, specify a name and location, and click **Save**.
-

Loading Clips

PREREQUISITE

Select a stereo track for stereo clips and a mono track for mono clips.

PROCEDURE

1. In the montage window, on an empty part of a track, right-click where you want to insert the clips.
 2. From the pop-up menu, select **Insert Clip Files**.
 3. Select a `.clip` file, and click **Open**.
-

RESULT

The clips are inserted on the selected track. If you selected more than one clip, the first clip is positioned at the audio montage cursor, and any following clips are placed according to the default pre-gap time that is set in the **Audio Montages Preferences**. When you import several clips, they are sorted alphabetically according to their the file names.

Rearranging Clips

You can freely arrange clips in the montage window.

Selected and Active Clips

There is a distinction between selected and active clips. Some editing functions can only be processed on an individual clip or active clip, while others can be processed on multiple clips or selected clips.

- A selected clip is a clip that you have selected using any of the selecting clips procedures. Several clips can be selected at the same time. This allows you to edit multiple clips at the same time using functions such as copy, delete, move, etc. Selected clips have a different background color. Right-clicking in the top part of a clip opens the **Clip Selected Range** menu.
- An active clip is the clip that you selected, clicked, or edited last. Only one clip can be active at a time. By default, the active clip is distinguished by a highlighted name label. Some functions can only be processed on a active clip. Right-clicking in the lower part of a clip opens the **Active Clip** menu.

Mouse Zones

Basic rearranging of clips in the audio montage is achieved by clicking and dragging with the mouse. However, the results of dragging with the mouse depend on where in the clip you click. The different areas in a clip are called mouse zones.

By default, the mouse zones have the following basic functionalities:

Top Clip Area

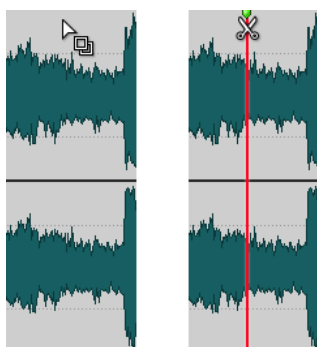

- Copy a clip by dragging.
- Open the source file by double-clicking.
- Split at cursor position by double-clicking the edit cursor or pressing **S**.

Upper Clip Area

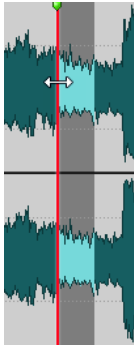

- Select a range.
- Open the **Clip Selected Range** menu by right-clicking.

Lower and Bottom Clip Area

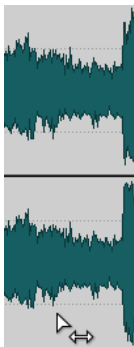

- Move a clip by dragging.
- Open the **Active Clip** menu by right-clicking.

Clip Edges

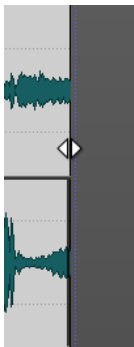

- Resize a clip by dragging the edges, while keeping the audio source static.
- Resize the left or right side of a clip while letting the audio follow by holding **Ctrl/Cmd** and dragging the left or right edges.

Clip Name



- Rename the clip by double-clicking.

When you move the mouse cursor over a mouse zone, the info line at the bottom left indicates the corresponding actions.

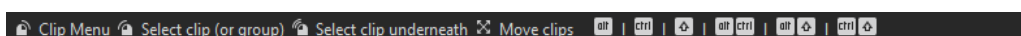

Info Line

The info line at the bottom of the **Audio Montage** window shows what happens when you click the mouse button with or without modifier keys, depending on the cursor position.

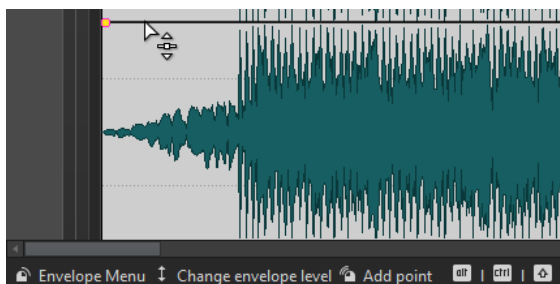

- To activate/deactivate the info line, open the **Audio Montages Preferences**, and on the **All Audio Montages** tab, activate/deactivate **Display Indications of Possible Actions**.

The following symbols are used on the info line:

Single-click



Indicates what happens when you click.

Double-click



Indicates what happens when you double-click.

Right-click



Indicates that you can right-click to display a menu. The name of the menu is displayed to the right of the symbol.

Ctrl/Cmd-click



Indicates that you can **Ctrl/Cmd**-click for an additional function.

Alt-click



Indicates that you can **Alt**-click for an additional function.

Shift-click



Indicates that you can **Shift**-click for an additional function.

Drag up/down



Indicates what happens when you click and drag up or down.

Drag left/right



Indicates what happens when you click and drag left or right.

Drag in any direction



Indicates what happens when you click and drag an item in any direction within the audio montage.

Drag out of the audio montage



Indicates what happens when you click and drag an item out of the audio montage.

Moving/Resizing clips or changing envelope values



This indicates that you are moving or resizing clips, or changing envelope values, for example.

Combined modifier keys



Indicates that you can use combined modifier keys.

Magnetic Bounds in Audio Montages

Some positions, such as markers or the start and end of a clip, can be defined as magnetic. Dragg ed elements can snap to these positions. This makes it easier to position items accurately.

For example, when you move or resize a clip, and its edges or its cue point get close to one of the magnetic bounds, the clip snaps to this position. A label is displayed, indicating the snap position.

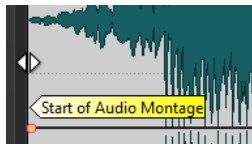

To place the cursor at a magnetic position, click the time line and hold the mouse button pressed. When you now move the cursor vertically, the cursor jumps to the next magnetic bound.

Activating Snapping to Magnets

To make use of the magnetic bounds function, **Snap to Magnets** must be activated.

PROCEDURE

1. In the **Audio Montage** window, select the **Edit** tab.
 2. In the **Snapping** section, activate **Snap to Magnets**.
-

Magnets Menu

In this pop-up menu, you can specify which positions should be magnetic. When **Snap to Magnets** is activated, items that you move snap to these positions.

- To open the **Magnets** pop-up menu, select the **Edit** tab in the **Audio Montage** window, and click **Magnets** in the **Snapping** section.

You can let items snap to the following positions:

Start of Montage

Makes the start of the audio montage magnetic.

Clip Start

Makes the start of the clips magnetic.

Clip End

Makes the end of the clips magnetic.

Clip Cue Point

Makes the cue point in the clips magnetic.

Clip End Cue Point

Makes the position that is located after the clip end magnetic. If this option is deactivated, all end cue points are invisible in the audio montage.

Time Ruler Marks

Makes the main time units that are displayed in the ruler magnetic.

Markers

Makes the markers magnetic.

Markers in Audio Sources

Makes the markers in the original audio files of the clip magnetic if they are visible.

Time Selection Edges

Makes the edges of the selected time range magnetic.

Cursor

Makes the edit cursor magnetic.

Selecting Clips

You can edit multiple selected clips at once.

- To select a clip, click the lower clip area. Selected clips are displayed in a different color.
- To select multiple clips, **Ctrl/Cmd**-click the lower clip areas.
- To select a range of clips, **Shift**-click them.
- To select several adjacent clips, double-click the upper clip area, and after the second click, drag to select the adjacent clips.

- To select several clips on several tracks with a selection rectangle, hold down **Ctrl/Cmd-Shift**, and drag the rectangle.
- To choose between several clip selection options, open the **Clips** window and select an option from the **Select** menu, or right-click the top clip area of a track and select from the **Clip Selected Range** pop-up menu.

Selection Ranges in Audio Montages

A selection range is a selected area on a track. The selection range can be entirely or partially within a clip or an empty section of the track.

Selection ranges are useful for the following:

- To edit clips by cutting or erasing the selection, or trimming the clip to the selection.
- To create a new clip by dragging the selection range to another track.
- To open a montage window with the selection range from the source audio file by dragging the selection range to the **Audio Editor**.
- To play back only the selection range, either the whole audio montage or only the clip with the intersecting clip part.
- To loop the playback within the selection by activating the loop and selecting the **Loop** mode on the transport bar.

Creating and Editing Selection Ranges in Audio Montages

You can resize, create, move, and remove selection ranges.

- To create a selection range in an empty area on a track, click and drag with the mouse. The start and end position and the length of the range are displayed on the info line.
- To create a selection range within a clip, click and drag with the mouse in the upper clip area. The start and end position and the length of the range are displayed on the info line.
- To create a selection range of the area between two markers, double-click between the markers.
- To create a selection range from a region marker pair, press **Shift**, and double-click the start or end marker. In the **Markers** window, you can also double-click the **Length** field of a region marker.
- To create a selection range from a CD track, open the **CD** window and double-click the number to the left of the corresponding track.
- To create a selection range from a clip, open the **Clips** window and **Alt**-click the number to the left of the corresponding clip. To zoom in on the selected clip, double-click the number to the left of the clip.
- To resize a selection range, **Shift**-click and drag to the left or to the right, or click and drag the edges of the selection range.
- To move a selection range, press **Ctrl/Cmd** and **Shift**, and drag the selection range to the left or right.
- To deselect a selection range, click elsewhere in the audio montage, or press **Esc**.

Clip Context Menus

Many editing functions for clips can be accessed via the clip context menus. Depending on where you right-click the clip, different context menus are available.

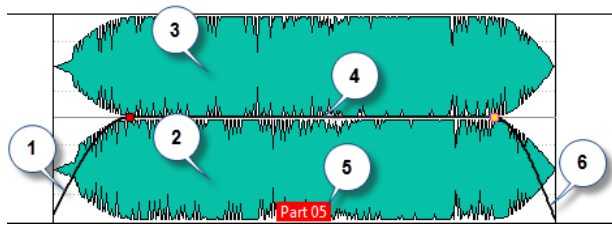

- 1 Fade in section**
Opens the **Fade In** pop-up menu where you can edit the fade in.
- 2 Bottom area of a clip**
Opens the **Active Clip** pop-up menu where you can edit the active clip.
- 3 Upper area of a clip**
Opens the **Clip Selected Range** pop-up menu where you can select specific areas of a clip, lock a clip, etc.
- 4 Sustain section**
Opens the **Envelope** pop-up menu where you can edit the envelope.
- 5 Clip name**
Opens the **Effects** pop-up menu where you can add effects to the clip.
- 6 Fade out section**
Opens the **Fade Out** pop-up menu where you can edit the fade out.

Clip Editing

All clips are displayed in the **Clips** window. In this window, you can edit and rearrange clips and drag them into the audio montage.

The active clip is highlighted in the clips list.

RELATED LINKS

[Clips Window](#) on page 238

Clips Window

This window contains a list of the clips that are placed in the active audio montage together with additional information about the clips.

- To open the **Clips** window, open an audio montage and select **Tool Windows > Clips**.

	Src	Name	Track	FX	Pre-Gap	Start	End	Length	Pre-Gain	Post-Gain	Mute	Comment
1	>>	Track A	1		0 s	0 s	10 mn 9 s 465 ms	10 mn 9 s 465 ms	0 dB	0 dB	<input type="checkbox"/>	
2	>>	Track B	2		0 s	10 mn 9 s 465 ms	20 mn 5 s 240 ms	9 mn 55 s 775 ms	0 dB	0 dB	<input type="checkbox"/>	
3	>>	Track C	2		2 s 227 ms	20 mn 7 s 466 ms	20 mn 15 s 615 ms	8 s 149 ms	0 dB	0 dB	<input type="checkbox"/>	
4	>>	Track D	2		3 s 644 ms	20 mn 19 s 259 ms	20 mn 24 s 800 ms	5 s 541 ms	0 dB	0 dB	<input type="checkbox"/>	

Clip List

In the clip list columns, you can edit the following settings for each clip:

- Name
- Track number
- Pre-gap
- Start and end time
- Length
- Pre-effect gain
- Post-effect gain
- Comment

You can also mute and lock clips, search for clip names, and play back a clip with or without pre-gap. The playback buttons work in the following way:

From Start with Pre-Roll



Playback from start with a pre-roll.

You can also press **Alt** and click **From Start with Pre-Roll** to play back from the start with a short pre-roll.

From Start



Playback from start.

The FX icon indicates that a clip contains one or more plug-ins. Double-clicking the FX icon opens the **Effects** window.

- To zoom in on the clip, click the name of the clip.
- To select the time range corresponding to the clip, **Alt**-click the number to the left of the clip name.
- To zoom in and select the time range at the same time, double-click the number to the left of the clip name.

Select Menu

Select All Clips

Selects all clips in the audio montage.

Select Clips on Selected Track

Selects all clips that are included in the selected track.

Select Clips Inside Selected Time Range

Selects all clips that are fully encompassed in the selected time range on all tracks.

Select Clips Located Before the Cursor (on Selected Track)

Selects all clips that have their end point to the left of the cursor on the selected track.

Select Clips Located Before the Cursor (on All Tracks)

Selects all clips that have their end point to the left of the cursor on all tracks.

Select Clips Located After the Cursor (on Selected Track)

Selects all clips that start to the right of the cursor on the selected track.

Select Clips Located After the Cursor (on All Tracks)

Selects all clips that start to the right of the cursor on all tracks.

Inverse Selection

Deselects all selected clips and selects all other clips.

Deselect All Clips

Deselects all selected clips.

Functions Menu

Create Super Clip from Selected Clips

Replaces the selected clips with a super clip that refers to a sub-montage.

Export Clip List as Text

Opens a plain text version of the clip list in the default text editor.

Batch Renaming

Opens the **Batch Renaming** dialog in which you can batch-rename any number of clips.

Use Audio File Name for Selected Audio Clips

Names each clip after the audio file to which it refers.

Update BWF Time Stamps (Selected Clips)

Updates the time stamp of each audio file that is referenced by a selected clip to reflect the clip position in the audio montage.

The file header of a WAV audio file may contain a time stamp in the Broadcast Wave Format. This time stamp makes it possible to insert audio at precise positions in different applications. The audio files are marked as modified and must be saved.

Move Selected Clips to Their Related BWF Time Stamp

Moves the selected clips to the positions that are contained in their source audio files, provided the audio files contain a time stamp.

Align Clips

Opens the **Align Clips** dialog which lets you align all selected clips on the selected track relatively to one another.

Resize Selected Clips to Match the Active Clip

Uses the length of the active clip as reference to change the length of all selected clips.

Mute/Unmute Selected Clips

Mutes/unmutes all selected clips.

Lock/Unlock Selected Clips

Locks the clip to avoid that it is accidentally edited.

Lock/Unlock Moving and Resizing

Locks the position and size of a clip. Other editing options are still possible.

Show/Hide Clip Ruler and Markers of Source File

Changes the visibility of the ruler and the marker display of the source audio files for all selected clips.

Options Menu

Only Show Selected Clips

If this option is activated, only clips that are selected in the montage window are displayed. This is useful to display only the clips that belong to a specific group (**Groups** window) or to a specific audio file (**File Browser** window).

Show Audio Clips

If this option is activated, only audio clips are displayed.

Show Picture Clips

If this option is activated, only picture clips are displayed.

Show Global Pre-Gaps

Displays the length of the gap between the start of a clip and the end of the previous clip on any track in the **Pre-Gap** column. If the clips overlap, the length is displayed in red.

Show Pre-Gaps by Track

Displays the length of the gap between the start of a clip and the end of the previous clip on the same track. If the clips overlap, the length is displayed in red.

Zoom the Clip When Selected

If this option is activated when you select a clip in the list, the clip fills the track area in the most efficient way.

Make Clip Entirely Visible When Selected

If this option is activated when you select a clip in the list, the track area is scrolled and/or zoomed to display the whole clip.

Customize Command Bar

Opens the **Customize Commands** dialog which contains options to hide or show specific command bar buttons.

Filtering Clip Names

The search field in the **Clips** window allows you to filter the clips list.

You can perform a text search in the **Name** and **Comment** columns. To perform a text search in the **Comment** column, this column must be sorted. Otherwise, the name column is searched. The **Select All** function selects the filtered items.

- To search for clips, click in the search field, and enter text.
- To switch the focus from the search field to the clips list, press the arrow down key.
- To switch the focus from the clips list to the search field, press **Ctrl/Cmd-F**.

Align Clips Dialog

This dialog allows you to align clips at specific positions and add a space between them. You must select at least two clips to use this function.

- To open the **Align Clips** dialog, open the **Clips** window, and select **Functions > Align Clips**.

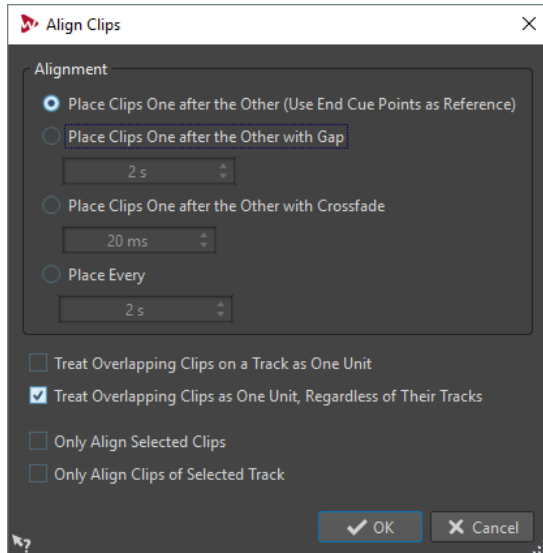

NOTE

Clips can be moved independently from the group to which they belong.

Place Clips One after the Other (Use End Cue Points as Reference)

Positions the selected clips successively on the selected track. Each clip is aligned at the end cue point of the preceding clip.

Place Clips One after the Other with Gap

Positions the selected clips on the selected track. In the time field, specify the time between the end of a clip and the start of the next clip.

Place Clips One after the Other with Crossfade

Positions the selected clips on the selected track and creates crossfades between them. In the time field, specify the crossfade time.

Place Every

Lets each clip start at the specified interval from the start of the preceding clip. In this case, the clips can overlap each other. In the time field, specify the interval between the start of a clip and the start of the next one.

Treat Overlapping Clips on a Track as One Unit

All overlapping or adjacent clips on a track are treated as one unit. This means that all clips are aligned with the same offset.

Treat Overlapping Clips as One Unit, Regardless of Their Tracks

All overlapping or adjacent clips on a track are treated as one unit, even if they are on different tracks. This means that all clips are aligned with the same offset.

Only Align Selected Clips

If this option is activated, only selected clips are moved. If a group of overlapping clips contains a clip that is not selected, the group is not moved.

Only Align Clips of Selected Track

If this option is activated, only clips of the selected track are moved. For example, if a group of overlapping clips contains a clip that is not part of the selected track, the group is not moved.

Reordering Clips in Audio Montages By Dragging

In the **Clips** window, you can re-order clips by dragging them to another position in the list.

PROCEDURE

1. Open the **Clips** window.
2. In the clip list, drag a clip to another position in the list.
The option **Move Overlapping Clips Together** is taken into account.
You can move more than one clip at the same time, by selecting multiple clips and dragging them. If more than one clip is selected, all clips between the leftmost selected clip and the rightmost selected clips are moved.

RELATED LINKS

[Clips Window](#) on page 238

Exporting the Clip List as Text

You can export clip list information like names, source files, tracks, and clip length.

PROCEDURE

1. Open the **Clips** window.
2. In the **Clips** window, select **Functions > Export Clip List as Text**.
3. Activate the option for the information that you want to export.
4. Select the output format from the pop-up menu.
5. Click **OK**.

RESULT

The clip list opens in the selected output format. If you select **Print**, the **Print Preview** window opens. The text file is saved in the folder for temporary files.

RELATED LINKS

[Temporary Files](#) on page 86

Export Clip List as Text Dialog

This dialog allows you to export the clip list in various file formats, or to print it out. You can select what clip information is included in the exported file.

- To open the **Export Clip List as Text** dialog, open the **Clips** window, and select **Functions > Export Clip List as Text**.

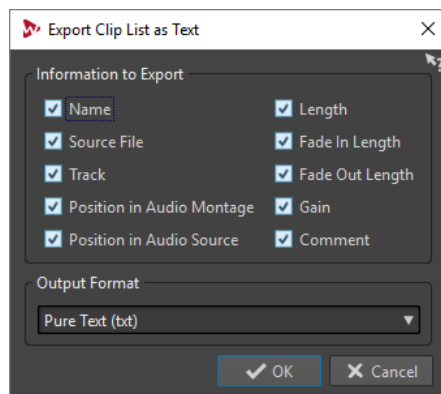

Moving and Crossfading Clips

You can let clips overlap other clips, move them, and create crossfades between clips.

Moving Clips

NOTE

The channel configuration of the clip must match the destination track.

PROCEDURE

1. In the montage window, select the clips that you want to move.
 2. Click the lower clip area, and drag the clips in any direction.
While dragging, the info line displays the current start position of the clip.
-

Moving Clips with Auto Grouping

The options for auto grouping allow you to specify how clips are moved. The options can be selected in the **Audio Montage** window, on the **Edit** tab, in the **Auto Grouping** section.

RELATED LINKS

[Options for Moving and Crossfading Clips](#) on page 245

Optimized Crossfades When Snapping to Other Clips

If you line up clips so that one clip ends exactly where the next one starts, for example, by using the **Magnets** option, the waveforms at the intersection point probably do not match. To avoid sudden level changes, that may result in pops and clicks, you can optimize the crossfade when snapping to other clips.

On the **Edit** tab, in the **Snapping** section, open the **Crossfading** pop-up menu, and activate **Snap to Waveform When Crossfading**. When this option is activated and you move a clip so that its start snaps to the end of another clip, the following happens:

- WaveLab Pro scans the waveforms of the clips within a short range to find the position where the waveforms of the two clips match best. This is the same automatic phase matching as in the **Wave Matching** window. You can specify how far you want the program to scan into the clips, by selecting a search range on the menu of the **Wave Matching** window.
- The position of the clip that you moved is adjusted slightly to achieve the best possible match between the waveforms. This creates a short crossfade.

NOTE

This function only applies when moving from right to left, for example, when you let the start of the moved clip snap to the end of the clip on the left.

RELATED LINKS

[Magnetic Bounds in Audio Montages](#) on page 235

[Wave Matching Window](#) on page 279

Overlapping Clips

You can move clips so that they overlap each other.

Note the following:

- The tracks in the audio montage are polyphonic, which means that each track can play back several overlapping clips at the same time. Overlapping clips are transparent, allowing you to see the underlying clips and their waveforms.
- To select an overlapped clip, click the bottom clip area of the crossfade area.
- There are crossfading options that automatically adjust the level envelope curves when you overlap clips.

Options for Moving and Crossfading Clips

There are several options that help you when moving and crossfading clips. You can choose how you want clips to be handled when they are moved, decide whether automatic fades are created or not, and select the behavior of clips when they are moved.

Ripple

The ripple options are available in the **Edit** tab of the **Audio Montage** window.

Track

If this option is activated and you move a clip horizontally, all clips on the selected track that are located to the right of the edited clip are also moved. This option also applies when moving or resizing clips, and when inserting or pasting more than one clip at the same time.

Global

If this option is activated and you move a clip horizontally, all clips on all tracks that are located to the right of the edited clip are also moved. This option is taken into account when moving or resizing clips, and when inserting or pasting more than one clip at the same time.

Auto Grouping

The auto grouping options are available in the **Edit** tab of the **Audio Montage** window.

Track

If this option is activated and you move a clip horizontally, all overlapping or adjacent clips on the same track are also moved.

Global

If this option is activated and you move a clip horizontally, all vertically overlapping clips on all tracks are also moved.

Crossfading

The following crossfading options are available in the **Fade** tab of the **Audio Montage** window in the **Options** section.

Overlaps

This pop-up menu allows you to set the automatic crossfading behavior.

- If **No Automatic Crossfading** is activated, no automatic crossfading is performed when clips overlap.
- If **Free Overlaps** is activated, automatic crossfades are created when a clip overlaps another clip on the same track. The length of the overlap determines the length of the crossfade.
- If **Fade In Constrains Overlaps** is activated, the fade in length of a clip constrains the maximum possible overlap, and thus the crossfade time. If the clip on the right side, that is, the clip with the fade in in the overlap, is moved to the left past the set overlap time, the other clip is progressively resized.

Moving the other clip to the right into the clip that contains the fade in in the overlap produces the same result.

- If **Fade Out Constrains Overlaps** is activated, the fade out length of a clip constrains the maximum possible overlap, and thus the crossfade time. If the clip on the left side, that is, the clip with the fade out in the overlap, is moved to the right past the set overlap time, the other clip is progressively resized. Moving the other clip to the left into the clip that contains the fade out in the overlap produces the same result.

Automatic Crossfading

This pop-up menu allows you to make automatic crossfading settings.

- If **Allow Automatic Crossfading with Clips on Selected Track** is activated, crossfades are automatically created when you move a clip so that it overlaps another clip that is located on the selected track.
- If **Allow Multiple Automatic Crossfades** is activated, crossfades are automatically created for all moved clips that overlap other clips on their track. If this option is deactivated, a crossfade is only created for the clip that you drag, even if several clips are moved simultaneously.

Options

- If **Create Default Fades in New Clips** is activated, all new clips get the default fade in and fade out shape and length. For clips that are created by splitting a clip, only the default fade time is used.
- If **Lock Fade Times When Adjusting Clip Edges** is activated, the defined fade in and fade out lengths are locked to the clip start or end, even if you adjust the clip edges. This means that if you resize a clip by dragging its edge, the corresponding fade junction point moves accordingly, while maintaining the fade length.

The following crossfading options are available in the **Edit** tab of the **Audio Montage** window, in the **Snapping** section.

Crossfading

This pop-up menu allows you to make snapping settings for crossfades.

- If **Snap to Waveform When Crossfading** is activated and you create a crossfade by dragging a clip towards another one located on its left side, the position of the moved clip is automatically adjusted to obtain a good correspondence between the clip waveforms. This correlation process provides a crossfade that is aligned in phase.
- If **Create Crossfade and Snap to Waveform When Snapping to Left Clip** is activated and you move a clip to let its start snap to the end of another clip on its left, the clip is slightly moved to the left to create a short crossfade that is based on an optimal correlation between the two waveforms. This correlation process provides a crossfade that is aligned in phase.
- If **Create Crossfade When Snapping to Left Clip** is activated and you move a clip to let its start snap to the end of another clip on its left, the clip is slightly moved to the left to create a crossfade.

The length of the crossfade is the fade in length of the clip on the right. If the fade in length is zero, the fade out length of the left clip is used as a basis instead. If that length is also zero, the **Create Crossfade and Snap to Waveform When Snapping to Left Clip** function is performed if activated.

Creating Clips from Selection Ranges

You can create clips from a selection range. If no clip is overlapping the selection, an empty clip is created.

PROCEDURE

1. In the montage window, select a clip.
 2. Select a range in the clip.
 3. Select the **Edit** tab.
 4. In the **Clip** section, click **Create from Selection**.
-

Duplicating Clips

NOTE

The channel configuration of the clip must match the destination track.

PROCEDURE

1. In the montage window, select one or more clips.
 2. Click the upper clip area and drag the clips in any direction.
While you are dragging, a dotted line indicates where the first of the copied clips will be placed. The position is also indicated on the info line.
If you dragged a single clip, a pop-up menu opens. Select the option that you want to apply to the duplicate of the clip. The ripple and auto grouping settings are taken into account.
-

Duplicating with Ripple and Auto Grouping

If you duplicate more than one clip, the auto grouping and ripple settings affect the result.

The following options are available on the **Edit** tab, in the **Ripple** section:

- If **Track** is activated and you move a clip horizontally, all clips on the selected track that are located to the right of the edited clip are also moved.
- If **Global** is activated and you move a clip horizontally, all clips on all tracks that are located to the right of the edited clip are also moved.

The following options are available on the **Edit** tab, in the **Auto Grouping** section:

- If **Track** is activated and you move a clip horizontally, all overlapping or adjacent clips on the same track are also moved.
- If **Global** is activated and you move a clip horizontally, all vertically overlapping clips on all tracks are moved.

Repeating Clips

You can make a number of copies of a clip and position them at various intervals on the current track of your audio montage.

NOTE

Repeating clips does not create overlapping clips.

PROCEDURE

1. In the montage window, select the clip that you want to repeat.
 2. Optional: Place the edit cursor.
 3. Select the **Edit** tab.
 4. In the **Clip** section, click **Repeat Clip**.
 5. In the **Repeat Clip** dialog, select one of the following options:
 - Select **Count**, and specify the number of copies.
 - Select **Repeat Until Cursor**.
 6. Select one of the **Placement** options.
 7. Click **OK**.
-

RESULT

The clips are repeated. If you chose **Repeat Until Cursor**, the last clip starts to the left of the audio montage cursor.

Repeat Clip Dialog

This dialog allows you to specify the number of clones to produce and control their placement, alignment, and spacing.

- To open the **Repeat Clip** dialog, select the **Edit** tab in the **Audio Montage** window, and click **Repeat Clip** in the **Clip** section.

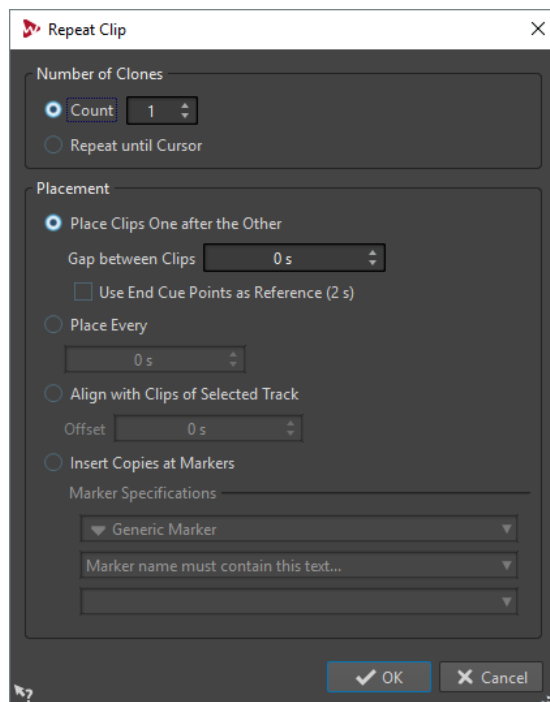

Number of Clones

Count creates the specified number of clones.

Repeat until Cursor creates clones up to the edit cursor.

Placement

Place Clips One after the Other places the clips one after the other on the track.

Use End Cue Points as Reference places the selected clips one after the other on the focused track. Each clip is aligned with the end cue point of the preceding clip.

Gap between Clips sets the gap duration between clips.

Place Every places the copied clips in the time interval that you set in the field below. This is the interval between two succeeding clip starts.

Align with Clips of Selected Track aligns the copied clips with the starting position of the clips on the selected track, including any offset value that you can set in the **Offset** field.

Insert Copies at Markers aligns the copied clips with specific markers. Specify these markers on the menus below.

Creating New Clips by Dragging Selections

You can drag selection ranges to create a new clip.

PROCEDURE

1. In the montage window, select a range.
If the selection range covers more than one clip, only the section that is part of the active clip is copied.
2. Click the upper clip area and drag the selection to the new position.
When you are dragging, the position of the pointer is displayed on the info line. The magnets settings are taken into account.
3. Select one of the insert options.

NOTE

Envelopes and effects are not included when you copy selection ranges.

Clip Resizing

In this context, resizing usually means moving the start and end points of a clip. This reveals more or less of the original audio file. You can keep the audio source static relative to the time line of the audio montage, or relative to the resized edge of the clip.

Resize Clips With a Static Audio Source

To resize clips, click the left or right edge of the clip and move the start or end point to the left or to the right.

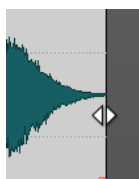

The start and end positions and the length of the clip are displayed on the info line while you are dragging. You cannot drag the edge of a clip past the start or end point of the audio file to which it refers.

When you drag the right edge of a clip, the **Ripple** settings are taken into account. If **Track** is activated, all the following clips on the track are moved when you resize the clip. If **Global** is activated, all clips on all tracks in the audio montage are moved.

If you press **Alt**, all selected clips are resized by the same value.

Resize Clips With Tied Audio Sources

You can resize a clip while having the audio source tied to the edge that you are moving. You **Ctrl/Cmd**-click the left or right edge of the clip and move the start or end point to the left or to the right.

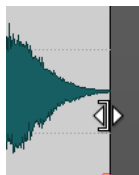

The start and end positions and the length of the clip are displayed on the info line while you are dragging. Magnetic bounds and the auto grouping options apply.

If you press **Alt-Ctrl/Cmd** when resizing, all selected clips are resized by the same value.

RELATED LINKS

[Options for Moving and Crossfading Clips](#) on page 245

Resizing Clips by Cropping

You can crop clips to remove material at the beginning and end of a clip.

PROCEDURE

1. In the montage window, select a clip range.
 2. Select the **Edit** tab.
 3. In the **Removal** section, click **Crop Clip**.
-

RESULT

The clip is resized so that it contains only the selected audio.

Sliding Audio in Clips

You slide the audio in a clip. This moves the section of the audio source that the clip refers to.

PROCEDURE

1. In the montage window, position the mouse cursor over the lower area of the clip.
2. Press **Ctrl/Cmd-Alt**, and drag left or right to slide the audio source.

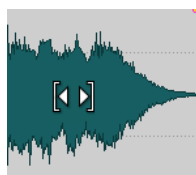

Moving Clips With Fixed Audio Sources

You can move the clip while the audio source remains fixed in position.

PROCEDURE

1. In the montage window, position the mouse cursor over the lower area of the clip.
2. Press **Shift-Alt**, and drag left or right to move the clip.

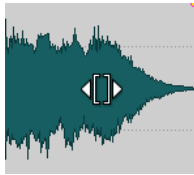

This reveals other sections of the underlying audio source.

Splitting Clips

PREREQUISITE

Decide whether you want to automatically create crossfades between the left and right clip. To activate/deactivate this option, select the **Fade** tab, click **Options** in the **Options** section, and activate/deactivate **Create Default Fades in New Clips**.

PROCEDURE

1. In the montage window, click the position where you want to split the clip.
2. Position the mouse cursor on the edit cursor position in the top clip area.
The cursor becomes a pair of scissors.

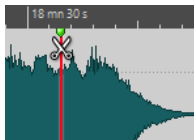

3. Double-click.
-

RESULT

The clip is split in two. The two clips have the same name and settings. Envelopes and fades are converted so that the two clips play back as if they were still one clip.

To split clips on all tracks, select the **Edit** tab, right-click **Split Clip** in the **Split** section, and select **Split Clips on All Tracks**.

Erase Selections of Clips

You can erase a selection range within a clip.

Erasing Parts of Clips Inside Selection Ranges

Erasing the part of a clip inside a selection range results in a gap between the two resulting clips.

PROCEDURE

1. In the montage window, select a range in a clip.
2. Select the **Edit** tab.
3. In the **Removal** section, click **Erase Selected Range**.

If **Snap to Waveform when Crossfading** or **Create Crossfade when Snapping to Left Clip** are activated, the position of the right clip is adjusted for the best possible phase match between the clips.

The auto grouping settings are taken into account.

RELATED LINKS

[Snapping](#) on page 203

Deleting Parts of Clips Inside Selection Ranges and Patching Up

Deleting the part of a clip inside a selection range removes the selected range and moves the right section of the clip to the left to fill the gap.

PROCEDURE

1. In the montage window, select a range in a clip.
2. Select the **Edit** tab.
3. In the **Removal** section, click **Delete Selected Range**.

If any of the automatic crossfading modes or the option **Create Default Fades in New Clips** are activated, a default crossfade is created between the resulting two clips. This creates a clean transition.

Deleting Clips

- Right-click a clip and select **Delete**.
- Select a clip and press **Delete**. To ensure that there is no selection range, press **Esc**.

Locking Clips

You can lock clips to prevent them from being accidentally moved, edited, or deleted.

PROCEDURE

1. In the montage window, select a clip.
 2. Do one of the following:
 - Select the **Edit** tab, open the **Lock** pop-up menu in the **Clip** section, and activate **Full Lock** or **Time Lock**.
 - In the **Clips** window, select **Functions**, and activate **Lock/Unlock Selected Clips** or **Lock/Unlock Moving and Resizing**.
-

RESULT

A lock symbol indicates that a clip is locked.

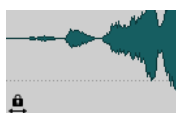

Unlocking Clips

Use one of the following methods to unlock a clip:

- Click in the lower area of the locked clip, and click **Yes** in the message.
- Select the **Edit** tab, open the **Lock** pop-up menu in the **Clip** section, and deactivate **Full Lock** or **Time Lock**.

Clips and Cue Points

A cue point is a defined position marker that belongs to a clip. It may be positioned inside or outside the clip. Cue points are displayed as dotted vertical lines.

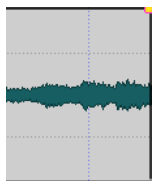

When you move a clip, its cue point is magnetic to any edges, markers, or positions that are activated on the **Magnets** menu. Magnetic cue points allow for easy selection. There are several uses for this:

- Set the cue point at a relevant position in the audio to align the clip with other clips, etc.
- Set the cue point before the start of a clip to position clips in a row with pre-defined spaces.
- Set the cue point at the fade in or fade out point of a clip to maintain defined fade lengths when crossfading.

NOTE

Each clip can only have one cue point. If you select another cue point insert option, the cue point is moved to a new position.

Adding Cue Points

You can add one cue point for each clip.

PROCEDURE

1. In the audio montage, click the clip position where you want to set a cue point.
 2. Select the **Edit** tab.
 3. In the **Clip** section, open the **Cue Point** pop-up menu.
 4. Select one of the following options:
 - **Set at Cursor**
 - **Set at Default Gap Position**
 - **Follows Fade In End Point**
 - **Follows Fade Out Start Point**
 5. Optional: Select **Custom Cue End** and specify a custom cue end point.
-

About Nudging

Nudging in the montage window allows you to make fine adjustments. You can nudge clips, objects, and properties.

Each time that you use the nudge function, the selected element is nudged by a specific amount. By holding down user-specified modifier keys, you can nudge the element by smaller or larger amounts.

Magnetic bounds are not taken into account. Nudged elements do not snap to positions but can be moved freely.

Nudging

PROCEDURE

1. In the montage window, select the objects that you want to nudge.
 2. Select the **Edit** tab.
 3. In the **Nudge** section, click **Target**.
 4. In the **Target** pop-up menu, activate the elements that you want to nudge or activate **Auto Select Item**.
 5. Click **Nudge -** or **Nudge +** in the **Nudge** section or use the nudge icons on the transport bar.
By holding down the user specified modifier keys, you can nudge the element by smaller or larger amounts.
-

Setting the Default Nudge Impulse

You can set the nudge value that is used to adjust the elements. The large, small, and micro impulses are relative to the default value.

PROCEDURE

1. Select **File > Preferences > Audio Montages**.
 2. Select the **All Audio Montages** tab.
 3. In the **Basic Amplitudes for Nudging** section, specify a default time for the nudge impulse in the **Time** field.
 4. In the **Gain** field, specify the default impulse gain for the nudging volume.
-

Elements That Can Be Nudged

The **Target** pop-up menu lists the elements and properties that can be nudged.

- To open the **Target** pop-up menus, select the **Edit** tab in the **Audio Montage** window, and right-click **Target** in the **Nudge** section.

Auto Select Item

Attempts to automatically select what should be nudged, depending on your last action. For example, if your last action was to select or move a clip, the **Clip Position** option is automatically selected in the **Target** menu. In most cases, this allows you to use the nudge feature without having to manually select nudge elements on the submenu.

Clip Position

Moves all selected clips.

Clip's Left/Right Edge

Resizes the active clip. This function is similar to resizing with a static audio source.

Clip's Fade In/Fade Out

Moves the fade in/fade out junction points of the active clip. If the envelope is a stereo envelope, both sides are adjusted.

Clip's Crossfade

Narrows or widens the crossfade zone by moving the junction points of both clips in the crossfade. This nudging only functions if you select the second clip (the one to the right) in a crossfade pair.

Edit Cursor

Moves the edit cursor.

Left Edge of Selected Time Range

Moves the left edge of a selection range.

Right Edge of Selected Time Range

Moves the right edge of a selection range.

Selected Marker

Moves the selected audio montage marker. To select a marker, click it in the area above the ruler.

Volume of Active Clip

Adjusts the volume of the active clip step by step according to the **Gain** setting in the **Audio Montages Preferences**.

Volume of All Selected Clips

Adjusts the volume of all selected clips step by step according to the **Gain** setting in the **Audio Montages Preferences**.

Pan of Active Clip

Adjusts the pan of the active clip. **Nudge +** pans to the left and **Nudge -** to the right.

Pan of All Selected Clips

Adjusts the pan of all selected clips. **Nudge +** pans to the left and **Nudge -** to the right.

Surround Pan of Active Clip

Adjusts the pan of the active clip. **Nudge +** pans to the left and **Nudge -** to the right.

Surround Pan of All Selected Clips

Adjusts the pan of all selected clips. **Nudge +** pans to the left and **Nudge -** to the right.

Displaying Clips in Mid and Side View

- To activate the mid/side view, right-click the upper area of a clip, and select **Show/Hide Mid/Side Channels**.

NOTE

This does not affect playback and plug-in processing.

Audio Montages within Audio Montages

You can insert external audio montages in an audio montage or gather several clips of an audio montage to an internal sub-montage. This makes it easy to build large audio montages while hiding edit complexities inside other audio montages.

This also increases the performance of your system as it provides options to freeze edits and audio effects in cached audio files.

RELATED LINKS

[Super Clips](#) on page 256

Super Clips

A super clip is the representation of an audio montage within an audio montage. It refers to an audio file that is rendered from either an internal sub-montage or an external sub-montage.

A super clip behaves like any other clip. To edit the tracks and clips in a super clip, you can reopen it and then render the changes to update the super clip.

A super clip can either be a mono or a stereo audio montage.

An example: You have an album that is composed of 15 songs. Each song requires complex edits. In this case you can create 15 super clips, of which each one represents a song. The main audio montage will be composed of these super clips, while each song can have its own audio montage.

Moreover, because super clips can represent external audio montages with different sample rates, you could provide your songs in high-resolution audio (96k sample rate), and build an audio montage album in 44.1k for a CD and another album at 96k for a DVD-Audio, for example.

External Sub-Montages

A super clip can refer to an external sub-montage which is an audio montage in another file. An external sub-montage is independent from the audio montage in which you insert it.

External sub-montages can be shared between projects and used in audio montages with a different sample rate. They can be nested to any depth.

External sub-montage files can contain other external audio montages to any depth.

Super clips that refer to external sub-montages are indicated by an external sub-montage icon.

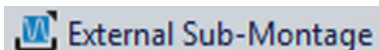

A super clip that refers to an external sub-montage is also called X-Clip.

NOTE

An external sub-montage is a normal audio montage. The term “external” is to point out its inclusion in another audio montage.

Internal Sub-Montages

A super clip can refer to an internal sub-montage, which is an audio montage that is saved in the same file as the audio montage of the super clip. Such a super clip can be regarded as a folder that contains another audio montage.

Internal sub-montages are handled within a single audio montage file. For example, when you have finished editing specific clips of your audio montage, you can render them as a super clip.

An internal sub-montage cannot contain another internal sub-montage. However, it can contain super clips that represent external audio montages.

Super clips that are internal sub-montages are indicated by an internal sub-montage icon.

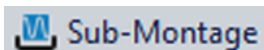

A super clip that refers to an internal sub-montage is also called I-Clip.

Creating a Super Clip

You can render clips of an audio montage to a super clip. This super clip can be part of an internal sub-montage or an external audio montage.

PROCEDURE

1. Open the audio montage in which you want to create a super clip.
 2. In the montage window or in the **Clips** window, select the clips that you want to render to a super clip.
 3. Select one of the following options:
 - Right-click in the upper half of one of the selected clips, and select **Create Super Clip from Selected Clips**.
 - In the **Clips** window, select **Functions > Create Super Clip from Selected Clips**.
 4. In the **Create Super Clip** dialog, decide whether to create an I-Clip (internal sub-montage) or an X-Clip (external sub-montage).
 5. Optional: Enter a name for the super clip.
 6. Click **OK**.
-

RESULT

The clips are rendered as a super clip inside the audio montage.

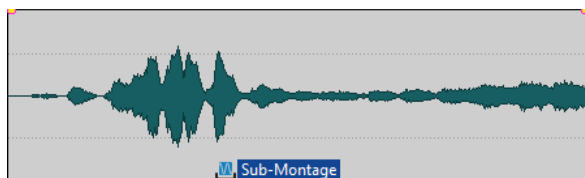

Create Super Clip Dialog When Creating Super Clips from Selected Clips

In this dialog, you specify how to create super clips for internal and external sub-montages.

- To open the **Create Super Clip** dialog, right-click the upper half of one or several selected clips, and select **Create Super Clip from Selected Clips**.

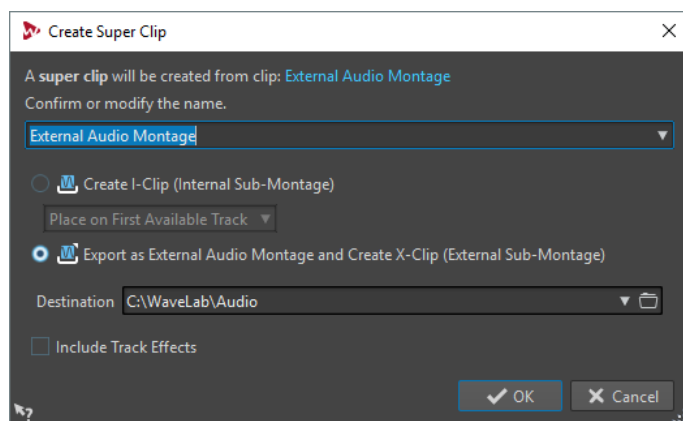

Name

Allows you to specify a name for the super clip. For X-Clips, the name is also used for the audio montage.

Create I-Clip (Internal Sub-Montage)

Creates a new audio montage inside the open audio montage and inserts a super clip to reference it.

Place on First Available Track/Place on Last Available Track

If you create a sub-montage from clips that reside on different tracks, the pop-up menu allows you to specify on which track the super clip is inserted.

Export as External Audio Montage and Create X-Clip (External Sub-Montage)

Creates an independent audio montage and a super clip that refers to this audio montage.

Destination

Lets you select the destination folder of the external sub-montage.

Include Track Effects

If this option is activated, the track effects are included in the sub-montage. If you want to keep the super clip on the track, deactivate this option.

NOTE

Output effects are not included to prevent double processing.

Create Super Clip Dialog When Inserting External Audio Montages

In this dialog, you can select whether to create X-Clips or I-Clips when inserting an external audio montage in another audio montage.

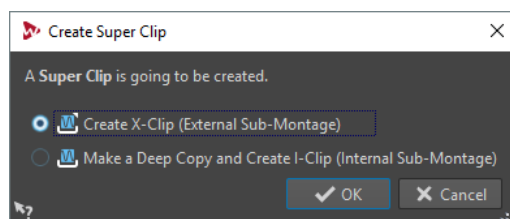

Create X-Clip (External Sub-Montage)

The super clip refers to the audio montage file.

Make a Deep Copy and Create I-Clip (Internal Sub-Montage)

The audio montage is copied into the other audio montage. The super clip refers to this independent copy.

Inserting External Sub-Montages into Audio Montages

You can insert an external sub-montage as a super clip into another audio montage.

PROCEDURE

1. Open the audio montage in which you want to insert another audio montage.
 2. Do one of the following:
 - Right-click an empty area of the montage window, select **Insert Audio Montages > Browse**, select the audio montages that you want to insert, and click **Open**.
 - Drag the audio montage that you want to insert from the File Explorer/macOS Finder or from inside WaveLab Pro and drop it in the montage window.
 3. In the **Create Super Clip** dialog, select whether to create an X-Clip or an I-Clip, and click **OK**.
 4. From the pop-up menu, select how to add and mix the external sub-montage.
-

RESULT

The external sub-montage is rendered, and the resulting super clip is inserted at the edit cursor position.

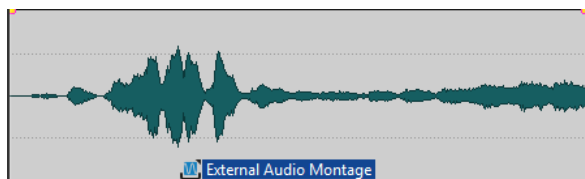

Editing Super Clips

You can reopen the sources of super clips, edit the clips that they contain, and apply the changes to update the super clips of the external or internal audio montages.

The changes in the internal or external audio montage are applied to the parent audio montage when the sub-montages are rendered.

Editing External Sub-Montages of Super Clips

PROCEDURE

1. In the montage window, right-click the bottom area of a super clip of an external sub-montage and select **Edit Source**, or double-click at the top area of the super clip.
The external sub-montage opens in another tab.
 2. Edit the external sub-montage, and save the changes.
 3. Decide on how you want to update the audio montage.
 - To apply the changes to all audio montages that refer to the updated audio montage, select **File > Export**, and select **Render > Render Super Clip**.
 - To apply the changes to a single audio montage, go back to the audio montage that contains the external sub-montage that you have updated. Select the updated audio montage, open the **Files** window, and select **Menu > Update Rendering of Selected Audio Montage**.
 4. Save the audio montage.
-

Editing Internal Sub-Montages of Super Clips

PROCEDURE

1. In the montage window, right-click the bottom area of a super clip of an internal sub-montage and select **Edit Source**, or double-click the top area of the super clip.
The internal sub-montage opens in another tab.
 2. Edit the clips of the internal sub-montage, and save the changes.
-

RESULT

The changes are automatically rendered to update the super clip.

Freezing External Sub-Montages

Freezing external sub-montages renders the external sub-montage to an audio file while converting the super clips into regular clips.

IMPORTANT

Once a sub-montage has been frozen, it is no longer possible to edit it as an audio montage.

PROCEDURE

1. In the montage window, select the external sub-montage that you want to freeze.
 2. In the **Files** window, select **Menu > Freeze External Sub-Montage**.
 3. Specify a name and a location, and click **Save**.
-

Managing Source Files of Clips

The **Files** window helps you to manage files that are used in the current audio montage.

It displays all files that are used by clips in the current audio montage along with their location, size, and last modification date. In addition, the following file operations are available:

- Replace files in the audio montage
- Rename files (all internal clip references are updated)
- Open files that are used in the audio montage in the **Audio Editor**
- Export file names as text

Files Window

This window helps you to manage files that are used in the current audio montage, including internal and external montages.

- To open the **Files** window, open an audio montage, and select **Tool Windows > Files**.

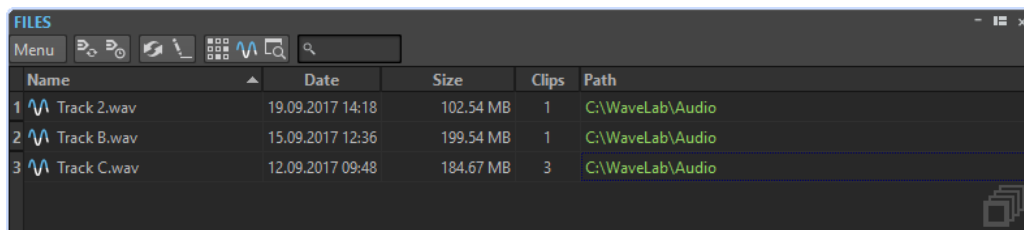

Name	Date	Size	Clips	Path
1 Track 2.wav	19.09.2017 14:18	102.54 MB	1	C:\WaveLab\Audio
2 Track B.wav	15.09.2017 12:36	199.54 MB	1	C:\WaveLab\Audio
3 Track C.wav	12.09.2017 09:48	184.67 MB	3	C:\WaveLab\Audio

Files List

The files list shows the names, dates, sizes, and paths of the files that are used in the current audio montage. The **Clips** column shows how often a clip uses the corresponding audio file. The location and type of the files determine how paths are displayed:

- If the path is relative to the file audio montage location, the path is displayed in green.
- If the path is on the same partition as the audio montage, for example in a subfolder, the path is displayed in blue.
- If the path is on another partition, the path is displayed in red.
- Internal sub-montages have no path.

Menu

Update Rendering of Selected Audio Montage

Renders the focused audio montage to a new audio file. This is necessary to forward the changes that you have made in the selected sub-montage to the open audio montage.

Update Outdated Renderings

Renders all audio montages that have been modified since their rendered audio file was created.

Replace With

Allows you to replace the selected file with another one.

Freeze External Sub-Montage

Renders the external sub-montage to an audio file while converting the super clips into regular clips.

Rename File

Lets you change the file name. The internal references of the audio montage are updated accordingly.

Export File Names as Text

Creates a text file that lists all files that are used in the active audio montage.

Select Clips of Selected File

Selects all clips that refer to the selected file.

Edit Source

Opens the selected files in the **Audio Editor**. If the selected files are sub-montages, the related audio montage opens in the **Audio Montage** window.

Reveal in File Explorer

Opens the File Explorer/macOS Finder to locate the selected file.

Customize Command Bar

Opens the **Customize Commands** dialog which contains options to hide or show specific command bar buttons.

Replacing Source Files of Clips

You can replace a source file of a clip with another file and have all clips that refer to the old source file refer to the new source file.

PROCEDURE

1. Open an audio montage.
 2. Select **Tool Windows > Files**.
 3. In the **Files** window, select the file that you want to exchange.
 4. Select **Menu > Replace With**.
 5. Select the replacing file.
-

Changing Names and File Locations of Audio Files

You can change the name and location of an audio file in your audio montage project. All clips that reference this file are automatically updated.

PROCEDURE

1. Open an audio montage.
 2. Select **Tool Windows > Files**.
 3. In the **Files** window, select the file that you want to rename.
 4. Select **Menu > Rename File**.
 5. In the **Rename File** dialog, enter a new name.
 6. To enter a new file location, activate **Change Folder**, and enter a new file location.
 7. Optional: If you want the related clips to change their name according to the new file name, activate **Rename Related Clips as File Name**.
 8. Click **OK**.
-

Exporting File Names as Text

You can export the file names list as text to various formats. The list contains the names and paths of the audio files in the active audio montage.

PREREQUISITE

Set up your audio montage.

PROCEDURE

1. Open an audio montage.
 2. Select **Tool Windows > Files**.
 3. In the **Files** window, select **Menu > Export File Names as Text**.
 4. Choose the information that you want to export and the output format.
 5. Click **OK**.
-

RESULT

The file names list opens in the selected output format. When selecting **Print**, the **Print Preview** window opens. The text file is saved in the specified folder for temporary files.

Editing Source Files of Clips

Editing the audio montage may require that you process or edit the actual audio files that are referenced by the clips.

Use one of the following methods to edit the source file of a clip:

- Right-click the bottom area of the clip that you want to edit, and select **Edit Source**, or double-click the top area of the clip. The source file of the clip opens in the **Audio Editor**. Edit the clip, save it, and return to the audio montage.
- Drag the clip and drop it in the **Audio Editor**.

Note the following:

- Any editing that you perform this way affects the source audio file and thereby all clips that use the audio file, including clips in other audio montages.

- You can undo/redo all changes in audio files. These changes are reflected immediately in all open audio montages.
- If you use **File > Save As** to save the source audio file with a different name, all open audio montages that refer to the file now refer to the new file.

About Cloning and Substituting Source Files of Clips

Cloning an audio source file avoids the risk that other clips are affected when the source file of a clip is edited.

Use the **Clone and Substitute** function to create a copy of the audio source file, and make the clip reference to the new file. As a result, you can edit the source file without affecting other clips or the original audio file.

The cloned audio file has the original file name with the suffix `_#x`, where X is a number. The cloned audio file is saved in the implicit folder that is specified in the **Audio Montages Preferences** on the **Active Audio Montage** tab.

The implicit folder is used when WaveLab Pro needs to create new files that can be referenced by an audio montage. Files that are saved in the implicit folder are not temporary, that is, they are not deleted when you close WaveLab Pro. This is necessary because the audio montage contains references to the files.

Cloning and Substituting Source Files of Clips

PROCEDURE

- In the montage window, right-click the bottom area of a clip, and select **Clone and Substitute**.

RESULT

A clone of the source file replaces the selected clip. All clips that are referring to the original file are referenced to the new file.

Replacing Audio Files of Clips

You can replace the audio file of a clip to compare different takes.

NOTE

You cannot replace a stereo file with a mono file and vice versa.

PROCEDURE

1. In the montage window, right-click the bottom area of a clip, and select **Replace Audio File**.
2. Select the file to which you want to reference, and click **Open**.

RESULT

The selected audio file replaces the clip. All clip settings are retained. Clip references to the replaced file are still available.

Track Activity Indicator

The track activity indicator shows the volume level for audio tracks. It is located on the right side of the track control area in the **Audio Montage** window.



The track activity indicator provides an overview of which tracks are playing back audio at what approximate level.

Envelopes for Clips

For clips in the audio montage, you can create envelopes for level and fades, for panning, and for effects that are routed to a clip.

You can create an independent level envelope curve to automate level, to create fades and crossfades, and to mute clip sections.

You can also draw pan envelopes to automate pan settings for clips. For mono clips, pan governs the left/right position in the stereo field. For stereo clips, pan sets the left/right balance.

Edit the envelope settings in the **Envelope** tab, or by right-clicking an envelope curve. The settings menu is different, depending on whether you click the fade in part, the fade out part, or the sustain part.

RELATED LINKS

[Routing a Plug-in to a Clip](#) on page 290

How Envelopes are Displayed

By default, all clips display a level envelope curve. You can view the envelope as three separate envelopes: the fade in part, the sustain part, and the fade out part.

The points on the left and right side of the curve are the fade in and fade out junction points that separate the fade parts from the sustain part.

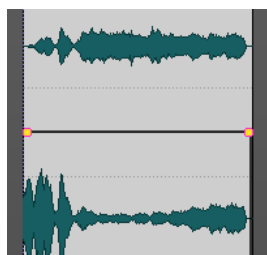

The envelope curve indicates if points, fade ins, or fade outs have been defined. In addition to the curve, changes in the level envelope are also reflected in the waveform.

You can activate/deactivate the **Map Waveform to Level** option in the **Peaks** section of the **View** tab.

Selecting Envelopes

You can select volume/fade envelopes and pan envelopes.

PROCEDURE

1. In the montage window, select a clip.
 2. Select the **Envelope** tab.
 3. In the **Selector** section, open the **Envelope Type** pop-up menu, and select which envelope to edit.
-

Hiding Envelope Curves

All clips display envelopes by default. You can hide these envelopes. However, hidden envelopes are still active.

PROCEDURE

1. In the montage window, select a clip.
 2. Select the **Envelope** tab.
 3. In the **Selector** section, open the **Envelope Type** pop-up menu, and select **Hide All**.
-

Clip Envelope Editing

Curve points allow you to create volume curves, pan curves, and fade curves for a clip. You can edit the envelope curve by adding and moving curve points.

Editing Curve Points

Many of the editing operations that are commonly used in the context of your computer operating system can be applied when editing curve points. On top of these, a number of specific procedures apply.

- To add a curve point, double-click the envelope curve.
- To delete a curve point, double-click the curve point. The curve point between the sustain and fade parts of the envelope cannot be deleted.
- To delete multiple curve points, select the curve points that you want to delete, right-click one of the points, and select **Delete Selected Points**.
- To select a range of points, **Alt**-click and drag to create a selection rectangle.
- To move all selected points, click one of the selected points and drag.
- To raise or lower the value of two consecutive curve points, **Ctrl/Cmd**-click the segment between the points and drag up or down.
- To change the time position of two consecutive curve points, **Shift**-click the segment between the points and drag left or right.
- To raise or lower the entire envelope curve, make sure that no curve point is selected, click the envelope curve, and drag up or down. Do not drag a segment that is limited by selected points.
- To adjust the envelopes in all selected clips, hold down **Alt**, and drag any envelope curve up or down. This is a quick way to adjust the level or pan of multiple clips at the same time and also to adjust both sides of a stereo envelope simultaneously.
- To move a fade in/fade out point vertically, **Ctrl/Cmd**-click and drag the fade point.
- To change the level or the fade in/out time of multiple envelopes at the same time, select the clips that you want to edit, press **Alt**, and edit the envelope with the mouse.

Resetting Curve Points

You can reset curve points to the default level 0 dB.

- To reset a single point to 0 dB, select the point, right-click it, and select **Reset Selected Points**.
- To reset the whole envelope curve to default, right-click the envelope curve, and select **Reset Level to 0 dB**.

Copying Envelopes

You can copy envelope curves from other clips.

PROCEDURE

1. In the montage window, right-click an envelope curve, and select **Copy Shape**.
 2. Right-click the envelope curve of the destination clip, and select **Paste Shape**.
-

Raising Selection Levels

You can raise the audio level with specific fall and rise times (by default 20 ms) and then adjust the level.

PROCEDURE

1. In the montage window, in a clip, select the range for the section that you want to raise in level.
 2. Right-click the envelope curve, and select **Raise Level of Selection with Envelope**. The level of the selection range is raised.
 3. Click the envelope of the selection range and drag up or down to adjust the level.
-

Muting Selected Ranges of Clips

You can mute a selected range by lowering the volume to -144 dB.

Muted sections are not affected when you drag the envelope curve up or down.

PROCEDURE

1. In the montage window, in a clip, make a selection range for the section that you want to mute.

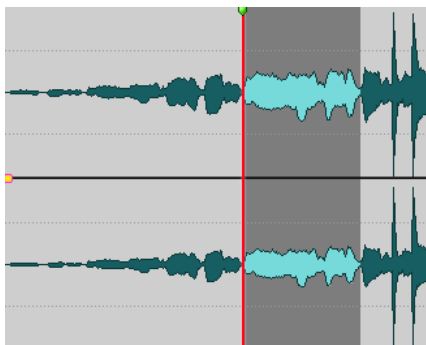

2. Right-click the envelope curve, and select **Mute selection with envelope**.
-

RESULT

The section is muted. A fade in and fade out of 20 ms is applied to the muted section.

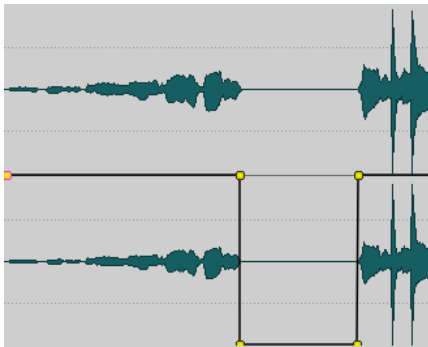

Envelope Smoothing

To produce smoother, more natural envelope curves, you can activate the **Smoothing** function.

- To activate this function, select the **Envelope** tab, and activate **Smoothing** in the **Clip Options** section.

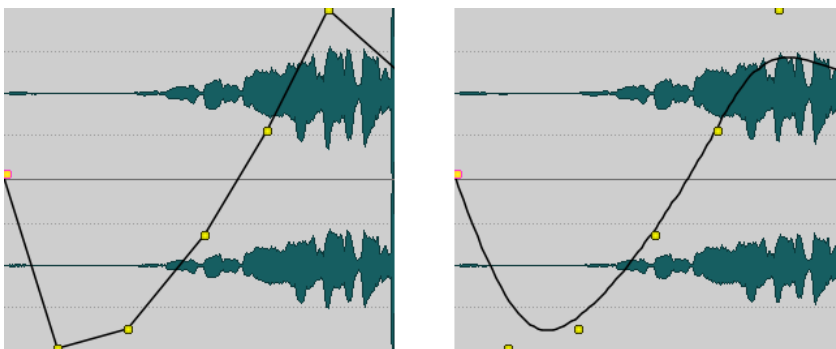

Creating Envelope Presets

You can create envelope presets that you can later recall and apply to other clips. There are separate presets for the sustain parts (envelope presets) and the fade parts.

PROCEDURE

1. In the montage window, activate the clip with the envelope curve that you want to save as a preset.
 2. Select the **Envelope** tab.
 3. In the **Preset** section, open the **Presets** pop-up menu.
 4. Select **Save As**.
 5. In the **Save Preset As** dialog, enter a name for the preset, and click **Save**.
-

Applying Envelope Presets

PROCEDURE

1. In the montage window, activate the clip to which you want to apply the envelope preset.
 2. Select the **Envelope** tab.
 3. In the **Preset** section, open the **Presets** pop-up menu.
 4. Select a preset from the list.
-

RESULT

The envelope curve is applied.

NOTE

Level envelope presets can only be applied to level envelopes. Other envelope presets such as pan and effect presets can be applied to any other non-level envelope, but not to level envelopes.

Locking an Envelope Curve

When an envelope curve is locked, the level envelope curve points are hidden and cannot be edited with the mouse. However, you can drag the whole curve up or down.

PROCEDURE

1. In the montage window, activate the clip that you want to lock.
 2. Select the **Envelope** tab.
 3. In the **Clip Options** section, activate **Hide Curve Points**.
-

Locking All Envelope Curves

If you lock all envelope curves globally, they cannot be edited with the mouse.

PROCEDURE

1. In the **Audio Montage** window, select the **Envelope** tab.
 2. In the **Selector** section, activate **Lock Mouse Editing**.
-

RESULT

The envelopes and their points are still displayed, but cannot be selected or edited.

Changing Overall Level Envelopes of Clips

The default envelope curve contains no level envelope points, but you can use it to change the overall level for a clip.

PROCEDURE

1. In the montage window, place the mouse cursor on the envelope curve.
The mouse cursor takes the shape of a circle with two arrows that point up and down.

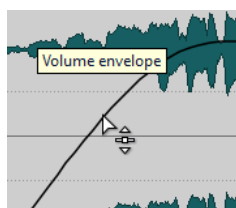

2. Click and drag the curve up or down to change the clip envelope level.
-

Converting Envelopes to Mono or Stereo

It is possible to display two level envelope curves for stereo clips, allowing you to control the level separately for the left and right channels.

NOTE

Only level envelopes can be converted to stereo.

PROCEDURE

1. In the montage window, select a clip.
 2. Select the **Envelope** tab.
 3. In the **Shape** section, click **Convert**.
 4. Select **Convert to Stereo** or **Convert to Mono**.
-

Pan Modes

The power of the sum of the channels drops by about 3 dB if a signal is panned hard left or right, compared to the same signal being panned center. This can be compensated with pan modes.

Experiment with the modes to hear which fits best. The pan modes can be set for tracks, clips, and the montage output.

- To set the pan modes for clips, use the **Pan Law** pop-up menu in the **Envelope** tab, or use the **Pan Law** pop-up menu and knob in the **Effects** window.
- To set the pan modes for tracks and the montage output, use the **Pan Law** pop-up menu and knob in the **Effects** window.

The following pan modes are available:

Channel Damp (0 dB/Mute)

This mode does not compensate for power loss at all. If a signal is panned hard left or right, the power of the sum of the channels drops by 3 dB.

Constant Power (+3 dB/Mute)

This is the default mode. Regardless of the pan position, the power of the sum of the channels remains constant.

Channel Boost (+4.5 dB/Mute)

If this mode is selected and a signal is panned hard left or right, the power of the sum of the channels is higher than with a signal-panned center.

Channel Boost (+6 dB/Mute)

If this mode is selected and a signal is panned hard left or right, the power of the sum of the channels is higher than with a signal-panned center. This is the same as the previous option, but with even greater power boost.

Modulating Audio With Other Audio

You can use the audio signal of one track to modulate the compression factor of another track. The signal of the upper audio track (clip) is usually called the carrier signal, because it contains the audio to be transmitted.

The **Ducker** clip plug-in is used for this purpose as it lowers the volume of one signal whenever another signal is present.

RELATED LINKS

[Ducking Clips](#) on page 269

Ducking Clips

Ducking happens when the level or send effect of one clip is modified through the presence of another signal on another track or channel. You can create ducking effects between clips on two adjacent tracks.

If you use the **Ducking** option, the presence of another clip on an adjacent track causes ducking.

A typical application for ducking would be a music track with a commentary voice-over on another track. Whenever the commentary voice starts, the level of the music track is lowered by a specific level through automatically created level envelope curves.

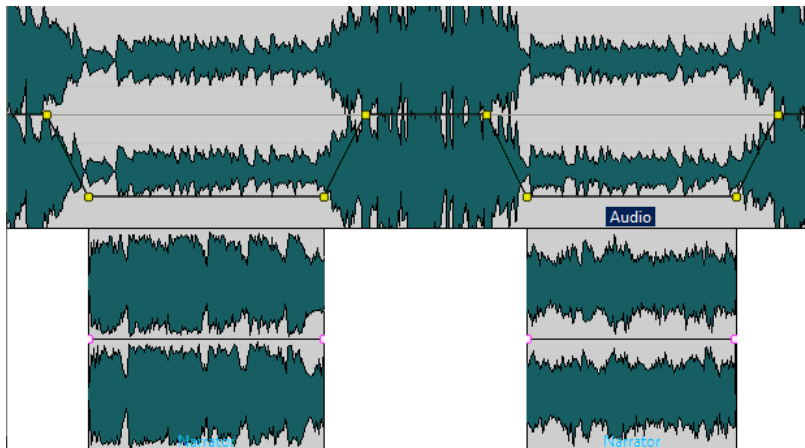

You can also create a ducking effect for effect envelopes that are routed to a clip. Each clip plug-in has its independent envelope. When the envelope is all the way down, only the wet signal is applied. When the envelope is all the way up, the processed/wet signal is at its maximum.

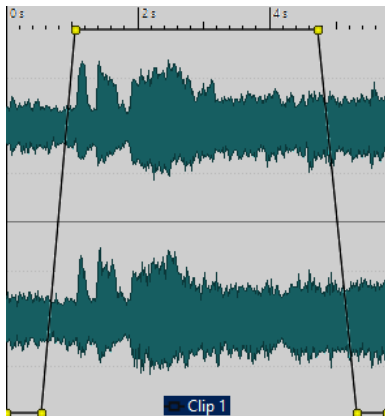

NOTE

- The method of ducking clips is independent from clip modulation, though they share some concepts. Ducking clips is more flexible but needs more manual adjustments.
- The clips that cause ducking must be positioned completely inside the time range of the clip to which ducking is applied.
- If the clips that cause ducking contain silent passages, ducking does not function properly. These clips must be edited so that each phrase is a separate clip without any silence.
- When **Ducking** is performed it is applied to one clip at a time. For example, if the music consists of several clips that have been spliced together, only one of the clips is ducked by the voice-over. To solve this issue, you can repeat the function for each clip or use the **Render** function in the **Master Section** to create a specific (single) file from the separate clips and re-import this as a new clip in the audio montage.

RELATED LINKS

[Routing a Plug-in to a Clip](#) on page 290

Creating Voice-Over Ducking Effects

In the following example, the track to which ducking is applied contains music and an adjacent track that causes ducking contains a voice-over.

PROCEDURE

1. In the montage window, place the clips that contain the music and the voice-over on separate adjacent tracks.
The voice-over clips must be located inside the time range of the music clip.
2. Select the clip containing the music.
3. Select the **Envelope** tab.
4. In the **Selector** section, open the **Envelope Type** pop-up menu, and select **Volume/Fades**.
5. In the **Level** section, click **Ducking**.
6. In the **Ducking Settings** dialog, make your settings.
Depending on whether the voice-over track is above or below the music track, you must select **Previous Track** or **Next Track**.
7. Click **OK**.

RESULT

The level of the music is automatically lowered by the voice-over clips.

RELATED LINKS

[Routing a Plug-in to a Clip](#) on page 290

Ducking Settings

In the **Ducking Settings** dialog, you can create ducking effects.

- To open the **Ducking Settings** dialog, select the **Envelope** tab in the **Audio Montage** window, and click **Ducking** in the **Level** section.

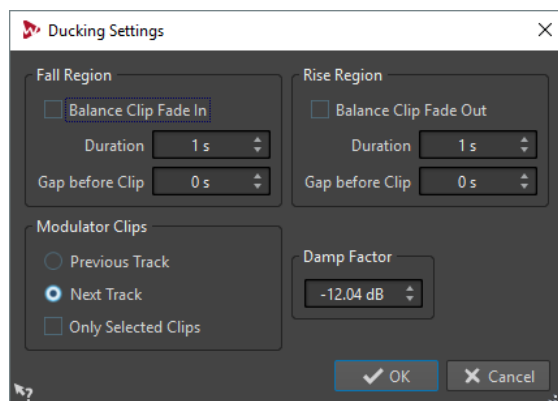

Fall Region

Balance Clip Fade In ignores any duration or gap settings in the **Fall Region** section. Instead, the ducking envelope lowers the volume from the fade in end position of the voice-over clip.

Duration allows you to set the time it takes for the level to fall when ducking starts.

Gap before Clip allows you to set the time between the end of the fall region and the start of the voice clip.

Rise Region

Balance Clip Fade Out ignores any duration or gap settings in the **Rise Region** section. Instead, the ducking envelope raises the volume from the fade out start position of the voice-over clip.

Duration allows you to set the time it takes for the level to rise to the original level after ducking ends.

Gap before Clip allows you to set the time between the end of the voice clip and the start of the Rise region.

Modulator Clips

Previous Track and **Next Track** define whether the modulator track should be the one before (**Previous Track**) or after (**Next Track**) the track that is to be ducked.

If **Only Selected Clips** is activated, only the selected clips on the modulator track cause ducking.

Damp Factor

Sets the amount of ducking, that is, the degree of attenuation that is applied to the affected clip.

Fades and Crossfades in Audio Montages

A fade in is a gradual increase in level and a fade out is a gradual decrease in level. A crossfade is a gradual fade between two sounds, where one is faded in and the other faded out.

Creating Fades

By default, all clips display fade in and fade out junction points. These can be dragged horizontally to create a fade in or fade out for a clip.

You can add envelope points to a fade just as with level envelopes.

- To create a fade in, click the fade in point at the start of a clip, and drag it to the right.
- To create a fade out, click the fade out point at the end of a clip, and drag it to the left.
- To create a fade in or fade out at a specific time position, use set **Apply Fade Time** option in the **Fade** tab. Enter the time value in the time field and click **Apply Fade Time**.
- To move a fade in/fade out point vertically, press **Ctrl/Cmd** while dragging.

The resulting fade in/fade out curve is displayed in the clip, and the fade is also reflected in the waveform. If you position the mouse over the fade in point, the fade in time is displayed in seconds and milliseconds and the volume in dB.

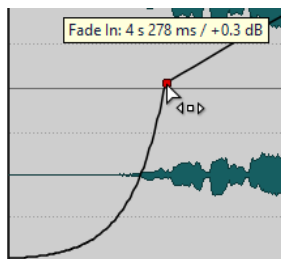

Fade In and Fade Out Menus

In this menu, you can select various preset fade curves and other fade-related options.

- To open the **Fade In** or **Fade Out** pop-up menu, right-click the fade in or fade out points.

Zoom to Fade In Range/Zoom to Fade Out Range

Adjusts the view to mainly display the fade in/fade out part of the active clip.

Copy

Copies the fade in/fade out shape to the clipboard.

Paste

Replaces the fade in/fade out shape and length with the shape and length that was copied to the clipboard.

Paste Shape Only

Replaces the fade in/fade out shape with the shape that was copied to the clipboard. The original length is preserved.

Paste to Selected Clips

Replaces the fade in/fade out shape of all selected clips with the shape that was copied to the clipboard. The original length is preserved.

Linear

Changes the level linearly.

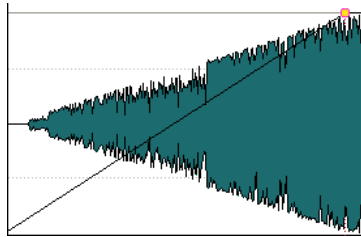

Sinus (*)

Changes the level according to the first quarter period of the sine curve. When used in a crossfade, the loudness (RMS) remains constant during the transition.

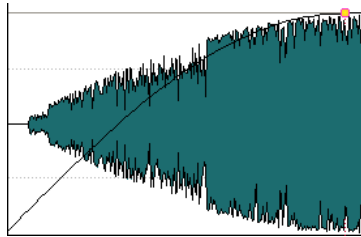

Square-root (*)

Changes the level according to the square-root curve. When used in a crossfade, the loudness (RMS) remains constant during the transition.

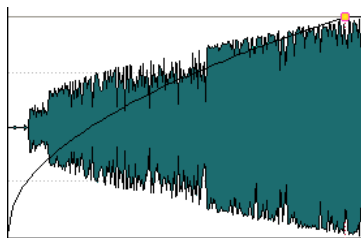

Sinusoid

Changes the level according to a half period part of the sine curve.

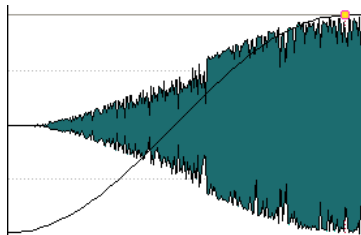

Logarithmic

Changes the level logarithmically.

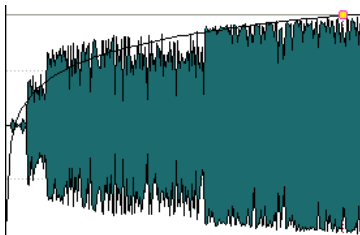

Exponential

Changes the level exponentially.

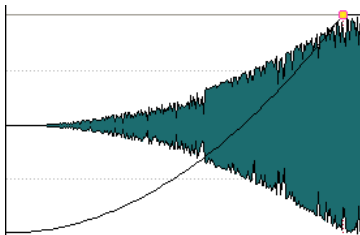

Exponential+

Changes the level strongly exponentially.

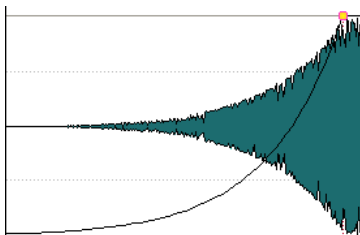

Saving Fade Ins/Fade Outs as Default

The default fade in/fade out curve shape is linear. You can change this setting and define a default shape and/or length separately for fade ins and fade outs.

PROCEDURE

1. In the montage window, drag the fade in/fade out point to the position that you want to set as default.
2. Select the **Fade** tab.
3. In the **Edit** section, activate **Fade In** or **Fade Out**.
4. In the **Preset** section, open the **Presets** menu.
5. Depending on whether you want to save the current fade as default for fades and/or crossfades, select one of the following options:
 - **Save Current Fade as Default for Automatic Fade Ins**
 - **Save Current Fade as Default for Automatic Fade Outs**
 - **Save as Default for Automatic Crossfades**

RESULT

When you select a clip and click **Apply Default** in the **Fade** tab, the saved fade is applied. In addition, when you create a new clip and **Create Default Fades in New Clips** is activated, the default fade is used.

NOTE

The default fades are saved for each audio montage. If you want to use the same default fade for several audio montages, you should update the audio montage template file.

Applying Default Fade Ins/Fade Outs

PROCEDURE

1. In the montage window, select the clip for which you want to apply the default fade in/fade out.
 2. Select the **Fade** tab.
 3. In the **Edit** section, select **Fade In** or **Fade Out**.
 4. In the **Preset** section, click **Apply Default**.
-

RESULT

The fade in/fade out time is set to the defined default value.

Applying Default Fades to New Clips

All new clips that are imported or recorded in the audio montage get the default fade in and fade out shape and length if **Create Default Fades in New Clips** is active. In this case, the default crossfade shapes are used. This also applies to clips that are created by splitting clips.

PROCEDURE

1. Open an audio montage and select the **Fade** tab.
 2. In the **Options** section, open the **Options** pop-up menu.
 3. Activate **Create Default Fades in New Clips**.
-

Locking Fade Times When Adjusting Clip Edges

PROCEDURE

1. Open an audio montage and select the **Fade** tab.
 2. In the **Options** section, open the **Options** pop-up menu.
 3. Activate **Lock Fade Times When Adjusting Clip Edges**.
-

RESULT

The defined fade in/fade out length is locked to the clip start or end, even if you adjust the clip edges.

Copying Fades

You can copy a fade in or fade out and paste it in another clip.

PROCEDURE

1. In the montage window, right-click a fade in/fade out point, and select **Copy**.
 2. Right-click the fade in/fade out point for which you want to apply the fade, and select **Paste**.
-

RESULT

The fade is applied to the clip.

Setting Fade/Level Envelopes After the Effects

When using dynamic processors that alter the level of the clip, it is useful to place the level/fade envelope after the clip effect section.

PROCEDURE

1. Open an audio montage and select the **Envelope** tab.
 2. In the **Selector** section, make sure that **Volume/Fades** is selected.
 3. In the **Clip Options** section, activate **Envelope after Effects**.
-

Deactivating Automatic Fade Changes for Individual Clips

You can deactivate automatic fade changes for individual clips. This can be used if you have set a fade that you do not want to be altered in any way, even though you may want to overlap the clip with another clip.

PROCEDURE

1. In the montage window, select the clip for which you want to disable automatic fade changes.
 2. Select the **Fade** tab.
 3. In the **Clip Options** section, deactivate **Automatic Changes**.
-

Creating Automatic Crossfades in Audio Montages

Crossfades in audio montages can be created automatically when clip edges overlap. You can specify the type of crossfade that is performed.

PROCEDURE

1. Open an audio montage and select the **Fade** tab.
 2. In the **Options** section, open the **Overlaps** pop-up menu and select one of the following crossfade types:
 - **Free Overlaps**
 - **Fade In Constrains Overlaps**
 - **Fade Out Constrains Overlaps**
 3. Move a clip so that it overlaps the edge of another clip.
-

RESULT

The crossfade is automatically created in the overlap.

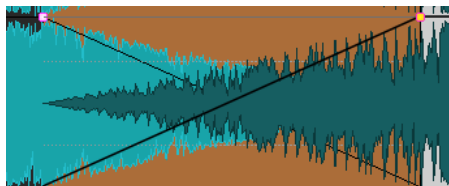

Crossfade Editing

You can create crossfades with independent shapes and lengths for the fade in and fade out curves.

The default automatic crossfade is linear. It uses the same shape and fade lengths for fade in and fade out. The following rules apply:

- A crossfade includes fade in and fade out.
- You can edit the fade in and fade out curves in crossfades in the same way as fades.
- To resize the crossfade time symmetrically, press **Shift**, click the crossfade area, and drag left and right.
- To move the crossfade region while keeping its length, press **Ctrl/Cmd**, click the crossfade area, and drag left and right.
- When you move a clip so that it overlaps another clip to create a crossfade, and neither clip has a defined fade in the overlap, a default crossfade is created if one of the auto crossfade options is activated.
- When moving a clip with a defined fade curve so that it overlaps another clip without a defined fade, the unmoved clip automatically gets the same fade shape as the moved clip, with amplitude compensation. This only applies if the fade out length of the unmoved clip is set to zero.

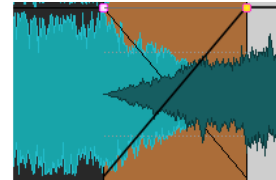
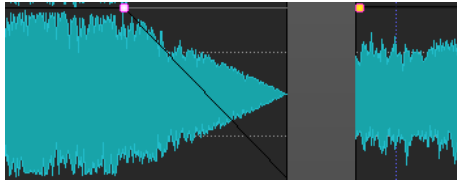

- If both clips have different defined fade curves, an asymmetrical crossfade is created.

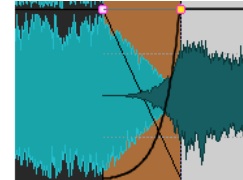
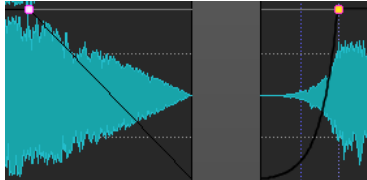

Additionally, other factors govern the result when creating crossfades. In the following example a pre-defined fade out and an undefined fade in are used. What happens depends on the type of fade out curve that is used.

- If the fade out is a preset (except **Sinus (*)** or **Square-Root (*)**) that uses **Pure Shape**, the corresponding fade in gets the same preset with amplitude compensation.
- If the fade out is a preset that uses a compensation attribute, the fade in gets the same preset, but with **Pure Shape** activated, for the compensation to take effect.
- If the fade out uses either the **Sinus (*)** or **Square-Root (*)** presets with the **Pure Shape** setting, the fade in gets the same preset also with the **Pure Shape** setting. In fact, power compensation is used. This is because the **Sinus (*)** and **Square-Root (*)** curves provide constant power crossfades by themselves.

RELATED LINKS

[Options for Moving and Crossfading Clips](#) on page 245

Crossfading with Fade Constrained Overlaps

PREREQUISITE

To use fade in/fade out constrained overlaps, there must be a defined (not set to zero) fade in/ fade out in the overlap. Otherwise, **Free Overlaps** is activated for that crossfade.

The following description applies to fade in constrained overlaps and fade out constrained overlaps. For the latter, however, the defined fade out length constrains the overlap, and accordingly, the left edge of the right clip is adjusted.

PROCEDURE

1. Open an audio montage and select the **Fade** tab.
 2. In the **Options** section, open the **Overlaps** pop-up menu.
 3. Activate **Fade In Constrains Overlaps**.
 4. On a track that contains several clips, create a fade in curve in a clip.
 5. Drag the clip to the left so that it overlaps another clip, past the right clip edge.
A crossfade is created in the overlap.
 6. Continue dragging the clip, so that the fade in point of the dragged clip overlaps the right edge of the left clip.
 7. Drag the clip to the right again.
The resized clip is gradually uncovered. The original clip length is memorized, so you can later restore the resized clips.
 8. Separate the two clips again without creating an overlap so that they return to the original left/right position relative to each other.
 9. Drag the left clip to the right so that it overlaps the other clip, and continue dragging to the right.
The right edge of the left clip is progressively resized as you drag the clip further to the right.
Fade constrained overlaps can also be used with the options **Allow Multiple Automatic Crossfades** and **Allow Automatic Crossfading with Clips on Selected Track**.
-

RELATED LINKS

[Automatic Crossfading](#) on page

Crossfades Between Clips

The **Wave Matching** window shows a magnified view of the beginning of the selected clip and allows you to adjust the crossfade point for two adjacent clips.

The main purpose of this is to help you splice two consecutive clips together. The zoom view displays the end of the left clip and the start of the right clip. This type of splicing is achieved by applying short crossfades.

There are two main types of crossfades:

Artistic crossfades

For example, if you want to crossfade two songs to make a nice transition. Usually, these types of crossfades are quite long and can easily be created from the audio montage window.

Patch crossfades

For example, if you want to replace a section of audio, without audible discontinuity in the resulting audio. In this case, short crossfades should be used. These crossfades are best created in the **Wave Matching** window.

RELATED LINKS

[Wave Matching Window](#) on page 279

Adjusting Crossfades Between Clips

Adjusting the crossfades between clips is important to avoid clicks at the junction points. WaveLab Pro analyzes the waveforms to automatically find the best crossfade offsets.

PROCEDURE

1. In the montage window, on a track, align the two clips that you want next to each other.
2. Select the clip that is located on the right.
3. Select **Tool Windows > Wave Matching**.
This shows a close-up of the two clips.
4. In the **Wave Matching** window, set the zoom factor using the icons above the zoom view, or select a zoom factor from the **Menu**.
If you activate **Menu > Automatic Level Zooming**, the waveforms are automatically zoomed vertically to fill out the zoom view.
5. If necessary, move or resize the clip located on the right in the zoom view.
6. Set the search range using the icons above the zoom view, or select a search range from the **Menu**.
7. Decide whether you want to move the right clip to the left or to the right.
 - To move the clip to the left, select **Menu > Move to Left (Match Waveform)**.
 - To move the clip to the right, select **Menu > Move to Right (Match Waveform)**. This is useful if the two clips are already overlapping.

RESULT

WaveLab Pro scans the audio to the left of the splice point and moves the clip on the right to the position which provides the best possible phase match, to avoid harmonic cancellation. When the clip on the right is moved over the clip on the left, a short crossfade is automatically created.

RELATED LINKS

[Wave Matching Window](#) on page 279

Wave Matching Window

In the **Wave Matching** window, you can find the best crossfade point for two adjacent clips.

- To open the **Wave Matching** window, open an audio montage and select **Tool Windows > Wave Matching**.

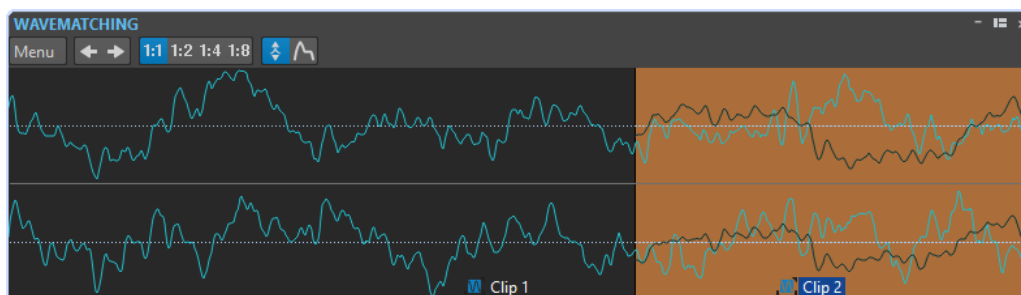

On the **Menu**, you have the following options:

Move to Left (Match Waveform)

Scans the audio to the left of the splice point and finds the best possible phase match to avoid harmonic cancellation. The clip on the right is moved over the clip on the left. This automatically creates a short crossfade, ensuring the smoothest possible splice.

Move to Right (Match Waveform)

Scans the audio to the right of the splice point and finds the best possible phase match to avoid harmonic cancellation. The clip on the right is moved further to the right. This automatically creates a short crossfade, ensuring the smoothest possible splice. This function is useful if the two clips already overlap.

Search Range

Determines how WaveLab Pro scans the clips when searching for the best possible phase match. Higher values result in greater accuracy but also longer processing times. If the sounds contain a lot of bass, avoid the shortest search range setting.

Zoom

Sets the zoom factor. For example, 1:4 means that 1 pixel on the screen corresponds to 4 audio samples.

Automatic Level Zooming

Automatically zooms the waveform vertically to fill the view.

Show Envelope

Displays the envelope curves of the clips in the view. Which curves are displayed depends on the settings of each clip.

Clip Time Stretching

You can adjust the length of a clip by using time stretching.

The best results are achieved when using small or moderate amounts of time stretch.

NOTE

Avoid time stretching of already time stretched material.

When you perform time stretching on a clip, a copy of the original audio file is created that contains the audio range that is used in the clip. The time stretch is applied to the copy, and the clip now references the copy.

- The copied audio file has the same name as the original, but with the suffix “_#X” where X is a number.
- The copied audio file is saved in the implicit folder that is specified in the **Audio Montages Preferences**.

Time-Stretching Clips

PROCEDURE

1. In the montage window, move the edit cursor to the position where you want the clip to end.
 2. Right-click the lower part of the clip that you want to time-stretch, and select **Time-Stretch to Cursor**.
 3. In the **Time Stretching** dialog, edit your settings, and click **OK**.
Only the **Method** section is available for editing, because the other settings are determined by the edit cursor position.
-

RESULT

The clip is stretched or compressed so that it ends at the edit cursor position.

NOTE

Because the new copied audio file contains exactly the audio range that the clip uses, it is not possible to lengthen the clip by resizing after **Time-Stretch to Cursor** has been applied.

RELATED LINKS

[Time Stretching Dialog](#) on page 184

Clip Pitch Shifting

You can adjust the pitch of a clip by using pitch shifting.

When you perform pitch shifting on a clip, a copy of the original audio file is created that contains the audio range that is used in the clip. The pitch shift is applied to the copy, and the clip references the copy.

- The copied audio file has the same name as the original, but with the suffix “_#X” where X is a number.
- The copied audio file is saved in the implicit folder that is specified in the **Audio Montages Preferences**.

Pitch-Shifting Clips

PROCEDURE

1. In the montage window, right-click the lower part of a clip for which you want to apply pitch shifting, and select **Pitch Shifting**.
 2. In the **Pitch Shifting** dialog, edit your settings, and click **OK**.
-

RELATED LINKS

[Pitch Shifting Dialog](#) on page 186

Effects for Tracks, Clips, and the Montage Output

You can add VST effect plug-ins to individual clips, tracks, or the output of an audio montage. Clip effects affect individual clips only, track effects affect all clips on a track, and the montage output affects the whole audio montage.

Only VST 2 and VST 3 plug-ins can be used in the audio montage. Each clip, audio track, and the montage output can be independently processed by up to 10 VST effect plug-ins.

Effects are configured as follows:

- As inserts, where the entire audio is processed by the effects.
- As send effects (split mode), where the balance between the unprocessed sound and the effect send level can be controlled by effect envelope curves (clip effects and specific VST 2 plug-ins only).

An icon in front of a clip name indicates that effects are applied to a clip.

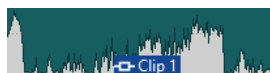

Hovering over a clip name shows the effects that are used for the clip.

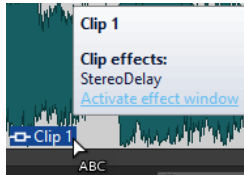

NOTE

- Only clip effects for clips that are active at the current playback position consume CPU power. Track and montage output effects are always active.
- The first time that you play an audio montage after it has been opened or copied, the program has to load all effects into memory. If you have many effects, this can result in a short silence before the playback starts.
- Effects that are used for tracks must support stereo audio, even if the audio track is mono.

Montage Output Effects

You can add montage output effects to an audio montage. While the **Master Section** is shared among all audio montages, the montage output effects are local to each montage. This allows you to have a fully embedded project, without needing to use the **Master Section**.

The montage output effects are located at the output of the audio montage.

NOTE

If you want to use a dithering plug-in, place it in the montage output.

Effects Window

This window lets you add effect plug-ins to tracks, clips, and the montage output, import the plug-ins from the **Master Section**, and make pan and gain settings.

- To open the **Effects** window, open an audio montage and select **Tool Windows > Effects**.

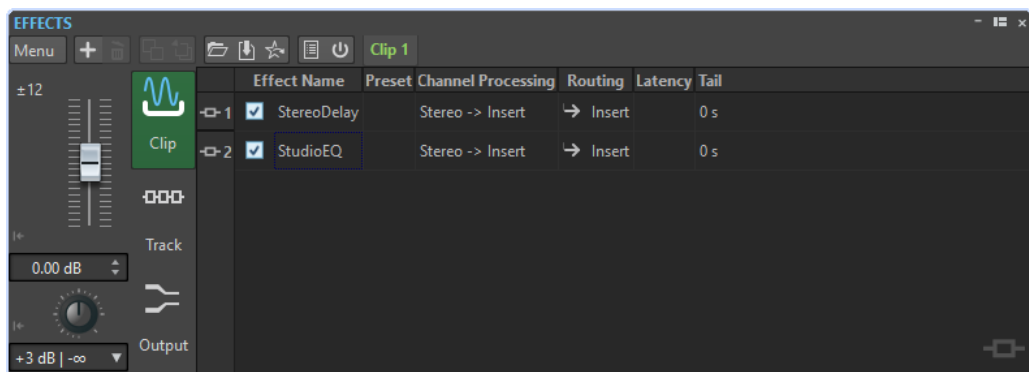

Menu

Clip Effects

Displays the plug-ins of the active clip.

Track Effects

Displays the plug-ins of the active track.

Output Effects

Displays the plug-ins of the montage output.

Add Slot

Adds a slot into which an audio plug-in can be inserted.

Remove Selected Plug-ins

Removes the selected plug-ins.

Remove Selected Plug-ins from Selected Clips

Removes the plug-ins from the selected clips.

Copy

Copies the selected plug-in and its settings to the clipboard.

Copy All

Copies the settings of all plug-ins to the clipboard.

Paste (Insert)

Inserts the plug-in that was copied to the clipboard before the first selected slot. If no slot is selected, the plug-in is inserted at the end of the plug-in list.

Paste (Replace)

Replaces the selected plug-in with the plug-in that was copied to the clipboard. If no slot has been added, a new slot is created.

Paste to Selected Clips

Replaces the selected plug-in with the plug-in that was copied to the clipboard on all selected clips. If no slots have been added, new slots are created.

Load Plug-in Chain

Replaces the current plug-ins with a plug-in chain that has been saved on disk.

Save Plug-in Chain

Saves the current plug-in chain as a preset.

Import Master Section Plug-ins

Imports the plug-ins that are loaded in the **Master Section**. Existing plug-ins are overwritten.

Close All Windows

Closes all plug-in windows that relate to this audio montage.

Plug-in Map

Opens the **Plug-in Map** dialog that displays all plug-ins that are used in the audio montage and the clips and tracks that are using them.

Bypass All Plug-ins

If this option is activated, all plug-ins of the active clip or track are bypassed during playback.

Bypass All Plug-ins in the Montage

If this option is activated, all plug-ins of the active audio montage are bypassed during playback.

Plug-in Window Handling

Opens the **Plug-in Window Handling** dialog where you can set up the appearance of plug-in windows.

Customize Command Bar

Opens the **Customize Commands** dialog which contains options to hide or show specific command bar buttons.

Effects List

The effects list displays the effect plug-ins of the selected track, clip, or montage output. In the list, you can replace effect plug-ins, change the effect order, and edit the **Send Level** and **Tail** of effects.

	Effect Name	Preset	Channel Processing	Routing	Latency	Tail
1	<input checked="" type="checkbox"/> StereoDelay		Stereo -> Insert	↳ Insert	0 s	
2	<input checked="" type="checkbox"/> StudioEQ		Stereo -> Insert	↳ Insert	0 s	

Plug-in window icon

Opens the plug-in window.

Effect Name

Clicking an effect name opens the **Plug-ins** menu where you can select a new effect. The checkbox allows you to activate/deactivate the clips.

Preset

Shows the preset that is used by the plug-in. If no preset is used, this field is empty.

Channel Processing

Allows you to specify which channel to process. If you select one channel, the other channel is bypassed.

Routing

Allows you to set the routing of the processed signal. You can control the mix between the dry and the processed signal with an envelope. The following routing options are available:

- **Insert (Standard)**
- **Blend Wet into Dry (Send)**
- **Parallel Processing**

Edit Automation Envelope opens the **Envelope** tab and selects the automation envelope.

Latency

Shows the latency in the audio path. Plug-ins with latency cannot be used for adjusting the send level.

Tail (clip effects only)

Some effects, such as reverb and delay, produce audio tails. This means that the effect sound continues after the clip sound ends. For example, if you add echo to a clip without specifying a tail value, the echo effect is muted as soon as the clip ends. Set the tail length so that the effect is allowed to decay naturally. If you add another plug-in to the clip that also produces a tail, there is no need to set a separate tail value for this plug-in, unless you want the decay to sum up. The overall tail length for the clip is the sum of the tail of each plug-in. The maximum tail setting is 30 seconds.

Gain/Pan Section

In this section, you can edit **Gain** and **Pan** settings for each clip and track.

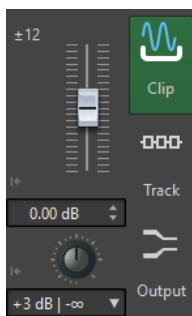

Global Gain Section

In this section, you can set the global gain for the active audio montage. This gain can be applied before or after the montage output, depending on the setting of the pre/post button on the left of this section. Pre is the default setting.

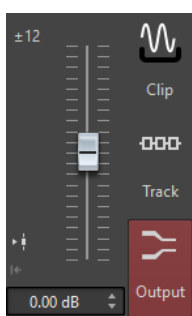

The Loudness Meta Normalizer can change the global gain to set the audio montage output loudness, for example, to match the EBU R-128 recommendation.

RELATED LINKS

[Pan Modes](#) on page 269

Adding Effects to a Track, a Clip, or to the Montage Output

You can add effect plug-ins to every track and clip of the audio montage, and to the output of the audio montage.

Adding Effects Via the Effects Window

PROCEDURE

1. Open an audio montage.
2. Select **Tool Windows > Effects**.
3. In the **Effects** window, select the **Clip**, **Track**, or **Output** section.
4. Click **Add Slot**.

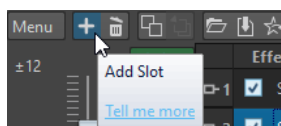

5. In the **Effect Name** column, select the added slot.
6. Select a plug-in.

RESULT

The selected effect opens in a window.

NOTE

You can add effects during playback. However, if you add an effect with a latency larger than zero, it is better to stop and restart playback to avoid timing discrepancies. In addition, a small number of VST plug-ins may change its latency depending on the parameter settings. If that is the case, make sure to stop and restart playback after the latency is changed.

Additional Ways of Adding Effects

- To add an effect to a track, click the **FX** button in the track control area, select **Add Effect**, and select an effect from the menu.

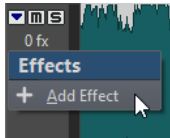

- To add an effect to a clip in the montage window, right-click the clip name, select **Add Effect**, and select an effect from the menu.

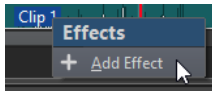

Adding the Master Section Effects to the Track, Clip, or Montage Output

You can add the **Master Section** effects to a clip, a track or the output of an audio montage.

PREREQUISITE

Set up the **Master Section** plug-ins.

PROCEDURE

1. Open an audio montage.
 2. Select **Tool Windows > Effects**.
 3. In the **Effects** window, select the track, clip, or montage output to which you want to add the **Master Section** effects.
 4. Select **Menu > Import Master Section Plug-ins**.
-

RESULT

The **Master Section** effects are added to the selected track, active clip, or montage output.

NOTE

To copy a single **Master Section** effect, drag it from a **Master Section** slot to the effects list of the **Effects** window.

Removing Effects from Tracks, Clips, or the Montage Output

PROCEDURE

1. Open an audio montage.
 2. Select **Tool Windows > Effects**.
 3. In the **Effects** window, select the **Clip** section, **Track** section, or **Output** section.
 4. Click the effect that you want to remove, and select **Remove Plug-in**.
-

RESULT

The effect is removed from the slot.

Rearranging the Order of Effects

The order of the effects in the list determines the processing order.

PROCEDURE

1. Open an audio montage.
 2. Select **Tool Windows > Effects**.
 3. In the **Effects** window, in the effects list, drag the effect that you want to rearrange to another position.
-

Applying Plug-in Chain Presets to Tracks, Clips, or the Montage Output

You can save the plug-in chain of a track, a clip, or the montage output as a preset and apply it to other clips or tracks, or to the montage output of another audio montage.

PROCEDURE

1. Open an audio montage.
 2. Select **Tool Windows > Effects**.
 3. In the **Effects** window, set up your plug-in chain.
 4. Select **Menu > Save Plug-in Chain**.
 5. Enter a name and the file location for the effect chain, and click **Save**.
 6. Select the track, clip, or montage output to which you want to apply the effect chain.
 7. Select **Menu > Load Plug-in Chain**.
 8. Select a plug-in chain, and click **Open**.
-

Copying Effect Settings to Tracks, Clips, or the Montage Output

You can copy the effect and its settings of a track, a clip, or the montage output to other tracks, clips, or the montage output of the same or another audio montage.

PROCEDURE

1. Open an audio montage.
 2. Select **Tool Windows > Effects**.
 3. In the **Effects** window, select the effect from which you want to copy the settings.
 4. Select **Menu > Copy**.
 5. Decide whether you want to paste the effect settings to a new slot or replace an existing effect.
 - To paste the effect settings to a new slot, add a new slot, and select **Menu > Paste (Insert)**.
 - To replace an existing effect, select the effect, and select **Menu > Paste (Replace)**.
 - To copy the effect settings to multiple clips, select the clips, and select **Menu > Paste to Selected Clips**.
-

Undoing Effect Changes

You can undo/redo changes to the effect settings. However, WaveLab Pro only registers the changes when the **Effects** window loses focus.

PROCEDURE

1. In the plug-in window, click another window to lose focus of the plug-in in which you want to undo the settings.
 2. Go back to the plug-in in which you want to undo the settings.
 3. On the command bar, click **Undo** or **Redo**.
-

Channel Processing

In the **Master Section**, in plug-in windows, and in the **Effects** window, you can specify for each plug-in which channels to process. This allows you to use each plug-in in mid/side mode, for example.

You can process all channels or only the left, right, mid, or side channel. When you select one channel, the other channel is bypassed.

To use a different plug-ins for each channel, use one effect slot for each channel.

Insert

Stereo

All channels are processed by the plug-in.

Left

Only the left channel is processed by the plug-in.

Right

Only the right channel is processed by the plug-in.

Mid

Only the mid channel is processed by the plug-in.

Side

Only the side channel is processed by the plug-in.

Send (Return to Stereo)

Left

Only the left channel of the plug-in is processed. The left wet signal of the plug-in is mixed to the left/right dry signal.

Right

Only the right channel of the plug-in is processed. The right wet signal of the plug-in is mixed to the left/right dry signal.

Mid

Only the mid channel of the plug-in is processed. The mid wet signal of the plug-in is mixed to the mid/side dry signal.

Side

Only the side channel of the plug-in is processed. The side wet signal of the plug-in is mixed to the mid/side dry signal.

Setting Up the Channel Processing

You can set up which channel to process in the **Master Section**, in plug-in windows, and in the **Effects** window.

Channel Processing in the Master Section

In the **Master Section**, on the **Effects** pane, click **Channel Processing**, and select which channel you want to process.

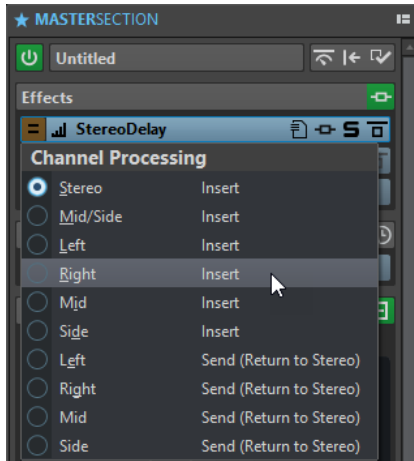

Channel Processing in Plug-in Windows

In a plug-in window, click **Channel Processing** and select which channel you want to process.

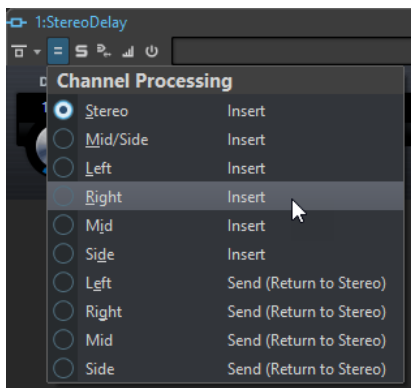

Channel Processing in the Effects Window

In the **Effects** window, click in the **Channel Processing** column for a plug-in and select which channel you want to process.

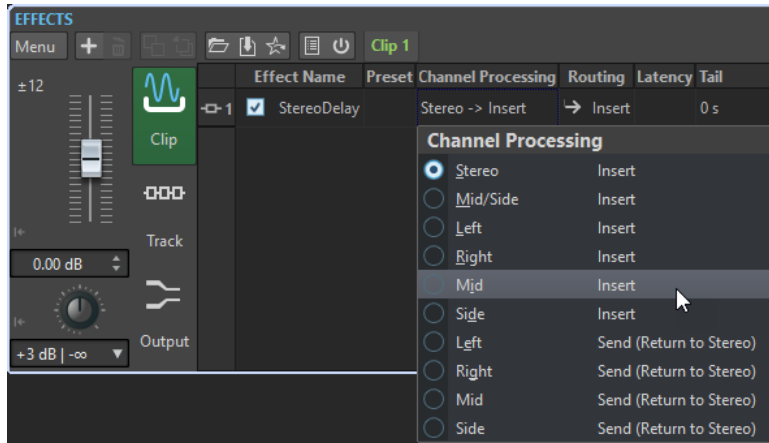

Clip Plug-in Routing

You can route clip plug-ins to a clip. This, in conjunction with envelopes, allows you to control which part of the clip is processed by the plug-in.

Each clip plug-in has its independent envelope. When the envelope is all the way down, only the dry signal is applied. When the envelope is all the way up, the processed/wet signal is at its maximum.

The automation envelope can be independent for the left and right audio channels.

The following routing options are available:

Insert (Standard)

Replaces the dry signal with the processed signal.

Blend Wet into Dry (Send)

Mixes the wet part of the plug-in output with the dry signal. The amount of mixing is determined by a fixed gain and/or an automation envelope. The corresponding envelope can be selected in the **Selector** section of the **Envelope** tab in the **Audio Montage** window.

Parallel Processing

Mixes the processed signal with the dry signal. The level of the dry signal remains unchanged. The amount of mixing is determined by a fixed gain and/or an automation envelope. The corresponding envelope can be selected in the **Selector** section of the **Envelope** tab in the **Audio Montage** window.

This mode can be used for parallel compression.

The **Edit Automation Envelope** option opens the **Envelope** tab and selects the automation envelope.

RELATED LINKS

[Routing a Plug-in to a Clip](#) on page 290

[Ducking Clips](#) on page 269

Routing a Plug-in to a Clip

You can route a plug-in to an entire clip or only to parts of the clip.

PROCEDURE

1. Select **Tool Windows > Effects**.
2. In the **Effects** window, select the **Clip** section.

3. Click **Add Slot**.

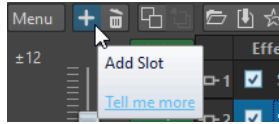

4. In the **Effect Name** column, select the added slot.
 5. Select a plug-in.
 6. Click in the **Routing** column and select one of the following routing options:
 - **Insert (Standard)**
 - **Blend Wet into Dry (Send)**
 - **Parallel Processing**
 7. If you have selected **Blend Wet into Dry (Send)** or **Parallel Processing**, you can edit the effect envelope to route the plug-in only to parts of the clip. Click in the **Routing** column and select **Edit Automation Envelope**.
The **Envelope** tab in the **Audio Montage** window opens and the plug-in is selected as envelope type.
 8. In the montage window, edit the envelope curve.
-

RELATED LINKS

- [Adding Effects Via the Effects Window](#) on page 285
- [Ducking Clips](#) on page 269
- [Envelopes for Clips](#) on page 264

Using Effect Envelopes

You can automate the effect send level for clip effects that use **Split Mode** by using effect envelope curves.

PREREQUISITE

Set up a **Split Mode** effect plug-in for a clip.

PROCEDURE

1. Open an audio montage.
 2. Select the **Envelope** tab.
 3. In the **Envelope Type** pop-up menu, select the effect that you want to use for the envelope curve.
 4. Create the envelope curve.
-

RELATED LINKS

- [Effects for Tracks, Clips, and the Montage Output](#) on page 281

Setting Pan and Gain for Effects

You can set the **Pan** and the **Gain** of the effects for each clip and track individually.

PROCEDURE

1. Open an audio montage.
2. Select **Tool Windows > Effects**.
3. In the **Effects** window, select a clip or track.

4. Adjust the **Pan** and the **Gain** using the controls on the left of the **Effects** window. For clips, the **Gain** is applied post-effect.

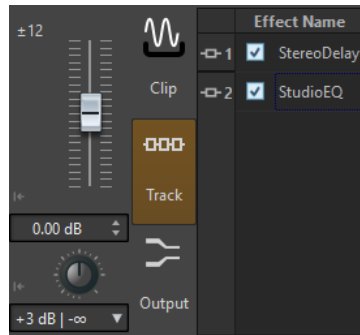

Setting the Global Gain for Effects

You can set a global gain for the montage output effects of your audio montage and apply it before or after the montage output effects.

PROCEDURE

1. Open an audio montage.
2. Select **Tool Windows > Effects**.
3. In the **Effects** window, select **Output**.
4. Adjust the global gain using the fader on the left of the **Effects** window.

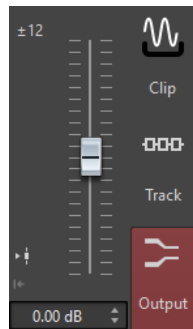

5. Click the pre/post button to apply the global gain before or after the montage output effects.



Global gain before montage output effects



Global gain after montage output effects

If you use a dithering plug-in, set the gain to be pre-master.

Plug-in Window

In this window, you can display the effect plug-ins that are used for a track, clip, or the montage output. You can display all effects in one plug-in window or have separate windows for each effect, for all track effects, all clip effects, or all montage output effects.



Plug-in chain window



Single plug-in window

When you add a new effect plug-in to a track, a clip, or the montage output, the plug-in window opens automatically. In the plug-in window, the effects are displayed in a plug-in chain by default. To change the processing order of the effects, you can drag each effect to a new position in the chain.

You can adjust the handling of the effects in the plug-in window in the **Plug-in Window Handling** dialog.

RELATED LINKS

[Plug-in Window Handling Dialog](#) on page 295

Opening the Plug-in Window

You can open the plug-in window from different locations.

- To open the plug-in window from the **Effects** window, in the effects list, click the plug-in window icon to the left of a plug-in.
- To open the plug-in window for a clip from the montage window, right-click the bottom part of a clip, and select **Edit Plug-ins**. You can also right-click the clip name and select a plug-in.
- To open the plug-in window for a track, click the **FX** button in the track control area.

Adding Effects From Within the Plug-in Window

Effects that are added to a clip, track, or the montage output in the **Effects** window are automatically displayed in the plug-in window. However, you can also add effects to a track or a clip from within the plug-in window.

PROCEDURE

1. In the **Plug-in Window Handling** dialog, activate **Use Plug-in Chain Windows**.
2. Open the plug-in window for the clip, track, or montage output to which you want to add an effect.
3. In the plug-in window, click the **Add Plug-in** button.



4. Select an effect from the menu.
The effect is added at the end of the plug-in chain.
 5. Optional: If you want to move the added effect in the plug-in chain, drag it to another position.
-

RELATED LINKS

[Plug-in Window Handling Dialog](#) on page 295

Changing Effects From Within the Plug-in Window

PROCEDURE

1. Open the plug-in window for the clip, track, or montage output for which you want to change an effect.
2. Click the plug-in menu icon, and select a new effect from the menu.



3. Optional: If you want to move the changed effect in a plug-in chain window, drag it to another position.
-

Switching Between Track, Clip, and Montage Output Effects in Plug-in Windows

In the plug-in window, you can switch between the effect chains of clips, tracks, and the montage output. You can also switch between plug-in windows, when you have opened several plug-in windows.

- To skip through the clip and track effects of the active audio montage, use the left and right arrow icons.

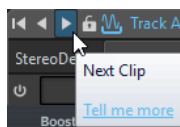

- When using one plug-in window for both clips and tracks of an audio montage, you can switch between the plug-ins of the active clip or the track that contains the active clip by clicking the **Show Clip Plug-ins** or **Show Track Plug-ins** icons.

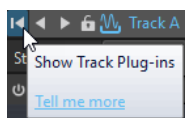

- To lock a plug-in window, activate **Lock Window**. If this option is activated, and you select another track or clip, another plug-in window opens. If this option is deactivated, and you select another track or clip, the effects are displayed in the same plug-in window.

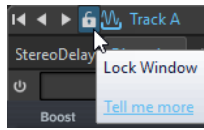

NOTE

The **Lock Window** button is only visible if **Use Plug-in Chain Windows** and **Unlimited Number of Open Windows** is activated.

Closing All Plug-in Windows

PROCEDURE

1. Open an audio montage.
 2. Select **Tool Windows > Effects**.
 3. In the **Effects** window, select **Menu > Close All Windows**.
-

Plug-in Window Handling Dialog

In this dialog, you can set up the appearance and behavior of the plug-in windows.

- To open the **Plug-in Window Handling** dialog, open the **Effects** window and select **Menu > Plug-in Window Handling**.

Use One Window Per Plug-in

If this option is activated, each plug-in opens in an individual window.

Close Other Windows When Opening a New One

Closes all open plug-in windows of an audio montage each time that you open a new plug-in window. This means that only one plug-in is displayed at a time for a each audio montage.

Use Plug-in Chain Windows

Shows all open plug-ins in the plug-in window as tabs, which allows you to quickly switch between the plug-ins.

Unlimited Number of Open Windows

Allows for an unlimited number of plug-in chain windows to be open at the same time. There can be one window for each track and one for each clip.

Lock Window on Opening

Automatically locks a plug-in each time that a plug-in chain window is opened.

If a plug-in window is locked, and you select another track or clip, another plug-in window opens. If this option is deactivated, and you select another track or clip, the effects are displayed in the same plug-in window.

Use One Window for Clips and One for Tracks

Uses one plug-in window for all clips, one for all tracks, and one for the montage output.

Use One Window per Montage

Uses one plug-in window for the clips, tracks, and the montage output of an audio montage.

Auto Switch between Tracks and Clips

If this option is activated and you click the track control area of a track, the plug-in window switches to display the track plug-ins. If you click a clip, the plug-in window switches to display the clip plug-ins.

CD Markers

A track in the audio montage is defined by CD track start and end markers or CD track splice markers.

- CD track splice markers indicate the end of one track and the start of the next.
- If you delete the CD markers defining a track, the track is deleted from the **CD** window.
- If you edit a marker position of a CD track, the change is reflected in the track in the **CD** window.
- The name of a CD track is the name of the CD track start marker. Editing the marker name also changes the CD track name, and vice versa.

CD Window

In this window, you can create an audio CD or DVD-Audio.

It displays a list of CD tracks along with information about each track. You can edit each track and the playback properties of the CD, check the conformity to the Red Book standards, add and edit CD-Text, add UPC/EAN and ISRC codes, generate a CD report, and write the CD.

When you select a clip in the montage window, the corresponding track is highlighted in the **CD** window.

A CD track in the audio montage is defined by CD markers. You can reorder CD tracks in the CD track list using drag and drop.

- To open the **CD** window, open an audio montage and select **Tool Windows > CD**.

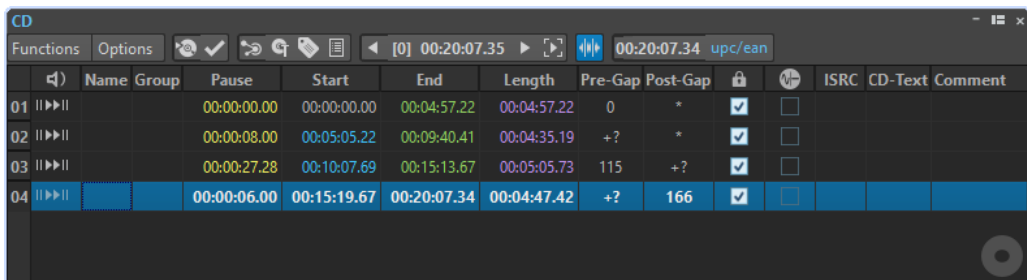

Track List

Play Pre-Roll



Plays back the corresponding track from the start with a pre-roll.

You can also press **Alt** and click **Play Pre-Roll** to play back the corresponding track from the start with a short pre-roll.

Play



Plays back the corresponding track from the start.

You can also hold **Ctrl/Cmd** and double-click a CD track start marker triangle to start playback from the marker position.

Name

Shows the track name. To change the name, double-click in the corresponding cell, and enter a new value.

Group

Allows you to define track groups.

Pause

Shows the pause between two tracks.

Start

Shows the start position of the track.

End

Shows the end position of the track.

Length

Shows the time value from the CD track start position to the corresponding end or splice marker.

Pre-Gap

Shows the pre-gap of a track.

Post-Gap

Shows the post-gap of a track.

Lock

The lock icon indicates a track copy protection flag. Note that not all CD-R units can handle this flag.

Emphasis

The rainbow-colored symbol indicates the emphasis flag. This setting is used to indicate if the track was recorded with emphasis or not. Activating/Deactivating this option does not apply/remove emphasis from the audio. It is just an indicator for how the file was created.

ISRC

Lets you enter an ISRC code. To change the code, double-click the corresponding cell, and enter a new value.

CD-Text

Lets you specify the CD-Text. To change the CD-Text, double-click the corresponding cell, and enter a new value.

Comment

Allows you to enter a comment. To enter a comment, double-click a cell.

Functions Menu**Write Audio CD or DDP**

Opens a dialog that allows you to write a CD or DDP.

Check CD Conformity

Verifies that the settings for the audio montage are in accordance with the Red Book standard.

CD Wizard

Opens a dialog that helps you generate and adjust CD markers.

Edit CD-Text

Opens the **CD-Text Editor** that allows you to enter descriptive text for the tracks that are written on CD.

Edit CD Metadata

Opens the **CD Metadata** editor that allows you to associate metadata with each CD track. When rendering CD tracks via the **Render** dialog, the audio files inherit this metadata.

Import ISRC Codes from Text File

Allows you to import a text file that contains ISRC codes.

Generate Audio CD Report

Opens a dialog that lets you create a text report that describes the contents of the audio CD.

Rename CD Tracks as CD Text

Replaces the name of each CD track with the name that is specified in the CD-Text **Title** field.

Play Previous CD-Track/Play Next CD-Track

This is used to audition the track before/after the selected track. This depends on the pre-roll settings.

Play All CD-Track Starts

This is used to check the transitions between all tracks. In the **Edit Playback Times** dialog of the **CD** window, you can set the playback length for this function.

Options Menu

Audio in Pauses

Usually, when you create a CD, only the sections between track markers are written, and the pauses between tracks are replaced by silence. However, if **Audio in Pauses** is activated, the exact image of the audio montage is written, including any audio between tracks. This makes it possible to hear audio either between CD tracks or before the first track, for example, to create a hidden track.

Preserve Post-Pauses when Reordering

If this option is activated, the pause after a CD track is preserved when you reorder tracks. If this option is deactivated, the pause before a CD track is preserved when you reorder tracks.

Show Times Relative to Track #1

If this option is activated, the start of track #1 is the time code reference, excluding any pause before that track.

Show Times Relative to CD's Absolute Zero

If this option is activated, the beginning of the CD, including any pause before track #1, is the time code reference.

Time Code with CD Frames

If this option is activated, the time code is displayed in hours, minutes, seconds, and CD frames.

Time Code with Milliseconds

If this option is activated, the time code is displayed in hours, minutes, seconds, and milliseconds.

Pre-Roll Mode

If this option is activated, all tracks start with a pre-roll time when they are played back using the commands of the **CD** window.

Edit Playback Times

Opens a dialog where you can adjust the time values that are related to CD track playback.

Customize Command Bar

Opens the **Customize Commands** dialog which contains options to hide or show specific command bar buttons.

Toolbar

The following indicators are only available on the toolbar of the **CD** window:

Position in CD Track

Indicates the position of the playback/edit cursor, relative to the start of the CD track in which it is located.

UPC/EAN Code

Opens a dialog in which you can specify an UPC/EAN code.

Edit Playback Times Dialog

In this dialog, you can edit time values that are related to the playback of the CD track when using the playback commands of the **CD** window.

- To open the **Edit Playback Times** dialog, open the **CD** window and select **Options > Edit Playback Times**.

CD Track Pre-Roll

Specifies how much time before the start of a CD track is played back to help you evaluate the transition between CD tracks.

Add One Second of Silence before Playback

If this option is activated, WaveLab Pro waits one second before starting playback of the next CD track start.

Test Time

Specifies the playback length of CD track starts for the **Play All CD-Track Starts** function in the **CD** window.

Metadata for CD Tracks

You can associate metadata with individual CD tracks or with an entire CD. When rendering CD tracks via the **Render** dialog, the audio files can inherit this metadata.

Because standard CD Text is not unicode, it does not always provide the optimum text data. To solve this issue, WaveLab Pro provides variables.

For CD tracks, there are two type of variables:

- Auto variables
- Custom variables

Auto variables are automatically added by WaveLab Pro. For example, ISRC, track names, and CD-Text. Custom variables can be manually edited to add additional metadata for the track.

- To see and edit the CD track metadata, open the **CD** window, and select **Functions > Edit CD Metadata**.

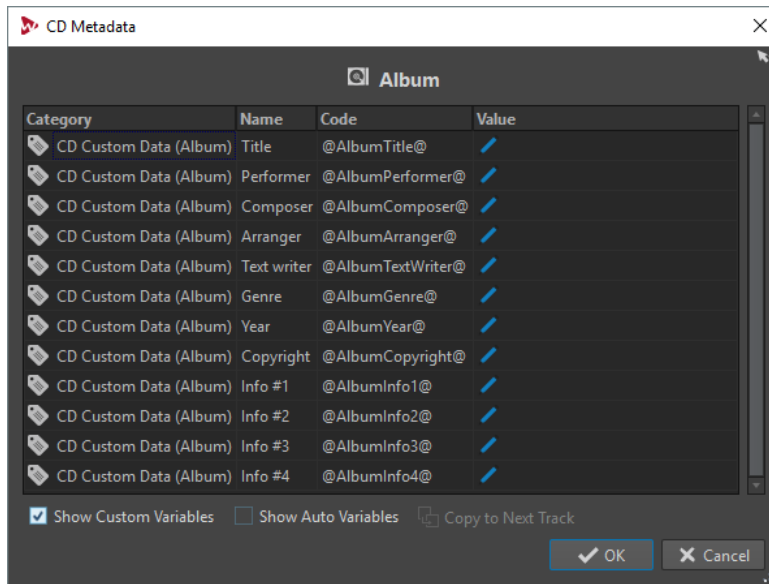

NOTE

In this dialog, you prepare the metadata. How they are saved, is specified in the **Metadata** dialog.

RELATED LINKS

[Metadata](#) on page 146

Creating Audio CD Tracks From Clips

The **CD Wizard** tool lets you generate CD track and splice markers from clip regions and crossfade points. You can use the **Check CD conformity** option to check whether the audio montage is ready for writing to audio CD.

PROCEDURE

1. Make sure that the audio montage contains the material that you want on the audio CD. CD tracks must have a length of at least 4 seconds.
 2. In the **CD** window, select **Functions > CD Wizard**.
 3. Edit the settings in the **CD Wizard** dialog, and click **Apply**.
 4. Audition the tracks in the **CD** window, and make corrections if necessary.
 5. In the **CD** window, select **Functions > Check CD Conformity**.
 - If a warning message appears, make corrections and check the CD conformity again.
 - If no warning message appears, the audio montage is ready to be written to an audio CD.
-

CD Wizard Dialog

In this dialog, you can generate and adjust CD markers for audio montages.

- To open the **CD Wizard** dialog, open the **CD** window and select **Functions > CD Wizard**.

Generate CD Track Markers

If this option is activated, the CD Wizard automatically generates CD track markers according to the sub-options.

Create Markers at Clip Boundaries

If this option is activated, CD track start and end markers are added at the beginning and end of all non-overlapping clips.

Use Splice Markers (Keep Pauses within Tracks)

If this option is activated, single splice markers are generated instead of start/end markers. Instead of a standard pause, pause spaces are generated. The pauses are kept within tracks. This can be useful for electronic distribution and for compatibility with portable players.

Create Markers at Crossfade Points

If this option is activated, CD track splice markers are created at all crossfade intersection points. Activate this option if you have clips that overlap each other and that should become different tracks on the CD.

Keep Locked CD Track Markers

Normally, any previously created CD track markers in the montage are removed by the CD Wizard. If **Keep Locked CD Track Markers** is activated, the locked CD track markers are kept.

CD Marker Naming

Allows you to set up a naming scheme.

Start Marker

On this menu, you can select a naming scheme for the CD track start markers. The following options are available:

- **As Clips:** The name of the closest clip.
- **Specific Name:** The name specified below.
- **Specific Name + Number X:** The name and a number.
- **Specific Name + Number XX:** The name and a number that is padded on the left with 0.
- **Specific Name + Number (Auto):** As **Specific Name + Number XX**, but only if the number of tracks is greater than 10.
- **Number X + Specific Name:** A number and a name.
- **Number XX + Specific Name:** A number that is padded on the left with 0 and a name.
- **Number (Auto) + Specific Name:** As **Number XX + Specific Name**, but only if the number of tracks is greater than 10.
- **Custom:** Opens the **Rename Markers** dialog where you can rename multiple markers according to specified settings.

End Marker

On this menu, you can select the name of the CD track end marker. The following options are available:

- **No Name**
- **As Start Marker**
- **As Start Marker + "(End)"**
- **Custom**

Adjust Pauses before Tracks

If this option is activated, pauses before tracks are automatically adjusted according to the sub-options.

Set Time

If this option is activated, you can specify the length of the pauses between tracks.

Round Existing Pauses to Closest Second

If this option is activated, the existing pauses between tracks are rounded to seconds.

Do Not Change First Pause

If this option is activated, the pause between the start of the montage and the first track is not changed. If you change the length of the pauses to anything other than 2 seconds and want to be conform to the Red Book standard, you must activate this option.

Adjust Gaps between Markers and Sound (as CD Frames)

If this option is activated, small adjustments to the spacing before and after the CD track markers are made according to the sub-options. This is useful to ensure that a low-quality CD player does not miss the start of tracks or cuts them off before their actual end. In most cases, the default settings are sufficient.

Silence after First Track Start Marker

Lets you add a few frames of silence before the first track of the CD. Usually, the pause needs to be longer for the first track than for the other tracks to ensure that a low quality CD player does not miss the start of the first track.

Silence after Track Start Marker

Lets you add a few frames of silence before each track on the CD to ensure that a low quality CD player does not miss the start of tracks.

Silence before Each Track End Marker

Lets you add a few frames of silence after each track of the CD to ensure that a low quality CD player does not cut off tracks before their actual end.

Silence before Last Track End Marker

Lets you add a few frames of silence after the last track of the CD to ensure that a low quality CD player does not cut off the end of the track or that the listener is not disturbed by any clicks or motor noise that the player makes at the end of a CD.

Ensure Required Minimum Size for CD Tracks

If this option is activated, markers are adjusted to ensure that each CD track has the minimum length that the Red Book standard requires.

Quantize CD Markers to Nearest CD Frame

If this option is activated, markers are quantized to the nearest CD frame.

Generate ISRC Codes

If this option is activated, ISRC codes for the CD tracks are created. Each code is based on the code that is specified in this option, but with an ending number that is set according to the order of the tracks.

UPC/EAN Code (13 Digits)

Lets you specify an optional UPC/EAN code for the CD.

RELATED LINKS

[Batch Renaming Dialog for Markers](#) on page 529

Audio in Pauses

Normally, when you write an audio montage on an audio CD, only the sections between the CD markers are written, and the pauses between tracks are replaced by silence. However, if **Audio**

in Pauses is activated, the exact image of the audio montage is written on the CD, including any audio between tracks.

Using Audio in Pauses

The following describes two use cases for the **Audio in Pauses** function.

Adjusting CD Track Markers to Hide Audio Sections

If you have a live recording with a section of applause between two songs, you can move the track markers so that the applause section is between the tracks and activate **Audio in Pauses**. Thus the applause cannot be heard if you play any of the two tracks on their own, but you can hear it when playing through the CD tracks.

PROCEDURE

1. In the montage window, place the CD track end marker of the first track at the position where the music ends, but before the applause section.
 2. If necessary, place the CD track start marker of the following track at the position where the music starts.
 3. In the **CD** window, select **Options > Audio in Pauses**.
-

Placing a Clip Before Track 1

You can create a hidden CD track before track 1, for example.

PROCEDURE

1. In the montage window, place a clip without CD track markers prior to the first track start marker in the audio montage.

NOTE

It is recommended that you do not place the hidden track at the very start of the montage but leave a little room between the montage start and the start of the hidden track.

2. In the **CD** window, select **Options > Audio in Pauses**.
 3. Proceed with writing the CD.
To hear the hidden track after writing the disc, rewind from the start of track 1.
-

Snapshots

You can save a number of snapshots of your audio montage, to capture the current scroll position, zoom factor, cursor position, audio selection, and clip selection status.

You can recall a snapshot at any time and update snapshots.

Selecting a saved snapshot restores all of its view settings. You can also choose to recall only specific view properties by activating the corresponding options for a snapshot.

RELATED LINKS

[Snapshots](#) on page 199

Capturing the Current View

Capturing the current view saves the current zoom factor, cursor position, scroll position, clip selection status, and time range.

PROCEDURE

1. Set up the view of the montage window.
2. Select the **View** tab.
3. In the **Snapshots** section, click **Take Snapshot** .
4. Click one of the preset buttons to save the snapshot.

RESULT

The snapshot is saved and can be recalled by clicking the corresponding preset button.

Updating Snapshots

You can update a snapshot with the current view.

PROCEDURE

1. Set up the view of the montage window.
2. Select the **View** tab.
3. In the **Snapshots** section, click **Take Snapshot** .
4. Click the preset button that you want to update.

RESULT

The new snapshot replaces the selected snapshot.

Mixing Down – The Render Function

The **Render** function allows you to mix down the whole audio montage or sections of it to a single audio file or to several files in case of a multichannel audio montage. It also allows you to render to an audio CD, to a CD image and cue sheet, or to a new audio montage.

A mixdown is necessary to produce an audio file from the audio montage. The **Render** function can be used for the following purposes:

- Write a CD from a CPU-intensive audio montage, because it allows you to first render all track and clip effect processing to recreate a new audio montage and then write the CD in a second pass.
- Render audio files, audio montages, or marker regions in audio montages to multiple file formats at the same time.
- Render surround channels as multiple files while retaining the stereo/mono status of the individual surround channels.
- Create a CD image and cue sheet.
- Render audio montages to a single file or render various parts of a montage to multiple audio files in one operation. For example, you can render regions, groups, clips, or CD tracks.

RELATED LINKS

[Rendering](#) on page 350

Rendering to Audio File

You can render to a single audio file format or to multiple audio file formats at the same time.

PREREQUISITE

Set up your audio montage. If you want to render to multiple file formats, create file format presets.

PROCEDURE

1. In the **Audio Montage** window, select the **Render** tab.
2. In the **Source** section, specify which part of the audio file you want to render.
3. In the **Results** section, activate **Named File**.
4. In the **Output** section, click the **Format** field and do one of the following:
 - If you want to render to one audio format, select **Edit Single Format**.
 - If you want to render to multiple file formats, select **Edit Multi Format**.
5. Make your settings in the **Audio File Format** dialog.
 - To add multiple file formats in the **Multi Audio File Format** dialog, click **Plus** and select the file format presets that you want to render to.
6. Click **OK**.
7. Optional: Make additional settings on the **Render** tab.
8. In the **Render** section, click **Start**.

RESULT

The audio montage is rendered.

If you render a surround mix to **Multi Stereo/Mono** files, the mono/stereo status of the rendered files reflects the mono/stereo status of the surround channels. If the audio montage uses a 6 channel (5.1) surround mode, two stereo files (Lf/Rf and Ls/Rs) and two mono files (C/Lfe) are rendered. The names of the rendered files reflect the name of the surround channel to which they belong.

If you render an 8 channel configuration using the **Multi Stereo/Mono** option, the channels are grouped as logical pairs (1-2, 3-4, etc.). For tracks that are routed to only one channel in a pair, a mono file is created.

Under Windows, you can also render single multichannel surround files in the WMA 5.1 and 7.1 formats. Use the Windows Media Audio 9 Professional encoder.

RELATED LINKS

[Multi Audio File Format Dialog](#) on page 352

[Creating Multiple Audio File Format Presets](#) on page 352

Loudness Meta Normalizer

This tool is a key mastering component to ensure that all songs get the same loudness and to prevent clipping. It allows you to adjust the loudness of each clip in the audio montage so that they all have the same loudness. It is also possible to adjust the loudness of the audio montage mixdown as well as the loudness at the **Master Section** output.

This tool operates on gains. It does not affect the underlying audio files or use any audio compressor.

If it is not possible to modify the loudness of a particular clip without clipping, the level of the other clips is reduced so that all clips still achieve the same loudness. This does not happen if the

Ignore Peaks option on the **Peaks** pop-up menu in the **Loudness Meta Normalizer** dialog is selected.

To avoid clipping at the **Master Section** stage, you can limit the mixdown output of the audio montage before it goes into the **Master Section** and/or the **Master Section** output.

The loudness is calculated according to the EBU R-128 recommendation. The reference loudness can either be the loudness of the loudest clip, of a specific clip, or a custom value.

There are three possible loudness references:

- Loudness of an entire file (EBU R-128 recommendation).
- Top of a loudness range, that is, the average loudest 3 second audio section of a file. This ensures that a single unusually loud sound is not taken into account for the reference.
- Maximum short-term loudness, that is, the maximum loudness that is found in a 3 second audio section of the file, for example, the loudness of a short music passage.

NOTE

- The audio path in the audio montage uses 64-bit floating point processing. You can therefore overload it, for example, use levels above 0 dB in clips, without causing clipping in the signal path. The only section of the audio path that can introduce clipping is the output of the **Master Section** or the output of the audio montage. Both of these issues can also be solved by the Loudness Meta Normalizer.
- Because loudness requires several seconds of audio to be correctly calculated, this tool should not be used for very short clips (under 3 seconds).

Loudness Meta Normalizer Dialog

In this dialog, you can adjust the loudness of each clip in the audio montage so that they get the same loudness. You can also adjust the whole output, while taking the EBU R-128 audio measurement recommendation and a true peak analysis into account.

- To open the **Loudness Meta Normalizer** dialog, select the **Process** tab in the **Audio Montage** window, and click **Meta Normalizer** in the **Loudness** section.

Clips, Master Section Output, and Audio Montage Output

- If **Clips** is activated, the gain settings of all clips in the audio montage are adjusted individually so that all clips play back at equal loudness.
- If **Audio Montage Output** is activated, the gain setting of the audio montage is modified so that the audio montage mixdown matches a specific loudness.
- If **Master Section Output** is activated, the **Master Section** gain is adjusted so that the audio montage mixdown that is processed through all **Master Section** plug-ins matches a specific loudness. The audio montage itself is not modified by this operation.

The following options are available for the gain settings of clips, the audio montage output, and the **Master Section** output.

Match loudness menu

Select whether the audio montage output should match a specific loudness. The following options are available:

- **Do Not Change Loudness**
- **Match Loudest Clip**
- **Match Loudness of Active Clip**
- **Match Specific Loudness**
- **Equalize Peak Levels**
The highest peak is used as reference.

Loudness

Determines the loudness to match. For example, specify -23 LUFS if you want to follow the EBU R-128 recommendation for broadcast.

Reference menu

Select the loudness that WaveLab Pro should reference:

- **Loudness of Entire Clip** (EBU R-128 recommendation)
- **Top of Loudness Range** (average loudest 3 second audio section)
- **Maximum Short-Term Loudness** (loudest 3 seconds audio section)

Peaks menu

Select whether WaveLab Pro should limit the sample values (digital peaks), the analog reconstructed samples (true peaks), or ignore the peaks.

Maximum Peak

Determines the maximum peak value that must not be exceeded.

Force Equal Loudness

If **Limit True Peaks** or **Limit Digital Peaks** is selected, some clip might not reach the required gain for the reference loudness. In that case, activate **Force Equal Loudness** to reduce the loudness of the clip that is used as a reference to achieve equal loudness across all clips.

Additional Options

Exclude Audio Montage Effects

If this option is activated, audio montage effects are not taken into account when you use the Loudness Meta Normalizer.

This option also affects the **Pre-Gain** and **Post-Gain** options in the **Clips** window.

- If **Exclude Audio Montage Effects** is activated, the Loudness Meta Normalizer changes the **Pre-Gain** value of the clips.
- If **Exclude Audio Montage Effects** is deactivated, the Loudness Meta Normalizer changes the **Post-Gain** value of the clips.

Only Selected Clips

If this option is activated, only the selected clips are processed with the Loudness Meta Normalizer.

Show Log

If this option is activated, a log window opens after the process to show the analysis result.

Test Only

If this option is activated, a test analysis is performed. A log window opens to show the result of this analysis. The test analysis does not apply the loudness settings to the audio.

Navigator Window

This window displays an overview of the entire active audio montage and allows you to quickly navigate in it.

- To open the **Navigator** window, open an audio montage and select **Tool Windows > Navigator**.

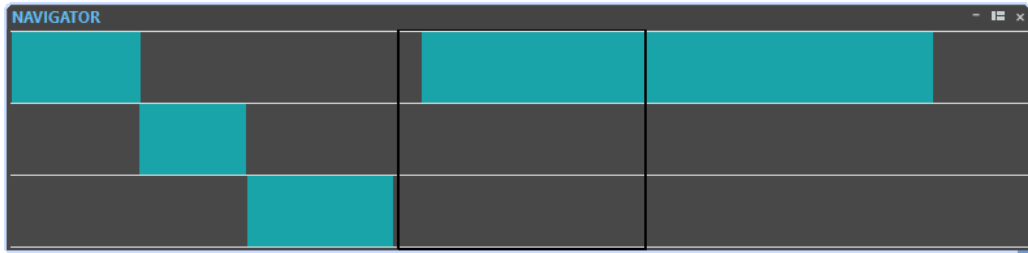

Each clip is represented by a colored block. The visible window content is shown by a black rectangle.

Navigating in the Navigator Window

The **Navigator** window allows you to quickly find positions in large audio montages.

Dragging with the mouse in any direction scrolls the main audio montage window, allowing you to navigate to a location in your audio montage.

- To adjust the visible range of the active window, you can resize the rectangle vertically and horizontally by dragging its edges. You can also resize by **Shift**-clicking in the rectangle edges and dragging.
- To zoom in on a clip, click its corresponding block. If the clip is inside the rectangle, double-click it.
- To completely zoom out, right-click anywhere in the window.

Notes Window

This window allows you to enter notes about the current audio montage session.

- To open the **Notes** window, open an audio montage and select **Tool Windows > Notes**.

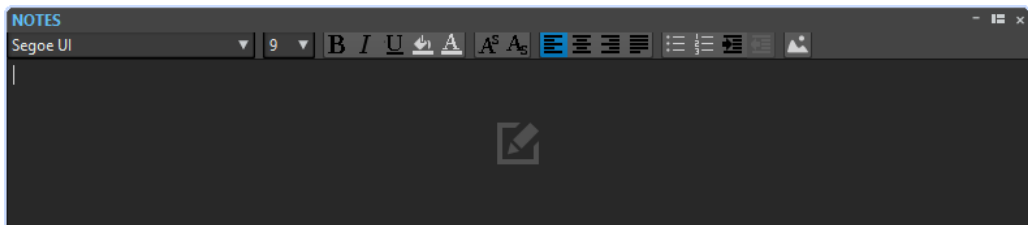

You can enter the text directly in this window and use the standard HTML text editor controls to format the text, and to add images and lists. The notes are saved with the audio montage.

Groups

Groups are selections of clips that can be accessed via the **Groups** window or by clicking any clip of a group.

A clip cannot be part of more than one group. If you add a clip to a group, it is automatically removed from any other group. You can select a specific color for a group to make it easy to discern it in the track view.

You can render all groups as individual files in the **Render** dialog of the **Master Section**.

- To create nested groups, drag a group into another group.
- To deactivate a group, deactivate its checkbox in the list. If a group is deactivated, you can move the individual clips.
- To rename a group, double-click its name and enter a new name.

- To select all clips of a group in your audio montage for editing, click the group.

RELATED LINKS

[Super Clips](#) on page 256

Groups Window

This window displays a list of the groups that are part of the current audio montage.

- To open the **Groups** window, open an audio montage and select **Tool Windows > Groups**.

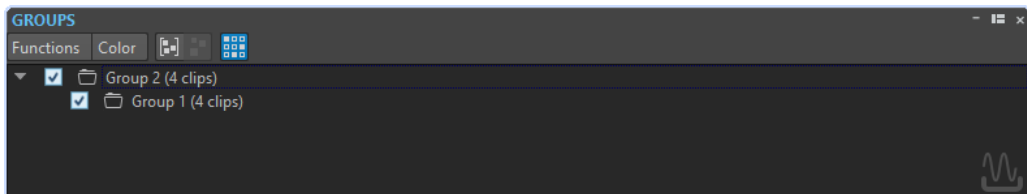

Group Selected Clips

Creates a group from all selected clips.

Remove Selected Group

Removes the group that is selected in the list. The clips themselves are not removed from the montage.

Click Selects Group

If this option is activated, selecting a clip in the track view automatically selects all clips in the same group.

If this option is deactivated, selecting a whole group requires that you click the group name in the groups view list. This is useful if you want to be able to modify the relative positions of clips in the group without having to remove them from the group.

Color

Lets you select a color for the group.

Customize Command Bar

Opens the **Customize Commands** dialog which contains options to hide or show specific command bar buttons.

Grouping Clips

PROCEDURE

1. In the montage window, select the clips that you want to group.
 2. In the **Groups** window, select **Functions > Group Selected Clips**.
 3. Enter a name for the group, and click **OK**.
-

RESULT

The new group is displayed in the group list. The group name is prepended to the names of the clips that are included in the group.

Adding Clips to an Existing Group

PROCEDURE

1. In the montage window, select the clips that you want to add to a group.

2. In the **Groups** window, select **Functions > Group Selected Clips**.
 3. Select the group to which you want to add the clips, and click **OK**.
-

Removing Groups

PROCEDURE

1. In the **Groups** window, select a group.
 2. Select **Functions > Remove Selected Group**.
-

RESULT

The group is removed. The clips themselves are not removed from the montage.

Coloring Groups

PROCEDURE

1. In the **Groups** window, select a group.
 2. Open the **Color** menu and select a color.
Any individual color selections for the clips override the group color.
-

Audio Montage Backups

The audio montage backup mechanism allows you to maintain previous versions of saved audio montages and to automatically save audio montages.

Whenever you save an audio montage, the previously saved version is copied to the subfolder `Backup.mon` which is located in the same folder as the audio montage file. This backup folder is automatically created by WaveLab Pro. The backup files are named "Montage_#X", where "Montage" is the name of the audio montage and "X" is a number.

You can specify how many previous versions you want to keep (maximum 1000). Once the specified number of backups is reached, the oldest file is overwritten each time that the audio montage is backed up.

NOTE

The numbers in the backup file names are not related to the age of the backup files. Instead, you must check the dates of the files to know which backup is the most recent.

Unsaved and untitled audio montages are also backed up. The backup files for untitled audio montages are saved in the temporary folder, and use a number as name, so that the files are called "Y_#X", where "Y" is a number identifying the audio montage, and "X" is the number of the backup file.

Setting Up the Audio Montage Backup

You can specify the number of audio montage backups and define how often the backup should be performed.

PROCEDURE

1. In the **Audio Montages Preferences**, select the **All Audio Montages** tab.
2. In the **Backups** section, specify the maximum number of backups.
To deactivate the backup function, set this setting to 0.

3. Optional: Activate **Auto Save**, and specify how often the backup should be performed.
-

Opening an Audio Montage Backup

You can open the backup of an audio montage to restore a former version of the audio montage.

PROCEDURE

1. Select **File > Open**.
 2. Click **Audio Montage**.
 3. Do one of the following:
 - To close the current unsaved audio montage and open the last saved version, click **Revert to Saved File**. This replaces the current audio montage.
 - To open the saved version in a new window without closing the current, unsaved version, click **Revert to Backup**.
-

Multichannel Operations in the Audio Montage

WaveLab Pro supports the use of up to 8 ASIO inputs and outputs. If you use a multichannel audio interface with an ASIO driver, you can route audio montage tracks to up to 8 separate channel outputs and to up to 6 surround outputs.

You can also record up to 8 channels simultaneously. This automatically creates new tracks in the montage, one for each recorded channel or channel pair.

To be able to use WaveLab Pro for multichannel/surround projects, you need an audio card/interface with multiple inputs and outputs. You must also set up an ASIO driver in the **Audio Connections** tab and specify how the internal input/output channels are connected to your audio card.

RELATED LINKS

[Audio Connections Tab](#) on page 11

Multichannel Configuration

You can configure the number of channels to use for each audio montage.

There are two operational modes that you can use for multichannel operation:

- In the **Multichannel (DVD-Audio Compatible)** mode, in surround mode, tracks can be routed to one or several surround output channels (Left/Right Front, Center, etc.). You can assign up to 6 surround channels.
- In the **Multichannel (Free Configuration)** mode, channels refer to the names of the 8 WaveLab Pro output channels instead of the surround channels. Track channels can be routed to one (mono tracks) or two (stereo tracks) of the 8 available output channels.

Which configuration you should select depends on a number of factors:

- The number of outputs that are available on your audio card. If you only have 4 outputs on your card, you can only use surround formats with 4 or less channels.
- Whether or not you intend to mix the audio montage to a surround format. If not, select the **Stereo** mode or the **8 Channels** mode.
- The intended use of the final surround mix. For example, if you want your mix to be compatible with the 5.1 surround set-up, select the **6 Channels** mode.

All multichannel configurations except the free configuration mode have surround formats and are internally assigned to surround channels in WaveLab Pro. This means that the channels go through the **Master Section** and then to the audio card.

Assigning Track Channels to Output Channels

When you select a multichannel configuration, you must create and assign track channels to surround output channels manually.

PROCEDURE

1. In the **Audio Montage** window, in the track control area, click **Audio Track Dispatching** for an audio track.



2. In the **Audio Track Dispatching** dialog, route each channel of the track to an output channel by activating the corresponding channels. Which channels are available depends on the selected channel configuration.
3. Click **OK**.

RESULT

If you have selected a surround format, you can route a track channel to several or all surround output channels. If you select more than one output channel for a stereo track channel, the Surround Panner automatically opens in the track control area for the corresponding track.



Audio Track Dispatching Dialog

In this dialog, you set up to which channels the top and bottom audio channels of a track in the audio montage are sent. The available channels depend on the selected channel configuration.

- To open the **Audio Track Dispatching** dialog, click **Audio Track Dispatching** for an audio track in the track control area of the **Audio Montage** window.

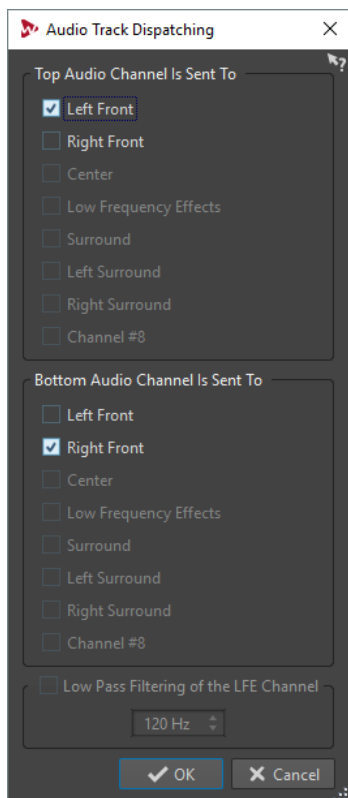

Top Audio Channel Is Sent To

Lets you select to which audio montage audio outputs the left channel of the track is sent.

Bottom Audio Channel Is Sent To

Lets you select to which audio montage audio outputs the right channel of the track is sent.

Low Pass Filtering of the LFE Channel

If an LFE output is selected, a low pass filter (12 dB/octave) can be applied to the track signal so that only the low frequency content can pass. The cutoff frequency for the filter can be adjusted.

Surround Panning

You can use surround panning to position a track freely in the surround image.

The **Surround Panner** lets you adjust the pan of your audio between surround channels. Each track can have its own Surround Panner, and several of these windows can be open at the same time.

Using Surround Panning

You can route any audio montage channel of a track to a surround channel or to a combination of surround channels using the **Audio Track Dispatching** dialog. However, if you also want to position a track freely in the surround image, you can use the surround panner.

PREREQUISITE

In this example, it is assumed that you have set up an audio montage in 5.1 surround format and that you want to use the surround panner for a stereo track.

PROCEDURE

1. In the **Audio Montage** window, in the track control area, click **Audio Track Dispatching** for the track that you want to use for surround panning.

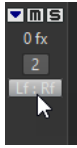

2. In the **Audio Track Dispatching** dialog, activate the surround channels. You can activate different surround channel combinations for the top (left) and bottom (right) audio channels.

3. Click **OK**.
A Surround Panner display opens in the track control area.



4. Click and drag in the surround panner display to make coarse adjustments. For a more precise control of the imaging, right-click the surround panner display to open the **Surround Panner** dialog.
5. In the **Surround Panner** dialog, click the blue square and move the mouse. This pans the audio of the top channel. The other channel is automatically mirrored horizontally. Right-click the display to choose from a number of positioning presets.
6. To view and edit the other channel, click the gray square. The gray square turns to red, and red speaker lines indicate the speaker levels.
7. When you have finished your settings, click **Close**.

Surround Panner Dialog

This dialog allows you to adjust the pan of your audio between surround sound channels.

Set up a multichannel, DVD-Audio compatible, audio montage, and select 2 or more output channels per track channel. For each track that is set to **Surround** in the **Audio Track Dispatching** dialog, a small Surround Panner is displayed in the track view.



- To open the **Surround Panner** dialog, right-click on the small surround panner.

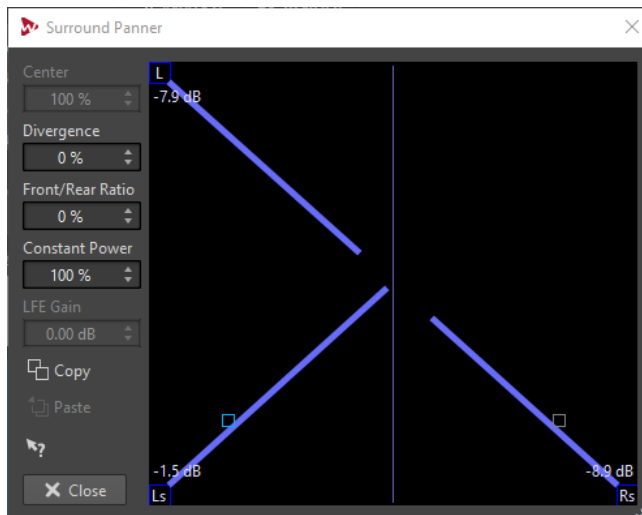

In the graphic display, the positions of the left/right audio channels of the clip are shown as small squares. The signal levels of the individual speakers are indicated by colored lines from the speakers to the center of the display.

The graphic display shows the surround imaging of either the top (blue) track audio channel, or the bottom (red) track audio channel. The color of the speaker lines shows which channel is selected for viewing and editing.

If you are viewing the top channel, you see a blue square indicating the position of the audio. The other, gray square represents the other channel. Click the gray square to view and edit this channel. The gray square turns to red and red speaker lines indicate the speaker levels.

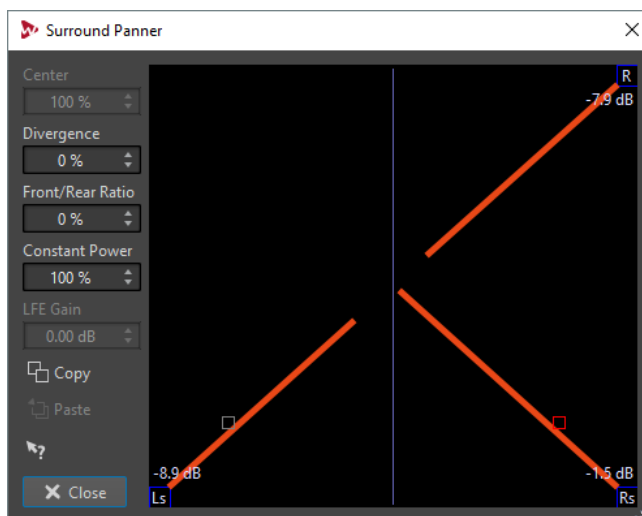

Center

Determines how much the track signal should be mixed into the audio montage output corresponding to the center speaker. This is only available if the center channel is activated in the **Audio Track Dispatching** dialog.

Divergence

Determines the attenuation curve that is used when positioning sound sources. If this is set to 0 %, positioning a sound source on a speaker sets all other speakers to zero level, except for the center speaker which depends on the center level. With higher values, the other speakers receive a percentage of the sound source. This makes the sound less localized.

Front/Rear Ratio

Determines how much the front and rear levels are affected by the vertical positioning in the **Surround Panner** dialog. The higher the ratio, the less difference exists between sounds that are panned front and rear. If set to 100 %, the rear and front levels are always the same.

Constant Power

Determines whether the loudness (RMS) or the level of the summed signals is preserved. If set to 100 %, the total loudness is the same regardless of panning settings. If set to 0 %, the total level is preserved.

LFE Gain

Sets the amount of signal that is sent to the LFE channel. This is only available if the LFE channel is activated in the **Audio Track Dispatching** dialog.

Copy

Copies the settings of the selected Surround Panner to the clipboard.

Paste

Applies the copied settings to the Surround Panner.

Presets menu

Right-click the graphic display of the Surround Panner to select from different surround panning presets.

Surround Pan Envelopes

You can automate the surround panning for individual clips using envelopes. This is slightly different from using regular volume and pan envelopes.

- Internally, there is a single surround pan envelope where each envelope point contains a complete surround state (left-right position, front-rear position, and LFE amount).
- When you look at the envelope for a clip, you can choose to view either the left-right, front-rear, or the LFE curve.
- When setting envelope points for either one of the envelope types, that point is automatically added to the other envelope types at the same position in the clip.

Setting Up Surround Panning Envelopes

You can use the Surround Panner to program each envelope point. This makes it easy to set up automated surround panning for a clip.

If you want the signal to start at the front center position, then move to the left rear speaker, and finally move to the right rear speaker, do the following:

PROCEDURE

1. In the **Audio Montage** window, set up a track for surround panning by activating the surround channels in the **Audio Track Dispatching** dialog.
2. Select the clip, and select the **Envelope** tab.
3. In the **Selector** section, select one of the Surround Pan envelopes.
For example, **Surround Pan (Left <-> Right)**.
4. In the montage window, double-click the envelope to add a new envelope point in the middle of the clip.
This determines the position where the signal reaches the left rear speaker. Only the position in the clip is important when you create envelope points at this stage, not the vertical position of the point.

5. In the track control area, right-click the Surround Panner display.
6. In the montage window, select the envelope point at the start of the clip.
7. Use the **Surround Panner** dialog to position the sound. In our example, the panning should start in the front center position. Drag the position square to the top middle of the display. You can also right-click the display and select the **Front Center** preset.
8. In the montage window, select the next envelope point in the clip, and in the dialog, drag the position square to the lower left corner of the display. You can also right-click the display and select the **Rear Left** preset.
9. In the montage window, select the last envelope point, and in the dialog, drag the position square to the lower right corner of the display. You can also right-click the display and select the **Rear Right** preset.

The left-right surround envelope curve now looks like this:

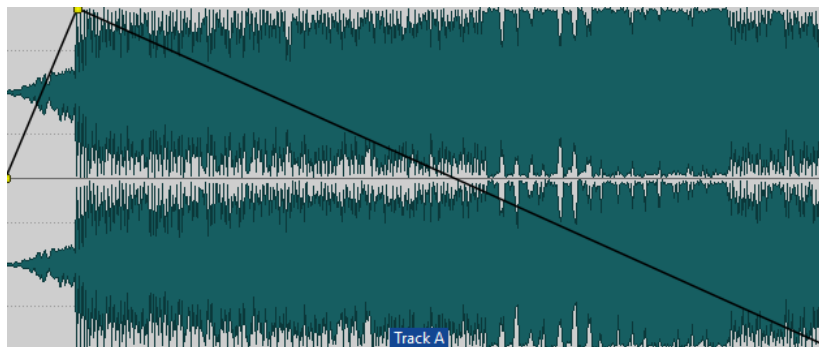

10. On the **Envelope** tab, in the **Selector** section, select **Surround Pan (Front <-> Rear)**. The Front-Rear surround envelope curve looks like this:

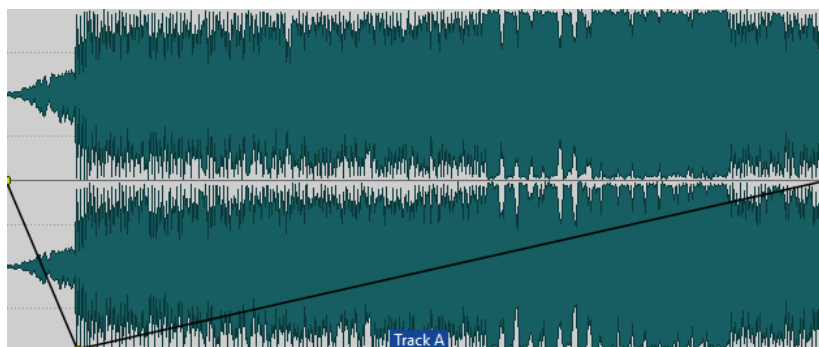

11. Play back the clip.
You should hear the sound move from center front to left rear to right rear.
12. To create more complex surround panning, add more envelope points and program these in the same way.

Editing Envelope Curves

You can edit the envelope curves without affecting other panning settings, by adjusting their points in the clip. This can be useful if you only want to change the LFE amount without affecting panning, or if you only want to change the left-right panning without affecting front-rear panning and vice versa.

NOTE

If you move an envelope point in time, all surround pan envelopes are affected in the same way.

Multichannel (DVD-Audio Compatible) Mode

If **Multichannel (DVD-Audio Compatible)** mode is activated for an audio montage, you can choose between various multichannel configurations.

In the **Info** dialog of the audio montage, select **Multichannel (DVD-Audio Compatible)**. On the **Channels** menu, the following multichannel configurations are available:

Left/Right Front (Lf, Rf)

This is used in all surround configurations. These correspond to standard left/right stereo speaker positions in front of the listener.

Center (C)

This is placed in between the Lf/Rf surround speakers.

Low Frequency Effects (LFE)

The LFE channel is connected to a subwoofer and provides low frequency content (normally below 120 Hz). It can be used to provide special low frequency effects like deep rumbles, explosions, etc. For each channel that is routed to the LFE channel, there is a low-pass filter that allows you to extend or lower the low frequency range that is reproduced by the LFE channel.

Surround (S)

This is sometimes referred to as the back surround channel and is normally placed in between the left/right surround channels.

Left/Right Surround (Ls, Rs)

These are placed behind the listening position, mirroring the left/right front speakers.

Free Configuration Mode

If **Multichannel (Free Configuration)** mode is selected, you can route track channels to one of the 8 output channels. This mode is not surround oriented and allows you to use the audio montage as an 8 channel recording/playback environment.

- To activate this mode, open the **Info** dialog of the audio montage, and from the **Mode** menu, select **Multichannel (Free Configuration)**.

Channels are grouped as stereo pairs (1-2, 3-4, etc.), which is reflected in the **Master Section** and when rendering to multiple files.

Enable Additional DVD-Audio Configurations

The DVD-Audio specification allows for mixed bit depths within the same channel configuration, which therefore needs to be divided into two separate groups. For example, the Lf/Rf channel group could, according to the standard, have a higher sample rate resolution than the other surround channels in the same configuration.

The slash in the surround channel menu indicates which channels belong to which group.

However, the use of mixed resolutions is not supported in WaveLab Pro and deactivated by default.

- To activate additional DVD-Audio configurations, click the **Audio Montage Properties** button below the montage window. Then, in the **Audio Montage Properties** dialog, select **Multichannel (DVD-Audio Compatible)**, and activate **Enable Additional DVD-Audio Configurations**.

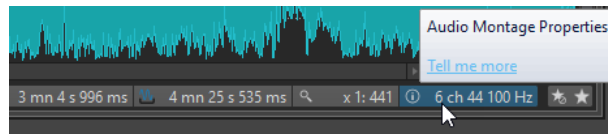

Multichannel Recording

You can record up to 8 channels simultaneously in the audio montage.

Multichannel Recording Preparations

PREREQUISITE

Set up how the inputs on your audio card are connected to the internal channels of WaveLab Pro.

PROCEDURE

1. On the transport bar, click **Record**, or press * on the numeric key pad.
2. In the **File to Create** section, select whether to create a named file or a temporary file.
3. If you want to create a named file, specify a file name and the location where you want to save the file.
4. Click the audio format text to open the **Audio File Format** dialog.
5. Select the audio file format.
6. On the **Channels** menu, select **Multi Stereo/Mono** or **Multi Mono**.
Multi Stereo/Mono produces single stereo or mono files, depending on the activated channels in the **Recording Channels** dialog. The channels are logically grouped as pairs (1-2, 3-4, etc.). This governs the mono/stereo status of the recorded files and the tracks they will end up on. For example, if you have activated the channels 1, 2, and 3, one stereo file (containing channels 1 and 2) and one mono file (channel 3) will be created.
7. Click **OK**.
8. On the menu below the file format, select **Add to Selected Track of Montage**.
9. Click **Set Input**, activate the channels from which you want to record, and click **OK**.
For each of the activated recording channels, a meter is displayed in the **Recording** dialog.
10. Optional: Make further settings.

Recording a Multichannel Project

PREREQUISITE

Prepare a multichannel recording.

PROCEDURE

1. In the montage window, set the edit cursor where you want to start recording.
 2. In the **Recording** dialog, click **Record**.
 3. When you have finished recording, click **Stop**.
When you record on multiple channels, new tracks are automatically created in the audio montage, one for each mono or stereo clip that is recorded. Each track is routed to the same output by default, but can be routed to any output that is used in the current configuration in the **Audio Track Dispatching** dialog.
-

RESULT

If you have activated more than 2 input channels in the **Recording Channels** dialog and select any channel option except the **Multi Mono** or **Multi Stereo/Mono** options, the activated recording inputs are mixed and produce a single file (or two if you selected **Dual Mono**).

Multichannel Configurations in the Master Section

The **Master Section** automatically rearranges itself when starting playback of a multichannel audio montage. You can rearrange the **Master Section** without starting playback by clicking **Rearrange** in the **Settings** menu at the top of the **Master Section**.

The output channels for the selected channel configuration are displayed in the **Master Section**, with one level fader and clip indicator for each output channel.

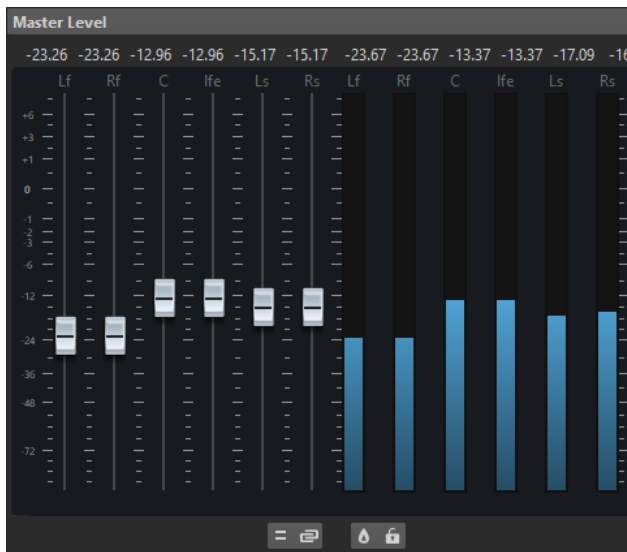

RELATED LINKS

[Master Section](#) on page 332

Monitoring a Stereo Mixdown of Multichannel Configurations

In the **Master Section**, you can monitor a stereo mixdown of a multichannel configuration. This allows you to preview a stereo mixdown setting for a DVD-Audio project, for example.

PROCEDURE

1. In the **Master Section**, open the **Master Level** pane.
 2. Below the master meter, click **Audio Channel Monitoring**.
 3. Select **Mix to Stereo**.
-

Master Effects and Multichannel Audio Montages

Handling effects for a multichannel audio montage is similar to handling effects when working in stereo mode. However, not all plug-ins support multichannel operations. In this case, a warning is displayed when you try to insert them.

XML Export and Import of Audio Montages

You can export and import audio montages as XML.

This option can be used for the following:

- Change many file names that are used by the audio montage.
- Generate audio montages from scratch or from a template.
- Compare two audio montages with a text file comparing tool.

Exporting and Importing XML Files

- To export an audio montage to XML, select **File > Export** and select **Audio Montage to XML**. Then specify a name and file location, and click **Export**.
- To import an audio montage that was saved as an XML file, select **File > Import** and select **XML**. Then select the XML file and click **Import**.

AES-31 Files Export and Import

The AES-31 standard is an open file interchange format for overcoming format incompatibility issues between different audio hardware and software. It can be used for transferring projects from one workstation to another, retaining time positions of events, fades, etc.

AES-31 uses Broadcast Wave as the default audio file format. AES-31 files can be transferred to and used with any digital audio workstation that supports AES-31, regardless of the used hardware and software, as long as the workstation can read Broadcast Wave files.

The exported files are XML files but with the extension `.ad1` (audio decision list).

Exporting AES-31 Files

When exporting audio montages to an AES-31 file, the file contains all audio track data, including audio file references.

PROCEDURE

1. Select **File > Export**.
 2. Click **Audio Montage to AES-31**.
 3. Specify a name and file location, and click **Export**.
 4. In the **AES-31 Export Options** dialog, edit the settings and click **OK**.
-

AES-31 Export Options Dialog

- To open the **AES-31 Export Options** dialog, select **File > Export** and select **Audio Montage to AES-31**. Then specify a name and file location, and click **Export**.

Render Linear Fades as Audio Files

If this option is activated, linear fades, which are dynamically computed by WaveLab Pro, are rendered to small audio files while preserving the exact audio effect.

Render Curved Fades as Audio Files

If this option is activated, complex fades, which are dynamically computed by WaveLab Pro, are rendered to small audio files while preserving the exact audio effect.

Render Crossfades as Audio Files

If this option is activated, crossfades, which are dynamically computed by WaveLab Pro, are rendered to small audio files while preserving the exact audio effect.

Skip Muted Clips

If this option is activated, muted clips are not included in the AES-31 file.

After Exporting, Import File

If this option is activated, the exported file is immediately imported. This lets you check the export result.

Importing AES-31 Files

PROCEDURE

1. Select **File > Import**.
 2. Click **AES-31**.
 3. In the file browser, select the AES-31 file that you want to import, and click **Import**.
 4. In the **AES-31 Import Options** dialog, edit the settings and click **OK**.
-

RESULT

The imported AES-31 file opens as a new, untitled audio montage that contains all the audio tracks that are saved in the AES-31 file.

AES-31 Import Options Dialog

- To open the **AES-31 Import Options** dialog, select **File > Import** and select **AES-31**. Then select the AES-31 file and click **Import**.

Use Linear Fade Files, If Available (Otherwise, Create Dynamic Fades)

If this option is activated, the available audio files for linear fades are used. If no files are available, dynamic fades are created.

Use Curved Fade Files, If Available (Otherwise, Create Dynamic Fades)

If this option is activated, the available audio files for complex fades are used. If no files are available, dynamic fades are created.

Importing AES-31 Files Created in Nuendo

By importing an AES-31 file, you can import a project that was created in Steinberg's Nuendo into WaveLab Pro, for example.

In this case, it is possible to add specific codes to the marker names in Nuendo to facilitate their conversion into WaveLab Pro-specific markers. For example, if an AES-31 file that was exported in Nuendo is imported into WaveLab Pro, the markers that it contains are interpreted as WaveLab Pro markers upon import.

For the CD track markers, you can use the following codes:

Marker Type	Marker Code	Example Marker Name
CD track start	[t-start]	"So it begins [t-start]"

Marker Type	Marker Code	Example Marker Name
CD track end	[t-end]	"The end [t-end] of the road"
CD track splice	[t-splice]	Intermission [t-splice]
CD track index	[t-index]	[t-index] Hello

- In Nuendo, a marker track must be created for the specific markers.
- When importing AES-31 projects that contain specific markers, the marker codes are not displayed in WaveLab Pro.

Recording

You can record audio in the **Audio Editor** and in the **Audio Montage** window.

Setting Up the Recording Dialog

Before you start recording, set up the **Recording** dialog.

PROCEDURE

1. In the **Audio Editor** or the **Audio Montage** window, click the **Record** button, or press * on the numeric key pad.
 2. In the **File to Create** section, open the pop-up menu, and select whether you want to record a named file or a temporary file.
 3. In the **File to Create** section, select a file name and the location where you want to save your file.
 4. Select the audio format by doing one of the following:
 - Click the down arrow button to select a preset audio format.
 - Click the audio format text to open the **Audio File Format** dialog, select the format, and click **OK**.
 5. Select whether you want to record to an audio file or an audio montage track, by selecting one of the following options:
 - **Create New Audio File Window**
 - **Add to Active Audio File**
 - **Add to Selected Track of Montage**
 6. Select an **Input** mode, depending on whether you want to record the audio card input or the playback output of the **Master Section**.
 7. Select **Set Input**, activate the channels that you want to record to, and click **OK**.
For each of the activated recording channels, a meter is displayed in the **Recording** dialog.
 8. Select whether you want the **Level** or the **Spectrum** display.
 9. Optional: Make further settings in the **Options** section, and on the **Options** and **Values** tabs.
 10. Click **Record** to start recording.
If you have selected one of the Auto-start options, the recording goes into **Pause** mode until the specified Auto-start criteria are met.
The background of the **Recording** dialog turns red to indicate that you are recording.
 11. Optional: Pause the recording by clicking the **Pause** button.
 12. Optional: Drop markers during recording by clicking the drop marker buttons.
 13. When you have finished recording, click **Stop**.
 14. Optional: If you want to record another take, click **Record** again.
-

Dropping Markers During Recording

When you are recording, you can click the marker buttons to add markers to the recorded file.

PROCEDURE

1. Open the **Recording** dialog.
2. Optional: If you want to name the markers that you drop rather than using generic markers, do the following:
 - Select the **Options** tab and activate **Confirm Name of Markers to Drop**.
 - On the **Method** tab, enter the name in the **Next Marker Name** field.
3. Make your settings and start recording.
4. Select the type of marker that you want to drop.
 - To drop a numbered generic marker, click the yellow marker button, or press **Ctrl/Cmd-M**.
 - To drop numbered generic region start and end markers, click the white buttons, or press **Ctrl/Cmd-L/Ctrl/Cmd-R**.

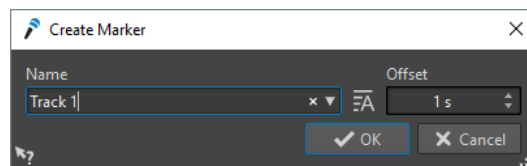

When you chose to confirm marker names to drop, a dialog opens each time that you drop a marker. In this dialog, you can enter a name and specify an offset, which allows you to place a marker at a specific time before you triggered the command.

RESULT

A marker is dropped each time that you click the marker button.

NOTE

If you insert two or more region start markers in a row with no region end markers in between, only the last of these start markers is kept. The same applies for region end markers.

Recording Dialog

In this dialog, you can make recording settings and start recording an audio file.

- To open the **Recording** dialog, open the **Audio Editor** or the **Audio Montage** window, and on the transport bar, click **Record**.

Main Buttons

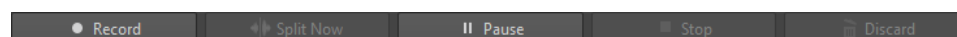

Record

Starts recording. Depending on the recording options, the **Pause** mode is activated.

Split Now

Opens the audio already recorded in a new window while recording continues. By clicking this button, you can decide when the file is split. The button is activated if you are recording a named file, you are not pausing, and **Auto-Split** is not activated.

Pause

Pauses recording.

Stop

Stops recording.

Discard

Stops recording and deletes anything recorded so far.

Method Tab

On this tab, you can define options for starting, stopping, and pausing the recording automatically. You can select an input device and choose to start a recording at a specific time or stop if after a specific duration.

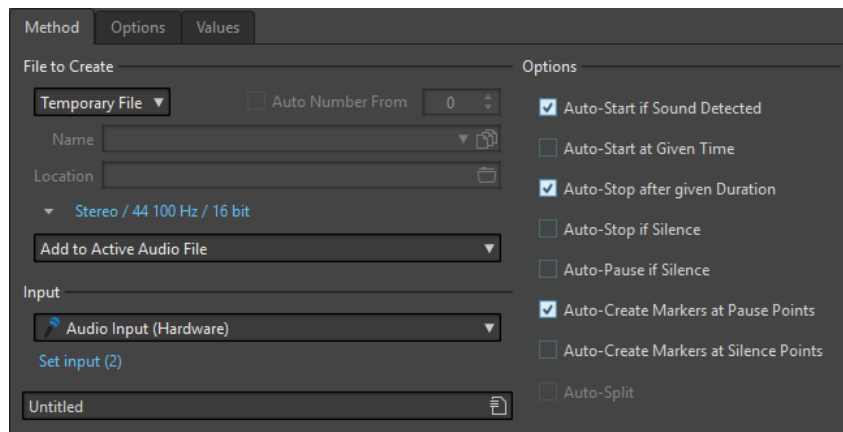

File to Create

Specify whether you want to record a temporary file to be saved later, or record to a file with a specific name and location.

Auto Number From

If this option is activated and you record multiple files, increasing numbers are added to the file names of the files.

Name

The name of the file to be written, without the path. When typing, all files in the selected folder that start with the same letters are displayed. To display all files in the selected folder, click the list icon.

Location

Specifies the folder where you want to save the recording.

Audio File Format

Opens the **Audio File Format** dialog, where you can specify the file format.

Location of the Recording

Specifies where the audio is recorded:

- If **Create New Audio File Window** is selected, the audio is recorded in a new audio file window.
- If **Add to Active Audio File** is selected, the audio is recorded in the active audio file window at the edit cursor position (if no audio file window exists, a new one is created).
- If **Add to Selected Track of Montage** is selected, the audio is recorded in an existing audio montage at the edit cursor position (if no audio montage exists, a new one is created).

Input

Specify if you want to record the audio device input or the audio output from the **Master Section**.

Set Input

If you are using an ASIO driver, this button opens the **Recording Channels** dialog, where you can activate channels for recording. Up to 8 input channels can be used simultaneously. When additional inputs are selected, the number of meters in the dialog is automatically updated.

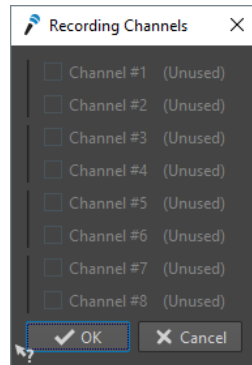

Auto-Start if Sound Detected

If this option is activated, recording starts when the audio input level exceeds the threshold level specified on the **Values** tab.

Auto-Start at given Time

If this option is activated, recording starts at a specified time. Specify the time on the **Values** tab.

Auto-Stop after given Duration

If this option is activated, recording stops automatically after the duration specified on the **Values** tab.

Auto-Stop if Silence

If this option is activated, recording automatically stops when the audio input level drops below a specified threshold level and stays there for a specific amount of time. Specify the level and the duration on the **Values** tab.

Auto-Pause if Silence

If this option is activated, recording automatically pauses when the audio input level drops below a specified threshold level and stays there for a specific amount of time. Specify the level and the duration on the **Values** tab.

Auto-Create Markers at Pause Point

If this option is activated, a generic marker is created each time you click **Pause** during recording.

Auto-Create Markers at Silence Points

If this option is activated, a generic marker is created each time the audio input level drops below a specified threshold level and stays there for a specific amount of time. Specify the level and the duration on the **Values** tab.

Auto-Split

If this option is activated, the recording is automatically split into several audio files either after a specific amount of time or at a specific file size. **Auto-Split** is useful if you make long continuous audio recordings, such as live recordings.

The **Auto-Split** option is only available when **Named File** is selected. Selecting **Auto-Split** automatically activates the **Auto Number** option for audio file names. Split files are contiguous, that is, there are no gaps between the files.

- To set the file size after which you want the recording to create a new file, select the **Values** tab and specify the **File Size** in the **Auto-Split Parameters** section.
- To set the duration after which you want the recording to create a new file, select the **Values** tab and specify the **File Duration** in the **Auto-Split Parameters** section.

NOTE

It is recommended to save each **Auto-Split** recording in an empty folder. This prevents the **Auto Number** option from creating files with names that already exist in this location.

Options Tab

On this tab, you can make additional settings for the recording process.

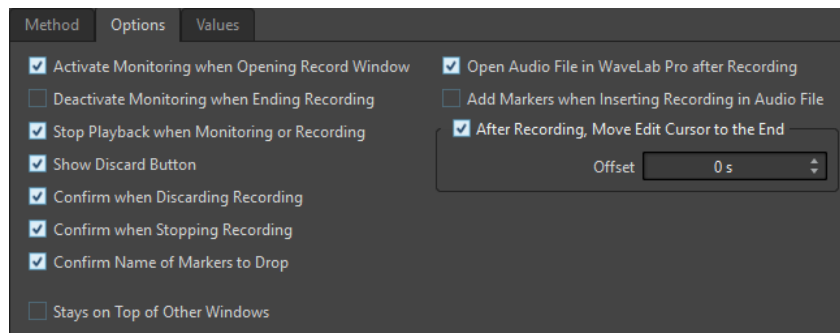

Activate Monitoring When Opening Record Window

If this option is activated, the meters are activated when the **Recording** dialog opens. If this option is deactivated, the meters and the audio thru are displayed when pressing **Record** or activating **Monitor**.

Deactivate Monitoring When Ending Recording

If this option is activated, the meters and the audio thru are deactivated when recording ends. This releases the audio device input.

Stop Playback When Monitoring or Recording

If this option is activated, playback stops before monitoring or recording starts.

Show Discard Button

Determines whether the **Discard** button is visible or hidden.

Confirm when Discarding Recording

If this option is activated, you are asked to confirm before discarding a recording.

Confirm when Stopping Recording

If this option is activated, you are asked to confirm before stopping a recording.

Confirm Name of Markers to Drop

If this option is activated, you are asked to enter a name for the last dropped marker.

Open Audio File in WaveLab Pro after Recording

If this option is activated, the audio files are opened in WaveLab Pro after recording.

Add Markers when Inserting Recording in Audio File

If this option is activated and a recording is inserted into an audio file, markers are added encompassing the new samples.

After Recording, Move Edit Cursor at the End

If this option is activated, the edit cursor is moved to the end of the recording.

Values Tab

On this tab, you can define values for the various recording options.

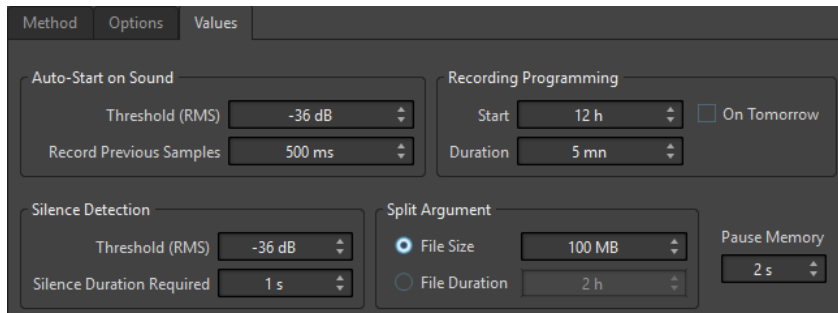

Auto-Start on Sound – Threshold (RMS)

Specify the sound level that will trigger recording.

Auto-Start on Sound – Record Previous Samples

Allows you to include a short section of audio before the start point, to capture attacks, for example. It is only relevant if **Auto-Start if Sound Detected** is activated.

Silence Detection – Threshold (RMS)/Silence Duration Required

The threshold value used for the options **Auto-Stop if Silence** and **Auto-Create Markers at Silence Points**. It is used in conjunction with the **Silence Duration Required** setting, so that recording is stopped or a marker is added if the input level stays below the threshold value for the specified duration.

Recording Programming – Start

Determines the time at which recording starts when the option **Auto-Start at Specific Time** is activated.

Recording Programming – On Tomorrow

If this option is activated, you can specify a time on the next day (starting midnight).

Recording Programming – Duration

Determines the length of the recording if **Auto-Stop after Specific Duration** is activated.

Auto-Split Parameters

If **File Size** is activated, a new file is created when the recorded file reaches the size specified in the corresponding value field. This option is only active if **Auto-Split** is activated in the **Method** tab.

If **File Duration** is activated, a new file is created when the recorded file reaches the length specified in the corresponding value field. This option is only active if **Auto-Split** is activated in the **Method** tab

Pause Memory

This is a safety buffer when you are using the **Pause** button. When you resume recording, this buffer is used to restore the last short section of audio before you deactivated the **Pause** button. This way, you can resume recording even if you deactivated the **Pause** button a bit too late.

Meter Display

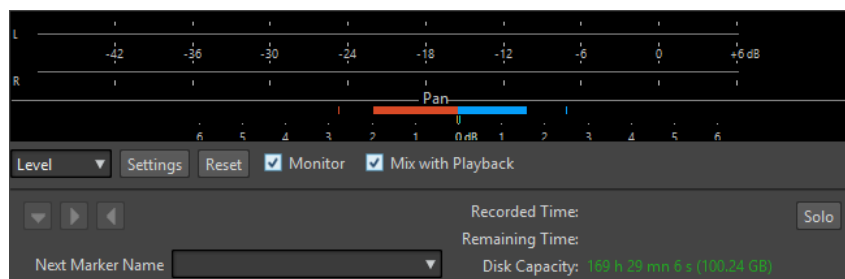

Level/Spectrum

Specifies which meter to display.

Settings

Opens the **Level/Pan Meter Settings** dialog, where you can customize the meter settings.

Reset

Resets the peak values.

Monitor

If this option is activated, the audio input is also sent to the output ports (not available if Windows MME drivers are used).

Mix with Playback

If this option is activated and the same audio ports are selected for monitoring and for playback (in the **VST Audio Connections** tab), the signals are mixed. If this is not activated, the monitoring signal has priority.

This allows you to toggle between the auditioning of the recorded signal and the playback signal, and to have full control over the monitor outputs.

Marker

Allows you to set markers during the recording.

Next Marker Name

Edit the name of the next marker to insert.

Solo

Reduces/Increases the size of the window and hides/shows all other WaveLab Pro windows.

Meter Display

In the lower part of the **Recording** dialog, you find a meter display. This is useful for checking the input level and the frequency spectrum of the input signal.

You can activate the meters by activating the **Monitor** checkbox. This is done automatically if **Activate Monitoring when Opening Record Window** is activated on the **Options** tab in the **Recording** dialog.

To reset the meters, click the **Reset** button.

Level Meter

In the **Level Meter**, horizontal bars show the peak level (outer bars) and average loudness (VU, inner bars) of each channel. Values are also shown numerically. When you click the **Settings** button, the **Level/Pan Meter Settings** dialog opens.

Spectrometer

The **Spectrometer** shows a bar diagram, providing a continuous graphical representation of the frequency spectrum. From the **Settings** pop-up menu you can choose whether to restrict to high audio levels, or to include medium or low audio levels.

Disk Capacity Indicator

This indicator at the bottom of the **Recording** dialog indicates the approximate amount of available disk space on the hard disk specified in the **File to Create** section, or the hard disk that you have selected for temporary files.

NOTE

When there is less than 30 seconds of available hard disk space left, the disk capacity indication is displayed in red.

Recording in the Audio Montage Window

You can record audio as clips in the audio montage.

Recording from the Cursor Position

PROCEDURE

1. In the **Audio Montage** window, click at the position where you want the recorded clip to start.
 2. To the left of the track, open the **Track** pop-up menu.
 3. Select **Record at Cursor**.
 4. In the **Recording** dialog, make your settings.
 5. Click **Record**.
-

Recording During Playback

PROCEDURE

1. In the **Audio Montage** window, start playback.
2. Select **Track > Record at Cursor**.
3. In the **Recording** dialog, make your settings.
4. Click **Record**.

NOTE

If you first go into **Pause** mode and then activate recording, you get a pre-roll time according to the pause buffer, allowing you to capture the audio just before you start recording.

Playing Back During Recording

When you record in a multitrack environment, it is often necessary to have the existing track play back during recording, performing an overdub.

For this to be possible in the audio montage, **Stop Playback when Monitoring or Recording** must be deactivated on the **Options** tab of the **Recording** dialog.

Master Section

The **Master Section** is the final block in the signal path before the audio is sent to the audio hardware, to an audio file, or to the audio meters. This is where you adjust the master levels, add effects, resample, and apply dithering.

The settings and effects in the **Master Section** are taken into account in the following cases:

- When playing back an audio file in the wave window.
- When playing back an audio montage.
Note that the **Master Section** effects are global for all clips and tracks in an audio montage.
- When using the **Render** function.
- When using the **Audio Input** plug-in.
- When writing a CD from an audio montage.

Bypassing the Master Section

By default, the **Master Section** is active. You can bypass it for each file individually or globally. If the **Master Section** is bypassed, only the **Playback Processing** pane of the **Master Section** is active during playback.

- To bypass the **Master Section** for individual audio files or audio montages, activate the **Bypass Master Section** button at the bottom of the wave/montage window.

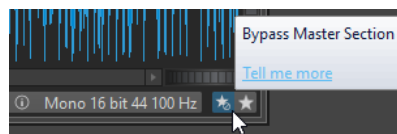

- To bypass the **Master Section** globally, activate the **Bypass Master Section** button at the top left of the **Master Section**. All other **Master Section** panes are bypassed. However, rendering to file still takes into account all plug-ins.

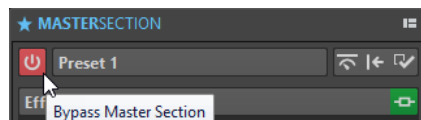

Master Section Window

In this window, you can apply effect plug-ins, adjust the master level, apply dithering, and render the audio file or audio montage.

- To open the **Master Section** window, select **Tool Windows > Master Section**.



The **Master Section** consists of the following panes:

- **Effects**
- **Resampling**
- **Master Level**
- **Final Effects/Dithering**
- **Playback Processing**
- **Speaker Configuration**

Signal Path

The panes in the **Master Section** window correspond to the processing blocks of the **Master Section**.

The signal passes through these blocks from top to bottom:

1. Audio from WaveLab Pro
2. Effects
Reordering the effect slots affects the signal path.
3. Resampling
4. Master Level

The **Master Section** meters monitor the signal between the **Master Level** pane and the **Playback Processing** pane.

5. Final Effects/Dithering

6. Playback Processing

The meters in the Meter windows monitor the signal between the **Playback Processing** pane and the **Speaker Configuration** pane.

7. Speaker Configuration

8. Audio hardware or file on disk

In the **Master Section**, the signal passes all plug-ins, even if some plug-ins are soloed. However, the sound is not affected by this because the muted plug-ins are bypassed from the playback process stream.

Other meters in WaveLab Pro, for example, **Oscilloscope** or **Wavescope**, monitor the signal directly after the **Final Effects/Dithering** pane, by default. You can also monitor the signal directly after a particular slot if you activate **Monitoring Point** for a slot.

Master Section Tools

The tools and options at the top of the **Master Section** window allow you to make various settings before rendering the file, make bypass settings, and decide whether the playback signal passes the **Master Section**.

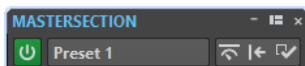

Bypass Master Section

If this option is activated, only the **Playback Processing** pane of the **Master Section** is active during playback. All other **Master Section** panes are bypassed. However, rendering to file still takes into account all plug-ins.

Presets

Lets you save and recall **Master Section** presets. The **Presets** menu offers additional options to save and load default banks and effects.

Smart Bypass

Opens the **Smart Bypass** dialog, where you can make special bypass settings.

Reset Master Section

Removes all active effects from the slots and sets the master output to 0 dB.

Settings

Opens the **Settings** pop-up menu, where you can make settings for the **Master Section**.

Settings Pop-up Menu

Hide Plug-in Windows when Master Section is not Visible

If this option is activated, plug-in windows are hidden when the **Master Section** is not visible.

Show Plug-in Controls in the Plug-in Window

If this option is activated, the plug-in controls are displayed in plug-in windows.

Use Plug-in Chain Window

Shows all open plug-ins in the plug-in window as tabs, which allows you to quickly switch between the plug-ins.

Plug-in Windows Move with Master Section

If this option is activated, the plug-in windows are also moved when you move the floating **Master Section**.

Restore Last Configuration at Next Start-Up

If this option is activated, the plug-in configuration and fader positions in the **Master Section** are restored at the next WaveLab Pro start.

Section Visibility

Allows you to show or hide the **Master Section** sections.

Monitor 16 bit Dithering

Allows you to hear what the effect of the dither plug-in sounds like during playback. You can try different dither plug-ins, to find out which one has the best dither effect on the audio.

Rearrange

Rearranges the **Master Section** according to the sample rate and channel configuration of the active audio file. The internal bus of the **Master Section** and any active plug-ins are configured accordingly.

This operation is performed automatically before playback or rendering. It is sometimes helpful to manually rearrange the **Master Section**, because some plug-ins do not accept a mono or stereo signal as input, or a given sample rate. In that case, clicking the button informs you about any problems, before playback or rendering.

This operation has no effect if playback is already in progress or if there is no active audio file.

RELATED LINKS

[Final Effects/Dithering Pane](#) on page 343

Effects Pane

This pane in the **Master Section** allows you to add up to 12 effect plug-ins in series, and manage them.

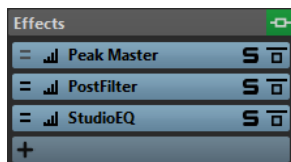

Fold/Unfold Pane

Expands or collapses the pane.

Bypass All Effects

Bypasses any effect processing during playback and optionally when rendering.

Add Effect

Allows you to add an effect to an empty effect slot.

Channel Processing

Allows you to specify how a VST plug-in processes the stereo stream. You can process all channels or only the left, right, mid, or side channel. This allows any VST plug-in to become mid/side capable.

Monitoring Point

Lets other meters in WaveLab Pro, for example, **Oscilloscope** or **Wavescope**, monitor the signal directly after this plug-in.

If no monitoring point is specified, the monitoring point is after the **Final Effects/Dithering** section and before the **Playback Processing** section.

The **Master Level** meter of the **Master Section** always monitors the level after the faders.

Effect plug-in name

Once you have added a plug-in to a slot, you can click the plug-in name to open and close the corresponding plug-in window.

Presets pop-up menu

Lets you save and recall preset settings. The **Presets** pop-up menu offers additional options to save and load default banks and effects.

Effect Options pop-up menu

Allows you to load another effect to the effect slot. Furthermore, the following options are available:

- **Remove Plug-in** removes the effect from the slot.
- **Shift All Plug-ins Down/Shift All Plug-ins Up** allows you to move the effects to another position.
- If **Active** is activated, the effect is active. If **Active** is deactivated, the effect is excluded from playback and rendering.
- If **Lock** is activated, the effect slot is locked. The plug-in in the slot remains as is when a **Master Section** preset is loaded, or when **Reset Master Section** is used.

Solo (Bypass)

Soloes the plug-in.

Bypass Processing

Bypasses the plug-in during playback and optionally during rendering. The signal is still processed by the plug-in, but is not injected in the audible stream.

Supported Effect Plug-in Formats

WaveLab Pro supports WaveLab Pro-specific plug-ins, VST 2 plug-ins, and VST 3 plug-ins.

WaveLab Pro-specific Plug-ins

Some specific plug-ins are included in WaveLab Pro, for example, the Audio Input and External Gear plug-ins. These are only available if you are using an ASIO driver.

VST Plug-ins

Steinberg's VST plug-in format is supported by a lot of programs and plug-in manufacturers. You find a number of VST plug-ins included with WaveLab Pro. Other plug-ins can be purchased separately from Steinberg or other manufacturers.

Setting Up Effects

The number of available effects depends on the number and format of the plug-ins that you have installed.

- To select an effect plug-in for a slot, click the slot, and select an effect from the pop-up menu. When you have selected an effect, it is automatically activated, and its control panel opens.

- To turn off an effect, right-click the slot, and deactivate **Active**. To activate the effect, activate **Active** again.
- To remove an effect plug-in, right-click the slot and select **Remove Plug-in** from the pop-up menu.
- To show/hide a plug-in window, click the effect slot.
- To solo an effect, click its **Solo (Bypass)** button. This allows you to check the sound of that effect only. You can also bypass effects via their control panels.
- To change the order of the slots, that is, the order in which the signal passes through the effects, click a slot, and drag it to a new position.

Master Section Plug-in Window

In the plug-in windows of the **Master Section**, you can make settings for a **Master Section** effect plug-in.

- To show a plug-in window, click the effect slot.

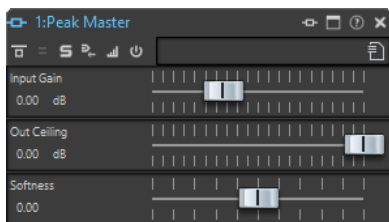

Plug-in Chain

If **Use Plug-in Chain Window** is activated on the **Settings** pop-up menu of the **Master Section**, the effects of the active audio file are displayed in a plug-in chain at the top of the plug-in window.

You can right-click a plug-in tab or an empty tab to select a new plug-in for the slot.

Bypass Processing

If this option is activated, this plug-in is bypassed during playback, and optionally for a rendering operation. To deactivate an effect when rendering, right-click an effect slot, and deactivate **Active** in the **Effects** pane of the **Master Section**.

Bypass Modes

Right-click **Bypass Processing** to open the **Bypass Modes** pop-up menu. Here, you can select **Bypass Effect** or **Bypass Source Signal**.

Channel Processing

Allows you to specify how a VST plug-in processes the stereo stream. You can process all channels or only the left, right, mid, or side channel. This allows any VST plug-in to become mid/side capable.

Solo (Bypass)

Soloes the plug-in.

Render in Place

Processes the audio in place. Bypassed plug-ins are excluded and the rendered audio is crossfaded at boundaries.

Monitoring Point

Lets other meters in WaveLab Pro, for example, **Oscilloscope** or **Wavescope**, monitor the signal directly after this plug-in.

If no monitoring point is specified, the monitoring point is after the **Final Effects/Dithering** section and before the **Playback Processing** section.

The **Master Level** meter of the **Master Section** always monitors the level after the faders.

Switch Effect On/Off

If you deactivate a plug-in, it is excluded from both playback and rendering.

Presets

Opens a menu to save/load presets for this plug-in.

Effect Plug-in Presets

With WaveLab Pro comes a number of factory presets for the included effect plug-ins. You can use them as they are or as a starting point for your own settings.

Third-party plug-ins can provide their own factory presets. To access the presets for an effect, click the **Presets** button in its control panel window or the **Presets** button for its effect slot. The available functions depend on the type of plug-in.

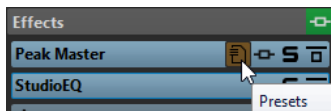

Presets for VST 2 Plug-ins

VST 2 plug-ins have their own preset handling.

When you click the **Presets** button for this type of effect, a pop-up menu with the following options opens:

Load/Save Bank

Loads and saves complete sets of presets. The file format is compatible with Cubase.

Load/Save Default Bank

Loads the default set of presets or saves the current set of presets as the default bank.

Load/Save Effect

Loads or saves a preset. This is also compatible with Cubase.

Edit Name of Current Program

Allows you to define a name for the preset.

Preset List

Allows you to select one of the loaded presets.

Channel Processing

In the **Master Section**, in plug-in windows, and in the **Effects** window, you can specify for each plug-in which channels to process. This allows you to use each plug-in in mid/side mode, for example.

You can process all channels or only the left, right, mid, or side channel. When you select one channel, the other channel is bypassed.

To use a different plug-ins for each channel, use one effect slot for each channel.

Insert

Stereo

All channels are processed by the plug-in.

Left

Only the left channel is processed by the plug-in.

Right

Only the right channel is processed by the plug-in.

Mid

Only the mid channel is processed by the plug-in.

Side

Only the side channel is processed by the plug-in.

Send (Return to Stereo)

Left

Only the left channel of the plug-in is processed. The left wet signal of the plug-in is mixed to the left/right dry signal.

Right

Only the right channel of the plug-in is processed. The right wet signal of the plug-in is mixed to the left/right dry signal.

Mid

Only the mid channel of the plug-in is processed. The mid wet signal of the plug-in is mixed to the mid/side dry signal.

Side

Only the side channel of the plug-in is processed. The side wet signal of the plug-in is mixed to the mid/side dry signal.

Setting Up the Channel Processing

You can set up which channel to process in the **Master Section**, in plug-in windows, and in the **Effects** window.

Channel Processing in the Master Section

In the **Master Section**, on the **Effects** pane, click **Channel Processing**, and select which channel you want to process.

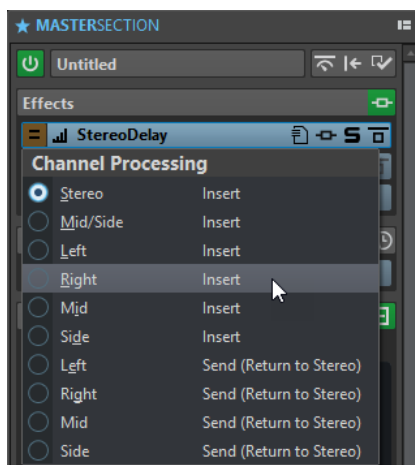

Channel Processing in Plug-in Windows

In a plug-in window, click **Channel Processing** and select which channel you want to process.

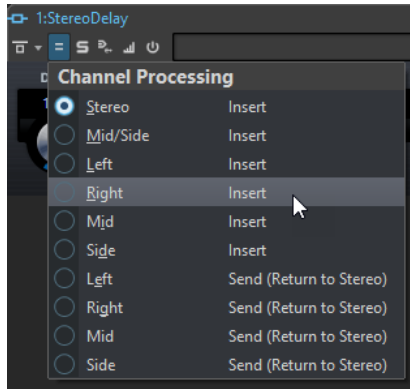

Channel Processing in the Effects Window

In the **Effects** window, click in the **Channel Processing** column for a plug-in and select which channel you want to process.

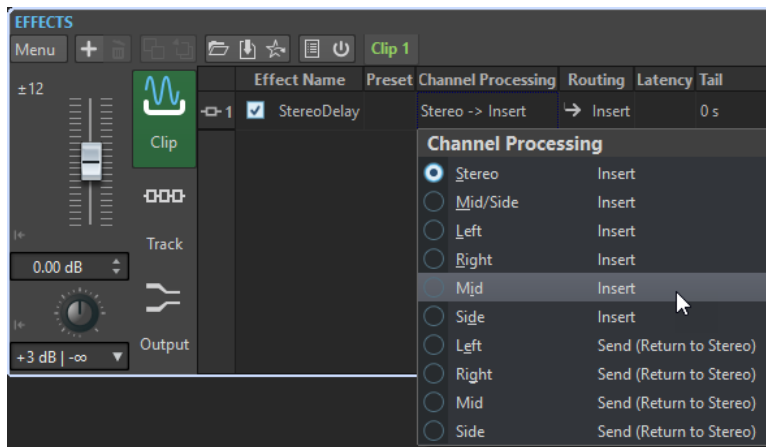

Resampling Pane

This pane in the **Master Section** allows you to resample the signal. With the Resampling plug-in, you can check the peaks before the master gain and meters, and before limiting and dithering.

You can select one of the common sample rate values or create custom sample rate values via the **Customize Sample Rate Menu** dialog.



Fold/Unfold Pane

Expands or collapses the pane.

Off

Deactivates the resampling effect.

Use Preferred Sample Rate

If this option is activated, resampling matches the sample rate that is specified as the preferred sample rate on the **Audio Connections** tab.

NOTE

The sample rate is used for playback only. This allows you to play back sample rates that your audio device does not support.

Monitoring Point

Lets other meters in WaveLab Pro, for example, **Oscilloscope** or **Wavescope**, monitor the signal directly after this plug-in.

If no monitoring point is specified, the monitoring point is after the **Final Effects/Dithering** section and before the **Playback Processing** section.

The **Master Level** meter of the **Master Section** always monitors the level after the faders.

Sample Rate menu

Allows you to select a sample rate.

You can select one of the common sample rates or click **Customize** to open the **Customize Sample Rate Menu** dialog, where you can specify custom sample rates. The selected sample rate is used for playback and rendering.

RELATED LINKS

[Audio Connections Tab](#) on page 11

[Customize Sample Rate Menu](#) on page 341

Customize Sample Rate Menu

The **Customize Sample Rate Menu** dialog allows you to customize the available sample rate values for the sample rate pop-up menu of the Resampling pane. You can add common sample rate values to the menu or create custom sample rates.

- To open the **Customize Sample Rate Menu** dialog, open the **Resampling** pane in the **Master Section** window, click the sample rate, and select **Customize**.

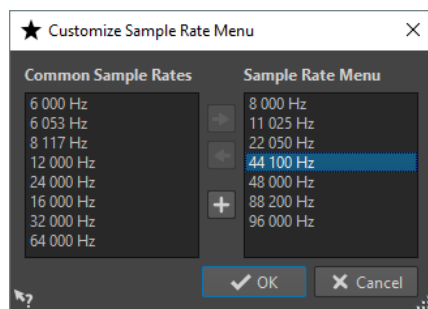

Add Common Sample Rate to Menu

Adds the selected sample rate to the sample rate pop-up menu.

Remove Sample Rate from Menu

Removes the selected sample rate from the sample rate pop-up menu.

Add Custom Sample Rate

Opens the **Custom Sample Rate** dialog, where you can specify custom sample rate values.

Master Level Pane

This pane in the **Master Section** allows you to control the master level of the active audio file.

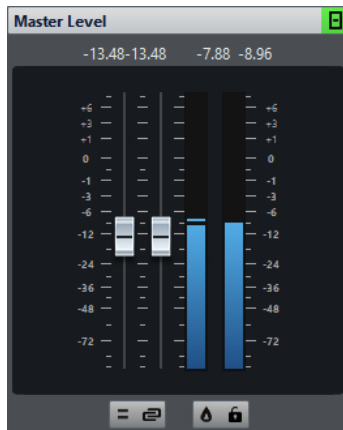

Faders

The faders in the **Master Level** pane govern the final output level. Use the faders to optimize the level of the signal that is sent to the audio hardware.

NOTE

It is important to avoid clipping, especially when mastering. Clipping is indicated by the clip indicators of the **Master Section**.

- To lock the faders, activate **Lock Faders** below the fader section. Locked faders cannot be changed with the mouse. Other editing methods, for example via remote control or shortcut, are still possible.

Meters

The **Master Section** meters show the signal level of the signal before dithering or any other plug-in that you have applied post-master fader.

Use these meters to get an overview of the signal levels. The numeric fields above the faders show the peak levels for each channel. The peak indicators turn red whenever the signal clips. If this happens, you should do the following:

- Lower the faders.
- Right-click the clip indicators and select **Reset Peaks** to reset the clip indicators.
- Play back the section again until no clipping occurs.

NOTE

For critical level metering, we recommend using the **Level Meter**. It is more precise, and it is applied after the whole **Master Section** (after dithering) and therefore shows the actual signal level that is sent to the audio hardware.

Mixing Stereo Channels into Mono Channels and Multichannel into Stereo

The options on the **Audio Channel Monitoring** pop-up menu allow you to transform the left and right channels of a stereo track into two mono channels or surround channels to stereo channels. The output level is automatically reduced by -6 dB to avoid clipping. This is useful for checking the mono compatibility of stereo mixes or stereo compatibility of surround mixes. You can also render the channels into a mono file.

Default Channels

The default channels.

Mix to Mono

Mixes the stereo channels into mono channels.

Mix to Mono (L-R)

Mixes the stereo channels into mono channels and removes the right channel from the left channel. If both channels are the same, you hear silence. This allows you to check if the audio is true mono.

Left Channel Only

Mixes the left stereo channel into two mono channels.

Right Channel Only

Mixes the right stereo channel into two mono channels.

Mid Channel Only

Mixes the mid stereo channel into two mono channels.

Side Channel Only

Mixes the side stereo channel into two mono channels.

Mix to Stereo

If you have a surround setup with more than two channels, you can mix the surround channels to stereo.

NOTE

If another option than **Default Channels** is selected on the **Audio Channel Monitoring** pop-up menu, the indicator for the **Master Level** pane is lit, even if the master level is not adjusted. This helps you avoid accidentally using audio channel monitoring.

Unlink Faders

Determines whether you can adjust the faders individually or together.

If **Unlink Faders** is deactivated, moving one fader also moves the other by the same amount. Activating **Unlink Faders** allows you to correct improper stereo balancing by adjusting the level of the channels individually.

If you offset the faders with **Unlink Faders** activated and then deactivate **Unlink Faders**, you can adjust the overall level without changing the level offset between the channels.

Fader offsets are not preserved at the end of the range of movement or once the mouse button is released.

True Peak Analyzer Button

If **True Peak Analyzer** is activated, the analog reconstructed peaks (true peaks) are displayed in the **Master Level** meter. If this button is deactivated, the sample values (digital peaks) are displayed.

Final Effects/Dithering Pane

This pane in the **Master Section** allows you to add final effects and dithering to the signal before it is sent to the audio hardware or saved as a file on disk.



Fold/Unfold Pane

Expands or collapses the pane.

Bypass All Effects

Bypasses the effects in the **Final Effects/Dithering** pane.

Monitoring Point

Lets other meters in WaveLab Pro, for example, **Oscilloscope** or **Wavescope**, monitor the signal directly after this plug-in.

If no monitoring point is specified, the monitoring point is after the **Final Effects/Dithering** section and before the **Playback Processing** section.

The **Master Level** meter of the **Master Section** always monitors the level after the faders.

Presets pop-up menu

Lets you save and recall preset settings. The **Presets** pop-up menu offers additional options to save and load default banks and effects.

Effect Options pop-up menu

Allows you to load another effect to the effect slot. Furthermore, the following options are available:

- **Remove Plug-in** removes the effect from the slot.
- **Shift All Plug-ins Down/Shift All Plug-ins Up** allows you to move the effects to another position.
- If **Active** is activated, the effect is active. If **Active** is deactivated, the effect is excluded from playback and rendering.
- If **Lock** is activated, the effect slot is locked. The plug-in in the slot remains as is when a **Master Section** preset is loaded, or when **Reset Master Section** is used.

Bypass Processing

Bypasses the plug-in during playback and optionally during rendering. The signal is still processed by the plug-in, but is not injected in the audible stream.

Dithering

Dithering is the technique of adding small quantities of noise to a signal to reduce the audibility of low level distortion in a digital recording. A small amount of random noise is added to the analog signal before the sampling stage, reducing the effect of quantization errors.

By adding a special kind of noise at an extremely low level, the quantization errors are minimized. The added noise can be perceived as a very low-level quiescent hiss added to the recording. However, this is hardly noticeable and preferred to the distortion that occurs otherwise. The **Noise Shaping** options allow you to filter this noise to a frequency area less sensitive to the human ear.

In WaveLab Pro, dithering is applied when reducing the number of bits in a recording, for example, when moving from 24 to 16 bits, and when applying processing. You can choose between WaveLab Pro's internal dithering algorithm, Izotope's MBIT+ algorithm, or any external dithering plug-in.

NOTE

Dithering should always be applied after the output bus fader stage, and after any kind of audio process.

Dithering Plug-ins

WaveLab Pro comes with two dithering plug-ins: Internal dithering and the MBIT+ dithering. However, you can also add other dithering plug-ins.

- To select and activate a dithering plug-in in the **Master Section**, click the plug-in slot in the **Final Effects/Dithering** pane, and select one of the options from the pop-up menu.
- To deactivate the dithering plug-in, open the **Final Effects/Dithering** pop-up menu, and select **Remove Plug-in**.

Adding Other Plug-ins to the Final Effects/Dithering Pane

If you want to use another dithering plug-in than the internal or UV22HR dithering, you can add it to the **Final Effects/Dithering** pane.

NOTE

The meters in the **Master Section** monitor the signal before the **Final Effects/Dithering** pane. To avoid clipping, check the level/pan meter and adjust the output level of the plug-in, if available.

PROCEDURE

1. Select **File > Preferences > Plug-ins**.
 2. Select the **Organize** tab.
 3. Locate the plug-in that you want to add to the **Final Effects/Dithering** pane in the list, and activate the checkbox in the **Final** column for the plug-in.
-

RESULT

The plug-in is available via the pop-up menu in the **Final Effects/Dithering** pane, and can be inserted after the **Master Level** faders. The plug-in is still available for selection as a regular pre-master effect if the corresponding entry in the **Effect** column in the **Plug-ins Preferences** is activated.

When to Apply Dithering

The basic rule is that you should apply dithering when converting an audio file to a lower precision. For example, preparing a 24-bit file for mastering to CD, that uses 16-bit format.

However, even if you are playing back or rendering a 16-bit or 24-bit file to the same precision, you need to apply dithering if you are using any real-time processing in WaveLab Pro. The reason for this is that WaveLab Pro works with an internal precision of 64 bit (floating point) for supreme audio quality. This means that as soon as you perform any kind of processing, the audio data is treated at this high precision instead of the original 16 bit or 24 bit, thus making dithering necessary.

Examples of real-time processing include level adjustments, effects, mixing of two or more clips in an audio montage, etc. The only time when a 16-bit file is played back at 16-bit precision is if you play it without any fades or effects, and with the **Master Level** faders set to 0.00 (no level adjustment – master level indicator turned off).

NOTE

To check whether you need to apply dithering, use the **Bit Meter** to see the actual precision of your audio signals.

RELATED LINKS

[Bit Meter](#) on page 396

Testing the Quality of the Dithering Plug-ins

In the **Master Section**, you can compare the quality of different dithering plug-ins, by making the quantization noise and the dithering signal more audible.

- To activate this option, click **Settings** at the top of the **Master Section**, and activate **Monitor 16 Bit Dithering**.

Now, when you activate a dither plug-in and play back an audio section, you can hear what the effect of the dither plug-in sounds like. You can try out different dithering plug-ins, to find out which one has the best effect on the audio.

IMPORTANT

Make sure to deactivate **Monitor 16 Bit Dithering** when you are done testing the dithering quality.

NOTE

Only dither to 16 bit, otherwise the result does not have any meaning.

Playback Processing Pane

This pane in the **Master Section** contains the **Encoder Checker** that allows you to compare audio encoders. You can also add your own plug-ins to the **Playback Processing** slots.

NOTE

The plug-ins in the **Playback Processing** pane are only part of the playback processing. It is not applied when rendering files or CDs.

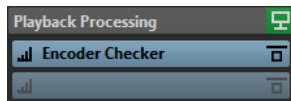

Fold/Unfold Pane

Expands or collapses the pane.

Bypass All Effects

Bypasses the effects in the **Playback Processing** pane.

Monitoring Point

Lets other meters in WaveLab Pro, for example, **Oscilloscope** or **Wavescope**, monitor the signal directly after this plug-in.

If no monitoring point is specified, the monitoring point is after the **Final Effects/Dithering** section and before the **Playback Processing** section.

The **Master Level** meter of the **Master Section** always monitors the level after the faders.

Effect Options pop-up menu

Allows you to add an effect to the effect slot. You can load your own plug-ins or use the included **Encoder Checker**. Furthermore, the following options are available:

- **Remove Plug-in** removes the effect from the slot.
- **Shift All Plug-ins Down/Shift All Plug-ins Up** allows you to move the effects to another position.
- If **Active** is activated, the effect is active. If **Active** is deactivated, the effect is excluded from playback and rendering.

- If **Lock** is activated, the effect slot is locked. The plug-in in the slot remains as is when a **Master Section** preset is loaded, or when **Reset Master Section** is used.

Presets pop-up menu

Lets you save and recall preset settings. The **Presets** pop-up menu offers additional options to save and load default banks and effects.

Bypass Processing

Bypasses the plug-in during playback and optionally during rendering. The signal is still processed by the plug-in, but is not injected in the audible stream.

RELATED LINKS

[Plug-ins Preferences](#) on page 560

Encoder Checker

The **Encoder Checker** plug-in allows you to compare the quality between different audio encoders. It is applied in the **Playback Processing** pane of the **Master Section**.

With the **Encoder Checker** you can find the best settings for your encoders and test the effect of other plug-ins on the compression. The **Encoder Checker** is only used for playback and is bypassed during audio file rendering.

IMPORTANT

The **Encoder Checker** does not support multichannel audio montages.

NOTE

The more encoders are selected in the **Encoder Checker** dialog, the more CPU power is used. Also, the more audio compression is applied to the audio file, the higher the latency. The latency is determined by the encoder with the highest latency.

Checking the Quality of Encoded Audio Files

PROCEDURE

1. Open the audio file that you want to check in different encoding qualities.
2. In the **Master Section**, right-click the effect slot in the **Playback Processing** pane, and select **Steinberg > Encoder Checker**.
3. In the **Encoder Checker**, click in the first numbered field and select a factory preset or select **Edit** to specify a custom audio file format.
4. Optional: Specify more audio file formats.
5. Play back the audio file.
6. Click **Original Sound** and the number icons to compare the sound of the original audio with the sound of the encoders.
If the **Encoder Checker** window is active, you can also press the **1**, **2**, and **3** keys on your keyboard to switch between the encoders and click **.** to select the original sound.

NOTE

If you select or edit an encoder, the plug-in synchronizes the new encoder settings with the other active encoders and the original sound. This can result in short audio artifacts.

AFTER COMPLETING THIS TASK

If you have found the best encoder, click **Render** to render the audio file to the selected audio file format. You can also click **Batch Processor** to open the **Batch Processor** window with an audio file format preset that corresponds to the selected encoder.

Checking the Quality of Encoded Audio Files Using the Blind Modes

To make sure that you only rely on your ears when checking the encoder quality, you can use the **Blind** modes to compare the encoders without knowing which encoder is playing.

PROCEDURE

1. Open the audio file that you want to check in different encoding qualities.
2. In the **Master Section**, right-click the effect slot in the **Playback Processing** pane, and select **Steinberg > Encoder Checker**.
3. In the **Encoder Checker**, click in the first field and select a factory preset or select **Edit** to specify a custom audio file format.
4. Optional: Specify more audio file formats.
5. Do one of the following:
 - To compare only the encoders, activate **Blind (Encoders)**. For this function, at least 2 encoders must be selected.
 - To compare the encoders and the original sound, activate **Blind (Encoders + Original Sound)**.
6. Play back the audio file.
7. Use the up/down or left/right arrow keys to switch between the encoders.
8. Use the + and - keys to rate the encoder that you are listening to.
9. Deactivate **Blind** mode.

RESULT

The encoder that you have heard last is highlighted and you can see the ratings of the encoders.

AFTER COMPLETING THIS TASK

If you have found the best encoder for your needs, click **Render** to render the audio file to the selected audio file format.

Encoder Checker Dialog

In this dialog, you can compare the quality of different audio encoders.

- To open the **Encoder Checker** dialog, right-click the effect slot in the **Playback Processing** pane, and select **Steinberg > Encoder Checker**.

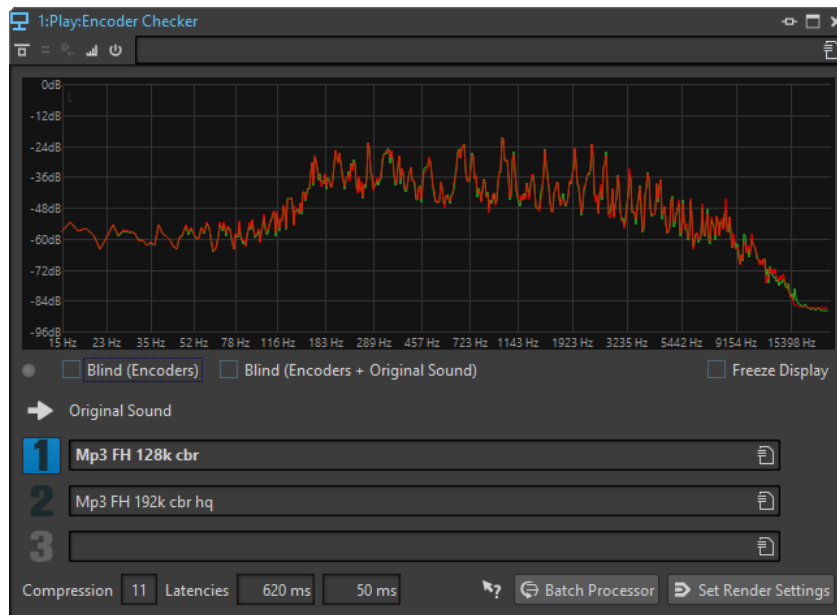

Display

Displays the spectrum (FFT) of the original sound (green) and of the selected encoder (red). This gives you a rough estimation of the effects that the encoder has on the audio spectrum.

Switch indicator LED

In the **Blind** modes, this LED lights up each time that a new encoder is selected via the arrow keys.

Blind (Encoders)

If this option is activated, the original sound is selected. When you use an arrow key, a random encoder is used. You can use the arrow keys to switch between the selected encoders without being able to see which encoder is selected.

You can use the + and - keys to rate the encoder that you are listening to. The rating results are displayed when you deactivate **Blind** mode.

Blind (Encoders + Original Sound)

If this option is activated, a random encoder or the original sound is selected. You can use the arrow keys to switch between the selected encoders and the original sound without being able to see which one is selected.

You can use the + and - keys to rate the encoder that you are listening to. The rating results are displayed when you deactivate **Blind** mode.

Freeze Display

If this option is activated, the FFT display freezes.

Original Sound

Lets you hear the original audio file during playback.

Presets

Lets you select different audio encoders and switch between them during playback.

Rating

Shows the number of plus and minus marks that were set during the **Blind** modes.

Compression

The real-time estimation of the audio compression ratio with a 16-bit file size as reference.

Latencies

The first latency value indicates how long you have to wait until you hear the new encoder when you select another encoder. The second latency value indicates the delay when switching between encoders.

Batch Processor

Opens the **Batch Processor** window with an audio file format preset that corresponds to the audio file format that is being monitored.

Open Render Tab

Opens the **Render** tab with the selected Encoder Checker settings defined as the output file format.

Speaker Configuration Pane

This pane of the **Master Section** allows you to select the speaker configurations. The speaker configurations are set up in the **VST Audio Connections**.



Fold/Unfold Pane

Expands or collapses the pane.

Speaker Configuration

Lets you select eight different speaker configurations.

Audio Connections

Opens the **Audio Connections**, where you can set up the speakers for the speaker configuration buttons.

Speaker Gain

Lets you edit the gain of the speaker configuration. Positive gains are indicated by a red LED, and negative gains are indicated by an orange LED. When the gain is zero, the LED is dark green (off). The gain is not rendered to file.

RELATED LINKS

[Speaker Configuration](#) on page 106

[Audio Connections Tab](#) on page 11

Rendering

By rendering the effects using the **Render** function in the **Master Section**, they become a permanent part of a file. So instead of performing all processing in real-time during playback, you can save the audio output to a file on disk.

You can render to a single file format or to multiple audio file formats.

Writing the output of the **Master Section** to a file on disk allows you to apply **Master Section** processing to an audio file, or mix down an audio montage to an audio file. In case of a multichannel audio montage, several files can be created, one for each channel in the selected configuration.

There are several uses for rendering:

- Mix down a complete audio montage to an audio file.

- Process a file and save a file to a new audio file, including **Master Section** effects, dithering, and other settings. You can choose the format of the new audio file, which allows you to create an MP3 file and add effects at the same time, for example.
- Process one or more regions of an audio file in place or to new files.

Multiple File Format Rendering

You can render to multiple audio file formats simultaneously. To do so, you must first create file format presets for these formats.

You can also create multiple audio file format presets. These are a list of single file format presets.

Rendering Files

You can render to a single file format or to multiple file formats.

PREREQUISITE

Set up your audio file or audio montage. If you want to render to multiple file formats, create the necessary audio file format presets.

PROCEDURE

1. In the **Master Section**, make your settings.
2. On the bottom of the **Master Section**, click **Render**.
3. Do one of the following:
 - To render a single file, click **Single**.
 - To render multiple files, click **Multi**.
4. Make your rendering settings.
5. In the **Result** section, activate **Named File**.
6. Click the **Format** field and do one of the following:
 - To render to one audio format, select **Edit Single Format**, and make your settings in the **Audio File Format** dialog.
 - To render to multiple file formats, select **Edit Multi Format**, and in the **Multi Audio File Format** dialog, click **Add**, and select the file format presets that you want to render to.
7. Click **OK**.
8. When you have set up the rendering process, click **Start**.

RESULT

The file is rendered. You can see the progress in the **Tasks** window.

NOTE

Several rendering operations can be performed at the same time when using different files.

RELATED LINKS

[Audio File Format Dialog](#) on page 127

[Multi Audio File Format Dialog](#) on page 352

[Creating Single Audio File Format Presets](#) on page 352

[Creating Multiple Audio File Format Presets](#) on page 352

[Tasks Window](#) on page 365

Creating Single Audio File Format Presets

PROCEDURE

1. In the **Audio File Format** dialog, specify the audio file format.
 2. Open the **Presets** pop-up menu and select **Save As**.
 3. Enter a name for the preset and click **Save**.
-

RELATED LINKS

[Audio File Format Dialog](#) on page 127

Creating Multiple Audio File Format Presets

PREREQUISITE

Create a preset for each audio file format that you want to add to the multi format preset.

PROCEDURE

1. In the **Audio File Format** dialog, click **Multiple File Format**.
2. Click **Add** and select the preset that you want to use.
3. Add as many audio file format presets as you need.
4. Optional: To make changes to an existing preset, right-click it and select **Edit**.

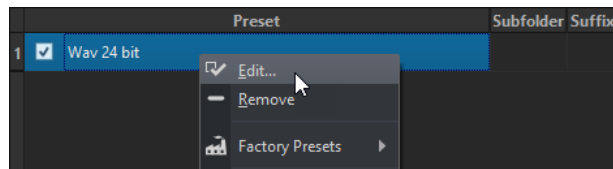

5. Open the **Presets** pop-up menu and select **Save As** to save the multiple format as preset.
-

RELATED LINKS

[Multi Audio File Format Dialog](#) on page 352

Multi Audio File Format Dialog

In this dialog, you can select audio file format presets. These allow you to render an audio file or an audio montage to multiple file formats.

- To open the **Multi Audio File Format** dialog, select **File > Export**, and select **Render > Single** or **Render > Multi**. Then click in the **Format** field and select **Edit Multi Format**. You can also open the **Multi Audio File Format** dialog via the **Format** tab in the **Batch Processor** window.

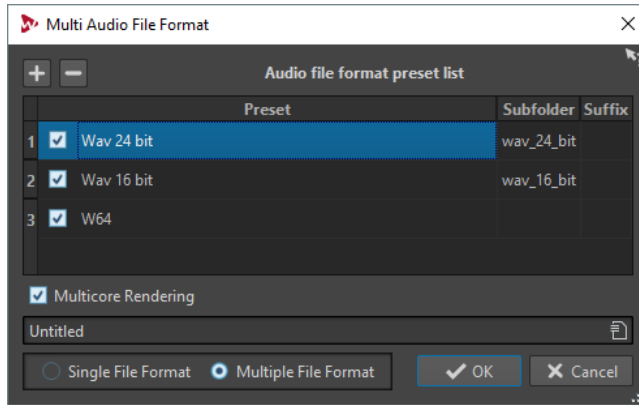

Add

Opens a menu from which you can select a file format preset to add it to the preset list.

Remove

Removes the selected preset from the list.

Preset list

Shows the selected audio file format presets, an optional subfolder in which the files are rendered to, and an optional suffix for the rendered files. The **Subfolder** column allows you to sort the output files to different subfolders. The **Suffix** column helps to avoid name conflicts.

Multicore Rendering

If this option is activated, all audio files are generated at the same time, each with a different CPU core, if possible. This increases the rendering speed.

NOTE

It is recommended to deactivate the **Multicore Rendering** option if a batch processor is running that already uses multiple CPU cores.

Single File Format/Multiple File Format

Switches the view between the **Audio File Format** dialog and the **Multi Audio File Format** dialog.

In-Place Rendering

In the **Audio Editor**, you can process a section of an audio file or the whole audio file. This is a quick way to process several audio sections in an audio file, or test the effect of different plug-ins on an audio file.

You can select the **Render in Place** function in the following places:

- On the **Render** tab of the **Audio Editor**
- In the **Master Section**, in the context menu of the **Render** button
- In the command bar of a plug-in window

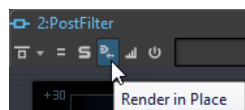

When selecting **Render in Place** via the **Render** tab, you can make additional render settings on the **Options** pop-up menu. When selecting **Render in Place** via the **Master Section** or a plug-in window, the following render settings are always active:

- Fade in/out at boundaries
- Exclude bypassed plug-ins

NOTE

Once an audio section has been processed, there is no automatic bypass of plug-ins or the **Master Section**.

An example for using in-place rendering:

Let's say that you are restoring a file and have 3 favorite plug-ins, for example, 3 **DeClicker** plug-ins. Now you want to use the one that gives the best results.

1. Load all 3 plug-ins in the **Master Section**.
2. Select a region, solo plug-in #1, and play the region.
3. Solo plug-in #2, and play the region.
4. Solo plug-in #3, and play the region.
5. Solo the plug-in that you think sounded the best, and click **Render in Place**, or press **Alt-A**.

RELATED LINKS

[Render Tab](#) on page 355

Rendering an Audio Selection In-Place

You can render the plug-ins of a section of an audio file or the whole audio file.

PREREQUISITE

In the **Audio Editor**, open the audio file that you want to render, and set up the **Master Section**.

PROCEDURE

1. Optional: If you only want to use some plug-ins of the **Master Section**, solo the plug-ins that you want to use.
 2. In the wave window, select the audio section that you want to process.
 3. Select the **Render** tab.
 4. In the **Source** section, open the **Source** pop-up menu and select **Selected Audio Range**.
 5. In the **Result** section, activate **In Place**.
 6. In the **Options** section, open the pop-up menu and make render settings.
 7. In the **Render** section, click **Start**.
-

RESULT

The audio section or the audio file is processed.

Using the Master Section Settings in a Batch Process

You can open a Batch Processor that uses the same plug-in setup as the one that is used in the **Master Section**. This allows you to process more files in a batch, or add offline processors to the audio processing chain.

PROCEDURE

1. At the bottom of the **Master Section**, right-click **Render**.
 2. Select **Create Batch Processor from Settings**.
-

RESULT

The **Batch Processor** window opens with the same plug-in setup as the one that was used in the **Master Section**.

AFTER COMPLETING THIS TASK

Add more files to the batch process and/or make additional configurations in the plug-in chain.

RELATED LINKS

[Batch Processing](#) on page 490

Render Tab

This tab allows you to select which parts of an audio file to render, into which format, and what to do with the result.

- To open the **Render** tab, click **Render** at the bottom of the **Master Section**. If you want to render to a single file format, select **Single**. If you want to render to multiple file formats, select **Multi**.

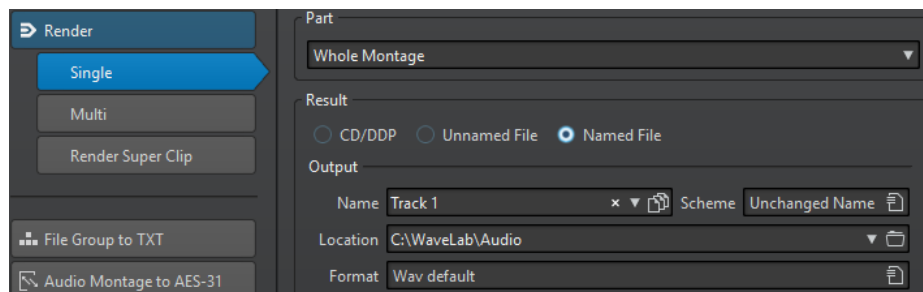

The following options are available for rendering audio files and audio montages.

Part

- **Selected Audio Range** processes and renders the selected audio range.
- **Specific Region** processes and renders an audio range that is specified using region markers. In the pop-up menu next to this option, select the region that you want to render. For example, a CD track.
- **All Regions** processes and renders each marked audio range to an independent file, or renders in place, according to the settings. By defining multiple isolated regions in an audio file, you can process them in place in one operation. In the pop-up menu next to this option, select the type of marked regions you want to render.

In Place

If this option is activated, the rendered audio range replaces the source audio range.

Unnamed File

If this option is activated, the file is named `untitled`.

Named File

If this option is activated, you can specify a name for the rendered file.

Name

Enter a name for the rendered file. Clicking the arrow icon opens a menu that offers you several automatic naming options.

Scheme

Allows you to automatically create file names according to custom variables, text snippets, or auto variables. For example, when rendering multiple sources, you can activate this option to add a numeric prefix to all rendered files.

Location

Select a folder for the rendered file.

Format

Opens the **Multi Audio File Format** dialog, where you can select the file format.

Bypass Master Section

If this option is activated, the plug-ins and gain of the **Master Section** are bypassed when rendering.

Auto Save Master Section Preset

If this option is activated, the **Master Section** preset is automatically saved in the audio file or audio montage when you render the file. You can load the **Master Section** preset via the **Load Master Section Preset** option in the lower right corner of the wave window or the montage window.

Fade In/Out at Boundaries

If this option is activated, a fade is performed at the audio range boundaries when a new file is created, or a crossfade with the audio neighborhood is created if the audio range is processed in place.

Crossfades allow a smooth transition between the processed and the non-processed parts. The crossfade time and shape are set in the **Audio Files Preferences**. If the fade time is longer than half the length of the processed file, it is not performed.

No Reverb Tail

If this option is activated, the audio tail produced by effects such as reverb is not included in the rendered file.

Some plug-ins do not provide a tail duration to WaveLab Pro. In this case, this option has no effect. For such plug-ins, you could add the **Silence** plug-in to add extra samples at the end of the file.

Copy Markers

If this option is activated, markers that are included in the range to process are copied to the rendered file.

Skip Exclusion Regions

If this option is activated, audio ranges that are marked as muted are skipped and not included in the result.

Open Resulting Audio File

If this option is activated, the rendered files are opened in a new file group.

Bypass Master Section on Resulting Audio File

If this option is activated, playback of the resulting audio file bypasses the entire **Master Section** after rendering. This setting can be toggled by clicking on the button at the bottom right of the wave window or montage window.

NOTE

It is recommended to activate this option, because you do not need to monitor this new file through the effects again when the effects have been applied to a file.

Export to SoundCloud

If this option is activated, the rendered file is uploaded to SoundCloud after the rendering process is finished.

Render Tab for Audio Files

The following options on the **Render** tab are exclusive to rendering audio files.

Part

Whole File processes and renders the whole file.

In Place

If this option is activated, the rendered audio range replaces the source audio range.

Render Tab for Audio Montages

The following options on the **Render** tab are exclusive to rendering audio montages.

Part

- **Whole Montage** processes and renders the whole audio montage.
- **Union of Selected Clips** processes and renders the audio range that starts from the first selected clip and ends with the last selected clip. Only the selected clips are included in the process.
- **Selected CD Track** processes and renders the selected CD track in the CD window.
- **All Clip Groups** processes and renders each clip group to an independent file. The group names are used for the output file names.
- **All Selected Clips** processes and renders each clip to an independent file. The clip names are used as output file names.
- **CD Track Group** processes and renders the selected CD track group.
- **All CD Tracks in Group** processes and renders all CD tracks in the selected CD track group.

Depending on the **Part** setting, different additional options are available.

Create Basic Audio CD

If this option is activated, a file of the whole audio montage, including clip effects and master effects, is created. Then a **Basic Audio CD** window opens.

Create CD Image and Cue Sheet

If this option is activated, the audio montage is exported as a CD image with an accompanying cue sheet, that is, a text file identifying the CD tracks in the image file. The cue sheet and the image file it describes can then be imported into any CD recording application that supports this function, including WaveLab Pro, and written onto a CD. The CD image is a wave file. You can use this option with any sample rate.

Create Audio Montage from Result

If this option is activated, the rendered audio file is imported in a new audio montage.

Render Audio File, Do Not Change Audio Montage

If this option is activated, the rendered audio file is saved at the specified location and the audio montage is not changed.

Replace on Same Audio Montage Track

If this option is activated, the rendered audio file replaces the audio montage track.

Add to Next Empty Audio Montage Track

If this option is activated, the rendered audio file is added to the next empty audio montage track.

Add to New Audio Montage Track

If this option is activated, the rendered audio file is added to a new audio montage track.

Bypass Clip Plug-ins

If this option is activated, clip plug-ins are bypassed when rendering.

Bypass Volume/Pan Envelopes

If this option is activated, volume/pan envelopes are bypassed when rendering.

Replace Clips with Rendered Audio Files

If this option is activated, the rendered audio files replace the selected clips.

Include Pause before Track

If this option is activated and you render CD tracks, a pause is included before each CD track in the rendered file.

Include Pause after Track

If this option is activated and you render CD tracks, a pause is included after each CD track in the rendered file.

Render Multi Tab

The **Multi** tab in the **Render** tab allows you to render multiple audio files and audio montages at once.

- To open the **Render** tab for multiple file formats, click **Render** at the bottom of the **Master Section**. Then select **Multi**.

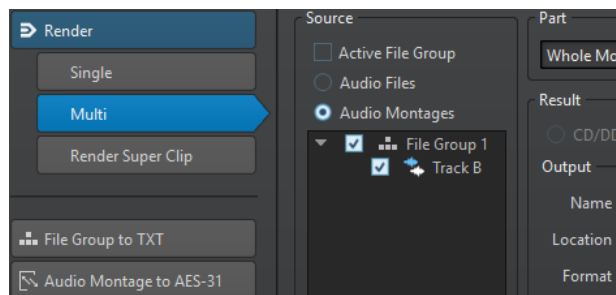

The file list displays all open file groups and their included files. You can filter the file list to only display the active file group, and only audio files or audio montages.

In the file list, select the files that you want to render.

You can also select multiple file tabs and render the files via the **Render** tab.

RELATED LINKS

[Check Tab/Uncheck Tab](#) on page

Recording from an ASIO Input

You can record an audio file to disk from an ASIO input, while the audio is collected from the audio input. The audio from the ASIO input is rendered through the **Master Section** including its plug-ins and saved as a file, as when rendering normally.

This is another way to record. When you record normally, no plug-ins are used, but more options are possible.

Rendering the ASIO Input to File

PREREQUISITE

In the **Audio Connections**, set up the input and output channels of the ASIO plug-in.

PROCEDURE

1. In the **Master Section**, in the **Effects** pane, add the **Audio Input** plug-in to the first effect slot.
2. In the lower part of the **Master Section**, click **Render**.
3. Make your settings.

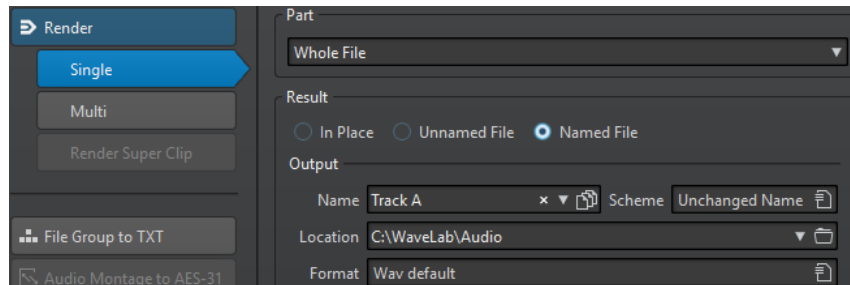

4. Click **Start**.
-

RESULT

The audio file is recorded to disk from the ASIO input, until you click the **Stop** button on the transport bar.

RELATED LINKS

[Audio Connections Tab](#) on page 11

Smart Bypass

Smart bypass allows you to compare the original signal to the processed signal with a level correction applied to it. This function is particularly useful when you are making final level adjustments to a recording, for example, during mastering.

Smart bypass compares the signal at the input of the **Master Section** to the signal at the output of the **Master Section**, and adjusts the level accordingly.

The main reason for smart bypass is that processing audio often changes the level or loudness of the signal. When comparing the processed signal with the original signal, your ears are sensitive to this loudness change. If you need to compare the sound of the effect independently from the loudness change, a level correction is required.

Using Smart Bypass

PROCEDURE

1. At the top of the **Master Section**, click **Smart Bypass**.
2. In the **Smart Bypass** dialog, select one of the play modes.
You can also use key commands to select a **Play** option. Press **A** for **Original Audio**, **B** for **Processed Audio + Level Correction**, and **C** for **Processed Audio**.
3. Select one of the **Level Correction** modes.
4. Depending on your selection, you have the following options:
 - If you have selected **Match Loudness (RMS)** or **Match Peaks**, specify the time range that you want to analyze in the **Analysis Time** field, and proceed with step 5.
 - If you have selected **Custom Correction**, specify a value, start playback, and proceed with step 7.
5. Play back the audio and wait for the analysis to complete.

Wait as long as the time specified in the **Analysis Time** field.

6. Click Update Gains.

Depending on the selected correction method, the level correction that is applied is shown below the corresponding button.

You can also press **U** to update the gains.

7. Switch between the three play mode options to compare the processed audio with level correction, the processed audio without level correction, and the original audio (unprocessed).

If you change the analysis time or start playback from another position you have to wait for the set time, and then click **Update Gains** again to update the analysis.

Smart Bypass Dialog

The **Smart Bypass** dialog allows you to choose whether to bypass all the active effects in the **Effects** slots, including faders. This allows you to compensate for any level differences introduced by the **Master Section**.

- To open the **Smart Bypass** dialog, click **Smart Bypass** at the top of the **Master Section**.

NOTE

This applies to playback only, not to file rendering.

Play – Original Audio

Monitors the unprocessed signal at the **Master Section** input.

Play – Processed Audio + Level Correction

Monitors the signal at the **Master Section** output plus the applied level correction. To be able to listen to the corrected level, click **Update Gains** first.

Play – Processed Audio

Monitors the unprocessed signal at the **Master Section** output without level correction.

Level Correction – Match Loudness (RMS)

If this option is activated, the output is adjusted so that the loudness of the processed signal corresponds to that of the original signal.

Level Correction – Match Peaks

If this option is activated, the output is adjusted so that the peak levels of the processed signal correspond to those of the original signal.

Level Correction – Custom Correction

Allows you to set a custom level compensation (no analysis).

Level Correction – Analysis Time

Determines how many samples are used to calculate the reference loudness.

Level Correction – Update Gains

Updates the volume analysis.

Saving Master Section Presets

You can save all settings that are made in the **Master Section** as a preset. This includes which processors are used, which settings are made for each one of them, and the dithering options.

PROCEDURE

1. Set up the **Master Section**.
 2. Click **Presets** at the top of the **Master Section**, and select **Save As**.
 3. Optional: In the **Save Master Section Preset** dialog, click the path name, enter a name, and click **OK** to create a new subfolder in the **Master Section** preset folder.
 4. Enter a name for the preset in the **Name** field.
 5. Select the options that you want save in the preset.
 6. Optional: Activate **Create Shortcut for Selecting the Preset**, to assign a shortcut to open the preset, after you clicked **Save**.
 7. Click **Save**.
-

Save Master Section Preset Dialog

In this dialog, you can save a **Master Section** setup as preset and define which parts of the current **Master Section** you want to include in the preset.

- To open the **Save Master Section Preset** dialog, click **Presets** at the top of the **Master Section**, and select **Save As**.

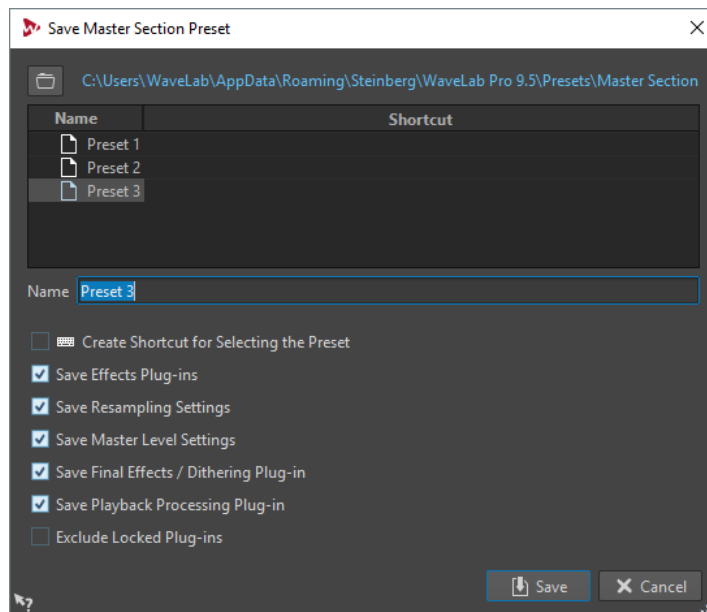

Location

Opens the root folder of the preset in the File Explorer/macOS Finder. Here, you can create subfolders in which presets can be saved.

Presets list

Lists all existing presets.

Name

Lets you specify the name of the preset to save.

Create Shortcut for Selecting the Preset

If this option is activated and you click **Save**, the **Shortcut Definitions** dialog opens, where you can define a shortcut for applying this preset.

If a preset already has a shortcut, this option is grayed out. To change the existing shortcut, double-click the preset name in the presets list.

Save Effects Plug-ins

If this option is activated, the effect plug-ins are saved with the preset.

Save Resampling Settings

If this option is activated, the resampling settings are saved with the preset.

Save Master Level Settings

If this option is activated, the master level settings are saved with the preset.

Save Final Effects/Dithering Plug-in

If this option is activated, the final effects/dithering plug-in is saved with the preset.

Save Playback Processing Plug-in

If this option is activated, the playback processing plug-ins are saved with the preset.

Exclude Locked Plug-ins

If this option is activated, locked plug-ins are not saved as part of the **Master Section** preset.

Loading Master Section Presets

You can load a previously saved **Master Section** preset, a temporarily saved **Master Section** preset, or import WaveLab Pro 4/5/6 presets.

Open the **Presets** pop-up menu at the top of the **Master Section** window.

- To load a preset that has been previously saved in the `Presets\Master Section` folder, select a preset from the **Presets** pop-up menu.
- To load a preset from any location, select **Load Preset**, select a preset, and click **Open**.
- To load a temporarily saved preset, open the **Restore** submenu, and select a preset.
- To import a WaveLab Pro 4/5/6 preset, select **Load WaveLab 4/5/6 Preset**, select a preset, and click **Open**.

Saving a Master Section Preset in an Audio File or Audio Montage

You can save the current settings of the **Master Section** along with an audio file or inside an audio montage.

- To save the current settings of the **Master Section** along with an audio file, open the **Master Section Preset Settings** pop-up menu on the lower right of the wave window, and select **Save Master Section Preset**. In the **Save Master Section Preset** dialog, make your settings and click **Save**.
The preset is saved in companion files.
- To save the current settings of the **Master Section** as part of an audio montage, open the **Master Section Preset Settings** pop-up menu on the lower right of the montage window, and select **Save Master Section Preset**. In the **Save Master Section Preset** dialog, make your settings and click **Save**.

Loading a Master Section Preset to an Audio File or Audio Montage

You can apply the **Master Section** settings that have been saved along with an audio file or inside an audio montage to the project.

If the option **Open Options Dialog when Selecting Preset** is activated on the **Presets** menu of the **Master Section**, the **Load Master Section Preset** dialog opens when applying a **Master Section** preset. In this dialog, you can specify which parts of a saved **Master Section** preset to load when opening it.

- To load a **Master Section** preset that is saved along with the opened audio file, open the **Master Section Preset Settings** pop-up menu on the lower right of the wave window, and select **Load Master Section Preset**.
- To load a **Master Section** preset that is saved inside the opened audio montage, open the **Master Section Preset Settings** pop-up menu on the lower right of the montage window, and select **Load Master Section Preset**.

Load Master Section Preset Dialog

In this dialog, you can specify which parts of a saved **Master Section** preset to load when opening it.

- To open the **Load Master Section Preset** dialog, click **Presets** at the top of the **Master Section**, and select **Load Preset**.

This dialog only opens if it is activated on the **Presets** menu of the **Master Section**. Open the **Presets** menu at the top of the **Master Section**, and activate **Open Options Dialog when Selecting Preset**.

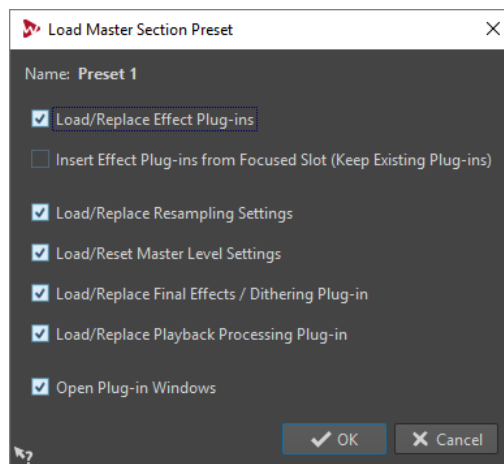

Now, when restoring a temporarily saved preset or opening a saved preset a dialog with the following options opens:

Name

Displays the name of the preset.

Load/Replace Effect Plug-ins

If this option is activated, the active effect plug-ins are removed, and any new plug-ins are inserted from the top slot.

Insert Effect Plug-ins from Focused Slot (Keep Existing Plug-ins)

If this option is activated, the current effect plug-ins are kept, and any new plug-ins are inserted from the top slot.

Load/Replace Resampling Settings

If this option is activated, the current resampling settings are reset, and any new settings are loaded.

Load/Reset Master Level Settings

If this option is activated, the current **Master Level** settings are reset, and any new settings are loaded.

Load/Replace Final Effects/Dithering Plug-in

If this option is activated, the current final effects/dithering plug-in is removed, and the new plug-in is loaded.

Load/Replace Playback Processing Plug-in

If this option is activated, the current post-processing plug-in is removed, and the new plug-in is loaded.

Open Plug-in Windows

If this option is activated, the plug-in window opens when you load a new **Master Section** preset.

Including a Master Section Preset When Rendering

You can include the **Master Section** preset that is saved with the audio montage in the rendering process of super clips' audio montages.

This means that if this option is activated for an audio montage, anytime this audio montage is rendered so that its image is used in a parent montage, its associated **Master Section** preset is used in the rendering process.

- To include the **Master Section** preset when rendering a super clip, open the **Master Section Preset Settings** pop-up menu on the lower right of the montage window, and select **Include Master Section Preset when Rendering as Super Clip**.

Master Section Presets Pop-up Menu

This pop-up menu offers several options for saving, managing, and restoring **Master Section** presets.

- To open the **Presets** pop-up menu, click the presets pane at the top of the **Master Section**.

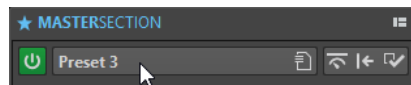

Save

Saves the changes you have made to an existing preset.

Save As

Opens a dialog where you can specify a name and a location for the preset.

Organize Presets

Opens the **Preset** folder of the **Master Section**, where you can rename or delete presets.

Define Shortcut for Current Preset

Opens the **Shortcut Definitions** dialog, where you can define key sequences and keywords.

Load Preset

Allows you to load a **Master Section** preset via the File Explorer/macOS Finder. For example, this is useful if you want to load a preset that is provided by another source and not located in your default root folder.

Load WaveLab Pro 4/5/6 Preset

Allows you to load WaveLab Pro 4/5/6 presets via the File Explorer/macOS Finder.

Open Options Dialog when Selecting Preset

If this option is activated, a dialog opens that allows you to choose how to load the preset you select.

Store Temporarily

Lets you select one of the slots to temporarily save a preset.

Restore

Lets you restore a previously saved preset.

List of saved presets

Lists the presets that are saved in the **Presets** folder of the **Master Section**.

Monitoring Background Tasks

When rendering, you can monitor the process, and pause or cancel tasks.

You can adjust the priority with which tasks are processed, pause, or cancel them. This is useful if you have a number of lengthy processes underway and want to free up some processing power to focus on editing. You can either lower the priority of a task so that it does not use as much of the computer processor capacity, or pause the task.

To automatically open the **Tasks** window when a task starts, select the **Options** tab in the **Global Preferences**, and activate **Make Tasks Monitor Visible When Task Starts**.

A status bar below the wave window and the montage window shows the progress of the current rendering process, and lets you cancel and pause the rendering, without opening the **Tasks** window.



RELATED LINKS

[Global Preferences](#) on page 570

Tasks Window

This window allows you to view all background rendering processes that are in progress.

- To open the **Tasks** window, select **Tool Windows > Tasks**

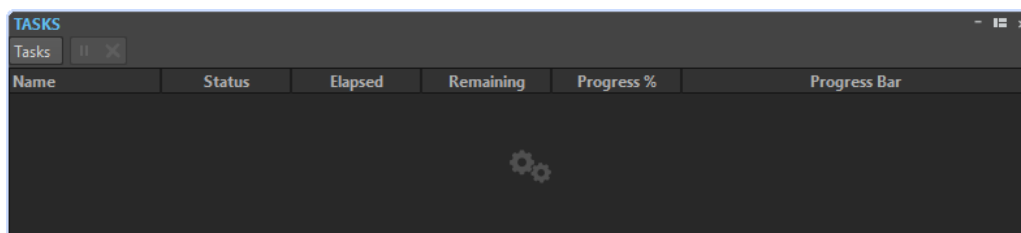

The list of background tasks shows the following information about the rendered file during the rendering process:

- Name

- Status
- Elapsed Time
- Remaining Time
- Progress in %
- Progress bar

With the **Pause** and **Cancel** buttons, you can pause and cancel the rendering process.

From the **Tasks** menu, you can select the following options:

Suspend

Pauses the selected task.

Suspend All

Pauses all tasks.

Resume

Resumes the selected paused task.

Resume All

Resumes all paused tasks.

Cancel

Cancels the selected task.

Lowest Priority

Runs the task at a the lowest speed to leave processing power to other tasks, and only when the mouse or keyboard are not in use.

Low Priority

Runs the task at a low speed to leave processing power to other tasks.

High Priority

Runs the tasks as fast as possible while giving you the possibility to continue working in WaveLab Pro.

Dropouts

A dropout most likely occurs when your computer does not have the processing power to handle all used effect processors.

To avoid dropouts, try the following:

- Use fewer effects.
- Consider rendering the processing rather than running it in real time. Then master from the processed file without applying effects. Dropouts never occur when rendering to a file.
- Do not process any files in the background.
- If neither of the above helps, check the audio card preference settings. You might need to adjust the audio buffer settings. If a dropout occurs during a real-time mastering process we recommend that you re-master. Stop playback, click the dropout indicator to reset it, and try again.

Markers

Markers allow you to save and name specific positions in a file. Markers are useful for editing and playback.

For example, markers can be used for the following:

- Indicate cue points or absolute time locations.
- Highlight problem sections.
- Visually separate tracks.
- Set the wave cursor to a specific position.
- Select all audio between two positions.
- Define CD tracks.
- Loop sections in an audio file.

There is no limit to the amount of markers that you can have in a file.

The following marker types come in pairs: CD, loop, mute, region, error and correction. When you delete a marker of a marker pair, the other marker is also deleted.

Because you cannot have a CD track that starts but never ends, a loop end point without a start, etc., special rules exist for creating, deleting, and moving these types of markers. CD track markers must always be balanced. For example, if you delete a track start, the corresponding end marker is also deleted.

Loop, mute, correction, error, and region markers only have a functionality when balanced.

NOTE

The functions in the **Markers** window are the same for audio files and audio montages. However, the **Markers** window for audio montages offers additional options regarding clips.

Marker Types

The following marker types are available:

Generic markers

Allow you to locate positions and select all the audio between two points, for example. Generic markers can be created during recording.

Temporary markers

Can be used for any purpose. Temporary markers are deleted when the corresponding file is closed.

Playback start markers

Define a playback start point.

CD track start and end markers

Denote where a CD track begins and ends. CD track start and end markers also serve for DVD-A discs. CD/DVD markers are used in pairs.

CD track splice markers

Are used when a CD track starts exactly where another ends. CD track splice markers also serve for DVD-A discs.

CD track index markers

Are used to create index points in CD tracks. CD track index markers also serve for DVD-A discs.

Region start and end markers

Define start and end points for generic regions. Region start and end markers can be created during recording and are used in pairs.

Loop start and end markers

Are used to define loop points and are required to access loop editing functions on the **Process** tab of the **Audio Editor**. Loop start and end markers are connected to the **Loop** mode when playing back audio. These markers are useful for editing and creating loops before transferring a sound to a sampler. Loop markers are used in pairs.

Exclusion start and end markers

Let you temporarily silence a section. Sections between exclusion regions are skipped if **Skip Range** is activated in the **Play Audio Range** pop-up menu on the transport bar. The **Render** dialog also allows you to exclude regions from being rendered. Exclusion markers are used in pairs.

Error start and end markers

Are used to highlight errors, such as clicks. Error start and end markers are saved in audio files if **Save Error and Correction Markers** is activated in the **Audio Files Preferences**, on the **File** tab. Error start and end markers can be placed manually, but their main use is in combination with the **Error Correction** tool.

Correction start and end markers

Are used to highlight corrections performed on regions previously marked as errors. Correction start and end markers are saved in audio files if **Save Error and Correction Markers** is activated in the **Audio Files Preferences** on the **File** tab. The correction markers can be placed manually, but their main use is in combination with the **Error Correction** tool.

Markers Window

In this window, you can create, edit, and use markers while working on an audio file or audio montage.

- To open the **Markers** window, open an audio file or audio montage and select **Tool Windows > Markers**.

Clip Reference (only available for markers in the Audio Montage window)

A marker can be attached to the left or right edge of a clip, and to its waveform. When you move a clip, the corresponding marker moves along. The clip reference column shows the name of the clip.

Offset (only available for markers in the Audio Montage window)

Shows the distance between the marker and the reference point.

Comment

Allows you to enter a comment. To enter a comment, double-click in a cell.

Functions Menu

Depending on whether the **Audio Editor** or the **Audio Montage** window is open, different options are available. The following options are available for audio files and audio montages:

Select All

Selects all markers in the markers list.

Invert Selection States

Inverts the selection status of all markers.

Select in Time Range

Selects the markers located in the selection range.

Deselect All

Deselects all markers.

Delete Selected Markers

Deletes all markers that are selected.

Select Markers to Delete

Opens the **Delete Markers** dialog, where you can select the markers to delete according to various criteria.

Copy

Opens a submenu with the following options:

- **Copy All Markers** copies all markers of the open audio file or audio montage to the clipboard. When pasting these markers, the marker positions will be relative to the file start.
- **Copy Markers in Selected Range** copies all markers of the open audio file or audio montage that are located in the selected range to the clipboard. When pasting these markers, the marker positions will be relative to the first copied marker.

Paste Markers

Pastes the markers that were copied to the clipboard at the edit cursor position. Sample rate differences between the source and destination file are taken into account when pasting markers.

Convert Marker Types

Opens a dialog where you can convert markers to another type.

Move Multiple Markers

Opens the **Move Multiple Markers** dialog, where you can select which markers you want to move by a specified amount.

Default Marker Names

Opens the **Default Marker Names** dialog, where you can select default marker names for each marker type.

Batch Renaming

Opens the **Batch Renaming** dialog where you can rename several markers in one go.

Export Markers List as Text

Opens a dialog where you can export the markers list in various file formats, or as print out. You can decide which information about the markers to include in the exported file.

Generate Markers

Opens the **Generate Markers** dialog where you can specify a sequence of markers to create.

Lock Selected Marker

Locks the selected marker. If this option is activated, the marker cannot be moved or deleted.

Customize Command Bar

Opens a dialog where you can customize marker-related menus and shortcuts.

The following options of the **Functions** menu are only available for audio montages:

Import Markers from Active Clip's Audio File to Audio Montage

Automatically adds all markers of the clip's source audio file to the audio montage. To visualize these markers before importing them, it is recommended to activate **Source's Ruler and Markers** in one of the following ways:

- On the **View** tab of the **Audio Montage** window, in the **Clip** section, activate **Ruler**.
- In the **Clips** window, select **Functions**, and activate **Show/Hide Clip Ruler and Markers of Source File**. You can also right-click the upper part of a clip, and activate this option in the pop-up menu.

Bind Selected Markers to Start of Active Clip

Makes the marker position relative to the start of the active clip. When the start of this clip moves, the marker moves, too.

Bind Selected Markers to End of Active Clip

Makes the marker position relative to the end of the active clip. When the end of this clip moves, the marker moves, too.

Bind Selected Markers to Audio Samples of Active Clip

Locks the selected marker in relation to the audio samples referenced by the active clip. The marker moves when the audio samples move relatively to the start of the montage.

Detach Selected Markers from Their Associated Clip

Makes the marker position relative to the start of the audio montage.

Automatically Attach New Marker to the Most Suitable Clip

Links all newly created markers to a clip when a reasonable pattern is detected. For example, an end marker at the end of a clip or slightly beyond, or any marker inside a clip. The marker type and its position relatively to the closest clip determine the type of bond.

Full Clip Attachment

Attaches markers to a clip so that they are copied or deleted when the clip is copied or deleted.

Customize Command Bar

Opens the **Customize Commands** dialog which contains options to hide or show specific command bar buttons.

Filter Menu

Use the **Filter** menu to determine which types of markers are displayed in the markers list and on the timeline.

Filtering Markers

The search field allows you to filter the markers list by names.

You can search for text in the **Name** and **Comment** columns. The search only happens in the sorted columns. The function **Select All** only selects the filtered items.

- In the toolbar of the **Markers** window, click in the search field, and enter the text that you want to search for. You can use wildcard characters. "*" substitutes for zero or more characters, and "?" substitutes for any character.
- To switch the focus from the search field to the markers list, press **Down Arrow**.
- To switch the focus from the markers list to the search field, press **Ctrl/Cmd-F**.
- To view all markers again, cancel the search.

About Creating Markers

Markers can be created during playback or in stop mode. You can generate a sequence of markers or mark a selection range, for example. You can create specific markers if you already know what you want to mark, or create generic markers.

Creating Markers

You can create markers in the wave window and montage window in stop mode or during playback.

PROCEDURE

1. Do one of the following:
 - Start playback.
 - In the wave/montage window, set the cursor to the position where you want to insert the marker.
 2. Do one of the following:
 - In the **Audio Editor** or **Audio Montage** window, select the **Insert** tab, and click a marker icon in the **Markers** section.
 - Right-click the upper part of the time ruler, and select a marker from the context menu.
 - Press **Insert/M**. This creates a generic marker.
 - To create CD start/end markers for audio montages, open the **CD** window, and use the **CD Wizard**. This only works in stop mode.
-

Creating Markers at Selection Start and End

You can mark a selection for looping or review, for example.

PROCEDURE

1. In the wave window or the montage window, create a selection range.
 2. Do one of the following:
 - In the **Audio Editor** or the **Audio Montage** window, select the **Insert** tab and select a marker pair in the **Markers** section.
 - In the wave window, make a selection range, right-click it, and select one of the marker pairs.
 - In the wave window or the montage window, create a selection range, right-click above the time ruler, and select one of the marker pairs.
-

Duplicating Markers

This is a quick way to create a marker from an existing marker.

PROCEDURE

- In the wave window or the montage window, hold down **Shift**, click a marker, and drag.
-

Generating a Sequence of Markers

You can generate several markers at once in a specified time range. This allows you to create markers at every beat, or create markers as guidelines for inserting silence when you want to distribute demo sounds, for example.

PROCEDURE

1. To decide where you want to insert the generated markers, do one of the following:
 - To generate markers in a specific time range, create a selection range in the wave window or the montage window.
 - To generate markers from the cursor position to the end of the audio or generate a fixed number of markers from the cursor position, set the cursor position where you want the first marker to be created.
 2. In the **Markers** window, select **Functions > Generate Markers**.
 3. Select the type of marker and specify the gap between markers, and if you have selected a marker pair, the region length.
 4. Optional: Activate **Naming** and select a naming scheme.
 5. Select a numbering scheme.
 6. Click **OK** to generate the markers.
-

Generate Markers Dialog

This dialog allows you to generate markers at regular intervals in a specified time range. You can fill a selected time range, the region between the cursor position and the end of the audio, or specify a fixed number of markers to be generated.

- To open the **Generate Markers** dialog, open the **Markers** window and select **Functions > Generate Markers**.

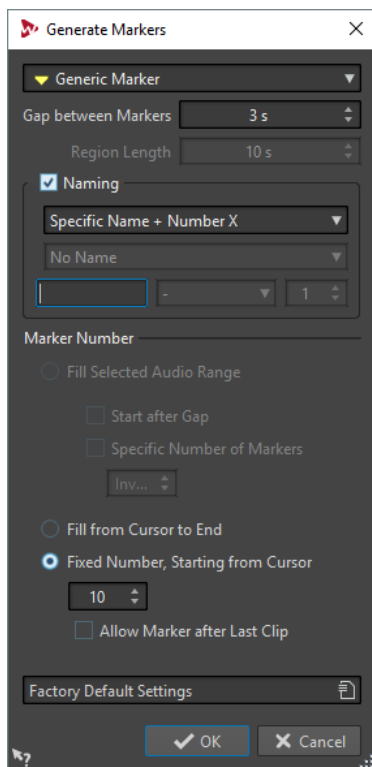

Marker type

Specifies the type of marker to be generated.

Gap between Markers/Gap between Regions

Sets the time between two markers or two regions.

Region Length

Sets the length for the region to be generated.

Naming

Allows you to set up a naming scheme.

Depending on whether you have selected a single marker or a start/end marker, you can specify the naming scheme for a single marker, or one naming scheme for the start marker and one for the end marker.

If you select **Custom**, the **Marker Naming** dialog opens, where you can specify a custom naming scheme.

Naming Fields

Allows you to specify a base name for the markers, an optional separator between name and marker number, and the start value of the marker index.

The base name is also used as a basis for the **Custom** naming scheme.

Fill Selected Time Range

Generates markers in the selected time range.

Start after Gap

If this option is activated, the first generated marker is inserted after the gap time specified at the top of the dialog.

Specific Number of Markers

If this option is activated, you can specify the number of markers that you want to generate.

Fill from Cursor to End

Generates markers between the edit cursor position and the end of the audio.

Fixed Number, Starting from Cursor

Generates a specified number of markers or regions, starting at the edit cursor position.

Allow Marker after Last Clip (audio montage only)

Determines whether markers can be generated beyond the end of the last clip, when **Fixed Number, Starting from Cursor** is activated.

Deleting Markers

Markers can be deleted in the wave window or the montage window, in the **Markers** window, and in the **Delete Markers** dialog.

Deleting Markers in the Wave/Montage Window

- In the wave/montage window, right-click a marker and select **Delete**.
- Drag and drop a marker icon upwards outside the time ruler.

Deleting Markers in the Markers Window

This is useful if your project has many markers or if the marker that you want to delete is not visible in the wave/montage window.

PROCEDURE

1. In the **Markers** window, select one or several markers.
You can also select **Functions > Select All**.
 2. Click **Delete Selected Markers** or select **Functions > Delete Selected Markers**.
-

Deleting Markers by Type

This is useful to delete markers of a specific type in the whole wave/montage window or in a selection range.

PROCEDURE

1. Optional: If you only want to delete markers in a specific time range, create a selection range in the wave/montage window.
 2. In the **Markers** window, select **Functions > Select Markers to Delete**.
 3. Select the marker types that you want to delete.
 4. Optional: Define conditions that have to be met for markers to be deleted.
 5. In the **Range** section, select in which range you want to delete markers.
If you have selected an audio range and want to use it, activate **In Selected Audio Range**.
 6. Click **OK**.
-

Delete Markers Dialog

In this dialog, you can define which markers to delete by selecting marker types and conditions.

- To open the **Delete Markers** dialog, open the **Markers** window and select **Functions > Select Markers to Delete**.

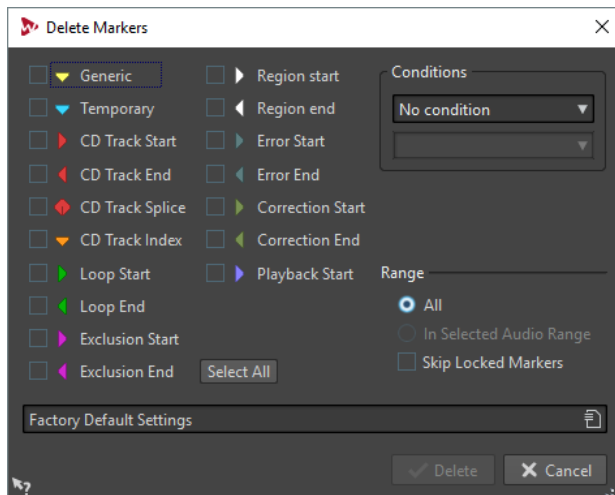

Marker types

Allows you to select the marker types to delete.

Conditions

Allows you to select a condition that has to be met for markers to be deleted. For example, **Marker Name Must Contain This Text**.

Select All

Selects/deselects all marker types.

Range - All

Select this if you want to delete all markers.

Range - In Selected Audio Range

Select this if you want to delete all markers in the selected time range.

Range - Skip Locked Markers

If this option is activated, locked markers are not deleted.

Moving Markers

You can adjust marker positions in the wave window and the montage window.

PROCEDURE

- In the wave/montage window, drag a marker to a new position on the time ruler.
If **Snap to Magnets** is activated, the marker snaps to the cursor position, or the beginning/end of a selection or waveform.
-

Moving Multiple Markers

You can move multiple markers simultaneously, keeping the relative distances between the markers.

PROCEDURE

1. Optional: If you only want to move markers in a specific time range, create a selection range in the wave window or the montage window.
2. In the **Markers** window, select **Functions > Move Markers**.
3. Specify the amount of time by which you want to move the markers.

4. Select the marker types that you want to move.
 5. Optional: Define conditions with or without regular expressions.
 6. Optional: If you have selected an audio range and want to use it, activate **In Selected Audio Range**.
 7. Click **OK**.
-

Move Multiple Markers Dialog

In this dialog, you can specify which markers you want to move by a specific amount.

- To open the **Move Multiple Markers** dialog, open the **Markers** window and select **Functions > Move Multiple Markers**.

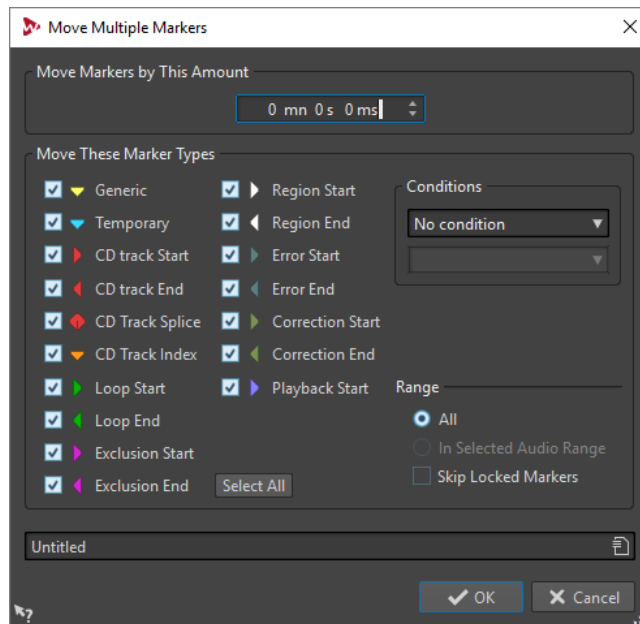

Move Markers by This Amount

Defines the distance that the markers are moved.

Move These Marker Types

Allows you to select the marker types that are moved.

Conditions

Allows you to select a condition that has to be met for markers to be moved. For example, **Marker Name Must Contain This Text**.

Select All

Selects/deselects all marker types.

Range - All

Select this if you want to move all markers.

Range - In Selected Audio Range

Select this if you want to move all markers in the selected time range.

Range - Skip Locked Markers

If this option is activated, locked markers are not moved.

Navigating to Markers

You can jump to the previous or next marker using the corresponding marker buttons.

- To jump to the previous/next marker, select the **View** tab, and, in the **Cursor** section, click **Previous Marker/Next Marker**.
- To set the wave cursor to a marker position, in the wave window or the montage window, double-click a marker triangle.

Hiding Markers of a Specific Type

For a better overview, you can hide marker types.

PROCEDURE

1. In the **Markers** window, select **Filter**.
 2. Deactivate the marker type that you want to hide.
You can make the markers visible again by activating the corresponding marker type.
-

Converting Marker Types

You can convert markers of a specific type to another type.

Converting the Type of a Single Marker

PROCEDURE

1. In the **Markers** window, click the marker icon that you want to convert.
 2. Select a new marker type from the list.
-

Converting All Markers of a Specific Type

You can convert loop markers to CD track markers, for example.

PROCEDURE

1. Optional: If you only want to convert markers in a specific time range, create a selection range in the wave window or the montage window.
 2. In the **Markers** window, select **Functions > Convert Marker Types**.
 3. Use the **From** and **To** pop-up menus to specify the source and target marker types.
 4. Optional: Specify a condition.
 5. Select whether you want to convert all markers or only the markers in the selected range.
 6. Click **OK**.
-

Convert Marker Types Dialog

In this dialog, you can convert marker types.

- To open the **Convert Marker Types** dialog, open the **Markers** window and select **Functions > Convert Marker Types**.

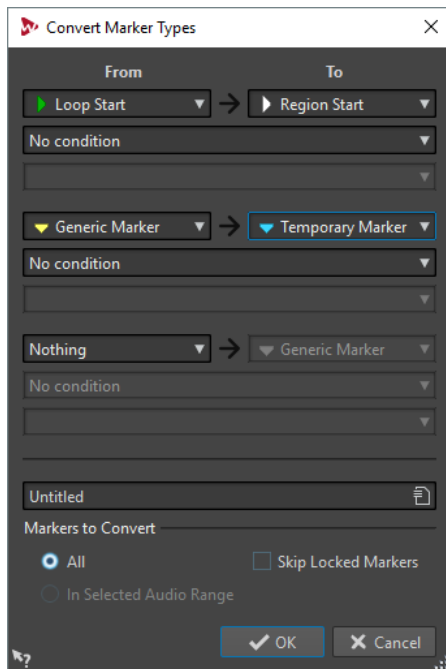

From

Specifies the source marker type.

To

Specifies the target marker type.

Conditions pop-up menu

Allows you to specify conditions for the conversion. Select an option and enter a text in the text field below.

Markers to Convert - All

Converts all markers.

Markers to Convert - In Selected Audio Range

Converts only markers of the selected audio range.

Markers to Convert - Skip Locked Markers

Excludes locked markers from the conversion.

Renaming Markers

You can change the names of markers.

- To rename a marker in the wave window or the montage window, right-click a marker, select **Rename**, and enter a new name.
- To rename markers in the **Markers** window, double-click a marker name in the **Name** column, and enter a new name.
- To batch rename multiple markers according to specified settings, in the **Markers** window, select **Functions > Batch Renaming**.
- To edit the default names, in the **Markers** window, select **Functions > Default Marker Names**.

RELATED LINKS

[Batch Renaming](#) on page 527

Default Marker Names Dialog

In this dialog, you can specify the default marker names.

- To open the **Default Marker Names** dialog, open the **Markers** window and select **Functions > Default Marker Names**.

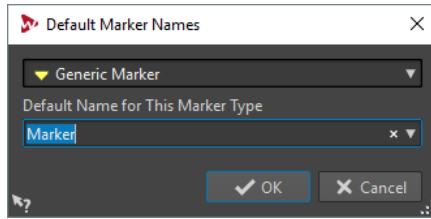

Marker type

Lets you select the type of marker for which you want to specify the default name.

Default Name for This Marker Type

Lets you specify the default name for the selected marker type.

Selecting Markers

There are several ways to select markers.

- In the wave window or the montage window, click a marker.
- In the **Markers** window, click in a cell. The corresponding marker is selected.
- Use **Ctrl/Cmd** and **Shift** to select multiple markers.

The marker icon changes its background to indicate the selected marker.

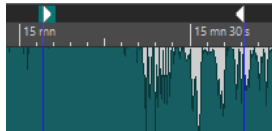

Selecting the Audio Between Markers

You can select the audio between two adjacent markers or between any two markers. This allows you to select a section that has been marked.

- To select the audio between two adjacent markers, double-click between two adjacent markers in the wave window or the montage window.
- To select several regions between two adjacent markers, double-click between two adjacent markers, and after the second click, drag to select the adjacent regions.
- To select the audio between a region marker pair, hold down **Shift**, and double-click a region marker.
- To extend the selection until the end of a marker region, in the wave/montage window, hold down **Shift**, and double-click in the marker region that you want to select.
- To open the **Markers** window and display further information about a specific marker, hold down **Alt**, and double-click a marker.

Binding Markers to Clips in the Audio Montage

In the **Audio Montage** window, you can bind markers to clips. By doing this, the marker remains in the same position relative to the clip start/end, even if the clip is moved or resized in the audio montage.

You can find the options regarding binding clips and markers on the **Functions** menu of the **Markers** window, and when right-clicking a marker.

When a marker is bound to a clip element, its name is preceded by a blue character.

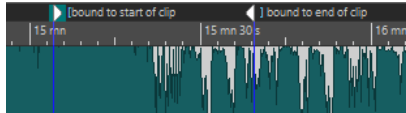

RELATED LINKS

[Markers Window](#) on page 368

Exporting the Markers List as Text

You can export the markers list as text. The markers list contains the marker names, positions, region lengths, types, and comments.

PROCEDURE

1. Open the **Markers** window.
2. Select **Functions** > **Export Markers List as Text**.
3. Choose the information that you want to export, and the output format.
4. Click **OK**.

RESULT

The markers list opens in the selected output format. When you select **Print**, the **Print Preview** window opens. The text file is saved in the specified folder for temporary files.

RELATED LINKS

[Specifying Folders](#) on page 87

Export Markers List as Text Dialog

This dialog allows you to export the markers list in various file formats, or as print out. You can decide which information about the markers to include in the exported file.

- To open the **Export Markers List as Text** dialog, open the **Markers** window and select **Functions** > **Export Markers List as Text**.

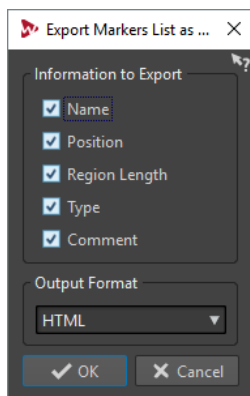

How Marker Information is Saved

WaveLab Pro uses MRK files as a way to save information that is independent of the file format. However, to make marker information exchangeable between applications, WaveLab Pro also saves some information in the Wave headers.

This makes saving files quicker if only a marker setting was changed. However, this only applies if **Write Markers in WAV File Header** is deactivated in the **Audio Files Preferences** on the **File** tab. By default, MRK files are created and information are saved in the Wave headers.

- When you import a file for the first time, any loop points are imported and displayed as loop markers.
- When you save a file in the Wave format, the loop points are saved both as part of the actual file and in the MRK file.
- When you open a file that includes markers that were added in WaveLab Pro, and markers that were added in another application, all markers are displayed in WaveLab Pro.

Metering

WaveLab Pro contains a variety of audio meters that you can use for monitoring and analyzing audio. Meters can be used to monitor audio during playback, rendering, and recording. Furthermore, you can use them to analyze audio sections when playback is stopped.

Meter Windows

Audio meters can be used in the WaveLab window and in the **Control Window**.

There can only be one instance of each audio meter.

The axis of most audio meters can be rotated, to view the graphics horizontally or vertically. For some meters, you can also style and customize parameters via a settings dialog.

RELATED LINKS

[Docking and Undocking Tool Windows and Meter Windows](#) on page 46

Real Time vs. Non-Real Time

Metering can be used to measure audio in real time, that is, while the audio is being played back, or in non-real time, that is, in stop mode.

Metering Monitor Modes

You can choose which audio source to monitor and select a mode for displaying information in the meters.

The following metering modes are available on the **Analyze** tab in the **Monitoring** section of the **Audio Editor**.

Playback

This is the standard metering mode, in which the meters reflect the audio that is played back. Metering occurs after the **Master Section**, which means that effects, dithering, and master faders are taken into account. You can monitor audio files, audio montages, audio CD track lists, etc.

Audio Input

In this mode, the meters reflect the audio input. Typically, this is the mode to use when recording. The **Master Section** settings are not taken into account.

Freeze Meters

This mode freezes the values for all open meters. The meters remain frozen until you select another monitor mode.

File Rendering

In this mode, you can monitor what is being written to disk during file rendering or when recording. Like **Audio Selection**, average and min/max peak values are

calculated. After rendering, the meters freeze until you refresh or change monitor mode.

Edit Cursor (Audio Editor only)

In this mode, the meters are static, showing the levels and other values for the audio at the position of the edit cursor, in stop mode. This allows you to analyze a specific position in an audio file in non-real-time. The **Master Section** settings are not taken into account.

Audio Selection (Audio Editor only)

In this mode, the meters display the average values calculated for the selected range. The **Master Section** settings are not taken into account.

When you change the selection, you have to update the meter displays by clicking **Update Selection Analysis**.

Update Selection Analysis (Audio Editor only)

Analyzes the audio selection again and updates the meters.

Meter Settings

You can set up most meters in the corresponding settings dialogs. For example, you can adjust the behavior, scale, and color of the meters.

- To open the settings dialog for a meter, select **Functions > Settings**.
- To check the results after changing the settings without closing the settings dialog, click **Apply**.
- To close the settings dialog and discard any changes that you have made, even if you have clicked the **Apply** button before, click **Cancel**.

Multichannel Metering

WaveLab Pro features 8 audio channels that can be routed to inputs and outputs on a multi i/o audio card. The audio montage supports various surround channel configurations using up to 8 channels.

WaveLab Pro can display multiple meters. When working with multiple channels in an audio montage, each channel has its own meter. This applies to all meters (up to 8 real-time FFTs, 8 level meters, 4 pan meters, 4 phase scopes, etc.). If a surround configuration is selected, each meter indicates the corresponding surround channel (Lf, Rf, LFE, etc.).

When working with more than two channels, it is recommended to use floating meter windows, because they can be resized more easily.

Resetting the Meters

You can reset the display of some meters, for example, the **Level Meter**.

PROCEDURE

- In the meter window, click **Reset**, or select **Functions > Reset**.

RESULT

All values and numerical indicators of the meter are reset.

Using Presets in the Meter Windows

You can save the settings that you have made for a meter window as a preset. By assigning presets to preset buttons, you can quickly switch between different level scales and display modes, for example.

- To save your settings as a preset, select **Functions > Settings**, click **Presets**, and select **Save As**.
- To assign a preset to one of the preset buttons, select **Functions > Settings**, click **Presets**, and from the **Assign to Preset Button** submenu, select a preset button.
- To apply a preset, select it from the **Functions** menu, or click the corresponding preset button.

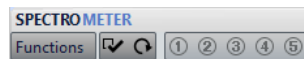

Preset buttons 1-5

Level Meter

The **Level Meter** displays the peak and average loudness/decibel levels of your audio file, and the balance between the left and right channels in a stereo file.

- To open the **Level Meter**, select **Meters > Level Meter**.

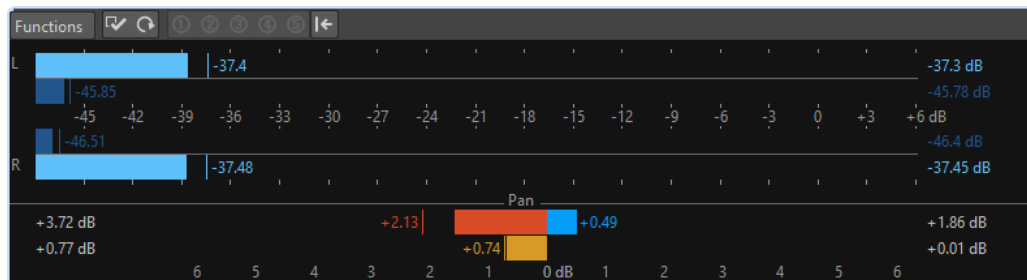

Level Meters

The upper part of the window shows the peak level and the average loudness in the following way:

- The peak level meters display the peak levels of each channel, graphically and numerically.
- The VU meters measure the average loudness (RMS) of each channel. These meters have a built-in inertia, evening out loudness variations over a user-defined time span. If you are monitoring playback or the audio input, you can see two vertical lines following each VU meter bar. These lines indicate the average of the most recent minimum RMS values (left line) and the average of the most recent maximum RMS values (right line). To the left, the difference between the minimum and maximum average values is displayed. This gives you an overview of the dynamic range of the audio material.
- If you are monitoring real-time audio (playback or input), the maximum peak and loudness values are displayed to the right of the meter bars. The numbers in brackets to the right of the maximum peak values indicate the number of times that clipping occurs (0 dB signal peaks). Values between 1 and 2 are acceptable, but if you get a larger number, you should lower the master level to avoid digital distortion.
- Recording levels should be set so that they only rarely clip. If the master level is set too high, the sound quality and frequency response are compromised at high recording levels, with unwanted clipping effects. If the level is set too low, noise levels can be high relative to the main sound being recorded.

Pan Meters

The lower part of the window shows the difference in level between the left and right channel of a stereo audio file.

- The upper pan meters show the peak level difference between the channels. The level bars can go to the left or right, indicating which channel is loudest.
- The lower pan meters show the average difference in loudness between the channels. This gives you a visual indication of whether a stereo recording is properly centered, for example.
- If you are monitoring real-time audio (playback or input), the maximum balance difference values (peak and loudness) for each channel are displayed numerically to the left and right of the meter bars.

Level/Pan Meter Settings

In the **Level/Pan Meter Settings** dialog, you can adjust the behavior, scale, and color of the meters.

- To open the **Level/Pan Meter Settings** dialog, open the **Level Meter** window, and select **Functions > Settings**.

Peak Meter Section

Peaks pop-up menu

On this pop-up menu, select **Digital Peaks** if you want WaveLab Pro to use sample values and **True Peaks** if you want WaveLab Pro to use analog reconstructed values.

Ballistics – Release Rate

Determines how fast the peak level meter falls after a peak.

Ballistics – Peak Hold Time

Determines how long a peak value is displayed. The peak can be displayed as a line or a number. If the meter's height is too narrow, only the line is displayed.

Top/Middle/Low Zone

The color buttons allow you to select colors for the low, middle, and top zones of the level meter. You can define the range for the top and middle zones by changing the corresponding values.

Cursor Mode – Unit

If this option is activated, you can specify which unit is used to display the peak value.

Show Value of Single Sample

If this option is activated, the value of the single sample is displayed at the cursor position. If this option is deactivated, several samples are scanned around the cursor to determine the peak value. Generally, this is best activated when you have zoomed in on the waveform to see the details.

VU Meter (Loudness) Section

VU Meter (Loudness)

Activates/Deactivates the VU meter.

Modes pop-up menu

On this pop-up menu, you can choose between the standard mode and three K-System modes. The settings for K-System modes are shown in the **Zones** section.

Ballistics – Resolution

Sets the time that is used to determine the loudness. The smaller this value, the more the VU meter behaves like the peak meter.

Ballistics – Range Inertia

Sets the time that is used to determine the recent minimum and maximum value lines, and therefore determines how quickly these respond to changes in loudness.

Top Zone/Middle Zone/Low Zone

The color buttons allow you to select colors for the low, middle, and top zones of the VU level meter. You can define the range for the top and middle zones by changing the corresponding values.

Cursor Mode – Samples to Scan

Determines how many samples are scanned when calculating the VU meter value in **Monitor Edit Cursor Position** mode.

Panning Meter Section

Panning Meter

Shows/Hides the panning meter in the **Level Meter** window.

Range

Determines the dB range of the panning meter.

Peak and Loudness Left/Right, Global Colors

Lets you specify the colors for the different elements.

Global Colors Section

In this section, you select colors for the meter background, marks (scale units), and grid lines.

Global Range (Peak and VU Meter) Section

In this section, you specify the minimum and maximum values of the displayed level range.

K-System VU Meter Modes

K-System integrates standardized metering, monitor calibration, and level practices.

In WaveLab Pro, you can choose between three metering modes which all set the 0 dB VU point below the standard level meter. To fully utilize the K-System, you have to calibrate your monitor level so that 0 VU equals 83 dB.

You should use a pink noise reference signal and a SPL level meter. Use C weighting (slow response), and adjust your playback level so that your noise meter indicates 83 dB SPL per channel or 86 dB SPL when played on the two channels simultaneously.

The K-System has three meter operating modes (selectable from the VU-Meter pop-up in the **Level/Pan Meter Settings** dialog). These are intended for different uses:

- K-System 20: This places 0 VU 20 dB lower than standard VU mode, and is intended for music with a very wide dynamic range, e.g. classical music.
- K-System 14: This places 0 VU 14 dB lower than standard VU mode, and is intended for music with a slightly more compressed dynamic range. Use this for pop, R&B, and rock music.
- K-System 12: This places 0 VU 12 dB lower than standard VU mode, and is intended for broadcast applications.

Loudness Meter

The **Loudness Meter** is an audio meter for monitoring loudness, according to the EBU R-128 standard.

- To open the **Loudness Meter**, select **Meters > Loudness Meter**.

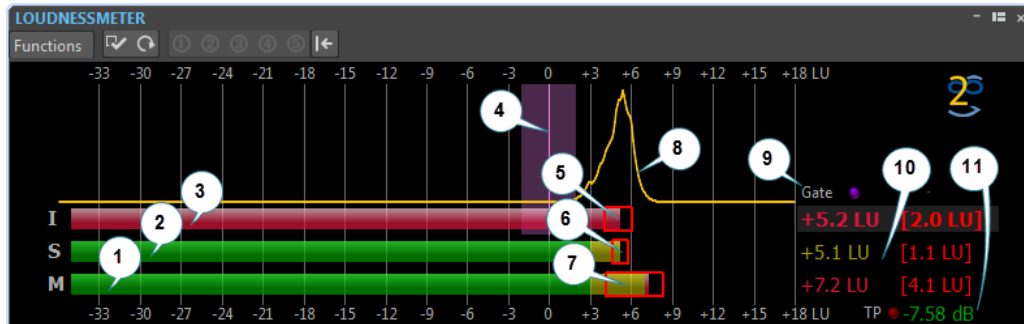

1) Momentary loudness bar

Displays the loudness of a 400 milliseconds slice that is evaluated every 100 milliseconds.

2) Short-term loudness bar

Displays the loudness of a 3 seconds slice that is evaluated every second.

3) Integrated loudness bar

Displays the average loudness. This bar is evolving over time, because it makes an average of the loudness by measuring 400 millisecond slices every 100 milliseconds.

4) Target loudness

The purple vertical line corresponds to the target loudness defined in the **Loudness Meter Settings** dialog. The purple shadow around it corresponds to the acceptable deviation.

5) EBU R-128 Loudness Range (LRA)

This loudness range displays the difference between the estimates of the 10th and the 95th percentiles of the loudness distribution. The lower percentile of 10 % can, for example, prevent the fade out of a music track from dominating the loudness range. The upper percentile of 95 % ensures that an unusually loud sound, such as a gunshot in a movie, is not responsible for a large loudness range.

The EBU R-128 loudness range, the dynamics range of the short-term loudness, and the dynamics range of the momentary loudness help to decide if dynamic compression is necessary, by giving instant feedback about the dynamics (too low, good, too much).

6) Dynamics range of the short-term loudness

This loudness range monitors the recent minimum/maximum loudness measurements to provide a hint about the short-term dynamics.

7) Dynamics range of the momentary loudness

This loudness range monitors the recent minimum/maximum loudness measurements to provide a hint about the momentary dynamics.

8) Loudness curve

This curve shows where the loudness is distributed in a song. The audio signal is divided into small blocks, and the loudness of each block is computed. The curve informs about how often audio events with a given loudness appear in the file in comparison to all other events. If the curve has a peak, the given loudness often appears in the song.

The curve is always normalized. The peak shows which loudness is the most represented in a song. The curve is related to the LRA as the LRA starts at the left part of the curve and ends at the right part, with a 10%/95% tolerance.

9) Gate LED

The **Gate** LED lights up when audio is discarded from measurement. The EBU standard discards audio below a specific level, relative to the average loudness.

10) Numerical values of the bars

This section shows the numerical values of the bars. The values in brackets are the loudness ranges.

11) True Peak LED

The **True Peak** LED is based on a true peak analysis and lights up when clipping is detected.

RELATED LINKS

[EBU Loudness Standard R-128](#) on page 37

Loudness Meter Settings

In the **Loudness Meter Settings** dialog, you can set up the appearance of the **Loudness Meter** window.

- To open the **Loudness Meter Settings** dialog, open the **Loudness Meter** window, and select **Functions > Settings**.

Short-term Loudness/Momentary Loudness

Top Zone/Middle Zone/Low Zone

Here, you can specify the colors for the top, middle, and low zones of the meter.

From

Allows you to specify the starting point for the middle and top zones.

Show Maximum Values

If this option is activated, the maximum short-term and momentary values are displayed instead of the loudness range values.

Loudness Range

If this option is activated, a moving rectangle is displayed, which symbolizes the short-term loudness range/momentary loudness.

Ballistics

Determines the inertia of the loudness range for the short-term loudness/momentary loudness, that is, how fast the range edges meet each other after a new minimum or maximum loudness is reported.

Integrated Loudness

Target Loudness

Allows you to specify the ideal loudness to match. The EBU R-128 recommendation for broadcast is -23 dB.

Acceptable Deviation

Allows you to specify the loudness range that is considered to be an acceptable deviation from the target loudness.

Outside the Acceptable Deviation

Allows you to specify a color for the range that is outside the acceptable deviation.

Loudness Range

Range Color

Lets you specify the range colors if the range size is above the associated value (**Too Much**), exactly as the associated value (**Good**), or below the associated value (**Not Enough**).

Below/From

A loudness range that you consider to be not enough (**Below**) and too much (**From**).

Transition

Lets you specify how fast the color changes from **Good** to **Too Much**, and from **Good** to **Not Enough**. 0 % means that the color changes abruptly when a threshold is reached. 100 % means that the color changes gradually.

Additional Settings

Background/Marks/Grid/Curve

Lets you set the colors for the meter background, marks, grid lines, and the loudness distribution curve of the **Loudness Meter**.

Peak Hold Time

Determines how long the peak LED remains lit after a true peak.

Show Loudness Histogram

If this option is activated, a loudness histogram is displayed in the **Loudness Meter**.

Scale

In this section, you can specify the low and high end of the displayed level range.

The EBU +9 scale and the EBU +18 scale are EBU recommendations. Both of these scales are centered around 0 LU, which represents -23 LUFS, the recommended EBU loudness.

Phasescope

The **Phasescope** indicates the phase and amplitude relationship between two stereo channels.

- To open the **Phasescope**, select **Meters > Phasescope**.

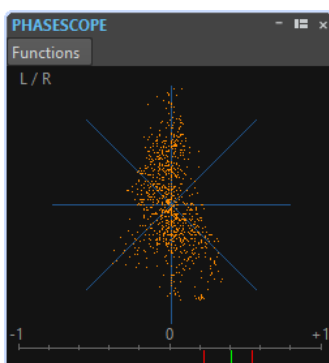

Reading the Phasescope

The **Phasescope** works as follows:

- A vertical line indicates a perfect mono signal (the left and right channels are the same).
- A horizontal line indicates that the left channel is the same as the right, but with an inverse phase.

- A fairly round shape indicates a well balanced stereo signal. If the shape leans to one side, there is more energy in the corresponding channel.
- A perfect circle indicates a sine wave on one channel, and the same sine wave shifted by 45° on the other.
- Generally, the more you can see a thread, the more bass is in the signal, and the more spray-like the display, the more high frequencies are in the signal.

Phase Correlation Meter

The phase correlation meter at the bottom of the display works as follows:

- The green line shows the current phase correlation, and the two red lines show the recent minimum and maximum values.
- With a mono signal, the meter shows +1, indicating that both channels are perfectly in phase.
- If the meter shows -1, the two channels are the same, but one is inverted.
- Generally, for a good mix, the meter should show a value between 0 and +1.

The phase correlation meter is also available in **Analyze Audio Selection** mode, showing an average value for the selected range.

Phasescope Settings

In the **Phasescope Settings** dialog, you can adjust the behavior, scale, and color of the meters.

- To open the **Phasescope Settings** dialog, open the **Phasescope** window, and select **Functions > Settings**.

Background

Click this to change the background color.

Coil Display

Allows you to adjust the color for the grid and phase coil display.

Auto-Size (Maximize)

If this option is activated, the display is optimized to fit in the window.

Correlation Display

This is where you select colors for the elements in the phase correlation meter display, and adjust the peak hold time for the maximum and the minimum indicator.

Number of Samples to Display

This setting affects the length of the phase coil and the density of the display. For audio with high sample rates, you might want to raise this value.

Spectroscope

The **Spectroscope** shows a graphical representation of the frequency spectrum, analyzed into 60 separate frequency bands, represented as vertical bars.

- To open the **Spectroscope**, select **Meters > Spectroscope**.

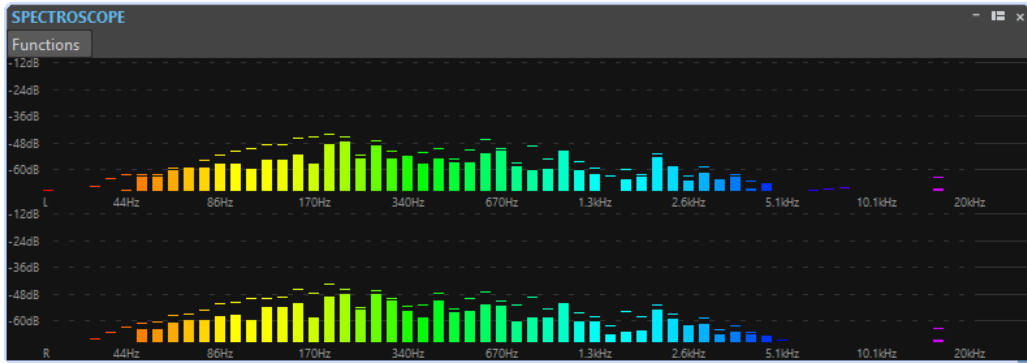

Peak levels are shown as a horizontal lines above the corresponding bands, indicating recent peak/maximum values. The **Spectroscope** offers a quick spectrum overview. For a more detailed analysis of the audio spectrum, use the **Spectrometer**.

On the **Functions** menu, you can specify whether only high audio levels are displayed, or whether medium and low levels are also shown.

Spectrometer

The **Spectrometer** uses FFT (Fast Fourier Transform) techniques to display a frequency graph, providing a precise and detailed real-time frequency analysis.

- To open the **Spectrometer**, select **Meters > Spectrometer**.

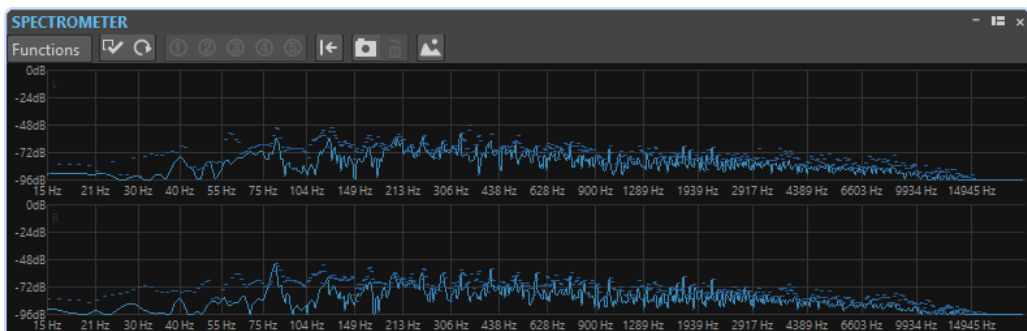

The current frequency spectrum is shown as a linear graph. Spectrum peaks are shown as short horizontal lines.

Zooming

In the **Spectrometer** window, you can zoom in on a frequency area.

- To zoom in on a frequency area, click and drag a rectangle in the spectrum. The display is zoomed in so that the selected frequency range fills the window.
- To return to full-scale display, select **Functions > Zoom out Fully**, or double-click in the spectrum.

Spectrometer Snapshots

You can take snapshots of the current spectrum, to check the effects of adding EQ, for example.

The snapshots are displayed on the spectrum graph. Up to five snapshots can be displayed. The sixth snapshot replaces the earliest snapshot.

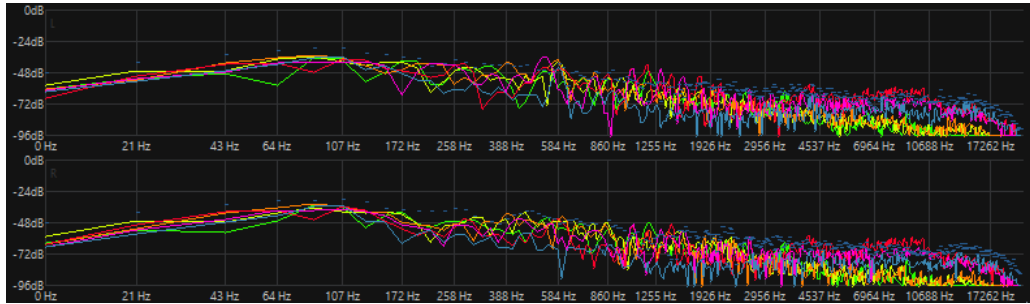

- To take a snapshot, select **Functions > Add Snapshot**.
- To erase the last snapshot, select **Functions > Erase Last Snapshot**.

Exporting FFT Data as ASCII Text

FFT (Fast Fourier Transform) analysis is a method to convert a waveform from the time domain to the frequency domain. You can export the displayed FFT data as a text file.

PROCEDURE

1. In the **Audio Editor**, select the **Analysis** tab.
2. In the **Monitoring** section, activate **Edit Cursor** or **Audio Selection**.
3. In the **Spectrometer** window, select **Functions > Export FFT Data as ASCII**.
4. Specify a file name and location.
5. Click **Save**.

RESULT

The resulting text file can be imported into Microsoft Excel, or other applications that allow graph plotting from text files.

Spectrometer Settings

In the **Spectrometer Settings** dialog, you can adjust the behavior and display of the meters, and assign up to five sets of spectrometer settings to the preset buttons.

- To open the **Spectrometer Settings** dialog, open the **Spectrometer** window, and select **Functions > Settings**.

Process Tab

Analysis Block Size

The higher this value, the higher the accuracy in the frequency domain, that is, the spectrum is divided into more bands. At the same time, the time localization is reduced. This means that the higher the value, the less easy to know where a given frequency starts and ends in time.

NOTE

Raising the block size value also requires more CPU power and introduces a higher latency. Therefore, high values should only be used for offline monitoring.

Analysis Overlapping

To get more accurate results, the program can analyze overlapping blocks. This setting determines the amount of overlap between these blocks – the higher the value, the more accurate the results.

NOTE

Raising this value is very CPU intensive. A setting of 50 % requires twice the amount of CPU power, a setting of 75 % requires four times the CPU power, etc.

Smoothing Window

Allows you to choose which method to use for pre-processing the samples in order to optimize the **Spectrogram**.

Display Tab

Frequency Ruler

Determines the frequency range to be shown, at full-scale display. The lowest frequency to be shown depends on the **Analysis Block Size** setting and the highest actual frequency depends on the sample rate.

Logarithmic Scale

When this is activated, each octave occupies the same horizontal space in the display. If you need more resolution in the high frequency range, you may want to turn this off.

Level Ruler

Determines the range of the vertical level ruler, in dB or as a percentage value.

Normalize Display to 0 dB

If this option is activated, the level display is offset, so that the highest point on the curve is displayed as 0 dB. This is only possible in non-real-time mode.

Optimize Scale

Optimizes the level scale so that only the relevant level range is shown. This is only possible in non-real-time mode.

Display Type

Allows you to toggle the display between curve and bar graph.

Peak Hold Time

Determines for how long the peak level graph remains displayed when the levels drop.

Colors

This is where you select colors for the curves, grid, background, etc.

Live Spectrogram

The **Live Spectrogram** shows the last seconds of the audio stream. This allows you to detect disturbances in the spectrogram, and monitor the noise level and frequencies, for example.

- To open the **Live Spectrogram**, select **Meters > Live Spectrogram**.

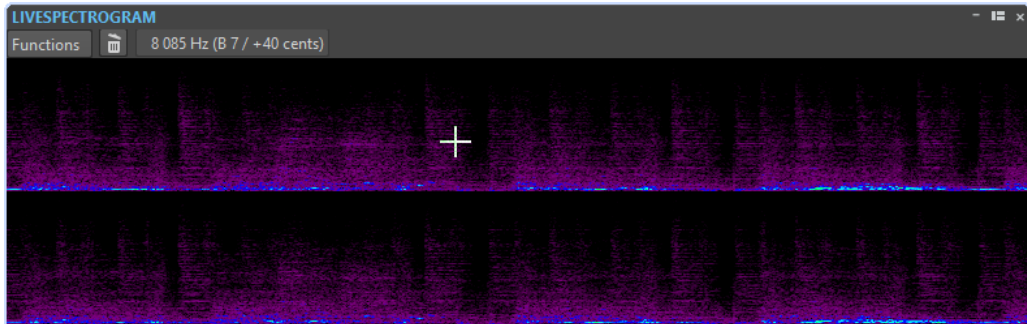

Live Spectrogram Settings

The **Live Spectrogram** settings allow you to adjust the behavior and display of the **Live Spectrogram**.

- To open the **Live Spectrogram** settings, open the **Live Spectrogram** window, and open the **Functions** menu.

Clear

Clears the spectrogram.

Clear on Playback

Clears the spectrogram when you start playback.

Start Scrolling from Left

If this option is activated, the spectrogram starts scrolling from the left edge of the **Live Spectrogram** window.

Start Scrolling from Right

If this option is activated, the spectrogram starts scrolling from the right edge of the **Live Spectrogram** window.

Wrap

If this option is activated, the spectrogram restarts from the left when it reaches the right edge of the **Live Spectrogram** window.

Slow Scroll Speed/Medium Scroll Speed/Fast Scroll Speed

Allows you to select the scroll speed of the spectrogram.

Default Style

The spectrogram uses the style that is defined as default in the **Spectrogram Options** dialog.

Style of Current Audio File

The spectrogram uses the style of the active audio file.

Custom Style

Opens the **Spectrogram Options** dialog that allows you to customize the style of the spectrogram.

Rotate

Allows you to rotate the axis of the spectrogram to view the graphics horizontally or vertically.

Bit Meter

The **Bit Meter** shows how many bits are used.

- To open the **Bit Meter**, select **Meters > Bit Meter**.

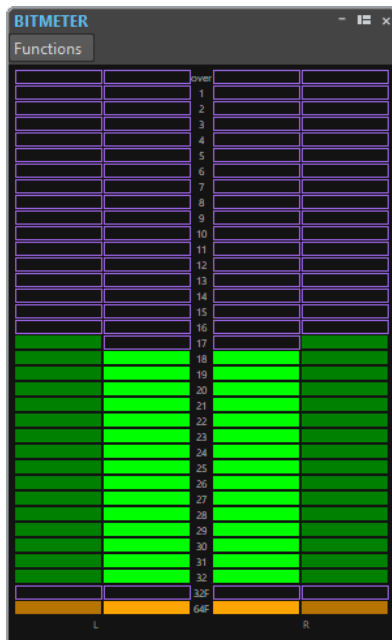

While you may expect the maximum number of bits to be the same as the precision of the audio file, this is not necessarily the case.

As soon as you perform any kind of real-time processing on an audio file, the audio data is treated at a much higher precision (64-bit floating point) to allow for pristine audio quality. The only time when a 16-bit file is played back at 16-bit precision is, for example, if you play it without any fades or effects, and with the master faders set to 0.00.

How to Read the Bit Meter

- The inner meters show how many bits are used.
- The outer meters show how many bits were recently in use.
- The **Over** segment indicates clipping.
- The **32F** segment indicates samples with 32-bit float precision.
- The **64F** segment indicates samples with 64-bit float precision.

When to Use the Bit Meter

The **Bit Meter** is useful in the following situations:

- To check whether dithering is necessary. If you are playing back or mixing down to 16 bits, and the **Bit Meter** shows that more than 16 bits are used, you should apply dithering.
- To see the actual precision of an audio file. For example, even though a file is in 24-bit format, only 16 bits may be used, or a 32-bit file may only use 24 bits.
- To see the bit depth output of a plug-in.
- To see whether samples are 32-bit float, 64-bit float, or any PCM precision between 8 bit and 32 bit at the monitoring point.

Bit Meter Settings

In the **Bit Meter Settings** dialog, you can adjust the behavior and display of the **Bit Meter**.

- To open the **Bit Meter Settings** dialog, open the **Bit Meter** window, and select **Functions > Settings**.

Colors

You can adjust the colors of the meter segments, grids, background, etc. by clicking the corresponding color buttons.

Bit Hold Time

Determines for how long peak values are held by the outer meters.

Bit Display

Determines how the bits are displayed. In **Intuitive Mode**, the absolute value of the signal is shown. The bar graph goes higher with higher signal levels, similar to a common level meter.

In **True Mode**, the meter shows the direct mapping of the bits. However, because the actual values may be negative, there is no intuitive relationship with the level. This mode is useful if you want to check the full range, because all bits are displayed, regardless of the audio signal level.

Oscilloscope

The **Oscilloscope** offers a highly magnified view of the waveform around the playback cursor position.

- To open the **Oscilloscope**, select **Meters > Oscilloscope**.

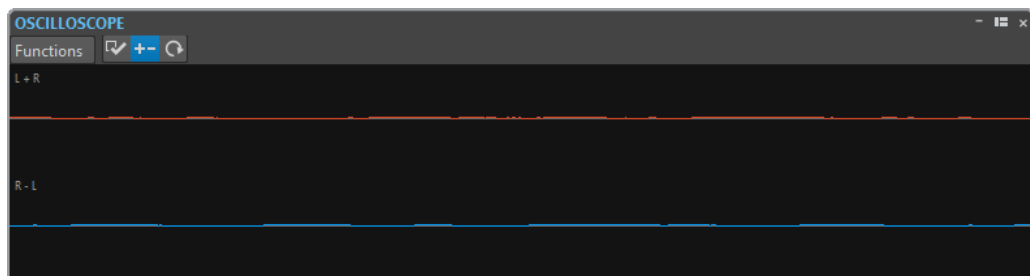

If you are analyzing stereo audio, the **Oscilloscope** normally shows the separate levels of the two channels. However, if you activate **Show Sum and Subtraction** on the **Functions** menu, the upper half of the **Oscilloscope** shows the mix of the two channels and the lower half shows the subtraction.

Oscilloscope Settings

In the **Oscilloscope Settings** dialog, you can adjust the display colors, and activate/deactivate **Auto-Zoom**. When **Auto-Zoom** is activated, the display is optimized so that the highest level reaches the top of the display at all times and even small signals are visible.

- To open the **Oscilloscope Settings** dialog, open the **Oscilloscope** window, and select **Functions > Settings**.

Wavescope

The **Wavescope** meter displays a real-time waveform drawing of the audio signal being monitored. It can be useful when recording or rendering a file if **Monitor File Rendering** mode is active.

- To open the **Wavescope**, select **Meters > Wavescope**.

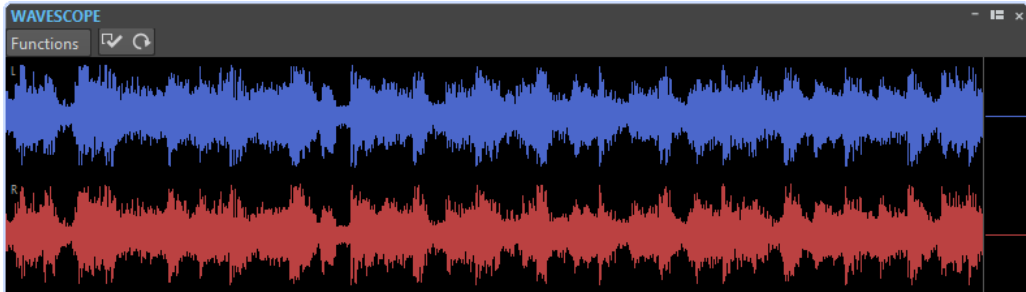

Wavescope Settings

In the **Wavescope Settings** dialog, you can make various color settings for the background, grid, and waveform display, and set the waveform rendering speed and vertical zoom.

- To open the **Wavescope Settings** dialog, open the **Wavescope** window, and select **Functions > Settings**.

Colors

Lets you select colors for the waveform graphics.

Waveform Rendering Speed

Determines how much the waveform display is compressed.

If **Same As Live Spectrogram** is activated, the rendering speed of the **Wavescope** display has the same speed as the **Live Spectrogram** display.

Level Zoom

Determines the level zoom. Set a high value if the waveform has a low amplitude.

Clear Waveform when Reaching Right of Pane

If this option is activated, the waveform display is cleared each time the cursor reaches the right end of the display. If this option is deactivated, the new waveform overwrites the previous waveform.

Basic Audio CD

In WaveLab Pro, you can write Basic Audio CDs that are compatible with the Red Book standard.

In the **Basic Audio CD** window, you create your audio CD by adding audio files to a list of tracks. Each track contains a reference to the external audio file. This means that you can save your Basic Audio CD layout as its own session and continue editing individual tracks, for example.

A Basic Audio CD project contains the information about the CD track start position and the length of the referenced audio file. If the CD markers of an audio file are deleted, the audio file is removed from the Basic Audio CD project.

Once you have set up your CD layout, you can check the CD for conformity to the Red Book standard, write the CD, or export it to the **Audio Montage** window for further editing. You can also consolidate the audio files in the CD into a single audio file containing track markers.

A Basic Audio CD can also be used as a generic playlist. It allows you to assemble lists of files or sections of files with adjustable pauses in between.

IMPORTANT

Writing Basic Audio CDs offers only basic functionality. For professional CD creation you should use the **Audio Montage** window.

RELATED LINKS

[CD Window](#) on page 296

Basic Audio CD Window

In this window, all tracks of the Basic Audio CD are listed. Here you can assemble and write Basic Audio CDs that are compatible with the Red Book standard.

- To open a new Basic Audio CD file, select **File > New** and click **Basic Audio CD**.
- To open a saved Basic Audio CD file, select **File > Open** and click **Basic Audio CD**. Select the Basic Audio CD file that you want to open and click **Open**.

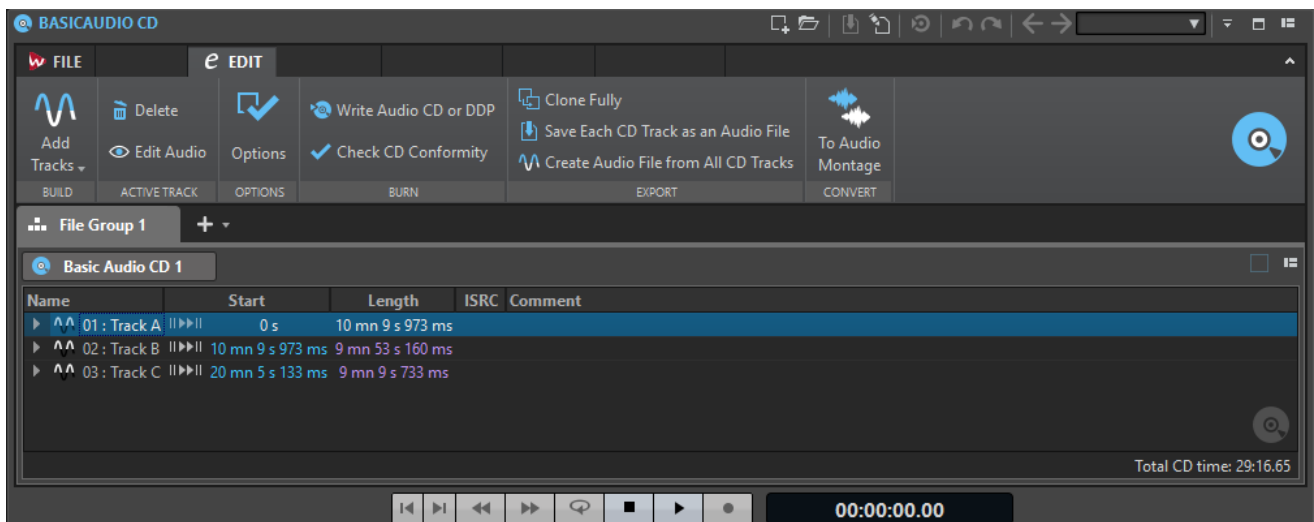

Track List

The track list shows information about the CD tracks. Apart from the entries in the **Name** column, you cannot edit the information shown in this window. The following information are available for each track:

- Name
- Start position
- Length
- ISRC code
- Comment (not saved on the CD)

To show the markers and pauses of a track, click the arrow icon in front of the track.

The total time of the CD is displayed at the bottom of the window.

Playback Buttons

The playback buttons in the **Start** column allow you to play back the corresponding track.

Play Pre-Roll



Playback from start with a pre-roll.

You can also press **Alt** and click **Play Pre-Roll** to play back from the start with a short pre-roll.

Play



Playback from start.

Edit Tab

Add Tracks

Allows you to select the audio files that you want to add to the Basic Audio CD.

Delete

Deletes the selected track from the Basic Audio CD.

Edit Audio

Displays the audio of the selected track in the wave window.

Options

Opens the **Basic Audio CD Options** dialog.

Write Audio CD or DDP

Opens a dialog from which you can write a CD or DDP.

Check CD Conformity

Verifies that the structure of the Basic Audio CD is correct according to the Red Book standard.

Clone Fully

Creates a single audio file that contains all the audio material used by the Basic Audio CD, as well as a new Basic Audio CD file. The new Basic Audio CD is independent from the audio files and markers that are referenced by the active Basic Audio CD.

Save Each CD Track as an Audio File

Opens a dialog where you can specify a location to save each track as separate audio file.

Create Audio File from All CD Tracks

Creates an audio file that recreates the structure of the Basic Audio CD and opens it in the wave window, without writing any audio sample to disk.

Convert to Audio Montage

Creates an audio montage with the same structure of CD tracks as the Basic Audio CD.

Basic Audio CD Options Dialog

In this dialog, you can specify an UPC/EAN code for the CD, add silence before and after tracks, specify pauses, and decide whether to play back the audio through the **Master Section**.

- To open the **Basic Audio CD Options** dialog, open a Basic Audio CD file, and on the **Edit** tab, click **Options**.

UPC/EAN Code

Here you can specify an optional UPC/EAN code for the CD.

Adjust Gaps between Markers and Sound (as CD Frames)

If this option is activated, WaveLab Pro performs small adjustments to the spacing before and after the CD track markers. This is useful to ensure that a low-quality CD player does not miss the start of tracks or cut them off before their actual end, for example. You can specify the silence length for the following options:

- **Silence after First Track Start Marker**
- **Silence after Track Start Marker**
- **Silence before Each Track End Marker**
- **Silence before Last Track End Marker**

Default Pause

Allows you to add silence before the first track of the CD. Usually, the pause needs to be longer for the first track than for the other tracks, to ensure that a low-quality CD player does not miss the start of the first track, for example.

Reset Pause of All Tracks

If this option is activated, the pauses of all tracks are reset to the default value when you close the dialog.

Play through Master Section

If this option is activated, playback of the Basic Audio CD passes the **Master Section**.

NOTE

You cannot use this option when writing a Basic Audio CD.

Save as Default Settings

If this option is activated, the settings made in this dialog are used for newly created Basic Audio CDs.

CD Markers

A track in the **Basic Audio CD** window is defined by CD track start and end markers or CD track splice markers.

- CD track splice markers indicate the end of one track and the start of the next. If you insert a start marker after another start marker, the second marker is automatically converted into a splice marker.
- If you delete the CD markers defining a track, the track is deleted from the Basic Audio CD list.
- If you edit the marker position of a CD track, the change is reflected in the track in the Basic Audio CD.
- When you create a CD track start marker, a CD track end marker is automatically created at the start of the next track or at the end of the audio file, whichever comes first.
- If you try to move CD track markers beyond the end of the corresponding file, to a position inside another track, etc., the marker is automatically moved to the closest valid position.
- The name of a CD track equals the name of the CD track start marker. Editing the marker name also changes the CD Track name, and vice versa.

Preparing a Basic Audio CD

You can add any type of file to a Basic Audio CD. However, when writing the files to CD, the files must meet specific specifications.

- 44100 Hz (44.1 kHz)
- Mono, dual mono, or stereo.
- 8, 16, 20, or 24-bit precision. During the writing process, files are converted to 16-bit stereo.

A track can only be used once in a Basic Audio CD.

Creating a Basic Audio CD

PROCEDURE

1. Select **File > New** and click **Basic Audio CD**.
2. Add tracks to the Basic Audio CD project using the following methods:
 - In the **Basic Audio CD** window, on the **Edit** tab, click **Add Tracks**, and select the audio files that you want to add.
 - Drag audio files from the file browser of your computer to the **Basic Audio CD** window.
 - Drag a selection of an audio file from the wave window to the **Basic Audio CD** window.

If a file contains CD start and sub-index markers, these are used to define the track in the list.

If a file does not contain markers, a dialog asks you if you want to use the file start and end as boundaries for the track.

3. Select **File > Save**, specify a name and location, and click **Save**.
-

RESULT

The audio files are added to the Basic Audio CD project.

Saving a Basic Audio CD

PREREQUISITE

Set up your Basic Audio CD.

PROCEDURE

1. In the **Basic Audio CD** window, click the **Save** button, or select **File > Save**.
 2. In the **Save Basic Audio CD** dialog, specify a file name and location.
 3. Optional: Activate one of the following options:
 - Open standard file selector before this dialog
 - Save copy
 4. Click **Save**.
-

Opening a Basic Audio CD Project

PROCEDURE

1. Select **File > Open**.
 2. Select **Basic Audio CD**.
 3. Select **Browse**.
 4. Select a Basic Audio CD file and click **Open**.
-

RESULT

All audio files that are referenced by the Basic Audio CD are opened in WaveLab Pro. However, they do not appear in the wave windows.

Deleting CD Tracks from a Basic Audio CD

You can delete a CD track from a Basic Audio CD project by deleting its CD track markers or by deleting it from the Basic Audio CD list.

- In the wave window, right-click the CD track start or end marker of the CD track that you want to delete, and select **Delete**.
- In the **Basic Audio CD** window, select a track, and on the **Edit** tab, click **Delete**.

Adjusting Pauses in CD Tracks

You can change the length of the pause that is played before the beginning of a track in the Basic Audio CD.

PROCEDURE

1. In the **Basic Audio CD** window, click the arrow icon next to a track to unfold it.
 2. Double-click the **Length** column of the **Pause** row, enter a value, and press **Return**.
-

Opening CD Tracks for Editing

You can open the tracks of a Basic Audio CD in a wave window to edit the audio or open the tracks as a clip in an audio montage.

- To open an entire CD track, double-click it in the **Length** column. A wave window opens and the entire CD track is selected.
- To open an entire CD track and position the cursor at track start or end, click the arrow icon to unfold the CD track, and double-click the **Length** column of the **Track Start** or **Track End** rows.
- To insert a CD track into an open audio file, drag the CD track on the open audio file in the wave window.
- To open a CD track as a clip in an audio montage, drag the CD track into the audio montage and select one of the insert options.

Playing Back Files in the Track List

There are several ways to play back files in the track list of a Basic Audio CD.

- In the **Start** column, click the time information of the track that you want to play back. What you hear during playback is identical to the audio that is played back from the actual CD. All pauses and other adjustments are taken into account.
If you have audio files in the list that do not have the correct sample rate (44.1 kHz), they can still be played back. However, when you activate playback, all files play back at the same rate. The inherent rate of the selected file is used for all files.
- Select a track, and click **Play** on the transport bar. Press **Stop** to stop playback.
- To play back from the marker position, click the right play icon of a track in the **Start** column. To play back from the marker position with a pre-roll, click the left play icon.

Playing Back Files in the Track List Through the Master Section

Playing back files through the **Master Section** takes all the settings and effects in the **Master Section** into account.

PROCEDURE

1. In the **Basic Audio CD** window, on the **Edit** tab, click **Options**.
 2. Activate **Play through Master Section**, and click **OK**.
-

Saving Basic Audio CD Tracks as Separate Files

You can save tracks of a Basic Audio CD as separate audio files on your hard disk. This is useful for archiving, for example.

PROCEDURE

1. Set up a Basic Audio CD.
 2. In the **Basic Audio CD** window, on the **Edit** tab, click **Save Each CD Track as an Audio File**.
 3. Specify a location and the output format.
 4. Click **OK**.
-

RESULT

The tracks in the list are saved as separate audio files in the specified folder.

Saving Basic Audio CD Tracks as One File

You can save tracks of a Basic Audio CD as a single audio file on your hard disk.

PREREQUISITE

Set up a Basic Audio CD. A track must be at least 4 seconds long.

PROCEDURE

1. In the **Basic Audio CD** window, on the **Edit** tab, click **Clone Fully**.
 2. Specify a location.
 3. Click **OK**.
-

RESULT

The tracks in the list are saved as a single audio file in the specified folder.

DVD-Audio

In WaveLab Pro, you can author a DVD-Audio from a collection of audio montages and write it to DVD-Audio.

You can add your audio montages to the **DVD-Audio** window, check the DVD-Audio layout for conformity, and write a DVD-Audio disk.

Compared to a Basic Audio CD, the DVD-Audio has the following advantages:

- More disk space
- Higher audio quality with up to 192 kHz and 24 bit
- Surround support
- Picture slide show support

The contents of a DVD-Audio project are saved in a folder named AUDIO_TS (Audio Title Set), which includes all audio, still picture, text, and visual menu data.

The AUDIO_TS contents are created when you render a DVD-Audio project. These data files are readable by the DVD-Audio player, but cannot be opened or edited in WaveLab Pro.

You can use DVD+R, DVD-R, DVD+RW, DVD-RW, DVD-RAM for writing DVD-Audio compatible discs.

NOTE

Throughout WaveLab Pro, where “CD” is mentioned (for example, in messages or marker names), this usually also applies for DVD-Audio.

Structure of a DVD-Audio Project

You structure your DVD-Audio projects in groups.

- An album can contain up to 9 groups. In WaveLab Pro, a group corresponds to an audio montage. A group is similar to a CD and can be represented by an audio montage.
- Each group can contain up to 99 tracks. Tracks are defined by CD track start and end markers in the audio montage.

DVD-Audio Formats

A DVD-Audio project can contain audio in a variety of resolutions.

The sample rates can be 48 kHz, 96 kHz, 192 kHz, 44.1 kHz, 88.2 kHz, or 176 kHz and the bit-depths can be 16 or 24.

You can use other bit depths for audio files in a montage, but they are saved on the DVD-Audio disc as either 16-bit or 24-bit audio samples, regardless of the original precision. The sample rate of the DVD is specified on the **Info** tab of the corresponding audio montage.

DVD-Audio Format Considerations

There are two main considerations when planning a DVD-Audio project: the total size of the album and the highest allowable data rate for a group.

A single album cannot contain more data than 4.7 GB (using a standard single layer DVD).

Highest Allowable Data Rate for a Group

The data rate is the data bandwidth that is necessary to reproduce a given number of channels at a specific bit depth and sample frequency. The DVD-Audio specification allows for a maximum data rate of 9.6 Mbps when using an uncompressed PCM audio format.

To keep a DVD-Audio project within the allowable data rate limit, use the following list as a guide.

6 Channels

Maximum bit depth/sample rate: Up to 16 bit/96 kHz or 24 bit/48 kHz

4 Channels

Maximum bit depth/sample rate: Up to 24 bit/96 kHz

2 Channels

Maximum bit depth/sample rate: Up to 24 bit/192 kHz

DVD-Audio Window

In this window, you can author DVD-Audio and write it to DVD.

- To open a new DVD-Audio file, select **File > New** and click **Create DVD-Audio**.
- To open a saved DVD-Audio file, select **File > Open** and click **DVD-Audio**. Select the DVD-Audio file that you want to open and click **Open**.

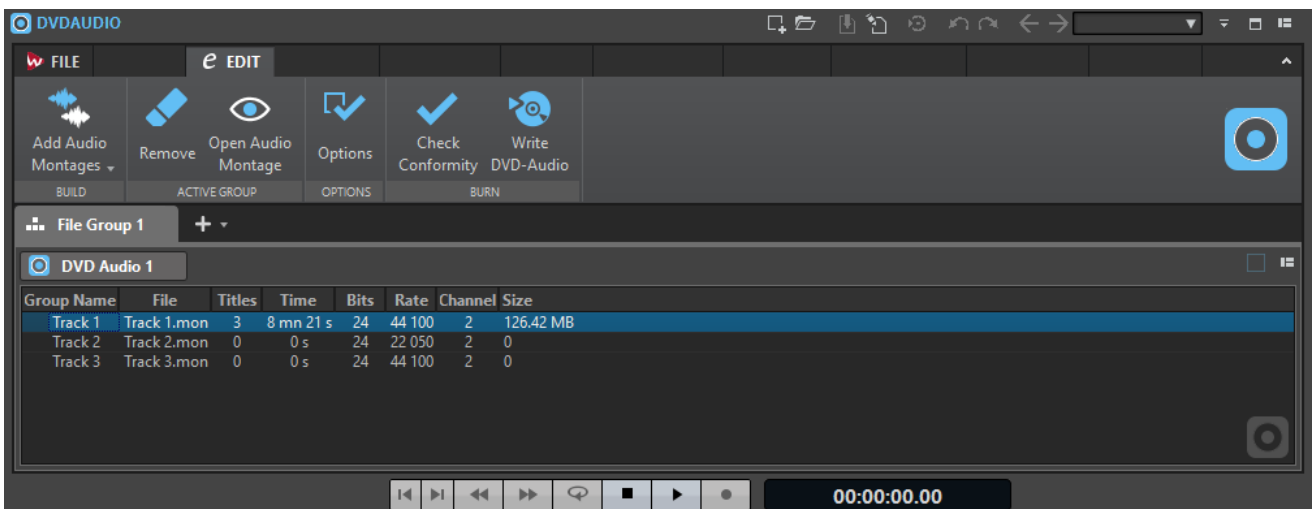

DVD-Audio List

The columns in the **DVD-Audio** window show information about the audio montages in the project. Apart from the entries in the **Group Name** column, you cannot edit any of the information shown in this window.

Group Name

If you double-click the name, you can enter a new name for the group. By default, the name of the audio montage is used as the group name. The group name is shown in the DVD menu display.

File

The name of the audio montage. If you double-click the audio montage name, the corresponding audio montage opens.

Titles

The number of titles in the audio montage.

Time

The total time of all titles.

Bits

The bit depth of the samples in the audio montage as they will be saved on the final DVD.

Rate

The sample rate of the audio montage.

Channel

The number of audio channels used in the audio montage.

Size

The total size of the audio montage.

Edit Tab**Add Audio Montages**

Opens the file browser where you can select the audio montages that you want to add to the DVD-Audio.

Remove

Removes the selected audio montage from the DVD-Audio.

Open Audio Montage

Opens the montage window of the selected audio montage.

Options

Opens the **DVD-Audio Options** dialog.

Check Conformity

Verifies that the structure of the DVD-Audio conforms to the standard.

Write DVD-Audio

Opens a dialog from which you can write a DVD.

DVD-Audio Options Dialog

In this dialog, you can make various settings for the DVD-Audio.

- To open the **DVD-Audio Options** dialog, open a DVD-Audio file, select the **Edit** tab, and click **Options**.

Disc Identification

Volume ID and **Number of Volumes** allow you to specify disc information. For example, if you have a project that has 3 DVD discs, you can specify 3 volumes, and specify the ID for the volumes 1, 2, and 3.

Album Name allows you to type in the name of the album. This name is also used as the DVD volume name.

Provider Information allows you to type in information about the DVD-Audio provider.

Options

If **Generate Menus** is activated, a basic menu displaying the album/group/tracks structure is automatically generated. This menu appears when playing back the DVD-Audio in a DVD player.

If **Include Still Picture Tracks** is activated, pictures placed on audio montage picture tracks are included on the DVD, and are displayed by a compatible DVD player.

If **Auto Play** is activated, DVD playback starts automatically when the DVD is inserted into a compatible DVD player.

TV System

Specifies whether the DVD-Audio disc should conform to the NTSC or PAL/SECAM video standard.

Default Still Picture

If this option is activated, you can define a default still picture that is displayed when the DVD-Audio is played back.

Still Picture Effects

Lets you define effect transitions between pictures. Choose a mode and a duration of the transition for start and end of playback. Not all DVD players support this feature.

TV Systems

If you want to use still pictures, you need to specify whether the DVD-Audio disc should conform to the NTSC or PAL/SECAM video standard.

This is important because the NTSC (used in North America and Asia) and PAL/SECAM (used in Western Europe, Australia/France, and Eastern Europe) use different resolutions.

Preparing a DVD-Audio

Creating a DVD-Audio

PROCEDURE

1. Select **File > New** and click **Create DVD-Audio**.
 2. Add tracks to the DVD-Audio project using the following methods:
 - In the **DVD-Audio** window, on the **Edit** tab, click **Add Audio Montages**, and select the audio montages that you want to add.
 - Drag audio montages from the file browser of your operating system to the **DVD-Audio** window.
 - Drag an audio montage tab to the **DVD-Audio** window.
 3. Select **File > Save**, specify a name and location, and click **Save**.
-

RESULT

The audio montages are added to the DVD-Audio project.

Saving a DVD-Audio

PREREQUISITE

Set up your DVD-Audio.

PROCEDURE

1. In the **DVD-Audio** window, click **Save As**, or select **File > Save As**.
 2. In the **Save DVD-Audio** dialog, specify a file name and location.
 3. Click **Save**.
-

Opening a DVD-Audio Project

PROCEDURE

1. Select **File > Open** and click **DVD-Audio**.
 2. Select **Browse**.
 3. Select a DVD-Audio file and click **Open**.
-

RESULT

All audio montages that are referenced by the DVD-Audio file are opened in WaveLab Pro. However, they do not appear in the montage window.

Setting an Audio Montage to DVD-Audio Mode

To be able to write an audio montage to DVD-Audio, the mode of the audio montage must be DVD-Audio compatible.

PROCEDURE

1. In the **Audio Montage** window, click the **File** tab.
 2. Click **Info**.
 3. Open the **Mode** menu and select **Multichannel (DVD-Audio Compatible)**.
 4. Click **File > Save** to save the changes.
-

Removing Audio Montages from a DVD-Audio

When removing audio montages from a DVD-Audio, the audio montage references are removed from the DVD-Audio, but the audio montage files are not deleted.

PROCEDURE

1. In the **DVD-Audio** window, select an audio montage.
 2. On the **Edit** tab, click **Remove**.
-

Opening Audio Montages for Editing

There are several ways to open an audio montage of a DVD-Audio project for editing in the **Audio Montage** window.

- Double-click the audio montage in **DVD-Audio** window.
- Select an audio montage from the list, select the **Edit** tab, click **Open Audio Montage**.
- Drag an audio montage from the **DVD-Audio** window to an open audio montage, or the **Audio Montage** window area.

Checking the DVD-Audio Conformity

Before rendering the DVD-Audio project, you can use the **Check Conformity** function to make sure that the settings conform to the DVD-Audio standard. This is also done automatically before writing to disk.

PROCEDURE

1. In the **DVD-Audio** window, select the **Edit** tab.
2. Click **Check Conformity**.

RESULT

All audio montages that are part of the DVD-Audio project are checked for their conformity. Afterwards, a message opens stating the result of the conformity check.

Writing Operations

To start the CD/DVD writing process, you must have completed all CD/DVD writing preparations. Refer to the description about Basic Audio CD, DVD-Audio, and CD window for a description of the preparations before following the instructions here.

RELATED LINKS

[Basic Audio CD](#) on page 399

[DVD-Audio](#) on page 406

[CD Window](#) on page 296

Write Audio CD or DDP Dialog

In this dialog, you can write your audio CD project and audio montage to audio CD or DDP image.

- If you want to write audio files to an audio CD or a DDP image, open the **Basic Audio CD** window, select the **Edit** tab, and click **Write Audio CD or DDP**.
- If you want to write audio montages to an audio CD or a DDP image, open the **CD** window, and select **Functions > Write Audio CD or DDP**.

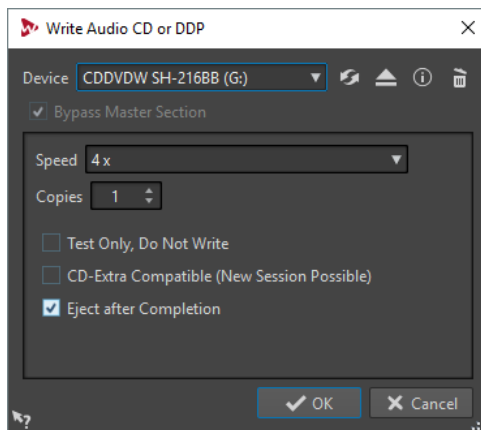

The following options are the same for writing both audio files and audio montages to audio CD or DDP image.

Device

Allows you to select the disc writer that you want to use or select **DDP Image** to write a set of DDP files on the hard drive.

NOTE

On the Mac, insert a medium in the drive after opening WaveLab Pro. Otherwise, the drive is under the control of the operating system and is not available for WaveLab Pro.

Refresh

Scans the system for connected optical devices. This is done automatically when this dialog opens. Click the refresh icon after you insert a new blank medium to update the **Speed** menu.

NOTE

On the Mac, insert a medium in the drive after opening WaveLab Pro. Otherwise, the drive is under the control of the operating system and is not available for WaveLab Pro.

Eject Optical Medium

Ejects the optical medium present in the selected drive.

Device Information

Opens the **Device Information** dialog that shows information about the selected device.

Erase Optical Media

Erases the optical medium present in the selected drive, provided it is a rewritable medium.

If **DDP Image** is selected, clicking the button erases the existing DDP files.

Bypass Master Section

If this option is activated, the audio signal is not processed through the **Master Section** before being written to the medium. For writing a Basic Audio CD, this option is always activated.

Destination Folder (DDP image must be selected)

Allows you to specify the destination path. If you type a non-existing path, it is automatically created.

Write Table of Contents and Customer Information (DDP image must be selected)

If this option is activated, a file called `IDENT.TXT` is written in the DDP folder. It contains a table of contents of the tracks and some customer information. This file is not officially part of the DDP specification, but it can be used by the recipient of the DDP image to identify the files.

Speed

Allows you to select the writing speed. The highest speed depends on the capabilities of your writing device and the medium present in the device.

Copies

Allows you to define the number of copies that you want to write.

Test Only, Do Not Write

If this option is activated, clicking **OK** initiates a simulation of writing the CD. If this test is passed, the real write operation will succeed. If the test fails, try again at a lower writing speed.

Render to Temporary File before Writing (only available for writing audio montages)

If this option is activated, a disk image is created before writing, which eliminates the risk of buffer underruns. This is useful if your project uses many audio plug-ins while writing. It is activated automatically when writing multiple copies. While this option makes the writing operation longer, it allows you to select a higher writing speed.

CD-Extra Compatible (New Session Possible)

If this option is activated, the resulting audio CD is compatible with the CD-Extra format.

Eject after Completion

If this option is activated, the medium is ejected after the writing operation.

Erase Optical Media Dialog

In this dialog, you can quickly or fully erase an optical disc before writing.

- To open the **Erase Optical Media** dialog, open the **Write Audio CD or DDP** dialog and click the garbage icon.

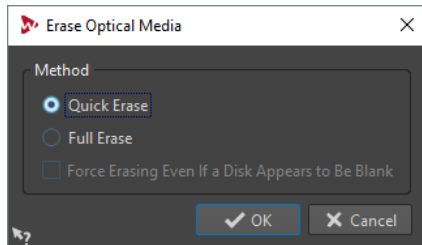

Quick Erase

Erases the table of contents of the disc.

Full Erase

Erases all parts of the disc.

Force Erasing Even If a Disk Appears to Be Blank

If this option is activated, the disc is erased, even if it is declared as blank. Use this option to make sure that discs that were partially or minimally erased are fully erased.

About Writing Audio Files

You can write the audio files of a Basic Audio CD project to an audio CD or a DDP image.

Writing Audio Files to an Audio CD

PREREQUISITE

Set up a Basic Audio CD project.

NOTE

On Mac, insert a medium in the drive after opening WaveLab Pro. Otherwise, the drive is under the control of the operating system and is not available for WaveLab Pro.

PROCEDURE

1. Optional: In the **Basic Audio CD** window, select the **Edit** tab, and click **Check CD Conformity** to check that all settings conform to the Red Book standard.
2. Insert an empty CD into your drive.
3. In the **Basic Audio CD** window, on the **Edit** tab, click **Write Audio CD or DDP**.
4. From the **Device** pop-up menu, select the writing device that you want to use.
5. Select the writing speed from the **Speed** pop-up menu.
6. Optional: Activate one or several of the following options:
 - Activate **Test Only, Do Not Write** if you want to test if the writing operation is successful.

- Activate **CD-Extra Compatible (New Session Possible)** if you want the resulting audio CD to be compatible with the CD-Extra format.
 - Activate **Eject after Completion** if you want the disc to be automatically ejected after the writing operation.
7. Click **OK** to start the writing operation.
-

RELATED LINKS

[Write Audio CD or DDP Dialog](#) on page 412

Writing Audio Files to DDP Image

There might be situations when you want to freeze an entire Basic Audio CD, without actually writing a CD. This is done by saving it as a DDP image.

PREREQUISITE

Set up a Basic Audio CD project.

PROCEDURE

1. Optional: In the **Basic Audio CD** window, select the **Edit** tab, and click **Check CD Conformity** to check that all settings conform to the Red Book standard.
 2. In the **Basic Audio CD** window, on the **Edit** tab, click **Write Audio CD or DDP**.
 3. From the **Device** pop-up menu, select **DDP Image**.
 4. Specify the destination folder.
 5. Optional: Activate **Write Table of Contents and Customer Information** to create a text file, containing information about the DDP file.
 6. Click **OK** to start the writing operation.
-

RELATED LINKS

[Write Audio CD or DDP Dialog](#) on page 412

Writing an Audio CD from a DDP Image

You can write a CD from a DDP image that you have previously created with WaveLab Pro or another application.

PROCEDURE

1. Select **File > Tools > Write Audio CD from DDP Image**.
 2. In the **Write Audio CD from DDP Image** dialog, open the **Device** pop-up menu, and select the writing device that you want to use.
 3. Select the writing speed from the **Speed** pop-up menu.
 4. Select the DDP image folder.
 5. Optional: Activate one or several of the following options:
 - Activate **Test Only, Do Not Write** if you want to test if the writing operation would be successful.
 - Activate **Eject after Completion** if you want the disc to be automatically ejected after the writing operation.
 6. Click **OK** to start the writing operation.
-

Write Audio CD From DDP Image Dialog

This dialog allows you to write a CD from a DDP image that you have previously created with WaveLab Pro or another application.

- To open the **Write Audio CD from DDP Image** dialog, select **File > Tools > Write Audio CD from DDP Image**.

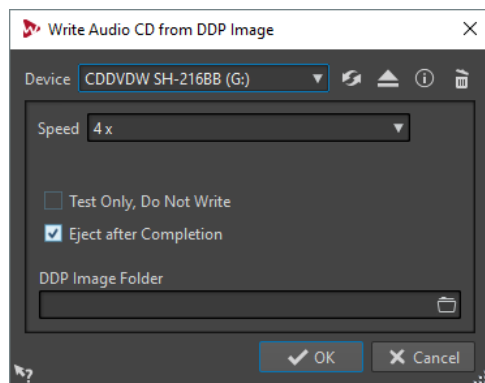

Device

Here, select the disc writer that you want to use.

NOTE

On the Mac, insert a medium in the drive after opening WaveLab Pro. Otherwise, the drive is under the control of the operating system and is not available for WaveLab Pro.

Refresh

Scans the system for connected optical devices. This is done automatically when this dialog opens. Click the update icon after you insert a new blank medium to update the **Speed** menu.

NOTE

On the Mac, insert a medium in the drive after opening WaveLab Pro. Otherwise, the drive is under the control of the operating system and is not available for WaveLab Pro.

Eject Optical Medium

Ejects the optical medium present in the selected drive.

Device Information

Opens the **Device Information** dialog that shows information about the selected device.

Erase Optical Disc

Erases the optical disc present in the selected drive, provided it is a rewritable medium. If **DDP Image** is selected, clicking the button erases the existing DDP files.

Speed

Allows you to select the writing speed. The highest speed depends on the capabilities of your writing device and the medium present in the device.

Test Only, Do Not Write

If this option is activated, clicking **OK** initiates a simulation of writing the CD. If this test is passed, the real write operation will succeed. If the test fails, try again at a lower writing speed.

Eject after Completion

If this option is activated, the medium is ejected after the writing operation.

DDP Image Folder

Lets you specify the source path of the DDP image.

About Writing Audio Montages

You can write audio montages to an audio CD or a DDP image.

Writing an Audio Montage to an Audio CD

PREREQUISITE

Set up your audio montage and make your CD writing settings in the **Global Preferences**.

NOTE

On Mac, insert a medium in the drive after opening WaveLab Pro. Otherwise, the drive is under the control of the operating system and is not available for WaveLab Pro.

PROCEDURE

1. Optional: In the **CD** window, select **Functions > Check CD Conformity** to check that all settings conform to the Red Book standard.
 2. Insert an empty CD into your drive.
 3. In the **CD** window, select **Functions > Write Audio CD or DDP**.
 4. From the **Device** pop-up menu, select the writing device that you want to use.
 5. If you want to bypass the **Master Section**, activate **Bypass Master Section**.
 6. Select the writing speed from the **Speed** pop-up menu.
 7. Select the number of copies that you want to write.
When you want to write more than one copy, it is recommended to activate **Render to Temporary File before Writing**.
 8. Optional: Activate one or several of the following options:
 - Activate **Test Only, Do Not Write** if you want to test if the writing operation would be successful.
 - Activate **Render to Temporary File before Writing** if your audio montage uses many plug-ins. This way, the audio data is sent to the CD writer fast enough.
 - Activate **CD-Extra Compatible (New Session Possible)** if you want the resulting audio CD to be compatible with the CD-Extra format.
 - Activate **Eject after Completion** if you want the disc to be automatically ejected after the writing operation.
 9. Click **OK**.
-

RESULT

The writing operation starts.

RELATED LINKS

[Write Audio CD or DDP Dialog](#) on page 412

Writing an Audio Montage to a DDP Image

PREREQUISITE

Set up your audio montage and make your CD writing settings in the **Global Preferences**.

PROCEDURE

1. Optional: In the **CD** window, select **Functions** > **Check CD Conformity** to check that all settings conform to the Red Book standard.
 2. In the **CD** window, select **Functions** > **Write Audio CD or DDP**.
 3. From the **Device** pop-up menu, select **DDP Image**.
 4. If you want to bypass the **Master Section**, activate **Bypass Master Section**.
 5. Specify the destination folder.
 6. Optional: Activate **Write Table of Contents and Customer Information** to create a text file, containing information about the DDP file.
 7. Click **OK** to start the writing operation.
-

RELATED LINKS

[Write Audio CD or DDP Dialog](#) on page 412

Writing Audio Montages With Any Sample Rate

You can write audio montages to CD/DDP even if they are not at 44.1 kHz. To be able to do this, set up the **Resampler** plug-in in the **Master Section**. This procedure is not automated so that you can customize the resampling quality, limiting, and dithering.

PREREQUISITE

Set up your audio montage.

PROCEDURE

1. In the **Master Section**, add the **Resampler** plug-in to an **Effects** slot.
 2. In the **Resampler**, set the **Sample Rate** to 44.1 kHz.
 3. Optional: Add a **Peak Limiter** and a **Dithering** plug-in at the end of the **Master Section**.
 4. Write the audio montage as you would write any other audio montage.
-

RELATED LINKS

[Writing an Audio Montage to an Audio CD](#) on page 417

[Writing an Audio Montage to a DDP Image](#) on page 418

Checking the Transition Between Tracks

You can set up a pre-roll time before tracks start and then play back all tracks. This way you can check the transition between tracks.

PREREQUISITE

Set up your audio montage.

PROCEDURE

1. In the **CD** window, select **Options > Edit Playback Times**.
 2. Make your settings, and click **OK**.
 3. In the **CD** window, select **Functions > Play All CD-Track Starts**.
-

RESULT

Each track start point and end point is played back according to the values set in the **Edit Playback Times** dialog.

CD-Text

CD-Text is an extension of the Red Book Compact Disc standard and allows you to save text information such as title, songwriter, composer, and disc ID on an audio CD.

The text data is then displayed by CD players that support the CD-Text format. The CD-Text can also be included in the audio CD report.

CD-Text Editor Dialog

In this dialog, you can specify information such as track title, performer, and songwriter, that is written onto the CD as CD-Text.

You can add information about the disc itself and each individual track. This information is entered in the text fields that scroll horizontally. There is one pane of fields for the disc itself and a pane for each track.

- To open the **CD-Text Editor** dialog, in the **CD** window, select the track for which you want to edit the CD-Text, and select **Functions > Edit CD-Text**.

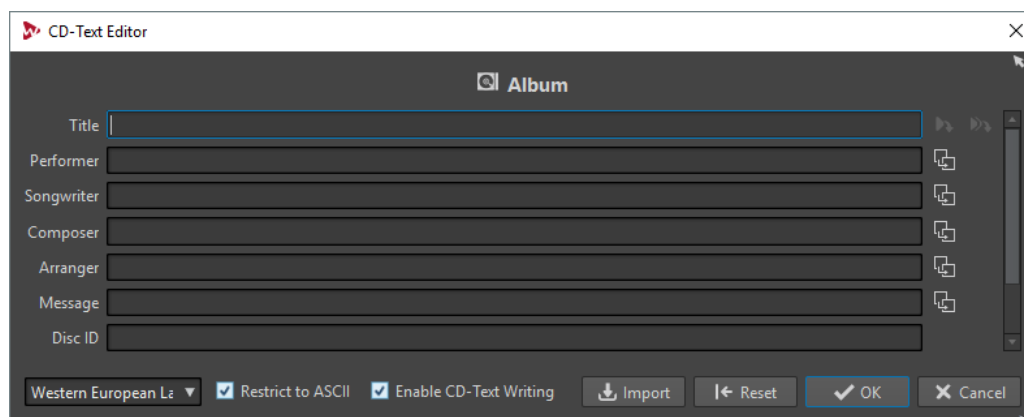

Copy CD Track Marker Name



Copies the name of the CD track marker to this field.

Copy CD Track Start Marker Name to All CD Track Titles



Copies the name of each CD track start marker to the title field of each CD track.

Copy Text to All Following Tracks



Copies the text to all tracks that are located after the current one.

Scrollbar

Allows you to navigate across all CD-Texts. The first position corresponds to the whole CD, other positions to individual tracks.

Language

Here, select how characters should be encoded on the CD.

NOTE

If a character is not CD-Text compatible, it is displayed as a ? character.

Restrict to ASCII

To ensure the maximum compatibility with CD players, it is recommended to restrict the characters to ASCII when using the **Western European** option. If this option is activated, and you type a non-compatible character, a ? character is displayed.

Enable CD-Text Writing

If this option is activated, the CD-Text is written onto the CD.

Import

Allows you to import a text file that contains CD-Text.

Importing CD-Text

You can import CD-Text that has been written in a standard CSV text file in UTF-8 format.

- To import CD-Text, click **Import** in the **CD-Text Editor** dialog and select the text file that you want to import.

Importing CD-Text replaces the content of the **CD-Text Editor** dialog.

You can specify the CSV delimiter in the **Global Preferences** on the **Formats** tab. The CSV file must only contain the text and between 1 and 7 fields per line. The text must be in the following order:

1. Title
2. Performer
3. Songwriter
4. Composer
5. Arranger
6. Message
7. Disc ID

RELATED LINKS

[Formats Tab](#) on page 574

Audio CD Reports

An audio CD report is a detailed report about the active audio CD. This report includes a full track listing with ISRC codes, track times, and CD-Text.

The audio CD report can be output in HTML, Adobe PDF, XML, simple text format, CSV format, or printed out. You can choose the details of what is displayed and include your custom logo. You can send the audio CD report to your client, an album artwork designer, or to the CD replication house when presenting them with a master CD, for example.

There are two types of variables:

- Factory variables provide automatically generated information about a project, such as number of tracks, track times, track names, etc., based on the actual contents of the project.
- User defined variables contain personal data such as company name and copyright information, etc.

Along with the variables, the audio CD report can also include any CD-Text that you have specified, for example, composers or performers.

Generating an Audio CD Report

An audio CD report should be generated when an audio montage is fully prepared and ready for CD writing.

PROCEDURE

1. Open the audio montage that you want to create a report for.

NOTE

The audio montage must be in stereo mode.

2. Select **Tool Windows > CD**.
3. In the **CD** window, select **Functions > Generate Audio CD Report**.
4. On the **Rich Text** tab, in the **Output format** section, specify one of the following output formats:
 - HTML
 - Adobe PDF
 - Print
 - XML
 - CSV
5. Make your settings.
6. Optional: On the **Raw Text** tab, select a cue sheet template or enter cue sheet information.
7. Optional: If you want to save the audio CD report to a specific location, activate **Specify File Name and Location**, and specify a file name and location.
8. Click **Apply**.

Audio CD Report Dialog

In this dialog, you can generate an audio CD report and specify which information to include in this report.

- To open the **Audio CD Report** dialog, in the **CD** window, select **Functions > Generate Audio CD Report**.

Global Options

The following option is available on the **Rich Text** tab and the **Raw Text** tab.

Specify File Name and Location

Lets you specify a name and location for the report. The file is created when you click **Apply**.

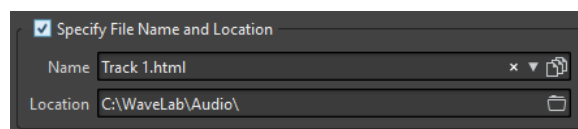

Rich Text Tab

CD Tracks

Allows you to select whether you want to create an audio CD report for all tracks or for a specific track group.

Font/Font Size

Determines the font and font size to use in the report.

Header Image

Lets you select an image to be inserted at the top of the report.

Center Image

Centers the image horizontally. If deactivated, the image is placed on the left.

Header

Adds general information at the start of the report.

Custom Text

Lets you enter text to be inserted at the top of the report. To insert custom variables, right-click the text field.

Extra Lines

Lets you select which of the following information you want to add to the header:

- **Date**
- **Audio Montage Name**
- **UPC/EAN Code**
- **Number of Tracks**
- **Disc Duration**

Skip Lines with Empty Values

If this option is activated, a line is not added to the report if the line contains an empty variable.

Ignore CD Pre-Gap

If this option is activated, the default 2 second gap at the start of a red-book CD is ignored.

ISRC

Adds a column to the report to display the ISRC code.

Pre-Emphasis Status

Adds a column to the report to display the track pre-emphasis status.

Copy Status

Adds a column to the report to display the copy status of the track.

Time Details

Adds a description of the pause, track start, and possible sub-indexes to the report.

Pause

If this option is activated, the pause information is included in the report.

Sub-Indexes

If this option is activated, track sub-indexes are described in the report.

Sub-Indexes Relative to Track

Sets the sub-index values to be relative to the start of the corresponding track. If deactivated, they are relative to the start of the CD.

Start Time (in Audio Montage)

Adds a column to the report to display the event times from the start of the audio montage.

Start Time (on CD)

Adds a column to the report to display the event times from the start of the CD.

CD-Text

If this option is activated, the CD-Text is included in the report. You can specify which CD-Text information you want to include in the report.

Output Format

Lets you select the output format for the report.

- **HTML** generates an HTML file with a UTF-8 character format.
- **Adobe PDF** generates a PDF file.
- **Print** generates a preview of the report, allowing you to print the report. If no printer is connected, the preview is empty.
- **XML** generates an XML file that includes the CD information.
- **CSV** generates a CSV file that can be imported in a spreadsheet. The CSV file can only save the main properties of the CD report. You can set the type CSV delimiter in the **Global Preferences** dialog on the **Formats** tab.

Value Format

Opens the **Value Formats** dialog, where you can edit the format of the auto-generated values. These variables are part of any presets saved for this dialog.

Raw Text Tab

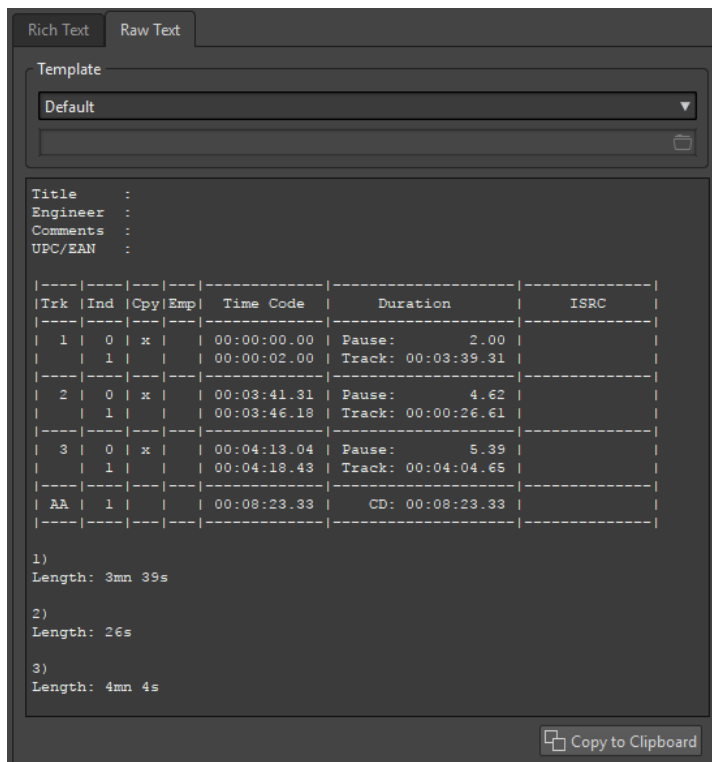

Template

Lets you select a template for the report layout. When selecting **Custom**, you can also create your own cue sheet template.

Cue sheet field

Lets you write a cue sheet.

Copy to Clipboard

Copies the text to the clipboard.

Cue Sheet Templates

A cue sheet is an alternate form of the CD report, based on raw UTF-8 text, and can be customized in several ways. Creating a cue sheet requires an understanding of computers and some knowledge about programming, because it makes use of the commands and variables concept.

TIP

You can make a copy of a factory cue sheet template to create a custom cue sheet template. The factory templates are located in the following locations:

- **Windows:** C:\Program Files\Steinberg\WaveLab Pro 9.5\Factory Presets\Presets\AudioCdCueSheetTemplates\
- **macOS:** /Applications/WaveLab Pro 9.5.app/Contents/Factory Presets/Presets/AudioCdCueSheetTemplates/

Cue sheets are organized in the following way: There are a number of codes, commands, and variables, which you place in a text file – the template. If you ask the program to generate a cue sheet, it creates the text file based on the codes it finds in the template.

If the program encounters a variable, it replaces this with some information about the CD. For example, there is a variable called "NUM_TRACKS". When the program finds this, it replaces it with the actual number of tracks in the CD.

Commands, on the other hand, are instructions for the program to do something. For example, the command "TIMECODE SEPARATOR =" followed by a few special characters, instructs the program what characters should be inserted between time code values, so that you can get time code values printed out in the format 00:00:00.00, "00 00 00 00", or anything else you prefer.

The following codes can be entered for specific purposes:

\$

A variable. The text that follows right after the "\$" is the command name, for example, "\$TITLE". A variable can occur anywhere on a line, and there can be any number of variables on a line.

#

A command. The text that follows after the "#" is the command name, for example, "#FOR EACH TRACK". There can only be one command per line and there should not be anything else on that line.

;

If a line starts with a semi-colon ";", the line is interpreted as a comment. Nothing on such a line is used in the cue sheet. This is useful for making notes, for example.

All other text characters can be entered on their own lines or among the variables, and are used as they are. For example, if you type "Title: \$TITLE" and the title you have entered is "My Greatest Hits!", the text "Title: My Greatest Hits" appears in the cue sheet.

To find out more about the available commands and how they are used, you can open the included templates and study them. The following variables are available:

Track Number

T0

As decimal number "1" or "22"

T1

Blank Justified Two Digit Number "1" or "22"

T2

Zero Justified Two Digit Number "01" or "22"

Track Index

I0

As decimal number "1" or "22"

I1

Blank Justified Two Digit Number "1" or "22"

I2

Zero Justified Two Digit Number "01" or "22"

Copy Protection Status

C1

"x" or " "

C2

"Y" or "N"

Emphasis Status

E1

"x" or " "

E2

"Y" or "N"

Absolute Time of Index

TIME_IA_0

As decimal number

TIME_IA_1

Blank justified 7 digit decimal number

TIME_IA_2

Time as "hh:mm:ss:ff"

TIME_IA_3

Time as "hh:mm:ss:ff" blank justified, leading zero not displayed

TIME_IA_4

Time as "hh:mm:ss:ff" compressed if there are no hours, none are displayed

TIME_IA_5

Time as "mm:ss:ff" no hours displayed

TIME_IA_6

Time as "mm:ss:ff" blank justified, leading zero not shown, no hours displayed

TIME_IA_7

Time as “mm:ss:ff” no minutes displayed if not required, no hours displayed

TIME_IA_8

Time format as “1h 2mn 3s 4f”

TIME_IA_9

Time format as “1h 2mn 3s”

Index Time Relative to Start of CD

TIME_IR_0

As decimal number

TIME_IR_1

Blank justified 7 digit decimal number

TIME_IR_2

Time as “hh:mm:ss:ff”

TIME_IR_3

Time as “hh:mm:ss:ff” blank justified, leading zero not displayed

TIME_IR_4

Time as “hh:mm:ss:ff” compressed if there are no hours, none are displayed

TIME_IR_5

Time as “mm:ss:ff” no hours displayed

TIME_IR_6

Time as “mm:ss:ff” blank justified, leading zero not shown, no hours displayed

TIME_IR_7

Time as “mm:ss:ff” no minutes displayed if not required, no hours displayed

TIME_IR_8

Time format as “1h 2mn 3s 4f”

TIME_IR_9

Time format as “1h 2mn 3s”

Index Time Relative to Start of Track

TIME_IT_0

As decimal number

TIME_IT_1

Blank justified 7 digit decimal number

TIME_IT_2

Time as “hh:mm:ss:ff”

TIME_IT_3

Time as “hh:mm:ss:ff” blank justified, leading zero not displayed

TIME_IT_4

Time as “hh:mm:ss:ff” compressed if there are no hours, none are displayed

TIME_IT_5

Time as “mm:ss:ff” no hours displayed

TIME_IT_6

Time as “mm:ss:ff” blank justified, leading zero not shown, no hours displayed

TIME_IT_7

Time as “mm:ss:ff” no minutes displayed if not required, no hours displayed

TIME_IT_8

Time format as “1h 2mn 3s 4f”

TIME_IT_9

Time format as “1h 2mn 3s”

Pause Length

TIME_PA_0

As decimal number

TIME_PA_1

Blank justified 7 digit decimal number

TIME_PA_2

Time as “hh:mm:ss:ff”

TIME_PA_3

Time as “hh:mm:ss:ff” blank justified, leading zero not displayed

TIME_PA_4

Time as “hh:mm:ss:ff” compressed if there are no hours, none are displayed

TIME_PA_5

Time as “mm:ss:ff” no hours displayed

TIME_PA_6

Time as “mm:ss:ff” blank justified, leading zero not shown, no hours displayed

TIME_PA_7

Time as “mm:ss:ff” no minutes displayed if not required, no hours displayed

TIME_PA_8

Time format as “1h 2mn 3s 4f”

TIME_PA_9

Time format as “1h 2mn 3s”

Track Length

TIME_TR_0

As decimal number

TIME_TR_1

Blank justified 7 digit decimal number

TIME_TR_2

Time as “hh:mm:ss:ff”

TIME_TR_3

Time as “hh:mm:ss:ff” blank justified, leading zero not displayed

TIME_TR_4

Time as “hh:mm:ss:ff” compressed if there are no hours, none are displayed

TIME_TR_5

Time as “mm:ss:ff” no hours displayed

TIME_TR_6

Time as “mm:ss:ff” blank justified, leading zero not shown, no hours displayed

TIME_TR_7

Time as “mm:ss:ff” no minutes displayed if not required, no hours displayed

TIME_TR_8

Time format as “1h 2mn 3s 4f”

TIME_TR_9

Time format as “1h 2mn 3s”

CD Length

TIME_CD_0

As decimal number

TIME_CD_1

Blank justified 7 digit decimal number

TIME_CD_2

Time as “hh:mm:ss:ff”

TIME_CD_3

Time as “hh:mm:ss:ff” blank justified, leading zero not displayed

TIME_CD_4

Time as “hh:mm:ss:ff” compressed if there are no hours, none are displayed

TIME_CD_5

Time as “mm:ss:ff” no hours displayed

TIME_CD_6

Time as “mm:ss:ff” blank justified, leading zero not shown, no hours displayed

TIME_CD_7

Time as “mm:ss:ff” no minutes displayed if not required, no hours displayed

TIME_CD_8

Time format as “1h 2mn 3s 4f”

TIME_CD_9

Time format as “1h 2mn 3s”

Various

NUM_TRACKS

Total number of tracks as decimal number

UPC

UPC/EAN code

ISRC

ISRC code

FILE

File name (no path)

PFILE

File name (with path)

TRACK_NAME

Track name

TRACK_COMMENT

Track comment

Creating a Cue Sheet Template

You can create a cue sheet template and load it each time you want to create an audio CD report.

PROCEDURE

1. Open an audio montage that contains CD tracks.
The audio montage must be in stereo mode.
2. Select **Tool Windows > CD**.
3. In the **CD** window, select **Functions > Generate Audio CD Report**.
4. Select the **Raw Text** tab.
5. In the **Template** section, open the template menu and do one of the following:
 - To start with an empty cue sheet, select **Custom**.
 - To start with a cue sheet template that you can then modify, select one of the available cue sheets.
 - To start with a custom template, select **Custom**, click the folder icon and select the text tile that you want to open.

TIP

You can make a copy of a factory cue sheet template to create a custom cue sheet template. The factory templates are located in the following locations:

- **Windows:** C:\Program Files\Steinberg\WaveLab Pro 9.5\Factory Presets\Presets\AudioCdCueSheetTemplates\
- **macOS:** /Applications/WaveLab Pro 9.5.app/Contents/Factory Presets/Presets/AudioCdCueSheetTemplates/

-
6. Enter the cue sheet information.
 7. Activate **Specify File Name and Location**, and specify a file name and location.
 8. Click **Apply** to save the cue sheet template.
-

Write DVD-Audio Function

Before writing an audio montage to DVD-Audio, the contents of the DVD-Audio project must be rendered to an AUDIO_TS folder. This folder is automatically added to a Data CD/DVD project, from which you can start the actual writing operation.

DVD-Audio Creation Dialog

This dialog allows you to make settings for the DVD-Audio creation.

- To open the **DVD-Audio Creation** dialog, in the **DVD-Audio** window, set up the DVD-Audio project and click **Write DVD-Audio**.

Test Only

If this option is activated, all data is checked and rendered in memory to know if the DVD-Audio project is complete and ready for rendering. When the test is finished, a report opens.

Render Each Audio Montage with Its Own Plug-in Set

If this option is activated, each audio montage is rendered with its own **Master Section** effects.

Use Current Master Section Settings for All Audio Montages

If this option is activated, all audio montages are rendered using the selected **Master Section** settings.

Ignore

If this option is activated, the audio montages are rendered without any **Master Section** effects.

Output Folder

Lets you select the destination folder for the rendered files.

Rendering the DVD-Audio

To be able to write the DVD-Audio project to disc or ISO image, you must render the DVD-Audio project first.

PREREQUISITE

Set up the DVD-Audio project.

If you want to use the **Master Section** plug-ins when rendering the project, set up the **Master Section** to your liking.

PROCEDURE

1. In the **DVD-Audio** window, select the **Edit** tab.
2. In the **Burn** section, click **Write DVD-Audio**.
3. In the **Master Section** plug-ins section, select one of the following options:
 - **Render Each Audio Montage with Its Own Plug-in Set**
 - **Use Current Master Section Settings for All Audio Montages**
 - **Ignore**
4. Specify an output folder.
5. Click **OK**.

RESULT

The **Write Data CD/DVD** dialog opens, allowing you to write your DVD-Audio project.

Write Data CD/DVD Dialog When Writing DVD-Audio

In this dialog, you can write your DVD-Audio project to a CD/DVD or an ISO file.

- To open the **Write Data CD/DVD** dialog, set up the DVD-Audio project in the **DVD-Audio** window and click **Write DVD-Audio**. After the rendering operation is finished, the **Write Data CD/DVD** dialog opens.

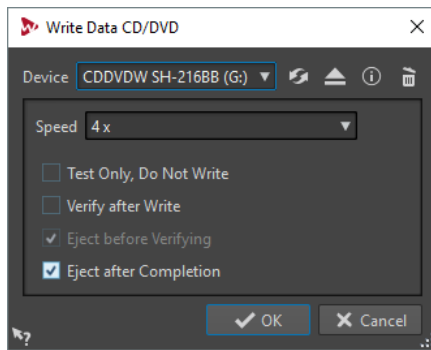

Device

Lets you select the disc writer that you want to use, or select **ISO Image** to write a file on the hard drive. You can use an ISO image to create an optical medium that you want to write to disc in the future.

NOTE

On Mac, insert a medium in the drive after opening WaveLab Pro. Otherwise, the drive is under the control of the operating system and is not available for WaveLab Pro.

Refresh

Scans the system for connected optical devices. This is done automatically when this dialog opens. Click the update icon after you insert a new blank medium, to update the speed menu.

NOTE

On Mac, insert a medium in the drive after opening WaveLab Pro. Otherwise, the drive is under the control of the operating system and is not available for WaveLab Pro.

Eject Optical Medium

Ejects the optical medium present in the selected drive.

Device Information

Opens the **Device Information** dialog that shows information about the selected device.

Erase Optical Disc

Erases the optical disc present in the selected drive, provided it is a rewritable medium. If **ISO Image** is selected, clicking the button erases the existing ISO file.

ISO File Name

If **ISO Image** is selected on the **Device** menu, specify the file name and file location of the ISO file in the text field.

Speed

Allows you to select the writing speed. The highest speed depends both on the capabilities of your writing device and the medium present in the device.

Test Only, Do Not Write

If this option is activated, clicking **OK** initiates a simulation of writing the CD. If this test is passed, the real write operation will succeed. If the test fails, try again at a lower writing speed.

Verify After Write

If this option is activated, the data on the medium is automatically verified after the writing process.

Eject Before Verifying

If this option is activated, the disc is ejected and retracted before the verification process, to force the drive out of the write state. This is only possible if the disc can be retracted automatically.

Eject After Completion

If this option is activated, the medium is ejected after the writing operation.

Writing a DVD-Audio Project to a Data CD/DVD

After rendering the DVD-Audio project, you can write it to a Data-CD/DVD.

PREREQUISITE

You have set up and rendered a DVD-Audio project.

IMPORTANT

On Mac, insert a medium in the drive after opening WaveLab Pro. Otherwise, the drive is under the control of the operating system and not available for WaveLab Pro.

PROCEDURE

1. Insert an empty DVD into your drive.
 2. In the **DVD-Audio** window, select the **Edit** tab.
 3. In the **Burn** section, click **Check Conformity** to check that all settings are compatible with the Red Book standard.
 4. Click **Write DVD-Audio**.
 5. In the **Master Section** plug-ins section, select one of the following options:
 - **Render Each Audio Montage with Its Own Plug-in Set**
 - **Use Current Master Section Settings for All Audio Montages**
 - **Ignore**
 6. Specify an output folder.
 7. Click **OK**.
 8. In the **Write Data CD/DVD** dialog, open the **Device** pop-up menu, and select the disc writing device that you want to use.
 9. Select the writing speed from the **Speed** pop-up menu.
 10. Optional: Activate one or several of the following options:
 - Activate **Test Only, Do Not Write** if you want to test if the writing operation would be successful.
 - Activate **Verify After Write** if you want the file to be verified after the writing operation.
 - Activate **Eject Before Verifying** and/or **Eject After Completion** if you want the disc to be automatically ejected at the corresponding situations.
 11. Click **OK** to start the writing operation.
-

Writing a DVD-Audio Project to an ISO Image

If you want to save an entire DVD-Audio project without actually writing a DVD, you can save the project as an ISO image.

PREREQUISITE

Set up and render a DVD-Audio project.

PROCEDURE

1. In the **DVD-Audio** window, select the **Edit** tab.
 2. In the **Burn** section, click **Check Conformity** to check if all settings are compatible with the Red Book standard.
 3. Click **Write DVD-Audio**.
 4. In the **Master Section** plug-ins section, select one of the following options:
 - **Render Each Audio Montage with Its Own Plug-in Set**
 - **Use Current Master Section Settings for All Audio Montages**
 - **Ignore**
 5. Specify an output folder.
 6. Click **OK**.
 7. In the **Write Data CD/DVD** dialog, open the **Device** pop-up menu and select **ISO Image**.
 8. Specify an ISO file name and location.
 9. Click **OK** to start the writing operation.
 10. When the operation is finished, click **OK**.
-

Data CD/DVD Projects

A data CD/DVD project can be used to compile and write a data-only CD, DVD, Blu-ray, or to write to ISO image. You can enter a name for your disc and change the disc file structure before writing your data to a CD, DVD, Blu-ray, or ISO image.

Creating a Data CD/DVD Project

A data CD/DVD project can be used to compile and write a data-only CD, DVD, Blu-ray, or to write to ISO image.

PROCEDURE

1. Select **File > Tools > Data CD/DVD**.
 2. Add files to the project, using one of the following methods:
 - Drag the files from the WaveLab Pro **File Browser** window or from the File Explorer/ macOS Finder into the **Data CD/DVD** window.
 - Drag an audio file or audio montage tab into the **Data CD/DVD** window.
 - Right-click a file tab, and select **Add to > Data CD/DVD**.
 3. Optional: Click **New Folder**, specify a folder name, and arrange the files by dragging.
-

Writing a Data CD/DVD Project

PREREQUISITE

Open the **Data CD/DVD** dialog, and add the files that you want to write to a data CD/DVD.

PROCEDURE

1. Click **Write Data CD/DVD**.
 2. Select a writing device.
 - If you select **ISO Image**, specify a file name and file location.
 - If you select a CD/DVD writer, specify the writing speed and make further settings.
 3. Click **OK**.
-

Data CD/DVD Dialog

In this dialog, you can create a data CD/DVD project, and write it to a CD, DVD, Blu-ray, or an ISO image.

- To open the **Data CD/DVD** dialog, select **File > Tools > Data CD/DVD**.

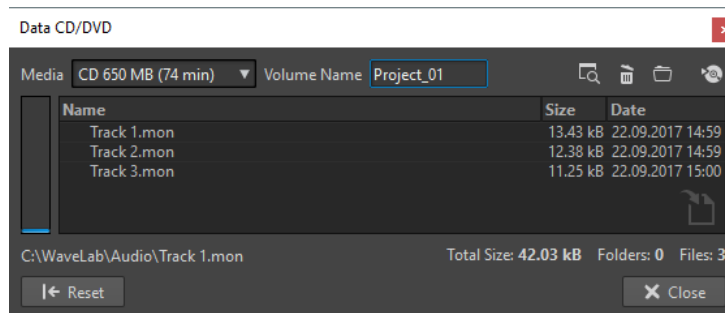

Media

Allows you to select the media type you want to write. If the media size that you want to use is not listed, select the media type that offers the size closest to your requirements.

Volume Name

Allows you to specify the volume name of the CD/DVD.

Open File Explorer/macOS Finder

Opens the File Explorer/macOS Finder to show the location of the selected file.

Remove Selected Files and Folders

Removes the selected files and folders from the CD/DVD project.

New Folder

Creates a folder. You can also create sub-folders.

Write Data CD/DVD

Opens the **Write Data CD/DVD** dialog from which you can write the medium.

Data CD/DVD list

Shows the contents of the CD/DVD project, and the size creation date, and number of files.

Available space on media

Indicates how much space is used on the media. The **Total Size** of the data CD/DVD project is shown below the data CD/DVD list.

Reset

Removes all files from the data CD/DVD project.

Write Data CD/DVD Dialog

In this dialog, you can write a data CD/DVD project to a CD/DVD or an ISO file.

- To open the **Write Data CD/DVD** dialog, open the **Data CD/DVD** dialog and click **Write Data CD/DVD**.

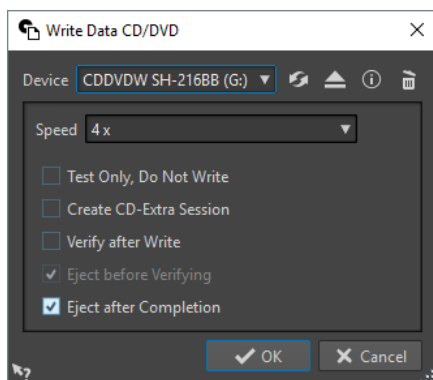

Device

Allows you to select the disc writer that you want to use or select **ISO Image** to write a file on the hard drive. Writing an ISO image creates a copy of a future optical medium.

NOTE

On the Mac, open WaveLab Pro without a medium in the drive. Otherwise, the drive is under the control of the operating system and is not available for WaveLab Pro.

Refresh

Scans the system for connected optical devices. This is done automatically, when this dialog opens. Click the update icon after you insert a new blank medium, to update the speed menu.

Eject Optical Medium

Ejects the optical medium present in the selected drive.

Device Information

Opens the **Device Information** dialog that shows information about the selected device.

Erase Optical Medium/ISO Image

Erases the optical medium present in the selected drive, provided it is a rewritable medium. If **ISO Image** is selected, clicking the button deletes the existing ISO file.

ISO File Name

If **ISO Image** is selected in the **Device** menu, specify the file name and file location of the ISO file in the text field.

Speed

Allows you to select the writing speed. The highest speed depends on the capabilities of your writing device and the medium present in the device.

Test Only, Do Not Write

If this option is activated, clicking **OK** initiates a simulation of writing the CD. If this test is passed, the real write operation will succeed. If the test fails, try again at a lower writing speed.

Create CD-Extra Session

If this option is activated, the data is written in a new session, after the audio tracks. This creates a CD Extra, also known as Enhanced CD and CD Plus. For this to work, the CD in the drive must have audio tracks on it, written with the CD Extra option. Otherwise the operation fails.

Verify After Write

If this option is activated, the data on the medium is automatically verified after the writing process.

Eject Before Verifying

If this option is activated, the disc is ejected and retracted before the verification process, to force the drive out of the write state.

NOTE

This is only possible if the disc can be retracted automatically.

Eject After Completion

If this option is activated, the disc is ejected after the writing operation.

Audio CD Formats

This chapter provides you with background information on the CD format, to help you better understand how to create your own CDs.

Basic CD Formats

There are a number of different formats for the contents of a CD disc. For example, audio CDs, CD-ROMS, and CD-I. These are all slightly different.

The audio CD specification is called Red Book. It is this standard to which WaveLab Pro conforms.

NOTE

Red Book CD is not a real file format. All the audio on the CD is saved in one big file. This is different from hard disks, for example, where each file is saved separately. Keep in mind that all the audio is in fact one long stream of digital data.

CD-Extra Support

CD-Extra is a format that allows for the writing of both audio and data on a single CD, just like Mixed Mode CDs. When writing an audio CD, you can prepare it for CD-Extra support (also known as Enhanced CD or CD Plus).

The difference is that when Mixed Mode CDs are written with the audio placed on the last tracks of the CD, for CDs in the CD-Extra format the audio is contained in the first tracks of the CD, and the data follows subsequently.

All features of the Red Book audio CD are possible with CD-Extra, unlike with Mixed Mode CDs. After an audio CD has been written with CD-Extra support, the data can be added to the CD in a separate session, by creating and writing a data CD project.

NOTE

Some computer CD drives may not recognize CDs in the CD-Extra format.

Types of Events on an Audio CD

There are three types of events that can be used to specify various sections of audio on the CD.

Track start

There can be up to 99 tracks on one CD. Each is identified by its start point only.

Track sub-index

On advanced CD players, a track can be divided into sub-indexes (sometimes called only indexes). These are used to identify important positions within a track. There can be 98 sub-indexes in each track. However, because it is difficult and time-consuming to search for and locate to a sub-index, many CD players ignore this information.

Pause

A pause is added before each track. Pauses can be of variable lengths. Some CD players indicate the pauses between tracks on their displays.

Frames, Positions, Small Frames, and Bits

The data on an audio CD is divided into frames.

A frame consists of 588 stereo samples. 75 frames make up one second of audio. This is because $75 \times 588 = 44100$, and because the sampling frequency of the CD format is 44100 Hz (samples per second), this equals one second of audio. When you specify positions on the CD, in WaveLab Pro, you do it in the format mm:ss:ff (minutes:seconds:frames). The frame values go from 0 to 74, because there are 75 frames to a second.

Technically, there is no way to specify something smaller than a frame on a CD. One effect of this is that if the sample length of a track on the CD does not equal a perfect number of frames, some blank audio must be added at the end. Another effect of this is that when you play the CD, you can never locate to anything closer than a frame. If you need some data in the middle of a frame, you still have to read the whole frame. Again, this is unlike a hard disk, where you can retrieve any byte on the disk, without reading the surrounding data.

But frames are not the smallest block of data on a CD. There is also something called “small frames”. A small frame is a container of 588 bits. 98 small frames together make up one regular frame. In each small frame there is only room for six stereo samples, which means that a lot of space is left for data other than the actual audio. There is information for encoding, laser synchronization, error correction, and the PQ data to identify the track boundaries. This PQ data is of major importance to anyone who wants to create their own CD, and handled effortlessly in WaveLab Pro.

PQ Codes Handling

The PQ codes convey information about track start, sub-indexes, and pauses.

However, when creating a CD there are a number of rules you must take into account. For example, there should be some silent frames before each track, sub-indexes should be slightly early, there should be pauses at the beginning and end of the entire CD, etc.

When creating CDs from an audio montage, these rules and settings are handled by the **CD Wizard**. If you do not change these settings, you will get default values that ensure your CD will work properly. However, you can still adjust the PQ codes to your liking. We recommend to leave the settings as they are.

WaveLab Pro only exposes intuitive CD markers and automatically generates the corresponding PQ codes to be written to CD.

ISRC Codes

International Standard Recording Code (ISRC) is an identification that is only used on CDs intended for commercial distribution. WaveLab Pro allows you to specify an ISRC code for each audio track. These codes are provided by your publisher or clients.

The ISRC code is structured as follows:

- Country Code (2 ASCII characters)
- Owner Code (3 ASCII characters or digits)
- Recording Year (2 digits or ASCII characters)
- Serial Number (5 digits or ASCII characters)

The groups of characters are often presented with hyphens to make them easier to read, but hyphens are not part of the code.

Importing ISRC Codes

You can import ISRC codes that has been written in a standard text file. The ISRC text file must have one ISRC code per line.

- To import ISRC codes, select **Functions > Import ISRC Codes from Text File** in the **CD** window, select the text file that you want to import, and click **Open**.

UPC/EAN Codes

UPC/EAN code – the Universal Product Code/European Article Number, is a catalog number for an item (such as a CD) intended for commercial distribution. On a CD, the code is also called the Media Catalog Number and there is one such code per disc. These codes are provided by your publisher or clients.

UPC is a 12-digit barcode widely used in the USA and Canada. EAN-13 is a 13-digit barcoding standard (12 + a checksum digit) defined by the GS1 standards organization. EAN is now renamed as International Article Number, but the abbreviation has been retained.

Pre-Emphasis

CD pre-emphasis refers to process designed to increase, within a band of frequencies, the magnitude of some (usually higher) frequencies compared to the magnitude of other (usually lower) frequencies in order to improve the overall signal-to-noise ratio by lowering the frequencies during reproduction.

Pre-emphasis is commonly used in telecommunications, digital audio recording, record cutting and in FM broadcasting transmissions. The presence of pre-emphasis on a track is sometimes

indicated by a checkmark in the **Pre-Emphasis**  column on the **Import Audio CD** dialog.

Disc-At-Once – Writing CD-Rs for Duplication Into Real CDs

WaveLab Pro only writes audio CDs in Disc-at-Once mode.

- If you want to create a CD-R to use as a master for a real CD production, you must write the CD-R in Disc-At-Once mode. In this mode, the entire disc is written in one pass. There are other ways of writing a CD, namely Track-At-Once and Multi-Session. If you use these writing formats, the link blocks created to link the various recording passes together will be recognized as uncorrectable errors when you try to master from the CD-R. These links can also result in clicks when playing back the CD.
- Disc-At-Once mode provides more flexibility when specifying pause lengths between tracks.

- Disc-At-Once is the only mode that supports sub-indexes.

Writing On The Fly vs. CD Images

WaveLab Pro writes a CD on the fly, that is, it does not create a CD image before writing. This method makes writing CDs/DVDs faster and requires less disc space. However, you can also create an image prior to writing a CD/DVD.

Spectral Editing

Spectral editing allows you to edit and process individual frequency ranges instead of the full frequency spectrum.

Spectral editing is intended for audio restoration of short time ranges. You can also process an individual frequency range via the **Master Section**. Spectral editing operates on a spectrum region, which is defined using one of the spectrum selection tools. The selected region is defined by a time and a frequency range. This allows you to edit and process audio both in the time domain and in the frequency domain of the selected region.

Spectral editing can consist of many different types of processing. Although it is developed for audio restoration, it can also be used for artistic purposes or special effects.

You can perform spectral editing on the left and right channels or on the mid and side channels of a stereo file.

Spectral editing comprises the following steps:

- Defining the region that you want to edit.
- Editing the region with the **Spectrum** tab by applying filter operations, by copying regions, or by sending it to the **Master Section** to apply effects.

Spectrogram

The **Spectrogram** in the wave window shows the frequency spectrum in relation to time.

- To see the spectrum view of the audio file in the **Audio Editor**, click **Spectrum** below the **Waveform** display.
- To see the spectrum view of the audio file and activate spectral editing mode, select the **Spectrum** tab in the **Audio Editor**.
- To switch between the spectrum view for the left/right channels and the mid/side channels, click the **LR/MS** button at the bottom left of the spectrogram.

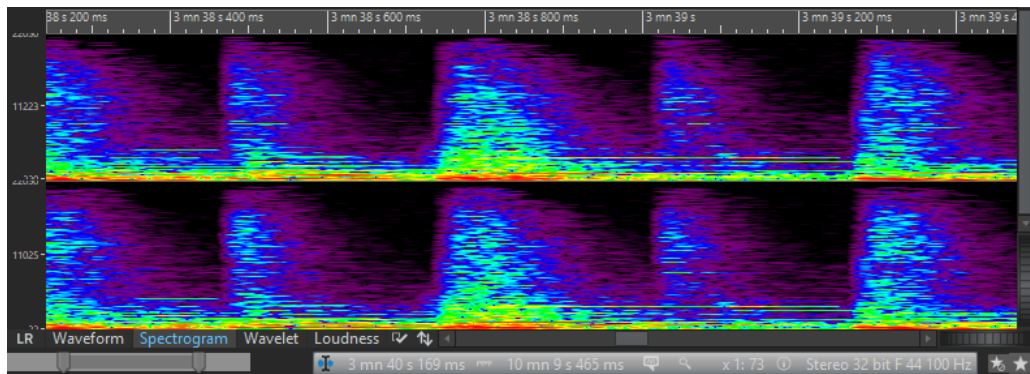

Each vertical line represents the frequency spectrum at a particular time position.

- You can make time selections and frequency selections in the **Spectrogram**.

If you make frequency selections in the **Spectrogram**, you can use the WaveLab Pro spectrum editing tools on the **Spectrum** tab to edit the spectrogram. If you point the mouse cursor at a defined frequency selection, a tooltip displays the frequency range and the time range for the current selection.

You can also use the WaveLab Pro editing tools on the **Edit** tab to edit the spectrogram.

- Low frequencies are shown at the bottom of the display and high frequencies at the top.
- In the **Spectrogram Options** dialog, you can define how the frequency spectrum is displayed.
- The vertical ruler on the left shows the frequency range in Hz.
- The status bar shows the time/frequency position of the mouse cursor.
- If you are in spectrum editing mode, you can right-click in the spectrogram to open a context menu with additional options.

Wavelet Display

The **Wavelet** display shows a higher time resolution in high frequencies and a higher frequency resolution in lower frequencies.

- To see the **Wavelet** display of the audio file in the **Audio Editor**, click **Wavelet** below the **Waveform** display.
- To switch between the **Wavelet** display for the left/right channels and the mid/side channels, click the **LR/MS** button at the bottom left of the **Wavelet** display.

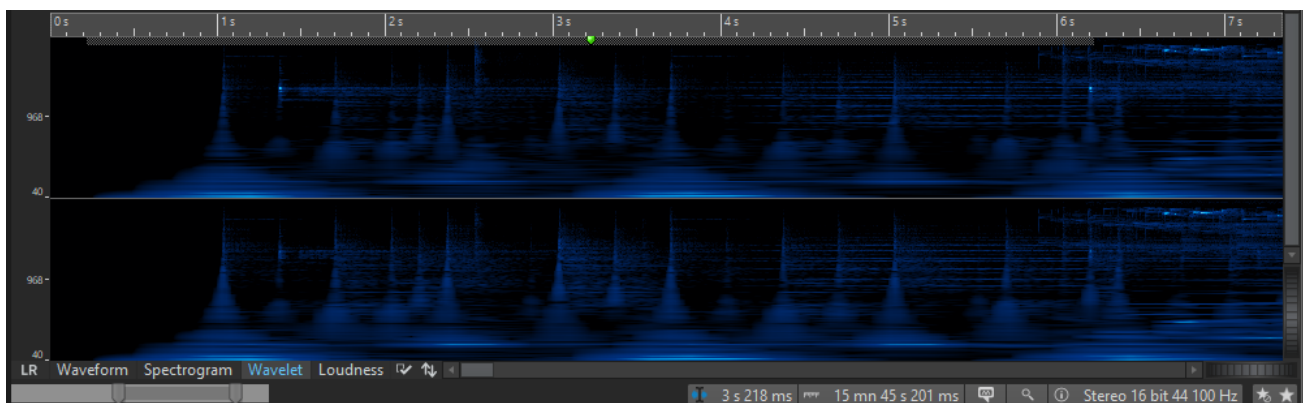

Each vertical line represents the frequency spectrum at a particular time position.

- You can make time selections and frequency selections in the **Wavelet** display.
If you make frequency selections in the **Wavelet** display, you can use the WaveLab Pro spectrum editing tools on the **Spectrum** tab to edit the wavelet. If you point the mouse cursor at a defined frequency selection, a tooltip displays the frequency range and the time range for the current selection.
You can also use the WaveLab Pro editing tools on the **Edit** tab to edit the wavelet.
- Low frequencies are shown at the bottom of the display and high frequencies at the top.
- In the **Spectrogram Options** dialog, you can define how the frequency spectrum is displayed. It can be represented in color or in black and white.
- The vertical ruler on the left shows the frequency range in Hz.
- The status bar shows the time/frequency position of the mouse cursor.
- If you are in spectrum editing mode, you can right-click in the **Wavelet** display to open a context menu with additional options.

NOTE

In the **Wavelet** display, you cannot zoom in and out as far as in the **Spectrogram** due to performance constraints.

RELATED LINKS

[Spectrogram Options Dialog](#) on page 442

Spectrogram Options Dialog

The **Spectrogram Options** dialog allows you to define how the frequency spectrum is displayed in the **Spectrogram** and in the **Wavelet** display.

- To open the **Spectrogram Options** dialog, click **Spectrogram Options**.

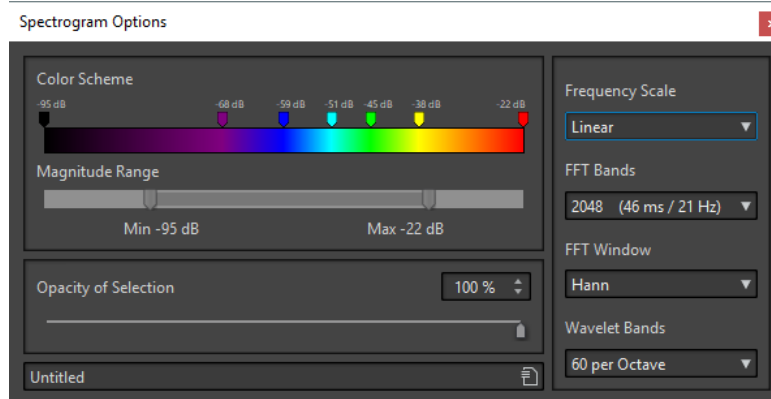

The following options are available:

Color Scheme

Allows you to customize the color scheme for the frequency levels in the **Spectrogram** and the **Wavelet** display.

- To change the color scheme for different frequency levels, move the color markers with the mouse.
- To change the color of a marker, right-click it and select a new color.
- To create a new color marker, double-click on the color bar.

Magnitude Range

Allows you to specify the spectral amplitude range that you want to display in the **Spectrogram** and the **Wavelet** display.

Opacity of Selection

Allows you to specify the opacity of the selection in the **Spectrogram** or the **Wavelet** display.

Frequency Scale

Allows you to select the scale on which the frequency spectrum is displayed in the **Spectrogram**. If **Log** is activated, the frequency spectrum is displayed on a logarithmic scale, thus spacing the octaves equally. This comes closest to the perception of pitch of the human ear. **Mel**, **Bark**, and **ERB** are psycho-acoustic scales.

FFT Bands

Allows you to adjust the trade-off between temporal resolution and frequency resolution in the **Spectrogram**. If you specify a higher value, more frequencies are analyzed but they are located less accurately in the time domain.

FFT Window

Allows you to select the shape that most effectively reduces the artifacts of the audio analysis.

Wavelet Bands

Allows you to set the number of bands per octave for the **Wavelet** display.

Presets

Allows you to save and restore presets for spectrum process settings.

Spectrum Tab

The **Spectrum** tab allows you to use high-quality linear-phase filters to process a spectrum range selection for audio restoration and processing.

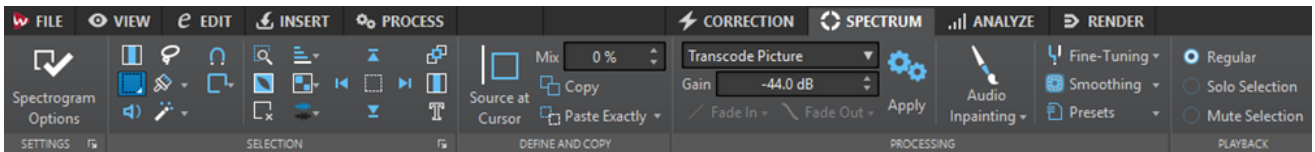

Settings

The **Settings** section allows you to customize the **Spectrogram** and the **Wavelet** display.

Display Options

Allows you to define how the frequency spectrum is displayed.

Spectrum Settings

Allows you to make settings for the **Spectrogram** and the **Wavelet** display.

To open the **Spectrum Settings** dialog, click the arrow icon in the lower right of the **Settings** section.

- If **Show Information about Selections** is activated and you hover over a spectrum selection, a tooltip in the **Spectrogram** and the **Wavelet** display shows you information about the selection.
- If **Show Magnitude Range Slider below Spectrogram and Wavelet Display** is activated, a slider below the **Spectrogram** and the **Wavelet** display allows you to specify the minimum and maximum spectrum values that are displayed. The minimum and maximum values represent frequency amplitudes. The left color of the color scheme determines the color of the amplitudes that are equal to or below the minimum value. The right color of the color scheme determines the color of the amplitudes that are equal to or above the maximum value.

Selection

The **Selection** section allows you to select the spectrum that you want to process. You can undo/redo all selection operations.

Time Selection

This tool allows you to select a time range. This deactivates the spectrum editing functions.

Rectangle Selection

This tool allows you to select a frequency range with fixed bottom and top frequencies.

Play

This tool allows you to play back the audio file at the position where you click.

Lasso Selection

This tool allows you to draw a free shape to make a spectrum selection.

Brush Selection

This tool allows you to paint a spectrum selection with a round brush. You can change the size of the brush.

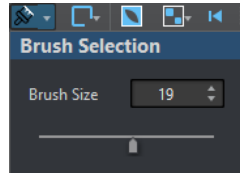

Magic Wand

This tool allows you to click on the spectrogram and automatically select the surrounding spectral content that has a similar dB magnitude, according to the **Time Expansion** and **Frequency Expansion** values.



Snap Mode

If this option is activated, the mouse cursor snaps to the spectral hot points when creating a selection with the **Lasso Selection** or the **Rectangle Selection**.

Selection Modes

The selection options allow you to add and remove spectrum selections.

- **New Selection** allows you to create a new selection in the spectrum while removing the old selection.
- **Add Selection** allows you to add another selection to the spectrum while also keeping the old selections. You can also press **Shift** and click with the mouse to add a selection.
- **Remove From Selection** allows you to remove parts of existing selections. You can also press **Ctrl/Cmd-Shift** and click with the mouse to remove parts of an existing selection.

You can click on a selection and move it. To only allow horizontal movement, **Shift**-click the selection and move the mouse. To only allow vertical movement, press **Alt-Shift**, click the selection, and move the mouse.

Zoom Selection

Zooms in on the selected region on both the time and frequency domain.

Invert Selection

Inverts the frequency selection inside the selected time range.

Deselect All Regions

Deselects all frequency selections.

Harmonics

Allows you to add harmonics to the spectrum selection while keeping the shape of the selection. By default, no harmonics are added.

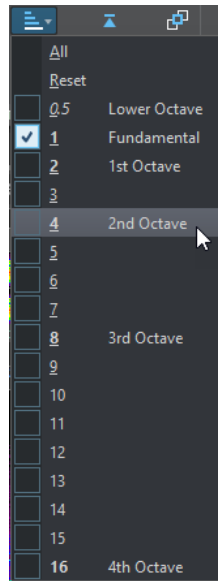

Edit Settings

Allows you to make settings for the **Spectrum** and the **Wavelet** display.

- If **Group Editing** is activated and more than one region is selected, you can move and resize all selected regions simultaneously. You can also double-click a region to activate or deactivate group editing for this selection.
To remove a region from a group, right-click a region and select **Deselect This Region**.
To deselect all selected regions, double-click in the **Spectrogram** or the **Wavelet** display or press **Esc**.
When **Group Editing** is deactivated, you can individually group regions. Press **Shift** and click the regions that you want to group. You can then move or resize regions without changing other regions.
- If **Show Resizing Frame** is activated, a frame encompasses the selected regions. This allows you to resize the selected regions.

Channel Selection

Allows you to select if the spectrum selection should be on either the left channel, the right channel, or both channels.

NOTE

If there is no spectrum selection, you can also press **Shift** and use one of the spectrum selection tools to make a selection on either the left or the right channel. If there is a spectrum selection, you can press **Shift** to add another selection.

Select until Start of File/Select until End of File

Extends the selection to the start/end of the audio file.

Select until Top/Select until Bottom

Extends the selection to the top/bottom of the frequency axis.

Share Selection

If this option is activated, you can share a selection among audio files of the same file group. This allows you to use the same selection in all audio files of a stem, for example. The selection must fit in the other audio file.

To share a selection in another audio file of the same file group, activate **Share Selection**, make a selection, and select another audio file tab.

NOTE

You have to apply the processing to each audio file individually.

Crop

Removes all audio outside of the selection.

Text Selection

Use the **Rectangle Selection** tool to select a rectangle that you want to replace with a selection that outlines text. This allows you to create a watermark in your spectrum to protect your audio, for example.

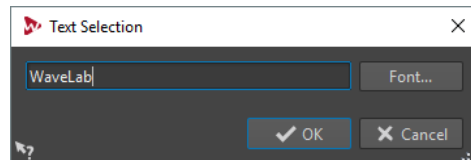

Range Selection

Opens the **Range Selection** dialog. This dialog allows you to define selection ranges and frequency ranges very accurately.

Define and Copy

Source at Cursor

Duplicates the selection rectangle at the current cursor position and defines it as source region for copy operations. This ensures that the selection to copy and the selected region that you want to edit have the same size. This allows you to quickly find the best source region to replace the destination region.

Mix

Allows you to mix the source frequency with the target frequency. 100 % means all of the source region is copied to the target region.

Copy

Copies the selected audio spectrum to the clipboard. If you close the audio file from which you copied the audio spectrum, the clipboard content is deleted. If you modify the audio spectrum in the source audio file, the clipboard is updated accordingly.

Paste Exactly

If **Source at Cursor** is activated, **Paste Exactly** pastes the defined source region exactly.

If **Source at Cursor** is deactivated, **Paste Exactly** pastes the clipboard content.

Paste Ambience

Pastes an average of the frequencies of the source region, blurring the original dynamics and pitches, and making the copied region appear less identifiable. Depending on the audio material, this may avoid a repetition effect.

Processing

Processing Algorithm

The **Processing Algorithm** menu allows you to select the type of processing algorithm that is applied to the selected audio spectrum. The following options are available:

- **Change Level** attenuates or boosts the level of the selected region according to the set gain.
- **Blur Peaks** attenuates or boosts the level of the frequencies with the highest level in the selection according to the set gain. If the gain is set to a negative value, these frequencies are blurred. This is useful for removing acoustic feedback, for example.
- **Dispersion** blurs the dynamics and frequency phases of the selected region according to the set gain without changing the frequency content.
- **Master Section** allows you to render Master Section plug-ins to the selection.
- **Fade Out** gradually filters out the frequencies in the region along the time axis, creating a fade out. The **Fade Out Shape** option in the **Processing** section allows you to select a fade out shape.

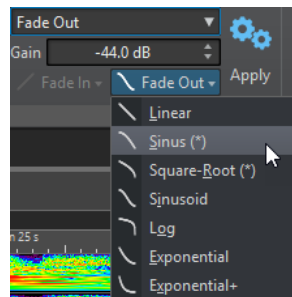

- **Fade In** gradually lets pass frequencies in the region along the time axis, creating a fade in. The **Fade In Shape** option in the **Processing** section allows you to select a fade in shape.
- **Fade Out then Fade In** lets the frequencies fade out and fade in again. The **Fade In Shape** and **Fade Out Shape** options in the **Processing** section allow you to select the shapes of the fades.
- **Fade In then Fade Out** lets the frequencies fade in and fade out again. The **Fade In Shape** and **Fade Out Shape** options in the **Processing** section allow you to select the shapes of the fades.
- The **Noise Mixing** options allow you to mix in different types of noise to the spectrum selection according to the set gain.
- **Transcode Picture** allows you to insert a picture into your spectrogram to add a watermark, for example.

NOTE

It is recommended to display the spectrum with a linear scale, because the picture scaling is frequency-linear based. You can activate the linear frequency scale in the **Spectrogram Options** dialog.

Gain

Determines the level of the filter processing. Negative gain settings attenuate the effect, positive gain settings boost the effect.

Fade In

Allows you to select a fade in shape for the fade processing algorithms.

Fade Out

Allows you to select a fade out shape for the fade processing algorithms.

Apply

Applies the selected processing algorithm.

Audio Inpainting

The **Audio Inpainting** algorithm allows you to remove or attenuate sounds in the spectrum. Audio inpainting restores a spectrum selection based on the content to the left and to the right of the selection rectangle.

The following options are available:

- If **Show Surrounding Region** is activated, you can customize the length of the surrounding region that the **Audio Inpainting** function takes into account. You can resize the surrounding region with the mouse cursor. Only the active region is customized.
- **Bands** allows you to define the number of frequency bands that the algorithm works on. If you work on rhythmic content or modify high frequencies, use low values. If you work on harmonic content or modify low frequencies, use high values.
- **Precision** allows you to specify the precision of the audio inpainting. Low precision results in a more blurry spectrum. High precision results in a more detailed spectrum. Higher precision settings increase the processing time.
- **Persistence of Original** allows you to specify how much of the original spectrum is kept when audio inpainting is applied to the content inside the selection rectangle. To ignore the content inside the selection rectangle, set the value to 0%. To attenuate the original spectrum inside the selection rectangle, set the value to 100%.

Fine-Tuning

Allows you to control the quality of the audio processing.

- **Window** allows you to select the smoothing shape that reduces the artifacts of the audio processing most effectively.
- **Bands** allows you to define the number of frequency bands that the algorithm will work on. If you work on rhythmic content, use low values. If you work on harmonic content, use high values. Use low values if you modify high frequencies and bigger values if you modify low frequencies.
- If **Multiresolution** is activated, multiple band settings are used at the same time. This option increases the processing time.

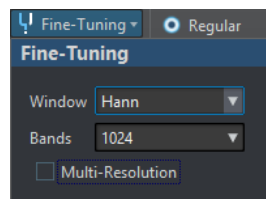

Smoothing

The **Smoothing** options allow you to create a crossfade between the processed and the unprocessed signal in the time and in the frequency domain.

The following options are available:

- **Time** allows you to set the duration of the crossfade between the processed and the unprocessed signal in the time domain.
- **Frequencies** allows you to create a crossfade in the frequency domain between the processed and the unprocessed section. If the value is high, the

selected region contains much of the unprocessed signal near the frequency edges.

- If **Outside** is activated, the smoothing effect is applied to the area outside of the selection.
- If **Inside** is activated, the smoothing effect is applied to the area inside of the selection.

Presets

Allows you to save and restore spectrum processing presets.

Playback

Regular

If this option is activated, all frequencies play back without any kind of filtering when you press **Play**.

Solo Selection

If this option is activated, only the selected spectrum is played back when you press **Play**.

Mute Selection

If this option is activated, the selected spectrum is muted when you press **Play**.

RELATED LINKS

[Range Selection Dialog](#) on page 26

[Spectrum Watermark](#) on page 454

[Spectrogram Options Dialog](#) on page 442

Spectrum Processing

Spectrum processing can be used to process short regions of up to 60 seconds offline. This type of processing can be used to reduce, remove, or replace unwanted sound artifacts in the audio material with great precision.

NOTE

To apply spectrum processing to regions over 60 seconds, use the **Rectangle Selection** tool and activate **Master Section** in the **Processing Algorithm** menu.

For example, you can replace a part of a live recording that contains an unwanted noise such as a mobile phone ring tone, with a copy of a similar region of the spectrum that contains a clean signal.

NOTE

In general, the spectral copy/paste combination gives the best results if the source and destination regions are properly chosen.

First, you have to define a time/frequency region. Once a region has been set, you can use the spectrum processing functions. Filtering operations allow you to filter the selected region in various ways. Copy operations allow you to copy the spectrum region and apply it to another region.

Defining a Region for Spectral Editing

All spectral editing functions are applied to a selected region, or from a selection region if **Master Section** processing is used. A region that is set in the **Spectrogram** or the **Wavelet** display contains a time range and a frequency range.

PREREQUISITE

Zoom in on the time range where you want to perform spectral editing.

PROCEDURE

1. In the **Audio Editor**, select the **Spectrum** tab.
2. In the **Selection** section, select one of the spectrum selection tools.
3. In the **Spectrogram** or **Wavelet** display, drag the selection around the region that you want to edit.

When defining a region in a stereo file, a corresponding region is automatically created in the other channel.

To define a region only on the right or the left channel, **Shift**-click while dragging with the spectrum selection tool.

The selection range is also displayed in the overview display. This allows you to see both the time domain and the frequency domain of the selection range. You can also resize the time range for the frequency selection by adjusting the selection edges on the waveform display.

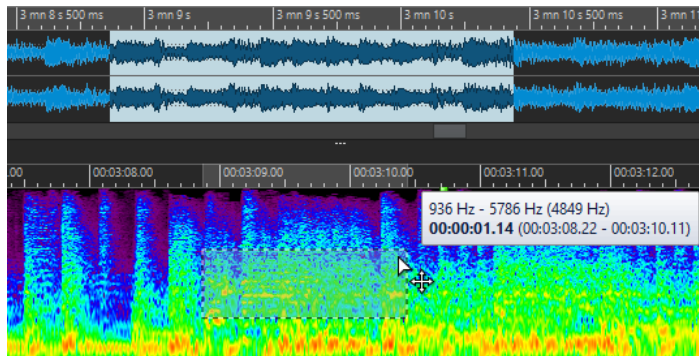

4. Optional: Click and drag the defined region to move it.
 5. Optional: Move the cursor over a region edge, and click and drag to resize the defined region.
-

AFTER COMPLETING THIS TASK

Process the selected region in the **Spectrum** tab.

Filtering Individual Frequencies

Filtering individual frequencies is useful for audio restoration purposes.

PROCEDURE

1. In the **Spectrum** tab, select one of the spectrum selection tools in the **Selection** section.
2. In the **Spectrogram** or **Wavelet** display, make a spectrum selection.

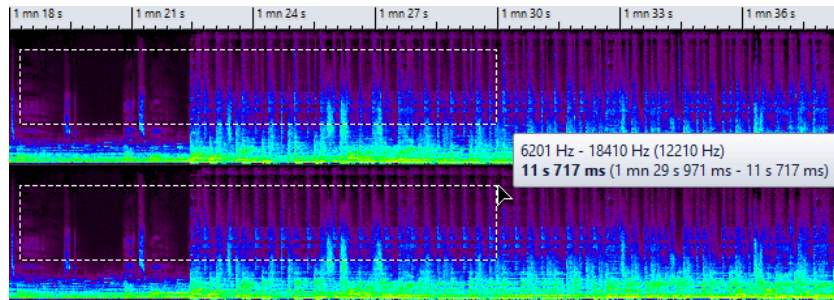

3. In the **Processing** section, select a processing type.
 4. In the **Filter Settings** section, make the filter settings that you want to use.
 5. Click **Apply**.
-

Spectral Editing by Copying Regions

Spectral editing by copying regions is useful for removing unwanted sounds in the audio material.

PROCEDURE

1. In the **Audio Editor**, select the **Spectrum** tab.
 2. In the **Selection** section, select one of the selection tools.
 3. In the **Spectrogram** or **Wavelet** display, define a source region.
 4. In the **Define and Copy** section, click **Copy**.
To copy the source region to another audio file, use **Ctrl/Cmd-C**.
 5. Place the playback cursor at the position that you want to define as the target region.
 6. In the **Define and Copy** section, use the **Mix** option to specify how much of the source region you want to copy to the target region.
 7. Right-click the **Paste Exactly/Paste Ambience** pop-up menu and select the paste method that you want to apply. The following options are available:
 - To copy the defined source region to the target region, select **Paste Exactly**.
 - To copy an average of the frequencies of the source region, blurring the original dynamics and pitches, and making the copied region appear less identifiable, select **Paste Ambience**.
The paste method that you select via the menu will be saved as default.To paste the source region to another audio file, you can also use **Ctrl/Cmd-V**.
The audio is pasted and, if **Smoothing** is activated, crossfaded both in the time domain and in the frequency domain.
 8. Play back the audio file to hear the result.
-

Copying Spectral Regions by First Defining a Target Region

Spectral editing by copying regions is useful for removing unwanted sounds in the audio material. You first define a target region and a source region. Then you copy the audio from the source region to the target region while using the same frequency range and duration.

PROCEDURE

1. In the **Audio Editor**, select the **Spectrum** tab.
2. In the **Selection** section, select one of the selection tools.

3. In the **Spectrogram** or **Wavelet** display, define a target region.
4. In the **Define and Copy** section, click **Source at Cursor**.
5. Place the playback cursor at the position that you want to define as the source region.

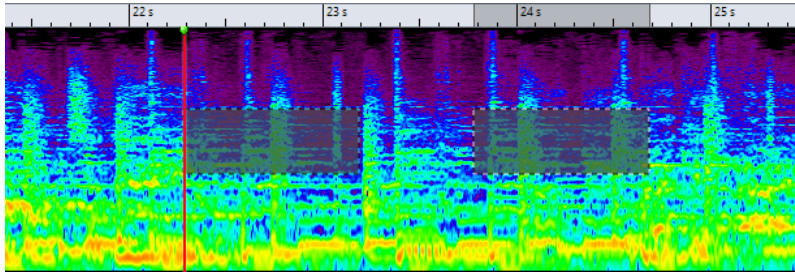

For example, the left rectangle defines the source region at the edit cursor position and the right rectangle defines the target region.

When you have defined a source region on a single channel of a stereo file, you can click in the upper part of the left channel or the lower part of the right channel to define the source region on the other channel. The source region must be in the same audio file.

6. In the **Define and Copy** section, use the **Mix** option to specify how much of the source region you want to copy to the target region.
7. Right-click the **Paste Exactly/Paste Ambience** pop-up menu and select the paste method that you want to apply. The following options are available:

- To copy the defined source region to the target region, select **Paste Exactly**.
- To copy an average of the frequencies of the source region, blurring the original dynamics and pitches, and making the copied region appear less identifiable, select **Paste Ambience**.

The paste method that you select via the menu will be saved as default.

The audio is copied and, if **Smoothing** is activated, crossfaded both in the time domain and in the frequency domain.

8. Play back the audio file to hear the result.
If **Source at Cursor** is activated, press **F6** to play back the source. If **Source at Cursor** is deactivated, **F6** plays back the selection.

Rules and Tips for Spectral Editing by Copy Operations

The **Source at Cursor** function is recommended for copy operations in the **Spectrogram** and **Wavelet** display that are intended for audio restoration purposes. You first define a source region and a destination region, and then you copy audio from the source region to the destination region.

- Setting the source region just before or after the sound to remove can produce very accurate results, as this region probably contains a similar frequency spectrum as the target region containing the artifact.
- In the low to low-mid frequency range, the masking or removal of unwanted artifacts is difficult to achieve without audible interruptions. Finding a limited frequency area is important to not interrupt the flow of the audio when removing artifacts.

RELATED LINKS

[Copying Spectral Regions by First Defining a Target Region](#) on page 451

Copying Spectral Selections to a New Window

PROCEDURE

1. In the **Spectrogram** or **Wavelet** display, make a spectrum selection.
 2. Right-click the selection and select **Copy Selection to New Window**.
-

RESULT

The spectral selection opens in a new window.

Creating New Audio Files from Spectral Selections

You can render a spectrum selection to a new audio file that only contains the selected frequencies.

PROCEDURE

1. In the **Spectrogram** or **Wavelet** display, make a spectrum selection.
 2. In the **Selection** section of the **Spectrum** tab, click **Invert Selection**.
 3. In the **Processing** section, open the **Processing Algorithm** pop-up menu and select **Master Section**.
 4. In the **Master Section**, drag the **Master Level** faders to the bottom.
This reduces unwanted frequencies.
 5. Select the **Render** tab.
 6. In the **Source** section, open the pop-up menu and select **Selected Audio Range**.
 7. In the **Result** section, select **Unnamed File** or **Named File**.
 8. In the **Render** section, click **Start**.
-

RESULT

The rendered audio file opens in a new tab.

Audio Inpainting

The **Audio Inpainting** algorithm allows you to remove or attenuate sounds in the spectrum. Audio inpainting restores a spectrum selection based on the content of the surrounding region.

Applying Audio Inpainting

PROCEDURE

1. In the **Audio Editor**, select the **Spectrum** tab.
2. In the **Selection** section, select one of the spectrum selection tools.
3. Click in the **Spectrogram** or in the **Wavelet** display and make a spectrum selection around the region that you want to correct.
4. Optional: If **Show Surrounding Region** is activated, you can resize the surrounding region with the mouse cursor.
The surrounding area of the spectrum selection determines the spectrum that audio inpainting uses as a source to correct the spectrum selection.

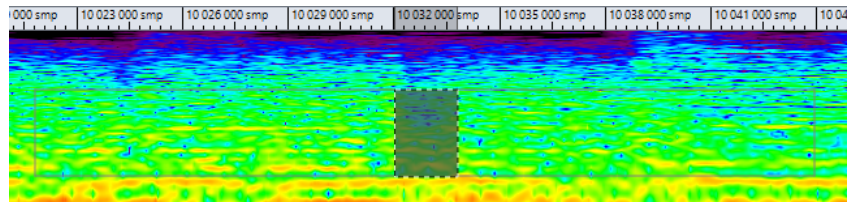

5. In the **Processing** section, right-click **Audio Inpainting** and make additional settings.
 6. Click **Audio Inpainting**.
-

Spectrum Watermark

You can transcode text and pictures in the spectrum and thereby define a watermark. Other spectrogram applications are able to display the watermarks. The watermarks are compatible with lossy encodings.



You can create a watermark file and use the **Audio Mixer** batch plug-in or the **Audio Injector** batch plug-in to apply a watermark to multiple files.

Transcoding a Text in the Spectrogram

You can transcode text in the spectrogram and thereby define a watermark. The transcoding is audible in the audio file.

PROCEDURE

1. In the **Audio Editor**, select the **Spectrum** tab.
2. In the **Selection** section, select the **Rectangle Selection** tool.
3. In the **Spectrogram** or in the **Wavelet** display, define the region in which you want to apply the text.

NOTE

It is recommended to display the spectrum with a linear scale, because the text scaling is frequency-linear based. You can activate the linear frequency scale in the **Spectrogram Options** dialog.

4. In the **Selection** section, click **Text Selection**.
5. In the **Text Selection** dialog, enter the text and click **OK**.
You can resize and move the text frame.

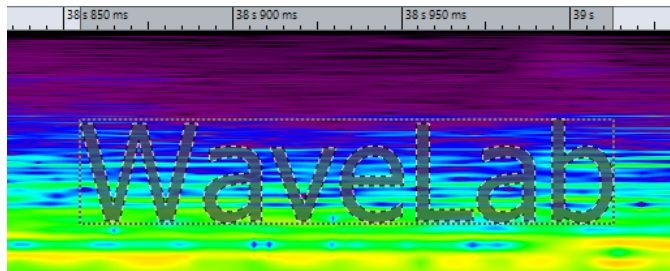

6. In the **Processing** section, open the **Processing Algorithm** menu and select **Change Level** or one of the **Noise Mixing** options.
7. Specify the **Gain** level.
For example, if you place the text in the high frequencies and set the **Gain** to -120 dB, the text is visible in the spectrum but not audible.
8. Click **Apply**.

RESULT

The text is written into the spectrogram.

RELATED LINKS

[Spectrum Tab](#) on page 443

[Spectrogram Options Dialog](#) on page 442

Transcoding a Picture in the Spectrogram

You can transcode pictures in the spectrogram and thereby define a watermark. The transcoding is audible in the audio file.

PROCEDURE

1. In the **Audio Editor**, select the **Spectrum** tab.
2. In the **Selection** section, select the **Rectangle Selection** tool.
3. In the **Spectrogram** or in the **Wavelet** display, define the region in which you want to apply the picture.

NOTE

It is recommended to display the spectrum with a linear scale, because the text scaling is frequency-linear based. You can activate the linear frequency scale in the **Spectrogram Options** dialog.

4. Specify the **Gain** level.
5. In the **Processing** section, open the **Processing Algorithm** menu and select **Transcode Picture**.
6. In the file browser, select the picture that you want to transcode and click **Open**.

RESULT

The picture is written into the spectrogram.

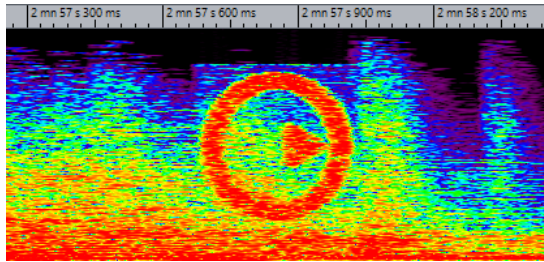

RELATED LINKS

[Spectrum Tab](#) on page 443

Master Section Processing

Master Section mode allows you to process an individual frequency range via the **Master Section**.

The selected or non-selected regions of the spectrum can be processed differently. You can also use a number of filters (bandpass/low-pass/high-pass) to further refine the range of frequencies to be affected by any **Master Section** effects.

The signal is split so that one part (selected spectrum or non-selected spectrum) is sent to the plug-ins, while the other part can be mixed with this processed signal, after the **Master Section** output.

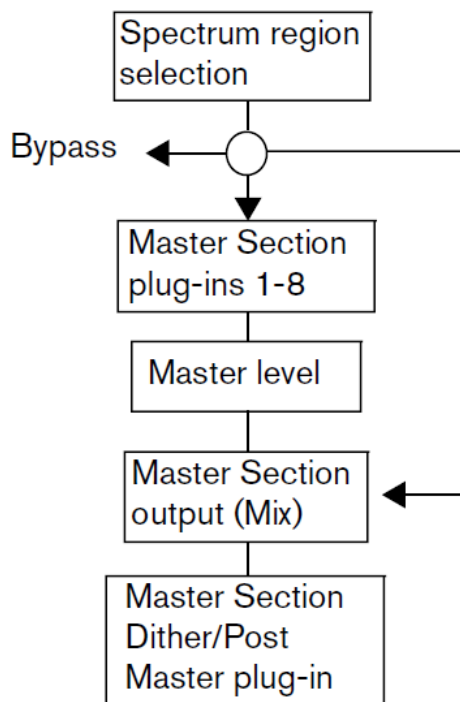

The arrows show the three possible routing options for the spectrum region selection. The non-selected spectrum has the same options, although it cannot use the same routing destination as the region selection.

The spectrum selection goes through the **Master Section** and the non-selected part goes to the output mix.

Applying Master Section Processing

PROCEDURE

1. In the **Audio Editor**, select the **Spectrum** tab.
 2. In the **Selection** section, select a selection tool.
 3. In the **Spectrogram** or in the **Wavelet** display, define the region in which you want to apply the plug-in processing.
 4. In the **Processing** section, open the **Processing Algorithm** menu and select **Master Section**.
 5. Click **Apply** to apply the settings.
-

Auto Split

The auto split function allows you to automatically split audio files or clips in an audio montage according to specific rules.

Auto split can create new audio files or audio montage clips referencing the original files. The new audio files or clips can be automatically named and/or numbered.

Auto Split in Audio Files

You can use the auto split function, for example, to cut a recorded audio file into single takes, to cut a drum loop into its individual drum hit samples, to output individual tracks from an album master file, or to silence the regions between audio information in an instrumental take.

You can use auto split to split audio files at the following positions:

- Markers
- Regions containing silences
- Beats using beat detection
- Specific intervals
- Specific regions derived from a text file

Auto Split Dialog in the Audio Editor

In this dialog, you can set up auto split rules for audio files.

- To open the **Auto Split** dialog for an audio file, select **File > Tools**, and select **Auto Split**. You can also select the **Process** tab in the **Audio Editor**, and click **Auto Split**.

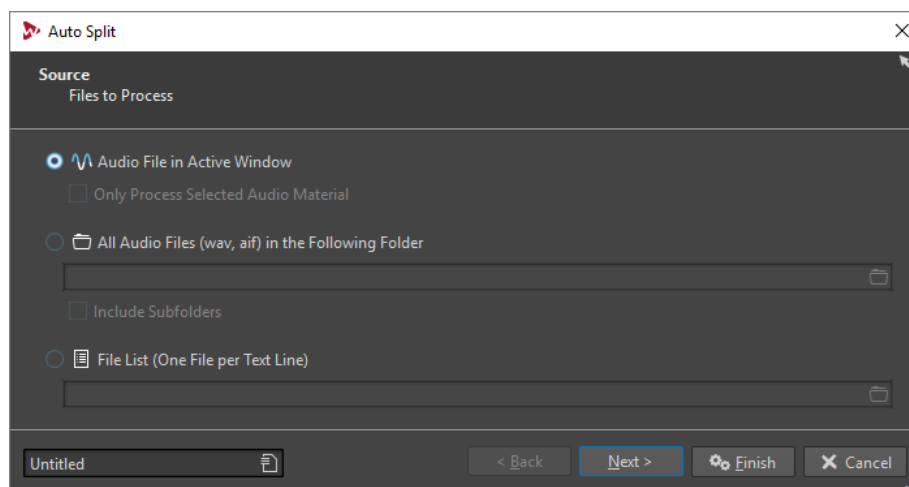

The **Auto Split** dialog contains a series of pages, with different parameters and options depending on the selected auto split method.

On the first page, you specify which files to process. You have the following options:

- The audio file in the active window.
- All audio files are in a specified folder.
- The audio files derived from a file list.

On the second page, you select the type of splitting that you want to perform. The following types are available:

Split According to Markers

Splits the files at specific marker positions. If you select this option, you can specify the marker type that will be used for the splitting on the next page.

Split at Specific Intervals

Splits the files at specific time intervals. If you select this option, you can specify the time interval, that is, the duration of each region, on the next page.

Split at Silences

Splits the files so that all non-silent sections become separate regions. If you select this option, you can specify the minimum region duration, the minimum duration of a silent section, and the signal level that should be considered as silence on the next page.

Split at Beats

Detects beats in the audio material and splits the files at each beat. If you select this option, you can specify the sensitivity of the beat detection, the minimum beat level to create a split point, and the minimum region duration on the next page.

Cut Head and Tail

Removes sections from the start and/or end of the files, silent sections, or specified sections.

Learn Regions from a Text File

Splits an audio file according to a description of regions that is saved in a text file.

Convert Stereo Files to Two Mono Files

Splits stereo files into two mono files.

The third page of the dialog varies according to the selected split method. The following pages of the dialog are common to all types of auto split, except that some options are grayed out in the dialogs if they are not applicable.

On the fourth page, you specify what to do with the regions that are created by auto split. You can save the regions as separate files or create clips and add these to a new or an existing audio montage. You can also create markers at the split points instead of splitting the files.

On the fifth page, you can insert silence at the start and/or end of the files, or automatically assign root key note numbers to the files.

On the last page, you specify how to name the files, clips, or markers that are created by auto split. Options include name as source file name plus a key name or number, or name as specified in a text file. To open a saved naming scheme file, click **Open**, select the text file that you want to open, and click **Open**.

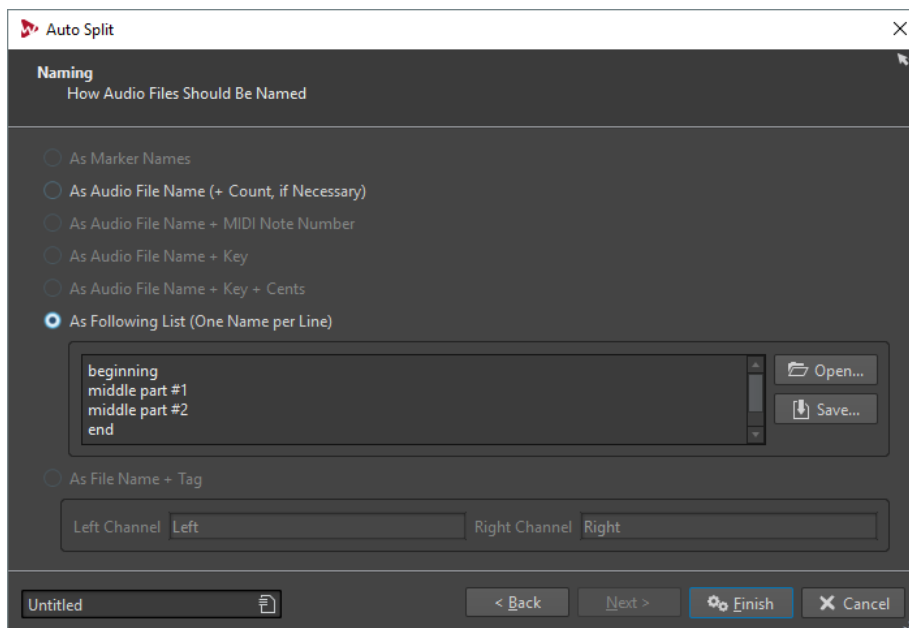

The **Finish** button is available from all pages. If you are sure about your settings, you can click **Finish** without having to go to all pages. For example, when you are using a preset and you know that you do not want to make changes on the last pages, you can click **Finish** earlier.

Learn Regions From Text File

You can split an audio file according to a description of regions that is saved in a text file.

Each region must be described by a name, a start position, and an end position (or region length). The text file must be placed in the same folder as the audio file, with the same name, and with the extension that you specify in the WaveLab Pro dialog (for example, "txt" or "xml").

You can use four tags to specify the regions.

- Region name
- Start
- End
- Length

These tags can be customized in the **Auto Split** dialog. The text file must specify either the **End** or the **Length** parameter.

Each parameter must be located on a separate text line.

The time values must be in samples or in timecode format.

- Hours:minutes:seconds:samples

You can use three text formats.

- "Tag"="Value": The tag comes first, then "=", then the value.
- "Tag" Tabulation "Value": The tag comes first, then a tabulation, then the value.
- XML style: The tag comes first, surrounded by < and >, then the value, then the tag surrounded by </ and >.

Text files must be in UTF-8 format.

Example for Using Auto Split for Audio Files

You can split a long recording into samples. This is useful if you are working with a sampler, for example, HALion.

PROCEDURE

1. Open an audio file in the **Audio Editor**.
2. Select the **Process** tab.
3. In the **Split** section, click **Auto Split**.
4. In the **Auto Split** dialog, select **Audio File in Active Window** and click **Next**.
5. Select **Split at Silences** and click **Next**.
6. Set up the page according to the audio file and click **Next**.
Adjust the first setting according to the length of the shortest recorded note, the second setting according to the shortest period of silence between two notes, and the third setting according to the level of the silence between the notes.
7. Select **Save as Separate Files**, specify the format and location for the new files, and click **Next**.
8. On the **Options** page, activate **Assign Key**, select **Detect Pitch**, and click **Next**.
This way, the correct key is assigned to each sample. If you activate **Quantize to Nearest Semitone**, WaveLab Pro sets the key according to the closest semitone. If not, the **Detune** setting in the sample may also be adjusted, according to any pitch deviations.
9. Select the naming option **As Audio File Name + Key** and click **Finish**.

RESULT

The file is split according to your settings, and new files are created in the specified location.

Auto Split in Audio Montages

You can use the auto split function to split the active clip. You can use the auto split function in many situations, for example, to cut a single clip of a recording into separate takes, to cut a drum loop into its individual drum hit samples, to output individual tracks from an album master file, or to silence the regions between audio information in an instrumental take.

During the analysis, only the audio files of the audio montage are taken into account. Envelopes and effects are ignored.

You can use auto split to split the active clip at the following positions:

- Markers
- Specific intervals
- Between silences
- Beats

Auto Split Dialog in the Audio Montage Window

In this dialog, you can set up auto split rules for audio montages.

- To open the **Auto Split** dialog for an audio montage, open the **Audio Montage** window, select the **Process** tab, and click **Auto Split**.

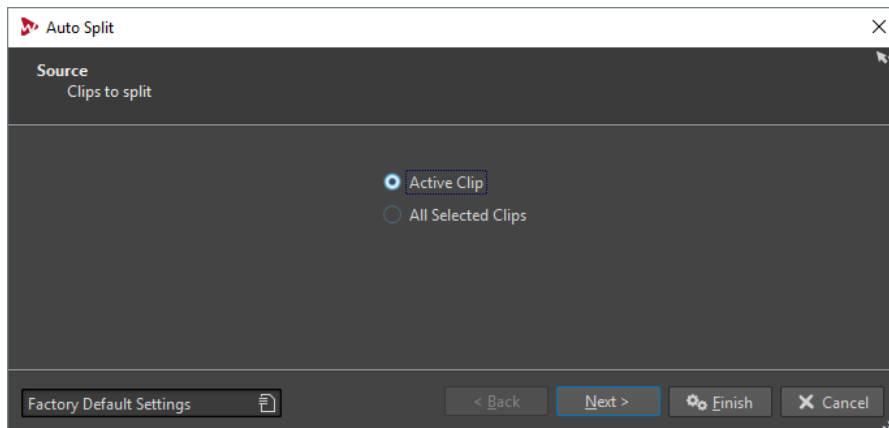

The **Auto Split** dialog contains a series of pages, with different parameters and options depending on the selected auto split method.

On the first page, you select the target for the auto split.

On the second page, you select the type of splitting. The following types are available:

Split According to Markers

Splits the files at specific marker positions. If you select this option, you can specify the marker type that will be used for the splitting on the next page.

Split at Specific Intervals

Splits the files at specific time intervals. If you select this option, you can specify the time interval, that is, the duration of each region, on the next page.

Split at Silences

Splits the files so that all non-silent sections become separate regions. If you select this option, you can specify the minimum region duration, the minimum duration of a silent section, and the signal level that should be considered as silence on the next page.

Split at Beats

Detects beats in the audio material and splits the files at each beat. If you select this option, you can specify the sensitivity of the beat detection, the minimum beat level to create a split point, and the minimum region duration on the next page.

Cut Head and Tail

Removes sections from the start and/or end of the files, silent section or specified sections.

The third page of the dialog varies according to the selected split method. The following pages of the dialog are common to all types of auto split, except that some options are grayed out if they are not applicable.

On the fourth page, you specify what to do with the regions that are created by auto split. You can split the regions or remove silent parts. You can also create markers at the split points instead of splitting the files.

On the last page, you specify how to name the clips that are created by auto split. Options include name as marker names, name as clip name, or name as specified in a text file. To save this text file, select **Save**, enter a name and location, and select **Save**. To open a saved naming scheme file, click **Open**, select the text file that you want to open, and click **Open**.

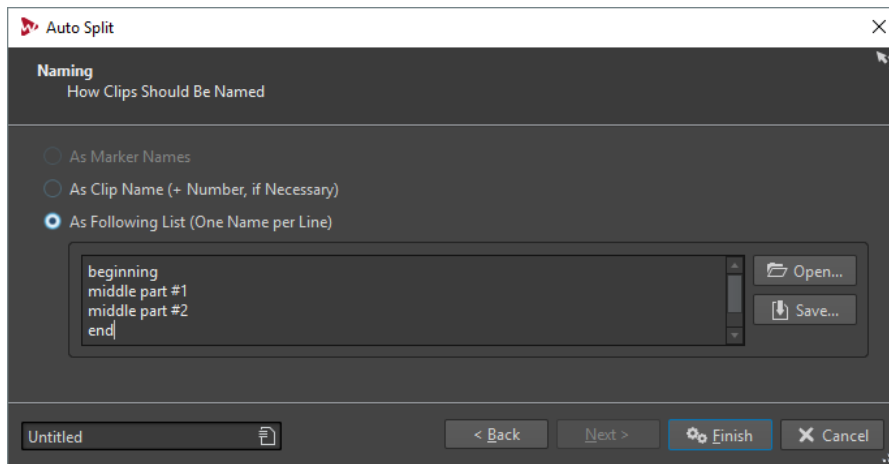

The **Finish** button is available from all pages. If you are sure about your settings, you can click **Finish** without having to go to all pages. For example, when you are using a preset and you know that you do not want to make changes on the last pages, you can click **Finish** earlier.

Loops

This chapter describes various operations that are related to looping. Looping is used to simulate the infinite or at least very long sustain of many instrumental sounds. WaveLab Pro has tools for creating smooth loops, even for the most complex types of sounds.

Basic Looping

Looping a sound allows you to repeat a section of the sample indefinitely in order to create a sustain of unlimited length. Instrumental sounds in samplers rely on looping organ sounds, for example.

In WaveLab Pro, loops are defined by loop markers. Loop markers are added, moved, and edited just as any other type of marker.

To ensure that you find a good loop point, note the following:

- A long loop usually sounds the most natural. However, if the sound does not have a stable section in the middle (an even sustain part), it might be hard to find a good long loop. For example, a piano note which decays continuously is hard to loop because the start point of the loop is louder than the end point. A flute is much simpler, because the sound in the sustain section is very stable.
- A loop should start shortly after the attack, that is, when the sound has stabilized to a sustaining note.
- If you set up a long loop, it should end as late as possible but before the sound starts decaying to silence.
- Short loops are difficult to position within the sound. Try to position them near the end.

NOTE

More information about looping in general, and the exact capabilities of your sampler in particular can be found in the manual of the sampler.

Creating a Basic Loop

PROCEDURE

1. In the **Audio Editor**, select the audio section that you want to loop.
2. Right-click above the ruler and select **Create Loop from Selection**.
3. On the transport bar, activate **Loop**.
4. Play back the loop and adjust the position of the markers to change the loop.

AFTER COMPLETING THIS TASK

Creating a loop this way does not necessarily lead to good loops, because clicks or abrupt changes in timbre at the turning point can occur.

We suggest that you use this method for setting up the basic length of the loop and then use the **Loop Tweaker** and **Loop Tone Uniformizer** for optimizing.

About Refining Loops

The **Loop Tweaker** tool allows you to refine a region of audio for seamless looping. Use the **Loop Tweaker** to tweak an existing loop selection so that it loops perfectly or use it to create a loop from material which is not perfectly suited to create a loop.

You can automatically detect loop points by scanning the area between two loop markers. You can specify parameters that determine how accurate the program should be when suggesting loop points.

If the automatic search for loop points is not successful, you can process the waveform to allow for smoother loops by crossfading areas of the waveform close to the loop start and end points.

To use the **Loop Tweaker**, you must first define a loop using a pair of loop markers.

Loop Points Adjustment Tab

Use the **Loop Points Adjustments** tab in the **Loop Tweaker** dialog to manually refine a loop selection by dragging the waveform to the left/right or by using the automatic search buttons to find the nearest suitable loop point. The aim is to align the waveforms so that they meet at a zero-crossing point where the waveforms match as closely as possible. When you adjust your loop start and end points in the dialog, the start and end loop markers in the main waveform window adjust accordingly. Note that this movement may not be visible depending on how much you move the markers and on the zoom factor that you have selected.

It may be helpful to activate **Loop** on the transport bar during playback so that you can hear the difference when you adjust the loop markers. If you are not using a crossfade or post-crossfade, you do not have to click **Apply** when tweaking loop points. You can also leave this dialog open and manually adjust the position of the markers in the main waveform windows.

Crossfade Tab

This tab allows you to apply a crossfade between the audio at the end of a loop and the audio at the beginning of the loop. This can be useful to smooth the transition between the end of a loop and its beginning, especially when you use material that is not perfectly suited to create a loop. Use the envelope drag points or value sliders to adjust the crossfade envelope. Click **Apply** to create the crossfade.

Post-Crossfade Tab

This tab allows you to apply a crossfade at the end of the loop by mixing a copy of the loop back into the audio. Use the envelope drag points or value sliders to adjust the crossfade envelope. Click **Apply** to create the post crossfade.

Post-crossfading means crossfading the loop back into the audio after the end of the loop so that there is not glitch when playback continues after the loop. This is done by mixing a copy of the loop back into the audio.

Refining Loops

You can refine loops using the **Loop Tweaker** tool.

PREREQUISITE

Set up a basic loop.

PROCEDURE

1. In the **Audio Editor**, select the loop that you want to refine by clicking between its loop start and loop end marker.
 2. Select the **Process** tab.
 3. In the **Loop** section, click **Tweaker**.
 4. In the **Loop Tweaker** dialog, refine your loop.
 5. Click **Apply**.
-

Moving Loop Points Manually

If your loop still has glitches or bumps at the transition points, you can use the **Loop Tweaker** tool to move the points in small steps to remove the glitch.

This is similar to moving the loop points in the wave display, but with a visual feedback to facilitate finding good loop points.

There are two ways of moving the loop points manually on the **Loop Points Adjustment** tab in the **Loop Tweaker** dialog:

- Drag the waveform to the left and right.
- Use the green arrows below the waveform to nudge the audio to the left and right. Each click moves the loop point by a single sample.

The following applies when moving the loop points manually:

- To move the end point to a later or earlier position, move the left part of the display.
- To move the start point to a later or earlier position, move the right part of the display.
- To move the start and end points simultaneously, activate **Link Start and End Points**. This way, when adjusting a loop point, the length of the loop stays the same, but the entire loop is moved.
- You can also adjust the loop markers in the wave window.

Automatically Detecting Good Loop Points

The **Loop Tweaker** tool can automatically search for good loop points.

PROCEDURE

1. In the **Audio Editor**, select the loop that you want to refine by clicking between its loop start and loop end marker.
 2. Select the **Process** tab.
 3. In the **Loop** section, click **Tweaker**.
 4. In the **Loop Tweaker** dialog, on the **Loop Points Adjustment** tab, make sure that **Link Start and End Points** is deactivated.
 5. In the **Automatic Search** section, specify the **Aimed Correspondence** and the **Search Accuracy**.
 6. Click the yellow arrow buttons to start the automatic search for a good loop point. WaveLab Pro scans from the current point forwards or backwards, until it finds a point that matches. You can stop at any time by clicking the right mouse button. The program then jumps back to the best found match.
 7. Check the loop by playing it back.
 8. Optional: If you think there might be a better loop point, continue with the search.
-

Temporarily Saving Loop Points

Temporarily saving and restoring loop points allows you to compare different loop settings.

PREREQUISITE

Set up a basic loop and open the **Loop Tweaker** tool.

NOTE

- There are five slots for temporarily saving loop points for each wave window and montage window. If you have several sets of loops in your file, you must be careful to not recall the wrong set.
- Only loop positions are temporarily saved.

PROCEDURE

1. On the **Loop Points Adjustment** tab, in the **Temporary Memories** section, click **M**.
 2. Select one of the five memory slots.
-

Crossfades in Loops

Crossfading is useful to create smooth transitions between the end of a loop and its beginning, especially when using material that is not perfectly suited to create a loop.

Sometimes it is impossible to find a loop that does not cause any glitches. This is especially true for stereo material, where you might be able to find a perfect candidate for only one channel.

In this case crossfading smears the material around the end loop point so that it loops perfectly. This is achieved by mixing material from before the loop start with material that is located before the loop end.

NOTE

This technique alters the waveform and therefore changes the sound.

Creating a Crossfade

PROCEDURE

1. In the **Audio Editor**, create as good a loop as you can.
2. Select the **Process** tab.
3. In the **Loop** section, click **Tweaker**.
4. In the **Loop Tweaker** dialog, decide if you want to create a crossfade or a post-crossfade:
 - If you want to create a crossfade, click the **Crossfade** tab.
 - If you want to create a post-crossfade, click the **Post-Crossfade** tab.
5. Make sure that **Crossfade Audio at End of Loop with Audio before Loop (Crossfade tab)** or **Crossfade Audio after Loop with Audio of Loop Start (Post-Crossfade tab)** is activated.
6. Specify the length for the crossfade either by dragging the length handle or by adjusting the **Length** value below the graph.
7. Specify the crossfade shape by dragging the shape handle or by adjusting the **Shape (from Equal Gain to Equal Power)** value.
8. Click **Apply**.

The sound is processed. Each time that you click **Apply**, the previous loop process is automatically undone. This allows you to try out different settings quickly.

NOTE

Do not move the loop points after you have performed a crossfade. The waveform has been processed specifically for the current loop settings.

AFTER COMPLETING THIS TASK

- You can check the crossfade visually by opening the **Loop Points Adjustment** tab and activating **Display Processed Audio**. If this is activated, the display shows a preview of the crossfaded waveform. If this option is deactivated, the display shows the original waveform. Switching back and forth allows you to compare the two.

Post-Crossfades

Post-crossfading means crossfading the loop back into the audio after the end of the loop so that there is not glitch when playback continues after the loop. This is done by mixing a copy of the loop back into the audio.

The post-crossfade can be set up on the **Post-Crossfade** tab of the **Loop Tweaker** dialog.

The post-crossfade analyzes the part of the waveform that occurs just after the loop start and processes a specific area that begins at the end of the loop. The length parameter adjusts the size of this area. Everything else is identical with regular crossfading.

Loop Tweaker

This dialog allows you to adjust the loop start and end points, and crossfade the loop boundaries. The loop start and end points are specified with the loop start and end markers.

If more than one loop marker pair is available in the audio file, click in the area between a loop marker pair to tweak the corresponding start and end points.

- To open the **Loop Tweaker** dialog, open the **Audio Editor**, select the **Process** tab, and in the **Loop** section, select **Tweaker**.

Loop Points Adjustment Tab

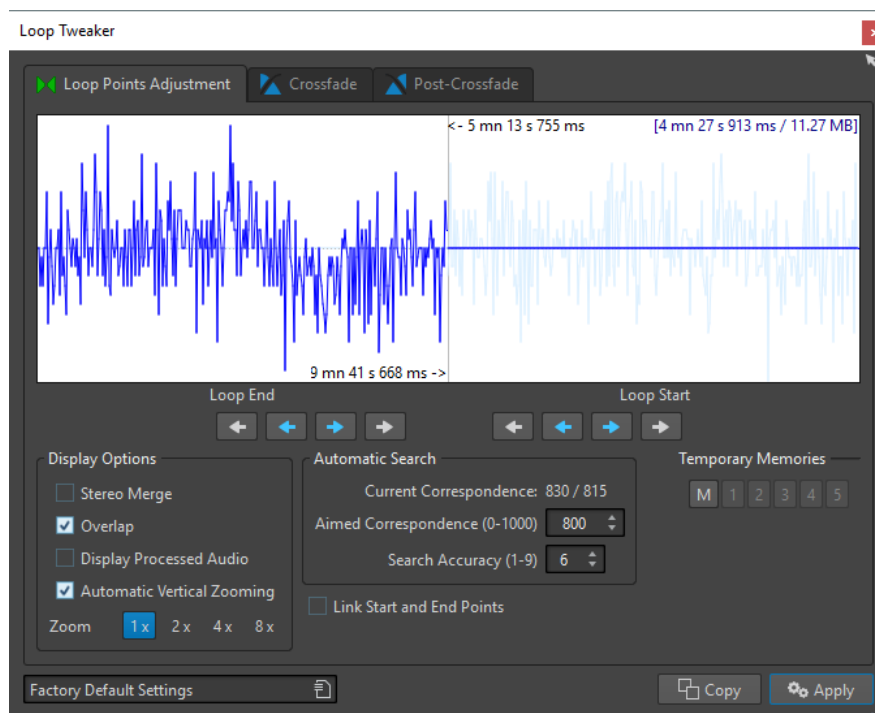

The top of this dialog shows the beginning and the end of the waveform between the loop markers. The bottom of this dialog offers the following options:

Loop End – Inner Arrows

Move the loop end points to the left/right.

Loop End – Outer Arrows

Invokes an automatic search for the nearest good loop point to the left/right of the loop end point and moves the end point to that position.

Loop Start – Inner Arrows

Moves the loop start points to the left/right.

Loop Start – Outer Arrows

Invokes an automatic search for the nearest good loop point to the left/right of the loop start point, and moves the start point to that position.

Stereo Merge

If this option is activated for a stereo file, the two waveforms are overlaid, otherwise they are shown in two separate sections.

Overlap

If this option is activated, the waveforms of both halves are continued in the other half. This shows how the waveform looks like right before and after the loop.

Display Processed Audio

If this option is activated, the display shows a preview of the waveform after crossfading. If this option is deactivated, you see what the waveform looks like without crossfading. This option only makes sense after you have applied a crossfade.

Automatic Vertical Zooming

If this option is activated, the vertical magnification is adjusted so that the waveform always fills the entire display vertically.

Zoom

Sets the zoom factor.

Current Correspondence

Indicates how well the waveforms near the loop points match one another. The left value estimates the similarity across several wave cycles, while the right value estimates the similarity of the few samples near the loop points. The higher the values, the better the match.

Aimed Correspondence (0-1000)

Sets up the automatic search for good loop points. This defines how well the found section must resemble the section to which it is compared, in order to be considered a match. The higher the value, the more precise the resemblance must be. A value of 1000 requires a 100 % perfect match.

Search Accuracy

Determines how many samples should be taken into account by the auto-find analysis. Higher values result in greater accuracy, but also in longer processing times.

Link Start and End Points

If this option is activated, both the start and end points move simultaneously when you adjust the loop points manually. That is, the loop length stays exactly the same and the entire loop moves.

Temporary Memories

Allows you to save up to five different sets of loop points which you can later recall. This allows you to try out different loop settings. To save a set, click this button, then on one of the buttons 1-5.

Crossfade Tab

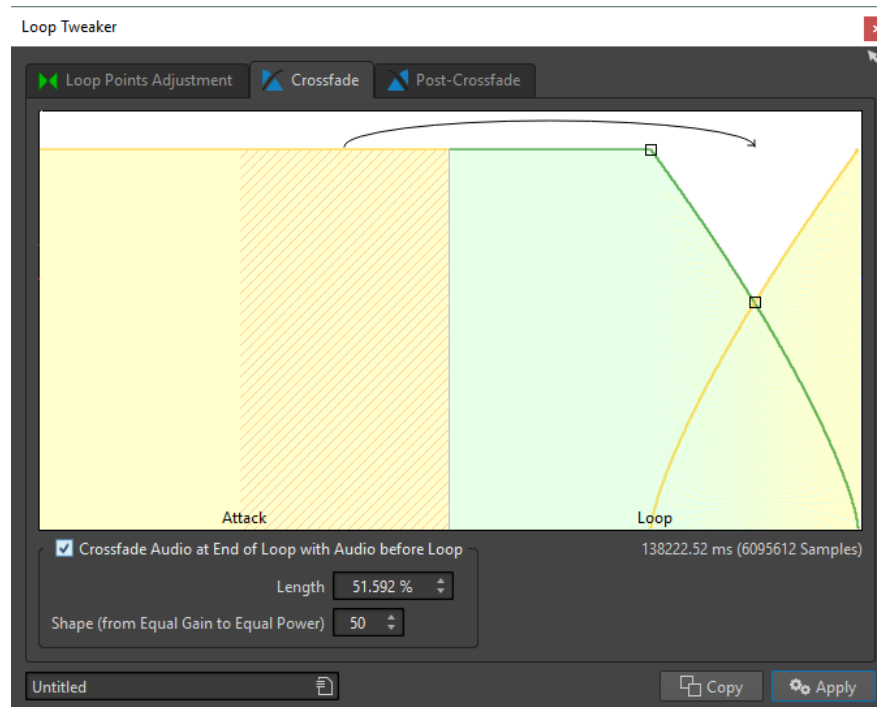

Crossfade Audio at End of Loop with Audio before Loop

To enable crossfading, activate this checkbox. The crossfade is applied when you click **Apply**.

Length

Determines the length of the crossfade. Generally, you want the crossfade to be as short as possible, with an acceptable result.

NOTE

- Using a long crossfade smoothens the loop. However, more of the waveform is processed, which changes its character.
- A shorter crossfade affects the sound less, but the loop is not as smooth.

Shape (from Equal Gain to Equal Power)

Determines the shape of the crossfade. Use low values for simple sounds and high values for complex sounds.

Post-Crossfade Tab

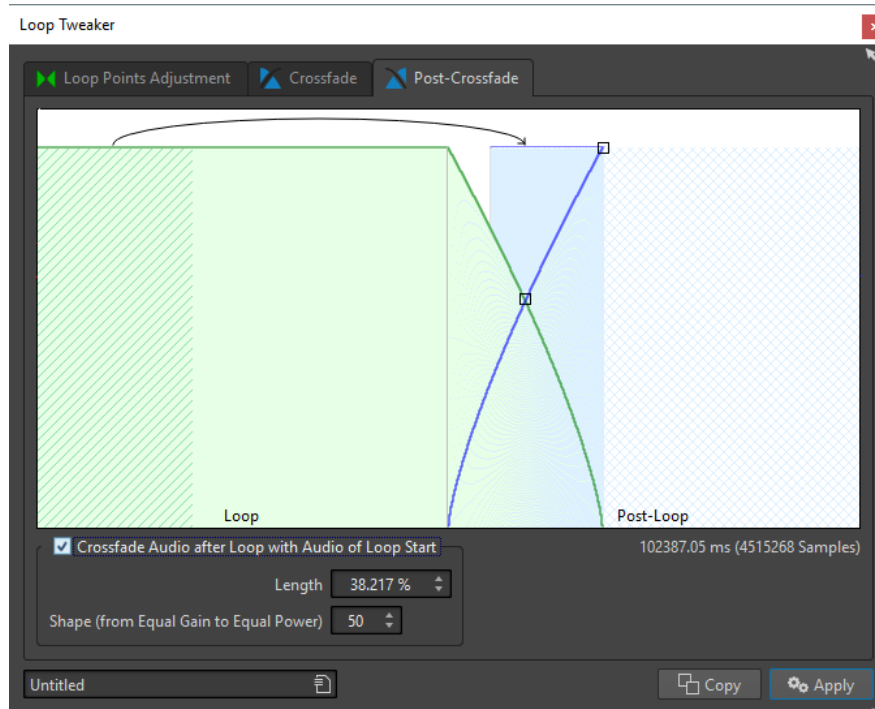

Crossfade Audio after Loop with Audio of Loop Start

To enable crossfading, activate this checkbox. The crossfade is applied when you click **Apply**.

Length

Determines the length of the post-crossfade. Generally, you want the post-crossfade to be as short as possible, with an acceptable result.

NOTE

- Using a long post-crossfade smoothens the loop. However, more of the waveform is processed, which changes its character.
- A shorter post-crossfade affects the sound less, but the loop is not as smooth.

Shape (from Equal Gain to Equal Power)

Determines the shape of the post-crossfade. Use low values for simple sounds and high values for complex sounds.

Looping Audio Which Is Not Very Well Suited for Looping

Sounds that constantly decay in level or continuously change in timbre are difficult to loop. The **Loop Tone Uniformizer** allows you to create loops from these kind of sounds.

The **Loop Tone Uniformizer** applies processing to the sound that evens out changes in level and timbral characteristics in order for a sound to loop properly. For example, this is useful for creating looped samples for a softsynth or hardware sampler.

The **Loop Tone Uniformizer** includes a crossfade option allowing you to fade in the original sound into the processed sections when playback approaches the loop start.

To use the **Loop Tone Uniformizer**, you must have created a loop by setting a pair of loop markers. The original length of the loop is not changed.

Looping Seemingly Unloopable Audio

PROCEDURE

1. In the **Audio Editor**, set up a basic loop.
2. Select the **Process** tab.
3. In the **Loop** section, click **Tone Uniformizer**.
4. In the **Loop Tone Uniformizer** dialog, make sure that either **Slice Mixing** and/or **Chorus Smoothing** is activated and make the settings.
5. Optional: Select the **Pre-Crossfade** tab, and set up a crossfade.
6. Click **Apply**.
The sound is processed. Each time that you click **Apply**, a new loop is defined. This allows you to try out different settings quickly.

NOTE

Do not move the loop points after you have performed a crossfade. The waveform has been processed specifically for the current loop settings.

AFTER COMPLETING THIS TASK

After using the **Loop Tone Uniformizer**, the transition between the end of the loop and the end of the file might not sound very natural. This can be fixed by creating a post-crossfade using the **Loop Tweaker**.

Loop Tone Uniformizer

This dialog allows you to create sounds that loop from audio which is not very well suited for looping. These are normally sounds that constantly decay in level or continuously change in timbre.

- To open the **Loop Tone Uniformizer** dialog, open the **Audio Editor**, select the **Process** tab, and in the **Loop** section, select **Tone Uniformizer**.

Uniformizers Tab

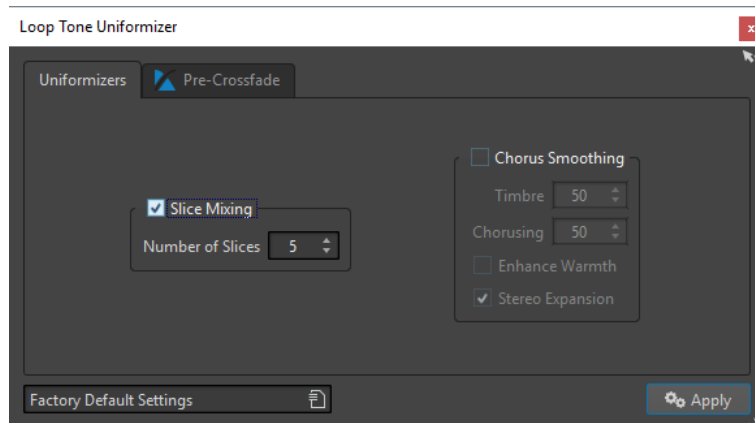

This tab allows you to specify the methods that are used to even out the sound that you want to loop.

Slice Mixing

Cuts the loop in slices, which are then mixed together to uniformize the sound.

For slice mixing, you need to determine the number of slices. Only experimentation can tell how many slices are needed, but generally, the more slices you have, the more natural the sound. However, the program puts a restriction on the number of slices, so that each one is never shorter than 20 ms.

For example, if you specify eight slices, the loop is cut up into eight sections of equal length. These sections are then overlapped and mixed together as one sound which is repeated eight times. This new piece of audio replaces all audio inside the loop so that no harmonic cancellation due to phase offsets occurs.

Slice Mixing – Number of Slices

The more slices you use, the more the sound changes.

Chorus Smoothing

This processor uses a phase vocoding method to filter the harmonics. This method is recommended for looping ensemble and choir sounds and can drastically change the timbre.

Chorus Smoothing – Timbre

Governs the amount by which the timbral characteristics of the sample should be evened out. The higher the value, the more pronounced the effect.

Chorus Smoothing – Chorusing

Determines the depth of the chorus effect.

Chorus Smoothing – Enhance Warmth

Creates a smoother, warmer sounding effect.

Chorus Smoothing – Stereo Expansion

Increases the width of the sample in the stereo sound image.

Pre-Crossfade Tab

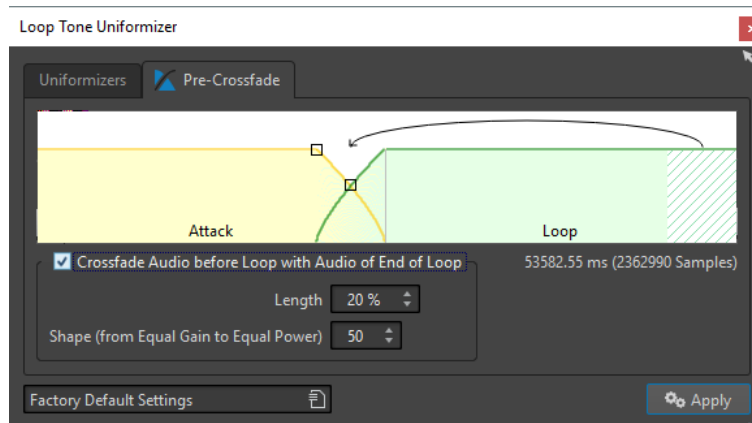

This tab allows you to crossfade the end of the loop with the start of the newly processed section so that the transition into the looped section is smoother during playback. Use the envelope drag points or value sliders to adjust the crossfade.

You need to use this feature because the **Loop Tone Uniformizer** changes the timbre only inside the loop. This means that the transition into the loop is not as smooth as expected unless you apply crossfading.

Crossfade Audio before Loop with Audio of End of Loop

Enables crossfading, which is applied when you click **Apply**.

Length

Determines the length of the crossfade. Generally, you want the post-crossfade to be as short as possible, with an acceptable result.

- A long crossfade produces a smoother loop. However, more of the waveform is processed, which changes its character.
- A shorter crossfade affects the sound less, but the loop is not as smooth.

Shape (from Equal Gain to Equal Power)

Determines the shape of the crossfade. Use low values for simple sounds and high values for complex sounds.

Sample Attributes

Sample attributes allow you to define settings for an audio sample before loading it into a hardware or software sampler.

Sample attributes do not process the sample, they just provide the file properties that the receiving sampler can use. This includes information about the pitch of the sample, which can be detected automatically, the key range that the sample should span, and the velocity range to occupy. For WAV and AIFF files, this information is saved in the header of the file. By default, there are no sample attributes in an audio file.

NOTE

Depending on your sampler and the protocol that you use for communicating, the sample attributes may not be supported.

Editing Sample Attributes

PROCEDURE

1. Open the **Audio Editor**.
2. Select **Tool Windows > Sample Attributes**.
3. In the **Sample Attributes** window, click **Create**.
4. Optional: If you want to automatically detect the pitch of an audio selection, select an audio range, and select **Detect from Audio Selection**.
5. Specify the sample attributes.
6. Save the audio file to save the sample attributes settings in the audio file.
The sample attribute is only saved in WAV and AIFF files.

Sample Attributes Window

In this window, you can create sample attributes for an audio sample.

- To open the **Sample Attributes** window, open the **Audio Editor** and select **Tool Windows > Sample Attributes**.

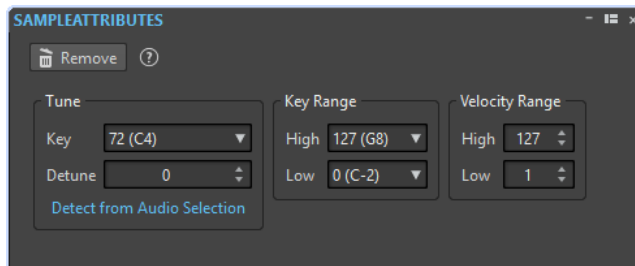

Create/Remove

Creates/Removes sample attributes for the active audio file.

Tune – Key

Specifies which key plays back the sound at its basic pitch.

Tune – Detune

Specifies whether the sample should be played back at a slightly different pitch. The range is $\pm 50\%$ of a semitone, which translates into a quarter tone in each direction.

Detect from Audio Selection

Detects the pitch from an audio selection. Make sure that the audio selection contains a clearly defined pitch.

Key Range – High/Low

Specifies the key range for the sample if the sample is part of a multi-sample key map.

Velocity Range – High/Low

Specifies the velocity range for the sample if the sample is part of a multi-sample key map with velocity-switchable samples.

Generating Signals

In WaveLab Pro, you can generate synthesized sounds and DTMF or MF tones.

Signal Generator

The **Signal Generator** allows you to generate complex synthesized sounds in mono or stereo.

You can layer different waveform generators together and if outputting a stereo file, adjust different settings for both the left and right channels.

Use the **Signal Generator** for the following:

- Testing the specifications of audio equipment
- Measurements of various kinds, including calibrating tape recorders
- Testing signal processing methods
- Educational purposes

The **Signal Generator** is based on a waveform generator that can generate a large number of basic waveforms, such as sine, saw, pulse, and various types of noise.

The **Signal Generator** has a multitude of settings for character (**Source** tab), frequency (**Frequency** tab), and amplitude (**Level** tab).

You can combine up to 64 **Signal Generators** into layers and make separate settings for the left and right channel.

NOTE

The **Signal Generator** is not intended for synthesizing musical sounds.

Signal Generator Dialog

This dialog allows you to generate complex synthesized sounds in mono or stereo.

- To open the **Signal Generator** dialog, select **File > Tools > Signal Generator**.

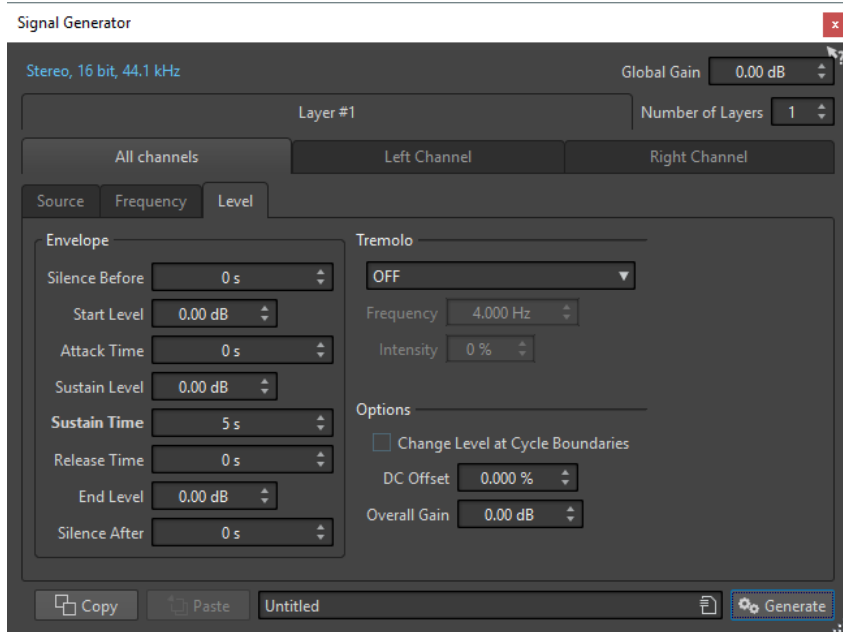

Audio Properties

Opens the **Audio Properties** dialog in which you can select sample rate, bit depth, etc.

Global Gain

Adjusts the global level of all combined layers.

Number of Layers

Determines the number of layers, for example, the number of independent signals to be combined.

All Channels/Left Channel/Right Channel

Determines whether the settings on the tab are applied to the left or right channel of the selected layer, or to both channels. This option is only available for stereo files.

Copy

Copies all settings of the current layer.

Paste

Pastes the settings to the selected layer.

NOTE

Clicking **Paste** replaces the source, frequency, and level settings on all tabs, not just on the selected one.

Generate

Applies the settings.

Source Tab

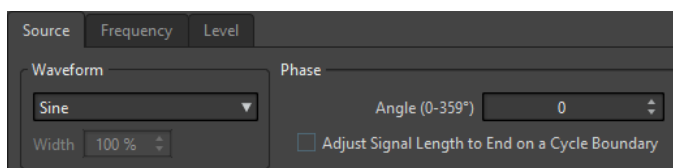

Waveform

Use this pop-up menu to select a waveform for the selected layer.

Width

If you select one of the pulse waveforms, you can set this parameter to the width of the pulse, specified as a percentage or a number of samples.

Angle (0-359°)

Sets the phase of the signal for the selected layer.

Adjust Signal Length to End on a Cycle Boundary

If this option is activated, the generated waveform ends with a complete cycle, regardless of the phase setting.

Frequency Tab

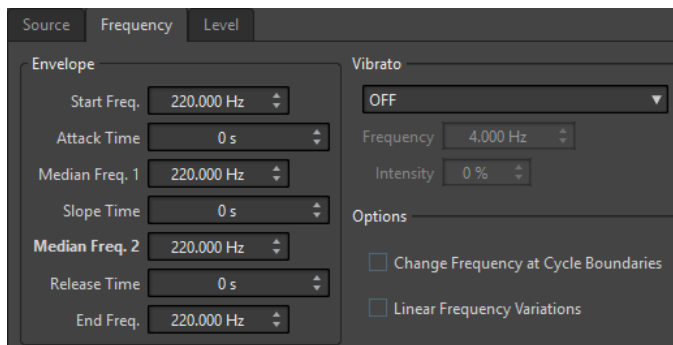

Envelope Section

In this section, you can set up the frequency envelope of the selected layer. The envelope consists of four frequency values and three duration values in between the frequency values.

If you want to set a static frequency (no envelope curve), make sure that all time values are set to 0, and set the frequency with the **Median Freq. 2** parameter.

Vibrato Section

In this section, you can add a vibrato to the frequency of the selected layer. You can select a waveform for the vibrato, set the frequency, and adjust the intensity.

Change Frequency at Cycle Boundaries

If this option is activated, the vibrato is not continuously applied from sample-to-sample, but recomputed after each cycle.

Linear Frequency Variations

If this option is activated, the frequency varies linearly.

Level Tab

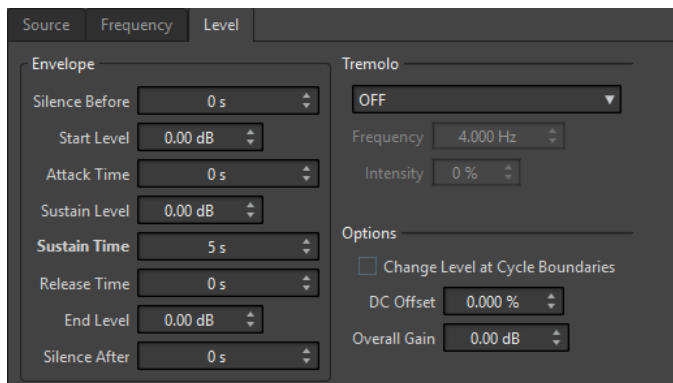

Envelope

In this section, you can set up the amplitude envelope of the selected layer. The envelope consists of three level values and three duration values in between the level values. In addition, the **Silence Before** and **Silence After** parameters allow you to include a period of silence before or after the signal of the selected layer.

NOTE

The **Overall Gain** parameter determines the overall level of the layer.

Tremolo

In this section, you can add a tremolo (continuous level variation) to the selected layer. You can select a waveform for the tremolo, set the frequency, and adjust the intensity.

Change Level at Cycle Boundaries

If this option is activated, the tremolo is not continuously applied from sample-to-sample, but recomputed after each cycle.

DC Offset

Allows you to add a DC offset to the signal of the selected layer.

Overall Gain

Allows you to set an overall level for the selected layer.

Generating an Audio Signal

PROCEDURE

1. Select **File > Tools > Signal Generator**.
2. In the **Signal Generator** dialog, click the audio properties.

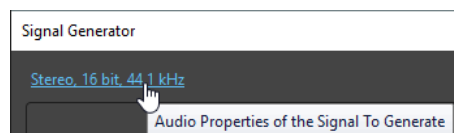

3. In the **Audio Properties** dialog, set up the channels, sample rate, and bit depth.
4. Choose how many layers of signal generators you want to use by setting the **Number of Layers** parameter.
5. Set the **Global Gain**.
6. For each layer, edit the settings on the **Source**, **Frequency**, and **Level** tabs.

7. If you have selected stereo channels, you can make changes for both or just one of the channels by selecting **All Channels**, **Left Channel**, or **Right Channel**.
 8. Once all settings are made, click **Generate**.
The file is generated and opens in a new window.
-

DTMF Generator

With the **DTMF Generator** you can generate DTMF (Dual Tone Multi Frequency) or MF tones as used by analog telephone systems.

These tones are created by combining two sine waves with variable frequencies. Push button telephones generate these two sine waves at different frequencies depending on the number that you press. These dial pulses are then decoded by the telephone exchange to identify which letters or numbers you pressed.

DTMF Generator Dialog

This dialog allows you to generate DTMF or MF tones.

- To open the **DTMF Generator** dialog, select **File > Tools > DTMF Generator**.

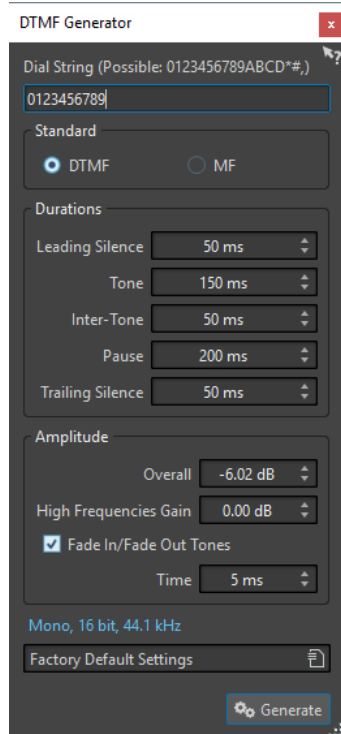

Dial String

Lets you enter the numbers that you want to convert into DTMF tones. The characters that you can use for DTMF are **0123456789ABCD*#,)** and for MF **0123456789ABC*#,,**

DTMF

DTMF is the most commonly used standard. DTMF strings are limited to 16 characters.

MF

MF uses a different frequency than DTMF. MF strings are limited to 15 characters.

Leading Silence

Determines the length of the silent region before the first tone.

Tone

Sets the length of each tone.

Inter-Tone

Adjusts the time interval between the tones.

Pause

Determines the length of any pauses in the dial string. A pause is entered by typing a comma character in the dial string.

Trailing Silence

Determines the length of the silent region after the last tone.

Overall

Controls the level of the tone's mix.

High Frequencies Gain

The DTMF signal consists of a mix between two tones. One high frequency tone and one low frequency tone. You can either choose to let the two tones have the same amplitude by leaving this at zero, or you can raise the high frequency tone by up to 12 dB. On some telephone lines, the high frequency tones are set 2 dB higher than the low ones.

Fade In/Fade Out Tones

If this option is activated, the generated tones will fade in and out.

Time

Lets you set the time of the fades if the corresponding option is activated.

Audio Properties

Opens the **Audio Properties** dialog in which you can select sample rate, bit depth, etc.

Generating DTMF Files

PROCEDURE

1. Select **File > Tools > DTMF Generator**.
2. In the **DTMF Generator** dialog, enter a dial string in the text field at the top of the dialog. The characters that you can use are shown above the text field.
3. Select the standard to use.
4. Make the settings for **Durations** and **Amplitude**.
5. Click the audio properties to select a bit depth and a sample rate.

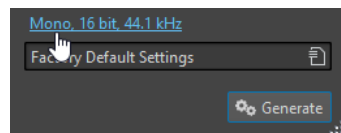

The **Audio Properties** dialog opens where you can edit settings for the audio file.

6. Click **Generate**.
The file is generated and opens up in a new window.
-

Importing Audio CD Tracks

You can read audio tracks from regular CDs and save them as a digital copy in any audio format on your hard disk.

Although WaveLab Pro supports a large number of CD drives, there are some restrictions you need to be aware of:

- There are a number of different protocols for retrieving audio from a CD-ROM/CD-R drive. WaveLab Pro supports as many of these methods as possible, but there are no guarantees that it works with any particular drive. This applies for CD-Text and ISRC.
- Observe and respect any copyright notices on the CDs from which you are importing tracks.

When importing tracks, they are named "Track XX" by default, where XX is a number starting at 01. The numbering scheme can be changed.

NOTE

- Importing audio CD tracks is technically more complicated than reading files from a CD-ROM or hard disk, because audio sectors can be hard to detect. Some CDs which do not conform completely to the CD standard may cause problems, especially when they are copy protected.
- If you import a CD track with Emphasis, and later want to use this on a CD of your own, remember to activate Emphasis for that track in the audio montage or **Basic Audio CD** window.

Import Audio CD Dialog

In this dialog, you can import one or more tracks from an audio CD.

- To open the **Import Audio CD** dialog, select **File > Import**, and click **Audio CD**.

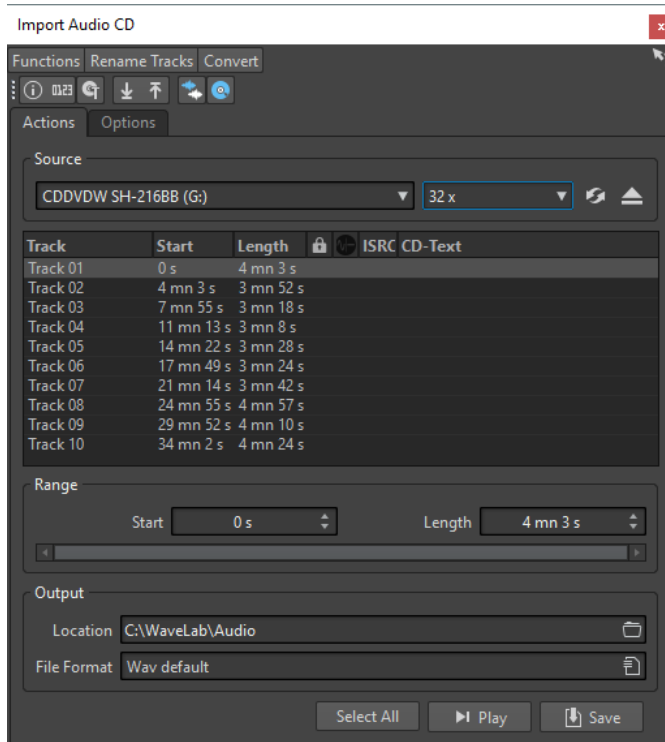

Functions Menu

CD Info

Displays the CD length and the UPC/EAN code, if available.

Extract ISRC Codes

Reads the ISRC codes and displays them in the track list. Depending on your CD drive, this can take a while.

Examine CD-Text

Opens the **CD-Text** dialog where you can view the CD-Text. Not all CD drives support CD-Text.

Extract CD-Text

Extracts the CD-Text and displays a summary in the track list.

Rename Tracks Menu

Name

Renames the tracks according to the selected renaming scheme.

Search Track Names on the Internet (FreeDb)

Searches track names from an Internet database. If the album is found, the CD track list is updated.

Submit Track Names to the Internet (FreeDb)

Submits the information about the audio CD to the FreeDb database of CD information.

Convert Menu

Convert All Tracks to Audio Montage

Extracts all audio CD tracks and uses them to create an audio montage.

Convert Selected Tracks to Audio Montage

Extracts the selected audio CD tracks and uses them to create an audio montage.

Convert All Tracks to Basic Audio CD

Extracts all audio CD tracks and uses them to create a Basic Audio CD.

Convert Selected Tracks to Basic Audio CD

Extracts the selected audio CD tracks and uses them to create a Basic Audio CD.

Actions Tab

Source

Select the CD drive from which you want to import audio CD tracks.

Speed

Allows you to set the writing speed. The highest speed depends on your writing device and on of the medium present in the device.

Refresh

If you insert a CD while the **Import Audio CD** dialog is open, you need to click this button to show the contents of that CD in the list.

Eject Optical Medium

Ejects the medium from the selected drive.

Track List

Shows the tracks on the CD.

Range – Start/Length

If you want to import only a section of a track, use the **Start** and **Length** fields to define a start point and length.

Output – Location

Allows you to set the output location.

Output – File Format

Allows you to set the output file format.

Select All

Selects all CD tracks in the track list.

Play

Plays back the selected CD track.

Options Tab

Trim Silence

If this option is activated, silence between imported tracks is removed. Only digital silence is removed, that is, samples with a zero level.

Automatically Refresh on CD Change

If this option is activated, WaveLab Pro checks for the presence of a new CD in the drive several times a second. If a new CD is found, the track list display is refreshed.

Automatically Extract ISRC Codes

If this option is activated, ISRC codes are automatically extracted when a CD is inserted.

Automatically Extract CD-Text

If this option is activated, CD-Text is automatically extracted when a CD is inserted.

Automatically Search Track Names on the Internet

If this option is activated, track names are automatically searched on the Internet when a CD is inserted.

Grab Pause before First Track (If Available)

If this option is activated, when a section of audio is located before the first track, it is extracted together with the first track. This way, you can import hidden bonus tracks.

Use a Japanese CD-Text Decoder

If this option is activated, CD-Text is interpreted as Japanese the next time it is extracted.

Create Peak File

If this option is activated, a peak file is created together with the rendered files.

Show Times with CD Frame Units

If this option is activated, times are shown in CD frame units. There are 75 CD frames per second.

Play through Master Section

If this button is activated, the **Master Section** is ignored. If the button is deactivated, the audio is played through the **Master Section**.

Convert Titles and CD-Text to Metadata

If this option is activated when importing tracks into an audio format supporting metadata (for example, MP3 and WMA), the titles of the tracks and the CD-Text are automatically added to the file header.

Ultra-Safe Mode (Slow)

If this option is activated, each CD track is read several times until the same result is found (checksums are used). Specify the number of times that a track must be read with the same result before it is saved to disk.

Real Audio Before and After Tracks

You can ensure that tracks are imported in their entirety by defining how much audio should be read before and after each CD track.

Importing Audio CD Tracks

PROCEDURE

1. Insert a CD into the CD-ROM/CD-R device.
2. Select **File > Import**.
3. Click **Import Audio CD**.
4. In the **Import Audio CD** dialog, in the **Source** section, select the drive from which you want to read, and specify the read speed.
5. Optional: Rename the files and adjust the numbering scheme.
The tracks must have unique names if you want to import them all.
6. Optional: On the **Options** tab, in the **Read Audio Before and After Tracks** section, define how much audio should be read before and after each CD track.
7. In the track list, select the tracks that you want to import.
8. Optional: If you have only selected one file, in the **Range** section, you can define a **Start** and **Length**, to import just a part of the track.
9. In the **Output** section, click the folder icon, and select an output location.
You can also drag one or more CD tracks onto an audio montage track.

10. In the **Output** section, click the file format field, and select a file format for the imported audio files.
 11. Click **Save**.
-

RESULT

The tracks are imported to the specified location.

Searching Track Names on the Internet

You can search for information about your CDs using the FreeDb database of CD information.

PREREQUISITE

You must be connected to the Internet to use the FreeDb function.

PROCEDURE

1. Insert a CD into the CD-ROM/CD-R device.
 2. Select **File > Import**.
 3. Click **Import Audio CD**.
 4. In the **Import Audio CD** dialog, select **Rename Tracks > Search Track Names on the Internet (FreeDb)**.
-

Submitting Track Names to the Internet

You can submit information about an audio CD to the FreeDb database of CD information.

PREREQUISITE

You must be connected to the Internet to use the FreeDb function.

PROCEDURE

1. Insert a CD into the CD-ROM/CD-R device.
2. Select **File > Import**.
3. Click **Import Audio CD**.
4. In the **Import Audio CD** dialog, rename each track.
5. Select **Rename Tracks > Submit Track Names to the Internet (FreeDb)**.
6. In the **Submit CD Information** dialog, fill out the text fields and enter an e-mail address.

NOTE

An e-mail address is required to report submission errors. It will not be saved.

The FreeDb database does not offer the possibility to enter different artists or genres for individual tracks. If the artists differ from track to track, you can write the track title in the following way: `Title/Artist`

7. Click **OK**.
-

Ultra-Safe Mode

Sometimes, a small bit of a CD track is not properly retrieved which results in unpleasant clicks and pops in the audio. This depends on the quality of your CD drive. To solve this issue, you can activate the **Ultra-Safe Mode** in the **Import Audio CD** dialog options.

If this option is activated, you can specify how many times each CD track must be read with the same result, before it is saved to disk.

Converting Audio CD Tracks to an Audio Montage

PROCEDURE

1. Insert a CD into the CD-ROM/CD-R device.
 2. Select **File > Import**.
 3. Click **Import Audio CD**.
 4. Optional: In the **Import Audio CD** dialog, on the **Options** tab, select which information you want to extract from the Audio CD when converting.
 5. Decide whether to convert only selected tracks or all tracks.
 - To convert only selected tracks, select **Convert > Convert Selected Tracks to Audio Montage**.
 - To convert all tracks, select **Convert > Convert All Tracks to Audio Montage**.
-

RESULT

When the conversion is finished, the imported files open in the **Audio Montage** window.

Converting Audio CD Tracks to a Basic Audio CD

PROCEDURE

1. Insert a CD into the CD-ROM/CD-R device.
 2. Select **File > Import**.
 3. Click **Import Audio CD**.
 4. Optional: In the **Import Audio CD** dialog, on the **Options** tab, make your settings.
 5. Decide whether to convert only selected tracks or all tracks.
 - To convert only selected tracks, select **Convert > Convert Selected Tracks to Basic Audio CD**.
 - To convert all tracks, select **Convert > Convert All Tracks to Basic Audio CD**.
-

RESULT

When the conversion is finished, the imported files are added to the **Basic Audio CD** window.

WaveLab Exchange

You can use WaveLab Pro as an external editor for Cubase Pro, Cubase Artist, and Nuendo, and vice versa.

IMPORTANT

- WaveLab Exchange is only available for Cubase Pro 8.5.10 or higher, Cubase Artist 8.5.10 or higher, and Nuendo 7.1.20 or higher.
- WaveLab Exchange supports the file format Wave.

WaveLab Pro as External Editor for Cubase/Nuendo

You can open Cubase/Nuendo events in WaveLab Pro. This allows you to use the editing capabilities of WaveLab Pro and apply them to Cubase/Nuendo events.

For example, the following editing options are exclusively available in WaveLab Pro:

- Audio error correction
- Audio spectral editing
- Independent channel editing and processing
- Mid/Side editing and processing
- Loudness normalization (EBU R-128 recommendation)
- Analysis meters, global analysis (EBU R-128 recommendation), and 3D frequency analysis
- RestoreRig
- MasterRig

Editing Cubase/Nuendo Audio Events in WaveLab Pro

PREREQUISITE

Open your Cubase/Nuendo project in Cubase/Nuendo.

PROCEDURE

1. In the Cubase/Nuendo **Project** window, select the audio event that you want to edit in WaveLab Pro.
You can also select only a part of the audio event with the **Object Selection** tool.
2. Select **Audio > Edit in WaveLab**.
3. In WaveLab Pro, edit the audio event.
4. When you have finished the editing, click **Trigger Cubase/Nuendo Update** on the command bar.

RESULT

The changes to the audio event are applied to the Cubase/Nuendo project.

Cubase/Nuendo as External Editor for WaveLab Pro

When you are working on an audio file or clip in WaveLab Pro, you can open the project of the audio file in Cubase/Nuendo. This allows you to correct issues that you have identified during mixing and correct these issues in the audio file in Cubase/Nuendo.

When you then export the audio file in Cubase/Nuendo, and you use the same file name, the audio file or clip is automatically updated in WaveLab Pro.

Preparing the Cubase/Nuendo Project for WaveLab Exchange

PROCEDURE

1. In Cubase/Nuendo, open the project that you want to prepare for WaveLab Exchange.
 2. Select **File > Export > Audio Mixdown**.
 3. In the **Export Audio Mixdown** dialog, specify a file name and path.
 4. In the **File Format** pop-up menu, select **Wave File** or **Wave 64 File**.
 5. Activate **Insert iXML Chunk**.
 6. Click **Export**.
-

Editing the Audio File in Cubase/Nuendo

PREREQUISITE

The Cubase/Nuendo project is prepared for WaveLab Exchange.

PROCEDURE

1. In WaveLab Pro, open the audio file in the **Audio Editor**.
A yellow line above the file tab indicates that the file has been rendered in Cubase/Nuendo.
2. Select the **Edit** tab.
3. In the **Source** section, click **Edit Project**.
The Cubase/Nuendo project that contains the audio file opens.
4. In Cubase/Nuendo, edit the audio file.
5. Select **File > Export > Audio Mixdown**.
6. In the **Export Audio Mixdown** dialog, activate **Insert iXML Chunk**.

IMPORTANT

Do not change the file name and path.

7. Click **Export**.
-

RELATED LINKS

[Preparing the Cubase/Nuendo Project for WaveLab Exchange](#) on page 489

[Tab Colors](#) on page 78

Batch Processing

Batch processing in WaveLab Pro allows you to process any number of audio files or audio montage files with **Master Section** plug-ins and presets, offline effects, and other plug-ins that are unique to batch processing.

Each file is processed and then saved to a folder of your choice. You can change the file format, rename the file according to a set of rules, and run an external application when the batch is finished. You can process as many files as you want taking advantage of multi-processing on multi-core processors.

When you save batch processor files, you can run batches repeatedly, if required. For example, you may have a folder of 24-bit audio files which you want to normalize, add a fade out to, and dither down to 16 bit 44.1 kHz. You could save this as a batch processor file, and re-run the batch each time that you update the original files. This procedure can be simplified using batch templates.

Advantages of the WaveLab Pro Batch Processor

While processing multipass plug-ins, other plug-ins of the plug-in chain are only gone through when necessary and file writing is reduced to a single writing process. This results in an improved performance of the batch processing. The following graphic shows the advanced uses of the multipass plug-ins of the batch processor.

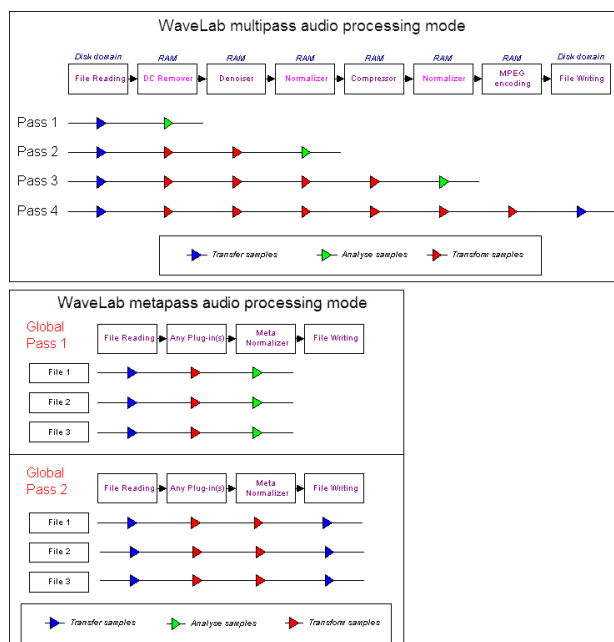

Batch Processing Metadata

You can batch process metadata. For this you can set up the **Metadata** dialog in the **Batch Processor** window, and apply this metadata to the files of the batch process.

RELATED LINKS

[Metadata in the Batch Processor Window](#) on page 149

Batch Processor Window

This window allows you to process any number of audio files or audio montages with **Master Section** plug-ins and presets, offline effects, and other plug-ins.

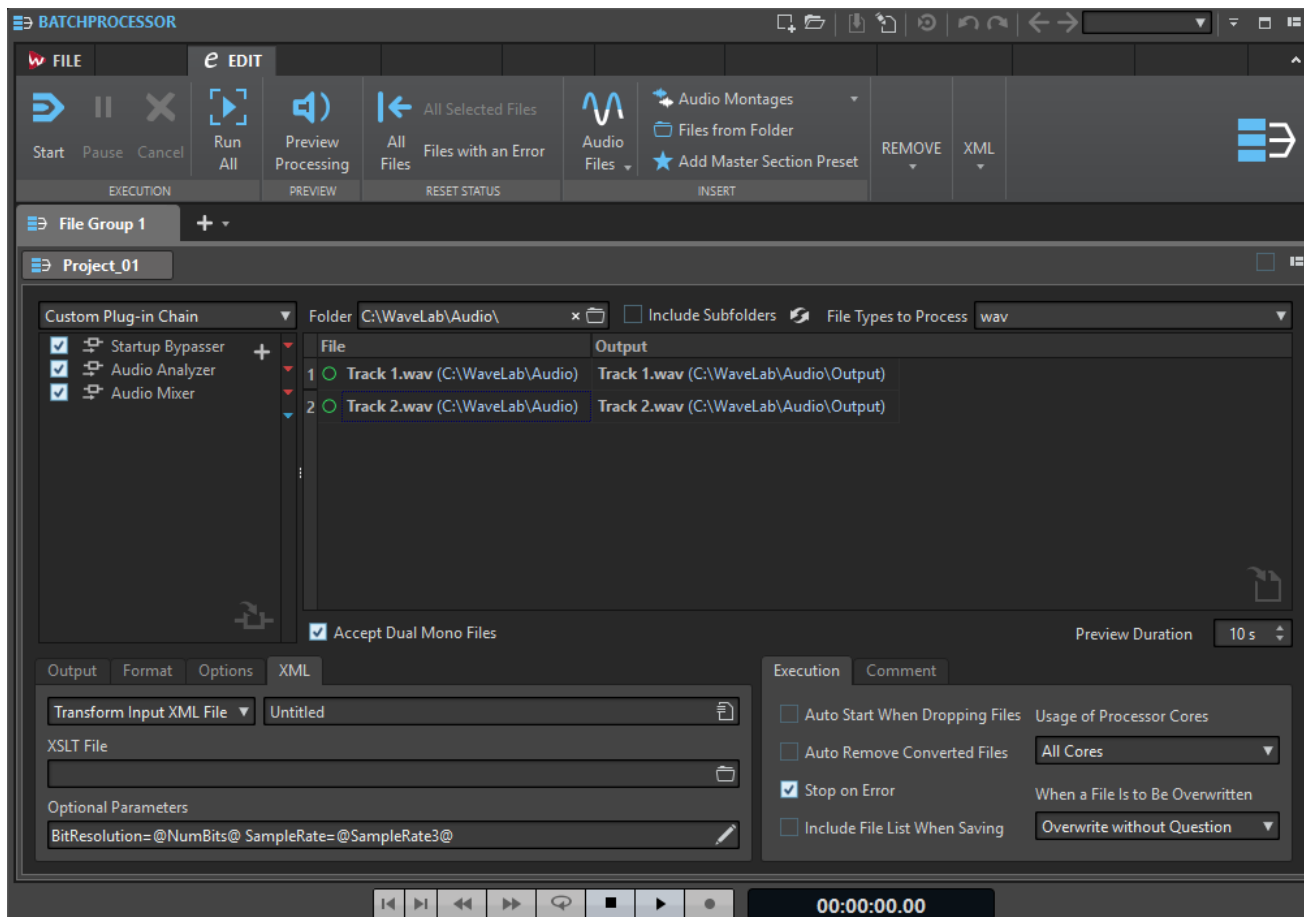

Edit Tab

Execution

Start

Runs the batch process.

Pause

Interrupts the process to reduce the CPU load. You can continue the process by clicking **Pause** again.

Cancel

Cancels the running process.

Run All

Runs all open batches sequentially. That is, a batch process starts when the previous one ends. An error does not prevent a new batch process from starting. If you stop the active process, the global process stops.

Preview

Preview Processing

Allows you to preview the effect of the batch processor on any file of a batch. The preview includes all effects and the file format.

Reset Status

All Files

Sets the files with the status "Done" or "Error" to "To do".

All Selected Files

Sets all selected files with the status "Done" or "Error" to "To do".

Files with an Error

Sets the files with the status "Error" to "To do".

Insert

Audio Files

Allows you to select the audio file that you want to add to the batch process.

Audio Montages

Allows you to select the audio montage that you want to add to the batch process.

Files from Folder

Opens the **Add Files from Folder** dialog, where you can add files of a specific type from a folder to the batch process.

Add Master Section Preset

Adds the **Master Section** plug-ins to the batch process.

Remove

All Files

Removes all files from the list that are not being processed.

Selected Files

Removes the selected files from the list that are not being processed.

All but Selected

Removes all files from the list that are not selected and not being processed.

Successfully Processed Files

Removes all files with the status "Success" from the list.

Files with Errors

Removes all files with the status "Error" from the list.

XML

XML Audio Description

Opens the **XML Audio Description** dialog, in which you can instruct WaveLab Pro how to understand the structure of the XML file that you want to read.

Audio Plug-in Chain

Here, you can add plug-ins that the audio signal traverses, from top to bottom.

You set up the list by dragging plug-ins from the plug-ins section.

- To remove a plug-in from the list, select it and press **Delete**, or right-click a plug-in and select **Remove**.
- To edit a plug-in, double click it, or right-click a plug-in and select **Edit**.

Red, green, and blue arrows on the right of the audio plug-in chain visualize the audio signal path when plug-ins have been added to the list.

You can prevent a plug-in from processing by deactivating it.

Files to Process

Here, you specify which files to process. You can add files to the list via drag and drop or use the insert options on the **Edit** tab.

Options on Context Menu

You can right-click a file, to access a context menu with the following options:

Reset Status

Sets the status of the selected files to “unprocessed”.

Remove

Removes the selected files from the list.

Open in WaveLab Pro

Opens the selected file in WaveLab Pro.

Reveal in File Explorer/Finder

Opens the folder of the selected file in the File Explorer/macOS Finder.

Open with Default Application

Opens the selected file with the default application, for example, a media player.

Preview Processing

Allows you to preview the effect of the batch processor on the selected file. The preview includes all effects and the file format.

Insert Audio Files

Opens a submenu that allows you to select the audio files that you want to insert in the file list.

Insert Audio Montages

Opens a submenu that allows you to select the audio montages that you want to insert in the file list.

Options Above the File List

The following options are available above the files list:

Folder

Lets you select the folder that you want to add to the batch process.

Each time you start the batch process, the selected folder is scanned and the audio files that are found in the folder are processed.

To disable this option, clear the path name.

NOTE

If you want to use XML files in the folder mode, you must select **XML Descriptors** in the **File Types to Process** menu.

Include Subfolders

If this option is activated, the subfolders of the selected folder are also scanned. The audio files inside these subfolders are added to the batch process.

Refresh

Refreshes the selected folder and, if **Include Subfolders** is activated, its subfolders. All audio files inside the folders are added to the batch process.

File Types to Process

Lets you specify which file types should be added to the batch process. You can also select that all file types should be added to the batch process.

Options Below the File List

The following options are available below the files list:

Accept Dual Mono Files

If this option is activated, you can add dual mono files to your batch process.

Preview Duration

Determines the length of the preview duration.

Output Tab

On this tab, you can specify the output location for the files that you want to process.

Destination folder type

Define a type of destination folder. The following types are available:

- **Temporary (Can Be Undone)**
Writes the processed audio in a temporary file. For this, the source file must already be open in the **Audio Editor**.
- **As Source Path**
The file is rendered in its own folder.
- **Subfolder of Source Path**
The file is rendered in a customizable subfolder of its own folder.
- **Subfolder "Output" in Source Path**
The file is rendered inside the `Output` subfolder of the Watch Folder. This subfolder is created automatically by WaveLab Pro.
- **Explicit Path**
The file is rendered in a destination folder that you must specify.
- **Explicit Path + Source Folder**
As previous option, but the folder name of the source file is added to the path.
- **Explicit Path + Source Folder (2 Levels)**
As previous option, but the folder name of the source file, and its parent, are added to the path.
- **Explicit Path + Source Folder (3 Levels)**
As previous option, with one more added element of the source path.
- **No Audio Output**
Processing takes place while no file is written to the disk.
When using Watch Folders, this option only makes sense if you use the Audio Analyzer plug-in to produce a text file from the source audio file, without rendering a new audio file. The text file is always written in the `Output` subfolder of the Watch Folder.

NOTE

For Watch Folders, the destination folder can also be determined by an XML file that contains this information.

Path

Specify the folder into which the files are rendered.

Rename Files

If this option is activated, the source file names are processed through a renaming preset, to produce new names for the rendered files.

Renaming Field

Allows you to open the **Rename Files** dialog, where you can set up a renaming scheme.

Name Scheme

Allows you to define naming schemes for the audio files or audio montages that you want to render. You can save naming schemes as presets.

RELATED LINKS

[Naming Schemes](#) on page 84

Format Tab

On this tab, you can specify the file format for the files that you want to process and specify how to handle metadata.

File Format

Allows you to open the **Audio File Format** dialog for single file formats or multiple file formats.

Batch Metadata

Lets you select one of the following options for handling the batch metadata:

- Ignore the batch metadata and preserve the metadata in the audio file.
- Merge the batch metadata with the metadata found in the audio file.
- Replace the metadata of the audio file with the batch metadata.

These options only have effect if **Inherit From Source File** is activated in the **Audio File Format** dialog.

For Audio Montages, Render CD Images and Cue Sheets

If this option is activated, audio montages are rendered as CD images together with cue sheets.

Options Tab

On this tab, you can make additional settings for the batch process.

Create Peak Files

If this option is activated, peak files are created for each rendered file.

No Reverb Tail

If this option is activated, a fade is performed at the audio range bounds when a new file is created, or a crossfade with the audio neighborhood is created if the audio range is processed in place.

Crossfades allow a smooth transition between the processed and the non-processed parts. The crossfade time and shape are set in the **Audio Files Preferences**. If the fade time is longer than half the length of the processed file, it is not performed.

Copy Markers

If this option is activated, markers that are included in the range to process are copied to the rendered file.

On Success, Run External Tool

Allows you to select an external tool to run after the batch process is finished. For example, you could email, upload, or archive the resulting files. To be able to select tools, you need to specify them in the **Configure External Tools** dialog.

This option has no effect when using Watch Folders.

Audio Files without Valid Header

- If **Accept Unknown Audio** is activated, you can apply batch processing to audio files that do not include any header information such as sampling rate, bit depth, endian, or number of channels.

Click on the **Presets** field to open the **Special File Format** dialog. This dialog allows you to specify how to interpret the format of the audio file that you want to open.

- If **Reinterpret Header Sample Rate** is activated, you can specify the sample rate that is applied to the audio stream in the batch process.

IMPORTANT

This option could produce files with a wrong sample rate. Use this option with care.

RELATED LINKS

[Special File Format Dialog](#) on page 137

XML Tab

On this tab, you can make settings to generate XML files containing information about the audio files.

Process

Lets you select whether the output XML file should be generated from scratch (**Generate XML/HTML File**) or can use the input XML files as reference (**Transform Input XML File**). If you do not want to use an XML process, select the **No XML Process** option.

Presets

Lets you save and restore setting presets.

XSLT File

The path of the XSLT file that is used to generate the XML file.

Optional Parameters

The list of the parameters to send to the XSLT process. You can type new parameters into the text field or click the pen icon to open the **Parameters for XSLT Processing** dialog and enter the new parameters there.

Execution Tab

On this tab, you can make additional settings for the batch process.

Auto Start When Dropping Files

If this option is activated, the processing starts automatically when dragging a file into the list.

Auto Remove Converted Files

If this option is activated, a file is removed from the list once it is successfully processed.

Stop on Error

If this option is activated, the global process stops if an error is encountered. If it is deactivated, the file associated with the error is marked in red, and the next file is processed.

This option has no effect when using Watch Folders.

Include File List When Saving

If this option is activated, the list of files (with their status) is saved with the batch processor document.

Usage of Processor Cores

Allows you to select how many cores are to be used simultaneously. The contents of this pop-up menu depend on your computer hardware.

When a File is to Be Overwritten

Specify the behavior when a file is to be overwritten. The following options are available:

- **Overwrite without Question**
- **Stop and Ask**
- **Report as Error**
- **Skip and Mark as Done**
- **Auto-Rename**

This option has no effect when using Watch Folders.

Comment Tab

On this tab, you can enter a comment for the active batch process document.

Batch Plug-ins Window

The **Plug-ins** window for batch processes allows you to select plug-ins and **Master Section** presets for the batch process. A plug-in or preset can be dragged into the audio plug-in chain of the active batch processor document. You can also double-click a plug-in to add it at the end of the chain.

- To open the **Plug-ins** window, open a batch process file and select **Tool Windows > Batch Plug-ins**.

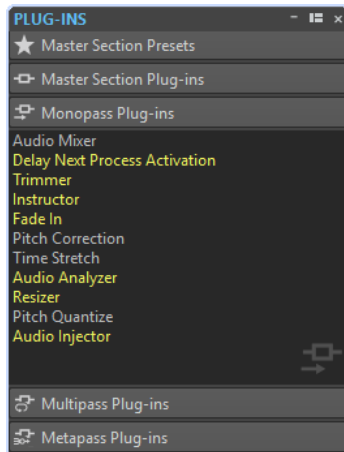

From the following categories, you can select plug-ins or **Master Section** presets:

Master Section Presets

This is the list of **Master Section** presets.

Master Section Plug-ins

This is the list of all plug-ins available in the **Master Section**.

Monopass Plug-ins

This is the list of monopass plug-ins. Monopass means that the audio signal needs to pass through the plug-in only once to be processed. These plug-ins are not available in the **Master Section**.

Multipass Plug-ins

This is the list of multipass plug-ins. Multipass means that the audio needs to be analyzed at least once before it is modified. These plug-ins are not available in the **Master Section**. Some are unique to the **Batch Processor**.

Metapass Plug-ins

This is the list of metapass plug-ins. Metapass means that the audio is analyzed once, and is processed after all other files have been analyzed, to take all analyses into account. These plug-ins are not available in the **Master Section** and are unique to the **Batch Processor**.

Offline Processors

There are several different types of plug-ins that can be applied to a batch process.

The following types of batch processing plug-ins are available:

- **Monopass** plug-ins only require one pass when processing. A monopass plug-in effect processes the signal and then outputs it to any subsequent plug-in.
- **Multipass** plug-ins require two or more passes (one or more analysis passes followed by a process pass) before processing the audio. Some are unique to the **Batch Processor** window while others are also found as offline processors in the **Audio Editor**.
- **Metapass** plug-ins are unique to the **Batch Processor** window and require at least one analysis pass on all audio files before audio is processed. After analyzing the audio, a metapass plug-in takes into account all other plug-ins in the effects chain before processing the audio.

Master Section Presets

These presets are updated each time that you save a new preset in the **Master Section**. The presets also contain the **Master Section** gain settings.

Master Section Plug-ins

These plug-ins are all the plug-ins available from the **Master Section**, sorted in the same manner.

Metapass Plug-ins

A metapass plug-in analyzes all files in the batch, collects the results, and processes the files by varying amounts. The result of the analysis of one file can affect how other files are processed.

A typical example of a metapass plug-in is the **Loudness Meta Normalizer**, which can process a number of files so that they all get the loudness of the loudest file in the batch.

Metapass plug-ins can be freely combined with other types of processors. For example, you can use both the **Loudness Meta Normalizer** and a regular **Normalizer** in the same batch. You may also combine metapass plug-ins with multipass plug-ins.

A metapass plug-in requires two processing passes. During the first pass all the files in the batch are analyzed and during the second pass they are all processed.

This is different from other multipass plug-ins, where each file is analyzed/processed twice or more times if required.

Avoid Clipping When Increasing the Signal Level

Processors often increase the signal level. If you are not careful, your file may be distorted when it exits the batch. To prevent this, you can use the **Only if Clipping** option of the **Level Normalizer** multipass plug-in.

It is no problem for the signal to be amplified above 0 dB (full level) within the audio stream, because WaveLab Pro uses 64-bit internal processing. There is a lot of extra headroom and the signal will not be clipped. However, when a signal that exceeds 0 dB is converted to a 16-bit file at the output of the Batch Processor, clipping occurs.

To remedy this, you can insert the **Normalizer** effect at the end of the signal chain. The Normalizer raises or lowers the levels as required so that the signal peaks exactly at the specified value just before it is converted to a file. This is useful to do even when **Only if Clipping** is not activated.

If you only want the **Normalizer** to be applied to avoid clipping, activate **Only if Clipping**. When this is activated, the signal output may be low, but the audio does not clip due to amplification within any of the processors.

This allows you to use the **Normalizer** as a completely distortion-free limiter.

If you reduce the bit depth, add the dithering plug-in after the Normalizer plug-in.

Working with the Batch Processor

Creating a Batch Process File

Batch process files allow you to set up a batch process.

PROCEDURE

1. Select **File > New**.

If you have specified a template to be the default template, clicking **New** opens a new template with the settings of the default template.

2. Click **Batch Processor**.
 3. Do one of the following:
 - To open an empty batch process file, select **Create Empty**.
 - To create a batch process file that contains all files that are open in WaveLab Pro, select **From Current File**.
 - To create a batch process from a template, select **Templates** and click the template that you want to use.
-

Saving a Batch Process File

PREREQUISITE

Set up your batch process.

PROCEDURE

1. Do one of the following:
 - To save a batch process file that has never been saved before, select **File > Save As**.
 - To save a batch process file that has been saved before, click **Save**, or select **File > Save**.
 2. Specify a file name and location.
 3. Optional: Activate **Include File List**.
 4. Click **Save**.
-

Save Batch Processor Dialog

In this dialog, you can specify the name and location of the batch processor file that you want to save.

- To open the **Save Batch Processor** dialog, click the **Save As** button, or select **File > Save As**.

Name

The name of the file to write.

Location

The location where you want to save the file.

Include File List

If this option is activated, the file list is also saved, including the status of each file.

Save

Saves the file.

Save Copy

Allows you to save a copy of the open batch processor file. The batch process continues to refer to the source file. Click the arrow at the bottom right of the **Save** button to access the **Save Copy** option.

Adding Files to a Batch Process

You can add audio files and audio montages to a batch process.

Adding Audio Files to a Batch Process

PREREQUISITE

Create a new batch process file or open an existing file.

PROCEDURE

1. In the **Batch Processor** window, select the **Edit** tab.
2. In the **Insert** section, click **Audio Files**.
3. Select **Browse**.
4. Browse to the location of the audio file that you want to add, and select it.
5. Click **Open**.

RESULT

The audio file is added to the batch process.

NOTE

You can also add audio files by right-clicking the **Files to Process** window, and selecting **Insert Audio Files > File Group > Select All**, or selecting one of the open audio files from the list.

Adding Audio Montages to a Batch Process

PREREQUISITE

Create a new batch process file or open an existing file.

PROCEDURE

1. In the **Batch Processor** window, select the **Edit** tab.
2. In the **Insert** section, click **Audio Montages**.
3. Select **Browse**.
4. Browse to the location of the audio montage that you want to add, and select it.
5. Click **Open**.

RESULT

The audio montage is added to the batch process.

NOTE

You can also add audio montages by right-clicking the **Files to Process** window, and selecting **Insert Audio Montages > File Group > Select All**, or selecting one of the open audio montages from the list.

Adding Files from a Folder to a Batch Process

You can add all files that are included in a folder to a batch process.

PREREQUISITE

Create a new batch process file or open an existing file.

PROCEDURE

1. In the **Batch Processor** window, select the **Edit** tab.
 2. In the **Insert** section, click **Files from Folder**.
 3. In the **Add Files from Folder** dialog, specify the folder location.
 4. Optional: Activate **Include Subfolders** if you want to include files located in subfolders.
 5. Specify the file type.
 6. Click **OK**.
-

RESULT

All files are added to the list of files to process.

Adding Files from a Default Folder to a Batch Process

You can specify a default folder in which you put the files that you want to batch process. Each time that you start the batch process, the selected folder is scanned and the audio files that are found in the folder are added to the file list and processed.

PREREQUISITE

Create a new batch process file or open an existing file.

PROCEDURE

1. In the **Folder** field, specify the source folder.

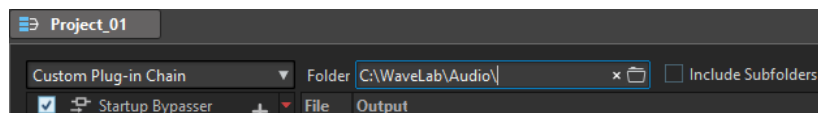

2. If you want to include the files that are located in the subfolders, activate **Include Subfolders**.
 3. From the **File Types to Process** pop-up menu, select which audio file types you want to include.
 4. To start the batch process, select the **Edit** tab and click **Start**.
-

Custom Plug-in Chain vs. Associated Master Section Preset

You can batch process files using a common custom plug-in chain or batch process each file with its own associated **Master Section** preset. You can also choose to use no plug-in at all for the batch process and only use the other features of the **Batch Processor** window, for example, the file format conversion or metadata processing.

Adding Plug-ins to a Batch Process

You can create a custom plug-in chain and include it in the batch process.

PREREQUISITE

Create a new batch process file or open an existing file.

PROCEDURE

1. Open the batch processing pop-up menu and select **Custom Plug-in Chain**.

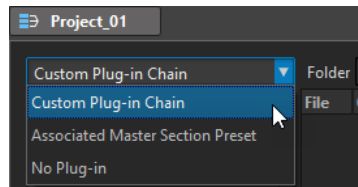

2. In the **Plug-in** window, do one of the following:
 - Select the plug-in or the **Master Section** preset that you want to use, and drag it to the **Custom Plug-in Chain**.
 - Double-click a plug-in or a **Master Section** preset to add it at the end of the plug-in chain.
-

Audio Signal Path

The audio signal path of a batch process is indicated by red, green, and blue arrows in the audio plug-in chain list.

- A red arrow indicates that the signal is processed, then sent to the next plug-in.
- A green arrow indicates that the signal is analyzed at this stage of the audio chain, but is not yet modified and therefore not sent to the next plug-in. When the audio stream comes to an end, it is restarted. Next time the signal reaches this plug-in, it is modified, and sent to the next plug-in. Some plug-ins need several analyses before passing to the next plug-in.
- A blue arrow indicates that the signal has been fully processed at this stage and is written to disk.
- A vertical separator line indicates that a meta-pass happens. This means that the files are read and processed again one after the other.

NOTE

Some multipass plug-ins request more than one analysis pass, or send the signal further in the chain without ordering the audio stream to restart. This behavior depends on the plug-in settings and on the audio material and cannot be influenced.

Removing Files and Plug-ins from the Batch Process

PROCEDURE

- In the **Custom Plug-in Chain** or **Files to Process** list, right-click the item that you want to remove, and select **Remove**, or select the item and press **Delete**.
-

Changing the Order of the Plug-ins in the Batch Process

PREREQUISITE

Create a new batch process file or open an existing file.

PROCEDURE

- Select a plug-in or **Master Section** preset from the audio plug-in chain list, and drag it to another position.
-

Previewing the Effect of Batch Processing

You can preview the effect of the batch processor on any file of a batch. The preview includes all effects and the file format.

PREREQUISITE

Set up your batch process.

PROCEDURE

1. In the lower right corner of the **Batch Processor** window, set up the **Preview Duration**. The preview duration can be between 2 seconds and 59 seconds.
 2. Right-click the file that you want to preview and select **Preview Processing**.
-

Processing Open Files

If you are processing a file that is already open there are things to consider.

- If the new file will have the same name and is saved in the same location, the file will not be saved because it is already open.
- If the new file will have the same name and is saved in the same location, and the number of channels changes in the file (mono becomes stereo or vice versa), a new document is created, which is opened in an untitled window.

Selecting an Output Format for the Batch Process

You can render to a single audio format or to multiple audio formats.

PREREQUISITE

Create a new batch process file or open an existing file.

PROCEDURE

1. In the **Batch Processor** window, select the **Format** tab.
 2. Click the **File Format** field.
 3. Select **Edit Single Format** or **Edit Multi Format**.
 4. In the **Audio File Format** dialog, make the settings, and click **OK**.
-

Setting Up a File Location for the Batch Process

PREREQUISITE

Create a new batch process file or open an existing file.

PROCEDURE

1. In the **Batch Processor** window, select the **Output** tab.
 2. Set the type of destination folder and the folder in which the audio files are rendered.
-

Specifying an Overwriting Strategy

PREREQUISITE

Create a new batch process file or open an existing file.

PROCEDURE

1. Select the **Execution** tab.
 2. From the **When a File Is to Be Overwritten** pop-up menu, select one of the following overwriting strategies:
 - **Overwrite without Question**
 - **Stop and Ask**
 - **Report as Error**
 - **Skip and Mark as Done**
 - **Auto-Rename**
-

Naming Rendered Audio Files

With the renaming function of the **Batch Processor** window, you can generate new names for the rendered files according to custom rules.

PREREQUISITE

Open a batch processor file.

PROCEDURE

1. In the **Batch Processor** window, select the **Output** tab.
 2. Activate **Renaming**, and click the renaming field.
 3. Make your settings, and click **OK**.
-

Running and Stopping the Batch Process

Once all settings are made, you can start the batch process. You can pause and cancel the processing procedure at any time.

- To start the batch process, select the **Edit** tab and click **Start**.
- To pause the batch process, select the **Edit** tab and click **Pause**. You can continue the batch processing by clicking **Pause** again.
- To cancel the batch process, select the **Edit** tab and click **Cancel**.

Batch Processing Status Icons

The icons next to the file number indicate the status of the files in the **Files to Process** list.

Green circle

Indicates that the file is ready to be processed.

Cogwheel icon

Indicates that the file is being processed. The **Batch Processor** window cannot be closed if any files have this status.

Yellow dot

Indicates that the process is done partially. For example, the files have been analyzed (analysis pass), but not yet processed (modifying pass).

Green dot

Indicates that the file has been successfully processed. In order to process the file again, you need to reset its status.

Red dot

Indicates that an error occurred.

Resetting the Status of Batch Processed Files

To apply the batch process again on already processed files, you need to reset the status of these files.

- To reset the status of one or several files in the **File to Process** list, select one or several files, right-click them, and select **Reset Status**.
- To reset the status of all files in the **Files to Process** list, select the **Edit** tab and, in the **Reset Status** section, click **All Files**.
- To reset the status of all files with an error in the **Files to Process** list, select the **Edit** tab and, in the **Reset Status** section, click **Files with an Error**.

Multitasking During the Batch Process

You can select how many CPU cores of your computer should be used simultaneously. The available number of cores depends on your computer hardware.

Each task uses one core, therefore the multitasking setting represents the maximum number of tasks that can be run in parallel. It is not always recommended to use the highest settings for the following reasons:

- If you want to continue working with your computer during batch processing, you need to spare power.
- The disk is slower.
- Graphics performance and user interface responsiveness are reduced.
- If your processor uses hyper-threading, half of the cores are virtual and do not bring as much power as real cores.

If many large files are written, using multitasking is not always recommended, because the files can become more fragmented on your disk. The resulting files might be slower to read, unless you are using SSD drives.

NOTE

The number of cores to be used can be changed at any time. Tasks that are already running are continued or paused, depending on the new setting.

Selecting Processor Cores for the Batch Process

PROCEDURE

1. In the **Batch Processor** window, select the **Execution** tab.
 2. Open the **Usage of Processor Cores** pop-up menu and select the number of processor cores that you want to use.
-

Watch Folders

Watch Folders can be used to automate batch processing tasks. By copying files into a Watch Folder, a predefined batch processor is automatically applied to these files.

In the batch processor, you can use all audio processing functions that WaveLab Pro offers. For example, processing with VST plug-in chains, R-128 loudness normalizing, audio analysis reports, MP3 conversions, etc.

NOTE

To fully take advantage of the Watch Folder feature, you must be acquainted with the **Batch Processor** window in WaveLab Pro.

Any kind of File Explorer/macOS Finder folder can be defined as Watch Folder. You can drag or copy files into the folder, or save audio files into a Watch Folder from any application. Watch Folders can process both audio files and audio montages.

You can set up multiple Watch Folders, each corresponding to a different audio process.

WaveLab Pro processes any files that are copied into Watch Folders, even if it is not the active application.

The procedure to set up a Watch Folder is to set up a batch processor, create a Watch Folder, associate the Watch Folder with the batch processor, and then activate the Watch Folder. When you now drag files into this folder, they are processed automatically.

The files that you drag into the Watch Folder can be located in folders with subfolders. The processed files in the output folder will have the same folder structure as the source files.

You can also drag XML files that specify the audio files that you want to process into the Watch Folder.

RELATED LINKS

[Batch Processing](#) on page 490

[XML Files in Batch Processing](#) on page 519

Setting Up a Batch Processor for Watch Folders

You can associate any existing batch processor configuration with your Watch Folders or set up a new batch processor configuration for your Watch Folders.

A Watch Folder can be associated with multiple batch processor tasks. For example, copying a file into a Watch Folder could automatically produce a 96 kbps MP3 file, a 192 kbps MP3 file, an OGG file, and a normalized WAVE file.

- To edit the batch processor, double-click a batch processor in the **Watch Folder** window.
- To edit the output folder of a batch processor, double-click the **Output Folder** column of a batch processor in the **Watch Folder** window.

IMPORTANT

Plug-ins that show a validation dialog on startup cannot be used.

RELATED LINKS

[Working with the Batch Processor](#) on page 499

[Multitasking During the Batch Process](#) on page 506

Watch Folders Window

In this window, you can set up and edit the Watch Folder configuration.

- To open the **Watch Folder** window, open the **Batch Processor** window and select **Tool Windows > Watch Folder**.

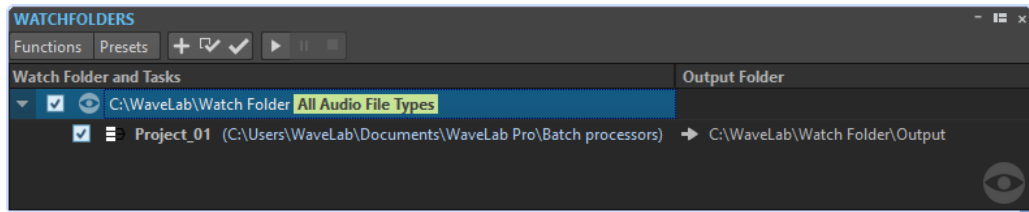

NOTE

The configurations that you make in the **Watch Folder** window are automatically saved as you edit.

Watch Folder List

The Watch Folder list shows the selected Watch Folder and its associated batch processors.

- To edit a Watch Folder, double-click the folder in the list.
- To exclude batch processors from being triggered, deselect the corresponding checkbox in the **Watch Folders** window.

Functions Menu

Add Watch Folder Task

Opens the **Add Watch Folder Task** dialog, where you can assign a new Watch Folder to a batch processor.

Remove Watch Folder Task

Removes the selected watch folder task.

Settings

Opens the **Watch Folder Settings** dialog, where you can make additional settings for the Watch Folder.

Verify Configuration

Verifies that the Watch Folder configuration is valid and ready to be activated. This check is automatically performed when you activate the Watch Folder.

Start

Activates the Watch Folder. If you drag files into an active Watch Folder, the associated batch processors are applied.

Pause

Pauses the Watch Folders.

Stop

Stops the Watch Folders. All tasks that are running are canceled.

Multi Computer Processing

Allows you to activate the Watch Folders as master instance or slave instance.

Presets Menu

Save As

Allows you to save the active Watch Folder configuration as a preset.

Presets List

Lets you select a Watch Folder configuration preset.

Defining a Watch Folder

PREREQUISITE

Set up a batch processor.

PROCEDURE

1. In the **Batch Processor** window, do one of the following:
 - In the **Watch Folders** window, select **Functions > Add Watch Folder Task**.
 - In the **Watch Folders** window, click the + icon.
 - Drag a folder that you want to make a Watch Folder or a batch processor file into the **Watch Folders** window. This opens the **Watch Folder Task** dialog and sets the corresponding folder or batch processor file as default.
2. In the **Add Watch Folder Task** dialog, do the following:
 - Specify the path of the folder that you want to use as a Watch Folder.
 - Specify the file types that you want to process.
 - Specify the path of the batch processor that you want to trigger in the selected Watch Folder.

If a batch processor is already open in the **Batch Processor** window, it will be proposed by default in the **Batch Processor File** field.

3. Click **OK**.
The Watch Folder setup is added to the Watch Folders list.
 4. In the **Watch Folders** window, select **Functions > Settings** and make additional settings for the Watch Folders.
 5. To validate the Watch Folder setup, select **Functions > Verify Configuration**.
 6. Optional: Assign another batch processor to the Watch Folder.
-

AFTER COMPLETING THIS TASK

When you are done creating a Watch Folder configuration, you must activate it.

RELATED LINKS

[XML Files in Batch Processing](#) on page 519

[Watch Folder Settings Dialog](#) on page 514

Add Watch Folder Task Dialog

In this dialog, you can specify the Watch Folder location, its associated batch processor file, and the file types that should be processed.

- To open the **Add Watch Folder Task** dialog, open the **Watch Folders** window, and select **Functions > Add Watch Folder Task** or click the + icon.

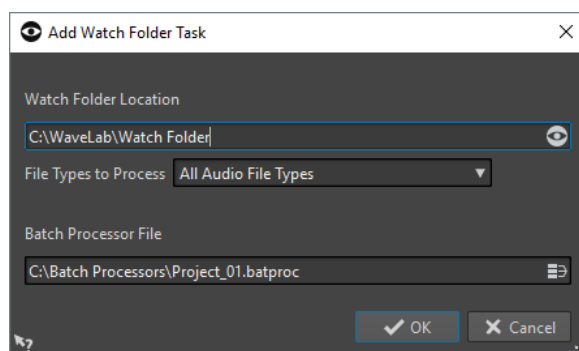

Watch Folder Location

Allows you to specify the Watch Folder location.

File Types to Process

Allows you to select the file types that are associated with the Watch Folder. Only files with the corresponding file format are added to the batch process.

Batch Processor File

Allows you to specify the batch processor file that you want to associate with the Watch Folder.

You can click the icon at the right of the text field to see a list of all open batch processors and a list of all recently used batch processors.

Activating the Watch Folder Configuration

Once you have set up a Watch Folder configuration, you can activate it.

PREREQUISITE

Set up a batch processor and create one or more Watch Folders.

PROCEDURE

1. In the **Watch Folders** window, select **Functions > Start**.
2. In the **Watch Folder Activation** dialog, make your settings, and click **Activate**.

RESULT

The Watch Folder configuration is active. Once you drag a file into a Watch Folder, the associated batch processors are triggered.

IMPORTANT

To apply the changes that you have made for an active Watch Folder configuration, you must stop and restart the Watch Folders.

AFTER COMPLETING THIS TASK

Via the system tray icon you can access information about the activated Watch Folder, and pause or stop the processing.

Processing Watch Folders in the Background

WaveLab Pro's Watch Folder feature can be used as a background task. For this, an additional instance of WaveLab Pro is opened in the background. The two instances can run simultaneously.

The GUI mode is mainly used for setting up the Watch Folder and test the functionality. Once everything has been set up, you can activate the Watch Folder configuration using the WaveLab Pro background instance.

The background instance can be used once you have set up the Watch Folder. When you drag files into your Watch Folder, the WaveLab Pro background instance processes the files. You can have the background instance launched automatically with the operating system.

You can use the **Multi Computer Processing** option to run a WaveLab Pro background instance on a different computer to increase the processing speed.

NOTE

Once a background instance is opened, it is independent from the instance that you work with.

RELATED LINKS

[Watch Folder Activation Dialog](#) on page 512

[Multi Computer Processing](#) on page 511

Automatically Starting a Background Instance on Startup

You can start a WaveLab Pro background instance automatically with the operating system.

- To activate or deactivate the automatic startup function, open the **Watch Folder Activation** dialog, and select **Activate Watch Folders at Computer Startup**.

You can also deactivate the automatic startup function outside WaveLab Pro.

- On Windows, remove the WatchFolders.lnk file from the following location:
`C:\Users\[UserName]\AppData\Roaming\Microsoft\Windows\Start Menu\Programs\Startup`
- On Mac, remove the WaveLab Pro entry from the login items list.
`System preferences/Users & groups/Login items`

RELATED LINKS

[Activating the Watch Folder Configuration](#) on page 510

Multi Computer Processing

You can use several computers that are located in the same network to process the same Watch Folders. For example, if there are 10 computers and 800 files to process, each computer processes 80 files. This increases the processing speed.

If the Watch Folder is located on a shared network path, the processing tasks are distributed between the computers. One instance of WaveLab Pro is the “master” version that distributes the files between the other computers that are in “slave” mode. This allows for much faster processing of the files.

The Watch Folder configuration of the master instance is used and shared with the slave instances.

The multi computer processing option uses the background instance mode for each computer in the setup.

IMPORTANT

- All computers in the network must be either Windows or Mac.
- All computers in the network must be set to the same language.
- Each computer must be set up with the plug-ins that are used by the batch processors.
- The paths specified in the Watch Folder configuration must be specified in a universal form.

On Windows, this must be in the following form: `\\ServerName\volume`

On Mac, this must be in the following form: `/ServerName/volume`

- If a task depends on specific settings (for example, the XML settings), these settings must be set on each computer. You can use the **Synchronization Settings** option in the WaveLab Pro global preferences to synchronize the computers.

Activating a Multi Computer Processing Watch Folder

PREREQUISITE

Set up a batch processor and create one or more Watch Folders.

PROCEDURE

1. In the **Watch Folders** window, do one of the following:
 - To activate a master instance, select **Functions > Multi Computer Processing > Start as Master**.
 - To activate a slave instance, select **Functions > Multi Computer Processing > Start as Slave**.

NOTE

When you are setting up a new multi computer processing, you must first start the master instance.

2. Specify the network setting path.
3. Decide whether to activate the Watch Folders at computer startup.
4. Click **Activate**.

RESULT

The Watch Folder starts in master or slave mode.

Watch Folder Activation Dialog

In this dialog, you can set up the Watch Folder mode for the Watch Folders that you are activating.

Depending on whether you are activating a standard Watch Folder or use the multi computer processing mode, the **Watch Folder Activation** dialog has different options.

Standard Watch Folder Activation Dialog

In this dialog, you can specify whether the Watch Folder runs in GUI mode or as a background application.

In the **Batch Processor** window, in the **Watch Folders** window, set up a Watch Folder task, and select **Functions > Start**.

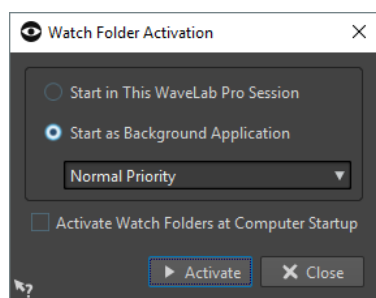

Start in This WaveLab Session

If this option is activated, the active WaveLab Pro instance is used for processing files in the Watch Folders. When files are copied into a Watch Folder, the corresponding batch processor file is activated. This allows you to see the progress of the processing from within WaveLab Pro.

This mode is useful for setting up the Watch Folder configuration.

Start as Background Application

If this option is activated, a new WaveLab Pro instance is launched in the background. This instance is used for processing the Watch Folders.

Priority

When using a WaveLab Pro background instance for processing files in the Watch Folders, this can slow down other programs when files are processed. You can set the priority with which the background instance uses the resources of the computer.

The following priorities are available:

- **Normal:** Causes the WaveLab Pro background instance to run with the same priority as all other programs.
- **Low:** Causes a WaveLab Pro background instance to run with a lower priority. Processing is slower, leaving more power to other applications.
- **Lowest:** Causes a WaveLab Pro background instance to run with the lowest priority. Processing is slower, leaving more power to other applications than the **Low** option.

Activate Watch Folder at Computer Startup

If this option is activated, a background instance of WaveLab Pro automatically launches when the computer starts. This instance is used for processing files in the Watch Folders.

Watch Folder Activation Dialog for a Master or Slave Instance

In these dialogs, you can set up the multi computer processing. This allows you to distribute the processing of the batch processor files over several computers in the network.

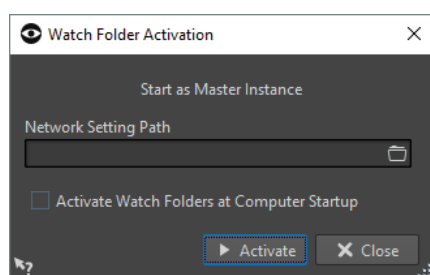

Network Setting Path

When using multi computer processing, the Watch Folder configuration must be shared among all computers and the network path must be accessible for all computers in the network.

Activate Watch Folder at Computer Startup

If this option is activated, a background instance of WaveLab Pro automatically launches when the computer starts. This instance is used for processing files in the Watch Folders.

Using the Watch Folder

Once you have set up the Watch Folder configuration, you can start to process files.

PREREQUISITE

Set up one or several batch processor files, associate them with one or more Watch Folders, and activate the Watch Folder configuration.

PROCEDURE

- Drag, copy, or save audio files into your Watch Folders.
You can also drag entire folders into the Watch Folder.

NOTE

- If you drag an empty folder into the Watch Folder, it is automatically deleted.

- If you have set up the **Scheduled Folder** option, place the files into the `Scheduled` subfolder inside the Watch Folder. Otherwise, they are processed immediately.
-

RESULT

The files are processed according to your settings.

Saving a Watch Folder Configuration as Preset

You can save the Watch Folder settings and list as a preset. However, the preset does not include the batch processor files, which are independent files.

PROCEDURE

1. Set up a Watch Folder configuration.
 2. In the **Watch Folders** window, select **Presets > Save As**.
 3. In the **Save Preset As** dialog, do one of the following:
 - To save the preset in the default folder, enter a name and click **Save**.
 - To save the preset in a custom subfolder of the default folder, click the folder icon, enter a name for the subfolder, and click **OK**. Then select the subfolder, enter a name for the preset and click **Save**.
-

Watch Folder Settings Dialog

In this dialog, you can make settings for the Watch Folders.

- To open the **Watch Folder Settings** dialog, in the **Watch Folders** window, select **Functions > Settings**.

Main Tab

After Processing Input File

After an input file is successfully processed, it has to be removed from its folder. The following options are available:

- **Move Input File to the "Sources" Subfolder**
If this option is activated, processed files are moved to a folder called `Sources`, inside the Watch Folder. The original folder structure is preserved.

NOTE

When using an XML file to describe the files to process, an audio file can be located anywhere outside the Watch Folder. In that case, the **Move It to Source Subfolder** option has no effect.

- **Delete Input File**
If this option is activated, processed files are deleted from the Watch Folder.

If an Input File Cannot Be Processed

If an input file cannot be successfully processed, it has to be removed from its folder. The following options are available:

- **Move Input File to the "Errors" Subfolder**
If this option is activated and a file cannot be successfully processed, it is moved to a folder called `Errors`, inside the Watch Folder. The original folder structure is preserved.
- **Delete Input File**

If this option is activated and a file cannot be successfully processed, it is deleted from the Watch Folder.

Scheduled Folder

You can specify a time range for the processing of Watch Folders. This allows you to automatically process files over night or during lunch break, for example.

To do so, create a folder named `Scheduled` inside the Watch Folder, activate the **Scheduled Folder** option, and specify the time range.

Files that reside copied outside the `Scheduled` subfolder are processed immediately.

Notification after Processing

If this option is activated, a system tray notification pops up when the files have been processed successfully. Clicking this notification opens the folder where the last file was rendered.

Add Readme File to Each Watch Folder

If this option is activated, a file called "readme.html" is added to the root folder of each Watch Folder. The readme file contains information about the settings of the Watch Folder.

Advanced Tab

Timing

- **Poll Period**

This is the period during which WaveLab Pro scans Watch Folders. The shorter the time, the sooner the files that are copied into the Watch Folder are processed.

- **Delay before Processing Starts**

A file must be fully written to the Watch Folder before processing can start. Therefore, WaveLab Pro monitors how the file size increases and the time stamp of the file. Once these indicators are stable, WaveLab Pro waits for the specified time before starting the batch processors.

If the files are written by another application, for example, a Cubase mixdown, a value of 2 seconds is recommended. If the audio files are copied or moved from the File Explorer/macOS Finder, you can use a smaller value.

- **Wait for Companion File**

If an audio file is copied into the Watch Folder along with a marker file (.mrk), the processing should only start when both files are present in the Watch Folder. The delay value specifies how long WaveLab Pro waits for a marker file.

If you never process audio files with marker files, you can set this value to 0.

WaveLab Pro also waits for both mono audio files of a dual mono file if this is activated in the batch processor. The **Wait for Companion File** option is independent from the dual mono file capability, which relies on file naming analysis that you can set up in the **Audio Files Preferences**.

Log File

You can create a log file that is continuously updated with messages about the batch processing inside the Watch Folders. The log file helps you locate errors in the Watch Folder configuration.

- **File Path**

Here, you can specify the name and the location of the log file.

If you use Watch Folders in a distributing network environment, one independent log file is created on each computer.

- **Clear Log File when Activating Watch Folders**

If this option is activated, the log file is cleared each time Watch Folders are activated. This option is always activated if the log file has a markup format.

- **Only Report Errors**

If this option is activated, only error messages are written to the log.

- **Format**

Lets you select whether the log file is a raw text file or a markup file (XML or HTML).

For markup files, an end tag is added only when the Watch Folders are deactivated. In case of a distributing computing environment, this tag is added by the master computer.

RELATED LINKS

[XML Files in Batch Processing](#) on page 519

[Dual Mono Files](#) on page 138

System Tray Icon

If Watch Folders are active, a system tray icon is displayed that gives information about the progress and errors, and offers several options regarding the active Watch Folder.

To open the context menu, click the system tray icon.

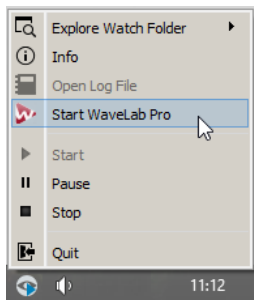

System tray icon on Windows.

Explore Watch Folder

Lets you open the active Watch Folders in the File Explorer/macOS Finder.

Info

Opens a pop-up message about the number of successfully processed files and the number of error messages.

Open Log File

Opens the log file for the Watch Folders.

Start WaveLab Pro

If the system tray icon corresponds to a background instance of WaveLab Pro, this option opens a new WaveLab Pro instance.

If there is already a visible instance of WaveLab Pro, it is put to the front.

Start

Activates the Watch Folders. If this option is not available, the Watch Folders are already activated.

Pause

If this option is activated, WaveLab Pro stops watching folders. If files are being processed, their processing is paused. It will continue as soon as **Pause** is deactivated.

Stop

If this option is activated, WaveLab Pro stops watching folders and cancels any batch processing that is taking place.

Quit

Quits WaveLab Pro and cancels any batch processing that is active. This option is only available if WaveLab Pro is running in the background.

System Tray Status Icons

The system tray icon changes according to the status of the Watch Folder.

Active



Indicates that the Watch Folder is active.

Processing



Indicates that the Watch Folder is processing.

Pause



Indicates that the Watch Folder is paused.

Stop



Indicates that the Watch Folder is stopped.

Error



Indicates that an error occurred during processing. However, processing is not stopped.

Folder Structure

There are different types of subfolders that WaveLab Pro automatically creates inside a Watch Folder.

Output, **Sources**, **Errors**, **Scheduled**, and **\$TEMP\$** are reserved for WaveLab Pro. You cannot create a subfolder with one of these names.

Output

When you create a new batch process, this is the folder where processed files are written by default. You can change the output folder in the **Output** tab of each batch processor.

Sources

This is the folder where processed files are moved when they are successfully processed. For this, the corresponding option must be activated in the Watch Folder settings.

Errors

This is the folder where files that could not be processed are moved. For this, the corresponding option must be activated in the Watch Folder settings.

Scheduled

If you want to process some files only at a specific time, this is the folder where you must place the files. These files are only processed at the time that is specified in the Watch Folder settings.

\$TEMP\$

This is a temporary folder that is created and deleted by WaveLab Pro during processing.

Controlling the WaveLab Background Application via Command Line Parameters

You can control the WaveLab Pro background instance via command line parameters.

The following options are available:

--serviceLaunch

This command launches a WaveLab Pro background instance. It must be followed by one of the following options:

- **alone:** Causes a WaveLab Pro background instance to be launched for use in a single computer system.
- **master:** Causes a WaveLab Pro background instance to be launched in **Master Mode** for a multi computer system.
- **slave:** Causes a WaveLab Pro background instance to be launched in **Slave Mode** for a multi computer system.

For these commands, a background WaveLab Pro instance is launched in stop mode by default. This command can be followed by the commands **--serviceCommand start** and **--servicePriority**, for example.

```
--serviceLaunch alone --serviceCommand start --servicePriority low
```

--serviceAuto

This command causes a WaveLab Pro background instance to be launched in the mode that was active when you last selected **Activate Watch Folders at Computer Startup** from the **Watch Folder Activation** dialog.

For such an instance, the Watch Folders are automatically activated.

--serviceCommand

This command starts, pauses, or stops the WaveLab Pro background instance. It must be followed by one of the following options:

- **start:** Starts the WaveLab Pro background instance.
- **pause:** Pauses the WaveLab Pro background instance.
- **stop:** Stops the WaveLab Pro background instance.

--servicePriority

This command defines the priority with which the WaveLab Pro background instance is using the processing power of the computer. It must be followed by one of the following options:

- normal
- low
- lowest

--serviceSettingPath

This command specifies the network path used to synchronize the configuration between the computers when you are running WaveLab Pro in master and slave mode. For example:

```
--serviceSettingPath "\\server\volume\test"
```

An example to start a master instance:

```
--serviceLaunch master --serviceCommand start --serviceSettingPath  
"\\server\volume\test"
```

An example to start a slave instance:

```
--serviceLaunch slave --serviceCommand start --serviceSettingPath  
"\\server\volume\test"
```

--serviceStatus

This command instructs WaveLab Pro to write the status of the Watch Folder to a file. This command must be followed by a file name and WaveLab Pro must run as a background instance.

The status file gives information about whether WaveLab Pro is running, paused, or stopped, the number of error messages, and success messages.

This command is useful to check the status of the Watch Folder system.

```
--serviceStatus "d:\tests\status.txt"
```

XML Files in Batch Processing

WaveLab Pro can read information from XML files, such as audio file location and metadata. WaveLab Pro can also write information to XML or HTML files, such as custom data, metadata, and audio analysis.

This is useful for handling and tagging huge amounts of audio files. Also, the batch input to WaveLab Pro and the batch output from WaveLab Pro can be controlled externally with XML files.

The input XML files must not be formatted in a restricted way. You can instruct WaveLab Pro to understand the structure of your XML files.

XML Input

You can add an XML file to a batch processor to pass information to WaveLab Pro.

There are three types of elements that WaveLab Pro can identify.

Input file path and file name

To instruct WaveLab Pro where to find the audio file that you want to process. This information is mandatory.

Output file path

To instruct WaveLab Pro where to render the audio file. This information is optional. If this information is available, it has priority over the output path settings that you make for the batch process on the **Output** tab.

Metadata

To transmit metadata that WaveLab Pro can add to the audio files that you want to process. This information is optional.

Instructing WaveLab to Understand your XML Files

You must instruct WaveLab Pro to understand your XML files, in order to make use of the XML input function.

PROCEDURE

1. In the **Batch Processor** window, select the **Edit** tab.
2. In the **XML** section, click **XML Audio Description**.
3. In the **XML Audio Description** dialog, specify the input location.
4. Optional: Specify more elements.
If you have selected **User Variable (to Import Metadata)**, specify a user variable.
5. Specify a tag and, if necessary, an attribute name and value.

NOTE

You can only specify one attribute per tag. If your XML file has other attributes, these are ignored by WaveLab Pro.

6. If necessary, specify the enclosing element tag and its attribute name and value.
7. Optional: To save the settings as preset, click the presets field, select **Save As**, enter a name, and click **OK**.
8. Click **OK**.

RESULT

WaveLab Pro can understand the structure of your XML file. You can now add the XML file to your batch process.

XML Audio Description Dialog

In this dialog, you can instruct WaveLab Pro how to understand the structure of the XML file that you want to read.

- To open the **XML Audio Description** dialog, open the **Batch Processor** window, and in the **XML** section on the **Edit** tab, click **XML Audio Description**.

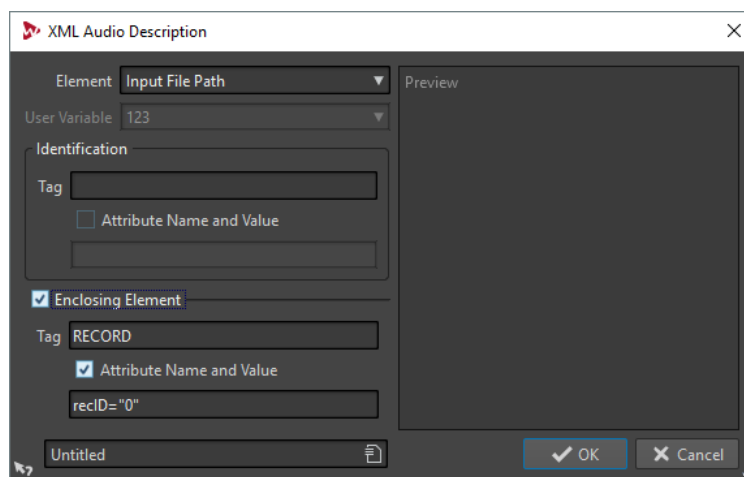

Element

Lets you select the element that you want WaveLab Pro to identify in the XML file. You can specify the file location of the input file and the file location of the output file. The following input and output elements are available:

- **Input Folder/Output Folder**

The input folder is the folder where the audio file is located. The output folder is the folder where you want to save the file. These paths can be relative to the path of the XML file.

If no input/output folder is found, the file path of the XML file is used instead.

- **Input File Name/Output File Name**

The file name of the input/output file. For example, `Piano.wav`.

- **Input File Path/Output File Path**

The complete input/output path including the file name. For example, `C:\AudioFiles\Piano.wav`.

For the input, you must specify either the **Input File Path** or the **Input Folder + Input File Name**. If the audio file is located in the same folder as the XML file, it is sufficient to specify only the **File Name**.

If you do not make any output settings, the settings of the batch processor are used.

User Variable

Lets you specify custom variables that you want WaveLab Pro to identify in the XML file. This option is available if you have selected **User Variable** on the **Element** menu.

The custom variables are shared throughout WaveLab Pro. To edit the variables, select **File > Preferences > Variables**.

Identification - Tag

Lets you specify the XML tag that describes the element to identify.

Identification - Attribute Name and Value

If this option is activated, you can specify an XML attribute and its value for the tag to identify an element. In the text field, you must write the name and value in the following style:

```
attr="value"
```

Enclosing Element

If this option is activated, the element must be further identified by a parent tag.

Enclosing Element - Tag

Lets you specify the XML tag of the enclosing element.

Enclosing Element - Attribute Name and Value

If this option is activated, you can specify an XML attribute and its value for the tag of the enclosing element to identify an element. In the text field, you must write the name and value in the following style:

```
attr="value"
```

Preview

Shows a preview of the structure that WaveLab Pro expects in the XML file.

RELATED LINKS

[Variables and Text Snippets](#) on page 564

XML Output

After a batch process, WaveLab Pro can automatically produce an XML or HTML file that describes the processed audio files. This file can contain the type of processing, the embedded metadata, and the audio analysis result, for example.

An XSLT file must be specified to instruct WaveLab Pro how to generate the XML/HTML file. The XSLT file must use the UTF-8 character set.

You can generate the XML/HTML file from scratch or generate an XML file that is based on an existing XML file. The structure of the existing input XML file must be specified in the **XML Audio Description** dialog. The input XML file can contain the location of the audio files that you want to process and information that you want to find in the XML/HTML output file, for example.

Once the XML/HTML files are generated, you can import them to a database or a podcast, for example.

RELATED LINKS

[Instructing WaveLab to Understand your XML Files](#) on page 520

[XML Tab](#) on page 496

XSLT Files

WaveLab Pro needs an XSLT file to create an XML output file or transform an XML or HTML document to another XML document.

XSLT is a language for transforming XML documents into other XML documents, or generating XML documents from scratch. The WaveLab Pro XSLT processor is compatible with the XSLT 2.0 standard. However, not all features are supported, for example, xsl:output.

The XSLT file in WaveLab Pro determines whether the generated output file will be in XML or in HTML format. WaveLab Pro provides XSLT example files to generate XML or HTML files that describe the processed audio files.

- To use the XSLT example files, select the **XML** tab, open the **Presets** pop-up menu, and select **Factory Presets > HTML Example** or **Factory Presets > XML Example**.

In order for the example to work properly, the processed audio file must contain information for the ID3v2 metadata fields **Title** and **Genre**.

Parameters for XSLT Processing

You can specify which parameters will be included in an XML or HTML output file that you can generate with the batch process. For example, you can include metadata and the results of an audio analysis in such an output file.

To transmit parameters to the XSLT script, define them in the **Parameters for XSLT Processing** dialog.

NOTE

ID3v2 metadata can have custom fields (“TXXX”) that WaveLab Pro cannot list automatically on the menu. However, you can enter them manually.

Including Audio Analyzer Results in the XML or HTML Output File

You can include the audio analysis results of the Audio Analyzer batch processor monopass plug-in in the XML or HTML output file.

PROCEDURE

1. Open the **Audio Analyzer** monopass plug-in.
 2. In the **Audio Analyzer** dialog, activate the **Send Analysis Results to XML Processor** option.
 3. Open the **Parameters for XSLT Processing** dialog and select the parameters of the audio analysis that you want to include in the output XML.
-

Parameters for XSLT Processing Dialog

In this dialog, you can edit the parameters that you want to find in the XML or HTML file that you can generate with the batch process.

- To open the **Parameters for XSLT Processing** dialog, in the **Batch Processor** window, select the **XML** tab, and click the pen icon.

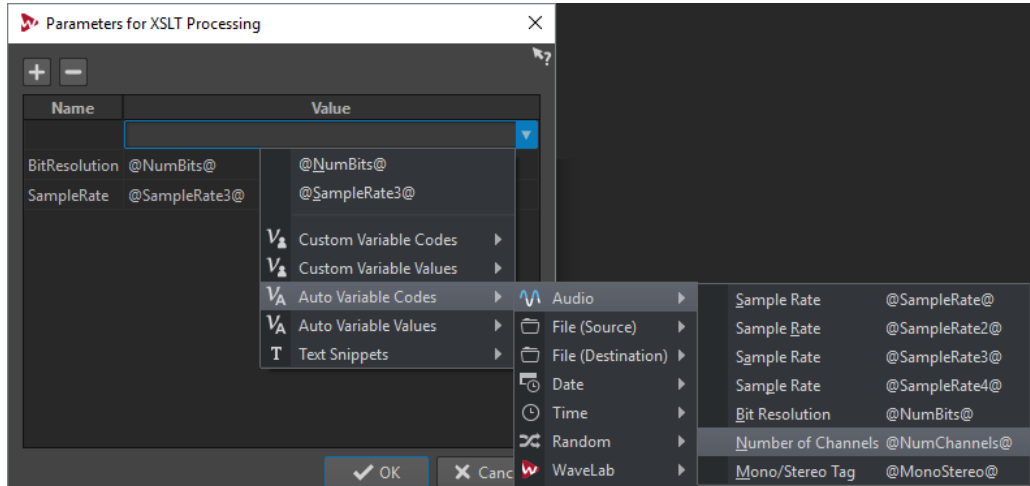

Create Parameter



Creates a new parameter.

Remove Parameter



Removes the selected parameter.

Parameter List

In the left column, you can specify a parameter name that is known by your XSLT file. In the right column, you can specify the value for the parameter.

The parameter values can be custom variable codes, custom variable values, auto variable codes, auto variable values, and text snippets. To see a list of all available parameters, click the arrow icon.

RELATED LINKS

[Variables and Text Snippets](#) on page 564

Generating an XML or HTML File From Scratch

PREREQUISITE

- Set up your batch process.
- Set up an XSLT file.

PROCEDURE

1. In the **Batch Processor** window, select the **XML** tab.
2. On the output pop-up menu, select **Generate XML/HTML File**.
3. In the **XSLT file** field, specify the path to your XSLT file.
4. Optional: In the **Optional Parameters** field, click the pen icon and specify additional parameters.

5. On the **Edit** tab, click **Start** to start the batch process.
-

RESULT

The audio files are processed and an XML/HTML file is generated with the information that are specified by the XSLT script.

The XML/HTML file is saved in the same location and with the same name (extension `.xml` or `.html`) as the rendered audio file. If **No Output** is activated, the XML/HTML file is saved in the `Output` subfolder of the Watch Folder.

Generating an XML File Based on an Existing Input XML File

PREREQUISITE

- Set up your batch process.
- Set up an XSLT file.
- Instruct WaveLab Pro how to understand the input XML file.

IMPORTANT

The input XML file must be valid to the structure that is specified in the **XML Audio Description** dialog.

PROCEDURE

1. In the **Batch Processor** window, select the **XML** tab.
2. On the output pop-up menu, select **Transform Input XML File**.
3. In the **XSLT file** field, specify the path to your XSLT file.
4. Optional: In the **Optional Parameters** field, click the pen icon and specify additional parameters.
5. Add the input XML file to the batch process.
The audio files that are specified in the input XML file are displayed in the batch processor list.

IMPORTANT

Do not manually add audio files to the batch process. The location of the audio files that you want to process is taken from the input XML file.

6. On the **Edit** tab, click **Start** to start the batch process.
-

RESULT

The audio files are processed and an output XML file is generated with the information that are specified by the XSLT script.

The XML file is saved in the same location and with the same name (extension `.xml`) as the rendered audio file. If **No Output** is activated, the XML file is saved in the same location as the source file.

RELATED LINKS

[Instructing WaveLab to Understand your XML Files](#) on page 520

[XML Audio Description Dialog](#) on page 520

Batch Conversion

You can convert multiple files simultaneously to another format. If no processing is needed, this can be done using the **Batch Conversion** dialog.

Batch Conversion Dialog

This dialog allows you to convert the file format of a group of audio files.

- To open the **Batch Conversion** dialog, select **File > Tools > Batch Conversion**.

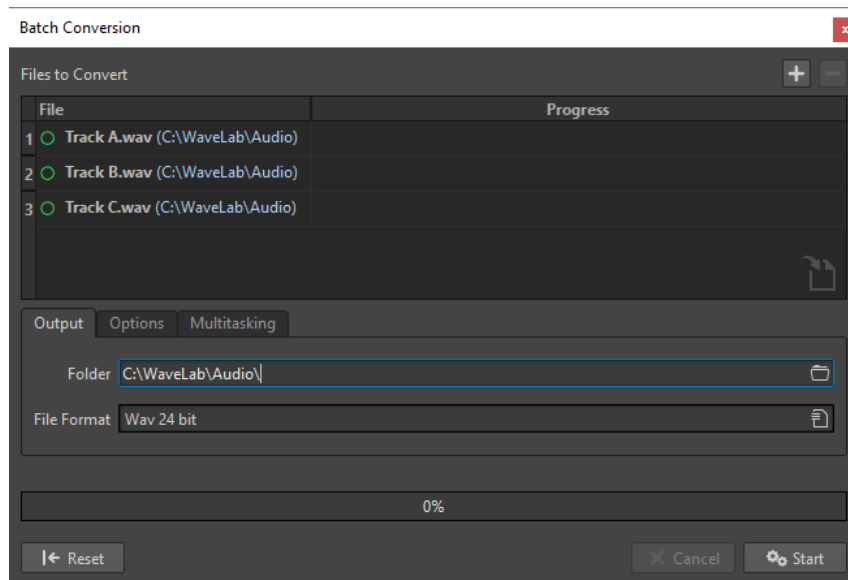

Add File



Opens a dialog, where you can select files to add to the list.

Remove Selected Files



Removes the selected item from the list.

List of files to convert

Shows the files to convert.

Output Tab

Folder

Allows you to specify the folder in which the converted files are saved.

File Format

Allows you to open the **Audio File Format** dialog, where you can set the file format.

Options Tab

Auto Start When Dropping Files

If this option is activated, the conversion starts automatically when you drag a file into the list.

Auto Remove Converted Files

If this option is activated, a file is removed from the list once it is successfully converted. Otherwise, it remains in the list with a green mark indicating its status.

Stop on Error

If this option is activated, the global process stops if an error is encountered. If this option is deactivated, the file associated with the error is marked in red, and the next file is processed.

Multitasking Tab

Usage of Processor Cores

Allows you to select how many cores to use simultaneously. The contents of this menu depend on your computer hardware.

Batch Converting Files

PROCEDURE

1. Select **File > Tools > Batch Conversion**.
 2. Click the plus icon to add files, or drag the files into the **Files to Convert** list.
 3. On the **Output** tab, select a file location and a file format.
 4. Optional: Make further settings on the **Options** and **Multitasking** tabs.
 5. Click **Start** to begin converting the files.
-

Batch Renaming

With the batch renaming functions, you can batch rename multiple files, markers, and clips. You can convert, remove, format, import, and insert text. This allows you to batch rename file names according to user specified rules.

You can use simple options to match text, or you can build your own regular expressions. Batch renaming can be useful with large projects, for example, to apply easily identifiable names to all referenced files, clips, and markers belonging to the project.

You can use batch renaming for the following operations:

- Rename files
- Rename clips in an audio montage
- Rename markers in audio files and audio montages

Batch Renaming Dialogs

The **Batch Renaming** dialogs for files, clips, and markers share most features, with some differences.

The **Batch Renaming** dialog has 3 pages.

1. The first page defines which files, clips, or markers are renamed. It is different for all renaming operations.
2. The second page defines how the renaming is performed. It is identical for all renaming operations.
3. The third page shows you a preview of the resulting names.

Batch Renaming Files

You can batch rename multiple files according to specified settings.

PROCEDURE

1. Select **File > Tools > Batch Renaming**.
 2. In the **Batch Renaming** dialog, select the files that you want to rename and click **Next**.
 3. Define the batch rename operation and click **Next**.
 4. Verify that the renaming is performed as intended, then click **Finish**.
-

RELATED LINKS

[Batch Renaming Dialog for Files](#) on page 528

[Renaming Operation Categories and Types](#) on page 532

[Previewing and Performing All Renaming Operations](#) on page 538

Batch Renaming Dialog for Files

In this dialog, you can batch rename individual files. Any open files that reference these files are updated automatically.

- To open the **Batch Renaming** dialog, select **File > Tools > Batch Renaming**.

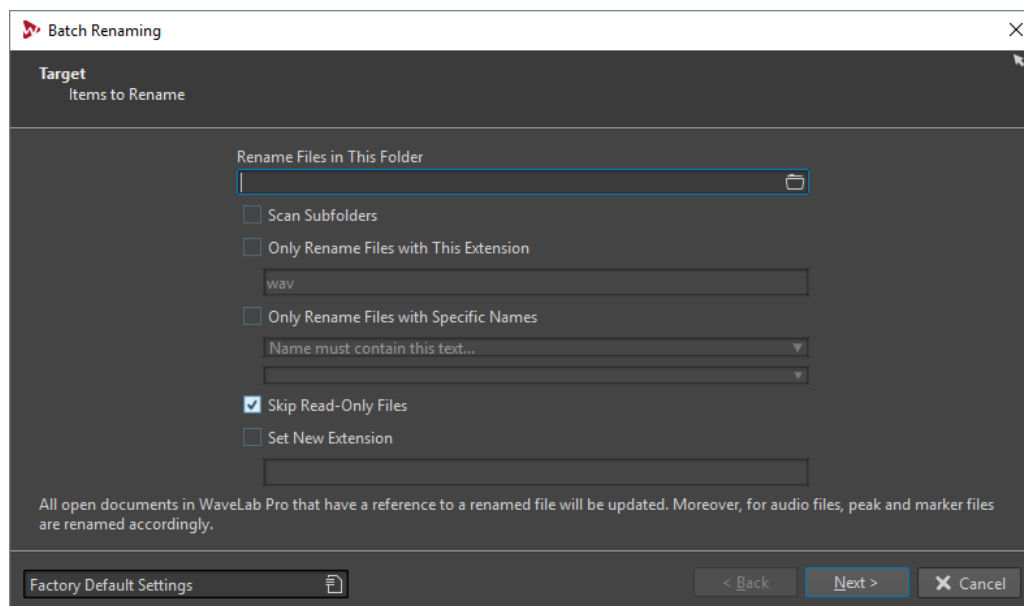

On the first page of this dialog, you can define which files to rename, by using the following options:

Rename Files in This Folder

Allows you to specify the folder that contains the files to rename.

Scan Subfolders

If this option is activated, files are also searched in subfolders.

Only Rename Files with This Extension

If this option is activated, only files with the extension specified in the text field below are renamed.

Only Rename Files with Specific Names

If this option is activated, only files that correspond to a specific name are renamed. You can type in a text string in the text field below, and select one of the following options from the menu:

- **Name must contain this text**
- **Name must NOT contain this text**
- **Name must contain this text (with wild cards)**
- **Name must NOT contain this text (with wild cards)**
- **Name must contain this regular expression**
- **Name must NOT contain this regular expression**

Skip Read-Only Files

If this option is activated, files that are read-only are not renamed.

Set New Extension

If this option is activated, the extension of files is replaced with the extension specified below.

Batch Renaming Markers

You can batch rename multiple markers in audio files or audio montages according to specified settings.

PROCEDURE

1. Optional: If you only want to rename markers in a specific time range, create a selection range in the wave window or the montage window.
2. Open the **Markers** window, and select **Functions > Batch Renaming**.
3. In the **Batch Renaming** dialog, on the **Target** page, make your settings, and click **Next**. If you have made an audio selection and want to use it, activate **All Markers in Audio Selection**.
4. Define the batch rename operation, and click **Next**.
5. Verify in the preview list that the renaming is performed as intended, and click **Finish**.

RELATED LINKS

[Batch Renaming Dialog for Markers](#) on page 529

[Renaming Operation Categories and Types](#) on page 532

[Previewing and Performing All Renaming Operations](#) on page 538

Batch Renaming Dialog for Markers

In this dialog, you can batch rename markers of any type.

- To open the **Batch Renaming** dialog for markers, open the **Markers** window and select **Functions > Batch Renaming**.

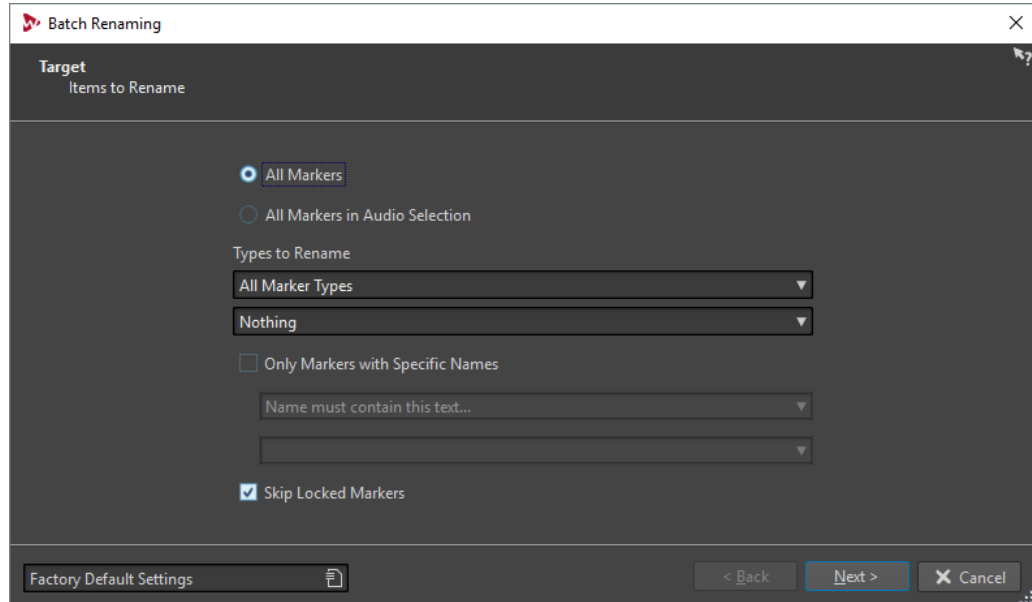

All Markers

If this option is activated, all markers in the selected file are renamed.

All Markers in Audio Selection

If this option is activated, all markers in the selected audio range are renamed.

Types to Rename

Only the markers of the type selected here are renamed.

Only Markers With Specific Names

If this option is activated, only markers that correspond to a specific name are renamed. You can type in a text string in the text field below, and select one of the following options from the menu:

- **Name must be empty**
- **Name must contain this text**
- **Name must NOT contain this text**
- **Name must contain this text (with wild cards)**
- **Name must NOT contain this text (with wild cards)**
- **Name must contain this regular expression**
- **Name must NOT contain this regular expression**

Skip Locked Markers

If this option is activated, markers that are locked are not renamed.

Batch Renaming Clips

You can batch rename multiple clips according to specified settings.

PROCEDURE

1. In the **Clips** window, select **Functions > Batch Renaming**.
 2. In the **Batch Renaming** dialog, select the clips that you want to rename and click **Next**.
 3. Define the batch rename operation and click **Next**.
 4. Check in the preview list if the renaming is as intended, then click **Finish**.
-

RELATED LINKS

[Batch Renaming Dialog for Clips](#) on page 530

[Renaming Operation Categories and Types](#) on page 532

[Previewing and Performing All Renaming Operations](#) on page 538

Batch Renaming Dialog for Clips

In this dialog, you can batch rename audio montage clips.

- To open the **Batch Renaming** dialog for clips, open the **Clips** window and select **Functions > Batch Renaming**.

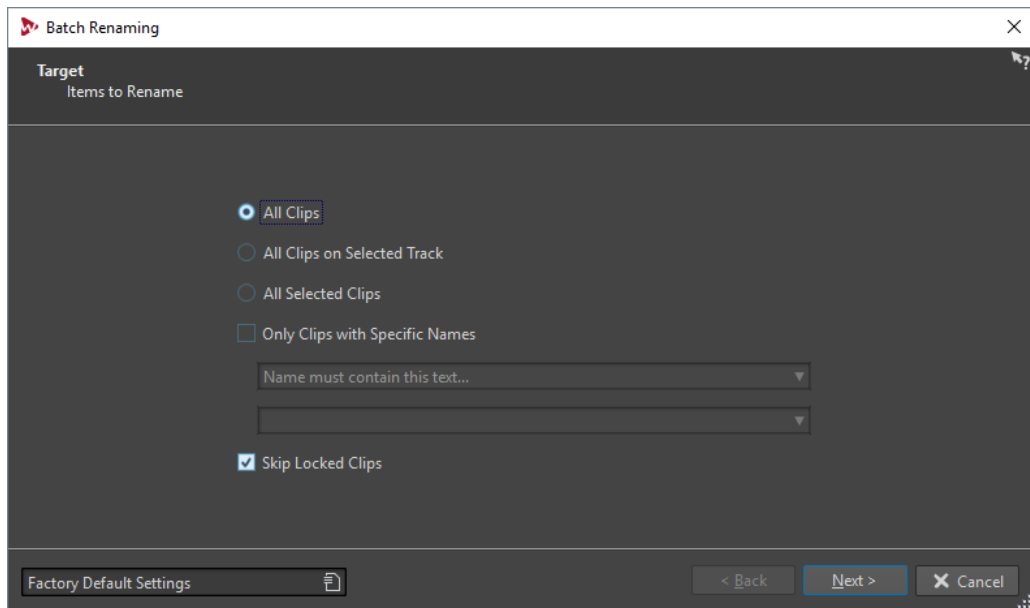

On the first page of this dialog, you can define which clips to rename, by using the following options:

All Clips

If this option is activated, all clips are renamed.

All Clips on Selected Track

If this option is activated, all clips on the selected track are renamed.

All Selected Clips

If this option is activated, all selected clips are renamed.

Only Clips With Specific Names

If this option is activated, only clips that correspond to a specific name are renamed. You can type in a text string in the text field below, and select one of the following options from the menu:

- **Name must be empty**
- **Name must contain this text**
- **Name must NOT contain this text**
- **Name must contain this text (with wild cards)**
- **Name must NOT contain this text (with wild cards)**
- **Name must contain this regular expression**
- **Name must NOT contain this regular expression**

Skip Locked Clips

If this option is activated, clips that are locked are not renamed.

RELATED LINKS

[Clips Window](#) on page 238

Renaming Operation Categories and Types

On the second page of the **Batch Renaming** dialog, you set up the renaming operation that you want to perform for clips, files, or markers.

The **Category** pop-up menu lists the renaming operation categories. The **Type** pop-up menu lists the various types of renaming operations. When you select a type, the related controls are displayed. The types depend on the selected category.

Remove

All

Removes all characters from the selected range.

Spaces

Removes all spaces from the selected range.

Spaces at Start/End

Removes all spaces at start and end of the selected range.

Duplicate

Replaces two consecutive identical characters by one. Specify the character to remove in the **Character** field.

Specific Characters

Removes all instances of one or more characters. Specify the characters to remove in the **Character** field.

Surrounded Text

Removes all instances of one or more characters. In the **Left Character** field, specify the characters from which on the text is removed. In the **Right Character** field, specify the last character to remove.

Then specify in the **Occurrence** pop-up menu which character to remove if several are found.

Convert

To Lower Case

Sets all characters in the selected range to lower case.

To Upper Case

Sets all characters in the selected range to upper case.

Capitalize

Sets the first character to upper case, and the rest to lower case. On the menu, you can specify whether only the first word or all words should be capitalized.

Initials to Upper Case

Sets only isolated letters to upper case. For example, u.s.a to U.S.A.

Specific Character to Text

Replaces each instance of a specific character with a custom string. In the **Character to Replace** field, enter the character you want to replace. In the **Replacement** field, enter the replacement string.

Pad Number with Zeros

Pads a number present in the selected range with zeros at the left side. On the menu below, specify how many digits the number should consist of.

Invert Character Order

Inverts the order of the characters in the selected range.

Replace with New Text

Replaces the selected range by a specific text string. In the text field below, enter this string.

Insert

Nothing

Inserts nothing.

Counter

Inserts a number at the selected position, and updates its value with each insertion. Set up the counter with the additional options.

Specific Text

Inserts a string at the selected position. In the text field below, enter the text to be inserted.

Part of Original Name

Inserts a part of the original name (before the first operation was performed) at the selected position. In the text field below, enter the regular expressions. Clicking the asterisk opens a menu with shortcuts for several regular expressions.

Pair of Characters around Text

Inserts specific characters before and after the selected range. In the **Left Character** field, specify the characters to insert before the selected range. In the **Right Character** field, specify the characters to insert after the selected range.

Spaces around Text

Inserts a space before and after the selected range.

Space after Specific Characters

Inserts a space after specific characters. In the field below, enter the characters that should be followed by a space.

Space before Each Capitalized Word

Inserts a space before each word starting with an upper case letter. For example, this changes "MyNicePiano" to "My Nice Piano".

If **Only Capitalize First Word** is activated, only the first word is capitalized.

Today's Date/Time

Inserts the current date and time.

Universal Unique Identifier

Inserts a unique identifier. This is useful for recordings, for example.

Random Word

Inserts a random pronounceable word.

Import and Insert External Data

This category allows you to insert information taken from a file or current context. This is mostly audio-oriented as some features analyze the audio file headers. The available options differ depending on the selected **Batch Renaming** dialog.

Sample Rate

Inserts the sample rate of the file. In the fields below, enter a prefix and suffix, and select how to format the imported data.

Number of Channels

Inserts the number of channels of the file. In the fields below, enter a prefix and suffix, and select how to format the imported data.

Bit Depth

Inserts the bit depth of the file. In the fields below, enter a prefix and suffix, and select how to format the imported data.

Bit Rate

Inserts the bit rate of the file if the file is encoded. In the fields below, enter a prefix and suffix, and select how to format the imported data.

Variable/Constant Bit Rate

Inserts the tag VBR or CBR if the file is encoded. In the fields below, enter a prefix and suffix.

File Length

Inserts the length of the file. In the fields below, enter a prefix and suffix.

File Extension

Inserts the extension of the file. In the fields below, enter a prefix and suffix.

Date/Time

Inserts the date/time of the file at the selected position. In the **Format** field below, enter a date.

Folder Name

Inserts the name of the folder containing the file. In the fields below, enter a prefix and suffix.

Folder Name (2 Positions Up)

Inserts the name of the folder located two positions higher up in the hierarchy. In the fields below, enter a prefix and suffix.

Folder Name (3 Positions Up)

Inserts the name of the folder located three positions higher up in the hierarchy. In the fields below, enter a prefix and suffix.

Sample: MIDI Note

Inserts the sample note of the file, if available. In the fields below, enter a prefix and suffix, and select how to format the imported data.

Sample: Detune

Inserts the detune information for the sample, if available. In the fields below, enter a prefix and suffix.

Sample: Key Range

Inserts the key range of the sample, if available. In the fields below, enter a prefix, suffix, and separator, and select how to format the imported data.

Sample: Velocity Range

Inserts the velocity range of the sample, if available. In the fields below, enter a prefix, suffix, and separator, and select how to format the imported data.

Metadata: Title

Inserts the title if this information is present in the metadata of the file. In the fields below, enter a prefix and suffix.

Metadata: Artist

Inserts the artist if this information is present in the metadata of the file. In the fields below, enter a prefix and suffix.

Metadata: Genre

Inserts the genre if this information is present in the metadata of the file. In the fields below, enter a prefix and suffix.

Metadata: Album

Inserts the album if this information is present in the metadata of the file. In the fields below, enter a prefix and suffix.

Metadata: BWF description

Inserts the corresponding metadata. You can insert the title, artist, genre, album, and BWF description.

Timeline Position

Inserts the position of the file in the timeline. In the fields below, enter a prefix and suffix.

Variable

Inserts the value of a variable. The value of the variable is retrieved from the corresponding source audio file. In the field below, enter the variable name.

Line [x] from Text File

Inserts the specified line from a text file to the specified renaming operation. In the field below, specify the location of the text file (UTF-8) from which the strings should be collected.

Find and Replace from Table

This category allows you to define a table of words and to associate each word with a replacement. This feature is useful to reformat a text according to a new style. For example, it can be used to map a series of numbers to a series of tags, to change a numerical sequence like "000 - 127" to "C-2 - G8" (MIDI notes).

Find Anywhere in Text

Replaces the words in the table with their specified replacement if they can be found anywhere in the selected range.

Find Exact Text

Replaces a word of the table with its specified replacement if it is identical to the word in the selected range.

In the table below these types, you can define a list of strings to find, and define a replacement for each one. Double-click the cells to edit the list. If a file cell is empty, it is ignored.

If **Case Sensitive Search** is activated, the search takes the letter cases into account. If **Keep Letter Case** is activated, the case of the replacement text is adapted to the case of the found text.

List of Renaming Operations

In this section on the **Operation** page of the **Batch Renaming** dialog, you can create, delete, and arrange renaming operations.

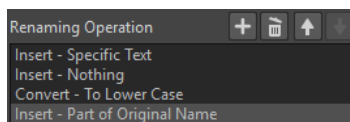

Add Renaming Operation



Adds a new renaming operation at the end of the list.

Remove Selected Renaming Operation



Removes the selected renaming operation from the list.

Arrow Up/Down



Moves the selected renaming operation one position up/down.

Renaming Operations

Lists all renaming operations that are performed on the original name. The operations are performed one after the other.

Preview Section

In this section on the **Operation** page of the **Batch Renaming** dialog, you can preview the result of the selected renaming operation.

When you enter a name in the **Original** field, the change is automatically reflected in the **Output Format** field. This preview is continuously updated.

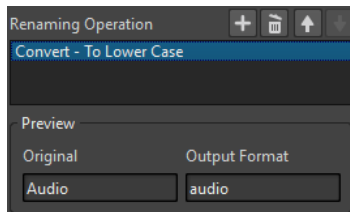

If the preview cannot display missing data, an "X" is shown instead.

Range Parameters

The range parameters on the **Operation** page of the **Batch Renaming** dialog allow you to specify where in the name the operation is performed.

- To access the range parameters, click **Advanced Editing** at the bottom of the **Batch Renaming** dialog.

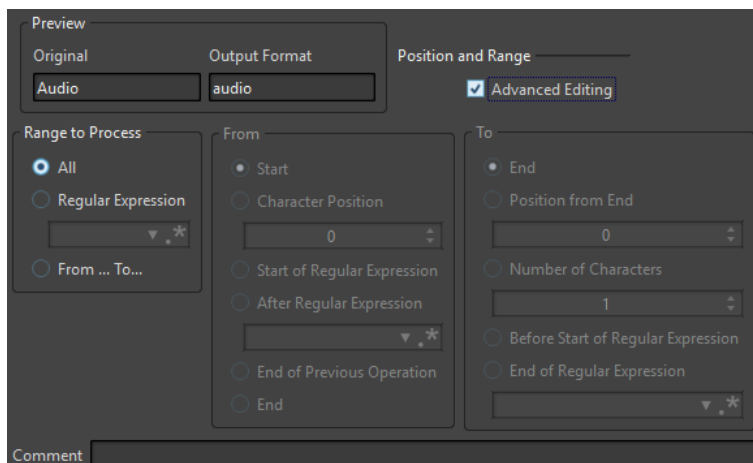

Range to Process

All

If this option is activated, the whole name is processed by the operation.

Regular Expression

Select this option if you want only a part of the name to be processed by the operation. In this case, you need to define a regular expression. Clicking the asterisk opens a menu with shortcuts for several regular expressions.

From/To

If this option is activated, you can set the start and end position of the range independently in the **From** and **To** sections.

From

Start

If this option is activated, the position is the beginning of the source name.

Character Position

If this option is activated, the position is a fixed offset from the beginning of the of the source name.

Start of Regular Expression

Select this option if you want the position to be the one of the sub-strings found by the regular expression applied on the source name.

After Regular Expression

Select this option if you want the position to be the one right after the sub-string found by the regular expression applied on the source name.

End of Previous Operation

If this option is activated, the position corresponds to the end of the change performed by the previous operation.

End

If this option is activated, the position is the end of the source name.

To

End

If this option is activated, the position is the end of the source name.

Position from End

If this option is activated, the position is a fixed offset before the end of the source name.

Number of Characters

If this option is activated, the end position is given by the start position plus a number of characters.

Before Start of Regular Expression

Select this option if you want the position to be just before the sub-string found by the regular expression applied on the source name.

End of Regular Expression

Select this option if you want the position to be the end of the sub-string found by the regular expression applied on the source name.

Comment

Comment

Allows you to add a comment to the batch renaming operation.

Previewing and Performing All Renaming Operations

On the last page of the **Batch Renaming** dialog, you can see how all the selected file, clip, or marker names are changed before you start the batch renaming. Note that if the name contains a random item, this item name will most likely be different in the preview.

PREREQUISITE

You made your settings on the first two pages of the dialog.

PROCEDURE

1. In the list, check if the changes are as you intended.

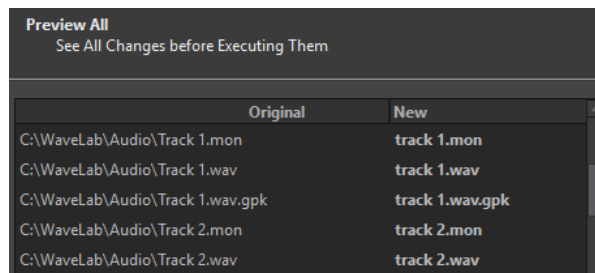

2. Click **Finish**.
-

Regular Expressions

A regular expression is a formula composed of characters that have special meanings (called operators). Other characters are plain letters and numbers that are searched for. The search engine browses the target text one character at a time and stops as soon as it finds a sequence of characters that matches the regular expression.

At various places in WaveLab Pro, you can use regular expressions to build complex text matching operations into your conversion and renaming processes. A regular expression is a set of text symbols that describe a method to find a specific text string within a large body of text, and then apply a specific operation to this text string. Regular expressions are available to perform powerful string search/replace operations, for example, in batch renaming or batch processing.

Throughout WaveLab Pro, wherever you see an asterisk, there is a field where you can create your own regular expressions. A menu containing shortcuts to build up the basic syntax of an expression is also available.



Regular expressions icon

Common Regular Expressions

There are various versions of regular expressions. WaveLab Pro uses a version that represents a good compromise between power and ease-of-use.

The term “expression” refers to a single character, a character class, or a sub-expression enclosed with () or {}. Searches for regular expressions are not case sensitive.

Regular Expressions Pop-up Menu

Menu Item	Operator	Description
Any Character	.	Symbolizes any character.
Character in Range	[]	A bracketed text is treated as a single character, for example: [AEW13] means A or E or W or 1 or 3. A hyphen within the brackets specifies a range of characters. For example, [F-I] means F or G or H or I, and [A-Z0-9] matches all letters and all digits.
Character Not in Range	[^]	A circumflex located at the first position in a bracket is a complement operator. It describes a situation where all characters match except those included in the bracket. For example, [^E] means any character except E.
0 or 1 Match (1 if Possible)	?	Matches 0 or 1 time the preceding expression. 1 repeat if possible is grabbed, then the rest of the regular expression continues to be evaluated.
0 or 1 Match (0 if Possible)	??	Matches 0 or 1 time the preceding expression. 0 repeat if possible (the NEXT step in the regular expression is also evaluated and has priority).
0 or More Matches (as Many as Possible)	*	Matches 0 or more times the preceding expression. As many repeats as possible are grabbed, then the rest of the regular expression continues to be evaluated.
0 or More Matches (as Few as Possible)	*?	Matches 0 or more times the preceding expression. As few repeats as possible are grabbed (the NEXT step in the regular expression is also evaluated and has priority).
1 or More Matches (as Many as Possible)	+	Matches 1 or more times the preceding expression. As many repeats as possible are grabbed, then the rest of the regular expression continues to be evaluated.
1 or More Matches (as Few as Possible)	+?	Matches 1 or more times the preceding expression. As few repeats as possible are grabbed (the next step in the regular expression is also evaluated and has priority).
Or		OR operator. Use this to separate two expressions and to match expression #1 or expression #2. For example, Piano Drum matches all texts that contain Piano or Drum.
Not	!	Negation operator: the expression following ! must not match the text. For example, a!b matches any "a" not followed by "b".
Generic Group	()	Grouping operator. Useful to form a sub-expression.

Menu Item	Operator	Description
Capture	{ }	Capture operator. By default, the found text corresponds to the entire regular expression. But it is possible to limit a part of the regular expression with { }, and if a part is matched, this will be the retained part. For instance the regular expression "ab{cd}ef" that is applied on "abcdef" will return "cd".
Beginning of Text	^	Use the circumflex sign to specify that the text must be located at the start of the browsed text. Any match not located at the start of the browsed text is ignored.
End of Text	\$	Use this sign to specify that the text must be located at the end of the text. Any match not located at the end of the text is ignored.

Special Characters Submenu

On this submenu, all special characters for regular expressions are available.

Shortcuts Submenu

Menu Item	Operator	Description
Any Digit (0-9)	/d	Symbolizes any digit, as [0-9].
Any Non-Digit (not 0-9)	/D	Symbolizes any non-digit, as [^0-9].
Any Letter (a-z or A-Z)	/l	Symbolizes any letter, as [a-z].
Any Non-Letter (not a-z, not A-Z)	/L	Symbolizes any non-letter, as [^a-z].
Any Alphabetic (a-z, or A-Z, or 0-9)	/w	Symbolizes any alphabetic character, as [0-9a-z].
Any Non-Alphabetic (not a-z, not A-Z, not 0-9)	/W	Symbolizes any non-alphabetic character, as [^0-9a-z].
Number	/u	Symbolizes a number (without a sign).
Number (with Possible +- Before)	/i	Symbolizes a number which can be preceded by a + or - sign.
Quoted String	/q	Symbolizes quoted text.
Simple Word	/z	Symbolizes a simple word (a sequence of letters surrounded by non-letters, for example, spaces).

Presets Submenu

Menu Item	Operator	Description
1st Word	/z	Searches for the first word (separated by a space).
2nd Word	/z/L+{/z}	Searches for the second word (separated by a space).
3rd Word	/z/L+/z/L+{/z}	Searches for the third word (separated by a space).
Last Word	{/z}/L*\$	Searches for the last word (separated by a space).
1st Expression in Parentheses	.*?{/(*?/)}	Searches for the first string enclosed in parentheses.
2nd Expression in Parentheses	.*?/(*?{/(*?/)}	Searches for the second string enclosed in parentheses.
3rd Expression in Parentheses	.*?/(*?/ (*?{/(*?/)}	Searches for the third string enclosed in parentheses.
Last Expression in Parentheses	.*{/(*?/)}.*\$	Searches for the last string enclosed in parentheses.
1st Expression in Brackets	.*?{/[*?/]}	Searches for the first string enclosed in brackets.
2nd Expression in Brackets	.*?/[*?{/[*?/]}	Searches for the second string enclosed in brackets.
3rd Expression in Brackets	.*?/[*?/ [*?{/[*?/]}	Searches for the third string enclosed in brackets.
Last Expression in Brackets	.*{/[*?/]}.*\$	Searches for the last string enclosed in brackets.

Podcasts

Podcasting is a method of distributing multimedia files over the Internet, for example, for playback on mobile devices and personal computers.

A podcast can be downloaded automatically, using software that is capable of reading RSS feeds. RSS (Really Simple Syndication) is a standard for distributing news and other information via the Internet. An RSS news feed sends short messages on a specific topic from a specific web site. In order to read the messages, the user employs a program that has the ability to monitor multiple feeds and automatically download new messages on a regular basis. This can be a special feed reader or an Internet browser, for example.

A podcast is an RSS feed including data content, such as audio or video files. This can be a show of which new episodes are released regularly. The file formats .mp4a, .mp3, and .ogg are commonly used for podcasts.

Podcast Editor

The **Podcast Editor** is divided into two panes. The upper pane shows the information for the feed or an episode, depending on the item that is selected in the list below. This is where you can add files, Internet links, or textual information to the podcast feed and its episodes. The lower pane shows an item list of the basic feed and all episodes that are included in the podcast.

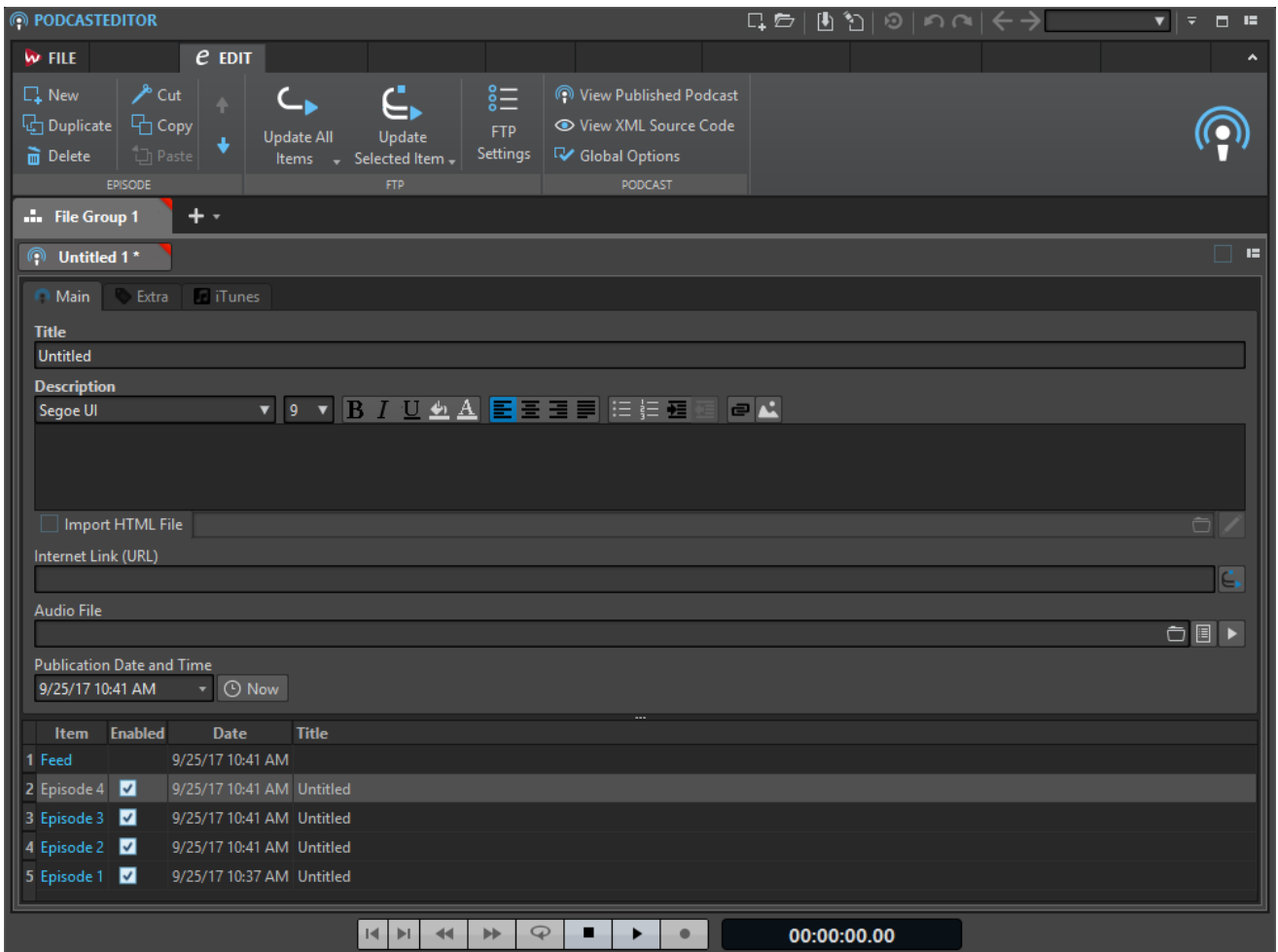

Episode Section

In the **Episode** section, you can create, delete, and move individual podcast episodes.

New

Adds a new untitled episode.

Duplicate

Adds a new episode, copying all the information from the existing episode to the new one.

Delete

Deletes the selected episode. Alternatively, you can exclude an episode from the podcast by deactivating the **Enabled** box.

Cut/Copy/Paste

Cuts, copies, and pastes the selected episode.

Move Up/Move Down

Moves the selected episode one position up or down in the list. Alternatively, use drag and drop.

FTP Section

In the **FTP** section, you can define where your podcast is going to be uploaded via FTP.

Update All Items

Uploads/updates the XML podcast file on the FTP server. It also uploads all associated media files, but only if they are not yet available on the FTP server. This is the most common function to upload and update your podcast.

Update Selected Item

Uploads/updates the XML podcast file on the FTP server. It also uploads the media file of the selected item in the list, but only if it is not yet available on the FTP server.

Upload/Replace All Items

This is the same as above, but it always uploads/replaces all of the media files belonging to the item. This is useful if you have changed the audio data, for example.

Upload/Replace Selected Items

This is the same as above, but it always uploads/replaces the media file of the selected item in the list. This is useful if you have changed the audio data, for example.

FTP Settings

Opens the **FTP Settings** dialog, which allows you to edit the FTP settings that are related to this podcast.

Podcast Section

View Published Podcast

Opens your podcast (via the URL that is specified in your FTP site settings) using your default browser.

View XML Source Code

Opens an XML editor to display the source code of the podcast.

Global Options

Edit the automatic picture resizing, set a time offset with Greenwich Mean Time, and specify the path of the HTML editor.

Main Tab

On the **Main** tab, you can assign parameters to your podcast. The available parameters change, depending on whether you select a feed or an episode. Field labels in bold letters mark fields that are mandatory to fill.

Title

Sets the title of the feed, for example, the topic of your podcast.

Description

Gives space for a further description of the feed content.

Import HTML File (only available for episodes)

Lets you browse for an HTML document that replaces the description.

Internet Link (URL)

The main link of the feed that the user sees. Use this to direct people to a web site that is related to your feed. Clicking the world icon opens the specified URL in your default Internet browser.

Audio File (only available for episodes)

This sets the path to the audio file that you want to add to the episode. The audio file can be of any file type that is supported by the media reader of your browser. An MP3 file provides best compatibility. Click the icon to list the audio files that are already open in WaveLab Pro. Select one for your episode.

Alternatively, you can drag the list icon of an audio file into the audio file pane. Click the play icon to open the specified file in the default media player or viewer of your system, for previewing or checking purposes.

Picture (only available for feeds)

According to the RSS standard, this picture may not be larger than 144 x 400 pixels, so the picture is automatically resized. Clicking the picture icon opens the specified picture in your default image viewer of your system.



Picture icon

Publication Date and Time

Sets the publication date and time of the feed or episode. Clicking the **Now** button transfers the current date and time of your system.

As Most Recent Episode (only available for feeds)

If this option is activated, the date and time of the most recent episode are automatically matched.

Extra Tab

On the **Extra** tab, you can assign parameters to your podcast. The available parameters change, depending on whether you select a feed or an episode.

The following parameters are available for a feed:

- Webmaster (E-Mail Address)
- Editor (E-Mail Address)
- Copyright
- Category
- Related Domain (URL)
- Language
- Frequency of Updates
- Skip Hours (0 to 23, Comma Separated)
- Time to Live (Number of Minutes)

The following parameters are available for an episode:

- Author (Email Address)
- Comments (URL)
- Category
- Related Domain (URL)
- Title
- Original Domain (URL)

iTunes Tab

On the **iTunes** tab, you can activate the iTunes extension that allows you to specify additional feed and episode information. The available parameters change, depending on whether you select a feed or an episode.

The following parameters are available for a feed:

- Subtitle
- Summary
- Categories

- Keywords (Comma Separated)
- Author
- Owner Name
- Picture
- New URL of Feed
- Hide in iTunes
- Explicit Material

The following parameters are available for an episode:

- Subtitle
- Summary
- Keywords (comma separated)
- Author
- Duration
- Hide in iTunes
- Explicit material

Global Podcast Options

Some additional options are valid for all **Podcast Editor** tabs.

- To open the **Global Podcast Options** dialog, open the **Podcast Editor**, select the **Edit** tab, and click **Global Options**.

Automatic Picture Resizing (Not for iTunes)

Defines what to do if specified pictures exceed the maximum size allowed by the RSS standard. If pictures need resizing, the original images on your hard disk are not modified.

Time Offset with GMT (Greenwich Mean Time)

The displayed dates and times are local. If your system is properly set up, WaveLab Pro automatically adjusts the time offset in relation to GMT. However, if you want to have time and date relative to a different time zone, adjust the value with this option.

HTML Editor

Sets the path to the external HTML editor that is launched when you click the pen button in the **Import HTML File** section.

Creating a Podcast

There are several ways to create a new podcast feed or episode.

- To create a new podcast, select **File > New** and click **Create Podcast**.
- To add a new untitled episode to a podcast, in the **Podcast Editor**, select the **Edit** tab, and click **New**.
- To add an audio file to the selected episode, select the **Main** tab, click in the **Audio File** field, and select **Select File Using Standard Selector**. Select the audio file in the file browser and click **Open**.
You can also drag an audio file from the **File Browser** window to the **Audio File** field.
- To duplicate the selected episode, select the **Edit** tab, and click **Duplicate**. This adds a new episode, and copies all information from the existing episode to the new one.

Setting Up a FTP for Podcast Publishing

To be able to upload a podcast to your FTP server, you must enter the FTP server details first.

PROCEDURE

1. In the **Podcast Editor**, select the **Edit** tab.
 2. In the **Podcast** section, click **FTP Settings**.
 3. In the **FTP Settings** dialog, enter the following details:
 - The log-in details for your FTP server.
 - The relative path and file name of the podcast (extension `.xml`).
 - Your web site address including the path to the feed.
 4. Click **OK**.
-

Publishing Podcasts

You can upload a podcast from within WaveLab Pro to your FTP server.

PREREQUISITE

Set up your FTP settings within WaveLab Pro.

PROCEDURE

1. In the **Podcast Editor**, select the **Edit** tab.
 2. In the **FTP** section, select one of the following options:
 - Update All Items
 - Update Selected Item
 - Upload/Replace All Items
 - Upload/Replace Selected Items
 3. In the **FTP Settings** dialog, check if the FTP settings are correct, and click **OK**.
-

RESULT

The podcast is uploaded to your FTP site.

FTP Settings Dialog

In the **FTP Settings** dialog, you can manage all required information for the podcast upload process.

- To open the **FTP Settings** dialog, open the **Podcast Editor**, select the **Edit** tab, and click **FTP Settings**.

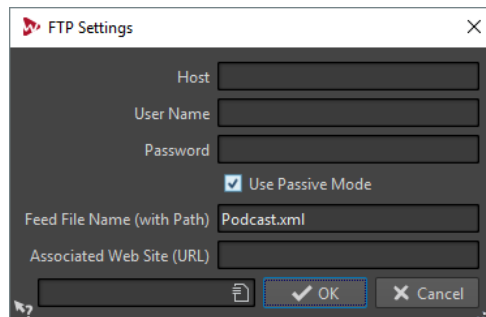

Host

The host name or IP address of the FTP server.

User Name

The login name to your FTP server.

Password

The password to the login.

Use Passive Mode

Keep this activated and only change this if you experience problems with the FTP connection.

Feed File Name (with Path)

The podcast file name that is displayed on your FTP server (extension `.xml`), including the relative path. File name and path are part of the final public Internet address of the podcast, so you may want to avoid long names.

Associated Web Site (URL)

Your own web site address including the path to the feed.

FTP Settings Example

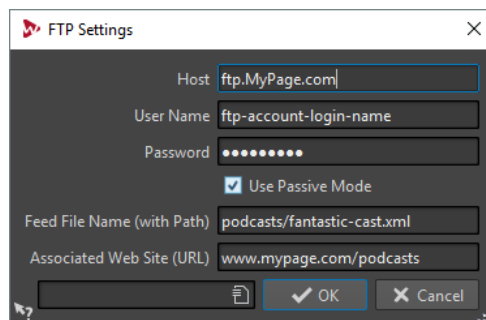

- Your FTP host address is “ftp.MyPage.com”, your public web site address is “www.MyPage.com”.
- The feed file name setting is “podcasts/fantastic-cast.xml”, the associated web site setting is “www.MyPage.com/podcasts”.
- The media files of the podcast will be uploaded to the FTP server at “ftp.MyPage.com/podcasts”.
- The podcast file itself and the Internet address to be distributed will be found at “www.MyPage.com/podcasts/fantastic-cast.xml”.

Each podcast saves its own complete FTP site information. It is also possible to save and recall FTP site presets using the **Preset** functions at the bottom of the dialog.

Checking the Podcast

After creating and publishing a podcast, you can check if the upload was successful.

- To visualize the contents of the feed XML file in your default XML editor, open the **Podcast Editor**, select the **Edit** tab, and click **View XML Source Code**.
- To open your default Internet browser and receive the podcast that you have just published from the Internet, open the **Podcast Editor**, select the **Edit** tab, and click **View Published Podcast**.

Customizing

Customizing means making settings so that the program behaves and looks the way that you want it to.

Workspace Layout

Workspace layouts are used for creating various work displays for different situations.

You can create a workspace layout that always appears when you launch WaveLab Pro. Optionally, the snapshots and the files that you had opened automatically reopen.

You can save a workspace layout to recall your favorite layout for a specific editing task. Because workspaces can be complex, it is useful to have layouts with a reduced number of visible tool windows to perform a given task.

Working with Workspace Layouts

Depending on your computer setup or the kind of project that you are working on, you may want to use different window layouts. You can select layout presets or create your own layouts.

You can save the placement of the workspace frame and all its tool windows and/or the layout of tabbed data windows.

- To select a layout preset, select **Workspace > Layout** and select a layout preset.
- To save the current layout as a preset, select **Workspace > Layout > Save As**. In the **Workspace Layout** dialog, specify the folder where you want to save the preset, enter a name, and click **Save**.
- To save the current layout as default, select **Workspace > Layout > Save Current Layout As Default**.
- To restore the default layout, select **Workspace > Layout > Restore Default Layout**.
- To organize the layout preset folder, select **Workspace > Layout > Organize Presets**. The File Explorer/macOS Finder opens. You can then create folders and subfolders and organize layout presets in them. The folder structure will be reflected as submenus on the **Layout** menu.

Workspace Layout Dialog

This dialog allows you to save the window layout of the active workspace as a preset.

- To open the **Workspace Layout** dialog, select **Workspace > Layout > Save As**.

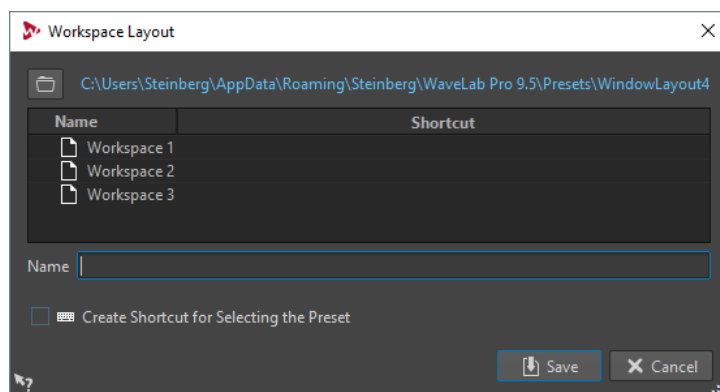

Path name

Opens the root folder of the preset in the File Explorer/macOS Finder. Here, you can create subfolders in which presets can be saved.

Presets list

Lists all existing presets.

Name

Lets you specify the name for the preset.

Create Shortcut for Selecting the Preset

If this option is activated and you click **Save**, the **Shortcut Definitions** dialog opens, which allows you to define a shortcut to apply to this preset.

If a preset already has an assigned shortcut, this option is grayed out. To change the existing shortcut, double-click the preset name in the presets list.

Starting WaveLab Pro With a Workspace Layout Preset

You can start WaveLab Pro with a specific workspace layout by entering a preset name in the command line.

The format of the command line is "--layout presetName".

If the preset is saved inside a folder in the layout preset, you must specify the relative path. If the preset name contains spaces, put the name in quotes. For example, --layout "My Folder/presetName".

EXAMPLE

An example of setting up the command line.

1. Set up a workspace layout and save it as **Layout 1**.
 2. Start WaveLab Pro with the command line **--layout "Layout 1"**.
-

Customizing the Wave Window and the Montage Window

You can set up the wave/montage window by adjusting colors of waveforms, background, cursor lines, etc., and changing the look of the ruler and other window details.

Customizing can be done in the following ways:

- By changing the default style.
- By assigning different styles, according to specific conditions. For example, a specific file type or a specific file name.

Assigning Custom Colors to the Wave Window or the Montage Window

PROCEDURE

1. Depending on whether you want to customize the colors of the wave window or the montage window, do the following:
 - For the wave window, select **File > Preferences > Audio Files** and select the **Style** tab.
 - For the montage window, select **File > Preferences > Audio Montages** and select the **Style** tab.
 2. Select the part that you want to color from the **Parts** list.
 3. Specify a color using the color picker or the RGB fields.
-

Assigning Custom Colors According to Conditions

You can apply different color schemes automatically to different clips, according to their names or the properties of their audio files.

IMPORTANT

If you redefine colors, be careful not to choose colors that cause other elements to disappear.

PROCEDURE

1. Depending on whether you want to customize the colors of the wave window or the montage window, do one of the following:
 - For the wave window, select **File > Preferences > Audio Files** and select the **Style** tab.
 - For the montage window, select **File > Preferences > Audio Montages** and select the **Style** tab.
 2. Do one of the following:
 - In the **Audio Files Preferences**, select one of the **Conditional** options from the pop-up menu at the top of the dialog.
 - In the **Audio Montages Preferences**, in the **Parts** list, select one of the **Custom** entries.
 3. Specify a color using the color picker or the RGB fields.
 4. In the **This Style Is Used If These Conditions Apply** section, specify the conditions.
 5. Click **OK**.
-

Copying Color Settings

You can copy the color settings of one part, or all parts of a custom color schema.

- To copy a color setting, select the part from which you want to copy the color, and select **Copy Color**. Then select the part to which you want to copy the color, and select **Paste**.
- To copy all color settings of a custom color setting, drag the name of a custom color setting onto another custom color name, and click **OK**.

Customizing Shortcuts

In WaveLab Pro, you can control many functions via shortcuts to speed up your workflow. You can edit existing shortcuts and create new shortcuts.

Most shortcuts are restricted to a specific editor, which means that you can reuse the same shortcut combination in different editors. The exception is the **Master Section** where all shortcuts are global to the application.

The shortcuts in the **Navigation (Numeric Pad)** and **View and Navigation** sections on the **Shortcuts** tab are dedicated to navigating through WaveLab Pro.

Shortcuts that cannot be edited are grayed out. The shortcuts that you created are displayed in blue in the editor.

You can create new shortcuts in the following ways:

- By specifying a key sequence of up to four keys that must be pressed in a specific order to invoke the operation.
- By specifying a MIDI command. You need a MIDI controller device connected to your computer for this to work.
- By specifying keywords.

RELATED LINKS

[Shortcuts Tab](#) on page 555

Keywords

Keywords are custom words that are assigned to a function in the **Customize Commands** dialog or to a preset in the **Shortcut Definitions** dialog. When you enter the keyword in the **File Search and Keyword** field, the corresponding function is triggered.

EXAMPLE

For example, if you want to have a quick way to normalize audio to -1 dB, proceed as follows:

1. In the **Audio Editor**, select the **Process** tab.
2. In the **Normalizing** section, click **Level**.
3. In the **Level Normalizer** dialog, set the **Peak Level** to -1 dB.
4. Click the **Presets** field, and select **Save As**.
5. In the **Save Preset As** dialog, enter a name for the preset, and activate **Create Shortcut for Applying the Preset**.
6. Click **Save**.
7. In the **Shortcut Definitions** dialog, enter `norm_1` as a **Keyword**, and click **OK**.
8. Now, to trigger the preset, enter `.norm_1` in the **File Search and Keyword** field, and press **Return**.

The dot in front of the keyword instructs WaveLab Pro to interpret the text as a keyword. Without the dot, the **File Search and Keyword** field is used for finding file tabs.



RELATED LINKS

[Shortcuts Tab](#) on page 555

[Shortcut Definitions Dialog](#) on page 556

[Searching for Open Files](#) on page 64

Indexed Key Commands

Indexed key commands allow you to quickly jump to specific locations in your project, for example, to a specific marker or **Master Section** slot.

The available indexed key commands are listed on the **Shortcuts** tab, in the **Navigation (Numeric Pad)** section.

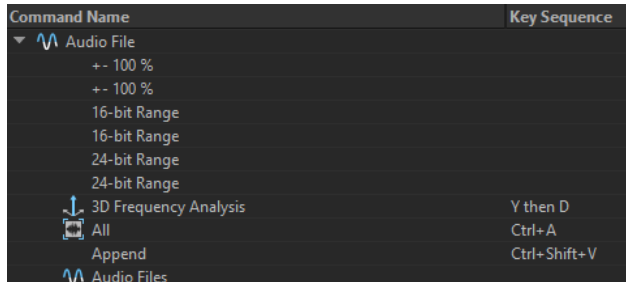

Command Name	Key Sequence
Audio File	
+- 100 %	
+- 100 %	
16-bit Range	
16-bit Range	
24-bit Range	
24-bit Range	
3D Frequency Analysis	Y then D
All	Ctrl+A
Append	Ctrl+Shift+V
Audio Files	

- To trigger an index key command, type the number of the item that you want to jump to and press the corresponding key on your keyboard.

EXAMPLE

If you want to jump to the 5th marker in your file window, press **5** on your keyboard and then press **M**.

If you want to jump to the 10th file tab, press **10** on your keyboard and then press **F**.

RELATED LINKS

[Shortcuts Tab](#) on page 555

Editing Shortcuts

You can see the list of all shortcuts in the **Shortcuts** tab, and edit and define shortcuts on the **Shortcut Definitions** dialog.

The **Shortcuts** tab provides a different command set for each menu or dialog.

- To open the **Shortcut Definitions** dialog, select **File > Preferences > Shortcuts**, select a command, and click **Edit Shortcut**.
- You can enter a keyword which you can later use to activate a command by typing it into the **File Search and Keywords** field in the command bar.

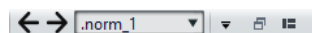

- You can define a command to be triggered by an external MIDI controller. For example, this can be useful for issuing transport commands from your midi keyboard. You can specify a sequence of up to three midi events. The MIDI shortcut is displayed in the **MIDI Trigger** column.
- You can define one key shortcut, and/or one MIDI shortcut, and/or one keyword per command. Each shortcut can be a sequence of up to four keystrokes or three MIDI events. A keyword can be of any length.
- To reset some or all types of shortcuts to their factory default use the **Reset** button.

Defining Key Sequences

You can define key sequences for a keyboard and for a MIDI controller.

PREREQUISITE

If you want to define a key sequence for a MIDI controller, make sure that your MIDI controller is connected to your computer, and selected on the **Remote Devices** tab.

On a Mac, commands for the main menus must consist of a single key command.

When using multiple key stroke commands, make sure that the key commands do not interfere with each other. For example, when you have one shortcut **Shift+L, M** and define another to be **Shift+L**, this second shortcut has no effect.

PROCEDURE

1. Select **File > Preferences > Shortcuts**.
2. In the commands list, select the command for which you want to define a key sequence, and click **Edit Shortcut**, or double-click the **Key Sequence** column of the corresponding command.
3. In the **Shortcut Definitions** dialog, click in the **Key Stroke** fields and press the buttons that you want to use as the key sequence.
4. Click **OK**.

RESULT

When you now press the keys/buttons specified in the dialog, the corresponding operation is performed. The key strokes must be executed one after the other.

RELATED LINKS

[Remote Devices Tab](#) on page 13

Selecting a MIDI Controller for Defining MIDI Commands

Before you can use MIDI commands, you have to select a MIDI controller.

PROCEDURE

1. Select **File > Preferences > Remote Devices**.
2. On the **Device Editing** tab, select **MIDI Shortcuts for Menus** from the pop-up menu at the top.
3. Select **Active** to activate the selected device.
4. From the **In-Port** pop-up menu, select a MIDI input port.

Generating a List of All Shortcuts

You can generate an HTML file or print out a list that contains all shortcuts.

PREREQUISITE

If you want to print out the list, make sure a printer is connected to your system.

PROCEDURE

1. Select **File > Preferences > Shortcuts**.
2. Click **Summary**, and select one of the following options:
 - To open the **Print Preview** dialog, from which you can print out the list of all shortcuts, select **Print Preview**. For **Print Preview** to be available, a printer must be connected.
 - To open the list of all shortcuts in the HTML file format in the standard browser, select **HTML Report**.

Shortcuts Tab

This tab allows you to customize your own shortcuts for WaveLab Pro. It shows a list of the assigned shortcuts for WaveLab Pro commands and menu options.

- To open the **Shortcuts** tab, select **File > Preferences > Shortcuts**.

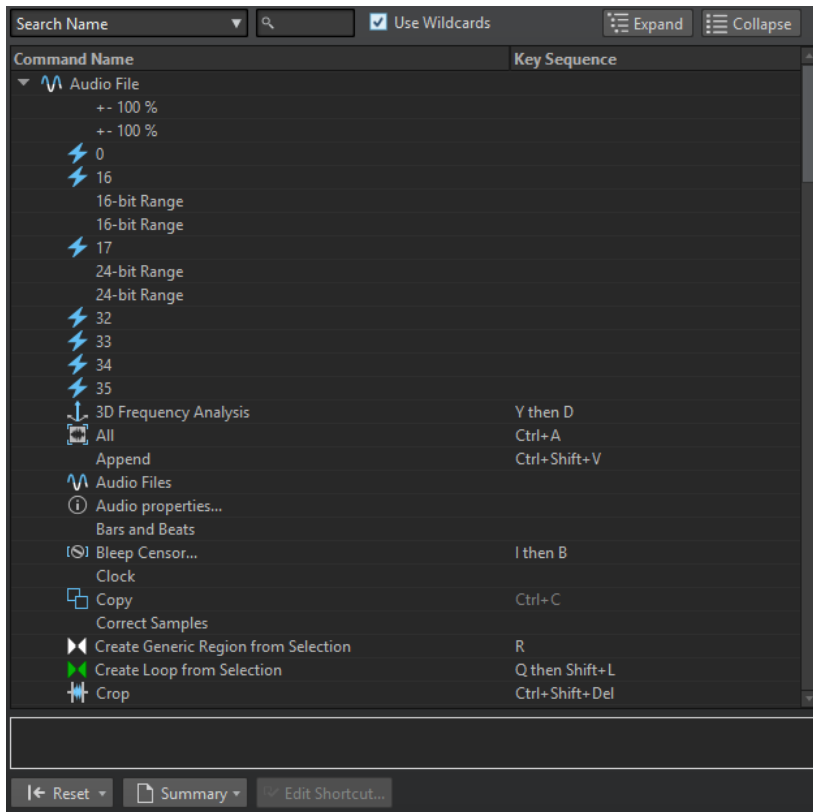

Search pop-up menu

Allows you to select the part of the commands list in which the search is performed.

Search field

Allows you to search for a command.

Use Wildcards

If this option is activated, the wildcard characters "*" and "?" can be used.

"*" substitutes zero or more characters, and "?" substitutes any character.

For example, if **Search Keyboard Shortcut** is selected, type "*" to display all commands that are already associated with a shortcut.

Expand/Collapse

Expands/Collapses the folder tree.

Commands list

Shows all commands and their shortcuts.

Reset

Resets the commands to the factory settings.

Summary

Opens a menu from which you can generate a list of all commands and their shortcuts, either in HTML or as a print out.

Edit Shortcut

Opens the **Shortcut Definitions** dialog where you can edit the shortcuts for the selected command.

Shortcut Definitions Dialog

This dialog allows you to define your own customized shortcuts for a particular function.

- To open the **Shortcut Definitions** dialog, select **File > Preferences > Shortcuts**, select a command, and click **Edit Shortcut**.

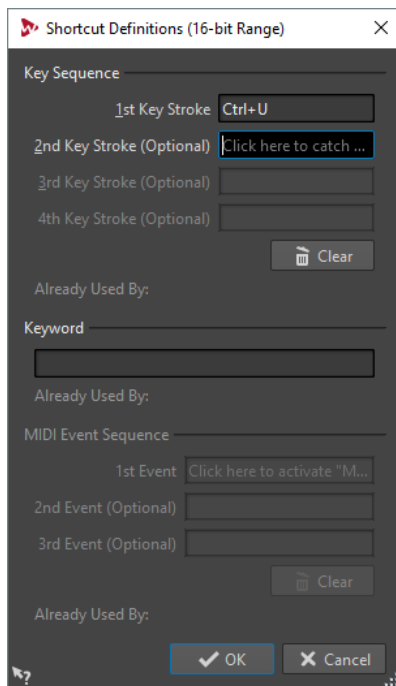

Key Sequence

1st Key Stroke

Lets you select the first key of a sequence that can consist of up to four keys. Set the focus to the key stroke field, then press the key combination. If nothing is displayed, a key is not allowed in this context.

2nd/3rd/4th Key Stroke (optional)

Lets you select additional keys that must be used to execute the command. The command is only executed if this key event happens after the first one.

Clear

Erases all key event fields.

Keyword

Lets you type in a keyword that invokes the command.

MIDI Event Sequence

This section is only available if a MIDI input port is specified in the main preferences in WaveLab Pro.

1st Event

Lets you select the first MIDI event of a sequence that can consist of up to four MIDI events. Set the focus to the event field, then trigger the MIDI event from your MIDI controller.

2nd/3rd Event (optional)

Lets you select additional MIDI events that must be triggered to execute the command. The command is only executed if this MIDI event happens after the first one.

Clear

Erases all MIDI event fields.

Customizing Command Bars

You can hide or show individual command bar buttons. This way you can customize command bars by removing unwanted commands.

PROCEDURE

1. In a tool window, open the menu and select **Customize Command Bar**.
 2. To show a specific command on the command bar, activate the checkbox in the **Bar** column for the corresponding command.
 3. Click **OK**.
-

Plug-in Organization

WaveLab Pro comes with various plug-ins, and additional plug-ins can be added. To retain an overview over the plug-ins that are relevant to your project, you can organize your plug-ins in groups.

On the **Organize** tab of the **Plug-ins Preferences**, you can specify how your plug-ins appear on menus in the program. In the plug-ins list, you find subfolders representing groups of plug-ins.

Initially, plug-ins are categorized by vendor, category, favorite plug-ins, and recently used plug-ins.

If the 32-bit and 64-bit versions of WaveLab Pro are used on the same system, their settings are shared. An exception to this rule are the following options in the **Plug-ins Preferences**:

- **Additional VST Plug-in Folders**
- **Ignore Plug-ins Located in the following Subfolders**

This is because 32-bit plug-ins cannot be used in WaveLab Pro 64 bit and vice versa.

RELATED LINKS

[Plug-ins Preferences](#) on page 560

Deactivating Plug-ins

You can deactivate plug-ins. This is useful if you do not want to use particular plug-ins in WaveLab Pro.

PROCEDURE

1. Select **File > Preferences > Plug-ins**.
2. Select the **Organize** tab.

3. In the plug-ins list, navigate to the plug-in that you want to deactivate.
 4. Deactivate the checkbox in for the plug-in. When selecting multiple plug-ins, you can deactivate all of them with a single click.
 - To deactivate the plug-in on the plug-in selection menus, deactivate the checkbox in the **Effect** column.
 - To deactivate the plug-in on the **Final Effects/Dithering** panel of the **Master Section**, deactivate the checkbox in the **Final** column.
 - To deactivate the plug-in on the **Playback-Processing** panel of the **Master Section**, deactivate the checkbox in the **Play** column.
 - To deactivate a clip plug-in when a clip is not streamed, deactivate the checkbox in the **Dyn** column.This allows you to save DSP power when using hardware plug-ins.
-

Adding Plug-ins to the Favorites Menu

You can add plug-ins that you are using regularly to the **Favorites** menu of the plug-in selection menu.

PROCEDURE

1. Select **File > Preferences > Plug-ins**.
2. Select the **Organize** tab.
3. In the plug-ins list, navigate to the plug-in that you want to add to the favorites.
4. Activate the checkbox for the corresponding plug-in in the **Favorites** column.



Favorites

NOTE

If the **Favorites** menu is empty, it does not appear in plug-in selection menus.

Customizing Plug-in Groups

You can customize the appearance and sorting of plug-ins on the **Organize** tab of the **Plug-ins** preferences.

- To update the tree, click the **Show Changes** button.

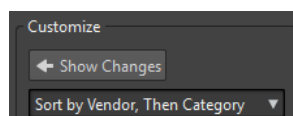

- To create a custom category for a plug-in, click the **Custom Category** column for the corresponding plug-in, and enter a new category name. **Alt**-click to delete the category. Use the character “|” to create subcategories, for example, “Folder-1 | Folder-2”. If you select multiple plug-ins, the category name is applied to all selected plug-ins.
- To rename a custom category, click the category name in the **Custom Category** column, and select **Rename Category** from the pop-up menu. In the **Rename Category** dialog, enter the name of the category that you want to rename in the **Find** field, and the name that you want to replace it with in the **Replace with** field. Then click **Replace All**.
- The category labels that are used to create the hierarchy are supplied by the plug-in manufacturers. To change the category name, navigate to the **Category Renaming** table, click in the **Original** column, and select the category that you want to rename. Then click in the **Modified** column, and enter a new name.

- To change the sorting of plug-in groups, select whether to sort by category or by vendor in the sorting menu of the **Customize** section. If a plug-in does not publish a vendor name or category, the name of the enclosing plug-in folder on disc is used as vendor name or category if it is not the VST plug-in root folder.
- To group all plug-ins that start with the same prefix in one submenu, activate **Create Submenus Based on Prefixes**, and specify the number of plug-ins that must start with the same prefix. Only if this number is reached, a submenu is created.
- To group plug-ins in a single submenu if their number is below a specified value, activate **Compress Hierarchy**, and specify the threshold. A tree is flattened to a single submenu if the number is below the threshold. This prevents too small submenus.
- To activate the **Recently Used** category, activate **Submenu with Recently Used Plug-ins**, and specify the maximum number of recently used plug-ins that should be displayed in this category.
- You can make the **Recently Used** category global to all places or individual for each context, for example, for the **Master Section**, audio montage track, or audio montage clip. To make the **Recently Used** category individual for each context, activate **Independent Recently Used Plug-ins Menus**.

RELATED LINKS

[Plug-ins Preferences](#) on page 560

Adding Additional VST Plug-ins

You can specify folders where additional VST plug-ins can be found. This is useful if you are using third-party VST plug-ins that you do not want to save in the standard VST folder.

PROCEDURE

1. Select **File > Preferences > Plug-ins**.
 2. Select the **General** tab.
 3. In the **Additional VST Plug-in Folder (WaveLab Specific)** section, click the folder icon, and navigate to the folder that contains the VST plug-ins that you want to add.
-

Excluding Plug-ins

You can specify a list of plug-ins that WaveLab Pro does not open.

PROCEDURE

1. Select **File > Preferences > Plug-ins**.
 2. Select the **General** tab.
 3. In the **Do Not Load the Following Plug-ins** section, type in the name of the plug-in that you do not want to open:
 - Enter the exact file name, without path and without file extension.
 - Enter one name per line.
 - If you put "*" in front of the name, any plug-in that contains the name is ignored.
-

Replacing Missing Plug-ins

When you open an audio montage and some plug-ins for tracks or clips are missing, you can select plug-ins to replace the missing plug-ins.

PROCEDURE

1. In the **Missing Plug-ins** dialog, click the **Replacement** column, and select a replacement for the plug-in displayed in the **Original** column.

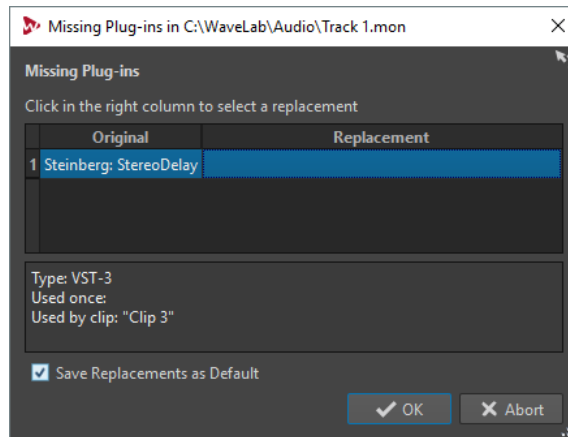

2. If you want to use the new plug-in from now on, activate **Save Replacements as Default**.
3. Click **OK**.

Plug-ins Preferences

On this tab, you can access a number of options for managing your VST plug-ins.

You can specify where WaveLab Pro should search for your VST plug-ins and which ones it should ignore. It also allows you to choose how your VST plug-in controls respond to mouse actions and how frequently graphics are updated.

If you use your own file structure to organize and save VST plug-ins, this dialog allows you to gain full control over which plug-ins are loaded and which are ignored. This is useful if you want to deactivate a particular plug-in or if you want to ignore plug-ins that you never want to use with WaveLab Pro.

- To open the **Plug-ins Preferences**, select **File > Preferences > Plug-ins**.

General Tab

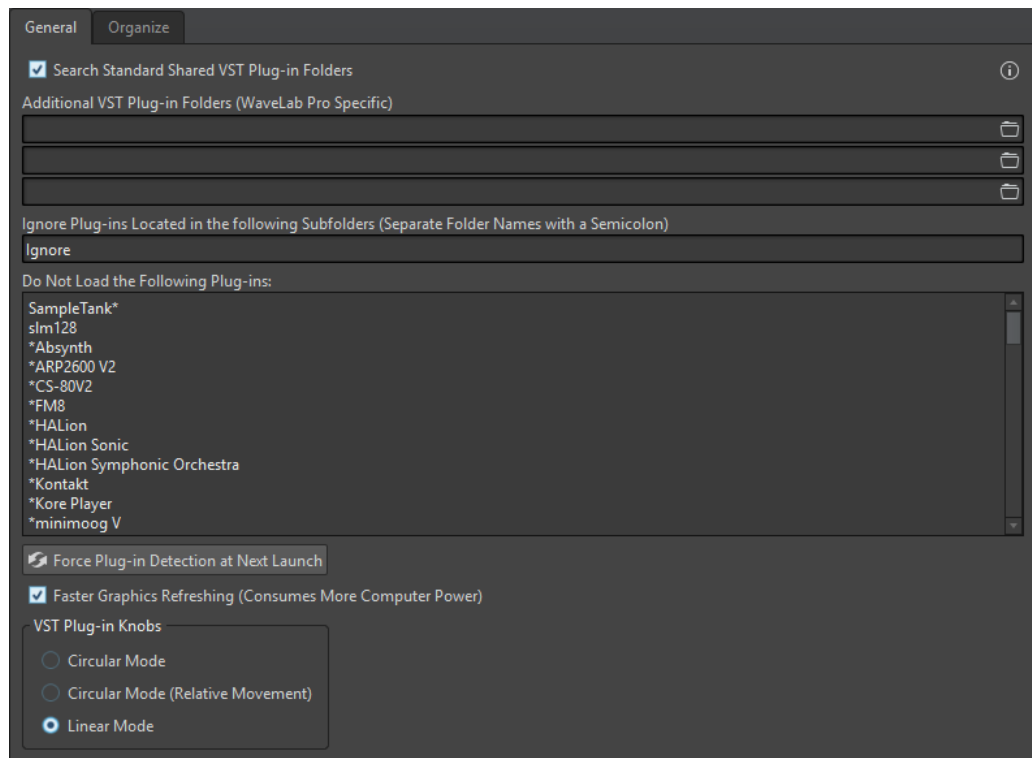

Search Standard VST Plug-in Shared Folders

If this option is activated, WaveLab Pro searches for VST plug-ins in the default VST plug-in folders.

Information About the Searched Folders



Click on the info icon to see in which folders WaveLab Pro searched for plug-ins when it was launched. If you cannot find a plug-in in WaveLab Pro, this helps you to determine whether you have specified the correct folder, for example.

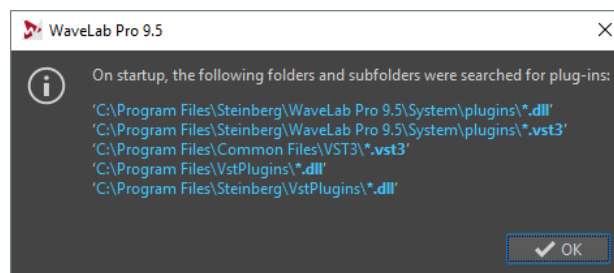

Additional VST Plug-in Folders (WaveLab Pro Specific)

Lets you specify additional folders where VST plug-ins can be found.

Ignore Plug-ins Located in the following Subfolders (Separate Folder Names with a Semicolon)

Lets you specify folder names that WaveLab Pro skips when searching for VST plug-ins.

Do Not Load the following Plug-ins

Lets you specify plug-ins that WaveLab Pro does not open. Enter the file names, without path and without file extension. Write each plug-in on a new line.

If you put the character * in front of the name, any plug-in that contains the name is ignored.

Force Plug-in Detection at Next Launch

Analyzes the plug-ins when launching WaveLab Pro the next time. To reduce the start time of WaveLab Pro, the plug-ins are not analyzed every time WaveLab Pro is started. However, WaveLab Pro keeps a list of plug-ins and updates this automatically when a date or size change is detected.

Keep Plug-ins in Memory until WaveLab Pro Quits

If this option is activated, the plug-ins are kept in memory even when they are no longer used. This results in a faster reopening of plug-ins. However, if you use many plug-ins, too much memory could be used after a specific time, which slows down the application.

Faster Graphics Refreshing (Consumes More Computer Power)

Refreshes the graphics of VST plug-ins more quickly.

VST Plug-in Knobs

Lets you set the mode for using knobs in plug-ins. You can set the mode to **Circular**, **Circular Mode (Relative Movement)**, and **Linear**.

Organize Tab

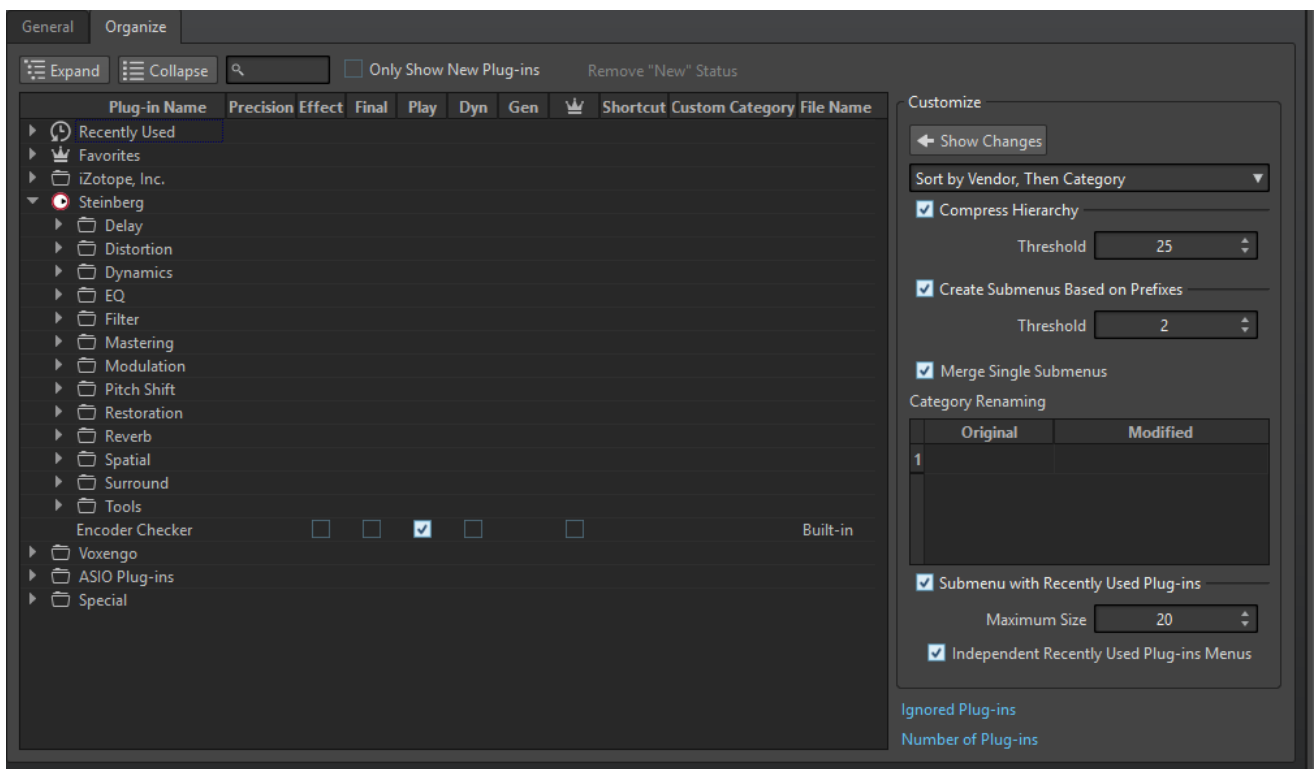

Plug-ins list

Displays the hierarchy of the plug-ins in WaveLab Pro. Here, you can specify whether a plug-in is available on the plug-in selection menus and/or the **Final Effects/Dithering** panel and **Playback-Processing** panel of the **Master Section**.

You can add plug-ins to the **Favorites** list, create shortcuts for plug-ins, specify custom categories, and decide whether to use the generic user interface or the plug-in specific user interface.

The **Precision** column displays the processing precision of each plug-in. 64-bit float plug-ins are capable of double precision processing. In other effects menus

throughout WaveLab Pro, plug-ins that are capable of double precision processing are marked with "64 F" for 64-bit float.

Leveler	64 F
/// MasterRig	64 F
Peak Master	64 F
Resampler	64 F

NOTE

Processing in 64-bit float means double precision but slightly longer process time than 32-bit float.

Expand/Collapse

Expands/Collapses the folder tree.

Search field

Allows you to filter the plug-ins list for names.

- Click in the search field, and enter the text that you want to search for.
- To switch the focus from the search field to the plug-ins list, press **Down Arrow**.
- To switch the focus from the plug-ins list to the search field, press **Ctrl/Cmd-F**.

Filter menu

Allows you to only display plug-ins that have certain properties.

- **Show All Plug-ins** displays all plug-ins.
- **Show New Plug-ins** only displays recently detected plug-ins.
- **Show 32-bit float Plug-ins** only displays plug-ins that are capable of 32-bit float processing.
- **Show 64-bit float Plug-ins** only displays plug-ins that are capable of 64-bit float processing.
- **Show Plug-ins with a Custom Category** only displays plug-ins that have a custom category.
- **Show Plug-ins without a Custom Category** only displays plug-ins that do not have a custom category.

Remove "New" Status

Resets the "new" status of the recently detected plug-ins.

Show Changes

Refreshes the plug-in tree according to the current settings.

Sorting

Determines how the plug-ins are sorted. The other parameters act on that hierarchy.

Compress Hierarchy

Merges all items into a single submenu if a submenu and all its submenus contain less than a specific number of plug-ins (**Threshold**).

The **Threshold** value determines the minimum number of items that are needed to compress the hierarchy.

Create Submenus Based on Prefixes

Creates a submenu that is labeled as the prefix if several items in a submenu start with the same prefix.

The **Threshold** value determines the minimum number of items that must start with the same prefix that are needed to create submenus that are labeled as the prefix.

Merge Single Submenus

Merges submenus that contain another submenu with only a single item in it.

Category Renaming

The category labels used to create the hierarchy are supplied by the plug-in manufacturers. In this section, you can change the category name. This can also be useful to merge two categories into one, by renaming these two categories with the same name.

Submenu with Recently Used Plug-ins

If this option is activated, the **Recently Used** submenu is shown.

The **Maximum Size** value determines the maximum number of plug-ins on the **Recently Used** submenu.

The **Independent Recently Used Plug-ins Menu** option determines whether the **Recently Used** submenu is global to all places where plug-ins can be selected, or if it is local to each context.

Ignored Plug-ins

Opens the **Ignored Plug-ins** dialog, where you can see plug-ins which were not loaded. This dialog lets you instruct WaveLab Pro to rescan these plug-ins at the next launch. This is faster than a full rescan.

Number of Plug-ins

Shows the number of plug-ins that are available in WaveLab Pro.

Variables and Text Snippets

You can define and use custom variables and text snippets, or use auto variables in various places in WaveLab Pro, for example, in the **Metadata** dialog.

Custom variables can be used to replace codes with a specified text in metadata saved within audio files. For example, you can define the variable `%proj%` to be replaced by the name of the current project. A custom variable can also contain references to other variables. For example, `%comment%` can be defined as `"%proj% started on @Date1@"`.

Variable codes are replaced with the variable values when the file is written. For example, when the metadata is saved inside an audio file.

Auto variables are automatically set by WaveLab Pro. For example, the current date, the sample rate, the bit depth, or metadata values that are found in audio files.

Text snippets can be used to define words that you are using regularly when filling in text fields. These can be inserted into a text field via the **Text Snippets** menu.

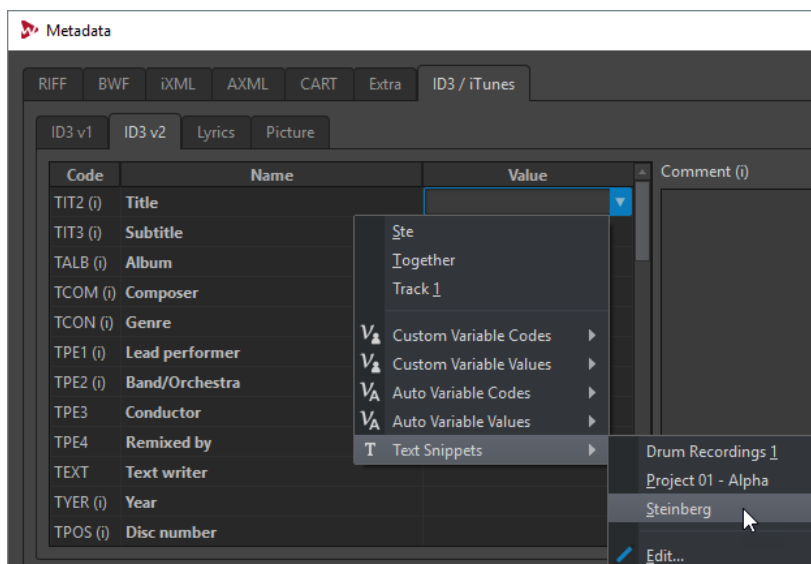

Some auto variables depend on the context. For example:

- CD Text variables are only used when rendering an audio montage.
- Auto variables that relate to CD tracks are only used when rendering CD tracks from an audio montage. To render CD tracks, activate one of the following options in the **Render** dialog: **Selected CD Track**, **One Region** (CD Track markers), or **Regions** (track markers).

If a variable is used in a wrong context, it is replaced with a blank.

Defining Variables and Text Snippets

You can create new variables and text snippets, and define values for them.

PROCEDURE

1. Select **File > Preferences > Variables**.
2. Do one of the following:
 - On the **Custom Variables** tab, click the plus icon to add a new variable, or double-click an existing variable that you want to modify.
 - On the **Text Snippets** tab, click the plus icon to add a new definition, or double-click an existing definition that you want to modify.
3. For custom variables, enter the name, code, and value for the variable. For text snippets, enter the text.

NOTE

Variable codes are case sensitive. It is recommended to select the codes from the menus.

Applying Variables and Text Snippets

You can apply custom variables, auto variables, and text snippets at various places in WaveLab Pro.

PREREQUISITE

Define custom variables and text snippets.

PROCEDURE

1. In a value field, click the arrow icon. If several fields are selected, right-click to access the pop-up menu.

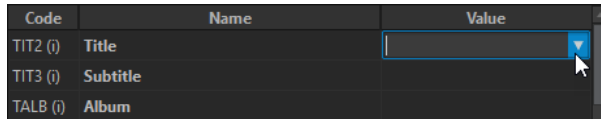

2. From the menu, select a custom variable, an auto variable, or a text snippet.

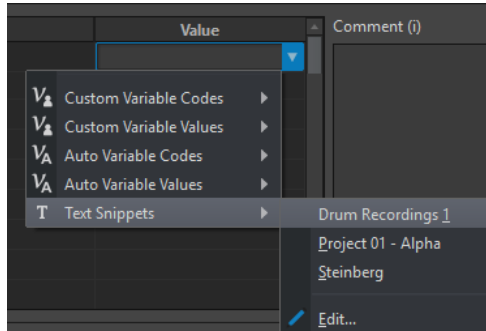

The variable or text snippet is added to the value field.

Variables and Text Snippets Dialog

This dialog allows you to define custom variables, see the auto variables, and define text snippets.

- To open the **Variables and Text Snippets** dialog, select **File > Preferences > Variables**.

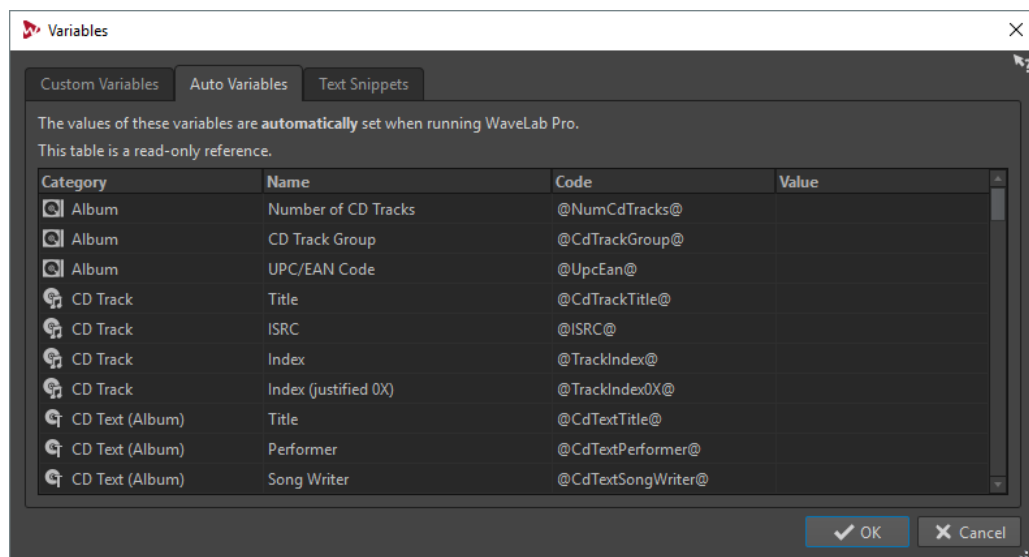

Plus icon

Adds a new custom variable/text snippet.

Minus icon

Removes the selected custom variable/text snippet.

Scripting

WaveLab Pro contains a powerful scripting language to help advanced users create their own scripts to automate tasks. Using basic scripts can be useful for automating repetitive editing tasks such as trimming and cropping a file at specific times, for example.

You can write scripts that perform other basic editing commands, apply offline processing, place markers, and display information about the active file. You can script commands to edit the active audio file or the active audio montage. If you have some experience of programming with modern scripting languages you should have no problem writing utility scripts for WaveLab Pro.

The WaveLab Pro scripting language is based on ECMAScript, with the addition of WaveLab Pro specific commands.

- The WaveLab Pro specific scripting functions are available in the **WaveLab Pro Scripting** documentation. The documentation is available on the Internet from <https://steinberg.help/>.
- On Windows, there is an additional scripting interface to control WaveLab Pro from external applications using VBScript or JScript. The **WaveLab Pro ActiveX Scripting** documentation is available on the Internet from steinberg.help and in the following folder:
Steinberg\WaveLab Pro 9.5\Tools\Windows Scripting\
- For a broader look at the complete subset of commands that are available, see the ECMAScript Language Specification.

This chapter is about scripts that are executed from within WaveLab Pro.

Script Editor

The **Script Editor** allows you to write and execute scripts in WaveLab Pro.

- To open a new script file, select **File > New** and click **Script**.
- To open a saved script file, select **File > Open** and click **Script**. Select the script file and click **Open**.

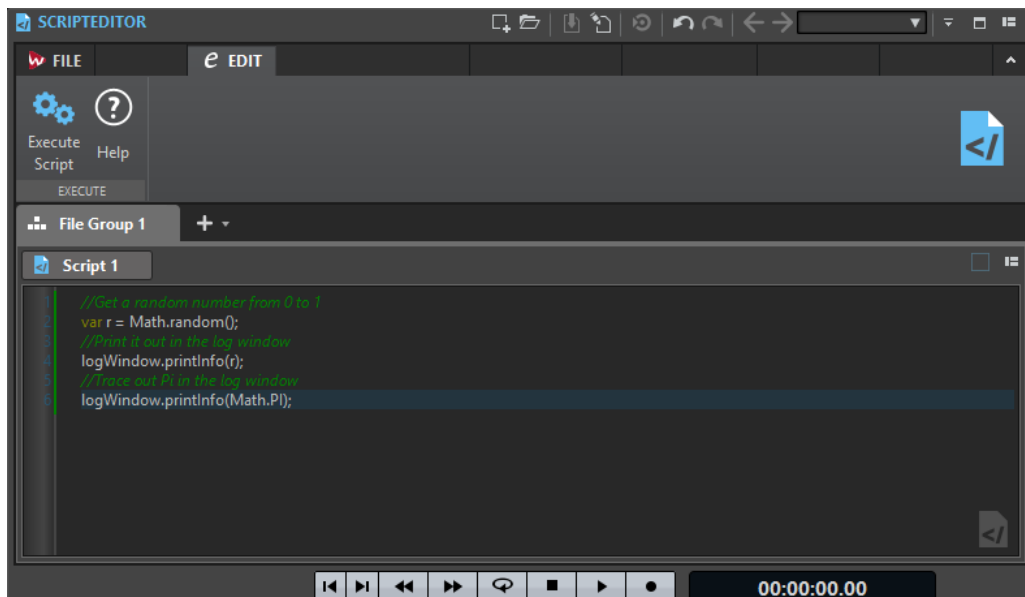

Execute Script

Executes the script.

Writing and Executing a Script

PROCEDURE

1. Select **File > New**.
2. Click **Create Script**.
3. In the **Script Editor**, type your script or copy and paste it from an external text editor.
4. To run the script, select the **Edit** tab, and click **Execute Script**.

NOTE

Only one script can be executed at a time.

RESULT

The script runs if there are no syntax errors. Any errors appear in a dialog box to help you debug them.

NOTE

There are several free utility text editors that are context sensitive. This means that they can color and highlight parts of your code to make it more readable. If you use one of these for writing and editing your scripts, choose Javascript as the editing language and/or save the file with a `.js` (Javascript) extension.

Using the Log Window When Scripting

It is a good idea to begin scripting by writing some simple scripts that output some text to the **Log** window.

The goal of the following example is to output a simple text message to the **Log** window.

PROCEDURE

1. Select **Tool Windows > Log**.
2. Copy and paste the following script into the **Script Editor**.

```
//output the number of samples in the active wave as text in the log window.  
logWindow.printInfo("This file has " + activeWave.size() + " samples");
```

NOTE

Any lines of a script that begin with two forward slashes `//` are comments, and are ignored when the script is executed.

3. Execute the script.
-

RESULT

In the **Log** window, the number of samples used in the active file is displayed.

Touch Bar (macOS only)

The Touch Bar at the top of your keyboard gives you shortcuts to the WaveLab Pro functions. The Touch Bar changes automatically based on where you are in WaveLab Pro and offers a subset of the available options. You can customize the Touch Bar according to your needs.

NOTE

The Touch Bar is only available on certain Apple products.

Customizing the Touch Bar (macOS only)

- To open the Touch Bar customization window, select **WaveLab Pro 9.5 > Customize Touch Bar**.
- To add an option to the Touch Bar, use your cursor to drag your favorite options from the customization window down into the Touch Bar.
When you are done, tap **Done** in the Touch Bar or click **Done** on the screen.
- To rearrange options within the Touch Bar, drag them to the left or right.
- To remove options from the Touch Bar, drag them up and out of the Touch Bar.

Configuring WaveLab Pro

You can configure WaveLab Pro according to your needs.

NOTE

The settings that you make in the preferences are applied when you switch to another WaveLab Pro window.

Global Preferences

Global Preferences are preferences that apply throughout WaveLab Pro. Before you start working with WaveLab Pro, it is recommended to edit these preferences according to your needs.

- To open the **Global Preferences**, select **File > Preferences > Global**.

General Tab

This tab allows you to change the location of settings files and the user interface language. You must restart the application for changes to take effect.

General

Language

Allows you to select the user interface language.

Setting Location

Common for All Users

Shares the preferences settings with all users on this computer.

Independent for Each User

Lets each user on this computer make their own preferences settings.

Application Folder (Portable Installation)

Saves settings in the application directory. Use this option to install the application on a portable device.

Specific Folder

Allows you to save the settings in a specified folder.

Open Setting Folder

Opens the folder that is used to save settings. This way you know where the settings are saved and you can back up the settings.

Synchronization Settings

Master Folder

Lets you specify where the preference settings are saved.

Synchronize at Every Launch

If this option is activated, the settings are synchronized whenever WaveLab Pro is launched.

Synchronize at Next Launch

If this option is activated, the settings are synchronized the next time that WaveLab Pro is launched.

Preferences Handling

Determines how to synchronize the preferences, that is, all settings except the presets. You can either ignore or mirror the preferences.

Preset Handling

Determines how to synchronize the presets that are saved in the master folder. The following options are available:

- If **Ignore Presets** is activated, the presets are not synchronized.
- If **Mirror Presets** is activated, the presets are restored from the master folder, regardless of their time stamp. Any additional local presets are deleted.
- If **Import New Presets** is activated, the presets in the master folder that are unavailable on the computer are imported.
- If **Update Old Presets** is activated, existing presets are overwritten if a newer version is found in the master folder.

Ignore the following Preset Folders (Separate Them with a Semicolon)

Lets you specify which preset folders you want to ignore when synchronizing the settings. For example, to ignore the Audio Connections settings, add "Audio Connections" to the field.

Update Master

If you click this button, the settings that were used when launching WaveLab Pro are used to update the master folder.

NOTE

This procedure should only be run by the system administrator if multiple WaveLab Pro workstations are used.

Display Tab

This tab allows you to change many aspects of the user interface that apply across the whole application. These options provide information and usability functions but can be deactivated to streamline the interface.

Theme

Theme

Allows you to switch between the WaveLab Pro color schemes.

Workspace

Show Tab If There Is a Single File Window

If this option is activated, the tabs are always visible, even if there is only one active file.

Display Active File Path in Title Bar

Displays the file path of the active file in the title bar of the workspace.

When Closing the Active Tab

Determines the behavior of the program when closing the active tab.

Tool Windows

Show Title for Single Tool Windows

Allows you to show or hide the title bar for single tool windows.

Animate Slide-Out Windows

If this option is activated, slide-out windows open with an animation.

Window Transparency

Sets the degree of transparency for windows that have this option activated.

Miscellaneous Options

Show Application in High DPI (Windows only)

If this option is activated and your display supports high resolution, WaveLab Pro is displayed in high resolution. If your display does not support high resolution, this option will be ignored.

NOTE

Plug-in windows are not displayed in high-resolution. If plug-in windows appear too small, deactivate **Show Application in High DPI**.

Use the System File Selector to Open Files

If this option is activated, the standard file selector opens when you select the **Save As** option.

Open Quick File Selector When Saving Files

If this option is activated and you save a file via the save shortcut, a dialog opens instead of the **File** tab.

Undo/Redo Does Not Scroll/Zoom Audio

If this option is activated, the undo and redo functions for audio files and audio montages do not restore the snapshot that was active when the operation was performed.

Show WaveLab Pro Logo on Startup

Determines whether the WaveLab Pro logo is displayed during initialization.

Show Tooltips

If this option is activated, tooltips are displayed when you move the mouse cursor over markers or command bar buttons.

Hide Top Level Windows When the Application Is Not Active (Windows only)

If this option is activated, all floating windows are automatically hidden when another application becomes active. If this option is deactivated, floating windows remain on top of other application windows.

History

Maximum Number of Items in Recent File Menus

Sets the maximum number of files that are listed in recent file menus.

Maximum Number of Items in Recent Files Tab

Sets the maximum number of files that are listed in the **Recent Files** tab.

Maximum Number of Items in the Recent Folders Menu

Sets the maximum number of files that are listed in the **Recent Folder** menus.

Audio Tab

Resample Conversion Quality

Allows you to specify the resample conversion quality.

Default Fade/Crossfade

Allows you to specify the default duration and shape of the fades or crossfades that WaveLab Pro creates automatically during specific processes.

Processing Precision

Plug-in Processing allows you to select the processing precision for plug-ins.

- If you select **64 bit float** and a plug-in is capable of processing 64-bit samples, processing takes place in lossless 64 bit.
If a plug-in is only capable of handling 32-bit samples, WaveLab Pro converts all 64-bit float samples to 32-bit float before sending them to the plug-in. After the plug-in processing is completed, WaveLab Pro converts the 32-bit float samples back to 64-bit float without loss.
- If you select **32 bit float**, WaveLab Pro converts all 64-bit float samples to 32-bit float before sending them to the plug-in. After the plug-in processing is completed, WaveLab Pro converts the 32-bit float samples back to 64-bit float without loss.

In the plug-in menus, the “32F” and “64F” indicators next to the plug-in name show whether a plug-in is capable of 32-bit float or 64-bit float.

NOTE

Processing in 64-bit float means double precision but slightly longer process time than 32-bit float.

Temporary Files allows you to select the precision of temporary files that WaveLab Pro creates when processing audio.

By default, WaveLab Pro creates temporary files in 32-bit float. Use the **64 bit float** option if you want to create 64-bit float audio files or 32-bit PCM files.

NOTE

Temporary files in 64-bit float have double precision but take longer to read and write than 32-bit float and their file size is twice as big.

RELATED LINKS

[Temporary Files](#) on page 86

Formats Tab

This tab allows you to adjust settings for some of the audio formats and units that WaveLab Pro uses.

Formats

Use AES17 Standard for RMS Values

Determines how RMS values are reported.

- If this option is activated, the displayed level for a full scale sine audio file is 0 dB. This follows the AES17 standard.
- If this option is deactivated, the displayed level for a full scale sine audio file is -3 dB.

Loudness Analysis Reference

Allows you to define the loudness reference value. The EBU R-128 recommendation for broadcast is -23 dB.

The loudness reference value is used in the following contexts:

- To display the zero point marker in the bottom scale of the **Loudness Meter**.
- To display the loudness value in relation to the reference value in the **Global Analysis** dialog.
- To display the loudness value in relation to the reference value in the **Audio Analyzer** plug-in of the **Batch Processor** window.

Pitch of A3 (Used in Frequency To Note Conversions)

Sets the reference pitch in WaveLab Pro. The frequency-to-note conversions take this pitch into account.

Create Windows-Compatible File Names (macOS only)

Some characters in file names, for example, | and \, are not supported by Windows. If this option is activated and you save a file, WaveLab Pro converts unsupported characters to characters that are supported by Windows.

MIDI Note Display

The options in this section allow you to choose whether to display the different key values in WaveLab Pro with the pitch or the MIDI note number of the key. In musical notation, keys are denoted according to their pitch. For example, C3 means the note C in the third octave.

Each key corresponds to a MIDI note number from 0 to 127. For example, key C3 corresponds to the MIDI note number 48. MIDI note numbers make it possible for samplers to automatically map samples to the correct keys.

Numeric Style

Determines the format for MIDI notes that are displayed as numbers.

Middle C (Note #60)

Determines the key convention for the MIDI note range (0-127).

Display

Determines how MIDI notes are displayed throughout the application.

CSV Delimiter

CSV Delimiter

Several areas of WaveLab Pro allow you to export information in the CSV text format. This option lets you set the delimiter character that a third-party software requires to import CSV files.

CD Writing Tab

This tab allows you to set a number of parameters for CD writing and for the creation of DDP images.

CD Writing

Use Burnproof

Fixes possible buffer underrun errors automatically, provided that the CD writer supports this technology.

Allow Disc Overflow

Allows WaveLab Pro to attempt writing more data (max. 2 minutes) than the official capacity of the disc.

Maximum Audio CD Size

Allows you to specify the maximum length for a CD. A warning message will appear if the project exceeds this length. The standard maximum length is 74 minutes.

DDP Creation

DDP Creation – Format 1.0/Format 2.0

Determines which format to create when producing DDP files for an audio project.

Write Checksum File (CRC-32)

If this option is activated, a file called `CHECKSUM.CHK` is added to the DDP files that are created on the hard drive. The checksum contains the CRC32 checksums of the created DDP files.

Write Checksum File (MD5)

If this option is activated, a file called `CHECKSUM.MD5` is added to the DDP files that are created on the hard drive. The checksum file contains the MD5 checksums of the created DDP files.

Write Log File

If this option is activated, a text file called `gear.log` is added to the DDP files that are created on the hard drive. The log file logs all operations.

Warn If Files Already Exist

If this option is activated, a warning message is displayed if files are about to be overwritten in the specified destination folder.

Options Tab

This tab allows you to control application-wide start-up options. You can also reset the default message boxes.

Make Tasks Monitor Visible When Task Starts

If this option is activated, the **Tasks** window opens when a background task starts.

Play a Sound When a Long Task Completes

Allows you to select a sound that is played when a task finishes.

Minimum Duration

Specifies how long a task must be for a sound to be triggered when the task is finished. If the task duration is shorter, no sound is triggered.

Path and Name of the Audio File

Lets you select which audio file is played. On Windows operating systems, the file format must be WAV, and on macOS operating systems, the file format can be WAV or AIFF.

Only Play the Sound for Blocking Tasks

If this option is activated, the sound only plays if tasks prevent you from working elsewhere in WaveLab Pro. For example, background tasks do not trigger a sound when they are completed.

Alternative External File Browser

Allows you to specify an alternative external file browser that opens when you use the **Reveal Folder in File Explorer/macOS Finder** or **Reveal Files in File Explorer/macOS Finder** options in WaveLab Pro.

If the application needs a special command line formatting, you can specify it in the **Command Line** field. Use %1 as a placeholder for the file or folder to which you want to browse.

Interval for Zoom Key Command

Allows you to specify how much the waveform zoom factor changes each time that the zoom shortcuts are triggered. Higher values allow you to zoom in and out more quickly but with bigger steps.

Reset Default Answers

Resets all message box options to their default settings. For example, all "Do not show again" options are deactivated.

Audio Files Preferences

This dialog allows you to define settings for editing in the **Audio Editor**. However, these settings also effect other parts of WaveLab Pro. You can choose defaults for editing and playback, adjust the visual appearance of the waveform displays, and determine how WaveLab Pro works with audio and peak files.

- To open the **Audio Files Preferences** dialog, select **File > Preferences > Audio Files**.

Editing Tab

Display

Save View Settings in Companion File

If this option is activated, zoom settings, ruler settings, and optionally the **Master Section** preset that is associated with the audio file are saved in a companion file. if the audio file is reopened, these settings are used. Deleting a companion file does not alter the audio contents.

Save in an Independent Folder

If this option is activated, the companion file is not saved in the same folder as the related audio file but in a folder that you can specify.

Edit

Opens the **Folders** dialog that allows you to specify where to save the companion files.

Show Overview when Opening new Audio Files

If this option is activated and you open an audio file, the overview is also displayed. If this option is deactivated, only the main view is displayed.

Show Overview when Opening new Audio Files in Multiple Tab Groups

If this option is activated and 2 or more tab groups are available, the overview is also displayed in the wave window when you open an audio file. If this option is deactivated, only the main view is displayed.

Overview: Passive Range Indicator Also Covers the Waveform

If this option is activated, the range indicator that is displayed in the time ruler of the overview also covers the waveform area. Unlike the time ruler indicator, the range indicator is passive and cannot be modified.

Analog Waveform Emulation at Sample Level Zooming

If this option is activated and a waveform is zoomed at the sample level in the timeline, an analog emulation of the waveform is displayed.

Auto-Zoom for Overviews

If this option is activated and you open an audio file, the zoom of the overview is set to display the whole file.

Display File Extension on Tabs

If this option is activated, tabs display file names with their extension. For example, "piano.mp3" instead of "piano".

Number of Seconds to Display on Opening

Lets you specify the time range to display when opening an audio file for the first time. WaveLab Pro converts this time range to the appropriate zoom factor.

Whole Audio File

If this option is activated, the horizontal zoom is set to display the whole file.

Editing

Select All Channels with the Mouse

If this option is activated and you select a range with the mouse in a stereo file, both channels are selected. To select the channels individually, press **Shift** while selecting. To switch from one channel selection to the other, press **Tab**.

Process Whole File If There is No Selection

If this option is activated and a process is to be applied to an audio file, the whole file is processed if no audio is selected. In the same situation, if the option is deactivated, a warning appears.

Playback Scrubbing

Restrict to Play Tool

If this option is activated, this function only works if the **Play Tool** is used.

Sensitivity

Lets you set the micro audio loop duration that is performed when you move the mouse cursor over the time ruler.

Snap Selection to Zero-Crossing

Do Not Snap at High Zoom Factors

If this option is activated, snapping does not occur if the waveform is displayed at a high zoom factor.

Scan Range

Lets you define how far WaveLab Pro searches a zero-crossing point in the left and right direction.

File Tab

Warn When Opening a File with a Malformed Header

If this option is activated, a message opens when you open a file with a corrupt header. This might be a damaged file, or a file that is not properly formatted by another application.

If this option is deactivated, WaveLab Pro tries to open the file, but you are not informed about possible issues.

Support RF64 File Format

If this option is activated, WaveLab Pro creates `WAV` files that can be larger than 2 GB.

NOTE

This file format is not supported by all applications.

Default Sample Rate for Files without Header

Lets you specify the sample rate of audio files that do not have a header describing this property.

Create Optimized Audio File Headers

If this option is activated, WaveLab Pro increases the `WAV` file headers to a value that improves disk access. Although this is a standard procedure, some applications cannot open these files correctly.

Save Audio Files in the Background

If this option is activated, WaveLab Pro saves audio files in the background so that you can continue working.

Write Markers in WAV File Header (Riff Format/BWF Format)

If this option is activated, markers are written in WAV file headers. Thus, the markers are always available even if you open the files in another application.

Write Markers in Separate File

If this option is activated, markers are written in a separate file (extension `.mark`) that is saved in the same folder as the audio file. This allows marker support in file formats where markers are usually not supported.

Save Error and Correction Markers

If this option is activated, error and correction markers are saved with the other markers.

Create Peak Files in an Independent Folder

If this option is activated, peak files are not saved in the same folder as the related audio file. To specify the folder location, click **Edit**.

Create Peak Files When Writing Audio Files

If this option is activated, WaveLab Pro writes peak files while rendering audio files.

Delete Peak Files When Closing Audio Files

If this option is activated, peak files are deleted after use. This saves disk space but means that audio files take longer to open.

Allow Opening of Dual Mono Files

Allows recognizing multiple selected mono files as stereo files according to their name, and edit them as one stereo file.

Name Creation/Name Interpretation

You can define a name creation pattern and up to 7 name interpretation patterns for different naming schemes.

- Name creation pattern (only 1) is used by WaveLab Pro to add the specified suffix to audio files when creating dual mono files. The default suffix is "-L" and "-R".
- Name interpretation patterns (up to 7) are used by WaveLab Pro to identify the original channel of mono files through an analysis of their name.

Left Channel ID/Right Channel ID

These IDs are the character sequences that are used to identify the left and right channel files in their name. For example, "_l" for the left channel and "_r" for the right channel.

Suffix

In this mode, the channel ID string must be located at the end of the file name.

Advanced

In this mode, the channel ID string can be located anywhere in the file name and not only as a suffix. For this purpose, a name pattern must be defined. This name pattern must have a {capture} section.

The default suffixes for recognizing dual mono files are as follows:

- -L/-R
- _L/_R
- .L/.R

This mode is only available for input patterns.

Style Tab

This tab allows you to specify custom colors for parts of the wave window.

Styles

Lets you select the default style and conditional styles.

Parts

Shows parts that can be colorized. Click a part to edit the color.

Hide (for specific parts only)

Hides the selected part.

Dotted Line (for specific parts only)

Changes the line to a dotted line.

Transparency (for specific parts only)

Lets you edit the degree of transparency of the selected element.

Element Size (for specific parts only)

Lets you edit the size of the selected element.

Change Both Channels

Allows you to make separate color settings for the left and the right side of a stereo file. If this option is activated, settings for the left side of a file are automatically mirrored on the right side, and vice versa.

Change Both Main View and Overview

Allows you to make separate color settings for the main view and the overview. If this option is activated, settings for the main view are automatically mirrored on the overview, and vice versa.

Color Picker

Lets you select the color for the selected part. Click the surrounding circle to select the hue. Click in the triangle to adjust the saturation and lightness.

Red/Green/Blue

Lets you specify the red, green, and blue components of the RGB color spectrum.

Copy Color

Copies the current color to the clipboard.

Paste

Pastes the color from the clipboard.

This Style Is Used If These Conditions Apply

Lets you define conditions under which a specific color style is applied.

File Extension Is Any Of

If this option is activated, the color style is applied to files with the specified extension. Separate extensions with a ";" character.

Name Contains Any of These Keywords

If this option is activated, the color style is applied to files with specific keywords in their name. Separate keywords with a ";" character.

Sample Rate Is in the Range

If this option is activated, the color style is applied to files that have a sample rate within the specified range.

Bit Depth Is in the Range

If this option is activated, the color style is applied to files that have a bit depth within the specified range.

Number of Channels Is

If this option is activated, the color style is applied to files that have the specified number of channels.

Color Elements in the Audio Editor

You can assign custom colors to various elements of the **Audio Editor**. Depending on the selected element, additional settings can be made for transparency, appearance, or whether a line should be dotted, for example.

Left/Right Channel

Waveform

The waveform color.

Waveform (Selected)

The waveform color of the selected part of the waveform.

Waveform Outline

The outline color of the waveform.

Waveform Outline (Selected)

The outline color of the selected part of the waveform.

Background Top

The color of the background top.

Background Top (Selected)

The color of the selected part of the background top.

Background Bottom

The color of the background bottom.

Background Bottom (Selected)

The color of the selected part of the background bottom.

Waveform Main Axis

The color of the waveform main axis and its style.

Waveform 50 % Axis

The color of the waveform 50 % axis and its style.

Waveform Elements

Channel Separator

The color of the channel separator line.

Cursor (Edit)

The color of the edit cursor, its width, and transparency.

Cursor (Edit, No Focus)

The color of the edit cursor for a file that does not have the focus.

Cursor (Play)

The color of the cursor during playback.

Marker Line

The color of the marker lines and an optional transparency.

End of File Indicator

The color of the end of the file indicator.

Time Ruler Style

The color of the time ruler and its style.

Time Ruler Font

The color of the font on the time ruler and the font size.

Level Ruler Style

The color of the level ruler, its style, and transparency.

Level Ruler Font

The color of the font on the level ruler and the font size.

Audio Montages Preferences

This dialog allows you to set up general parameters for all audio montages or for the active audio montage only.

- To open the **Audio Montages Preferences** tab, select **File > Preferences > Audio Montages**.

Active Audio Montage Tab

The settings made on this tab apply only to the active audio montage.

Default Gap

Sets the default gap for clips. This setting is used for separating clips, for example, when you insert several clips at the same time.

DVD-Audio Resolution

Defines the DVD-Audio resolution for writing the audio montage to DVD-Audio. You can select 16 bit (smaller file size) or 24 bit (best quality).

Folder for Audio Files

Sets the path, which is relative to the audio montage folder, to the folder where audio files are implicitly created. For example, if you enter `Data` in the text field, a folder named `Data` is created in the audio montage folder. Files in this folder are not deleted when you close the audio montage.

If no folder is defined, the audio montage folder is used.

Reset Plug-ins When Starting Playback

If this option is activated, all active effect plug-ins are instructed to release all samples in their memory when you start playback.

Use this option if you experience clicks or noises when the playback position reaches the start of a clip that contains effects (typically reverb or delay). Otherwise, leave this option deactivated because it could lead to a delayed response upon playback start.

It is recommended that you deactivate this option, unless you experience shortage of memory that is caused by too many plug-ins.

Reset Plug-ins before Rendering

If this option is activated before rendering, all active plug-ins are reloaded.

Use this option if you experience clicks or noises in rendered audio files.

Auto Save Master Section Preset

Automatically saves the current **Master Section** preset along with the audio montage when saving the audio montage. This is recommended if you work on one audio montage at a time.

All Audio Montages Tab

The settings made on this tab apply to all audio montages.

Maximum Number of Backups

Specifies how many previous versions are kept.

Auto Save

Automatically saves the audio montage in intervals which you can specify in the time field below.

Clear After Each Saving

Clears the memory that is used by the operation history each time the audio montage is manually saved. Any operations that were performed before saving can no longer be undone.

Group Similar Operations

Groups similar successive operations into one undo operation to save memory on your hard disk.

For example, if you need several steps to move a clip until you find the right position, you can undo each step as usual. However, as soon as you perform another operation, all the previous steps are considered as one entry in the undo history.

When Closing Unmodified Montages

Defines the actions that are performed when closing an unmodified audio montage. An audio montage is only tagged as modified if the audio-related data has been modified. The following options can be selected:

- **Save and Update Time Stamp:** The audio montage is saved to remember its current state, for example, selection and zoom, and the time stamp of its file is updated.
- **Save and Retain Time Stamp:** The audio montage is saved to remember its current state, and the time stamp of its original file is retained.
- **Do Not Save:** The audio montage is not saved and therefore not preserved for the next launch of WaveLab Pro.

Display Indications of Possible Actions

Displays hints in the status bar of the audio montage about what you can do at the current mouse position in the montage window.

Display Envelope Tooltip While Editing

Displays a tooltip when you click and drag an envelope element. The tooltip indicates the value of the performed editing.

Auto Activate Clip when Selecting Audio Range

If this option is activated and you select an audio range, the corresponding clip becomes the active clip.

Auto Select the Active Clip

If this option is activated, you can click anywhere on a clip to select it. If this option is deactivated, the clip is only selected when you click in the bottom clip area.

Basic Amplitudes for Nudging – Time/Gain

Defines the amount with which elements are adjusted when you modify them with the nudge commands. This is used for nudging the position of objects or edges and for nudging volume gains.

CD Cue Sheets – Write Audio File Names without Path

If this option is activated, audio files are referenced without a path when generating CD cue sheets.

When an Audio File Is Replaced in a Clip

When you replace the audio file in a clip, the clip is resized accordingly.

This applies in the following situations:

- When replacing the audio file of a clip
- When replacing an audio file in an audio montage
- When rendering a super clip
- When re-rendering a sequencer project whose file is used by one or more clips

Markers that are attached to the clips are automatically shifted.

The following options determine what happens when you replace the audio file in a clip.

- If **Synchronize Clip Length with Audio File** is activated, the clip length is set to the length of the new audio file.
- If **Shift Clips on the Right** is activated, the clips on the right of the clip retain their relative position.

NOTE

This only applies to clips that represent the whole audio file. If a clip is only a limited view of a larger audio file, these options have no effect.

Clip Time Ruler – Time is Relative to Clip Start

If this option is activated and **Show/Hide Clip Ruler and Markers of Source File** is activated in the wave window, the clip ruler time at the start of a clip is set to zero. If this option is deactivated, the clip ruler time is relative to the time of the audio file source.

Style Tab

This tab allows you to specify custom colors to clips and parts of a clip in the montage window.

Parts

Shows parts that can be colorized. Click a part to edit the color.

Checkbox

Allows you to select multiple parts to colorize multiple parts at the same time.

Undo

Undoes the last change.

Redo

Allows you to redo changes that were undone.

Hide

Hides the selected part.

Change Both Channels

It is possible to make separate color settings for the left and the right side of stereo clips. If this option is activated, settings for the left side of a clip are automatically mirrored on the right side, and vice versa.

Color Picker

Lets you select the color for the selected part. Click the surrounding circle to select the hue. Click in the triangle to adjust the saturation and brightness.

Red/Green/Blue

Lets you specify the red, green, and blue components of the RGB color spectrum.

Copy Color

Copies the current color to the clipboard.

Paste

Pastes the color from the clipboard.

This Style Is Used If These Conditions Apply

Lets you define conditions under which a specific color style is applied.

File Extension Is Any Of

If this option is activated, the color style is applied to clips referencing a file with the specified extension. Separate extensions with a “;” character.

Name Contains Any of These Keywords

If this option is activated, the color style is applied to clips with specific keywords in their name. Separate keywords with a “;” character.

Sample Rate Is in the Range

If this option is activated, the color style is applied to clips referencing a file that has a sample rate within the specified range.

Bit Depth Is in the Range

If this option is activated, the color style is applied to clips referencing a file that has a bit depth within the specified range.

Number of Channels Is

If this option is activated, the color style is applied to clips that have the specified number of channels.

Color Elements in the Audio Montage

You can assign custom colors to various elements of the montage window.

Clip Colors

The following clip types are available:

Crossfade Region

Allows you to set the background color for overlapping clip sections.

Default

The default colors, used for clips for which you have not selected any specific color.

Mid/Side

The colors used for mid/side clips.

Locked

The colors used for fully locked clips.

Muted

The colors used for muted clips.

Custom

These options correspond to the items on the color submenus. You can set up conditions in the **This Style Is Used If These Conditions Apply** section for when these should be automatically applied.

The following color elements are available:

Background Top/Bottom (Normal/Selected/Selected Range)

The background colors of the clip for selected and unselected clips and the selection range. The resulting display backgrounds are gradient fades from the top colors to the bottom colors.

Waveform (Normal/Selected/Selected Range)

The waveform color for selected and unselected clips and the selection range.

Waveform Outline (Normal/Selected/Selected Range)

The color of the waveform outline for selected and unselected clips and the selection range.

Edge

The left and right edge of the clip.

Edge (Selected)

The left and right edge of a selected clip.

Edge (Selected Range)

The left and right edge of a selected clip if within a selection range.

Axis (Level Zero)

The color of the horizontal dotted line in the middle of a clip, indicating the zero level.

Axis (Half Level)

The color of the horizontal dotted lines halfway up and down from the middle of a clip, indicating 50 % level.

Channel Separator (Stereo Clip)

The line dividing the two sides in a stereo clip.

Clip Name

The name label of the clip.

Active Clip Name

The name label of the active clip.

Active Clip Name Background

The name label background of the active clip.

Miscellaneous

Background Top/Bottom

The background colors of the track view for areas without a clip.

Background (Selected Range) Top/Bottom

The background colors in selected ranges.

Cursor (Edit)/Cursor (Edit, No Focus)/Cursor (Playback)

The color of the corresponding cursor.

Marker Line

The color of the marker lines in the audio montage.

Cue Point Line/End Cue Point Line

The color of the vertical dotted cue point lines and end cue point lines.

Marker Line (Source File)

The color of marker lines from the source montage window. The marker lines are displayed if **Show/Hide Clip Ruler and Markers of Source File** is activated on the **Functions** menu of the **Clips** window.

Time Ruler (Source File)

The color of the source ruler. The source ruler is displayed if **Show/Hide Clip Ruler and Markers of Source File** is activated on the **Functions** menu of the **Clips** window.

Time Grid Lines

The color of the time grid if activated in the menu of the time ruler.

Synchronizing WaveLab Pro Settings on Several Computers

You can make some reference settings available to other WaveLab Pro installations. These settings can then be used by other WaveLab Pro workstations to keep the settings synchronized on several computers.

PROCEDURE

1. Select **File > Preferences > Global**.

2. Select the **General** tab.
 3. In the **Setting Location** section, specify where to save the settings.
-

Multi-User Settings

If you use multiple WaveLab Pro stations in your studio or in your school, for administration, etc., you can set up one WaveLab Pro station to be the master station. The shared preferences and presets of this station can then be used by other slave stations.

These settings can be saved on the local network, for example.

If the administrator updates these settings, the different WaveLab Pro stations can synchronize with the master settings. You can also use this feature for individual computers to back up a reference setting and revert to this if necessary.

The settings in the **General** tab of the **Global Preferences** dialog are not synchronized. These are saved for each user in the `startup.ini` (Windows) or `startup.plist` (Mac).

IMPORTANT

Settings cannot be synchronized between PC and Mac.

Setting Up a Multi-User Setup

You can use the settings that you have made on a master WaveLab Pro station for other slave WaveLab Pro stations.

PROCEDURE

1. Set up a WaveLab Pro station with all settings and presets that you want to use on other WaveLab Pro stations.
 2. Assign read-only access to the settings folder of the master WaveLab Pro station.
 3. Open WaveLab Pro on another station for which you want to use the master settings.
 4. Select **File > Preferences > Global**.
 5. Select the **General** tab.
 6. In the **Synchronization Settings** section, set up the **Master Folder**, specify when the settings should be synchronized, and specify whether to include the preferences and/or presets.
 7. Close WaveLab Pro.
 8. Copy the `startup.ini` (Windows) or `startup.plist` (Mac) of the slave WaveLab Pro station to the settings folder of the other slave WaveLab Pro stations.
-

RESULT

All slave WaveLab Pro stations use the settings of the master WaveLab Pro station.

External Tools

You can configure external tools to work with WaveLab Pro. You can pass command line arguments on to the external tools so that they can process the current file/folder on which you are working, or the settings folder of WaveLab Pro.

This function is useful if you want to edit an audio file in another application, or if you want to compress all your audio files into a backup ZIP file, for example.

Once you have defined an external tool, you can run it by selecting it from the **External Tools** pop-up menus in the **Audio Editor** and **Batch Processor** window.

NOTE

An external tool only works within the editor in which it is defined. Thus, each editor type can have its own external toolkit.

RELATED LINKS

[Configuring External Tools](#) on page 588

[Configure External Tools Dialog](#) on page 589

Configuring External Tools

To be able to select external tools from the **Tools** menu, you must configure them.

PROCEDURE

1. In the **Audio Editor** or the **Batch Processor** window, open the **Configure External Tools** dialog.
 2. In the **Configure External Tools** dialog, click the plus icon to create a new tool definition.
 3. Specify a title, the path to the external tool that you want to run, arguments, an initial folder, and a comment.
 4. Optional: Add more tool definitions by clicking the plus icon again.
-

RESULT

The external tool is configured and can be selected from the **Tools** menu.

Once an external tool has been configured, you can assign a shortcut to it.

RELATED LINKS

[Configure External Tools Dialog](#) on page 589

[Customizing Shortcuts](#) on page 552

Running an External Tool After a Batch Process

You can specify external tools to run after a batch process is completed. For example, you can run a tool to zip the output files or an FTP tool to upload the files to the Internet.

PREREQUISITE

Configure the external tool that you want to run after the batch process.

PROCEDURE

1. In the **Batch Processor** window, select the **Options** tab.
 2. From the **On Success, Run External Tool** pop-up menu, select the external tool that you want to run after the batch process.
-

RELATED LINKS

[Configuring External Tools](#) on page 588

[Configure External Tools Dialog](#) on page 589

Configure External Tools Dialog

In this dialog, you can configure external tools to work with WaveLab Pro. For example, you can run a tool to zip the output files or an FTP tool to upload the files to the Internet.

- To open the **Configure External Tools** dialog for audio files, select the **Process** tab in the **Audio Editor**, click **External Tools** in the **Other** section, and select **Configure External Tools**.
- To open the **Configure External Tools** dialog for batch processes, select the **Options** tab in the **Batch Processor** window, open the **On Success, Run External Tool** pop-up menu, and select **Configure External Tools**.

List of external tools

The list of all external tools that are defined, in the order as they appear in the **Tools** menu.

Create item

Creates a new tool definition.

Delete item

Deletes the selected tool definition from the list.

Move selected item one position up/down

Moves the selected tool definition one position up/down.

Title

The title for the tool definition.

Application

The full path and file name of the application to run.

Arguments text field

The list of arguments to pass on to the application. Normally, there is at least one argument, for example, the active file name in WaveLab Pro. The required arguments depend on the application to run. Refer to the related documentation.

The arguments must be separated from one another by a space character. If an argument contains space characters, it must be enclosed in quotes.

Predefined arguments can be selected via the menu button next to this text field.

Arguments button

Opens a menu with a list of predefined arguments. These are placeholders that are replaced by actual values at runtime.

For example, if you select from the menu **Active File Name with Its Path**, the following text is inserted: **\$(FilePathAndName)**. At runtime, this symbol could be replaced by **C:/Music/Piano.wav**, presuming that this is the active file in WaveLab Pro.

Initial Folder

Specify the reference path that might be needed by the application. This path depends on the application. This setting is optional.

Comment

Allows you to add comments.

Before Execution – Warn If Active File Has Unsaved Changes (Audio Editor only)

If this option is activated, WaveLab Pro warns you if the active file has unsaved changes before running the external tool.

Before Execution – Close Active File (Audio Editor only)

If this option is activated, WaveLab Pro closes the active file before running the external tool. This is useful if the tool is meant to modify the active file.

Before Execution – Stop Playback (Audio Editor only)

If this option is activated, WaveLab Pro stops playing back the file before running the external tool. This is useful if the tool is meant to play back the file.

RELATED LINKS

[External Tools](#) on page 587

[Configuring External Tools](#) on page 588

Index

- 32-bit float
 - Bit Meter [396](#)
- 64-bit float
 - Bit Meter [396](#)

A

- AAC [124](#)
 - Encoding [131](#)
 - Metadata presets [148](#)
- AES-31
 - Exporting [321](#)
 - Importing [321](#)
 - Importing AES-31 files created in Nuendo [322](#)
- AIFF [124](#)
 - Sample attributes [474](#)
- Analysis
 - 3D frequency analysis [167](#)
 - Audio analysis [156](#)
 - Audio File Comparator [165](#)
 - Error detection and correction [169](#)
 - Global analysis [157](#)
 - Live Spectrogram [394](#)
 - Loudness Normalizer [177](#)
 - Metering [383](#)
 - Phasescope [390](#)
 - Spectrometer [392](#)
 - Spectroscope [391](#)
 - Type [158](#)
- Anchor
 - Play from anchor [94](#)
 - Play until anchor [94](#)
 - Playing back [94](#)
- ASCII text
 - FFT data [393](#)
- ASIO
 - Driver [10](#)
 - Recording from ASIO input [358](#)
 - Rendering ASIO input to file [358](#)
- Attributes
 - Metadata [146](#)
 - Metadata dialog [147](#)
 - Sample attributes [474](#)
- Audio
 - Analyzing [156](#)
 - Copying [143](#)
 - Moving [142](#)
 - Reversing [183](#)
 - Selecting [24](#)
- Audio analysis [156](#)
 - Exporting audio analysis results [522](#)
- Audio cards [9](#)
- Audio CD [399](#)
 - Importing audio CD tracks [482](#)
- Audio CD Report [420](#)
 - Cue sheet templates [424](#)
 - Dialog [421](#)
 - Generating [421](#)
- Audio Connections [9](#)
 - Defining [10](#)
 - Tab [11](#)
- Audio Editor [39, 116](#)
 - Analyze tab [121, 156](#)
 - Colors [580](#)
 - Correction tab [169](#)
 - Display modes [109](#)
 - Edit tab [118](#)
 - Insert tab [120](#)
 - Loudness [111](#)
 - Process tab [121, 173](#)
 - Render tab [122](#)
 - Spectrogram [110](#)
 - View tab [116](#)
 - Wave window [108](#)
 - Waveform [110](#)
 - Wavelet display [111](#)
- Audio File Comparator [165](#)
- Audio file formats [124](#)
 - Batch conversion [525](#)
 - Changing [129](#)
 - Dialog [127](#)
- Audio files
 - Auto split [458](#)
 - Changing names and file locations [262](#)
 - Comparing [165](#)
 - Creating [126](#)
 - Dual mono files [138](#)
 - Fades [181](#)
 - Preferences [576](#)
 - Saving [127](#)
 - Saving in another format [127](#)
 - Templates [80](#)
- Audio in pauses [302](#)
- Audio Inpainting [453](#)
- Audio montage window [197](#)
 - Analyze tab [210](#)
 - Edit tab [200](#)
 - Envelope tab [208](#)
 - Fade tab [206](#)
 - Insert tab [204](#)

- Process tab 205
- Render tab 211
- View tab 197
- Audio montages 40, 194
 - Assembling 221
 - Audio montages within audio montages 255
 - Auto split 461
 - Backups 310
 - Colors 584
 - Creating 214
 - Creating from audio file 136, 219
 - Crossfades 272
 - Duplicates 216
 - Fades 272
 - Overview 307
 - Preferences 581
 - Properties 215
 - Signal path 214
 - Sub-montage 255
 - Super clips 255
 - Templates 81
 - Window 194
 - Within audio montages 255
- Audio properties
 - Changing 145
 - Info tab 43
- Audio ranges
 - Playing back 93
- Audio selection
 - Snapshot 151
- Audio signal path
 - Batch process 503
- Audio signals
 - Generating 479
- Audio track dispatching 312
- Auto split 458
 - In audio files 458
 - In audio montages 461
- B**
- Background noise
 - Inserting 152
 - True silence vs. background noise 153
- Background tasks
 - Dropouts 366
 - Monitoring 365
 - Tasks window 365
- Backups
 - Audio montage 310
 - Automatic backups 79
 - External tools 587
 - Remote control definition files 18
- Basic Audio CD 399
 - Deleting CD tracks 403
 - Opening 403
 - Opening CD tracks for editing 404
 - Options 401
 - Pauses in CD tracks 404
 - Preparing 402
 - Saving 403
 - Window 399
 - Writing operations 412
- Batch conversion 525
 - Dialog 525
 - Files 526
- Batch process 490
 - Adding audio files 501
 - Adding audio montages 501
 - Adding files 501
 - Adding files from a folder 501
 - Adding plug-ins 502
 - Audio signal path 503
 - Batch plug-ins 497
 - Changing the plug-in order 503
 - Creating 499
 - External tool after batch process 588
 - File location 504
 - Files to process 493
 - Metadata 149
 - Multitasking 506
 - Naming rendered audio files 505
 - Offline processors 498
 - Output format 504
 - Overwriting strategy 504
 - Plug-in chain 492
 - Previewing the effect 504
 - Processor cores 506
 - Regular expressions 538
 - Removing files and plug-ins 503
 - Running 505
 - Saving 500
 - Status icons 505
 - Stopping 505
 - Watch Folders 506
 - Window 491
 - XML 519
 - XML output 521
 - XSLT 522
- Batch Processor window 491
 - Comment tab 497
 - Edit tab 491
 - Execution tab 497
 - Format tab 495
 - Options tab 495
 - Output tab 494
 - XML tab 496
- Batch renaming 527
 - Clips 530
 - Dialog 527
 - Files 527
 - Markers 529
 - Regular expressions 538
- Bit depth 36
- Bit Meter 396
 - Settings 397
- Bleep censor 154
- BWF
 - Metadata 146
- Bypass
 - Smart bypass 359
- C**
- CART
 - Markers 148

- Metadata 146
- CC121
 - Controls 18
 - Remote devices 13
- CD 399
 - Audio CD formats 436
 - Audio CD Report 420
 - Basic CD formats 436
 - Data CD 433
 - Information 486
 - Markers 296, 402
 - Playback times 299
 - Recorders 13
 - Window 296
 - Writing operations 412
- CD tracks
 - Adjusting pauses 404
 - Deleting from Basic Audio CD 403
 - Grouping 223
 - Metadata 299
 - Opening for editing 404
 - Saving as one file 405
 - Saving as separate files 405
- CD wizard 300
- CD writing 399, 416
- CD-Extra 436
- CD-Text 419
 - Audio CD Report 420
 - Editor 419
 - Importing 420
 - Variables 564
- Channel processing 288, 338
 - Setting up 289, 339
- Clip
 - Context menu 238
- Clip effects
 - Adding 285
 - Rearranging 287
 - Removing 286
 - Routing 290
- Clip envelopes 264
 - Copying 266
 - Display 264
 - Editing 265
 - Editing curve points 265
 - Hiding 265
 - Locking envelope curve 268
 - Muting clip range 266
 - Presets 267
 - Resetting curve points 266
 - Selecting 265
 - Smoothing 267
- Clip groups 308
 - Adding clips to clip groups 309
 - Coloring 310
 - Removing 310
- Clip list
 - Exporting as text 243
- Clip plug-ins
 - Routing 290
- Clip source
 - Removing 231
- Clipping
 - Detecting 163
 - Loudness Meta Normalizer 305
 - Master level 342
 - Provoking 177
 - Signal level 499
- Clips 224
 - Adding audio clips to audio montages 225
 - Adjusting crossfades 279
 - Aligning 241
 - Audio montage 194
 - Batch renaming 530
 - Cloning and substituting source files 263
 - Creating empty clips 231
 - Crossfading 244
 - Cue points 253
 - Deleting 252
 - Duplicating 247
 - Editing 238
 - Editing source files of clips 262
 - Effects 281
 - Empty 230
 - Exporting audio files of clips 263
 - Filtering clip names 241
 - Grouping 309
 - Inserting multiple clips 229
 - Inserting options 227
 - Loading 231
 - Locking 252
 - Managing source files of clips 260
 - Mid/Side view 255
 - Mouse zones 232
 - Moving 244
 - Moving with fixed audio sources 250
 - Muting 105
 - Overlapping 244
 - Pitch shifting 281
 - Playing back 105
 - Rearranging 232
 - Reordering 243
 - Repeating 247
 - Replacing source files of clips 261
 - Resizing 249
 - Saving 231
 - Selected vs. active 232
 - Selecting 236
 - Selection status 232
 - Splitting 251
 - Super clips 256
 - Time stretching 280
 - Unlocking 252
 - Window 238
- Colors
 - Audio Editor 580
 - Audio montages 584
 - Montage window 551
 - Tabs 78
 - Wave window 551, 579
- Command bar 48
- Command bars
 - Customizing 557
- Command line parameters
 - Watch Folders 518

- Companion files [36](#)
 - Comparing
 - Audio files [165](#)
 - Audio montages [321](#)
 - Encoder quality [348](#)
 - Original signal to processed signal [359](#)
 - Configuring
 - External tools [588](#)
 - WaveLab [570](#)
 - Context menus [50](#)
 - Control Window [41](#)
 - Docking [41](#)
 - Tab groups [33](#)
 - Converting
 - Audio CD tracks to audio montage [487](#)
 - Audio CD tracks to Basic Audio CD [487](#)
 - Batch converting [526](#)
 - Marker types [378](#)
 - Mono to stereo [140](#)
 - Multiple files [525](#)
 - Resample [190](#)
 - Sample rate [191](#)
 - Stereo to mono [140](#)
 - Copying
 - Audio information to clipboard [89](#)
 - Files [78](#)
 - Correction
 - Pitch bend [189](#)
 - Pitch quantizing [188](#)
 - Pitch shift [186](#)
 - Crossfades [182](#)
 - Creating [182](#)
 - In audio montages [272](#)
 - In loops [467](#)
 - Paste and crossfade options [182](#)
 - Post-crossfades [468](#)
 - Crossfades in clips [278](#)
 - Adjusting [279](#)
 - Automatic crossfades [276](#)
 - Editing [277](#)
 - Wave Matching window [279](#)
 - Cubase
 - WaveLab Exchange [488](#)
 - Cue points
 - Adding [253](#)
 - Clips [253](#)
 - Cue sheet
 - Templates [424](#)
 - Cursor
 - Cursor position indicator [234](#)
 - Memorize position [28](#)
 - Setting the position [53](#)
 - Snapshot [151](#)
 - Customizing [549](#)
 - Command bars [557](#)
 - Montage window [550](#)
 - Plug-in groups [557](#), [558](#)
 - Presets [73](#)
 - Scripting [567](#)
 - Shortcuts [552](#)
 - Text snippets [564](#)
 - Variables [564](#)
 - Wave window [550](#)
 - Workspace layout [549](#)
- ## D
- Data and audio [436](#)
 - Data CD/DVD [430](#)
 - Creating [433](#)
 - Dialog [434](#)
 - Projects [433](#)
 - Writing [433](#)
 - DC offset [183](#)
 - Global analysis [162](#)
 - Removing [184](#)
 - DDP [416](#)
 - Digital Signal Processing [186](#)
 - Disc-at-Once [438](#)
 - Disk capacity indicator [331](#)
 - Dithering [344](#)
 - Master Section [343](#)
 - MBIT+ [345](#)
 - Plug-ins [345](#)
 - Quality [346](#)
 - When to apply [345](#)
 - Document folders [86](#)
 - Double precision
 - Processing precision [573](#)
 - Temporary files [86](#)
 - Drag operations [65](#)
 - Driver
 - ASIO [10](#)
 - Windows MME [10](#)
 - Dropouts [366](#)
 - DSP [186](#)
 - DTMF Generator [480](#)
 - Dialog [480](#)
 - Dual mono files [138](#)
 - In the Audio Editor [139](#)
 - In the Audio Montage window [139](#)
 - In the Batch Processor window [140](#)
 - Opening [139](#)
 - Ducking [269](#)
 - Clips [269](#)
 - Settings [271](#)
 - DVD
 - Data DVD [433](#)
 - DVD-Audio [406](#)
 - Recorders [13](#)
 - Writing operations [412](#)
 - DVD-Audio [406](#)
 - Configurations [318](#)
 - Conformity check [411](#)
 - Creating [409](#)
 - Formats [406](#)
 - Multichannel configurations [318](#)
 - Opening [410](#)
 - Options [408](#)
 - Preparing [409](#)
 - Project structure [406](#)
 - Rendering [430](#)
 - Saving [409](#)
 - TV systems [409](#)
 - Window [407](#)
 - Writing [429](#)

- Writing to data CD/DVD [432](#)
 - Writing to ISO image [433](#)
- ## E
- EBU R-128 [37](#)
 - Analysis [159](#)
 - Defining loudness reference [574](#)
 - Loudness Meta Normalizer [305](#)
 - Loudness Meter [388](#)
 - Loudness Normalizer [177](#)
 - Loudness tab [111](#)
 - Pan Normalizer [179](#)
 - Effects
 - Adding [285](#)
 - Clip effects [281](#)
 - Dropouts [366](#)
 - Effects window [282](#)
 - Envelopes [291](#)
 - Final effects [343](#)
 - Gain [291](#)
 - Insert [288](#), [338](#)
 - Master effects and multichannel audio montages [321](#)
 - Master Section [335](#)
 - Montage output [282](#)
 - Montage output effects [281](#)
 - Morphing [191](#)
 - Panning [291](#)
 - Presets [338](#)
 - Rearranging [287](#)
 - Removing [286](#)
 - Send [288](#), [338](#)
 - Track effects [281](#)
 - Undoing changes [288](#)
 - Window [282](#)
 - Encoder Checker [347](#)
 - Blind modes [348](#)
 - Dialog [348](#)
 - Playback processing [346](#)
 - Quality of encoded audio files [347](#)
 - Encoding
 - AAC [131](#)
 - Audio files [130](#)
 - Encoder Checker [347](#)
 - FLAC [134](#)
 - MP2 [133](#)
 - MP3 [130](#)
 - OGG [134](#)
 - Quality of encoded audio files [347](#)
 - WMA [135](#)
 - Envelope
 - Dialog [179](#)
 - For clips [264](#)
 - Operations [180](#)
 - Surround panning [316](#)
 - Equipment
 - Connecting [9](#)
 - Error correction [172](#)
 - Error detection [172](#)
 - Errors
 - Correcting [172](#)
 - Correction tab [169](#)
 - Detecting [172](#)
 - Detection and correction [169](#)
 - Global analysis [162](#)
- ## Exchange
- WaveLab Exchange [488](#)
- ## Exporting
- AES-31 [321](#)
 - Clip list [243](#)
 - FFT data as ASCII text [393](#)
 - File names as text [262](#)
 - Markers list as text [381](#)
 - Remote control definition files [18](#)
 - XML [321](#)
- ## External editor
- Cubase as external editor for WaveLab [489](#)
 - Nuendo as external editor for WaveLab [489](#)
 - WaveLab Exchange [488](#)
- ## External gear
- Tab [11](#)
- ## External sub-montages
- Inserting into audio montages [258](#)
- ## External tools
- After batch process [588](#)
 - Configuring [588](#)
- ## F
- ## Fades
- Creating fade ins and fade outs [181](#)
 - Crossfades [182](#)
 - Easy Fades [181](#)
 - In audio files [181](#)
 - In audio montages [272](#)
- ## Fades in clips
- Copying [275](#)
 - Creating [272](#)
 - Deactivating for individual clips [276](#)
 - Default fade ins/fade outs [275](#)
 - Default fades in new clips [275](#)
 - Saving as default [274](#)
- ## Fast Fourier Transform
- [393](#)
- ## Favorite files
- Filtering [77](#)
 - Tab [76](#)
- ## FFT
- [393](#)
- ## File browser
- [31](#)
- ## File formats
- AAC [124](#)
 - AIFF [124](#)
 - Changing [129](#)
 - FLAC [124](#)
 - MP2 [124](#)
 - MP3 [124](#)
 - MPEG [124](#)
 - OGG [124](#)
 - RF64 [124](#)
 - Special file formats [137](#)
 - Unknown file formats [137](#)
 - WavPack [124](#)
 - WMA [124](#)
- ## File groups
- [63](#)
 - Creating [64](#)
 - Exporting as text [64](#)

- Saving [64](#)
- Templates [81](#)
- File tab [42](#)
- File tab groups [33](#)
 - Creating [34](#)
 - Using [35](#)
- Files
 - Batch renaming [527](#)
 - Closing [56](#)
 - Copy [78](#)
 - Deleting [86](#)
 - Favorite [76](#)
 - Files window [260](#)
 - Focus [89](#)
 - Groups [63](#)
 - Opening [59](#)
 - Operations [75](#)
 - Recently used [75](#)
 - Renaming [84](#)
 - Rendering [351](#)
 - Searching [64](#)
 - Switching between files [24](#)
 - Temporary [86](#)
 - Window [260](#)
- Final effects
 - Master Section [343](#)
- FLAC [124](#)
 - Encoding [134](#)
- Float files [126](#)
- Focus [89](#)
- Folders [86](#)
 - Batch processing [506](#)
 - Specifying [87](#)
 - Tab [87](#)
 - Watch Folders [506](#)
- FreeDb [486](#)
- FTP [547](#)
 - Podcast publishing [547](#)
- Full screen
 - Activating [57](#)

G

- Gain
 - Dialog [175](#)
 - Effects [291](#)
 - Global gain for effects [292](#)
- Glitches
 - Detecting [163](#)
- Global analysis [157](#)
 - Errors tab [162](#)
 - Extra tab [162](#)
 - Loudness tab [159](#)
 - Peaks tab [158](#)
 - Performing [163](#)
 - Pitch tab [161](#)
 - Results [164](#)
 - Type [158](#)
- GPK
 - Peak files [35](#)
- Groups
 - Clip groups [308](#)
 - Plug-in groups [558](#)

- Tab groups [33](#)
- Window [309](#)

H

- Help [6](#)
- Hidden CD track [303](#)
- History
 - Undo and redo [67](#)
 - Window [67](#)
- Hot points
 - Focusing [165](#)
 - Markers [164](#)

I

- ID3
 - Metadata [146](#)
- Image
 - Data CD/DVD [433](#)
- Importing
 - AES-31 [321](#)
 - Audio CD tracks [482](#)
 - Audio montage import options [220](#)
 - Remote control definition files [18](#)
 - XML [321](#)
- In-place rendering [353](#)
 - Audio selection [354](#)
- Info line [234](#)
- Info tab [43](#)
- ISRC [438](#)
 - Importing Codes [438](#)
- iXML
 - Metadata [146](#)
 - WaveLab Exchange [489, 489](#)

J

- Jog function [103](#)

K

- K-System [387](#)
- Key commands
 - Customizing [552](#)
 - Indexed [553](#)
 - Key sequences [553](#)
- Key sequences [553](#)
- Keywords [552](#)

L

- Latency [9](#)
- Left/Right
 - Channel processing [288, 338](#)
 - Master level [342](#)
 - Tracks [224](#)
- Level
 - Master level [342](#)
- Level Meter [385](#)
 - Settings [386](#)

- Level Normalizer
 - Dialog [176](#)
- Level ruler [51](#)
- Live Spectrogram [394](#)
 - Settings [395](#)
- Log
 - Scripting [568](#)
 - Window [57](#)
- Loop Tone Uniformizer [472](#)
- Loop Tweaker [468](#)
- Loops [464](#), [472](#)
 - Creating [464](#)
 - Crossfades [467](#)
 - Detecting automatically [466](#)
 - Loop Tone Uniformizer [472](#)
 - Loop Tweaker [468](#)
 - Looping seemingly unloopable audio [472](#)
 - Moving manually [466](#)
 - Playback [96](#)
 - Post-crossfades [468](#)
 - Refining [465](#)
- Loudness
 - EBU R-128 [37](#)
 - Envelope curves [112](#)
 - Global analysis [159](#)
 - Momentary [388](#)
 - Normalizing [177](#)
 - Reference [574](#)
 - Short-term [388](#)
 - Tab [111](#)
- Loudness Meta Normalizer [305](#)
 - Dialog [306](#)
- Loudness Meter [388](#)
 - Settings [389](#)
- Loudness Normalizer
 - Dialog [177](#)
- LR/MS
 - Editing [145](#)
- M**
- M/S
 - Tracks [224](#)
- Magnetic bounds
 - Audio montages [235](#)
 - In audio files [114](#)
- Marker types [367](#)
 - Converting [378](#)
- Markers [367](#)
 - Batch renaming [529](#)
 - Binding to clips [381](#)
 - CART [148](#)
 - CD markers [296](#), [402](#)
 - Converting marker types [378](#)
 - Creating [372](#)
 - Deleting [375](#)
 - Duplicating [373](#)
 - Exporting markers list as text [381](#)
 - Hiding [378](#)
 - Hot points [164](#)
 - Moving [376](#)
 - Navigating to [378](#)
 - Recording [325](#)
 - Renaming [379](#)
 - Selecting [380](#)
 - Sequence [373](#)
 - Types [367](#)
 - Window [368](#)
- Master level
 - Master Section [342](#)
- Master Section [332](#)
 - Channel processing [288](#), [338](#)
 - Dithering [345](#)
 - Effects pane [335](#)
 - Loading Master Section presets [362](#)
 - Master Level pane [342](#)
 - Multichannel configurations [320](#)
 - Playback Processing pane [346](#)
 - Plug-in window [337](#)
 - Processing [456](#)
 - Render tab [355](#)
 - Rendering [350](#)
 - Resampling pane [340](#)
 - Sample rate [341](#)
 - Saving Master Section presets [361](#)
 - Settings [334](#)
 - Signal path [333](#)
 - Stereo mixdown of multichannel configurations [320](#)
 - Supported effect plug-in formats [336](#)
 - Tools [334](#)
 - Window [332](#)
- Master Section presets
 - Companion files [36](#)
 - Including when rendering [364](#)
 - Loading [362](#)
 - Saving [361](#)
 - Saving in audio files or audio montages [362](#)
- MBIT+ [345](#)
- Metadata [146](#)
 - Batch Processor window [149](#)
 - CD tracks [299](#)
 - Dialog [147](#)
 - Merging [149](#)
 - Presets [148](#)
 - Text snippets [564](#)
 - Variables [149](#), [564](#)
- Metapass plug-ins [499](#)
- Meter windows [45](#)
 - Docking and undocking [46](#)
 - Opening and closing [45](#)
- Metering [383](#)
 - Monitor modes [383](#)
 - Multichannel [384](#)
 - Presets [385](#)
 - Real-time vs. non-real time [383](#)
 - Windows [383](#)
- Meters [330](#)
 - Bit Meter [396](#)
 - Docking in Control Window [41](#)
 - Format [53](#)
 - Level Meter [385](#)
 - Live Spectrogram [394](#)
 - Loudness [388](#)
 - Oscilloscope [397](#)
 - Pan Meter [385](#)

- Phasescope [390](#)
 - Resetting [384](#)
 - Settings [384](#)
 - Spectrometer [392](#)
 - Spectroscope [391](#)
 - Wavescope [398](#)
 - MF tones
 - DTMF Generator [480](#)
 - Mid/Side
 - Channel processing [288](#), [338](#)
 - Clips [255](#)
 - Editing [145](#)
 - Master level [342](#)
 - Tracks [224](#)
 - MIDI
 - Remote devices [13](#)
 - Shortcuts [552](#)
 - Missing files
 - Dialog [221](#)
 - Missing plug-ins
 - Replacing [560](#)
 - Mixdown [304](#)
 - Loudness Meta Normalizer [305](#)
 - Momentary loudness [388](#)
 - Monitor
 - Modes [383](#)
 - Monitoring
 - Background tasks [365](#)
 - Mono
 - Dual mono files [138](#)
 - Handling [124](#), [143](#)
 - To stereo [140](#)
 - Montage output effects [282](#)
 - Adding [285](#)
 - Rearranging [287](#)
 - Removing [286](#)
 - Montage window
 - Colors [551](#)
 - Customizing [550](#)
 - Morphing
 - Effects [191](#)
 - Mouse position indicator [234](#)
 - Mouse zones [232](#)
 - Moving audio [142](#)
 - MP2 [124](#)
 - Encoding [133](#)
 - MP3 [124](#)
 - Encoding [130](#)
 - Metadata presets [148](#)
 - MPEG
 - MP2 [124](#), [133](#)
 - MP3 [124](#), [130](#)
 - Multi computer setup [586](#)
 - Multi-user settings [587](#)
 - Multichannel [311](#)
 - Assigning track channels to output channels [312](#)
 - Audio track dispatching [312](#)
 - Configurations [311](#), [318](#)
 - Free configuration [318](#)
 - Master effects [321](#)
 - Master Section [320](#)
 - Metering [384](#)
 - Recording [319](#)
 - Stereo mixdown of multichannel configurations [320](#)
 - Mute
 - Clips [105](#)
 - Tracks [105](#)
- ## N
- Naming schemes [84](#)
 - Defining [84](#)
 - Dialog [85](#)
 - Navigator window [307](#)
 - Noise
 - Shaping [344](#)
 - Silence Generator [152](#)
 - Normalizing
 - Level Normalizer [176](#)
 - Loudness [177](#)
 - Loudness Meta Normalizer [305](#)
 - Pan [179](#)
 - Notes window [308](#)
 - NTSC
 - DVD-Audio [409](#)
 - Nudging [253](#)
 - Moving audio [143](#)
 - Nuendo
 - Importing AES-31 files created in Nuendo [322](#)
 - WaveLab Exchange [488](#)
- ## O
- Offline processing [173](#)
 - Applying [175](#)
 - Plug-ins [498](#)
 - OGG [124](#)
 - Encoding [134](#)
 - Oscilloscope [397](#)
 - Settings [397](#)
- ## P
- PAL
 - DVD-Audio [409](#)
 - Pan
 - Clip envelopes [264](#)
 - Effects [291](#)
 - Modes [269](#)
 - Surround panning [313](#)
 - Pan Meter
 - Level Meter [385](#)
 - Settings [386](#)
 - Pan Normalizer
 - Dialog [179](#)
 - Pause
 - In CD tracks [404](#)
 - PCM
 - Bit Meter [396](#)
 - Peak files [35](#)
 - Rebuilding [36](#)
 - Settings [35](#)
 - Peaks
 - Global analysis [158](#)

- Pen tool 155
 - Phase correlation 390
 - Phase inverting 183
 - Phasescope 390
 - Settings 391
 - Picture track 222
 - Pitch 161
 - Bend 189
 - Global analysis 161
 - Quantizing 188
 - Shift 186
 - Pitch shifting
 - Clips 281
 - Play tool
 - Using 101
 - Playback 90
 - Audio ranges 93
 - Clips 105
 - From an anchor or until an anchor 94
 - In background 9
 - In the Audio Montage window 105
 - Loops 96
 - Play button 93
 - Post-roll 97
 - Pre-roll 97
 - Scroll 104
 - Scrubbing 101
 - Shortcuts 99
 - Speed 97
 - Starting from ruler 101
 - Stop button 93
 - Transport bar 90
 - Using the Play tool 101
 - Playback processing 346
 - Playback times
 - Editing 299
 - Plug-in chain presets 287
 - Plug-in window 293
 - Adding effects 293
 - Changing effects 294
 - Closing all plug-in windows 295
 - Handling 295
 - Master Section 337
 - Opening 293
 - Switching between effects 294
 - Plug-ins
 - Adding to favorites 558
 - Adding VST plug-ins 559
 - Batch plug-ins 497
 - Clip effects 281
 - Customizing plug-in groups 558
 - Deactivating 557
 - Effect presets 338
 - Effects window 282
 - Excluding 559
 - Groups 557
 - Master Section 336, 497
 - Metapass 497, 499
 - Monopass 497
 - Montage output 282
 - Montage output effects 281
 - Multipass 497
 - Organization 557
 - Preferences 560
 - Replacing missing plug-ins 560
 - Track effects 281
 - Podcast Editor 40, 542
 - Podcasts 542
 - Checking 548
 - Creating 546
 - Editor 542
 - FTP settings 547
 - Options 546
 - Publishing 547
 - Post-roll 97
 - Dialog 97
 - PQ codes 437
 - Pre-emphasis 438
 - Pre-roll 97
 - Dialog 97
 - Preferences
 - Audio files 576
 - Audio montages 581
 - Global 570
 - Plug-ins 560
 - Presets 73
 - Audio file format 352
 - Clip envelope 267
 - Deleting 74
 - Loading 74
 - Metadata 148
 - Meter windows 385
 - Modifying 74
 - Plug-in chain presets 287
 - Saving 73
 - Temporary 74
 - Transport bar 99
 - Watch Folders 514
 - Processing precision 36
 - Preferences 573
 - Processor cores
 - Batch process 506
 - Project Manager
 - Window 62
 - Projects 60
 - Creating 60
 - Default projects 61
 - Project Manager window 62
 - Saving 61
 - Templates 82
 - Properties
 - Audio montage 215
 - Audio properties 43
- ## R
- Real time
 - Metering 383
 - Recent Files tab 75
 - Recording 324
 - ASIO input 358
 - Dialog 325
 - Disk capacity indicator 331
 - During playback 331
 - From the cursor position 331
 - In the Audio Montage window 331

- Markers [325](#)
- Multichannel [319](#)
- Setting up [324](#)
- Tab [11](#)
- Red Book standard
 - Basic Audio CD [399](#)
 - Basic CD formats [436](#)
 - CD-Extra [436](#)
 - CD-Text [419](#)
- Redo [66](#)
- Regular expressions [538](#)
 - Common regular expressions [538](#)
- Remote devices
 - CC121 [13, 18](#)
 - Tab [13](#)
- Renaming
 - Batch renaming [527](#)
 - Files [84](#)
 - Markers [379](#)
 - Naming schemes [84](#)
- Rendering [304](#)
 - ASIO input to file [358](#)
 - Audio montage to audio file [305](#)
 - Dropouts [366](#)
 - DVD-Audio [430](#)
 - Files [351](#)
 - In-place [353](#)
 - Including Master Section preset [364](#)
 - Master Section [350](#)
 - Multiple file formats [350](#)
 - Tasks window [365](#)
- Report
 - Cue sheet templates [424](#)
- Resample
 - Customize sample rate [341](#)
 - Master Section [340](#)
 - Resampler [190](#)
- Restoration
 - Error detection and correction [169](#)
 - Filtering individual frequencies [450](#)
 - Waveform [155](#)
- Reversing audio [183](#)
- RF64 [124](#)
- Ripple [247](#)
- Ruler
 - Level ruler [51](#)
 - Meter format [53](#)
 - Options [51](#)
 - Start position [53](#)
 - Time ruler [51](#)
- S**
- Sample attributes [474](#)
 - Editing [475](#)
 - Window [475](#)
- Sample rate
 - Conflicts [144](#)
 - Converting [191](#)
 - Customize [341](#)
 - Mismatched when inserting audio files [230](#)
 - Resample [190](#)
 - Writing audio montages with any sample rate [418](#)
- Saving
 - Clips [231](#)
 - Master Section presets [361](#)
 - Multiple files [78](#)
- Script Editor [567](#)
- Scripting [567](#)
- Scrolling
 - During playback [104](#)
 - Snapshot [151](#)
- Scrubbing [101](#)
 - Preferences [102](#)
 - Using the Play tool [101](#)
 - Using the time ruler [102](#)
- SECAM
 - DVD-Audio [409](#)
- Selection
 - Deleting [30](#)
 - Extending and reducing [30](#)
 - Memorize length [28](#)
 - Moving [29](#)
 - Muting [153](#)
 - Replacing with silence [153](#)
- Selection ranges
 - Creating clips [247](#)
- Short-term loudness [388](#)
- Shortcuts
 - Customizing [552](#)
 - Editing [553](#)
 - List [554](#)
 - Playback [99](#)
 - Tab [555](#)
- Shuttle function [103](#)
- Signal Generator [476](#)
- Signal path
 - Audio montage [214](#)
 - Batch process [503](#)
- Signals
 - Audio signals [479](#)
 - DTMF Generator [480](#)
 - Generating [476](#)
 - Signal Generator [476](#)
- Silence
 - Generator [152](#)
 - Inserting [153](#)
 - Replacing a selection with silence [153](#)
 - True silence [152](#)
 - True silence vs. background noise [153](#)
- Slide-out windows [45](#)
- Sliders [31](#)
- Sliding audio in clips [250](#)
- Smart bypass [359](#)
 - Dialog [360](#)
 - Using [359](#)
- Snapping [114, 235](#)
 - Crossfades when snapping to other clips [244](#)
 - Zero crossing [115](#)
- Snapshots [151, 303](#)
 - Capturing [151, 304](#)
 - Recalling [151](#)
 - Spectrometer [392](#)
 - Updating [151, 304](#)
- Solo
 - Tracks [105](#)

- SoundCloud [89](#)
 - Speaker configuration [106](#)
 - LED colors [106](#)
 - Pane [350](#)
 - Setting up [106](#)
 - Spectral editing
 - Copying regions [451](#), [451](#)
 - Defining regions [450](#)
 - Filtering individual frequencies [450](#)
 - Processing [449](#)
 - Spectrogram [440](#)
 - Display [110](#)
 - Options [442](#)
 - Picture [455](#)
 - Text [454](#)
 - Watermark [454](#), [455](#)
 - Spectrometer [392](#)
 - Settings [393](#)
 - Snapshots [392](#)
 - Zooming [392](#)
 - Spectroscope [391](#)
 - Spectrum
 - Audio Inpainting [453](#)
 - Editing [440](#)
 - Splitting
 - Auto split [458](#)
 - Clips [251](#)
 - Stereo tracks into mono tracks [224](#)
 - Status bar [49](#)
 - Stereo
 - Handling [124](#), [143](#)
 - Splitting stereo tracks into mono tracks [224](#)
 - To mono [140](#)
 - Stop button [93](#)
 - Sub-montages
 - Audio montages within audio montages [255](#)
 - External sub-montages [256](#)
 - Freezing [260](#)
 - Internal sub-montages [256](#)
 - Super clips [256](#)
 - Creating [257](#)
 - Editing [259](#)
 - Surround panning [313](#)
 - Dialog [314](#)
 - Envelopes [316](#)
 - Using [313](#)
 - Synchronizing
 - Settings [586](#)
 - System
 - Setting up [9](#)
- T**
- Tab groups [33](#)
 - Creating [34](#)
 - Docking in Control Window [41](#)
 - Managing [55](#)
 - Using [35](#)
 - Tabs
 - Colors [78](#)
 - Loudness [111](#)
 - Managing [55](#)
 - Spectrogram [110](#)
 - Unsaved changes indicator [78](#)
 - Using tab groups [35](#)
 - Waveform [110](#)
 - Wavelet display [111](#)
 - Tasks
 - Window [365](#)
 - Templates [79](#)
 - Audio file templates [80](#)
 - Audio montage templates [81](#)
 - Creating [80](#)
 - Default [83](#)
 - Deleting [83](#)
 - File groups [81](#)
 - Project templates [82](#)
 - Renaming [83](#)
 - Tab [79](#)
 - Tempo
 - Meter format [53](#)
 - Temporary files [86](#)
 - Text snippets
 - Applying [565](#)
 - Customizing [564](#)
 - Defining [565](#)
 - Dialog [566](#)
 - Time format
 - Dialog [53](#)
 - Time ruler [51](#)
 - Menu [51](#)
 - Time stretching [184](#)
 - Clips [280](#)
 - Dialog [184](#)
 - Digital Signal Processing (DSP) [186](#)
 - Limitations [186](#)
 - Playback speed [97](#)
 - ZTX [186](#)
 - Timecode
 - Window [102](#)
 - Tool windows [45](#)
 - Docking and undocking [46](#)
 - Docking in Control Window [41](#)
 - Opening and closing [45](#)
 - Tab groups [35](#)
 - Touch Bar [569](#)
 - Track activity indicator [264](#)
 - Track effects
 - Adding [285](#)
 - Rearranging [287](#)
 - Removing [286](#)
 - Tracks [222](#)
 - Adding [222](#)
 - Assembling the audio montage [221](#)
 - Displaying more or less [73](#)
 - Effects [281](#)
 - Folding and unfolding [223](#)
 - Grouping CD tracks [223](#)
 - Left/Right [224](#)
 - Locking and unlocking [223](#)
 - Mid/Side [224](#)
 - Moving in the track view [222](#)
 - Mute [105](#)
 - Picture track [222](#)
 - Removing [223](#)
 - Solo [105](#)

- Transition between tracks [418](#)
 - Transport bar [90](#)
 - Hiding [101](#)
 - Play button [93](#)
 - Position [100](#)
 - Presets [99](#)
 - Stop button [93](#)
 - True peaks
 - Analysis [158](#)
 - EBU R-128 [37](#)
 - Level Meter [385](#)
 - Level Normalizer [176](#)
 - Loudness Meta Normalizer [305](#)
 - Loudness Meter [388](#)
 - Loudness tab [111](#)
 - TV systems [409](#)
- ## U
- Undo [66](#)
 - UPC/EAN [438](#)
- ## V
- Variables
 - Applying [565](#)
 - Customizing [564](#)
 - Defining [565](#)
 - Dialog [566](#)
 - Metadata [149](#)
 - Video standard [409](#)
 - Voice-over ducking effects [270](#)
 - Volume level
 - Track activity indicator [264](#)
 - VS
 - Companion files [36](#)
 - VST plug-ins
 - Adding [559](#)
 - VU meter
 - K-System VU meter modes [387](#)
 - Settings [386](#)
- ## W
- Watch Folders [506](#)
 - Activating [510](#)
 - Background processing [510](#)
 - Command line parameters [518](#)
 - Defining [509](#)
 - Folder structure [517](#)
 - Multi computer processing [511](#)
 - Presets [514](#)
 - Setting up [507](#)
 - Settings [514](#)
 - Status [516](#)
 - System tray icon [516](#)
 - Using [513](#)
 - Window [507](#)
 - WAV
 - Metadata presets [148](#)
 - Wave Matching window [279](#)
 - Wave window [108](#)
 - Colors [551](#)
 - Customizing [550](#)
 - Display modes [109](#)
 - Loudness [111](#)
 - Spectrogram [110](#)
 - Waveform [110](#)
 - Wavelet display [111](#)
 - Waveform
 - Restoration [155](#)
 - Tab [110](#)
 - WaveLab
 - Configuring [570](#)
 - Projects [60](#)
 - Synchronizing settings [586](#)
 - WaveLab Exchange [488](#)
 - Wavelet
 - Display [111](#), [441](#)
 - Options [442](#)
 - Wavescope [398](#)
 - Settings [398](#)
 - WavPack [124](#)
 - Windows
 - Handling [23](#)
 - Layout [549](#)
 - Transparency [47](#)
 - Windows Media Audio
 - Encoding [135](#)
 - Windows MME
 - Driver [10](#)
 - WMA [124](#)
 - Encoding [135](#)
 - Work folders [86](#)
 - Workspace
 - Elements [39](#)
 - Layout [549](#)
 - Slide-out windows [45](#)
 - Window [39](#)
 - Workspace layout
 - Dialog [549](#)
 - Restoring [549](#)
 - WPR
 - WaveLab projects [60](#)
 - Writing operations [412](#)
 - Audio CD formats [436](#)
 - CD-Text [419](#)
 - Data CD/DVD projects [433](#)
 - DVD-Audio [429](#)
 - DVD-Audio project to data CD/DVD [432](#)
 - DVD-Audio project to ISO image [433](#)
 - Rendering DVD-Audio [430](#)
 - Writing audio CD from DDP image [415](#)
 - Writing audio files [414](#)
 - Writing audio files to audio CD [414](#)
 - Writing audio files to DDP image [415](#)
 - Writing audio montages [417](#)
 - Writing audio montages to audio CD [417](#)
 - Writing audio montages to DDP image [418](#)
- ## X
- XML
 - Batch processing [519](#)

Exporting [321](#)
Importing [321](#)

XSLT

Batch process [522](#)
Parameters for XSLT processing [522](#)

Z

Zero crossing [115](#)

Zoom [68](#)

Audio montage [72](#)
Options [71](#)
Snapshot [151](#)
Spectrometer [392](#)
using the keyboard [71](#)
using the mouse [70](#)
Zoom controls [69](#)
Zoom tool [70](#)

ZTX

Time stretching [186](#)