



**BINDING
TECHNICAL
MANUAL
2010/11**

ROSSIGNOL 

DYNASTAR 

LOOK

 **ROXY**

1	TRAINING
2	INDEMNIFICATION
4	VISUAL INSPECTION
	Boot
	Binding
5	TOOLS
	Bits, Taps, Glue
6	SKI MOUNTING MARKS
8	TEMPLATES
9	STANDARD BINDING INSTALLATION
11	BOOT-BINDING ADJUSTMENT
	Standard Bindings
12	TPI ² / Fluid
14	Zip/C-Cube
16	Race Bindings and Plates
18	FKS/Pivot bindings
20	RENTAL-DEMO
21	RENTAL MOUNTING
22	Flash IRS
24	RENTAL ADJUSTMENT
27	RENTAL
	Release Settings and Maintenance
28	Rental Inspection Procedure
33	SKIER CLASSIFICATION
34	RELEASE VALUE ADJUSTMENT
35	INDICATOR SETTING CHART
36	DISCRETIONARY SETTINGS
38	RELEASE SETTINGS TESTING AND FINAL INSPECTION
40	DOCUMENTATION
41	SKIER INSTRUCTIONS
42	POST ACCIDENT REPORT
43	WARRANTY
44	FORMS
46	RETAIL TECHNICAL REVIEW
47	RENTAL TECHNICAL REVIEW
48	PARTS
49	WARRANTY FAQ'S

BINDINGS

Welcome to the technical support program for The Rossignol Group ski binding brands (including Rossignol, Look, Dynastar, and Roxy ski bindings). Within this manual, and on our technical training websites, you will find all the comprehensive information on all current and recent ski bindings you'll need to know.

This manual includes instructions for inspection, mounting, testing, adjusting and dispatch of all retail, rental and demo binding models. It also lists all current indemnified binding models for four brands.

It also explains all precautions to take and the sequence in which assembly and adjustment procedures must be performed to ensure they are executed correctly.

You'll find enclosed within this manual a copy of the binding Technical Review which is one of the requirements for qualifying for Indemnification. You can complete and submit this Review, or you can complete the review on-line. Information on completing the Review on-line is mailed directly to Dealers in September.

Please keep a copy of this manual on hand for reference purposes when working with bindings. Additionally, we strongly suggest that you watch our current Binding Technical Video and attend one of our branded binding clinics and/or the Ski Mechanics Workshop prior to working with any Rossignol, Look, Dynastar, Roxy or Movement bindings. If you need more information, or if you do not find what you are looking for within these pages, feel free to call Customer Service at 435-252-3300 (U.S.) or 450-378-9971 (Canada).

The Rossignol Group binding brands pride themselves on delivering a uniquely-effective combination of performance, protection and ease-of-use tailored for each specific type of ski and skier.

TECHNICAL TRAINING

Completing the Technical Review is one of the requirements of The Rossignol Group Indemnification Program.

All technicians who mount, adjust, inspect, test or dispatch Rossignol, Look, Dynastar, Roxy and Movement bindings must have completed a Technical Review acknowledged by The Rossignol Group (both Technical Reviews are found at the back of this manual, or on-line at: <http://techtraining.mountaincenter.com>). Access to the on-line training requires you to enter your account # and password that is mailed to all Rossignol, Look, Dynastar, Roxy and Movement binding Dealers.

U.S. only:

We encourage all technicians to attend a technical clinic provided by a representative or the Ski Mechanics Workshop each year.

The technicians who attend the clinic should, with the aid of a Technical Training Video and Technical Manual, instruct the other technicians in the shop on the sales and service of Rossignol, Look, Dynastar, Roxy and Movement bindings.

All Rossignol Group Training Acknowledgments are valid for a two-season period, unless otherwise stipulated.

To receive a Training Acknowledgment, complete the following:

1. Work for a shop that has accepted online, a current Rossignol Group Indemnification Agreement.
2. Read this manual. Watch the Tech Training Video. *(U.S. only)*
3. Gain knowledge on Rossignol, Look, Dynastar, Roxy and Movement bindings.
4. Mount and adjust a Rossignol, Look, Dynastar, Roxy or Movement binding.
5. Attend a Technical Clinic or a SKI MECHANICS WORKSHOP or complete the Rossignol Group Training Review, under the direction of a technician who has attended a clinic. *(U.S. only)*
6. Complete a Technical Review online, which is located at: <http://techtraining.mountaincenter.com>

Shops must execute a Rossignol Group Alpine Ski Binding Indemnification Agreement each year BEFORE techs can access the Tech Training Site (see page 2).

or mail a completed Technical Review to:

U.S.

The Mountain Center
Attn: Technical Reviews
PO Box 981060
Park City, UT 84098

Canada

Skis Rossignol Canada
Attn: Technical Reviews
955 rue André Liné
Granby, Québec J2J 1J6

If you attend a Ski Mechanics Workshop binding course (U.S. only) you will have completed The Rossignol Group training requirements; or mail the Technical Review to The Mountain Center or Canadian head office and you will receive an Acknowledgment or request to resubmit a new Review. We recommend that the shop keep a copy of all Acknowledgments. To transfer an Acknowledgment to another shop, please inform The Rossignol Group in writing of your intentions. Shops that lose their technicians should contact The Rossignol Group Customer Service immediately to arrange for another technician to complete the Technical Review.

U.S. Rossignol Group Technical Training Fees

The Rossignol Group will bill to your shops account:

- **A \$10 fee for each Technician who completes a Technical Review on-line with a maximum per storefront of \$50**
- **A \$25 fee will be charged for all paper Technical Reviews that are submitted, with NO maximum.**
- **Technical Training completed at the Ski Mechanics Workshops is free.**

CANADA Rossignol Group Technical Training Fees

- **Free for all Rossignol, Dynastar, Look, Roxy and Movement Authorized Dealers who complete the Technical Review online.**
- **A \$25 fee will be charged for all paper Technical Reviews that are submitted by any Rossignol, Dynastar, Look, Roxy and Movement Authorized Dealers with a maximum of \$50 per storefront.**
- **A \$25 fee for each technician who completes a Technical Review without being an Authorized Dealer.**

INDEMNIFICATION

The Rossignol Group Alpine Ski Binding Indemnification Agreements are available to all Rossignol, Look, Dynastar, Roxy and Movement ski binding dealers. New Indemnification Agreements are required each year. Indemnification Agreements are accessed at <http://indemn.rossignol.com>. The specific shop ID for your store is mailed by letter to Rossignol, Look, Dynastar, Roxy and Movement Ski Binding dealers.

Subject to the terms of The Rossignol Group Alpine Ski Binding Indemnification Agreement, The Rossignol Group agrees to hold the shop harmless from any liability relating to claims for personal injury sustained by the customer as a result of the use of Rossignol, Look, Dynastar, Roxy and Movement bindings. This is providing the shop follows all of the terms and conditions of The Rossignol Group Indemnification Agreement and the procedures described within this manual. The Rossignol Group Alpine Ski Binding Indemnification Agreement is not effective until executed by the dealer and accepted by The Rossignol Group. Read your agreement carefully, this is only a summary.

INDEMNIFIED BINDINGS

The following list of bindings are those that are included in The Rossignol Group Alpine Ski Bindings Indemnification program. Only those bindings that were distributed by The Rossignol Group, Rossignol Ski Company, Skis Rossignol Canada, Skis Dynastar, Skis Dynastar Canada and ROI Recreation Outfitters, Inc. will qualify for indemnification.

ROSSIGNOL

FKS 180 XXL	Saphir 300 (all versions)	Axium 200 (all versions)	FKS (all versions)
FKS 140 XXL	Saphir Pucci	Axium 300 (all versions)	Freeski ² 180 (all versions)
FKS 120	Saphir JCC	Axium Scratch (all versions)	Freeski ² 150 (all versions)
SAS ² (all versions)	Saphir 120 (all versions)	Axium 120 (all versions)	Freeski ² 140 (all versions)
SAS (all versions)	Saphir 110 (all versions)	Axium 110 (all versions)	Freeski ² 120 (all versions)
Axial ² Race	Saphir 100 (all versions)	Axium 100 (all versions)	Freeski ² 100 (all versions)
Axial ² Race Jr. (all versions)	Saphir 90 (all versions)	Axium 95 (all versions)	Freeski 110 (all versions)
Axial ² 100 (all versions)	Saphir 95 (all versions)	Axium 90 (all versions)	Freeski W 110 (all versions)
Axial ² 120 (all versions)	Carbon Pro	Axium 70 (all versions)	Freeski 100 (all versions)
Axial ² 140 (all versions)	Saphir Jr.	Axium Jr. (all versions)	Freeski W 90 (all versions)
Axial ² WC (all versions)		Fun Girl Jr.	Flash IRS (all versions)
Axial ² Freeride		FDX Saphir	Zip 100 (all versions)
Zip/Axium 100		FKJ Pro	Freeski 70 Jr (all versions)
WZip/Saphir 90		Scratch Jr.	Saphir 70 Jr (all versions)
Zip/Comp J		SAS Jr.	Freeski 45 (all versions)
Power 140 (all versions)		Axial 100 Race Jr.	Saphir 45 (all versions)
Power 120 (all versions)		Equipe Race Jr.	Zip Kid (all versions)
Power 100 (all versions)		Equipe J	
Power 95 (all versions)		Equipe 80	
Axial 140 (all versions)		Comp J (all versions)	
Axial 120 (all versions)		Comp Baby (all versions)	
Axial 110 (all versions)		Comp Kid (all versions)	
Axial 100 (all versions)			
Scratch (all versions)		Free Rando	
Scratch 140 (all versions)		Free Rando NX21	
Scratch 120 (all versions)			
Scratch 100 (all versions)			
FK			

INDEMNIFIED BINDINGS

LOOK/DYNASTAR

Z RV18
Pivot (all versions)
PX18 (all versions)
PX Racing (all versions)
PX15 (all versions)
PX14 (all versions)
PX12 (all versions)
PX Team
Nova 11
Nova 9 (all versions)
Nova 7 (all versions)
NX (all versions)
Nova (all versions)
AIS (all versions)
C-Cube (all versions)
P18
P15
P14 (all versions)
P12 (all versions)
P11 (all versions)
P10 (all versions)
P12 Demo
P10 Demo
Pivot Jib
P9.0 (all versions)
P8.0 (all versions)
P9.0 Jr.
P7.5 (all versions)
P7.0 (all versions)
ZR R
P9.0L
P8.0L
P7.0L (all versions)
P Sport (all versions)
Team 4 (all versions)
ZRC
Team P10
Team 8 Maxplate
Team 8
Team 4 – adult/junior boot sole
Team 2RL – junior boot sole
TT9.0 Jr.
ZR Jr.
LJ 4.5

Legend Early Tram
Legend
Legend Exclusive

ROXY

Abracadabra N7 Demo
Abracadabra T4 NA FS Girl
Ala N9 Lifter
Alakazam N9+ FS Teen
Black Magic PX12 Jib W BC Pro
Broom Stix Light NX 10 Jib FS Pro
Broom Stix PX 12 Jib FS Pro
Chevron N9 Lifter
Hocus Pocus N7+ FS Teen
Integral Juicy and Sparkle 140-150
Integral Bliss N9 AFC Int Adv
Integral Girl Sparkle 100-130
Integral Girl Wonder 100-130
Integral Joyrider NX12 Int XPT
Integral Juicy N9 Int Beg V2
Integral Light Juicy
Integral Light Teen Girl Wonder 140-150
Integral Phoenix NX 12 Int W
Integral Sugah N9 AFC Int Intm
Integral Swell N9 Int Beg V1
N7 Demo 2
N7 Demo 2 Pixie Stix
N7 Demo 2 Teen 70-85mm
N7 Snow Angel
N7 Teen (all versions)
N7 Teen+ Hocus Pocus-Pixie Stix 85mm
N9 AFC Int Bliss-Swell-Bliss Rent
N9 Demo2
N9 Integral (all versions)
N9 Palm Beach Polka
N9 Sidewalk Surf
N9+ AFC Integral Hocus Pocus Mini Rox
N9+ Integral Hocus Pocus
NX10 Demo2 Wide 80-100mm
NX10 Jib Wide 80-100mm
NX10 Jib Wide BC Alakazam
NX12 Demo
NX12 Integral Joyrider
NX12 Joyrider Int
Pixie Stix - N7 Teen Advanced
Pop Art N9
PX12 Jib Wide Helter Skelter-Broom Stix
PX12 Jib Wide 80-100mm
PX15 Jib Pro XXL 100-115
PX15 Jib Pro Helter Skelter-Broom Stix
Rocker - T4 Girl
Rocker & Sweetheart - T4 Girl

T2 Roxy Baby 75mm
T4 Girl RL (all versions)
T4 Girl (all versions)
T4 Mini & Strip It NA
T4 Mini Girl
T4 PokaDots.com
T4 Quickset NA
Tease Me NX 10 L
Wista NX10 Jib
Wista Teen N7

MOVEMENT

Freeski 100
Freeski 120
Bonkers 100
Bonkers 120
Bonkers 140
Freeski 100 Demo
Freeski 120 Demo

VISUAL INSPECTION

The boot/binding system may not operate correctly with boots that do not comply with international standard, ISO 5355. The technician is responsible for visual inspection of both boots before assembly and adjustment.

BOOTS

Visually inspect BOTH BOOTS for the following:

- Conformity to ISO sole dimensions: *
 - Ramped area under the toe.
 - The glide area (where the AFD contacts the boot is flat and clean).
 - The boot can operate the brake.
 - Inspect that boot/binding interfaces have the correct shape (not modified, excessively worn, damaged or distorted). If in doubt, compare the boot sole in question to a boot sole that has the correct shape.
 - The toe and heel height projections of the boot are correct.
- Flat sole (sight down the sole to detect warpage).
- Excessive wear of the sole.
- Boot/binding interfaces are not excessively worn, damaged, or have mold flashing.
- Hard shell material.

Boots that have a milky look and can be permanently indented with a fingernail are unacceptable. These are commonly referred to as low-grade thermoplast boots and will fail a clean versus lubricated test.

If the boots fail any of these inspections, it should be replaced. If the boot is questionable in any of the preceding five inspections, you should perform a clean versus lubricated test.

Note: Under no circumstances should the surface of AFD's be modified. This includes any method of canting that modifies the boot to binding interface. Use a canting method that does not affect the performance of the ski boot/binding system.

Important note on boot modification: Virtually all traditional alpine ski boots sold today are certified by their manufacturers to conform to ISO standard 5355, which prescribes dimensions, materials and other specifications that are necessary for boot-binding compatibility. Look for a reference to ISO on the sole. When a technician modifies a boot by beveling or shimming, it is the shop's responsibility to assure that the modified boot still complies with the standard. Boot and binding manufacturers are not responsible for any modifications. Use of a non-standard boot can have adverse affects on the performance and safety of the ski-boot-binding system.

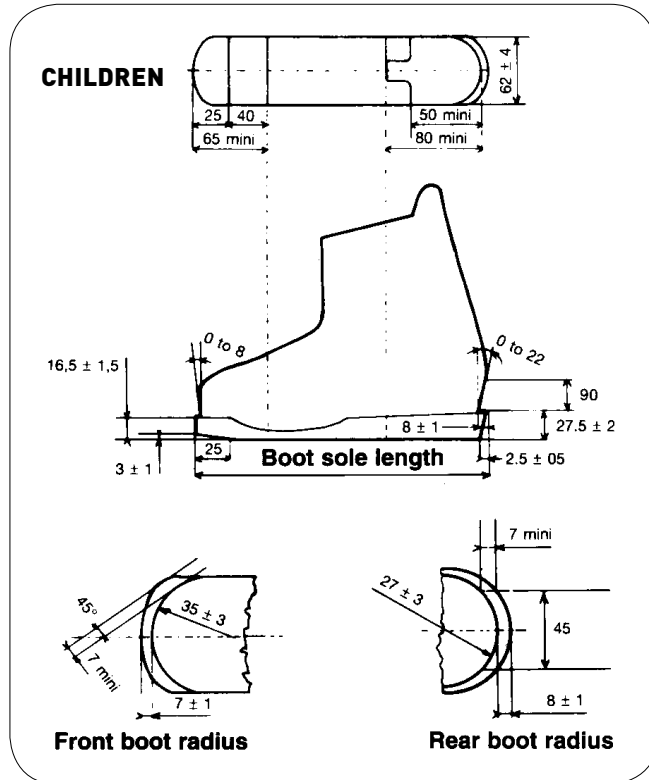
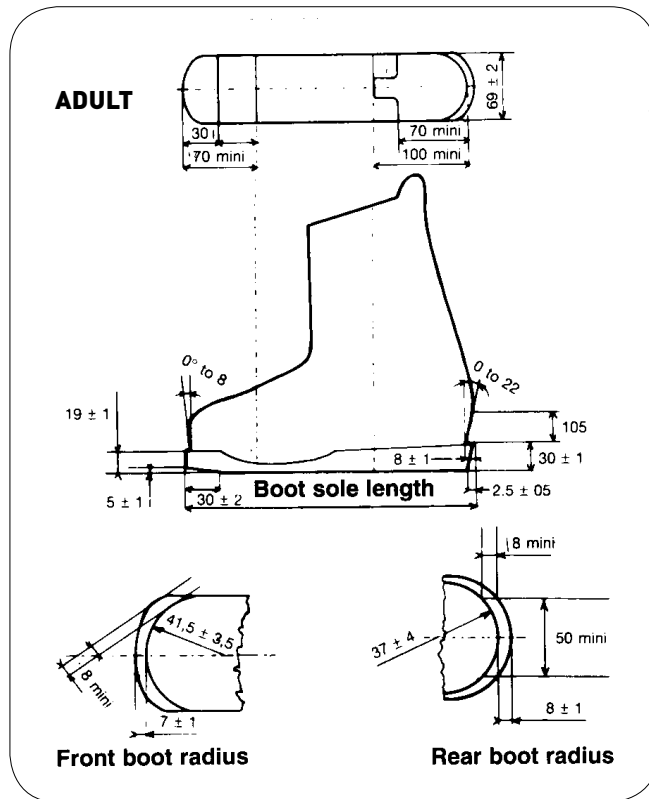

BINDINGS

All ski bindings distributed by The Rossignol Group comply with ISO standard 9462 and ASTM F-504. However it is essential to make a visual inspection before mounting, particularly when re-using bindings.

Check that:

- The release value range is correct for the skier.
- The bindings are compatible with the boots (adult binding w/adult sole).
- The screw lengths are compatible with the thickness of the ski.
- The brakes work correctly.
- The toe-piece rollers move freely.
- The low friction interfaces are undamaged. Replace if necessary.
- The bindings are clean - wipe with a dry or slightly damp rag.
- Inspect heels and lubricate the track with grease that is available from The Rossignol Group.
- Inspect the mechanical AFD by moving the glider off center, inspect for contamination and lubrication.
- Lubricate binding interfaces after mechanical testing is completed with a silicone binding lubricant.

WARNING

When installing a lifter or a plate with a binding that will give greater than 7 mm. of lift, use a longer brake. **To check that a system is compatible, put the ski on a table and confirm that the brake lifts the ski off the table and that the brake fully extends and works freely and easily. Also the brake arms must extend at least 30 mm below the base of the ski.**

SKIS

Most skis are manufactured in accordance with ISO 8364 ensuring a reinforced mounting area.

Follow the ski manufacturer guidelines in regards to drill bit selection and when to use a tap.

All Rossignol, Dynastar and Roxy non-system skis are marked in the center instructing what drill bit size to use and when to tap (T) the skis or not. (Photo #1)

Protect the base of the ski during installation. Measure the position of the mounting mark on the skis to confirm that they are both in the correct position.

WIDE SKIS

See page 48 for brake options.

The following 10/11 skis require XXL 120mm extra wide brakes:

S7 Freeride
S6 Freeride
S110W Freeski
Legend Big Dump
Legend Pro 115
6th Sense Huge
Mumbo Jumbo

The following 10/11 skis require L 90mm wide brakes:

S86 Freeride
S4 Jib
S86W Freeski
S7 Pro Freeride
Legend Sultan 85
6th Sense Distorter
6th Sense Spin
Exclusive Legend Eden

The following 10/11 skis require XL 100mm wide brakes:

S3 Freeride
S97 Freeride
S5 Jib
S110W Freeski size 159cm
S90W
Legend Sultan 94
6th Sense Slicer
Exclusive Legend Paradise
Broomstix
Shazam

NOTE: PX Racing/Axial² WC/Freeski² 180,150,140,120 brakes are not the same as PX/Axial² 100/Axium 120 brakes.

TOOLS

You may need the following tools:

- Templates
 - Go to page 8 for a complete list of templates.
- Drill Bits
 - 4.1 mm x 9.5 mm drill bit
 - 3.5 mm x 9.5 mm drill bit
 - 4.1 mm x 7.5 mm drill bit
 - 3.5 mm x 7.5 mm drill bit

(+0.5 mm on the depth of the drill bit is acceptable)

- # 12 AB tap
- Ski Binding Glue
- #3 POZIDRIVE screwdriver
- The 2010 Rossignol Group Adjustment Chart

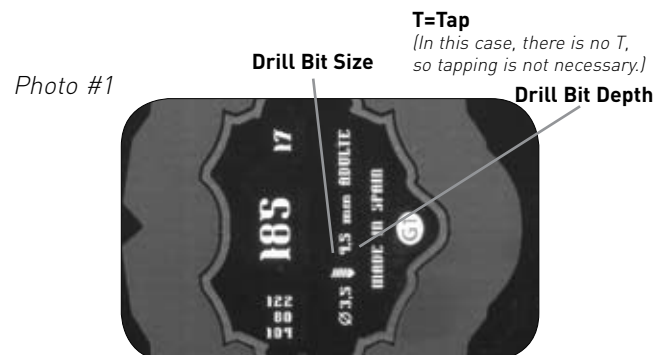

MOUNTING MARKS

DYNASTAR 10-11 FLAT SKI MID-BOOT MOUNTING MARK MEASUREMENTS

<i>Unisex Model</i>	<i>size</i>	<i>"0" mid mark</i>
Legend Big Dump	192	82.0cm
Legend Pro Rider 115	184	74.0cm
	175	68.5cm
	166	64.5cm
Legend Sultan 94	189	80.5cm
	184	78.5cm
	178	75.5cm
	172	73.0cm
	165	69.5cm
Legend Sultan 85	184	81.0cm
	178	78.5cm
	172	75.5cm
	165	72.5cm
Legend Sultan 80	158	69.0cm
	178	78.0cm
	172	75.5cm
	165	72.5cm
	158	69.0cm

<i>Unisex Model</i>	<i>size</i>	<i>"0" mid mark</i>
6th Sense Huge	185	85.5cm
	175	81.0cm
6th Sense Slicer	187	85.0cm
	181	82.0cm
	175	79.5cm
	169	76.5cm
	161	73.0cm
6th Sense Distorter	185	84.0cm
	179	81.5cm
	173	78.5cm
	167	76.0cm
6th Sense Spin	185	84.0cm
	179	81.5cm
	173	78.5cm
	167	76.0cm
6th Sense Superpipe	182	83.5cm
	175	80.5cm
	165	75.5cm
	155	71.0cm
6th Sense Serial	168	77.5cm
	158	73.0cm
	148	68.3cm
	138	63.2cm

6th Sense usage mounting recommendations

powder	-2 cm
freeride	0 cm
jib	+3 cm
park	+5 cm
demo	0 cm

<i>Women's Model</i>	<i>size</i>	<i>"0" mid mark</i>
Exclusive Legend Eden	172	77.0cm
	165	74.0cm
	158	70.5cm
	152	68.0cm
Exclusive Legend Paradise	175	79.5cm
	169	76.5cm
	161	73.0cm
Exclusive Legend Idyll	170	76.0cm
	164	73.5cm
	158	70.5cm
	152	67.5cm
	146	64.5cm

* mounting measurement is to the "0" unisex mid sole mounting line.

Recommended women's mounting is +1 cm which is the forward graphic line

ROSSIGNOL 10-11 FLAT SKI MID BOOT MOUNTING MARK MEASUREMENTS

<i>Unisex Model</i>	<i>size</i>	<i>"0" mid mark</i>
S7 Freeride	195	89.3cm
	188	86.0cm
	178	80.4cm
	168	78.0cm
S6 Jib	186	84.9cm
	174	78.9cm
S5 Jib	185	84.9cm
	178	82.1cm
	171	78.9cm
S4 Jib	181	83.0cm
	174	80.0cm
	168	77.1cm
	160	74.0cm
S3 Freeride	186	84.6cm
	178	79.7cm
	168	75.3cm
	159	71.3cm
S1 Jib	168	78.1cm
	158	73.5cm
	148	68.8cm
	138	63.7cm
S7 Pro Freeride	160	74.5cm
	150	69.8cm
	140	64.7cm
S4 Pro Jib	158	73.5cm
	148	68.8cm
	138	63.7cm
	118	54.6cm

<i>Unisex Model</i>	<i>size</i>	<i>"0" mid mark</i>
S97 Freeride	186	82.6cm
	178	78.9cm
	170	75.3cm
S86 Freeride	186	82.6cm
	178	78.9cm
	170	75.3cm
	162	71.6cm
	155	68.8cm
S80 Freeride	185	85.3cm
	180	83.0cm
	175	80.6cm
	170	78.2cm
	165	75.4cm
	160	73.5cm
	155	71.1cm
	150	68.8cm

S Series usage mounting recommendations

powder	-2 cm
freeride	0 cm
jib	+3 cm
park	+5 cm
demo	0 cm

<i>Women's Model</i>	<i>size</i>	<i>"0" mid mark</i>
S110W Freeski	178	80.4cm
	168	78.0cm
	159	71.3cm
S90W Freeski	170	79.1cm
	160	74.5cm
	150	69.8cm
	140	64.7cm
Trixie Freeski	168	78.1cm
	158	73.5cm
	148	68.8cm
	138	63.7cm

<i>Women's Model</i>	<i>size</i>	<i>"0" mid mark</i>
S86W Freeski*	170	75.3cm
	162	71.6cm
S80W Freeski*	170	78.2cm
	165	75.4cm
	160	73.5cm
	155	71.1cm
S74W Freeski*	168	74.2cm
	160	70.2cm
	154	67.5cm
	146	63.2cm

* mounting measurement is to the "0" unisex mid sole mounting line. Recommended women's mounting is +1 cm which is the forward graphic line

TEMPLATES

ADULT MOUNTING TEMPLATE

Item # FC6F003
Opens: 60mm - 130mm w/rubber feet on
Boot sole length: 250mm - 385mm (mondo 21.5-35)
Mounts: Rossignol - Axial² WC, Axial², Axium, Saphir, Speedset, Rental
Dynastar / Look - PX Racing, PX, NX, Nova, Demo, Demo2, Quickset, Rental
Roxy - PX, NX, N, Demo
Movement- Freeski, Freeski Demo, Bonkers

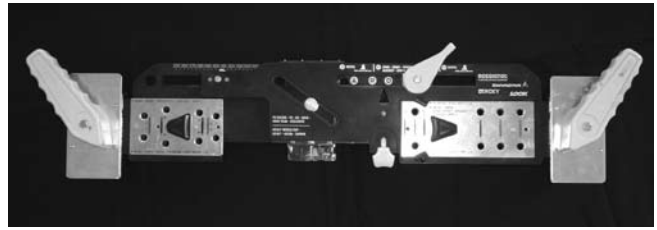

JUNIOR MOUNTING TEMPLATE

Item # FC6F018
Opens: 60mm - 130mm w/rubber feet on
Boot sole length: 250mm - 385mm (mondo 21.5-35)
Mounts: Rossignol - Comp J, Comp Kid,
Comp J EPR, Comp J Rental
Dynastar / Look - Team 4, Team 2RL, Team 4 Quickset, Team 4 Rental
Roxy-T4 Girl, T4 Girl Wide



PIVOT/FKS WIDE MOUNTING TEMPLATE

Item # FC8NF02
Opens: 80mm - 125mm w/rubber feet on
Boot sole length: 250mm - 385mm (mondo 21.5-35)
Mounts: Rossignol - FKS, Axial², Axium, Saphir, Speedset, Rental
Dynastar / Look - P18, P15, P12, NX, Nova, Rental, Pivot (2010)
Movement- Freeski



NOTE: For best range and adjustability, close the template 5mm from the actual boot sole length.

PIVOT/AXIAL¹ MOUNTING TEMPLATE

Item # F9PD060
Opens: 60mm - 100mm w/rubber feet on
Boot sole length: 250mm - 385mm (mondo 21.5-35)
Mounts: Rossignol - Axial¹
Look - Pivot (prior to 2005)



STANDARD BINDING INSTALLATION

USING TEMPLATES

Using Templates on traditionally mounted skis.

1. Take the mounting template so that the two grips are facing away from you. (picture 1)
2. Open the clamps of the template by rotating the two grips.
3. Place the template flush on the ski and release the grips.
4. Place the boot in the template. The template can be adjusted in length by releasing lever A. After adjusting the template to the boot, lock lever A.
5. Align the template on the ski by lining up the center mark of the boot with the center mark of the ski. Should the boot have no center mark use the center mark on the template point B. Should the center mark on the boot and the center mark on the template not line up, use the boot as reference.
6. If mounting a ski that uses a toe mount, use the point D on the template and line it up with the boot toe mark on the ski.
7. Remove the boot without unlocking lever A.

Note: For junior boots, which are shorter than the smallest adjustment on the template, there is an option:

Close the template to its shortest position and lock the lever A. Take the boot and push it all the way forward in the template. Next, align the center mark on the boot with the center mark on the ski. Drill the toe holes only. After drilling the toe holes only, place the boot back into the template and slide the boot all the way to the back of the template. Now align the center mark on the boot with the center mark on the ski and drill the heel holes.

Note:

WIDE SKIS

When mounting wide skis using a template, the rubber feet can be arranged to accommodate different width skis. Be careful to have all four arranged the same. (picture 2)

Note:

PIVOT/FKS BINDINGS

For best range and adjustability, close the template 5mm from the actual boot sole length.

ADULT TEMPLATE

picture 1

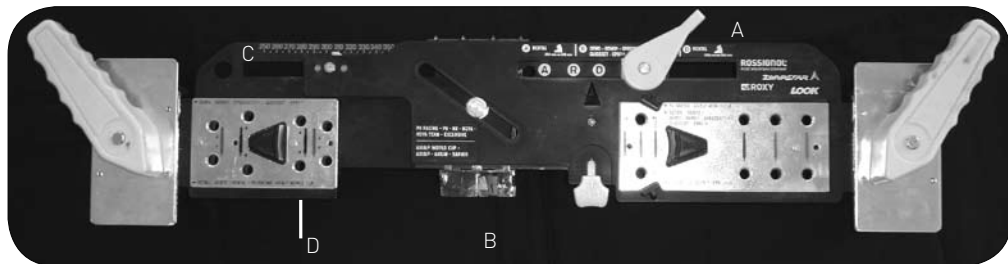

picture 2

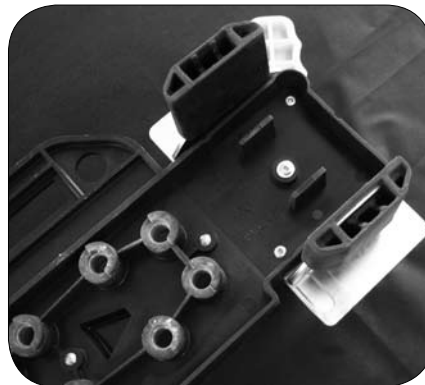

DRILLING

Select the drill bit recommended by the ski manufacturer, usually indicated on the ski manufacturers ski. Information window on the ski indicates drill dimension and whether to tap. The binding type determines which holes in the template to use. (see below)

RETAIL

Adult Template	Axial ² WC/ Freeski ² 180, 150, 140, 120 PX Racing
Toe Piece Heel Piece	"Black" color "Purple" color
Adult Template	Axial ² /Axium/Saphir PX/NX/Nova Movement Freeski/Bonkers
Toe Piece Heel Piece	"Black" color "Green" color
FKS/Pivot Template	FKS/Pivot <i>(close the template 5mm from the actual boot sole length)</i>
Toe Piece Heel Piece	"Black" color "Purple" color
Junior Template	Comp J/Comp Kid Team4/Team2/T4
Toe Piece Heel Piece	"Red" color "Orange" color

RENTAL

Adult Template	Speedset/Quickset
Toe Piece Heel Piece	"Red" color "Green" color
Adult Template	Rental (fixed toe)
Toe Piece Heel Piece	"Black" color "Orange" color
Junior Template	Speedset/Quickset
Toe Piece Heel Piece	"Black" color "Orange" color
Junior Template	Rental
Toe Piece Heel Piece	"Red" color "Orange" color

- Be sure to check binding and template holes before drilling ski.
- For Junior, Children's, check screw length and ski thickness, grind or replace screw if necessary. The ski will indicate drill bit dimensions. If the ski indicates to use 9.0 mm depth bit the max penetration at the screw will be 8.5 mm or 8mm. If the ski indicates to drill with a 7mm depth bit the max penetration of the screw is 6mm or 6.5mm.
- Drill the toe piece holes.
- Drill the heelpiece holes.
- Turn the ski over to remove debris.

TAPPING

- Tap the holes if manufacturer recommends tapping (picture 3).
- Turn the ski over again to remove debris.

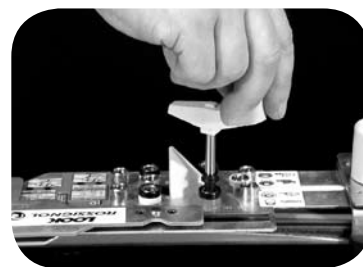

picture 3

GLUING

Put a small amount of ski binding glue into the holes. Do not use wood glue. We recommend using ski binding glue. It is essential to use glue to insert screws as this will lubricate the screws, prevent the screws from working loose and give a watertight seal.

INSTALLING TOE AND HEEL

- Use a pozidrive screwdriver #3.
- If using a screwshooter, set the torque correctly (maximum 5 Nm). **If the torque is not set to 5 Nm, pull the trigger intermittently.**
- After inserting the screws, sight under the toe and heel for a snug connection with the top surface of the ski.

Non-System Toes

- Position the toe piece over the drill holes.
- Insert the pre-fitted screws in a cross pattern until the toe is firmly attached to the ski.

Non-System Heel Pieces

Axial²/Axium, PX/Nova, FKS/PIVOT

- Position the heel piece over the holes.
- Insert the screws in a cross pattern until the heel is firmly attached to the ski. Sight at the ski for a snug connection.

Axial¹/Pivot

- Mount the Axial heel track and lifter onto the ski.
- On Axial bindings insert the brake prongs into the base and align the brake and base. Slide the base and brake onto the track and position according to the boot sole length.

Brakes

- Skis wider than 80 mm will require the use of a wide brake (see page 48 for brake options).

NOTE: After mounting the binding and all the screws are tight, check that the binding sits flush on the ski. (picture 4)

picture 4 = example of correct mounting



Make sure there is no gap between base of binding and ski.

BOOT-BINDING ADJUSTMENT

ALL LOOK-DYNASTAR, ROSSIGNOL, ROXY AND MOVEMENT TOES

All toe height and wing adjustments are automatic.



LOOK-DYNASTAR PX ROSSIGNOL AXIAL² ROXY PX, MOVEMENT BONKERS

Be sure to open the heel as completely as possible.

Adjust the heel by lifting the tab at the back of the heel. Reposition until the heelpiece almost contacts the boot sole.

Release the tab and confirm that it locks into the track.

Place the boot in the binding with authority.



Check that the yellow indicator covers half of the window.



Remove the boot from the binding then reinsert the boot and check the forward pressure setting again. Readjust if necessary.

LOOK-DYNASTAR PX RACING ROSSIGNOL AXIAL² WC/FREESKI²

To check the correct forward pressure, the mark on the screw should be lined up with the black plastic piece as shown below.

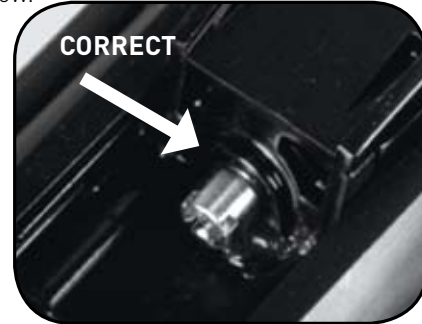

DYNASTAR NX/NOVA ROSSIGNOL AXIUM/SAPHIR ROXY NX AND N, MOVEMENT FREESKI

Place the boot in the toe piece and let the brake support the heel. Insert the end of a medium screwdriver under the bar at the rear of the heel. Twist the tool to lift the tab mechanism. Bring the heel forward until the heelpiece contacts the boot.

Release the tab and tap the heel forward to confirm that the heel is locked into the track. **Insert the boot and check that the forward pressure indicator is over the middle scribe marks.** Readjust and recheck if necessary.



DYNASTAR AUTODRIVE INTEGRATED AND ROSSIGNOL INTEGRAL SYSTEM

Integral and AIS Toeieces

The Rossignol Integral binding attachment system, or Dynastar AIS offers a quick mounting system on specific skis. To install the toe align the rear edge of the toe base with the marks that correspond with the boot sole length. Slide the toe forward about 2mm and then tighten the center posi screw until snug. View the binding from the side to confirm it fits flush on the plate. For boots longer than 370mm, the heel track can be moved back to move the heel track. Remove the heel track using a T25 driver. A second position is marked in the lifter for the heel screws. Drive the screws through the marks.

Integral and AIS Heelpieces

The Rossignol Integral and Look/Dynastar AIS heelpieces slide into the heel track with tool. Use the boot to position the heelpiece, then move the removable tool to the right or left to lock the heel in the track. Readjust the heelpiece position if necessary.

Axium/Nova

- Position the heelpiece over the holes.
- Insert the screws in a cross pattern until the heel is firmly attached to the ski. Sight at the ski for a snug connection.

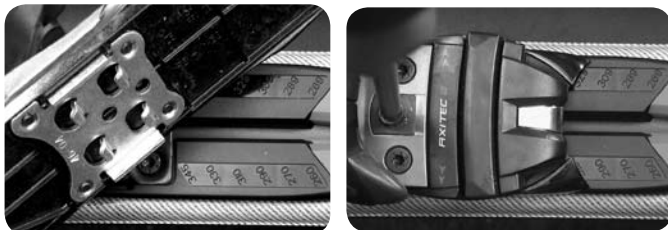

DYNASTAR TEAM 4/TEAM 2RL ROSSIGNOL COMP J/COMP KID ROXY T4 GIRL, T4 GIRL WIDE

To adjust the forward pressure, lift the tab at the rear of the heelpiece with your finger. With the boot toe in the toe cup and the brake supporting the heel, bring the heelpiece up to the boot sole until it almost touches. Release the tab and tap the heel forward. Insert the boot in the binding and check that the scribe line on the tab is within the marks of the side of the heel. The forward pressure can be fine-tuned as necessary when testing. For higher settings (3 or 4 - CompJ, Team 4) the scribe mark can be over the forward marks. For lower settings, the mark on the tab can be over the scribe marks toward the back.

NOTE: Comp J/Team 4/ Roxy T4 Girl/ Integral Light Teen bindings will accommodate both children and adult ISO boot soles. Comp Kid/Team 2RL accommodates children soles only.

DYNASTAR FLUID ROSSIGNOL TPI²/WTPI² ROXY INTEGRAL

- The toe and heel simply slide onto the rail/beam that is built into the ski for tool-free mounting. Install the heel first, then the toe.
- Position the heelpiece over the middle of the rail/beam with the thumb lever in the open position and slide the heelpiece all the way back.
- Holding the thumb lever in the open position, place the toe piece over the middle of the rail/beam. Put the toe down over the rail and slide it forward. Position the toe so that the AFD end of the toe aligns with the sole length mark on the rail/beam. Lock the thumb lever in the closed position. Confirm that the toe piece is locked into the track by pushing the toe forward.
- With the boot toe positioned in the toe cup and the sole supported by the brake, put the heelpiece against the sole. Fine-tune the forward pressure so that the yellow indicator covers the front half of the window by lifting the tab at the rear with a slotted screwdriver.
- Adjustment charts on Page 13.

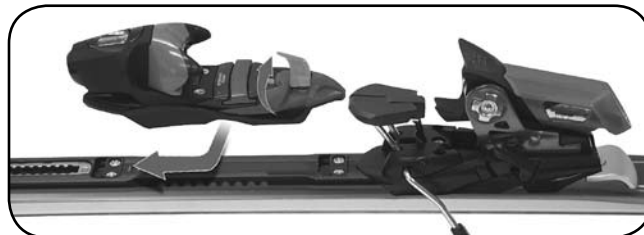

DYNASTAR FLUID AND EXCLUSIVE FLUID ROSSIGNOL TPI² & WTPI² ROXY INTEGRAL

*FOR RETAIL AND DEMO USE

NUMBERS ON HEEL TRACK

Radical 9GS Ti Contact 4x4
 Radical 9SL Ti Contact Cross
 Strato 80 Ltd Ti Legend Sultan 85 Fluid
 Strato 70 Ltd Ti
 Avenger 82 Ti
 Avenger 82 Carbon
 Attraxion XIII Echo
 S86 Rental
 S80 Rental

LETTERS ON HEEL TRACK

Avenger 76 Ti Legend Sultan 80 Fluid
 Avenger 76 Carbon Contact Groove
 Avenger 74 Carbon Booster 12
 Avenger 74 Composite Booster 8
 PMC 3D Carbon Exclusive Eden Fluid
 Attraxion III Echo Exclusive Idyll Fluid
 Attraxion 1 Exclusive Elite
 Attraxion Exclusive Fluid
 Harmony 2 Exclusive Active
 Exclusive Sensation

mm			mm		
265 - 266	265-272	1	324 - 326	315-328	4
267 - 268		1	327 - 328		5
269 - 272		1	329 - 330		4
273 - 275	273-286	1	331 - 333	329-342	4
276 - 278		1	334 - 336		5
279 - 281		2	337 - 339		5
282 - 284		2	340 - 342		5
285 - 286	287-300	2	343 - 346	343-356	5
287 - 288		2	347 - 349		5
289 - 291		2	350 - 352		6
292 - 294		2	353 - 356		6
295 - 297		3	357 - 359		6
298 - 300	301-314	3	360 - 362	357-370	6
301 - 304		3	363 - 365		6
305 - 307		3	366 - 368		7
308 - 310	315-328	3	369 - 370	371-377	7
311 - 314		4	371 - 372		6
315 - 317	315-328	3	373 - 375	371-377	7
318 - 320		4	376 - 377		7
321 - 323		4			

mm			mm		
263 - 266	263-275	A	302 - 305	302-314	C
267 - 269		A	306 - 308		C
270 - 272		A	309 - 311		C
273 - 275		B	312 - 314		D
276 - 279	276-288	A	315 - 318	315-327	C
280 - 282		B	319 - 321		D
283 - 285		B	322 - 324		D
286 - 288	289-301	B	325 - 327	328-340	D
289 - 292		B	328 - 331		D
293 - 295		B	332 - 334		D
296 - 298		C	335 - 337		E
299 - 301	301-314	C	338 - 340	341-347	E
			341 - 344		E
			345 - 347		E

**DYNASTAR C-CUBE
ROSSIGNOL ZIP
ROXY INTEGRAL LIGHT**

ADULT

1. Slide toe piece onto front track
2. Position back of toe piece with boot sole range
3. Pull red pin out of toe piece
4. Slide heel piece onto track. Slide heel piece snug against heel of boot
5. Pull red pin from heel piece.
6. Insert boot into binding system and check forward pressure. Yellow forward pressure indicator should be in front half of window.



JUNIOR

1. Slide toe piece onto front track.
2. Position back of toe piece with boot sole range
3. Pull red pin out of toe piece
4. Install heel piece by lifting adjustment tab while sliding back on heel track
5. Install brake using a #3 pozidrive screwdriver
6. With boot toe against toe piece, lift finger adjustment tab on heel piece to position heel piece against heel of boot
7. Insert boot into system and check forward pressure. Forward pressure is correct when the scribe on the metal within the marked area on the heel piece.

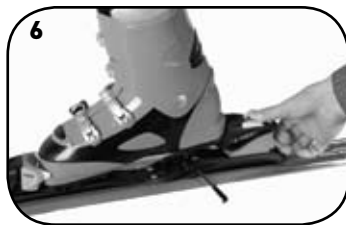

DYNASTAR C-CUBE, C-CUBE EXCLUSIVE, C-CUBE JR ROSSIGNOL ZIP & ZIP JUNIOR ROXY INTEGRAL LIGHT, INTEGRAL LIGHT TEEN

C-CUBE / ZIP

DIN 2.5-10

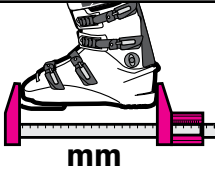
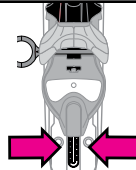
 mm	
261 - 266	261
267 - 272	267
273 - 278	273
279 - 284	279
285 - 290	285
291 - 296	291
297 - 302	297
303 - 308	303
309 - 314	309
315 - 320	315
321 - 326	321
327 - 332	327
333 - 338	333
339 - 344	339
345 - 350	345
351 - 356	351
357 - 362	357
363 - 368	363
369 - 374	369
375 - 380	375
381 - 386	381

C-CUBE / ZIP / INTEGRAL LIGHT WOMEN / JUNIOR

Avenger Pro X1 Jr (sizes 140-150)
Fun Girl Jr (sizes 140-150)

DIN 2.5-10

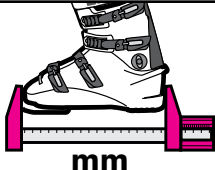
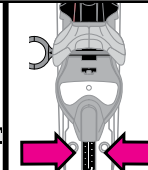
 mm	
261 - 266	261
267 - 272	267
273 - 278	273
279 - 284	279
285 - 290	285
291 - 296	291
297 - 302	297
303 - 308	303
309 - 314	309
315 - 320	315
321 - 326	321
327 - 332	327

C-CUBE KID / ZIP KID INTEGRAL LIGHT TEEN

Avenger Pro X1 Jr (sizes 100-130)
Fun Girl Jr (sizes 100-130)

DIN .75-4.5

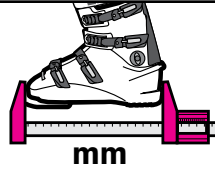
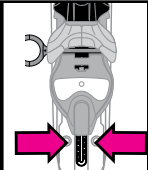
 mm	
210 - 219	210
220 - 229	220
230 - 239	230
240 - 249	240
250 - 259	250
260 - 269	260
270 - 279	270
280 - 289	280
290	290

LOOK PX RACING MAXFLEX ROSSIGNOL AXIAL² WORLD CUP MFX

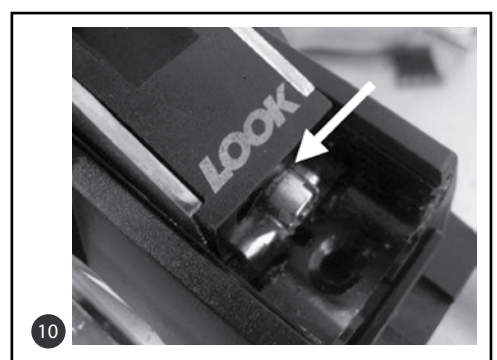
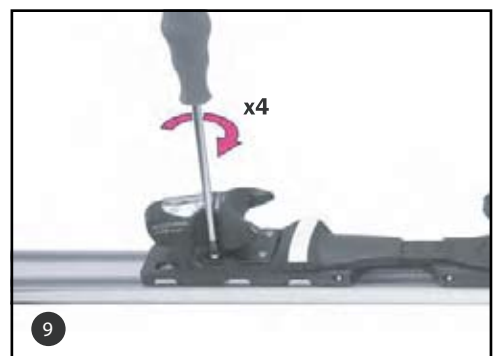
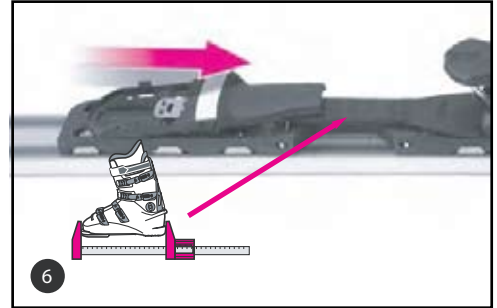
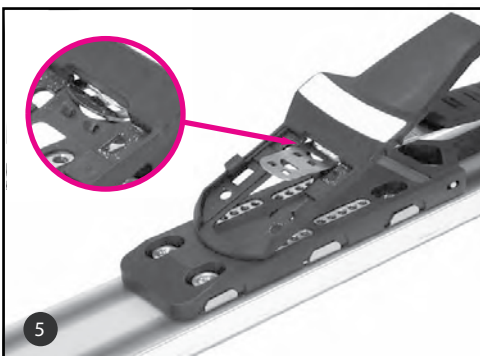
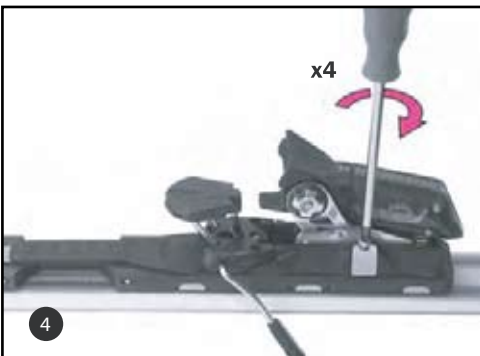
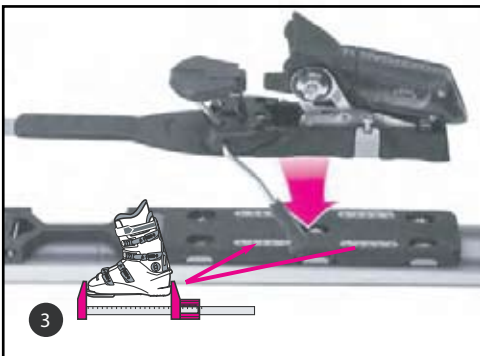

1. Insert cover at 30° angle to heel.
2. Push down toward metal bar to lock center plate in place.
3. Align heel with appropriate boot sole range. See chart on Page 17.
4. Tighten screws and ensure heel piece is flush with ski or plate.
5. While lifting the front of the metal bar, insert AFD plate.
6. Slide AFD plate to the appropriate boot sole range.
7. AFD plate must match boot sole marking.
8. Position AFD by using the forward pressure screw at heel. Once the holes from the AFD align with the proper holes on the plate, connect the toe piece to AFD. See chart on Page 17.
9. Tighten the screws with 5Nm of torque and ensure toe piece is flush with ski or plate.
10. To check the correct forward pressure, the mark on the screw should be lined up with the black plastic piece as shown below.
11. Go to page 35 for adjustment settings.

I-BOX WC / I-BOX / RACE FLEX WC PLATE BINDING MOUNTING

FOR DYNASTAR PX RACING MAXFLEX AND
ROSSIGNOL AXIAL² WORLD CUP MFX



Quick Reference Chart for Binding Placement

<i>sole length range</i>	<i>toe piece mounting</i>	<i>heel piece mounting</i>
264-280mm		
281-294mm		
295-308mm		
309-325mm		
326-341mm		

LOOK PIVOT ROSSIGNOL FKS

MOUNTING

Option 1 - Refer to page 8 for drilling instructions using the **Pivot/FKS template**.

Note: For best range and adjustability, close the template 5mm from the actual boot sole length.

Option 2 - Sticker template

1. Reconfirm center mounting position on ski
2. Measure or confirm boot sole length (see photo A)
3. Using sticker #1 (front), align boot sole length on ski mounting center line. At the same time aligning sticker with the ski's width center line and/or using the sidecut ruler on the outsides of the sticker (see photo B)
4. Repeat for heel using sticker #2 (rear), making sure the boot sole center lines match with sticker #1
5. Use center punch to mark drill holes (see photo C)
6. Repeat on 2nd ski
7. Visually inspect your center punch marks then drill with appropriate drill indicated on ski
8. Proceed to page 10 for tapping, gluing and toe & heel installation



photo A



photo B



photo C

FORWARD PRESSURE ADJUSTMENT

The forward pressure adjustment on the FKS/Pivot bindings may take some fine tuning/adjustment.

1. Adjust the forward pressure by the two adjustment screws at the back of the heel. Make sure to adjust the screws on the arms evenly (see photo D)
2. Latch the boot into the binding
3. Confirm that the White/Yellow tab aligns with, or is just past the two raised features on the heel base (see photo E)
4. Grab the heel piece with your right hand and if you are able to twist/rotate the heel easily, tighten the forward adjustment (see photo F)
 - a. Make sure not to over tighten the forward pressure. The forward pressure is correct when you cannot lightly rotate the heel on the boot and the heel has a strong elastic snap
5. Confirm the elastic travel at the heel and toe. If the forward pressure is too tight, the elastic travel will be negatively affected
6. **Setting bindings for individual skiers: The ski/boot/binding system must be inspected by a dealer using testing device. Refer to pages 38-39 for testing procedures, settings and skier instructions. Refer to the release adjustment chart on page 35.**



photo D

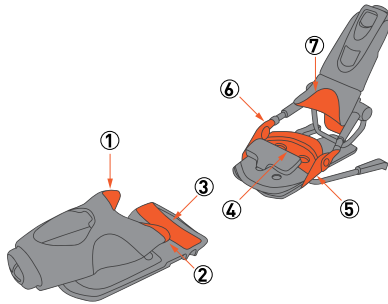

photo E



photo F

TECHNICAL BENEFITS OF THE LOOK PIVOT AND ROSSIGNOL FKS



7 CONTACT POINTS

Benefit: More control, better edge grip, quicker response, more feel. No other binding offers seven distinct points of contact between binding and boot -- three at the toe and four at the heel. By holding the boot toe flashing, the boot toe, the heel flashing and heel sides, you get better coupling between ski and boot than with any other binding.

Translation: More control, accuracy and feel.

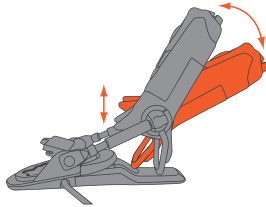

ELASTIC TRAVEL / SHOCK ABSORPTION

Benefit: The FKS/Pivot binding has the longest elastic travel on the market (40/45mm lateral at toe, 25mm vertical at heel). One of the most effective preventers of pre-release, long elastic travel at the toe and heel ensures that your ski will stay on when you want it to, even after a quick jolt that would otherwise cause an unwanted inadvertent release.

Translation: Less inadvertent release and ability to set bindings at lower release values.



TURNTABLE HEEL

Benefit: The FKS/Pivot binding offers the best reduction of inadvertent release and consistent release values found in any alpine ski binding on the market. The heel piece rotates with the boot directly under the tibia, release torque values are much more consistent, reliable and manageable.

Translation: Your binding releases when it should and keeps you in when it should for more reliable binding performance in stressful situations.

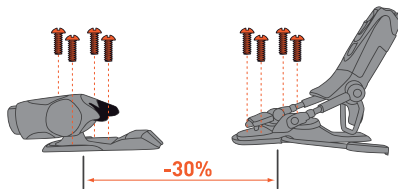

SHORT MOUNTING ZONE

Benefit: Deeper, rounder, more consistent ski flexing, turning, floating and "smearing". A shorter mounting zone where the binding is screwed to the ski under the boot, instead of in front of and behind it, allows today's freeskiers to make turns, spin tricks, and ride lines that demand the most flexibility out of the ski.

Translation: Butter turns, slope "smears", quick turns in tight trees, all are easier.

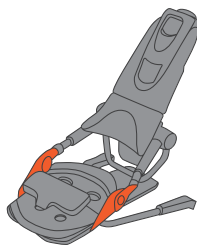

LATERAL HEEL HOLD

Benefit: Further reduction of unwanted release and increased ski/boot coupling and control, lateral heel hold keeps the boot more secure in the binding and on the ski than any other binding. Because the turntable heel rotates with the boot during release to facilitate exit from the system, the heel piece can wrap and hold the boot heel from the rear and sides.

Translation: Another means to reduce inadvertent release and gain more control over your ski.

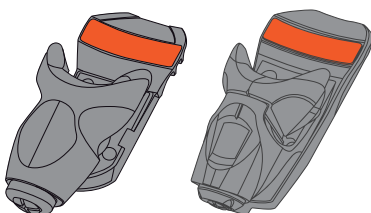

EXTRA WIDE AFD

Benefit: The widest AFD on the market 72mm. More leverage and control over the edges, especially on wide skis. Skis get wider every year, particularly freeski skis. The widest platform and screw pattern offers the most leverage over the edges of even the widest skis.

Translation: Wider footprint equals more leverage equals more control.

RENTAL / DEMO

The rental department is often a great profit center for most shops and so it is important that we focus on ensuring the rental equipment operates properly. For a multitude of reasons the process of mounting of rental equipment is often rushed through without much thought of the consequences.

We would like to take a few minutes to review some important mounting information of rental skis. The rental shop manager can reduce the risk of mounting problems following these guidelines.

Warning:

When mounting any rental or demo system, test mount one system before drilling the entire inventory. Use the boot sizer and a selection of boots to confirm the template adjustment.

- Don't rush through the process. The average rental ski is in use for three seasons. A few extra minutes in the mounting process is immaterial to the overall shop profits.
- Be sure to use the correct template.
- Tape over or plug the bushings that will not be used.
- If mounting a Rossignol Speedset, Look Quickset, Roxy Demo or Movement Demo adult binding set the template to 290mm. For junior, set template to 250mm.
- Check that the template sits flush on the ski.
- For mounting Rossignol, Dynastar or Roxy adult fleet rental skis, use a new 3.5 x 9.5 mm drill bit sizes 132cm to 172cm adult skis. For junior fleet rental skis, use a new 3.5 x 7.5 drill bit. (Check the information window on the ski).
- A word of caution: When mounting other manufacturers rental bindings on shorter length Rossignol, Dynastar or Roxy rental ski, be sure to check the ski will accept the drill depths before drilling.
- Also, if using a larger template setting be sure to check the drill bit depth before drilling.
- Drill deep enough to deburr the top skin of the ski.
- Remove debris from the holes.
- Use SKI BINDING glue. Ski binding glue can be purchased from any binding manufacturer. Do not use white glue or wood glue.
- Insert the screws with a maximum 4-5 Nm. of torque. If using a screw shooter pull the trigger intermittently. Screws can be partially stripped without the screw spinning.
- Test mount one ski and confirm a selection of boot sizes.

Comp J Speedset, Team 4 Quickset, Roxy T4 Girl RL, Zip Kid, C-Cube Kid, Integral Light Teen will accommodate both junior and adult boot soles. All other current rental bindings accommodate adult boot soles only.

RENTAL MOUNTING

**Rossignol Axial² Speedset /
Axium Speedset
Dynastar Demo² / PX Demo / NX Demo²
Roxy NX Demo / N Demo
Movement Freeski Demo**
Adult boot soles only

Template: Adult template

Boot Sole Length: Speedset/Demo² = 258-386mm
Demo = 258-379mm

Drilling - Mounting:

- Position the removable feet according to the width of the skis
- Place the template in front of you, the two handles turned outwards
- Unlock the locking lever
- Align the Rental mark and the position "R" or to the sole length 290 mm
- Lock the template using the locking lever
- Position the template on the ski
- Align the template retail mid mark with the ski mid sole mark
- Drill the speedset toe holes coded red
- Drill the heel holes using the bushings coded green
- Remove the template
- Tap the ski if recommended by the ski manufacturer

Follow the drilling, tapping and gluing instructions described on page 10.

- Mount the toe track
- Place the heel track on the ski
- Tighten each screw progressively

The tightening torque must not exceed 5 Nm maximum.

- The brakes are pre-mounted, check they are correctly connected to the heel
- Install the toe on the track from the front

**Rossignol Comp J EPR
Dynastar Team 4 QS**

Will accommodate adult and junior boot soles

Template: Junior template

Boot Sole Length: 205 to 304 mm

Drilling - Mounting:

- Unlock the template lever
- Align the Rental mark and the position "R" on the template, position 250 mm
- Lock the template using the locking lever
- Align the template mid sole mark with the ski mid sole mark
- Drill the speedset holes using the bushings with no ring
- Drill the holes in the heel using the bushings with no ring
- Remove the template
- Tap the ski if the manufacturer recommends
- Use ski binding glue
- Mount the toe track on to the ski. The arrow on the track points to the ski tip
- Position the heel with its lifter on the ski
- Slide the toe on to the track from the front of the track
- Tighten each screw progressively

The tightening torque must not exceed 4 Nm maximum.

Rossignol Axium Rental Dynastar Nova 9 Rtl / Nova 7 Rtl *Adult boot soles only*

Template: Adult template

Boot Sole Length adjustment range:

- A : 254 to 340 mm
- D : 298 to 384 mm

Drilling - Mounting:

- Determine what length adjustment range you require for your rental bindings
- Length adjustment range marks are situated on the red sticker on the template
- Position the template to the arrow engraved "RENTAL" is in line with the white arrow A or D
 - A: Sole length between 254 and 340 mm
 - D: Sole length between 298 and 384 mm
- Align the middle sole mark and the template transparent mark using the "Rental" side (see label on template)
- Lock the template using the locking lever
- Drill the toe holes using the bushings with the black rings
- Drill the heel holes using the bushings with green and grey rings
- Remove the template

Follow the drilling, tapping and gluing instructions described on page 10.

Insert screws with 4 Nm of torque

Axium Rental / Nova Rtl assembly on junior ski:

- **These bindings are supplied for mounting on adult standard skis. For assembling on junior standard skis, replace the long screws by shorter screws (delivered with the bindings)**
- **These bindings are not compatible with children standard soles.**

Length and forward pressure adjustment

- Place the boot in the binding. Make sure the boot is inserted in the toe
- Lift the locking lever at the back of the heel and adjust until it touches the sole of the boot
- Release the lever and tap the back of the heel with your hand to make sure it is properly latched into the track
- Put the boot in the binding to check the forward pressure
- **The forward pressure is correct if the pressure indicator is near the middle of the window on the side of the heel**
- If this is not the case, open the heel and raise the lever at the back of the heel to adjust the setting by moving the heel forward or backward
- Check the forward pressure again

Flash IRS

Template: Adult template

Boot Sole Length: 287mm to 371mm

Drilling - Mounting:

- Set the template to 300mm boot sole length for all sizes of skis
- Mark the mounting point of the ski 1cm ahead of boot sole mark
- Line up the templates boot sole center to the new 1cm ahead midsole mark on the ski
- Drill the toe holes marked in black
- Drill the heel holes marked in orange
- Tap the ski if recommend by the ski manufacturer
- Remove the template
- Insert a small amount of ski binding glue in holes
- Position the toe on the ski
- Position the heel on the ski
- Insert screws - The tightening torque must not exceed 4 Nm maximum

Installation of Flash IRS ski and binding:

- Insert a small amount of ski binding glue in holes of the ski
- Position the toe on the ski
- Position the heel on the ski
- Insert screws - The tightening torque must not exceed 4 Nm maximum

Rossignol Axium JR Rental

These bindings accommodate adult ISO sole boots and come supplied with screws for adult skis.

If you mount these bindings on a children's ski you must change the screws.

**Rossignol Comp J Rental
Dynastar Team 4 RTL
Roxy T4 Girl RL, T4 Girl RL Wide**

Will accommodate adult and junior boot soles

Template: Junior template

Boot Sole Length adjustment range:

- A: 203 – 255 mm
- B: 245 – 305 mm

Drilling - Mounting:

- Determine what length adjustment range you require for your rental bindings
- Length adjustment range marks are situated on the red sticker on the template
- Adjust the template until the arrow engraved "RENTAL" is in line with the white arrow
 - A: Sole length between 203 and 255 mm
 - B: Sole length between 245 and 305 mm
- Lock the template using the locking lever
- Align the template's retail mid sole mark with the ski mid sole mark
- Drill the toe holes using the drill bushings with rings for the Comp J
- Drill the holes for the heel using the bushings with no color for the heel
- Tap the ski if recommended by the ski manufacturer
- Remove the template
- Insert a small amount of ski binding glue
- Position the toe on the ski
- Position the heel on the ski

The tightening torque must not exceed 4 Nm maximum.

- Position the end of stopper at the back of the track and insert
- Test mount one ski and check with a variety of boots before drilling more skis

Mounting Comp J/Team 4/Integral Light Teen, Zip Kid, C-Cube Kid on adult skis:

- **Comp J/Team 4 bindings are delivered to be mounted on junior skis. When mounting on adult ski, replace the short screws with longer ones (available from The Rossignol Group)**
- **The Comp J/Team 4 bindings are compatible with junior and adult boots**

Length and forward pressure adjustment

- Place the boot in the binding. Make sure the boot is inserted in the toe
- Lift the locking lever at the back of the heel and adjust until it touches the sole of the boot
- Release the lever and tap the back of the heel with your hand to make sure it is properly locked into the track
- Latch the boot in the binding to check the forward pressure
- The pressure is correct when the line on the lever is in the middle of the scribed area on the housing
- If this is not the case, open the heel and manually raise the lever at the back of the heel to adjust the setting by moving the heel forwards or backwards
- Lock the heel once or twice to check the pressure again (see instructions on page 12)

RENTAL BOOT-BINDING ADJUSTMENT

FLASH IRS ADJUSTMENT CHART

COLOR CODE	HEEL TRACK CODE	BOOT SOLE LENGTH	ROSSIGNOL FLASH IRS	DALBELLO VANTAGE 4 FACTOR	HEAD BYS
Pink	1	287mm	288mm Pink		289mm Black
	•			290mm Orange	
	3	293mm			
	•				
	5	299mm			
	•				
	7	305mm			
	•				
	9	311mm			
	•				
Red	11	317mm	318mm Red		
	•			320mm Purple	
	13	323mm			
	•				
	15	329mm			329mm Yellow
	•				
	17	335mm			
	•				
	19	341mm			
	•				
Black	21	347mm	348mm Black		
	•			350mm Blue	
	23	353mm			
	•				
	25	359mm			
	•				
	27	365mm			365mm Silver
Silver	•		368mm Silver	370mm Green	

 mm	QUICKSET SPEEDSET ROXY DEMO		
258 - 259	258-262	258	WHITE
260 - 262		260	
263 - 266	263-275	263	GREEN
267 - 269		267	
270 - 272		270	
273 - 275		273	
276 - 279	276-288	276	PINK
280 - 282		280	
283 - 285		283	
286 - 288		286	
289 - 292	289-301	289	PURPLE
293 - 295		293	
296 - 298		296	
299 - 301		299	
302 - 305	302-314	302	YELLOW
306 - 308		306	
309 - 311		309	
312 - 314		312	
315 - 318	315-327	315	RED
319 - 321		319	
322 - 324		322	
325 - 327		325	
328 - 331	328-340	328	BLUE
332 - 334		332	
335 - 337		335	
338 - 340		338	
341 - 344	341-386	341	BLACK
345 - 347		345	
348 - 350		348	
351 - 353		351	
354 - 356		354	
357 - 359		357	
360 - 362		360	
363 - 365		363	
366 - 368		366	
367 - 371		369	
372 - 374		372	
375 - 377		375	
378 - 380		378	
381 - 383		381	
384 - 386		384	

FLASH IRS
PINK



FLASH IRS
RED

FLASH IRS
BLACK

FLASH IRS
SILVER

COMP J SPEEDSET TEAM 4 QUICKSET ROXY T4 GIRL RL, T4 GIRL RL WIDE		
Sole Length mm	CODE	
	Toe	Heel
205-210	G	1
211-215	F	1
216-219	F	2
220-223	E	1
224-227	E	2
228-230	F	3
231-234	D	2
235-237	D	3
238-241	D	4
242-245	C	3
246-248	C	4
249-251	C	5
252-254	C	6
255-257	C	7
258-261	C	8
262-265	B	7
266-268	B	8
269-271	B	9
272-275	A	8
276-278	A	9
279-281	A	10
282-284	A	11
285-288	A	12
289-292	O	11
293-296	O	12
297-299	O	13
300-303	O	14
304-306	O	15

COMP J RENTAL ADJUSTMENT

Heel Position	Sole Length A		Sole Length B	
				
1	195	198	245	248
2	199	201	249	251
3	202	205	252	255
4	206	208	256	258
5	209	212	259	262
6	213	215	263	265
7	216	219	266	269
8	220	222	270	272
9	223	226	273	276
10	227	229	277	279
11	230	233	280	283
12	234	236	284	286
13	237	240	287	290
14	241	243	291	293
15	244	247	294	297
16	248	250	298	300
17	251	254	301	304
18	255	257	305	307

RENTAL

Note: Rental, Demo and Speedset/Quickset products are considered rental products. If rental products are sold to a skier, you must supply customers with a copy of retail in-box instructions.

RELEASE SETTINGS

TOE PIECE

Adjust the release setting screw on the end of the toe piece.

The release indicator is visible in the window located on the top of the toe piece.

Release values must comply with THE ROSSIGNOL GROUP recommendations (Table pg 35) or to ASTM F-939 or ISO 8061.

HEEL PIECE

Set release values by the screw located at the rear of the heel piece.

The release indicator can be seen in the the window located under the heel piece lever.

Release values must comply with THE ROSSIGNOL GROUP recommendations (Table pg 35) or to ASTM F939 or ISO 8061.

DISPATCH

Show the skier how to get in and out of the binding.

Show the indicator value on the binding and the rental form.

Have the skier read, sign and date the rental form and give them a copy.

Discuss the risks of skiing including that ski/boot/binding systems cannot prevent all injuries.

MAINTENANCE

Rental equipment needs special care at the end of the season. Repairs have to be made and the equipment has to be prepared for storage.

The main steps are:

- Reduce all release settings to the minimum.
- Close all heelpieces.
- Check boot/binding connections and that there is no play in screws and components.
- Check that brakes operate correctly.
- Clean and lubricate the boot/binding interface and the Axitec, AFC or Teflon AFD's.
- Replace worn or damaged Axitec, AFC or Teflon AFD's.
- Dismantle the toe and heel sections on SPEEDSET/ QUICKSET/DEMO models, and clean the tracks with a damp cloth.
Re-lubricate with Rossignol grease and then reassemble.
- Never clean bindings with solvents, hot water or a pressure wash.
- Always store equipment in a dry place.
- We recommend cleaning and lubricating binding at least two times per season.

RENTAL INSPECTION PROCEDURE

Seasonal rentals should be inspected the same as retail equipment. See page 38.

The following are step-by-step instructions of The Rossignol Group rental procedures. The procedures are in two separate parts; preseason and in-season. The preseason inspection tests the system by component. The in-season inspection tests the components as a system. The preseason begins with testing all rental bindings with a typical boot, then testing single samples of boots with a binding. The in-season inspection involves sampling bindings and sampling boots.

REFERENCE BOOT SELECTION

1. Take five single boots with sole lengths 311-330mm, preferably the same model.
2. Clean all five boots with a mild detergent and water.
3. Adjust a rental binding to one of the boots and to a setting of 5.
4. Release the boot from the binding three times in each direction.
5. Perform three twist tests in each direction and write down the middle quantitative value.
6. Test the other four boots with the same procedure.
7. Reject any boot with a clockwise and counter clockwise difference of more than 5 Nm.
8. Choose the boot with the middle value. This is a twist reference boot.

The forward bending reference boot will be chosen in the identical way but by performing forward bending tests.

1. Take five single boots with a sole length of 311-330mm, preferably the same model.
2. Clean all five boots with a mild detergent and water.
3. Adjust a rental binding to one of the boots and to a setting of 5.
4. Release the binding three times in the heel, then perform three tests.
5. Test all five boots in forward bending.
6. Choose the boot with the middle value. This is a forward bending reference boot.

PRE-SEASON BINDING PREPARATION

Preseason Binding Preparation

1. Visually inspect the bindings.
 - a. For screw tightness.
 - b. For the condition of AFD.
 - c. Check that the brakes work freely.
 - d. Check that the indicators are readable.
 - e. Check that the heel moves in the track.
2. Adjust all bindings to the reference boot and to a setting of 5.
3. Lubricate all boot/binding interfaces with a liquid dish detergent and water solution.
4. Place the reference boot in the binding. Check the elastic travel by striking the boot toe using a sharp blow.
5. Check the travel of the heel by moving the boot heel up 10 mm and see that it returns quickly.

PRE-SEASON BINDING INSPECTION

1. Perform three twist tests in each direction and record the middle quantitative value.
2. Set the ski aside if the middle quantitative value is not 43Nm to 58Nm.
3. Perform three forward bending tests.
4. Set the ski aside if the middle quantitative value is not 165-229 Nm.

For junior bindings set the binding at a value of 2 and use a boot that has a sole length of approximately 260mm. Set aside any binding where the twist value is outside 17-23 Nm and the forward lean is outside 64-87 Nm. If a longer boot with a sole from 271 mm to 290 mm is used set the binding to 3 and use 27-37 Nm for the toe and 102-141 Nm to evaluate the heel.

Troubleshooting

1. If many bindings are outside the tolerance, select another reference boot.
2. Reinspect the binding adjustments and retest if changes are made.
3. Corrections to the indicator are allowed and should be notated on the ski and maintenance record.

PRE-SEASON BOOT INSPECTION

1. Randomly take any two skis with bindings that passed the binding inspection.
2. Clean the bindings with a mild detergent and water.
3. Lubricate all boot/binding surfaces with a mild liquid detergent.
4. Put the reference boot into each binding and adjust the bindings to the same release value.
For example: set both bindings with a testing device so they both release at 50Nm. of torque on the testing device.
5. Clean the detergent from one binding.
6. Test the boot in the clean binding then the lubricated binding. Test only clockwise in twist.
7. Record all results. Do not use a boot with a difference of more than 20%.

Sample Boots:

1. For boots that are new to inventory or never inspected, take a single boot from each cell (a cell is make, model and shell size).
2. For used boots, take a 10% random sample using a selection of sizes.

NOTE: To determine 20%, multiply the clean value by .80. If the lubricated value is greater than or equal to this number, the boot passes.

If there is a result greater than 20%, the 16 single boots in that cell should be inspected.

1. Take 16 boots in the cell and clean if necessary.
2. First test the boot in the clean binding, then in the lubricated binding.
3. Record all results.
4. Retest boots that are greater than 20%.

NOTE: On completion of the preseason inspection, clean the dish detergent from the equipment and lubricate the binding with Rossignol grease or equivalent.

RENTAL INSPECTION PROCEDURE

IN SEASON INSPECTION BOOT/BINDINGS

The following instructions should be used when the rental boot manufacturer does not give instructions for boot inspection. Boot and binding random sampling can be done at the same time. Sampling size is 5% of the inventory. Test only one ski of the pair. Any random technique that gives any boot and binding the same chance of being selected as any other is acceptable. For example, a random technique for sampling both boot and binding would be taking every tenth rental ticket and inspecting that equipment as a system.

Example:

1. Choose tickets from the day of the sample.
2. Take, as returned, every tenth ticket and assemble a boot and binding from the pair.
3. Determine the skier code from the skier information.
4. Check elastic travel.
5. Test the boot in twist (one direction), then in forward bending.
6. Compare the results to the chart on page 35.
Test only one boot/binding system from the pair.

Example: From the skier's personal information, you determine a skier's code is (E) if the twist results are:

17-23 Nm then indicate Pass

14-17 Nm then indicate Class 1 Deviation
or 23-27 Nm

<14 or >27 Nm then indicate Class 2 Deviation

Maintenance Decision Trees

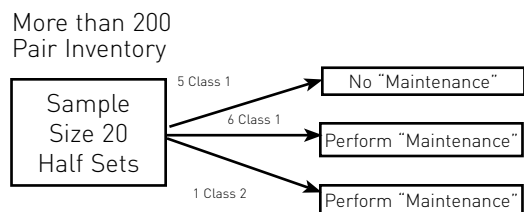
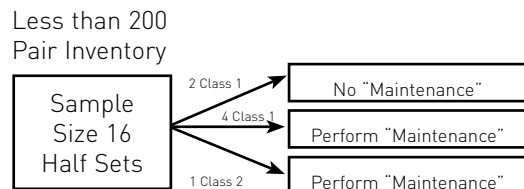

Inspection Schedule

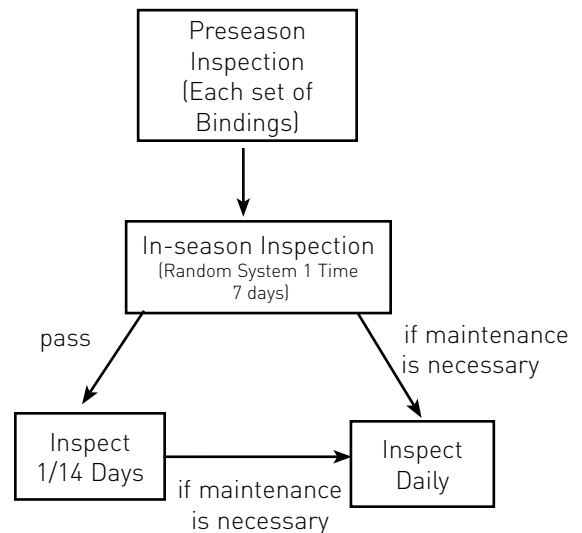

RENTAL INSPECTION PROCEDURE

SAMPLE EVALUATION

Note the number of Class 1 and Class 2 deviations. The sample would pass if there were less than 20% Class 1 deviations but not if there were more than 20% Class 1 deviations. The sample would also not pass if there were any Class 2 deviations.

Maintenance would be performed if the sample had more than the allowed deviations. Maintenance would consist of identifying and correcting whatever caused the deviations.

Visual inspection and correction of the problem in the inventory would follow. This would require that the sampling procedure be repeated each day until two consecutive samples passed at which point sampling would be once a week.

DOCUMENTATION

Service logs should be kept on all equipment for at least the statute of limitations. These "logs" should include service descriptions, date and initials of the technician performing the work. Test results should be recorded by pass or class I or II deviations.

INCOMPLETE RENTAL SYSTEMS

The following procedure is for those customers who bring their own boot and rent your skis. For skiers that bring in their own skis and rent boots—perform a complete system inspection with a testing device on the equipment, every time.

Boot Inspection

1. Inspect to see that there is a ramped area at the toe.
2. Inspect that the glide area (where AFD contacts) is flat and clean.
3. Inspect that the boot can operate the brake.
4. Inspect that boot/binding interfaces have the correct shape (not modified, worn, damaged or distorted).
When in doubt, compare the sole in question with a sole that has the correct shape.
5. Inspect the toe and heel for correct thickness.
6. Reject the boot if it has a shiny milky surface and can be permanently indented from dragging a fingernail across it.

If the boot is satisfactory on these six points, lubricate the binding where the sole contacts the boot.

Adjust the binding to the boot and to the physical characteristics of the person according to the specifications on page 34-35.

Notify the customer that a full test is available if desired. Dispatch the system to the customer.

NOTE: Boot soles after a minimal amount of use may not exactly meet all the dimensional requirements of the ISO standard but this may or may not affect the performance of the boot/binding system. As technicians become more experienced with the use of testing devices, they will know how much wear will adversely affect the performance of the system. When in doubt, perform a clean versus lubricated test.

INCOMPLETE RENTAL SYSTEMS SAMPLE

1. Take a 5% sample of incomplete systems once a week.
2. Determine the appropriate number of units to sample (5% of incomplete rental units).
3. Choose a random sample technique. (Example: Every 20th incomplete unit to be returned will be sampled.)
4. As the equipment is returned (every twentieth one), or any convenient time, put the customer's boot into the binding and check fitting adjustments.

Sample Preparation:

1. Clean all boot and binding interfaces with mild detergent and water.
2. Move boot toe off-center horizontally 10 mm and see that it returns to center quickly. Move the heel off-center vertically 10 mm and see that it returns to center quickly.
3. Perform tests in twist and forward bending.
4. Compare the measured results to the appropriate inspection range for that person's information.

Take samples daily if more than the maximum number of Class 1 deviations occur within any sample (see top left hand of this page for the maximum number allowed).

RENTAL INSPECTION PROCEDURE

CLEAN VS LUBRICATED TEST

To determine if a shell material is hard, try to permanently indent the boot by dragging your fingernail along the material. If the material does not permanently indent, then it is hard enough. If your fingernail will indent it, and/or it is questionable, perform a clean versus lubricated test as described below. This test determines whether the boot and binding are compatible.

1. Perform a twist test in each direction.
2. Lubricate the boot/binding interface with a thin film of Rossignol grease or equivalent.
3. Perform another twist test in either direction.
4. Compare the results of the clean and lubricated tests. A difference between these tests of more than 20% is not acceptable. [Example: If the clean test is 20 Nm, and the lubricated test is 15 Nm, the difference equals 25%. Use the clean test results as the base line.]

TROUBLESHOOTING AND CORRECTIVE ACTION

Being able to identify the correct cause of a functional problem is extremely helpful for quick maintenance. Careful observation or repeated cause and effect situations may help to initiate a specific form of preventative maintenance.

For example, if a Class 1 deviation is caused by only a worn or damaged AFD, then maintenance of the remaining full sets pertains to AFD inspection and replacement only. Systems may have multiple issues. Therefore, troubleshooting requires careful observation for multiple problems, corrective action, and to determine if the problem has been solved. With experience, these types of problems can be resolved rapidly.

LUBRICATION OF RENTAL BINDINGS



To enhance the longevity and consistency of The Rossignol Group bindings, lubricate the toe piece at the beginning of each ski season. To lubricate the toe piece and heel track start by turning the release indicator down until the wings can be held to one side. Insert a small amount of Rossignol tube lubrication or equivalent in the channel between the wing and the housing that is now exposed. Push the wing off in the other direction to lubricate the other channel. Push the wings off center several times in both directions of twist, then wipe off any excess lubrication that is on the outside of the binding. To lubricate the heel track, remove the heel from the track and apply a small amount of Rossignol tube lubrication in the inside channels of the heel track. Re-install the heel track and re-check the forward pressure. See Page 11 for setting the forward pressure.

Display the most current Skier Classification poster in your shop and direct the skier to use it.
Skier type is not the same as skier ability - this is an important part of the system adjustment process, making the skier an active participant in the adjustment process.
The skier classification decision should be made by the skier.

Classify Yourself

DETERMINING YOUR SKIER TYPE IS YOUR RESPONSIBILITY

Your Skier Type, height, weight, age, and boot sole length are used by the shop technician to determine the release/retention settings for your bindings. Consult these descriptions to select your classification. Be sure to provide accurate information. Errors may increase your risk of injury.

 <p>Type I</p> <p><i>Cautious skiing on smooth slopes of gentle to moderate pitch</i></p> <p>Skiers who designate themselves as Type I receive lower than average release/retention settings. This corresponds to an increased risk of inadvertent binding release in order to gain releasability in a fall. This type also applies to entry-level skiers uncertain of their classification.</p>	<p>Skiers not classified as Type I or III</p> <p>Type II</p> <p>Skiers who designate themselves as Type II receive average release/retention settings appropriate for most recreational skiing.</p>	 <p>Type III</p> <p><i>Fast skiing on slopes of moderate to steep pitch</i></p> <p>Skiers who designate themselves as Type III receive higher than average release/retention settings. This corresponds to decreased release-ability in a fall in order to gain a decreased risk of inadvertent binding release.</p> <p><small>(This classification is not recommended for skiers under 48lbs.)</small></p>
--------------------------------------------------------------------------------------------------------------------------------------------------------------------------------------------------------------------------------------------------------------------------------------------------------------------------------------------------------------------------------------------------------------------------------------------------------------------------------------------------	-------------------------------------------------------------------------------------------------------------------------------------------------------------------------------------------------------------------	---------------------------------------------------------------------------------------------------------------------------------------------------------------------------------------------------------------------------------------------------------------------------------------------------------------------------------------------------------------------------------------------------------------------------------------------------------------------------------------------------------------

If from experience, you have been dissatisfied with the release/retention settings that result from your skier classification, mention this to your binding technician.

2010-2011 BINDING ADJUSTMENT

STEP ONE: WEIGHT AND HEIGHT

Find the skier's weight and height in the two left hand columns. To the right of these figures, in the next column, find the corresponding skier code. If the weight and height of the skier generate two different code letters, use the letter closest to the top of the chart.

(EXAMPLE: "H" and "I" use "H").

STEP TWO: SKIER TYPE

This chart applies to type "I" skiers. For type "II" skiers, move down the chart one row (EXAMPLE: "H" to "I"). For type "III" skiers, move down two rows (EXAMPLE: "H" to "J"), except for skiers less than 48lbs—where you increase one row maximum.

STEP THREE: AGE OF SKIER

For those age 50 and over move toward the top of the chart one row. (EXAMPLE: "H" to "G").

For those skiers 9 and younger, move toward the top of the chart one row, ("F" to "E").

STEP FOUR: BOOT SOLE LENGTH

Using the skier code and boot sole length as references, select the indicator setting for the binding.

Note: If the box has no number move across.

STEP FIVE: TORQUE RANGE

Follow the appropriate skier code across to the Twist Torque Range. The number in the Torque Range on the Skier Code line is the Reference Torque. The numbers directly above and below the Reference Torque are the Inspection Range, while the numbers two above and two below the Reference Torque are the In Use Range.

23
27
31
37
43

EXAMPLE:

- Using a skier code of H will give a Twist Reference Torque of 31 Nm.
- The numbers above and below the Twist Reference Torque, within the black circle, are the Inspection Range (27 - 37 Nm.).
- The top and bottom numbers within the gray circle are the In Use Range (23 - 43 Nm.).
- See the retail testing section of the 2010/2011 Rossignol Group Technical Manual for a more detailed explanation.

**Reference to Skier Classification System in the Rossignol Group Technical Manual.*

- **Do not use any other chart to adjust Rossignol Group bindings. This chart is effective July 2010.**
- Only use the Rossignol Group's most current release setting chart (as shown in this year's Manual).
- This binding adjustment chart is for the setting and inspection of ski equipment to be dispatched to the skier.
- The information contained in this chart is not appropriate for post-accident evaluation, as the acceptable range of performance for systems after they have put into use is broader than the tolerances that are expected of systems on the workbench.
- Follow the instructions in the Discretionary Setting Section of the Rossignol Group Manual for those skier's who have special concerns or those who are not satisfied by the setting generated by this chart.

NOTE: The initial indicator settings found in this table are only the starting point in the boot/binding system setting process. The initial values may need to be modified to achieve the correct measured release values.

			INDICATOR SETTING sole length (mm)								TORQUE RANGE		
Weight (lbs)	Height (ft'in")	SKIER CODE	1 ≤ 230	2 231-250	3 251-270	4 271-290	5 291-310	6 311-330	7 331-350	8 ≥ 351	SKIER CODE	Twist (Nm.)	Lean (Nm.)
												5	18
22-29		A	.75	.75	.75						A	8	29
30-38		B	1	.75	.75	.75					B	11	40
39-47		C	1.5	1.25	1.25	1					C	14	52
48-56		D	2	1.75	1.5	1.5	1.25				D	17	64
57-66		E	2.5	2.25	2	1.75	1.5	1.5			E	20	75
67-78		F	3	2.75	2.5	2.25	2	1.75	1.75		F	23	87
79-91		G		3.5	3	2.75	2.5	2.25	2		G	27	102
92-107	≤4'10"	H			3.5	3	3	2.75	2.5		H	31	120
108-125	4'11"- 5'1"	I			4.5	4	3.5	3.5	3		I	37	141
126-147	5'2"- 5'5"	J			5.5	5	4.5	4	3.5	3	J	43	165
148-174	5'6"- 5'10"	K			6.5	6	5.5	5	4.5	4	K	50	194
175-209	5'11"- 6'4"	L			7.5	7	6.5	6	5.5	5	L	58	229
≥ 210	≥6'5"	M				8.5	8	7	6.5	6	M	67	271
		N				10	9.5	8.5	8	7.5	N	78	320
		O				11.5	11	10	9.5	9	O	91	380
		P						12	11	10.5	P	105	452
												121	520
												137	588

Skiers less than 48lbs. MAXIMUM INCREASE ONE ROW

Note 1: For skiers 29lbs and under, no further correction is appropriate.
 Note 2: For skiers 38lbs and under, **Skier Type (-I)** is inappropriate.



DISCRETIONARY SETTINGS

If a skier **has special concerns or if they have been dissatisfied with the release/retention settings** which result from normal skier classification, they may wish to select higher or lower classifications (Skier Type -I or III+) or select skier type designations that are different for twist and forward lean. For skiers who request a lower setting normally the toe is set lower. For skiers who request a higher setting normally only the heel is set higher.

Type (- I)

Type (- I) is for skiers who desire lower release/retention settings than Type I, and will further increase the risk of inadvertent binding release in order to gain increased releasability in a fall. **This will result in a different setting for the toe and the heel. The toe setting will be lower than the heel setting.** Document the two skier types, two skier codes and release settings on the work shop ticket.

For Example - Skier Code: (J/K)

Skier Type: [-I/I]

Type III+

Type III+ is for skiers who desire higher release/retention settings than Type III, and will further decrease releasability in order to gain decreased risk of inadvertent binding release. To attain a higher setting, calculate the initial indicator setting by increasing the Skier Classification by one setting. **This will result in a different release setting for the toe and the heel.** The heel setting will be higher than the toe. Document the two types, two skier codes and release settings on the work shop ticket.

For Example - Skier Code: (J/K)

Skier Type: [III/ III+]

The release/retention settings used to set your equipment comply with applicable International Standards, including ASTM F939, ASTM F1063, and ISO 8061 and ISO 11088. These standards were developed by a consensus of industry representatives, safety organizations, consumer groups, government agencies and independent scientists, and are believed to represent an effective compromise between the release and retention needs of recreational skiers. Adhering to these procedures will reduce the risk of injuries resulting from improper release selection, but skiing involves many risks which are not related to binding retention and release, and even a properly adjusted binding cannot release under all injury-producing loads or retain the boot during all skiing maneuvers.

NOTE: Skiing at higher settings increases retention but reduces the chances of release. Skiers using higher release settings must acknowledge and accept the increased risk.

NOTE: The Rossignol Group Release Adjustment Chart conforms to ASTM Standard F-939 and ISO 8061. Other charts or settings based on F-939 or ISO 8061 are acceptable.

If based on further skiing, and it is believed that higher settings are needed, the settings may be increased as long as release is possible.

HEEL SETTING

1. Have the skier stand on one foot only, with the boot fully buckled as it is during skiing
2. The ski should not be restrained.
3. Instruct the skier to release the heel by bending the lower leg forward (move the knee forward and down — toward the forebody of the ski). Do not lunge forward with the opposite leg. This will cause an undesirable upward pulling on the Achilles tendon.
4. Readjust the setting to the skier's "comfort threshold".

TOE SETTING

1. Have the skier place the ski on its inside edge by rolling the lower leg inward and then slowly twist the foot inward. Rapid twisting should be avoided.
2. Readjust the setting to the skier's "comfort threshold".

INFORMATION FOR SKIERS REQUESTING DISCRETIONARY SETTINGS

1. Your normal release/retention settings comply with ASTM standards. Although these guidelines may be inappropriate for some types of competitive skiing or competition training, they are believed to provide an effective compromise between the release and retention needs of most recreational skiers.
2. Adhering to these guidelines may help to reduce the risk of injuries resulting from improper release/retention setting selection. However, skiing involves inherent risks. Injury can result from simply falling down, impact with an object, or from many other actions. Many injuries are unrelated to the function of the release system. Furthermore, even a properly adjusted binding cannot protect the skier in all situations.
3. Difficulties with release or retention may be unrelated to release/retention settings. They can result from your skiing style, the incompatibility of your boots and bindings, wear, damage, or contamination of the release system. Be sure to describe your circumstances to the shop technician and to authorize recommended inspections and repairs before proceeding.
4. If you have been dissatisfied with the release/retention settings that result from your normal skier classification, you may wish to consider changing your skier classification, designating skier type classifications that are different for twist and forward lean, or request discretionary release/retention settings that are higher or lower than the normal range.

Lower settings correspond to an increase in the risk of inadvertent binding release in order to gain increased releasability in a fall.

Higher settings correspond to a decrease in releasability in a fall in order to gain a decreased risk of inadvertent binding release.

Although the shop technician may help you to record your choice on the appropriate form, the final decision on your release/retention settings is yours.

RELEASE SETTINGS, TESTING AND FINAL INSPECTION

RELEASE SETTING FOR HEEL PIECES

Set release values by the screw on the top of the Axial/PX heel or by the screw located at the rear of the heelpiece on Axium/Nova bindings. The release value indicator is visible in the window, located at the side of the heel or below the heelpiece lever. Release values must comply with ROSSIGNOL GROUP recommendations, (Table page 35) or to ASTM F-939 or ISO 8061.



RELEASE SETTING OF TOE PIECES

Adjust the release setting screw on the end of the toe piece.

View the indicator perpendicular to the window.

Release values must comply with The Rossignol Group recommendations, (Table page 35) or to ASTM F-939 or ISO 8061.



RETAIL INSPECTION PROCEDURES

We recommend that skiers have their bindings serviced every 30 days of skiing or annually, whichever comes first. Servicing should include a complete visual inspection of boot, binding and ski components and a system inspection with a testing device.

This procedure is required on all equipment as a final check on the performance of the three components as a system and is required for Indemnification in the US and is recommended in Canada.

This procedure should also be used any time that any adjustment is made to the boot/binding system that may change the performance of the system.

1. Condition the boot/binding system by releasing it in all directions.
2. Perform three tests in each direction. Compare the middle quantitative value of the three releases with the Inspection Range. If the first two test results in any direction are the same, a third test is not necessary.
3. If the results are within the Inspection Range, the system passes and can be dispatched to the customer.

TROUBLE SHOOTING

If the results are not within the Inspection Range:

1. Inspect all boot-to-binding interfaces and release settings and repeat tests if a change is made. If the retest results are within the Inspection Range, the system passes. If the retest results are within the In Use Range, go to 2.
2. Perform a clean versus lubricated test to determine if the boot/binding system is compatible. If the boot passes, then readjust the release setting until the results are within the Inspection Range.

Note: When testing a system, if the boot releases from the heel in twist, increase the forward pressure so that the arrow is over the forward scribe marks. Also increase the forward pressure if the heelpiece is closed after a forward lean release.

Note: If the clockwise and counter clockwise values appear to be at the extremities of the Inspection Range perform a lubricated test and readjust evenly in the Inspection Range.

FINAL DETERMINATION

If the results of the system test fall outside the In Use Range, visually inspect the system for any obvious deficiencies. If no problems are detected with the system, the component should be returned for warranty replacement. See warranty procedures on page 43.

The Inspection Range is found by following the skier code across to the Torque Range. The number in the Torque Range on the skier code line is the Reference Torque. The number directly above and below the Reference Torque is the Inspection Range. The numbers that are two numbers above and two numbers below the Reference Torque value are the In Use Range.

CLEAN VS. LUBRICATED TEST

This is a test to determine if a boot is compatible with the binding as a system. Perform a test on the equipment in question, and then lubricate the binding everywhere the boot contacts it with silicone or equivalent and perform a twist test in one direction. If there is a difference of more than 20% between the results of the clean vs. lubricated test, the boot should not be used with that binding.

Note on the use of Vermont calibrator: When testing the heelpiece, position the ski in the "Built-To-Tilt" vise so that the rear clamp is close to the heelpiece. Also, position the calibrator strap so that it is behind the brake treadle. Be sure to follow the manufacturer's suggestions on checking the calibration of testing devices.

WINTERSTEIGER TEST DEVICES

Note on the use of Wintersteiger Test Devices: Positioning the ski/boot/binding system is important to achieve correct results. When testing a step-in binding for twist and forward lean, align the laser mark, respectively the 30mm mark, with the end of the boot.

Turntable bindings: For twist tests align the axis of rotation of the boot/binding system with the 0 mark on the device (pivot point). When testing the heelpiece, align the laser mark, respectively the 30mm mark, with the end of the boot. For detail please refer to the Wintersteiger Testing Device Operating Instructions.

FINAL INSPECTION

COMPLETE THE FOLLOWING INSPECTION:

TOE PIECES

Check that the toe screws are firmly inserted.

Check that the release value indicators are present and readable.

Check the re-centering of the toe piece.

- Hit the boot with a sharp blow at the boot toe
- The boot must return powerfully to the skis center

If this is not the case, check that the:

- Forward pressure is correct
- AFD is in good, clean condition
- Sole is clean
- Sole is not worn and complies with current ISO standards
- Contamination on the boot sole. Clean the sole and toe piece using warm water and soap
- Too much forward pressure. Re-adjust according to instructions (refer to pages 9). For binding set with a release setting in the lower half of the range, the forward pressure can be adjusted slightly below the mid point of the forward pressure scale.
- Contaminated or worn out AFD. Clean or replace Teflon AFDs or lubricate the Glider by holding it off to one side and applying grease/lube to the back side of the Glider.
- Loose mounting screws in the toe.
- Contamination of the heel track. De-grease with warm water and soap and relube using binding grease.

HEEL PIECES

Check that the heel piece screws are firmly inserted.

Check that the release value indicators are present and readable.

Check that the brakes operate correctly.

REMEMBER

When customers pick up their equipment be sure to discuss the eight points on page 41 of this manual. Also have them read and sign the work ticket and give them the instructions from the binding box.

DOCUMENTATION

RECORD REQUIREMENTS

It is required to record and save the following information for each binding service. Retain this information for five years or the statute of limitations in your state; whichever is longer.

- Name
- Address
- Weight
- Height
- Skier Type (I, II, III) (-I, III+)
- Age
- Boot sole length
- Boot brand, model
- Ski brand, model and serial #
- Indicator setting, skier code
- Indicate pass, inside or outside the In-Use range
- Date of service
- Identification of technician involved with service
- Signature of customer, agent, parent or legal guardian

The skier or agent should sign at the end of the transaction after all necessary information is recorded. Some shops may require additional signatures.

Note: The signature of a minor is acceptable if the minor can understand the skier classification system and the release language on the work ticket. It is best to get the signature of both the minor and the parent when possible.

The signature of a person other than the skier noted on the ticket is acceptable if it is noted on the form that the person is acting as an agent and will communicate all information and warnings to the skier. The skier should be shown what the agent will be signing when the agent picks up the equipment.

After completion of the service, documentation, and discussion of the risks associated with the sport, give the skier a copy of the work ticket and the instructions that are packaged with the binding.

THE SKIER'S SIGNATURE AND INDEMNIFICATION

The skier's signature on a liability release is required in order to qualify for The Rossignol Group Indemnification program. Rossignol/Look/Dynastar/Roxy dealers are not otherwise required to use liability releases, but those who do not use liability releases will not qualify for indemnification in the event of a legal claim. The full requirements for indemnification are stated in The Rossignol Group Alpine Ski Binding Indemnification Agreement.

Dealers who use liability releases should be sure to advise customers that they are signing a liability release. Some customers may object to signing a liability release. How to deal with such customers should be a consistent shop policy. It may be advisable to remind customers that if they do not wish to use services of your shop, they are free to have their equipment installed or maintained by another technician of their choice, although it is highly recommended that a technician who has completed a Rossignol Group technical review be used.

Dealers who choose not to use liability release agreements should provide all appropriate warnings to customers regarding the inherent risks of skiing and the limitations of the boot/binding system to protect them from injury.

Efforts should be made to segregate the sale and service portions of any transaction. It should be made clear that the signing of the liability release only pertains to the service aspect of the transaction and not the sale of the equipment.

When a customer or agent picks up ski equipment, be sure to:

- 1. Give the in-box instructions.**
- 2. Give a copy of the completed and signed work ticket.**
- 3. Demonstrate how the binding works and discuss the warnings and instructions on page 41.**

SKIER INSTRUCTIONS

We want people to enjoy skiing. Therefore, it is important that they fully understand the capabilities of their equipment and specifically, how to use and maintain their bindings. Go over the following information with every customer of Rossignol Group bindings:

1. A NOTE ON SKIING
Skiing, like all sports, involves a certain degree of risk which must be recognized and accepted.
2. The binding is:
Designed to release the boot from the ski in twist directions, forward and backward direction and to retain the boot to the ski during controlled skiing maneuvers.
3. The binding will not:
Release under all injury-producing loads.
4. Cleaning:
Dirt and other foreign matter that is found in snow will accumulate in the binding and must be removed.
5. Advise Skiers:
To use protective covers when transporting their equipment. Advise skiers to store skis in a warm and dry area after skiing so that snow and ice melt rather than become refrozen in the working mechanism.
6. THE BOOT:
Instruct skier to keep all buckles secured during skiing. Significant wear of the boot sole will have an adverse effect on the function of the binding.
7. Tell the skier:
 - a. To remove dirt, snow and ice from the boot sole. Place the toe of the boot in the toe piece, push the ski forward to ensure that the boot is in the toe cup and step in at the heel.
 - b. To get out, press down on the heel cap with a ski pole and step out.
8. Release adjustments:
Show the skier their personal indicator settings on the bindings and have them sign your work order form indicating that they have acknowledged these specific settings.

At the start of each ski season and every 30 skiing days thereafter (whichever comes first), the skier should go to a Rossignol, Look, Dynastar or Roxy dealer for a boot/binding system inspection. If anything appears to be wrong at any time, the skier should return to a Rossignol, Look, Dynastar or Roxy Dealer for service.

A clean, undamaged AFD is critical to the function of the ski-boot-binding system. It should be inspected visually on a daily basis. Skiers should routinely check for the looseness of the binding, mounting screws, binding components and the boot/binding connection. Also advise the skier to release the boot from the ski in the twist and forward directions every ski day. This exercises the working mechanism. *(Note: this can be done by pushing each wing open and by opening and closing the heel by hand).*

Advise skiers that they should never change these settings without the advice of a Rossignol, Look, Dynastar or Roxy dealer. They should be warned of the consequences of making an over correction:

- Lowering the indicated setting too much may cause inadvertent release.
- Increasing the indicated setting too much may prevent release. Skiers should therefore go to a Rossignol, Look, Dynastar or Roxy dealer for the correct system adjustment.

POST ACCIDENT REPORT

Considering the litigious nature of our society, it is best to be cautious when dealing with a reported accident or injury. When an injury has been reported or if someone makes comments about a legal claim or suit, you should observe, listen and gather information. Be polite and sympathetic, but do not apologize, do not argue, and do not get involved in confrontations or discussions of blame, fault, or "who will pay for this." If a legal claim is presented, it will be turned over to the lawyers and claims adjusters, who will decide what to do after completing their investigations. Your job is to gather information and to avoid jumping to conclusions or making unauthorized statements. Even well-meaning comments about legal issues can lead to misunderstandings, and must be avoided. Nothing you say is "off the record" or "just among friends." If you are pressed to make a statement, simply say that you are not authorized to speak about the issue and turn the matter over to your manager or legal counsel.

While the information is fresh and the customer (or their friends or family) are in your shop, take the opportunity to find out the basic information (i.e., injured person's name, address, witness names and addresses, type of injury, what they saw, where it happened, etc.). If you have the equipment involved in the incident, testing should be part of the investigation. Record actual test results, not just pass/fail. Perform forward bending tests first. We recommend that an NSAA post-accident inspection form be used.

Fill out the report accurately and completely, without any editorial comment. Use quotes if you are taking down exactly what someone has told you. If part of the information called for in the report is unavailable, enter "not available" or another reason why the information has not been written down. This document may become part of a legal case years later, when your personal recollection is not as strong, so it is important to get the information accurately and completely while it is fresh.

WARRANTY

LIMITED WARRANTY

The Rossignol Group Alpine Ski Bindings carry a "LIMITED WARRANTY" for five years from the date of purchase.

The Rossignol Group acting as an agent for the manufacturer will repair or replace (at The Rossignol Group's option) the bindings, or any part, if the bindings are found to qualify for warranty. This warranty does not extend to damage resulting from misuse, neglect or abuse, normal wear and tear, accidents or to changes in exterior appearance or color.

TO THE FULLEST EXTENT ALLOWED BY LAW, THE ROSSIGNOL GROUP SHALL NOT BE LIABLE FOR INCIDENTAL OR CONSEQUENTIAL DAMAGES. Some states do not allow the exclusion or limitation of incidental or consequential damages, so the above limitations of exclusion may not apply to you.

ALL WARRANTIES OF ANY KIND ARE LIMITED IN DURATION TO FIVE YEARS FOLLOWING THE ORIGINAL DATE OF RETAIL PURCHASE.

There are no other warranties, express or implied.

Please review the instruction manual for important information concerning safety, maintenance and use of your Rossignol Group bindings.

WARRANTY RETURNS

Please make sure to send a copy of the testing results in specific values. Make every effort to follow the outlined Retail Inspection Procedures. Be sure, no matter what the boot type or condition, to perform a clean versus lubricated test. Remember to send both binding sets, two toes and two heels.

WARRANTY PROCEDURE **THE ROSSIGNOL GROUP**

Rossignol, Dynastar, Look, Roxy

Before submitting bindings for warranty, take every opportunity to utilize the troubleshooting procedures that are discussed in this manual. We have found that most bindings that are returned for calibration reasons pass when tested with a different boot.

Ship the entire pair of bindings in question together with a concise explanation of the problem.

All US Dealers should ship to:
The Mountain Center : Service Center
Attn: Warranty and Repair
267 North Depot Drive
Ogden, UT 84404

Shipments to Canada should be made to:
Group Rossignol Canada Inc.
Attn: Warranty and Repair
800 Georges-Cros
Granby, Quebec, Canada J2J 1N2

WARRANTY PROCEDURE **MOVEMENT**

Movement Binding retailers must contact the North American distributor for a return authorization.

ROI Recreation Outfitters, Inc.
Phone: 1-877-322-3351
E-mail: info@roirecreation.com

Once return authorization is granted, all US dealers should ship to:

ROI Recreation Outfitters, Inc.
1465 Slater Road
Ferndale, WA 98248

Once return authorization is granted, all Canadian dealers should ship to:

ROI Recreation Outfitters, Inc.
3058 Beta Avenue
Burnaby, BC V5G 4K4

TAKEN BY:	DATE DUE:	DATE:
NAME		
ADDRESS		
CITY	STATE	ZIP
TELEPHONE		

WEIGHT	HEIGHT	AGE	SKIER TYPE <input type="checkbox"/> I <input type="checkbox"/> II <input type="checkbox"/> III	RIDER <input type="checkbox"/> REG. <input type="checkbox"/> GOOFY	ANGLES <input type="checkbox"/> FRONT <input type="checkbox"/> BACK
--------	--------	-----	----------------------------------------------------------------------------------------------------------	------------------------------------------------------------------------------	-------------------------------------------------------------------------------

SKIS SKI BOARD SNOWBOARD	SERIAL NUMBER	BRAND	MODEL	AMOUNT
BOOTS	MODEL	LENGTH		
BINDINGS	BRAND	MODEL		
POLES	BRAND	LENGTH		
OTHER				
TOTAL EQUIPMENT (A)				
WORK REQUESTED:				
SPECIAL INSTRUCTIONS:				

ESTIMATED COST:	ACTUAL LABOR COST: (B)	\$
-----------------	------------------------	----

ALPINE SYSTEM INSPECTIONS	SKIER CODE	SUB-TOTAL (A)+(B)
	PASS FAIL N/A	TAX
	VISUAL INSPECTION OF SYSTEM TEST FOR ELASTIC TRAVEL & RETURN TEST OF BOOT-BINDING COMPATIBILITY RELEASE VALUE WITHIN SPECIFIED RANGE	TOTAL
		DEPOSIT
		BALANCE

<input type="checkbox"/> WORK CANNOT BE PERFORMED OR COMPLETED DUE TO SYSTEM COMPONENTS THAT ARE OUT OF STANDARD OR OTHERWISE UNSUITABLE.	INITIAL SETTINGS	
	FINAL INDICATOR SETTINGS	
	TOE	HEEL

COMMENTS:

SPECIAL INSTRUCTIONS TO SKIER/RIDER:

TECHNICIAN'S SIGNATURE

I HAVE READ AND UNDERSTAND THE TERMS ON THE BACK OF THIS RETAIL WORKSHOP FORM, INCLUDING THE RELEASE CLAUSES, AND I VOLUNTARILY AGREE TO THEM.

SKIER/RIDER DATE

IF SKIER/RIDER IS A MINOR, THE SIGNATURE OF PARENT, LEGAL GUARDIAN OR AGENT IS ALSO REQUIRED. (PLEASE CHECK ONE)

PARENT
 LEGAL GUARDIAN
 AGENT

WORKSHOP (RETAIN FOR YOUR RECORDS)

WARNING/LIABILITY RELEASE & AGREEMENT NOT TO SUE

I have received the equipment listed on this agreement and have been instructed on its use. I verify that the personal information (height, weight, age, skier classification) on this ticket is correct. If at any time I feel the equipment is not functioning properly, I will stop using it and return it for inspection, repair or adjustments.

In understand and agree that skiing, ski boarding, snowboarding and other winter sports are HAZARDOUS activities, that INJURIES from various causes are an INHERENT RISK of participating in these activities, and that injuries to any or all parts of my body are a COMMON AND ORDINARY OCCURRENCE during these activities. I freely accept and ASSUME ALL RISKS OF INJURY OR DEATH that may occur while using this equipment.

ALPINE SYSTEMS: I have confirmed that the visual release indicators on the alpine ski bindings are the same as those designated on this ticket. I understand that alpine ski/boot/binding systems CANNOT RELEASE OR RETAIN in all situations where release or retention may prevent injury and that they THEREFORE CANNOT GUARANTEE MY SAFETY.

SNOWBOARDS AND X-C: I understand that the binding systems on snowboards and cross-country skis are NOT INTENDED TO RELEASE in a fall or upon impact.

To the fullest extent allowed by law, I agree to RELEASE FROM LIABILITY and to INDEMNIFY AND HOLD HARMLESS Rossignol Ski Company, Incorporated, all other manufacturers and distributors of the equipment provided to me under this agreement, any involved winter sport area, shop or service technician, and their owners, agents, employers and employees for any injuries, damages or death related to the use of this equipment. I FURTHER AGREE NOT TO MAKE A CLAIM OR SUE FOR INJURIES OR DAMAGES RELATING TO THE USE OF THIS EQUIPMENT, whether such a claim is based on NEGLIGENCE, breach of warranty, product defect or any other theory. I accept this equipment AS IS with no warranties, express or implied, except the manufacturer's written limited warranty if any.

THIS DOCUMENT IS A LEGALLY BINDING CONTRACT which supersedes any other agreements or representations by or between the parties. It shall be interpreted to provide as broad and inclusive a release of liability as is legally possible, but is not intended to assert any claims or defenses which are prohibited by law. If any part of this agreement is deemed void or unenforceable, the remainder shall be given full force and effect. The specific rights of the parties under this contract may vary from state to state.

Signature _____ Date _____

Parent, Legal Guardian or Agent _____

PERSON RESPONSIBLE FOR EQUIPMENT		
NAME LAST	FIRST	
HOME ADDRESS STREET		
CITY	STATE	ZIP
HOME PHONE	TODAY'S DATE	

SKIER / RIDER 1	NAME					
	SKIER TYPE <input type="checkbox"/> I <input type="checkbox"/> II <input type="checkbox"/> III		RIDER <input type="checkbox"/> REG <input type="checkbox"/> GOOFY	AGE	HEIGHT FT. IN.	WEIGHT LBS.
	SOLE LENGTH mm	SKIS SKI BOARD SNOWBOARD	BOOTS		TOTAL 1	
	SKIER CODE	TECH SIGNATURE	POLES		\$	
		TOE	HEEL		CASH CHARGE	
		TOE	HEEL		DEPOSIT	
					\$	
	I HAVE READ, UNDERSTAND AND AGREE TO THE WARNING, RELEASE AND AGREEMENT.					
	SKIER/RIDER SIGNATURE (Parent or Guardian)				DATE	

SKIER / RIDER 2	NAME					
	SKIER TYPE <input type="checkbox"/> I <input type="checkbox"/> II <input type="checkbox"/> III		RIDER <input type="checkbox"/> REG <input type="checkbox"/> GOOFY	AGE	HEIGHT FT. IN.	WEIGHT LBS.
	SOLE LENGTH mm	SKIS SKI BOARD SNOWBOARD	BOOTS		TOTAL 2	
	SKIER CODE	TECH SIGNATURE	POLES		\$	
		TOE	HEEL		CASH CHARGE	
		TOE	HEEL		DEPOSIT	
					\$	
	I HAVE READ, UNDERSTAND AND AGREE TO THE WARNING, RELEASE AND AGREEMENT.					
	SKIER/RIDER SIGNATURE (Parent or Guardian)				DATE	

SKIER / RIDER 3	NAME					
	SKIER TYPE <input type="checkbox"/> I <input type="checkbox"/> II <input type="checkbox"/> III		RIDER <input type="checkbox"/> REG <input type="checkbox"/> GOOFY	AGE	HEIGHT FT. IN.	WEIGHT LBS.
	SOLE LENGTH mm	SKIS SKI BOARD SNOWBOARD	BOOTS		TOTAL 3	
	SKIER CODE	TECH SIGNATURE	POLES		\$	
		TOE	HEEL		CASH CHARGE	
		TOE	HEEL		DEPOSIT	
					\$	
	I HAVE READ, UNDERSTAND AND AGREE TO THE WARNING, RELEASE AND AGREEMENT.					
	SKIER/RIDER SIGNATURE (Parent or Guardian)				DATE	

NOTES	GRAND TOTAL
	\$

WARNING/LIABILITY RELEASE & AGREEMENT NOT TO SUE

I have received the equipment listed on this agreement and have been instructed on its use. I verify that the personal information (height, weight, age, skier classification) on this ticket is correct. If at any time I feel the equipment is not functioning properly, I will stop using it and return it for inspection, repair or adjustments.

In understand and agree that skiing, ski boarding, snowboarding and other winter sports are HAZARDOUS activities, that INJURIES from various causes are an INHERENT RISK of participating in these activities, and that injuries to any or all parts of my body are a COMMON AND ORDINARY OCCURRENCE during these activities. I freely accept and ASSUME ALL RISKS OF INJURY OR DEATH that may occur while using this equipment.

ALPINE SYSTEMS: I have confirmed that the visual release indicators on the alpine ski bindings are the same as those designated on this ticket. I understand that alpine ski/boot/binding systems CANNOT RELEASE OR RETAIN in all situations where release or retention may prevent injury and that they THEREFORE CANNOT GUARANTEE MY SAFETY.

SNOWBOARDS AND X-C: I understand that the binding systems on snowboards and cross-country skis are NOT INTENDED TO RELEASE in a fall or upon impact.

To the fullest extent allowed by law, I agree to RELEASE FROM LIABILITY and to INDEMNIFY AND HOLD HARMLESS Rossignol Ski Company, Incorporated, all other manufacturers and distributors of the equipment provided to me under this agreement, any involved winter sport area, shop or service technician, and their owners, agents, employers and employees for any injuries, damages or death related to the use of this equipment. I FURTHER AGREE NOT TO MAKE A CLAIM OR SUE FOR INJURIES OR DAMAGES RELATING TO THE USE OF THIS EQUIPMENT, whether such a claim is based on NEGLIGENCE, breach of warranty, product defect or any other theory. I accept this equipment AS IS with no warranties, express or implied, except the manufacturer's written limited warranty if any.

THIS DOCUMENT IS A LEGALLY BINDING CONTRACT which supersedes any other agreements or representations by or between the parties. It shall be interpreted to provide as broad and inclusive a release of liability as is legally possible, but is not intended to assert any claims or defenses which are prohibited by law. If any part of this agreement is deemed void or unenforceable, the remainder shall be given full force and effect. The specific rights of the parties under this contract may vary from state to state.

Signature Date

Parent, Legal Guardian or Agent

THE ROSSIGNOL GROUP

2010-2011 RETAIL TECHNICAL REVIEW



Ask your manager for the SHOP ID and PASSWORD, and complete your review online. <http://techtraining.mountaincenter.com>

Tech Name _____

E-mail Address _____

Please print complete address

Shop Account Number _____

Shop Name _____

Shop Address _____

Shop City _____ State _____ Zip _____

Date test taken _____

Retake:(circle) Yes No

Note: This is not a measure of your proficiency. It is meant to have you actively review the information that is in the Technical manual and/or was just communicated to you. A score of 100% should be easy to achieve. It is unnecessary to complete the **RENTAL** Technical Review if you completed the Technical review.

To pass, 21 of 24 questions must be answered correctly. **Questions 13 through 18 must be correctly answered.**

Acknowledgment of a satisfactory completion will be sent to the shop.

Choose one correct answer to the following questions. You may circle the answers on the sheet.

1. Completing the Technical Review is one of the requirements of the Indemnification Program:
A. True B. False

2. The Acknowledgment received after a technician has successfully completed the Technical review is valid for:
A. one year B. two seasons
C. three seasons

3. Visual inspection of BOTH boots is required.
A. True B. False

4. A low grade thermoplast boot will fail a clean vs. lubricated test and should not be used:
A. True B. False

5. If during the visual inspection, the boot is questionable, you should:
A. Lubricate and dispatch
B. Perform a clean verses lubricated test
C. Mount, adjust and dispatch
D. Replace the boot

6. When inspecting a brake on a mounted ski, be sure that:

- A. The brake completely extends
- B. Extends at least 30 mm below the base of the ski
- C. Works freely and easily
- D. All of the above

7. When installing the binding and your screwshooter is not set to 5 Nm of torque, you should:

- A. Use less pressure on the screwshooter
- B. Pull the trigger intermittently

8. After mounting the binding, observe the binding from the side and check:

- A. That the binding sits flush on the ski
- B. The correct drill dimension

9. The forward pressure of a Axial2/PX binding is correct when:

- A. The yellow indicator covers half of the window
- B. When the end of the FP screw is flush with the base plate
- C. Both A & B

10. Which boot soles are compatible with the Comp J/ Team 4/ T4 Girl bindings?

- A. Adult sole only
- B. Children's soles only
- C. Adult and Children's soles

11. There is a new Binding Adjustment Chart for 2010/11.

- A. True B. False

12. When calculating a skiers indicator setting and the box on the chart is empty:

- A. Move across the row
- B. Move up or down the column

13. Skier weight is 150 lbs., height 4'9", skier type I, age 26, boot sole length 280 mm.. The indicator value is:

- A. 2.75 B. 3 C. 3.5

14. Skier weight 38 lbs., height 3'0", skier type I, age 3, boot sole length 200 mm. The indicator value is:

- A. 1 B. .75

15. Skier weight is 172 lbs., height 5'7", skier type II, age 58, boot sole length 315 mm. The indicator value is:

- A. 4 B. 5 C. 6

16. Skier weight 45 lbs., height 4'0", skier type III, age 9, boot sole length 260 mm. The indicator value is:

- A. 2 B. 1.5 C. 1.25

(note: skiers < 48 lbs, max increase 1 row)

17. Skier weight 70 lbs., height 4'8", skier type III, age 9, boot sole length 282 mm.

The indicator value is:
A. 3 B. 2.75 C. 2.25

18. Skier weight 135 lbs., height 6'0", skier type III, age 18, boot sole length 351 mm.

The indicator value is:
A. 6.5 B. 5 C. 8

19. For use when testing; If the sole length is 323 mm. and the indicator value is 4., what is the Inspection Range in twist ?

- A. 39-47 Nm
- B. 31-58 Nm
- C. 37-50 Nm

20. For use when testing. If the sole length is 330 mm. and the Indicator value is 6., what is the Reference Torque in forward bending ?

- A. 165 Nm
- B. 229 Nm
- C. 194 Nm

21. For use when testing; If the sole length is 230 mm., and the indicator value is 2, what is the In Use Range in forward bending ?

- A. 40-87 Nm
- B. 42-62 Nm
- C. 29-75 Nm

22. It is acceptable practice to set a toe and a heel piece to two different settings:

- A. True B. False

23. A complete test of a boot/binding system is:

- A. Only on used equipment
- B. Any time an adjustment is made to the system that may change the performance of the system

24. When a customer or agent picks up ski equipment, be sure to:

- A. Give the in-box instructions
- B. Give a copy of the completed and signed work ticket
- C. Demonstrate how the binding works and discuss warnings
- D. All of the above

Mail completed Technical Reviews:

The Mountain Center PO Box 981060 1413 Center Drive Park City, UT 84098
-OR- Group Rossignol Canada Inc. 955 André Liné Granby, Quebec, J2J 1J6 Canada

Fax: 435-252-3301

An Acknowledgement will be returned to the shop or a request to resubmit another technical review.

THE ROSSIGNOL GROUP

2010-2011 RENTAL TECHNICAL REVIEW



Ask your manager for the SHOP ID and PASSWORD, and complete your review online. <http://techtraining.mountaincenter.com>

Tech Name _____

E-mail Address _____

Please print complete address

Shop Account Number _____

Shop Name _____

Shop Address _____

Shop City _____ State _____ Zip _____

Date test taken _____

Retake:(circle) Yes No

Note: This is not a measure of your proficiency. It is meant to have you actively review the information that is in the Tech manual and/or was just communicated to you. A score of 100 % is easy to achieve. To pass, 17 of 20 questions must be answered correctly. **Question 8 through 18 must be correctly answered.**

➤ This Rossignol Group Rental Review is intended for Rental technicians who determine indicator settings or dispatch rental equipment only.

Acknowledgement of a satisfactory completion will be sent to the shop.

➤ It is unnecessary to complete the RENTAL Technical Review if you completed the Technical review.

Choose one correct answer to the following question. You may circle the answers on the sheet.

1. Which boot sole is compatible with a Comp J/Team 4 Rental/Roxy T4 Girl RL?

- A. Adult ISO sole only
- B. Children's ISO sole only
- C. Adult and Children's ISO sole

2. Which boot sole is compatible with an Axiom Rental/Nova 9 Rental?

- A. Adult ISO sole only
- B. Children's ISO sole only
- C. Adult and Children's ISO sole

3. A low grade thermoplast (TP) boot can be identified by:

- A. A "milky" appearance
- B. The ability to permanently indent the material with your fingernail
- C. Failure of a clean versus lubricated test
- D. All of the above

4. When adjusting the forward pressure on a Rossignol Axiom/Nova 9 Rental binding:

- A. The indicator is set in the middle part of the window
- B. Align the yellow tab with the two forward pressure set marks.

5. The Skier Classification decision should be made by?

- A. The technician
- B. The skier's agent
- C. The skier

6. If the boot fails the visual inspections, you should:

- A. Lubricate and dispatch
- B. Don't use the boot

7. There is a new Binding Adjustment Chart for 2010/11.

- A. True
- B. False

8. Skier weight 146 lbs., height 5' 11", skier type II, age 22, boot sole length 352 mm. The indicator value is:

- A. 3
- B. 4
- C. 5

9. Skier weight 136 lbs., height 4' 9", skier type I, age 18, boot sole length 295 mm. The indicator value is:

- A. 2.5
- B. 3
- C. 3.5

10. Skier weight 150 lbs., height 6' 0" ,skier type II, age 52, boot sole length 320 mm. The indicator value is:

- A. 5
- B. 6
- C. 7

11. Skier weight 110 lbs., height 5' 2", skier type II, age 40, boot sole length 268 mm. The indicator value is:

- A. 5.5
- B. 6
- C. 6.5

12. Skier weight 32 lbs., height 3' 6", skier type I, age 3, boot sole length 230 mm. The indicator value is:

- A. 1
- B. 1.5
- C. .75

13. Skier weight 170 lbs., height 6' 0", skier type II, age 50, boot sole length 285 mm. The indicator value is:

- A. 5
- B. 6
- C. 7

14. Skier weight 45 lbs., height 4' 0", skier type III, age 9, boot sole length 265 mm. The indicator value is:

- A. 1.25
- B. 1.5
- C. 2

[note: skiers < 48 lbs, max increase 1 row]

15. Skier weight 175 lbs., height 5'9", skier type II, age 28, boot sole length 285 mm. The indicator value is:

- A. 6
- B. 6.5
- C. 7

16. Skier weight 180 lbs., height 6' 5", skier type III, age 54, boot sole length 320 mm. The indicator value is:

- A. 7
- B. 8
- C. 8.5

17. Skier weight 58 lbs., height 3' 8", skier type III, age 9, boot sole length 265 mm. The indicator value is:

- A. 2.5
- B. 3
- C. 3.5

18. Skier weight 150 lbs., height 5' 4", skier type II, age 58, boot sole length 300 mm. The indicator value is:

- A. 5
- B. 4.5
- C. 4

19. The discretionary settings section of the manual deals with:

- A. Skiers with special concerns with normal settings.
- B. Skiers who request higher settings.
- C. A and B

20. When the customer is given the ski equipment, be sure to:

- A. Show the indicator value on the form and binding.
- B. Demonstrate how the binding works and discuss warnings
- C. Give a copy of the completed and signed rental ticket
- D. A , B, and C

Mail completed Technical Reviews:

The Mountain Center PO Box 981060
1413 Center Drive
Park City, UT 84098

-OR-

Group Rossignol Canada Inc.
955 André Liné
Granby, Quebec, J2J 1J6
Canada

Fax: 435-252-3301

An Acknowledgement will be returned to the shop or a request to resubmit another technical review.

QUICK REFERENCE - PARTS LIST

BRAKES

PART # **ITEM DESCRIPTION**

PX/Axial2/Axium120: no slot

PX Racing/Axial²WC: look for the slot

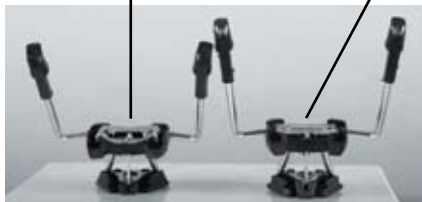

PX RACING/AXIAL² WC

FC6F124 80mm
 FC8F011 90mm
 FC6F125 100mm
 FC6F126 120mm

* Use this brake for all short heel tracks using worm-screw forward pressure adjustment, Axial² WC, Freeski² 180, 150, 140, 120, PX Racing



PX/AXIAL²/AXIUM120/TPI² & FLUID SYSTEM

FC3F050 80mm
 FC8F012 90mm
 FC3F048 100mm
 FC6F006 120mm

* Use this brake for all long heel tracks using flat tab forward pressure adjustment, Freeski² 100, Freeski 110, Axium 120, all PX, all NX



AXIUM/NOVA

FC4F017 73mm (flat bindings only)
 FC5F006 85mm (flat bindings only)

* Use this brake for all Axium 110, 100, Axium Jr. Saphir, Nova, Nova +



AXIUM/NOVA SYSTEM

FC7F027 73mm (TPI²/Fluid System)
 FC7F028 85mm (TPI²/Fluid System)

* Use this brake for all Axium 110, 100, Axium Jr Saphir, Nova, Nova +



AFDS

PART # **ITEM DESCRIPTION**

FC4F011 Full Drive AFD Teflon

This is the most common AFD we send out for rental bindings.



FC6F066 Axitec² AFD

PX, NX, Axial², Axium 300/120 AFD



FC6F067 Axitec¹ AFD

Axial¹, Pivot, Nova 11/10,



FC6F016 Comp J/Team AFD

(North America)



FC7F005 Axitec³ AFD

PX, NX, Axial², Axium



FC7F007 Teflon AFD

PX, NX, Axial², Axium
 All Rental EPR⁴
 All Rental Demo²



FC8F014 Maxflex AFD



FC9F006 Freeski² 180/150

PX Racing FS XXL
 PX Racing 15 WB



ROSSIGNOL AXIUM JUNIOR, DYNASTAR NOVA TEAM, ROXY N7

All Axium Junior, Nova Team, Hocus Pocus and Pixie Stix bindings accommodate adult boot sole norms. If boot sole is marked with a "C", you must use a conversion kit. Conversion kits for junior boot sole norms are available through Customer Service.

Note: Axium Junior Pro Race and Freeski Junior include conversion kit in binding box.



Item #: FC6F002

WARRANTY FAQ'S

DO I NEED RA #?

- No RA# is required to return product for warranty consideration. We track returns from dealers by dealer account number and any internal number or name you want to use.
- Consumer returns are tracked by name only.

DO I NEED TO RETURN THE PRODUCT THROUGH AN AUTHORIZED DEALER?

- We strongly urge you to work through the dealer that you purchased the product from or another authorized dealer. Many times they are able to help correct the problem without the expense of returning it to us. In the case of difficulty doing this we do accept shipments direct from consumers.

WHAT DO I NEED TO INCLUDE WITH MY RETURN?

Please be sure to include the following inside the packaging of the returned product.

- Name
- Return Address
- Phone number
- Email address if available
- Brief explanation of the problem
- Proof of purchase

- *If returning boots please return both left and right boot.*
- *Alpine bindings should have both toes and both heels returned*
- *Skis and binding sold as systems should have both skis and binding returned.*
- *Skis that are not system skis should have the bindings removed before returning them.*

I DON'T HAVE MY PROOF OF PURCHASE CAN I STILL RETURN PRODUCT FOR CONSIDERATION?

- If you are unable to locate a proof of purchase you may still return the product for consideration. However there may be cost associated with repair or replacement of the product. If there are charges or the product is not found to be defective you will be notified before any more work is done.
- Product waiting for approval of charges or more information will be held for a maximum of 60 days before the product is returned or destroyed at our option. Notification is by US Postal Service.

HOW LONG DOES IT TAKE?

- We make every effort to inspect and determine a course of action within 24 hours of the day the product is received.
- Product replaced normally ships within 48 hours provided inventory is available.
- Product being repaired normally ships within 14 working days of receipt.
- Normal transit times are approximately 8 days from the east coast and 3 days from the west coast. Express shipping can reduce the transit time but the cost will be the responsibility of the person returning the product to us.

WHO PAYS THE SHIPPING CHARGES?

- The person returning product for consideration is responsible for the freight coming to us. We will not accept collect shipments or issue call tags.
- If the product is deemed a warranty issue we will pay the freight to return the product to you by normal ground transportation.

WHERE DO I SEND IT?

- All products being returned for service or warranty consideration should be returned to the following address:
The Rossignol Group Distribution Center
ATTN WARRANTY
267 N Depot Dr.
Ogden, UT 84404

- **DO NOT return it to our corporate address in Park City. It will just delay the processing of your claim.**

HOW DO I SEND IT?

- We suggest using either Federal Express Ground or UPS as they can provide you with a tracking number. US Postal Service does not provide daily delivery to this location and pickups from the post office can be sporadic creating some additional delay with processing.
- Packaging need not be excessive. Appropriate sized cardboard boxes or skis / snowboards wrapped in cardboard are generally sufficient. The use of packing peanuts is strongly discouraged.
- Careful thought to packaging may prevent oversize charges on some items.

QUICK REFERENCE / NOTES

SHOP ID _____

PASSWORD _____

THE ROSSIGNOL GROUP CONTACT:

Sales Rep(s) _____

Customer Service Rep _____

USA

Customer Service 435-252-3300
Service Center / Warranty 435-252-3300 -- use option #6

CANADA

Customer Service 450-378-9971
Service Center / Warranty 450-378-9971 -- ext. 267

MOVEMENT

877-322-3351, info@roirecreation.com

ROSSIGNOL

GROUP _____

UNITED STATES

The Mountain Center
1413 Center Drive, PO Box 981060
Park City, UT 84098
Phone 435 252.3300 • Fax 435 252.3301

CANADA

Rossignol Group
955 rue André Liné
Granby, Québec J2J 1J6
Phone 450 378.9971 • Fax 450 378.3244